

---

COYNE  
HISTORICAL MUSEUM  
SCHOOL

---

---

REFERENCE  
MUSEUM  
LIBRARY

---



ESTABLISHED 1899

# COYNE

## *Electrical School*

CHICAGO ~ ~ ILLINOIS



COPYRIGHT 1942

# DIRECT CURRENT POWER AND MACHINES

## *Section Three*

### D. C. Motors

#### Operation and Principles

#### Types, Series, Shunt, and Compound

#### Uses and Applications, H. P. and Efficiency Tests

#### Controllers

#### Manual Starters, Speed Controls, Automatic Controllers

#### Drum Controls, Overload Devices

#### Carbon Brushes

#### Types, Applications, Pressure, Fitting and Care

#### Maintenance of D. C. Machines

#### Trouble Charts, Testing, Tools, Repairs

## DIRECT CURRENT MOTORS

An electric motor, as you have already learned, is a device for converting electrical energy into mechanical energy, or to perform just the opposite function to that of a generator. Motors supply mechanical energy to drive various machines and equipment by means of belts, gears, and direct shaft connections.

When electricity from the line is supplied to terminals of the motor, it develops mechanical force or energy which tends to rotate its armature and any equipment which may be attached to its shaft. This twisting effort or force is known as the Torque of the motor.

### 114. TYPES OF D. C. MOTORS

Direct current motors can be divided into three general classes, the same as D. C. generators were, namely, **Shunt, Series, and Compound** motors. These motors are classified according to their field connections with respect to the armature, in the same manner in which the generators were classified.

Compound motors can be connected either cumulative or differential. With generators we find that the shunt, series, and compound types each have different voltage characteristics. With motors, the effect of these different field connections is to produce different speed and torque characteristics.

Motors are made with various types of frames, known as **Open Type, Semi-enclosed, and Closed Type** frames.

Fig. 105 shows a modern D. C. motor with an open type frame. A frame of this type allows easy access to the commutator, brushes and parts, for adjustment, cleaning and repairs; and also allows good ventilation. Open type motors are generally used where they are to be operated in clean places, and where there is no danger of employees coming in contact with their live parts; and no danger of fire or explosions which might be caused by sparks at their brushes.

Fig. 105-A shows a motor with a semi-enclosed frame. Frames of this type will enclose all the live and moving parts of the motor, and at the same time allow ventilation through the small openings provided in the end plates and around the motor frame.

Fig. 106 shows a motor with a completely enclosed frame. Motors of this type are often built larger and wound with larger wire, so they do not develop as much heat. In some cases they are practically air-tight, and have ventilating tubes attached to their casings to bring cooling air from another room.

Motors with enclosed frames of this type can be used in places where the air is filled with dust and dirt, or possibly vapors or explosive gases.

Enclosed frame motors should always be used

where abrasive dust or metal dust is present in the air, or in mills where wood or grain dust might be exploded by any possible sparks from brushes.

### 115. MOTOR SPEEDS AND H. P.

D. C. motors are always rated in horse power, and range in size from those of a small fraction of one horse power to those of several thousand horse power each. The smaller motors are used for driving household appliances, laboratory equipment, and small individual shop machines, such as drill presses, small lathes, etc. Medium-sized motors, ranging from one horse power to several hundred horse power each, are used for driving machinery in factories and industrial plants, for street railways and electrical locomotives, and for elevator machinery. The larger types, ranging from several hundred to several thousand horse power each, are used principally in steel mills and on electrically-driven ships.

The horsepower ratings of motors refer to the maximum continuous output they can deliver without overheating.

The speed at which D. C. motors are designed to operate depends principally upon their size, because the diameter of the armature, as well as the R. P. M., are what determine the centrifugal forces set up in the conductors and commutator bars.

Very small motors commonly have speeds from 2000 to 4000 R. P. M., while motors of medium or average size, ranging from 1 to 25 h. p., usually rotate at speeds from 1000 to 2000 R. P. M.

Very large motors operate at much lower speeds, generally ranging from 100 to 500 R. P. M.; although some large steel-mill motors have speeds as low as 40 R. P. M.

The speed at which any D. C. motor operates is always determined by the counter-E. M. F. which is generated in its armature.

This counter-E. M. F., or back-voltage, we might

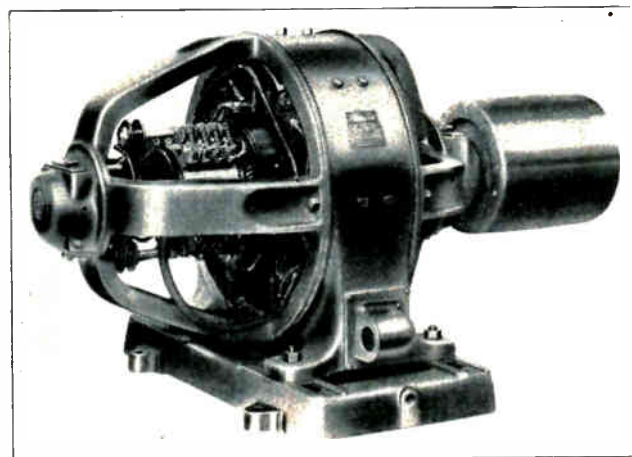

Fig. 105. This photo shows a modern D. C. motor with an open type frame. Note the easy access a frame of this construction provides to the commutator, brushes, and field coils.

say acts as a throttle to control the current flow through the armature, and therefore acts as a governor of the motor speed. In the following pages this principle will be explained more fully in connection with the characteristics of the different types of motors.

### 116. MOTOR SPEED REGULATION AND CONTROL

In referring to the characteristics and operation of electric motors, we frequently use the terms Speed Regulation and Speed Control. These terms have entirely separate meanings, and their difference is very important.

Speed Regulation refers to changes in speed which are automatically made by the motor itself, as the load on the machine is varied. Speed regulation is largely determined by the construction of the motor and its windings and is a very important factor in the selection of motors for different classes of work.

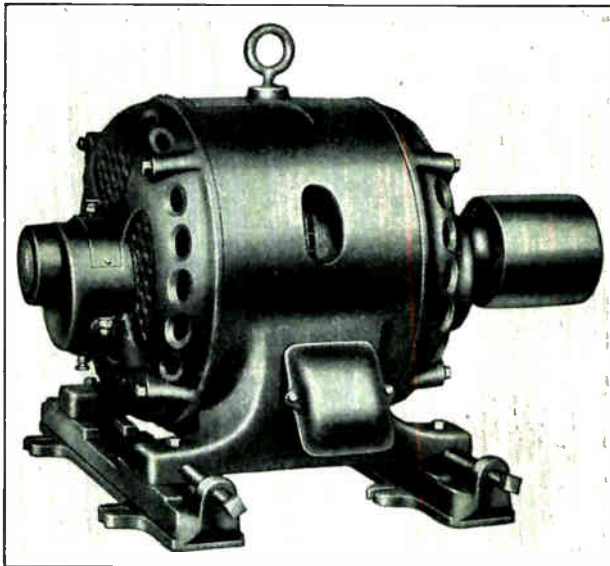

Fig. 105-A. This motor has a frame of the semi-enclosed type. The openings at the ends and around the frame are provided for air circulation and cooling.

The speed regulation of a motor is usually expressed in percentage and refers to the difference in the speed of the machine at no load and full load. It can be determined by the following formula:

$$\text{Speed regulation} = \frac{\text{No load R. P. M.} - \text{full load R. P. M.}}{\text{No load R. P. M.}}$$

For example, if we have a motor that operates at 1800 R. P. M. when no load is connected to it and slows down to 1720 R. P. M. when it is fully loaded, its speed regulation would be:

$$\frac{1800 - 1720}{1800}, \text{ or } .044 +$$

This would be expressed as 4.4%.

Motor speed regulation is entirely automatic and is performed by the motor itself, as the load varies.

The term Speed Control refers to changes which are made in the motor speed by the use of manual

or automatic control devices. These speed control devices are usually external to the motor and consist of some form of variable resistance. They will be fully explained in the following pages.

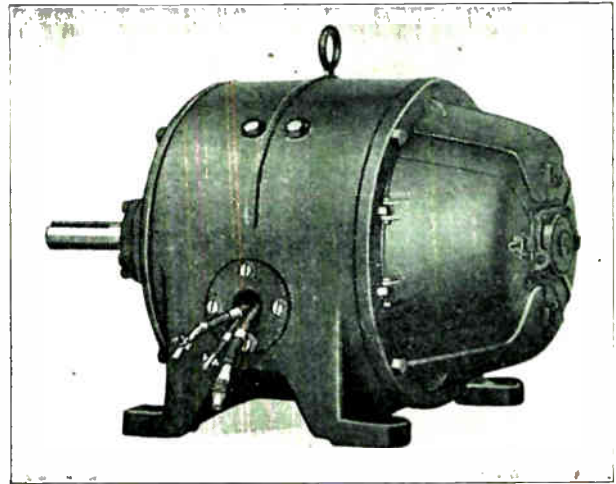

Fig. 106. The above motor has a frame of the enclosed type. Motors of this type are particularly well suited for operation in places where the air is full of dust or vapor.

### 117. MOTOR RATINGS IN VOLTS, AMPERES, AND H. P.

The rating of a D. C. motor in horse power, amperes, and volts depends on the same factors in their design as the rating of generators does. The motor ratings in horse power are also based on the same factor of the temperature increase in their windings when operated at full rated load.

For example, a 10 h. p. motor is one that when supplied with the proper voltage for which it is designed will drive a 10 h. p. mechanical load continuously without overheating its windings. The current required by a motor is, of course, proportional to the mechanical load in h. p. which it is driving.

In addition to carrying the load without heating the windings, the motor must also be able to carry its full load current without excessive heating or sparking at the brushes and commutator.

Motors are generally designed to carry overloads of a greater amount and for longer periods of time than generators are. Most D. C. motors can carry a 25% overload for a period of two hours, without serious overheating.

We have already learned that D. C. motors are similar to D. C. generators in all details of their mechanical construction. In fact, manufacturers frequently use the same D. C. machines either as motors or generators, by merely changing the name plates on them and making a few minor changes in the connections of the field windings and setting of the brushes.

### 118. MOTOR PRINCIPLES

Electric motors develop their torque or turning effort by reaction between the flux around the armature conductors and the flux of the field poles, as has been previously explained. When the magnetic

lines of force from the field poles attempt to pass through the armature core and windings, they collide with the revolving flux around the armature conductors, as shown in Fig. 107.

Where the lines of force passing from the N. to S. field poles collide with lines of armature flux in the opposite direction, they will, of course, tend to unite and travel in the same direction. This causes the majority of the magnetic lines leaving the N. pole in Fig. 107 to swing upward over the positive conductor, creating a very dense magnetic field above it and a weaker field below it. As the field lines go on across the armature and collide with the downward lines on the left side of the negative armature conductor, the majority of the lines will again join with this revolving flux and pass on the under side of this conductor.

As we know that magnetic lines of force always tend to shorten themselves, or take the most direct path possible through any external circuit, it is evident that this distortion of the field flux and the crowding of the lines above the positive conductor and under the negative conductor will tend to revolve the conductors in a counter-clockwise direction. From the illustration in Fig. 107, we can see that the torque of a D. C. motor is obtained largely from the reaction between the magnetic lines of force of the armature and field flux. There is also the force of attraction and repulsion between the field poles and the poles which are set up on the surface of the armature. That is why D. C. motors are often said to operate on the "repulsion" principle.

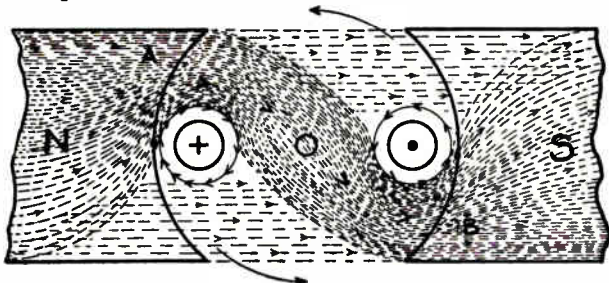

Fig. 107. The above diagram illustrates the manner in which the reaction between the lines of force from the armature and field windings set up the torque or turning effort in a motor.

### 119. MOTOR TORQUE, SPEED AND H. P.

The torque exerted by such a motor will, of course, depend on the strength of the magnetic flux from the field poles and the strength of the armature flux. Therefore, the torque exerted by a motor can be increased by increasing either the field strength or the armature current, or both.

The horse power or mechanical power output of a D. C. motor is proportional to the product of its torque and speed. The higher the speed at which a motor is operated while maintaining the same amount of torque, the greater will be its horse power.

D. C. motors rated at higher speeds will produce the same horse power with smaller frames and armatures. The cost of high speed motors is there-

fore much less per h. p. A motor frame that is rated at 5 h. p. at 900 R. P. M. will deliver 10 h. p. at 1800 R. P. M.

### 120. DIRECTION OF MOTOR ROTATION

The direction of rotation of a D. C. motor can be easily determined by the use of Fleming's left-hand rule. This rule is similar to the right-hand rule which we have learned to use for generators.

Hold the first finger, thumb, and remaining fingers of the left hand all at right angles to each other. Let the first finger point in the direction of flux from the field poles, the remaining fingers in the direction of current through the armature conductors, and the thumb will then indicate the direction of rotation of the armature.

This rule can be quickly and easily applied to diagrams such as shown in Fig. 107 and can also be used on the actual machines, when the armature conductors and connections to the commutator can be seen and the polarity of the field poles is known.

The direction of rotation can also be easily determined with diagrams such as shown in Fig. 107, by simply remembering that the repelling or crowding force on the armature conductor will be on the side where its flux lines join with those of the field flux.

From this study of the direction of rotation of motors, you can see that any D. C. motor can be reversed either by reversing the direction of current through the armature winding or by reversing the field connections to change the polarity of the field poles. Refer to Fig. 107, and using the left-hand rule, note the direction in which these conductors would rotate if their current were reversed or the poles of the motor were reversed.

### 121. COUNTER E. M. F. IN MOTORS

You have already learned that a voltage will be induced or generated in the armature conductors of a motor whenever the machine is running, and that this voltage is called Counter E. M. F. As the armature of the motor rotates, its conductors will be going through the field flux and so will produce counter-voltage in the same direction as that of the voltage of a generator rotated in the same direction as the motor. Therefore, this counter E. M. F. induced in a motor is always in a direction opposing the applied line voltage, but of course is normally not quite as great as the applied voltage.

The amount of counter-voltage which will be generated depends upon the number of conductors in the armature, the strength of the motor field, and the speed at which the machine is operated.

Keep this rule well in mind, because the effects of counter-voltage are extremely important in the operation of D. C. motors and control equipment.

In Fig. 108, the direction of the current and voltage applied to the armature conductors from the line is shown by the solid black symbols in the two armature conductors, and the direction of the counter-voltage generated in these conductors with the polarity and rotation shown, is indicated by the lighter symbols above the conductors.

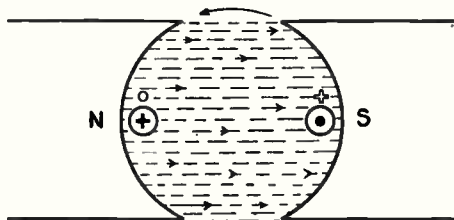

Fig. 108. The above sketch illustrates the manner in which the counter-voltage is generated in the opposite direction to the applied voltage in a motor armature.

As the counter-voltage is generated in the opposite direction to the applied line voltage, we can readily see how it limits or regulates the current which will flow through the armature and thereby acts as a governor of the motor speed.

The voltage applied to a D. C. motor armature is equal to the voltage drop in the winding plus the C. E. M. F., or

$$E_x = R_a I_a + C E_a$$

in which

- $E_x$  = Applied voltage
- $R_a$  = Resistance of armature
- $I_a$  = Current in armature
- $C E_a$  = Counter voltage of armature

Then, for example, the applied voltage of a certain 110-volt motor might be used as follows:

	$E_x$	$R_a I_a$	$C E_a$
No load:	110 =	1 +	109
Full load:	110 =	5 +	105

### 122. ARMATURE RESISTANCE NECESSARY WHEN STARTING D. C. MOTORS

When the motor armature is idle or at rest no counter-voltage is produced, and the current which would then flow through the armature would be determined entirely by its resistance and the voltage applied; according to the formula:

$$I = E \div R.$$

The resistance of D. C. motor armatures is very low, usually less than one ohm. Therefore, excessive currents would flow through them if we were to apply the full line voltage to start the machine.

For this reason, when starting D. C. motors of any but the very smallest sizes, it is necessary to place some resistance in series with the armature to limit the current until the machine comes up to speed. As the motor increases its speed the counter-voltage becomes higher and higher, until it limits the current to such an extent that the motor speed cannot further increase. At this point the difference between the counter-voltage and the line-voltage may be only a few volts, even on motors of quite high voltage.

The voltage effective in forcing current through the armature of a motor when it is running will be just that amount of the line voltage which is not neutralized by counter-voltage. In other words, the effective voltage will be line voltage minus counter-voltage. This is illustrated in Fig. 109, which shows the amount of the applied voltage which is neutralized by the counter-voltage developed in the armature. For this illustration we have used even

and convenient figures, but in actual operation of a motor running without load the counter-voltage would be even greater in comparison to the line voltage.

If we assume the resistance of the armature in this figure to be .2 of an ohm, the current which would flow through its winding if full line voltage were applied would be  $100 \div .2$ , or 500 amperes. That is, of course, provided that no external resistance were used in series with the armature.

If this same armature develops 90 volts counter-E. M. F. when rotating at full speed and under full load, the effective voltage is then only 10 volts. So, when running at this speed, the armature current would be  $10 \div .2$ , or 50 amperes. From this example you can see what a great effect counter-voltage has upon the current flow in a motor armature.

### 123. EFFECT OF COUNTER-VOLTAGE ON MOTOR SPEED

The current required to operate a D. C. motor when no load is connected to it is comparatively small. Let us say that the armature shown in Fig. 107 requires 50 amperes to operate it at full load, and only 5 amperes to operate it when the load is disconnected. As the resistance of the armature is only .2 of an ohm, the applied voltage to run the machine at full speed and at no load would be  $.2 \times 5$ , or 1 volt. So the counter-E. M. F. during the time this motor is running idle should be  $100 - 1$ , or 99 volts.

When the mechanical load is removed from a motor, its armature immediately tends to speed up; but as the speed increases it also increases the counter-E. M. F., thereby reducing the current flow from the line and holding the motor at a constant speed slightly higher than when operated under full load. This again serves to illustrate the manner in which counter-E. M. F. governs the speed of a D. C. motor.

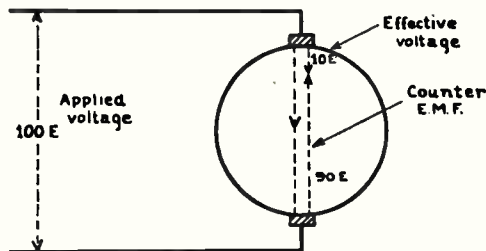

Fig. 109. From the above illustration you will note that the counter-voltage is often nearly as high as the applied voltage. This sketch illustrates the extent to which counter-voltage regulates or limits the flow through a motor armature.

### 124. D. C. MOTOR CHARACTERISTICS

In selecting D. C. motors for any particular work or application we must, of course, use a machine of the proper horse-power rating to start and carry the load the motor is intended to drive. In addition to the Horse Power Rating of the motor, the other essential points to be considered are its Starting Torque and Speed Regulation characteristics. These characteristics vary widely for shunt, series, and

compound motors, which will be thoroughly explained in the following paragraphs. Make a careful study of this section because it may often be of great advantage to you on a job to be able to select the proper motors for different applications.

**125. SHUNT MOTORS**

The field winding of a shunt motor is connected directly across the line or source of current supply, in parallel with its armature. This shunt field winding is made up of many turns of small wire and has sufficient ohmic resistance to limit the current through the coils to the safe carrying capacity of the conductors they are wound with. As the resistance of the shunt field winding is practically constant, this current and the strength of the field it sets up will be determined by the line voltage which is applied to the motor.

A simple diagram of the connections of the armature and field of a two-pole shunt motor is shown in Fig. 110.

**126. STARTING TORQUE OF SHUNT MOTORS**

The starting torque of shunt motors is only fair and they cannot start very heavy loads because their field strength remains approximately constant as long as the applied voltage is constant.

While a motor is starting the armature flux is very dense, because of the heavier currents flowing through the armature at this time.

This increased armature flux of course increases the motor torque, but it also weakens the field by distorting it and forcing it to take a path of higher reluctance; so shunt motors cannot build up as good starting torque as series or compound machines do.

As the torque of the motor depends upon its field strength as well as upon the armature current, we can see that the starting torque of a shunt motor will not be very good.

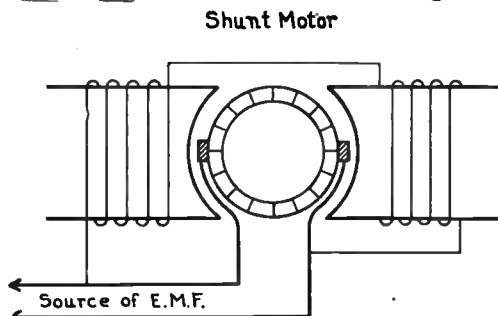

Fig. 110. Diagram of the connections for a simple shunt motor.

**127. STALLING TORQUE OF SHUNT MOTORS**

If a shunt motor is overloaded to too great an extent it will slow down and possibly be stopped entirely if the overload is great enough. A motor should never be allowed to remain connected to the line when in this stalled condition, or its windings will be burned out. This is due to the fact that when the armature is stopped it is generating no counter-voltage, and the applied line voltage will send a severe overload of current through the

low resistance armature. Fuses or circuit breakers should be provided to open the line circuit to the motor in a case of this kind.

The ability of a motor to carry overload without stalling is often referred to as the Stalling Torque of the motor.

Shunt motors will carry their full, rated load but should not be overloaded to any great extent, as their stalling torque is not very high.

**128. SPEED REGULATION OF SHUNT MOTORS**

The speed regulation of shunt motors is excellent, as the strength of their field remains practically constant, and as long as the proper line voltage is applied they will maintain practically constant speed under wide variations of the load.

The shunt motor will of course slow down a little when the load is increased; but, as soon as the armature speed is reduced even slightly, this reduces the counter-voltage generated and immediately allows more current to flow through the armature, thereby increasing the torque and maintaining approximately the same speed.

The speed of shunt motors ordinarily should not vary more than three to five per cent. from no load to full load. Fig. 111 shows a set of curves which illustrate the speed regulation of series, shunt, and compound motors. Note that the speed of the shunt motor only falls off very gradually as the load is increased.

**129. SPEED CONTROL AND APPLICATIONS OF SHUNT MOTORS**

The speed of shunt motors can easily be varied or controlled by inserting a rheostat in series with their field. If the field is weakened, the motor speed will increase, because the reduced counter-voltage allows more current to flow through the armature.

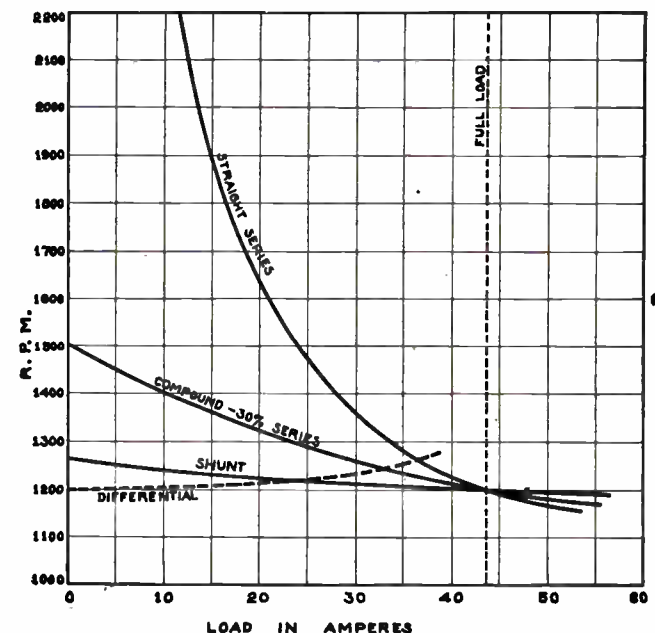

Fig. 111. The above diagram shows the characteristic speed curves for several types of D. C. motors. Note carefully the manner in which the speed varies with increase of load.

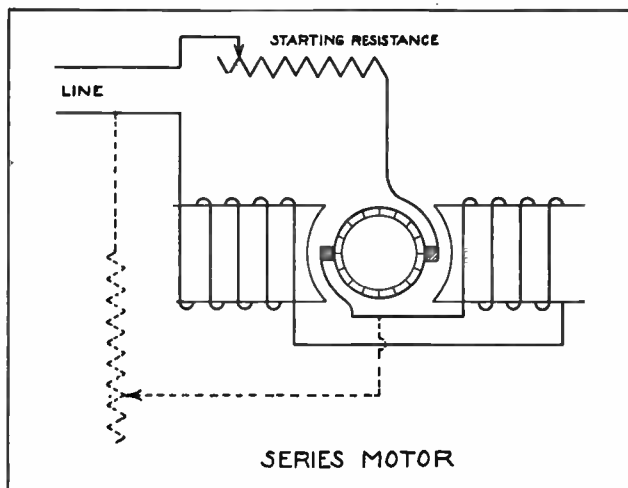

Fig. 112. Diagram of the connections for a simple series motor. The dotted lines show where a shunt can be connected in parallel with the field coils for varying the speed.

If the field is strengthened, the motor speed will decrease, because this stronger field allows the normal counter-voltage to be generated at lower speed.

The uses and applications of shunt motors are many and varied. They may be used on any job where more than full-load torque is not required for starting and where practically constant speed is essential. They are extensively used for pumps, elevators, motor-generator sets, and for the operation of lathes and various machines used in manufacturing appliances.

### 130. SERIES MOTORS

Series motors have their field coils connected in series with the armature and the line, as shown in Fig. 112. The windings for the fields of series motors are made of heavy copper wire or strap copper, and may consist of anywhere from a few dozen to a few hundred turns.

The strength of the field of the series motor depends upon the amount of current flowing through the armature and series field coils.

As the armature current depends upon the motor load and speed, the field strength of a series motor will be much greater at heavy loads and low speeds than at light loads and higher speeds, when the armature is developing a greater counter-E. M. F.

### 131. STARTING TORQUE

The armature current is usually at its greatest value when starting a motor because when the armature is idle or rotating at low speeds it doesn't generate much counter-E. M. F., and very heavy currents will flow through the armature until it comes up to speed. For this reason the starting torque of series motors is excellent.

The torque of motors of this type varies directly with the square of the armature current, because any increase of current through the armature also increases the field strength, as the two windings are in series.

Series motors are capable of starting very heavy loads, and this makes them particularly adaptable for use on street cars and electric railways, and other

special applications where the machinery to be driven is difficult to start.

### 132. STALLING TORQUE

Series motors also have excellent stalling torque, because, when they are overloaded, their speed is reduced and less counter-voltage will be generated in the armature. This allows more current to flow both through the armature and field coils, greatly increasing the flux around the armature conductors and from the field poles.

It is almost impossible to stall a series motor with any reasonable load, because the slower the speed becomes, the more current will flow through the armature and field of the motor, and the greater its torque becomes.

Of course, it is possible to burn out a series motor by overloading it in this manner, if the overload is left on it too long.

### 133. SPEED REGULATION

The speed regulation of series motors is very poor, because their speed varies inversely with the load applied. Any increase of load actually strengthens the field flux of the series motor. This causes a higher counter-voltage to be generated and momentarily reduces the armature current, until the speed of the motor drops enough lower to bring the counter-voltage back to normal or less than normal, to allow the increased current flow required for the additional load.

If some of the load is removed from the series motor, this decreases the flow of current and weakens its field. The weaker field develops less counter-voltage and momentarily allows more current to flow, until the speed is increased enough to build the counter-voltage up again somewhat above normal value.

Thus, series motors will operate at very high speeds when the load is light and they will overspeed if the load is entirely disconnected. For this reason series motors should never be operated without load, or the speed will increase to a point where centrifugal force may throw the armature apart.

Series motors should always be attached to their load by gears or direct shaft connection, and never by belts. If a series motor were belted to its load and the belt should break or slip off the pulleys, the motor might dangerously overspeed before it could be stopped.

In Fig. 111, the speed curve for a series motor is shown, and you will note how rapidly the speed decreases with any increase of load.

There are certain applications for motors, however, where the decrease of speed with increase of load is very desirable.

### 134. SPEED CONTROL

The speed of a series motor can be controlled or varied at will by the use of resistance in series with the motor. Increasing this resistance will reduce the voltage applied to the armature and series field, and tends to momentarily reduce the current flow and the torque, until the motor reduces its speed and



counter-E. M. F. to a point where the counter-E. M. F. and the effective voltage again balance the reduced applied voltage.

This is one of the methods used to vary the speed of electric street cars, by cutting resistance in or out of the motor circuit with the drum controller. When the resistance in series with the machine is varied, the voltage across the armature is varied accordingly, and the armature slows down or speeds up correspondingly until the counter-E. M. F. and effective voltage again equal the applied voltage.

The speed of series motors can also be varied by connecting a shunt in parallel with their field coils, as shown by the dotted lines in Fig. 112. This shunt merely passes a certain amount of the armature current around the field winding, and thereby weakens the field strength and increases the speed of the motor. These shunts can not be used to decrease the motor speed below normal.

### 135. USES AND APPLICATIONS OF SERIES MOTORS

The uses and applications of series motors are somewhat limited because of their wide variation in speed when the load is varied, and their tendency to overspeed when the load is removed. Series motors are not adapted to driving machinery or equipment which place a variable load on the motor and require practically constant speed.

Series motors are used principally for electric cranes, hoists, and railway service, and are well suited to this work because of their high torque at low speeds and low torque at high speeds. They are particularly well adapted to electrical traction work because of their splendid starting torque, which enables them to start heavy cars quickly and also climb hills with heavy loads. Their speed characteristic is also an advantage in this case, because it is possible to obtain high speeds with cars operated by this type of motor when the cars are running on the level or with light loads.

### 136. COMPOUND MOTORS

Compound D. C. motors have some of the characteristics of both the shunt and series motors, as they have both a shunt and series field winding on each pole. The shunt field of the ordinary machine is made up of many turns of small wire and is connected in parallel with the armature and line, as shown in Fig. 113. The strength of the shunt field flux will therefore be proportional to the applied line voltage and will be practically constant as long as this voltage is not varied.

The series field winding is usually made of very heavy copper wires or strap copper and may vary from a few turns to 100 turns or more per pole. This winding is connected in series with the armature, as shown in Fig. 113, and carries the full load current which passes through the armature.

The strength of the series field will therefore be proportional to the load applied to the motor. The shunt field, however, is the one that always determines the polarity of the machine under ordinary

conditions and, therefore, it is called the main field winding.

Compound motors can be connected either cumulative or differential, by simply reversing the connections of their series field windings. The connections shown in Fig. 113 are for a cumulative compound motor, and most D. C. motors are understood to be connected in this manner, unless they are marked or designated as differential-compound.

With the series field connected for cumulative-compound operation, the current flows through these coils in the same direction that it does through the shunt coils, and therefore aids in setting up a stronger field when there is any load on the motor.

### 137. STARTING AND STALLING TORQUE

Cumulative-compound motors have a very much better starting-torque than shunt motors, because the heavier armature currents which flow during starting also pass through the series field and greatly strengthen its flux, thereby increasing the motor torque.

Motors of this type can be used for starting very heavy loads or machinery that is difficult to start and bring up to speed.

The stalling torque of cumulative-compound motors is also quite high, because any increase of load on the machine will increase its armature current and the current through the series field. This increases the flux of the field poles, which in turn increases the motor torque and enables it to carry the additional load at slightly reduced speed.

Such motors can be allowed to carry reasonable overloads of 15 to 25 per cent. as long as they don't overheat enough to damage their insulation.

### 138. SPEED REGULATION AND APPLICATIONS

The speed regulation of cumulative-compound motors can be considered as fair. Their speed will vary inversely with the load, because any increase of load also increases the field flux due to the action of the series winding; and when the field flux is increased, the armature speed must decrease, in order

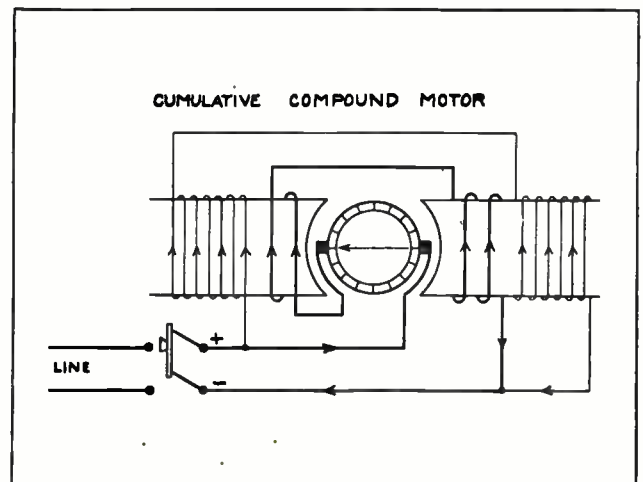

Fig. 113. Diagram of connections for a cumulative compound motor. Note that the series field winding is connected so it will aid the shunt field winding in providing a strong field.

to lower the counter-E. M. F. sufficiently to allow enough current to flow to carry the load. The stronger the field of any motor, the lower will be the speed at which it can generate the normal counter-E. M. F.

Compound motors are used extensively to drive power shears, the rolls of steel mills, and in factories and industrial plants for running machines which require good starting and stalling torque and don't require very close speed regulation.

### 139. DIFFERENTIAL COMPOUND MOTORS

When compound motors are connected for differential operation their characteristics change considerably from those of cumulative machines.

A differential compound motor has its series field so connected that the current will flow through it in the opposite direction to that of the current in the shunt field windings, as shown in Fig. 114. This tends to weaken the field flux whenever any load is being carried by the motor.

The shunt field winding is the main winding and under ordinary conditions it determines the polarity of the field poles. Occasionally, however, when these motors are started up rather suddenly and under heavy load, the current flow through the differential series winding becomes very strong; and due to its strong flux and the inductive effect which it has on the shunt field coils during the time this flux is building up around the series winding, it may overcome the shunt field flux and reverse the polarity of the field poles. This will cause the motor to start up in the wrong direction.

To avoid this, the series field of a differential motor should be short-circuited when starting. This can be done by the use of a single-pole knife switch of the proper size, connected across the series field terminals, as shown in Fig. 114.

### 140. STARTING TORQUE AND STALLING TORQUE

The starting torque of an ordinary differential-compound motor is very poor, even poorer than that of a shunt motor. This is due to the effect of the heavy starting currents flowing through this field and weakening the flux of the shunt field to such an extent that the motor has very poor starting torque. Motors of this type are usually started without any load connected to them.

A reversing switch can be used to reverse the polarity of the differential field and make the motor operate cumulative during starting, and thereby improve the starting torque of this motor.

Differential motors will not carry overload without stalling. In fact they will usually only carry about 75% of the full rated load of a shunt motor of the same size. Whenever the load on such a machine is increased, the series field current is increased and, because it flows in the opposite direction of that in the shunt winding, it tends to neutralize and weaken the total field flux and also weaken the load-pulling torque.

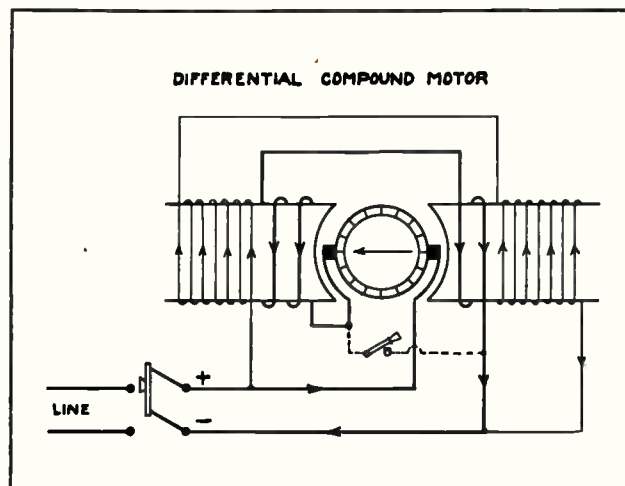

Fig. 114. Differential compound motor connections. Note that the series field is connected so it will oppose and weaken the effect of the shunt field.

### 141. SPEED REGULATION AND APPLICATIONS

Differential-compound motors have excellent speed regulation up to a certain amount of load. As the load is slightly increased, the motor tends to slow down, but the increased current through the differential series field immediately weakens the shunt field flux and thereby causes the counter-E. M. F. in the armature to be reduced.

This allows more current flow through the armature and maintains the speed at normal value. With just the proper number of turns on a differential series field, the tendency of the motor to slow down with increased load and the tendency to speed up with weakened field can be so balanced that they will neutralize each other, and the speed will remain almost perfectly constant if the load change is not too great.

Note the speed curve shown for this type of motor in Fig. 111.

Differential-compound motors are not used very extensively, because of their very poor starting torque; but they have certain applications where very little starting torque is required and good speed regulation is essential. The operation of textile mill machinery is a good example of this application.

A convenient, practical method for determining whether a compound motor has its series field connected differential or cumulative is to operate the motor and note its speed. Then reverse the series field connection and again note the speed. Whichever connection gives the most speed is the differential connection of the series field winding.

### 142. BRAKE HORSE-POWER TEST FOR MOTORS

Occasionally it may be desirable to make an actual test of the horse-power output of a motor, in order to determine its condition or efficiency. This can be done by arranging a brake or clamp to apply load to the pulley of the motor and thereby measure the pull in pounds or the torque exerted by the motor.

This method is known as the Prony Brake Test.

Fig. 115 shows the equipment and method of its use for making this test. The brake can be made of wood blocks cut to shape to fit the pulley and fitted with bolts and wing nuts so the grip or tension of the blocks on the pulley can be adjusted. When making a number of these tests, it is also a good plan to line the curved faces of the block with ordinary brake lining such as used on automobiles. This makes it possible to apply a smoother braking effect without generating too much heat due to the friction.

An arm or bar, of either wood or metal, can be attached to the brake blocks as shown in the figure, and fitted with a bolt or screw eyes for attaching the scales to the end of the bar. A spring scale, such as shown in Fig. 115, can be used, or the bolt on the underside of the arm end can be allowed to rest on the top of a platform scale.

The brake arm should preferably be of some even length, such as 2 ft. or 3 ft., in order to simplify the horse-power calculation. The arm length is measured from the center of the shaft to the point at which the scale is attached.

With a device of this kind, load can be gradually applied to the motor by tightening the brake shoes or clamps until the motor is fully loaded.

An ammeter can be used in series with one of the line leads to the motor to determine when the machine has been loaded to its rated current capacity. In case an ammeter is used, a voltmeter should also be used, to see that the proper line voltage is applied to the motor at the time of the test. A wattmeter can be used instead of the voltmeter and ammeter if desired.

When the brake has been adjusted so that the motor is drawing its full rated load in watts, the pound pull on the scale should be noted and the speed of the motor in revolutions per minute should be carefully checked.

The adjustment on the brake should be maintained to keep the motor pulling the same amount on the scales and drawing the same load in watts during the time the speed is being checked.

The motor speed can easily be checked by means of a speed counter or tachometer applied to the end

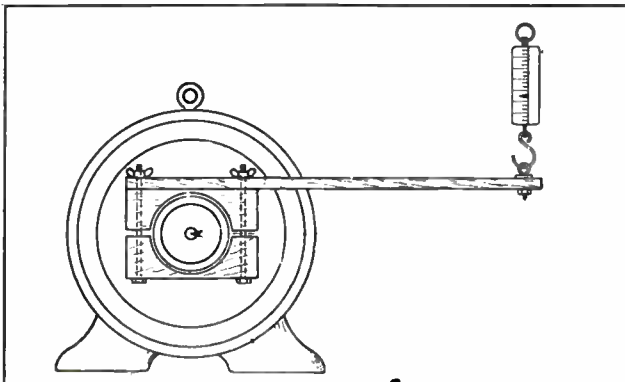

Fig. 115. The above diagram illustrates the method of making a brake-h. p. test on a motor.

of its shaft while running. A watch with a second-hand should be used for gauging the time accurately.

#### 143. HORSE POWER CALCULATION

The horse power of a motor is proportional to the product of its torque and speed. Therefore, when we know the length of the lever arm in feet, the pull in lbs. on the scales, and the speed of the motor in R. P. M., we can easily determine the horse-power output by the following simple formula:

$$h. p. = \frac{2 \times \pi \times R. P. M. \times P \times L}{33,000}$$

In which:

h. p. = the horse power developed by the motor  
 $\pi$  = 3.1416, or the ratio between the diameter and circumference of a circle. ( $2 \times \pi = 6.28$ )

R. P. M. = Speed of the motor in revolutions per minute

P = Lbs. pull on the scale

L = Length of lever arm in feet

33,000 = Number of foot-pounds required per minute for one h. p.

As an example, suppose we have made a test on a motor using a brake arm two ft. in length, and have found that when the motor is fully loaded according to the electrical instruments, it applies 9 lbs. pull on the end of the arm and revolves at a speed of 1500 R. P. M. Then, according to our formula:

$$h. p. = \frac{6.28 \times 1500 \times 9 \times 2}{33,000} \text{ or } 5.1 \text{ h. p.}$$

#### 144. EFFICIENCY TESTS

The efficiency of a motor is, of course, an important item, especially where a large number of motors are being chosen for continuous operation of certain equipment. The higher the efficiency of any motor, the greater the h. p. it will produce from a given amount of electrical energy in watts, and the less power will be wasted in losses within the machine.

These losses are partly mechanical, such as bearing friction and "windage" due to the armature revolving through the air at high speed. They are also partly electrical, such as losses in the armature and field windings due to resistance and to a certain amount of energy being transformed into heat, and the slight magnetic losses due to hysteresis and eddy currents.

The efficiency of D. C. motors may vary from 50% or less for the very small fractional horse power machines up to 90% for the larger ones, and even higher than this for extremely large motors.

The efficiency of ordinary motors from 5 to 50 h. p. will usually range between 75 and 90 per cent; so, when the efficiency of a machine is not known, a good average figure to use is 80% or 85%.

As a general rule, the larger the motor, the higher will be its efficiency. Fig. 116 shows a table in which are given the efficiencies of several sizes of

EFFICIENCY OF 230VOLT COMPOUND D.C. MOTORS			
SIZE IN H.P.	AT ½ LOAD	AT ¾ LOAD	AT FULL LOAD
5	73%	78%	80%
10	79%	82.5%	85%
25	84%	87%	87.5%
50	85%	87.5%	88.5%
200	87%	89%	91.5%

Fig. 116. This table gives the approximate efficiencies of various sized D. C. motors at various percentages of load.

motors, from 5 to 200 h. p. You will also note by examining this table that the efficiency of any motor is better at full or nearly full load. Therefore, it does not pay to operate motors lightly loaded whenever it can be avoided by the selection and use of motors of the proper size. In many cases, motors which are larger than necessary have been installed to operate certain machines, because these machines require considerable starting torque. In a case of this kind, the selection of a different type motor with a better starting torque can often effect considerable power saving.

#### 145. EFFICIENCY CALCULATION

The efficiency of any motor can be found by dividing its output in watts by the input in watts. This is stated by the following formula:

$$e = \frac{W O}{W I}$$

In which:

$e$  = the efficiency of the motor in per cent.

$W O$  = watts output

$W I$  = watts input

The output and input can both be determined in horse power or kilowatts, if preferred, and used in the same manner in the formula.

When we have made a test of the horse power of a motor by the Prony brake method and have measured the electrical power input either with a

wattmeter or a voltmeter and ammeter, it is then an easy matter to determine the efficiency of the machine with the formula just given.

For example, suppose we have tested a machine and found its full load output to be 35.5 h. p. During this test the wattmeter connected to the motor leads indicated that it was consuming 31,150 watts. To obtain the output in watts, we multiply 35.5 by 746, as there are 746 watts in each h. p., and we find that the output is 26,483 watts.

Then, according to the formula, the efficiency of this motor will be found as follows:

$$e = \frac{26,483}{31,150}, \text{ or } 85+ \% \text{ efficiency}$$

Fig. 117-A shows the method of connecting a wattmeter to the terminals of a motor for determining the input or energy consumed. At "B" in this same figure are shown the proper connections for a voltmeter and ammeter used to determine the input of the motor.

The readings of the voltmeter and ammeter can be multiplied to obtain the power input in watts.

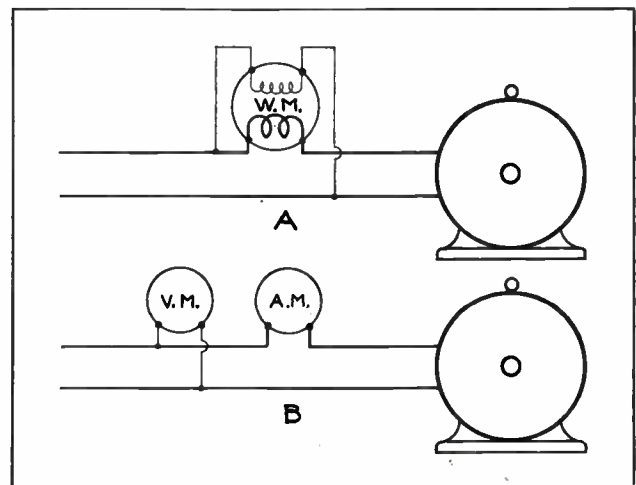

Fig. 117. The above diagram shows the method of connecting a wattmeter or voltmeter and ammeter, to determine the KW or h. p. input to a motor.

## D. C. MOTOR STARTERS AND CONTROLS

There are two general types of D. C. motor control equipment. One of these is used for starting duty only, and the other can be used both for starting and for controlling or regulating the speed of the motors while running.

Motors of ¼ h. p. or less can be started by connecting them directly across the line, as their armatures are so small and light in weight that they come up to full speed almost instantly. Therefore, the heavy rush of starting current does not last long enough to overheat their windings.

Medium-sized and larger D. C. motors should never be connected directly across the full line voltage to start them, as their heavier armatures require more time to speed up and develop the necessary counter-voltage to protect them from excessive starting current.

If these armatures are connected directly across full line voltage when they are at rest, the rush of starting current through them is likely to be more than 10 times full-load current. This excessive current will overheat the winding, and also possibly damage the insulation of the coils by the powerful magnetic field it sets up and the mechanical forces the coils exert on the slots in trying to practically jerk the armature up to full speed.

So, for this reason, a starting resistance should always be connected in series with the armature of a D. C. motor when starting it, and left in the circuit until the motor armature has reached full speed and has built up its own protective counter-voltage.

When the current flows through this resistance, it causes sufficient voltage drop so that only about one-fourth of the line voltage is applied to the arma-

ture. Fig. 118 shows the method of connecting the starting resistance in series with the motor armature.

These starting resistances are usually arranged so they can be gradually cut out of the armature circuit as the motor comes up to speed, and when full speed is reached the resistance is all cut out.

The starting current for D. C. motors should be limited to about  $1\frac{1}{2}$  to  $2\frac{1}{2}$  times full-load current. It is therefore necessary that starting rheostats have the proper resistance value and current capacity for the motors with which they are used.

**146. TIME ALLOWED FOR STARTING MOTORS**

The period of time for which the starter resistance should be left in series with the motor when starting, depends upon the size of the motor and the nature of the load attached to it. A motor connected

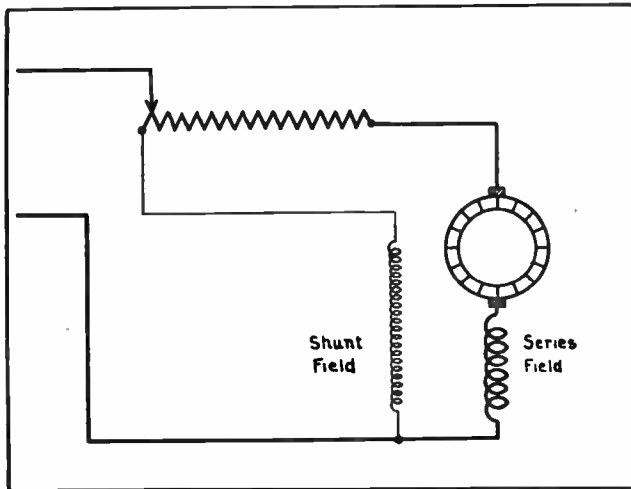

Fig. 118. This simple sketch shows the manner in which a resistance is used in series with the armature when starting a D. C. motor.

to a heavy load, of course, requires more time to come up to full speed, and the larger the armature of a motor, the more time is required for it to reach full speed.

Usually from 15 to 30 seconds will be required on ordinary motors. This rule, however, cannot be strictly followed, as the time allowed for starting a motor must be largely a matter of observation and good judgment on the part of the operator. One can readily tell by the sound of the motor when it has reached full speed

While starting and operating various motors you will gain considerable practice in judging the time required for different motors. Always watch and listen to the motor closely when starting it up, and never leave the resistance in the circuit any longer than necessary, or it is likely to become damaged by overheating.

**147. MOTOR STARTING RHEOSTATS**

Starting resistances or Rheostats, as they are called, should never be used to regulate the speed of a motor after it is running. Starting rheostats are designed to carry the armature current only for a very short period and should then be cut

out of the circuit. If they are used for speed regulation and left in the circuit for longer periods, they are very likely to become overheated to a point where the resistance metal will burn in two and result in an open circuit in the rheostat.

Armature starting resistances for small machines are usually made up of iron wire, or wire consisting of an alloy of nickle and iron. This resistance wire is wound on an insulating base, or form of asbestos or slate. The turns of the coil are so spaced that they don't short together.

The taps are made at various points along the coil and are connected to segments or stationary contacts which are mounted on the face-plate of the starter. A lever arm with a sliding contact is then used to cut out the resistance gradually as the motor comes up to speed. See Figs. 121 and 123.

**148. SPEED CONTROL RHEOSTATS**

Speed-regulating resistance can be used for starting motors and also for controlling their speed over indefinite periods. Rheostats for this use are made of larger and longer resistance material and are designed to carry the armature current for long periods without damage from overheating.

Speed-regulating resistances are in some cases made of heavy iron wire, but for medium and larger sized motors are generally made of cast iron grids or grids consisting of an alloy of nickle and iron. The nickle alloy is generally preferred in the better class controls.

**149. METHODS OF CONTROLLING THE SPEED OF D. C. MOTORS**

The speed of shunt and compound motors may easily be controlled by the use of a rheostat in series with the shunt field, as shown in Fig. 119. By varying the resistance of the field rheostat, we can vary the current through the field of the motor. If the field is weakened, the counter-E. M. F. generated in the armature is momentarily reduced and more current is allowed to flow through the machine.

This will cause the machine to speed up until the counter-voltage produced in this weaker field is again normal. If the motor field is strengthened, the

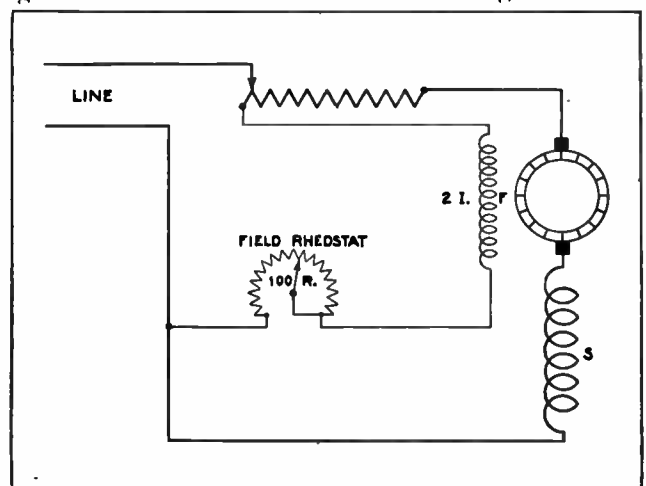

Fig. 119. This diagram shows the armature starting resistance and also a shunt field rheostat for varying the speed of the motor.

counter-voltage developed in the armature will be increased, and this will cause the current flowing through the machine to be reduced, allowing the speed to decrease until the counter-voltage developed in this stronger field is again normal.

It is possible to vary the speed of a motor only above its normal speed by the use of shunt field rheostats.

The torque of a motor armature will vary inversely with the speed when the field is weakened in the manner just described. The output in h. p., however, will remain approximately the same, as the h. p. is proportional to the product of the speed and torque.

For example, if a certain motor normally rotates at 1000 R. P. M. and develops 10 lbs. torque at the end of a brakearm, the product of this speed and torque is  $1000 \times 10$ , or 10,000.

Now, if we were to increase the speed of this motor to 2000 R. P. M., or double its normal speed, the torque, which varies inversely with the speed, will be reduced to 5 lbs., or one-half its former value. In this case, the speed times the torque equals  $2000 \times 5$ , or 10,000 as before.

Motors that do not have interpoles should not ordinarily be operated at speeds greater than 65 to 70 per cent above their normal speed ratings. On motors that have interpoles, it is possible to obtain speed variation as great as 6 to 1 ratio.

Field control is a very economical means of speed variation for D. C. motors, since the output of the motor in horse power remains practically unchanged and the power lost in the field rheostat is very small.

The power lost due to heating in any resistance is equal to the square of the current multiplied by the resistance, or  $I^2 \times R = W$ .

For example, let us assume that the resistance of the field rheostat shown in Fig. 119 is 100 ohms, and that the field current required by this motor is 2 amperes; then the power lost in the field rheostat would be  $2^2 \times 100$ , or 400 watts.

### 150. SPEED CONTROL BY USE OF ARMATURE RESISTANCE

The speed of shunt, series, and compound motors can also be regulated or varied by means of a rheostat in series with the armature, as shown in Fig. 120. An armature resistance used in this manner merely produces a voltage drop as the machine current flows through it, and thus it varies the voltage applied to the armature.

When this method of speed control is used, the strength of the shunt field of the motor is not varied, as it is connected directly across the line so it is not affected by the armature resistance. Observe this method of connection in Fig. 120.

When the voltage applied to the armature is decreased by cutting in the resistance of the armature rheostat, this will decrease the armature current and the speed of the motor. Since the torque of any motor varies with the product of the armature

current and field flux, any change of this armature current produces a corresponding change in the torque and speed developed by the machine. When the motor slows down to a speed at which its counter E.M.F. and effective armature voltage again balance the applied voltage, the current and torque will again be the same as before changing the speed, providing the load torque remains constant.

### 151. SPEED CONTROL BY FIELD RESISTANCE MOST ECONOMICAL GENERALLY

Speed control by means of armature resistance is very wasteful of power because of the very heavy armature current which must be passed through the rheostat, and the losses due to heat and I R drop in the rheostat.

If the armature shown in Fig. 120 requires 50 amperes for full load operation and the speed regulating rheostat has .5 of an ohm resistance, then the energy lost due to heat in the rheostat will be  $I^2 \times R$ , or  $50^2 \times .5$ , which equals 1250 watts.

If the field resistance were used for speed control of this motor, the losses would be much less. We will assume the field current to be 2 amperes, and the field rheostat resistance 100 ohms. Then the loss with this form of speed control would only be  $2^2 \times 100$ , or 400 watts.

The speed regulation of the motor which is controlled by armature resistance is very poor when the machine is operated below normal speed, while the speed regulation of a motor controlled by the field rheostat is very good, because the armature in this case is always operated at the same voltage.

Shunt field rheostats for ordinary motors are small compact devices, because they don't need to carry a great amount of current or to have a large heat radiating surface.

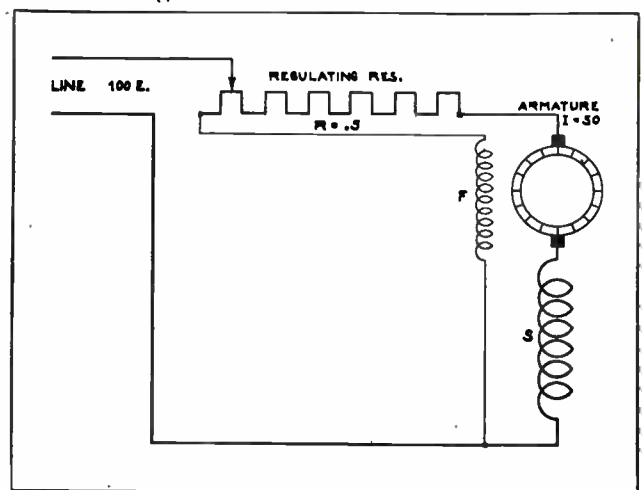

Fig. 120. Rheostats for speed regulating duty use heavier resistance units to stand the continued current load without overheating.

Armature rheostats are much larger and usually made of heavy cast iron grids, or, in the case of some of the latest type controls, they are made from alloy of manganese and copper.

From the foregoing material, it is easy to see that the use of the field rheostat provides a much more economical method of motor speed control than the

use of armature resistance, and it should therefore be used whenever possible.

The three principal advantages of field control over armature control are as follows:

1. The horse power output remains practically unchanged with field control but decreases considerably with armature control.
2. Power lost in the field rheostat is much lower than in armature rheostats, which must carry the heavier armature current.
3. The speed regulation of a motor which is controlled by field rheostats is much better than that of a machine controlled by armature resistance.

Resistance should never be cut in to both armature and field circuits at the same time on any motor, because resistance in the armature circuit tends to reduce the speed, while resistance in the field circuit tends to increase speed. So each one would tend to defeat the purpose of the other.

Both armature and field control are often used together on the same motor, however, **cutting out** resistance from the armature circuit to bring the speed from zero up to normal, and **cutting in** resistance in the field circuit to raise the speed above normal.

## 152. D. C. MOTOR CONTROLLERS

There are many types of D. C. motor starters and speed controllers, but the general principles of practically all of them are very much the same. Their function is usually to place resistance in series with the motor armature when the machine is started, and gradually cut out this resistance as the machine comes up to speed.

Some controllers also make a slight variation in the resistance in the shunt field circuit at the same time the armature resistance is cut out. Some types of controls have reversing switches or contacts in addition to the rheostat element, so they can be used for starting and reversing of motors.

The operation of controllers may be either **Manual** or **Automatic**. In the manual types the lever arm or sliding contact which cuts out the resistance is operated by hand; while, in automatic types, the movement of the sliding contact or switches which cut out the resistance is accomplished by means of electro-magnets or solenoids, which may be operated by a small push button switch located either at the controller or some distance from it. Because of this feature, certain controllers are known as **Automatic Remote-Control** devices.

The design of the various controllers depends in each case upon the size of the motors they are to operate and upon the class of duty they are to perform.

## 153. CONSTRUCTION FEATURES

Common small motor controls consist of a box or panel on which are mounted the stationary contacts and sliding contact or controller arm; and usually some form of latch or holding magnet to

hold the arm in running position, and frequently some form of line switch or, possibly, reversing switch.

On some of the smaller type controllers these contacts, coils, and switches are on the outside of the box or on what is called a "face plate," made of slate or insulating material.

Controllers used for small motors frequently have the resistance coils mounted inside the box, directly behind the face plate. In such cases the box is usually of well-ventilated construction, to allow the heat to escape.

On larger controllers, the resistance coils or grids are frequently located in a separate box or on a panel, and have copper leads run from the contacts on the panel to the resistance element.

Modern automatic types of controls frequently have the entire assembly of magnets, switches, and contacts enclosed in a metal safety cabinet.

Regardless of the type or application of the controller, you should be able to easily understand their circuits and principles, with the knowledge you already have of electrical circuits, electro-magnets, switches and rheostats.

## 154. THREE AND FOUR POINT STARTERS

Some of the most simple and common types of controls used with shunt and compound motors are called 3-point and 4-point controllers. The names 3-point and 4-point are derived from the number of connections or terminals on the face plate of these controllers. The 3-point control is usually arranged for starting duty only, but in some cases it may also be used for speed control, if it is properly designed.

Fig. 121 shows the wiring and electrical connections of a simple 3-point starter. In this diagram all parts and connections are in plain view and the path of the armature current is marked with solid black arrows, while the field circuit is shown by the dotted arrows. Trace this circuit out thoroughly and become familiar with the principles and operation of this fundamental type of starter.

To operate a controller of this type and start the motor, the first step will be to close the line switch

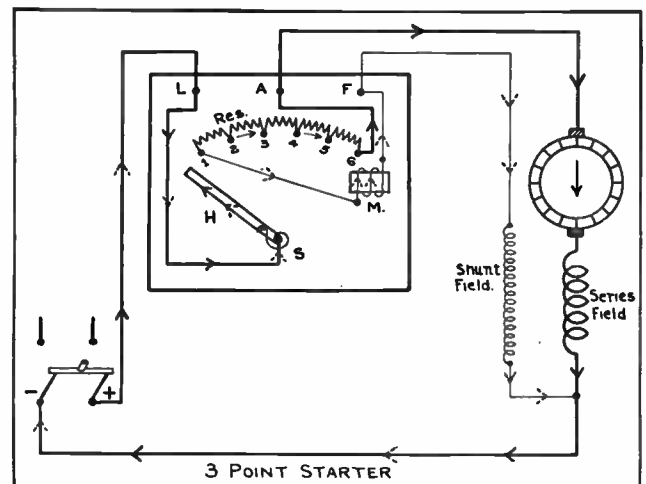

Fig. 121. This diagram shows the connections for a simple 3-point D. C. motor starter. Trace the circuit carefully with the accompanying instructions.

to apply the line voltage to the controller and motor.

You will note that one side of the line connects directly to the motor and that the controller is inserted in the other line wire, so that its resistance will affect both the armature and field circuits during starting.

The first step after closing the line switch is to move the lever arm "H" to the first point or contact attached to the left end of the controller resistance. Current will then start to flow from the opposite line wire, through the controller arm, and through the entire resistance to the motor armature and series field, and then back to the negative line wire, as shown by the solid arrows.

Another circuit can also be traced from the lever arm when it is in contact with point No. 1, as the current divides at this point and a small amount flows through the holding magnet "M", then through the shunt field winding and back to the negative line wire, as shown by the dotted arrows.

As soon as the motor starts to turn, the controller arm can be moved slowly across the contacts in order, 1, 2, 3, etc. This cuts out the resistance from the armature circuit step by step as the armature develops speed and begins to generate counter-voltage.

When the last contact point is reached, all resistance has been cut out of the armature circuit, and the lever arm will be held in this running position by the holding magnet "M", which is in series with the shunt field circuit.

#### 155. "NO VOLTAGE" and "NO FIELD" RELEASE COIL

The reason for connecting this holding magnet in series with the motor field is to provide what is known as "no field" protection.

We have learned that a motor with a very weak field is likely to overspeed dangerously. This would probably be the case if an open circuit should occur in the shunt field coils or connections of a motor of this type, when it is not loaded.

However, with the holding magnet, "M", connected in series with the shunt field, if any break occurs in this circuit the magnet, "M", will be de-energized and allow the controller arm to be thrown back to the "off" position by means of a spring. This will stop the motor before it has a chance to overspeed.

This holding magnet also acts as a "no voltage" release, so that if the voltage or power supplied at the line should fail, the starter will be released and return to normal position and thus stop the motor.

If this protection were not provided and the controller arm were left in running position, the motor might be burned out or injured when the power came back on the line, because there would then be no resistance in series with the motor armature.

This holding magnet is often referred to as a **no-field or no-voltage release coil**, and provides this

very important protection to the motor, in addition to serving its function of holding the starter arm in place.

#### 156. ALL RESISTANCE OUT OF FIELD CIRCUIT DURING STARTING

You will note by tracing the circuit when the starter arm is in the running position, that the field current will then have to pass back through the entire starter resistance, through coil "M", and the shunt field. We find, therefore, that as the controller cuts the resistance out of the armature circuit, it places the same resistance in the shunt field circuit. The advantage of this is that it provides maximum strength of the shunt field during starting of the motor, when it is naturally desired to provide the best possible starting torque.

As the motor comes up to speed, the shunt field strength can be reduced to normal by causing its current to flow through the starter resistance.

The value of the armature resistance in ohms is very low and it therefore doesn't affect the shunt field as much as it does the armature, because the very small current required by the shunt field doesn't create much voltage drop when flowing through this resistance.

#### 157. STOPPING A MOTOR

To stop the motor, we should always open the line switch, which will interrupt the current flow through the armature and field, and also allow the controller arm to fall back to starting position.

Never attempt to stop a motor by pulling the controller arm back across the contacts while the line switch is closed.

This would cause severe arcing and damage to the controller contacts, which should always be kept smooth and in good condition.

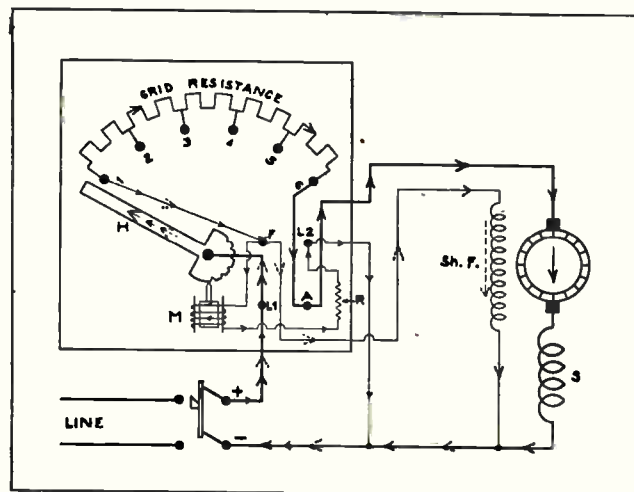

Fig. 122. Wiring diagram of a 4-point starter for speed regulating. Observe the connections and operating principle carefully.

#### 158. STARTER TERMINALS AND CONNECTIONS

You will note in Fig. 121 that the terminals on the starter are marked L, A, and F, to indicate the connections for the line, armature, and field. This makes



it a very simple matter to connect up controllers of this type to the line and motor.

The principal point to keep in mind is that one line wire should connect directly to the motor, being attached to both the shunt field and armature, or series field leads. The other side of the line should connect to the line terminal on the controller, and the remaining armature and field leads of the motor should connect respectively to the armature and field terminals on the controller. These terminals are usually marked on the controller or on the blue print supplied with it by the manufacturers.

### 159. SPEED REGULATING CONTROLLERS

Fig. 122 shows a 4-point controller of the type which can be used both for starting and speed regulation of D. C. motors. The resistance element of this controller is made of heavier grids of iron or nickle alloy, and is designed to carry the full armature current of the motor for indefinite periods.

The principal differences between this controller and the one shown in Fig. 121 are the larger resistance element, the use of 4 terminal points instead of 3, and the arrangement of the holding magnet, "M". With this speed-regulating controller, the lever arm and holding magnet are mechanically arranged so that the arm can be held in any position between No. 1 and 6 on the resistance contacts.

This allows the arm to be set for any desired speed of the motor. In this case, both line wires are connected to the controller terminals marked "L-1" and "L-2". The reason for connecting the negative line wire to the controller at "L-2" is merely to complete the circuit of the holding coil "M", directly across the line.

The small resistance "R" is placed in series with the magnet coil to keep it from overheating.

The armature path of current in Fig. 122 is shown by the large solid arrows, the shunt field current by the dotted arrows, and the current through the holding coil "M", by the small solid arrows. Trace each of these circuits out very carefully to be sure you thoroughly understand the operation of this controller.

Fig. 123 shows two views of a simple motor starter of the 3-point type. The view on the left shows the starter completely enclosed in the safety box with just the handle projecting from the front cover. When the cover is closed this handle con-

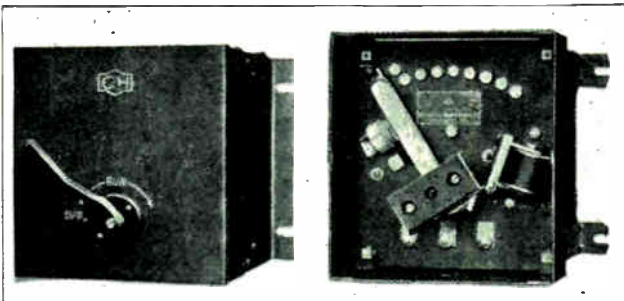

Fig. 123. Photo of a simple 3-point starter enclosed in a metal safety box.

nects with the sliding contact arm inside the box. The view on the right shows this arm as well as the stationary contacts and holding magnet.

Where small, low priced starters of the type just described are used, fuses are generally used with them to provide overload protection for the motors. Sometimes these fuses as well as the line switch are enclosed in the same box with the starter, as shown in Fig. 124.

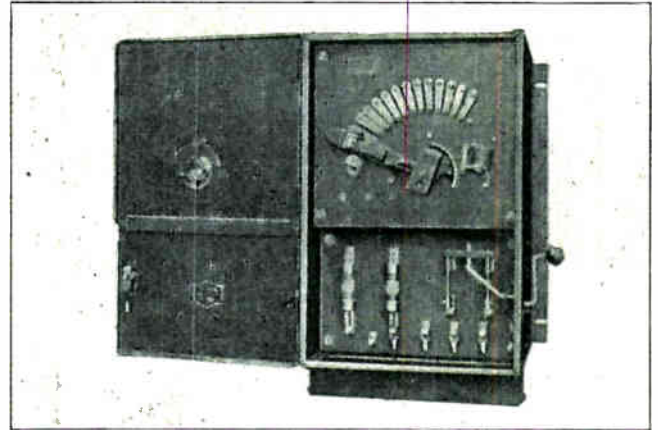

Fig. 124. Speed regulating controller with fuses and line switch enclosed in a controller box.

The switch in this case is also operated by a safety handle on the outside of the box.

Fig. 125 shows three forms of resistance elements such as are commonly used with motor starters. In the lower view, the resistance wire is wound on insulating forms of heat-resisting material, and then coated over with a plaster-like substance of the same nature. Note how a number of these coils can be mounted on a rack and spaced to allow ventilation. We can then connect several such units or coils in series or parallel, as desired, to obtain the proper resistance with convenient standard units.

The view on the upper right shows a heavy-duty resistor made in the form of grids. These grids are clamped together with bolts as shown, and are spaced with washers of porcelain or some other insulating and heat resisting material.

Resistance coils are frequently wound on tubular shapes or forms, and mounted in the starter box, as shown at the upper left in Fig. 125. The copper wires or leads shown attached to these coils are used for connecting them to the stationary segments or contacts on the starter plate.

### 160. CARBON PILE STARTERS

In some classes of work, such as the operation of textile mill machinery and certain other equipment, it is desirable to have very gradual application of the starting torque of the motor when the machines are first put in motion.

To accomplish this, it would, of course, be necessary to start the motor with extremely high resistance in the armature circuit, so that the starting current could be limited to only a very small fraction of the load current. For this purpose, some starters are made with

resistance elements consisting of small carbon disks stacked in tubes of non-combustible material with an insulating lining, as shown in the left-hand view in Fig. 126.

As long as these carbon disks are left loose in the column or tube, the resistance through them is very high, because of the loose contact between each disk and the next. If pressure is gradually applied to the ends of this column by means of a lever and spring, this tightens the contacts between the disks and very gradually reduces the resistance through the pile.

One or more of these tubular piles or resistance elements can be arranged in a starter as shown in the right-hand view of Fig. 126; so that pressure can be smoothly applied to them by means of the lever shown in this view. Starters of this type are known as carbon pile starters, and they afford a means of starting motors more gradually and smoothly than with practically any other device on the market.

#### 161. SMOOTH STARTING OF MOTORS WITH CARBON STARTERS

When using a starter of this type, there is practically no sudden increase in the starting current through the motor, as there is when the lever arm of the "step by step" starter is shifted from one contact to the next.

In addition to the pressure-applying device in starters of this type, there must also be some form of switch or contactor to short circuit the carbon piles entirely out of the armature circuit after full pressure has been applied and the machine is up to speed. The reason for using this short-circuiting switch is that the resistance of the carbon pile is still too high to leave in the motor circuit, even when the disks are under maximum pressure; and they would tend to overheat if left in the circuit too long.

Tubes with larger disks are provided, however, for use with speed-regulating controllers, and these can be left in the circuit while the motor is running.

Two or more of these carbon pile tubes can be connected in series or parallel to obtain the proper current-carrying capacity of different controllers. If the disks

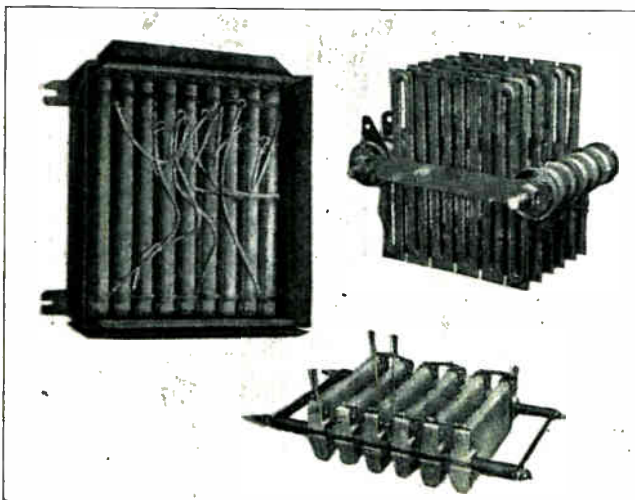

Fig. 125. Several styles of resistance units commonly used with motor starters and speed controls.

become worn or damaged at any time, they can easily be replaced by removing the tubes from the controller and replacing with complete new tubes; or the end plug can be removed from any tube and the disks taken out, so that one or more of those which may be damaged or cracked can be replaced.

Carbon pile controllers are also made in automatic types as well as those for manual operation.

Motor controllers are made in various h. p. ratings, and when purchasing or installing them, care should be used to see that they are of the proper size to carry the current for the motor which they are operating, without overheating of the resistance elements or burning the contacts.

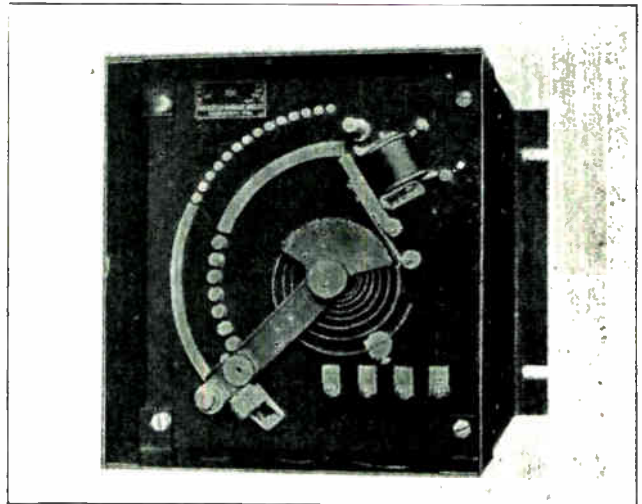

Fig. 125-A. Simple type of D. C. motor starter and speed control. Note the extra sets of contacts for the field resistance used in varying the speed.

#### 162. CIRCUIT OF A CARBON CONTROLLER

Fig. 127 shows the circuit of a simple, manual-type, carbon pile, motor starter. In this diagram the path of the armature current is shown by the solid arrows and can be traced from the positive line wire through the armature of the starter to contact 1. From this point, the armature current flows through the lower wire to the bottom of the carbon pile, up through the carbon disks, out at the top through a flexible lead, on through the armature and series field, and back through the negative line wire.

As soon as the starter arm makes contact with 1, field current can also flow, as shown by the dotted arrows from the positive line, through the starter arm; and from contact 1 the current flows up through the curved brass strip, through the holding coil, "M"; through the shunt field; and then back through the negative line wire.

As the starter arm is moved slowly upward, it applies more and more pressure to the carbon disks by means of the hook and spring shown in the figure. When the starter arm reaches contact 2, full pressure has been applied to the carbon disks; and the arm, upon touching contact 2, short-circuits the carbon pile out of the armature circuit.

The current then flows from the starter arm to contact 2, out at the armature terminal "A" through the motor, and then to the negative line wire.

### 163. AUTOMATIC STARTERS

As previously mentioned, a great number of motor starters and controllers are equipped with solenoids or electro-magnets which operate the switches or arms which cut out the starting resistance as the motor comes up to speed. This type of construction eliminates manual operation of the controller and reduces liability of damage to motors and controllers by improper use when controllers are operated manually by careless operators.

If a manual starter is operated too rapidly and all of the resistance is cut out before the motor comes up to speed, or if the starter is operated too slowly thus leaving the armature resistance in the circuit too long, it is likely to damage both the controller and the motor.

Automatic controllers which are operated by solenoids or electro-magnets usually have a time control device, in the form of a dash-pot attached to the solenoid or starter arm. By the proper adjustment of the dash-pot, the controller can be set so that it will start the motor in the same period of time at each operation.

Other controllers have the time period which they are left in the circuit regulated by the armature current of the motor so that the resistance cannot all be cut out of the circuit until the starting current has been sufficiently reduced by the increased speed of the motor.

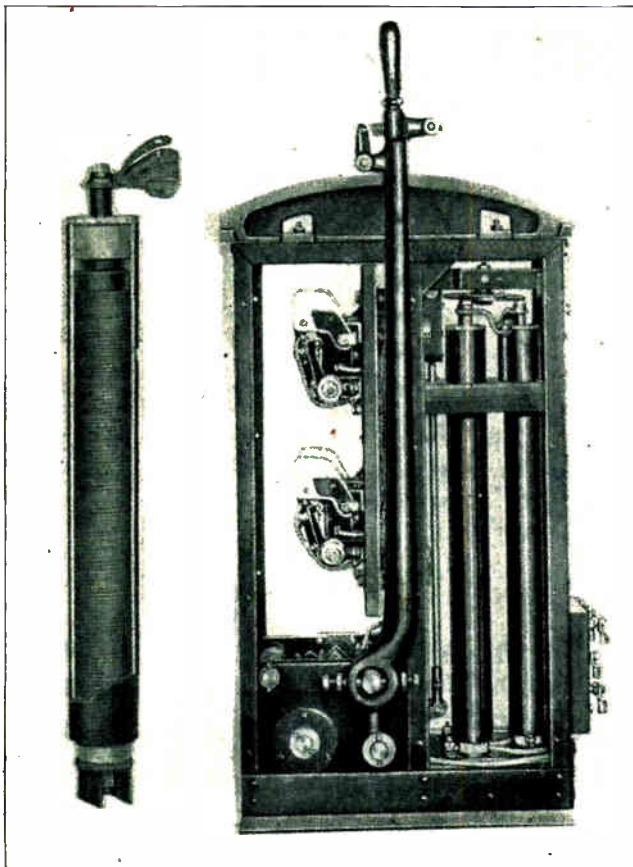

Fig. 126. Carbon-pile rheostat for starting D. C. motors very gradually. On the left is shown one of the carbon resistance elements used with such starters.

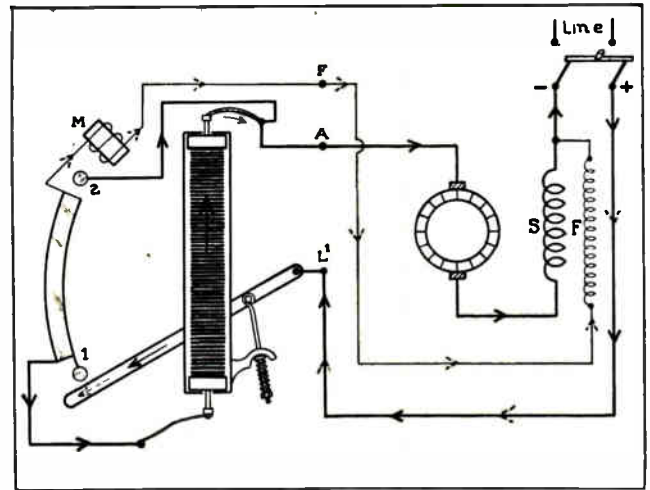

Fig. 127. Wiring diagram for a carbon-pile motor starter. Trace this circuit carefully.

### 164. REMOTE CONTROL

Another great advantage of magnetically operated controllers is that they can be controlled or operated from a distance by means of push-button switches which close the circuit to the operating solenoids or magnets.

For example, a motor located in one room or on a certain floor of a building can be controlled from any other room or floor of the building. Elevator controls are a good example of the use of remote control equipment. Elevator motors are usually located on the top floor of the building and are controlled by a switch in the car of the elevator which merely operates the circuits of the magnets or solenoids on controllers located near the motors.

Remote control devices can be used to improve the safety of operation of many types of machinery driven by electric motors. Push buttons for stopping and starting the motor which drives a machine can be located at several convenient places around the machine, so that they are always within reach of the operator in case he should become caught in any part of the running machinery.

Automatic and remote types of controllers are, of course, more expensive to install, but they will usually save considerably more than the difference in their first cost, by increasing the life of the motor and control equipment, and by reducing repair bills which are caused by careless operation of manual starters.

There are many types of automatic starters on the market and in use, but their general principles are very much the same; so you should have no difficulty in understanding or installing any of the common types, if you will make a thorough study of the principles covered in the following pages.

### 165. OPERATION OF AUTOMATIC CONTROLLERS

Fig. 128 shows a diagram of an automatic starter which uses a solenoid coil at "S" to draw up an iron core or plunger and at the same time raise the contact bar "B", which in this case takes the place of the lever arm used on the previously described controllers.

This controller is arranged for remote control by means of the stop and start push buttons shown at the upper right-hand corner. When the "start" button is closed, it completes a circuit through the solenoid coil, as shown by the small dotted arrows.

Trace the circuit of this controller in Fig. 128 very carefully while reading the following explanation.

Assuming the line switch to be closed when the start button is pressed, current will flow as shown by the small dotted arrows from the positive line wire, through the solenoid coil and contacts "B", which are closed at this time; leaving the controller at terminal 1 and passing through the closed circuit stop switch, through the starting switch, and back to terminal 3,

From this point, it passes through a wire inside the controller to terminal L-2 and back to the negative line wire, thus completing the solenoid circuit. This energizes the solenoid coil and causes it to lift its plunger and raise the upper main contact bar "B".

This bar is prevented from rising too rapidly by a dash-pot attached to the solenoid plunger. The dash-pot consists of a cylinder in which are enclosed a piston and a quantity of oil. As the piston rises it presses the oil before it and retards the motion of the plunger, allowing it to move upward only as fast as the oil can escape around the edges of the piston, or through a by-pass tube which is sometimes arranged at the side of the cylinders.

As soon as the solenoid plunger starts to rise, it allows the spring contact "A" to close and complete the "holding" circuit through the solenoid, without the aid of a start button.

The start button then can be released and current will continue to flow through the solenoid, as shown by the small solid arrows, causing it to continue to draw up the plunger.

As the plunger moves up a little further, the copper contact bar "B" touches the contact finger or spring 1,

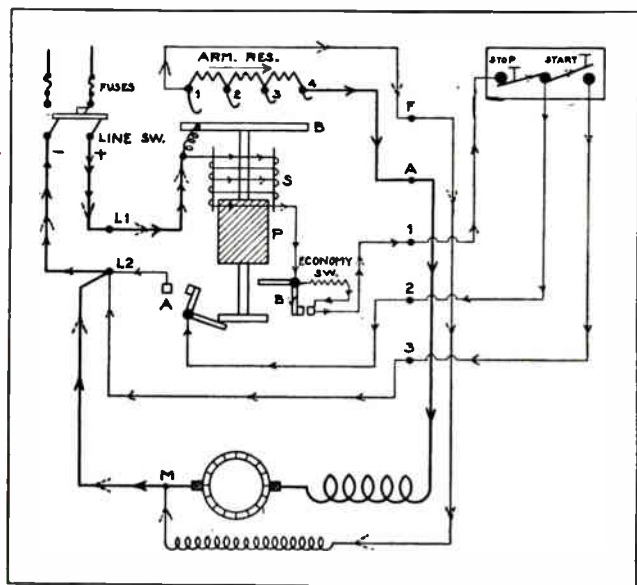

Fig. 128. This diagram shows the wiring for an automatic starter of the solenoid type. Trace each circuit until you thoroughly understand the operation of this controller.

which connects to the first step of the armature resistance. This allows current to flow as shown by the large solid arrows, from the positive line wire and line terminal "L-1", through the flexible connection to bar "B", contact spring No. 1, then through the full armature resistance to armature terminal "A", series field, motor armature, back to terminal "L-2", and the negative line wire.

A circuit can also be traced through the shunt field of the motor, as shown by the large dotted arrows.

As the solenoid continues to draw the plunger slowly upward, the bar "B" next makes contact with springs 2, 3, 4 in succession, thus short circuiting and cutting out the armature resistance one step at a time.

When the bar touches contact spring 4, the current will flow directly from the bar to terminal "A", and through the motor armature, without passing through any of the starter resistance.

#### 166. ECONOMY COIL

The small auxiliary switch shown at "B" below and to the right of the solenoid in Fig. 128 is for the purpose of cutting a protective resistance in series with the solenoid coil, after the plunger has been raised to the top of its stroke. When the plunger reaches this point, it will lift the arm of this switch, causing the contacts to open.

The current required to hold the plunger in position once it is up is much less than the current required to start it and pull it up. This smaller holding current will flow through the economy resistance, instead of through the contacts at "B", as it did while starting.

Cutting in this economy resistance not only saves current but prevents the solenoid coil from becoming overheated when it holds the controller in operation for long periods. The economy resistance will usually reduce the current flow through the solenoid coil to one-half or less than one-half its value during starting.

#### 167. STOPPING THE MOTOR

To stop the motor with a controller of this type, it is only necessary to press the stop button. This breaks the holding circuit through the solenoid coil and allows the plunger to fall. The plunger is permitted to fall rapidly by means of a flap valve, which allows the oil to escape rapidly when the piston moves in a downward direction. When the plunger reaches the bottom of its stroke, it trips open the switch "A" in the holding circuit; so it will then be necessary to close the starting switch to energize the solenoid once more. The motor can also be stopped by opening the line switch.

Fig. 129 shows the front view of a solenoid-type starter very similar to the one just described. The spring contact-fingers which cut out the armature resistance are slightly different on this starter than on the bar and spring type illustrated in the diagram, but their electrical principle is identically the same.

Beneath the solenoid in Fig. 129 can be seen the oil dash-pot which slows the operation of the

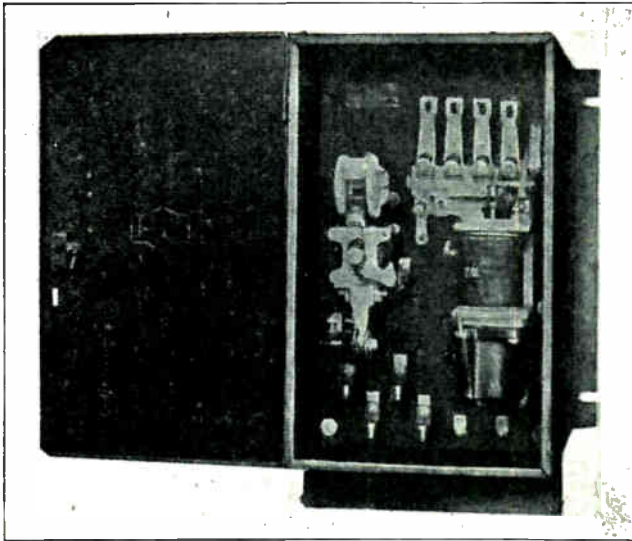

Fig. 129. Photo of a solenoid operated motor starter. Note the arrangement of the contact fingers and also the main line contactor on the left, and the oil dash-pot on the solenoid.

plunger, and on the left side of this dash-pot is shown a small adjusting screw by which the speed of the plunger operation can be varied as desired.

Fig. 130 shows several types of push-button stations such as are used with remote controllers.

**168. DASH-POTS FOR TIME DELAY ON CONTROLLERS**

Fig. 131 illustrates the principle of the dash-pot timing device used with many automatic starters. When the plunger rod "R" is drawn up by the solenoid, the piston on the lower end of this rod lifts the oil by the suction of the piston and forces it through the needle valve "V", and around into the lower part of the cylinder.

The speed with which the plunger will rise can, therefore, be adjusted by means of the screw of the needle valve, which will allow the oil to pass more or less rapidly through this opening.

During the period that the piston is lifting against the oil, the disk "D" holds tightly against the openings or ports at "P" in the piston. When the line switch is opened or the stop button is pressed, allowing the plunger to fall, the pressure on the under side of the piston forces the disk "D" to open the ports at "P", and allows the plunger to fall very rapidly.

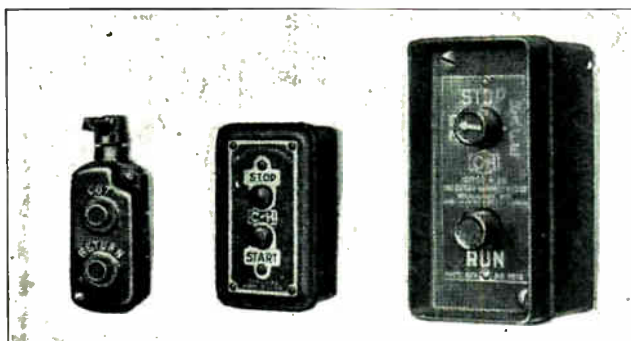

Fig. 130. Several types of push-button stations used with automatic remote controllers.

This dash-pot time-delay device should be carefully adjusted, according to the load on the motor and the time required for the motor to accelerate this load to full speed.

**169. MAGNETIC STARTERS**

The term magnetic starter is commonly used to apply to starters on which the operation depends almost entirely on relays, although they may have either a solenoid or an electro-magnet for overload protection.

Controllers of this type have a number of separate contactors, each operated by its own electro-magnet. These contactors and their circuits are so arranged that they operate in succession, and thus gradually short out resistance from the motor armature circuit.

Controls of this type are used very extensively on large industrial motors, steel mill motors, elevator motors, etc.

On medium-sized motors, the controller mechanism and contactors are often assembled inside the metal box or cabinet. For very large motors the contactors and magnets are usually assembled on a panel similar to a switchboard, and the resistance grids or elements are generally located at the rear of this panel, either on the floor or in a special rack above.

Fig. 132 shows a diagram of a magnetic controller. This controller operates as follows:

After closing the line switch, either of the start buttons at the remote control stations can be pressed to close a circuit through the remote control relay "A", as shown by the small dotted arrows.

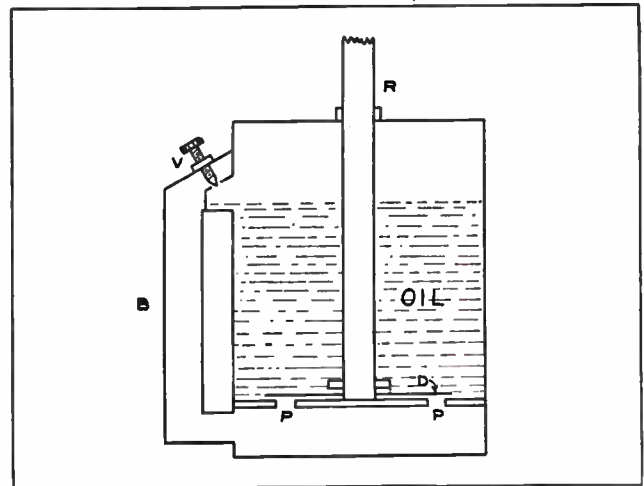

Fig. 131. The above sketch illustrates the principle of an oil dash-pot used as a time control on motor starters.

This relay magnet then attracts its double armature and closes contacts 1 and 2. Contactor 2 completes a holding circuit through relay "A" in series with the stop switches of the remote control stations. This circuit is shown by the small solid arrows.

The same contactor, No. 2, also completes a circuit through relay "B", as shown by the small curved

The current for this relay passes through the lower portion of the armature resistance and doesn't close circuit through relay "B", as shown by the small curved

contactor 4 immediately. Current for coil "B" is limited by the voltage drop in the armature resistance.

Contactor 1, which was operated by relay "A", closes a circuit through the overload release coil, "O. L.", to the motor terminal "M", as shown by the large dotted arrows. At this point the current divides and passes through both the armature and field circuits in parallel, and through the controller back to the negative line wire.

The armature current shown by the solid black arrows returns through the terminal "A-1" on the controller, through the winding of relay "F" and armature starting resistance in parallel. This current divides through the relay winding and armature resistance in proportion to the resistance of each path. As the relay winding is of much higher resistance than the armature resistance unit, most of the current will pass through the armature resistance and back to the line. However, enough current flows through the winding of relay "F" to cause it to become energized and close contactor 3, which short circuits the field rheostat, "F R", cutting this resistance out of the shunt field circuit of the motor.

The armature resistance used with this controller performs the same function as with any other type, namely that of causing a voltage drop and reducing

the current flow through the motor armature during starting.

When contactor 3 is closed, the shunt field of the motor is connected directly across full line voltage, thus allowing the shunt field to receive full strength current and produce the good torque necessary for starting.

### 170. TIME OF STARTING DEPENDS ON STARTING CURRENT

We recall that relay "B" didn't energize when the circuit through its coil was first closed because it is in series with about one-third of the armature resistance. Therefore, as long as the heavy starting current is flowing through this armature resistance and causing considerable voltage drop, part of that voltage drop being in series with the coil of relay "B", limits its current and prevents it from becoming strong enough to close its armature.

As the motor comes up to speed and develops counter-E. M. F., thereby reducing the starting current through the armature resistance, this will also reduce the voltage drop through that section of the resistance which is in series with coil "B". This allows the current through coil "B" to increase slightly and causes it to close contactor 4. When this contactor closes it places a short circuit on the coil of relay "F", which can be traced from X to X-1, and

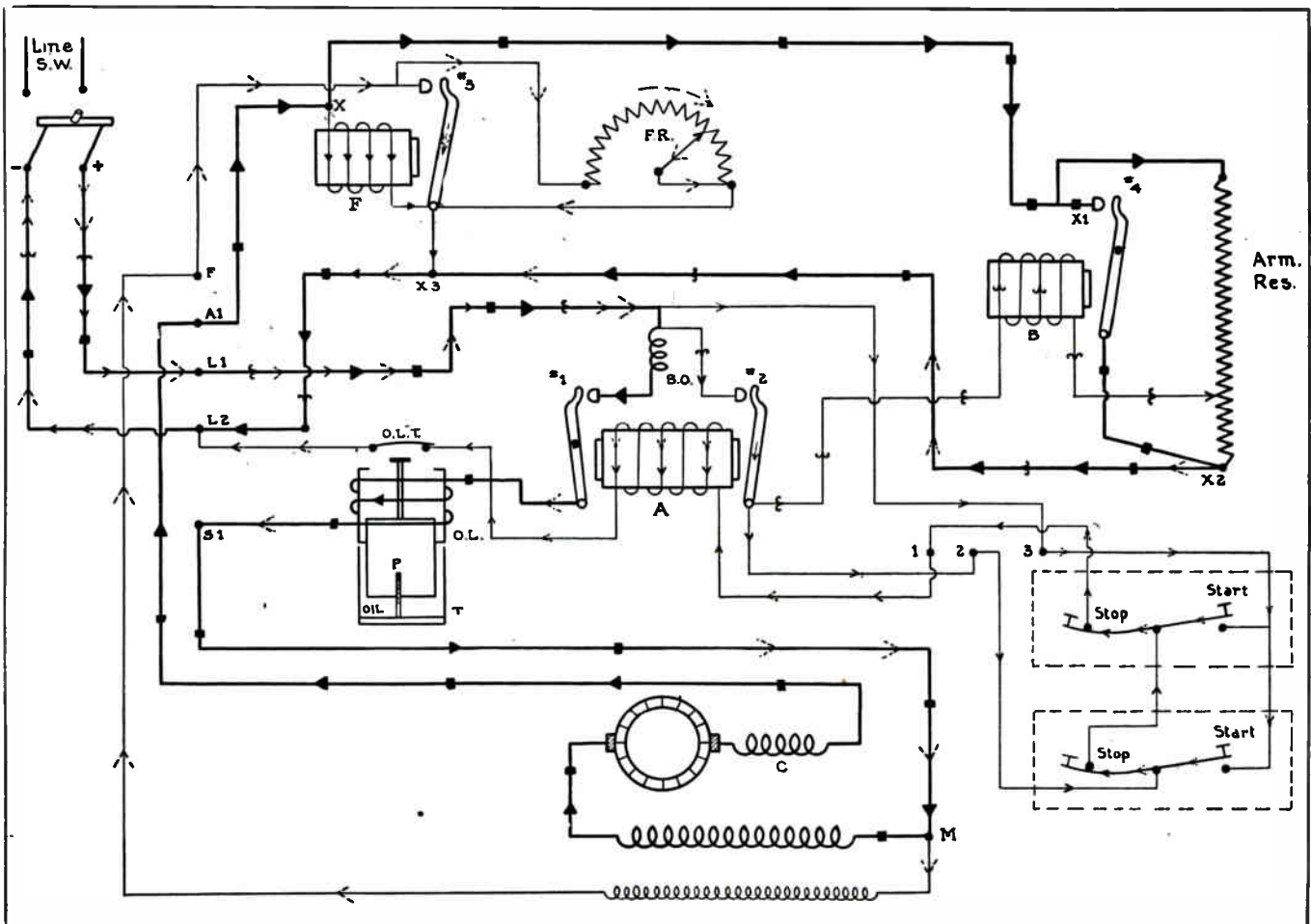

Fig. 132. This diagram shows the complete wiring of a modern magnetic type controller. You will find it very interesting and exceedingly well worthwhile to trace each circuit and obtain a thorough understanding of the operating principles of this starter.

X-2 to X-3. This shorts the current around the coil of relay "F" and causes it to de-energize and release contactor 3.

When this contactor opens, it releases the short circuit on the field rheostat, "F. R." and places this resistance back in series with the shunt field of the motor. This allows the motor speed to make its final increase for the starting operation, and also allows the field rheostat to be used for regulating the speed of the motor.

Contactor 4 is adjustable and can be set to pull in on any desired voltage within the range of this controller. By adjusting the screws to allow the relay armature to normally rest farther away from the core, it will require a higher voltage to operate this contactor.

This means that the motor will have to reach a little higher speed, develop more counter-E. M. F., and further reduce the starting current flowing through the armature resistance, and thereby reduce the voltage drop, allowing a higher voltage to be applied to the coil of relay "B" before it will operate.

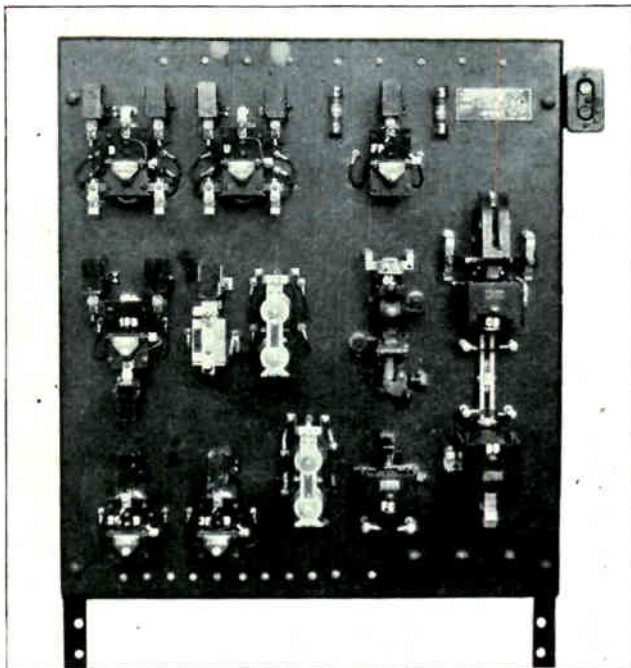

Fig. 132-A. This photo shows the manner in which the magnetic contactors of industrial controls of the larger type are often mounted on an open panel.

When this relay does operate, it short-circuits the armature resistance completely out of the motor circuit by providing a path of copper around the resistance from X-1 to X-2. So we find that the time delay on this relay and controller depends upon the reduction of the starting current through the motor armature and the armature resistance of the controller.

Therefore, if the motor is more heavily loaded at one time of starting than at another and requires longer to come up to full speed and develop the proper counter-voltage, this controller will automatically leave the armature resistance in series that

much longer. For this reason it is a very practical and dependable type of control.

After the motor is up to full speed and the controller starting operation completed, the armature current will then be flowing through the circuit as shown by the square dots.

### 171. OVERLOAD PROTECTION

In tracing this circuit you will find that the armature current passes continuously through the coil of the overload relay "O. L." as long as the motor is in operation.

The purpose of this overload relay, which is included with many controllers of this type, is to protect the motor from overload, both during starting and while the motor is running at full speed.

The coil of this relay is in series with the motor armature and therefore consists of a very few turns of heavy conductor capable of carrying the full armature current for indefinite periods.

If an overload is placed on the motor, thereby increasing its armature current, the increased current will increase the strength of the coil of the overload-relay solenoid.

This will cause it to draw up the plunger "P" slowly against the action of the oil in the dash-pot "T". This dash-pot can be so adjusted that it will require more or less time for the plunger to complete its upward stroke, and so that an overload which only lasts for an instant does not raise the plunger far enough to stop the motor.

The dash-pot is often called an **inverse time limit device**, because the time required to draw up the plunger is inversely proportional to the current or amount of overload on the motor. A severe overload

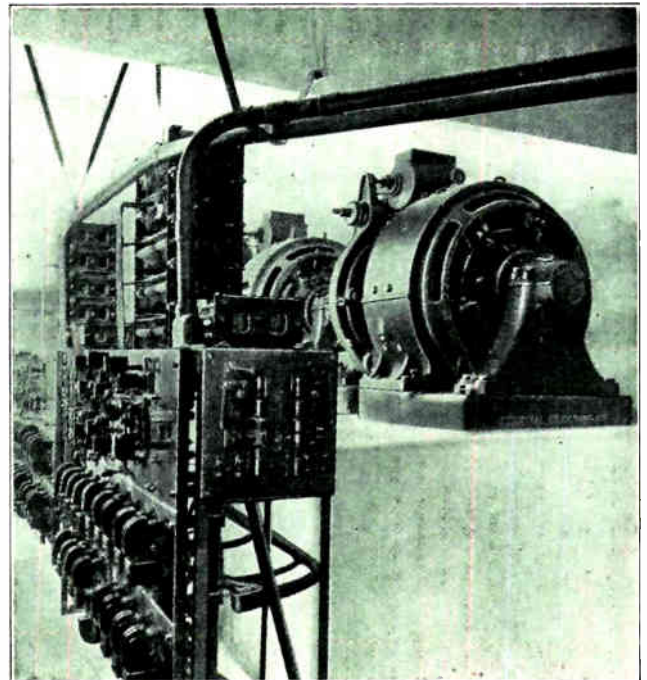

Fig. 132-B. Photo of the control panels for a group of elevator motors. Note the contactors on the face of the panel and the resistance grids located above.

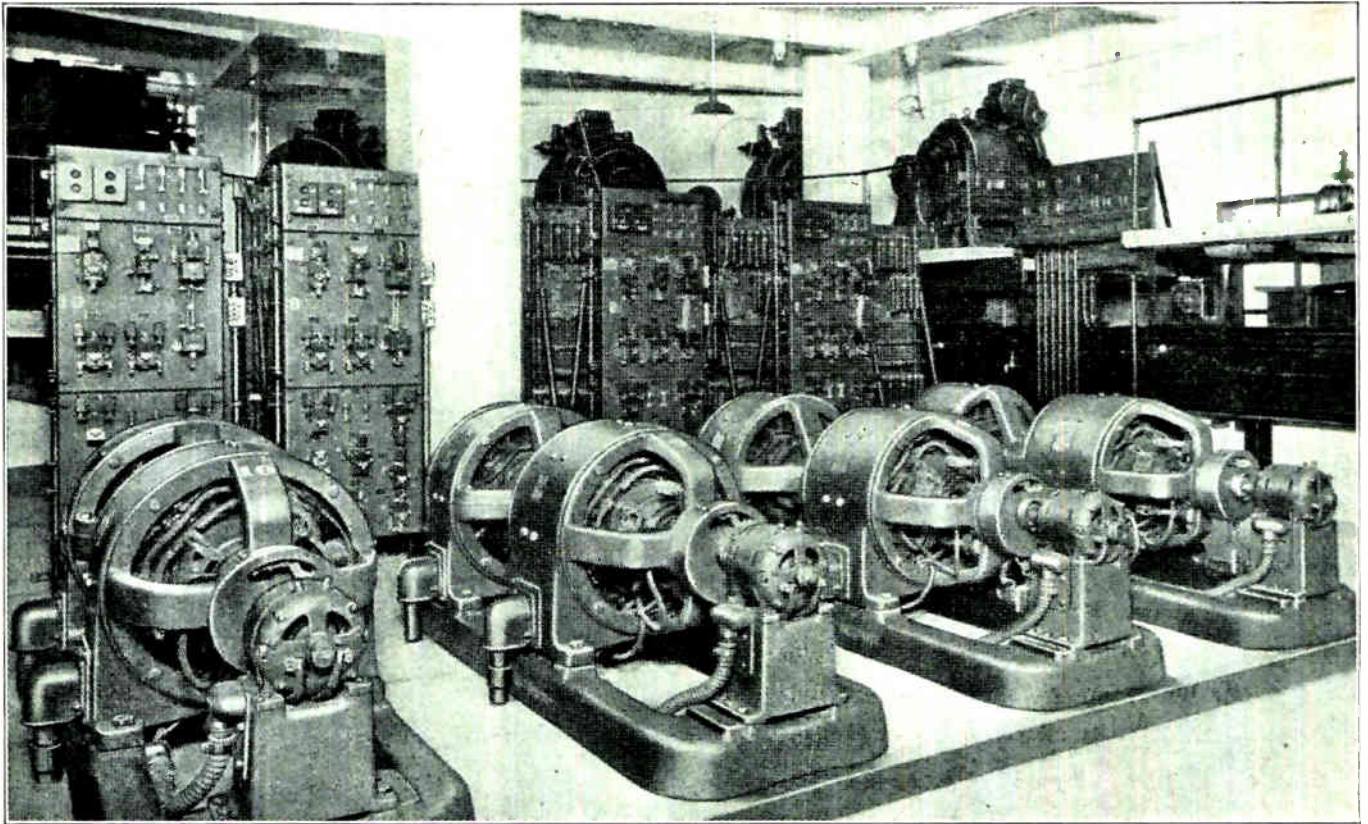

Fig. 132-C. This view shows the control panels for a group of modern elevator machines of the motor-generator type. The magnetic contactors on these panels are operated by remote control from the elevator car.

increases the strength of the coil to such an extent that the plunger will come up very quickly.

If the overload remains on the motor, the plunger will be drawn up completely until it strikes the overload-trip-contact, "O. L. T.". This opens the circuit of the relay coil "A", allowing it to release both its armatures and contactors 1 and 2.

When contactor 1 is opened, it disconnects the motor from the line, and 2 breaks the holding circuit of coil "A", requiring it to be closed again, by means of the start buttons, after the overload on the motor is removed.

#### 172. "BLOW-OUT" COIL

The magnetic blow-out coil, "B. O." is for the purpose of providing a strong magnetic flux for extinguishing the arc drawn at contactor 1 when the motor circuit is broken at this point.

The action of this blow-out coil is purely magnetic. The few turns of which it consists are wound on a small iron core, which has its poles placed on either side of the contacts where the circuit will be broken. This provides a powerful magnetic field at the exact point where an arc would be formed when the circuit is broken by this contactor.

As the arc is in itself a conductor of electrical current and has a magnetic field set up around it, this field will be reacted upon by the flux of the blow-out coil and cause the arc to become distorted or stretched so that it is quickly broken or extinguished. This prevents the arc from lasting long

enough to overheat and burn the contacts to any great extent.

Regardless of the extent of the overload, the magnetic blow-out coil is very effective, because the entire load current of the motor flows through its turns and its strength is therefore proportional to the current to be interrupted at any time.

Fig. 133 illustrates the principle and action of this blow-out coil on an arc drawn between two contacts which are located between the poles of the magnet.

In the view at the left, the solid lines between the contacts "A" and "B" represent the arc and the current flowing through it, while the dotted lines between the magnet poles represent the strong flux which is set up by them.

In the view at the right, the circle and dot represent an end view of the arc, and the direction of the flux around the arc is shown by the three arrows. The dotted lines show the magnetic flux from the poles of the blow-out magnet.

By noting the direction of this flux and that around the arc, we find that the lines of force will tend to be distorted as shown, and will stretch the arc out of its normal path in the direction shown by the dotted arrow.

The circuit of a controller such as shown in Fig. 132 may at first seem rather complicated, but you will find after carefully tracing through each part of it several times, that its operation is exceedingly simple. It is only by tracing such circuits as these,



both in the diagrams and on the actual equipment, that you will be able to fully understand the operation of controls of this type and become competent in testing their circuits to locate any troubles which may develop in them.

This diagram and the explanation given in the accompanying paragraphs are, therefore, well worth thorough and careful study.

The controller shown in Fig. 132 uses a field rheostat for controlling the speed of the motor. This rheostat can be adjusted, or set at various points, by hand.

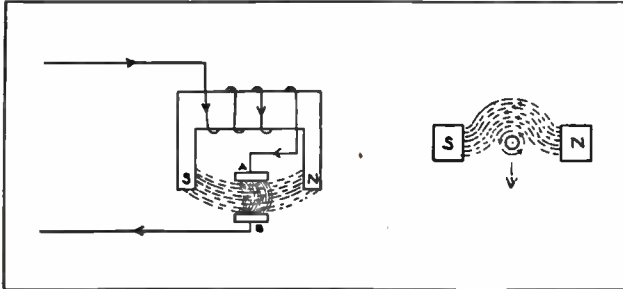

Fig. 133. The above sketch illustrates the principle by which the magnetic blow out coil extinguishes arcs on controller contacts.

Fig. 134 shows a magnetic type of controller very similar to the one for which the circuit is shown in Fig. 132. The several magnetic contactors and overload trip coil can be seen mounted on the panel in the cabinet. This view, however, does not show the field rheostat for speed regulation.

### 173. DRUM CONTROLLERS

Drum controllers are very extensively used in the operation of D. C. motors where it is required to be able to start, stop, reverse, and vary the speed of the motors. The name drum controller comes from the shape of this device, and the manner in which the contacts or segments are mounted on a shaft or drum. This cylindrical arrangement of the contacts is made in order that they may be rotated part of a turn in either direction and brought into connection with one or more sets of stationary contacts.

Drum controllers are usually manually operated

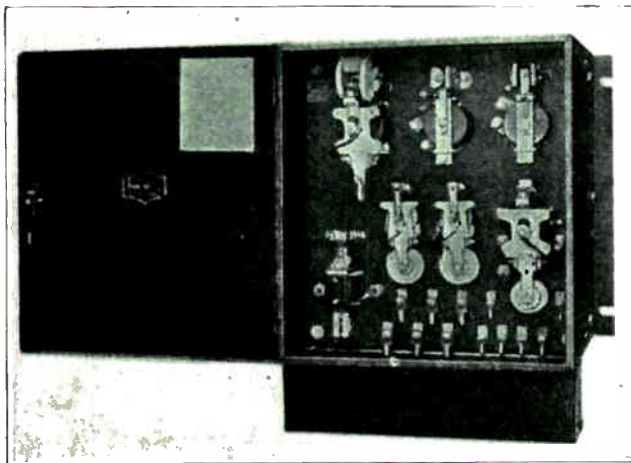

Fig. 134. Photo of an enclosed type magnetic starter for small and medium sized motors.

and can be provided with almost any number and desired arrangement of contacts. Drum controls are extensively used for controlling the motors used on street cars and electric trains, cranes, hoists and machine-tool equipment, where it is necessary to be able to reverse and vary the speed of the motors.

### 174. OPERATION OF SIMPLE DRUM CONTROL

Fig. 135 shows a very simple form of drum control and illustrates the manner in which the movable drum contacts can be used to short out the armature resistance step by step from the motor circuit. When the drum shown in this figure is rotated the first step and brings the movable segments "A" and "B" into connection with the stationary contacts, current will start to flow through the entire set of resistance coils, through segments "B", and the jumper which connects it to "A", through segments "A" to contact 1; then through the motor armature and back to the negative side of the line.

When the drum is rotated another step to the left, segment "C" touches contact 3, and as "C" is connected to "B" by the jumper, this short circuits the resistance between contacts 3 and 2.

Rotating the drum two more steps will short out the remaining two sections of resistance in the same order. Thus a simple drum-control can be used to gradually cut out the resistance as the motor comes up to full speed.

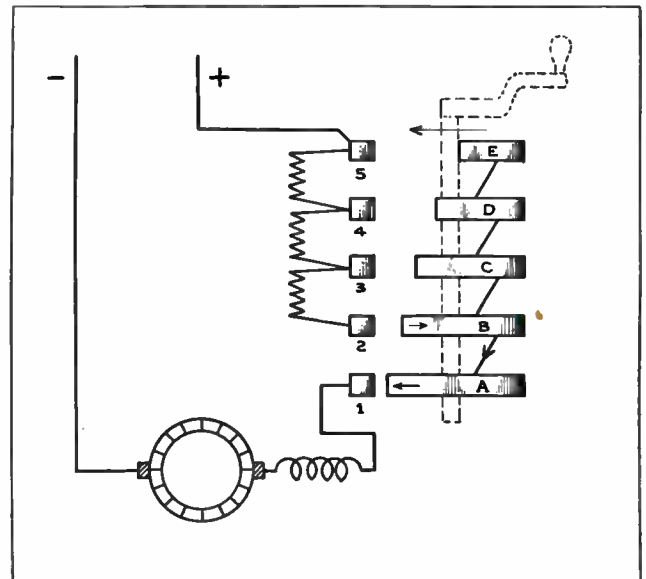

Fig. 135. Simple drum controller showing the method in which the contacts and segments cut out the armature resistance when starting the motor.

By making the resistance elements large enough to carry the motor current continuously, and the drum contacts and segments of heavy copper so they can stand the arcing and wear caused by opening and closing the motor armature circuit, this type of drum controller can be used for speed-regulating duty as well as for starting.

The motor used with this controller in Fig. 135 is

a straight series motor similar to the type used on street cars and traction equipment.

### 175. REVERSING ROTATION OF MOTORS

We have learned that, in order to reverse a D. C. motor, it is necessary to reverse either the field or the armature current, but not both. Some controllers are connected to reverse the field of a motor, while others reverse the armature. On ordinary shunt motors the field is usually reversed, but with compound motors it is necessary to reverse both the shunt and series field if this method of reversing the motor is used.

So, for motors of this type, it is common practice to reverse the armature and leave both the shunt and series fields remain the same polarity. To reverse the armature leads will require only half as many extra contacts on the controller, as would be required to reverse both the series and shunt field leads.

When the direction of rotation of a compound motor is changed by reversing the field, both the series and shunt field leads should always be reversed; because if only one of these fields were reversed the motor would be changed from cumulative to differential compound.

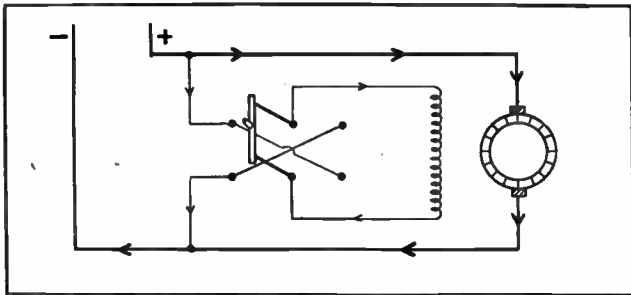

Fig. 136. The above sketch shows the manner in which a motor can be reversed by reversing its field with a double-pole, double-throw knife switch.

Fig. 136 shows the manner in which a simple double-pole, double-throw, knife switch can be used to reverse a shunt motor by reversing the connection between the field and the line.

When switch blades are closed to the left, current will flow through the shunt field in the direction shown by the arrows. If the switch is thrown to the right, the current will flow through the field in the opposite direction, as can readily be seen by tracing the circuit through the crossed wires between the stationary clips. This same switching method can, of course, be used to reverse the connections of the armature to the line, if desired. This reversing switch effect can be built into a drum controller by the proper arrangement of its contacts.

### 176. REVERSING DRUM SWITCHES

Fig. 137 shows a simple reversing drum-control used for reversing the direction of current through the armature only. This diagram doesn't show the starting resistance or contacts, but merely illustrates the principle or method by which several of the contacts on a drum controller can be used for a reversing switch.

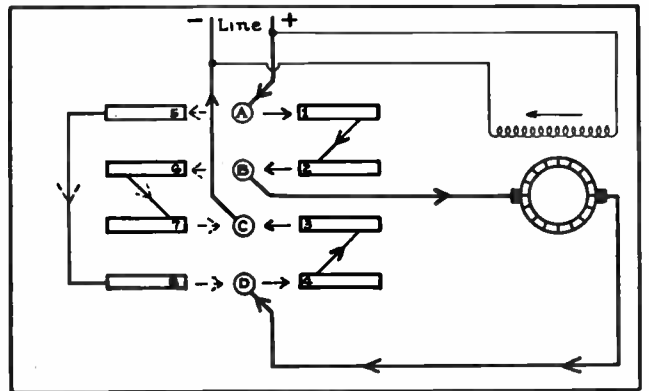

Fig. 137. Drum control with the contacts arranged to reverse the direction of current through the armature and thereby reverse the motor.

The drum control shown in Fig. 137 has one set of stationary contacts—A, B, C, and D, and two sets of moving segments or contacts, Nos. 1 to 8. These two sets of moving contacts are mounted on the same drum and both revolve at the same time, but in diagrams of this sort these parts are shown in a flat view in order to more easily trace the circuit.

If the drum contacts are moved to the left, the movable contacts 1, 2, 3, and 4, will be brought into connection with the stationary contacts A, B, C, and D. The current flow through the armature can then be traced by the solid arrows, from the positive line wire to stationary contact "A", movable segment 1, through the jumper to movable segment 2, stationary contact "B", through the armature in a right-hand direction, then to stationary contact "D," movable segment 4, through the jumper to movable segment 3, stationary contact "C"; and back to the negative line wire.

If the drum contacts are moved to the right the movable segments 5, 6, 7, and 8 will be brought into connection with the stationary contacts, and the armature current will then flow as shown by the dotted arrows. The field of the motor is left the same polarity and only the armature circuit is reversed. If the field and armature of a motor were both reversed at the same time, the direction of rotation would still remain the same.

### 177. REVERSING DRUM CONTROLLERS

Fig. 138 shows the circuit of a drum controller which is used for starting a D. C. motor, as well as for reversing duty. This controller has two sets of stationary contacts and two sets of movable segments. The diagram also shows the armature resistance used for starting the motor and while it is being brought up to speed. The contacts and parts of this drum are also laid out in a flat view in the diagram.

The two sets of movable segments are arranged on opposite sides of the drum, as are the stationary contacts. This is illustrated by the small sketch in the lower left-hand corner, which shows from a top view the position of the contacts at the time segments 1 to 5 are approaching the stationary contacts, "P" to "U".

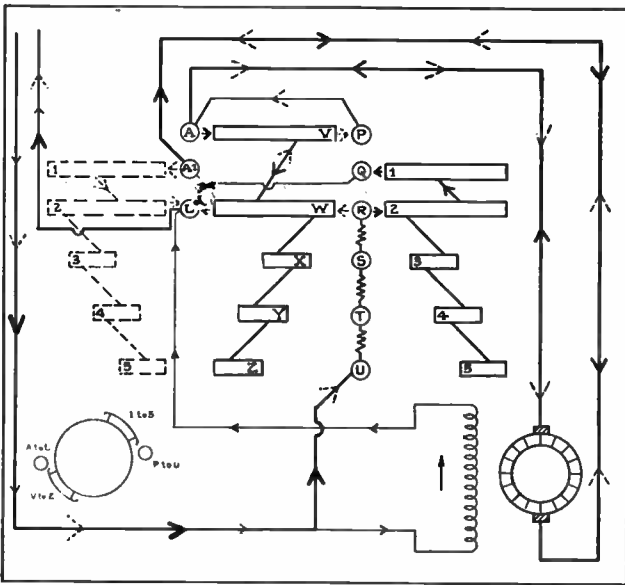

Fig. 138. Wiring diagram of a drum controller for starting and reversing shunt motors.

Now, suppose we move the drum of this controller so it will shift both sets of movable segments to the left in the diagram. The first step of this movement will bring movable segments 1 and 2 into connection with stationary contacts "Q" and "R", and will also bring segments "V" and "W" into connection with stationary contacts "A" and "L". A circuit can then be traced, as shown by the solid arrows, from the positive line wire to stationary contact "U", through all of the armature resistance to stationary contact "R", movable segment 2, through the jumper to movable segment 1, stationary contact Q to stationary contact A-1; then through the motor armature, back to stationary contact "A", movable segments "V" and "W", stationary contact "L", and back to the negative side of the line.

As we advance the controller still farther in this same direction, the successive steps will bring movable segments 3, 4 and 5 into connection with stationary contacts "S", "T", and "U", thus gradually shorting out the armature resistance step by step.

When the controller has been moved as far as it will go in this direction and all armature resistance has been cut out, the circuit is from the positive line wire to stationary contact "U", movable segment 5, through the jumpers and segments to movable segment 1, stationary contact Q, and on through the armature and back to the negative side of the line.

You will note that the movable segments 1 and 2, and "V" and "W" are all of sufficient length to remain in connection with the stationary contacts as they slide around and allow the step by step movement which brings the larger segments into connection with their stationary contacts.

To reverse the motor, we will now move the controller in the opposite direction, which will bring the movable segments 1 to 5 clear around on the opposite side to the position shown by the dotted segments, 1 to 5; and the movable segments "V" to

"Z" will be brought into connection with stationary contacts "P" to "U".

Before attempting to trace the circuit, get well in mind the position of these movable segments in this new location. Another reference to the circular sketch in the lower corner of the figure will help you to see the manner in which the movable segments are brought up on the opposite side of the stationary contacts as the drum is revolved in the opposite direction.

We now find that, on the first step of the drum movement, the movable segments "V" and "W" will be brought into connection with the stationary contacts "P" and "R", and the movable segments 1 and 2 (dotted) will be brought into connection with stationary contacts "A-1" and "L".

We can now trace a circuit through the armature, as shown by the dotted arrows, from the positive line to stationary contact "U", through the full armature resistance to stationary contact "R", the movable segments "W" and "V", stationary contacts "P" and "A"; then through the armature in the opposite direction to what it formerly flowed, and back to stationary contact A-1; then through movable segments 1 and 2 to negative line terminal "L".

As the controller is advanced step by step in this direction, the movable segments "X", "Y", "Z" will cut out the armature resistance as the machine comes up to speed. In this position the movable segments 3, 4, and 5 will be idle.

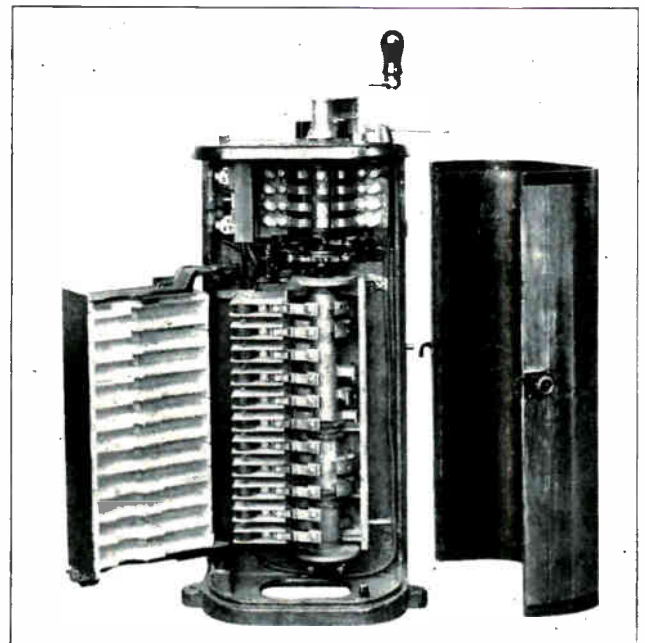

Fig. 139. The above photo shows the mechanical construction and arrangement of parts of a modern drum control. Note the flash barriers on the inner cover which is shown opened to the left.

The shunt field connections of this motor are left the same, so its polarity will remain the same at all times. Trace this diagram carefully until you are able to trace the circuit very readily in either direction or position of the control. A good knowledge

of the principles and circuits of these controllers will be of great help to you in the selection of the proper controller for various applications in the field, and also in locating troubles which may occur in controllers of this type or the resistance attached to them.

### 178. CONSTRUCTION OF DRUM CONTROLS

Fig. 139 shows a photo of a drum controller with the cover removed so that all of the parts can be quite clearly seen. The movable segments are made of copper and are attached to the shaft or drum, which is operated by the crank or handle.

The stationary contacts are in the form of fingers with flat springs to hold them in good contact with the segments when they are passed under these fingers. You will note that the copper shoes of the rotating segments and the individual fingers or stationary contacts are both removable, so they can easily be replaced when they are worn or burned by arcing which occurs during the operation of the controller.

These contacts should always be kept in good condition in order to assure the proper operation of the motor to which the controller is attached. At the left of the stationary contact fingers, can be seen a row of blow-out coils all of which are in series with their respective contacts and circuits. These blow-out coils, as previously mentioned, are for the purpose of extinguishing the arc drawn when the circuits are broken at the contacts.

The inner hinged cover, which is shown swung out to the left, is simply an assembly of boards or barriers made of fireproof material. When this group of barriers is swung into place, one of them comes between each stationary contact and the next. The purpose of these barriers is to prevent a flash-over or short-circuit between adjacent contacts.

This particular drum controller has a separate set of reversing contacts mounted in the top of the case and operated by a separate small handle, which is shown at the right of the main crank.

In addition to the functions of starting, reversing, and varying the speed of motors, some controllers are also equipped with extra contacts for short-circuiting the armature through a resistance, in order to provide what is known as **dynamic braking**.

This form of braking, which is frequently used to stop large motors, operates on the principle of a generator, using the counter-voltage generated in the armature to force a current load through the dynamic brake resistance. This method provides a very effective and smooth braking, and will be explained more fully in later paragraphs.

### 179. DRUM CONTROL FOR REVERSING AND SPEED REGULATING

Fig. 140 shows a diagram of a drum control which is arranged for starting, reversing, speed-regulating, and dynamic braking duty. This controller has two sets of heavy-duty segments and contacts for the armature circuit, and in the upper section are two

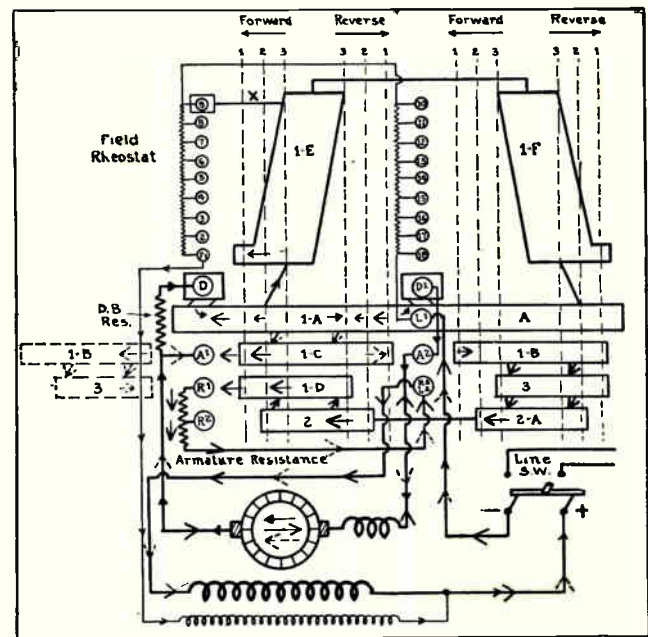

Fig. 140. This diagram shows the wiring for a drum controller used for starting, reversing, and varying the speed of a compound motor.

sets of smaller contacts which are used in the shunt field circuit, and are short circuited by two large angular segments.

The shunt field resistance, or rheostat, is shown divided into two sections in the diagram; but you will note that the taps made to this resistance run consecutively from No. 1 to 18, and the resistance itself can be located all in one group and have the separate leads brought to the two rows of contacts as shown. One of the heavy-duty resistances is used for the armature during starting, and the other is used for the dynamic braking.

When this controller is operated in either direction, the first step will close the armature circuit through the armature resistance, and energize the field at the same time, thus starting the motor. As the controller is advanced step by step, the armature resistance will first be cut out and then resistance will be cut in to the shunt field circuit, causing the motor to speed up as much more as desired.

When the controller is in idle position, as shown in the diagram, the motor armature is short circuited by the small movable segments which are now resting on the contacts "D" and "D-1". These contacts are the ones used for the operation of the dynamic brake circuit.

### 180. FORWARD POSITION, STARTING

The long movable segment "1-A" is continuous around the drum and always makes contact with "L-1". When the controller is moved to the left one step, the movable segment "1-B" connects with the stationary terminal "A-2" in the center of the diagram, and the segments "C" and "D" connect with stationary contacts "A-1" and "R-1" at the left of the diagram.

This completes a circuit through the motor armature and full armature resistance, as shown by the

larger solid arrows. In tracing this circuit, remember that this first step of movement of the controller will remove the short segments from contacts "D" and "D-1", thus breaking the short circuit on the armature.

The armature circuit which has just been closed can be traced from the positive line wire to "L-1", to the left through segment "1-A", through the jumpers to segment "1-C", then to terminal "A-1", and through the armature in a right-hand direction, on to terminal "A-2", segment "1-B", through the jumpers and segments 3 and 2-A of the right-hand group, through jumpers and segments 2 and 1-D of the left group, then to contact "R-1", through all of the armature resistance, to the contact which is marked "R-3" and "L-2"; then through the series field winding and back to the negative side of the line.

This first step or movement of the controller also causes the approaching tip of the large angular segment "1-E" to connect to contact "F-1" and close a circuit directly through the shunt field of the motor, without any resistance in series. This circuit can be traced from the positive side of the line to contact "L-1", segment "1-A" up through jumper to segment "1-E", contact "F-1", and then through the shunt field winding and back to the line.

When the controller is advanced another step, segment 2 of the left group connects with contact "R-2", and cuts out the upper section of the armature resistance. When the controller is moved still another step, segment 3 of the right-hand group connects with the contact which is marked "R-3" and "L-2", and cuts out the entire armature resistance.

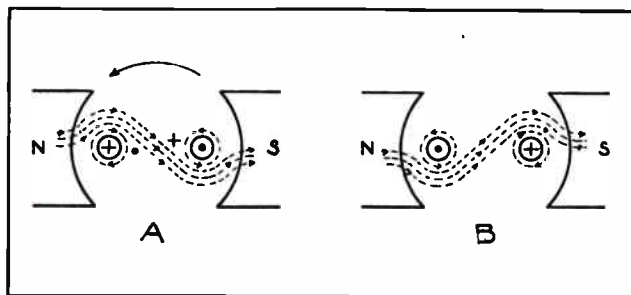

Fig. 141. The above sketch illustrates the principle of dynamic brake action in a motor when its armature is short circuited.

By checking the circuit again with the controller in this position, you will find that a circuit can be traced from the line through the controller and the motor armature, back to the line, without passing through the armature resistance.

The dotted lines which run vertically through the controller and are numbered 1, 2, 3 at their top ends, show which segments make connection with the stationary contacts on the first, second, and third steps of either the forward or reverse rotation of the controller.

For example, the dotted lines No. 1 in both forward groups touch only the segments which will connect with the stationary contacts on the first joint of the controller. The dotted lines No. 2 run through the seg-

ments which will connect with the stationary contacts on the second step of the controller. Etc. The dotted lines in the columns marked "reverse" show which segments make contact in order when the controller is moved in the reverse direction.

So far we have moved the controller only three steps to the left or in the forward direction, and we find that this has cut out all of the armature resistance and brought the motor up to approximately normal speed.

### 181. SPEED CONTROL

During these three steps or movements, the large angular segment "1-E" has been moving across contacts 1 to 9 of the shunt field resistance. These contacts are all shorted together by the segment "1-E", but this makes no difference, because they are not in the field circuit after the first step of the controller.

When the controller is moved the fourth step to the left, the lower end of segment "1-E" will have passed clear across the stationary contacts, and its lower right edge will begin to leave these contacts in the order —1, 2, 3, etc. This begins to cut in resistance in series with the shunt field winding of the motor, thus increasing the speed of the machine as much as desired.

During the time that segment "1-E" has been breaking away from contacts 1 to 9, the segment "1-F" has been moving across contacts 10 to 18; and after the upper right-hand corner, or segment "1-E", has cut in the last step of the resistance from 1 to 9, the segment "1-F" starts to cut in the resistance in the steps from 10 to 18. This gives a wide range of speed variation by means of the shunt field controller. The shunt field circuit is traced with the small solid arrows through the controller for the first position only.

### 182. REVERSE POSITION

To reverse the motor, the controller will be returned to neutral or "off" position, and then advance step by step in a right-hand direction. As the controller advances the first step in this direction, the right-hand ends of the movable segments will make connections with the groups of stationary contacts opposite to which they were connected before.

This means that segments "1-B" and 3 will have passed around the drum and will approach contacts "A-1" and "R-1" from the left, as shown by the dotted segments "1-B" and 3; and segments "1-C" and "1-D" will approach contacts "A-2" and "R-3" from the left.

With the controller in the first step of this reversed position, current can be traced through the armature by the dotted arrows, and we find it is in the reverse direction to what it formerly flowed through the motor armature.

This circuit is traced from the positive line wire to "L-1", segment "1-A", jumpers and segment "1-C" to contact "A-2", and then through the armature to the left, to contact "A-1", segments "1-B" and 3, contact "R-1", through the full armature starting resist-

ance to contact "L-2"; then through the series field in the same direction as before and back to the negative line wire.

In tracing this circuit, we find that the direction of current through the armature has been reversed but that it remains the same through the series field winding. It is necessary to maintain the polarity of the series field the same in either direction of rotation, in order to keep the motor operating as a cumulative compound machine.

If the controller is advanced in the reverse direction, the additional steps will cut out the armature resistance and begin to insert resistance in the shunt field circuit, the same as it did in the former direction.

### 183. DYNAMIC BRAKING

When the controller shown in Fig. 140 is brought back to neutral or off position, we find that the short movable segments directly above the long segment "1-A" will be brought to rest on contacts "D" and "D-1", thus short-circuiting the motor armature through the dynamic braking resistance, contact "D", segment "1-A", contact "D-1", and the commutating field.

When the current is shut off from the motor armature by bringing the controller to the "off" position, if the motor is a large one or if the load attached to it has considerable momentum, the motor and machine or car which it is driving, will tend to keep on moving or coasting for some time before coming to a complete stop.

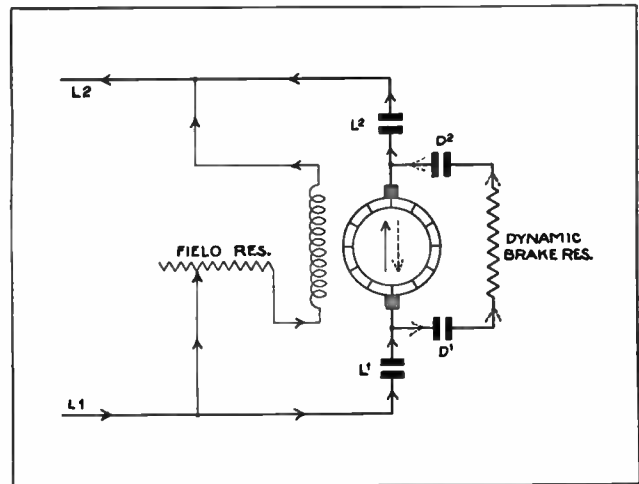

Fig. 142. Diagram showing connections and contacts used for switching a dynamic brake resistance across the armature of a D. C. motor when the line is disconnected.

If we leave the shunt field excited during this period, the motor armature will continue to generate its counter-voltage as long as it is turning. Then, if we short circuit the armature through the dynamic brake resistance, this counter-voltage will force a heavy load of current to flow and the coasting motor armature will act as a generator.

We know that it requires power to drive a generator armature; so, when this short or load is placed on the motor armature, the energy of its momentum is quickly absorbed by the generator action, thus bringing the armature to a smooth, quick stop.

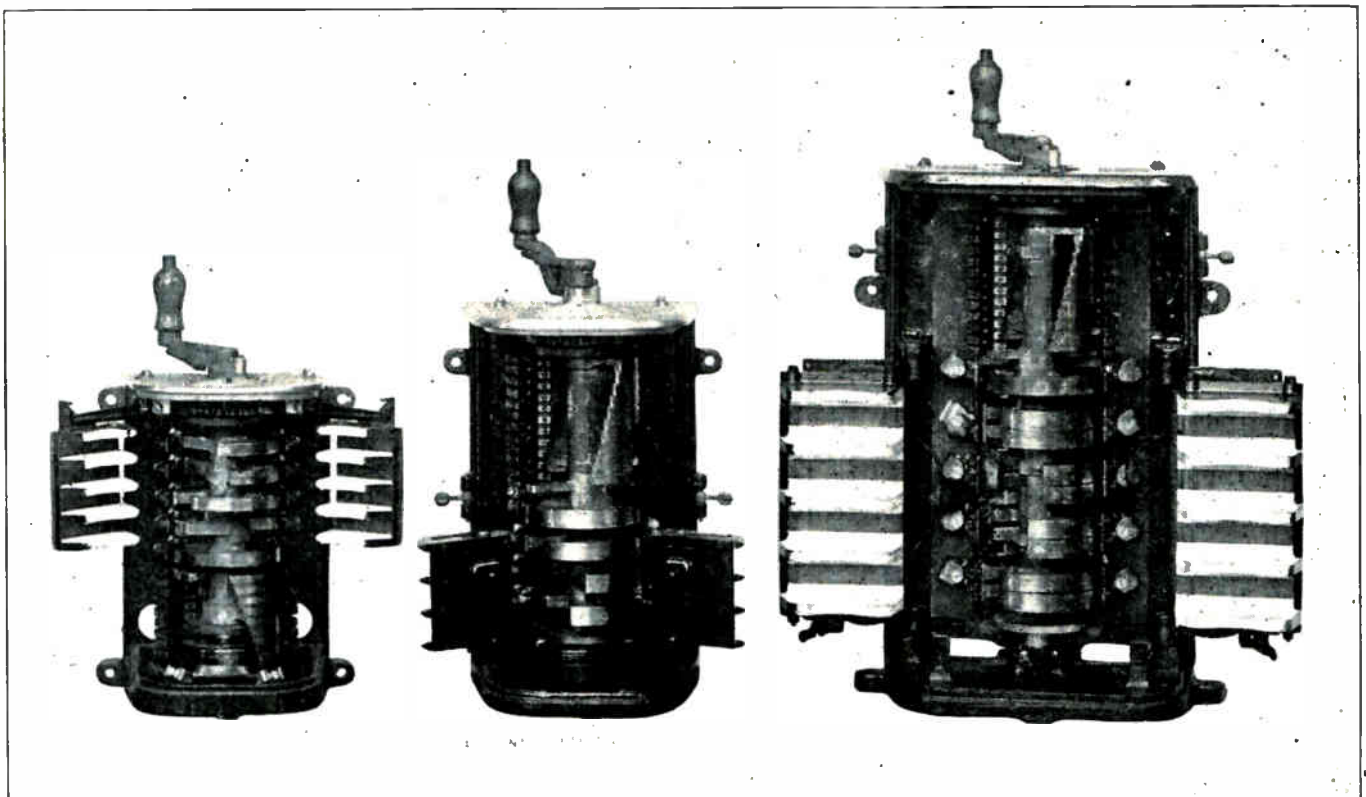

Fig 143. The above photo shows several types and sizes of modern drum controllers. Examine carefully the construction and arrangement of parts of each of these controls.

The field circuit is left complete when the controller is in the off position and as long as the line switch remains closed. This circuit can be traced from the positive line wire to contact "L-1", segment "1-A", segment "1-E", and the jumper at "X", segment "F D", contact 9 and through one-half of the shunt field resistance, then through the shunt field back to the negative line wire.

This half of the shunt field rheostat is left in series with the field for dynamic braking so that the motor armature will not generate too high a counter-voltage.

Another way of illustrating the effect of dynamic braking is as follows: You have learned that the counter-voltage is in the opposite direction to the applied line voltage which rotates the motor. Then, when we disconnect the armature from the line and connect it across the dynamic brake resistance, the armature continues to rotate in the same direction and will produce counter-voltage in the same direction; which will force current through the armature and braking resistance in the opposite direction to what the line current formerly flowed.

As this current resulting from counter-voltage is in the opposite direction to the normal armature current, it will tend to reverse the direction of the armature rotation. This is illustrated by the two diagrams in Fig. 141.

In the view at "A", the symbols marked within the conductors show the direction of the applied voltage and current during motor operation. The symbols marked at the side of the conductors illustrate the direction of the counter-voltage induced in them, which is opposite to the applied voltage and current. With the direction of the motor field as shown, the machine will normally rotate counter-clockwise.

In the view at "B", the line current has been shut off from the motor winding and the direction of current set up by counter-voltage through the armature winding and dynamic braking resistance is shown by the symbols within the conductors.

The polarity and direction of the motor field remain the same, but the direction of flux around the armature conductors is now reversed, and thus it tends to produce rotation in the opposite direction.

The effect of dynamic braking and the period of time in which the motor armature can be stopped by this method will depend upon the strength of field excitation which is left on the motor when the controller is placed in the off position, and upon the amount of resistance used for dynamic braking.

Fig. 142 shows a simplified connection diagram for a shunt motor equipped with dynamic braking. This diagram shows only the controlling contacts which would be used for dynamic braking alone. The solid arrows show the normal direction of current flow

through the armature when it is operating from the line voltage, and with contacts "L-1" and "L-2" closed. During this time the contacts "D-1" and "D-2" are, of course, open.

When this motor is stopped, line contacts "L-1" and "L-2" are opened and contacts "D-1" and "D-2" are closed. The counter-voltage in the armature then sends current through it in the reverse direction, as shown by the dotted arrows.

The shunt field is connected across the line in series with its resistance and, as long as it remains excited, the current in the reverse direction will tend to reverse the rotation of the armature. As the motor armature slows down, the counter-voltage generated becomes less and less, and the effect of dynamic braking is reduced.

When the motor armature reaches a complete stop, the voltage in its conductors, of course, ceases to be generated. This results in a sort of cushioning effect and provides one of the smoothest forms of braking which can be used on D. C. motors.

#### 184. REGENERATIVE BRAKING

In some cases, for example with railway motors, the principle of dynamic braking is used in what is known as regenerative braking, to actually feed current back to the line.

In order to accomplish this, it is necessary to leave the armature connected to the line and over-excite the field. Then, when an electric car or train, for example, starts down a grade and attempts to rotate its armature rapidly, the motor armature will generate a higher counter-voltage than the applied line voltage.

This will actually force current back into the line, as though this machine were operating in parallel with the power-plant generators.

Dynamic braking effects great savings in this manner and in some cases may supply from 10 to 35 per cent of the energy required by all trains on the system.

Dynamic braking on electric railway applications also saves an enormous amount of wear on brake shoes and air-brake equipment, and a great amount of wear and tear in cases where it is used for cranes, hoists, etc.

Neither dynamic braking nor regenerative braking is effective when the machine is at a stop or practically stopped. Therefore, it is necessary to have either mechanical or magnetic brakes to hold the motor armature stationary if there is some load which tends to revolve it, such as the load on a crane or elevator motor, or the tendency of a train to run down a grade.

Fig. 143 shows three drum controllers of different sizes and types. Note the various arrangements of contacts which can be provided to obtain different control features on the motors.

## CARBON BRUSHES

The brushes play a very important part in the operation of any D. C. motor or generator, and are well worth a little special attention and study in this section.

The purpose of the brushes, as we already know, is to provide a sliding contact with the commutator and to convey the current from a generator armature to the line, or from the line to a motor armature, as the case may be. We should also keep in mind that the type of brush used can have a great effect on the wear on commutators and in producing good or bad commutation.

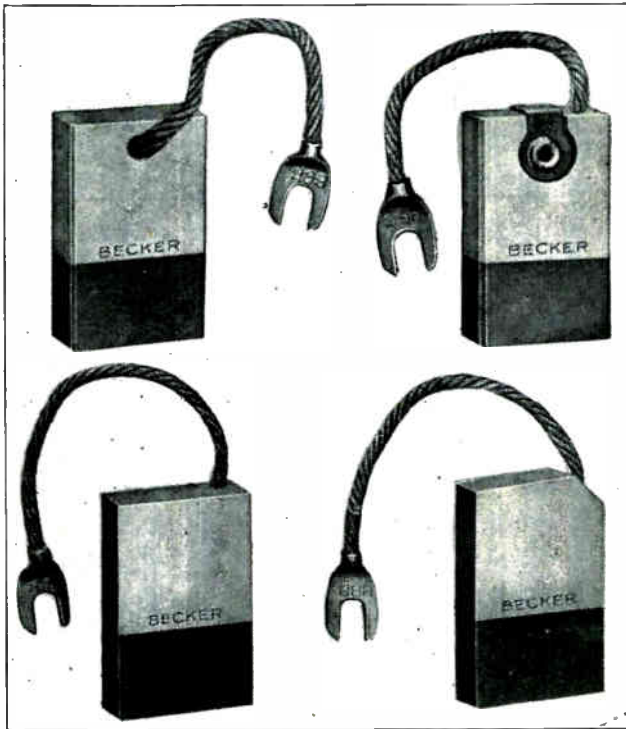

Fig. 144. Above are shown several carbon brushes of common types, such as used on D. C. motors and generators.

It should not be assumed, just because any brush will carry current, that any piece of carbon or any type of brush will do for the replacement of worn brushes on a D. C. generator or motor. This is too often done by untrained maintenance men, and it frequently results in poor commutation and sometimes serious damage to commutators and machines.

Many different grades of brushes are made for use on machines of various voltages and commutator speeds and with different current loads.

In order to avoid sparking, heating, and possible damage to commutators, it is very important when replacing worn brushes to select the same type of brushes or brush materials as those which are removed.

In special cases it is necessary to use only the brushes made by the manufacturers of certain mo-

tors or generators for those particular types of machines. Or, in difficult cases of brush or commutator trouble, it may be necessary to have a specialist from a brush manufacturing company determine exactly the type of brush needed. But in the great majority of cases you can replace brushes very satisfactorily by applying the principles and instructions given in the following paragraphs.

### 185. BRUSH REQUIREMENTS

A good brush should be of low enough resistance lengthwise and of great enough cross-sectional area to carry the load current of the machine without excessive heating. The brush should also be of high enough resistance at the face or contact with the commutator to keep down excessive currents due to shorting the armature coils during commutation. In addition, the brush should have just enough abrasive property to keep the surface of the commutator bright and the mica worn down, but not enough to cut or wear the commutator surface unnecessarily fast.

Figs. 144 and 145 show several carbon brushes of different shapes, with the "pigtail" connections used for carrying the current to the brush-holder studs.

### 186. BRUSH MATERIALS

The most commonly used brushes are made of powdered carbon and graphite, mixed with tarry pitch for a binder, and molded under high pressure into the shapes desired. This material can be molded into brushes of a certain size, or into blocks of a standard size from which the brushes can be cut.

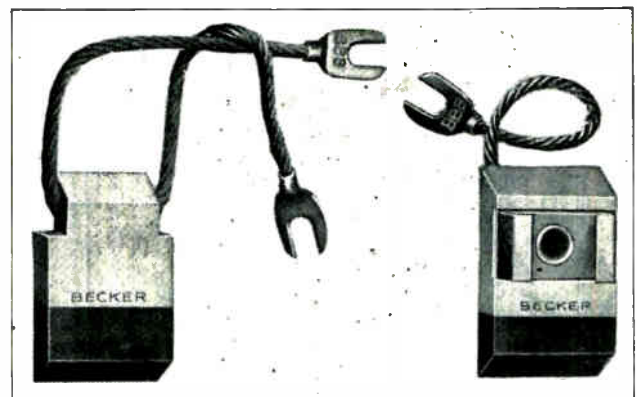

Fig. 145. Two carbon brushes of slightly different shapes, such as used with reaction type brush holders.

The molded material is then baked at high temperatures to give it the proper strength and hardness and to bake out the pitch and volatile matter.

Carbon is a very good brush material because it is of low enough resistance to carry the load currents without too great losses, and yet its resistance is high enough to limit the short circuit currents



between commutator bars to a fairly low value. Carbon also possesses sufficient abrasiveness to keep commutator mica cut down as the commutator wears.

Graphite mixed with carbon in the brushes provides a sort of lubricant to reduce friction with the commutator surface. It also provides a brush of lower contact resistance and lower general resistance, and one with greater current capacity.

Powdered copper is sometimes added or mixed with graphite to produce brushes of very high current capacity and very low resistance. These brushes are used on low-voltage machines such as automobile starting motors, electro-plating generators, etc. They often contain from 30 to 80 per cent of copper, and such brushes will carry from 75 to 200 amperes per sq. in.

Lamp-black is added to some brushes to increase their resistance for special brushes on high-voltage machines.

### 187. COMMON BRUSH MATERIAL. BRUSH RESISTANCE

A very common grade of carbon-graphite brush is made of 60% coke carbon and 40% graphite, and is known as the "utility grade". Brush material of this grade can be purchased in standard blocks 4" wide and 9" long, and in various thicknesses.

Brushes for repairs and replacement can then be cut from these blocks. They should always be cut so that the thickness of the block forms the thickness of the brush, as the resistance per inch through these blocks is higher from side to side than it is from end to end or edge to edge. This is due to the manner in which the brush material is molded and the way the molding pressure is applied, so that it forms a sort of layer effect or "grain" in the carbon particles.

This higher "cross resistance" or lateral resistance is a decided advantage if the brushes are properly cut to utilize it, as it helps to reduce short-circuit currents between commutator bars when they are shorted by the end of the brush.

Fig. 146 shows how brush measurements should be taken and illustrates why it is an advantage to have the highest resistance through the thickness of the brush and in the circuit between the shorted commutator bars.

The resistance of ordinary carbon-graphite brushes usually ranges .001 to .002 ohms per cubic inch, and these brushes can be allowed to carry from 30 to 50 amperes per sq. in. of brush contact area.

These brushes can be used on ordinary 110, 220, and 440-volt D.C. motors; and on small, medium, and large sized generators which have either flush or undercut mica, and commutator surface speeds of not over 4000 feet per min.

### 188. HARDER BRUSHES FOR SEVERE SERVICE

These utility grade carbon-graphite brushes can be obtained in a harder grade, produced by special

processing, and suitable for use on machines which get more severe service and require slightly more abrasiveness. These harder brushes are used for steel mill motors, crane motors, elevator motors, mine and mine locomotive motors, etc.

Brushes with a higher percentage of carbon can be used where necessary to cut down high mica, and on machines up to 500 volts and with commutator speeds not over 2500 feet per minute. This type of brush is usually not allowed to carry over 35 amperes per square inch, and is generally used on machines under 10 h. p. in size.

### 189. GRAPHITE USED TO INCREASE CURRENT CAPACITY

Brushes of higher graphite content are used where high mica is not encountered, and for heavier current capacity. Such brushes are generally used only on machines which have the mica undercut; and are particularly adapted for use on older types of generators and motors, exhaust fans, vacuum cleaners, washing machines, and drill motors.

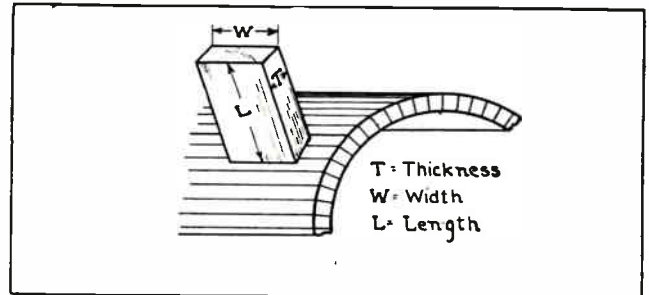

Fig. 146. This sketch illustrates the method of taking measurement for the length, width, and thickness of carbon brushes.

Brushes with the higher percentage of graphite do not wear or cut the commutators much, but they usually provide a highly-polished surface on both the commutator and brush face. After a period of operation with these brushes the surface of the commutator will usually take on a sort of brown or chocolate-colored glaze which is very desirable for long wear and good commutation.

### 190. SPECIAL BRUSHES

Some brushes are made of practically pure graphite and have very low contact resistance and high current-carrying capacity. Brushes of this nature will carry from 60 to 75 amperes per square inch and they can be used very satisfactorily on machines of 110 and 220 volts, or on high-speed slip rings with speeds even as high as 10,000 feet per minute.

The greater amount of graphite offers the necessary lubrication properties to keep down friction at this high speed.

Another type of brush consisting of graphite and lamp-black, and known as the electro-graphitic brush, is made for use with high-voltage machines which have very high commutator speeds. These brushes have very high contact resistance, which promotes good commutation. They can be used to

carry up to 35 amperes per square inch and on commutators with surface speeds of 3000 to 5000 feet per minute.

These brushes are made in several grades, according to their hardness; the harder ones are well adapted for use on high-speed fan motors, vacuum cleaners, drill motors with soft mica, D. C. generators, industrial motors, and the D. C. side of rotary converters. They are also used for street railway motors and automobile generators, and those of a special grade are used for high-speed turbine-driven generators and high-speed converters.

### 191. BRUSH PRESSURE OR TENSION

It is very important to keep the springs of brush holders or brush hammers properly adjusted so they will apply an even amount of pressure on all brushes. If the pressure is higher on one brush than on another, the brush with the higher pressure makes the best contact to the commutator surface and will carry more than its share of the current. This will probably cause that brush to become overheated.

To remedy this, the spring tension should be increased on the brushes which are operating cool, until they carry their share of the load.

Brush pressure should usually be from  $1\frac{1}{4}$  to 3 lbs. per square inch of brush contact surface. This brush tension can be tested and adjusted by the use of a small spring scale attached to the end of the brush spring or hammer, directly over the top of the brush. Then adjust the brush holder spring until it requires the right amount of pull on the scale to lift the spring or hammer from the head of the brush. One can usually tell merely by lifting the brushes by hand, whether or not there are some brushes with very light tension and others with too heavy tension or pressure.

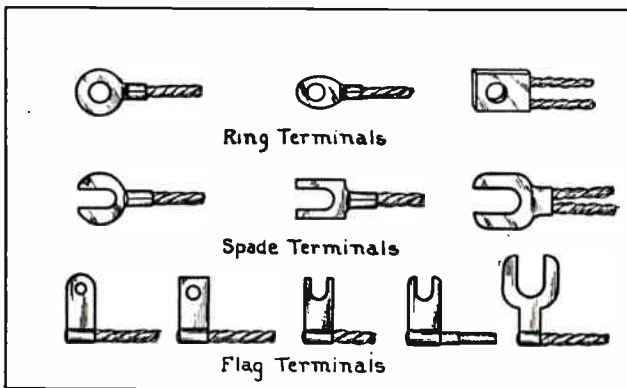

Fig. 147. Above are shown several types of terminals for brush shunts or leads.

Motors used on street cars, trucks, and moving vehicles, or in places where they are subject to severe vibration, will usually require a higher brush-pressure to keep the brushes well seated. On such motors the pressure required may even range as high as 4 lbs. per square inch.

### 192. BRUSH LEADS OR SHUNTS

All brushes should be provided with flexible copper leads, which are often called "pigtailed" or brush shunts. These leads should be securely connected to the brushes and also to the terminal screws or bolts on the brush holders, and their purpose is to provide a low-resistance path to carry the current from the brush to the holder studs.

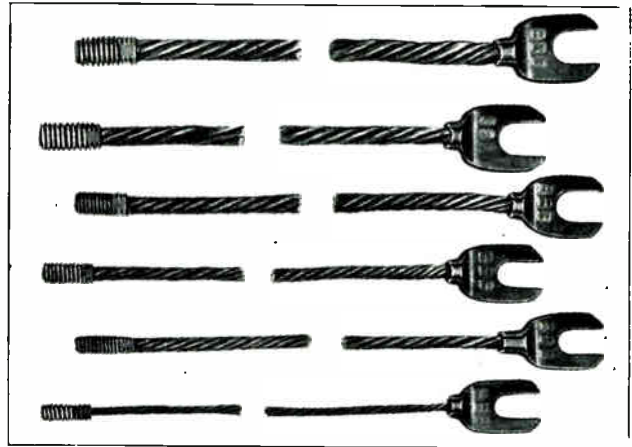

Fig. 148. Brush shunts can be obtained with threaded plugs on their ends for securely attaching them to the brushes.

If these brush shunts or leads become loose or broken, the current will then have to flow from the brush through the holder or brush hammers and springs. This will often cause arcing that will damage the brush and holder and, in many cases, will overheat the springs so that they become softened and weakened and don't apply the proper tension on the brushes.

The brushes shown in Figs. 144 and 145 are equipped with leads or brush shunts of this type and Fig. 147 shows a number of the types of copper terminals or clips that are used to attach these leads to the brush holders by means of terminal screws or bolts.

When new brushes are cut from standard blocks of brush material, the pigtailed can be attached by drilling a hole in the brush and either screwing the end of the pigtail into threads in this hole or packing the strands of wire in the hole with a special contact cement.

Fig. 148 shows a number of brush shunts or leads with threaded plugs attached to them. These leads can be purchased in different sizes already equipped with threaded end plugs.

Fig. 148 illustrates the method of preparing a brush and inserting the threaded ends of the brush shunts. The top view shows a bar of brush stock from which the brushes may be cut, and in the center is shown the manner of drilling a hole in the corner of the brush.

Carbon graphite brushes are soft enough to be drilled easily with an ordinary metal drill, and they are then tapped with a hand tap, as shown in the left view in Fig. 148. The threaded plug on the

end of the copper lead can then be screwed into this hole in the brush by means of pliers, as shown in the lower right-hand view of the same figure.

Brush leads of this type save considerable time in preparing new brushes, and insure a good low resistance connection to the brush. These leads can be unscrewed and removed from worn brushes, and used over a number of times.

**193. CEMENT FOR ATTACHING LEADS TO BRUSHES**

When brush leads with threaded tips are not available, a special compound or cement can be made by mixing powdered bronze and mercury. The bronze powder should first be soaked in muriatic or hydrochloric acid, to thoroughly clean it.

The acid should then be washed from the powder with lukewarm water. The bronze powder can then be mixed with mercury to form a thick paste. This paste is tamped solidly around the copper strands of the brush lead in the hole in the carbon brush, and will very soon harden and make a secure connection of low resistance.

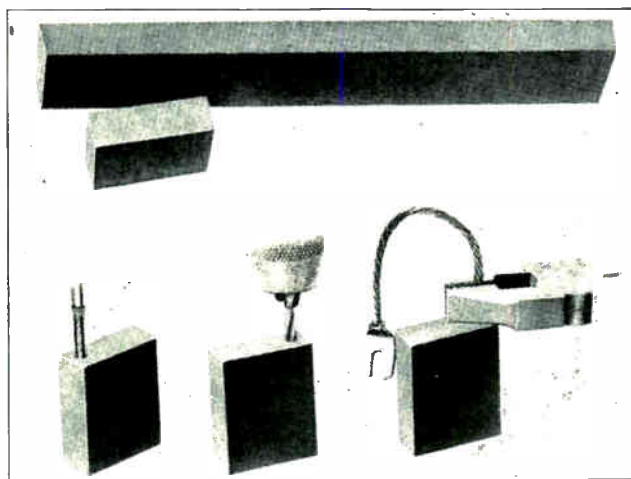

Fig. 148-A. These views illustrate the method of preparing a carbon brush to attach the threaded end of the brush lead or pigtail.

Care must be used not to make this cement too thick or it may harden before it can be tamped in place. It is usually advisable to mix only a very small quantity of the paste at one time, because it may require a little experimenting to get it just the right consistency.

**194. DUPLICATING AND ORDERING BRUSHES**

Worn or broken brushes should always be promptly replaced, before they cause severe sparking and damage to the commutator. Always replace brushes with others of the same grade of material if possible. The new brushes should also be carefully cut to the same size, so they will span just the same width on the commutator bar and will not fit too tight or too loose in the holders.

If it is necessary in emergencies to replace one or more brushes with others of a slightly different

grade, place all those of one grade in the positive brush holders, and those of the other grade in the negative holders. If brushes of different grades are placed in the same set of holders, the current will divide unequally through them and cause heating of certain ones, and it may also cause unequal wear on the commutator.

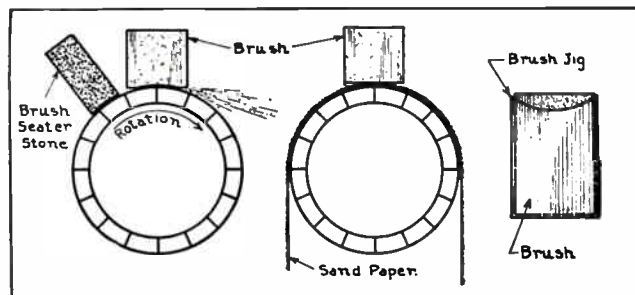

Fig. 149. The above sketches show several methods of cutting brush faces to fit the commutator surface. Each is explained in the accompanying paragraphs.

When ordering new brushes for any certain machine, careful measurements should be taken of the brush width, thickness, and length. The brush thickness is measured in the direction of travel of the commutator or slip rings; the width is measured parallel to the armature shaft or commutator bars; and the length is measured perpendicularly to the commutator or slip ring surface. These measurements are shown in Fig. 146. Any other special measurements should also be given, and in some cases it is well to send the old brush as a sample.

The length of brush leads or shunts should also be specified when ordering new brushes. They are usually provided in standard lengths of five inches, but can be furnished shorter or longer where required.

The style of terminal or end-clip should also be given, along with the diameter of the slot or hole by which they are attached to the bolts on the brush-holder studs.

It is generally advisable to have on hand a few of the brushes most commonly required for re-

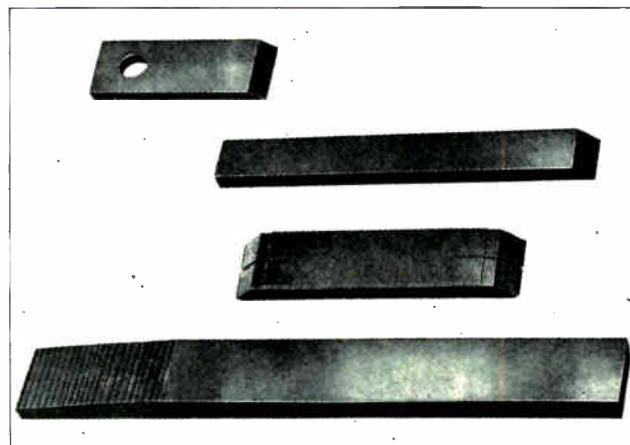

Fig. 150. Brushes made of copper strips or copper "leaf" construction are often used for low voltage machines which handle very heavy currents.

placement on any machines you may be maintaining. It is also well to have a catalogue of some reliable brush manufacturer, to simplify ordering by giving the number and exact specifications of the brushes required.

### 195. FITTING NEW BRUSHES TO THE COMMUTATOR

New brushes should always be carefully fitted to the surface or curvature of the commutator. This can be done by setting the brush in the holder with the spring tension applied, and then drawing a piece of sandpaper under the contact surface or face of the brush, as shown in the center view in Fig. 149. **Never use emery cloth for fitting brushes, as the electrical conducting of the emery particles tends to short circuit the commutator bars.**

The sandpaper should be laid on the commutator with the smooth side next to the bars and the rough or sanded side against the face of the brush. Then, with the brush held against the paper by the brush spring, draw the paper back and forth until the face of the brush is cut to the same shape as the commutator surface.

Be sure to hold the ends of the sandpaper down along the commutator surface so these ends will not cut the edges of the brush up away from the commutator bars.

On small machines where it is difficult to use sandpaper in the manner just described, a brush-seater stone can be used. These stones consist of fine sand pressed in block or stick form with a cement binder.

The brush seater is held against the surface of the commutator in front of the brush, as shown on the left in Fig. 149, and as the commutator revolves it wears off sharp particles of sand and carries them under the brush, thus cutting out the end of the brush until it fits the commutator.

When fitting a number of brushes, a brush jig such as shown on the right in Fig. 149 can be used to save considerable time. This jig can be made of either metal or wood, and in the form of a box into which the brush will fit. The open end of the box or jig has its sides cut to the same curve as the commutator surface.

A new brush can then be dropped in this box and its face cut out to the curve or edge of the box by means of a file. The bulk of the carbon can be cut out very quickly in this manner, and the brush can then be set in the holder and given a little final shaping with sandpaper as previously explained.

Graphite brushes should generally be used on iron slip rings on three-wire generators, and metal-graphite brushes on copper rings.

On certain very low voltage machines where heavy currents are handled, "copper leaf" brushes are used. These are made of a number of thin flat strips of hard drawn copper, with the end of the group beveled as shown in Fig. 150.

When brushes of too low resistance are used, they will generally cause long, yellow, trailing sparks at the commutator surface behind the brushes.

Brushes of too high resistance will cause blue sparks and will also cause the brushes to overheat.

If the commutator mica is not being cut down by the brushes and becomes too high, it will cause sparking and burned spaces to the rear of the mica segments, on the leading edges of the commutator bars.

The proper type of brushes and their proper fitting, well deserve thorough attention on the part of any electrical maintenance man or power plant operator; as a great many troubles in motors and generators can be prevented or cured by intelligent selection and care of brushes.

## MAINTENANCE OF D. C. MACHINES

Direct current motors and generators are so similar to each other in mechanical construction and electric operation that many of the same rules for care and maintenance apply to both.

With the many thousands of these machines in use in factories, mines, power plants, steel mills, stores, and office buildings, and on railways, the electrician who can intelligently and efficiently operate and maintain them is in great demand.

Most of the repairs and adjustments which have to be made on D. C. machines are usually on parts that are easily accessible and which can be easily handled with simple tools.

In the majority of cases, the brushes, commutator, and bearings require closer attention and more frequent repair than other parts of the machines. These should not, however, require an excessive amount of attention if the motors or generators are operating under favorable conditions and are given the proper care.

The windings of motors and generators very seldom give any trouble, unless the machines are frequently overloaded or if the windings are very old or are subjected to oil and dirt.

### 196. IMPORTANCE OF CLEANING

One of the most important rules for the maintenance of all electric machines is to keep them clean and well lubricated. If this simple rule is followed it will prevent a great many of the common troubles and interruptions to the operation of the equipment.

If dust and dirt are allowed to accumulate in the windings of motors or generators, they clog the ventilation spaces and shut off the air which is necessary for proper cooling of the machine. A layer of dust is also an excellent insulator of heat, and tends to confine the heat to the windings and prevent its escape to the surrounding air. Dust and dirt also absorb and accumulate oil and moisture.

For these reasons, the windings of all electric

machines should be kept well cleaned by brushing them with a duster or cloth and occasionally blowing out the dust from the small crevices by means of a hand-bellows or low pressure compressed air. Never use compressed air of over 40 lbs. pressure per square inch, or air that contains particles of grit or metal or any moisture.

Sometimes it is necessary to wash off an accumulation of oily or greasy dirt from the windings of machines. This can be done with a cloth and gasoline. If the windings are well impregnated with insulating compound, the gasoline will not penetrate deeply into them, but if it is allowed to soak into the windings to any extent they should be thoroughly dried before the machine is again connected to a line or operated.

A mixture of from  $\frac{1}{4}$  to  $\frac{1}{2}$  of carbon-tetra-chloride with gasoline reduces the danger of fire or explosion when using it as a cleaning solution.

### 197. EXCESSIVE OIL VERY DETRIMENTAL TO ELECTRIC MACHINES

Oil is very detrimental and damaging to the insulation of machine windings and should never be allowed to remain on them. Once a winding becomes thoroughly oil-soaked, it will probably have to be rewound.

In some cases, if the oil has not penetrated too deeply, it may be possible to wash it out with gasoline and then thoroughly dry out the gasoline before the winding is put back in service.

When oiling the bearings of a motor or generator, extreme care should be used not to fill the oil-cups or wells too full and cause oil to run over on to the commutator or windings of the machine.

It is practically impossible to secure good commutation if the commutator of a motor or generator is covered with dirt and oil. This will cause the faces of the brushes to become glazed and packed with dirt and will in many cases cause considerable sparking.

Dirt and oil will form a high-resistance film on the surface of the commutator, which will tend to insulate the brushes and prevent them from making good contact.

Oil is also very damaging to the cement used in the mica segments of commutators.

If any oil accidentally gets on the surface of a commutator, it should be wiped off immediately with a cloth and a small amount of kerosene or gasoline and carbon-tetra-chloride. Gasoline should not be used around a running machine because of the danger of igniting it by a spark from the brushes.

### 198. KEEP BEARINGS WELL LUBRICATED

The bearings of all motors and generators should be kept well oiled but not flooded with oil. The oil in the bearings should be examined frequently to make sure that it is clean and free from dirt and grit, and should be changed whenever necessary.

If the oil in a bearing has become exceptionally dirty or mixed with any abrasive dirt, the oil should be drained and the bearing and oil-cup washed out with kerosene or gasoline. The bearing and cup should then be refilled with clean fresh oil and when the machine is started it should be revolved slowly at first, to be sure that all the kerosene or gasoline on the bearing surfaces has been replaced by oil before the machine is running at full speed.

Bearings should not be filled from the top when regular oil openings or vents are provided on the side.

Bearings which are equipped with oil rings should be inspected frequently to make sure that the rings are turning and supplying oil to the shaft. Check the temperature of bearings frequently either by means of a thermometer, or by feeling of them with the hand to make sure that they are not operating much above normal temperature.

A great amount of work and trouble and costly shut-downs of electrical machinery can be prevented by proper attention to lubrication of bearings.

### 199. WINDING TEMPERATURES

The temperature of machine windings should be frequently checked to see that they are not operating too hot, that is at temperatures higher than  $40^{\circ}$  C. above that of the surrounding air.

Convenient thermometers can be obtained for this use and placed in crevices in the winding or against the side of the winding with a small wad of putty pressed around the thermometer bulb and against the winding.

All terminals and connections on electric machines should be frequently inspected and kept

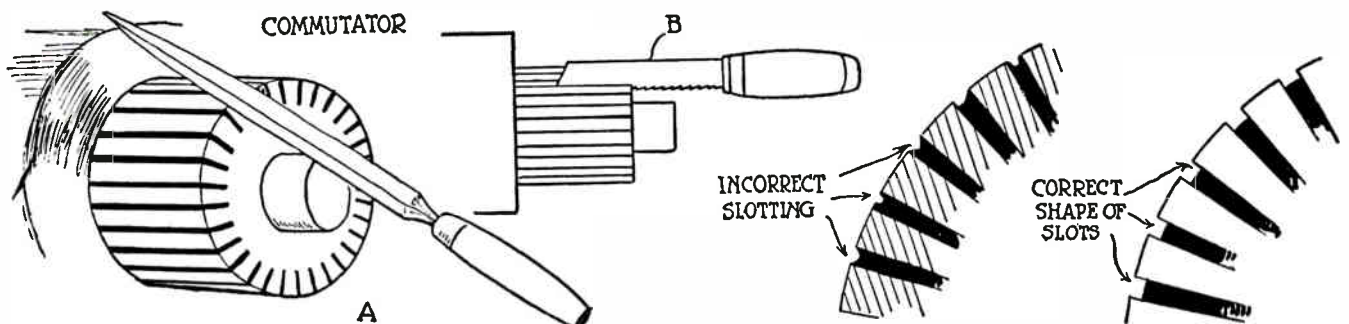

FIG. 151. The above sketch shows methods of undercutting mica segments on the commutator. Mica must be kept down even with, or below the surface of the commutator bars, or it will cause the brushes to make poor contact and cause severe sparking.

securely tightened. This includes those at the line, at the controller or starting switches, and at the brushes and field coils.

## 200. PROTECT MACHINES FROM WATER

Moisture or water is always a menace to the insulation and operation of electrical machinery, and machines should be thoroughly protected to keep all water away from their windings and commutators. If a motor or generator is located where water from above may drip upon the commutator, it is very likely to cause flash-overs and damage to the brushes and commutator.

If the windings of a machine become water-soaked or damp, they must be thoroughly dried, either by baking in an oven or by passing low-voltage direct current through the machine to dry them out.

Where a machine is too large to put in an oven or where no oven is available, the armature can be locked to prevent its rotation and then, by the use of a rheostat, low-voltage direct current can be applied in just the right amount to dry out the winding.

Water should be carefully excluded from oil wells and bearings, as it is not a good lubricant and it may cause serious damage if it mixes with the oil.

Motors that operate pumps may often have to be enclosed in a special box or shielding to prevent any drip or spray from coming in contact with them.

## 201. BRUSH ADJUSTMENT AND MICA UNDERCUTTING

Brushes should be frequently inspected to see that they are seated properly on the commutator and have the proper spring tension. If the commutator mica becomes high it should be corrected, either by using brushes of a type that will keep the mica cut down, or by undercutting the mica with a tool for this purpose.

Commutator mica on small machines can be undercut by hand with a piece of hack-saw blade equipped with a handle, as shown in Fig. 151. The views on the right in this figure show the correct and incorrect methods of undercutting mica.

Mica should be cut squarely with smooth, easy strokes of the hack-saw blade held in a vertical position. The mica should not be cut away too deeply, or the grooves will tend to accumulate dust and dirt, and cause short circuits between the commutator bars.

On small and medium-sized machines, the undercutting need not be deeper than from  $\frac{1}{64}$  to  $\frac{1}{32}$  of an inch. Care should be taken not to scratch or scar the commutator bars while undercutting mica, and one should also be careful not to leave on the edges or corners of the bars any burrs which might cause a short circuit between them.

A small, three-cornered file can be used for cleaning the ends or corners of the mica segments, as shown in the left view in Fig. 151, but a file or three-cornered object should not be used for undercutting

mica, as the top of the mica segments must be cut squarely, as shown in the right-hand view in the figure.

For undercutting the mica on large machines, a regular motor-driven mica cutter can be used. These machines consist of a small rotary saw, driven by a motor with a flexible shaft and equipped with handles for guiding the saw blade in the mica slots.

## 202. RESURFACING AND TRUING OF COMMUTATORS

If the surface of the commutator becomes rough and pitted it can be cleaned with sandpaper. Small spots of dirt or very lightly burned spots may be removed by holding sandpaper against the commutator while the machine is running.

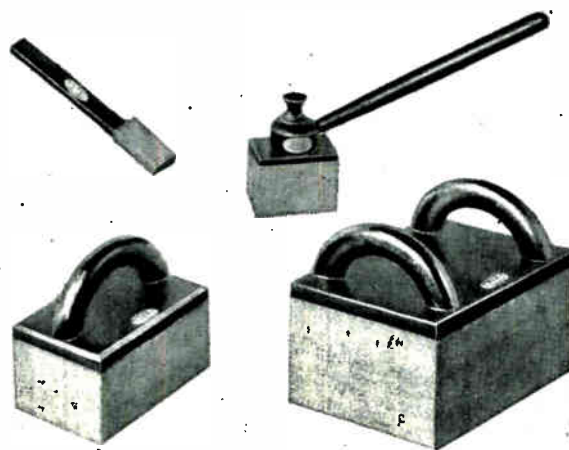

Fig. 152. Commutator stones of the above types are used for dressing or grinding down the burned and rough spots on commutator surfaces.

If the commutator requires much sand-papering it should be done with a block, with a curved surface to fit the commutator, to hold the sandpaper in a manner that will tend to smooth out hollow spots or high spots on the bars, and bring the commutator back to a true round shape.

Several strips of sandpaper can be folded over the curved end of a block of this type and fastened in place with clamps or tacks. As each strip becomes worn it can be removed, exposing the next strip, etc.

Special commutator stones can be obtained for dressing or re-surfacing commutators. These stones consist of a block of grinding or abrasive material equipped with handles for convenient application to the commutator surface. Several stones of this type are shown in Fig. 152. These can be obtained in different sizes and degrees of hardness for use with machines having commutators of different diameters and surface speeds.

If a commutator has become badly pitted or burned or out of round, it may be necessary to remove the armature from the machine and turn the commutator down in a lathe, as shown in Fig. 154. When truing a commutator in a lathe one should never remove any more copper than is absolutely necessary, because even a very light cut with a lathe

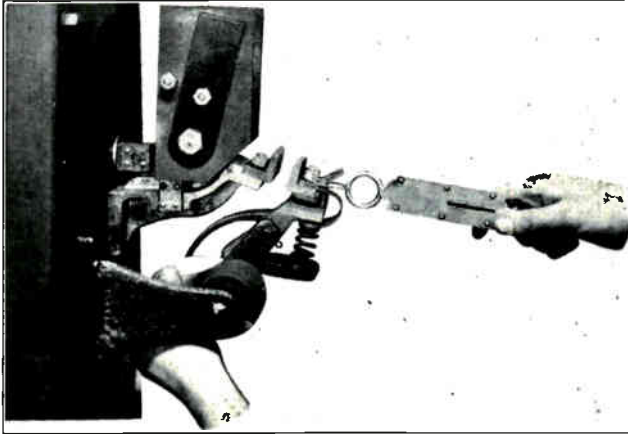

Fig. 153. The above photo illustrates the method of testing the contact pressure or tension of controller contacts. The scale can be used in the same manner for adjusting tension on brushes.

tool will remove more copper from the bars than several years of ordinary wear would destroy.

The armature should be carefully centered to run true in the lathe, and the tool set to remove only a very thin coating of copper, no thicker than a thin piece of paper. If this first cutting doesn't remove the flat spots, another cut can be made.

Commutators should never be turned down except as a last resort or when they are badly out of round.

Special tools and tool holders are often used for turning large commutators right in the machine.

Motors and generators should always have secure and firm foundations and should be anchored so that they don't vibrate while running. If the machine is allowed to vibrate, it may cause serious damage to the bearings and possibly also damage the commutator, shaft, or windings.

### 203. CARE OF CONTROLLERS

All switches, circuit breakers, and controllers used in connection with motors and generators should be kept in good condition, because if they are allowed to become defective, they may cause damage to the machines by frequent interruptions in the current supply, or by causing voltage drop and lower voltage than the machine is supposed to operate on, or by failure to protect the machine in case of overload.

All contact shoes or fingers on starting and control equipment should be kept in good condition and securely tightened. Bolts, nuts, screws, and terminals should also be kept tight and clean.

Sliding contacts or make-and-break contacts of controllers should be kept properly lubricated to prevent excessive wear. A good grade of vaseline serves very well for this purpose, as it will remain where applied on the contacts and will not run or spread over the equipment.

Resistance elements of starting and control equipment should be kept in good condition. In case of open circuits in resistance units, it may be necessary to temporarily bridge this open section of the resistance with a shunt or jumper, in order to keep the

machine in operation; but the defective resistance unit should be replaced with a new one as quickly as possible to prevent overloading the machine when starting, due to having insufficient resistance in the armature circuit.

Dash pots and time element devices should be kept properly adjusted to allow the proper time for starting of motors.

### 204. CARE OF OVERLOAD PROTECTIVE DEVICES

Fuses and overload devices on control equipment or anywhere in the circuit to electrical machines should be kept in good condition, and should be of the proper size and adjustment to protect the machines from current overloads. Fuses should never be replaced with others of larger current ratings than the machines are supposed to carry.

Overload trip coils on circuit breakers should be kept properly adjusted to trip at any current above the normal percentage of overload which the machine is allowed to carry.

If breakers or fuses open frequently in the circuit, it is an indication of some overload or fault on the machines, and the trouble should be located and remedied, instead of setting the circuit breakers for heavier currents or using larger fuses.

### 205. LIST OF COMMON TROUBLES

In the following lists are given a number of the more common troubles of D. C. machines and the symptoms which indicate these troubles:

#### MOTORS

##### MOTOR FAILS TO START

1. Fuse out, causing an open circuit
2. Brushes not making proper contact
3. Line switch open
4. Bearings "seized" due to lack of oil
5. Motor overloaded. This will usually blow the fuse
6. Open field circuit at the terminal block or in the starting box  
"No voltage" release magnet burned out
7. Open armature or line connections, either at the motor or controller
8. Grounded winding, frequently blows the fuse
9. Brushes not set on neutral point
10. Armature wedged. Remove the wooden wedges from air gap of new machines
11. Dirty commutator or brush faces
12. High mica insulation on commutator preventing brush contact
13. Field coils short-circuited or grounded. Will usually cause excessive armature currents and blow the fuses
14. Reversed field connections. Test for polarity with a pocket compass
15. Low voltage
16. Pulley, gear, or coupling, may be tight against the bearing
17. Bent shaft, causing armature to stick on pole faces

18. Badly worn bearings allowing armature to rub field poles.

19. Burned out armature.

#### 206. MOTOR STARTS TOO QUICKLY

1. Starting box resistance too low for the motor
2. Starting box resistance short-circuited
3. Insufficient time allowed for starting
4. Line voltage too high
5. Series motor without enough load for the starting resistance used with it
6. Too much resistance in field circuit.

#### 207. MOTOR ROTATION REVERSED

1. Reversed field connections
2. Brush connections reversed or brushes in wrong position
3. Compound motor connected differential and starts in reverse direction from the series field. Speed will be high and torque very low
4. No field. Residual magnetism may start the motor in reverse direction on very light loads only. Motor will not start under heavy load
5. Wrong field connection in starting box. Armature resistance may be in series with the field.

#### 208. SLOW STARTING OF MOTORS AND WEAK POWER

1. Low voltage
2. Resistance of starting box too high
3. Brushes off neutral, and will cause bad sparking
4. Motor overloaded
5. Heavy flywheel on driven machines
6. Weak field due to resistance in its circuit
7. Dirty or loose connections
8. Dirty or loose brushes
9. Brushes improperly spaced on commutator
10. Armature defects, shorts, grounds or opens
11. Wet armature or commutator.

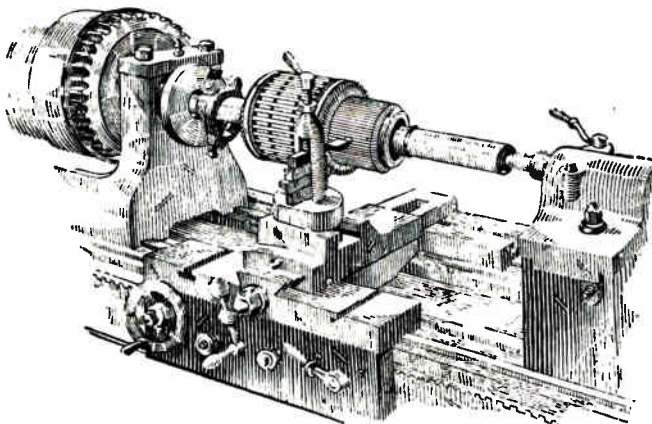

Fig 154. Commutators that are badly burned or out of round can be resurfaced and trued up in a lathe as shown above.

#### 209. MOTOR BUCKING OR JERKING

1. Overloaded motor
2. Reversed interpole polarity

3. Loose field connections which alternately open and close the field circuit and cause the motor to run jerkily
4. Wet or shorted field coils
5. Defects or loose connections in starting box.

#### 210. MOTOR OVERSPEEDS

1. Open field circuit, may cause dangerously high speed
2. Shorted or grounded field coils
3. Load suddenly reduced on compound motor using field control
4. Brushes off neutral
5. Shorted or grounded armature conductors
6. Line voltage too high
7. Series motor overspeeds on light loads or no load.

#### 211. SPARKING AT BRUSHES

1. Brushes or commutator dirty
2. Rough or burned commutator
3. High or low bars in commutator
4. Commutator out of round
5. Commutator segments shorted by carbon or copper dust in the mica slots, or by solder bridged across the bars
6. High mica
7. Brushes off neutral
8. Wrong type of brushes
9. Brushes poorly fitted
10. Brushes stuck in holders.
11. Poor or unequal brush tension
12. Weak field, due to short circuits or grounds in the coils
13. Reversed field coils
14. Opens or shorts in armature winding. Opens usually cause long blue sparks and shorts are generally indicated by yellow or reddish sparks. The location of the defective coils will usually be indicated by burned bars to which they are connected
15. Oil grease or water on the commutator
16. Unequal air gaps due to worn bearings
17. Unbalanced armature winding
18. Bent shaft which causes brushes to chatter
19. Poor foundation, permitting vibration of the machine.

#### 212. OVERHEATING OF MACHINES

1. Overloading will cause heat on both motors and generators due to excessive current passing through their windings and brushes
2. Excessive brush friction and brush tension too great
3. Brushes of too high resistance
4. Brushes off neutral
5. Damp windings
6. Excessive sparking at commutator, which may cause enough heat to melt the solder and loosen the armature connections
7. Opens or shorts in armature winding
8. Hot field coils caused by high voltage or short circuits in the coils



9. Field shunts loose or disconnected
10. Windings shorted by oil-soaked insulation
11. Hot field poles may be due to poor design causing eddy currents in the pole shoes. Unequal air gaps may cause field poles closest to the armature to heat
12. Hot bearings due to poor lubrication. May be caused by poor oil, stuck oil rings, or clogged oil wicks. Also caused by poor shaft alignment or excessive belt tension
13. Armature out of center with field poles, due to worn bearings. Causes excessive currents in parts of the armature winding and eddy currents in the field poles. Bearings should be repaired immediately
14. Clogged ventilating ducts
15. Loose connections between armature coils and commutator bars
16. Weak field, not allowing sufficient counter-E.M.F. to be generated to keep the armature current normal
17. Heat transfer through direct shaft connections from air compressors, steam engines or other machinery.

Normal operating temperatures of D. C. motors should not exceed 40° C. above the surrounding room temperature when operated at full load, or 55° C. at 25% overload for two-hour periods. If the machines are operated at temperatures above these values for any length of time, the insulation of the windings will become damaged and eventually destroyed. Safe operating temperature is about 140 to 150 degrees F.

#### 213. UNUSUAL NOISES

1. Belt slapping due to a loose, waving belt
2. Belt squealing due to belt slipping on the pulley, caused by loose belt or overloads
3. Brush squealing due to excessive spring tension, hard brushes, or dry commutator surface. Application of a good commutator compound will usually stop the squealing due to a dry unlubricated commutator
4. Knocking or clanking may be caused by a loose pulley, excessive end play in the shaft, a loose key on the armature spider, or a loose bearing cap
5. Chattering vibration, caused by poor brush adjustment and loose brushes, hard brushes, or commutator out of round
6. Heavy vibration due to unbalanced armatures, bent shaft, or loose foundations.

#### 214. GENERATOR TROUBLES. FAILURE TO BUILD UP VOLTAGE

1. Residual field lost or neutralized
2. Reversed field
3. Poor brush contact or dirty commutator
4. Open field circuit due to loose connections or broken wires
5. Field rheostat open or of too high resistance
6. Series field reversed so it opposes the shunt field

7. Shunts disconnected or improperly connected
8. Wet or shorted field coils
9. Too heavy load on a shunt generator
10. Residual magnetism reversed by flux from nearby generators.

#### 215. POOR VOLTAGE REGULATION

1. Loose field shunts or connections
2. Poor regulation of engine speed
3. Belt slipping (if generator is belt driven)
4. Brushes off neutral
5. Improper resistance of field rheostat, or loose connections at this rheostat
6. Series field shunts not properly adjusted
7. Overheated field coils
8. Loose or grounded field wires between generator and switchboard
9. Armature out of center
10. Brushes improperly spaced
11. Weak field caused by short circuits or grounds in the field windings
12. Shorts, opens, or grounds in the armature coils
13. Excessive and frequent variations in load
14. Improper compounding

#### 216. GENERATORS WILL NOT OPERATE IN PARALLEL

1. Poor speed regulation on prime mover, caused by improper governor adjustment
2. Open equalizer connections
3. Incorrect field shunts, open or loose field connections, or weak fields
4. Defective field rheostat
5. Wet field coils
6. Improper adjustment of series fields for compounding effects
7. Extreme difference in size, causing the smaller machine to be more responsive to load changes than the larger machine
8. Belt slipping, on belt-driven generators
9. Variations in steam pressure, on generators driven by steam engines
10. Defective voltmeter, causing operator to make wrong adjustment.

#### 217. SYSTEMATIC TESTING

The preceding lists of common troubles and their symptoms are given to serve as a general guide or reminder of the possible causes of trouble in D. C. machines. They do not cover every possible trouble or defect, but intelligent application of the principles covered throughout these sections on D. C. equipment and careful systematic testing, should enable you to locate any of the troubles listed or any others.

Keep well in mind the advice previously given in this Reference Set, to the effect that even the troubles most difficult to locate can always be found by methodically and systematically testing circuits and equipment.

Let us remind you once more that any defect or trouble in electrical equipment or circuits can be found, and that someone is going to find it. It

will be to your credit to be able to locate any and all troubles, and the best way to gain experience and confidence is to undertake willingly every trouble-shooting problem you can find. Go about it coolly and intelligently, use your knowledge of the principles of electricity and electrical equipment and circuits, and in this manner you will save a great deal of time and many mistakes.

You will also be surprised to find out how very simple some of the apparently baffling electrical troubles are, to the trained man who knows how to test and locate them.

## 218. TEST EQUIPMENT FOR LOCATING FAULTS

Some of the more common devices used for trouble shooting and testing are as follows:

1. Test lamp and leads
2. Magneto tester
3. Battery and buzzer tester
4. Voltmeter (portable type)
5. Ammeter (portable type)
6. Thermometer
7. Speed indicator
8. Wheatstone bridge
9. Megger.

Every maintenance electrician's kit should include a test lamp and a battery and buzzer test-outfit. These are very inexpensive and can easily be made up in a few minutes' time. It is a good idea to use two sockets and bulbs in series, for a test lamp which can be used either on 220 or 110-volt circuits. The two lamps will burn at full brilliancy when connected at 220 volts, and at one-half brilliancy on 110-volt circuits.

## 219. USE OF TEST LAMPS, BUZZERS AND MAGNETS

Test lamps of this type can be used for locating open circuits, short circuits, and grounds on the machines themselves or the wires leading to them. They are also very convenient for testing to locate blown fuses and to determine whether or not there is any voltage or the proper voltage supplied to the terminals of the machines.

The battery and buzzer test-outfit can be made of one or two dry cells taped together, with the buzzer taped securely to them. This unit should then be supplied with flexible test leads several feet long. The dry cells and buzzer can be located in a portable box if desired.

A simple test outfit of this kind can be used for locating grounds, opens, and short circuits on machines or circuits that are not alive.

The magneto test-outfit is very effective for locating high-resistance short circuits or grounds. These hand-driven magnetos generate voltage sufficiently high to break down the resistance at the point of the fault or defect, while a battery test set or test lamp used with ordinary line voltage might not show the fault.

When installing any new circuits to generators,

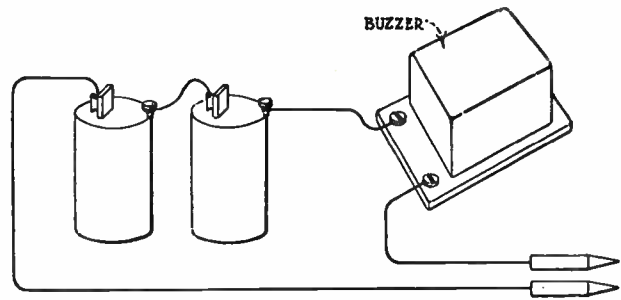

Fig. 155. A simple test set consisting of dry cells and buzzer is a very effective device for trouble shooting and locating of faults in electric circuits and machines.

motors, or controllers, the wiring should be thoroughly tested for grounds, shorts, and opens before connecting the machines.

An ordinary A.C. test magneto will ring through 20,000 to 40,000 ohms resistance. The use of magnetos above 50,000 ohms is not advised because they will ring through the insulation of conductors on long circuits.

In some cases an A. C. magneto will cause its bell to ring when the terminals are attached to the windings of very large machines, due to capacity or condenser effect between the windings and the frame of the machine. In such cases the ringing of the magneto doesn't necessarily indicate defective insulation.

## 220. USE OF PORTABLE VOLTMETERS AND AMMETERS

Voltmeters are very essential in plants having a great number of electrical machines and circuits. Voltmeters should be used for measuring line voltages or voltage drop on various circuits, to determine whether or not the proper voltage is supplied to the equipment.

It is very important that D. C. motors be operated at their proper rated voltage and not at voltages 10% or more below this, which sometimes results from overloaded line circuits and excessive voltage drop.

Low reading voltmeters are very satisfactory test devices for locating faults in armatures and field coils, as well as commutator defects. They can also be used for testing voltage drop in controller coils and resistors and to locate defective coils in this manner.

Ammeters can be used to measure the current through any circuit or machine and to determine whether wires or machine windings are properly loaded or overloaded.

One or more ammeters should always be available in plants where numerous electrical machines are to be operated and maintained.

## 221. THERMOMETERS

Thermometers should be used to determine the temperature at which various machines are operated, and especially if a machine is known to be operating somewhat overloaded. On machines that are not overloaded, if the temperatures rise above

the rated temperature increase for a normal load, the cause should be determined and remedied at once.

By checking the temperatures at different points on a machine or its windings, the exact location of the fault or trouble can frequently be found by noting the points of higher temperature. Some thermometers for this use are marked with the centigrade scale, while others are marked with the Fahrenheit scale.

A convenient rule for converting the temperature in either scale to the other is as follows:

$$\text{Temperature C.} = \frac{5}{9} \times (\text{Temperature F.} - 32)$$

$$\text{Temperature F.} = \left(\frac{9}{5} \times \text{Temperature C.}\right) + 32$$

## 222. SPEED INDICATORS

Speed indicators or revolution counters are commonly used to determine the speed of various machines. If machines are overloaded or thought to be operating at low voltage, it is often necessary to test their speed.

In other cases, checking the speed of machines may assist in locating certain faults within the machine or its own windings. In many industrial plants and factories it is very important that the motors driving production machines be kept operating at their proper rated speed, in order not to delay the production of the article being manufactured.

With the ordinary low-priced revolution counters or speed indicators, a watch with a second-hand can be used to check the time during which the revolutions are counted, and to get the speed in R.P.M.

Where a large number of machines are to be tested frequently, a higher-priced speed indicator known as a "tachometer" may be used. This device when placed against the shaft of any revolving machine indicates the speed in R.P.M. instantly.

## 223. IMPORTANCE OF RESISTANCE TESTS ON INSULATION

As previously mentioned, the megger and Wheatstone bridge are very effective devices for testing the insulation resistance of electrical machines and circuits. Regular inspection of the motors and generators with one or the other of these instruments will often save many serious cases of trouble or winding failures. In this manner it is also possible to prevent delays in production caused by the shut-

down of machinery, on which the faults could have been located and repaired in advance by proper inspection and testing with such instruments.

In medium-sized and larger plants, instruments of this type will very soon save much more than their original cost.

Electric instruments are usually furnished by the employers or plant owners, although in some cases the maintenance man and electrician can well afford to own one or more low-priced portable instruments for the great convenience and aid they give in his work.

Whether these instruments are supplied by the employer or owned by the electrician, they should always be handled with proper care and intelligence.

Most meters are delicate devices and they should not be carelessly handled or banged around. Extreme caution should always be used not to connect ammeters across a line or in circuits with greater loads than the ammeter is designed for. The same warning applies to connecting voltmeters and wattmeters, which should never be connected to circuits of higher voltage than the instrument is made for.

## 224. COMMON TOOLS FOR MAINTENANCE WORK

A few of the more common tools used by the electrical maintenance man are as follows:

1. Knife
2. Pliers (side cutting)
3. Gas pliers
4. Screw drivers
5. Adjustable wrenches
6. Pipe wrenches
7. Machinist's hammer
8. Center punch
9. Cold chisels
10. Soldering iron
11. Blow torch
12. Tin snips
13. Bearing scrapers
14. Speed indicator
15. Air-gap gauge
16. Files; flat, round, and three-cornered
17. Hack saw
18. Breast drill

This list covers the more essential tools for ordinary jobs. Various other tools can be added for certain things, according to the class of work and equipment to be handled. A few good pointers in

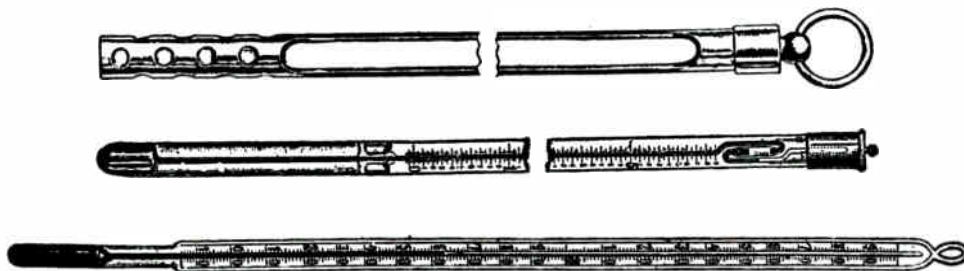

Fig. 156. Convenient thermometers of the above type are used for determining the temperature of the machine windings, by attaching the bulb to the windings with a small amount of putty.

the selection and use of these tools are given in the following paragraphs.

An electrician's knife should be a good substantial one, with one sharp blade that can be used for the removal of insulation from conductors, and one general utility blade for miscellaneous cutting, scraping, etc.

The most common and handy size of pliers is the 7-inch length, and if only one pair is used this should be the size. If one wishes to carry or to have on hand two or more sizes, the 6-inch and 8-inch sizes should also be included.

Cheap pliers never save any money, and only good pliers with strong jaws and good cutting blades should be purchased. Pliers larger than 9-inches are seldom used, except for the handling of very heavy wires and cables. Good pliers are made of the best grade of tempered steel and should never be held in the flame of a torch or allowed to become overheated in any way. Pliers should not be used to cut hard steel bolts or spikes.

The gas pliers are very convenient for holding cable lugs when heating them to melt solder and apply to cable ends, and for other general uses such as gripping bolts, nuts, and small parts. An 8 or 10-inch size is usually most convenient.

You should have at least three or four sizes of screw drivers and sometimes more. It is well to have one short and one long screw driver, both with points to fit a No. 7 wood screw; one short and one long driver to fit a No. 10 wood screw; and at least one large screw driver for No. 14 to No. 16 screws.

Never use a screw driver for a crow bar or chisel, as such abuse will only bend their bits or split the handles and render them unfit for the purpose for which they were intended.

If screw drivers become dull they can be carefully reground on the flat side of an emery wheel. Never grind them to a sharp point, as it tends to make them slip out of the slots in screws.

Adjustable wrenches should be of the 6-inch, 8-inch and 10-inch sizes, and these will handle all except the very heavy work. These tools are used for tightening bolts and nuts on motors, controllers, and all kinds of electrical equipment; and both for taking apart and re-assembling motors and machines to be repaired.

When using an adjustable wrench, always tighten the jaws securely on the nut before applying any pull on the handle, as this will avoid slipping and injury to the operator as well as "rounding" of the corners on nuts or bolt heads.

Never use a wrench upside down or backward, and don't hammer the handles, as it will only spring the jaws and spoil the wrench. Wrenches are made with handles long enough to apply by a steady pull all the pressure their jaws will stand.

Pipe wrenches should be used for loosening stubborn or worn nuts on which the adjustable wrench slips, and also for making BX or conduit connections. One 10-

inch and one 12-inch pipe wrench will usually be sufficient for ordinary repair work.

A good hack saw is indispensable for cutting bolts, BX, conduit, and heavy cables. Usually the 12-inch rigid or non-adjustable frame is best, and several good sharp blades should always be on hand for this saw.

When using a hack saw, the object to be cut should be securely held in a vise or clamp. If the object is allowed to wobble or twist it will crack the teeth out of the saw blade.

A machinist's hammer of one lb., one and a half lbs., or two lbs. weight will usually be found most convenient.

Center punches are very handy for marking places for drilling holes in metal, or for marking the end-plates of motors or machines before they are removed, so you can be sure of getting them replaced properly.

A small breast drill or Yankee drill with a dozen or more short drills will be found very convenient in making many time-saving repairs.

Several sizes of cold chisels are needed for cutting bolts, screws, metal strips, etc., on which the hack saw cannot be conveniently used.

Tin snips are very convenient for cutting strips of hard insulation, such as fibre, or for cutting shims of thin metal for lining up bearings or machine bases. They can also be used for cutting shims to place under field poles when adjusting air gaps on the poles of motors or generators.

A set of bearing scrapers, such as used on automotive work are usually very convenient. These are to be used for scraping sleeve-bearings to fit the shafts of motors or generators.

An air-gap gauge consists of a group of thin metal feeler gauges that can be used for determining the air gap between the armature core and various field-pole faces.

It is quite important to keep the armature centered in the machine, in order to secure best operation, and when bearings become worn and allow the armature to drop below the center, an air-gap gauge can be used to re-center the armature or determine which poles it is closest to.

One or more pieces of hack saw blade can be easily fitted with file handles and used for undercutting mica on small and medium-sized machines, as was explained in a previous article.

Flat files are very convenient for resurfacing and dressing the faces of contacts on controllers, and hundreds of other uses which are not necessary to mention, as most everyone knows the common uses for a file.

Where most of the work to be done is within reach of electrical circuits of the proper voltage, an electric soldering-iron is generally most convenient. Where electric supply of the proper voltage is not available or where very heavy soldering is to be done, a blow torch is essential. One or more soldering coppers can then be used, by heating them in the flame of the blow torch.

## 225. OPERATION AND CARE OF BLOW TORCHES

At this point it will be well to give a few general hints on the use of gasoline blow-torches.

A torch of one quart size is usually most convenient for ordinary work. To fill the torch, unscrew the cap in the bottom and pour the gasoline in the opening with a funnel. If any gasoline is spilled on the bottom of the torch it can be run inside by gently rocking the torch back and forth until most of it runs into the opening.

After filling, replace the cap, making sure that the composition washer is in place, to seal the torch airtight and prevent leakage of gasoline. Tighten the screw cap securely and pump a small amount of air into the tank. Six to ten strokes of the pump is sufficient for starting a torch. Then hold the hand or some object over the torch nozzle, tipping the torch back slightly, and open the needle valve a small amount. The gasoline which is allowed to escape will then drain into the small vessel or cup under the torch. The cup should be nearly full before the valve is closed.

This gasoline should then be carefully ignited with a match and allowed to burn away almost completely before opening the valve again.

This flame heats the torch nozzle and gas generator so the liquid gasoline will be turned into vapor as it escapes. This is necessary for proper operation and to secure the full heat of the flame.

When the torch is well-heated, open the needle valve and adjust it until the flame is a sort of blue color with a slightly pink tinge.

If the torch is operated in a breeze or wind, turn the torch so the flame points against the breeze. This

will tend to confine the heat of the flame where it will do the most good and keep the torch hot enough to operate.

When through using the blow torch, it should be extinguished by closing the needle valve; never by blowing or smothering the flame. After extinguishing the torch, let it stand a few minutes; then open the needle valve until a hissing sound is heard. This relieves the pressure in the tank and the needle valve can then be close gently and the torch put away until it is to be used again.

Never use a pliers on the needle valve or you may damage the soft metal seat of the valve. **Never use one blow torch to heat another, or it may result in an explosion and dangerous burns.**

These few general hints on the types of tools and the methods of their use are intended simply to aid those who have never used tools of this kind to become properly acquainted with them.

Thoughtfulness, pride, and care in your work, and the application of a little mechanical ability along with practice, are all that are required to make most anyone proficient in the use of these tools and in ordinary electric maintenance work.

Always do all repair work neatly and thoroughly. You will find that in the long run it saves time and trouble. Take a reasonable pride in all electrical machinery and equipment which you may be operating or maintaining, and also in your knowledge of the proper operation and care of this equipment.

Conscientious and intelligent application of the knowledge you can gain from this section, should enable you to qualify in the operation or maintenance of practically any Direct Current equipment.



ESTABLISHED 1899

# COYNE

## *Electrical School*

CHICAGO ~ ~ ILLINOIS



COPYRIGHT 1942

# ALTERNATING CURRENT AND A. C. POWER MACHINERY

## *Section One*

Nature of Alternating Current  
 Generation of Voltage, Sine Curve, Values, Frequency  
 Single-phase and Polyphase Currents  
 A. C. Circuits  
 Inductance, Capacity, Impedance  
 Ohms Law for A. C., Circuit Calculations  
 Power Factor  
 Lagging and Leading Currents  
 A. C. Power Problems  
 Power Measurement  
 Meter Connections

## ALTERNATING CURRENT

Alternating current electricity provides one of the greatest fields of opportunity and one of the most fascinating branches of work and study in the entire electrical industry today.

In the last few years, alternating current and A.C. machines have come into such extensive use in nearly all industries that no electrical man can afford to be without a knowledge of this very interesting form of energy and equipment.

One of the greatest advantages of alternating current is that it can be much more economically transmitted over long distances than direct current can. This is due to the fact that the voltage of alternating current energy can easily be stepped up to very high values by means of transformers.

The economical high-voltage transmission of alternating current makes it possible to generate this form of energy more cheaply in large and efficient central generating stations or power plants, and then transmit it to towns and factories at considerable distances.

High tension transmission lines also make possible the use of water power produced in large hydro-electric plants which are often a long distance from the towns and places where the electrical energy is used.

Thousands of miles of high-voltage transmission lines, operating at voltages from 66,000 to 290,000, tie together the great steam and hydro generating stations in vast super-power networks throughout this country. These lines carry hundreds of thousands of horse-power of clean, silent, and efficient electric energy to turn the wheels in our great factories, to light our homes and city streets, and to operate electric railroads, etc.

Interconnection of the greatest power generating plants and centers by high voltage A. C. lines makes possible greater economies of operation and dependability of electric supply than can be obtained in any other way. It tends to balance or equalize the varying loads of the different towns, communities, and factories, into a more uniform average load on all of the interconnected generating plants; and thereby reduces the number of spare generators that must be carried in any of the plants for peak loads. Connecting a great number of power plants together also makes it possible for one generator, plant, or line to be shut down for repairs without interrupting the electric supply to the users, as the full load can be carried temporarily by the other plants on the system.

For these reasons, alternating current transmission lines have been developed with tremendous rapidity so that at present their voltages run as high as 290,000, and new power lines are constantly

being installed in a great network throughout the entire country. Engineering tests and experiments are now being carried on toward the development of 330,000-volt transmission lines.

Even with our present super-power lines it is possible to economically transmit many thousands of horse power over distances of several hundred miles.

Great generating plants in Chicago have supplied power to the city of Pittsburg, and have for a short test period supplied power to light the streets of Boston. Chicago has some of the largest generating plants in the world, and these plants are connected with others in a vast system with transmission lines reaching to the eastern and southern coasts of the U. S., and long distances north and west.

Huge electric generating plants producing from 100,000 kw. to 1,000,000 kw. each feed the alternating current to the transmission lines; and new power plants are constantly being built to supply the ever-increasing demand for electric power.

It is almost impossible to comprehend the tremendous rate at which alternating-current electrical equipment has been developed, and the present rate of expansion of this great industry.

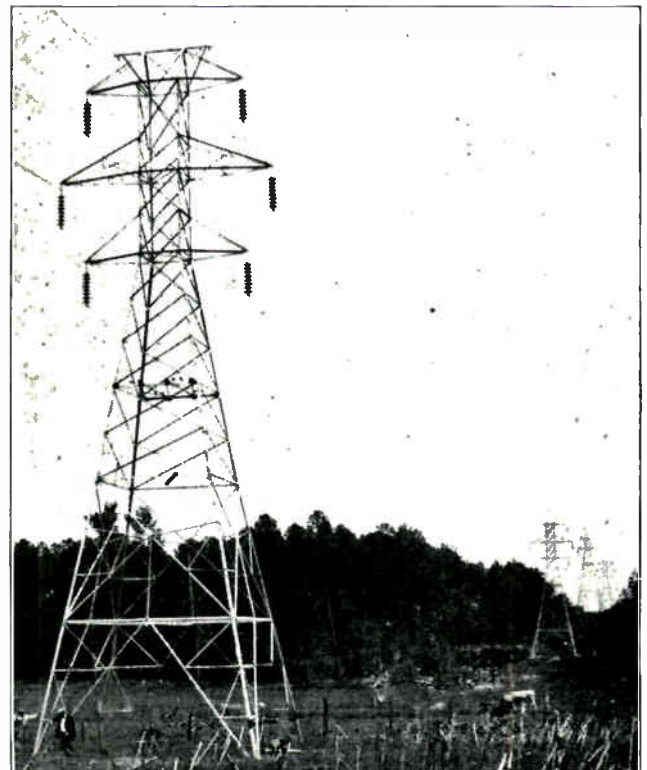

Fig. 1. This photo shows a high voltage power line of the type which carry thousands of h. p. of electrical energy throughout the country.



Fig. 2. The above view shows a high voltage arc created by passing current at a potential of several hundred thousand volts through air.

In 1889 an A. C. generating unit of 400 kw. capacity was put into operation, and was thought to be a very large unit at that time. The size of A. C. generators kept increasing until, in 1917, units of 45,000 kw. were in use, and a unit recently installed in one of Chicago's new power plants is of 208,000 kw. capacity. This is equivalent to about 275,000 h. p. Fig. 3 shows a mammoth

steam-turbine-driven A. C. generator of 165,000 kw. capacity.

Hydro-electric plants have also developed rapidly. In 1890 only a few thousand h. p. were produced at Niagara Falls, but now its electrical output has been increased to over one million h. p.

A new hydro plant of the Philadelphia Electric Company, at Conowingo, Maryland, produces nearly one-half million h. p. of electric energy; and there are hundreds of other water-power plants which generate from 10,000 to 100,000 h. p. and more each. Fig. 4 shows a photo of the great dam and power house at Conowingo.

The operating of all these steam and hydro-electric power plants provides steady jobs at good pay and clean, fascinating work, for many thousands of trained electrical men. The construction of new plants and power lines, and the inspection and maintenance of existing lines, employs thousands more.

Then there is the manufacture, installation, and maintenance of the vast number of A. C. electrical machines and devices that use the millions of h. p. generated by all these power plants.

Electrical manufacturers produce approximately

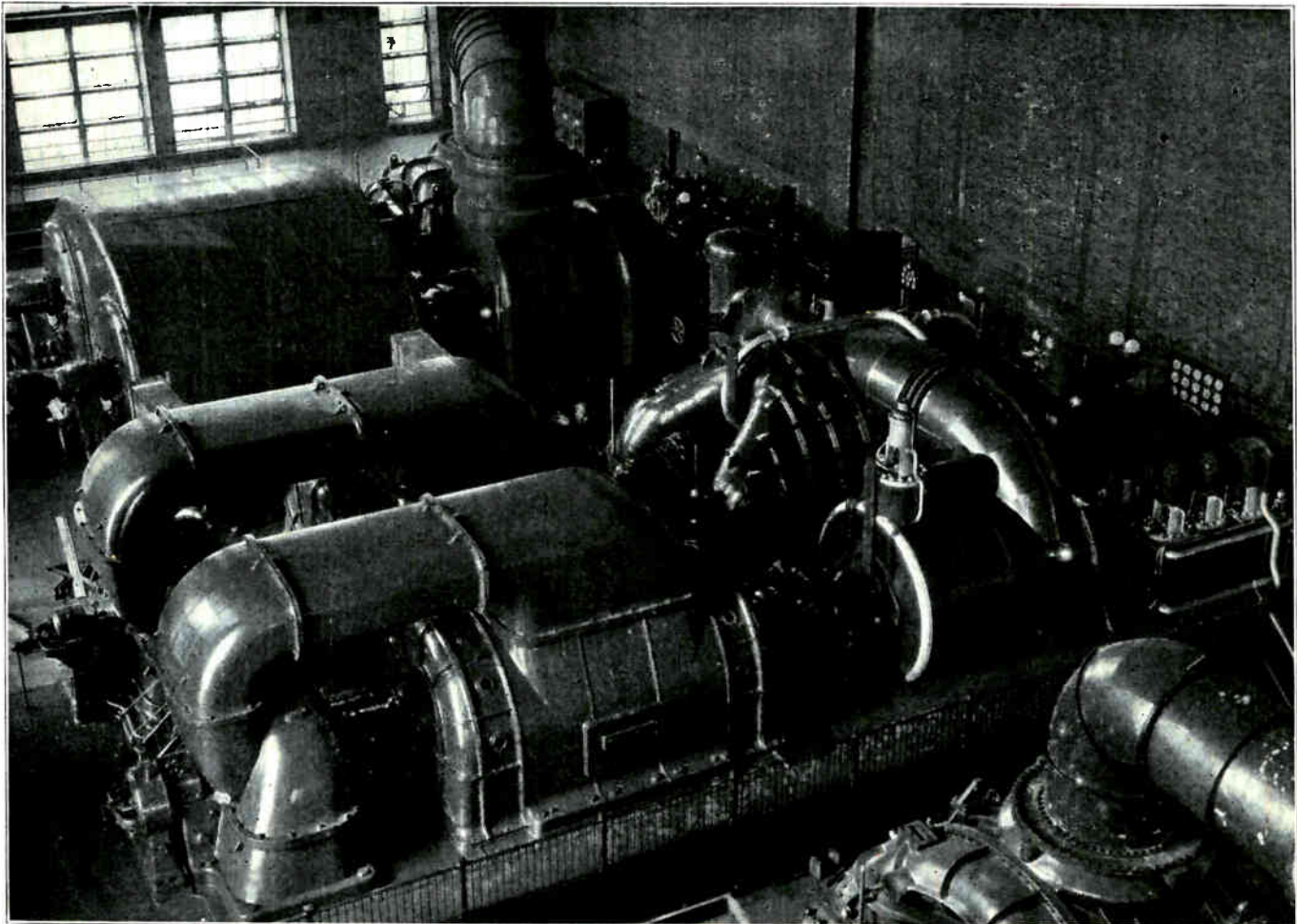

Fig. 3. Modern steam generators of the above type produce many millions of h. p. of electrical energy, for use in lighting and the operation of power machinery. The generator shown in this photo is of 165,000 kw. capacity and is driven by steam turbines. (Photo courtesy of American Brown Boverly Co.)



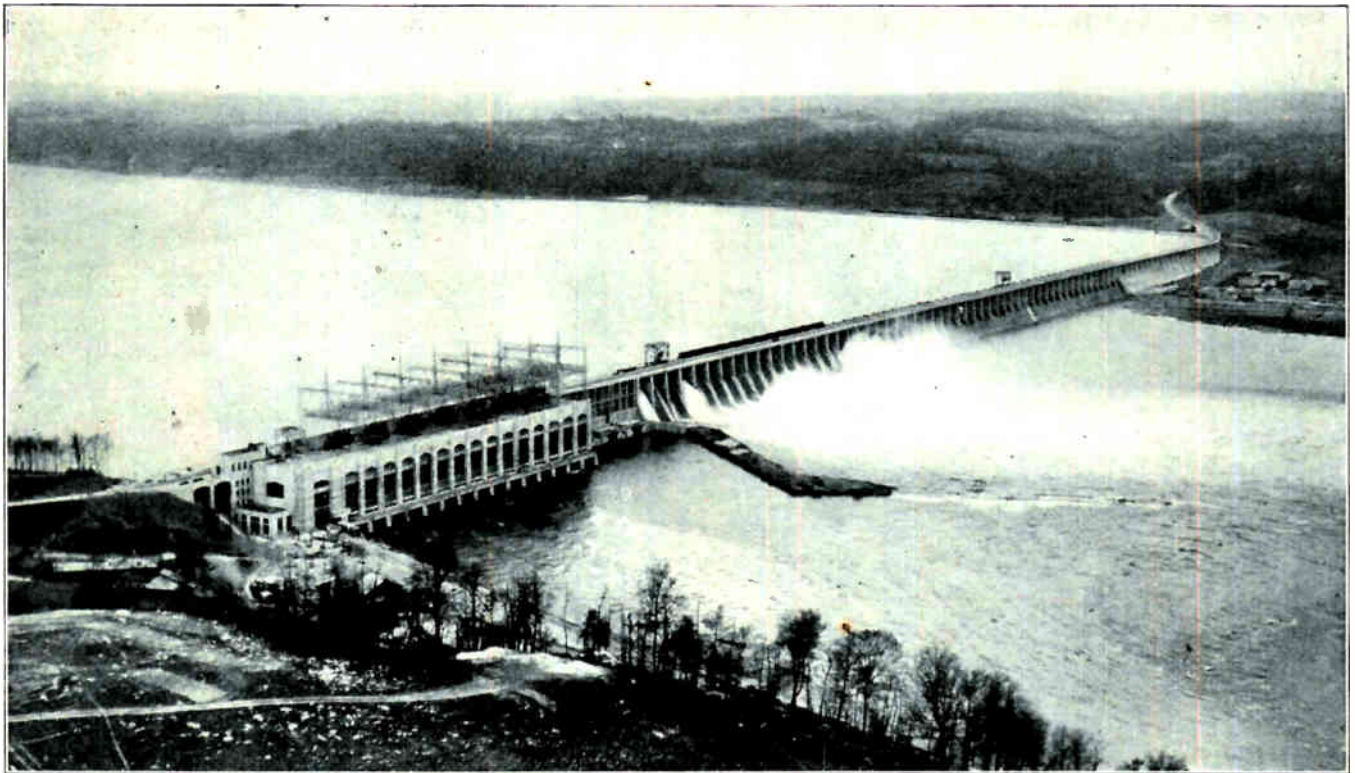

Fig. 4. Enormous hydro-electric generating stations also produce many millions of h. p. to supply the extensive needs for electrical energy. This hydro plant is at Conowingo, Md., and is one of the largest in this country. It produces several hundred thousand h. p. (Photo courtesy Philadelphia Electric Co.)

2½ billion dollars worth of electrical equipment yearly. Try to imagine, if you can, the additional number of men required each year to produce, install, operate, and maintain that equipment.

Approximately 80% of all the money invested in the electrical industry in the U. S. is invested in sixty-cycle, A. C. equipment; and about 90% of all the electric power generated is A. C. So you can readily see the value of a good knowledge of this branch of electricity.

Manufacturing and industrial plants in this country are over 80% electrified at present. The machines in these plants are largely driven by A. C. motors, because of their practically constant speed, rugged construction, and low maintenance costs. Fig. 5 shows a typical example of A. C. motors used for individual drive of machines in a textile mill.

The most common type of A. C. motors have no commutators or brushes, which greatly reduces their wearing parts and the amount of care they require.

Special types of A. C. motors with high starting torque have been developed for certain uses for which D. C. motors were formerly considered necessary, and now there are A. C. motors available for practically every need.

Alternating-current synchronous motors are ideal for operating equipment where absolutely constant speed is required.

In addition to the hundreds of thousands of h. p. used in A. C. motors, factories also use alternating

current very extensively for spot welding and butt welding machines, enameling ovens, heat-treating furnaces, and other processes, as well as for lighting.

Sixty-cycle alternating current is very suitable for lighting with incandescent lamps, as the periods of zero voltage between the alternations are so very short that they do not allow time for any noticeable dimming of the light from the lamp filaments. So wherever alternating current is used for power purposes it is also used for lighting; and in homes, offices, and stores alternating current is by far the most generally used for lighting.

Some very important branches of the electrical industry actually depend upon alternating current for their existence. Radio is one of these, and as the energy used in radio transmission is high-frequency A.C., the study of alternating current principles is very essential to anyone who plans to follow radio work.

The increase in the use of alternating current in the last few years and the thousands of uses which have been developed for it so far, make it almost impossible to over-estimate the extent to which A. C. will undoubtedly be used in the near future.

The high rate of development and expansion in this field requires thousands of additional trained men yearly. There are many of electricians in the field today who have followed D. C. work almost exclusively and know very little about the principles of alternating current and A. C. machines.

Therefore, this branch offers the finest of opportunities to trained practical men who have a good knowledge of alternating current.

And let us emphasize again that, in addition to being a very valuable subject to know, alternating current electricity is one of the most fascinating and interesting subjects any ambitious student can ever hope to find.

Alternating current differs from direct current in many ways, but practically all the principles of electricity which you have learned so far can, with a few modifications, be easily applied to A.C.

Alternating current is often thought to be a difficult subject to master. It does not need to be at all, when properly explained in a practical manner.

In the following pages the principles of alternating current and the operation and care of A. C. machines will be covered in a simple non-technical manner, for the needs of the practical man.

Study these pages carefully for the sake of your future earning capacity, and to qualify yourself for some of the splendid opportunities in this field.

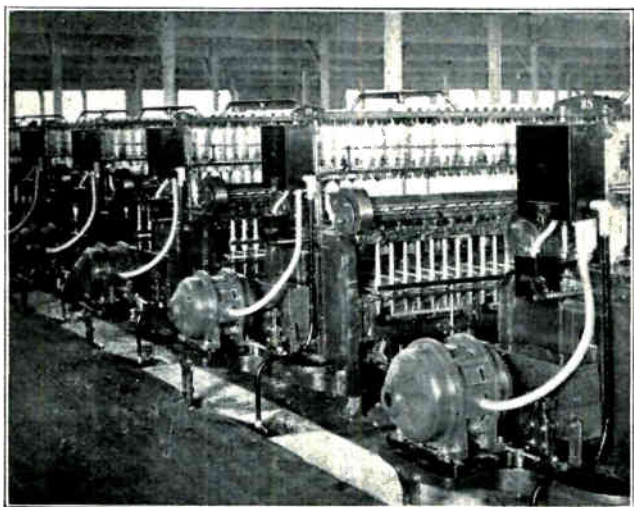

Fig. 5. This view shows a number of A. C. motors being used for individual drive on machines in a textile mill. Thousands of factories and industrial plants use electric motors in this manner for driving their various machines and equipment. (Photo courtesy G. E. Company)

## 1. NATURE OF ALTERNATING CURRENT

In previous sections of this Reference Set we have already explained to some extent the difference between alternating current and direct current. We shall, however, review some of these points and also take up others in detail, as it is very important to have a thorough understanding of the nature and principles of alternating current, in order to properly understand the operation of A. C. machines.

Alternating current is current that constantly changes in value and periodically reverses in direction.

This reversal of the current is caused by the armature conductors passing first a north and then a south pole in the generator.

You have learned that A. C. is induced in the

conductors of any ordinary generator armature, and that to obtain D. C. we must rectify the current from a generator armature by means of a commutator.

Alternating current can be made to produce heat, light, and magnetic effects just as D. C. can. The principal difference in the magnetic fields of A. C. and D. C. circuits is that alternating current produces a constantly varying flux, the lines of which are always in motion or expanding and contracting around the conductor. This alternating or moving magnetic field of alternating current is what makes possible the operation of transformers, to step the voltage up or down as desired.

## 2. INDUCTANCE AND CAPACITY IN A. C. CIRCUITS

The moving A. C. flux also sets up in any A. C. circuit, self-induction due to inductance. This inductance and also a condenser effect, or capacity, which is caused by the constantly varying voltage of A. C. circuits, are the two principal differences between A. C. and D. C. circuits.

We have learned that the important factors in any direct-current circuit are pressure, current, and resistance. We have the same three factors to consider in any A. C. circuit and also the two additional factors—inductance and capacity.

Ohms law applies also to A. C. circuits, with a slight modification to include the inductive and capacity effects on the current, as well as the effects of resistance.

Many of the most important advantages of A. C. and many of the greatest achievements in the electrical industry are based on these two additional factors in A. C. circuits—namely, inductance and capacity. They will both be thoroughly explained a little later.

## 3. GENERATION OF ALTERNATING VOLTAGE

The development or generation of alternating-current voltage is shown in Fig. 7. At the left

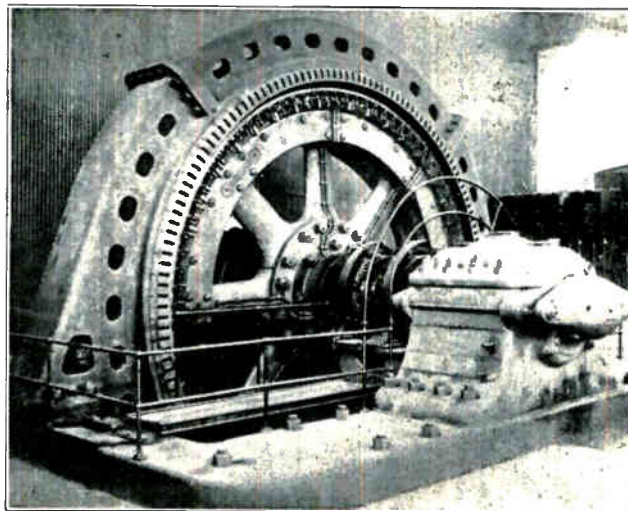

Fig. 6. This large A. C. induction motor is in use in a steel mill and is rated at 6500 h. p. (Photo courtesy G. E. Company)

of this figure is a sketch of a simple two-pole generator in which the progress of the conductor throughout one revolution is shown in eight steps of 45° each. The successive values of voltage which will be induced in this conductor are plotted or projected along a horizontal base-line at the right side of the figure.

The values above the line are positive voltage values and those below the line are negative. Electrical degrees and time are also plotted along this axis line. The electrical degrees are represented by spaces of uniform length and drawn to scale, for example ¼-inch for each 45 degrees, or ½-inch for each 90 degrees, etc.

Other spacing values can be used to suit the size of the drawing desired.

Time "later" is indicated in a right-hand direction and time "earlier" in a left-hand direction. To illustrate this, a vertical line "X Y" is drawn through the axis; and all values on the right-hand side of this vertical line are later in time, while all values on the left are considered to be earlier in time.

While the conductor shown at No. 1 is moving in the neutral plane of the magnetic field it will have no voltage induced in it. Therefore, the voltage value at this point will be as shown at "a" on the axis line. The axis line always represents zero voltage value.

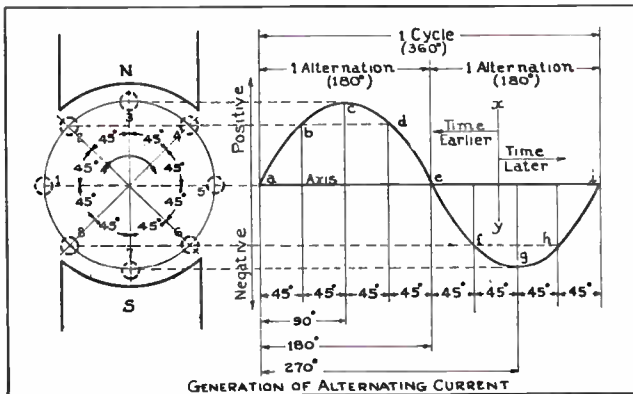

Fig. 7. The above diagram illustrates the manner in which alternating voltage is produced in a simple two-pole generator. The sine curve shows the variations and reversal of voltage for one revolution of the armature. Study this diagram very carefully with the accompanying explanation.

As the conductor moves around the armature 45 degrees in a clockwise direction it comes to position 2, where it is beginning to cut into the field flux of the N pole, and at a more and more abrupt angle. At this point the voltage value will be as shown at "b", or the point where the dotted line running to the right from conductor 2 intersects the vertical time line which is just 45 degrees later than the one at "a".

When the conductor moves another step, or 45 degrees, farther to position 3, it will then be cutting at right angles to the dense flux of the N pole, and will produce a voltage value as shown at "c", where the dotted line from the conductor intersects

the time line, which is now 90 degrees later than the one at "a".

When the conductor moves to position 4 it is beginning to leave the flux from the N pole and its induced voltage will be somewhat lower, as shown at "d". As the conductor moves on to position 5 it is again passing through the neutral plane or at a point where it doesn't cut any appreciable amount of flux, and its voltage will again be at zero value, as shown at "e".

The voltage values which this conductor will produce in passing from position 5 back to 1 will be the same as those from 1 to 5, except that the voltage will be in the reverse direction, as the conductor is now cutting in the opposite direction through the flux of the S pole. These negative values are represented at the points, f, g, h, and i, or below the axis line.

The armature conductor has now passed through a complete set of positive and negative values and through one complete revolution or 360 electrical degrees.

#### 4. SINE CURVES; ALTERNATION, CYCLE, FREQUENCY

If we connect the points a, b, c, d, e, f, g, h, and i all together with a curved line, that line will form what is known as a sine curve. This curve gives us a clear mental picture of the manner in which the voltage varies in amount or value and reverses in direction in an alternating-current circuit.

The values from "a" to "e" are all positive and constitute 180 E°, or one alternation. The values from "e" to "i" form the negative alternation. These two successive alternations, one positive and one negative, complete one cycle.

If we were to go on revolving the conductor rapidly it would produce one cycle after another of alternating current, provided the coil were connected to a closed circuit. The number of these cycles which occur in each second of time is called the frequency of an alternating current circuit, and is expressed in cycles per second. Nearly all A. C. systems in this country today use 60-cycle frequency.

Examine the diagram in Fig. 7 very carefully, until you are sure you know the number of electrical degrees in one alternation and in one cycle.

A conductor in a generator must always pass one pair of poles, or one north and one south pole, to complete a cycle. Therefore, the greater the number of poles in a generator the greater will be the number of cycles it will produce per revolution. The frequency of any A. C. generator can always be determined by the following simple formula:

$$f = \frac{\text{RPM}}{60} \times N$$

In which:

- f = frequency in cycles per second
- RPM = revolutions per minute of generator
- 60 = no. of seconds per min.
- N = no. of pairs of poles in generator

## 5. FLOW OF ALTERNATING CURRENT

If an alternating voltage such as shown in Fig. 7 is applied to a closed circuit, alternating current will flow. The current will, of course, vary in amount and reverse in direction, just as the voltage does. These alternations or impulses of current can be shown by a curve similar to the one for voltage in Fig. 7. Current first starts to flow around the circuit in one direction, and continues in this direction during one alternation, or  $180^\circ$ . In a 60-cycle circuit this would be for  $\frac{1}{120}$  part of a second.

During this period the current value or intensity keeps gradually increasing up to maximum during the first  $90^\circ$ , or one-half alternation. Then it starts to decrease in amount, but continues in the same direction for another  $90^\circ$ , or the last half of the alternation.

When the current in this direction has fallen to zero value, it then reverses and flows in the other direction for one alternation or  $\frac{1}{120}$  part of a second, again rising and falling in value or amount.

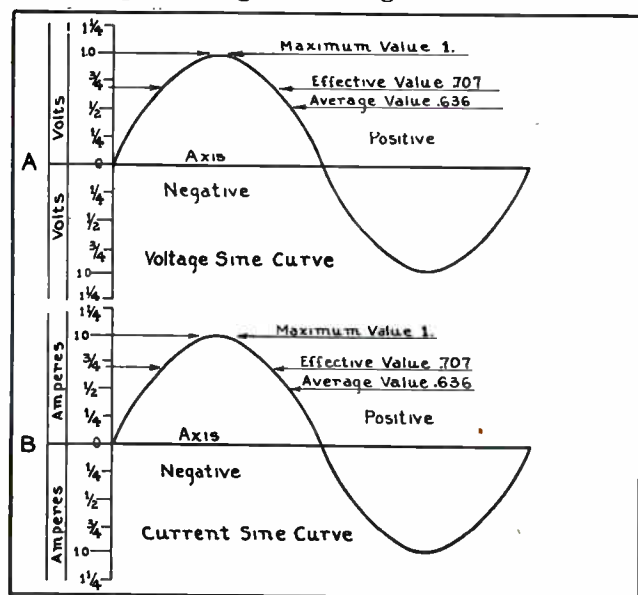

Fig. 8. These sketches show the maximum, effective, and average values of alternating voltage and current.

## 6. MAXIMUM AND EFFECTIVE VALUES OF ALTERNATING CURRENT

Fig. 8-A shows a curve for one complete cycle of single-phase alternating voltage, and Fig. 8-B shows a curve for the current that we will assume is caused to flow by that same voltage cycle.

These curves show maximum values of one volt and one ampere for this circuit. You will note that these maximum values last for only a very short period during each alternation. So, if we were going to determine the heating effect or power that would be continuously produced by such an A. C. circuit with one volt maximum pressure and one ampere maximum current, we could not expect as great a result as from a D. C. circuit with one volt continuous pressure and one ampere continuous current.

By actual test we find the heat produced by the

A. C. circuit is about 70%, or to be more exact .707 of that produced by the D. C. circuit.

We therefore say that the effective voltage and current values of an A. C. circuit are .707 of the maximum values. It is this effective value that we consider in ordinary work and calculations with A. C. circuits. Ordinary A. C. voltmeters and ammeters are calibrated to read the effective values and not the maximum values.

Therefore, if an A. C. circuit has meter readings of 100 volts and 100 amperes, we know these to be the effective values; and this circuit would produce just as much heating effect as a D. C. circuit of 100 volts and 100 amperes.

Compare carefully the effective and maximum values shown in Fig. 8. You will note that the effective value is nearly three-quarters of maximum value.

If an A. C. circuit has a maximum voltage value of 100 volts, the effective value would be  $.707 \times 100$ , or 70.7 volts.

## 7. CALCULATION OF EFFECTIVE AND MAXIMUM VALUES

The effective values of an A. C. voltage or current curve for any alternation, can be calculated by what is called the root mean square (R.M.S.) method.

This calculation is made by getting the instantaneous values of the curve at points one degree apart and squaring all these values. Next all these squares are added together and averaged, by dividing the sum by the number of squares. Then, taking the square root of this average, we would have the root mean square; or, in other words, the square root of the average square of the separate values.

This method of squaring the curve values and then getting the square root to obtain the effective value, is used because the heating effect of any A. C. circuit is proportional to the square of current at any instant.

The process just described may seem somewhat technical, but with a little reviewing you will find that the principle is quite simple.

You may not have occasion or need to use the R.M.S. method in any calculation in your ordinary electrical work for some time; but it may be very handy for some future reference, so it is given here for your convenience at any later time. It is also given as a matter of interest, so you may know how the effective value is obtained and where the figure .707 comes from.

Remember that an A. C. circuit will perform just as much work per volt and per ampere as a D. C. circuit, because ordinary A. C. meters read the effective values only, and these are the values commonly considered in A. C. work.

One of the most important points to be considered, however, is that to produce a given effective voltage in an A. C. circuit, the maximum voltage for its short periods during each alternation will be considerably higher than the effective voltage

registered by the meter. This places a higher voltage strain on the insulation of an A. C. circuit of a given effective voltage value, than on a D. C. circuit of the same voltage.

When either the maximum or effective value of an A. C. circuit is known, the other can be found by one of the following formulas:

$$\begin{aligned} \text{Effective value} &= \text{Max. value} \times .707 \\ \text{Maximum value} &= \text{Eff. value} \div .707 \end{aligned}$$

It is often easier to multiply by the reciprocal of a number than to divide by the number itself, and the same result can be obtained by either method. You will recall that the reciprocal of a number is equal to 1 divided by the number. So, in the case of the effective value .707, its reciprocal is equal to  $\frac{1}{.707}$ , or 1.414.

Accordingly, the above formula for finding maximum value can be changed to read:

$$\text{Max. value} = \text{eff. value} \times 1.414$$

The use of this formula is illustrated by the following example.

If we have a motor which is being rewound to operate on a 2200-volt circuit, what would be the maximum voltage stress on its insulation?

If the effective value is 2200 volts, then:

$$\text{Max. value} = 2200 \times 1.414, \text{ or } 3110.8 \text{ volts}$$

This would be the maximum voltage impressed on the insulation of the motor winding and, allowing enough extra for safety factor to prevent possibility of puncture of the insulation, it would probably be insulated for 5000 volts or over.

## 8. AVERAGE VALUE OF ALTERNATING CURRENT

By referring again to Fig. 8, you will note that an average value of the curves is also shown. The average value is .636 of the maximum value. This figure is used in a few electrical calculations and in the design of electrical machines, but not a great deal in ordinary electrical work.

Because of the shape of the sine curves for alternating current and the fact that the heating effect is proportional to the square of the current values, the effective value is actually a little higher than the average value, as shown in Fig. 8.

The voltage alternations produced by an actual power generator would not be quite as smooth or perfect in shape as the curves shown in these figures. Instead they would have little irregularities or ripples in them; but as they follow the same general shape, all ordinary circuit calculations for A. C. are based on the true sine curves as shown.

## 9. SINGLE-PHASE AND POLYPHASE CURRENTS

You have already learned that A. C. circuits are of single-phase, two-phase, and three-phase types; and in the section on A. C. armature winding the method of generating single-phase and polyphase currents was explained. If you find it necessary to refresh your memory on these points, review pages 1 to 5 of Section Two of Armature winding.

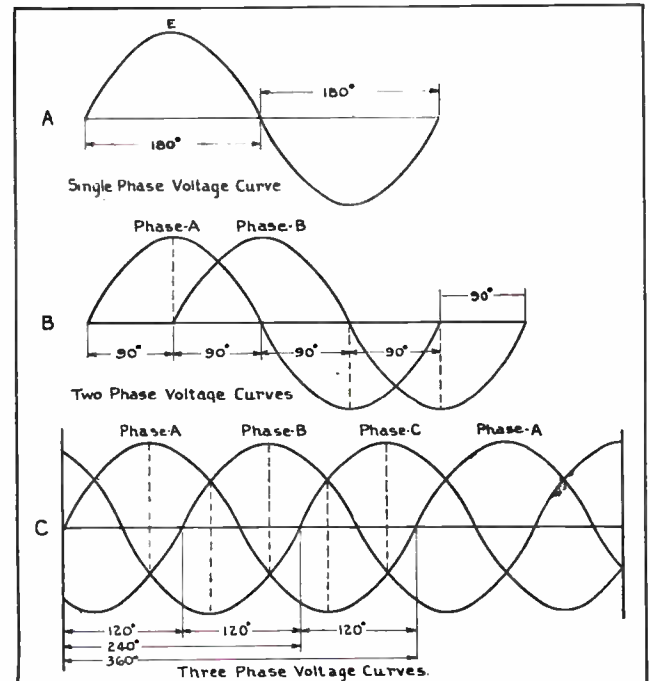

Fig. 9. The above diagram shows the sine curves for single-phase, two-phase, and three-phase alternating voltages.

You will recall that the term "phase" refers to the number of parts of an A. C. circuit or the number of separate sets of alternations in the circuit.

Fig. 9 shows three sets of curves for single-phase, two-phase, and three-phase circuits. The single-phase curve at "A" has successive alternations of  $180^\circ$  each. The two-phase circuits have two sets of alternations occurring  $90^\circ$  apart; that is, they start, reach their maximum values, and finish always  $90^\circ$  apart. Three-phase circuits have three sets of alternations,  $120^\circ$  apart, as shown at "C" in the figure.

You will recall that these alternations are generated with the various spacings in degrees, by spacing the armature conductors the same number of electrical degrees in the generators.

Each alternation of any single-phase or polyphase circuit consists of  $180^\circ$ , and each cycle consists of  $360^\circ$ . Keep in mind also that the poles in an alternator are always spaced 180 electrical degrees apart, and that a pair of poles constitutes 360 electrical degrees.

Six-phase energy is also used in some cases, for converters and rectifiers. Fig. 10 shows a set of curves for six-phase energy. Two-phase circuits are still used to some extent in older installations. Single-phase and three-phase systems are by far the most commonly used. Single-phase systems are used extensively for incandescent lighting and small power motors, and three-phase systems are used almost exclusively for large motors, general power work, and transmission lines.

## 10. PHASE RELATIONS OF VOLTAGE AND CURRENT

The voltage and current of an A. C. circuit can both be shown in the same diagram by separate sets

of curves drawn along the same zero or axis line, as shown in Fig. 11. This figure shows the curves for a three-phase circuit. The solid lines represent the voltage impulses and the dotted lines represent the current impulses.

In this diagram the current value is shown to be slightly less than the voltage value by the lower height of the curves; but the current alternations are in phase or in step with the voltage alternations. In other words, the current and voltage alternations of each phase start together, reach their maximum values together, and finish together.

This seems to be the proper or natural condition, as you know that the current variations are caused by the variations in pressure or voltage; so it would seem quite natural that the two should be in step, or "in phase", as we say.

It is possible, however, to have the current impulses occur out of phase with the voltage impulses in A. C. circuits, due to the effects of inductance or capacity in these circuits.

The current may either lag or lead the voltage, according to whether the inductance or capacity is greatest in the circuit. These conditions will be fully explained a little later.

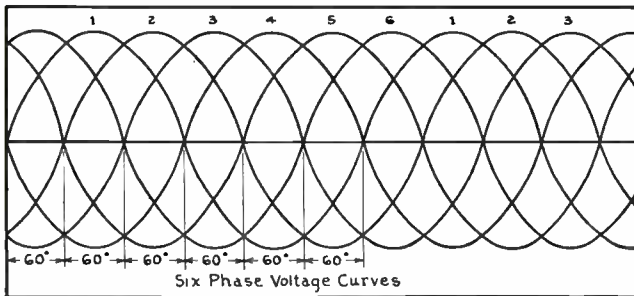

Fig. 10. This sketch shows the sine curves for the voltage of a six-phase A. C. circuit. Compare these sketches carefully with the ones in Fig. 9, and note the number of degrees spacing between each phase and the next.

## 11. EFFECT OF LAGGING OR LEADING CURRENT ON POWER

When the current and voltage impulses are in phase with each other, or working together in the same direction, they will, of course, produce more useful power in watts than when they are out of phase or working in opposite directions part of the time.

When current and voltage are in phase as shown in Fig. 12, the product of the voltage and current values at any instant will give the watts power at that instant.

The power curve in this diagram is shown by the heavy line, and is all above the axis line, representing useful power.

In Fig. 13 the voltage and current are slightly out of phase, and the current is lagging a few degrees behind the voltage. This causes short periods during each alternation when the voltage and current are in opposite directions, as shown between the lines "a" and "b". During this period there is no useful power in watts produced and the power curve

is shown below the axis line, representing what is known as wattless power.

This wattless power does not produce any useful power on the system, but merely produces additional heating of the conductors, and thereby limits the capacity of generators, motors, and lines in which this condition exists.

When multiplying the values of voltage and current curves to obtain the power in watts at any instant, the polarity of the curves must be carefully observed. When voltage and current curves are of the same direction or polarity, their product will all be positive or useful watts, and is shown by the power curve above the axis line. At points where the voltage and current curves are of opposite polarity, their product will give negative or wattless power, shown by the power curve below the axis line.

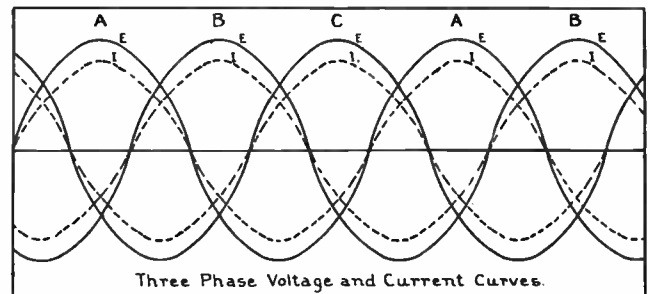

Fig. 11. Voltage and current curves of a three-phase circuit. The voltage is shown by the solid lines and the current by the dotted lines.

## 12. A. C. CIRCUITS

The practical man will often have occasion to make simple measurements and calculations with the voltage, current, and power of A. C. circuits, in his work in the field as an electrical construction man, power plant operator, or maintenance man.

These calculations can be made with A. C. circuits in very much the same manner that you have already learned for D. C. circuits; and just as easily, once you have a thorough knowledge of A. C. principles and the important factors which control the current and power in A. C. circuits.

It is sometimes difficult for a student to see how these calculations can be made with A. C., because of the manner in which the voltage and current are continuously and rapidly varying in value and re-

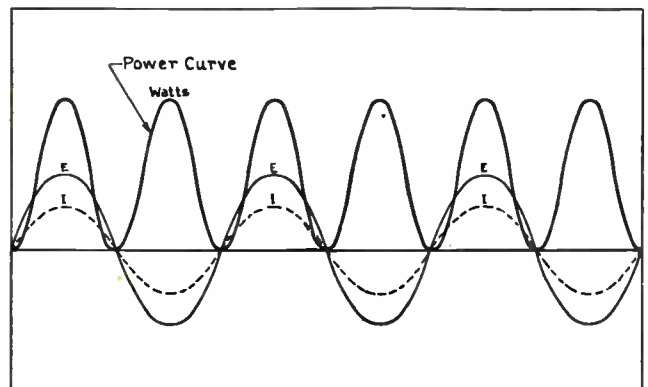

Fig. 12. This diagram shows the curves for the voltage, current, and power of single-phase A. C. circuit, in which the voltage and current are in phase with each other.

versing in direction. It is our purpose to simplify these points and avoid the unnecessary misunderstanding and difficulties which so frequently worry students and electricians who do not have a proper understanding of the simple fundamentals of alternating current.

An excellent fact to keep in mind at all times is that an alternating current circuit can at any particular instant be compared to a D. C. circuit.

As we usually work with the effective values of current and voltage in A. C. circuits and can always consider the circuit during a certain period of one alternation, or as the current is flowing in only one direction for the moment, this greatly simplifies tracing the flow of current in the circuit and making any calculations with the current or voltage.

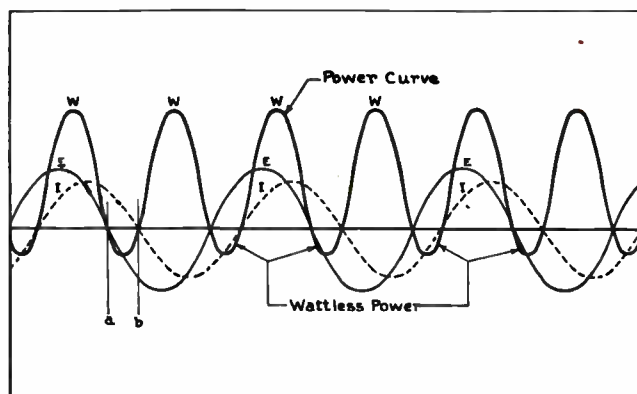

Fig. 13. Voltage, current, and power curves of a single-phase circuit in which the voltage and current are out of phase. The current, represented by the dotted curves, is shown lagging behind the voltage in this case.

### 13. INDUCTIVE REACTANCE, CAPACITY REACTANCE, and IMPEDANCE

We have already mentioned that in A. C. circuits there are always two other factors besides resistance which control the current flow, and these are inductance and capacity.

The effects or opposition offered by inductance and capacity to the current and voltage of an A. C. circuit, are known as inductive reactance and capacity reactance.

If resistance, inductive reactance, and capacity reactance all tend to control the current flow in A. C. circuits, we should be able to sum these all up together to get the total controlling effect on the current and thus simplify our calculations and problems. That is exactly what we can do.

The total opposition offered to the flow of current in an A. C. circuit, is called impedance. The impedance of an A. C. circuit therefore, compares with the resistance of a D. C. circuit.

The factors that make up the impedance can be illustrated in another way as shown in Fig. 14.

Impedance is here shown as being composed of the resistance and total reactance. The total reactance is then subdivided into its two classes, Inductive reactance and Capacity reactance.

The impedance and reactance of A. C. circuits are both measured in the unit ohm, to be comparable to the resistance in ohms.

The symbols used to indicate these very important factors of A. C. circuits are as follows:

- Z = Total impedance in ohms
- X = Total reactance in ohms
- X<sub>L</sub> = Inductive reactance in ohms
- X<sub>C</sub> = Capacity reactance in ohms
- R = Resistance in ohms.

### 14. OHMS LAW FOR A. C. CIRCUITS

Now that we know the factors that control the flow of current in A. C. circuits and also that they can all be grouped into impedance in ohms, it is easy to see how Ohms law can be applied to an A. C. circuit by simply substituting the ohms of total impedance for the ohms resistance used in D. C. Ohms law.

From Ohms law for D. C. circuits we learned that the current flow could be determined by dividing the voltage by the resistance in ohms. Then for A. C. circuits, the current can be determined by dividing the effective voltage by the impedance in ohms. Or,

$$I = \frac{E}{Z}$$

And from this we can obtain by transposition the other two very convenient formulas:

$$Z = \frac{E}{I}, \text{ and } E = I \times Z$$

As inductance and capacity are such important factors in A. C. circuits, and are the cause of inductive reactance and capacity reactance, it will be well to learn more about them. In addition to offering opposition to the current and voltage, inductance and capacity also cause the current to be out of phase with the voltage in most A. C. circuits. For these reasons we will explain them in detail in the following paragraphs.

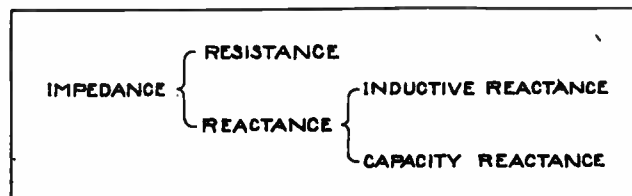

Fig. 14. This figure shows the several different factors which make up the impedance in an A. C. circuit.

### 15. INDUCTANCE

Inductance is that property or ability which an electric circuit possesses for developing a counter electro-motive force within the circuit itself, by electro-magnetic induction.

The counter-E. M. F. due to inductance is caused by the variations or changes of current strength in the circuit, and the corresponding changes or variations in the magnetic flux around it.

All A. C. circuits will have a certain amount of inductance. In some cases this inductance is so small that it can be disregarded entirely in ordinary problems; while in other cases the inductive effect is so great that the whole operation of the circuit or device may depend upon it.

Inductance tends to oppose every change of current that occurs in any circuit, by generating or inducing a counter-voltage of self-induction as the changing flux cuts across the conductors of the circuit itself.

For this reason, A. C. circuits which have coils or machine windings connected in them, have a much greater inductance than straight wires or lines, or incandescent lighting circuits. This is because coils and windings set up very strong fields of concentrated magnetic flux, and as these lines of force cut across the turns of the coil they generate considerable counter-voltage of self-induction.

A. C. circuits to which are connected induction motors and transformers are very highly inductive, because of the windings of these machines and their location on the iron cores of the device, in a manner which is ideal for establishing very strong magnetic fields.

Ordinary incandescent lighting circuits are considered as practically non-inductive because their inductance is so small that it is usually not considered in ordinary calculations.

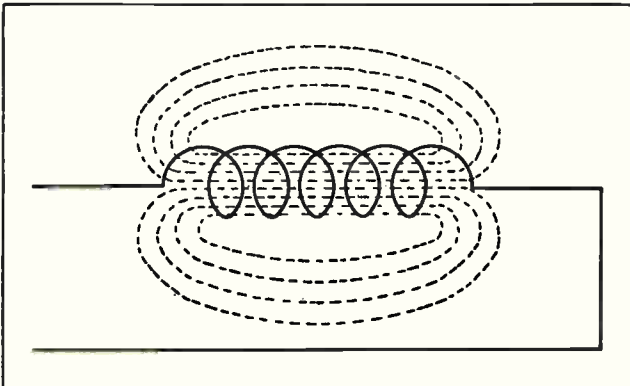

Fig. 15. The alternating flux around coils or wires of A. C. circuits produces voltage of self-induction and inductive reactance in the circuits.

The counter-voltage and inductive reactance which result from inductance in the winding of A. C. machines, regulates or limits the current flow a great deal more than the ohmic resistance does. This is the reason why many A. C. machines and devices will be burned out almost immediately if they are connected to a D. C. circuit of the same voltage.

The direct current, being constant in value, does not have a continually varying or moving flux to set up the counter-voltage of self-induction.

The unit with which we measure inductance in a circuit is called the henry. A circuit has an inductance of one henry when a current change of one ampere per second will induce one volt counter-voltage of self-induction in that circuit.

The unit "henry" is sometimes known as the coefficient of self-induction, and the symbol for this unit, "henry", is the capital letter L. Therefore, the expression 10 L means 10 "henrys" of inductance in the circuit.

Sometimes the inductance of a circuit is much

less than one henry, and is expressed in milli-henrys (M. H.), or 1/1000 part of a henry.

## 16. COUNTER-VOLTAGE OF SELF-INDUCTION

Fig. 15 illustrates the manner in which the counter-voltage is built up by induction in a coil in an A. C. circuit. The current flowing through the coil sets up a strong magnetic field around all its turns.

We know that with alternating current these lines of force will be constantly expanding and contracting, and reversing in direction, as the current varies in amount and reverses in direction.

As the lines of force expand and contract, and cut across the turns of the coil in first one direction and then another, they will induce a voltage which opposes the applied voltage.

It will be well to keep this fact always in mind—that the electro-magnetically induced currents are always in such a direction that the field set up by them tends to oppose or stop the force which produces them. This is known as Lenz's Law, as it was discovered by an early experimenter named Lenz.

The manner in which the counter-voltage is set up by induction is illustrated more in detail in Fig. 16. In this figure we have shown a sectional view of a coil of wire as though the turns were all cut in half, lengthwise through the coil. The current set up by the applied line voltage at the particular instant, is shown flowing in at the lower conductor ends and out at the top ends.

The flux which will be set up by this current is shown around the lower end of the right-hand turn of the coil. Flux would, of course, be set up around all the turns but, for convenience in illustrating the principle of induction, is shown only around this one turn.

When the current of one alternation in the circuit builds up in the turns of the coil, the flux shown around the conductor or single turn will expand

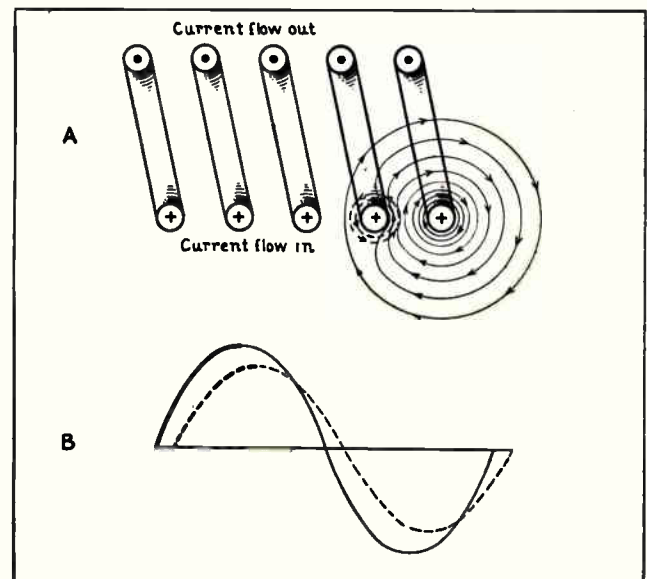

Fig. 16. The above diagram illustrates the manner in which the counter-voltage of self-induction is built up in an inductance coil.



more and more until the current reaches maximum value. During this building up of the current and flux, the lines will be cutting across adjacent turns of the coil in the direction shown, and will be inducing a voltage in them.

By applying the right-hand rule for induced voltages, we find that the direction of the voltage induced in the second turn of the coil, will be opposite to the applied voltage. This also checks with Lenz's law which says that the direction of the induced current will be such that its field will oppose the force that produces it.

When we consider that the flux of a coil in an A. C. circuit will be continually cutting across all turns of that coil, and that the counter-voltage it will induce in all these turns will add together as the turns are all in series, we can then see that the counter-voltage of self-induction in such a coil may greatly limit the flow of current through it.

If we place an iron core in such a coil, and allow it to build up a much stronger field, this will greatly increase the inductance of the coil. Such coils are often called choke coils because of the "choking" or limiting effect which their counter-voltage has on the flow of alternating current through them.

A coil of several hundred turns wound on a large iron core and connected across a 110 or 220-volt, 60-cycle circuit, may produce nearly as much counter-voltage as the applied line voltage, and allow only a very small current to flow through the coil.

This explains why coils of A. C. devices or machines are usually wound with a much smaller number of turns than are D. C. devices for circuits of the same voltage; because on A. C. circuits the inductive reactance or counter-voltage controls the current even more than the ohmic resistance does.

This self-induced voltage caused by the inductance of a coil as shown in Fig. 16-A, being in a direction which opposes the applied line voltage, actually

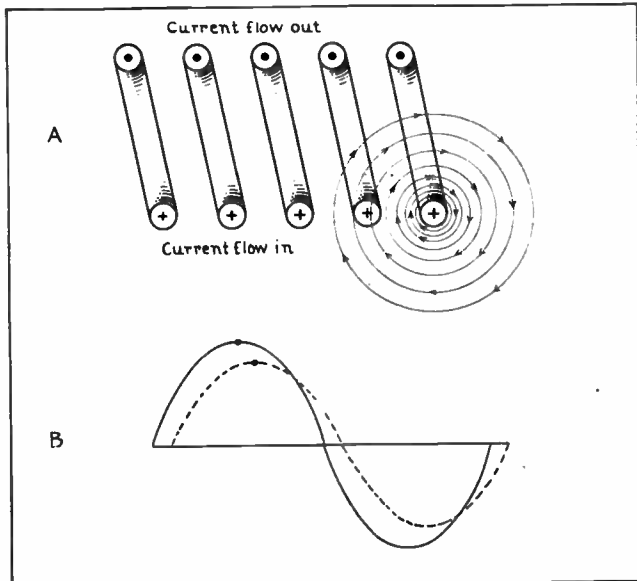

Fig. 17. This view shows the flux around one turn of a coil during the period when the current is at maximum value. The flux is neither contracting nor expanding at this period, and therefore produces no voltage of self-induction.

tends to make the current in the coil lag behind its voltage. That is, the current alternation does not reach its maximum value until a few degrees later than the voltage does, as shown by the curves in Fig. 16-B.

When the voltage of the alternation reaches maximum value, the current tends to stop increasing, but this causes the flux around the conductor to stop expanding and also to stop generating the counter-voltage in the turns of the coil. This allows the current to rise to its full maximum a little later than the voltage reaches its peak.

This is illustrated in Fig. 17-A, where the flux has stopped expanding and producing counter-voltage; and on the curves at "B" the current and voltage peaks are marked by the round dots.

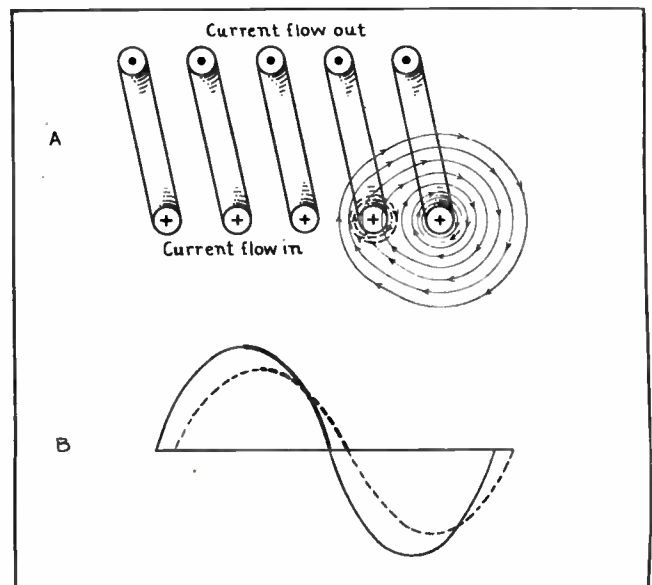

Fig. 18. This sketch shows the same coil as in Figs. 16 and 17 during a period when the current through the coils is decreasing from maximum to zero value. Note how the flux contracts and cuts across the turns of the coil.

As the voltage starts to reduce and causes the current to decrease, the lines of force around the turns of the coil will start to contract or die down as shown in Fig. 18-A. They are now cutting across the turns of the coil in the opposite direction to what they formerly were, and so they induce a voltage in the same direction as the applied voltage. This self-induced voltage now adds to, or aids, the applied voltage, which still further explains why the current flow reaches its maximum value after the voltage does.

As the voltage dies on down to zero and the current also tends to decrease to zero, the contracting lines of force keep on inducing voltage that tends to make the current continue in the same direction, even for a short instant after the applied voltage has reached zero.

Thus the current of the alternation reaches its zero value slightly later than the voltage does.

## 17. LAGGING CURRENT CAUSED BY INDUCTANCE

From these illustrations we can see that induct-

ance causes the current to reach its maximum and zero values a few degrees later than the voltage, or to lag behind the voltage. Inductance, therefore, causes the current to be out of phase with the voltage. The greater the inductance of an A. C. circuit, the farther its current will lag behind the voltage.

In circuit diagrams inductance is usually represented by turns of a coil, as shown in Fig. 15.

In a circuit that has practically all inductance and very little resistance, the current would lag almost 90 degrees behind the applied voltage. If it were possible to have a circuit with all inductance and no resistance, the current lag in that circuit would then be 90°. This condition is, of course, not possible, because all circuits have some resistance.

Fig. 19 shows the curves for the applied voltage  $E$ , counter-voltage of self-induction  $E_c$ , current  $I$ , and flux  $F$ , for a circuit that we shall assume has inductance only and no resistance.

The change in current value and the corresponding flux change are much more rapid as the current passes its zero point. This can be seen by noting the various amounts of current change along the curve  $I$ , between the vertical time lines which divide the alternation into even time periods of  $\frac{1}{8}$  alternation each. You will note that the current change from "l" to "m" is much greater than in the next equal time period from "m" to "n".

This very rapid change of current and flux will cause the maximum counter-voltage to be induced at the time the current passes through its zero value. The curve  $E_c$  shows the counter-voltage at maximum during this period.

The current changes at the lowest rate when near its maximum value, or from "o" to "p", and "p" to "q". The correspondingly slower flux change at this point causes the induced counter-voltage to be at or near zero value during this period.

So we find that the counter-voltage of self-induction in this case lags behind the current by 90 degrees. The applied line voltage to overcome the counter-voltage is 180° out of phase with it, or in direct opposition to the counter- $E$ . M. F.

The applied voltage therefore "leads" the current by 90°, or as we more commonly say, the current "lags" the voltage by 90°.

In actual circuits, the current would never lag this far but would be somewhere between this point and the "in phase" position, according to the amount of inductance in the circuit.

The curve  $E$ , which represents the applied voltage to overcome the voltage of self-induction, is shown 180° out of phase with the voltage of self-induction and 90° ahead of the current.

In any actual circuit the energy voltage would be a few degrees later than the voltage curve  $E$  in this figure, because there would be a little resistance to overcome.

The applied voltage in Fig. 19 is shown at zero value when the current is at maximum, while in an actual circuit having some resistance, the energy

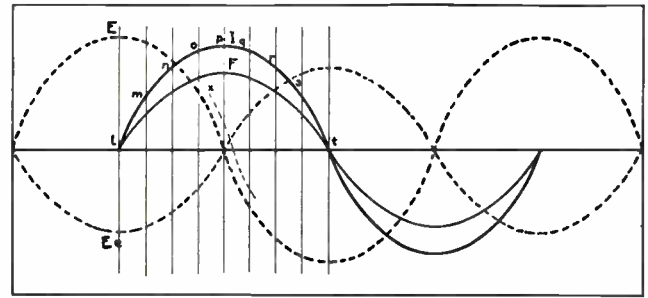

Fig. 19. Curves for a single-phase circuit in which the current and voltage are approximately 90° out of phase with each other, due to inductance in the circuit.

voltage would still be a little above the zero value, as shown by the short dotted section of the curve at "X".

## 18. SELF-INDUCTION IN D. C. CIRCUITS

While there is practically no inductive effect or counter-voltage of self-induction in a D. C. circuit as long as the current does not vary, there is often considerable voltage of self-induction set up in windings of large D. C. machines or magnets when the circuit is first closed or opened. This effect is encountered with the rotors or fields of large alternators, as their coils are excited by D. C.

When D. C. voltage is first applied to the field winding of large machines, it may actually require several seconds or more for the current to build up to its full value and overcome the effects of self-induced counter-voltage set up by the expanding flux.

When such circuits are opened, the sudden collapse of flux around the coils may induce very high voltage, which tends to oppose the decrease of current or keep the current flowing in the same direction. This accounts for the very severe arcs drawn when some highly-inductive D. C. circuits are opened.

The choking effect or counter-voltage of self-induction in an A. C. circuit will vary directly with the frequency of the current, or the rapidity with which the flux changes and reversals are made.

This fact is taken advantage of in constructing certain devices, such as choke coils for lightning arresters, load-limiting reactors, etc. These devices will be explained later.

## 19. CALCULATING INDUCTANCE AND INDUCTIVE REACTANCE

The amount of inductance which any coil or device may have in henrys can be calculated by the following formula:

$$L = \frac{\text{Maximum flux} \times \text{no. of turns}}{\text{Maximum current} \times 10^8}$$

In which:

$10^8 = 100,000,000$ , or the no. of lines of force necessary to be cut in one second to produce one volt.

When the inductance of a certain device or circuit is stated or known in henrys, the inductive reactance in ohms can be found by the following formula:

$$X_L = 2\pi \times f \times L$$

In which:

$X_L$  = inductive reactance in ohms

$\pi$  = 3.1416, or ratio of circumference to diameter of a circle

$2\pi$  = 6.2832

$f$  = frequency in cycles per second

$L$  = inductance in henrys

This formula is very important, as the inductive reactance is one of the factors we need to know in order to apply the A. C. ohms law for making any A. C. circuit calculations.

As most A. C. power circuits are highly inductive due to the machine windings, as previously explained, inductive reactance is the factor most commonly encountered in ordinary A. C. work in power plants and industrial plants.

Induction motors and transformers are highly inductive devices.

## 20. CAPACITY

In alternating current circuits there is always a certain amount of condenser effect, or tendency to store an electro-static charge as the varying voltage of each alternation is applied. This condenser effect is known as the capacity of a circuit.

You will recall, from an explanation of condensers in the Elementary Section of this set, that a condenser consists of two or more surfaces or areas of conducting material, separated by an insulator or dielectric. This condition exists in an electric circuit, as the wires form the conducting areas, and their insulation, or in some cases air only, forms the dielectric between them.

You have also learned in the earlier discussion of condensers that the amount of charge in coulombs which a condenser will absorb depends on the voltage applied.

On ordinary low-voltage A. C. circuits of short length, the condenser or capacity effect is so small that it need not be considered in every day problems. On high-voltage transmission lines of great lengths, the capacity effect is often very great and must be carefully considered in several ways.

For example, such lines may store such a charge that even after they are disconnected from the power plant they may hold a charge of thousands of volts and many kilowatts. In fact, they often hold so much of a charge for a short period after the voltage source has been disconnected from them, that the wires would be very dangerous to handle until after they have been shorted together or grounded by placing a ground wire across them. This discharges the capacity charge stored in the line and makes the wires safe to handle.

## 21. UNIT OF CAPACITY

Capacity of electric circuits or condensers is measured and expressed by the unit, farad. A condenser has one farad capacity when a charge of one coulomb will raise the condenser potential one volt.

The coulomb, you will recall, is a flow of one am-

pere for one second. A condenser of one farad capacity will take a charge of one coulomb when one volt is applied to its terminals.

Most condensers have capacities of only a few millionths of a farad; so the unit micro-farad, meaning  $\frac{1}{1,000,000}$  of a farad, is much more commonly used than the larger unit.

Capacity is, however, always expressed in farads or fractions of a farad when used in calculations. For example, 50 microfarads would be expressed as .000,050 farad. The symbol for farads or capacity is the large letter "C".

## 22. CONDENSER CHARGING CURRENT

When voltage is first applied to the terminals of a condenser, as shown in Fig. 20, a current will at once start to flow into the condenser to store up its electro-static charge. If the direction of the applied voltage and current for the instant are as shown by the arrows in Fig. 20-A, the top plate of the condenser will become positively charged and the lower plate negatively charged, as shown.

When the voltage is first applied to a condenser and before its plates have had time to build up their charge of voltage, the current flow into the condenser will be very rapid and at maximum value, even though the applied voltage is still very low. This is illustrated by the curves in Fig. 20-B. The curve E represents the applied voltage; the curve I, the current flow to the condenser; and the dotted curve  $E_c$ , the counter-voltage of the condenser. These curves are shown for a circuit that has practically all capacity and very little resistance.

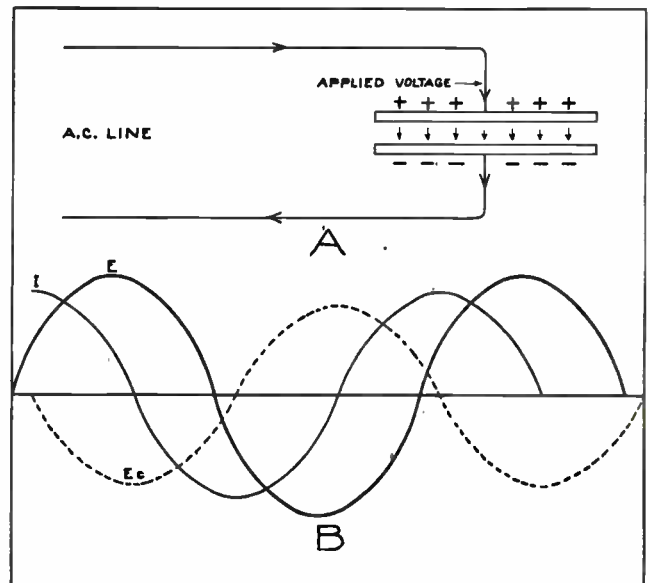

Fig. 20. This diagram shows the current leading the voltage by nearly 90°, due to capacity or condenser effect in the circuit.

You will note at the first curve on the left that the current reaches maximum value just a little later than the applied voltage starts from zero value. Then, as the applied voltage keeps on increasing, the counter-voltage,  $E_c$ , of the condenser is building up and reduces the flow of current, until it reaches

zero value just after the applied voltage reaches maximum.

In this circuit, therefore, the current leads the voltage by nearly 90 degrees. If it were possible to have a circuit with all capacity and no resistance, the current would lead the voltage by 90°.

When the applied voltage passes its maximum value and starts to die down, the condenser starts to discharge, causing the current to start to flow in the reverse direction just after the applied voltage reaches maximum.

As the condenser discharges, its counter-voltage dies down as shown by the dotted curve  $E_c$ , until it reaches zero value just a few degrees later than the applied voltage does.

When the alternating voltage reverses, the current flows into the condenser in the opposite direction and charges its plates with opposite polarity.

In this manner a condenser receives its heaviest or maximum current just as the applied voltage reverses and starts to build up in a new alternation, and then the condenser discharges its current ahead of the next voltage reversal, causing the current in such a circuit to lead the voltage.

Current does not actually flow through a condenser as long as its insulation is not punctured by too high voltage, but the rapid flow of alternating current in and out of a condenser as it charges and discharges, provides a flow of current that can be measured by an ammeter or used to operate devices, just as though it actually flowed clear through the circuit.

The amount of the charging current is proportional to the size or capacity of the condenser, and is also proportional to the amount and frequency of the applied voltage.

When a condenser is connected in a high frequency circuit it will allow a much greater flow of current than when in a low frequency circuit.

Condensers in a D. C. circuit do not allow any current flow except during the first instant that the voltage is applied, and while the condenser is taking its charge. If a condenser which has been charged in this manner is short-circuited, it will discharge its energy in one violent rush of current.

### 23. CAPACITY REACTANCE

Capacity of an A. C. circuit causes capacity reactance, or condensive reactance, as it is often called. This condensive reactance tends to oppose the flow of current similarly to resistance and inductive reactance.

Capacity reactance tends to oppose any change in the voltage of a circuit, and causes the voltage to lag behind the current, as previously explained.

We learned that inductive reactance causes the current to lag behind the voltage; so we find that in this respect capacity reactance is opposite to inductive reactance.

Lagging voltage can also be expressed as "leading current", as both terms express the same condition in the circuit. In describing the phase relations

of the voltage and current, we usually say "lagging current" or "leading current"; and seldom refer to lagging voltage.

When the capacity of any circuit is known in farads, the capacity reactance in ohms can be determined by the following formula:

$$X_c = \frac{1}{2\pi \times f \times C}$$

In which:

$$\begin{aligned} X_c &= \text{capacity reactance in ohms} \\ f &= \text{frequency in cycles per sec.} \\ C &= \text{capacity in farads} \\ 2\pi &= 6.2832 \end{aligned}$$

This formula is very important, as we want to be able to convert the apparent resistance effect of capacity into ohms capacity reactance, in order to apply Ohms law to any A. C. circuit problems.

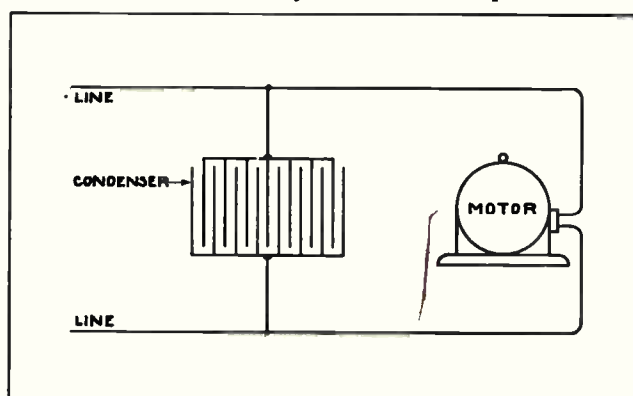

Fig. 21. A condenser connected in parallel with a motor will cause lagging voltage or leading current, and will neutralize effects of induction produced by the motor.

Capacity effect or condensers are usually shown in circuit diagrams by a symbol such as is used in Fig. 21. This symbol represents the plates of a condenser, the two groups of which are connected to the two wires of the circuit. In an actual condenser the insulation between the plates may be any convenient form of dielectric, such as fibre, glass, rubber, paper, or oil. In the case of A. C. circuits and lines, this insulation which forms the dielectric for the condenser effect may be the insulation on the wires or, as in the case of transmission lines, merely the air between the wires.

As capacity reactance is opposite in effect to inductive reactance, special condensers are often connected in A. C. circuits in industrial plants, to neutralize the effects of inductance and lagging current. The advantages of this will be explained later.

In Fig. 21 the condenser is connected in parallel with a motor. When the voltage of any alternation starts to build up on this circuit, the condenser takes a charge and its voltage opposes the building up of the applied energy voltage, thus causing it to lag.

When the energy voltage reaches maximum, the condenser will be fully charged and, as the energy voltage starts to decrease, the condenser voltage will then be applied to the circuit and will tend to oppose the dying down of the energy voltage, or will maintain it longer. This retards the dying down

of the energy voltage and causes it to reach its zero value an instant later. After the energy voltage reaches zero the condenser will still be discharging or applying a little voltage to the circuit.

Thus we have another illustration of the manner in which a condenser causes the lagging voltage, or leading current as it is more frequently expressed.

The effects of capacity are very useful and valuable in many circuits.

Static condensers are often used on highly-inductive power circuits to improve the power factor by neutralizing the effect of excessive inductance.

Condensers are also used extensively in radio and telephone work to pass currents of certain frequencies and stop those of lower frequency or D. C. in various circuits.

## 24. SUMMARY OF INDUCTANCE AND CAPACITY

Some of the most important points to remember about inductance and are summed up briefly in the following:

Inductive equipment in A. C. circuits consists of coils, windings of transformers, motors, generators, choke coils of lightning arresters, current-limiting reactors, etc.

Capacity effects in A. C. circuits are produced by static condensers, over-excited synchronous motors, long transmission lines or underground cables, etc.

- (a) { Inductance opposes current changes  
Capacity opposes voltage changes
- (b) { Inductance causes lagging current  
Capacity causes leading current
- (c) { The effect of inductance is opposite to that of capacity, or their effects are  $180^\circ$  apart and tend to neutralize each other
- (d) { Excessive inductance is detrimental to the power-carrying capacity of a circuit  
Excessive capacity is detrimental to the power-carrying capacity of a circuit
- (e) { Inductance may be used to neutralize the effect of excessive capacity  
Capacity may be used to neutralize the effect of excessive inductance
- (f) { Inductance causes low power-factor, "lagging"  
Capacity causes low power-factor, "leading"
- (g) { Lagging power-factor may be compensated for by static condensers or over-excited synchronous motors.

## 25. SERIES A. C. CIRCUITS

There are four classes of series circuits commonly encountered in alternating current work. These are as follows:

- (a) Circuits with resistance only
- (b) Circuits with resistance and inductive reactance
- (c) Circuits with resistance and capacity reactance

- (d) Circuits with resistance, inductive reactance, and capacity reactance.

Incandescent lighting circuits and those supplying similar non-inductive equipment are considered to have resistance only. Actually these circuits have a slight amount of inductance and capacity, but it is so small that it is negligible.

Circuits of this type can be treated similarly to D. C. circuits, because the resistance is the only opposing force to the current and therefore the resistance equals the total impedance. To determine the current flow in such circuits it is only necessary to divide the applied voltage by the resistance or impedance in ohms.

The most common types of circuits encountered in alternating current power work are those which have resistance and inductive reactance. The method of determining the impedance and currents of such circuits will be covered in the following paragraphs.

## 26. CALCULATION OF IMPEDANCE IN SERIES A. C. CIRCUITS

Fig. 22-A shows a resistance and an inductance connected in series. The resistance of 8 ohms is represented by the usual symbol, with which you are already familiar, and the inductive reactance of 6 ohms is represented by the coil symbol which is commonly used for showing inductance in circuits.

At first thought, it might seem that we can merely add the ohms resistance and ohms inductive reactance to get the total impedance in the circuit; because this was a method used in D. C. circuits with two or more resistances in series. This method cannot be used with resistance and inductive reactance, however, because their effects on the current are out of phase with each other.

If this circuit had only resistance, the current which would flow when alternating voltage is ap-

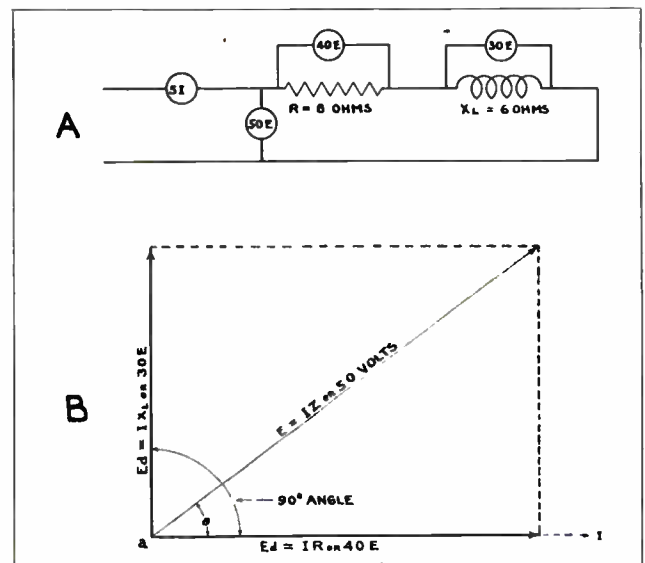

Fig. 22. "A". A resistance coil connected in series with an inductance coil in an A. C. circuit. "B". This sketch shows the method of determining the amount of impedance of the circuit shown at "A".

plied would be in phase with the voltage. If the circuit had only inductance, the current which would then flow would be  $90^\circ$  out of phase with the voltage, or lagging  $90^\circ$  behind it.

## 27. GRAPHIC SOLUTION FOR RESISTANCE AND INDUCTIVE REACTANCE IN SERIES

As the inductive reactance and resistance both tend to affect the flow of current and its phase position with respect to the voltage, we can determine these effects by the use of a diagram such as shown in Fig. 22-B. A current of 5 amperes is assumed to be flowing through circuit "A". In Fig. "B" we have a horizontal line used to represent the voltage drop  $E_d$  across the 8 ohms resistance which is in phase with "I" and a vertical line at an angle of  $90^\circ$  with the horizontal line, to represent the voltage drop  $E_d$  across the 6 ohms inductive reactance.

These two lines can be drawn to scale, so that the length of each will represent the proper value in ohms. In diagrams of this type the lines are all considered to be revolving, like the spokes of a wheel, in a counter-clockwise direction around the point where they join at "a".

Keep this fact well in mind whenever examining or working with such diagrams.

If these lines are revolving counter-clockwise, then the shorter line representing the voltage drop across the inductive reactance  $X_L$  will be  $90^\circ$  ahead of the long line, which represents the  $E_d$  across "R".

As the current which flows through the resistance "R" would be in phase with the voltage drop across "R", the horizontal line can also be allowed to represent the current in phase with the voltage drop across "R".

If we now draw dotted lines as shown to complete the rectangle we will have what is known as a parallelogram of forces, and the length of the diagonal line "IZ" will indicate the total voltage drop across the circuit and its position with respect to the line "IR", will indicate the angle of phase difference between the current and the applied voltage.

If the lines representing the voltage drop across the resistance and inductive reactance are carefully drawn to scale (in this case  $\frac{1}{20}$ " per volt) and at the proper angle, then by measuring the length of the line "IZ" we will get the total applied voltage. The line "IZ" will also represent the total impedance with the scale drawn to allow  $\frac{1}{4}$ " per ohm.

This graphic method provides an exceedingly simple way of solving such problems. It would not, of course, be very accurate on large values or figures, because it would be difficult to make the lines long enough or to measure them with sufficient accuracy. This diagram will, however, show the manner in which the amount of current lag in degrees is determined by the proportion of resistance and inductive reactance in the circuit.

By examining the diagram in Fig. 22-B, or by drawing another like it with a longer line to represent a greater amount of inductive reactance, you can readily see that this would swing the diagonal line "IZ" farther upward, or would cause a greater angle of phase difference between the current and voltage.

On the other hand, if we were to increase the amount of resistance and lengthen the horizontal line, this would swing the diagonal line down and nearer to the resistance line, and bring the resulting current nearer in phase with the voltage.

## 28. FORMULA FOR IMPEDANCE OF RESISTANCE AND INDUCTIVE REACTANCE IN SERIES

The impedance of such a circuit, with resistance and inductive reactance in series, can be calculated accurately by the following formula:

$$Z = \sqrt{R^2 + X_L^2}$$

We can obtain the impedance in ohms by squaring the resistance and inductive reactance in ohms, adding these squares together, and then extracting the square root of the sum, as shown by this formula.

In the case of the circuit shown in Fig. 22, where we have 8 ohms resistance and 6 ohms inductive reactance, our problem would be:

$$Z = \sqrt{8^2 + 6^2}, \text{ or}$$

$$Z = \sqrt{64 + 36}, \text{ or}$$

$$Z = \sqrt{100}, \text{ or } 10 \text{ ohms impedance}$$

This illustrates the various steps in solving such a problem with the exception of the details of finding the square root. If you require it you can obtain assistance on this process from your instructor.

It will be a very good plan to practice a few square root problems until you can handle these problems easily, because there are numerous opportunities in alternating current electric problems to use square root to excellent advantage.

On the great majority of ordinary electrical jobs it will not be necessary to use such problems; but, if you desire to work up to higher positions, you will want to be able to work out the problems pertaining to the various circuits and machines you may be operating.

## 29. RESISTANCE AND CAPACITY IN SERIES

Fig. 23-A shows a circuit in which a resistance and capacity are connected in series. The resistance of 4 ohms is represented by the usual symbol and the capacity reactance of 3 ohms is represented by the symbol for a condenser.

For the graphic solution of this problem we will again draw a horizontal line of proper length to represent the 4 ohms resistance, and a vertical line to represent the 3 ohms capacity reactance. This time, however, we will draw the vertical line  $90^\circ$  behind of the horizontal line which represents the resistance. The line is drawn in this position be-

cause we know that capacity reactance tends to make the current lead the voltage.

If the circuit were all capacity and no resistance, this lead would be  $90^\circ$ ; but, as there are both resistance and capacity, we make the lines of proper length and space them  $90^\circ$  from each other, to determine what the angle of lead of the circuit will be.

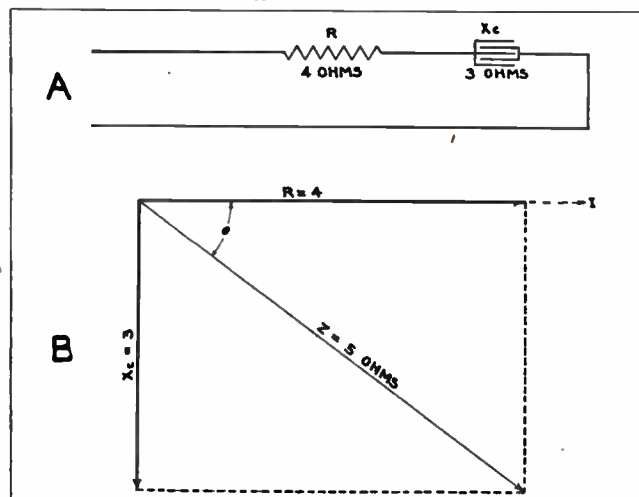

Fig. 23. "A". This circuit has a resistance connected in series with a condenser. "B". The vector diagram shows the method of determining the impedance and angle of lead between the current and voltage for a circuit such as shown at "A".

By again completing the parallelogram with dotted lines and drawing the diagonal line through it cornerwise, this line "Z" will represent the total impedance and will also show the phase position or angle of lead of the current. The lines in this figure are drawn to scale, using  $\frac{1}{2}$ -inch per ohm, and you will find by measuring the line "Z" that it shows the total impedance to be 5 ohms.

This, of course, is not the sum of the two values 4 and 3, which would be obtained if they were added by arithmetic, but it is the correct vectorial sum of the two values when they are out of phase  $90^\circ$  as shown.

The impedance of the circuit shown in Fig. 23 can be calculated by the use of a formula very similar to that used for the circuit in Fig. 22. The formula is as follows:

$$Z = \sqrt{R^2 + X_c^2}, \text{ or, in this case}$$

$$Z = \sqrt{4^2 + 3^2}, \text{ or}$$

$$Z = \sqrt{16 + 9}, \text{ or}$$

$$Z = \sqrt{25}, \text{ which gives 5 ohms impedance}$$

### 30. RESISTANCE, CAPACITY, AND INDUCTANCE IN SERIES

Fig. 24-A shows a circuit in which we have resistance, inductance, and capacity all in series.

In Fig. 24-B, all three of these values are represented by the solid lines, R,  $X_c$ , and  $X_L$ . In this case we have again drawn a horizontal line to represent the resistance. The line  $X_L$ , representing inductive reactance, is drawn  $90^\circ$  ahead of the resistance line; and the line  $X_c$ , representing capacity reactance is drawn  $90^\circ$  behind the resistance line.

We know that inductive reactance and capacity

reactance have opposite effects in the circuit and will therefore tend to neutralize each other. As the inductive reactance is the greater in this case, our first step will be to subtract the 10 ohms capacity reactance from the 22 ohms of inductive reactance.

This neutralizes or eliminates the 10 ohms capacity reactance and 10 ohms of the inductive reactance. The remaining 12 ohms of inductive reactance which are not neutralized by the capacity effect, and the resistance, will be the factors which determine the total impedance and the phase angle of the current.

Once more drawing our parallelogram with the remaining factors or values, we find that the current still lags behind the applied voltage and that the total impedance is 20 ohms. The scale to which the lines are drawn in this case is  $\frac{1}{16}$  of an inch per ohm.

The total impedance of a circuit such as shown in Fig. 24-A can be more accurately calculated by means of the formula:

$$Z = \sqrt{R^2 + (X_L - X_c)^2}$$

$$\text{In this case } X_L - X_c \text{ is } 22 - 10, \text{ or } 12.$$

$$\text{Then, } 12^2 = 144.$$

The next step indicated by the formula is to square the resistance. This will be  $16 \times 16$ , or 256. Then,  $256 + 144 = 400$ .

And the final solution of the problem will be:

$$Z = \sqrt{400}, \text{ or } 20 \text{ ohms.}$$

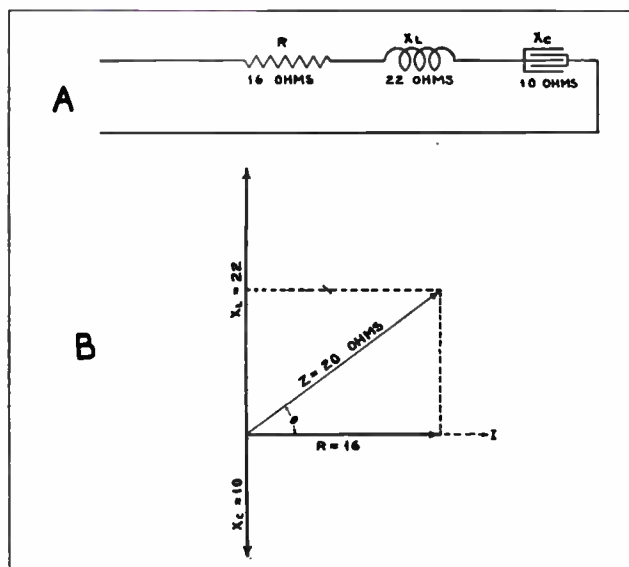

Fig. 24. "A". Resistance, inductance, and capacity connected in series in an A. C. circuit. "B". Note how the capacity reactance is subtracted from the inductive reactance, as the two neutralize each other in the circuit.

### 31. PARALLEL A. C. CIRCUITS

Parallel alternating current circuits are of the same four general types as series circuits. That is, they may contain resistance only, resistance and inductance in parallel, resistance and capacity in parallel, or resistance, inductance, and capacity in parallel.

To determine the impedance of parallel A. C. circuits we must use the reciprocal method, somewhat similar to that which was explained for parallel resistances in D. C. circuits.

You will recall that with D. C. circuits when the resistances were in series we added the resistance in ohms of all the circuits to obtain the total resistance. But when resistances were in parallel we first added the conductances or reciprocals of the resistance to obtain the total conductance, and then inverted this or obtained its reciprocal, which is the total resistance.

This is the same general method used in determining the total impedance of parallel A. C. circuits.

The opposite of impedance in A. C. circuits is the admittance. Admittance in this case means the same as conductance in D. C. circuits. Admittance is, therefore, always the reciprocal of the impedance and is expressed in mhos, the same as conductance for D. C. circuits.

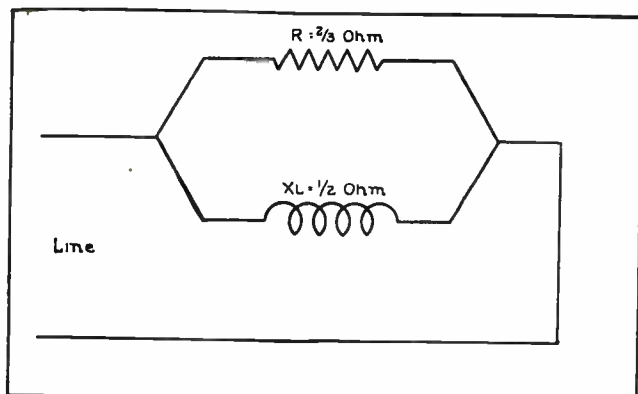

Fig. 25. Resistance and inductance in parallel. The impedance for this circuit can be determined by the formulas given on this page.

### 32. RESISTANCE AND INDUCTANCE IN PARALLEL

Fig. 25 shows a resistance of  $\frac{2}{3}$  ohm connected in parallel with an inductive reactance of  $\frac{1}{2}$  ohm. The total impedance of this circuit can be determined by the following formula:

$$Z = \frac{1}{\sqrt{\left(\frac{1}{R}\right)^2 + \left(\frac{1}{X_L}\right)^2}}$$

According to this formula we must first obtain the separate reciprocals of the resistance and inductance by dividing the number 1 by each of these values in ohms. These reciprocals are then squared and added together and the square root of their sum next obtained. The final step is to obtain the reciprocal of this square root by dividing the number 1 by it, as shown by the formula.

Using with the formula the values given in Fig. 25, the problem becomes:

$$Z = \frac{1}{\sqrt{\left(\frac{1}{\frac{2}{3}}\right)^2 + \left(\frac{1}{\frac{1}{2}}\right)^2}}$$

Here we have substituted the  $\frac{2}{3}$  ohm resistance for the "R" shown in the formula, and the  $\frac{1}{2}$  ohm inductive reactance for the  $X_L$  shown in the formula.

We next divide the number one by each of these values, to obtain their reciprocals, and our problem then becomes:

$$Z = \frac{1}{\sqrt{\left(\frac{3}{2}\right)^2 + 2^2}}$$

Then by squaring these reciprocals as indicated by the formula, the problem becomes:

$$Z = \frac{1}{\sqrt{\frac{9}{4} + 4}}$$

Before we can add  $\frac{9}{4}$  and 4, they must both be converted to like fractions, or:

$$Z = \frac{1}{\sqrt{\frac{9}{4} + \frac{16}{4}}} \text{ or } \frac{1}{\sqrt{\frac{25}{4}}}$$

Then obtaining the square root of  $\frac{25}{4}$ , our problem is reduced to  $\frac{1}{\frac{5}{2}}$ ,

We then divide 1 by  $\frac{5}{2}$  to get the reciprocal, which equals  $\frac{2}{5}$  ohms, total impedance.

### 18. RESISTANCE AND CAPACITY IN PARALLEL

Fig. 26 shows a circuit with a resistance of  $\frac{1}{4}$  ohm and a capacity reactance of  $\frac{1}{3}$  ohm, connected in parallel. The total impedance of this circuit can be determined by a formula similar to the one just used, or as follows:

$$Z = \frac{1}{\sqrt{\left(\frac{1}{R}\right)^2 + \left(\frac{1}{X_C}\right)^2}}$$

Substituting the values given for the circuit, the problem becomes:

$$Z = \frac{1}{\sqrt{\left(\frac{1}{\frac{1}{4}}\right)^2 + \left(\frac{1}{\frac{1}{3}}\right)^2}}$$

When we divide the figure 1, in each case, by the resistance and reactance to get their reciprocals, we then have:

$$Z = \frac{1}{\sqrt{4^2 + 3^2}} \text{ or } \frac{1}{\sqrt{16 + 9}}$$



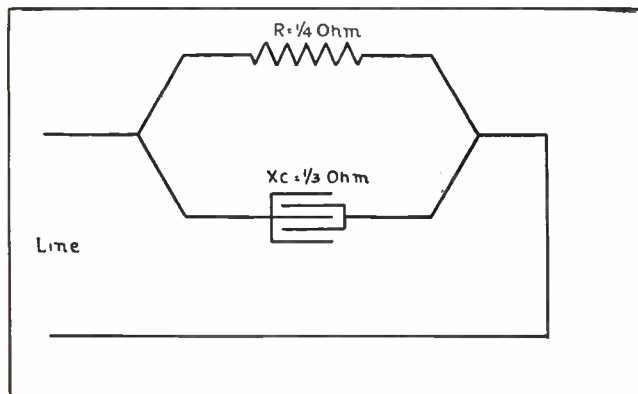

Fig. 26. Resistance and capacity in parallel in an A. C. circuit. Practice using the formulas given on these pages for determining the impedance of such circuits.

As  $16 + 9 = 25$ , the problem now remains:

$$Z = \frac{1}{\sqrt{25}}$$

The square root of  $25 = 5$ , so this reduces the problem to:

$$Z = \frac{1}{5}, \text{ or } \frac{1}{5} \text{ ohm impedance}$$

### 19. RESISTANCE, INDUCTANCE, and CAPACITY IN PARALLEL

Fig. 27 shows a circuit with inductance, resistance, and capacity in parallel.

The total impedance of this circuit can be found by the formula:

$$Z = \frac{1}{\sqrt{\left(\frac{1}{R}\right)^2 + \left(\frac{1}{X_C} - \frac{1}{X_L}\right)^2}}$$

Note the similarity between this formula and the one which was used for impedance of series circuits having inductance, resistance, and capacity. The principal difference is merely that with parallel circuits we use the reciprocals of the values, instead of the values in ohms themselves.

You will also note that with parallel circuit problems we subtract the reciprocal of the inductive reactance from the reciprocal of the capacity reactance, as one of these effects tends to neutralize the other, as they did in series circuits.

In the circuit shown in Fig. 27 the inductive reactance in ohms is larger than the capacity reactance, but when the reciprocals of these values are obtained their relative sizes will be reversed, as shown by their subtraction in the formula.

In a circuit where the capacity reactance might be the greatest, we would reverse the order of subtraction, in order to subtract whichever reciprocal is smallest from the one that is largest.

Substituting the values from the circuit in Fig. 27, for the symbols given in the formula, the problem of determining the total impedance becomes:

$$Z = \frac{1}{\sqrt{\left(\frac{1}{1\frac{1}{3}}\right)^2 + \left(\frac{1}{\frac{3}{8}} - \frac{1}{1\frac{1}{2}}\right)^2}}$$

Our first step will be to convert the whole numbers and fractions, to fractions, as follows;

$$1\frac{1}{3} = \frac{4}{3}, \text{ and } 1\frac{1}{2} = \frac{3}{2},$$

$$\text{Then } Z = \frac{1}{\left(\frac{1}{\frac{4}{3}}\right)^2 + \left(\frac{1}{\frac{3}{8}} - \frac{1}{\frac{3}{2}}\right)^2}$$

Then by dividing 1 by each of the fractions to obtain their reciprocals we have:

$$Z = \frac{1}{\left(\frac{3}{4}\right)^2 + \left(\frac{5}{3} - \frac{2}{3}\right)^2}$$

Next subtracting  $\frac{2}{3}$  from  $\frac{5}{3}$  as shown in the latter part of the formula, we have:

$$Z = \frac{1}{\left(\frac{3}{4}\right)^2 + \left(\frac{3}{3}\right)^2} \text{ or } Z = \frac{1}{\left(\frac{3}{4}\right)^2 + 1^2}$$

Then  $\frac{3}{4}$  squared equals  $\frac{9}{16}$ , and 1 squared equals

$$1, \text{ So, } Z = \frac{1}{\sqrt{\frac{9}{16} + 1}}, \text{ or } Z = \frac{1}{\sqrt{\frac{25}{16}}}$$

Obtaining the square root of  $\frac{25}{16}$  gives  $\frac{5}{4}$ .

$$\text{So, } Z = \frac{1}{\frac{5}{4}}, \text{ or } \frac{4}{5} \text{ ohm impedance}$$

Once more let us remind you that on your first electrical jobs you may not have much use for problems or formulas such as the foregoing. But as you may wish to be able to calculate the impedance of A. C. circuits at some future date, these problems have been worked out step by step in these pages to provide a guide or reference for you, in case you need them in the future.

Working them out carefully and also applying these formulas to other similar circuit problems will be very good practice, and will also help you to more clearly understand certain points about impedance, admittance, and reactance in A. C. circuits.

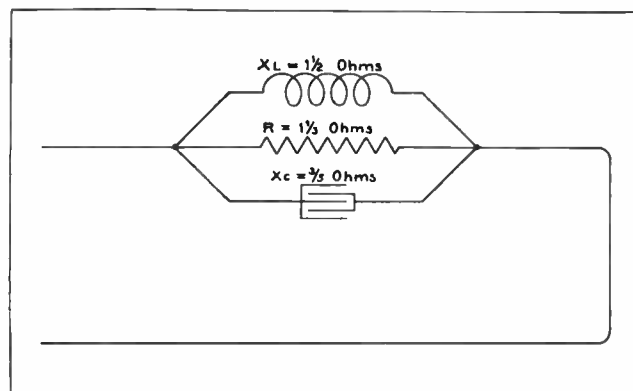

Fig. 27. This sketch shows inductance, resistance, and capacity connected in parallel. The method of determining the impedance of such a circuit is thoroughly explained on this page.

### 35. CURRENT IN PARALLEL CIRCUITS

The total line current or resultant current as it is called, and also the amount of lag or lead of the current in parallel A. C. circuits, can be worked out by the use of vector diagrams such as those shown in Figs. 22, 23 and 24 for series circuits.

When using vector diagrams for parallel circuits, the lines can be allowed to represent the currents through the resistance, inductance, and capacity branches of the circuit.

The current through the separate branches of the circuit, or the devices which contain the resistance, inductance, and capacity, can be determined by the use of an A. C. ammeter, or by the use of Ohms law formulas for each branch, as follows:

$$I = \frac{E}{R}, I = \frac{E}{X_L}, I = \frac{E}{X_C}, \text{ etc.}$$

For example, in Fig. 28 is shown a circuit with resistance, inductance, and capacity in parallel. We can assume that these are a heater resistance, a transformer winding, and a condenser all operated from the same 40-volt line. Separate tests made with an ammeter in the circuit of each device show 8 amperes flowing through the resistance or heater, 4 amperes through the inductance or transformer coil, and 2 amperes in the condenser circuit.

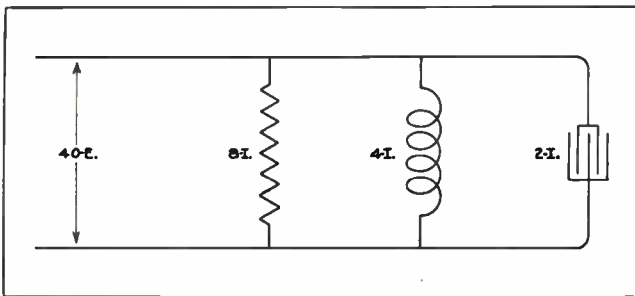

Fig. 28. Note the amount of current in each of the branches of the above circuit and compare this sketch with Fig. 29, while determining the total current in the circuit.

By use of Ohms law formulas, we can determine the resistance and reactance in ohms of each of these devices as follows:

$$R = \frac{E}{I} \text{ or } R = \frac{40}{8}, \text{ or } 5 \text{ ohms}$$

$$X_L = \frac{E}{I} \text{ or } X_L = \frac{40}{4}, \text{ or } 10 \text{ ohms}$$

$$X_C = \frac{E}{I} \text{ or } X_C = \frac{40}{2}, \text{ or } 20 \text{ ohms}$$

We can represent the currents of this circuit by the vector diagram shown in Fig. 29.

The solid horizontal line represents the current through the resistance; and as this current will be in phase with the line voltage, this same line can represent the phase position of the voltage.

The vertical line, which is 90° behind the horizontal current and voltage line, represents the current through the inductance.

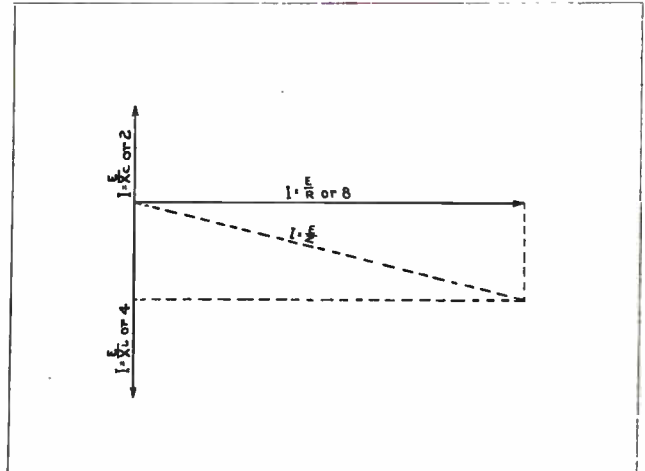

Fig. 29. This diagram illustrates the method of determining the current in parallel A. C. circuits which have all three factors; resistance, inductance, and capacity.

The shortest vertical line, which is 90° ahead of the horizontal line, represents the current through the condenser.

Now if we subtract the leading current from the lagging current, and draw dotted lines to form the parallelogram with the remaining lagging current and the current which is in phase with the voltage, the diagonal line,  $I = \frac{E}{Z}$ , through this parallelogram will represent the total line current.

It may seem peculiar that the total line current or vectorial sum of the three currents is only slightly more than the current through the resistance. This is due to the fact that the leading and lagging currents, which are balanced, tend to neutralize each other, or actually circulate between the condenser and inductance in Fig. 28, and do not flow on the line wires from the generator. This interesting fact will be further discussed later in a section on power factor.

### 36. POWER FACTOR

We have learned so far in our study of alternating current and A. C. circuits, that inductive reactance and capacity reactance often cause the current in these circuits to be out of phase with the voltage.

We have also found that this reduces the amount of effective or true power in watts and causes a certain amount of wattless energy. This was illustrated by the voltage, current, and power curves shown in Fig. 13.

In a D. C. circuit the power in watts can always be obtained by multiplying the volts by the amperes. It can also be obtained with a wattmeter. When the current and voltage of an A. C. circuit are in phase with each other the power can be determined by the same method as used for D. C. circuits. That is, by obtaining the product of the volts and amperes.

### 37. TRUE POWER AND APPARENT POWER

When the voltage and current of an A. C. circuit are out of phase their product will not give the true power in the circuit, but instead gives us what we call apparent power. The apparent power of A. C. circuits is commonly expressed in kilovolt amperes, abbreviated kv-a.

Alternators, transformers, and certain other A. C. machines are commonly rated in kv-a. When an A. C. wattmeter is connected in a circuit which has lagging or leading current it will read the true power and not the apparent power. This is due to the fact that the coils which operate the pointer in the meter depend upon true or effective power for their torque which moves the pointer against the action of the spring.

It is very important to remember that you can always obtain the true power of an A. C. circuit by means of a wattmeter. The product of voltmeter and ammeter readings in the circuit will give the apparent power, and this figure will usually be more than the true power, because the current in most A. C. circuits lags somewhat behind the voltage.

Keep in mind that true power is expressed in watts and kilowatts and apparent power in volt-amperes or kilovolt-amperes.

### 38. POWER FACTOR DEFINITION AND FORMULA

The ratio between the true power and apparent power in any circuit is known as the power factor of that circuit. This power factor is expressed in percentage and can always be found by dividing the true power by the apparent power, or this can be expressed as a formula in the following manner:

$$\text{Power Factor} = \frac{\text{True power}}{\text{Apparent power}}$$

The practical man, doing electrical maintenance work or power plant operating in the field, is likely to have many occasions to use this formula and method of determining the power factor of various machines or circuits with which he is dealing. Therefore, it is well to keep in mind that you can always determine the apparent power of a circuit or machine by means of a voltmeter and ammeter and obtaining the product of their readings; then obtain the true power by means of a wattmeter, and finally determine the power factor by means of the formula just stated.

If the apparent power in kv-a. is known for any circuit or machine, and the power factor of that circuit or machine is also known, then the true power can be determined by the following formula:

$$\text{True Power} = \text{App. power} \times \text{P. F.}$$

As many A. C. machines are rated in kv-a. and have their power factor stated on the name-plate, this formula will often be very handy for determining the amount of true power the machine will supply.

In case the true power and the power factor of a circuit are known, the apparent power can be determined without the aid of meters by the following formula:

$$\text{Apparent Power} = \frac{\text{true power}}{\text{P. F.}}$$

The greater the angle of phase difference between the current and voltage in an A. C. circuit, the less true power will be obtained and the lower will be the power factor. Therefore we find that power factor will always depend upon the amount of lag or lead of the current.

### 39. LAGGING OR LEADING CURRENT

Tests show that the power factor is mathematically equal to what is called the cosine of the angle of lag or lead between the voltage and current. When the voltage and current are exactly in phase this angle is zero, and its cosine and the power factor will then be 100%.

This condition is often called unity power factor. As the voltage and current get out of step or out of phase, the power factor starts to drop below 100%, and the greater the angle of phase difference becomes the lower the power factor will drop.

When the angle of phase difference is 90° either lagging or leading, the power factor will be zero, and, regardless of the amount of voltage or the amount of current flowing, there will be no true power developed.

A lag or lead of 90° is not encountered in electrical circuits, because there is always a certain amount of resistance, and no circuit is entirely made up of inductance or capacity.

The term "angle of phase difference" which will be used considerably from now on is represented by the symbol  $\Theta$  or  $\emptyset$ .

### 40. CAUSES OF LOW POWER FACTOR

As previously mentioned, the majority of A. C. circuits possess considerable inductance. Therefore, we usually find lagging current on most power circuits in the field.

Lightly loaded A. C. power equipment, such as motors, alternators, and transformers have much lower power factor than fully loaded machines. For this reason idle or lightly loaded A. C. machines should be avoided as much as possible, and all such equipment kept operating as nearly at full load as possible.

A great number of factories and industrial plants, using large amounts of A. C. equipment, fail to realize the importance of power factor and of having machines of the proper size and type so that they can be kept operating fully loaded. This results in low power factor on their circuits, and in the overheating of conductors and machines by the excessive currents set up by wattless power. This condition provides a splendid field of opportunity for the trained electrical maintenance man who has a knowledge of power factor, and the ability to measure the power required for various loads and

select suitable motors and other equipment to handle these loads in the most efficient manner.

In many cases hundreds of dollars per month can be saved on power bills, machines and circuits relieved of current overloads, and frequent damage to windings prevented, by simply correcting the power factor in the plant. A great many untrained electrical men have little or no real conception of this subject and its importance. So you will find it very well worthwhile to carefully study and obtain a good understanding of these principles, and of the methods for correcting power factor, which will be covered later.

#### 41. EXAMPLES OF LOW POWER FACTOR

The following problems, which are very typical of conditions often encountered in the field, should help you to more fully understand and appreciate this material given on power factor.

Let us suppose that on a certain job you have measured a circuit with a voltmeter and ammeter, and found 30 amperes flowing at 220 volts. Multiplying these two figures gives us 6600 watts of apparent power. A wattmeter connected in this same circuit shows a reading of only 3960 watts true power, which indicates that the power factor is rather low.

By the use of the formula:

$$\frac{\text{true power}}{\text{app. power}} = \text{power factor}$$

which, in this case would be  $\frac{3960}{6600} = .60$  P.F.,

it is easy to see that a great deal of the current which is flowing in this circuit is not producing effective power.

If the company in whose plant this condition exists is generating its own power, the generators may be overloaded and overheated by wattless current, which doesn't produce power at the motors or equipment.

In case the power is being purchased from some generating company, we should keep in mind that these concerns very often give lower power rates if the consumer's power factor is kept up to a certain value. In other cases the customer may be charged a penalty rate for having low power factor.

Therefore it is often good economy to change the motors which are causing the low power factor, or to install power factor corrective equipment, such as synchronous motors or static condensers.

These devices provide condenser or capacity effects which neutralize the effects of induction motors and transformers, and thereby prevent excessive lagging current on the line and generators.

A. C. machines are commonly rated in kv-a., or kilovolt amperes, because the heating effect in their windings is proportional to the square of the current in amperes which these windings are caused to carry.

If these machines were rated in kw. and the power factor was exceedingly low, they might be

forced to carry more current than their windings could stand, in an attempt to produce the proper amount of true power in kw.

This is exactly what happens in a number of cases in various plants, where there are no trained electricians who understand or appreciate the importance of power factor, and the necessity for measuring the current in amperes as well as the watts or kw. shown by the wattmeters.

Suppose that in another case there is a transformer in the plant where you are employed, and this transformer is rated at 10 kv-a. and connected to a 500-volt line. A wattmeter in the circuit of the transformer shows the load to be only 9 kw., but the transformer continually operates at a rather high temperature, as though its windings might be overloaded.

An ammeter could be used to determine the current flow, but in this case let us assume that the test is made by a portable power factor indicator, and that it shows the power factor to be 75%.

If we check up on these figures with the formula previously given for apparent power, it will soon show why the transformer is operating above normal temperature.

In the first place a 10 kv-a. transformer designed to operate on 440 volts would have a current capacity of about 22.7 amperes. This could be proven in the following manner.

10 kv-a. is equal to 10,000 volt-amperes or apparent watts.

Then, according to the formula  $\frac{W}{E} = I$ , from

Watts law, we find that in this case there would be:

$$\frac{10,000}{440} \text{ or } 22.7 + \text{ amperes,}$$

full load current for the transformer.

The actual load on the transformer we have found is 9 kw. at 75% P.F.  $9 \text{ kw.} \div .75 = 12 \text{ kv-a.}$  apparent power.

Then, as 12 kv-a. is equal to 12,000 apparent watts, the current for this load can be determined as follows:

$$\frac{W}{E} = I, \text{ or } \frac{12,000}{440} = 27.3 \text{ amperes.}$$

This shows that the transformer is carrying 5.6 amperes more than its full rated load, or is about 20% overloaded. This is not an excessive overload and would probably not cause any damage if the transformer is well ventilated and the load not left on too long.

This 10 kv-a. transformer would be fully loaded under each of the several following conditions.

- 10 kw. output at 100% P.F.
- 9 kw. output at 90% P.F.
- 8 kw. output at 80% P.F.
- 7 kw. output at 70% P.F., etc.

#### 42. POWER IN SINGLE-PHASE CIRCUITS

Thus far we have only mentioned power in single-phase circuits.

With balanced polyphase circuits the power of the system will be the product of the power in one phase multiplied by the number of phases.

If the power is considerably unbalanced in the several phases, it should be calculated separately for each phase, and the power of the separate phases is then added together to get the total power on the system.

The apparent power in a single-phase circuit is determined by the usual Watts Law formula:

$$\text{App. } W = E \times I$$

The true power in kw. for a single-phase circuit is found by the formula:

$$\text{True } W = E \times I \times P. F.$$

When the apparent power, or kv-a., and the voltage of a single-phase circuit are known, the current can be determined as follows:

$$\text{App. } W = \frac{E \times I}{P. F.}$$

#### 43. POWER IN TWO-PHASE CIRCUITS

In balanced two-phase circuits, the power is calculated the same as for two single-phase circuits, that is, by the formulas:

$$\text{App. } W = 2 \times E \times I$$

$$\text{True } W = 2 \times E \times I \times P. F.$$

To determine the current in either phase of a balanced two-phase circuit when the voltage and total kv-a. are known, use the formula:

$$\text{App. } W = \frac{2 \times E \times I}{P. F.}$$

Two-phase power is used very little at present, but you may occasionally encounter some older installations of this type which are still in use.

#### 44. POWER IN THREE-PHASE CIRCUITS

The power of balanced three-phase circuits can be determined by the formulas:

$$\text{App. } W = E \times I \times 1.732$$

$$\text{True } W = E \times I \times 1.732 \times P. F.$$

These formulas will apply to any balanced three-phase circuit, whether it is connected star or delta.

The constant 1.732 is used in three-phase formulas because the power of one phase of a three-phase circuit is always:

$$\text{App. } W = \frac{E \times I}{1.732}$$

This is due to the fact that in delta-connected systems the line current is always 1.732 times the phase-winding current of any device on the system; and in star-connected systems the line voltage is always 1.732 times the phase-winding voltage.

Therefore, part of the current in any line wire of a three-phase, delta circuit is not effective in producing power in that phase, but is used in the other phases; and part of the voltage between any two line wires of a three-phase, star system is effective in producing power in more than one phase.

So the apparent power in any one phase will always be:

$$\frac{E \times I}{1.732}$$

To obtain the power for all these phases we would then use the formula:

$$\text{Total 3-ph. app. } W = \frac{3 \times E \times I}{1.732}$$

However, as 1.732 is also the square root of 3, it is not necessary to multiply the single-phase power by 3 and then divide by 1.732, as the same result is obtained if we simply multiply the single-phase power by 1.732, as shown in the first two formulas given for three-phase power.

These two formulas are well worth memorizing, as you will have frequent use for them in any work with three-phase power circuits or machines, and you can always depend upon them to quickly and easily determine the apparent power or true power.

To get the true power always use the formula which includes the power factor.

#### 45. CURRENT IN THREE-PHASE CIRCUITS

To determine the current of any phase of a balanced three-phase circuit, when the apparent power in kv-a. and the voltage are known, the following formula can be used:

$$I = \frac{\text{App. } W}{1.732 \times E}$$

When the voltage, true power in watts and power factor are known, the current can be determined as follows:

$$I = \frac{\text{True } W}{1.732 \times E \times P. F.}$$

To determine the voltage when apparent power and amperes are known:

$$E = \frac{\text{App. } W}{1.732 \times I}$$

To determine the voltage when true power and amperes are known:

$$E = \frac{\text{True } W}{1.732 \times I \times P. F.}$$

The voltage and current can also be determined with voltmeter and ammeter, when they are available. Check these formulas by actual meter tests while you are in the A. C. Department of your shop course.

#### 46. PRACTICAL FIELD PROBLEMS

What will be the true power of a balanced three-phase circuit which has 20 amperes flowing at 440 volts, and at 80 per cent P. F.?

Using the formula:

$$\text{True power} = 1.732 \times E \times I \times P. F.$$

our problem becomes:

$$440 \times 20 \times 1.732 \times .80$$

$$440 \times 20 = 8800$$

$$8800 \times 1.732 = 15241.6 \text{ apparent power}$$

$$15241.6 \times .80 = 12193.28 \text{ true watts}$$

The apparent power in kv-a. will then be:

$$\frac{15241.6}{1000}, \text{ or } 15.24 \text{ kv-a.}$$

The true power in kw. will be:

$$\frac{12193.28}{1000}, \text{ or } 12.2 \text{ — kw.}$$

Suppose that in another case you have made a meter test on the circuit to a 65 h. p., three-phase induction motor. The voltmeter shows 230 volts across any one of the three phases, and an ammeter connected first in one phase and then the others, shows that the load is properly balanced and that 85 amperes is flowing in each wire. What is the apparent power of this circuit in kv-a?

Using the formula:

$$3 \text{ Ph. App. W.} = E \times I \times 1.732$$

We find that  $E \times I = 230 \times 85$ , or 19,550

Then  $19,550 \times 1.732 = 33,860.6$  watts, and  $33,860.6 \div 1000 = 33.86+$  kv-a.

Testing this same circuit with a wattmeter, we find only 20,320 watts or 20.32 kw. of true power in the circuit.

Assuming that both the voltmeter and ammeter test and the wattmeter tests were made at the same time, and while the motor was operating under the normal mechanical load which it drives, what is the power factor of the circuit?

$$P. F. = \frac{\text{true power}}{\text{apparent power}}$$

or, in this case,

$$P. F. = \frac{20.32}{33.86} \text{ or } .60 + P.F.$$

This is a very low and undesirable power factor, and if we check the motor input in h. p., we will find the probable cause of the low power factor.

The motor is rated at 65 h. p., but is consuming only 20.32 kw. of true power when running with its

normal connected load. As 1 kw. is equal to 1.34 h. p., then  $20.32 \times 1.34 = 27.2+$  h. p., and this is less than half of the motor's full rating.

Lightly-loaded induction motors operate at a much lower P. F. than fully loaded ones, and are common causes of low power factor.

In cases such as the one in this problem, if the mechanical load on the motor is never more than 27.2 h. p. and not particularly difficult to start, the 65 h. p. motor should be changed to one of about 27 or 30 h. p., to obtain better P. F. and higher efficiency.

If the total true power in a balanced, 440-volt, three-phase system is 125 kw., and this system is operating at 90 per cent. power factor, what will be the current in each phase?

Referring back to the formula given for finding current in a 3 Ph. circuit, when the true power, power factor, and voltage are known, we find that:

$$I = \frac{\text{True watts}}{1.732 \times E \times P. F.} \text{ or}$$

in this case, 125 kw. = 125,000 true watts; therefore,

$$I = \frac{125,000}{1.732 \times 440 \times .90} \text{ or } 182.2+ \text{ amperes.}$$

Work out this problem and prove the figures. Practice working problems with the formulas given in this section until you are quite familiar with their use and the manner in which the power factor affects such calculations on actual circuits and machines which you will encounter in your work.

## POWER MEASUREMENT

In the preceding articles we have mentioned several times the use of meters to measure the voltage, current, or power of A. C. circuits.

It is very important that you appreciate the great value of meters in such work, and also that you know how to properly connect and use them. This fact was emphasized in the section on Direct Current and it is equally as important, or even more so, in connection with A. C. circuits and machines.

The intelligent use of the proper meters often helps to improve the efficiency of operation of various power machines, and also prevents damage to equipment by making sure that the voltage and current are right for the design and rating of that equipment.

In many cases very great savings can be effected by permanently connecting the proper meters to certain heavy power circuits or the circuits of individual machines, to allow frequent observation of voltage, load, and power factor conditions.

Frequently the saving effected in this manner will more than pay for the cost of the meters, in the first few months of their use.

On circuits where no meters are permanently installed, it is well to make periodic tests with port-

able meters, to see that the machines or circuits are operating at proper voltage, and that they are not overloaded. These tests will also show if certain machines are operating lightly loaded and causing low power factor and poor efficiency.

Many of the values for A. C. circuits can be easily calculated when certain others are known, by the use of the formulas which have been given in the preceding articles. In other cases, it may be much quicker and easier to use meters to determine these values. By using meters where necessary or most convenient, and the simple formulas where meter readings are not obtainable, practically any problem can easily be solved.

### 47. CONNECTING INSTRUMENTS

When making any tests with portable meters or when installing permanent meters, it is very important to get all connections properly made. Otherwise, incorrect readings will be obtained, and wrong connections may result in damage to the instruments, or danger to the person making the connections.

With A. C. voltmeters, ammeters, and wattmeters also, the same general rule applies as was given for

D. C. meters: always connect voltmeters and potential elements of wattmeters across the line, and always connect ammeters and current elements of wattmeters in series with the line — never in parallel.

The coils or shunts of ammeters and of the current elements of wattmeters are of so low resistance that if they were connected across the line, a short circuit would result and probably burn out the instrument. In such cases there is also danger of the operator being burned by flying drops of molten copper, or of his getting "flashed eyes" from the blinding flash of the arc which may be caused by the short circuit, when wrong connections are made to live circuits.

The following connection diagram and instructions for the use of meters on various tests are given to enable you to make such tests correctly and safely.

#### 48. POWER MEASUREMENT ON SINGLE-PHASE CIRCUITS

Fig. 31 shows the proper connections for a voltmeter, an ammeter, and a wattmeter in a single-phase circuit. Note that the voltmeter and potential coil of the wattmeter are both connected across the line; and that the ammeter and the current coil of the wattmeter are both connected in series with the line.

It does not matter which side of the line the ammeter and wattmeter are connected in, as all the current to the motor must flow through each line wire, and correct total readings can be obtained from either wire.

The voltmeter in this case will indicate whether or not the line voltage is proper for the voltage rating of the motor as given on the name-plate of the machine.

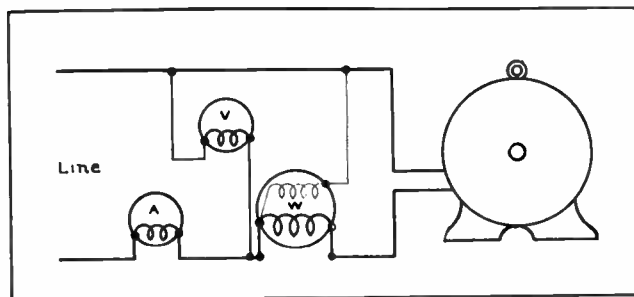

Fig. 31. This sketch shows the method of connecting the meters to measure voltage, current, and power of a single-phase motor.

Too low a voltage will cause reduced torque and poor efficiency of motors, and possibly also cause them to overheat.

The ammeter when connected as in Fig. 31 will indicate the current load on the motor and show whether the machine is overloaded, or possibly too lightly loaded. The full-load current rating of A. C. motors is usually stamped on their name-plates.

The wattmeter may be used instead of the ammeter to determine the load on the machine; but

if the power factor is low, the wattmeter reading divided by the voltage is not a reliable indication of the current load on the machine; because with low power factor there may be considerable wattless current flowing.

The wattmeter can be used with the voltmeter and ammeter to determine the power factor of the machine. The wattmeter will read the true power, and the product of the voltmeter and ammeter readings will give the apparent power. Then, dividing the true power by apparent power will give the power factor, as previously explained.

The wattmeter reading gives the true power input to the motor, and enables one to calculate the h. p. the motor should deliver if it is operating properly.

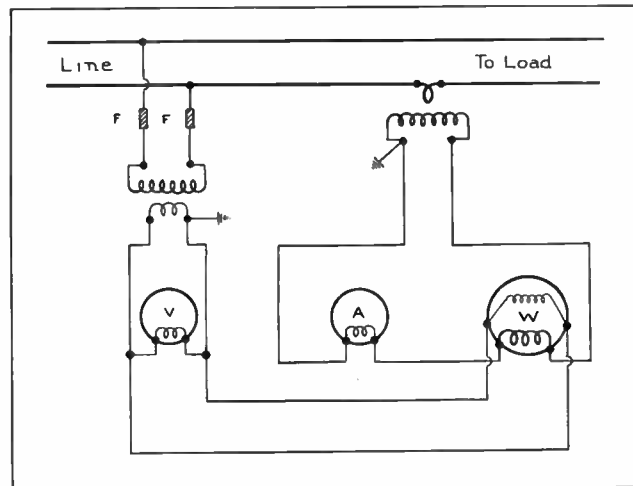

Fig. 32. When meters are used to measure the energy of high voltage lines instrument transformers are used to reduce the voltage and current to the meters.

#### 49. METER CONNECTIONS FOR HIGH VOLTAGE CIRCUITS

Fig. 32 shows the meters and connections for measuring the voltage, current, and power of a high-voltage circuit, where instrument transformers are used.

On circuits over 600 volts, meters are very seldom connected directly to the line, because of the danger to operators and the difficulty and expense of insulating the meter elements for the higher voltages.

Special transformers are used to reduce the voltage and current at the meters to a definite fraction of the voltage and current on the line. These transformers are called **current transformers** and **potential transformers**, and are designed to maintain on their secondaries a fixed ratio of the voltage or current on their primaries. The meters used with such transformers can, therefore, be calibrated to read the full voltage, current, or power on the line.

The potential transformer on the left in Fig. 32, has its primary winding connected across the line, and its secondary supplies both the voltmeter and the potential coil of the wattmeter, which are connected in parallel.

The current transformer on the right has its primary coil connected in series with the line, and its secondary supplies both the ammeter and the cur-

rent coil of the wattmeter, which are connected in series.

You will note that the secondaries of both transformers are grounded, to prevent damage to instruments and danger to operators in case the insulation between the high-voltage primary and the low-voltage secondary coils should fail.

The potential transformer is equipped with fuses in its primary leads.

Never disconnect an ammeter from a current transformer without first short-circuiting the secondary coil of the transformer.

If the secondary of a current transformer is left open while its primary is connected to the line, dangerously high voltages may be built up in the secondary. This will be more fully explained in a later section on transformers.

## 50. DETERMINING RESISTANCE OF A. C. CIRCUITS

Resistance measurements on A. C. circuits can be made by use of a Wheatstone bridge or a megger, both of which were explained in the section on D. C. meters. The Wheatstone bridge is most frequently used for making accurate tests on lines or devices of various resistances, although the megger is very convenient for making tests where extreme accuracy is not required.

The resistance of an A. C. circuit or device can also be calculated from voltmeter and ammeter readings, by passing low-voltage direct current through the circuit under test. Inductance does not oppose the flow of D. C., so the current flow will be proportional to the voltage and resistance only.

When the voltage and current readings are obtained with D. C. meters and with D. C. voltage applied to the circuit, the resistance can then be determined by the formula  $E \div I = R$ , with which you are already familiar.

It is well to remember that the resistance of wires and metallic circuits of copper, aluminum, iron, etc., will increase with any increase in the temperature of the conductors. This is particularly true of iron or resistance alloys in rheostats, and of the filaments in incandescent lamps.

The resistance of lamp filaments when heated to incandescence may be from 4 to 10 times as high as it is at 70° F., or ordinary room temperature.

## 51. CURRENT MEASUREMENTS ON THREE-PHASE CIRCUITS

Fig. 33 shows a three-phase motor with an ammeter connected in one of its phase wires to measure the current. If the motor is operating properly, the current should be very nearly the same, or balanced in all three phases. Prove this by actual tests on some of the motors in the A. C. Department of your shop course.

The current rating on the name-plate of any three-phase motor is the amount of current that should flow in each of the three wires leading to the motor. Therefore, if the motor shown in Fig. 33 has a name-plate rating of 50 amperes, an ammeter should

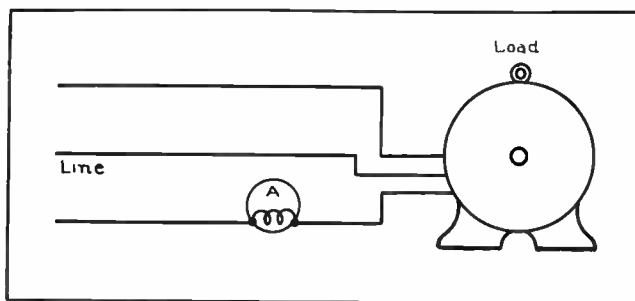

Fig. 33. Ammeter connected to measure the current in one phase of a three-phase motor.

show 50 amperes in any of the three phases when the motor is operating fully loaded.

If the current is unbalanced to any great extent, it indicates that there is probably a fault in one or more of the phases in the motor winding.

Where the current of a three-phase system is known to be balanced at all times, one ammeter permanently connected in any phase is all that is required to determine the current.

It is well, however, to occasionally test all three phases with a portable ammeter, to locate any possible unbalance which may occur due to faulty machine windings; or to locate unbalance which may occur on main wires by connecting more single-phase equipment on some one phase than on another.

All single-phase load connected to a three-phase system should be kept balanced as much as possible, by connecting an equal number of devices or equal loads in kv-a. to each phase.

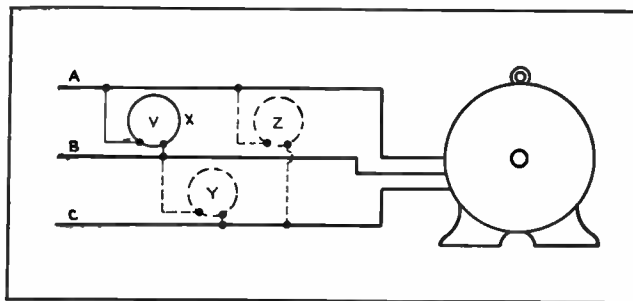

Fig. 34. This diagram shows three different connections for a voltmeter used to measure the voltage of each phase of the three-phase line to this motor.

Where the load is likely to be unbalanced and the amount of load on the different phases is varying, it is often well to have three ammeters, one connected in each phase.

## 52. VOLTAGE MEASUREMENTS ON THREE-PHASE CIRCUITS

Fig. 34 shows the method of connecting a voltmeter to indicate the voltage of a three-phase system or motor. The voltmeter can be connected between any two of the three wires, and should show approximately the same reading on all phases.

Slight variations of voltage between the various phases generally do no harm, but if the voltmeter shows widely varying readings when connected first at X, then at Y, and then at Z, it indicates that the circuit is probably unbalanced.



This unbalance and reduced voltage on certain phases will decrease the torque and efficiency of three-phase motors operating on the line.

### 53. POWER MEASUREMENTS ON THREE-PHASE CIRCUITS

For measuring the power of three-phase circuits, either single-phase or polyphase wattmeters can be used. The readings of single-phase wattmeters can be totalled up to obtain the three-phase power, while a three-phase wattmeter will read directly the true power of all three phases.

Where single-phase wattmeters are used, the two wattmeter method shown in Fig. 36 is very commonly applied.

In order to obtain correct results with the two meters, it is necessary to test them to make sure that corresponding coil leads are brought out to the same meter terminals; or, if they are not, to get them correctly marked so that the meters can be connected properly to the three-phase wires to get the right polarity of the meter coils.

To test the meters, connect them both to a single-phase circuit, or to the same phase of a three-phase circuit, as shown in Fig. 35-A. Make sure that there is some load on the circuit to enable the meters to show a reading.

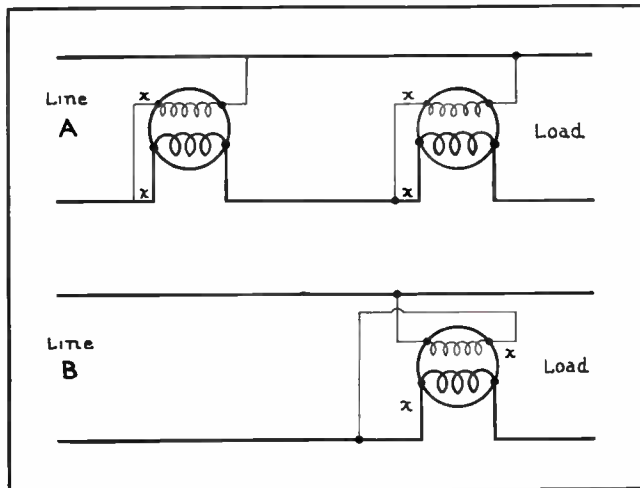

Fig. 35-A. Above is shown the method of connecting wattmeters to a single-phase circuit to locate the proper terminals of the potential and current coils.

Fig. 35-B. This sketch illustrates the method of reversing the leads to the potential coil if necessary, to make the meter read properly.

If both meters give the same indication with their pointers moving across the scale in the right direction, then carefully mark or tag the terminal of the potential coil and the terminal of the current coil which are connected together and to the line. In this figure these leads are each shown marked with an "X".

If one of the meters reads "backwards" when connected as shown in Fig. 35-A, the potential coil leads should be reversed as shown in Fig. 35-B. The meter should then read "forward"; that is, its pointer should swing to the right across the scale. The terminals or leads should then be marked as shown.

With the two meters now connected to the three-

phase circuit as shown in Fig. 36 and with the proper terminals connected together and to the lines, the meter readings will be called "positive" readings. The sum of the two meter readings will be the total three-phase power of the circuit. If the meters are properly connected as shown in Fig. 36 and the pointer of one meter attempts to swing backwards, or below zero, the potential leads of that meter should be reversed, as shown on meter No. 2 in Fig. 37. Its reading is then called "negative," and should be subtracted from that of the positive meter to get the three-phase power.

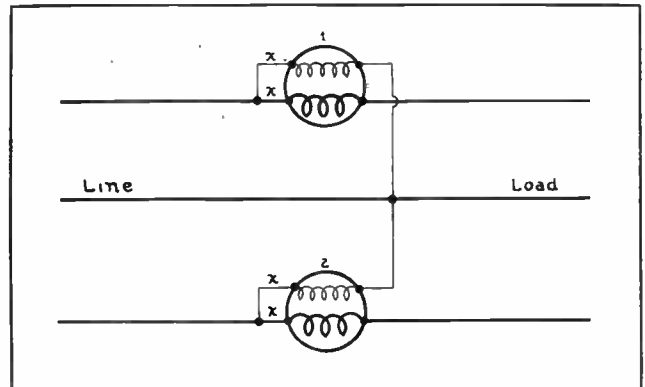

Fig. 36. This sketch shows the connections for using two single-phase wattmeters to measure the power in a three-phase circuit.

### 54. CORRECT CONNECTIONS NECESSARY FOR ACCURATE RESULTS

Fig. 38 also shows the connections for the "two wattmeter method" but shows the current coil of one of the meters connected in a different phase from what it was in Fig. 36. The current coils of the two wattmeters can be connected in any two of the three phases, and if the potential coil leads are properly connected the results should be the same. However, one of the potential coil leads of meter No. 2 is connected wrong in Fig. 38, as this connection will give correct readings only when the power factor is unity, or 100%.

As unity power factor is seldom found on any A. C. circuit, this connection should usually be avoided, and the potential coil lead should be connected as shown by the dotted line.

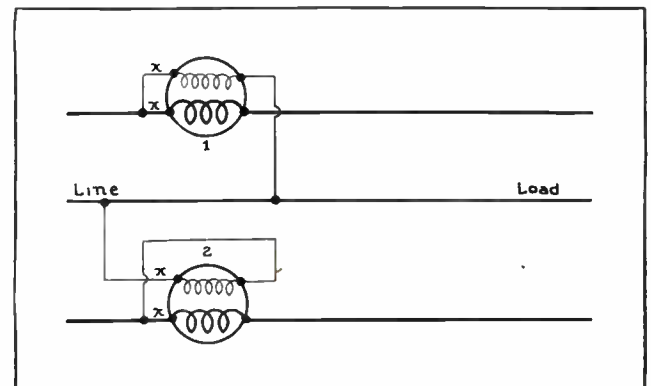

Fig. 37. This diagram shows the connections to the lower wattmeter reversed to obtain proper readings on circuits with low power factor.

When the "two wattmeter method" is used, the ends of the potential coils which are not attached directly to the same wire with their current coils should connect to the phase wire in which no current coil is connected; as shown in Fig. 36, or in Fig. 38 after the one lead is corrected as shown by the dotted line.

It may at first seem peculiar that two wattmeters used in this manner will give the total three-phase power of the circuit. This is true, however, because the current which flows to the load through the un-metered wire at any instant must be flowing back to the alternator through one or both of the other wires, thus allowing the two meters to read full  $3 \phi$  power.

The phase relations between the currents and voltages of a balanced three-phase system are such that the "two wattmeter method" will accurately give the total three-phase power, if the connections are properly made and the readings are added if they are both "positive", or subtracted if one is "negative" and the other "positive".

If wattmeter No. 1 in Fig. 36 reads 8000 watts and meter No. 2 reads 6000 watts, the total power will be  $8000 + 6000$ , or 14,000 watts.

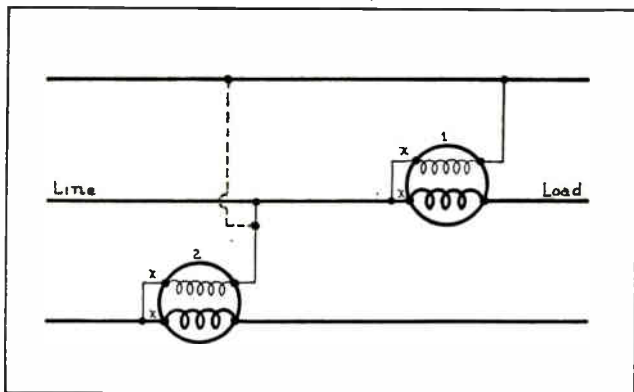

Fig. 38. This sketch shows the correct and incorrect methods of connecting one of the wattmeters when measuring three-phase power by the "two wattmeter method".

If the meters must be connected as shown in Fig. 37 to obtain readings above zero, then the negative reading must be subtracted from the positive reading to get the total power.

For example, if meter No. 1 in Fig. 37 reads 20,000 watts and meter No. 2 reads 6,000 watts, then the total power will be:

$$20,000 - 6,000, \text{ or } 14,000 \text{ watts.}$$

In all circuits where the power factor is less than 50 per cent., one of the two wattmeters will give a negative reading.

On circuits where the load is quite constant, one wattmeter can be used to determine the three-phase power, by connecting it first in one phase and then in another, as shown at positions 1 and 2 in Fig. 39.

The reading of the meter in position 1 is noted, and the meter is then shifted to position 2, and the reading is again noted. If both readings are "positive", their sum will give the total true power. If

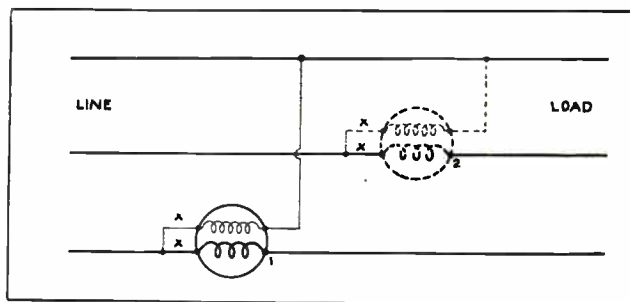

Fig. 39. The above diagram shows the manner of connecting one wattmeter in two different phases of a three-phase system in order to measure the total power.

one reading is "positive" and one negative, their difference will give the total true power.

One wattmeter should not be used to determine total three-phase power on circuits where the load varies much, as the load may change while the meter connections are being changed, and thus give an incorrect total.

## 55. POWER MEASUREMENT ON HIGH VOLTAGE CIRCUITS

Fig. 40 shows the connections for the "two wattmeter method" of measuring three-phase power on high-voltage circuits where instrument transformers are used.

Separate potential transformers supply the voltage from the two phases to the potential elements of the wattmeters. Separate current transformers supply the proportional current from the two phases to the current elements of the two wattmeters.

The same procedure of marking the potential and current coil leads and checking the positive or negative readings is followed in this case as when no instrument transformers are used.

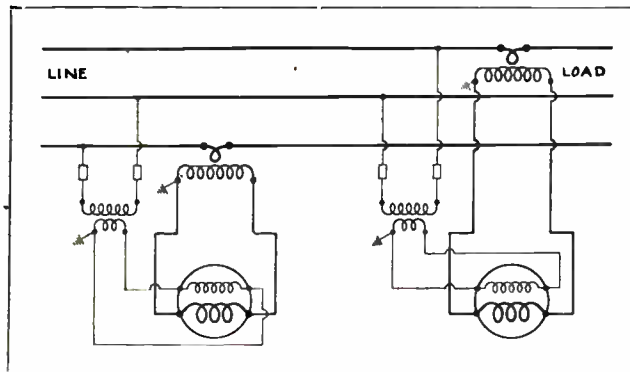

Fig. 40. Connections for two wattmeters on a three-phase circuit, using instrument transformers to reduce the voltage and current to the meters.

## 56. THREE METER METHOD OF POWER MEASUREMENT

Fig. 41 shows three wattmeters used to measure the total power of a three-phase system.

With this connection we use a "Y box" which consists of three separate resistances, connected together at one end to form a star connection and provide a neutral point to which one end of each wattmeter potential coil is connected.

When connected in this way, each wattmeter measures only the power of the phase in which it is connected, and the total power will be the sum of the three meter readings.

For example, if meter No. 1 reads 14,000 watts, meter No. 2 reads 16,000 watts, and meter No. 3 reads 17,000 watts; the total power will be 47,000 watts.

Wattmeters connected in this manner will always read "positive" regardless of the power factor.

This makes the method very simple and reliable and one which is very commonly used on large power circuits, where very accurate readings are important and all chance of error should be avoided.

For measuring the total power of a three-phase, four-wire system, the connections shown in Fig. 42 are used. In these systems the neutral wire is already provided by the fourth wire which is connected to the star point of the windings of the alternator or at the transformer connections, and therefore no Y box is needed.

The total power of the three-phase, four-wire system thus measured will be the sum of the three meter readings.

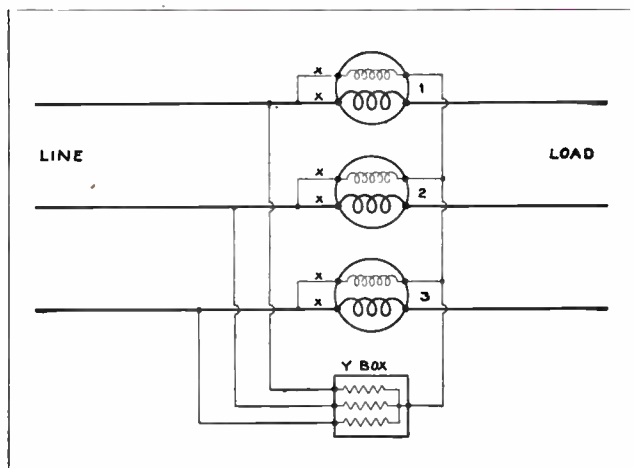

Fig. 41. Meter connections for a "three wattmeter method" for measuring the total power in a three-phase circuit. The Y Box shown in this diagram is explained in the accompanying paragraphs.

### 57. METERING THE OUTPUT OF AN ALTERNATOR

Fig. 43 shows the meters and connections for measuring the power output of an alternator, both in true power and apparent power, and also for determining the voltage, current, and power factor.

We will assume that the meter readings are as follows:

$$\begin{aligned} \text{Voltmeter} &= 440 \text{ E} \\ \text{Ammeter} &= 60 \text{ I} \\ \text{Wattmeter No. 1} &= 18,250 \text{ W} \\ \text{Wattmeter No. 2} &= 21,750 \text{ W} \end{aligned}$$

The total three-phase true power will then be  $18,250 + 21,750 = 40,000 \text{ W}$ , or 40 kw.

The total three-phase apparent power will be  $E \times I \times 1.732$ , or  $440 \times 60 \times 1.732 = 45,724.8$  watts or approximately 45.725 kv-a.

The power factor will then be  $\frac{\text{true power}}{\text{app. power}}$   
or,  $40 \div 45.725 = .874$ , or 87.4% P.F.

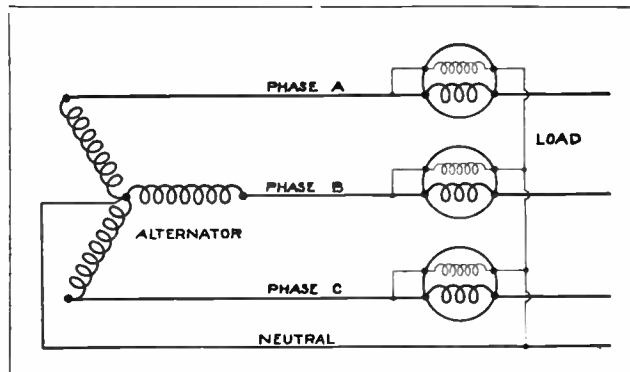

Fig. 42. This diagram shows the connections for three wattmeters to measure the power of a three-phase, four-wire system.

### 58. PRACTICAL METER TEST AND POWER PROBLEMS

The following practical examples are given for your practice, to make you thoroughly familiar with the use of the formulas and methods commonly used on actual circuits in the field.

In a great many cases the men who can make these calculations as well as operate and maintain the machines intelligently are the men who become foremen or chief operators.

Assume that we have made a meter test of a single-phase circuit and have obtained the following readings:

$$\begin{aligned} \text{Voltmeter} &= 220 \text{ E} \\ \text{Ammeter} &= 80 \text{ I} \\ \text{Wattmeter} &= 14,000 \text{ W} \end{aligned}$$

What will be the kw., kv-a., and P.F. of this circuit?

Use the proper formulas in each case, looking them up in the preceding articles if necessary, and work out each part of the problem step by step, and carefully.

The answers are given here to enable you to check your results.

$$\text{kw.} = 14, \text{ kv-a.} = 17.6, \text{ and P.F.} = 79.5\%$$

In another case, you are called upon to make a test of an alternator and you obtain the following meter readings:

$$\begin{aligned} \text{Voltmeter} &= 2200 \text{ E} \\ \text{Ammeter} &= 50 \text{ I} \\ \text{Wattmeter} &= 160,000 \text{ W} \end{aligned}$$

What will be the kw., kv-a., and P.F.?

Answers: kw. = 160, kv-a. = 190.5+, and P.F. = .839 or 84-%.

On a two-phase system we find a voltage of 200 E on each phase, current of 60 I on each phase, and a wattmeter reading shows 9,000 watts on each phase. What will be the kw., kv-a., and P.F.?

Answers: kw. = 18, kv-a. = 24, and P.F. = .75

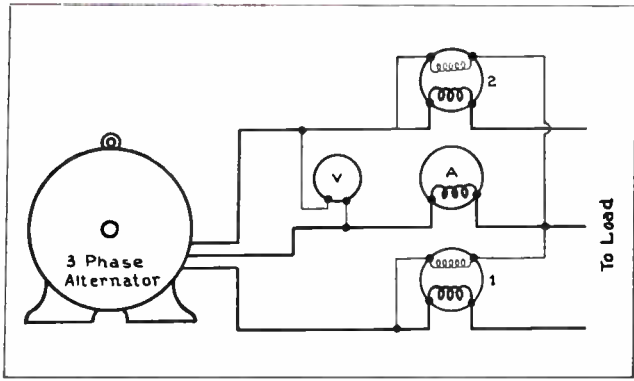

Fig. 43. Voltmeter, ammeter, and wattmeter connected to measure the voltage, current, and power output of a three-phase alternator.

If a coil or winding of an A. C. machine has a flow of 5 amperes through it when connected to 200 E, A.C., and has 20 amperes through it when connected to 100 E, D.C., what will be the impedance, the resistance, and the P.F. of the winding?

On A. C. circuits:

$$Z = \frac{E}{I}, \text{ therefore } \frac{200}{5} = 40 \text{ ohms impedance}$$

On D. C. circuits:

$$R = \frac{E}{I}, \text{ therefore } \frac{100}{20} = 5 \text{ ohms resistance}$$

When both the resistance and impedance are known,

$$\text{P.F.} = \frac{R}{Z}, \text{ therefore } \frac{5}{40} = \frac{1}{8} = \text{---}, \text{ or } .125, \text{ or } 12\frac{1}{2}\% \text{ P.F.}$$

If a circuit with a condenser or capacity effect, causing a capacity reactance of 20 ohms, is connected in series with a resistance of 12 ohms, what is the total impedance and the P.F.?

$$Z = \sqrt{R^2 + X_c^2}, \text{ or } Z = \sqrt{12^2 + 20^2}$$

$$12^2 = 12 \times 12 \text{ or } 144$$

$$20^2 = 20 \times 20 \text{ or } 400$$

$$144 + 400 = 544$$

$$\sqrt{544} = 23.3 +, \text{ ohms impedance}$$

$$\text{P.F.} = \frac{R}{Z}, \text{ or } \frac{12}{23.3} = .515, \text{ or } 51.5\% \text{ P. F.}$$





ESTABLISHED 1899

**COYNE**  
*Electrical School*  
CHICAGO ~ ~ ILLINOIS



COPYRIGHT 1942

**ALTERNATING CURRENT  
AND  
A. C. POWER MACHINERY**

*Section Two*

**A. C. Meters**

**Types, Construction, Operating Principles**

**Voltmeters, Ammeters, Wattmeters**

**Watt-hour Meters**

**Demand Indicators, Power Factor Meters**

**Frequency Meters, Synchrosopes**

## ALTERNATING CURRENT METERS

Alternating current meters are in many respects very similar to direct current meters, which were explained in the D. C. Section Two.

Ordinary A. C. meters consist of: The moving element, which is delicately balanced and mounted in jeweled bearings and has the pointer or needle attached to it; a controlling force or spring to limit the movement of the pointer and movable element; a stationary coil or element to set up a magnetic field; a damping vane or element to prevent vibration or excessive "throw" of the pointer; and the meter scale and case.

One of the principal differences between A. C. meters and D. C. meters is that, while certain types of D. C. meters use permanent magnets for providing the field in which the moving element rotates, A. C. meters use coils instead.

Some types of A. C. meters, also, operate on the induction principle, which is not used in D. C. meters.

### 59. TYPES OF A. C. METERS

There are several different types of A. C. meters each of which uses different principles to obtain the torque for moving the pointer. Some of the most common of these types are: The moving-iron repulsion type; inclined coil and moving vane type; dynamometer type; induction type; and hot-wire type.

Some types of A. C. meters can also be used on D. C. circuits with fair results, but they are usually not as accurate on D. C.

### 60. MOVING IRON TYPE INSTRUMENTS

The moving-iron principle used in some makes of A. C. voltmeters and ammeters is illustrated by the several views in Fig. 44. This is one of the simplest principles used in any type of alternating current meter, and is based upon the repulsion of two soft pieces of iron when they are magnetized with like polarity.

If two pieces of soft iron are suspended by pieces of string within a coil, as shown in the upper left-hand view of Fig. 44, and current is passed through this coil, the flux set up within the turns will magnetize the two parallel pieces of iron with like poles at each end. The repulsion of like poles will cause the two iron strips to push apart, as shown in the top center view. This effect will be produced with either D. C. or A. C. flowing in the coil, because it makes no difference if the poles of the iron strips do reverse, as long as like poles are always created together at the top and bottom ends of each strip.

The view at the upper right shows the poles reversed, and the strips still repel as before. They must, of course, be made of soft iron so their polarity can reverse rapidly with the reversal of the A. C.

Now, if the two iron strips are again suspended in a horizontal coil, as shown in the lower left view, and one of the strips is in this case rigidly attached to the side of the coil and the other suspended by a string so that it is free to move, the strips will again repel each other or push apart when current is passed through the coil, as shown in the lower center view.

The view at the lower right shows how this principle can be applied to move the pointer of the meter. One small piece of soft iron is attached to the coil in a fixed position as shown. The other piece is attached to the movable element or pointer, which is mounted on a shaft and pivots, so it is free to move.

When alternating current is passed through the coil, the two iron vanes are magnetized with like poles, and the repulsion set up between them causes the movable one to rotate in a clockwise direction and move the pointer across the scale.

### 61. A. C. VOLTMETERS AND AMMETERS

This principle and method of construction can be used for both voltmeters and ammeters, by simply making the coil of the proper resistance and number of turns in each case.

A. C. ammeter coils usually consist of a very few turns of large wire, as they are connected in series with the load or to the secondary of a current transformer. Ammeters designed for use with shunts or current transformers, however, usually have coils of smaller wire and a greater number of turns.

Voltmeter coils are wound with a great number of turns of very fine wire, in order to obtain high enough resistance so they can be connected directly across the line.

Separate resistance coils are sometimes connected

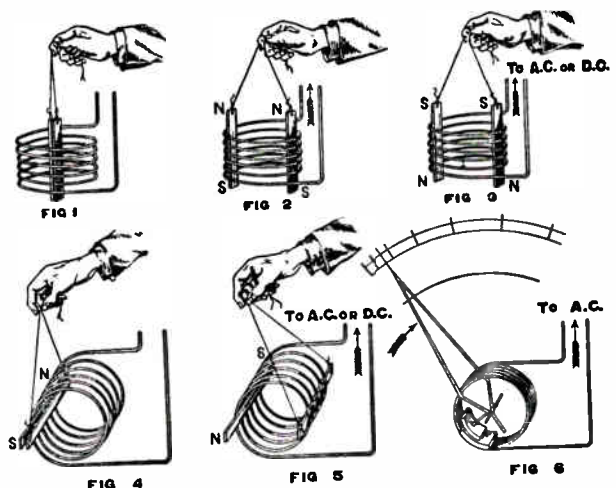

Fig. 44. The above views illustrate the principle of the moving-iron type meter. Note how the iron bars repel each other when they are magnetized with like poles, by the flux of current through the coils.

in series with the coils of voltmeters to provide sufficient resistance to limit the current through them to a very small amount. The current required to operate a voltmeter usually does not exceed a very few milli-amperes.

Fig. 45 shows a meter of the moving vane type. The iron vanes are made in several different shapes, but always operate on the same principle of the repulsion between like poles.

Some meters of this type depend upon the weight of the moving iron vane and a small adjustable counter-weight to react against the magnetic force as the pointer is moved across the scale. Other meters use a small coil spring to oppose the pointer movement.

This type of meter can be used on D. C. circuits also, but may not be as accurate, because of the tendency of the iron vanes to hold a little residual magnetism from the constant direct current flux which is applied to them.

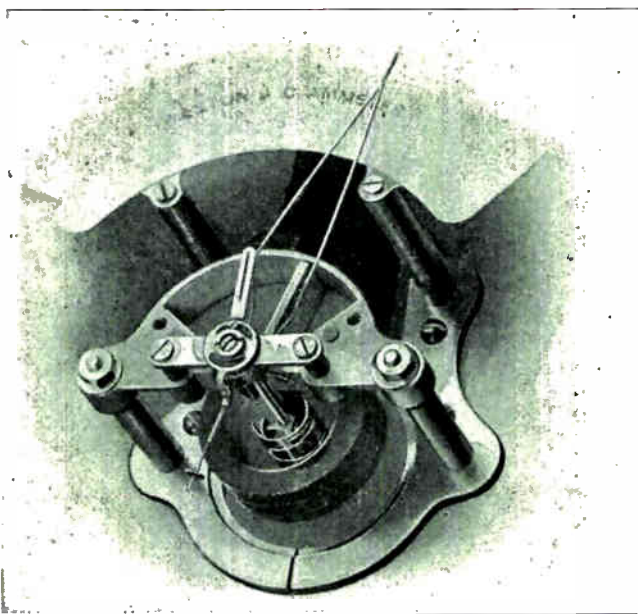

Fig. 45. This photo shows the construction and important parts of an iron-vane meter. Note the position and shape of the iron vanes within the coil and also note the damping vane and chamber above the coil.

## 62. DAMPING OF METERS

The damping chamber can be seen directly behind the lower part of the pointer in Fig. 45. The damping vane, made of very light-weight material and attached to the pointer, moves in this air chamber as the pointer moves. This vane doesn't touch the sides of the chamber but fits closely enough so that it compresses the air on one side or the other as it moves in either direction. This prevents oscillation of the pointer with varying loads and permits more accurate readings to be obtained.

For damping the pointer movement some instruments use a small aluminum disk which is attached to the pointer and moves between the poles of a permanent magnet. This operates similarly to the damping disk and magnet explained for D. C. watt-

hour meters, the retarding effect being produced by the eddy currents induced in the disk.

Fig. 46 shows the movable assembly of the moving-iron type of instrument, on which can be seen the damping vane, mounted directly beneath the pointer, and also the movable iron vane at the lower end of the shaft, and the small coil spring which controls the pointer movement across the scale.

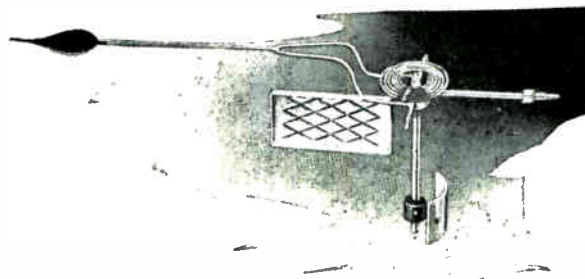

Fig. 46. Moving element of an iron-vane type meter. This view shows the shaft, iron vane, damping vane, pointer, and spring.

## 63. THOMPSON INCLINED COIL INSTRUMENTS

The Thompson inclined coil and moving vane type of construction is quite extensively used in some makes of A. C. voltmeters and ammeters. This type of meter uses a coil inclined at an angle of about 45 degrees with the back of the instrument, as shown in Fig. 47. This coil supplies the flux to operate a small moving vane of soft iron, which is also mounted at an angle on the shaft of the meter so that it is free to move and operate the pointer which is attached to the same shaft.

When the meter is idle and has no current flowing through the coil, the small coil spring at "C" holds the pointer at zero on the scale. When the shaft is in this position, the movable iron vane is held at an angle to the axis of the coil or to the normal path of the flux set up by the coil when it is energized.

When the coil is energized and sets up flux through its center, as shown by the arrows, the iron vane tends to move into a position where its length will be parallel to this flux. This causes the pointer to move across the scale until the magnetic force exerted is balanced by the counter-force of the spring.

This type of construction is used both for voltmeters and ammeters, by winding the coils with the proper number of turns, as previously explained.

## 64. DYNAMOMETER TYPE INSTRUMENTS

Dynamometer type instruments are used for voltmeters, ammeters, and wattmeters. Meters of this type have two coils, one of which is stationary and the other which is movable and attached to the shaft and pointer. The torque which moves the pointer is produced by the reaction between the fields of the two coils when current is passed through both of them.

There is no iron used in the two elements of this meter; the moving coil being light in weight



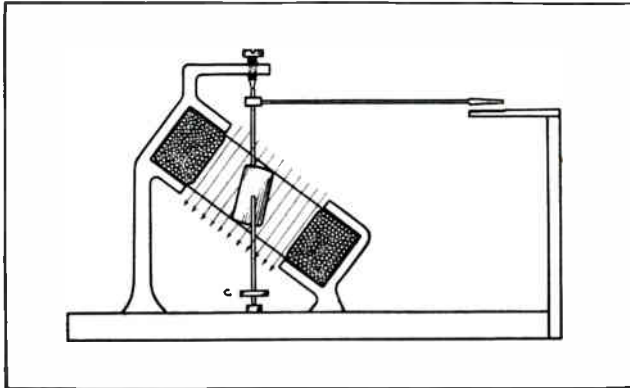

Fig. 47. The above diagram shows the construction and principle of the Thomson inclined-coil meter.

and delicate in construction, but rigid enough to exert the proper torque on the shaft.

In some meters of this type, the movable coil is mounted within two stationary coils, as shown in Fig. 84; while in other types it is mounted near to the side of one large coil, as shown in Fig. 49. In either case, the movement of the smaller coil is caused by the reaction between its flux and the flux of the stationary coil or coils.

When both the stationary and movable coils are excited or energized, the lines of force through their centers tend to line up or join together in one common path. When the pointer is at zero, the movable coil rests in a position so that its axis and the direction of its flux will be at an angle to that of the stationary coils. So, when the current is applied the reaction of the two fields will cause the movable coil to force the pointer across the scale against the opposing force of the delicate coil springs, which can be seen in both Figs. 48 and 49.

These coil springs are usually made of phosphor-bronze alloy, and in some cases they carry the current to the movable coil.

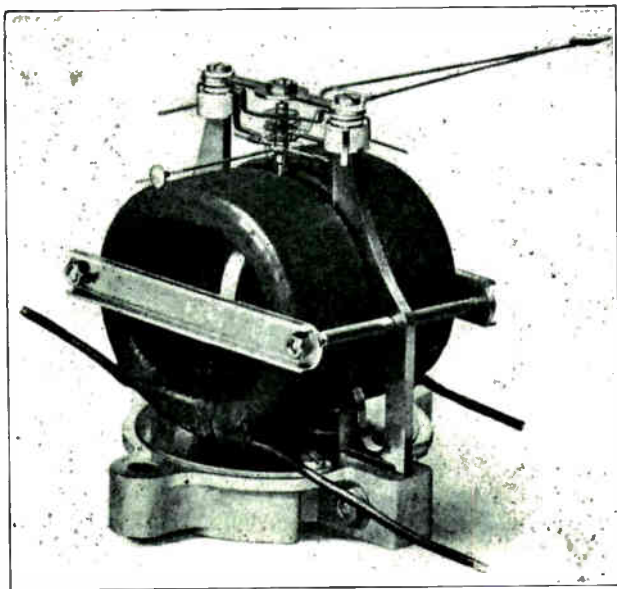

Fig. 48. This view shows the coils of an electro-dynamometer type meter.

Voltmeters of the electro-dynamometer type usually have the two coils connected in series with each other and also in series with a resistor, and then connected across the line.

Ammeters of this same type may have the two coils connected in series and then across a current transformer which carries the main load current. In some cases the stationary coil of an ammeter may carry the full load current, while the movable coil is connected to a current transformer so that it carries only a small fraction of the current.

The movable coil is not designed to carry much current in any case, because it must be light in weight and delicate in construction to obtain the proper accuracy in the operation of the meter.

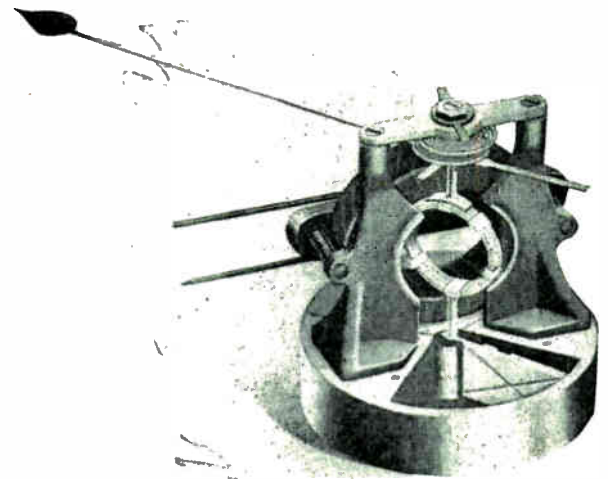

Fig. 49. Another dynamometer type meter with slightly different arrangement of the coils. Note the damping vane attached to the bottom end of the shaft so that it rotates in the damping chamber under the meter element.

## 65. A. C. WATTMETERS

Wattmeters using the electro-dynamometer principle have elements very similar to those shown in Fig. 48. The stationary coils are used for the current element and may be connected in series with the load or across a current transformer. The movable coil is the potential coil and is connected in series with a resistance, and then across the line.

Resistances used in connection with the coils of A. C. meters are generally of the non-inductive type, so they will not affect the reading of the meter by introducing inductive reactance in the circuit.

While shunts are used in some cases with certain types of A. C. meters, instrument transformers are also commonly used to reduce the amount of current and voltage applied to the coils of the meters. This eliminates the necessity for current coils with very heavy windings and the necessity of winding potential coils with a great number of turns to obtain high resistance to permit them to be connected across high-voltage lines. It also reduces insulation difficulties, and hazards in testing high voltage circuits.

As the current coils in the wattmeter will always carry a current proportional to the amount of load,

and the potential coil will carry a current proportional to the voltage applied to its terminals, the torque set up by the magnetic fields of these two coils will be proportional to the power in watts in the circuit. The scale can therefore be graduated and marked to read directly the watts or kw. of the circuit to which the meter is connected.

Since the torque acting on the movable element is proportional to the instantaneous current and voltage, the meter will register the true power of the circuit, regardless of the power factor.

Fig. 53 shows a sketch which further illustrates the principle of the dynamometer-type wattmeter. You will note that stationary current coils which are connected in series with the line, set up a flux which tends to repel the flux of the movable coil and will cause it to move the pointer across the scale to the right.

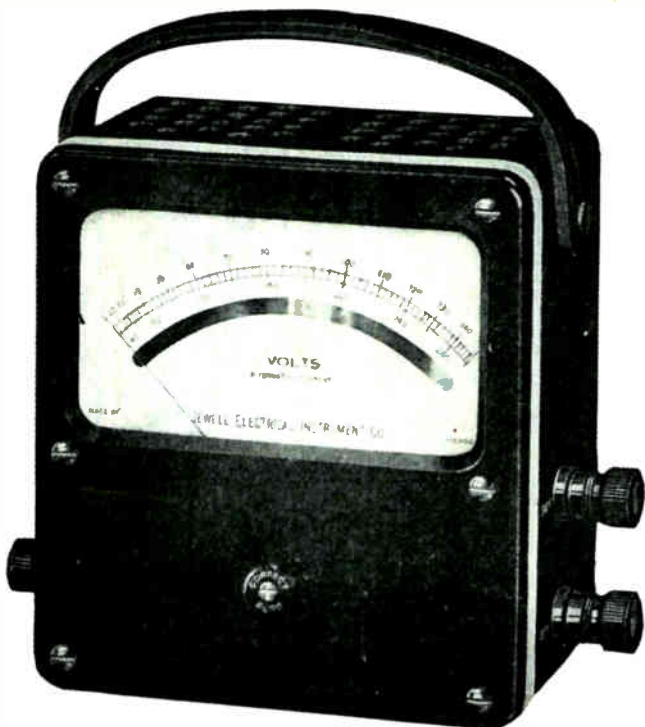

Fig. 50. A convenient style of portable voltmeter used for testing circuits and electrical machinery. (Photo courtesy Jewell Instrument Company.)

Electro-dynamometer type meters are somewhat more delicate and less simple in construction than the moving iron types, but the former are more accurate and therefore generally preferred where exact measurements are desired.

The scale over which the pointer of this instrument moves is not graduated with spaces of even width, because of the fact that the opposing force is a spiral or helical spring and, therefore, becomes greater as the pointer moves farther from zero.

## 66. INDUCTION TYPE INSTRUMENTS

Induction type A. C. meters operate on a principle similar to that of an induction motor, using the magnetic flux of stationary coils to induce cur-



Fig. 51. This portable meter has two elements and two scales, and can be used to measure either volts or amperes. The voltmeter element has an extra terminal to provide increased voltage range of this instrument. (Photo courtesy Jewell Instrument Company.)

rents in a rotating element in the form of a metal cylinder or drum; or in some cases a metal disk.

Fig. 57 shows a sketch of an induction meter of this type which can be used either as a voltmeter or an ammeter, according to the manner in which the coils are wound and connected.

A set of primary coils and also a set of secondary coils are wound on the upper part of the iron core. The primary coil, being connected to the line, sets up alternating magnetic flux which magnetizes the core and also induces in the secondary coils a current which is out of phase with that in the primary.

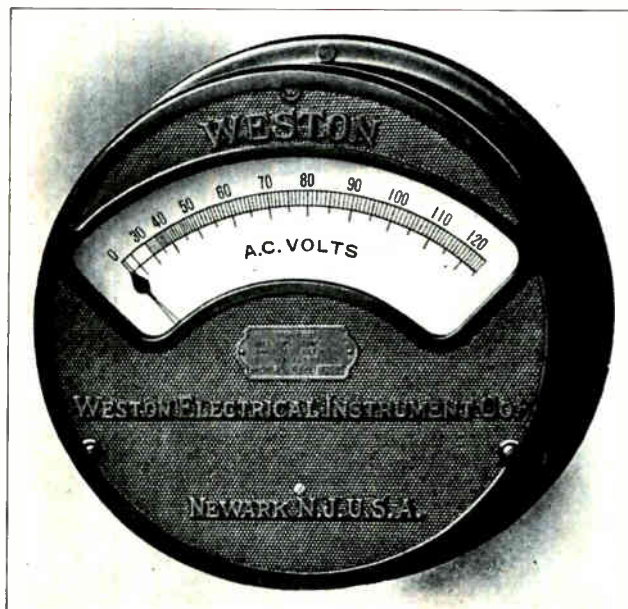

Fig. 52. Switchboard type A. C. voltmeter. Note the tapering graduation at the left end of the scale.

These secondary coils are connected in series with a third set of coils wound in slots at the lower end of the core near the movable drum. The different phase relations between the currents of these coils tend to set up a flux which is out of phase with that established in the core by the primary coil, thereby producing a sort of revolving field which induces eddy currents in the drum. The reaction between the flux of these eddy currents and the flux set up by the coils then causes the drum to tend to rotate by the same principle as used in A. C. induction motors.

The pointer is attached to this drum, so that, when the drum is rotated, the pointer is moved across the scale against the action of the coil springs.

When an instrument of this type is used for an ammeter, the primary coil is wound with a few turns of heavy wire and is connected in series with the line, or it can be wound with small wire and connected in parallel with a shunt or to the terminals of a current transformer.

When used as a voltmeter, the primary coil is wound with more turns of fine wire and is connected in series with a resistance and then across the line.

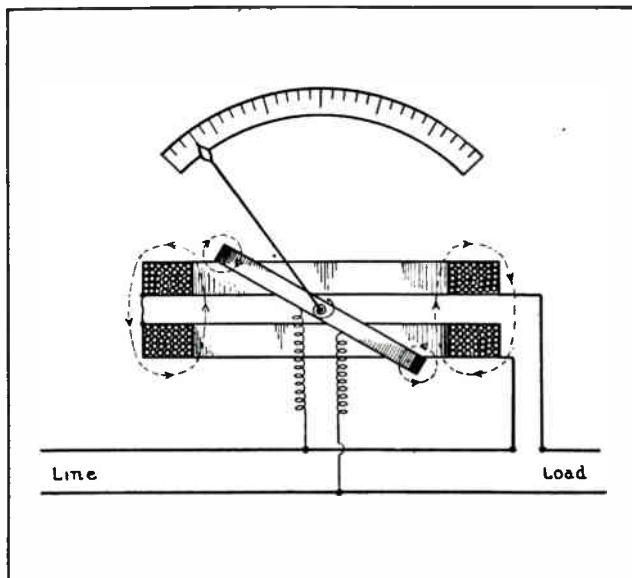

Fig. 53. This diagram illustrates the construction and principles of the dynamometer type instrument. Note the action between the flux of the moving and stationary coils.

### 67. INDUCTION TYPE WATTMETERS

This same induction principle can be applied to wattmeters, as shown in Fig. 58.

In this case, the potential element consists of the primary coils "P" which are connected in series with a reactance coil "B", and then across the line. The secondary coils "S" have current induced in them by the flux of the primary, and are connected in a closed circuit with a variable resistance "R".

In this manner, the amount of induced current which flows in the secondary coils may be varied by adjusting the resistance, so that the reaction between their flux and that of the primary coils

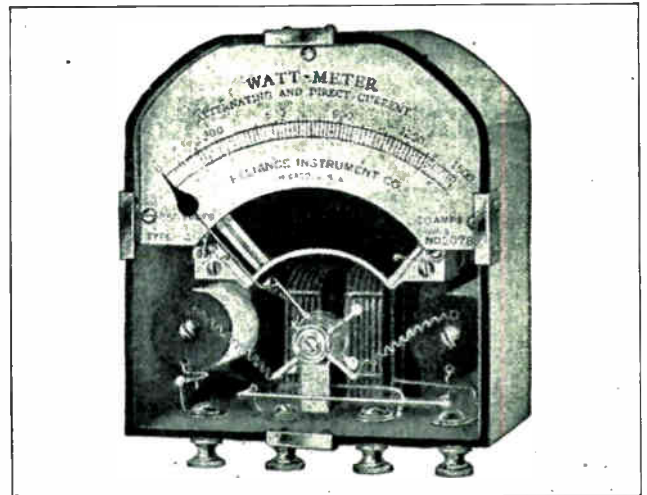

Fig. 54. This view shows the interior construction of a dynamometer type wattmeter. The current coils of the meter, the resistance coils, and damping vane in its chamber can all be plainly seen. (Photo courtesy Reliance Instrument Company.)

will produce the proper phase relation between the flux set up in the core and the flux of the current coils "C", which are wound in slots near the movable drum.

This current element is connected in series with the line, or to the proper shunt or instrument transformer.

When both sets of coils are excited, a revolving field is set up, which induces eddy currents in the movable drum, similarly to the operation of the induction voltmeter in Fig. 57.

In this case the strength of the combined flux set up by the potential and current coils will be proportional to the product of the voltage and current of the line. So, with the proper graduation of the scale, this meter can be made to record directly in watts the power of the circuit to which the meter is attached.



Fig. 55. Switchboard type wattmeter which has its scale calibrated to indicate the load in kilowatts. (Photo courtesy Weston Electrical Instrument Co.)

### 68. SHADED POLE INDUCTION METERS

Another type of induction meter which uses the induction disk, or shaded pole principle, is illustrated in Fig. 60.

This type of instrument has the torque produced on a moving disk, by inducing eddy currents in the disk by means of the large exciting-coil, and small shading coils, on the soft iron core.

When alternating current is passed through the large coil it sets up an alternating flux in the iron core and induces eddy currents in the edge of the disk which is between the poles of the core. The flux also induces secondary currents in the small shading coils, which are built into slots in one side of the pole faces and are short-circuited upon themselves to make closed circuits.

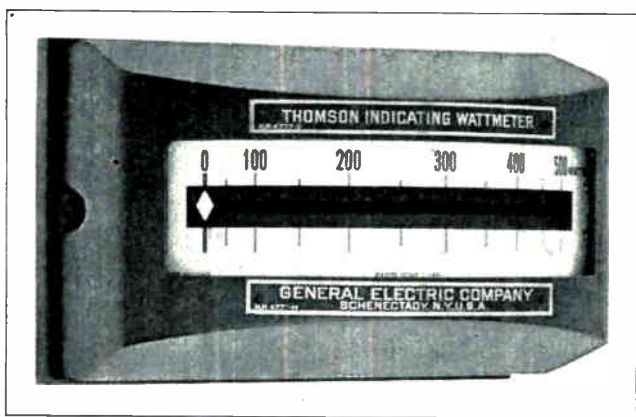

Fig. 56. Another type of switchboard meter known as the "horizontal-edgewise" type. Meters of this type are very commonly used in power plants. (Photo courtesy G. E. Company.)

The induced currents in these shading coils are out of phase with the current in the large coil, and therefore they set up flux which is out of phase with the main core flux. This causes a sort of shifting or sliding flux across the pole faces, which reacts with the flux of the eddy currents in the disk and causes the disk to tend to rotate.

The disk can rotate only part of a revolution, as its movement is opposed by a spring on the shaft. The rotating movement of the disk moves the pointer across a scale as in any other meter.

The movement of the disk and pointer is damped by the drag magnet on the right, which induces eddy currents in the disk when it moves and thereby tends to slow its movement and prevent jumping or oscillation of the pointer.

The sides of the moving disk or ring are often cut in a slightly varying or tapering width, to obtain greater torque as the pointer moves farther against the force of the spring. This allows uniform graduation of the scale.

When instruments of this type are used for ammeters, the main coil is connected in parallel with a special alloy shunt, the resistance of which changes with temperature and load changes, to compensate for heat and increased resistance in the coil or disk.

When used as a voltmeter, the coil of the instrument is connected in series with a reactance coil to compensate for changes in frequency, and also in parallel with a shunt to compensate for temperature and resistance changes.

This same principle of induction is applied to A. C. induction watt-hour meters, frequency meters, and various types of A. C. relays; so it is well worth thorough study to obtain a good understanding of the manner in which it produces the torque in the disk.

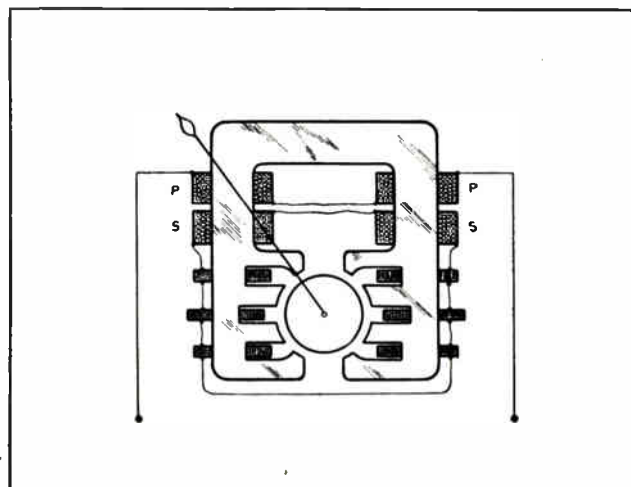

Fig. 57. This diagram shows the core and coils of an induction type meter. Study the principles of this meter thoroughly with the accompanying explanations.

### 69. HOT-WIRE INSTRUMENTS

Hot-wire instruments are those which obtain the movement of their pointers by the expansion of a wire when it is heated by the current flowing through it.

This principle is illustrated by the diagram in Fig. 61. When the terminals "A" and "B" are connected to a line and current is passed through the wire "W", it becomes heated by the current and expands.

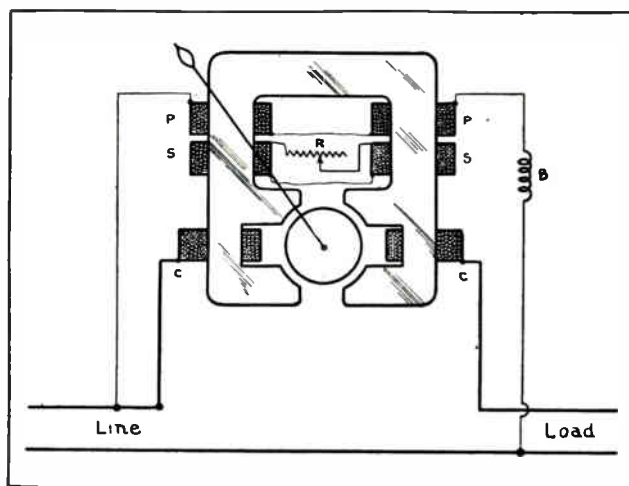

Fig. 58. Core and coils of an induction type wattmeter. Note how the current and potential coils are connected to the line.

This expansion causes it to loosen and sag, and allows wire "X" to become slack. Wire "Y" is attached to wire "X" and is wrapped around a pulley on the shaft to which the pointer is attached. The other end of this wire is attached to a spring which is fastened to the meter case. This spring maintains a continual pull on wire "Y"; so that, as soon as wire "X" becomes slack, wire "Y" is drawn around the pulley and causes it to rotate and move the pointer across the scale.

When the current decreases or stops flowing through wire "W", this wire cools and contracts back to its tight condition and draws wires "X" and "Y" back against the action of the spring; thus returning the pointer to zero.

When instruments of this type are used as ammeters, the wire "W" is connected in series with the line or in parallel with a shunt which is in series with the line. When the device is used as a voltmeter, the wire "W" is connected in series with a resistance and then across the line.

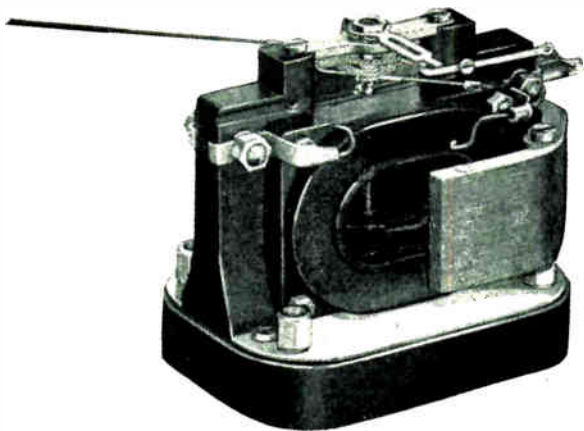

Fig. 59. This photo shows a meter element with part of the magnetic shield in place around it. These shields are made of soft-iron laminations and prevent magnetic flux from other machines or circuits from interfering with the accuracy of the meter. One-half of the shield is shown removed in this view.

Hot-wire instruments are made in a number of different forms, and with various arrangements of their wires and parts; but all of them operate on the same general principle. Fig. 62 shows the working parts of a hot-wire meter of slightly different construction from that shown in Fig. 61.

Meters of this type can be used on either D. C. or A. C. circuits; but they are particularly adaptable to high frequency A. C. circuits, such as in radio stations, X-ray work, and laboratories where very high frequencies are used. Having no coils in their construction, hot-wire meters are non-inductive and therefore offer less impedance to high frequency currents and operate more accurately on varying frequencies.

## 70. ELECTRO-STATIC VOLTMETERS

Electro-static voltmeters are often used for measuring very high voltages. These meters operate on the principle of the attraction between bodies with unlike charges of static or high-voltage elec-

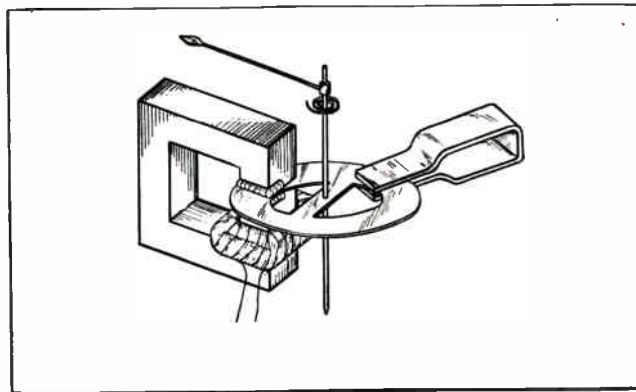

Fig. 60. Diagram illustrating the principles and construction of a disk type induction meter. The torque on the disk is produced by the action of the flux from the shaded pole.

tricity. Fig. 63 shows an electro-static voltmeter, with the case opened to show all the working parts clearly.

This instrument consists of a set of stationary metal vanes, and a pair of movable vanes of light weight metal. In normal or zero position, the movable vanes hang free of the stationary vanes due to gravity action on a counter-weight attached to the shaft.

When the wires of a high-voltage line are connected to this instrument, one wire to the stationary vanes and one to the movable vanes, charges of opposite polarity will be set up on the vanes. This causes them to attract each other and the movable vanes will be drawn nearer to the stationary ones, or in between them. This moves the pointer across the scale a distance proportional to the voltage applied.

Electro-static voltmeters can be obtained to measure voltages as high as 50,000 volts, or even more. They can also be made to measure quite low voltages, by using a number of vanes, closely

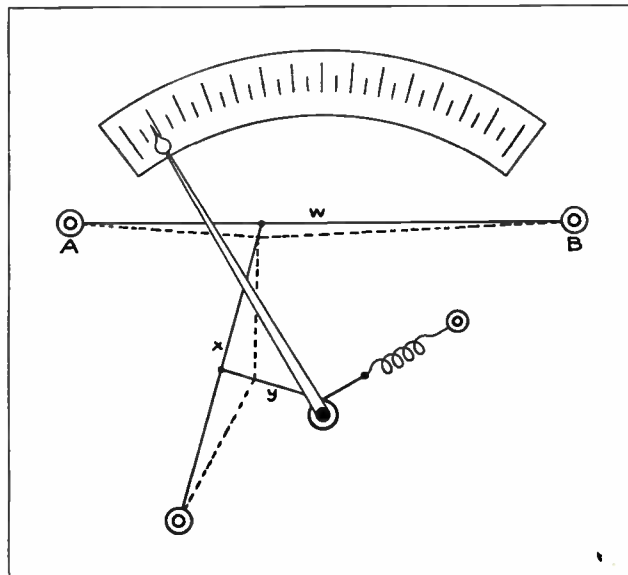

Fig. 61. This sketch shows the operation of a hot-wire meter, in which the movement of the pointer is obtained by the expansion of a wire when heated by passing current through it.

spaced. These instruments will work on either D. C. or A. C. circuits, because it makes no difference if the polarities reverse, as long as the movable and stationary vanes are always of opposite polarity at any instant.

### 71. A. C. WATTHOUR METERS

A. C. watthour meters are quite similar in many ways to those for D. C., which were explained in the section on D. C. meters. They consist of current coils and potential coils which set up flux and turning effort on the rotating element. The rotating element drives a chain of gears which operate the pointers on a row of four dials, and total up the power used in kilowatt-hours.

Some A. C. watthour meters are of the electro-dynamometer type. They have the potential coil wound on the moving armature and are equipped with commutator and brushes similar to those of D. C. watthour meters. The more common type of A. C. meter uses the induction disk principle, as meters of this type are much simpler and more rugged, have fewer wearing parts, and therefore require less care than the other types.

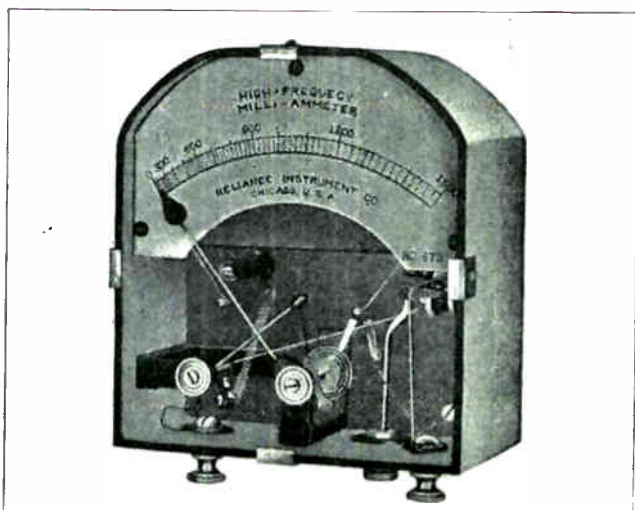

Fig. 62. This view shows the inside parts of a hot-wire meter of slightly different construction than the one illustrated in Fig. 61.

In the induction type watthour meter, both sets of coils are stationary and the rotating element is simply a light-weight aluminum disk mounted on a vertical shaft. There are no commutators or brushes to produce friction or get out of order. Fig. 64 is a photo of a modern A. C. induction watthour meter, and it shows clearly the principal parts of such a meter, with the exception of the gears, dials, and the damping magnets, which are on the other side of the meter.

The two coils of heavy wire on the lower part of the core are the current coils, and the large coil above is the potential coil. Between these coils the rotating disk can be seen.

Fig. 65 shows a diagram of the core, coils, disk, and one damping magnet of a meter of this type, and further illustrates its operating principle.

The potential coil "P" is wound with a great

number of turns of very fine wire, and on the upper leg of the soft, laminated-iron core; and the current coils "C" and "C" are wound with very few turns of heavy wire, on the two lower core legs.

The large number of turns in the potential coil make this winding highly inductive, and cause the current which flows through it to be nearly 90 degrees lagging, or out of phase with that in the current coils. As the current coils consist of only a very few turns, their circuit has very little inductance, and the current through them will be nearly in phase with the line voltage.

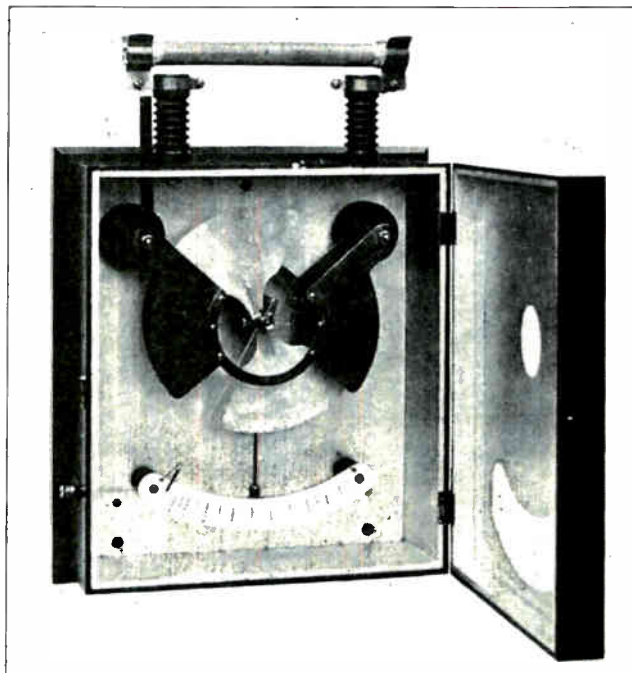

Fig. 63. This photo shows an electro-static voltmeter for measuring the potential of high voltage circuits. The pointer movement is obtained by the attraction between the moving and stationary metal vanes when they are charged with opposite polarity.

The potential coil is connected across the line or across the terminals of a potential transformer. The current coils are connected in series with the line on small power and lighting circuits; or to the secondary of a current transformer on heavy power circuits.

The reversing flux of the current coils alternately leaves one of these poles and enters the other; while the flux of the voltage coil leaves its pole and splits or divides between the two poles at its sides and the two poles of the current coils under the disk.

These two different fluxes which are set up by the out-of-phase currents in the potential and current coils, create a shifting or rotating field effect, which induces eddy currents in the disk; and the reaction between the flux of these eddy currents and the main flux causes the torque and rotation of the disk. This is called the motor element.

One of the damping or "drag" magnets is shown at "D" in Fig. 65. There are two of these magnets, located one on each side of the disk; and when

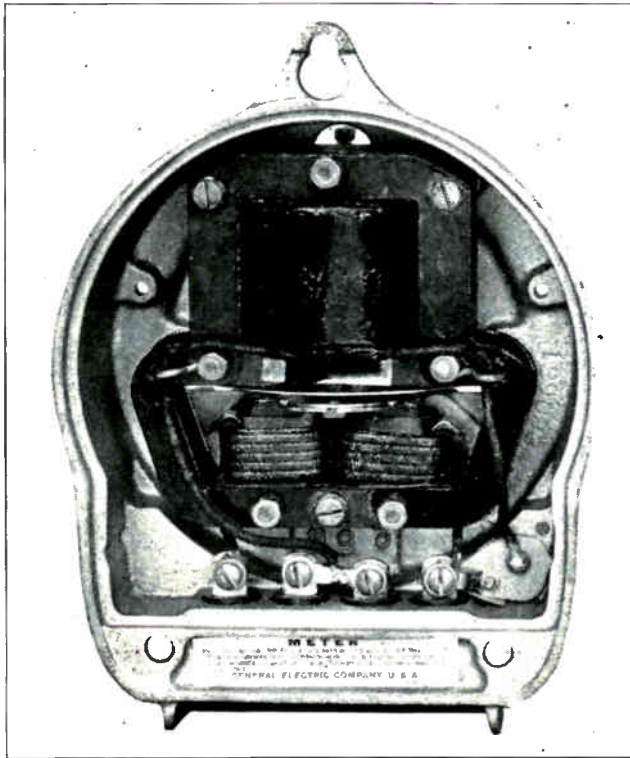

Fig. 64. Interior view of a modern watthour meter, showing the current and potential coils, and the induction disk.

the edge of the disk revolves between the magnet poles, their flux induces in the disk eddy currents which tend to retard its motion. This retarding or damping force will always be proportional to the speed of the disk.

As the current and flux of the potential coil are proportional to the line voltage, and the current and flux of the current coils are proportional to the load current, the torque exerted on the disk by these fluxes will always be proportional to the product of the volts and amperes. This is also proportional to the load in watts on the line.

This force acting against the retarding effect of the damping magnets will cause the meter speed to be proportional to the power used at any time.

The upper end of the shaft on which the disk is mounted is fitted with a worm which drives the first gear of a chain of several gears, which in turn operate the pointers, exactly as described for D. C. watthour meters in Article 102, Section Two, of Direct Current.

A. C. watthour meters are also read in exactly the same manner as explained in Article 103 of Section Two on Direct Current.

## 72. CREEPING

Sometimes the disk of an A. C. watthour meter will continue to revolve very slowly when the load is all disconnected from its circuit. This is known as *creeping*; and it may be caused by vibration, too high line-voltage, wrong adjustment of the friction compensating device, wrong connection of the potential coil, a short circuit in the current coil;

or by a high-resistance ground or leakage on the line.

The potential coil of a watthour meter is connected directly across the line; so, as long as there is voltage on the line, there will always be a very small amount of current flowing in this coil whether there is any load on the line or not.

If the meter is over-compensated for friction by the light load adjustment, this may set up enough torque to rotate the disk slowly. Vibration of the meter reduces the friction on its bearings and may be the cause of starting the creeping.

If the line voltage rises above normal, it will increase the amount of current flowing in the potential coil and thereby increase the torque set up by the light-load, friction-compensating device.

The potential coil should be connected across the line between the current coils and the service, as shown in Fig. 65; because, if it is connected on the load side of the current coils, the small current which is always flowing through the potential coils will also flow through the current coils, and may set up enough flux and torque to cause the meter to creep.

If a short-circuit occurs in the current coils, making a closed circuit of one or more turns, the flux of the potential coil will induce a current in these shorted turns. The flux of this secondary current, working on the disk with that of the potential coil, will cause the meter to creep.

High-resistance grounds or leaks on the line may cause enough current leakage to operate the meter slowly, and yet not enough current to blow a fuse.

Some watthour meters have two small holes drilled on opposite sides of the disk to prevent creeping. The nature of the eddy currents set up around these holes will tend to stop the disk when the holes come between the poles of the magnets.

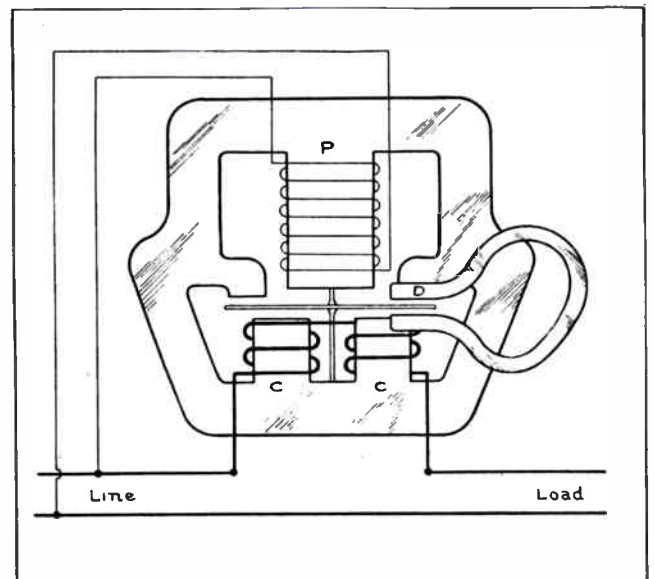

Fig. 65. This diagram illustrates the construction and principles of an induction watthour meter. Note the manner in which the current and potential coils are connected to the line.

### 73. A. C. WATTHOUR METER ADJUSTMENTS

The light-load adjustment, or friction compensation, on some watthour meters consists of a small coil placed near the current or potential coil and short-circuited so that it will have current induced in it by the flux of the main coil. The current and flux of this auxiliary coil are out of phase with those of the main coils, so they set up a small amount of "split-phase" or shifting flux, which adds just enough to the torque of the disk to compensate for friction at light loads.

In other meters, this adjustment consists of a small plate located between the disk and the poles of the current coil cores, to distort part of their flux and thereby produce a slight shifting flux and torque on the disk. These auxiliary coils or plates are usually adjustable by means of a screw, so that they can be accurately set to provide the right amount of compensation.



Fig. 66. Watthour test meter or rotating standard, used for calibrating watthour meters.

A. C. watthour meters often have another adjustment to compensate for inductive load and lagging current on the line.

On some of the latest type meters this adjustment consists of a copper punching mounted under the meter disk and directly under the pole of the potential coil.

The secondary current induced in this copper plate, or ring, sets up flux of a proper phase relation with the main field to compensate for lagging load currents.

By moving this plate back and forth by means of an adjusting screw, the meter can be adjusted properly for various inductive loads.

The full-load adjustment for calibrating watthour

meters is made by shifting the damping magnets in or out at the edge of the disk.

If the meter runs too fast, the poles of the permanent magnets are moved farther out on the disk, to produce a greater retarding effect. If the meter runs too slowly, the damping magnets are moved farther in.

On later type meters, the damping magnets are mounted in a brass clamp which is adjustable by means of a screw.

### 74. TEST METERS AND POLYPHASE WATTHOUR METERS

Fig. 66 shows a portable test meter or rotating standard, used for calibrating and adjusting watthour meters, in the manner explained in the section on D. C. meters. This test instrument is connected to the same circuit or load as the meter under test, and the number of revolutions of its pointer are compared with the revolutions of the meter disk. By this comparison, and careful consideration of the watthour constant on the disk of the meter, we can determine whether the meter under test is operating accurately, or is running too fast or too slowly.

Polyphase watthour meters are used for measuring the power in kw. hours in a three-phase circuit. These meters have two or three separate elements for measuring the power either by the "two meter" or "three meter" method.

Fig. 67 shows a polyphase induction watthour meter for use on a three-phase, four-wire circuit.

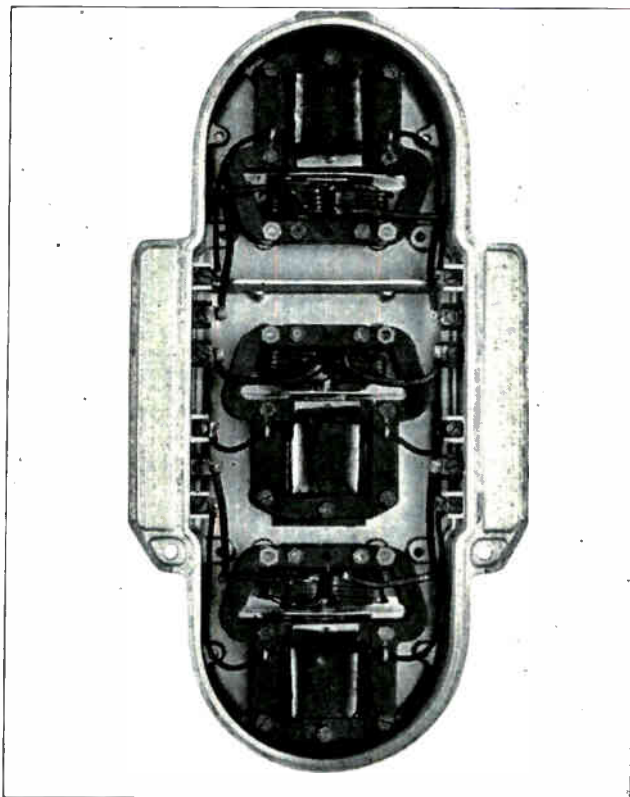

Fig. 67. This photo shows a three-phase watthour meter with three separate meter elements, one of which is connected to each phase.



## 75. DEMAND INDICATORS

In the section on D. C. meters one type of maximum demand indicator was explained. This type, you will recall, uses the heating effect of the load current to expand the air in a glass tube, and force a liquid over into an index tube to indicate the maximum demand on the system. This same type of demand indicator can also be used on alternating current systems.

In addition to this thermo-type of demand indicator, other A. C. maximum demand indicators are used which are operated either by electro-magnets or the induction disk principle.

One of these is simply a wattmeter element which moves a pointer over a scale a certain distance proportional to the maximum load, and leaves the pointer locked in this position until a higher load advances it farther, or until it is reset by the meter reader. This type is known as an indicating demand meter.

Another type has a marker operated by a magnet so it makes a mark on a moving paper tape each time the watt-hour meter makes a certain number of revolutions. These are called recording demand indicators.

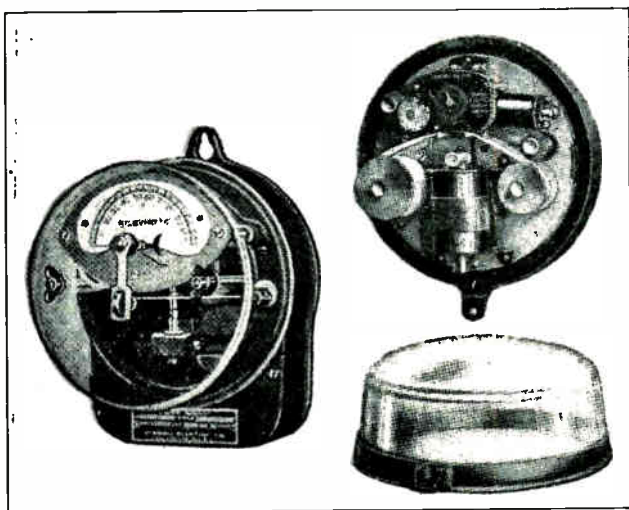

Fig. 68. Two types of maximum demand indicators. The one on the left is of the indicating type, and the one on the right is a recording type meter.

These indicators are used in connection with a watt-hour meter which is equipped with a contact-making device, so that it closes the circuit to the control magnet coils of the demand indicator every time the watt-hour meter makes a certain number of revolutions.

On the indicating type of demand meter, the pointer or needle is advanced across the scale a distance proportional to the amount of maximum load during any period that the instrument is energized.

On recording type demand indicators the speed of the tape is constant, so the number of marks for any given time period will vary in frequency and spacing according to the speed of the watt-hour meter during that period.

These marks, therefore, provide an indication of the maximum amount of power during any period.

Spring wound clocks or electric clocks are often used with demand indicators to control the time element or tape.

Some of the spring type clocks used with these meters, will run from 8 to 40 days with one winding.

Fig. 68 shows an indicating type of maximum demand meter on the left, and one of the recording type at the right. The cover is removed from the instrument at the right, showing the magnet coils and paper tape on which the record is printed.

Recording wattmeters using paper charts and operating on the same general principles as the recording wattmeters explained in the D. C. Meter Section, are also used in A. C. work.

## 76. POWER-FACTOR METERS

It has previously been mentioned in this section that power-factor meters can be used to indicate directly the power factor of any A. C. circuit. Power-factor meters are designed to register on their scale the power factor, or the cosine of the angle of lag or lead between the current and voltage of the circuit to which they are attached.

There are a number of different types of power-factor meters. One of the very common types which operates on the electro-dynamometer principle is illustrated in Fig. 69. This instrument has two movable coils, "A" and "B", mounted at right angles to each other on the shaft to which the pointer is attached. Coil "B" is connected in series with a resistance unit, "R", and coil "A" in series with an inductance "S"; then they are connected across the line of which the power factor is to be measured.

The stationary coils, "Z" and "Z-1", are connected in series with each other and then in series with one side of the line. The current through coil "B" will be approximately in phase with the line voltage; while the current through coil "A" will lag nearly 90 degrees behind the voltage, because of the inductance which is connected in series with this coil.

As the stationary coils are connected in series with the load, their current will be in phase with the load current. At unity power factor, the current through the stationary coils will be in phase with the current through the movable coils "A" and "B", and their magnetic fields will be at maximum value at the same time.

The flux of these coils tends to line up or flow through the same axis, and therefore holds coil "B" in its present position with the needle resting at 1.00, or unity power factor.

This is also often called 100 per cent. P.F.

While the power factor is unity, the current and flux of coil "A" will be approximately 90 degrees out of phase with the flux of the stationary coils; therefore, there will be just as much tendency for this coil to try to turn in one direction as in the other, so it doesn't exert any definite torque in

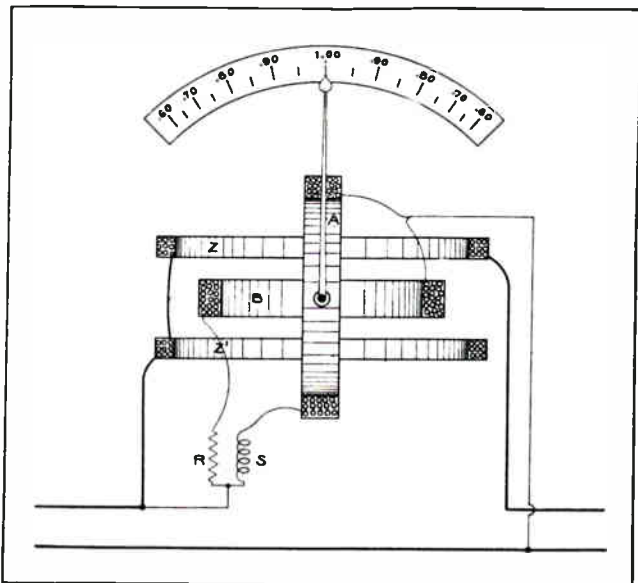

Fig. 69. This diagram shows the important parts and operating principles of a power factor meter.

either direction and allows coil "B" to hold the pointer in an upright position.

If the line current and voltage were approximately  $90^\circ$  out of phase, then the current in coil "A" would be in phase with the current in the stationary coils, and its flux would tend to turn coil "A" until its axis lines up with that of the stationary coils "Z" and "Z-1". It may turn either to the right or left according to whether the current lags or leads the line voltage.

During such a period, when the line current lags the voltage nearly  $90^\circ$ , the flux of coil "B" would be approximately  $90^\circ$  out of phase with the flux of the stationary coils, and it would therefore exert no appreciable torque in either direction.

If the line current and voltage were about  $45^\circ$  out of phase with each other, then the flux of both coils "A" and "B" would tend to line up with the flux of the stationary coils and the needle would assume a position of balance at about 71% power factor.

In this manner, any degree of lag or lead of the line current will cause the two coils to take a corresponding position, dependent upon the angle between the currents in the stationary coils and those in coils "A" and "B".

When the instrument is used as a power-factor indicator, the scale is marked to indicate the cosine of the angle of lag or lead, so that the power factor can be read directly from the scale.

The scale of this meter can also be marked to indicate in degrees the amount of lag or lead in the current, and can then be used to indicate the phase relations between the line voltage and the current.

Fig. 70 shows a switchboard-type power-factor meter. The scales of these instruments are seldom marked lower than 45 or 50 per cent, because it is very seldom that the P.F. is found to be lower

than this on any system. You will note that the needle can swing either to the right or left of unity and thereby indicate whether the power factor is lagging or leading.

Meters of this type will operate satisfactorily with voltage variations as much as 25% either below or above normal.

Single-phase power-factor indicators will not give accurate readings if the frequency of the circuit varies more than 2%. For high-voltage or heavy power circuits, current and potential transformers are used with such meters to reduce the voltage and current applied to their windings.

Power plants and large industrial plants which use considerable amounts of alternating current power are usually equipped with power-factor meters, and portable instruments of this type can often be used to make very valuable tests on machines or circuits throughout various plants.

## 77. FREQUENCY METERS

A frequency meter is an instrument which, when connected across the line the same as voltmeters are connected, will indicate the frequency of the alternating current in that line.

There are many cases where it is necessary to know or maintain the exact frequency of certain circuits or machines, and in such cases a frequency meter is used to conveniently determine the frequency of the circuit.

Power plants supplying A. C. usually regulate the frequency very carefully so that it will stay almost exactly at 60 cycles per second, or whatever the frequency of the generators is intended to be.

There are two types of frequency meters in common use, one known as the vibrating-reed type and the other of the induction type.

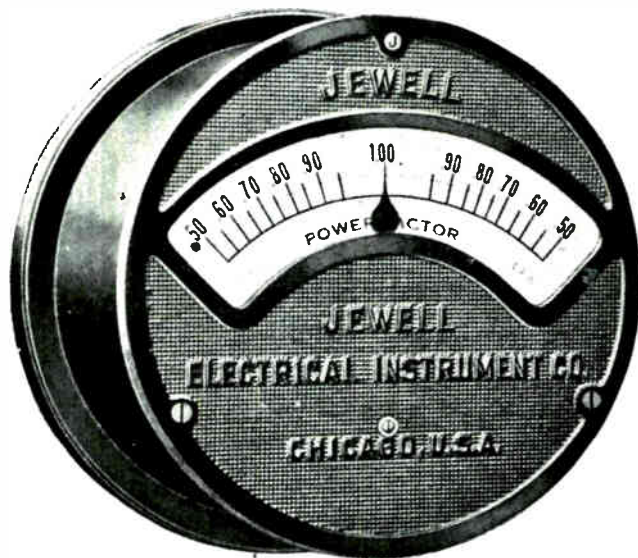

Fig. 70. Switchboard type power factor meter, such as commonly used in power plants and large industrial plants.

## 78. VIBRATING-REED TYPE INSTRUMENT

A vibrating-reed instrument is a very simple device, consisting principally of an electro-magnet which is excited by the alternating current, and a

number of steel reeds which are like thin, flat springs. These reeds are caused to vibrate by the changing strength and reversing flux of the magnet.

Fig. 71 illustrates the principle of this type of frequency meter. The large electro-magnet is wound with a coil of fine wire which is connected in series with the resistor and across the line. When alternating current is passed through this coil, it magnetizes the core first with one polarity and then another.

The polarity is constantly reversing and varying in strength, in synchronism with the frequency of the current. This causes the ends of all the steel reeds to be slightly attracted each time the end of the magnet becomes strongly charged.

These reeds are about  $\frac{1}{8}$  of an inch wide and approximately 3 inches long, but they each have slightly different natural periods of vibration. In other words, they are somewhat like tuning forks which will vibrate more easily at certain frequencies, depending upon the weight and springiness of the elements.

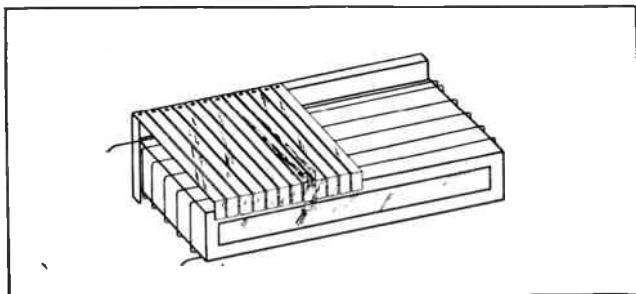

Fig. 71. Diagram of a vibrating-reed type frequency meter. Only part of the reeds are shown in this view. Note the appearance of one reed which is vibrating more than the others.

The reeds of the frequency meter can be made to vibrate at different frequencies either by making them of slightly different thicknesses or by weighting the ends very accurately with small amounts of lead. In this manner they are graduated from one end of the instrument to the other, so that the reeds on one end have a lower rate of vibration, and as they progress toward the other end each one has a slightly higher rate of vibration.

This arrangement will cause one or two of the reeds which have a natural rate of vibration closest to the frequency of the alternating current, to vibrate more than the others do when the magnet coil is energized.

The vibration of most of the reeds will be barely noticeable, because the magnetic impulses do not correspond with their natural frequencies. But the reed which has a natural vibration rate approximately the same as that of the alternating current, will vibrate up and down from  $\frac{1}{8}$  to  $\frac{1}{4}$  of an inch or more, and perhaps one reed on each side of it will vibrate a little.

The front ends of the reeds are bent downward in short hooks to make them plainly visible and, when viewing them from the front, the end of the reed which is vibrating will appear longer than the

others. Then, by reading on the scale directly under this vibrating reed, the frequency can be determined.

Another meter using this same principle, but of slightly different construction, is shown in Fig. 72. This meter has the reeds attached to a bar, "B", that is mounted on a stiff spring, "S", in such a manner that the whole bar with all of the reeds can be vibrated. There is also an iron armature, "A", attached to this bar and projecting out over the reeds beneath the poles of a pair of electro-magnets, "M".

These magnets are excited by the alternating current, the same as the large magnet shown in Fig. 71, and they cause the iron armature to vibrate and rock the bar, thereby causing the reeds to vibrate also.

This vibration of the reeds will be hardly noticeable, except on those that have a natural rate of vibration the same as the speed of the bar movement and the frequency of the alternating current which excites the magnets. These several reeds will vibrate so that their ends will be plainly noticeable, as previously explained.

This type of frequency meter has an adjusting screw for varying the distance between the electro-magnets and the armature "A". By changing this adjustment, the amount of vibration of the reeds can be regulated.

If the circuit to which a meter of this type is connected has a frequency of 60 cycles, the reed directly above the number 60 on the scale will be the one which vibrates the most.

This reed, however, will be moving at the rate of 120 vibrations per second, or once for each alternation of the 60 cycles.

## 79. INDUCTION-TYPE FREQUENCY METERS

The induction-type frequency meter is more commonly used than the vibrating-reed type. This meter operates on the induction-disk and shaded-pole principle, similar to that which was explained for induction voltmeters and ammeters.

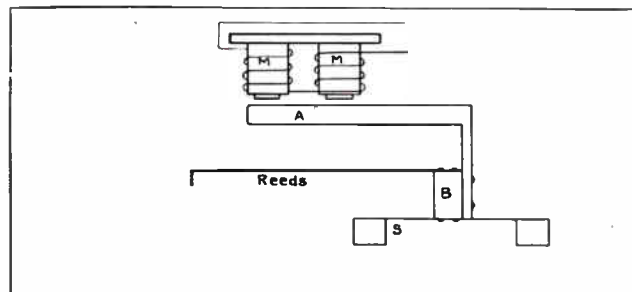

Fig. 72. This sketch shows a side-view of another type of vibrating-reed frequency meter. This instrument uses a pair of small electro-magnets to vibrate the armature to which the reeds are attached.

Fig. 73-A shows a side view of the cores, and disk of an induction-type frequency meter.

Each of the cores, "C" and "C-1", is wound with exciting coils, one of which is connected in series with a resistor "R", and the other in series with an inductance "X".

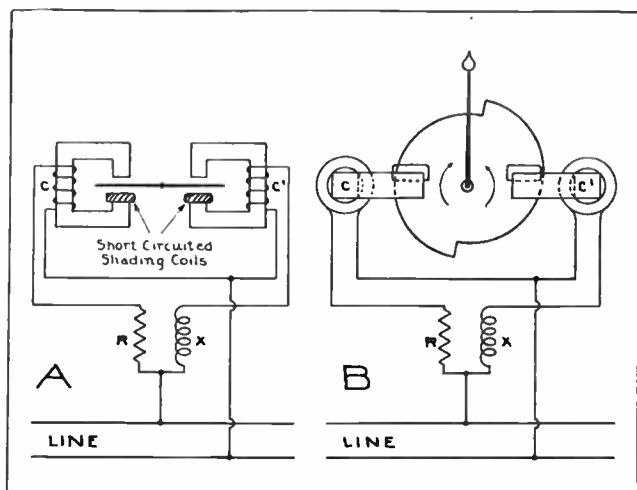

Fig. 73. "A" shows a side-view of an induction type frequency meter. This instrument uses the shaded-pole method of producing torque on the disk by induction. "B", Top view of an induction frequency meter, showing the shape and position of the disk between the poles.

These inductance coils, such as shown at "X", are sometimes called reactors. One end or pole of each of the magnet cores is equipped with a shading coil or small, short-circuited coils which are imbedded in one side of the pole faces.

When the coils "C" and "C-1" are excited with alternating current, the flux which is set up in the cores induces secondary currents in the short-circuited shading coils. The flux from these secondary currents in the shading coils reacts with the flux from the main coils and sets up a shifting flux across the edges of the disk.

This induces eddy currents in the disk and tends to set up torque and rotation of the disk. The position of the shading coils and the shape of the disk can be noted in Fig. 73-B.

You will also note in this view that the shading coils are placed on the same side of each magnet, so that they will both tend to exert opposing forces on the disk, each trying to revolve the disk in the opposite direction.

When the instrument is connected to a circuit of normal frequency, or 60 cycles, the current flow through each of the coils "C" and "C-1" will be balanced, and the pointer will remain in a vertical position as shown.

You will recall that the inductive reactance of any coil varies in proportion to the frequency. Therefore, if the frequency of the line increases or decreases, it will vary the amount of current which can pass through the inductance "X" and the coil "C-1".

If the frequency is increased, the inductive reactance of coil "X" will become greater and decrease the current through coil "C-1". This will weaken the torque exerted on the disk by this magnet and allow the disk to rotate a small distance to the right.

If the line frequency is decreased below normal, the inductive reactance of the coil "X" becomes less, allowing more current to flow and strengthen coil

"C-1". This will cause the disk to rotate to the left a short distance.

If the disk were perfectly round it would continue to rotate; but it is so shaped that the side under the poles of coil "C" always presents the same amount of surface to the pole, while the side under the poles of coil "C-1" presents a smaller area to the pole as the disk revolves to the left. Therefore, it will turn only a short distance until the increased strength of coil "C-1" is again balanced by the decreased area of the disk under this pole.

The reverse action takes place as the disk rotates to the right, so it will always come to rest at a point corresponding to the frequency of the line to which the meter is connected. The current through coil "C" remains practically constant, because it is in series with the resistor, and the impedance of this non-inductive resistor does not vary with the changes in frequency.

Fig. 74 shows a switchboard-type frequency meter with the needle resting in the normal position, indicating 60 cycles frequency. The scale is graduated to indicate frequencies as low as 50 cycles and as high as 70 cycles per second.

Instruments of this type will operate satisfactorily on voltages either 25% below or above normal. When used on 110-volt circuits, these meters are usually connected directly across the line, the same as a voltmeter.

## 80. CONNECTIONS OF FREQUENCY METERS

When used on higher voltage, a potential transformer can be used to step the voltage down. In other cases a resistance box may be used in series with the meter so that it can be operated directly from lines as high as 440 volts.

Fig. 74-A shows the connections of a frequency meter of this type, with its resistance and reactance units which are enclosed in one box. There are

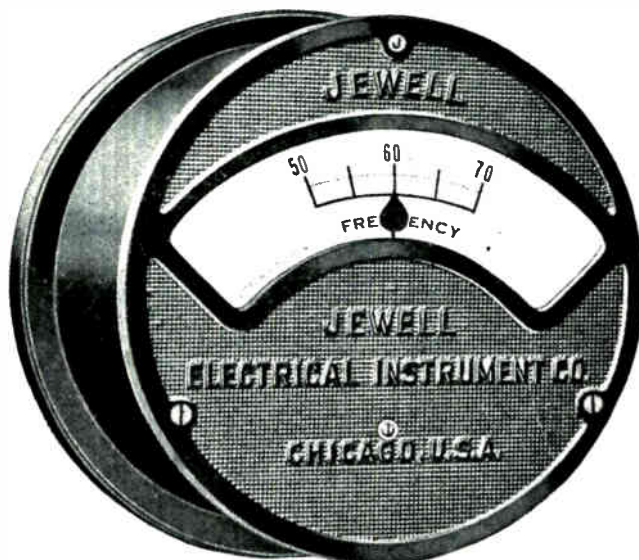

Fig. 74. This photo shows a switchboard type frequency meter, such as commonly used in power plants. The connections to instruments of this type are made to brass terminal bolts which project through the switchboard from the back of the meter.

three terminals on the meter and three on the resistance and reactance unit.

The terminal "R" of the reactance box is connected to the right-hand terminal of the meter, while the terminal "L" from the box connects to the left-hand terminal of the meter. The center terminal of the meter connects to the line wire opposite to that to which the common wire of the reactance box is connected.

Sometimes these meters fail to register properly because of no voltage or very low voltage on the circuit, or because the moving element has become stuck. If the meter reads extremely high, it may be caused by a bent disk, a short-circuit in the resistance coil, or an open circuit in the reactor coil. Testing with a voltmeter will locate either of these faults in the resistance and reactance box.

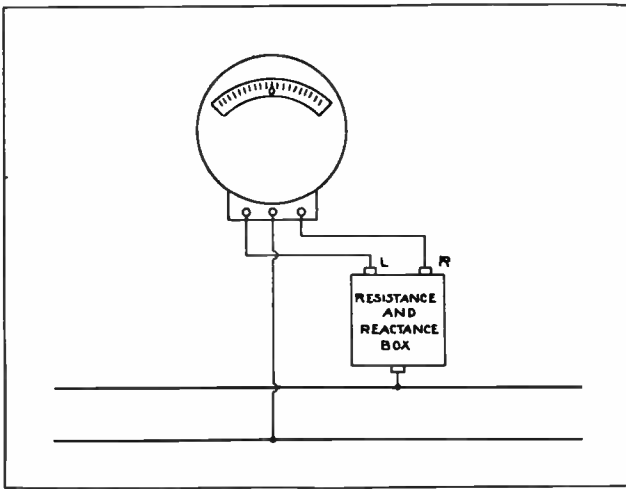

Fig. 74-A. This sketch shows the connections for a frequency meter and the resistance and reactance box which is used with the meter.

If the meter reads too low, it may be due to the moving element having become stuck or to an open circuit in the resistance unit. If the meter reads opposite to what it should, that is, if the needle indicates a lower frequency when you know the frequency is increased, or if it indicates a higher frequency when the line frequency is decreased, then the two outside terminals at the meter or at the reactance box should be reversed.

## 81. SYNCHROSCOPE

When paralleling A. C. generators, it is necessary to have a device to indicate when the machines are in phase or in step with each other. For this purpose an instrument called a synchroscope is used.

A synchroscope will indicate the phase difference between the running generator and the one which is being brought on to the bus, and will also indicate which machine is running the fastest, so that their speeds can be properly adjusted and the machines brought into perfect step or in phase with each other. This synchronizing is absolutely necessary before paralleling any A. C. generators.

The construction and operation of the ordinary synchroscope is practically the same as that of a single-phase power-factor meter.

Fig. 75 shows the construction and connections of a common type of synchroscope. The operating principle of this type of device is similar to that of a two-pole motor. The stationary coils on the field poles, "O" and "P", are connected to the running generator. The frequency of the current supplied to these coils will therefore be constant.

The movable coils, "A" and "B", are mounted on a shaft or rotor, at right angles to each other. The coil "A" is connected in series with a resistor, and coil "B" in series with a reactor. The two coils, with their resistance and reactance, are then connected in parallel and across one of the phases of the "incoming generator".

The current flowing in coil "B" will be approximately  $90^\circ$  out of phase with that in coil "A", because of lagging effect produced by the reactance coil in series with coil "B". This phase displacement of the currents produces a sort of revolving field around the rotor winding of the movable coils.

Let us assume that, at a certain instant, the current which is being supplied to the stationary field coils by the running generator reaches its maximum value at the same time as the current in the rotor coil "A", which is supplied from the incoming generator.

We shall assume also that at this instant these currents are both of the proper polarity to set up fluxes in the same direction, or from left to right between the field poles "O" and "P", and also from left to right through the center axis of the coil "A". Then these lines of force will tend to join together or line up with each other and cause the rotor to assume the position shown in the diagram.

If the frequency of the two generators remains the same, and if they are in phase, the rotor will remain in this position and the pointer will indicate that the machines are in synchronism.

If the maximum value of the current from the

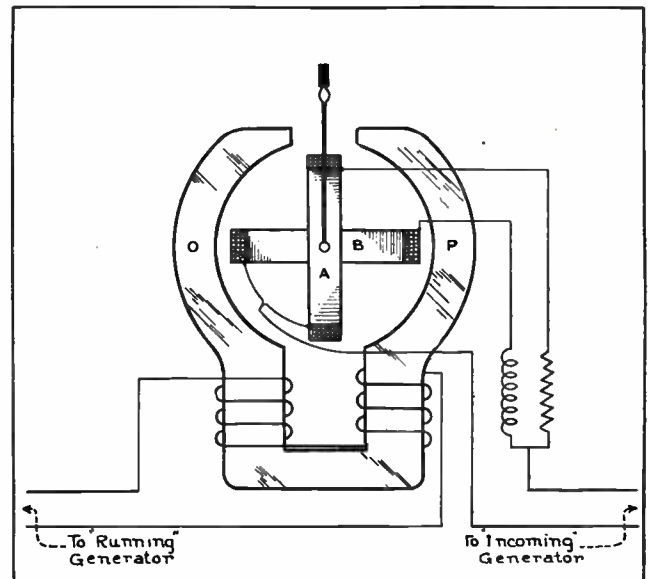

Fig. 75. The above diagram shows the important parts and illustrates the principles of a synchroscope. This diagram also shows the connections of the coils to the "running" and "incoming" generators.

running generators occurs about  $\frac{1}{4}$  of a cycle or  $90^\circ$  later than the maximum value of the current from the incoming generator, then the current in the field poles will be in phase with the current in the rotor coil "B"; because the current through this coil is lagging approximately  $90^\circ$ , due to the inductance in series with it.

When the maximum flux and current occur at the same time at the field poles "O" and "P" and in the movable coil "B", this will cause the flux of coil "B" to line up with that of the field poles, and will cause coil "B" to turn into the position now occupied by coil "A" in the diagram.

If the angle of phase difference between the maximum currents of the two generators becomes still greater, the pointer will move a still greater distance from the point of synchronism.

### 82. SYNCHROSCOPE SHOWS WHICH MACHINE IS RUNNING TOO FAST

If the incoming generator is operated a little slower and at lower frequency than the running machine, the needle will move to the left; and when the current of the incoming machine drops  $360^\circ$  behind that of the running generator, the pointer will have made one complete revolution to the left.

If the incoming machine is rotating faster and producing higher frequency than the running generator, the pointer will revolve to the right, and the faster the pointer revolves, the greater is the difference in speed and frequency between the two machines.

Fig. 76 shows a synchroscope for switchboard mounting. The left side of its scale is marked "slow", and the right side marked "fast", with arrows to show the direction of rotation of the pointer for each condition. These terms marked on the scales of such instruments refer to the incoming machine.

Some types of synchrosopes have an open face or glass cover over the entire front, so that the entire pointer is in full view at all times. In other cases, the pointer moves behind a transparent scale such as shown in Fig. 76. These instruments have a small lamp located behind the scale, so that the pointer can be seen through the scale as it passes across the face of the meter.

This lamp, however, is lighted only when the two generators are nearly in phase with each other. This will be explained in a following paragraph.

Whether the synchroscope uses a lamp or not, it indicates that the machines are in synchronism only when the pointer comes to rest over the dark spot at the top center of the scale.

### 83. SYNCHROSCOPES WITH LAMPS

The diagram in Fig. 75 is for a synchroscope of the type on which the needle revolves in plain view around the open face of the meter, when the generators are operating at different frequencies.

The pointer of the meter shown in Fig. 76 does not revolve clear around, but only swings back and forth behind the scale when the machines are out of

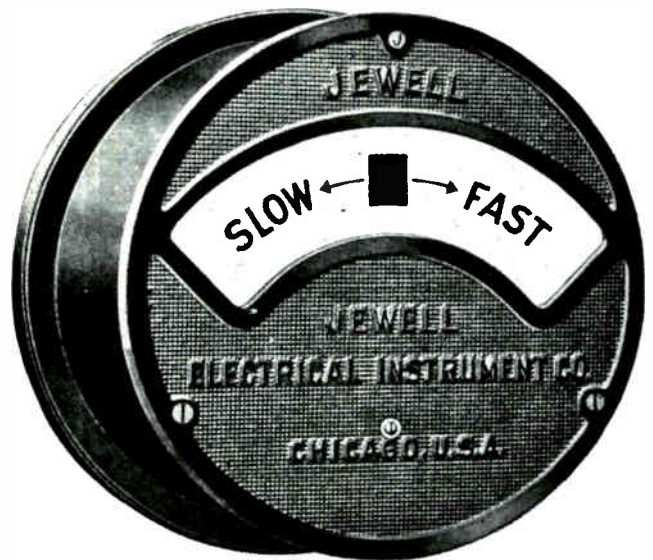

Fig. 76. Switchboard type frequency meter. With this type of instrument the pointer swings back and forth behind a transparent scale when the machines are out of phase.

phase. But as the lamp behind the scale and pointer lights up only when the pointer is passing the lamp and dark spot on the scale, the pointer appears to be rotating either to the right or to the left. In this manner, this type of meter also indicates whether the incoming machine is running slower or faster than the running machine.

Fig. 77 shows the inside of a synchroscope of this type and Fig. 78 shows the connection of its coils and also the transformer which operates the lamp.

The stationary coils, "C" and "C-1", are connected in series with a resistor and then across the busses of the running machine. The movable coil, "M" is connected in series with a resistor, "R", and a condenser, "X", and then across the busses of the incoming machine.

When the two generators are in phase the movable coil holds the pointer in a vertical position, but when the machines are out of phase the pointer will swing back and forth with a speed proportional to the amount of difference between the generator frequencies.

If the generators are running at the same frequency, but just a few degrees out of phase, the pointer will stand at a point a little to the left or right of the mark on the scale.

The lamp used with these synchrosopes is caused to light up and go out by being connected to the secondary of a small transformer which has two primary coils, one of which is connected to the running machine and the other to the incoming machine.

These primary coils are so wound that, when the machines are in phase opposition, the flux of the two coils joins around the outer core of the transformer, leaving the center leg idle, and the lamp dark.

When the two machines are in phase or nearly so, the fluxes of the two primary coils oppose each

other and set up sufficient flux in the center leg of the core to induce a voltage in the secondary coil and light the lamp. Therefore, the lamp will light when the machines are in phase and will go dark when the machines are  $180^\circ$  out of phase.

A. C. generators can also be synchronized with a lamp bank, as will be explained in a later section, but the synchroscope is a more convenient and reliable device and it is practically always used for synchronizing alternators in power plants.

As it is not practical to synchronize and parallel more than one incoming generator at a time, one synchroscope can be used for several generators connected to a large switchboard. The synchroscope is frequently mounted on a hinged bracket or arm at the end of the switchboard so it will stand out where it can be seen by the operator from any point along the board.

In larger power plants a synchroscope with a very large face or dial is used in this manner, so it is plainly visible to operators. More complete instructions on paralleling generators by means of synchrosopes will be given in a later section.

Most synchrosopes have their coils wound for operation on 110-volt circuits, but external resistors can be used with them for connecting the instruments to 220 or 440-volt circuits. When they are used with generators of higher voltages, potential transformers are used to reduce the voltage to the instrument.

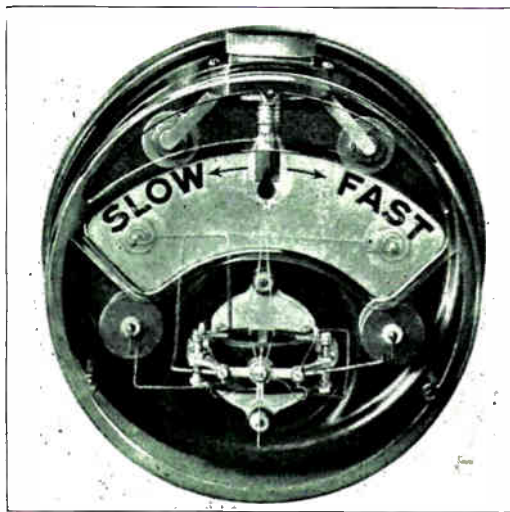

Fig. 77. This view shows the inside of a synchroscope and the arrangement of the various parts, including the lamp and meter coils.

#### 84. INSTALLATION AND CONNECTIONS OF SYNCHROSCOPES

When installing and connecting a synchroscope, care should be taken to see that the proper terminals of the resistor and reactor are connected to the similarly marked terminals on the instrument. It is very easy to make mistakes in these connections, if they are not very carefully made.

The synchroscope, when shipped from the factory,

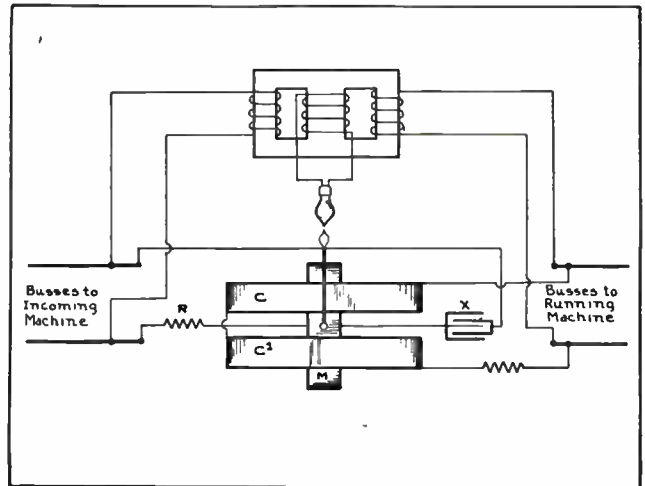

Fig. 78. This diagram shows the important parts and connections of a synchroscope similar to the one shown in Figs. 76 and 77.

has usually been tested and is packed in good condition. Therefore, if it doesn't operate correctly after it has been installed and connected, the fault is probably not in the meter, and the external wiring should then be checked over very carefully.

If the meter develops no torque, the trouble may be in the connections from the incoming generator. In this case the circuits through the resistor and reactor should be tested for opens, and the circuits through the meter should also be tested.

If the meter rotates but develops very little torque, the trouble may be in the connections from the running generator and its voltage and connections should be checked. A pair of test lamps can be used to determine whether the synchroscope is operating properly or not. If the lamps are connected to burn brightly when the two machines are in synchronism, and the synchroscope doesn't indicate synchronism at the same time the lamps do, the cause is probably wrong external connections, or the pointer may be displaced on the shaft.

Disconnect the meter from the generator busses and connect both elements to a single-phase circuit of the proper voltage. If the pointer now stands in vertical position, the meter is correct and the external connections must be checked.

If the instrument indicates synchronism when the two generators are  $180^\circ$  out of phase according to the lamp test, then reverse the two leads from the running generator. If the synchroscope rotates slowly when the generators are operating at widely different speeds and rotates rapidly when the generators are operating at nearly the same speed, the incoming generator may be connected to the running machine terminals of the meter.

The foregoing material on various types of A. C. meters, of course, does not cover every meter made, but does cover the more common types and the general principles on which they operate.

A good understanding of these principles and the applications of the various meters explained will be of great value to you in most any branch of electrical

work, and will be very helpful in choosing proper meters and installing and testing them on various jobs.

Always remember when handling or working with electric meters of any kind, that they are usually very delicate in construction and should never be bumped or banged around. Even slight jars may damage the jeweled bearings, shaft points, or some part of the moving element.

Connecting instruments to circuits of too high voltage or too heavy current for the range of the meter, will often bend the pointer or damage the moving element, and possibly burn out the coils.

Always try to appreciate the great convenience and value of electric meters for measuring the values of electric circuits, and handle these instruments intelligently and carefully on the job.

Intelligent selection of the proper meters for new electrical installations, or for old ones that do not have proper or sufficient meters, may often result in a promotion for you.

So give this subject proper consideration, and always handle any meters you may have to work with, in a manner that will be a credit to yourself and your training.

Norman Beder,  
41 Georgia Ave.  
Brooklyn 7, N. Y.







ESTABLISHED 1899

# COYNE

## *Electrical School*

CHICAGO ~ ~ ILLINOIS



COPYRIGHT 1942

# ALTERNATING CURRENT AND A. C. POWER MACHINES

## *Section Three*

### **A. C. Generators**

**Types, Construction Features, Cooling  
Field Excitation, Exciter Generators and Connections  
Alternator Voltage Control, Automatic Regulators  
Operation and Paralleling  
Phasing Out and Synchronizing  
Starting Alternators, Adjusting Load  
Shutting Down**

## ALTERNATING CURRENT GENERATORS

As most of the electrical power generated is alternating current, the operation and care of A. C. generators, or alternators as they are commonly called, is a very important subject. This section will deal principally with the common types of alternators; their construction, operation, and care.

The windings used in alternators and the principles by which they generate alternating voltage have been covered in the sections on Armature Winding and in Alternating Current, Section One.

Alternators are made in sizes ranging from the small belt-driven or engine-driven types of from 1 to 50 kv-a. up to the mammoth turbine-driven units of over 200,000 kv-a.

Alternators can be divided into the following classes: (A) Revolving armature or revolving field types; (B) Vertical or horizontal types; (C) Turbine or engine types.

### 85. REVOLVING FIELD ALTERNATORS

Practically all A. C. generators of over 50 kv-a. capacity are of the revolving-field type, because this type of construction permits the generation of much higher voltages in the stationary armature windings, and also because it eliminates the necessity of taking high-voltage energy from a revolving member through sliding contacts. This greatly simplifies the construction of the machine and reduces insulation difficulties.

Revolving-field alternators are commonly made to generate voltages as high as 13,200, and some are in operation producing voltages of 22,000 directly from their stator windings. Alternators can now be constructed to produce voltages as high as 36,000. The generation of such high voltages makes possible very economical transmission of this energy, and also reduces the necessary winding ratio of transformers when the voltage is to be stepped up still higher for long distance transmission.

At the left in Fig. 79 is shown the stator, or stationary armature, of an alternator. The rotor, or revolving field, which has been removed from the stator, is shown at the right. Note the stator coils or windings which are practically the same for alternators as for A. C. induction motors.

These windings were thoroughly described, both as to construction and connections, under Three-Phase Stator Windings in the Armature Winding Section.

Note also the construction of the revolving field element and the manner in which the poles are mounted on the spider. The collector rings, through which the low-voltage direct current is passed to the field coils, can be seen at the end of the rotor.

Some of the smaller A. C. generators have revolving armatures which are wound very similarly to those for D. C. generators, and have connections brought out to slip rings so the generated energy can be transferred from the revolving armature to the line by means of these slip rings and brushes.

However, many of the smaller alternators are also built with revolving fields. Fig. 80 shows a belt-driven alternator of 125 kv-a. capacity, with a revolving field and stationary armature. This generator is driven at 900 R.P.M. and produces three-phase, sixty-cycle energy at 2300 volts. Note the three leads which are brought out from the stator for permanent connection to the switchboard or line when the machine is installed. In this manner the load current flows directly from the stationary armature to the line without any slip rings or sliding connections in the circuit. Note the D. C. exciter-generator which is attached directly to the end of the shaft of this alternator.

Fig. 81 shows the revolving field for a small alternator of the type shown in Fig. 80. Note carefully the construction of the field poles on this rotor, and also the slip rings and D. C. exciter-armature on the end of the shaft.

The direct current energy required to excite the field of an A. C. generator is very small in comparison with the A. C. output of the machine. This energy for excitation varies from three-fourths of one per cent. to two and a half per cent. of the total capacity of the alternator.

It is easy to see, therefore, that the revolving field will require much smaller and lighter conductors than a revolving armature would; and also that the handling of this smaller amount of energy through

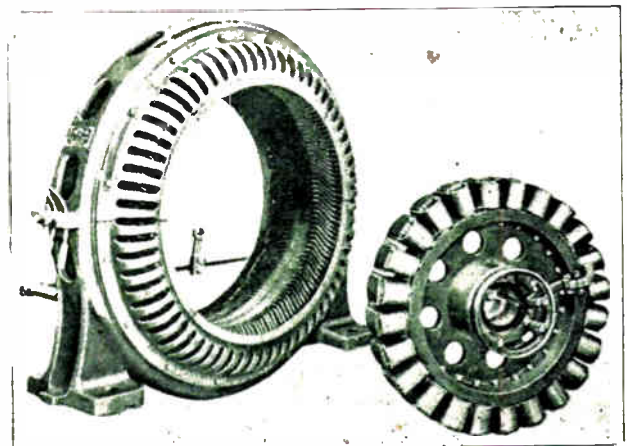

Fig. 79. Above are shown the complete stator of an A. C. generator on the left and the revolving field or rotor on the right. The field coils on the rotor are excited with direct current and revolved within the stator to generate alternating current in its windings.

brushes and slip rings at low voltage, is a much simpler proposition than to handle the total load current of the machine at the high voltages used on modern alternators.

Keep in mind that it makes no difference in the nature or amount of voltage generated by the machine whether the field poles revolve past the stationary armature conductors or the armature conductors revolve past the stationary field poles. As long as the same field strength and speed of motion are maintained, the cutting of the lines of force across the conductors will in either case produce the same voltage and the same frequency.

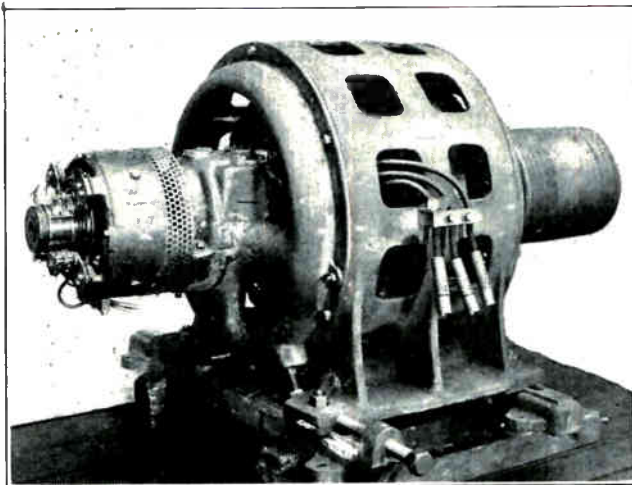

Fig. 80. This photo shows a 125 kv-a. alternator of the horizontal belt-driven type. Note the D. C. exciter-generator which is direct connected to the left end of the shaft. (Photo Courtesy Allis Chalmers Mfg. Co.)

### 86. VERTICAL TYPE AND HORIZONTAL TYPE ALTERNATORS

The terms vertical and horizontal as applied to A. C. generators refer to the position of the shaft. Belt-driven alternators, or generators that are connected directly to steam engines, are usually of the horizontal-shaft type. The generator shown in Fig. 80 is of the horizontal type.

Large steam-turbine-driven generators are also more commonly made in the horizontal types, although some of these are in operation which have vertical shafts.

Water-wheel generators are more commonly made in the vertical type, as this construction allows the generator to be placed on an upper floor, with the water-wheel on a lower level and attached to the generator by means of a vertical shaft.

This reduces the danger of moisture coming in contact with the generator windings due to any possible leakage or dampness around the water-wheel.

Fig. 82 shows a large, vertical type, water-wheel-driven generator. This machine has a capacity of 18,750 kv-a. and produces 60-cycle alternating current at 6600 volts. Machines of this type usually operate at quite low speeds, this particular one having a normal speed of 112½ R.P.M.

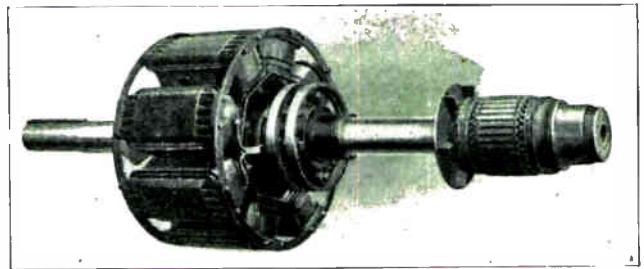

Fig. 81. This view shows the construction of the rotor or revolving field of an alternator similar to the one shown in Fig. 80. Examine its construction carefully and note the position of the collector rings and exciter-armature on the shaft.

Note the D. C. exciter-generator mounted on top of the shaft above the thrust bearing and main support members of the generator frame. The water-wheel attaches to this generator at the coupling which is shown on the lower end of the shaft.

Horizontal-type generators usually present a much simpler bearing problem, as the horizontal shaft lies in simple sleeve-bearings which support the weight of the revolving field at each end of the shaft.

Vertical-type generators require special thrust-bearings to support the weight of the shaft and rotor, and also a set of guide bearings to keep the rotor in proper alignment within the stator core.

Vertical-type machines require less floor space, which is one advantage in their favor where the power plant must be as small as possible.

### 87. TURBINE TYPE AND ENGINE TYPE ALTERNATORS

The terms "turbine" and "engine" type as applied to alternators refer to the type of prime mover by which the alternator is driven. As there is considerable difference between the speeds of ordinary reciprocating steam engines and those of steam tur-

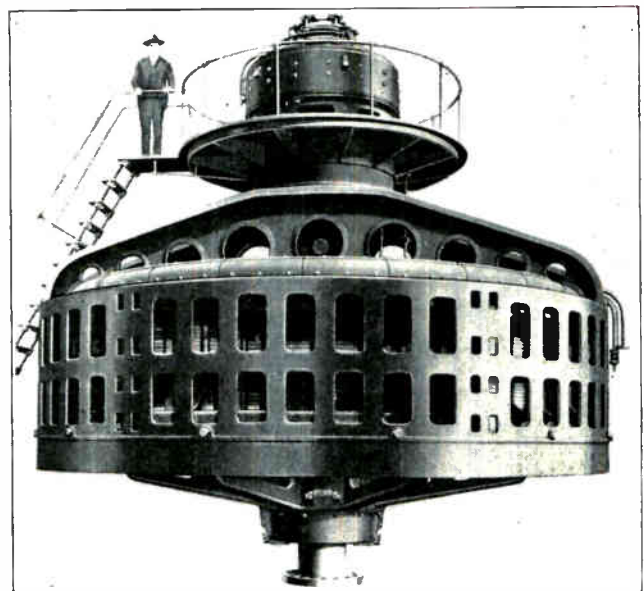

Fig. 82. Large vertical type alternator for water-wheel drive. The stator core and windings of this machine lay in a horizontal position just inside the lower frame work, and the field poles revolve on the vertical shaft within the stator. (Photo Courtesy Allis Chalmers Mfg. Co.)

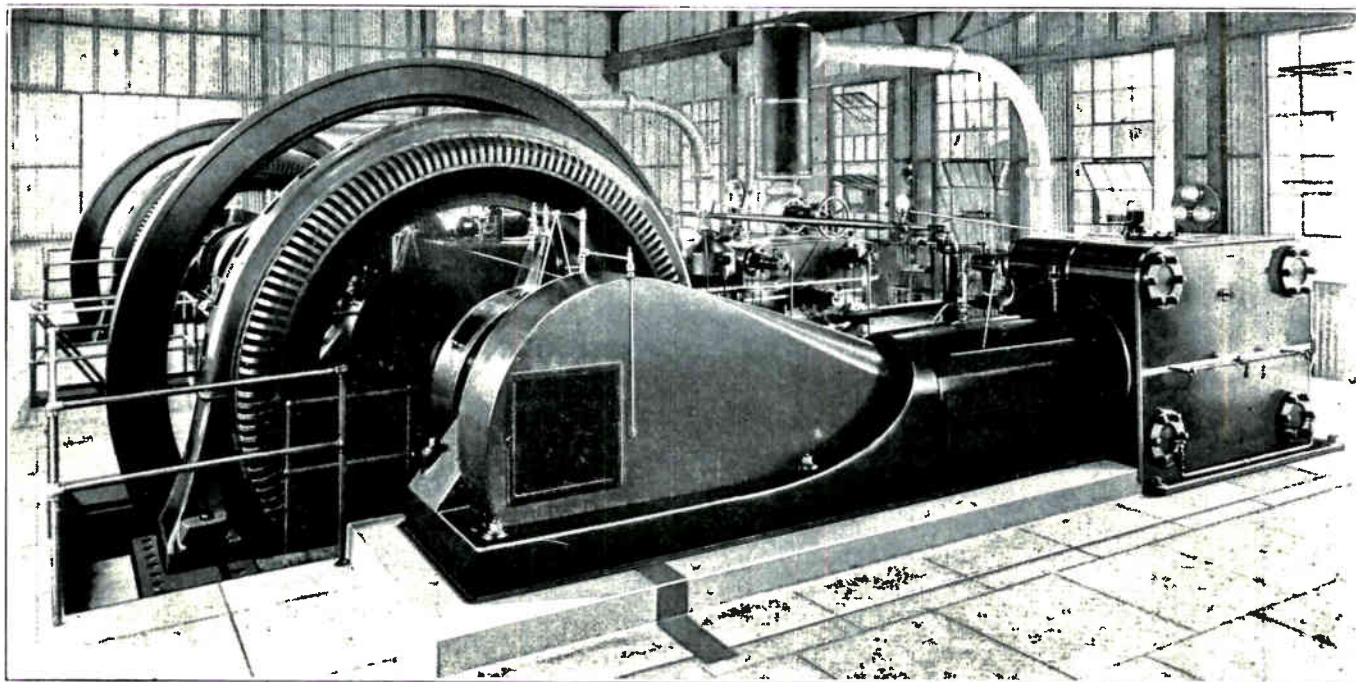

Fig. 83. This photo shows a view in a power plant equipped with horizontal type steam-engine-driven alternators. These alternators are made with large diameters because of the relatively low speed at which they are driven. (Photo Courtesy Allis Chalmers Mfg. Co.)

bines, the generators designed for engine drive are of considerably different shape and construction than those designed for high-speed turbine drive.

Engine-driven alternators are usually of quite large diameter and narrow in width from one side to the other of the stator core. The rotors for these machines usually have a rather large number of field poles, in order to obtain the proper frequency at their low operating speeds.

Fig. 83 shows a horizontal-type engine-driven alternator of 1000 kv-a. capacity, and gives a good general idea of the shape and construction of these machines. Note the large fly-wheel used in connection with such alternators to maintain a more even speed in spite of the pulsations delivered by the piston of the engine.

Steam-turbine-driven generators, or turbo-alternators as they are commonly called, are usually made with much smaller diameters and greater in length than the engine-type generators are. The very high speeds at which steam turbines operate makes necessary the small diameter of the revolving field of the generator, in order to reduce centrifugal stresses.

These higher operating speeds also make possible the generation of ordinary 60-cycle energy with a very small number of field poles.

Turbine-driven generators are commonly made with two or four poles on the revolving field. Fig. 84 shows a large steam-turbine-driven alternator of 50,000 kw. or 62,500 kv-a. capacity. The generator is on the left in this view and the steam turbine on the right. The two are directly connected together on the same shaft.

This alternator is completely enclosed in an air-

tight casing to keep out all dirt and moisture from its windings, and to allow cooling by forced air circulation within this casing.

## 88. CONSTRUCTION OF ALTERNATORS. ARMATURES

Regardless of the type or construction of the alternator, the two principal parts to be considered are the armature and the field. The main A. C. winding, whether it is placed on the rotor or in the stator, is usually referred to as the armature; and, as previously mentioned, these armature windings for ordinary A. C. generators are practically the same as those for the stators of induction motors. In fact, the same winding can be used for either a motor or generator, if the squirrel cage is exchanged for a revolving field with the proper number of poles, or vice versa.

On large machines there are enormous magnetic stresses set up between the conductors of the winding when the generators are heavily loaded or during times of sudden surges due to overloads or short-circuits. For this reason, it is necessary to securely anchor or brace the coils, not only by slot wedges but also by using at the coil ends, special supports which are rigidly connected to the stator frame.

The coils are securely tied or wrapped to these braces or supports and in some cases are mechanically clamped down on the supports to prevent distortion or warping of the coils due to magnetic stresses set up by the flux around them.

The view on the left in Fig. 85 shows the frame of a turbine-driven alternator with one of the first stator punchings or core laminations in place. This view shows the manner in which these core lamina-

tions are fitted in the stator frame and held in place by the dovetail notches in the frame.

When the complete core is assembled, the laminations are also held more firmly together by the use of clamping rings and bolts which apply pressure at the ends of the stator core.

The view at the right in Fig. 85 shows the same stator with the core completely assembled and the windings in place. Note the heavy connections which are made between the phases and coils of the winding and also the manner in which these connections are rigidly secured to the end of the stator core.

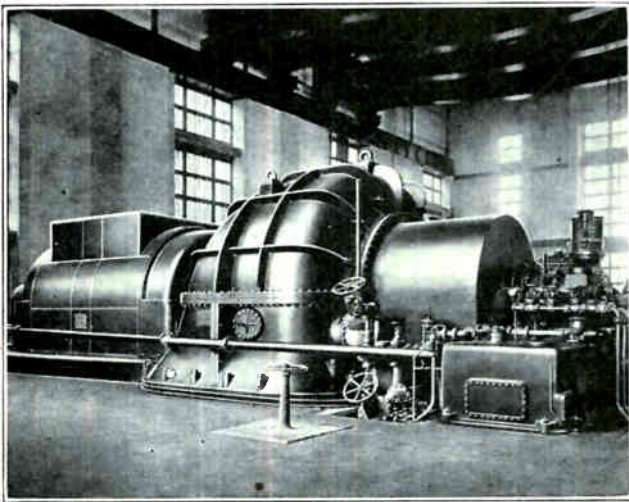

Fig. 84. Large steam-turbine-driven alternator. The turbine with its control mechanism is on the right. The alternator is enclosed in the air-tight casing at the left. This unit is typical of hundreds of great steam-driven generators in use in modern power plants throughout this country. (Photo Courtesy General Electric Co.)

Fig. 86 shows an excellent view of the end of the winding in a large turbine-driven generator, and shows clearly the method of bracing and tying the coils in place. Note the comparatively small dia-

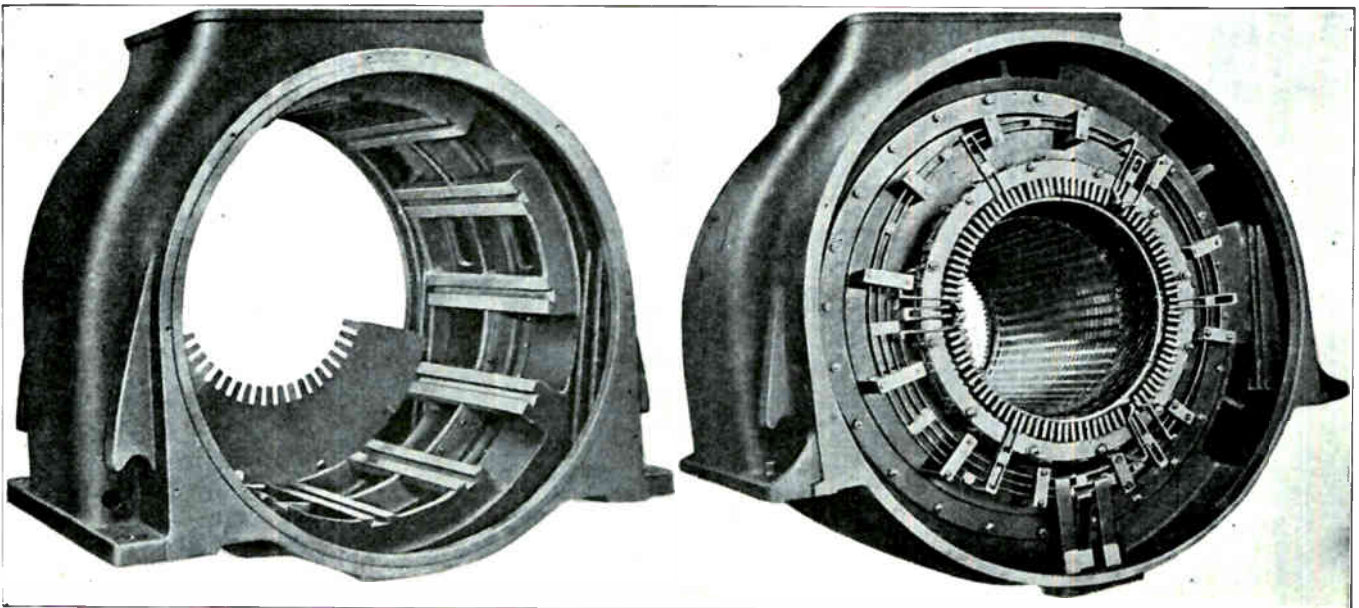

Fig. 85. The above two views show very clearly the method of construction of the stator core and windings of high speed steam-turbine-driven alternators.

meter and great length of the stator openings on the machine shown in Figs. 85 and 86.

The armature coils on large alternators are usually made of heavy copper bars and consist of only a few turns to each coil. These coils are heavily insulated according to the voltage of the machine, and are securely wedged into the slots.

Spaces or air ducts are left at intervals throughout the stator when the laminations are assembled, to allow free circulation of the cooling air throughout the windings.

### 89. FIELD CONSTRUCTION

The field of an A. C. generator is constructed very much the same as the field of a D. C. generator, except that the field of an alternator is usually the revolving element. Low-speed alternators of the large diameter engine-driven types usually have the field poles mounted on a spider or wheel-like construction of the rotor, as shown in Fig. 79.

Fig. 81 also shows the mounting of the field poles on a smaller rotor of the solid type which is used for a small diameter, medium-speed alternator.

The poles consist of a group of laminations tightly clamped together and equipped with a pole-shoe, or face, of soft iron. They are attached to the rotor core or spider, either by means of dovetail ends and slots or by means of bolts.

Fig. 87 shows several views of field poles of the dovetail type. These views also show the pole shoes and the rivets which hold the laminations together. The coils for field poles of this type may be wound with either round or square wire, or thin, flat, copper ribbon of the type shown in Fig. 88.

Field poles and coils of this type are sometimes called "spool wound", because of the shape of the poles and the manner in which the coils are wound on them.

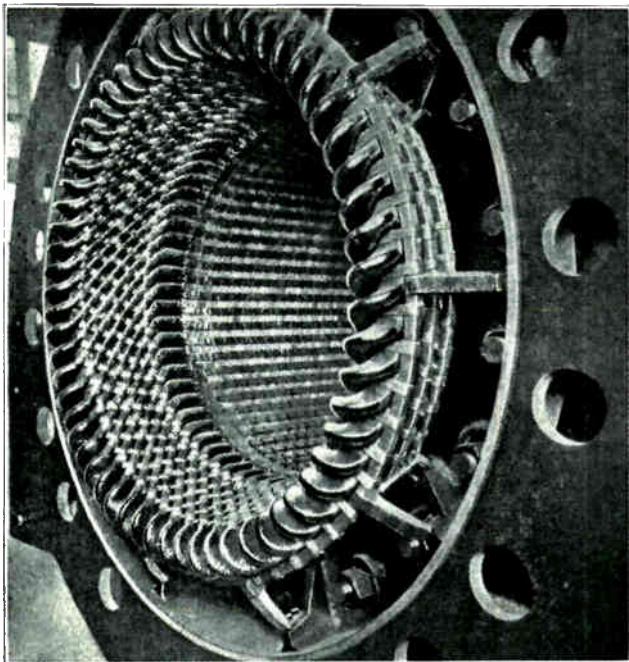

Fig. 88. This photo shows the end of a stator winding for a high speed turbo-alternator. Note the rigid bracing of the coil ends.

The field coils are connected either in series or in series-parallel groups, according to the size of the machine and the exciter voltage which is applied. They are always connected to give alternate north and south poles around the entire field. Alternator fields always have an even number of poles.

On high-speed turbine-driven alternators which have long rotors of narrow diameter it would be very difficult to construct field poles of the "spool wound" type, and also extremely difficult to hold the coils in place because of the great centrifugal force at these high speeds. For such machines the field coils are usually wound in the slots cut in the surface of a long, solid field rotor or core.

Fig. 89 shows a two-pole rotor of this type, in which the field coils can be plainly seen at the left end of the slots. These coils are wound with strap or bar copper. When the rotor is completed, a metal casing or sleeve is placed over both ends of the coils as shown at the right end of this rotor. This sleeve protects the coils from damage or mechanical injury and also holds them securely in place and prevents them from being thrown or bent

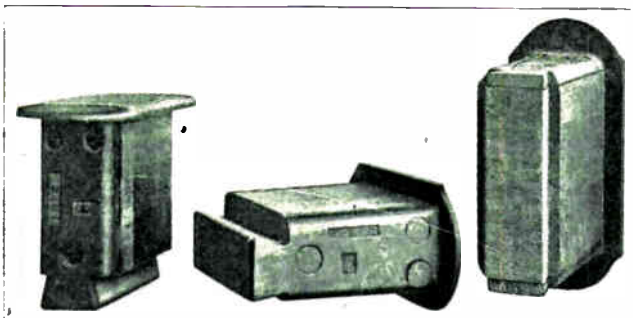

Fig. 87. Several views of laminated field poles such as commonly used in revolving field alternators.

outward by the high centrifugal force exerted upon them during operation.

Fig. 90 shows a closer view of the end of a rotor of this type, on which the slip rings and ventilating blades can be clearly seen. This type of rotor construction provides a very rugged field element and very secure mounting of the coils and is, therefore, ideally suited to the very high speeds at which steam-turbine alternators are operated.

## 90. COOLING OF GENERATORS

All electrical equipment produces a certain amount of heat in proportion to the losses which take place within the windings. Large A. C. generators produce considerable heat, even though their efficiencies often approach 98%. In the enormous sizes in which generators are built today the cooling of these machines becomes a serious problem.

The heat must be removed or carried away from the windings as rapidly as it is created or the windings would soon overheat to a point where the insulation would be damaged. As the resistance of copper conductors increases with any increase in temperature, the efficiency of the machine would also be reduced by allowing it to operate at temperatures higher than normal.

Natural air circulation is not sufficient for effective cooling of the windings of these large machines, as it is with smaller D. C. and A. C. generators. Therefore, it is necessary to use one of the several forms of artificial cooling or forced ventilation.



Fig. 89. Field coil which is wound with thin copper strip, making a coil which is very compact and easily cooled.

One very common method of cooling is to completely enclose the generator in a housing, such as shown on the machine in Fig. 84, and force a blast of air under low pressure through this housing and the machine windings. The air used for this purpose is first washed with a spray of water to cool it and clean it of all dust and dirt, and then the air is dried before being passed through the generator windings.

This clean air is then kept dry and is recirculated through the generator over and over again, being

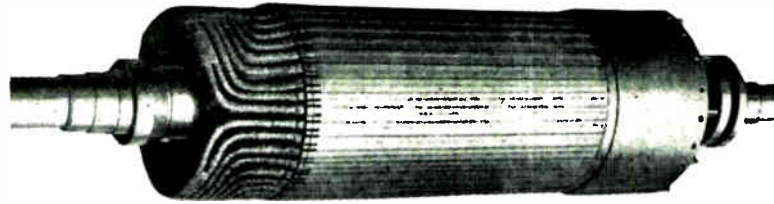

Fig. 89. This photo gives an excellent view of a high speed field rotor such as commonly used in turbine-driven alternators. Note how the field coils are placed in slots in the solid rotor so that when they are excited with D.C. they will create two field poles on opposite sides of the rotor. (Photo Courtesy Allis Chalmers Mfg. Co.)

cooled each time it leaves the machine, by being passed over a set of cold water pipes.

It is of the greatest importance that this ventilating air be kept circulating constantly through large alternators during every moment of their operation, and also that the air be kept clean and dry.

Some other gases are more efficient than air for carrying off the heat from machine windings. Hydrogen gas is being successfully used for this purpose. Because of its efficiency in absorbing heat from the windings and transferring it to the cooling pipes through which the gas is circulated outside of the generator, the use of hydrogen in this manner makes possible increased efficiencies and reduced sizes of alternating current machines.

Hydrogen being an explosive gas, it is necessary to eliminate all possibility of its becoming ignited around the generator; otherwise an explosion and serious damage would result.

Large alternators are usually equipped with thermometers or electrical temperature indicators to show the temperature of their armature windings at all times during operation. Many large high-speed alternators have water-cooled bearings, with water circulating through passages in the metal around the bearings, to carry away the heat.

#### 91. ALTERNATOR FIELD EXCITATION

The field of an alternating current generator is always excited or energized with direct current and in this manner constant polarity is maintained at each pole. As alternators do not produce any direct current themselves, they cannot be self-exciting, as many D. C. generators are.

The direct current for excitation of alternator fields is produced by a separate D. C. generator, known as the exciter generator. The exciter machine may be belt-driven from a pulley placed on the shaft of the main alternator, or it may be directly connected and driven by the end of the alternator shaft as on the machines in Figs. 80 and 82.

In some cases in large power plants the exciters are driven by separate prime movers. Sometimes one large exciter-generator is used to furnish direct-current field energy for several alternators, each of which obtains its field current from the exciter bus.

In other cases, there may be a number of exciter-generators which are all operated in parallel to supply the exciter bus with direct current; and any or all of the alternators can obtain their field current from this bus.

Exciter-generators are usually of the compound type and of a voltage ranging from 110 to 250 volts. It is not necessary to use high voltage for field excitation, as this current is only used to produce magnetic flux, the strength of which is determined by the number of ampere turns on the field poles.

The direct current from the exciter generator or busses is conducted to the revolving field poles of the alternator through brushes and slip rings, as previously explained. These slip rings can be plainly seen on the revolving field units shown in Figs. 81 and 89.

#### 92. CONNECTIONS OF EXCITER AND ALTERNATOR FIELD CIRCUIT

Fig. 91 shows the connection diagram and circuit of an exciter-generator connected to a three-phase alternator. This alternator has four poles on its revolving field and in this case all of the poles are connected in series.

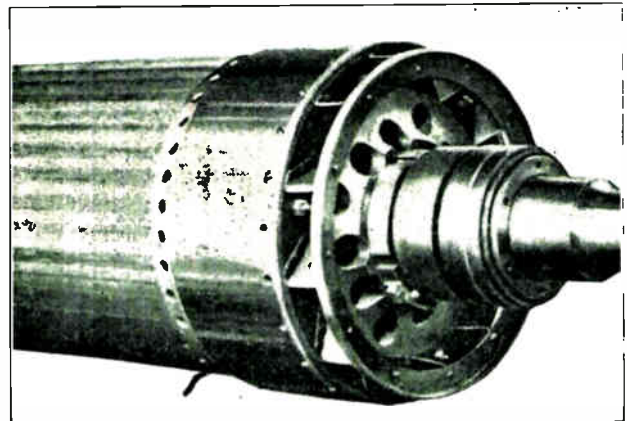

Fig. 90. End-view of high speed field rotor showing shield ring over the coil ends and also showing ventilating blades and slip rings.

The stator winding is of the ordinary type which has been previously described in the section on A. C. Armature Windings, and in this diagram it is simply shown as a continuous winding around the stator, having three line leads which are connected to points 120 degrees apart around the winding.

When the field of this alternator is excited with direct current and the poles revolved so their flux cuts across the conductors of the stator winding, three-phase alternating current will be generated and supplied to the line or busses.

If this four-pole machine has its field revolving at 1800 R.P.M., the frequency of the generated A. C. will be 60 cycles per second, according to the formula given in Article 4 of A. C. Section One.



The exciter shown in this figure is a compound-wound D. C. generator and has its voltage controlled by means of a shunt-field rheostat, R. The exciter voltage can be controlled either by manual operation of the field rheostat or by an automatic voltage regulator in connection with the field rheostat. This regulator will be explained in later paragraphs and in this figure we shall consider the rheostat to be manually operated.

A voltmeter and ammeter are shown connected to the exciter circuit between the D. C. generator and the field discharge switch, S, of the alternator. They are connected at this point because it is desirable to know the exciter voltage before the field switch is closed, and also because of the high voltages which may be induced in the alternator field if the field discharge switch should accidentally be opened while the alternator is operating in parallel with others.

The ammeter indicates the amount of field current which is being supplied to the alternator at any time, and furnishes an indication of the field strength and normal or unusual operating conditions in the alternator.

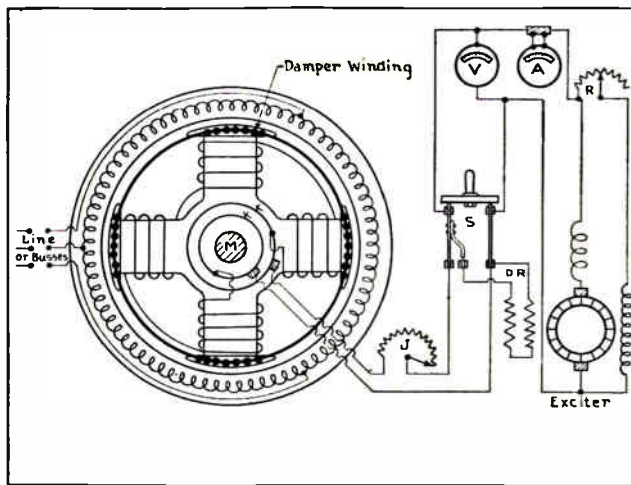

Fig. 91. This diagram shows the connections of the stator and rotor of a three-phase alternator with the exciter-generator, rheostats, meters, and field discharge switch.

### 93. FIELD DISCHARGE SWITCH

The field discharge switch is a special type of switch which has a third or auxiliary blade attached to one of the main blades and is arranged to make contact with an extra clip just before the main blades of the switch are opened, and also during the time that this switch is left with the main blades open.

This places the field discharge resistance, D. R., across the collector rings and field winding of the alternator when its circuit to the exciter is open. The purpose of this discharge resistance is to prevent the induction of very high voltages in the field winding when its circuit is interrupted and the flux allowed to collapse across the large number of turns of the field winding.

Placing this resistance across the field winding allows the induced voltage to maintain a current

through this closed circuit for a short period after the switch is open. This uses up the self-induced voltage and magnetic energy of the field, and allows the current to die down somewhat gradually.

If the flux of the alternator field were allowed to collapse suddenly by completely opening the circuit, the induced voltage might be sufficiently high to puncture the insulation of the field windings and cause short-circuits or grounds between the winding and the core.

### 94. EXCITER AND ALTERNATOR RHEOSTATS

Between the field discharge switch and the slip rings is an alternator field rheostat, "J". This rheostat is used to obtain very fine and accurate adjustment of the alternator voltage, and its resistance is usually so proportioned that its full range of voltage operation is just equal to the change in voltage obtained by moving the arm of the exciter rheostat one point.

It is easy to see that the voltage of the main alternator can also be conveniently controlled by adjusting the voltage of the exciter generator. As the exciter voltage is varied, more or less current will be forced through the field winding. By the proper use of both the exciter field rheostat, R, and the alternator field rheostat, J, a wide range of voltage adjustment in very small steps can be obtained on the alternator.

For example, suppose that the exciter shunt field rheostat has 10 points, which will make it possible to obtain 10 voltage changes on both the exciter output and the alternator output. If the alternator field rheostat has 20 points, we can obtain 20 steps or variations in the alternator voltage between each two adjacent points of the ten-point exciter rheostat.

With this combination it is therefore possible to obtain 200 voltage variations, which will permit very accurate voltage adjustment of the alternator.

### 95. FACTORS GOVERNING VOLTAGE AND FREQUENCY OF ALTERNATORS

From the alternator field rheostat we follow the exciter circuit to the brushes which rest on the slip rings, K-K. The slip rings are mounted on the rotor shaft but are well insulated from the shaft and from each other. Leads are taken from these rings to the field coils. The slip rings and brushes form the sliding connection between the stationary part of the exciting circuit and the revolving alternator field.

Regardless of whether the alternator field is constructed with spool type coils on projecting poles as shown in Fig. 91 or with coils imbedded in the slots of the solid rotor as used on high-speed turbine generators, as long as direct current is passed through these coils a powerful magnetic field will be set up at each pole of the electro-magnets formed by the coils.

When the alternator field is thus excited or energized and is then revolved within the armature or

stator core, it is evident that the lines of force from the field poles will be cut by the stationary armature conductors. In this manner a voltage is induced in the armature conductors and, as we have already learned, this voltage will be proportional to the number of lines of force in the field, and to the speed with which the field poles are rotated, as well as the number of conductors in series in the armature winding.

As the frequency of the alternator depends upon its speed and the number of field poles, we cannot vary the speed of the alternator to vary its voltage, as we can with direct current generators.

The frequency must be kept constant in order to maintain constant speed of the motors attached to the system, and if the speed of the alternator were to be varied it would, of course, change the frequency. For this reason, the voltage of an alternator must be adjusted by means of the alternator field rheostat or the exciter field rheostat.

The voltmeter in Fig. 91 is across the armature leads of the exciter generator and will show any variations in the voltage produced by the exciter when its rheostat is adjusted.

When once the setting of the alternator rheostat, J, has been established, the voltmeter will give somewhat of an indication of the variations brought about in the alternator field strength when varying the exciter voltage.

The ammeter provides a more accurate indication, because its readings will show the amount of current flowing through the alternator field with any adjustment or change in either the exciter or alternator rheostats.

## 96. CONTROL AND ADJUSTMENT OF ALTERNATOR VOLTAGE

It is often necessary to change the voltage produced by the armature of an A. C. generator while it is in operation, in order to compensate for voltage drop in the lines with increasing load on the system. In other words, when the load is increased, the added current flowing through the line will cause a greater voltage drop; and, in order to maintain constant voltage at the load, the alternator voltage should be increased.

We have already mentioned that the alternator voltage can be controlled either by manual operation of the rheostats by the plant operator, or by an automatic regulating device.

Manual or hand regulation is generally used only in small power plants which are not operating as a part of a large system.

The accuracy and uniformity of hand regulation depend upon the faithfulness and skill of the operator. This method is not usually satisfactory in large plants or on systems where there are frequent variations of considerable amounts in the load, because it requires almost constant attention on the part of the operators and even then doesn't prevent some voltage variation at the load.

It is very important to have constant voltage on most electrical machines and devices, in order to maintain their rated torque and speed. This is particularly true where any lighting equipment is connected to the system, because if the voltage is allowed to vary to any extent, it causes noticeable fluctuations in the brilliancy of incandescent lamps.

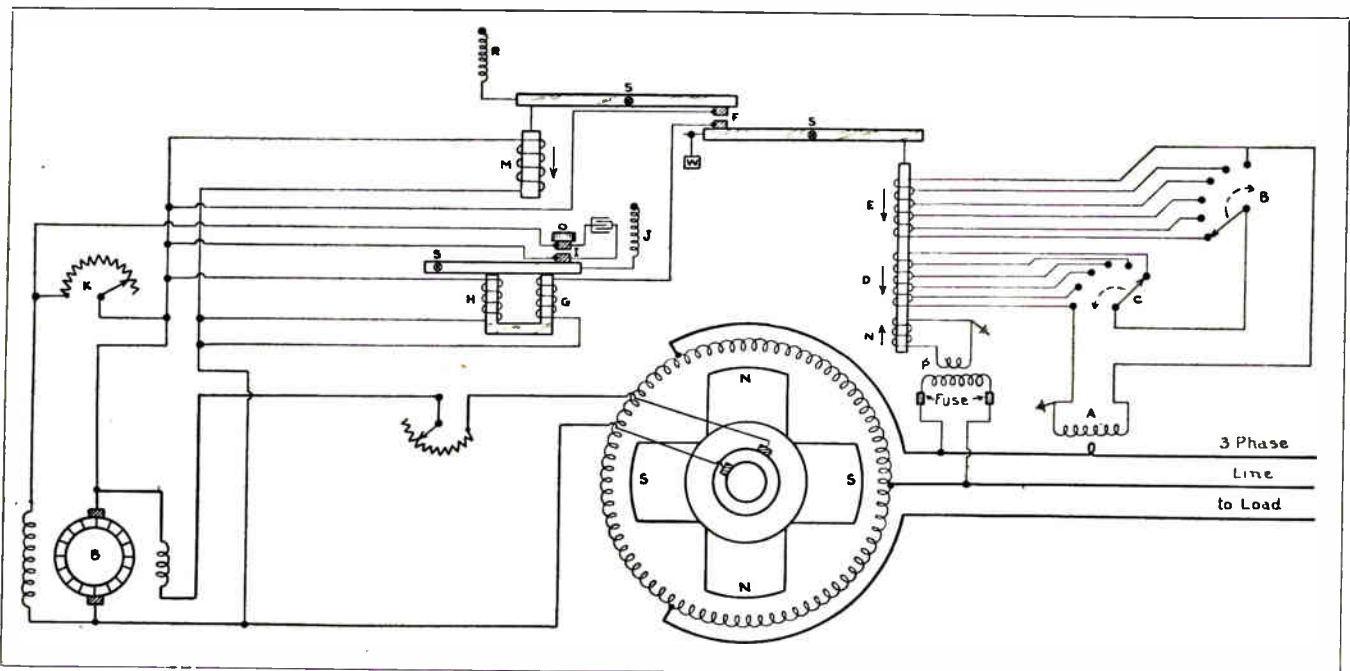

Fig. 92. The above diagram shows the wiring and illustrates the principles of a Tirrill automatic voltage regulator, properly connected to the exciter and line leads of a three-phase alternator.

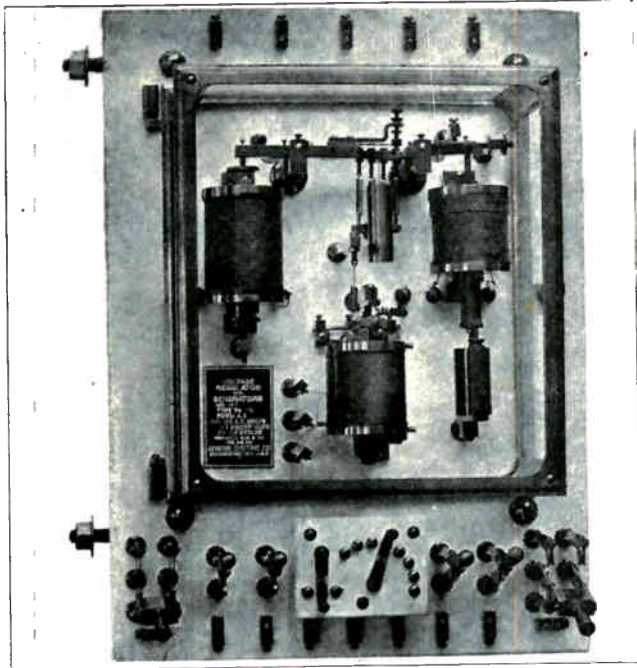

Fig. 92-A. This photo shows an automatic voltage regulator of a type similar to the one for which the wiring was shown in Fig. 92. and shows the arrangement of the solenoids and relays on the panel. (Photo Courtesy General Electric Co.)

## 97. AUTOMATIC VOLTAGE REGULATORS

To obtain more accurate and immediate voltage adjustment for all variations in load, automatic voltage-regulators are generally used in connection with the exciter field rheostat. One of the most common types of these devices is known as the Tirrill voltage regulator. This device automatically regulates the alternator voltage within very close limits by means of a set of relays which cut resistance in or out of the field rheostat of the exciter-generator.

The relays are operated by variations in the voltage and current load on the lines leading from the main alternator.

Fig. 92 shows the connection diagram of a Tirrill automatic voltage-regulator. If you will trace out each part of this diagram very carefully, you will be able to easily understand the operating principle of this device.

Whenever the load on the alternator is increased, this will increase the amount of current flowing in each wire of the three-phase line, and the current transformer, A, will have an increased current flow in its secondary winding.

The secondary of this transformer is connected through a set of multiple point switches, B and C, to the solenoid coils, D and E. When these two coils have their current increased, they tend to pull the plunger downward and operate the lever arm to close the contacts at F.

When the contact F is closed it completes a circuit through coil G of the differential relay which is energized by direct current from the exciter-generator. Coil H of this relay is connected directly

across the exciter-armature and is normally energized at all times.

Coil G is so wound that when it becomes energized it neutralizes the magnetism set up in the core by coil H, and this allows the armature to release and be drawn upward by the spring, J, thus closing the contacts at I.

These contacts are connected across the exciter field rheostat, K, and can be arranged to short-circuit all or part of this resistance. When the resistance of this rheostat is cut out of the shunt field of the exciter it allows the exciter voltage to increase, thereby increasing the field strength and the voltage of the main A. C. generator.

If the A. C. generator voltage rises above normal, it will increase the voltage induced in the secondary coil of the potential transformer, P, thereby strengthening the solenoid coil, M, which will raise the plunger and open the contacts, F.

When the contact opens at F this de-energizes coil G of the differential relay, allowing the magnetism of coil H to draw the armature down and open contacts at I.

This removes the short-circuit from the exciter rheostat and places the resistance back in series with the shunt field. The contacts at F can also be opened by the coil M if the exciter voltage rises too high.

When using a regulator of this type, the exciter field rheostat K should be set at a point so that if it were used alone it would maintain a voltage slightly lower than that required by the system.

The automatic regulator will then short out the resistance of the rheostat often enough to maintain the voltage at its proper value. The arm which

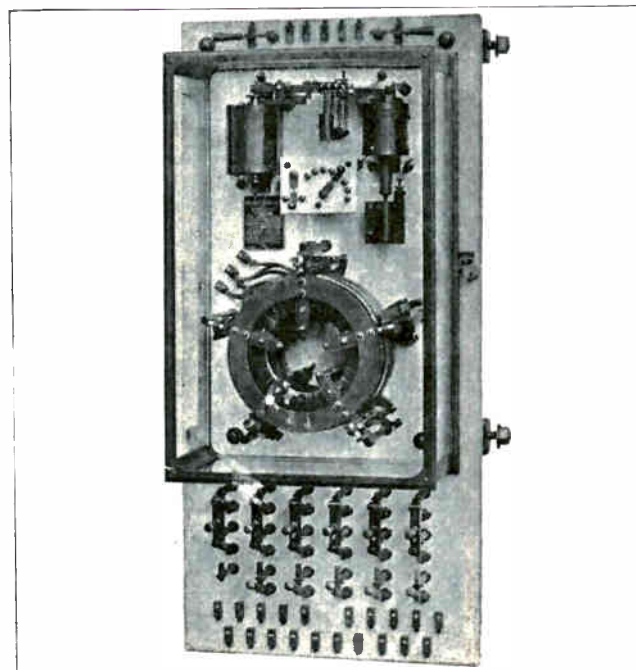

Fig. 92-B. Automatic voltage regulator for controlling the voltage of several alternators in parallel. (Photo Courtesy General Electric Co.)

operates the lower contact at F continually vibrates or oscillates, and opens and closes the contacts at frequent intervals during the operation of this device.

These contact arms are accurately balanced and adjusted by means of adjusting screws on the counter-weight, W, and the tension of the spring, R.

A condenser, O, is connected across the contacts I to reduce arcing and prevent burning and pitting of these contacts when they open and close the short-circuit on field rheostat K.

The relay armatures which operate the various contacts are pivoted at the points marked S. The switches, B and C, are used to vary the strength of the solenoid coils, E and B, and thereby adjust the regulator to operate at the proper amount of increased load current.

### OPERATION AND PARALLELING OF ALTERNATORS

It is only in very few cases, such as in small isolated power plants, that a single A. C. generator is operated alone. Usually several A. C. generators are operated in parallel in the same plant, and in a great many cases a number of power plants generating A. C. are all tied together in parallel.

In our study of D. C. generators we found that it is absolutely necessary to have their voltages equal and polarities right if the machines are to be operated in parallel.

In order to operate alternators in parallel we **must have their voltages equal** and in addition to this, the machines must be properly **phased out** and **synchronized**.

These three conditions are the principal ones which must be observed before connecting any alternator in parallel with another.

You have already learned how to adjust the voltage of A. C. generators. Voltage adjustment, of course, can only be used to vary the voltage within a limited range above and below that of the normal voltage of the machine. Therefore, alternators must all be designed for the same voltage in order to operate successfully in parallel. Then the final adjustments can be made with the rheostats to exactly equalize the voltage.

### 98. PHASING OUT ALTERNATORS

"Phasing out" consists of identifying the phases of polyphase generators, in order to get the corresponding phase leads of two or more machines connected together. For example, the three-phase alternator, which is by far the most common, usually has the phases marked or designated A, B, and C. When connecting an alternator to one or more others, or to the busses in a power plant in which other generators are operating, each phase must connect to the corresponding phase of the busses or other alternator: A to A, B to B, and C to C.

Phasing out is usually necessary only when a machine is first installed or after some changes have been made in the connections of the windings of the machine. Once the generator has been prop-

erly phased out and the connections, permanently made to the busses on the switchboard, it is not necessary to test the phases again unless changes are made in the generator or in the plant.

If a generator is disconnected even temporarily, the phases should be plainly and accurately marked, so that they can be connected back in the same manner when the machine is again attached to the busses or leads to the other alternator.

If an armature of an alternator has been rewound or if the connections have been changed in any way, the machine should always be phased out before reconnecting it to the busses or line.

Synchronizing is an operation which must be performed every time an A. C. generator is paralleled with other running machines. This will be explained in later paragraphs.

There are several methods that can be used for phasing out A. C. generators. Two of the most common are known as the **lamp-bank method** and the **motor method**.

Equally good results can be obtained with either method, and the choice of one or the other will usually depend upon the convenience or the adaptability of the available equipment.

### 99. LAMP-BANK METHOD OF PHASING OUT

Fig. 93 shows the connections and illustrates the principle of the lamp-bank method of phasing out alternators. In this diagram two alternators are shown properly connected and furnishing power to the busses and outgoing line. A third similar generator is shown suitably located and ready to be phased out and connected to the live busses. The lamps to be used in the phasing-out operation are shown connected around the oil switch.

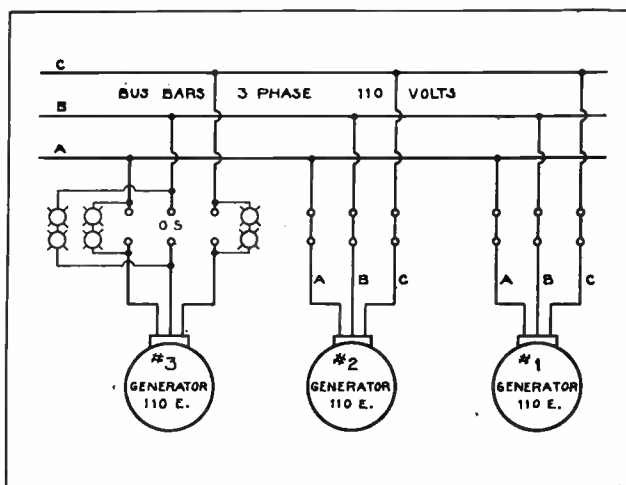

Fig. 93. This diagram shows the method of connecting lamps for phasing out an alternator which is to be operated in parallel with two others.

A sufficient number of lamps must be connected in series in each phase to withstand double the voltage of the alternator. It can readily be seen, therefore, that if the voltage of the machine is higher than 440 volts, it would require a considerable num-

ber of lamps in order to use this method, that is if the lamps only were used.

So, with higher voltage machines step-down transformers are often used to reduce the voltage to the lamps. Small power transformers or instrument transformers can be used.

In phasing out a new generator by this method it is necessary to bring it up to its rated speed and voltage. The lamps connected as shown in Fig. 93 will then alternately light up and go dark, due to the generator voltages being out of phase and in phase at different periods.

If all three sets of lamps become bright and dark together or at the same time, it indicates that the proper phases of the new generator are connected to corresponding phases on the opposite side of the oil switch. If the lights do not burn bright and dim together it is then necessary to interchange or reverse any two leads of the generator which is being phased out.

While this interchange can be made anywhere between the generator and the oil switch or between the oil switch and the busses, it is usually best to reverse the leads right at the generator terminals. We should never reverse the leads of any other machine to make the phases match with the new generator, as this would reverse the rotation of all of the three-phase motors operating on the system.

Extreme caution should be used never to connect even a small generator in parallel with another one or to live busses, without first carefully phasing it out; because if one A. C. generator is connected in parallel with others when out of phase, it results in practically a short-circuit on the running machines, the same as though one D. C. generator of the wrong polarity were connected in parallel with others.

Care should also be used to see that the lamps are of sufficient number and resistance to stand double the voltage of the alternator, because at certain periods during the alternations they may be subjected to the voltage of the new machine plus that of the running machines, in series.

When phasing out higher voltage machines and using lamps and transformers, the primary and secondary leads of the transformer should be carefully marked and tested if necessary, to determine whether they are of additive or subtractive polarity. These terms will be explained later, in the section on transformers.

Care should also be taken not to reverse either the primary or secondary leads of the transformer, but to have them all connected with the same respective leads both to the alternator and busses.

#### 100. MOTOR METHOD OF PHASING OUT

Fig. 94 shows the connections for phasing out an alternator by means of a three-phase motor. To use this method conveniently and to avoid making mistakes in connections, it is usually best to connect the leads of the three-phase motor in uniform order

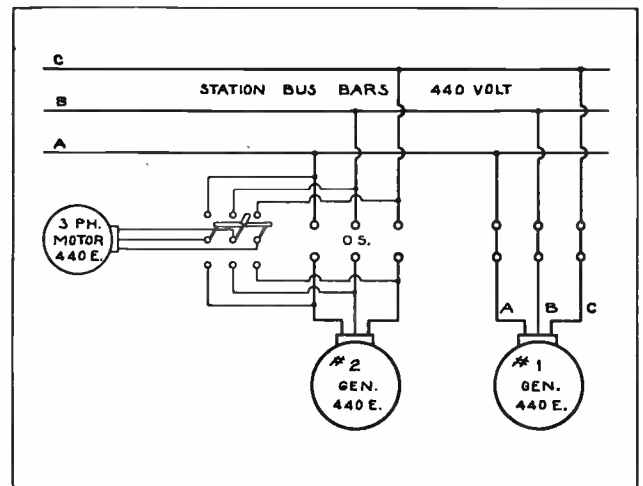

Fig. 94. The above sketch shows the connections and illustrates the method for phasing out an alternator by means of a three-phase motor.

to the blades of a double-throw, three-pole, knife switch.

The outer contacts or clips of the switch on one side are connected to the busses or running generators, while the clips on the other side are connected to the machine which is to be phased out. With this connection the motor can be operated either from the new generator or the running machines. When the connections are properly made, the generator which is to be phased out is brought up to rated speed and voltage. The knife switch is then closed to operate the motor from this generator, and the direction of the motor rotation is carefully noted.

To avoid mistakes, it is best to mark this clockwise or counter-clockwise direction of rotation with a chalked arrow, either on the pulley or the frame of the machine, on the side from which you are observing it. Then open the double-throw switch and allow the motor to come to a full stop. The switch is then closed in the opposite direction, to run the motor from the bus bars and running alternators, and the direction of rotation is again noted.

If the motor rotates in the same direction in both cases, the generators have like phases connected opposite to each other on the switch terminals. If these same leads are carefully connected to the oil switch in the same respective manner, the generators should operate satisfactorily in parallel after having been synchronized.

If the motor rotates in the reverse direction when the switch is in the second position, it will be necessary to interchange or reverse any two leads of the generator which is being phased out. The connections should then be tested again by running the motor from each side of the switch, and it should run in the same direction in both positions of the switch blades.

If the voltage of the alternator is too high for any available motor, small power transformers can be used to reduce the voltage for making this test of the phases.

### 101. SYNCHRONIZING OF ALTERNATORS

As previously mentioned, any A. C. generator must be carefully and accurately synchronized before being connected in parallel with other running generators.

Synchronizing is one of the most critical operations to be performed in a power plant, and should be given careful study in this section of the Reference Set as well as in your department lectures and practice. Be sure to practice this operation thoroughly with the alternators in the A. C. Department of your shop course.

This is one operation which you want to be sure you can perform skillfully and confidently before applying for any position as a power plant operator.

Synchronizing means to bring the generators into step or so that their positive and negative alternations occur at exactly the same time. On large machines this must be accurate to within a few degrees; that is, the same alternations of each machine must have their maximum and zero values occurring at the same instant in each phase.

By referring back to the sine curves which were shown for the voltage alternations in the first A. C. Section of this set, and also by drawing a few curves for yourself, if necessary, you will soon see what is meant by having the alternations occur in phase or in step with each other.

If alternators were connected together when out of phase more than a very few degrees, it would result in very heavy surges of current between the two machines, because of the difference in their voltages at any instant. If two machines were connected together when they were  $180^\circ$  out of phase, this would mean that one generator would be producing positive voltage while the other was producing negative voltage, and it would result in a double voltage short-circuit, the same as though two D. C. generators were connected together with wrong polarity.

The nearer the two machines are to being in phase, the less will be the difference in their instantaneous voltages at any point of the cycle.

By careful adjustment of the speed of the "incoming" alternator, we can by means of a synchronizing device get the two machines exactly in phase with each other. A skillful operator can then close the oil switch at just the right instant and connect the machines in parallel with practically no resulting surge or current flow between the "incoming" and running generators.

If large generators are connected together when they are very much out of phase, it is likely to wreck the machine windings and possibly cause serious damage to the generators and other plant equipment.

The two most common methods for determining when alternators are in synchronism are by the use of either a synchroscope or lamp-bank. A voltmeter is sometimes used for this purpose also. A synchroscope is by far the more reliable and convenient, as

it shows whether the incoming generator is running too slowly or too fast and indicates which way the governor or throttle of the prime mover should be adjusted in order to bring this machine to the same frequency as the running machines.

The pointer of the synchroscope also indicates more accurately when the generators are exactly in phase with each other.

The operation and connections of the synchroscope were explained in the section on A. C. Meters, and you should practice synchronizing A. C. generators with a synchroscope as well as the lamp banks in your shop department.

When voltmeters are used, they are connected the same as the lamp bank, which will be explained in the following paragraphs.

Voltmeters to be used for synchronizing should be of the "dead beat" type, or well damped so that their pointers do not oscillate or swing too far beyond the actual voltages. Voltmeters are seldom used for this purpose because of their cost and the fact that a synchroscope, costing very little more, is much more convenient and reliable.

### 102. SYNCHRONIZING WITH LAMPS

The lamp-bank method of synchronizing is used quite extensively in small plants, where the generators are not large and the cost of the synchroscope is considered prohibitive.

Fig. 95 shows the connections for using lamps to synchronize two alternators. You will note that these connections are practically the same as when lamps are used to phase out an alternator, except that the lamps are arranged with a double-throw, three-pole switch, so they can be used to synchronize either alternator with the busses, according to whichever machine may be running at the time.

The incoming generator, which in this case is No. 1 in the figure, is started and brought up to speed and voltage. The synchronizing switch, S, is then closed to the right and the lamps will alternately become bright and dark, the same as in phasing out an alternator, except that in this case the

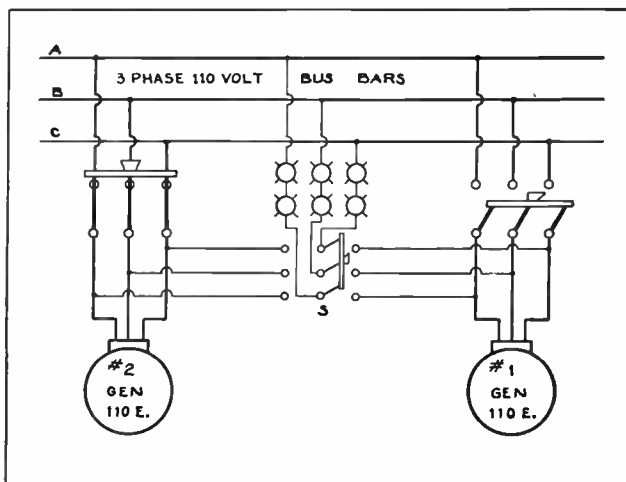

Fig. 95. Connection diagram for synchronizing either of two alternators with the bus bars by means of a lamp bank and double-throw switch.

alternators are presumed to have been phased out and the three sets of lamps should all go bright and dark together.

When the generators are  $180^\circ$  out of phase, or one machine positive and the other negative, their voltages will add together through the lamps and cause the two lamps in series in each phase to burn brightly.

When the generators are exactly in phase—that is, phase A of generator No. 1 reaches its maximum voltage at the same time phase A of generator No. 2 does—these voltages are then opposing each other on the busses and no current will flow through the lamps.

If the frequency of the incoming machine is only slightly different from that of the running machine, the lamps will brighten and darken very slowly; but if the frequency of the incoming machine is considerably different from that of the running machine, the lamps will flicker on and off very rapidly.

So, by adjusting the governor or throttle of the prime mover which drives the incoming generator and watching the operating of the synchronizing lamps, we can tell whether we are approaching the frequency of the running generator or if we are getting farther away from it.

When the speed of the incoming generator is properly adjusted and the frequencies are almost exactly the same, the lamps should go on and off very slowly, actually remaining dark for a second, or two, and requiring several seconds to change from bright to dark each time.

During the middle of this dark period, the switch which connects the incoming generator to the busses should be closed. By watching the speed with which the lamps brighten and go dark throughout several of these periods, one can approximately time the length of the dark period so that the switch can be closed about the middle of this period.

This requires good judgment and skill, which can be obtained only by practice, and you should be sure to obtain this practice on the generators in the A. C. shop department.

One of the disadvantages of using lamps for synchronizing is the fact that an incandescent lamp requires a considerable proportion of its rated voltage to cause the filament to light even enough to be noticeable. Therefore, there may be some small difference in voltage between the two alternators even when the lamps are dark. This is the reason for closing the switch at the middle of the dark period, when the voltage difference between the two machines should be zero.

Alternators should never be paralleled as long as the lamps are burning at all; or, in case a synchroscope is used, as long as it indicates any phase difference between the two machines. If the phase difference is small when the machines are paralleled, they may pull in step; and while there may not be any serious damage the first time this is

done, if it is done a number of times the severe shock to the windings will sooner or later damage their insulation or the coil bracing.

The very heavy surges of current which result through the generator windings when they are paralleled slightly out of phase, set up enormous magnetic stresses which tend to distort the conductors at the end of the coils and also apply very heavy pressures against the insulation in the slots. This also results in severe mechanical shock to the entire machine.

### 103. SYNCHRONIZING WITH SYNCHROSCOPES

The lamp-bank method will probably be encountered in a number of small plants and may often be very handy to you in synchronizing small generators when no synchroscope is available. The synchroscope is, however, by far the most commonly used in modern plants of any size, and because of its extreme accuracy this instrument should be used whenever possible.

Another of the decided advantages of the synchroscope over the lamp-bank is that its pointer indicates whether the incoming generator is running too fast or too slow.

When the synchroscope is used, the governor or throttle of the prime mover is adjusted according to the indication of the synchroscope pointer and whether it is revolving in the direction showing that the incoming generator is running too fast or in the opposite direction showing that it is running too slow.

When the speed of the incoming generator has been adjusted to a point where the synchroscope is revolving very slowly in the "fast" direction the knife switch or oil switch which connects the incoming machine to the busses can then be closed, just as the pointer reaches the mark on the center of the scale.

By connecting the alternators together when the incoming machine is running slightly faster than the running machines, it enables the incoming gen-

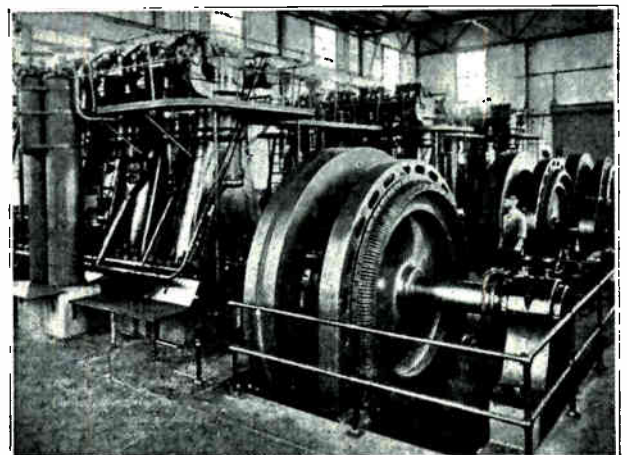

Fig. 95-A. This photo shows a group of alternators driven by Diesel oil engines. Many power plants located in the oil fields, or in places where water and coal are difficult to obtain, are equipped with engines and generators of this type.

erator to pick up its share of the load more readily and smoothly.

When paralleling alternators by means of remote controlled oil switches it is often necessary to allow a fraction of a second for the actual closing of the oil switch. This is done by closing the remote control switch just before the synchroscope pointer reaches the mark on the scale, so that the oil switch will close and parallel the alternators just at the time the pointer is on the mark and the machines are in exact synchronism.

#### 104. STARTING UP ALTERNATORS

The procedure to be followed when starting an alternator and preparing to bring it on to the busses in parallel with others may vary in certain details with the operating policies of different plants, but there are certain general methods and precautions to be followed.

The following material on this subject applies only to alternators which are already installed and in operating condition. The procedure for starting new alternators which are to be operated for the first time will be covered in a later section on the installation and operation of electrical machinery.

When starting an alternator in a small plant, the electrician or switchboard operator may also have to start the prime mover. In large power plants the prime movers are usually started and controlled by the turbine engineers or men of the steam crew.

In either case, a certain amount of time must be allowed for the routine and preparations necessary in starting the prime movers. These points will be covered more fully in a later section on prime movers.

Before starting an alternator we should make sure that the armature and field switches are open. The field switch should be set in the discharge position.

If the exciter is separately driven, it should be started and brought up to full rated speed before the alternator is started. If the exciter is driven from the alternator shaft it will, of course, come up to speed at the same time the main alternator does.

In either case the exciter voltage should be kept low, usually at about 50% of its rated voltage, until after the field circuit to the alternator has been closed. This allows the voltage to be built up more gradually in the armature of the alternator.

The alternator field switch can next be closed, to energize the field poles. Then adjust the exciter voltage until the alternator armature develops its full rated voltage. If the generator is to operate alone and supply power to a line, the armature switch may then be closed. If the generator is to operate in parallel with others, it must first be properly synchronized before closing the armature switch.

In some cases, when starting a single alternator that is to be operated alone, it is desirable to close its armature switch to the line with the alternator voltage at about one-half its full rated value. This

allows the generator to pick up any load which may have been left connected to the system, without such heavy current surges through the machine. The voltage can then be brought up to normal by means of the field rheostats, after the armature switch is closed.

Always remember that the three most important requirements before paralleling A. C. generators are: (A) They must be of equal voltage; (B) Generators must have been phased out and have like phases ready to connect together; (C) The generators must be in synchronism.

When these conditions have been obtained the armature switch may be closed and the incoming generator connected in parallel with the bus bars and running machines. The alternators should then operate satisfactorily in parallel, if they are of the proper design and characteristics.

#### 105. ADJUSTING AND TRANSFERRING LOAD ON ALTERNATORS

The next step is to make the alternator which has just been connected pick up its share of the load on the system. This cannot be done by increasing the armature voltage, as is done with direct current generators.

Alternating current generators are caused to take more of the load by slightly increasing the power applied by the prime mover. This is done by adjusting the governor or throttle of the prime mover so it will deliver slightly more power to the alternator.

This, of course, tends to make that alternator on which the power is increased run slightly faster than the others, but the tendency of two or more alternators to hold together in synchronism after they are once paralleled prevents the machine from actually running any faster than the others.

Instead, the additional power applied by the prime mover merely causes this generator armature to advance a few degrees in phase ahead of the others, and this will cause it to pick up its share of the load.

The field rheostat can then be adjusted to reduce any cross currents or wattless currents between the armatures of the alternators in parallel. This is very important, and the field current should be adjusted until the armature current of each alternator is at the minimum for the load they are carrying at that time.

In other words, by having wrong field adjustment on alternators, it is possible to have the sum of the currents from the separate machines equal considerably more than the total load current being taken from the busses. These cross currents between the alternators may result in heating, if they are not kept at a minimum.

When the proper load distribution has been obtained between the generators operating in parallel, they should maintain this division of load, provided the governor of the prime movers is properly



adjusted so that all machines respond alike to variations in the load.

### 106. SHUTTING DOWN AN ALTERNATOR

When the load on a certain power plant or group of alternators is reduced to such an extent that it is not economical to keep all of the alternators operating, one of the machines can be disconnected from the bus and shut down until such time as increased load may again require its operation.

Shutting down an alternator is a simple operation, but there are several important steps to be followed in order to perform this operation properly.

In some small plants A. C. generators are taken off the busses by merely opening their armature switches. This, however, results in a very sudden dropping of the load of the disconnected machine and may result in heavy current surges and fluctuations in the voltage of the other machines.

For this reason many power companies object to this practice, and require that the load be gradually dropped from the machine which is to be disconnected. This can be done in the following manner.

The throttle valve on the prime mover of the generator to be shut down is first closed little by little until the generator drops practically all of its load and the ammeter or wattmeter in its circuit shows its current output to be at a very low value. In up-to-date plants of medium or large size, wattmeters or watt-hour meters give the most reliable indication when the load is reduced to zero, as an ammeter might still show some flow of wattless current.

This load is, of course, automatically picked up by the other generators, or is in reality simply transferred by reducing the power applied to the alternator which is being shut down.

When by adjustment of field excitation the load on the machine as shown by the ammeter, has been

reduced to zero or a very low value, the armature switch is then opened, disconnecting the generator from the busses. The throttle valve of the prime mover is then closed all the way and the generator is allowed to drift to a stop.

After the armature switch has been opened, the field switch may be opened if desired; or the field can be left energized temporarily, in order to bring the generator to a stop in a little shorter time. Brakes are used for this purpose on larger machines. The field switch should never be opened before the armature switch has been opened.

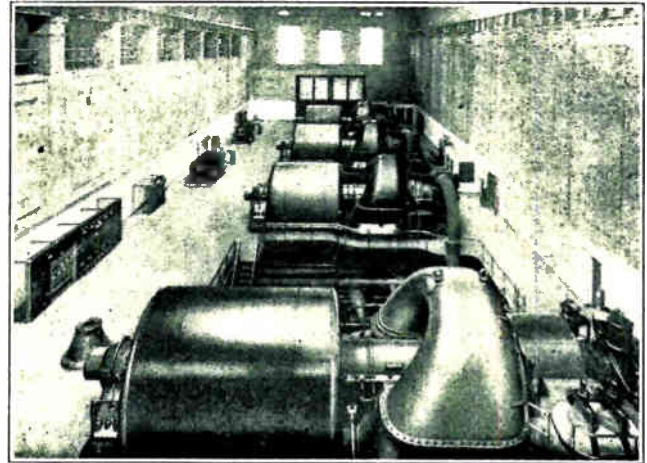

Fig. 97. Interior view of a large power plant showing several of the steam-turbine-driven alternators and also part of the switchboard and the exciter-generators.

When the generator comes to a complete stop and is standing idle, the field switch should always be open. It is also a very good precaution to open any disconnect switches which are between the generator, oil switch, and the bus bars. This will prevent any power flow from the busses to the generator armature if the oil switch should accidentally be closed when the machine is standing idle.

Different generating companies have various special rules to meet the operating conditions in their various plants, and any operator should make a careful study of these rules as well as the general rules and principles which are covered in this section. All such rules are made to provide safety for operators and machines, as well as to provide satisfactory service to the customers to whom the power is supplied.

### 107. ARRANGEMENT OF INSTRUMENTS AND CONNECTIONS FOR ALTERNATORS

Fig. 96 shows a diagram of the connections for an alternator and its exciter. This diagram also shows the meters to measure the voltage and current of each machine. The three A. C. ammeters are connected, by means of current transformers, to measure the current in each line wire of the alternator.

The A. C. voltmeter is connected by means of

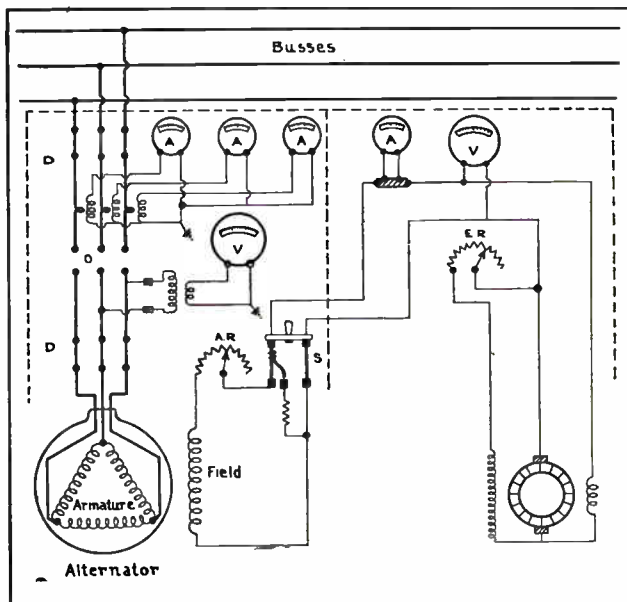

Fig. 96. This diagram shows the wiring and arrangement of a three-phase alternator, and the meters and equipment commonly used on the switchboard panels.

a potential transformer to indicate the voltage of the alternator. This voltage, of course, should be the same on all three phases; so it is only necessary to measure it on one phase.

You will note that the voltmeter connections are made between the alternator and the oil switch, O; so that the voltage of the alternator can be read before the oil switch is closed to parallel this machine with any others which may be connected to the busses.

Two disconnecting switches, D, are provided, one on each side of the oil switch. After the oil switch is open and the alternator shut down, these disconnecting switches can be opened with a switch pole, or by hand in the case of low voltage circuits, and thus the oil switch and instrument transformers are separated from the live busses.

This permits any necessary repair work to be done on these devices with safety. The alternator rheostat, A.R., and the field discharge switch, S, are mounted on the alternator panel of the switchboard. The alternator panel is also very often provided with a wattmeter and a watthour meter. The wattmeter is to indicate the power output of the machine at any instant and the watthour meter shows the power in kw. hours which is produced by the machine during any certain time period.

The alternator panels are often provided with switches or plugs for connecting the synchroscope or synchronizing lamps to any machine that is being started. These auxiliary devices are not shown in the diagram in Fig. 96, but they will be covered more fully in a later section on switchboards.

The exciter panel at the right in Fig. 96 contains the D. C. ammeter and voltmeter, for measuring the current to the field of the alternator and the voltage generated by the exciter. The exciter field rheostat, E.R., is also on this panel.

In some power plants the exciter panel is located adjacent to the alternator panels in this manner. In other large plants the direct current from the exciters may be metered and controlled from an entirely separate switchboard.

Among the more important features to be checked and watched in the care of alternators are the following. The temperature of both the windings and bearings should be frequently checked, and the meters watched to see that the machines are not overloaded. The speed and frequency of alternators should be accurately maintained, and the fields properly adjusted to keep cross currents at a minimum between parallel alternators. Tests should be made periodically on the insulation of alternator windings to note any weakness before it results in a complete failure of the machine.

Always see that there is plenty of cool, clean, dry air available for cooling the machines. All parts of the generators should be kept clean, and the windings should be cleaned with compressed air to keep dust or dirt from blocking ventilating passages and causing excessive heating. Additional material will be given on the care of generators in a later section on maintenance of electrical machinery.

Fig. 97 shows the generating room in a large power plant with four large steam-turbine-driven

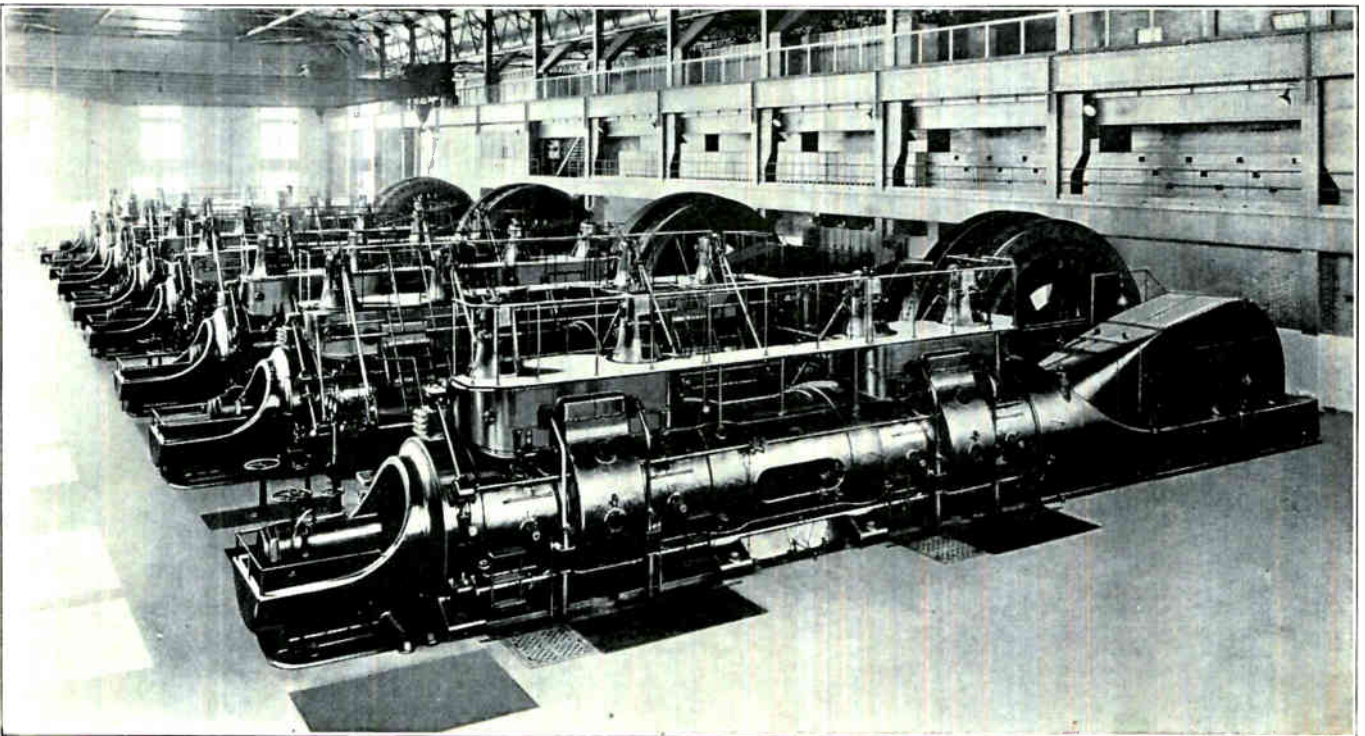

Fig. 98. Privately owned power plant producing alternating current for use in steel mill operations. These alternators are driven by gas engines which burn waste gases as a fuel. (Photo Courtesy Allis Chalmers Mfg. Co.)

alternators which are operated in parallel. Part of the switchboard and also the small exciter generators can be seen at the left of the photo.

Fig. 98 shows a section of a large industrial power plant in a steel mill. Waste gases from blast furnaces are used to operate twin tandem gas engines, and these engines in turn drive the alternators, which are operated in parallel to supply electricity used in the mill.

A great many of the larger factories and industrial plants have their own private power plants

to generate the vast amount of electrical energy which they use.

Operation of electrical equipment in plants of this type as well as in the mammoth generating stations which are owned and operated by public utility companies, provides fascinating and profitable work for many thousands of trained men.

To be able to qualify for a responsible position in a plant of this kind is well worth a thorough study of everything covered in this entire Reference Set.

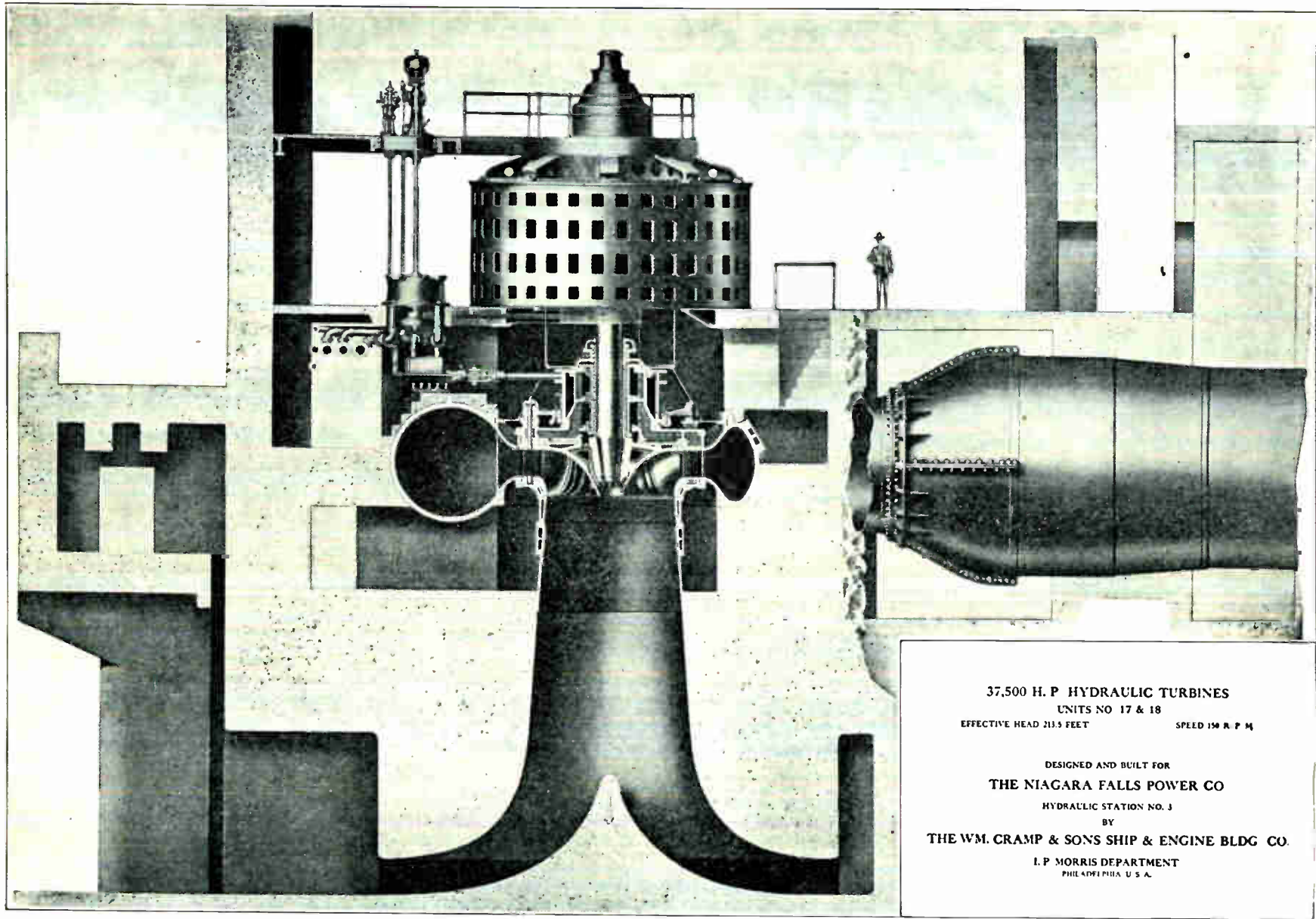

**37,500 H. P. HYDRAULIC TURBINES**  
 UNITS NO 17 & 18  
 EFFECTIVE HEAD 213.5 FEET      SPEED 150 R. P. M.

DESIGNED AND BUILT FOR  
**THE NIAGARA FALLS POWER CO**  
 HYDRAULIC STATION NO. J  
 BY  
**THE WM. CRAMP & SONS SHIP & ENGINE BLDG CO.**  
 I. P. MORRIS DEPARTMENT  
 PHILADELPHIA, U. S. A.

Fig. 98-A. This photo shows a large water-wheel driven alternator and also an excellent sectional view of the hydraulic turbine which drives the alternator. Note the size of the generator compared with the man in the picture. Hundreds of machines of this type are in use in hydro-electric power plants throughout the country.





# COYNE

## *Electrical School*

CHICAGO ~ ~ ILLINOIS



ESTABLISHED 1899

COPYRIGHT 1942

# ALTERNATING CURRENT AND A. C. POWER MACHINERY

## *Section Four*

### **Transformers**

**Construction Features**

**Methods of Cooling**

**Operating Principles**

**Ratios, Voltages, Polarities**

**Connections**

**Star and Delta, Paralleling, Phasing Out**

**Polarity Tests, Grounding**

**Special Transformers**

**Tap Changing, Scott, Auto Transformers**

**Induction Regulators, Instrument Transformers**

**Tests, Field Problems, Maintenance**

# TRANSFORMERS

We have already mentioned that it is necessary to use high voltage in order to transmit large amounts of electrical power economically over long distance lines. This, you will recall, is one of the principal advantages mentioned for alternating current, because it is possible to economically increase the voltage of alternating current with transformers.

A transformer is a device by means of which alternating voltages may be stepped up or down as desired. When the voltage of a circuit is raised or lowered by means of a transformer, the current capacity is usually varied in the opposite direction by the same proportion.

If we raise the voltage the current is reduced, or if we decrease the voltage the current is increased. For example, if we consider a circuit having 5,000 watts at 100 volts, the current in this case will be  $W \div E$ , or  $5000 \div 100$ , which equals 50 amperes.

If we were to raise the voltage of this same circuit to 1000 volts the current necessary to develop the same power would then be  $5000 \div 1000$ , or 5 amperes.

It is easy to see that a much smaller conductor could be used to carry the 5 amperes than would be needed for 50 amperes, so the same amount of power can be transmitted over smaller wires when higher voltage is used. This is the principle applied to modern transmission lines, and whenever a large amount of power is to be transmitted to some distant location the voltage is stepped up by means of transformers to some one of the standard high voltages, and the necessary current is thereby reduced a corresponding amount.

It is then possible to use a much smaller amount of copper in the conductors, and yet operate the transmission lines at a certain economical percentage of loss. These smaller conductors require much lighter supporting structures, such as the poles and steel towers, and lighter insulators and fittings.

As the cost of the copper in a transmission line is very great and the poles or towers also represent a large investment, the saving effected by the use of higher voltage is enormous.

For example, 50,000 kw. can be transmitted many miles at a potential of 100,000 volts over a copper conductor less than an inch in diameter, but if this same amount of energy were to be transmitted at 500 volts, it would require a conductor over a foot in diameter to carry the current with the same amount of loss.

From these points just mentioned, it is evident that alternating current provides a very convenient and economical means of transmitting large amounts of power for considerable distances, by stepping up the voltage at the generating plant with transformers and then stepping it down again

to safe and suitable voltages for the equipment at the point where the energy is to be used.

By far the greater amount of electrical energy is used at voltages from 110 to 440. Some of the larger motors, however, are operated at voltages from 2300 to 6600, and in some cases as high as 12,000 volts or more.

Transformers are one of the most efficient pieces of electrical equipment that we have; the efficiencies of some of the very largest sizes, ranging over 99%. These high efficiencies are obtainable because the transformer has no moving or wearing parts and therefore no friction or mechanical losses.

For this same reason, transformers require very little care and attention, except to maintain the proper insulation and cooling of their windings.

Power transformers are often referred to as **static transformers**, even though they have nothing to do with static electricity. This term is used because their parts are all stationary. We mention this term at this point because it is often confusing to the student or electrician to hear a transformer called by this term, if he doesn't know what it means.

## 108. TYPES OF TRANSFORMERS

We have already learned that a transformer consists primarily of an iron core which provides a path for the magnetic flux and on which are placed the two windings; one called the **high tension winding** and the other the **low tension winding**. The high tension winding (H.T.) is the one which has the greatest number of turns, and the low tension winding (L.T.) is the one which has the smaller number of turns.

These windings are also commonly referred to as **primary** and **secondary** windings. The primary winding is always the one which is connected to the source of power. The secondary winding is always the one which receives its power from the primary by induction, and is the one connected to the load.

There are several common types of transformers and they are classified according to the manner of their core construction. These are known as: the **core type**, **shell type**, and **distributed type**.

It may help you to distinguish between these types by remembering the number of magnetic paths or circuits which each type of core provides for its flux. The simple core type provides one path; the shell type, two paths; and the distributed type, three or four paths.

The sketches in Figs. 99 and 100 show the differences between these common types of transformer cores. Fig. 99 shows the plain core-type transformer, consisting of four sides, or legs as they are commonly called, arranged in the form of a

square or rectangle. The primary and secondary coils can be wound on opposite legs, as shown in this figure, or they can both be wound on the same core leg if desired.

When the primary winding is excited with alternating current, it sets up an alternating magnetic flux which is carried by the core over to the secondary winding. As the lines of force expand and contract, due to the alternations of the current, they cut across the turns of the secondary winding, thereby inducing voltage in this winding by the principles of electro-magnetic induction which were explained in the Elementary Section of this reference set.

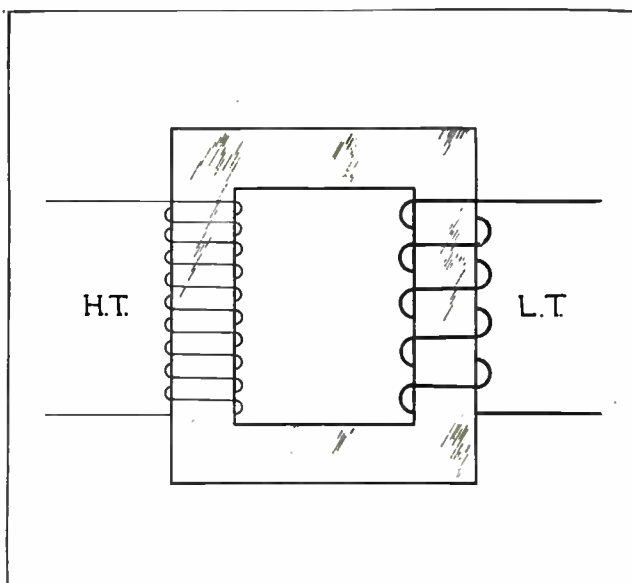

Fig. 99. This sketch shows the core and windings of a simple transformer. The winding on the left with the greater number of turns is the high tension winding, and the one on the right the low tension winding.

The amount of voltage which will be induced in the secondary winding depends upon the ratio of the number of turns in the primary and secondary coils. If the secondary has fewer turns than the primary, the voltage will be stepped down; on the other hand, if the secondary has a greater number of turns, the voltage will be stepped up.

An ordinary transformer can be used to step the voltage either up or down, depending upon which of the windings is made the primary, or excited by the applied voltage. So we find that, in the case of step-up transformers, the primary is the winding with the fewer turns; while on a step-down transformer, the primary is the winding with the greatest number of turns.

#### 109. TRANSFORMER CONSTRUCTION

The purpose of the transformer core is to provide a low reluctance path for the magnetic flux. Transformer cores are therefore made of thin laminations of soft iron or silicon steel, and are built up of thin laminations. These laminations are insulated from each other, either by a coating of insulating varnish

or by an oxide scale which is formed on their surfaces by a heat-treating process.

This laminated construction reduces eddy currents which would otherwise be set up by the alternating flux and would cause the core to over-heat.

The left view in Fig. 100 shows a sketch of a shell type transformer core with the primary and secondary windings both placed on the center leg. On the right in Fig. 100 is shown a sketch of the distributed type core on which the coils are also wound on the center leg and are surrounded by the four outside legs of the core.

This distributed-type core is used principally for low-voltage lighting and distribution transformers in sizes under 50 kv-a. The large area of core iron, well distributed around the coils, makes the "no load" losses very low with this type of transformer, so that it is ideal for use on lighting circuits where the load may be very small at times.

The core-type and shell-type transformers are both suitable for large capacity and high voltage work. The core-type is best suited for the very high voltages, because its coils can be more easily wound and insulated than those of the shell-type. The windings of the core-type transformer, being located more on the outside of the core, can therefore radiate heat away from the windings more rapidly.

The shell-type core, because of its shape and the location of the windings on the center leg, provides somewhat better mechanical protection for the coils during handling in and out of the transformer case. The shell-type transformer is best suited for moderate voltages and heavy currents.

Fig. 101 shows a complete distributed-type, transformer core of the three-leg construction. This view shows the manner in which the core legs are assembled from the thin laminations and also the

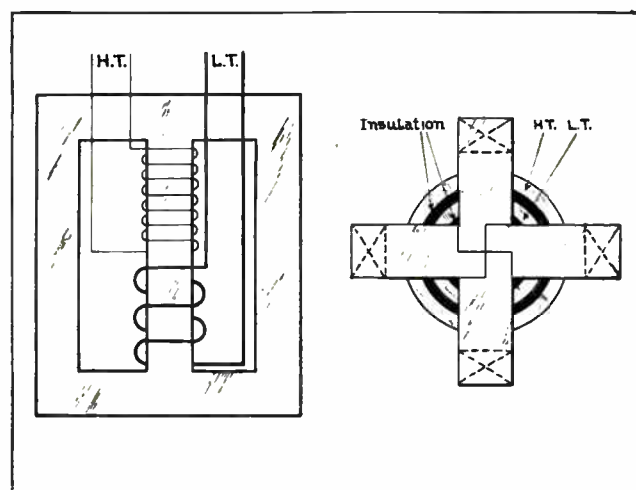

Fig. 100. The diagram on the left shows a transformer with a shell-type core, and on the right is shown the top view of a transformer with a distributed-type core. This view shows the top edges of the coils and insulation, while the sketch on the left shows a schematic diagram of the coils in their position on the core.



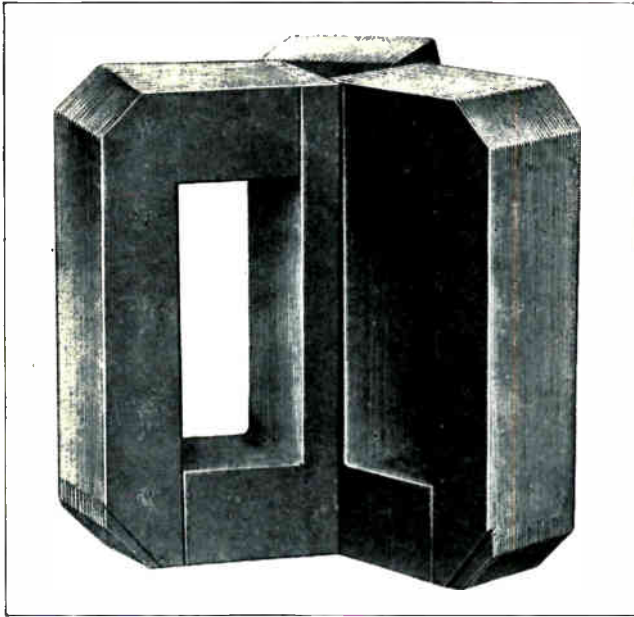

Fig. 101. The above photo shows a complete core of the three-sided type for a distributed core transformer. (Photo courtesy General Electric Co.)

manner in which the laminations are overlapped at the corners of the core, in order to provide a good magnetic path of low reluctance.

#### 110. TRANSFORMER WINDINGS

Transformer coils are wound with insulated copper wire, some of the smaller sizes being wound with round wire, while square or rectangular wire is used for practically all of the medium and larger sized units.

The square and rectangular wires form a more compact and solidly built coil and also provide better conductivity for the heat to flow out of the windings. The coils are usually built up in a number of carefully wound layers and each layer is well insulated from the preceding and following ones.

It is only in a few types of very small transformers that the coils are wound directly on the core legs. In practically all medium-sized and larger transformers the coils are form-wound and then slipped over the legs of the transformer core before the core is completely assembled.

The coils, after being wound, are thoroughly dried by being heated in ovens and are then dipped in hot insulating compound to thoroughly insulate every turn from the adjoining turns.

In many cases the dipping or impregnating process is performed in air-tight tanks, so that the coil can first be subjected to a high vacuum to draw out every bit of moisture and air from the windings. The hot insulating compound is then applied under pressure to force it into every crevice and space in the turns of the winding.

The coils are then thoroughly baked to dry out and harden the insulating compound so it will present a smooth, hard surface and prevent moisture,

dust, and dirt from getting into the windings during operation of the transformer.

After the coils are thoroughly insulated and baked, they are placed upon the well-insulated legs of the iron core. The core insulation consists of several layers of fiber or fish paper; or, in some cases on the higher voltage units, it consists of a special bakelite or composition tube.

Fig. 102 shows the partly assembled core for a distributed-type transformer, and the primary and secondary coils ready to be set in place over the center leg of this core as soon as it is insulated. The primary coil, shown in the center of this figure, is built up of several layers which have been form-wound and then thoroughly insulated by a wrapping of tape. The secondary winding, shown on the right, is built up of a number of separate coils, each of which is well insulated from the others.

These coils are then connected in series to form a complete high-voltage winding. This type of construction provides better separation and insulation of the sections of the secondary winding, between which very high voltages exist.

A heavy layer or tube of high-grade insulation is also placed between the low tension and high tension windings to prevent a flash-over from the high-voltage winding to the low-voltage coil.

After the L.T. and H.T. coils are in place on the core, they are securely wedged and anchored, to prevent any possible moving or distortion due to heavy magnetic stresses set up around the coils when the transformer is loaded, or during the possible occurrence of short-circuits.

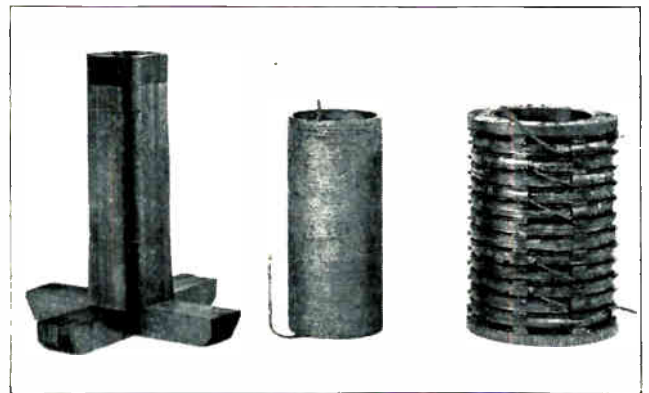

Fig. 102. This view shows a partly assembled core of the distributed type and the primary and secondary windings which are ready to be placed on the core. (Photo courtesy General Electric Co.)

Fastening the coils securely in place also prevents them from rubbing against the core and having their insulation damaged by the slight vibration which is set up by the alternating fluxes in the core laminations.

Fig. 103 shows a completed transformer element with the windings in place on the core, the laminations of the outer and top sides of the core having been assembled after the windings were placed on the center leg. The whole core is then securely

clamped by means of bolts to prevent excessive vibration of the laminations.

If these laminations are not clamped tightly together, the reversing magnetic fluxes will cause them to vibrate excessively and create a great deal of noise during the operation of the transformer. Loose laminations might also chafe the insulation of the windings.

In Fig. 103 you may also note the manner in which the leads are connected to the coils and brought up to a terminal plate of porcelain or insulating material. The heavy, stiff, copper leads are then carried on up to the point where they leave the tank or transformer case.

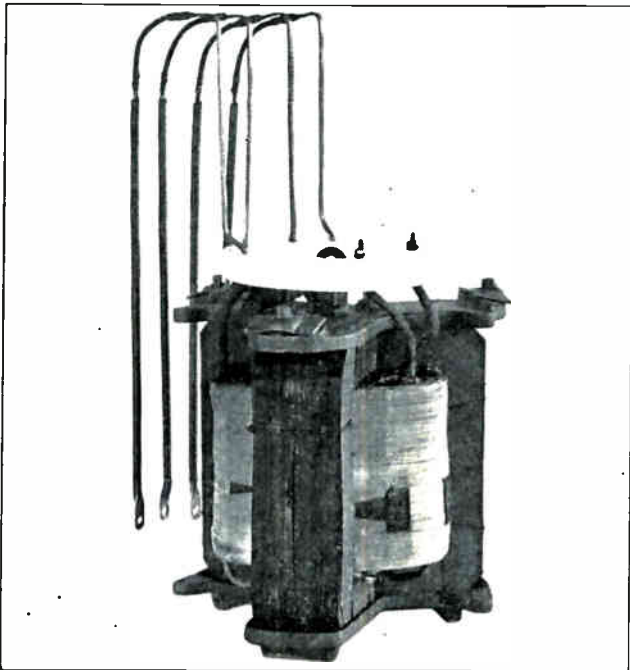

Fig. 103. Complete transformer core and windings. Note how the legs of the core are assembled to form complete magnetic paths around the coils. (Photo courtesy General Electric Co.)

Fig. 104 shows another transformer winding, consisting of form-wound coils assembled in several layers. These layers are separated or spaced from each other by strips of wood, the ends of which can be seen around the left end of the winding. This type of construction not only insulates the sections of the coil from each other, but also provides spaces for the circulation of the cooling air or oil to carry away the heat from the inside of the winding more easily.

A winding built up of a number of separate layers or sections in this manner may have these sections connected either in series or parallel, according to the voltage and current capacity desired from the transformer.

#### 111. SINGLE-PHASE AND POLYPHASE TRANSFORMERS

The transformers we have so far considered and shown in the figures have been of the single-phase type. Transformers are also made in polyphase

types, as shown in Fig. 105. This photo shows a complete three-phase transformer element with the primary and secondary windings of each phase located on a separate leg of the core.

From this it is easy to see that a three-phase transformer is simply a combination of three single-phase transformers all assembled on one core. The low voltage windings of the transformer shown in Fig. 105 are inside the high voltage coils and next to the core legs. The high voltage coils which are placed over the others can be clearly seen in this view. Note carefully the manner in which the separate sections of the coil are insulated from each other, and also the insulating barriers placed between the three coils to prevent a flash-over from one winding to the next. The leads for connecting the coils to the line are shown carefully taped and marked, and brought up to separate insulating supports above the core.

A three-phase transformer requires less core material than three single-phase transformers of the same capacity. This is due to the fact that in the three-phase transformer the magnetic fluxes of each phase use the same core at alternate periods as the alternations and fluxes of each phase occur  $120^\circ$  apart. Therefore, the advantages of polyphase transformers are: that they require less core material; are lighter in weight; and occupy less floor space in a power plant or substation than three single-phase transformers of the same capacity.

One of the disadvantages of a polyphase transformer is that, in case of trouble or breakdown in the insulation or windings, all three phases must be cut out of service for repairs; while, in the case of single-phase transformers, the one defective unit can be disconnected for repairs, and service can be maintained to the customers either by substituting another single-phase unit or by a special open-delta

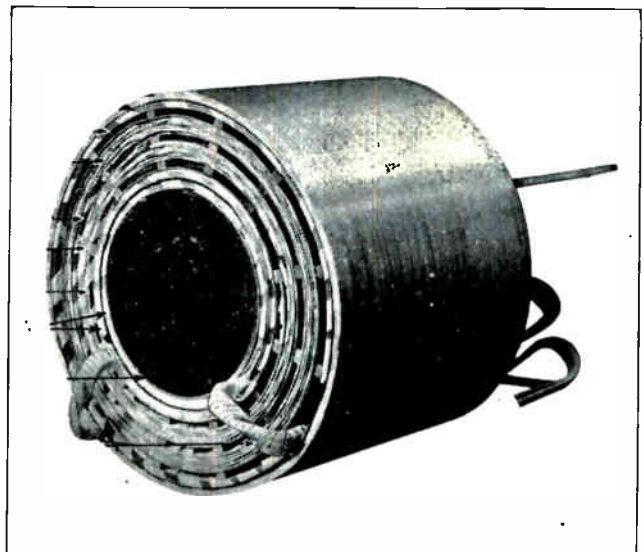

Fig. 104. This view shows a transformer winding which is built up in layers that are spaced apart with wood strips to allow circulation of cooling oil through the winding. (Photo courtesy General Electric Co.)

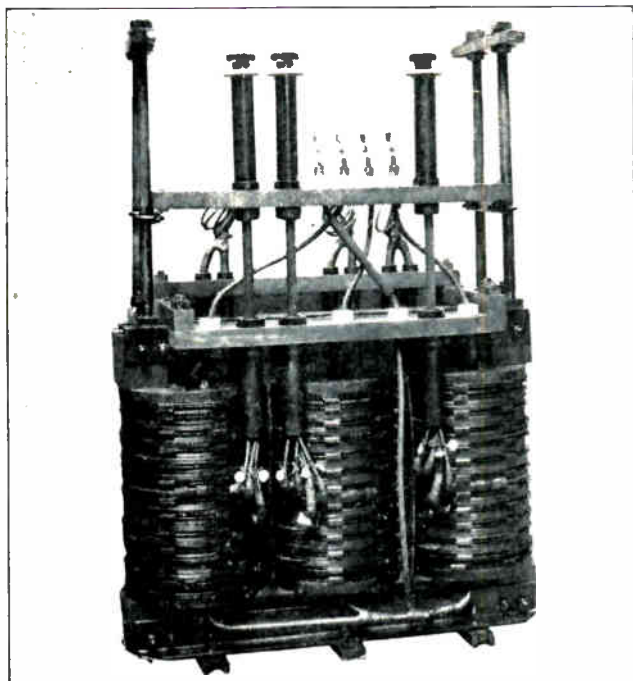

Fig. 105. Complete three-phase transformer core and windings ready to be placed in the tank and covered with oil. (Photo courtesy General Electric Co.)

connection to the remaining two units. This connection will be explained in later paragraphs.

In modern transformers, however, the construction and insulation of the coils is such that under ordinary operating conditions there is very little chance of breakdown or failures.

### 112. TRANSFORMER LOSSES

Although transformers are very efficient devices, they have certain small losses which take place within their windings and cores during operation. These losses are commonly referred to as **copper losses and core losses**.

The copper loss is due to resistance of the coils, which causes a certain amount of the energy to be transformed into heat within the windings. This loss is proportional to the square of the current in the windings, and is therefore approximately zero at no load and maximum at full load.

The core loss consists of eddy current losses and hysteresis losses which are set up in the core by the reversing magnetic flux. Eddy currents, you will recall, are low-voltage short-circuited currents which are caused to flow in various areas of the core by the magnetic lines of force cutting across the core in varying intensities. These eddy currents are reduced and kept at a minimum by the laminated construction of the core; but the small amount which still exists, even in the best core construction, will cause a certain amount of heat to be developed in the iron.

Hysteresis loss is due to the reversal of the magnetic charges of the molecules of the iron as the alternating flux constantly reverses in the core.

This loss also tends to produce a certain amount of heat in the core.

The core losses remain approximately the same at no load or full load of the transformer, because they are always proportional to the magnetizing current and flux.

These losses and tests to measure them will be more fully discussed in later paragraphs of this section.

### 113. TRANSFORMER COOLING

In a transformer which is operating under full load, a considerable amount of heat is produced by the copper and core losses. This heat must be removed and carried away from the windings and core, because if it were confined and stored up within them it would soon cause the temperature to rise so high that it would burn or damage the insulation of the windings.

Transformers must also be kept cool to maintain their high operating efficiency, because the resistance of the copper in the windings increases with the temperature increase and thereby increases the  $I^2R$  loss.

In very small transformers, such as bell-ringing and toy transformers, instrument transformers, etc., the heat is carried away by the natural circulation of air around the core and windings.

On larger power transformers some additional means of cooling the windings must be provided. Transformers are often classified according to their methods of cooling, as follows: **natural air cooled, forced air-blast cooled, oil cooled, and oil and water cooled.**

Natural air cooling is used only in the smaller types, as previously explained.

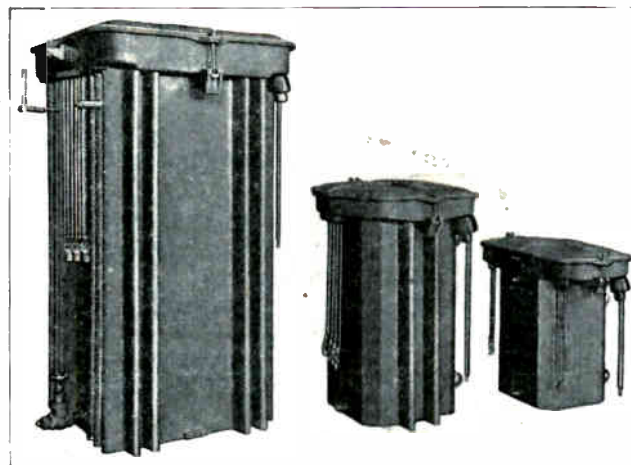

Fig. 106. This view shows three different sizes of common power transformers. Note the cooling flanges or ribs in the tanks of the two larger ones. (Photo Courtesy General Electric Co.)

### 114. AIR-BLAST COOLING OF TRANSFORMERS

Transformers that are cooled by forced air circulation have their core and windings enclosed in an iron case or jacket which is open at the bottom and top. Clean, dry air under low pressure is forced

upward through the windings and, in this manner, carries away the heat much more rapidly than natural air-circulation would.

The air for cooling transformers of this type is supplied by motor-driven fans and is usually fed to the transformers through an air passage or chamber which runs under the floor on which the transformers are located.

Air passes up through the transformers and exhausts, into the room in which they are located, escaping through open windows or air-vents in the building.

Quite often a small ribbon or cord is attached to the top of the transformer casing, directly in the exhaust air opening, so that it will be blown upward and kept fluttering in the air. This provides an indication of failure of the air supply.

It is very important that the air be kept circulating at the proper rate through transformers of this type or otherwise they would quickly overheat.

The air intake for supplying fresh air to air-blast transformers should be located where it will not draw any moisture or dust, as either of these would quickly deteriorate the insulation on the transformer windings, and dust would tend to clog the air passages between and around the coils.

Very often a cloth screen is placed over the air intake to stop the passage of fine dust and a certain amount of moisture.

#### 115. OIL-COOLED TRANSFORMERS

The common oil-cooled transformers of the small and medium sizes have their cores and windings

immersed in a tank of insulating oil. This is by far the most common type of transformer in use.

The oil, which is of a special grade known as transformer oil, not only serves as a cooling agent for the windings and core, but also serves as an excellent insulation between the layers of the winding and the core.

This oil flows into all crevices and passages between the windings and conducts the heat through the liquid to the metal tank, from which it is given off to the outside air.

Fig. 106 shows several transformers of the oil-cooled type, the capacities of which, from left to right, are: 150 kv-a., 37½ kv-a., and 15 kv-a. The tanks of these transformers are made of either cast iron or pressed steel. The pressed steel tanks are much lighter in weight and more durable mechanically; because, if they are dropped or bumped, it will usually only dent the tank instead of cracking it, as often occurs with cast iron.

On the small sizes of transformers, the tanks usually have a plain, flat surface on each side, as shown on the 15 kv-a. unit at the right in Fig. 106. On the larger sizes, the sides of the tank are usually corrugated or provided with projecting fins as shown on the two larger transformers in this figure. This construction greatly increases the area or surface of the metal which is in contact with the air, and thus enables the air to absorb and carry away the heat from the tank much more rapidly.

Note the manner in which the coil leads are brought out of the transformer case through insulating bushings, which are usually made of porcelain. The cases are equipped with covers which can be removed for inspection of the windings or for changing the connections at the terminals inside. These covers are provided with a washer or gasket around their edges so that, when they are clamped securely in place by the bolts and nuts shown in the figure, they seal the transformer tightly and keep out practically all dirt and moisture.

Transformers of this type and smaller, ranging down to 1 kw. in size, are the types commonly seen on poles throughout the cities and in many rural districts. They are used to step the voltages of the transmission or distribution lines down to that used in homes for lighting or in shops for power purposes.

Fig. 107 shows a complete three-phase transformer which has the entire surface of the case deeply corrugated to provide sufficient cooling area. The high-tension winding of this transformer is constructed for 25,000 volts, and you will note the much larger insulating bushings through which the high-voltage leads are brought out at the top of the case.

You will note also that the transformer cases shown in these figures are provided with drain plugs or valves at the bottom, so that the oil can be drained out and replaced whenever it becomes dirty or has absorbed too much moisture.

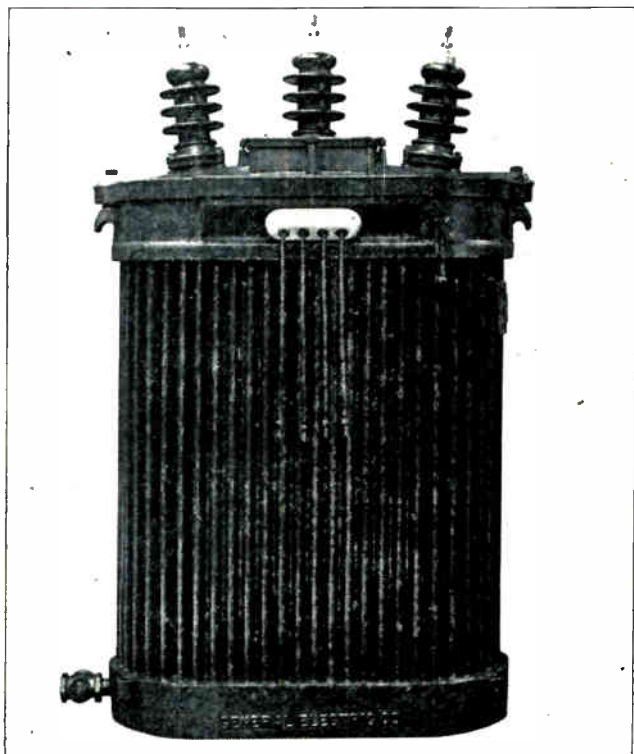

Fig. 107. Three-phase power transformer for high voltage operation. Note the large insulating bushings and also note the manner in which the entire tank is corrugated to provide a greater heat-radiating surface.

During operation throughout a period of several months or longer the oil will often absorb a little moisture, and the presence of even very slight amounts of water in the oil greatly reduces its insulating qualities. It is therefore necessary at times to replace or dry out this oil. This will be more fully covered later under Care and Maintenance of Transformers.

#### 116. COOLING TUBES OR RADIATORS

On very large power transformers, ranging from 300 kv-a. to 10,000 kv-a. and up, the cases are usually provided with a number of pipes or tubes on the outside, as shown in Fig. 108. Some smaller transformers are equipped with these cooling tubes, if they are to be located in places where it is difficult to cool them otherwise. These tubes connect to the top and bottom of the tank and allow the oil to circulate through them from top to bottom, by the natural movement of the oil caused by its being heated inside the transformer and cooled in the tubes.

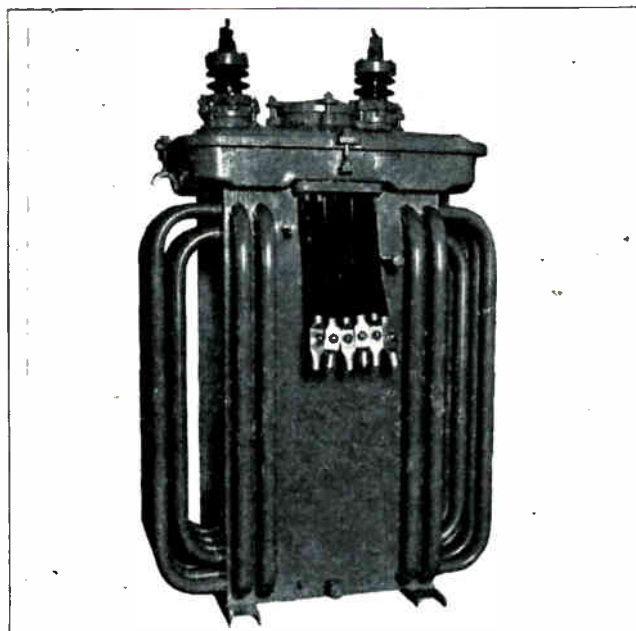

Fig 108. This transformer is equipped with cooling tubes to allow the oil to circulate outside of the tank and give off its heat more rapidly to air.

The heated oil around the transformer coil and windings tends to rise to the top and pass out of the tank into the top ends of the tubes. In the tubes it is cooled off more rapidly, as they are completely surrounded by air, and the oil is thus caused to flow to the bottom of the tubes and back into the transformer.

The oil is kept continually circulating in this manner by the thermo-siphon principle just explained.

Fig. 109 shows a bank of three large single-phase power transformers, each of which has a capacity of 30,000 kv-a. These transformers have a high-voltage winding which produces 220,000 volts. Note

the very large insulating bushings through which the high voltage leads are taken out to the line.

These transformers are equipped with groups or sets of cooling fins or tubes which are commonly called radiators and are clearly shown in this photo. These sets of cooling fins are adjustable to take advantage of spacing of the transformers and the air currents around them. They are also removable for cleaning.

The cooling of this type of transformer is sometimes further improved by directing a blast of air against these cooling fins by means of motor-driven fans and sheet metal tubes to direct the air through the cooling fins.

#### 117. OIL AND WATER COOLED TRANSFORMERS

In some cases, where it is difficult to sufficiently cool transformers by means of natural oil circulation through cooling tubes, oil and water cooled transformers are used. In transformers of this type a coil of copper tubing or pipe is located in the oil, above the core and windings.

Cold water is circulated from the outside through this copper piping and rapidly absorbs the heat from the top level of the oil, which is always the hottest in any transformer. Fig. 110 shows a transformer equipped with a cooling coil of this type.

The heat passes easily through the copper tubing because copper, as you will recall, is a good conductor of heat. The heat is thus absorbed by the water and continually carried away by the new supply of cool water which is circulated constantly through the cooling coil, by a pump or by a connection to a local water supply system.

#### 118. AUXILIARY OIL TANKS AND BREATHING PORTS

In Fig. 109 you will note a special oil tank or reservoir mounted on top of each of the transformers. This tank, which is commonly called an oil conservator, is used to maintain the oil level above the top of the main tank and thereby keep the transformer tank completely filled with oil and exclude all air from it.

The smaller outside tank, which is only partly filled with oil, provides the necessary air space to allow for expansion of the oil in the main tank with increased temperature during increases of load. This type of construction also exposes a much smaller area of the top surface of the oil to the air, and thereby reduces the amount of moisture that the oil will absorb in a given time.

In some cases the transformers are provided with a breather port or opening which allows the air to pass in or out of the tank, during expansion and contraction of the oil with temperature changes. This breather can be equipped with a filter of calcium chloride through which the air must pass.

Calcium chloride has a great affinity or attraction for water and therefore absorbs practically all mois-

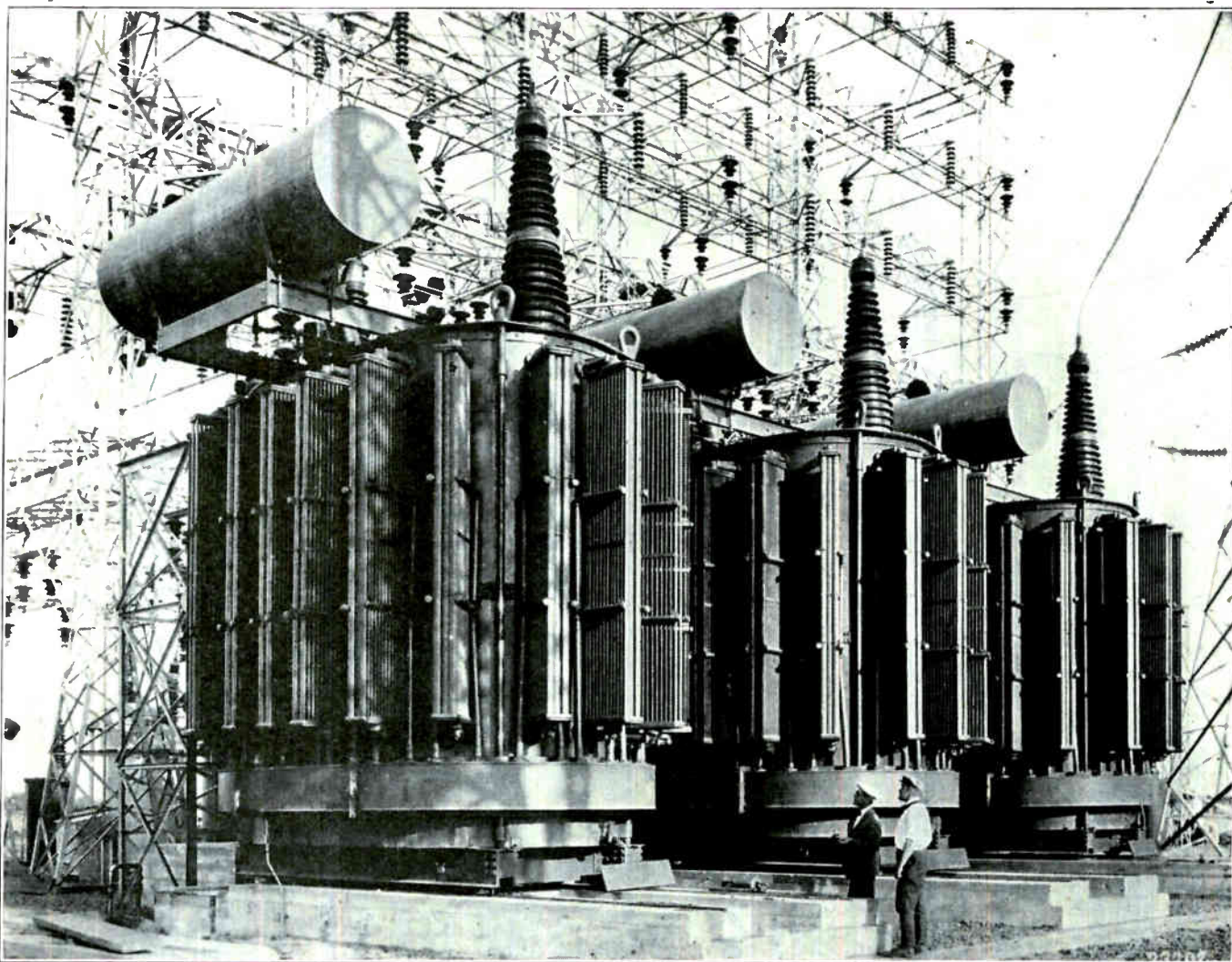

Fig. 109. This photo shows a bank of large power transformers in the foreground and the structure of a high voltage switching station in the background. Note the cooling radiators on the sides of the transformer tanks and also the large insulating bushings which are used for the 220,000-volt leads. Transformers of this type are used in connection with high voltage transmission lines to step the voltage up or down at the sending or receiving ends of the line. (Photo courtesy General Electric Co.)

ture from the air before it is allowed to enter the transformer.

### 119. TRANSFORMER OPERATING TEMPERATURES

Transformers are commonly designed to withstand temperature increases of  $55^{\circ}\text{C}$ . to  $75^{\circ}\text{C}$ . above normal temperature. This variation in maximum operating temperatures is due to the different classes of insulation which are used.

Transformer windings which are insulated with impregnated cotton, silk, and paper cannot be operated at such high temperatures as those which are insulated with mica and other special insulating compositions.

Practically all large transformers are provided with thermometers which indicate the operating temperatures at all times. When operating or caring for transformers which use forced air or circulating water in their cooling, it is very important to regulate the air and water so that the maximum temperatures for which the unit is designed will not be exceeded.

It is also well to remember always that the temperature ratings of electrical machinery are commonly given in the centigrade scale.

When we say that a transformer is allowed to operate at 55 degrees centigrade above normal temperature, its temperature is considerably higher than 55 degrees Fahrenheit. The centigrade scale has its zero point at 32 degrees on the Fahrenheit scale, and its 100-degree point is at 212 degrees Fahrenheit. One degree of the Fahrenheit scale is equal to only  $\frac{5}{9}$  of a degree centigrade.

So, to determine the value in degrees F. of any certain temperature above freezing, which is expressed in degrees C., we can use the following formula, or rule:

$$\text{Temp. F.} = \left( \text{C}^{\circ} \times \frac{9}{5} \right) + 32$$

Or, to determine the C. temperature of a certain F. value, we can use the formula:

$$\text{Temp. C.} = (\text{F}^{\circ} - 32) \times \frac{5}{9}$$

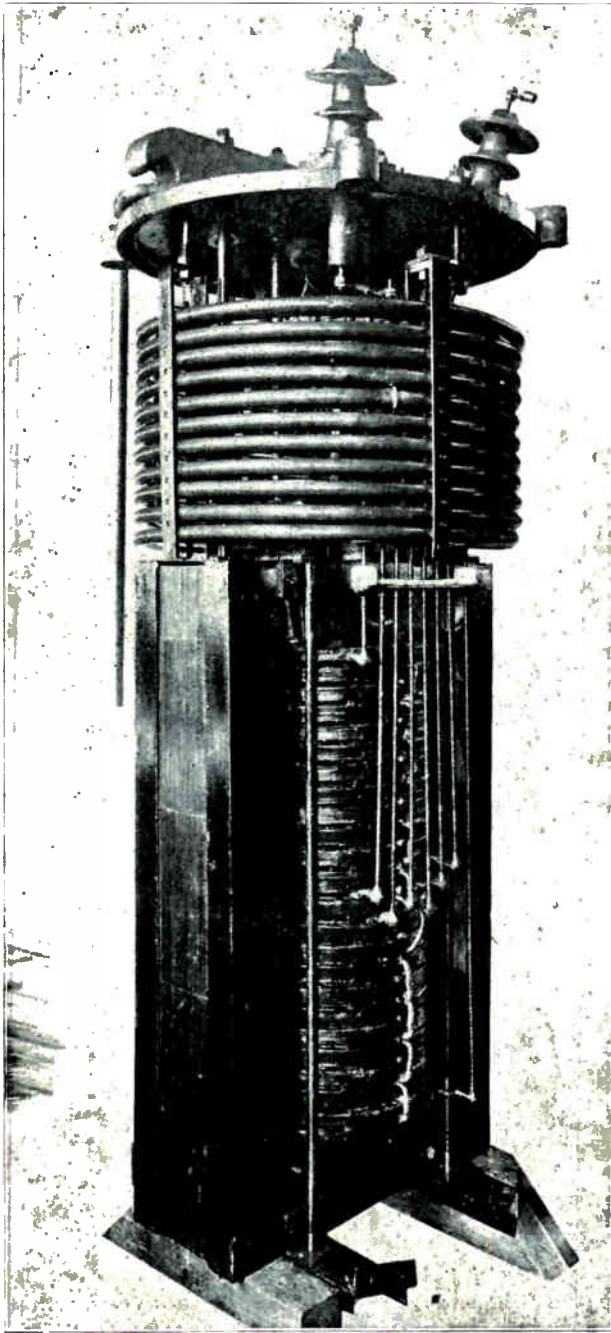

Fig. 110. This view shows a single-phase power transformer equipped with a coil of copper tubing through which water is circulated to cool the transformer and the oil which surrounds it.

Fig. 111 gives a convenient table of comparative temperature values in both the centigrade and Fahrenheit scales. From the table we can quickly find that  $55^{\circ}\text{C}$ . is equal to  $131^{\circ}\text{F}$ ., and  $75^{\circ}\text{C}$ . is equal to  $167^{\circ}\text{F}$ ., etc.

## 120. SPECIAL TEMPERATURE AND LOAD INDICATOR DEVICE

For small and medium-sized transformers which are to be mounted upon poles, a device known as a *thermotel* is often used to indicate when the transformers are overloaded or operating at too high temperatures. This device can be read from the ground and therefore does not necessitate climbing

the pole to determine the operating temperature of the transformer.

Fig. 112 shows a photograph of a *thermotel* unit which is equipped with an extension to be inserted under the cover of the transformer tank. These devices operate by the expansion of a liquid in a tube immersed in the oil. When the oil becomes heated the liquid expands and increases the pressure on the walls of a thin, curved, metal tube attached to the pointer of the device.

The increased pressure tends to straighten out the tube and thereby causes the pointer to move across the scale a certain distance, in proportion to the temperature of the transformer oil.

As this temperature is proportional to the amount of load, the scale of the *thermotel* can be marked so that the pointer will indicate the percentage of load or overload at which the transformer is operated.

If the transformer is overloaded and the pointer is caused to move beyond the 100% load mark, it trips a white vane or semaphore which falls into view in the window of the device. This indication is clearly visible to an inspector on the ground and shows that the transformer has been overloaded. These devices are exceptionally convenient because they can be read from the ground and can be installed on a transformer by simply hanging over the edge of the transformer case a hook-like extension which carries a tube of liquid.

Cent.	Fahr.	Cent.	Fahr.	Cent.	Fahr.	Cent.	Fahr.	Cent.	Fahr.
-40	-40	15	59	70	158	150	302	800	1472
-35	-31	20	68	75	167	160	320	900	1652
-30	-22	25	77	80	176	170	338	1000	1832
-25	-13	30	86	85	185	180	356	1200	2192
-20	-4	35	95	90	194	190	374	1400	2552
-15	+5	40	104	95	203	200	392	1600	2912
-10	+14	45	113	100	212	300	572	1800	3272
-5	+23	50	122	110	230	400	752	2000	3632
0	+32	55	131	120	248	500	932	2200	3992
+5	+41	60	140	130	266	600	1112	2400	4352
+10	+50	65	149	140	284	700	1292		

Fig. 111. This convenient table gives the comparative temperature values in degrees centigrade and Fahrenheit. With this table it is easy to convert the degrees centigrade from the rating or temperature of any electrical equipment into degrees of the Fahrenheit scale.

## 121. INSULATING BUSHINGS

Where the primary and secondary leads of the transformer coils are brought out of the tank or case for connection to the line, these leads must be carefully insulated from the metal case, in order to prevent flash-overs and grounding of the circuit.

On low-voltage transformers, ranging from 110 to 2300 volts, the insulated wires are brought out through small porcelain bushings or collars, as shown in Fig. 106. On transformers operating at

voltages from 2300 to 33,000 volts, much larger porcelain bushings are used. These bushings are equipped with flanges or petticoats to increase the creepage or flash-over distance which an arc would have to travel in order to jump from the lead-in wire to the tank.

Bushings of this type are shown on the high-voltage terminals of the transformers in Fig. 107 and 108. The low-voltage leads on both of these transformers are brought out through the ordinary small porcelain bushings.

On transformers operating at voltages from 50,000 to 220,000 volts or more, special oil-filled porcelain bushings or condenser-type bushings are used. The high-voltage bushings on the 220,000 volt transformers shown in Fig. 109 are of the oil-filled porcelain type. The porcelain of these bushings is hollow and is filled with oil, which is separated into layers by a number of thin insulating tubes.

High-voltage bushings of this type have a metal rod extending through them from one end to the other, to serve as a conductor. The coil and line leads are connected to the top and bottom ends of this rod by means of bolts or threaded connections.

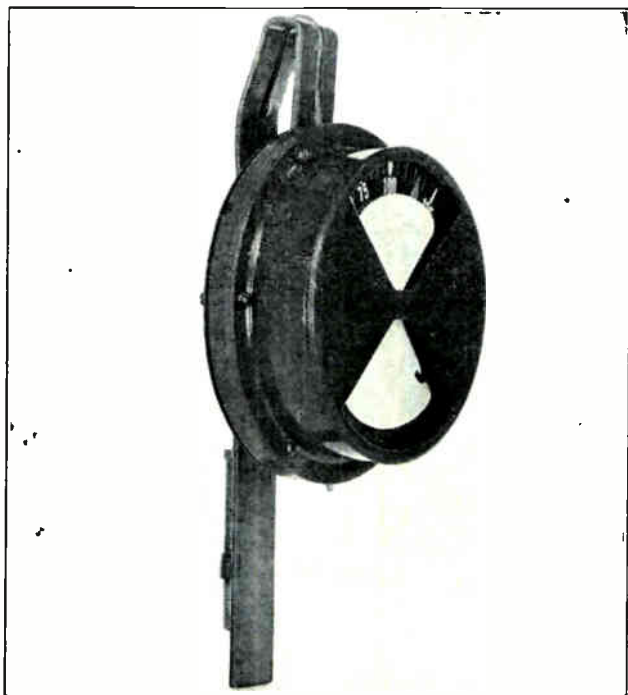

Fig. 112. This photo shows a temperature-indicating device for use with pole type transformers. This device is called a thermotol and indicates both excessive temperatures and overload of a transformer on which it may be installed.

The condenser-type bushing consists of a number of alternate layers of insulation and metal foil wrapped tightly around the conductor rod. The reason for using layers of metal foil in a bushing of this type, instead of using solid insulation, is that the metal distributes the voltage stress more evenly over the entire surface of the insulation layers and thereby reduces the tendency to puncture at one spot near the iron tank of the transformer.

Fig. 113 shows a polyphase transformer removed from its tank, but with the cover in place so the lower ends of the insulating bushings can be seen. The smaller bushings in the front are those of the low-voltage leads and the larger bushings in the rear are those of high-voltage leads.

You will also note that the connecting lead between the two outer windings is carried across through a special tube of insulating material, to prevent flashing over to the center coil.

Power transformers are built in voltages ranging from 110 to 220,000, while special testing transformers used in research and laboratory work are built to develop voltages as high as 250,000 or more from one unit.

A number of these transformers can be connected in series or cascade connection to obtain potentials as high as several million volts. Voltages of this order are used in making flash-over and puncture tests on line insulators, transformer bushings, high-voltage cables, etc. They are also used for determining the effects of lightning on transmission line equipment, electrical machinery, and buildings. Fig. 114 shows a demonstration of an arc from the high-voltage transformers which can be seen in the right rear of this photo.

Special industrial transformers are made to step voltages down as low as 1 or 2 volts and to produce

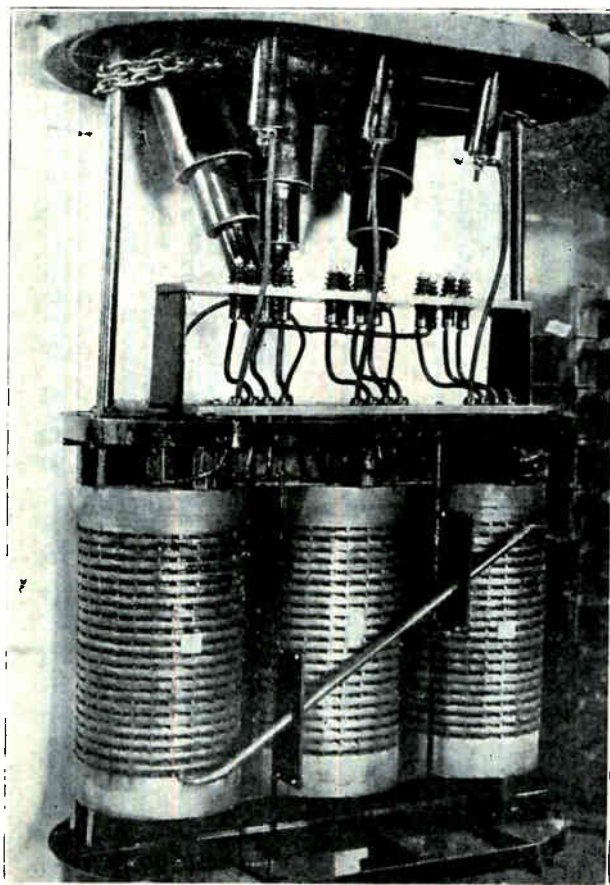

Fig. 113. This view shows the core and windings of a high voltage, three-phase transformer and also the lower ends of the insulating bushings through which the high voltage and low voltage leads are taken from the tank.



many thousands of amperes from very low voltage secondary windings, to be used in butt welding, spot welding, etc.

Transformers are rated in kv-a. and are built in sizes from a fraction of one kv-a. to 40,000 kv-a. or more.

## 122. TRANSFORMER PRINCIPLES

When the primary winding of a transformer is excited with alternating current, the powerful magnetic field which is set up around this winding and through the core will cut across the turns of the secondary winding as the flux expands and contracts with the variations and reversals of the current in the primary winding.

As this flux cuts back and forth across the turns of the secondary winding, it induces a voltage in each of these turns by the principle of electro-magnetic induction which has already been explained.

As the induced voltage in the secondary coil depends upon the movement of the primary flux, and as this flux moves in synchronism with the alternations of the primary current, the secondary current will always be of the same frequency as that in the primary.

The secondary current will, however, always be approximately  $180^\circ$  out of phase with the primary current. This is due to the fact that the most rapid change of primary flux occurs during the period when the primary alternations are passing through or near their zero values, as was shown with the sine curves in Section One of Alternating Current.

It is at this point of most rapid flux change that the maximum voltage is induced in the secondary;

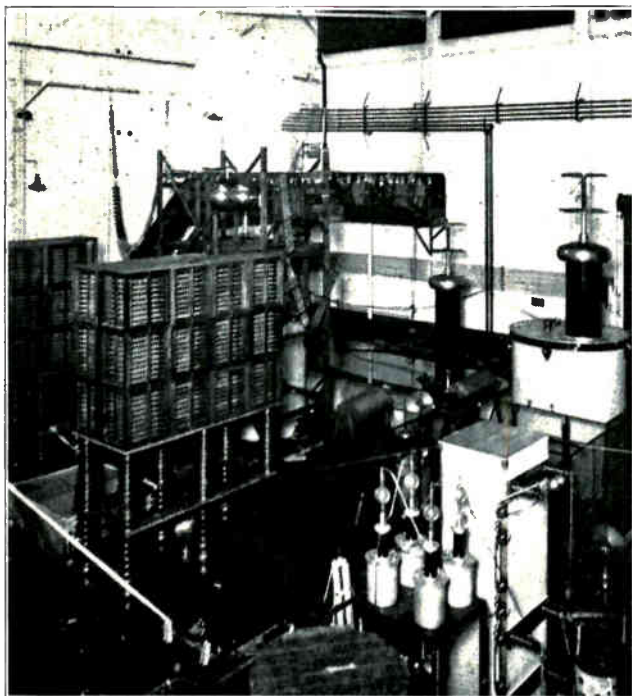

Fig. 114. The above photo shows a high voltage test room at the plant of the General Electric Company. Transformers in this room are capable of producing over one million volts and an enormous arc produced by this voltage can be seen above the sphere gap and condenser slightly to the left of the center of the picture.

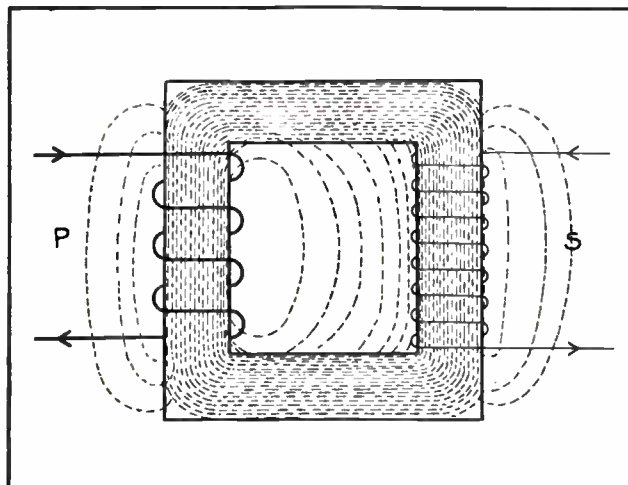

Fig. 115. This sketch illustrates the operating principle of a simple transformer and shows the manner in which the primary flux passes through the core and induces voltage in the secondary winding.

therefore, the maximum secondary voltage occurs approximately  $90^\circ$  later than the maximum primary current.

As a transformer winding is highly inductive and has very little resistance, the secondary current will lag approximately  $90^\circ$  behind the induced secondary voltage. Thus, the secondary current is approximately  $180^\circ$  behind the primary current. This is a very good point to remember because it means that when the current flows through the primary coil in one direction, as shown by the arrows in Fig. 115, it will be flowing in the opposite direction through the secondary coil.

Therefore, if the primary and secondary coils are wound alike, the voltage polarities produced at the ends of the secondary coil will be opposite to those applied to similar ends of the primary coil.

You will note in Fig. 115 that, while the greater part of the magnetic flux set up by the primary follows the iron core, a certain amount of this flux will be set up around the windings outside of the core and also across the opening between the core legs. This is called leakage flux and is considerably greater at full load of the transformer than at no load.

## 123. TRANSFORMER RATIOS AND SECONDARY VOLTAGES

In a simple transformer, all of the turns of the secondary coil are in series with each other, so their induced voltages will add together and the voltage at the terminals of the secondary winding will be the sum of the voltages induced in all the turns.

Therefore, the greater the number of turns in the secondary winding of any transformer, the higher will be the voltage induced in this winding.

From this, we find that in any transformer the amount of voltage change, or the ratio between the primary and secondary voltages, will be proportional to the ratio between the number of turns in the primary and secondary windings.

For example, if the primary winding of the trans-

former shown in Fig. 115 has fifty turns and the secondary winding has one hundred turns, the transformer will be a step-up transformer with a ratio of one to two.

The first figure of a transformer ratio always refers to the primary and the second figure to the proportional number of turns in the secondary.

If, in another case, we have a step down transformer with a primary winding of 1000 turns and a secondary winding of 100 turns, the ratio of this transformer would be expressed as 10:1; and if we were to apply 2200 volts to the primary winding, 220 volts would be produced by the secondary winding.

From these illustrations we can see that the following formula applies:

$$\frac{\text{Primary turns}}{\text{Secondary turns}} = \frac{\text{Primary voltage}}{\text{Secondary voltage}}$$

or, in the case of the transformer just mentioned,

$$\frac{1000}{100} = \frac{2200}{220}, \text{ or } \frac{10}{1} = 10:1$$

If we know the ratio between the number of turns on the primary and secondary windings of any transformer and know the amount of primary voltage which is applied, we can easily determine the secondary voltage, because it will bear the same relation to the primary voltage as the number of secondary turns bears to the number of primary turns.

To find the secondary voltage of either a step-up or step-down transformer, divide the primary voltage by the ratio of primary to secondary turns, or in other words,

$$\text{Secondary E} = (\text{Primary E} \times \text{last figure of ratio}) \div \text{first figure of ratio.}$$

For example, if a step-up transformer with a ratio of 1 to 10, has 100 volts applied to its primary, the secondary voltage will be  $(100 \times 10) \div 1$ , or 1000 volts.

If, in another case, a step-down transformer with a ratio of 20 to 1 has 2200 volts applied to its primary, the secondary voltage will be  $(2200 \times 1) \div 20$ , or 110 volts.

The formula for finding the approximate secondary current is as follows:

$$\text{Sec. I} = (\text{Pri. I} \times \text{first figure of ratio}) \div \text{last figure of ratio.}$$

#### 124. POWER OUTPUT OF TRANSFORMERS

If a transformer were 100% efficient, the amount of power in kv-a. that would be obtained from the secondary would always be the same as that supplied to the primary, regardless of the amount that the voltage might be stepped up or down.

Of course, no transformer can be 100% efficient, but the efficiency of large power transformers is so high that for simple illustrative problems we may ignore the slight loss.

If a step-up transformer produces a secondary voltage ten times as high as the voltage applied to the primary, then the full load current in the

secondary winding will be just one-tenth of that in the primary winding.

For example, if a 10 kv-a. transformer with a ratio of 1 to 10 has 200 volts and 50 amperes applied to its primary and increases the voltage to ten times higher, or 2000 volts on the secondary, the full load secondary current will then be 5 amperes.

If we multiply the volts by the amperes in each case, we will find the same number of volt-amperes or kv-a. in the secondary as in the primary. The primary voltage times primary current will be:

$$200 \times 50 = 10,000 \text{ volt-amperes, or } 10 \text{ kv-a.}$$

The secondary volts times the secondary amperes will be:

$$2000 \times 5 = 10,000 \text{ volt-amperes, or } 10 \text{ kv-a.,}$$

as before. From this, it is evident that the high-voltage winding of any transformer can be wound with correspondingly smaller wire, according to the ratio between the high-voltage and low-voltage windings. Therefore, the high-tension winding of any transformer is always the one with the smaller wire and the greater number of turns; while the low tension winding is the one with the larger wire and the smaller number of turns.

This has been mentioned previously but it is repeated here as a reminder of a very simple way to determine which is the high-voltage coil and which is the low voltage coil of any transformer.

As power factor doesn't enter into the kv-a. rating of a transformer or into the calculations for volt-amperes, it is a simple matter to find the current rating of any transformer winding merely by dividing the volt-amperes by the voltage of that winding.

To obtain the volt-amperes, remember, it is only necessary to multiply the kv-a. rating by 1000, as one kv-a. equals 1000 volt-amperes.

One volt-ampere is the same as one watt of apparent power. For example, if we have a 10 kv-a. transformer with a ratio of five to one, and a primary voltage of 550, the secondary voltage would be 110 volts. If we multiply the kv-a. rating of 10 by 1000, we get 10,000 volt-amperes. The primary current will then be  $10,000 \div 550$ , or 18.2 amperes, and the secondary current will be  $10,000 \div 110$ , or 91—amperes.

If the power factor of a transformer were 100%, we could obtain the same number of actual kw. of true power as the kv-a. rating of the transformer. However, the power factor of a transformer and its attached load is usually much lower than 100%, so it is often possible to have a 10 kv-a. transformer fully loaded and yet supplying only 5 to 8 kw.

This is the reason transformer capacity is always rated in kv-a.

#### 125. EFFECT OF SECONDARY LOAD CURRENT ON PRIMARY CURRENT

When a transformer is operating idle, that is, connected to the line but having no load connected to the secondary, only a very small amount of cur-

rent will flow in the primary winding. This current is called the **magnetizing current** and is just the amount required to strongly magnetize the core.

As long as a transformer is not loaded, the lines of force of this very strong field set up by the magnetizing current are constantly cutting across the turns of the primary winding and thereby inducing a counter-voltage which is very nearly equal to the applied voltage. This limits the current flow to a very small amount.

As soon as the load is connected to the secondary, the primary current will automatically and immediately increase in proportion to the amount of this load. If the secondary is fully loaded, the primary current immediately comes up to full load value. If the secondary is overloaded the primary will also be overloaded, and it is thus possible to burn out the primary or both the primary and secondary windings by connecting too much load to the secondary of any transformer.

This automatic variation in the current taken by the primary whenever the load on the secondary is changed, is caused by the reaction of the secondary flux on the flux of the primary coil. When there is no load connected to the secondary winding there will, of course, be no current flowing through it, even though full voltage is induced in this winding. As soon as its circuits is closed by connecting some load to the secondary leads, current starts to flow through this winding and sets up a magnetic field around it.

We recall that the current in the secondary winding is always  $180^\circ$  out of phase or in the opposite direction to that in the primary; therefore, the magnetic flux set up by the secondary is in the opposite direction to the primary flux in the core.

This secondary flux neutralizes a certain amount of the primary flux and reduces the number of lines of force which are cutting across the primary turns. This reduces the counter-voltage set up in the primary and allows more current to flow through it.

The resistance of the primary winding is so low as to be almost negligible, so the transformer depends largely upon the counter-voltage of self-induction to limit the current flow through this winding.

If the secondary load is increased to such an extent that the flux of its currents neutralizes a large part of the primary flux, the counter-E.M.F. generated in the primary winding will be so low that an excessive flow of current will result and possibly burn out the winding.

This is a very important principle to keep in mind in connection with transformers and certain other alternating current machines. It explains the reason why A. C. windings will usually be burned out very quickly if connected to a D. C. circuit; because direct current, with its constant and unchanging flux, doesn't develop counter-voltage to limit the current flow.

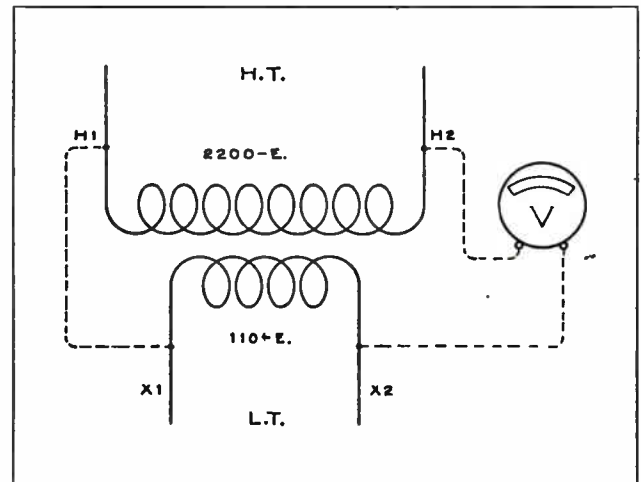

Fig. 116. This diagram shows the methods of connecting a shunt and a voltmeter to the high tension and low tension terminals of a transformer for making a polarity test.

## 126. POLARITY OF TRANSFORMER LEADS

Nearly all modern transformers have their H.T. and L.T. leads marked with polarity markings. These marks would be for example: H-1 and H-2 on the high-tension side of a single-phase transformer, and X-1 and X-2 on the low tension side.

On a three-phase transformer, the leads would be marked H-1, II-2, and H-3 on the high-tension side; and X-1, X-2, and X-3 on the low-tension side. These polarity markings indicate the order in which the leads are brought out from the windings, and also indicate the respective polarities of primary and secondary leads at any instant.

We know, of course, that the polarity of alternating-current windings is continually and rapidly reversing; but, as the secondary always reverses with the same frequency as the primary and is always  $180^\circ$  out of phase with the primary, we can determine the respective polarities at any instant of any alternation.

These polarity markings aid in making the proper connections for transformers to be operated in parallel, as it is necessary to have similar leads connected together, in order to have the transformers operate with the proper phase relations for satisfactory parallel operation.

If a transformer winding is marked H-1, H-2, H-3, and H-4, it will usually be found that H-1 and H-4 indicate the end-leads or full-winding terminals, while H-2 and H-3 are intermediate taps taken off at certain sections of the winding. If transformers are connected in parallel with wrong polarity they will burn out or blow the fuses.

The highest and lowest numbers are placed at the end-leads or full winding, while the intervening numbers are placed on the part-voltage taps. The H-1 lead is usually located on the right-hand side, when facing the high tension side of the transformer. With transformers marked in this manner, if the H-1 and X-1 leads are connected together, as shown by the dotted line in Fig. 116, then when the voltage is applied to the H.T. winding the vol-

tage between the remaining X-2 and H-2 leads will be less than the full voltage of the high-voltage winding.

In Fig. 116 a voltmeter is shown connected across the H-2 and X-2 leads of the single-phase transformer. The reason its reading will be lower than the applied voltage on the primary winding is because the polarity of the low-voltage winding is opposite to that of the high-voltage winding, and the two voltages will therefore oppose each other; so that the voltmeter will read their difference; or  $2200 - 110$  equals  $2090$ . A transformer with the leads arranged and marked in this manner is said to have **subtractive polarity**.

If the leads are brought out of a transformer so that the voltmeter when connected to the adjacent H and X leads, as shown in Fig. 116, reads the sum of the voltages of the high tension and low tension windings, then the transformer is said to have **additive polarity**. In this case the markings of the X-1 and X-2 leads would be reversed.

On transformers which have their leads properly marked, the markings indicate whether the leads are arranged for subtractive or additive polarity.

Fig. 117 shows on the left a transformer with the leads marked for subtractive polarity and on the right another transformer with the leads marked for additive polarity.

When facing the high-tension side of a transformer, if the X-1 lead is on the right-hand side, it indicates that the polarity is subtractive; while, if the X-1 lead on the left, it is then known to be additive polarity.

Leading transformer manufacturers have adopted standard connections and polarity markings for their transformers. Most power transformers are arranged with subtractive polarity, except distribution transformers of 200 kv-a. and under and with voltage ratings of 7500 volts and less; and these transformers are arranged with additive polarity.

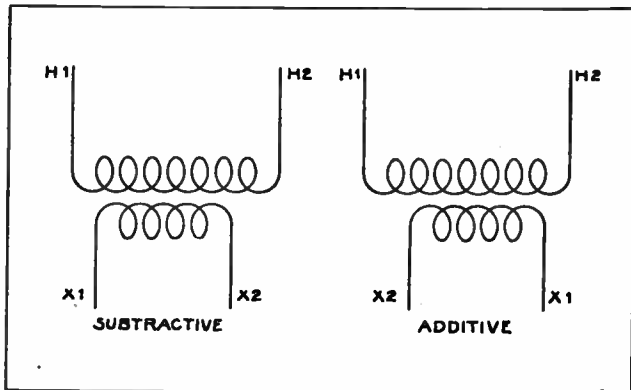

Fig. 117. This sketch shows windings of two transformers with their leads properly marked for subtractive and additive polarities.

### 127. VOLTMETER TEST FOR TRANSFORMER POLARITY

When the leads of a transformer are not marked in any manner, we can determine whether it has additive or subtractive polarity by simply connecting a jumper between the high-tension and low-tension leads on one side and a voltmeter of the proper rating between the high-tension and low-tension leads on the other side, as shown in Fig. 116.

If, when the primary is excited with its rated voltage, the voltmeter reads the difference between the voltages of the high and low voltage windings, the transformer has subtractive polarity, and the leads should be marked as shown in Fig. 116.

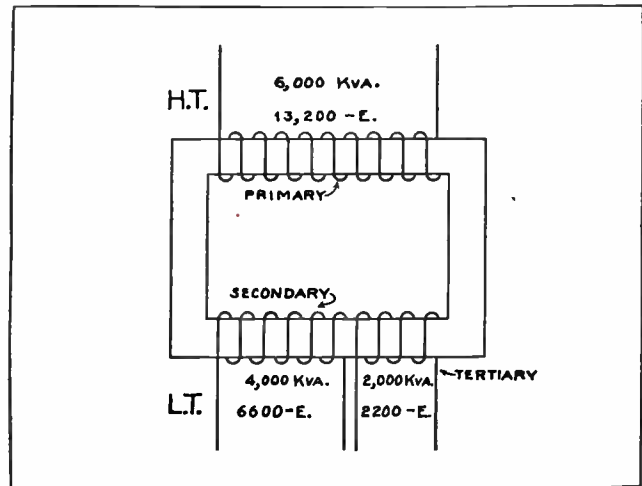

Fig. 118. Diagram of a transformer which is equipped with three windings. The high tension winding in this case is the primary, and the low tension winding is divided into two sections, called the secondary and tertiary windings.

If the voltmeter reads the sum of the voltages of the high and low voltage windings, the transformer has additive polarity, and the leads should be marked as shown in the sketch at the right in Fig. 117.

Sometimes a transformer may have on its core a third winding which really acts as an additional secondary winding and is for the purpose of supplying a separate circuit of a different voltage. This third winding is commonly called a tertiary winding.

Fig. 118 shows a transformer with primary, secondary, and tertiary windings. The primary winding is designed for 6000 kv-a. at 13,200 volts. The secondary winding, or larger of the two low-tension windings, is designed for 4000 kv-a. at 6600 volts. The tertiary winding, or smaller of the two low-tension windings, is designed for 2000 kv-a. at 2200 volts.

Some special transformers may also use tertiary windings to obtain certain power factor and voltage control characteristics.

## TRANSFORMER CONNECTIONS

Transformers can have their primary and secondary windings connected in a number of different ways, using series and parallel connections to obtain different voltages, current capacities, etc. A number of the most common connections are thoroughly explained in the following paragraphs and illustrated with the accompanying diagrams. Observe each of these connections carefully and note the results obtained and the purpose for which each connection is used. Connections for single-phase transformers will be covered first and those for polyphase and special transformers will follow.

Fig. 119 shows a sketch of the windings and leads of an ordinary single-phase transformer, such as is commonly used for supplying current to lights and small motors. This transformer has a ratio of 20:1, with the primary winding designed for 2300 volts for connection to the regular 2300-volt distribution lines which are commonly run down streets or alleys to supply power to homes and small shops.

The secondary winding is designed for 115 volts and has two leads for connection to the service wires running to the house or shop. The outline of the tank is shown by the dotted line surrounding the windings.

The high-tension and low-tension leads are usually brought out on opposite sides of the tank, as shown in this diagram. The position and manner in which these leads are brought out was also clearly shown on the two smaller transformers in Fig. 106. Refer back to this photograph so that you may note and have well in mind the manner in which these leads are brought out at the top of the transformer case.

In Fig. 119, one side of the low-voltage secondary winding is shown grounded. This is done for safety reasons and to provide the grounded wire for polarized lighting systems, as previously explained in the section on wiring for light and power. It is well to mention again that this ground affords a definite safety protection against damage to connected equipment or accident to persons, in case of failure of the insulation between the high-voltage and low-voltage windings.

For this reason, the ground wire which is attached to the secondary wire and carried down the pole to a ground rod should be carefully connected and protected from breakage or damage.

### 129. SINGLE-PHASE TRANSFORMERS WITH SPLIT SECONDARIES

Most single-phase transformers are made with the secondary winding in two sections and have four leads brought out from this winding. This allows a choice of two voltages for light and power purposes, and also provides connections to obtain a three-wire Edison system with grounded neutral for lighting purposes.

Secondary windings arranged in this manner are known as split-secondary, or series-multiple secondary, windings. Fig. 120-A shows a diagram of a transformer of this type and also shows the manner in which the center leads of the split-secondary are usually crossed inside the transformer tank. This is done for convenience in connecting them in either series or parallel outside of the tank.

Fig. 120-B shows how the two sections of the secondary winding can be connected in series by simply connecting the two center leads together on the outside of the tank. Each half of the secondary is designed to supply 115 volts, so that when the two are connected in series, 230 volts will be obtained across the outside wires and 115 volts across either outside wire and the center wire.

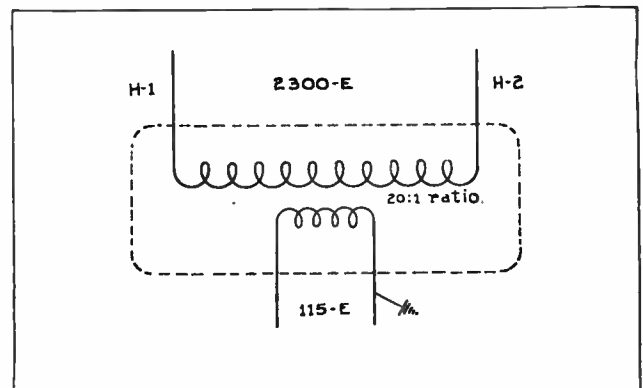

Fig. 119. The above sketch shows a schematic diagram of the primary and secondary windings of a single-phase transformer. This transformer has a step-down ratio of 20:1 and one side of the secondary is grounded, as is common practice.

If only 230-volt service is desired, the center wire can be left off and just the two outside wires used, but if three-wire, 115-volt and 230-volt service is desired, the center wire is connected to the point where the secondary coils are joined together, as shown. The ground connection should be attached to the center point when the three-wire system is used, and can be attached either to the center or to one of the outside wires when 230-volt, two-wire service is used.

Fig. 120-C shows the manner in which the two secondary windings can be connected in parallel to supply 115 volts and double the current capacity of either winding. This makes the entire output of the transformer available at 115 volts.

You will note from this diagram that having the center leads crossed inside the transformer makes possible a very convenient parallel connection by simply connecting together the adjacent leads outside of the tank.

The connections shown in Fig. 120-B for providing 115 and 230-volt service, brings three wires from the secondary of the transformer. The circuit, however, remains single-phase and should never

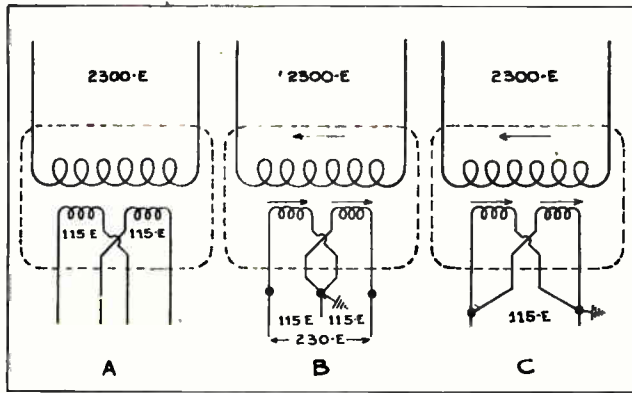

Fig. 120. A shows a single-phase transformer with the secondary winding in two sections. Note the manner in which the leads are crossed inside of the tank. B, Secondary windings connected for 115 and 230-volt service. C, Secondary windings connected in parallel for 115-volt service.

be confused with a three-phase transformer just because they both have three wires.

Keep in mind when connecting load to a three-wire system, that the load should be balanced as evenly as possible between each outside wire and the neutral, in order to prevent operating one side of the transformer secondary heavily loaded while the other is idle or lightly loaded.

The arrows shown above the windings in Figs. 120-B and 120-C indicate the direction of the voltage that would be induced in the secondary coils with respect to the voltage in the primary at a certain instant when the right-hand primary wire is considered to be positive.

These arrows will show how the voltages of the two secondary coils add together in Fig. 120-B and how the currents would add together in Fig. 120-C.

### 130. TESTING SPLIT-SECONDARY LEADS BEFORE MAKING CONNECTIONS

In connecting the two coils of the secondary winding of a transformer in either series or parallel, if there is any doubt as to the way connections have been brought out of the tank, the leads before being connected together should be carefully tested by means of test lamps or a voltmeter.

To test them for finding the proper leads to connect in series, connect together two leads, one from each coil, and then connect a lamp or voltmeter between the remaining two leads. If when the primary is excited, the lamps burn brightly or the voltmeter indicates the sum of the voltages of the two secondary windings, the connection is correct for series operation.

The first two leads which were joined can then be permanently connected together, and the line wires connected to the two wires to which the lamp or voltmeter were attached.

In testing the leads for parallel connection, again temporarily join together one lead from each coil and connect the lamps or voltmeter between the remaining two leads. If when the primary is excited, the lamps do not burn or the voltmeter shows no indication, the leads to which they are connected may be safely joined together to one of the line

wires for parallel operation. The other leads can be permanently connected together and attached to the opposite line wire.

If the lamps light or the voltmeter indicates voltage, the leads are improperly connected and should be reversed before being permanently connected for parallel operation.

It is very important that the proper leads be used when connecting transformer secondaries in parallel; otherwise, the windings will probably be burned out when the primary is excited.

### 131. PARALLELING SINGLE-PHASE TRANSFORMERS

Two or more single-phase transformers can be connected in parallel to supply a greater current or kv-a. of power than the capacity of one transformer will provide. In this manner additional transformers can be installed to take care of increasing load which has grown beyond the capacity of transformers already installed, or two or more small transformers can be temporarily connected in parallel to replace one larger transformer in emergencies when the larger transformer is to be taken out of service for repairs.

In paralleling transformers it is necessary to connect together transformers of similar characteristics; otherwise, one transformer may assume more than its share of the load and possibly blow the primary fuses. This would throw all of the load on the remaining transformers and would either overload them, or blow the fuses in their primary leads.

It is also very important to see that leads of the proper polarity are connected together; because, if the wrong secondary leads are connected in parallel, it would result in a double-voltage short-circuit, the same as though two single-phase alternators were connected in parallel when 180° out of phase.

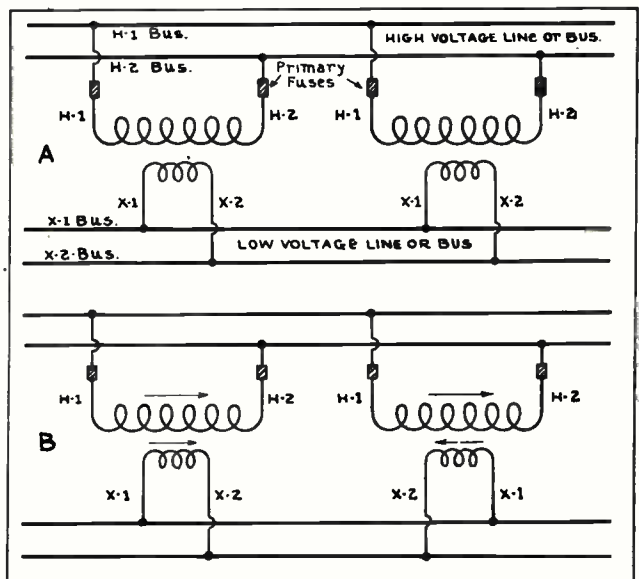

Fig. 121. A shows two single-phase transformers with like polarities connected in parallel. B shows the proper method of connecting two single-phase transformers in parallel when the polarity of one is subtractive and the other is additive. Note the polarity markings in each case.

Transformers with different ratios should never be connected in parallel, as even a small difference in the secondary voltages of two or more transformers would result in very heavy cross currents between the units if they were connected together.

When the primary and secondary leads are properly marked, it is a simple matter to connect two or more single-phase transformers in parallel, as leads with like polarity markings can then be safely connected together, as shown in Fig. 121-A.

In connecting together two transformers, one of which has additive polarity and the other subtractive polarity, the leads should be arranged in parallel, as shown in Fig. 121-B.

**132. TESTING SECONDARY LEADS FOR PARALLELING SINGLE-PHASE TRANSFORMERS**

If the leads of the transformers are not marked, then the secondary leads should be tested with a voltmeter or lamp bank before being connected in parallel. This test is illustrated in Fig. 122, and is similar to the tests made for parallel connections of the two secondary windings of one single-phase transformer.

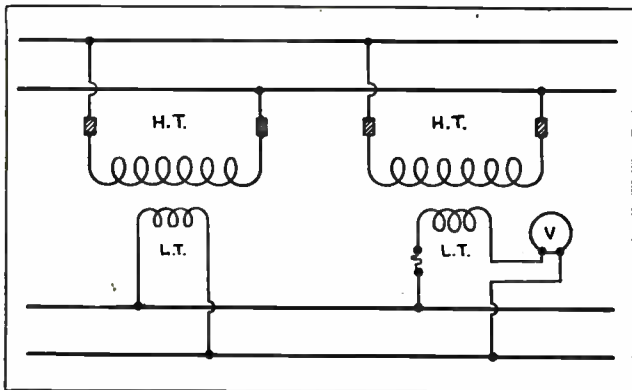

Fig. 122. This diagram illustrates the method of using a voltmeter to test the polarity of a transformer secondary before connecting it in parallel with another.

The high-tension leads can be connected to the supply line in a uniform manner, as shown in the diagram. The secondary leads of one transformer can then be connected to the low-voltage line, and the secondary leads of the other transformer should have an instrument fuse connected in one and a voltmeter connected in the other; then they can be connected to the line in the same manner as those of the other transformer.

If the voltmeter shows no reading, the connections are correct for parallel operation and the fuses can be eliminated and the voltmeter removed from the circuit. If the voltmeter does show a reading, the connections are wrong and the leads of one transformer secondary should be reversed and then connected to the line after testing again with the voltmeter to make sure that they are right.

**133. CONNECTING TRANSFORMER PRIMARIES IN SERIES**

In certain cases it might be desired to connect a back of single-phase transformers to a high-tension

line which has a voltage higher than the voltage rating of the high-tension winding of the transformers. As the more common distribution and transmission voltages usually vary in multiples such as 2200 volts, 6600 volts, 13,200 volts, etc., it is often possible to connect the primaries of two or more transformers in series to the high-voltage line. The secondaries can then be connected in parallel or series as desired.

Fig. 123 shows three single-phase transformers with 2200-volt primary windings connected in series to a 6600-volt line. The impedance of the three windings in series is the same as that of one 6600-volt winding of the same kv-a. capacity and will therefore limit to the proper value the current which will flow through the windings at 6600 volts.

The secondaries of these three transformers are shown connected in parallel to the low-voltage line. If each of the transformers has a 10:1 ratio, the low-voltage line will be supplied with 220 volts and the power that can be taken from this line will be equal to the sum of the kv-a. ratings of the three transformers. The extent to which such series connections can be applied is limited by the insulation between the transformer coils and ground.

Fig. 124 is a photograph of a transformer installed on a pole, and shows the method of connecting the low-voltage secondary leads together and to the wires which run to the buildings for three-wire service. You will also note the lightning arresters which are attached to the high voltage wires and have their lower ends grounded, and the fuse cut-outs which are mounted on the rear cross-arm and connected in series with the primary leads.

This view also shows the installation of a thermometer temperature and load indicator which is inserted under the edge of the transformer tank cover.

**134. THREE-PHASE TRANSFORMER CONNECTIONS**

To step the voltage of a three-phase circuit up or down, it is necessary to use either a polyphase transformer or three single-phase transformers; except in certain cases where, by means of special connections, two single-phase transformers can be used.

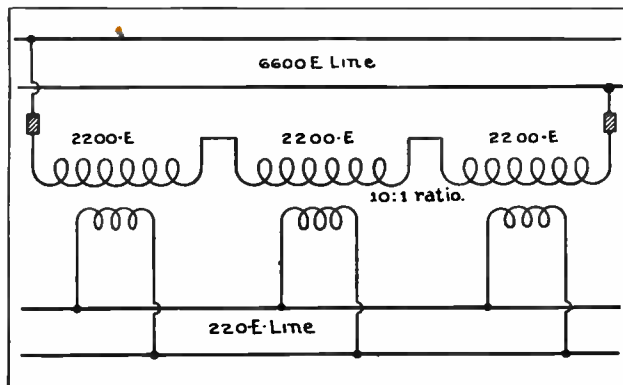

Fig. 123. Transformer primaries are sometimes connected in series to a line of higher voltage as shown above. The secondaries can then be connected for parallel operation.

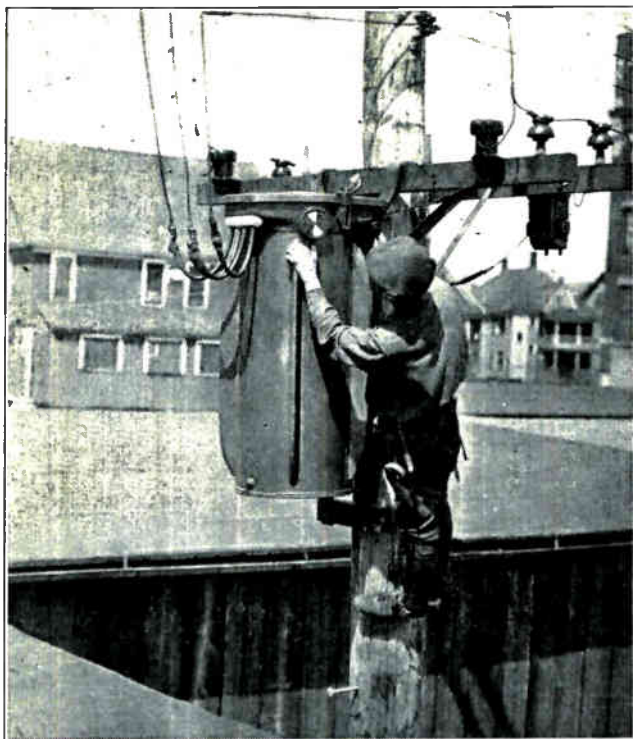

Fig. 124. This photo shows a pole type transformer and the method of making primary and secondary connections. Also note the thermometer temperature indicator near the hand of the electrician.

Each method will be explained in the following paragraphs.

Polyphase transformers are quite commonly used where space is limited, because they are more compact and require less space than three single-phase transformers of the same kv-a. rating.

Where flexibility is desired, three single-phase transformers are frequently used because of the advantage in the fact that if one transformer is taken out of service the load can be temporarily carried by the other two, by making a slight change in the connections.

Fig. 125 shows the arrangement of the primary and secondary coils on the core of a three-phase step-down transformer. This sketch also shows the connections of the primary and secondary windings to high-voltage and low-voltage three-phase lines.

In each of the following connection diagrams three primary and three secondary windings will be shown without the cores, and these can be used to represent either three single-phase transformers or the three sections of a three-phase transformer.

When three single-phase transformers are connected together to a three-phase system they are commonly referred to as a bank of transformers.

### 135. STAR AND DELTA CONNECTIONS, AND THEIR VOLTAGE AND CURRENT RATIOS

There are three types of connections commonly used with transformers on three-phase systems, and these connections are known as the star, delta, and open-delta connections.

Ordinary star and delta connections and their

voltage and current ratios have been explained both in the second section on Armature Winding and in the first section on Alternating Current, in connection with A. C. motor and generator windings. The same ratios and values for these connections apply to transformers as well as to motors or generators, and they will therefore be repeated here for convenience.

You will recall that the star connection provides a sort of series arrangement of the windings of any electrical machines connected in this manner; while the delta connection is a parallel arrangement of the windings.

The star connection always increases the line voltage above that of the phase windings, while the delta connection increases the line current above that of the phase windings.

When transformer or generator windings are connected star, the line voltage will be 1.732 times the phase-winding voltage and the line current will be the same as the phase-winding current.

When transformers or generators are connected delta, the line current will be 1.732 times the phase-winding current and the line voltage will be the same as that of the phase windings.

We recall that multiplying either the current or voltage by the constant 1.732 gives the actual sum of two values which are added together  $60^\circ$  out of phase. Note.—These values are  $60^\circ$  out of phase in the machine windings, but  $120^\circ$  out of phase with the line. To make it very easy to determine the voltage or current that can be obtained by the use of star or delta connections with transformers, we can arrange the material from the preceding statements in the following simple rules.

Rules for Star connections:

- (A) Line I = Phase I
- (B) Phase I = Line I
- (C) Line E = Phase E  $\times$  1.732
- (D) Phase E = Line E  $\div$  1.732

Rules for Delta connections:

- (A) Line E = Phase E
- (B) Phase E = Line E
- (C) Line I = Phase I  $\times$  1.732
- (D) Phase I = Line I  $\div$  1.732

### 136. THREE-PHASE STAR CONNECTIONS

Fig. 126 shows a diagram of the connections for either three single-phase transformers, or the three sets of windings of a polyphase transformer, in which both the primaries and secondaries are connected star, or Y.

This connection is known as the star-star or Y-Y connection.

You will note that, with this connection, the right-hand ends of each of the transformer windings are connected together to one common point or wire, and the left-hand ends are connected separately, one to each phase wire of the lines.

Tracing out this connection from each line wire through the phase windings, you will find it results



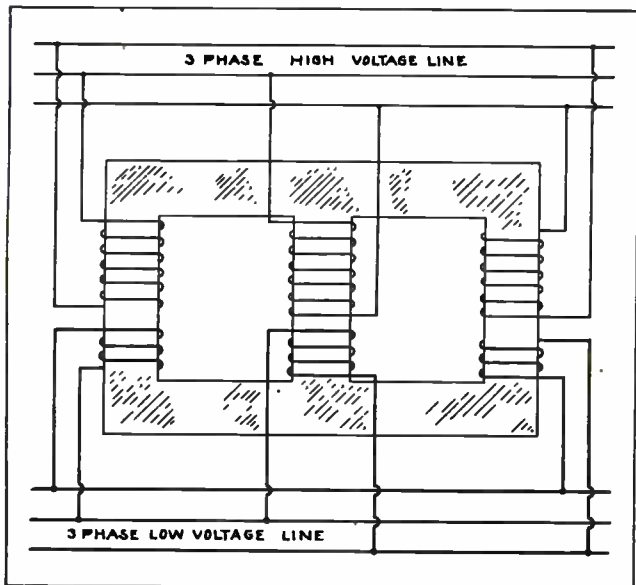

Fig. 125. The above sketch shows the primary and secondary windings of a three-phase transformer. Both primary and secondary are connected delta to the line wires.

in a star-shaped connection, as shown by the small simplified sketch at the left in Fig. 126.

To remember how to make this star connection, it is only necessary to keep in mind that one end of each winding is connected to a common wire or neutral point and that the remaining ends are connected in order to respective phases.

Where transformers are placed in an ordinary row or bank and where they have their terminals arranged and marked symmetrically, the connections to the high-voltage and low-voltage lines can usually be made in the same neat and symmetrical order as shown in Fig. 126. Following a definite and orderly system in this manner whenever possible, will help you to avoid mistakes when making such connections.

With this connection the primary line voltage will be found between L A and L B, L B and L C, and between L C and L A. This line voltage can also be found between any two of the three phase wires, A, B, and C.

The primary phase voltage is the voltage between L A and D, L B and D, and L C and D.

The secondary line voltage can be measured between S A and S B, between S B and S C, or between S C and S A.

It can also be measured between any two of the three phase wires, A, B, and C.

The secondary phase voltage can be measured between S A and E, S B and E, or S C and E.

For the purpose of illustrating the various voltage and current values on the primary and secondary line leads and phases, we shall assume that the primary line voltage is 1000 volts and the primary line current 10 amperes; and that the step-down ratio of the transformers is 10:1.

Then, according to rule D for Y connections, the primary phase voltage will be:  $1000 \div 1.732$ , or 577 volts across each phase winding.

According to rule B for the current in Y connections, the primary phase current will be 10 amperes. Then, considering the 10:1 ratio, the secondary phase voltage will be  $577 \div 10$ , or 57.7 volts.

The secondary current will be increased in the same proportion that the voltage is decreased; so that the secondary phase current will be  $10 \times 10$ , or 100 amperes through each phase winding.

The secondary line voltage will be  $57.7 \times 1.732$ , or 99.9+ volts.

According to rule C for Y connections, the secondary line current will be the same as that in the phase windings, or 100 amperes. According to rule A for Y connections, the apparent power in the secondary line would be equal to the apparent power in the primary line, minus the very small percentage of loss in the transformers. When the transformers are operating at or near full load, this loss is so small that it is generally not considered in the ordinary approximate calculations used in field problems.

To calculate the power of the three-phase bank of transformers from the primary line voltage and current, we would use the three-phase power formula given in Section One of Alternating Current, or:

$$\text{Three-phase app. power} = E \times I \times 1.732$$

With the values given in Fig. 126 this would be:

$$1000 \times 10 \times 1.732, \text{ or } 17.3+ \text{ kv-a.}$$

Following the same rule for the secondary, we would have:

$$99.9 \times 100 \times 1.732, \text{ or } 17.3+ \text{ kv-a.}$$

If the primary line voltage used on a star connection such as shown in Fig. 126 were 4000 volts instead of the 1000 volts assumed in this problem, then the primary phase voltage would be  $4000 \div 1.732$ , or approximately 2309 volts across the primary winding of each transformer.

This voltage is very commonly used where the primaries of three transformers are to be connected in star and the secondaries used separately for sup-

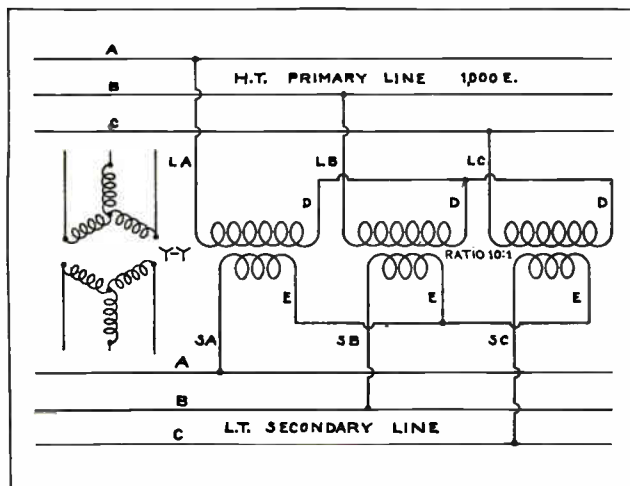

Fig. 126. Connection diagram for a bank of three transformers connected star-star.

plying single-phase light and power load at 115 and 230 volts.

**137. THREE-PHASE DELTA CONNECTIONS**

Fig. 127 shows the connections for a bank of three single-phase transformers, or the three sets of windings of a three-phase transformer, which are connected delta-delta, or  $\Delta-\Delta$ . These transformers are also of the 10:1 step-down ratio, and we shall assume the same values of 1000 volts and 10 amperes on the primary line.

If the primary line voltage is 1000, then, according to the rule B for delta connections, the primary phase voltage is also 1000. According to rule D for delta connections, the primary phase current will be  $10 \div 1.732$ , or 5.77 amperes through each phase winding.

With the 10:1 step-down ratio, the secondary phase voltage will be  $1000 \div 10$ , or 100 volts from "c" to "d" across each phase winding, and the secondary phase current will be  $10 \times 5.77$  or 57.7 amperes through each phase winding.

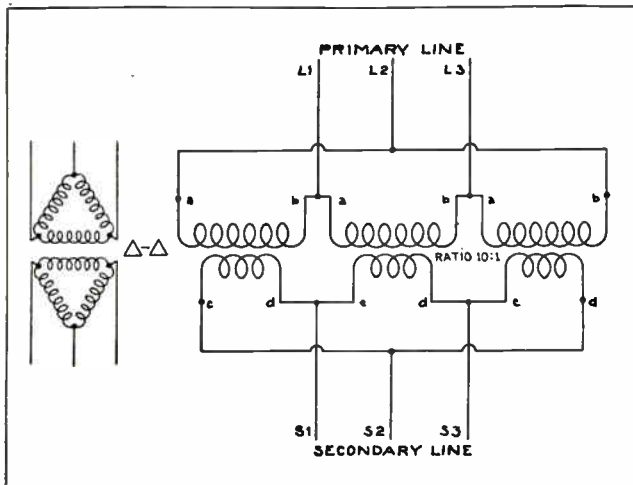

Fig. 127. Connection diagram for a three-phase bank of transformers connected delta-delta. Compare the large diagram with the small schematic sketch at the left and also with the explanation given in these paragraphs.

According to rule A for delta connections, the secondary line voltage will be 100; and according to rule C for delta connections, the secondary line current will be  $57.7 \times 1.732$ , or 99.9+ amperes.

The apparent power in kv-a. will again remain the same on the secondary as on the primary, with the exception of the slight loss in the transformers. So we find that it makes no difference in the amount of power the transformer will handle whether it is connected star or delta.

When a bank of transformers are connected either star-star or delta-delta, the difference between their primary and secondary line currents and voltages will only be that difference which is caused by the ratio between the transformer windings.

**138. THREE-PHASE STAR-DELTA CONNECTIONS**

Fig. 128 shows a bank of three transformers connected star-delta, or  $Y-\Delta$ . The phase winding leads and line leads are marked the same in this diagram

as in Fig. 127, and this transformer is also a step-down transformer with a ratio of 10:1.

We shall again assume the primary line voltage to be 1000 and the primary line current to be 10 amperes. With this connection, the primary phase voltage will be  $1000 \div 1.732$ , or 577 volts between "a" and "b", or across each phase winding.

The primary phase current will be the same as the line current, or 10 amperes. With the 10:1 step-down ratio, the secondary phase voltage across each phase winding, or between "c" and "d", will be  $577 \div 10$ , or 57.7 volts. The secondary phase current will be  $10 \times 10$ , or 100 amperes.

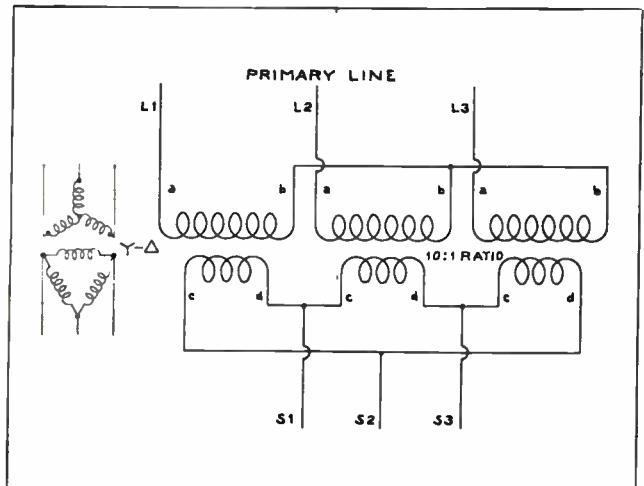

Fig. 128. Three-phase transformer bank with the primary connected star and the secondary delta. This connection is called "star-delta."

The secondary line voltage will be the same as the secondary phase voltage, or 57.7; because the secondary is connected delta. Check this with rule A for delta connections.

The secondary phase current will be  $10 \times 10$  or 100 amperes, and the secondary line current will be  $100 \times 1.732$ , or 173.2 amperes, according to rule C for delta connections.

**139. DELTA-STAR CONNECTIONS**

Fig. 129 shows a bank of three transformers connected just the opposite to those in Fig. 128. In this case, the primary is connected delta and the secondary is connected star. This is called a delta-star or  $\Delta-Y$  connection.

You will note that in referring to these connections with the terms delta or star, the primary is always mentioned first; the same as when speaking of the ratio between primary and secondary windings.

Assuming the same figures of 1000 volts and 10 amperes on the primary line and a 10:1 step-down ratio for these transformers in Fig. 129, the primary phase voltage will be 1000 from "a" to "b" in any phase winding, according to rule B for delta connections. The primary phase current will be  $10 \div 1.732$ , or 5.77 amperes through each phase winding, according to rule D for delta connections.

With the 10:1 step-down ratio, the secondary phase voltage will be 100; and the secondary phase

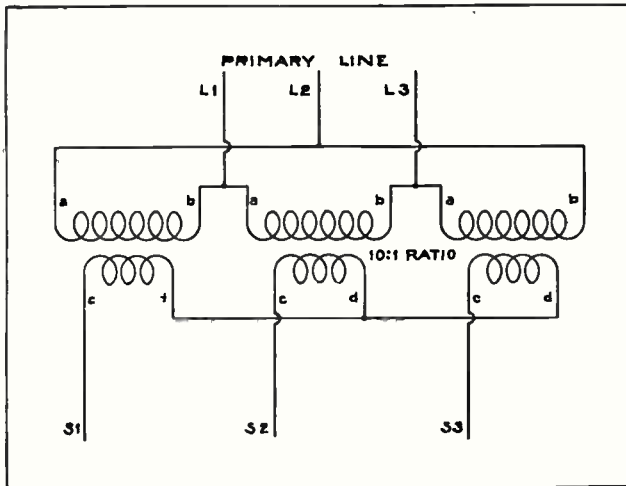

Fig. 129. Three-phase transformer bank connected delta-star. Observe carefully the methods of making the connections shown in each of the diagrams in this section.

current will be  $10 \times 5.77$ , or 57.7 amperes. The secondary is connected star; so, according to rule C for star connections, we find that the secondary line voltage will be  $100 \times 1.732$ , or 173.2 volts.

This voltage would be found between S-1 and S-2, or between S-2 and S-3, or S-3 and S-1.

The secondary line current will be the same as the phase current, or 57.7 amperes. Check this with rule A for star connections.

If you determine the apparent power in kv-a. of both the primary and secondary windings in either Fig. 128 or Fig. 129, by using the formula,

$$\text{three-phase app. power} = \text{Line E} \times \text{Line I} \times 1.732,$$

and using the voltage and current values given for the lines in each case, you will find the power to be the same on the secondaries as on the primaries.

This will be very good practice and will help you to become more familiar with the use of the three-phase power formula and calculations.

The four transformer connections which have just been explained and illustrated are the ones most commonly encountered in the field. Some companies may make slight variations or changes in these, but the general principles involved remain the same.

#### 140. ADVANTAGES OF STAR CONNECTIONS FOR TRANSMISSION LINES

One of the principal advantages of the star connection for transformers is that it provides higher voltages for use on long-distance transmission lines, with the lower ratios between the primary and secondary windings.

When used in this manner, the transformer supplying the power to the line is usually connected delta-star, to step up the voltage as high as possible with a given transformer ratio. The transformer at the receiving end of the line can then be connected star-delta, in order to reduce the voltage the maximum amount with a given transformer ratio.

Fig. 130 illustrates the use of these connections

with a transmission line. A power plant alternator develops 2300 volts which is fed to the delta-connected primary of the step-up transformer. This transformer, having a ratio of 1:10, will produce a phase voltage of 23,000 volts in each phase of the star-connected secondary. The line voltage, however, will be  $23,000 \times 1.732$ , or 39,836 volts.

If we had used either a delta-delta or star-star connection, the line voltage would only be 23,000 with a 1:10 transformer ratio. Knowing that the higher the voltage used on the transmission line the greater will be the economy of transmission and the saving in copper costs, we can readily see the advantage of this connection.

At the receiving end of the line shown at the right, the step-down transformers use the opposite connection, or star-delta, to step the voltage down a maximum amount for a given ratio. Here a 10:1 ratio transformer with star-connected primary and delta-connected secondary will reduce the secondary line voltage to 2300 volts. This voltage can be used directly on large 2300-volt power motors, or it can be stepped down again with smaller banks of 10:1 transformers, using split secondaries to obtain 115 and 230 volts for lighting purposes.

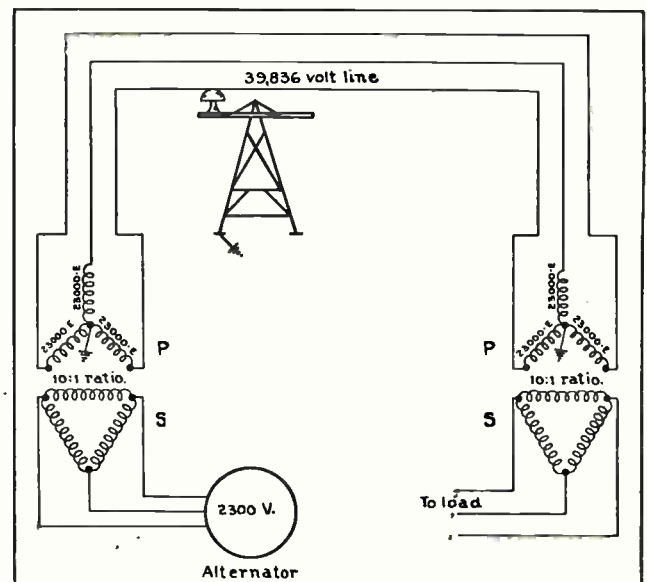

Fig. 130. This diagram illustrates the method and advantage of using star-delta and delta-star transformer connections with transmission lines.

When using transformers with the secondaries connected star and attached to high-voltage transmission lines, the neutral point of the star connection is commonly grounded. This provides another great advantage for the star connection because it makes possible the use of higher transmission line voltages with less voltage strain between the line wires and ground.

This greatly reduces the tendency to flash-over the line insulators and makes possible the use of smaller insulators, thereby reducing the cost of the transmission line.

You will note that, while the voltage between

the line wires in Fig. 130 is 39,836 volts, the voltage between any line wire and ground or the steel tower supporting the insulator will only be 23,000 volts, or that of one phase winding of the step-up transformer secondary.

This is due to the fact that the neutral point of the star connection is grounded and will always be at approximately the same potential as the tower supporting the insulators.

**141. OPEN-DELTA CONNECTIONS**

One of the advantages of the delta connection for transformers is that one transformer can be taken out of service for repairs, and service maintained on the remaining two by what is known as the open-delta or V connection.

In other cases where it is desired to provide three-phase service with only two transformers, the open-delta connection is used for permanent installations. The total three-phase capacity of two transformers used in this manner will only be 57.7% of the capacity of three transformers of the same size.

An installation of this type is sometimes made where the average load to be supplied is rather light at the time, but is expected to become heavier as the plant or community expands. When the load increases beyond the capacity of the two transformers, a third one can be added and the connection changed to straight delta. The addition of this third transformer increases the capacity of the group 73% over what it was with the two transformers.

Fig. 131 shows the method of connecting two single-phase transformers in open-delta. The phase voltage in systems connected open-delta will be the same as the line voltages, or the same as with regular delta-delta connections.

The line current will be the same as the phase current, instead of being greater, as with ordinary delta connections. This is due to the fact that line 1 and line 3 have only one path through the

phase windings, instead of two paths, as with the straight delta connection.

Where three transformers are connected delta-delta, if one becomes defective it is a very simple matter to connect the remaining two in open-delta. By overloading the transformers to a certain extent, it is possible to maintain nearly full load service for short periods while the defective transformer is being repaired.

Both the primary and secondary of the defective transformer should always be disconnected from the line when changing to open-delta connection with the other two transformers.

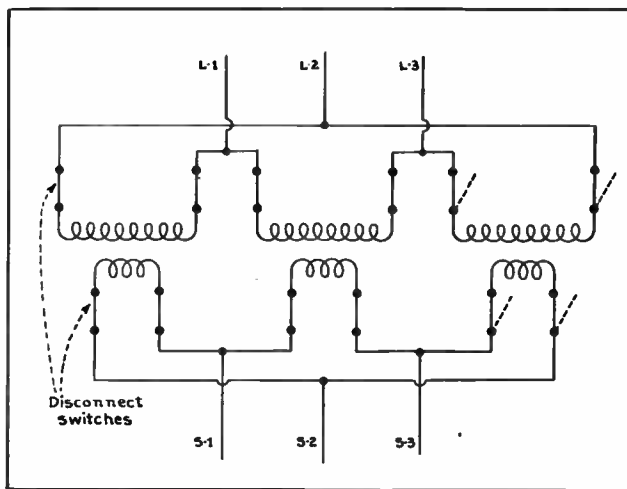

Fig. 132. This diagram shows a convenient method of arranging a bank of transformers with disconnect switches to quickly change over to open-delta operation in case of trouble on one transformer.

It is possible to use the open-delta connection on two of the phase windings of the three-phase transformer, in case one phase becomes defective. If the transformer is of the core type, both the primary and secondary coils of the damaged winding should be left open; but if the transformer has a shell type core, both the primary and secondary windings of the defective phase should be short-circuited upon themselves when the open-delta connection is made on the two good phases.

Fig. 132 shows three single-phase transformers connected delta-delta and equipped with disconnect switches in each of the primary and secondary leads. This arrangement permits a quick change-over to open-delta operation of two transformers if any one should become defective.

For example, if the right-hand transformer should become defective, the disconnect switches could be opened as shown by the dotted lines, and the remaining two transformers would then be operating open-delta. The same change could be made on either of the other two transformers with the same result.

When three transformers are connected either star or delta or in any combination of these except the open-delta, the total kv-a. capacity on the secondary side is equal to three times the capacity of one transformer.

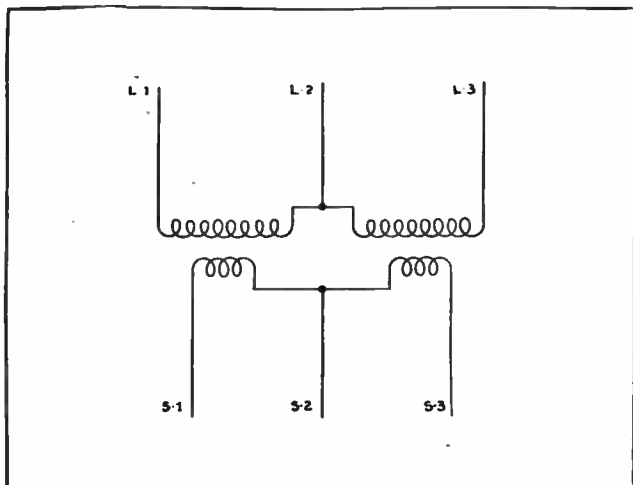

Fig. 131. Connections for using two single-phase transformers to provide three-phase service by what is called the "open-delta" connection.

Transformers which are to be connected together in a star or delta on three-phase lines should have similar characteristics; that is, similar kv-a. and voltage ratings, and also similar ratios, impedance, reactance, etc. If the characteristics are not the same the result may be excessive heating of one or more of the transformers or unbalanced line conditions.

#### 142. GROUNDING OF TRANSFORMERS

As previously mentioned, the high-voltage winding of star-connected transformers is frequently grounded at the neutral point, when these transformers are used in connection with transmission lines.

It is quite common practice also to ground the low-voltage secondary windings of step-down transformers connected either star or delta as explained in earlier paragraphs, this protects the low-voltage circuit in case of failure or puncture of the insulation between the high-voltage and low-voltage windings.

It is well to keep in mind that the secondary windings and the circuits to which they are connected are only insulated for the low voltage, and the insulation is not heavy enough to stand the high voltage applied to high-tension primary windings. So, if it were not for the ground on the low-voltage side a flash-over of the high voltage to the low-voltage secondary would tend to puncture the insulation of the low-voltage circuits or some of the devices connected to them.

Having the ground already on the low-voltage circuits provides an easy path for the high voltage to go to ground. This flow of current from the high-voltage winding through the fault to the ground will frequently blow the primary fuses, thus indicating the trouble at once, so that it can be repaired.

The larger sketch on the right in Fig. 133 shows the method of grounding the delta-connected secondary of a three-phase bank of transformers. This ground is commonly made from the center tap, which is taken from the middle of one phase of the secondary winding.

The small sketch on the left in Fig. 133 shows a schematic diagram of the secondary connections and also illustrates the position of the ground.

Assuming that the secondary of these transformers has a voltage of 220 between any two phase wires, the voltage from the various phases to ground will be as follows: A phase to ground, 110 volts; B phase to ground, 190.5 volts; C phase to ground, 110 volts.

The reason for this variation in the voltage between the different phase wires and ground can be noted by careful observation of either of the connection diagrams shown in Fig. 133.

You will note that only half of the center phase winding is between either phase A or phase C and the ground, so there will be only half the voltage

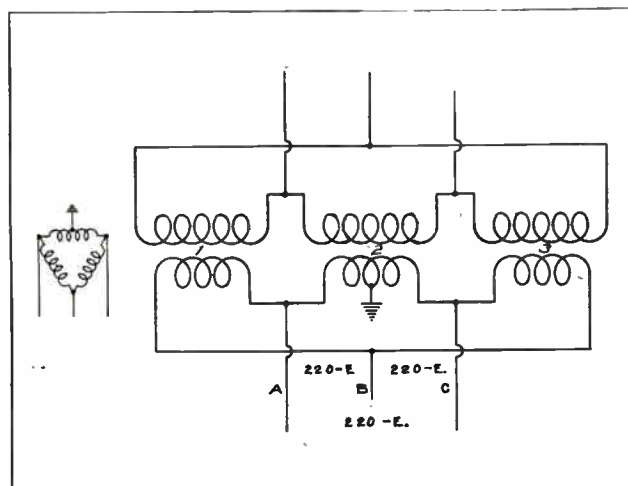

Fig. 133. This sketch shows the method of grounding the secondary circuit of a bank of transformers on which the secondary is connected delta.

of this winding, or 110 volts, between either of these phase wires and ground.

Tracing the circuit from phase B in either direction to ground, we must pass through the secondary winding of transformer No. 1 or No. 3 in series with one-half of the winding of No. 2 to get to ground. This adds the voltages of one whole winding and half a winding, together in series, but 120° out of phase.

To get the effective sum of 220 volts plus 110 volts when these two values are out of phase 120° we add the two voltages and then divide by 1.732, which gives approximately 190.5 volts.

Fig. 134 shows the common method of grounding the low-voltage secondary of a bank of transformers, when the secondary is connected star. The ground connection is made at the common connection, or neutral point, of the three secondary phase windings.

This is illustrated both by the larger sketch at the right and the small schematic diagram at the left in Fig. 134.

If the ground connection were not used on a bank of star-connected transformers, the voltage from any line wire to ground would be the same as the voltage between any two line wires. When the ground is used, the voltage between any line wire and ground is only 57.7% of the voltage between any two line wires, as was previously explained for the high-tension side of transformers which were connected to transmission lines.

This reduces the voltage strain on the insulation of the conductors and devices connected to the secondary circuit and also reduces the shock hazard.

#### 143. PARALLELING THREE-PHASE TRANSFORMERS

When paralleling three-phase transformers the same precautions must be followed as when paralleling three-phase alternators. It is first necessary to phase out the leads and determine like phases.

This can be done by the lamp-bank or motor method explained in the section on A. C. generators.

The two or more transformer banks should be operated from the same primary line. They will then have like frequencies and will operate in synchronism, once they are properly phased out and connected.

When all of the transformer primaries and secondaries are properly marked in the manner previously explained, it is a simple matter to connect leads of like polarity together. If they are not marked, or in any case where the marks are not known to be dependable, the leads should be tested by means of a voltmeter or test lamps, in order to get connected together the leads of like polarities and between which there is no voltage difference.

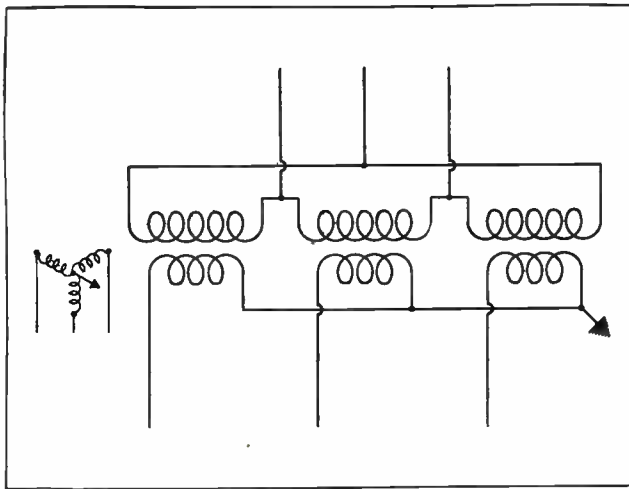

Fig. 134. This sketch shows the location of the ground connection on a bank of transformers with the secondary connected star. Read carefully the explanation of the advantages of this system which are given in the accompanying paragraphs.

#### 144. THREE-PHASE, FOUR-WIRE SYSTEMS

The three-phase, four-wire system is obtained by bringing out the fourth wire from the neutral or grounded point of a star-connected bank of transformers as shown in Fig. 135. This system is used

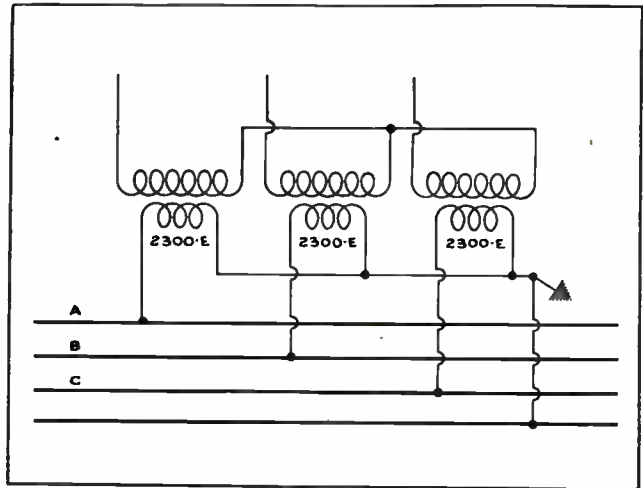

Fig. 135. Connections for three-phase, four-wire service from the star-connected secondaries of a three-phase bank of transformers.

by a great many power companies for distribution circuits of 2300 to 4000 volts which feed power and lighting equipment.

The three-phase, four-wire system provides two different voltages, one of which is obtained between any two of the line wires A, B, and C; and the other between any of the line wires and the neutral wire.

Assuming the secondary phase voltage of the transformers in Fig. 135 to be 2300 volts, the voltage between any two of the line wires A, B, and C will be approximately 4000 volts; while the voltage between any one of the line wires A, B, or C and the neutral wire will be 2300 volts. The voltage from any one of the line wires to ground will be 2300 volts, while the voltage from the neutral wire to ground will be zero.

In any four-wire, three-phase system in which the fourth or neutral wire is taken from the Y point, or common connection of the star-connected transformer windings, the voltage from any line wire to neutral is equal to the voltage between the line wires multiplied by .577, which is the same as dividing by 1.73.

## SPECIAL TRANSFORMERS

In addition to the common types of single-phase and polyphase transformers for which the connections were explained in the preceding section, there are several special transformer connections which are frequently encountered in the field.

These special transformers each have certain special applications and are very important in the particular work for which they are designed. You should, therefore, have a good understanding of the principles and uses of the more common types.

### 145. TAP-CHANGING TRANSFORMERS

It is often desirable to make slight changes in voltage delivered by a bank of step-up or step-down transformers, in order to compensate for varying line drop. In other cases we may wish to change the ratio of the transformer slightly to adapt it to changed operating conditions with other transformers or line equipment.

For this purpose a Tap-Changing transformer is frequently used.

Transformers of this type are equipped with extra leads or taps brought out from a certain section of the winding so that, by shifting a sliding connection from one of these taps to the other, the number of turns in the winding can be varied.

This will, of course, vary the ratio between the transformer primary and secondary and will thereby increase or decrease the voltage, according to whether turns are being cut out or added in the winding.

It is usually desirable to be able to accomplish this change without disconnecting a transformer or interrupting service.

There are several different ways of accomplishing this, and one common method is shown in Fig. 136. With this type of transformer, a certain portion of the end of the primary winding is divided into two sections or windings in parallel and marked M and N in the diagram. These sections are equipped with taps and provided with a set of sliding contacts, X and Y, which can be moved from one tap to another. Either of these tapped sections of the transformer winding will carry the entire load for a few seconds without overheating.

The tap switches should not be shifted or changed during the time that load current is flowing through them, or the contacts would be badly burned by the arc set up by the heavy current and high voltage.

To prevent this, an oil switch is provided in each of the parallel circuits or leads to the tapped sections of the winding.

In order to increase the voltage on the secondary we decrease the number of turns on the primary, thereby decreasing the step-down ratio between the two windings.

This is done in the following manner. Oil switch "A" is first opened to temporarily shift all of the load over to the section N of the tapped winding

and thereby stop the current flow through section M. The movable contact X is then shifted from stationary contact 3 to 2. Oil switch "A" is then closed, and oil switch "B" opened to shift all of the load to section M.

Movable contact Y is then shifted from stationary contact 3 to 2 in order to balance the number of turns in the two parallel tapped sections. Then oil switch "B" is again closed, allowing the load to divide between the two tapped sections of the winding.

Quite a number of large power transformers are being built with tap changing switches or mechanisms, which are installed either in the top of the transformer case or in an auxiliary box on the side of the transformer.

Some of these tap-changing switches are designed for hand-operation while others are operated by remote control motors or by an automatic voltage-regulating device.

The use of tap changers aids in keeping electric service to customers at the proper voltage and greatly increases the flexibility of transformers equipped with them.

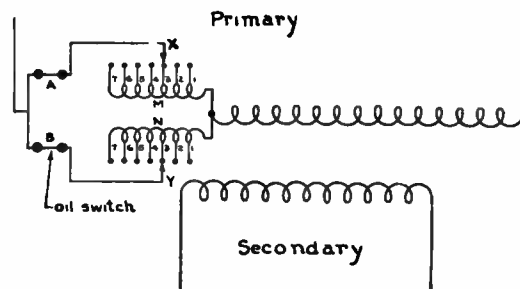

Fig. 136. This diagram shows a method of arranging adjustable connections on the primary of a tap-changing transformer.

### 146. SCOTT TRANSFORMERS

Sometimes it is desired to change two-phase energy to three-phase, or vice versa. This can, of course, be done with motor-generator sets, but in a number of cases it may only be desired to convert a small amount of power from one system to the other and, therefore, doesn't justify the installation of costly machinery.

In certain older plants which are equipped with two-phase motors, it may be desired to change over to modern three-phase service; or it may be that the power company, in changing over its equipment, can furnish only three-phase service.

In order to prevent scrapping or discarding all of the two-phase motors installed, it is often desirable to change the three-phase energy which is supplied, to two-phase energy to operate a number of the

motors, until they are worn out and can be economically replaced with three-phase machines.

This change from three-phase to two-phase or the reverse can be economically made by means of two single-phase transformers, one of which is equipped with a center tap and the other with a tap at 86.6% of its winding.

Two transformers connected in this manner are shown in Fig. 137. This connection is known as the Scott Transformer connection and is named after its inventor, Charles F. Scott, former consulting engineer of the Westinghouse Electric and Manufacturing Company.

Two of the three-phase line leads are connected to leads L-1 and L-2 of the single-phase transformer which has the center tap. The third three-phase line lead is connected to the 86.6% tap on the remaining single-phase transformer winding.

The other end of this winding is connected to the center tap of the other unit, as shown in the diagram. When three-phase energy is applied to these three line leads, two-phase energy can be taken from the transformer secondaries at the leads marked "phase A" and "phase B".

On the other hand, if two-phase energy is applied to A and B phase, three-phase energy can be obtained from leads L-1, L-2, and L-3.

The small sketch at the right illustrates this type of transformer with a schematic diagram, and shows the manner in which the three-phase voltages and relations are obtained from the two transformers.

Assuming the voltage of each of the complete transformer windings on the three-phase side to be 100 volts, we find that there will be 50 volts in each of the sections on either side of the 50% tap of the left winding, and 86.6 volts in the active section of the right-hand winding.

Connecting the end of the right-hand winding to the center tap of the left winding causes the voltages in these two windings to be 90° out of phase with each other.

The 86.6% of the right-hand winding is in series with either half of the left winding when tracing from L-3 to L-1 or L-2.

When 86.6 volts are added in series with 50 volts, but are 90° out of phase, the resultant voltage will be 100 volts. So we find that there will be 100 volts between L-1 and L-2, between L-2 and L-3, and also between L-3 and L-1.

Special single-phase transformers can be bought with taps arranged for this connection, or in some cases where it is desirable to change over a small amount of power, two small single-phase transformers can have either their primaries or secondaries rewound and equipped with taps at the middle of one and at 86.6% of the winding of the other.

#### 147. AUTO TRANSFORMERS

The auto transformer is one in which a single tapped coil is used for both the primary and secondary, as shown in Fig. 138-A and B.

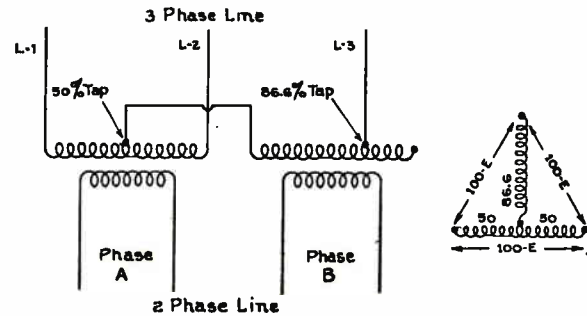

Fig. 137. The Scott transformer connection shown above is often used to change three-phase energy to two-phase or vice versa.

The principal application of auto transformers is for use with starting compensators, to reduce the starting voltage of A. C. induction and synchronous motors.

Auto transformers use somewhat less copper than the regular type of static transformer, but their efficiencies are usually somewhat lower.

The diagram at A in Fig. 138 shows an auto transformer used to step the voltage down, while the diagram at B shows a step-up transformer.

When alternating voltage is applied to the terminals of the full winding in Fig. 138-A there will be a voltage drop across the entire coil, which is equal to the amount of applied voltage.

As the resistance of the coil is very low, the self-induced counter-voltage of the full coil will also be nearly as high as the applied voltage. The induced counter-voltage in the small secondary section of the coil will be proportional to the number of turns included in this section. Therefore, the voltage obtained on the secondary leads will depend upon the point at which the tap, or wire A, is connected to the winding, and the number of turns between wires A and B.

If the secondary section of an auto transformer is wound with heavier wire, a considerably greater current can be taken from this section than is supplied to the primary leads. This is due to the fact that the flux of the upper section of the main coil also cuts across the turns of the lower section, and will thereby induce added energy in this coil.

For starting induction motors this is ideal, because the heavy starting currents which are required can be obtained at low voltage from the secondary of an auto transformer without drawing such a heavy surge of current from the power line.

In the step-up auto transformer in Fig. 138-B, the secondary voltage will be equal to the voltage across the primary coil plus the voltage induced in the secondary section by the flux of the primary coil. In this manner the voltage can be stepped up as much as desired, by properly arranging the ratio of turns in the primary and secondary sections.

Auto transformers are frequently equipped with taps, so that the wire A can be moved back and forth to include more or less turns in the primary or secondary windings.



If wire A in diagram A is moved to a higher point, it will include more turns in the secondary, thereby increasing the secondary voltage of the transformer.

Auto transformers of this type are very convenient for obtaining variable voltages for certain special applications.

Fig. 138-C shows a diagram of an auto transformer connection that can be used to supply 110-volt and 220-volt energy from a 440-volt line, for operation of lights and 220-volt motors. It is also very convenient for obtaining various voltages for test purposes.

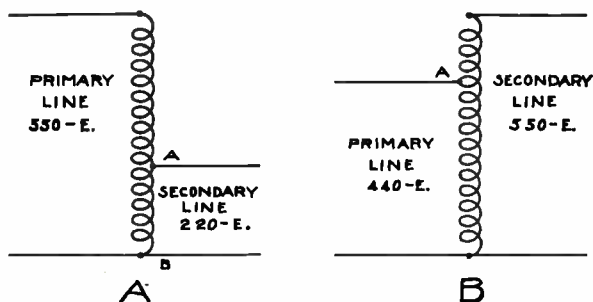

Fig. 138. A shows a step-down auto transformer. Note the reduction obtained in the voltage between the primary and secondary lines. B shows a step-up auto transformer to increase the secondary voltage.

Auto transformers with low ratios such as 2 to 1, are sometimes used on very large installations because of their cost being much lower than that of two-coil transformers. They are not often used however for general light and power service because of the very high voltage to ground which they place on the secondary leads, and the danger that this would create to equipment and persons handling it.

Three-phase auto transformers are used for starting three-phase induction motors, as well as for certain other special applications.

Fig. 139 shows a three-phase auto transformer in which the three ends, one from each coil, are connected together to form a star connection at Y. The other end of each coil is connected to its respective line lead.

A little current will be flowing through the windings of an auto transformer as long as it is connected to the line, the same as the magnetizing current which exists in the primary of any transformer even when no load is on the secondary.

When the secondary of an auto transformer is loaded, the primary current of course increases; but, in the case of a step-down auto transformer such as commonly used with motor starters, if the step-down ratio is 2 to 1, then the primary current will increase only one-half as much as the secondary load current is increased.

Many auto transformers used for motor starters or compensators have their coils equipped with taps, so that the secondary leads to the motor can be changed to obtain higher or lower starting volt-

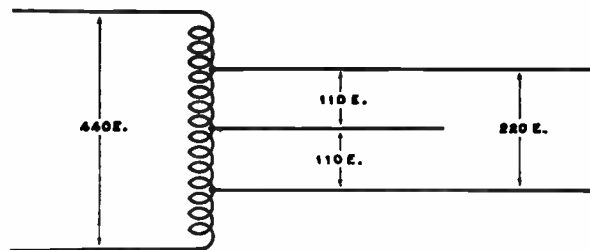

Fig. 138-C. Auto transformer connection for obtaining both 110 and 220 volts from a 440-volt line.

age and thereby increase or decrease the starting torque of the motor.

The diagram in Fig. 139 shows the windings equipped with three taps of this nature. It is quite common to have these taps arranged so that, when the secondary leads are placed on the terminals A, the secondary will deliver 50% of the line voltage to the motor. When the taps are placed on terminal B, the motor will receive 65% of the line voltage. When they are placed on the terminal C, the motor will receive 80% of the full line voltage, etc.

Added diagrams and further explanations of auto transformers will be given in a later section in connection with a A. C. motor controllers.

#### 148. INDUCTION VOLTAGE-REGULATORS

On distribution lines which feed energy to light and power equipment there is practically always a certain amount of load variation as the lights and motors of different buildings are switched on and off.

This variation in the load on the feeder wires also causes a variation in voltage drop on these wires, and a certain amount of variation in the voltage supplied to the load devices.

It is extremely undesirable to have more than a very few per cent. of voltage variation at the load—particularly on circuits which supply current to incandescent lights.

Low voltage causes reduced efficiency of incandescent lamps and reduces the torque and efficiency of motors; and sudden voltage variations cause objectionable flickering of lights. For this reason it is necessary to have some means of automatically regulating the voltage of feeder and distribution circuits which supply energy from the substations to customers' premises.

As the various feeder lines running out from substations usually have different lengths and different

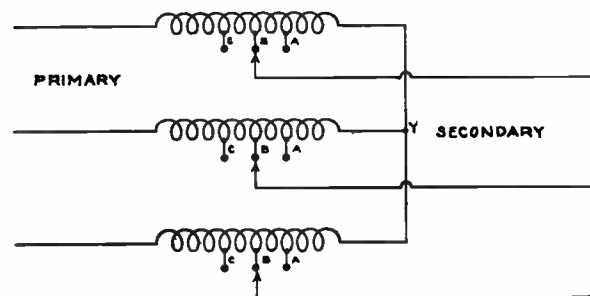

Fig. 139. Three-phase auto transformer in which each winding has several taps so that the secondary voltage can be varied.

amounts of load it is not possible to regulate the voltage of all of these circuits by controlling the voltage at the substation busses. These busses are therefore supplied with one uniform voltage of the proper value to compensate for the ordinary line drop in the feeders and distribution lines.

The voltage of each of the distribution circuits is then automatically regulated to compensate for the load and voltage variations, by means of a device known as an induction voltage-regulator.

#### 149. OPERATING PRINCIPLES OF INDUCTION REGULATORS

An induction voltage-regulator is simply a form of transformer which has a movable secondary winding which can be shifted or rotated with respect to the primary winding. The primary winding is called the stator and the movable secondary is called the rotor.

By turning the secondary winding into various positions with respect to the primary, the voltage induced in the secondary can be varied in amount over a wide range and, by turning the secondary winding far enough, the voltage induced in it can actually be reversed.

In this manner the secondary voltage of the regulator can be made to either aid or oppose the line voltage. Figs. 140-A, B, and C show the connections for an induction voltage regulator.

The primary winding, P, consists of a large number of turns of comparatively small wire and is connected directly across the line. The secondary winding consists of a very few turns of heavy wire which is large enough to carry the entire load current, and this winding is connected in series with the load and one side of the line.

In Fig. 140-A the secondary rotor winding is shown in a position so that it is receiving the maxi-

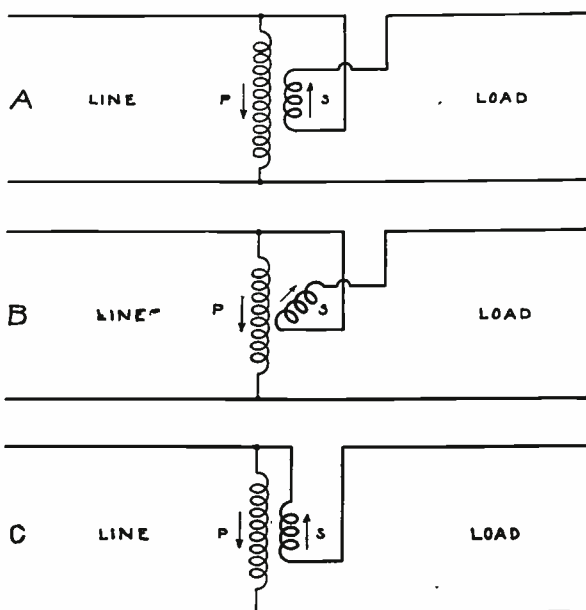

Fig. 140. The above three sketches show the connections and illustrate the principle of an induction voltage regulator. Study carefully each of the three diagrams while reading the explanations given on these pages.

mum induced voltage from the primary, and this voltage is in a direction to add to the primary voltage in series and thereby increase the line voltage.

In this figure, it is assumed that the top wire is positive for the instant, and the arrows near the primary and secondary coils indicate the direction of the voltages in them.

You will recall that when current flows in one direction through the primary winding of an ordinary transformer, it will be flowing in the opposite direction, or  $180^\circ$  out of phase, in the secondary, provided the coils are wound alike.

In Fig. 140-B the secondary rotor is shown turned at somewhat of an angle with the primary winding, and in this position the secondary receives less induced voltage from the primary and therefore doesn't aid or increase the line voltage as much.

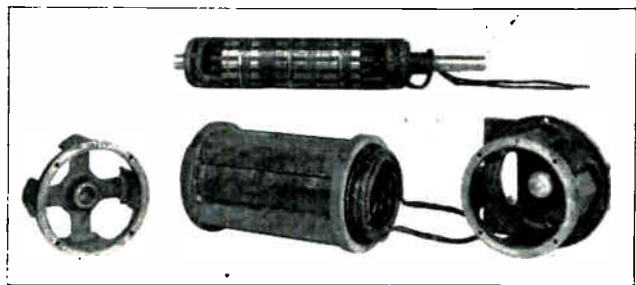

Fig. 141. This photo shows the stationary, primary, and rotating secondary windings of an induction voltage regulator. (Photo Courtesy General Electric Co.)

In Fig. 140-C the secondary has been turned to a position  $180^\circ$  from where it was in A. In this position it is receiving maximum induced voltage from the primary and its voltage is in a direction opposing the primary voltage, so that it reduces the voltage applied to the line.

Fig. 141 shows the stationary primary winding, and also the movable secondary winding which is placed on the rotor. These units are shown removed from the voltage regulator case. This photograph shows very clearly the construction of these elements. Note how the flexible leads of the movable secondary are given a few turns around the shaft of the rotor so that they can be permanently connected in series with the line and yet allow the rotor to make one-half turn, or  $180^\circ$  of rotation. This eliminates the necessity for slip rings and brushes.

#### 150. AUTOMATIC OPERATION OF INDUCTION REGULATORS

The boosting or bucking effect of the induction voltage regulator usually ranges from 5% below normal line-voltage to 5% above line-voltage. These regulators are usually operated automatically by means of small A. C. motors which drive a worm gear and rotate the secondary of the regulator.

The motor is controlled or started, stopped, and reversed by a set of potential relays or contact-making voltmeters with auxiliary contacts on the movable element.

When the voltage on the distribution line drops below normal, the relays close the circuits of the

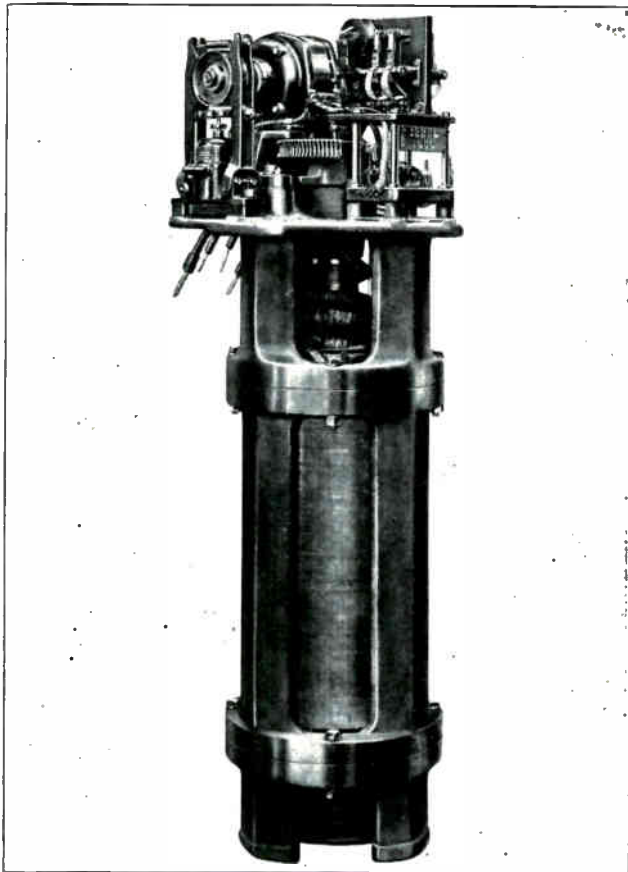

Fig. 142. Complete stator and rotor of a single-phase voltage regulator with the operating motor attached. (Photo Courtesy General Electric Co.)

motor to revolve the secondary winding of the regulator to a position where it will receive a greater induced voltage of a direction to aid and increase the line voltage. If the line voltage rises too high because of removal of practically all the load from the line, the relay contacts close another circuit to reverse the motor and rotate the secondary winding of the regulator to bucking position, where its voltage will oppose that of the line.

Fig. 142 shows a completely assembled primary and secondary unit of an induction regulator. The operating motor and part of the contacts are shown attached to the top of the stator frame in this view.

Fig. 143 shows a complete single-phase regulator with the primary and secondary enclosed in a tank of insulating oil. The sensitive voltage relay, adjustable tap-control, and resistance box and switch are shown mounted on a panel on the front of the regulator.

Induction regulators are also made for three-phase operation. These are wound similarly to the stator of the three-phase induction motor. Regulators of the induction type are in very common use in modern substations which supply alternating current to feeder and distribution circuits. Therefore, it will be well worth your while to obtain a thorough understanding of the principles of this device and to carefully observe and study the vari-

ous parts of the control and operating mechanism of the regulator in your A. C. shop Department.

#### 151. INSTRUMENT TRANSFORMERS

While on the subject of transformers, it will be well to consider more fully the principles and construction of instrument transformers which are used in connection with meters on high-voltage A. C. circuits.

The use of these transformers has already been explained to some extent in the section on Alternating Current Meters. Those which are used to reduce the current of heavy-duty power circuits and to operate ammeters and the current elements of wattmeters and watt-hour meters, trip coils of oil switches, operating coils of current relays, etc., are known as **current transformers (C.T.)**

The other type, which are used to reduce the voltage of high-tension circuits and to operate voltmeters, potential elements of wattmeters and watt-hour meters; power-factor meters, synchrosopes, potential relays, etc., are known as **potential transformers (P.T.)**

Instrument transformers are carefully and specially designed to give very accurate ratios of transformation on voltage and current values within the range of which they are designed.

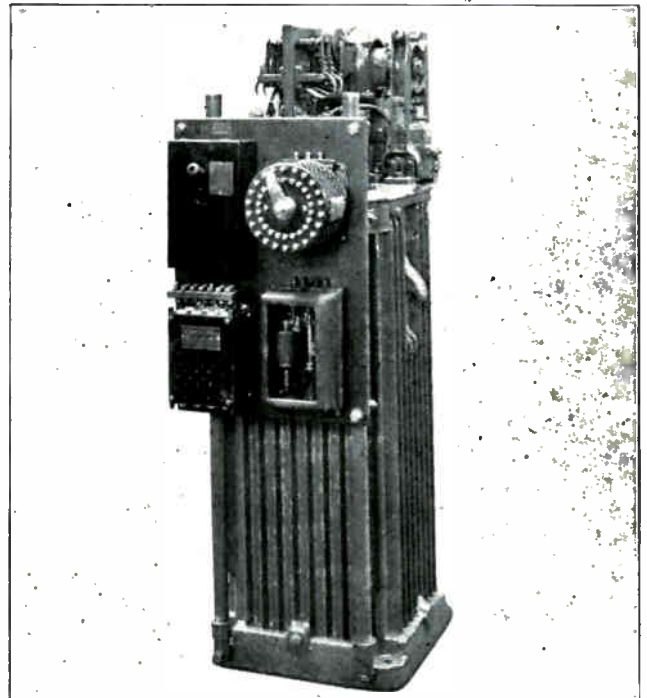

Fig. 143. This photo shows a single-phase regulator enclosed in its tank and equipped with the operating motor and control relays. (Photo Courtesy General Electric Co.)

#### 152. CURRENT TRANSFORMERS

The primary of a current transformer is always connected in series with the line of which the current is to be measured, as shown in Fig. 144-A. This primary winding usually consists of only one or two turns and in some cases of just a straight conductor passed through the core around which

the secondary is wound. This produces the same effect and ratio as one loop or turn.

On circuits carrying very heavy currents, the flux set up by one turn, or even just a short section of the straight conductor, is sufficient to induce the proper voltage in the secondary winding, as the instruments require very little power to operate their moving elements.

The secondary winding consists of a great many turns and its terminals are connected directly to the terminals of the ammeter, wattmeter, or relay which the transformer is to operate.

The secondary of the current transformer should always be grounded for safety in case of a breakdown of the insulation, which might allow the high voltage of the line to get to the low-voltage circuit.

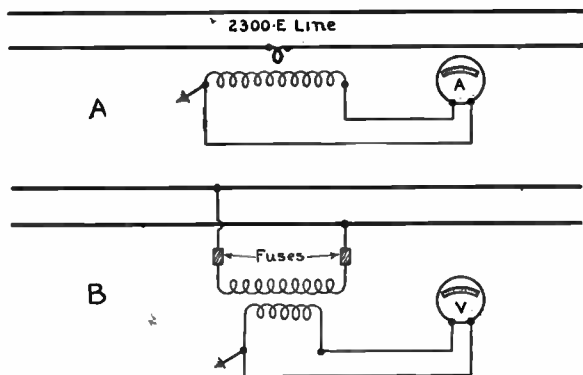

Fig. 144. A shows the connections for a current transformer which is used to operate A. C. ammeters, wattmeters, and current relays. B. Connections for potential transformer used to operate voltmeters, potential elements of wattmeters, potential relays, etc.

Fig. 145 shows a current transformer which is designed for connecting in series with power cables or lines. The cables are connected to the leads of the heavy primary conductor by the copper lugs and bolts shown attached. The leads to the instrument are taken from the two small terminals on the connection block on the lower left of the transformer core.

Fig. 145-A shows a current transformer which is designed for connection in series with a bus bar on a switchboard.

### 153. CAUTION

As previously mentioned in the lesson on A. C. Meters, the current transformer which has its pri-

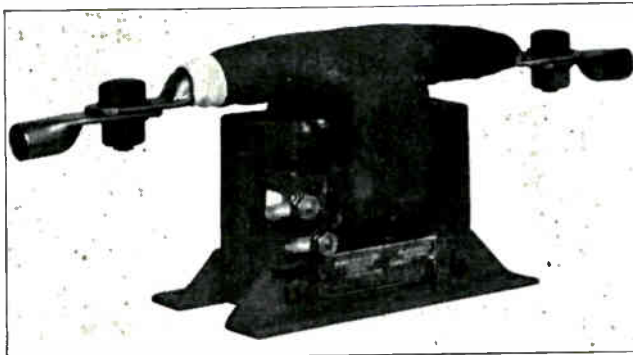

Fig. 145. This photo shows a common type of current transformer for use with cable lines or small bus bars.

mary connected in a live line should never be left with its secondary open-circuited.

Before disconnecting the meter leads or relay leads from the secondary of the current transformer, the transformer secondary should be short-circuited with a good, secure connection. If this is not done, when the instrument is removed there will be a dangerously high voltage built up in the secondary winding of the transformer. This high voltage may puncture the insulation of the transformer secondary winding, or of the meter just as it is being disconnected or reconnected; or it may cause a serious shock to the operator who is making or breaking the connections.

You will note by observation of the diagram in Fig. 144-A that, with one turn in the primary and a considerable number of turns in the secondary, a current transformer resembles a step-up transformer with the secondary as the high-voltage winding. It would act as such if it were not for the fact that the meters and devices connected to the secondary are of very low resistance, and the current which normally flows through the secondary sets up a flux that opposes the primary flux, and thereby limits the amount of induced voltage to a very low value.

This principle was explained in Article 125.

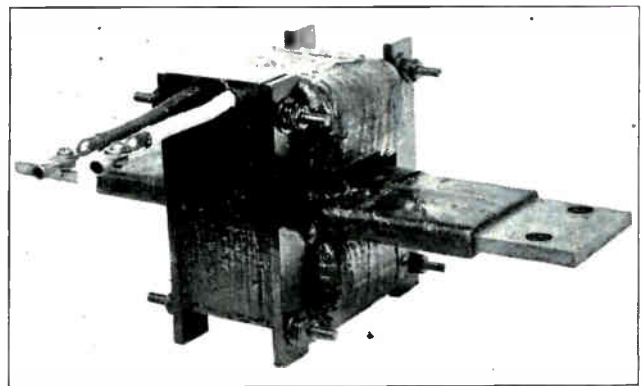

Fig. 145-A. Bus-bar type current transformer for use with large bus bars on switchboards. (Photo Courtesy General Electric Co.)

The short-circuit should always be left on the secondary winding until after the meters or devices have been reconnected to it. This short-circuit will not cause the secondary winding to become damaged or burned by overload because the increased current which tends to flow through the secondary winding, when shorted, immediately sets up a heavy flux that more completely neutralizes the flux of the primary and thereby allows very little voltage to be induced in the secondary as long as its circuit is closed.

If this circuit were left open, however, there would be no current flowing and no secondary flux to oppose the primary field, and this would allow the primary flux to build up to full normal value and induce in the secondary the very high voltage which has been mentioned.

#### 154. POLARITY MARKINGS AND RATIOS

The polarity of current transformers is usually indicated by permanent white markings placed on the primary and secondary leads.

The relative instantaneous directions of the current will be into the marked primary lead, and out of the marked secondary lead.

Current transformer ratios can be expressed in different ways. One common method is as follows: 80:5, 400:5, 250:5, etc.

These respective indications or markings mean that the maximum secondary rating is 5 amperes when the primary is fully loaded by the number of amperes expressed by the first figure of the rating. In other words, transformers are designed with the various proper ratios so that 80 amperes through the primary will produce a flow of 5 amperes in the

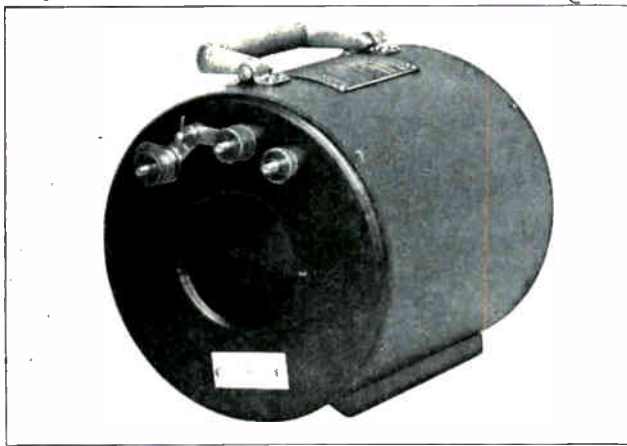

Fig. 146. Portable current transformers of this type are very convenient when making tests on lines or electric machines with portable ammeters and wattmeters. (Photo Courtesy General Electric Co.)

secondary; or, in the case of another transformer, 400 amperes flowing through the primary will produce a flow of 5 amperes through the secondary, etc.

With current transformers of this type it is possible to use ammeters which have windings with a maximum capacity of 5 amperes. The ammeter scale is then calibrated according to the ratio of the transformer so that the meter will indicate the full line current rather than the amount of current actually passing through the meter coil itself.

Another method of expressing current transformer ratios, is as follows: 80:1, 600:1, 1200:1, etc.

The principle involved in this method is the same as that of the transformer ratios previously explained; and ammeters of 5 ampere maximum capacity are used and have the scales calibrated according to the transformer ratio.

#### 155. ADVANTAGES AND APPLICATIONS OF CURRENT TRANSFORMERS

Ammeters for use without current transformers and designed for a flow of more than 100 amperes through their coils, are usually not very accurate and require very heavy and bulky coils to carry the current.

As many alternating current power circuits carry

loads of several thousand amperes, current transformers are very commonly used. They serve the same general purpose as ammeter shunts do in direct current circuits, even though the transformers operate on a principle of induced voltage entirely different from that of voltage drop due to resistance in the shunts.

Fig. 146 shows a portable current transformer which can be conveniently used with portable ammeters or wattmeters for making tests on heavy power circuits. This transformer is so constructed that the cable or line on which the current is to be measured can be passed through the hole in the center of the transformer core. The flux around the line conductor is sufficient to operate the transformer secondary and instruments attached.

In cases where the voltage of the line on which the current is to be measured exceeds 500 volts and possibly ranges up into the thousands of volts, it is much safer to use current transformers to operate meters and relays. By using a transformer, the windings of the ammeters or relays are kept insulated from the line voltage. Some power companies make it a general practice to use current transformers on all lines of 220 volts and over.

There is often a tendency on the part of operators and electrical men in the field to overload current transformers by connecting too many instruments on one transformer. This is not good practice, as it causes inaccurate meter readings, particularly where the current elements of wattmeters are connected to the same transformer with ammeters.

Most meters are matched and calibrated to operate with certain current transformers and for accurate readings these should be kept together.

Other types of current transformers are designed to operate overload trip-coils, relays, etc., and these should not be used with ammeters or wattmeters.

#### 156. POTENTIAL TRANSFORMERS

A potential transformer resembles an ordinary single-phase power transformer, except that it is of only a few watts capacity. The primary windings of potential transformers consist of a great number of turns, and are connected across the high voltage lines and protected with special fuses known as potential transformer fuses.

The secondaries are commonly wound for 100 or 110 volts. Fig. 144-B shows the connections for a potential transformer, and the voltmeter properly connected to its secondary. The secondaries of these transformers are also grounded for safety reasons and to immediately ground the high voltage in case of failure of the insulation between the primary and secondary windings.

Voltmeters and the potential elements of wattmeters which are designed for use with potential transformers are found and constructed the same as voltmeters for lines of 100 or 110 volts, and their scales are calibrated according to the ratio of the

potential transformer, so the meters will indicate the full line voltage.

It is quite general practice to use potential transformers for the operation of voltmeters, wattmeters, and potential relays on lines of 200 volts and over.

It is very seldom advisable or practical to use voltmeters directly connected to lines of over 600 volts.

On the left in Fig. 147 is shown a potential transformer for a primary voltage of 220 volts. The terminal markings, H-1 on the primary and X-1 on the secondary, can be seen in this photo.

The view on the right in this figure shows a large oil-insulated current transformer for use with a line of 25,000 volts. The in-going and out-going leads to the primary are both carried through the large porcelain insulating bushing. One lead is in the form of a small rod which goes down through the center of the bushing, and the other lead is in the form of a metal sleeve which surrounds the inner rod but is well insulated from it.

Potential transformers for use on very high voltage lines are also built with their windings immersed in tanks of oil and have two high-voltage insulating bushings for their primary leads, which are connected across the line.

Oil-insulated instrument transformers of this type are commonly installed outdoors in the substation structure where the high voltage lines enter or leave the station.

### 157. TRANSFORMER TESTS

Three very common tests which you may often be called upon to make on transformers are those for determining the core loss, copper loss, and the regulation of various power transformers.

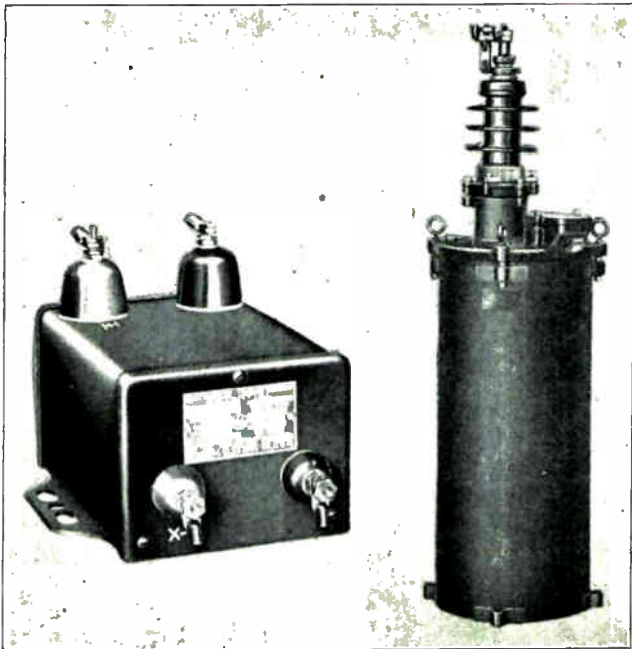

Fig. 147. At the left is shown a small potential transformer with the high-voltage terminals on the top and the low-voltage terminals on the end. Note the polarity markings on the case. On the right is shown a large oil-insulated power-type current transformer.

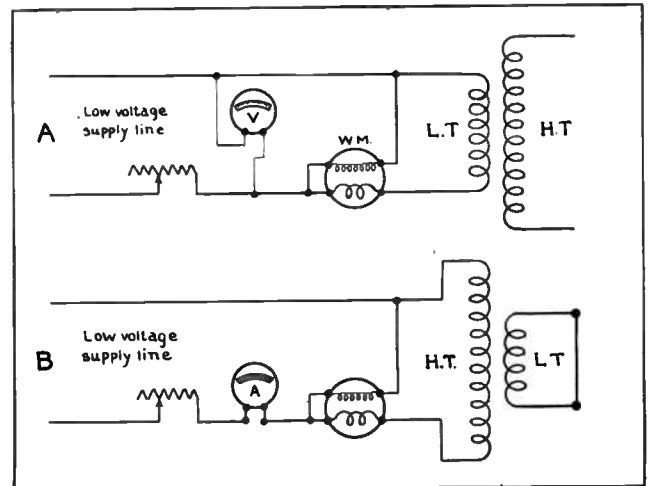

Fig. 148. A shows the method of connecting a voltmeter and ammeter to a transformer to make a core loss test. B shows the connections for making a copper loss test.

These losses and figures on the characteristics of the transformer can usually be obtained from the manufacturers, but the tests for determining them are very simple and are often performed in the field.

The connections for making the core-loss test are shown in Fig. 148-A. When performing this test it is generally more convenient to use the low-tension winding for applying the power, thus avoiding unnecessarily high voltage on the instruments.

For making the core-loss test, the wattmeter and voltmeter of the proper ratings and some form of rheostat are required, and they should be connected as shown in the diagram. The secondary of the transformer should be left open-circuited during the test. The rheostat should be adjusted until normal voltage is applied to the primary winding, and the wattmeter reading will then indicate the core loss of the transformer in watts.

In other words, when the secondary of the transformer is open and not loaded, the energy required to magnetize the core will be the core loss. As previously mentioned, the core loss of a transformer is practically the same at no load as at full load.

The connections for making the copper-loss test are shown in Fig. 148-B. In this test it is usually more convenient to use the high-voltage winding of the transformer as the primary to be excited. The low-voltage secondary should be short-circuited during the test.

A low voltage is then applied to the high-tension coil and the rheostat is adjusted until the ammeter indicates that the current flow is equal to the full load current rating of the high-tension winding. When this current value is reached, the wattmeter reading will indicate the full-load copper-loss.

With the secondary short-circuited in this manner it is usually necessary to apply only 1 to 3 per cent. of the rated high-tension voltage to bring the current up to full-load value for the high-tension winding.

The regulation of a transformer may be determined approximately by the following method.

First, measure the secondary voltage under full load, with the transformer primary supplied with rated voltage and frequency. When the secondary load is removed, the voltage will rise and the amount of increase should be noted.

This increase, or difference between the full load and no load voltage, divided by the full load secondary voltage will give the per cent. of regulation.

### 158. FIELD PROBLEMS

In each of the following problems except the last one, the answers are given; but you should carefully work them out, and also make in each case a connection diagram of the equipment mentioned, or that which would be required, just as you would connect it up right on the job.

Suppose that you were to install a bank of three single-base transformers to supply current to a motor load of 150 h. p. What size transformers would you install?

It is considered good practice to install about 1 kv-a. of transformer capacity per h. p. of secondary load. This will allow for the loss in the transformers and motors and also for the power factor, which is usually somewhat below unity on a system loaded with motors.

So, as the exact power factor and current ratings of the motors in this case are not known, we should install transformers with a total three-phase capacity of 150 kv-a.

When 150 kv-a. is divided among three single-phase transformers, it will require transformers of 50 kv-a. each.

In another case, suppose you wish to determine the amount of current that can be taken from each

secondary line wire of a three-phase bank of transformers which have a total capacity of 600 kv-a. and a secondary voltage of 440 volts.

We know that the apparent watts divided by (volts  $\times$  1.732) will give the line current on any line wire of the three-phase system.

Then, as apparent watts are equal to 600 kv-a.  $\times$  1000, or 600,000 watts, the current will be found in the following manner:

$$I = \frac{600,000}{440 \times 1.732}, \text{ or } 787 \text{ amperes per line conductor.}$$

If on some future job you have a bank or transformers with a step-down ratio of 2:1, with the primary windings connected star to a 440-volt circuit and the secondary windings connected delta, what voltage will be obtained from the secondary line leads?

This problem can be solved in the following manner:

If the transformer primaries are connected star to a 440-volt line, the voltage across each of the primary phase windings will be:

$$440 \div 1.732, \text{ or approximately } 254 \text{ volts.}$$

Then, if the transformer step-down ratio is 2:1, the voltage across the secondary phase windings will be:

$$254 \div 2, \text{ or } 127 \text{ volts.}$$

As the secondary windings are connected delta, the line voltage will be the same as the phase winding voltage, or 127 volts.

If an alternator supplying 6000 volts is connected to the primary of a delta-star bank of step-up transformers which have a ratio of 1:11.55, what will

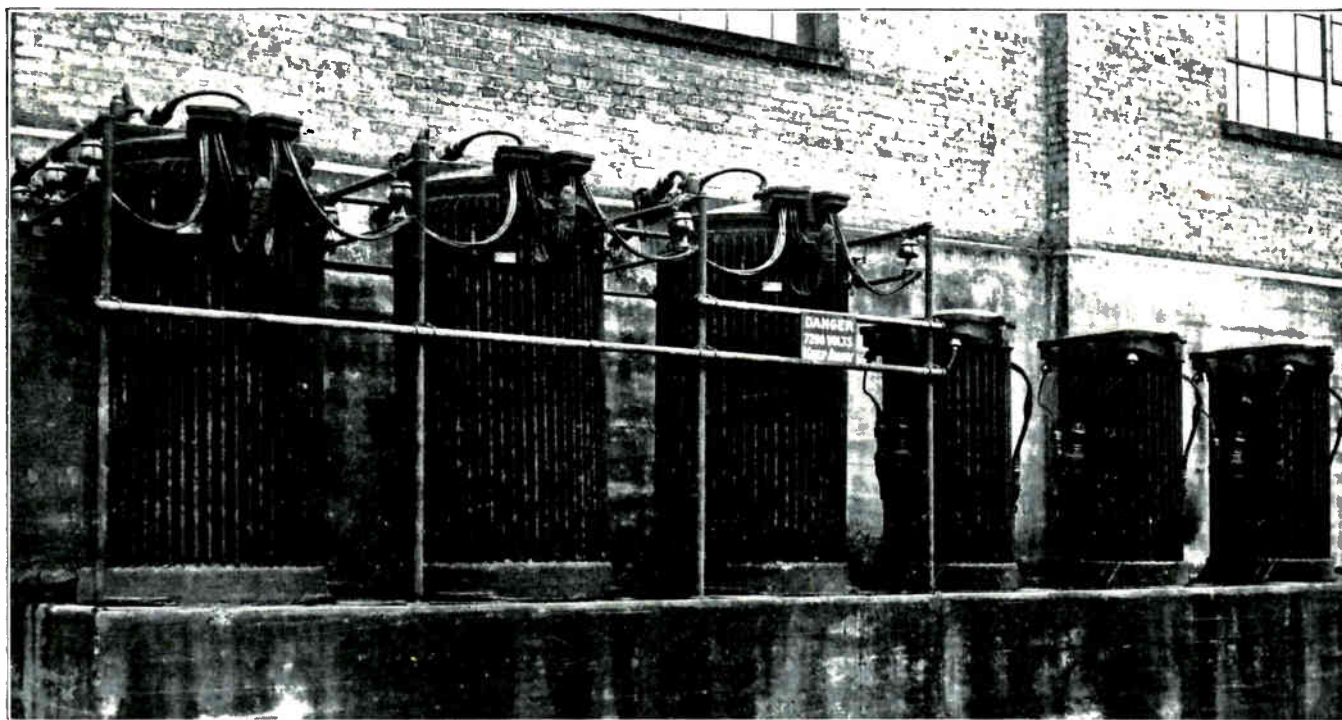

Fig. 149. This photo shows two three-phase banks of transformers of different sizes. Note the manner in which the connections are made. Connections from transformer banks are very frequently run through conduit or lead-covered cables to the circuits they are to supply. In some cases connections are made to rigidly supported bus bars which may lead to a switchboard or switching station.

be the high-tension line voltage obtained from the star-connected secondaries of the transformers?

This problem can be solved in the following manner:

If 6600 volts are applied to the delta-connected primaries of the transformers, then the voltages across each of the primary phase windings will be 6600. With a step-up ratio of 1:11.55 the voltage across each of the phase windings on the secondaries of the transformers will be 76,230 volts.

Then, if these secondaries are connected star, the line voltage will be  $76,230 \times 1.732$ , or 132,030 volts.

This same line voltage can be obtained with a bank of transformers connected in this manner and having an even ratio of 1:10, by simply increasing the alternator voltage from 6600 to a little over 7622 volts.

Which transformer connections could be used to raise the voltage of a 13,200-volt alternator to 132,000 volts for the transmission line, if the bank of transformers has a step-up ratio of 1:10?

### 159. MAINTENANCE AND CARE OF TRANSFORMERS

Transformers usually require considerably less maintenance than most other electrical machines; because transformers have no moving or wearing parts, such as bearings, etc.

There are, however, certain important features which should not be overlooked when installing new transformers and also in the regular inspection and care of these devices, to make certain that they are operating under proper conditions.

When installing transformers they should whenever possible be placed in a location where there is plenty of free circulation of fresh air to carry away the heat developed in the transformers.

Transformers are quite often installed in special rooms, known as transformer vaults, inside of various buildings. These rooms should be well provided with openings for ventilation, and in many cases it is advisable to have some sort of fan or blower system to constantly circulate fresh air through the transformer vaults.

Where transformers have water-cooling coils in the tanks, the circulation of air around the tanks is not so important; but, even with these types of transformers, a great deal of the heat will be carried away and their operating temperature kept lower if plenty of fresh air can come in contact with the tanks.

When transformers are installed out-of-doors, the air problem will usually take care of itself; but, if the transformers are equipped with water-cooling coils, they should be inspected frequently to see that the circulating water supply is not interrupted by failure of the pumps, and also to see that this water as well as the transformer itself are kept at the proper temperature.

In certain cases where transformers may be temporarily overloaded to maintain service during emergencies, or where conditions make their cool-

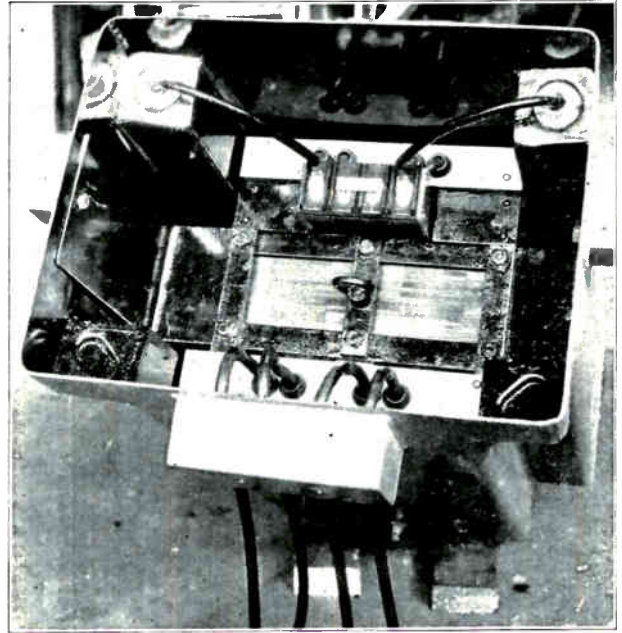

Fig. 159. This photo shows the inside of a small distribution transformer with the oil removed. Many transformers of this type are provided with a terminal block mounted on the core inside of the tank so that the connections can be changed to obtain different voltages.

ing difficult, they may be kept at safe temperatures by means of fans or blowers to direct air against their tanks or radiators. Sometimes a spray of water against the tanks from a set of perforated pipes will greatly aid in cooling them. The water should, of course, be kept away from high voltage lead-in wires and bushings.

As previously mentioned, most large transformers are provided with thermometers to indicate the temperature; and for highest operating efficiency, as well as for safety of the insulation of the windings, the temperature should be kept at or below the maximum rating which is usually marked on the transformer name-plate.

### 160. DRYING OUT TRANSFORMERS

When installing new transformers which have been shipped without the oil in the tanks, or used transformers which have become damp, it is very important to see that the windings and tanks are thoroughly dried out before the oil is placed in the transformers.

This is usually accomplished with some form of air heater and fan arrangement for blowing dry, heated air through the windings. Large transformers may require several days to thoroughly dry out.

In emergency cases the windings may be heated to dry them out by short-circuiting the secondary winding and applying from 1 to 2 per cent. of the normal rated voltage to the primary.

A rheostat is generally used in series with the primary winding to avoid too rapid temperature rises, and the actual drying temperature should not be reached for several hours after starting to apply the low voltage to the primary.



This method of drying out a transformer must be performed with great care at the start or the inner sections of the winding may reach dangerously high temperatures before the outside sections become warmed up.

The principal reasons for drying out transformers so carefully are both to prevent moisture from reducing the dielectrical strength of the insulation on the windings and to prevent any of this moisture from being absorbed by the oil when it is placed in the transformer tank.

The degree of dryness obtained can be determined by measuring the insulation resistance between the winding and core with a megger.

#### 161. EFFECT OF WATER ON TRANSFORMER OIL

The presence of even a very slight amount of water in the oil will greatly reduce its dielectric strength or insulating qualities. The dielectric strength of good transformer oil is usually between 220 and 250 volts per mil. In other words, it will require a voltage of this amount to puncture or break through 1/1000 of an inch of good transformer oil.

The common test for transformer oil is made by placing a sample of the oil in a testing cup or receptacle in which is submerged a pair of round test electrodes one inch in diameter, and with flat faces spaced 1/10 of an inch apart.

When high voltage from a test transformer is applied to these terminals of the test gap, the 1/10 inch layer of oil between them should stand a potential of about 22,000 volts before breaking down. If the oil flashes through at a much lower voltage than this, it indicates the presence of moisture or dirt in the oil.

If oil which has almost no water in it, or we will say not over 1/10 part of water in 10,000 parts of oil by volume, has a breakdown voltage of over 20,000 volts, when water is added to the extent of one part of water in 10,000 parts of oil, the oil will usually break down at less than 10,000 volts; showing that its dielectric strength has been reduced more than one-half by even this very small moisture content.

Only a good grade of mineral oil should be used in transformers. The principal requirements are that such oil should be free from moisture, dust, dirt, and sediment. It should also be free from acid, alkali, and sulphur. It should have a low flash point, and should have the previously mentioned dielectric strength of about 220 volts per mil.

During normal operation of the transformer it is quite probable that the oil will absorb more or less moisture from the atmosphere.

Most transformer manufacturers equip their transformers with air-tight or water-tight insulating bushings around the conductors or leads where they leave the tank, and also with moisture seals under the tank covers. In spite of this, a certain amount of moisture may enter the tank by the "breathing"

action which is due to expansion and contraction of the oil with changes of temperature in the transformer, and which causes air to be forced in and out of the transformer tank with these changes in temperature.

Even when transformers are equipped with the air-dryer or moisture-absorbing units in the breather or ventilator previously explained, some moisture may gradually be absorbed by the oil.

The presence of this moisture may not be visible to the eye when the oil is examined, but it can be detected by the voltage-breakdown test.

If a pint of oil and a pint of water are vigorously shaken together in a container and then allowed to stand for a few minutes they will separate because oil is the lighter of the two. Most of the water will settle to the bottom, but a certain number of very small particles of water will be retained in suspension in the oil.

The same condition is met in the case of transformers. Most of the first moisture which enters the tank remains suspended in the oil until the oil can hold no more water, and then the water begins to settle to the bottom of the tank.

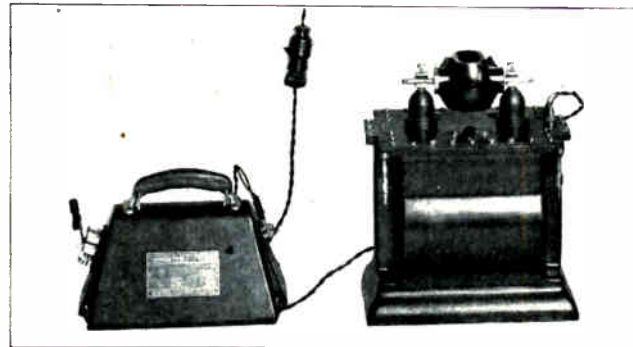

Fig. 151. Portable oil testing outfit consisting of high voltage transformer oil test cup and voltage adjuster. (Photo Courtesy General Electric Co.)

#### 162. TESTING TRANSFORMER OIL

We should never wait for water to appear at the bottom of the tank; but, instead, the oil should be periodically tested by removing small samples from the drain valve at the bottom of the tank and testing these samples in a high-voltage test gap such as previously described.

If, at any time, the oil removed from the bottom of the tank breaks down at voltages below 16,500 on a standard test gap, the oil should be both dried out and cleaned. If this is neglected it may result in the dielectric strength of the oil becoming so low that it will cause a flash-over between the transformer windings and result in serious damage.

Fig. 151 shows a convenient portable oil-testing device which consists of a small high-voltage transformer capable of producing secondary voltages of from 15,000 to 25,000 volts. The oil test cup or receptacle is mounted above the transformer and is attached to the high-voltage terminals. The oil cup is made of an insulating composition and has the metal electrodes inside the cup with their shafts

extending through the ends to the transformer terminals.

One of the electrodes is adjustable so that the cup can be accurately set for various tests. There is also provided a voltage adjustment knob, located between the electrode posts. The power required by a test outfit of this kind is so small that it can be operated directly from an ordinary 110-volt lighting circuit.

When testing oil with such a test outfit, the cup is usually filled so that the oil is about an inch above the electrodes, and after allowing sufficient time for the oil to flow between the gap faces and for all bubbles to rise to the top, the voltage is applied, low at first, and gradually increased until the sample breaks down. Several samples are usually tested to obtain average results and avoid mistakes.

### 163. CLEANING TRANSFORMER OIL

There are three common methods of removing moisture and dirt from transformer oil. These methods are boiling, filtering, and the use of centrifugal separators.

The first method is the least used of the three and is generally only resorted to in emergencies.

Oil filter presses are quite commonly used by a number of plants and power companies, and the centrifugal separator is very extensively used where large amounts of oil must be cleaned frequently.

To dry the moisture out of oil by boiling is a somewhat crude method but it may occasionally be handy in emergencies. To do this, it is only necessary to heat the oil to a temperature slightly above the boiling point of water, or 212° F. Maintaining the oil at this temperature will gradually boil out the water.

The temperature of the oil should not be raised more than about 20° above the boiling point of water, or the excessive heat may injure the quality of the oil and lower its dielectric strength.

Oil filtering is accomplished by forcing the oil through a series of filter papers. These filter papers are similar to blotting papers. A number of them are held securely clamped in a special press, such as shown in Fig. 152; and oil is forced through these filter papers one after another, by means of an electrically-driven pump.

The filter papers will allow the oil to pass slowly through them, but will stop and hold most of the moisture. They will also stop most of the dirt and sediment which the oil may contain.

A pressure gauge is connected in the oil-circulating system between the pump and the filter press, so that the proper pressure may be maintained on the filter papers. After the pump has been started a few minutes, the pressure should be noted. If at any time during operation the gauge indicates a sudden pressure drop, the pump should be immediately shut down, because the reduced pressure is usually due to some of the filter sheets having been punctured by water.

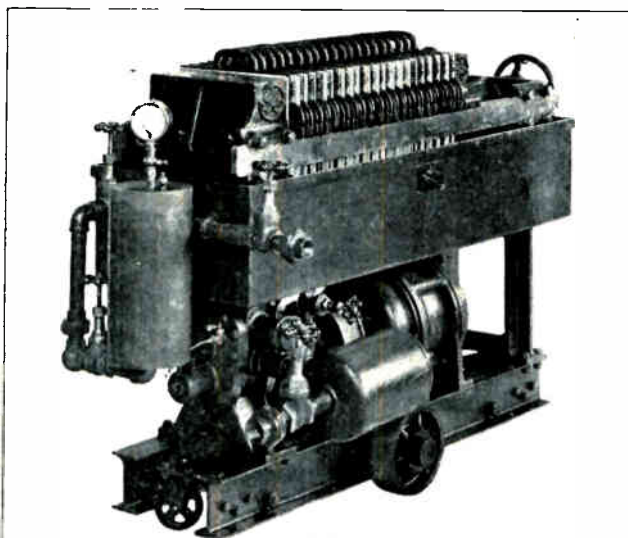

Fig. 152. This photo shows a filter press for cleaning and removing the moisture from insulating oil. Note the motor-driven pump mounted underneath the filter press. (Photo Courtesy General Electric Co.)

It is then necessary to drain the oil from the filter and replace the punctured sheets as well as several adjacent sheets on each side of them. This is done in order to guard against missing a few sheets which have very small punctures that may not be easily seen.

The moisture-laden oil which is drained from the filter each time it is shut down, should be set aside and filtered at the end of the run. This will eliminate a lot of unnecessary shut downs, as a considerable amount of the water may have settled out of the bad oil during the time it was left standing.

Centrifugal oil separators such as the one shown in Fig. 153 separate the oil and water by whirling them at high speed, causing the two to leave the separator disks at different levels because of the different weights or specific gravities of oil and water.

This method is very rapid, convenient, and clean, and is very commonly used in large power plants and by power companies which have to clean large amounts of insulating oil from transformers, oil switches, etc.

Large transformers are usually provided with oil drain connections at the bottom of the tank and refilling connections at the top. It is not necessary to take a transformer out of service in order to clean the oil, as connections can be made to both the bottom and top of the tank; so that the oil can be run through the filter press or centrifugal separator and the clean oil returned to the top of the tank as fast as the dirty oil is withdrawn from the bottom.

By this method some of the oil may, of course, be run through the cleaning process several times; but, as soon as the sufficient moisture and dirt have been removed so that a test sample of the oil in the transformer rests up to the proper voltage again, the cleaning process can be stopped and the filter or separator disconnected from the transformer.

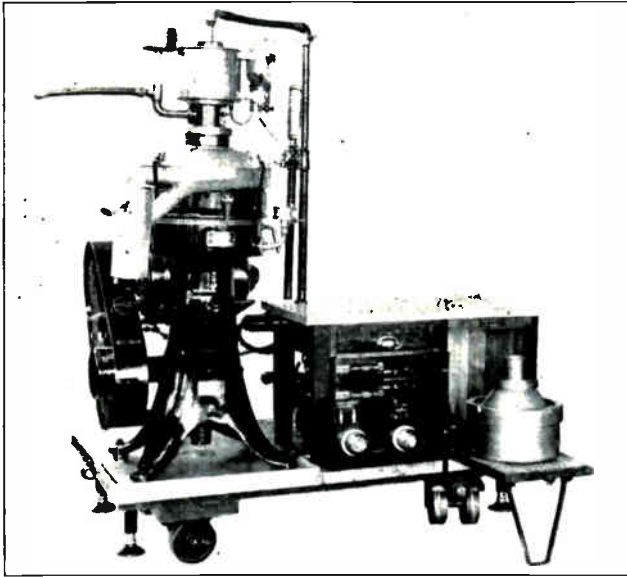

Fig. 153. Motor-operated centrifugal oil purifier which separates water and dirt from the oil by revolving them at high speeds. (Photo Courtesy General Electric Co.)

Sometimes it is necessary to take a transformer out of service and thoroughly clean the tank and windings to remove all sediment and dirt from the bottom of the tank and also any accumulations of dirt or oil sludge which may be clinging to the windings and clogging up the oil circulation spaces, thus preventing proper cooling and causing the transformer to overheat.

There are many thousands of small and large transformers in use in power plants, substations, and industrial plants today; and it is because you will undoubtedly have frequent occasion to use a good working knowledge of these devices that their operating principles, connections, and care have been quite thoroughly covered in this section.

This subject is of sufficient importance so that you should make sure that you have a thorough understanding of the material covered in this section.

## TRANSFORMER DESIGN DATA

We have found that transformers are made in many different sizes and types, and for almost any purpose or need. Very often the alert electrician can think of profitable uses for transformers other than the uses in which they are commonly found.

In some cases, one may have a need for a special transformer which is not available or which may be too costly to buy for the particular purpose, and you may desire to build a unit from available core iron, and wire, which may have been salvaged from some other transformer. Or you can purchase core iron cut to specifications from various steel companies, and magnet wire from electrical supply houses, for building special transformers.

The design of large power transformers for maximum efficiency and power factor is a job for technically trained engineers, and it is not our purpose to go into such details or mathematical problems. However, it is not a very difficult matter for the practically trained electrician to build a simple transformer of small or medium size, which may be very satisfactory for some certain job or requirement. The following convenient transformer construction data is provided for this purpose.

Before starting to design or construct any transformer, it will be well for us to have well in mind just what a transformer is, or what are its essential parts such as the core, the primary winding, the secondary winding, and the necessary insulation. The core, consisting of thin iron strips or laminations must be large enough to carry the required magnetic flux without saturation or too

heavy losses. The amount of flux to be carried by the core will depend on the size or wattage rating of the transformer.

The primary winding is to excite or magnetize the core and provide a magnetic flux to induce the desired voltage in the secondary winding. The number of turns and size of wire in the primary winding will depend on the applied voltage and the desired power rating.

You have already learned that the secondary voltage of any transformer will depend on the voltage applied to the primary and the ratio of primary to secondary turns.

Therefore, the principal factors to be determined in building a transformer are the core size, area and weight; the number of turns and size of wire for primary and secondary windings, the number of turns per volt in the windings, and the amount and grade of insulation.

Important points to keep in mind in the construction of any transformer are:

Do not skimp on core iron, wire size or insulation. Liberal core size means higher efficiency and requires less turns of wire per volt. Ample wire size prevents overheating. Careful and sufficient insulation tends to prevent breakdowns due to short circuits or voltage flash overs.

Before trying to determine the size or area of the core we should decide which type of core we desire to use. The two best types for simple transformer construction are the "core type," and the "shell type" shown in Figures 99 and 100 of this Section.

The plain "core type" with four legs or sides, is often the easiest to build, and when voltages of 1000 or over are desired on the secondary, it is much easier to insulate the winding on this type of core. The shell type core is somewhat more efficient and compact and not very difficult to build.

As a general rule, we should allow a core area of at least 6 square inches for a transformer of 1 kilowatt size. It is also customary to allow a flux density of 50,000 lines per square inch of core if the core iron is of a good grade of silicon steel. For continuous duty without overheating, we should allow 1000 to 1200 circular mils of wire area per ampere of load, on both primary and secondary windings. For intermittent or temporary duty, on very small transformers that are easy to cool, and where efficiency is not so important, this allowance may run somewhat lower, from 600 to 800 C.M. per ampere.

The number of turns required in each coil will be proportional to the applied or induced voltage, and inversely proportional to the cross sectional area of the core. A convenient figure for rough design or checking of small transformers is 7 turns per volt, for a core area of 1 square inch, if the transformer is to be used continuously; or 4 turns per volt if it is to be operated for only a few minutes at a time.

The relations between volts, amperes and watts in transformer design can easily be determined by the use of ohms and watts law formulas with which you are already familiar.

For simplicity and convenience in securing practical design data for small transformers, we have prepared the following table, which gives all the necessary values on core area, wire size and number of turns for six sizes of transformers ranging from 50 watts to 1500 watts.

This data is given for transformers that are intended for use on 110 volt circuits. That is, their primary windings are designed for 110 volts at 60 cycles frequency.

Watts Input	Core Area	Turns Per Volt	Number of Pri. Turns	Size of Pri. Wire
50	1¼ x 1¼	4.8	530	23
100	1½ x 1½	3.3	365	20
250	1⅞ x 1⅞	2.25	250	16
500	2⅞ x 2⅞	1.66	185	13
1000	2½ x 2½	1.2	130	10
1500	2¾ x 2¾	1.	110	9

The above sizes of transformers would be convenient for bell circuits, signal circuits, electrical toys, neon signs, testing insulation, small spot welders, tesla coil operation, etc. The three larger ones might be used for light and power purposes. The number of turns and size of wire for the secondary windings is not given, as this will depend on the desired secondary voltage or whether the transformer is to be a step-up or step-down unit.

The number of secondary turns can be easily determined for any desired voltage by multiplying

the turns per volt given in the table, by the desired voltage. The full load secondary current can be determined by dividing the wattage rating of the transformer by the secondary voltage. Then the C. M. area of secondary wire can be determined by multiplying the current by 1000, and getting the gauge number to correspond from a wire table.

Another convenient method of getting the various design figures for small transformers of any size from 50 watts to 1000 watts is by use of the chart or graphs shown in Fig. 153-A.

For example, suppose we wish to determine the values for a 500 watt, or 500 volt-ampere transformer.

The weight of the core is found by running horizontally along the 500 V.A. line to the solid line A, and then vertically down to the top row of figures marked weight of core. We find the core weight to be 25 pounds.

The core width can be found by running horizontally along the 500 V.A. line to the curve Y, and then down to the middle line of figures, marked width of core, where we read slightly over 2 inches. Call it 2 inches.

In this particular design the core depth is assumed to be 1½ times core width, or in this case, 3 inches. Then the core area will be  $2 \times 3 = 6$  inches. This is somewhat more liberal core design than given in the foregoing table, but will make the required turns per volt a little lower, and the transformer efficiency a little higher. It will also change some of the other values slightly, but they are all close enough for practical purposes, whether taken from the table or the chart.

To find the turns per volt, locate the core area or 6, on the bottom line of figures and run vertically up to curve T, and then horizontally over to the left column of figures, and we find 1.4 turns per volt.

Then multiply this figure by the primary voltage to determine the number of primary turns, and by the desired secondary voltage to determine the secondary turns. If the primary voltage is 110 volts, then  $1.4 \times 110$  equal 154 turns. If the desired secondary voltage is 10, then  $1.4 \times 10 = 14$  turns for the secondary.

The primary current at 500 V.A. will be  $500 \div 110$  or 4.5 amperes. Assuming that this transformer is only intended for intermittent duty, and allowing 600 C.M. per ampere, we find that  $600 \times 4.5 = 2700$  C.M. wire area required. From a wire table we find that a #15 wire is suitable.

The secondary full load current would be  $500 \div 10 = 50$  amperes. Then  $50 \times 600 = 30,000$  C.M. this would require a #5 wire, or two #8 wires in parallel for better flexibility than the heavy wire.

Values for transformers of other sizes such as 50, 100, 250, 750, or 1000 volt-amperes, and any primary or secondary voltages can easily be determined from this same chart and the simple rules and calculations in the foregoing example.

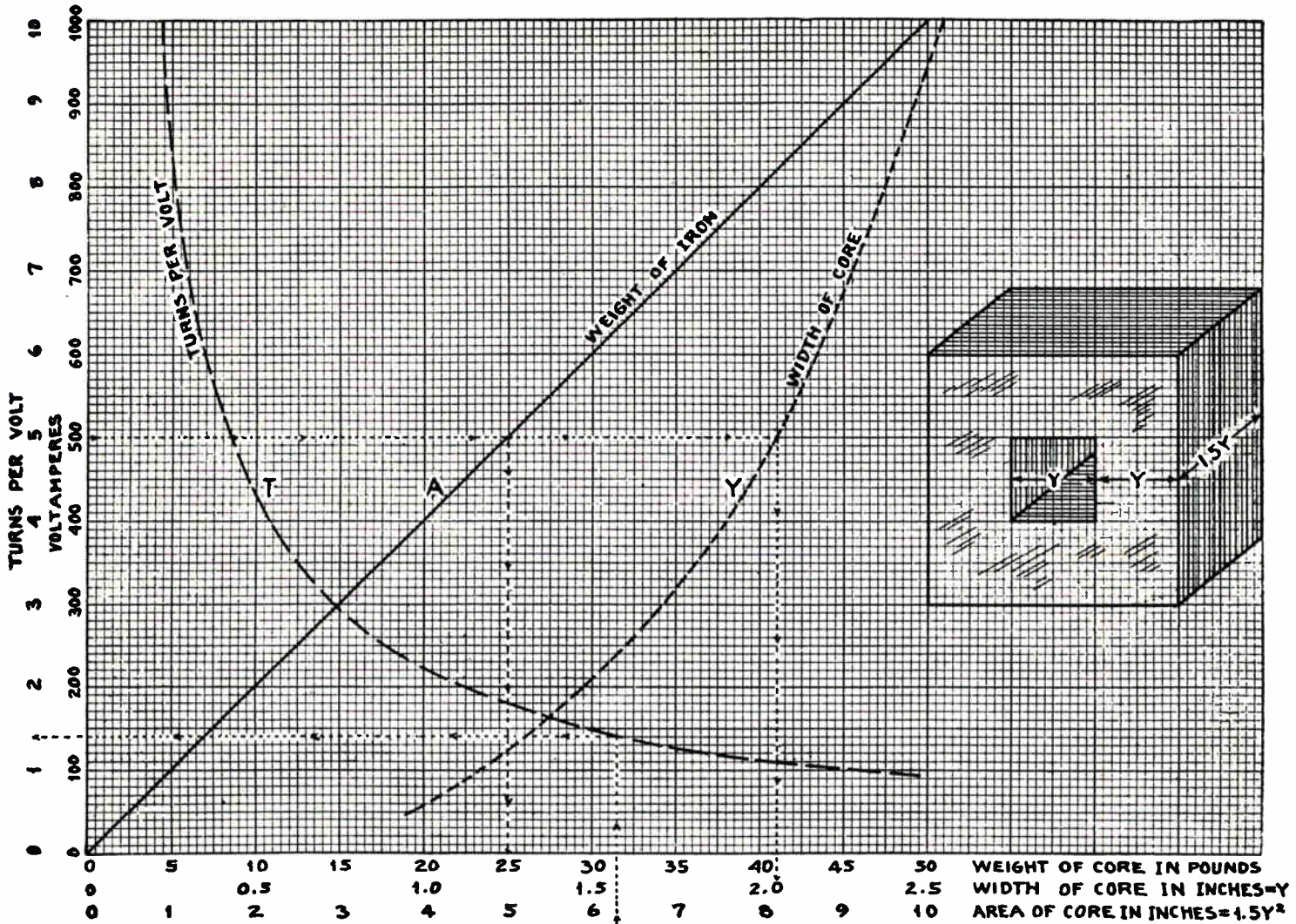

Fig. 153-A. Transformer design chart.

163-A. TRANSFORMER FORMULAS

The following data and formulas may at times be very convenient for designing transformers of other sizes than those for which the data has been given in the accompanying table and chart.

As previously mentioned, the size of a transformer core as well as the size of wire in the primary, depends on the wattage or volt-ampere rating. The primary wattage also has a bearing on the "volts per turn" of wire in the primary.

It is often desirable to have two or more separate secondary windings on a transformer, for obtaining different voltages and different amounts of current. In this case, the primary wattage can be determined by adding up the wattages of all secondaries and then adding about 10% more for losses in the transformer.

After the primary wattage has been determined, the volts per turn can be found by the formula:

$$E = \frac{\sqrt{W_p}}{50} \text{ for 60 cycle transformer of the plain "core type," or}$$

$$E = \frac{W_p}{83} \text{ for 25 cycle transformers of the plain "core type," or}$$

$$E = \frac{W_p}{25} \text{ for 60 cycle transformers of the shell "core type," or}$$

$$E = \frac{W_p}{41} \text{ for 25 cycle transformers of the shell "core type."}$$

In these formulas:

E=volts per turn  
Wp=primary watts

The figures 50, 83, 25 and 41 are constants which have been worked out for your convenience, and to simplify the formulas.

As the "turns per volt" is often only a fraction, it is convenient to change this factor to "volts per turn" by simply inverting the fraction.

For example, if the volts per turn should be 1/6, then the turns per volt would be 6.

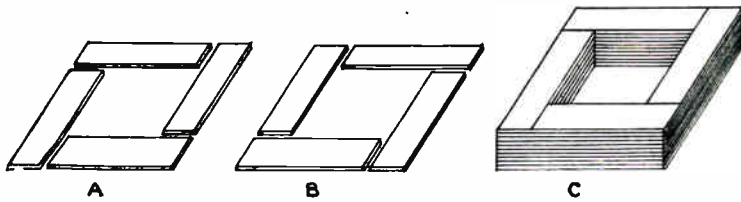

Fig. 153-B. A core type transformer core may be constructed with alternate layers of laminations as shown above.

After finding the turns per volt, the required number of turns for either the primary or secondary winding can be found by simply multiplying the turns per volt by the voltage to be applied to the primary, or the induced voltage desired in the secondary.

In other words:— $N = V \times Tv$ .

In which  $N$ =number of turns

$V$ =voltage across the coil

$Tv$ =turns per volt.

The full load current of either winding can be determined by dividing its wattage rating by its voltage. Then the size of wire for either winding can be determined by multiplying the current in amperes by 600 to 800 C.M. for small well ventilated transformers, or those for intermittent duty; or by 1000 to 1200 C.M. for larger transformers with deeper windings, and for continuous duty.

The area of the core can be determined from the formula:—

$$A = \frac{E \times 100,000,000}{4.44 \times F \times B}$$

In which

$A$ =area of core in sq. in.

$E$ =volts per turn

100,000,000=number of lines of force to cut in one sec. to produce one volt.

4.44=a predetermined constant

$F$ =frequency of primary supply

$B$ =number of lines for force per sq. inch.

Allowing 50,000 lines of flux per square inch of core as previously mentioned, if we work out this formula for a 60 cycle transformer it becomes:

$$A = \frac{E \times 100,000,000}{13,320,000}, \text{ or } A = E \times 7.5$$

For 25 cycle frequency the formula becomes:

$$A = \frac{E \times 100,000,000}{5,550,000}, \text{ or } A = E \times 18$$

These formulas have been first given in full, and then reduced down, in order to show you the factors involved and to simplify the final formula for your use in designing transformers. With a little practice you should find it quite easy to determine core and winding data for various transformers by the use of the foregoing formulas.

### 163-B. GENERAL INFORMATION ON TRANSFORMER CONSTRUCTION

When we refer to core area, we mean the area of one leg only, or the area of the magnetic path at any point in its circuit.

The required area can be obtained by stacking laminations to form a square core, or a core  $1\frac{1}{2}$  to 2 times as deep as it is wide, or other rectangular shapes.

The length of the core sides should be kept as short as possible and still allow the proper sized window or center opening to accommodate the windings. The shorter the core or magnetic path, the better will be the regulation of the transformer, but one must be careful not to get the window too small.

The required window size can be determined by taking the wire diameter (including insulation) from a wire table, and then calculating the number of turns per sq. inch, and allow a little extra space for insulation of the coil layers. On many small transformers the window size need not be any larger than the area of the core leg, but on other transformers for high voltages, the window may need to be two or three times the core area.

Transformers will be more efficient if only thin good grade laminations are used. No. 26 or No. 28 gauge are generally best for small units.

When assembling the core laminations, be sure to carefully lap the joints as shown at C in Fig. 153-B, so that the magnetic leakage and reluctance will be kept as low as possible.

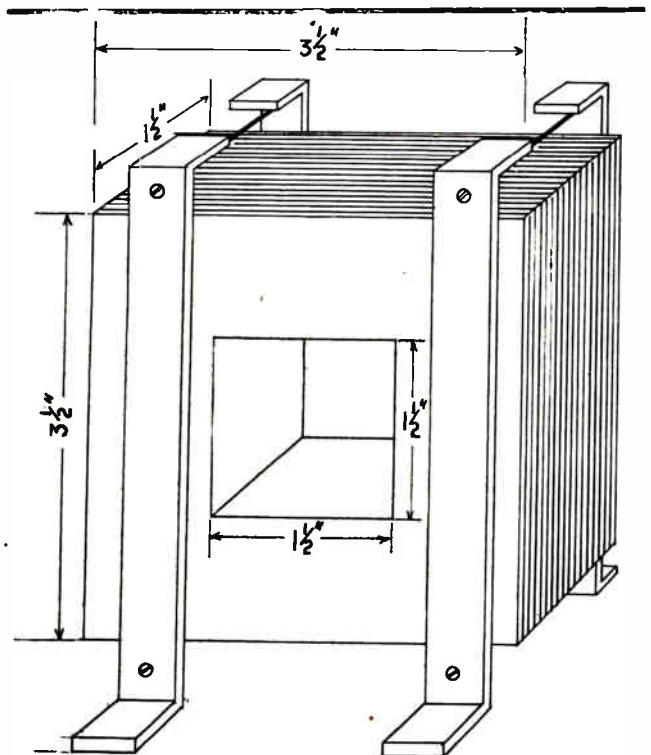

Fig. 153-C. A 50 w. transformer core constructed from strips  $1\frac{1}{2} \times 2\frac{1}{2}$ ". Note the method of binding the strips together.

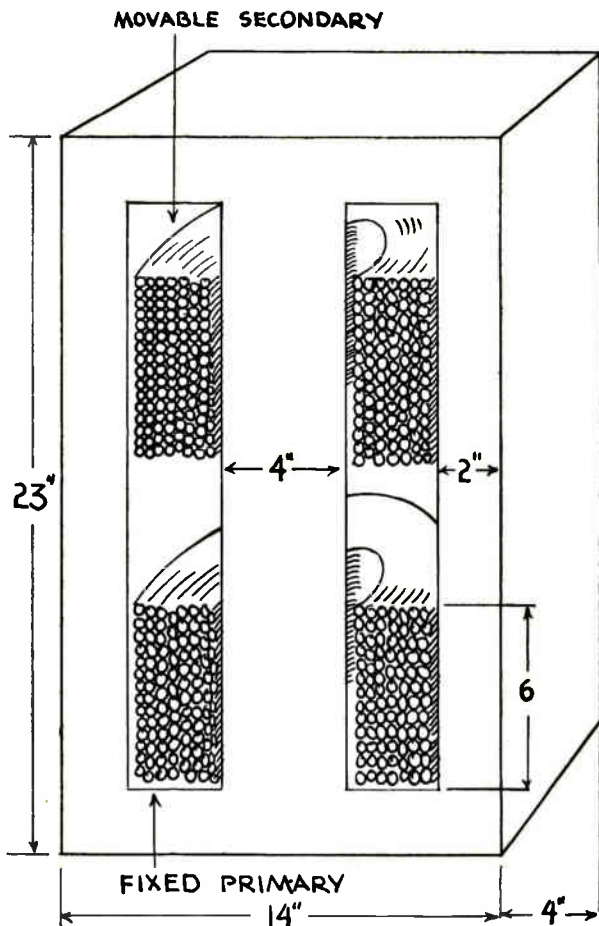

Fig. 153-D. A 10 Kv-a. welding transformer designed for operation on a 220 volt line.

If old laminations are used, they should be cleaned, but be careful not to scrape the oxide film or insulation from them, as each lamination should be insulated from adjacent ones to keep down eddy currents. For this same reason, care should be taken not to leave rough or burred edges on the laminations.

When preparing to clamp the laminations, it is best to use clamps and external bolts as shown in Fig. 153-C, rather than to drill holes through the laminations and possibly short them together.

When using old core laminations, if their coating of oxide or varnish has been destroyed they can be coated with a thin insulating varnish.

For the best efficiency, the copper and core losses should be about equal.

In arranging the windings on the core, the primary and secondary coils may be placed on opposite legs of the core, or they can be placed one over the other on the same core leg. The closer they are together, the better will be the regulation of the transformer.

If several different voltages are to be obtained from the secondary, several separate windings can be used, or the secondary winding can be tapped at proper points and individual leads brought out for the different voltages.

If the current load is to be different on the various sections of the secondary, then they are commonly wound separately and should use different sizes of wire according to their load in amperes. For example, we might have one secondary winding of 5000 turns of No. 30 wire, and another of 3 turns of 0000 cable on the same transformer.

When windings are placed one over the other on the same core leg, the lower voltage winding is often placed next to the core because of less difficulty in insulating it from the core. This is not always the case, however.

Windings should be carefully insulated from the core, preferably with a fibre spool, or at least with a wrapping of several layers of heavy oiled paper or tape. Fibre end collars help to hold the wires in place in the coil layers, and also insulate them from the core.

Each layer of wire should be wound neatly and evenly, avoiding crossed wires as they tend to cut through their insulation and short circuit if pressed too tightly together.

Each layer should be insulated from the others by a layer of oiled paper or varnished cloth. Great care should be used to prevent end turns of one layer dropping down near the turns of layers deeper in the winding as this will generally result in a short circuit and cause the entire winding to fail and necessitate rewinding. This is particularly true on high voltage windings. End turns can be held securely in place by placing short pieces of thin tape under the last several turns and then folding the free ends of the tape back over these turns and binding them down with the next layer.

Starting and finish leads of each coil should be protected and anchored by covering with spaghetti tubing several turns into the coil to prevent their being broken off. On windings using very small wires, short pieces of heavier wire are often soldered on at the ends and used for the several end turns, being well bound into the coil to relieve the small wires of any strain.

Don't skimp on insulation, or it will frequently result in breakdowns or shorts, and necessitate complete rewinding. On the other hand, don't pile up unnecessarily thick layers of insulation, as these tend to prevent the escape of heat to the outside of the winding and may cause hot spots. Mica is very good insulation for the core, and for high voltage windings.

Magnet wire for transformer winding is generally insulated with one or two layers of cotton, and sometimes a layer of thin enamel of high dielectric strength to prevent voltage breakdown or puncture.

The cotton affords good mechanical protection to the enamel as well as some added insulation value.

Where the wires are fairly large, or with smaller wires that are machine wound, plain enameled wire is sometimes used. This makes possible a

very compact winding, and permits very free flow of heat to the outside of the winding. Cotton is much more of a heat insulator than is enamel.

After a winding is completed, it should be covered with one or two layers of tape, cloth or paper and shellaced or varnished for mechanical protection to the wires, for neater appearance and to keep moisture and dirt out of the windings.

When convenient, it is often well to dip finished transformer coils in hot insulating wax or compound, to exclude moisture and to bind the turns more securely in place.

When winding coils, a wooden form just slightly larger than the core leg makes a convenient coil form. Slightly tapering this form, and wrapping with a layer or two of waxed paper makes it easier to remove the finished coil. Winding a layer of cord on the form first, and then pulling out this cord also simplifies removing the finished coil.

When repairing or rewinding damaged transformers, always observe and carefully record the size of wire, number of turns, and the grade and amount of insulation removed so you can duplicate them in the new winding.

Careful workmanship and liberal or safe design allowances, on size of core and wire, and on insulation should enable you to do many profitable and satisfactory transformer construction or repair jobs. Building one or more small transformer is well worth the cost of time and materials just for the experience and confidence it will give you.

### 163-C. WELDING TRANSFORMERS

A practical arc welding transformer can be built with a core such as shown in Fig. 153-D, using about 220 lbs. of iron, and 86 turns of No. 3 wire on the primary, and 45 turns on No. 1 wire on the secondary.

This unit is for operation on 220 volts, and is capable of supplying secondary currents up to 200 amperes.

Square wire should be used in these windings if possible to avoid waste space between turns. The layers of the winding should be spaced with  $\frac{1}{8}$ " wood strips to permit ventilation. The secondary coil should be arranged so it can be moved up or down on the core leg to permit varying the welding current for different jobs.

Such a transformer can also be used for thawing out frozen pipes, by connecting its secondary leads to a length of frozen pipe, and adjusting the current to warm the pipe, but not to overheat it.

### 163-D. BELL RINGING OR TEST TRANSFORMER

A practical 50W transformer may be constructed with core dimensions shown in Fig. 153-C, but for experience, let us work out the design from the information just covered.

Our first step is to determine the size of window opening necessary for the primary and secondary

coils. So by referring to the table on page 39, we find that a 50W transformer primary should have 530 turns of No. 23 wire. The number of secondary turns will be found by multiplying the desired voltage by 4.8 (the number of turns per volt shown in the table.) Assuming that we desire a 12 volt secondary, we multiply 12 by 4.8 and obtain 57.6, (use 58) as the number of turns necessary.

The secondary current is found according to Watts law by dividing Watts which in this case is 50 by the volts. So the secondary current will be  $50 \div 12$  or  $4 +$  amperes.

We have learned that for intermittent use 600 C.M. per ampere is required. Therefore,  $600 \text{ C.M.} \times 4 \text{ amperes} = 2400 \text{ C.M.}$  Referring to a wire chart, we find that No. 16 wire has a circular mill area of 2583 which should be ample.

The winding space may be determined by referring to Fig. 13, Armature Winding Section 1. The chart shows that 1" will take 1293 turns of #23 wire so  $\frac{1}{2}$ " will be ample for 530 turns. Number 16 requires 1" for 282 turns, so 58 turns will require about .3 of one inch. Adding .5" and .3", we obtain .8" or less than one inch actual winding space, but since we must allow for insulation, a window of 1" square would be rather crowded. In order to insure having plenty of room, let us use a window opening  $1\frac{1}{2}" \times 1\frac{1}{2}"$ .

The length of the laminations will be equal to the length of the window, plus the width of the laminations. In this case, the window length of  $1\frac{1}{2}" \times 1"$ , (the width of the laminations) gives us a lamination length of  $2\frac{1}{2}"$ .

The chart in Fig. 153-A shows that about  $2\frac{1}{2}$  lbs. of iron will be required. The amount of wire may be estimated by multiplying the number of turns by the average length per turn, and then referring to wire charts which show the number of ft. per pound. In this case,  $\frac{1}{2}$  lb. of #23 will be ample for the primary, and about 4 oz. of #16 will be required for the secondary.

The core may be stacked with alternate layers as shown by Fig. 153-B, A and B. The first layer may be arranged as at A and the second layer as at B, the third as at A, etc. This arrangement breaks joints so that the completed core may be bound rigidly together as shown at C.

After the core is assembled, three sides should be temporarily bound together with tape, and the remaining side should be removed so that the coils may be placed on the core.

After the core legs are insulated, and the coils placed on the core, the strips may be replaced and the completed core may then be permanently bolted together with strips of wood, or pieces of strap iron or angle iron. A piece of insulating material such as fibre or wood should be attached to the core to make a mounting base for the terminals. The secondary coil may be tapped at the 29th turn to provide 6 volts.







# COYNE

## *Electrical School*

CHICAGO ~ ~ ILLINOIS



ESTABLISHED 1899

COPYRIGHT 1942

# ALTERNATING CURRENT POWER AND A. C. POWER MACHINES

## *Section Five*

### **Alternating Current Motors**

**Types, Construction, Principles, Characteristics**

**Single Phase and Polyphase Motors**

**Squirrel-Cage Induction Motors, Slip Ring Motors,**

**Synchronous Motors**

**Special Motors**

**Power Factor Correction**

**Proper Selection and Loading of A. C. Motors**

**Static Condensers, Synchronous Condensers**

**Power Factor Correction Problems**

**Calculation of Condenser Sizes**

## ALTERNATING CURRENT MOTORS

By far the greatest part of all the electrical energy generated is used for power purposes, and most of this mechanical power is developed by alternating current motors.

A. C. motors are made in sizes from 1/1000 h. p. and less, up to 60,000 h. p. and over, and they can be built even larger if any need for more powerful motors arises.

A. C. motors are made to meet almost every conceivable need and condition in the driving of machinery and equipment of all kinds. Some of the latest type A. C. motors are designed to produce excellent starting torque and give a wide range of speed control, and many other desirable characteristics which it was formerly thought possible to obtain only with D. C. motors.

**Alternating current motors have the advantage of practically constant speed; and the A. C. squirrel-cage induction motor, which is the most commonly used type, has no commutator or brushes and therefore eliminates all sparking and fire hazard and reduces the number of wearing parts.**

A. C. motors are quiet, safe, and efficient in operation, and very convenient to control, and are therefore an ideal type of power device. An operator can start or stop a unit of several thousand h. p. by merely pressing a button of an automatic remote controller such as is used with many large A. C. motors.

A. C. electric motors are rapidly replacing steam and gas engines and other forms of power in older factories; and practically all new factories, mills, and industrial plants are completely operated by electric motors. Millions of A. C. motors are in use in machine shops, wood working shops, saw mills, automobile factories, and industrial plants of all kinds.

Fig. 154 shows a group of A. C. motors driving machines in a textile mill, and Fig. 155 shows two large motor-driven planers in a wood working plant.

Motor installation and maintenance provides one of the greatest fields of opportunity in the entire electrical industry, for trained men to cash in on their knowledge in interesting and good paying work.

### 164. TYPES OF A. C. MOTORS

Alternating current motors are made in a number of styles or types, depending upon the class of service and type of power supply they are intended for. The most common of these are the repulsion, induction, and synchronous types.

Repulsion motors are used on single-phase circuits only, but induction and synchronous motors are made in single-phase, two-phase, and three-phase types.

Single-phase motors are most commonly made in

sizes from 1/2 to 10 h. p., although in a few cases larger ones are used. They are usually wound for circuits of 110, 220 or 440 volts.

Two-phase motors are still in use to some extent in a few older plants and factories, but the great majority of A. C. motors are three-phase. Three-phase motors are commonly made in sizes from 1/2 h. p. to several thousand h. p. each, and can be made as large as any present requirements demand.

Fig. 156 shows a 3000-h. p., A. C. induction motor in use in a modern steel mill. The control panel is shown at the left of the motor.

### 165. VOLTAGE RATINGS AND SPEEDS

The majority of three-phase motors are operated at 220, 440 and 550 volts, but many of the larger ones of several hundred h. p. and up, are designed for voltages of 1100, 2300, and up to 12,000 volts.

Medium-sized A. C. motors are commonly made to operate at speeds ranging from 900 to 3600 R.P.M. and very large motors operate at lower speeds, from 200 to 600 R.P.M. Very small single-phase motors of the repulsion or series universal type are made to operate at speeds from 4000 to 12,000 R.P.M.

Power motors of the higher speed types develop more h. p. for a given size than the low speed motors.

### 166. CONSTRUCTION FEATURES AND GENERAL PRINCIPLES

A. C. motors are also made with various types of open and enclosed frames, to adapt them to uses in different locations and under various conditions.

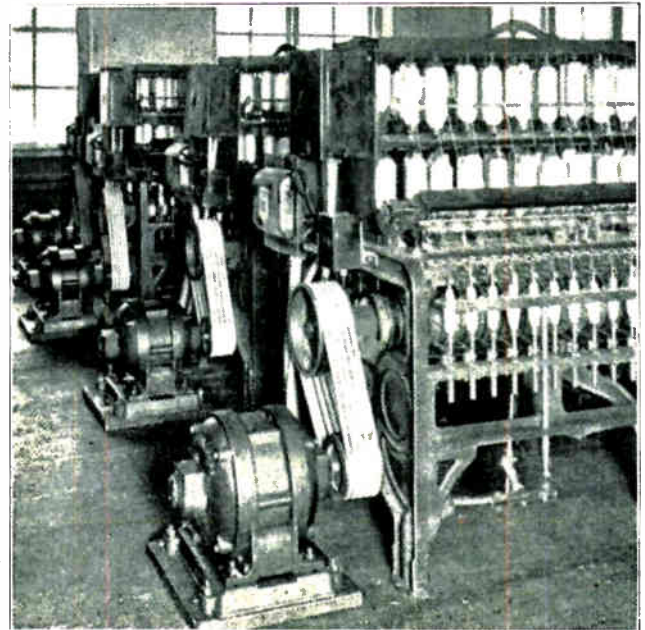

Fig. 154. This photo shows a group of machines in a textile mill, each of which is driven by an individual A. C. motor.

Fig. 157 shows a 5-h. p., three-phase, 220-volt, induction motor of a common type, such as is used by the tens of thousands in this country for turning the wheels of industry.

Fig. 158 shows an A. C. motor with an enclosed-type frame, which keeps all dust and dirt from its windings.

The constructional features and general operating principles of A. C. motors have been covered in this Reference Set in Section Two of Armature Winding, and so they need not be repeated in detail here. It will be a very good plan for you to carefully review Articles 66 to 75 inclusive and to re-examine Figs. 45 to 57 in Section Two of Armature Winding, and get these points well in mind again before proceeding further with this section.

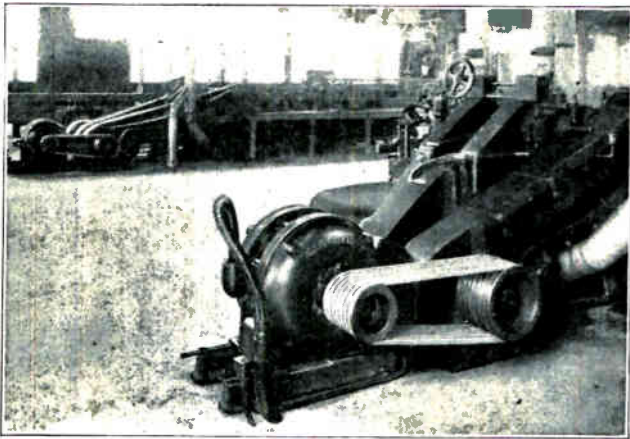

Fig. 155. An A. C. induction motor in use for driving a woodworking machine. The motor is connected to the machine by means of a special rope drive. (Photo courtesy Allis-Chalmers Mfg. Co.)

You have already learned that the principal parts of ordinary A. C. induction motors are the stator and rotor.

You will recall that the stator is commonly connected to the line and receives alternating current which sets up a revolving magnetic field around the inside of the stator winding. This revolving flux cuts across the bars or windings of the rotor, inducing a secondary current in them, and the reaction between the flux of the rotor currents and that of the revolving stator field produces the turning force or motor torque.

Fig. 159 shows the stator of an A. C. induction motor, and Fig. 160 shows a squirrel-cage rotor for the same type motor. Fig. 161 shows a sectional view of an induction motor, with the rotor in place inside the stator core.

Some A. C. induction motors have wire windings on their rotors, instead of bars such as are used on squirrel-cage rotors. These wire-wound rotors are called phase-wound rotors and will be explained in later paragraphs.

### 167. MOTOR CHARACTERISTICS

Each of the different types of A. C. motors has certain different characteristics with respect to their

starting torque, load "pull out" torque, speed regulation, power factor, efficiency, etc. It is very important for you to know these different characteristics and to be able to compare them for various motors, so you will be able to select the proper motors for the various power drives and applications you may encounter on the job.

Some of these motor characteristics you are already familiar with from your study of D. C. motors; while others apply only to A. C. motors and are covered for the first time in this section.

Motor characteristics depend largely on their design, and therefore the characteristics of any certain type of motor can be varied considerably by the manufacturers. Motors are available in common types with the required characteristics for most any power need, and for special requirements the designers and manufacturers can build motors of just the proper type to fit the needs of most any job.

In the following pages we shall take up each common type of A. C. motor separately, and thoroughly explain its principles, characteristics, and applications.

Before doing this, however, there are a few general terms and expressions which apply to all A. C. motors and with which you should be familiar. These terms will be frequently used in explaining the various motors, and if you will carefully familiarize yourself with them now, it will make the following material much easier to understand.

### 168. SYNCHRONOUS SPEED

The term synchronous speed as used in connection with A. C. motors refers to the speed in R.P.M. of the rotating magnetic field which is set up around the stator by the current supplied from the line.

Synchronous motors revolve at the same speed as the rotating magnetic field in their stators, and thus maintain constant speed as long as the frequency of the line current remains unchanged.

The speed of the rotating magnetic field of any A. C. motor and the operating speed of synchronous motors depend upon the frequency of the current on which they operate and the number of poles in their stator winding.

This synchronous speed can always be found by the simple formula:

$$S = \frac{120 \times f}{p}$$

In which:

S = synchronous speed in R.P.M.

f = frequency in cycles per sec.

p = number of poles in the motor.

120 = twice the number of seconds in one minute.

The constant 120 is used instead of 60 seconds per minute, because a pole of the rotor must pass one pair of poles during each cycle.

For example, if a four-pole motor is operated on

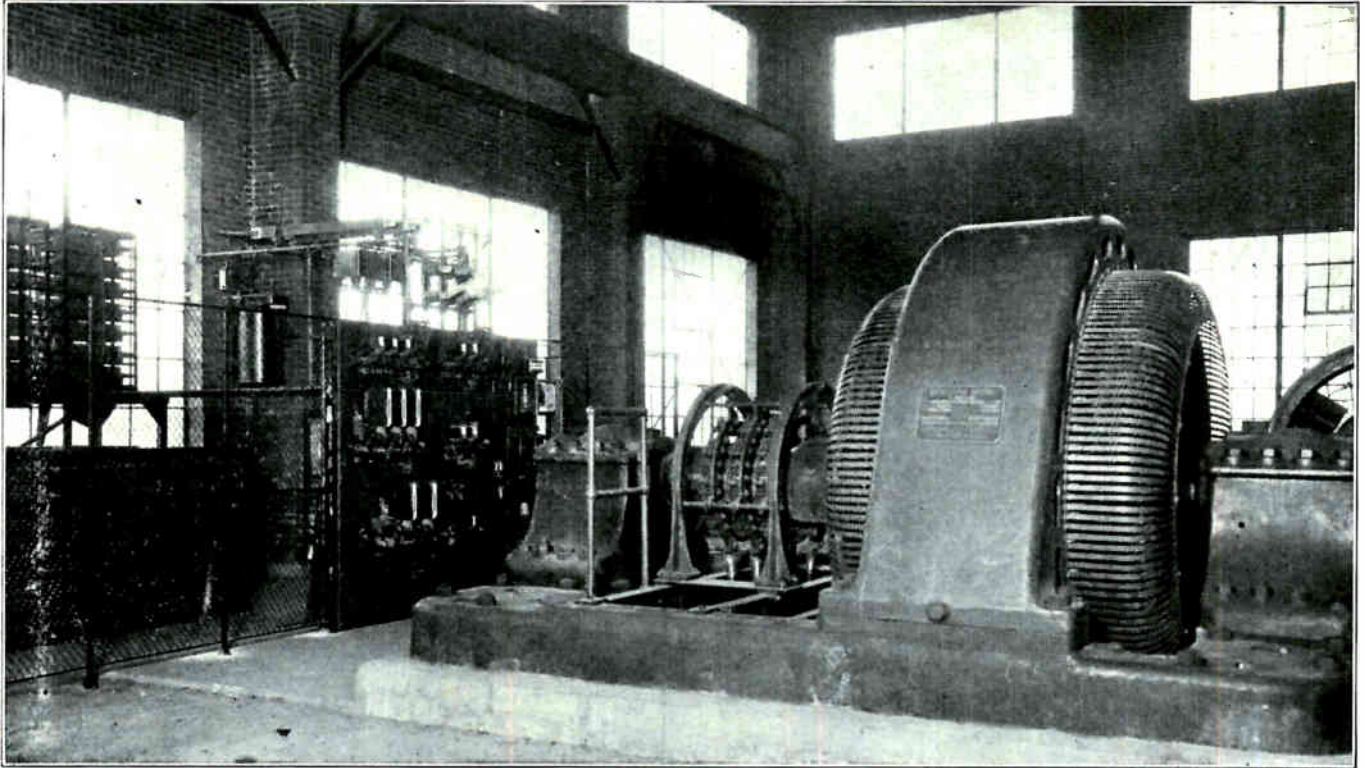

Fig. 156. This photo shows a 3000-h. p., 375 RPM, A. C. induction motor in use in a steel mill. Note the control panel and resistors for starting and speed regulation shown in the left of this view. (Photo Courtesy General Electric Co.)

a 60-cycle circuit, its synchronous speed will be:

$$S = \frac{120 \times 60}{4}, \text{ or } 1800 \text{ R.P.M.}$$

### 169. SLIP

A. C. induction motors never operate at exactly synchronous speed, as their rotors must always turn at slightly lower speed than the rotating magnetic field, in order that the lines of force will cut across the rotor conductors and induce the necessary current in them.

This difference between the actual operating speed of induction motors and the speed of their rotating magnetic fields is called the slip of the motor. The slip is generally expressed in per cent. of synchronous speed.

For example, if a six-pole induction motor is operated on a 60-cycle circuit, it will have a synchronous speed of 1200 R.P.M., but its actual speed when fully loaded is only 1140 R.P.M.

To find the per cent. slip, we can divide the amount of slip by the synchronous speed, or in the case of the motor just mentioned,  $1200 - 1140 = 60$

R.P.M. of slip, and  $\frac{60}{1200} = .05$ , or 5%, slip.

The slip of a motor will vary with the amount of load. Increasing the load causes the rotor to slow down a little and allows the magnetic field to cut across the rotor conductors more rapidly, and therefore develop in the rotor the increased amount of in-

duced current needed to maintain the added torque for the heavier load.

The slip of various induction motors usually ranges from 2 to 8 per cent., according to the size and type of motor and the amount of load connected to it. The larger motors have less slip than small ones do.

### 170. TORQUE: STARTING, FULL LOAD and PULL-OUT

You have already learned that the term torque applies to the twisting or turning effort developed by a motor. Torque is expressed and measured in

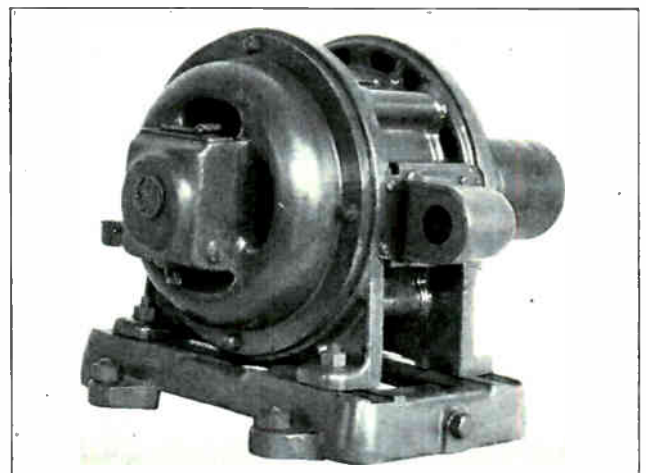

Fig. 157. Common type of 5-h. p. A. C. induction motor. Motors of this type are used by the thousands in factories and industrial plants throughout the country. (Photo courtesy General Elec. Co.)

pounds-feet; a torque of twenty pounds-feet being equal to a pull of 20 lbs. at a radius of one foot, or a pull of 10 lbs. at a radius of 2 feet, etc.

You have also learned that the important torque values to consider in selecting motors of proper characteristics, are: the starting torque, full load torque, and pull-out or stalling torque.

The full load torque of a motor is taken as a base and the starting and stalling torque are compared with it, and expressed as a certain percentage of the full load torque. For example, if a motor has a full load torque of 15 pounds-feet, and a starting torque of 30 pounds-feet, the starting torque is two times the full load torque, or 200%.

As the full load torque is used as a base for comparison, it is important to have some means of determining this torque. The full load torque of a motor can be found by the following formula.

$$T = \frac{5252 \times \text{H. P.}}{\text{R.P.M.}}$$

In which:

T = full load torque in pounds-feet.

5252 = constant.

H.P. = horse power rating of motor.

R.P.M. = motor speed in rev. per min.

As an illustration, if a 10 h. p. motor has a speed of 1800 R.P.M., its full load torque would be:

$$\frac{5252 \times 10}{1800}, \text{ or } 29.2 \text{ — pounds-feet}$$

The starting torque or turning effort exerted by a motor during starting is very important and should always be considered when selecting motors

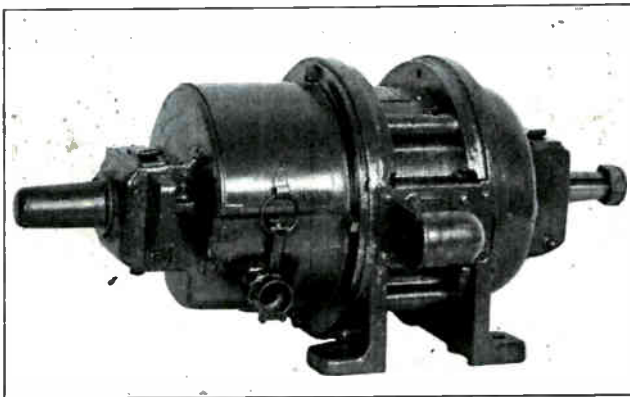

Fig. 158. A. C. induction motor with totally enclosed frame to keep out dust and dirt from the windings and also prevent fire and explosion hazard. (Photo courtesy General Electric Co.)

that are to start up under heavy loads. The starting torque of common induction motors will vary from 2 to 5 times the full load torque, according to the design of the motor and the amount of line voltage applied during starting.

The starting torque of an induction motor varies directly with the square of the applied voltage during starting.

The pull-out torque of a motor is the torque required to cause the motor to pull out of step with

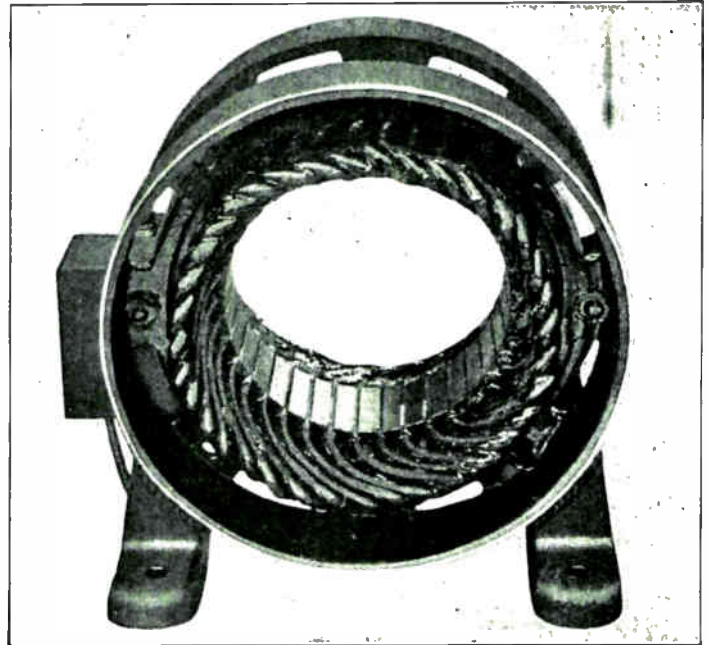

Fig. 159. This view shows a stator of an induction motor with the end shields and rotor removed. When A. C. is applied to the winding a revolving magnetic field is set up around the inside of the stator core.

the line frequency, slow down, and come to a complete stop if the overload which exceeds the pull-out torque is left on the machine. In other words, the pull-out torque expresses the ability of a motor to carry overloads without stalling.

The pull-out torque of common A. C. motors ranges from 1½ to 3 times full load torque.

The starting torque, full load torque, and pull-out torque of an A. C. motor can be found by means of the brake horse-power test which was explained in Articles 142 and 143 in Section Three of Direct Current Motors.

### 171. EFFICIENCY AND POWER FACTOR

As you have already learned, the efficiency of any motor is the ratio of its output to input, or

$$\text{eff.} = \frac{\text{Mech. h. p. output}}{\text{Elec. h. p. input}}$$

The mechanical h. p. output of any motor can be determined by means of the brake h. p. test, and the electrical h. p. input can be found by using a wattmeter or voltmeter, ammeter, and power factor indicator, and then dividing the watts by 746.

The efficiency of A. C. motors varies with their design and also with their size. The efficiency of common induction motors generally ranges from about 78% to 82% on motors of 1 to 5 h. p., and up to 90% or better on motors from 25 h. p. to several hundred h. p.

The efficiency of any A. C. motor is always higher when the motor is operated at or near full load, and becomes much lower when the motor is operated lightly loaded.

This is also true of the power factor of A. C.

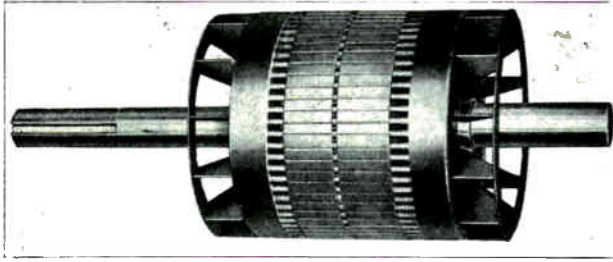

Fig. 160. Squirrel-cage rotor from an A. C. induction motor. Note the manner in which the bars are imbedded in the core slots and also note the ventilating fans at the ends of the rotor.

motors. The power factor of large motors is usually higher, ranging from 78% to 85% for motors of 1 to 5 h. p. to 93% for motors of 200 h. p. and up. **The power factor of an induction motor is much better when the motor is fully loaded, and is very poor when motors are operated lightly loaded or without any load.**

The method of determining the power factor of any A. C. machine or device was explained in Articles 36 to 41 of Section One on Alternating Current.

Very often in ordinary field problems, where approximate figures are all that are required, if the power factor and efficiency of certain motors are not known, they are both assumed to be about 80% for induction motors of 1 h. p. to 10 h. p., and about 88% for motors of 10 to 50 h. p.

Synchronous A. C. motors can be made to operate at 100% or unity power factor, or even at a leading power factor if desired, by properly exciting their D. C. fields. This will be explained in the section on synchronous motors.

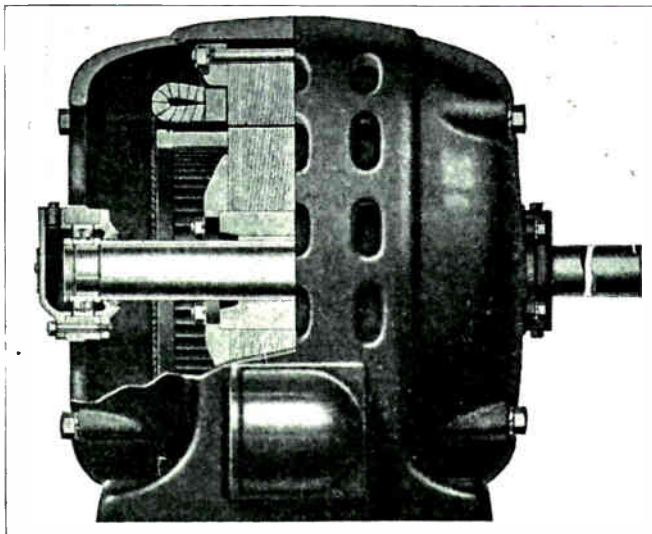

Fig. 161. Sectional view of a squirrel-cage induction motor showing the position of the rotor and bars with respect to the stator core and winding.

## 172. HORSEPOWER, VOLTAGE and FREQUENCY RATINGS

Motors as well as other electrical machinery have their load ratings or maximum output capacity determined by the heat developed in them. A. C. motors heat up due to copper losses and core losses,

as explained in the section on transformers. The horse power rating of any A. C. motor is the load it can carry continuously without overheating.

Unless otherwise specified, motors are usually rated at full load with a 40° C. rise in temperature. Most A. C. motors are designed to carry overloads of not over 25% for periods of 2 hrs. with a temperature rise not exceeding 55° C.

Nearly all modern motors have their h. p. ratings and temperature rise limits stated on their name-plates.

The voltage given on the name-plate of a motor is the proper voltage at which the motor should be operated. Practically all ordinary A. C. motors are designed to give full-load rating as long as the voltage does not vary more than 10% above or below normal, provided other conditions are normal.

A. C. motors will develop full rated h. p. on frequencies not exceeding 5% variation above or below the normal frequency for which they are designed, provided the voltage and other conditions are normal.

If the voltage and frequency of the line are both off normal, their combined variation should not exceed 10%.

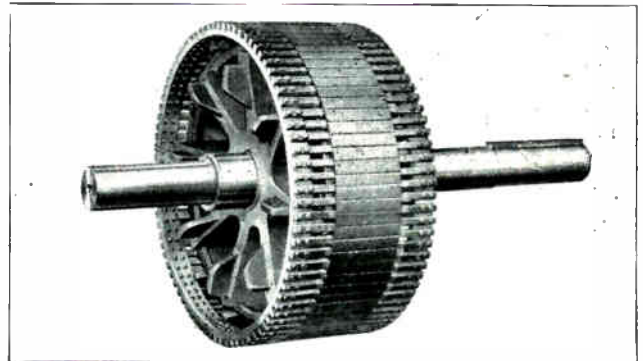

Fig. 161-A. This photo shows an excellent view of a squirrel-cage rotor using square bars which are riveted to heavy end rings.

## 173. CURRENT RATINGS

The name-plate current rating of an A. C. motor refers to the current required by the motor at full load. This current can also be found by placing an ammeter in any one of the line leads to the motor when it is operating at full load.

For example, a three-phase motor having a name-plate rating of 25 amperes should give an ammeter reading of 25 amperes in each of the three line leads to the motor, when operating at full load.

The approximate current of a three-phase motor can easily be determined by the following formula:

$$I = \frac{\text{h. p.} \times 431}{\text{eff.} \times \text{P. F.} \times \sqrt{3}}$$

This is a simplified formula used to shorten the working of such problems. The current can also be found by first converting the h. p. into watts and dividing this by the product of efficiency and power factor to get the apparent power; and then using

the three-phase current formula given in Article 45 of Section One on A. C.

The table in Fig. 162 gives the approximate currents for standard A. C. squirrel-cage induction motors of different h. p. and voltage ratings, and of single, two, and three-phase types.

Special squirrel-cage motors with high reactance rotors, and motors with phase-wound rotors may take from 1 to 5 amperes more than the current ratings given in the table for the same h. p. and voltage.

**174. SINGLE-PHASE MOTORS**

Single-phase motors are quite extensively used in small sizes, ranging from 1/4 h. p. or less to 10 h. p. for general purposes. Special single-phase motors for railway service are sometimes made as large as several hundred h. p., but for general industrial power purposes they are seldom made larger than 10 h. p.

Small single-phase motors from 1/8 to 1/2 h. p. find a very wide application in the operation of small power-driven machines in homes and small shops, where it is desirable to operate these devices from the ordinary single-phase lighting circuits.

Washing machines, electric ironers, oil burners, refrigerators, fans, pumps, drill presses, etc., are commonly driven by motors of this type.

Some idea of the great extent to which fractional h. p. single-phase motors are used can be obtained from the fact that several millions of new motors of this type are manufactured each year.

For operating machines or equipment requiring more than one h. p., it is seldom advisable to use single-phase motors if three-phase service is available, as the efficiency and power factor of single-phase machines is considerably lower than with

three-phase motors. For a given horse power, a single-phase motor must be considerably larger than a three-phase motor of the same rating.

Single-phase motors are made in several different types, the most common of which are: split-phase, repulsion, repulsion-induction, and series universal motors.

Another type sometimes used is known as the shaded-pole, single-phase, induction motor.

Straight single-phase motors can be made with just one winding in the stator, and a few of the older type motors were made this way. A motor of this type will not start itself, but if it is started by hand or by some other method, it will develop torque due to the reaction between the stator flux and the flux of the current induced in the rotor once it is started to turn.

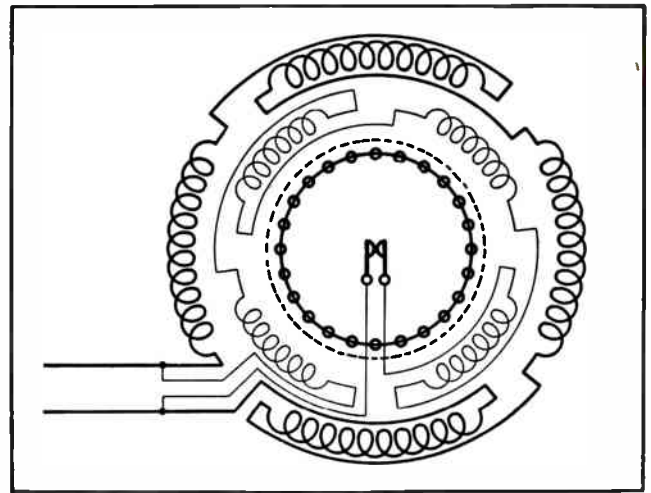

Fig. 163. This sketch shows the connections of the starting and running windings of a single-phase, split-phase A. C. motor.

**175. SPLIT-PHASE, SINGLE-PHASE MOTORS**

The split-phase principle is used to make single-phase motors self-starting and is in reality a simple method of obtaining a sort of polyphase winding and field.

One of the most common ways of obtaining this split-phase effect is by winding the stator with two sets of coils, the poles of which are displaced from each other by 90 electrical degrees. The main winding is known as the "running" winding, and the starting winding, which consists of fewer turns of smaller wire, is used only during the starting of the motor.

As soon as the motor is nearly up to speed, the starting winding is disconnected and cut out of service by a centrifugal switch, as explained in Articles 72 and 73 in Section Two of Armature Winding.

Fig. 163 shows a simple schematic diagram of a single-phase, split-phase induction motor. The running winding is shown by the heavy lines and the starting winding by the lighter lines. The squirrel-cage rotor is represented by the circular ends of the bars which are shown arranged in the circle in the center of the diagram and are all short-circuited

Approximate Currents taken by Standard Squirrel Cage Motors. (Full Load)															
SIZE OF MOTOR IN H. P.	110 Volts			220 Volts			440 Volts			550 Volts			2200 Volts		
	1 Ph	2 Ph	3 Ph	1 Ph	2 Ph	3 Ph	1 Ph	2 Ph	3 Ph	1 Ph	2 Ph	3 Ph	1 Ph	2 Ph	3 Ph
1/6	3.34			1.67											
1/4	4.8			2.4											
1/2	7	4.3	5	3.5	2.2	2.5	1.1	1.3		.9	1.				
3/4	9.4	4.7	5.4	4.7	2.4	2.8	1.2	1.4		1.0	1.1				
1	11.	5.7	6.6	5.5	2.9	3.3	1.4	1.7		1.2	1.3				
1 1/2	15.2	7.7	9.4	7.6	4.	4.7	2	2.4		1.6	2.				
2	20	10.4	12	10	5	6		3	3		2.	2.4			
3	28			14	8	9		4	4.5		3	4			
5	46			23	13	15		7	7.5		6	6			
7 1/2	68			34	19	22	17	9	11		7	9			
10	86			45	24	27	21.5	12	14		10	11			
15				33	38			16	19		13	15			
20				45	52			23	26		19	21			
25				55	64			28	32		22	26	6	7	
30				67	77			34	39		27	31	7	8	
40				88	101			44	51		35	40	9	10	
50				108	125			54	63		43	50	11	13	
60				129	149			65	75		52	60	13	15	
75				156	180			78	90		62	72	16	19	
100				212	246			106	123		85	98	22	25	
125				268	310			134	155		108	124	27	32	
150				311	360			155	180		124	144	31	36	
200				415	480			208	240		166	193	43	49	

Fig. 162. The above convenient table gives the approximate current per phase required by common squirrel-cage motors of different sizes and different voltages.



together by a ring. The dotted circle represents the air-gap or division between the stationary and rotating members of the machine.

### 176. SPLIT-PHASE MOTOR PRINCIPLES

You will recall from the explanation given in Section Two of Armature Winding that the current which flows in the starting winding of a split-phase motor is considerably out of phase with that in the running winding, because of the different amounts of inductance and resistance in these two windings.

This causes the maximum current and flux to occur in these poles a fraction of a second earlier than in the poles of the running winding and produces a sort of shifting or rotating magnetic field around the stator. This rotating flux cuts across the bars or windings in the rotor and induces in them a heavy secondary current at low voltage.

The reaction between the stator flux and the flux of the rotor currents sets up the starting torque required to rotate the motor and bring it up to speed. After the rotor is turning at full speed the split-phase effect and starting winding are not necessary, as the normal reaction between the flux of the moving rotor conductors and the alternating flux of the stator will then maintain the running torque.

The centrifugal switches of motors of this type are arranged with weighted contacts or segments which are thrown apart by centrifugal force when the motor reaches full speed. The contacts of these switches are connected in series with the starting winding, as shown in Fig. 163; so they keep this winding open-circuited as long as the motor continues to run at full speed.

When the motor is stopped or slows down below a certain speed, the centrifugal force on the switch elements is reduced and a spring causes the contacts to again close and bring the starting winding back into service.

### 177. ROTOR CONSTRUCTION

Fig. 164 shows the squirrel-cage rotor of a small single-phase motor, and also the centrifugal switch which is attached to the plate on the right-hand end of the rotor. The copper bars of the rotor shown in this view are imbedded in slots in the laminated rotor core. The narrow openings of these slots can be noted in the figure.

The bars are, of course, too large to be inserted

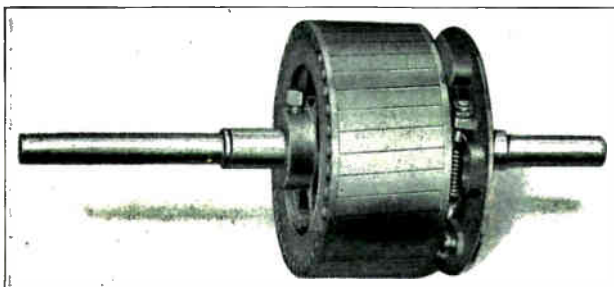

Fig. 164. Small squirrel-cage rotor such as used in single-phase induction motors. Note the centrifugal switch mechanism on the right end.

through these openings and are therefore inserted endwise through the slots. The end rings which short-circuit the bars to complete the closed circuits under each pole of the stator winding are shown fitted tightly to the sides of the laminated core. These end rings are securely attached to the bars by riveting the bar ends tightly into the holes in the rings or by brazing or soldering them in.

In some cases the squirrel-cage element complete, consisting of the bars and end rings, is cast from aluminum in one piece within the rotor core. On large squirrel-cage motors the bars are sometimes bolted or welded to the end rings.

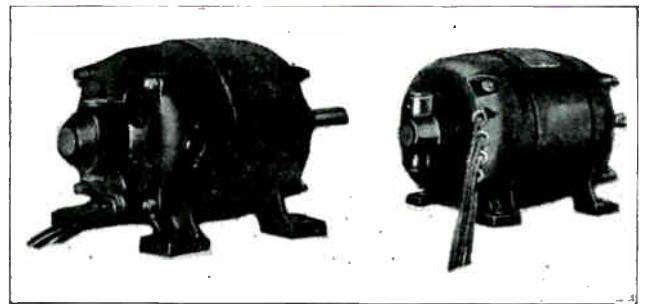

Fig. 165. Two small fractional h. p. A. C. motors of the single-phase, split-phase type. There are millions of A. C. motors of approximately this size in use today.

The bars of squirrel-cage rotors are usually not insulated from the slots, as the copper or aluminum from which the bars are made is of so much lower resistance than the core iron that the low-voltage induced currents practically all flow through the bars, because they afford the easier path. In some cases, however, the rotor bars are insulated with a layer of stiff paper around them.

Fig. 165 shows two common types of single-phase split-phase motors of fractional h. p. size. Note the four leads which are brought out of each of these motors, two of which are the leads to the starting winding and two to the running winding.

To reverse a split-phase motor of this type it is necessary to reverse either the starting winding or the running winding leads. Some single-phase motors have their windings arranged so the coils can be connected either in series or parallel for operation on either 110 or 220 volts, and motors of this type also have four leads brought out of the frame.

The standard direction of rotation is clockwise when the motor is viewed from the end on which the pulley is placed or the end which has the shaft extension for the pulley.

### 178. CONDENSER TYPE SPLIT-PHASE MOTORS

The split-phase principle can be applied to single-phase motors by the use of a condenser or an inductance placed in series with one section of the stator winding. The leading or lagging current which is set up in the circuit by the condenser or inductance produces the separation or split-phase

effect of the magnetic fields which occur in the different sections of the motor winding.

Figs. 166-A and B show two different methods used with split-phase motors of this type. These motors use a three-phase winding and depend upon the third wire from the condenser or inductance to supply current which is displaced in phase from that on either of the other two leads to the winding.

Another method which is quite often used with a later type of fractional h. p. single-phase motor is to use two windings displaced  $90^\circ$  from each other, one of which has a condenser connected in series with it. Both windings are left permanently connected to the line and the motor operates similarly to a two-phase motor.

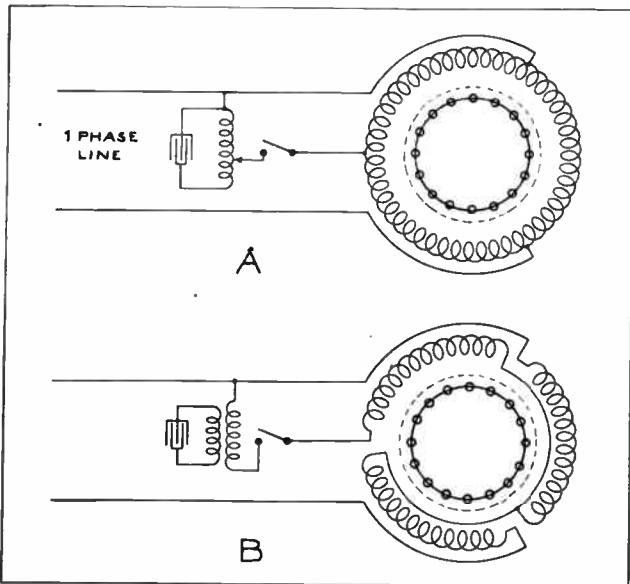

Fig. 166. The above two diagrams show the connections for two different types of single-phase, split-phase motors which use condensers and transformers to obtain the split phase currents for their stator windings.

This method entirely eliminates the use of the centrifugal switch. This is a particularly desirable feature, because the operation of motors equipped with centrifugal switches often causes considerable interference with radio receiving sets, when the

motors of such devices as oil burners, refrigerators, and washing machines are started and stopped.

By using the proper size of condenser the lagging current effects produced by the motor windings can be neutralized to quite an extent by the leading current produced by the condenser. In this manner it is possible to obtain with these new single-phase motors, much higher power factor than the older types have.

Fig. 167 shows a condenser-type motor for single-phase operation. This motor uses a polyphase winding and has a regular squirrel-cage rotor, both of which can be clearly seen in this disassembled view. The condenser is shown completely enclosed in the metal box on the right.

### 179. SHADED-POLE MOTORS

Another method of producing torque in a single-phase A. C. motor is by the use of shaded poles similar to those explained under A. C. induction meters in Article 68 of Section Two on Alternating Current.

Fig. 168-A shows a diagram of a 6-pole, single-phase motor of the shaded-pole type, and at B is illustrated the manner in which the shading coil distorts the magnetic flux of the main pole.

The shading coil consists of a small coil of a few turns of wire wound into a slot and around one side of the main pole. This coil is short-circuited, so that it always forms a complete circuit and acts as a secondary winding, receiving induced current from the flux of the main pole winding.

When the main winding is excited with A. C. it sets up a powerful alternating magnetic field which induces current in the rotor bars and also in the short-circuited shading coil. The induced current in the shading coil sets up a flux approximately  $90^\circ$  out of phase with that of the main winding.

The flux set up by the shading coil will therefore distort the flux of the main pole as shown at B in Fig. 168.

The reaction between these two magnetic fields which are out of phase with each other causes a

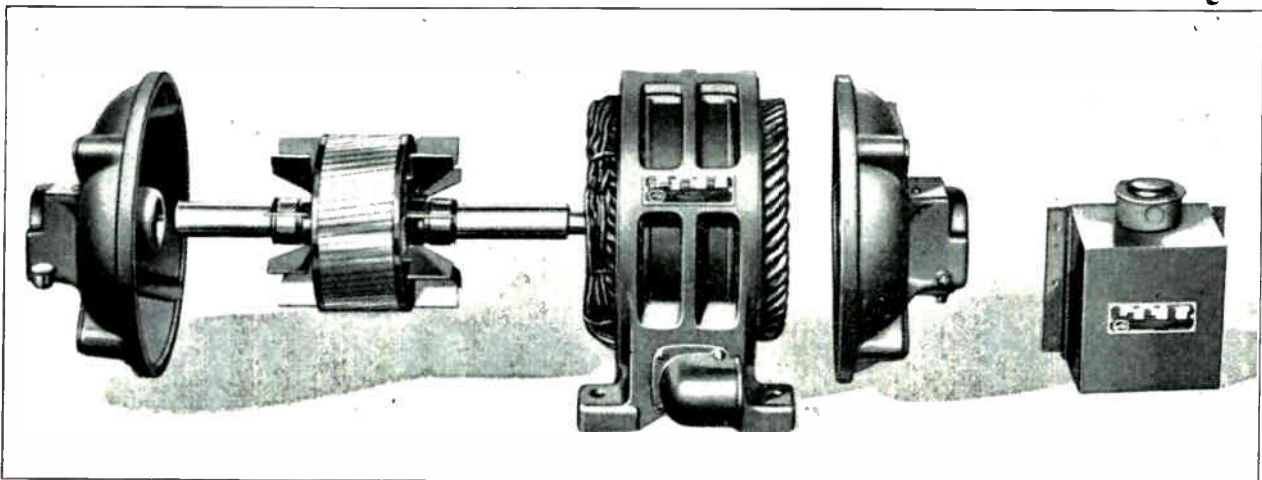

Fig. 167. This photo shows an excellent disassembled view of a squirrel-cage induction motor for single-phase operation and also the condenser by which it obtains the split phase currents for its stator winding.

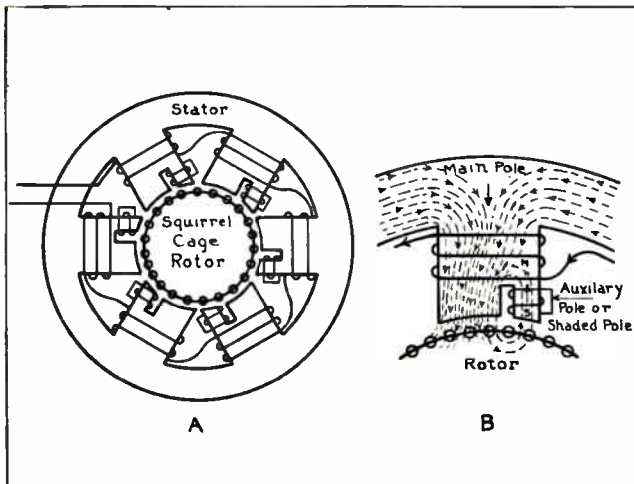

Fig. 168. The above two sketches show the construction and illustrate the principles of the shaded-pole type induction motor.

shifting flux across the face of the main poles, which produces a sort of rotating field effect.

This shifting or rotating field from the shaded stator poles reacts with the flux of the induced current in the rotor and sets up the torque required to operate the motor.

Motors of this type are self-starting and do not require any centrifugal switches or other circuit-breaking devices. They can be reversed by changing ends with the stator, that is by removing the stator, changing it end for end, and replacing it in the frame.

Shaded-pole motors are used in some electrical fans and for certain other devices requiring fractional horse power motors, but they are not used very often in larger sizes because of their rather low power factor and efficiency.

### 180. REPULSION MOTORS

Another type of single-phase motor very commonly used is the repulsion motor. This motor doesn't operate on the split-phase principle but obtains its torque by repulsion between definite poles induced in the rotor and the poles set up in the stator by the current supplied from the line.

Fig. 169 shows a simple diagram of a single-phase repulsion motor. The stator of this machine has only one winding, which is excited by alternating current from the line and sets up an alternating field or reversing magnetic poles in the stator.

The rotor, which is represented by the symbol for the commutator in Fig. 169, has a wire winding of the wave type similar to that used in D. C. motors. The brushes which rest on the commutator are short-circuited together so they form complete circuits through various sections of the armature winding.

The alternating flux set up by the stator winding induces secondary currents in the rotor or armature winding, and these currents flowing through the paths created by the commutator bars and shorted brushes set up definite alternating poles at certain points on the rotor.

Only two brushes are required with ordinary wave windings but four brushes are quite commonly used on motors of four poles. The two small sketches at the right in Fig. 169 show different methods of connecting the brushes for short-circuiting them together. In some cases the brushes are simply grounded to the frames or to a metal ring, as illustrated in the lower small sketch at the right in this figure.

The great majority of repulsion motors are made in the four-pole type, but a few of the two-pole and six-pole type are also made.

### 181. OPERATING PRINCIPLE

The location of the poles set up by the induced current in the rotor will depend upon the position in which the brushes are set. These brushes are located so that the centers of the induced rotor poles will be built up at a point a few electrical degrees to one side or the other of the center of the stator poles; and so that the polarity of the induced poles in the rotor will be the same as the polarity of the nearby stator pole.

The magnetic repulsion which takes place between these like poles which are only a few degrees apart from each other, will exert a strong turning force on the rotor and thus develop the torque required to operate the motor.

By shifting the brushes a short distance, the induced rotor pole can be set up on the opposite side of the stator pole and thus cause the motor to reverse its direction of rotation.

The speed of repulsion motors can also be varied widely by shifting the brushes so that the rotor poles are induced at a point closer to or farther away from the stator poles.

Repulsion motors produce very good starting torque and have fair efficiency and power factor.

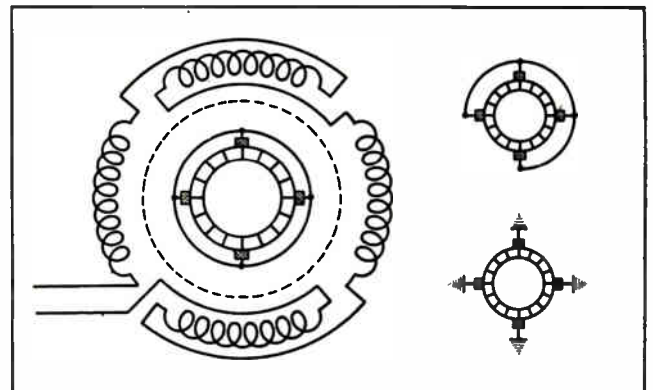

Fig. 169. This diagram shows the connections of the stator winding and brushes of a single-phase A. C. repulsion motor.

### 182. COMPENSATING WINDINGS

In some cases they are equipped with an auxiliary winding which is connected to an extra set of brushes and is known as a **compensating winding**. Fig. 170 shows the connections for the compensating winding of a motor of this type. The compensating winding is the one shown in lighter lines and is connected to brushes B and B-1. Brushes A

and A-1 are the main brushes which short-circuit the proper sections of the rotor winding to produce the regular motor torque.

The purpose of this compensating winding is to improve the power factor and stabilize the speed of the repulsion motor.

Repulsion motors are commonly made in sizes from fractional h. p. to 10 h. p. They, of course, have the disadvantage of requiring a commutator and brushes, which add extra wearing parts to the motor and at times cause a certain amount of sparking if they are not properly cared for.

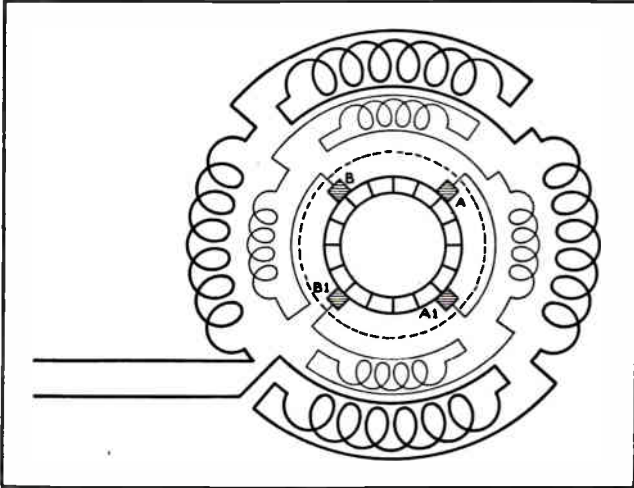

Fig. 170. Diagram of the connections for a repulsion motor with a compensating winding which improves the power factor of this type of machine.

Fig. 171 shows a disassembled view of a single-phase repulsion motor. Note the single-phase winding in the stator core and the typical D. C. armature winding on the rotor. The other parts shown are the end shields, bearing sleeves, rings, brush holders and ring, end-bracket bolts, brushes, and the rails upon which the motor frame is mounted for belt tightening adjustment.

### 183. REPULSION-INDUCTION MOTORS

Single-phase repulsion-induction motors are simply a combination of the repulsion and induction motor principles. A motor of this type starts as a repulsion motor and runs as an induction motor; thus, the name, repulsion-induction motor.

These motors have one winding in the stator and a wire-wound armature equipped with a commutator and brushes as shown in Fig. 172. During starting, the brushes rest on the commutator, thus short-circuiting only certain sections of the rotor winding, setting up like poles near the stator poles, and causing the repulsion torque, the same as the straight repulsion motor.

When the motor reaches nearly full speed a centrifugal device, shown at "A" in Fig. 172, short-circuits all the bars of the commutator together, thus shorting the entire rotor winding and making it act similarly to a squirrel-cage winding.

In some cases the centrifugal device also lifts the

starting brushes off the commutator to reduce the wear on the commutator and brushes while the machine is running normally.

After the commutator is shorted, the machine runs as an ordinary single-phase induction motor. In this manner, good starting torque and moderate starting current of the repulsion motor are obtained during starting of the load, and the motor when running operates with the constant speed characteristics of an induction motor.

By equipping these motors with a compensating winding, their power factor can be kept very high when operating at full speeds. Repulsion-induction motors will develop from  $2\frac{1}{2}$  to 5 times full load torque during starting and require only from about 2 to  $2\frac{1}{2}$  times full load current for starting.

### 184. SERIES OR UNIVERSAL A. C. MOTORS

If a motor has a wire-wound armature and a commutator of the D. C. type connected in series with its stator winding as shown in Fig. 173, and is then connected to a single-phase A. C. line, the motor will operate very much the same as a series D. C. motor. This is due to the fact that when the armature and stator are connected in series, the alternating current reverses in both of these windings at the same time, and causes the magnetic poles set up in the rotor and stator to also reverse at the same time, and thereby retain a fixed relation to each other at all times.

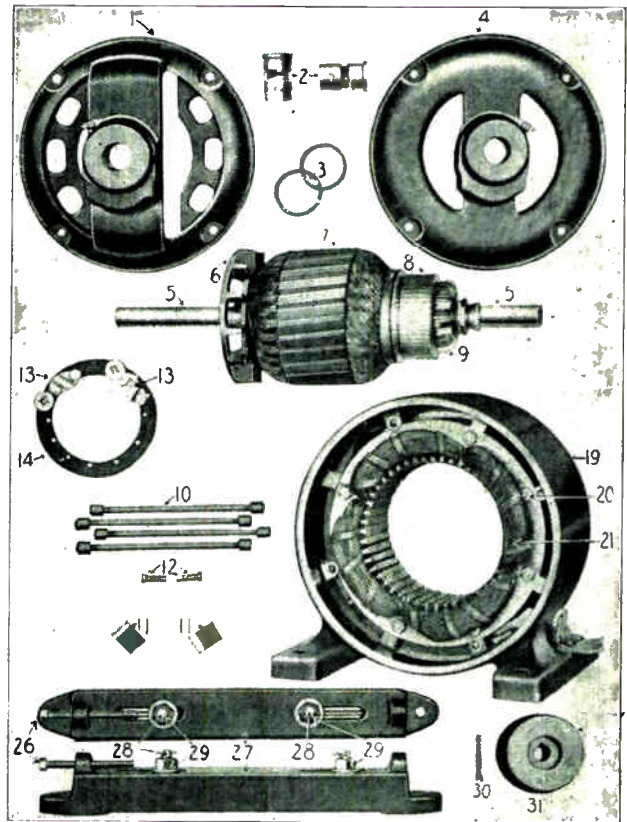

Fig. 171. Disassembled view showing important parts of an A. C. single-phase repulsion motor.

As an illustration: We know that if we reverse both the armature and field leads of a shunt D. C. motor, the machine will continue to operate in the same direction; so we can see that if the polarity of both the armature and field are reversed continually but always at the same time, the motor will continue to develop torque in one direction.

Small ordinary D. C. motors can be operated in this manner on single-phase alternating current, provided the field poles are of laminated construction so they don't overheat due to eddy currents when alternating current is applied.

It is because of the fact that this type of motor can be operated either on direct current or alternating current that it is very commonly called a universal motor.

A great many small, fractional horse power, universal motors are made for use with electric fans, household appliances, dentists' tools, and other equipment which may have to be changed from D. C. circuits to A. C. circuits.

The characteristics of series A. C. motors are very similar to those of D. C. series motors. The A. C. series motor will produce excellent starting torque but has very poor speed regulation.

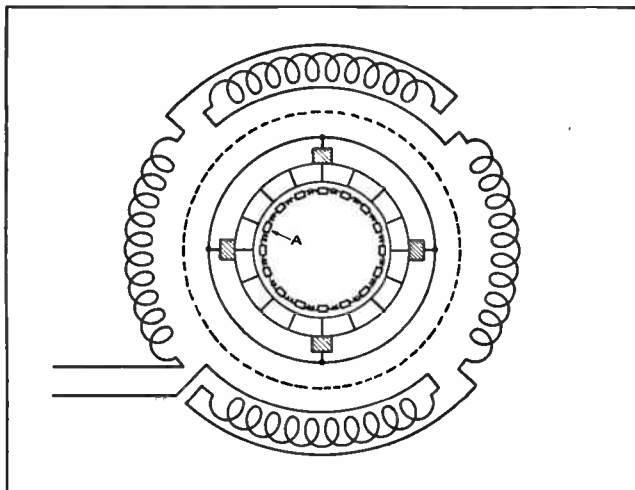

Fig. 172. This diagram shows the connections and arrangement of the short-circuiting device of a repulsion-induction motor. The short-circuiting mechanism at "A" lays around the inside of the commutator bars and short-circuits them all together when the machine comes up to speed.

The speed of these motors can be varied either by connecting a rheostat in series with them or by varying the applied voltage with an auto transformer.

Series A. C. motors of large sizes are quite commonly used in traction service on electrically-operated railway cars and locomotives.

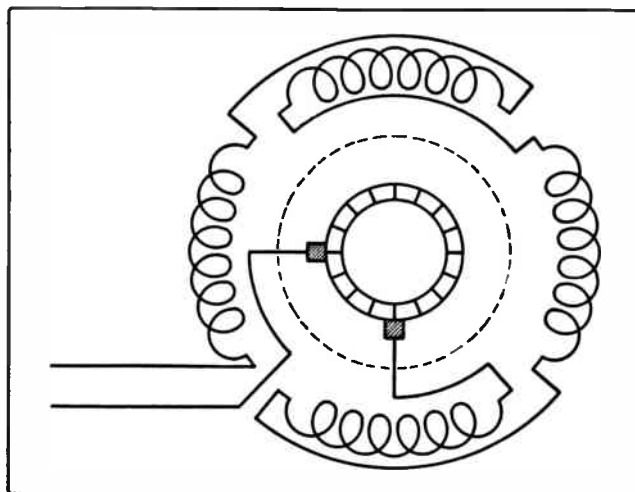

Fig. 173. Stator and armature connections for a series A. C. motor of the universal type which can be operated on either D. C. or A. C.

Besides having the necessary starting torque and speed variation range which are ideal for railway work, these motors possess the added advantage of being able to operate on either D. C. or A. C. trolleys.

For example, the New York, New Haven & Hartford Railroad have been using motors of this type for many years. Their trains are operated on alternating current when outside of New York City, and when within the city they operate from direct current.

## 185. STARTING SINGLE-PHASE MOTORS

Single-phase motors of fractional h. p. and those up to 2 h. p. are commonly started by connecting them directly across the line. Snap switches are generally used for starting those under  $\frac{1}{2}$  h. p., and small knife-switches of the enclosed safety type are used for starting those over  $\frac{1}{2}$  h. p.

Single-phase motors of 2 h. p. to 10 h. p. are often started with a simple starting-box of the resistance or inductance type, to reduce the starting voltage and prevent too heavy surges of starting current.

The use of starting boxes is particularly desirable where the motors are operated from circuits to which lights are connected, as otherwise the heavy starting currents may cause objectionable voltage drop and dimming of the lights.

Where the motors are operated from power circuits, even the largest single-phase motors are sometimes started directly across the line.

## POLYPHASE A. C. MOTORS

Polyphase A. C. motors are the most extensively used of any form of power device. They are made in a wide range of sizes from  $\frac{1}{2}$  h. p. up to thousands of h. p. each, and are designed to operate at speeds from less than 100 R.P.M. to 3600 R.P.M. on 60 cycles.

Polyphase motors are self-starting without the aid of auxiliary windings or centrifugal switches. The most commonly used type of polyphase motor has no commutator or brushes, and therefore has very few wearing parts and produces no sparking hazard.

Polyphase motors can be obtained to fit practically any class of drive or power need, and these are by far the most common type motor used for large power equipment. Fig. 174 shows a modern polyphase induction motor.

There are three general types of polyphase motors, known as: squirrel-cage induction motors, slip ring or phase-wound induction motors, and synchronous motors.

Any of these types can be obtained for either two or three-phase operation, but two-phase motors are not very extensively used any more.

### 186. OPERATING PRINCIPLES

The operating principles of both two and three-phase motors were explained and illustrated, Articles 74 and 75 of Section Two of Armature Winding, and before proceeding farther with this section you should carefully review these articles and Figs. 56 and 57 of Section Two on Armature Winding.

You will recall that the stator winding of a polyphase motor sets up a revolving magnetic field, which induces secondary currents in the rotor winding or bars. The reaction between the flux of the stator winding and the flux of this rotor current causes a smooth and powerful torque which turns the rotor.

By reviewing Article 74 of Section Two of Armature Winding, you will find that two-phase motors have two windings which are displaced 90 electrical degrees from each other in the stator core.

A simple method of representing the windings of a two-phase motor in electrical diagrams is shown in Fig. 175. The two small sketches in Fig. 175-B show the two-phase "mesh" or delta connection above, and the two-phase star connection below.

When two-phase motors are equipped with wound rotors, regular three-phase wound rotors are generally used. This eliminates the need for four collector rings, and the three-phase rotor winding works equally well on the induced current which it receives from the rotating magnetic field of the stator.

When the stator windings shown in Fig. 175-A are supplied with two-phase current, a rotating field is set up, as explained in Article 74, Section Two of Armature Winding. This rotating magnetic field will induce secondary currents in the squirrel-cage, or in wound rotor, whichever is used; and the reaction between the flux of the rotor currents and that of the stator field produces the motor torque.

The same squirrel-cage rotor can be used in either a two-phase or three-phase motor, provided they both have the same diameter of stator core opening.

Two-phase motors can be reversed by reversing the leads of either phase.

### 187. THREE-PHASE MOTORS

As three-phase energy is so convenient and economical for power transmission purposes and as it is also ideal for producing a uniform revolving field in polyphase motors, three-phase motors are by far the most commonly used of any type of electric motor for the heavier power needs.

In Section Two on Armature Winding we learned that the stators of three-phase motors have a uniform and continuous winding, to which the line leads are connected 120 electrical degrees apart.

Review carefully the manner in which these windings are arranged and connected for obtaining different numbers of poles, and also the manner in

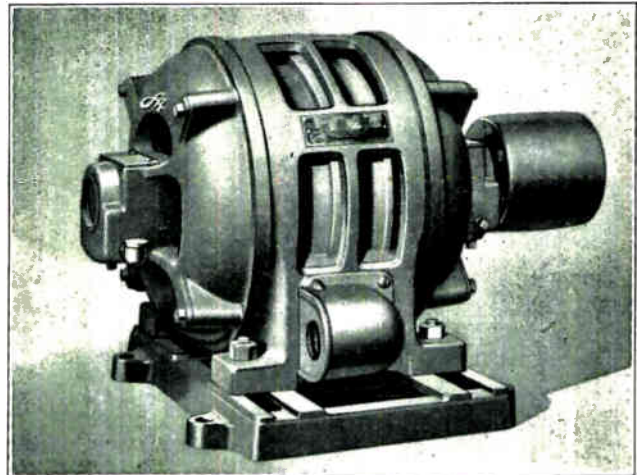

Fig. 174. This photo shows a modern polyphase induction motor. The three phase leads from the line are connected to the stator leads in the connector box shown on the side of the frame.

which they set up the revolving magnetic field when the stator is supplied with three-phase energy.

It is easy to see that this revolving field will cut across the bars of a squirrel-cage rotor, or across the conductors of a phase-wound rotor, and induce in them the secondary currents which, by the reaction of their flux with the flux of the stator, produce the motor torque.

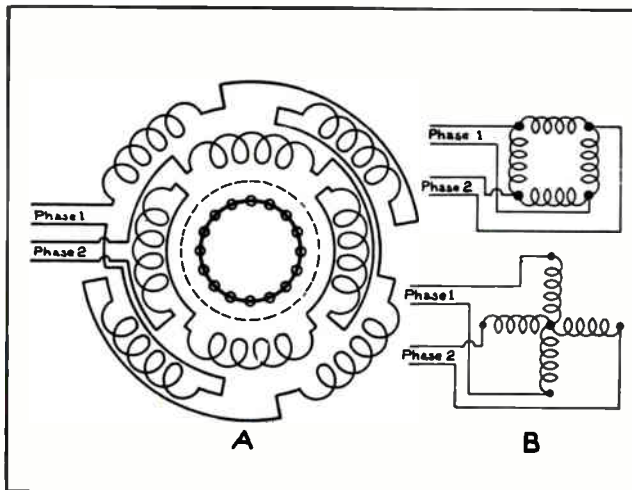

Fig. 175. A. This diagram shows the connections of the stator windings of a two-phase induction motor. At B are shown two schematic diagrams illustrating different methods of connecting two phase windings.

> Fig. 176 shows two excellent cut-away views of a modern three-phase squirrel-cage induction motor. This figure shows clearly the important constructional features and the location of all the parts in the assembled motor. Note carefully all details of the construction of the rotor, stator, windings, frame, bearings, ventilating openings, etc.

The windings of a three-phase motor can be

represented in simple schematic diagrams as shown in Fig. 177-A or B, according to whether they are connected delta or star.

As three-phase motors are so extensively used, the following discussion of characteristics of the various types of motors will refer principally to three-phase machines. Many of the same characteristics are, however, also found in two-phase motors.

### 188. SQUIRREL-CAGE MOTOR CHARACTERISTICS

Squirrel-cage motors are commonly referred to as constant speed motors; but their speed is not quite constant, as they do not operate at synchronous speed and their "slip" varies with the amount of load applied to them.

When a squirrel-cage motor is not loaded, its speed will be very near to that of the revolving magnetic field, or synchronous speed. As load is applied to the motor, its speed is gradually reduced until at full load the slip is usually from 3 to 5 per cent. on large motors, and may be as much as 8 or 10 per cent. on small single-phase machines.

The full load torque of a squirrel-cage motor of any given size is the same as that of a slip-ring or synchronous motor of the same size; because the full load torque, you will recall, depends entirely

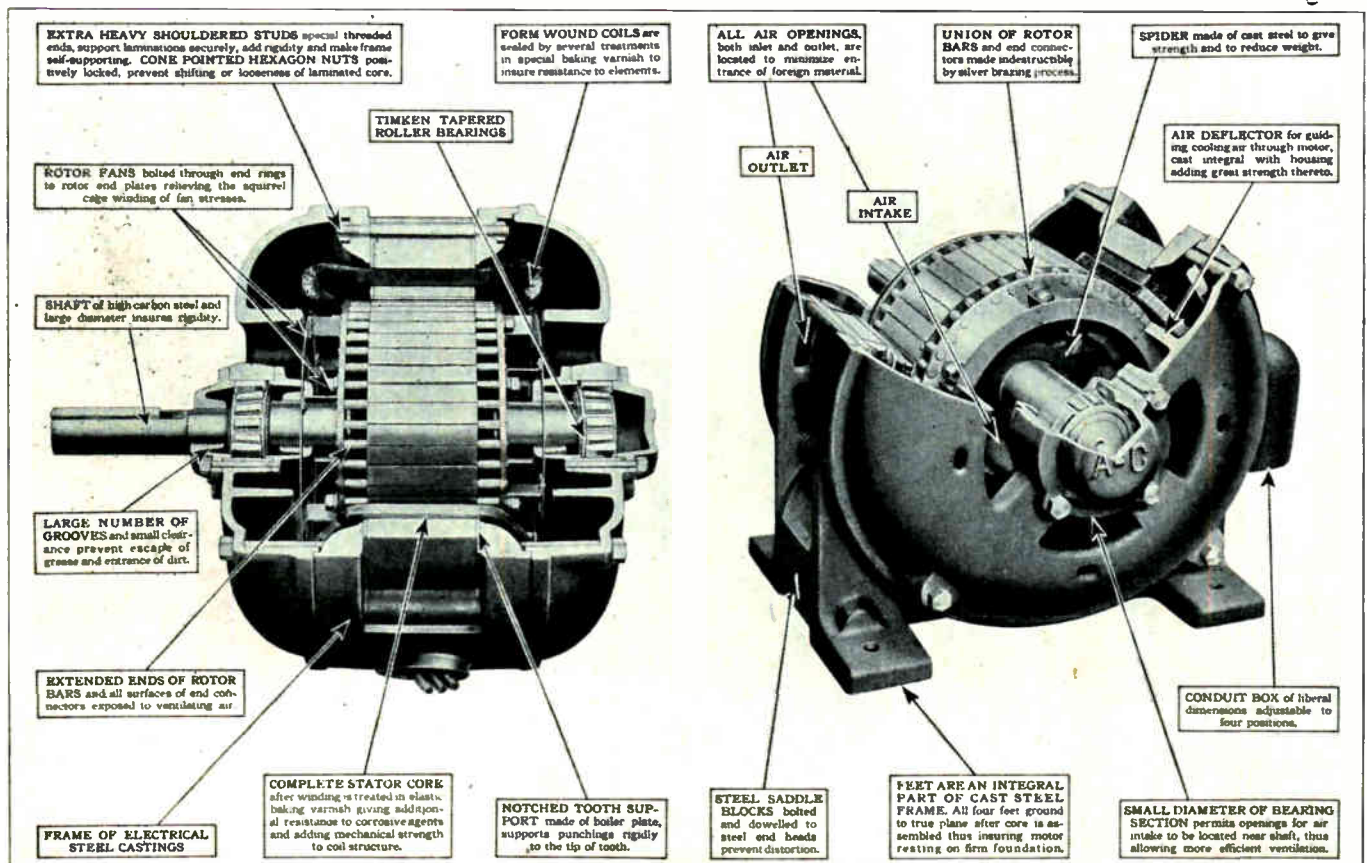

Fig. 176. The above photo shows two cut-away views of a polyphase squirrel-cage induction motor. The important parts of the motor are clearly shown in these two views and you should carefully note the descriptions given for each part. A careful study of this figure will show a number of very important features of induction motor construction. (Photo courtesy Allis-Chalmers Mfg. Co.)

upon the speed and horse power rating for which the motor is designed.

The load pull-out torque of the squirrel-cage motor should not be less than 150% of the full load torque, and with certain types of motors it will be as high as 250% of the full load torque.

Having a pull-out torque considerably greater than the full load torque enables the motor to carry momentary overloads without stalling.

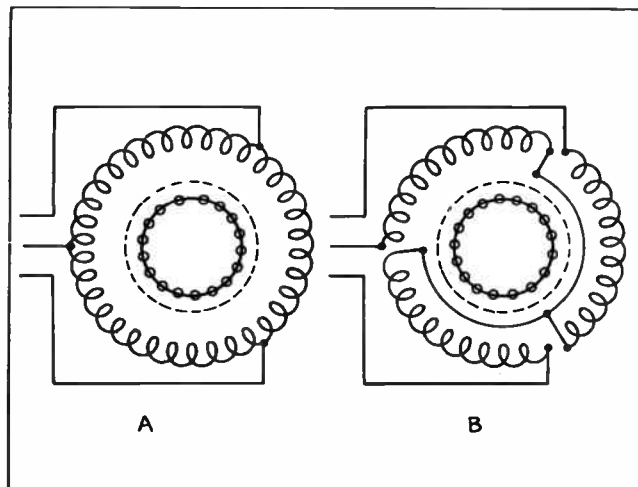

Fig. 177. A shows a delta-connected stator winding for an induction motor. The sketch at B shows a star-connected winding.

### 189. STARTING TORQUE

The starting torque of squirrel-cage motors depends upon the design of the rotor and upon the value of the voltage applied to the stator winding during the starting period.

A very important rule to keep in mind when working with induction motors is as follows: the starting torque of an induction motor varies with the square of the applied voltage.

Good starting torque can be obtained with squirrel-cage motors by starting them on the full line-voltage or the rated voltage of the machine. When started in this manner, the current taken by the motor will be several times the normal full load current; and if heavy loads are being started, the starting current may range from 4 to 9 times full load current.

If the load should require considerable time to come up to speed, the heavy starting current required during this time may overheat and possibly damage the stator windings. For this reason the type of load to be started must be taken into consideration when determining the starting voltage to be applied to the motor.

The very heavy surge of starting current which results when squirrel-cage motors are started at full line-voltage is often very objectionable, as it causes voltage drop in the line and this voltage drop may interfere with the operation of other power equipment or cause considerable variation in the bril-

liancy of lights that may be attached to the same circuit.

In some cases the supply lines may not be large enough to permit the starting of induction motors on full line-voltage. In many cases power companies object to or do not permit this method of starting motors which are connected to their lines. So, for these reasons, many squirrel-cage motors of 5 horse power and larger are started at reduced voltage by the use of some form of motor-starting devices.

A. C. motor starters are explained in a later section. Their principal function, however, is to reduce the voltage to the motor by means of resistance or inductance in the circuit of the stator winding during the starting period. When the starting voltage is reduced, the heavy surge of starting current will also be greatly reduced and, of course, the starting torque developed by the motor will also be considerably lower.

The convenient table in Fig. 178 shows the effect which reduced starting voltage has on the starting current and starting torque of common induction motors. The various starting voltages shown in the table range from 33% to 100% of the rated motor voltage, and the starting current and starting torque for each different voltage are given in percentage of full-load current and full-load torque of the machine.

Some induction motors are designed with special squirrel-cage rotors to improve the starting torque. These machines will be explained in later paragraphs.

Fig. 178-A gives a set of curves which show the starting torque and starting current of a typical squirrel-cage motor. Curve A shows the starting torque on full line voltage, and curve A-1 shows the starting current for the same condition. Curves B and B-1 show the starting torque and current of a squirrel-cage motor with a high resistance rotor. Note how the added resistance increases the torque and decreases the current.

Curves C and C-1 show the starting torque and current when a starting compensator is used with an ordinary squirrel-cage motor. Note how the torque at reduced stator voltage is lower than with

Starting voltage in percent of rated motor voltage	Starting current in percent of full load current	Starting torque in percent of full load torque
33%	75%	22 %
40 "	110 "	33.3 "
50 "	175 "	50 "
60 "	250 "	70 "
66 "	300 "	88 "
80 "	450 "	130 "
100 "	700 "	200 "

Fig. 178. The above table shows the effect of reduced starting voltage on both the starting current and starting torque of induction motors.



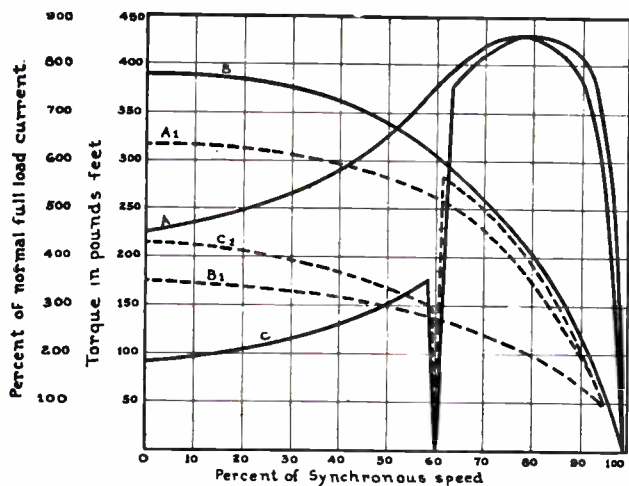

- A = Starting torque at full line voltage
- A1 = " current " " " " with low resistance rotor.
- B = " torque " " " " high " " "
- B1 = " current " " " " " " " "
- C = " torque on reduced E by means of compensator.
- C1 = " current " " " " " " " "

Fig. 178-A. The above diagram shows voltage, current, and torque curves of an ordinary squirrel-cage motor. A careful study of these curves will help you gain an understanding of these very important characteristics of squirrel-cage motors.

either of the other methods of starting, and also the interruption and sudden increase of torque when the compensator switches over to full voltage.

190. POWER FACTOR AND EFFICIENCY

The power factor of three-phase, squirrel-cage motors operated at full load may vary from 60 to 70 per cent. in the case of small low speed motors, to 75 to 90 per cent. for medium-sized motors; and as high as 90 to 96 per cent. for large motors of several hundred horse power and up.

Power factor is a very important characteristic to be considered when selecting large induction motors or a large number of small ones; because, as explained in an earlier section, a great deal of money can be saved on power bills by keeping the power factor of the system as high as possible.

It is also very important to remember that any induction motor operates at a much lower power factor when it is lightly loaded, and for this reason motors should be properly chosen so that during normal operation they will be running at or near full load a greater part of the time.

The efficiency of squirrel-cage motors varies similarly to the power factor. Small low-speed motors may have efficiencies ranging from 50 to 80 per cent., while the larger machines will operate at efficiencies from 90 to 95 per cent.

The efficiencies are usually best when the motors are operating above 75% of their full rated load. High-speed motors of the two and four-pole type generally have the highest efficiency and power factor.

Fig. 178-B shows the power factor and efficiency curves for a 100 h. p. squirrel-cage motor. Note

that the P.F. and efficiency are both very low at light loads, under 20 h. p., and then rapidly rise to high values on loads between 60 and 100 h. p., but fall off again when the motor becomes overloaded. This figure also shows the current and speed curves of the motor at various loads.

191. FACTORS CONTROLLING SPEED OF INDUCTION MOTORS

As explained in the earlier part of this section, the speed of induction motors depends upon the number of poles in the stator winding and upon the frequency of the alternating current on which they are operated.

As induction motors are designed to operate on practically constant frequency, their speed should not be varied to any appreciable extent by varying the frequency.

The speed of squirrel-cage induction motors can be changed by changing the number of poles in the stator winding, as explained in Section Two of Armature Winding. If the speed change is to be permanent, the stator can be reconnected for a different number of poles; while, if it is desired to frequently make a certain change in the speed during operation of the motor, the stator winding can have the pole leads brought out separately to terminals of a switching device by means of which the number of poles can be quickly changed by regrouping them. The switching device and connections for this method of varying the speed of squirrel-cage motors will be explained in a later section on A. C. Motor Controls.

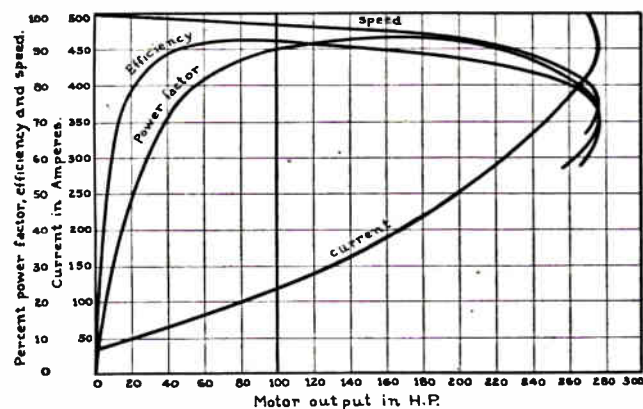

Fig. 178-B. This diagram shows the efficiency, power factor, speed, and current curves for a 100-h. p., squirrel-cage motor. Note carefully how the efficiency and power factor vary with different amounts of load up to full rated load, and also on various overloads.

The direction of rotation of a three-phase induction motor can be reversed by reversing any two of the three-phase leads to the motor.

192. GENERAL APPLICATION

Because of their very rugged construction and small number of wearing parts, squirrel-cage induction motors find a very wide field of application. They require very little maintenance and repair, if they are operated under the proper conditions.

Having no commutator brushes or other sliding contacts they do not produce any sparking and can therefore be used in many locations where other types of motors cannot be used because of the danger of explosions. This applies to buildings or locations where explosive gases or dust may be in the air.

When selecting and installing motors it is well to keep in mind that sawdust, coal dust, starch, flour, grain dust of any kind, sugar, etc., are very explosive when mixed with air in just the right proportions. This is also true of paint and varnish fumes, oil vapors, and vapors from certain chemicals.

To eliminate fire and explosion hazard, squirrel-cage motors are invariably used in modern plants manufacturing or handling materials such as those just mentioned. Fig. 179 shows a number of squirrel-cage motors of various sizes, and Fig. 180 shows a 100-h. p. squirrel-cage motor installed in a cotton gin plant.

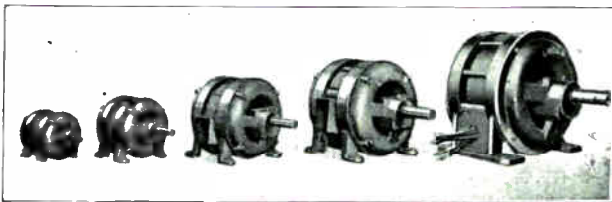

Fig. 179. This photo shows a group of polyphase induction motors of various sizes. Motors of this type are available in practically any size required.

Some of the uses to which squirrel-cage induction motors are commonly put are as follows:

- Machine drives in industrial plants
- Machine drives in wood-working plants
- Operating machines in general manufacturing plants
- Textile mill drives
- Saw mills
- Paper mills
- Steel mills
- Grain elevators
- Flour mills
- Mining machinery
- Electric ship propulsion
- Passenger and freight elevators
- Motor-generator sets
- Small hoists
- Pumps and fans

### 193. SLIP-RING MOTORS

From the foregoing material on squirrel-cage motors, it is evident that they are not well adapted to variable speed service. Where variable speed duty is required, slip-ring induction motors are commonly used.

These slip-ring or phase-wound motors have stators and stator windings of exactly the same type as those used in squirrel-cage motors, but their

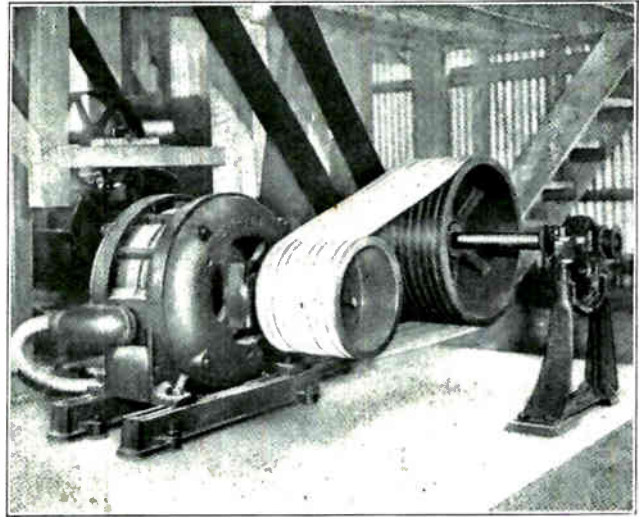

Fig. 180. This photo shows a 100-h. p. squirrel-cage motor driving machinery in a cotton mill. The motor operates the large pulley on the line shaft by means of the "texrope" drive, and belts convey the power from this shaft to the driving machinery. (Photo courtesy Allis-Chalmers Mfg. Co.)

rotor windings are made of insulated copper wire or bars somewhat similar to those used on direct current machines.

Generally these rotors are wave-wound and star-connected, although in some cases they are lap-wound and delta-connected. The star-connected wave-winding is somewhat easier to install and produces better mechanical strength and balance of the rotor.

Three leads are connected to the rotor winding at points 120 electrical degrees apart and are brought out along the shaft and connected to three slip rings.

Fig. 181 shows a wound rotor of a slip-ring motor and the slip rings can be clearly seen mounted on the shaft. These rings are usually made of brass and are well insulated from each other and from the shaft. This rotor in Fig. 181 has a winding of insulated copper wire.

Fig. 181-A shows another phase-wound rotor which has a winding of insulated copper bars, which are properly connected to the slip rings on the shaft.

During operation of slip-ring motors the brushes slide on the rings and provide a connection for the

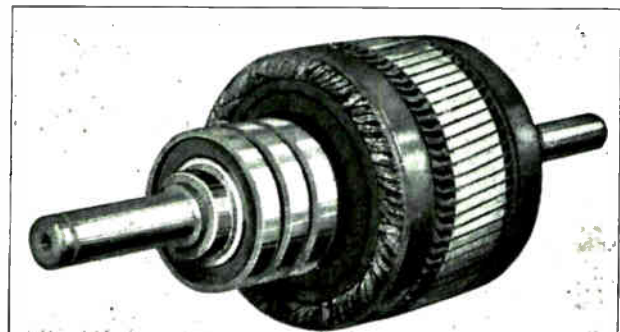

Fig. 181. Wound rotor of a variable speed slip-ring motor. This rotor has windings of insulated copper wire similar to those in D. C. armatures.

induced currents to flow from the rotor winding to a control resistance in the external circuit. By varying this resistance the secondary current flow in the rotor can be varied; and this will increase or decrease the amount of torque and slip, and thus vary the speed of the motor.

Controllers of the face-plate type or drum type are commonly used with variable speed, slip-ring motors.

Fig. 182 shows a 440-volt induction motor of the slip-ring type. Note the brushes resting on the three slip rings and also note the three leads which are brought out from these brushes for connection to the controller by which the speed of the motor is varied.

The connections of the stator winding are made at the hooded outlet shown on the side of the motor frame. The slots shown between the sections of the laminated stator core of this motor are provided for the circulation of cooling air.

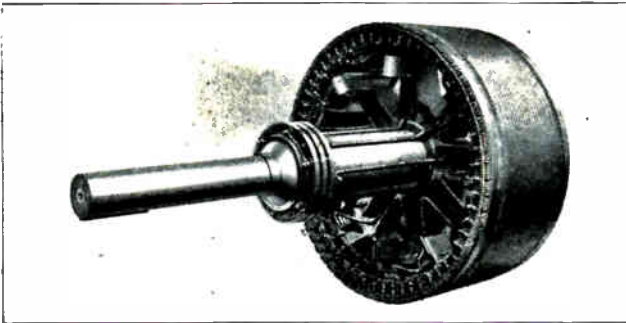

Fig. 181-A. Phase wound rotor of a large slip-ring induction motor. This rotor has heavy bar windings which are not shorted together like those of a squirrel-cage rotor, but instead have connections brought out from each phase to the slip rings.

#### 194. STARTING AND SPEED CONTROL WITH EXTERNAL RESISTANCE

Fig. 183 shows a schematic diagram of the connections for the stator, rotor, and starting or speed-control resistance of a slip-ring motor. The resistance is shown connected star, the same as the rotor windings, and if you trace the circuit from each section of the rotor winding you will find that the complete resistance of two sections of the controller is in series with it.

The three sliding-contact arms which are indicated by the arrows are connected together at the central point and are arranged to cut out this resistance as they are rotated in a clockwise direction.

This resistance is used for starting slip-ring motors as well as for controlling their speed, and if the amount of resistance is properly proportioned these motors have a very good starting torque with moderate starting currents.

Before starting the motor by closing the line switch, the controller should be set so that the maximum amount of resistance is in the rotor circuit. Then this resistance is gradually cut out as the motor comes up to speed.

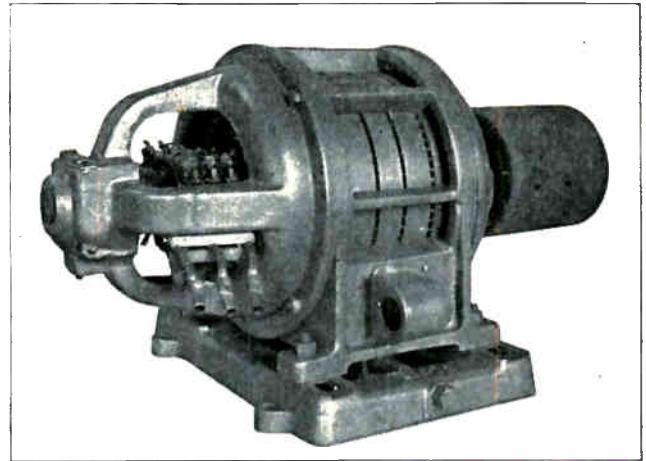

Fig. 182. This photo shows a complete slip-ring motor to which variable resistance can be connected for starting and speed-regulating duty. Note the slip rings and rotor connections on the left-hand end of the machine. (Photo courtesy General Electric Co.)

In many cases slip-ring motors with resistance starters are used just because of their good starting torque and lower starting currents, even though they may not be required to give variable speed service.

If the resistance is only used for starting duty it can be much smaller and lighter than when used for speed-regulating duty. When used for regulating the speed of the motor the rheostat must have resistance elements large enough to carry the full load current continuously without overheating.

After the motor is up to speed, if resistance is again cut into the rotor circuit, the speed will be decreased in proportion to the amount of resistance inserted.

Fig. 184 shows a diagram of a heavy-duty slip-ring motor with the starting and speed regulating resistance arranged so it can be cut in or out of the rotor circuit by means of short-circuiting switches.

The motor is started with all of the resistance switches open and the full resistance in the rotor circuit. When switch No. 1 is closed it shorts out the first section of resistance; switch 2 shorts the second section, and switch 3 shorts out the last of

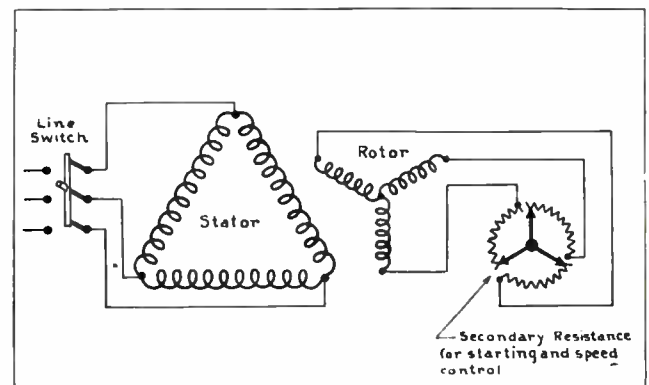

Fig. 183. The above diagram shows the connections of the stator and rotor of a slip-ring induction motor, and also the variable resistance used in the rotor circuit for starting and speed control.

the resistance, bringing the motor up to full speed.

For starting and controlling the speed of large motors of this type magnetically operated contactors or breakers are used in place of the knife switches shown in Fig. 184.

The value of the induced voltage in the secondary or rotor winding of a slip-ring motor may vary between 25 and 60 per cent. of the stator voltage, according to the design of the motor.

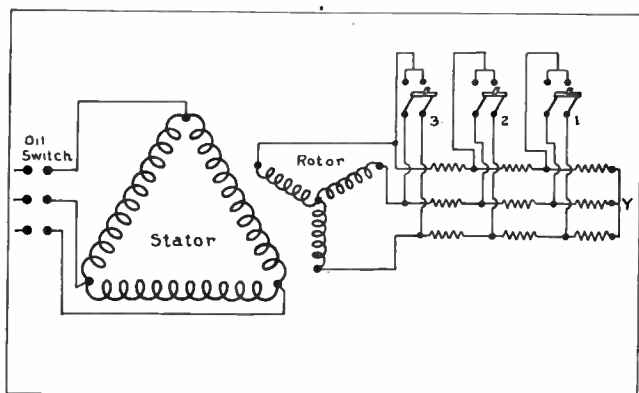

Fig. 184. Connection diagram of slip-ring induction motor with knife switches used to cut out the starting or speed control resistance step by step.

### 195. INTERNAL RESISTANCE MOTORS

On small motors with phase-wound rotors the secondary resistance is often mounted in the rotor spider so that it revolves with the rotor winding and can be connected directly to it, thus eliminating the necessity for collector rings and brushes.

In such motors the resistance may be cut out or short-circuited by a centrifugal switch as the motor comes up to speed. In other cases motors of this type are equipped with a hollow shaft, through which a rod is run and connected to the mechanism which operates the contacts to cut the rotor resistance in or out of the circuit.

This rod is provided with a knob on the outer end and can be pushed back and forth by hand while the motor is operating. Motors of this type with the internal secondary resistance should not be used on loads which require too great a length of time to come up to speed, or the resistance units may be damaged by overheating.

Motors with internal rotor resistance are usually not made in sizes over 20 h. p. Motors larger than this are practically always equipped with slip rings and external resistance and many of the smaller slip-ring motors also have external resistance.

### 196. CHARACTERISTICS OF SLIP-RING MOTORS

Slip-ring motors can be designed to give a starting torque of 250% or more of the full load torque. A starting torque of 125% may be obtained with a stator current of 150% of full load current rating; and a starting torque of 200% can be obtained with 250% of full load current, etc.

This ability to produce good starting torque with moderate starting currents makes the slip-ring motor very desirable where loads must be frequently started and stopped, and where it is necessary to avoid heavy starting current surges of 4 to 6 times the running current value.

Figs. 185-A and B give a set of curves which show the starting torque and starting current of a slip-ring motor during the various steps of starting, and as the resistance is cut out of the rotor circuit step by step.

These curves may appear a bit complicated at first glance, but study them carefully for a few minutes and you will find them very simple to understand. You will also find that they give a lot of valuable information on the characteristics and performance of slip-ring motors.

### 197. EFFECT OF SECONDARY RESISTANCE ON STARTING TORQUE

The upper set of curves at A show the starting torque developed by the motor at various percentages of its synchronous speed, and with different amounts of resistance in the rotor circuit.

The heavy irregular line which jumps from curve T-1 to T-2, T-3, and T-4 shows the variations and amount of starting torque as the resistance is cut out and as the motor picks up speed during starting.

To read the value of the torque at any point on any curve, just follow the horizontal chart lines to the left edge of the figure, where the torque can be read approximately, in per cent. of full load torque of the motor. By following the vertical lines downward from any point on a curve, the per cent. of synchronous speed at that point can be found.

For example: The motor is started with full resistance in the rotor circuit, and curve T-1 shows the starting torque commencing at about 185% of full load torque and dropping off to about 160% as the motor reaches 35% speed. Here the first section of resistance is cut out, and the torque is increased to about 295%. Again it gradually reduces as shown by curve T-2, to about 220% when the motor has reached 70% speed.

Cutting out another section of resistance brings the torque back up to about 325% from where it decreases as shown by curve T-3 to about 125% when the motor reaches 92% speed.

Then cutting out the last step of resistance raises the torque once more to slightly over 200%, from which point it drops as shown by curve T-4 to 100% or full load torque as the motor reaches its actual running speed of about 97% synchronous speed.

By cutting out the resistance in this manner, the starting torque is kept high during the entire starting period.

The dotted line at the left end of the heavy line in curve T-2 shows the value of the starting torque

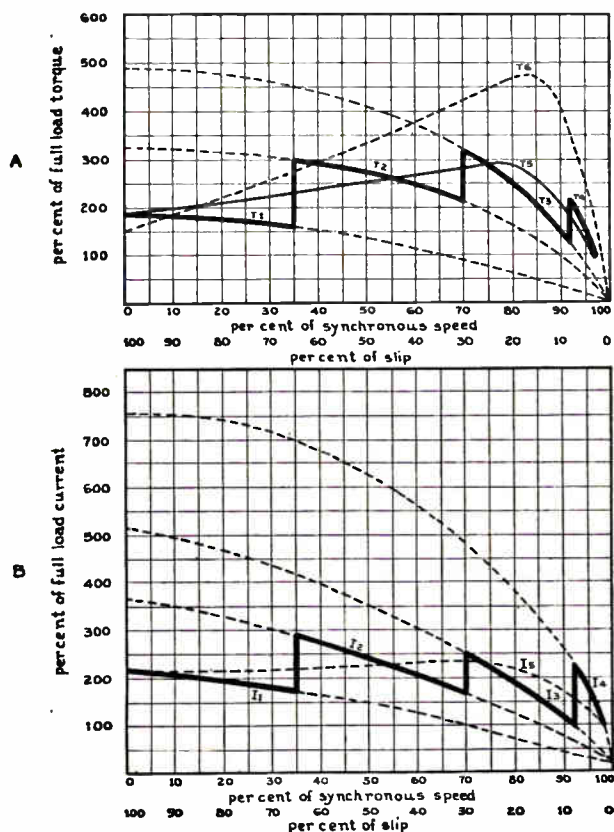

Fig. 185. A shows the torque curves of a slip-ring induction motor as the resistance is cut out of the rotor circuit and the motor comes up to speed. B shows the current curves of the same motor and corresponding to the various steps of the torque curves. Study these curves very carefully with the accompanying explanation.

that would be obtained if the motor were started with one section of resistance already out of the rotor circuit. The dotted line forming the left end of curve T-3 shows the starting torque when starting the motor with two sections of resistance cut out.

The dotted lines forming the right-hand ends of the curves T-1, T-2, and T-3 show how the torque will continue to fall off very rapidly, if the resistance is not cut out as the motor picks up speed.

The light continuous curve T-5 shows the gradual variation in starting torque which would be obtained if the resistance was cut out very smoothly and gradually, instead of in sections or steps.

The continuous dotted curve T-6 shows the starting torque obtained by starting the motor without any resistance and allowing it to come up to full speed in this manner. This curve shows the very important fact that the torque obtained by starting without any starting resistance in the rotor circuit is at first actually lower than when starting with resistance in the circuit.

This corresponds with what has previously been mentioned, that the starting torque of induction motors can be increased by using the proper amount of resistance in the rotor circuit.

Note also from curve T-6 how the starting torque on constant voltage keeps increasing as the motor

speed increases, becoming maximum at about 83% of synchronous speed, and then falling off as the motor approaches closer to synchronous speed.

This is due to the fact that when an induction motor is first started, the difference between the rotor speed and the speed of the revolving magnetic field is very high, and therefore the frequency of the induced rotor currents is high. At this high frequency the rotor currents lag considerably behind the induced voltage, and the torque or power produced is very low.

As the rotor speed increases, the difference between its speed and that of the revolving magnetic field of the stator is less, the frequency of the induced rotor currents is lower, and the power factor is higher; which results in increased torque.

Of course, when the rotor reaches nearly synchronous speed, the lines of force of the rotating magnetic field do not cut across the rotor conductors as rapidly, and the induced voltage and current in the rotor begin to decrease. This causes the torque to reduce somewhat as the motor approaches its rated speed and settles down to operate at its normal percentage of slip, which is always required to produce full load torque.

The percentage of slip is also marked from right to left along the lower side of Figs. 185-A and B. This slip, of course, decreases as the percentage of synchronous speed of the rotor increases.

## 198. STARTING CURRENT OF SLIP-RING MOTORS

In Fig. 185-B, or the lower set of curves, is shown the current during the various steps of starting a slip-ring motor. You will note that when the motor is started with full resistance in the rotor circuit the starting current as shown by curve I<sub>1</sub> is at first about 215% of normal full load running current. This current reduces gradually as the rotor increases its speed and reduces the slip.

When the motor reaches 35% speed and the first section of resistance is cut out, the current is increased to about 285%, as shown by curve I<sub>2</sub>, and so on throughout the following steps of starting the motor.

After the last section of resistance is cut out at about 92% speed, the current decreases as shown by curve I<sub>4</sub>, until at about 97% synchronous speed or actual operating speed of the motor, the current has reached 100% or normal full load current.

Note the very heavy starting currents which will be drawn by the motor if it is started without any resistance or with only one or two sections of resistance in the rotor circuit. This is shown by the dotted lines forming the left ends of curves I<sub>4</sub>, I<sub>3</sub>, and I<sub>2</sub>. If this particular motor were started without any resistance the starting current at first would be about 750% or 7½ times full load current, and

it would then gradually decrease as the motor speed increases and the slip decreases.

Also note from curved  $I_s$ , the more uniform starting current which would be obtained by cutting out the resistance gradually instead of in steps.

The current shown by curve  $I_s$  corresponds to the starting torque shown by curve  $T_s$  in Fig. 185-A.

Each of the other current curves corresponds to the torque curve of the same number in the upper figure.

The efficiency and power factor of slip-ring motors are generally a little lower than those of squirrel-cage motors, but this small loss is frequently more than offset by the other advantages of the slip-ring motors.

When slip-ring motors are used for variable speed service and are being operated below normal speeds their power factor and efficiency will be correspondingly lower than when running at their full rated speed.

The horse power output of motors of this type varies in proportion to the speed at which they are operated. Slip-ring motors generally have approximately the same percentage of slip, or in some cases a little more than that of squirrel-cage motors.

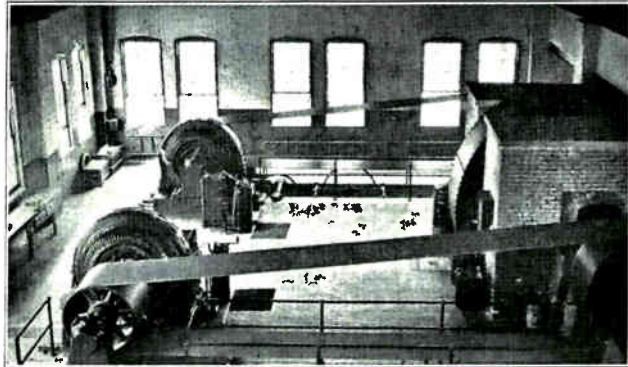

Fig. 186. This photo shows two large slip-ring motors driving a ventilating fan in a mine. The motors are connected to the fan by means of special multiple rope drives.

## 199. APPLICATIONS OF SLIP-RING MOTORS

Because of their very good starting torque with moderate starting currents and due to the fact that they can be used for variable speed duty, slip-ring induction motors have a large number of applications and types of service to which they are ideally suited.

They are extensively used for driving machines which require frequent starting and stopping, and which are hard to start because of the nature of the load. They are also used for operating devices which require speed variation over a greater range than can be obtained by changing the number of poles of squirrel-cage motors.

Some of the common uses for slip-ring motors are as follows:

- Pump and compressor drives
- Variable speed fans and blowers
- Hoists and cranes
- Rotary dryers and kilns
- Grinders and crushers
- Electric railways
- Electric ship drives.

Fig. 186 shows two 450-h. p. slip-ring induction motors driving a large mine ventilating fan, and Fig. 187 shows a 300-h. p. slip-ring motor which is used to operate a large hoist.

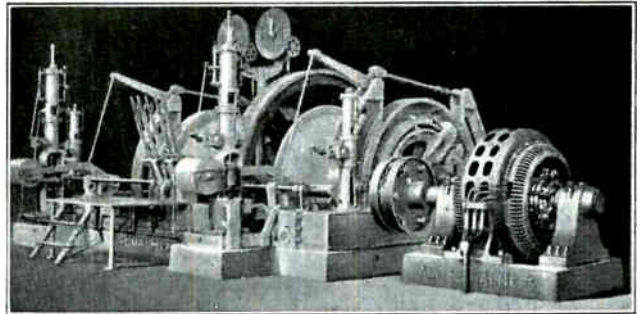

Fig. 187. Large slip-ring motor used to drive the drums of a hoisting machine. Note the manner in which the stator leads are brought up to the motor in conduit which is imbedded in the floor. (Photo courtesy Allis-Chalmers Mfg. Co.)

## 200. SYNCHRONOUS MOTORS

Synchronous motors operate at synchronous speed, or in exact step, with the applied frequency and the rotating magnetic field of the machine.

When in normal operation, the synchronous motor has no slip, or "zero slip" as it is often called. The speed of these motors is inversely proportional to the number of poles in the stator and directly proportional to the frequency of the applied line voltage, and as long as the number of poles and frequency remain unchanged the speed will not vary.

Therefore, a synchronous motor is a constant-speed motor and can be used where a certain speed must be accurately maintained at all times.

Another great advantage of synchronous motors is that their power factor is very high, and they can actually be operated at leading power factor in order to improve the power factor on a system which is loaded with inductive equipment.

In many cases synchronous motors are used only for power factor correction and are operated without any mechanical load attached. In such cases the motors are connected to the system or lines and allowed to run idle or float on the lines, with their D. C. field poles strongly excited; so that they actually generate and feed leading current into the line and thus help to neutralize the effects of the lagging current produced by induction motors or other inductive equipment on the line.

When these machines are used for power factor

correction in this manner they are called **synchronous condensers**; because their effect on the system is the same as that of a static condenser, which also produces leading current.

Synchronous motors are made for power drives and power-factor-correction in sizes ranging from a few horse power to 50,000 kv-a. or more.

Power companies have synchronous condensers as large as 50,000 kv-a. connected directly to lines of 13,200 volts for correcting the power factor on their systems.

Special synchronous motors are made in very small sizes for the operation of electrical clocks and such devices. Some of these small motors operate on a fraction of one watt of electrical energy.

### 201. CONSTRUCTION AND EXCITATION

Synchronous motors are constructed almost exactly the same as alternators; in fact, an alternator may in many cases be operated as a synchronous motor. Synchronous motors have the A. C. armature winding or element and a D. C. field the same as alternators.

Small synchronous motors are sometimes made with stationary field poles which are excited by direct current, and with a revolving A. C. armature to which the line current is fed through slip rings.

Most medium and all large-sized synchronous motors, however, are made with revolving fields, the same as large A. C. generators. On these motors the alternating current line-energy is fed to a stationary armature or stator winding which sets up a revolving magnetic field, the same as in induction motors. The field poles on the revolving field or rotor receive their D. C. exciting current through slip rings.

As synchronous motors are always operated from alternating current lines, it is necessary to have some source of direct current for exciting their fields. This field supply is usually obtained from small D. C. exciter-generators, which are either mounted directly on the end of the synchronous motor shaft or may be belt-driven from a pulley on the shaft.

Fig. 188 shows a 75-h. p. synchronous motor of the revolving field type. This motor has its D. C. exciter-generator mounted on the end bracket and driven by the end of the main motor shaft. Note the slip rings and brushes, which are located just inside the end-plate of the synchronous motor and through which direct current from the exciter-generator is passed to the revolving field poles. This motor has six poles and is designed for 60-cycle operation, so its speed will be 1200 R.P.M.

Fig. 189 shows the stator of a large slow-speed synchronous motor, and Fig. 190 shows a large diameter revolving field for a synchronous motor of this type.

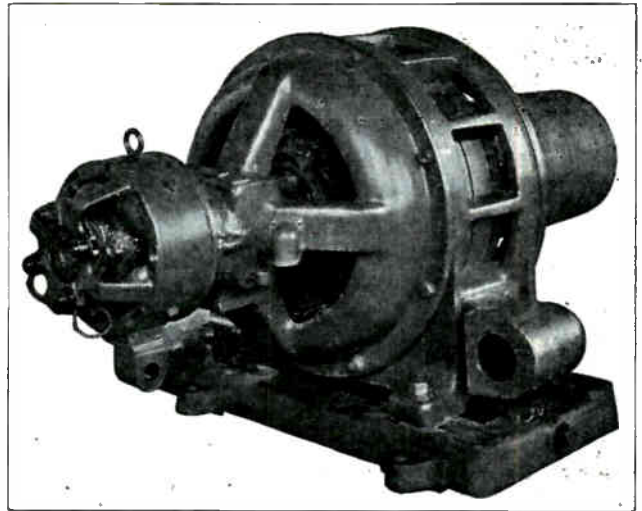

Fig. 188. This photo shows a 75 h. p. synchronous motor of the revolving field type. Note the small exciter-generator which supplies D. C. to the field of the large motor. (Photo courtesy General Electric Co.)

Large synchronous motors with a great number of poles can be made to operate at very low speeds and are, therefore, frequently used to drive slow-speed pumps or machinery by direct connection.

### 202. DAMPER WINDINGS

In addition to the D. C. windings on the fields of synchronous motors, they are usually provided with a **dampener winding** consisting of short-circuited bars, similarly to the squirrel-cage windings used on induction motors. This dampener winding can be clearly seen on the outer ends of the poles of the field rotor in Fig. 190.

Dampener windings are provided on synchronous motors to obtain sufficient starting torque to enable the motors to start with some load attached, and also to prevent what is known as **hunting**. Hunting of synchronous motors will be explained a little later.

### 203. OPERATING PRINCIPLES

When synchronous motors are started, their D. C. fields are not excited until the rotor has reached practically full synchronous speed; so the starting torque to bring the rotor up to speed must be produced by induction.

When the stator winding of a synchronous motor is excited by being connected to the A. C. line, it immediately sets up the rotating magnetic field with which we are already familiar. The rotating flux of this field cuts across the dampener winding of the revolving member or rotor and induces secondary currents in the bars of this winding.

The reaction between the flux of these secondary currents and that of the revolving stator field produces the torque necessary to start the rotor in motion and bring it up to speed.

If no dampener winding is provided a synchronous motor will have very poor starting torque, as it must then depend upon the induced currents in

the high-resistance field coils and the slight eddy currents in other parts of the rotor. This, however, is sufficient to start some of the older type synchronous motors which were not provided with damper windings, or to start alternators when they are used as synchronous motors.

When some of the older type synchronous motors were used to drive machinery which had to be started under load, they were often started and brought up to speed by means of a separate induction motor just large enough for this purpose.

In other cases, the synchronous motor was attached to the load by means of a friction clutch or magnetic clutch, so that the rotor could be disconnected from the load during starting and then allowed to pick up the load by means of the clutch after the rotor had reached synchronous speed and its D. C. field poles were excited.

This is not necessary with most modern synchronous motors which are properly adapted to their load; because it is possible, by properly proportioning the squirrel-cage damper winding, to design synchronous motors with fair starting torque.

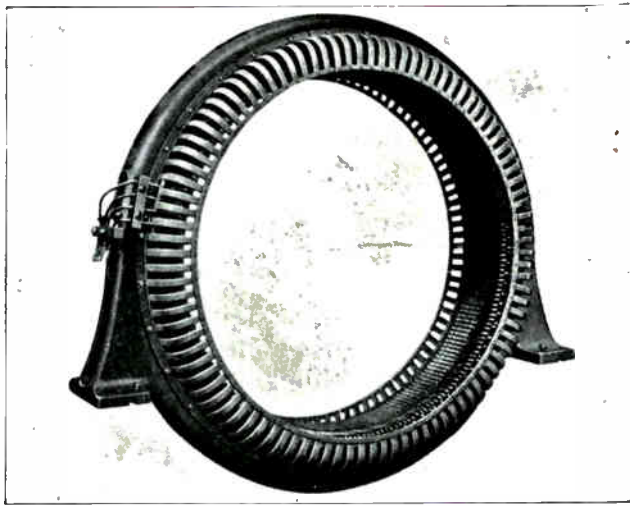

Fig. 189. Above is shown the stator of a large synchronous motor. You will note that the stator, frame, core, and windings are the same as those used for alternators.

When a synchronous motor has been brought up to nearly synchronous speed and is operating as an induction motor because of the damper winding, then the D. C. field poles are excited and the powerful flux of these poles causes them to be drawn into step or full synchronous speed with the poles of the rotating magnetic field of the stator.

During normal operation the rotor continues to revolve at synchronous speed, as though the D. C. poles were locked to the poles of the revolving magnetic field of the stator.

As a synchronous motor has no slip after the rotor is up to full speed, no secondary current is induced in the bars of the damper winding during normal operation.

## 204. PULL OUT TORQUE

If a synchronous motor is overloaded to the extent where the D. C. rotor poles are made to lag or pull out of step with the poles of the rotating stator field, the slip which results will again cause current to be induced in the damper winding and to develop torque by induction, as during starting.

If the overload is not too great or doesn't last for more than an instant, this torque developed by induction in the damper winding may enable the rotor to pull back into step; but if the overload is too great and lasts too long, the rotor will be pulled out of step with the revolving magnetic field, and the motor will lose its torque and will stall.

If the D. C. current supplied to the revolving field of a synchronous motor is interrupted during operation, the motor will, of course, lose its synchronous torque and will stop if there is a very heavy load connected to it.

We have found that a synchronous motor develops its torque by the attraction between the poles of the revolving magnetic field set up by the stator and the D. C. poles of the rotor, which are maintained at constant polarity by direct current through their coils.

We know that magnetic lines of force are more or less elastic, so we can readily see that it is possible for the D. C. poles of the rotor to be pulled back a little or caused to lag slightly behind the center of the revolving poles of the stator, without actually being pulled out of step far enough to lose the attraction between the poles and thereby lose the torque. This might be caused by sudden surges of load of very short duration.

With a moment's thought we can also see that if a north pole of the revolving field is pulled back and caused to lag a little behind the center of an

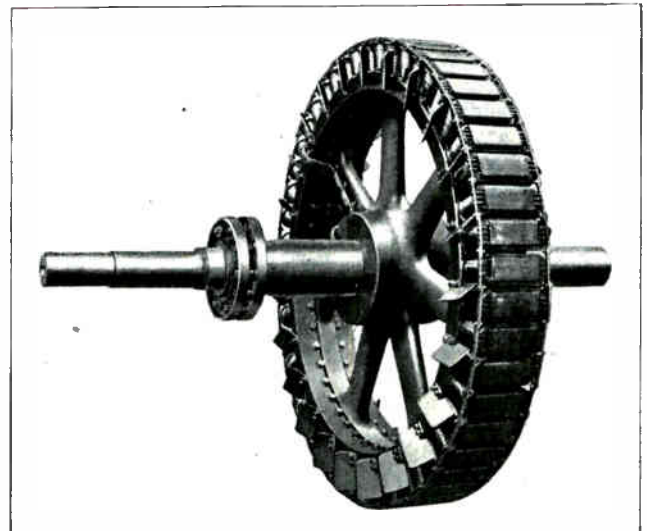

Fig. 190. Revolving field or rotor of a large slow-speed synchronous motor. Note the squirrel-cage damper winding attached to the pole faces and also the slip rings through which the D. C. is passed to the revolving field poles.



unlike pole or south pole of the stator field, this north pole of the rotor will be drawn closer to the adjacent north pole of the stator, which will tend to repel it and add to the torque, thereby keeping the rotor in step if the load is not too great.

### 205. HUNTING

If a heavy load is suddenly removed from the synchronous motor, the rotor will tend to surge ahead and, due to the elastic nature of the flux, the D. C. poles may for an instant actually surge a little ahead of the revolving poles of the stator.

Sometimes fluctuations in the mechanical load or in the line voltage may in this manner cause the rotor of a synchronous motor to surge or oscillate back and forth more or less irregularly. This is known as hunting.

The hunting of the synchronous motor can usually be noticed by a change in the normal operating sound or the smooth, steady hum which is given off by a motor when it is operating properly. The hunting causes a rise and fall, or sort of throbbing note, to come into this sound. This audible note may be of very low frequency, even as low as several oscillations per minute, or it may be of much higher frequency. This will be according to the size and design of the machine and according to the nature of the disturbance which causes the hunting.

Another indication of hunting may be had by watching the pointers of any ammeters connected in the line circuit to the motor. Hunting causes the stator current to increase and decrease, and this will cause the ammeter needle to swing back and forth at the same frequency as that at which the sound or hunting note occurs. During normal operation, the ammeter pointer should change only when the load is changed or when the field excitation is varied.

Hunting may be due to anyone of the following causes: (A) Fluctuations in mechanical load on the motor. (B) Surging of generators on the line. (C) Switching surges. (D) High or low frequency surges. (E) Irregular or pulsating electric loads on the line. (F) Hunting of other synchronous motors on the same line.

Hunting should not be allowed to continue, because it may set up very dangerous mechanical stresses within the motor, and it will also produce objectionable surges of current on the A. C. line supplying the motor.

Damper windings play a large part in the prevention of hunting, because, as soon as the rotor attempts to fall behind or surge ahead of the poles of the rotating stator field, the slip at once causes secondary currents to be induced in the damper winding, and thereby develops inductive torque which tends to hold the rotor at constant speed.

In some cases a synchronous motor may have a tendency to hunt, even though it is equipped with damper windings. Changing the voltage applied

to the D. C. field may cause the motor to stop hunting, and if this doesn't stop it, it may be necessary to shut the motor down and restart it. This will often eliminate the hunting.

Sometimes a slight increase or decrease of the mechanical load on the motor may help to stabilize its speed and prevent hunting.

If none of these things will stop it, it will then be necessary to definitely locate and eliminate the cause; which may be in the A. C. supply line, in the exciter-generator, or in the mechanical load.

Fig. 191 shows a large synchronous motor of 2000 h. p., designed for operation on 2300 volts and at unity power factor. Note the exciter-generator, which in this case is mounted on a separate pedestal at the right of the motor. The armature of the exciter is mounted on the motor shaft and is directly driven at the same speed as the synchronous motor.

Fig. 192 shows a three-phase synchronous motor of 150 h. p. which has its exciter driven by means of a large pulley on the end of the motor shaft and a special rope belt. This makes possible the use of a small, high-speed, D. C. generator.

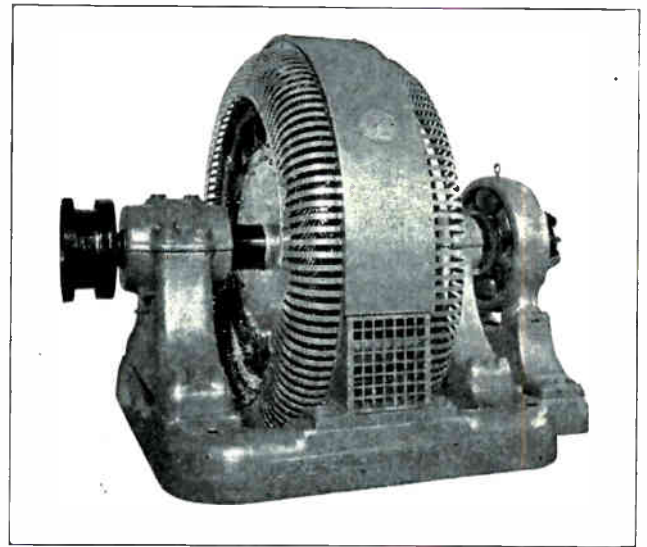

Fig. 191. This photo shows a 2000-h. p., 2300-volt, synchronous motor which operates at 100% power factor. The D. C. exciter-generator is shown on the right-hand end. (Photo courtesy General Elec. Co.)

### 206. CONNECTIONS OF SYNCHRONOUS MOTORS

Fig. 193 shows a diagram of the connections for a synchronous motor and its exciter-generator. You will note that the wiring and connections for this machine are practically identical with those for an alternator, with the exception that a rheostat is not always used in the field circuit of the synchronous motor.

Regardless of the A. C. voltage at which the synchronous motor may be operated, the exciter voltage is seldom higher than 250 volts. The capacity of the exciter-generator in kw. usually ranges from 1 to 3 per cent of the kv-a. rating of the synchronous motor.

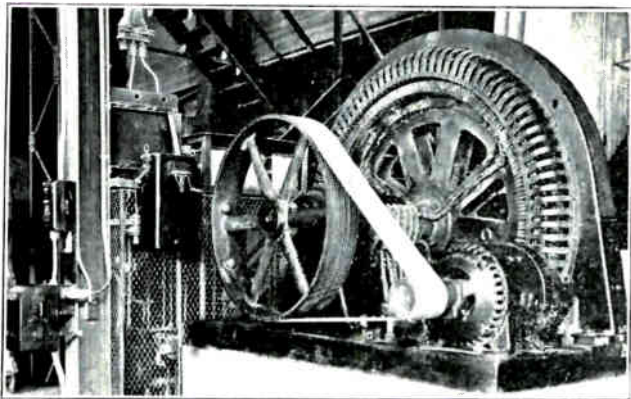

Fig. 192. 150-h. p., 2300-volt, low-speed, synchronous motor and exciter. The speed of the large motor is 144 RPM. (Photo courtesy Allis-Chalmers Mfg. Co.)

By adjusting the exciter field rheostat (F), the voltage applied to the D. C. field of the synchronous motor can be varied. This varies the current flow through the field coils and changes the magnetic strength of the poles. By means of this rheostat the strength of the motor field can be properly adjusted for the mechanical load which it is to drive, and for the amount of power-factor correction it is to perform.

The field discharge switch, D, and resistance, E, are for the same purpose as when used with alternators; that is, to prevent high induced voltages in the field winding when the circuit is interrupted.

The damper winding of the rotor is shown in this diagram by the short-circuited bars in the pole faces.

### 207. STARTING SYNCHRONOUS MOTORS

When starting the motor, the stator is supplied with alternating current by closing the knife switch or oil switch at "B". Some form of compensator is generally used with large synchronous motors to reduce the voltage applied to the stator when starting, and in this manner keep down the heavy surges of starting current which would otherwise occur.

When starting a synchronous motor, there are a certain number of steps or operations which should be performed in the proper order. This is particularly important when starting large motors. The procedure is as follows:

First, open all switches and see that the field switch is in the discharge position; then apply about 50% of the rated voltage to the stator winding. It may be necessary to apply higher voltage if the motor is to start heavy loads.

As soon as the rotor has reached nearly full speed, see that the exciter rheostat is properly adjusted so that the D. C. generator produces a low voltage as indicated by the voltmeter, V; and with this low voltage excite the field of the synchronous motor very weakly.

Then apply full line voltage to the stator and gradually increase the field excitation until the

motor pulls into step, and then adjust the field strength to the proper value to enable the motor to carry the mechanical load, in case it is driving any load of this nature, and for the proper power factor at which the motor is supposed to operate.

Large synchronous motors usually have A. C. ammeters connected in series with the line leads to the stator, and the current input to the motor should not exceed the name-plate current rating, except as per instructions furnished by the manufacturer in regard to the overload capacity of the motor.

Even though a synchronous motor is not driving any mechanical load, it is possible to overload the stator winding with A. C. by over-exciting the D. C. field and thus causing the motor to draw a large leading current. This, of course, tends to correct the power factor of the system to which the motor is attached, but the synchronous motor should not be overloaded for this purpose any more than it should for driving mechanical load.

### 208. ADJUSTING POWER FACTOR BY CHANGING FIELD EXCITATION

By adjusting the exciting current, the power factor of a synchronous motor may be varied in small steps from low lagging power factor to a low leading power factor. This makes it possible to vary the power factor of these machines over a wide range and places this characteristic of the motor under the control of the operator at all times.

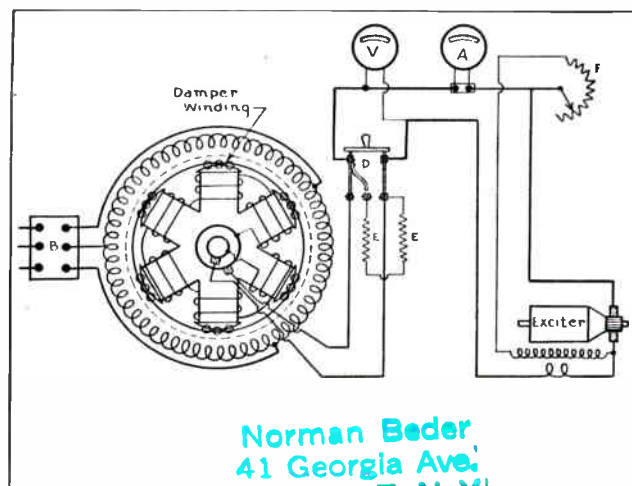

Fig. 193. The above diagram shows the connections for the stator and field of a synchronous motor and also the exciter-generator field discharge switch and instruments.

If a synchronous motor which has normal field excitation were driven as a generator, it would develop the same armature voltage as that which is applied by the A. C. line when the machine is operating as a motor. If the field current is increased above this normal value, the motor will have a leading power factor; and if the field current is below normal value, the motor will have a lagging power factor.

When a synchronous motor is used to drive

mechanical load and also to correct power factor, the field will require a small additional amount of exciting current.

### 209. STARTING COMPENSATORS AND PROTECTIVE DEVICES

Fig. 194 shows a diagram of the connections for a large synchronous motor, including the starting compensator, A. C. ammeter, circuit-breaker, and protective devices.

When starting, the contacts B are opened and contacts C and D are closed, thus supplying reduced voltage to the motor armature J by means of the auto transformer E.

After the motor comes up to speed, the contacts C and D are opened and B is closed, thus supplying the armature or stator winding with full line-voltage.

If at any time during operation the motor is overloaded and the current flow to the stator winding becomes too great, the current in the secondaries of the current transformers H will be increased and will energize the overload trip coils G and G strongly enough so that they will open the circuit-breaker contacts B.

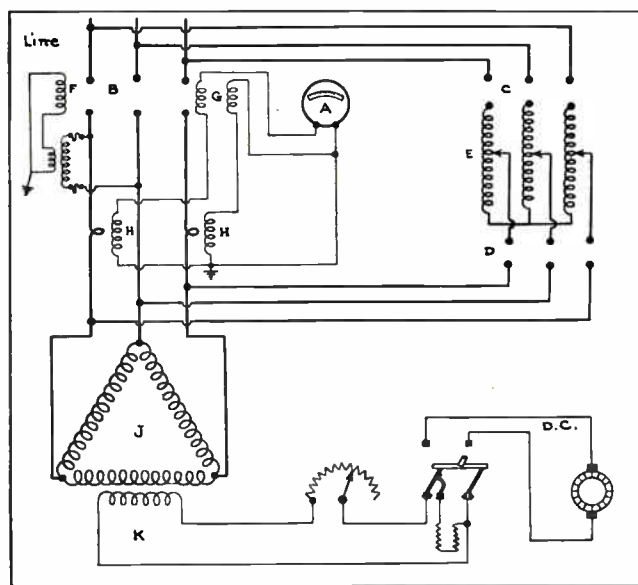

Fig. 194. Diagram of connections for a large synchronous motor with a compensator for starting at reduced voltage. Also note the protective device connected with a circuit-breaker in the line leads.

If the A. C. line-voltage should fail or become too low during operation of the motor, this would also reduce the voltage of the potential transformer secondary and weaken the under-voltage trip-coil F, allowing it to release its armature and open the circuit-breaker B. The D. C. field of the synchronous motor is shown at K.

To stop a synchronous motor or condenser, first decrease the field excitation to normal and then open the line switch. Next open the field-discharge switch and leave it in the discharge position. This switch can be left closed until the machine stops if desired, but should always be opened then.

### 210. CHARACTERISTICS AND ADVANTAGES OF SYNCHRONOUS MOTORS

The efficiency of medium and large-sized synchronous motors ranges from 88% to 96%, depending upon the size, speed, design, etc. Some very large synchronous motors have been built with efficiencies of nearly 98%.

The starting torque of synchronous motors is usually slightly lower than that of induction motors, but many of the later type synchronous motors are designed with starting torques approximately equal to those of squirrel-cage motors.

These starting torques vary from 50% to 150%, according to the design of the machine.

The pull-out torque of synchronous motors varies from 150% to 200% or more of full-load torque.

Several of the outstanding advantages of synchronous motors are: (a) their constant speed; (b) ability to correct power factor, which in turn results in better voltage regulation; (c) higher efficiency at low speeds than induction motors.

The ability of synchronous motors to correct power factor is one of the most important of their advantages.

Synchronous motors have several features which may be considered as disadvantages and these are: (a) they are somewhat more complicated than induction motors; (b) lower starting torque of the older types; (c) tendency to hunt and therefore to fall out of step and stall; (d) they require more skilled attention than induction motors do; (e) they require a supply of both A. C. and D. C.; (f) in case of shorts on the line, synchronous motors act as generators and supply current to the short as long as the inertia keeps the rotor moving at a fair speed. This latter disadvantage can, however, be eliminated with proper protective relays.

### 211. APPLICATIONS OF SYNCHRONOUS MOTORS

The advantages of synchronous motors for certain classes of service much more than make up for the disadvantages which have just been mentioned.

Fig. 195 shows two 2600 h. p. synchronous motors used to drive low-pressure water pumps of the screw-propeller type. Fig. 196 shows a group of synchronous motors driving compressors in an ice plant.

Synchronous motors have a very wide field of application and their use is being rapidly extended to other classes of power drives each year. A large number of power generating and public utility companies insist that all motors of 50-h. p. and larger which are connected to the lines must be of the synchronous type. This is done in order to improve the power factor of the system and thereby permit better utilization of the generator line and transformer capacities.

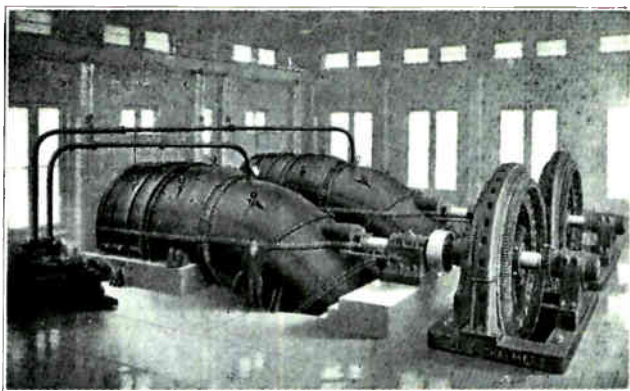

Fig. 195. This photo shows 2600-h. p. synchronous motors driving low-pressure, screw type water pumps. (Photo courtesy Allis-Chalmers Mfg. Co.)

With lower power factors, a large portion of the generator, line and transformer capacities must be used for the circulation of lagging wattless currents.

A number of the more common uses or applications for synchronous motors are as follows:

Operation of compressors and pumps; operation of fans and blowers, motor-generators, and frequency changers; steel mill drives; paper mill drives; crushers and grinders; line-shaft drives; and as synchronous condensers for power-factor correction only.

## 212. SUPER-SYNCHRONOUS MOTORS

It has previously been mentioned that, in order

to start with loads, synchronous motors are sometimes connected to the load by means of friction or magnetic clutches. A variation of this principle is used on a special synchronous motor which has been designed for starting heavy loads and is known as a super-synchronous motor.

This type of motor has the stator frame arranged so that during starting the entire frame and core can revolve on auxiliary bearings on the motor shaft. This allows the rotor, which is attached to the load, to remain stationary until the stator is revolving around it at full synchronous speed.

The field is then excited with D. C. and a brake is gradually applied to the stator frame, causing it to reduce speed and finally bringing it to a complete stop. This gradually exerts upon the rotor poles the full running torque of the synchronous motor, and as soon as the brake is applied the rotor begins to turn and drive the load, coming up to full synchronous speed by the time the stator frame is completely stopped.

This method permits the use of the full running torque to start the load and allows the starting to be accomplished at much higher power factor.

Fig. 197 shows a 300-h. p. super-synchronous motor of the type just described. In this figure you will note that the stator frame is not attached to the bearing pedestals but is instead mounted on its own bearings on the motor shaft. You will also note

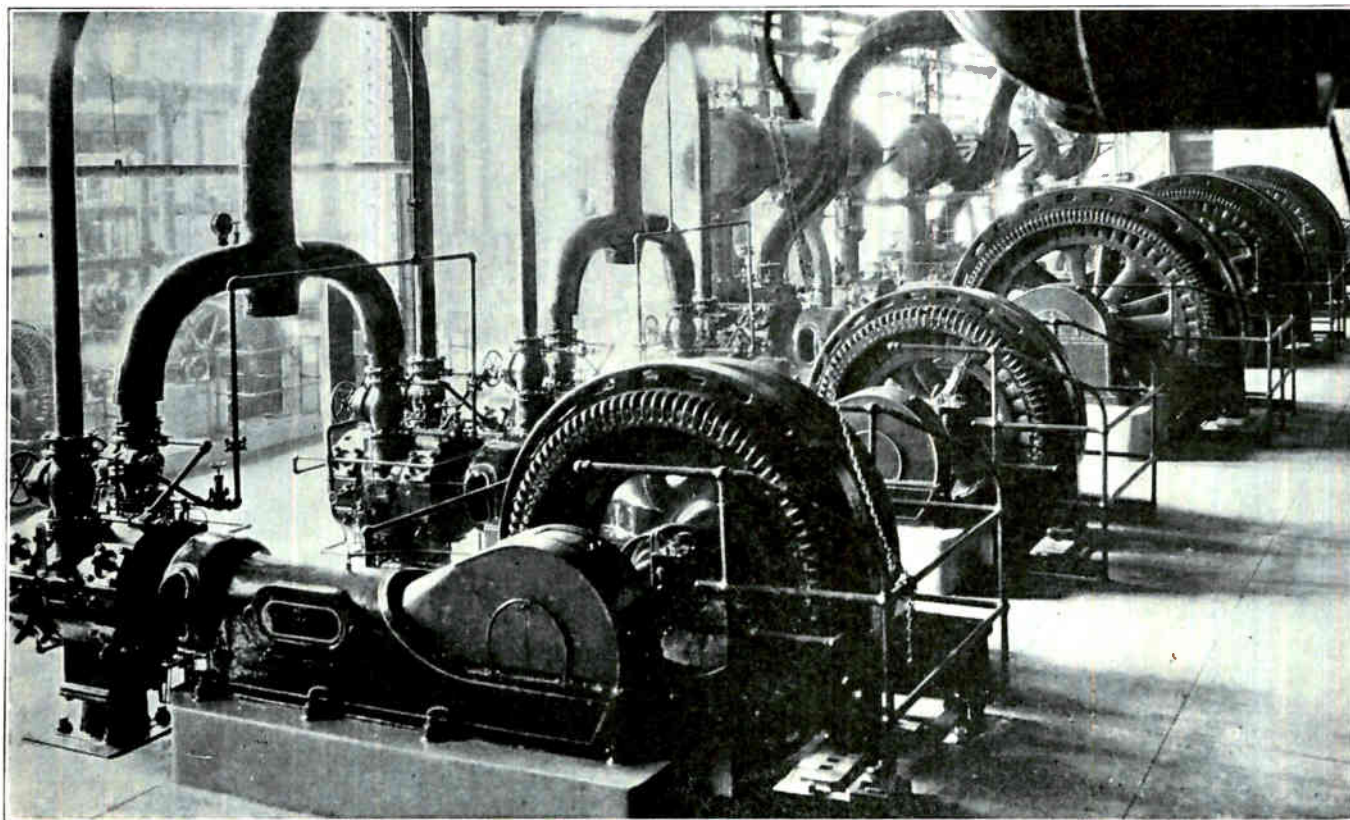

Fig. 196. Group of large synchronous motors used to drive compressors in an ice plant. Many large ice plants and refrigerating plants use motors of this type to operate their ice machines.

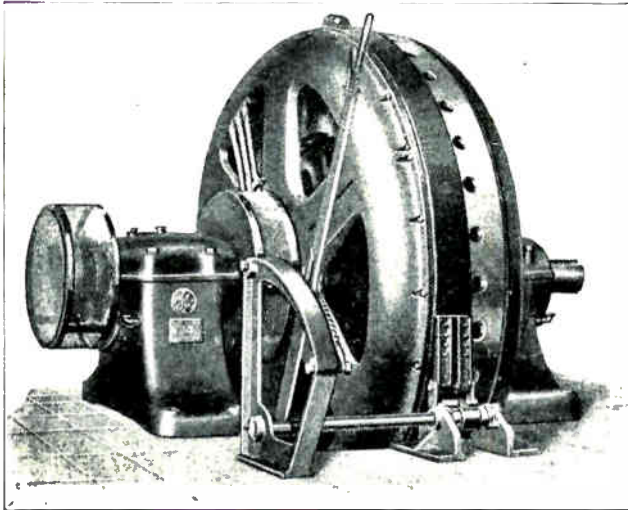

Fig. 197. Super-synchronous motor which is equipped with a revoluble stator and brake to obtain high starting torque. (Photo courtesy G. E. Company.)

the brake-band around the outside of the stator frame and the brake-link and lever which are used to tighten the band and stop the rotation of the stator and thereby cause the rotor to start the load.

The slip rings of this motor are mounted on the left end of the shaft inside of the protective screen, and the leads are taken through the hollow shaft to the D. C. rotor poles.

Fig. 198 shows a group of large super-synchronous motors in use in a cement mill. Two sets of slip rings must be used with motors of this type; one set for conveying the alternating current energy to the stator or armature when it is revolving during starting period, and the other set for supplying the direct current to the rotor, which revolves all the time during the operation.

The method of calculating the proper size of synchronous condenser to use for correcting the power factor of a system, will be covered in later paragraphs.

### 213. SPECIAL A. C. MOTORS

In addition to the common types of A. C. motors which have just been explained and which are in very general use throughout the entire electrical industry, there are also a number of special A. C. motors which are designed with certain characteristics to meet unusual requirements.

Several types of these which have been more recently developed are proving very satisfactory and have excellent advantages for certain classes of work. Some of these motors, or the principles involved in their design, will come into much more extensive use in the next few years, and for this reason they are worth a little special attention at this point.

The principles on which these motors operate are in general more or less similar to those of common

types of machines with which you are already familiar. Therefore, it is not necessary to go into great detail in discussing them; so we shall merely explain the application of these principles to several of the most popular types of special motors and shall also explain the characteristics and applications of these machines.

### 214. DOUBLE SQUIRREL-CAGE MOTORS

We have already learned that it is possible to obtain much better starting torque from induction motors by the use of a certain amount of resistance in the rotor circuit. It is not always desirable to use a slip-ring motor with the auxiliary controls required; and, if squirrel-cage motors are designed with rotors of very high resistance, this resistance while improving their starting torque, will also decrease their running efficiency.

To obtain the very good starting torque of the high-resistance rotor and also the higher running efficiency of the low-resistance rotor, induction motors have been developed with what are called double squirrel-cage rotors.

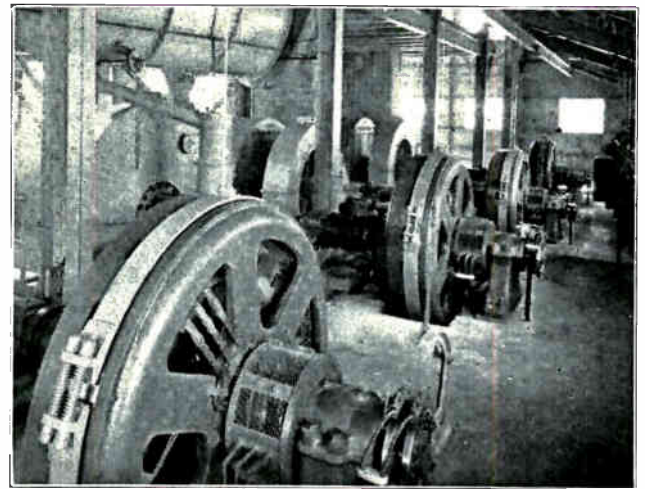

Fig. 198. This photo shows four large low-speed super-synchronous motors operating at 2200 volts and driving machines in a cement mill. (Photo courtesy G. E. Company.)

These rotors consist of the usual core of laminated iron equipped with specially-shaped slots in which are imbedded the bars of two squirrel-cage windings. One squirrel-cage with large bars of low resistance is imbedded deeply in the iron core in the bottoms of the slots, and another squirrel-cage with smaller bars of higher resistance is located close to the outer surface of the rotor core with the bars placed just beneath the core surface.

Fig. 199 shows on the left a sectional view of such a rotor which has been cut in two to show the position of the high-resistance squirrel-cage at "A" and the low-resistance squirrel-cage at "B". On the right in this figure is another view of a double squirrel-cage of this type from which the iron core has been removed by acid. This view shows very

clearly the construction of the inner or low-resistance element and the outer or high-resistance element.

Fig. 200 shows a complete rotor of the double squirrel-cage type in which the bars and end rings of the squirrel-cages are cast of aluminum which has been poured directly into the openings in the iron core, thus making it one very solid unit when completed.

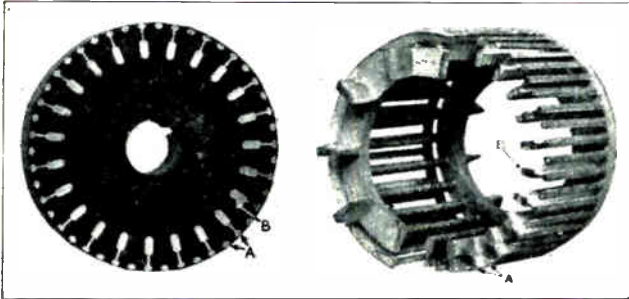

Fig. 199. This figure shows two views of a double squirrel-cage rotor. On the left is a sectional view and on the right the core iron has been eaten out by acid, clearly showing the construction and shape of the double squirrel-cage. (Photo courtesy General Electric Co.)

## 215. OPERATING PRINCIPLES

These motors have an ordinary stator winding, the same as any polyphase induction motor. When the stator is supplied with A. C. from the line, the revolving magnetic field induces secondary currents in both of the squirrel-cage windings and sets up the torque which starts the motor.

During starting, however, the outer or high-resistance squirrel-cage is the one which is most active, and very little current is carried by the inner cage during this period. This is due to the fact that the smaller high-resistance bars are located near the outer edge of the rotor core and have much less iron or magnetic material around them. This means that they provide a path of much lower reactance than the inner bars, which are completely surrounded with a heavy path of iron.

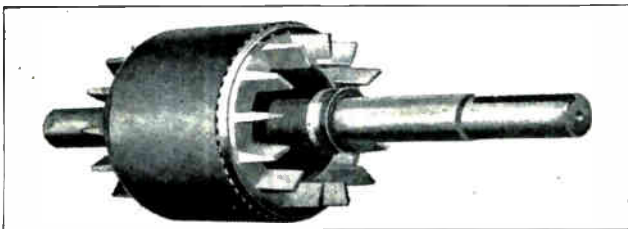

Fig. 200. Complete rotor of the double squirrel-cage type. Note that there are no open slots around the rotor core, the bars being cast into the rotor.

This outer winding of low reactance provides a much easier path for the high-frequency secondary currents which are induced during starting when the slip of the motor is very great. After the motor is up to nearly full speed and the slip is very small, the frequency of the induced rotor currents is then

much lower, and as low frequency A. C. can pass through an inductive circuit much easier than high frequency, the low-resistance bars of the inner squirrel-cage now offer an easy path for the flow of rotor current during normal running of the motor.

We find, therefore, that the changeover of the current from the high-resistance, starting squirrel-cage to the low-resistance, running cage is entirely automatic and requires no switches or moving contacts; being due entirely to the change of frequency and magnetic characteristics of the rotor between the period of high slip during starting and reduced slip when running.

Double squirrel-cage motors are very suitable for jobs which require heavy starting torque and where simple, rugged motors requiring a minimum of maintenance are desired. The double-squirrel-cage principle is not altogether new, having been used in induction motors since their early development; but it is only in recent years that this principle has come into general use in commercial power motors.

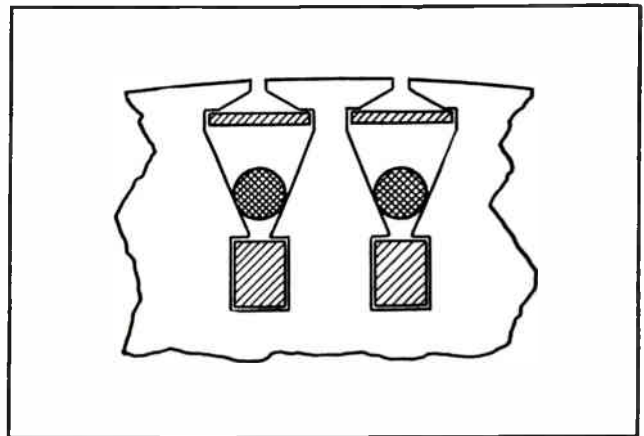

Fig. 201. This sketch shows the slot and bar construction of double squirrel-cage rotors using iron "choker bars" to change the resistance of the field and outer circuits.

## 216. DOUBLE-SQUIRREL-CAGE MOTORS WITH "CHOKER BARS"

Several different styles of double-squirrel-cage motors are in use at present. Some of these use different variations of the principle, but in general their operation is very much the same. One motor of this type which is made by the Fairbanks Morse Company, uses a set of loose iron bars or rods which are placed in the slots between the inner and outer squirrel-cage bars. These bars change their position by centrifugal action when the motor comes up to speed, thus changing the magnetic path and thereby varying the reactance of the squirrel-cage circuits.

Fig. 201 shows a cross-sectional view of two slots of a rotor of this type. The low-resistance squirrel-cage bars are located in the inner slots, and the high-resistance squirrel-cage bars are the thin flat ones shown near the outer edges of the slots.

When the motor is first started, the round iron

bars are held in the bottom of the slots by the magnetic action of the flux set up in the rotor. This completely closes the iron path around the inner squirrel-cage, making this path one of very high impedance, so that only a very small amount of the starting current flows in this winding.

When the motor reaches nearly full speed, the iron bars are thrown outward by centrifugal force, thereby decreasing the amount of magnetic material around the inner bars, and increasing the amount of iron around the outer bars.

This reduces the reactance of the inner squirrel-cage and increases the reactance of the outer one which, we recall, is already of high resistance. This causes a very decided shift of the lower frequency currents induced in the rotor during running, from the high-resistance rotor to the one of low resistance.

### 217. BTA VARIABLE-SPEED A. C. MOTORS

Another type of A. C. motor, known as the BTA motor, has been developed by the General Electric Company to meet the needs of various power-driven machines which require adjustable speed A. C. motors with characteristics similar to those of the shunt D. C. motor.

These motors have a stator winding and two windings on the rotor, and also use a commutator and brushes similar to those of a D. C. machine.

Fig. 202 shows a diagram of the windings and connections of a motor of this type. You will note that the alternating current line connects to one of the rotor windings, "P", by means of the brushes and slip rings. When this winding is excited with A. C. from the line, it sets up a revolving magnetic field and also induces secondary currents in the stator windings: S-1, S-2, and S-3.

The winding in the stator is constructed similarly

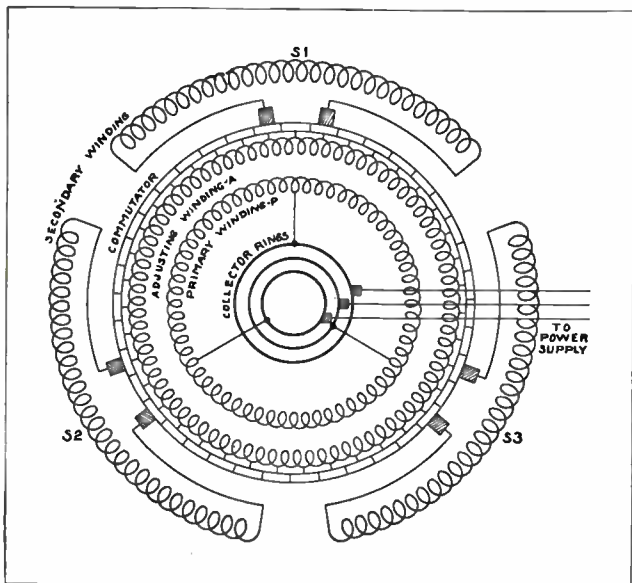

Fig. 202. This diagram shows the connections of the armature and stator windings of a BTA variable speed A.C. motor. Examine the diagram carefully while reading the accompanying explanation.

to stator windings of ordinary induction motors, except that the three phases are connected separately to the three pairs of brushes which rest on the commutator. These brushes are adjustable and can be moved closer together or farther apart. When they are resting on the same commutator segment the stator windings are short-circuited, so that a rather heavy flow of induced secondary current is set up in these windings.

The adjusting winding, "A", which is also carried on the revolving armature and is connected to the bars of the commutator, generates a certain amount of voltage which is applied to the brushes that connect to the stator winding.

When these brushes are moved farther apart, a greater amount of adjusting voltage is applied to the stator windings. By shifting the brushes and varying this voltage, the speed of the motor can be changed.

### 218. CHARACTERISTICS

These motors are usually built for a range of speed variation of three to one, and are designed to operate at constant torque at any speed within their range. This means that the horse power will be proportional to the speed at which they are operated.

The efficiency of these motors remains nearly constant over the greater part of their speed range, but is slightly lower at the lowest operating speeds. Their average efficiency is high compared with that of wound-rotor induction motors having secondary resistance.

The power factor of this type motor is about the same at synchronous speed as the power factor of an ordinary induction motor of the same size, and becomes higher when the motor is operated at higher speeds.

BTA motors will develop from 140 to 250 per cent. of full-load torque during starting and with starting currents of only 125 to 175 per cent. This ability to develop heavy starting torques with comparatively small starting current is one of the very desirable features of these motors.

When operating at their lower speeds, the pull-out torque of these motors is from 140 to 250 per cent. of full-load torque, and when operating at higher speeds the pull-out torque varies from 300 to 400 per cent. of normal-load torque.

Fig. 203 shows the armature of a BTA motor removed from the machine. The commutator is connected to the adjusting winding on the armature similarly to the connections for an ordinary D. C. motor armature and commutator. The slip rings on the left end of the shaft have leads taken from them through the hollow shaft to the A. C. winding on the armature.

You will note also the ventilating fan which is attached to the armature at the rear of the commutator.

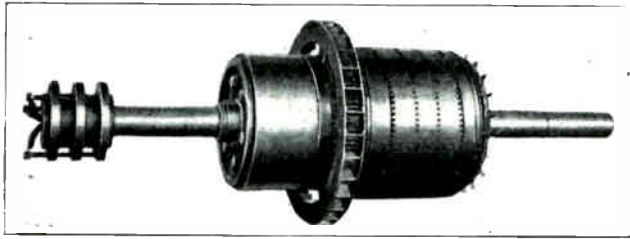

Fig. 203. Armature of a BTA motor showing the commutator, slip rings, and ventilating fan. (Courtesy G. E. Company)

Fig. 204 shows a complete BTA motor. The small hand-wheel on the upper arm of the end-bracket is used for adjusting the position of the brushes and thereby changing the motor speed. The collector rings on the end of the shaft are enclosed in a safety hood or guard, as shown. The line leads are brought out of this hood for connection to the three-phase A. C. line.

The small box on the side of the motor frame near the base contains an overload relay to protect the motor from too heavy overloads. This relay is connected to the starting switch or motor controller so that it will trip the starter and open the line circuit in case of excessive overload currents to the motor.

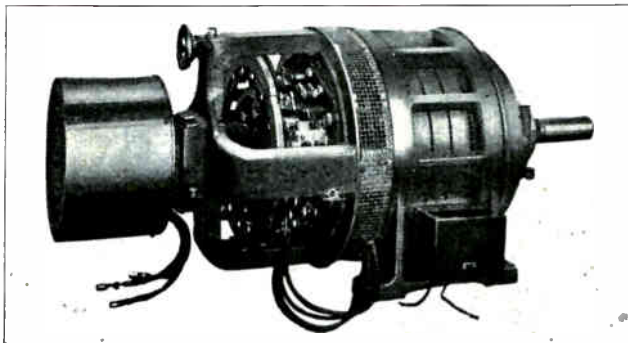

Fig. 204. This photo shows the completely assembled BTA motor. The brush-shifting wheel can be seen on the upper corner of the frame and the slip rings are enclosed in the housing at the left end of the shaft. (Courtesy G. E. Company)

Fig. 205 shows the standard ratings of type BTA motors. These are made in six, eight, and ten-pole types for normal speeds of 1200, 900, and 720 R.P.M. You will note from the table that the six-pole machines can be varied above or below their normal speed of 1200 R.P.M., within a range of 550 to 1650 R.P.M. The normal speed of 900 R.P.M. for the eight-pole machines can be varied from 415 to 1215 R.P.M. and the normal speed of 720 for ten-pole machines can be varied from 333 to 1000 R.P.M.

You will also note from the center column of the table that the horse power varies in proportion to the speed. For instance, the 5-h. p. motor develops only 1.67 h. p. at its lowest speed of 550 R.P.M. In other words, when the speed is reduced to one-third the horse power is also reduced to one-third.

The motor with maximum rating of 10-h. p. at

high speed develops only  $3\frac{1}{8}$  h. p. at its lowest speed, etc.

### 219. FYNN-WEICHSEL MOTORS

Another special type of motor which is manufactured by the Wagner Electric Corporation, is known as the Fynn-Weichsel motor. These motors are really combination induction and synchronous motors, and have excellent starting torque and very high power factor when running fully loaded. They start as an induction motor and will start loads of 150% or more of full load, quickly bringing them up to full speed, and at this point the motor changes over and runs as a synchronous motor during normal operation.

If during operation the motor is overloaded beyond 160% of full load current, it will pull out of synchronism and again operate as an induction motor up to overloads of approximately 250% or more before it will stall.

These characteristics have made this type of motor very popular in the last few years for certain classes of drives where motors with good starting torque, constant speed, and high power-factor are required.

Another decided advantage of the Fynn-Weichsel motor is that it supplies its own direct current for exciting the D. C. field winding, and therefore does not require separate exciter-generators as ordinary synchronous motors do.

### 220. CONNECTIONS AND OPERATING PRINCIPLES

Fig. 206 shows a diagram of the windings and connections for a Fynn-Weichsel motor. The revolving armature or rotor has a main A. C. winding connected to slip rings and to the A. C. line. In addition, it also has a small D. C. winding which is connected to the commutator and develops in the neighborhood of 24 volts of direct current for excitation of the D. C. field poles.

This field winding is placed in the slots of a stator and is uniformly distributed over the stator core, instead of being wound on projecting field poles as in the ordinary synchronous motor.

The diagram in Fig. 206 shows the D. C. field-winding connected to the brushes of the commuta-

Rating of Standard BTA Motors

Number of Poles	H.P.	Full Load Speed
6	5/1.67	1650/550
6	7.5/2.5	1650/550
6	10/3.33	1650/550
6	17.5/5.83	1650/550
8	25/8.33	1250/415
8	35/11.67	1200/415
10	50/16.67	1000/333

Fig. 205. The above table gives the horsepower rating and speed ranges of standard BTA motors. Note how the h.p. varies with the speed.



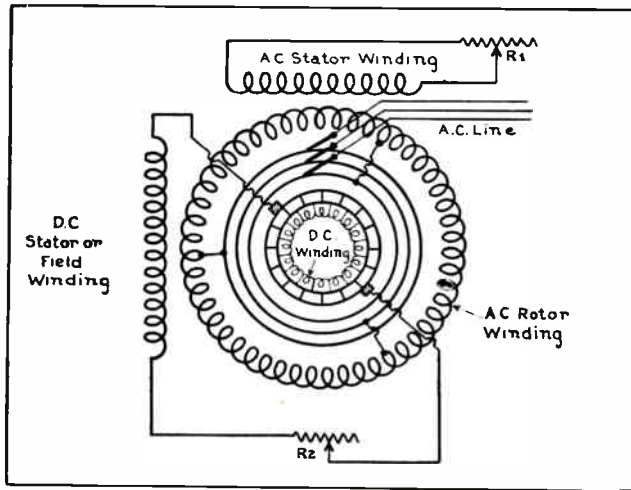

Fig. 206. Diagram showing the connections of the armature and field of a Fynn-Weichsel motor. Note that both the stator and armature have two separate windings.

tor and equipped with a rheostat for varying the field strength. In this simple diagram the single coil or winding shown is used to represent the entire field winding and whatever number of poles it may actually contain.

There is also an A. C. winding which is placed in the slots of the stator and is connected through a rheostat to form a closed circuit upon itself. This winding is located 90 degrees from the D. C. winding in the stator.

When alternating current is applied to the slip rings and the A. C. winding on the rotor, it sets up a revolving magnetic field and also induces secondary currents in both the A. C. stator-winding and the field winding.

The reaction between the flux set up around these windings and the field of the A. C. rotor winding, develops excellent starting torque and quickly brings the motor up to full speed. As the speed of the motor increases to synchronism, D. C. voltage is obtained from the commutator and small winding and applied to the brushes. This D. C. voltage is applied to the field and increases the strength of the D. C. field winding and causes the motor to hold in synchronism and operate as a synchronous motor during normal running conditions.

If the motor is overloaded beyond the pull-out torque capacity of about 160% full-load torque, it will then fall out of step and operate as an induction motor, once more continuing to carry the overload at slightly reduced speed.

During starting of the motor, rheostat R-1 is adjusted to include the proper amount of resistance in series with the A. C. secondary winding in the stator. This resistance is cut out as the motor comes up to speed and the winding is then short-circuited.

When the motor pulls into synchronous speed there is no more slip, so there will be no appreciable

current induced in this stator winding as long as the motor operates as a synchronous machine.

If the motor is overloaded to a point where it pulls out of synchronous operation and slightly reduces its speed, this recurrence of the slip will immediately cause current to be induced in the stator winding once more and thus develop by induction the added torque which enables the motor to carry the very heavy overloads which it is capable of carrying as an induction motor.

## 221. LEADING POWER FACTOR AND P. F. ADJUSTMENT

Rheostat R-2 can be adjusted to obtain the proper strength of the D. C. field-winding according to the load the motor is required to carry and the power factor which it is desired to maintain.

At full load the Fynn-Weichsel motor generally has a power factor of about 92% leading. From this we can see that if one or more motors of this type are used in a plant with induction motors and other inductive equipment they will improve the power factor considerably.

In fact, a 15-h. p. Fynn-Weichsel motor with its leading power factor will just about neutralize the lagging power factor of the 15-h. p. slip-ring, induction motor, thereby keeping the power factor at approximately unity on the line or system on which the two motors are operated in parallel.

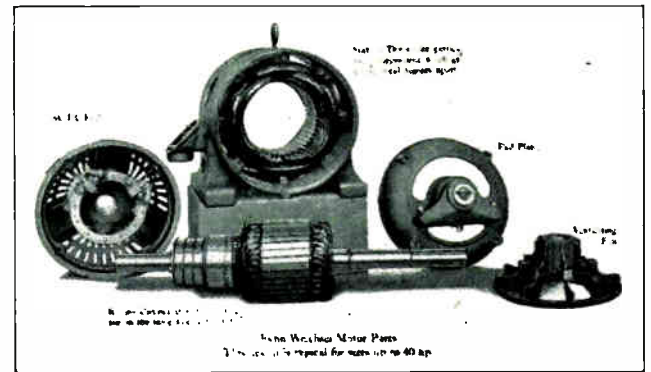

Fig. 207. Disassembled view of Fynn-Weichsel synchronous motor. Note the commutator and slip rings both on the same end of the shaft and also the two windings in the stator. (Photo courtesy Wagner Electric Corp.)

While the power factor of squirrel-cage induction motors becomes very low when they are operating lightly loaded, the power factor of the Fynn-Weichsel motor remains practically constant with any decrease of load which ordinarily occurs on a motor properly selected for its drive.

Fig. 207 is a disassembled view of a Fynn-Weichsel motor and shows clearly the construction of the rotor with its commutator and slip rings, and also the arrangement of the D. C. and A. C. windings in the stator.

Fig. 208 shows a complete Fynn-Weichsel motor with protective guards over the commutator, slip rings, and brushes.

## 222. SPECIAL ENCLOSED-TYPE MOTORS

In certain plants and classes of work where motors must operate in an atmosphere that is filled with dust or vapors it is often very difficult to keep the ventilating spaces in the motor windings from clogging with dust or to prevent the insulation of the windings from being damaged by vapors.

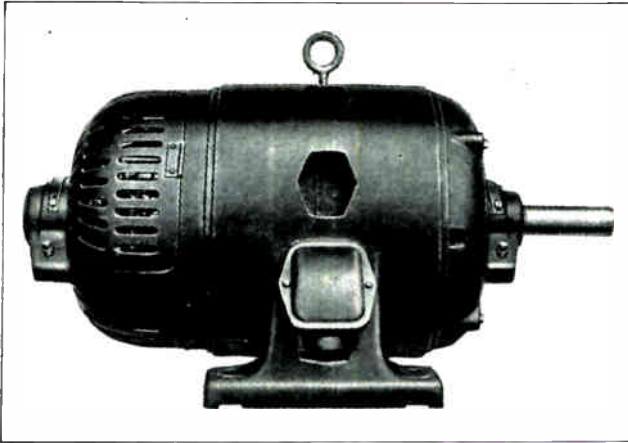

Fig. 208. This photo shows a completely assembled Fynn-Weichsel motor with a guard enclosing the slip rings and commutator. (Courtesy Wagner Electric Corp.)

To meet these conditions there are motors now being built with the winding, rotor, and bearings completely enclosed in an air-tight casing. These motors are so designed that the heat from the windings is conducted to the outside through the metal shell or casing. The regular motor casing is in turn enclosed in an outer jacket which guides a strong draft of cooling air directly over the surface of the motor casing, thus greatly aiding in the cooling of the machine.

Fig. 209 shows several views of a motor of this type. The upper left view shows the end from which the cooling air is exhausted from the jacket. The upper right view shows the air-intake end, with a screen which prevents coarse objects from getting into the fan and also protects an operator's hands from coming in contact with the revolving fan-blades. The lower view shows the motor and its enclosing frame removed from the air jacket and also shows the large ventilating fan used to form the strong draft of air over the motor casing. Motors of this type can be operated in extremely dusty places without injury to field windings or bearings by dust or vapors in the air, and also without the explosion hazard which accompanies the use of open commutator or slip ring types.

There are a number of other special types of motors which have been developed to fit almost every requirement and class of service for which a power drive is required. However, the general principles of these machines are very much alike and are similar to those which have been described in this section; so you will have no trouble in

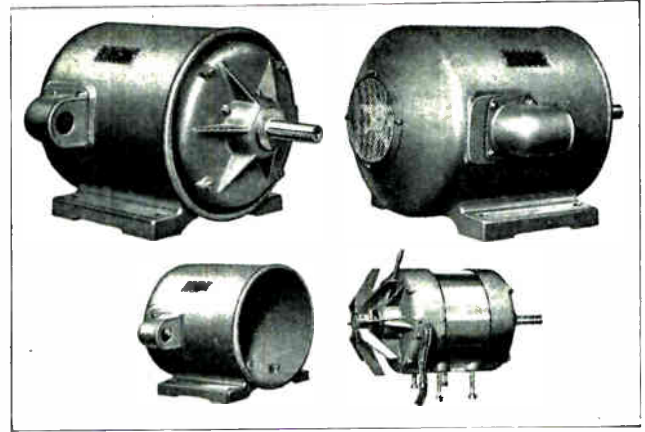

Fig. 209. Completely enclosed A.C. induction motor with special air-jacket to direct the cooling air over the surface of the motor casing. These motors are ideal for use in extremely dirty locations or in places where there are explosive vapors or dust.

understanding almost any type which you may encounter.

## 223. PORTABLE MOTORS FOR FARM USE

Fig. 210 shows a polyphase induction motor and push-button starter mounted on a convenient portable truck, with a heavily insulated extension cord for connecting the motor to a nearby line or transformer. Portable motors of this type are very convenient for certain temporary drives in industrial plants and factories, and are also coming into quite extensive use on farms.

There are numerous profitable uses for electric power on the farm, and many thousands of farms are well electrified and making excellent use of electricity for both light and power purposes.

Fig. 211 shows a portable electric motor being used for driving a hay baler. Motors of this type can also be used to operate threshing machines, pumps for irrigation and stock watering purposes, ensilage cutters, feed grinders, line-shafts in machine repair shops, and many other uses.



Fig. 210. Portable A.C. induction motor particularly adapted for use on farms and for driving portable machinery. (Courtesy G. E. Company.)

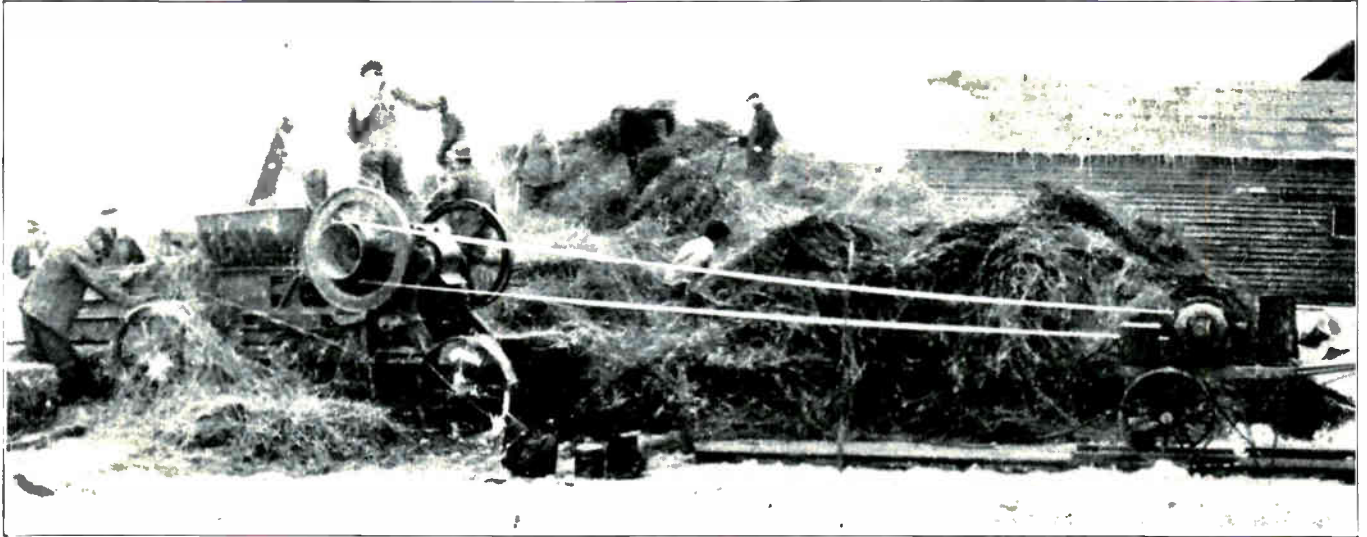

Fig. 211. This photo shows a portable A.C. motor driving a hay baler. Many thousands of farms are making excellent use of electricity to save time and money in many ways, and taking advantage of the increased safety obtained by use of electrical power equipment. (Photo courtesy G. E. Company)

#### 224. ELECTRIC MOTORS FOR USE ON SHIPS

Electric motors are also used extensively in ships of all classes. Battle ships are using enormous electric motors for driving their propellers, and also numerous small motors for handling equipment aboard the ship. Merchant marine ships use numerous electrical motors for operating cranes, derricks, hoists, elevators, and conveyers in handling materials when loading and unloading the ship.

Many of the smaller and medium sized motors for deck use on ships are enclosed in special air and water-tight casings, to exclude all salt water and vapor.

Electrical dredges use powerful electric motors to operate soil and rock cutting tools as well as the enormous suction pumps with which these dredges are equipped.

Modern passenger liners may have as many as several hundred medium and large sized electrical motors, in addition to the numerous small ones which are used for fans and convenience devices.

Two of the large ships in the U. S. navy are each equipped with eight motors of 22,500 h. p. each, which are used for propeller drives.

So we find electric motors are the principal source of mechanical power in practically all classes of industry and even on the farms and ocean-going ships.

Norman Beder  
41 Georgia Ave.  
Brooklyn 7, N. Y.

## POWER-FACTOR CORRECTION

Throughout the first section on A. C. and in a number of places in this section on A. C. motors, we have mentioned the desirability of maintaining good power factor on alternating-current systems.

We have also found that induction motors operate at lagging power factor even when fully loaded, and that they are particularly detrimental to the power factor when they are allowed to operate lightly loaded.

Some of the disadvantages of low power factor are as follows: It causes wattless currents to flow through the feeder lines and alternator windings, thereby requiring larger alternators, transformers, lines, switches and fuses, or causing overheating of those already in use. Low power factor causes increased voltage drop and poor voltage regulation on the lines and systems in which it exists. This voltage drop may result in low voltage at the terminals of motors and other equipment and cause them to develop very poor starting torque.

So we find that low power factor makes necessary the use of expensive voltage-regulating equipment, larger alternators and transformers, larger conductors in the lines and feeder circuits, and increased size of motors to perform a given amount of mechanical work.

In addition to these things, low power factor is often the cause of increased power bills because some power companies have in their power contracts a penalty clause on low power factor.

We have learned that lagging power factor can be neutralized and the power factor of a system improved by the use of synchronous motors or static condensers, which operate at leading power factors and supply leading currents which neutralize the lagging currents of inductive equipment.

### 225. USE OF SYNCHRONOUS MOTORS AS CONDENSERS

Synchronous motors operating with over-excited fields and used as synchronous condensers are very frequently installed for correcting the power factor in industrial plants and on the lines of power companies.

Synchronous condensers are generally used for power-factor correction where more than 500 kv-a. of corrective energy is to be handled, and they are also commonly used in sizes down to 50 kv-a.

In industrial plants where a large number of A. C. induction motors are in use, it is often advisable and economical to replace some of these with synchronous motors to drive certain machinery or

equipment which is suited to the characteristics of synchronous motors.

In this manner the synchronous motors can be used to furnish mechanical power and also to correct power factor. In other cases, medium or large sized synchronous motors are connected to the lines or system wiring without any mechanical load and allowed to float on the system just for power-factor corrective purposes. They are then known as synchronous condensers.

Sometimes an idle A. C. generator can be used in this manner and allowed to run idle on the A. C. lines with its field strongly excited. This improves the power factor on the system and will often greatly reduce the amount of wattless current flowing in the lines and required from the other alternators which feed the system.

Synchronous condensers of large capacity have the advantage of being of lower first cost than static condensers of equal capacity, and also of being much smaller in size for a given kv-a. capacity on the larger units. They also possess the advantage of affording easy adjustment of the power factor by regulation of their field excitation, and their operating characteristics tend to maintain good voltage regulation on the circuits to which they are attached.

The disadvantages of synchronous condensers are that they have somewhat higher losses and require more care and maintenance than static condensers. Synchronous condensers are commonly installed where the power factor of a large system can be corrected from one central point.

Fig. 212 shows a synchronous condenser of 5000 kv-a. capacity, for 2300-volt operation. This machine is enclosed in an air-tight casing and is cooled by clean, dry, ventilating air which is forced

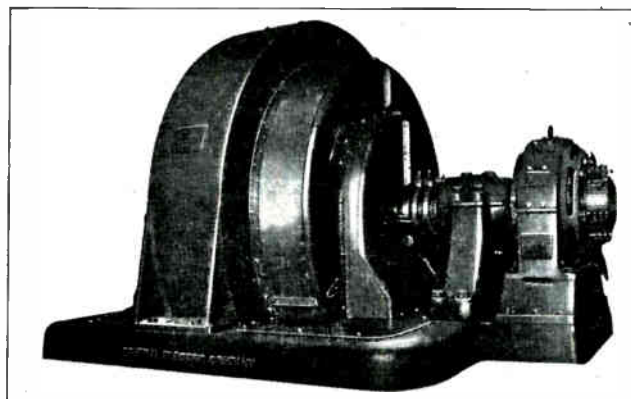

Fig. 212. 5000-kv-a., 2300-volt, enclosed-type, synchronous condenser. The exciter for this machine is shown on the right. (Photo courtesy G. E. Company)

through this casing from openings in the bottom of the frame. The exciter-generator shown is mounted on a separate base on the end of the main condenser base and is driven by the end of the main shaft.

## 226. STATIC CONDENSERS

The use of static condensers for power-factor correction has become quite general during the last few years. These devices have the advantage of being simple to install and of requiring practically no care or maintenance, as they have no moving or wearing parts.

They are of somewhat higher first cost and have the additional disadvantage of not being adjustable except by changing the number of condenser units which are connected to the system.

Static condensers can be used in large banks or groups to correct the power factor of the entire system, by connecting them at the switchboard or transformer bank where the power enters the plant or buildings. Small condensers can be used to correct the power factor of individual induction motors by connecting them directly to terminals of these motors and locating the condenser within a few feet of the motor itself.

Fig. 213 shows a 300 kv-a. static condenser for operation on 2500 volts. This unit consists of a number of small condensers located in racks and

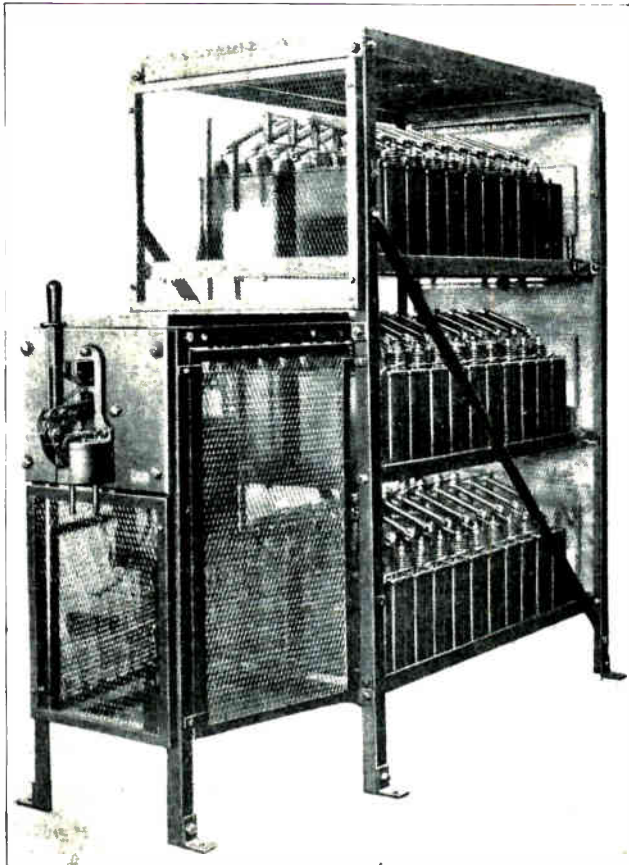

Fig. 213. 300-kv-a., three-phase, 2500-volt, capacitor or static condenser, used for improving power factor. (Courtesy General Electric Co.)

properly connected across the three phases of the line. These condensers can be seen mounted in three banks in the three levels of the frame. The oil switch mounted on the front of the unit is for disconnecting the condenser from the system whenever necessary.

Fig. 214 shows a pair of condenser units, or capacitor units as they are often called. These units are equipped with resistors of the cartridge type for discharging them when they are disconnected from the line. If it were not for these resistors shunted across the condensers they would hold a charge of high voltage for a considerable period after being disconnected, and this would make them dangerous for an operator to work on.

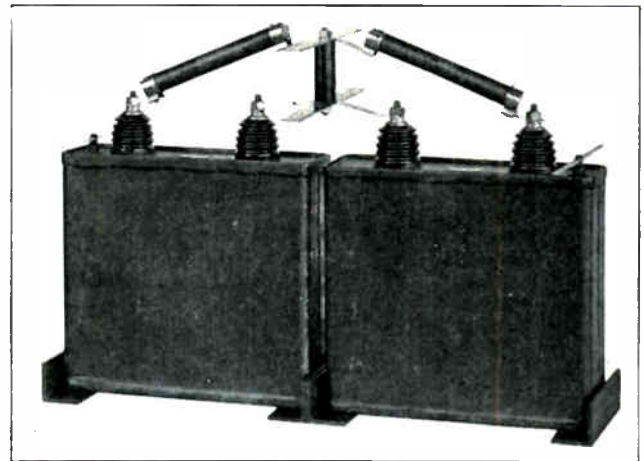

Fig. 214. Two single-phase condenser units connected together with discharge resistors in their circuit. (Courtesy G. E. Company)

It is also advisable to short-circuit any condenser with a piece of insulated wire, to make sure that it is discharged before working on it.

The resistance units are of high enough resistance so that they do not appreciably short-circuit the condensers or cause any considerable loss during operation. When the condensers are disconnected from the line, however, it requires only a few seconds for the energy stored in them to discharge through the resistance units.

## 227. CONSTRUCTION OF STATIC CONDENSERS

You are already quite familiar with the construction of condensers and have learned that they consist primarily of thin conducting plates of metal foil, separated by sheets of insulation or dielectric of the proper thickness and quality to stand the voltage at which the condenser is designed to operate.

These alternate sheets of metal and insulation can be arranged either in a flat stack with every other metal plate connected to opposite terminals, or in a roll with a good many square feet of each material rolled into one compact unit and these

long metal strips then connected in parallel to the terminals.

Fig. 215 shows two views of roll-type condenser units in which the strips of metal foil are rolled between strips of insulating paper. Note the terminals which are brought out on the ends of these units for connecting a number of them in series or parallel to obtain the proper voltage and capacity rating of the condenser.

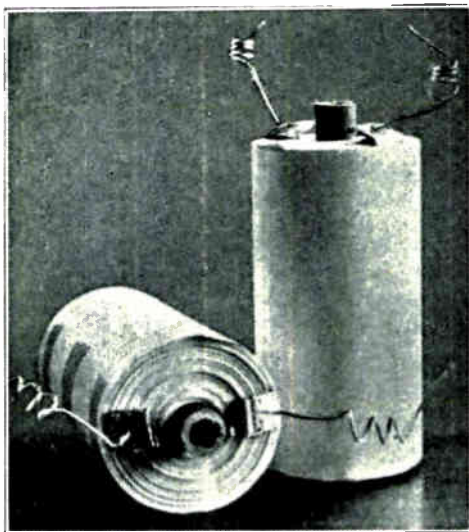

Fig. 215. Roll-type condenser units in which the long strips of metal foil and insulating paper are rolled into one compact condenser element. (Courtesy Electric Machinery Mfg. Co.)

Fig. 216 shows a number of these roll-type condensers mounted in one tank or case and connected three-phase to the terminals in the box on the front of the tank.

The condenser tanks are generally filled with insulating oil or compound to add insulating strength, and also to keep out all moisture and thereby preserve the quality of the insulation of the units.

Fig. 217 shows a complete condenser unit with an oil switch mounted on the front of the tank for making and breaking the connections between the condenser and line.

Condensers which are enclosed in water-proof tanks such as shown in Figs. 215 and 216 can be used either indoors or outdoors, and in some cases they are mounted on poles or platforms with the outdoor transformers.

## 228. OPERATION OF STATIC CONDENSERS

You have already learned that when a difference of potential is applied to the terminals of two parallel conducting surfaces which are located close together but insulated from each other, they will absorb or store up an electro-static charge. When the applied voltage is removed and the condenser short-circuited, this static energy will discharge in the form of dynamic current.

When alternating current is applied to a con-

denser it charges the unit during the period of the alternation when the voltage is increasing from zero to maximum, and allows the condenser to discharge back into the line when the voltage starts to fall from maximum to zero.

The current thus supplied by the condenser leads the applied line-voltage by approximately  $90^\circ$  and thereby neutralizes the effect of lagging currents in the circuit.

When a condenser is connected to terminals of an induction motor as shown in Fig. 218, the condenser supplies wattless current or magnetizing current to the motor so that this lagging current doesn't flow through the line between the transformers or alternators and the motor.

The opposite characteristics of the induction motor and the static condenser cause a continual circulation or interchange of current between the two during operation. By preventing this flow of wattless current through the lines, the static condenser reduces the voltage drop in the line and in many cases makes possible the use of smaller line or feeder conductors to the motor. It also reduces the amount of wattless current carried by the alternator windings.

## 229. LOCATION OF CONDENSERS

When the motors are of medium or large size it is often desirable to correct the lagging power

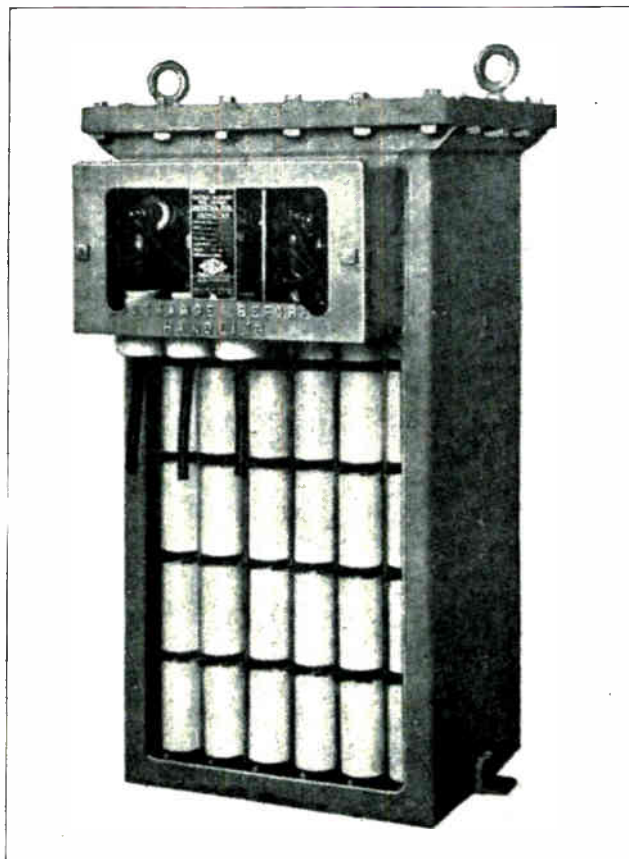

Fig. 216. Complete static condenser with side of tank cut away to show arrangement of roll-type condenser units. (Courtesy Electric Machinery Mfg. Co.)

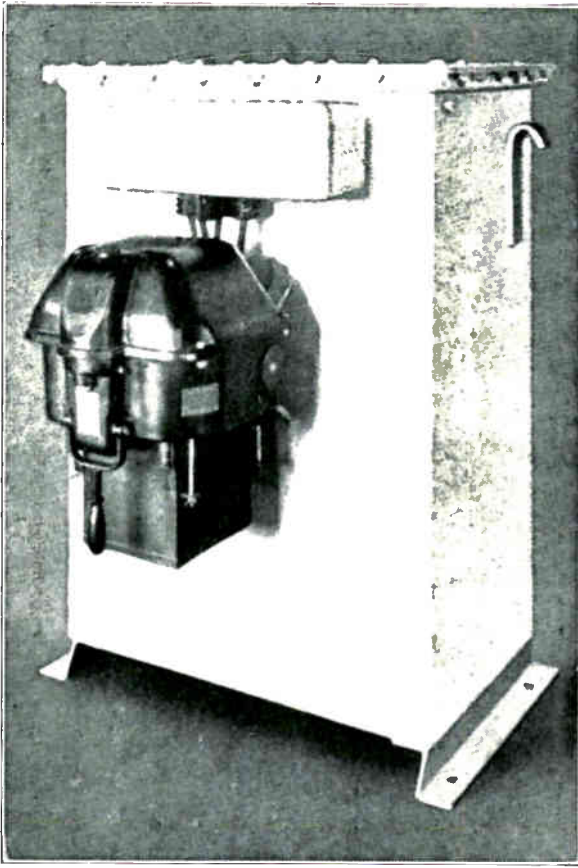

Fig. 217. This photo shows a static condenser enclosed in a moisture-proof metal tank and equipped with an oil switch for breaking the circuit between the condenser and the line. These condensers are made for both indoor and outdoor service. (Courtesy Electric Machinery Mfg. Co.)

factor right at its source by connecting small condensers to the motor terminals. This prevents the flow of wattless current or magnetizing current through the feeders in the plant and through the power line and alternators. In other cases, where this is not convenient and there are a number of small or medium-sized motors connected to the wiring system in a plant, it may be better to attach a large condenser or bank of condensers to the line or feeders at a point as near to the load center as possible.

In many cases the condensers are connected to the secondaries of the transformers which step down the voltage of the alternating current where the power enters the plant or building.

This relieves the transformers, power lines, and alternators at the generating plant from carrying the wattless current, but it doesn't remove this wattless current from the feeders and circuit within the plant where the low power factor exists.

Correcting the power factor in this manner may be satisfactory to the power company and relieve the customer of the penalty charge for low power factor, but it doesn't eliminate the voltage drop and losses which occur in the feeders and circuits of the customer's plant, nor the reduced efficiency of

motors and equipment which may result from this voltage drop.

For this reason it is more desirable to correct the low power factor right at its source by using condensers at the terminals of individual large motors whenever practical. Where it is not possible or practical to locate condensers at the terminals of large motors or where a large number of small motors are used, it is often more practical to install one large condenser as near as possible to the center of the load, so that it will correct the power factor for a group of small motors and supply the magnetizing current to these machines through the shortest possible length of the feeder wires.

Fig. 219 shows three large motors, each equipped with an individual static condenser connected directly to its terminals and also a number of small motors with one condenser, "D", located approximately at the center of the small motor load. The condensers, A, B, and C, confine the flow of wattless current for the large motors to the short wires between the motors and condensers, and if these condensers are of the proper size, none of the

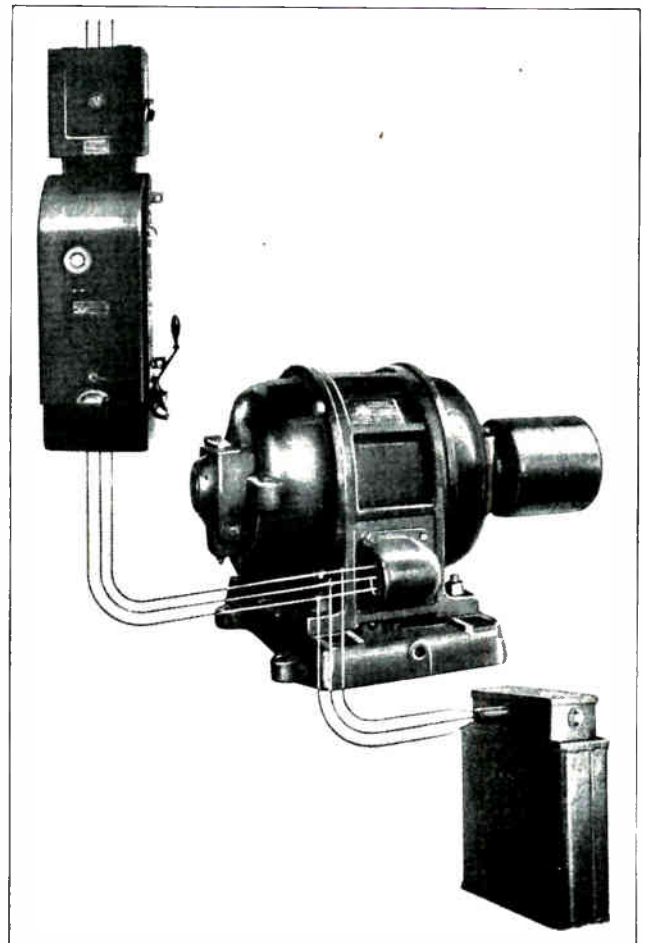

Fig. 218. Static condensers can be connected direct to the terminals of individual induction motors as illustrated in the above view. The condenser then supplies the magnetizing current to the motor and corrects the lagging power factor at its source. (Courtesy G. E. Company)

magnetizing current for these machines will flow through the main feeder wires.

If condenser D is of the proper size to supply the magnetizing or wattless current for all of the small motors, then this wattless current will only flow through a very short section of the main feeders and in this manner will be prevented from causing voltage drop in the longer feeder lines.

Keep in mind, in the case of condenser D, that the wattless current for each of the small motors located near this condenser will only flow between the motors and the condenser.

If, for any reason, it were not desirable to use the small condensers A, B, C, and D distributed throughout this power wiring system, a large condenser could be located at "X", as shown by the dotted lines. While this would not remove the wattless current from the feeders throughout the plant, it would prevent the transformers, power line, and alternator from being overloaded by the wattless current.

In some cases synchronous condensers are used right at the power plant for the sole purpose of relieving the alternators of wattless current. Sometimes an idle alternator can best be used as a synchronous condenser just floating on the busses to supply magnetizing current, instead of using up steam to drive this alternator to make it carry its share of the total effective current and magnetizing current.

### 230. POWER FACTOR CORRECTION BY PROPER LOADING AND PROPER SELECTION OF MOTORS

Before installing any power factor corrective equipment, such as synchronous or static condensers, it is generally best to do everything possible to improve the power factor by changing or rearranging the existing motors. Lightly loaded induction motors operate at very low power factor.

Very often it will be found that oversize induction motors have been chosen to drive certain machines which require the starting torque of a large induction motor; but which, after they are running, keep this motor loaded at only one-fourth to one-half of its rating.

In such cases it would be better to replace these squirrel-cage induction motors if possible with slip-ring motors or special squirrel-cage motors with better starting torque, so that motors of the proper size can be used and then operated at approximately full load during running.

In many instances it is possible to change motors around so that they are better fitted for the power requirement of the machines they drive, and in such cases it may not be necessary to discard or replace more than a few motors.

In a plant which is largely operated by squirrel-cage induction motors and is known to have a very

low power factor, great care should be used in selecting additional motors whenever new equipment is added.

If synchronous motors are used to drive as much as possible of the new equipment or if synchronous motors are installed to drive some of the old equipment which may be better fitted to their characteristics, this will release induction motors from the old equipment to drive the new machines.

On any equipment that cannot be satisfactorily operated by ordinary synchronous motors, it will probably be possible to use special high-torque synchronous motors, or at least to use slip-ring motors in order to get the necessary starting torque with the best possible efficiency and power factor.

When inspecting or changing old motors, or installing new ones in any plant where you may be employed, always keep in mind the great savings which can be effected by the proper selection and proper loading of A. C. motors.

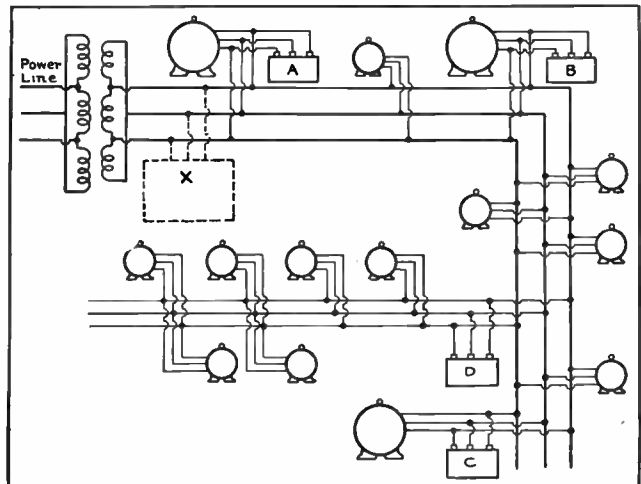

Fig. 219. This diagram illustrates the manner in which condensers can be connected to individual large motors and also at load centers to correct the power factor for a group of small motors.

### 231. SELECTION OF POWER FACTOR CORRECTIVE EQUIPMENT

When everything possible has been done in this manner, the power factor may still be too low and may be causing serious overloading of existing feeders and circuits and excessive voltage drop at the motors and equipment to be operated. It may also be causing a penalty charge on the power bill or overloading of transformers and alternators in case the company generates its own power. If this is the case then some other means of power factor correction should be considered.

The equipment used for this purpose should not be installed by guess work just because it is known that it will improve the power factor. Instead the entire system should be carefully gone over and tested to determine what the power factor actually is and what the extent of the load is on the alternators, transformers, and feeders in proportion to their capacity.



In many cases it is also advisable to check the power factor on different main branches of the system and the voltage drop at the terminals of equipment in different parts of the plant.

If the power is being purchased, the power bills should also be carefully checked to see how much can be saved by improving the power factor. In this manner the power factor corrective equipment can be intelligently selected to give results where they are most needed and to effect the greatest possible saving.

In determining the type of corrective equipment to use or in choosing between synchronous motors, synchronous condensers or static condensers, further care should be exercised.

If there are in the plant a number of machines or devices which are well suited to synchronous motor drive, and if there is some other use for the induction motors which will be replaced; or if these machines can be profitably sold or are old enough to be discarded, then synchronous motors of the proper size for driving the machinery and also correcting the power factor are generally a wise choice.

If the plant in which the power factor is to be corrected is a large one and has several centers of heavy load at low power factor, the installation of synchronous condensers at these load centers is often advisable.

Before choosing synchronous condensers, however, we should keep in mind that they require the same amount of skilled attention and maintenance that synchronous motors require.

If the plant is of small or medium size and if the motors and loads are widely scattered at the ends of long feeders and circuits, the installation of static condensers properly located throughout the plant may be most economical.

In numerous cases where alternators, transformers, and feeders may be overloaded to the point where it is necessary to replace them with larger ones or to add new ones to operate in parallel, it may be found that a considerable portion of this load is wattless current.

If correcting the power factor will relieve this condition and enable the existing equipment to be used for several years more, it is generally much cheaper to buy power-factor-corrective equipment and save the cost of the new generators and transformers.

Considerable copper cost can also be saved where the feeders or lines are of considerable length.

In some cases where the power is purchased and even though the power contract may not contain a penalty clause for low power factor, it may be possible to obtain a lower power rating or a rebate on the power bills by going to the power company with a definite proposal for improving the power factor of the customer's load to a certain amount.

### 232. DETERMINING THE PROPER SIZE OF CONDENSER REQUIRED

It is a very simple matter to calculate the actual amount of saving that can be effected by correcting power factor a certain amount, and also to calculate the size of the synchronous condenser or static condenser which will be required to correct the power factor the desired amount.

To determine the proper size of the condenser or the amount of corrective kv-a. required, it is first necessary to note the amount of actual load in kw. and the power factor of this load.

The next step is to decide to what new and higher value the power factor of the load should be raised. Generally it is not economical or practical to try to raise the power factor to unity or 100%, because the closer to unity the power factor is raised the greater will be the amount of corrective kv-a. required to increase the power factor any additional amount. So we reach a point where the very great cost of corrective equipment overbalances the saving and benefits derived from correction.

Furthermore, this unity power factor is not desirable on some systems, because a very small change in the load or power factor when the system is already at unity power factor, results in a considerable change in the current and tends to make the system unstable.

For these reasons a desirable power factor is usually somewhere between 85 and 95 per cent. When the load in kw. and the power factor of the plant or system are known, it is easy to calculate the apparent power in kv-a. and also the wattless energy or reactive kv-a. This latter is often called the wattless component, meaning the wattless portion or part of the energy.

### 233. PRACTICAL FIELD PROBLEMS

For example, suppose we are considering an industrial plant in which the actual power load is 1440 kw. and we find that the power factor of this load is 60%. This power factor can be determined by tests with voltmeter, ammeter, and wattmeter, or with a power-factor indicator, as explained in an earlier section.

We shall assume that we desire to increase this power factor to 90%. Our first step is to find the kv-a. at the present power factor. This will be:

$$1440 \div .60, \text{ or } 2400 \text{ kv-a.}$$

Now, to find the wattless component or reactive kv-a., we square both the actual power and the apparent power and then obtain the square root of the difference between these figures.

This can be stated in the following simple formula:

$$\text{Reactive kv-a.} = \sqrt{\text{kv-a.}^2 - \text{kw.}^2}$$

In the case of the problem we are considering, the reactive kv-a. will be:

$$\sqrt{2400^2 - 1440^2}, \text{ or } 1920 \text{ kv-a.}$$

This is the wattless power at 60% power factor.

The next step is to find what the wattless component will be at 90% power factor. This is found in the same manner as we have used for the 60% power-factor condition.

At 90% power factor, the apparent power of the system will be  $1440 \div .90$ , or 1600 kv-a.

Note the great reduction in the apparent power which is required to produce the same amount of actual power at the higher power factor. While at 60% power factor it required 2400 kv-a. to produce 1440 kw., at 90% power factor it requires only 1600 kv-a. to produce 1440 kw.

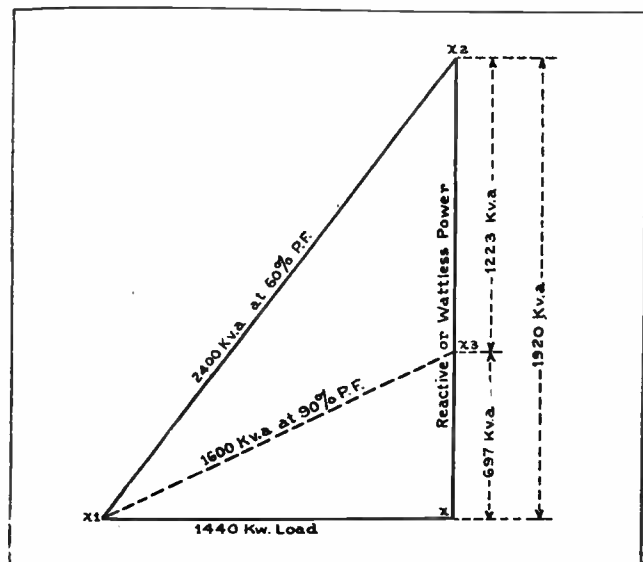

Fig. 220. The above sketch shows the simple method by which power factor problems can be solved graphically by drawing to scale the lines representing the various factors in the problem. Study this diagram very thoroughly with the accompanying explanations.

As we know that the current is proportional to the volt-amperes divided by volts, we can immediately see that the increased power factor will greatly reduce the current flowing in the circuits.

We can now determine what the wattless power or reactive kv-a. will be at the new power factor. This is found by the same formula as previously given, and, in this case, the reactive kv-a. equals:

$$\sqrt{1600^2 - 1440^2}, \text{ or } 697 \text{ kv-a.}$$

If the reactive kv-a., or wattless power, was 1920 at 60% power factor and is now only 697 at 90% power factor, then the difference between these two will be the reactive kv-a. required to increase the power factor from 60 to 90 per cent., or  $1920 - 697 = 1223 \text{ kv-a.}$ ; which will be the capacity of the condenser required to correct the power factor this amount.

In other words, the condenser must have a capacity of 1223 kv-a.

This problem is further illustrated by the diagram in Fig. 220. The horizontal line forming the base of the triangle represents the 1440 kw. of actual

power or load. This line is drawn to a scale of  $\frac{1}{8}$  of an inch per 100 kw.

The vertical line forming the adjacent side of the triangle represents the wattless or reactive kv-a. This line is drawn to the same scale and its full length represents the 1920 kv-a. of wattless power at 60% power factor. The lower section from X to X-3 represents the 697 kv-a. of wattless energy at 90% power factor.

The difference between these two, or the upper section of the line from X-3 to X-2, represents the 1223 kv-a. which will have to be neutralized by an equal amount of leading kv-a. from the condenser.

The long diagonal line from X-1 to X-2, or the hypotenuse of this large triangle, represents the 2400 kv-a. of apparent power at 60% power factor. The lower diagonal line drawn from the point of 697 kv-a. on the reactive power line to the point of the angle represents the 1600 kv-a. apparent power which will be required at 90% power factor.

### 234. GRAPHIC SOLUTION OF POWER FACTOR PROBLEMS

This same problem can be solved approximately with very few figures by laying out lines carefully measured to the proper length to represent the various values to scale.

For example, let us take a sheet of paper with square corners and, starting at the lower right-hand corner of the sheet as at "X" in Fig. 220, we shall first lay out to the left along the lowest edge of the sheet a line which is the proper length to represent the load in kw. Any suitable scale, such as  $\frac{1}{8}$ ,  $\frac{1}{4}$ , or  $\frac{1}{2}$  inch, can be used to represent 10, 50, or 100 kw., according to the amount of load and the size of the paper available. The larger the scale used, the more accurate the measurements can be made.

If we next determine the apparent power by dividing the kw. load by the known power factor of the system, we can then lay out a line of the proper length to represent this apparent power in kv-a. on the same scale as that used for the base line representing the load in kw.

If we lay out a line of this length on the edge of the ruler or straight strip of paper, and then lay this line from the left end of the kw. line, or X-1, and so that the opposite end of the line falls at the right edge of the sheet of paper at X-2, we can then measure the distance along the edge of the paper from X to X-2, and thus find the wattless or reactive kv-a. for this load and power factor, by measuring this distance on the same scale as we used for both of the other values.

Then if we develop another line to represent the kv-a. of apparent power at 90% power factor and lay this line from X-1 to the edge of the paper at X-3, we can measure from X-3 to X and obtain the approximate reactive kv-a. at the improved power factor.

### 235. SAVING EFFECTED BY POWER FACTOR IMPROVEMENT

In the problem we have just considered, we find that increasing the power factor from 60 to 90 per cent. reduces the apparent power from 2400 to 1600 kv-a. This is a reduction of 800 kv-a. or, in other words, the alternators, lines, and transformers can supply the same actual power with a reduction of 800 kv-a. load on their windings.

If the greater part of this energy is fed throughout the customer's plant at 440 volts, this will mean considerable reduction of the current load on the feeders.

This can be determined as follows:

$$\text{volt-amperes} \div (E \times 1.732)$$

or

$$800,000 \div (440 \times 1.732) = 1049 \text{ amperes}$$

Increasing the power factor will also reduce the current load by the same amount in the 440-volt secondaries of the transformers at the customer's premises.

If this energy is supplied to the primaries of the transformers by a 2300-volt distribution line from the power company's substation, the current on this line and primary winding of the transformers will be approximately 200 amperes less.

Of course, the actual reduction in current will not be quite this great if a synchronous motor is used for the power factor correction, because this machine will require a small amount of energy current to overcome the friction and windage-loss of the machine. This amount, however, is so small that it is hardly worth considering.

In case a static condenser is used for power-factor correction in this problem, the loss will also be extremely small; as the loss of this device is generally less than  $\frac{1}{2}$  of 1%.

The method used to calculate the capacity of either a synchronous condenser or static condenser is the same, as long as the synchronous condenser is used only for power factor correction and not to drive any mechanical load.

To see the great importance of having a proper knowledge of power factor and its correction, we need only to note the amount of saving that can be effected by power factor improvement in the problem we have just considered.

The great reduction made in the current load on the transformers, lines, and alternators might enable a plant to avoid the installation of new transformers and alternators, and take care of expansion and growth for possibly several years longer, by this correction of power factor.

Considering it from the standpoint of monthly power bills in case the power is purchased from a generating company, the saving is also considerable.

For example, if the 1440 kw. load which was used in this problem is taken to be the average load throughout an eight-hour day in the plant of the customer, the total power consumed in one month

of 26 working days would be 299,520 kw. hours.

At a cost of approximately 1 cent per kw. hour, the monthly power bill would be \$2,995.20. If the power company from whom this energy is purchased has a power-factor-rate clause in the contract, it is possible that the reduction in the rate between the 60% and 90% power factor conditions would be as much as 10% of the power bills.

This would result in a monthly saving of \$299.52, or a yearly saving of \$3,594.24. So we find that this would soon pay for the cost of a 1223 kv-a. synchronous condenser at approximately \$6,000.00.

### 236. PROBLEM

As another illustration, suppose you are working as maintenance electrician in an electrical plant where the total load of induction motors, welders, and electrical ovens amounts to 560 kw. Let us assume that this is the normal true-power load shown by the wattmeter under average operating conditions in the plant.

If this energy is fed to the motors and equipment at 440 volts and a total of the ammeter readings on the different feeder circuits shows the current load to be approximately 1130 amperes, then the apparent power is equal to  $440 \times 1130 \times 1.732$ , or approximately 861 kv-a.

Then, to determine the power factor of the system, we divide the true power by the apparent power, or  $560 \div 861 =$  approximately 65% power factor.

We shall assume that you wish to raise this power factor to 90%. The present load in kw. can again be represented by the horizontal base line of the triangle in Fig. 221.

In this figure a scale of  $\frac{1}{2}$  inch to 100 kw. is used. Now, assuming that the vertical line is the right-hand edge of a square sheet of paper and that the base line is on the lower edge of this same sheet of paper, we will lay out a line to the scale of  $\frac{1}{2}$  inch per 100 kv-a. and of the proper length to represent the 861 kv-a. of apparent power.

Running this line from the point X-1 at the left end of the kw. line to X-2 at the right edge of the paper, we have represented the apparent power by the hypotenuse of the triangle.

Now, if you measure the line from X-2 to X-3, you will find it is slightly over  $3\frac{1}{4}$  inches long and, on the basis of  $\frac{1}{2}$  inch per 100 kv-a., this will equal approximately 654 kv-a. of wattless, or reactive, power. This we have marked "R kv-a."

Now, to find the amount of reactive kv-a. or wattless power which we will have when the power factor is improved to 90%, we must first determine the total kv-a. of apparent power at 90% power factor.

True power  $\div$  power factor = apparent power, so,

$$560 \div .90 = \text{approximately } 622 \text{ kv-a. apparent power at } 90\% \text{ p. f.}$$

Using the scale of 1/2 inch per hundred kv-a., we shall represent the 622 kv-a. with a line slightly under 3 1/8 inches long. Marking off this line on the edge of a ruler or straight piece of paper, set one end of the line at X-1, and swing the other end over to the point where it touches the right edge of the paper, or line X-2 to X-3. We find that the end of the line meets the vertical line at X-4.

Now measuring the portion of the vertical line from X-4 to X-3, we find that it represents approximately 271 reactive kv-a. according to the same scale of 1/2 inch per 100 kv-a.

Now, to determine the amount of corrective kv-a. required, we subtract 271 from 654 and find 383 R kv-a., which is the amount to be corrected and which will be the required capacity of the synchronous or static condenser to use for this job.

We can now check these figures by the more accurate method, using the formula:

$$R \text{ kv-a.} = \sqrt{\text{kv-a.}^2 - \text{kw.}^2}$$

with which we obtained the values in the previous problem.

In the first condition, with 65% power factor and 861 kv-a., the total reactive kv-a. or wattless power will be:

$$\begin{aligned} \sqrt{861^2 - 560^2}, \text{ or } 654 \\ 861^2 = 741,321 \\ 560^2 = 313,600 \\ \text{and } 741,321 - 313,600 = 427,721. \end{aligned}$$

The square root of 427,721 is 654; so we find that the value of the reactive kv-a. shown by the vertical line from X-2 to X-3 is correct.

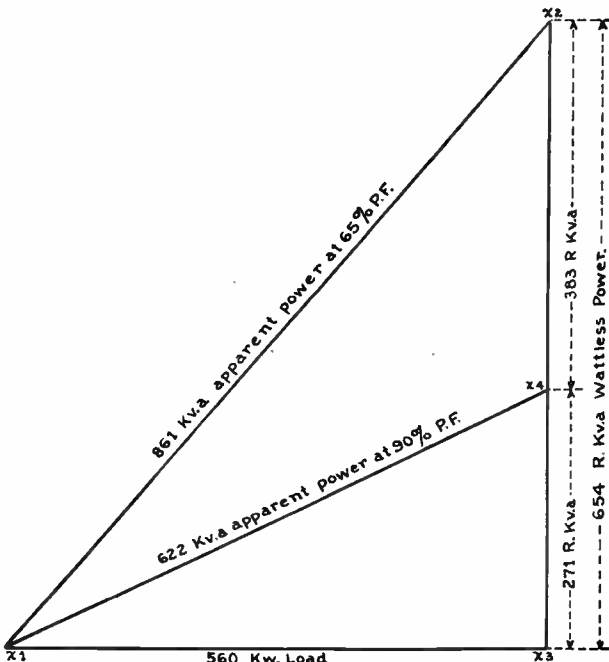

Fig. 121. This diagram also shows the reduction obtained in the apparent power and wattless power by improving the power factor of a system. By carefully measuring the top section of the vertical line in the diagram we can find the size of the condenser required to correct the power factor.

We shall next find the reactive kv-a. at 90% power factor: which will be:

$$\begin{aligned} \sqrt{622^2 - 560^2}, \text{ or } 271 \text{ R kv a.} \\ 622^2 = 386,884 \\ 560^2 = 313,600 \\ 386,884 - 313,600 = 73,284 \end{aligned}$$

The square root of 73,284 is approximately 271, which proves that the value of the reactive kv-a. shown by the vertical portion of the line from X-4 to X-3 is also correct.

With just a little practice to get the steps of these power factor problems well in mind, you will find it very simple to determine the size of condenser required for correcting the power factor of any given load at low power factor and to bring it up to the desired higher power factor.

It will be well worth your time to practice both the approximate method with the triangle diagram and also the accurate method using the formula.

By improving the power factor from 65% to 90% in the plant we have considered in this last problem, we shall have reduced the apparent power from 861 to 622 kv-a. or by 239 kv-a. This means that the alternators, transformers, and feeders will be relieved of this amount of load. On the 440-volt feeders this will amount to approximately 314 amperes, as can be determined by the following formula:

$$I = \frac{\text{volt-amperes}}{E \times 1.732}$$

or, in this case,

$$I = \frac{239,000}{440 \times 1.732}, \text{ or } 314 \text{ — amperes}$$

You can readily see that relieving the feeder cables of this amount of current would decrease the voltage drop in them considerably—especially if they were already overloaded at the low power factor. Relieving the transformers of this load would enable them to carry an increased load of useful power; and the same thing applies to the alternators of the power company, or the alternator which may be owned and operated by your employer if the plant in which you work generates its own power.

### 237. USE OF SYNCHRONOUS MOTORS FOR P. F. CORRECTION AND MECHANICAL LOAD

When it is desired to use a synchronous motor both for driving a certain amount of mechanical load and for correcting the power factor of the load already on the system, we must, of course, allow sufficient capacity of the machine for both of these duties. The actual problem or calculation, however, remains very much the same.

Let us assume that in a certain plant there is an existing load of 600 kw. at a power factor of 60%. We wish to improve this power factor of 90% by the use of a synchronous motor and we also wish

to operate with this motor a new mechanical load of 300 kw.

We shall represent the existing load by the horizontal line from X to X-1 in Fig. 222, and the additional new mechanical load of 300 kw. by the addition to this line from X-1 to X-2. The scale in this diagram is  $\frac{1}{4}$  inch per 100 kw.

At 60% power factor the apparent power of the existing load will be  $600 \div .60$ , or 1000 kv-a.

We shall represent this kv-a. by the same scale of  $\frac{1}{4}$  inch per 100 kv-a. and by a line  $2\frac{1}{2}$  inches long, running from X to a point where its opposite end strikes a vertical line which we have drawn up from the base line at X-1.

This hypotenuse line, representing the 1000 kv-a. of apparent power, will strike the vertical line at X-3, and if we measure the line from X-3 to X-1, we find it is two inches long. On the same scale used for the other values, it will therefore represent 800 R kv-a. of reactive or wattless power.

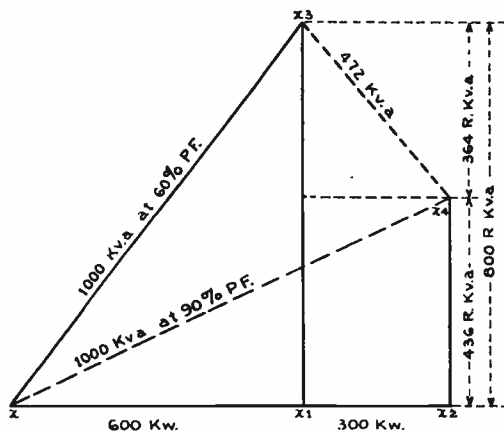

Fig. 222. This diagram shows the graphic solution of a problem in which the synchronous motor is used for mechanical power purposes as well as power factor correction. The figure should be easily understood by referring to the explanations in the accompanying paragraphs.

Checking this calculation by the more accurate method of using the formula:

$$R \text{ kv-a.} = \sqrt{1000^2 - 600^2}$$

we find the answer is exactly 800 kv-a.

The next step will be to determine the kv-a. of apparent power of the existing load plus the new mechanical load at the desired power factor of 90%. The entire load will be 900 kw., and at 90% power factor the kv-a. will be:

$$900 \div .90, \text{ or } 1000 \text{ kv-a.}$$

It is interesting to note at this point that with the improved power factor we can obtain a 50% increase in the true power load with the same kv-a. as existed with the 600 kw. load.

Representing this 1000 kv-a. on the scale of  $\frac{1}{4}$  inch per 100, or by a line  $2\frac{1}{2}$  inches long, we shall first run this line from X to the point where it strikes a vertical line above X-2. This vertical

line from X-2 to X-4 will represent the reactive kv-a., or wattless component, for the entire load of 900 kw.

Measuring this line to scale, we find that it represents approximately 436 reactive kv-a.

We shall now check this figure by the more accurate method with the formula:

$$R \text{ kv-a.} = \sqrt{1000^2 - 900^2}, \text{ or } 436 - R \text{ kv-a.}$$

Subtracting this from the former reactive kv-a. we find  $800 - 436 = 364$  R kv-a., which must still be corrected to bring the power factor to 90%.

The capacity of the synchronous motor must therefore be:

$$\sqrt{300^2 + 364^2}, \text{ or } 472 - \text{kv-a.}$$

This capacity or kv-a. of the synchronous motor can also be found by measuring the distance from X-3 to X-4, as shown by the dotted line in Fig. 222, and using the same scale of  $\frac{1}{4}$  inch per 100 kv-a.

The power factor rating of the synchronous motor, or the power factor at which it will need to operate to carry this mechanical load and also correct the reactive kv-a., will be found by dividing its true power or mechanical load by its total kv-a. rating, or:

$$300 \div 472 = \text{approximately } 64\% \text{ leading power factor.}$$

#### 237-A. TABLE FOR DETERMINING REQUIRED SIZE OF CONDENSERS

The convenient table in Fig. 223 greatly simplifies the method of determining the proper capacity of the synchronous or static condenser to correct the power factor a certain desired amount for any given load.

This table gives figures which can be used as constants to be multiplied by the kw. load to obtain the leading reactive kv-a. required to improve the power factor from one value to another.

For example, if the kw. load, as indicated by the wattmeter in a plant, is 200 kw. at an existing power factor of 65% and we desire to increase the power factor to 90%, we look in the table under the column heading "Original Power Factor" and find 65; then, reading to the right under "Desired Power Factor" in the column for 90%, we find the figure .685.

We now simply multiply this figure by the load in kw., or:

$$200 \times .685 = 137 \text{ kv-a. capacity}$$

or the size of condenser required to bring lagging power factor from 65 to 90 per cent.

If, in another case, we have a load of 525 kw. at a power factor of 70% and we wish to increase the power factor to 85%, we find in the middle column under "Original Power Factor", the figure 70. Then, reading to the right in the fourth column under "85% Desired Power Factor", we find the figure .400. Multiplying this figure by our load

of 525 kw. gives 210 kv-a. as the required size of the condenser.

Table with columns: ORIGINAL POWER FACTOR %, DESIRED POWER FACTOR (100%, 95%, 90%, 85%, 80%), ORIGINAL POWER FACTOR %, DESIRED POWER FACTOR (100%, 95%, 90%, 85%, 80%). Rows 20-60.

Fig. 223 The above table gives some very convenient figures by which we can simply multiply the kw. load of a plant with lagging power factor in order to obtain the amount of leading kv-a. or condenser capacity required to correct the power factor any desired amount.

238. PROBLEM

Next, suppose that you have an induction motor on which a wattmeter shows 41 kw. input during operation of the motor at its normal load; a voltmeter shows 220 volts at the motor terminals; and an ammeter shows approximately 144 amperes in any one of the three phase leads to the motor. To determine the power factor at which the motor is operating we must first determine the kv-a. input.

Three-phase kv-a. = I x E x 1.732 or, in this case, 144 x 220 x 1.732 = 54,869, or approximately 54.9 kv-a.

Now, to determine the power factor of the motor, we can divide the true power input by the apparent power, or:

41 ÷ 54.9 = .75 power factor.

Let us say that we wish to raise the power factor of this motor to 95%. Then, from the table in Fig. 223 we select the power factor of the motor, or .75, found in the middle column under "Original Power Factor"; then, in the column under "95% Desired Power Factor", we find the corresponding figure, .553.

To determine the size of static condenser required to make this power factor improvement on the motor, we simply multiply .553 by the kw. input of the motor, or 41; and this gives 22.67 kv-a. for the condenser. Connecting a condenser of this size to the motor terminals doesn't actually improve the power factor of the motor within the motor

itself, but it does bring the power factor of the two units in parallel to 95% on the feeder to which they are connected.

239. CONDENSER TABLE

Fig. 224 shows another convenient table which gives the approximate sizes of condensers required for use with squirrel-cage induction motors to bring their power factors up to either 90% or 95%, as may be desired.

Of course, the power factors of various types of squirrel-cage motors vary considerably; so these figures are necessarily only approximate. They are usually close enough, however, for the selection of condensers to use with motors that normally operate at loads between 50% and 100% of their full-load rating.

This table gives the condenser sizes for motors from 1/2 h.p. to 200 h.p. at various speeds, and at both the ordinary low and high voltages. Referring to this table, we find that to increase the power factor of a 30-h.p., 440-volt, 1800 r.p.m. motor to 90% we require a 3-kv-a. condenser, and that it will require a 5-kv-a. condenser to bring this power factor up to 95%.

Capacitor Kv-A. for Squirrel-Cage Induction Motors (To correct to 95 or 90 at one-half load)

Complex table with columns: MOTOR (H P, Volts), Capacitor Kv-A. for Desired Power Factor (95, 90), MOTOR (H P, Volts), Capacitor Kv-A. for Desired Power Factor (95, 90), MOTOR (H P, Volts), Capacitor Kv-A. for Desired Power Factor (95, 90). Includes sub-sections for 1800 R.P.M., 1200 R.P.M., 900 R.P.M., 600 R.P.M., 1300 R.P.M., and 720 R.P.M.

Low means 220, 440, or 550 volts. Table above gives the nearest standard capacitor kv-a. ratings to correct power factor of squirrel-cage induction motors to .95 or .90. Although the magnetizing current requirement of the induction motor varies somewhat from no load to full load, if the motor is corrected to the desired power factor at 1/2 load (values in the table above) it will be corrected approximately to this power factor at all loads. Actually the power factor will be somewhat higher at no load and slightly lower at full load. Inasmuch as the power-factor characteristics of induction motors of the same rating vary considerably with different manufacturers the values above are necessarily approximate. The capacitor sizes indicated will be proper however, in the majority of cases.

Fig. 224. This table gives the approximate sizes of condensers required for use with individual squirrel-cage motors to correct the power factor to either 90 or 95 per cent, as desired. It will be well worth your time to become thoroughly familiar with the use of this table and the one in Fig. 223.

A 30-h.p., 2200-volt motor requires a 4-kv-a. condenser to increase its power factor to 90%; or a 7½-kv-a. unit to increase the power factor to 95%.

The discussion of power factor correction which has been given in this section, and also the examples of practical problems and calculations along with the convenient tables, should be given very careful consideration and you should not leave this subject until you are quite sure that you have a good general understanding of the application of these principles and calculations to problems which you may encounter in the field.

In a great number of industrial plants, factories, and other places where electric power equipment is in use and where you may be employed, the owners or even the men in charge of the electrical work may not realize the importance of power factor or the great amount of savings which can in many cases be effected by improving the power factor.

It is not uncommon to find plants with loads of several thousand kw. operating at a power factor ranging from 50 to 90 per cent. In some cases feeder conductors are seriously overloaded and transformers and alternators are overloaded and

operating at excessive temperatures, which can be avoided by improving the power factor.

In other cases transformers, alternators, or feeders may be loaded to their utmost capacity and the management may be planning to install additional units and circuits.

If the power factor of the system is very low, it may be possible to avoid the expense of the new alternators and transformers by installing power-factor corrective equipment of much lower cost than new machines. This is particularly true in cases where the company generates its own power and the addition of another alternator would also require added boiler-plant capacity and a turbine or engine to drive the alternator.

The trained man very often has splendid opportunities to suggest and lay out the method of correcting power factor in the plant where he is employed and thereby saving substantial sums for his employer.

For this reason, we suggest you review this material and be sure to keep it well in mind for reference and to use in any job where you may have a chance to apply it to your employer's advantage and your own credit.



# COYNE

## *Electrical School*

CHICAGO ~ ~ ILLINOIS



ESTABLISHED 1899

COPYRIGHT 1942

# ALTERNATING CURRENT POWER AND A. C. POWER MACHINES

## *Section Six*

**Rectifiers and Converters**

**Vibrating, Electrolytic, Electronic, Copper Oxide  
and Mercury Arc Rectifiers**

**Construction, Operation, Care, Applications**

**Synchronous Converters**

**Construction, Operating Principles, Characteristics**

**Voltage Ratios, Voltage Control**

**Starting and Operating, Auxiliaries, Care**

**A. C. Motor Controls**

**Types, Applications and Advantages of Each  
Resistance, Auto Transformer and Drum Types**

**Manual, Automatic and Remote Controllers**

**Connections and Circuits. Protective Devices**

**Installation, Care and Maintenance**



## RECTIFIERS AND CONVERTERS

While the greater part of the electrical energy used today is generated and transmitted in the form of alternating current, there are a number of special power uses which require direct current.

In plants where a large amount of D.C. is used, it is often produced in this form by D.C. generators, as previously explained. In other cases, where it is cheaper to buy A.C. from a power company or where only very small amounts of D.C. are required, it is common practice to rectify or convert A.C. to D.C.

The most common devices used for this purpose are rectifiers, converters, and motor-generators.

There are several types of rectifiers in common use. These are as follows: Vibrating, Electrolytic, Electronic, Oxide Film and Mercury Vapor.

The vibrator, electrolytic, and bulb types of rectifiers are generally used only for converting small amounts of energy to D.C., for such work as battery charging, and furnishing D.C. for radio sets, electro-magnets, D.C. arc lights, bell and signal systems, experimental and laboratory work, etc.

Mercury arc rectifiers are used in small sizes for the above purposes, and also in large sizes of 1000 kw. and more for supplying D.C. to electric railways, etc.

Rotary converters are also used for changing A.C. to D.C. and are made in large sizes from 100 kw. to several thousand kw., for supplying D.C. to railways and for industrial-power motors and equipment.

Motor-generators are sometimes used in large sizes of several thousand kw. for supplying D.C. for steel mill motors and such uses, where the service and load variations are very severe; and in smaller sizes for arc welding, etc.

### 240. VIBRATING RECTIFIERS

Vibrator-type rectifiers are generally used only on low voltages and very small currents. One of their disadvantages is that they have a number of wearing parts and require considerable care and maintenance.

These vibrating rectifiers are synchronous switching devices which reverse the circuit connections at each reversal or alternation of the A.C. supply. They generally operate by the repulsion and attraction of a permanent magnet armature by a pair of A.C. electro-magnets. The moving armature operates the contacts which rapidly reverse the connections of the circuit.

Fig. 225 shows a diagram of the connections and parts of a common type of vibrating rectifier. This rectifier is shown connected to a low-voltage battery which, of course, requires direct current to charge it.

The transformer, T, steps down the voltage from the 110-volt A.C. line to the proper value for operating the magnets of the rectifier and charging the battery.

As the alternating current reverses through the coils of the two electro-magnets M and M-1 which are both wound in the same direction, the polarity of these magnets is rapidly reversed and causes the permanent-magnet armature to vibrate back and forth in synchronism with the alternations of the current.

The secondary of the transformer is provided with a center tap and only half of its winding is used to magnetize the coils. Only half of this winding is used at any instant to charge the battery.

### 241. OPERATION

When the right-hand end of the secondary is positive, both magnets will have north poles on their lower ends; and the right-hand end of the armature will be repelled, closing the circuit at the adjustable contact X-1.

This allows current to flow from the right-hand end of the transformer winding through resistance R-1, contacts at X-1 through the armature, and to the positive terminal of the battery. This current returns from the negative side of the battery to the center tap of the transformer secondary, thus completing the charging circuit.

Direct current doesn't flow through the small condensers C and C-1 which are merely shunted across the contacts to prevent arcing and burning of the points.

When the alternating current reverses and the left-hand end of the transformer secondary is positive, the lower ends of both electro-magnets will then be south poles and the left-end of the armature will be repelled, closing the contact at X.

The current then flows from the left-end of the transformer secondary through resistance R, contact X, and armature A, to the positive side of the battery, and again returns from the negative terminal of the battery to the center tap of the transformer winding.

The resistance R-2 is used to adjust the strength of the electro-magnets.

You will note that with this type of rectifier both halves of the cycle are used in charging the battery; so it is known as the "full wave" type.

The pulsating direct current always leaves the armature terminal and re-enters the center tap of the secondary winding, so that with a rectifier of this type it is important to get the battery connected with the proper polarity in order to charge it.

Some vibrating rectifiers have a small winding around the movable armature and connected to the terminals which lead to the battery, as shown by the dotted lines in this diagram. This winding reverses the polarity of the armature in case the battery is reversed and thereby makes the direct current flow through the battery in the proper direction, regardless of which way it is connected.

A number of vibrating rectifiers are made, and some of them use different connections and arrangement of parts than those mentioned, but in general their principles are all very much alike.

The high speed at which the armature is required to vibrate and the continual opening and closing of the contacts causes them to become worn and in some cases burned and pitted by the arc formed when the current is interrupted.

For this reason the contacts may require frequent cleaning and adjustment if the rectifier is used for very long periods.

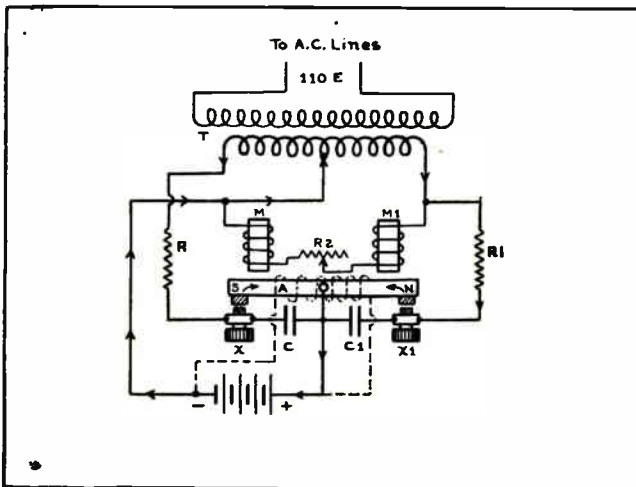

Fig. 225. The above diagram shows the parts and connections of a simple mechanical rectifier of the vibrating type. The synchronous operation of the contacts delivers pulsating D.C. to the battery circuit.

242. ELECTROLYTIC RECTIFIERS

The electrolytic type of rectifier is also limited to small capacities, due to its low efficiency and general tendency to heat up under load because of the large resistance losses which take place within the rectifier itself.

Fig. 226-A shows a simple electrolytic rectifier connected in series with a lamp bank to limit the current flow, and in series with the battery which is to be charged by the pulsating current.

This type of rectifier consists of a jar containing a strong solution of ammonium phosphate, sodium phosphate, or just a mixture of water and common borax. In this solution are immersed a plate of either lead, carbon or iron, and one of aluminum.

The electrolytic action which is set up between the surface of the aluminum electrode and the electrolyte solution will allow the current to flow from the solution into the aluminum, but will immedi-

ately build up a very high resistance film when the current is reversed and tries to flow from the aluminum into the electrolyte.

This high-resistance film shuts off the greater part of the current flow during every other alternation, and thus allows the impulses of current to get through the rectifier in only one direction; so that the current applied to the battery is pulsating D.C.

A lamp bank consisting of several lamps in parallel, or some other form of resistor, is often used in series with these rectifiers to limit the current to the proper low value.

The resistance of the rectifier itself is often so low that if it and the battery were connected in series across the line it would result in practically a short circuit and blow the fuses.

243. HALF WAVE AND FULL WAVE RECTIFIERS

A rectifier such as shown in Fig. 226-A uses only every other alternation and is therefore known as a half-wave rectifier. This is because the current flow in one direction is blocked except for a small amount of leakage which is required to build up the resistive film on the electrodes.

Fig. 226-B shows another electrolytic rectifier which is of the full-wave type and in which both alternations are used to supply impulses in the same direction through the battery. With this device an auto transformer or choke coil is connected across the 110-volt leads and equipped with taps near the ends of its winding, so that the voltage applied to the rectifier and battery can be varied or adjusted.

When the left end of the transformer is positive, current will flow through that half of the auto transformer winding to the center tap, where a part of the current branches off through the battery and through the rectifier cell from the lead or carbon electrode to the aluminum electrode on the right, and then back to the right-hand line wire. No current can flow from the left-hand line wire

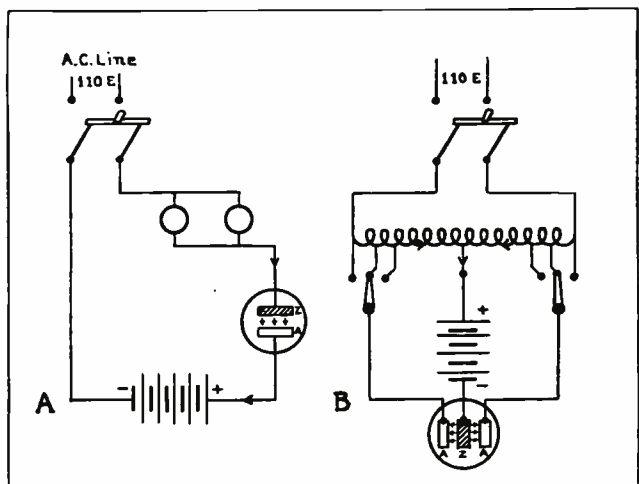

Fig. 226-A. Shows a half-wave, electrolytic rectifier and B shows an electrolytic rectifier of the full-wave type. Current can only pass through these devices in one direction.

to the aluminum electrode A and then to the center lead electrode, because the current cannot pass through the rectifier in this direction.

When the polarity of the A.C. line reverses and the right-hand end of the auto transformer becomes positive, current will then flow from the line through the right section of the winding to the center tap. At this point part of the current again branches off through the battery and flows from the lead plate of the rectifier to the aluminum electrode A on the left, and back to the left side of the line.

At all times during the operation of this rectifier a certain amount of current is wasted by passing directly through the winding of the auto transformer which is connected across the A.C. line.

#### 244. CONSTRUCTION AND CARE

This simple electrolytic, valve-type, rectifier can be purchased in various small sizes, or can be easily and simply made from a few inexpensive materials.

A glass jar of about one-quart size or larger can be used to contain the solution of borax and water, and the strips of lead or aluminum are very easily obtainable. An iron rod or carbon rod can be used in place of the lead strip, if desired.

These electrodes should be suspended or held in the solution in such a manner that they cannot fall together and short-circuit the rectifier.

In mixing the electrolyte with borax, a saturated solution should be made; in other words, stir into the water as much borax as it will hold in suspension after being well stirred.

Very small rectifiers of this type are quite often used as "trickle chargers", to keep batteries up to fully charged conditions at all times.

Fig. 227 shows another type of full-wave electrolytic rectifier, using four separate jars to obtain a more positive valve effect by causing the current to pass through two jars in series, one in the positive lead and one in the negative lead of the battery.

During the time that the left line-wire is positive, the current flow through the rectifier and battery

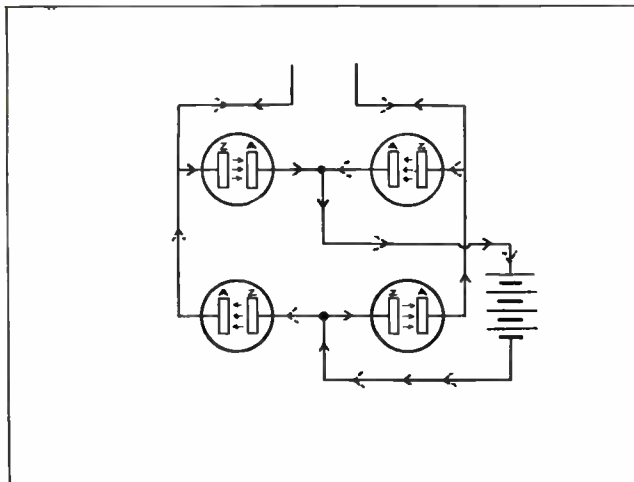

Fig. 227. Full-wave, electrolytic rectifier using four cells connected in a "bridge" circuit.

is in the direction shown by the solid arrows. When the polarity of the A.C. line reverses and the right line-wire becomes positive, the current flows through the circuit indicated by the dotted arrows.

If rectifiers of this type overheat seriously they should be placed in larger containers so that they will have more area to radiate the heat.

After an electrolytic rectifier is used for a considerable length of time, heavy deposits will form on the electrodes and interfere with the proper action of the rectifier. The electrodes should then be scraped clean or renewed, and the solution should also be renewed occasionally.

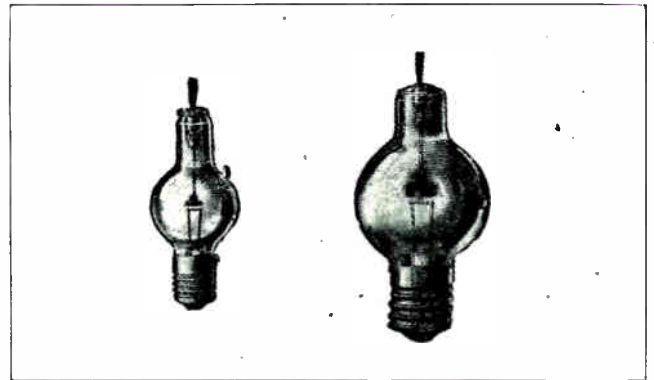

Fig. 228. The above view shows two different sized rectifier bulbs such as commonly used in battery chargers and other small rectifiers.

#### 245. ELECTRONIC RECTIFIERS

Rectifiers using gas-filled bulbs with heated filaments emitting electrons are very extensively used for battery charging and the operation of radio sets, as well as for other miscellaneous uses where only small amounts of direct current are required.

The valve element in these rectifiers consists of a gas-filled bulb such as shown in two different sizes in Fig. 228. These bulbs are evacuated and are generally filled with argon gas. They enclose a filament which is heated by passing low-voltage alternating current through it, and an electrode of graphite to which is connected the other terminal to complete the circuit through the bulb.

#### 246. OPERATING PRINCIPLES

When the filaments of these bulbs are heated, electrons are thrown off into the gas and form a conducting path so that current will flow between the graphite electrode and the filament.

Due to the nature and action of the electrons thrown off by the filament, the current can pass in only one direction through the arc thus formed, or from the graphite electrode to the filament. It cannot flow in the opposite direction to any appreciable extent; so when the A. C. reverses, the opposite half of the wave is shut off by the valve action of the bulb.

Fig. 229-A shows a simple half-wave rectifier of the bulb type. An auto transformer is used to supply the low voltage at about 2 or 3 volts to light

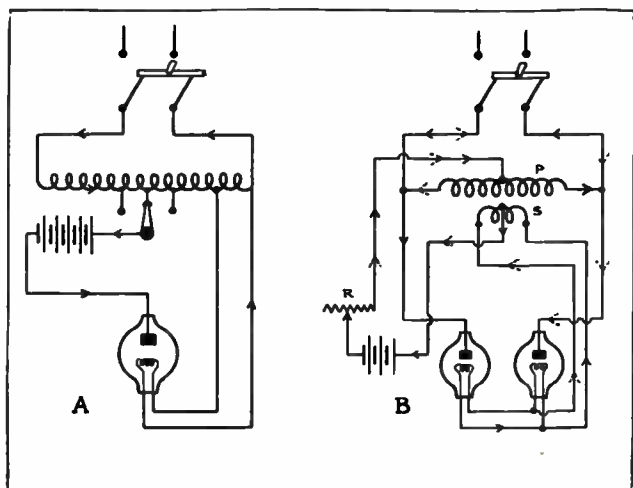

Fig. 229-A. Shows a circuit of a simple half-wave rectifier of the bulb type, and B shows the circuit of a full-wave rectifier using two bulbs. Trace each of these circuits very carefully.

the filament, and also to reduce the voltage applied to the battery and rectifier bulb.

As long as the filament is lighted, negative electrons are thrown off from it continuously. During the time that the graphite electrode is positively charged it attracts these negative electrons, causing them to stream across the space and complete a path or arc through which current can flow to charge the battery.

When the graphite electrode is negatively charged it repels the negative electrons from the filament and prevents the majority of them from getting across the gap, and thus they are prevented from forming a path over which the low-voltage current can flow.

The bulb in this manner acts as a valve, shutting off every other alternation of current. The taps provided on the winding of the auto transformer permit the adjustment of the voltage applied to the battery to allow changing the rate of current flow and the rate at which the battery is being charged.

During the operation of a rectifier of this type it is necessary for the secondary of the auto transformer to apply to the battery and bulb circuit a voltage high enough to overcome the counter-voltage of the battery plus about 20 to 26 volts drop through the bulb. The voltage drop through the arc in the bulb varies with the amount of load or charging current which is flowing. The counter-voltage of the battery depends upon the number of cells in series which are being charged at one time.

#### 247. FULL-WAVE BULB-TYPE RECTIFIERS

Fig. 229-B shows a full-wave, bulb-type rectifier using two bulbs to make use of both alternations of the A.C. supply. The transformer primary winding, P, is connected directly across the 110-volt line, and induces the low voltage in the secondary winding, S, to light the filaments of both bulbs in parallel.

When the left line-wire is positive, the current flows in through the left rectifier bulb, passing through this bulb from the graphite electrode to the filament, out along the filament lead to the transformer secondary, and leaves this winding at the center tap, then passing through the battery and rheostat R, back to the center tap of the primary winding, and through the right-hand side of this winding to the negative line-wire. This circuit is shown by the solid arrows.

When the line polarity reverses, current flows as shown by the dotted arrows: through the right-hand bulb to the secondary of the transformer, from the center tap of this winding through the battery in the same direction as before, then to the center tap of the primary winding, and out through the left section of this winding to the line wire.

The resistance R in this case is used to control the flow of current through the battery and thereby regulate the charging rate.

While bulb-type rectifiers of this class are not very efficient because of the voltage drop and resistance losses through the bulbs, they are nevertheless very popular because they have no moving or wearing parts and no electrodes to accumulate deposits. Therefore, bulb-type rectifiers require very little attention, except the occasional replacement of a bulb when they burn out after a certain number of hours of use.

Two common types of these rectifiers are made under the trade names "Tungar" and "Rectigon". The first named is made by the General Electric Company and the other by the Westinghouse Electric & Manufacturing Company.

#### 248. WIRING AND CIRCUITS OF BULB-TYPE RECTIFIERS

Fig. 230 shows a wiring diagram for a Tungar rectifier for charging from 1 to 10 six-volt batteries in series. By carefully tracing this circuit you will find that the 110-volt line-leads pass through the switch S and connect to leads A and B of the auto transformer winding, so that this winding is connected across the line and is excited by 110-volt A.C.

This acts as a primary winding and induces the low voltage current in the secondary section from A to C to supply the filament current. When the filament is lighted, current passes during every other alternation from the bottom A.C. line-wire up through the switch and through that portion of the primary winding to the tap on which the rotary arm D may rest.

The current then passes through this arm and back through another bar of the switch, through the fuse F to the positive terminal of the battery, through the battery and back through the reactance coil R, through the ammeter A which indicates the charging current, through the bulb, out of the right-

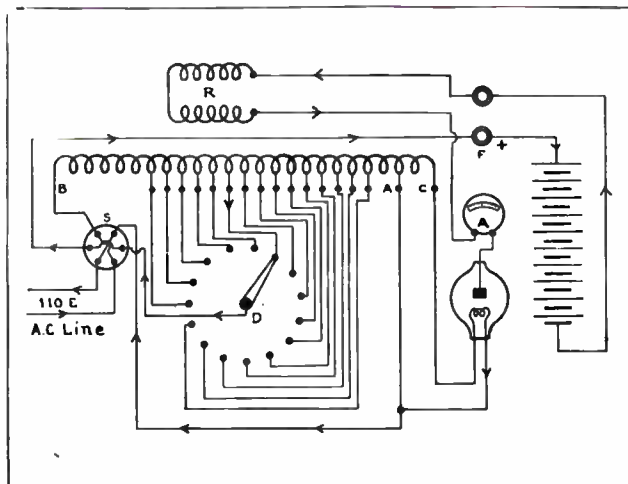

Fig. 230. Wiring diagram of a Tungar type bulb rectifier showing the taps on the auto transformer winding for varying the charging voltage.

hand filament wire, and back to the top A.C. line-wire.

When the current attempts to flow in the reverse direction the valve action of the tube prevents it from doing so. The taps on the primary winding and the adjustable arm D provide a wide range of voltage variation to properly adjust the charging rate for any number of batteries from 1 to 10 which may be in the circuit at the time.

Fig. 231 shows a Tungar rectifier of this type with one side of the case removed, showing the bulb and fuses inside. On the front panel of this unit can be seen the line switch, ammeter, and voltage adjustment knob.

When operating rectifiers of the bulb type, care should be used not to overload them; because if they are allowed to carry more current than the bulbs and windings are made to stand, it will burn out the bulbs almost immediately and may also overheat and burn out the windings of the transformers and choke coils.

The bulbs are commonly made in 2 and 6-ampere sizes, and fuses of the plug type are generally provided with these rectifiers to protect them from overload. These fuses should always be replaced with those of the proper size in order to protect the rectifier.

It is a good precaution to locate these rectifiers in a place where plenty of fresh air can circulate through them as this will help to prevent them from overheating.

Fig. 232 shows the simplified diagram of a full-wave Rectigon charger, of the type made by the Westinghouse Electric & Manufacturing Company.

#### 249. KENOTRON RECTIFIERS

The type of gas-filled bulb rectifier just described is particularly designed for operation on comparatively low voltages such as 110 and 220-volt A.C. supply lines.

For rectifying high voltages from 5000 to 100,000

volts or more, the Kenotron rectifier tube is used. These are larger tubes which have a vacuum instead of being gas filled. They also have a filament which is heated by low-voltage A.C. and a plate or anode in the form of a metal cylinder surrounding the filament.

These tubes or valves also operate on the electron principle, but have a much higher resistance and greater voltage drop through the space between the filament and plate. They are suitable for rectifying very high voltage and high-frequency A.C., such as radio energy.

#### 250. COPPER OXIDE RECTIFIERS

Another type of rectifier which is quite extensively used is one which uses a film of copper oxide on the surface of a copper disk, to act as a valve and pass current through it only in one direction.

These devices provide a very convenient portable type of rectifier for use where small or moderate amounts of current are required. They are very commonly used in radio sets and for the operation of certain D.C. signalling equipment, battery charging, etc.

They are also used to provide direct current for the operation of electro-magnets, magnetically-operated oil switches, and similar equipment in power plants and substations.

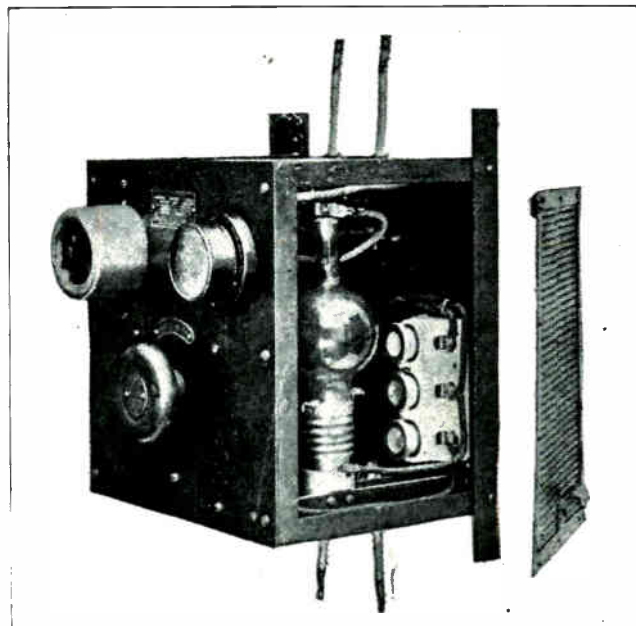

Fig. 231. The above photo shows a side-view of a Tungar rectifier with the bulb in place in the socket and the tap adjusting knob on the front panel. (Courtesy General Electric Company).

These rectifiers operate on a principle similar to that of the copper oxide lightning arrester, and the current can pass through them only in one direction, from the oxide to the metal plate.

These disks can be made in different sizes according to the current capacity desired, and a number of them can be stacked or clamped in series to build

up the proper resistance according to the voltage which is to be used on them.

Fig. 233 shows a group of the rectifier disks clamped together and equipped with projecting metal disks of larger diameter to assist in radiating the heat from the unit.

Fig. 234 shows the manner in which a number of these units can be connected in series or parallel and mounted in a panel or bank to provide a rectifier of the proper voltage-rating and current capacity.

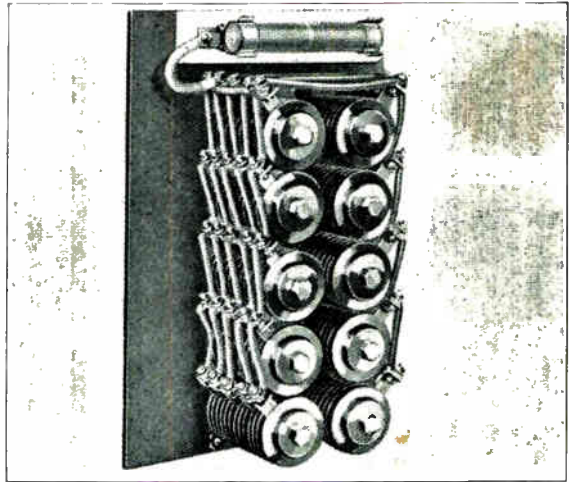

Fig. 234. Copper oxide rectifier consisting of a number of units connected in series and parallel to obtain increased voltage and current capacity. (Courtesy Westinghouse Elec. & Mfg. Co.)

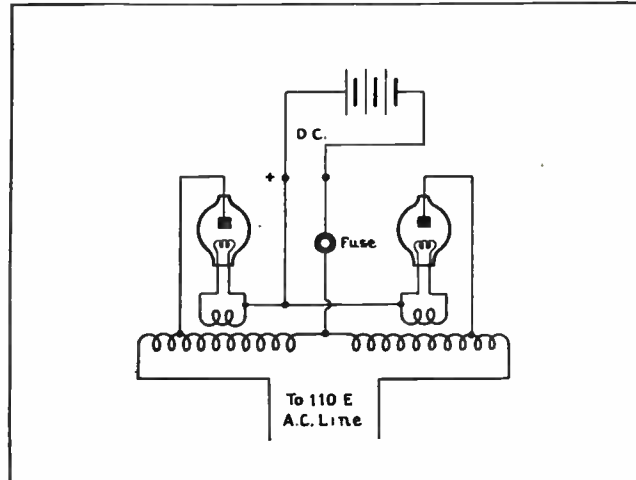

Fig. 232. This diagram shows the circuit of a full-wave Rectigon charger of the type made by Westinghouse Electric & Manufacturing Company. By carefully tracing this circuit you can get a very good idea of the principle of its operation.

Fig. 235 shows a diagram of the connections of a full-wave, copper oxide rectifier using four groups of disks connected in a "bridge" circuit. The solid arrows show the direction of current flow through the rectifier during one alternation, and the dotted arrows show the direction of current flow during the opposite alternation.

Rectifiers of this type can be made in capacities from a fraction of an ampere to 100 amperes or more. Having no moving mechanical parts to wear out and no liquid electrolyte to spill or leak, they provide a very convenient and popular type of rectifier.

The maximum life of the copper oxide disks seems to be undetermined, for a number of these units have been operated for several years without any noticeable reduction in efficiency.

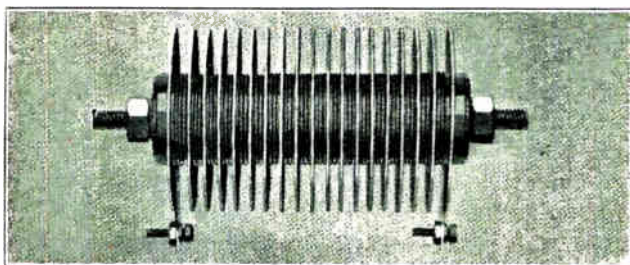

Fig. 233. Single unit of a copper oxide rectifier, consisting of a number of copper disks coated with copper oxide and clamped into one series group. Current can only pass through these devices in one direction. (Courtesy of Westinghouse Elec. & Mfg. Co.)

Fig. 236 is a photo made by an oscillograph showing the alternating current wave on the lower line and the rectified, pulsating, direct current on the upper line.

251. MERCURY ARC RECTIFIERS

Rectifiers using the valve effect of electrodes and an arc in mercury vapor can be made in sizes ranging from those of a few amperes at low voltage for battery charging purposes, to those of 1000 kw. or more which are used for converting A.C. to D.C. in electrical railway and industrial substations.

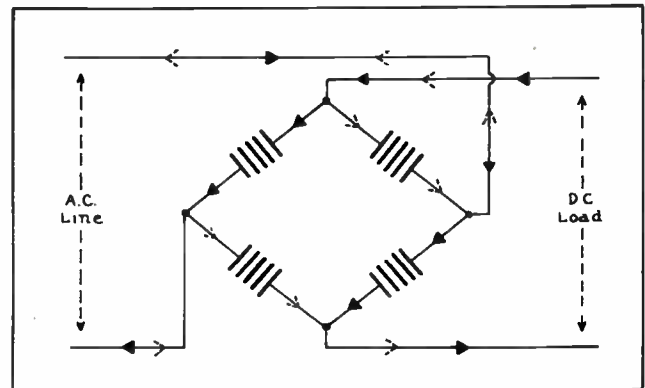

Fig. 235. Connection diagram of a full-wave, copper oxide rectifier with four units connected in a "bridge" type circuit.

Rectifiers of this type which are used for battery charging and D.C. arc lighting purposes are designed to operate on A.C. voltages from 110 to several hundred volts, and to produce rectified D.C. in amounts from 2 or 3 amperes to 50 amperes or more.

These small units often use a glass bulb in which a small pool of mercury is enclosed, and which has the required electrodes sealed into the bulb at the proper locations.

Several common types of these mercury-arc rectifier bulbs are shown in Fig. 237.

Larger rectifiers for power use are designed to operate on voltages from 200 up to 5000, and to

handle currents of several hundred to 1000 amperes or more. These units have the mercury enclosed in an iron tank from which the air is exhausted, and into which are sealed the insulated electrodes to conduct the current to and from the tank.

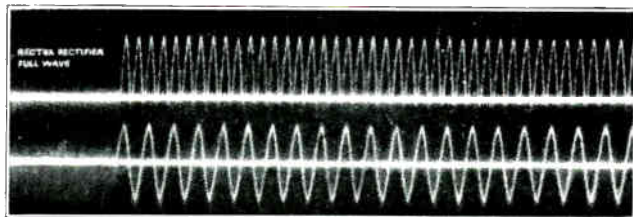

Fig. 236. Photo taken from an oscillograph record, showing the alternating current wave below and the rectified, pulsating D.C. wave above. (Courtesy Westinghouse Elec. & Mfg. Co.).

### 252. VALVE EFFECT

In the section of this Reference Set covering Illumination and dealing with the mercury vapor lamp, we learned that current can flow in only one direction through a mercury-vapor bulb or tube of this type; that is, **from the anode to the mercury.**

The current will not flow in the reverse direction from the mercury pool to the anodes or positive metal electrodes. The mercury vapor forms a path of moderate resistance through which the current flows in the space between the metal anodes and the mercury cathode (negative electrode). This valve effect can be used to form a half-wave or full-wave rectifier for single-phase circuits; and, by adding the proper number of electrodes, mercury-vapor rectifiers can also be used on polyphase circuits.

In Fig. 237 the pool of mercury can be seen in the lower neck or extension of the glass bulb. The anodes or metal electrodes are sealed into the ends of the arms or extensions on the sides of the bulb.

These electrodes and the mercury pool are connected to the metal caps or ferrules on the outside by means of lead-in wires which are sealed into the glass.

The air and foreign gases are withdrawn from these bulbs, so that they operate under a partial vacuum with only the mercury vapor inside them.

### 253. CONNECTIONS AND OPERATION

Fig. 238 shows a diagram of the connections for a full-wave mercury-arc rectifier of the type used for battery charging. The transformer supplies alternating current at the proper voltage to the two anodes or electrodes in the glass extensions or arms on the side of the bulb.

When the left lead of the transformer is positive, current passes down from the left electrode to the mercury, and then from the terminal at the bottom of the mercury pool through the battery and choke coil or reactor R, returning to the transformer secondary at the center tap, completing the circuit through the left half of the secondary winding.

During the next alternation, when the opposite

wire is positive, current flows down from the right-hand electrode to the mercury pool and again through the battery in the same direction, returning to the center tap of the transformer and completing the circuit through the right half of this winding. In this manner both halves of the cycle are used, thus making the unit a full-wave rectifier.

### 254. STARTING

To start a mercury arc rectifier of this type, it is necessary to first establish the mercury vapor in the tube and to form the hot spot on the surface of the mercury pool. In some cases this is done by means of high voltage applied through an auxiliary electrode above the surface of the mercury and used to draw an arc or apply high voltage from a spark coil. More commonly, however, rectifiers of the bulb type, such as shown in Fig. 238, have an auxiliary starting electrode in the small projection or leg, S, at the lower right. When the bulb is in normal operating position the level of the mercury in the main cathode stem and in the starting arm is such that the two pools are separated by the glass neck between them.

To start these rectifiers, the tube is tilted a little to one side so that some of the mercury from the main pool runs into the starting arm, momentarily bridging the gap and connecting the two pools together. This closes a circuit from the right half of the transformer winding through the resistor T, through the mercury, and out of the main cathode terminal at the bottom, then through the battery, reactor R, and back to the center tap of the transformer.

This allows current of the proper amount to flow through the mercury, so that when the tube is

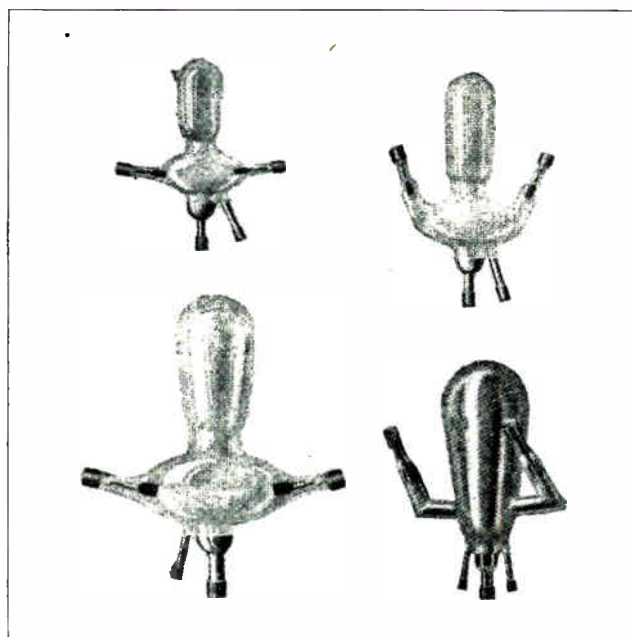

Fig. 237. Four mercury arc rectifier bulbs of different sizes and shapes. Note the mercury cathode in the bottom end of each bulb and the metal anodes in each of the main side arms.

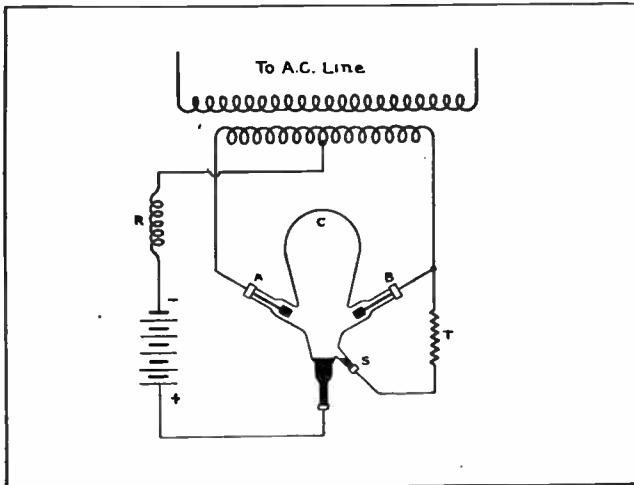

Fig. 238. Circuit diagram of a bulb type mercury arc rectifier used for battery charging purposes. Trace this circuit carefully with the accompanying explanation.

tilted back to normal position and the two pools are separated an arc is drawn between them. This arc sets up the required hot spot on the mercury cathode or pool and vaporizes sufficient mercury to start the flow of current from the anodes A and B.

Keep in mind that the anodes are always the positive terminals or the ones from which current flows into the mercury and that the cathode, or negative, in this case is the mercury pool. This applies to the internal circuit of the rectifier. The current leaves the rectifier at the terminal attached to the mercury, so this is the positive terminal of the external D.C. circuit.

Current cannot flow directly across between anodes A and B because of the valve action of the mercury vapor, and due to the shape and characteristics of these electrodes in contact with the mercury vapor. Therefore, current cannot flow from the mercury vapor into either anode, and this prevents any short circuit between them. The current actually flows alternately from first one anode and then the other into the mercury pool and out to the battery, but during normal operation it never flows in the reverse direction.

The large upper part of the bulb C forms a condensing chamber or dome in which the surplus mercury vapor cools and condenses, running back down the sides of the glass into the pool at the bottom.

Fig. 239 shows a complete mercury-vapor rectifier. The bulb and transformer are shown mounted on the back of the frame. The bulb can be arranged for tilting either by hand or by means of a magnet when starting.

Sometimes when the bulb is cold it may be necessary to tilt it several times and repeat the forming of an arc in order to get the unit to start. As soon as the current flow from the anodes starts and the rectifier begins to operate, the interior of the bulb glows with a peculiar bluish tint

characteristic of the mercury-vapor arc formed when current is passed through the vapor in the bulb.

Numerous units of this type are in use for battery charging in large garages or places where fleets of electric trucks are used, and also in older substations supplying direct current to D.C. arc lights.

These rectifiers are also used in motion picture theatres for supplying direct current to the arc lights of projector machines.

## 255. CARE AND TESTING OF BULBS

It is absolutely necessary to maintain the proper vacuum in the rectifier bulb, in order that the rectifier may operate properly. For this reason the bulbs should be handled very carefully, because the slightest crack anywhere in the glass or at the points where the terminals are sealed into the ends of the glass arms will allow air to leak into the bulb and prevent its operation.

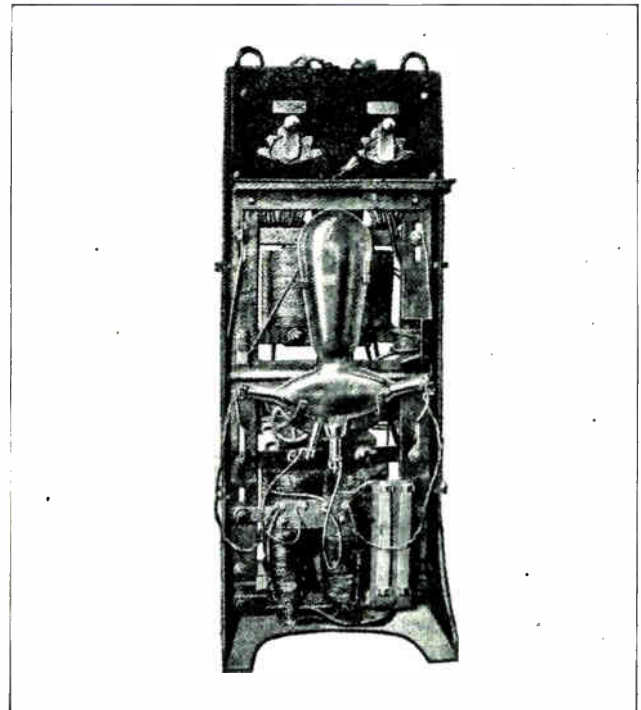

Fig. 239. Rear view of a complete mercury arc rectifier showing the bulb and also the auto transformers, resistors, tap adjusters, etc.

A simple test to determine whether the bulb is good or whether it has lost its vacuum, is similar to the one described for mercury-vapor lamps in the section on Illumination. If the bulb is removed from its clamps or holder and is tilted enough to allow the mercury to splash a little, a sharp clicking sound will be heard if the vacuum is good. If air has leaked into the bulb through a crack or if foreign gases have been formed inside of the bulb, the sound of the mercury running from one point to another will be very dead and soft, indicating that the vacuum in the bulb has been destroyed.

These rectifiers should not be overloaded beyond



their current capacity for any great length of time or the bulbs may overheat and become damaged. A good mercury-arc rectifier bulb, if handled and operated properly, will often have a useful life of many years.

### 256. POWER RECTIFIERS

Large mercury arc rectifiers for power purposes have the mercury and electrodes enclosed in an iron tank as previously mentioned.

Fig. 239-A shows a 600-kw. mercury-arc rectifier for operation at 575 volts. The mercury is in a small pool or insulated pot at the bottom of the large iron tank, and the tank contains the mercury vapor and the arc during operation of the rectifier.

This large tank also serves to condense the mercury vapor which is continually being generated by the arc, and allows the condensed mercury to run back to the pool at the bottom.

The rectifier shown in Fig. 239 is for 6-phase operation, and the six anodes or positive terminals enter the tank through specially constructed and sealed insulating bushings, clearly shown on top of the tank in this view. The large ribbed elements on each of these six leads are provided to radiate the heat and aid in cooling the anodes.

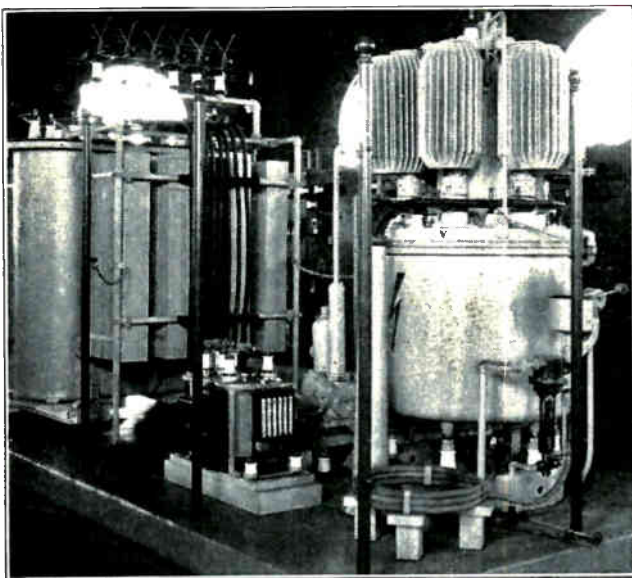

Fig. 239-A. The above photo shows a 600-kw., 575-volt, mercury arc power rectifier with the transformer and auxiliaries at the left. Note the cooling fins or radiators on the anodes. (Photo courtesy American Brown Boveri Co.).

The mercury pool at the bottom of the tank acts as the cathode and has a heavy cable or conductor connected to it by means of a terminal which projects into the bottom of the mercury pool. This conductor leads to the positive D.C. line.

Because it is practically impossible to avoid all leakage of air to the inside of the tank, these large rectifiers are equipped with an auxiliary vacuum pump which operates from time to time to remove air and gases from the tank, and to maintain the

vacuum necessary for proper operation of the rectifier.

The transformer, which supplies six-phase alternating current at the proper voltage, is shown at the left of the rectifier and vacuum pump equipment.

### 257. OPERATION

The operating principle of these large rectifiers is practically the same as that of the smaller ones using the glass bulb.

The current flows in turn from each of the six anodes at the top of the unit, through the mercury vapor in the lower chamber, to the hot spot on the mercury pool.

During normal operation the currents from the six separate phase anodes do not interfere with each other but all flow in the proper direction to the mercury.

An auxiliary electrode in the form of a metal rod is generally provided for starting these rectifiers. This rod passes into the top of the tank at the center through a special bushing which allows the rod to be moved up or down.

### 258. STARTING

To start the unit, the rod is lowered until it touches the surface of the mercury, closing the circuit for the proper amount of current required to form the starting arc. The rod is then lifted, causing the lower end to break contact with the surface of the mercury and draw the arc. This arc forms a hot spot on the surface of the mercury and starts the formation of mercury vapor necessary for the unit to commence operation.

The starting rod or electrode is generally operated by means of a solenoid which draws it into contact with the mercury, and a spring which again raises the rod to draw the arc.

### 259. COOLING AND TANK INSULATION

The main tank generally consists of two separate tanks, one within the other. The inner tank contains the mercury and maintains the vacuum around the mercury and the anodes, while the outer tank serves as a cooling shell and contains water which completely surrounds the inner tank.

During operation a small amount of water is continually circulated through this shell to carry away the heat developed.

The entire unit is mounted on insulators on the bottom of the outer tank, because the tank and the metal parts of the rectifier are always at slightly higher voltage than the mercury and cathode terminal which forms the high-voltage direct current lead that connects to the trolley in case of railway service.

### 260. EXCITER ANODES

To maintain the operating arc requires a certain small amount of current passing through the rectifier at all times. For this reason rectifiers of this

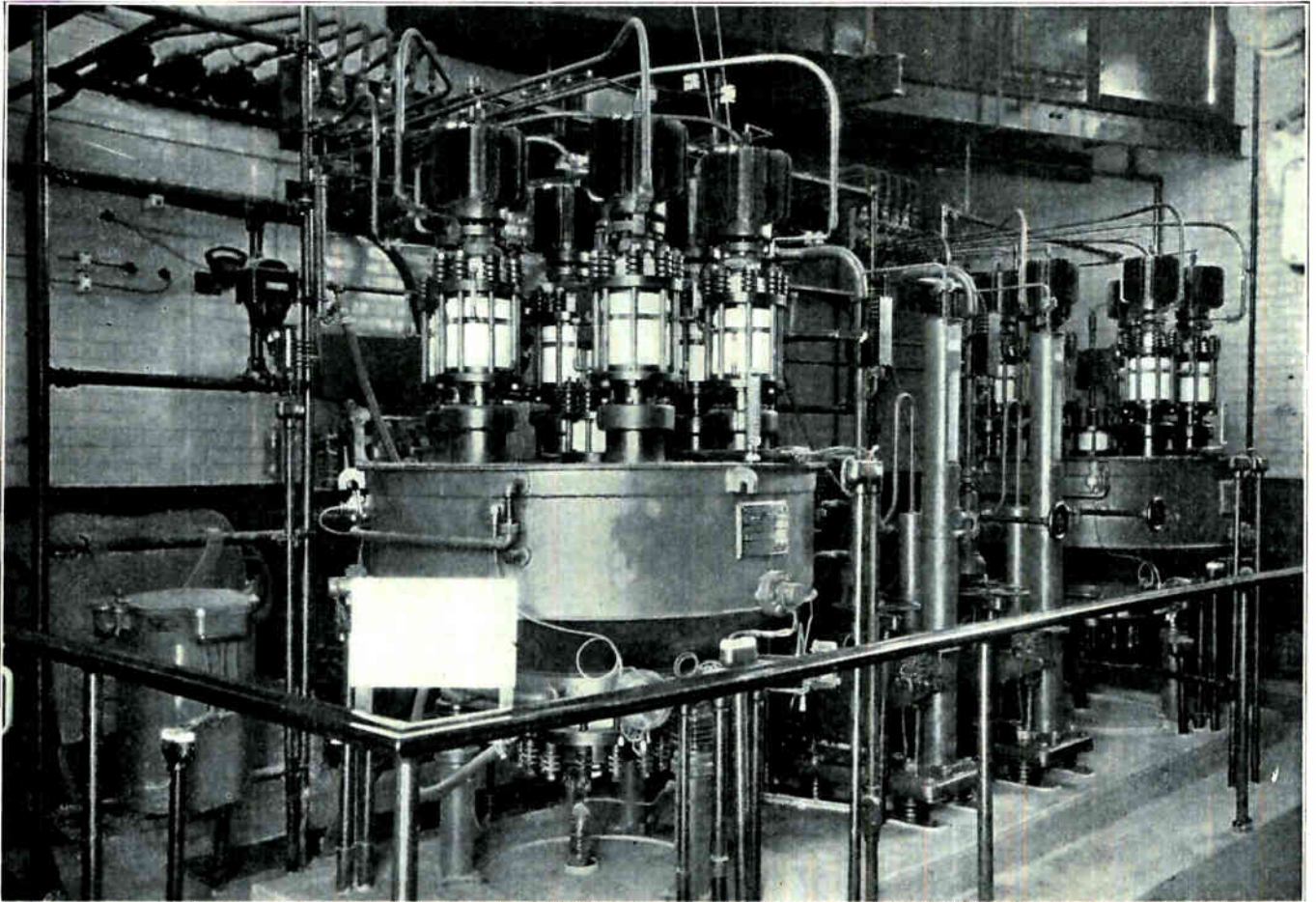

Fig. 240. This photo shows an excellent view of two 500-kw., 600-volt. mercury arc rectifiers. Note the insulators on the tank supports and also the insulating bushings through which the anodes enter the tank at the top. The vacuum pumps and a number of pieces of auxiliary equipment can be seen between the two units and in the background of the photo. (Courtesy General Electric Co.)

type are generally provided with auxiliary exciter anodes which keep up a small flow of current to maintain the hot spot on the surface of the mercury during any periods when the entire D.C. load may be removed from the rectifier.

Fig. 240 shows two 500-kw., 600-volt, 60-cycle mercury-arc rectifiers in a substation. In this photo you can see clearly the insulating bushings through which the anodes enter the tank and also the A.C. and D.C. leads to and from the rectifier. The vacuum pumps and gauges are located between the two rectifier units. This view also shows the manner in which the tanks are supported on steel posts, with insulators between the tops of the posts and the tanks.

Fig. 241 shows a sectional view of a six-phase mercury-arc rectifier. This view shows clearly the location of the mercury in the metal container, which is insulated from the bottom of the main tank; and also the positions of the starting rod or anode and one of the main A.C. anodes. The rest of the main anodes are not shown in this view.

Note the barrier provided around the lower end of the main anode to prevent flashovers during unusual operating conditions. This view also shows the separation between the inner and outer tanks,

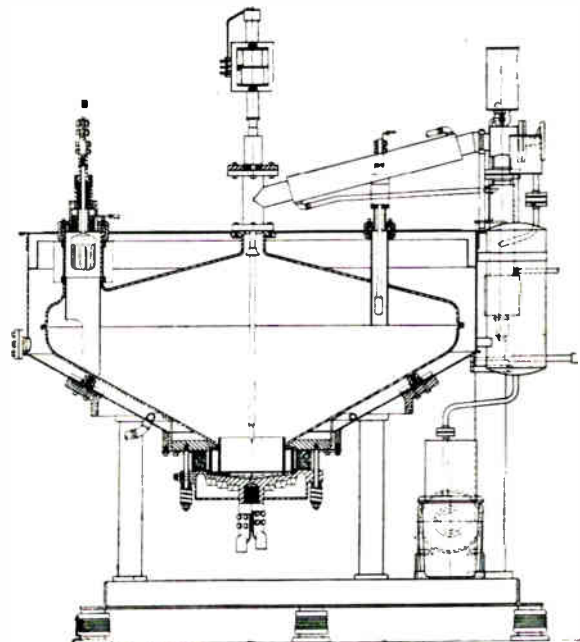

Cross Section of 1000-kw.,  
600-volt Rectifier

Fig. 241. This diagram shows a sectional view of a six-phase, mercury arc rectifier. Note the small pool of mercury which forms the cathode beneath the starting electrode.

the manner in which the tanks are mounted on insulated bases, and the connection terminals for the positive D.C. lead to the bottom of the rectifier.

The small anode shown on the right is one of the exciter anodes used for maintaining the arc during the removal of the D.C. load. On the right in this figure is shown also some of the auxiliary vacuum-pump equipment.

Fig. 242 shows a sectional view of another rectifier of slightly different construction. This rectifier and the one shown in Fig. 241 are made by different manufacturers but they both operate on the same general principle. This view shows one of the main anodes on the left and one of the smaller exciting anodes on the right.

### 261. CONNECTIONS AND CIRCUITS

Fig. 243 shows the starting and exciting circuits only, for a mercury-arc rectifier such as made by

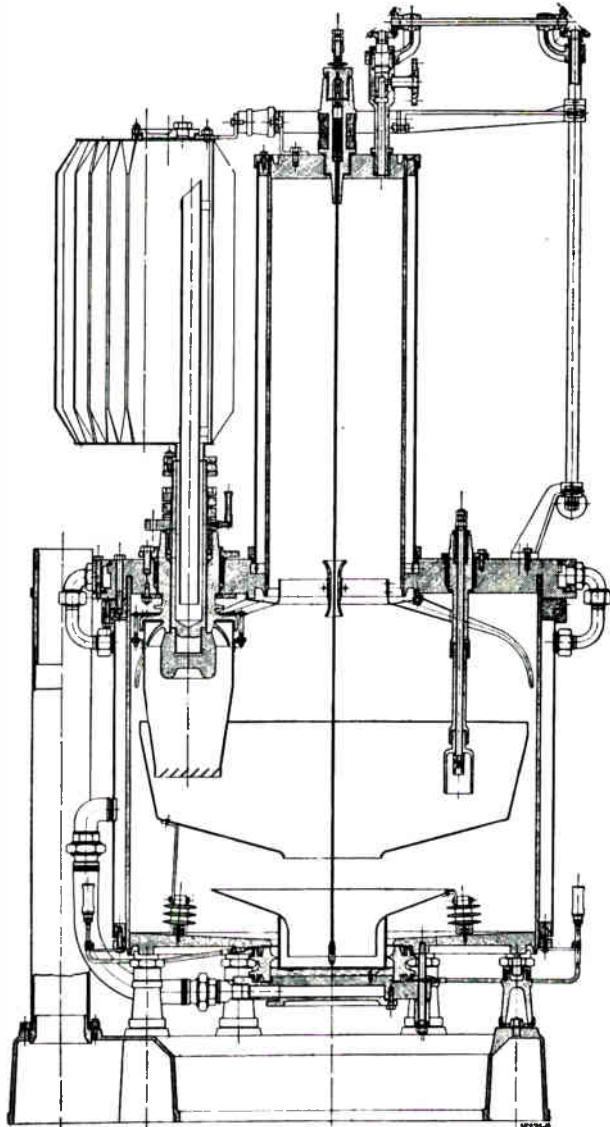

Section through Brown Boveri mercury-arc power rectifier.

Fig. 242. Sectional view of another type of six-phase, mercury arc rectifier showing one of the main anodes on the left and one of the smaller exciter-anodes on the right. The ignition anode or rod is shown in the center.

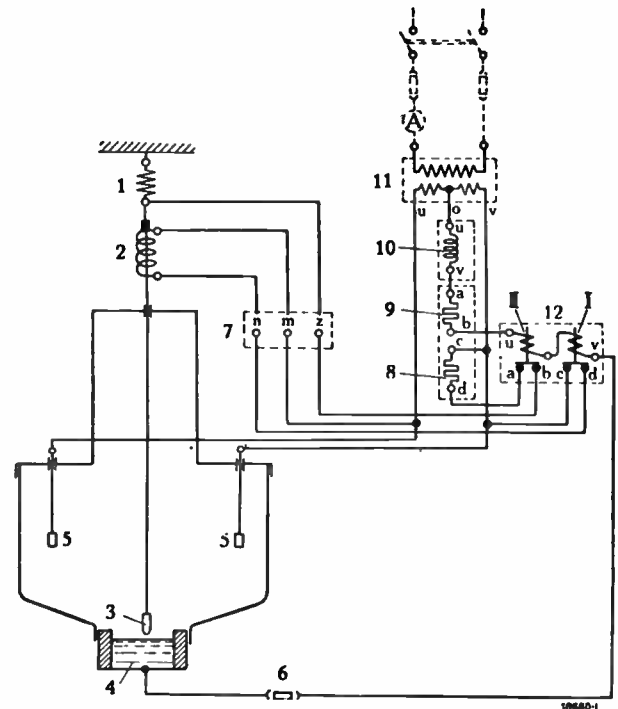

Connections of the ignition device for alternating current.

1. Spring.
  2. Ignition coil.
  3. Ignition anode.
  4. Cathode.
  5. Excitation anode.
  6. Fuse.
  7. Terminal board on rectifier.
  8. Ignition resistance.
  9. Excitation resistance.
  10. Excitation choke coil.
  11. Excitation transformer.
  12. Relay casing.
- I and II. Relays.

Fig. 243. Connection diagram for a single-phase, full-wave, mercury arc power rectifier. (Courtesy American Brown Boveri Co.).

the American-Brown Boveri Company, and Fig. 244 shows both the excitation circuit and the main power-circuit through a rectifier of this type.

You will note that the transformer secondaries are divided in two sections each, and have the six-phase A.C. leads taken from the respective ends of each of these sections.

The opposite ends of each winding are connected together to one common point and then to the negative or grounded D.C. bus. The positive D.C. bus is connected through a circuit-breaker to the bottom of the rectifier tank and to the cathode, or mercury pool.

Fig. 245-A shows a simple schematic diagram of the power-circuit connections for a three-phase mercury-arc rectifier. The primary of the transformer is connected delta to the A.C. supply. The secondary is connected star, with one end of each phase-winding connected to its respective anode of the rectifier unit. The center or neutral point of the star connection is taken through a resistor unit R and a reactor or inductance coil L, to the negative D.C. lead. The positive D.C. lead connects to the mercury pot of the rectifier.

Fig. 245-B shows the connections for a six-phase rectifier-transformer primary, connected three-phase delta to the A.C. supply; and the secondary windings are connected six-phase star to the mercury arc rectifier.

Another connection sometimes used is the triple single-phase connection shown in Fig. 245-C. This connection uses the opposite ends of each single-phase secondary winding to connect to separate anode terminals and thereby provides six-phase operation of the mercury arc rectifier. The center points of each phase of the secondary winding are connected through reactors to a common or neutral terminal which in turn is connected to the negative D.C. bus.

Fig. 246 shows a diagram of the connections for a six-phase rectifier, including the main A.C. and D.C. power circuits, ignition and excitation circuits, etc. Trace out this diagram carefully and observe the descriptions which are printed in the diagram for the various parts.

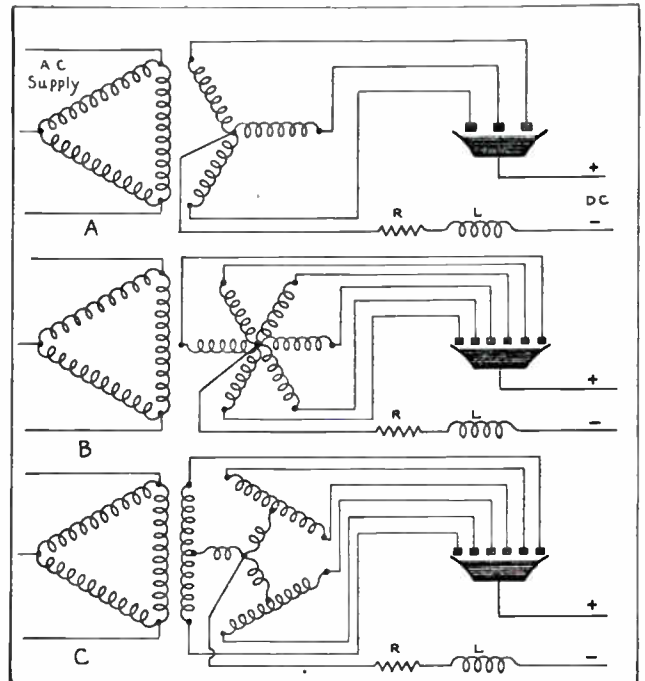

Fig. 245. The above diagrams show three different types of transformer connections which are commonly used with three-phase and six-phase mercury arc rectifiers.

262. VOLTAGE, EFFICIENCY AND POWER FACTOR

There are numerous other connections that can be used to obtain three-phase or twelve-phase operation of these rectifiers. The reason for commonly using six-phase connections to these units and sometimes twelve-phases, is because the greater the number of phases used, the more frequent will be the impulses of rectified D.C.

This reduces the amount of fluctuation and smooths out the voltage of the D.C. supply. The

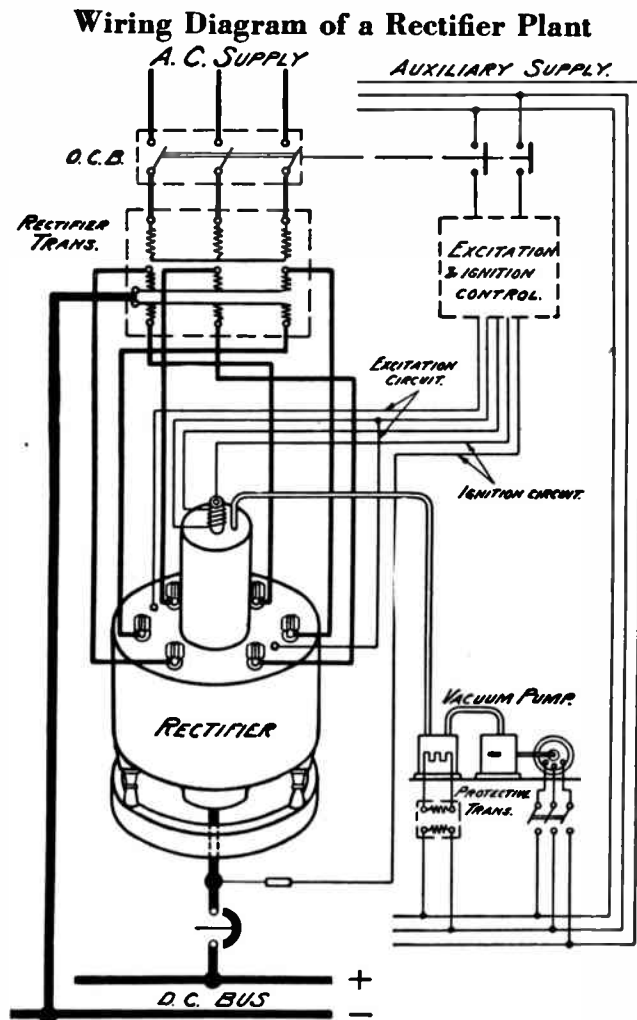

Fig. 244. Wiring diagram showing the power and auxiliary circuits for a six-phase mercury arc power rectifier. (Courtesy American Brown Boveri Co.).

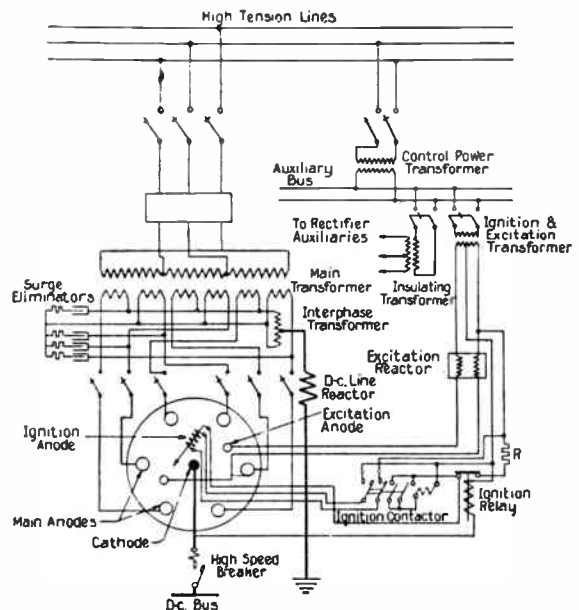
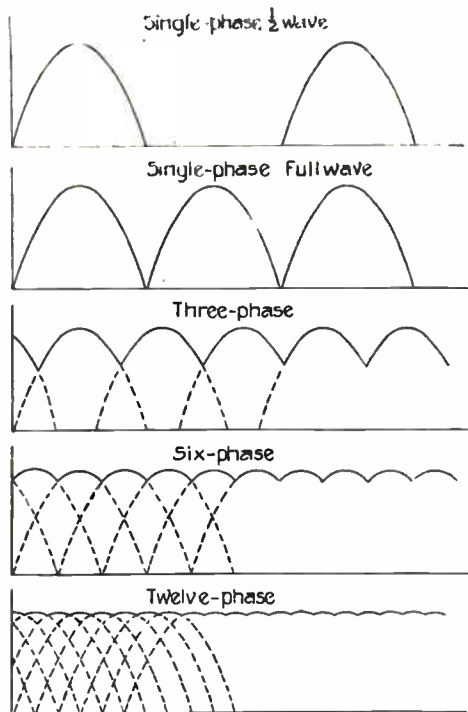

Fig. 246. Wiring diagram of a six-phase rectifier showing transformer connections and auxiliary control circuits. (Courtesy American Brown Boveri Co.).



Comparison of Ripple in D.C. Output  
for Various Number of Phases

Fig. 247. These sine wave diagrams show the amount of pulsation or ripple in rectified D.C. from units operating on different numbers of phases. Note the much smoother voltage curve obtained with the six and twelve phases.

reactance coils which are used in series with the D.C. leads also serve to choke down the ripples or pulsations and thereby smooth out the voltage wave. Fig. 247 shows the differences between the D.C. voltages of 1, 3, 6, and 12-phase units.

Fig. 248 shows a bank of five 1200-kw., 600-volt, manually-operated mercury-arc rectifiers. Mercury-arc rectifiers have a number of decided advantages, such as high efficiency, high power-factor, absence of moving parts to wear out, and very quiet operation.

Power rectifiers of the type just described have efficiencies ranging from 90 to 97 per cent. and power factors which range from 75 to 95 per cent. at the various loads.

Fig. 249 shows the efficiency curves of several rectifiers designed to operate on different voltages. These curves show the variations in efficiency from below 25% to over 150% of the rated load of the units.

The higher efficiencies of mercury arc rectifiers are obtainable only with those designed for operation at above 400 volts. Below this voltage synchronous converters are more efficient.

Fig. 250 shows the power-factor curve of a rectifier and shows the variation in the power factor from under 25% up to 150% load. You will note that the power factor increases gradually with the

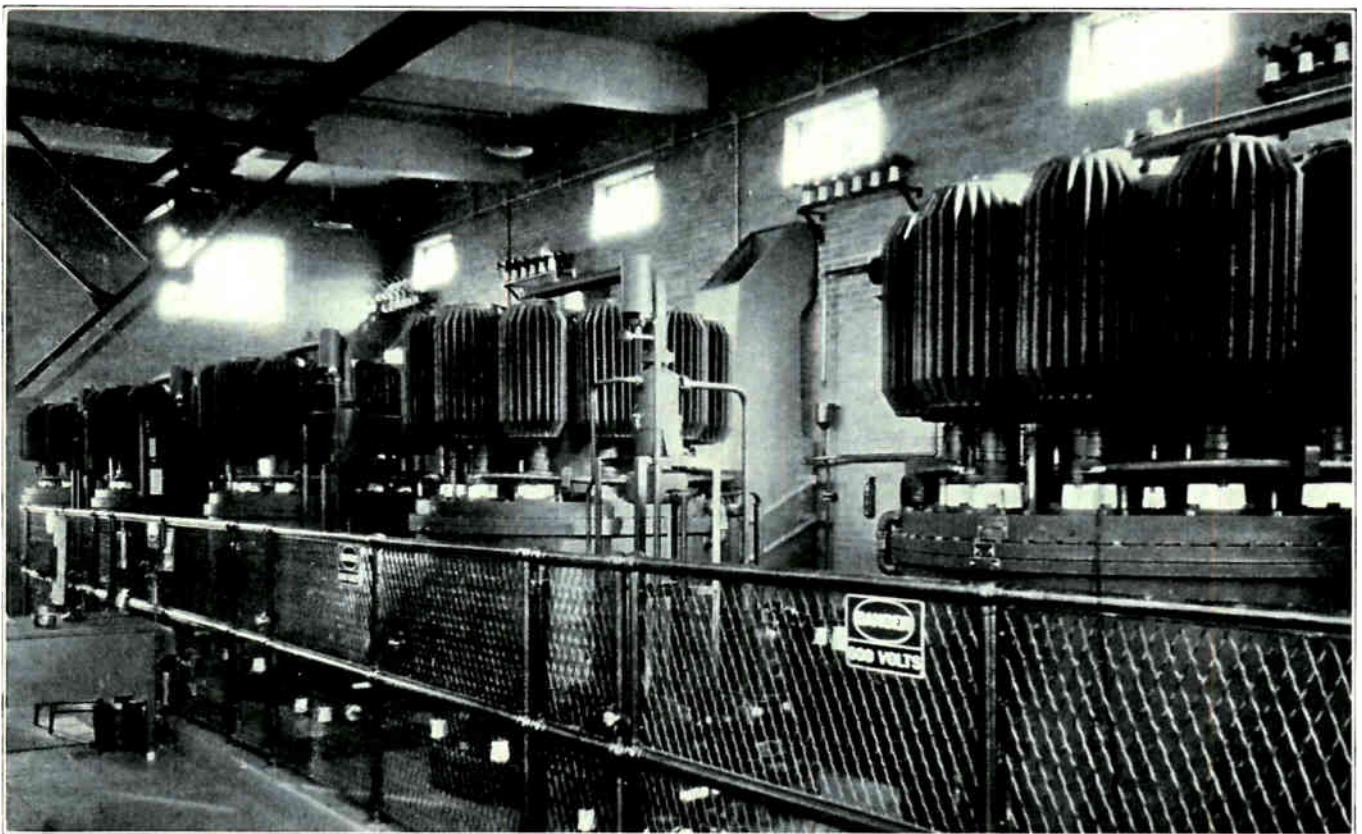

Fig. 248. Five 1200-kw., 600-volt, mercury arc power rectifiers in use in a sub-station. This station has a capacity for producing 6000 kw. of rectified D.C. from the alternating current supplied. (Photo courtesy American Brown Boveri Co.)

load, from 25 to 75 per cent. of the rated capacity of the unit, and from this point on up. The power factor is practically constant at 95%.

These rectifiers are not as seriously affected by short circuits on the D.C. leads as are rotary converters and motor-generators, which are used for the same purpose; that is, changing A.C. to D.C.

The output-voltage of mercury arc rectifiers with common connections can be determined from the following ratios:

- single-phase — 2 anodes — .636
- three-phase — 3 anodes — .827
- quarter-phase — 4 anodes — .900
- six-phase — 6 anodes — .955

The figures given are the ratio of the average D.C. pulsating voltage output to the maximum A.C. voltage input. For example, if we apply 100 volts A.C. to a six-phase unit, the D.C. voltage will be  $100 \times .955$ , or 95.5 volts.

The greater the number of phases, the higher is the D.C. output voltage for a given A.C. voltage input.

**263. OPERATION AND CARE**

If the pressure of the mercury vapor in these rectifiers is allowed to become too high, the recti-

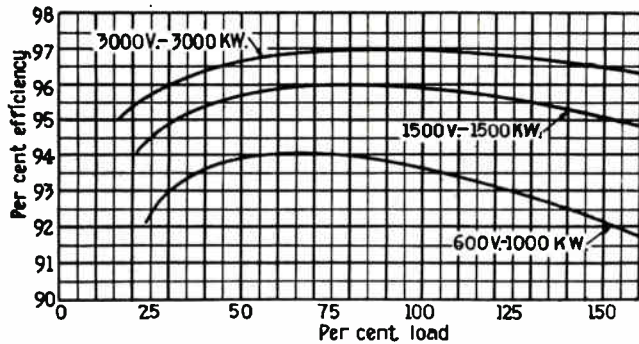

Over-all Station Efficiencies for Rectifiers for 600, 1500, and 3000 Volts

Fig. 240. The above curves show the efficiencies of mercury arc power rectifier stations operating on different voltages and at different percentages of rated load.

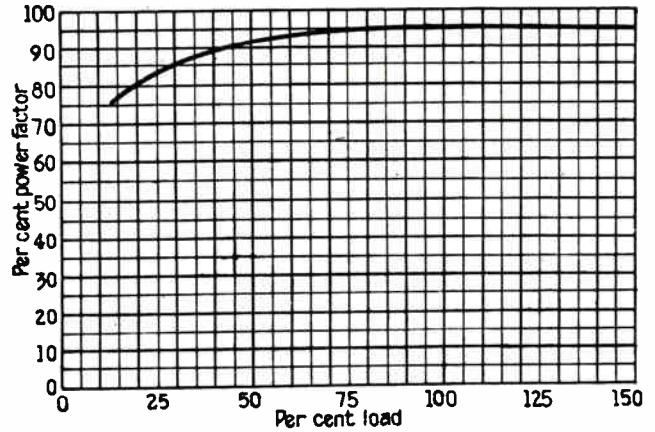

Power-factor of Rectifier at Various Loads

Fig. 250. This curve shows the power factor of a mercury arc rectifier at various percentages of its full rated load.

fier will have a tendency to arc back, or lose its valve action or rectifying property, allowing current to flow in either direction.

If the pressure becomes too low, the voltage drop through the arc becomes excessive.

For these reasons it is very important in operating mercury arc power rectifiers to maintain the proper temperature for condensation of the vapor, by proper adjustment of the cooling water; and to maintain proper vacuum by means of the vacuum pump.

The water and vacuum pumps are often controlled automatically by means of temperature and pressure relays.

When the units are manually operated the pressure and temperature gauges should be carefully watched and the proper adjustments made, in order to secure satisfactory operation.

Mercury arc rectifiers can be operated in parallel with each other or in parallel with synchronous converters by the use of the proper reactors and resistance units to obtain the proper voltage regulation and division of load currents.

## SYNCHRONOUS CONVERTERS

A synchronous converter is a rotating machine used for changing A. C. to D. C. In construction these machines are a sort of combination of a D. C. generator and an A. C. synchronous motor of the revolving-armature type.

Synchronous converters always have stationary field poles, and their fields are constructed the same as those of D. C. generators. A few converters are made with shunt field-windings only, but the great majority of commercial machines have compound field-windings, the same as compound D. C. generators.

Converter armatures have one ordinary winding the same as the winding used in a D. C. generator. These windings can be connected to the commutator bars either lap or wave, although most synchronous converters use lap windings.

In addition to the connections which are made to the commutator bars, converter armatures also have taps taken at equally spaced points around the winding and leading to the collector rings, which are generally placed on the end of the shaft opposite from the commutator.

Fig. 251 shows a modern synchronous converter. In this photo the commutator and D. C. brushes are on the left and the slip rings and A. C. brushes are on the right. The end of the armature winding

can be seen extending from the right side of the opening between the field poles.

You have already learned that the voltage generated in an ordinary winding when it is revolving in the flux of field poles can be taken off to the line in the form of D.C. by use of a commutator, or A.C. by means of slip rings.

If the armature of a synchronous converter is driven by mechanical power, the machine can be used as either a D. C. or A. C. generator, or both.

Direct current can be taken from the brushes on the commutator, and three-phase alternating current from the brushes on the slip rings of a machine such as shown in Fig. 251; or both D. C. and A. C., up to the capacity of the armature winding, can be taken from these machines when driven by mechanical power.

As a motor, this machine can be operated either by D. C. or A. C. If direct current of the proper voltage is applied to the brushes on the commutator, the machine will run as a D. C. motor; or if three-phase A. C. is applied to the slip rings, it will run as a synchronous motor with a stationary field and revolving armature.

Most synchronous converters are operated from A. C. and produce D. C., although in some cases they are supplied with D. C. and change it to A. C.

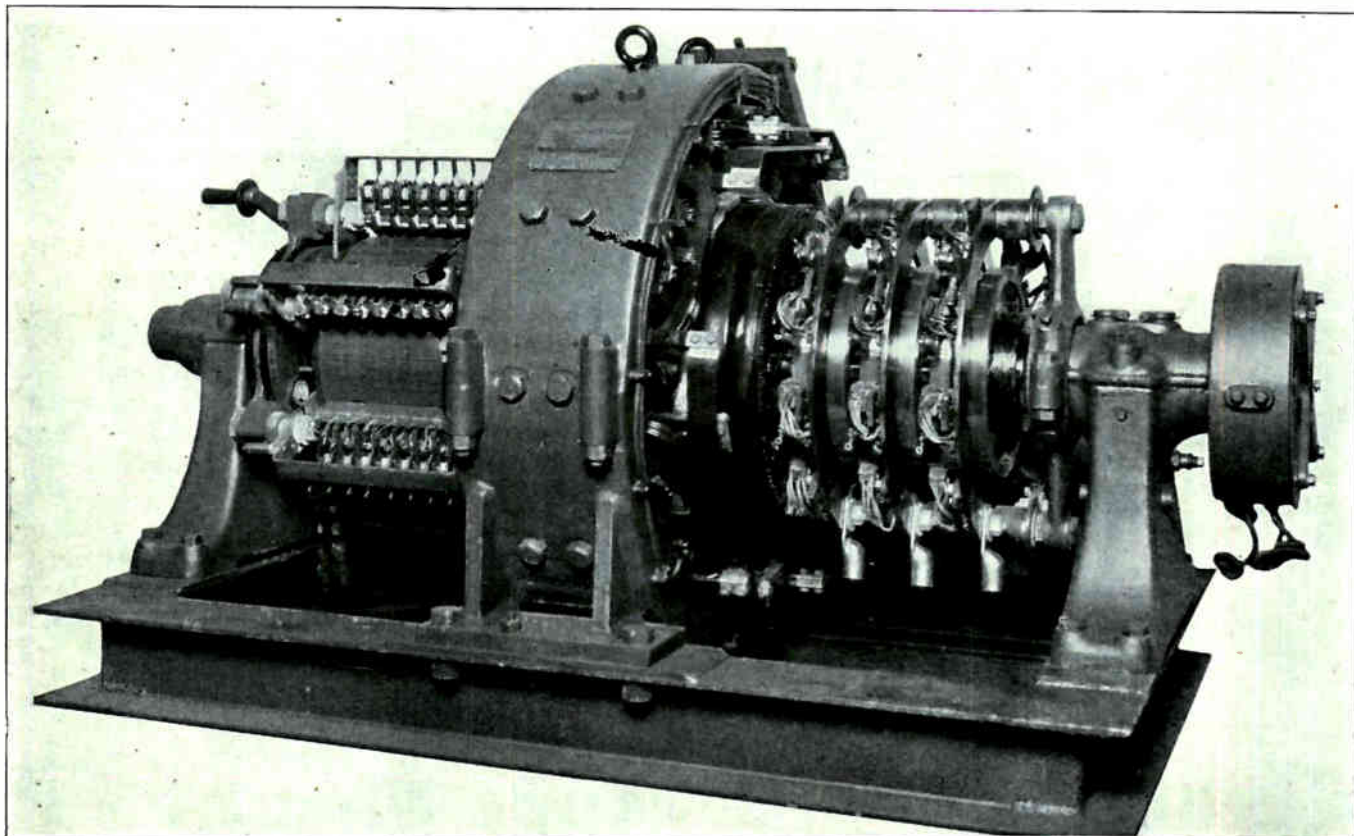

Fig. 251. The above photo shows an excellent view of a modern synchronous converter used for changing A.C. to D.C. The commutator and D.C. brushes are shown on the left and the slip rings and A.C. brushes on the right. Also note the armature, and the shunt and series windings on the field poles. The device on the right-hand end of the shaft is an overspeed safety switch. (Photo courtesy General Electric Co.).

When used in this manner they are called inverted rotary converters.

## 264. CONSTRUCTION

Fig. 252 shows another synchronous converter and gives a better view of the D. C. end. The field poles with their shunt and series windings can be plainly seen in this view, and you will note that this machine is also provided with interpoles to improve commutation on the D. C. end. The D. C. brushes are provided with arcing shields or flash barriers to prevent flash-overs between the positive and negative sets of brushes in case of short circuits or severe overloads on the machine.

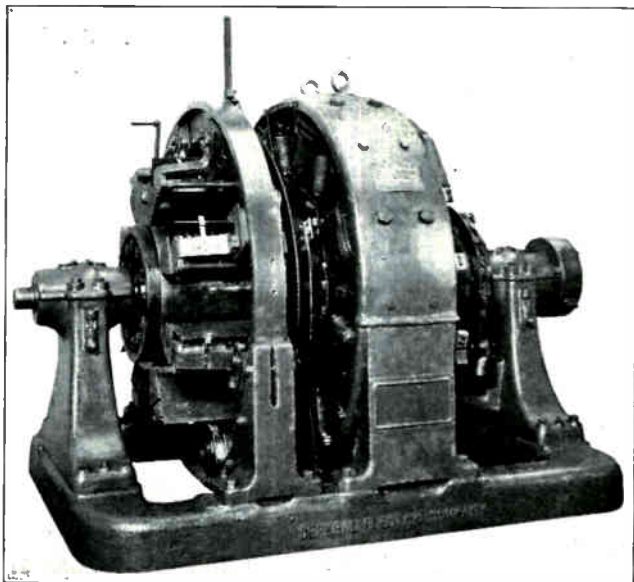

Fig. 252. D.C. end of a large synchronous converter showing brush-lifting mechanism, and flash barriers around the brushes. (Courtesy General Electric Co.).

Fig. 253 shows the field frame and poles of a synchronous converter with the armature removed. In this view you may note the damper winding which is built into the faces of the field poles. This winding is used both in starting the machine as an induction motor and to prevent hunting during operation.

Fig. 254 shows the armature of a 500-kw. rotary converter which is equipped with six slip rings on the A. C. end for operation on six-phase A. C. The commutator of this machine, being rather long in order to accommodate the necessary brushes and carry the large amounts of direct current, is equipped with a banding ring in the center, to hold the bars in place against the action of centrifugal force.

## 265. OPERATING PRINCIPLES

When alternating current of the proper frequency and voltage is applied to the slip rings of a synchronous converter this excites the armature winding with A. C. and sets up a revolving magnetic field around the armature. This field induces secondary currents in the squirrel-cage damper

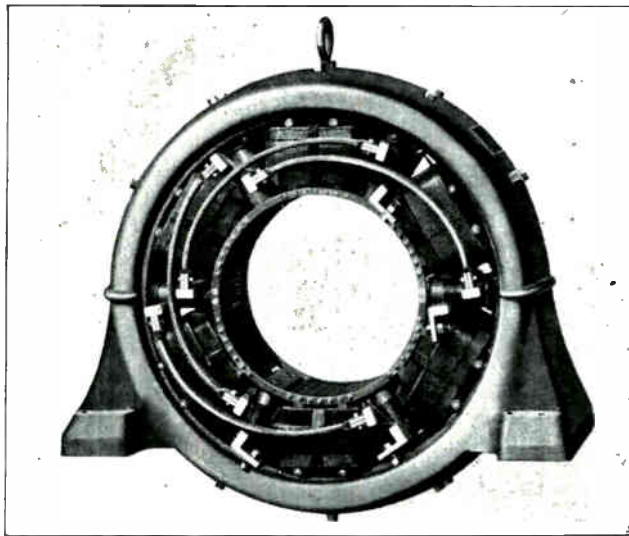

Fig. 253. Side-view of the field of a synchronous converter. Note the squirrel-cage damper winding in the faces of the main poles. Also note the interpoles located between the main poles. (Courtesy Allis-Chalmers Mfg. Co.)

winding, and the reaction between the flux of these secondary currents and the flux around the armature conductors sets up torque and causes the machine to start as an induction motor.

When the armature comes up to nearly synchronous speed, the D. C. field poles are excited and the machine then pulls into step and operates at synchronous speed, the same as any synchronous motor. Direct current can then be taken from the brushes at the D. C. end.

From this description alone one might conclude that the machine operates purely as a motor-generator, using alternating current to drive the motor and thereby generating D. C. in the windings. This, however, is not the case, as when synchronous converters have their armature windings supplied with A.C. of the proper voltage, this current merely passes through the windings to the D.C. end, where it is commutated or rectified into D.C.

A small amount of the energy derived from the alternating current is used up in overcoming the friction and losses in the machine, but by far the greater part of the A. C. energy is simply passed through the armature winding from one end to the other and commutated into D. C. at the D. C. end.

For this reason commutators on converters are much larger than those on D. C. generators of the same armature size.

The voltage at the D. C. end of a synchronous converter is generally a little higher than the A. C. energy supplied, because the current in passing through the few turns which it does in the armature winding has a little generated voltage added to it as the armature conductors revolve through the flux of the D. C. field poles. But it is much better to think of a synchronous converter merely as a **synchronously-driven commutator** instead of considering it as a motor-generator set.



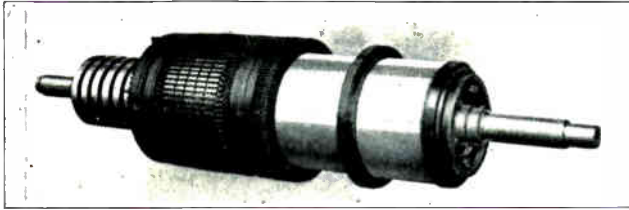

Fig. 254. Photo of converter armature clearly showing the armature winding, slip rings and commutator. A.C. enters at the slip rings and D.C. is taken off from the commutator when this armature is revolved at synchronous speed in the flux of D.C. field poles. (Courtesy Allis-Chalmers Mfg. Co.).

Converter armatures do not require as many turns as would a D. C. generator to produce the same D. C. voltage. This is because the alternating current supplied to the A. C. end of the armature from the line or power plant generators is already at quite high voltage.

For this reason converters do not have as great an armature resistance or copper loss as motor-generators do and, therefore, converters operate at much higher efficiency. This is one of the reasons for their very extensive use in substations supplying D. C. to electric railways or for industrial power purposes.

A three-phase synchronous converter will develop only 59% of the heat produced in a D. C. generator of the same capacity, and a converter of a given size will have 131% of the capacity of a D. C. generator of the same size. A six-phase converter develops only 27% of the heat and has 194% of the capacity of a D. C. generator of the same size.

## 266. CHARACTERISTICS

As converters of this type operate at synchronous speed, their A. C. characteristics are similar to those of a synchronous motor, and the power factor of synchronous motors under ordinary operating conditions is very high.

The efficiency of these machines is best when they are operated at unity power factor. If desired, they can be operated at leading power-factor by over-exciting the field poles, and in this manner they can be made to correct the power factor of the A. C. lines.

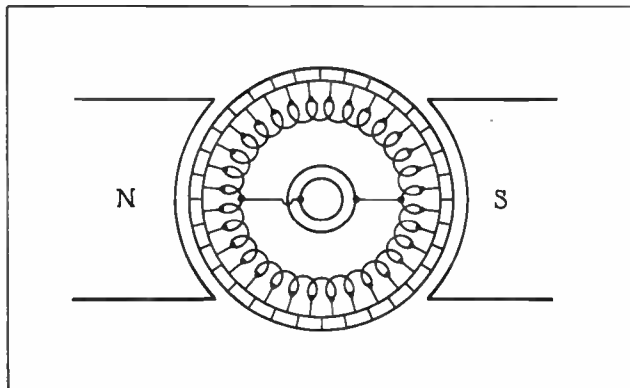

Fig. 255. Diagram of the armature connections for a simple two-pole, single-phase, synchronous converter. Note that the slip ring connections are taken at points 180 electrical degrees apart on the winding.

As the efficiency and desired characteristics of synchronous converters fall off very rapidly when they are operated at less than 90 or 95 per cent. power factor either leading or lagging, these machines are not generally used to perform much power factor correcting duty.

As most motors, generators, and converters operate a greater part of the time at about 75% load, synchronous converters are usually designed and adjusted for 100% power factor at three-fourths of their rated load. This provides very good operating characteristics at loads from about half to full load.

## 267. ARMATURE CONNECTIONS

Some small converters are made for single-phase operation but most of them are designed for operation on either three or six-phase A. C. circuits. A greater number of the larger sizes and modern power converters are operated on six-phase A. C.

Fig. 255 shows a diagram of the armature connections to the commutator and slip rings of a two-pole, single-phase, synchronous converter. Note that the connections from the A. C. rings to the armature windings are made diametrically opposite, or at points 180 electrical degrees apart on this two-pole machine.

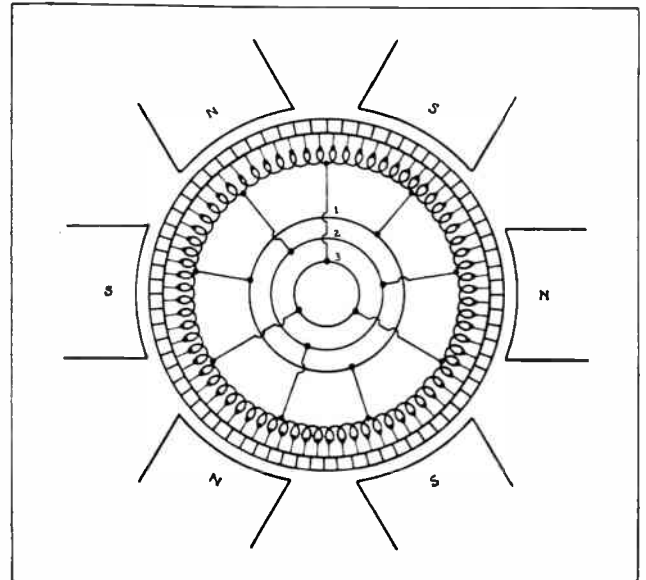

Fig. 256. Diagram of armature connections for a six-pole, three-phase, synchronous converter. The slip ring connections for each phase are taken at points 120 electrical degrees apart.

Fig. 256 shows the connections for a six-pole, three-phase converter. This machine has three slip rings, one for each phase, and each ring has as many connections to the winding as there are pairs of field poles. These connections to the same ring are made at points 360 electrical degrees apart, so that they come under the same positions under like poles throughout the entire machine.

Examine this carefully on the connections shown to ring No. 1. Now checking around the winding clockwise we find that the connections to ring 2 are

taken at points 120 electrical degrees from those to ring 1. The same applies to the taps or connections for ring 3, which are taken at points 120 electrical degrees from those of ring 2.

A good rule to remember in connection with the A. C. taps to a synchronous converter armature winding is as follows:

There are taken from the armature winding to each slip ring as many equally-spaced taps as there are pairs of poles.

On single-phase machines the taps to each ring are always made 180 electrical degrees apart on the armature winding, or the distance between the center of a north pole and the center of the adjacent south pole. On three-phase machines the taps to each separate ring are taken at points 120 electrical degrees apart. On six-phase machines these taps are taken at points 60 E° apart.

Fig. 257 shows the armature connections for a six-pole, six-phase converter.

### 268. FIELD CONNECTIONS

Converters with compound field-windings have the usual shunt winding, consisting of a large number of turns of comparatively small wire wound next to the core on each pole.

The series winding generally consists of a very few turns of large cable or copper bars wound around the outside of the pole or over the shunt winding. The series coils are connected in series with the D. C. brushes and load, so that the compounding effect will be proportional to the load at all times.

On machines which have interpoles or commutating poles these are also connected in series with the D. C. brushes and load. The shunt field coils can be connected either in series or parallel, or grouped into series-parallel combinations according

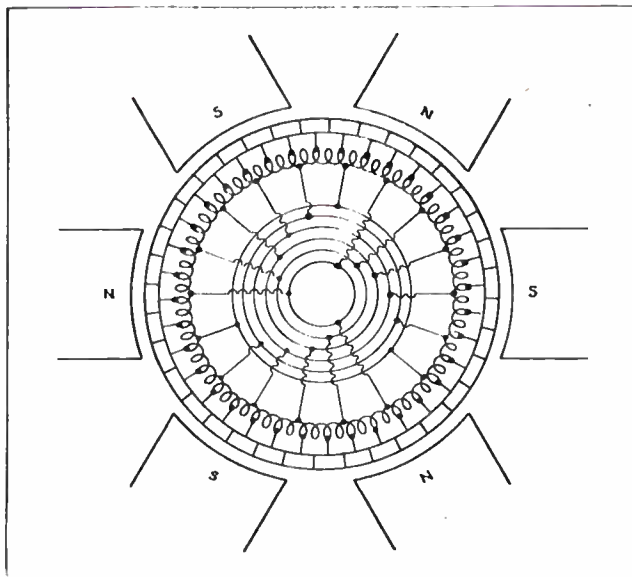

Fig. 257. Diagram showing the armature connections for a six-pole, six-phase, synchronous converter. The connections of the different phases of this winding are made 60 electrical degrees apart.

to the voltage applied and the resistance of their windings.

The shunt field coils are often connected to a field break-up switch which when opened separates the connections between the shunt field coils to prevent the induction of very high voltages during starting of the converter as an induction motor. See Figs. 260 and 261.

If these shunt field coils were left connected in series, dangerously high voltages would be induced in this circuit by transformer action when the alternating current is first applied to the armature and during the starting period when the slip is greatest and the frequency of the alternating flux is highest.

This flux from the armature cuts across the field windings at full line frequency during the first period of starting, but when the armature comes up to synchronous speed there is no longer any slip and therefore very little voltage is induced in the field windings from the armature flux during normal operation.

### 269. FIELD EXCITATION

The field poles usually receive their excitation from the D. C. brushes of the converter, although in some cases small separate exciter-generators are used. These separate exciters, when used, serve as a protection against the converter building up with wrong polarity when started, and also as a protection against dangerous overspeeding which might otherwise occur in case of a D. C. feed-back during failure of the A. C. supply to the slip rings.

When a number of converters are operated in parallel, if the A. C. supply to one machine is interrupted this causes the D. C. voltage of that machine to drop, and the other converters will then feed direct current in the reverse direction through the armature and the series field and cause this one machine to operate as a differential D. C. motor.

Reversing the current through the series field weakens the field flux by this differential action and will tend to cause the converter to overspeed and act as an A.C. generator if it is left connected to the A.C. supply from the transformer. The flux of the A.C. further weakens the field poles and may cause the machine to overspeed dangerously and possibly wreck the armature and commutator by centrifugal force, if the machine is not immediately disconnected from the D.C. circuit.

When the converters are equipped with separate exciters driven by the main armature shaft, the exciter also speeds up with any increase in armature speed and thereby strengthens the shunt field, which helps to keep the speed of the converter down.

Synchronous converters are usually equipped with an overspeed contact device which is attached to the end of the armature shaft. In case the machine overspeeds, centrifugal force causes a small weighted arm to fly outward and close a circuit to a relay, which trips the main D. C. breaker, thus

stopping the back feed of direct current to the armature. The box or casing which contains this overspeed device can be clearly seen in Figs. 251 and 252.

### 270. EFFECT OF FIELD STRENGTH ON VOLTAGE AND POWER FACTOR

The strength of the shunt field of synchronous converters is generally controlled by means of a rheostat placed in series with one of the D. C. supply leads to the field coils.

By adjusting the strength of the field with the shunt-field rheostat the D. C. output voltage of the converter can be varied within a very limited range. The shunt-field rheostat is more commonly used, however, for adjusting the power factor of the machines. The effect on the power factor is the same as that obtained by the field rheostat on synchronous motors.

When the field strength is increased the power factor is advanced from lagging toward unity, and if the field is over-excited the machine can be made to develop leading power factor.

### 271. CONTROL OF D. C. OUTPUT VOLTAGE. VOLTAGE RATIOS

The adjustment of the D. C. output voltage of synchronous converters over any considerable range is generally accomplished by means of voltage regulators or tapped transformers on the A. C. side, or by means of a D. C. booster generator attached to the same shaft and connected in the D. C. circuit. A. C. booster converters or generators are also often used in series with the A. C. supply.

The D. C. output voltage of synchronous converters depends almost entirely on the applied A. C. voltage and upon the type of armature connections used.

In a single-phase converter the D. C. voltage is equal to the maximum value of the applied A. C. voltage.

For example, if 100 volts A. C. is applied to the slip rings, the D. C. voltage at the brushes will be equal to  $\frac{100}{.707}$ , or 141.4 volts.

The ratios of A. C. to D. C. voltages which are obtained with different converter connections are as follows:

Connections	Ratio of A. C. to D. C. voltage
One-phase	.707
Two-phase diametrical	.707
Two-phase adjacent taps	.5
Three-phase	.612
Six-phase diametrical	.707
Six-phase adjacent taps	.354

The three-phase and six-phase diametrical connections are the ones most commonly used in power converters. To determine the D. C. voltage output of a three-phase machine we simply divide the A. C. voltage applied to the slip rings by the figure .612.

For example, if 370 volts A. C. is used to operate the converter, we will obtain  $\frac{370}{.612}$ , or approximately 604 volts D. C.

If we apply 440 volts A. C. to a six-phase diametrical converter, we will obtain  $\frac{440}{.707}$ , or approximately 622 volts D. C.

### 272. TRANSFORMER CONNECTIONS TO CONVERTERS

Synchronous converters are designed and insulated for the voltages at which they are intended to operate, and the proper A. C. voltages for application to their slip rings are usually obtained by means of step-down transformers. The A. C. power is usually sent from the power plants over transmission lines at rather high voltage.

Fig. 258-A shows the transformer connections for a simple two-pole, single-phase converter. The taps are connected to the armature 180 electrical degrees apart, as previously explained.

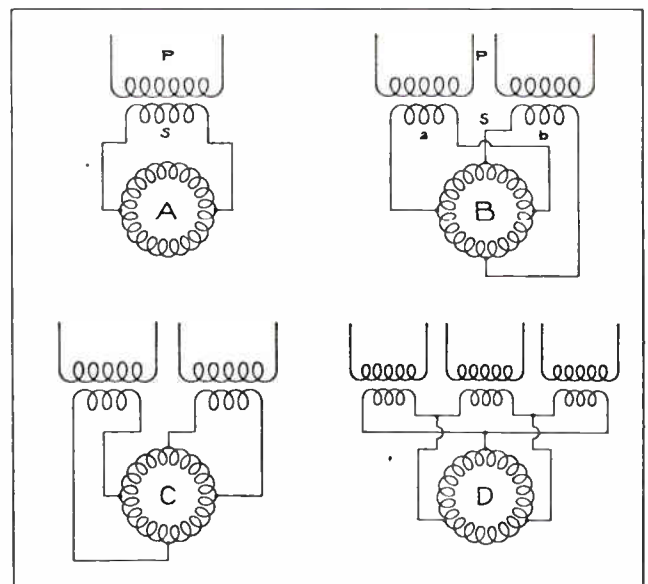

Fig. 258. A. Transformer connections for a single-phase converter. B. Transformer connections for a two-phase, diametrical converter. C. Transformer connections for a two-phase, adjacent tap converter. D. Transformer connections for a three-phase converter. The armature connections in all of the above diagrams are for two-pole machines.

Fig. 258-B shows the transformer and the armature tap connections for a two-pole, two-phase diametrical connection. The opposite leads of each phase of the transformer secondaries are connected diametrically opposite, or 180 electrical degrees apart, on the armature winding.

In these simple diagrams the connections are shown made directly to the armature winding, while on the actual machines the transformer leads of course go to the brushes on the slip rings, and the rings connect to the armature winding.

Fig. 258-C shows a diagram of the transformer and armature connections for two-phase adjacent

taps. In this connection the opposite ends of each phase of the transformer secondaries are attached to the winding at points 90 E° apart.

Fig. 258-D shows the connections for a two-pole, three-phase converter armature, with the leads of the delta-connected transformer secondaries tapped on the winding at points 120 E° apart.

Fig. 259-A shows the connections for a two-pole, six-phase converter with the transformer secondaries connected to the armature winding six-phase diametrically. Note that the starts, or left-hand leads of the transformer secondaries, connect to the converter winding at points 120 E° apart; and the finishes, or right-hand leads of these same secondaries, connect 180 electrical degrees from their starting leads, or diametrically opposite on the armature winding from the point where the starts connect.

On machines with more than two poles this series of connections would be repeated for each 360 E° or the space covered by each pair of poles. So there would be as many A connections to each slip ring as there are pairs of poles; also as many B and C connections.

Fig. 259-B shows the connections for a two-pole, six-phase converter using the six-phase adjacent tap system of connecting the transformer leads to the winding.

Fig. 259-C shows the connections for a six-phase, double-star-connected converter.

Fig. 260 is a diagram of a four-pole synchronous

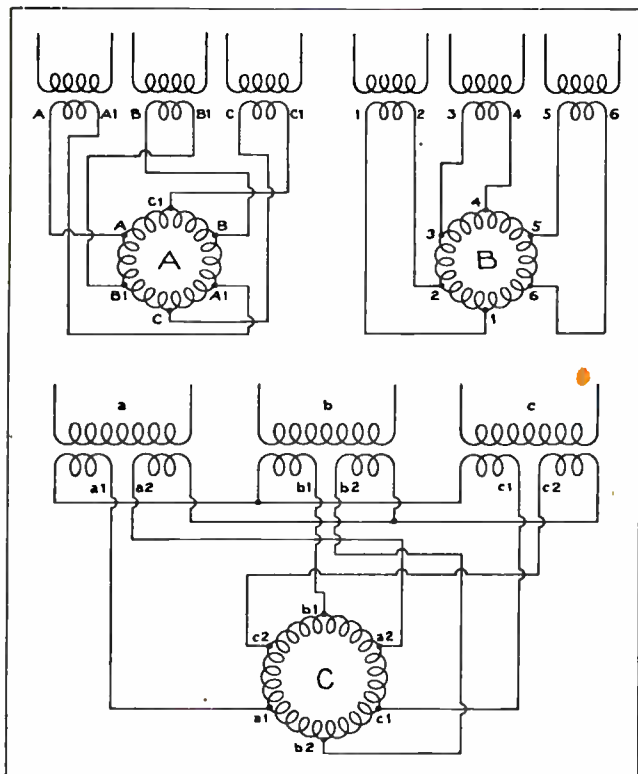

Fig. 258. A. Transformer connections for a six-phase, diametric converter. B. Transformer connections for a six-phase adjacent tap converter. C. Transformer connections for a six-phase, double star-connected converter. Each of these diagrams show the connections for a two-pole machine.

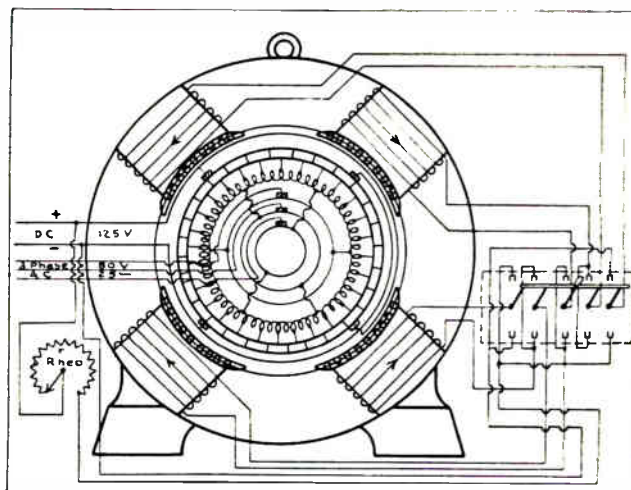

Fig. 260. Wiring diagram showing armature and field connections, and also the field break-up switch and rheostat for a four-pole, three-phase converter. Trace out the field circuit both with the switch in the upper and lower positions and note that the polarity reverses when the switch is changed.

converter and shows the D. C. connections to the brushes on the commutator, the A. C. connections to the brushes on the slip rings, and also the field "break-up" switch which is used to break-up the shunt field circuit during starting of the machine.

The connections for a shunt-field rheostat are also shown in this diagram. The series field and commutating field are not shown in this figure; but when they are used they are connected in series with one of the D. C. leads.

### 273. STARTING SYNCHRONOUS CONVERTERS

Synchronous converters may be started in several different ways, three of which are as follows: 1. By applying reduced A. C. voltage to the armature and starting the machine as a synchronous motor. 2. By applying reduced D. C. voltage to the armature and starting the machine as a D. C. motor. 3. By using a starting motor to bring the armature up to the proper speed before synchronizing with the A. C. line.

The first method mentioned is by far the most commonly used and is so similar to the method previously explained for starting synchronous motors that it doesn't require much additional explanation here.

Reduced A. C. voltage, generally about 50% of the normal operating voltage, is applied to the armature at the slip rings. This causes alternating current to flow through the armature winding and sets up a revolving magnetic field which induces secondary currents in the damper winding which is mounted in the faces of the field poles.

The reaction between the flux of these secondary currents and that of the armature conductors causes the machine to start as an induction motor. The reduced voltage for starting can be obtained from an auto transformer but it is more often obtained from an extra set of leads which are brought out

from the center taps in the middle of each phase of the transformer secondary windings, as shown in Fig. 261.

When the three-pole, double-throw starting switch is thrown to the upper position, the left-hand leads and center taps of each transformer secondary are connected to the slip rings and supply only half voltage to the converter-armature. When the machine has reached approximately full speed the switch is thrown quickly to the lower position to apply full voltage to the armature. Carefully trace the circuits from the transformers and starting switch to the converter rings in Fig. 261.

In modern substations magnetically-operated remote control circuit-breakers or contactors are used instead of the hand-operated knife switch. One set of these contacts opens the circuit to the starting taps just a fraction of a second before the other set closes the circuit to the full voltage taps, thus performing the switching operation very quickly.

## 274. BUILDING UP D. C. VOLTAGE

If the D. C. voltmeter indicates that the polarity on the D. C. end of the converter has built up in the right direction when the machine comes up to speed, the D. C. circuit-breaker can be closed to the D. C. busses and load, as soon as the converter is running at full speed and full voltage.

In case the converter is operating in parallel with others it is necessary to see that its voltage is properly adjusted for paralleling before closing the D. C. breaker. It is also necessary to close the equalizer switch before paralleling a compound converter.

A synchronous converter when started from the A. C. side in the manner just described will often build up voltage with the wrong polarity at the D. C. brushes. This polarity which will be built up depends upon whether the converter-armature pulls into step on a positive or negative alternation.

So, with some machines the polarity is just as likely to be built up wrong as to build up right.

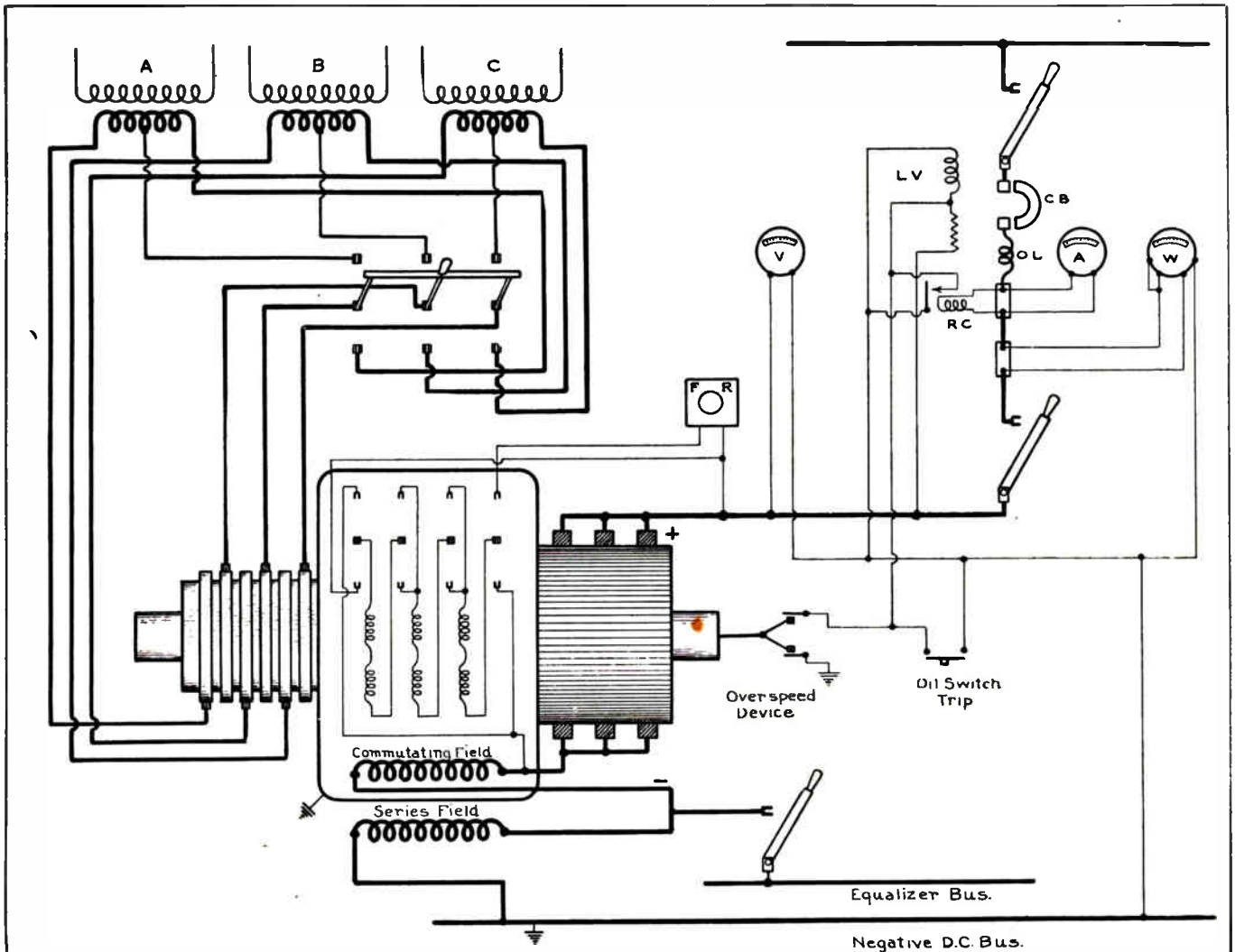

Fig. 261. This diagram shows the connections of the transformer secondaries to the A. C. slip rings of a six-phase, synchronous converter, and also shows the starting switch used for obtaining half voltage to start the machine from the A. C. end. Note the connections of the shunt field windings to the field break-up switch and rheostat, and also the connections of the commutating and series field windings to the equalizer bus and negative D. C. bus. The equalizer bus will be used only in case the machine is operating in parallel with other converters. Note the low-voltage trip coil, L.V., which will open the circuit breaker in case of voltage failure, and the overload trip coil, O.L., which will open the breaker in case of D. C. overload. The reverse current relay, R.C., will short-circuit the low-voltage trip coil and open the breaker in case of a D. C. feed-back to the converter.

Some machines, because of certain characteristics in their design, will nearly always build up with right polarity while others will almost always build up the wrong polarity. This polarity must, of course, be corrected before the converter can be connected to the busses or trolley in parallel with any other machines.

### 275. CORRECTING POLARITY

Several of the more common methods of correcting this polarity are as follows:

- (a) "flashing" the field
- (b) separate excitation
- (c) field-reversing switch
- (d) strengthening field at the instant of correct polarity.

"Flashing" the field consists of sending D. C. in the correct direction through the shunt-field winding when the converter is nearly up to full speed. This causes the armature to pull into step at the right field poles.

If the polarity has been built up wrong flashing the field will cause the armature to slip back one pole thus causing the converter to reverse polarity. The converter will then properly excite its own field from the commutator and brushes.

The direct current for flashing the field is generally obtained from a small constant-polarity motor-generator which is usually not over 1 to 5 kw. in size.

Converters which are separately excited from a small D. C. generator on the shaft of the main unit or from a small motor-generator will practically always build up the right polarity because of the residual magnetism of the poles of these small D. C. generators.

The field break-up switches that are used with synchronous converters are often made double-throw as in Fig. 260, for the purpose of reversing the polarity of the shunt-field poles. Trace the shunt field circuits in Figs. 260 and 261 with the switches in both positions, and note that the current through the field coils reverses when the switches are reversed.

Converters normally operate with this switch in the upward position, but if they build up with wrong polarity the switch can be thrown downward for a short period to reverse the polarity. When this is done the polarity of the field poles becomes the same as that of the magnetic poles set up in the armature directly under them.

This causes a strong repelling action which tends to retard the movement of the armature. This repelling action, windage, and the friction of the brushes on the commutator soon cause the armature to drop back one pole, or 180 electrical degrees.

This reverses the polarity of the D. C. voltage at the brushes and would also reverse the polarity of the field which is connected to these brushes if nothing more were done.

By watching the voltmeter at the time the field-reversing switch is thrown to the lower position you will note that the voltage decreases to zero and then reverses.

At the instant the voltmeter needle passes over the zero point, the field-reversing switch should be closed into the upward or running position. This again reverses the field poles, bringing them back to their original polarity and with the polarity at the D. C. brushes now in the right direction to excite the field poles properly.

The whole operation simply causes the armature to slip back one pole and thereby causes the reversal of polarity of the D. C. circuit.

When a converter is approaching synchronous speed the D. C. voltmeter will often oscillate to the right and left of zero, showing a sort of faltering or reversing action of the D. C. voltage just as it starts to build up.

A polarized relay can be connected in the D. C. circuit so that it will close a circuit to the shunt field at the instant the voltage is in the right direction. This will cause the converter to retain the correct polarity.

### 276. CONVERTER AUXILIARIES

Modern synchronous converters generally have a number of auxiliary devices to aid in securing proper operation and to protect the machine against damage from various causes. Some of the most common of these auxiliary devices are as follows:

1. Field-reversing or break-up switch, which has already been described.
2. Brush lifting mechanism.
3. Armature oscillator.
4. Armature overspeed centrifugal switch.
5. Arc chutes and barriers.
6. Separate exciter or field "flashing" generators, when used.
7. Flash-over relays.
8. Temperature relays.

### 277. BRUSH LIFTING MECHANISM

When a converter is first started from the A. C. end, the current flows directly through the low-resistance conductors of the armature and through the circuits which are completed at the commutator by alternate sets of D. C. brushes being connected together.

If these brushes are left on the commutator during starting it results in heavy cross-currents flowing in certain sections of the armature and through the brushes, and this tends to cause severe sparking during the starting of the machine.

For this reason many of the larger machines which have interpoles are equipped with brush-lifting devices, which lift all of the brushes, except one brush of the positive group and one of the adjacent negative group from the commutator during starting.

These two brushes are known as pilot brushes and they are used to give the D. C. voltmeter polar-

ity readings and to supply the direct current to excite the field for obtaining the correct polarity.

The brush groups are all mechanically connected together by means of a steel cable and operating gear so they can be raised and lowered by means of an operating lever which, in turn, may be either manually or motor operated. See Fig. 252.

All brushes except the pilot brushes should be raised before starting the converter and they should be lowered as soon as the machine is up to speed and the correct polarity has been established.

### 278. ARMATURE OSCILLATOR

If the armature and commutator were allowed to run with the brushes at exactly the same position at all times, the brushes would tend to wear grooves and ridges in the surface of the bars. Such wearing increases commutation troubles and makes more difficult the proper care of the commutator and the proper fitting of the brushes.

To avoid the grooving or "tracking" of the brushes on the commutator converters are often equipped with an armature oscillator which keeps the entire armature unit oscillating slightly back and forth endwise so that the brushes will wear evenly over the entire surface of the commutator.

To accomplish this oscillation the converter is set with one end slightly higher than the other so that the armature and shaft tend to slide to the lower end as they rotate.

One type of oscillator uses a steel ball placed between the end of the shaft and a plate which is set at a slight angle as shown in Fig. 262. As the shaft drifts to the lower end it pinches the ball between the shaft end and the plate and causes the ball to rotate or roll around in the direction the shaft turns.

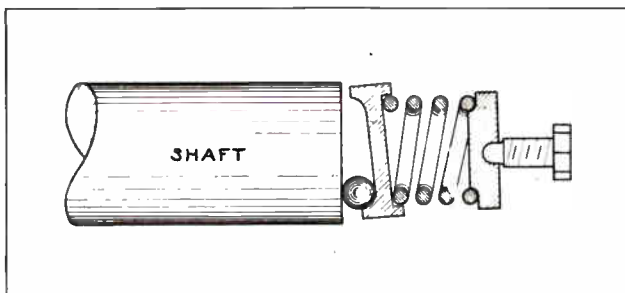

Fig. 262. Diagram showing ball and spring oscillator to cause converter armature to move endwise and promote even wear on the commutator.

This wedges the ball up into the narrower opening between the tilted top of the plate and the shaft end, compressing the heavy spring behind the plate and pushing the shaft and armature back toward the high end of the machine. The ball then drops down and repeats the operation again and again as long as the armature rotates.

Other machines are equipped with a powerful electro-magnet placed near the high end of the shaft, to draw the armature back each time it slips to the low end of the machine.

A set of contacts can be arranged at the low end

of the shaft so that they close the circuit to the electro-magnet each time the shaft reaches the end of its oscillation in the low direction.

### 278. OVERSPEED DEVICE

As previously explained, any synchronous converter will tend to overspeed dangerously if the A. C. supply is interrupted and D. C. is fed into the armature from the trolley or other converters with which it is operating in parallel.

Converter armatures are generally designed and tested to stand only about 50% overspeed. When operated as a differential motor by D. C. feed-back, and if allowed to generate and feed A. C. to the transformers they will quickly exceed the speed limit if some means is not provided to interrupt the D. C. circuit to the armature.

Fig. 263 shows two views of a centrifugal speed-limit device which can be used to either make or break a circuit to trip the main D. C. circuit-breaker, thus stopping the converter when it is operating from the D. C. end.

The revolving element is attached to the end of the converter shaft and if it is revolved at about 25% above normal speed, the weighted pin is thrown outward by centrifugal force against the action of the coil spring, which can be clearly seen in this view.

This causes the end of the pin to strike the toggle or cam on the contact arm, and make or break the operating circuit to the breaker trip coil. Fig. 261 shows the connection of the over-speed switch and the circuit by which it shorts and weakens the low-voltage release-coil, LV, thus tripping the D. C. breaker. Fig. 261 also shows the connections of a reverse current relay, RC, which attracts its polarized armature in case the current reverses.

The small hand-lever extending from the case of this overspeed device is for resetting the contacts in normal position before the machine is again started.

### 279. ARC CHUTES AND BARRIERS

When converters are subject to occasional heavy

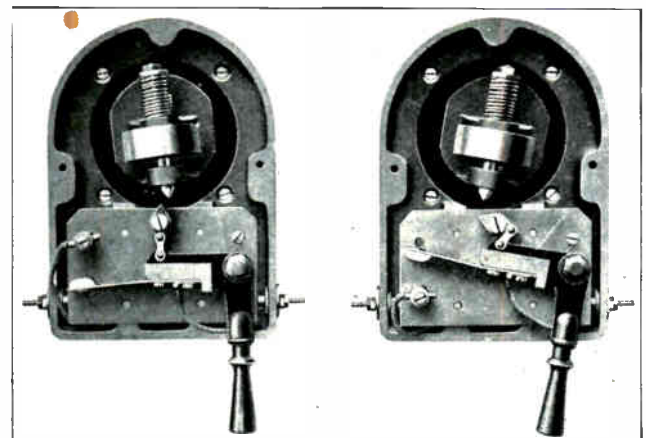

Fig. 263. Two views of a centrifugal overspeed switch showing two possible arrangements of the contact for either an open or closed circuit system.

overloads or possible short circuits, the sparking is likely to cause flash-overs or arcs between positive and negative sets of brushes, or between the commutator or brush rigging and the frame of the machine.

Barriers of fireproof insulating material, such as asbestos composition, can be provided around the brush groups and between positive and negative groups. This insulation considerably reduces the tendency to flash-over and helps to extinguish any arcs which may occur in this manner.

Fig. 264 shows a section of a commutator and illustrates the manner in which the arc barriers, B, and arc chutes, C, are placed around and between the brushes.

The lower edges of the barriers around the brush groups clear the commutator by only about 1/32 of an inch, and tend to confine sparking or arcing to the neighborhood of the brush and prevent the arc from travelling around the commutator to the next set of brushes.

The lower edges of the arc chutes are also very close to the surface of the commutator, and the strips of insulating material are set at an angle against the direction of rotation. In this manner they deflect outward the currents of air which tend to follow the surface of the commutator and this helps to prevent the arc from being carried or blown from one set of brushes to the other.

Fig. 252 clearly shows the position of the flash barriers on the D. C. or commutator end of a synchronous converter.

### 280. FLASH OVER RELAYS AND TEMPERATURE RELAYS

In some cases the frames of converters are insulated by a leatheroid or fiber plate from the floor or base on which they are mounted so that any currents which may flow from the commutator to the frame during a flash-over must pass through the coil of a relay to get to ground.

This causes the relay to operate and cut the machine out of service in case of severe flash-overs. If the flash-overs were allowed to continue they would seriously burn and pit the commutator bars, brush rigging, or parts of the frame from which the arc is drawn.

Synchronous converters are often equipped with temperature relays operated by small tubes of liquid which are placed at different points in or near the windings and are connected to an expansion bellows in the relay.

When the liquid in these tubes is overheated it expands, forcing the bellows to close the relay contacts and operate the circuit-breaker to remove the load from the machine or shut the machine down entirely as desired.

### 281. AUXILIARY BRUSH FOR BEARING CURRENTS

Sometimes the bearings of converters are seri-

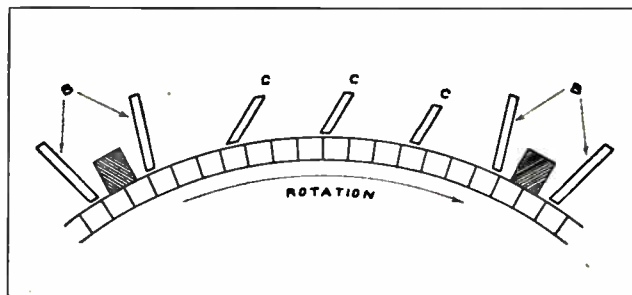

Fig. 264. This diagram shows the position of the flash barriers and arc chutes used to prevent flash-overs between positive and negative sets of brushes on the D.C. end of converters.

ously damaged and rapidly worn by the flow of induced eddy currents from the armature core and shaft to the bearing metal and frame of the machine.

The portion of the shaft which rests on the bearings is, if properly lubricated, surrounded by a thin film of oil during operation. When the induced currents arc through this oil film they pit and burn the surface of the shaft and bearing metal.

To prevent this a carbon brush is often mounted to rest on the end of the shaft and then this brush is securely grounded to the frame of the machine with a low-resistance connection. This provides an easier path for the circulation of induced eddy currents and prevents them from flowing through the oil film and pitting the bearings and shaft.

### 282. CARE AND OPERATION

A great many of the general rules which you have already learned for the care and operation of D. C. generators and A. C. synchronous motors can be applied to the operation and care of synchronous converters. Commutators, slip rings, and brushes should be kept clean and in good condition, and the insulation of windings should also be kept clean and should be occasionally tested for dielectric strength.

Oil rings and oil in the bearings should be frequently inspected, the oil should be changed whenever necessary, and the bearing temperature should be frequently observed during operation to make sure that the bearings are not overheating.

The load on the machine should be frequently checked by means of an ammeter or wattmeter, and the temperature of the machine windings should be carefully watched to see that it doesn't rise above the maximum rated temperature for which the machine is designed.

The care of the commutator and D. C. brushes on synchronous converters is of the greatest importance, because these parts are usually required to carry very heavy currents during full-load operation of the machines.

If the commutator is allowed to become dirty or covered with copper-dust in the grooves between segments or if the brushes are poorly fitted or set off neutral, the sparking which results is likely to cause serious flash-overs and troubles.



All dirt and dust, and particularly copper-dust which wears off the commutator, should be kept well cleaned from all parts of the converter by wiping with a cloth and occasional blowing out with compressed air.

All protecting devices, such as overload, over-speed, temperature, and flash-over relays, circuit-breakers, etc., should be kept in good operating condition and frequently tested to make sure that they will protect the machine in case of faults or troubles.

## A. C. MOTOR CONTROLLERS

Large alternating current motors often require starters and controllers in order to protect the motors themselves from excessive currents and mechanical stresses during starting; to limit current surges on the lines to which they are connected; and to obtain the proper performance of the motors in connection with the machines or equipment they are used to drive.

A. C. industrial controllers are, therefore, of great importance and every electrical man should have a good understanding of their operation and care. You will also find the mechanical principles and electric circuits of many of these devices very interesting.

In general, the functions of controllers are as follows:

- (a) To conveniently start and stop motors, either by manual or automatic control
- (b) To limit the current flow in the line during starting
- (c) To provide overload protection for the motor
- (d) To provide uniform acceleration of the motor and driven machinery
- (e) To provide definite procedure and time delay during starting
- (f) To protect the motor against failure of voltage
- (g) To provide speed control and reversing of motors
- (h) To provide safety to operators.

The simplest of controllers may provide only one or two of the above named functions, namely starting and stopping. More complete controllers which provide the additional protective features are often used even with small and medium sized A. C. motors, and nearly always with larger A. C. motors.

The speed regulating and reversing controllers are used only with motors which drive machines that require this performance.

### 283. CONVENIENCE AND SAFETY

All forms of motor controllers provide a much greater degree of convenience and safety for the operators than when the motors are started by ordinary knife switches.

Most manually-operated controllers have their contacts enclosed within a metal box or, in some cases, in an oil tank. These contacts are operated from the outside by a handle or lever and the operator is thus protected from the danger of arcs or flashes when the circuit is made or broken.

Magnetically-operated controllers can be operated from push buttons either on the controller or located at a distance. This also adds a great deal to the convenience and safety features of controllers—especially when they are used with large motors operating at high voltages.

The use of controllers having resistance units or auto transformers to reduce the voltage to the motors during starting greatly reduces the heavy surges of starting current which would otherwise be drawn by the motor. These surges are very objectionable because of the voltage drop and variations which they cause in the line voltage. This voltage drop may interfere with the satisfactory operation of the other power equipment connected to the same lines and will usually cause very bad flickering or dimming of any incandescent lamps connected to the same lines with motors.

### 284. OVERLOAD, TIME DELAY AND NO-VOLTAGE DEVICES

Practically all controllers are equipped with some form of overload-protective device to open the circuit to the motor in case it is overloaded. These devices prevent the motor winding from being burned out or damaged by overheating in case an overload is left on the machine too long.

In this manner the overload devices on controllers, if they are kept in proper condition and adjustment, will often save very costly "shut-downs" and repairs.

Controllers which reduce the voltage to the motor during starting by means of auto transformers or resistance allow the torque to be applied gradually to the rotor and driven machinery, thereby relieving the motors and other machines of unnecessary mechanical stresses.

Certain types of machinery require very smooth and gradual starting, either because of the delicate nature of some of the machine parts or because of the material which the machines are handling. This is particularly true of textile machines, printing presses, paper-making machinery, etc. Special controllers using resistance which is very gradually cut out of the circuit are used to start motors which drive such equipment.

Automatic controllers are generally equipped with dash pots or some form of time-delay element which regulates the time allowed for the motor to come up to speed. Such controllers can be adjusted and set to provide definite starting procedure or the

same rate of acceleration each time the motor is started.

Many controllers are also equipped with no-voltage release coils to protect the motor in case of failure of the line voltage. If the line voltage drops too low or fails entirely, these coils release a plunger or arm and trip the main contacts open, thus stopping the motor.

If it were not for the no-voltage protection the line voltage might fail and allow the motor to come to a complete stop, and then when the line trouble is corrected and the voltage reapplied, the motor controller would still be in running position and the motor would receive full line-voltage which would result in a very heavy starting current and possibly severe mechanical stresses on the motor or driven machinery.

No-voltage trip coils prevent this by returning the starter or controller to the off position at any time the voltage fails.

### 285. FULL VOLTAGE OR ACROSS-THE-LINE STARTING

Small A. C. motors under 5 h. p. in size are often started at full line-voltage by connecting them directly across the line, but larger motors generally require some form of starter which reduces the voltage to avoid excessive starting current surges in the line and relieves the motor and driven equipment of heavy mechanical stresses during starting.

However, when motors are connected to circuits which supply current to power equipment only and have no lighting equipment on them, quite large motors are often started directly across the line.

This is often done with squirrel-cage motors of

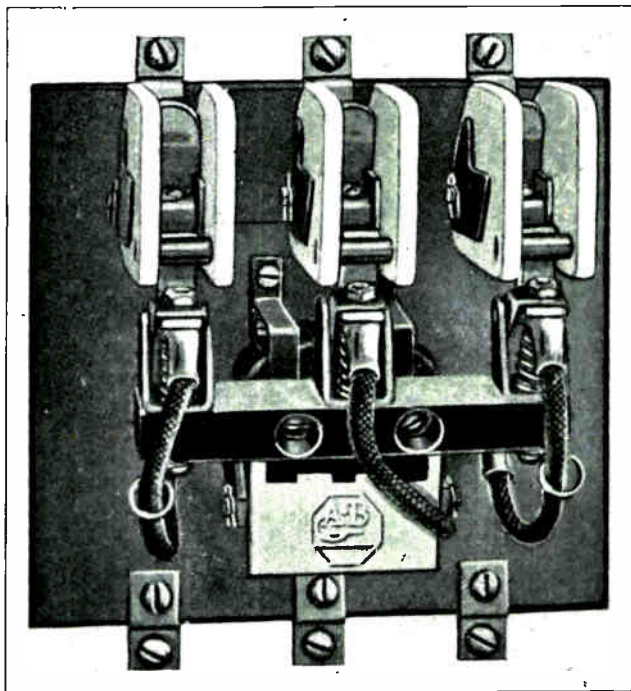

Fig. 285. Contactor mechanism of a magnetically operated across-the-line starter for A.C. motors. (Courtesy Allen Bradley Co.).

several hundred horse-power where they are used to drive pumps and auxiliaries in power plants, etc.

When motors are started directly across the line their circuits can be closed by means of a knife switch, generally enclosed in a safety switch box; or by means of a magnetically operated set of contactors known as an across-the-line starter (sometimes called "line starters"). Fig. 265 shows a set of magnetically-operated contactors, such as are used in across-the-line starters. The strips of fire-proof insulating material on each side of the contacts are flash barriers, which are used to prevent flash-overs due to the arc formed when the contacts are opened.

### 286. THERMAL AND MAGNETIC OVERLOAD RELAYS

Across-the-line starters are usually equipped with fuses or some form of thermal or magnetic release to provide overload protection for the motor. The view on the left in Fig. 266 shows the mechanism of another across-the-line starter equipped with thermal relays or overload-trip devices, located beneath the contactors. On the right are shown two views of these thermal relays, the top one being closed and the bottom one open.

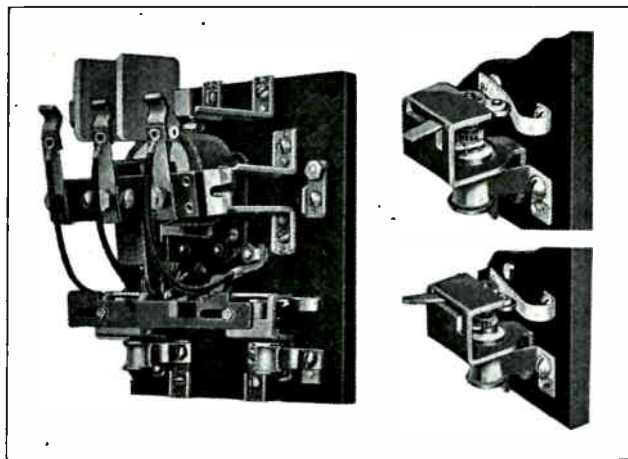

Fig. 266. This view shows on the left another type of an across-the-line starter, the mechanism being removed from the cabinet to show its construction. Also note the thermal overload-relays shown at the bottom of the panel on the left and in larger views on the right. (Courtesy Allen Bradley Co.).

All or part of the motor current is passed through a strip or element which overheats when the motor current becomes excessive, and this heat causes the spring or strip to expand and warp so that it releases or opens a set of contacts in the circuit of the magnet coil which holds the contactors in the motor circuit closed. When the circuit to this magnet is broken by the thermal relay contacts, the magnet releases the main contactors and opens the line circuit to the motor.

After the overload has been removed from the motor, the thermal relay can be reset by means of a small lever or handle shown in the views on the right in Fig. 266.

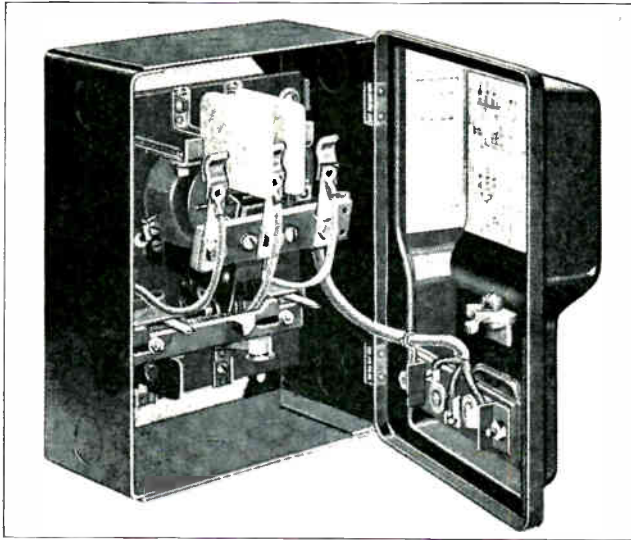

Fig. 267. This view shows a complete across-the-line starter for a three-phase, A.C. motor. The mechanism is enclosed in a safety cabinet with push button control attached to the cabinet cover. (Courtesy Allen Bradley Co.).

There are many different types of thermal relays used on motor starters, but many of them work on the same general principle of expansion of a metal strip or element by the excessive heat when the motor current becomes too great. One type uses a small quantity of low melting point metal to release a trigger or spring and open the circuit when the soft metal becomes heated and melts.

Magnetic overload relays or trip devices are also used with motor starters. These devices were explained in the section on D. C. controllers, and you will recall that their coils are connected in series with one or more of the leads to the motor, so that when the motor current becomes excessive the magnets are strengthened and caused to raise a plunger which trips the line contactors.

The overload devices on any motor controller are very important, as they protect the motor winding from being burned out when the machine is overloaded. Every motor starter should have fuses or some form of thermal or magnetic overload protection.

Fig. 267 shows a complete across-the-line starter in its metal box, and equipped with thermal overload (O. L.) releases. For convenient control the operating magnet is wired to push buttons in the cover of the starter box.

Fig. 268 shows another line starter equipped with magnetic overload release coils.

### 287. ACROSS-THE-LINE STARTER CONNECTIONS

Fig. 269 shows a connection diagram of a simple across-the-line starter. The main line-circuit to the motor can be traced by the heavy lines, through the contactors, C, overload elements, R, to the motor terminals.

When the start button is pressed current flows from line 3 through this button, through the closed

stop button, to the operating magnet; then back through the thermal trip contacts, T, to line 2.

The magnet draws up the armature and bar shown by the dotted lines, and this bar closes the contactors C, starting the motor.

At the same time the magnet closes contacts C it also closes an auxiliary contact A, which maintains a circuit from line 3 through the magnet after the start button is released.

To stop the motor the closed circuit stop button is pressed, de-energizing the magnet and allowing all the contacts to open.

If the motor becomes overloaded during operation, the excess current flowing through the thermal elements R, causes heat enough to expand strips T and open the circuit of the magnet at this point, thus releasing main contactors C and stopping the motor.

### 288. COUNTER-VOLTAGE OF A. C. MOTORS

In our study of D. C. motor starters and controllers we learned that resistance units were inserted in the armature circuit to cause a voltage drop and thereby reduce the applied voltage and amount of current during starting.

After the armature of a D. C. motor comes up to speed it generates counter-voltage which opposes the line voltage and thereby limits the current to the proper full-load value.

With A. C. induction motors of the common type the line voltage is applied to the stator winding. This winding has generated within it counter-voltage of self-induction due to constant expanding and contracting of the alternating current flux, and also by the magnetic lines of the rotor current flux, cutting across the stator conductors when the motor is running.

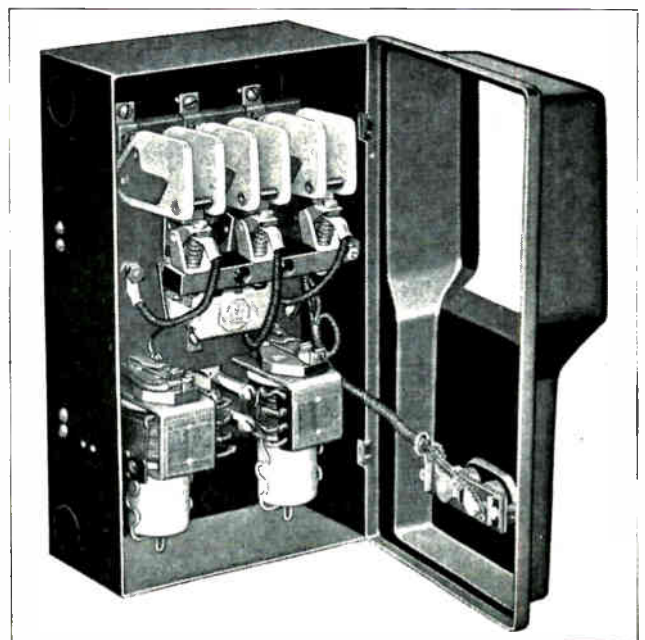

Fig. 268. In this view are shown the overload-relays located beneath the magnetic contactors of an across-the-line starter. (Courtesy Allen Bradley Co.).

Before an induction motor is started and while its rotor is stationary, the counter-voltage generated in the stator is much lower than when the rotor comes up to speed and is revolving at nearly synchronous speed.

When the motor is running the flux set up by the induced secondary currents in the rotor is being whipped rapidly across the stator conductors and helps to generate higher counter-voltage in the stator winding.

This is the reason that the surge of starting current to the stator winding of an induction motor is several times greater than the full-load running current after the motor comes up to speed.

### 289. METHODS OF REDUCING VOLTAGE IN A. C. CONTROLLERS

Resistance can be used in series with the line wires to the motor to reduce this starting current on A. C. motors, just as it is used with D. C. machines.

Many simple A. C. motor starters use resistance units connected in series with one line wire, in the case of single-phase motors; or in series with two or all three of the line wires, on polyphase motors.

Most A. C. motor starters, however, use auto transformers instead of resistance to reduce the starting voltage. With resistance starters the voltage reduction is obtained entirely by voltage drop through the resistance, and they cause considerable power loss by the energy which is converted into heat in their resistance units.

Auto transformers are much more efficient and reduce the voltage by magnetic action through the step-down ratios of their windings.

Another decided advantage of the auto transformer is that by stepping down the voltage on the secondary winding it is possible to obtain the required starting currents for the motors from the secondary winding with less current flowing from

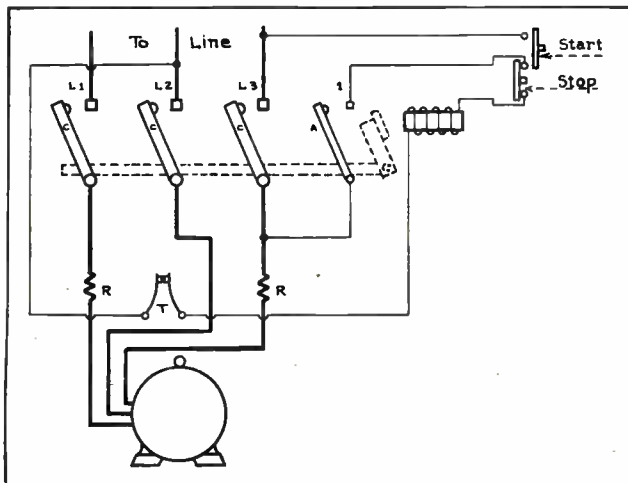

Fig. 289. Circuit diagram showing the connections for a simple across-the-line starter with the contactors operated by an electro-magnet which in turn is controlled by the stop and start buttons. Also Note the thermal overload contacts, T, which are operated by expansion from the heat of resistors, R.

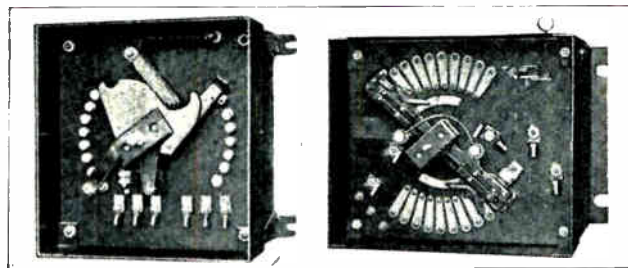

Fig. 270. This view shows two different face plate starters of the resistance type for use with either single-phase or three-phase A.C. motors. (Courtesy Cutler Hammer Mfg. Co.).

the line to the primary. When resistance starters are used the full amount of starting current must be taken from the line.

Auto transformers and their principles and connections were described in detail in Article 147 of A. C. Section Four. It would be well to review this article before going farther in the study of this type of A. C. motor starter.

Some types of starters for small A. C. motors use plain choke-coils to reduce the current during starting or to obtain speed control. Even these are more economical in A. C. circuits than resistance units are, because the voltage drop in a choke coil is caused by the induced counter-voltage which opposes the line voltage, instead of being caused by resistance which produces the  $I^2 R$  loss.

So keep in mind that in general it is much more economical to use choke coils or auto transformers rather than resistance units to reduce the voltage in A. C. circuits. Resistance controllers are often used, however, where very gradual starting or a wide range of speed regulation in smooth, gradual steps is required.

### 290. RESISTANCE TYPE STARTERS

Resistance can be used in the line leads to the stator of an A. C. motor, or, as previously explained, in the secondary leads from the rotor in the case of slip-ring motors.

As the torque of an induction motor varies with the square of the voltage applied to its stator, slip-ring motors with secondary resistance are generally used where frequent starting or speed regulation and good torque are required.

For the gradual starting of ordinary squirrel-cage motors, resistance-type starters are often used and connected in the primary or stator circuit.

Fig. 270 shows two types of resistance starters which use sliding contacts to cut out resistance as the motor comes up to speed. These controllers have two sets of contacts to cut resistance out of two line-leads to a three-phase motor.

The controller shown in Fig. 271 has three sets of contacts, one for each phase of a three-phase motor.

Non-inductive resistance coils or grids can be used with these controllers, and they can be used

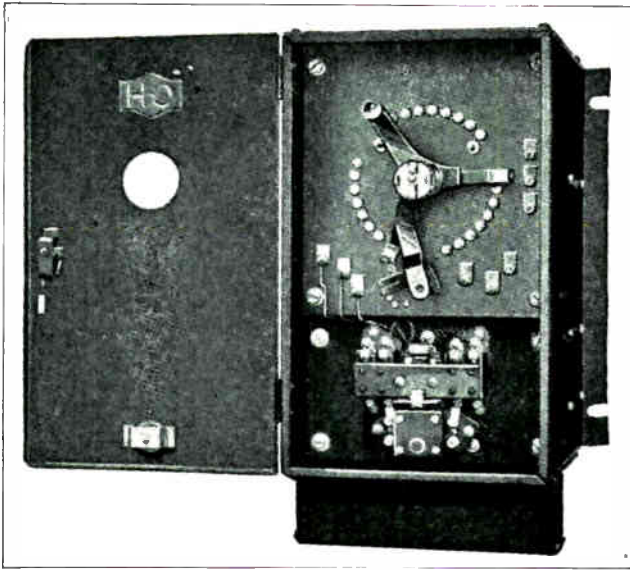

Fig. 271. Three-phase resistance starter of the face plate type. When the rheostat armature is rotated, resistance is cut out of all three phases at once. (Courtesy Cutler Hammer Mfg. Co.).

either in the primary stator circuits or secondary rotor circuits of motors, by proper arrangement of contacts and selecting the proper sized resistance units.

Fig. 271-A shows several styles of resistance units which are commonly used with resistance starters.

Controllers of this type with small contacts and resistance can be used for starting duty only; or, with heavier contacts and resistors, for both starting and speed-regulating duty.

Fig. 272 shows the connections of a simple resistance starter used in the primary circuit of a three-phase squirrel-cage motor. The movable arm carries two metal strips, which are placed one at each end and are insulated from the arm and from each other.

As the arm is moved the sliding metal strips make contact between the long metal segments, B, and the small contacts which cut out the resistance step

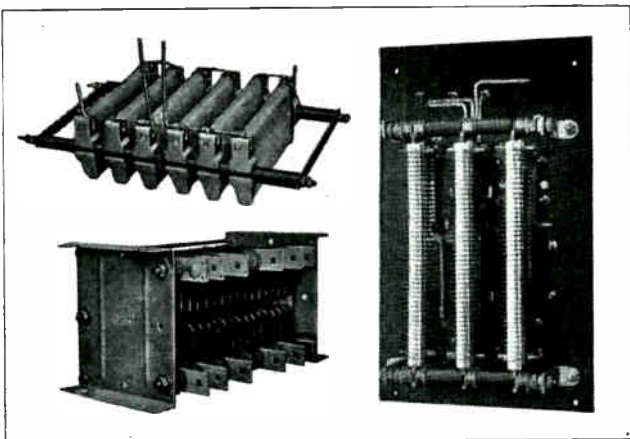

Fig. 271-A. This photo shows several types of resistance units used with A.C. motor starters. On the upper left are shown non-inductive, coil-wound resistors; on the lower left grid type resistors; and on the right edge-wound resistors made of strips of resistance metal wound edgewise around non-combustible cores.

by step as the arm is moved in a clockwise direction.

Fig. 273 shows the connections of a resistance controller used in the secondary or rotor circuit of a slip-ring motor. The sliding arms in this case are all connected together so that they short out the resistance as they are rotated clockwise.

Either a plain starting-switch or a starter with resistance or auto transformer coils can be used at A, according to whether it is desired to start the motor at full-line voltage or with reduced voltage on the primary.

Fig. 274 shows a magnetic controller for remote push-button operation. This controller uses magnetically-operated contactors to cut out the resistance in two steps only.

### 291. CARBON PILE STARTERS

Carbon-pile starters, such as were described in the section on D. C. Controllers, can also be used for A. C. motors by equipping them with the proper number of carbon resistor units, one for each phase.

The view on the left in Fig. 275 shows a three-phase carbon-pile motor-starter of the manually-operated type and on the right in this same figure is shown a rear view of the starter mechanism. The columns or tubes containing the carbon disks can be clearly seen in this view.

When the handle on the outside of the box is moved upward it first closes the circuit from the line to the motor through the full resistance of the carbon piles with the disks in their loose condition.

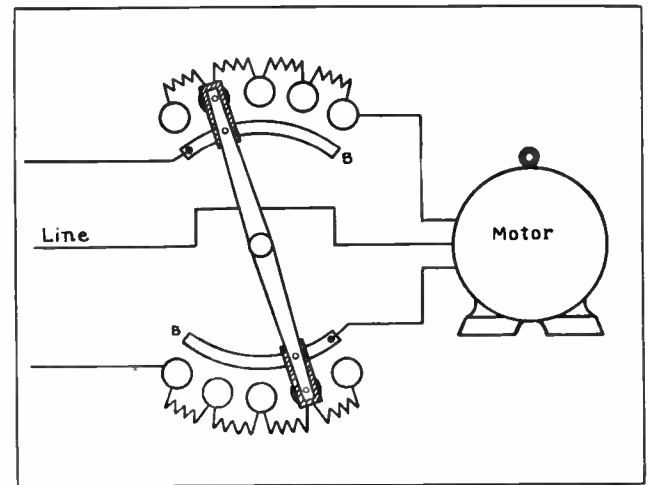

Fig. 272. Diagram showing the connections and circuit through a three-phase resistance type starter.

As the handle is gradually moved farther upward it applies more and more pressure to the disks in the tubes, thus gradually reducing the resistance in the motor circuit. The pressure is applied to these disks by means of the rod and top bar connected to the starter handle, and arranged to apply even pressure to the springs shown on top of each resistance element.

When the handle has reached the running posi-

tion it closes a circuit to the magnet which operates the main contactors shown on the front of the panel in the left view in Fig. 275. These contactors then close and short-circuit the remaining resistance of the tubes completely out of the motor circuit.

The magnetic overload coils and dash pots can be clearly seen on the front of the panel in this figure, and you will also note the connections running to the push button in the front of the starter cover. This push button can be used to trip or release the starter and stop the motor.

## 292. CIRCUIT AND OPERATION

Fig. 276 shows a diagram of the connections for a manually-operated carbon-pile starter. Trace this circuit through carefully until you thoroughly understand its operation.

When the handle is pushed up it forces the set of three top contacts down on to the carbon disks, closing the line circuit through the carbon piles to the motor. When the motor is up to speed and the handle has been pushed clear up to running position, the auxiliary contact at "A" closes a circuit from line 1, through the trip contacts of the left overload coil, through the closed circuit stop switch to the coil C of the holding magnet; then back through the trip contacts of the right overload coil to line 3.

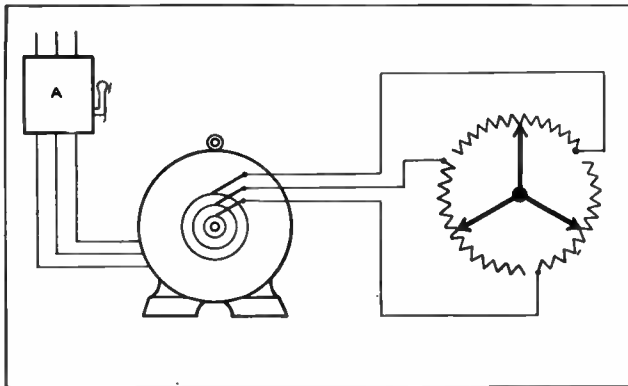

Fig. 273. Diagram showing the connections of a resistance starter in the secondary or rotor circuit of a slip-ring motor. The line switch at "A" is used to energize the stator circuit.

When this holding magnet becomes energized it closes the running contactors and completes a circuit directly from the line through these contactors, through the overload coils, and to the motor. This shunts out the carbon piles entirely, thus removing all of their resistance from the circuit during running.

As the main running contactors close they draw up an auxiliary contact, B, which closes the "stick" circuit through the holding coil; so it is not necessary for "A" to remain closed any longer.

In case of overload on the motor the increase of current strengthens the overload coils and causes them to lift their plungers, which strike the tripping contacts and open the circuit to the holding magnet.

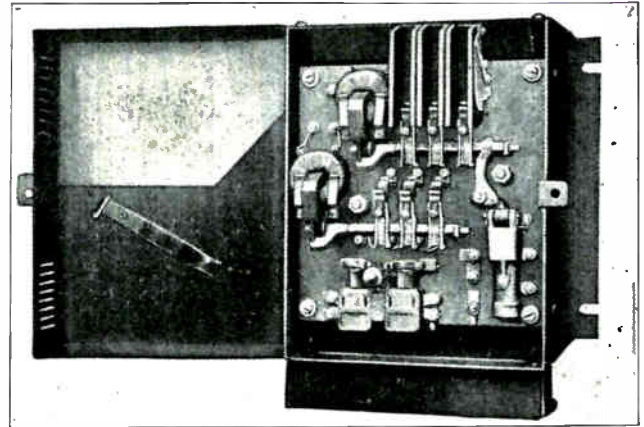

Fig. 274. Automatic controller which uses magnetically-operated contactors to cut the resistance out of the motor circuit in two steps. (Courtesy Cutler Hammer Mfg. Co.).

This causes the magnet to de-energize and release the running contactors, thus breaking the line circuit and stopping the motor.

The overload coils are equipped with dash pots to slow the action of their plungers, so that a momentary overload which lasts only for a very short period will not cause the plungers to rise high enough to trip the holding magnet and stop the motor. But if the overload remains on the motor long enough to cause the machine to begin to overheat, this period is also long enough to allow the plungers to lift to the top of their stroke and trip open the contacts to stop the motor.

When it is desired to stop the motor by hand it is only necessary to push the stop switch, as this switch is also connected in series with the holding magnet.

The holding magnet in this case also acts as the no-voltage and under-voltage relay. This magnet is across the line from wire L-1 to L-3; so that if the line voltage drops or fails the magnet is weakened and allows the running contactors to fall open, thus

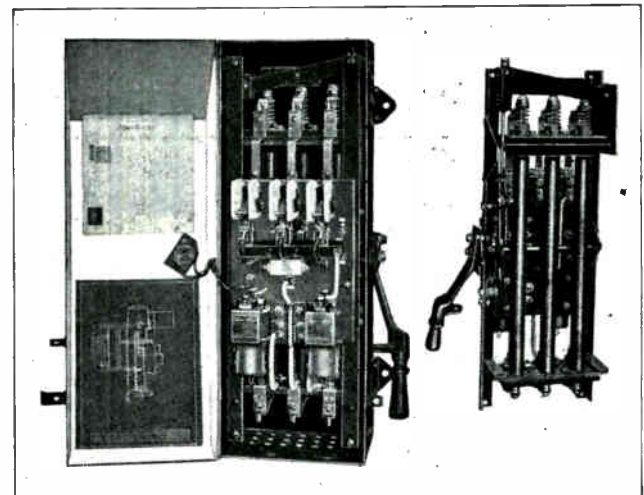

Fig. 275. On the left is shown a complete three-phase resistance starter of the carbon pile type for A.C. motors. On the right is shown the starter mechanism and tubes of carbon disks removed from the cabinet for a rear view. (Photo courtesy of Allen Bradley Co.).

requiring the motor to be properly started through the resistance again when the line voltage returns.

The blow-out coils which are marked in this diagram consist of a few turns of heavy wire wrapped around a strip of iron, the ends of which project on either side of the running contacts. The strip can be seen on the outside of the arc barriers in the left view in Fig. 275.

As these blow-out coils are connected in series with the line wires, they carry the full load current at all times and maintain strong alternating magnetic poles at the ends of the iron strips on which they are wound.

When the running contactors open, the flux from these blow-out coils and strips quickly extinguishes the arcs, thereby eliminating unnecessary burning or damage to the contacts.

Carbon-pile motor starters and controllers are quite often used on motors up to 50 or 75 h. p. where very gradual application of starting torque is required. These controllers are not so often used on motors larger than those mentioned because of their  $I^2 R$  losses and the reduction in starting torque which occurs when the voltage to the stator or primary of an induction motor is reduced.

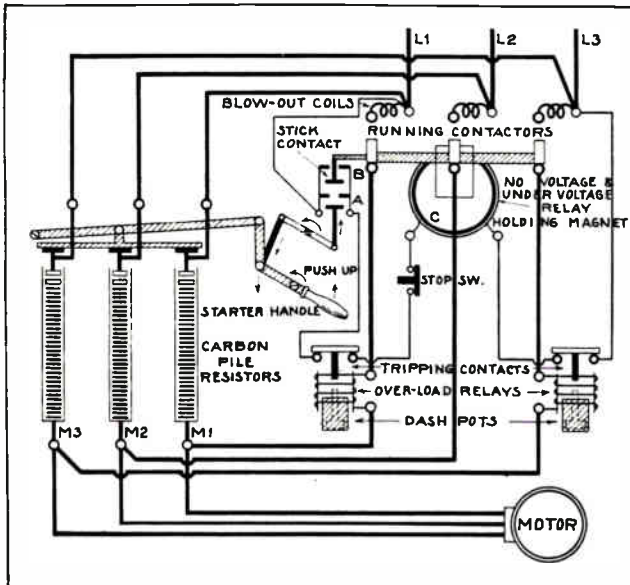

Fig. 276. Diagram showing the wiring and connections of a manually-operated carbon pile resistance starter for three-phase A.C. motors. Trace this circuit carefully with the accompanying explanation.

### 293. AUTOMATIC CARBON PILE STARTERS

Carbon-pile motor starters and controllers are also made in automatic types, as shown in Fig. 277. The view on the left in this figure shows a complete automatic starter of the carbon-pile type for a three-phase A. C. motor.

The panel of this controller has two sets of contactors, two overload coils, and one timing relay coil which can be seen below. The timing relay is the one in the center.

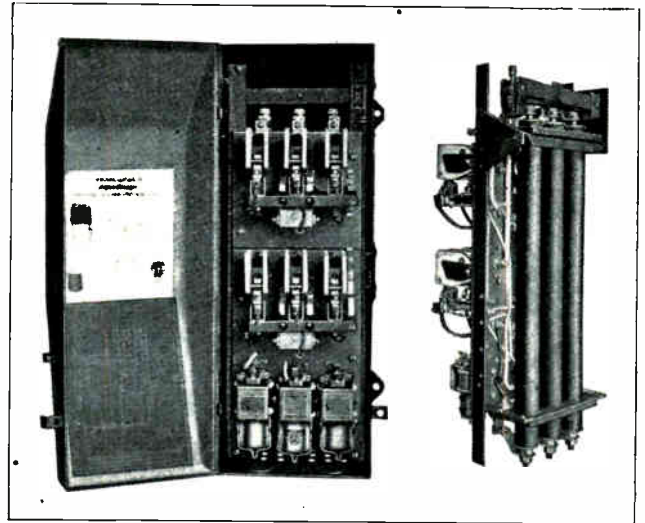

Fig. 277. Front and rear views of an automatic, three-phase, carbon pile starter. The magnetically operated contactors cut the resistance out of the motor circuit as it comes up to speed. (Courtesy Allen Bradley Co.).

On the right is shown a rear view of the controller mechanism and carbon-pile tubes.

Controllers of this type cut out all the resistance in one step when the motor is nearly up to full speed. You will note at the top of the right-hand view in Fig. 277 an adjusting screw by means of which the pressure on the three carbon piles can be properly adjusted or set for the motor with which the controller is being used.

These controllers are operated entirely by push buttons. When the starting button is pressed the top set of contactors closes and completes a circuit through the carbon resistance elements to the motor.

You will recall from the studies in an earlier section on the resistance of various materials, that the resistance of carbon decreases with increase of temperature. This causes the resistance in the motor circuit to be reduced a certain amount as the starting current warms up the resistor elements. Then, when the motor is nearly up to full speed, a slow-acting timing relay closes the operating magnet of the second set of contactors. When these running contactors close they short-circuit the carbon resistance units out of the motor circuit and apply full line-voltage.

### 294. CIRCUIT AND OPERATION

Fig. 278 shows the connection diagram for an automatic carbon-pile controller of this type. Trace this diagram carefully and step by step, until you are sure you understand the operation of these controllers. In this diagram are shown two push-button stations for controlling the motor from two different points.

Note that the open-circuit start buttons are always connected in parallel and the closed-circuit stop buttons are always connected in series. This

rule holds true regardless of the number of push-button stations which may be used to control any single motor.

When either of the start buttons is pressed, a circuit is closed as shown by the small open arrows, from line 1 through the closed contacts of the left overload relay; then dividing through both the timing relay and the starting magnet, S.M., and joining again at X; through the start button (the top one in this case), through both stop buttons, through the contact of the right-hand overload relay; and back to line L-3.

This energizes both the starting magnet and the timing relay. The starting magnet immediately closes the starting contactors and completes a circuit which is easily traced by the heavy lines through these contactors, and through the carbon-pile resistors to the motor. All three lines can very easily be traced through this circuit at the same time.

When the starting magnet closes the starting contactors it also closes the auxiliary holding contact "A". This provides a holding circuit for the starting magnet, so that the starting button can now be released and opened. The circuit for the starting magnet and timing relay can then be traced from point X by the dotted arrows, up through contact "A", down through contact "B", which is still closed; then back up through the stop button, and on back to line 3 as before.

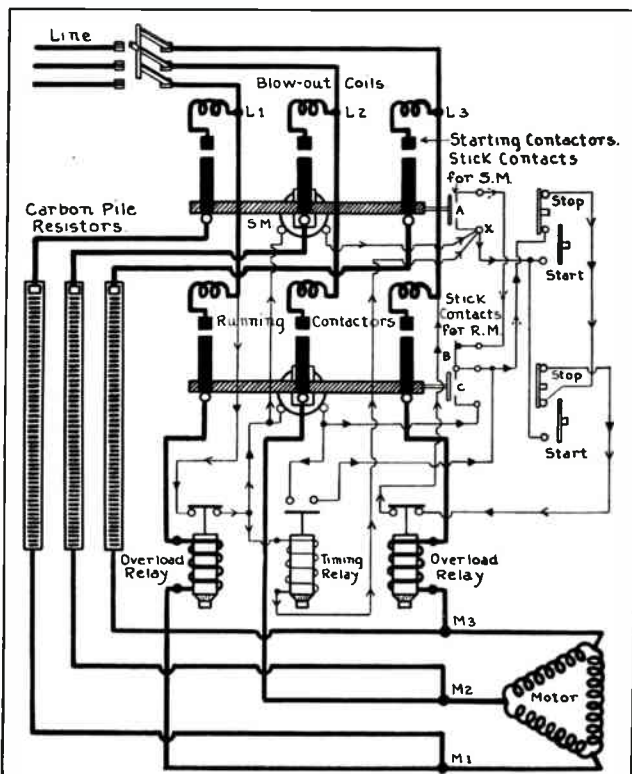

Fig. 278. Diagram showing wiring of an automatic, three-phase, carbon pile starter. Note the main power circuit traced in heavy lines from the line switch to the motor and also the auxiliary control circuits traced in light lines.

The timing relay is slowed in its action by a dash pot, and therefore requires a longer period to close its contacts. This period of time can be regulated by adjusting the dash pot of the timing relay according to the length of time which should be allowed for the motor to come up to speed.

When the timing relay reaches the top of its stroke and closes its contacts this completes a circuit as shown by the solid arrows, from line 1 through the contacts of the left overload relay, through the running magnet, down through the timing-relay contacts, on through the stop buttons and contacts of the right overload-relay, back to the line 3.

This energizes the running magnet and causes it to immediately close the running contactors. These contactors shunt out the carbon-pile resistors and close a circuit, as shown by the heavy lines, directly from the three-phase line through the running contactors, through the overload relay coils, to the motor.

As the running contactors close they also close the auxiliary contact at C and open the one at B. When B is opened it breaks the circuit of the starting magnet and allows these contactors to fall open. When C is closed this completes the holding or "stick" circuit for the running magnet, so that this current no longer needs to pass through the contacts of the timing relay.

You will find, however, that the circuit for the running magnet still continues through both of the stop buttons in series and also through both of the overload-relay contacts, so the motor can be stopped either by pressing one of the stop buttons or by an overload which causes the overload-relay plunger to rise and open its contact. Blow-out coils are shown above both sets of contacts in this diagram.

## 295. CONSTRUCTION OF CONTACTORS AND O. L. RELAYS

Fig. 279 shows an enlarged view of a set of contactors for a heavy-duty automatic controller of this type. In this view you will note the operating magnet and armature which closes the contactors. The arc barrier on the right-hand contactor has been raised so the contact shoes are in plain view. You can also see the three large turns of the blow-out coils which are wound around an iron bar directly beneath each pair of contacts. The black iron strips which are attached to the ends of this bar or core and project up along the sides of the arc barrier, form the poles to direct the flux of the blow-out coils across the arc when the contacts are opened.

Fig. 280 shows a sectional view of an overload-trip coil and its dash pot and contacts. When the plunger is lifted by an overload of current through the coil, it strikes the small pin above it and this pin pushes open the copper strip or spring-like contact at the top of the relay. The dash pot or oil cup can



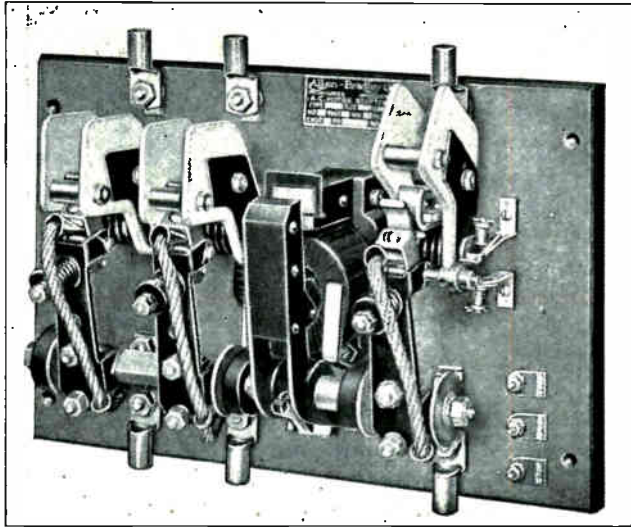

Fig. 279. This photo shows a good view of the magnetically operated contactors used with an automatic, carbon pile resistance starter. Note the arc barriers and blow-out coils on each contactor. (Photo courtesy Allen Bradley Co.)

be removed by pushing to one side the wire clip which is plainly shown in this view.

Fig. 281 shows several other types of A. C. relays which are used with motor controllers.

#### 296. COMPENSATORS, or AUTO TRANSFORMER STARTERS

Auto transformers are by far the most common device used in reducing the voltage to A. C. motors during starting. As previously mentioned, these devices are much more economical and efficient than are resistance starters.

Auto transformers reduce the voltage by transformer action and the loss caused by resistance and heat is not as great as that of resistance starters.

An auto transformer which reduces the voltage to one-half of line voltage will deliver from its secondary to the motor twice as much current as is drawn from the line.

Auto transformers used for A. C. motor starters almost always have on their coils a number of taps for varying the secondary or starting voltage. The number of these taps may vary from 1 to 5, or more, depending upon the number of starting voltages or steps with which it is desired to start the motor.

The taps usually provided are for 50%, 65% and 80% of line voltage.

Auto transformer starters which have only one tap in use and start the motor with only one step of reduced voltage are commonly called compensators.

These compensators are made in both manual and automatic types, and are very extensively used on motors from 5-h.p. to 100-h.p., and sometimes larger.

Fig. 282 shows a compensator of the manually-operated type, with the front cover removed to

show the transformer coils, no-voltage release, and magnetic and overload relay.

Fig. 283 shows another compensator with the oil tank removed to show the stationary and moving contacts which are operated by the handle or lever on the side of the box. During operation these contacts are immersed in oil, so that the arcs which are drawn when the circuit to the motor is broken will be quickly extinguished by the oil, and unnecessary damage to the contacts will thereby be prevented.

#### 297. PROCEDURE FOR STARTING A MOTOR WITH A COMPENSATOR

To start a motor with a compensator of this type, the starting handle or lever is first pushed in one direction as far as it will go, and is held in this position by the operator until the motor comes up to nearly full speed.

When the motor ceases to accelerate the handle is quickly pulled in the opposite direction as far as it will go, and locks in this position.

In the first position the handle closes the starting contacts to the reduced voltage taps of the auto transformer, applying low voltage to the motor during starting.

When the lever is swung to the second position, the starting circuit is broken and the contacts to the full line-voltage are immediately closed, thereby completing the running circuit.

These compensators are generally provided with a latch, so that the starting handle cannot be moved into the running position first, but must first be moved into the starting position and then drawn quickly over to the running position, after the motor is up to speed.

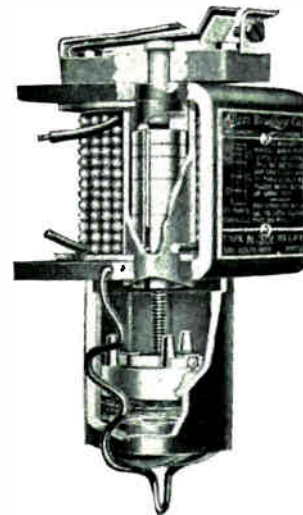

Fig. 286. Sectional view of a magnetic overload-relay and dash pot. When the core is lifted the rod above it forces open the spring contacts which break the circuit to the holding magnet. (Courtesy Allen Bradley Co.)

This last operation should be performed quickly because during the time the lever is being moved from starting to running position the motor circuit is momentarily broken, so if the lever is brought

back slowly the motor will lose considerable speed before the running contacts are closed.

In some cases slow operation will also allow the latch to fall in place again, thereby requiring the starting operation to be repeated.

During starting the lever should be firmly held in the starting position to keep the contacts tightly together; otherwise they may arc and seriously burn or pit the contact shoes.

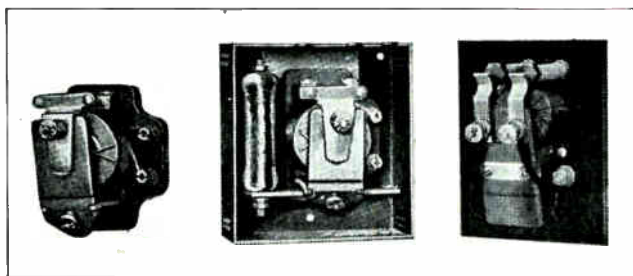

Fig. 281. Three different types of A.C. relays used with motor controllers. (Courtesy Cutler Hammer Mfg. Co.).

The lever and contacts of these compensators are held in the running position by a mechanical latch which is often provided with a hand trip on the outside of the controller. In other cases the controller may have a push button for breaking the circuit of the no-voltage release coil in order to stop the motor.

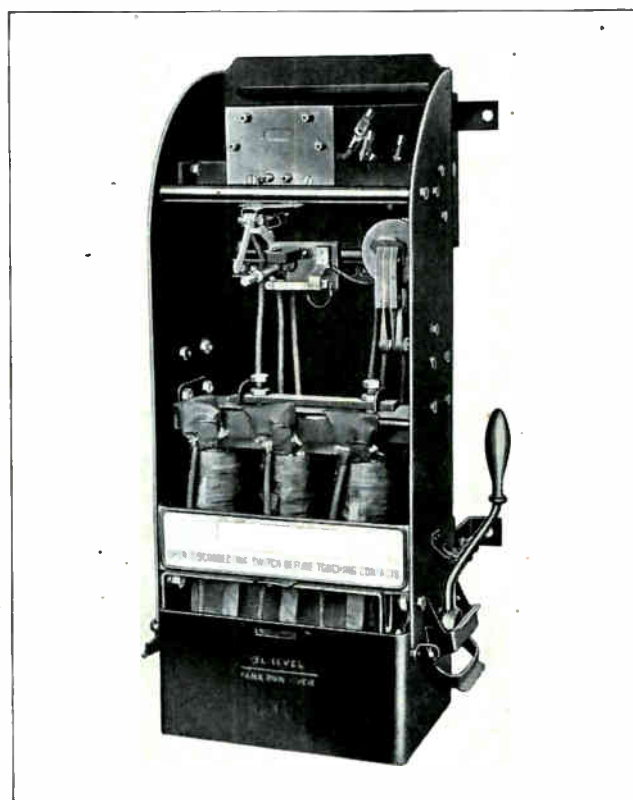

Fig. 282. This photo shows a front view of a three-phase, auto transformer starter or compensator used for starting squirrel-cage motors at reduced stator voltage. (Photo courtesy General Electric Co.)

## 298. PROTECTIVE FEATURES

The no-voltage release coil and the overload-trip coil on compensators of this type are usually so arranged that when they raise or drop their plungers the plungers strike the trigger or release on the latch, allowing the lever and contacts to be returned to normal or open-circuit position by means of a spring.

The contacts in starters of this type are generally mounted in rows and fastened on bars of wood or a fibre-like composition of good insulating quality. The operating handle is also attached to the movable contacts by an insulating bar, and this eliminates the chances of shock hazard to the operator when starting high-voltage motors.

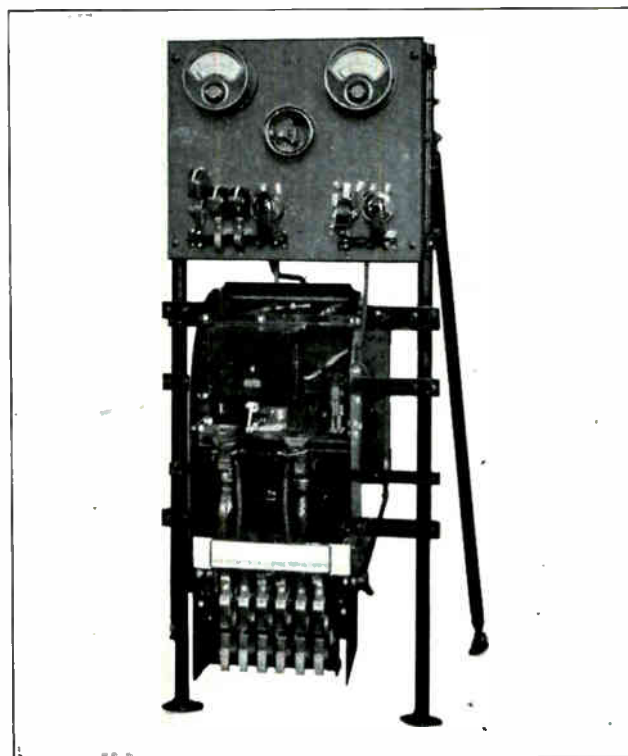

Fig. 283. This photo shows another view of a compensator with both the front cover and the oil tank removed. The contacts which operate under oil can be seen at the bottom of the controller. (Courtesy General Electric Co.).

Making and breaking circuits under oil and inside the metal case eliminates the danger of burns and flashed eyes which might occur to operators if large motors were started and stopped by means of ordinary knife-switches.

## 299. CIRCUIT AND OPERATION

Fig. 283-A shows a connection diagram for a simple Western Electric compensator or auto transformer starter for a three-phase motor. When the compensator handle is thrown to the starting position all of the moving contacts on the center bar are caused to connect with the lower set of stationary contacts.

This completes a circuit as shown by the open arrows, from the three line wires to the primary terminals, P, of the auto transformer; and also from

the secondary terminals, S, of the auto transformer to the motor terminals, M-1, M-2, and M-3, and to the motor winding. The motor is thus supplied with reduced voltage from the auto transformer secondary.

In tracing this circuit you will note that the starting current doesn't pass through the overload relay coils, because this starting current is much heavier than normal full-load running current and would be likely to cause the overload relays to trip out before the motor could reach full speed.

When fuses are used in connection with compensators of this type they are also placed so that they are only in the running circuit and not in the starting circuit.

When the handle is thrown to the reverse position the moving contacts on the center bar are caused to connect with the upper set of stationary contacts. This completes a circuit from each line wire to the motor, supplying full line-voltage for running.

The running circuit from line 1 can be traced by the solid arrows from line wire 1 to terminal L-1, then up through the left overload coil, and down to terminal, T-1, through the controller contacts, and up to M-1, and to the top lead of the motor.

The circuit from line 2 can also be traced by the solid arrows to terminal L-2, through both bars of the center controller contacts, and back up to terminal M-2, then to the center wire of the motor.

The circuit from line 3 can be traced to terminal L-3, then up through the right-hand overload coil, down to T-3, through the controller contacts, and back up to M-3; then to the lower wire of the motor.

While in this diagram all of the arrows have been shown leading toward the motor, we know, of

course, that with A. C. applied, the current in these motors would be rapidly reversing in direction, first flowing in on one wire and out on the other two; then in on a different wire and out on the remaining two; etc.

We have found in tracing this running circuit that the currents of two of the phases pass through the overload relay coils, so we know that if the motor becomes overloaded the strength of these coils will increase and raise their plungers, tripping open the contacts which are in series with the no-voltage release coil.

This de-energizes the no-voltage release, allowing its plunger to fall and trip the latch which releases the controller handle and contacts, and allows them to move to the off position.

The no-voltage release coil will also trip the compensator if the line voltage becomes too low or fails entirely.

The circuit for this coil can be traced from line 1 to M-2, up through the left overload coil, down to L-1, through the N.V. release coil, and up through both of the overload relay contacts in series, down through the controller contacts, and back up to line 2.

### 300. STARTING VOLTAGE ADJUSTMENT

On compensators that are equipped with several taps on the coils of the auto transformer, if the motor doesn't start as rapidly as it should (ordinarily 10 to 30 seconds) with the secondary leads on the low voltage tap, these leads can then be shifted to a tap of higher voltage.

Compensators should not be operated with the secondary leads on different voltage taps, such as for instance one lead on a 40% tap, another on a 60% tap, etc. The leads should all be carefully connected to taps of equal voltage.

Fig. 284 shows the diagram of another starting compensator such as is made by the Westinghouse Electric & Manufacturing Company. The auto transformer coils of this starter are connected open-delta, instead of star as they are in Fig. 283-A.

Trace this circuit in the same manner as the one in Fig. 283-A was traced, making sure that you can follow the circuit of the three line wires to the auto transformer connections when the compensator is in the starting position; also from the auto transformer secondary to two of the motor leads, and from one line wire direct to the center motor lead during starting.

Then trace the circuit from the line through the overload trip coils to the motor when the compensator is in running position.

### 301. AUTOMATIC REMOTE CONTROLLED STARTERS

Compensators of the types just described can be arranged for remote operation by using such mechanical connections as rods, light-weight piping,

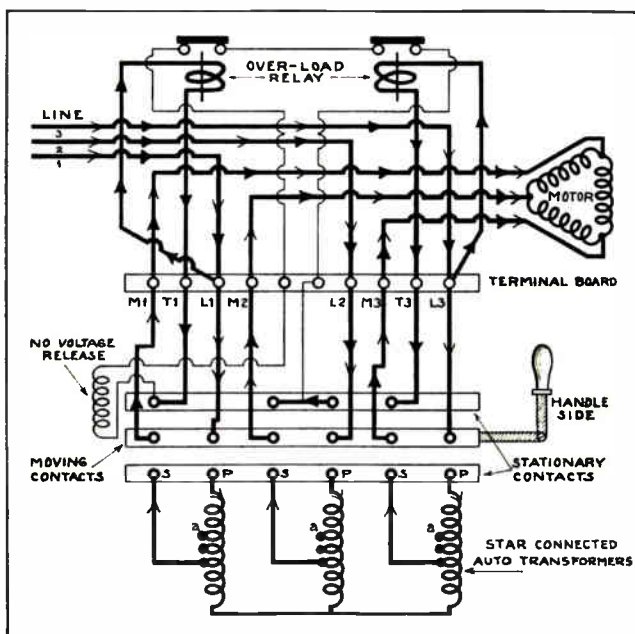

Fig. 283-A. Wiring diagram of a manually-operated compensator used for starting three-phase, squirrel-cage motors. Carefully trace the starting and running circuits with the accompanying explanation and also note the overload protective circuit.

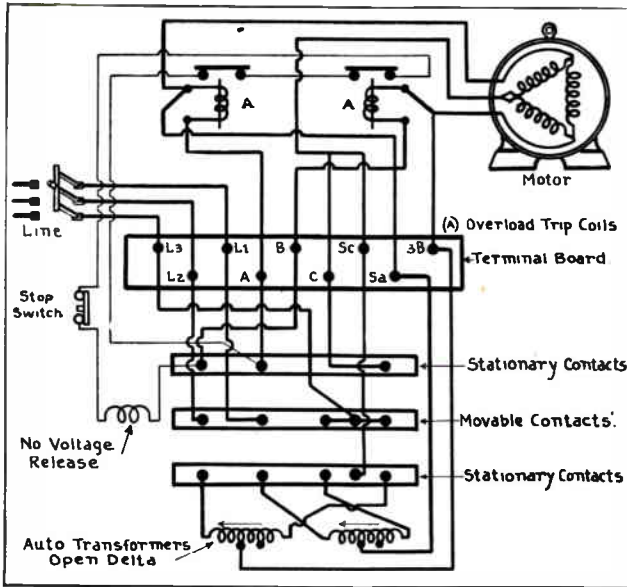

Fig. 284. Wiring diagram of a three-phase Westinghouse compensator using open-delta-connected auto transformers, and a stop switch in series with the no voltage release.

or steel cables; or they can be arranged for electrical remote operation by using electro-magnets to move a laminated armature which takes the place of the ordinary hand-operated starting lever.

In other cases the leads from the line, motor, and auto transformer are connected to two sets of special magnetically-operated contactors mounted on a panel similar to those described for resistance starters.

These contactors are then operated by their magnets, which are in turn controlled by push buttons used to start and stop the motor.

Fig. 285 shows a connection diagram for a General Electric automatic starter of this type.

The starting and running circuits from the line to the motor can easily be traced through the controller by the heavy lines, and the auxiliary control circuits are shown by the lighter lines.

This controller has a motor-operated timing element which regulates the period of time that the motor will be kept on reduced voltage during starting. This timing element is operated by the small relay motor shown in the lower left section of the main diagram.

The four small sketches beneath the main circuit diagram show the several positions of the contacts in the timing element. Examine these carefully and compare them with the timing element contacts in the main diagram while tracing out the circuit for normal, starting, and running positions.

**302. CIRCUIT AND OPERATION**

When either of the start buttons is pressed, a circuit can be traced as shown by the dotted arrows, from line 1, through the heater element of the thermal overload relay, through the start button to the terminal X.

With the timing element contacts in the normal

position as shown in the main diagram, the current divides at this point, part of it flowing to the left and through the relay magnet, back to the right through the thermal overload contacts to line 3; which completes this circuit.

When the relay magnet is energized it attracts the armature "A", causing it to make contact with the holding circuit through the closed-circuit stop buttons. This position of the relay contact is shown in the lower diagram No. 2.

Going back to point X, the other part of the current which divided at this point flows up through the relay contacts C and divides again; part going through the relay motor starting it in operation, and the other part going up to the starting magnet and then back through the thermal overload contacts, and to line 3.

When this starting magnet is energized it closes the starting contactors. A circuit can then be traced as shown by the small open arrows, from line wires 1 and 3, down through the heater elements of the thermal overload relay, back up through the blow-out coils and contactors, and to the primary terminals of the auto transformer.

The circuit from line 2 is traced directly through the blow-out coil and contactor to the center primary lead of the auto transformer.

The reduced-voltage circuit to the motor can be traced by the large open arrows from the taps on the auto transformer coils, up through the other starting contactors to the motor. The left-hand

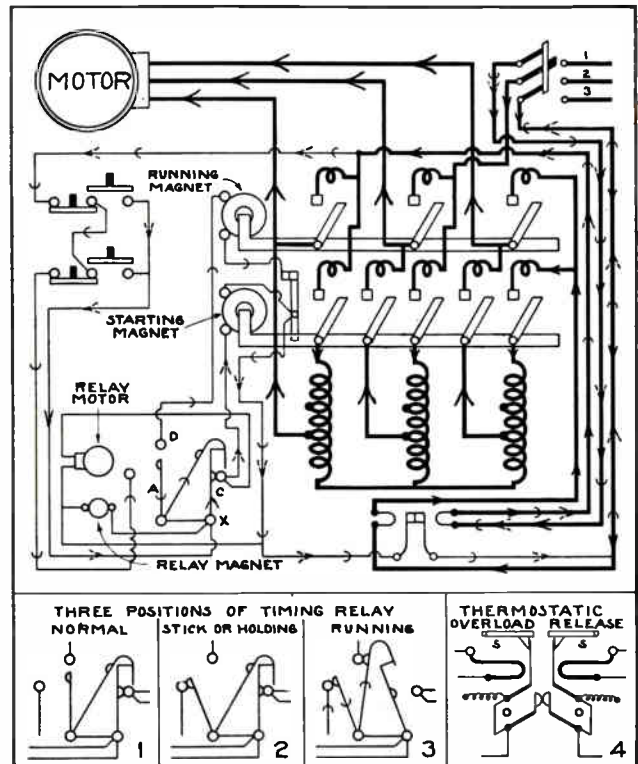

Fig. 285. This diagram shows the complete circuits of an automatic controller with magnetically-operated contactors in the starting and running circuit, and a motor-operated timing relay to regulate duration of the starting period. Trace all parts of this circuit carefully with the accompanying explanation.

wire from the transformer tap runs directly to the motor without passing through any contactor.

The auxiliary contacts at B near the starting magnet are normally closed when the controller is in the off position and are opened at the same time the starting magnet closes the starting contactors. This acts as an electrical interlock and prevents the running magnet from being energized until the starting magnet releases and opens the starting contactors and again closes these contacts.

A mechanical interlock in the form of a bar is also very often provided between the operating mechanisms of the starting and running contacts, so that the running contacts can never close until the starting contacts are open. This precaution must be taken in order to prevent short-circuiting the auto transformer windings.

After the relay motor is started it runs at a definite speed and operates a chain of small gears which very slowly turn the timing disk. When this disk makes a certain part of one revolution it brings around a trip pin that snaps the hook-shaped contact assembly of the timing mechanism over into the position shown in the small diagram 3 at the bottom of Fig. 285. This opens the circuit at "C", de-energizing the relay motor and the starting magnet; allowing the starting contactors to fall open and at the same time closing the auxiliary contact at D to complete the circuit to the running magnet.

The contacts which are moved over by the relay motor also close a circuit at D which energizes the running magnet.

This circuit can be traced by the round arrows from line 1, through the heater element of the thermal relay, through the closed circuit, stop buttons, armature A, and contact, D, of the timing device, through the coil of the running magnet, auxiliary interlock contacts, thermal relay contacts and back to line 3.

When the running magnet is thus energized it closes the upper set of running contactors and completes a circuit directly from the line to the motor. You will note, however, that the circuit from line wires 1 and 3 passes through the heater elements of the thermal overload-relay, so that any excessive overload on the motor will cause the contacts of this relay to open and break the circuit of the running magnet holding-coil. This will open the running contactors and stop the motor.

The two closed-circuit stop buttons are also in series with this magnet, so pressing either of these will stop the motor.

### 303. TIME ELEMENT DEVICE AND O. L. RELAY

A motor-operated timing device such as used with this controller can be set to give the desired period of time during which the motor is operated

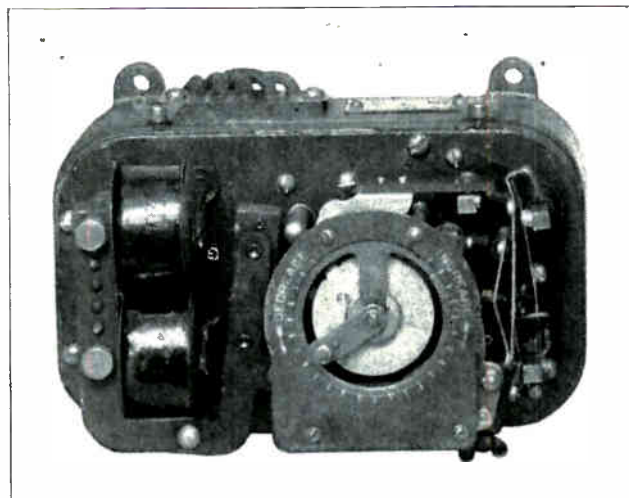

Fig. 286. This photo shows a front view of the motor-operated timing relay for which the connections were shown in Fig. 285. Note the relay magnet and time-setting dial on this unit. (Photo courtesy General Electric Co.).

at reduced voltage while it comes up to speed, and according to the amount of load connected to it.

Fig. 286 shows a photograph of a motor-operated timing relay of this type. The cover is removed, showing the relay magnet on the left and the adjusting dial on the right. By moving the small arm on this dial in one direction or the other the length of the starting period can either be increased or decreased as desired. The operating motor is enclosed within the case of the relay.

The advantage of timing relays of this type is that they are very accurate and will always start the motor in exactly the amount of time for which they are set.

On certain other types of controllers small motors are sometimes used to drive a set of drum contacts similar to those on a sign flasher. As the drum slowly revolves, the contacts close circuits in the proper order to the operating magnets, which close the main contactors, cutting out resistance and increasing the motor voltage step by step as the machine comes up to speed.

The small diagram number 4 at the lower right in Fig. 285 shows the thermal overload relay in more detail. When excessive current flows through the curved heater elements the heat produced in them warms up the expansion strips, S, directly above them, causing these strips to warp upward until their ends slip off the tops of the vertical springs and allow the relay contacts to fly apart.

Fig. 287 shows an excellent photograph of one of these thermal overload-relays. The expansion strips are partly covered by the two small metal hoods at the upper left and right. The relay contacts are clearly shown in the center of this photo, and you can also see the adjusting pointers projecting out in either direction from the insulating members which carry the relay springs.

This particular relay is equipped for resetting by pulling on the cord to draw the contacts back to-

gether. Other relays of this type can be reset by means of a push button which raises a V-shaped wedge, forcing the bottom ends of the contacts apart and closing them at the top.

It is very important that the thermal overload relays as well as the motor-operated timing device be properly adjusted according to the current rating of the motor and the nature of the load attached to it, in order to properly protect the motor from overheating during running or starting.

Automatic controllers with properly adjusted time element devices have the decided advantage of accurately regulating the period of time allowed for starting the motor each time the operation is performed.

The life of motors is generally much longer when they are started in this manner than when they are carelessly started with manual controllers.

Unless the operators of manual controllers are very careful there is likely to be a considerable variation in the periods of time allowed between the steps of starting, and this may result in very heavy surges of starting current and heavy mechanical stresses on the motor and driven machines.

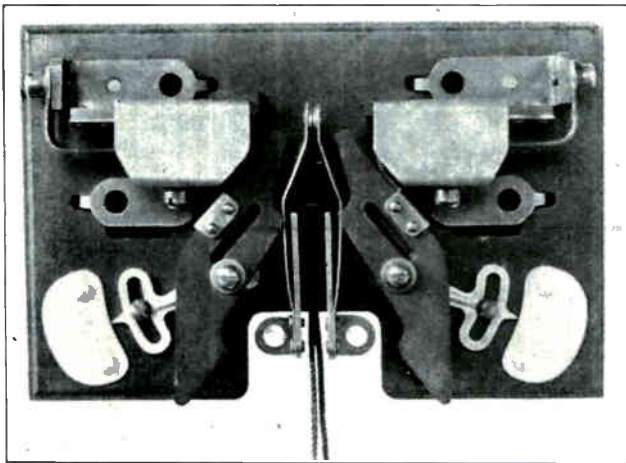

Fig. 287. Excellent view of thermal overload-relay such as used on automatic controllers manufactured by the General Electric Co. Note the current setting pointers and also the resetting cord on this device. (Courtesy General Electric Co.).

### 304. AUTO STARTERS AND PRINTING PRESS CONTROLLERS

Automatic starters which apply the voltage more gradually in several steps during starting are commonly called auto starters. Starters of this type have auto transformers with several taps, each of which is connected to a separate set of contactors.

These contactors operate in the proper order to apply the voltage to the motor in gradually increasing amounts during starting. For example, the auto transformer may have taps providing starting voltages of 50%, 65%, and 80%, and if these voltages are applied in order as the motor comes up to speed it will result in a fairly uniform rate of acceleration and will greatly reduce the starting current surges in the line and motor winding.

Fig. 288 shows an automatic controller for use with printing press motors. This controller has a variable resistance which can be set by hand for any speed at which it is desired to operate the motor. The contacts and arm of this rheostat can be seen at the lower left corner of the controller panel. The rheostat can be set for the desired speed before the motor is started, or it can be adjusted during operation.

On the face of the panel are shown the contactors which cut out the various steps of resistance, bringing the motor up to speed. Controllers of this type are operated by push button stations located at a number of different points on the printing press.

Fig. 289 shows the panels for two other types of printing press controllers. These controllers have the rheostat operated by a small motor which is remotely controlled by means of push buttons and relays.

Automatic controllers using large contactors on panels are commonly used to control very large A. C. motors, even up to several thousand h.p. For such large motors as these the contactors used must be quite large air circuit breakers in order to handle the heavy currents.

Fig. 156 in Section Five on A. C. Motors shows a large panel-type controller in use with a 3000-h.p. A. C. motor of the slip-ring type. The controllers on this panel cut in and out large banks of resistance grids, which are shown behind the controller at the left.

Automatic motor controllers can be arranged for operation by floats in tanks, by pressure or temperature relays and in many other ways, so that they start, stop, and vary the speed of pump motors and other equipment entirely automatically whenever the water level, pressure, or temperature requires it.

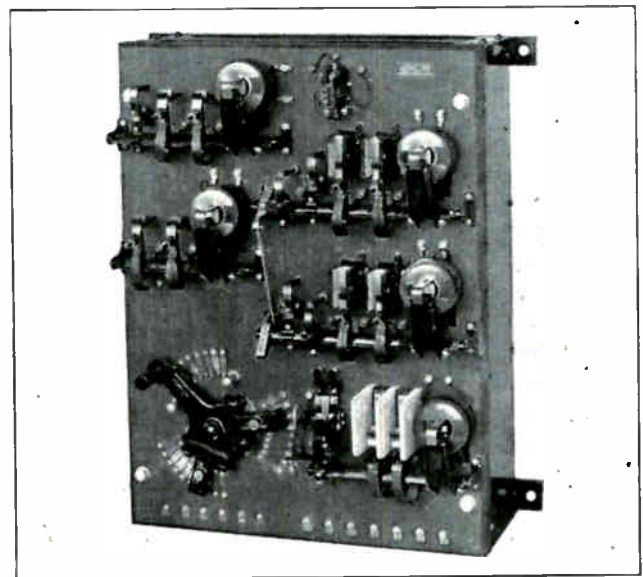

Fig. 288. This photo shows a front view of an automatic, panel type controller with a hand-operated, speed-regulating rheostat. (Photo courtesy General Electric Co.).

### 305. DEION ARC QUENCHERS

Controller contacts are always subject to more or less damage by the arcs formed when the circuits are broken. On controllers which have the contacts immersed in oil the arc is extinguished or quenched much more quickly by the oil, thus considerably prolonging the life of the contacts.

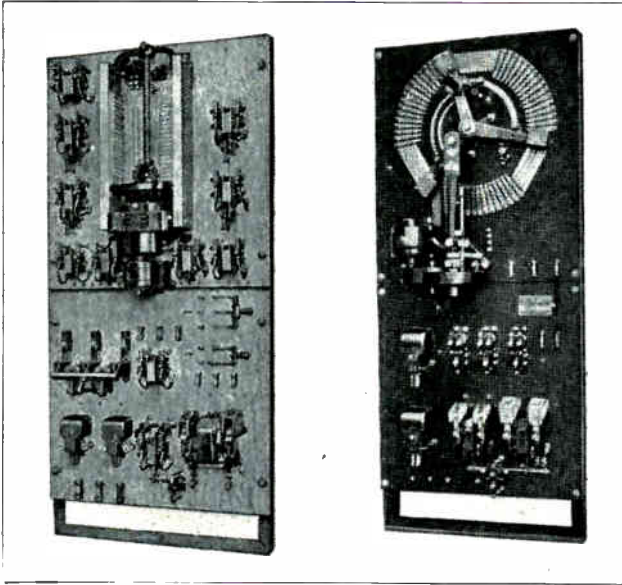

Fig. 289. Two different types of motor-operated, automatic printing press controllers. Small electric motors are used to operate the rheostat for controlling the speed of the main motors. (Courtesy Cutler-Hammer Mfg. Co.).

Controllers of the panel type with contacts which break the circuit in air, generally have the arcing greatly reduced by means of blow-out coils, as previously explained.

Another form of device which has been developed for quickly extinguishing the arcs at contacts of air breakers is known as the Deion arc-quenching device. This device consists of a hood made of fireproof insulating material and containing a set of metal grids or slotted blades into which the arc is blown when it is formed.

On the left in Fig. 290 are shown two views of one of these Deion hoods, and on the right in this same figure is a sectional view showing the manner

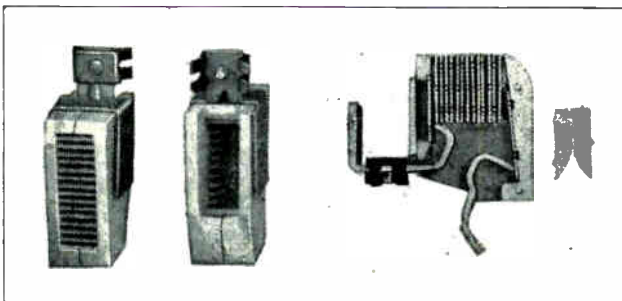

Fig. 290. This photo shows several views of Deion arc quenchers. The sectional view on the right shows the manner in which these devices are placed over the contacts, to quickly extinguish the arc when it passes up into the metal blades. (Courtesy Westinghouse Elec. & Mfg. Co.).

in which the hood is placed over the contacts of the breaker. The effect of these grids is to quickly separate the arc into a number of small arcs in series and thereby break it up.

These devices are used not only on small contactors on motor controls, but also on large circuit-breakers on high-voltage power lines. They are very effective in extinguishing arcs and actually break up the arc and interrupt the current flow within one-half cycle from the time the contacts are opened.

Fig. 291 shows a double set of contactors equipped with Deion hoods, which can easily be removed or lifted from the contactors to allow repairs to the faces or horns of the contacts themselves.

### 306. DRUM CONTROLLERS

Drum controllers are very extensively used for starting and speed control of A. C. motors of the slip-ring type. You are already familiar with the general construction and operation of drum controllers from the material covered in the Section on D. C. Motor Controls.

When used with A. C. motors, the drum controller contacts can be used to cut out step by step the resistance of the secondary or rotor circuit, or to shift the connections from one tap to the next of the auto transformer in the stator circuit.

On small motors up to 10-h.p. face-plate type resistance-starters, such as described earlier in this section, are commonly used, but with motors larger than this drum controllers are generally preferred because their contacts are much heavier and more capable of handling the heavy currents required.

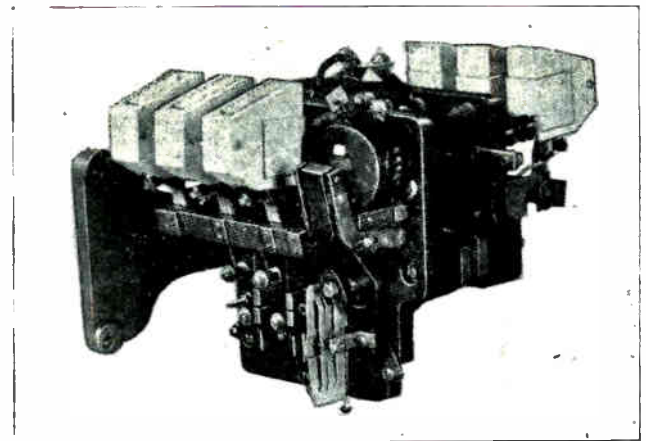

Fig. 291. Two sets of contactors on a controller equipped with Deion arc extinguishers. (Courtesy Westinghouse Elec. & Mfg. Co.).

Fig. 292 shows an A. C. drum switch or controller with the cover removed. In this view the revolving segments, stationary contact fingers, arcing barriers, and blow-out coils can all be clearly seen.

The sliding motion with which the revolving segments are brought into contact with the stationary fingers tends to keep the contact surfaces worn bright and smooth, thereby providing good low-

resistance connections as long as the contacts are kept in proper condition and are not allowed to become too badly burned or pitted by the arcs.

Fig. 293 shows three different sizes and types of A. C. drum controllers. By observation of the controllers shown in this figure you will see that it is possible to make drum controllers with almost any desired number or arrangement of contacts. For this reason drum controllers can be used with A. C. motors to perform a wide variety of switching operations for gradual starting or wide ranges of speed variation.

Where very large A. C. motors, ranging from several hundred to several thousand horse power, are to be controlled by drum controllers, the drum will be used merely as a remote control for large magnetically-operated contactors located on a panel.

When used in this manner, the drum and contacts handle only small amounts of current at low voltage and these currents in turn operate the magnets which close the heavy current circuits at high voltage. This provides a much greater degree of safety for the operators.

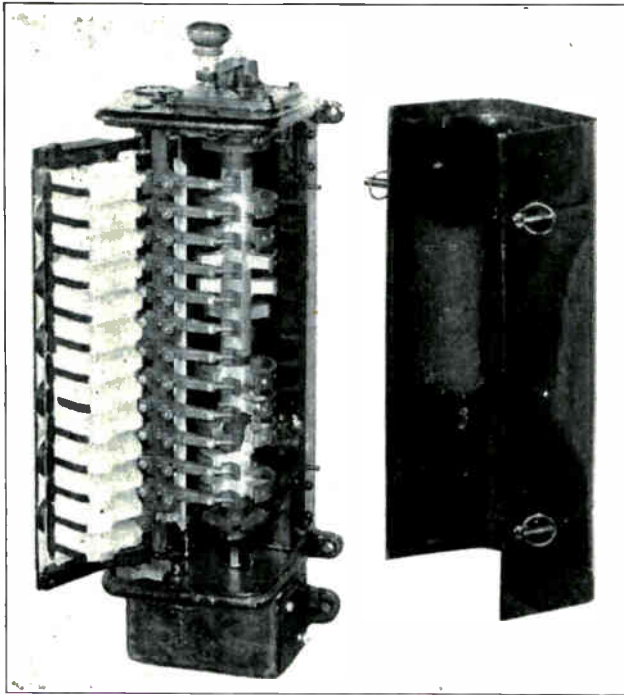

Fig. 292. This view shows an A.C. drum controller with the cover removed. Note the rotating segments, stationary contact fingers, arc barriers, and blow-out coils. (Courtesy General Electric Co.).

### 307. STARTING, REVERSING AND SPEED CONTROL

In addition to starting and varying the speed of A. C. motors, drum controllers are commonly used for reversing the machines as well. You will recall from previous articles that a three-phase A. C. motor can be reversed by reversing any two of the phase leads.

This operation can be performed by one set of contacts on the drum, while another set is used to

vary the resistance or voltage from the taps of the auto transformer.

Fig. 294 shows a simple type of drum controller used for starting and reversing a three-phase A. C. motor. Two of the line leads running to the stator winding of the motor are taken through the contacts and segments of the drum for reversing the connections to the stator and thereby reversing the direction in which the motor will start.

The six upper sets of contacts and segments are used for gradually cutting out the resistance during starting, or if the resistance elements and contacts are made heavy enough they can also be used for varying speed during operation of the motor.

When the drum is moved to the left the segments strike their contacts in the order 1, 2, 3, 4, 5, as shown by the numbers on the segments. Each additional step cuts out a little more resistance; until, on the fifth step, the resistance units are all short-circuited and are cut entirely out of the secondary or rotor circuit of this slip-ring motor.

During the process of cutting out this resistance it is not always evenly cut out of each phase, as at certain times there is a little more resistance left in one phase than in another.

During starting, however, these periods are generally very short and the slight unbalance in the rotor currents does not seriously affect the operation of the motor.

When the controller drum is moved to the right, or in the opposite direction, the segments pass clear around and approach the stationary contacts from the opposite side in the order shown by the numbers which are placed near the ends of these segments.

In tracing the circuits through this controller and the resistance units, when the drum contacts are in the various positions, it will be easier to trace the secondary circuit by starting each time on the center wire from the motor and going through the

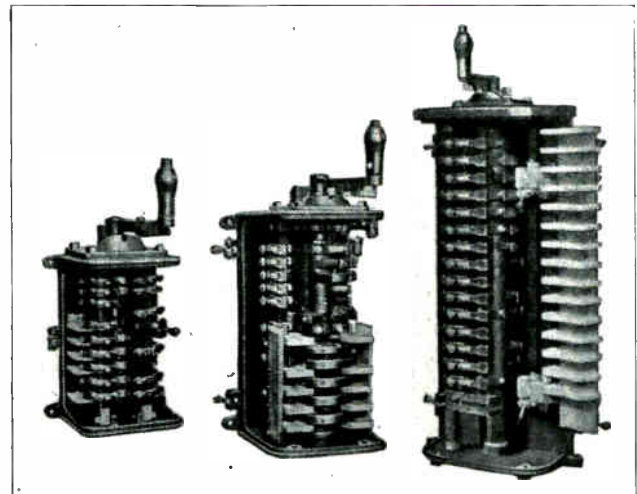

Fig. 293. Three drum controllers of different types and sizes showing the variety of arrangements that can be made with their contacts and segments. (Courtesy Cutler Hammer Mfg. Co.).



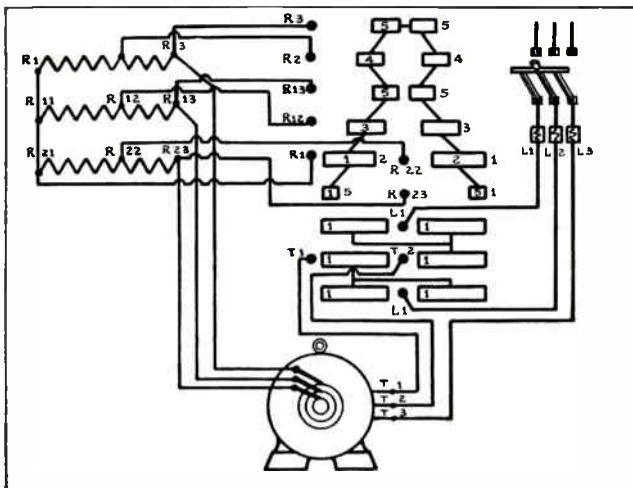

Fig. 294. Circuit diagram of a simple drum controller for starting and reversing three-phase, slip-ring motor. Trace the circuit carefully with the accompanying explanation.

proper sections of resistance, first to the left wire and then to the right wire.

It is not extremely important to trace out each circuit on the different steps of operation of controllers of this type because, when new drum controllers are being installed, the manufacturer generally supplies a connection diagram.

The connection diagrams shown here are used to show general operating principles, but it is well to remember that changes are continually being made in machines and methods of connections, and that correct diagrams for latest types of equipment can generally be obtained from the manufacturers.

### 308. DRUM CONTROLLER CONNECTIONS

It is particularly important to make the connections of the resistance to the proper stationary contacts on the drum controller so that the segments will cut out the resistance in the proper order.

Most new controllers and resistors have their terminals marked with corresponding letters and numbers, as shown in Fig. 294, thus making it a comparatively simple matter to properly connect them if the markings are carefully followed.

The resistance for three-phase drum controllers is generally divided into three equal sections, the ends of which are connected together in a star or Y connection as shown in Fig. 295.

One commonly used method of numbering the terminals of the resistance is to allow the numbers from 1 to 10 to represent one section of the resistance from Y to A; the numbers from 11 to 20 to represent the next section from Y to B; and the numbers from 21 to 30 to represent the third section from Y to C.

This plan can be followed even though each section doesn't use the whole ten numbers. The lowest number of each group is placed at the star connection. In the resistance shown in Fig. 295 there are only three divisions or four taps to be numbered on each section; so the numbers 1 and 4 are used

on the upper section, 11 to 14 on the center section, and 21 to 24 on the lower section.

The resistance shown in this figure is for a controller which provides ten different speeds of the motor. The number of speeds which controllers are arranged to provide is usually a multiple of 3, plus 1; as, for example, 4, 7, 10, 13, 16, etc.

When motors are arranged for a number of speeds which is other than a multiple of 3, plus 1, they cut out two or more sections of resistance at once.

In connecting up a resistance such as shown in Fig. 295, or any other resistance using this system of marking, the points marked 1, 11, and 21 are connected together to form the star or Y connection.

The opposite ends, or lines A, B, and C, are then connected to respective brushes on the slip rings of the motor and also to the proper corresponding contacts on the drum control.

If you have to connect a resistance which is not marked, it is comparatively easy to place small tags on the terminals and then mark them in the manner shown in Fig. 295.

The marked secondary resistances of this type for use with slip-ring A. C. motors can be properly connected to a drum controller by the following procedure, even though no blue print is available.

First, place the controller handle in the off position and then move it to the first step or starting position. Note which of the controller fingers now rest upon the segments of the drum. There will usually be two in contact in this first position on non-reversing drums, and more on drums of the reversing type.

Ignoring the contacts which are used for reversing, connect to one of the other two a wire from the Y connection of the resistance, and to the remaining contact connect a wire from terminal 2 of the resistance.

Next, place the handle of the controller in the second position, note the contact which is thus brought into connection with the segment, and connect to it a wire from terminal 12 of the resistance. At each successive step or position of the controller handle another finger will be brought to rest upon a new contact, and to each of these successive fingers connect wires from the resistance terminals in the order—2, 12, 22; 3, 13, 23; 4, 14, 24; etc.

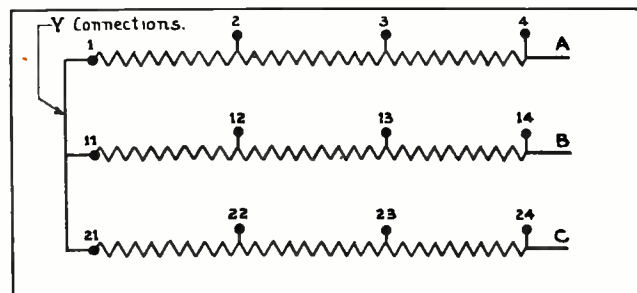

Fig. 295. The above sketch shows a common method of marking resistance units for use with drum controllers.

If the controller is of the reversing type there will sometimes be only one finger resting upon a segment in the first position. In this case, attach the Y connection to this finger and for the remaining connections proceed as previously explained.

Be careful to note that as the controller handle is moved, the contact for each new position may be found on either the right or left-hand finger-board of the controller. In other words, the contacts which are made in order—1, 2, 3, 4, etc., may not all be on the same finger-board. The finger-board is the strip on which the contact fingers are mounted.

This general method or procedure of connecting resistance to drum controllers is often very handy and valuable for a man to know when out on the job, because in many cases the diagrams for certain controllers may have become lost or resistances may be used which are not marked when supplied.

Fig. 296 shows a connection diagram for a three-phase drum controller used with a hoist motor for providing five speeds and for reversing duty. This diagram shows, in addition to the drum controller, a line oil switch and magnetically-operated contactor, thermal overload-relay, and the motor windings, which are equipped with separate leads so that the machine may be operated on either 440 or 220 volts.

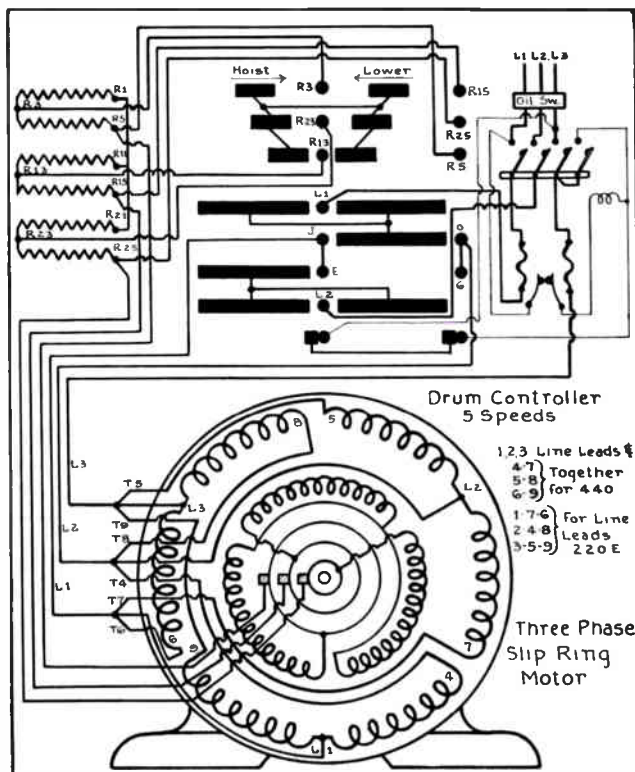

Fig. 296. Wiring diagram of a speed-regulating controller connected to a slip-ring motor. Carefully trace the circuits both to the stator and rotor of this machine.

Fig. 297 shows a connection diagram for another type of drum control. This diagram is of the type furnished with equipment manufactured by the General Electric Company and uses a different sys-

tem of numbering. However, if you follow the numbers on any diagram or blue print of this type, it is a very easy matter to make the proper connections between the resistance and controller, and also to the motor and line.

This particular diagram also shows the terminals of a line switch or contactor which is operated by remote push-button control.

The wiring diagram for this switch is also furnished by the manufacturers upon request from customers who may be installing such equipment.

### 309. STAR-DELTA STARTERS

Squirrel-cage induction motors which have their stator windings connected for delta operation sometimes have the start and finish leads of each phase brought out to a three-pole double-throw switch so that the windings can be changed to star for starting the motor at reduced voltage.

This reduces the voltage applied to each phase of the winding to 57.7% of the normal line voltage. This provides a very simple and economical method of starting motors at reduced voltage.

However, this method is not extensively used because it only provides one starting voltage and because it can only be used on motors that are to be operated with the stator windings delta-connected. Nevertheless, it is often a very convenient method of starting squirrel-cage induction motors in an emergency when no compensator is available.

Fig. 298 shows a method of connecting the start and finish leads of a stator winding to the three-pole switch for star-delta starting of an A. C. motor. The clips on one side of the switch are all shorted to-

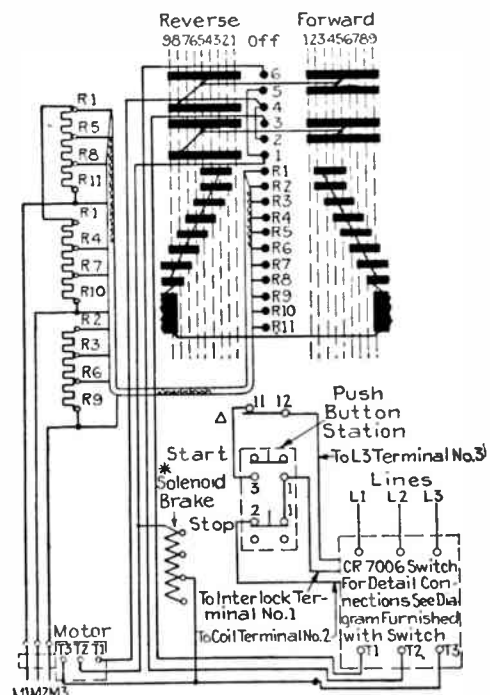

Fig. 297. Wiring diagram of a General Electric drum controller for starting, reversing, and speed regulation of a three-phase, slip-ring motor. Note how the numbers simplify the making of proper connections, even though the wires from the resistance to the drum contacts may be bunched in a cable.

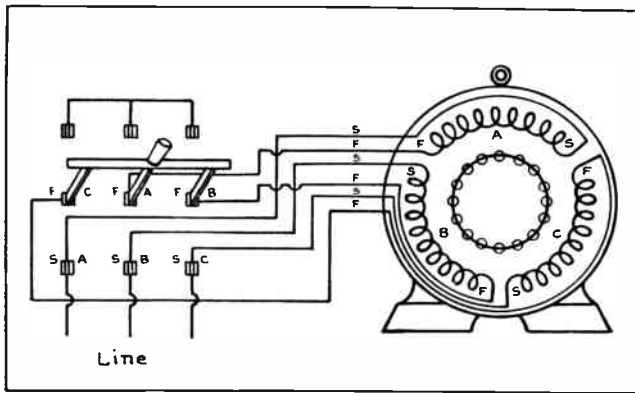

Fig. 298. This diagram shows the method of using a three-pole, double-throw switch for star-delta starting of squirrel-cage induction motors.

gether to form the Y or star connection for starting.

The starts of all three phases are connected in rotation to clips on the opposite side of the switch, and the finish leads of the three phases are connected to the blades in such a manner that when the switch is thrown down in the running position the start of one phase will connect to the finish of the next. etc.

To start a motor in this manner the switch is first closed in the upper position which connects the phase windings in star and applies 57.7% voltage to them. When the motor speed has increased as much as it will with this connection and no further increase of speed can be noted, the switch is then quickly thrown to the lower position connecting the windings delta so that they receive their full rated voltage from the line.

### 310. INSTALLATION OF CONTROLLERS

When installing controllers it is general practice to locate them near the motor, in order to shorten the leads between the controller and motor as much as possible.

In many cases, however, it may be much more convenient to have the controller located at some distance from the motor, where it is within easier reach of the operator of the machinery which is driven by the motor.

Controllers are frequently mounted upon a post or pillar or on the wall of the building in which they are installed. In other cases they are mounted on frames of angle iron or steel piping.

Regardless of whether the controller is located within a few feet of the motor or at some distance from it, the circuits between them should generally be run either in rigid conduit, flexible conduit, or B. X.; and good, secure connections should be made between the conduit and the frame of the motor and also between the conduit and the controller box. This insures a complete ground circuit between the devices and is a necessary safety precaution.

Flexible conduit is a very convenient material for running the wires between motors and controllers because it is easily bent to fit the openings and

attachment fittings on the machines, and to run along motor frames or bases or along the walls or machines to which it is attached.

Fig. 299 shows a photo-diagram of a synchronous motor and its exciter-generator, starting compensator, overload-relays, and meters; and the various connections or wires between them. These wires are merely drawn in the photograph to show their position in this figure, but in an actual installation they would be enclosed in rigid or flexible conduit; or B.X. which has the right number of wires for the different runs can be used.

Fig. 300 shows two views of induction motor installations, but doesn't show the supports for the controllers. On the left is a squirrel-cage induction motor equipped with a starting compensator; and the wires running between them are enclosed partly in rigid conduit and partly in flexible conduit.

On the right is shown a slip-ring induction motor with an oil switch in the line circuit to the stator, and a drum controller and resistance in the rotor circuit for starting and speed variation.

The wires between these units are run in rigid conduit which is attached to the motor and controller by proper fittings.

Three-hole porcelain covers are used in the fittings on the ends of the conduit where the connections are made to the slip rings and to the oil switch.

The use of flexible conduit where the leads attach to the motor is a decided advantage when the motor must occasionally be shifted to loosen or tighten the belt. The flexible conduit allows this to be done without changing any of the wiring or piping.

Controllers should always be securely mounted so that they will not sway or vibrate when the handles are operated.

### 311. CARE AND MAINTENANCE OF CONTROLLERS

There are several parts and devices on motor controllers that require frequent inspection, adjustment, and maintenance to secure the best operation of the controllers.

Controller contacts are always subject to a certain amount of burning or pitting from the arcs which are formed when the contacts make and break the circuit. This is true even though they may be operated in oil or with blow-out coils and other devices to quickly extinguish the arcs, and it is particularly true where the controller is used frequently for starting and stopping or varying the speed of the motor.

To provide efficient operation of the motor, the controller contacts must be kept clean and bright, and of the proper tension and contact adjustment. When these contacts become pitted or burned they should be smoothed off, first with a coarse file and then finished down with a fine file.

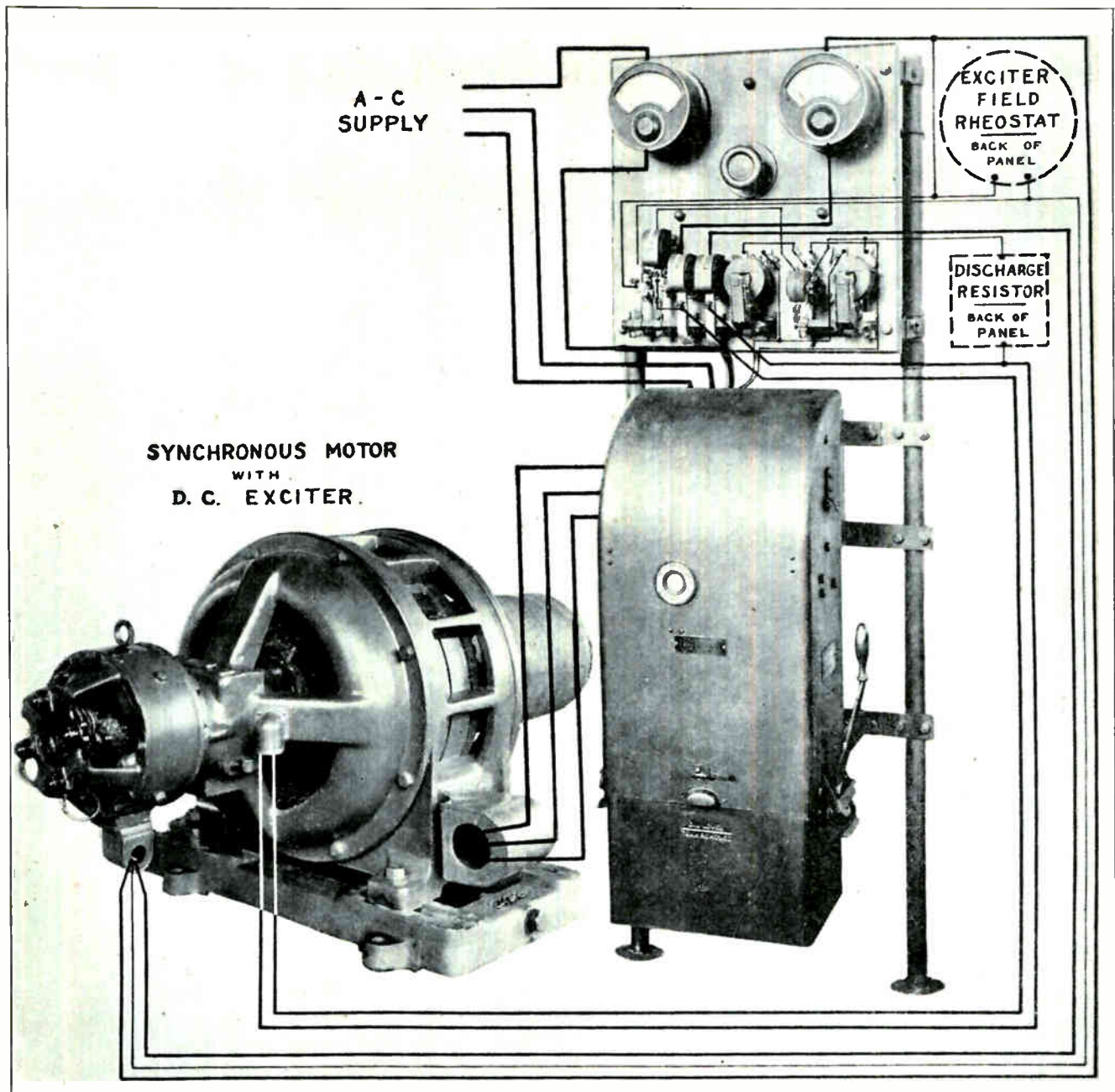

Fig. 299. This photo-diagram shows the arrangement of the connections between a synchronous motor and its exciter, and the controller and instruments used with it. On an actual installation these wires would, of course, be run in conduit or B.X. The three-phase line circuit through the compensator to the stator of the synchronous motor is shown by the heavy lines. The exciter and field circuits are shown by the lighter lines. (Courtesy General Electric Co.).

This operation can be most easily performed by removing the contacts from the controller and holding them in a vise, and a better job can usually be done if a new contact is used as a pattern for reshaping the old ones.

Sharp corners and edges on sliding contacts or segments of drum controllers should be carefully smoothed and rounded off, as shown at A in Fig. 301.

At B in the same figure is shown a set of contacts which are not properly rounded off on the corners; and the stationary contact finger in this view is not set in the proper position. When the

controller segment is moved in the direction indicated by the arrows it will jam against the tip of the contact finger and probably bend this contact out of shape.

When placing a new or repaired contact back into service its surface should be given a thin coating of vaseline. This will prevent excessive wear and scratching and cause the contacts to wear with a smooth surface.

Contact faces or surfaces should always be parallel with the faces of the segments or other contacts against which they fit or slide, as shown in Fig. 301-C.

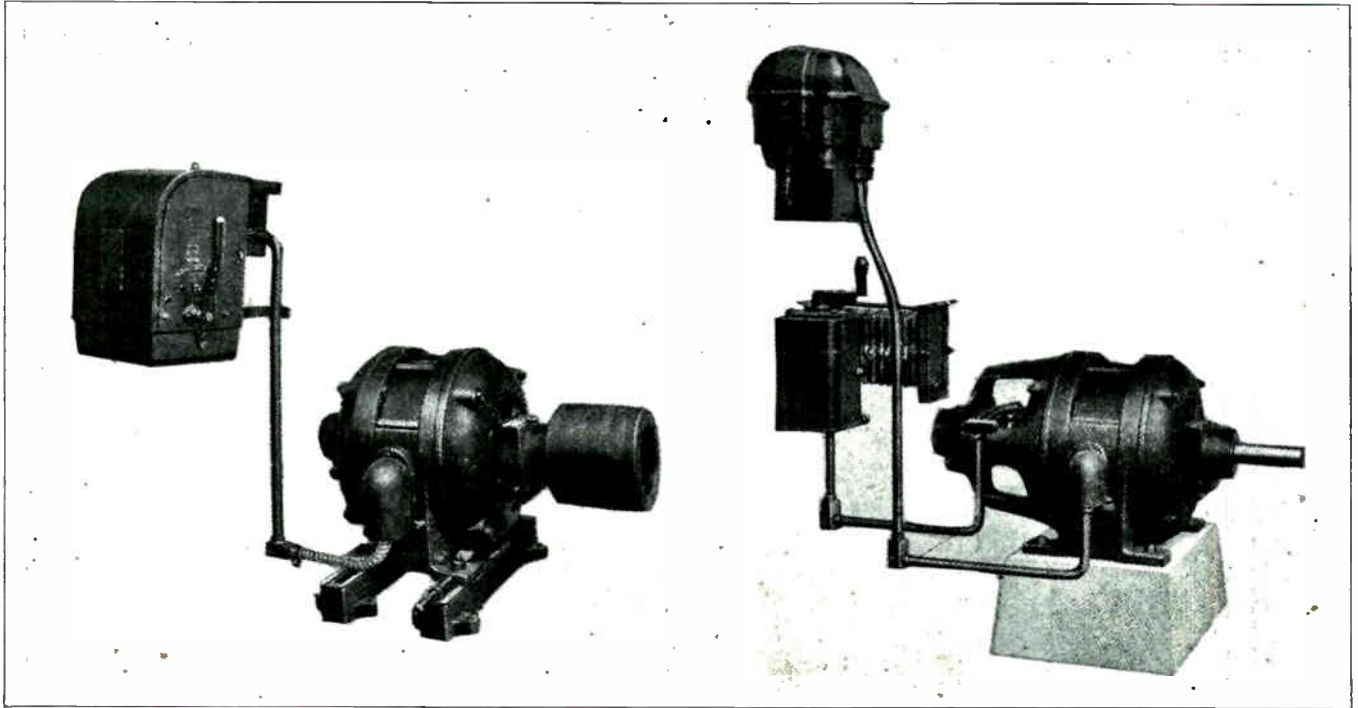

Fig. 300. The above two views show methods of connecting compensators and drum controllers to induction motors by means of rigid and flexible conduit. While in some temporary installations open wires which are properly supported and protected may do very well, in general a neat, permanent installation of the wires in conduit is a much safer and better arrangement.

If these contacts are allowed to get out of alignment as shown in Fig. 301-D it will result in high-resistance contacts and probably in serious overheating or burning of the contacts.

The contacts should be carefully adjusted as to position and spring tension. When adjusting the tension on the contacts of drum controllers it is a good plan to move the controller handle occasionally and determine by the feel whether or not the tension is too great. One should be able to move the handle freely with one hand and yet be able to feel a reasonable amount of pressure when the segments make contact.

Sometimes controllers which operate hard or stiffly should have a few drops of oil placed on the controller shaft where it rubs on the bearings at each end, and a light application of vaseline to the contacts will often make them wear smoother and run more easily. If the controllers are allowed to operate hard or stiff it often results in their being abused or jammed by the operators.

All terminals should be frequently inspected, cleaned and kept securely tightened, so that they make good contact with the wires at all times.

If a thin coating of vaseline is applied to the terminals after they are cleaned it will prevent corrosion and keep them in much better condition.

Arcing barriers that are badly burned or broken should always be promptly replaced to prevent the serious damage which might otherwise result from flash-overs between the different sets of contacts.

### 312. CARE OF OIL USED ON OIL-IMMERSED CONTACTS

On controllers in which the contacts are operated under oil the oil should be frequently inspected, and renewed whenever it becomes dirty or blackened by the burned materials from the contacts.

Dirt and carbonized contact material, if allowed to remain in the oil, greatly reduces its insulating quality and also reduces the ability of the oil to extinguish or quench the arcs at the contacts.

Dirty oil is also likely to cause flash-overs between phases and to the grounded metal case of the controller. One severe flash-over of this kind is likely to be much more expensive than the cost of several changes of oil.

After removing dirty oil from a controller the tank should be thoroughly cleaned and again filled to the oil level marking before it is replaced on the controller.

The oil used in controllers and oil switches is of a grade similar to that used in transformers and, in fact, transformer oil is very frequently used for this purpose.

### 313. PROTECTIVE RELAYS AND AUXILIARY CIRCUITS

All relays for overload and under-voltage protection should be kept properly adjusted and in good condition, in order to protect both the motor and controller from serious damage in case of overloading or failure of voltage. These protective devices generally give very little trouble except for occasional breakage of the small wires connected

to them or the working loose of terminal nuts and connections.

Their contacts should be inspected occasionally to see that they are not burned or stuck together but are working freely and making a good contact and have bright, clean surfaces.

The auxiliary circuits of controllers do not carry power or load current, but are the ones which connect to the start and stop buttons, starting and running contactor magnets, overload and under-voltage relays, etc.

For these circuits No. 12 wire is generally used, although in some cases No. 14 or No. 16 is used. Asbestos-covered wire insures greater reliability and longer life on these circuits. These wires should require very little attention or care, provided they are located where they don't vibrate and where they are not rubbed by the moving parts of the controller.

### 314. CARE OF DASH POTS AND TIMING DEVICES

Dash pots and other forms of time elements on controllers should be carefully adjusted to allow the proper time for starting the machine. The oil in dash pots should be kept clean and occasionally renewed, and these devices should be filled only with oil intended for use in them, as other oils of different thickness or consistency may cause them to operate much slower or faster than intended.

Dirty oil in dash pots will often close by-pass valves or cause the piston or plunger to stick and fail to rise. The oil should be kept at the proper level so that it completely covers the piston when it is in its highest position.

If the piston stem becomes bent or the casing of

the oil pot becomes dented, it will often result in sticking and failure of the dash pot to operate.

Careful study of this section on Controllers is very important because of the very great convenience and time saving and the economies which can often be effected by the selection and use of proper motor control equipment, and because of the added safety which these devices provide for operators as well as the protection they give to the motors and driven machines.

A great deal of your future success in electrical work may depend upon your ability to properly install and maintain A.C. motor-control equipment, as this is one of the most important duties of the electrical maintenance man in many large industrial plants.

Additional material on controller maintenance will be given in a later section on Installation and Maintenance of Electrical Machinery.

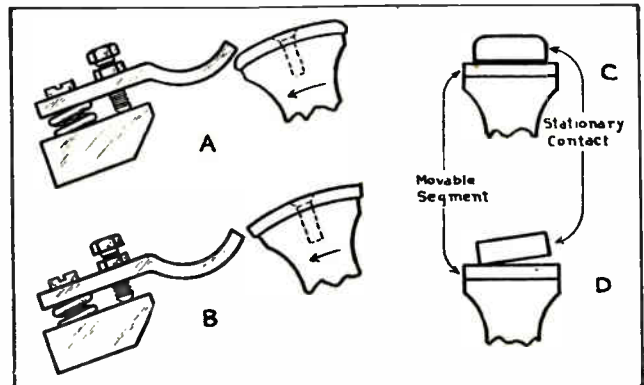

Fig. 301. At "A" is shown the proper shape and position of the segment and contact finger of a drum controller. At "B" is shown the wrong position and unrounded corners of these contacts. At "C" and "D" are shown the right and wrong positions of the stationary contact on the movable segment.





ESTABLISHED 1899

**COYNE**  
*Electrical School*  
 CHICAGO ~ ~ ILLINOIS



COPYRIGHT 1942

**ALTERNATING CURRENT POWER**  
**AND**  
**A. C. POWER MACHINERY**

*Section Seven*

**Generating Stations**

**Location, Prime Movers, Boilers, Turbines**

**Electric Power Transmission and Distribution**

**Underground Cables, Overhead Lines**

**Conductors, Insulators, Poles, Towers**

**Line Calculations, Losses, Stresses**

**Erection, Maintenance**

**Lightning Arresters**

**Types, Connections, Operation, Care**

**Distribution Systems and Lines**



## GENERATING STATIONS

By far the greatest part of the electrical energy used in this country is generated in large power plants called central stations, although there are also a large number of smaller privately-owned power plants supplying electricity in industrial plants, hotels, office buildings, etc. In a number of small and medium sized towns and cities there are also municipally owned and operated plants.

Electricity can usually be generated much cheaper in large plants which have large highly efficient generators and equipment. So, in most cases the small user can buy power from the power company cheaper than he can generate it himself.

There are many cases, however, where electric power can be produced very cheaply in a privately-owned plant, if some other use is available for the low-pressure exhaust steam from the turbines or engines used to drive the generators.

In other cases waste gases or materials which are by-products of manufacturing plants, can be used as cheap fuel for generating steam to run steam-driven electric generators.

The lowest rates obtainable from the public utility or generating company and the dependability of their service should be carefully considered in comparison with the costs of fuel, operation, overhead, and interest on the investment of a privately-owned plant before recommending its installation.

Considerably more than two-thirds of the electric power generated in this country is produced by steam plants, and less than one-third by hydro-electric plants or water power.

Many people think that electric energy can be produced much more cheaply by water power than by steam plants. This is not always the case, because the cost of developing some water power sites is very high.

Another great drawback in the use of much of the available water power is that the best sites for its development are frequently long distances from any large towns or heavy users of power, and very great losses would be involved in transmitting power over these great distances.

Some of the larger and more modern steam plants produce a kw. hr. for each  $1\frac{1}{2}$  lbs. of coal burned, and under other low operating costs, and these steam plants can therefore in many cases deliver power to their customers much cheaper than it could be generated and sent from the nearest water-power source.

Small privately-owned power plants which supply electrical energy to just one factory or building often generate their power at 220 or 440 volts, or the same voltage as that of the equipment which uses the energy. In plants supplying very large

factories the generators are often operated at 2300 volts. Some large motors in the factory are then operated directly on this voltage, and smaller motors and lights operate on reduced voltage from transformers.

### 315. SELECTION OF THE LOCATION OF A POWER PLANT

Steam plants can usually be located in or near some large town, and very close to the load center or heaviest users of electric power. In this manner a large portion of the electric energy produced can often be sold within a radius of a few miles of the power plant.

It is, of course, desirable to locate any power plant as close to the load center as possible and thereby avoid unnecessary losses in transmission. There are, however, a number of other very important factors which enter into the selection of the location for a steam power plant. Some of these are: the availability or transportation of fuel, preferably by rail or boat; the availability of good boiler feed-water, and sufficient condenser water; ground values on the land required for the plant and fuel yards, switching equipment, etc.; and local building or zoning restrictions.

Large power plants which use coal for fuel are generally located at a railroad, river, canal, or body of water that accommodates boats or barges; as too much re-handling or hauling by trucks will add too greatly to the cost per ton of the coal.

Boiler feed water should preferably be of a grade that does not cause excessive scale formation in the boilers or corrosion of engines or turbines; although difficulties due to water impurities can often be largely eliminated by filtering and chemical treatment of the feed water.

Where condensing engines or turbines are used, a large volume of water is required for cooling the condensers which convert the exhaust steam back into water for the boilers to use again.

In some parts of large cities ground values are so high that taxes and interest on the money invested in the land would make it impractical to locate a power plant there. In such cases the generating plant is usually located nearer the edge of town or in some manufacturing district where property values are lower.

Zoning laws often prohibit the location of any buildings of the nature of a power plant or factory in certain sections of cities. Many of the more recently built power plants and substations are very attractive buildings and thereby a great deal of the objection which was formerly raised against the appearance of power plants has been eliminated.

Fig. 302 shows a large modern steam-driven gen-

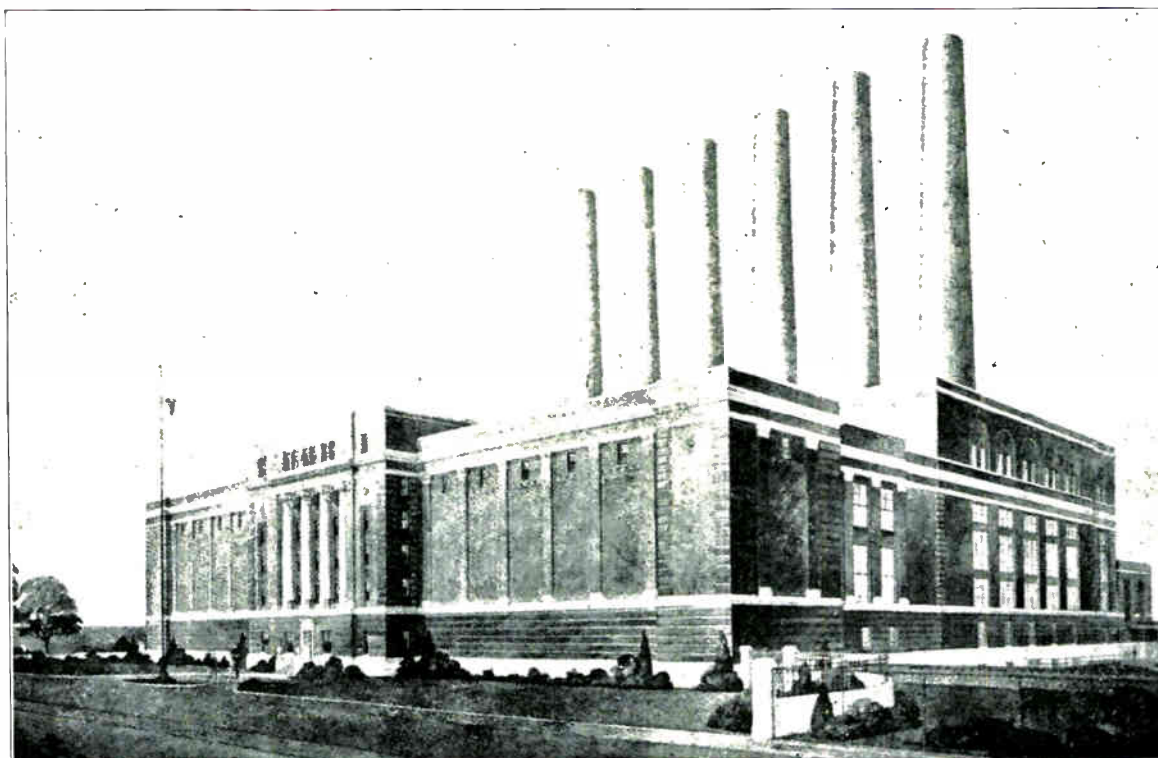

Fig. 302. This photograph shows an exterior view of a large modern central station generating plant of the steam-operated type. Note the very neat and attractive outside appearance of this plant.

erating plant with a very attractive building and front appearance. The fuel storage yard and the river from which condenser water is obtained are at the rear of the plant.

Fig. 303 shows at P.H. a power house near the river and railroad, for its supply of coal and condensing water, and feeding power at high voltage into substations in the city. The substations step the voltage down and distribute the energy to the various sections of the city.

A modern central-station, steam-power plant will produce less smoke while burning 100 tons of coal than an ordinary steam locomotive or small factory produces in burning one or two tons. This is because of the highly efficient stokers and boiler furnaces used, and the carefully regulated draft to the furnaces, etc.

### 316. CHOICE OF PRIME MOVERS

The choice of prime mover to be used in a power plant depends on the type and price of fuel available, whether or not condenser water can be had, and upon the class of service the plant is intended for.

In large central stations steam turbines are the most common form of prime mover, as they are very efficient and are well adapted to operation at high speeds and high steam pressures. They are also very compact and small in size for the tremendous amount of power they deliver.

Coal is by far the most common form of fuel used for producing steam, although there are in

the western and southwestern states some generating stations that are operated with oil and gas fuel.

In large plants the coal is fed to the boiler furnaces by automatic stokers or traveling grates; and in many of the later type plants the coal is pulverized and blown into the furnaces with air, being practically exploded or burned instantaneously as it enters the white hot furnace. This method of

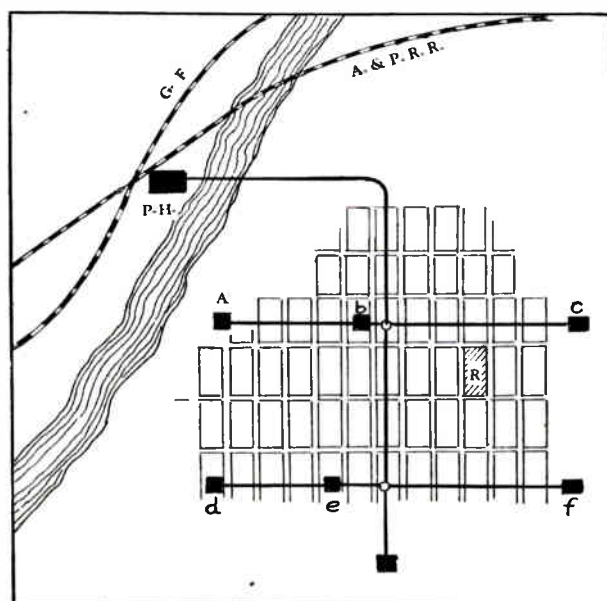

Fig. 303. This diagram shows how a power plant should be located near a convenient source of fuel supply and condenser water. Transmission and distribution lines then carry the energy from the power plant to the substations and consumers.

burning powdered coal is a very efficient one and creates very little smoke or ash.

Fig. 304 is a view of the interior of a large steam-operated generating station and shows four large turbine-driven generators in operation.

In smaller privately-owned plants either steam turbines or reciprocating steam engines are used. The steam engine, being well adapted to operation on lower steam pressures, lower speeds, and simple to operate, is often used to drive low-speed generators of the open type, as shown in Fig. 305.

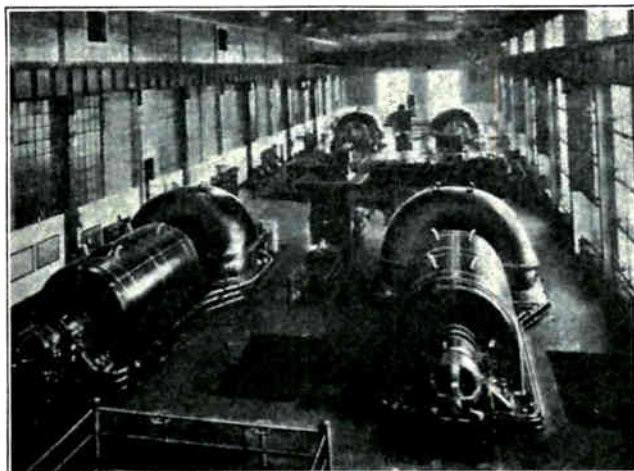

Fig. 304. Interior view of a large power plant showing several modern steam turbine-driven alternators.

In localities where coal and condenser water are difficult to obtain, and where oil is plentiful and cheap, Diesel Engines are often used as prime movers in generating plants. They are also very well suited for use in stand-by plants which are used only during certain hours of the day to help carry peak loads on other plants.

A Diesel engine operated unit can be quickly started and does not require previous firing up of boilers or the carrying of stand-by boilers to enable it to be quickly started and placed in service.

Diesel-operated plants require no condensing water, no boiler feed-water, no large fuel storage yards, and very little care and repair, as these engines are simple in operation and rugged in construction. Fig. 306 shows two large Diesel engine-driven generators in a power plant.

Diesel-operated plants require very little space and operate on low cost fuel oil, producing power at very low cost. Plants of this type are extensively used in oil field regions and are also coming into very general use for privately-owned and municipal plants. Diesel engine-driven generators are extensively used on electrically operated ships.

### 317. BOILERS, STEAM TEMPERATURES AND PRESSURES

In this section no attempt has been made to cover all of the details of the steam and mechanical equipment and operation in power plants. This work does not fall in the field of the electrical operator,

but this section does cover certain points of general interest and importance which any electrical operator should know about the plant in which he may be working.

Boilers for producing steam are of two general types called fire-tube and water-tube boilers. Fire-tube boilers are those in which the hot gases from the fire box or combustion chamber pass through steel tubes which are surrounded by the water in the boiler. This type of boiler is used very little nowadays, except in smaller and older plants.

Water-tube boilers are those which have a large number of tubes connected to drums or headers, the water being contained in the tubes and lower drum, and steam in the top of the upper drum. The fire and hot gases from the combustion chamber pass upward between these water tubes and all around their surfaces, thus imparting the heat to the water inside the tubes.

Fig. 307 shows a sectional view of a modern water-tube boiler and combustion chamber. The coal hopper and stoker mechanism are shown at A, the grates and fuel bed at B, the combustion chamber or fire box at C, and the ash pit at D. The hot gases first pass upward between the boiler tubes, and then to the right and slightly downward over the baffles and on out to the smoke stack.

Fig. 308 shows a diagram of another type of water-tube boiler in which the tubes are straight and are fastened to flat vertical "headers" at each end. The furnace of this boiler has a water-cooled inner wall, in the tubes of which the boiler feed-water is heated to quite an extent before entering the boiler proper.

This boiler is fired with pulverized coal, and the coal hopper, pulverizer, and chute or pipe which carries the powdered coal to the boiler furnace, can all be seen in this diagram. The hot gases pass up between the right-hand ends of the boiler tubes, then down between a set of baffle plates and through the center section of the tubes, and finally up be-

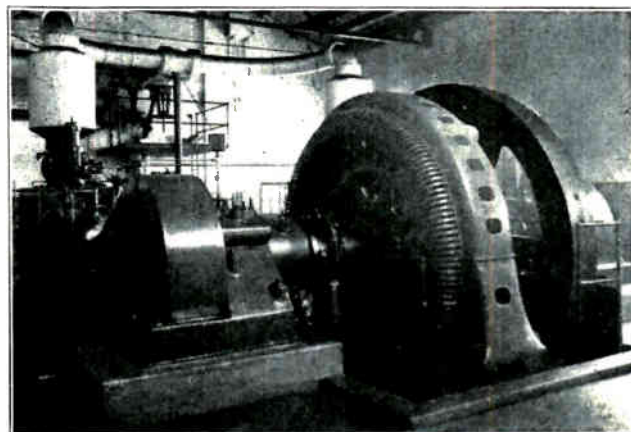

Fig. 305. This photo shows a direct connected steam engine-driven alternator in a small power plant. Note the flywheel used to stabilize the alternator speed and smooth out the pulsations of the engine strokes. Courtesy Allis-Chalmers Mfg. Co.

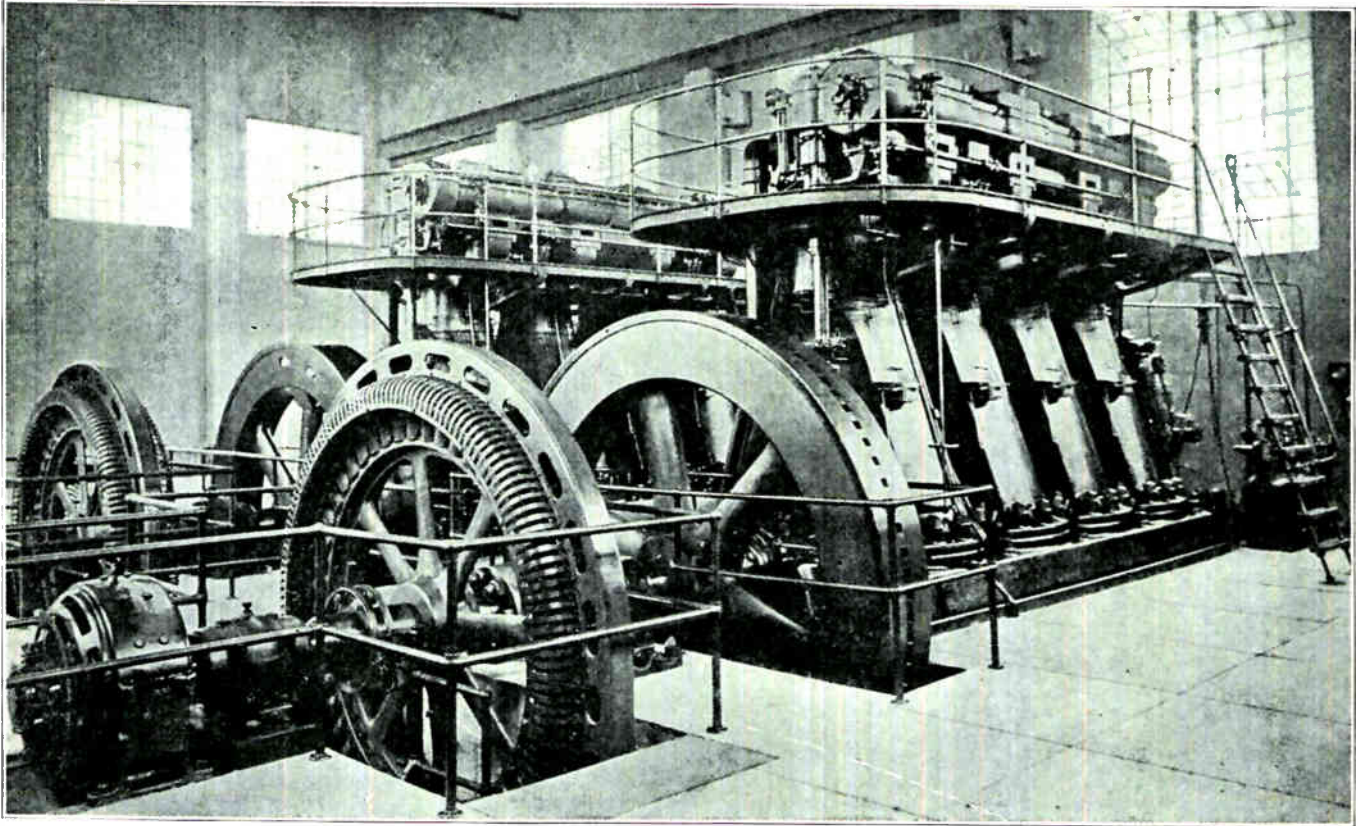

Fig. 306. Oil burning diesel engines of the above type are very commonly used as prime movers for generators in small and medium sized power plants. These engines are very economical in fuel cost and are simple and easy to operate and maintain. They are particularly desirable for use where coal and condensing water are difficult to obtain and where only limited space is available for a generating station.

tween the left ends of the tubes. From here the gases pass through an economizer, or another set of tubes, where they give up still more of their heat to the boiler feed-water, before passing on out of the stack.

Fig. 309 shows a sectional-view diagram of another modern type of power plant boiler using pulverized coal and having multiple sets of tubes and drums above the combustion chamber. In this boiler the powdered coal is blown downward into the combustion chamber from the tube at the upper left corner, and literally explodes as it strikes the white hot, roaring interior of this furnace.

Modern power-plant boilers have motor-driven draft fans operated by variable speed motors for accurate control of the draft, and in some cases the draft air is preheated by stack gases before being fed to the furnace. Some plants use exhaust steam from the turbines and also the partly-cooled furnace gases to preheat the boiler feed water. By these methods very high efficiency is obtained.

Power-plant boilers commonly produce steam at pressures ranging from 200 to 600 lbs., and in some cases as high as 2000 lbs. or more, per square inch; and at temperatures ranging up to 1000 degrees F. and higher.

To obtain steam at such high temperatures extra tubes and drums are provided in the upper section of the boiler just to heat the dry steam after it has

been produced in the main boiler. These extra heater elements are called superheaters.

### 318. EXHAUST STEAM CONDENSERS

In modern power plants the steam which is exhausted from the turbines or engines is condensed

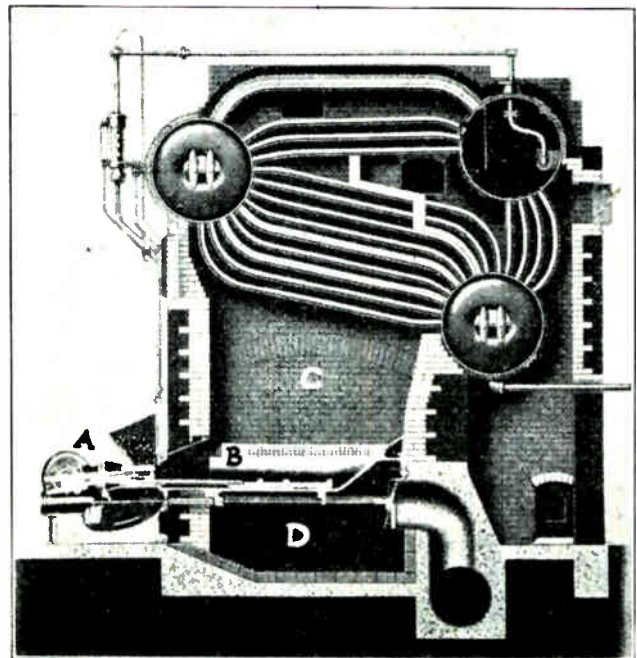

Fig. 307. Sectional view of a water tube boiler with an automatic stoker to feed the coal to the burners or combustion chamber "C".

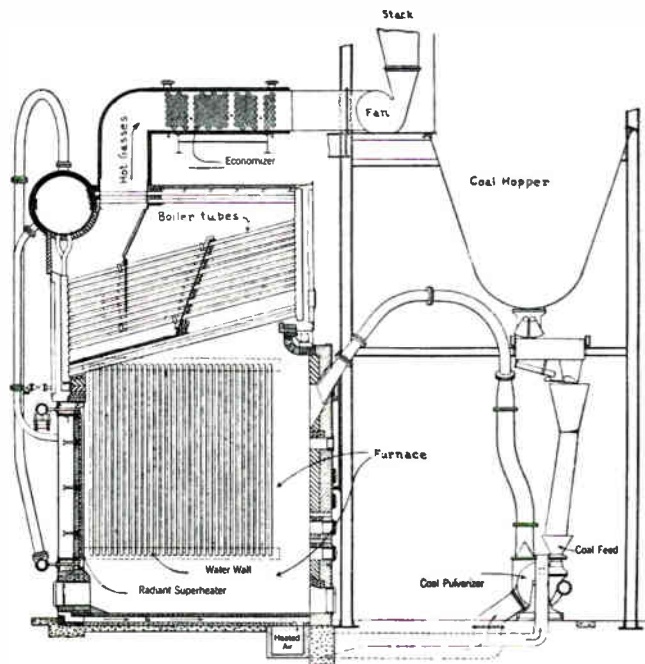

Fig. 308. Diagram of a modern power plant boiler using pulverized coal for fuel. Note the coal hopper, pulverizer, furnace feed tube, and also the economizer which is located above the boiler.

back into hot water and is used over and over again in the boiler. This saves a great deal of heat energy that would otherwise be wasted in exhaust steam and also reduces the cost of filtering and treatment of the boiler water.

In some plants this last item alone is quite a large one because the boiler feed-water has to be chemically treated to prevent it from depositing large amounts of scale in the boiler tubes. This scale, if allowed to accumulate, interferes with the transfer of heat from the tube walls to the water and greatly reduces the efficiency of the boilers.

The water which is taken from the condensers is much warmer than fresh feed water would be and is frequently heated up still more before being passed back to the boiler.

### 319. STEAM CYCLE

Fig. 310 shows a simple diagram of the steam cycle in a power plant. The water in the main boiler, B, is evaporated into steam and the steam is then heated to very high temperature by means of the superheater, S. From here the dry steam is fed through an insulated pipe line to the turbine. Expanding through the blades of the turbine it delivers mechanical power to drive the generator and then exhausts from the lower side of the right-hand end of the turbine casing and into the condenser.

Here the steam passes over many hundreds of small copper tubes through which cold water is kept constantly circulating. The contact of the hot steam with these cool pipes causes it to condense back into warm water and run to the bottom of the condenser to a collector called the hot well.

In Fig. 310 the rotary pump, W.P., circulates a large volume of cold water from a river, lake, or

pond, through the cooling tubes of the condenser. The small pump, C.P., takes the condensate or warm water from the hot well and sends it through a feed-water heater where the temperature of the water is considerably increased by a small amount of live steam which is bled off from one of the stages of the turbine.

From the feed-water heater the water goes to a multiple stage, high-pressure boiler-feed pump which forces it on through a preheater or economizer where the water is still further heated by the hot gases leaving the furnace and passing to the stack.

After this final heating the water again re-enters the boiler at high enough temperature so that it only requires the addition of a little more heat energy to once more evaporate it into steam.

A steam cycle of this kind greatly increases the thermal efficiency of a power plant, and it is such engineering as this along with improved design of modern generators which has kept the cost of electricity low, and in many localities reducing year by year.

It is a very interesting fact that over a period of years in which the price of food, clothing, and most all other commodities have increased considerably, the cost of electricity has not increased but instead has considerably decreased.

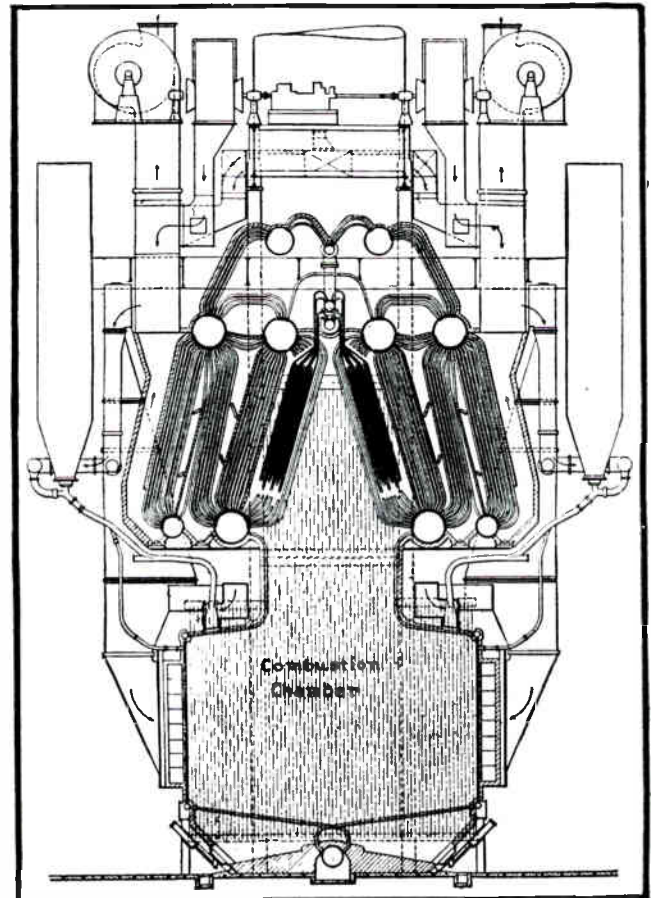

Fig. 309. Another type of large modern power plant boiler showing the combustion chamber, boiler tubes, super-heater, draft fans, etc

Fig. 311 is a view in the interior of a large power plant and shows the end of the steam condenser directly beneath the turbines of one of the units. The size of the condenser and the circulating water pipe shown in this figure give some idea of the vast amount of water required for condensing the steam of a large generating unit.

### 320. STEAM TURBINES

Most everyone knows the general operating principles of an ordinary steam engine, in which the steam is admitted by a valve to first one end of the cylinder and then the other, so that its expansion pushes the piston back and forth. This piston is attached to the drive rod which in turn fastens to the crank pin on the shaft which rotates the fly wheel.

As the intake valve is opened admitting steam to one end of the cylinder, the exhaust valve on the opposite end is opened, allowing the expanded steam which has just finished its work in that end to escape. These valves operate in synchronism with the travel of the piston and with the proper timing to admit the steam each time to the end of the cylinder at which the piston has just completed its stroke, thus forcing it back again in the other direction.

In this article we shall not attempt to cover in detail the mechanical construction or operation of

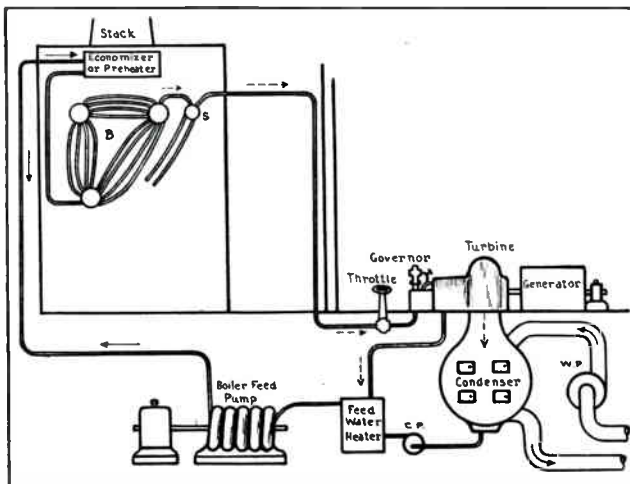

Fig. 310. This simple diagram illustrates the steam cycle or method of recirculating the boiler feed water in a modern power plant.

all the parts of steam engines. But there are a great many students who have very little conception of the operating principle of a steam turbine, and as this device is so commonly used in modern power plants, a brief, general explanation of its operation will be of interest.

Steam turbines are of two general types, called the impulse type and reaction type. In the impulse turbine live steam is directed from small nozzles directly against the blades or buckets of the rotating members of the turbine. In the reaction turbine the steam is first passed through a set of stationary

blades or vanes which direct it at an angle against a set of rotating blades located close to the stationary ones.

Large turbines are often made up of a number of these sets of stationary and rotating blades which are called stages; the several stages in the turbine being arranged so that the steam must pass through all of them before it finally exhausts to the condenser.

In this manner almost the very last bit of power can be extracted from the steam as it expands through one stage after another, with a loss of pressure and velocity at each stage.

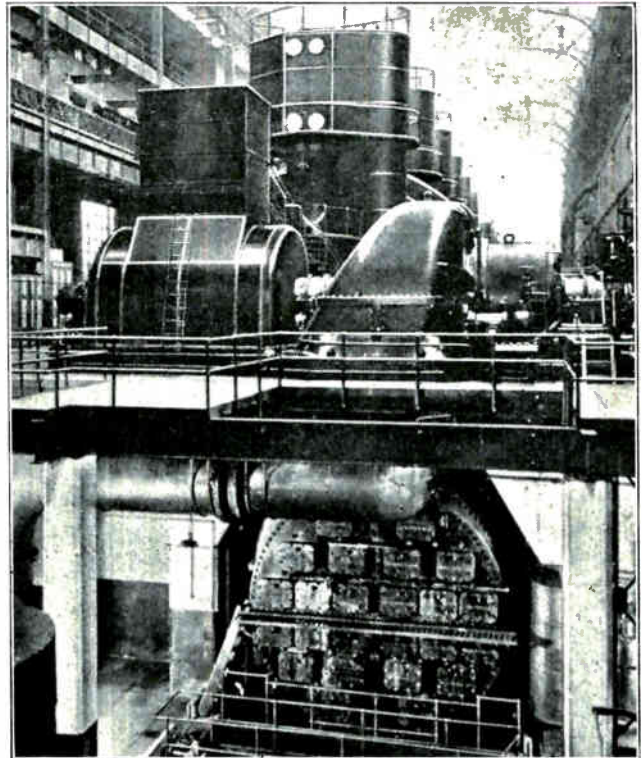

Fig. 311. This view shows a row of turbine-driven alternators above the power plant floor, and one of the large steam condensers below the floor and directly beneath the turbine in the foreground.

Fig. 312 shows a set of turbine nozzles and several sets of moving and stationary blades or buckets. By following the path of the steam as traced with the arrows in this sketch you will note that it is directed against the first set of moving buckets by the nozzles and then as it leaves the edges of these moving buckets it is redirected by the stationary blades against the next set of moving buckets, thus rotating them all in the same direction.

The same action is again repeated by the next set of nozzles and moving buckets, and so on throughout the several stages of the turbine.

Fig. 313 is a turbine rotor removed from its casing and shows the several sets of moving blades which are mounted on the outer edges of disks that are fastened securely to the shaft.

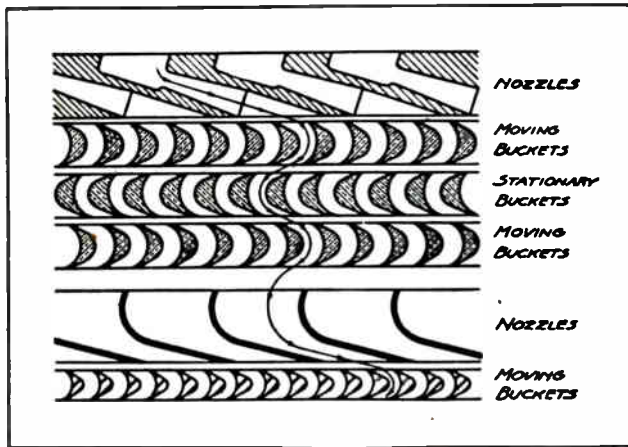

Fig. 312. This sketch illustrates the operating principles of a steam turbine. Note the nozzles and stationary and moving blades or buckets. Courtesy of Elliott Company.

Fig. 314 shows one-half of a turbine casing with the sets of stationary blades for each stage.

You will note that the casing is smaller in diameter and the blades shorter in length at the high pressure end where the steam is first admitted to the turbine, and that both become larger as the steam expands toward the low pressure or exhaust end.

Fig. 315 shows a sectional view of a turbine, which clearly illustrates the manner in which the steam enters the turbine at the right and then passes through the several sets of stationary and rotating blades or buckets which become larger toward the exhaust end. At this end the steam discharges from the enlarged portion of the casing to the condenser, which is usually connected directly beneath the turbine.

Fig. 316 shows a view in a large steam-driven power plant and in the fore-ground is a 165,000-kw. generator consisting of two units operated together as one. The turbines are both shown on the left and the generators on the right. The large tubes or ducts rising from the top of the generators and passing down through the floor at the right are air passages for cooling the generators. The unit in the rear is driven by the smaller high-pressure turbine, and the steam exhausts from this turbine through the larger low-pressure turbine which drives the unit in the fore-ground.

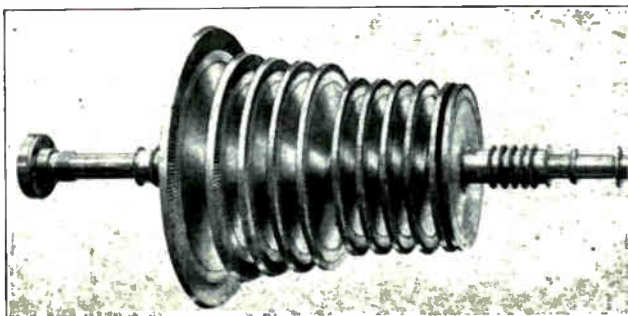

Fig. 313. Complete rotor of a modern steam turbine, showing several sets of moving blades through which the steam passes in succession. Courtesy of Elliott Company.

### 321. HYDRO-ELECTRIC PLANTS

There are throughout this country numerous hydro-electric generating stations producing millions of horse power. These plants are located along various streams and rivers where the water has considerable fall or drop within reasonable distances, and where it is practical and economical to erect power plants, and usually where dams can be erected or natural reservoirs obtained in which to store reserve water during high-water seasons, to keep the plant operating through low-water periods.

Hydro plants are also located near to or within economical transmitting distance of the cities or markets which will consume their power.

Fig. 317 shows the interior of a large hydro-electric generating station with five large vertical type, water-wheel-driven generators. The generator units and excitors are above the power plant floor and the water wheels are located below the floors and connect to the generators by means of vertical shafts.

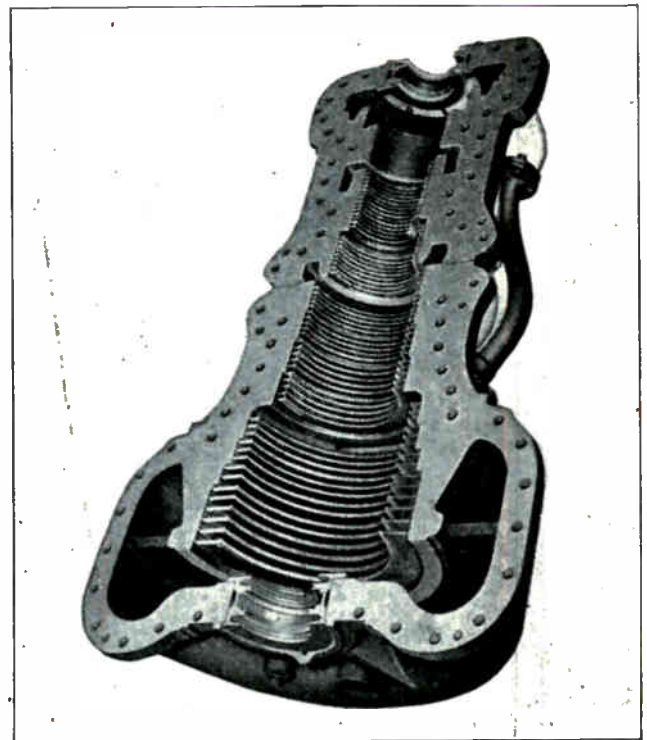

Fig. 314. One-half of a steam turbine casing showing a series of stationary blades between which the movable blades or buckets revolve. Courtesy of Allis-Chalmers Mfg. Co.

Hydro-electric developments usually require some form of dam. The dam may be a large one and produce the total fall by raising the level of the water from the base to the crown of the dam. In other cases only a small dam may be required to close off the flow of some stream high up in a mountainous region and store water in a natural reservoir at this elevation.

In either case the water is taken under pressure from the dam through a penstock or large pipe leading down to the turbine or water wheels at the

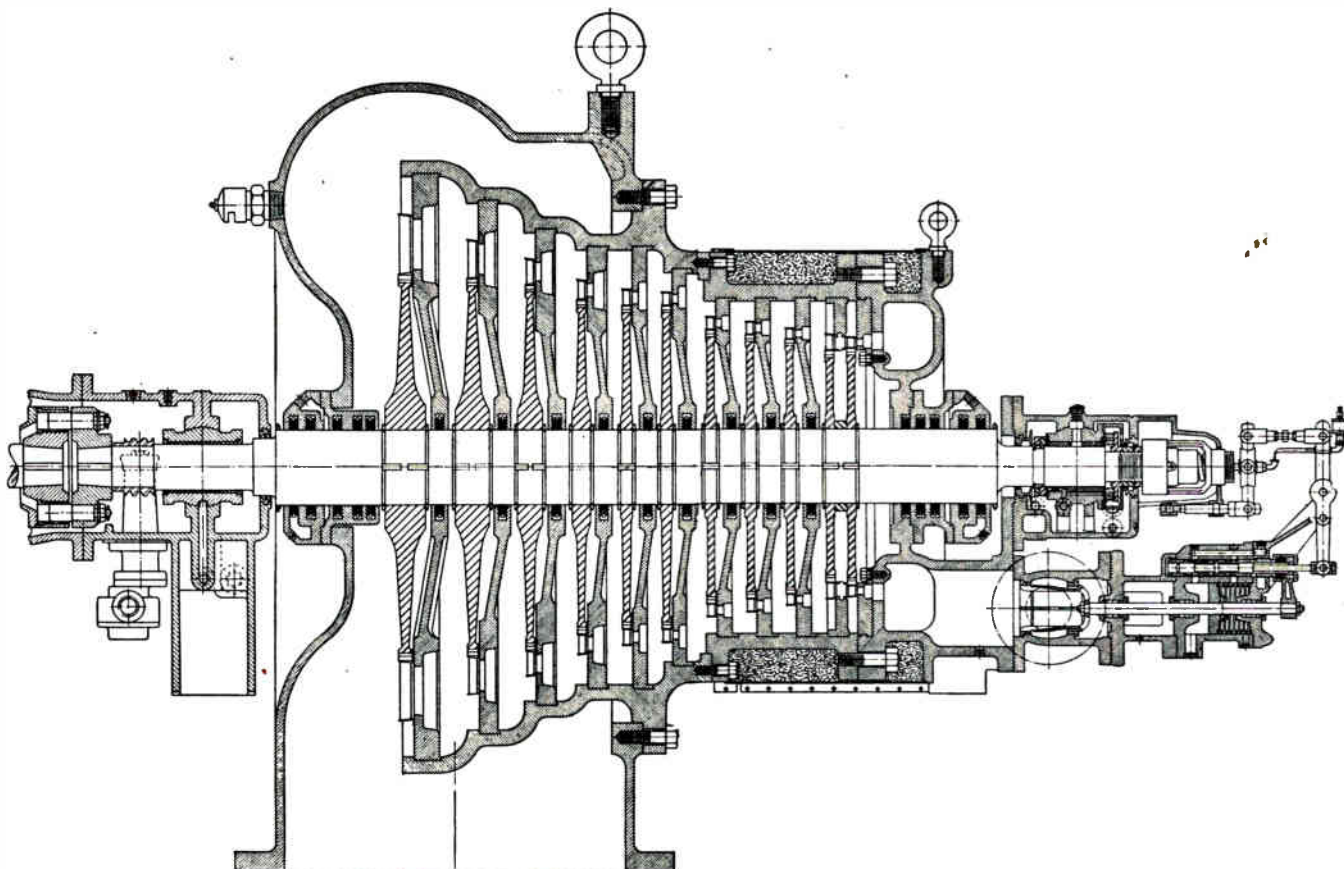

Fig. 315. An excellent sectional view of a modern steam turbine showing how the steam enters the high pressure end at the right and passes through one set of blades after another as it expands toward the exhaust end on the left. The stationary blades redirect the steam to apply its force against each successive ring of movable blades. Courtesy of Elliott Company.

power house, which may be located at the base of the dam or at the foot of the mountain, whichever the case may be. The water is then delivered through the proper valves and guide vanes to the blades or runner of the water wheel.

The horse power developed will be proportional both to the height in feet, or pounds pressure developed by this height, and to the volume of water which passes through the wheel. Some large water-power plants operate on a head or fall of only 10 or 12 feet, where enormous volumes of water are available at all times of the year.

In other cases some of the hydro plants in operation in the Rocky Mountain region of the western part of the United States utilize a height or fall of over 2,000 feet. This delivers the water to the buckets of impulse-type water wheels under terrific pressure and bullet-like velocity, and requires a much smaller volume of water to deliver a given amount of horse power.

### 322. WATER WHEELS AND TURBINES

Water wheels for operation with large volumes of water at lower pressure are generally of the reaction type, having blades somewhat similar to those of a ship's propeller and operating within a casing and set of guide vanes which direct the water against the blades of the runner at the proper angle to produce maximum efficiency and power.

Fig. 318 shows a sectional view of a large water wheel of this type. The generator is shown above and connected to the runner of the water wheel by a large vertical shaft. On the left can be seen a large floating valve which admits the water to the turbine. The water discharges from the turbine downward through the draft tube and out into the tail race in the stream below the plant.

In "high head" plants, where the water pressure and velocity are much greater, the water is often delivered from a tapered nozzle in a hard jet which strikes against the blades or buckets of an impulse wheel or Pelton turbine, and rotates the wheel and generator at much higher speed than those in low head plants.

Fig. 319 shows a row of generators which are driven by water wheels located beyond the wall at the right and coupled to the generators by horizontal shafts. This view is in one of the older plants at Niagara Falls. On the left can be seen the operating gallery and control board.

Fig. 320 shows a view in a smaller water-power plant with 560-kw. generators on the right and the switchboard on the left.

Fig. 321 shows a view in a small automatic hydroelectric plant in which the vertical-type generators are driven by water wheels beneath the floor and controlled automatically by relays on the switch-



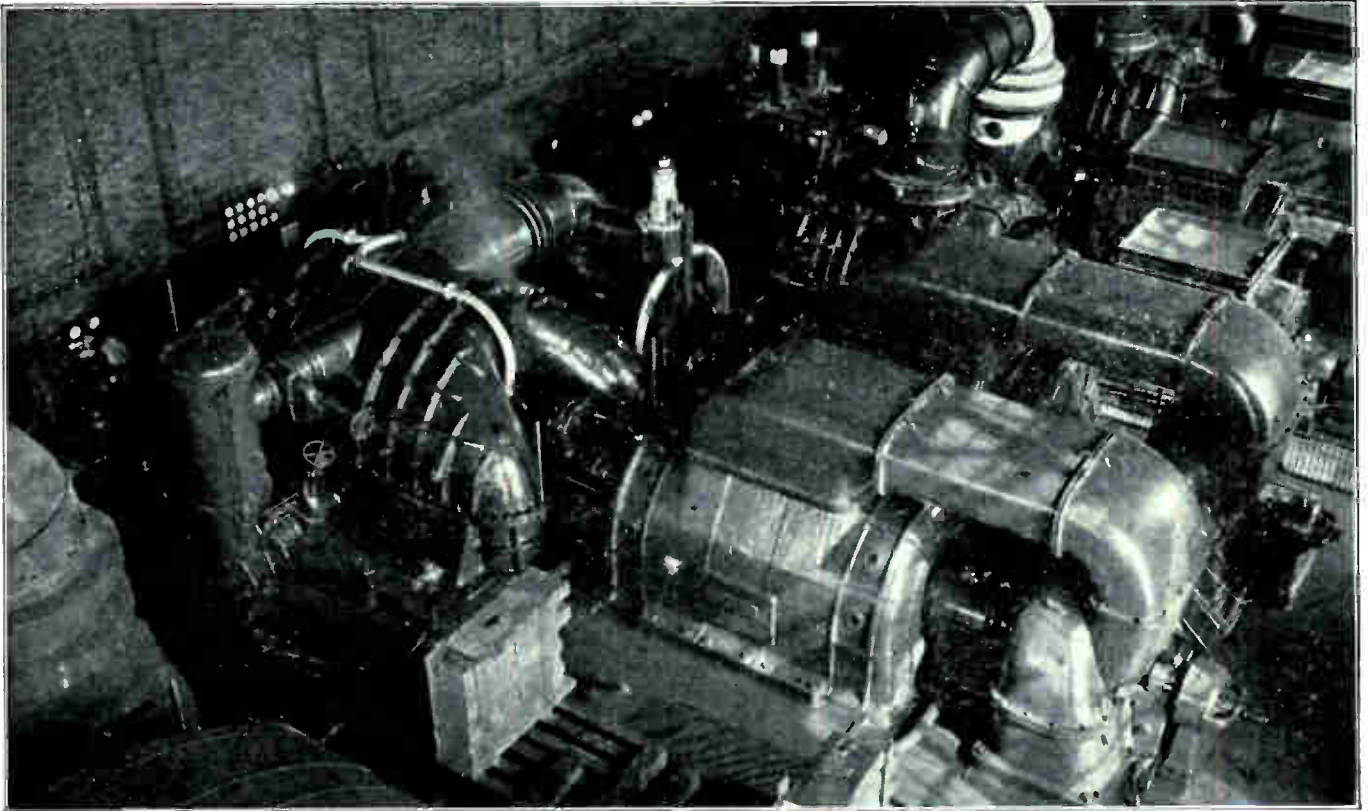

Fig. 316. The above photo shows a 160,000-kw. turbine-driven alternator in a modern central station. At the time of taking this photo this unit had just been installed and was under test. This same power plant has a number of other large turbine-driven alternators with which the new machine operates in parallel to help carry total load. Courtesy American-Brown Boveri Company.

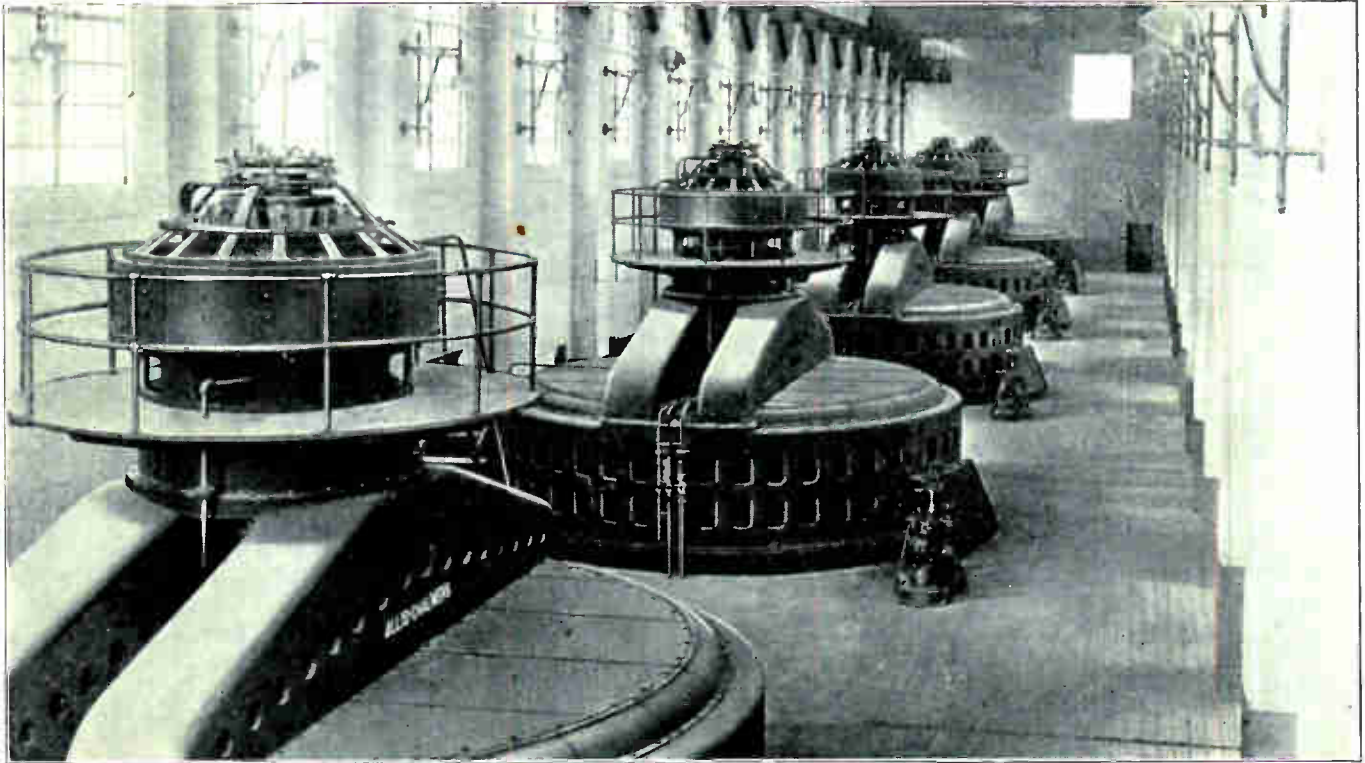
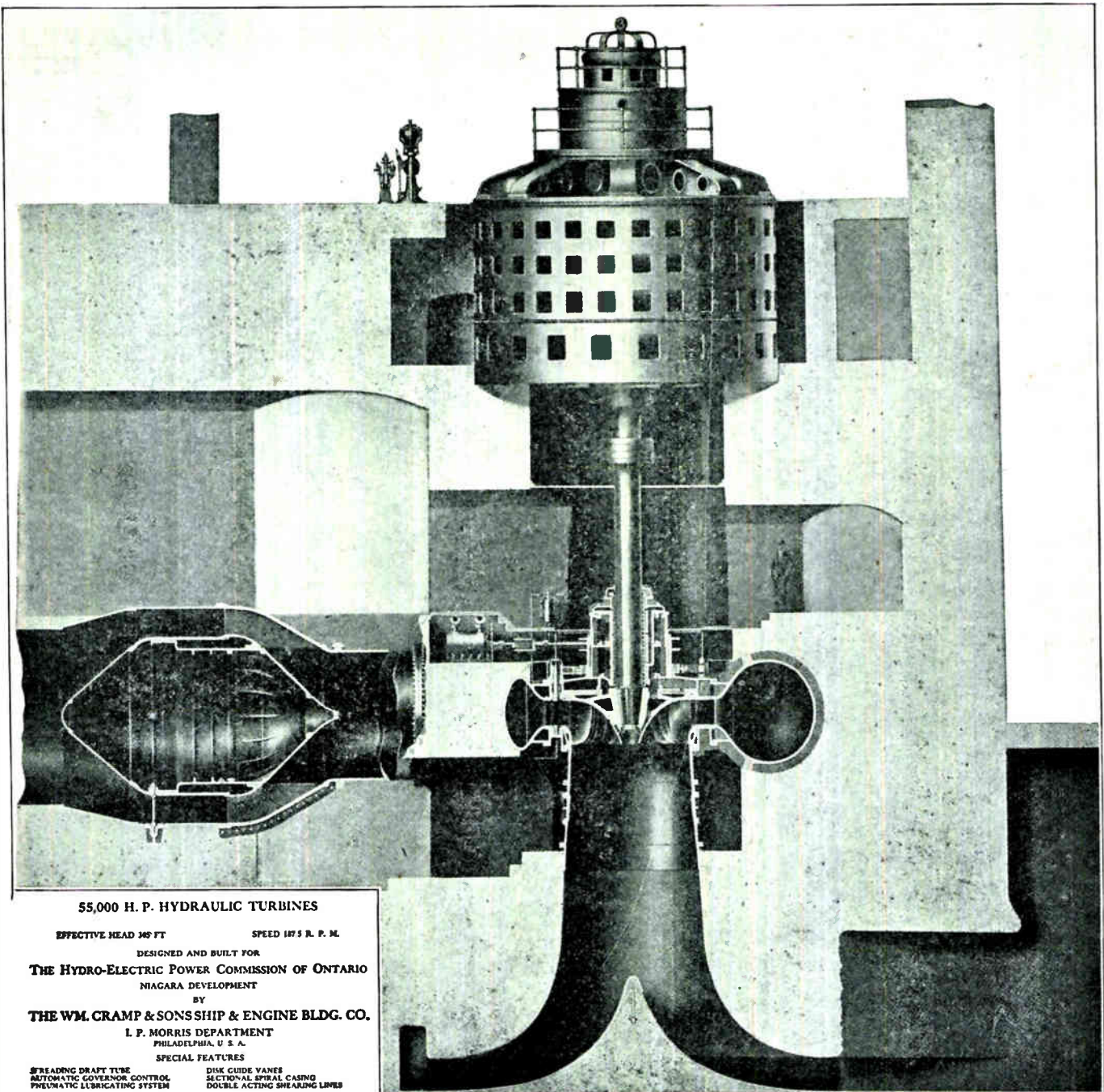

Fig. 317. Interior view of a hydro-electric generating station showing a row of large water-wheel-driven vertical type alternators. The water wheels are located beneath the generator floor and direct-connected to the vertical shafts of the generators. Each unit develops 17,500 horsepower at 100 RPM. Courtesy Allis-Chalmers Mfg. Co.



### 55,000 H. P. HYDRAULIC TURBINES

EFFECTIVE HEAD 365 FT      SPEED 187.5 R. P. M.

DESIGNED AND BUILT FOR

THE HYDRO-ELECTRIC POWER COMMISSION OF ONTARIO  
NIAGARA DEVELOPMENT

BY

THE WM. CRAMP & SONS SHIP & ENGINE BLDG. CO.

L. P. MORRIS DEPARTMENT  
PHILADELPHIA, U. S. A.

SPECIAL FEATURES

SPREADING DRAFT TUBE      DISK GUIDE VANES  
AUTOMATIC GOVERNOR CONTROL      SECTIONAL SPIRAL CASING  
PNEUMATIC LUBRICATING SYSTEM      DOUBLE ACTING SHEARING LINES

Fig. 318. Excellent sectional view of a large hydro-electric generator unit. Note the casing and runner of the water wheel and also the draft tube through which the water discharges to the tail race. The valve controlling the water flow through the wheel or turbine is shown on the left. The main part of the generator is set down in the concrete so that just the top of the unit and its exciter project above the operating floor. Courtesy Wm. Cramp & Sons Co.

boards shown in the background. Plants of this type are coming into quite extensive use for supplying power to small towns or to industrial plants which are located near to a convenient source of water power.

### 323. STARTING AND CONTROL OF PRIME MOVERS

In all power plants, whether they are operated by steam engines, steam turbines, Diesel engines or water wheels, the prime movers are equipped with throttle valves and governors. The throttle valves are used for starting up the prime mover

and generator, and for adjusting the speed when paralleling one machine with another.

The governors are adjusted to maintain the proper speed-regulation with variations of load on the generator and thereby prevent the generator from over-speeding when load is removed, and from slowing down when the load is increased.

The proper operation of governors is therefore very essential in maintaining satisfactory parallel operation and proper voltage regulation to customers.

In some small plants the electrical operator may

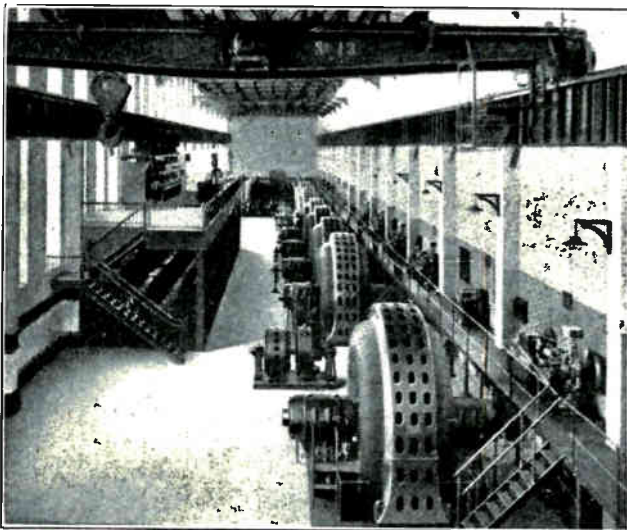

Fig. 319. Interior view of one of the power plants at Niagara Falls showing horizontal type water-wheel-driven alternators manufactured by Allis-Chalmers Mfg. Co. Also note the operating gallery and switchboard on the elevated platform at the left.

be required to start and take care of the prime movers as well as the generators. In large plants the prime movers are generally operated and maintained by a separate crew and the switchboard and electric operation is handled by the electrical crew.

Great care should always be used in starting prime movers and generators to start them gradually and give them the proper time to accelerate, and also in watching for any abnormal operation or indications during starting.

One should carefully check all switches in the generator circuit to see that they are in the proper positions before starting the machine, and the voltmeter and sometimes other instruments should also be carefully watched during starting.

Thorough attention should also be given to the lubrication of the prime mover before starting it, and if pressure lubrication is used the oil pumps should be started before starting the prime mover and generator. Some of the rules and steps to follow when starting generators were given in the

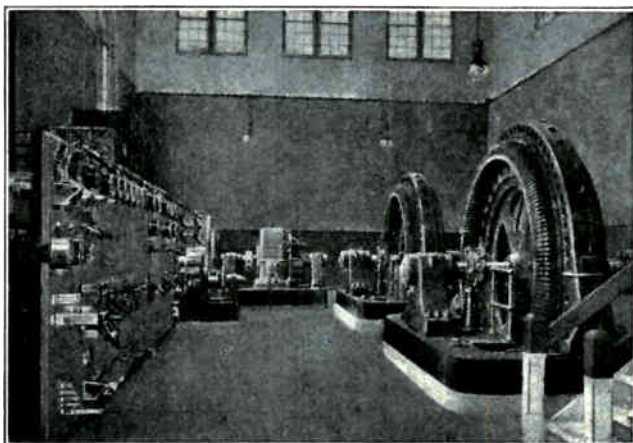

Fig. 320. View showing two small alternators and the switchboard in a hydro-electric station. Courtesy Allis-Chalmers Mfg. Co.

section on A. C. Generators, and others will be given later in the section on Operation and Maintenance.

#### 324. AUXILIARY EQUIPMENT IN POWER PLANTS

In addition to the prime movers, main generators and switchboards in power plants, there is usually also a certain amount of auxiliary equipment such as motor-operated boiler feed pumps, condensate pumps, vacuum pumps, circulating pumps, fans or blowers for cooling generators, and for boiler furnace draft, etc.

Many power plants also have step-up transformers, oil switches, and lightning arresters in an outdoor transformer and switching station, in addition to the bus oil-switches inside the plant.

The care of switchboards, meters, transformers, oil-switches, and auxiliary motor and control equipment in power plants often forms a very important part of the operator's duties.

In addition to the exciter-generators, power plants are often equipped with small D. C. or A. C.

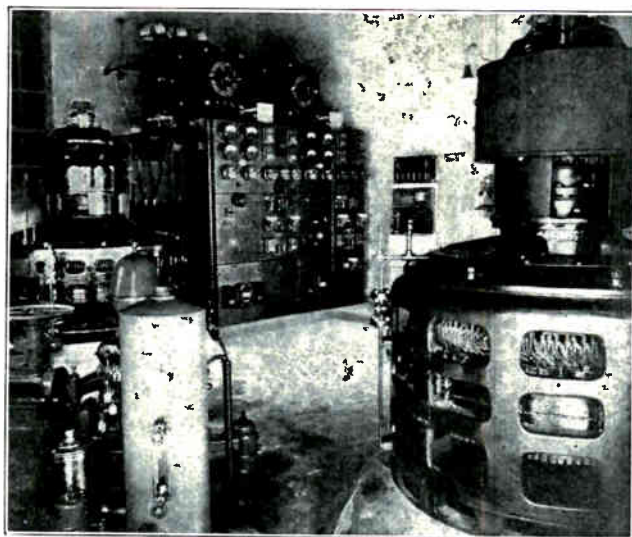

Fig. 321. Interior view of a small automatic hydro-electric generating station. The two generators can be seen in the foreground, and the switchboard in the background of this photo. Courtesy Allis-Chalmers Mfg. Co.

auxiliary generators called house generators, for supplying power to the auxiliary motors and equipment, at lower voltage than that produced by the main generators.

Large power plants are usually operated by remote control switchboards both for convenience and safety reasons. The remote control boards are equipped with the proper meters and instruments, and a number of small push-pull switches, knife switches, rheostats, etc., which operate low-voltage circuits which in turn energize and operate the large high-voltage oil switches, motor-controlled rheostats, throttles, governors, etc.

The low-voltage energy for operating the oil switches and remote-controlled equipment is gen-

erally obtained from operating busses supplied with low-voltage D. C. from a small D. C. generator.

Large storage batteries are also included in many power plants for supplying energy for the operating busses, exciter busses, emergency lighting equipment, etc., in case of trouble with the D. C. generators or plant circuits.

### 325. POWER PLANT RULES

In all large plants there are rigid operating rules and safety rules to be followed in order to protect expensive equipment, to protect operators, and to provide satisfactory and uninterrupted service to customers.

These rules vary somewhat according to the type of plant and the policies of the power company or owners. The majority of the more important rules have been covered in preceding sections of this

Reference Set; and careful application of your knowledge of the operation and care of electrical equipment, and good common sense combined with a desire to learn and co-operate with any special rules which may be maintained by any power company for whom you may be employed, will be of greatest importance to your success in this field.

Power plant operation is one of the most fascinating and interesting branches of electrical work and offers splendid opportunities to the man with thorough practical training who will perform his operating duties thoughtfully, cautiously, and intelligently, and who is willing to study conscientiously all phases of plant operation and companies' policies in order to obtain promotion. By following this policy you can reach positions of excellent pay and considerable responsibility in this field.

## ELECTRICAL POWER TRANSMISSION AND DISTRIBUTION

Electrical power transmission and distribution provide a very great field of opportunity for trained electrical men in one of the most interesting and profitable branches of work in the electrical field.

We have already learned that one of the principal advantages of A. C. electricity is that it can be transformed to very high voltage for more economical transmission over long distances.

Many thousands of miles of high-voltage transmission lines span this country today, and silently and efficiently carry thousands of horse power of electrical energy from large steam and water-power generating plants to the various towns and industrial plants where it is used.

Many recently installed lines are supplying low cost electrical energy to small towns and communities which formerly were entirely without electricity or which had only a limited supply at almost prohibitive cost to the users.

Fig. 322 shows a high-voltage transmission line running across the country on steel towers. One three-phase circuit is already in operation on this line and space for another circuit is provided on the opposite side of the same towers.

The construction of electrical transmission lines has progressed even beyond the towns and larger load centers to a point where hundreds of thousands of farms are now connected to electrical lines and supplied with the great conveniences and economical benefits of electricity.

Economical transmission of electrical power has played a very large part in the industrial progress and general prosperity of this country and Canada, as well as many others of the more progressive countries in the world today.

It is difficult to find in this country a town of any

size that is not supplied with electricity or even to find a rural district of very large area in which some of the farms are not already supplied with electricity.

Electrification is rapidly progressing throughout all parts of the country and the trained man who has a good knowledge of power transmission and distribution can find numerous opportunities for

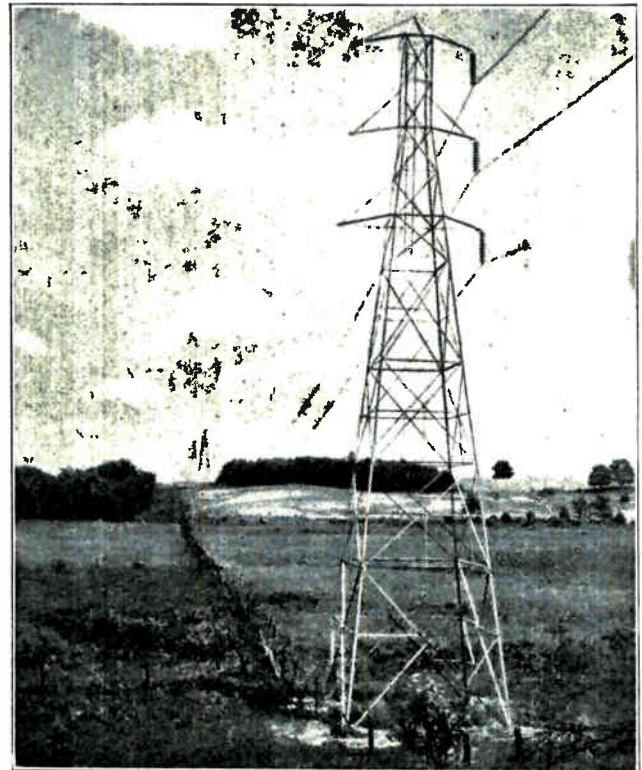

Fig. 322. Modern high-voltage transmission line carrying thousands of horsepower silently and efficiently across the country on small copper conductors

interesting and profitable work with power companies who are constantly building new lines and extending their present ones. There is also a tremendous field of opportunity for trained men to go into various rural districts and promote farm electrification.

### 326. TRANSMISSION VOLTAGES AND SYSTEM LAYOUT

The electrical power generated in central stations is generally transmitted at high voltages to substations, from which it is distributed at lower voltage to the customers.

Large towns may have a number of substations located in various sections of the city, and small towns and large factories may each have their individual substations.

Fig. 303 showed a sketch of a number of substations in one town and fed by a central generating station, and Fig. 322-A shows a sketch of a power plant located at a river and feeding power over three transmission lines and a branch, to substations in a number of small towns.

Large power plants generate most of their power at voltages ranging from 2300 to 13,200 volts, or more. These voltages are high enough for economical transmission and distribution over distances from 3 to 15 miles and can be reduced to the voltage used for light and power by means of transformers at the substations or customer's premises.

Where power is to be transmitted greater distances the voltage is stepped up by transformers at the power plant to values ranging from 22,000 to 290,000 volts, according to the distances the power is to be transmitted.

Practically all large transmission lines in this

country are 3-phase and most of them are 60 cycle, although some still operate on 25 cycle energy.

A number of large central stations as well as many of the smaller power plants are commonly tied together into one vast super-power system or network, greatly improving the operating efficiency of many of the plants and also improving the dependability of service to the customers.

Connecting a number of plants together in this manner makes it unnecessary to carry so much reserve equipment at each plant for peak loads and enables all of them to operate at nearer full-load capacity. The peak loads on various plants often come at different periods of the day and are distributed over all the stations connected in such a network.

These interconnections also provide a much greater total generating capacity on the system and decrease the liability of service interruption in case of failure of any one generator or plant.

Fig. 323 shows an excellent view of another high-voltage transmission line running through a mountainous region in one of the southern states.

### 327. UNDERGROUND TRANSMISSION

There are two general methods of electrical power transmission, namely the underground and overhead systems. The overhead system costs a great deal less per mile and is therefore generally used for lines extending through the country.

Underground systems are used principally in large cities where it would be very undesirable to have a network of high-voltage wires overhead. One can readily see that running high-voltage power lines on poles, along with all the wires used for lighting, telephone, and telegraph service in large cities would not only create a bad appearance but

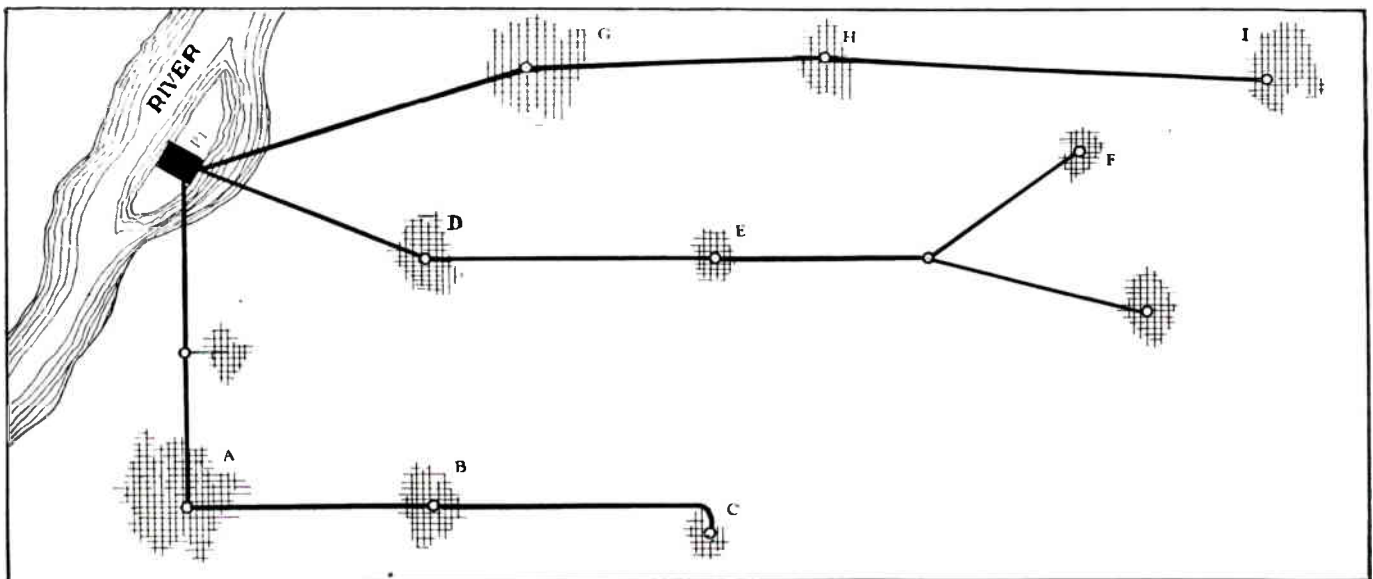

Fig. 322-A. This diagram shows the location of a central station power plant and the layout of a transmission system. The power plant is located at the river where fuel and condensing water are easily available and the transmission lines feed the generated energy to substations located in the various towns.

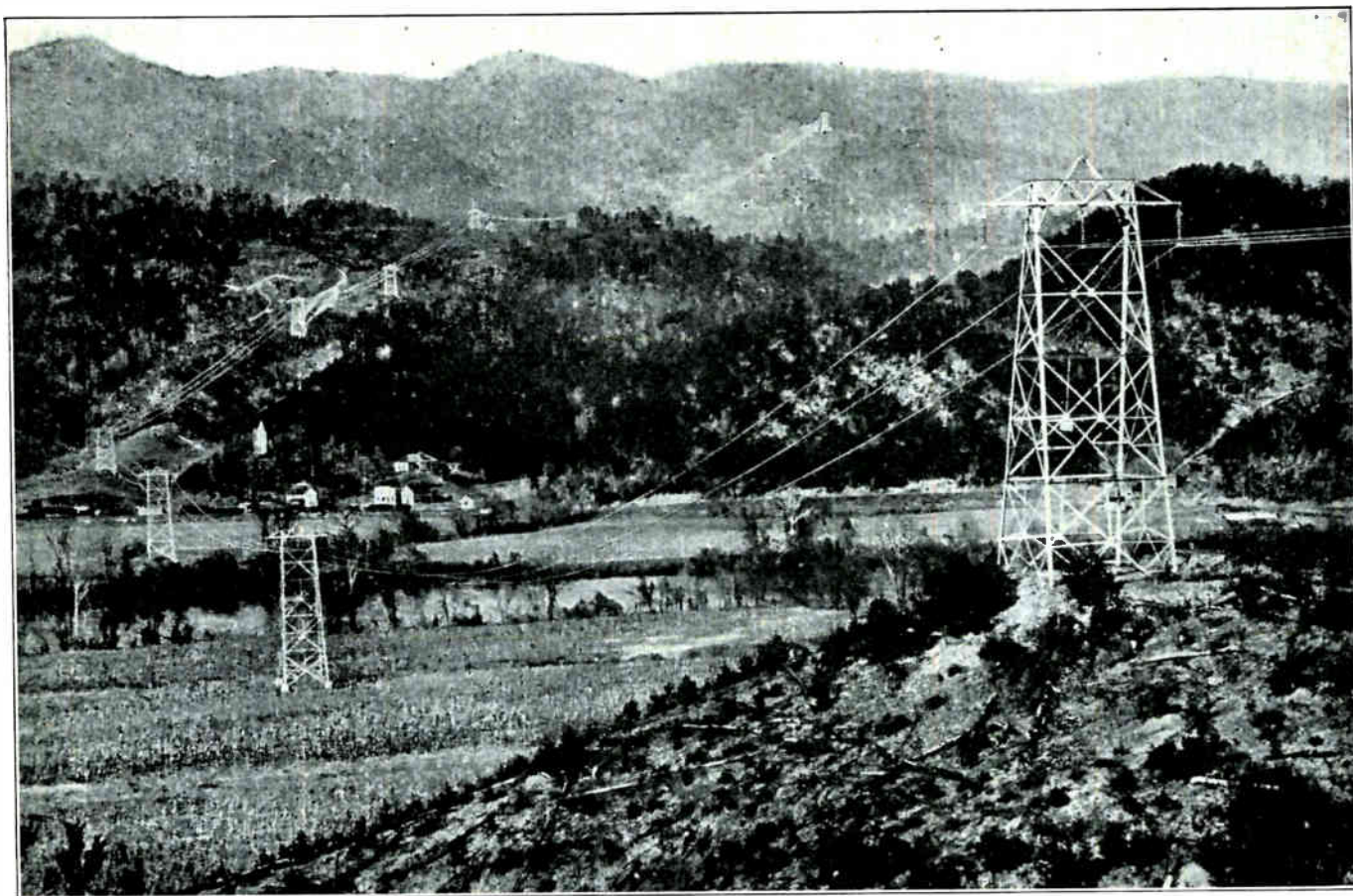

Fig. 323. This photo shows a modern high-tension line supported on sturdy steel towers through a mountainous section of country. Note the arrangement of conductors, insulators, and cross arms on the towers.

would also cause inconvenient obstruction and actually be dangerous.

For this reason in practically all large cities electrical power wires are run through underground conduits or tunnels. Underground conductors are generally run through ducts or conduits which are laid several feet below the street level and have outlets provided at small underground rooms or compartments located at intervals of several hundred feet apart.

Access can be had to these underground compartments by means of manholes provided in the streets and equipped with heavy, iron covers. Lengths of cable can be spliced together and branch runs attached in these manhole compartments, and in some cases small transformers or other equipment may also be located in them.

Underground ducts are commonly made of vitrified clay or tile, which is obtained in standard lengths and laid in a ditch or trench. The ends of the short lengths are cemented together to prevent dirt or water from entering at the joints and the tile is then covered over with dirt and pavement.

In some cases ducts made of concrete and special fibre are also used for underground work.

Ducts for underground wiring are laid with a small amount of slope toward the manholes, so

that if any water leaks into the ducts it will drain to one end where it can be run off into a sewer or pumped out so that it doesn't ground the electrical conductors.

These ducts are provided with 2, 4, 6, 8, or more, separate openings or compartments, as shown in Fig. 324-A. On large important circuits just one cable is often run in each duct or compartment, while with smaller circuits at lower voltage the several conductors of the complete circuit may be run in one compartment.

### 328. PULLING IN UNDERGROUND CABLES

To get the wires and cables into an underground duct a fish tape or pilot line is first passed through the duct and then used to draw in the cables by pulling them in a section at a time from one manhole to the next.

In some cases the fish tape is pushed through the duct from one manhole to the next by use of joined sections of wooden rods which can be attached together one section at a time in the manhole compartments as the rod is pushed through the duct.

It is then taken apart and removed one section at a time from the next manhole opening, except in cases where it may be desired and possible to push it on through for several more runs.

In other cases a small cord is blown through the

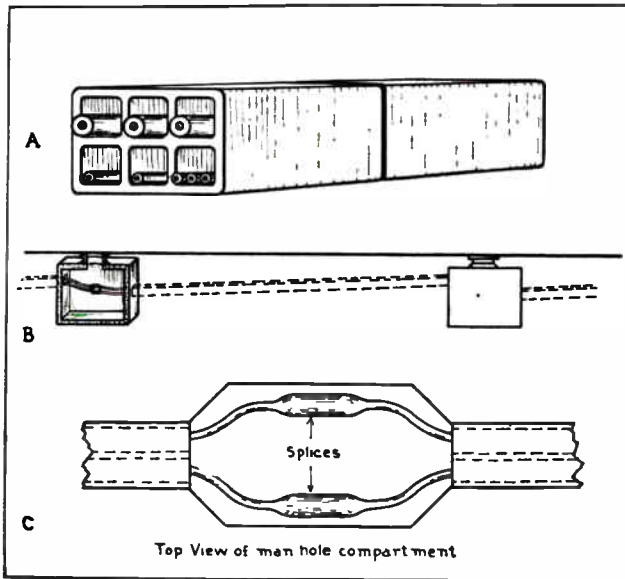

Fig. 324. "A" shows underground conductors run in tile ducts. "B". This sketch shows the arrangement of man holes and cable ducts underground. "C". Cables spread apart and supported in racks on the walls of man holes allow working room for making splices, tests, etc.

duct by compressed air and then used to pull in a heavier rope, which in turn is used to draw in the cables. The cable is usually supplied in large reels which are placed close to the manhole opening at which the end of the cable is to be started into the duct.

Proper guides or protection should be provided to prevent excessive friction and damage to the cable sheath or insulation where it rubs on the corners of the manhole.

Pulling in large underground conductors requires considerable power, and a hand or motor-operated winch is generally used for this purpose. Liberal application of powdered soapstone or mica will tend to lubricate and greatly aid the passage of the conductors through the conduit. When the sections of conductor have been pulled into the ducts their ends can then be spliced at the manhole compartments.

### 329. TYPES OF UNDERGROUND CABLES

There are many different kinds of cable in use for underground work. Some of them have heavy insulation with a moisture-proof covering, and most of them also have a lead sheath over the surface of the insulation. Lead sheath cables are much more moisture-proof and less subject to mechanical injury to the insulation.

The thickness of the lead sheath ranges from about  $1/32$  of an inch on small conductors to well over  $1/8$  of an inch on larger cables. Some underground cables have only one conductor, while others have two or three conductors separately insulated but enclosed within the one lead sheath.

A section of each of these types of lead-covered cable is shown in Fig. 325.

Various types of insulation are used on under-

ground cables, some of the most common being rubber, varnished cambric or empire cloth, oiled paper, and various insulating compounds.

Cables with a solid group of stranded conductors twisted into one and insulated with these materials, can be designed for voltages as high as 66,000 by applying the proper thickness of insulation between the conductor and lead sheath.

For quite a number of years it was thought that 66,000 volts was the highest practical voltage for underground cables, but within recent years the General Electric Company of this country and the Parelli Company of Italy have each developed a special type of cable which is capable of withstanding pressures of 132,000 volts. Sections of this cable several miles long are in operation at 132,000 volts both in Chicago and in New York, and other installations are being planned.

In these cables the insulation consists of  $23/32$  of an inch of special paper between the conductor and the lead sheath. The copper conductor is of the stranded type, which is twisted or built up around an inner brass spiral which serves to provide a hollow opening throughout the conductor from one end to the other.

This opening allows the free circulation of insulating oil throughout the cable at all times, and this is one of the important factors in its successful operation at this very high voltage.

When this cable is installed in the ducts the ends are joined in special oil tanks located every few hundred feet apart. The air is then exhausted from the cable by vacuum pumps and insulating oil allowed to enter to fill all spaces not occupied by the conductor and insulation.

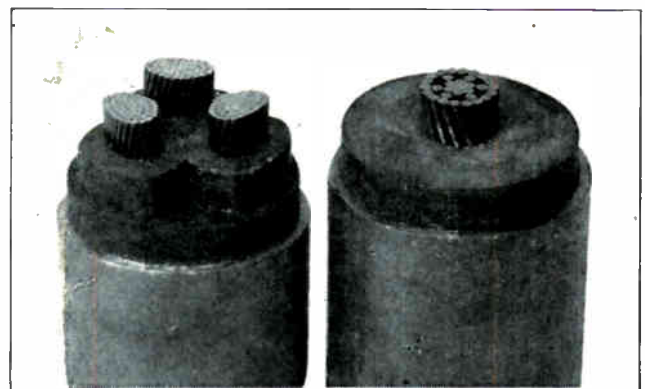

Fig. 325. These views show sections of high-voltage three conductor and single conductor, underground transmission cables. Note the arrangement of conductors and insulation inside of the lead sheath. Courtesy General Electric Co.

All cables are subject to a certain amount of expansion and contraction due to changes of temperature and load during operation. This expansion and contraction produces one of the most serious difficulties encountered in the operation of high-voltage cables.

In ordinary cables the expansion causes the forc-

ing out of insulating compound and possible bulges in the cable sheath and insulation. Then when the cable cools and contracts air pockets are formed at these points. These air pockets provide weak spots at which the insulation is much more likely to puncture or break down.

In the new high-voltage cable just described this condition is prevented by allowing the free circulation of oil throughout the cable's length. When the cable expands the oil is forced out of the cable and into the reservoirs. When the cable cools and contracts the oil is again drawn in. This prevents the formation of air pockets and also prevents the breathing in of any moisture as would occur if air were allowed to enter the cable.

### 330. CABLE HANDLING AND SPLICING

When installing any lead-covered cable great care should be exercised not to allow the sheath to become damaged in any way. The cables should not be bent in sharp curves or angles at any time during their handling, as this greatly weakens the dielectric strength of the insulation and is also likely to crack the lead sheath.

In making splices in underground cables the joint in the conductor must be carefully and thoroughly insulated with special tapes of rubber, paper, or varnished cloth, which is carefully and tightly lapped back over the insulation on the cable ends to provide insulation over the joint as good as that along the cable.

A large lead sheath which has been slipped over one end of the cable before making the splice is then drawn into place over the insulated joint and securely soldered to the lead sheath on the cable ends. The joint can then be boiled out by pouring hot compound through it, and finally filled with hot insulating compound and sealed to exclude all moisture.

Figs. 31 and 32 in Section One on Electrical Construction and Wiring showed several very good views of cable splices in the process of being made.

### 331. OVERHEAD TRANSMISSION LINES AND COMMON VOLTAGES

Overhead transmission lines as previously mentioned are much more extensively used for transmitting power over long distances across the country, because of their cost being much lower than underground construction. There are a number of different voltages in use on high-tension transmission lines today, but there is a general tendency at present to standardize on the more common and convenient of these voltages.

Newer installations of both transmission and distribution lines will generally be found to have one of these more or less standard or preferred voltages. This greatly reduces the variety and number of different voltage designs of transformers and electrical equipment used with the lines, and greatly

Common voltages	Industrial Plant motor voltages	Generating voltages	Transmission voltages	Preferred voltages
110	*			*
220	*			*
440	*			*
550	*			
2200 or 2300	*	*	*	*
4000			*	*
4400		*		
6600		*		
11000		*	*	
12000		*		
13200		*	*	*
22000		*	*	
33000		Developing	*	*
44000			*	
66000			*	*
88000			*	
110000			*	
132000			*	*
140000			*	
165000			*	
220000			*	*
330000			Future	

Fig. 30c. The above table shows the more common voltages in present day use for lighting and power purposes and for electric power distribution and transmission.

increases the convenience and economy of inter-connection between different lines.

Standardization of generators, transformers, lightning arresters, insulators, and line equipment means that more devices of one kind can be produced and thereby reduce their cost.

The table in Fig. 326 shows a number of the different voltages which are in common use, except the last one of 330,000 volts which is planned for future transmission line developments. The small stars in the columns following these voltages indicate the uses to which they are most commonly put, and those in the last column under "preferred voltages" indicate the voltages which are more generally used and are becoming standard.

Whenever you may be placed in a position to select new equipment or plan a transmission line installation, it will be well for you to select the equipment for one of these preferred voltages, unless existing equipment and conditions make it impractical. You should at least give one of these voltages considerable thought before selecting any other.

The method of calculating the proper voltage to use for a given transmission line will be covered in later articles in this section.

Overhead transmission lines consist primarily of the proper conductors to carry the current; insulators to support the conductors and give them the required insulation according to the voltage used; line supports, such as poles or steel towers; and the proper protection from lightning, overload, and short circuits.

Each of these important items will be considered separately.

### 332. CONDUCTORS

There are now in use for transmission lines several different types of conductors, the most com-



mon of which are copper, aluminum, and copper-clad steel. Each of these has its advantages for different applications.

Copper conductors are used on the great majority of lines because copper is an excellent conductor, is reasonably cheap, and is available in large quantities.

We know that silver is a slightly better conductor of electricity, but because of its very high cost it would be prohibitive for use as a transmission line conductor.

Copper is the next best conductor and it is therefore generally used, even though its cost is high enough to make it one of the major items of cost in the construction of a line.

333. HARD DRAWN COPPER CONDUCTORS

There are two forms of copper wire, namely hard drawn copper and annealed or soft copper. Hard drawn copper has approximately twice the tensile strength of annealed copper, and for this reason is most generally used on transmission lines, where considerable strength is required to support the long spans between poles and towers.

Hard drawn copper has a tensile strength of about 55,000 lbs. per square inch of conductor cross-sectional area.

Annealed copper has a conductivity within two or three per cent. of that of silver, while hard drawn copper has a conductivity just slightly less than annealed copper.

For lines of small capacity solid hard drawn copper conductors are commonly used, but on lines requiring wires larger than No. 2 or No. 4 B. & S. gauge, stranded copper conductors are generally used. The stranded conductors are more flexible and provide better heat radiation.

In handling and installing hard drawn copper wire great care must be exercised not to make any deep scratches or nicks in the wire, or it is likely to break off at these points.

Joints or splices in hard drawn solid copper are frequently made by means of a splicing sleeve or short piece of twin copper tubing, known as a Mc-Intyre sleeve. The conductor ends are placed in this short section of tubing from opposite ends and both the conductors and the tubes are then twisted around each other, resulting in a joint which is secure both mechanically and electrically.

These joints do not require soldering and thereby avoid the heat of the soldering operation, which would tend to soften the hard drawn copper and reduce its strength.

One of the advantages of copper conductors over aluminum is that they can be readily soldered when necessary and this is often a great advantage in localities where the conductors are subjected to corrosive gases or salt mist.

Special splicing devices in the form of short pieces of heavy copper tubing are often used, and are grip-

PROPERTIES OF BARE AND INSULATED STRANDED COPPER WIRE

Table with columns: American Wire Gauge (B & S), Area, Number of Wires in Strand, Diameter in Inches (Bare, 3-Strand, 4-Strand), Weight in Pounds per 1000 Feet (Bare, 3-Strand, 4-Strand), Resistance Ohms per 1000 Feet at 75°C (Bare, 3-Strand, 4-Strand), Area in Square Inches, and American Wire Gauge (B & S).

For weight or resistance per mile multiply values per 1000 feet by 5.28.  
Weight and resistance of actual strand may vary from calculated quantities in table.  
Due to twist in strand weight and resistance increase about 2% over solid wire.

Fig. 327. This table gives a lot of valuable data on stranded copper wire for transmission line conductors and will be very convenient for reference in making calculations for any transmission line.

ped securely to the ends of the conductors by means of special threaded wedge grips or by squeezing under hydraulic pressure.

The table in Fig. 327 gives some very convenient data on large stranded copper conductors, and Fig. 327-A gives additional comparative data on solid and stranded conductors. These tables will be very convenient for reference on transmission line construction problems.

334. ALUMINUM CONDUCTORS

Aluminum conductors are also quite extensively used for overhead transmission lines. Aluminum has less than 1/2 the tensile strength of copper and for this reason aluminum line conductors are generally made with a steel core or wire in their center to provide the added strength necessary for supporting the long spans. Such conductors are usually referred to as A.C.S.R., meaning "aluminum cable—steel reinforced".

Very few all aluminum conductors are used, because of their low tensile strength and due to the fact that a very small amount of swaying will cause the cable to break at points where it is fastened to insulators.

An aluminum conductor of a given size weighs only about 1/3 as much as a copper conductor of the

CONDUCTOR DATA—COPPER (H. D.)

Table with columns: A. W. Gauge, Area Cir. Mills, OUTSIDE DIAM.—INCHES (Solid Bare, Cable Bare, Cable T.B.W.), STRENGTH—LBS. (Solid Bare, Cable Bare).

Fig. 327-A. This table gives convenient data on hard drawn copper conductors of both the solid and stranded types and also on insulated cables.

same size, and the aluminum conductor has about 62% of the conductivity of the copper conductor.

Considering both of these factors, we find that of two lines of equal current capacity, one being made of copper and one of aluminum, the aluminum conductor will have a weight of only 48% of that of the copper conductor.

For this reason steel-core aluminum conductors are frequently used for long spans where transmission lines are required to cross rivers, lakes, or valleys in which it is difficult to place towers.

Aluminum also has the added advantage that sleet ice will not cling to its surface as it does to a copper conductor. This greatly reduces the weight on aluminum conductors and the strain on insulators and towers during sleet storms.

One of the disadvantages of aluminum conductor is that it is very difficult to solder. For this reason most of the splices or joints in these conductors are made with special clamps or mechanical grip devices.

One method of splicing these conductors is to place their ends in an aluminum sleeve, which is then subjected to a pressure of about 100 tons by means of a hydraulic jack. This great pressure causes the aluminum of the conductor and that of the splicing sleeve to actually flow together, thereby making a solid joint.

The table in Fig. 328 gives a comparison of a number of the important characteristics of copper, aluminum, and steel conductors.

Characteristics	Annealed Copper	Hard Drawn Copper	Aluminum	Steel
Conductivity in per cent	100	98	62	12.2
Tensile Strength in lbs per sq. in.	34000	55000	26000	65000
Expansion Coefficient per deg. F.	.0000096	.0000096	.0000128	.0000064
Weight in lbs. per cu. ft.	555	558	167	490
Weight in lbs. per cu. in.	.321	.323	.0967	.284

Fig. 328. Comparative data on conductivity, strength, weight, and expansion of copper and aluminum conductors.

weather-proof insulation, while the conductors of high-voltage transmission lines outside of the city limits are practically always bare.

Whether these conductors are insulated or not, they must be supported on special insulators to keep them permanently and well insulated from the poles or towers on which they are mounted.

The size and shape of these insulators depends upon the voltage used and they must always be large enough to prevent a flashover of the high-voltage energy from the conductor to wet poles or steel towers which are grounded.

Transmission line insulators are commonly made of porcelain or glass which is molded into the proper shapes and sizes.

Pyrex glass has become quite commonly used in the last few years, particularly for insulators of the smaller sizes. This glass possesses the advantage of being transparent so that any small defects can easily be noted, but it has the disadvantage of being easily broken or shattered if bumped against any hard object.

Porcelain is somewhat more rugged and a light bump will usually only chip the insulator instead of shattering it as is more likely to occur with the glass.

For these reasons porcelain is by far the more commonly used for line insulators. Porcelain is made chiefly from non-metallic rock known as feldspar, and silica. Sometimes these materials after being finely ground are mixed with other forms of clay and the entire mass is then molded into the proper shapes and baked or fired in a kiln.

After this first baking or firing the insulators are given a coat of glazing material which is evenly distributed over their surfaces. They are then replaced in the kilns and again heated to a temperature which melts the glazing material, causing it to flow evenly over the surface and unite with the porcelain.

This glazing material forms a hard, glassy surface on the outside of the insulators and prevents moisture, dust, and dirt from entering the pores of the porcelain. The glazing greatly improves the dielectric strength of the insulator and increases its life under outdoor weather conditions.

CONDUCTOR DATA—A. C. S. R. BARE

(Aluminum Cable, Steel Reinforced)

A.C.S.R. Area in C.M. or A.W.G.	Copper Equivalent C.M. or A.W.G.	Diam. Ins.	USUAL STRANDS			Elas. Limit Lbs.	Ult. Strength Lbs.
			Al	St.	Diam.		
1590000	1000000	1 544	51	7	1716	38500	55900
1510500	950000	1 506	54	7	1673	36500	53200
1431000	900000	1 465	54	7	1628	34700	50300
1351500	850000	1 424	54	7	1582	32700	47400
1272000	800000	1 382	54	7	1535	30800	44600
1192500	750000	1 337	54	7	1486	28900	41900
1113000	700000	1 292	54	7	1436	26900	39000
1033500	650000	1 246	54	7	1384	25000	36300
954000	600000	1 196	54	7	1329	23100	33500
874500	560000	1 162	54	7	1291	21800	31600
795000	500000	1 093	54	7	1214	19250	27500
715500	450000	1 036	54	7	1151	17360	25200
636000	400000	977	54	7	1085	15400	22300
606500	380500	953	54	7	1059	14675	21270
500000	314500	904	30	7	1291	17400	24680
477000	300000	883	30	7	1261	16600	22600
397500	250000	806	30	7	1151	13800	19170
336400	0900	741	30	7	1059	11715	16200
266800	000	633	6	7	2108	6470	9385
					0705		
211600	00	564	6	1	1880	5940	8435
167805	0	501	6	1	1670	4690	6650
133079	1	447	6	1	1490	3780	5300
105534	2	398	6	1	1327	2960	4200
83694	3	355	6	1	1182	2355	3340
66373	4	316	6	1	1052	1860	2660
52634	5	281	6	1	0938	1480	2100
41742	6	250	6	1	0834	1170	1665

Fig. 327-B. Convenient data on sizes, number of strands, and strength of steel cored aluminum cable. Refer to these tables frequently when working the transmission line problems on the following pages, and also for data to simplify your problems in the field.

Fig. 329 shows another table which gives dimensions, resistance, weight, and other characteristics of aluminum conductors of different sizes. Observe these tables carefully and note the data given, and then remember where to refer to this information on any future line problems which you may have.

335. INSULATORS

The conductors of low-voltage overhead distribution lines within city limits are often covered with

## ALUMINUM CABLE STEEL REINFORCED (A.C.S.R.)

A.C.S.R.		COPPER EQUIVALENT		USUAL STRANDING (INCHES)		ELASTIC LIMIT, LBS.	ULTIMATE STR. TH. LBS.	OHMS PER 1000 FEET (61%)	DIAM. INS.	WEIGHT—POUNDS						
										PER 1000 FEET			PER MILE			
B. & S. GAGE NO. (A.W.G.)	ALUMINUM AREA		C. M. OR NO.	SQUARE INCHES	ALUMINUM	STEEL				TOTAL	AL.	STEEL	TOTAL	AL.	STEEL	
	CIRC'LAR MILS.	SQUARE INCHES														
.....	900000	.7060	566000	.4442	54 x.1291	7 x.1291	21800	31600	.0193	1.162	1158.0	844.0	314.0	6120	4462	1658
.....	795000	.6244	500000	.3927	54 x.1214	7 x.1214	19250	27950	.0217	1.093	1024.0	747.0	277.0	5407	3944	1463
.....	715500	.5620	450000	.3532	54 x.1151	7 x.1151	17360	25200	.0241	1.036	920.0	671.0	249.0	4857	3542	1315
.....	605000	.4750	380500	.2987	54 x.1059	7 x.1059	14675	21270	.0286	.953	779.0	568.0	211.0	4113	2999	1114
.....	500000	.3927	314500	.2468	30 x.1291	7 x.1291	17400	24080	.0347	.904	783.0	469.0	314.0	4135	2477	1658
.....	397500	.3122	250000	.1962	30 x.1151	7 x.1151	13250	19170	.0435	.806	622.0	373.0	249.0	3284	1969	1315
.....	336400	.2642	No. 4/0	.1662	30 x.1059	7 x.1059	11715	16200	.0515	.741	527.0	316.0	211.0	2783	1669	1114
.....	266800	.2094	No. 3/0	.1318	6 x.2108	7 x.0705	6470	9385	.0648	.633	343.0	250.0	93.0	1811	1319	492
No. 4/0	211600	.1662	No. 2/0	.1045	6 x.1880	1 x.1880	5940	8435	.0816	.564	295.0	199.0	96.0	1556	1052	504
No. 3/0	167805	.1318	No. 1/0	.0829	6 x.1670	1 x.1670	4690	6660	.1026	.501	232.5	157.0	75.5	1227	830	397
No. 2/0	133079	.1045	No. 1	.0657	6 x.1490	1 x.1490	3730	5300	.1294	.447	185.0	125.0	60.0	977	660	317
No. 1/0	105534	.0829	No. 2	.0521	6 x.1327	1 x.1327	2960	4200	.1639	.398	147.0	99.5	47.5	776	525	251
No. 1	83694	.0657	No. 3	.0413	6 x.1182	1 x.1182	2355	3340	.2070	.355	117.0	79.0	38.0	617	417	200
No. 2	66373	.0521	No. 4	.0328	6 x.1052	1 x.1052	1860	2660	.2610	.316	92.4	62.5	29.9	488	330	158
No. 3	52634	.0413	No. 5	.0260	6 x.0938	1 x.0938	1480	2100	.3291	.281	73.4	49.7	23.7	387	262	125
No. 4	41742	.0328	No. 6	.0206	6 x.0834	1 x.0834	1170	1665	.4150	.250	58.0	39.3	18.7	306	207	99
No. 5	33102	.0260	No. 7	.0163	6 x.0743	1 x.0743	930	1315	.5217	.223	46.0	31.0	15.0	243	164	79
No. 6	26250	.0206	No. 8	.0130	6 x.0661	1 x.0661	735	1045	.6577	.198	36.4	24.6	11.8	192	130	62
No. 7	20816	.0163	No. 9	.0103	6 x.0586	1 x.0586	575	820	.8293	.176	28.5	19.3	9.2	151	102	49
No. 8	16509	.0130	No. 10	.0082	6 x.0525	1 x.0525	465	660	1.0450	.158	23.0	15.6	7.4	121	82	39

Fig. 329. This table also gives very valuable and convenient data on size, number of strands, strength, resistance, and weight of steel cored aluminum cable. You will also note in the third and fourth columns the comparative sizes of copper conductor which would have the same carrying capacity in amperes of any of the aluminum conductors.

Great care should be used in handling porcelain insulators not to crack or chip the protective glazing on the surface.

Line insulators are made in several different forms, the most common of which are the Pin type, Suspension type, Strain type, Pedestal type, and Bushing type.

### 336. PIN TYPE INSULATORS

Fig. 330 shows two common types of pin insulators designed for different voltages which are marked above them in the figure. This figure shows part of each insulator cut away to provide a sectional view which clearly shows the shape and construction of each unit.

You will note that the 13,000-volt insulator on the left has several ribs and grooves on its under side, to provide surfaces which will be free from dirt and water even during storms and thereby increase the creepage distance from the line conductor to the pin.

The high-voltage insulator on the right is built up of three separate sections securely cemented together. This cement has very high mechanical strength and forms a secure bond between the surfaces of the insulator sections.

You will note that the center section is larger than the bottom one and the top one still larger than either of the others, thus creating an overhanging or umbrella effect which provides the clean, dry undersurface in the grooves which are protected from dirt and moisture.

These outer flanges on insulators of this type are commonly called "skirts" and make it much more difficult for the line voltage to flash over the surface of the insulator.

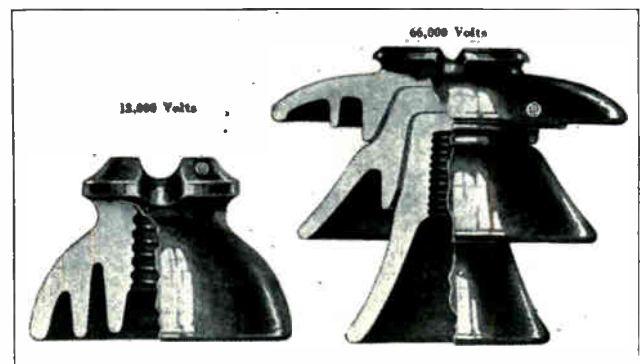

Fig. 330. The above photo clearly shows the shape and construction of both small and large pin type insulators of the type used on high-voltage lines. Courtesy of Ohio Brass Co.

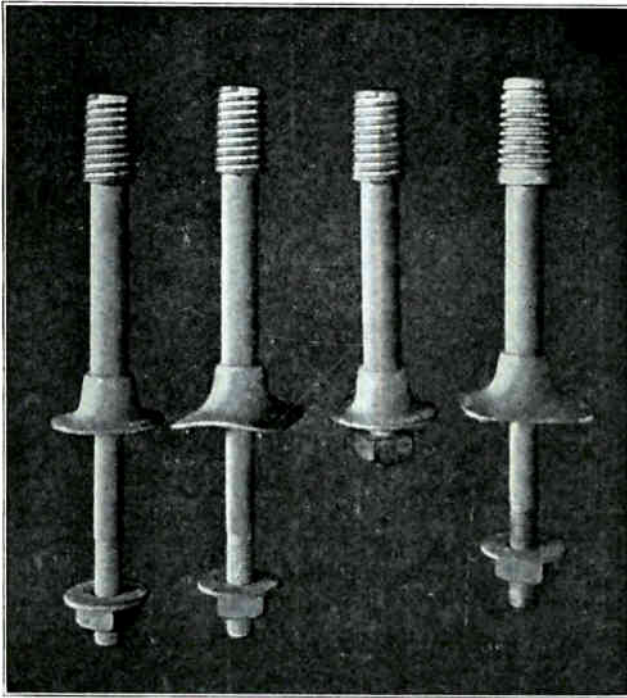

Fig. 331. Several styles of insulator pins used for attaching pin type insulators to wood and steel cross arms. Courtesy of Ohio Brass Company.

Pin insulators of this type are provided with grooves on the top or cap section, in which the line conductor is laid and then tied in place with a tie wire which is wrapped around the groove in the sides of the knob on the insulator cap.

Pin type insulators are provided with threaded holes on their under sides or in their lower sections that enable them to be screwed onto wood or iron pins by which they are attached to the cross arms on the poles or towers.

Fig. 331 shows several different styles of metal insulator pins. The one on the left has a flat base for use on wood cross arms with flat tops. The next pin to the right has a curved base for use on wood cross arms with curved or "roofed" tops. The pin with the short bolt is for use on metal cross arms. These three pins all have lead tips to enable them to screw snugly into the porcelain insulators

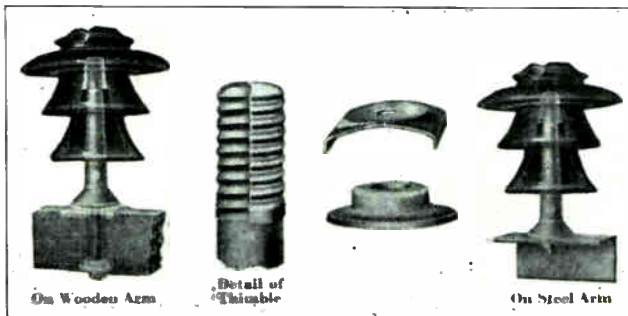

Fig. 332. Above are shown the methods of mounting insulators on pins and attaching the pins to wood and metal cross arms, and also the soft lead thimble which enables the insulator to be securely tightened on the pin without damaging the threads in the porcelain. Courtesy of Ohio Brass Company.

without splitting them. The last pin on the right has a separable lead thimble.

Fig. 332 shows the method of mounting pin type insulators on wood or metal cross arms, and also shows several of the pin fittings.

Pin type insulators are extensively used on lines with voltages up to 50,000, and occasionally on lines of 80,000 volts or more.

Fig. 333 shows a three-phase, 33,000-volt transmission line on pin type insulators and wood poles.

### 337. FASTENING CONDUCTORS TO PIN TYPE INSULATORS

Line conductors are generally laid in the grooves on the caps of pin type insulators as long as the direction of the line carries them straight across the top of the insulators. When lines make a turn or bend at certain poles, the conductors are generally drawn into the groove on the side of the cap,

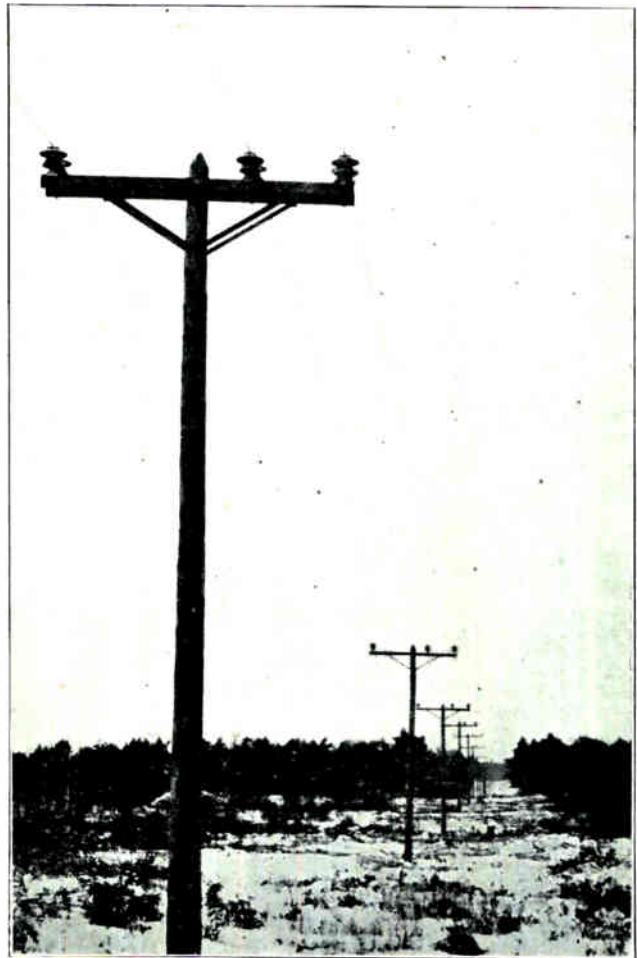

Fig. 333. Photo of a very neat pole type transmission line carrying the conductors of a three-phase line on pin type insulators.

and on the outer side of the line curve. Both of these methods are clearly shown in Fig. 334; top ties being shown in views 4, 5, 6, 7 and 9, and side ties in views 1, 2, 3, and 8.

On poles where the line curves, two insulators per conductor are often used as shown in views 2.

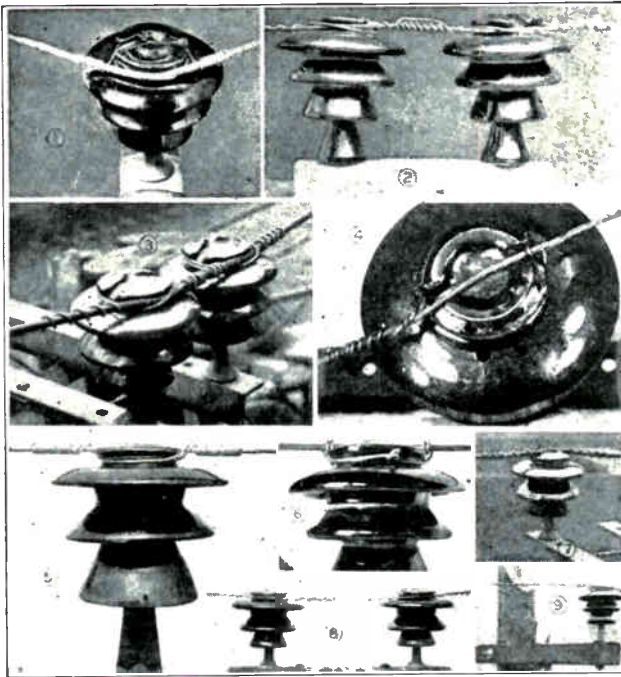

Fig. 334. Above are shown a number of common types of line ties used for attaching conductors of transmission and distribution lines to pin type insulators. Examine each type very carefully as you read the accompanying descriptions and also compare them with the sketches in Fig. 335. Courtesy Lapp Insulator Company, Inc.

3, and 8 in Fig. 334. This is done because of the increased side strain placed on the insulators and pins at such points.

Line conductors are attached to pin type insulators by means of tie wires of soft drawn copper or aluminum. The tie wires should be of the same material as the conductor, and are usually a little smaller than the line conductors. Insulated tie wires are generally used for fastening insulated conductors.

Fig. 335 shows a number of types of ties in common use, and also the names of each. These sketches show top views of the line conductor and tie wires, the loops being shown in the same position as they would actually be in the groove around the side of the insulator cap. Careful observation of each of these ties will clearly show the manner in which they are made.

The "cross top" and Western Union ties shown in this figure are very good ones and very commonly used. The looped Western Union ties are also frequently used.

In some cases, before the tie is made the conductor is first wrapped with an armor of flat, metal ribbon at the point where it rests on the insulator cap. This prevents scratching or wear of the cable at the point of contact with the insulator.

Tie wires will vary from three feet to twenty-five feet in length according to the size of the insulators and the type of tie that is used.

Fig. 334 shows several photographs taken in the field, of actual line ties on pin type insulators.

View No. 1 shows an armored, looped Western Union tie on an insulator at which the line makes a bend. View No. 2 is a looped Western Union tie which is not very neatly done, as you will note from the general looseness of the turns and the down-hanging pig tail at the right. No. 3 shows a looped Western Union tie which is well done. No. 4 is a poorly done "Mongrel" tie and has very little mechanical security. No. 5 shows a very well made armored "stirrup" two-piece tie. No. 6 is a special tie of rather poor design and very carelessly made. Note the projecting or "flying" pin-tail. No. 7 shows a well made cross-top tie, and No. 8 shows a carelessly made looped Western Union tie. No. 9 shows a poorly made cross top tie.

In making line ties pig tails or sharp ends which are allowed to project down are very bad and reduce the flash over voltage of the insulator from 5 to 20%. If planned to save the conductor in case of arc-overs, they are quite useless unless carefully designed and uniformly installed.

In general it is better practice to turn all pig tails up or "serve" them tightly around the conductor. All tie wires should be tightly "served" around the insulator because loose tie wires may cause considerable radio interference, by very poor contact with the insulator surface and sparking which occurs when a very small amount of high-voltage energy leaks off to a wet or dirty insulator surface.

Fig. 336 shows a special design of pin type insulator for use on lines which are subject to salt fog or mist, and bad accumulations of dirt or dust which tend to make the insulator surface more or less conductive.

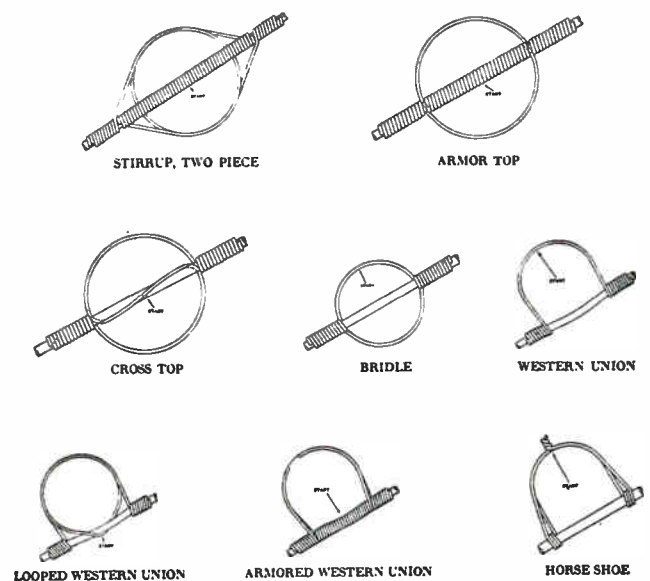

METHODS OF TYING LINE WIRE TO INSULATORS

Fig. 335. The above sketches show the methods of making some of the most common types of line ties. Note carefully how the tie wires are wrapped around the insulator cap and around the conductor. Courtesy Lapp Insulator Company, Inc.

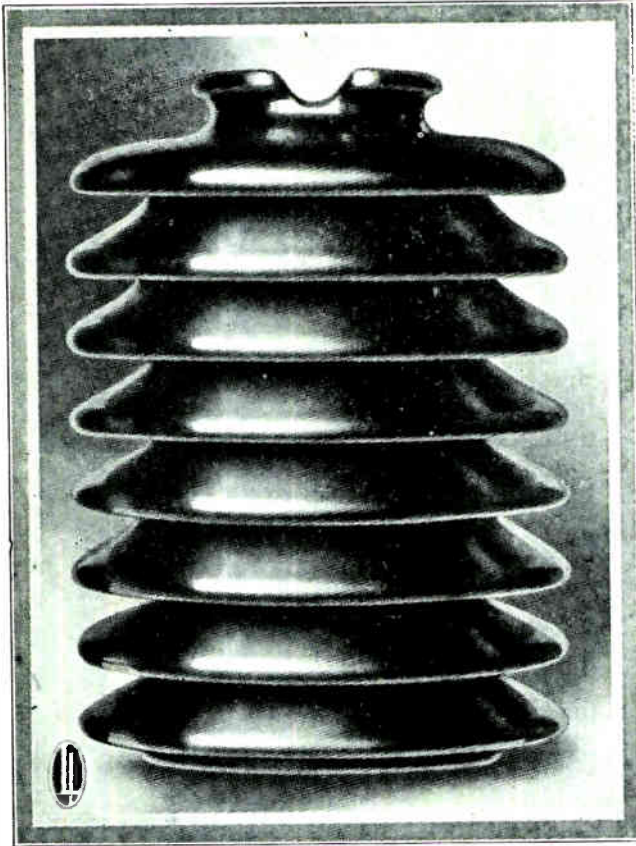

Fig. 336. Large special fog type pin insulator having a number of extra skirts to prevent flashovers in districts subject to heavy salt fogs, mist, dirt, etc. Courtesy Lapp Insulator Company, Inc.

### 338. PILLAR TYPE INSULATORS

Pin type insulators are often fitted with metal caps and special metal pins having bolt holes in them so the insulators can be mounted one above the other as shown in Fig. 337. These are called pillar type or pedestal type insulators and are used for supporting high-voltage busses on the switching stations and in places where there is very little side strain placed on the insulators.

Insulators of this type can be built up with the proper number of units to provide the necessary insulation for very high voltages.

Pillar type insulators will not stand excessive side strains, however, and are therefore not used on transmission lines where the long conductor spans are subject to wind stresses and the strain of unequal sag on the spans.

### 339. SUSPENSION TYPE INSULATORS

For insulating conductors of transmission lines using very high voltages suspension type insulators are more commonly used. These insulators obtain their name from the manner in which they are suspended in strings from the cross arms.

Fig. 338 shows two pairs of suspension insulator units which use different methods of attaching the units together in the strings. Those on the left are fastened together with short, heavy pins which

project through the bottom eye of one insulator and the top eyes of the other. The units on the right are fastened together by means of a large headed metal pin on the under side of the top unit, which fits into a properly shaped cavity on the top cap of the unit below.

Each insulator consists of a single piece of porcelain with grooved under sides and a bulge or crown projecting upward from its center. A malleable iron cap is securely cemented to the top of the insulator and a bolt or plug which is equipped with the proper eyes or enlarged head is securely cemented into the center cavity on the under side of the insulator.

Fig. 339 is a sketch showing a sectional view of a common type of suspension insulator, illustrating the manner in which the cap and pin are cemented to the top and bottom of the porcelain and completely separated from each other by the porcelain.

Fig. 339 also gives the dimensions both in inches and millimeters of this particular insulator shown. As porcelain has a much higher dielectric strength than air, it is not necessary to have the metal pin and cap of the insulator separated by a thickness of porcelain as great as the flash-over distance around the extended flange of the insulator.

Suspension insulator units are usually made to withstand voltages of from 10,000 to 30,000 volts

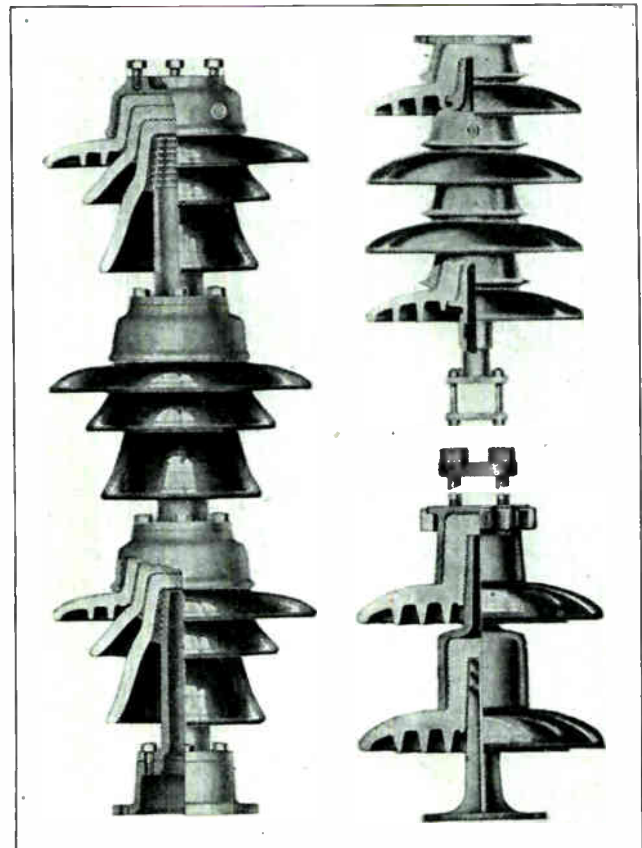

Fig. 337. Three styles of pedestal type insulators which can be built up in rigid pedestal or pillar form to support high-voltage bus bars and switching equipment.

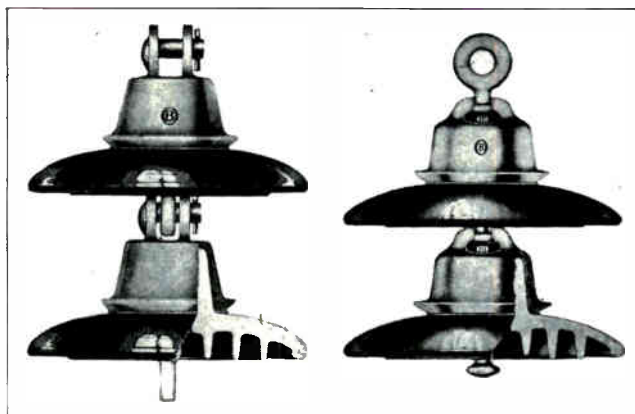

Fig. 338. Suspension insulators which can be fastened together in long strings to insulate high-voltage conductors. Note the two different types of fasteners used for attaching these insulators together. Courtesy of Ohio Brass Co.

per unit. For higher voltages than this two or more units can be connected in series, and in fact, by connecting a sufficient number of these insulators in series in a string, it is possible to insulate a line for practically any commercial voltage.

Strings of suspension insulators have the decided advantage, in that they are flexible and cannot be broken off by ordinary swaying or side stresses of the line. Suspension insulators are used almost exclusively on lines of over 66,000 volts, and in a great many cases on lines as low as 22,000 volts.

Fig. 340 shows a three-phase, 220,000-volt transmission line using suspension insulators with 14 units in each string.

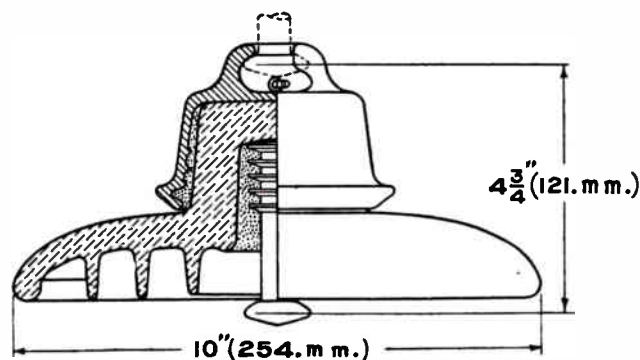

Fig. 339. Sectional view of a suspension type insulator unit showing how the metal cap and pin are securely cemented to the porcelain insulator disk. Courtesy Ohio Brass Co.

Fig. 341 shows a string of 10 suspension insulators flashing over on a test in which nearly 500,000 volts was applied. Tests of this kind are frequently made to determine the actual flash-over voltage of insulator strings before installing them on transmission lines.

### 340. STRAIN INSULATORS

Strain-type insulators are constructed almost the same as the ordinary suspension type and in fact resemble them so closely that in some cases it is difficult to tell them apart by ordinary observation. The principal difference between them is that the

strain-type insulator is generally made much stronger mechanically.

These insulators are used where lines are dead ended, or where the lines make sharp or right-angle bends and at other places where there is considerable horizontal stress or strain placed upon the insulators.

Fig. 342 shows strain insulators in use on 132,000-volt line having two three-phase circuits. You will note that the insulator strings are pulled out into almost horizontal position by the strain placed upon them by the dead ended sections of the line on each side of the tower. The line conductor is looped around the insulators by means of the suspended jumper, as shown.

Fig. 343 shows a heavy strain tower used for "dead ending" a 132-kv. line by means of the strain insulators at the upper left on each line conductor.

Suspension insulators are used on this same tower to support the line where it runs down at an angle to the switching equipment, which is not shown in this view.

Pillar-type insulators can also be seen on the structure in the background, where they are used

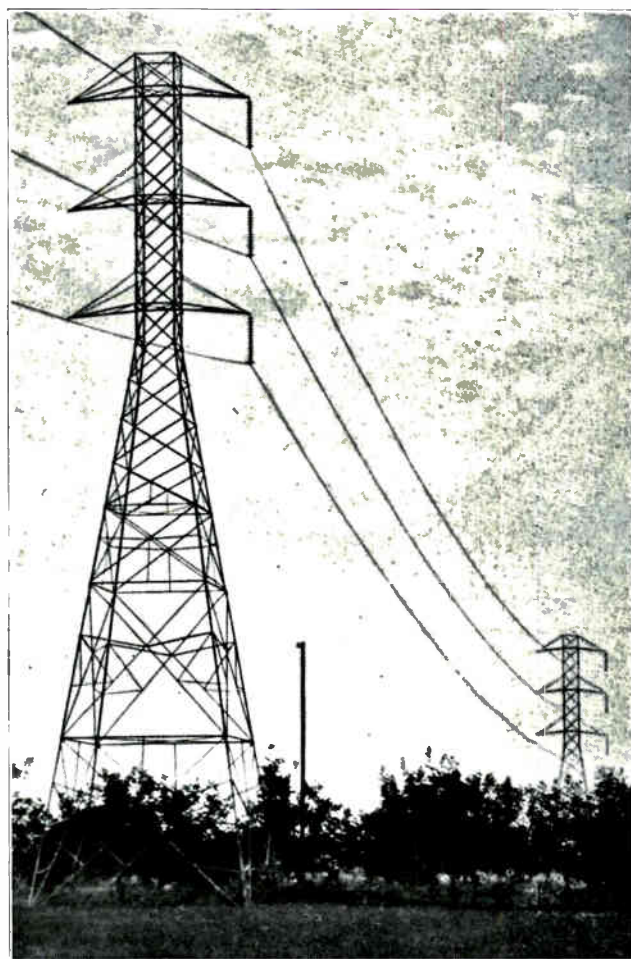

Fig. 340. 220-kv. line on which each conductor is supported by a string of 14 suspension insulator units. Note the arrangement of the three conductors on one side of the towers allowing space for another three-phase line to be put on the opposite side of the towers in the future.

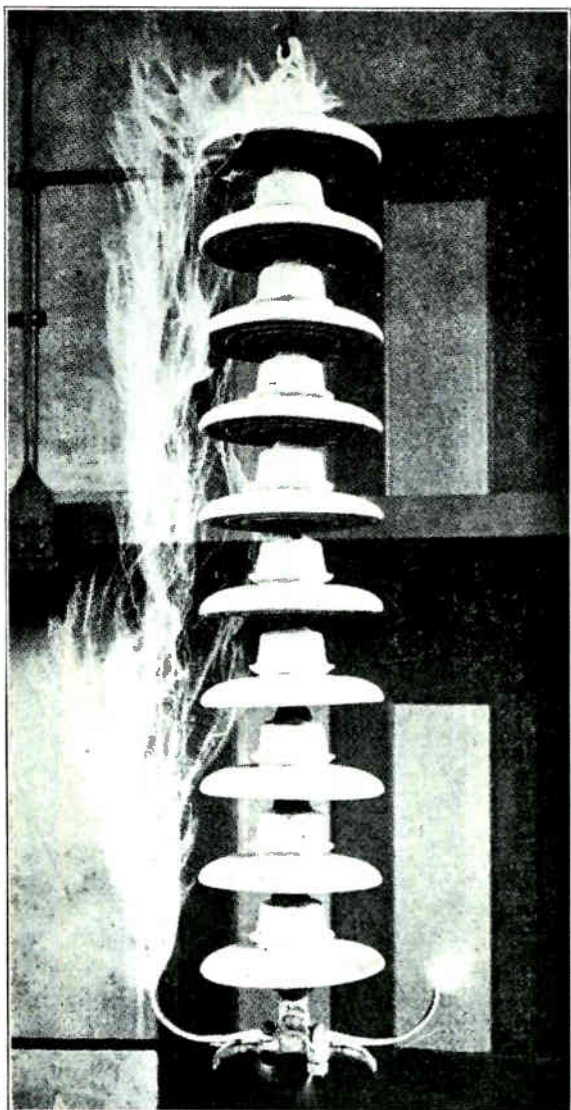

Fig. 341. This very interesting photograph shows an actual flashover or high-voltage arc on a string of 10 suspension insulator units. This flashover was made with 500,000 volts in a test laboratory, but similar flashovers occur on line insulators in service, due to lightning. Courtesy Ohio Brass Co.

to support blades and clips of high-tension air-break switches.

Fig. 344 shows sketches of strain insulators used to anchor the conductors where a line is dead ended to the wall of a power plant or substation building.

The strain insulators are used in these installations to take all strain of the conductor off from the insulating bushings where the conductor runs through the wall.

Where extremely long or heavy conductor spans must be supported and dead ended, if the strength of one string of ordinary strain insulators is not sufficient two or more strings can be used, the strain being divided evenly between the two strings by means of special "evener" yokes, as shown in Fig. 345.

Fig. 346 shows an excellent view of a heavy strain tower with six strings of strain insulators used to support each cable of the long span on the

right-hand side. This tower is used on a 110,000-volt line of the Northern States Power Company, where it crosses the St. Croix River at Afton, Minnesota. The length of the span across the river is 3,800 feet and it has a sag of 160 feet.

Steel-core aluminum cables are used and they carry a maximum load of 30,000 lbs. per cable. This tower was designed and erected by the Byllesby Engineering and Management Corporation. Ordinary strings of strain insulators can be seen on the cables leading to the left, and suspension insulators are used to support the jumper or connection between the river span and the cables at the left.

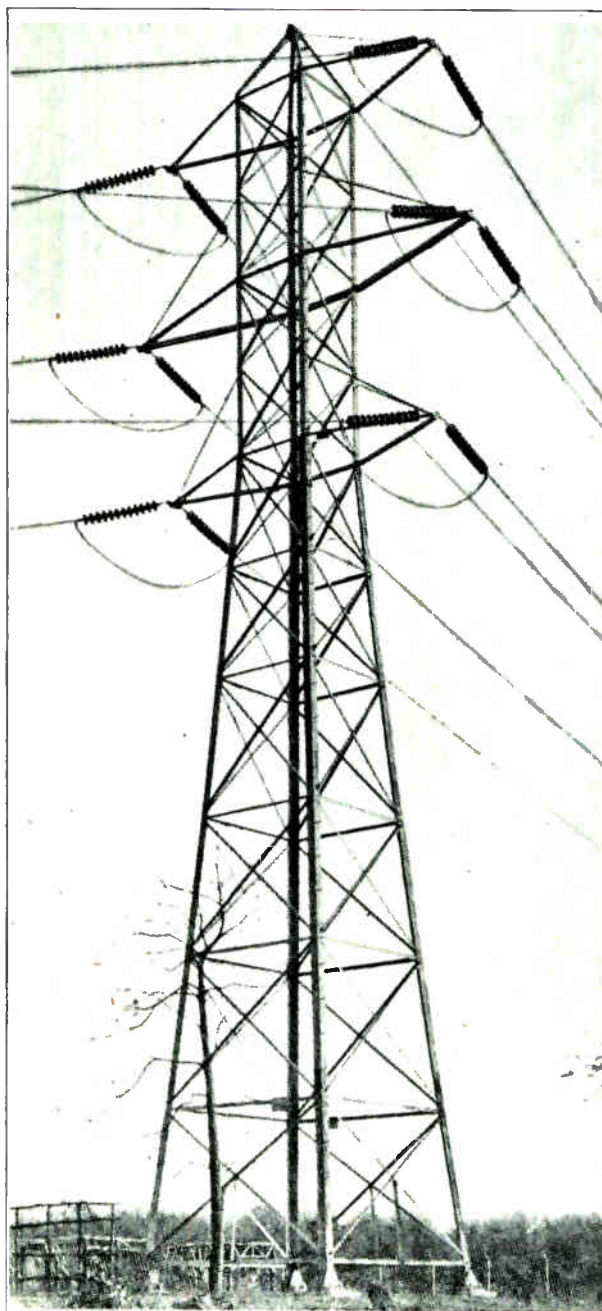

Fig. 342. This photograph shows the use of strain insulators to dead end the conductors of both spans and take all strain in either direction on this one heavy tower. Courtesy Lapp Insulator Company, Inc.



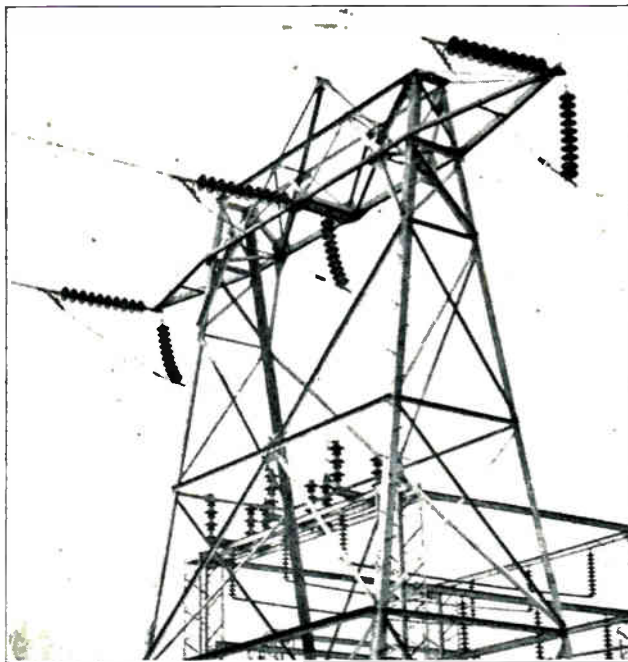

Fig. 343. This photo shows a heavy strain tower with strain insulators supporting the tension of the conductor span, suspension insulators supporting the conductor loops which run down to a substation, and pedestal type insulators in the background supporting high-voltage air break switches. Courtesy Ohio Brass Co.

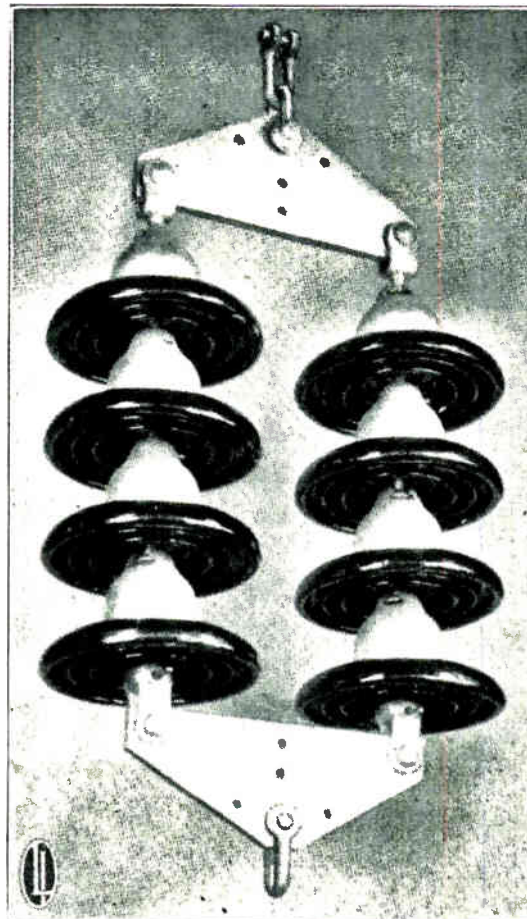

Fig. 345. Two strings of strain insulators fastened together with evener bars to take the strain of a very heavy conductor span. Courtesy Lapp Insulator Co., Inc.

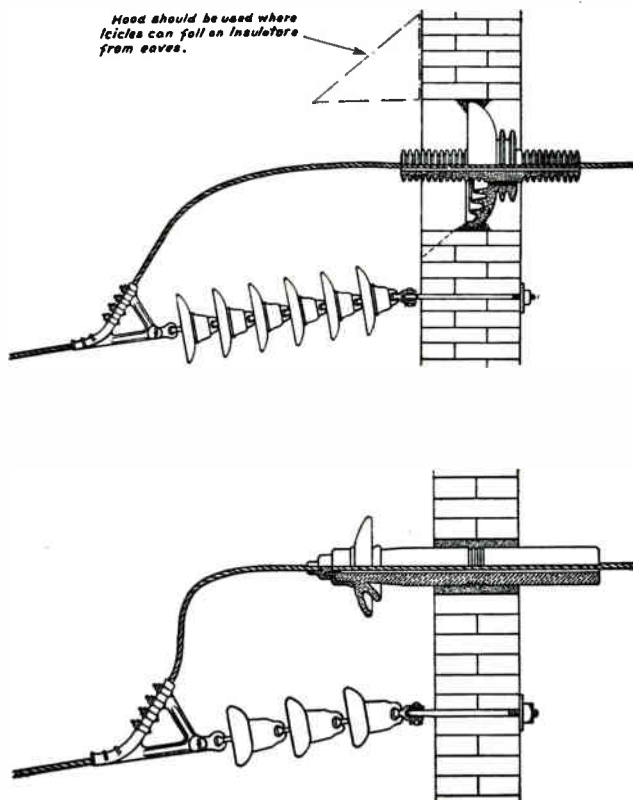

Fig. 344. The above diagrams show methods of using strain insulators to attach line conductors to the walls of substation buildings and keep the strain from the conductor where it enters the building through wall type insulator bushings. Courtesy Ohio Brass Company.

For dead ending small low-voltage conductors and also for insulating guy wires small porcelain strain-insulators of the types shown in Fig. 347 are often used. These insulators have no metal fittings but are simply provided with holes through them on opposite ends and sides so that the conductors can be looped through and tied as shown in the upper view.

#### 341. BUSHING INSULATORS

Bushing-type insulators are used where conductors pass through the roofs or walls of buildings or into cases of transformers, oil switches, etc.

Several bushings of this type are shown in Fig. 348. You will note that they are made with a sort of tubular construction so the conductor can be passed through their centers, and insulated from the surrounding wall or metal tanks by one or more porcelain cylinders of the insulator.

On the left in Fig. 348 is a wall or roof bushing for 6600-volt conductors. The diameter of the skirts on this insulator is approximately five inches, while the length of the unit is about 25 inches. The center view in this figure shows a wall or roof bushing for use on conductors of 100,000 volts. This insulator has a diameter of approximately 16 inches and a length of over 66 inches.

On the right in Fig. 348 is shown a bushing of the oil-filled type, such as used on tanks of oil switches and transformers. Insulators of any type or size are rated in voltage according to actual flash-over tests made by the manufacturers on both wet and dry insulators.

In ordering insulators for any line it is only necessary to specify the line voltage and the type of insulators desired, and any reputable manufacturer will select the proper size and give you prices on them.

In some cases where lines are subject to unusually bad storms, salt or alkali vapors, or highly conductive dust, it may be necessary to over-insulate or use larger insulators or a greater number of units per string than are ordinarily used.

In general, however, insulators that are rated for a given voltage are designed with a certain safety factor or allowance which enables them to stand considerably more than the rated voltage before they will flash over.

### 342. LINE-SUPPORTING STRUCTURES

All overhead lines must be supported a sufficient distance above the earth to prevent grounds and shorts and also to prevent moving objects, animals, or people from coming in contact with the conductors.

The minimum clearance between conductors and ground is generally at least 15 feet or more on low-voltage lines, and 30 to 40 feet or more on lines between 100,000 and 220,000 volts.

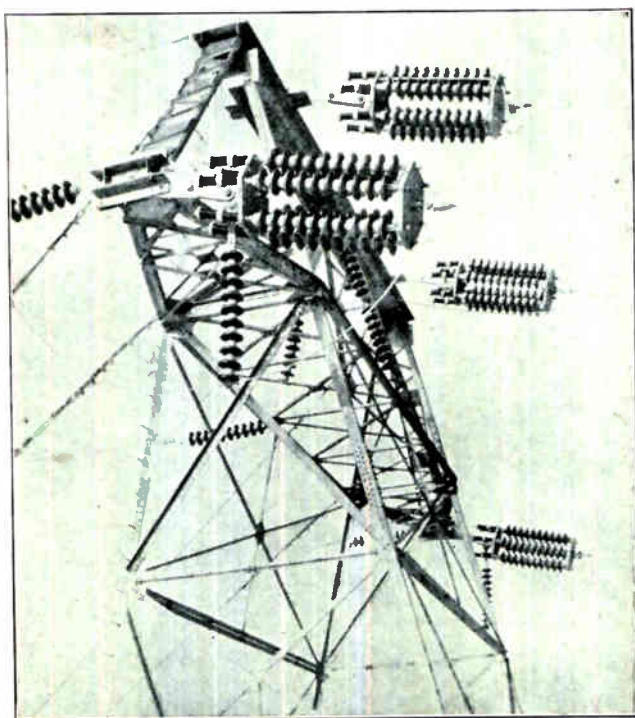

Fig. 346. Extra heavy strain tower with six strings of insulators grouped together on evener plates for each conductor. Note the heavy coil springs on the left evener plates to allow the heavy tension of these 3500-ft. river spans to equalize on all six insulator strings. Courtesy Lapp Insulator Co., Inc.

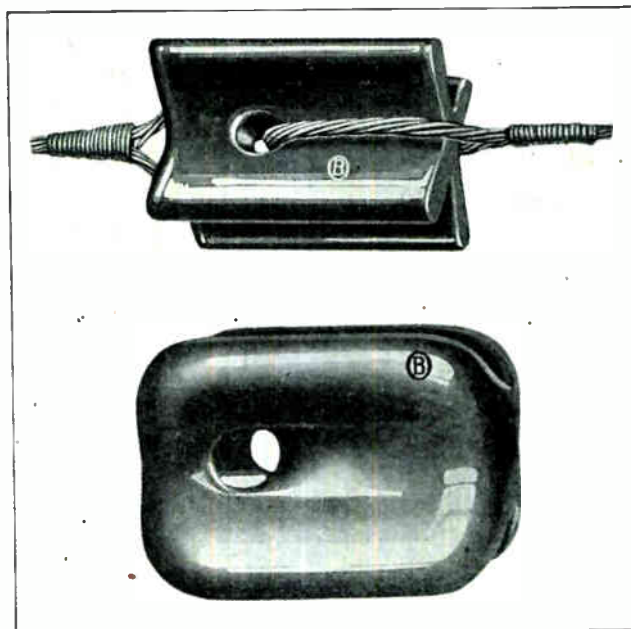

Fig. 347. Two types of small porcelain strain insulators for use on guy wires and low-voltage conductors. Courtesy Ohio Brass Co.

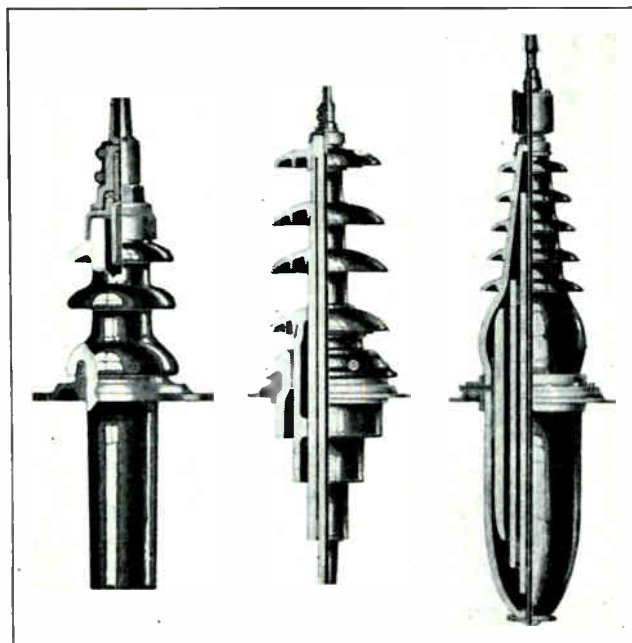

Fig. 348. Three different types of insulator bushings used for transformers and oil switches where the high-voltage conductors enter the metal tanks. Courtesy Ohio Brass Co.

Exact minimum clearances for safety will be covered a little later in this section.

Several different types of transmission line supports are in use. The most common of these are wood poles, concrete poles, expanded steel poles, and steel towers.

Wood poles are very extensively used for transmission lines operating at voltages from 13,200 to 66,000 volts and carrying small or moderate kw. loads. In many cases they are used for higher voltages up to 110,000 volts and even more.

The woods most commonly used for these poles are cedar, pine, chestnut, oak, and cypress. Approximately 60% of all the poles in use in this country are cedar, as these are light in weight and have a very good life.

The principal advantages of wood poles lie in the fact that the wood itself is an insulator and in their low first cost. The main disadvantage is their rather short life, which generally varies from five to fifteen years, according to the kind of wood used and the nature of the climate and soil in the district where the poles are used.

The life of wood poles can be considerably increased—in fact, approximately doubled—by treating the end which enters the ground with a compound that makes them more resistant to moisture and decay. For this purpose a coal tar product known as creosote is commonly used. It is heated and forced into the pores of the wood under pressure. This treatment not only prevents to a great extent the effects of moisture and frost but it also tends to keep various bugs and worms from eating into poles.

In selecting poles it should be remembered that those which are straight and free from knots, twists, bends, and dry rot have the greatest mechanical strength and best appearance, and should generally be chosen even though their cost is somewhat higher than the poorer grade poles.

Pole Length in feet	Class A	Class B	Class C	Class D
	Minimum Top Circumference 28 inches. Min. Cir. 6ft. from butt	Minimum Top Circumference 25 inches. Min. Cir. 6ft. from butt	Minimum Top Circumference 22 inches. Min. Cir. 6ft. from butt	Minimum Top Circumference 18½ inches. Min. Cir. 6ft. from butt
20	30	28	26	24
22	32	30	27	25
25	34	31	28	26
30	37	34	30	28
35	40	36	32	30
40	43	38	34	32
45	45	40	36	34
50	47	42	38	35
55	49	44	40	36
60	52	46	41	38
65	54	48	43	39

Fig. 349. The above table gives recommended sizes of wood poles of various heights.

Poles of the proper size should be used, in order to give the required strength, and it is not good economy to try to use poles much smaller than those of standard recommended practice.

### 343. POLE SIZES

First-class red cedar poles should have a minimum top circumference of 28 inches, while second and third class poles may have top circumferences of 25 and 22 inches respectively. These circumferences correspond to diameters of approximately 9, 8, and 7 inches respectively.

The table in Fig. 349 gives the dimensions for poles of various lengths, as recommended for power and telephone lines.

This table gives the minimum top circumference for the various classes of poles and also the minimum butt circumference, which is measured at a point six feet from the butt of the pole.

You will note from this table that most poles come in lengths varying in steps of five feet, the one exception being the 22 ft. length.

In certain locations where the line turns a corner or makes a sharp bend, or at points where the line is dead ended, heavier poles than those listed in this table should be used to provide the additional mechanical strength required. Guy wires should also be used on such poles and they should be placed at such an angle as to draw on the pole in the opposite direction to that in which the pull of the line occurs.

### 344. POLE SPACING

Wood poles are commonly spaced from 100 to 150 feet apart, although in some cases on very light lines they may be spaced as far apart as 500 feet. As there are 5280 feet in a mile, these spacings would give approximately 11 to 50 poles per mile, a fair average for ordinary lines being 25 to 35 poles per mile. The actual spacing chosen depends, of course, upon the size of the conductors, the importance of the line, and the contour of the land.

Poles should be set sufficiently deep in the ground to stand the side strain placed upon them by wind stresses on the poles and conductors, slightly unequal tension on the spans, etc. This depth generally varies from 5 to 9 feet, according to the height of the pole and the nature of the soil in which it is set. Earth or rock fill should be securely tamped around the base of the pole to give it a firm anchorage.

The table in Fig. 349-A gives proper pole setting depths for poles of various heights, set in different soil conditions.

In sandy or swampy ground large barrels set in the ground around the pole butt and filled with stones or concrete, will greatly improve the pole foundations.

Guy stubs should always be set at least 7 feet deep in any soil except solid rock.

Where lines are subjected to extra heavy wind pressures or strains or where the soil is rather soft,

Pole Height	Depth of Pole Settings				
	Solid Ground Pole Depth		Soft Ground Pole Depth		Solid Rock Pole Depth
	Straight Line	Corners	Straight Line	Corners	
22	5	5	5	5	3
25	5	5½	5½	6	3
30	5	5½	6	6½	3½
35	6	6½	6½	7	4
40	6½	7	7	7½	4
45	6½	7	7	7½	4½
50	7	7½	7½	8	4½
55	7½	8	8	8½	5
60	8	8½	8½	9	5½
65	8½	9	9	9½	5½

Fig. 349-A. Convenient table giving proper depths to which poles of various heights should be set in the ground under varying soil conditions.

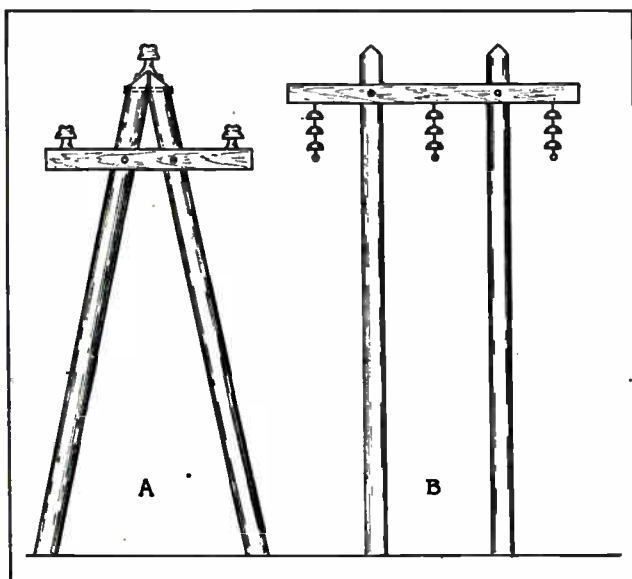

Fig. 350. Two methods of securing additional strength and better footing for pole lines. The structure at "A" is known as an "A frame", while that at "B" is known as an "H frame".

two poles are frequently set with their tops fastened together and the bottoms spaced several feet apart in what is called an "A" frame construction, as shown in Fig. 350-A.

In other cases two poles are set vertically side by side and several feet apart with the cross arm attached to the tops of both in what is called an "H" frame construction, as shown in Fig. 350-B.

### 345. CROSS ARMS

Cross arms of either wood or metal are used on pole lines to support the insulators and conductors. Wood cross-arms for transmission lines are generally about 4 inches wide by 5 inches high, and their length depends upon the number of conductors they are to carry, and the spacing between conductors according to the voltage of the line.

The pole is notched or slightly flattened where the cross arm is attached, and the arm is securely bolted to the pole. Wood cross arms are generally braced by pieces of strap iron or angle iron, forming a V from each side of the cross arm to the pole underneath it.

Cross arms made of angle iron are used where heavy conductors are to be supported or where severe strains are placed on the arms.

### 346. SETTING OF POLES

In setting wood poles, holes of the proper depth are dug with the top opening about six inches greater in diameter than the butt of the pole. If the pole butt is widely flared it may be necessary to dig the bottom of the hole even a little larger than the top in order to allow for shifting the pole when setting and aligning it, and also to allow proper tamping of earth or rock fill around the pole.

Poles are set up in the holes by a crew using pikes, or by means of pole setting machines oper-

ated on the back ends of trucks. In erecting a pole by hand the edge of the hole at which the pole lies should be cut down at a slight angle to allow the pole to slide in the hole more easily. A board can be set on the opposite side of the hole and the base of the pole butted against this board. This helps to guide the pole butt into the hole when the top end is raised.

Heavy poles are often raised by means of a gin pole and block and line.

### 347. STEEL TOWERS

Steel towers are used on the more important transmission lines operating on the higher voltages and carrying large kw. loads. Steel towers provide line supports which are much more dependable and have a much greater life than wood poles, and for this reason steel towers are generally used on heavy lines where it is important that service interruptions be kept at an absolute minimum.

These towers are made from structural steel and are fabricated in the steel shops. They are then shipped in sections to the locations where they are to be erected. These sections are bolted together and set on small concrete foundations to give them secure and permanent anchorage.

The steel used in these towers is heavily galvanized to prevent rust and corrosion and give them longer life.

The size and weight of steel towers varies considerably according to the size and weight of the line conductors and the location of the towers. Towers located at bends in the line or at points where the line is dead ended are generally built much heavier than the others in the same line, in order to stand the added strains.

The spacing for steel towers generally ranges between 500 and 1000 feet, although in many cases they are spaced at considerably greater distances.

In mountainous regions or where lines cross rivers, spans of several thousand feet are often used. The Southern California Edison Company has several spans nearly a mile in length, using aluminum conductors of over one million circular mils area, and carrying power at a potential of 220,000 volts.

Several types of steel towers have been shown in various figures of this section. Examine each of these and carefully note their construction and bracing. You will note that on all of the taller towers the lower section is flared out to provide a wide base to make their anchorage more secure and enable them to stand side stresses due to wind pressure on the conductors and towers.

The cross arms used on steel towers are usually also built of structural steel fabricated into shapes which provide the best mechanical bracing and the greatest possible strength with light-weight material.

Small steel towers are sometimes bolted together

while lying on the ground and are then erected or set up by means of a gin pole and block and line. The larger and heavier towers are usually erected one section at a time, the first large section being set on the concrete foundations and bolted to stubs which are imbedded in the concrete.

The steel pieces for the upper sections are then pulled up a piece at a time and bolted together on top of the section previously completed.

In addition to the large broad-base steel towers slender fabricated steel poles are often used on lighter lines of less importance but where supports with greater life than wood poles are desired.

Tubular steel poles and concrete poles of both solid and hollow construction are also often used for line supports.

**348. LINE FITTINGS**

In addition to the supports, insulators, and conductors, there are also used in line construction a number of small fittings known as line fittings or line hardware. A number of these fittings are used in fastening suspension insulators to cross arms and attaching conductors to the insulators, both for ordinary suspension and also for dead-ending.

Fig. 351 shows a number of these fittings which are commonly used, and also gives the size and dimensions of some of them. No. 6228 is a socket clevis; 6226 and 6420, socket eyes; 6227 is a ball clevis; 6421 and 6422 are ball eyes; 6453, thimble clevis; 6430, 6375, and 6423 are various types of clevis eyes; 6428 and 6225 are hooks for attaching

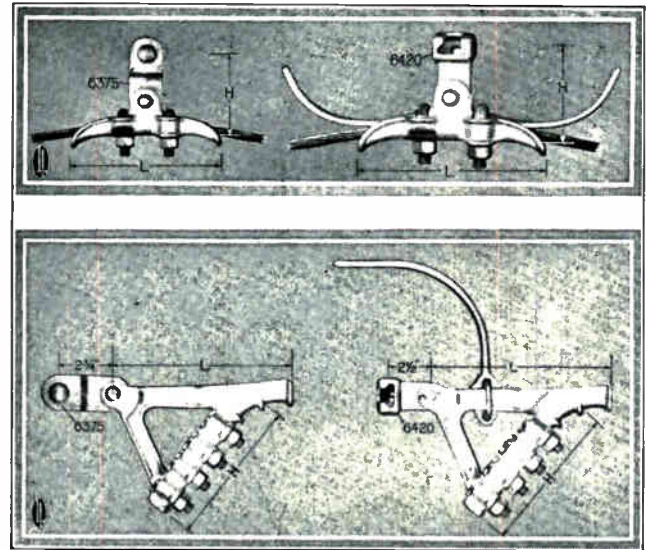

Fig. 352. In the top view are shown two types of conductor clamps for use with suspension insulators. Below are shown strain clamps for dead ending conductor spans. Courtesy Lapp Insulator Co., Inc.

insulator strings to cross arms; 535, 6410, and 6413 are various types of clevises; 6414, 529, 539, 6491 and 6429 are various types of links.

The upper view in Fig. 352 shows two suspension clamps for attaching conductors to the bottom of suspension insulator strings. The one on the left is called a clevis-type, and you will note the clevis which is used to attach it to the bottom insulator. The clamp on the right is called a socket type. The socket used for attaching it to the insulator string can be seen fastened to the top of the clamp.

The clamp on the right is also equipped with arcing horns which serve to protect the conductor from burning and pitting in case of a flash-over on the insulator string.

On clamps equipped with these arcing horns any flash-over arc will generally be drawn from the end of one of the horns, and if the arc lasts long enough to do any burning, the end of the horn is burned instead of the conductor from which the arc would otherwise be drawn.

If severe arcs occur between the conductor and tower cross-arm, the conductor is likely to be burned enough to cause it to break and thus put the line out of service.

The lower view in Fig. 352 shows two strain clamps for attaching line conductors to strain insulators. The one on the left is of the clevis type and the one on the right of the socket type. The clamp on the right is also equipped with an arcing horn to carry any flash-over arcs above the string of insulators, which in this case would be hanging in a more or less horizontal position.

The conductor is gripped tightly under the several U-bolts on these clamps, providing a very secure fastening which will stand a great deal of strain.

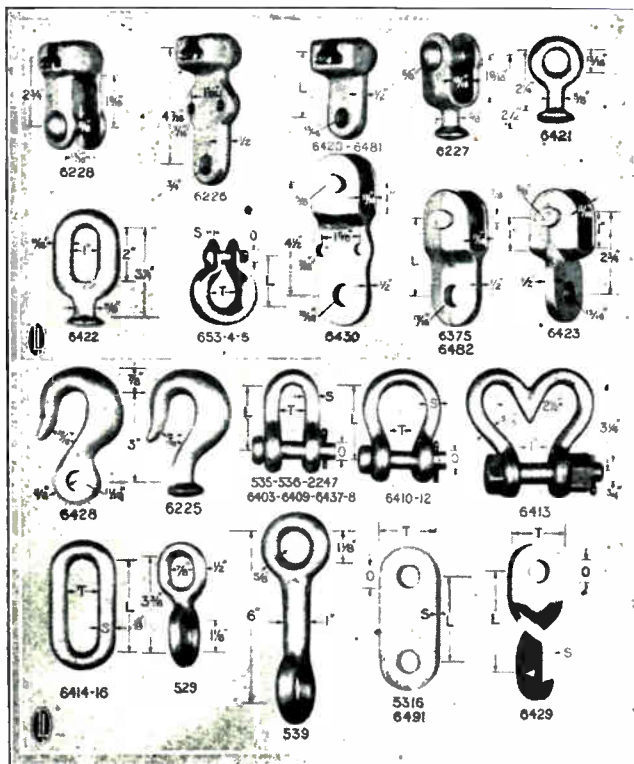

Fig. 351. Above are shown a number of the commonly used types of line fittings or hardware used in connection with suspension insulators. Courtesy Lapp Insulator Co., Inc.

**349. LINE-CONDUCTOR ARRANGEMENT AND SPACING**

Transmission-line conductors can be arranged on the poles or towers by a number of different methods. Sometimes they are located in a horizontal plane, as in any one of the top views in Fig. 353. In other cases they are located one above the other nearly in a vertical plane, as shown in any of the center views in Fig. 353.

Another very common arrangement on pole lines is to place the conductors in an equilateral triangle with respect to each other, as shown in the lower views in Fig. 353. The lower center view shows a very uniform and economical arrangement which is extensively used. It requires only one cross arm and provides the same spacing distance between any two of the three conductors. It is from this fact that this arrangement obtains its name of "equilateral triangle", which means a triangle with all sides equal.

Sometimes the conductors of a line are arranged in a triangle with unequal sides or unequal spacing distance between the conductors.

In the lower right-hand view is shown a method of arranging two three-phase lines for the same uniform triangular spacing by placing the three conductors of one line on one side of the pole and those of the other line on the opposite side of the pole.

The center and right-hand views of the center row in this figure each show two three-phase lines.

In spacing conductors or insulators on cross arms, sufficient clearance must be left between conductors of opposite phases or polarity, and also between each conductor and the pole or tower, to prevent any possibility of a flash-over between conductors or from any conductor to the tower.

On towers where suspension insulators are used, the possibility of a certain amount of swaying in the wind must also be considered.

The following list gives practical average conductor spacings for lines of different voltages:

LINE VOLTAGE	CONDUCTOR SPACING IN FEET
2,300.....	1 to 1.5
6,600.....	1.5 to 2
13,200.....	1.5 to 2.5
22,000.....	2.5 to 3
33,000.....	3 to 4
44,000.....	4 to 5
66,000.....	6 to 8
88,000.....	8 to 10
110,000.....	10 to 12
132,000.....	12 to 14
140,000.....	12 to 16
220,000.....	16 to 20

The spacing between conductors should be increased from 10 to 12 inches for each additional 10,000 volts.

On lines where long spans are used there is more

possibility of conductors swaying together, and in such cases considerably greater spacing distances are often used.

For example, on heavy power lines with the conductors arranged as in the center or right-hand views in the top row of Fig. 353, the spacing between the conductor and pole or tower as shown at "A" should be approximately two feet on lines of 33,000 volts, 4 feet on lines of 66,000 volts, and 7 to 8 feet on lines of 110,000 volts, etc.

The spacing between the conductors of different phases as at "B" should be about 4 feet for lines of 33,000 volts; 9 to 10 feet for lines of 66,000 volts; and 13 to 15 feet for lines of 110,000 volts; etc.

With the conductors of two separate lines arranged as shown in the center view in Fig. 353, the horizontal spacing between conductors of opposite lines should be somewhat greater than the vertical spacing between phases of the same line.

For a line constructed in this manner the horizontal spacing as at "A" between conductors on the same cross arms would be approximately 10 to 12 feet for lines of 66,000 volts; 15 feet for lines of 110,000 volts; 16 to 20 feet for lines up to 220,000 volts; etc.

The vertical spacing as at "B" would be approximately 7 feet for 66,000 volt lines; 10 feet for 110,000 volt lines; and 14 to 15 feet for lines from 150,000 to 220,000 volt lines.

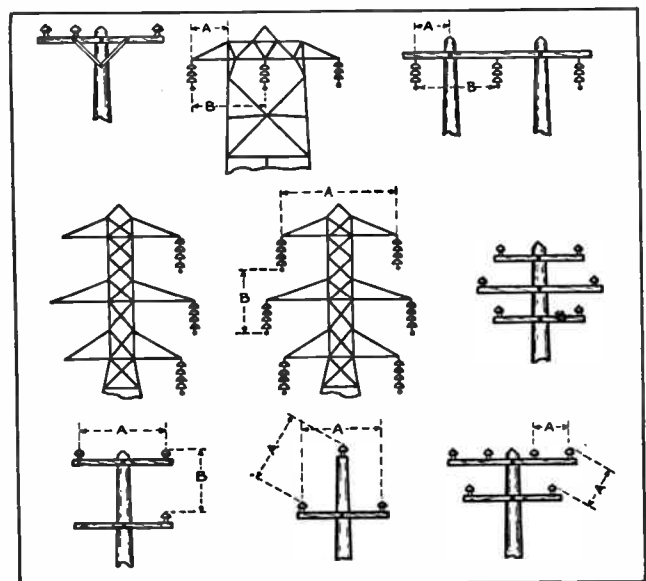

Fig. 353. The above sketches show several different methods of arrangement for conductors on pole and tower lines. Examine each very carefully.

Fig. 354 is a list of a number of transmission lines of different voltages which are in actual service. This is a list of lines which use aluminum conductors supplied by the Aluminum Company of America.

The list gives the types of supporting structures used on each line, the normal and maximum lengths of spans, types of insulators used, number of cir-



Following each of the wires on through the second and third transpositions, we find that each has returned to its original position.

The center view in Fig. 355 shows one transposition in which the conductors are rotated one-third of a spiral between two special towers. These towers are called transposition towers and each has one cross arm which extends farther out than the other two. By locating this longer cross arm on the top of one tower and on the bottom of the next, the wire can be carried across the other two as shown in the figure, and yet it is held out the proper distance away from the others by the extended cross arms.

At the next step of transposition on this line the long cross arms would be placed one in the center and the other at the top or bottom, according to which wires are being transposed.

### 351. TRANSPOSITION TOWERS

Special types of towers are designed and equipped with strain insulators for dead-ending the conductors, so that the cross-over or transposition can be made right at the tower and thus avoid crossing the wires between the towers.

This method is illustrated by the lower sketch in Fig. 355. Examine this sketch carefully and note that all three conductors change their position on this tower, and are supported in such a manner that

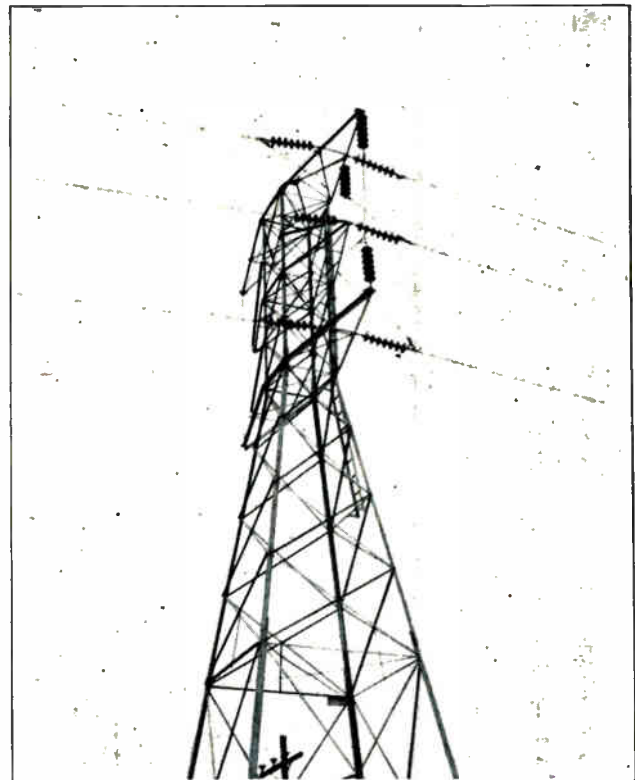

Fig. 356. The above photo shows a transposition tower in a high-voltage line. Note carefully the arrangement of insulators and conductors, and compare this photo with the lower sketch in Fig. 355.

it is practically impossible for any two of them to swing together.

The photo in Fig. 356 shows a transposition made at a tower of this type, and in Fig. 356-A is another view of a transposition tower which is equipped with two extra cross arms at right angles to the main arms, so that the conductor which is carried from the top to the bottom may be crossed over inside of the line wires instead of outside as shown in Fig. 356.

Transpositions in power lines may be repeated at distances ranging from five to forty miles apart, according to the line conditions and according to the location of any neighboring telephone or telegraph lines.

### 352. REDUCING INTERFERENCE WITH SIGNAL LINES BY TRANSPOSITION

In addition to the benefits derived from equalizing the line voltages by transposition, another very important reason for transposing power lines is to avoid serious interference with neighboring telephone and telegraph lines.

When telephone and telegraph lines run along the same right of way, or even along roads or railways within several hundred feet of power lines for any great distance, there will be a certain amount of sixty-cycle energy induced in the signal lines. This induction causes a very objectionable sixty-cycle hum in telephone equipment and other interference with telephone and telegraph devices.

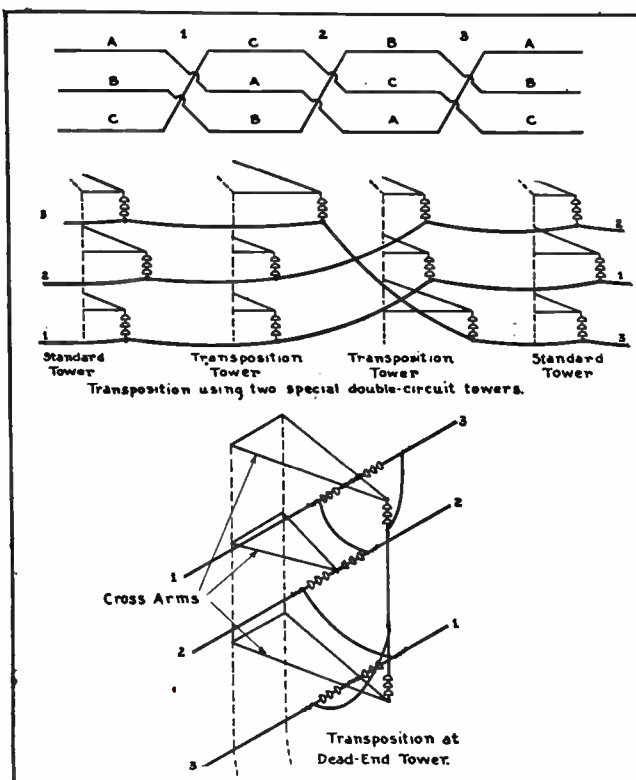

Fig. 355. The top view shows a schematic diagram of transpositions in a power line. The center view shows one method of making a transposition by crossing the conductors between towers, having special extended cross arms, and the lower view shows another method of making a transposition right at one tower with specially constructed cross arms.



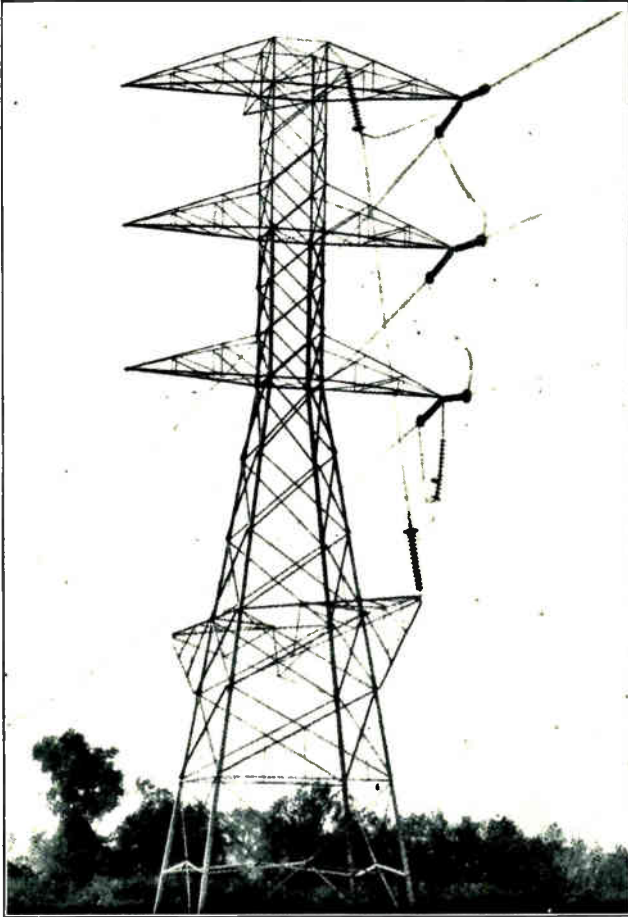

Fig. 356-A. This photo shows another type of transposition tower on which the cross-over of the conductors is accomplished in a slightly different manner from that shown in Fig. 356. Trace each line conductor through from one side of this tower to the other and note how they change in position.

By transposing the power line so that first one phase and then the other is closer to the signal wires, the induction can be largely neutralized or balanced out, because the fluxes of the various phases are 120 electrical degrees out of phase with each other. For this reason it is also a common practice to transpose telephone and telegraph lines from five to twenty times per mile when they run in close proximity to high-voltage power lines.

Power lines which have the conductors arranged in an equilateral triangle do not need to be transposed if they are isolated or located considerable distances away from all telephone and signal lines. But even power lines with this conductor arrangement should be transposed if they run at all near to any signal lines.

Transpositions should be made uniformly so that the conductor will be running in a spiral or screw effect and not merely crossed back and forth in a haphazard manner.

### 353. LINE CALCULATION

Generally the work of the practical electrician in connection with transmission lines pertains to erec-

tion, maintenance, or testing, and very seldom has to do with the design of the lines.

You may, however, at some time or other be required to have in connection with your other work a general knowledge of the more important factors entering into the design of transmission lines. A knowledge of these more essential features of transmission-line construction will at least help you to appreciate the importance of certain requirements in line construction and maintenance work.

You may also have an opportunity to plan and install a complete small transmission or distribution line of the more economical pole-construction, to carry power at moderate voltages for a distance of several miles or more.

While the design of a long transmission-line to carry great amounts of power at extremely high voltage requires a great deal of accurate calculation in order to assure best efficiency and economy of operation, there are a number of simple rules which have been established by long experience and practice with various transmission line installations and by which it is possible to plan and install a practical, small transmission or distribution line without the use of any complicated mathematics or calculations.

One of these very important rules is as follows:

For economical transmission allow 1000 volts for each mile of line length and allow 1000 circular mils of copper conductor area for each ampere of current which the line is to carry.

(Note: This rule does not mean that 1000 volts are lost per mile but that 1000 volts actual operating-voltage are to be allowed for each mile of line length.)

There are many short lines which operate at voltages higher than would be obtained by this rule, and there are other lines which operate at lower voltages and are considered to be fairly economical under the conditions; but this rule is very dependable and forms a good, practical basis from which to work or check your figures.

### 354. PROBLEM

Let us see how this rule can be applied to a practical problem. Suppose we wish to build a line between two points twenty miles apart and to carry 1200 kw. at 80% power factor.

One important part of our problem is to determine what voltage we should use and what size conductor should be installed. We can readily see that the longer the line, the greater the voltage which will be necessary; and the greater the load, the larger conductor we must use in order to secure practical economy.

According to the rule of 1000 volts per mile, we should use  $20 \times 1000$ , or 20,000 volts. As 22,000 volts is standard we shall select equipment for this voltage.

To determine the load in amperes we can use the formula:

$$I = \frac{\text{kw.} \times 1000}{1.732 \times \text{p.f.} \times E}$$

or, in this case:

$$I = \frac{1200 \times 1000}{1.732 \times .8 \times 22,000}, \text{ or } 39.3 \text{ amperes.}$$

Then, according to our rule of 1000 circular mils conductor area for each ampere of current, our conductor size should be:

$$39.3 \times 1000, \text{ or } 39,300 \text{ circular mils.}$$

As this is very close to the 41,740 C.M. area which represents a No. 4 conductor, we shall select this size of wire.

Sometimes conductors larger than those required by the formula are used in order to obtain the necessary mechanical strength for the spans between poles. A No. 4 conductor is about as small as can be used practically for transmission line spans of any length; although smaller wires are sometimes used on short distribution lines in towns or rural districts.

It is generally considered that a transmission line, in order to be practical, should not have losses greater than ten per cent. of the total power transmitted.

The transmitting voltage and conductor size arrived at by use of the simple rule just given can very easily be checked by using Ohms law formulas with the known load in amperes and the resistance of the conductor chosen.

We know that  $I \times R = E$ , or, in this case, the line current times the line resistance will give the voltage drop of the line.

This voltage drop when multiplied by the line current will give the line loss in watts; so if the voltage drop is not over 10% the line loss will not be over 10%.

For example: in the problem just given we have the resistance of 20 miles of No. 4 wire to consider. The table in Fig. 327 shows that the resistance of No. 4 wire is about .25 ohms per 1000 feet.

There are 5280 ft. per mile, so 20 miles equals  $20 \times 5280$ , or 105,600 ft. As the resistance is given in ohms per 1000 ft., we first divide 105,600 by 1000, and get 105.6. Then the total resistance of one line conductor will be  $.25 \times 105.6$  or 26.4 ohms.

We know that the line loss in watts in any conductor is equal to  $I^2R$ ; therefore, the watts lost in each line will be  $39.3^2 \times 26.4$  or 40,774 watts, and the total line loss in three wires is  $3 \times 40,774$  or 122,322, or approximately 122 kilowatts. This is slightly more than 10% of the power supplied.

The voltage drop in any pair of wires in a 3 phase, 3 wire system is equal to  $1.73 \times I \times R$ , where  $I$  is the current in one wire and  $R$  is the resistance of one wire. Substituting the values from our problem, we have  $1.73 \times 39.3 \times 26.4 =$

1793 volts. This is approximately 8% of the supply voltage.

### 355. FORMULA FOR CONDUCTOR SIZE

The circular mil size of conductor which should be used for a given load on small low-voltage, single-phase lines can be easily calculated by means of the same formula given in Section Two on Electrical Wiring for calculating the size of feeder conductors. This formula is repeated here for your convenience:

$$\text{C. M. area} = \frac{10.8 \times L \times 2 \times I}{E_d}$$

In which:

$L$  = length of line one way

$I$  = load in amperes

$E_d$  = allowable voltage drop.

For three-phase lines the formula can be used with the constant 1.732, as follows:

$$\text{C. M. area} = \frac{10.8 \times 1.732 \times L \times I}{E_d}$$

In which:

$$1.732 = \sqrt{3}$$

$$I = \text{current per phase, or } \frac{\text{kw.} \times 1000}{1.732 \times E \times \text{P. F.}}$$

$$\text{or } \frac{\text{kv-a.} \times 1000}{1.732 \times E}$$

$L$  = length of line in feet, one way only.

### 356. LINE REACTANCE AND CAPACITY

So far we have considered only the losses due to resistance, and voltage drop caused by resistance in the lines; but A. C. lines have a certain amount of inductive reactance and capacity reactance, both of which cause line losses and must be considered in calculations for long high-voltage transmission lines.

The capacity reactance is usually negligible on small low-voltage lines, and the inductive reactance in ohms can also often be ignored on small lines.

The inductive reactance varies with the size of the conductors and the distance they are spaced apart.

The table in Fig. 357 gives the inductive reactance ( $X_L$ ) in ohms per 1000 ft. of line for various

Wire Gauge	Spacing between wire centers.									
	1inch	2inches	6inches	1foot	1½feet	2feet	3feet	4feet	5feet	6feet
8	.0687	.0845	.1097	.1256	.1349	.1415	.1508	.1574	.1625	.1667
6	.0633	.0792	.1044	.1203	.1296	.1362	.1455	.1521	.1572	.1613
4	.0580	.0739	.0991	.1150	.1243	.1309	.1402	.1468	.1519	.1561
2	.0527	.0686	.0938	.1097	.1190	.1256	.1348	.1414	.1466	.1507
1	.0501	.0659	.0911	.1070	.1163	.1229	.1322	.1388	.1439	.1481
0	.0474	.0633	.0885	.1043	.1136	.1202	.1295	.1361	.1412	.1454
00	.0447	.0606	.0858	.1017	.1110	.1176	.1269	.1335	.1386	.1427
000	.0421	.0580	.0832	.0991	.1084	.1150	.1242	.1308	.1360	.1401
0000	.0394	.0553	.0805	.0964	.1057	.1123	.1216	.1282	.1333	.1374
Circular mils										
350,000			.0746	.0905	.0998	.1064	.1157	.1223	.1274	.1316
500,000			.0710	.0864	.0957	.1023	.1116	.1182	.1233	.1274
1,000,000			.0630	.0784	.0877	.0943	.1036	.1102	.1153	.1194

Fig. 357. This convenient table which gives the inductive reactance in ohms per thousand feet for various conductor sizes and spacings can be used to save considerable time in making transmission line calculations.

sized conductors having different spacings. These figures are given for 60-cycle lines. For 25-cycle lines the inductance in ohms for any certain conductor size and spacing will be 25/60 of that given in the table.

The values in the table will also be the volts drop per ampere, per 1000 ft. of conductor.

By referring to the table you will note that with large conductors closely spaced, the inductive reactance is very small; while on other lines with small conductors widely spaced, the inductive reactance in ohms may be equal to or even more than the resistance in ohms.

Assuming that the No. 4 conductors in our last problem are spaced 36 inches apart, we find in the table that such a line would have .1402 Ohms XL per 1000 ft. of conductor.

Then, as our line length was 20 miles or 105.6 thousands of feet, the inductive reactance per conductor will be  $105.6 \times .1402$ , or 14.8 ohms; as compared with 26.4 ohms resistance.

Then, to get the approximate impedance of the line, we combine the resistance of 26.4 ohms which we have previously found with the inductive reactance of 14.8 ohms, by means of the formula for impedance of series A. C. circuits, or

$$X = \sqrt{R^2 + XL^2}$$

or,

$$Z = \sqrt{26.4^2 + 14.8^2}, \text{ or approximately } 30 \text{ ohms.}$$

For making calculations as to the size of conductors for a transmission line there is another convenient rule which often serves as a practical guide. It is known as Kelvin's Law. This rule is as follows:

The economical conductor is one in which the current density is such as to make the annual interest on the value of each mil-foot of conductor equal to the annual value of the power lost on each mil-foot.

There are some cases in which this rule cannot be strictly followed, but it is a very good rule to keep in mind. Both this rule and the one of 1000 volts per mile and 1000 circular mils per ampere will be very handy in checking any of your figures on such problems and will help you avoid making any serious mistakes in planning a small transmission or distribution line.

In addition to the resistance and impedance losses in transmission lines there is also the capacity reactance and loss which was previously mentioned, and which is negligible on small lines but must be considered on long high-voltage lines.

### 357. CHARGING CURRENT

The capacity or condenser effect of a long transmission line with its high-voltage conductors running parallel and separated by air is quite considerable; and such long lines often draw quite a large amount of charging current, even when the load is disconnected from the receiving end.

This charging current flows in and out of the line

at the generator just as though the generator terminals were connected to a huge condenser.

Lines operating at voltages in the neighborhood of 100,000 or more will often require charging currents of several amperes, and this current flowing at the high voltages used causes the line to draw a charging load of several thousand kv-a. or more in many cases.

Knowing that transmission lines can store a charge of this amount we can readily see the necessity for short-circuiting or grounding them before working on the conductors, even though we know they have been disconnected from the power source.

### 358. SKIN EFFECT AND CORONA

Another factor which is sometimes considered on very long lines, and particularly on those of higher frequencies, is the skin effect of alternating current.

The term skin effect refers to the tendency of A. C. to flow more in the outer area of the conductor than through the center. This is caused by the action of the flux around the conductor upon the current within it, and the higher the frequency the greater is this tendency of the current to crowd toward the outer surface of the conductor.

On very high frequency equipment such as that used in radio stations skin effect is a very important factor, but on transmission lines operating at 60 cycles or lower frequencies it is a much smaller item, and is negligible on the smaller lines of moderate voltages.

Another loss sometimes considered on very high voltage lines is a brush discharge from the conductors into the atmosphere. This discharge is called corona. Corona discharge takes place more freely on small conductors and from sharp points on the conductors or live metal fittings on the lines, and actually causes a small amount of energy loss.

Large diameter aluminum conductors are somewhat less subject to corona losses and skin effect than smaller copper conductors.

### 359. SAG AND TENSION

In planning a transmission line or distribution line there are certain important mechanical factors which must be taken into consideration in addition to the electrical loss and current capacity of the line.

The sag and tension of the line conductors are two of these very important mechanical factors, as they determine the amount of strain on the conductors. Transmission line conductors between poles or towers cannot, of course, be drawn up absolutely straight or until there is no sag; because even to draw them up until there is no noticeable sag would place on the conductors a tension and strain sufficient to break them.

For this reason a certain definite amount of sag is always planned and allowed, according to the size and type of conductors and the length of the spans. A certain amount of sag or slack in the con-

Breaking Strength and allowable tension of hard drawn and annealed copper conductors				
Wire Size in ctmils & B & S Gauge	Hard Drawn Copper		Annealed Copper	
	Breaking Strength in Pounds.	Safe Tension in Pounds	Breaking Strength in Pound	Safe Tension in Pounds
350,000 C.M.	15125	7562	9350	4675
250,000 C.M.	10780	5390	6664	3332
0000	8260	4130	5320	2660
000	6550	3275	4220	2110
00	5440	2720	3340	1670
0	4530	2265	2650	1375
1	3680	1840	2100	1050
2	2970	1485	1670	835
3	2380	1190	1323	661
4	1900	950	1050	525
5	1580	790	884	442
6	1300	650	700	350
7	1050	525	556	278
8	843	421	441	220

Fig. 358. This table should be referred to in determining the sag and tension of copper conductor spans in order not to exceed the safe operating tension on the conductors.

ductors is also necessary to allow for expansion and contraction with changes of temperature. If the conductors were strung up very tightly during hot summer weather they would break from contraction during cold weather.

An excessive amount of sag is likewise undesirable because it gives a bad appearance to the line and requires higher poles or towers to keep the conductor the required distance from the ground; and also because it allows the conductor to sway excessively in the wind and creates the risk of their shorting together.

For these reasons the sag and tension of transmission line conductors is generally calculated quite accurately in planning and erecting the lines. The proper sag in feet for any given conductor span can be determined by the following simple formula:

$$S = \frac{L^2 \times W}{8T}$$

In which:

S = sag in feet

L = length of span in feet

W = weight of conductor in lbs. per foot

T = tension in lbs. on the conductor.

The allowable tension can be determined from a table of strengths or safe working tensions for various conductors. The table in Fig. 358 gives both the breaking strength and the safe allowable tension on copper conductors of the sizes more commonly used for small lines.

The allowable tension on larger conductors can be taken from the manufacturer's data or can be determined from the known breaking strength per square inch of hard drawn copper or aluminum, whichever conductor may be used. You will note from this table that the practical allowable tension on any of the conductors is considered to be about half of the actual breaking strength.

If lines were constructed with tensions much closer to the actual breaking strength of the con-

ductor, the copper would become stretched and the risk of broken conductors and interrupted service would be too great.

### 360. PROBLEMS

To use the formula for determining the sag in a practical problem, let us suppose we are running conductors of No. 0 hard drawn copper wire on poles 200 feet apart. From the table in Fig. 327 we find that the weight of bare No. 0 copper wire is 322.4 lbs. per 1000 feet, which would be .3224 lbs. per foot. From the table in Fig. 358 we find that the safe tension for No. 0 hard drawn copper is 2265 lbs.

Now, putting these values into the formula, we have:

$$S = \frac{200^2 \times .3224}{8 \times 2265}, \text{ or approximately } .71 \text{ feet}$$

which should be the sag of this conductor.

This amount of sag would be correct for the conductor as long as the temperature remained the same as during the time the conductor was being installed.

But if the line is erected during hot summer months, a little extra sag should be allowed so that the tension will not be too great during colder weather.

Sags of 2 to 5 feet are common with pole lines having short spans, and sags of 5 to 15 feet are common with steel tower lines having longer spans. Sags of 15 to 30 feet are often used on special long spans, and where conductors may cross wide rivers or valleys the sag may be 100 feet or more in a span of several thousand feet between towers.

The tension (T) in pounds which will be placed on the conductors by any given sag in feet can be calculated by the following simple formula:

$$T = \frac{L^2 \times W}{8S}$$

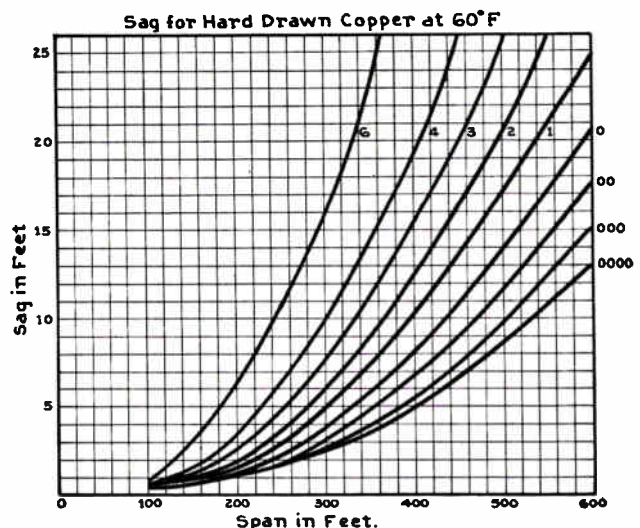

Fig. 359. The proper sag for various spans and various sized copper conductors between No. 0000 and No. 6 can be quickly and easily found from the above chart and curves as explained in the accompanying paragraphs.

For example, suppose we wish to find the tension that will be placed upon a No. 000 conductor on spans 500 feet long if the conductor is sagged 10 feet between towers.

From the table in Fig. 327 we find that the weight of 000 bare copper wire is approximately 512 lbs. per thousand feet, or .512 lbs. per foot. Then, according to the formula:

$$T = \frac{500^2 \times .512}{8 \times 10}, \text{ or } 1600 \text{ lbs.}$$

By looking in the table in Fig. 358 we find the safe tension in lbs. for 000 hard drawn copper is 3275 lbs. or nearly double the tension on the span in this problem.

Suppose in another case that an observation made during cold weather showed the sag on a certain 600-foot span of 000 hard drawn copper conductor to be only 5 feet; then we find that according to the formula the tension on this span equals

$$\frac{600^2 \times .512}{8 \times 5}, \text{ or } 4608 \text{ lbs.}$$

which the table in Fig. 358 shows is considerably more than the safe tension for 000 hard drawn copper.

In such a case this span should be given more sag before the conductor is stretched or broken.

The chart in Fig. 359 gives curves from which it is easy to determine the recommended sag in feet for conductors ranging from No. 6 to No. 0000 on spans ranging from 100 to 600 feet. These recommendations apply to conductors which are being erected and sagged at temperatures of approximately 60° F.

To determine the recommended sag it is only necessary to start at the proper point on the bottom of the chart for the span in question, and then run upward to the point where the vertical line strikes the curve for the size of conductor to be used.

The table in Fig. 360 gives recommended sags for steel-reinforced aluminum conductors ranging in sizes from 4 to 0000 and for spans of 200 to 1000 feet. These sags allow for a temperature range from 40 degrees below zero to 110 degrees above zero, Fahrenheit, and also for one-half inch of sleet and a sixty-mile wind, and the additional stress that these factors occasionally place upon the conductors.

### 361. ICE AND WIND STRESS

In many parts of the country sleet, ice and wind greatly increase the stress placed on line conductors. In certain localities it is not uncommon for line conductors to be coated occasionally with from one-half inch to an inch or more of sleet.

The ice not only increases the weight on the conductor but also increases the conductor area, thereby increasing the amount of wind stress placed upon it. Ice weighs approximately 57 lbs. per cubic foot: and one-half inch of ice all around a No. 0000

Sag in feet	Sags for Steel Cored Aluminum Conductors.							
	Sag in feet Conductor Sizes in D & S Gage							
	4	3	2	1	0	00	000	0000
200	4.1	3.4	2.8	2.5	2.	1.8	1.5	1.3
300	9.3	7.7	6.2	5.5	4.6	4.	3.4	2.8
400	16.5	13.7	11.1	9.7	8.2	7.	6.	5.
500	26.	21.4	17.3	15.1	12.7	10.9	9.3	7.8
600	37.	31.	25.	22.	18.3	15.7	13.5	11.3
700	50.5	42.	34.	29.5	24.9	21.4	18.3	15.3
800	66.	54.5	44.	39.	32.6	28.	24.	20.
900	84.	69.	56.	49.	42.	35.4	30.	25.3
1000	103.	85.	68.	60.	51.	44.	37.3	31.2

Fig. 360. This convenient table gives the proper sag for various length spans and various sizes of aluminum conductor.

cable will make the total weight just about double that of the bare conductor, or approximately 1.28 pounds per foot of conductor length.

From this we can see how very important it is to allow for the additional stress which may be placed upon conductors in many localities by sleet.

Strong winds place considerable additional side stress on both the conductors and the supporting poles or towers.

### 362. PROBLEMS

The wind pressure in lbs. on a round conductor may be easily determined by the following simple formula:

$$P = .0025 \times V^2 \times D \times L$$

In which:

P = total wind pressure in lbs.

.0025 = constant

V = wind velocity in miles per hr.

D = diameter of conductor in feet (not in inches)

L = length of wire or span in feet.

For example, suppose we wish to determine the wind stress of a 60-mile wind on the three conductors of a 1000-foot span, using steel-reinforced, aluminum cable of 715,500 circular mils area.

From the table in Fig. 327-B we find that the diameter of this conductor is just slightly more than one inch. As the formula requires the use of the conductor diameter in feet or a fraction of one foot, our conductor diameter in this case will be stated as 1/12 of a foot, or .083 ft.

Now, using these figures in the formula, we have:

.0025  $\times$  60<sup>2</sup>  $\times$  .083  $\times$  1000, or 747 lbs. stress on each conductor.

Then, to get the total stress on all three conductors, we must multiply by 3; and 3  $\times$  747 = 2241 lbs. total stress on the three conductors of this span.

In case these conductors became covered with a half-inch of sleet this will increase their diameter to twice that of the bare metal, and thereby double the wind stress.

From this we can see that the wind stress on transmission lines is also a very important factor and must be considered and allowed for in the construction of lines and in determining proper

strengths of poles, towers, and cross arms; security of foundations; etc.

In many cases where lines are frequently subjected to high velocity winds blowing at right angles to the line, side-guys are used and consist of guy wires run out on each side of the poles or towers.

The wind pressure on a round pole can be calculated by the same formula as used for conductors, except that the diameter and length of the pole are substituted for those of the conductor.

To determine the wind stress on flat surfaces of towers, we can use the simple formula:

$$P = .0036 \times V^2 \times A$$

In which:

P = pressure in lbs. per square foot

V = velocity of wind in miles per hr.

A = area in sq. ft. of tower surface exposed to wind.

### 363. LINE COSTS

In building any transmission lines, large or small, careful listing of all materials and planning of all work in advance will save great amounts of time and money.

The principal items of expense on a small pole line are as follows: Cost of right of way, clearing right of way, poles, crossarms, conductors, insulators, fittings, shipping and hauling of materials, labor costs, overhead and miscellaneous expenses, accident insurance for employees, etc.

In shipping and hauling materials to the locations along the right of way, great care should be used to see that the right materials and amounts are left at each point.

A lineman who understands these fundamentals is the man who will make a good foreman and be of great value to his employer; or, in case you plan and build a small line yourself as some of our graduates have done, keeping these points well in mind will help you to save time and money and make the job practical and profitable.

The list of items and costs of materials shown in the following estimate form for a 132-kv., 100-mile transmission line will, if carefully studied, give you a good idea of the comparative costs of various items, and will also familiarize you with the various terms and materials used in a large high-voltage line.

Small pole lines would, of course, involve only a small fraction of this number of items and of the costs given in this estimate.

#### ESTIMATE

The following is a convenient form for estimating the cost of a single-tower, double-circuit, 132 kv., 100-mile transmission line:

##### Physical Characteristics—

1. Width of right of way.....120 ft.
2. Total number of towers.....660

3. Number of strain towers..... 40
4. Number of semi-strain towers.....100
5. Number of suspension towers.....520
6. Average number of towers per mile..... 6.6
7. Weight of steel including footings of each strain tower.....13,340 lb.
8. Weight of steel including footings of semi-strain tower.....10,970 lb.
9. Weight of steel including footings of each suspension tower..... 9,000 lb.
10. Type and size of conductors, 21,600 c.m. stranded copper.....
11. Number of conductors per tower..... 6
12. Weight of conductors per mile of line .....20,124 lb.
13. Weight of reels per mile of line..... 3,240 lb.
14. Total weight of conductors and reels per mile of line.....23,364 lb.
15. Type and size of guard wire 7/16 in. (7 No. 7 wires) copperweld
16. Number of guard wires per tower.... 2
17. Weight of guard wires per mile of line ..... 4,414 lb.
18. Weight of reels per mile of line..... 1,080 lb.
19. Total weight of guard wires and reels per mile of line..... 5,494 lb.
20. Size of insulator units..... 10 in.
21. Number of units per string..... 10
22. Number of strings required..... 5,280
23. Weight of insulators per string..... 120 lb.
24. Weight of hardware per string..... 30 lb.

##### Costs—

25. Right of way 120 ft. wide at \$3,000 per mile.....\$300,000

##### Materials—

26. Steel for towers and footings, 6,310,600 lb. at 5.5 cents per lb.....\$347,083
27. Plus 10 percent. for special construction ..... 34,708
28. Conductors, 2,143,360 lb. at 18 cents per lb..... 385,805
29. Guard wires, 441,400 lb. at 15 cents per lb..... 66,210
30. Insulators 5280 strings at \$23..... 121,440
31. Insulator hardware for 4230 strings at \$5.50..... 23,760
32. Insulator hardware for 960 strings at \$9.00..... 8,640
33. Concrete footings for dead-end towers, 1500 yd. at \$20..... 30,000
34. Total cost of materials.....\$1,017,646

##### Railroad Freight—

35. On towers and footings, 6,941,660 lb. at 30 cents per 100 lb.....\$ 20,825
36. On conductors and guard wires, 3,016,760 lb. at 45 cents per 100 lb... 13,575
37. On insulators and hardware, 1,056,000 at 40 cents per 100 lb..... 4,224

38. On returned reels, 432,000 lb. at 45 cents per 100 lb.....	1,944
39. Total railroad freight.....	\$ 40,568
<b>Hauling to Site of Erection.</b>	
40. On all materials, 7500 tons at \$5 per ton .....	\$ 37,500
41. Total cost of items 34, 39 and 40....	1,095,714
<b>Labor—</b>	
42. Clearing right of way \$300 per mile..	30,000
43 Excavation and backfill:	
9300 yd., earth at \$5 per yd.,	\$46,500
2300 yd., rock at \$13 per yd.,	29,900
44. Erecting 660 towers averaging \$125 each .....	82,500
45. Stringing conductors at \$200 per mile .....	20,000
46. Stringing ground wire at \$50 per mile .....	5,000
47. Handling insulators and hardware, \$110 per mile.....	11,000
48. Repairing and clearing up, \$60 per mile .....	6,000
49. Total labor cost.....	\$ 230,900
50. Insurance, 0.9 percent. on item 49....	2,078
51. Total labor and insurance.....	232,978
52. Total material and labor (items 41 and 51) .....	\$1,328,692
53. Total items 25 and 52.....	1,628,692
54. Superintendence, engineering, and contingencies, 12 percent. item 53..	195,443
55. Total of items 53 and 54.....	1,824,135
56. Contractor's profit, 10 percent. of item 55 .....	182,413
57. Total of items 55 and 56.....	\$2,006,548
58. Interest until operation begins at 4.5 percent.....	90,294
59. Total of items 57 and 58.....	2,090,842
60. Total cost per mile.....	\$ 20,968
or approximately....	\$ 21,000

**364. LINE ERECTION**

The poles or towers of an entire line, or a considerable section of it, are generally erected complete before running or pulling up any conductors. The conductors are then reeled off and laid out along the line. This can be done either by mounting the reels on stationary iron bars or pipe shafts and pulling the conductors off the reels and along the line; or by fastening the conductor ends and moving the reels along the line on a truck or wagon, allowing the conductors to unwind as the reels are moved.

The latter method is generally best, as it does not drag or slide the conductors along the ground and run the danger of scratching or nicking them on sharp stones. Small reels can often be carried on a bar by two men.

The wire or cable lengths are next spliced together into complete line conductors. The splices are commonly made with splicing sleeves as previously explained.

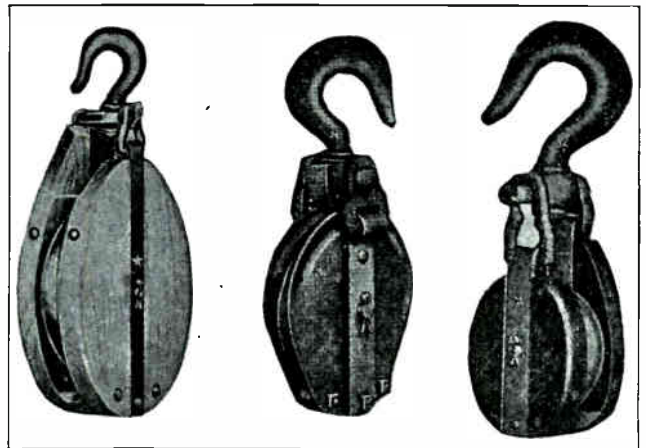

Fig. 362. Several types of snatch blocks or pulleys used for stringing line conductors.

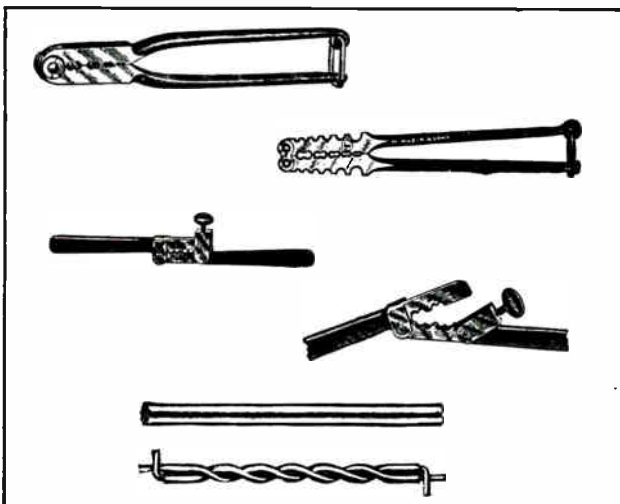

Fig. 361. Above are shown several styles of linemen's splicing clamps, and also a splicing sleeve and completed splice.

Fig. 361 shows several styles of linemen's splicing clamps, a twin splicing sleeve, and a completed sleeve splice.

After placing the conductor ends in the splicing sleeves, they are twisted by means of a pair of splicing clamps, which are placed one on each end of the splice and then rotated in opposite directions.

As the conductors are run along the line they are pulled up and laid on top of the cross arms by linemen using a light rope called a hand-line.

After the conductors are up on the cross arms they are next pulled up to the proper tension and sag by securely tying or anchoring them at one end and pulling on the other end with a block and line or with a truck or tractor.

Conductors can be allowed to slide over wooden cross arms as they are pulled up, but they should not be slid over steel cross arms on account of the danger of scratching the conductors on the sharp corners of the metal.

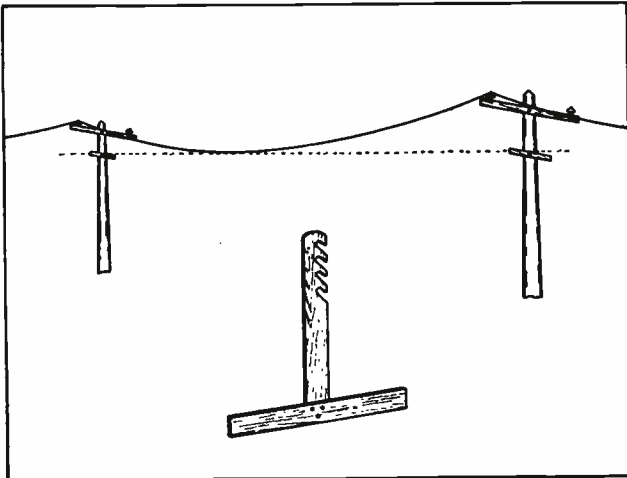

Fig. 363. The above sketch illustrates the method of sighting conductor sag and also shows a convenient form of sagging tee which can easily be made from pieces of wood.

Conductors on steel tower lines are generally hung from the cross arms in snatch-blocks or special pulleys, as shown in Fig. 362.

These pulleys have openings in the side of their hangers to allow the conductors to be laid in them, and the pulleys allow the conductors to slide freely, thus keeping the sag and tension even as the wires are pulled up.

When pulled up over wooden cross arms, conductors should be given from 15 to 30 minutes on short pulls and up to several hours on long pulls, to allow them to creep or slowly slip over the arms and equalize the sag and tension on the different spans before the conductors are fastened to the insulators.

### 365. "SAGGING TEES" AND "PULLING GRIPS"

The proper amount of sag can be determined by sighting over marks which are placed just the right distance beneath the cross arms on two adjacent poles or towers. Small straight sticks can be nailed on the poles for this purpose. The lineman by sighting over these markers along a line, as shown by the dotted line in Fig. 363, can tell when the conductor is properly sagged, as the lower point of the conductor should just come in his sight over the markers.

Convenient sighting tees, or sagging tees (T's), can be made as shown in the lower view in Fig. 362, by nailing two thin wood strips together at right angles, and notching the vertical piece so it can be hung from the conductor at the poles from which the lineman is sighting.

The T's can be made with a number of properly spaced notches in the vertical handle for various amounts of sags.

In pulling up line conductors and in anchoring them at any desired points, special grips or clamps, often called come-alongs, are used. Several of these are shown in Fig. 364.

These devices consist of a pair of gripping jaws, operating lever, and pulling eye. The pulling rope or cable is attached to the eye, and the harder the pull the tighter the jaws grip the conductor, because the pulling eye is attached to the operating lever.

Some transmission line poles are equipped with iron steps or bolts driven into the wood, and others have bolt heads projecting a short distance from the wood so that metal steps can be hooked onto them.

### 366. CLIMBERS AND SAFETY BELTS

In the majority of cases, however, a lineman climbs the poles by means of spurs or climbers strapped to his legs and feet.

A lineman can with practice learn to rapidly climb poles by firmly and easily pressing his climber spurs into the pole and going up a step at a time, using both hands to grip the pole as he climbs.

The spurs should not be jabbed into the wood, or they will be hard to pull out. The knees should be held well out from the pole when climbing in order to keep the spurs biting into the wood.

Hugging the pole with your knees will cause the climber spurs to break out of the wood and slip.

When a lineman reaches the position where he wishes to work on a pole, a strong leather safety strap is placed around the pole and carefully and securely snapped into the rings on a heavy tool-belt worn around his waist. Then, while still keeping the hands on the pole, lean back into the belt, testing its fastenings finally before releasing the grip on the pole.

The spurs can then be set in the pole at the proper point to place the body in a comfortable angle and position, and you are free to work with both hands.



Fig. 364. Several different types of "come-alongs" or pulling grips used for drawing up conductors or transmission lines.

Even when working on cross arms it is best to have your safety strap around the pole to prevent a bad fall in case of a slip.

Safety straps and belts should be given frequent inspection and testing, and the best of care, as a lineman's life depends on their being in good condition.

It is a good plan to frequently test the strength of the belt and strap by placing the spurs in a



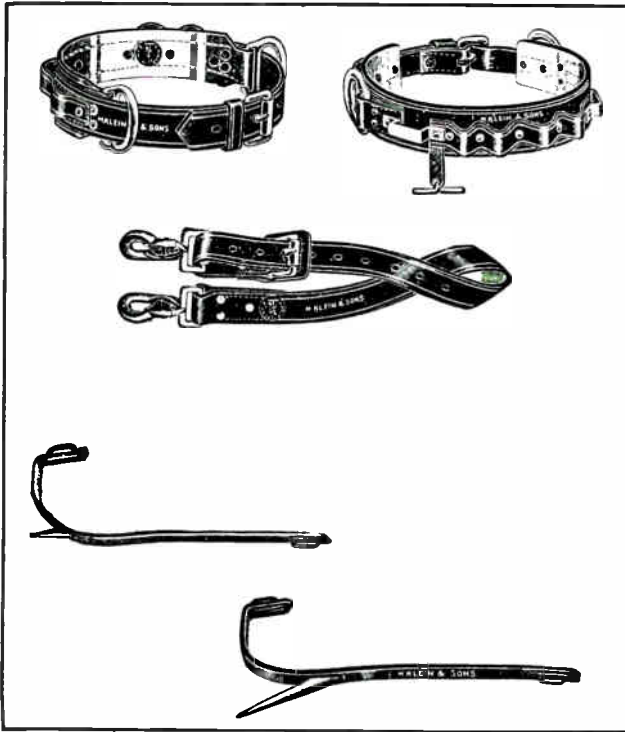

Fig. 365. Above are shown two views of a lineman's safety belt, a safety strap, and two types of climber spurs.

pole a few inches from the ground, and then leaning back hard into the belt. In case it does break a fall from this height is not very dangerous.

Fig. 365 shows two types of tool belts and a safety strap above, and two types of climbers without their leg straps are shown below.

When descending a pole the climber spurs need not be pulled out of the wood, but should be merely broken out by swinging the knee outward to release the spur.

Linemen should always be very careful in placing their spurs not to puncture insulation on conductors or injure fellow linemen working below them.

### 367. SAFETY-GROUNDING DEAD LINES BEFORE WORKING ON THEM

It is often necessary to make repairs or changes in transmission lines after they are erected. Whenever possible this work is done with the line dead or disconnected from the power plant, as the work can be done much more safely and much faster in this manner.

Before starting to work on any line that has been disconnected and is supposed to be dead, all of the line conductors should be thoroughly grounded at the point where the work is to be done. This grounding can be accomplished by throwing a dry rope or hand-line over the conductors and then using this line to pull up a bare flexible copper cable over the line conductors. One end of this cable should be well grounded to the tower or to a ground rod before drawing the other end over the line. The hand-line should be securely tied to the pole or a

stake or weight to hold the ground conductor in place.

Great care should be used to see that the ground cable is held securely against all line conductors, even using, if necessary, extra hand-lines to hold it against certain wires, as shown in Fig. 366.

Shorting and grounding the line conductors in this manner discharges any static energy that may be stored in the line, and also protects the lineman in case the line should become accidentally alive while he is working on it.

Ground chains were formerly used for this purpose, but as the contacts between chain links are often poor, rusty, and of high resistance, stranded copper cable is much safer and better.

Grounding cables are often provided with clamps which can be attached to the line conductors by means of a "hot stick" or wood pole with special metal hooks and fittings on one end.

### 368. "HOT" LINE WORK AND PROTECTIVE EQUIPMENT

In certain cases it is inadvisable to "kill" a line for minor repairs or changes, because of the interruption this would cause in the customer's service. In such cases linemen are sometimes required to work on "hot" or live lines. This is quite often done on distribution lines of 2300 to 6600 volts, and occasionally on lines of much higher voltage.

On distribution lines of around 2300 to 4000 volts hot line work can be performed by linemen wearing rubber gloves to provide insulation for their hands. These rubber gloves should always be protected from wear and mechanical damage or puncture by sharp wire ends or tools, by wearing leather gloves over them.

Rubber gloves should also be frequently tested by filling them with water, immersing them up to the wrist in water, and applying 10,000 volts to the water inside and outside the gloves to see if they will puncture or leak current.

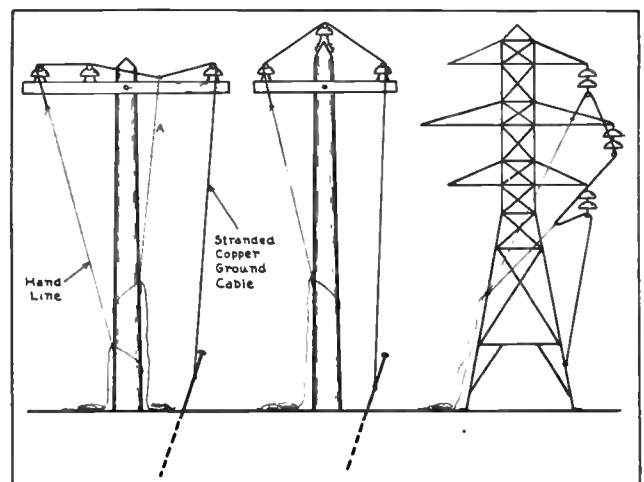

Fig. 366. The above sketches show methods of placing a ground wire over line conductors, to make a secure contact and safe ground on all conductors for the protection of linemen working on them.



Fig. 367. On the left is shown a lineman's rubber glove and on the right a soft leather protector glove to prevent mechanical injury or puncture of the rubber insulating glove.

Fig. 367 shows a lineman's rubber glove on the left and a leather "pull over" glove on the right.

In addition to rubber gloves, rubber blankets and rubber protectors in the form of split tubes or hose are also used to protect linemen from accidental contact with wires on which they are not working.

These rubber protectors are split along their lower sides to allow them to be easily slipped over the line conductors. Some of them are also pro-

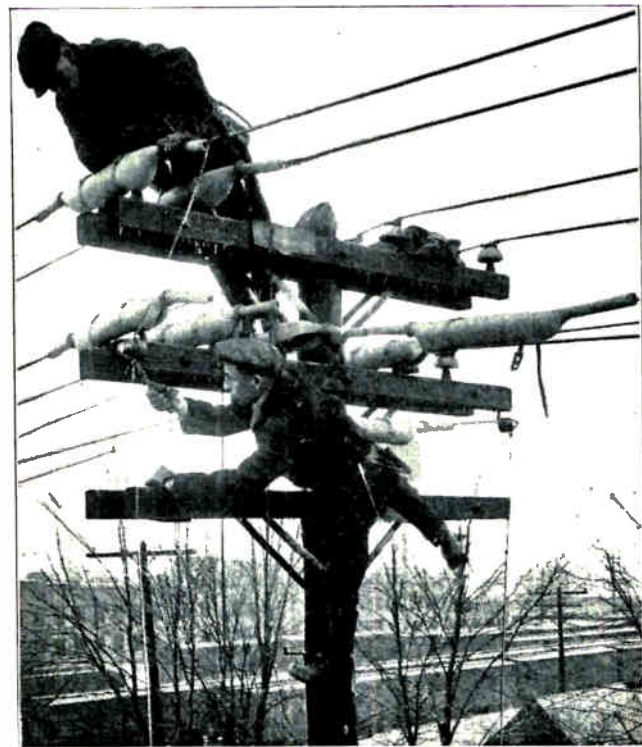

Fig. 368. This photograph shows the use of rubber line hose or "pigs" to protect linemen when working on live transmission or distribution lines. Photo Courtesy Lineman Protector Company.

vided with enlarged sections to fit over pin-type insulators and conductors at the same time. Protectors of this type are often called "pigs".

Fig. 368 shows a number of protectors or pigs in use to protect two linemen working on a pole which carries several lines.

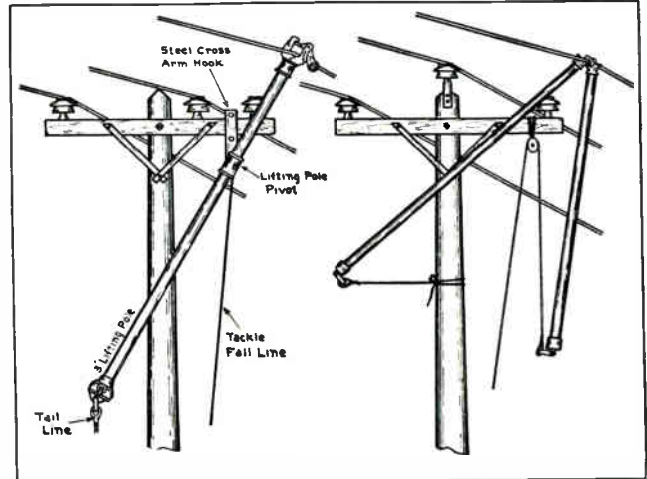

Fig. 369. The above diagrams show the use of live line tools to move live high-voltage conductors safely out of the way for replacing insulators or making other repairs. Courtesy Johnson Mfg. Co.

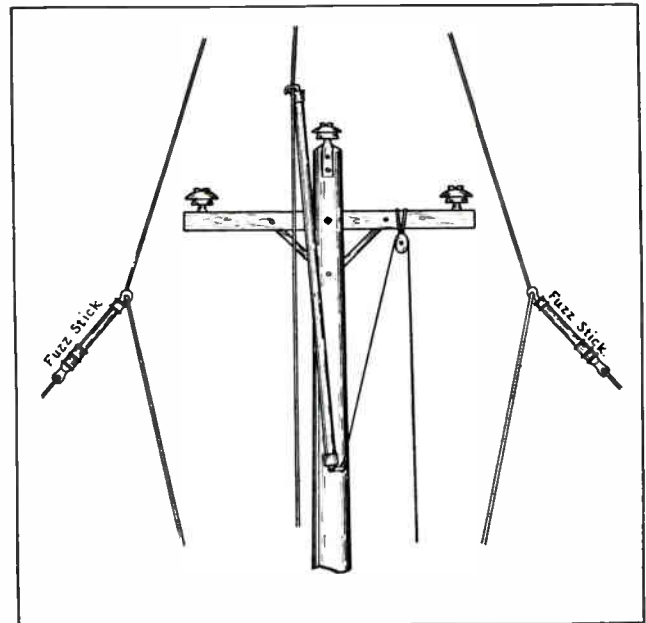

Fig. 370. This view shows the method of using a live line tool known as a "jew claw" to raise the center conductor; and two other tools known as "fuzz sticks" to draw aside the outer conductors and thereby allow a lineman to work safely on any of the three insulators on the pole and cross arm. Courtesy Johnson Mfg. Co.

### 369. "HOT" LINE TOOLS

A number of special tools and devices are available for use when working on hot lines. These devices consist of special connection clamps, jumpers, pulling clamps, etc., which can be attached to the live conductors by means of the wood sticks previously mentioned.

Other wood sticks with hooks and clamps are used to hold live conductors safely out of the way

while a lineman replaces insulators or makes other repairs on line poles or towers. Two of the most commonly used of these devices are the lifting pole and fuzz stick.

Lifting poles consist of a varnished or oiled wood pole ranging from 3 to 12 feet long and from 2 to 3 inches in diameter, according to the size and voltage of the conductors to be handled.

These sticks are equipped with a conductor-holding clamp on the top end, an eye for the hand line at the bottom end, and a pivot for supporting them on a cross-arm hook. One or more of these poles can be used for holding conductors out to the side or up above the line insulators while the lineman is working upon them.

On the left in Fig. 369 is shown a lifting pole in use to hold one line conductor above and to one side of the insulator from which it has been removed. Note the steel cross-arm hook which holds the weight of the conductor and lifting pole, and also note the hand line or tail line which is attached to the clevis or eye at the bottom of the lifting pole and holds the pole at the proper angle and position.

The sketch on the right in Fig. 369 shows another method of supporting a line conductor away from the insulator and cross arm, by means of two poles, a pulley, and two tail lines. The poles used in this manner are often called Jew Claws. Their hooks

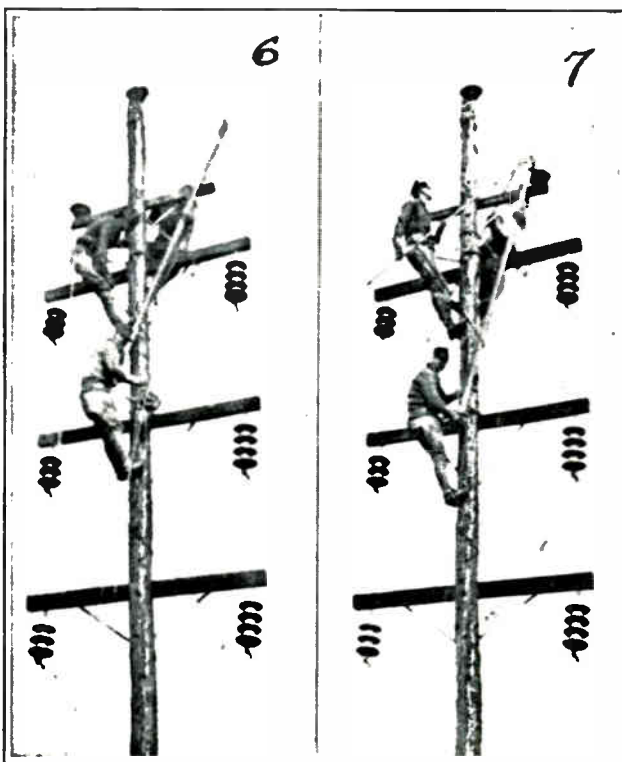

Fig. 371. The above two photos show linemen at work on a "hot" or live line, replacing insulators by means of live line tools. This work requires extreme care and accuracy and is generally done by specially trained line crews. Courtesy Johnson Mfg. Co.

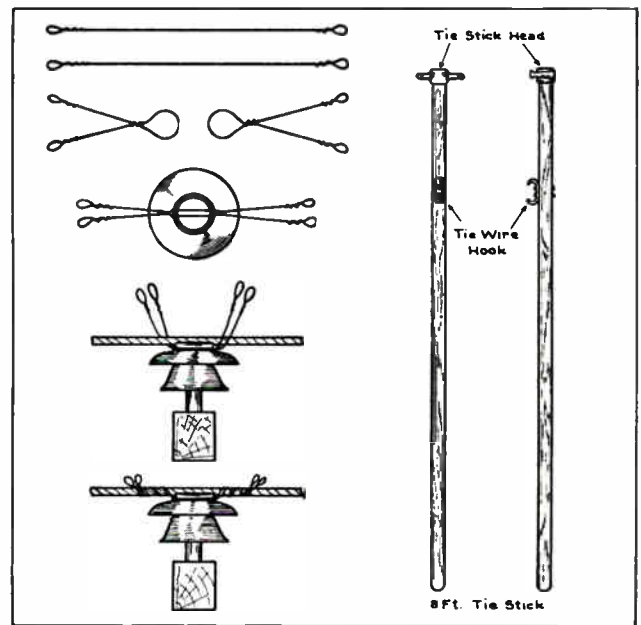

Fig. 372. The above sketches illustrate the steps and method of making a line tie by means of looped tie wires and the tie sticks shown on the right. Courtesy Johnson Mfg. Co.

are placed over the conductor and then screwed down tight by twisting the pole handle.

Fig. 370 shows one lifting pole and two fuzz sticks in use for holding all three conductors of a line away from the insulators and cross arm and to allow a lineman to work freely and safely on any of the insulators. These hot-line tools can be used in a great variety of ways for performing various operations on live lines.

The two photographs in Fig. 371 show a group of three linemen changing a pin-type insulator on a pole which carries several high-voltage lines. Note that the linemen are all wearing gloves; are keeping their bodies well away from other line conductors; and are handling the conductor which is being worked upon entirely by means of the wood handled tools.

By means of these hot-line tools with insulating handles, conductors can be disconnected from either pin or suspension-type insulators; conductor ties on pin-type insulators can be either removed or remade; and it is even possible to make actual splices in line conductors without ever touching them with the hands.

Fig. 372 shows several of the steps in making a tie on a pin-type insulator. Note that the ends of the tie wires are prepared with small loops, so that they can be wrapped around the insulator cap and also around the conductor by means of the wood handled tie-stick shown on the right.

Hot-line work should only be done by men who are specially trained for this work, and power companies generally have special hot-line crews who are specially drilled in the use of correct hot-line tools and on safety precautions and rules for this work.

## LIGHTNING ARRESTERS AND LINE PROTECTION

As transmission lines are made of metal and are good conductors of electricity, and also because they are elevated considerably above the ground, they are quite subject to lightning strokes and disturbances.

When a direct stroke of lightning hits a transmission line the tendency of this high-voltage energy charge is to flow along the line to some point where it can most easily discharge from the line to ground.

Ordinarily one of the easiest paths to ground would be through the windings of grounded electrical machinery connected to the line. Therefore, unless something is done to prevent lightning surges from flowing into connected electrical equipment, the excessive voltage of the lightning surges will very often puncture the insulation of transformers, generators, etc.

In some cases high-voltage lightning surges also tend to flash over the insulators to the grounded towers or wet wooden poles and thus take a more direct path to ground, instead of flowing over a long section of the line to reach grounded equipment.

In addition to direct lightning strokes, transmission lines often receive very heavy induced surges which are set up in the conductors by induction from nearby lightning discharges. These local discharges may occur from cloud to cloud above the line or from a cloud to earth near the line.

Other high-voltage surges and disturbances are often set up in transmission lines by switching operations in which loads of considerable value are suddenly cut off or on to the line. The sudden change in current throughout the length of a long transmission line when a considerable portion of its load is cut off will cause rather high voltages of self-induction in the line.

Transmission lines and their connected electrical equipment can be protected to quite an extent from flash-over of the line insulators and from puncturing of the insulation on machine windings by using lightning arresters and other protective devices.

Among the devices commonly used for this purpose are horn and sphere gaps, choke coils, lightning arresters, overhead ground wires, arcing rings and horns, etc. Each of these devices will be explained separately in the following paragraphs.

### 370. HORN AND SPHERE GAPS

Horn gaps and sphere gaps are often used to provide an easier path for high-voltage surges to escape from the line to ground by jumping these gaps instead of flashing over line insulators or puncturing machinery insulation.

Fig. 373-A shows a single-line diagram of a transmission line with a horn gap connected to the line near the transformer.

Fig. 373-B shows another line using a sphere gap instead of a horn-type gap.

One side of each of these gaps is connected directly to the line, while the other side is connected to ground. By properly adjusting the spacing distance between the two horns or spheres of such gaps they can be set so that voltage that is much higher than the normal line operating-voltage will jump across the gaps and discharge to ground before it will jump across the line insulators or through the insulation of the transformer windings.

Horn gaps derive their name from the shape of the electrodes or horns between which the arc is drawn in case of a discharge from a line to ground.

After the high-voltage lightning or switching surge has established an arc across one of these gaps there is a tendency for power energy to continue to flow from the line to ground.

Horn gaps tend to prevent this and quickly extinguish the arc as soon as the abnormal voltage has discharged from the line. The arc naturally

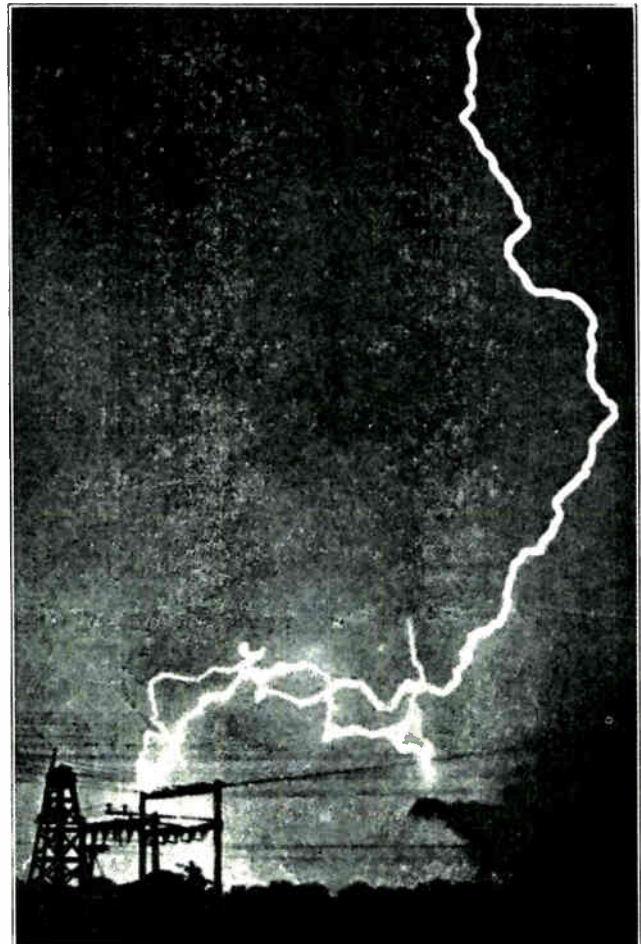

Fig. 372-A. This photograph shows a very severe lightning flash of the type which often cause disturbances on transmission lines, and in some cases cause flashovers of insulators and momentary grounding of the line energy.

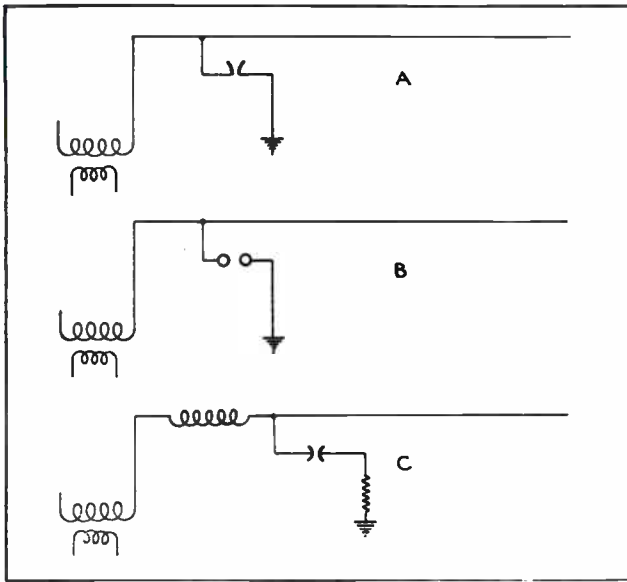

Fig. 373. The above sketches show horn, sphere, and hemisphere gaps, connected to line conductors to ground lightning or high-voltage surges. The lower sketch also shows a choke coil between the line and the transformer windings.

forms at the bottom of the horns where they are closest together, but the heat of the arc causes an upward circulation of air which drives the arc quickly toward the top of the horns where they are much wider apart, and therefore stretch the arc out to such a length that it is extinguished.

So we find that these gaps act as a sort of safety valve to allow high-voltage surges to escape from the line and then to quickly shut off or stop any flow of power current which would otherwise tend to follow the high-voltage discharge to ground.

For proper operation horn gaps should be mounted so that they are level and with the horns projecting upward in a vertical position. Care should be used to see that the gap is adjusted for the proper voltage and flash-over value, and also to see that the horns are not bent out of shape.

Sphere gaps or hemisphere gaps are often used in parallel with horn gaps or in connection with other forms of lightning arresters. Gaps of this type have a much greater discharge rate and capacity than horn or needle gaps, because of the greater surface area of the spheres. So, where lines or arresters are subject to very heavy current surges, sphere gaps are often used.

While it requires a higher voltage to jump across a sphere gap than to jump a needle or horn gap of the same distance, the sphere gap discharges more quickly when its breakdown voltage is reached. This is a very important feature, because it is necessary to relieve a transmission line of any high voltage surge as quickly as possible and before this surge has time to do damage to other equipment on the line.

In the design of lightning arrester equipment and various types of gaps, time periods as short as one

micro-second (one-millionth part of a second) or less are frequently considered.

Fig. 374 shows a table in which the sparking distances of needle gaps and sphere gaps are given for different voltages. From this table you will note that it takes approximately 20,000 volts to jump a gap of one inch between needle points, while between spheres of approximately 2½ inch diameter 20,000 volts will jump only about ⅓ of an inch.

The larger the spheres—or, in other words, the more blunt the surfaces of the gaps—the higher the voltage which will be required to jump any given distance.

You will also note that, while it requires 20,000 volts to jump a one-inch gap between needle points, 40,000 volts will jump a little more than two inches, and so on up. The higher the voltage goes, the less voltage it requires per inch to flash the gap.

SPARKING DISTANCES OF VARIOUS GAPS					
Barometer 760 m.m. Temperature 25° C.					
VOLTAGE	DISTANCE IN INCHES				
	Very Sharp Needle Points	2.46 Inch Spheres	4.92 Inch Spheres	9.84 Inch Spheres	19.69 Inch Spheres
1,000	.06				
2,000	.13				
3,000	.16				
4,000	.22				
5,000	.23				
10,000	.47	.17			
15,000	.73				
20,000	1.00	.34			
25,000	1.30				
30,000	1.63	.55	.55		
35,000	2.00				
40,000	2.45	.75	.75		
50,000	3.55	.98	.95		
100,000	9.60		2.17	2.00	2.00
200,000				4.84	4.17
300,000				9.09	6.73
400,000					10.12

Fig. 374. The above table gives the distance which various voltages will flash through air between different types of gaps.

### 371. CHOKE COILS

Choke coils consisting of 10 to 20 turns of solid wire large enough to carry the line current are often used in series with transmission lines and in connection with lightning arresters. The purpose of these choke coils is to set up considerable reactance to the high-voltage, high-frequency lightning surges.

Tests have indicated that lightning and other line disturbances set up brief surges which are not only of very high voltage but are also of rather high frequency.

We have already learned that a coil of a certain inductance will offer a great deal more impedance in a high-frequency circuit than in one of low frequency. For this reason choke coils are connected in series with the transmission line and at a point between the lightning arrester connection and the transformers or other station equipment, as shown in Fig. 373-C.

These devices are connected in this manner so

that the choke coil will tend to block or stop any high-frequency, high-voltage surges, prevent them from reaching the windings of transformers or other devices, and cause these surges to take the non-inductive path through the gaps and lightning arrester to ground.

Small choke coils made of stiff solid copper wire and in cylindrical form are generally self-supporting, but large coils are often made with a number of wood slats or strips running through them lengthwise and bolted to the turns in order to make the coils more rigid and keep them in better shape. If it were not for this bracing the magnetic stresses set up between the turns during heavy current surges would tend to distort the choke coils from their natural shape.

Choke coils are sometimes made with the center turns smaller in diameter than those on each end, in order to give them greater stiffness and enable them to be self-supporting. Coils of this type are frequently called hour-glass type choke coils.

Fig. 375 shows a choke coil of 200 amperes current capacity and insulated for 15,000 volts.

Some recent experiments and tests made with choke coils seem to indicate that they have very little beneficial effect in stopping high-voltage, high-frequency line surges and that lightning arresters are almost as effective without choke coils as with them.

However, this point has not been conclusively proven and numerous choke coils will undoubtedly still be installed. There are also in service many thousands of these devices which will probably remain in use for many years to come.

### 372. LIGHTNING ARRESTERS

There are in use a number of different types of lightning arresters; but the general purpose of all types is the same, namely to discharge or drain

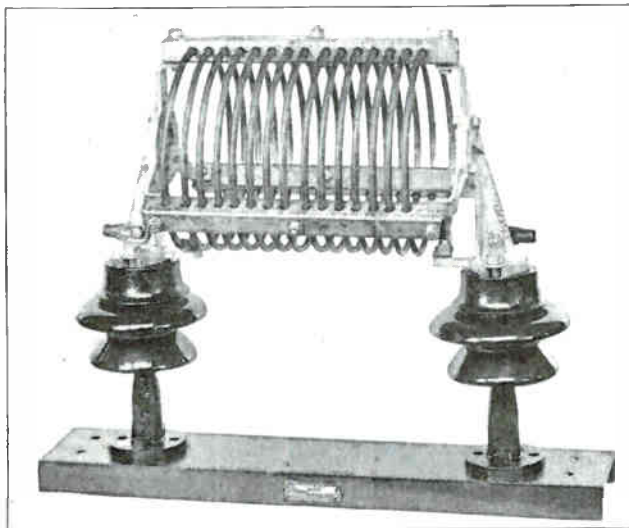

Fig. 375. This photo shows a 200-ampere choke coil insulated for 15,000 volts. Choke coils of this type are used in connection with lightning arresters as explained in the accompanying paragraphs. Courtesy G. E. Company.

from the lines any surges of excessively high voltage, and then to immediately interrupt and stop the flow of power current which tends to follow the lightning discharge through the arrester.

Some of the most common types of lightning arresters in use are the horn gap and resistance type, graded-shunt resistance type, auto valve, series gap type, oxide film type, and electrolytic or aluminum cell type.

The first two arresters mentioned are generally used on lines of the lower voltages, ranging up to about 15,000 volts. The auto valve and oxide film arresters are made for use with lines of practically any voltage by placing more or less of their small units in series. Electrolytic or aluminum cell arresters are not very often installed any more, but there are many thousands of these units in use on various lines throughout the country.

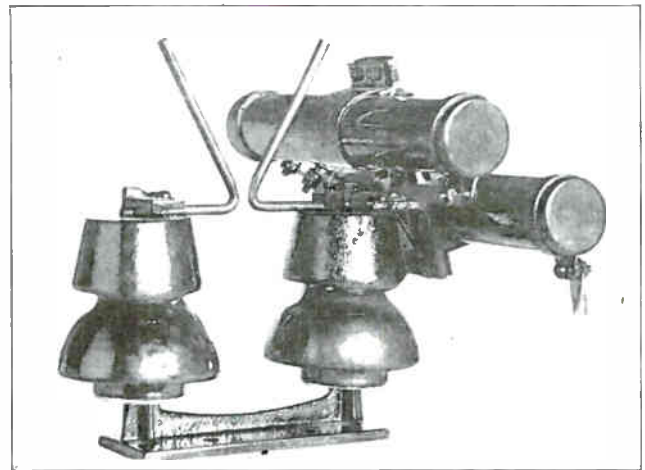

Fig. 376. Small horn gap type lightning arresters and resistance units which are connected in series with the gap and the ground. Courtesy G. E. Company.

Fig. 376 shows a simple horn-gap arrester with two tube-like resistance units which are connected in series with the gap and the ground terminal. While the resistance units do not prevent the high-voltage lightning surges from discharging through them to ground, they do tend to limit the flow of power current at normal line-voltage and thereby help to extinguish the arc after the lightning or switching surge has been discharged.

### 373. GRADED SHUNT ARRESTERS

Arresters of this type consist of an insulating base or panel upon which are mounted a certain number of small metal alloy cylinders, arranged to provide a number of gaps in series according to the voltage of the line on which the arrester is to be used.

These discharge gaps between the round surfaces of the cylinders are shunted or bridged by two or more non-inductive high-resistance units, as shown in the diagram in Fig. 377. Low or moderate frequency surges of high voltage will flow through

the higher resistance "B" and then through the three gaps in series at the lower end of the unit and to ground. Surges of somewhat higher frequency will discharge through the lower resistance "A" and the six series gaps to ground.

Surges of extremely high frequency will discharge directly across all of the gaps in series, because the slight capacity effect of the surfaces of the metal cylinders and the entire lack of inductance in this path makes it the easiest one for the high-frequency surges to follow.

The large number of gaps in series keeps the arc broken up into a number of small arcs, thus making it easy to extinguish at the zero point of the alternation of the line current.

The alloy of which the round metal knobs or cylinders are made is also of a nature that doesn't readily maintain an arc between their surfaces. Arresters of this type are generally used only on small power lines operating at voltages under 15,000.

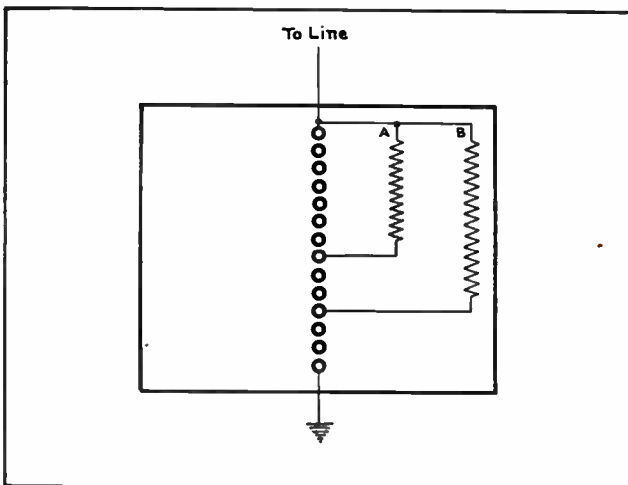

Fig. 377. The above sketch shows the arrangement and connection of parts for a simple series-gap graded-shunt lightning arrester.

### 374. AUTO VALVE ARRESTERS

Auto-valve lightning arresters are manufactured by the Westinghouse Electric & Manufacturing Company and are very extensively used on transmission lines of all voltages. These devices get their name from the automatic valve action by which they allow the discharge of a high-voltage surge and then immediately shut off the flow of power current afterward.

Auto valve arresters consist primarily of a series or stack of thin carbon-composition disks which are spaced just a few thousandths of an inch apart by thin mica rings or washers, as shown in the sketch in Fig. 378.

An assembly of this type provides both the resistance of the composition disks and the resistance of the small series gaps between the disks. This unit with its resistance is then connected in series with a spark gap and to the line wire and ground.

By using the proper number of disks in series and a properly adjusted spark gap, the arresters can be made suitable for different line voltages.

They are usually made and adjusted so that normal line voltages or small surges which are only a few percent. above the line voltage will not cause any flow of current to cross the spark gap or through the disk gaps; but as soon as a surge occurs which is considerably greater than line voltage, it will break down the resistance of the air in the spark gap and that in the gaps between the composition disks and allow the surge energy to discharge to ground.

Fig. 379 shows a sectional view of a small auto valve arrester for operation on 7500-volt lines. The stack of disks is mounted within a porcelain casing and the small hemisphere-shaped spark gap can be seen in the top of the unit, and a ground connection is shown leading from the bottom. The entire unit is provided with a clamp or mounting bracket for convenient mounting on cross arms or poles.

### 375. OPERATION

The mica washers are slightly larger in outside diameter than the carbon disks, as can be noted in Fig. 378, and this projecting edge of the mica prevents discharges from taking place at the edges or corners of the carbon disks.

The inner opening of the mica ring or washer is nearly as large as the diameter of the carbon disks, so that it leaves the greater part of their surface area exposed for the arc to take place between them. When a discharge occurs through an arrester of this type the very short arcs between disks are widely and evenly spread out in a sort of brush or spark discharge all over the surface of the carbon disks.

An arc of this type is very easy to extinguish as soon as the excessive voltage has been reduced by discharging to earth. So, for this reason, the auto valve arrester has become a very popular type and is extensively used on both low-voltage distribution lines and higher voltage transmission lines.

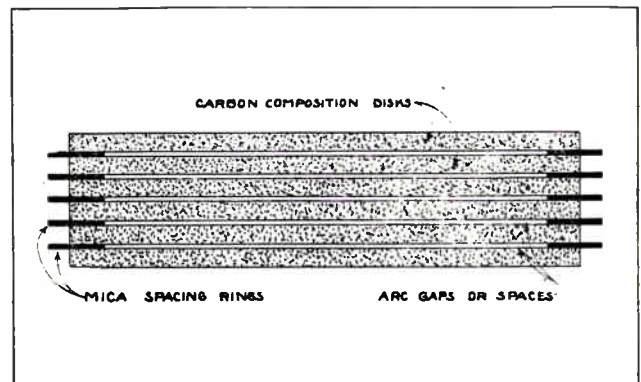

Fig. 378. This sketch shows the construction and arrangement of parts of an auto-valve lightning arrester. The discharge occurs in the short gaps between the composition disks which are separated by insulating rings.

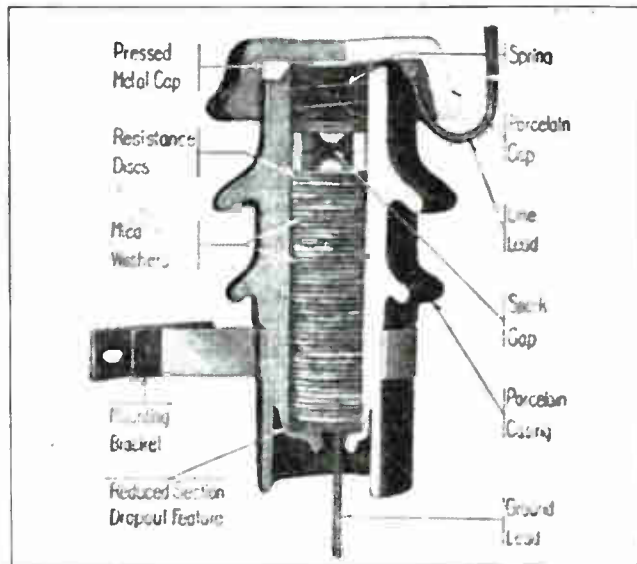

Fig. 379. Cut-away view of a small auto-valve lightning arrester for pole type mounting. Note the stack of disks and the small spark gap placed above them. Courtesy Westinghouse Electric & Mfg. Co.

By increasing the area of the disks of an auto valve arrester these devices can be made to handle very heavy discharges.

Fig. 380 shows a number of auto valve arresters for interior use and ranging in voltage from 3000 volts to 73,000 volts. Large outdoor arresters of this type are provided with metal skirts to protect them from rain and ice, and have a hooded sphere-gap connected in series with each unit or phase leg of the arrester.

One of these units or phase legs is connected to each line wire, as shown in the diagrams in Fig. 381. The view on the upper left in this figure shows both front and side views of a three-phase, pole-type installation on a 33,000-volt line. On the upper right is shown another 33,000-volt, three-phase installation with the arrester units mounted in the frame of a substation. The lower view shows a three-phase, 66,000-volt installation with the arresters mounted on a concrete foundation and the disconnect switches mounted on the steel framework of the substation. The strain insulators and choke coils can also be seen in this view.

The bottoms of all three arrester units are connected together and to ground in each case.

### 376. OXIDE FILM ARRESTERS

These arresters are manufactured by the General Electric Company and get their name from the valve action of lead peroxide powder packed between brass disks which are held separated a certain distance by an insulating porcelain ring, as shown in Fig. 382.

Fig. 383 shows one disk of an arrester of this type. A number of these disks can be stacked in series to provide the proper resistance and breakdown voltage for practically any line voltage. The

breakdown voltage of each cell or unit is approximately 300 volts.

The surfaces of the metal plates are coated with an insulating varnish before the cells are assembled and filled with the lead peroxide powder.

When a lightning discharge takes place through an arrester of this type the current flows through the lead peroxide, which is of moderate resistance, and punctures the varnish film in small spots.

The heat developed by the current flow through the lead peroxide immediately changes some of this material to red lead and litharge, which is of very high resistance, and therefore tends to stop the flow of current and extinguish the arc. Some of this melted red lead and litharge also flows into the punctured spots on the film, thus renewing their insulating quality and dielectric strength.

As these cells have a rather large active area they can stand a great number of ordinary discharges or punctures before becoming inefficient and requiring replacement.

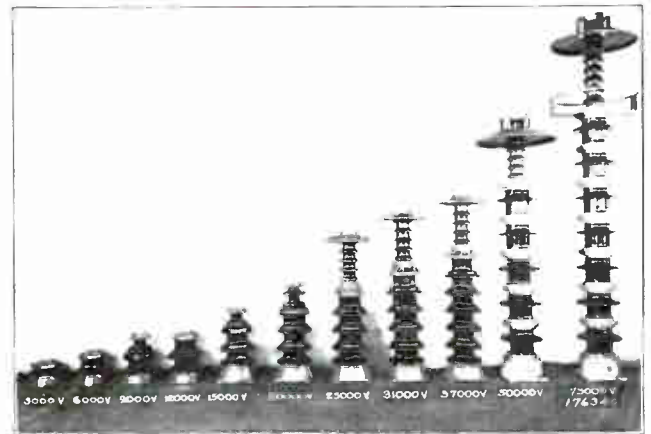

Fig. 380. This photo shows a number of single-phase auto-valve lightning arrester units for use on lines of different voltages.

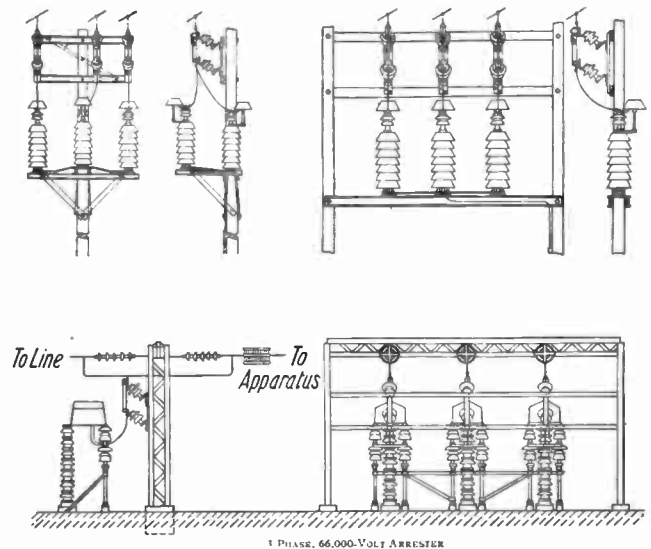

Fig. 381. The above sketches show connections and arrangement of the phase units for three-phase lightning arresters. Note the manner of connection to the line conductors and to ground, and also note the disconnect switches used to break the circuit between the line and arrester units.



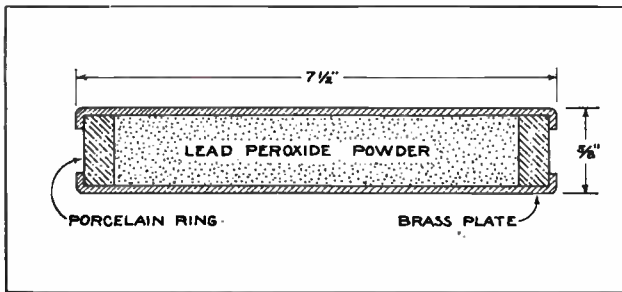

Fig. 382. This sketch shows the construction of one disk or unit of an oxide film lightning arrester.

Oxide film arresters for outdoor use on high-voltage lines are equipped with weather-protecting skirts and hooded sphere-gaps as shown in Fig. 384. This photo shows the three legs of a three-phase arrester for 25,000-volt service, and with one side of the skirts removed from the center leg so the oxide film disks can be clearly seen.

These arresters are connected to a three-phase line in the same manner as the auto valve type shown in Fig. 381. Smaller oxide film arresters for pole mounting are made in the form of insulating tubes filled with small pellets of lead peroxide that are coated with a litharge film.

The principle of these arresters is the same as that of the flat oxide film cell type, except that the discharge takes place through the high-resistance films on the surface of the lead peroxide pellets, instead of on the surface of the flat metal disks.

The high resistance sealing effect which shuts

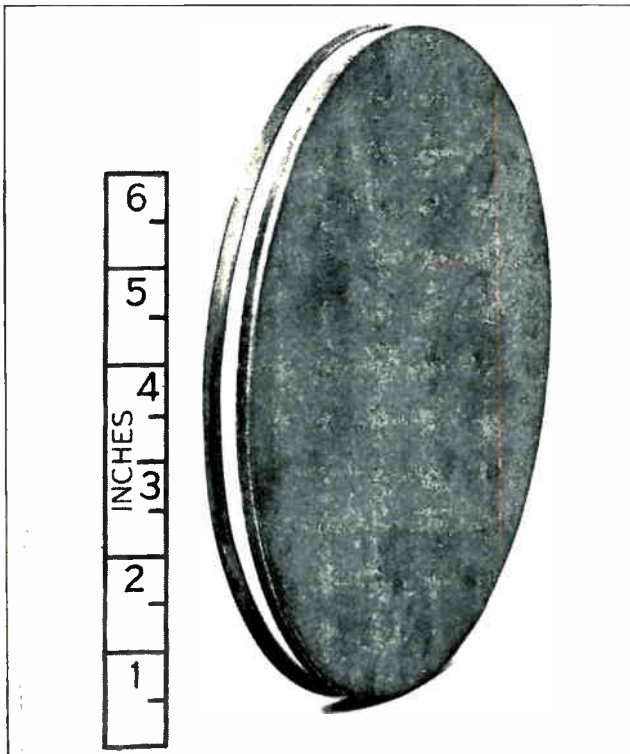

Fig. 383. Photograph showing the size and appearance of a single disk of an oxide film arrester unit. Courtesy General Electric Co.

off the flow of power energy to ground after the lightning discharge takes place in these arresters, is the same as in the flat-cell type.

Fig. 385 shows several of these pellet-type oxide film arresters, ranging from 3,000 to 15,000 volts.

### 377. ALUMINUM CELL ARRESTERS

Aluminum cell or electrolytic arresters are in use on transmission lines of practically all voltages from 10,000 to 220,000 volts. Arresters of this type possess the advantage of having a very large discharge capacity and of being readily adaptable to practically any present day voltage.

They have the disadvantage, however, of being subject to freezing when installed outdoors in cold climates.

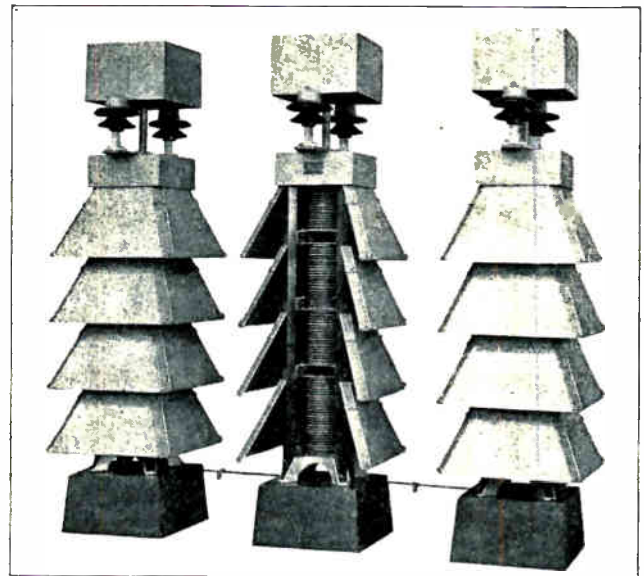

Fig. 384. This photo shows a complete three-phase lightning arrester of the oxide film type for outdoor use. Note how the disks are protected from the water by metal skirts and also note the metal housing which encloses the spark gap at the top. Courtesy G. E. Company.

Aluminum cell arresters are made up of a stack of aluminum cones which are placed point downward one within the other, and separated or spaced from .3 to .4 inches apart by means of small insulating buttons. The sketch in Fig. 386 shows a sectional view of an arrester of this type.

The spaces between these cones are then filled with an electrolyte solution of ammonium phosphate, and the whole assembly is immersed in a tank of insulating oil. As the electrolyte is heavier than the oil it will remain in place between the cones and will not mix with the oil. The oil insulates the cone stack from the arrester tank and also prevents discharges from taking place between the edges of the cones.

Arresters of this type are generally installed with horn gaps in series between their top lead or connection and the line. The lower cone is grounded to the tank and the tank in turn is grounded to earth.

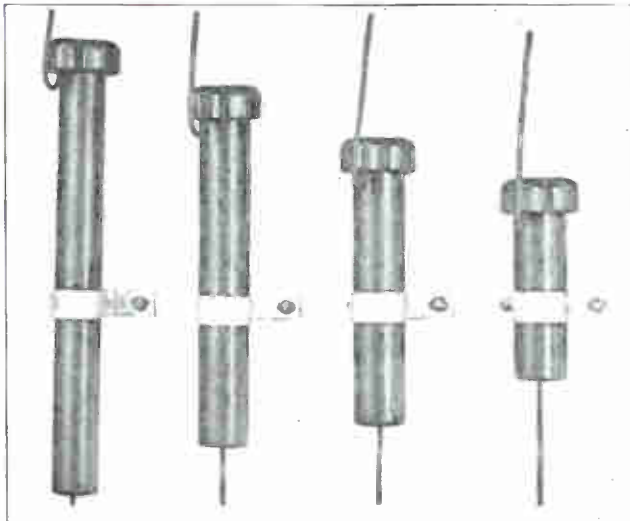

Fig. 385. A number of pellet type oxide film arresters for pole mounting on lines of 3000 to 15,000 volts. Courtesy G. E. Company.

### 378. CHARGING ALUMINUM CELL ARRESTERS

Before placing aluminum cell arresters in service they must be charged several times by shorting out the horn gap and connecting them directly to the line. This allows a small amount of current to flow through the resistance of the arrester cells and the flow of current forms a very high-resistance film of aluminum hydroxide. It is this film that builds up the proper resistance of the arrester unit.

During the first charge of a new arrester unit the current flow may be very heavy and for this reason they are sometimes charged on lower voltages than that of the line on which they are to be operated. In other cases, a fuse or auxiliary resist-

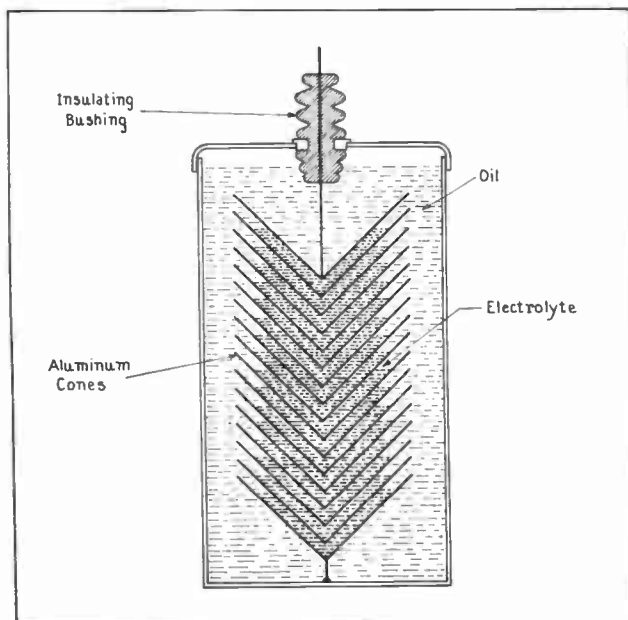

Fig. 386. The above sketch shows the construction and arrangement of parts of an electrolytic or aluminum cell arrester. Note the electrolyte between the aluminum cones and also the insulating oil surrounding them.

ance is placed in series during this charging process, to prevent an excessive flow of current.

After an aluminum cell arrester has been in normal operation it should be charged daily to maintain the high-resistance film on the surface of the aluminum cones.

During these charging operations the current flow will be approximately one-half ampere through each leg or stack of the arrester.

In a properly charged aluminum cell arrester each cone will withstand a pressure of about 300 to 325 volts, so an arrester unit with a stack of 200 cones is suitable for a 60,000-volt line.

If a lightning surge or switching surge causes the line voltage to rise much above this value, a discharge will take place across the horn gap and down through the series of cones and the electrolyte between them. This flow of current tends to build up a still higher resistance film of the oxide on the surface of the aluminum cones, and thereby shuts off or stops the flow of power current to ground immediately after the lightning surge has been discharged.

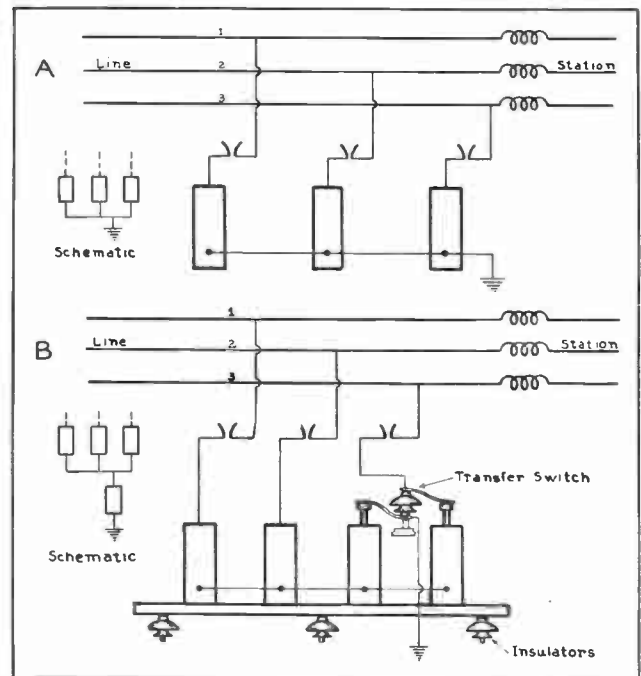

Fig. 387. "A" shows the proper connection of electrolytic arresters on a star-connected, three-phase line. "B". Connections for electrolytic arresters on an ungrounded delta-connected line.

For convenience in charging aluminum cell arresters they usually have one horn of each pair arranged so that it can be moved or rotated by means of a lever or wheel mounted within reach of the operator and well insulated from the horns by a wooden operating shaft.

When the movable horns are rotated a small auxiliary spur or horn which is attached to each one is brought into contact with the stationary horn, thus shorting the gap and connecting the

arrester directly to the line. Holding the horns in this position for a period of approximately five seconds will usually charge the arrester sufficiently for another twenty-four hour period.

The horns are then swung back to normal position, breaking the arc from the spur to the stationary horn as they are moved back.

In charging arresters which have four units and a transfer switch as in Fig. 387-B, the charging should be done in two short intervals, between which the transfer switch should be changed in order to properly charge both units 3 and 4.

For example, the daily charging procedure should be: To first charge the arrester for a few seconds before changing the transfer switch, then shift this switch and again charge the arrester a few seconds. This completes the operation for that day.

The fact that aluminum cell arresters require this daily charging is one of their disadvantages. Oxide film and auto valve arresters do not require any attention of this kind and are therefore becoming much more generally used than the aluminum-cell type.

### 379. CONNECTIONS OF ALUMINUM CELL ARRESTERS

Fig. 387-A shows a diagram of the connections for a three-phase aluminum cell arrester on a line which is connected star with a grounded neutral at the transformers.

You will recall that on lines connected in this manner the voltage from any phase to ground is only 57.7 per cent of the voltage between phases. With the connections shown, arrester units having sufficient resistance to prevent a discharge from any line wire to ground will also be sufficient to prevent a discharge from one phase to the other.

You will note by tracing the circuit that current in order to flow from any phase wire to another would have to pass through two arrester units and horn gaps in series.

Fig. 387-B shows the connections for a three-phase arrester used with an ungrounded delta-connected line. In this case the voltage from any phase to ground is the same as the voltage between phases; so a fourth or extra cell stack is used to provide two arrester units in series from any phase to ground, as well as two in series between any two phases.

Note that in this installation the arrester tanks are all connected together but are insulated from the ground, so a discharge passing from any one of the line wires must pass through two arrester units to reach ground.

For example, a discharge from line wire No. 1 would pass through the horn gap and No. 1 arrester unit; then up through No. 3 unit and to ground. A discharge from line 2 would flow through its horn gap, down through arrester unit No. 2 and

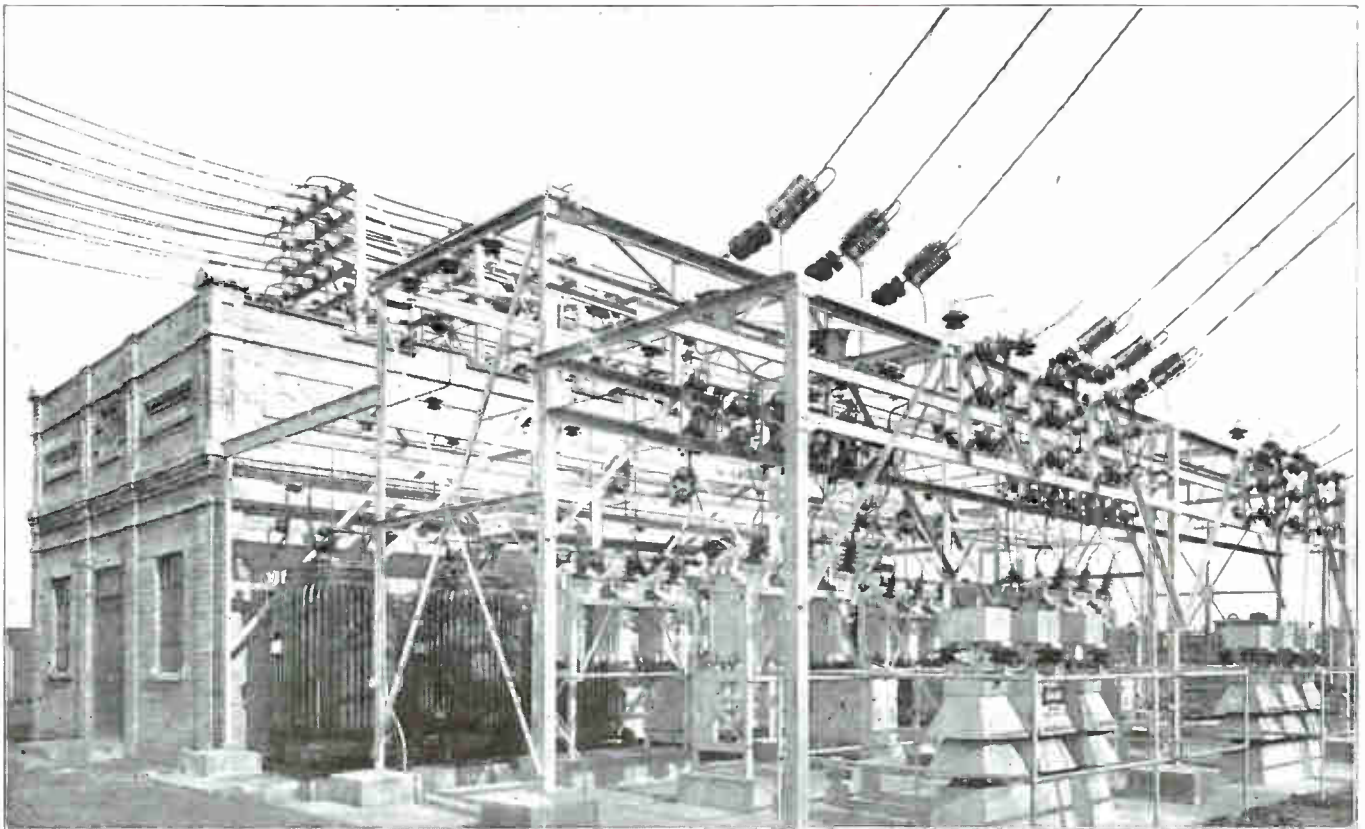

Fig. 388. This photo shows an excellent view of a substation with two sets of three-phase lightning arresters in the foreground, and their choke coils and disconnect switches directly above them. Also note the oil switches and step-down transformers in the background. Courtesy G. E. Company.

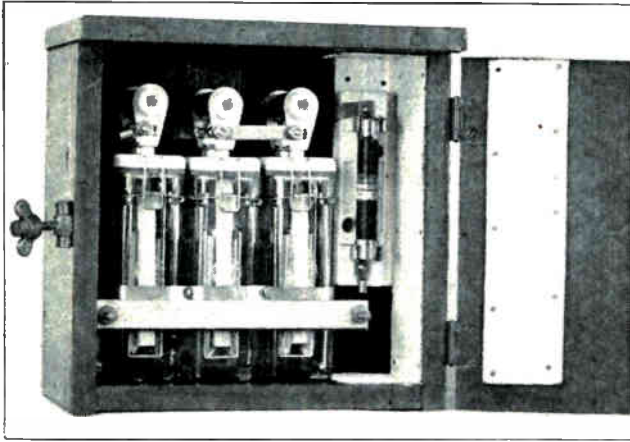

Fig. 389. Small electrolytic arrester for use on low-voltage D.C. circuits. Courtesy G. E. Company.

up through No. 3 to ground. A discharge from line wire 3 would flow down through its horn gap unit 4; then up through 3 and to ground.

Note that arrester units 3 and 4 are provided with a transfer switch which consists of curved copper blades or arms mounted on a large insulator which separates them from each other and which can be rotated by means of a hand wheel. This allows units 3 and 4 to be interchanged, so that first one and then the other can be used as the auxiliary or fourth leg, thus occasionally reversing the direction of discharge flow through them.

Fig. 388 is an excellent view of a substation in which the lightning arresters and choke coils for two three-phase lines can be clearly seen in the right foreground. Note the disconnect switches above the arresters. These switches can be used to disconnect the arrester units from the line for making repairs or adjustments.

Fig. 389 shows a small aluminum cell arrester for use on D. C. trolleys or lines of 500 to 750 volts.

When installing any kind of lightning arresters they should be thoroughly grounded with heavy copper wire leading to a ground rod, for small arresters; and copper cable leading to large buried ground plates or cables for large substation arresters. These ground connections should be frequently inspected to see that they are secure and in good condition, and the resistance of the ground system at power plants or substations should occasionally be tested to be sure it is low enough to freely carry heavy discharges.

Lightning arresters should always have separate grounds from those used for other equipment at a substation.

### 380. OVERHEAD GROUND WIRES

Ground wires are often run above the line conductors on transmission lines, to protect them from lightning discharges.

These wires are also called "earth wires" and "lightning wires". They are usually made of gal-

vanized steel and are from  $\frac{1}{2}$  to  $\frac{5}{8}$ " in diameter. They are not insulated, but are mounted directly on steel tops of towers or on small steel masts attached to tower or pole tops. Either one or two ground wires can be used.

On tower lines the lightning wires are grounded at each tower by their contact with its frame. On pole lines the lightning or earth wires should be grounded at least every 500 feet, by a wire or cable running down a pole to a ground rod.

As lightning tends to strike the earth or grounded objects at their highest or nearest points to the charged clouds, the ground wire above the line conductors tends to take all lightning discharges and prevent them from reaching the line conductors.

In order to be most effective a ground wire should be high enough above the line wires to protect an area as wide as the conductors are spaced apart.

Fig. 390 shows how the proper height for ground wires can be determined. They should be high enough above the line conductors so that the angle X between the dotted lines, will not be less than 45 degrees, and preferably not less than 50 degrees.

Several of the photos of transmission lines in this section show ground wires in position on top of the towers.

### 381. GUARD RINGS AND HORNS

Lightning surges will often cause a discharge from the line to the cross arm of steel towers, in the form of a flash-over at insulator strings.

If such a discharge is heavy a power arc will usually follow and may be maintained for short periods lasting from a few cycles to several seconds. Such arcs often clear themselves by being extinguished by an air draft during the zero voltage period of an alternation.

In other cases it may require the opening of a circuit breaker at the power plant to clear the arc.

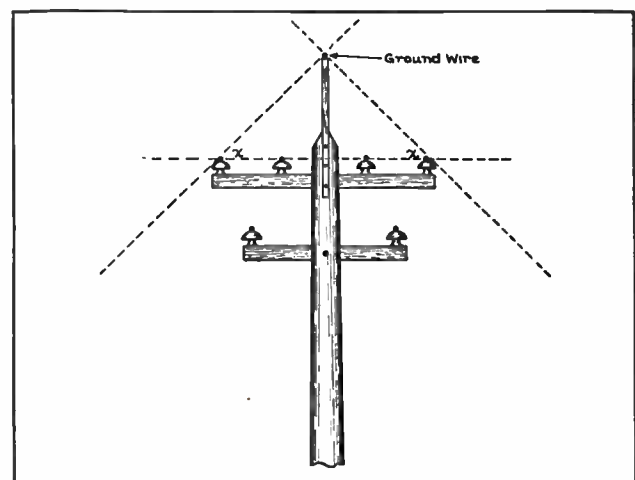

Fig. 390. The above diagram shows how to determine the proper position of a ground wire with respect to the position of the line conductors. Examine this figure carefully while reading the accompanying explanation.

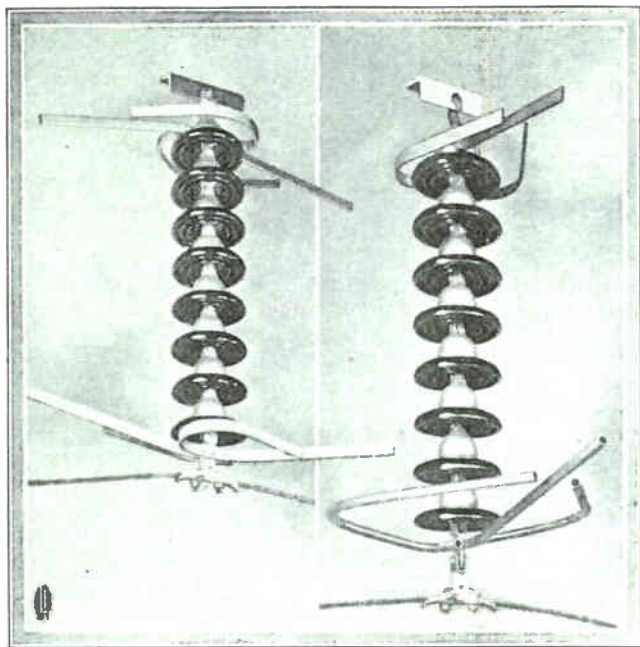

Fig. 391. The above photos show two types of arcing horns used to prevent damage to suspension insulator strings in case of flashover. Courtesy Lapp Insulator Co., Inc.

The heat of a flashover arc is so intense that if it lasts more than a fraction of a second it is likely to seriously burn the line conductor or crack some of the insulator units.

In any case the arc if allowed to cling to or cascade over the surface of the insulators will blacken them and coat them with a deposit of burned metal so that this string will be subject to flashovers again.

To avoid these troubles many power lines have their insulator strings equipped with guard rings or arcing horns, or both.

The purpose of these devices is to cause any flashover arcs to be formed away from the surfaces of the insulator, and also to keep the arc ends from the line conductor and cross arm ends.

Fig. 341 shows a flashover on a string of insulators equipped with a simple arcing horn at their lower end. You will note that this horn prevents burning of the conductor and also holds the arc somewhat away from the lower insulator units. It is not long enough, however, to prevent the arc from striking the edges of the upper insulators.

Fig. 391 shows two types of special arcing tips or guards which are designed to keep any arcs well away from the insulator and conductors.

Fig. 392 shows an insulator string equipped with a ring at the bottom and horns at the top. Rings of the type shown in this photo are often called grading shields, as they tend to distribute the voltage stress more evenly over the insulator string and thereby prevent flashovers to a certain extent.

In case of a heavy surge and a flashover the arc

is formed between the higher ends of the ring and the lowest tips of the horns, thus protecting both the line conductor and insulators quite effectively.

The table in Fig. 393 gives the arc-over values in kilovolts for several styles of insulators made by the Locke Insulator Corp. These values are obtained from actual tests made on the insulators both wet and dry, and the figures give a good idea of the number of insulators required in a string to obtain certain flashover values.

### 382. SURGE ABSORBERS

Another form of protective device for use on transmission lines is known as a surge absorber and consists of a choke coil surrounded by an iron tank which is grounded. The coil is insulated from the tank by oil and insulating bushings, and is connected in series with the line conductor.

These absorbers tend to block or stop line surges and reduce the voltage of such surges as they pass through the absorber.

The absorber tanks are usually made for horizontal mounting and they can be hung on poles or towers or in substation frameworks.

### 383. THYRITE ARRESTERS

A new material for lightning arresters has recently been developed by the General Electric Com-

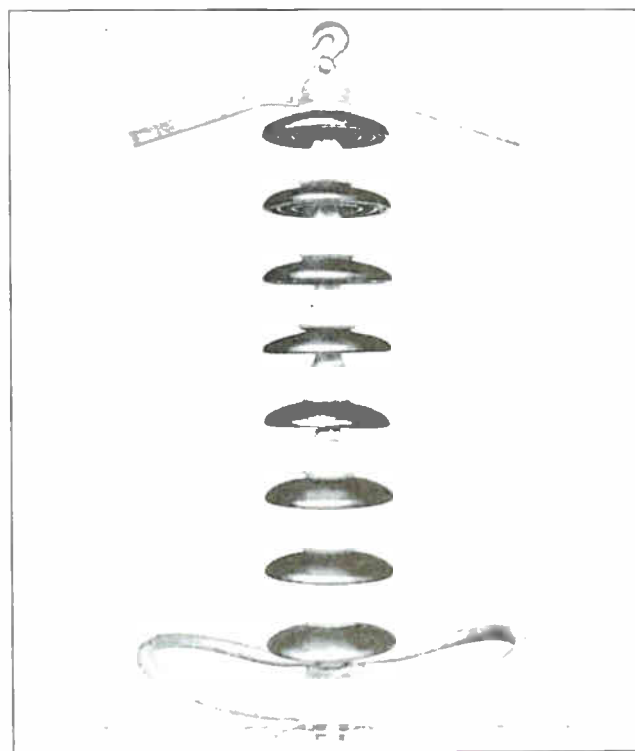

Fig. 392. String of suspension insulator units protected by a grading ring at the bottom and arcing horns at the top. This construction serves to protect the insulators from damage due to arcs and also to distribute the voltage stress more evenly over the insulator units in the string. Courtesy of Locke Insulator Corporation.

### Arc-over Values

In the following tabulations, average values, in kilovolts, are given, as measured by sphere gap, in accordance with A. I. E. E. standards.

No. 8401				No. 18034			
Number of Units	Dry	Wet	Number of Units	Dry	Wet		
1	75	45	1	75	45		
2	125	87	2	125	85		
3	175	130	3	170	125		
4	220	170	4	210	165		
5	260	210	5	250	205		
6	305	250	6	290	245		
7	345	290	7	330	285		
8	390	330	8	370	315		
9	435	365	9	410	345		
10	475	400	10	450	375		
11	520	430	11	490	405		
12	560	460	12	525	435		
13	600	485	13	565	460		
14	640	510	14	600	485		

No. 7794-1				No. 9140			
Number of Units	String No.	Dry	Wet	Number of Units	String No.	Dry	Wet
1	19101	75	45	1	9601	75	45
2	19102	130	75	2	9602	130	90
3	19103	182	110	3	9603	185	135
4	19104	230	145	4	9604	235	180
5	19105	277	180	5	9605	280	225
6	19106	325	220	6	9606	330	265
7	19107	373	255	7	9607	380	305
8	19108	420	290	8	9608	430	350
9	19109	467	320	9	9609	475	395
10	19110	512	350	10	9610	525	435
11	19111	557	380	11	9611	570	470
12	19112	600	410	12	9612	620	500
13	19113	645	440	13	9613	660	530
14	19114	685	470	14	9614	705	555

Fig. 393. The above table gives the voltages required to flash over various numbers of insulators of different types on tests made both wet and dry. Note: The voltages are stated in kv. or thousands of volts. Courtesy Locke Insulator Corporation.

pany and is called Thyrite. This material is somewhat like porcelain in its mechanical structure, but it has the peculiar property of being an insulator at certain voltages and a conductor at certain higher voltages.

A number of disks of this material can therefore be stacked in an arrester unit and as long as ordinary line voltage is applied practically no current will flow through it.

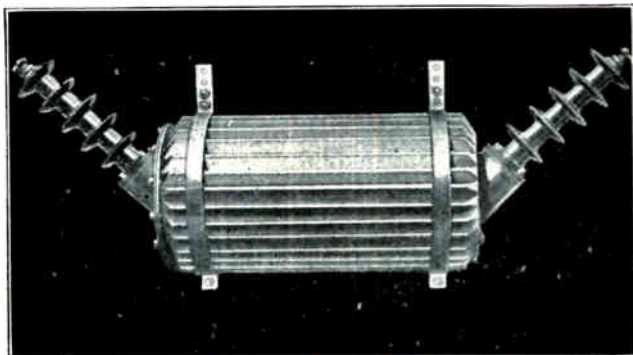

Fig. 393-A. This photo shows a surge absorber made by the Ferranti Company, Inc., and used to check and reduce high-voltage surges on transmission lines.

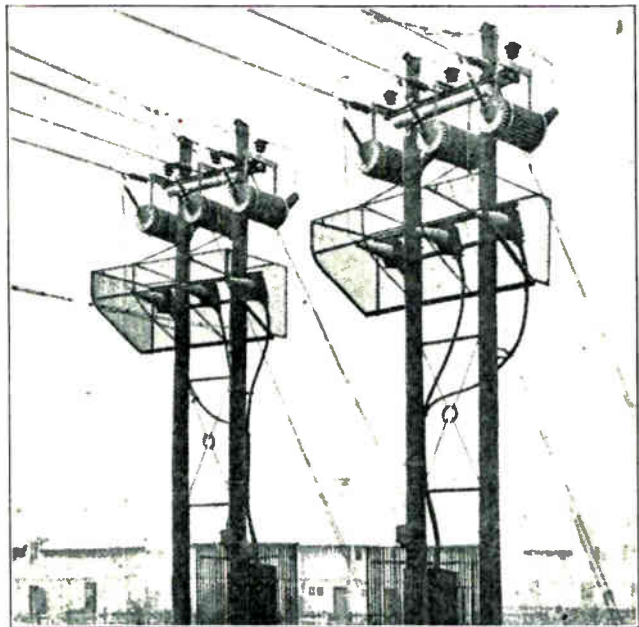

Fig. 393-B. Photograph of an actual installation of surge absorbers on two three-phase lines. Courtesy of Ferranti Company, Inc.

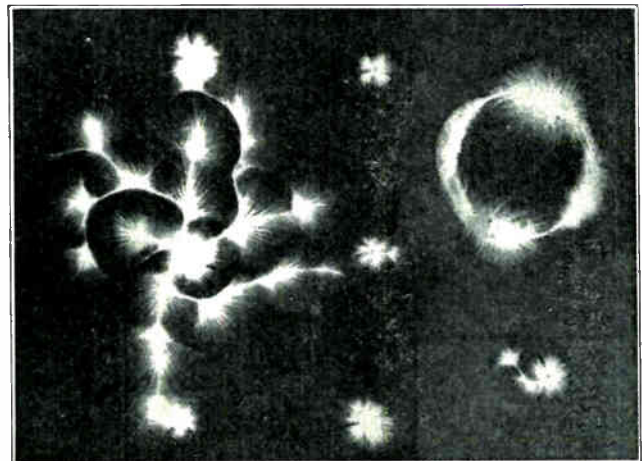

Fig. 393-C. This view shows a combination of several photographs of klydonograph records of lightning surges on transmission lines.

When excessive voltages of a considerably higher value are applied, quite a considerable current will flow through the Thyrite disks, thus relieving the line of the surge.

A great deal of testing and research work is constantly being done by power companies and electrical manufacturers, to devise better ways of protecting lines from lightning.

Interesting instruments and devices have been developed for recording the voltage values and indicating the nature and polarity of lightning surges.

One of these devices called a Klydonograph will actually photograph a small discharge from lines to which it is connected, and give a picture that indicates the voltage and polarity of the surge causing the discharge.

Special lightning generators consisting of high voltage transformers, rectifiers and condensers have been built and used to build up charges of 3,000,000 volts and more to make actual field tests of the effects of lightning on transmission lines.

Modern lightning arresters are very effective, and

proper consideration should always be given to this important equipment when building or planning any transmission line.

In maintaining lines great care should be taken to see that all arresters and protective devices are kept in good condition, and properly grounded.

## DISTRIBUTION LINES

Up to this point we have referred principally to transmission lines and the term "distribution line" has not been used to any great extent. In reality distribution lines are nothing but small transmission lines operating at lower voltages than long transmission lines.

In general the term transmission line applies to those lines running from power plants to substations or from one power plant to another, and the term "distribution lines" refers to those which run from the substation out to the transformers on the poles or in the vaults near the customers' premises.

Most modern primary distribution systems operate at voltages ranging between 2300 and 5000, and the voltages are reduced from this value to that required by the customers' equipment by means of step down transformers. In some cases, however, we have secondary distribution systems which may branch out from low-voltage transformer secondaries to a number of homes or small buildings and carry energy at voltages ranging from 110 to 500.

In general it is best not to have lines at this low voltage running more than a few hundred feet, but in some cases the load demand of individual customers is so small that it is not practical to install a separate transformer for each customer.

### 384. TYPES OF DISTRIBUTION SYSTEMS

Distribution systems may be either of the overhead or underground type and may operate on either D. C. or A. C.; the great majority being supplied with alternating current. Some of these systems are either single-phase or three-phase, although there are still a few two-phase distribution systems in existence.

Three-phase, four-wire systems are very extensively used for distribution because of the two different voltages that are easily obtainable with this system.

Transformers supplying systems of this type may have their secondaries connected star with the grounded neutral, and the fourth wire is run from this neutral connection as explained in the Section on Transformer connections.

With this connection, if the voltage between phases is 4000, then the voltage between any phase and the neutral wire will be slightly over 2300. Then by using step-down transformers with a ratio of

10:1 and split secondaries, the 2300 volts can be reduced at the customer's premises to 115 and 230 volts for Edison three-wire services or secondary distribution.

Using ordinary 2300-volt transformers with a 5:1 step-down ratio with primaries connected star to the 4000-volt wires and the secondaries connected delta will give 461 volts for the operation of 460-volt power equipment. With the usual amount of voltage drop in the service wires this provides approximately 440 volts at the terminals of the motors or power devices.

### 385. FEEDERS AND MAINS

Some distribution systems use an arrangement known as *feeders and mains*, such as shown in Fig. 394. The line running out from the source of supply to the various branch lines is known as the *feeder* and the branch lines from which the customers' connections are taken are known as *mains*.

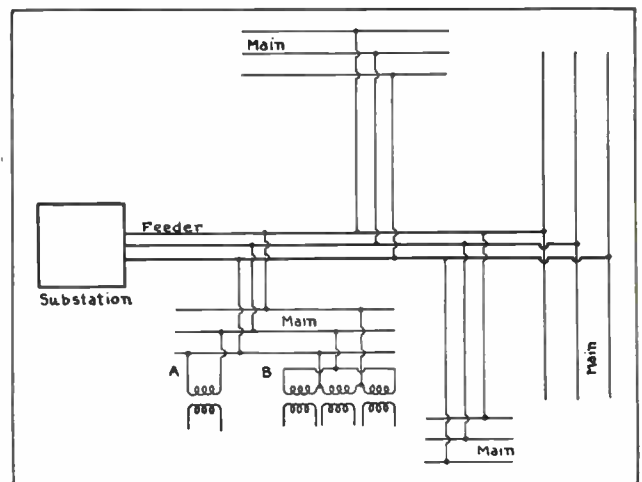

Fig. 394. Sketch showing arrangement of feeder and main distribution system.

At "A" and "B" are shown a single-phase and a three-phase service to customers. The number of customers connected to any main will depend upon the distance the customers are apart and the amount of load which each requires. This number may vary from one to several dozen or more.

Customers' connections are not shown on any of the mains except one in Fig. 394. This diagram shows a three-phase feeder and main system but

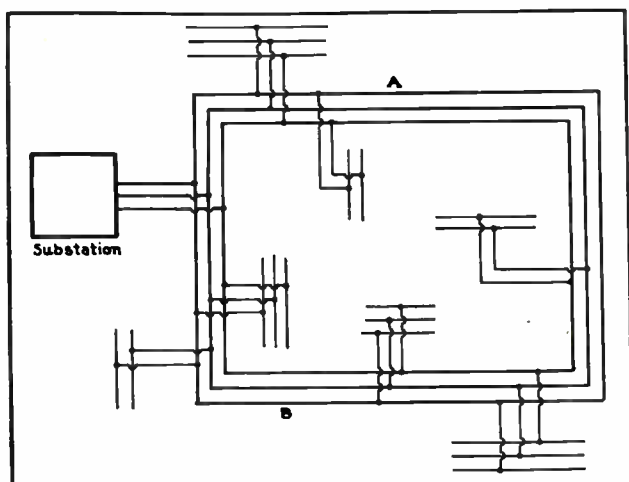

Fig. 395. This sketch illustrates the loop method of connection for distribution systems.

this same plan of connections can be applied to single-phase equally well.

In many distribution systems the loop connection, such as shown in Fig. 395, is used. In these systems either the feeders or the mains or both are arranged in a complete loop and this loop may be fed at one or more points.

In Fig. 395 the loop is fed from the substation at only one point. With a system of this type if some fault made it necessary to disconnect the line at "A" the customers on the main at the far end of the loop would still receive energy from the substation through the line on the other side at "B".

You will note that in Fig. 395 some of the mains connected to the feeder are for single-phase service only while the others are three-phase. In connecting single-phase mains to three-phase feeders they should be balanced as equally as possible on the three phases. The same thing applies when connecting customers' single-phase loads to three-phase mains, as shown in Fig. 396.

The transformers supplying single-phase mains, A, B, and C, each have their primaries connected to different phases of the three-phase feeder. The two banks of three-phase transformers supply the three-phase mains, D and E.

Care should also be taken to balance the loads on Edison three-wire systems. Fig. 397 shows a number of single-phase transformers with their primaries properly connected at "A" to balance the load on the three-phase, 2300-volt distribution line. The split secondaries of these transformers feed Edison three-wire lines from which the customers' service leads are taken.

Some of the customers have three-wire services shown at "C", while others have only two-wire service as at "D". The two-wire services are shown properly connected to balance the load on the Edison three-wire system and on the transformer secondaries.

At "B" is shown a connection to supply three-

phase power to motors. Also observe this diagram carefully to distinguish between the three-phase circuits and the Edison three-wire circuits.

### 386. GROUNDED SYSTEMS

Some power companies prefer to use grounded distribution systems, while others prefer the ungrounded systems. Each type of system has different advantages and disadvantages.

With grounded systems there is very little chance of the high primary voltage causing danger or trouble on the secondary lines, because of the tendency of this high voltage to first come to ground in case of any faults and thus blow the primary fuses, due to the short-circuit formed in this manner. The short circuit must then be immediately located and cleared before again putting power on the line.

With ungrounded systems one ground doesn't necessitate cutting off the power, as motors will operate even with one of the line wires grounded. When the ground is noticed it can be located and then repaired at some later and more convenient time when the power can be shut off with the least inconvenience to customers. While this ungrounded system may often give somewhat more continuous service it possesses the disadvantage of greater danger from the high primary voltage connecting on the secondary in case of insulation failure in the transformers.

The neutral wire of three-phase, four-wire system is often grounded at other points as well as at the transformer, in order to provide the greater safety in having more than one ground so that in case of failure of one there is sure to be some other good low-resistance ground at all times.

The neutral wire of such systems is usually identified and kept in the same position on the cross arms so that it can be easily located when making transformer connections. The neutral wire of three-wire Edison mains or services should always be kept in the center between the two 220-volt wires.

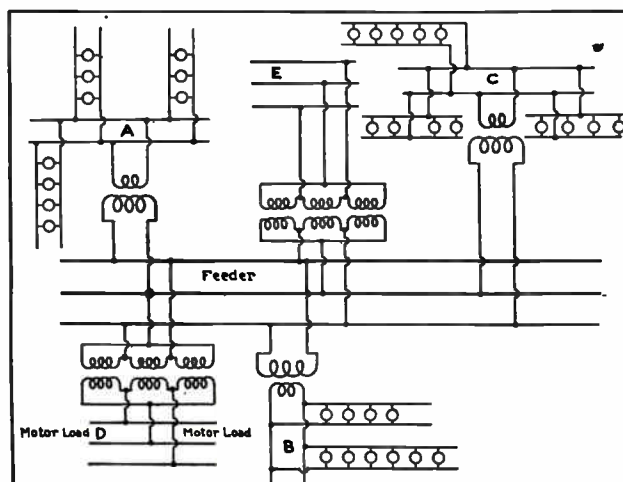

Fig. 396. Diagram showing method of balancing single phase customers' loads on three-phase distribution lines.



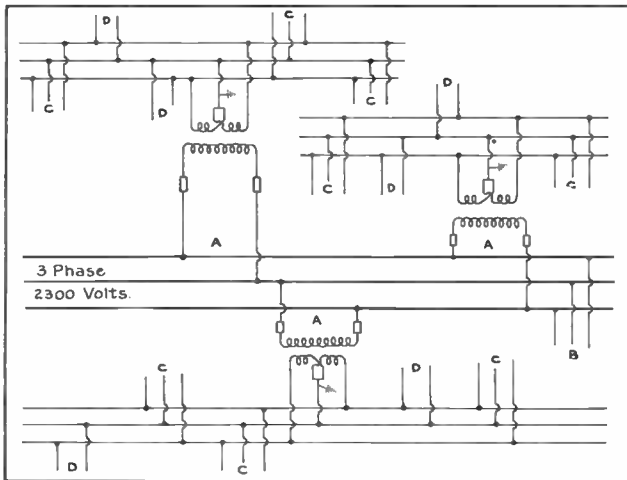

Fig. 397. Single-phase transformers with their primaries properly connected to balance the load on a three-phase distribution line, and their secondaries connected to supply three-wire Edison service to customers. At "B" is shown a connection for three-phase motor service directly from the distribution line.

This applies where the wires are run on cross arms, attached to strain insulators on buildings, and where they enter three-hole conduit covers.

### 387. GENERAL

In general most of the same things which have been covered in connection with transmission lines apply also to distribution lines. One principal exception to this is that most overhead distribution lines use insulated conductors, while those of transmission lines are practically always bare. There is, however, a growing tendency in many localities to use bare distribution conductors on wires of 2300 to 4000 volts or more, because it has been found that

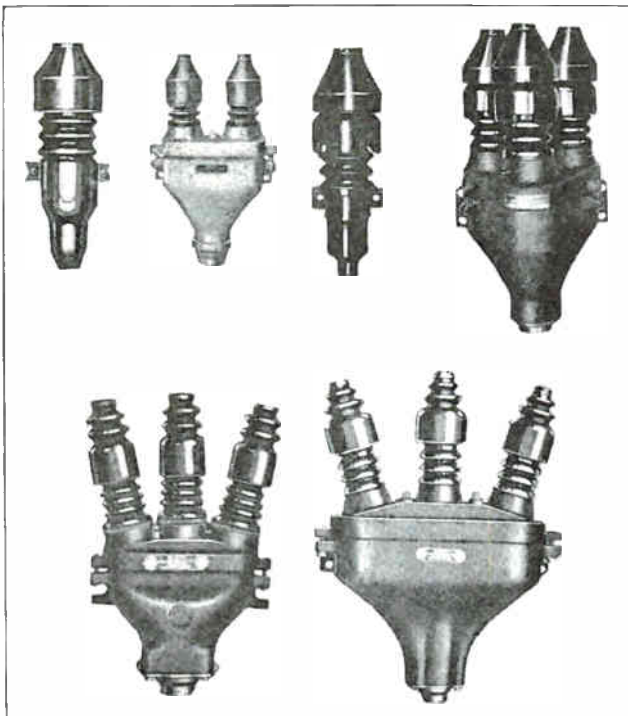

Fig. 398. Above are shown a number of different types of pot heads used for supporting and insulating high-voltage overhead conductors where they enter underground cables.

in many cases insulation several years old is not of much value on these outdoor conductors in case of other wires or conducting objects coming in contact with them.

In many cases this aged insulation of somewhat questionable value is often depended upon too much by people working on or near distribution lines, while if the wires were known to be bare greater caution would be used in handling other wires or metal objects around these lines.

Overhead construction is generally used for distribution lines as its cost is usually only about 20 to 30 per cent of the cost of underground distribution. In very congested business districts or restricted residence sections, where overhead lines are objectionable from the standpoint of danger or appearance, underground distribution may be used.

In overhead distribution line construction the distance between poles is often much less than that used with transmission lines and the question of conductor strength doesn't enter into the problem to such an extent.

Distribution line poles are generally spaced from 100 to 125 feet apart, and located at the lot lines when possible. Poles are often set closer than 100 feet to corner poles to help take some of the strain. Where ever necessary stranded steel guy wires are used to relieve the poles of excessive strain. These guy wires are usually from  $\frac{1}{4}$  to  $\frac{5}{8}$  inch in diameter, according to the load placed on them, and are fastened either to a ground anchor, guy stub pole, or to the bottom of an adjacent line pole. Strain insulators such as shown in Figure 347, are usually placed at one or two points in the guys.

Poles are generally of cedar, pine, chestnut, or cypress, and usually about 30 feet in length and with a top diameter of 7 inches, except where longer poles must be used to obtain a certain line height or clearance, or heavier poles for corner duty and heavy strains.

In ordinary soil, distribution poles are usually set from 5 to 6 feet deep, or up to 7 feet for extra high poles.

Distribution line cross arms are generally made of pine or fir, and are about  $3\frac{1}{4}$ " wide by  $4\frac{1}{4}$ " high, and 5'-7" long for 4 pins, or 8' long for 6 pins. These cross arms should be straight grained and free from any large knots in order to have sufficient strength to support the lineman as well as the conductors. The tops of arms are generally rounded slightly to shed water.

Cross arms are braced with strap iron or angle iron to make them more rigid and better able to support their loads. The arms are usually drilled for wood pins which support the small glass or porcelain insulators used in distribution work.

Conductors are generally drawn off from a reel placed at one end of the line, and pulled up over cross arms for a distance of 1000 to 2000 feet, then

made fast at one end and pulled up to proper tension and sag by means of a block and line.

Distribution conductors on ordinary 100 to 125 feet spans are usually sagged about 18" if put up during cold weather with temperatures about freezing, to about 26" if put up during hot summer weather with temperature of 80 to 90 degrees F.

Shorter spans of course use less sag, and a span of 50 or 60 feet would only need to be sagged about half as much as one of 100 to 125 feet.

Insulated distribution conductors are tied to the insulators with a simple side tie, using a short piece of the same insulated conductor material with the insulation left on. See the Western Union tie shown in Figure 335.

Conductors should be arranged as neatly and uniformly as possible on all poles, to facilitate tracing circuits and locating certain conductors. They should also be kept far enough apart at the center of the arm to allow a lineman to climb through at the pole, and should be kept spaced a safe distance from any higher voltage wires that may be carried on a top arm on the same pole.

In calculating the size of conductors for distribution lines the formulas already given for voltage drop should be applied, to make sure that the voltage at the customers' premises is of the right value for efficient operation of lights and power equipment. Allowance should also be made for increase of load as additional customers are connected to the lines, and as the load of present customers increases.

In calculating the load demand on distribution lines the total connected customer load is seldom used. A load factor or average is used, and this may vary from 15 to 75 per cent. of the connected load, according to the nature of the connected customers' equipment. It is quite common to allow about 300 watts average load for each ordinary residence building unless some of them are equipped with electric ranges or heating equipment.

Actual meter tests and observations of the various customers' loads and load factors will help determine the proper size of transformers and conductors.

These tests and load factors also help to determine the size of transformers to install. Distribution transformers in ordinary residence sections are usually placed along the lines about every 500 to 600 feet, or the length of an average city block. This spacing is quite economical, as closer spacing of smaller units runs up the cost of transformers and light-load losses, while greater spacing increases the cost of copper in the secondary mains more than the amount that can be saved by reduction of the number of transformers. The size of these transformers may range from 2 to 5 kv-a., in lightly loaded residence sections, to 10 to 100kv-a. or larger in apartment, business, or industrial sections.

Transformers are hung by means of heavy iron hooks, from extra heavy cross arms about 4" X 5".

They usually have high voltage fuses or cutouts connected in their primary leads to protect their windings and the secondary mains from damage in case of overloads or short circuits. Figures 106, 124 and 150 in Section Four of A. C., show several distribution transformers, and figures 119, 120, 121, 128, and 131 show common connections used.

Small autovalve and oxide film arresters such as shown in Figures 379 and 385 are commonly used for lightning protection on distribution lines.

Where high voltage conductors of distribution lines or transmission lines are taken from overhead poles or towers to underground cables or conduits they usually enter the cable or conduit through devices called pot heads, such as shown in Fig. 398.

These pot heads generally consist of a metal casing with a fitting for securely attaching them to cable or conduit, and one or more insulating bushings through which the overhead line conductors enter the pot head casing.

After the joints are made within the casing the pot head is usually filled with insulating oil or compound. Some pot heads are of the disconnecting type, having prongs attached to the lower ends of conducting rods which run through the bushings,

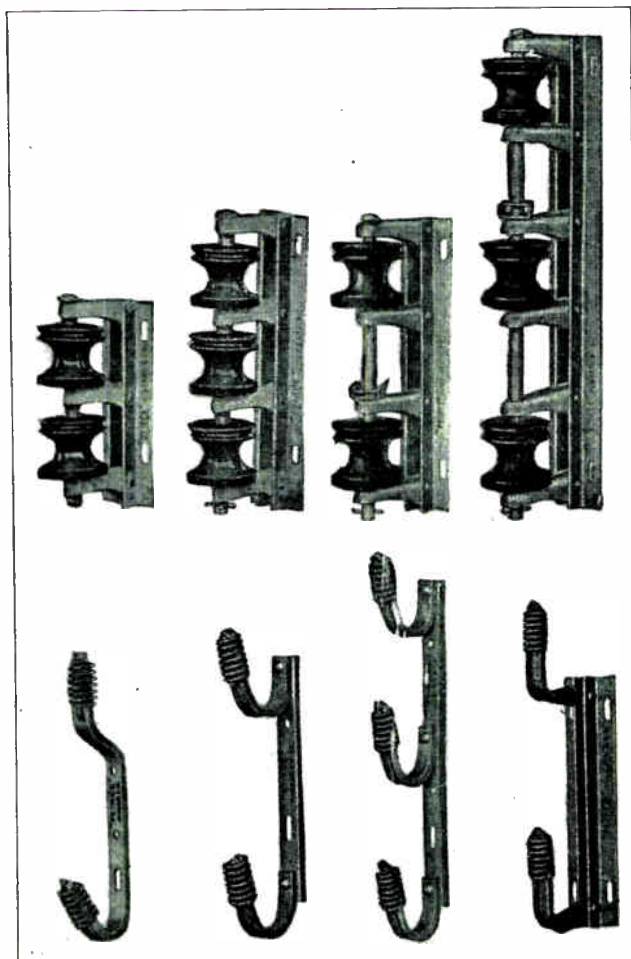

Fig. 398. The upper view shows cable racks used for supporting low-voltage wires on distribution poles or within factory buildings, and below are shown brackets for mounting small pin type insulators in groups on the sides of poles or buildings.

and these prongs fitted into spring sockets mounted in the lower section of the casing.

With this type of pot head it is only necessary to unbolt the cover and lift it and the bushings from the lower section, in order to disconnect the overhead from the underground line.

Low-voltage secondary wires of distribution systems are very often run on special metal brackets and knob insulators, known as secondary racks. Several of these secondary racks are shown in the upper part of Fig. 399. These racks can be attached to poles, cross arms, or to the sides of buildings, and are very convenient to mount and to support low-voltage insulated conductors.

In the lower view in Fig. 399 are shown several brackets for mounting small pin-type insulators on the sides of poles or buildings, or these metal

brackets for mounting small pin-type insulators on to support additional conductors.

The hundreds of thousands of miles of distribution lines in use in the cities throughout this country, and even in some of the rural districts, provide splendid opportunities for trained men in the maintenance and inspection of these lines with their connected transformers and equipment, as well as in the erection of many thousands of miles more which are added to these lines each year.

Thousands of men are required to erect, inspect, change over, and repair distribution transformers and make new service connections, as more customers are constantly added to the existing distribution lines, and thousands more are constantly employed in the erection of new distribution and transmission lines.



ESTABLISHED 1899

# COYNE

## *Electrical School*

CHICAGO ~ ~ ILLINOIS



COPYRIGHT 1942

# ALTERNATING CURRENT POWER AND A. C. POWER MACHINES

*Section Eight*

**Substations**

**Transformer, Converter, Motor Generator and Rectifier Stations  
Switchboards, Switchgear, Layout, Wiring, Operation  
Circuit Breakers, Oil Switches, H.T. Fuses, A. C. Relays**

**Installation and Maintenance**

**Motors, Generators, Controllers and Transformers  
Installing and Wiring**

**Inspection Schedules and Records**

**Tools, Instruments, Safety Precautions  
Bearings, Types, Lubrication, Care and Repair**

**A. C. Motor Troubles and Remedies**

**Maintenance Tests**

**General**

## SUBSTATIONS

Substations have already been mentioned frequently in this Reference Set and in this section they will be more fully described. In general a substation may be said to be a station which receives electrical energy over a transmission line from a generating plant and changes this energy to a voltage, frequency, and form suitable for distribution to the customers and consumers in the district.

Substations may be roughly divided into two general classes: Alternating current step-down stations, and alternating to direct current converting stations.

Alternating current substations may also be divided into two classes: (a) Transformer or step-down stations for distribution. (b) Frequency changer stations.

A. C. to D. C. converter stations can be divided into three types, according to the equipment used: (a) Motor-generator stations. (b) Synchronous converter stations. (c) Mercury-arc stations.

Any substation may be either of the manually or automatically operated type. In manually operated substations operators are in attendance at all times to start and stop the machines; perform switching operations; regulate load and voltage; check meter readings; keep station records; and perform minor repairs.

In automatic substations the starting, stopping, and switching operations are performed by sensitive relays which operate air circuit-breakers or oil switches in the machine and line circuits.

The relays themselves are caused to operate by changes in the voltage or current of the lines leading from the station. For example, in stations that start up when the load demand becomes great enough, a current relay or contact-making ammeter can be used to close the circuit to a motor-driven drum control.

This control in turn will close the various circuits in order, for starting up a converter or other equipment in the plant. In other cases the starting relays may be operated by a contact-making voltmeter or potential relay whenever the line voltage becomes low enough, due to voltage drop that is caused by increasing load on the line.

Various auxiliary and protective relays are operated by changes in the speed of rotating machinery, changes in the temperature of equipment, or by certain faults occurring in the station.

Many automatic substations have what is called supervisory control, which enables the relays to be operated by remote control over telephone or signal wires from a master substation or the generating

plant. Such stations are usually given a thorough inspection and checking once a day by an expert operator who may have charge of several stations.

### 388. DISTRIBUTION SUBSTATIONS

Distribution or transformer substations are by far the most numerous and common because the greater part of electrical energy used in this country is A.C. and therefore doesn't require conversion, as it is transmitted as A.C.

In distribution stations transformers are used to step the voltage down from that of the transmission lines to voltages ranging from 110 to 440 for nearby customers, and from 2300 to 4000 or more for distribution feeders supplying customers who are more than a few hundred feet from the station.

The transmission line wires are usually brought into such substations through an outdoor structure containing the lightning arresters, high-voltage air break switches, oil circuit-breakers, etc.

In some cases this equipment is located inside the substation building.

Some substations are supplied with power from two or more transmission lines and the switching equipment of each station is arranged so the station can be connected to any one of these lines in cases of trouble on others.

There may be one or more banks of transformers in a substation, according to its kv-a. capacity and the number of different voltages it is to supply. Transformer secondaries feed to various bus bars, which in turn feed through the proper circuit breakers to the separate distribution lines running from the station.

In case of trouble on any of these distribution lines their circuit breakers can be opened either automatically or by the operator, and thus prevent interference with the operation of the substation and other lines.

Substations supplying energy for lighting are frequently equipped with automatic induction voltage-regulators, as described in a previous section.

Distribution substations are generally equipped with a switchboard on which are mounted the various meters and instruments for checking and recording the load on different circuits. These boards often contain automatic relays for overload protection, reverse power, under-voltage, etc.

High-voltage oil switches or air break switches in the transmission line circuits feeding the substation, may be remotely controlled by small push buttons or knife switches on the board in the station, or they may in some cases be manually operated.

Small transformer substations such as those located in industrial plants may not require an operator at all times. Such stations are usually equipped with watt-hour meters and in some cases with other recording instruments which can be read once a day or less often when the equipment is given inspection by the plant electrician.

Fig. 400 shows one-line diagram of the circuit through a simple transformer substation. Diagrams of this type show only one of the three phase wires and therefore do not show all of the connections of the equipment completed, but they do show the general arrangement of the more important devices and connections, and they are much simpler to trace than complete wiring diagrams.

Study this diagram carefully to become familiar with its use, as most substation and power plant operators are supplied with single-line diagrams as well as complete wiring diagrams of their stations.

In Fig. 400 the transmission line which feeds the substation is shown at the upper left. The lightning arrester, L.A., and the disconnect switch, D.S., are the first devices connected to the line. The choke coil is in series with the line and all other station equipment.

Current and potential transformers are provided for metering the energy supplied by the line, and in some cases another line might also be supplying energy to the high-tension bus of the station through a connection such as shown by the dotted lines.

The oil switch, O.S., is to disconnect the line from the bus. The air break switch, A.B., can be used to "kill" the oil switch and instrument transformers when it is desired to work on them.

The current feeds from the high-tension bus through a disconnect, oil switch and current trans-

former to the step-down power transformer; then on through instrument transformers, oil switch and disconnect to the low-tension bus.

More than one bank of power transformers may be connected between the high-tension and low-tension busses in large substations. In such cases the separate sets of instrument transformers permit the load on each bank of transformers to be read and checked, and the separate oil switches allow any bank of transformers to be temporarily disconnected during light load periods, without shutting down the station.

From the low-tension bus the energy is taken off to the distribution feeders through disconnects, oil switches, voltage regulators, V.R., and metering transformers.

The switches allow any certain feeder to be disconnected from the L.T. bus in case of trouble, and the instrument transformers allow the separate metering of the load on each feeder, as well as providing overload protection by overload relays operated by the current transformer to trip the feeder oil switch. These relays are not shown in this diagram; and only one feeder circuit is shown, the rest being indicated by the dotted lines.

The complete connections of the various pieces of equipment shown in the diagram in Fig. 400 have all been explained in earlier sections.

In some cases small isolated outdoor substations consist of just the transformers, arresters, and high-voltage air break switches, as shown in Fig. 401.

Still smaller pole-type transformer installations are often made as shown in Fig. 402.

### 389. CONVERTER STATIONS

Steel mills, mines, electrified railroads and also certain industrial plants use large amounts of direct current, which is usually supplied from substations which change A.C. to D.C. by means of synchronous converters, mercury-arc rectifiers, or motor-generators. In converting A.C. to D.C. by any of these methods considerable power is lost, because in the average substation the load throughout a period of 24 hours varies considerably, with the result that during part of the time the equipment is likely to be operating lightly loaded and at reduced efficiency.

In synchronous converter or motor-generator stations the loss during light-load periods may be anywhere from 20 to 30 per cent. or more.

Mercury-arc rectifiers are much more efficient when operating at light loads than converters or motor-generator sets are.

For these reasons, some of the plants and railroads which were formerly operated by D.C. are gradually changing over to A.C. motors, and other new plants and electric railroads are using A.C. equipment entirely.

Synchronous converters are still the most commonly used machines for changing A.C. to D.C. in

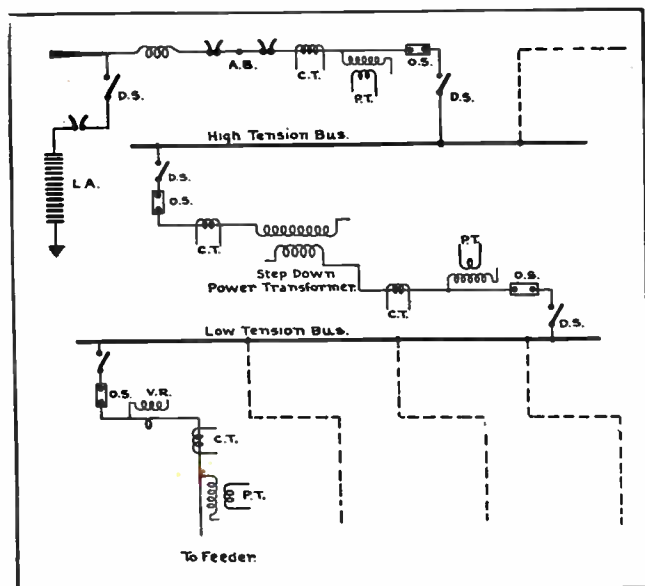

Fig. 400. Single line diagram of a distribution substation with one main power transformer for reducing the voltage from the transmission line. Trace this diagram carefully and familiarize yourself with each part from the explanations given on these pages.

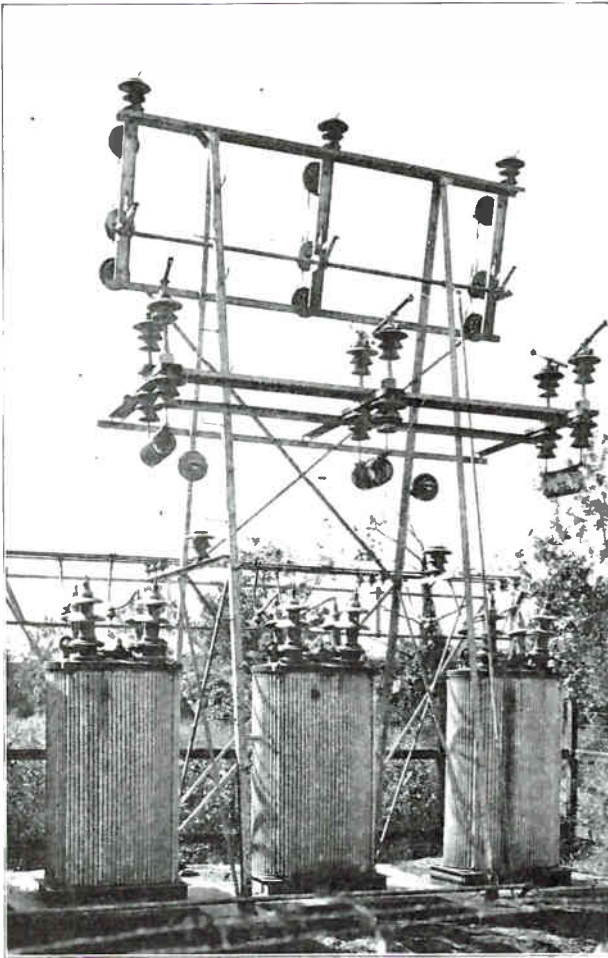

Fig. 401. Small outdoor transformer substation with transformers located on a base on the ground, and choke coils, fuses, and disconnect switches on the steel tower above them.

large amounts, although mercury-arc substations are rapidly coming into more general use.

The equipment of a complete converter substation generally consists of arresters, high-tension switching equipment, step-down transformers, synchronous converters, switchboard, oil switches, meters, protective relays, D.C. busses, etc.

The transformers reduce the voltage from that of the transmission line to that for which the A.C. ends of the converters are designed to operate on.

In most modern converter stations the transformer secondaries are connected so that they supply six-phase energy to the converter slip rings, as was shown in the preceding section on Synchronous Converters.

In most cases some form of switching equipment is provided for starting the converters from the A.C. end at reduced voltage from the transformer secondaries. This equipment may be either manually or automatically operated, according to the type of station.

The D.C. leads from the converter to the direct current busses are generally equipped with high-speed air-circuit breakers, to quickly disconnect the machines from the trolleys or feeders in case of se-

vere overloads or in case of D.C. feed backs to the converters during periods of failure of the A.C. supply.

### 390. CONNECTIONS OF A CONVERTER SUBSTATION

Fig. 403 shows a one-line diagram of a converter substation. You will note that the high-tension lightning arrester, air break switch, oil switch, instrument transformers, and high-tension bus circuits are practically the same as for the transformer substation down to and including the step-down power transformer.

Between the step-down transformer secondary and the converter is shown the starting switch, S.S., for supplying reduced voltage to the A.C. end of the converter during starting.

The converter, slip rings, and commutator are shown by simple symbols in this diagram; and the negative brush is shown connected through the commutating and series fields and negative knife switch to ground.

In the case of a D.C. industrial substation the negative lead instead of being grounded would connect to a negative bus. The positive lead from the converter passes through a wattmeter or watt-hour meter, W; positive knife switch; ammeter shunt; overload trip coil; and circuit breaker, C.B., to the positive bus.

From the positive bus one or more feeders or trolley connections can be taken; and these are usually

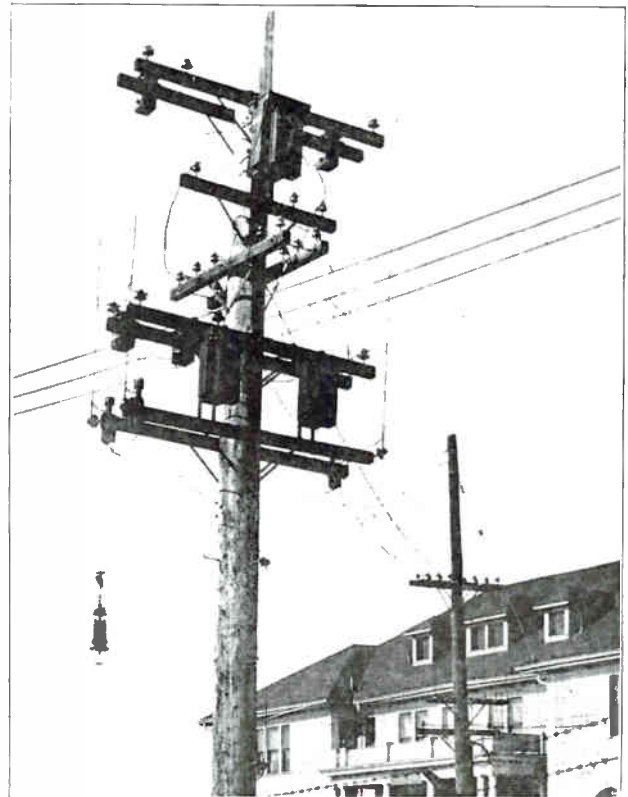

Fig. 402. Group of transformers mounted on heavy arms on an extra heavy pole.

provided with circuit breakers, with overload trip coils, and with ammeters for measuring the load on the separate trolleys or feeders. Note the small D.C. lightning arrester connected to the outgoing trolley or feeder wire.

If more than one converter is in operation in the station the equalizer connection and bus would be used as shown.

Fig. 261 in Section Six of this Reference Set shows in greater detail the connections for a six-phase rotary converter. It will be well to refer back to this diagram and keep it well in mind in connection with your studies of converter substations.

Fig. 404 shows a view of the inside of a synchronous-converter railway substation. The converter is shown in the foreground and the negative switch and field break-up switch can be clearly seen mounted on the side of the converter frame. Note the arc barriers around the brushes, and note also the motor which operates the brush-lifting mechanism. This motor is shown beneath the right-hand end of the machine shaft. The panel on the left contains the starting and running contactors for switching from low to full voltage during

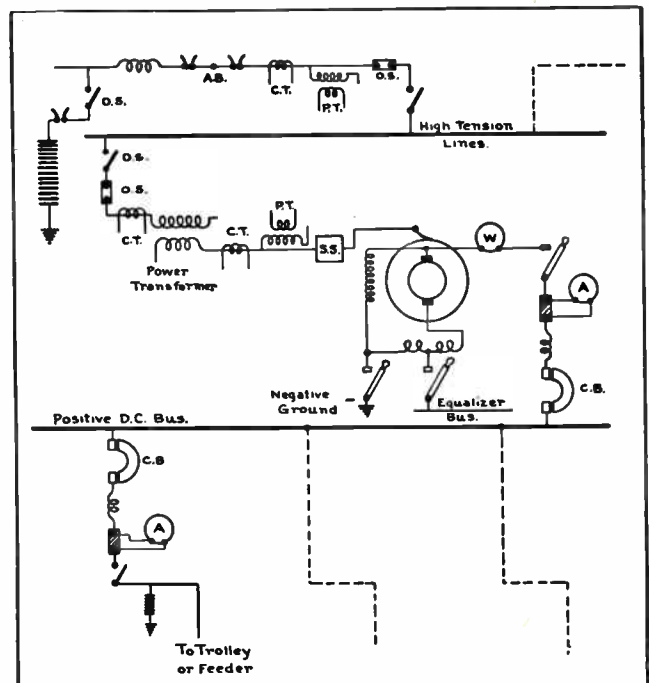

Fig. 403. Single line diagram of a synchronous converter substation, showing main step-down transformer, converter, and auxiliary equipment.

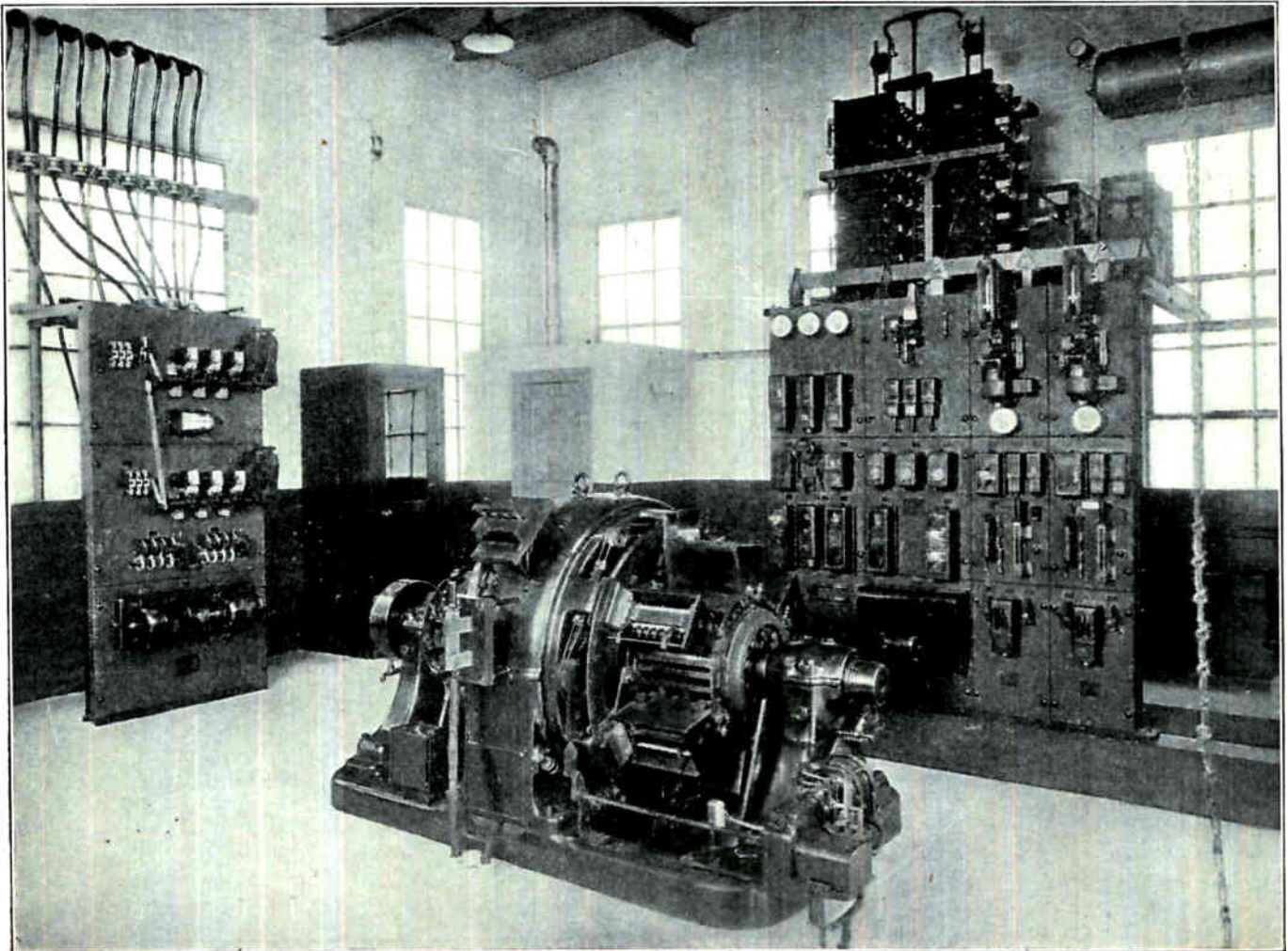

Fig. 404. This photograph gives an excellent view of the inside of an automatic converter substation. The converter is shown in the foreground, the starting panel at the left, and the main switchboard with the automatic control relays and circuit-breakers in the right background. Courtesy of General Electric Co.



starting of the converter. The small field-flashing motor-generator set is also shown on the bottom of this panel. The leads from the transformer secondaries can be seen entering the substation through the wall bushings and leading to the starting panel. The transformers at this station are located outdoors.

The main switchboard panel contains the positive breaker, feeder switches and breakers, motor-operated drum control for automatic starting of the station, and the various meters and relays.

The converter shunt-field rheostat wheel can be seen at the center left of the panel. The positive bus can be seen at the top of the board, and behind these are large banks of armature protective resistors which are automatically cut into the armature circuit of the converter in case of short circuits or overloads on the trolleys or feeders.

In case these overloads are left on the machine too long the resistor grids overheat, causing thermostats which are mounted above them to close circuits to the proper relay on the board; and this relay in turn trips the breakers, shutting the converter down.

The duties of an operator in a manually-operated converter station are to start and stop the machines as the load requires and as described in Section Six under Synchronous Converters.

The operator should also make frequent inspection of the bearing lubrication and the temperatures of the machine windings; take meter readings at regular intervals; keep the station records; reclose breakers in case of trip outs; and see that all circuit

breakers, relays, and protective equipment are kept in proper adjustment.

Further details have been outlined under the operation and care of the various devices previously explained.

### 391. MOTOR-GENERATOR SUBSTATIONS

In certain classes of substations motor-generators are used instead of synchronous converters for the purpose of changing A.C. to D.C. Such motor-generator sets may consist of either a squirrel-cage induction or a synchronous A.C. motor directly connected to a D.C. generator.

A considerable number of motor-generator substations have been installed in the past and are still in use, although converter substations are generally favored for present day installations because of the higher efficiency of synchronous converters.

There are, however, certain classes of very severe service, such as the widely varying loads in steel mills and certain industrial plants, where motor-generators are to be preferred because of their greater stability in operation and their very rugged mechanical construction.

Rotary converters are rather sensitive to sudden load fluctuations and are sometimes difficult to operate in parallel under severe service conditions.

In operating motor-generators there are to be considered the losses in both the motor and the generator. For example, if both the motor and the generator of an M.-G. set have efficiencies of 90% at full load, then the over all full-load efficiency of the unit will be 81%. At light loads this efficiency will be considerably lower.

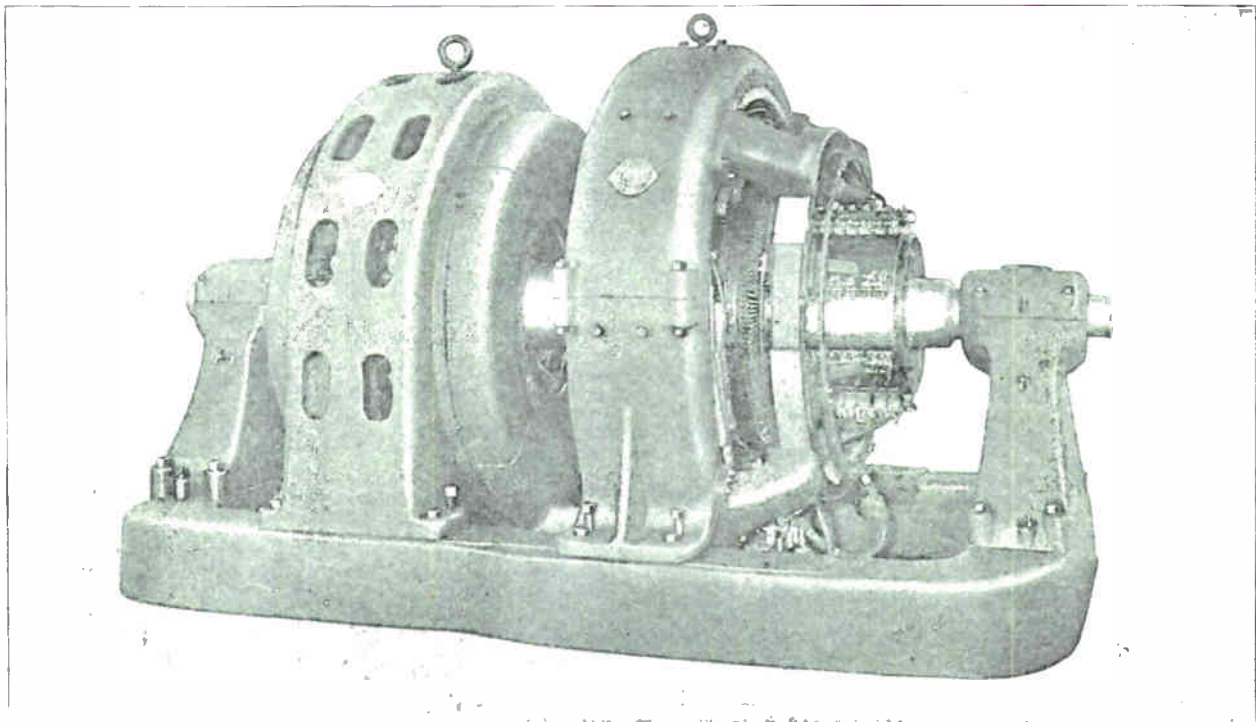

Fig. 405. Motor-generator set for converting alternating current to direct current. The A. C. motor on the left is direct-connected to the D. C. generator on the right.

Fig. 405 shows a large motor-generator with the A.C. motor on the left and the D.C. generator on the right. Both armatures of this machine are mounted on the same heavy shaft, and both the stator of the A.C. machine and the field frame of the D.C. generator are mounted on the same bed-plate.

Fig. 406 shows a 1000-kw. motor-generator set driven by a 4000-volt three-phase, synchronous motor. The exciter-generator for supplying the direct current field energy for the synchronous motor can be seen on the left.

In this unit the motor and generator armatures are mounted on separate shafts which are direct coupled and supported by a bearing between the machines as well as the two end bearings.

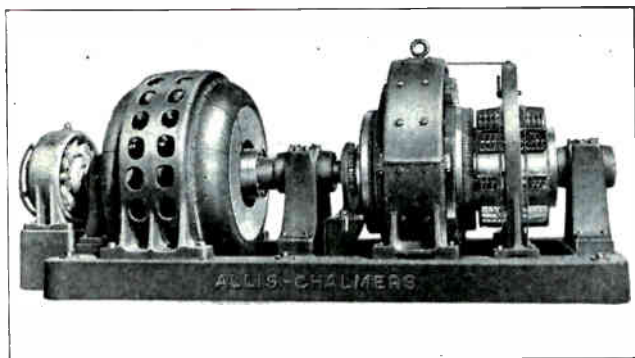

Fig. 406. 1000-kw. motor-generator set with an A. C. synchronous motor and exciter on the left, and the D. C. generator on the right. Courtesy of Allis-Chalmers Mfg. Co.

Where motor-generator substations are fed from high-voltage transmission lines they are equipped with arresters, step-down transformers, oil switches, etc., similar to those used in transformer or converter substations.

The starting equipment for the A.C. motor depends upon whether it is of the squirrel-cage induction or synchronous type. The methods of starting each of these machines have been described in previous sections on A.C. Motors and Controllers.

The D.C. energy from a motor-generator set is usually passed through the proper switches, circuit breakers, and meters on a D.C. switchboard in the substation and then to the various feeder circuits throughout the plant, or to trolleys in case of railway substations.

Motor-generator stations for steel mill use are often equipped with large, heavy fly-wheels as shown in Fig. 407, in order to enable the unit to carry heavy momentary overloads without using an excessively large A.C. motor.

During periods when the load on the D.C. generator is comparatively light the A.C. motor very slightly increases the speed of the fly-wheel and stores a considerable amount of energy in it.

When sudden, heavy overloads are placed upon the D.C. generator by large steel mill motors the speed of the motor-generator is slightly reduced,

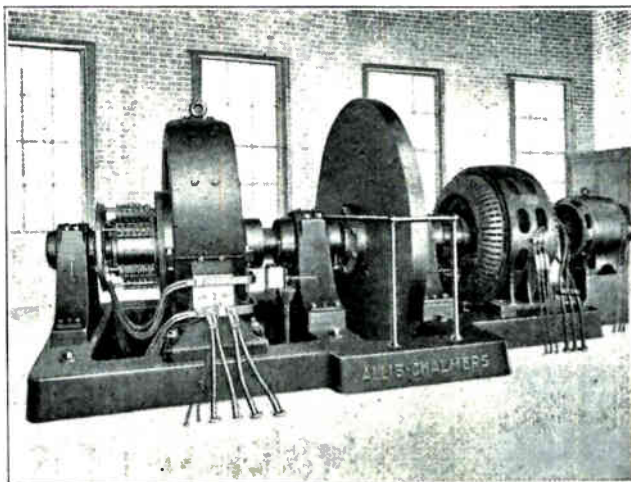

Fig. 407. Motor-generator set with large flywheel for carrying heavy momentary overloads in steel mill work and other classes of severe service. Courtesy of Allis-Chalmers Mfg. Co.

thus absorbing the mechanical energy from the fly-wheel.

On large units several thousand additional horse power can be delivered for periods of a few seconds by the energy in the fly-wheel.

In addition to supplying direct current in steel mill and railway substations motor-generator sets are commonly used for supplying small amounts of direct current for electro-plating, arc welding, or other special uses in industrial plants which are largely operated by A.C.

Fig. 408 shows a compact type of motor-generator set for use with D.C. elevator equipment. In addition to the main A.C. motor and D.C. generator units this machine also has a small exciter-generator, shown on the left, and a speed regulating generator, shown on the right, for controlling the D.C. field of the elevator machines.

### 392. FREQUENCY-CHANGER SUBSTATIONS

Motor-generator sets are also used for changing alternating current from one frequency to another. For example, if a transmission line supplies energy at 25 cycles to a factory or plant which has equipment that operates on 60 cycles then a motor-gen-

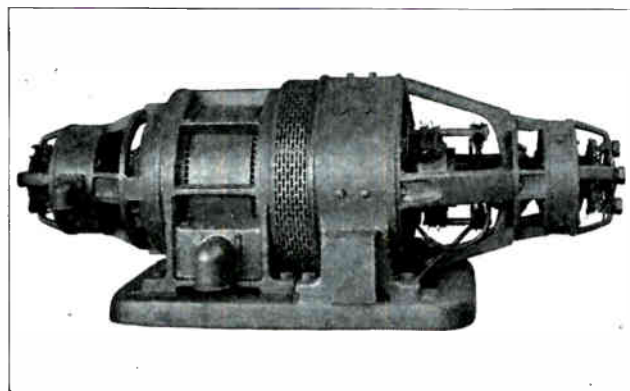

Fig. 408. Compact type of motor-generator set used for operating D. C. elevator motors. Courtesy of G. E. Company.

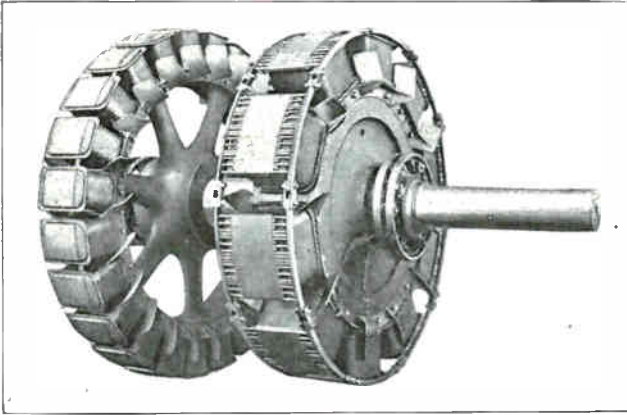

Fig. 409. Double rotor of a frequency changer motor-generator set. The ten-pole rotor operates on 25 cycles and the 24-pole rotor produces 60-cycle energy. Courtesy of Allis-Chalmers Mfg. Co.

erator frequency-changer is used to convert the 25-cycle energy into 60-cycle energy. A set of this type would use a 25-cycle synchronous motor to drive a 60-cycle A.C. generator.

Frequency changers are also used to tie 25 and 60 cycle lines or power systems together.

In directly connected frequency-changer sets the motor and generator must both revolve at the same speed; so, in order to obtain the different frequencies, it is necessary to have different numbers of poles in the two units.

For example, a machine to convert 25-cycle to 60-cycle energy and designed for operation at 300 RPM would have to have a synchronous motor with 10 poles and an alternator or A.C. generator with 24 poles.

The rotors for a 1200 kv-a. machine of this type are shown in Fig. 409, the 10-pole D.C. field of the synchronous motor being on the right and the 24-pole alternator field on the left.

A number of motor-generators of this type can be operated in parallel if they are properly phased out and synchronized just as alternators would have to be.

Frequency changers are built in sizes ranging from those of a few kv-a. to 50,000 kv-a.

Fig. 410 shows two A.C. motor generator units in a frequency-converter substation.

### 393. MERCURY-ARC SUBSTATIONS

As explained in a previous section, mercury-arc rectifiers are coming into quite extensive use for converting A.C. to D.C. in railway substations as well as for certain industrial uses. Mercury-arc rectifiers are in many cases preferred to either synchronous converters or motor-generator sets, because of their very quiet operation and their higher efficiency when operating lightly loaded.

In addition to the rectifier unit, mercury-arc substations include the usual lightning arresters, oil switches, circuit breakers, meters, relays and the step-down power transformers which are used for reducing transmission line voltage to the proper operating voltage for the converter.

Fig. 411 shows a view of the inside of an automatic mercury-arc rectifier substation. This photograph shows the mercury-arc rectifier on the left; and also shows the automatic-control switchboard with its meters; circuit breakers, and relays. The

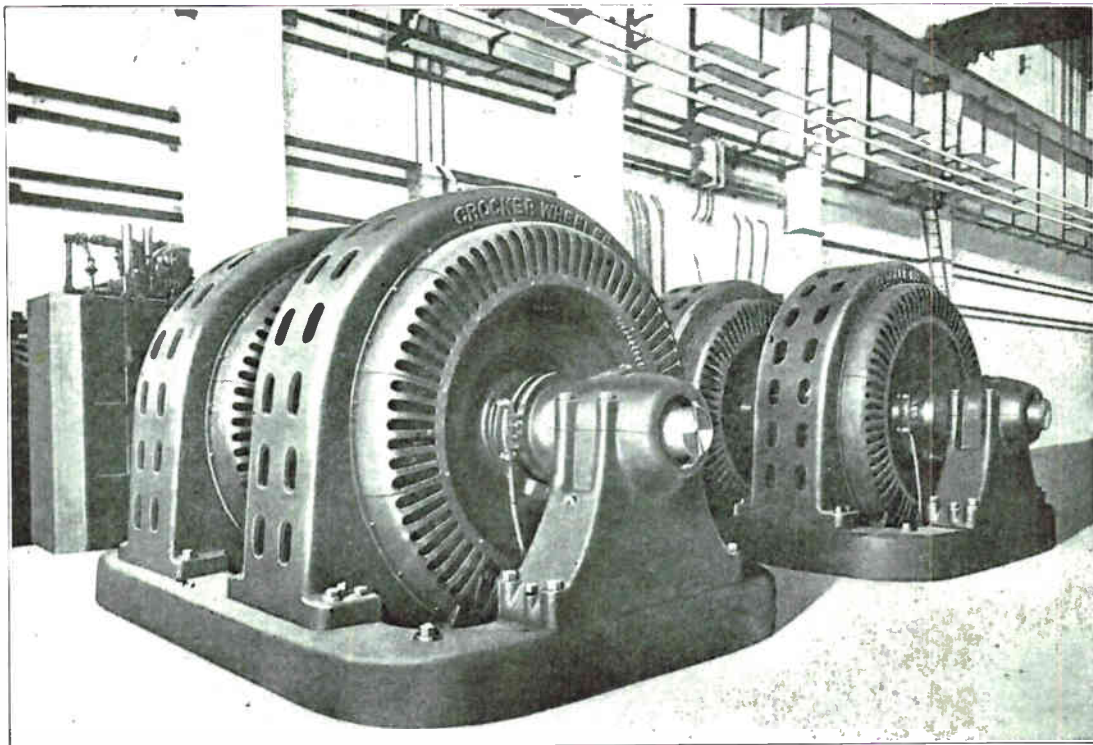

Fig. 410. This photograph shows two large motor-generator sets in a frequency converter substation. Machines of this type are used where it is necessary to change the frequency of the alternating current supply to another frequency required for the operation of certain motors or other electrical equipment.

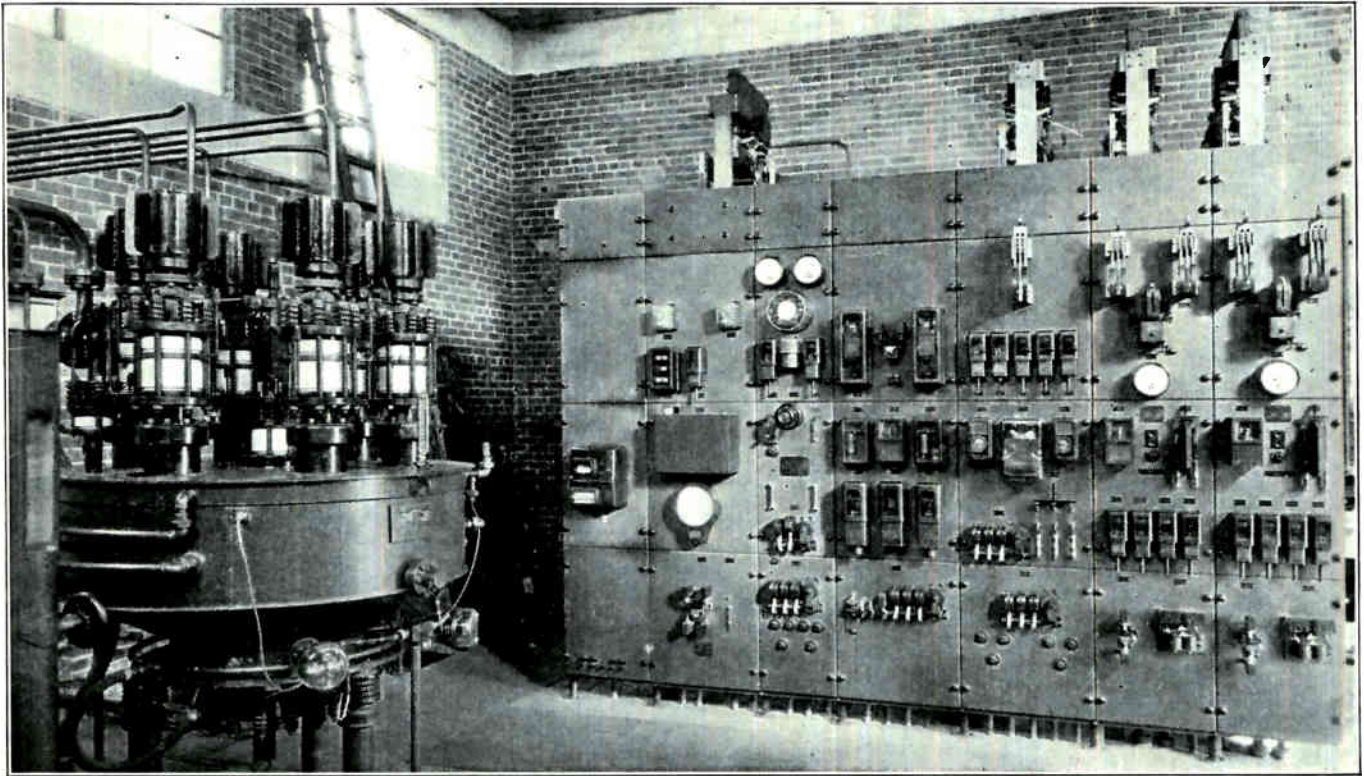

Fig. 411. This photo shows an excellent view of the interior of an automatic mercury arc rectifier substation. The rectifier is shown on the left and the automatic control switchboard with its relays and circuit breakers is shown on the right. Courtesy of General Electric Co.

transformers, lightning arresters, and high-tension switching equipment are located outside the station building.

The operation and care of mercury-arc rectifiers have been covered in the previous section, and the general features of the other equipment and the circuits for these substations are very similar to those of synchronous converter stations.

#### 394. COMBINATION SUBSTATIONS

In many cases large substations may combine two or more of the types of equipment and service already described. For example, a single substation may include step-down transformers for reducing the voltage from high-tension transmission lines to the proper value for local A.C. distribution; synchronous converters, with their separate transformers and equipment for supplying D.C. to local street railways or industrial plants; possibly also a later type mercury-arc rectifier operating in parallel with the synchronous converters; and even one or more motor-generator sets for supplying D. C. or A. C. of a different frequency for special purposes.

Fig. 412 shows the power transformers, lightning arresters, and disconnect switches, all of which are commonly located outside the substation structures. Such equipment as synchronous converters, mercury-arc rectifiers, and motor-generators are placed inside the building.

Switching stations or transformer stations such as shown in Figs. 413 and 414 are often used where transmission lines of different voltages, or lines

operated by different companies, are joined together. Such stations contain transformers, oil switches, air brake switches, and disconnects; and also high-tension transformer busses for shifting the connections from one line to another.

In Fig. 413 the transformers are shown in the left foreground. The oil switches are shown in the background. The high-tension air-break and disconnect switches and the high-voltage transformer busses are supported in the steel structure overhead.

Fig. 414 shows a 220,000-volt switching station, with lightning arresters on the right and huge oil switches on the left. Note the high-tension busses

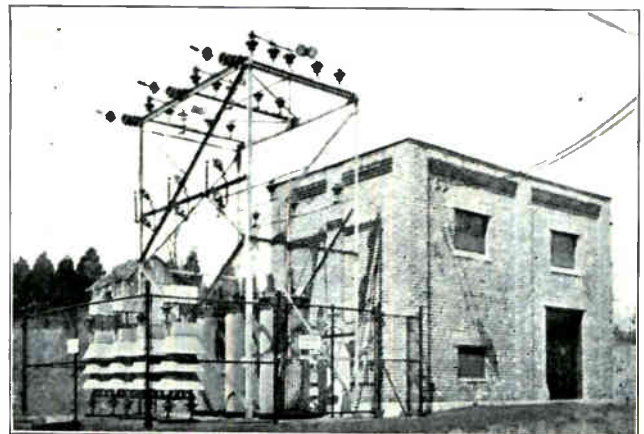

Fig. 412. Exterior view of a modern substation showing incoming line, choke coils, fuses, disconnects, lightning arresters, and power transformers outside of the building. The synchronous converters are located inside of the building.

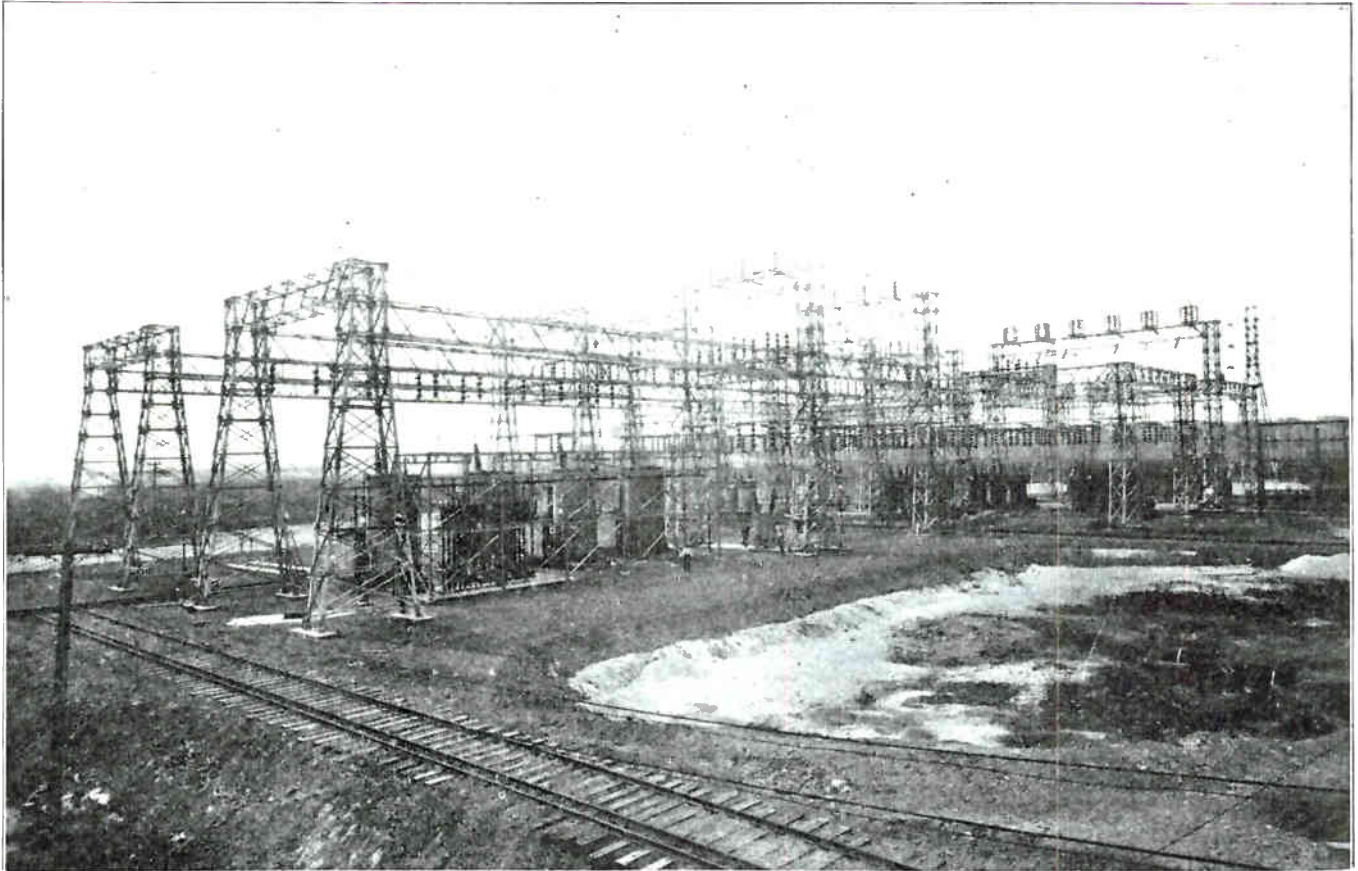

Fig. 413. Large outdoor switching and transformer station. Stations of this type are used where transmission lines of different voltages tie together, and to provide switching facilities for branch lines of the same voltage. Transformers are also sometimes used in such stations for feeding local distribution lines. The large mass of structural steel framework makes a station of this type look rather complicated, but by carefully tracing the conductors through the framework and tracing a plan of such a station on paper, the circuits will be found very simple. Courtesy of Walter Bates Steel Company.

and connections supported by pillar-type insulators in the steel framework overhead.

### 395. SWITCHBOARDS

Switchboards in A. C. power plants and substations are very similar to those which were described in Direct Current Section Two for D.C. plants, except that boards controlling three-phase circuits use three-pole switches and circuit breakers instead of two-pole units such as are used with D.C.

In converter and motor-generator substations switchboard equipment is often connected in the circuits on the A.C. ends, as well as from the D.C. ends of the machines. You are already familiar with D.C. switchboards.

Switchboards in A. C. power plants may be either of the vertical panel type, bench type, or truck type, all of which were previously described in Section Two of Direct Current.

The general construction features, bus bar arrangement, etc., are practically the same for A.C. boards as for D.C.

Meters on A.C. boards are generally operated from current and potential transformers, instead of from shunts and direct connections to the busses as on D.C. boards.

On manually-operated switchboards in A.C. generating stations oil switches are more commonly used than knife switches in the main circuits. The oil switches, being mounted behind the board and operated by a lever or handle on the front of the panel, provide a much safer arrangement for high-voltage circuits than would open knife-switches on the face of the board.

Fig. 415 shows an excellent view of a manual switchboard in a 2300-volt A.C. generating plant. The three main-generator panels are shown in the



Fig. 414. View of large oil switches and lightning arresters underneath the bus and switching structure of a 220,000-volt outdoor substation. Courtesy of Philadelphia Electric Company.

center, with their oil switches, meters, rheostat controls, and plug-type instrument switches.

On the right are shown four feeder panels equipped with oil switches, relays, and watt-hour meters. On the left are shown the controls for the exciter-generators and voltage regulator; and also the station ammeters, voltmeters, and synchroscope mounted on a hinged bracket at the extreme left of the board.

This switchboard is typical of the vertical-panel type, with all wiring and bus bars mounted on the rear and enclosed by a screen guard.

### 396. SWITCHGEAR

As previously mentioned in the D.C. Section, the switches and controls used on these boards are all classed as "switchgear" and are for the purpose of opening, closing and controlling the various generator and feeder circuits in the plant.

The switches on the generator panels control the generator-armature circuits and are used in starting, stopping, and paralleling these machines. The switches on the feeder panels control the energy which is distributed from the main busses through these feeder sections to the various loads.

Fig. 416 shows a diagram of a single switchboard

panel on the left, an end-view of a board in the center, and some of the principal circuits on the right. Note the arrangement of the meters, switches, and controls on the front of the panel at the left; and also the side-view of this equipment, including the current transformers, oil switch, busses, and the instrument resistors shown in the center.

Fig. 417 shows a remotely-controlled, bench-type switchboard such as is commonly used in large A.C. generating stations. The meters for the various generators are mounted on the vertical panel above the control board.

The push-button and push-pull type switches and the small hand wheels shown on this board are used to control circuit breakers, oil switches, and motor-operated rheostats which are located in another part of the plant.

In some cases the throttle and governor controls for the generator prime movers are also placed on these switchboards.

With boards of this type the heavy-duty oil switches handling large amounts of current at very high voltages can be located in a switching vault or room, thus keeping the operators safely away

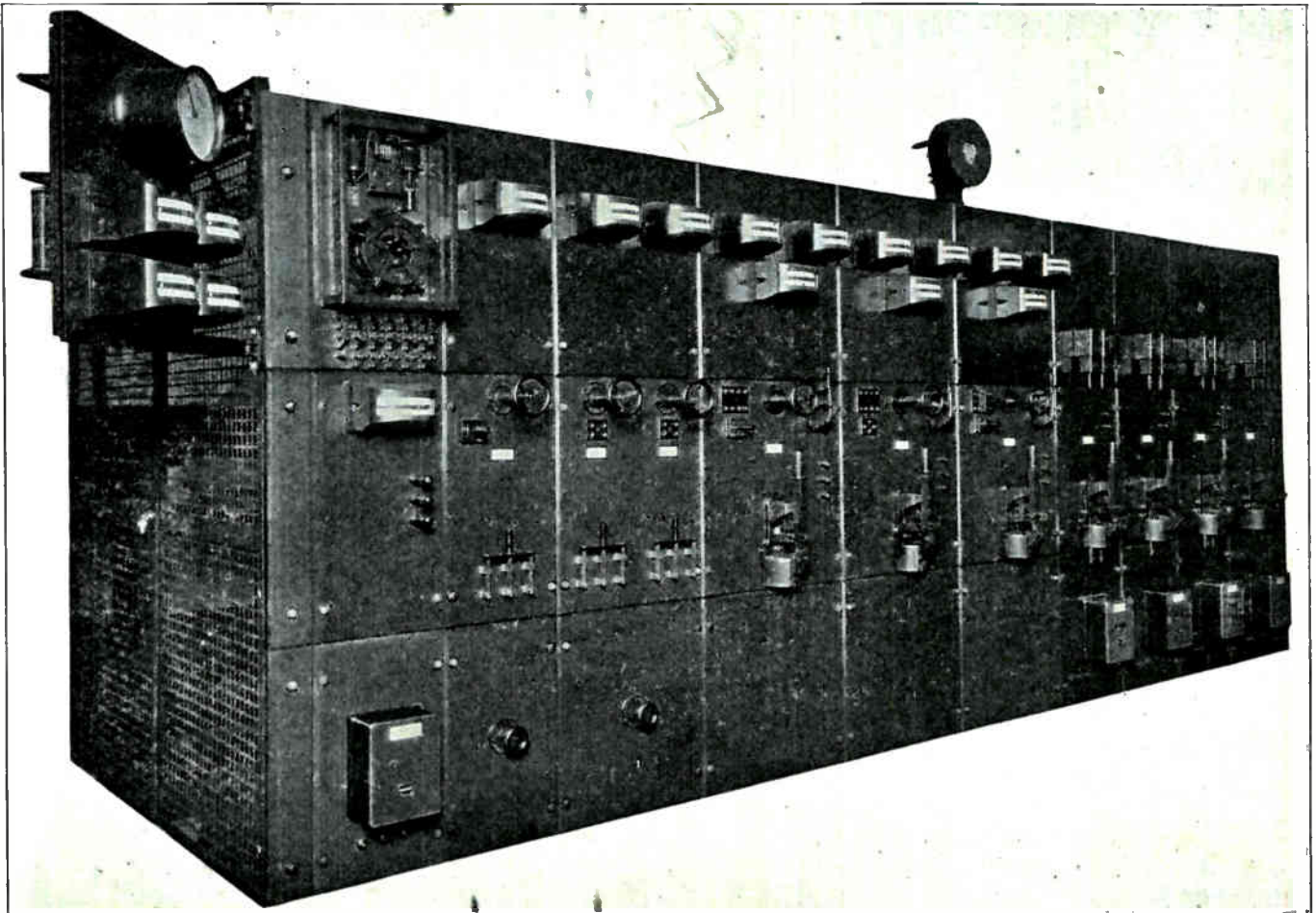

Fig. 415. An excellent view of a modern panel-type A. C. switchboard. Note carefully the location and arrangement of the meters, oil switches, relays, and rheostat controls. Courtesy of G. E. Company.

from all high-voltage circuits and the dangers of bad flashes or arcs.

Remote-control switchboards also permit grouping the controls of a large plant closely together, for convenient operation. The large oil switches and rheostats used in a central station would be too bulky to mount at the rear of any ordinary sized switchboard.

These remotely-controlled oil switches can be opened or closed by pushing or pulling the small switch knobs on the board.

These switches generally close circuits to powerful solenoids, electro-magnets, or small motors which operate the oil switches. Some oil switches are operated by compressed air or hydraulic cylinders, but these are not nearly as common as the solenoid-operated type.

The large generator and exciter rheostats can be controlled by switches which start, stop, and reverse the small motors which drive them.

Pilot lamps are commonly used on remote control boards to indicate when certain switches or breakers are open or closed and to show which circuits are alive.

Fig. 418 shows a modern truck-type switchboard, such as is coming into quite general use in substations and small industrial power plants. One

panel or unit of this board is shown withdrawn from the main group, illustrating the great convenience with which the oil switch, meters, and devices can in this manner be entirely disconnected and removed from the main board and live circuits.

When the unit is pushed back into place the spring clips or prongs shown at the rear are again automatically connected with the live bus bars and circuits. The increased convenience and safety features of this type of board are causing it to become very popular in many plants.

### 397. SWITCHBOARD LAYOUT AND ARRANGEMENT OF INSTRUMENTS

As the switchboards in generating stations or substations form the heart of the control for all machines and circuits in the plant, as well as for the power lines and circuits radiating from the plant, it is very important to make a careful study of the circuits and operation of the switchboard in any plant in which you may be operating.

Central stations of large capacity often combine a certain amount of distribution with higher voltage power-transmission. This is particularly true of stations located in or near large cities.

The switchboards should provide a convenient arrangement of generator and feeder panels for controlling the various machines and feeders.

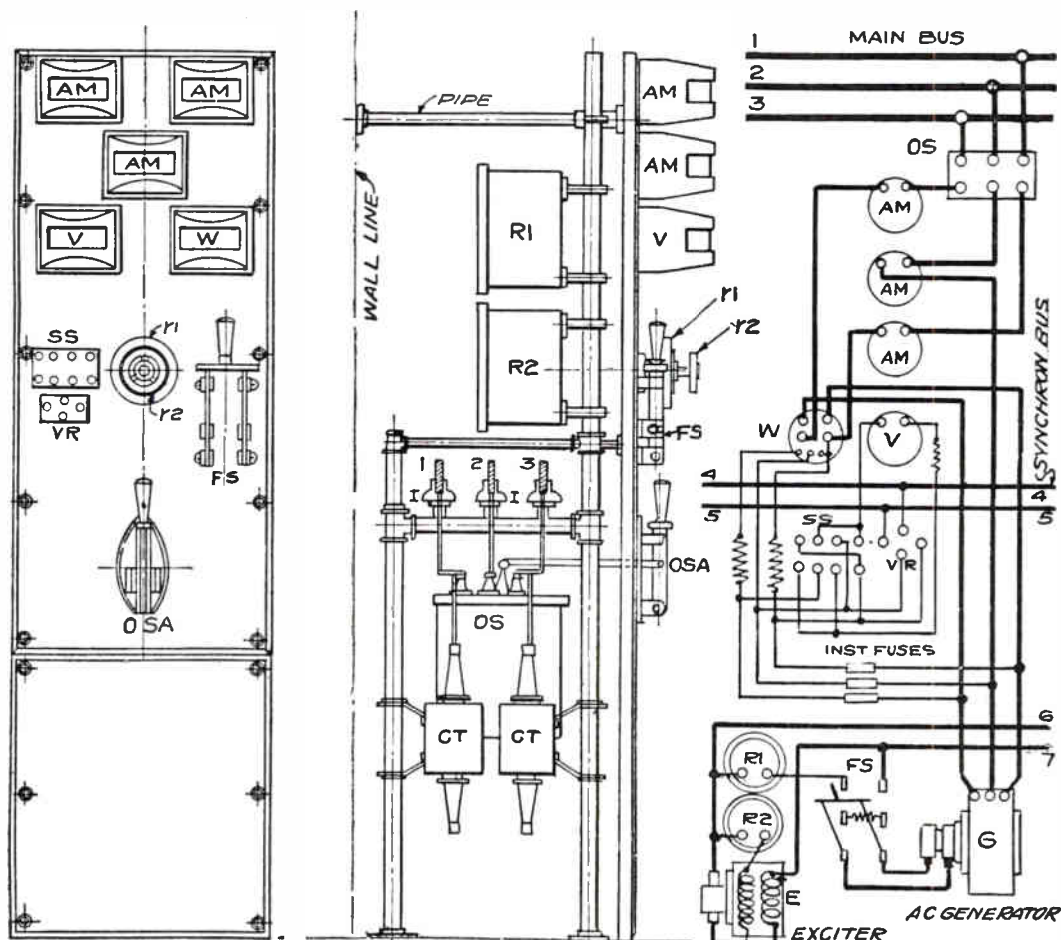

Fig. 416. These diagrams from left to right show respectively a front view, side view, and the wiring of a single panel in an A. C. plant.

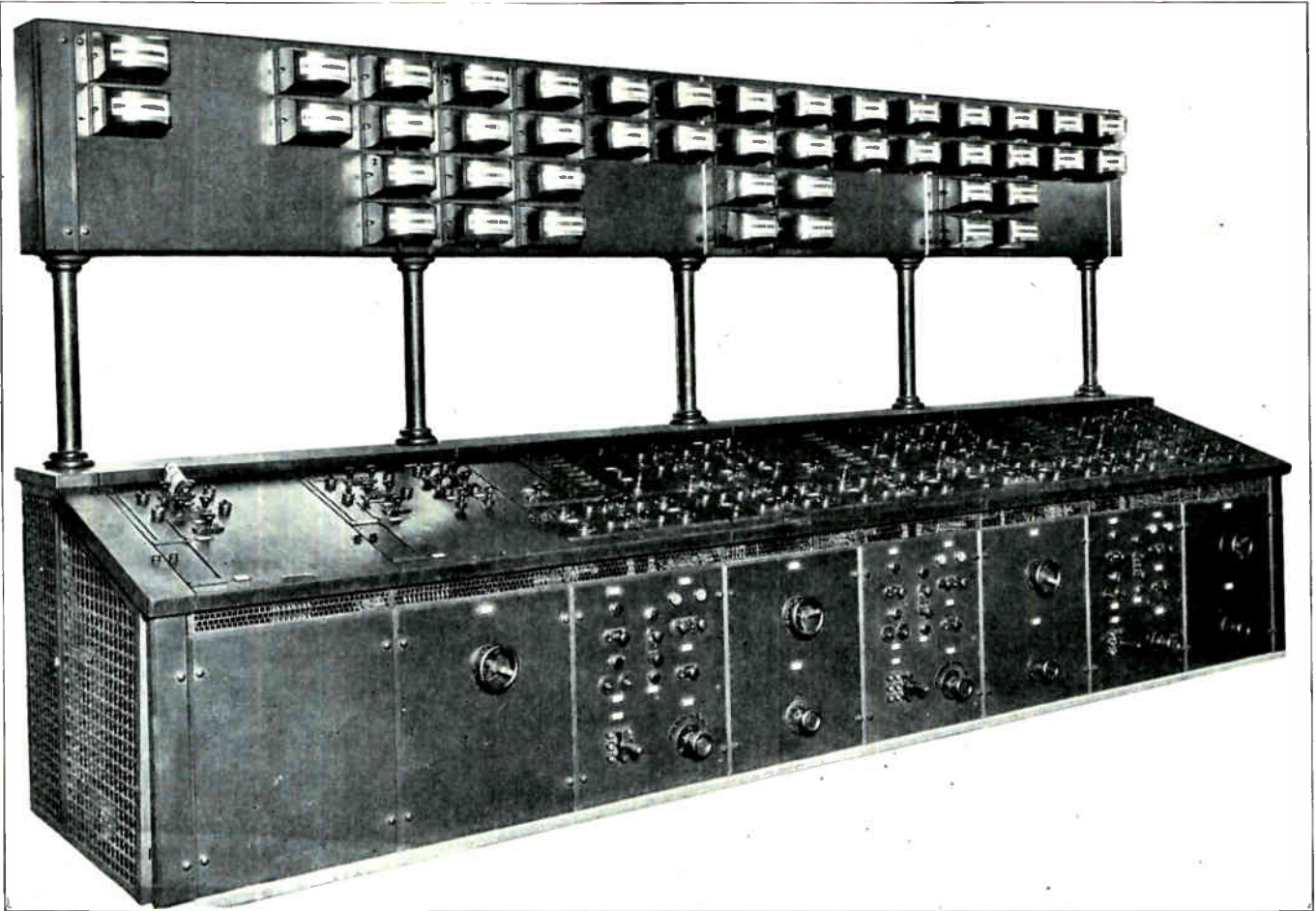

Fig. 417. Modern bench-type switchboard for remote control of generators and oil switches in a large central station. Note the arrangement of the meters and the push-pull switches which control the solenoid-operated and motor-operated oil switches and devices throughout the plant. Courtesy of G. E. Company.

For example, a central station may have five generators of 30,000 kv-a. capacity and 11,000 volts each. The output of any one of these generators may be controlled through one of a group of generator panels at the switchboard, where their outputs are all combined together in one main bus. From here it may be fed to step-up transformer banks.

Let us assume that there are three separate banks of transformers, one of which increases the voltage to 22,000 volts, another to 66,000 volts, and the third to 132,000 volts.

Energy may be taken from the 22,000-volt bus through feeders to a number of local substations. The 66,000-volt bus may be used for an interconnecting tie with another power line of this same voltage. The 132,000-volt bus may feed one or more long distance transmission lines to carry energy to some distant city or industrial center.

Switchboard meters are made in several different styles, such as round, square, and edgewise types, so that the desired spacing and appearance can be obtained on the panels.

Meters should never be crowded too closely together on switchboard panels, as sufficient room

should be provided for working on any individual meter without interference with adjacent ones.

The several views of switchboards shown on these pages show very neat and logical arrangements of meters.

Multiple instruments consisting of several meter elements within one case are often used to save space on switchboards. For example, three separate ammeter elements—one for each phase of a three-phase generator and each having its own scale—

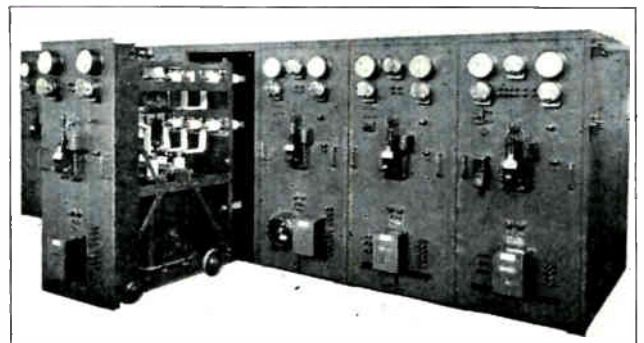

Fig. 418. View of truck-type switchboard showing one section removed to allow repairs or adjustments to be conveniently and safely made. Boards of this type are very popular in modern industrial plants as well as in certain power plants and substations. Courtesy of G. E. Company.



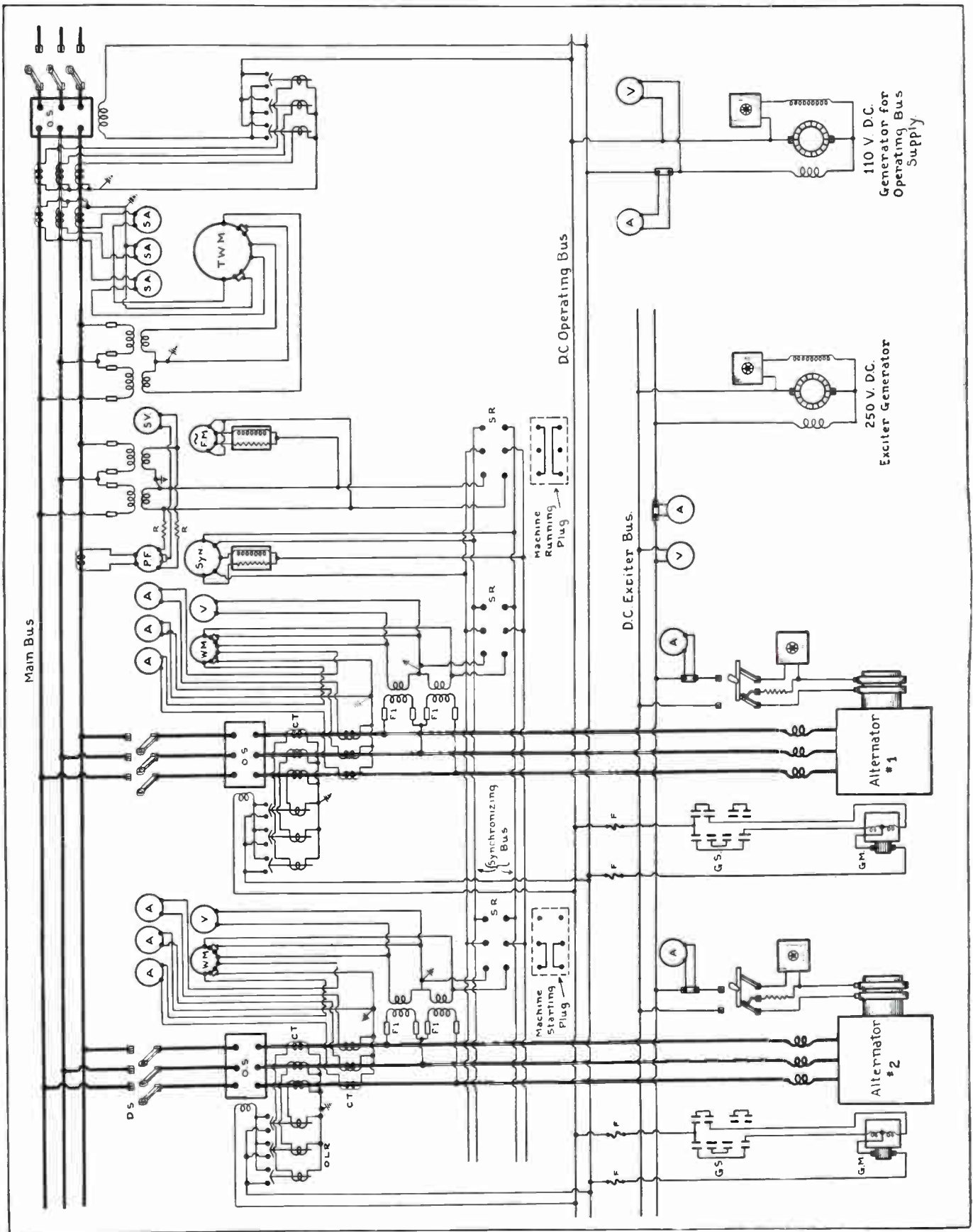

Fig. 419. Complete wiring diagram for a modern power plant switchboard, showing the connections of two three-phase alternators and their various auxiliaries, and also the connections of the meters, relays, and oil switches. Trace this diagram very carefully and locate each part referred to in the accompanying explanation.

can be built in one case to take the place of three separate ammeters.

Meters should be properly mounted and illuminated so that they can be easily read by the operators from a convenient position.

Watt-hour meters and recording instruments are sometimes exceptions to this rule and are quite often located near the bottom of switchboard panels as they usually don't have to be read as frequently as voltmeters, ammeters, and wattmeters.

### 398. SWITCHBOARD CIRCUITS AND WIRING

Fig. 96 in Section Three on Alternating Current shows a wiring diagram for the main generator and exciter panels of one three-phase alternator in a small power plant.

Fig. 419 shows a wiring diagram for two three-phase alternators and the instruments and equipment of a modern power plant switchboard to be used with these machines.

Examine this diagram very carefully and become thoroughly familiar with the circuits and equipment shown, and study out the operation and function of each circuit and device. A diagram of this kind is well worth several hours of your time, as it is quite typical of the arrangement of switchboard circuits in a great many modern power plants.

The main A.C. bus and alternator leads are shown in heavy lines so that they will be very easy to trace. Current passes from the alternators through a set of reactor coils, then through the instrument transformers, oil switch, O.S., and disconnect switches, D. S. to the main bus.

This circuit, of course, is completed only after the disconnect and oil switches are closed.

The upper set of current transformers are used to operate the overload relays, O.L.R., any one of which will close a circuit to the oil switch trip-coil in case of overload.

The current for the oil switch trip-coil is supplied from the D.C. operating bus, which runs the length of the switchboard and supplies direct current for the various devices which can be conveniently operated with D.C.

The lower set of current transformers are used to operate the three ammeters and the current elements of the polyphase wattmeter, W. M., in series. The potential transformer operates the voltmeter and the potential elements of the polyphase wattmeter.

This transformer also supplies the synchronizing bus when the machine starting plug is in place in the synchronizing receptacle, S.R.

You will note that the synchronizing bus runs the length of the board and connects to a receptacle for

synchronizing either alternator with the other, and also to a third receptacle at the right for synchronizing either alternator with the live line from outside the plant in case this station is operating in parallel with others.

The oil switch, meter, and synchronizing circuits of the second alternator are exactly the same as those of the first. The synchroscope is shown at "Syn"; frequency meter at "F.M."; power factor meter at "P.F."; station voltmeter at "S.V."; station ammeters at "S.A."; and a totalizing station wattmeter at "T.W.M."

The main line or bus oil-switch, O.S., is shown at the right with its overload trip coils, relays, and disconnect switches. The exciter bus supplies current through the alternator field ammeters, field-discharge switches, and field rheostats to the slip rings on the revolving field of the alternator.

The governor control motors, G.M., which operate the governors of the alternator prime movers, are also shown in this diagram. They are operated by the governor control-switch, G.S., by current supplied through the fuse, F., from the D.C. operating bus.

The power circuits on switchboards are usually run with heavy copper busses or cables, while the instrument and control circuits are wired with regular switchboard wire having heat resisting insulation, as explained in the Section on D.C. Switchboards.

All switchboard wiring should be done neatly and with a systematic arrangement of wires and circuits, in order to facilitate tracing the circuits and making repairs or additions to the wiring. Carefully examine the wiring on the large switchboards in the shop departments of the school.

### 399. SWITCHBOARD OPERATION

In order to qualify for a position as switchboard operator in either a power plant or substation one should be thoroughly familiar with the principles, care, and operation of generators, transformers, motors, converters, rectifiers, meters, switches, circuit breakers, relays, lightning arresters, etc.

Even though you feel well qualified to step in and operate a station, very few companies will allow any newly hired man to assume the full responsibility of an operator during the first few days, even though he may have had previous experience or training.

This is due to the fact that there are certain variations in the construction and arrangement of equipment in different plants and also variations in the operating rules and procedure of different companies.

You should, therefore, willingly and faithfully perform any minor and seemingly unimportant

duties to which you may at first be assigned, and pay strict and alert attention to every operation and bit of instruction you can observe from those who may be instructing you or breaking you in.

Large power companies are always looking for intelligent, ambitious, young men with practical training and good character, and the chief operators, plant foremen, and superintendents usually observe new men very closely; so it pays to be thoughtful, patient, and careful at all times when assigned to any duties in a power plant or substation.

During your first few weeks in a station you should in every way possible thoroughly familiarize yourself with all of the various pieces of equipment and the general plant layout. Read and make a note of the data on the various machine nameplates and memorize the capacity and voltage rating of the various machines.

Determine the sizes of the conductors leading from the generators to the switchboard and locate the proper switches and meters for each machine.

It is excellent practice to start by making a diagram showing the outline of the switchboard and all instruments and controls, completing the main panel first and then adding another panel to the diagram each day. In this manner you can very soon become familiar with the entire front of the switchboard.

Don't attempt to show any wiring in the diagram until you have all the instruments and devices in their proper location and thoroughly understand what each one is for in the operation of the plant.

It is good practice to lay aside your copied diagram and practice making sketches of the switchboard layout from memory.

Some power companies allow their operators to spend a certain amount of time on the job making diagrams and thorough studies of the plant, as well as to study any books or material which will help the operator in his work. Keep in mind that such studies should never be allowed to interfere with your work or alertness when on duty.

After completing diagrams of the switchboard equipment and plant layout a thorough study should be made of any wiring diagrams supplied by the company, and you should then make your own diagrams from the actual wiring on the board and in the plant, carefully checking and marking each wire so that you know its voltage and current and the instrument or device to which it leads.

A thorough step-by-step study of the plant equipment and circuits made in this manner will soon enable you to have in your mind a complete simplified picture of the entire plant and this will be of great help in trouble shooting or in time of emergency operation, as well as in your ordinary everyday operating duties.

Almost all power companies periodically examine their men with written, oral, and practical operating tests. Try to be well prepared for these examinations,

but don't worry too much about the possibility of failing in them as the company is merely trying to find out what progress you are making and to stimulate your thought and energy and develop your ability for promotion to positions of greater responsibility.

Always try to remain cool-headed and calm, whether during examinations or during emergencies which may arise in the operation of the plant. Think clearly and apply the principles of electricity, circuits, and machines which you have learned, and in this manner you can solve practically any problem or difficulty.

The responsibility of an operator in a large power plant or substation is very great, and the safety of the lives of fellow workers, the safety of costly machines owned by the company, and the satisfaction of customers with the service they receive depend to such a large extent upon plant operators that it pays to always be thoughtful and careful and to use your head as well as your hands at all times.

A few very good general rules or tips for the substation or power plant operator are as follows:

1. Always be careful and think before acting.
2. Practice safety-first and attend safety-first meetings.
3. Protect yourself and fellow operators with proper safety appliances.
4. Determine the functions of your station.
5. Keep accurate station records, such as daily meter or log sheets, repair sheets, trouble sheets, hold-cards, etc.
6. Keep the station and all equipment clean and orderly, and tools, safety appliances, etc., in their proper places at all times.
7. Learn thoroughly the procedure for starting and shutting down all machines.
8. Report to your superior all doubtful or unusual occurrences.
9. Never allow anyone except properly authorized persons inside of the station.
10. Never close a feeder switch without first being authorized to do so, and then make a record of the operation with the authorizer's name.
11. Repeat all telephone orders received from the chief operator or dispatcher.
12. Properly tag all outgoing lines which have been "killed" for workmen to make repairs on them. The tag should preferably be of red cardboard and should carry the date, your name, the name of the foreman of the repair crew, reason for or nature of repairs, etc. See that the switches of such circuits are locked open and grounded.
13. See that danger signs are placed on all high-voltage equipment and guard rails around dangerous places. High-voltage outdoor equipment should be fenced in.
14. Consider all wires and equipment to be alive unless you are sure they are disconnected and thoroughly grounded.

15. Take pride in the proper care and condition and in the operating efficiency of every piece of equipment in your plant, as well as the plant as a whole.

16. Attend first-aid meetings and learn the location of first-aid kits and equipment in your station.

17. Practice resuscitation.

18. Be co-operative, cheerful, and good-natured with both fellow employees and superiors, even in the face of discouraging circumstances.

19. Study carefully all company rules and encourage fellow workers to do the same.

20. Keep up-to-date by frequently reviewing your Reference Set and school notes, reading good electrical books, and subscribing to one or more good trade journals or electrical magazines.

between the two poles of the breaker when an arc is drawn in interrupting heavy current overloads in the circuit.

The series overload trip-coil and hand-trip button can be clearly seen in this photo. The small adjusting device is provided underneath the trip coil for setting the amount of load on which the breaker will trip open.

Fig. 421 shows a 500-ampere, 250-volt, three-phase A.C. circuit-breaker. This breaker has three poles, one for each phase; and two overload trip coils, one of which is connected in each of the outer phase wires.

Circuit-breakers of this type can be equipped for instantaneous opening or with time-delay devices in the form of dash pots or bellows on their tripping mechanisms.

The care of A.C. breakers is similar to that of those used for D.C. in that the contacts should be kept tight and in good condition, operating springs in good condition, and overload adjustment properly made to give desired protection to the equipment on the circuits in which the breakers are installed.

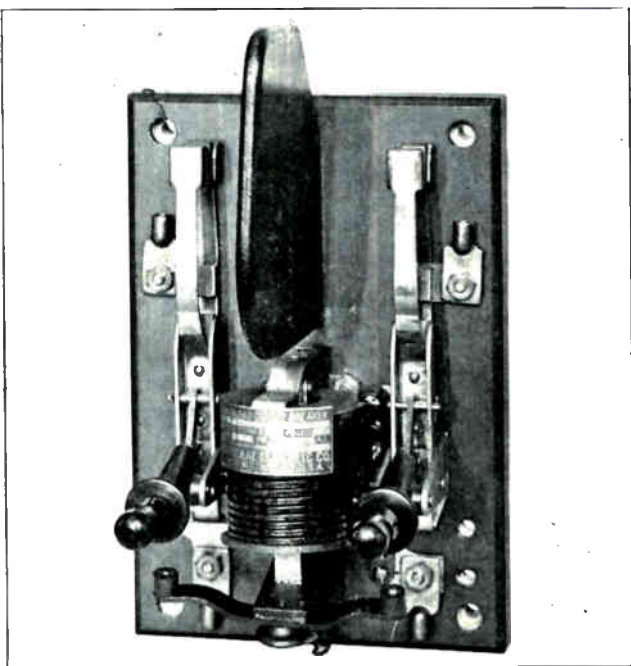

Fig. 420. Small air circuit-breaker for use on circuits of 600-volts and loads up to 100 amperes. Note the flash barrier placed between the two poles of the breaker. Courtesy of G. E. Company.

#### 400. CIRCUIT-BREAKERS

A. C. circuit-breakers are constructed very much the same as those used for D. C. circuits, except for the difference in the number of poles and a slight difference in the construction of their operating coils.

Ordinary air circuit-breakers are frequently used on A. C. circuits ranging from 110 to 600 volts, but on higher voltage circuits carrying heavier currents in large substations or power plants, oil switches are generally used because they are much safer in operation and more effective in quickly interrupting high-voltage circuits.

Fig. 420 shows a single-phase, 100-ampere, 600-volt, A.C. circuit-breaker. Each of the two poles is equipped with main contacts and auxiliary arcing contacts, as previously explained for D.C. breakers. The flash-barriers shown between the tops of the two contactors are for the purpose of preventing flashovers

#### 401. OIL SWITCHES

Oil circuit-breakers consist of breaker contacts which are operated under oil within a metal tank. The great advantage of breakers of this type lies in their greater safety and their ability to quickly interrupt high-voltage circuits because of the action of the oil in quenching out the arcs at the contacts as they are opened underneath the oil.

As soon as the switch is opened the insulating oil immediately flows into the space between the movable and stationary contacts and snuffs out the arc. This preserves the life of the contacts by preventing them from being so severely burned by the arc; helps to obtain speedy circuit-interruption in case of overloads, thus providing better protection for the equip-

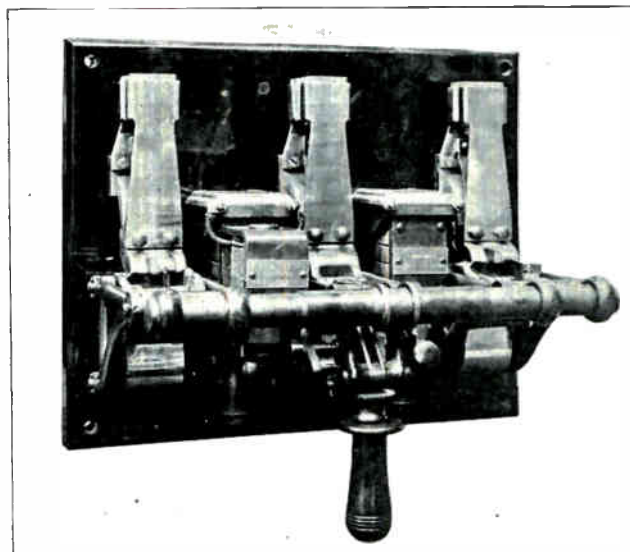

Fig. 421. Three-pole, 500-ampere, 250-volt A. C. air-breaker. Note the intermediate and arcing contacts and also the series overload trip coils. Courtesy of G. E. Company.

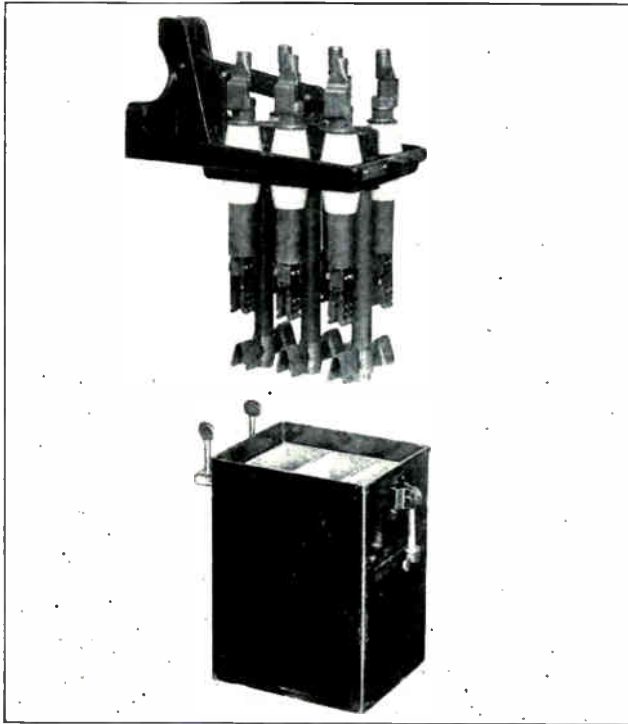

Fig. 422. View of a three-pole, 3300-volt, 200 ampere oil switch with oil tank removed to show contacts. Courtesy of G. E. Company.

ment on the circuits; and greatly increases the safety of operators because the circuits are interrupted within the metal tank.

For this reason, oil circuit-breakers are used on practically all A.C. circuits of 2300 volts or over.

Fig. 422 shows a small oil switch for use on three-phase circuits of not over 3300 volts and 200 amperes capacity. The switch mechanism is shown removed from the tank in this view, so that the stationary and movable contacts can both be clearly seen. The stationary contacts are supported by the insulating bushings through which the conductor leads are run. There are six of these bushings and terminals, and the line enters through the three on one side and leaves through the three on the other side.

The movable copper contacts, which are in this case shown dropped down or opened, are supported by the wooden insulating rods which are attached to the operating mechanism and lever on top of the switch. When these contacts are drawn up they press tightly into the spring fingers of the stationary contacts, thus making a good low-resistance connection. When the movable contacts are dropped they open the circuit in two places in series in each phase, thus very effectively interrupting the current flow.

Small oil switches of this type are generally manually-operated by handles or levers placed on the front of the switchboards or panels, as shown in Fig. 415. In some cases it is desired to locate the oil switches a few feet back of the switchboard, or perhaps behind the wall in another room. In this

case they can still be operated by remote mechanical control through a system of bell-cranks and rods, as shown in Fig. 422-A.

Oil switches should not be used in circuits with greater current loads than the capacity for which the switch is designed, and for effective operation and long life the contacts should be kept in good condition and the oil renewed frequently enough to maintain good insulating properties.

When oil switches are tripped open under heavy overloads or short circuits the contacts are likely to be burned to a certain extent in spite of the arc extinguishing properties of the oil. This means that the contacts should occasionally be inspected and resurfaced or replaced with new contact shoes or fingers when necessary.

The tank for the oil switch shown in Fig. 422 is provided with a set of inner barriers made of insulating and fire-resisting material. These barriers separate the oil into three different wells or cells in each of which a set of contacts is placed. This tends to prevent flashovers between phases when the switch is opened.

You will note that the tank can easily be removed to provide convenient inspection and care of the contacts as well as easy renewal of the oil.

Fig. 423 shows a larger view of a set of stationary and movable contacts for a manually-operated oil switch. This view clearly shows the manner in which the contacts can be removed for replacement by merely loosening the proper bolts and nuts.

The view at the upper left in Fig. 424 shows the operating mechanism of a three-phase oil switch of somewhat different construction from the one in Fig. 422. In this switch the main movable contact is made of a number of thin strips of copper arranged in a leaf construction that provides a good-

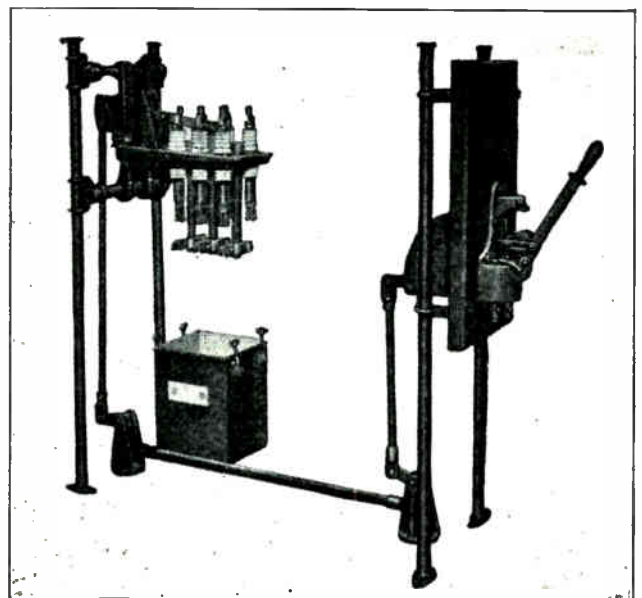

Fig. 422-A. This figure illustrates the method of obtaining remote mechanical control for an oil switch located several feet back of the switchboard. Courtesy of G. E. Company.

fitting, low-resistance contact with the stationary contact surfaces. The movable contact is also equipped with renewable arcing tips on each end. These arcing tips open last and the arc is therefore drawn from them, thus preventing the burning of the main-contact tips.

The view on the upper right in Fig. 424 shows an enlarged view of one set of these contacts in fully-closed position. At the lower left in the figure the contacts are shown partly opened; the main contact element having broken away from the stationary surfaces, leaving only the arcing tips in contact. At the lower right the switch is shown fully opened.

#### 402. HEAVY-DUTY OIL SWITCHES

High-voltage, heavy-duty oil switches are usually made with each set of contacts enclosed in a separate oil tank, to avoid all possibility of flashover between phases when the circuit is interrupted.

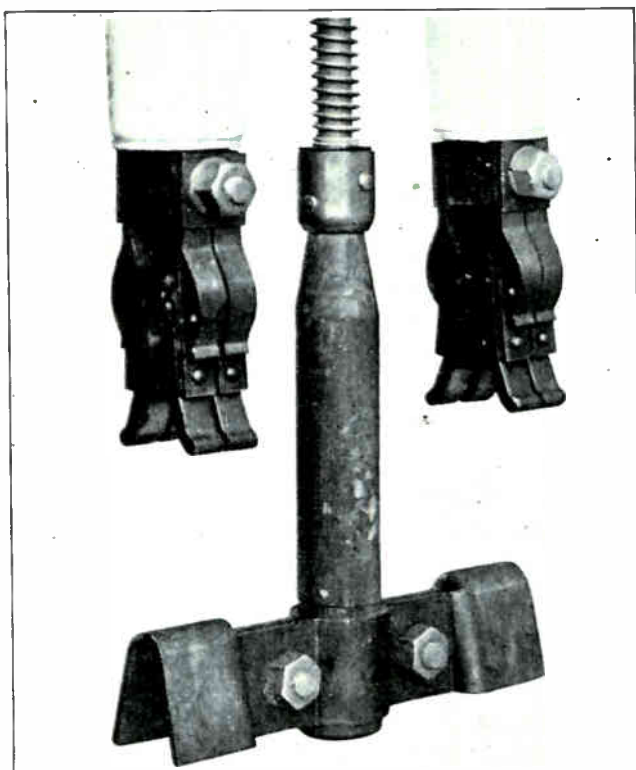

Fig. 423. Close-up view showing the details of construction of stationary and movable contacts of an oil switch. The upper stationary contacts are supported on porcelain bushings and the lower movable contact on a wooden insulating rod. Courtesy of G. E. Company.

Fig. 425 shows a 15,000-volt, 400-ampere, three-phase oil switch of this type, with the oil tank removed from the right-hand set of contacts. This view shows clearly the porcelain insulating bushings with the conductor terminals attached to their top ends and the stationary switch contacts attached to their bottom ends.

All three of the movable contacts can be moved at once by means of an operating shaft and lever, which are also shown in this figure.

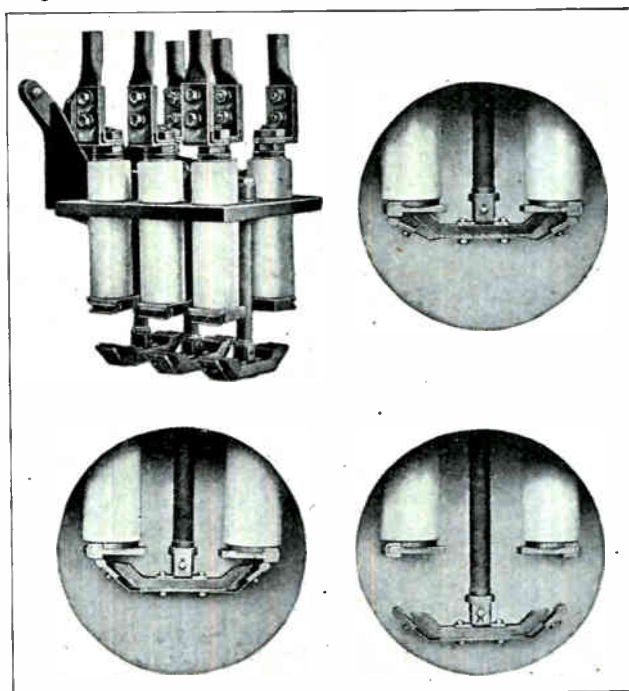

Fig. 424. At the upper left is shown the mechanism of a different type oil switch, and in the the three other views are shown the steps or movement of the contacts during the opening of a switch of this type.

Indoor-type oil switches used in power plants and high-voltage substations often have their separate phase units built into regular fireproof concrete cells or compartments, as shown in Fig. 426. This serves as additional protection to operators and also against interference with other circuits in the plant in case of a defect in or explosion of one of the oil switch units. It also makes convenient the connection of high-voltage conductors, which are also very often run through fireproof concrete ducts and cells throughout the plant.

The switch shown in Fig. 426 is of the remote-controlled, motor-operated type. The motor shown on top of the switch unit drives a gear which closes the switch and winds the heavy coil springs at the

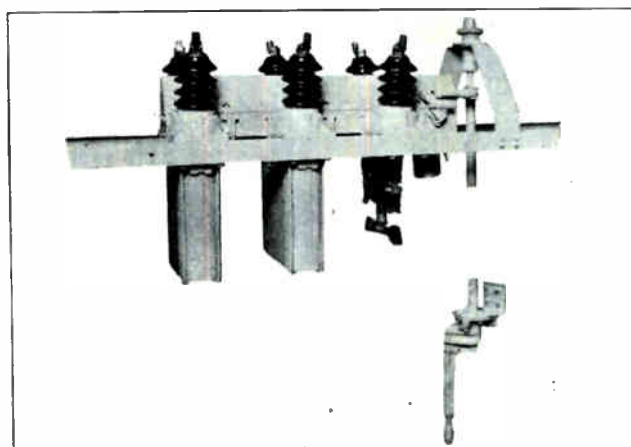

Fig. 425. 15,000-volt, 400-ampere, triple-pole oil switch with one tank removed. Note that the pole elements of this switch are each enclosed in a separate tank. Courtesy of G. E. Company.

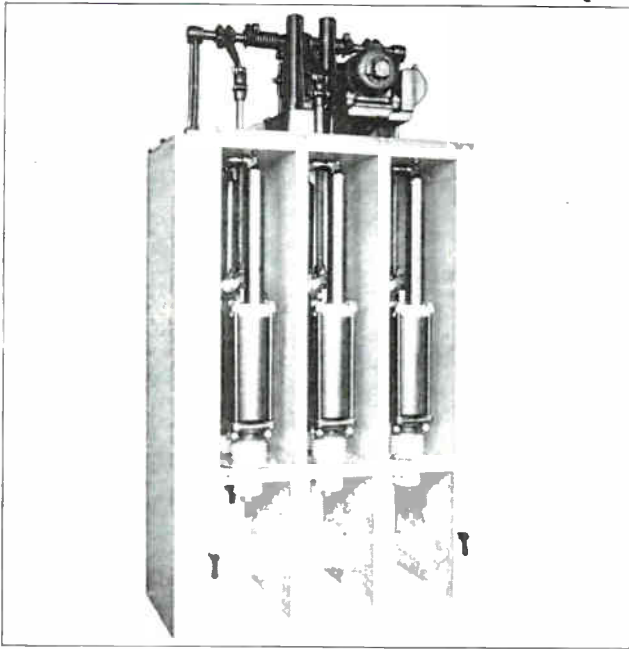

Fig. 426. Modern three-pole oil switch with expulsion type contacts and with pole units located in separate cells or compartments. Courtesy of G. E. Company.

same time. When the switch is tripped these coil springs quickly open the contacts.

Fig. 427 shows a huge outdoor oil-switch designed for operation in a three-phase, 150,000-volt circuit and to carry a load of 600 amperes. This switch has an interrupting capacity of 1,500,000 kv-a. in case of severe overloads or short circuits on the transmission line in which it is installed.

Fig. 414 shows a large group of 220,000-volt oil switches. Practically all of these large type oil-switches are operated automatically by motors or powerful solenoids.

In addition to the ordinary movable and stationary contacts operated under oil, some oil switches have contact prongs which open the circuit within an expulsion chamber. In switches of this type the gases created by the arc are temporarily confined

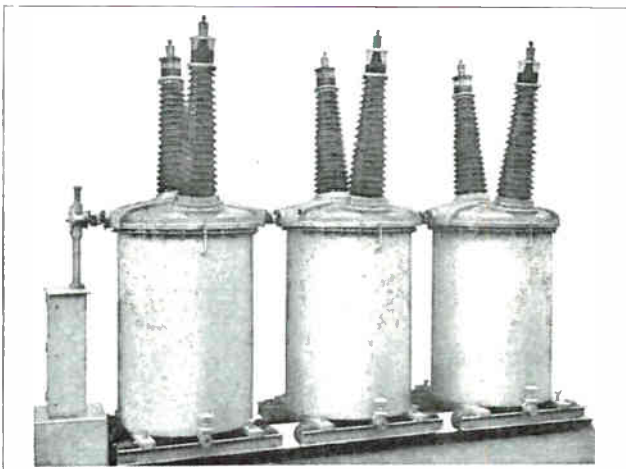

Fig. 427. Large outdoor oil switch for use in three-phase, 150,000-volt circuits. Courtesy of Condit Electric Mfg. Co.

within a special chamber and then blown violently out through a small opening through which the movable contact rod is withdrawn as the switch opens. The oil and gas which are forced out through this small opening quickly snuff out the arc.

On the left in Fig. 428 is shown a sectional view of one type of expulsion chamber for an oil switch of this type. In the center is a sectional view of a complete expulsion-type oil-switch with a slightly different chamber, and on the right is a view showing this switch in action just as the circuit is being opened.

A recent development in connection with oil switches is the use of deion grids on the stationary contacts and immersed in oil, to help extinguish the arc more quickly. These deion grids were previously described in the Section on Controllers. Fig. 428-B shows the inside of a large oil switch equip-

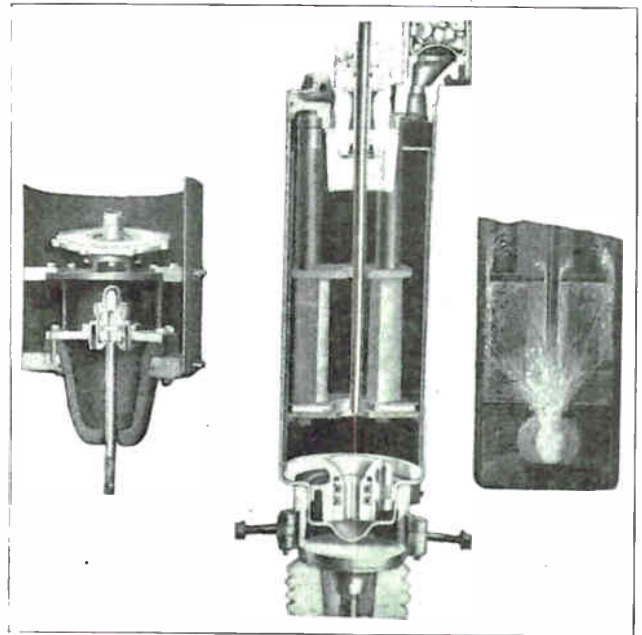

Fig. 428. The above views show two types of expulsion contacts used in modern oil switches and also one of these contacts in action opening a circuit.

ped with deion grids which can be seen on the lower ends of the stationary contacts.

Oil switch tanks should be thoroughly grounded to prevent the possibility of shocks due to leakage through their insulation, or due to capacity charges which may be built up on the tanks of high-voltage breakers.

The tanks of oil switches should also be provided with some small opening or vent to allow the escape of gases generated within the tank by the arcs when the circuits are opened. Very heavy arcs may generate considerable gas when the circuit is required to open under heavy short-circuits.

In addition to their use in substations and power plants oil switches are also used extensively for starting large high-voltage motors.

The operator who has charge of oil switches should always see that they are well filled with clean oil of the proper insulating quality; keep the insulating bushings clean by brushing or wiping them off with a brush or mop with a long wooden handle; and keep the contacts in proper condition and repair.

When performing on oil switches any work that involves the possibility of the operator's coming in contact with live parts, the switch should first be completely disconnected from the line by means of disconnect switches on either side of the oil switch. It is also a good added precaution to thoroughly ground the oil switch terminals.

### 403. HIGH-TENSION AIR-BREAK SWITCHES

Disconnect switches are used extensively both on inside busses in power plants and in outdoor substation structures. High-voltage air-break switches

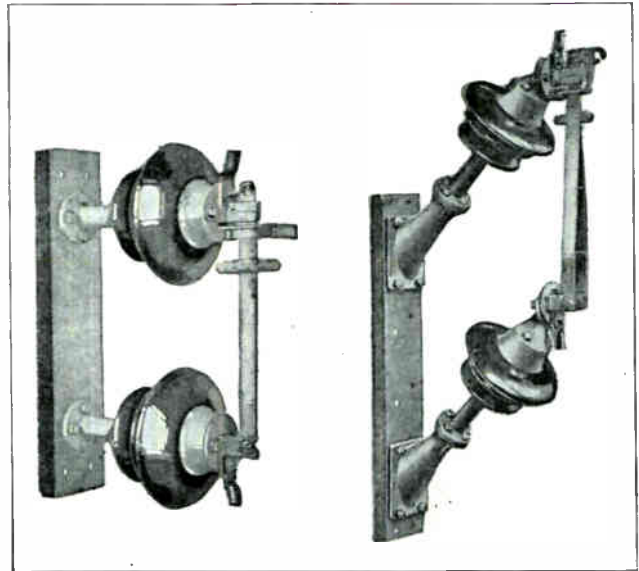

Fig. 429. Two types of disconnect switches for operation by means of a switch hook or pole having an insulated handle.

Disconnect switches of this type should never be used to open a circuit under load but should be opened only after an oil switch in series with them has opened the circuit and interrupted the current flow to the principal power load.

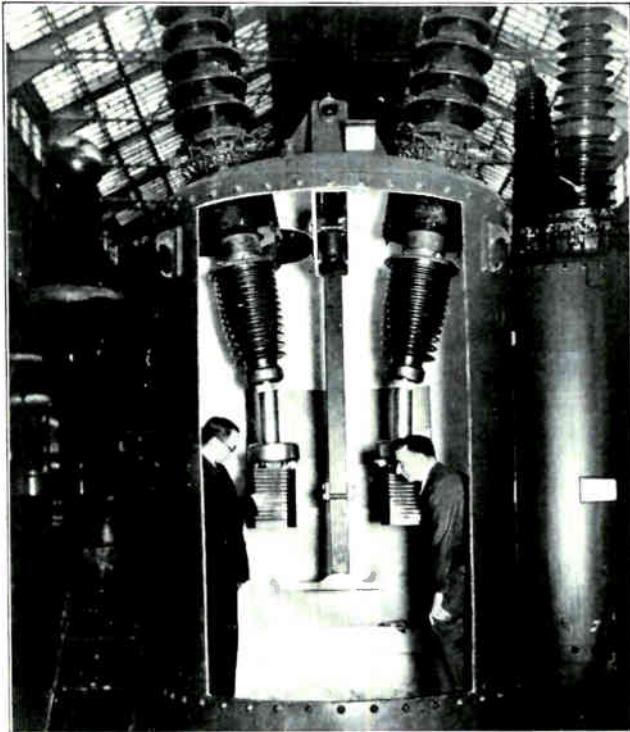

Fig. 428-B. This unique photograph clearly shows the inside of a large high-voltage oil switch equipped with Deion grids on the stationary contacts. Note the size of the contacts, insulators, and tanks required for handling the currents of high-voltage power lines. Courtesy of Westinghouse Elec. & Mfg. Co.

are also commonly used in outdoor switching and substation structures. Ordinary disconnect switches generally consist of a hinged blade and clips mounted on the proper insulators for the voltage of the line on which they are to operate.

Two switches of this type are shown in Fig. 429. You will note that the blades have eyes or holes at the top ends so that they can be operated by wooden switch sticks, or poles which have a small metal horn that can be placed in the eyes of the switchblade to pull it open.

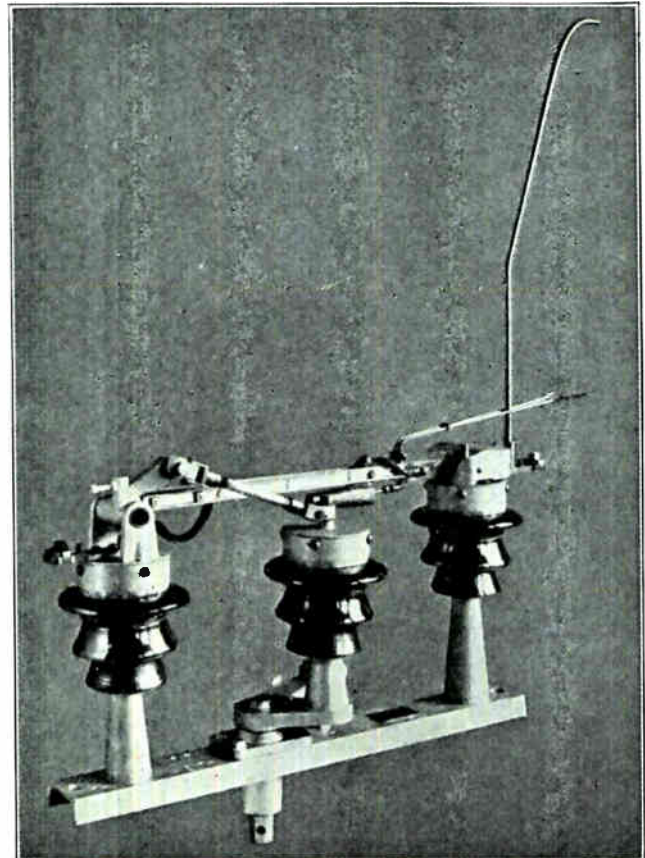

Fig. 430. High-voltage air break switch for pole top mounting or use in substation structures. Note the arcing horns used to prevent pitting and damage to the switch contacts. Courtesy of Hi-Voltage Equipment Company.



The disconnect switches can then be opened by means of the safety stick to completely disconnect the oil switches, lightning arresters, instrument transformers, and other equipment from the line.

Both of the switches shown in Fig. 429 are for 300-ampere, 37,000-volt circuits.

Special high-voltage air-break switches are made to open line circuits under load. These switches are generally equipped with arcing horns to carry the arc away from the current conducting blades and contacts as soon as the switch is opened.

The movable blades of air-break switches are often equipped with springs which snap them open quickly when the operating handle is moved.

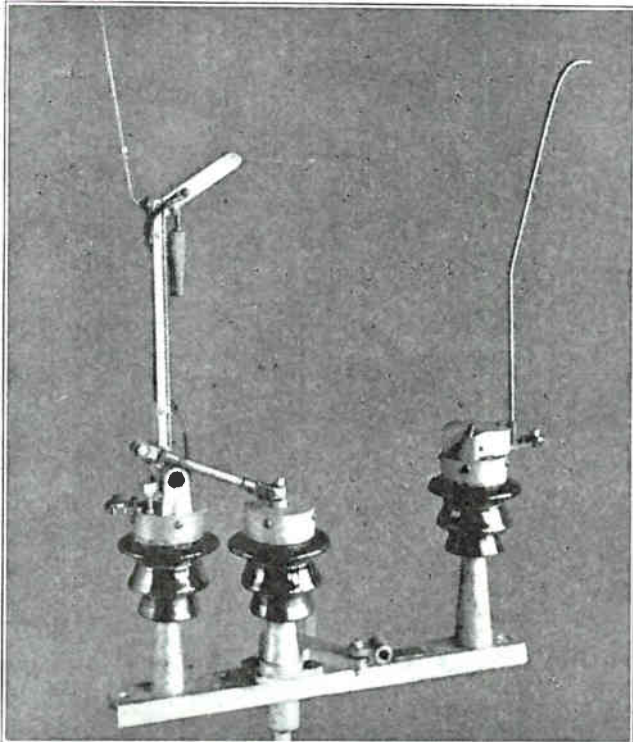

Fig. 431. This is another view of the same air break switch shown in Fig. 430. In this figure the switch is shown open. Note the movement of the center insulator by comparing the two views. Courtesy of Hi-Voltage Equipment Company.

Fig. 430 shows a switch of this type in closed position. Note the large vertical horn attached to the stationary clip and the small horns attached to the movable blade.

Switches of this type can be mounted on the tops of poles or on the steel frameworks of substation structures and operated by a long shaft running down to a handle within reach of an operator on the ground.

The switch in Fig. 430 is opened by rotating the center insulator, causing it to push on the small rod attached to the hinge of the movable switch blade and thus snap the switch open. Fig. 431 shows the same switch in open position.

Fig. 432 shows an air-break switch mounted on the top of a pole and being opened after dark. The long arcs which are drawn from the horns when the

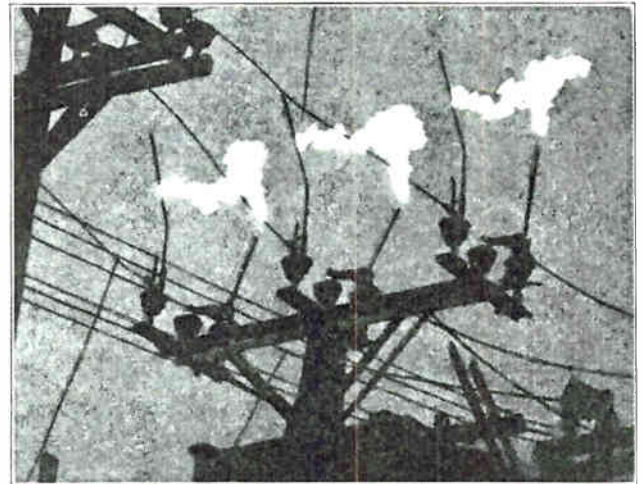

Fig. 432. This night photo of an air break switch opening under load shows the arcs which are drawn from the arcing horns just as the switch opens. Courtesy of Hi-Voltage Equipment Company.

switch interrupts the load current of the high-tension line can be clearly seen in this view.

Fig. 433 shows a one pole unit, heavy-duty, 600-ampere, air-break switch of somewhat different construction from those in Figs. 430 and 431. This switch is for use in a 120,000-volt circuit.

When the insulators at the right are rotated either by a motor or hand crank the long tubular blade is quickly raised, thus opening the circuit. When the movable blade is connected to the live incoming line and the stationary clip connected to the substation equipment, the grounding blade which is clearly shown in this view can be swung up to the ground clip after this switch has been opened, thus grounding the dead end of the line for safety to operators who may be working on the equipment attached to it.

Fig. 434 shows the three pole units of another type of air-break switch for 150,000-volt line. The blades of this switch are flat and are rotated in a

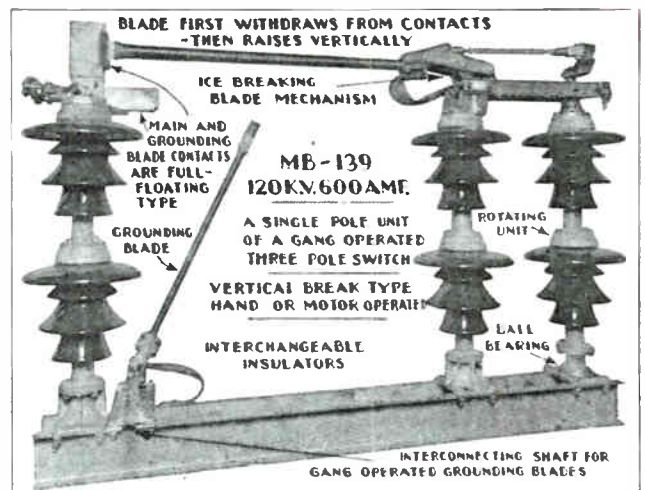

Fig. 433. Single pole unit of 120,000-volt, 600-ampere air-break switch with auxiliary grounding blade. Note the description of the various parts in this figure. Courtesy of Delta-Star Manufacturing Company.

horizontal position by turning the movable center insulators.

Most air-break switches are designed so they can be opened even when coated with ice. To make this possible the mechanism is usually arranged so that the blade first makes a short twisting or lengthwise pulling movement to break loose or shear any coating of ice which may be over the contact and clips. After this first shearing movement the blade swings freely into open position.

#### 404. HIGH-TENSION FUSES

It is often desirable to protect small transmission lines or branch lines which run off from main lines from local overloads so that these overloads will not affect the entire line and system.

Special high-tension fuses for mounting on the tops of poles or towers have been designed for this purpose and serve to quickly disconnect a branch or section of the line in case of severe overloads, short circuits, or insulator flashovers caused by lightning.

Fig. 435 shows an expulsion-type of high-tension fuse. This fuse has a small tube or barrel like a

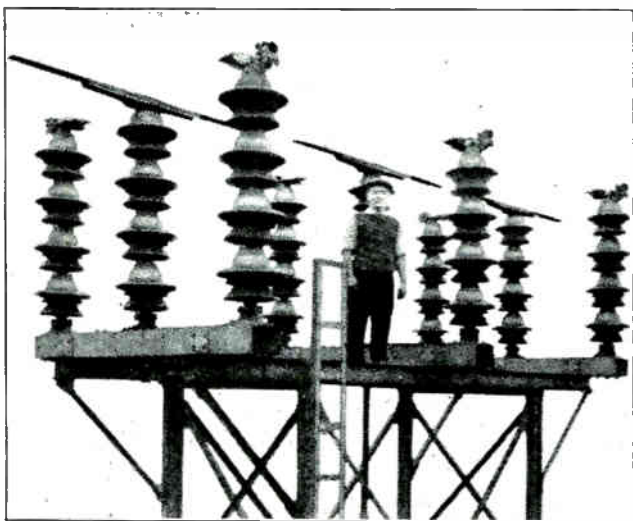

Fig. 434. Three-pole air break switch for use on 154,000-volt, three-phase lines. Note the rotating blades which are shown in open position in this view. Courtesy of Delta-Star Mfg. Co.

gun, into which is fastened the piece of lead fuse wire shown protruding from the right-hand end. When the fuse blows inside this tube, the gases formed by the arc quickly blow the remaining end of the fuse away from the end of the tube and actually blow out the arc, thus interrupting the line circuit.

Fig. 436 shows a photograph of a set of these fuses mounted on top of a pole and just in the act of blowing and opening a heavy short circuit.

Another type of high-voltage fuse which is very extensively used has a fusible strip and long coil spring enclosed in a glass tube which is filled with arc-extinguishing fluid. This fuse is so designed that when in normal condition the spring is held under tension, and when the fuse strip melts due

to an overload, the spring is released and quickly draws the lower arcing terminal downward, thus making a long gap which tends to extinguish the arc.

As the spring moves downward it also moves a liquid director or plunger which compresses the liquid in the tube and squirts it through an opening in the plunger and directly into the arc, thus effectively extinguishing the arc.

Fig. 436-A shows a diagram of a fuse of this type, in which all the essential parts can be clearly seen. Note the coil spring and the flexible copper cable which carries the current, and also note the liquid director attached to the arcing terminal at the upper end of the spring.

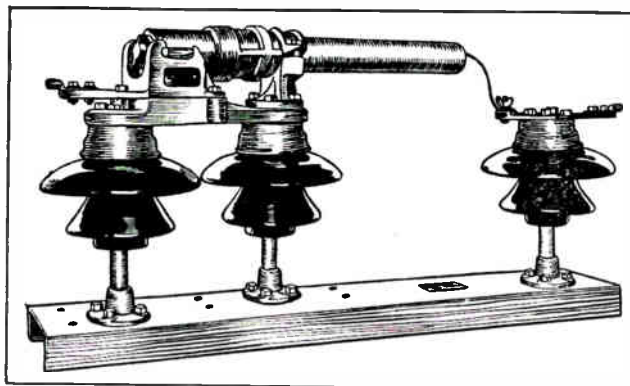

Fig. 435. Expulsion type high-voltage fuse. The fuse strip is violently blown out of the tube or barrel, thus quickly interrupting the circuit when this fuse blows. Courtesy of Hi-Voltage Equipment Co.

The spring is normally held extended by a small piece of strong tension wire that is connected in parallel with the fuse strip, but when the fuse strip blows the current load is shunted through the tension wire causing it to melt and release the spring.

Fig. 436-B shows a photo of a complete fuse of this liquid-filled type in the view on the left. The top center view shows one of the fuses after it

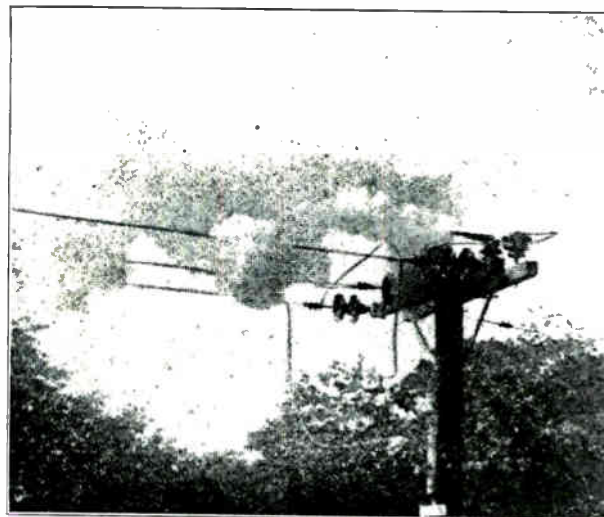

Fig. 436. This unusual photo shows a set of high-voltage fuses mounted on the top of a pole, at the exact instant of blowing or opening the circuit. Courtesy of Hi-Voltage Equipment Co.

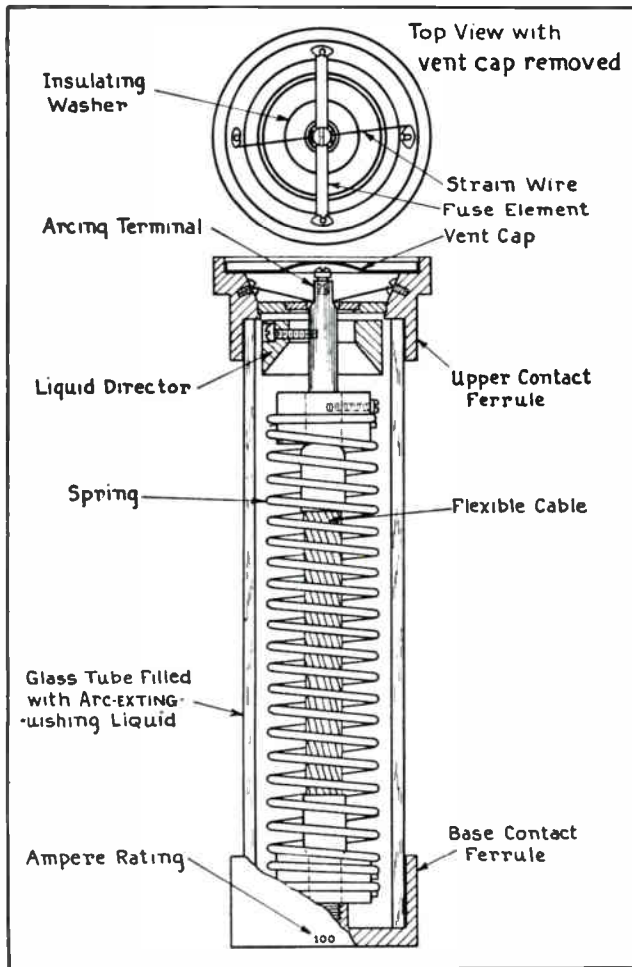

Fig. 436-A. The above sketch shows the principal parts of a high-voltage fuse of the liquid filled type. Examine each part carefully and compare with the explanations given on these pages. Courtesy of Schweitzer & Conrad, Inc.

has blown and the spring has drawn down and broken the arc.

The lower center views show two types of clips in which the fuses are mounted and locked by the clamping rings.

On the right are shown two views of such fuses equipped with weather-proof housings for outdoor use and for convenient mounting on poles or substation structures.

One of the great advantages of these fuses is that they will open the circuit, extinguish the arc, and clear an overload or short circuit in from  $\frac{1}{2}$  to  $1\frac{1}{2}$  cycles.

They are made in sizes from  $\frac{1}{2}$  to 400 amperes and for voltages from 2200 to 138,000.

The fuse is provided with a vent cap to allow the escape of the gases formed by the arc when the fuse blows, and thus prevent damage to the tube.

These fuses can be refilled at a nominal cost by returning them to the manufacturer after they have blown.

Fig. 436-C shows two types of wooden fuse tongs for removing and replacing high-voltage fuses, and

also a switch hook for opening and closing disconnect switches.

Oil switches and disconnect switches in the circuit should always be opened before removing or replacing fuses, in order to avoid drawing arcs at the fuse ferrules and clips.

#### 405. A. C. RELAYS

There are a number of different types of A. C. relays in common use in alternating current power plants and substations. Keeping in mind at all times that any relay is simply a magnetically operated switch, it is comparatively easy to understand their operation and care, as well as their purpose in the circuits in which you may find them.

A. C. relays are used in many of the same ways as the D. C. relays which were explained in an earlier section.

Some relays are designed to operate whenever the voltage of certain circuits to which they are connected becomes too high or too low. Such relays are known as over-voltage or under-voltage relays, and are sometimes called potential relays. They are connected across the phases of low-voltage A. C. circuits or to the secondaries of potential transformers which are connected to the high-voltage A. C. circuits.

Current relays are designed to operate whenever the current in certain circuits falls below or rises above a certain value for which the relay is set. These relays are generally operated from the

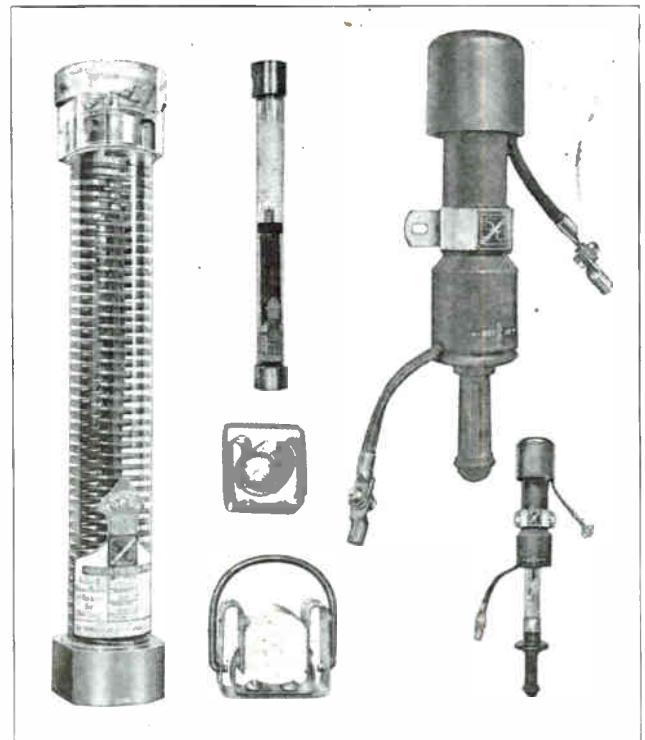

Fig. 436-B. The above views show high-voltage fuses of the liquid filled type both in normal and open condition, and also shows clips for mounting them. On the right are fuses of this type in water-proof housings for outdoor use. Courtesy of Schweitzer & Conrad, Inc.

secondaries of current transformers, as the relay itself is usually a rather delicate device and is not designed to carry much current.

Current relays are often called overload or under-load relays, according to the use for which they are intended.

Many relays are designed with very small contacts which are intended only to make or break the circuits to the coils of heavy-duty relays. These main relays in turn operate heavy contacts which open or close the circuits to large oil switches of the solenoid or motor-operated type.

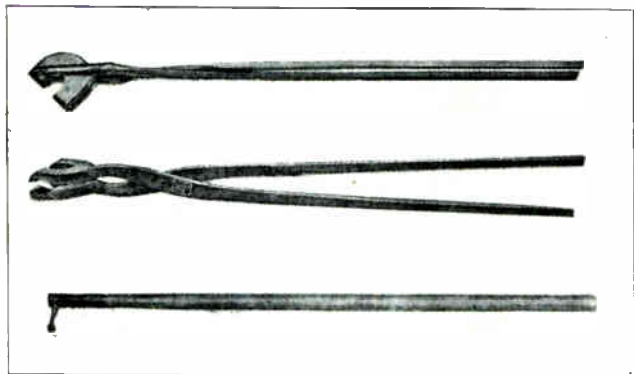

Fig. 436-C. At the top are shown two wood handled fuse tongs for removing and replacing high-voltage fuses, and below is shown a wood handled switch stick or pole for operating disconnect switches. Courtesy of Schweitzer & Conrad, Inc.

Fig. 437 shows a high-voltage cut-out relay. The operating coil, movable contacts, and relay adjustment screw can be clearly seen in this view.

Fig. 438 shows a solenoid-operated instantaneous overcurrent relay, with the cover removed from the contacts. The solenoid coil is in the casing to which the name-plate is attached, and the plunger adjustment by which the relay can be set to trip at various loads is shown at the bottom of the device. Relays

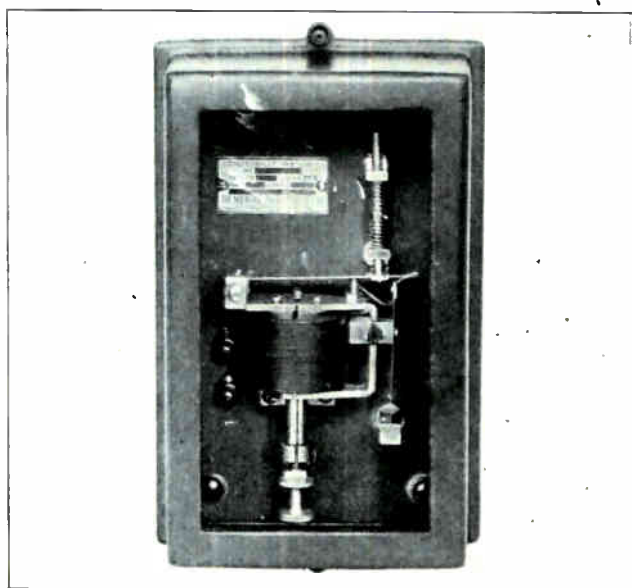

Fig. 437. Photo of a high-voltage cutout relay clearly showing the coil and contacts. Courtesy of G. E. Company.

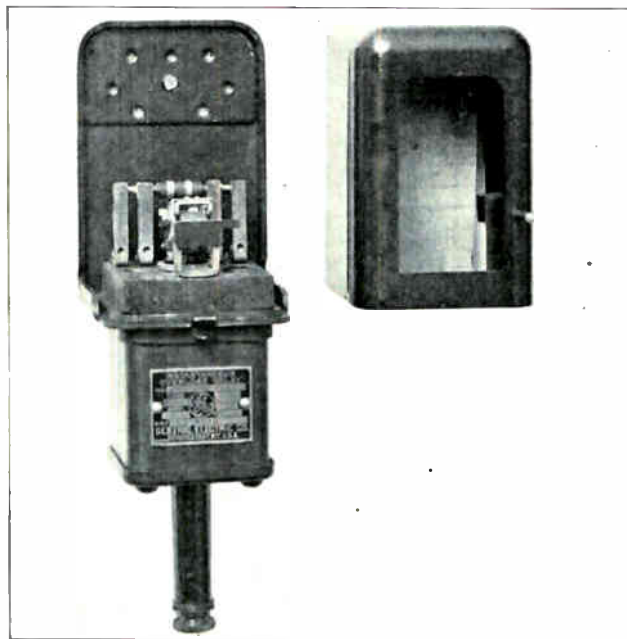

Fig. 438. This view shows an instantaneous operating overcurrent relay with contacts for closing three circuits. Courtesy of G. E. Company.

of this type can be made to open or close one or more circuits, as desired.

Many relays of the magnet or solenoid-operated type are instantaneous in their action or, in other words, they are designed to operate and close their contacts immediately, as soon as the voltage or current reach the values for which the relays are set.

Other relays are equipped with time delay devices, such as oil dash-pots or air bellows, so that they can be adjusted to open or close a circuit, provided the overload or excess voltage for which they are set remains on the circuit for a period of several seconds.

The purpose of relays of this type is to protect equipment from continued overloads or undesirable conditions, and yet not to trip out the breakers and interrupt the service on momentary overloads which would do the machines no harm.

An inverse time delay relay is one on which the period of time delay is inversely proportional to the amount of overload. In other words, the greater the amount of overloads the shorter will be the time delay and the quicker the relay will act to open and protect the circuit.

Great numbers of relays of different varieties are used in performing the various operations in automatic substations and power plants.

Fig. 439 shows an A.C. overload relay of the induction type. This relay operates on very much the same principal as an induction watt-hour meter, and has a disk in which eddy currents are induced by the current flowing through its coils. The movement of the disk is retarded by a spring which holds it in normal position during normal conditions on the circuit.

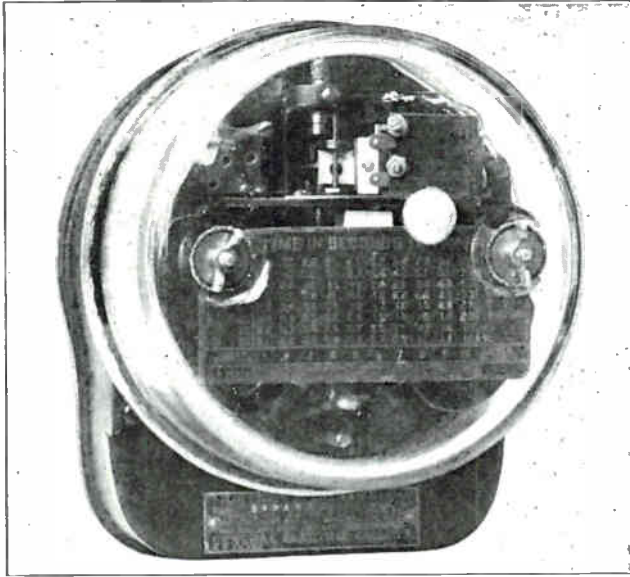

Fig. 439. Modern induction type overload relay such as very extensively used in A.C. power plants and substations. Courtesy of G. E. Company.

In case of overload the increased current increases the torque on the disk, causing it to turn slowly until a small lug or projection is rotated around to where it opens or closes the relay contacts.

By setting these relays so that the disk must rotate a smaller or greater distance before closing the contacts, the time-delay of the relays can be adjusted over quite a wide range. This is one of the very popular types of modern relays.

Fig. 440 shows a reverse-power relay which is used to operate circuit breakers in case the power flow on A.C. circuits is reversed in direction. This may at first seem queer to you, since you know that A.C. is constantly reversing in direction.

However, as long as power is flowing in one direction in an A.C. circuit, the voltage and current bear a certain phase relation to each other; while

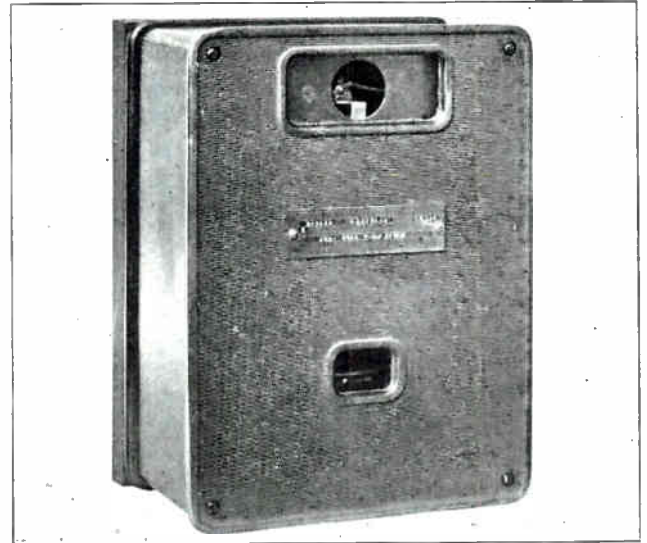

Fig. 440. Photo of a polyphase reverse-power relay for A. C. circuits in substations and power plants. Photo Courtesy of G. E. Company.

if the power flow reverses because of some fault on the line, the voltage and current will then have opposite phase relations to each other.

Reverse-power relays have both current and potential coils, which hold the relay disk in normal position as long as the power flows in the right direction; but as soon as the direction of power flow reverses, the relay disk starts to rotate and closes the contacts which operate the circuit-breakers.

Automatic substations and power plants use numerous relays of various types, to start and stop the machines and perform various switching operations either entirely automatically or by remote control from a master operator or load dispatcher at some other station.

Always be on the alert for opportunities to provide better protection for electrical machines, and to secure more economical operation of them by the application of the proper relays.

Norman Beder  
41 Georgia Ave.  
Brooklyn 7, N. Y.

## INSTALLATION AND MAINTENANCE

A certain amount of instruction has been given on the Care and Maintenance of various pieces of electrical equipment in the sections of this Reference Set in which they were described, and a great deal of the material covered in the section on Electrical Wiring can be applied to the installation of electrical machinery.

However, there are certain general important items pertaining to the installation and maintenance of electrical equipment that can well be emphasized and explained in detail in this section, now that you are familiar with the various types of machines and their uses.

Proper installation of electrical motors, controllers, generators, transformers, instruments, and other equipment is very necessary to secure the best operation and to avoid frequent and costly shut-downs and repairs after the devices are in service.

### 406. GENERATORS AND MOTORS

When installing electrical generators or motors of any size, care should be taken to see that they are mounted upon rugged and secure foundations to prevent vibration and trouble with misalignment of shafts and belts. Very large machines are practically always fastened to solid concrete foundations, and for the largest types of power plant generators these foundations are usually reinforced with steel.

Medium sized motors and generators can be mounted upon wooden beams or bases and securely fastened to them by means of lag screws or bolts of the proper size. The bases in turn can be mounted on the floor of the building in which the machines are used.

In some cases small or medium sized motors are mounted on substantial brackets on factory walls or columns, or even suspended from the ceiling. In such cases particular attention should be given to the fastenings to make sure that they will not pull loose, even after years of operation and the normal vibration to which the motors and belts may subject the fastenings.

It is very important to see that motors and generators are properly leveled to secure even wear on bearings and prevent leakage of bearing oil. In leveling up machines small wedges or shims made of wood, steel, or paper can be used under the feet or bed-plates. Extreme care and accuracy on this point is required in setting very large generators or motors.

Whenever possible, motors and generators should be located away from all moisture and dirt, and in places where they will have free circulation of clean air to carry away the heat the machines develop and not clog the windings with dirt or moisture. If

motors must be located in damp places or where water is likely to drip upon them, a cover or small roof of sheet metal, tarpaulin, or water-proof roofing material should be used above them.

### 407. CONTROLLERS AND SWITCHING EQUIPMENT

Motor controllers should always be mounted on solid angle-iron or pipe-work frames, or parts of the building structure where they are free from excessive vibration from other surrounding equipment and so that they will not vibrate when operated.

Controllers should be placed as near as possible to the motors they operate and yet, in the case of manually-operated controllers, they should be located within most convenient reach of the operators who may have to frequently start and stop the motors.

The tops of controllers should be carefully leveled and the controllers should as far as possible be placed in cool, clean, dry locations.

Controllers and switching equipment should be installed according to the instructions usually provided by the manufacturer and connected according to the diagrams which are also usually supplied.

Small starting switches enclosed in metal safety boxes are generally provided with knock-out openings for the attachment of conduit or BX.

When installing motors, generators, controllers, or any other electrical equipment, the rules of the National Electric Code should be carefully followed. One of the most important of these rules is that the frames of machines and the metal boxes of controllers must be securely grounded to prevent the danger of shocks to operators in case of failure of the insulation on some part of the machine windings or connections.

It is generally best whenever possible to have the wires between controllers and motors, and between generators and switchboards, run in either rigid or flexible conduit or approved cable.

On small machines BX is sometimes used for these connections, and in certain types of factory buildings, where it is allowed by the local inspection department, the wiring may occasionally be run open.

Fig. 441 shows a large slip-ring motor and the panel-type controller used with it. Note that in this installation conduit was apparently run through the cement floor at the time the building was erected. These conduits were equipped with the proper outlet fittings and covers so that the cables from the controller to the motor can be neatly installed as shown. Note the drip-shield above the controller, to keep any water from the ceiling from

dripping on live parts of this device. The large motor shown in this figure is mounted on a specially-cast iron base which is a part of the machine to which the motor is directly connected.

Fig. 442 shows a motor installation in which the machine is set on wooden beams and securely bolted to them. The leads from the controller are run through rigid conduit up to a point near the motor and then through flexible conduit and the proper fittings to the motor. This keeps practically all wires completely enclosed and is a very good type of installation.

The flexible conduit permits the motor to be moved a slight distance on its bed rails in order to tighten or loosen the belt or chain by which it drives the connected machinery.

Fig. 443 shows another motor installation in which the wires to the controller and motor are brought down from above through rigid iron conduit. Between the motor and controller box is shown a small capacitor or static condenser for power-factor correction. Above the starting box are shown the line switch and push-button control for the motor.

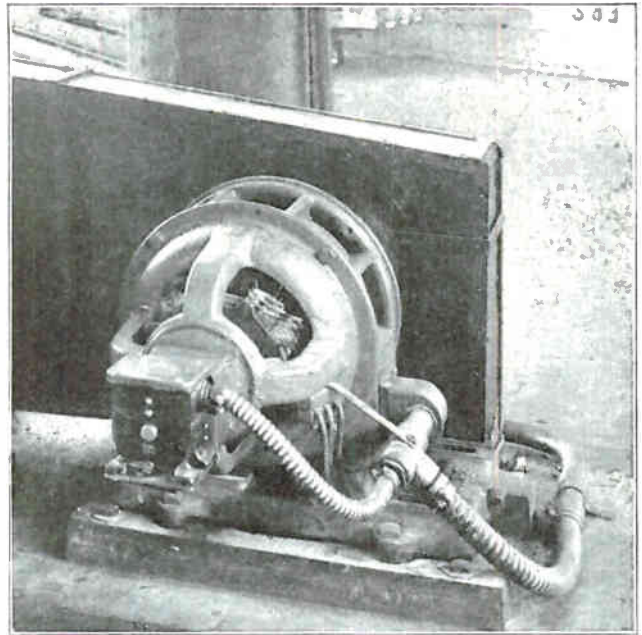

Fig. 442. Induction motor installation, using rigid conduit to bring the wires up to the motor, and flexible conduit to attach to the motor to allow it to be moved slightly for belt adjustment. Courtesy of G. E. Company.

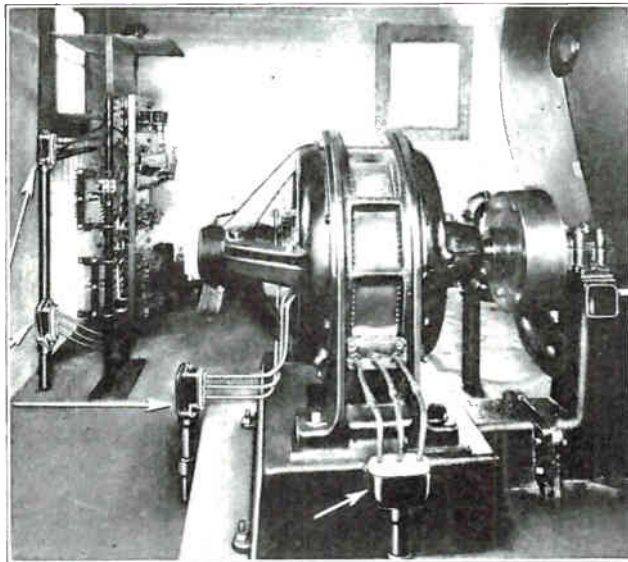

Fig. 443. This photo shows a very neat installation of the wiring to a slip ring motor and its controller. Courtesy of Crouse Hinds Co.

#### 408. CONDUIT AND CONDUCTORS

The section on Electrical Wiring thoroughly covered the methods of installing wiring in conduit and should be carefully reviewed before you install any wiring to motors or power equipment.

Power wiring generally requires much larger conductors and conduit than those used for lighting installations, and a few special features pertaining to this heavier wiring will be repeated here.

In running large conduits from the supply to controllers and motors, the run should be kept as straight as possible, avoiding all unnecessary bends. This will make a neater installation and will greatly facilitate the pulling in of large cables.

Bends can be made in conduit of from 1 to 4 inches in diameter by means of bending machines, and sizes up to 3 inches can sometimes be bent by bending the length of conduit around a substantial post or part of the building framework. The strength of several men or the use of a block and line may be required to do this and great care should be taken to make the bends smooth and uniform and to avoid crushing or flattening the pipe.

Capping one end and filling the pipe with dry sand and then capping the other end will greatly aid in making bends or offsets without flattening the conduit. It is often necessary to heat large pipes to bend them by hand.

A bend on which the pipe has been flattened even a small amount should be discarded, as it is likely to cause great difficulty when pulling the conductors in. It is usually cheaper and better to buy ready made bends and elbows for large conduit, and the work can also be simplified by the liberal use of proper junction or pull boxes and fittings.

The ends of conduit sections should be well threaded, carefully reamed, and securely tightened into all fittings and boxes. All conduit, whether rigid or flexible, and all BX. runs should be thoroughly grounded.

#### 409. PULLING IN CONDUCTORS

Large wires or cables can be pulled into conduit runs having not more than 4 right-angle bends by the use of steel fish tape or pilot line, as previously explained in the section on Electrical Wiring.

In heavy power wiring a light cord or line is often blown through the conduit by attaching a wad of paper or cloth to its end and applying compressed

air behind this at the end of the pipe. This light line is then used to pull through a strong Manila rope or fish tape, or in some cases a small steel cable.

On short runs of small cable one man may be able to pull in the conductors alone, but on longer runs consisting of several heavy cables it may require several men or a block and tackle or even some form of power winch.

Liberal use of powdered soapstone, mica or talc, rubbed on the insulation of the conductors or blown into the pipe will greatly ease the passage of the conductors through the conduit. Never use grease or oil of any kind, as it is injurious to the insulation of the conductors.

Careful and straight feeding of the conductors into the end of the conduit at which they are entering and steady even pulling on the pilot line or fish tape are both of the greatest importance in pulling in heavy conductors. The conductors should be fed in perfectly parallel without allowing them to kink, twist, or cross each other.

Sometimes feeding the conductors through a small piece of thick fibre with as many smooth-edged holes as there are conductors will help to keep the wires straight in feeding them into the conduit.

If conductors become stuck or jammed in some bend of the pipe it is often better to pull them out and start them over again, using more lubricant and keeping them straighter. If too much strain is placed upon them they are likely to be broken or the insulation may be damaged by excessive friction.

In many cases it is necessary to use a large junction box at each corner or turn in the conduit and to pull the wires through one section at a time, looping them back to start in again at each of these junction boxes.

All splices in large stranded conductors or cables should be neatly and carefully made and well soldered, or otherwise they may be of high-resistance and overheat when the conductors are subjected to heavy current loads, and this overheating may melt out the solder and burn off the taping, thus causing the cable to become grounded or open.

Never pull a splice of any kind into a run of conduit, but instead see that all splices are made at the proper junction boxes or fittings.

Splices can often be more conveniently made by sweating or soldering copper lugs of the proper size on the cable ends, and then bolting the flat tips of these lugs securely together. Such joints should be thoroughly and carefully taped to prevent the corners of lugs or bolts from puncturing the insulation and grounding a conductor against the junction box.

Where power conductors are connected to machines and equipment, properly soldered cable tip lugs should be used.

In selecting conductors for motors or power equipment of various kinds their current load should be carefully calculated, as previously explained, from the horse power and voltage rating of the machines.

The size of conductors should then be determined by the rules of the National Code and also by the use of the voltage drop formula given in the section on Electrical Wiring.

Conductors should be plenty large enough so they will not overheat or cause too great a voltage drop, which will result in low-voltage at the machines. It is generally much better to have conductors a little too large than to have them under size.

#### 410. TRANSFORMERS

Small power transformers are very commonly mounted on the tops of poles just beneath the line conductors to which they are attached. For mounting transformers in this manner two flat pieces of heavy strap-iron, having square hooked top ends to hang over the cross arms, are used.

Transformer cases are bolted to these strap-iron hooks and hung from the cross arms. When two or more medium or large sized transformers are installed outdoors for lighting service they are frequently placed on a platform supported by either one or two poles, as shown in Fig. 444.

Larger transformers for outdoor use are generally installed on concrete foundations or heavy wooden beams which have been properly treated to resist the action of the weather, and which are supported slightly above the ground by blocks or pole stubs.

Transformers which are located down low in this manner should be protected by strong, high, wire mesh fence with several barbed wires around the top to prevent the possibility of shocks to meddle-

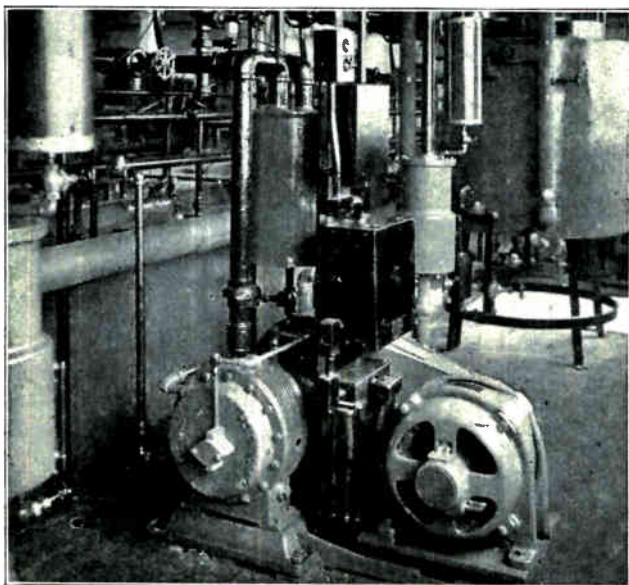

Fig. 443. This view shows a motor, push button control and a static condenser for power factor correction, all wired in conduit. Courtesy of G. E. Company.



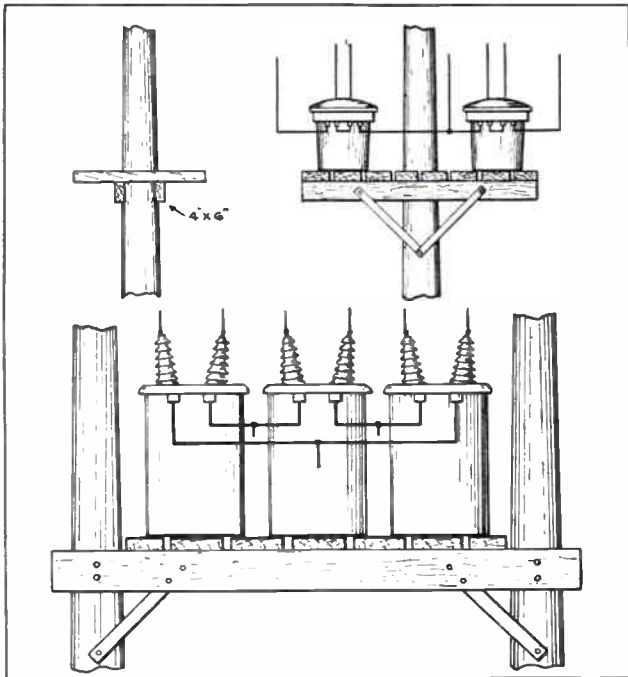

Fig. 444. The above sketches illustrate methods of mounting transformers on platforms on one or two poles.

some or curious people who might otherwise come in contact with some of their high-voltage terminals.

Signs warning of high voltage and danger should also be placed upon the transformers or fence.

Transformers should always be set with their bases level and in positions to allow the best possible circulation of air around them to facilitate their cooling. It is desirable, when possible, to select the shady side of a building for the location of transformers, as this will make a great deal of difference in their summer operating temperatures and efficiency.

Transformers for use inside substations or power plant structures should be provided with plenty of circulating air through the room or vault in which they are located.

On transformers that are air and oil cooled, fans or blowers to circulate air through the room or over their cooling radiators will often assist materially in keeping the transformers operating at proper temperatures.

Transformers which have water cooling coils should have an unfailing supply of cool circulating water at all times.

It is usually best to see that transformers are securely anchored to the floor or platform on which they are mounted, in order to prevent them from slowly creeping out of position due to their own vibration or that of other equipment around them. This is particularly essential with transformers mounted on platforms up on poles.

Connections to both the high-voltage and low-voltage leads of transformers should be made as neatly and symmetrically as possible, and in a manner to facilitate any necessary work or maintenance

which may have to be done around the transformers.

Fig. 445 shows a single transformer on the left and a bank of three transformers on the right, suspended from pole cross-arms by means of the mounting hooks previously mentioned.

Fig. 446 shows a bank of three transformers mounted on a substantial platform and supported by two poles. Also re-examine Figs. 124 and 149 in Section Four on Alternating Current.

Where outdoor space is not available, transformers for factories and industrial plants are often located in small fireproof rooms in basements or other parts of the plants. These rooms are commonly known as transformer vaults. They should be well ventilated and drained in order to keep the transformers cool and free from water.

Transformer vaults should never be used as store rooms, but should be kept clean and free of obstructions, so that the transformers are accessible for inspection and testing and so that emergency repairs can be made safely and conveniently.

Transformer vault doors should be locked or plainly marked with such signs as "high voltage", "dangerous", "keep out", so that unauthorized workmen other than the electrical crew will be warned against the danger of injury from contact with live wires or connections.

When installing any electrical equipment always remember that work which is neatly, thoroughly, and carefully done will result in a more reliable and efficient installation and in much better satisfaction to your employer or customer than work carelessly done. Make every job of electrical installation or wiring which you may ever do, one in which both

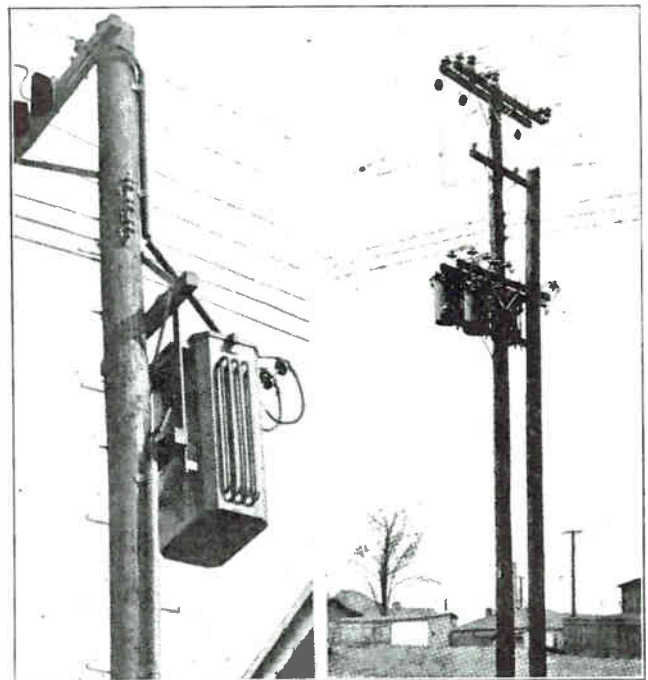

Fig. 445. These photos show transformers supported by heavy iron hooks over the cross arms.

you and your employer can take just pride, regardless of whether it is a small or large installation; and above all else make sure that the wiring and equipment are made as safe as possible from the standpoint of fire and shock hazard.

#### 411. ELECTRICAL MAINTENANCE

The term "electrical maintenance" includes the inspection, care, and repair of all kinds of electrical equipment, and this field forms one of the largest and finest branches of work in the entire electrical industry, providing splendid opportunities for any well-trained electrical man.

The great variety of maintenance work in practically all factories, industrial plants, and office and commercial buildings makes this work very interesting and fascinating.

When we consider that there are several billion dollars worth of new electrical equipment and devices installed every year and that the life of this equipment ranges from 10 to 30 years or more, we can readily see that electrical maintenance is a rapidly growing and expanding field of steady and profitable work.

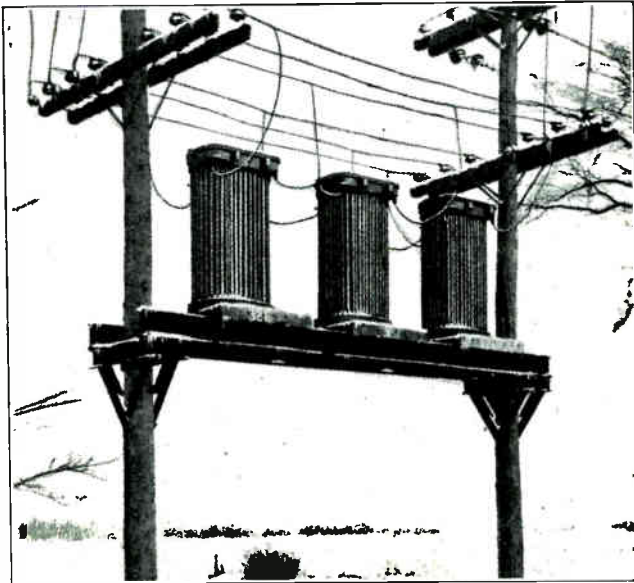

Fig. 446. Bank of three power transformers mounted on a neat platform between two strong poles.

A great deal of instruction has been given on the care and maintenance and also on the trouble shooting and testing of various D.C. and A.C. electrical devices, in the sections in which these devices were separately covered.

There is a certain amount of general information and knowledge which the electrical maintenance man should have, and this material is covered in this section along with the instructions on maintenance and care of A.C. machinery.

In some of the older plants the practice and policy used to be to allow electrical machinery to run with very little care or repair, until it refused to run any longer and required a complete shut

down to make the necessary repairs to put it back in operating condition.

In modern power plants and industrial plants this practice has become entirely out of date and the electrical equipment is given frequent and regular inspection, cleaning, testing, and minor repairs to keep it running at the highest possible efficiency and to prevent the necessity of shut downs and loss of time for major repairs which could have been avoided by taking care of the little things in time.

The aim of a successful maintenance electrician should be to keep all of the electrical equipment in his charge in such condition that shut downs and lost time will be at an absolute minimum, and he should try to correct every small defect or fault before it develops into a more serious trouble or causes complete failure of the equipment.

Intelligent employers and owners of large industrial plants realize that shut downs and the tying up of machinery, employees, and production, or the failure of electrical equipment, is very costly and they appreciate and are willing to pay well for the services of a well-trained and capable maintenance electrician.

In some of the smaller or older plants where these facts are not yet fully realized, trained men are frequently stepping in and putting modern maintenance methods into practice, thus convincing the employers of the great savings which can be effected in this manner and creating splendid positions for themselves, even in plants where a regular maintenance electrician was not formerly employed.

#### 412. INSPECTION SCHEDULE AND MAINTENANCE RECORD

In the maintenance of electrical motors and other equipment in large plants it is very important to maintain a regular inspection schedule for all of this equipment and keep notations or records of the results of tests and the condition of each machine or device on the date of each inspection period.

These regular, systematic inspections help to catch small troubles before they grow to be large ones; and occasional reviewing of the maintenance records and test data on important machines will often show up approaching troubles far enough in advance so that the machine can be shut down and repaired during some holiday or period when the plant is not in operation, instead of at a time when it is very badly needed.

Inspection periods may vary from daily inspection of very important expensive machinery to weekly or monthly inspection of less important equipment. In some cases certain devices may not need to be inspected more often than once every three to six months.

Experience in various plants will soon show how frequent the inspection of various equipment should be. The following list of items to be checked in connection with the inspection of A.C. motors is

given as an example of inspection sheets or schedules which can be developed for various types of equipment throughout any plant.

1. Clean off the motor
2. Check condition of stator windings
  - (a) general condition of insulation
  - (b) oil soaked coils
  - (c) hardened oil or grease on coils
  - (d) bare or skinned conductors
  - (e) poor taping
  - (f) clearance between coils and rotating parts
3. Condition of rotor windings (wound rotors or armatures)
 

(Items a, b, c, d, e, f, as above)
4. Bearing-oil level
5. Condition of oil
6. Leakage of oil, if any
7. Free movement of oil rings
8. Condition of oil well covers and drains
9. Condition of bearing dust-seals
10. Tendency of one bearing to heat more than the other
11. Tightness of bearing retaining set-screw
12. Amount of end play
13. Tightness and condition of gear, pulley, key, and key-way
14. Tightness of lugs and connections
15. Tightness of squirrel-cage bars
16. Condition of ground wire and ground connections
17. Tightness of motor on foundation
18. Tendency of motor to vibrate when running
19. Condition of centrifugal switch (if used)
20. Condition of slip rings
21. Condition of brushes and holders
22. Tightness of connections to brushes and holders
23. Check brush setting
24. Slant or angle of brushes with respect to direction of rotation
25. Condition of commutator (on repulsion or series motors)
26. Condition of short-circuiting devices (when used)
27. Investigate any unusual sounds or noises when the motor is running
28. Investigate any local heating of certain coils or groups
29. Note time required for motor to accelerate when starting
30. Tighten all mechanical parts, nuts, bolts, screws, etc.
31. Test insulation resistance of machine windings with Megger or Wheatstone bridge.

In many cases a detailed inspection such as outlined in the preceding list may be made only at intervals of once a month or less often, while more frequent daily or weekly inspection is made of a few more important items.

The most important of these items in connection with A.C. motors are the following: Clean windings, temperature of windings, open air ducts and ventilating ports, condition of insulation on windings, bearing temperatures, condition of bearing oil, free movement of oil rings, etc.

#### 413. INSPECTION RECORDS. AIR GAP MEASUREMENT

A simple form of maintenance record for individual motors is shown in Fig. 447. If a form of this type is used for each inspection of individual motors, particularly on those of the larger sizes, it helps to prevent overlooking certain items of importance and greatly simplifies the keeping of intelligent maintenance records.

The numbers shown in this form refer to the items given in the motor inspection list. The form shown in Fig. 447 has spaces at the top for the description and serial number which identify the machine, so that its monthly maintenance records can be filed together and accurately kept, no matter what part of the plant the machine may be moved to.

MAINTENANCE RECORD OF <u>3 ph Slip ring Mtr</u> Serial # <u>182173</u>		
Name of Manufacturer <u>C.E.S.</u> H.P. <u>20</u> R.P.M. <u>1140</u>		
Volts <u>440</u> Amperes <u>26</u> Cycles <u>60</u> Date <u>Nov. 15 1929</u>		AIR-GAP
1. Completed	13. Tightness of set-screw	25. Does not apply
2. All items O.K.	14. All tight & secure	26. Does not apply
3. All items O.K.	15. Does not apply	27. Motor runs normal
4. O.K.	16. O.K.	28. No local heating
5. Unrained & refilled	17. O.K.	29. 5 seconds
6. None	18. None	30. All mechanical parts tight
7. O.K.	19. Does not apply	31. 450,000 ohms
8. O.K.	20. All rings clean	32.
9. O.K.	21. Brushes in holder. Balance O.K.	33.
10. Both normal	22. O.K.	34.
11. O.K.	23. O.K.	35.
12. Normal	24. O.K.	36.
Inspector's Name <u>John Doe</u>		

Fig. 447. Sample of convenient motor inspection chart or form, to be kept in maintenance records.

Note the space provided in the upper right-hand corner of this form for marking the air gap readings. Four of these readings should be taken around the inside of the stator core in the position shown at the top, bottom, and right and left sides of the rotor.

Air gap readings are taken with an air-gap gauge, which is provided with several long, narrow, steel blades or leaves similar to those of a machinist's feeler gauge. Air-gap readings should always be taken when the motor is standing idle. The reading is taken from the largest gauge which can be pushed in between the rotor and stator in the same direction as the slots of the machine run.

Large air gaps may require measuring with two or more blades together, in which case the reading is the sum of the numbers on the blades used to fill the gap.

As an example of the usefulness of inspection records, suppose it is found that on a certain motor the oil level is very low at each inspection, although no definite trace of leakage can be found. This would indicate that the bearing was either leaking a small amount of oil or using it up quite rapidly in some manner and that it should be refilled more often.

Suppose that in another case the inspection record shows a certain section of the stator winding to be slightly warmer than the balance of the winding. If each successive record shows this heating to be continuing in the same spot and apparently somewhat increased each time, it would indicate defective insulation or a partial short or ground in the windings at this point, meaning that the machine should be taken down for re-insulation or repair of that section of the winding as soon as it can be done without interfering with production in the shop.

Suppose in another case that the Megger test one month shows the insulation resistance of a certain machine to be 1,250,000 ohms, 1,150,000 ohms three months later, and 1,000,000 ohms six months later. These reports would indicate that the insulation of that machine is deteriorating or failing as a result of moisture, oil soaking, or old age, and it would mean that the machine should be dried out, have the oil washed out of the windings; or, if neither of these faults is to blame, the winding would need to be re-insulated or replaced as soon as the machine could be taken out of service for a sufficient period.

#### 414. TOOLS AND INSTRUMENTS

The small hand tools and more common devices required for maintenance work were covered in Section Three on Direct Current. In addition to these items the maintenance shop will require other tools, such as vises, dies, wrenches, block and tackle, gear pullers, drill presses, etc.

Several portable test instruments should always be available for general testing purposes, as they are of the greatest importance in maintenance of electrical machinery. Among these instruments should be included voltmeters, ammeters, wattmeters, Megger, test lamps, test magnetos, dry cell and buzzer testers, etc.

#### 415. GROUND DETECTORS

Ground detectors can be used if the system is not of the normally grounded type. An accidental ground on a normally grounded system immediately results in a short circuit and in such cases the ground detector would be useless. These devices are very useful, however, in indicating the presence of grounds on ungrounded systems. When such a ground is indicated it should be immediately located and cleared.

Ground detectors generally consist of a simple meter similar to a voltmeter, which is connected between the line and the ground.

When a ground detector is not available a simple and inexpensive arrangement of lamps may be used to take its place. Fig. 448 shows in the upper sketch the connections for a continuous-type ground indicator using a bank of six lamps with two connected in series between each phase and ground.

A snap switch and fuse are also provided in series with each set of lamps. With this type of ground indicator all of the lamps will remain burning at about half voltage as long as there are no grounds on any phase, but as soon as a ground occurs on any phase the lamps between this phase and ground will go out, or become very dim if the ground is of high resistance. The remaining lamps will then burn at full brilliancy.

This action is due to the fact that some of the lamps are shunted or paralleled by the ground circuit whenever an accidental ground occurs on any phase.

Where it is desired to avoid the small cost of operating such a set of lamps continually, an intermittent ground detector can be used by connecting lamps with a selector switch, as shown in the lower sketch in Fig. 448. With this type of detector the lamps are normally switched off and a test is made once or twice a day by switching on the lamps and moving the selector switch from one phase to the other to determine if there is a ground on any phase.

#### 416. SAFETY PRECAUTIONS

When doing any kind of maintenance or repair work around electrical machinery extreme care should be used to protect both yourself and your fellow workmen. All companies consider the safety of their employees above everything else, and the man who always practices safety first not only eliminates a great deal of danger of injury to himself but also has a much better chance to become a foreman or chief electrician.

Protective apparatus such as rubber gloves, rubber blankets, hook sticks, and insulated platforms should be used in all cases when working on or around high-voltage equipment.

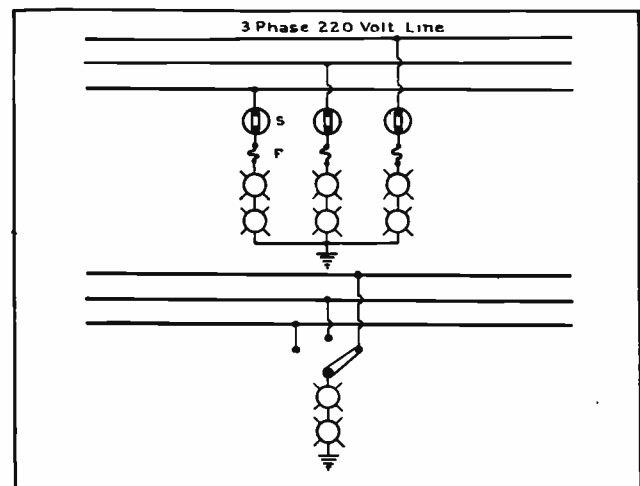

Fig. 448. Two methods of connecting lamps to serve as simple ground detectors on three-phase power circuits.

Fig. 449 shows a sketch of a simple insulated platform which can easily be made from short pieces of strong, dry board mounted upon four pin-type insulators as shown. Small pin-type insulators can be used in the inverted position as shown in the upper sketch, or larger pedestal type insulator units can be mounted on short pieces of board and attached to the under side of the platform as shown in the lower sketch. This latter method protects the insulators from breakage by being bumped on concrete floors.

When working on circuits of low and moderate voltages thick rubber mats can also be used to insulate a worker from a damp concrete floor. Mats of this type are usually tested to withstand voltages or pressures of 15,000 to 20,000 volts but are generally not depended upon entirely for the safety of operators working on equipment of over 1000 volts.

Stools or platforms on raised insulators should be used on circuits having voltages from 500 to 1000 volts and up.

Never attempt to operate by any other means disconnect switches or any equipment which is supposed to be operated with an insulated hook stick.

Always use rubber gloves and rubber blankets when working on live circuits over 550 volts and in many cases it is advisable to use them on any circuits of over 220 volts.

When working around live circuits, one should always be on the alert to avoid making a contact with the wires of two opposite phases or with one phase and ground, and allowing current to pass through any part of the body. When working around very high-voltage conductors one should always keep several feet away from them.

Be extremely careful not to make short circuits, even on low-voltage equipment, because short circuits are very dangerous regardless of the voltage of the circuit. Shorts on 110-volt circuits, or even on five or ten-volt battery or electro-plating circuits which have considerable generator or battery capacity attached to them, can be very dangerous and destructive by the terrific flashes and scattering of molten metal in case they are short-circuited with some low-resistance tool.

When handling conduit, ladders, or anything of this nature around live circuits be extremely cautious in moving them, as they are easily swung into live wires or rotating machinery.

All circuits should be considered as being alive until they have been proven otherwise and are thoroughly grounded. Persons working around rotating machinery should wear closely fitting clothes to reduce the chance of becoming entangled in the running parts. Be careful not to allow tools or loose parts of equipment to fall into running machines, and never leave tools lying on or around electrical machinery when it is started up, as the magnetic field of the machine may draw the tools

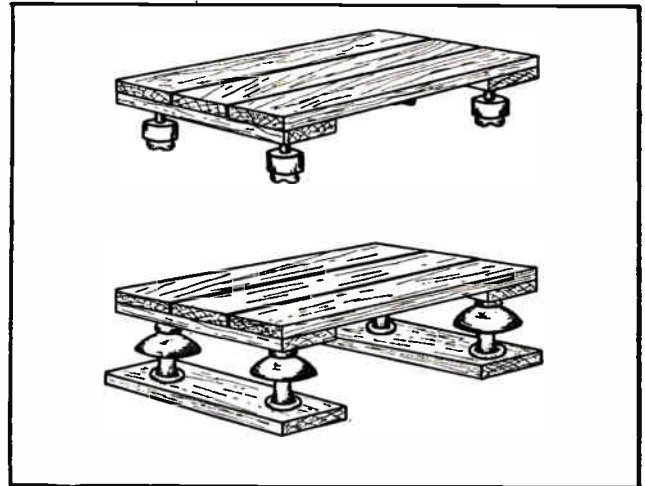

Fig. 449. The above sketch show two types of insulated stools or platforms for safety in working around live wires. These are very simple and inexpensive to make.

into the rotating parts and not only damage the machine but possibly injure a workman by throwing the tool violently out of the machinery.

When switches are opened to allow men to work on any line or circuit, the switches should be carefully tagged or labeled with a warning not to close them because men are working on the circuits or machines attached to them. Whenever possible such switches should be locked open by means of a padlock or clamp. The circuits which are thus "killed" for repairmen to work on should be carefully grounded by means of flexible copper cable equipped with clamps.

#### 417. BEARINGS

In the Armature Winding Section the more important methods of testing and repairing windings for either D.C. or A.C. motors or generators were covered; and considerable instruction was given on electrical repairs and maintenance for D.C. motors and generators in the Direct Current Section; and on alternating current motors, generators, and transformers in the Alternating Current Section.

Up to this point, however, very little has been said about the bearings of motors and generators except the instruction regarding their lubrication and temperatures. Bearings are about the only part of electric motors or generators aside from the commutators, slip rings, and brushes on which there is any mechanical wear or need of replacement and repair.

For this reason bearings will be considered in detail at this point. If bearings are properly lubricated they will often last for many years without any great amount of wear, but if they are not kept properly oiled and free from grit, dirt, etc., they will wear very rapidly and soon make it necessary to shut down the machine for replacing or repairing the bearings.

Even with the best of lubrication and care, ordi-

nary sleeve bearings will wear out in time and allow the rotors of machines to get out of center in the stator core or between the field poles. When the bearings are badly worn the rotor may even rub the teeth of the stator or the ends of field poles. This condition should not be allowed, but when it is noticed the bearings should be repaired at once. Unequal air gap between stator and rotor due to badly worn bearings reduces the efficiency and interferences with proper operation of motor.

There are three general classes of bearings, which are known as sleeve bearings, ball bearings and roller bearings.

Sleeve bearings consisting of a babbitt or bronze sleeve in which the shaft turns have been by far the most commonly used in the past, and there are still in service considerably more of this type than any other. During recent years, however, ball and roller bearings have become very popular and they are quite extensively used in newer type machines.

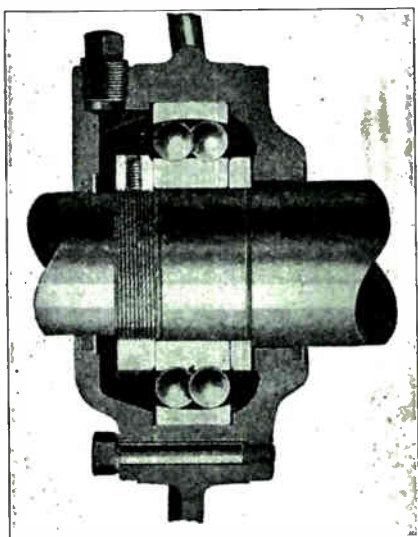

Fig. 450. Sectional view of a double-row ball bearing, showing inner and outer bearing races and some of the balls.

#### 418. BALL AND ROLLER BEARINGS

As ball and roller bearings generally require much less care and attention than sleeve bearings they will be covered here first.

Ball and roller bearings both have inner and outer rings or bearing races made of hardened steel, and between which the balls or rollers run.

Fig 450 shows a sectional view of a ball bearing in place around the shaft and within the bearing housing of a motor. The inner ring or bearing race is pressed tightly on the shaft and is held in place against the shoulder on the shaft by the clamping or retaining nut shown on the left.

This inner ring turns with the shaft at all times. The outer ring or bearing race is held securely in the bearing housing in the motor end-shield. This ring should always be stationary and it should not be allowed to rotate in the bearing housing.

The balls of bearings of this type are made of very hard steel, and if properly lubricated they are capable of withstanding many years of wear. These

balls are spaced and held in their proper positions by light metal cages, to prevent them from bunching up and jamming in the race and to keep them rolling freely and evenly around the bearing.

These cages should always be kept in good condition, or otherwise the balls will roll together and wear on the surfaces of each other, and also rapidly wear away the surface of the bearing race.

Fig. 161 in Section Five on A.C. shows a sectional view of a squirrel-cage motor equipped with ball bearings.

Fig. 176 in the same section shows an excellent sectional view of a motor equipped with roller bearings. Refer back to these figures and note carefully the manner in which the bearings are constructed and mounted in the motor.

Fig. 451 shows a larger view of a tapered roller bearing, such as is very commonly used in some of the modern motors. The hardened steel rollers are firmly held within the center ring, which rotates as the rollers run around between the inner and outer rings. The inner ring in this case also fits securely to the motor shaft and revolves with it, while the outer ring is held securely and stationary in the bearing housing in the motor end-shield. This tapered bearing construction prevents end-play of the motor shaft and rotor.

#### 419. LUBRICATION OF BALL AND ROLLER BEARINGS

Ball and roller bearings are generally lubricated with a good grade of light grease such as vaseline, and under ordinary conditions two or three applications of fresh grease per year are sufficient.

When motors are operating in very dusty places it may be necessary to grease the bearings more frequently. Grease guns are usually provided for filling bearings of this type.

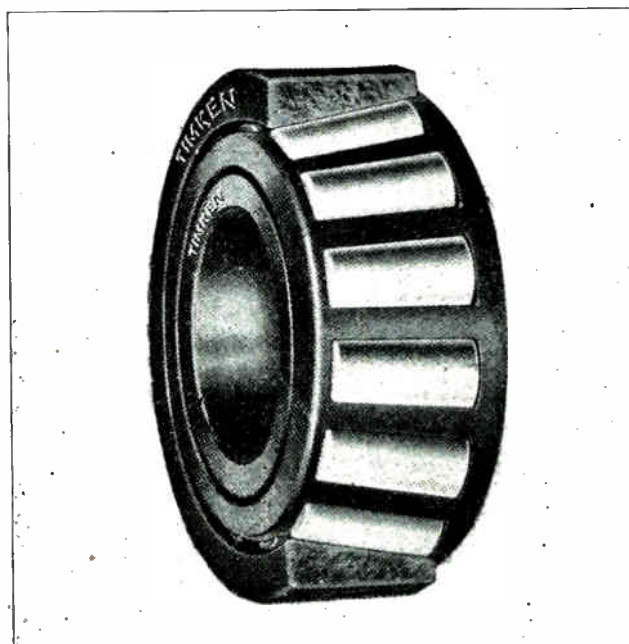

Fig. 451. Cutaway view of a Timkin tapered roller bearing such as commonly used in high grade motors.

Motors with ball or roller bearings cost somewhat more than those with sleeve bearings, but the longer life of the ball and roller bearings and the reduced maintenance cost will generally more than offset the small additional first cost of the machine equipped with ball or roller bearings.

Ball and roller bearings produce less friction than sleeve bearings and therefore make the machines slightly more efficient. The fact that these bearings wear very little also allows the use of a smaller air-gap, improving the characteristics of certain types of motors considerably.

Complete new ball and roller bearings can be obtained from the manufacturers of the motors or from bearing manufacturers, when it is necessary to replace worn bearings of this type. These bearings are generally made in standard sizes so that, by specifying the inner and outer diameters of the rings or races, or the bearing numbers which are plainly stamped on them, new bearings or repair parts can be ordered from bearing manufacturers as well as from the motor manufacturers.

#### 420. SLEEVE BEARINGS

Sleeve bearings are made in both the solid and split sleeve types. In either case the bearing forms a cylinder or sleeve with a uniform diameter and very smooth inside surface in which the shaft rotates freely on a thin film of oil.

Bearing metals must be different from the metal of the shaft in order to run freely and prevent excessive friction and wear. Bearing metals are generally an alloy of two or more metals, such as copper, lead, tin, zinc, and antimony, and are made in different degrees of hardness. This metal is commonly known just as bearing metal, and certain alloys are called babbit. Other bearings are made of soft bronze.

The inner diameters of bearing sleeves are always just a few thousandths of an inch larger than the shaft diameter in order to allow free rotation of the shaft. This clearance is generally approximately .005 of an inch on shafts of about 2 inches in diameter.

When installing new sleeve bearings it is very important to obtain a good fit on the shaft. If the new bearings are ordered from the motor manufacturers, or to exact size from a bearing maker, they will generally fit very well when received. Occasionally, however, a bearing sleeve may fit the shaft too snugly, in which case its inside diameter must be increased very slightly until the shaft will just rotate freely without friction or binding.

Bearings can be enlarged by use of a **bearing scraper**, which is used to scrape out what are called the "high spots" on the inside of the bearing sleeve. Bearing scrapers are very common tools in electrical maintenance shops, industrial plants, and auto repair shops. They consist of a curved shoe or blade of hollow ground steel which is

equipped with a handle. These hard steel blades are used to scrape a very thin layer of soft metal from the inside of the bearing. It is not usually necessary to scrape the entire inner surface of the bearing, because in most cases only a few spots are high.

To locate these high spots which must be scraped a thin film of Prussian blue, or what is known as "bearing blue", can be applied over the entire area of the shaft where it is normally supported by the bearing.

The bearing is then slipped on the shaft to its proper location and turned, and when it is again removed the high or tight spots can easily be located by the blue color on and around them.

These are then scraped down very slightly by means of the bearing scraper and the bearing is then again tried on the shaft. Proceed in this manner until the bearing turns freely on the shaft, but be careful not to enlarge it too much at a time and cause it to fit too loosely.

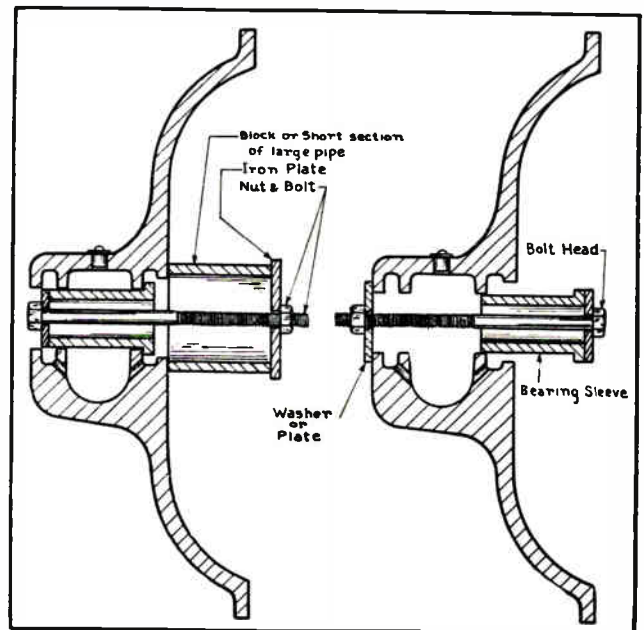

Fig. 452. The sketch on the left illustrates a convenient method of removing a sleeve bearing; and on the right is shown the method of replacing the bearing.

#### 421. INSTALLING BEARINGS

Solid sleeve bearings must be placed in the end-shield bearing housings before the end shield is placed on the motor or generator frame. The oil rings should be placed in the housings before forcing the bearings down into their proper location.

If the bearing fits in the housing quite loosely it may be forced into place by laying a wood block on the top end of the bearing and gently tapping it down in place with a hammer.

Always use a wood block for this purpose and never allow the hammer to strike sharply on the bearing, or the bearing metal may become badly dented or bruised.

Bearings which fit rather tightly may be pressed into their housings or pulled in by means of a long threaded bolt and several washers which will not slide through the bearing. This method is illustrated by the sketch on the right in Fig. 452, which shows a sectional view of a sleeve bearing being drawn into the bearing housing by means of such a bolt.

Care must be taken to start the bearings squarely into the bearing housing in a straight line with the bore, or otherwise the bearing may become jammed and pulled out of shape. Bearing sleeves may be very easily ruined in this manner.

Another very important precaution is to see that the top of the bearing sleeve is in line with the top of the end shield, or otherwise when the bearing is pulled in place the oil ring opening will be out of line and prevent the ring from resting on the shaft, resulting in a poorly lubricated and burned out bearing.

When the bearing sleeve has been carefully started and lined up in the bore of the housing, the nut of the draw bolt can be turned with a wrench, causing a pull upon the washers, which will force the bearing into place.

Bearings can also be removed from housings by the use of a draw bolt and blocks or a short section of pipe which is large enough to set on the end of the housing and allow the bearing sleeve to be drawn out of the housing and into the pipe stub, as shown on the left in Fig. 452.

Fig. 453 shows sectional views of two complete bearing housings with the bearing sleeves in place. These views also show the oil rings in proper position on the shaft. Note how the lower side of the oil ring hangs down into the oil well, so that as the shaft revolves the ring will carry the oil up to the top of the shaft.

The oil then runs from this point down over the shaft, maintaining a thin film of oil all around it between the surface of the shaft and that of the bearing.

The filler opening or cup at which new oil is poured into the bearing is shown on the top of the bearing housing in this case. The inner surfaces of

sleeve bearings are usually provided with oil grooves to allow the oil to flow more freely to all parts of the bearing sleeves.

Fig. 454 shows a phantom view of a bearing sleeve and the position of the oil grooves. In new bearings supplied by manufacturers these oil grooves are already cut and are generally about 1/8 to 3/16 inches in width and from 1/16 to 1/8 inch in depth, according to the size of the bearings.

When fitting a machine with Babbitt bearings the oil grooves can be cut in this soft metal by hand with a small tool designed for this purpose.

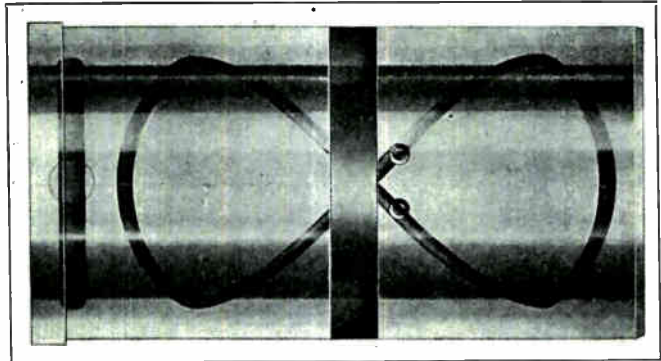

Fig. 454. Phantom view of sleeve bearing, showing oil grooves and oil ring slot.

#### 422. REASSEMBLING MOTORS AND GENERATORS

After new bearing sleeves have been placed in the end shields of motors or generators the rotor is placed in the stator or field frame and the end shields and bearings are slipped over the ends of the shaft and up to the motor frame, being careful to get the end shields right side up so that the bearing housings and oil wells are in the proper position.

The bolts or cap screws which are used to hold the end shields in place are next turned in by hand as far as they will go. A wrench is then used to uniformly tighten the bolts and draw the bolts up to the motor frame.

The bolts should be tightened alternately so that they are all drawn up together. Never draw up one

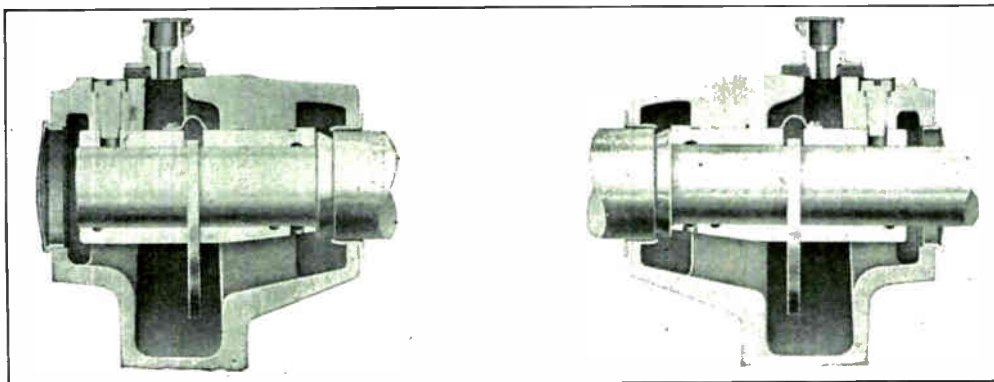

Fig. 453. Sectional views of two sleeve bearings, clearly showing the oil wells, oil rings, filler cups, etc.



bolt as tightly as possible and then go to the next, because this practice will generally result in the shaft becoming bent or sprung or in warping or damaging the bearing.

When the end shield has been pulled securely in place try turning the shaft and if it fails to turn freely check to see if the end shield is squarely against the frame or shoulder all around the machine. If it is and the bearing still remains tight it will be necessary to remove the end shield and scrape the bearing until a free running fit is obtained.

In replacing end shields on motor or generator frames it is a good plan to see that the machine surfaces or shoulders on both the end shield and frame are clean and free from dirt and grease. Sometimes it may be necessary to lightly tap the end shield with a mallet or wood block to get it to draw up tightly on the frame.

#### 423. LUBRICATION

Sleeve bearings are generally lubricated with a medium grade of lubricating oil instead of grease such as used in roller and ball bearings. A good grade of oil should always be used, as poor or cheap grades of oil often have a tendency to turn rancid or to "gum up" in use.

The use of good oil is of the greatest importance in obtaining satisfactory service and long life from bearings on electrical machinery. Reliable oil companies, such as the Standard Oil Company, Sinclair Oil and Refining Company, Cities Service, Vacuum Oil Company, Pennsylvania Oil Company, and others, supply good lubricating oil for various machines, and are usually glad to furnish the service of a lubrication expert to specify the proper grades of oil for any ordinary machinery or special requirements that the electrical maintenance man may have.

Fig. 455 shows a sectional view of a bearing housing and sleeve-type bearing in which the proper level of the oil can be noted in the oil well. The amount of oil required for various sleeve-type bearings may range from a few teaspoonfuls in very small motors up to several quarts on the larger machines.

The oil should always be kept clean and free from dirt and at the proper level.

The oil ring can also be seen in Fig. 455 with its lower side hanging in the oil and the upper side resting on the top of the shaft at the slot in the bearing sleeve.

Oil rings should always run freely whenever the machine is in operation and should never be allowed to bind or stick even for short periods, as the shaft and bearings depend entirely upon the rings for their constant supply of oil.

If oil rings become bent or bruised by careless inserting of the shaft into the bearings the rings will probably not turn. So considerable care should

be used when replacing bearings and end shields on the shafts.

If there is no oil in the bearing at the time it is replaced, the end shield and bearing housing can be turned upside down to allow the oil ring to fall out of the way and clear the inside of the bearing sleeve while the end of the shaft is being inserted.

If the bearing housing is filled with oil and must be kept in an upright position, the oil rings can be lifted out of the way either by means of a small wire hook inserted through the filler opening, or by means of a small stick inserted from the open end of the bearing sleeve.

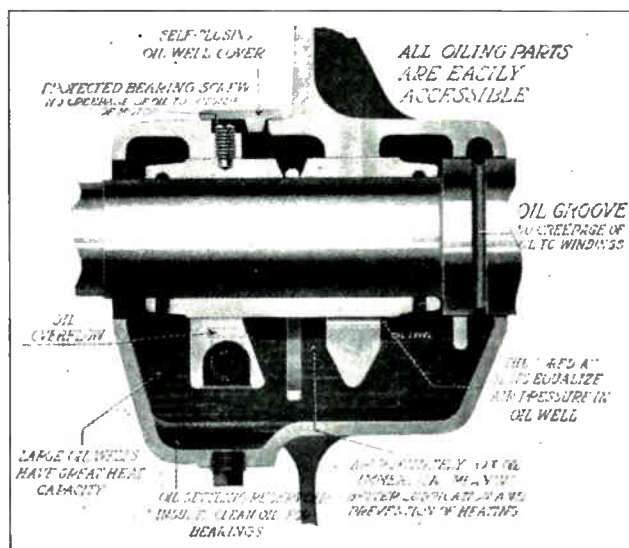

Fig. 455. Another excellent sectional view of a sleeve type bearing, showing oil level, oil ring, oil well cover, drain plug, bearing set screw, etc.

#### 424. DUST SEALS

Dust seals consisting of felt rings which are held in place around the shaft on either end of the bearing are often used to prevent dust and dirt from entering the bearing oil.

Devices of this kind help to maintain the lubricating qualities of the oil and greatly increase the life of the bearing. Most modern machines are equipped with dust seals of some form or other, but on older machines which are operated in dusty places the maintenance man can often save a great deal of bearing trouble by equipping the bearing housings with felt rings which are cut from felt having a thickness from  $\frac{1}{8}$  to  $\frac{3}{8}$  of an inch, and fitting them tightly to the shaft.

These felt rings can be held in place by thin metal rings or plates which are secured to the end shield or bearing housing by means of small machine screws threaded into small tapped holes in the iron frame around the shaft openings.

Ball and roller bearings often have what are known as labyrinth dust seals consisting of a special metal casing which fits around the shaft with a very small amount of clearance where the shaft enters the bearing housing.

The inside of this cylindrical casing is provided with a number of small grooves which are filled with grease by the overflow or squeezing out of grease from the bearing when it is filled. These little ridges of grease rotate with the shaft and, as their points or edges project up into the grooves in the metal casing, they form quite an effective barrier to dust which might otherwise be blown into the bearing.

When the dust and dirt comes into contact with the grease it is collected and held and is prevented from passing on into the vital wearing parts of the bearing. As new grease is forced into the bearing occasionally, the old dirty grease is forced on out of the dust seal rings.

Seals of this type provide another good reason for frequent and sufficient greasing of ball and roller bearings.

#### 425. CHANGING BEARING OIL

After oil has been in the wells of ordinary motor or generator bearings for a time it becomes dirty with dust and metal particles worn from the shaft and bearings.

The presence of dirt and foreign matter in lubricating oil can be detected by examining a drop of the oil on one's finger or hand, or on a bright nickel-plated metal surface. Another good way is to place a sample of the oil in a small glass bottle or test tube. By holding the bottle or tube up to a bright light or so that sunlight can shine through it, any dirt in the oil can usually be seen.

Dirty oil should not be left in a bearing, because the grit and dust in it causes rapid wear of the shaft and bearing.

The dirty oil should be drained from the bearing by removing the drain plug in the bottom of the oil well. See Fig. 455.

Next flush out the dirt which may have settled in the bottom of the well, by running gasoline or flushing oil through the oil well.

The inside of oil wells are sometimes painted white to enable any dirt settlements to be seen, and so one can tell when the well is flushed clean.

Refill the bearings with clean new oil, to the proper level according to oil mark or gauge. Do not fill them too full or oil will leak out and get onto the windings or commutators. Always fill oil wells at the filler ports when they are provided, and not at the top of the bearing except when this cannot be avoided.

#### 426 BREAKING IN NEW BEARINGS

When a new motor or generator is started up for the first time, or when starting a machine in which the bearings have just been replaced, the bearings are likely to heat more than usual because the surfaces of shaft and bearings are not yet worn as smooth as they are after a period of service.

For this reason, it is advisable to watch the bearings of such machines very closely for the first

thirty minutes to one hour of operation, and to continue to give them very frequent attention during the first few days. After this period the bearings and shaft usually become highly polished and smooth or get the "whiskers" worn off, as is often said; and thereafter they run with much less friction and heating.

When inspecting new bearings for high temperatures, merely holding the hand on the bearing housing is not always a good indication of the bearing metal temperature. It is best to place the finger tips on the bearing sleeve itself, where the temperature can be more accurately determined. Thermometers are often used to show the temperatures of bearings of very large motors or generators.

Never wait until a bearing smokes before taking steps to cool it, because by that time it may be seriously damaged.

When starting up new machines or those with new bearings the following several steps are very important.

- (a) Fill oil wells with good clean oil
- (b) See that oil rings are turning freely
- (c) See that shaft turns freely and easily
- (d) Test for end-play
- (e) Test for heating at bearing sleeve (not at outside of housing)
- (f) Watch bearing closely for one-half hour or more
- (g) If bearing overheats, cool it with fresh oil; or shut machine down if it continues to overheat.

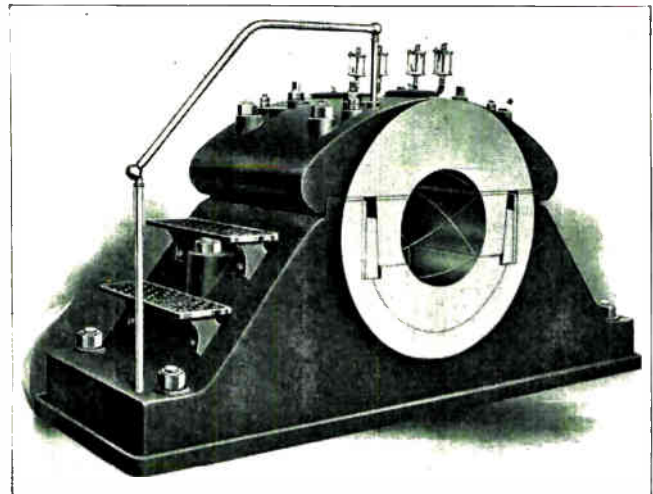

Fig. 455-A. Very large special sleeve bearing for use with steam engines. Note the adjustable sections in the sides of the bearing to prevent pounding due to bearing slack and engine thrust.

#### 427. LOSS OF OIL FROM BEARINGS

Bearings sometimes lose oil from one of the following causes: siphoning by air currents, worn or loose bearings, and leaks in oil wells around drain plugs or filler connections, or at cracks or sand holes in the iron.

Siphoning of oil from bearings is caused by the strong draft of air which is set up around and

through open-type bearing housings by the rotation of motor and generator armatures, and by the action of ventilating fans used on them.

This air passing over the surface of the oil carries away oil particles with it, often quickly reducing the oil level to a dangerously low point and also damaging the insulation on windings through which the oil-laden air passes.

As much as one-fourth to one-half pint of oil per week may often be carried from bearings in this manner.

Loss of bearing oil by air siphoning can be prevented by the use of felt seal rings, as previously described.

Loose bearings allow the shaft ends to whip around with load fluctuations and thus cause oil to be splashed out from between the surfaces of the shaft and bearing.

In addition to lowering the oil level in the oil well, the oil escaping in this manner often causes considerable damage to paper pulleys and rubber or leather belts, as well as making dangerous and unsightly oil pools or spots on the floor.

Loose bearings on 900-R.P.M., 25-h.p. motors, have been known to throw out more than a teacup full of oil per hour in this manner.

The best remedy in such cases is the installation of new bearings, although the trouble may be temporarily remedied by the use of felt seal rings to keep the oil in the bearing housing.

Loose drain plugs, drain cocks and oil gauges also cause loss of oil in many cases.

Sometimes rather mysterious loss of oil occurs through very small cracks or sand holes in the cast-iron oil well casing. Such cracks or holes can be closed by welding or soldering. A small sand hole can often be closed by tapping it shut with a round headed hammer, or by drilling out the hole and then driving or threading a metal plug tightly into the hole.

#### 428. OVERHEATED BEARINGS

Bearings practically always produce a small amount of heat because of the slight friction even when they are operating properly. Excessive bearing temperatures are commonly caused by one or more of the following items:

Tight bearings

End shield out of alignment

Bent shaft

Rough shaft or bearing surface

Dirty oil or poor grade of oil

Insufficient oil

Bearing up-side-down

Excessive belt tension

Misaligned gears

Insufficient end play

Motor not level

Heat transfer from hot commutator or brushes.

Bearings will sometimes turn bottom-side-up if the bearing set-screw becomes loose. This causes

the oil ring to be lifted off the shaft and will often result in a burned-out bearing if it is not noticed and corrected promptly.

In an effort to prevent belt-slip belts are often drawn up too tight. Excessive belt tension places unnecessary friction on one side of the bearing, and causes excessive wear and heating.

Proper care and arrangement of belts makes excessive tension unnecessary. Vertical belt drives should be avoided whenever possible, as they are often the cause of bearing trouble.

When motors drive machines by means of gears and pinions the gears should be carefully lined up so that their teeth mesh squarely and on their pitch lines, or otherwise they cause side-thrust and wear similar to that caused by tight belts.

Insufficient end-play is often caused by bearing sleeves not being properly drawn into the bearing housings, or by improperly machined end shields or shoulders on shafts. The result is pinching of the shaft between the ends of the bearings, and this causes excessive friction and heating.

The end-play should be checked on new machines or those on which bearings have been changed. The end-play movement will vary from  $\frac{1}{32}$ " in small motors to  $\frac{1}{4}$ " on large machines of 50 h.p. or more.

In a motor or generator which is not set level the rotor will slide to one end, causing the shaft shoulder to rub on the inner side of the bearing housing and heat up the bearing.

Sparking commutators or incorrect brushes sometimes produce so much heat that enough of it is transferred through the metal to the shaft to over-heat a bearing.

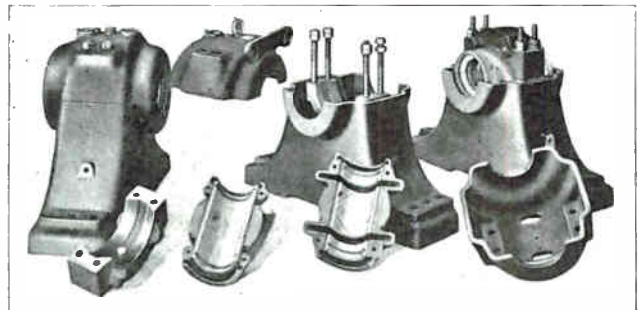

Fig. 456. Pedestal type sleeve bearings, showing parts of one bearing and housing disassembled.

#### 429. FROZEN BEARINGS

The term "frozen bearings", while sounding rather contradictory, is commonly used in the field to indicate a bearing which has become stuck or locked due to overheating. When a bearing becomes overheated beyond a certain point a thin layer of the bearing metal surface becomes soft and partly molten. If the shaft stops turning when the bearing is in this condition the bearing will cool and grip the shaft very tightly, often making it impossible to start the machine again.

When a bearing becomes smoking hot before its

Norman Beder  
41 Georgia Ave.  
Brooklyn 7, N. Y.

overheating is noticed, freezing can sometimes be prevented by applying heavy steam-cylinder oil to the top of the oil ring slot as the machine is carefully slowed down to allow the bearing to cool gradually. Never allow the machine to stop completely until the bearing has cooled somewhat, or it will be almost certain to immediately "freeze" to the shaft.

The heavy oil recommended for such emergencies provides much better lubrication at such high temperatures.

If an overheated bearing is not noticed in time and the motor or generator is allowed to continue running, the bearing will burn out or melt out completely and also cause serious damage to the surface of the shaft by scoring and roughening it.

The difficulty of removing frozen bearings from a shaft makes it well worth considerable precaution to avoid this condition.

Frozen babbitted bearings can be removed by applying enough heat from a blow torch to melt the babbitt out entirely, and the bearing shell can then be slipped off the shaft.

Brass bearings may be turned off in a lathe or split and pried off in pieces with a dull cold chisel, being very careful not to damage or nick the shaft.

#### 430. CARE IN HANDLING END SHIELDS

When removing end shields to repair or replace bearings, great care should be used to avoid bumping or roughening the face of the shield where it fits to the motor or generator frame. Care is also necessary to draw the bearing straight off the shaft and replace it straight in order to avoid damage to the ends of bearings.

See that all dirt and dust are removed from the shaft and bearings before replacing end shields.

End shields can be removed from small and medium-sized machines by hand, by one or two men; but large ones are usually of the sectional type and should be handled with a block and tackle, or proper blocking beneath them to allow them to be swung or slid freely on and off the shaft.

Many large machines have bearings in separate pedestals mounted on the end of the machine base, instead of having them in end shields. Fig. 456 shows several bearings of this type.

Note that the bearing housings are split and bolted to permit easy removal of bearings without driving or forcing them.

Bearings on small motors are sometimes oiled by means of cotton wicks or yarn packing which rub on the shaft and carry oil to its surface. Fig. 457 shows a bearing with cotton oil-feed packing.

#### 431. SHAFTS

Motor and generator shafts of the cheaper type are made of cold rolled steel, while those of better grade machines are made of nickel-steel or steel which is specially heat treated and hardened to get high strength and toughness as well as hard wearing surface.

On very large machines the shafts are often of drop-forged steel and are made hollow. This makes them lighter without materially decreasing their strength. For example, a 10"-diameter shaft with a 4"-hole has the same strength as a solid shaft 9.91" in diameter.

The bearing surface of shafts should always be kept bright and clean and should not be allowed to rust. When rotors or shafts are out of the machines and are to be laid away out of service for a time, the shafts can be coated with heavy grease to prevent rust. They can also be coated with white lead, which can be carefully cleaned off when the shafts are needed again.

It is well to wrap shafts with cloth or paper to prevent their surfaces from becoming bumped and damaged while they are out of machines.

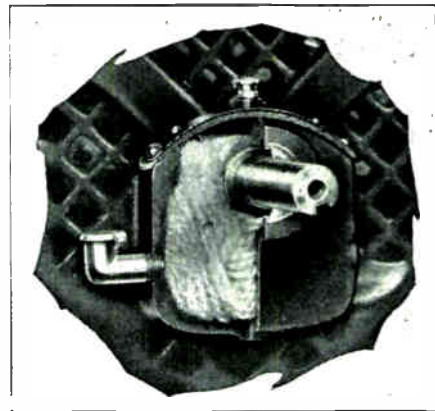

Fig. 457. Bearing with cotton filled oil well, for wick oil feed action to shaft.

Dents and rough spots on shafts can be filed off carefully and smoothly with a fine smooth file. Do not attempt to file out the dents or hollows but just the raised edges or burrs which would score the bearing.

A badly damaged shaft can be turned down in a lathe or reground with a grinding machine. Rust or very slightly roughed surfaces can be smoothed off by polishing the shaft with crocus cloth. Crocus cloth is similar to emery cloth but has a coating of extremely fine cutting material of dull red color. Its cutting action is very slow, but it gives the smooth surface required for good bearing operation.

The use of emery cloth on shafts should be avoided, as it leaves rough scratches in the surface of the shaft.

If a shaft requires turning or grinding down to a smaller size, a new bearing sleeve or bushing can be used, giving a smaller bearing opening to fit the shaft. Or, in other cases this shaft can be built up by electric welding and then reground to original size.

#### 432. KEYS, KEYWAYS, PULLEYS, AND GEARS

Keyways in shafts are accurately machined so that the keys will fit snugly and tightly in them, and

this tight fit is necessary to keep keys in place and to prevent the movement of pulleys or gears and the shearing or twisting of keys. For this reason, keys of the proper size should always be used, and keyways should not be filed except to remove from their corners slight burrs or dents which tend to prevent the insertion of the key.

Ordinarily square, cold rolled steel key stock can be purchased in 10-ft. lengths or less, and in any of the standard sizes which are commonly used by motor manufacturers. In a large shop it is well to always have a little key stock on hand.

Pulleys and gears should fit snugly on the shafts, to prevent slipping, rattling, and wearing of the shaft and the inside of the pulley opening. Never expect a key to hold a loose pulley or gear in place if there is any load on them.

Coating the shafts and keyways with a little flake graphite before pulleys and gears are put on makes it much easier to remove them later. Small pulleys and gears may be driven onto shafts with a hammer or small sledge. Always use a block of wood between the hammer and gear or pulley to avoid battering or cracking the metal, and always tap them evenly, first on one side and then the other, to prevent binding on the shaft.

Large pulleys or gears may be forced onto shafts with braces or jack screws. Pulleys and gears can be removed from shafts by loosening their set screws, driving out the keys, and then lightly tapping the pulley off the shaft with a hammer and block, as previously mentioned.

A better device for this purpose is a regular gear puller such as shown in Fig. 458. The hooks of this device are placed against the back of the gear or pulley and the large screw is then tightened against the center of the end of the shaft, thus drawing the gear or pulley off.

If possible, the keys should be driven out before removing pulleys or gears, but when it is difficult to remove the keys first they can often be taken out after the pulley or gear is off.

#### 433. AIR GAPS

A perfect motor should have the same air gap all around the rotor, or the same gauge readings at the top and bottom and right and left sides of the rotor. It is difficult, however, to machine rotors and stators as accurately as this and the air gap of a new motor may vary as much as .005 inch between the four gauge readings.

When the variation becomes considerably greater than this due to bearing wear, it causes an unequal air gap, reducing the efficiency of the motor or generator and in some cases causing excessive heating of certain coils in the stator. For this reason, it is very important to make frequent inspection of air gaps of motors and generators, using the convenient air-gap gauges previously described.

Fig. 459 shows an air-gap gauge having a num-

ber of blades of different thicknesses and each 16" long. All of the blades can be folded within the handle for convenient carrying and protection of their surfaces.

Small motors will generally have air gaps ranging from .005 to .015 of an inch, while motors of 10 to 50 h.p. have .020 to .035 of an inch. Larger machines may have clearances of .040 to .060 of an inch or more. Machines with ball or roller bearings usually have slightly less clearance than those with sleeve bearings.

If a motor when new has a gauge reading of .030 of an inch all the way around it should have new bearings before the gauge readings become less than .015 on one side and more than .045 on the other.

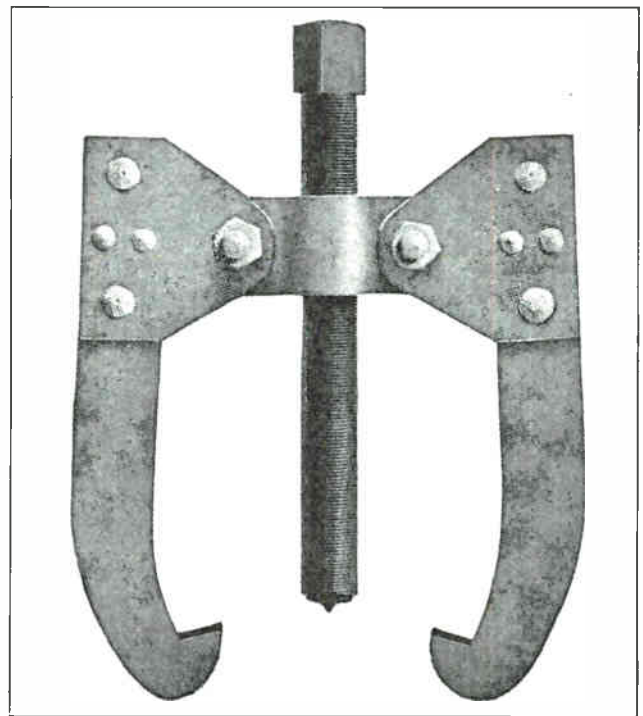

Fig. 458. Simple gear or pulley remover, commonly called a gear puller. Tight fitting gears and pulleys can be removed from shaft ends with such a device.

#### 434. SQUIRREL-CAGE ROTOR TROUBLES

The rotors of modern squirrel-cage motors are very ruggedly built and are not subject to very many troubles. The bars are generally welded, riveted, brazed, or cast to end rings which short circuit them together; and, while it doesn't very often happen with this type of construction, it is possible that occasionally a bar may become broken or loosened from the end ring by excessive mechanical strains or vibration.

With older types of rotors on which the bars are soldered or bolted to the end rings they quite often work loose and develop open circuits. With the soldered construction this may be due to poor soldering and workmanship or to overheating of the rotor at some time or other, thus causing the solder to melt out.

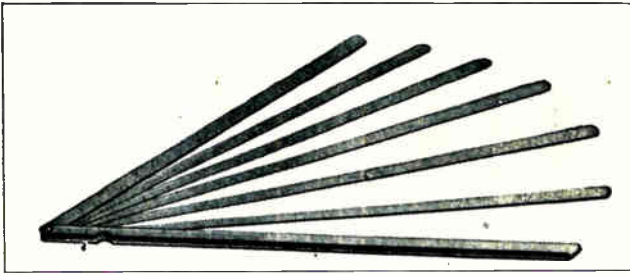

Fig. 459. Common motor air gap gauge, for measuring clearance between the armature or rotor and the field poles or stator. Note the several different "feelers" or blades which are of different thicknesses.

If solder splashings are found on the end of the stator windings opposite the rotor bar ends, it is usually an indication of loosened rotor bar connections. Bolted bars may loosen from strain and vibration and loose bars in rotors of this type can often be noticed by a series of small sparks at the end ring when the rotor is started. They can also be detected by a blackened or burned appearance of the bar or ring at the contact, or a slight rise in temperature at a loose contact after the machine has been running a short while. If the rotor bars are tapped lightly a different sound will be given off by those which are loose than by those which are tight and secure.

Loose bars of the bolt-connected type should be thoroughly cleaned and tightened, and those of the soldered or brazed type should have the joints cleaned and carefully resoldered or brazed to the end ring.

Loose or high-resistance joints between the rotor bars and end rings cause reduced starting torque and reduced operating efficiency of the motors, as well as increased heating.

Unusual noises in squirrel-cage rotors may be caused by the vibration of bars which have become loose at the end ring connections or loose in the slots of the rotor core.

Rotor heating may sometimes be caused by poor insulation between the laminations of the rotor core, allowing the circulation of heavy eddy currents.

#### 435. SLIP-RING ROTOR TROUBLES

Slip-ring motors have rotor windings of the phase-wound type with the same number of poles as the stator winding. Whether these rotors are of the wire-wound or bar-wound type, they are subject to the same troubles as stator windings. The most common of these troubles are defective insulation, shorts, grounds, opens, and loose connections. These troubles have been fully covered in the Section on Armature Winding.

Faults sometimes occur in the insulation or connections of the three leads which run from the rotor winding to the slip rings, or in the insulation of the slip rings themselves.

Oil leakage from bearings may be the cause of failure of the insulation between the slip rings and

shaft or between the three separate rings. This may cause the rings to loosen or to become grounded to the shaft or short-circuited to each other.

In some cases this trouble can be corrected by cleaning and drying out the insulation or by building it up slightly larger to make the slip rings fit tightly again, and in other cases it may require complete new insulation rings under the metal slip rings.

Small burned spots in the insulation which have been caused by a ground or short-circuit can often be scraped out and plugged with fiber or insulating compound to make temporary and even more or less permanent repairs.

Lightly burned surfaces on the insulation may be scraped and cleaned and then, after the oil or moisture is dried out, the insulation can be covered with several coats of shellac to keep out moisture and oil and preserve its insulating quality in the future.

Oil will sometimes cause an accumulation of dust and dirt on the brushes or brush holders and may cause brushes to stick in the holders or to build up on the contact faces of the brushes a dirty, greasy film of high-resistance.

Brushes in this condition can be cleaned by soaking and washing them in gasoline or benzine. Brush holders should be kept tight and in the proper position to prevent brushes from running over the edges of rings and causing uneven wear of both the brush and ring.

Slip rings that have been badly grooved or worn may need to be trued or turned down flat and smooth again in a lathe.

#### 436. SECONDARY RESISTANCE TROUBLES

Secondary starting or speed control resistances which are used with slip-ring motors sometimes develop opens or high-resistance connections which cause considerable trouble in the starting or operation of the motor.

An open or high-resistance connection in one phase of this resistor will prevent the proper amount of current from flowing through that phase of the machine rotor, and thereby considerably reduce the starting and running torque.

Cast-iron grids are commonly used as resistance elements in these rheostats, and the brittleness of the cast iron makes them more or less subject to breakage by vibration or rough handling.

Sometimes tools or metal parts are carelessly allowed to drop into resistance grids, either breaking or short-circuiting them. A sheet-metal cover placed a foot or two above a bank of such grids will serve to prevent objects falling into them and also keep out any possible moisture drippings. The cover should not be too close to the grids or it may prevent the free circulation of cooling air through them.

A further protection of coarse wire screen can often be used to very good advantage around the sides of such resistance grids.

Fig. 460 shows sketches of a separate iron grid, an insulated clamping rod, and a complete assembled unit of grids for resistors of this type. In the sketch of the complete unit an "open" or "break" is shown in one of the grids at "B".

Temporary repairs for breaks of this kind can be made by the use of jumpers made of heavy flexible copper wire equipped with terminals, as shown by the sketch in the lower left corner of Fig. 460.

A repair of this kind can be made by loosening the nuts which clamp the grids together and inserting the lugs of the jumper between the points marked "X" and "Y". When the nuts are again tightened the jumper is clamped securely in parallel with the broken grid.

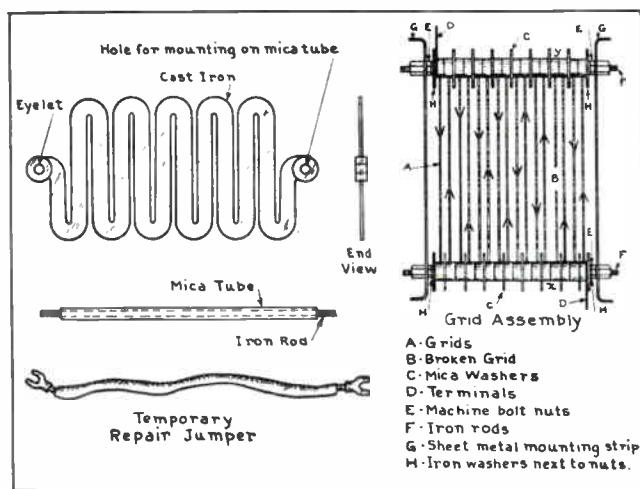

Fig. 460. Sketches showing construction of iron grid type secondary resistors for slip-ring motors. Also note the jumper used for making temporary repairs to open circuited units.

Shorting the grid out in this manner slightly reduces the resistance of that section of the rheostat, but usually not enough to materially affect the operation of the motor. The broken grid and jumper should, however, be replaced as soon as possible with a new grid.

The nuts which clamp resistors of this type together should be frequently inspected and tightened, as they occasionally work loose by vibration and thus cause poor contacts of high resistance between the ends or eyes of the grids.

This may cause burning and pitting of the contact surfaces of the eyes and necessitate the grids being removed and having the eyes ground or filed clean and smooth.

Careful observation of the sketch of the complete assembled grid on the right in Fig. 460 will show that the mica insulating-washers are properly placed to separate the ends of every other pair of grids on opposite sides, leaving the remaining ends together so that the complete circuit is formed through all of the grids in series in this one unit. Also note

the mica insulating-tube which prevents the iron clamping rod from short-circuiting the grids together.

Fig. 461 shows a photograph of several resistance grid units assembled in a compact bank or framework.

#### 437. TESTS FOR LOCATING FAULTS IN SECONDARY RESISTORS

An ammeter can be conveniently used for locating opens in secondary resistors by placing the ammeter first in one phase lead and then another and starting the motor each time. The phase in which the broken grid is located will be indicated by a zero current reading when the motor is started.

If three ammeters are available, one can be connected in each phase as shown in Fig. 462, thus making the test a little more quickly. With the open at the point marked "X", the center ammeter would show no reading when the motor starting switch is closed.

If the motor is loaded it will probably not start, while if there is no load connected to it it may start up slowly.

If the starting rheostat handle is moved gradually around to cut out the resistance, the center ammeter will suddenly show a reading when the sliding contact passes the break at "X", and if the motor has not started up to this time it will probably start rather suddenly when this point is reached; or if the motor has been running, its speed will increase as the break is passed.

By carefully watching the ammeter as the controller handle is moved, the exact location of the break can thus be determined.

High-resistance joints or cracks which are hard to find on resistors by ordinary inspection can be located by testing across the ends of the resistance grids with a voltmeter.

This test should be made while the motor is run-

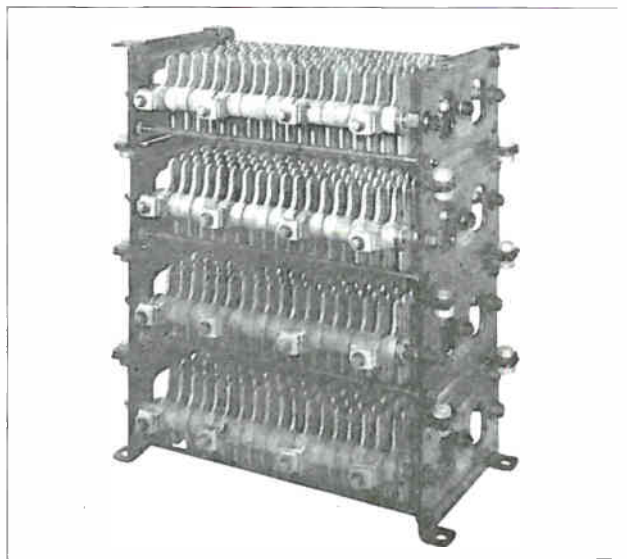

Fig. 461. Photo of complete grid resistor unit for slip-ring motor controllers.

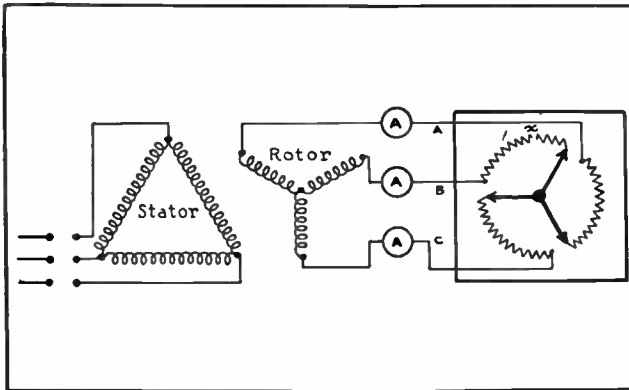

Fig. 462. Diagram showing methods of testing with ammeters to locate an open circuit in a secondary resistance.

ning and has its stator excited, and with the secondary-resistance controller on the first point. When the voltmeter leads are connected across good grids in the phase elements which are closed, only a very small voltage drop will be read.

When it is connected across good grids in the phase element which is open no reading will be obtained; but when the leads are connected across the grid which is broken or has the high-resistance connection, a higher reading will be obtained with the meter.

Intermittent opens which are caused by small breaks that are jarred open and shut by vibration, are sometimes the cause of rather mysterious troubles and are a little more difficult to locate.

By leaving an ammeter in each circuit for a time and watching the instrument for fluctuations in its readings, these intermittent or floating opens can be found.

Brushes which occasionally stick in the holders may also cause intermittent opens in the secondary circuit of slip-ring motors and these brushes can be located by connecting an ammeter in series with their leads and watching it for fluctuations.

A slip-ring motor with a properly wound rotor which is free from faults will give the same ammeter readings on each of the three secondary leads when all control resistance is shorted out of the circuit.

A rotor with slightly unbalanced currents may give good service with slightly lower efficiency and power factor. If the rotor currents in each line are considerably out of balance, the rotor winding should be checked for shorted coils, reversed poles, open circuits, etc.

A rotor which has balanced currents with all the secondary resistance cut out should also have balanced currents when all of the secondary resistance is in the circuit, provided the resistance is equally divided between the secondary phase leads and the resistance units are all in good condition.

If the ammeter readings vary considerably with a balanced rotor and all the resistance in the secondary circuit, it indicates that the secondary resistance

is unbalanced or that part of the resistance is short-circuited.

#### 438. STATOR TROUBLES

A number of the troubles or defects which occur in the stators of A. C. machines have been fully covered in Section Two on A. C. Armature Winding, and Articles 105 to 121 inclusive should be reviewed in connection with your study of maintenance.

In addition to the actual faults which may occur in stator windings there are a number of other things which relate to the stator and its current supply which may prevent an A. C. motor from starting.

Some of the most common of these troubles are as follows:

- (a) No voltage
- (b) Low voltage
- (c) Unbalanced voltage
- (d) Improper frequency
- (e) Overloaded motor
- (f) Polyphase motor attempting to start single phase.

In connection with the first item (a), a motor, of course, cannot start without voltage because there will be no current flowing in either the stator or rotor windings. It is a very simple matter to determine whether or not a motor is supplied with voltage by testing at the stator leads with a voltmeter or test lamps.

Test lamps connected in series can be used on 550 volts and under, and ordinary voltmeters can also be used on such circuits. On higher voltage motors or where the voltage is above the range of the voltmeter, potential transformers should be used.

Fig. 463-A shows a method of using either lamps or a voltmeter to test for voltage at the terminals of a 440-volt motor. Whichever the device used for testing, the test should be made from A to B, B to C, and A to C, to make sure that all phases are alive or supplied with the proper voltage.

Fig. 463-B shows a method of testing the leads of a high-voltage motor using a potential transformer with the voltmeter.

Failure of voltage at the stator leads to a motor may be caused by an open circuit in the line, such as blown fuses, open circuit breakers or switches, failure of the entire power supply, loose connection, or bad contact on the controller, etc.

In testing for low voltage a voltmeter should be used at the motor terminals. As the starting torque of an induction motor varies with the square of the applied voltage, the motor will be unable to start its load if the voltage is considerably below normal or that voltage for which the machine is rated.

If the line voltage is found to be correct the trouble may be that the starting compensator or resistance is reducing the voltage to the stator ter-



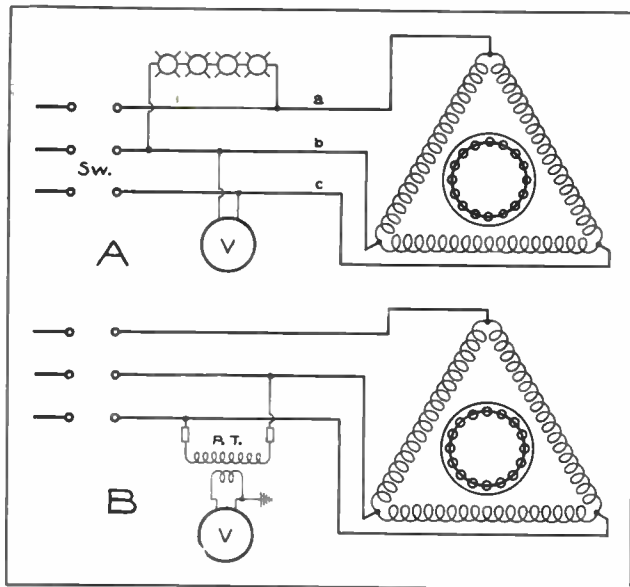

Fig. 463. The above sketches show connections for voltage tests on leads of three-phase squirrel cage motors.

minals too much. This can be corrected by changing the taps on the auto transformer or, in the case of rheostat starters, by cutting out more resistance.

Badly unbalanced voltages will considerably reduce the starting torque, running torque, and efficiency of a polyphase motor. A voltmeter can be used to detect this condition by a test across each phase as shown at 463A.

Unbalanced voltages may be caused by any of the following:

1. Unequally distributed single-phase loads on a three-phase system. (See Fig. 464-A.)
2. Entire system supplied with single-phase power but alive with three-phase power, due to phase converter action of three-phase motors. Fig. 464-B shows how this may occur with an open in one phase as shown and a three-phase motor operating lightly loaded from one phase. The phase wire which is open will be supplied by a certain amount of voltage through the stator windings of the running 3 phase motor.
3. Transmission-line voltage unbalanced because of no transpositions.
4. Wrong connections on transformers or use of transformers having widely different characteristics.

Improper frequency is not very often the cause of motor failure, except in cases where motors have just been installed and are being started for the first time. In such cases motors of one frequency may have been installed on a supply line of another frequency.

Check the name-plate frequency of the new motors with that of older motors which have been successfully operated on the system, or make a frequency meter test on the line.

### 439. OVERLOAD AND SINGLE-PHASING

A motor suspected of not starting on account of overload should be tested for other troubles to make sure that the cause actually is overload. If the motor tests okay in other respects and is supplied with the proper voltage and frequency it will make a good attempt to start and will generally produce a loud humming noise.

Place an ammeter in each phase lead to the motor. If these instruments register currents considerably greater than the full load current rating of the machine it is fairly safe to assume that the motor is overloaded. Try to turn the load by using a wrench on the shaft, and compare the pressure required on a one-foot wrench handle with the rated starting torque of the motor in foot pounds.

Three-phase motors which are loaded will not start unassisted when single-phase power is applied. Single-phasing may be due to a blown fuse, broken line-wire, loose connection, broken lead at the controller or motor, bad contacts on controllers, etc.

It might seem at first thought that a three-phase motor with one wire open would still be supplied with two-phase power. This, however, is not the case; with one wire open there are only two wires remaining closed and over two wires it is possible to get only single-phase energy. A third wire is needed to complete the circuit for the impulses of the other two phases at alternate periods.

One of the best ways to test for single-phasing is to place an ammeter in each line wire at the motor terminals. The line which is open will give a zero reading on the ammeter.

Testing with voltmeters or lamps will locate a dead phase if the leads are disconnected from the stator winding; but these tests may be somewhat misleading if the line leads are connected to the

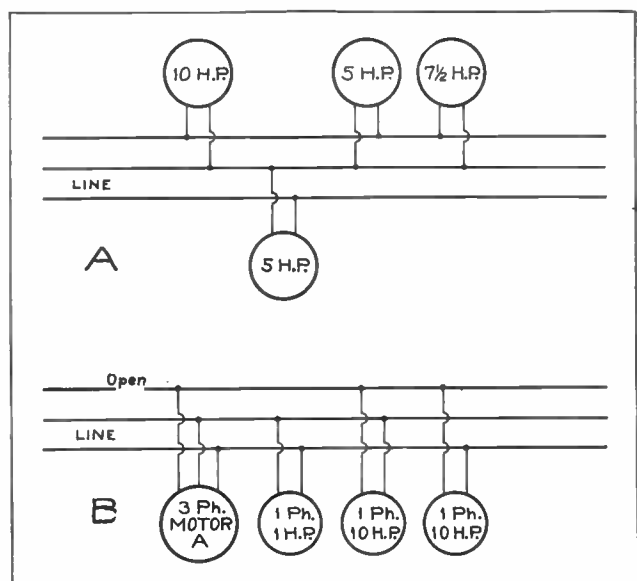

Fig. 464. Unbalanced voltage on three-phase circuits can be caused by unbalanced loads as at "A", or by an open on the line side of a polyphase motor as at "B".

stator, because the voltage drop due to current flowing through the windings from the live phase will cause voltmeters or test lamps to give an indication on the dead phase as well. (See Fig. 465).

While the voltmeter on the left would give higher readings than the others, they would all indicate some voltage. For this reason an ammeter test is the most dependable.

#### 440. REASONS FOR MOTORS OVERHEATING

Winding troubles, such as shorts, grounds, opens, reversed coils, oil soaked coils, etc., which cause overheating of A. C. motors, have been covered in Section Two of Armature Winding.

In addition to these troubles within the windings, motors may be caused to overheat by any of the following:

- (a) Low voltage
- (b) High voltage
- (c) Improper frequency
- (d) Single-phasing of three-phase motors
- (e) Overloaded motors
- (f) Poor ventilation.

If the voltage applied to the terminals of an A. C. motor is either considerably below or considerably above that for which the motor is rated the machine will overheat.

As the torque of an A. C. induction motor is proportional to the square of the applied voltage, when the voltage is low the machine cannot produce its rated torque and drive the load without drawing excessive current.

If the line voltage is too high it will force an excessive amount of current through the motor windings, whether the machine is loaded or not. A voltmeter can be used to easily determine whether the line voltage is correct for the design of the motor, by comparing the meter reading with the voltage marked on the name-plate of the motor.

Attempting to operate a motor designed for one frequency on a line of another frequency will cause the machine to overheat if the difference in frequency is more than five or ten per cent.

Frequency can be checked by comparing the reading of a frequency meter, or the name-plate frequency ratings of other motors on the line, with the frequency given on the name-plate of the motor which is heating.

A three-phase motor which is operating on single-phase due to some defect in the line or stator winding will overheat considerably if the load on the machine is much more than 50% of its full load rating. This fault sometimes occurs because of defective running contacts on the controller or starting compensator.

If the starting contacts are in good condition they may supply three-phase energy during starting and thus bring the motor up to speed. If the running contacts are defective the motor may receive only

single-phase energy when the controller is thrown to running position.

If the load is not too heavy the motor may continue to run at slightly reduced speed, but it is very likely to overheat in a short time. The test for locating an open phase or determining whether or not the machine is running single-phased has already been explained.

Motors are designed for a certain normal operating temperature at full load, and the full load current is practically always stamped on the name-plate. If this name-plate current rating is exceeded by placing too great a mechanical load on the motor the heating effect will increase approximately with the square of the current increase.

Ammeters placed in the line leads to a motor will quickly show whether or not it is overloaded, by comparing the meter readings with the name-plate current rating.

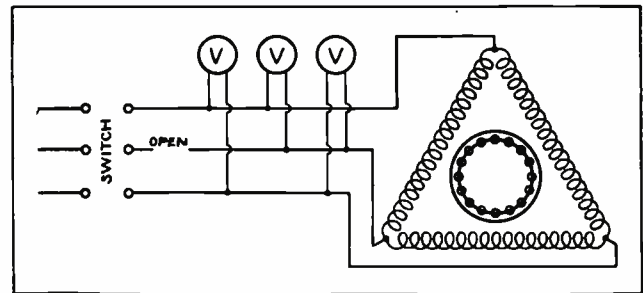

Fig. 465. Sketch illustrating wrong method of testing for an open phase. Ammeters provide a more dependable indication.

Badly worn bearings which allow the rotor to rub or run very close to the stator teeth on one side will also cause overheating.

As all motors develop a certain amount of heat during normal operation this heat must be allowed to escape by radiation or be carried away by circulation of air through the machine, in order to prevent building up excessively high temperatures. If either the radiation of heat from the machine or the circulation of air through it are interfered with, the motor will overheat seriously.

Sometimes, in an attempt to keep moisture or dirt from a motor, the machine is improperly covered in a manner that also prevents the circulation of air and the radiation of heat. In other cases, the ventilating ducts through the winding and core may have become badly clogged with dirt, thus preventing the proper circulation of cooling air.

#### 441. INSULATION TESTS WITH MEGGER

A megger test of the insulation resistance of any electrical machine is usually a fair indication of the condition of the insulation.

Machines on which the windings are soaked with oil or moisture or have old and defective insulation will give a much lower reading in megohms than machines of the same type and size with good new insulation.

As the insulation resistance should depend on the size and voltage rating of any machine, these factors should be considered in determining the proper resistance standard with which to compare test readings.

The following simple formula can be used for this purpose:

$$\text{Megohms should} = \frac{\text{rated voltage}}{\text{kw. rating} + 1000}$$

For example, a 20-h. p., 440-volt motor with good insulation should test .433 megohms or 433,000 ohms or more.

As:

20 h. p. =  $20 \times 746$ , or 14,920 watts, or 14.92 kw. then,

$$\text{Megohms} = \frac{440}{14.92 + 1000}, \text{ or } \frac{440}{1014.92}, \text{ or } .433+$$

As previously explained, if megger readings taken at successive inspection periods show continually decreasing insulation resistance on a certain machine, it indicates failing insulation due to aging, overheating, moisture, oil, or some such cause.

When drying out machines with damp windings, megger tests should show higher and higher resistance readings as the moisture is removed.

When further drying will not increase the insulation resistance any more, it indicates that the moisture is practically all out of the windings.

Megger tests are made by connecting one lead of the instrument to the machine winding and the other lead to the frame. Then turn the hand generator crank until the voltmeter element indicates proper D. C. voltage, and read the resistance in megohms from the ohmmeter scale.

#### 442. DIELECTRIC TEST

Another common test for the insulation of electric machines is the dielectric test, which is made by applying a certain excess voltage to the windings and frame of the equipment to see if the insulation will break down and ground the winding, or if it is good enough to stand the voltage without puncturing.

The standard voltage to use for the dielectric test is found as follows:

$$2 \times \text{rated voltage} + 1000$$

For example, the voltage to use for the dielectric test on a 20-h. p., 440-volt motor, would be:

$$2 \times 440 + 1000 = 1880 \text{ volts.}$$

Small portable test transformers with adjustable taps or rheostats used in their primary circuits to vary the secondary voltage can be used for making dielectric tests.

#### 443. SINGLE-PHASE MOTOR TROUBLES

As certain types of single-phase motors use commutators and short-circuiting devices, centrifugal switches, etc., their failure to start or operate properly may be due to defects in one of these devices

as well as to faults in the windings or failure of line supply.

On single-phase motors of the repulsion-induction type the centrifugal commutator short-circuiting device is supposed to leave the commutator free of the short circuit during starting and then to short circuit the commutator when the motor is fairly well up to speed.

If this short-circuiting device fails to operate properly the motor may not start or it may not come up to full speed. Failure of the short-circuiting device may be due to its becoming clogged with hardened oil and dirt, to worn out parts, burned or pitted contacts, dry or unlubricated moving parts, or the weakening or breaking of springs.

All single-phase commutator-type motors use brushes which are subject to the same troubles as those of D. C. machines. These troubles and their remedies were thoroughly covered in the Direct Current Section.

Repulsion-induction motors are the most common type which have commutator and brushes, and on these machines the brushes are short-circuited together and must be placed at a certain definite setting.

If loose or high resistance connections develop in the short-circuit path between these brushes or if the brushes slip out of their proper setting, the motor will not operate properly or may not even start.

The proper brush setting for these machines is usually marked on the frame and brush-holder yoke. One common type of marking is as shown in Fig. 466. In the upper sketch there are shown two small marks, "R H" and "L H", on the brush holder yoke; and one small mark on the frame.

When these marks bear the relative positions shown in this sketch the brushes are at neutral and

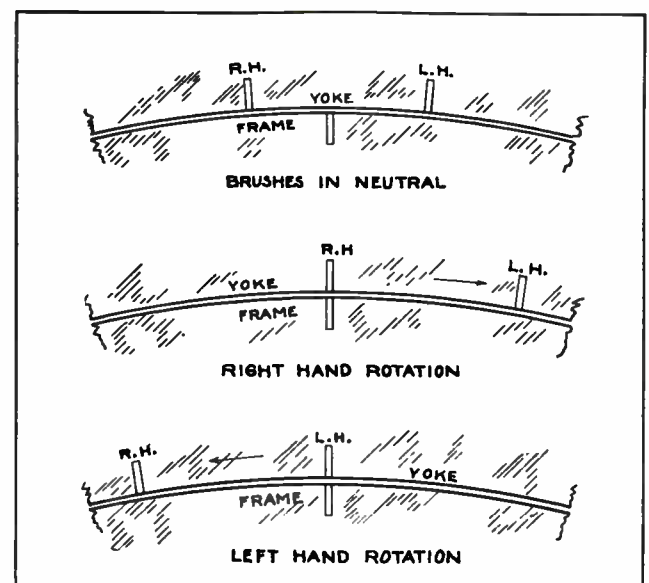

Fig. 466. The above sketches show markings on motor frame and brush yoke, for setting repulsion motor brushes for right or left-hand rotation.

the motor would probably not start in either direction. With the brush yoke shifted until the "RH" mark lines up with the mark on the frame, as shown in the center sketch, the motor should rotate in a right-hand direction and should give its full rated speed and torque.

When the brush yoke is shifted so that the "LH" mark lines up with the mark on the frame, as shown in the lower sketch, the motor should run in a left-hand direction.

Other troubles, such as dirty brushes, poorly fitted brushes, brushes stuck in the holders, poor brush tension, loose pig tails or connections, high mica, etc., apply to commutator type A. C. motors as well as to D. C. machines.

The centrifugal switches of fractional horsepower, single-phase, split-phase motors often cause failure of these motors to start or run properly, due to these switches becoming stuck with dirt and grease, developing loose or burned contacts, improper spring tension, broken or bent parts, etc.

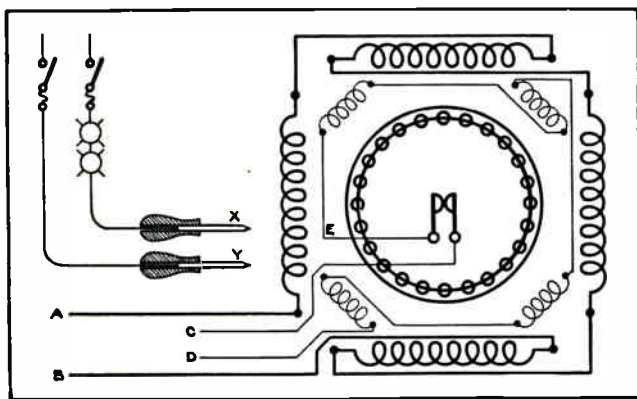

Fig. 467. Diagram illustrating connections and methods for convenient trouble tests on single-phase split-phase A. C. motors.

#### 444. TESTING SINGLE-PHASE, SPLIT-PHASE MOTORS

A convenient method of testing single-phase, split-phase motors to locate most of their common troubles is shown in Fig. 467. A set of test lamps and fuses are shown connected to a pair of test leads, "X" and "Y", with insulated handles.

The test lead "Y" should be connected in series with a fuse to the ground wire of the single-phase system, and the test lead "X" should be connected in series with a pair of test lamps and a fuse to the "hot" wire.

In testing for grounds, place Y on the frame of the motor making sure that it is not insulated from the iron by paint or grease. If the motor is not grounded the lamps should not light when X is touched to either A, B, C, D, or E.

If the lamps do light when X is touched to A or B, it indicates that the running winding is grounded. If the lamps light when X is touched to C, D, or E, it indicates that the starting winding or switch is grounded.

In testing for crosses or shorts between the starting and running windings, connect Y to either A or B. When X is touched to C, D, or E, the lamps should not light. If they do, it indicates a cross or shorted connection between the two windings.

In testing for "opens" in the running winding, connect Y to A and X to B. If the lamps fail to light it indicates that the running winding is open-circuited.

In testing for opens in the starting winding, first test the entire winding circuit by connecting X to C and Y to D. If the lamps do not light the circuit is open.

Next connect X to C and Y to E. If the lamps light the centrifugal switch is closed as it should be when the motor is idle. Then connect Y to D and X to E, and if the lamps do not light it indicates that the starting winding is open regardless of the position of the switch.

#### 445. PRECAUTIONS IN STARTING NEW MACHINES

When starting up for the first time, new machines such as motors, generators, converters, transformers, etc., you should exercise particular care and observe carefully a number of important items. No properly trained electrician with any respect for his job or the equipment of which he is in charge will ever start up a new machine and leave it to run unobserved.

Before the machine is started its entire circuit and all switches and connections should be carefully checked over, and care should be taken to see that no foreign objects or dirt are anywhere in the machine.

Check carefully the oil in bearings, the movement of oil rings, and also the ventilating air or cooling water supply to the machine. If these things are not carefully done it may result in considerable damage to the new equipment as well as danger to yourself or other workmen.

All new electrical machinery that has had any chance to become damp, and particularly that of high voltage and large capacity, must be thoroughly dried out before operating. This applies also to old equipment which has not been used for some time and may have absorbed considerable moisture.

The windings may be dried out by means of electrical heaters or steam coils and fans, or by allowing current not much in excess of full load value to flow through the windings at low voltage until the heat thus caused has evaporated the moisture.

One or more electric fans used to circulate the warm air from heaters through and around the windings will greatly reduce the time required for drying. Small machines or windings can be dried out conveniently in ovens, if they are available.

In some cases the drying out of large machines can be speeded up by building a temporary en-

closure around them and placing heaters of some sort inside this enclosure. Sheet metal will serve very well for such enclosures and asbestos board is excellent because of its heat-resisting and insulating qualities.

Never fail to have plenty of clean, dry air circulating through any ovens or enclosures used for drying out electrical equipment, as this circulating air is necessary to carry away the evaporated moisture.

New machinery or machines which have not been running for some time should always be carefully watched for unusual sounds or vibration which may be caused by single phasing; reversed phases; loose mechanical parts such as end shields, bearings, pulleys, rotor bars, coil wedges, etc. Loose laminations in stator or rotor cores will often set up loud humming noises.

Excessive vibration of the entire machine may be caused by improperly balanced rotating parts. Unusual vibration and noises are often caused by shorted coils or other defects in the windings on either rotors or stators.

All machinery should be carefully and frequently observed for signs of overheating. Overheated windings or bearings will generally give off an odor of hot or burning insulation or oil, and when any odors of this nature are first noticed the machine should immediately be shut down and the source of trouble located and corrected.

By shutting down motors and feeling the various parts of stator and rotor windings any spots which are particularly hotter than others can be located, thus helping to determine where the trouble is.

#### 446. USE OF TEST INSTRUMENTS

We have previously mentioned and will again emphasize here, the fact that any up-to-date plant should have a sufficient number of proper meters for testing and checking electrical machinery and circuits, and the electrical maintenance man should do everything in his power to see that these instruments are on hand and in good condition.

Much trouble and lost time can be saved by making the proper tests on new machinery and its circuits when the machines are installed, and also by testing machines for overloads and abnormal circuit conditions after they are running. Additional money can also be saved by making occasional efficiency and power factor tests on various machines and circuits, if the proper meters for this work are available.

#### 447. IMPORTANCE OF CLEANING

Always remember that it is very important to keep all electrical machinery well cleaned and free from collections of dust, dirt and oil. Regular and thorough cleaning will greatly prolong the life of insulation and will help to reduce operating temperatures and increase the efficiency of any electrical equipment.

Dust can be blown out of windings by means of

portable electrical blowers such as shown in Fig. 468; or, if blowers are not available, by wiping and brushing out windings with rags and soft brushes having long insulated handles.

Oil or grease can be wiped off windings with rags or waste, and the windings can then be washed with gasoline or benzine to thoroughly cleanse them of all oil or grease which may have started to soak into the insulation.

Mixing carbon-tetra-chloride with gasoline or benzine in mixtures of about half and half, will greatly reduce the fire hazard and the possibility of an explosion when using these solutions for cleaning.

After washing with such solutions to remove grease and oil, windings should be thoroughly dried and then given one or more coats of good air-dry insulating varnish. Varnish of this kind can be obtained in small or large cans from electrical supply houses and should always be kept on hand in any electrical maintenance shop. It helps to fill small cracks which develop in the insulation and thereby keeps out dirt, oil, and moisture and thus greatly increases the life of the equipment.

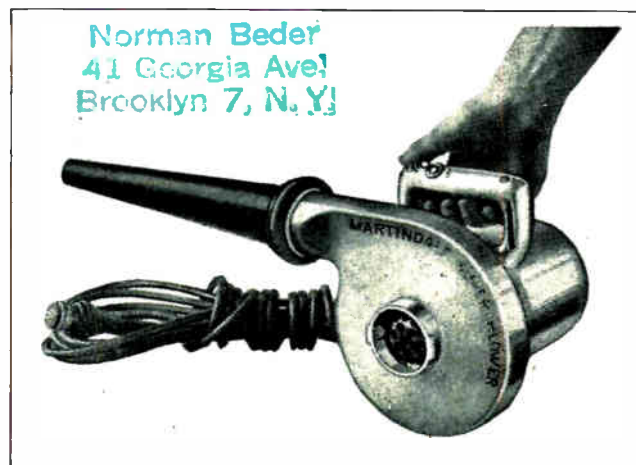

Fig. 468. Convenient portable electric blowers of the type shown above are often used for cleaning dust from electrical machines.

#### 448. CONTROLLERS

In order to secure proper starting and operation of A.C. motors it is necessary to keep their starters and controllers in good condition. Controllers should be given the same regular inspection as motors, and a regular form similar to the one shown for motor inspection can be used to cover the inspection of all moving or wearing parts, contacts, terminals, relays, overload protective devices, etc.

Controller terminals should be frequently inspected to see that they have not worked loose by vibration, and all contacts at which circuits are made and broken should also be frequently inspected to see that they are not partly burned and making poor or high-resistance connections.

As soon as contacts become severely burned or pitted they should be carefully filed smooth and bright, and when worn or pitted beyond the possi-

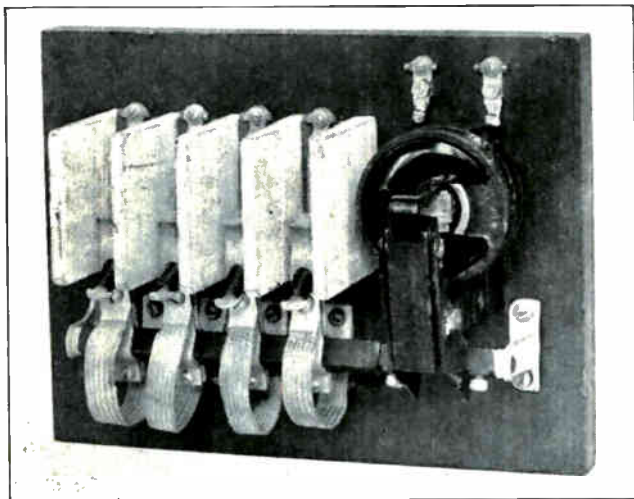

Fig. 469. Photo of contactor panel of an A. C. motor controller. These contacts and their connections require frequent attention by the maintenance electrician.

bility of efficient repair by this method the contact faces or shoes should be replaced with new ones.

Flexible connections and pig tails to movable controller contacts should be inspected frequently to see that they are not partly or wholly broken off due to repeated bending. These flexible connections can easily be replaced with new ones obtained from the manufacturer or by short pieces cut from a stock of flexible copper braid of the proper sizes, which should be kept on hand for just this purpose.

Contact springs, arcing tips, arc barriers, etc. should also be given frequent inspection and repaired when necessary.

It is particularly important that all overload-release coils, no-voltage coils, time-element devices, and other protective relays and equipment on controllers be kept in good adjustment and condition, in order to protect both the controller and the motor which it operates.

On starters of the remote control type the push buttons and their contacts should also be inspected and kept properly maintained, as these little devices may otherwise be the source of considerable trouble and may cause the controller and motor both to fail to operate, just because of some dirty contact or loose connection at the push button station itself.

#### 449. GENERAL

Some form of convenient speed indicator or revolution counter such as shown in Fig. 472 should be kept on hand among the maintenance man's tools for the purpose of checking the speed of various motors and driven machinery.

Reduced speed below that of the name-plate rating is often an indication of an overloaded motor, reduced line-voltage; or of some trouble which may be developing in the machine.

A convenient portable trouble lamp with an insulated handle, lamp protecting guard, and extension cord as shown by Fig. 473 should also be available for making emergency repairs on machines located

in dark corners and for examining the insides of controllers or large motors.

The small hook shown on the end of the guard provides a convenient means of supporting the lamp in places where work is to be done. Lamps of this kind are often provided with an extra wire on the extension cord for grounding the lamp socket and guard, thus affording added protection from shock hazard in case of a defect in the socket.

Another very convenient device for the electrician to have is one of the small pocket-size circuit testers of either the magnetic or neon tube type, for testing to see if low-voltage circuits are alive or not and approximately what their voltage is.

#### 450. STOCKING OF SPARE PARTS

A maintenance man should always give considerable thought to stocking or keeping on hand at least a few of the spare parts most commonly needed for repairs and replacement on the motors, controllers, and other devices which he may be maintaining. Even in plants where this has not been the practice a trained man can make his services much more valuable and save a great deal of time and money for his employer by determining as quickly as possible what parts are most often needed for repairs and replacement, and then recommending the purchase of a small supply of these parts to have on hand at all times.

This is a particularly great advantage when the plant or equipment is located at some distance from the supply house or manufacturers from whom repair parts can be obtained, as in such cases having the parts on hand saves considerable time in repairing and putting the machines back into service.

In large plants such stock parts should be neatly and systematically located and arranged in bins or shelves which are marked so that any particular part can be located.

Attaching to the repair parts themselves proper tags with complete markings and data will often

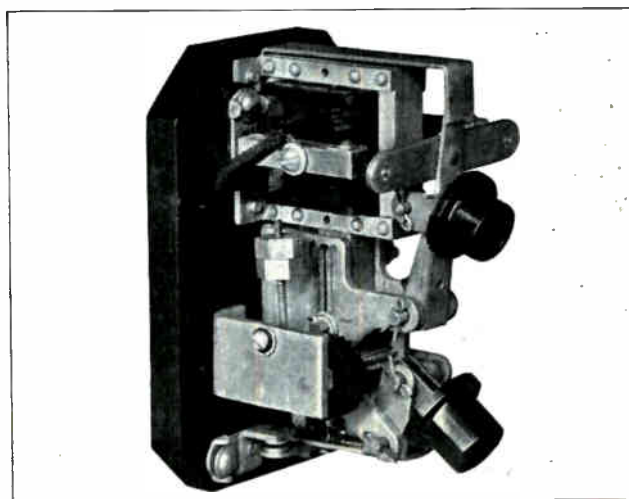

Fig. 470. Push button station with cover removed to show contacts and relay magnet.

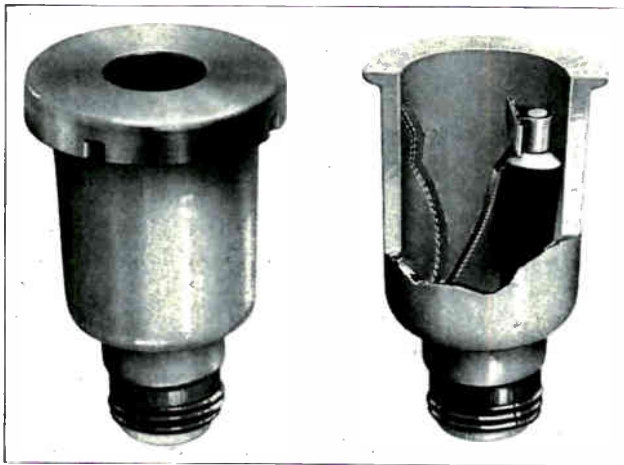

Fig. 471. Convenient plug type thermal relay for protection of circuits to small motors and other equipment.

help to quickly select the proper part for a certain machine.

A few of the small parts more commonly required may be carried in the tool kit of the maintenance man.

What spare parts should be kept on hand depends a great deal upon the amount and type of equipment in use in the plant. They may range all the way from small screws, springs, bolts, nuts, pig tails, contact shoes, brushes, relay coils, field coils, fuses, etc. to complete spare rotors or armatures, or even complete spare motors, transformers, oil switches, etc.

Small companies could not, of course, afford to carry these larger spare parts and machines; but in large plants, where dozen or hundreds of machines of one type may be in use, having on hand a spare motor or controller which can be used to quickly replace one of the others which has become defective, allows the defective unit to be taken out of service and repaired at leisure without very much loss of time due to shut-down of the driven equipment.

Some of the parts most commonly carried in stock are as follows:

1. Bearings
2. Controller and switch contacts
3. Brushes
4. Bearing oil
5. Oil for starters and oil switches
6. Fuses (plug and cartridge type)
7. Supply of the most commonly used sizes of wire
8. Cable lugs
9. Insulators and pins
10. Solder, flux and tape
11. Fish paper and varnished cloth
12. Air-dry insulating varnish
13. Wire for rewinding coils, or spare factory-made coils
14. A few lengths of most commonly used sizes of conduit

15. Sandpaper and crocus cloth
16. Screws, nuts, bolts, springs, etc.
17. Condulets, outlet boxes, lock nuts, and bushings
18. Lamps and sockets
19. A few feet of copper bus bar
20. Brush holders.

#### 451. FIRE PROTECTION

The maintenance man should also give some thought to proper fire protection of at least the electrical equipment in his charge. Small portable fire extinguishers located at points near equipment using quantities of oil, or equipment which may cause a certain amount of sparking or flashing, will generally be sufficient protection.

Carbon-tetra-chloride extinguishers can be safely used to extinguish fires on live electrical parts because this liquid is not a conductor of electricity. Most other extinguishers, such as the soda and acid type, and also any water bucket or water hose should never be used until you are absolutely certain that all wires and machine parts have been disconnected and grounded.



Fig. 472. Revolution counters or speed indicators of the above type are very convenient for checking the speeds of motors and generators.

One of the most modern and efficient methods of fighting fire around electrical equipment is the use of fire-extinguishing gases contained under pressure in metal cylinders equipped with a short length of hose and a tube for directing the gas into the fire or machine which may be burning.

Fig. 474 shows an extinguisher of this type being used to put out a fire in the oil pan of a voltage regulator.

#### 452. SECURING HELP FROM MANUFACTURERS

A great deal of cooperation can be secured from the manufacturers by any maintenance man who will take the trouble to write to them for it. Manufacturers are generally very glad to cooperate with users of their equipment and will furnish internal

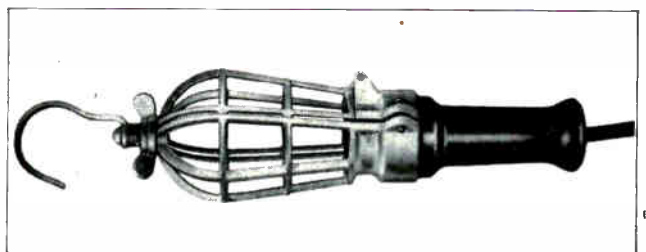

Fig. 473. Convenient trouble lamp with hook, guard, and insulating handle.

and external connection diagrams; instructions for installation, care and operation; data and prices on spare parts; or even to supply one of their expert engineers to help solve certain operating or repair problems with which the maintenance man may have exceptional difficulty.

In writing to manufacturers for any information of this kind you should always give complete name-plate data on the machines or devices for which the information is requested.

Never hesitate to ask the manufacturers any questions about their equipment because they are usually glad to help the maintenance man or operator produce the best possible results with their machines.

#### 453. KEEP UP-TO-DATE

It is also exceedingly well worth while to keep up-to-date as to modern operating and maintenance practice in different plants throughout the country. One way to do this is to subscribe to one or more of the best trade journals covering the class of work you may be doing.

These journals contain interesting articles by leading operating and maintenance engineers and by practical men of long experience in the field. The articles often show actual photographs and illustrations of certain installations and machines, and in many cases they give excellent shop hints



Fig. 475. This photo shows an installation of A. C. motors in a copper mill. Hundreds of thousands of motors in thousands of electrified factories and plants require the services of trained electrical maintenance men.

and suggestions for improvements, and tools and devices with which a great deal of time can be saved in making certain repairs.

Keeping yourself up-to-date in this manner and always looking for new ideas to use to the advantage of your employer is bound to result in more rapid promotion both in responsibility and in salary.

#### 454. OPPORTUNITIES

Always use your head as well as your hands continually on any electrical work you may be doing, and in this manner you will get a great deal more enjoyment out of your work each day; and you are also sure to get more pay out of your envelope if you strictly follow this practice.

The field of electrical construction, operation, and maintenance in all of the various lines such as power plants, industrial plants, telephone companies, railroads, and also in radio, automotive ignition, air craft ignition, etc., offers splendid opportunities to the practically trained man. Very few people fully realize or appreciate these opportunities when they are told about them, and usually not until they have obtained training and made the necessary effort to establish themselves in this great field of fascinating and profitable work.

A knowledge of the principles of alternating current and A.C. devices covered in this section will

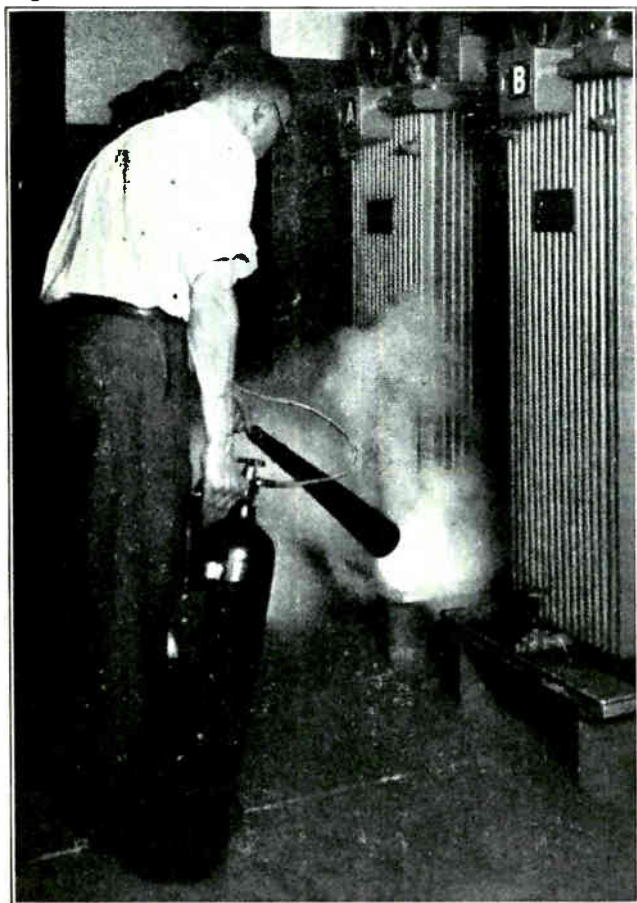

Fig. 474. This photo shows the use of a modern gas type fire extinguisher for fire protection in electric plants.



also be of great value to anyone planning to enter the radio field, because radio equipment utilizes high-frequency alternating current, and many of the fundamental principles of alternating current and A.C. power machinery are so closely related to those of radio circuits and equipment.

A great deal of time, effort and expense have been devoted to this section on alternating current and we would certainly advise every student to make an occasional review of these sections in order to keep himself thoroughly familiar with the very important material covered in them.

Keep in mind at all times that this Reference Set

is just what its name implies, and that it should be used for frequent reference to refresh your memory on any principle of which you are in doubt, or to obtain specific help and instruction on any problem of electrical construction, operation, maintenance, or trouble shooting which you may ever encounter.

The more frequently and constantly you refer to this set for help of this kind the more familiar you will become with the exact location of each subject and the more quickly and easily you will be able to locate practically anything you wish to find within these pages.

Norman Beder  
41 Georgia Ave.  
Brooklyn 7, N. Y.



**COYNE**  
*Electrical School*  
 CHICAGO ~ ~ ILLINOIS



ESTABLISHED 1899

COPYRIGHT 1942

## **ELECTRIC STORAGE BATTERIES**

### **Lead-Acid Cells**

**Plates, Pasting and Forming, Separators, Containers,  
 Electrolyte, Specific Gravity, Hydrometers,  
 Chemical Action.**

### **Battery Tests**

**Voltage Tests, Cadmium Tests, Hy-rate Discharge Tests  
 Battery Capacity and Capacity Tests.**

### **Charging**

**Charging Rates, Types of Chargers**

**Battery Troubles and Remedies**

**Care and Servicing, Repairs, Lead Burning, Shop Equipment**

### **Edison Nickel-Iron Cells**

**Construction, Advantages, Principles**

**Charging, Care, Servicing**

## ELECTRIC STORAGE BATTERIES

Storage batteries are used by the millions in automobiles, radios, telephone and telegraph systems, railway signal systems, electric trucks, train lighting, farm lighting plants, and for emergency power reserve in substations and power plants.

These batteries require charging, testing and care, and although they are very rugged in their construction, they require occasional repair due to the natural wear occurring on their elements by charging and discharging in normal use. So there are numerous opportunities for trained men in electric storage battery work.

It is also very easy for one to start a nice, profitable, small business of their own with very little capital in the repairing and servicing of automobile and radio batteries.

Fig. 1 shows a neat installation of storage batteries such as used for emergency lighting in public buildings, or with farm lighting plants.

Fig. 2 shows a single cell of a large power storage battery such as used in substations and power plants for supplying thousands of amperes during short periods.

You have already learned the principles of primary cells or batteries and how electric current can be produced by immersing unlike metals in an acid solution. It has also been explained previously that storage batteries are different from primary batteries in that they require charging before they are ready to supply electricity.

### 1. LEAD-ACID CELLS. PLANTE PLATES

One of the most common types of storage batteries is known as the lead plate battery. This is the type that is used very extensively in automobiles, for battery operated radio sets, and in large power plant batteries.

In 1860 a Frenchman named Gaston Planté discovered the principles of the lead plate storage cell. He found that if two strips of pure lead were immersed in an electrolyte of dilute sulphuric acid, a thin coating of lead sulphate would soon be formed on the surfaces of these plates.

He then discovered that by passing current through the cell the lead sulphate on the plate at which the current entered the solution would be changed to lead peroxide, or a compound of lead and oxygen. The lead sulphate on the other plate at which the current left the solution changed to pure lead in a spongy form. The term sponge lead is generally used in describing lead in this condition.

Thus the unlike materials required to produce the action in a cell were created by electrolytic action on lead plates which were formerly both alike.

After thus charging the cell, Planté found that it would give off current in the opposite direction. While discharging, the lead peroxide on one plate and the sponge lead on the other are again changed back to lead sulphate, and when all of the lead peroxide and sponge lead are changed back to lead sulphate, the plates are alike again and will not supply any more current.

However, if charged again by having current passed through them in the same direction as at first, the plates can again be made unlike and the cell brought back to charged condition, ready to produce current once more.

The lead peroxide plate from which the current flows during discharge is called positive, while the sponge lead plate at which the current enters during discharge is called negative.

From this we see that when charging a lead plate storage cell the charging current does not store electricity in the cell but merely makes the plates unlike by changing them chemically.

When a load or closed circuit is connected across the terminals of such a cell, current flows in the opposite direction to that in which the charging current flowed, and as the unlike material on the lead plates is gradually changed back to lead sulphate the voltage across the cell terminals becomes lower and lower, reaching zero when all of the material is reduced to lead sulphate and both plates are again the same.

The positive and negative plates for storage cells of the Planté type both consist of a sheet of pure lead, with grooves or corrugations on each side to increase the active area in contact with the electrolyte and thereby increase the capacity of the cell.

### 2. PASTED PLATES

One of the disadvantages of the Planté plate storage cell was the fact that the lead plates being non-porous had to be charged and discharged a considerable number of times before the coating of active material was of sufficient thickness to give the required capacity. This charging and discharging process was known as forming and was too lengthy and costly a process to make batteries of this type commercially practical.

To overcome this difficulty another Frenchman named Camille Fauré produced battery plates of pasted construction in 1880, and these plates turned out to be so much more efficient that they are the type still used in modern lead plate storage batteries.

Pasted or Fauré plates consist of a grid or framework of lead and antimony, upon which is applied a paste of lead oxide. The antimony is used

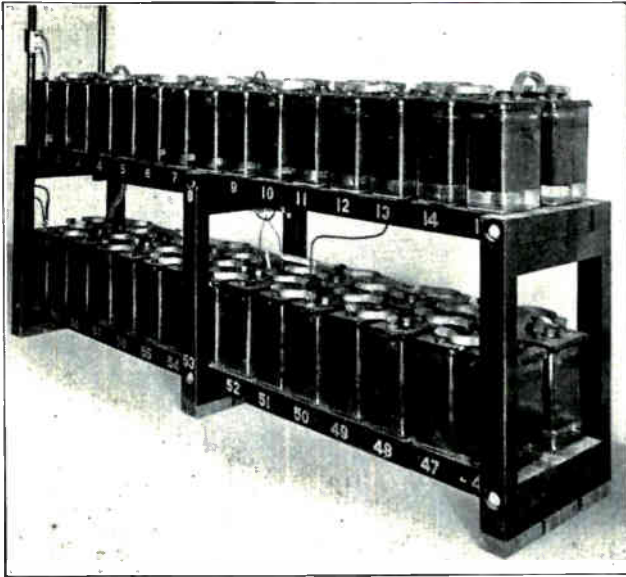

Fig. 1. This photo shows a large group of lead plate storage cells in glass jars. This battery installation is typical of those used for emergency lighting or farm lighting service, or for signal work. (Courtesy of Electric Storage Battery Co.)

with the lead to increase its mechanical strength and also to prevent the chemical action during charging and discharging from converting the grid into active material, as it would if pure lead only was used.

Fig. 3 shows a standard grid with a square mesh, and Fig. 4 shows a grid of the diamond type as used by one of the leading battery manufacturers.

The original Fauré plates had both positive and negatives pasted with red lead. In modern batteries litharge is also used with the red lead. The chemical term for red lead is:  $Pb_3O_4$ , and that for litharge is  $PbO$ . These terms or symbols are more fully explained in Article 14.

The paste commonly used for positive plates contains a large percentage of red lead while that used for the negative plates contains a large percentage of litharge. Lamp black is often added to the negative plate to make it more porous, as the negative plates tend to be rather dense on account of the large amount of litharge used in the paste.

The finished positive and negative plates are generally distinguishable by their difference in color, the positives being of a dark brown color and the negatives dark gray in color.

The upper part of Fig. 5 shows a positive plate on the left and a negative plate on the right. Note the difference in their color and also note the manner in which the paste is pressed into the grid flush with the surface so that both sides are smooth.

The lugs provided on the top corners of the plates are for attaching the terminals or group connectors to the cell.

In the lower part of Fig. 5 are shown a positive plate group and a negative plate group attached together by their connectors and terminal posts, and ready to place in the cells.

New battery plates for repairing worn out ones are generally purchased from some battery supply company, as the plates can be made much cheaper in factories equipped for this work than they can in the average repair shop. However, a general knowledge of plate construction and manufacture will be found interesting and possibly very valuable at some time or other; particularly if you should obtain a position in a battery manufacturing concern.

The following formula gives the materials commonly used in making the paste or active material for lead plates:

#### PLATE PASTE FORMULA

(Parts by weight)

POSITIVE	NEGATIVE
Red lead, 5 parts	Litharge, 5 parts
Litharge, 1 part	Red lead, 1 part
1.120 S. G. electrolyte,	1.150 S. G. electrolyte, 1
1 part	part
	1 ounce of lamp black per
	100 lbs. of litharge.

As lead oxides are dry powders some liquid must be used to mix them into a paste so they can be applied to the grids. Dilute sulphuric acid is generally used for this purpose. When mixed with the lead oxides the sulphuric acid causes a chemical action to take place which changes part of the oxides to lead sulphate, causing the paste to harden rapidly, so that it is necessary to work fast when applying paste to the grids.

In making battery plates the paste can be applied

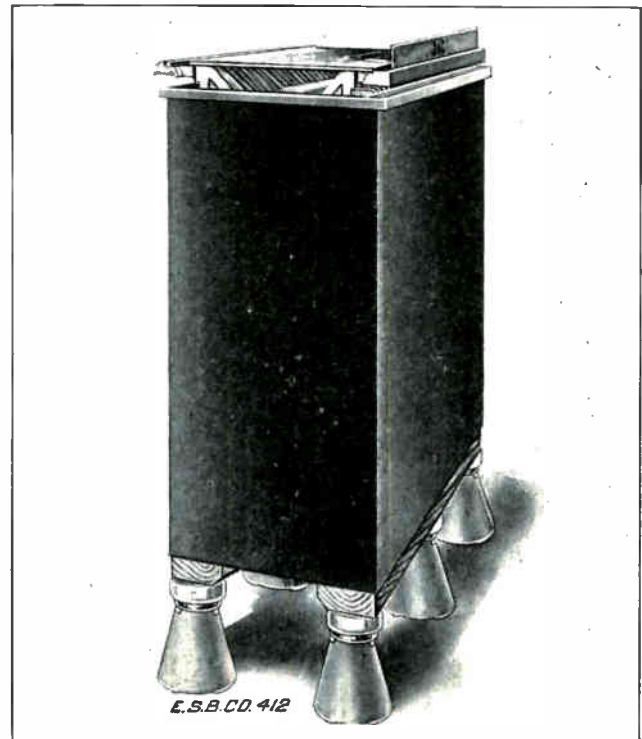

Fig. 2. Large lead plate storage cell in which the plates are supported inside of a lead lined wood tank which is in turn supported on insulators. Cells of this type are commonly used for emergency power and for D. C. control busses in power plants. (Courtesy of Electric Storage Battery Co.)

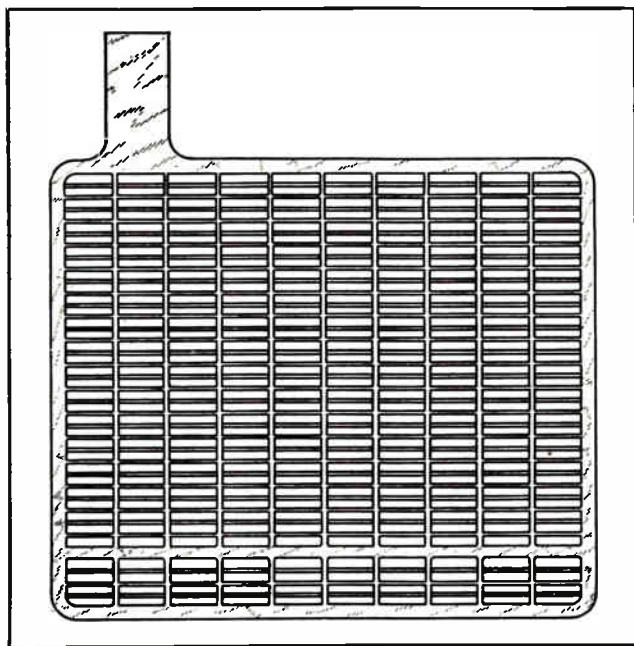

Fig. 3. The above drawing shows the construction of one common type of grid used for pasted plates. This drawing shows the grid before the paste has been applied.

either by hand or by special machines made for this work. When done by hand the pasting is generally done on a glass or marble covered table with sheets of blotting paper being placed between the grids and the table top. The paste is then applied to the grids from the top by means of a trowel, pressed firmly into the grid, and smoothed off flush with the surface.

After pasting, the plates are dried in a rack by circulating air over and around them at room temperature. The drying causes the paste to set and become hard and at the same time cements it firmly to the grid. As soon as the plates are dried they are ready for forming.

### 3. FORMING OF PLATES

We mentioned previously that it was necessary to form or condition lead plates of the Planté type by charging and discharging them. It is also necessary to form pasted plates by giving them one prolonged charge that changes the oxides of the paste into active material.

For forming the plates are assembled into groups, the positives together in one group and the negatives in another, and the plates separated far enough apart so that separators are not necessary between them.

These two groups are then placed in a tank filled with 1.150 specific gravity electrolyte, with the positive and negative plates in alternate positions, or one negative between each positive and the next, the same as they are arranged in the finished battery.

Direct current from a D. C. generator or line is then passed through the forming tank, being careful to connect the terminals so that the current flows

into the tank at the positive plates and out at the negative plates. In other words connect the positive terminal of the line or generator to the positive plate group.

The paste in the positive plates where the current enters will be changed to lead peroxide or  $PbO_2$ , while the paste on the negative group at which current leaves will be changed to sponge lead or  $Pb$ .

When the electrolyte begins to gas or bubble quite freely and the voltage between the positive and negative groups tests between 2.1 and 2.2, the plates are fully formed.

When the forming process is completed the plates are dried and are then ready for use in a battery.

### 4. STORAGE BATTERY CONSTRUCTION AND PARTS

So far we have discussed only the plates, which are the most important part of any storage battery. To complete the battery, however, requires a number of additional parts, such as container, jars, separators, connector straps, terminals, cell covers, etc.

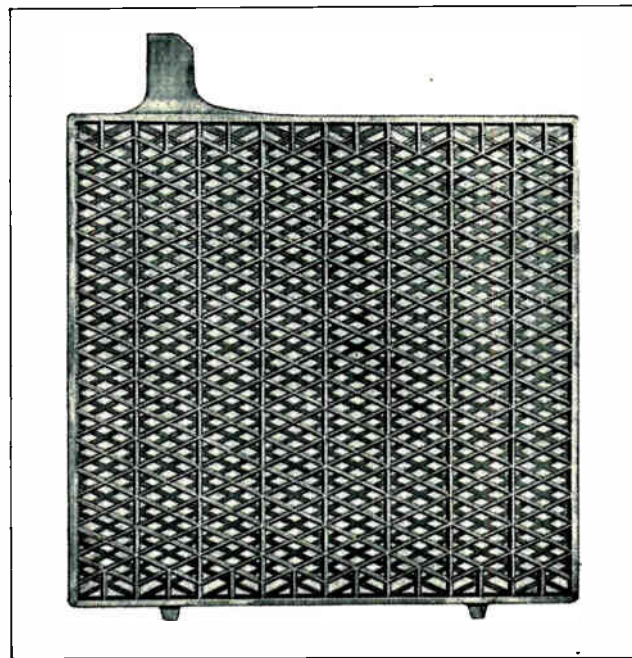

Fig. 4. Photo of another type of grid of the diamond type construction. The lead bars serve both as a frame to hold the paste or active material and as conductor to carry the current from the active material to the plate lug. (Courtesy of Philadelphia Battery Co.)

Fig. 6 shows a number of these parts required for a complete battery. On the extreme left and in the background is a complete cell and in front of this and to the right are shown two more positive and negative plate groups assembled together. In the center is shown a wood battery box or case and in front of it a stack of wood separators and two cell connector straps. On the right are shown two empty cell containers or jars with their covers and vent caps.

In constructing a storage battery of the lead plate type a number of positive plates are connected to-

gether by burning or welding them to a lead connector strap equipped with a terminal post, as shown in the lower left view of Fig. 5.

The number of plates selected depends on the size and capacity of the cell to be built. The greater the number or total area of the plates the greater will be the capacity of the cell.

A group of negative plates consisting of one more than the number of positives is then fastened together in the same manner and the positive and negative groups meshed together, as shown in the left foreground of Fig. 6.

The reason for always having one more plate in the negative group of a cell than in the positive group is because the capacity of cells is rated and determined according to the number and size of positive plates, and in order to work both sides of the positives it is necessary to have a negative plate on each outer side of the positive group, and this requires one additional negative in each cell.

The voltage of any single cell or group of positive and negative plates is slightly over 2 volts in the ordinary lead plate battery when fully charged. Lead plate cells are usually classed as 2 volt cells. The standard automobile battery consists of three such cells connected in series, and develops 6 volts. Twelve-volt batteries have been used to some extent for automotive work but are rapidly becoming obsolete, because of the tendency of car manufacturers to standardize on six-volt starting and lighting systems.

Fig. 7 shows three groups of positive and negative plates assembled together for a three-cell bat-

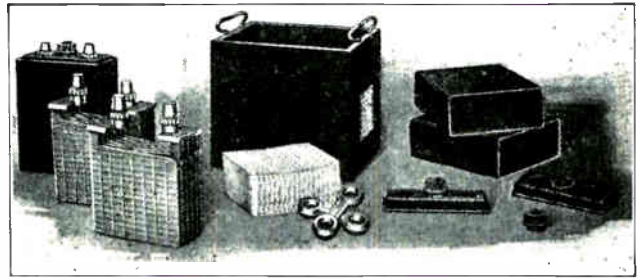

Fig. 6. This view shows the more important parts of a lead plate storage battery for automotive use. Note carefully these various parts when reading the accompanying paragraphs. (Courtesy of Universal Battery Co.)

tery. Such positive and negative groups are called elements.

## 5. SEPARATORS

After the positive and negative groups are fitted together as explained, the positives must be insulated from the negatives by inserting thin wood or rubber separators between them.

These separators are used to keep the plates from touching each other and thereby forming internal short circuits. The separators must be porous so the electrolyte can pass through them and so that they will offer the least resistance to the passage of current. They must also be designed to allow free circulation of electrolyte over the surface of the positive plates.

Although separators are made of both wood and rubber the wood separator is most generally used. Cedar and cypress separators are generally used because of their porosity which reduces the internal resistance of the cell, and because of their ability to resist the action of the acid in the electrolyte.

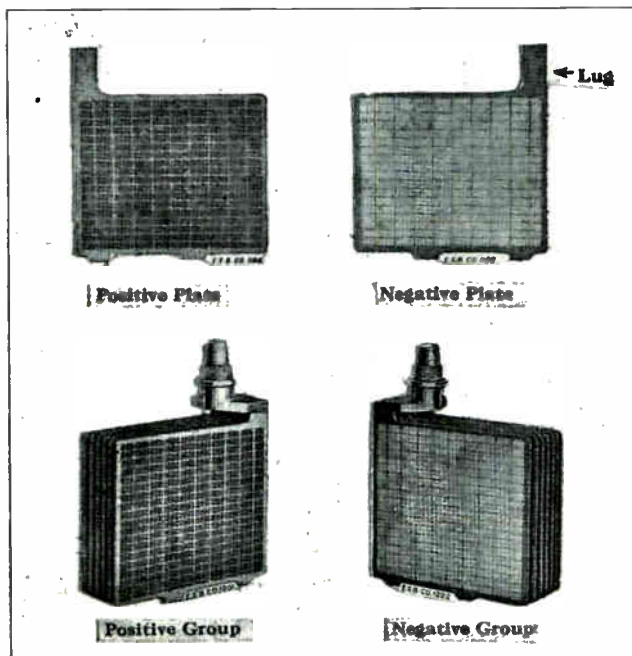

Fig. 5. The above views show completed or pasted plates of both positive and negative types. Single plates are shown above, and below the plates are shown grouped or connected together to the cell terminals. (Courtesy of Electric Storage Battery Co.)

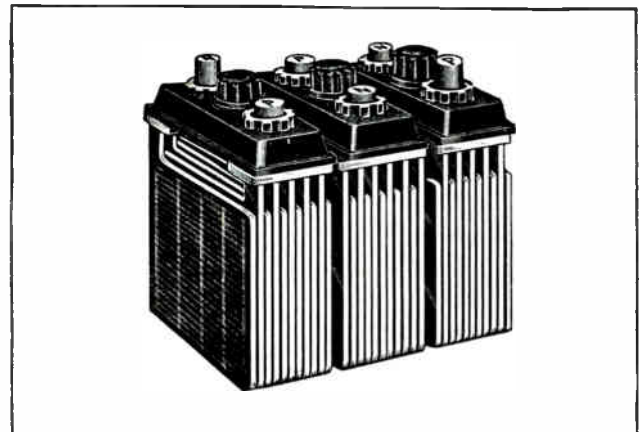

Fig. 7. Above are shown three groups of positive and negative plates assembled together and ready for separators before being placed in the cells of a battery.

Separators made of basswood and of hardwood are also sometimes used.

Separators are provided with grooves on one side and when inserted between the plates they should always be placed with the grooved side next to the positive plates and with the grooves running vertically, or up and down, so as to provide free circulation of the electrolyte.

After being sawed and grooved, cedar and cypress separators are always treated in a hot alkaline solution and then washed thoroughly. The purpose of this treatment is to remove certain substances from the wood which would otherwise form acetic acid if not removed. Acetic acid interferes with proper chemical action in the battery and may also damage the battery as it tends to corrode the lead. Sometimes plate lugs are so weakened and corroded due to presence of this acid that the plates drop off the lugs. The treatment also tends to increase the porosity of the separators and thereby reduce their resistance to the passage of current through the cell.

As the separators are treated at the factory where made they are shipped wet or damp and must be kept damp until they are put into service. If they are kept in water a small quantity of sulphuric acid should be put in the water to prevent the separators from becoming slimy or moldy.

Fig. 8 shows several different styles of wood separators with grooves of different sizes and various spacings.

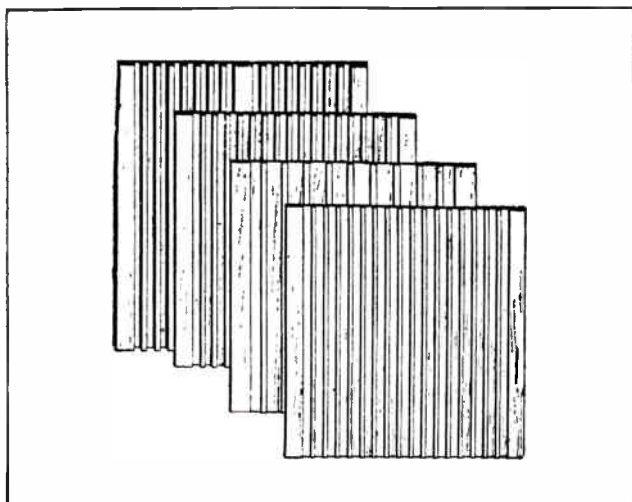

Fig. 8. Several different sizes of wood separators with different types of grooves. These separators are used to insulate the positive and negative plates from each other and prevent them from short circuiting within the cells.

When separators are fitted between the positive and negative plates they should be trimmed and set so that their tops will come at least  $3/16$  or  $1/4$  of an inch above the tops of the plates, in order to prevent short circuits that might otherwise be caused by foreign material dropping in the cell through the vent opening when the vent plugs are removed.

Special cutters or separator trimmers can be obtained for trimming wood separators to proper size. A separator trimmer consists of a flat board with a knife attached to its edge by a hinge, so that separator edges can be sheared off by placing them on the board under the knife.

Another type of separator developed by the Willard Storage Battery Company is known as the threaded rubber separator. This separator is made of a thin sheet of hard rubber which has a large number of short threads placed crosswise through the

rubber when the separator is molded. These threads number over 6000 to the square inch and serve as wicks to allow the electrolyte to circulate through the separator, and also to afford a path for the passage of current through the acid soaked threads.

The threaded rubber separator has ribs or corrugations on one side which correspond to the grooves on wood separators. When installed between the plates the ribbed side of the rubber separators must be placed next to the positive plates with the ribs running vertically, or up and down.

## 6. RETAINERS AND ISOLATORS

Some battery makers use thin perforated sheets of hard rubber about  $1/64$  of an inch thick, which are placed between the ribbed side of the wood separator and the positive plates. These thin rubber sheets are called retainers and are used to prevent the active material from shedding or falling out of the grids of the positive plates.

These retainers, however, have the disadvantage of a tendency to clog up, and thus increase the internal resistance of the cell.

One large battery manufacturing company uses additional notched strips of hard rubber which are fitted into slots cut in the edges of the grids. These strips are called Isolators and are for the purpose of locking the edges of the plates rigidly in position to prevent warping and distortion of the plates with age or severe use.

The use of these isolators doesn't eliminate the necessity for separators but the isolators give a great deal of added strength and rigidity to the plate groups, and prevent the plates buckling and cutting

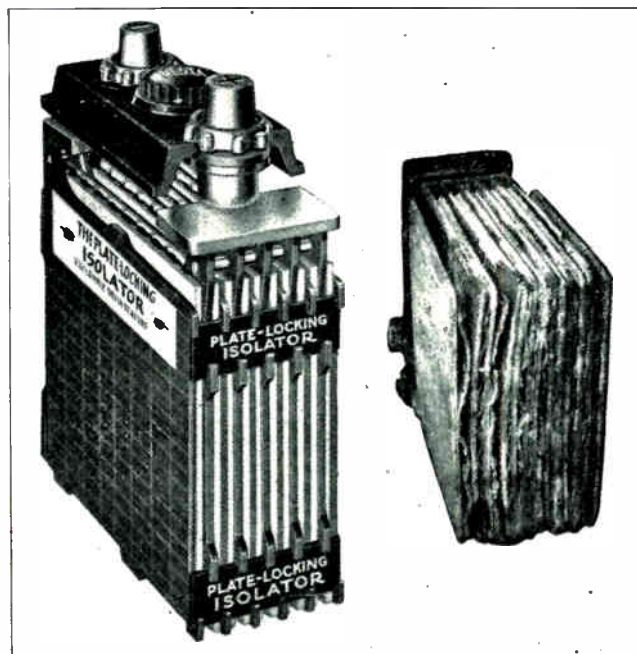

Fig. 8A. This photo shows on the left an excellent view of a cell element equipped with isolators for holding the plates in position and preventing warping or buckling; and on the right is shown a group of badly warped plates which were not equipped with isolators of this type. (Courtesy of Vesta Battery Co.)

through the separators where the plate corners would otherwise become warped against them.

When a separator becomes worn through by pressure from warped plates it allows the plates to short circuit and puts the cell out of commission.

The view on the left in Fig. 8-A shows an element or group of positive and negative plates equipped with isolators, and on the right in this same figure is a group of badly warped plates showing what may happen to a plate group that is not equipped with isolators.

The position of the wood separators and the manner in which their tops are allowed to project slightly above the plate tops are also shown in the left view of Fig. 8-A.

Isolators were formerly made from celluloid, but the disadvantage of this material was its tendency to melt or dissolve at high temperatures, so hard rubber is the material now used.

## 7. CELL CONTAINERS AND BATTERY CASES

After an element or group of positive and negative plates has been assembled with separators it is ready to be placed in the cell container. Each cell must, of course, be insulated and separated from the other cells in the battery, and the containers used for this purpose must be acid-resistant and able to withstand a certain amount of mechanical abuse and vibration.

Hard rubber meets this condition very well as it resists the action of the acid and is fairly tough and strong. Glass is also acid resisting and can be used in the construction of batteries for stationary use where they are not subjected to any mechanical abuse or severe vibration.

Fig. 9 shows a hard rubber jar or cell container on the left and a rubber jar cover on the right. Ribs or ridges about one inch high are provided in the bottoms of these jars to strengthen them and also to keep the plates up off the bottom of the cell, and prevent their being shorted by any active material which may shed from the plates during use and settle to the bottom on the container. The ribs in the jar bottoms form spaces in which this loosened active material settles and prevent it from reaching the lower edges of the plates.

Until recent years automotive battery cell groups

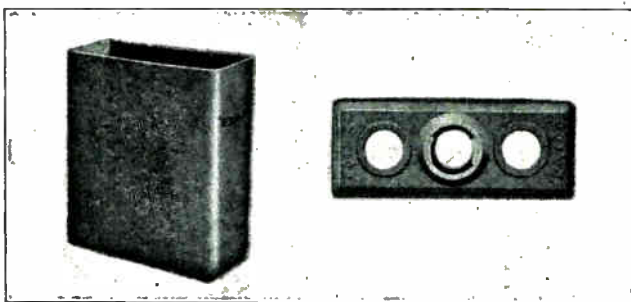

Fig. 9. This view shows a common type of hard rubber cell jar and cover such as used in automobile batteries with wood cases.

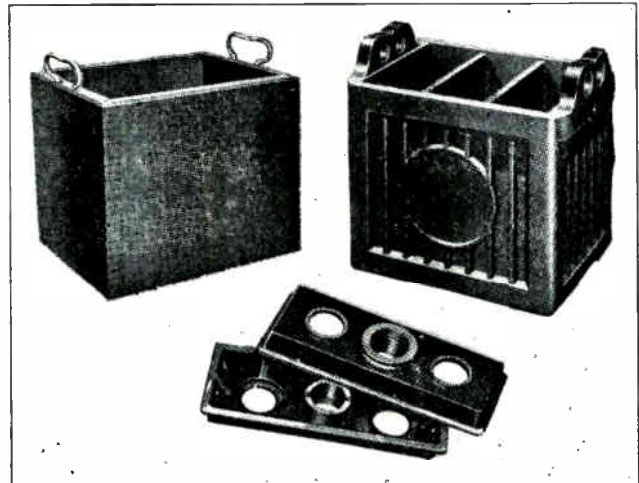

Fig. 10. Above are shown two types of cases commonly used with automobile batteries. The one on the left is made of wood and the one on the right is made of molded hard rubber. Two-cell covers are shown beneath the cases.

or elements were all placed in individual jars of this type and the three or six jars, or complete cells, then mounted in a wood box such as shown on the left in Fig. 10.

Wood battery cases have the disadvantage of being subject to rotting and rapid deterioration due to the action of the acid fumes or any acid spilled upon them. Their life can be greatly prolonged by coating the wood with acid-proof paint, but even then wood cases are not very satisfactory for automotive batteries or other uses where they receive rough treatment.

A much better battery case which has come into very general use for automotive and radio batteries in the last few years is the hard rubber case, such as shown on the right in Fig. 10. These cases are not affected by acid and, therefore, last much longer than wood cases and they are very strong and compact.

You will note that the cell partitions of hard rubber are built right into these cases so they do not require separate cell jars but are complete when fitted with rubber cell covers, such as shown beneath the cases in Fig. 10. These covers are used to close the tops of the cells and keep out dirt, water, etc., and to prevent spilling of the electrolyte.

The covers are each provided with three openings. One in the center for the vent and filler cap and one near each end for the terminal posts of the plate groups to project out to the connectors. The sides of the covers are so shaped that when they are installed in a jar or case a V-shaped space or groove is formed all around their edges between the cover and the side of the battery. Into this groove is poured hot sealing compound which hardens as it cools and forms an acid-resistant seal between the cover and container.

Fig. 11 shows two complete automobile batteries. The one above being built in a wood case and the one below in a rubber case.



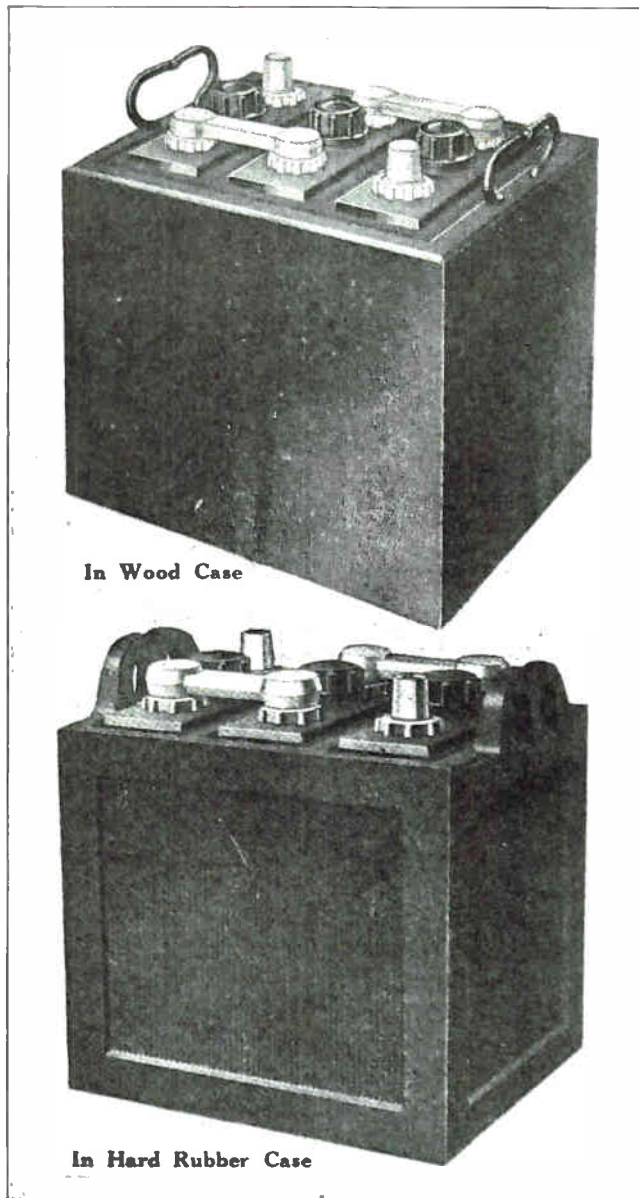

Fig. 11. Top view shows a completed wood case battery of the 3-cell, 6-volt type, and below is shown a complete battery of the same type but in a rubber case.

## 8. ELECTROLYTE

After a new battery is completed or an old one repaired each cell must be filled with electrolyte, and the level of this electrolyte should always be kept from  $\frac{3}{8}$  to  $\frac{1}{2}$  inch above the tops of the plates.

The electrolyte used in lead plate storage batteries consists of chemically pure sulphuric acid ( $H_2SO_4$ ) and distilled water. A commercial grade of acid should never be used, as it contains certain impurities which may cause local action and rapid deterioration of the battery plates even when the battery is not in use. For the same reason distilled water only should be used, as ordinary well water or water from a faucet contains chemicals that are detrimental to battery action and life. You will recall from an earlier article on primary cells that local action is caused by impurities in the plates or electrolyte,

setting up local short circuits or small active cells at various spots on the plate surface wherever the impurities lodge or collect.

## 9. SPECIFIC GRAVITY

The term specific gravity has already been mentioned and is one with which we should become thoroughly familiar at this point. Specific gravity refers to specific weight of any liquid or substance compared to the weight of an equal volume of pure water, or, in other words, the ratio of the weight of the substance to the weight of an equal volume of water.

The specific gravity (S. G.) of pure water is assumed to be 1, usually written 1.000, and is used as a standard for comparing the weights of similar volumes of other materials and thus establishing their specific gravity.

One pint of water weighs approximately one pound and one pint of sulphuric acid weighs 1.835 pounds. So we say the specific gravity (S. G.) of sulphuric acid is 1.835. This shows us the acid is about 1.8 times heavier than water.

## 10. HYDROMETERS

The specific gravity of any liquid can be easily and quickly determined by means of a device called a hydrometer.

Fig. 12 shows a hydrometer on the left, and in the view on the right one of these devices is shown in use to test the specific gravity of the electrolyte in a battery.

A hydrometer consists of a glass tube syringe containing a small float inside of the glass tube as shown in Fig. 12. The float is weighted at the bottom end so that it will float upright when the outer

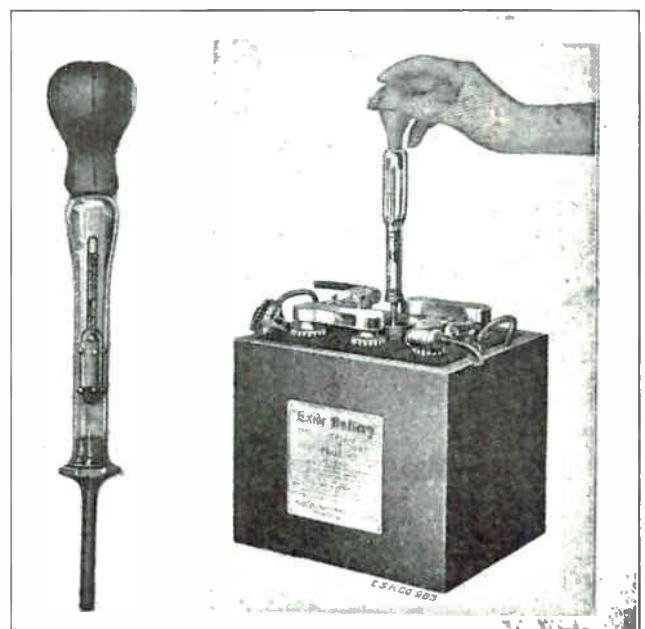

Fig. 12. On the left is shown a common battery hydrometer. Note the small float within the glass barrel of the hydrometer and also the rubber bulb on the top for drawing in the electrolyte. The view on the right shows the method of using a hydrometer for testing the electrolyte of a battery.

tube is filled with liquid which has been drawn in by the rubber bulb. The upper end of the float is marked with a graduated scale from 1.100 to 1.300 for ordinary automotive battery testing.

In speaking of specific gravity or hydrometer readings for battery electrolyte, instead of stating the figure in full as a fraction, we generally drop the decimal and shorten the expression. For example the reading 1.200 would be called twelve hundred, and the reading 1.275 called twelve seventy-five, etc. The decimal is also commonly left out of the figures marked on the scales of battery hydrometers.

In order to indicate the specific gravity of the liquid which is drawn into the hydrometer tube, the float is weighted just the right amount so that it would float in water with the mark 1 just at the surface of the water. Sulphuric acid being heavier than water the float will not sink as far in the acid but will float higher, and the specific gravity of the acid can be read at the float mark which is at the surface of the acid.

In using a hydrometer the bulb is depressed and the syringe tip immersed in the liquid to be tested. Releasing the bulb then draws the large glass tube partly full of liquid and causes the float to rise. Care should be taken to see that the float doesn't stick to the glass tube but rises freely in the liquid. If too much liquid is drawn into the hydrometer the top of the float may be held against the top of the syringe tube or up in the bulb, and some of the liquid should be forced out so that the float will ride freely at a convenient level for reading.

As the amount of acid in the electrolyte of a storage battery varies during charge and discharge and thereby varies the gravity of the electrolyte, hydrometer readings are a good indication of the state of charge. This method of testing will be explained later.

## 11. PREPARATION OF ELECTROLYTE

In preparing electrolyte for lead plate storage batteries for automobile use sufficient water is mixed with the sulphuric acid to bring its specific gravity to about 1.280 or 1.300 according to the strength desired. Sulphuric acid can be obtained in the concentrated form (1.835 specific gravity) but is more generally supplied partly diluted to 1.400 specific gravity for use in preparing battery electrolyte.

When mixing concentrated or 1.835 S. G. sulphuric acid and distilled water always add the acid to the water slowly, and stir the solution continuously while adding the acid.

If the water is added to the acid the mixture will heat up so much that it may break the container and injure the operator, or the violent boiling may splash acid in one's eyes.

Sulphuric acid even in its diluted form in battery electrolyte is very injurious to clothing and will burn the skin of the hands if not immediately

washed off. Strong sulphuric acid is very dangerous if carelessly handled and allowed to splash into the eyes or on the face and hands of the operator. Ammonia and strong soda water are good neutralizers for this acid, and should always be on hand and immediately used to wash off any acid from the flesh or clothing in case of an accident.

Mixing of electrolyte should be done in an acid-proof container of hard rubber, glass, earthenware, or lead. A wooden paddle or glass rod should be used to stir the solution. Don't use metals for this purpose.

The electrolyte should be allowed to cool below 90° F. before being put in battery cells.

When preparing electrolyte with prediluted sulphuric acid of 1.400 S. G. and distilled water it doesn't matter which one is poured into the other,

MIXING ELECTROLYTE BY VOLUME				
WATER		DILUTED ACID		SPEC. OF ELECTROLYTE
ADD 3% 4% 5% 6%	PINTS OF DISTILLED WATER	TO 1 GAL. OF 1.400 ACID	FOR 1.300 ELECTROLYTE	
4%	1	1	1	1.280
5%	1	1	1	1.275
6%	1	1	1	1.270
7%	1	1	1	1.265

Fig. 13. This convenient small table shows the amount, by volume, of water and acid to be mixed together to produce battery electrolyte of four different strengths.

but care should be used not to mix large quantities too fast and it is well to stir the solution while mixing.

A convenient table for preparing battery electrolyte from 1.400 S. G. acid is shown in Fig. 13. This table shows the number of pints of distilled water to be added to each gallon of 1.400 acid to produce electrolyte ranging from 1.300 to 1.260 S. G.

Another convenient table for mixing electrolyte ranging from 1.120 S. G. to 1.400 S. G. from concentrated acid of 1.835 S. G. is shown in Fig. 14. This table gives the amounts of water both by volume and by weight so that either method of measuring can be used according to which is most convenient. The table also gives in the last column the percentage of sulphuric acid in the electrolyte solution.

## 12. TEMPERATURE CORRECTION

You will note that in the table in Fig. 14 the temperature of both the acid and electrolyte is speci-

SPECIFIC GRAVITY OF SOLUTION OR ELECTROLYTE AT 70° F.	PARTS OF WATER TO 1 PART OF C. P. SULPHURIC ACID 1.835 SP. GR. AT 70° F.		PERCENTAGE OF SULPHURIC ACID IN SOLUTION
	MIXING TABLE		
	BY VOLUME	BY WEIGHT	
1.120	8.00	4.40	17.40
1.150	6.15	3.35	21.40
1.180	4.95	2.70	25.20
1.200	4.33	2.36	27.70
1.220	3.84	2.09	30.20
1.250	3.22	1.76	33.70
1.270	2.90	1.57	36.10
1.280	2.75	1.49	37.30
1.300	2.47	1.34	39.65
1.350	1.95	1.06	45.20
1.400	1.56	0.84	60.50

Fig. 14. This table shows the amounts, both by volume and by weight, of water and full strength acid which should be mixed together to produce electrolytes of different specific gravities.

fied to be 70° F. This temperature is mentioned because all hydrometer readings are based on an electrolyte temperature of 70° F., due to the fact that at other temperatures the readings will change, because the liquid expands and becomes lighter for a given volume when heated and contracts and becomes heavier when cooled.

As the weight or density of the liquid determines the height at which the hydrometer float will rest in the liquid and the reading which will be obtained, we can readily see that the temperature of the electrolyte will affect the hydrometer readings.

This is a very important point to remember when making hydrometer tests on electrolyte during mixing, or on the electrolyte of batteries that may have become overheated during use or charging, or that may be extremely cold or warm due to climatic conditions.

For correcting hydrometer readings according to the temperature of the electrolyte a device called a correction thermometer is commonly used. Fig. 15 shows a thermometer of this type which can be inserted in the electrolyte when mixing or into the electrolyte of the battery through the vent opening.

This correction thermometer has two scales. The scale on one side being used for the temperature readings and the one on the opposite side is the correction scale.

The reading on the correction scale at the point where the thermometer indicator line rests will give the number to add to or subtract from the hydrometer readings to get the corrected reading. The scale also shows by a + or - sign before each figure whether the number should be added to or subtracted from the hydrometer reading.

A convenient rule to use in making temperature corrections when a correction thermometer is not available but the temperature of the battery or electrolyte is known is as follows:

For every three degrees above 70° F. one point is added to the hydrometer reading, and for every three degrees below 70° F. one point is subtracted from the hydrometer reading.

For example, if we have electrolyte at a temperature of 100° F. and the hydrometer shows a reading of 1.270, then the electrolyte temperature being 100°, or 30° above 70°, we will divide 30 by 3 and find that 10 points must be added for correction of the hydrometer reading. Then  $1.270 + 10 = 1.280$  or the correct gravity reading.

### 13. CHEMICAL ACTION IN CELLS DURING CHARGE AND DISCHARGE

In order that you may more fully understand some of the tests used with storage batteries and be able to recognize certain trouble symptoms and give the batteries the proper care, it will be well at this point to consider the action that takes place within the cells while they are charging and discharging.

It is also particularly valuable to know the condition of the plates and electrolyte both in charged and discharged condition. Let us start first with a new battery that is fully charged and consider the action that takes place during discharge.

When a lead plate battery is fully charged the active material in the positive plates is in the form of lead peroxide and is brown in color. In the negative plates the active material is in the form of sponge lead which is gray in color. The electrolyte will be at maximum density which is between 1.280 and 1.300 S. G. for automotive batteries.

With the battery in this condition the open circuit voltage of each cell will be between 2.1 and 2.2 volts. Now if the cell is connected in a closed electrical circuit current will flow due to this voltage or pressure, from the positive terminal of the cell through the circuit, and back to the negative terminal.

As the cell discharges certain chemical changes take place within it. The acid in the electrolyte is gradually absorbed by the plates in the process of changing the lead peroxide and sponge lead into lead sulphate. Thus the plates which were unlike when the cell was charged tend to become alike on discharge, or both change to lead sulphate.

The specific gravity or density of the remaining electrolyte decreases in proportion to the acid absorbed by the plates, so as the discharge progresses the electrolyte becomes weaker and weaker. When

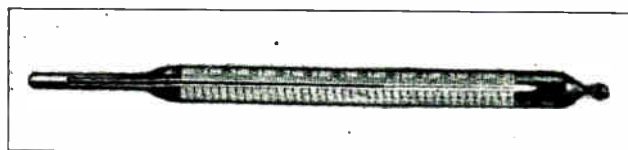

Fig. 15. Convenient type of battery thermometer for making corrections in hydrometer readings according to temperature of electrolyte.

the specific gravity shown by the hydrometer reading drops to 1.150 if we test the cell voltage with a voltmeter, while the cell is discharging at the normal eight hour rate, you will find that it is down to about 1.7 or 1.8 volts, and we then consider the cell discharged.

So we find that in a discharged cell we have two conditions to observe. First, the active material on both plates has been changed to lead sulphate. Second, the density or specific gravity of the electrolyte is very little above that of pure water. It is, of course, possible to obtain considerable current from a battery after the cell voltage has dropped below 1.7, but it is generally not considered practical and is not good for the battery to discharge it much below this point. So when the voltage drops this low and the hydrometer readings show about 1.150 the batteries should be recharged.

During charging a reverse action to that which occurred during discharge takes place. To charge a cell direct current is sent through it in a direction opposite to the flow of current when the cell was

discharging. This causes the sulphuric acid to be driven out of the plates back into the electrolyte, thus raising the density or specific gravity again. At the same time the lead sulphate in the positive plates is changed back into lead peroxide and the lead sulphate on the negative plates changed back into sponge lead.

When practically all of the acid has been driven out of the plates and the lead sulphate converted into lead peroxide and sponge lead the cell is said to be fully charged, and should show a specific gravity reading of between 1.280 and 1.300 and a cell voltage of 2.1 and 2.2 on open circuit test.

When the cells are fully charged some bubbling or "gassing" of the electrolyte will be noticed. This is due to the fact that when the charging current has no more lead sulphate to work on, it will convert the water in the electrolyte into hydrogen and oxygen gas which will come to the surface of the electrolyte in the form of small bubbles, thus indicating that the cell is about fully charged.

#### 14. CHEMICAL TERMS AND FORMULAS OF BATTERY ACTION

While it is of no great importance to the average battery service man to know the exact chemical reaction that takes place within the batteries during charge and discharge, it is often very interesting to know this action as described in chemical terms.

The chemical reaction which takes place in the cell during charge and discharge can be described as follows:

We know that the electrolyte is composed of sulphuric acid and water, or  $H_2SO_4$ , the  $H_2$  representing two parts of hydrogen gas, S one part of sulphur, and  $O_4$  four parts of oxygen. The lead peroxide on the positive plates consists of  $PbO_2$ , in which Pb represents one part of lead and  $O_2$  represents two parts of oxygen. The sponge lead on the negatives can be represented by the chemical symbol Pb which is one part of lead.

The lead sulphate which is formed on both positives and negatives during discharge is designated by the symbol  $PbSO_4$ , in which Pb represents one part of lead, S one part of sulphur, and  $O_4$  four parts of oxygen.

The action which takes place in the positive plate during discharge, or the uniting of the lead peroxide with hydrogen and sulphuric acid from the electrolyte, can be chemically explained as follows:

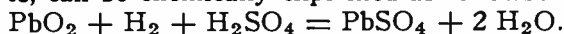

The action on the negative plates during discharge, or the uniting of sponge lead with sulphuric acid to form lead sulphate, is described as follows:

$$Pb + SO_4 = PbSO_4.$$

The action on the positive plate during charging and when current is sent backwards through the solution and plates, causing the chemical elements to reunite into their original form, is as follows:



The action on the negative plate during charge is  $PbSO_4 + H_2 = Pb + H_2SO_4 + O.$

As previously stated no particular effort needs to be made to study these chemical formulas, and they are given here only for convenient reference in case special questions arise regarding them.

#### 15. BATTERY TESTS

There are a number of different tests which can be made easily with hydrometer, voltmeter, ammeter, etc., to determine quite accurately the condition of lead plate storage batteries. These are of particular value for the practical battery service man to know.

This lesson should be carefully studied until you are sure you are thoroughly familiar with methods of making each test and the battery conditions indicated by them.

One of the most commonly used tests on storage batteries is the gravity test which is made with a hydrometer as previously described. In the preceding article we found that the specific gravity of the electrolyte in a battery changes considerably as the battery charges or discharges.

The gravity increases as the acid is driven out of the plates and into the solution during charge, and decreases as the acid is absorbed from the electrolyte by the plates during discharge. So we can readily see that a hydrometer reading taken at any time will indicate the approximate condition of charge or discharge.

Automotive batteries are commonly made so that when they are fully charged the specific gravity of the electrolyte will be 1.280 to 1.300, and when the gravity drops to 1.150 they are considered to be practically discharged and should be put on charge immediately as it is very harmful for a battery to stand in a discharged condition.

Automotive batteries built for use in tropical climates are made so that they are fully charged at about 1.200 S. G. The reason for this is that in such climates there is no danger of freezing, and the electrolyte being always warm is more active.

Furthermore electrolyte of the same acid strength will give a lower gravity reading because of its expanded and less dense condition at the warm temperatures.

The convenient chart in Fig. 16 shows the conditions indicated by various gravity readings. Fig. 16-A shows the position of a hydrometer float in

BATTERY CONDITIONS INDICATED BY GRAVITY TESTS			
1.150 Sp. Gr. -----	DEAD	} AUTO BATTERIES IN TEMPERATE CLIMATES	} ELECTROLYTE TEMPERATURE AT 70°F.
1.215 Sp. Gr. -----	1/2 CHARGE		
1.280-1.300 Sp. Gr. ----	FULL "		
1.200 Sp. Gr. -----	FULL CHARGE	} AUTO BATTERIES IN TROPICS	
1.225 Sp. Gr. -----	" "		

Fig. 16. Chart showing conditions of charge indicated by various hydrometer readings on lead plate storage batteries in different climates.

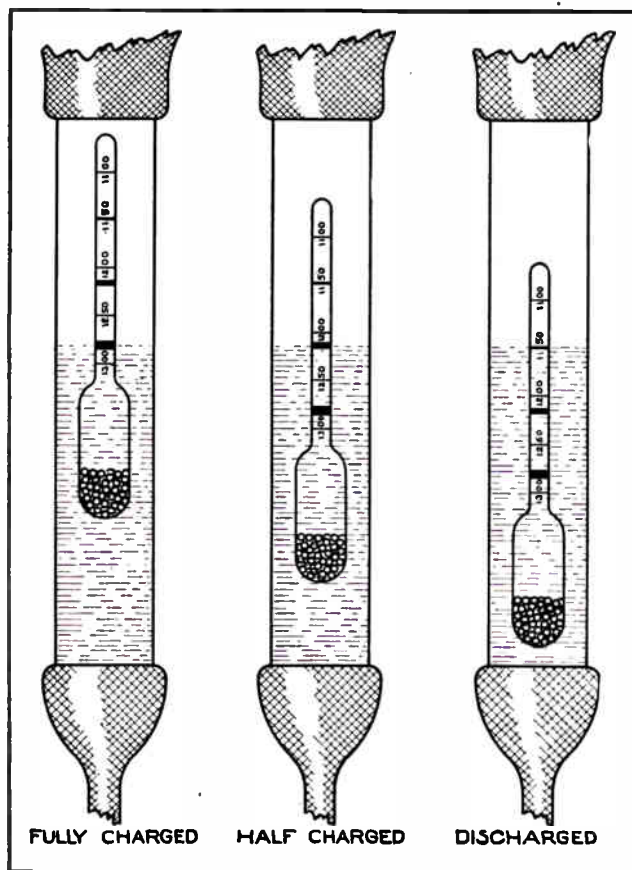

Fig. 16A. This drawing clearly shows how to read an ordinary battery hydrometer. Study each of the three views very carefully while reading the accompanying explanation.

three samples of electrolyte taken from charged, half charged, and discharged batteries. Careful observation of the hydrometer sketches in this figure will be of great assistance in learning to properly read these devices.

## 16. VOLTAGE TEST

While the hydrometer test must be used to determine the condition of the electrolyte and is generally a rather good indication of the state of charge of a battery, it is not altogether reliable for this latter purpose.

We know that there should always be a definite relation between the voltage of a cell and the specific gravity of its electrolyte, but in some cases the gravity of the electrolyte may have been altered by adding strong acid or by replacing a large quantity of spilled electrolyte with distilled water.

In either of these cases a gravity reading would not be an accurate indication of the true condition of the cell. So a voltage test made by connecting the terminals of a low-reading voltmeter across a cell or battery is a more reliable means of determining whether the battery is fully charged or not, and whether the positive and negative plates have been made as unlike as possible by the charging current; because it is only when the active material of these plates is fully converted back to its original charged

state that the voltage between the positive and negative terminals will be at maximum.

Comparing such a voltmeter reading with the hydrometer reading will also indicate whether the electrolyte is overrich or weak. For example, if the electrolyte shows a S. G. of 1.280 or 1.300 and a voltmeter only shows a reading of 1.8 volts per cell, this indicates that the electrolyte is too rich in acid and should be diluted with distilled water.

On the other hand if the voltmeter indicates a cell voltage of 2.2 and the hydrometer reading shows the gravity of the electrolyte to be only 1.230, this indicates that the electrolyte is too weak and should be slightly strengthened by adding more acid.

## 17. ON-THE-LINE VOLTAGE TEST

Voltmeter readings obtained when testing a battery will vary somewhat according to whether the battery is charging, is open-circuited and disconnected from the charging line, or is discharging under load.

The on-the-line voltage test is made while the battery is connected in the charging line and charging. At the end of the charge or when the cell is about fully charged the maximum cell voltage on this test will be about 2.5 volts. This voltage indicates a complete chemical change of the material in the plates. Old batteries often do not rise above 2.3 volts per cell on this test due to the negative plates retaining some of their lead sulphate.

Once the voltage of the cell reaches 2.5 volts there can be no further rise of gravity since the plates are free from lead sulphate. If the gravity is below or above the full charge specific gravity of the cell it should be corrected by adding acid or water accordingly.

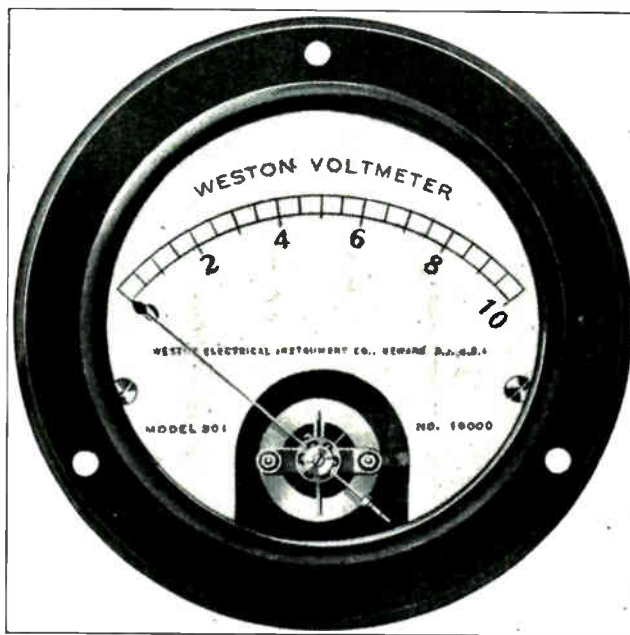

Fig. 17. Popular type of low reading voltmeter which can be mounted on a bench, panel, or portable test panel, and used for testing the voltage of storage cells or batteries. (Photo courtesy of Weston Electrical Instrument Co.)

It is not advisable to attempt to correct the density or gravity of the electrolyte before bringing the voltage up to maximum by charging.

### 18. OPEN CIRCUIT VOLTAGE TEST

As soon as a battery is removed from the charging line the cell voltage drops rapidly until it reaches 2.1 volts in from 5 to 10 minutes. This is caused by a thin layer of lead sulphate forming on the surface of the negative plates and between the grid and lead peroxide of the positive plate, due to a slight chemical or discharge action which occurs within the cell as soon as the charging circuit is broken.

Once this thin layer of lead sulphate is formed the rapid voltage drop ceases due to the resistance of the lead sulphate film. This discharge or local action doesn't cease entirely, however, and a lead plate cell will not stay charged indefinitely but will gradually become discharged even though not connected to any circuit or load. An idle lead plate battery will become discharged in about 100 days of idleness if not charged during the idle period.

During discharge of the battery, lead sulphate is formed on both groups of plates and causes the open circuit voltage to drop. Theoretically a cell can be discharged to zero voltage, but for all practical purposes the discharge should be stopped when the

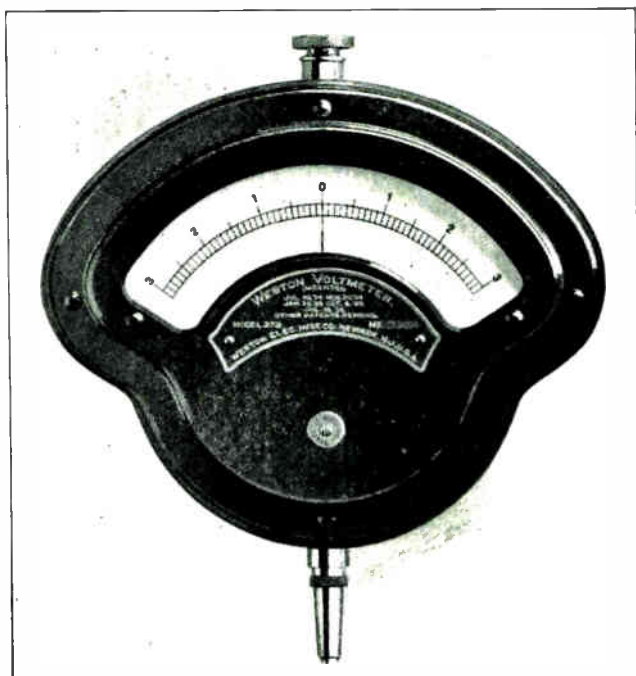

Fig. 18. Convenient type of portable voltmeter for testing the voltage of single cells. (Courtesy of Weston Electrical Instrument Co.)

cell voltage drops to 1.7 volts as indicated by a voltmeter test made with the battery discharging at the 8 hour rate.

If the discharge is carried beyond this point, so much of the active material will be converted into lead sulphate that the plates will be almost useless. The plates are then said to be sulphated. Plates

which have been allowed to get into this condition require a long slow charge to free them of all the lead sulphate.

Fig. 17 shows a D. C. voltmeter of the type which can be conveniently used for testing storage batteries. You will note that this meter has a low reading scale so that quite accurate tests can be made on one cell or on several cells of a complete three-cell battery. This meter can be equipped with flexible test leads and points and either mounted on a wall or bench, or carried to a car to make tests on the battery before removing it. A portable meter in a wood case is also very convenient for testing batteries while in the car.

Fig. 18 shows another type of battery voltmeter particularly adapted for portable use. This instrument has a test point or prod directly attached to its lower side and forming one terminal of the meter.



Fig. 19. This view shows a pair of test leads, one of which is equipped with a Cadmium stick for making Cadmium tests on storage batteries.

The other terminal on top of the case can be fitted with a flexible lead and test point. This meter has a scale which will allow the needle to read in either direction and only up to a maximum of 3 volts, thus giving very accurate readings on the low voltage of single cells.

### 19. CADMIUM TEST

The Cadmium method of testing a battery is very reliable as it reveals the actual condition of the plates better than any other test. With the Cadmium test we can determine two important facts regarding the condition of the battery.

1. Whether or not the capacity of both positive and negatives are equal.
2. Whether the battery is charged or discharged.

This test also serves as a check on both the voltage and specific gravity. The Cadmium test derives its name from the fact that a stick of cadmium metal is used in place of the usual negative voltmeter test point.

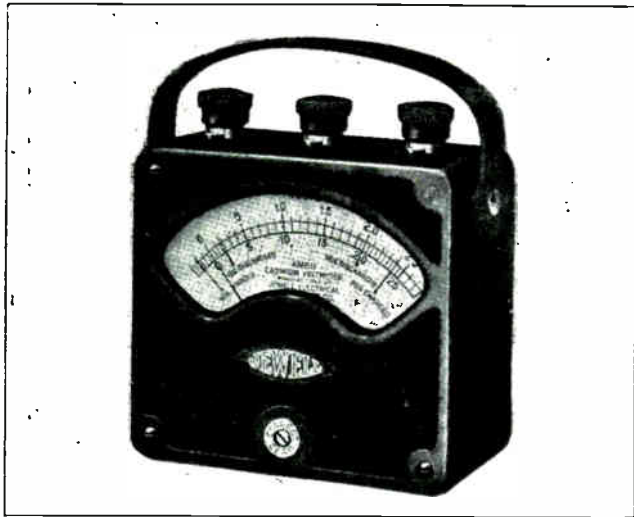

Fig. 20. Convenient portable voltmeter with special scale for making Cadmium test on lead plate battery. (Courtesy of Jewel Electrical Instrument Co.)

Fig. 19 shows a pair of voltmeter leads and test points for use in making cadmium tests. You will note the small round rod or stick of cadmium metal attached to the test point on the left.

This cadmium is a metallic element and not a mixture or alloy, and convenient small rods or cadmium sticks can be purchased from any battery material supply house.

When the cadmium stick is placed in the electrolyte of a cell with a voltmeter connected between the stick and one of the cell terminals, a definite voltage will be set up due to the difference in chemical action of the acid on the cadmium stick and the battery plates.

If the voltmeter is connected between the cadmium stick and the negative plates or terminal the voltage reading will vary according to the condition of the plates. If the plates are pure sponge lead or fully charged the voltage will be about .1 volt, the cadmium stick being positive and the plates negative in polarity. In this case the reading will be to the left side of zero on the voltmeter scale.

If the voltmeter is connected between the cadmium stick and the positive plates or terminals a different reading will be obtained. If the plates are pure lead peroxide or fully charged the voltage reading will be 2.4 volts and the cadmium stick will now be negative to the lead peroxide or positive plate.

When the cadmium stick is used in combination with lead sulphate or discharged plates a still different voltage will be obtained, all depending on the amount of lead sulphate on the plates tested.

Fig. 20 shows a voltmeter with a specially marked scale for cadmium tests, and Fig. 21 shows an enlarged drawing of the scale of a meter of this type.

Voltmeters for this work should be of high resistance for cadmium tests and should have a scale calibrated from 0 to 2.7 volts to the right of zero,

and .3 volt to the left of zero. These same voltmeters can also be used to make all ordinary battery voltage tests, but they should never be connected across more than one cell because their voltage capacity is low.

Cadmium tests should only be made with the battery on charge at the regular charging rate. The test lead to which the cadmium stick is attached should always be connected to the negative terminal of the voltmeter, while the plain test lead to be used on the cell terminals is to be connected to the positive terminal of the meter.

With the battery on charge the cadmium stick is inserted through the vent hole of the cell cover until it makes good contact with the electrolyte. The cadmium stick must not touch the plates and for this reason many of these sticks are equipped with insulating tips or with a perforated rubber tube over their ends.

The cadmium should remain in the electrolyte

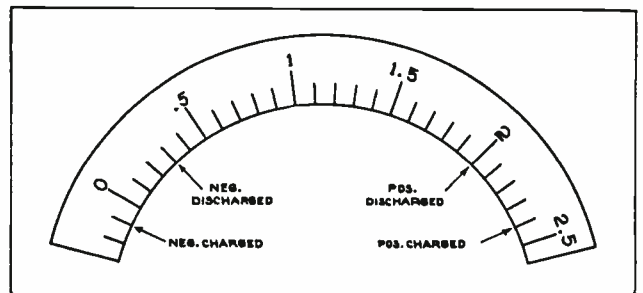

Fig. 21. Diagram showing the scale of a Cadmium test meter with the important test readings marked.

for a minute or two before taking the readings so that a thin coating of cadmium sulphate will form on the stick. The other test point can then be shifted between the positive and negative cell terminals to make the tests.

By attaching it to the negative terminal the condition of the negative plates can be determined, and when it is in contact with the positive terminal the condition of the positive plates can be determined by the voltmeter readings.

With the battery on charge the voltage reading between the cadmium stick and the positive terminal will be about 2.4 volts if the positive plates are pure lead peroxide or fully charged.

With the free test point on the negative terminal a reading of .1 volt to the left of zero will be obtained if the negative plates are pure sponge lead or fully charged.

If these two readings are added together their sum should equal the reading of a voltage test taken from positive to negative terminals. These voltages would indicate that both positive and negative plates are fully charged and in good condition.

If when making such a test the positive reading was 2.4 volts and the negative reading to the right of zero, the voltage of the cell would be obtained by subtracting the negative reading from the posi-

tive reading. Such a test would indicate that the negative plates are in bad condition since they are not charged while the positives are.

The cadmium test is the most reliable test that can be made and determines if both the positives and negatives are at the same state of charge, as they should be if both groups of plates are in good condition.

## 20. HY-RATE DISCHARGE TEST

The hy-rate discharge test is made on storage batteries by taking voltmeter readings across the individual cells while the battery is discharging at a heavy rate.

This test is particularly valuable in determining the condition of the various cells of a battery and is very commonly used in testing automobile batteries, as these batteries must maintain their voltage without excessive voltage drop while operating the starting motor which, as we have already learned, may draw several hundred amperes during starting of the engine.

For making this test some form of high rate discharge test set is generally used. These sets consist of a variable resistance, generally of the carbon pile type, an ammeter of sufficient capacity, and a voltmeter.

On some of these test sets three voltmeters are used, one being connected across each cell to eliminate the necessity of shifting the meter terminals from one cell to the next.

Fig. 22 shows three types of high rate discharge testers. The one above has a long tube filled with carbon disks and equipped with a knob and threaded rod at the right hand end to vary the pressure applied to these disks, and thereby vary their resistance and the rate of discharge of the battery connected to the set. The ammeter and voltmeter are also mounted on the base with the variable resistor.

On the lower left in Fig. 22 is shown another type of high rate discharge set with the meters and rheostat handle located on a vertical panel and equipped with both heavy-duty terminal clips and test prongs.

On the lower right in Fig. 22 is shown a convenient portable test device for making high rate discharge tests on individual cells. This device consists of a pair of heavy test prongs with a resistance element shunted across them, and the meter also connected across the prongs to read the voltage during the test.

This tester is conveniently portable and can be used right at the battery either on the charging bench or in the car, by merely pressing the sharpened test points down against the terminals or straps of the cell to be tested.

The discharge rate for making these tests is based on the number of plates per cell, the usual rate being 20 to 25 amperes per positive plate, figuring only the positive plates in one cell.

For example an 11-plate battery having eleven

plates per cell would have 6 negatives and 5 positives in each cell. As the discharge rate is based on the number of positives the high rate discharge current for testing such cells would be  $5 \times 20$ , or  $5 \times 25$ , or 100 to 125 amperes.

While the battery is discharging at this rate the voltage of each cell is measured separately, and if the battery is in good condition and fully charged the voltage should not drop below 1.75 or 1.78 volts per cell during the test. This voltage drop is caused by the heavy current flowing through the internal resistance of the cell.

If the cell's internal resistance is normal the voltage drop will not be excessive but if the cell is in bad condition the voltage drop will be much higher than usual.

The internal resistance of a cell is due to the resistance of the several parts and materials in the internal circuit of the cell. When the cell is discharging through some load the discharge current

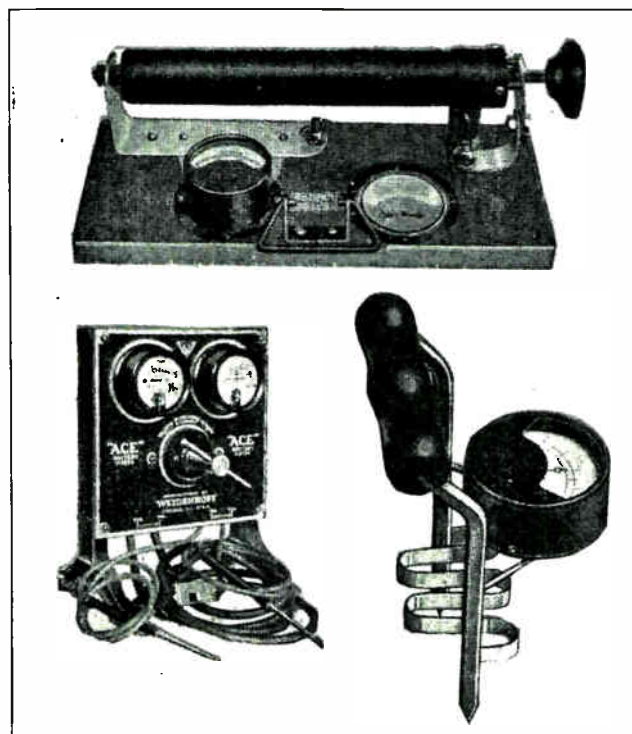

Fig. 22. Several styles of hy-rate discharge test sets. The one above is for either portable or bench use. The one at the lower left for bench use, and the one at lower right for portable use for testing individual cells.

also flows through the internal circuit and must pass through the plates, separators, and electrolyte; so the resistance of these materials determines the internal resistance of the cell.

Excessive voltage drop may be due to several causes such as spongy or worn out plates, clogged separators, or wrong specific gravity of the electrolyte.

Thin and worn separators may also be the cause of large voltage drop by allowing the plates to be short circuited during heavy discharge tests. A



high rate discharge can be used to very good advantage to locate defective cells in batteries that are being brought in to a shop to be charged.

The exact readings obtained on this test are not as important as the difference in readings between the several cells. A cell that gives a reading of more than .1 volt less than the other cells is generally defective and should be opened and examined.

Sometimes a high rate discharge test will cause one cell to give a reverse reading which indicates that the cell is shorted.

## 21. STORAGE BATTERY CAPACITY

The capacity of storage batteries or individual cells is rated in ampere-hours. This term refers to the product of the discharge current multiplied by the number of hours that the discharge can be maintained.

Capacity ratings for storage batteries of the automotive type are based on a discharge started from a fully charged condition, and continued until the battery reaches normal discharged condition with its voltage down to 1.7 volts per cell.

The discharge rate for capacity tests on automobile batteries is generally based on an eight-hour discharge period. For example, a battery rated at 80 ampere hours should be able to deliver 10 amperes for eight hours. The capacities of stationary batteries and those for use in electric vehicles are generally figured on a five-hour discharge rate.

One of the characteristics of storage batteries which it is very important to remember is that their capacity is affected by the rate of discharge, the capacity in ampere hours decreasing as the rate of discharge is increased.

For example, an 80 ampere-hour battery will not discharge at the rate of 80 amperes for one hour, but will deliver 4 amperes for considerably more than 20 hours. In other words, they will deliver more energy and show a higher efficiency at low rates of discharge than at high discharge rates.

The ampere-hour capacity of the storage battery depends upon several factors among which are: (a) plate area (b) porosity of active material (c) strength of electrolyte.

For all practical purposes the plate area is the most important factor, and principally controls the capacity of the battery. Therefore, all capacity formulas are based on plate area.

The chemical activity of a battery is always greatest at or near the surfaces of the plates where the active material and the acid are in contact with each other. This is particularly true during high rates of discharge when the acid is being used up very rapidly. So by increasing the plate surface exposed to the electrolyte we increase the amount of active material in contact with the acid, and thereby increase the capacity of the cell.

A simple formula for determining the approximate ampere-hour capacity of storage batteries ac-

ording to the plate area is as follows:

$$\frac{W \times L \times 2 \times P. P.}{144} \times 50 = \text{ampere hour (A.H.) capacity.}$$

In which: W = width of the plates  
L = length of plates  
2 = number of sides on each plate  
P. P. = number of positive plates in one cell  
144 = square inches in 1 sq. ft.

The average positive plate for use in automobile batteries is approximately  $4\frac{1}{2} \times 5\frac{1}{2}$  inches. So if we apply this formula to an ordinary 11-plate, 3-cell automobile battery the problem would be as follows:

$$\frac{4.5 \times 5.5 \times 2 \times 5}{144} \times 50, \text{ or approximately } 85.5 \text{ A.H.}$$

This battery would be rated in round figures as an 80 ampere-hour battery, allowing the slight excess capacity for reduction in efficiency with age.

The thickness of battery plates has very little effect on the ampere-hour capacity of the battery as under normal conditions a plate doesn't discharge actively clear through the plate, but discharges mainly on and near the surface. This is due to the fact that the pores in the active material soon become clogged and choked with lead sulphate.

When a battery is discharged down to the normal discharged condition it is very seldom that more than 25% of the active material is used, and that is largely at the surfaces of the plates.

While the plate thickness doesn't materially affect the ampere-hour capacity it does affect the discharge capacity or rate in amperes at which a cell or battery can be discharged.

Surprising as it may seem, thin plates always have a higher discharge capacity in amperes than thick plates. This is due to the fact that the electrolyte will diffuse through the thin plates much more rapidly and will quickly replace the acid used up by the active material during the discharge action of the plates.

Plates for automobile batteries are made in slightly different sizes in order to fit different styles of battery cases and to provide more or less capacity, according to the requirements of the car. This is well to remember when ordering plates for repairing various batteries and a good plan is to carefully measure or check the size of those removed when ordering the new ones to replace them.

Three common plate sizes are as follows:

Type	Symbol	Dimensions
Small	S	$4\frac{1}{2}$ " high $\times$ $5\frac{5}{8}$ " wide
Medium	M	$4\frac{3}{4}$ " to $5\frac{1}{4}$ " high $\times$ $5\frac{5}{8}$ " wide
Large	B	6" high $\times$ $5\frac{5}{8}$ " wide

These plates can also be had in three different thicknesses as follows:

Type	Symbol	
Thin	T	3/32" thick
Regular	R	1/8" "
Thick	T.T.	5/32" "

## 22. CAPACITY TESTS

The purpose of a capacity test on a battery is to determine the amount of work that it is capable of doing before its voltage drops to 1.7 volts per cell, or the normal discharged condition.

While formulas give us a theoretical idea or approximate knowledge of what the rated capacity of a battery should be, the actual capacity can be much more accurately determined by a test.

This test is performed by charging the battery fully and then discharging it through a variable resistance and ammeter until the battery reaches the normal discharged condition.

In order to obtain accurate results from a capacity test of this kind the following two factors must be carefully watched and checked:

1. Discharge rate must be maintained constant from start to finish.
2. The time required for the battery to reach normal discharged condition must be noted.

In order to maintain a constant rate of discharge throughout the entire test period an ammeter and some form of variable resistance are necessary; the ammeter to check the amount of current flow and the rheostat to keep it adjusted to a constant value.

When the battery is first put on test its voltage is high but as the test progresses the voltage gradually drops and the discharge rate would tend to decrease. It is, therefore, necessary to cut out a little resistance about every 15 minutes in order to keep the discharge rate in amperes constant.

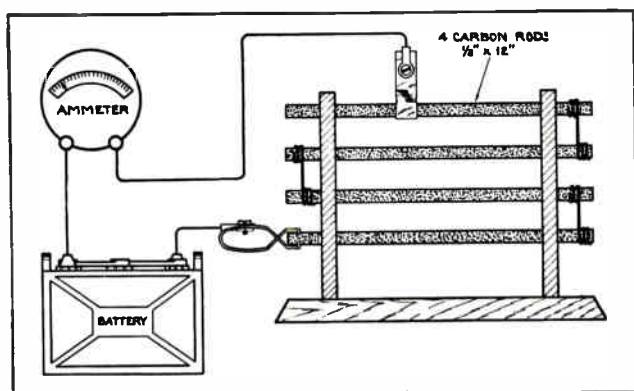

Fig. 23 Diagram showing construction and connections of a simple capacity test discharge resistance, which can be easily and cheaply made of carbon rods supported in an insulating frame of heat-resisting material.

Fig. 23 shows a diagram of a simple capacity test arrangement, the equipment for which is very low in cost and simple to set up for any battery shop. The battery is connected in series with an ordinary ammeter of the proper capacity and several carbon rods such as ordinary arc carbons.

These round carbon rods can be mounted in strips of heat-resisting material of an insulating nature, such as asbestos, marble, or slate with their ends securely connected together in series as shown. A heavy test clip can then be used to vary the resistance in the circuit by sliding the clip along the rods or moving it from one rod to another.

Convenient carbon pile rheostats can also be obtained for this work but are, of course, a little more expensive than the simple shop tester shown in Fig. 23.

The discharge rate at which to start a capacity test on an automobile battery can be determined by dividing the assumed or approximate ampere-hour capacity of the battery by 8, because as previously stated these tests are generally made at the 8-hour discharge rate.

For example, if we wish to run a capacity test on an automotive battery which we assume from the number of plates used is an 80 ampere-hour battery, the discharge rate would be obtained by dividing 80 ampere-hours by 8 hours, or  $80 \div 8 = 10$  amperes discharge rate.

If this battery when placed on capacity test can maintain a discharge rate of 10 amperes for 8 hours or more before the voltage drops to 1.7 volts per cell, and the gravity drops to 1.150, then the capacity is actually known to be 80 ampere-hours or more.

For example, if it required  $8\frac{1}{2}$  hours at the 10 ampere rate to bring the voltage and gravity down to the above mentioned figures then the capacity would be  $8\frac{1}{2} \times 10$ , or 85 ampere-hours.

The ampere-hour efficiency of a storage battery can be determined by dividing the discharge in ampere-hours by the charge in ampere-hours required to bring it back to the same state of charge as the test was started from. This efficiency of ordinary lead plate batteries often runs as high as 90% or over.

## 23. CYCLING STORAGE BATTERIES

Before putting into service a new lead plate battery or one that has been recharged and has had some of the old plates replaced with new ones the battery should be cycled, or charged and discharged several times.

This process more completely forms the new plates and greatly improves their condition and efficiency by more completely converting the paste into active material.

New batteries are generally cycled two or three times at the factory before being shipped out and this considerably increases their capacity and servability.

The original forming process described in an earlier article doesn't always change all of the paste into active material, and unless a new battery or one in which new repair plates have been installed is cycled, it will not deliver its rated capacity and may give trouble when first put in service.

A battery that has been neglected and allowed to become sulphated by standing for long periods in a discharged state will often fail to come up to full gravity and voltage when charged, due to the fact that one ordinary charging cannot convert all of the lead sulphate back into active material. Such a battery if given only the ordinary charge will not deliver its full rated capacity in ampere-hours and its performance will be rather poor.

Cycling a sulphated battery will convert more of the lead sulphate back into active material, thereby increasing the capacity and improving the performance of the battery. The rate of charge or discharge for cycling a battery should be at about the ordinary 8-hour rate, or a little slower generally, so that the battery can be discharged during the day and put back on the charging line throughout the evening.

As a rule the rate of discharge for cycling is between 2 and 3 amperes per positive plate in each cell. For example an 11-plate battery having 5 positive plates per cell would be discharged at about 10 to 15 amperes.

The same rheostat and ammeter used for making capacity tests can also be used along with a battery charger for cycling. However, as it is not necessary to keep the discharge rate constantly at the same value when cycling, a very simple and low cost discharge resistance can be made up from several automobile lamps connected in parallel and an ordinary automobile dash ammeter in series with them, as shown in Fig. 24.

If desired several small switches can be arranged to quickly connect more or less lamps in parallel, to vary the discharge rate for cycling different sized batteries.

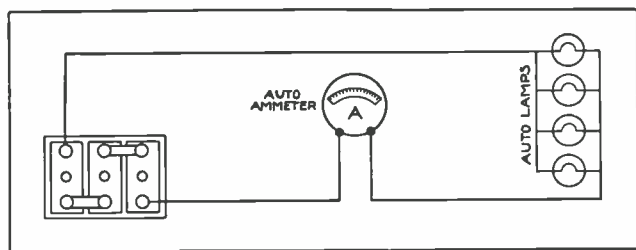

Fig. 24. This sketch shows the connections for using an ammeter and a group of automobile lamps for discharging a storage battery during a cycling process.

## 24. BATTERY CHARGING

As previously stated whenever the voltage of a lead plate storage battery drops down to 1.7 volts per cell the battery must be recharged. For charging storage batteries direct current is required because, in order to convert the lead sulphate back into active material on the plates and drive the acid from the plates back into the electrolyte, we must pass current constantly in one direction opposite to that of the discharge current.

This means that when connecting a storage battery for charging, the positive battery terminal must

be connected to the positive side of the charging line or direct current source, so that the charging current will be forced into the battery at the positive terminal and out at the negative.

If there is any doubt about the polarity of the charging line wires, a simple test can be made by immersing the wire ends in a small glass of water to which has been added a small amount of acid. When the wire ends are held about an inch apart bubbles will rise from each, and the wire at which the most bubbles are formed is the negative. Some resistance, such as a 100-watt lamp or similar devices which will limit the current to about 1 ampere should be connected in series with the line when making this test.

The polarity can also be determined by a compass test with current flowing in the line, as explained in an earlier lesson.

Where only alternating current is supplied it can be rectified or changed to direct current for battery charging purposes, by means of bulb type rectifiers or motor-generators. If 110-volt D. C. is available all that is required is suitable resistance connected in series with the battery to reduce the voltage of the line and regulate the charging current.

There are two general methods in use for charging batteries, one known as the constant current method and the other as the constant potential method.

The constant current method is sometimes known as series charging, because all of the batteries are connected in series and are all charged at the same current rate regardless of their size or condition. With this system about the same charging rate in amperes is maintained from start to finish of the charging period.

Constant potential charging systems generally use a motor-generator set for changing A. C. to D. C., and all of the batteries are connected in parallel directly across the low voltage D. C. generator bus bars. This system is sometimes called parallel charging, as the batteries are all connected in parallel and each battery forms an individual or separate circuit between the positive and negative busses.

The motor-generator consists of either an A. C. or D. C. motor, according to the available current supply, driving a low-voltage D. C. generator which connects to the charging busses, and supplies a constant potential of about 7.5 volts for charging 6-volt batteries or 15 volts for charging 12-volt batteries.

With the batteries connected across the bus bars in parallel and a constant voltage maintained by the generator, the current through each battery will be governed by the voltage and condition of that battery.

If a completely discharged battery is connected across the bus bars the charging current through that battery will be quite high at the start, since the voltage of the battery is very low and about the only

opposition it offers to the current flow from the generator, is its internal resistance.

As the battery becomes charged its voltage gradually increases and opposes the voltage of the generator, thereby causing the charging rate to decrease or taper off.

Constant potential charging is also often referred to as 8-hour charging, because the rather high rate of charge used with these systems generally charges the average battery in about 8 hours.

## 25. CHARGING RATES

Charging rates depend largely on the size of the battery and the type of equipment used. In commercial charging it is not always practical to regulate the current to suit each individual battery and in cases of this kind a rate is used that best suits the average battery.

Where the charging current can be regulated a good rule to determine the charging rate for any certain battery is to start charging at  $\frac{1}{8}$  of its rated capacity in ampere hours, and when it is a little over one-half charged reduce this rate to one-half the starting rate.

For example, if the capacity of a battery is 80 ampere-hours, the charging rate at the start would be  $\frac{1}{8}$  of 80, or 10 amperes and the finishing rate about 5 amperes. The reason for reducing the charging rate toward the finish of the charge is to prevent overheating of the plates, as the amount of lead sulphate and acid in the plates and being worked upon by the charging current is gradually being reduced, and the heavy charging current would develop too much heat.

In constant current or series charging it is not possible to regulate the current to suit individual batteries, since they are all connected in series and the same amount of current flows through each.

A commercial charging line may have connected to it batteries of different capacities, ranging from 80 to 120 ampere hours. In addition to having different ampere-hour capacities these batteries will probably vary a great deal as to their state of charge, so it is necessary to select a rate suitable for the group.

## 26. ELECTRON BULB CHARGERS

A very popular type of battery charger used for rectifying or changing A. C. to D. C. and for charging batteries on constant current systems is the electron bulb rectifier, also commonly known as the Tungar bulb charger.

Due to the low current capacity of ordinary electron bulbs these chargers are generally used with constant current or series charging systems. Bulb type chargers are made in two types known as half wave and full wave chargers.

A half wave charger is equipped with one bulb and has a maximum current output of 6 amperes of

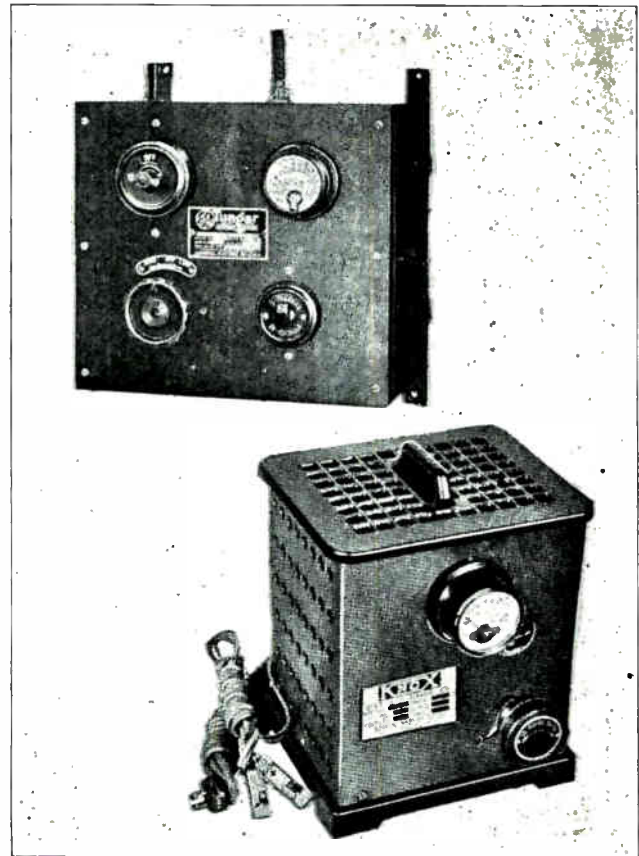

Fig. 25. Above are shown two common makes of bulb type rectifiers or battery chargers. The one above is a full-wave type, while the one below is a half-wave type.

pulsating D. C. from one-half of the A. C. wave, or every other alternation only.

Although the current output is low the voltage on the D. C. side of these chargers can be raised high enough to charge from 10 to 15 six-volt batteries in series. The voltage is regulated by means of a tap changing control which increases or decreases the number of turns in the winding of an auto transformer.

Full wave Tungar chargers use two rectifier bulbs and rectify both sides of the A. C. wave. The current output of these units is double that of the single wave chargers or about 12 amperes maximum. The voltage is controlled in the same manner as with single wave type. These chargers can, of course, be made to deliver more than the above mentioned amounts of current for short periods, but this will shorten the life of the rectifier bulbs much below their rated life which is between 800 to 1000 hours of operation.

For this reason their rated current capacity should not be exceeded. Vibration of the charger will also tend to reduce the life of the bulbs so these units should be mounted where they are free from excessive mechanical vibration. The efficiency of a well designed Tungar rectifier on full load is about 75%.

Fig. 25 shows two types of electron bulb chargers, the one at the upper left being the larger size full

wave type for wall mounting, and the one below is a smaller charger of the single wave type for shelf mounting or portable use. Note the ammeters for indicating the charging rate and the knob controls for adjusting the transformer taps to vary the charging rate.

A complete description of the operating principles and circuits of Tungar rectifiers was given in Alternating Current, Lesson 59, and it would be very well for you to review this material at this point.

## 27. OPERATION OF BULB TYPE CHARGERS

While these rectifiers are very simple in design and easy to operate, there are a few rules that must be observed to secure best results with them. Half wave rectifiers may be equipped with one or two control dials, but full wave rectifiers are generally equipped with four controls, two for each bulb.

Where two controls are used for each bulb one is used to raise or lower the voltage in large steps while the other is used to regulate the voltage in smaller steps. The regulation of the voltage, of course, regulates the charging current sent through the battery or batteries.

The following simple rule should be followed when starting Tungar chargers.

First be sure all controls are turned back to zero, then turn on the starting switch and observe the bulb to see if it lights or burns. Now with the batteries properly connected turn the lower or close-regulating dial clockwise until the proper current value is shown on the ammeter. If the ammeter fails to show a reading turn this dial back to zero and try the upper or coarse-regulating dial. Bring the charging rate as close as possible to the proper value with this coarse dial, and then use the lower dial for final adjustment.

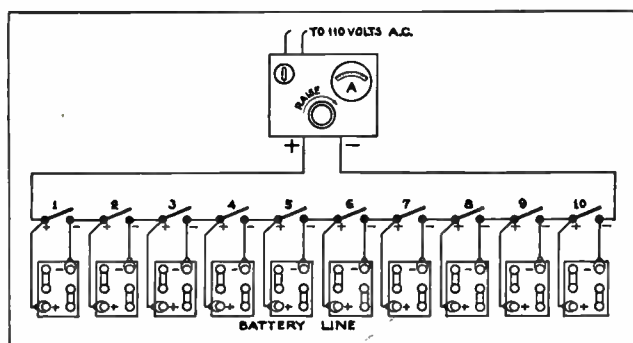

Fig. 26. Diagram showing the connections for charging up to ten batteries in series by means of a bulb type rectifier or the constant current system. Knife switches are used to close the circuit when a battery is removed from the line.

As more batteries are added to the line the charging rate drops so it will be necessary to readjust the controls to maintain the same current value. If a battery is accidentally connected backwards on a constant current charging circuit the charging rate will increase instead of decrease.

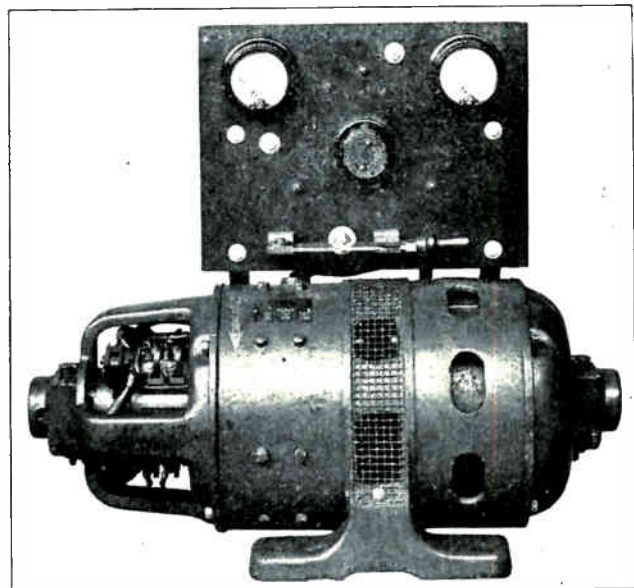

Fig. 27. This photo shows a neat, compact type of motor generator with its control and panel, for use in charging batteries by the constant potential method. (Courtesy of Roth Bros. Manufacturing Co.)

When part of the batteries are removed from the line the charging rate will automatically increase and if the controls are not readjusted the fuses will be blown. If the fuses are not of the proper size the bulb may be burned out instead. Ten-ampere fuses will generally give the proper protection.

If the Tungar charger fails to operate you can look for the following common troubles:

1. Examine supply line fuses.
2. Bulb filament may be open or burned out. Test bulb for open circuit or try a new bulb.
3. Make sure that the bulb is screwed tight in its socket.
4. If points of contact on bulb or in socket are dirty, clean them with sandpaper.
5. If the bulb glows but the ammeter fails to register examine the battery connections. Most troubles or interruptions with chargers of this type are caused by poor connections at the batteries.
6. Some chargers are provided with one fuse in series with the battery and if this fuse is blown no charging current will flow even though the bulb is glowing.
7. The rectifier bulb may fail to operate due to a slow leak in the glass having destroyed its vacuum, or due to a badly sagged filament.
8. Control contacts may be loose or dirty and not making proper connection in the circuit.

## 28. CONSTANT POTENTIAL CHARGERS

As already explained a constant potential charger consists of a motor-generator set, the motor being either D. C. or A. C. and designed for 110 or 220 volts, according to the available supply, and the generator producing direct current at  $7\frac{1}{2}$  volts for charging 6-volt batteries, or 15 volts for charging 12-volt batteries.

Fig. 27 shows a compact motor-generator charger of this type; the motor and generator units both being built into one frame. This machine is equipped with a panel on which are mounted the voltmeter and ammeter, voltage-regulating rheostat by which the charging rate is controlled, and a knife switch for closing the circuit to the bus bars and batteries.

Fig. 28 shows a neat charging bench equipped with a constant potential charger and the bus bars and batteries can be clearly seen in this view.

You will note that the batteries are all connected to the bus bars in parallel by means of flexible leads and battery clips, and the small knife switches are provided for disconnecting individual batteries.

Constant potential charging differs considerably from constant current or series charging in that with constant potential charging each battery regulates its own charging rate to quite an extent by its voltage and condition.

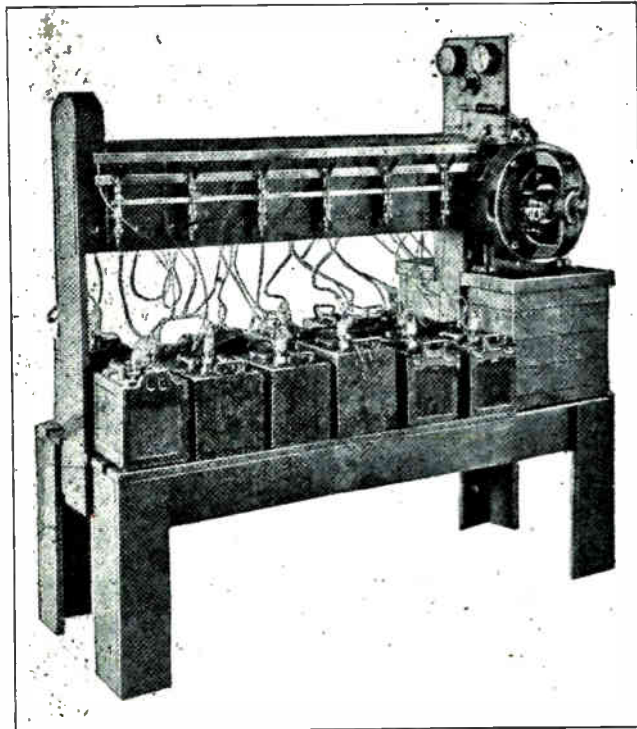

Fig. 28. Neat type of charging bench equipped with constant potential motor generator charger and convenient busses and switching arrangement for connecting and disconnecting the various batteries.

When a battery is first connected across the bus bars it charges at a very high rate due to its voltage being considerably lower than that of the generator, but this charging rate gradually decreases or tapers off as the battery voltage comes up to full charge.

When a completely discharged battery is placed on a constant potential system the charging current at the start may be as great as 20 amperes but will rapidly taper off as the battery voltage increases, dropping down to as low as 2 or 3 amperes when the battery becomes fully charged. Because of this

action this form of charging is sometimes called a tapering charge. It is also very often referred to as "eight-hour charging service."

From this we can see that it is possible to have a number of batteries connected in parallel to one of these chargers and each of the batteries charging at a different rate, according to their state of charge and condition.

The charging rate is limited only by excessive heating, and when any battery overheats the charging rate should be reduced by connecting a resistance in series with one of the leads to that particular battery. Convenient small resistance units equipped with a clip at the lower end for attaching direct to the battery terminal are obtainable for this use.

The temperature of the batteries should never be allowed to exceed 110° F. during charging and temperature tests should always be made on a cell in the center of the battery, as these cells tend to heat more than the outer ones because of poor ventilation, due to the fact that they are between the outer cells.

Where both 6 and 12-volt batteries are to be charged two 7.5-volt generators can be connected together in series and their terminals connected to three bus bars, as shown in Fig. 29.

This makes it possible to obtain two different voltages from the bus bars, 7½ volts between the center bus and either of the outside ones and 15 volts across the two outside busses. Six-volt or twelve-volt batteries can be connected as shown in the diagram and both types charged at the same time.

## 29. OPERATION OF CONSTANT POTENTIAL CHARGERS

When operating constant potential battery chargers the following simple rules would be well to keep in mind:

1. Batteries must be connected in parallel across the bus bars, with the positive terminal of each battery connected to the positive bus and negative terminals to negative bus. When the generator is idle the main switch on the control panel must be opened before connecting batteries.

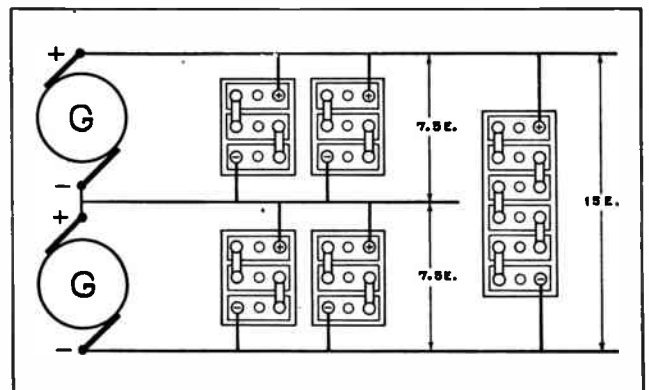

Fig. 29. This sketch shows the method of connecting two low voltage D. C. generators for charging both 6E and 12E batteries at the same time.

2. When starting the machine the motor of the M-G set is first started and allowed to come up to speed. The voltage is then regulated by means of the generator rheostat and is set at 7.5 volts for charging 6-volt batteries. This voltage adjustment is very important and must not be neglected.

3. When the voltmeter registers 7.5 volts the main switch on the control panel can be closed, completing the charging circuit and starting the batteries charging.

4. If it is necessary to stop the set for any reason, first open the main switch on the control panel in order to prevent the batteries from feeding current back through the idle armature of the generator. It is also advisable to disconnect the battery leads or open the individual battery switches when provided, and thus disconnect the batteries from the bus bars, or otherwise current will circulate between the batteries. This is caused by the ones which are of higher voltage or nearer to full charge discharging through the ones that are of lower voltage or have not been on charge as long.

The ammeter on the control panel will indicate the total charging current passing through all batteries. Each battery will take current according to its state of charge and condition, and if it is desired to know the charging current of any individual battery this can be obtained by connecting a small ammeter in series with one of the leads to that battery.

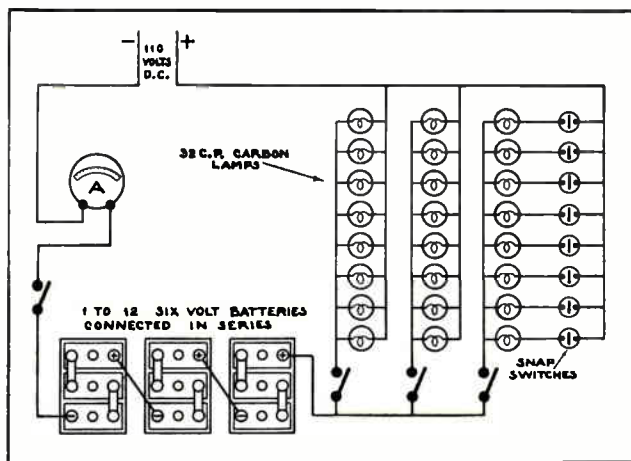

Fig. 30. Diagram showing the connections for using a lamp bank to charge from one to twelve six-volt batteries directly from a 110-volt D. C. line.

**Caution:** Be very careful never to accidentally connect a charging lead across the bus bars or from positive to negative bus, as this short-circuits the D. C. generator and you may receive a severe burn due to the heavy rush of current.

### 30. CHARGING DIRECT FROM D. C. LINES WITH RHEOSTATS

We have already mentioned that when a supply of 110-volt direct current is available, batteries can be charged directly from such a line by connecting a proper resistance in series with them. For charging

in this manner the batteries are all connected in series, as with the constant current or Tungsar charger systems.

Very economical charging resistances in the form of lamp banks, consisting of a number of lamps in parallel, can be made for this use or a simple water rheostat can be used. Adjustable factory-made rheostats can also be purchased for this use.

Fig. 30 shows a diagram of the connections for charging several automotive batteries with a lamp bank.

Any ordinary 110-volt incandescent lamps can be used for such lamp banks but it is quite common practice to use 32-candle-power, carbon filament lamps as they are very rugged and low in cost. A 32-C.P. lamp offers 110 ohms resistance and will allow 1 ampere to pass through it when connected directly across a 110-volt line.

However, when these lamps are used in a lamp bank and a string of batteries connected in series with them, the current through each lamp will naturally be a little less than 1 ampere due to the counter voltage and internal resistance of the batteries.

It is, therefore, necessary to use a number of lamps in parallel in order to obtain the desirable charging rate. The charging rate can be easily regulated by turning on or off one or more of the lamps by means of switches placed in series with them. With a lamp bank adjusted for a charging rate of 6 amperes the average automotive battery will be fully charged in 24 hours.

The diagram in Fig. 30 shows a sufficient number of lamps in the charging bank to enable a line of 10 or 12 batteries to be charged at a fairly good rate. It is, of course, not necessary to use all of these lamps when only charging a few batteries. The knife switches shown can be used to turn on or off complete groups of lamps, and the small snap switches shown in series with each of the lamps in the right-hand group can be used to turn on or off individual lamps of this group for final regulation of the charging rate.

The upper view in Fig. 31 shows a method of connecting a rheostat in series with a group of batteries for charging them directly from a 110-volt line, and the lower sketch in this figure illustrates the use of a water rheostat for the same purpose.

A simple water rheostat is a very convenient device for occasional charging of batteries, and can be made from a large earthen jar filled with water to which a small amount of sulphuric acid or salt has been added, to increase its conductivity and reduce its resistance.

The electrodes can be made of a couple of old battery plates or most any flat pieces of metal, and the charging rate can be varied by raising or lowering one or both of the electrodes in the solution.

Care must be taken with a water rheostat to see

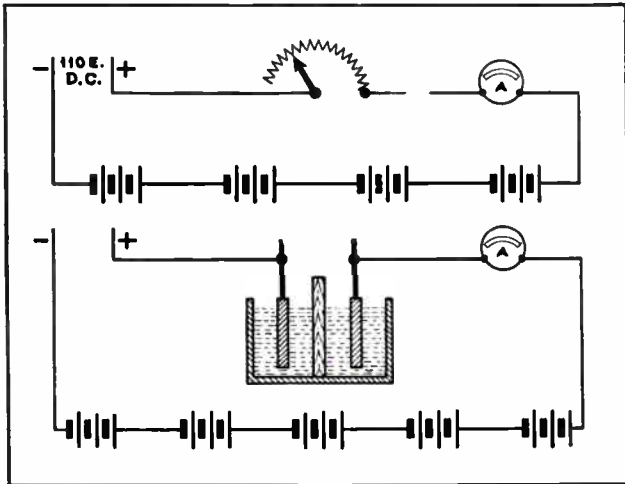

Fig. 31. The above sketch shows method of using an ordinary factory made rheostat and ammeter for charging batteries from 110-volt D. C. line. The sketch below shows a home made water rheostat used in place of the commercial rheostat.

that the liquid doesn't over-heat or boil away. It is a good plan to place a strip of wood or some other porous insulating material between the electrodes of a water rheostat to prevent them from accidentally becoming shorted together. Be careful to see that the insulator does not form a complete barrier and tend to prevent current flow from one electrode to the other.

The advantage of a water rheostat is that it can be quickly and easily made up from ordinary parts around a battery shop and used for emergency charging from 110-volt D. C. lines. In general, however, the lamp bank or commercial form of rheostat will be found more dependable and will require less attention.

### 31. BATTERY TROUBLES AND REMEDIES

Because of the very severe conditions under which the average automobile battery operates they require frequent inspection and occasional repairs. Automotive batteries are subjected to severe vibration, very heavy discharge rates, and very often excessive charging rates, and they are also quite generally subjected to neglect on the part of the car owner. These things will tend to shorten the life of a battery and to cause it to give unsatisfactory service, unless some battery service man who knows how, is frequently inspecting the battery and making the necessary repairs from time to time.

If given proper care, which simply means keeping it well charged, filled, and cleaned, a good grade of battery should ordinarily last from 2 to 3 years. On the other hand, a very good battery can be ruined or put in bad condition within a few months by abuse and improper care.

One of the most common abuses to which the average automobile battery is subjected is low electrolyte level caused by neglecting to inspect and refill at proper intervals. Many car owners forget that the water in their battery electrolyte is con-

stantly evaporating and thereby lowering the electrolyte level. This evaporation is particularly rapid during hot weather and the battery should be inspected and refilled with distilled water at least every 2 weeks in Summer and 4 weeks in Winter, or oftener in case of heavy use.

Another common abuse of automotive batteries is operating them in a semi-discharged condition, which causes the plates to sulphate and the battery to give poor service. This can be prevented by simply removing the battery from the car and having it fully charged in the shop, or by slightly increasing the charging rate of the car generator.

In many cases batteries are also damaged by maintaining an excessive charging rate which causes gassing and overheating. This can be avoided by simply adjusting the charging rate of the automobile generator. Some of the more common battery troubles with their symptoms and remedies are given in the following paragraphs.

When a battery will not hold a charge but runs down immediately after being fully charged this is generally due to broken down insulation caused by failure of the separators between the plates. Or, in some cases, it is caused by high sediment in the bottom of the jars due to the shedding of active material from old or abused plates.

In either case the cells will have to be opened and either new separators installed or the sediment removed.

Separator troubles or failure may be due to a number of causes such as wearing thin or completely through due to normal wear or buckled plates; carbonizing of the wood due to strong electrolyte, or overheating; cracks sometimes caused by low electrolyte exposing the upper portion of the separators to the air; poor quality of wood used in the separators. The only remedy for any of these faults is to replace the old separators with new ones.

When the battery appears weak and fails to operate the starter or lights properly the trouble may be either in the battery itself or in its connections. It may be that the battery is not fully charged due to too low a charging rate, or to excessive use of lights and starting motor. The trouble may be due to low electrolyte which allows only part of the plate surface to be active, or it may be due to worn out plates or broken plate connections. It may also be due to loose or corroded terminals or to the battery being too small in capacity for the load of drain placed upon it by the electrical equipment of the car.

Sulphation is quite a common cause of battery trouble. This condition occurs when the lead sulphate on the plates has had a chance to harden into a white crystal formation, which is a very poor conductor of electricity and tends to clog or seal the pores of the plates, reducing their porosity and activity.

Sulphated plates will not take a charge properly and even though the charging rate may be normal



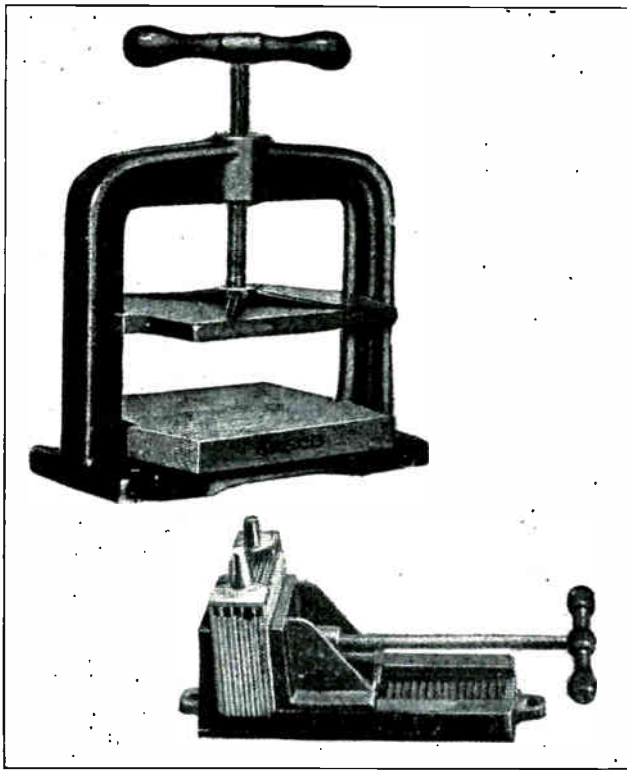

Fig. 32. Two types of plate presses used for straightening negative plates which have been warped or buckled out of shape, but are otherwise in fair condition.

the battery constantly appears weak and low in voltage. Sulphation may be caused by allowing the electrolyte to evaporate to a very low level. It may also be caused by the battery never having been fully charged or by overrich electrolyte.

Sulphation tends to reduce the ampere-hour capacity of the battery and in many cases causes the plates to warp or buckle. The only remedy for a sulphated battery is a prolonged charge at a low rate of between two to six amperes after which it should be cycled or discharged and recharged a couple of times as explained in Lesson 83.

### 32. BUCKLED PLATES

Buckled plates are quite often the cause of separator failure and defective battery operation. Warping or buckling of the plates may be due to overheating, over-discharging, or allowing the battery to stand a long time in a discharged condition.

When the plates warp or buckle in this manner their corners exert excessive pressure on the separators and, due to the vibration of the battery in the car, will soon wear completely through the separator and short circuit the cell.

If the negative plates are in good condition otherwise except for being warped they may be straightened by pressing them in a plate press, and put back into service. To straighten plates in this manner the positive and negative groups are separated and thin boards inserted between the plates of the group that is to be pressed.

This whole assembly is then placed in the plate press and pressure applied very gradually until plates are again straight and flat. Positive plates cannot be straightened successfully by pressing, as the active material cracks and drops from grids.

Fig. 32 shows two styles of plate presses which are commonly used in battery shops for this work.

Another trouble that is often caused by allowing batteries to become overheated is known as **granular plates**. When the temperature of batteries is allowed to become higher than 110° F. the plates gradually become soft, the positives loosening or shedding their active material and the negatives tending to swell up and become spongy or sandy appearing. The only remedy for granular plates is to replace them with new ones.

Lead plate batteries will freeze in cold weather if the electrolyte is allowed to become too low in specific gravity by operating the battery in a nearly discharged condition. Frozen plates can be readily detected when the plate groups are separated as the active material will fall off the positive plates in hard flakes, having been forced loose from the grid by the expansion of the electrolyte when it froze.

Frozen plates are always an indication that the battery was not fully charged, because it requires a temperature of 94° F. below zero to freeze electrolyte at 1.300 specific gravity.

The only remedy for frozen plates is, of course, to replace them with new ones.

Sometimes a battery will develop a cracked case or jars due to vibration, buckled plates, or freezing. The indication of a cracked case or jar is excessive loss of electrolyte in one cell, making it necessary to fill this cell more frequently than the others to keep the electrolyte at the proper level.

Where a rubber case is used electrolyte will also be noticed on the outside of the case if it is cracked. Where rubber jars are used in a wood box the bottom of the box will be wet with electrolyte and if the condition has existed for some time the wood may be badly rotted and softened by the action of the acid.

Fig. 33 shows how to test single battery jars or rubber battery cases for leaks. The method shown in the upper sketch is used for testing a rubber jar, by filling the jar with weak electrolyte and immersing it in electrolyte as shown. A pair of metal electrodes connected in series with a 10-watt lamp and to a 110-volt D.C. or A.C. line are then placed as shown, one in the electrolyte within the jar and the other in the electrolyte around the jar.

If the jar is cracked the lamp will light, but if the jar is good the lamp will remain dark. In making this test be sure to keep the upper edges of the jar slightly out of the electrolyte so that the whole jar is not immersed.

For testing rubber battery cases, as shown in the lower sketch in Fig. 33, each of the cell compart-

ments is filled nearly to the top with weak electrolyte and tests made with the electrodes on each side of both partitions.

The lamp will indicate a leak in either partition by lighting when the electrodes are placed on opposite sides of the cracked rubber wall.

### 33. BATTERY CARE

A few general rules that can be followed by the battery repair man and also by the car owner to avoid many of the common battery troubles are as follows:

1. Keep the battery well charged and frequently test the voltage and gravity. Also keep the electrolyte one-fourth inch or more above the tops of the plates at all times.

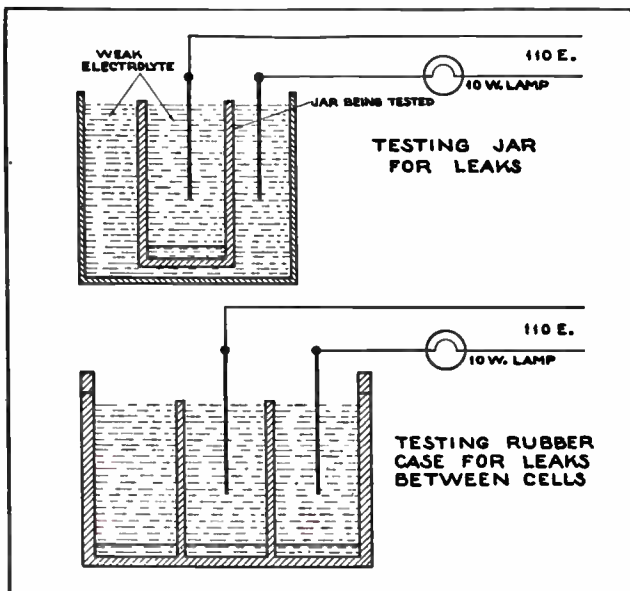

Fig. 33. The above two sketches illustrate the method of testing single cell jars or complete rubber battery cases for possible cracks or leaks.

2. Use only pure distilled water for refilling the battery and replacing evaporated water from the electrolyte.

3. In cold weather be particularly careful to keep the battery fully charged to prevent its freezing.

4. Inspect the battery every two or three weeks during the Winter and weekly in the Summer. Several times a week is not too often during long, fast trips in hot weather.

5. Do not allow the battery to overheat by excessive charging but instead reduce the charging rate either by adjusting the generator third brush or by burning the headlights while driving.

6. Do not overload the battery by using too many extra electrical accessories or light bulbs that are too large.

7. Do not use the starter excessively.

8. Keep the battery terminals tight and free from corrosion. Clean off any corrosion that may have



Fig. 33A. This view shows the use of a hydrometer for testing the gravity of a battery right on the car. This test is very important and should never be neglected when inspecting a customer's battery.

formed by wiping terminals with a cloth soaked in ammonia or strong soda water, and prevent further corrosion by coating terminals with vaseline.

9. See that the generator charges at the proper rate to keep the battery well charged but not high enough to overheat it.

10. If the gravity fails to come up to full charge reading when the car is in service, check the generator charging rate and increase it if necessary.

11. Keep the top of the battery dry and clean at all times.

12. Always remember to switch off the ignition even though the engine may have stopped due to stalling, and also remember to turn the light switch to the parking position when the car is idle at night, and thus prevent excessive drain on the battery.

### 34. STORAGE BATTERY SERVICE

In working in an automotive battery service station or operating a shop of your own, there are a number of common repairs and service operations which are most frequently performed. Some of the most common of these jobs and the methods of performing them are explained in the following paragraphs.

The battery service man is frequently called upon to inspect batteries on the cars, to determine the level of the electrolyte, and refill the battery with distilled water if necessary. This is an extremely simple operation but one which should be carefully done in order to be sure that all three cells of the battery are properly filled.

As previously explained the level of the electrolyte should be brought up to between  $\frac{1}{4}$  and  $\frac{1}{2}$  inch above the tops of the plates, but care should be taken not to fill the cells too full, so that the electrolyte will not be up to the tops of the filler open-

ings where it will leak or splash out through the small openings in the filler or vent caps.

Water or acid spilled on the top of an automobile battery tend to collect dust and create a muddy condition, and also tend to cause the battery terminals and connections to corrode.

Fig. 34 shows a convenient form of battery filler outfit consisting of an inverted one gallon glass bottle mounted in a carrier frame and stand which

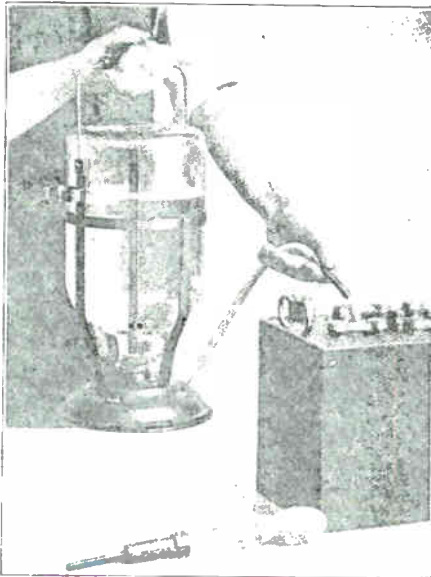

Fig. 34. Above is shown a very convenient type of battery filler used for adding distilled water to the cells of lead plate batteries for automotive or radio use.

has a cork to fit the neck of the bottle, and a flexible rubber tube for running the water into the cell openings.

These devices provide a small stream with which it is easy to fill the cells and yet easy to avoid spilling the water. They also permit the operator to see the level of the electrolyte inside the cell, which cannot be done if a funnel is used. When the cell is filled to the proper level the water can be immediately shut off by merely pinching the rubber tube. If a cell is too full some of the electrolyte can be removed by sucking it out with a hydrometer, or with a regular syringe made for this purpose and having a large rubber bulb and a slender rubber stem.

The operator in a battery shop should always encourage his customers and local automobile owners to come in regularly for this inspection and service on their battery, as the small amount of time required will be much more than repaid by the longer and more satisfactory service obtained from a battery that is kept properly filled.

A small charge can be made for this service if desired, or in many cases giving this service free will bring in a great deal of profitable battery business in the form of other repairs from customers whose good will and regular patronage has been obtained through this free service.

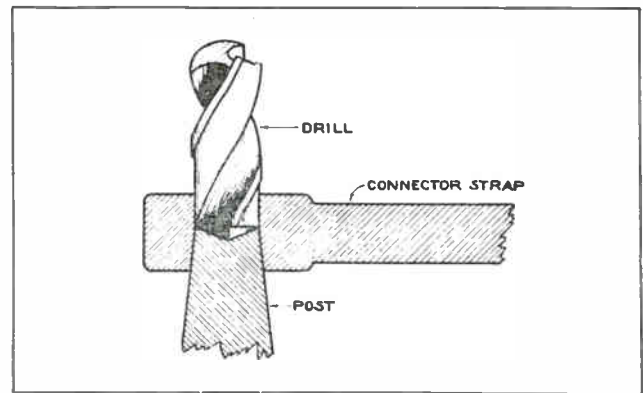

Fig. 35. Diagram showing the method of drilling out the tops of posts to remove connector straps when taking a battery apart.

Another test that is commonly made on the batteries while in the cars is the test of the battery voltage and of the specific gravity of the electrolyte. This test is also very easy to make with a portable voltmeter and a battery hydrometer.

In many cases the car owner's battery may be giving fairly good service in the operation of the lights and starter, and yet be getting very close to the discharged condition, where it will fail him just at some time when he most needs it.

This can be avoided by testing the voltage and gravity regularly and keeping the generator charging rate adjusted so that it will keep the battery well charged. In the Winter time these tests are particularly useful in avoiding frozen batteries, as frozen batteries are always due to having allowed the batteries to operate in a nearly discharged condition.

Leaky cells, and cells with shorted plates or other defects can also be detected by these tests in time to correct the trouble before all the plates of the cell are ruined by sulphation, due to low electrolyte, or badly damaged by short circuiting.

### 35. STORAGE BATTERY REPAIR

When a battery needs to be removed from the car and taken into the shop for repairs one of the first problems in the shop is to properly open the battery with the least loss of time, and without damaging any of its parts. There are three operations neces-

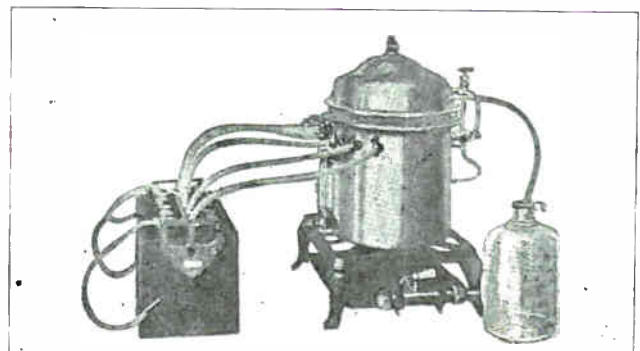

Fig. 35A. Common and convenient type of battery still and steamer, used both for steaming and softening compound when disassembling batteries, and for supplying distilled water for use in mixing electrolyte for refilling battery cells.

sary to open any automotive battery and these are as follows:—

1. Cell connectors or straps must be removed.
2. The sealing compound and cell covers must be softened and removed.
3. The elements or plate groups must be drawn from the cells.

The cell connectors or straps can be removed from the terminal posts by means of a large drill of about the same diameter as the top of the post. First mark the exact center of the posts and connectors, and then using a  $\frac{1}{2}$ " ,  $\frac{5}{8}$ " , or  $\frac{3}{4}$ " diameter drill, depending on the size of the post, drill about half way through the welded or burned-on portion of the strap and post connection, as illustrated in Fig. 35.

The connector straps can then be easily removed by means of a heavy pair of gas pliers.

Another way in which these connector straps are often removed is by using a lead burning torch to melt or soften the top of the strap directly over the

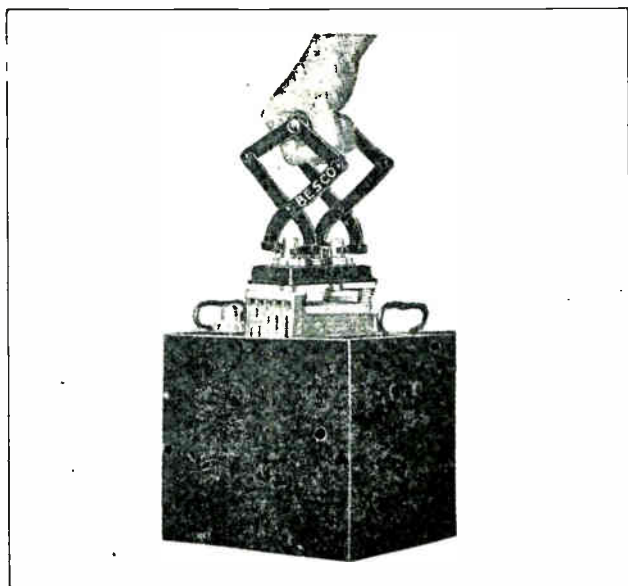

Fig. 36. This view shows a convenient type of cell puller used for lifting plate groups or elements from cell jars when taking down a battery for repairs.

post connection, while keeping an upward pressure exerted on the strap by prying from underneath with a screw driver.

As soon as the top of the strap has become melted or softened about half way through it will release from the post and pry upward.

The sealing compound and covers can be softened and loosened by heating or steaming. This is usually done by means of a regular battery steamer, such as shown in Fig. 35-A, and which supplies steam under low pressure through several rubber tubes which can be inserted into the cells through the vent openings.

This method requires from five to ten minutes to soften the compound so that the cell covers can be removed and the elements taken out. The device

shown in Fig. 35-A is a combination steamer and still.

By boiling water in this container placed over the gas flame, pure distilled water can be obtained from the hose on the right, which is shown placed in the top of the glass jar, and the unit also supplies steam from the tubes on the left for opening batteries.

When not in use for opening a battery these steam tubes can be shut off by means of small cocks or valves, and the steam allowed to condense in the upper part of the still and drip from the right hand tube into the jar in the form of distilled water.

The compound can also be softened by lightly playing a soft torch flame over the top of the battery in case no steamer is available.

When opening a battery it is not necessary to remove all of the electrolyte from the cells, but it is advisable to drain it down to the top of the separators by means of a filler syringe or hydrometer, as the steam process will add some distilled water to the cell and might cause it to overflow if the electrolyte level was high.

After softening the compound the elements, including the covers, are removed by taking hold of the cell posts with two pairs of pliers or with a regular cell group puller, such as shown in Fig. 36, and pulling upward. The elements can then be left setting in a slanting position on top of the jars, to permit them to drain and allow the electrolyte which runs from them to drip back into the jars.

After draining all compound should be carefully cleaned off from the covers and jar tops by means of a heated putty knife or scraper, both of which are shown in Fig. 37.

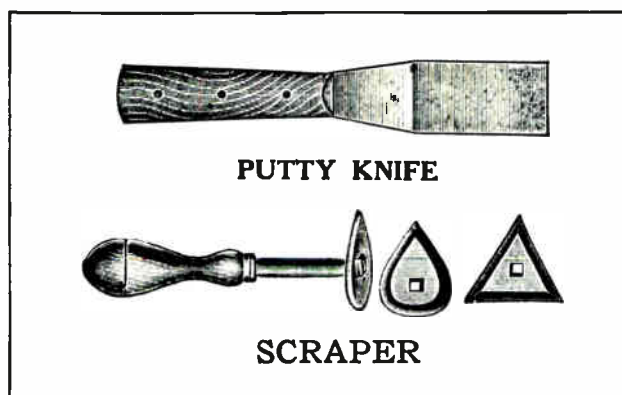

Fig. 37. A putty knife and scraping tool such as shown above are very convenient tools for removing or trimming sealing compound on storage batteries.

### 36. REPLACING DEFECTIVE PLATES AND SEPARATORS

After the elements are removed and the positive and negative plate groups separated, it is easy to tell by examining them and the separators what repairs are necessary.

If the separators are cracked, worn thin, or punctured they should be replaced with new ones, and if both sets of plates are in good condition they may not need to be renewed.

When either set of plates are badly worn or have lost considerable of their active material they should be replaced with new plates. Badly warped negative plates should either be straightened in a plate press or replaced with new ones. Granular plates or badly sulphated plates should also be replaced, unless perhaps in the case of sulphated plates the sulphation is not so bad but that it can be corrected by a prolonged charge and cycling.

The positive plates usually wear out somewhat faster than the negatives, and in some cases where the positive plates are in very bad condition, and the negatives still comparatively good, a new set of positives may be used with the old negatives and considerable service obtained from a battery rebuilt in this manner.

However, a battery which has had all of the plates replaced will be likely to give much more dependable and considerably longer service. A good point to remember in this connection is that it seldom pays to put back any parts into a battery if their life or service would be questionable, because even if your work is well done on the part which you repaired and some other part fails very shortly after the battery is back in service the customer is likely to blame your work for the failure.

In many cases, where all the plates are in bad condition, it is just about as cheap for the customer and much more profitable for the battery man to sell a new battery. This is particularly true where labor costs and wages are rather high and where factory made batteries can be obtained at low cost.

In other cases, however, where labor costs are low it may pay to replace the plates and rebuild the battery, using the case or jars and covers over again.

Where a new battery is sold to the customer the best of the used plates can be saved and used in rebuilt batteries for loan service. A small allowance can be made to the customer on his purchase of a new battery if the parts from the old one are worth it.

Very often the only thing wrong with a battery or the cell will be the separators, in which case they should all be replaced with new ones, and the cost of this repair job is low enough to be very practical.

### 37. REASSEMBLING REPAIRED BATTERIES

After repairs have been made on a battery it can be reassembled in the following manner. First assemble the positive and negative groups with the separators between the plates. Then place the groups in the jars or cell compartments of the battery case, taking care to arrange them according to polarity, or so that positive and negative terminals are in the proper position for conveniently connecting the cells in series for the battery.

When replacing the covers if there is any difficulty in forcing them onto the cells the covers should be steamed or heated until slightly softened, after which they will go in place very readily.

After the elements and covers are all in place the cells must be sealed with hot compound, the sealing compound being heated in a small pot over a gas flame, or in an electrically heated dipper which can be obtained for this purpose.

Before pouring the compound make sure that the covers fit snugly all around so that no compound will be allowed to run into the cell and also make sure that all surfaces are dry, as compound will not stick to wet spots.

The cover channels can be dried out by passing a soft-flame torch quickly and lightly over them.

After the battery is sealed the freshly poured compound can be given a much neater and better finished appearance by passing the torch flame lightly back and forth over it.

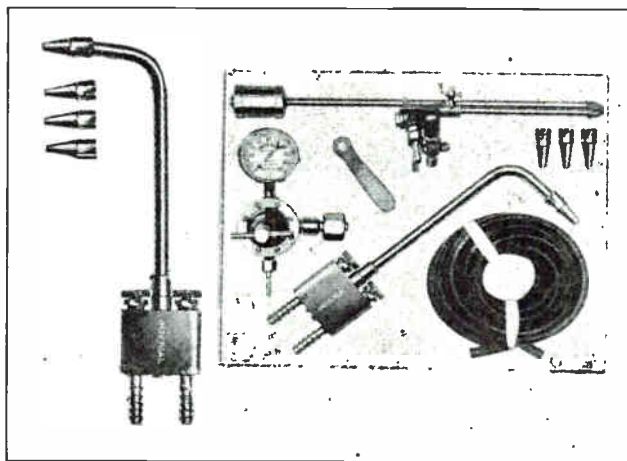

Fig. 38. On the right is shown a complete lead burning outfit, with the exception of the gas cylinder, and on the left is shown a larger view of the torch with its adjusting screws and extra tips for obtaining various sized flames.

### 38. LEAD BURNING

After the cells are back in place and the covers sealed, the next step is to connect the cells together in series by means of connector straps running from the positive post of one cell to the negative of the next, attaching these straps to the terminal posts by a process known as lead burning.

This is not really a burning process but merely refers to the melting or welding of the lead of the straps and posts together, to make a very rugged and low-resistance joint that will carry the heavy battery currents at low voltage.

Connections that are properly made in this manner are mechanically strong and will not become loosened by vibration. They will also resist corrosion much better than bolted connections would.

For lead burning a small and intensely hot flame is required. These flames are generally obtained by a combination of two gases such as oxygen and acetylene, oxygen and hydrogen, or oxygen and illuminating gas.

Compressed air instead of oxygen is sometimes used with illuminating gas or acetylene.

Where regular city gas or illuminating gas is available, oxygen can be purchased in steel cylin-

ders and used with this gas. In other cases both oxygen and acetylene can be purchased in cylinders, and the two gases used together by means of a mixing valve and light weight torch, such as shown on the left in Fig. 38.

On the right in this figure is shown a complete lead burning outfit with the exception of the gas cylinder. This outfit consists of the torch and mixing valve, pressure-regulating valve and gage, a trap and valve for the city gas line, extra tips for the torch, and a length of small flexible rubber tubing for connecting the torch to the gas cylinder and gas line.

Both of the torches shown in Fig. 38 have the gas mixing valves with their adjusting screws attached directly to the torch. Mixing valves can also be obtained for mounting on the bench so that one tube will carry the mixed gases to the torch, thus providing a little more flexibility in handling the torch.

Fig. 39 shows a torch of slightly different type, with one of its tubes connected to the water trap on the gas line and the other tube connected to the pressure-regulating valve on the oxygen cylinder.

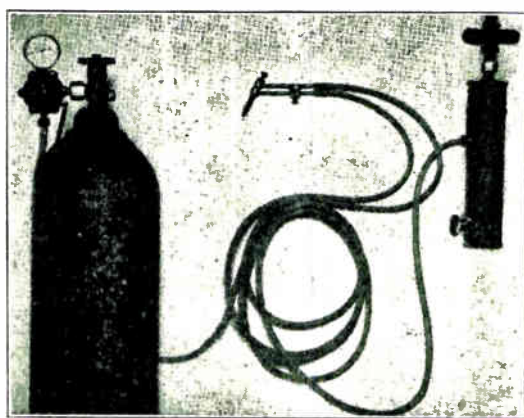

Fig. 39. This view shows the method of connecting a lead burning torch to the gas cylinder and piping, and also shows the mounting of the pressure regulating valve on the gas cylinder.

### 39. ADJUSTING THE LEAD BURNING TORCH

In order to do a good job of lead burning it is very important to have the correct pressures and mixtures of the different gases. The gases which are obtained in steel cylinders are stored in these cylinders under very high pressure, and this is the reason for the necessity of the pressure-regulating valve, shown in Figs. 38 and 39.

This valve when properly adjusted allows the gas to escape very slowly from the cylinder, and keeps it supplied at the proper pressure to the mixing valve and torch. When oxygen and hydrogen, or oxygen and acetylene are used each gas should be at a pressure of about 2 lbs. per square inch. When using oxygen and illuminating gas the oxygen should be at about 10 lbs. pressure and the illuminating gas at whatever pressure it is supplied, which is generally about 8 ounces.

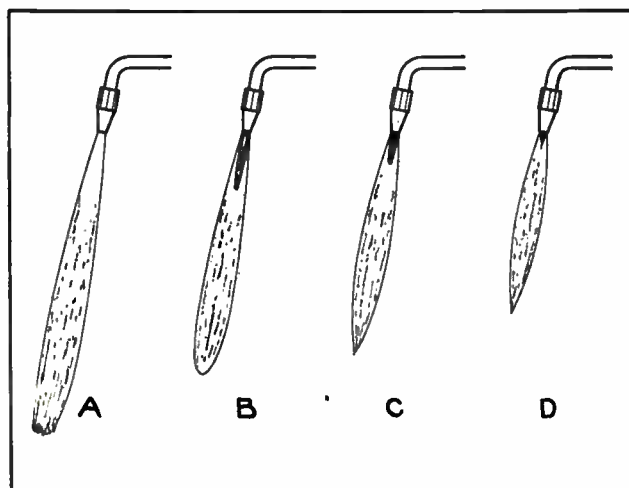

Fig. 40. The above sketch clearly shows the various steps in adjusting a lead burning torch. Examine each of these views very carefully while reading the accompanying explanation.

With these pressures right it is a comparatively simple matter to mix the gases in the right proportions with a mixing valve. This adjustment, however, is of the greatest importance in obtaining the proper kind of a flame for a good job of lead burning.

If too hot a flame is used the lead will oxidize rapidly on the surface and make the welding or uniting of the strap and post very difficult or next to impossible. If the flame is not hot enough the work is very slow and before melting temperature is obtained at the desired points, the entire terminal may be heated too much by the spread of heat and may melt down and run on to the battery.

The illuminating or acetylene gas is used to supply the body of the flame, and the oxygen is used to increase the heat of the flame. If too much gas or too little oxygen is used the flame will be yellow and will tend to carbonize and blacken the surface of the lead, making the burning or welding job very difficult. A plain gas flame doesn't give sufficient heat for this work.

If too much oxygen is used the flame will be too hot and the excessive heat and excess of oxygen will tend to oxidize the surface of the lead, giving it a yellow or sort of rainbow color, and producing a wrinkled and rather tough skin on the surface.

When a torch is first lighted with only the gas turned on, the flame will be long and yellow, with a soft brushy tip shaped as shown at "A" in Fig. 40. Then when the oxygen is first admitted, by means of the mixing valve, a slender blue flame will appear within the yellow flame near the tip of the torch, as shown at "B" in Fig. 40. This greatly increases the heat of the flame but doesn't yet produce sufficient heat for satisfactory lead burning.

As the proportion of oxygen is increased the blue flame gets shorter and hotter, forming a small blue cone which will be shaped as shown at "C" in Fig. 40. With the ordinary lead burning torch the oxygen should be adjusted until this blue flame is from

$\frac{3}{8}$  to  $\frac{1}{2}$  inch in length, with its tapered sides fairly straight or slightly full, and its tip very slightly rounded.

If too much oxygen is admitted the blue flame becomes very small and sharp-pointed as shown at "D" in Fig. 40, and the flame will be too hot and will tend to oxidize the lead. Admitting still more oxygen will often cause the flame to blow completely out on the ordinary small lead burning torch.

When the flame is correctly adjusted as at "C" in Fig. 40, it is then ready to use for lead burning.

The hottest part of the flame from a torch of this kind lies just beyond the tip of the blue cone, so the flame should be held in such a position that the blue cone almost touches the surface of the lead to be melted. Experience and practice will soon show the correct position for holding this flame.

It is very important to remember that to perform a good lead burning job all of the lead surfaces that are to be welded together must be absolutely clean and free from dirt, scum, or grease of any kind.

The inner surface of the openings in the connector straps can be cleaned and also reamed to fit the

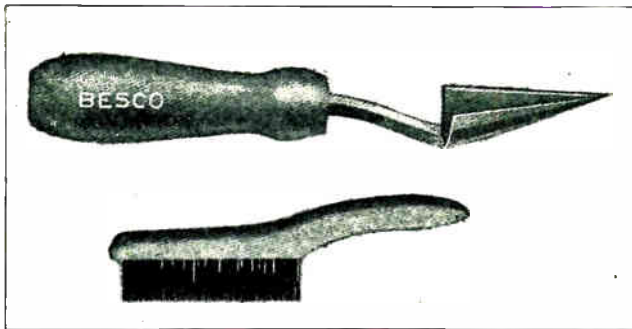

Fig. 41. Above is shown a convenient type of combination lead scraper and reamer, and below is a wire brush such as used in connection with lead burning on storage batteries.

posts by means of a hand reamer, such as shown in the upper view in Fig. 41, while the tops of posts and various other surfaces can be cleaned with a wire brush, such as shown in the lower view in Fig. 41, or with a coarse file.

#### 40. PROCEDURE FOR BURNING A CONNECTION

Before starting to burn a connector strap in place on the terminal posts of a battery one should see that the tops of the posts properly fit the circular lugs of openings in the strap ends, so that there are no large openings between the post and strap, or otherwise the molten lead will run through on to the top of the battery.

The top of the post should project only about half way up through the opening in the strap. If the crack around the edge of the post is practically closed or only very small, the top of the post can be softened with a torch flame, and by pointing the tip of the flame into this corner between the post and strap and working the flame round and round

in the cup-like depression, the lead of the post and strap will be melted and run together in a smooth, rounded joint.

The torch should then be removed quickly by raising it straight up. Additional lead melted from the tip of a slender lead filler stick or bar can now be run into the cup to build up the post a little at a time, thoroughly welding each added bit of lead to the top of the post and to the strap.

Right here is a point on which many inexperienced battery men fail to produce a good lead burning job. A good permanent connection can be made only by having the built up top of the post and the upper half of the strap connection melted together as one, so it will not do at all to merely run or drip hot lead from the "filler stick," or bar, onto the hardened or cold metal of the cup as the hot lead will not unite with cold lead that has been allowed to harden.

There is always a slight, almost invisible, film or scum which forms on the surface of the lead almost immediately when it cools and this film will prevent additional molten lead from properly uniting with the lead beneath, making a very weak joint and one that offers very high resistance to the flow of current through the battery connections.

For this reason the surface of the lead in the bottom of the cup must first be melted by momentarily applying the torch, before additional molten lead is run in. This requires a sort of double operation with the torch flame that can be acquired only by practice.

In order to get the molten lead from the filler stick into the cup before the molten spot in the bottom cools, it is necessary to keep the torch playing on the molten spot and feed the end of the filler bar into the flame at the same time. This requires plenty of practice because there is quite a tendency for the end of the strap to become overheated and melt down, making it very difficult to complete the connection because the solid ring or lug on the strap end is needed as a form or mold to hold the molten lead and build up a good connection.

If the strap edge is accidentally melted down in this manner it is often better to remove the strap entirely and replace it with a new one. This trouble can be avoided by being very careful to keep the torch flame directed into the center of the lug and not allow it to play for any length of time over the edges of the strap lug.

It is also a good plan to build one post only part way up and then work on another post for a short time, giving the strap on the first one time to cool. By working from one connection to another, and building each one up a little at a time in this manner, none of the terminals is as likely to overheat.

Where only one or two connections are being worked upon the strap can be cooled occasionally by placing a wet cloth around it. When doing this, however, be extremely careful not to get any water

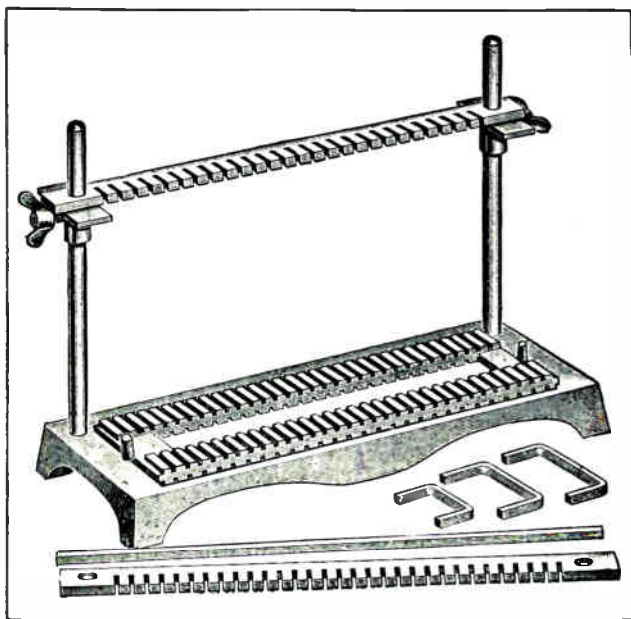

Fig. 42. Convenient racks of the above type are used for grouping and holding plates when burning on the terminal lugs on plate connectors.

into the cup, or it may cause molten lead to be blown into one's face when the lead burning is resumed.

When the post has been built up flush with the top of the lug or ring on the strap a very neat job can be done by adding a little more lead, and slightly rounding off the top of the connection.

This is a very critical operation and requires considerable skill and accuracy to avoid running the lead over the edge and melting down the side of the strap lug. Before placing this little additional cap on the connection it is well to let the work cool somewhat and brush off the top surface with a wire brush so that it is bright and clean.

The very center of this spot can then be slightly melted with the torch and a medium sized drop of lead run onto it. Then by raising the torch slightly and using a part of the flame which is not quite so hot, and running this flame quickly around in a circle the drop of molten lead can be pushed out just to the edge of the connection, making a very smooth and neat-appearing cap.

One should always be very careful not to jar or move a lead burned connection until the lead has had time to cool and harden, or otherwise the lead may be caused to crystallize as it sets, making a very weak and high-resistance joint.

#### 41. CAUTION

Extreme care should be used when working with a torch on batteries that have just been removed from the charging line, as the cells may have quite a little hydrogen gas under their covers. This gas is highly explosive, and if a flame is brought near the small vent openings in the cell caps it is likely to blow the caps or covers completely off the cell.

It is, therefore, best to remove the vent caps and blow out each cell with compressed air if it is avail-

able. If no air pressure is available gas may be burned out by removing all vent caps, examining the electrolyte to see that it is below the lower edge of the vent hole tubes, and then using a soft flame with all oxygen turned off.

Standing at arm's length from the battery direct this flame into each vent hole for a second or two, and any gas will be safely burned out.

After the gas has been removed in this manner the battery may be safely worked upon. It is good policy, however, to have all vent plugs out when using a flame on the top of a battery, even after the gases have been removed, because it is still possible that some additional gas might form within the cells. This same precaution of removing vent caps should also be observed when batteries are placed on a charging line, or otherwise the hydrogen gas generated while they are charging may be ignited by a spark at one of the clips or charging connections.

Battery rooms in which large power plant batteries are located, or rooms in which a large number of small batteries are being charged or plates being formed, should always be kept well ventilated to avoid the accumulation of large quantities of hydrogen gas and the danger of serious explosions.

#### 42. ASSEMBLING PLATE GROUPS. MOLDING STRAPS AND POSTS

The lead burning torch is also used when assembling plate groups, for welding on or attaching the terminal posts to the tops of the plate lugs.

Fig. 42 shows a burning rack used for spacing and holding the plates in a vertical position while the terminal posts are burned on to them. The small square bars shown beneath this rack are used for lengthening the lugs on plates, by laying the plate flat on a piece of hard asbestos or similar material, and using the little bars around the lug as a form in which to melt additional lead and run it together with the lead of the plate lug.

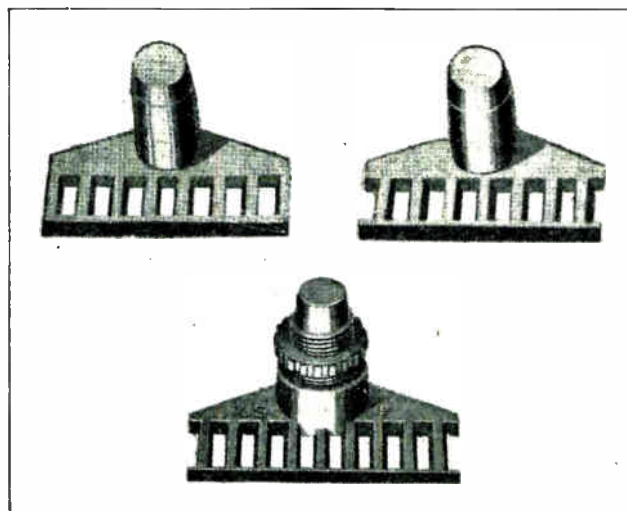

Fig. 43. Plain and threaded terminal posts and plate connectors for attaching positive and negative plates together in groups.



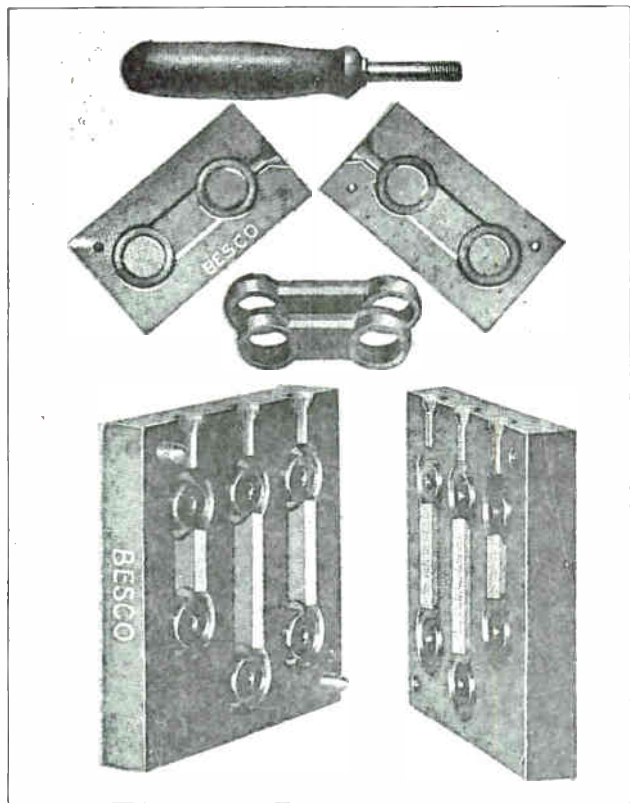

Fig. 44. Above are shown two types of strap or connector molds for molding lead straps of different lengths to be used in connecting together the separate cells of automotive batteries.

Fig. 43 shows several terminal posts which have been cast from lead and are ready for attaching to plate groups. The one on the upper left is a plain post for a positive group, and the one on the upper right a plain post for a negative group. The one shown below is called a "threaded type post" and has a cast lead nut which screws down on top of the cell cover after it has been slipped over the post.

Battery terminal posts and connector straps can be purchased from various battery supply houses, or they can be molded and cast from hot lead by means of special molds right in the battery shop.

Fig. 44 shows two types of strap molds, the one in the upper view being made for molding single straps of a certain length and the gang mold in the lower view is made for molding straps of three different lengths.

These molds are simply clamped in a vise in an upright position and the molten lead poured from a lead ladle into the funnel-shaped openings at the top of the mold.

When the mold is full and the lead has been given time to cool enough to set or harden, the mold is then removed from the vise or clamp and pried carefully apart. The straps can be removed by tapping on the back of the mold, or by prying up the filler tips and pulling them out with a pliers.

Carbonizing or blackening the surface of the mold with a plain gas flame torch will help to remove the

straps more easily and prevent them sticking in the mold.

The upper view in Fig. 45 shows a combination mold for casting threaded posts and lead nuts to go with them, while the lower view in this figure shows a simple mold for pouring straight slender bars of lead which are used for filling strap lugs and making cell connections.

Fig. 46 shows several types of post cutters which are used for trimming off the tops of battery posts that are too long, in order to make them properly fit the strap lugs and to keep the straps down close to the top of the battery.

#### 43. PREPARATION OF BATTERIES FOR STORAGE WHEN NOT IN SERVICE

There are two common ways of storing batteries when they are not in service, one known as the dry storage method and the other as the wet storage. If a battery is to be taken out of service for a long period of time, and if it is not possible to give it a monthly charge it should be stored dry.

For dry storage the following procedure should be taken:

1. Give the battery a thorough charge.
2. Remove the cell connectors and draw out the elements.
3. Remove the covers from the elements and separate the positive and negative groups.
4. Immerse the plates in distilled water for 10 to 12 hours keeping the positives and negatives separate.
5. Remove the plates from the water and allow them to dry. If the negatives heat up when exposed to air they should be immersed in the water again

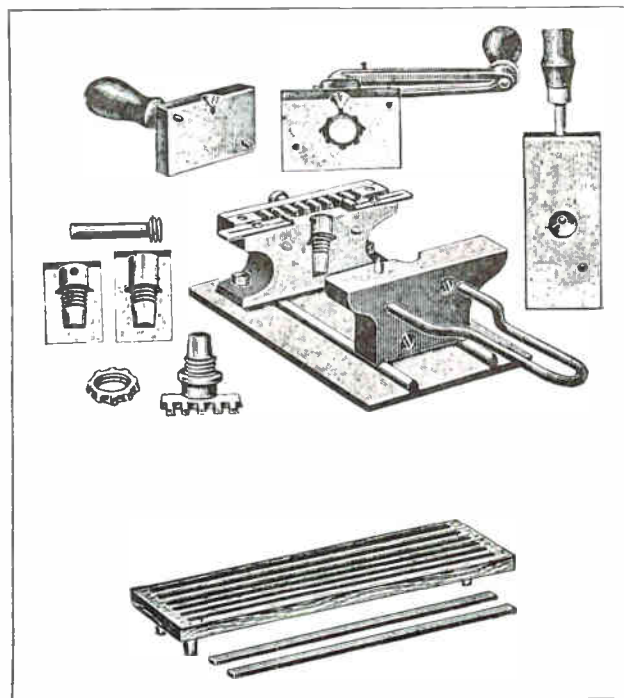

Fig. 45. Above is shown a combination mold used for casting threaded type posts and nuts, while below is a simple mold used for casting plain lead bars to be used in filling lugs when burning on connections.

to cool them, repeating this as long as they tend to heat, and then drying them thoroughly.

6. If the old separators are wood they should be discarded; if rubber they may be saved if they are in good condition. Clean the cell covers and all parts thoroughly and allow to dry.

7. When plates are perfectly dry put the positive and negative groups together, using cardboard instead of regular separators, and replace them in the jars or case in their proper positions.

8. Replace covers and vent plugs but do not seal the covers. Store in a dry place until ready to be put into service again.

9. To put the battery in service install new separators and reassemble the plate groups in the cells, replace the covers and seal them. Fill the cells with 1.320 specific gravity electrolyte, and allow the battery to stand for ten to twelve hours before putting it on charge. Then place the battery on charge at

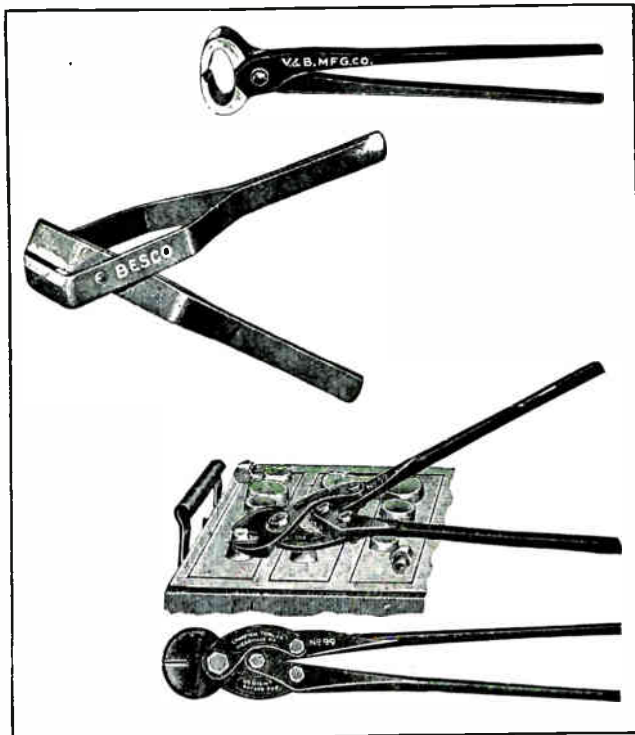

Fig. 46. Several different styles of posts cutters or trimmers for clipping off the tops of battery posts.

the normal rate of 1 ampere per positive plate until the gravity stops rising and remains stationary for five hours. At the end of the charge the gravity should be between 1.280 and 1.300. If the gravity is not between these limits it should be adjusted by withdrawing some of the electrolyte and replacing it with 1.400 electrolyte if the gravity is too low, or with distilled water if the gravity is too high.

For placing a battery in wet storage, first give it a complete charge and then remove it from the charging line, and clean the outside of the battery thoroughly. Apply vaseline or light cup grease to the terminals and check the level of the electrolyte, adding distilled water if necessary.

Store the batteries on dry shelves, allowing a little air space between each battery and the next. Once each month replace with distilled water any electrolyte lost by evaporation and then give the battery a charge in the usual manner.

Before putting back in service batteries which have been in wet storage give them a thorough charge and make a high rate discharge test.

#### 44. CHARGING NEW BATTERIES

After the parts for a new battery have been assembled and the battery is ready to be charged the procedure should be as follows:

First fill the battery with 1.250 specific gravity electrolyte. If stronger electrolyte is used the plates may overheat and become damaged.

After filling let the battery stand from six to twelve hours to allow the electrolyte to soak well into the plates and separators.

Next put the battery on charge at 1 ampere per positive plate. (5 amperes for 11-plate batteries, 6 amperes for 13-plate batteries, etc.) Keep the battery on the charging line until the voltage reaches from 2.4 to 2.5 volts per cell, with voltage test being made while charging. This voltage indicates that the active material on the positive plates is pure lead peroxide and that on the negative pure sponge lead. A gravity reading at this stage would be slightly below 1.250 if wet separators were used in assembling the battery.

The next step is to "set" the gravity by emptying out the electrolyte and replacing it with an equal amount of 1.350 specific gravity electrolyte. Then put the battery back on charge at 1 ampere per positive plate to equalize the electrolyte, and take the gravity reading after the battery has been on the charging line 30 minutes. The gravity should then be between 1.280 and 1.300. If it is below 1.280 withdraw some electrolyte and replace it with 1.400 specific gravity acid and put the battery back on the charging line again for 30 minutes, before taking another reading. If the gravity is above 1.300 remove some of the electrolyte and replace it with distilled water.

Correcting the gravity of a battery in this manner is sometimes known as "balancing", and it can be done while the battery is on the line and charging.

When the battery is ready to be removed from the line each cell should have a voltage of 2.4 to 2.5 volts, and the gravity should be between 1.280 and 1.300. Caution: Be sure that the battery is charging at the correct rate when making a voltage test. Otherwise the above mentioned voltages will not be obtained.

#### 45. SHOP EQUIPMENT

You may desire at some later date to start a shop and enter into a battery repair business of your own. It doesn't require a great deal of capital or material to start a shop of this kind.

The following is a list of tools and equipment needed for a small shop:

- 1 10 or 20 battery Tungar charger
- 1 battery steamer and still
- 1 lead burning outfit
- 1 plate burning rack
- 1 hot-plate and compound pot
- 1 6-in. vise
- 1 low-reading voltmeter (Cadmium type)
- 1 temperature correction thermometer
- 2 hydrometers
- 1 pair of terminal tongs
- 2 pair nut pliers
- 1 10-in. screw driver
- 1 6-in. screw driver
- 1 battery carrier
- 1 putty knife
- 1 Cherokee tool for reaming down size of tapered posts
- 1 set of post builders
- 1 set of steel number stamps
- 1 set of positive and negative stamps
- 1 paint brush
- 2 wire scratch brushes
- 1 separator trimmer
- 1 triangular lead scraper
- 2 Vixen lead files
- 1 pair of end cutters
- 1 drill press and drills  $\frac{1}{2}$ ",  $\frac{5}{8}$ " and  $\frac{3}{4}$ "
- 1 plate press
- 1 high-rate discharge set
- 1 cycling set
- 1 acid container
- 1 funnel.

Other tools such as saw, hammer, etc., will be found convenient. If a lead pot is used to melt lead for molding posts, straps, etc., in the shop, a set of assorted molds can be added.

Battery plates, separators, posts, straps, battery jars and cases, etc., can all be purchased from any regular battery supply company.

If you plan to open a shop of this kind at any time, remember at all times that courtesy, promptness, and first class workmanship are the essentials in building up trade and holding customers once obtained.

A sign on your place of business and some display of your work or supplies, along with some novel window attraction in the front of the shop, are great helps in getting attention and business.

Small ads placed in the local newspaper or little folders left at the homes of car owners in the locality will also help obtain business.

In many cases co-operative arrangement can be made with other local garages which may not have a battery shop, they sending their customers who need battery service to you, and you sending your customers who need general ignition or mechanical service to them.

## 46. GENERAL

Most of the material on lead plate batteries so far covered has been applied to the common small storage battery, such as used by the millions for automotive and radio work, as this is the field in which you will be most likely to have opportunity to make profitable use of storage battery knowledge.

However, it is well to keep in mind that there are numerous installations of large lead plate storage cells in power plant batteries, and that most of the general information covered in this Section can be applied to these batteries also.

Large cells such as shown in Fig. 2 and having plates with a surface area of several square feet are quite commonly used. These plates are generally set on porcelain bars or insulators laid in the bottom of lead-lined wood boxes.

Dozens or hundreds of these huge cells are then connected in series or series-parallel by means of heavy lead bus bars or lead coated copper cables, and kept in well-ventilated battery rooms at power plants or substations where they are used.

Such batteries are generally kept charged by means of motor-generator sets supplying D. C. at the proper voltage. In some cases the batteries are kept normally connected across the D. C. power busses, so that they are kept constantly charged up to the bus voltage, and ready to supply or feed current to the busses and load, as soon as any failure of the generators or any voltage drop on the system occurs.

In other cases special motor-generator sets known as boosters are kept connected to the batteries and are equipped with special relays or field connections so that they start charging the batteries at any time their voltage drops a certain amount.

Some large battery installations are equipped with additional cells known as end-cells, which can be manually or automatically cut in series with the main group as the voltages of the main battery drops slightly during discharge. By cutting in these end-cells one at a time the line voltage can be kept constant.

When charging batteries equipped with end-cells the steps of the switching process are just reversed, and the cells cut out one at a time after each has been charged the right amount. This gives the longest charge to those cells which were longest in service.

The voltage, electrolyte gravity, and the temperature are all kept carefully checked on such large battery installations.

It is well to give any storage battery about 10 to 15 per cent overcharge at regular periods to keep them in best condition.

Reversible ampere-hour meters are often used with batteries in power plants, farm lighting plants, emergency lighting installations, etc., to keep ac-

curate records of the amount of energy flow during charge and discharge, and to enable the operator to see that the right amount of charge is given both on normal charging and for the periodic overcharges.

#### 47. EDISON NICKLE-IRON STORAGE CELLS

Edison storage cells differ from lead plate storage cells in that no lead is used in their construction; nickle being used for the positive plates and iron for the negative. The electrolyte is also different and instead of using sulphuric acid the Edison cell uses an alkaline solution of potassium hydroxide and distilled water.

The positive plates for these cells consist of a layer or group of perforated steel tubes  $\frac{1}{4}$  inch in diameter and  $4\frac{1}{4}$  inches long, which are filled with alternate layers of nickle hydrate and pure flake nickle. The nickle hydrate is a green colored powder-like compound and is the real active material in the positive plates, while the flake nickle is put in to improve the electrical conductivity and reduce the resistance of the nickle hydrate.

These two materials are packed into the thin perforated steel tubes under high pressure. The tubes are then banded with eight equally spaced steel rings which fit tightly around the thin walled tubes, reinforcing and strengthening them, and preventing them from bulging with the tendency of the active material to expand.

The proper number of these tubes, according to the size of the plates and cell, are then clamped in a steel frame to make up the plate. For plates

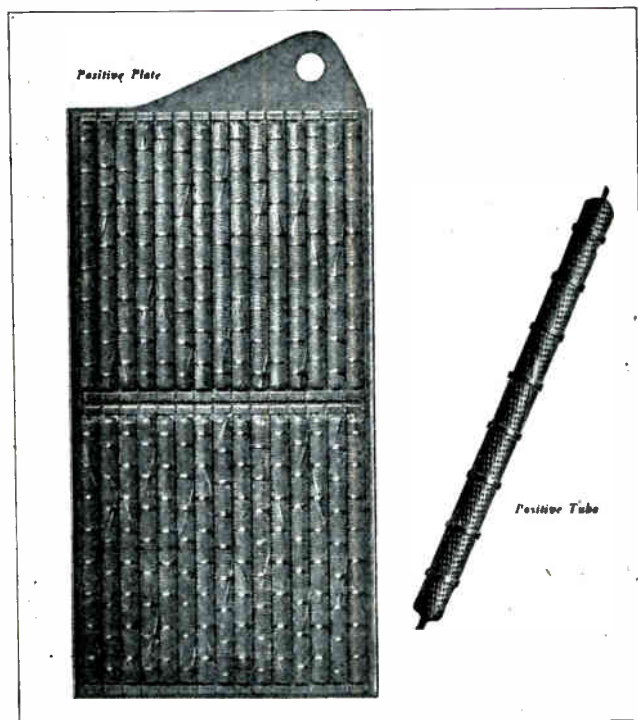

Fig. 47. This excellent photo view clearly shows the construction of the positive plate and individual positive tube for an Edison nickel-iron storage cell. Note the rugged construction of these parts. (Courtesy of Edison Storage Battery Co.)

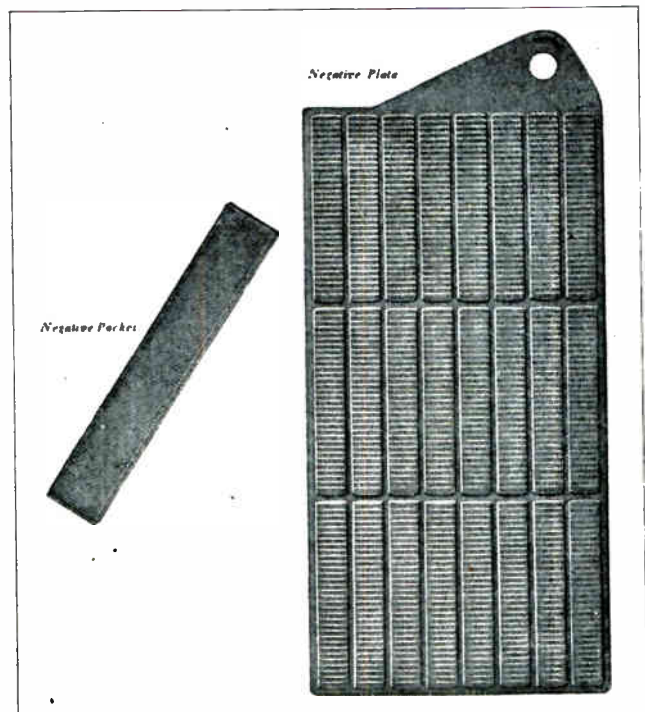

Fig. 48. Photo of complete negative plate and one separate negative pocket used in nickel-iron storage cells. The active material is contained within these pockets which are all grouped together in a steel frame. (Courtesy of Edison Storage Battery Co.)

longer than  $4\frac{1}{2}$  inches two or more sets of tubes are arranged end to end and held in a nickle plated steel frame, as previously explained.

Fig. 47 shows a complete positive plate for an Edison storage cell and also one of the separate positive tubes from which the plate is made up. Note the manner in which the tube is constructed of a spirally-wound, thin steel ribbon, and also note the numerous small perforations to allow the electrolyte to penetrate through the active material in the tube.

The negative plates in Edison storage cells consist of a group of perforated flat steel pockets which are filled with iron oxide as the active material of these negatives. Iron oxide is also commonly called "black iron rust".

A group of these small pockets are then arranged edge to edge and clamped in a steel frame to make up the complete negative plate, as shown in Fig. 48. These positive and negative plates are then assembled in groups by clamping them securely on a threaded steel rod with nuts which draw them tight, the plates being equally spaced by means of steel washers between their lugs where they attach to the rod. A vertical terminal post is also securely attached to this rod.

The positive and negative plate groups are then meshed together similar to those of lead plate storage cells, except that in the Edison cells slender, hard rubber rods called "pin insulators" are placed vertically between the positive and negative plates to act as separators and insulators.

The assembled positive and negative groups or cell elements are then placed in containers of nickle plated steel with welded seams. Thin sheets of hard rubber are placed between the elements and the metal container to act as insulators, and after slipping a hard rubber washer down over each terminal the metal covers are welded permanently in place on the containers. This permanent closing of the cell is possible because of the very long life of the cells, and due to the fact that they require practically no mechanical servicing or attention throughout their life.

The sides of these containers are corrugated to give maximum strength with light weight material. The terminal posts are insulated and sealed into the cover by means of rubber gaskets.

The cell tops are fitted with combination check valves for allowing the escape of gases formed in the cell, and a filler cap which can be opened to add distilled water to the electrolyte or to change the electrolyte when necessary.

Fig. 49 shows an excellent sectional view of a complete Edison alkaline or nickle-iron cell. Note carefully the arrangement of all the parts, and the general construction of this cell.

The completed cells are filled with a solution of potassium hydroxide and water, the specific gravity of which should be 1.200. This electrolyte doesn't attack iron or steel the way sulphuric acid does, and it is thus possible to use the steel containers and obtain a much more ruggedly built battery. A group of cells of the desired number are commonly assembled in trays or frames for convenient handling.

The voltage of Edison nickle-iron storage batteries when fully charged is 1.2 volts per cell which you will note is a little lower than that of lead plate storage cells.

#### 48. ADVANTAGES OF NICKLE-IRON CELLS

The Edison cell has a number of decided advantages, however, which make it much more suitable for many classes of work than lead plate storage cells.

Some of these advantages are as follows:

The all-metal construction provides a cell of maximum mechanical strength and durability, and the construction of the plates makes them much more rugged and able to stand severe vibration, such as batteries are subjected to when used on electrical vehicles or in train lighting service.

The electrolyte, being of a non-acid nature, will not corrode any of the metal parts of the battery or other metal parts on which it might be spilled. Neither does this alkaline electrolyte solution attack or use up the active material of the plates when the battery is not in use, as does occur with lead plate storage batteries if they are not frequently recharged. For this reason Edison cells can be left

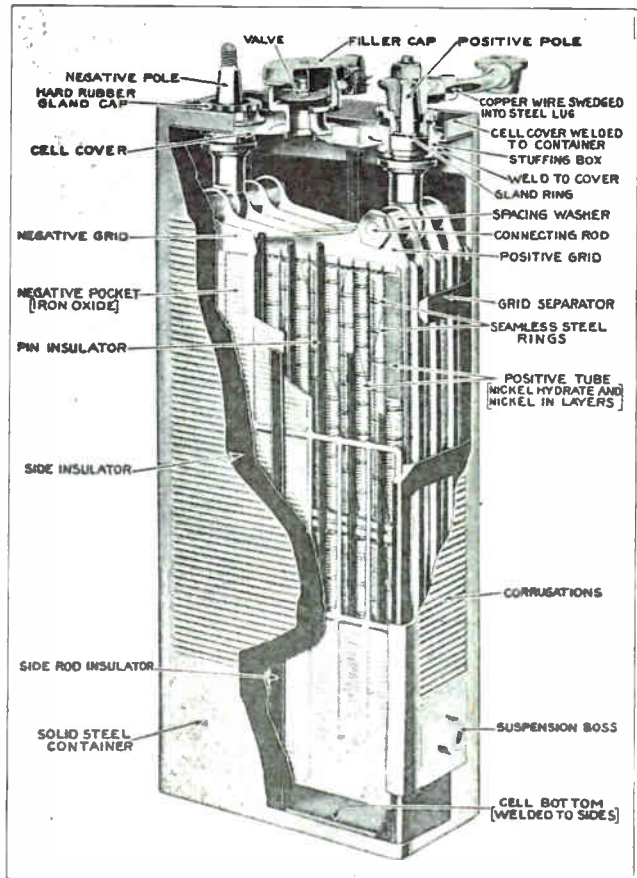

Fig. 49. This excellent cut-away view clearly shows the construction and parts of an Edison nickel-iron storage cell. Note the very rugged construction throughout, and also the strong sheet metal container used with these cells. (Courtesy Edison Storage Battery Co.)

standing idle for long periods in a discharged condition without injury.

These cells can be reversed and charged backward, or can be charged and discharged at very heavy rates, or even short-circuited without injury. The active material of the plates, being encased in steel tubes and pockets, doesn't shed so these cells do not have to be dismantled for plate repairs or cleaning out of sediment.

Another great advantage is that the plates of Edison cells are not subjected to warping and buckling under excessive current rates, and, being equipped with hard rubber separating strips, it is almost impossible for them to become short circuited as so often occurs with plates of lead and acid storage batteries.

#### 49. CHARGE AND DISCHARGE ACTION

The basic principle of the Edison cell is the reduction and oxidation of metals in an electrolyte which doesn't combine with or dissolve the metals or their oxides. Due to this fact the specific gravity of the electrolyte is always constant whether the cell is in a charged or discharged condition.

Hydrometer readings are, therefore, of no use in determining the state of charge of Edison storage cells.

After about 300 cycles of charge and discharge the electrolyte gravity tends to become lower, and the old solution should be emptied out and replaced with new solution of the correct gravity.

During charge the chemical reactions in Edison storage cells are as follows: The nickle hydrate or active material of the positive plate becomes oxidized and is changed to nickle oxide; while the iron oxide or active material of the negative plate is reduced to metallic iron.

Thus, for practical purposes, the charged positive plate can be considered to consist of nickle oxide ( $\text{NiO}_2$ ) and the charged negative plate consists of pure iron ( $\text{Fe}$ ).

During discharge some of the potassium from the electrolyte in the cells unites with the nickle oxide of the positive plate and reduces it to a lower oxide of nickle ( $\text{Ni}_3\text{O}_4$ ), and some of the oxygen unites with the pure iron, changing it to iron oxide ( $\text{Fe}_3\text{O}_4$ ).

When the cell has been discharged these actions can be reversed and the plates and electrolyte both changed back to their original charged condition, by passing current through the battery in the direction opposite to the flow during charge.

#### 50. CHARGING NICKLE-IRON CELLS

The charging voltage required for Edison batteries is from 1.7 to 1.85 volts per cell. These batteries can be conveniently charged by means of the constant current system, or with the batteries connected in series to the source of direct current of the proper voltage.

They are also sometimes charged by the constant potential or parallel method, but the handling of this system is very critical, because if the generator voltage rises at all above 1.7 volts per cell there will be a very heavy current surge through the battery, which may cause it to overheat.

External series resistances are sometimes connected in series with each battery when they are to be charged by the constant potential or parallel method. These resistances serve to limit the current flow and prevent heavy surges and charging current through the batteries.

The open circuited voltage of a fully charged Edison storage cell is about 1.5 volts per cell, but this falls off very rapidly as the rate of discharge is increased so the average discharge voltage of a well-charged cell is about 1.2 volts.

When the voltage drops to .9 volts per cell these batteries are considered to be discharged and should be put back on the charging line again. In many installations of batteries of this type they are recharged as soon as the voltage falls to 1 volt per cell. Nickle-iron storage batteries can be completely discharged, however, without damaging the plates as occurs with lead plate batteries.

While a hydrometer is of no use to indicate the state of charge of the nickle-iron storage cell, it

should be used occasionally to check the specific gravity of the electrolyte to determine whether the solution should be changed or not.

As previously mentioned, the gravity of the electrolyte gradually becomes lower with repeated cycles of charging and discharging, and when this gravity drops as low as 1.160 it should be changed and renewed with 1.200 gravity electrolyte.

Edison cells should not be operated with electrolyte of lower gravity than 1.160, or they become sluggish and lose capacity and are also subject to breakdown on severe service.

Caution: When using a hydrometer to test the specific gravity of the electrolyte in nickle-iron cells, if this device has been used with lead plate cells be sure that it is free from all traces of acid. Be careful never to use with Edison cells any utensils that have been used with sulphuric acid, as even a slight amount of acid may cause serious trouble or ruin the cells if it gets into the alkaline electrolyte solution.

#### 51. INTERNAL RESISTANCE AND EFFICIENCY

The internal resistance of nickle-iron cells is approximately three times as high as that of lead storage cells of the same capacity and voltage, and will cause a voltage drop of about 7% of the open circuit cell voltage when the cell is discharging at the five-hour rate.

Edison cells have a rather peculiar temperature characteristic in that their capacity falls off very rapidly when they are operated at cell temperatures below about 50° F. Under normal conditions, however, the charge and discharge action generally keeps the internal temperature of the cells considerably above this point, particularly if the batteries are enclosed in a box with temperature insulation when they are to be used in cold places.

The efficiency of nickle-iron cells is considerably lower than that of lead storage cells, so they require considerably more current in ampere hours to charge them than can be obtained from them during discharge.

Their efficiency is about 60% in ordinary operation. This lower efficiency is more than made up for, however, by the many other advantages previously mentioned which these cells have over lead plate batteries.

#### 52. CARE OF NICKLE-IRON STORAGE CELLS

In order to give the most satisfactory service nickle-iron storage cells should be recharged often enough to keep their voltage above .9 volt or 1 volt per cell, and will give still better service if used in such a manner that they can be given frequent boosting charges at intervals between the discharge periods, in order to keep the voltage up nearly to the full charged value.

It has already been mentioned that the electrolyte in these cells should be renewed approximately once every six or eight months, or after the cells have been charged and discharged about 300 times.

The cells should be refilled with standard refill solution obtainable from the Edison Storage Battery Company. Don't pour out the old solution until you have received the new and are ready to refill the cells with it, as they should not be allowed to stand empty.

When renewing the electrolyte, first completely discharge the battery at normal rate to zero and then short-circuit it for one or more hours. This is done to protect the battery elements. Next pour out half the solution and shake the cell vigorously, and then empty the balance.

Never rinse the cells with water but instead use only the old solution. Never use a galvanized funnel or one that has soldered seams, or anything else of this nature in handling solution for these batteries. Glass, enamel ware, or plain iron funnels and utensils should be used.

Under good operating conditions and with proper care the total life of these cells should be somewhat over 1000 complete cycles of charging and discharging. When the electrolyte level becomes too low due to evaporation these cells should be refilled with pure distilled water, the same as used for lead plate storage cells, except that it is well to use water that has not been exposed to air for any length of time, but which has instead been kept in a corked bottle or sealed container after distilling.

The level of the electrolyte in nickle-iron cells can be conveniently tested by lowering a  $\frac{1}{4}$  inch diameter glass tube vertically into the filler opening, until its lower end touches the tops of the plates. Then, by placing the finger tightly over the top end of this tube, it can be raised out of the cell and will hold a small amount of the electrolyte at its original level inside of the tube.

This level can be measured from the bottom of the tube, thus determining the height of the electrolyte above the plates.

A small piece of rubber tubing fitted tightly around the top end of the glass tube helps to provide a better air seal when the finger is placed against it.

The metal containers of nickle-iron cells must be kept carefully insulated from each other at all times or there will be a small leakage of current between them, and the cell containers may become punctured due to electrolytic action.

The cells and their trays should be kept well cleaned and free from collections of dirt and moisture. They can be cleaned by blowing with compressed air, or with a steam hose, but the steam hose should not be used on the cells while they are located in their compartments.

It is a good plan to coat the tops of these cells with a light coat of rosin-vaseline which has been warmed to about 180°, and thinned to paint consistency with benzine. This material can be applied with a small paint brush. The outsides of the cell containers should be kept painted with some good alkali-resisting insulating paint. Nickle-iron batteries should not be operated at temperatures above 120° F.

### 53. LOCATION AND CONNECTIONS

When locating nickle-iron cells in storage or carrier compartments, the compartments should be lined with wood and constructed to afford ample ventilation, good drainage, and ease in cleaning. A compartment should be provided with slots about an inch wide, running the full length under each battery tray where bottomless trays are used, and between the trays when trays with bottoms are used. These slots are for ventilation.

Openings should be provided in the sides of compartments above the highest point of the battery. These openings should have a total area slightly greater than the total of the bottom openings and they should be located to keep out as much dirt and water as possible.

If the battery is used out-of-doors in cold climates these openings should be closed during cold winter weather.

Nickle-iron cells can be connected in series or series-parallel, the connections being made and tightened under the nuts provided on the top of the terminal poles. Regular steel jumper connectors with terminal lugs are provided with batteries of this type. These lugs seat firmly on the terminal posts if the steel jumper wires are properly bent and shaped to allow them to.

The lugs should never be driven or hammered into place, but should have their jumpers so shaped and adjusted that the lugs slip easily in place where they can be securely locked by means of the nuts.

It is good practice to slightly grease the threads on the terminal posts, after the lugs are in place and before the nut is put on. Make sure that all contact surfaces between terminal posts and lugs are clean before making connections, and always see that all connections are kept tight and clean.

For removing these connector lugs after they have been forced tight with the terminal nuts, a small disconnecting jack or terminal puller is shipped with each battery. This jack can be placed straddle of the terminal post so that it engages the lug and will then pull the lug loose if the screw of the jack is turned.

One should be very careful never to handle flames of any kind around these cells when they are charging or discharging, as explosive gases are liberated from the cells during these periods.

The material covered in this Section on Storage Batteries of common types has been applied particu-

larly to automotive batteries of the lead and acid type, and to nickle-iron storage batteries which are so extensively used for operation of electrical vehicles, and in train lighting, and various classes of signal work.

However, a great many of the principles and rules given can also be applied to larger storage batteries

of the lead plate type, which are used in power plant work and which have been generally explained.

A good understanding of the material covered in this Section can be of great value to you in various classes of electrical work, such as telephone, telegraph, railway signal, farm lighting, radio, automotive, and power fields.

Norman Beder  
71 Georgia Ave.  
Brooklyn 7, N. Y.