



FOR THE HOME CONSTRUCTOR

PRACTICAL TRANSISTOR CIRCUITS

No. 2

CONTENTS

- | | | | |
|------|---------------------------------------|------|---------------------------------------|
| PK1 | 3 — TRANSISTOR HEARING AID | PK21 | SIMPLE TRANSISTOR INTER-COMM. |
| PK2 | VARIABLE FREQUENCY AUDIO OSCILLATOR | PK22 | TRANSISTOR METAL DETECTOR |
| PK3 | SUB-MINIATURE POCKET TRANSMITTER | PK23 | AUDIO TEST GENERATOR |
| PK4 | TRANSISTOR TIMER | PK24 | MODULATED RF SIGNAL GENERATOR |
| PK5 | 250mW PUSH-PULL AMPLIFIER | PK25 | MICROPHONE PRE-AMPLIFIERS |
| PK6 | HEADLAMP DIMMER OR NIGHT SWITCH | PK26 | AUDIO BRIDGE BALANCE INDICATOR |
| PK7 | TRANSISTOR PORTABLE BABY ALARM | PK27 | MAJOR-2 PERSONAL POCKET RADIO |
| PK8 | TELEPHONE PICK-UP AMPLIFIER | PK28 | 'TINY' CRYSTAL CONTROLLED TRANSMITTER |
| PK9 | HIGH IMPEDANCE PRE-AMPLIFIER | PK29 | SINGLE CHANNEL RADIO CONTROL RECEIVER |
| PK10 | MINIATURE RF, IF AUDIO TRACER | PK30 | 2 WATT POWER OUTPUT STAGE |
| PK11 | TAPE HEAD PRE-AMPLIFIER | PK31 | SQUARE WAVE GENERATOR |
| PK12 | TOP BAND "TONE" TRANSMITTER | PK32 | 3-12 MC/S CRYSTAL MARKER |
| PK13 | $\frac{1}{2}$ WATT PORTABLE AMPLIFIER | PK33 | TOP BAND TRANSMITTER |
| PK14 | TRANSISTOR HI-FI PRE-AMPLIFIER | PK34 | SHORT WAVE RECEIVER |
| PK15 | LIGHT SENSITIVE POWER SWITCH (1) | PK35 | 3-CHANNEL AUDIO MIXER |
| PK16 | LIGHT SENSITIVE POWER SWITCH (2) | PK36 | RF, IF AND AUDIO TRACER |
| PK17 | 10 WATT PORTABLE LOUD-HAILER | PK37 | CAR SAFETY FLASHER |
| PK18 | LOW IMPEDANCE PRE-AMPLIFIER | PK38 | TRANSMITTER KEYING MONITOR |
| PK19 | MOTOR-CYCLE TWO-WAY TELEPHONE | PK39 | TRANSISTOR ELECTRONIC ORGAN |
| PK20 | RF AND IF SIGNAL GENERATOR | PK40 | MULTI-CHANNEL RADIO CONTROL RECEIVER |

COMPILED BY
D. J. FRENCH, GRAD.I.E.E.

PRICE 3/6 Post Free

HENRY'S RADIO LIMITED
5 HARROW ROAD - LONDON - W.2
(at the junction of Harrow Rd. & Edgware Rd. near Marble Arch)

SHOP HOURS: 9 a.m. to 6 p.m. Monday to Saturday 1 p.m. Thursday. Telephone: PADdington 1008/9

PLEASE NOTE:

ALL COMPONENTS USED ARE AVAILABLE FROM STOCK SEPARATELY. PLEASE ALLOW POSTAGE AND PACKING ON INDIVIDUAL ITEMS WHEN ORDERING. TERMS ARE CASH WITH ORDER OR C.O.D. No. C.O.D. UNDER 20/-.

ALL COMPONENTS SUPPLIED BY US FOR USE WITH THE CIRCUITS DESCRIBED ARE FULLY GUARANTEED. SHOULD A COMPONENT BE SUSPECT, PLEASE RETURN IT WITH A COVERING LETTER AND RETURN POSTAGE FOR TEST. WE ARE UNABLE TO ACCEPT ANY UNITS BUILT FROM THESE CIRCUITS FOR TEST OR REPAIR.

WE ARE ABLE TO SUPPLY MOST OF THE COMPONENTS USED IN MAGAZINES, BOOKLETS AND CIRCUIT DIAGRAMS OF VALVE OR TRANSISTOR DESIGN. IF NOT AVAILABLE WE CAN SUGGEST SUITABLE REPLACEMENTS WHERE POSSIBLE.

OUR SPECIALITIES TRANSISTORS, QUARTZ CRYSTALS, VALVES AND MINIATURE COMPONENTS.

FREE CATALOGUES ALL OUR COMPONENT LISTS ARE FREE BY RETURN OF POST.

PORTABLE RADIOS. SEND FOR LEAFLETS OF OUR RANGE OF EASY DO-IT-YOURSELF PERSONAL POCKET RECEIVERS, POCKET SUPERHETS AND COMBINED PORTABLE CAR RADIOS.

TRANSISTOR BASE CONNECTIONS

Some popular types in use:

CONNECTION DIAGRAMS FOR TRANSISTORS

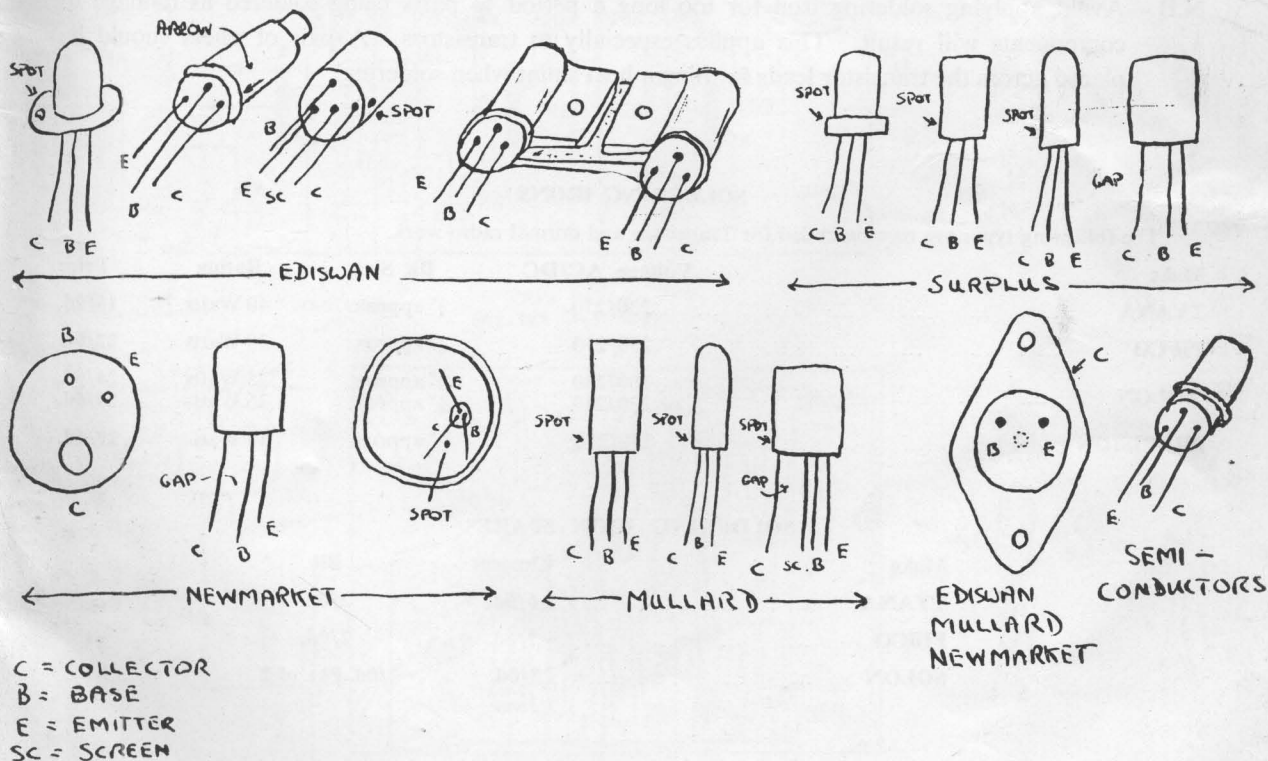

HINTS ON SOLDERING

1. The soldering iron must be at the right temperature. An electric iron is at the right temperature for soldering if it just begins to singe a piece of newspaper in ten seconds.
2. For all radio work a non-corrosive flux **MUST** be used, the ideal being a cored solder such as "Multicore" radio quality.
3. Clean the tip of the bit with emery cloth, then heat the iron until the solder melts instantly when applied to it. Let the solder flow on to each surface of the end of the bit; then wipe off the surplus with a pad of clean rag; the iron is now tinned and ready for use.
4. Make absolutely certain the two parts to be soldered together are clean, free from grease and tinned.
5. When soldering always place the solder on the work and lay the bit on the top of the solder. Never take the solder on to the bit and try to apply it to the work.
6. When wires are to be connected to tags it is a good plan to follow the professional practice of passing the wire through a hole in the tag and making a mechanical joint before the soldered one is effected.

N.B.—Avoid applying soldering iron for too long a period to parts being soldered as damage to components will result. This applies especially to transistors. A pair of pliers should be placed across the transistor leads forming a heat shunt when soldering.

SOLDERING IRONS

The following types are recommended for Transistor and normal radio work.

Make	Voltage AC/DC	Bit Size	Rating	Price
TYANA	230/250	¼" approx.	40 Watts	16/9d.
PIFCO	230/250	¼" approx.	30 Watts	22/6d.
SOLON	200/230 or 230/250	¼" approx. ¼" approx.	25 Watts 25 Watts	24/6d. 24/6d.
PRECISION	230/250	⅜" approx.	15 Watts	29/6d.

SOLDERING IRON SPARES

Make	Element	Bit
TYANA	6/6d.	2/0d.
PIFCO	7/6d.	2/0d.
SOLON	5/0d.	2/0d. Pkt. of 2

FLUXED CORED SOLDER at 6d., 2/6d., 5/0d., 7/6d. and 15/0d. per reel.

PK1 3-TRANSISTOR HEARING AID

A miniature high gain amplifier, size 3 x 2 x $\frac{1}{4}$ in., designed for use as a hearing aid. A sub-miniature magnetic microphone is used which is glued on to the underside of the lid. The two transformers used should be glued down on to the tagged chassis to prevent movement. Full volume control is effected by the 10K Ohm Potentiometer.

When used as a hearing aid no responsibility can be accepted concerning the tone correction and acoustic reproduction.

COMPONENTS LIST

OC71 TRANSISTOR	10/0d.	3 — TRANSISTOR HOLDERS ...	9d. ea.
2 — RED SPOT TRANSISTORS ...	3/6d. ea.	4 — 30 MFD ELECTROLYTICS ...	2/3d. ea.
2 — D1001 TRANSFORMERS ...	7/0d.	SUB-MINIATURE MICROPHONE ...	15/0d.
TAGGED CHASSIS	2/6d.	0.01 MFD CONDENSOR	6d.
PERSONAL EARPHONE	12/6d.	U16 1½ VOLT BATTERY	4½d.
RESISTORS:—	3d. ea.	10 K CONTROL WITH SWITCH ...	7/6d.
3 — 1K OHM (BROWN/BLACK/ RED)		6 INCH LENGTH BUS-BAR WIRE	} 6d.
2 — 15K OHM (BROWN/GREEN/ ORANGE)		6 INCH LENGTH HOOK UP WIRE	
1 — 5.6K OHM (GREEN/BLUE/RED)		CASE 3 x 2 x $\frac{1}{4}$ in.	1/6d.

SPECIAL INCLUSIVE PRICE
79/6d. p.p. 1/-

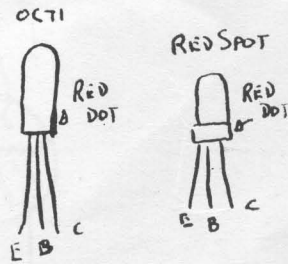
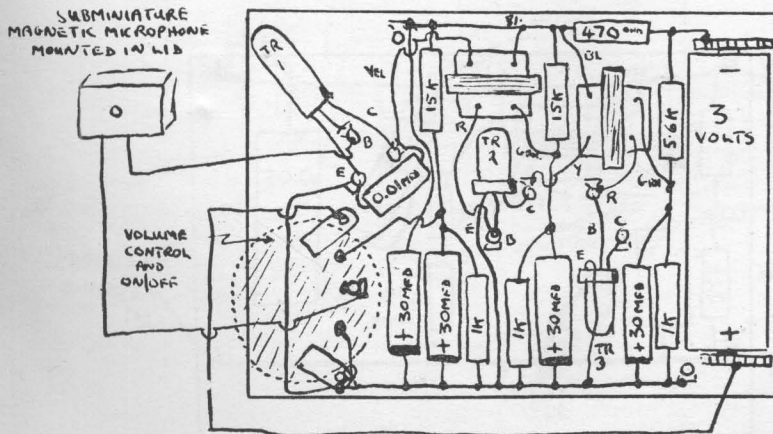
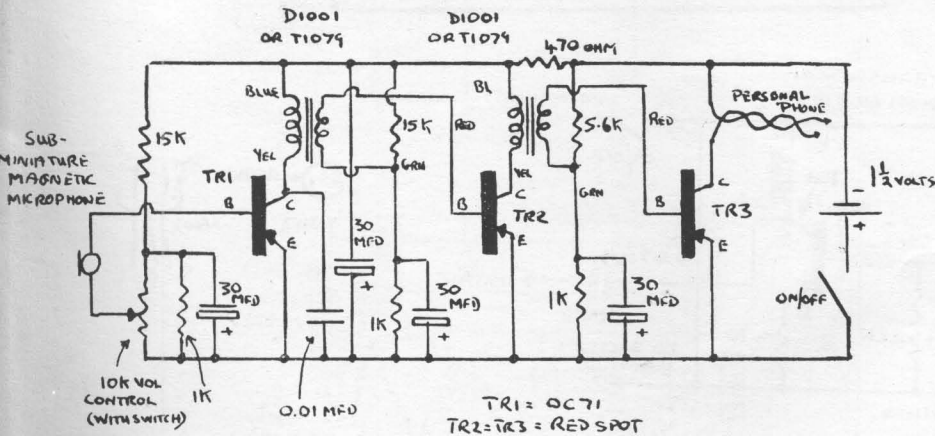

PK2 VARIABLE FREQUENCY AUDIO OSCILLATOR

This audio oscillator is for testing audio amplifiers and the audio and output sections of mains or transistor radios. A good sine wave output is obtained over the entire range. Connection is made via the 2 MFD. Condenser to the circuit under test. Larger output can be obtained by connecting a lead from the battery positive to the earth or common side of the circuit under test through another 2 MFD. Condenser.

Other uses include variable audio frequency modulator for RF signal generators, tone generator for radio control transmitters and electronic organ.

COMPONENTS LIST

XB112 OR XB102	7/6d.	0.01 CONDENSER	6d.
TRANSISTOR HOLDER	9d.	2 MFD CONDENSER	1/6d.
D1001 TRANSFORMER	7/0d.	150K (BROWN/GREEN/YELLOW)	3d.
25K CONTROL WITH SWITCH	4/6d.	22K (RED/RED/ORANGE)	3d.
DRILLED CABINET, 4 1/2 x 3 x 1 1/2 in. ...	3/0d.	470 OHMS (YELLOW/MAUVE/BROWN) ...	3d.
TAGGED CHASSIS (STD. 1)	1/6d.	4 INCH LENGTH BUS-BAR WIRE	6d.
PP6 9 VOLT BATTERY	2/9d.	1 - YARD SLEEVED WIRE	3d.
0.05 CONDENSER	9d.	FREQUENCY CONTROL KNOB	10d.

SPECIAL INCLUSIVE PRICE
29/6d. p.p. **1/6d.**

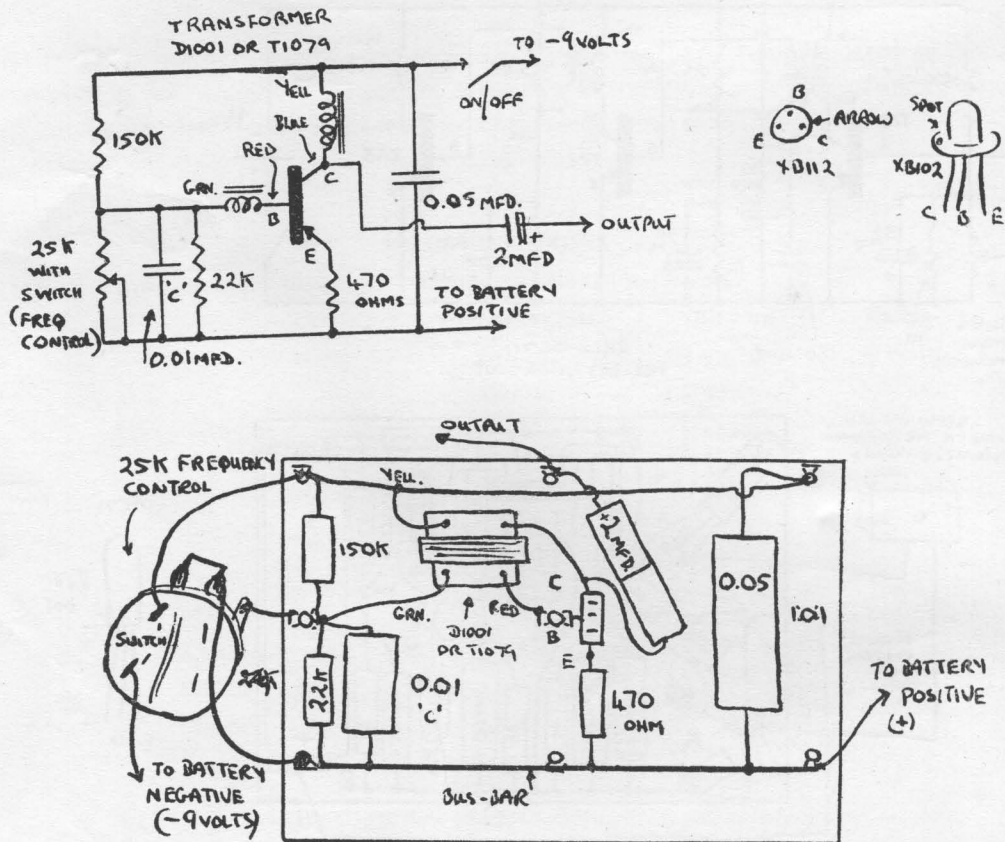

PK3 SUB-MINIATURE POCKET TRANSMITTER

A three transistor top band transmitter using sub-miniature components throughout. Overall size is 3 x 2 x $\frac{3}{4}$ inch including battery and built-in microphone. Designed nominally for top band operation (1.8 to 2 MC/S), this unit will give good clear reproduction over several hundred yards. Ideal for use with the sub-miniature top band receiver described elsewhere in this issue.

The aerial can be any stiff rod or wire of 2 to 4 feet length. To switch on connect the croc-clip to the positive bus-bar.

(Courtesy of Bernards Radio Manuals.)

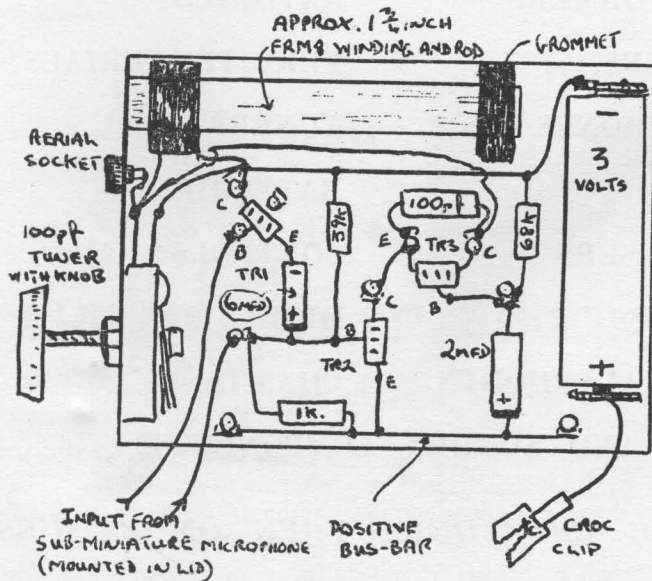
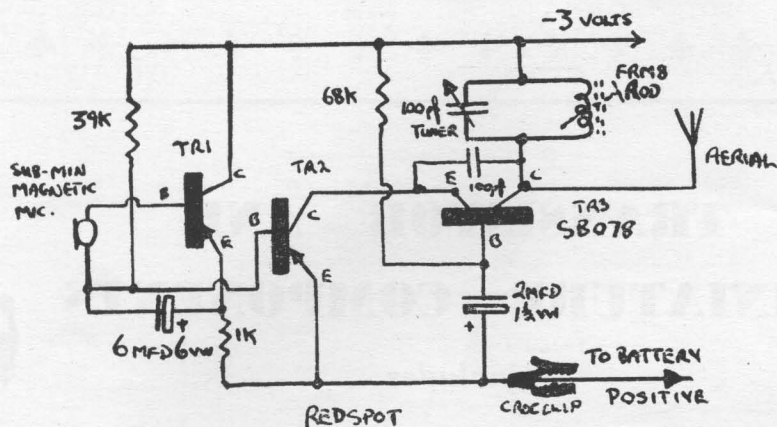

COMPONENTS LIST

SBO78 HF TRANSISTOR ...	7/6d.	3 — TRANSISTOR HOLDERS ...	9d. ca.
2 — RED SPOT TRANSISTORS ...	3/6d. ea.	2 MFD 1½ VW. CONDENSER ...	2/0d.
100 PF TUNER WITH KNOB ...	2/6d.	SUB-MINIATURE CROC-CLIP ...	6d.
SUB-MINIATURE MAGNETIC MIC... 15/0d.		AERIAL SOCKET ...	6d.
DRILLED AND TAGGED CHASSIS... 2/6d.		CABINET 3 x 2 x ½ inch ...	1/6d.
FRM8 AERIAL ...	5/0d.	100 PF CONDENSER ...	6d.
D22 3 VOLT BATTERY ...	10d.	4 INCH LENGTH BUS-BAR WIRE ...	6d.
39K OHM (ORANGE/WHITE/ORANGE) 3d.		6 INCH LENGTH HOOK UP WIRE ...	6d.
68K OHM (BLUE/ GREY/ORANGE)... 3d.		6 MFD 6 VW. CONDENSER ...	2/3d.
1K OHM (BROWN/BLACK/RED) ...	3d.		

SPECIAL INCLUSIVE PRICE
47/6d. **p.p. 1/-**



TRANSISTOR AND MINIATURE COMPONENTS



includes



TRANSFORMERS

SWITCHES



SPEAKERS

FERRITE AERIALS

MICROPHONES

TUNERS



COILS

BATTERIES

CONDENSERS

CONTROLS

FOR VALVE
 AND
 TRANSISTOR
 CIRCUITS

CABINETS

DIODES

ALL
 COMPONENTS
 FULLY
 GUARANTEED

PERSONAL 'PHONES

CHASSIS

AND SUNDRY COMPONENTS

COMPLETE CATALOGUE FREE ON REQUEST

WE STOCK THE COMPONENT FOR YOUR CIRCUIT

LARGEST RANGE OF MINIATURE COMPONENTS IN THE COUNTRY

PK4 TRANSISTOR TIMER

This unit gives controlled delays from 3 seconds to 2 minutes. A dial can be marked out by initially timing with a watch and varying the 2K Ohm wirewound control. To operate set the switch to "SET TIME", turn the control for the desired delay and then set the switch to "OPERATE".

Layout is not critical and may be constructed in a box size $4\frac{3}{8} \times 3 \times 1\frac{1}{4}$ inch. The 18 volt supply is made up of two 9 volt batteries in series.

Ideal as a photographic timer; mains supply is connected to AB of the relay contacts, CD to the timer lamp.

COMPONENTS LIST

XB102 OR XB112 TRANSISTOR	...	7/6d.	2 — PP4 BATTERIES	2/0d. ea.
500 MFD 25 VW. CONDENSER	...	3/0d.	BATTERY CLIPS (ONE PAIR)	1/6d.
ON/OFF SLIDE SWITCH	...	2/6d.	100 OHM RESISTOR	3d.
SINGLE POLE 2-WAY SLIDE SWITCH	...	2/6d.	POINTER KNOB	9d.
PLAIN CASE $4\frac{3}{8} \times 3 \times 1\frac{1}{4}$ INCH	...	2/6d.	2 K OHM W/W CONTROL	
PLAIN CHASSIS TO FIT	...	9d.	2000 TO 3000 OHM RELAY	

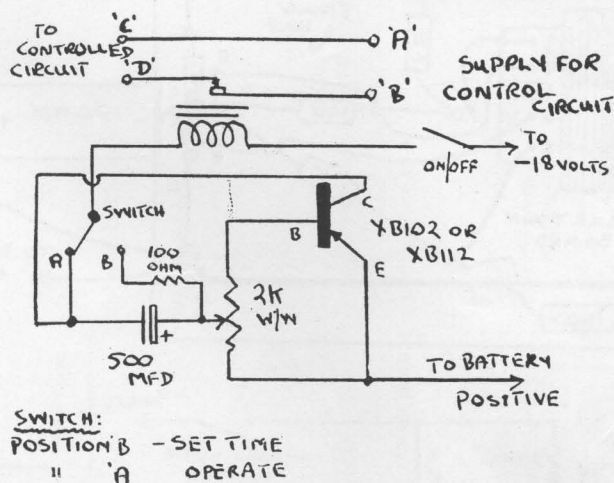

PK5 250 MILLIWATT 'ADDON' PUSH-PULL AMPLIFIER

The "ADDON" amplifier was developed to convert to speaker, most two or three transistor pocket radios using headphones or earpiece. A special socket is provided on the input which takes the standard plug fitted to earphone cords. Simply unclip the earphone and plug into the amplifier giving room filling volume from your personal radio.

For best results the cabinet provided should be drilled to make a speaker grill or a hole cut and suitable material glued across. Cabinet size is $5\frac{3}{4} \times 3\frac{1}{2} \times 1\frac{1}{2}$ inches. Battery life is approximately 3 to 4 months.

P.T.O. FOR DIAGRAMS

COMPONENTS LIST

2—XB112 OR XB102 TRANSISTORS	7/6d. ea.	UNDRILLED CABINET, 5½ x 3½ x 1½ in.	3/6d.
ON/OFF SLIDE SWITCH	2/6d.	TAGGED CHASSIS (STD. 1)	1/6d.
EN2082 TRANSFORMER	10/0d.	SUB-MINIATURE INPUT SOCKET	3/6d.
2—TRANSISTOR HOLDERS	9d. ea.	(TO TAKE STANDARD H/A. PLUG)	
0.04 MFD CONDENSER	9d.	PP6 9 VOLT BATTERY	2/9d.
100 MFD	1/6d.	2½ INCH 25 OHM SPEAKER	18/6d.
RESISTORS:—	3d. ea.	6—6BA NUTS AND BOLTS	
2—2.7K (RED/MAUVE/RED)		4 INCH LENGTH BUS-BAR WIRE	
2—100 OHM (BROWN/BLACK/BROWN)		2—1 YD. LENGTHS SLEEVED WIRE	} 1/0d.
		(2 DIFFERENT COLOURS)	

SPECIAL INCLUSIVE PRICE
59/6d. **p.p. 1/6d.**

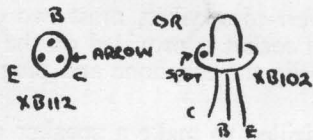
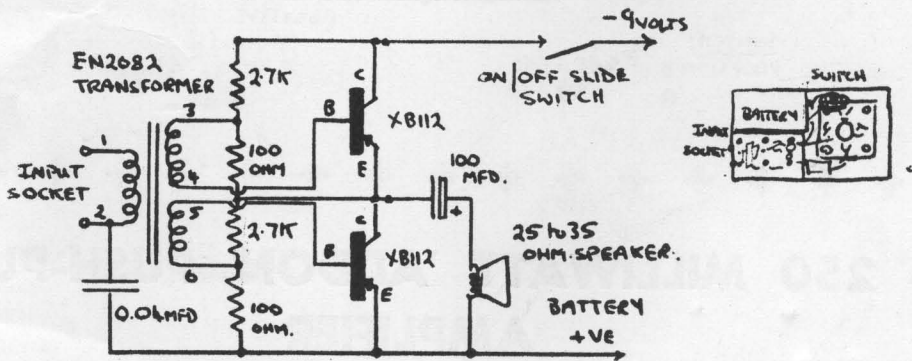
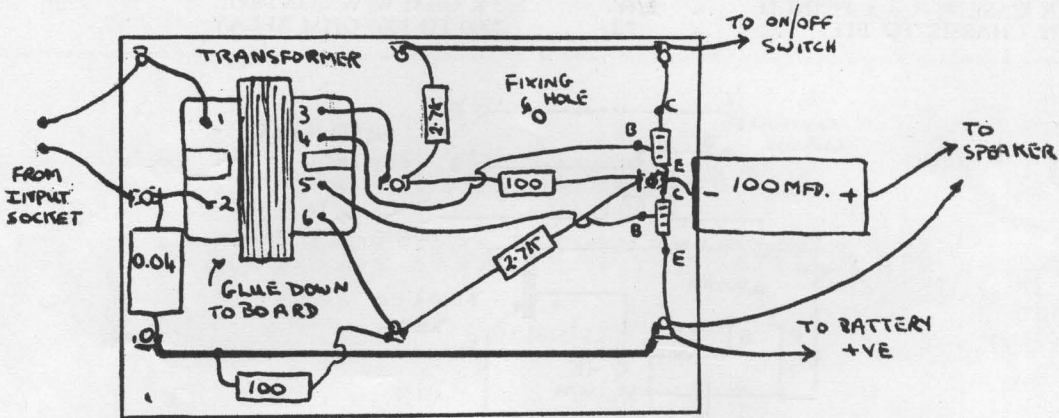

PK6 PHOTO-ELECTRIC HEADLAMP DIMMER OR NIGHT PARKING SWITCH

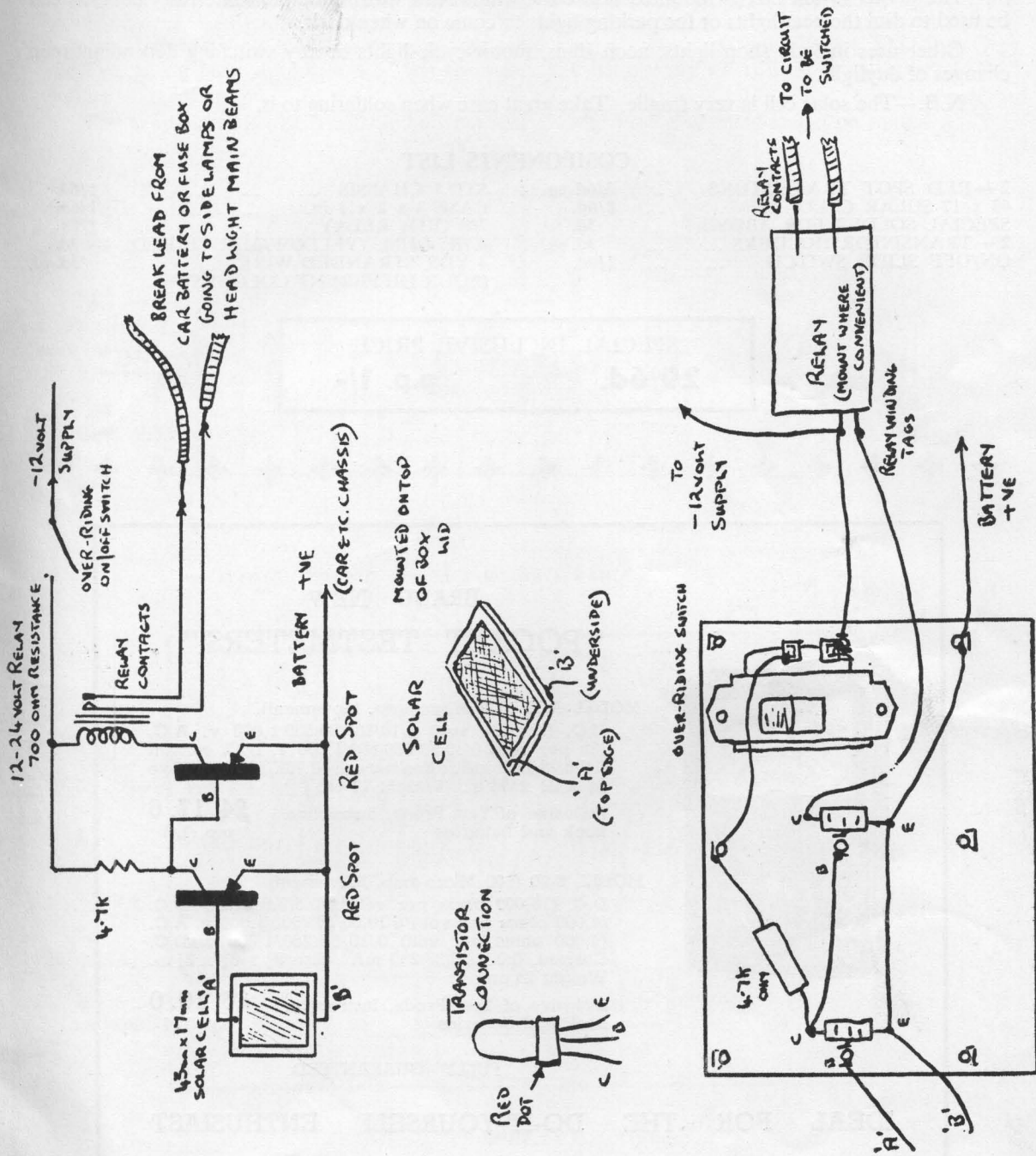

P.T.O.

Circuit uses a light sensitive solar cell with two transistor amplifier operating a relay. The solar cell is mounted on top of the lid of the box with glue after first having connected wires to the underside of the cell and the top silvered rim. Only the special solder provided should be used for these connections. The relay can be mounted under the car bonnet near the fuse box or anywhere convenient.

The photo switch box is mounted inside the windscreen with sellotape. The relay contacts can be used to dim the headlights or for parking lights to come on when dark.

Other uses include shop lights, neon signs, motor-cycle lights or any switching depending upon changes of daylight.

N.B.—The solar cell is very fragile. Take great care when soldering to it.

COMPONENTS LIST

2— RED SPOT TRANSISTORS	...	3/6d. ea.	STD.1 CHASSIS	...	1/6d.
43 x 17 SOLAR CELL	...	8/0d.	CASE 3 x 2 x 1/4 in.	...	1/6d.
SPECIAL SOLDER FOR ABOVE	...	3d.	700 OHM RELAY	...	7/6d.
2— TRANSISTOR HOLDERS	...	9d. ea.	4.7K OHM (YELLOW/MAUVE/RED)	...	3d.
ON/OFF SLIDE SWITCH	...	2/0d.	4 YDS. STRANDED WIRE	...	3d. yd.
			(FOUR DIFFERENT COLOURS)		

SPECIAL INCLUSIVE PRICE

29/6d.

p.p. 1/-



BRAND NEW

“POCKET TESTMETERS”

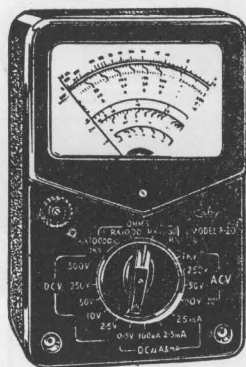

MODEL A-10 (500 Micro-amp. Movement).

D.C. (2k per volt) 0/10/50/250/500/1,000 v. A.C. (2k per volt) 0/10/50/250/500/1,000 v D.C. current 0/0.5/25/250 mA. Resistance: 0/10K/1 Meg. Size 5 1/2 x 3 1/2 x 1 1/2 in. Weight 17 oz.

Inclusive of Test Prods, Instruction Book and Batteries **£4. 17. 6**
p.p. 1/6

MODEL B-20 (100 Micro-amp. Movement).

D.C. (10,000 ohms per volt) p/0.5/2.5 volts. D.C. (4,000 ohms per volt) 0/10/50/250/500/1,000 v. A.C. (4,000 ohms per volt) 0/10/50/250/1,000 v. D.C. Current, 0/0.1/2.5/25/250 mA. Size 5 1/2 x 3 1/2 x 2 1/4 in. Weight 24 oz.

Inclusive of Test Prods, Instruction Book and Batteries **£6. 10. 0**
p.p. 1/6

FULLY GUARANTEED

IDEAL FOR THE DO-IT-YOURSELF ENTHUSIAST

OR SERVICE MAN

PK7 ALL TRANSISTOR PORTABLE BABY ALARM

A new-born baby or a young child should never be left alone. This can only be made possible by the use of a baby alarm. Fully transistorized, working from a 9 volt battery, the unit is therefore fully portable. It can be used over any distance via twin wire. The amplifier is very sensitive, giving large output in a 5 inch speaker. The battery life when used continually is 4 to 5 months.

The baby alarm is also available built-up and tested. Free illustrated leaflet on request.

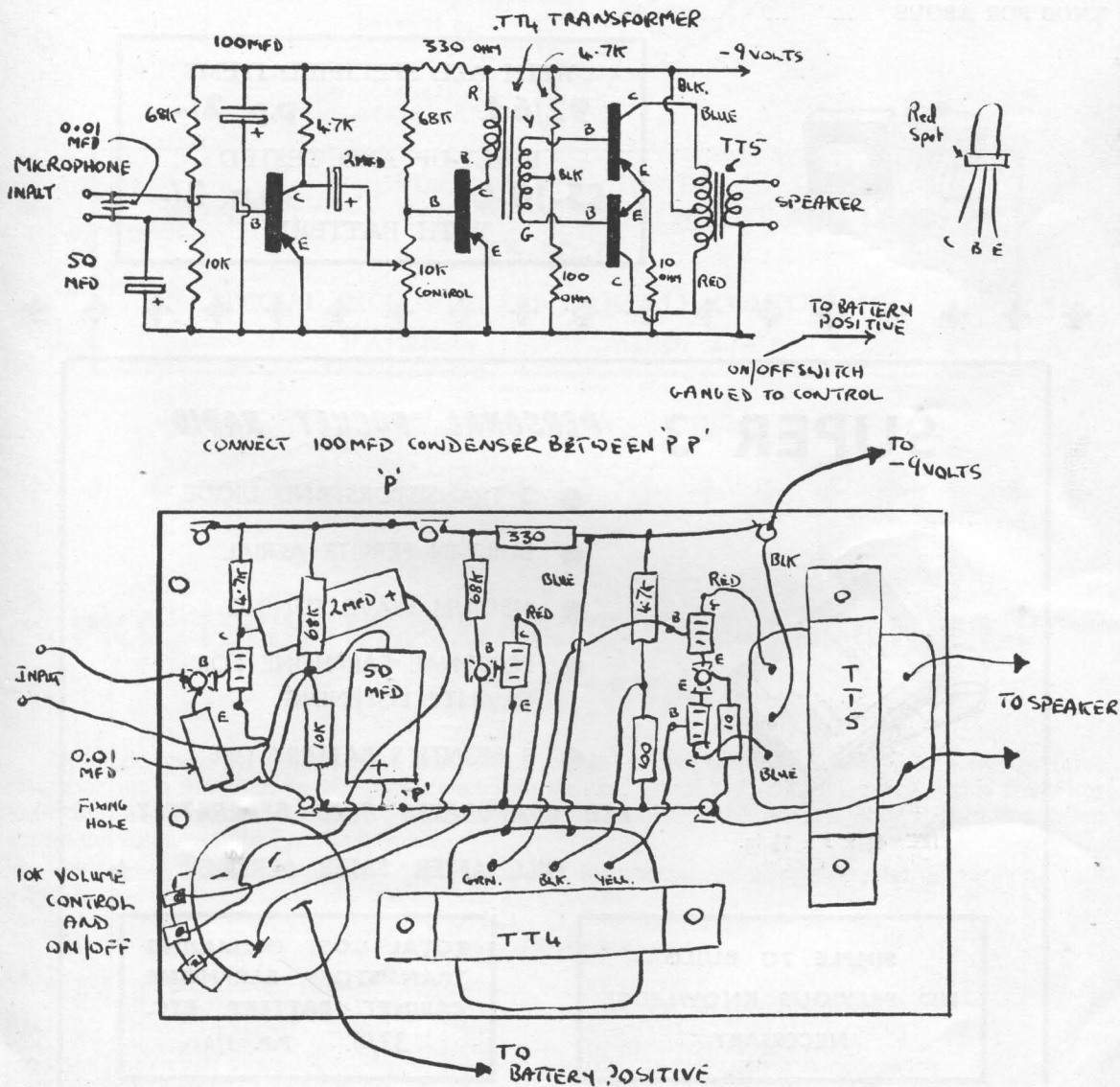

COMPONENTS LIST

4 — RED SPOT TRANSISTORS ...	3/6d. ea.	RESISTORS:—	3d. ea.
4 — TRANSISTOR HOLDERS ...	9d. ea.	2 — 68K (BLUE/GREY/ORANGE)	
TT4 TRANSFORMER ...	8/6d.	2 — 4.7K (YELLOW/MAUVE/RED)	
TT5 TRANSFORMER ...	8/6d.	1 — 10K (BROWN/BLACK/ORANGE)	
5 INCH SPEAKER ...	15/6d.	1 — 100 (OHM) (BROWN/BLACK/BROWN)	
PP9 9 VOLT BATTERY ...	3/6d.	1 — 330 (OHM) (ORANGE/ORANGE/BROWN)	
AMPLIFIER CABINET ...	15/6d.	1 — 6 INCH LENGTH BUS-BAR WIRE	} 6d.
MICROPHONE WITH CLIP ...	9/6d.	2 — 1 FT. LENGTHS PVC WIRE (2 DIFFERENT COLOURS)	
DRILLED AND RIVETED CHASSIS ...	2/6d.	4 — WANDER PLUGS ...	6d. ca.
BATTERY CLIPS ...	1/6d.	0.01 CONDENSER ...	6d.
100 MFD CONDENSER ...	1/6d.	1 — TWIN PANEL WANDER SOCKET	1/0d.
50 MF CONDENSER ...	1/6d.	TWIN CLEAR CONNECTION WIRE	
2 MFD CONDENSER ...	1/6d.	4d. PER YARD EXTRA.	
10K VOLUME CONTROL WITH SWITCH ...	4/6d.		
KNOB FOR ABOVE ...	9d.		



WITH ALL SPECIFIED ITEMS
92/6d. p.p. 2/-

BUILT-UP AND TESTED
£5-10-0 p.p. 2/-
WITH BATTERY



SUPER 3 PERSONAL POCKET RADIO

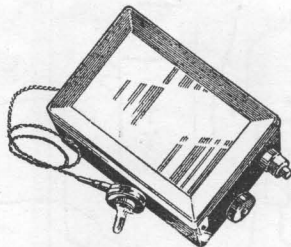

SIZE 4 $\frac{3}{8}$ x 3 x 1 $\frac{1}{2}$ in.

- 3 TRANSISTORS AND DIODE
- BUILT-IN FERRITE AERIAL
- MEDIUM WAVE TUNING
- PERSONAL EARPHONE FOR QUALITY LISTENING
- 9 MONTH'S BATTERY LIFE

ALL COMPONENTS SOLD SEPARATELY

★ FULL AFTER SALES SERVICE ★

SIMPLE TO BUILD
NO PREVIOUS KNOWLEDGE
NECESSARY

TOTAL COST INCLUDING
TRANSISTORS, EARPHONE
CABINET, BATTERY, ETC.
37/6 P.P. 1/6

IDEAL FOR BEGINNERS ● A WELCOME GIFT

PK8 TELEPHONE PICK-UP AMPLIFIER

Replacing the microphone of the baby alarm with a telephone pick-up induction coil produces a handy instrument for the office, works or home. The coil is mounted behind the telephone as shown. Any number of people can then listen to a telephone call, this saving time in explaining a conversation. When a telephonist/typist has to "hold-on" for a call she can continue typing and then switch off when the call comes through. Dictation can be taken down, etc., etc.

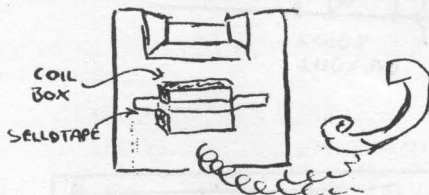

BUILT-UP AND TESTED
 WITH BATTERY, TELEPHONE ATTACHMENT AND LEADS
£5-10-0
 SPECIAL INCLUSIVE PRICE OF ALL COMPONENTS
92/6d. p.p. 2/-



PK9 HIGH IMPEDANCE PRE-AMPLIFIER.— ONE STAGE

A single stage pre-amplifier for matching a crystal microphone or pick-up into a two or three transistor main amplifier or low impedance line system. Ideal for converting a portable transistor radio into a portable radiogram or loud hailer. The output of the pre-amplifier is then connected across the volume control of the receiver.

Other uses include voice modulating of a CW transmitter, or using a crystal microphone with a long lead.

COMPONENTS LIST

XB102 OR XB112 TRANSISTOR ... 7/6d. TRANSISTOR HOLDER ... 9d. TAGGED CHASSIS—STD. 1 ... 1/6d. 25 MFD ELECTROLYTIC ... 1/6d. 100 MFD ELECTROLYTIC ... 1/6d. 2 OR 4 MFD ELECTROLYTIC ... 1/6d.	RESISTORS:— ... 3d. ca. 680-OHM (BLUE/GREY/BROWN) 4.7K (YELLOW/MAUVE/RED) 1K (BROWN/BLACK/RED) 15K (BROWN/GREEN/ORANGE) 4 INCH LENGTH BUS-BAR WIRE ... 6d.
-------------------------------------------------------------------------------------------------------------------------------------------------------------------------------------------------------------	---------------------------------------------------------------------------------------------------------------------------------------------------------------------------

P.T.O. FOR DIAGRAMS

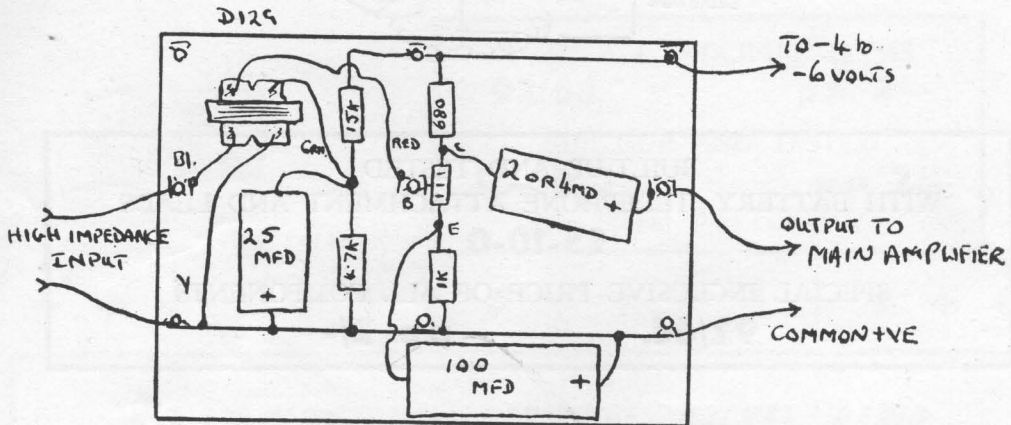
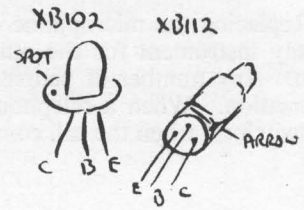
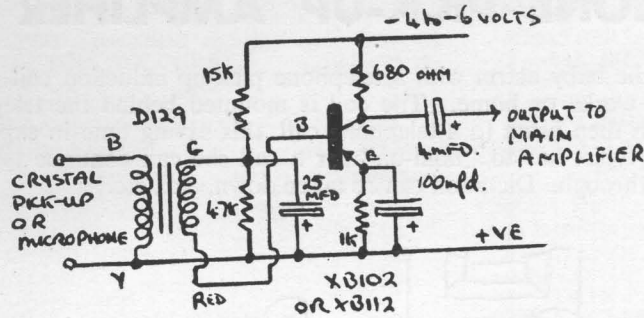

SPECIAL INCLUSIVE PRICE
14/6d. **p.p. 1/-**

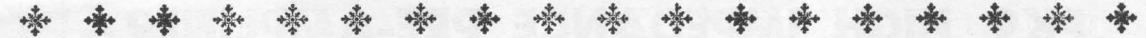

We are able to supply most of the components specified on circuits in the popular magazines and booklets. Where the exact item is not stock we can in most cases suggest a suitable alternative

PK10 R.F. I.F. AND AUDIO SIGNAL TRACER-MINIATURE VERSION

Pocket size test unit (3 x 2 x 3/4 inches) which tests radio receivers, amplifiers, etc. Circuit detects IF and RF frequencies up to many megacycles as well as audio frequencies. Output is to a personal earphone. The built-in 3 volt battery will give many months of use.

To use, connect a croc-clip from the "Common" input to the earth of the valve unit, or positive of the transistor unit under test. RF and IF circuits input and audio inputs are then plugged in to the appropriate socket.

Unit is ideal for fault finding on all types of receivers and as a signal peaker for alignment. (Courtesy of Bernard's Radio Manuals.)

COMPONENTS LIST

2 — RED SPOT TRANSISTORS	... 3/6d. ea.	DIODE DETECTOR 2/0d.
2 — TRANSISTOR HOLDERS	... 9d. ea.	2 — 10K (BROWN/BLACK/ORANGE)	3d. ea.
D1001 OR T1079 TRANSFORMER	... 7/0d.	1 — 33K (ORANGE/ORANGE/ORANGE)	3d.
PERSONAL EARPHONE	... 12/6d.	1 — 68K (BLUE/GREY/ORANGE)	
CASE 3 x 2 x 3/4 in.	... 1/6d.	3 — SUB. MIN. WANDER SOCKETS...	6d. ea.
STAMPED CHASSIS WITH CLIPS	... 2/6d.	3 — SUB. MIN. WANDER PLUGS	6d. ea.
ON/OFF SLIDE SWITCH	... 2/6d.	3 YDS. SLEEVED WIRE	3d. yd.
D22 3 VOLT BATTERY	... 10d.	(THREE DIFFERENT COLOURS)	
4 MFD 6 VOLT CONDENSER	... 2/0d.	3 — SUB. MIN. CROC. CLIPS	6d. ea.
0.1 MFD 150V. CONDENSER	... 6d.		

SPECIAL INCLUSIVE PRICE
45/- **p.p. 1/-**

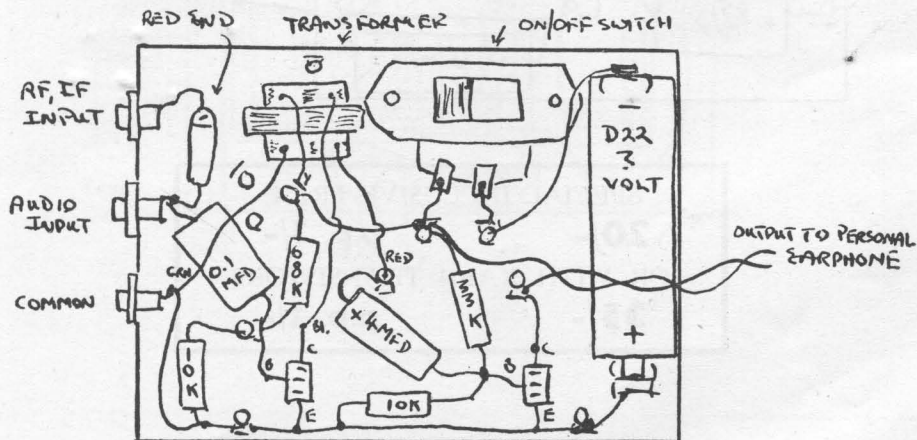
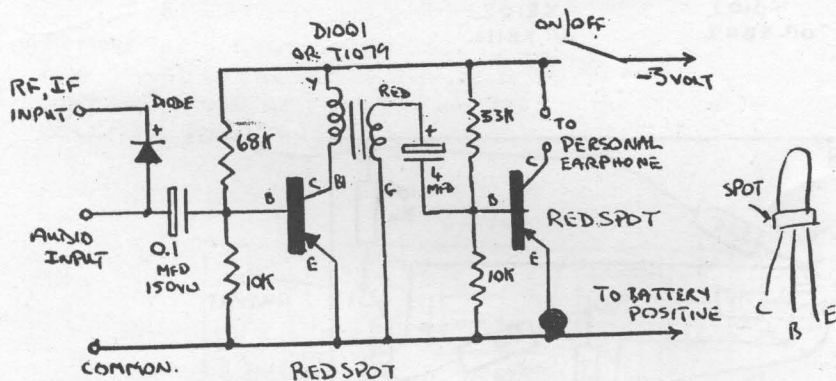

PK11 TAPE HEAD PRE-AMPLIFIER

A general purpose tape head pre-amplifier for low impedance tape heads. Output impedance is 10K Ohm. Good response is obtained from 30 C/S to 12 KC/S but can be improved by using XA104 type transistors. Overall unit size is $2\frac{3}{4}$ x 2 inches, so that it can easily be mounted into existing equipment.

COMPONENTS LIST

2—XB102 OR XB112 TRANSISTORS	7/6d. ea.	RESISTORS:—	3d. ea.
2—TRANSISTOR HOLDERS	9d. ea.	2—220 OHM (RED/RED/BROWN)	
TAGGED CHASSIS STD. 1	1/6d.	1—10K (BROWN/BLACK/ORANGE)	
25 MFD ELECTROLYTIC CONDENSER	1/6d.	1—4.7K (YELLOW/MAUVE/RED)	
0.25 MFD CONDENSER	9d.	1—22K (RED/RED/ORANGE)	
		4 INCH LENGTH OF BUS-BAR WIRE	3d.

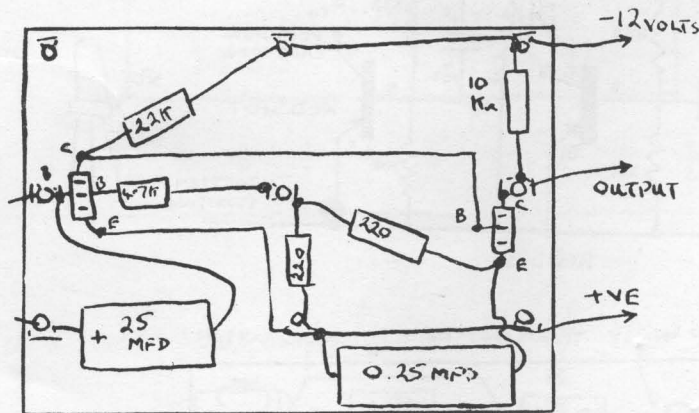
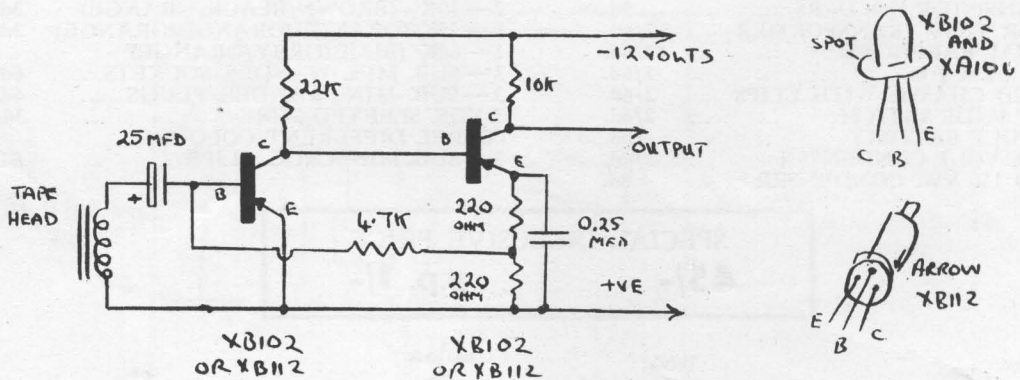

SPECIAL INCLUSIVE PRICE
20/- **p.p. 1/-**
 OR WITH XA104 TRANSISTORS
35/- **p.p. 1/-**

PK12 TOP BAND 'TONE' TRANSMITTER

A sub-miniature top-band transmitter (160-180 metres) for "Tone" transmission. Short range transmission can be had without an aerial; aerial connections can be made to the collector "C" of the white spot transistor.

The core of the P50/2CC coil is adjusted to $\frac{1}{8}$ -inch down inside the former. The tuner is then varied to the desired frequency.

WARNING: The transmitter is quite capable of being adjusted to cover the medium wave band. This is against Post Office regulations.

P.T.O.

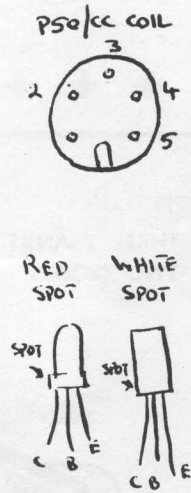
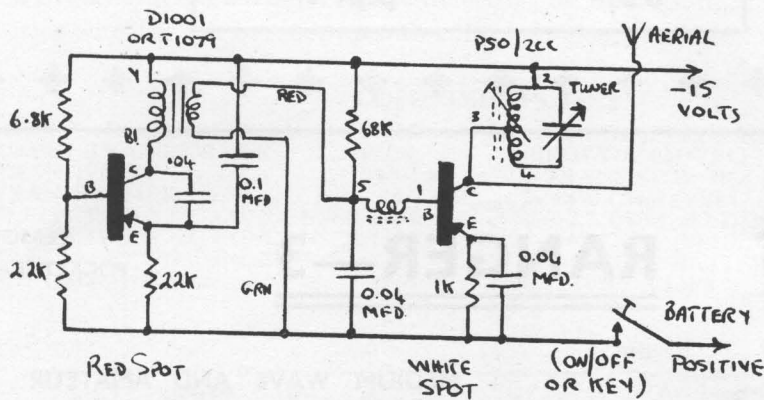

NOTE: REMOVE THE SCREENING CAN AND FIXED CONDENSER OF P50/2CC COIL CONDENSER WILL BE FOUND CONNECTED BETWEEN PINS 2 AND 4

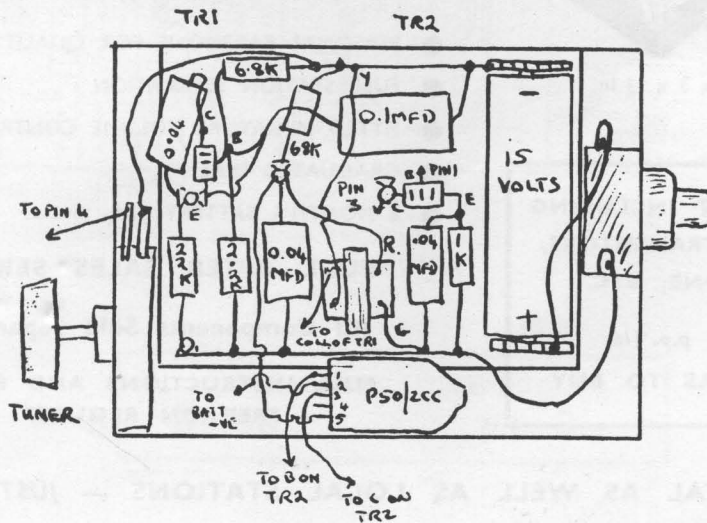

P.T.O.

COMPONENTS LIST

WHITE SPOT TRANSISTOR	5/0d.	PUSH-BUTTON SWITCH	1/6d.
RED SPOT TRANSISTOR	3/6d.	TAGGED CHASSIS	2/0d.
2— TRANSISTOR HOLDERS	9d. ea.	RESISTORS:—	3d. ea.
P50/2CC COIL	5/6d.	1— 6.8K (BLUE/GREY/RED)	
3— 0.04 MFD CONDENSERS	9d. ea.	1— 2.2K (RED/RED/RED)	
1— 0.01 MFD CONDENSER	6d.	1— 1K (BROWN/BLACK/RED)	
TUNING CONDENSER	2/6d.	1— 22K (RED/RED/ORANGE)	
D1001 TRANSFORMER	7/0d.	1— 68K (BLUE/GREY/ORANGE)	
B144 15 VOLT BATTERY	2/0d.	6 INCH LENGTH BUS-BAR WIRE ...)	6d.
CABINET 3 x 2 x 1/4 in. DRILLED ...	2/6d.	6 INCH LENGTH SLEEVED WIRE ...)	

SPECIAL INCLUSIVE PRICE

35/-

p.p. 1/-



THREE TRANSISTORS
TWO DIODES

RANGER—3

PERSONAL
POCKET RADIO

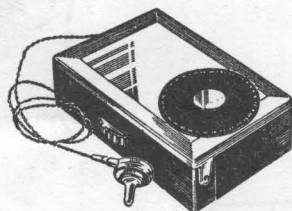

SIZE 4 3/8 x 3 x 1 1/4 in.

MEDIUM WAVE AND AMATEUR
'TOP BAND' TRANSISTOR RADIO

120 TO 500 METRES TUNING

LUXEMBOURG GUARANTEED
(where normally receivable)

- PERSONAL EARPHONE FOR QUALITY OUTPUT.
- FULL STATION SEPARATION
- FITTED MINIATURE VOLUME CONTROL
- GRADUATED DIAL
- 6 MONTH'S BATTERY LIFE

FULL AFTER SALES SERVICE

All Components Sold Separately

**FULL INSTRUCTIONS AND PRICES
FREE ON REQUEST**

**TOTAL COST INCLUDING
BATTERY, TRANSISTORS,
EARPHONE, ETC.**

79/6 p.p. 1/6

NO EXTRAS TO BUY

CONTINENTAL AS WELL AS LOCAL STATIONS — JUST LISTEN !

EASY TO BUILD — TROUBLE FREE QUALITY LISTENING

PK13 1/2 WATT PORTABLE QUALITY AMPLIFIER

The circuit shows a 1/2-watt transistor main amplifier for use with TRF or superhet tuner units or with the pre-set amplifiers described elsewhere in this issue.

Peak output on music is about 530 MW with the XC131 transistors mounted on a 3 x 3 inch aluminium plate. Layout is not critical, the whole circuit could be mounted on a chassis of 5 1/2 x 3 1/4 inches. Including a pre-amplifier.

Output impedance is to three Ohms. For best results this should be a good quality speaker. Improved frequency response can be had by connecting the feedback resistor as shown.

A single amplifier can be made up with a three position switch for low, high and tuner outputs.

COMPONENTS LIST

TT21 INTERSTAGE TRANSFORMER	17/6d.	120K OHM FEEDBACK RESISTOR ...	3d.
TT22 OUTPUT TRANSFORMER ...	17/6d.	(BROWN/RED/YELLOW)	
XC131 TRANSISTORS ...	34/0d. pr.	3 TRANSISTOR HOLDERS ...	9d. ca.
XB103 TRANSFORMER ...	10/-	2-470 OHM (YELLOW/MAUVE/BROWN)	3d.
500 MFD ELECTROLYTIC CONDENSER	1/6d.	1-2.7 OHM (RED/MAUVE/RED) ...	3d.
100 MFD ELECTROLYTIC CONDENSER	1/6d.	1-68 OHM (BLUE/GREY) ...	3d.
4 MFD ELECTROLYTIC CONDENSER	1/6d.	PP9 9 VOLT BATTERY	3/6d.
PLAIN CHASSIS 5 1/2 x 3 1/4 in. ...	1/3d.	BATTERY CLIPS ...	1/6d. pr.

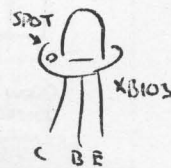
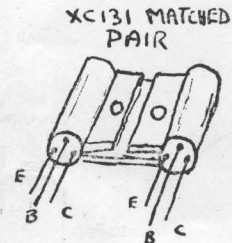
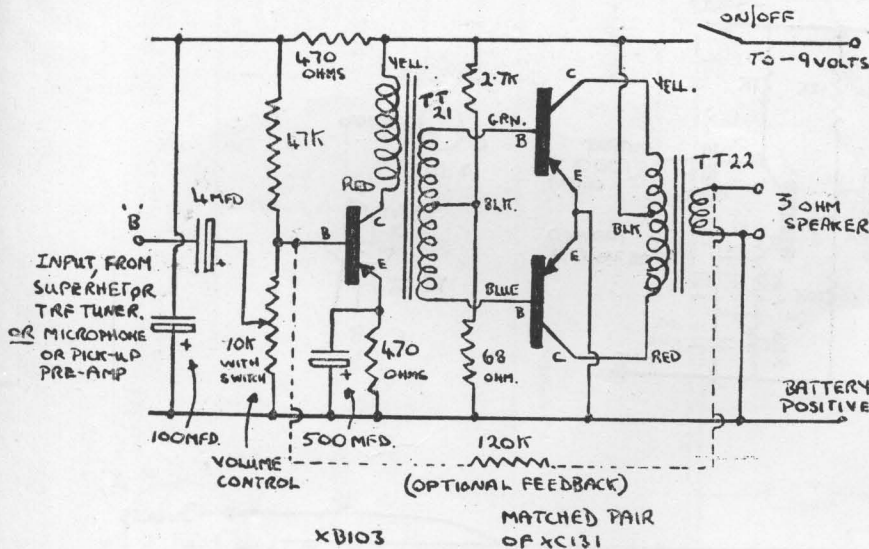

SPECIAL INCLUSIVE PRICE
89/6d. p.p. 2/-

PK14 TRANSISTOR HI-FI PRE-AMPLIFIER

A two stage hi-fi pre-amplifier having a flat response from about 30 c/s to 20 KC/S. It is free from hum, noise and microphonics usually found in this type of circuit. It can be used with any low impedance quality pickup cartridge or microphone and fed into any high impedance amplifier or tape recorder. It can also be used for transistor amplifiers.

The 3 volt supply can be taken from the existing equipment or from a D22 or No. 8 dry battery.

For best results select R1 for 1.2 volt drop across R2. Generally however a 1.8K will give the desired results.

COMPONENTS LIST

2 — XB112 OR XB102	...	7/6d. ea.	RESISTORS:—	...	3d. ea.
2 — TRANSISTOR HOLDERS	...	9d. ea.	2.2K (RED/RED/RED)		
TAGGED CHASSIS (3 x 2 in.)	STD. 1	1/6d.	2 OF 10K (BROWN/BLACK/ORANGE)		
10 MFD CONDENSER	...	1/6d.	1.8K (BROWN/BLACK/RED)		
2 MFD CONDENSER	...	1/6d.	1K (BROWN/BLACK/RED)		
100 TO 200 MFD ELECTROLYTIC	...	1/6d.	2 OF 18K (BROWN/GREY/ORANGE)		
0.25 MFD CONDENSER	...	9d.	330 OHM (ORANGE/ORANGE/ORANGE)		
			HOOK-UP WIRE 2 YDS. (2 COLOURS)		6d. ea.

SPECIAL INCLUSIVE PRICE
25/6d. **p.p. 1/-**

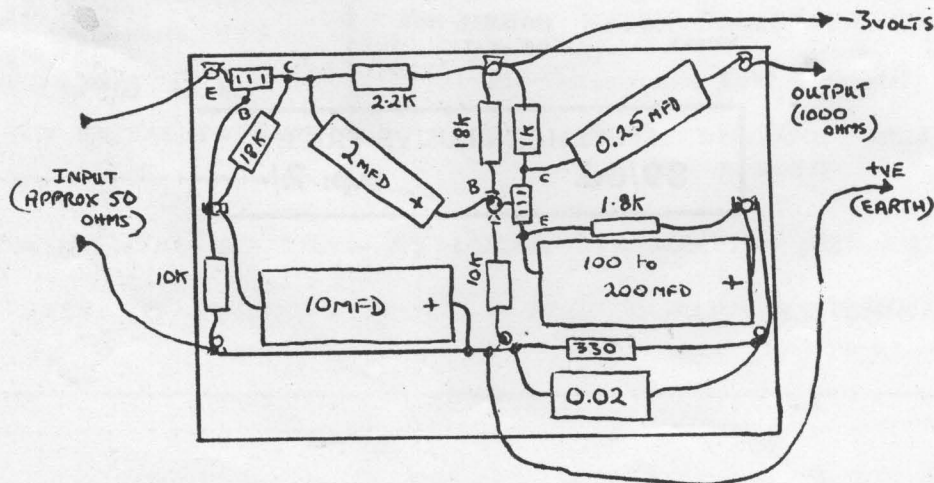
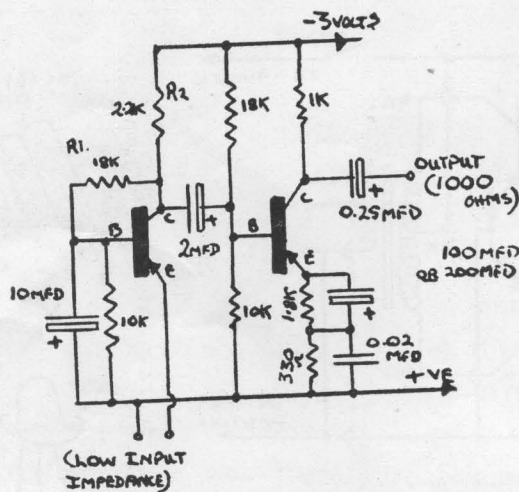

PK15 LIGHT SENSITIVE POWER SWITCH (1)

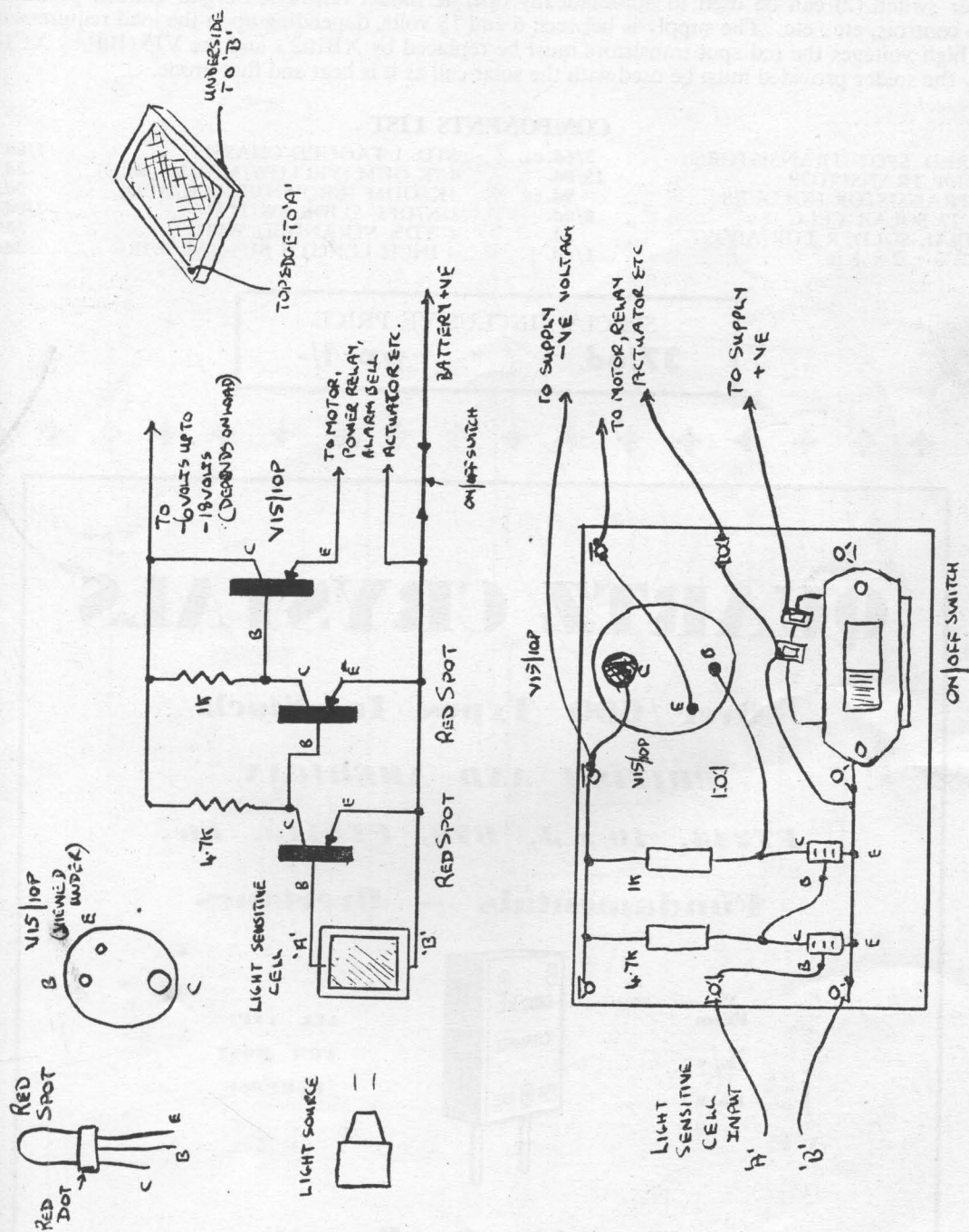

A three transistor light operated switching device for use with model motors, actuators, alarm bells and high power relays. A power transistor V15/10P is used and should be clamped down on to a 3 inch square or more metal plate to stop overheating. When light falls on to the cell, the relay or motor, etc., switches on. If the light is taken away the unit switches off. Both this circuit and power switch (2) can be used to automatically operate model railways, burglar alarms, production time controls, etc., etc. The supply is between 6 and 18 volts, depending upon the load requirements. For high voltages the red spot transistors must be replaced by XB102's and the V15/10P by XC141. Only the solder provided must be used with the solar cell as it is heat and flux prone.

COMPONENTS LIST

2 — RED SPOT TRANSISTORS	...	3/6d. ea.	STD. 1 TAGGED CHASSIS	...	1/6d.
V15/10P TRANSISTOR	...	15/0d.	4.7K OHM (YELLOW/MAUVE/RED)	...	3d.
2 — TRANSISTOR HOLDERS	...	9d. ea.	1K OHM (BROWN/BLACK/RED)	...	3d.
43 x 17 SOLAR CELL	...	8/0d.	ON/OFF SLIDE SWITCH	...	2/0d.
SPECIAL SOLDER FOR ABOVE	...	3d.	4 YDS. STRANDED WIRE	...	3d. yd.
CASE 3 x 2 x 1/4 in.	...	1/6d.	4 INCH LENGTH BUS-BAR WIRE	...	3d.

SPECIAL INCLUSIVE PRICE
37/6d. **p.p. 1/-**



QUARTZ CRYSTALS

Over 600 Types In Stock

BRITISH AND AMERICAN

FT243, 10 x J, B7G, FT241a, Etc.

Fundamentals — Overtones

From
5/-
Each



ALL TYPES
FOR MOST
PURPOSE

Free List On Request

PK16 LIGHT SENSITIVE POWER SWITCH (2)

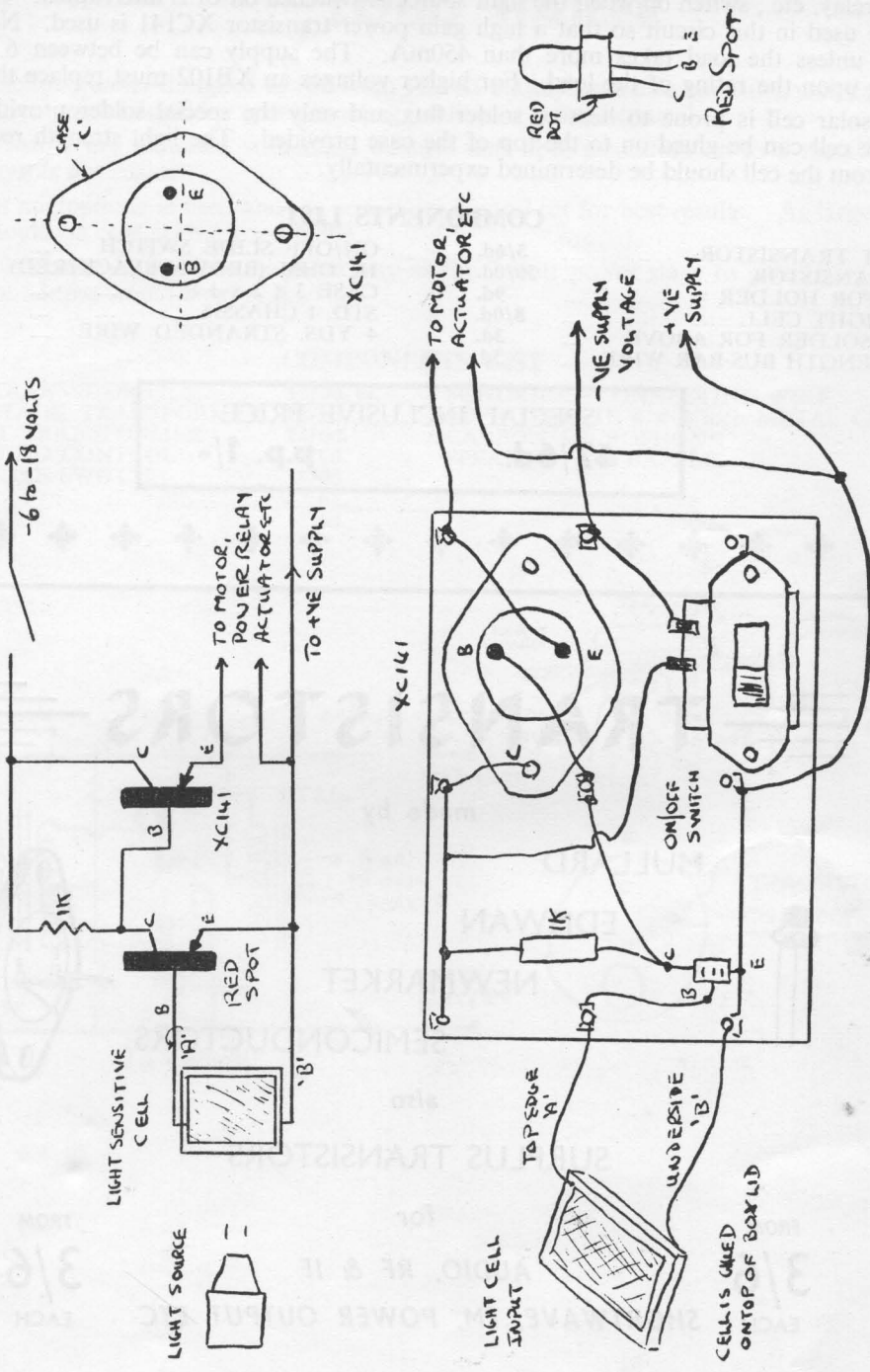

A two transistor light operated unit for use with model motors, relays of high voltage/current, alarm bells, actuators, etc. This version differs from the light sensitive power switch (1) in that the motor or relay, etc., switch on when the light source is switched off or is interrupted. Only two transistors are used in this circuit so that a high gain power transistor XC141 is used. No heat sink is necessary unless the load takes more than 450mA. The supply can be between 6 and 18 volts depending upon the rating of the load. For higher voltages an XB102 must replace the red spot.

The solar cell is prone to heat or solder flux and only the special solder provided should be used. The cell can be glued on to the top of the case provided. The light strength required and its distance from the cell should be determined experimentally.

COMPONENTS LIST

RED SPOT TRANSISTOR	3/6d.	ON/OFF SLIDE SWITCH	2/0d.
XC141 TRANSISTOR	30/0d.	1K OHM (BROWN/BLACK/RED)	3d.
TRANSISTOR HOLDER	9d.	CASE 3 x 2 x 1/4 in.	1/6d.
43 x 17 LIGHT CELL	8/0d.	STD. 1 CHASSIS	1/6d.
SPECIAL SOLDER FOR ABOVE	3d.	4 YDS. STRANDED WIRE	3d. yd.
4 INCH LENGTH BUS-BAR WIRE	3d.				

SPECIAL INCLUSIVE PRICE
47/6d. **p.p. 1/-**



≡≡≡ TRANSISTORS ≡≡≡

made by

MULLARD

EDISWAN

NEWMARKET

SEMICONDUCTORS

also

SURPLUS TRANSISTORS

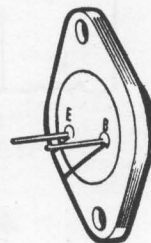

FROM

3/6

EACH

for

AUDIO, RF & IF

SHORTWAVE, FM, POWER OUTPUT ETC.

FROM

3/6

EACH

FREE LIST WITH DATA, USES AND PRICES ON REQUEST

PK17 10 WATT TRANSISTOR PORTABLE LOUD HAILER

A portable loud hailer designed to run from 12 volt battery such as a car battery or dry batteries (short intermittent use). Ideal for sports meetings, rallies or ground control.

The transistors are mounted with mica washers and fibre insulators on to a metal chassis as shown. Layout is not critical.

A carbon microphone is used and the sensitivity control set for best results. As large a speaker as possible should be used with a good baffle.

The amplifier can be used in the same way as the 2 watt power stage to give 10 watts from a portable radio. Input would be at A.B.

COMPONENTS LIST

2 — V15/10P TRANSISTORS	...	15/0d. ea.	SUNDRIES:—CONNECTING WIRE
TT23 INTERSTAGE TRANSFORMER	...	22/6d.	APPROXIMATE 6 x 4 inch METAL CHASSIS
TT24 OUTPUT TRANSFORMER	...	22/6d.	CARBON MICROPHONE
5K WIRE WOUND CONTROL	...	2/6d.	SPEAKER AND BAFFLE
ON/OFF TOGGLE SWITCH	...	2/0d.	
2 OHM	...	6d.	
120 OHM	...	6d.	

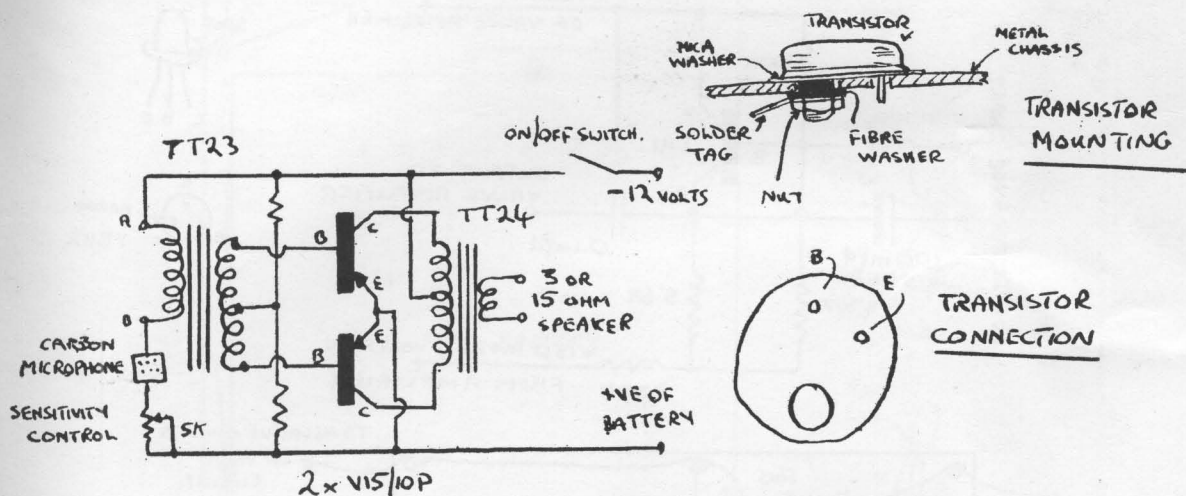

PK18 LOW IMPEDANCE PRE-AMPLIFIER FOR VALVE CIRCUITS

For feeding a low impedance microphone, pick-up or tuner unit into a valve amplifier. This pre-amplifier does away with the need for an input transformer normally required. The circuit has a useful gain and is entirely free from hum. The unit is powered from the smoothed hut supply of the mains amplifier.

COMPONENTS LIST

XB112 OR XB102 TRANSISTOR ...	7/6d.	470K OHM (YELLOW/MAUVE/YELLOW)	3d.
TRANSISTOR HOLDER ...	9d.	100 OHM (BROWN/BLACK/BROWN)	3d.
0.1 MFD 150V TO 350V CONDENSER	9d.	330K OHM (ORANGE/ORANGE/YELLOW)	3d.
100 MFD ELECTROLYTIC ...	1/6d.	TAGGED CHASSIS STD. 1 (3 x 2 in.)	1/6d.
100K OHM (BROWN/BLACK/YELLOW)	3d.	2 YDS. TWO COLOURS HOOK-UP-WIRE	6d.

SPECIAL INCLUSIVE PRICE
12/6d. p.p. 1/-

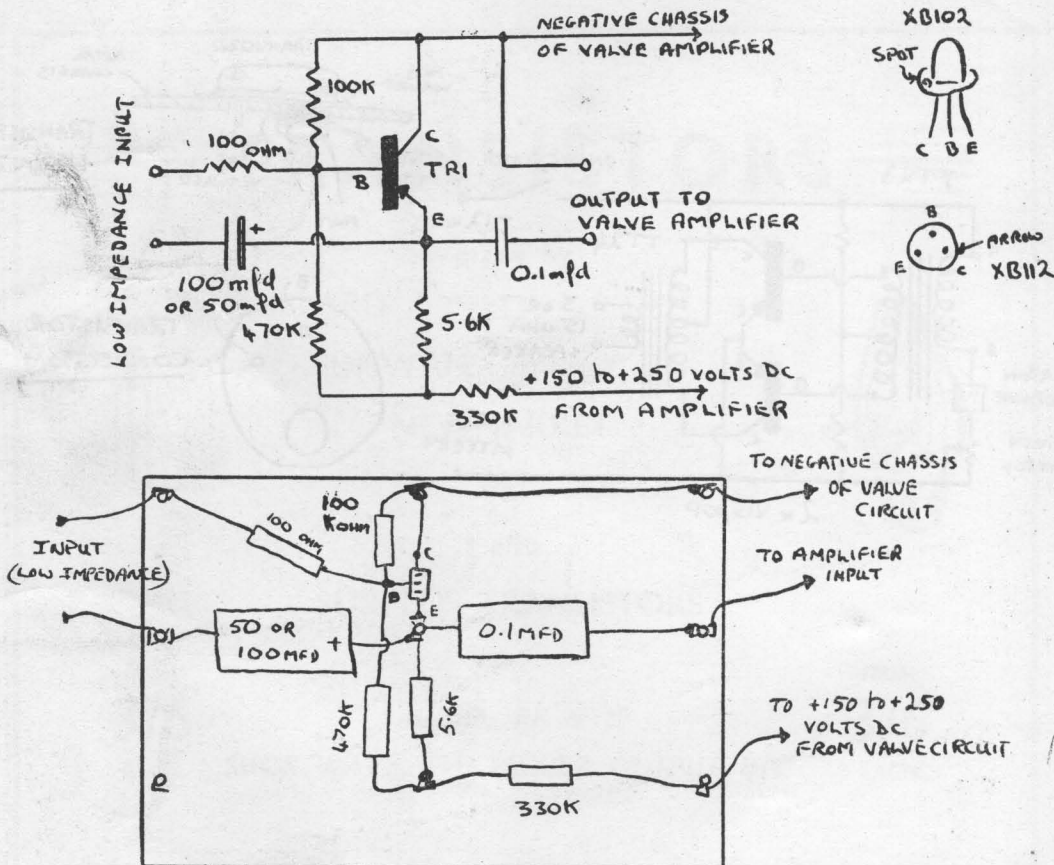

PK19 MOTOR-CYCLE TO SIDECAR TWO-WAY TELEPHONE

A two-way telephone designed for communication between the motor-cycle rider and sidecar or pillion rider. The rider wears a throat microphone and personal earphone enabling him to talk and listen at the same time. There are no talk-listen switches. The sidecar passenger wears a personal phone and has a microphone which can be mounted anywhere in the sidecar. The replacing of the sidecar microphone with a throat microphone enables the unit to be used between the pillion rider and sidecar or rider.

Battery life is 4-6 months depending upon use.

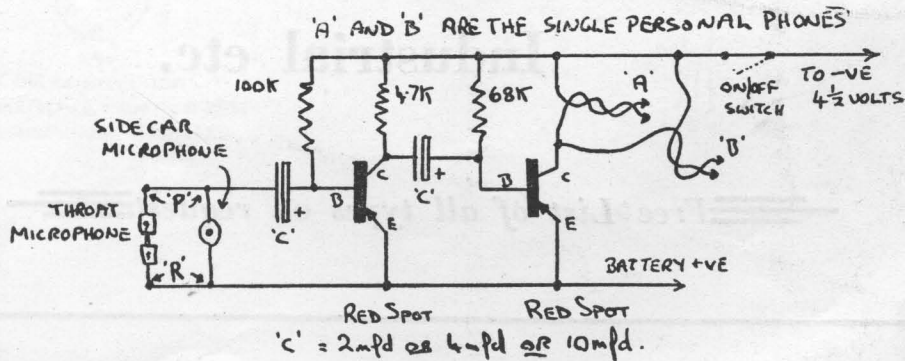
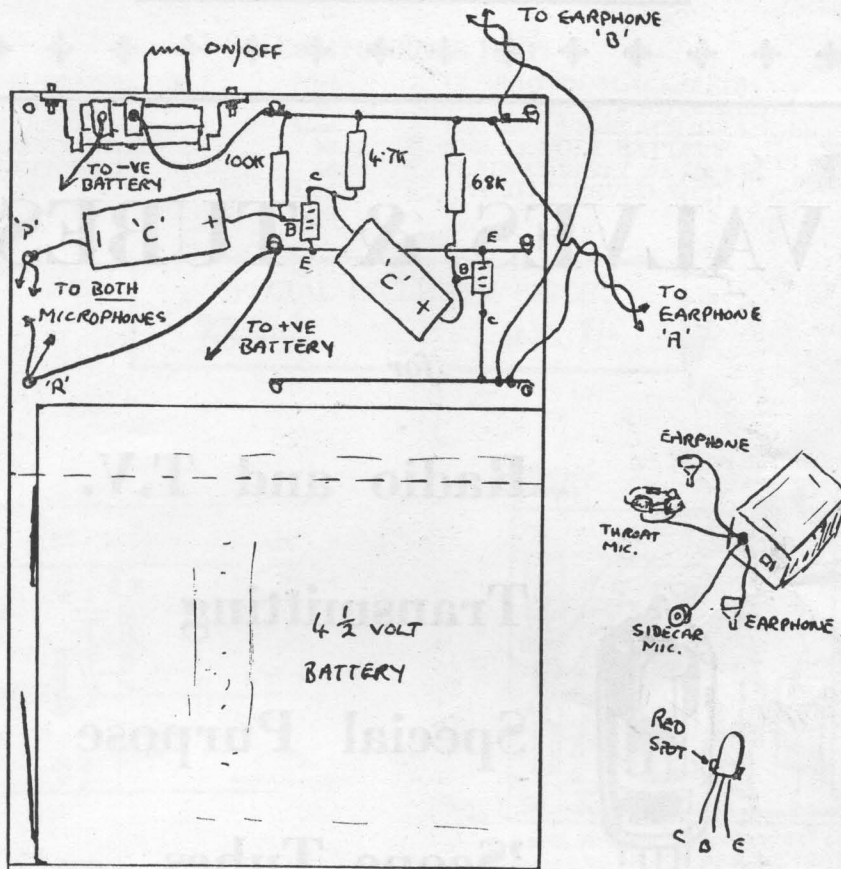

P.T.O.

COMPONENTS LIST

2— RED SPOT TRANSISTORS	...	3/6d. ea.	DRILLED CABINET 4½ x 3 x 1½ ins....	3/0d.
2— TRANSISTOR HOLDERS	...	9d. ea.	TAGGED CHASSIS STD. 1	1/6d.
2— PERSONAL EARPHONES	AND		4½ VOLT BATTERY	1/0d.
LEADS	...	12/6d. ea.	100K OHM (BROWN/BLACK/YELLOW)	3d.
THROAT MICROPHONE	...	4/6d.	68K OHM (BLUE/GREY/ORANGE)	3d.
SIDECAR MICROPHONE	...	3/6d.	4.7K OHM (YELLOW/MAUVE/RED)...	3d.
2 OR 4 MFD ELECTROLYTIC	...	1/6d.	1 YARD HOOK-UP WIRE	3d.
ON/OFF SLIDE SWITCH	...	2/0d.	2 YARDS TWIN WIRE	4d. yd.

SPECIAL INCLUSIVE PRICE
50/- **p.p. 1/6d.**



VALVES & TUBES

for

Radio and T.V.

Transmitting

Special Purpose

'Scope Tubes

Industrial etc.



≡
Free List of all types on request
≡

PK20 RF AND IF SIGNAL GENERATOR

A general purpose signal generator for alignment of mains or transistor radio receivers. Fundamental frequency is 450-470 KC/S with strong harmonic output at 450 KC/S intervals up to 4 MC/S.

Coupling is made by placing the unit near to the ferrite aerial, frame aerial or aerial coil of the receiver under test. For IF alignment or larger output, connection is made direct to the receiver via the 0.01 MFD. Condenser. The can of the oscillator coil is removed for best results.

To use as a 500 KC/S marker, tune the core of the coil out until whistles are heard at 500 KC/S, 1 MC/S, etc., on a known receiver.

Other uses include RF modulator or top band CW transmitter.

COMPONENTS LIST

XBL12 OR XB102 TRANSISTOR	...	7/6d.	1K (BROWN/BLACK/RED)	...	3d.
TRANSISTOR HOLDER	...	9d.	47K (YELLOW/MAUVE/RED)	...	3d.
P50/22C OR P50/3CC COIL	...	5/6d.	10K (BROWN/BLACK/ORANGE)	...	3d.
2—0.04 MFD. CONDENSERS	...	9d. ea.	B144 15 VOLT BATTERY	...	2/0d.
0.01 MFD. CONDENSERS	...	6d.	PLAIN CABINET 3 x 2 x 1/2 in.	...	1/6d.
TAGGED CHASSIS	...	2/0d.	1 YARD SLEEVED WIRE	...	3d.
SLIDE SWITCH ON/OFF TYPE	...	2/0d.			

SPECIAL INCLUSIVE PRICE
22/6d. p.p. 1/-

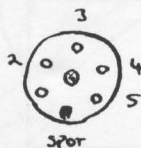
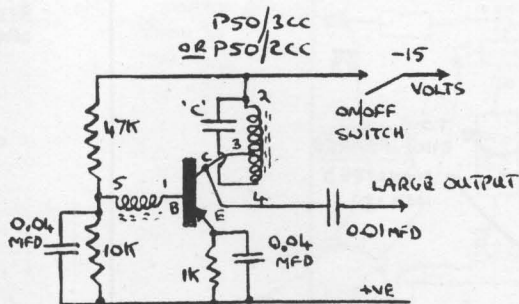

SPOT
COIL CONNECTIONS.
NB REMOVE CAN FOR BEST
COUPLING RESULTS.

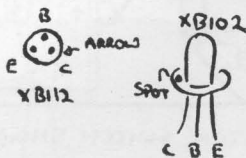
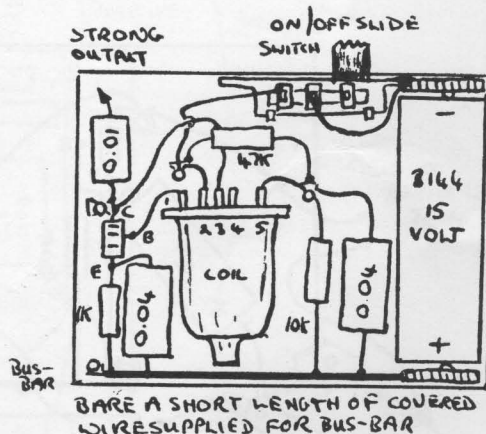

PK21 SIMPLE TRANSISTOR INTERCOMM

A small two-way intercomm. for home use. Ideal for house to shed or garage, room to room or car to caravan, etc.

Simple to operate with combined microphone/speakers. The intercomm. can be used over any distance via two-way wire. Battery life is approximately 3 months.

COMPONENTS LIST

RED SPOT TRANSISTOR	...	3/6d.	No. 8 3 VOLT BATTERY	...	7d.
TRANSISTOR HOLDER	...	9d.	DRILLED CABINET $4\frac{1}{8} \times 3 \times 1\frac{1}{4}$ in.	...	4/0d.
2 MFD OR 4 MFD OR 10 MFD, ETC.	...	1/6d.	SPEAKER/MIC. FOR ABOVE	...	3/6d.
2P 2 W SLIDE SWITCH	...	2/6d.	2ND UNIT SPEAKER/MIC.	...	4/6d.
100K (BROWN/BLACK/YELLOW)	...	3d.	INTERNAL WIRE 1 YARD SOLID	...	3d.
TAGGED CHASSIS WITH CLIPS	...	3/0d.			

A SIMPLE 2POLE 2WAY SWITCH IS USED

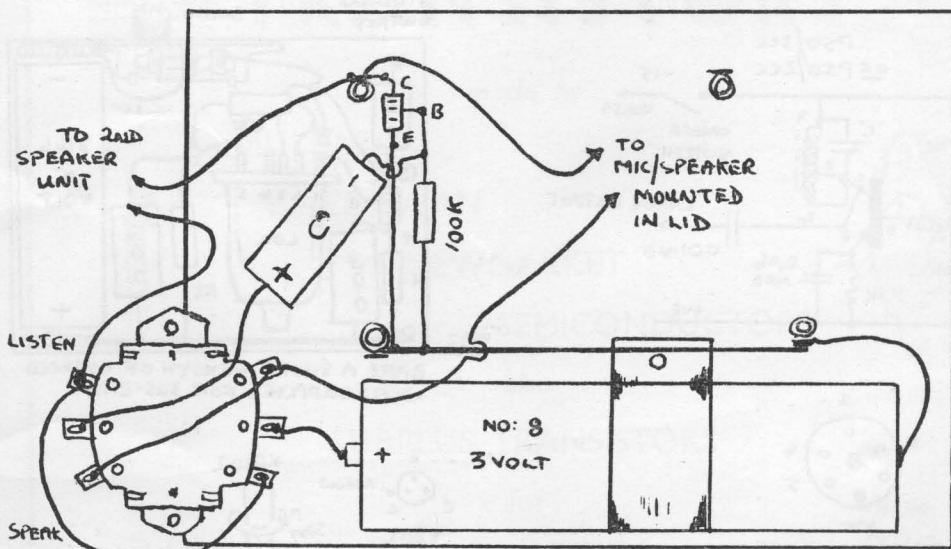
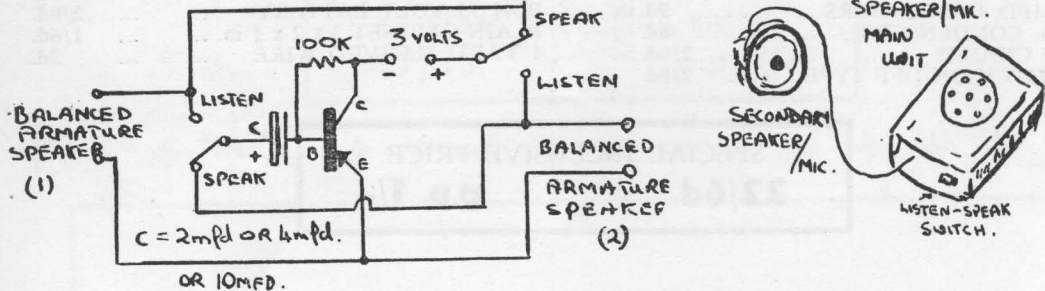

TALK-LISTEN SWITCH SHOWN OUT OF CABINET FOR CLARITY

SPECIAL INCLUSIVE PRICE
22/6d. **p.p. 1/-**

CONNECTING WIRE FROM MAIN UNIT TO SECONDARY
 4d. PER YARD

PK22 METAL DETECTOR

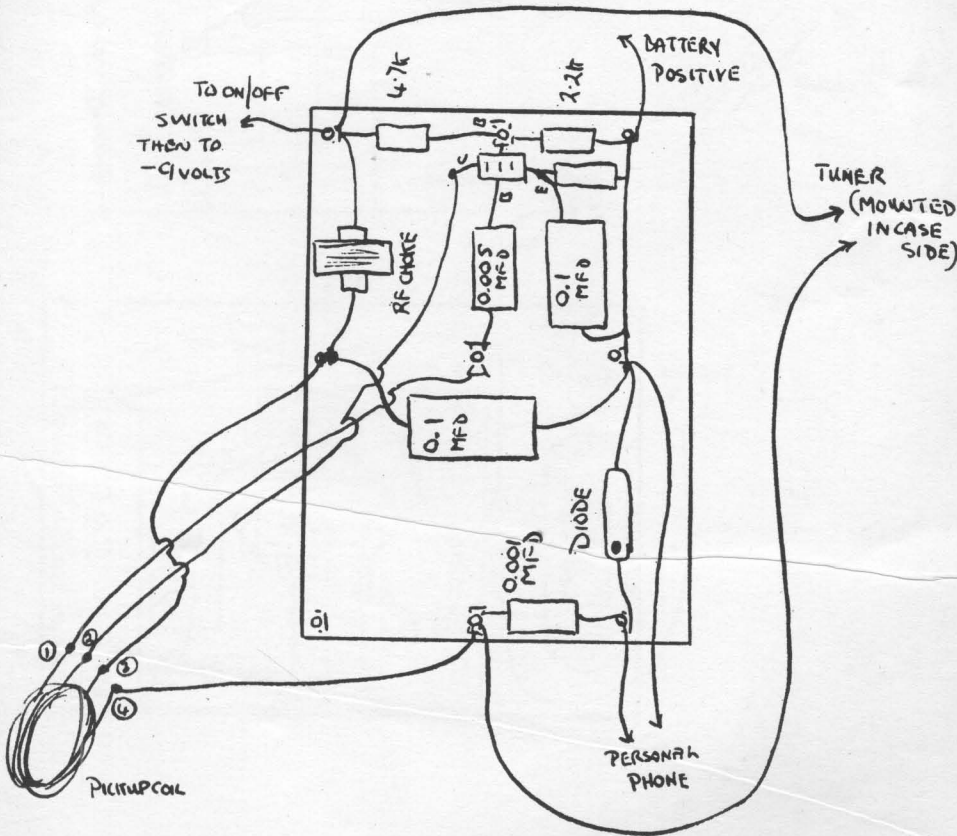
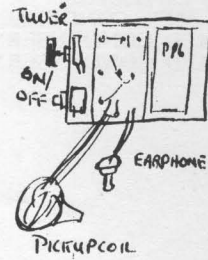
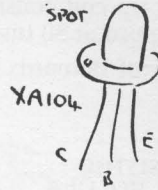
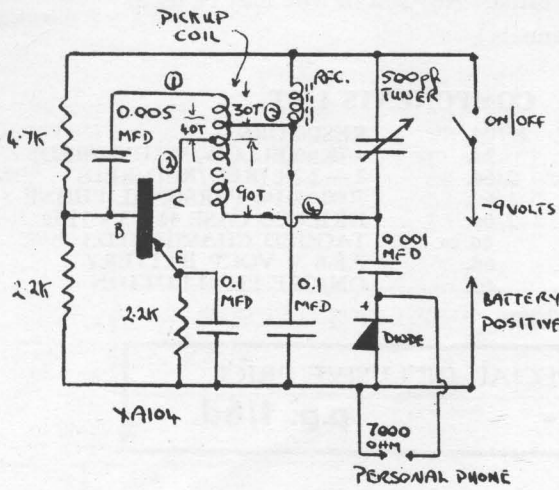

This handy gadget finds many uses as a metal detector. For finding metal hidden by walls, floors, or buried up to 1 ft. depth. Pipes and cables can be traced as well as locating lost objects such as metal tipped archery arrows. The tuner is adjusted for a clear note in the earpiece, when the pick-up coil is brought near a metal object, the frequency heard is altered and may stop.

The pick-up coil consists of 160 turns of covered wire on a diameter of 5 inches (i.e., old table tennis bat), tapped at 30 turns and 70 turns. Any sort of wire may be used.

(Courtesy of Bernards Radio Manuals.)

COMPONENTS LIST

XA104 TRANSISTOR	15/0d.	RESISTORS:—	
TRANSISTOR HOLDER	9d.	4.7K (YELLOW/MAUVE/RED)	3d. ea.
500 PF TUNER	2/6d.	2—2.2K (RED/RED/RED)	
RF CHOKE	1/6d.	7000 OHM PERSONAL PHONE	16/0d.
DIODE DETECTOR	2/0d.	DRILLED CASE 4½ x 3 x 1¼ in....	3/0d.
2—0.1 MFD CONDENSERS	6d. ea.	TAGGED CHASSIS STD.1	1/6d.
0.005 MFD CONDENSERS	6d.	P.P.6 9 VOLT BATTERY	2/9d.
0.001 MFD CONDENSERS	6d.	ON/OFF PUSH-BUTTON	1/6d.

SPECIAL INCLUSIVE PRICE

45/-

p.p. 1/6d.

PK23 AUDIO TEST GENERATOR

A compact audio test generator giving a clear note at approximately 1 KC/S. Ideal as a transmitter modulator, morse code practice unit, intercomm. caller or audio checking for amplifiers and output stages of radio receivers. Output impedance is about 1K Ohm.

Overall unit size is 3 x 2 x $\frac{3}{4}$ inches.

COMPONENTS LIST

T1079 OR D1001 TRANSFORMER	...	7/0d.	0.04 MFD CONDENSER	...	9d.
ON/OFF SLIDE SWITCH	...	2/0d.	XB112 OR XB102 TRANSISTOR	...	7/6d.
B144 15 VOLT BATTERY	...	2/0d.	22 K (RED/RED/ORANGE)	...	3d.
TAGGED CHASSIS	...	2/0d.	6.8 K (BLUE/GREY/RED)	...	3d.
CABINET 3 x 2 x $\frac{3}{4}$ in.	...	1/6d.	2.2 K (RED/RED/RED)	...	3d.
TRANSISTOR HOLDERS	...	9d.	2 YDS. SLEEVED WIRE (2 COLOURS)	...	3d. yd.
0.1 MFD CONDENSER	...	6d.			

SPECIAL INCLUSIVE PRICE
24/- p.p. 1/-

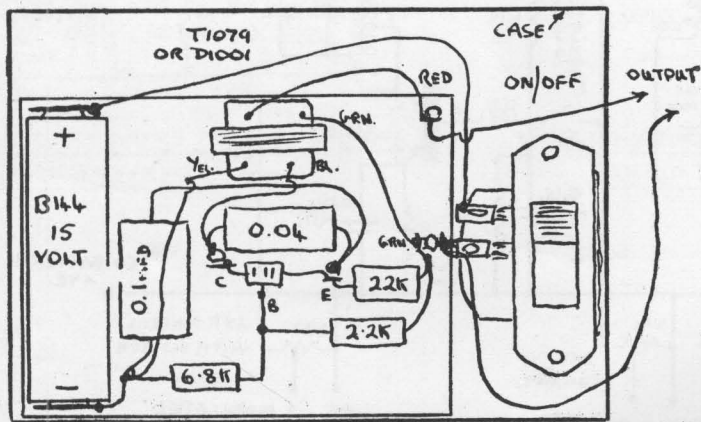
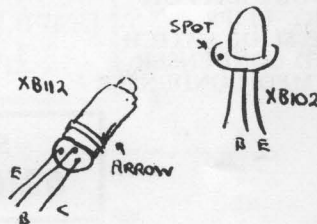
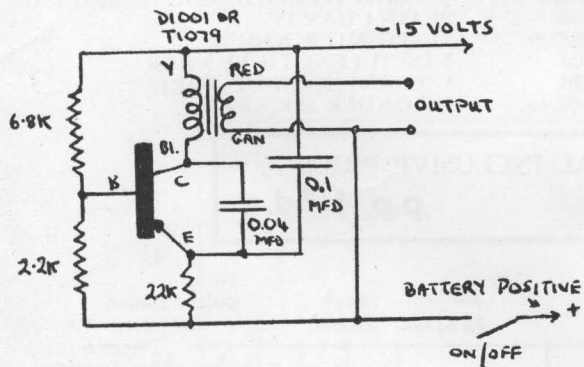

PK25 LOW AND HIGH IMPEDANCE MICROPHONE PRE-AMPLIFIERS

Two types of pre-amplifier are shown here, one for high impedance input and the other for low. They can be used for any three transistor amplifier up to 12 watts output and require 7 to 9-volts supply.

These pre-amplifiers have a higher output impedance than those previously described.

COMPONENTS LIST

TAGGED CHASSIS STD.1 (3 x 2 in.) ...	1/6d.	10K OHM (BROWN/BLACK/ORANGE)	3d.
XB112 OR XB102 TRANSISTOR ...	7/6d.	68 K OHM (BLUE/GREY/ORANGE) ...	3d.
500 MFD. ELECTROLYTIC CONDENSER	1/6d.	1 K OHM (BROWN/BLACK/RED)	3d.
4 MFD. ELECTROLYTIC CONDENSER	1/6d.	6.8 K OHM (BLUE/GREY/RED)	3d.

SPECIAL INCLUSIVE PRICE
12/- **p.p. 9d.**
 (LOW IMPEDANCE PRE-AMPLIFIER)
 WITH D129 INPUT TRANSFORMER
 (HIGH IMPEDANCE PRE-AMPLIFIER)
20/- **p.p. 9d.**

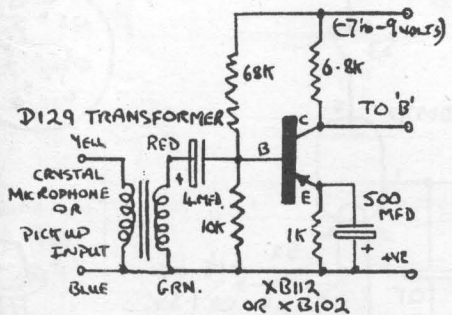

HIGH IMPEDANCE MICROPHONE OR PICK-UP PRE-AMP

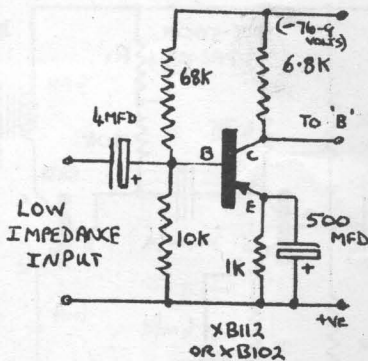

LOW IMPEDANCE MICROPHONE OR PICK-UP PRE-AMP

PK27 THE MAJOR-2

The Major-2 is a Two Transistor Personal Pocket Receiver with a single transistor output stage, giving good volume on a miniature earpiece. Tunable over most of the medium waveband, this radio will work anywhere. The first transistor is reflexed after the diode to provide additional output: the effect is of three transistors. No aerial or earth is required as signal pick-up is provided by the built-in ferrite aerial. A 15-volt battery provides up to 6 months life without battery replacement. Transistor holders are supplied, making damage to the transistors impossible. All necessary brackets and clips, etc., are pre-mounted on the chassis.

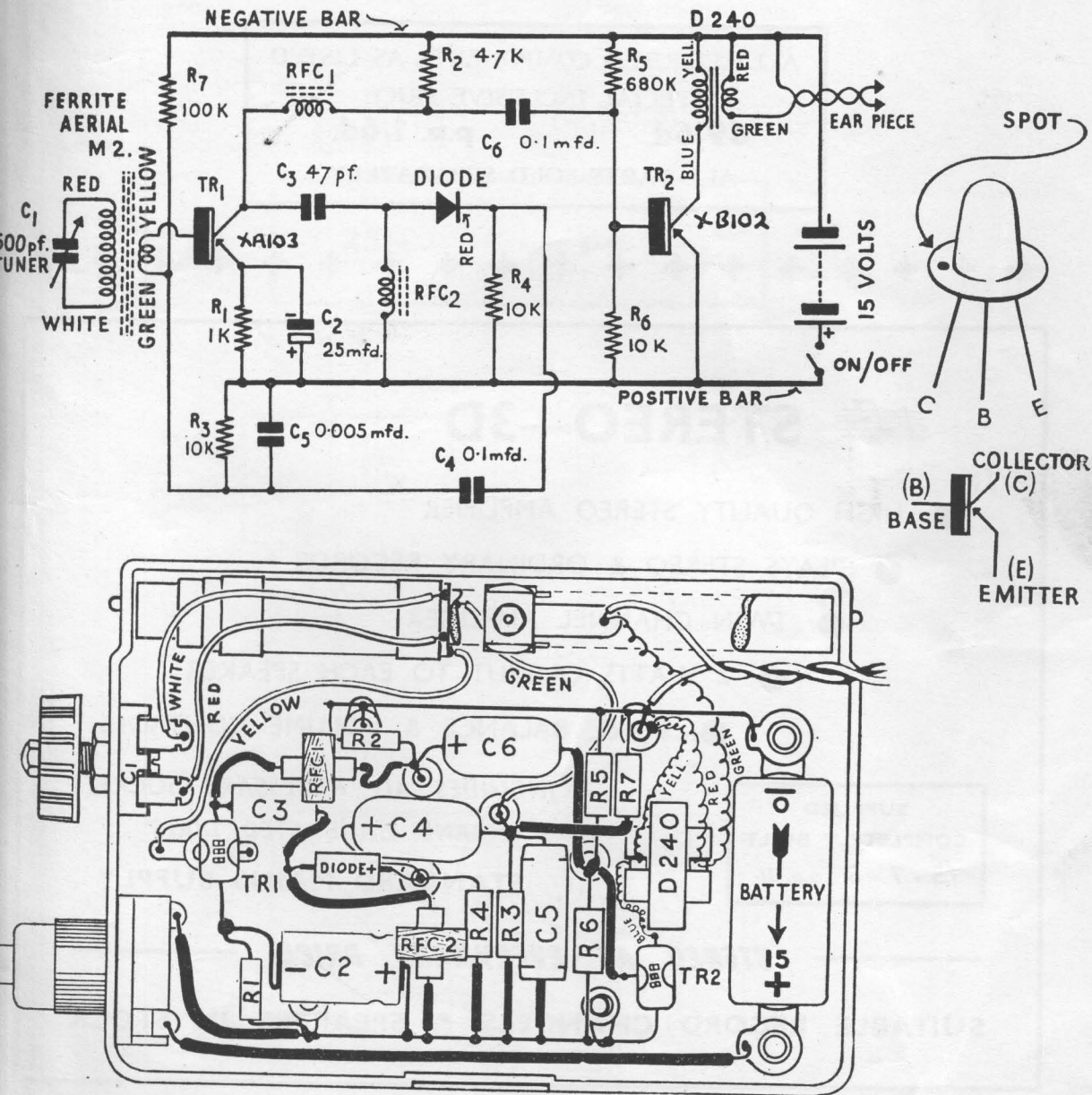

COMPONENTS LIST

EDISWAN XA103 R.F. TRANSISTOR...	12/6d.	DRILLED PLASTIC CASE	3/0d.
EDISWAN XB102 AUDIO TRANSISTOR	7/6d.	MOUNTED CHASSIS	3/0d.
(set	17/6d.)	MINIATURE EARPIECE WITH LEAD	
FERRITE ROD ASSEMBLY M2	6/0d.	AND PIP	12/6d.
B121 15 VOLT BATTERY	2/0d.	RESISTORS:	
DIODE (SENSITIVE TYPE)	2/0d.	(3) 10K, 1K, 100K, 4.7K, 680K	
CHOKES 2 OFF @ 1/6 EACH	3/0d.	3d. EACH SET	1/6d.
TUNING CONDENSER WITH KNOB	2/6d.	CONDENSERS:	
TRANSISTOR HOLDERS 2 OFF @ 9d.	1/6d.	47PF OR 50PF (2), .1MF, .005, 6d. EACH:	
D240 TRANSFORMER	10/0d.	25MF 1/6	3/6d.
PUSH BUTTON SWITCH	1/6d.	TOTAL	69/6d.

ALL SELECTED COMPONENTS AS LISTED

SPECIAL INCLUSIVE PRICE

69/6d.

p.p. 1/6d.

ALL PARTS SOLD SEPARATELY



STEREO—3D

- HIGH QUALITY STEREO AMPLIFIER
- PLAYS STEREO & ORDINARY RECORDS
- TWIN CHANNEL AMPLIFIER
- 2 WATTS OUTPUT TO EACH SPEAKER
- TONE, BALANCE & VOLUME CONTROLS

SUPPLIED
COMPLETELY BUILT

£5 - 7 - 6 p.p. 2/-

INCLUDES ALL NECESSARY SOCKETS
AND CALIBRATED DIALS

STANDARD MAINS SUPPLY

STEREO AT EVERYMANS PRICE

SUITABLE RECORD CHANGERS & SPEAKERS IN STOCK

PK28 'TINY' CRYSTAL CONTROLLED TRANSMITTER

A low powered CW transmitter, crystal controlled covering approximately 6 to 8 MC/S on fundamentals. Power supply is provided by two mercury cells wired in series. Overall case size (less key) is 3 x 2 x $\frac{3}{4}$ inches.

COMPONENTS LIST

SBO78 TRANSISTOR	...	7/6d.	TRANSISTOR HOLDER	...	9d.
100pf PRE-SET CONDENSER	...	1/6d.	100K OHM RESISTOR	...	3d.
TO59 COIL	...	3/0d.	0.01 MFD CONDENSER	...	6d.
2-1.3V CELLS	...	1/3d. ca.	10pf CONDENSER	...	6d.
QUARTZ CRYSTAL HOLDER	...	1/0d.	10PF CONDENSER	6d.
CASE 3 x 2 x $\frac{3}{4}$ in.	...	1/6d.	TAGGED CHASSIS (STD.1)	...	1/6d.
QUARTZ CRYSTALS	...	5/0d. and 7/6d.	1 YARD HOOK UP WIRE	...	3d.

(See enclosed list for frequency required)

SPECIAL INCLUSIVE PRICE
25/- **p.p. 1/-**
 (LESS KEY)

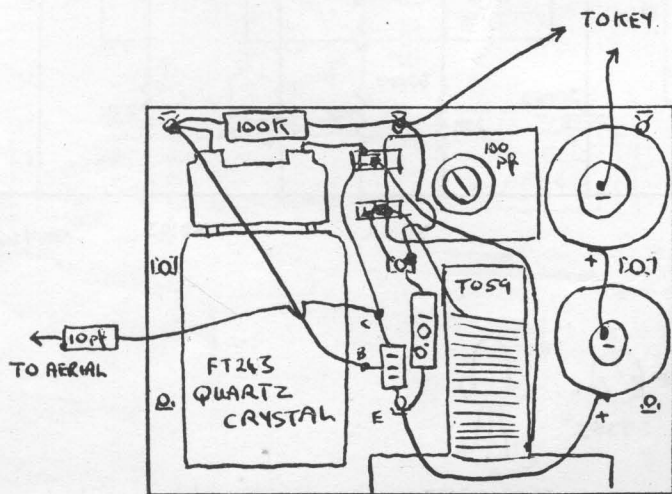
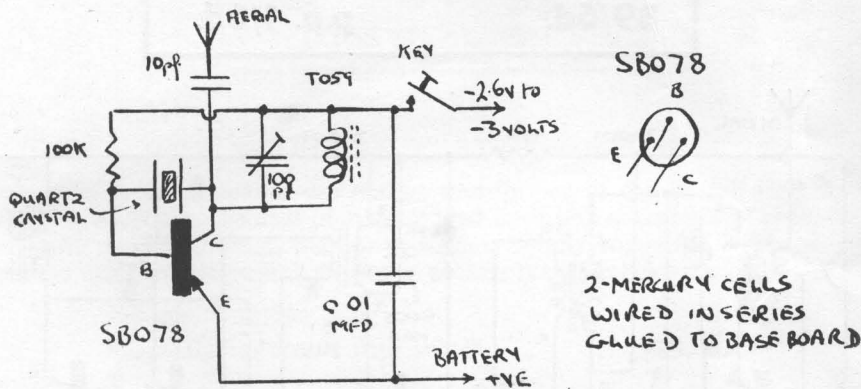

PK29 SINGLE CHANNEL RADIO CONTROL RECEIVER

A new radio control receiver operating an escapement, motor or similar actuator direct. Overall size less battery is 3 x 2 x 1 inches, weight about 2 ozs. The components should be mounted on both sides of the board. The aerial coil HF2 supplied should have 9 turns removed and 2 turns of sleeved wire overwound for aerial pick-up. Aerial length should be approximately 30 inches. The preset 50K (or 100K with 100K resistor) is adjusted for best result. Battery required is 4½ volts.

COMPONENTS LIST

SB305 TRANSISTOR	10/0d.	10 PF, 470 PF, 22 PF, 0.1 MFD, 0.005 MFD	...	6d. ea.
V13/20IP TRANSISTOR	25/0d.			
XB103 TRANSISTOR	10/0d.	1 MFD SUB-MIN.	...	2/3d.
XB102 TRANSISTOR	7/6d.	RESISTORS:—	...	3d. ea.
3—TRANSISTOR HOLDERS	9d. ea.	1—10K OHM (BROWN/BLACK/ORANGE)		
HF2 COIL	3/0d.	3—2.2K OHM (RED/RED/RED)		
RF CHOKE	1/6d.	1—1.2K OHM (BROWN/RED/RED)		
2—D1001 TRANSFORMERS	7/0d. ea.	1—6.8K OHM (BLUE/GREY/RED)		
3—30 MFD SUB-MIN.	2/3d. ea.	PLAIN CHASSIS 3 x 2 in.	...	6d.
2—50 MFD SUB-MIN.	2/3d. ea.	6 INCH LENGTH BUS-BAR WIRE	...	6d.
50K SUB-MIN. PRE-SET	2/0d.	2 YARDS HOOK UP WIRE	...	3d. yd.
				1 YARD SLEEVING	...	3d.

SPECIAL INCLUSIVE PRICE

89/6d.

p.p. 1/6d.

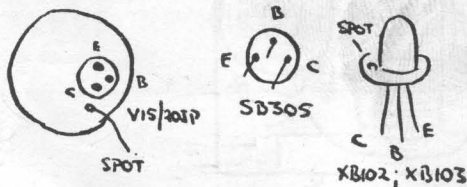
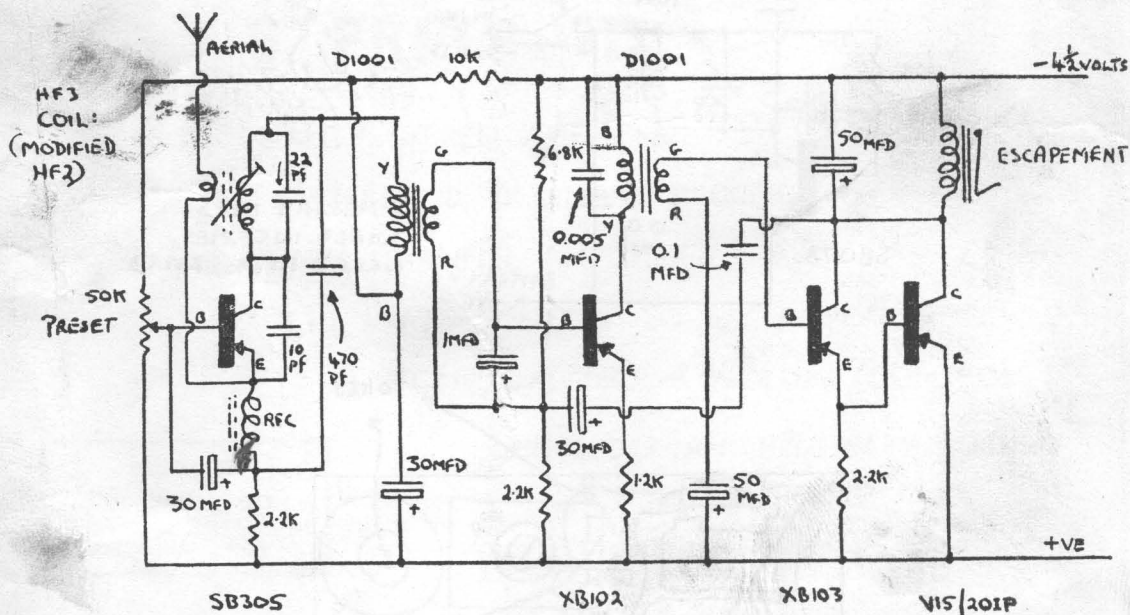

PK30 2 WATT POWER STAGE MK2

A single transistor power stage giving up to 2 watts audio output when fed from a suitable amplifier. The unit is ideal for use with push-pull single ended output stages such as is found in the "Continental" and similar 100 to 500mW output type receivers. Overall size less speaker is $4\frac{1}{2} \times 3 \times 2\frac{1}{4}$ inches.

For use in car or caravan where more volume may be required. The amplifier works from a 12 volt supply such as a car type battery. (6 volt versions can be supplied.)

NOTE: The nut on the transistor is the collector; this is bolted to the amplifier chassis which forms the heat sink for the transistor; washers must *not* be used. The chassis is therefore the collector electrode and should it come into contact with the car chassis the transistor will be damaged and so might your car battery!

COMPONENTS LIST

V15/10P TRANSISTOR	15/0d.	DRIVER TRANSFORMER TT11 ...	10/0d.
TT12 OUTPUT TRANSFORMER ...	12/6d.	3 — 100 MFD 18VW CONDENSERS ...	1/6d. ea.
W/W. 100 OHM, 14 OHM, 2 OHM ...	9d. ea.	DRILLED METAL CHASSIS ...	2/6d.
1 YARD TWIN CORE LEAD	9d.	ON/OFF SLIDE SWITCH	2/0d.
NUTS, BOLTS, SOLDER TAGS AND		2 YARDS WIRE (TWO COLOURS) ...	3d. yd.
TAG STRIPS	2/6d.		

SPECIAL INCLUSIVE PRICE
49/6d. **p.p. 2/-**
 (LESS SPEAKER)

CONNECTION TO PORTABLE RADIO

The power stage is connected to the output transformer of the portable: disconnecting the existing speaker first of all. In the case of single-ended push-pull circuits such as the "Continental" where there is no output transformer, the power stage is simply connected in place of the speaker. A suggested method using miniature jack plugs and sockets is shown below: —

Sub-miniature jack plug	3/0d.
Sub-miniature socket with switch	3/6d.

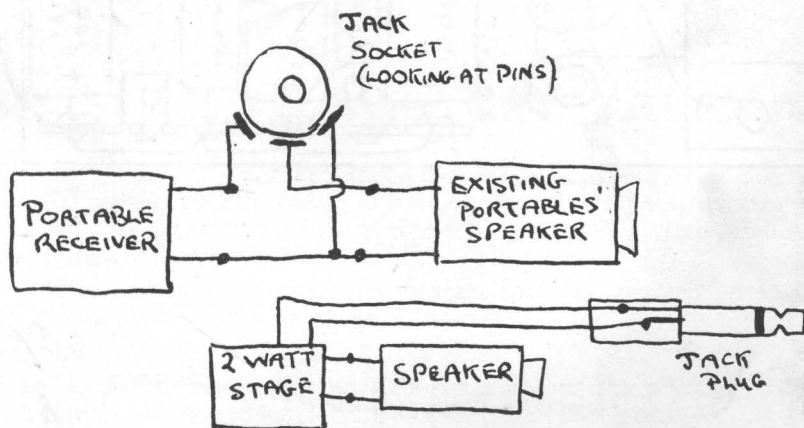

P.T.O.

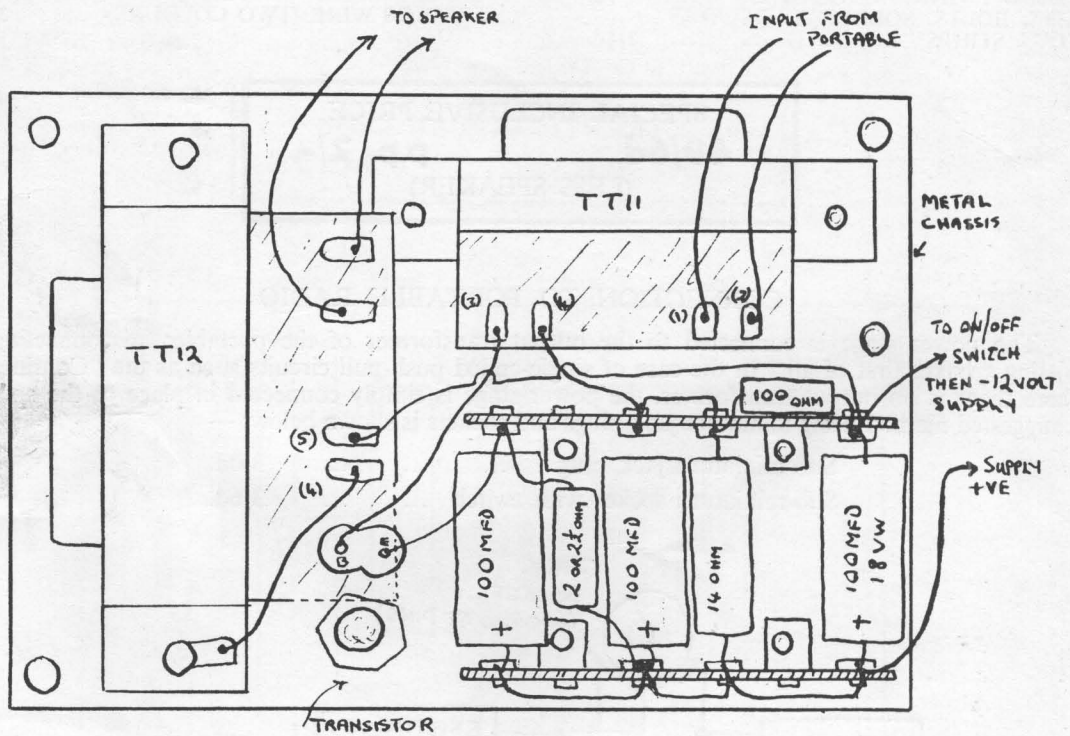
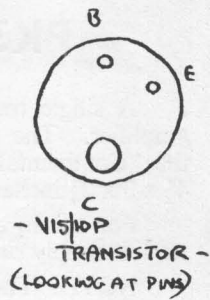
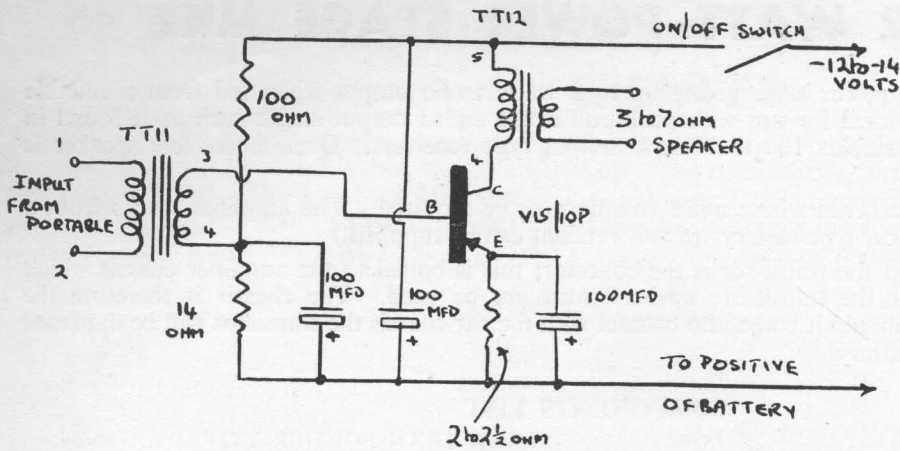

PK31 SQUARE WAVE GENERATOR

Useful two transistor generator producing square waves at approximately 6 KC/S. Useful for checking audio circuits or similar. Overall size of unit is $2\frac{1}{2} \times 1\frac{1}{2} \times \frac{3}{4}$ inches. Frequency may be altered by changing the values of 0.002 MFD initially and the 68K resistors.

COMPONENTS LIST

2 RED SPOT TRANSISTORS	3/6d. ea.	0.01 MFD: (2) 0.002 MFD	6d. ea.
TAGGED CHASSIS	2/0d.	2— TRANSISTOR BASES	9d. ea.
B144 15 VOLT BATTERY	2/0d.	2— 6.8K (BLUE/GREY/RED)	3d. ea.
ON/OFF SLIDE SWITCH	2/0d.	2— 68K (BLUE/GREY/ORANGE)	3d. ea.

SPECIAL INCLUSIVE PRICE
15/6d. **p.p. 1/-**

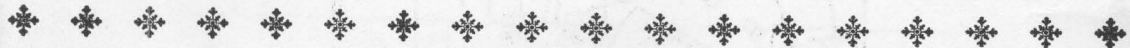
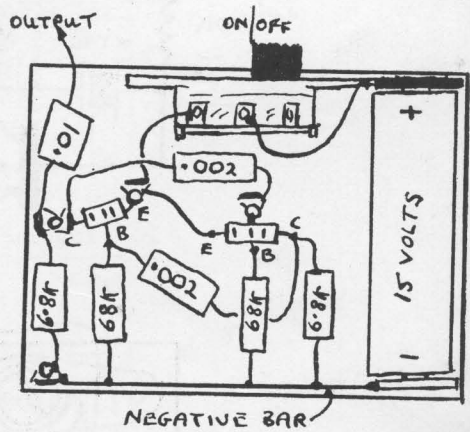
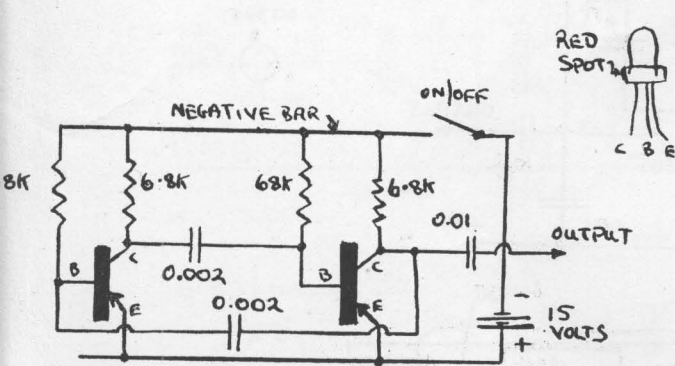

PK32 3 TO 12 Mc/s CRYSTAL MARKER

A general purpose crystal controlled transistor oscillator. Frequency coverage is from 3 to 12 MC/S (30 to 100 metres) giving a choice of over 400 frequencies using quartz crystals of FT 243, 10X and B7G types. A separate list is available free, giving all crystals usable. The transistor used is a high frequency unit type SB305.

The basic circuit, with suitable coils and crystals, may be operated up to many megacycles depending upon the transistor used.

Overall size of the completed unit is $3 \times 2 \times 1\frac{1}{2}$ inches.

Output may be taken directly via the 10pf condenser or the placing of the unit such that coupling is effected from the coil. Ideal for use as a frequency check or BFO.

P.T.O. FOR DIAGRAMS

COMPONENTS LIST

SB305 TRANSISTOR	10/0d.	10 PF CONDENSER	6d.
TRANSISTOR HOLDER	9d.	TAGGED CHASSIS (3 x 2 ins.)	2/0d.
D22 3 VOLT BATTERY	10d.	100 PF PRE-SET CONDENSER	1/6d.
ON/OFF SLIDE SWITCH	2/0d.	T059 SLUG TUNED COIL	3/0d.
0.01 MFD CONDENSER	6d.	100K OHM 1/4-WATT RESISTOR	3d.
			1 YARD SOLID HOOK UP WIRE	3d.

SPECIAL INCLUSIVE PRICE
20/- **p.p. 1/-**
 LESS CRYSTAL AND HOLDER
 (SEE SEPARATE LIST)

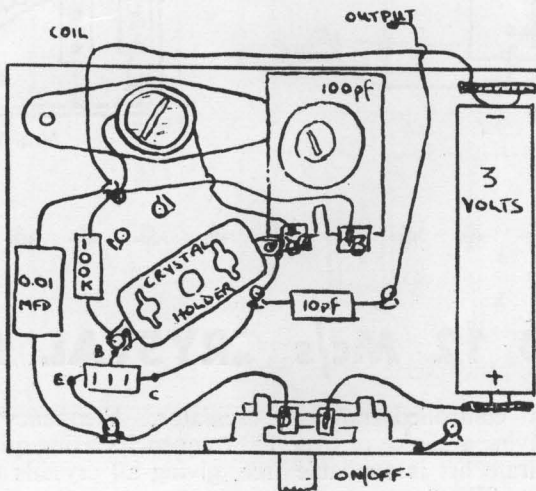
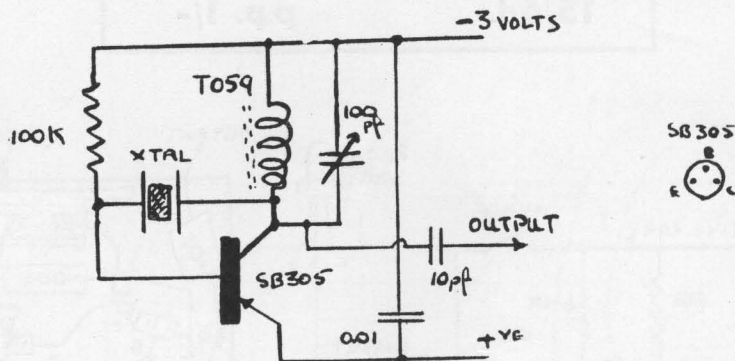

PK33 TOP BAND TRANSISTOR TRANSMITTER

A three transistor voice modulated transmitter working on top band (150 to 160 metres or 1.8 to 2 MC/S). The range on the three foot aerial provided on voice modulation will depend upon the sensitivity of the receiver used. This may be increased by the use of longer aerials.

The unit may be used as a C.W. Transmitter by connecting a morse key across the on/off switch. The range on C.W. will be several miles. Overall size of the unit is $4\frac{1}{2} \times 3 \times 1\frac{1}{4}$ inches: the chassis provided is complete with pre-mounted battery, aerial and soldering clips; the cabinet with all necessary holes pre-drilled.

The small size makes the unit an ideal short range pocket communications transmitter. A suggested pocket receiver would be the MAJOR-2 or MAJOR-3 (see separate free booklets), with 5 turns removed from the aerial winding and suitable adjustment of the choke referred to.

After building completion a three foot aerial should be plugged into the hole provided. Set the core of the P50/1AC coil about $\frac{3}{8}$ inch down inside the former. The 100pf compression tuner may then be adjusted for the desired frequency.

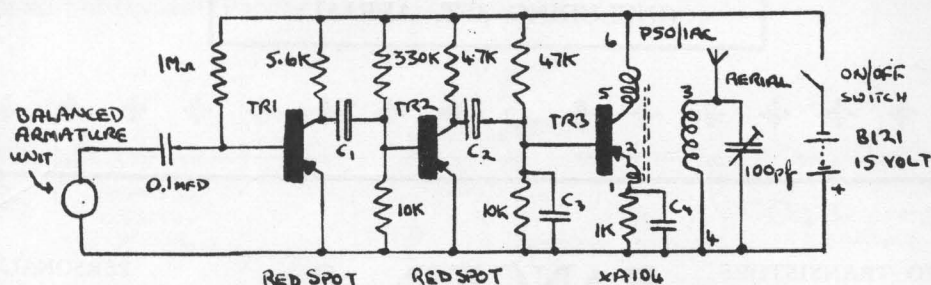

$C_1 = C_2 = 2\text{mfd } 9\text{V}$
 $C_3 = C_6 = 0.04\text{mFd}$

- P50/1AC COIL -

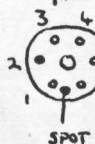

TRANSISTOR CONNECTIONS

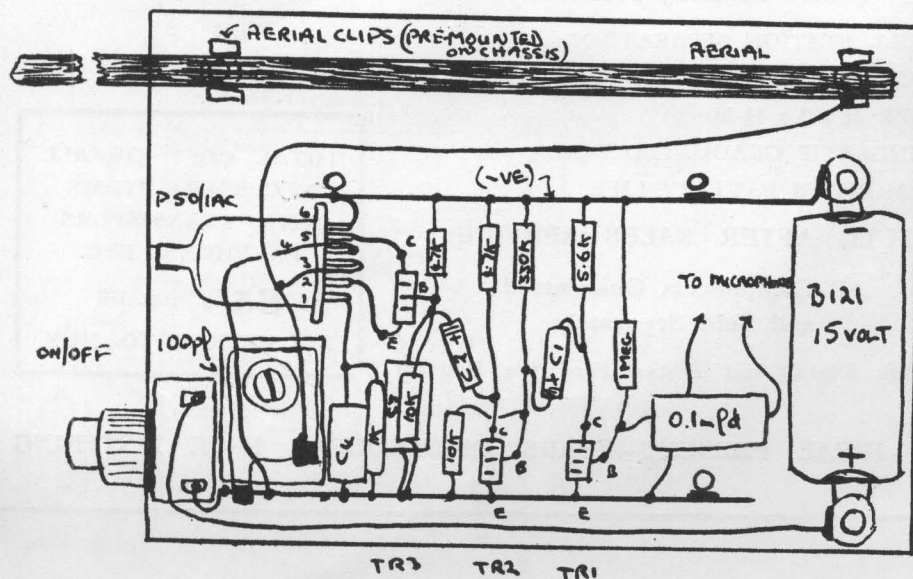
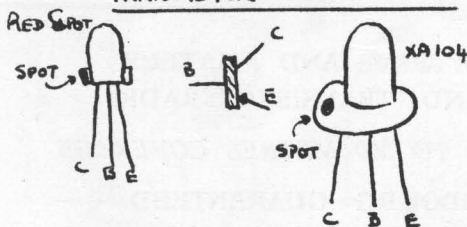

PK34 SUB-MINIATURE SHORT WAVE RECEIVER

A high gain two transistor receiver covering top band (1.8 to 2 MC/S) and the lower end of the medium wave band including Luxemburg and Light Programme. Ideal for use with the top band transmitters described elsewhere or as a pocket receiver. Size is $3 \times 2 \times \frac{3}{4}$ inches.

Replacing the FRM8 aerial with a type M1 and the tuner with a 450 PF version converts the receiver to medium waveband reception. Alternatively removing a few turns from the FRM8 winding converts the receiver to cover part of the trawler band. The length of external aerial required will be determined experimentally.

Wind a few turns of wire on to a former and slide it on to the ferrite rod forming the secondary. The volume control is set to a point just before oscillation occurs. Reverse the secondary leads is no reaction is heard.

(Courtesy of Bernards Publications.)

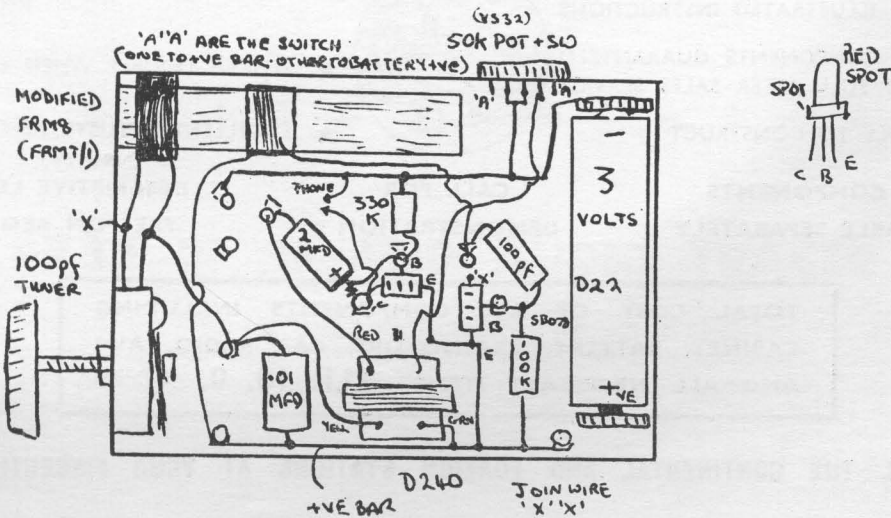
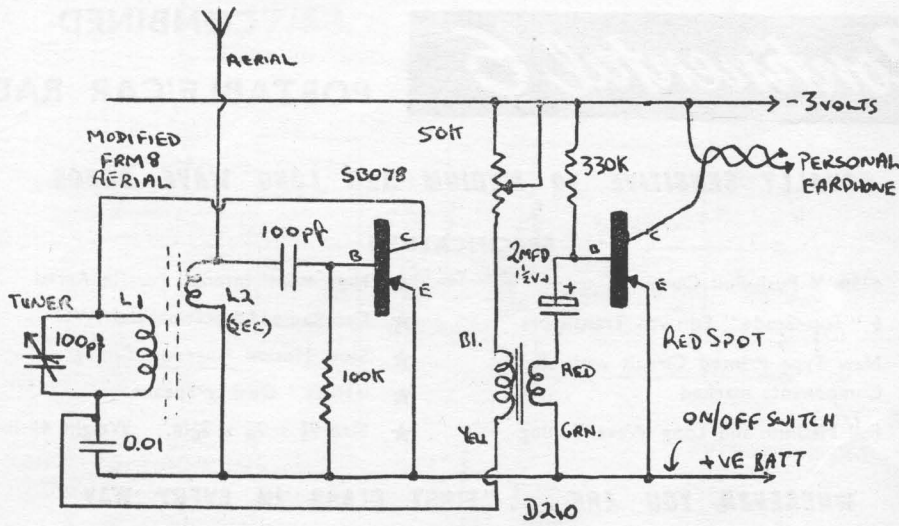

P.T.O.

COMPONENTS LIST

D22 3 VOLT BATTERY	...	10d.	6 INCH LENGTH BUS-BAR WIRE	6d.
SB078 HF TRANSISTOR	...	7/6d.	6 INCH LENGTH HOOK UP WIRE	6d.
RED SPOT AMPLIFIER	...	3/6d.	PERSONAL EARPHONE	12/6d.
2 — TRANSISTOR HOLDERS	...	9d. ea.	100 PF TUNER AND KNOB	2/6d.
AERIAL SOCKET	...	6d.	FRM8 AERIAL	5/0d.
D240 TRANSFORMER	...	10/0d.	100 PF CONDENSER	6d.
50K CONTROL WITH SWITCH	...	8/6d.	0.01 MFD CONDENSER	6d.
2 MFD 1½ VV	...	2/0d.	100K OHM (BROWN/BLACK/ORANGE)	3d.
TAGGED CHASSIS	...	2/0d.	330K OHM (ORANGE/ORANGE/YELLOW)	3d.
3 x 2 x ¼ IN. CABINET	...	2/0d.		

SPECIAL INCLUSIVE PRICE

55/-

p.p. 1/-

Continental "6"

**COMBINED
PORTABLE/CAR RADIO**

EQUALLY SENSITIVE TO MEDIUM AND LONG WAVE BANDS

SPECIFICATION

- | | |
|-------------------------------------------------------|---------------------------------------|
| ★ 425mW Push-Pull Output | ★ High "Q" Internal Ferrite Aerial |
| ★ 6 "Top-Grade" Ediswan Transistors | ★ Car Radio Adaptation and AVC |
| ★ New Type Printed Circuit with all Components marked | ★ Slow Motion Fingertip Tuning |
| ★ Full Medium and Long Wave Tuning | ★ "Hi-Fi" Quality Speaker |
| | ★ Size 9½ x 7½ x 3½ in. Weight 4½ lb. |

WHEREVER YOU ARE ... "FIRST CLASS IN EVERY WAY"

- ★ STEP BY STEP FULLY ILLUSTRATED INSTRUCTIONS

- ★ ALL COMPONENTS GUARANTEED AND FULL AFTER SALES SERVICE

- ★ SIMPLE TO CONSTRUCT

ALL COMPONENTS
AVAILABLE SEPARATELY



- ★ NO TECHNICAL KNOWLEDGE REQUIRED

- ★ WORTH DOUBLE WHEN BUILT

- ★ EXCELLENT RESULTS ANYWHERE

CALL FOR
DEMONSTRATION

DESCRIPTIVE LEAFLET
FREE ON REQUEST

TOTAL COST OF ALL COMPONENTS INCLUDING
CABINET, BATTERY, TRANSISTORS, CAR RADIO, AVC
AND ALL NECESSARY ITEMS **£11. 10. 0.** P.P. 3/6

ALL THE CONTINENTAL AND FOREIGN STATIONS AT YOUR FINGERTIPS

PK35 3-CHANNEL AUDIO MIXER

Single low noise transistor battery operated audio 3-channel mixer unit. Ideal for use with tape recorders to superimpose announcements, commentaries, etc., for use with sound track recorders, stage singing, etc. Coaxial plugs and sockets with screened coaxial wire should be used for input and output leads. Input impedance is approximately 5K Ohm per channel, output impedance 15K Ohm.

COMPONENTS LIST

XB102 OR XB112 TRANSISTOR	...	7/6d.	CABINET, 4½ x 3 x 1½	2/6d.
TRANSISTOR HOLDER	...	9d.	3—4.7K (YELLOW/MAUVE/RED)	3d. ea.
2—100K POTENTIOMETERS	...	3/6d. ea.	2.2 MEG (RED/RED/GREEN)	3d.
1—100K POT. WITH SWITCH	...	4/6d.	2.2K (RED/RED/ORANGE)	3d.
READY TAGGED CHASSIS	...	3/0d.	3—COAXIAL PLUGS	1/3d. ea.
No. 8 3 VOLT BATTERY	...	7d.	4—SOCKETS	1/3d. ea.
2—4 MFD CONDENSERS	...	1/6d. ea.	4 INCH LENGTH BUS BAR WIRE	6d.

SPECIAL INCLUSIVE PRICE
37/6d. **p.p. 1/-**

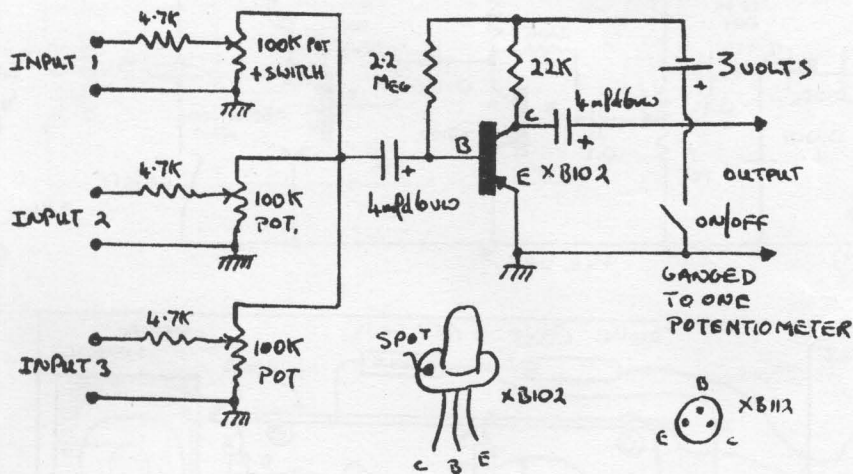

PK36 RF, IF AND AUDIO TRACER

Two transistor test unit for checking audio amplifiers, RF and IF amplifiers, etc. Ideal for use with signal generators as a signal speaker for alignment. Output is to headphones, or the unit may be fed into the "Addon" power stage. Overall size is 4½ x 3 x 1½ inches. The common lead is connected to the "Earthy" side of the unit under test and the "live" connected to the audio or RF input.

P.T.O. FOR DIAGRAMS

COMPONENTS LIST

2 — XB102 TRANSISTORS	7/6d. ea.	RESISTORS:—	
DIODE DETECTOR	2/0d.	220K (RED/RED/YELLOW)	3d. ea.
2 — TRANSISTOR HOLDERS	9d. ea.	100K (BROWN/BLACK/YELLOW)	
DRILLED CABINET, 4½ x 3 x 1¼ in.	3/0d.	4.7K (YELLOW/MAUVE/RED)	
CHASSIS AND CLIPS	3/0d.	4 INCH LENGTH BUS-BAR WIRE	6d.
No. 8 3 VOLT BATTERY	7d.	3 YDS. INSULATED HOOK UP WIRE	3d. yd.
100K, 250K, 500K OR 1 MEG CONTROL	2/6d.	3 CROC. CLIPS	6d. ea.
LOW IMPEDANCE HEADPHONES	6/0d.	MINIATURE ON/OFF SLIDE SWITCH	2/0d.
3 — 0.1 MFD CONDENSERS	6d. ea.	CONTROL KNOB	9d.

SPECIAL INCLUSIVE PRICE

37/6d. **p.p. 1/6d.**

OR

LESS HEADPHONES

32/6d. **p.p. 1/6d.**

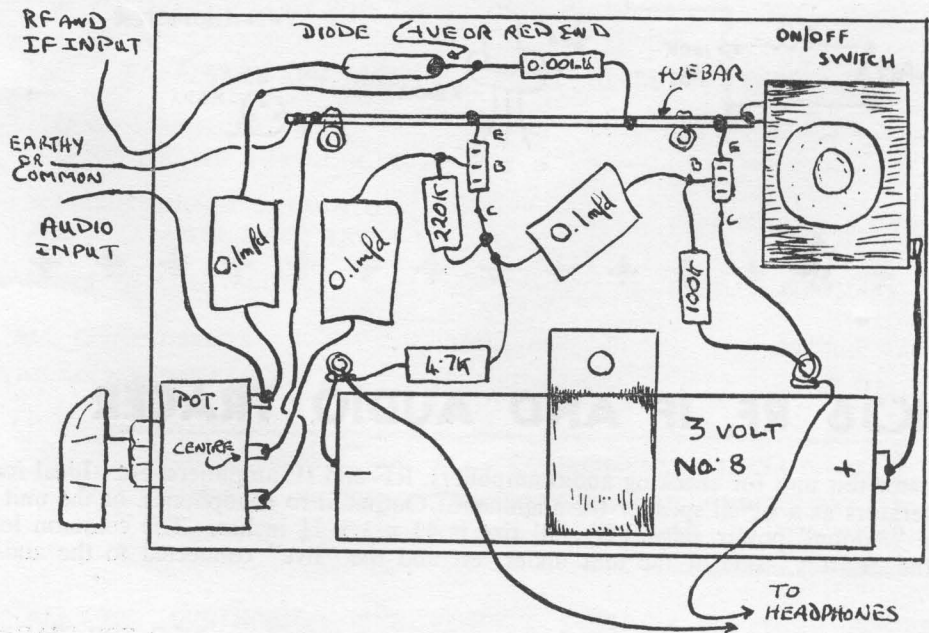
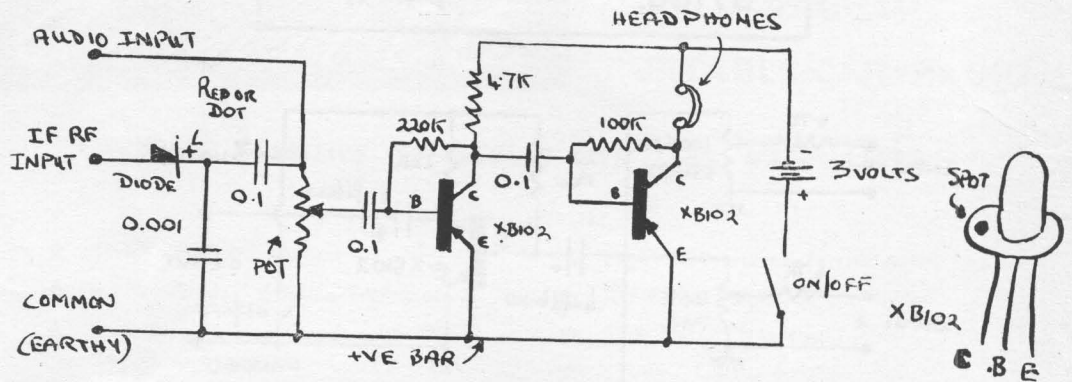

PK37 CAR SAFETY FLASHER

Working from 12 volt car battery or similar, this unit gives low frequency pulses which operate the lamp. Ideal for changing a car tyre late at night to give warning to other traffic. Other uses include sailing boat lights, mooring buoys, car direction indicators.

The V15/10P transistor is bolted down on to a piece of metal with the provided mica washer and other insulators as shown on the 10 watt power stage circuit. The type of lamp used is a 12 volt side light and suitable holder.

COMPONENTS LIST

V15/10P TRANSISTOR	15/0d.	470 OHM (YELLOW/MAUVE/BROWN)	3d.
XB102 OR XB112 TRANSISTOR	7/6d.	180 OHM (BROWN/GREY/BROWN) ...	3d.
TRANSISTOR HOLDER	9d.	SUNDRIES:—	
ON/OFF TOGGLE SWITCH	2/0d.	12 VOLT CAR LAMP	
2 — 100 MFD CONDENSERS	1/6d. ea.	HOLDER FOR LAMP	
15K OHM (BROWN/GREEN/ORANGE)	3d.	SMALL METAL BOX	
3.3K OHM (ORANGE/ORANGE/RED)	3d.	HOOK-UP WIRE	

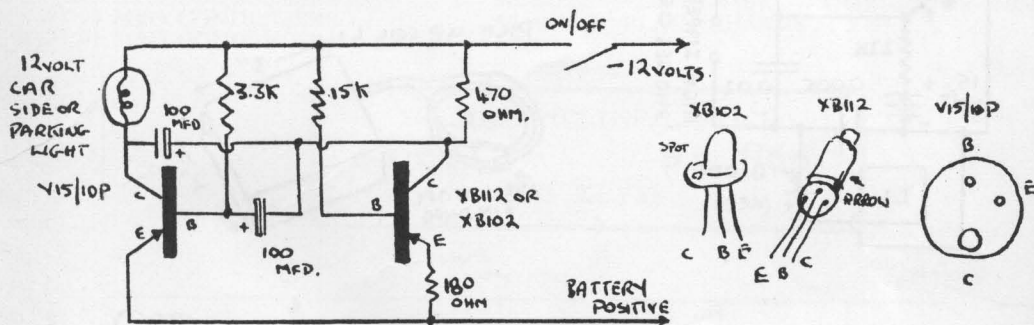

PK38 TRANSMITTER KEYING MONITOR

A handy gadget to enable the "Ham" or CW operator to hear his own transmissions without connection to the transmitter and without the use of elaborate equipment. To use, place the pick-up coil near to the tank circuit of the transmitter. Overall size is 3 x 2 x $\frac{3}{4}$ inches.

COMPONENTS LIST

PNP TRANSISTOR, XB112 OR XB102	7/6d.	B144 15 VOLT BATTERY	2/0d.
DIODE DETECTOR	2/0d.	HIGH IMPEDANCE EARPHONE	16/0d.
CASE 3 x 2 x $\frac{3}{4}$ in.	1/6d.	0.01 MFD; 0.005 MFD	6d. ea.
TRANSISTOR HOLDER	9d.	0.02 MFD CONDENSER	9d.
TAGGED CHASSIS WITH CLIPS	2/0d.	22K (RED/RED/MAUVE)	3d.
		2 YDS. PVC WIRE FOR COIL, ETC.	6d.

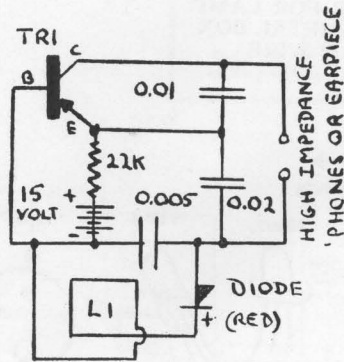

L1 = 6 TURNS OF SOLID INSULATED CONNECTING WIRE IN A 2 INCH LOOP

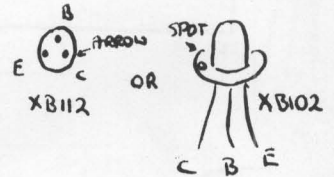
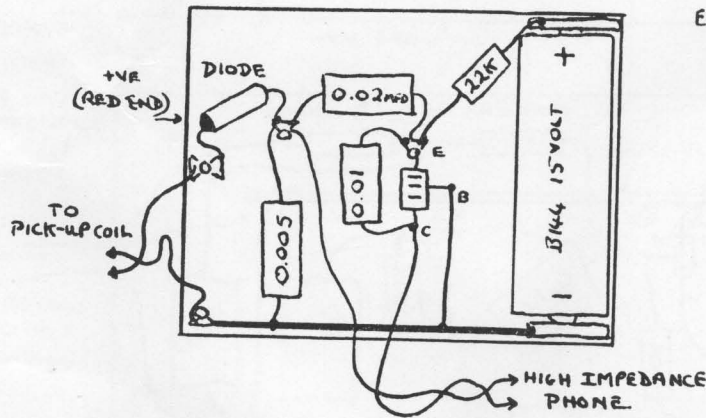
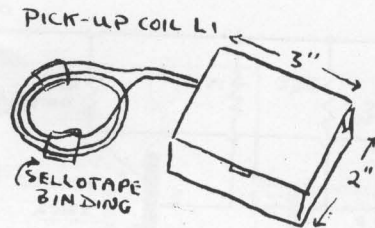

SPECIAL INCLUSIVE PRICE
32/6d. **p.p. 1/-**
 OR WITH HEADPHONES IN PLACE OF PERSONAL EARPHONES
27/6d. **p.p. 1/-**

PK39 TRANSISTOR ELECTRONIC ORGAN

The two transistor organ is ideal for building into toy pianos. This model covers approximately two octaves with a switch to change one octave to another. Only one key can be pressed at a time. If two are pressed it is possible that no note at all will be heard.

The keys of an existing toy piano would have to be turned into switches to operate the various notes.

(Courtesy of Bernards Radio Manuals.)

COMPONENTS LIST

XB102 OR XB112 TRANSISTOR	7/6d.	2—0.1 MFD CONDENSERS	6d. ea.
TRANSISTOR HOLDER	9d.	OL130 TRANSFORMER	2/6d.
10K OHM CONTROL WITH SWITCH	4/6d.	ON/OFF OCTAVE SWITCH	2/0d.
V15/10P TRANSISTOR	15/0d.	3.3K OHM (ORANGE/ORANGE/RED)	3d.
25 OHM 3 inch SPEAKER	22/6d.	1K OHM (BROWN/BLACK/RED)	3d.
PP4 9 VOLT BATTERY	2/0d.	8.2K OHM (GREY/RED/RED)	3d.
BATTERY CLIPS	1/6d.	22 OHM RESISTOR	6d.
4—0.25 MFD CONDENSERS	9d. ea.	15K OHM (BROWN/GREEN/ORANGE)	3d.
8—0.04 MFD CONDENSERS	9d. ea.	PLAIN CHASSIS 5½ x 3½	9d.
2—0.01 MFD CONDENSERS	6d. ea.		

SPECIAL INCLUSIVE PRICE
59/6d. p.p. **1/6d.**
 (LESS KEYS)

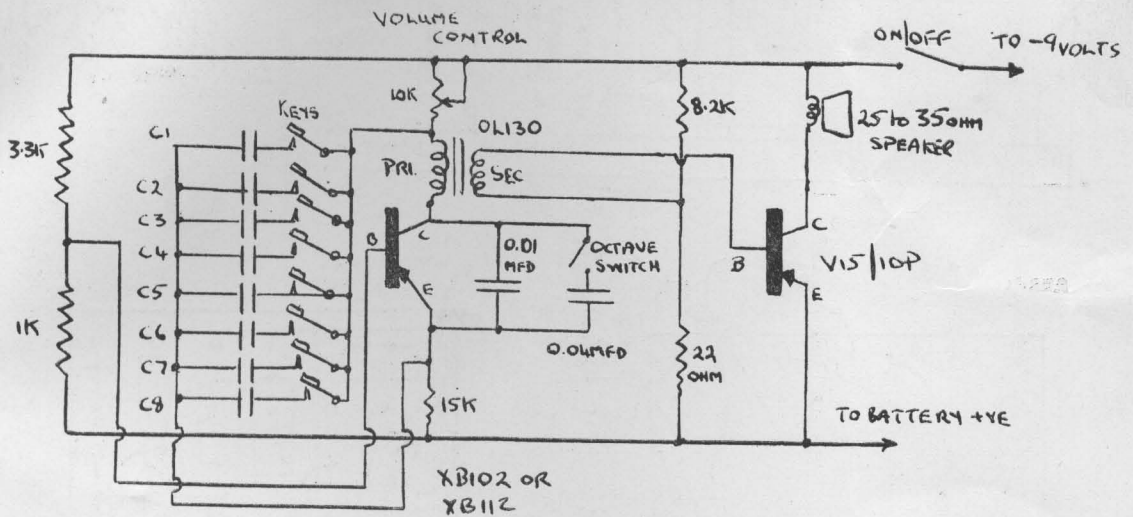

- C1 = 0.5 MFD (2-0.25 MFD //)
 C2 = 0.3 MFD (0.25 // 0.04)
 C3 = 0.25 MFD
 C4 = 0.14 MFD (0.1 // 0.04)
 C5 = 0.1 MFD
 C6 = 0.06 MFD (0.04 // 0.02)
 C7 = 0.05 MFD (0.04 // 0.01)
 C8 = 0.04 MFD

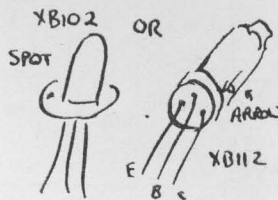

PK40 3-CHANNEL RADIO CONTROL RECEIVER

Short range 27 mc/s receiver operating vibrating reed unit up to 3 contacts. Transmitter must be of the modulated type and may be valve or transistorized. For best results the reed resistance should be 300 to 500 ohms. Overall size less batteries and reed is 2 x 1½ x 1¼ inches. Batteries required are 4½ volts and 1½ volts. The 4½ volt supply can be 3 - U16's in series.

COMPONENTS LIST

SB305 TRANSISTOR	10/0d.	D1001 TRANSFORMER	7/0d.
RED SPOT TRANSISTOR	3/6d.	RESISTORS	3d. ea.
XB103 TRANSISTOR	10/0d.	3-4.7k OHM (YELLOW/MAUVE/RED)	
2- 30 MFD CONDENSERS	2/6d. ea.	1-33k OHM (ORANGE/ORANGE/ORANGE)	
COIL TYPE AF3 (11 to 12 turns)	3/0d.	1-18k OHM (BROWN/GREY/ORANGE)	
2- 10pf: 2- 15pf: 0.005: 0.01	6d. ea.	TAGGED CHASSIS	2/6d.
0.004 MFD (4000pf)	1/0d.	HOOK UP & BATTERY WIRE 3 yds.	3d. yd.
MINIATURE RF CHOKE	1/6d.	4- U16 BATTERIES	4½d. ea.
		2-6BA NUTS, BOLTS & SOLDER TAGS	

SPECIAL INCLUSIVE PRICE
50/- p.p. **1/-**

