

ELECTRICAL ENGINEERING FOR ORDINARY NATIONAL CERTIFICATE

G. N. Patchett, B.Sc.(Eng.), Ph.D., M.I.E.E., M.Brit.I.R.E., M.I.R.E.
 Vol. 1—Current Electricity 7/6 Vol. 4—Direct Current Machines 8/6
 Vol. 2—Magnetism and Electrostatics 6/- Vol. 5—Basic Electronics 5/-
 Vol. 3—Alternating Current Theory 10/6

THE GENERAL COURSE IN ENGINEERING

F. B. Lockwood, B.Sc.(Eng.), A.M.I.E.E. and R. Dunstan, A.M.I.E.E.
 Experiments for Students—Vol. 1 (G1 year) 4/6; Vol. 2 (G2 year) 4/6
 Problems in Engineering Science—Vol. 1 (G1 year) 6/-; Vol. 2 (G2 year) 7/6

RADIO SERVICING

Vol. 1—Basic Electrotechnology 6/- Vol. 4—Fault Finding 5/-
 Vol. 2—Intermediate Radio Theory 8/6 Vol. 6—Specimen Answers 1955/1959 (Final) 8/6
 Vol. 3—Final Radio Theory 6/-

TELEVISION SERVICING

G. N. Patchett, B.Sc.(Eng.), Ph.D., M.I.E.E., M.Brit.I.R.E., M.I.R.E.
 Vol. 1 5/- Vol. 2 6/- Vol. 3 5/- Vol. 4 7/6

AUDIO HANDBOOK SERIES

N. H. Crowhurst, A.M.I.E.E., M.I.R.E.
 No. 1 AMPLIFIERS 3/6 No. 4 PUBLIC ADDRESS 4/6
 No. 2 FEEDBACK 3/6 No. 5 THE QUEST FOR QUALITY 6/-

RADIO SERVICING INSTRUMENTS 4/6

E. N. Bradley

ELECTRONIC NOVELTIES FOR THE CONSTRUCTOR 5/-

E. N. Bradley

RADIO CONTROL OF MODELS 5/-

G. Sommerhoff, M.A.

TELEVISION SYNCHRONIZING SEPARATORS 5/-

G. N. Patchett, B.Sc.(Eng.), Ph.D., M.I.E.E., M.Brit.I.R.E., M.I.R.E.

TRANSISTOR CIRCUITS FOR THE CONSTRUCTOR Nos. 1, 2, 3 & 4

E. N. Bradley each 3/6

TELEVISION TEST EQUIPMENT 5/-

E. N. Bradley

THE OSCILLOSCOPE BOOK 5/- **TELEVISION FAULTS** 5/-

E. N. Bradley

N. Stevens

TELEVISION TIMEBASE CIRCUITS 5/-

C. H. Banthorpe

ELECTRONIC GADGETS FOR THE CONSTRUCTOR 4/6

E. N. Bradley

PRACTICAL TV AERIAL MANUAL FOR BANDS I AND III 5/-

R. Laidlaw

OSCILLOSCOPE EQUIPMENT 5/-

D. W. Easterling

HOW TO GET THE BEST OUT OF YOUR TAPE RECORDER 8/6

Percival J. Guy

SERVICING TRANSISTOR RECEIVERS 7/6

F. R. Pettit

USING AN OSCILLOSCOPE 6/6

D. W. Easterling

EXTRA EQUIPMENT FOR YOUR TAPE RECORDER 6/-

A. H. Rasheed

SPECIMEN ANSWERS TO TELEVISION SERVICING QUESTIONS

(City & Guilds and R.T.E.B. 1958/1961)

A. R. Bailey and E. C. Bell 7/6

PRINCIPLES OF COLOUR TELEVISION 16/-

G. N. Patchett, B.Sc.(Eng.), Ph.D., M.I.E.E., M.Brit.I.R.E., M.I.R.E.

INTRODUCING HI-FI 6/-

A. H. Rasheed

BRITISH TRANSISTOR DIRECTORY 8/6

E. N. Bradley

SEMICONDUCTOR CIRCUIT DESIGN 7/6

R. V. Leedham, B.Sc.(Tech.), A.M.I.E.E.

WELDING SCIENCE—Vol. 1 5/-

J. Gardner, F.R.S.A., M.Inst.Met., A.Inst.W

Transistor Circuits for the Constructor

No. 3

E. N. BRADLEY

This continuation of *Transistor Circuits* contains full practical instructions for building a pocket-size REFLEX SUPERHET RECEIVER using only three transistors; a LOUD-HAILER for use at sports meetings and similar outdoor occasions; and a simple TWO-TRANSISTOR T.R.F. RECEIVER suitable for construction by the novice.

Of particular interest, however, is a complete THREE-CHANNEL MODEL CONTROL system, with a totally transistorized receiver, suitable for all types of radio-controlled boats, vehicles and similar models. The control gear, including an easily-built vibrating reed unit, is fully described. There is also a circuit of a suitable LOW-POWER TRANSMITTER.

LONDON: NORMAN PRICE (PUBLISHERS) LTD

Three shillings and sixpence net

TRANSISTOR CIRCUITS
FOR THE CONSTRUCTOR

No. 3

TRANSISTOR
CIRCUITS
FOR THE
CONSTRUCTOR

No. 3

E. N. Bradley

LONDON

NORMAN PRICE (PUBLISHERS) LTD.

NORMAN PRICE (PUBLISHERS) LTD.
150 OSSULSTON STREET, LONDON, N.W.1

CONTENTS

| | PAGE |
|---------------------------------------|------|
| 1. A THREE-TRANSISTOR REFLEX SUPERHET | 9 |
| 2. A TRANSISTORIZED LOUD-HAILER | 15 |
| 3. THREE-CHANNEL MODEL CONTROL | 18 |
| 4. A TWO-TRANSISTOR T.R.F. RECEIVER | 30 |

© NORMAN PRICE (PUBLISHERS) LTD., 1960
3rd impression 1963

Printed in Great Britain by
A. BROWN & SONS, LTD., Hull.

ILLUSTRATIONS

| FIG. | | PAGE |
|---------|------------------------------------------------------------|------|
| 1.1. | A Three-Transistor Reflex Superhet | 10 |
| 1.2. | The Layout | 11 |
| 1.3. | Point-to-Point Wiring Plan | 12 |
| 2.1. | A Transistorized Loud-Hailer | 15 |
| 2.2. | General Layout | 15 |
| 2.3. | Details of Handle | 16 |
| 3.1. | Three-Channel Model Control: The Receiver | 18 |
| 3.2. | The Receiver Layout | 20 |
| 3.3(a). | The Polepieces | 21 |
| 3.3(b). | Polepiece with Reeds Fitted | 21 |
| 3.4. | The Reed Unit: Side View | 22 |
| 3.5. | The Core Laminations | 22 |
| 3.6. | The Reed Unit Circuit | 23 |
| 3.7(a). | Simple Rudder Control System | 24 |
| 3.7(b). | Self-Centreing Rudder Control System | 24 |
| 3.8. | The Steering Gear Mechanical Arrangement | 25 |
| 3.9. | Three-Channel Model Control: The Low-Power, Transmitter | 26 |
| 4.1. | A Two-Transistor T.R.F. Receiver | 30 |
| 4.2. | Above-Chassis Layout | 31 |
| 4.3. | Under-Chassis Layout | 31 |

CHAPTER 1

A THREE-TRANSISTOR REFLEX SUPERHET

THE three-transistor circuit shown in Fig. 1.1 is a complete superhet receiver containing five stages: frequency-changer; two i.f. amplifiers; detector; and audio amplifier. The third transistor, Tr_3 , operates as both an i.f. and audio amplifier, the overall sensitivity of the receiver being such that it will give good results in any reception area from its internal ferrite slab aerial. The set is, moreover, very small and compact, the original being built inside a small plastic soap container. The layout, shown in Fig. 1.2, is made possible by the use of high efficiency midget components in the Repanco range.

A self-oscillating frequency-changer, Tr_1 , feeds the two common-base i.f. amplifiers. The third i.f. transformer passes the i.f. signal to a germanium diode detector, D_1 , from which the signal is taken to the volume control, R_3 , and a.v.c. is supplied to the first i.f. amplifier. Audio is coupled via C_{11} to the base of Tr_3 , giving an amplified output in the earpiece, E , between the primary of $I.F.T._3$ and the collector supply line. A 3V supply is adequate and permits the use of a small battery with good battery life.

The smallest possible components should be obtained for the receiver. Various methods of construction are possible. In the original the case was first drilled and slotted for the main two-gang tuner and the VOLUME CONTROL/ON-OFF switch, an Ardente control which is mounted on an end wall with its rim protruding through the case for edgewise adjustment. The oscillator coil, i.f. transformers and slab aerial were then mounted directly on the case by a sparing application of *Evostick*, the aerial being stuck by the edges of its rubber grommets and the cans being inverted so that their pins and cores were uppermost. This, however, makes the mounting permanent and if it is likely that the coils and aerial will be required at some future time for incorporation in another circuit it would be better to mount them by rigid wiring from the tuning capacitor. The coil and i.f. cans could be sweated to an earth wire by means of their lugs (which will take solder), the earth wire running in a square loop with both ends terminated at the tuner.

If the adhesive mounting is used remember to earth the four miniature cans, taking one mounting lug of the oscillator coil to tag 2 and a mounting lug of each i.f. transformer to its respective tag 5. These can earths are not shown in Fig. 1.3 to avoid confusion.

The battery holder and contacts are made from springy sheet brass bolted to a strip of paxolin, countersunk head bolts being used and the paxolin being stuck to the case.

The resistors, capacitors and transistors are mounted between the larger components. They are supported by their tags and the wiring, most of them falling conveniently into a vertical mounting position. Avoid an excess of

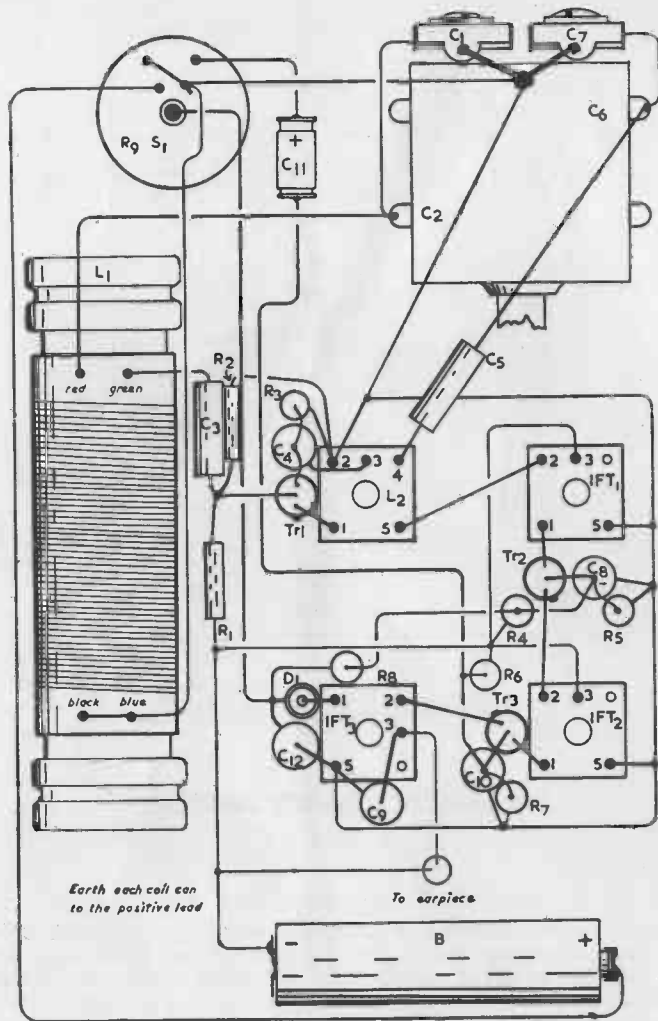

FIG. 1.3. POINT-TO-POINT WIRING PLAN

Aligning the Receiver

The miniature cores of the oscillator coil and i.f. transformers have very small slots and a suitable trimming tool must be used to avoid damage. If a standard tool is not to hand a substitute can be made from a short length of tinned copper wire of 18 or 20 s.w.g. which should be squeezed in a vice and so flattened into a blade. After any necessary trimming with a fine file this blade can then be mounted into a toothpick or orangestick "handle" and is strong enough to turn the cores but sufficiently soft, if carefully handled, to prevent damage.

The receiver is most easily aligned if a signal generator is available. The output lead from the generator should be placed near the slab aerial and with

the earpiece signal as an indication the i.f. transformers are tuned to 455kc/s, working from *I.F.T.*₃ back to *I.F.T.*₁. For this operation the tuner vanes should be fully meshed.

With the i.f. transformers aligned, open the tuner vanes about 30° from the fully in position, feed in a 690kc/s signal from the generator and adjust the oscillator core for maximum signal. Mark the case and tuner knob so that this setting can be repeated. If the signal is too weak the generator can be connected to the red and black terminals on the slab aerial but normally this will not be necessary.

Open the tuner vanes to about 130°, tune the signal generator to 1,080kc/s and adjust *C*₇ for maximum signal. Again, mark the case and knob so that the setting can be repeated.

Set the vanes back to the 30° position and again adjust the oscillator core for maximum signal, then slide the windings of the aerial along the ferrite slab to improve the signal as much as possible, reducing the signal generator output so that any change in signal level can easily be heard.

Return the vanes to the 130° position and again adjust *C*₇ for maximum signal, then tune *C*₁ to improve the signal as much as possible.

The receiver is then aligned and ready for use.

If no signal generator is available reliance must be placed on local stations and receiver noise. To align the i.f. transformers turn their cores for the greatest hiss in the earpiece—it may help to connect a length of wire, to give some extra noise pick-up, to the junction of *C*₃ with the green aerial tag. With the transformers roughly tuned in this way set *C*₁ and *C*₇ to approximately their mid-capacitance points and with the tuner vanes almost completely open endeavour to tune in either the West Home Service on 206 metres or Luxembourg on 208 metres. It may be necessary to wait for evening reception conditions to receive either station, and temporarily connecting a length of wire to the red tag on the aerial for extra signal strength may help. Various settings of *C*₁ and *C*₇ may be tried if the required station is not at first received.

When the station is heard adjust *C*₇ if necessary to bring it almost to the end of the tuning range with *C*₂, *C*₆ well open, and mark the tuning point.

Now tune over the band, turning the tuner vanes into mesh. Various stations should be received but results will probably fall off rapidly as the tuner is turned until no more signals are heard. Retune to the last faint signal clearly detectable and turn the core of *L*₂ in and out to improve reception to the best possible volume.

Now retune the receiver to the high frequency end of the scale—to the West Home Service or Luxembourg. Quite possibly the station will have disappeared, but in any case *C*₇ will require resetting. If the oscillator core was turned farther into the coil slightly reduce *C*₇; if the core was turned farther out of the coil slightly increase *C*₇. Adjust *C*₇ until the selected signal is again heard at its original tuning point.

Again turn the tuner towards maximum capacitance. The tracking should now be considerably improved with several more stations heard almost up to the low frequency end of the tuning scale. Select any station which can be heard with the tuner vanes about three-quarters fully meshed and again adjust the oscillator core for best results. Without altering the tuning, next slide the aerial windings along the ferrite slab further to improve reception if possible.

Retune once more to the high frequency station and again adjust *C*₇ to restore it to its original tuning point. Next adjust *C*₁ for best results.

The i.f. transformer tuning should now be checked, testing the setting of each core in turn for any possible improvement in the signal.

Retune once more across the band. Some slight further improvements may be possible to the settings of the oscillator core and aerial windings at

the lower frequencies, and to C_1 and C_7 at the higher frequencies, after which the receiver is ready for use.

COMPONENTS LIST FOR THE THREE-TRANSISTOR REFLEX
SUPERHET RECEIVER

(Fig. 1.1)

| | |
|---------------------------------|--------------------------------------------------------------------------------------------------------|
| L_1 | Slab Aerial Type FS3, Repanco. |
| L_2 | Oscillator Coil Type XO8, Repanco. |
| $I.F.T._{1,2}$ | I.F. Transformer Type XT6, Repanco. |
| $I.F.T._3$ | I.F. Transformer Type XT7, Repanco. |
| C_1, C_7 | 60pF compression trimmer. |
| C_2, C_6 | 208-176pF two gang tuner, Type OO, Jackson Bros. |
| $C_3, C_4, C_9, C_{10}, C_{12}$ | 0.01 μ F midget tubular. |
| C_5 | 300pF ceramic. |
| C_8 | 25 μ F 3v.w. midget electrolytic. |
| C_{11} | 2 μ F 3v.w. midget electrolytic. |
| R_1 | 33k Ω 1/10 or $\frac{1}{4}$ watt |
| R_2, R_3 | 10k Ω " " |
| R_4 | 82k Ω " " |
| R_5, R_8 | 4.7k Ω " " |
| R_6 | 1M Ω " " |
| R_7 | 47k Ω " " |
| R_9 | 1M Ω vol. control with s.p. switch, Type VC1126, Ardente. |
| Tr_1 | Mullard OC44 or equivalent. |
| Tr_2, Tr_3 | Mullard OC45 or equivalent. |
| D_1 | Mullard OA70 or equivalent. |
| E | Deaf-aid earpiece, 250 Ω d.c. resistance, Type E.R. 250, Ardente. |
| | Earpiece cord Type E6/E6 with plug at both ends or Type E6/— with plug at one end only. Ardente. |
| S_1 | On-off switch ganged with R_9 . |
| B | 3V battery, Type D22, Ever Ready. |
| | Case, tuning knob, etc. |

CHAPTER 2

A TRANSISTORIZED LOUD-HAILER

THE circuit of Fig. 2.1 is of a Class-B power amplifier driven by a carbon microphone and feeding a loudspeaker to serve as a loud-hailer, suitable for replacing megaphones and, in some cases, public address outfits at functions such as school sports days, garden parties, meetings and the like

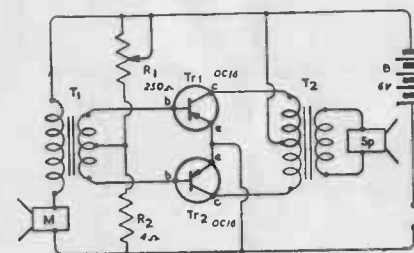

FIG. 2.1. A TRANSISTORIZED LOUD-HAILER

The unit is self-contained and is powered by a battery of 4 U2 cells; a 12V supply can be substituted for the 6V battery if desired with some extra output. Current drain is fairly heavy but since the battery is switched on only for the duration of each announcement, battery life is perfectly adequate.

The general layout of the loud-hailer is shown in Fig. 2.2. The original unit was built up from two aluminium pudding basins, one larger than the other. The larger basin held the loudspeaker, backed by a disc and rings of foam plastic whilst the smaller basin was bolted behind the larger and held the microphone, padded by more foam plastic to prevent acoustic feedback. The input and output transformers were mounted on the back of the larger basin, as were the transistors, the metal forming a heat sink. These parts

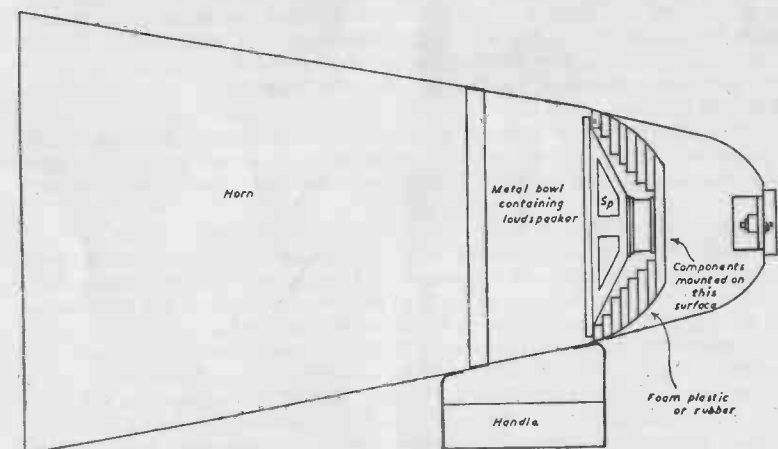

FIG. 2.2. GENERAL LAYOUT

and their associated small components were covered and protected by the smaller rear basin.

The batteries were placed in a hollow handle with thumb control of a microswitch, and the horn of the loud-hailer was made of sheet aluminium although stiff cardboard, given several coats of shellac varnish or a similar stiffening finish, is almost as good.

The hollow handle was shaped from aluminium sheet and bolted along the join. The length was made sufficient to enclose the U2 cells, as shown in Fig. 2.3, leaving room for end plugs cut and shaped from thick paxolin. The

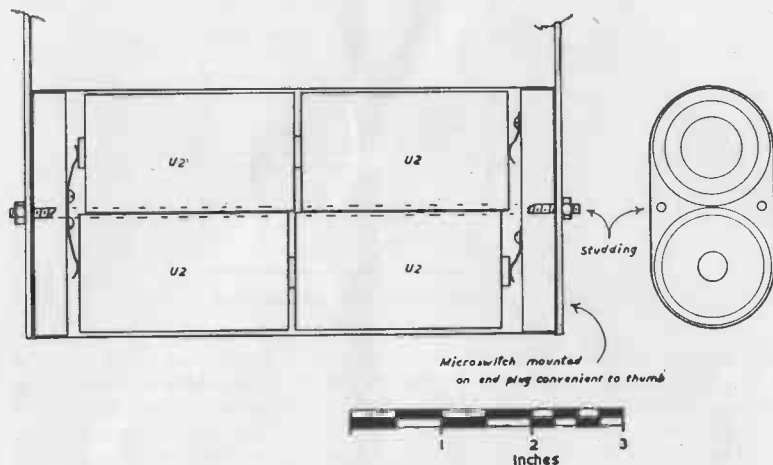

FIG. 2.3. DETAILS OF HANDLE

battery connectors were made from springy sheet brass and bolted to tapped holes in the paxolin. The end plugs were then drawn together, bringing the battery contactors into good connection and securing the end plugs into the hollow handle by passing two lengths of screwed studding right through the assembly and fitting bolts at both ends. To change the batteries the handle must be disassembled, the end plugs removed, and the hollow battery compartment freed. The handle supports are made of sheet aluminium and are therefore sufficiently flexible to allow the end plugs to be withdrawn from the handle.

The microswitch is placed on the rear handle support so that it falls conveniently under the thumb; a press-button switch may be used in place of a microswitch and should preferably be of the "press for on, press for off" type.

The ratios of T_1 and T_2 are important if the maximum output is to be achieved. Kits are now available from some radio houses for Class-B power output stages consisting of transistors and input and output transformers, and such a kit may be used in place of the present circuit if the constructor so desires. Alternatively, suitable transformers may be bought, or even made experimentally from stripped-down output transformers. The collector-collector load is 26Ω , which must be matched to the loudspeaker by a transformer with a centre-tapped primary. For a 3Ω loudspeaker the ratio will be practically 3 : 1 and the same ratio is satisfactory for coupling the carbon microphone into the amplifier bases. In this case, however, the secondary must be centre-tapped, the larger winding being in series with the

microphone to give step-down coupling into the amplifier. For a 12V supply the output transformer should have a ratio of 4 : 1.

The d.c. resistance of the transformer windings must be low and should ideally be below 1Ω . The constructor who tries his hand at winding such transformers should therefore use a fairly heavy wire gauge (such as 20 s.w.g. enamelled copper), proportioning his windings so as to fill as nearly as possible the available winding space in the chosen core. The laminations should be butt-jointed, all the Es and all the Is being bulked together as in a normal output transformer.

The adjustable bias control, R_1 , need not be accessible with the loud-hailer in normal use since this is set when the circuit is first built and will not be altered unless it becomes necessary to change a transistor or other component. Before first switching on set R_1 for maximum resistance and connect a 100mA meter between the output transformer centre-tap and the negative supply line. Switch on and with no sound input to the microphone adjust R_1 for 60mA on the meter. Switch off, disconnect the meter and make the permanent transformer-to-negative connection, when the circuit is ready for final mechanical assembly and use.

COMPONENTS LIST FOR THE LOUD-HAILER

(Fig. 2.1)

| | |
|--------------|-------------------------------------------------|
| R_1 | 250 Ω pre-set variable resistor. |
| R_2 | 4 Ω $\frac{1}{2}$ watt. |
| Tr_1, Tr_2 | Mullard OC16. |
| T_1 | 3 : 1 step-down, secondary centre-tapped. |
| T_2 | 3 : 1 step-down, primary centre-tapped. |
| M | G.P.O. type carbon microphone insert. |
| Sp | 3 Ω loudspeaker, 6" diameter or similar. |
| S | Microswitch or press-button on-off switch. |
| B | 6V battery, 4 U2 cells. |

Construction

No final dimensions are shown in the diagrams save for those of the handle, since the circuit is ideal for building up from existing parts. The dimensions of the main basin depend on those of the loudspeaker to be used, and the smaller basin need only be a fair fit to the rear of the larger, leaving room for the transformers which require most of the space. The microphone insert should preferably be "floated" in foam plastic or rubber so that it is not mechanically coupled to the loudspeaker, and should be protected by a perforated mouthpiece from an old handset.

It is strongly recommended that a test assembly be made before final construction so that any feedback or howling can be dealt with by experimenting with the amount of damping material behind the loudspeaker and microphone, etc.

CHAPTER 3

THREE-CHANNEL MODEL CONTROL

THE use of transistors in model control circuits confers several advantages, the most important of which are probably the reduction of receiver size, the elimination of h.t. batteries, and the reduction of i.t. current drain, insensitivity to knocks and vibration, and improved reliability. The first cost of a three-channel receiver such as that shown in Fig. 3.1 may be a little

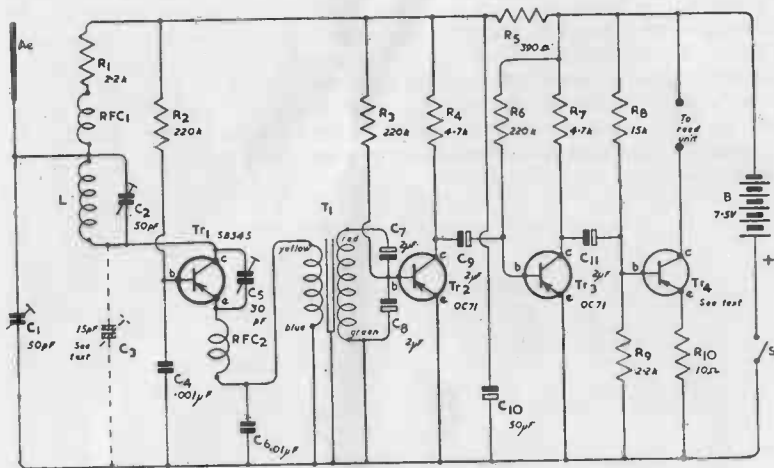

FIG. 3.1. THREE-CHANNEL MODEL CONTROL: THE RECEIVER

more than that of an equivalent valve circuit, but this is soon saved on batteries.

The system to be described has been tested on an Aerokit "Sea Scout" 24" electric powered launch with excellent results.

The three channels of control are provided by three vibrating reeds which take the place of a diaphragm in a telephone receiver. Three distinct tones are used to modulate the transmitter carrier, these tones being tuned to the vibratory frequencies of the three reeds. Only one tone can be transmitted at any one time; this signal, detected by the receiver and, after amplification, passed to the reed unit, causes the appropriate reed to vibrate. The vibrating reed closes a circuit which in turn operates a relay from whose contacts any mechanism in the model can be controlled. In the original system the three controls were (i) rudder port; (ii) rudder starboard; and (iii) astern. Since each control channel is separate and self-contained fully proportional rudder control is automatically provided, any degree of turn being obtainable for any time. If two channels are reserved for rudder control the third can be used for a variety of purposes or it can trigger off a set of sequential controls through a rotating switch, selector mechanism or other device.

The receiver circuit, shown in Fig. 3.1, consists of a superregenerative detector, Tr_1 , followed by two audio amplifiers, Tr_2 , Tr_3 , and a power output stage, Tr_4 . The carrier frequency used is 27Mc/s so that a high frequency transistor is necessary in the detector position, a Semiconductors surface barrier type, SB345, proving ideal. Tr_1 is connected as an emitter-collector feedback oscillator, C_5 providing regeneration to the tuned circuit consisting

of L , C_2 , the oscillator being isolated by two feed chokes, $R.F.C._1$, $R.F.C._2$. The amplitude of oscillation, and thus the sensitivity, is controlled by a variable by-pass capacitor C_1 , across which the aerial is also connected. The circuit is self-quenching, the quench frequency being decided by the values of the bias components, R_2 and C_4 .

The detector has a fairly broad tuning response as is common in super-regenerative circuits and in practice it is a simple matter to set the compression trimmer C_2 for the correct frequency. Nevertheless, a fine tuning capacitor can be added if required in the C_3 position and a 15pF tubular ceramic trimmer as used in TV tuning hearts has been used here.

The short-wave listener may be interested to know that if C_3 is made a small air-spaced tuning capacitor the circuit can be adjusted as a sensitive 10 metre band receiver. For this purpose either the first two audio amplifiers may be used alone, with a deaf-aid earpiece connected in place of R_7 , or a small loudspeaker with a suitable output transformer may be connected-in to the output stage in place of the reed unit.

R_1 is a safety resistance, preventing too high a supply voltage to the detector collector.

Audio output is taken from the emitter of Tr_1 via a miniature interstage transformer connected in the step-up ratio and feeding the base of Tr_2 via C_7 . Any quench frequency accompanying the required audio signal must be prevented from reaching Tr_2 since it would then be rectified in the base-emitter diode and tend to bias the amplifier incorrectly. C_8 is accordingly connected as a by-pass capacitor between the base and earth, the relatively high quench frequency thus being removed with little effect on the lower control signal frequencies.

The two amplifying stages are identical and employ the simplest biasing arrangements since, with the collector loads and the supply voltage provided, there is no chance of thermal runaway. Decoupling in the negative supply line by R_8 and C_{10} is necessary to stabilize the receiver.

The receiver was intended for operation with a home-built reed unit which included a low resistance (35 ohms) coil. Had a commercial reed unit been used, with a coil resistance of 1,000 ohms or so, the output stage design would have taken a different form and, indeed, it might well be possible to drive such a unit as a collector load for Tr_3 ; alternatively, Tr_4 could be an OC72, a TJ1 or similar transistor which would match well, with good output, to a 1k Ω load. In the present circuit a GET5 power transistor was available and served well, but an OC16 has been tested with similar results and it is probable that any power or medium power transistor can be used here, possibly with a change of bias to suit the component. The current drawn by the whole receiver from the 7.5V battery is approximately 45mA so that it is obvious that the power stage is providing only a fraction of the output of which it is really capable and that there is considerable room for experiment here.

The layout of the original receiver is shown in Fig. 3.2. The unit was built on to a miniature 18-way tagboard measuring 4 $\frac{3}{8}$ " long by 1 $\frac{1}{8}$ " wide, taken from the Radiospares range of tagboards. Radiospares components are not directly available to the home constructor but can usually be ordered from any good radio store. C_3 is not shown in the diagram but if required it can be mounted between C_1 and C_2 so that all controls are then grouped at one end of the receiver.

The tuning coil L has a rather large diameter and if the receiver is to be fitted into a very confined space a smaller diameter coil with an extra two turns or so may be used. The efficiency was good with the large diameter coil and since there was room in the launch cabin the size was not reduced.

Transistor holders were used for Tr_1 , Tr_2 and Tr_3 chiefly so that the transistors could be removed for the experimental insertion of other types

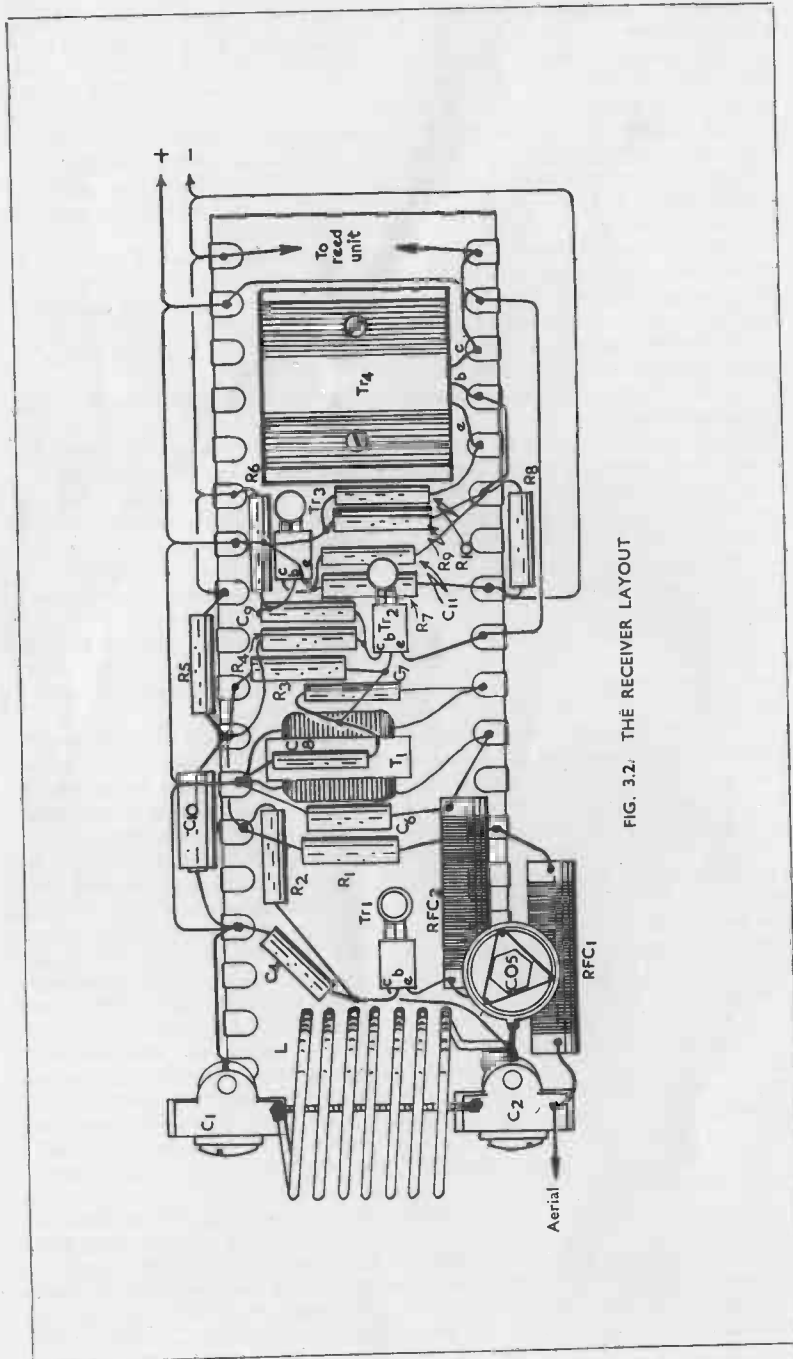

FIG. 3.2. THE RECEIVER LAYOUT

in the circuit, and also to make the surface barrier transistor readily available for use in other circuits without the attendant dangers of soldering and unsoldering. Small holders are obtainable from various sources advertised in technical journals and the mounting depends on the type used; as a general rule the holders are intended for printed circuits and require three small holes through which the tags may be passed and bent over. Leads of light flex can then be soldered to them on the rear of the board. The output transistor does not require a heat sink since the collector current is kept relatively low and is therefore mounted by 6 V.A. bolts and two stand-off pillars to keep it clear of the tags. The audio transformer, T_1 , has lug mountings which are passed through holes in the board and bent over, all other components being mounted in the wiring or (as in the case of C_5) supported directly between convenient tags.

The receiver can of course be built up in any other convenient form, and provided the detector wiring is kept short and compact there are no critical features in the circuit.

The chokes in the original were taken from a 45Mc/s Pye strip but suitable chokes can easily be wound from 34 s.w.g. enamelled wire or a similar small gauge, using ceramic-bodied (Erie) 100k Ω 1 watt resistors as formers. The winding should consist of 50 or 60 turns closewound, the ends of the winding being anchored to the resistor leads. The audio transformer may well be the type specified but a larger component could be tried if one is already available and there is space for it.

Long distance control was not necessary with the original system as the boat was used only on a boating pool and an upright aerial was not installed. The open well behind the cabin of the "Sea Scout" is made of ply and to conceal the edges of the wood narrow strips of thin sheet copper were cut and pinned down along the sides and after bulkhead of this well. The experiment was tried of using these copper strips sweated together at the joints as an aerial, and signal pick-up from the low power transmitter to be described was completely adequate. For control over large pools or on lakes or rivers a vertical whip aerial should be mounted on the boat.

The reed unit was made from a balanced armature earpiece sold as surplus equipment and coded REC. INSET B.A. No. 5 S. The bakelite case was removed and discarded as was the diaphragm and armature assembly, leaving the magnet, two polepieces, the coil and supporting pillars. These parts were then stripped down, the magnet being placed carefully aside; as the magnet is a single block it cannot conveniently be fitted with a keeper.

The polepieces of the unit are shaped as shown in Fig. 3.3(a). From one polepiece the central section, shown shaded in the diagram, was sawn away, the part remaining being fitted with three spring steel reeds as shown in Fig. 3.3(b). The reeds were cut from the main spring of a small clockwork toy, their dimensions being governed by the available space. The width of

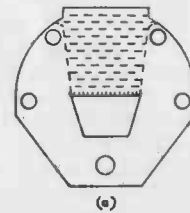

(a)

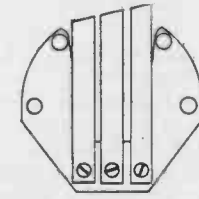

(b)

FIG. 3.3(a). THE POLEPIECES

FIG. 3.3(b) POLEPIECE WITH REEDS FITTED

the spring strip in the original was $\frac{3}{16}$ " but reeds of other widths should serve equally well and a slightly narrower strip would make for better clearance. The reeds were cut to a length which brought their free ends over the core (to be described) which was fitted to the coil, the arrangement being shown in Fig. 3.4 in side view.

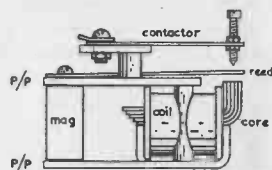

FIG. 3.4. THE REED UNIT: SIDE VIEW

The reeds must be free to vibrate, so that they are angled slightly upwards from the polepiece, and when plucked must give a clear and distinct note. In the original unit the ends of the springs, after mounting, were cut and filed at an angle, as shown in Fig. 3.3(b), to give three clear tones by trial.

The reeds must be very firmly anchored to the polepiece. The central reed was secured under the magnet fixing bolt and for the outer reeds holes were drilled and tapped 6 B.A. The extreme ends of the reeds were softened for drilling by gripping each reed in turn in a large pair of pliers, one end just protruding, this exposed end then being held on an electric hotplate to draw the temper. Clearance holes for 6 B.A. bolts were then drilled and the two outer reeds screwed down hard on the polepiece. The excess lengths of bolt on the underside of the polepiece were then cut off and filed smooth to restore the flush surface necessary for good mechanical contact with the magnet.

To exert an effect upon the reeds the original coil requires a shaped core, and this was fitted through the aperture in the coil former in which the original armature moved. The core was made from small transformer stampings taken from an old output transformer; some E stampings were found whose central leg was a good fit in the coil former and T shaped laminations were made by cutting the upright of the E on either side of the central leg, as shown in Fig. 3.5. The dimension (a) must be equal to, or

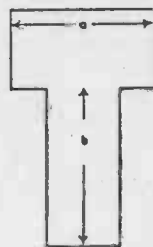

FIG. 3.5. THE CORE LAMINATIONS

slightly greater than, the width over the three reeds as shown in Fig. 3.3(b), and the leg length (b) must be sufficient to make magnetic contact on either side of the coil to the upturned central arms of the lower polepiece as shown in Fig. 3.4. In the original unit 5 stampings were all that could be accommodated by the coil former, but these made a satisfactory core.

The stampings were assembled in a stack and the cut edges filed smooth. The heads or crosspieces of the T were then gripped in a vice and the legs bent round through a right angle so that the core took on the shape shown in Fig. 3.4. The head of the core, immediately under the reeds, tended to

spring open but the laminations were brought back into a compact block by a single turn of light copper wire passed round them, twisted tight and the ends sweated.

The magnet, polepieces, coil and core were then assembled as shown in the diagram, the central reed being secured in place. Sufficient metal should remain in the side arms of the upper polepiece to grip the coil and bring its core into contact with the lugs on the lower polepiece whilst the side pillars, as before, locate the coil between them. The original unit was tested at this stage, before the upper contactors were added, by connecting a pair of headphones across the leads from the coil, each reed being plucked in turn. A clear note should be heard in the 'phones from each reed.

The contactors are a further three strips of the same spring steel carried above the vibrating reeds and insulated from the polepieces and each other. In the original unit they were bolted to a small paxolin board cut from sheet and mounted on short stand-offs above the reeds, the contactor springs having their ends drilled in the same way as those of the reeds. It is important that springy steel, rather than another metal, be used for these contactor arms, as they enhance the magnetic field and greatly add to the sensitivity of the unit.

The contact ends of the contactor arms were drilled to take 10 B.A. bolts, and three such bolts, $\frac{3}{8}$ " long, were pointed on a grindstone and secured in the arms by two nuts. The bolts were then screwed down just to touch the reeds when these were vibrating. Connections from external circuits were made to solder tags under the contactor arm fixing bolts, the three reeds being common to the main assembly.

The ends of the reeds were polished with very fine emery to ensure good contact and the unit was then ready for test.

No fixed dimensions are shown in the diagrams since the vibrating reed unit is best made by "cut and try" methods. A spring from a cheap plastic clockwork toy will provide material for several reeds and contactor arms, and a small scrap transformer, given a core of approximately the right size, will furnish a large number of laminations. The job is one which can be tackled confidently by any constructor.

The circuit of the reed unit with its accompanying relays is shown in Fig. 3.6. A layer-type deaf-aid battery of 30V provides relay operating

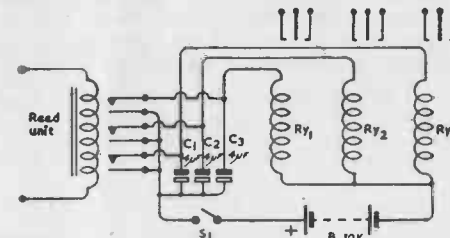

FIG. 3.6.
THE REED UNIT CIRCUIT

current, the relays in the original circuit being 5kΩ RipMax units. A point to note is that the capacitors which hold on the relays whilst the reeds are vibrating are connected across the vibrating contacts themselves rather than across the relay coils as is common in several model control circuits.

The reed unit, relays, switch and battery clips in the original circuit were mounted on a sheet of paxolin as a single control assembly, but in view of the fact that these components will necessarily be mounted to suit each particular model no layout diagram is shown.

Polarized plugs and sockets are used throughout the equipment as inter-connections between the units, 2-pin l.t. battery plugs and sockets being

employed as battery and reed unit connectors to the receiver and 3-pin h.t. battery plugs and sockets as connectors to the relay contacts, which are of the changeover type.

The main supply switch, S_1 of Fig. 3.1, in the receiver fitted to the "Sea Scout" was one pole of a 3-pole 4-way rotary switch mounted in the cabin. Position 1 was off; position 2, receiver on only; position 3 was receiver and relay controlled circuits on; and the final position brought in the main motor supply along with the control gear. This type of control is particularly useful in that the only receiver test normally required can be made by switching on the receiver alone and listening to the buzz from the reed unit as the transmitter is switched a convenient distance away or, with aerial removed, fairly close to the boat. No tuning meter is required as is the case with single-channel receivers and the tuning and sensitivity adjustments on the original apparatus have been found remarkably stable; no adjustments were necessary after a journey of several miles over hilly roads.

The steering gear used with the three-channel system is shown in Figs. 3.7 and 3.8. In Fig. 3.7(a) two relays are used as simple switches which connect

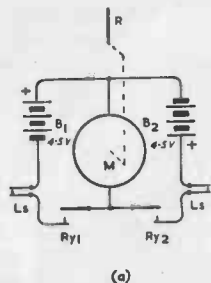

FIG. 3.7(a). SIMPLE RUDDER CONTROL SYSTEM

the steering motor to either of two batteries, their polarities being arranged so that each drives the motor in a different direction. Limit switches, made from relay contacts from old Post Office type relays, cut off the appropriate battery when the rudder is turned hard over in either direction. A Mighty Midget motor driving a 2 B.A. screwed rod and traveller turn the rudder sufficiently quickly to turn the boat in its own length.

This simple system is to be changed to a self-centring system as shown in Fig. 3.7(b). Here the relays are used as changeover switches and again

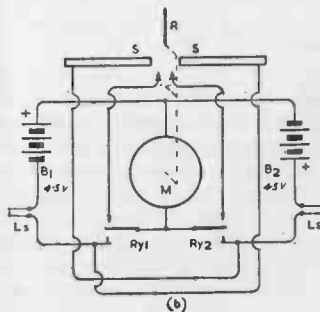

FIG. 3.7(b). SELF-CENTREING RUDDER CONTROL SYSTEM

connect the motor to two batteries for drive in either direction, whilst travel is again controlled by limit switches. Two extra contacts are moved in time with the rudder, however, and slide along the bars S . When the rudder is in the central position both contacts are just free of their respective bars. When the rudder turns to port the port slider contacts the port bar, and when the rudder turns to starboard the starboard slider contacts the starboard bar.

In either case the slider and bar play no part whilst the appropriate relay is energized and driving the rudder. When the relay is released, however, the changeover contact comes into play, connecting the battery of opposite polarity to the motor and thus driving the rudder back to centre. As the central position is reached the slider loses contact with its bar and the rudder motor stops.

A suitable mechanical arrangement is shown in Fig. 3.8, in plan at (a) and elevation at (b). The traveller along the screwed driving rod is a block

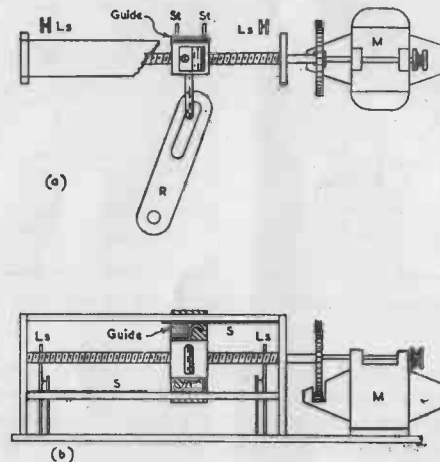

FIG. 3.8. THE STEERING GEAR MECHANICAL ARRANGEMENT

of paxolin or similar insulator. It carries two spring contacts, which press against the contact bars S ; the rudder actuating arm; a guide plate which bears against the upper and lower crossbars carrying the contact bars and which prevents the traveller from turning with the screwed rod, thus forcing it to run along the thread; and two limit switch strikers, St . The limit switches are set in a base board at Ls .

Connections to the two centring contact springs are made by light plastic covered flex.

A similar arrangement, without the centring springs and contact bars, was used for the first trials of the "Sea Scout" and was housed at the after end of the well under a dummy locker made of varnished veneer. The steering motor batteries were housed in the main cabin and supply lines run under the well flooring.

The Transmitter

In some reed units the reeds themselves are made adjustable between certain limits so that they can be tuned to the modulating frequencies provided by the transmitter. In the present system, however, the reeds are fixed and the transmitter audio oscillator is tuned by preset potentiometers to the three

reed frequencies. These three controls are brought out to the transmitter panel. Since different weather conditions and temperatures will affect both reeds and the transmitter modulator a rapid and convenient correction is desirable.

It was originally intended to modulate the transmitter by a transistor audio oscillator, but r.f. rectified on the transistor base altered the bias (and thus the modulating frequencies) to such a degree that it was found necessary to use a valve. The transmitter circuit is shown in Fig. 3.9.

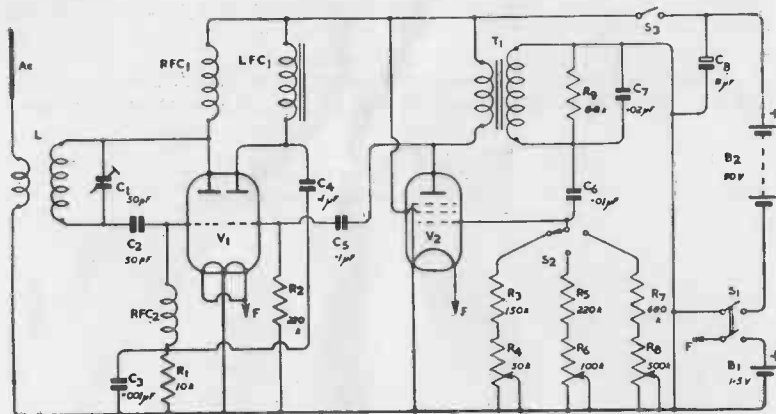

FIG. 3.9. THREE-CHANNEL MODEL CONTROL: THE LOW-POWER TRANSMITTER.

The power output from this transmitter is a matter of no more than a half-watt or so, but it is adequate for control over the normal boating pool especially if a whip aerial is mounted on the boat. The complete transmitter, including batteries, is built into a metal case $9\frac{3}{8}'' \times 4\frac{3}{8}'' \times 4\frac{3}{8}''$.

The audio oscillator employs a 5 : 1 transformer in the circuit round V_2 , which is a DF91. In the original equipment a Radiospares 5 : 1 Intervalve transformer is used but practically any 5 : 1 audio transformer should serve if C_7 , R_9 and the three tuning resistor chains are adjusted to suit the component. The correct sense of connection to the transformer primary to give oscillation should be found by trial. Deep modulation is required and the audio oscillator is therefore coupled to a triode modulator valve which in turn provides grid modulation of the transmitter. The r.f. oscillator and the modulator are the two sections of a DCC90 double triode.

Higher power transmitters can, of course, be used with advantage and a number of designs are available in model control literature.

COMPONENTS LISTS FOR THE MODEL CONTROL EQUIPMENT
(Figs. 3.1 to 3.9)

Coils

Receiver (Fig. 3.1):

- L 7 turns 16 s.w.g. tinned copper wire close wound on 1" dia. rod and allowed to spring open.

Transmitter (Fig. 3.9):

- L 6 turns 18 s.w.g. on low-loss ribbed 1" dia. coil former (e.g. Eddystone) turns spaced own thickness, secured by polystyrene cement. Aerial coupling coil 2 turns enamelled 18 s.w.g. spaced by trial from anode end of main coil, connected to whip aerial socket by coaxial cable, outer earthed to metal case at socket.

Components

Receiver (Fig. 3.1):

- C_1, C_2 50pF compression trimmer.
 C_3 (optional) 15pF ceramic tubular trimmer.
 C_4 0.001 μ F ceramic.
 C_5 3-30pF "beehive" trimmer.
 C_6 0.01 μ F midget tubular.
 C_7, C_8, C_9, C_{11} 2 μ F 12v.w. midget electrolytic.
 C_{10} 50 μ F 12v.w. midget electrolytic.
 R_1, R_9 2.2k Ω 1/10 or $\frac{1}{4}$ watt.
 R_2, R_3, R_6 220k Ω " "
 R_4, R_7 4.7k Ω " "
 R_5 390 Ω " "
 R_8 15k Ω " "
 R_{10} 10 Ω $\frac{1}{4}$ watt.
 $R.F.C._{1, 2}$ 60 turns 34 s.w.g. enamelled copper wire on 1 watt resistor. See text.
 T_1 T1052 Ardente, 4.5 : 1.
 Tr_1 Semiconductors SB345.
 Tr_2, Tr_3 Mullard OC71 or equivalent.
 Tr_4 General Electric Co. GET5 or equivalent. See text.
 B 7.5V battery, Type AD38, Ever Ready.
 Tagboard, etc., etc.

Transmitter (Fig. 3.9):

- C_1 50pF compression trimmer.
 C_2 50pF ceramic.
 C_3 0.001 μ F ceramic.
 C_4, C_5 0.1 μ F tubular.
 C_6 0.01 μ F tubular.
 C_7 0.02 μ F tubular.
 C_8 8 μ F 150v.w. electrolytic.
 R_1 10k Ω $\frac{1}{4}$ watt.
 R_2, R_3 220k Ω " "
 R_3 150k Ω " "
 R_4 50k Ω pre-set variable.
 R_6 100k Ω pre-set variable.
 R_7 680k Ω $\frac{1}{4}$ watt.
 R_8 500k Ω pre-set variable.
 R_9 6.8k Ω $\frac{1}{4}$ watt.
 $R.F.C._{1, 2}$ Same as $R.F.C._{1, 2}$ in receiver.
 $L.F.C._1$ 10 henrys choke.
 T_1 5 : 1 audio transformer. See text.
 V_1 Mullard DCC90 (3A5).
 V_2 Mullard DF91.
 S_1 2 pole on-off switch.

—continued.

| | |
|--------------------------------|--------------------------------------|
| S_2 | S.p. 3-way tone selector switch. |
| S_3 | Push-button on-off switch. |
| B_1 | 1.5V battery, Type AD35, Ever Ready. |
| B_2 | 90V battery, Type B126, Ever Ready. |
| Case, valveholders, etc., etc. | |

Reed/Relay Unit (Fig. 3.6):

| | |
|----------------------------------------------|----------------------------------------------------------|
| Reed Unit | See text. |
| Ry_1, Ry_2, Ry_3 | RipMax 5k Ω , changeover contacts, or equivalent. |
| C_1, C_2, C_3 | 4 μ F 150v.w. miniature electrolytic. |
| S_1 | S.P. on-off switch. |
| B | 30V battery, Type B123, Ever Ready. |
| Baseboard, made-up battery clips, etc., etc. | |

Setting-up and Adjustments

The receiver controls are rather unconventional and some practice is needed in their adjustment. The receiver is most easily tuned if an audio signal is used and a headphone similar to the type already mentioned should therefore be connected in place of the reed unit. A strong input signal is not required and a modulated signal generator working on 27Mc/s is the best signal source; the transmitter may be used if it is built and tuned correctly to the operating frequency. It should not be too close to the receiver.

The receiver should be connected to the aerial which will be used on the model, or to an aerial of similar size. Where a signal generator is employed for the tuning process its output lead should be run close to the receiver aerial.

With the receiver switched on, set C_1 to almost maximum capacitance and then screw in C_5 —the detector should go into oscillation and super-regeneration as C_5 is increased, as denoted by an increase in the hissing and noise heard in the earpiece. C_2 should be set to about its midway position.

Using an insulated screwdriver or trimming tool commence reducing the value of C_1 —the hiss will stop when some lower capacitance is reached and should be restored by further increasing the capacitance of C_5 . The aim is to use the lowest capacitance of C_1 which will give good superregeneration and present as low a shunting capacitance across the aerial input as possible. Reduce C_1 in steps, therefore, until C_5 has to be at almost full capacitance to restore regeneration.

Tune the signal generator until the signal is heard, and adjust C_2 accordingly, reducing its capacitance if the receiver is tuning to a low frequency and *vice versa*. If C_2 is adjusted more than a few picofarads either way the setting of C_1 will probably have to be changed since C_1, C_2, C_3 if fitted and C_5 are all interdependent. Adjustment of the controls is not at all difficult, however, and it should not take long to set the receiver to 27Mc/s. The signal generator output should then be reduced and the setting of C_1 and C_2 varied for the best sensitivity. The coil may be squeezed or slightly opened to assist in the tuning if necessary.

The audio section of the transmitter can be set roughly to the reed frequencies by ear. S_2 selects the appropriate tone for the reed it is required to operate; S_3 in the transmitter is a push-button control—the transmitter is on only whilst S_3 is depressed. During the setting-up procedure it is therefore convenient to short S_3 , switching on and off as required by S_1 .

Tune R_3, R_4 to the highest reed frequency, R_5, R_6 to the middle and R_7, R_8 to the lowest. A pair of high impedance headphones connected across R_1 of the transmitter enables the audio tone to be heard strongly: it may be necessary to insert a resistance in series with the 'phone lead as a volume

control. The reed tones can be heard by plucking the reeds with the finger, and tuning R_4, R_6 and R_8 (setting S_2 as required) will indicate whether the audio tuning ranges cover the reed frequencies. The values shown in Fig. 3.9 were those found by trial to suit the original reed unit, and different values may well be required for different reeds. Any necessary corrections should be made to the fixed resistors, R_3, R_5 and R_7 , increasing their values by resistance in series if the audio oscillator is found to be tuning too high, or reducing them, by further fixed resistors in parallel, if the oscillator is tuning too low. In either case the resistance value required must be found by trial.

The reed unit can now be connected to the receiver, the headphones being disconnected from the transmitter and the link across the push-button S_3 removed. With the transmitter off and the receiver on it should be possible to hear the superregenerative hiss from the reed unit; switching on the transmitter with a short length of wire plugged into the aerial socket, and operating S_2 and S_3 should cause the three reeds to operate. It now remains to adjust the contactor points so that they touch the reeds without damping their vibration too much, the relays closing correctly when the 30V relay battery is switched on.

If the receiver has been adjusted against a signal generator the transmitter can next be fitted with a good whip aerial and its tuning adjusted against that of the receiver. A convenient method of carrying out this procedure with a fair distance between the transmitter and receiver is to wire a lamp and battery to one of the relay contacts as an indicator, so that operation of the appropriate audio tone in the transmitter will cause the lamp to light. The transmitter can then be taken to a distance and its tuning finally adjusted so that it is possible to switch the lamp on and off over a wide operating range.

In the original transmitter C_1 was mounted across the ribbed coil-former, and was accessible through a hole in the back of the transmitter case to enable this tuning to be carried out.

The control system is then ready for use, and for connection to the control mechanisms in the model.

A licence must be obtained before controlling any model by radio. Application forms are obtainable from the Director General, Headquarters Building, General Post Office, St. Martins-le-Grand, London, E.C.1. The requirements are simple and the licence costs only £1 for a period of five years.

CHAPTER 4

A TWO-TRANSISTOR T.R.F. RECEIVER

A GREAT number of crystal detector-transistor audio amplifier receivers have been built but unless a fairly strong local signal is available, such circuits are often disappointing. In the author's reception area no crystal detector will give an audible signal except under the most favourable conditions and the same holds true for many other areas.

The three-valve t.r.f. receiver was popular for a very long time and a modernized version of the circuit is shown in Fig. 4.1. With a good aerial

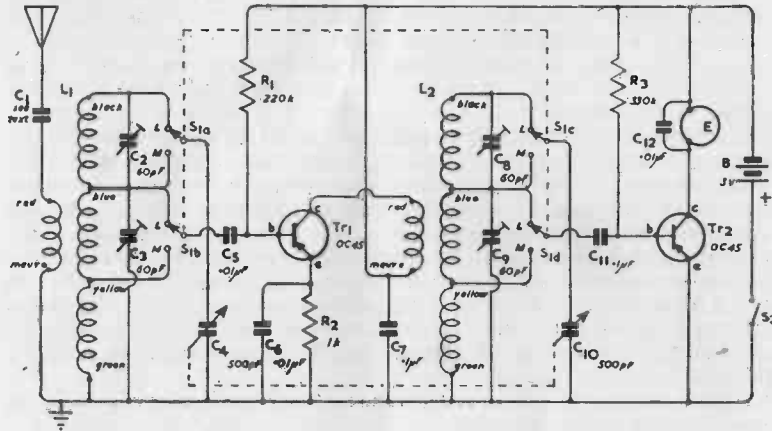

FIG. 4.1. A TWO-TRANSISTOR T.R.F. RECEIVER

and earth this will give excellent results in any reception location, whilst in strong signal areas it will probably overload unless only a small aerial is used. Under daytime reception conditions the quality is very pleasing and the circuit will serve well as a recording tuner; for evening conditions the selectivity, like that of any t.r.f. receiver, leaves something to be desired but the local station should generally override interference.

For best results first-grade transistors are necessary. Mullard OC45s were used in the original receiver; white spot or blue spot or similar second grade transistors may be tried when R_1 and R_2 may need some adjustment by trial. Tr_1 is an r.f. amplifier, its input inductively coupled to the aerial and its output inductively coupled into the detector stage round Tr_2 . The simplest possible biasing arrangements are used with complete safety since no more than a 3V supply is needed, and the circuit is particularly suitable for the beginner or junior constructor as it is very simple to align.

Almost any two-gang tuner may be used; a twin 500pF tuner is shown in the diagram but values down to about 350pF will serve unless very full low frequency coverage is required. Both the medium and long wave ranges are provided so that the Light Programme is obtainable in those areas where the medium wave Light Programme is poorly received.

As with the old valve circuit a little care is required in the layout if instability is to be avoided, a suitable arrangement being shown in Figs. 4.2 and 4.3. Here the two tuning coils are placed on either side of the tuner

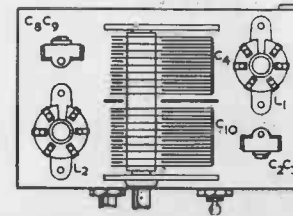

FIG. 4.2. ABOVE-CHASSIS LAYOUT

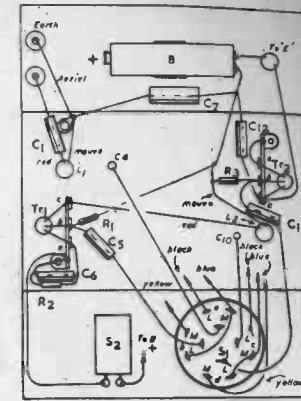

FIG. 4.3. UNDER-CHASSIS LAYOUT

which serves as a screen between them, the switch leads passing down through the open coil cores to the wavechange switch which is placed below the chassis; the battery can also be clamped in this space. A tuning scale and drive, if required, can be bolted to the front edge of the chassis but as a general rule direct drive, using a knob backed by a simple card or ivorine scale on the front of the tuner, will suffice.

An exploded view of the under-chassis arrangement is shown in Fig. 4.3. The transistors are supported on 3-way tagstrips with mounting feet, these strips anchoring most of the small components as well. The usual care should be taken when soldering the transistors and small parts in place. The battery is held on the rear chassis wall in a battery clamp easily made from paxolin and springy brass or similar metal; remember that any bolts securing battery contactors to the paxolin base must be insulated from the metal chassis.

In the prototype the chassis size was $4'' \times 2\frac{1}{2}'' \times 1\frac{1}{2}''$ and if a similarly small chassis is used the coils, trimmers and main tuner should be set out on the top by trial to ensure that the tuner vanes open without fouling any other parts.

The trimmers can be mounted directly between the coil tags if desired but in the original they were mounted vertically in pairs, C_3 and C_9 being bolted down to the chassis by one lug in the positions shown in Fig. 4.2, and C_2 and C_8 respectively being bolted to their upper lugs. If using this method, ensure that the plates in contact with the control screw in C_3 and C_9 are the plates in direct contact with the chassis. The trimmers are then wired directly to their coils, the top lugs of C_2 and C_8 going to "black" and the lugs bolted together giving the common connection between C_2 and C_3 , and C_8 and C_9 , respectively, to "blue". The earth connection to "green" is also made above the chassis, that of L_1 being taken to the bolt holding C_3 to the chassis and that of L_2 to the bolt holding down C_9 .

The receiver is not fitted with a volume control as generally this will not be required, though volume can be reduced if necessary by connecting a 100k Ω resistance from the base of Tr_2 to earth, the value being reduced to a lower resistance if desired. If the receiver should exhibit any instability despite careful placing of parts and wiring, adding this resistance should provide a cure; reversing the connections to "red" and "mauve" on L_2 should also be tried.

A deaf-aid type earpiece was used with the original set but high impedance headphones are also suitable. Leads direct to the 'phones can be taken

through a rubber grommet at the hole marked *E* in Fig. 4.3 but terminals or a socket may of course be fitted.

The value of C_1 , the aerial capacitor, should be determined by trial, being made fairly large if signals are weak, and small if a strong local station interferes with distant required signals. Suitable starting values for C_1 are $0.01\mu\text{F}$ for poor reception areas and 500 or 200pF for good reception areas.

COMPONENTS LIST FOR THE T.R.F. RECEIVER

(Fig. 4.1)

| | |
|------------------------------------------------------|----------------------------------------------------------------------------------------------------------------------------|
| L_1, L_2 | DRR2 Coils, Repanco. |
| C_1 | See text. |
| C_2, C_3, C_8, C_9 | 50pF compression trimmer. |
| C_4, C_{10} | 500pF two-gang tuner. |
| C_5, C_6, C_{12} | $0.01\mu\text{F}$ midget tubular. |
| C_7, C_{11} | $0.1\mu\text{F}$ midget tubular. |
| R_1 | $220\text{k}\Omega$ 1/10 or $\frac{1}{4}$ watt. |
| R_2 | $1\text{k}\Omega$ " " " |
| R_3 | $330\text{k}\Omega$ " " " |
| Tr_1, Tr_2 | Mullard OC45 or equivalent. |
| <i>E</i> | Deaf-aid earpiece, 250Ω d.c. resistance, Type E.R. 250, Ardente, with Cord Type E6/—, or high impedance headphones. |
| S_1 | 4-pole 2-way wavechange switch, miniature type. |
| S_2 | On-off switch. |
| <i>B</i> | 3V battery, Type D22, Ever Ready. |
| Chassis, tuning knob, aerial and earth sockets, etc. | |

Aligning the Receiver

With the receiver wiring checked, the tuning range of the medium waveband can be adjusted. If a signal generator is available feed in a weak signal to the receiver aerial and earth sockets; the receiver tuner should be opened to its fullest extent and the generator tuned to 200 metres, 1,500kc/s. With the set switched on, adjust C_9 and then C_3 , for best results. If the receiver will not tune right down to 200 metres slightly reduce the signal generator frequency until the signal can be heard, first ensuring that the receiver trimmers are all set to minimum capacitance.

Remove the signal generator connections and couple-in a good aerial and earth. Tune to the Light Programme on 247 metres and adjust C_3 for any possible improvement in reception.

If no generator is available tune the receiver, under evening reception conditions, to either the West Home Service (206 metres) or Luxembourg (208 metres). The tuner should be practically fully open, and with a good aerial and earth connected up. Set C_3 to minimum capacitance and adjust C_9 for best results; if necessary increase the capacitance of C_3 , should the value of C_9 need to be less than that of C_3 .

With the medium waveband adjusted, switch S_1 for long wave reception and tune to the Light Programme. Trim C_2 and C_8 by trial for best results.