

GETTING ACQUAINTED
WITH RADIO

ALFRED
MORGAN

GETTING
ACQUAINTED
WITH RADIO

By ALFRED MORGAN

THE BOY ELECTRICIAN
THE BOY'S OWN BOOK OF SCIENCE AND CONSTRUCTION
THE STORY OF SKYSCRAPERS
AN AQUARIUM BOOK FOR BOYS AND GIRLS
TROPICAL FISH AND HOME AQUARIA
A FIRST ELECTRICAL BOOK FOR BOYS
THINGS A BOY CAN DO WITH ELECTRICITY
THE PAGEANT OF ELECTRICITY
THINGS A BOY CAN DO WITH CHEMISTRY
GETTING ACQUAINTED WITH RADIO

GETTING ACQUAINTED WITH RADIO

By
ALFRED MORGAN



Illustrated by the Author

D. APPLETON-CENTURY COMPANY

Incorporated

NEW YORK

LONDON

1940

COPYRIGHT, 1940, BY

D. APPLETON-CENTURY COMPANY, INC.

All rights reserved. This book, or parts thereof, must not be reproduced in any form without permission of the publisher.

PRINTED IN THE UNITED STATES OF AMERICA

Contents

CHAPTER	PAGE
I. ADVENTURES IN SPACE	I
II. ABOUT RADIO WAVES	28
III. THE BASIC PRINCIPLES OF RADIO HAVE NOT CHANGED WITH RADIO PROGRESS	46
IV. THINGS YOU SHOULD KNOW ABOUT ELECTRICITY IN ORDER TO UNDERSTAND RADIO	51
V. RECEIVING RADIO MESSAGES	105
VI. TAKING THE MYSTERY OUT OF TUNING	115
VII. WHAT YOUR RADIO TUBE DOES	127
VIII. ABOUT ANTENNAS	148
IX. LEARNING TO TELEGRAPH AND OBTAINING A LI- CENSE	160
X. HOW TO BUILD SIMPLE RADIO RECEIVERS	173
XI. THE TRANSMITTER AND ITS APPARATUS	200
XII. THE POWER SUPPLY FOR AMATEUR RADIO	212
XIII. MORE ABOUT RADIO TUBES	228
XIV. AMATEUR TRANSMITTING ANTENNAS	238
ABBREVIATIONS AND DEFINITIONS	251
INDEX	281

Illustrations

	PAGE
How electromagnetic waves carry messages	5
Nature's radio waves	8
An early Ruhmkorff coil	9
Hertz oscillator and resonator	10
A wireless telegraph coherer and tapper	12
The progress of radio	21
The audion, first three-element tube	24
An electromagnetic "piano"	32
Low-power short-wave stations communicate long distances by means of sky-waves	34
Amateur spectrum	38
Effect of modulation	42
Connecting two dry-cells in series	54
A picture of the 60-cycle house-lighting current	55
An experiment	58
Pulsating magnetism	59
What carries sound	60
Resistance in circuit produces heat	63
Voltmeter and ammeter in a circuit	66
Magnetic phantom	68
The space around a wire	70
Electromagnetic induction	71
The principle of the transformer	73
Mutual inductance	74
An iron-core choke	76
Radio-frequency chokes	76
Laminated iron cores	77
Leyden jar	78
A variable condenser	80
Small fixed condensers	81
Electrolytic condensers	81
A reservoir for energy	83

	PAGE
Resistors	84
The difference between a rheostat and a potentiometer	85
Potentiometer or volume control	86
Telephone receiver	87
Inside a telephone receiver	88
Radio headset	89
Speaker with permanent magnet field	90
Dynamic speaker with electromagnetic field	91
A speaker cone or diaphragm	92
Resistances in series	95
Resistances in parallel	96
Condensers in series	97
Condensers in parallel	98
Coupling an amplifier to the speaker	99
Symbols used in circuit diagrams	101
Symbols used in circuit diagrams	102
Abbreviations used in circuit diagrams	104
A crystal detector	106
A simple untuned radio receiver	108
A simple tuned radio receiver	108
Essential units of three types of receiver	109
Circuit diagrams showing the methods of detecting or rectifying with triode tubes	110
Regenerative grid detection	112
Super-regeneration	113
Superheterodyne	114
Coupling	119
Coil and condenser arrangements employed to tune a circuit to resonance	121
Mounted piezo-electric crystal	124
Piezo-electric crystal oscillator	125
Inside a copper wire	128
An electric current	129
Two kinds of cathodes	132
The action inside a radio tube	134
A modern vacuum-tube	136
Small bias cell	138
Iron cores and air cores	140
Push-pull amplifier	140
Common audio-frequency interstage coupling methods	141
Audio-frequency transformer	142

	PAGE
Shielding	143
Primary and secondary windings of a transformer	144
Radio-frequency transformer	145
A trimmer condenser	145
Grid-voltage variation	146
Volume control	146
A simple antenna for the novice	149
Pyrex glass antenna insulator	150
Antenna and ground connection equipment	153
Lightning arresters	154
Loop antenna	157
Doublet receiving antenna	158
The continental code	164
Memorizing groups	165
How to hold a telegraph key	168
Code-practice set	169
Plan for radio receiver with crystal detector	178
Details of the coupler	179
Circuit diagram for the radio receiver with crystal detector	180
Test buzzer	181
One-tube regenerative receiver	184
Circuit diagram for one-tube regenerative receiver	185
Battery connections	186
A wave-trap	189
Plan for radio-frequency amplifier	191
Circuit diagram for radio-frequency stage of amplification	193
Circuit diagram for a single stage of resistance-coupled audio-frequency amplification	193
Circuit diagram for a single stage of transformer-coupled audio-frequency amplification	195
Three-tube regenerative receiver	196
Plan for two-stage audio-frequency amplifier	197
Circuit diagram for two-stage audio-frequency amplifier	198
The vacuum-tube as a regenerator and oscillator	203
Self-excited oscillators	206
Hartley oscillator circuits	207
Electron-coupled self-oscillator	208
A crystal-controlled oscillator	209
Six-volt storage-battery	213
The Eveready "Air Cell"	214
A Tungar rectifier bulb	216

	PAGE
Rectifiers for plate-circuit supply	217
How a power filter operates	218
Half-wave rectification	218
The action of a full-wave rectifier	219
The purpose and effect of the power-supply filter	220
Receiver power supply	221
Power transformers for plate and filament supply	222
A voltage divider	223
Adjusting a voltage divider	224
A voltage-doubler rectifier	225
"Transformerless" plate supply	226
A simple form of voltage-doubler rectifier	227
The beam-power tube	232
Automatic volume control	233
Electron-ray tube	235
Three common types of antenna	239
Relieving antenna strain	241
Marconi type antennas	241
Stand-off insulator	243
Hertz antenna with untuned feeder	245
Two-wire feeder system	249

GETTING
ACQUAINTED
WITH RADIO

CHAPTER I

Adventures in Space

RADIO is an adventure in space. It breaks down the barriers of remoteness, shortens distances all over the earth. It saves lives, keeps ships on their courses, spreads knowledge, promotes international understanding, brings entertainment, alters human folkways.

Perhaps, even in a day of automobiles, airplanes, electric power, and chemical magic, radio has brought the most significant change this generation has seen. By the magic of a lamp-like vacuum-tube, pictures, words, music, and telegraph signals can be flung into the heavens and snatched out again thousands of miles away. Wherever the necessary apparatus can be carried, whether it be deep in a mine, high on a mountain peak, in tropical jungle or polar region, from there radio messages can be sent and received. By means of radio, the commander of a submarine submerged in the Atlantic could communicate with the pilot of an airplane flying over the Pacific.

A CHANGING WORLD

Not many years ago when ships left port, nothing was heard from them until they reached their destination. For many days or even weeks their safety was uncertain. To-day, most vessels are equipped with radio and keep in constant touch with shore

and with each other. The captain can report his ship's position, secure weather forecasts, ask for assistance if needed. The larger ocean liners carry radio telephone equipment. Passengers or crew, while on the high seas, can be connected with any telephone ashore belonging to the Bell or associated systems. If you are aboard ship, half-way to Europe and suddenly remember that you forgot to lock all the windows when you left home, you can call a neighbor and ask him to do it for you.

With the exception of the electric light wherewith we see, after the sun disappears each night and darkness creeps upon the world, none of electricity's blessings has added so much to your and my comfort, safety and pleasure as the gift of radio.

Radio enables one part of the world to know instantly what the rest of the world is doing. It is said that nothing of any importance ever happens anywhere on either side of the Atlantic without a report of the matter appearing on the desk of the President of the United States or the Secretary of State within two hours of the event.

Radio has made its way into almost every home and brought to people a better understanding of their country. You know much more about what is going on in the world than your grandfather did at your age. Drama, literature, music, the arts and sciences are vastly better understood; people are more widely informed on more subjects than ever before. For this, radio must be given a large share of the credit.

In March, 1861, with secession and civil war threatening the United States, the country anxiously awaited Abraham Lincoln's inaugural address, but San Francisco did not know what the new president had said until seven days and seventeen hours after the speech was delivered. Telegraphed from Washington to St. Joseph, Missouri, copies were carried from there to the coast by the intrepid riders of the famous Pony Express.

In those days, this was "furious speed," something to be proud of. Sitting at home before a radio receiver, you can listen to a presidential address and actually hear one of the speaker's words before it reaches the outskirts of the crowd around the platform at the Capitol.

A democracy's welfare depends largely on the extent to which its citizens are kept informed on national affairs. Warren G. Harding was the last U. S. President to be elected without benefit of radio. Since then radio has brought the complete arguments of both sides in political campaigns directly into the home and thus voters have been able to make up their minds on the basis of adequate information.

Only a few thousand people can crowd into Westminster Abbey for a king's coronation, attend a National Eucharistic Congress, or gather in the Hollywood Bowl for the Easter Dawn Service. Only a few thousand can see such impressive events but, thanks to radio, millions can hear them.

There is no doubt about it—we live in a world which is different from the world it would have been if there were no radio.

If you are one of those lads who want to know "how and why" and are interested in scientific matters, you will enjoy experimenting with radio and building your own receivers, or perhaps even a transmitter with which you can "go on the air."

One of the first questions which any one who is interested in radio should have answered is:

WHAT IS RADIO?

Radio is an art. What is an art? Well, an art is the practical application of knowledge and skill. Radio is the application of electrical and physical science and skill in sending sound or

pictures from one place to another without the interconnecting wires used in ordinary telegraphy and telephony. Invisible waves which travel through space make the wires unnecessary. Sending and receiving sounds or pictures via radio consists of sending and receiving waves, called electromagnetic or Hertzian waves after the German scientist, Heinrich Hertz, who first discovered how to produce them. Rapidly alternating currents, that is, electric currents which flow in a circuit first in one direction and then in the other, are used to produce Hertzian waves. They are radiated or launched into space from an aerial wire called an antenna. An antenna is also usually employed at the receiving station to intercept the waves.

THE DIFFERENCE BETWEEN THE RADIOTELEGRAPH AND THE RADIOTELEPHONE

The waves may be broken up into the dots and dashes of the telegraph code with a key, or varied according to the sounds of the voice and music with a microphone. The first method is a radio telegraph; the second a radio telephone. When they reach the antenna of a receiving station, the waves produce therein feeble electric currents. The currents, if passed into a telephone receiver or a loud speaker, recreate the sounds of the telegraph signals, voice, or music. This is radio "in a nutshell."

THE BEGINNING OF RADIO

Radio was part of the world when the boys and girls of this generation arrived and so is taken by them more or less for granted, like trees and rivers. Older folk have seen the art develop, remember when there was no radio, were thrilled when they first heard of passengers saved from a sinking

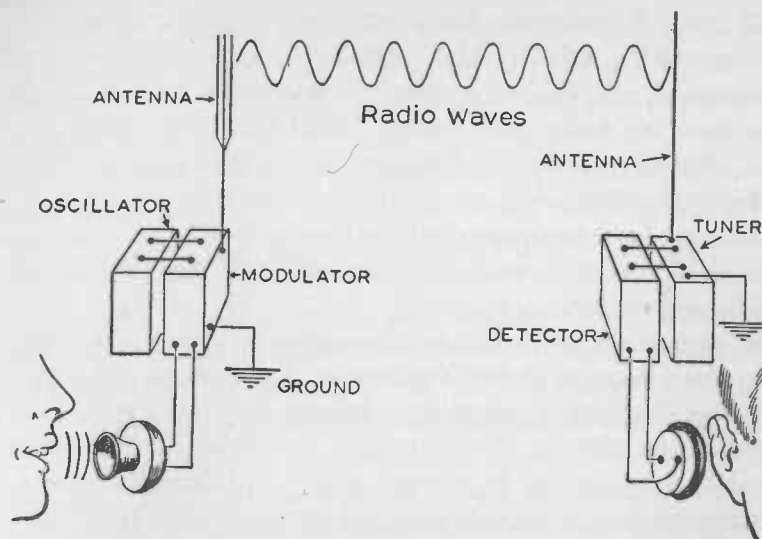

HOW ELECTROMAGNETIC WAVES CARRY MESSAGES

The oscillator of the transmitter generates high-frequency alternating currents which flow into the antenna system and produce radio waves. The waves may be varied or controlled by a modulator. If the modulator is controlled by a telegraph key, the transmitter is a radiotelegraph. If the modulator and consequently the waves are controlled by a microphone, the transmitter is a radiotelephone.

When the waves strike the antenna of a receiving station they create therein high-frequency currents which flow into a tuner. The tuner may be adjusted so as to prevent the currents carrying unwanted messages from reaching the detector. The detector is connected to a telephone receiver or speaker which translates the signals into sounds.

steamer by rescue ships summoned by wireless telegraphy.

Although radio first came to the attention of most people just after the close of the World War when the first broadcasting stations were opened, the story of radio really commences a hundred years ago. For its beginning, we must go back to Michael Faraday, the great English scientist who made the first dynamo and electric motor.

Michael Faraday was born September 22, 1791, in a small village not far from London, England. He was the son of a blacksmith, who died, after a long illness which interfered with his work for many years, when Michael was nineteen years old. The lad, destined to become the world's most eminent scientist, received only an elementary schooling. His father's illness made it necessary for him to assist in supporting the family. He went to work as an errand boy to a bookbinder when he was thirteen years old.

A year later, he became an apprentice bookbinder. He read and studied many of the books which came to his hands for binding. He built a variety of apparatus and did a great deal of experimenting in his spare time. An account of Michael Faraday's endeavors to educate himself, of how he became an apparatus and lecture assistant at the Royal Institution when he was not quite twenty-one years of age, of his rise to fame, is one of the most inspiring romances of science. Go to a library where you can borrow a biography* of this great man. Read it. You will find it intensely interesting.

Among the many valuable discoveries which Faraday made about electricity is that a current of electricity in one wire can make an electric current flow in another wire some distance away. We call this "induction" and say that one current "induces" the other. Moving magnets produce the same effect in wires. A current is also induced in wires which move near magnets. Hence we speak of "electromagnetic induction," an extremely valuable trick of electricity's which we use in generating and distributing electric power, telephoning, in radio, and in various other ways.

* The following books are suggested: *Michael Faraday*, by W. L. Randell; *Michael Faraday*, by Silvanus P. Thompson; *The Life and Discoveries of Michael Faraday*, by J. A. Crowther; *The Pageant of Electricity*, by Alfred P. Morgan.

Faraday wondered what was the means or the medium in space through which the electromagnetic effect which he had discovered was transmitted. Thinking about this brought a brilliant idea.

He suspected that there might be some relation between all forms of energy; that light, heat, electricity, and gravity were related, and he experimented to find out what the connection might be.

Faraday's experiments and speculations stirred the imagination of other scientists. One of these, James Clerk Maxwell a Scotch physicist and one of the world's greatest mathematicians, put his mind to work on the problem. He substituted a plausible theory for mere wonder. He soon had calculations and figures to show the relationship of light, magnetism, heat, and electricity. Said Maxwell—they are all waves in space; they all travel at the same speed (186,000 miles per second). The difference between them is merely that of frequency or rate of vibration. Light waves vibrate more rapidly than heat waves.

However, Maxwell's amazing proposal was merely a theory, that is, a logical, probable explanation. He was unable to prove his theory by demonstration or experiment. That was done later by another brilliant man. It was Heinrich Hertz who found out how to make an electric current produce waves, waves which he identified and measured and, vice versa, how the waves could be made to produce an electric current. Hertz's experiments, made at the age of thirty while professor of physics at the Technical High School at Karlsruhe, Germany, confirmed Maxwell's theory. The waves which Maxwell had built in his imagination became at the hands of Hertz definite and known quantities.

Whenever thunder-clouds obscure the sky and lightning

flashes overhead, Nature is sending powerful electromagnetic waves. Lightning is but a tremendous electric spark. In order to generate waves in space, Hertz merely copied Nature. In other words, he created a tiny flash of lightning in his laboratory. He produced small electric sparks with a device called an induction-coil.

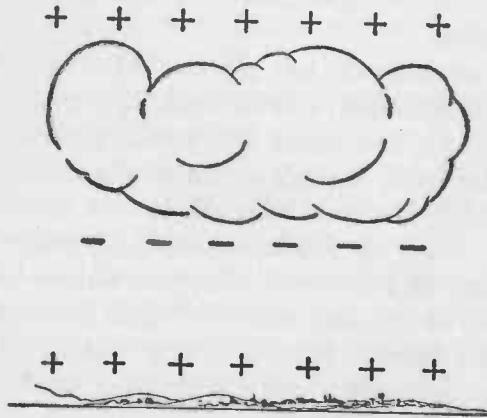

NATURE'S RADIO WAVES

There are two kinds of static: natural and the man-made interference. Man-made static is especially experienced in the reception of amateur and short-wave signals and is caused by domestic electrical equipment and automobile ignition systems. Natural static is due to atmospheric electricity. It is most prevalent just before and during thunderstorms. Lightning is the flashing discharge of static electricity that builds up on a cloud and reaches a potential high enough to break down the air between the cloud and the ground or another cloud with the opposite charge. Usually, the earth is positively charged, the underside of a thunder-cloud is negative and the top of the cloud positive.

Light can be seen but the electromagnetic waves which Hertz's sparks produced were invisible. To "see" or detect their presence, an artificial eye was needed. The "eye" which Hertz devised to "see" his waves was simply a metal ring which was not quite closed. Whenever he made sparks with the in-

duction-coil, minute sparks passed between the almost-meeting ends of the ring. Hertz called his "eye" a resonator. Many different types of eyes were invented after Hertz devised his resonator and we use them to-day in radio. We call them detectors.

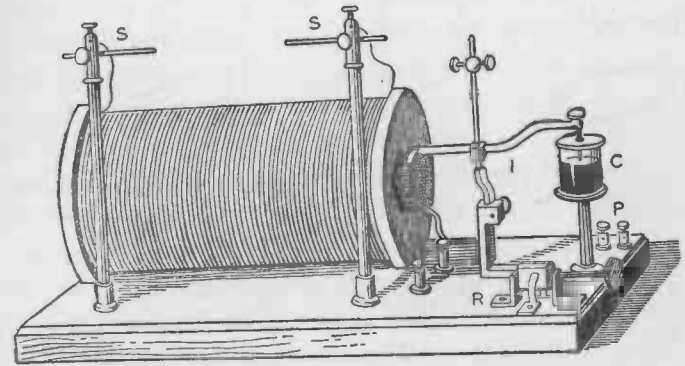

AN EARLY RUHMKORFF COIL

This type of Ruhmkorff coil was used for generating high potential currents at the time Hertz discovered electromagnetic waves and Roentgen discovered X-rays. The high potential secondary terminals are marked S and the primary binding posts P. The primary current was interrupted by a vibrating rod dipping in and out of a cup (C) of mercury. R is a current reverser.

The apparatus which Hertz devised for his experiments was actually a simple wireless telegraph transmitter and receiver, although he had no such purpose for it in mind. He was a scientist trying to investigate Maxwell's theory, to increase knowledge, not to make a commercial invention. Faraday, Maxwell, Hertz all were so engrossed in the scientific aspect of their work that they did not imagine their waves could be used for such an astounding purpose as telegraphing or telephoning without wires.

A YOUNG MAN NAMED MARCONI

It was Guglielmo Marconi who first used Hertzian waves for sending telegraph signals. He was the inventor of wireless telegraphy. He made his discovery by using the electromag-

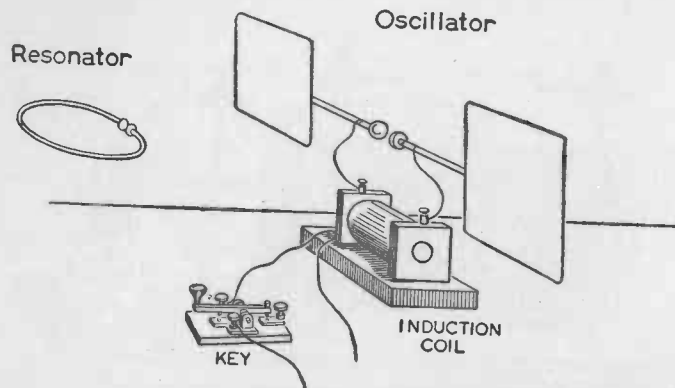

HERTZ OSCILLATOR AND RESONATOR

This apparatus was actually a simple wireless telegraph transmitter and receiver. Heinrich Hertz was first to discover how to create electromagnetic waves. He produced electric sparks with the device called a Ruhmkorff or induction-coil. The sparks took place between two metal balls fitted with plates or vanes. The sparks generated electric waves which could be detected by a resonator. The resonator was simply a metal ring which was not quite completely closed. When the ring was held near the induction-coil it was struck by electromagnetic waves and minute sparks jumped across the almost-meeting ends of the ring.

netic waves of Hertz, the vision of Clerk Maxwell, the stepping-stones of many other men of genius.

Eight years after the discovery of electromagnetic waves was announced at a meeting* of the Physical Society in Ber-

* When a scientist has made a new discovery he usually writes a paper telling about his work. The most important discoveries are generally announced to the world by reading a paper on the subject before some recognized scientific body.

lin, Marconi, then a young man of twenty-one, started experimenting with Hertz's apparatus near Bologna, Italy. The youthful scientist was fascinated by the idea that by means of Hertzian waves it might be possible to send telegraph signals, without using wires, far enough for such a system to have commercial value.

He used the same apparatus for producing waves that Hertz had employed, namely, an induction-coil or spark-coil connected to a spark-gap. But as a receiver Marconi replaced the simple wire ring of Hertz with a device called the Branly coherer. The coherer consisted of metal filings in a tiny tube of glass closed in at each end by metallic plugs.

Whenever a spark jumped across the gap at the transmitter, waves were produced. Whenever a wave struck the coherer, the metal filings clung together.

After a few experiments the Branly coherer was discarded in favor of a new one of Marconi's own design. It consisted of nickel and silver filings placed in a small gap between two silver plugs in a glass tube. It proved to be so much more sensitive and reliable that Marconi could send and receive wireless telegraph messages for a distance of about one mile.

The first inkling of such a new marvel as a practical system of telegraphing without wires came to the world in June, 1897, when Sir William Preece, then technical director of the British Post Office, told the Royal Institution of young Marconi's successful experiments. The following month, a group of some of the wealthiest men in England joined with Marconi to form the Wireless Telegraph and Signal Company. The company paid the young inventor \$300,000 in stock and \$75,000 in cash and placed him in charge of its development work. Marconi was now able to employ expert assistants and carry on expensive research. As a result, four years later the power and efficiency

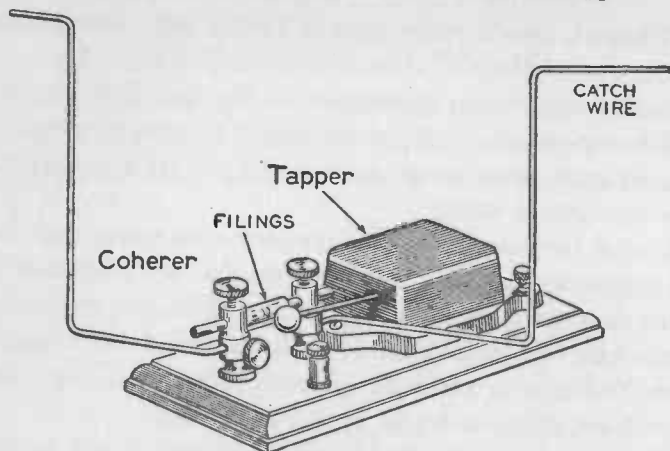

A WIRELESS TELEGRAPH COHERER AND TAPPER

This simple device, patterned after the coherer which Marconi used in his early experiments, was employed as a receiver at the turn of the century by the first "amateur wireless experimenters." An electric bell, with the gong removed, served as a tapper to shake the filings in the coherer. "Catch" wires were used in place of an antenna and ground connection to intercept the waves.

of apparatus had been so improved that signals were sent across the Atlantic Ocean from Cornwall, England, to Newfoundland.

HERTZIAN WAVES CROSS THE ATLANTIC

In a bitter cold room in an old barracks on Signal Hill, St. John's, Newfoundland, shortly after noon on December 12, 1901, Marconi received the first transoceanic radio message. The receiving antenna was a wire 400 feet long supported by a kite. The receiver was one invented by Lieutenant Solari of the Italian Navy, a simple little device, far more sensitive than the old Marconi coherer. It consisted of a tiny globule of mer-

cury between two electrodes in a glass tube, a battery, and a telephone receiver.

The most thrilling moment of Marconi's life came that afternoon when he heard three tiny clicks, the letter S in the Morse telegraph code, repeated several times and knew that they had been flashed across 1,700 miles of ocean from the transmitting station set up on the southwest tip of England.

By this time many other inventors and scientists had been attracted by the immense possibilities of the new method of communicating. Shore stations were being built in various parts of the world and many vessels were equipped for sending and receiving wireless telegraph messages. The French Navy acquired Popoff-Ducretet apparatus made in France. German and American naval vessels installed German built Slaby-Arco instruments. Russia, which then had a navy larger than that of the United States, bought Popoff sets. In America, Reginald Fessenden and Lee De Forest were experimenting. Both these men made valuable contributions to radio.

Although Marconi succeeded in sending signals across the ocean in 1901, it was several years before wireless telegraphy became a rival of the cables. Transoceanic communications were possible but regular service was not. Messages could be exchanged only under the most favorable circumstances.

The fact that Hertzian waves traveled outward from a transmitter in all directions like the ripples from a stone thrown into a pond made them ideal for broadcasting distress signals from vessels in peril. Wireless telegraphy (the distress call CQD) soon brought about several major sea rescues and proved itself to be a marine necessity rather than a luxury. But even then vessels did not become universally equipped with radio until law made it necessary.

In 1909, 237 non-equipped ships sank with a loss of life

which seems futile since a godsend like wireless was available. There were nineteen marine disasters in which wireless telegraphy played a part. One of them, the S.S. *Republic* disaster and rescue, occurring near the great metropolis of New York, provided the best publicity the wireless art had yet had as a life-saver.

On January 23, 1909, the White Star liner *Republic* was creeping cautiously toward New York through a thick fog off Nantucket Island. Suddenly she was rammed by the Italian S.S. *Florida* and commenced to sink. The *Republic* carried Marconi wireless and immediately flashed the CQD distress signal which brought rescue ships and saved all but six of the passengers and crew. Jack Binns, the wireless operator, was among the last to leave the ship and became a national hero.

The following year, the United States Congress passed a law declaring it unlawful for any United States or foreign passenger vessels carrying fifty or more human beings and plying between ports more than 200 miles apart to leave any port of the United States unless equipped with an efficient radio apparatus in good working order.

Just as according to the old adage, "great oaks from little acorns grow," so great developments in science sometimes come from the very smallest beginnings. This story has had a twofold purpose so far: First, to tell what radio essentially is and how it grew from a very small beginning—from scientific curiosity in the mind of the great Faraday, peer of electrical scientists; second, to show how radio in its early days, when it was known as wireless, was principally of value for communicating between ships and shore or from ship to ship. Later it became a rival of the cables; automobiles, airplanes, living-rooms, were equipped with radio. Radio became a part

of almost every one's life. How that happened is the rest of the story.

RADIO'S PAY-ROLL

One of radio's blessings is a chance to earn a living. Radio is a large employer of engineers, technicians, machinists, metal workers, wood workers, skilled workers of all sorts, assemblers, salesmen, accountants, book-keepers, stenographers, shipping clerks, clerks, men and women of many professions and trades.

It is impossible closely to estimate how many people in the entire world are directly employed in the radio industry but the figure is probably close to 1,000,000. In the United States, more than 350,000 men and women earn their living directly from radio by making, repairing, and selling radio sets and working in the broadcasting stations and radio networks of the nation. These people and their families total some 1,400,000 souls, a number which is almost equal to the population of Detroit, Michigan.

The 350,000 do not include the lumbermen, miners, refiners, metal workers, and others engaged in producing raw materials for the radio industry.

Radio is an important part of our economic life and produces a large share of the nation's weekly pay-roll. That it is a large and important industry is due to the fact that the crude and inefficient apparatus of forty years ago was wondrously improved when many minds took hold of its problems. From a not always dependable means of telegraphing between ships and the shore it became the indispensable, universal radio of to-day.

MANY MEN CONTRIBUTED TO RADIO'S DEVELOPMENT

A great art is never the work of a single genius. One man may make an invention or conceive an idea which starts a new art or industry, but long and patient work on the part of many men is required to perfect anything useful to the world in general.

After Marconi had showed the world that it was possible to telegraph without wires, radio ceased to be wholly Marconi's. He continued to experiment until his death a few years ago and contributed many improvements; but so did other men. Hundreds of other radio experimenters and inventors made important inventions and discoveries which hastened radio's progress. The radio apparatus of 1940 is not at all like that of 1897. It differs just as much as a horse and buggy differs from an automobile. Radio has made its greatest advances during the past two decades.

This fact does not detract a bit from the fame or glory of Marconi. The same thing is true of most epochal inventions. It is true in the case of Alexander Graham Bell and the telephone and of Thomas A. Edison and the electric light. They each made an important invention; gave the world something new and amazing, but crude if compared to the electric light and telephone of to-day. The honor for the perfected radio, electric light, and telephone must be divided among many men.

Most of the gifted, patient workers who contributed to the development of radio will probably always remain more or less *unsung* heroes. There are, however, a few men whose works are mile-posts in radio's progress. They will be mentioned.

The two big problems in the early days of wireless telegraphy were to increase the distance over which the apparatus would send and receive and to eliminate "interference" be-

tween stations so that one would not make a hodge-podge of the other's signals when two stations were operating at the same time.

THE FIRST TUNING

Marconi partially solved interference and increased distance by "syntony" or "tuning." Sir Oliver Lodge and Prof. Michael Pupin had shown that it is possible to adjust or "tune" an electrical circuit so that it will vibrate electrically at a certain rate just as the string of a musical instrument can be adjusted or tuned so that it will vibrate at a certain pitch. Marconi applied this principle to the circuits of wireless telegraph transmitters and receivers. His famous patent (No. 7,777) issued April, 1900, and known in the radio profession as the "four sevens" patent, covered tuned or syntonized radio, and for seventeen years was the basic radio patent of the world. Its fundamental principles have been used in radio circuits ever since. Whenever you turn the knob on a radio receiver to select a certain station, you are "tuning" and making use of the invention covered by Marconi's "four sevens" patent.

The distances over which messages could be sent and received were also greatly increased by replacing coherers with more sensitive devices called detectors. In the next four years, a great variety of detectors made their appearance. One of these, as we shall see later, brought about revolutionary changes in radio. More efficient methods of producing electromagnetic waves were soon devised. Special generators, better spark-gaps, arcs, high-frequency machines, and various innovations were made from time to time, which increased the range of stations and decreased interference.

THE FIRST RADIOTELEPHONE

Unending effort was made to give radio a voice, to make it sing and talk and carry telephone messages as well as telegraph signals. But for a long time, no one was able to make radio do this and do it well with the exception of Reginald Fessenden. He made the first radiotelephone.

The difficulty of making a practical radiotelephone lay in the method then used for producing Hertzian waves. The Hertz method, which was the one used by Marconi and other radio experimenters of that era, produced waves in groups. The waves were *damped*. Each one started off with a lot of energy but died away rapidly. There was actually a space or lapse of time between waves so that a Marconi telegraph signal sounded like a buzzer, or ringing door-bell. The waves would not carry a complete sound. They "left holes in sounds." The result was a jumble which sometimes bore a resemblance to speech but was usually untranslatable.

Reginald A. Fessenden was one of America's pioneer radio men. Although there were a number of systems in Europe, at first the only commercial radio in the United States was Marconi Wireless. America was slow in entering the radio field. The nation which had invented the telegraph and telephone and brought both to a high degree of perfection, in the beginning paid little attention to the new method of communicating. But the horse which starts first does not always win the race. The United States was destined soon to lead the rest of the world in radio developments.

But let's get back to Fessenden. He was a careful, thorough scientist who had been Edison's chief chemist. His work in radio was important not only because of the results he secured but because of its originality. He broke away from the Mar-

coni method of sending signals through space, went exploring into scientific territory and came back with new ideas.

It was in 1895, while Fessenden was Professor of Electrical Engineering in the Western University of Pennsylvania that he began experimenting with Hertzian waves. In 1900 the U. S. Weather Bureau, thinking to use wireless telegraphy to supplement the wire telegraph by which it gathered and disseminated weather information along the coast, had begun experiments. That same year Fessenden left the university to become associated with the Weather Bureau. Radiotelephony was an alluring possibility in his mind.

Fessenden's experiments for the Weather Bureau soon took him into unexplored territory. In 1892, Professor Elihu Thomson had discovered that the bow of dazzling flame called an electric arc, which will form between two electrodes connected to a powerful source of current, could be used to produce rapidly alternating currents. Fessenden used Thomson's arc to produce *continuous* Hertzian waves, not waves which "started off with a bang" and then died away, but waves of which each crest was exactly as "high" as those before and after it. He included a microphone in the circuit and modulated or varied the waves with his voice. Here was the first *real* radiotelephone transmitter. This was in 1901.

When it came to receiving the new *undamped* Hertzian waves, there was no receiver for the purpose. The coherer would not serve. It would respond only to the dots and dashes of the spark-produced waves.

A new problem had been presented. A new "detector" was needed. It should, it seemed, be some sort of device which would act as an electrical "valve" for the currents created in the receiving aerial by the waves—a device which would allow passage of only the half of the current traveling in one direc-

tion and would stop the other, oppositely bound, half. Such a "valve," if it could be built, would allow Fessenden to receive the words and music carried by the waves produced with an arc.

He found such a valve or detector in 1902, after long experimenting. It consisted of a small cup containing nitric acid. Into this dipped a tiny platinum wire. Included in the receiving circuit, this "liquid barretter," as it was called, was an excellent, sensitive detector.

Fessenden's continuous waves and new type of detector did not by any means constitute a satisfactory radiotelephon. They were, however, the first real departure from the Marconi spark system of telegraphy which other experimenters were merely imitating or modifying. They were the first pioneering steps toward the radio in our homes, the radio of broadcasting, airplane beacons, and transatlantic telephony.

ANOTHER ALADDIN'S LAMP

In modern radio both the sending and receiving of messages depends upon a miraculous vacuum-tube. Originally only a small incandescent lamplike detector, which amateur wireless experimenters had dubbed an "onion," it has developed into one of the most interesting and valuable creations of science. It will act as a detector, as an amplifier or "increaser" of feeble currents, and as a generator of alternating currents for producing *undamped* Hertzian waves. The vacuum-tube is truly the "heart" of radio.

Several hundred different types and sizes are manufactured, ranging from a "tiny" acorn to the large water-jacketed "bottles" * used in transmitting. The radio vacuum-tube was not

* Radio slang for transmitting tubes.

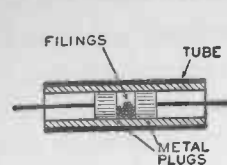

BRANLY
COHERER

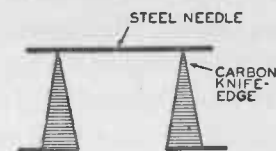

MICROPHONIC
DETECTOR

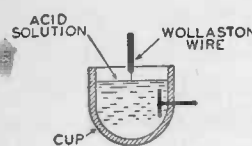

ELECTRO-
LYTIC

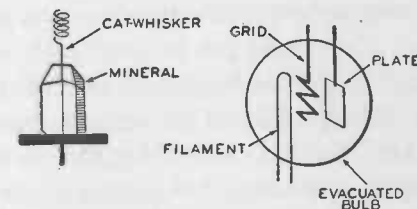

CRYSTAL

AUDION

THE PROGRESS OF RADIO

Five important stages in radio development are illustrated above. Marconi employed the Branly coherer to demonstrate that telegraphic communication by means of electromagnetic waves was possible. The microphonic types of detector greatly increased the range of the first wireless stations and proved that transatlantic wireless telegraphy was feasible. The electrolytic and mineral detectors, each in its turn, proved more sensitive and increased the receiving range. Modern radiotelegraphy, radiotelephony, and television is based upon development of the three-element vacuum-tube which was evolved from the audion.

the invention of one man. Many men shared in its development. Thomas A. Edison, J. A. Fleming, Lee De Forest, Edwin H. Armstrong, and Irving Langmuir contributed most.

This twentieth century Aladdin's lamp grew out of some experiments with an electric light.

When one of the old carbon-filament incandescent lamps

which preceded the modern tungsten lamp had been in use for a time, the inside of the glass bulb became darkened. This was a nuisance. When it happened, the lamps lost much brilliancy.

In order to investigate the cause, Edison built some lamps with a metal plate inside the bulb, near the filament but insulated from it. He was surprised to find that when the plate was connected to the positive terminal of a battery, a current would pass across the space between the plate and the filament. When the plate was connected to the negative terminal of the battery, no current would pass. This action, which at that time could not be explained, was called the "Edison effect" and provided a sort of electrical valve. It would permit an electric current to pass in one direction but not in the other. Here was something that in later years was to prove of inestimable value, but Edison made no use of his discovery.

Professor J. A. Fleming, a distinguished English scientist who knew Marconi well and was of great assistance to him, found a practical use for the Edison "effect." Fleming built some small incandescent lamps with a metal cylinder around the filament as a substitute for the rectangular plate which Edison had used. The device was christened the "Fleming valve." It could be used as a detector to receive wireless messages and was patented in 1905. The patent which covered broadly, the use of vacuum-tubes as detectors of Hertzian waves, became the property of the Marconi Company, and Fleming valves were put into operation in the Marconi stations.

Meanwhile, Dr. Lee De Forest, who was following Fessenden's footsteps and experimenting with the electric arc as a radiotelephone transmitter, needed a good detector and started looking for something better than had yet been found. He tried everything. With the aid of a glass-blower, he made some

Fleming valves. In a moment of inspiration he added a third element, a small screen or perforated plate called a grid, between the filament and the plate. The lamp bulb now contained three *elements*, a grid, a filament, and a plate. The grid was for the purpose of controlling the current which flowed across the space between the filament and the plate. De Forest called his new device the *audion*. Although for several years neither De Forest nor any one else understood the principle upon which the audion operated, it proved to be the best detector yet devised and, what is almost equally as important, an amplifier.

The third element, or grid, was all-important. When connected to a receiving antenna, it became alternately positive and negative as the alternating currents created by the incoming Hertzian waves surged in the antenna. When it was positive, it checked the flow of current across the space between the filament and plate; when it was negative, it stimulated and increased that flow.

Although the three-element audion was much more sensitive as a detector than was the Fleming two-element valve, De Forest was unable to use his three-element tubes for commercial radio purposes. This situation was the result of a patent suit which the Marconi Company, owners of the Fleming valve patent, won against De Forest for infringement. On the other hand, De Forest's audion patent, granted in 1907, prevented the Marconi Company from using the audion. These matters stood for some time, deadlocked.

The first audions were cranky affairs, fragile and undependable. They were made by the "trial and error" method. A batch were manufactured, and the good ones picked out by testing. If nothing further had been done with this little lamplike tube there would not be any radio such as we know to-day.

There were, however, three young men with a great deal of scientific curiosity intensely interested in the audion. Two of them were to do some revolutionizing things for radio. One, Edwin H. Armstrong, was a student of electrical engineering at Columbia University. The other was Irving Langmuir, Doc-

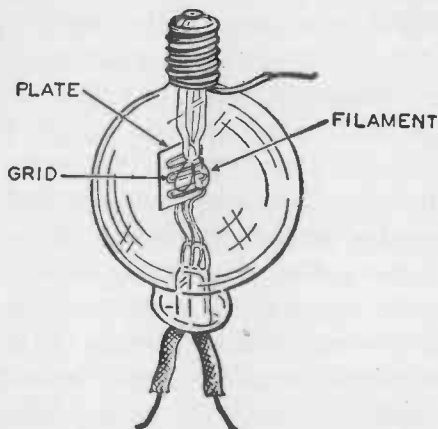

THE AUDION, FIRST THREE-ELEMENT TUBE

This cranky, undependable lamplike affair was developed into the modern radio tube. It consisted of an incandescent lamp filament, a wire grid and a metal plate enclosed in a glass bulb containing a vacuum. It was patented by Lee De Forest in 1907. De Forest did not understand how the tube operated and it remained for Langmuir, Armstrong, and others to discover its full possibilities.

tor of Science, a man in his middle thirties, of the General Electric Research Laboratories.

It was Armstrong who, while still an undergraduate student at Columbia, discovered the scientific principles underlying the operation of the audion and found how to make it the most sensitive detector yet produced. He invented a new method of operating the audion known as the feed-back.

THE AUDION BECOMES A GENERATOR

In order to use a two-electrode Fleming valve, only one battery was necessary, that which supplied current to light the filament. Two batteries were required to operate a De Forest audion, one to light the filament and the other to supply current for what is called the plate circuit. There were three circuits necessary to operate an audion tube, the filament circuit, the grid circuit, and the plate circuit.

Young Armstrong, one of a new generation of radio engineers, experimenting in a bedroom laboratory at his home in Yonkers, New York, found that by properly connecting, or "coupling," as it is called in this instance, the grid and plate circuits together, the audion would become a generator of alternating currents of very high frequencies. These currents could be made to alternate back and forth hundreds of thousands—millions—of times per second.

This invention of Armstrong's is called the regenerative, or feed-back, circuit. It not only vastly improved the audion as a detector, but gave it a brand new use. It became a generator for sending out undamped Hertzian waves, ideal for radio telephony because they could be easily modulated or varied in accordance with the sounds of the voice.

The present-day radio system is the work of hundreds of men; but it could not exist without the discovery which young Armstrong made in his bedroom laboratory.

As yet, however, audions were too small and too cranky to be used for radio telephone transmitters. Perfected tubes, stable, dependable tubes of all sizes, came largely as a result of Langmuir's work. Dr. Langmuir, who probably knew more about producing a perfect vacuum in a glass bulb than any one else at that time, decided to find out what went on inside

lamps and audion tubes. He experimented and studied until he knew everything there was to know about them. He discovered some very interesting things.

De Forest believed the action of the audion to be due to a small amount of air or gas remaining in the tube when it was evacuated. Whether or not this was true interested Dr. Langmuir in 1911. He made some audions with very high vacuums, much higher vacuums than the De Forest tubes possessed. He drove every infinitesimal particle of gas out from the pores of the glass and metal itself and took every precaution to produce tubes that had a perfect, permanent vacuum of a very high order. The new Langmuir tubes proved to be much superior to the highly undependable De Forest audions. A tube with a high vacuum was proved to be much better than a gassy tube. Thus the *modern* vacuum-tube was born.

While Dr. Langmuir was carrying on his tube experiments in Schenectady, Dr. H. D. Arnold, experimenting with the audion in the research laboratories of another large organization, was achieving identical results in the same manner. At that time neither Dr. Langmuir nor Dr. Arnold knew of the other's activities.

Dr. Arnold's experiments had a different object from those of Langmuir. Dr. Arnold was in search of a "telephone relay" and was trying to perfect the audion for that purpose. At that time the distance over which it was possible to telephone was hardly more than 1,000 miles. With a suitable telephone relay, the distance could be increased. Since it would intensify weak currents, the little audion seemed to have possibilities in increasing telephone distances. But at first it would not handle sufficient power to be of much value. The tiny bit of gas which De Forest thought essential to the operation of the tube distorted the voice except at very low powers. When it was

forced, the tube ceased to amplify at all or destroyed itself.

Dr. Arnold believed that if he could produce a better vacuum in the audion, he could get more power out of it. He succeeded. Both Langmuir and Arnold applied for patents covering the same invention.

The conflict which arose was one of the bitterest legal contests ever waged in this country. Time and again the courts declared in favor of Langmuir; said that he had made his invention first, but the telephone company appealed in each instance. Finally, after twelve years, the matter was settled in favor of Dr. Langmuir. He was declared the inventor; the patent was granted him and became the property of the General Electric Company.

CHAPTER II

About Radio Waves

THROW a stone into a pool of water and little waves will radiate from the spot where the stone struck the water, gradually spreading out in enlarging circles until they reach the shores or die away. It would be possible to arrange a set of signals so that by throwing several stones into the water at varying intervals, the waves would convey a meaning to a second person standing on the opposite side of the pool. The little waves would be the vehicle which carried intelligence from one point to another, and the water the medium in which the waves traveled.

Sending the receiving radio messages consists merely of creating and detecting *electromagnetic* waves in the great *pool of space*.

Nothing in the realm of science is more interesting than the amazing electromagnetic waves used to signal through space without wires. They are of interest not only to the radio engineer and physicist but to all of us as well, for it is *thought* that the blazing sun, twinkling stars, burning lamps, candles and bonfires all send their light and heat to us in the form of electromagnetic waves.

The word "thought" has been printed in italics in order to emphasize the fact that the explanation of the nature of light and heat is merely a *theory*. The theory is not a perfect one.

It does not supply a satisfactory explanation of some of the things that we know about light. On the other hand, neither do any of the other theories which have been offered in its place explain everything satisfactorily. Since we are not scientists, trained in the use of higher mathematics and interested in the fine points of a scientific dispute, let us accept electromagnetic waves. Right or wrong, the theory will help us to understand radio.

Among questions that a thinking person will surely ask about radio are: How do radio waves pass through brick walls or closed windows, how do they travel through earth or water to reach a radio set in a mine? Clearly it is not air that transmits radio waves. What transmits light? There are millions of miles of airless abyss between the sun and the earth and the stars and the earth. It is not air that transmits light.

To answer these questions scientists had to assume the existence of an invisible medium more diffused, much more subtle than air which they called "the ether." According to their assumption, the ether fills all space. It is all-pervading. There is no void. It fills even the cracks between the atoms and molecules of all things, whether they be cabbages, stones, jellyfish, or human bodies.

To believe in this ether required an imagination which was not too fussy about fine points, and so the fantastic ether theory has gone somewhat out of date. No satisfactory explanation has taken its place and once again we have asked questions which science can not honestly answer. How light travels through space from the sun for ninety million miles, passes through a piece of glass, how radio waves pass through the walls of a building, are all unanswerable questions. Throughout this book we will be content to refer to the medium through which radio waves travel simply as "space." We won't

bother our heads about "how" radio waves do certain things, we will be interested merely to know what they do.

A pebble dropped into a pool of water sets up water waves that are smaller than those produced by a large stone. The pebble's waves are not only smaller in height but their distance from crest to crest is shorter. It is this distance from crest to crest, not the height, that is called the *wave-length*. Electromagnetic waves, the waves of heat, light, and radio have a wave-length or definite distance from crest to crest. Even though such waves are invisible, their wave-length can be accurately measured by appropriate scientific instruments.

It is impossible to send or receive radio messages without considering either the lengths of the radio waves or their frequency. The frequency of a wave is the number of waves which occur in a second. In radio, wave-lengths are always measured in meters because scientists prefer the metric system of meters and centimeters to the English system of feet and inches. A meter is 39.37 inches, the equivalent of 3.28 feet.

The waves used in radio may vary from a few centimeters in length (a centimeter is approximately $\frac{3}{8}$ of an inch) to 30,000 meters. Large ocean waves may have a length of 100 meters (328 feet) or more, while light waves are only a tiny fraction of an inch in length.

Ocean waves, sound waves, light waves, and radio waves, in fact, all waves, vary in frequency or in the rate at which they occur. When the frequency of a wave is increased, its wave-length becomes shorter.

When the frequency of a wave is changed, some very interesting things occur. The result depends on what sort of wave it is, whether it is a sound wave, a light wave, or a radio wave.

Sounds are produced in the air by bodies that move back and forth or vibrate and thus create a train of waves. If the

waves come through the air regularly, we hear a musical note. When the frequency of a sound wave is changed, we hear a sound of different *note* or *pitch*. The pitch depends on how many waves reach our ears in a second; decreasing the frequency lowers the pitch. Increasing the frequency raises the pitch.

When the frequency of a light-producing electromagnetic wave is changed, we see a light of different color. When we say that one color is "red" and another "blue," we mean that the pitch or frequency of the color we call red is lower than the pitch of the color we call blue. Or, to put it another way, red has a longer wave-length than blue.

Frequency in radio corresponds with pitch in sound and with color in light.

Human eyes and ears have their limitations. There are sounds which are so low and sounds which are so shrill that they can not be heard. They are beyond the range of our ears. Our eyes can see only light produced by a limited range of vibration. Light produced by a wave having a length of approximately $\frac{3}{100,000}$ of an inch is of dull red color. Longer light waves, that is, lower-frequency waves than this are called infra-red or *below* the red and can not be seen. They are beyond human vision, but can be detected with a camera fitted with a properly sensitized film.

If the frequency of an electromagnetic wave producing a dull red light is gradually increased, thereby shortening the wave-length, the light will change to bright red, becoming in turn orange, yellow, green, blue, and violet. When the color becomes violet, the waves are about $\frac{15}{1,000,000}$ of an inch in length. If the vibrations are increased, the wave-length becomes still shorter, the violet color changes to ultra-violet or *above*-violet and can no longer be seen by human eyes. How-

ever, as in the case of the infra-red, it can be detected with a camera or certain sensitive chemicals.

Increasing the frequency of the electromagnetic waves beyond that of the ultra-violet produces X-rays. These rays are themselves invisible but they affect photographic chemicals and by their means it is possible to photograph the interior of solid substances.

In order to make all this clearer, imagine a sort of piano or organ with a long keyboard arranged so that when you press



AN ELECTROMAGNETIC "PIANO"

If apparatus having a keyboard like a piano could be arranged so that pressing the keys would produce electromagnetic waves of different frequencies, the effect would be as follows: when the keys at the left, or bass end of the keyboard were pressed, long radio waves would be sent into space. Pressing some of the keys to the right of the bass would produce heat. Pressing the proper key farther to the right would produce a bright red light. Other keys in the same octave would bring forth orange, yellow, green, blue, and violet light. Higher up, in the treble, pressing a key would release X-rays.

the different keys, electromagnetic waves of different frequency will be sent into space, instead of the usual sound waves which you might expect from a piano or organ.

If, then, you press the keys at the left end of the keyboard, bass notes of low-frequency, long electromagnetic waves will

be sent into space. These will be radio waves. Moving along the keyboard to the right and pressing some of the notes there will make you feel warmer because the shorter, higher frequency electromagnetic waves produced at this point are the waves of radiant heat.

Pressing the proper key still farther to the right will produce a bright red light. Pressing other keys in the same octave will bring forth orange, yellow, green, blue, and violet light. Farther along the keyboard where the waves produced are still shorter, pressing a key will bring forth X-rays.

WHY RADIO STATIONS SEND FARTHER AT NIGHT

Radio waves, since they are of the same nature as light waves—the only difference being in their wave-length—travel at the same terrific speed as light, which is 186,270 miles, or 300,000 kilometers, per second. The figure, 300,000 kilometers per second, is useful. With it you can easily change radio frequencies into radio wave-lengths or vice versa.

Many amateur transmitting stations operate in what is known as the 5-meter wave-length band. Suppose that you wish to know what frequency produces a wave-length of 5 meters. Simply divide 300,000 by 5. The answer is 60,000 *kilocycles*. A kilocycle is 1,000. In other words, the waves of a 5-meter station are sent out into space at the rate of 60,000,000 per second. The Columbia Broadcasting Company's powerful station, WABC, transmits at a frequency of 860 kilocycles. Divide 300,000 by 860 and you have the wave-length of this station in meters. The answer is 348.7 meters.

HOW RADIO WAVES BEHAVE

Radio waves, like light waves, can be reflected or refracted or bent. Whereas light waves are reflected by bright surfaces, radio waves are reflected by conductors such as tanks and wires. Reflection and refraction of radio waves occur in the upper atmosphere due to certain conditions which exist up there. By reflection is meant "a throwing back" and by refraction "a bending."

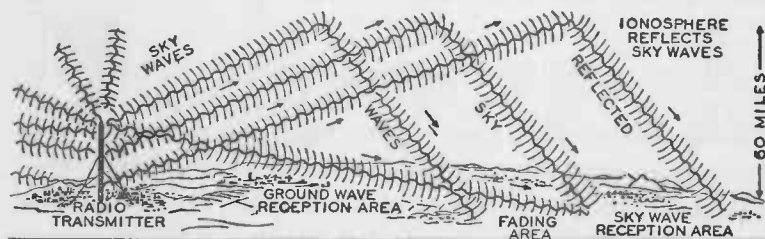

LOW-POWER SHORT-WAVE STATIONS COMMUNICATE LONG DISTANCES BY MEANS OF SKY-WAVES

Some of the waves emitted by a radio transmitter have "their feet on the ground." They follow the contour of the earth and are called *ground-waves*. Their strength fades rapidly with distance. Other waves, called *sky-waves*, travel outward and *upward* through space. Somewhere in the upper atmosphere, they meet the ionosphere and are reflected back to earth at points where the ground-waves are too weak to detect.

Radio waves, when they leave the antenna of a transmitting station, apparently travel out through space by two routes. One path is along the surface of the earth in the lower atmosphere. The waves which follow this route are called *ground-waves* by radio engineers and are used for broadcasting and short-distance communications.

The other path is through the upper regions far above the earth and the waves which travel this route, *sky-waves*, they

are called, are important for long-distance communication. They travel outward and upward from the antenna of the transmitting station far into space and would be of no practical use for communication purposes if they did not return to earth again. But that is exactly what happens. Somewhere in the upper atmosphere they meet a region which reflects and bends them so that they return to earth again.

This region, high in the heavens where the reflecting and refracting of radio waves take place, is known as the *ionosphere*. It is thought to consist of air and gases which are ionized or charged with electricity due to sunlight and ultraviolet radiations from the sun. Numerous experiments and measurements which have been made by scientists indicate that there are at least two distinct reflecting and refracting layers in the ionosphere. The lower layer is called the E layer. It probably is approximately 55 to 75 miles above the earth, while the F layer is apparently 135 to 195 miles up.

WHY LOW-POWER AMATEUR STATIONS CAN COMMUNICATE HUNDREDS OF MILES

The reflecting and bending action of the layers in the ionosphere upon radio waves explains why low-powered amateur stations sending out waves with frequencies of 7,000 to 30,000 kilocycles can communicate amazing distances.

Ground-waves quickly become weak as they travel away from the transmitting station. There is consequently often, between the limit of the ground-waves and the point where the sky-waves return, an area where no signals can be heard. This dead area of no signals is called the *skip distance*. The reflecting layers of the ionosphere are closest to the earth at noon

time and consequently the sky-waves return to earth closer to the transmitting station than they do at night. Radio stations can send farther at night than during the daytime.

The little waves that are set up when a stone is dropped into water radiate in all directions. When they are not confined, all waves radiate in circles. Unless a very special form of antenna is used, radio waves also circle out into space like the water ripples that follow a stone dropped into a pool. There is therefore nothing secret about radio, and every radio transmitting station is as public as the sun at noonday.

In order, as far as possible, to prevent stations from scrambling their waves together, neighboring stations are arranged to send on different wave-lengths or frequencies. If these wave-lengths are far enough apart, receiving stations can "tune" or adjust their apparatus so as to listen to one station at a time without interference or "jamming" from the others.

The process of adjusting or tuning radio stations so that they will transmit and receive waves only of a certain length or frequency is one of the most important developments of the radio art. Without it, no widespread use of radio such as now exists would be possible. The atmosphere would be a heaving Bedlam of words, music, and telegraph signals. Later in this book, the exact methods by which tuning is accomplished will be described. For the moment, we can get an idea of the principle involved in tuning radio sets by a comparison with sound and light waves.

When we tighten or loosen a string of a violin or piano, we raise or lower the frequency of the air waves which that string sends out when it produces sounds. We call this *tuning*. A violinist tunes his instrument so that its pitch or frequency agrees with the piano that his accompanist plays.

When we look through a piece of red glass, our eyes see the

world with light of one wave-length, that of red light. All other wave-lengths except red are shut out by the red glass. When we look through a piece of yellow glass we see the world with light of another wave-length. Our eyes receive only waves of a frequency which produce yellow. Thus we may sort of "tune in" on definite waves of light. When we tune a radio transmitter, we adjust it to send out only waves of a certain definite length or frequency, those which carry the message we wish to hear. All others are shut out.

THE RADIO SPECTRUM

Many people never have heard any radio other than broadcasting and are wholly unaware of the amazing activity going on in what is called the *radio spectrum*. By radio spectrum is meant the whole group of electromagnetic waves of suitable length to use for radio. The broadcasting stations utilize only a small part of the radio spectrum. There are hordes of stations operating on wave-lengths both longer and shorter than those which the broadcasters use.

An evening spent "listening in" with a sensitive receiver which will tune in the high frequencies (wave-lengths below the broadcast band) will reveal an astonishing number of stations sending telegraph and telephone signals. Press messages, police calls and reports, airplane dispatching, weather reports, signals from expeditions in remote parts of the earth, trans-oceanic telephone and telegraph messages, private yachts, amateur and experimental stations, international broadcasting of voice and music, all these and more crowd the short-wave end of the radio spectrum. On a near-by page is a diagram of the short-waves radio spectrum which shows the various wave-length and frequency bands in which the different classes of

stations are grouped. When we speak of short waves we mean waves shorter than 200 meters.

Operating on lower frequencies and longer wave-lengths than the broadcasting stations are merchant ships and naval vessels.

Since radio messages travel to the ends of the earth and the radio spectrum is limited in size, the wave-lengths or "chan-

AMATEUR SPECTRUM

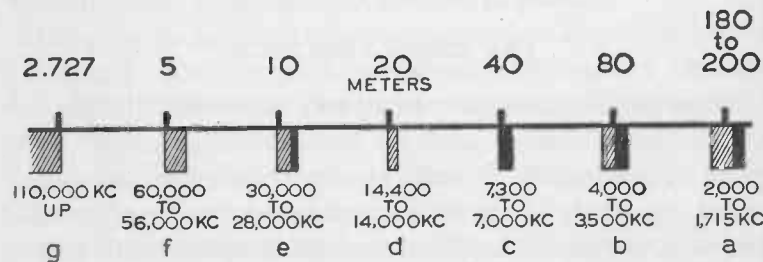

The radio spectrum, as allocated by the United States Federal Communications Commission extends from 10 kilocycles to 108 megacycles. This is a range in wave-length of from 30,000 to 2.72 meters. The portion allocated to amateurs consists of 7 bands ranging in wave-length from 2.727 to 200 meters. The portions of the bands indicated by shading in the diagram above may be used for either continuous-wave telegraphy or for radiotelephony. The portions indicated in black may be used for continuous-wave telegraphy only.

nels" or "frequencies" (they all mean the same thing to a radio man) are very precious. There are too few to meet all demands, and so the various wave-lengths which stations use are fixed by law and international agreement.

Once every four or five years, delegates representing the nations of the world meet in a great international conference and try to arrive at an agreement as to how to divide the wave-lengths and to settle some of their other radio problems. Without agreement and regulation, stations would "jam" or

interfere with one another to such an extent as to make radio communication impossible.

Transmitting stations located within the United States are regulated by the Federal Communications Commission. The Commission issues identifying call letters to each station and assigns each a wave-length or band within which it must operate.

Every transmitting station has its own call letters and no other station may legally use these letters. The nationality of each radio station is shown by the initial letter or letters of its call signal. The entire list of these prefixes is a long one but here are those of several countries whose stations can be heard in the United States:

COUNTRY	BLOCK ASSIGNED	AMATEUR PREFIX
Canada	CFA—CKZ CYA—CZZ VAA—VGZ VXA—VYZ	VE
Cuba	CLA—CMZ COA—COZ	CM CO
Commonwealth of Australia.	VHA—VMZ	VK-2-3-4-5-6-8
France	F	F3, F8
Germany	D	D
Italy	I	I
Japan	J	J1—J7
Mexico	XAA—XFZ	XE
Great Britain	G M	G
Union of Soviet Republics..	R	U
United States	N W	K-W N

RADIO "STRAYS" OR "STATIC"

Unfortunately, there are radio waves heaving around in space which do not originate from the antennas of transmitting stations. Nature is always sending radio signals of her own. Meteorologists have taken a sort of census of lightning which indicates that there are more than 44,000 thunderstorms a day and about 360,000 lightning flashes every hour over the earth as a whole. Even when there is no thunderstorm, neighboring clouds are constantly trying to relieve themselves of their electric charges. Electricity leaps from one to another and back again, creating radio waves which produce in a receiver the various objectionable clicking and crashing noises called *static*. In midsummer, static often proves very troublesome. In fact, increasing static often foretells approaching thunder and lightning a long time before the storm actually arrives.

Since television has come to occupy a band in the radio spectrum where man-made static is most serious, it is probable that more attention will be paid to eliminating unnecessary radio interference at its source.

SIDEBANDS

There is a very definite limit to the number of broadcasting stations which can operate in that part of the radio spectrum (550-1,600 kilocycles) assigned to them. If the frequency of a carrier wave is too close to that of another station broadcasting in the same area, there will be interference.

Each station sends out waves not only of the frequency of its carrier but of several other frequencies both above and below its carrier frequency. This space in the radio spectrum is known as the station's *band*. Radio telegraph transmitters

do not require as broad a band as a radiotelephone or broadcasting station.

When a carrier wave is modulated, it results in the production of two new radio frequencies called *sidebands*. One sideband has a frequency which is the frequency of the carrier wave *plus* the frequency of the modulating current. The other will have a frequency which is the frequency of the carrier wave *minus* the frequency of the modulating current.

To make this clear, let us assume that a carrier wave having a frequency of 1,000 kilocycles is modulated by a steady current of 5 kilocycles frequency. The result will be the generation of two additional frequencies, one of 1,005 kilocycles and another of 995 kilocycles. These are known as the *upper* and *lower sidebands* respectively.

Since the currents which modulate the carrier wave of a broadcasting station ordinarily vary from 30 to 7,500 cycles, sidebands of a great many frequencies are produced. A modulating frequency of 7,500 cycles will produce sidebands which extend 7,500 cycles either side of the carrier. The communication band of the station is therefore 15,000 cycles wide (15 kilocycles).

The modulating frequency produced by telegraphing with a key is relatively low compared with speech frequencies, averaging only a few cycles per second. Consequently the sidebands of a radio *telegraph* station differ only a few cycles from the carrier, and only a relatively narrow communication band (50 cycles) is required.

SHORT WAVES AND ULTRA-SHORT WAVES

There is no sharp dividing line where "long" radio waves cease to be long waves and become "short" waves. It is, how-

ever, customary to consider the radio spectrum as divided into the following sections or groups:

Long waves	200 to 30,000 meters
Medium short waves	34 to 200 meters
Short waves	10 to 34 meters
Ultra-short waves	2.5 to 10 meters

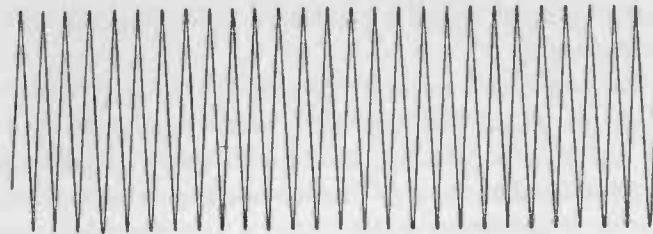

Steady (silent) continuous wave



Speech wave (audible)

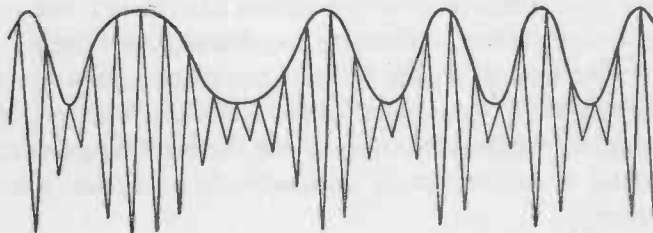

Speech-modulated continuous wave

EFFECT OF MODULATION

At top is a representation of a radio carrier wave as it is produced by the oscillator and antenna system of a radio station. It is unmodulated. The waving line in the center of the illustration represents a sound wave. When this sound wave is impressed upon the carrier wave by means of the modulation apparatus, the carrier wave is changed as shown (at bottom).

Modulating a carrier wave changes the amplitude of some of its vibrations. It also produces additional waves of slightly different frequency from the carrier. These additional waves constitute the sidebands.

The ultra-short waves, or those which are shorter than ten meters (also called ultra-high-frequency waves), are of extremely high frequency. Their frequency ranges from approximately 30,000 to 110,000 kilocycles, or stated more conveniently, from 30 to 110 megacycles.

The short wave portion of the spectrum was considered to be worthless for a long time by the engineering world. Then amateur operators showed entirely unexpected possibilities in this field. Now the short waves are more useful than the long waves.

Ultra-short waves lie in a region which still has great possibilities unknown at present. They can be made to do a number of things of which the lower frequencies are incapable. They have some of the qualities of heat and light waves. They can be reflected and refracted in much the same manner as visible light waves. In fact, the waves of extreme high frequency are often called *quasi-optical* waves.

In the construction of transmitters, receivers, and antennas for ultra-short waves, the materials used for insulation become highly important. Energy losses taking place in insulation assume important proportions at frequencies of 50 megacycles or higher. Radio apparatus designed for these frequencies is quickly recognized by the small size of condensers and inductances. The inductances have only a few turns or are straight rods; the variable condensers have only a few plates.

Due to the much smaller dimensions of an ultra-short-wave antenna, it is possible to secure directional effects not possible with longer waves. The fundamental form of antenna for ultra-high frequencies is a single wire one-half wave long. The trend in ultra-short-wave work is to employ horizontal antennas from which the waves are vertically polarized.

There is a pleasing absence of natural static in the ultra-high-frequency spectrum, practically the only interference being that which is man-made. The most noise comes from diathermy machines and automobile ignition systems which are not shielded.

THE EFFECT OF THE ATMOSPHERE UPON ULTRA-SHORT WAVES

It is impossible to forecast the actual range of communication possible on the ultra-high-frequency bands. The reliable range of a low-power transmitter is practically limited to a distance about 10 per cent greater than the range of vision from the station. There are times, however, when atmospheric refraction enters the picture and considerably increases the distance it is possible to communicate. Atmospheric refraction of ultra-short waves is due to temperature inversion. Normally the air close to the earth is warmer than that at higher altitudes. But there are times when warm, moist air overruns colder layers underneath. This condition, known as temperature inversion, is found to exist for a while every night.

During those exceptional periods when the ionosphere affects ultra-high-frequency waves, distances of 1,000 miles or more may be accomplished by a station whose normal range is only 15 to 20 miles.

There are two kinds of objectionable noises heard in radio

receivers. One is due to the natural static coming from Nature's electrical disturbances and the other has a man-made origin. There is nothing that can be done about natural static. It has to be endured or the receiver shut off until the disturbance has passed.

The situation is different in the case of man-made static. This variety comes from sparks produced in electric motors, automobile ignition systems, electric refrigerators, diathermy apparatus, and various electrical appliances. Apartment houses are fairly alive with these radio disturbances. They are radiated as waves from the electric-light wiring in the same way that radio signals are radiated from an antenna.

Natural static is usually at its worst on long wave-lengths or low frequencies. Man-made static interferes most severely with short waves or high frequencies. A radio receiver working in the 5-meter band (60,000 kilocycles) will pick up disturbances caused by the ignition systems of automobiles passing on a near-by highway. Fortunately, man-made static can be remedied by eliminating it at its source. This does not mean getting rid of automobiles, elevators, and other offending mechanisms, but providing them with devices called "filters" and "kick-back preventers" which remove the disturbance.

The Basic Principles of Radio Have Not Changed with Radio Progress

ALTHOUGH more than four decades have passed since the first "wireless" message flashed through space, radio communication of the present day is carried on by utilizing *the same basic principles* that Marconi employed before the turn of the century. The apparatus is more complicated and more efficient; it will send and receive messages farther and requires less power, but it still depends upon the discovery that a very rapidly alternating current of electricity flowing in a wire will throw off some of its energy in the form of invisible electromagnetic waves. When these waves strike a conductor, they create therein alternating currents similar to those by which they were produced.

Changing these feeble currents, produced by the waves, into sounds is the basis of radio reception.

THE TRANSMITTER

The alternating currents which are used to produce the waves which carry radio messages alternate from 100,000 to several million times *per second*. They are called oscillations, or radio-frequency, or audio-frequency sound-producing currents, which alternate less than 16,000 times per second.

There are several methods of generating high-frequency

currents for transmitting radio messages. They may be produced by specially built high-frequency alternators, by a triode or three-element vacuum-tube, by an electric arc, or by electric sparks.

High-frequency alternators, arcs, and sparks are the old methods. They are outmoded and seldom used to-day.

The essentials of a modern radio transmitter are a three-element vacuum-tube connected to a condenser and coil. The tube may be a small one like the tubes used in a radio receiving set or a huge affair consuming many horse-power of electrical energy and provided with jackets through which cooling water is pumped. Only those who have been intimately associated with radio for the past twenty years or have carefully studied its history can realize the immense changes brought about in radio by the discovery that a vacuum-tube could be made to generate radio-frequency currents. The discovery was made by Professor Edwin H. Armstrong while he was a young man studying electrical engineering at Columbia University.

When a three-element vacuum-tube is supplied with electric current and connected to a properly connected coil and condenser, it becomes a generator. It produces high-frequency currents, ideal for radio purposes. In order to radiate energy into space efficiently and create electromagnetic waves, it is merely necessary to connect or couple the arrangement to an *antenna* or to an antenna and the ground. The antenna may be a short metal rod or one or more elevated wires insulated from all surrounding objects.

CARRIER WAVES

In order to employ electromagnetic waves for carrying messages, it is not sufficient simply to produce radio-frequency

power and radiate it from an antenna. Something must be done to a wave to make it convey intelligence.

Radio engineers term the original wave before it is given its message to carry, the *carrier* or *carrier wave*.

MODULATION

A sheet of note-paper is like a carrier wave—while blank it bears no message; written upon, it bears words or pictures. It conveys intelligence from the sender to the recipient. A carrier wave must be “written upon.” It must be given its intelligence, its message to carry. This process is called *modulation*.

The word modulation appears frequently in radio books and it simply means the process of varying the carrier wave to impart to it the signal which it is desired to transmit. The signal may be any form of sound or it may be a picture or a moving image.

By arranging a switch or a telegraph key at the transmitter so that the carrier wave may be sent modulated in dot and dash groups corresponding to the letters of the telegraph alphabet, telegraph messages may be sent.

Modulating the carrier with special light-sensitive apparatus sends a radiophoto or a television picture.

THE DIFFERENCE BETWEEN RADIOTELEGRAPHY AND RADIOTELEPHONY

By substituting a telephone transmitter or microphone for the key at a transmitter, the electromagnetic waves sent out from the station may be varied or modulated in accordance with the sounds of the voice or music. Practically the only difference between a modern radiotelegraph transmitter and a

radiophone is that in the former the wave is chopped up into groups representing the dots and dashes of the telegraph code, whereas in the case of the radiotelephone they are continuous but are varied in accordance with sounds. The same apparatus is used to receive either radiotelegraph or radiotelephone signals.

FREQUENCY MODULATION

There are two basic methods of modulating a carrier wave. The older method and the one in almost universal use is called amplitude modulation. When sound waves are transmitted by amplitude modulation, the *strength* of the waves is varied in accordance with the sounds.

The newer method is called frequency modulation and was recently perfected by Professor E. H. Armstrong. A special type of receiver is necessary in order to pick up frequency-modulated messages. When sound waves are transmitted by frequency modulations, the *frequency* of the carrier wave is varied with the sounds. This system has not yet come into extended use. The advantage of frequency modulation is the complete absence of noise and static. Also, faithful reproduction of voice and music is more easily obtained by frequency modulation than by amplitude modulation.

Frequency modulation may eventually entirely replace amplitude modulation.

THE RECEIVER

A carrier wave bearing a message is a modulated wave. In order to make the message understandable to our human senses when the modulated wave arrives at the receiving station, a process of *demodulation* or *detection* takes place.

To receive radio signals requires a device (antenna) which will intercept the waves and translate the alternating currents set up therein into sound. Unfortunately, this can not be done merely by passing the currents directly into some instrument such as a telephone receiver or loud speaker. Before currents which alternate at such a high-frequency as those generated in the receiving antenna can be made to reproduce sounds in a telephone receiver, they must first be converted into direct current or into current which is alternating more slowly. The device which performs this function is called a *detector*. The modern detector is a "tube," the familiar radio tube developed from De Forest's cranky little audion.

In actual practise, the apparatus of a radio transmitter does not consist merely of a three-element vacuum-tube, coil, condenser, power source, antenna, and key or microphone. Neither does a receiving installation comprise merely an antenna, detector, and telephone receiver. These, of course, are the required essentials, but in order to obtain efficiency, to secure the greatest distance range with a minimum power, and to operate without interference with or from other stations, a great deal of auxiliary apparatus is required. In the main, this consists of various adjustable condensers, resistances, inductances, transformers, and amplifiers. Therefore, while a radio transmitter and receiver may look very complicated, in principle they are comparatively simple.

CHAPTER IV

Things You Should Know About Electricity In Order to Understand Radio

IT is not difficult for any practical person to assemble and operate a radio receiver by merely following directions. But in order fully to enjoy experimenting with radio and become proficient at building radio apparatus, it is necessary to know something of the "how and why" of the various condensers, resistances, inductances, transformers, and tubes, used and, in addition, something about electric currents and the science called physics.

The next few pages are an important part of the book for the experimenter who wants to understand some of the fundamentals of radio. Here you will find various properties and qualities of an electric current explained and a description of the various parts used in a radio circuit.

Radiotelegraphy, radiotelephony, television, all depend on "doing tricks" with an electric current. The actions of an electric current underlie the science of radio.

WHAT IS AN ELECTRIC CURRENT?

There are explanations or theories which attempt to answer this question but at the best they are merely very plausible scientific guesses. Science says that an electric current is a movement or flow of electrons, a sort of imaginary procession

of tiny particles of *electricity*. Such an explanation makes it necessary to ask another question.

What is electricity?

Electricity itself is a mystery. It is a form of energy which we have learned how to control and to make serve our needs in many ways. No one knows its real nature. There is a scientific explanation, but the explanation is not completely satisfying. There will always be plausible, useful theories with which to answer the questions, "What is an electric current?" and "What is electricity?" but the probable truth of the matter is that the final answer will always be out of reach.

However, inasmuch as science has learned its habits and knows how to control and utilize it, it is not necessary to know what an electric current actually is. We know that it is a force or energy which we can send through wires. It is invisible; we can't see or hear it. But we can see and hear the things which an electric current can *do*. Under the right circumstances, it will produce heat, light, magnetism, chemical action, and certain rays. The things that we have found out about electricity's behavior have become a beautiful science. The many different uses which have been discovered for its powers are so widespread that every man, woman, and child has his way of living affected by it and is made more comfortable in some way or other.

POSITIVE AND NEGATIVE

But let us get back to the subject of the probable nature of electric current for a moment. In the not-distant past, electricity was thought of as a sort of fluid. To-day, there are many reasons to believe that what we call electricity is the evidence of activity of electrons. It is believed that there is probably a

continuous change of electrons between the atoms of a solid body but that they are moving around in helter-skelter fashion. As soon, however, as something is done which forces the electrons to drift along from atom to atom in one direction, we find evidence of an electric current.

The electrons in a piece of copper wire ordinarily are moving from atom to atom in such confusion as to make negligible the average motion in any one direction. If, however, the ends of the copper wire are connected to the terminals of a battery, the electrons are caused to drift from atom to atom toward the end of the wire *connected* to the *positive* battery terminal. This orderly motion of the electrons is an *electric current*.

Back in those days when electricity was thought a fluid, electrical scientists arbitrarily assumed the direction of flow of an electric current to be from positive to negative. This idea still persists to some extent and since it is wrong is likely to cause confusion. The motion of electrons, *moving along as an electric current*, is always *from the negative to the positive terminal*. If you remember that, it will be easier for you to understand the action of a radio tube when it is explained later in these pages.

If the positive terminals of two battery cells are connected together, there will be no electron flow. The connecting wire must join the positive of one cell to the negative of the other in order for current to flow.

DIRECT AND ALTERNATING CURRENT

In radio circuits we find electric current in two different forms, *direct* and *alternating*.

An alternating current *changes* its direction of flow at regular intervals, but direct current flows constantly in the

WRONG

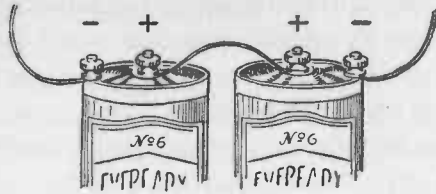

RIGHT

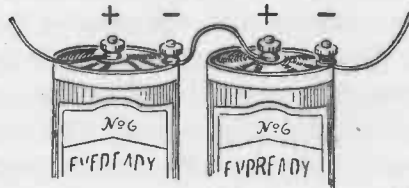

When connecting two dry cells in series to supply filament current, make certain that the positive terminal (center) of one cell is connected to the negative (outside) terminal of the next cell.

same direction. Alternating current is often called A.C., while direct current is spoken of as D.C. Batteries and certain types of dynamos produce direct current. There are various methods of producing alternating currents.

The electric current which comes into our homes from the power lines is almost without exception an alternating current. It is produced by a special form of dynamo called an *alternator*. Alternating current is generated by the power companies because it can be distributed at a distance more economically, that is, at less cost, than direct current. Direct-current power is used in the electrochemical industry and for operating trolley cars and electric trains.

Alternating currents and alternating-current circuits have

qualities or characteristics which make them behave quite differently from direct currents and direct-current circuits. For example, alternating current circuits may be tuned or adjusted like a musical instrument. Under the right conditions, alternating currents will surge back and forth in an open circuit; they do not require a closed circuit as a direct current does. The things which alternating currents do under certain circumstances make radio possible. A thorough understanding of the behavior of alternating currents is beyond the ability of the average boy. But there are many simple facts about them which are interesting and necessary to know in order to understand radio.

ALTERNATING CURRENTS

To explain alternating currents it is necessary to explain the meaning of certain technical terms such as *frequency*, *cycle*, and *alternation*.

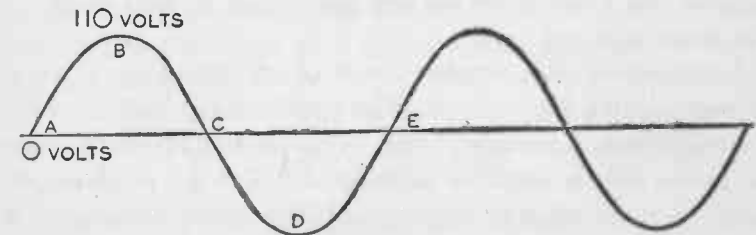

A PICTURE OF THE 60-CYCLE HOUSE-LIGHTING CURRENT

The straight line represents "no voltage" or zero volts. The 60-cycle alternating current starts at zero (A) and gradually increases in potential until it reaches approximately 110 volts, as shown at B. Then the voltage gradually dies away to zero—section of curve from B to C. At C, where the curve crosses the line, the voltage is zero. It then reverses its direction of flow and increases to 110 volts in the opposite direction (D). At this point it dies away again to zero (E). It has then completed a cycle. It repeats a cycle 60 times per second. The curve A B C D E represents a cycle. A B C and C D E are *alternations* or half cycles.

Between the intervals when an alternating current reverses, or actually turns about and goes in the other direction, the strength of the current gradually rises and falls. The commercial alternating current used for power and light in our homes varies at regular intervals from zero to approximately 110 volts. It decreases at the same rate from 110 volts to zero, starts to flow in the opposite direction, rising to 110 volts and then falling off to zero again. This may seem complicated at first, but think about it for a moment and you will understand. Perhaps the accompanying picture of an alternating current will help.

CYCLES, ALTERNATIONS, AND FREQUENCIES

Now for an explanation of a cycle.

When an alternating current has passed from zero to maximum in one direction, died away to zero, risen to a maximum in the other direction and gone back to zero again, it has completed one *cycle*.

Engineers draw a simple picture of an alternating current by representing it as a waving line which crosses and recrosses a straight line. A moving picture of an alternating current can be made with a sensitive instrument called an *oscillograph*. In an oscillograph, a moving spot of light traces a waving line representing alternating current on a fluorescent screen. The shape of the line has much significance to an engineer.

The *frequency* of an alternating current is the number of complete cycles which take place in one second. Modern commercial frequencies for light and power in the United States are 25 cycles and 60 cycles. Lamps do not operate satisfactorily on 25 cycles. They flicker to a noticeable extent with every alternation of the current. Sixty-cycle current is the most

common commercial frequency and eventually will entirely replace 25-cycle current.

The frequencies of alternating currents in radio circuits vary from forty per second to several million. Currents which alternate at a frequency of 20,000 cycles per second or more are called *radio-frequency* currents. They are also referred to as high-frequency and oscillatory currents. Radio-frequency currents travel on or near the surface of conductors. This uneven distribution of current is known as the *skin effect*. Low frequency and direct currents travel through the body of conductors. A metal tube will conduct high frequency currents as well as a solid metal rod of the same diameter. Under the proper conditions radio-frequency currents will surge or oscillate back and forth in an open circuit or single wire.

Those frequencies which will produce sounds within range of the human ear are known as *audio-frequencies*. There is no sharp dividing line between the radio-frequencies and the audio-frequencies, but it may be broadly stated that the audio-frequencies are those of a frequency of from 16 to 16,000 cycles per second.

AN EXPERIMENT

The 60-cycle alternating house-lighting current is, of course, in the audio-frequency range. It will produce a low musical note called the "sixty-cycle hum." The sound is frequently heard coming from alternating-current machinery. In the musical scale it is the note B, an octave below the B just below middle C. You can hear this note and also feel the effect of the constantly reversing current by a simple experiment.

Make an electromagnet by winding a large iron nail with forty or fifty turns of magnet wire. Connect it to a battery.

The magnetism which it produces will exert a steady, even pull toward other pieces of iron as long as the current flows. While the current is still flowing, bring the head of the nail close to a tin can. The ordinary "tin" can is sheet-iron plated with tin, and you will be able to feel the *steady* pull of the mag-

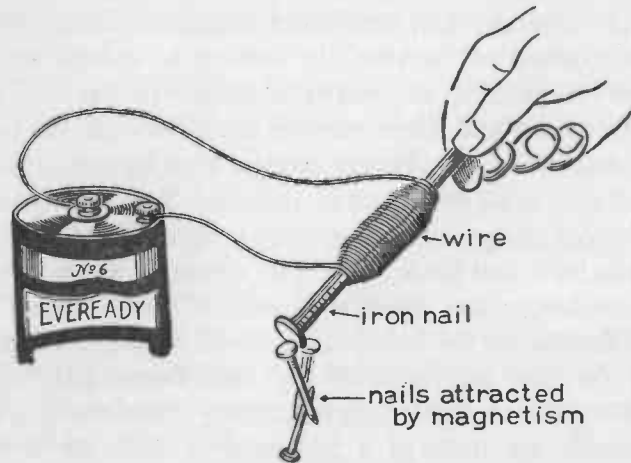

AN EXPERIMENT

Make an electromagnet by winding a large iron nail with forty or fifty turns of magnet wire. Connect it to a battery. The magnetism created in the nail by the current flowing through the coil will exert a steady even pull toward other pieces of iron as long as the current flows.

netism created by the electric current flowing through the electromagnet. There will be no sound except perhaps a slight click if the can is drawn against the magnet. An electromagnet connected to a battery is operating, of course, on direct current. That is why the magnetic pull is steady.

The different effect when an alternating current produces the magnetism is demonstrated by connecting the electromagnet to a bell-ringing transformer or a step-down transformer

such as is used for operating toy railroad trains. In this case, the current is changing its direction of flow 120 times per second and the magnetism is not steady but consists of 120 impulses per second. As you bring a piece of iron near the electromagnet, you can feel a slight vibration. If, while the current is still flowing, you bring the end of the electromagnet rapidly changing magnetism causes vibrations which produce the buzzing and humming.

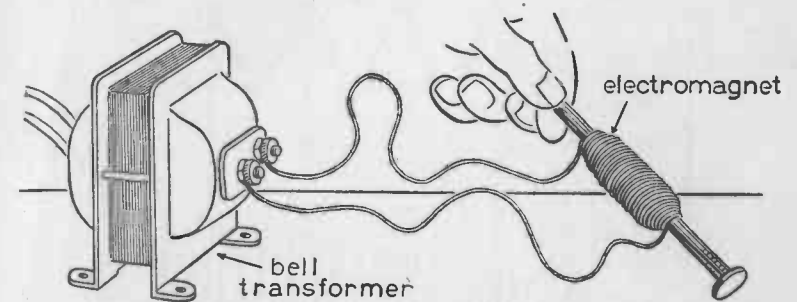

PULSATING MAGNETISM

If an electromagnet is connected to a bell-ringing transformer so that an alternating current flows through its coil, the magnetism is not steady, but consists of rapid impulses (120 per second on 60-cycle A. C.). As you bring a piece of iron near the electromagnet you can feel a slight vibration which does not exist when a direct current flows through the coil.

WHAT MAKES SOUND

Whenever we look for the source of a sound, we find that something has been set in motion. It may be that a bell has been struck, some one's vocal cords have been brought into action, or a string or a wire has been plucked. Always something has been set in motion which has caused a sound to be produced.

WHAT CARRIES SOUND

Ordinarily the air, which is everywhere about us, brings sound to our ears. The sounds arrive in the form of air waves which strike our ear-drums and cause the latter to vibrate. The study of what happens in the ear and brain is properly left to physiology and psychology. But solids, liquids, and gases as well as air may serve as carriers of sound.

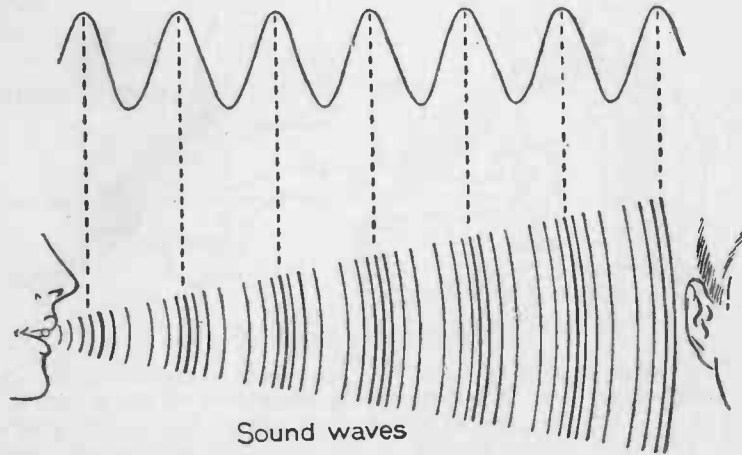

Sound waves

WHAT CARRIES SOUND

Sound waves travel through the air and through solid bodies. When you speak, waves, which may be represented by the rising and falling curve at the top of the illustration, spread out through the air. The air actually vibrates back and forth. It imparts its motion to the ear-drum of a person listening to your speech.

The radio engineer is interested in sound because it is employed to modulate the carrier wave in radiotelephony and broadcasting. The fact that the music of an orchestra consists of air waves varying in frequency from 40 to 7,500 cycles or more per second brings problems to the designing and building

of radio apparatus. Transformers, speakers, and circuits through which the audio-frequency currents flow must handle frequencies varying from 40 to 7,500 cycles without distortion in order to accomplish exact and faithful reproduction. The accompanying chart shows the frequency of various sounds.

THE SOUND SPECTRUM

Sound	Number of Vibrations Per Second
Thunder	20-40
Niagara Falls	40-50
Man speaking	128 average
Woman speaking	256 average
Bass viol	40-240
Cello	64-640
Clarinet	160-1,536
Violin	192-3,072
Flute	256-2,304
Piccolo	512-4,608

The ordinary telephone circuit can handle currents ranging in frequency from 250 to 2,750 approximately. The circuit has a wider range than the telephone instruments themselves, for the receiver and transmitter will respond only to currents and vibrations of approximately 300 to 1,800 per second.

The modern broadcast transmitter can pick up sounds ranging from 30 to 7,500 vibrations per second and modulate its carrier wave accordingly. A high-quality radio set can reproduce these frequencies but a small radio set or an inexpensive one can reproduce a range of only 250 to 2,200 vibrations per second.

CONDUCTORS AND INSULATORS

Copper is a good *conductor* of electricity. An electric current will flow through copper more easily than through any

other metal except silver. Consequently copper wires are usually employed to conduct electricity from one place to another.

Some metals conduct an electric current better than others. Those which do not conduct well are said to have resistance.

Below is a list showing various conductors, partial conductors through which a weak current of electricity can trickle, and some of the non-conductors or insulators. The conductors are arranged in the list according to their resistance. The metal at the top of the list is the best conductor. It has the *least* resistance. That at the bottom is the poorest conductor. It has the most resistance:

<i>Conductors</i>	<i>Partial Conductors</i>	<i>Non-Conductors or Insulators</i>
Silver	Cotton	Glass
Copper	Dry wood	Porcelain
Gold	Marble	Bakelite
Aluminum	Stone	Silk
Platinum	Damp air	Resin
Iron		Oils
Lead		Rubber
Mercury		Wax
Liquid acids and alkalis		Mica
Chemical salts in solution		Dry air
Impure water		
Earth		

THE EFFECT OF RESISTANCE IN A CIRCUIT

You can discover the effects of resistance in an electrical circuit by a simple experiment.

Connect a 2.8v. flash-light lamp to two dry cells. When the

lamp has been lighted for two or three minutes, feel the glass bulb. It will feel warm. Heat has been produced. The little filament of tungsten wire is white hot or incandescent. Why does the filament become hot? Here is the reason. Tungsten is not a good conductor. The tungsten filament has considerable resistance. When an electric current is sent through resistance, the tiny particles of electricity have to crowd their way through an obstructed path. Some of the electrical energy is expended in trying to crowd and push through the resistance and de-

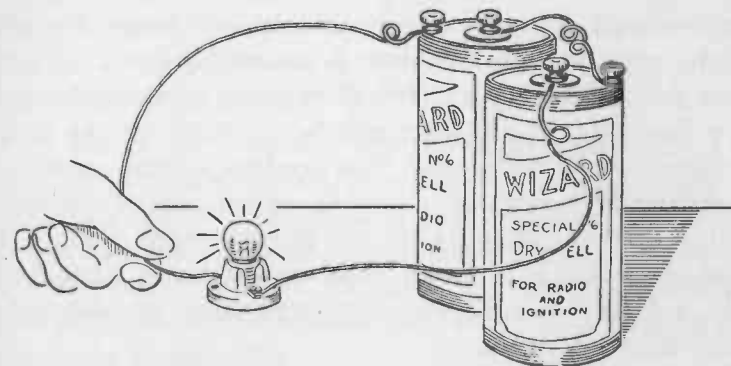

RESISTANCE IN CIRCUIT PRODUCES HEAT

Connect a 2.8v. flash-light lamp to two dry cells. Heat and light will be produced. Most of the resistance in the circuit is concentrated in the lamp filament. The filament becomes incandescent. The effect of resistance in a circuit is to impede the flow of current and change some of the electrical energy into heat.

velops *heat*. When enough current forces through the resistance, there is enough heat produced to make the wire white hot and *light is produced*.

The effect of resistance in a circuit is to impede the flow of current and change some of the electrical energy into heat.

HOW ELECTRICITY IS MEASURED

An electric current is invisible and weightless. For those and other reasons, it can not be measured by the quart, inch, or pound. But some method of measurement is necessary, and so ways have been devised to measure both the pressure and the amount of an electric current.

When an electric current passes through a solution of certain chemicals, it produces in the solution chemical changes which can be measured. The same amount of current will always produce the same amount of chemical change. For example, when an electric current is passed through a suitable silver solution by means of two silver plates or electrodes dipping into the solution, silver will be deposited on one plate and dissolved from the other. This provides a simple means of measuring the *volume* of an electric current and was the first method used. A current which will deposit .06708 grams * of silver in an hour is called an *ampere*, after André Marie Ampère, a French scientist who discovered many valuable facts about electric currents.

THE AMPERE, A MEASURE FOR QUANTITY

An ampere is the unit of electrical current measurement and indicates quantity. A current of ten amperes represents *twice* as much electricity as a current of five amperes.

THE VOLT, A MEASURE FOR PRESSURE

Electricity exerts a sort of pressure which is not called "pressure" in electrical language but is referred to as *potential*

* The fundamental unit of weight in the metric system.

or *voltage*. The pressure of a stream of water flowing through a pipe enables it to pass through small openings and to overcome the resistance offered by the pipe. It is the potential or voltage of an electric current which enables it to overcome the resistance offered by a wire and push through.

The pressure of water is measured in pounds, but the pressure of an electric current is measured in *volts*, a unit named after the Italian scientist, Alessandro Volta, who made the first battery. A *volt* is the electrical force which will push a current of one ampere through the amount of resistance called one *ohm*.

THE OHM

An ohm is the measure or unit of electrical resistance. The standard ohm, used the world over, is the resistance offered to an electric current by a column of pure mercury having a section of one square millimeter and a length of 106.3 centimeters at a temperature of 0° C. The name was adopted in honor of George Simon Ohm, a scientist who contributed much to our knowledge of electricity.

AMMETERS AND VOLTMETERS

For a time, the only method of measuring an electric current was to pass it through a chemical solution and weigh the amount of metal deposited, as has already been explained. But now indicating instruments called *ammeters* are used for the purpose. When an ammeter is placed in a circuit carrying a current, a movable pointer swings over a scale and indicates the amount of current flowing. Volts may be measured in the same way with an instrument called a voltmeter.

The illustration shows a voltmeter and an ammeter connected in a circuit with a battery and a lamp. Notice that *all* of the current flows through the ammeter but that the voltmeter is connected across the power supply so that the only

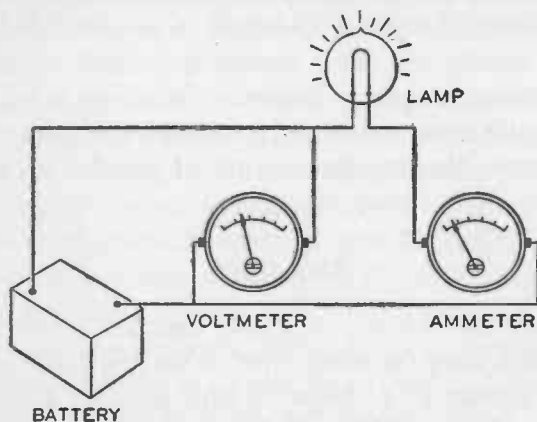

A voltmeter is always connected in a circuit so that it is in shunt or parallel with the current source. Only sufficient current flows through a voltmeter to cause it to register. An ammeter is placed in series with the current source so that all the current flows through it.

current flowing through the voltmeter is the small amount required to move the pointer.

MILLIAMPERES AND MICROAMPERES

In radio work, it is often necessary to deal with very small currents which are only a fraction of an ampere or have a potential of only a fraction of a volt. Such small values are measured in milliamperes, millivolts, microamperes or microvolts by means of instruments called milliammeters, millivoltmeters, microammeters, or microvoltmeters:

A milliampere is $\frac{1}{1,000}$ of an ampere

A millivolt is $\frac{1}{1,000}$ of a volt

A microampere is $\frac{1}{1,000,000}$ of an ampere

A microvolt is $\frac{1}{1,000,000}$ of a volt

KILOAMPERES, KILOVOLTS, AND MEGOHMS

In order to indicate very large quantities of amperes, volts, and ohms, the terms *kilovolts*, *kiloamperes* and *megohms* are used:

A kilovolt is 1,000 volts

A kiloampere is 1,000 amperes

A megohm is 1,000,000 ohms

THE WATT, A MEASURE FOR ENERGY

There is another term used in electrical measurements which the radio experimenter should understand. Since a current of electricity at a potential of ten volts represents more energy than the same current at one volt, it is necessary to have a unit of measure for electrical energy. It is called the *watt*. A watt, named after the inventor of the steam engine, is the energy represented by a current of one ampere flowing in a circuit at a potential of one volt. The number of watts in a direct-current circuit is found by multiplying the voltage by the amperage. Five amperes at a potential of 110 volts represent 550 watts. One thousand watts are a *kilowatt*.

THE SPACE IN THE NEIGHBORHOOD OF A MAGNET

The famous English scientist, Michael Faraday, was a pathfinder. It was Faraday's experiments that showed science how magnetism might be put to use in the practical world. He found the space in the neighborhood of a magnet to be as interesting as the magnet itself. Something invisible reached

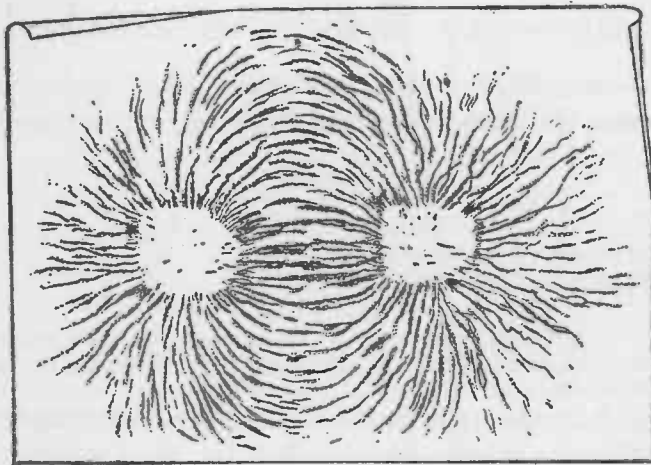

MAGNETIC PHANTOM

Iron filings sprinkled on a paper above the poles of a horseshoe magnet show the paths of the magnetic forces sweeping out into space and curving around back to the magnet again.

out into space from the magnet and exerted its influence at a distance. What was it?

Little is known of the exact nature of the forces which come into play in the space surrounding a magnet, but it is assumed that they follow the path of curved lines surrounding the magnet. They are termed *lines of magnetic force*. There is a simple

and interesting method of revealing the magnetic force in the space about a magnet.

Place a small horseshoe magnet under a stiff piece of paper and sprinkle some iron filings over the paper. If the paper is tapped gently, the iron filings will arrange themselves in curving lines. The filings show the paths of the magnetic forces sweeping out into space and curving around back to the magnet again.

ELECTRICITY PRODUCES MAGNETISM

When an electric current is passed through a wire, magnetic effects are produced. There are lines of magnetic force in the form of concentric circles around a wire carrying a current. These lines of force exist only when current is flowing through the wire. When the wire is wound into a coil of many turns, the magnetic effects are much greater because there are more lines of force concentrated in a small space. The same magnetizing effect can be secured with a great many turns of wire and a weak current or with fewer turns and a stronger current.

A group of lines of force is called a magnetic field. Iron filings sprinkled on a piece of paper over a coil of wire carrying an electric current will show the lines of force about the coil. The strength of this field will vary as the current varies.

MAGNETISM PRODUCES ELECTRICITY

Many of electricity's most mysterious tricks can be reversed. It is of interest to find that this is true of the relation between electricity and magnetism. When a magnetic field passes through a coil, a current is induced in the coil. This phenomenon, called *electromagnetic induction*, provides us with the

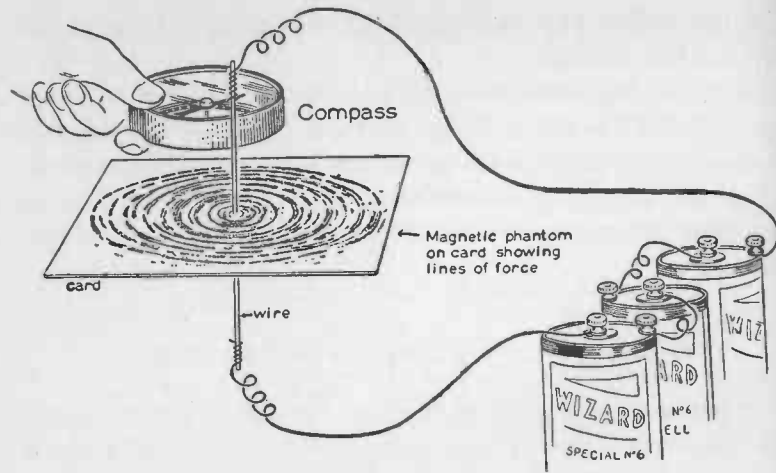

THE SPACE AROUND A WIRE

When an electric current passes through a wire, magnetic effects are produced in the neighborhood of the wire. A compass needle is deflected by a wire carrying a current. Iron filings sprinkled on a card through which the wire passes, will show the curving lines of magnetic force which fill the space around the wire.

explanation of many electrical effects. It serves in the present instance to give us some understanding of that useful device called a *transformer*.

TRANSFORMERS AND ELECTROMAGNETIC INDUCTION

A simple transformer consists of two coils of wire arranged so that the magnetic field produced by one of the coils passes through the second coil and induces a current therein.

You can make a small transformer and demonstrate electromagnetic induction by a simple experiment. Wrap two layers of paper around a large iron nail and then wind about fifty turns of magnet wire around the nail so as to form a coil near

one end. Wind a second and similar coil around the other end of the nail. Connect one of the coils to a battery and the other to a telephone receiver. Hold the telephone receiver to your ear. You will not hear any sound when the current from the battery is flowing steadily through the coil. But if you discon-

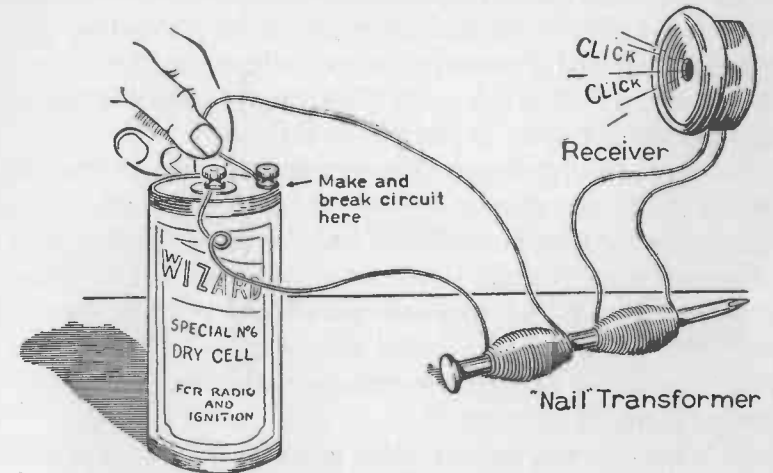

ELECTROMAGNETIC INDUCTION

The two coils wrapped around an iron nail are not electrically connected. They are coupled magnetically, and a change in the amount of current flowing in one coil will induce a current in the other coil, as is indicated by the sounds in the telephone receiver. The text tells how to perform the experiment.

nect one wire and make and break the circuit by tapping the end of the wire against the battery terminal so as to shut the current off and on, you will hear a clicking sound. When the current flows through the coil steadily, the magnetic field produced by the coil is also steady, but when you shut the current on and off, the magnetic field changes. This *changing* magnetic field travels through the nail and passes through the coil connected to the telephone receiver. It *induces* currents in the

coil which produce sounds in the telephone receiver. Current is induced in the coil only when the magnetism is changing, that is, growing stronger or weaker.

If you send an alternating current through one of the coils instead of direct current from a battery, it is unnecessary to make and break the circuit in order to induce a current in the second coil. The magnetic field produced by alternating current increases and decreases with each alternation, first in one direction and then in the other. This varying field will induce an alternating current in the second coil.

To prove this by means of an experiment, connect one coil of the "nail" transformer to the secondary of a bell-ringing transformer or a small step-down transformer of the type used to operate a toy railway. Connect the other coil to a telephone receiver. Listen in the telephone receiver and you will hear the low-pitched musical note called the "sixty-cycle hum." The hum is produced by the sixty-cycle current *induced* in the coil connected to the receiver.

In a transformer, the coil which furnishes the magnetic field is called the *primary*. The coil in which the current is induced is the *secondary*. The iron core concentrates the magnetic field. Transformers are made both with and without an iron core. Those without are called *air-core* transformers, those with are *iron-core* transformers.

Transformers of both kinds are used in radio circuits.

If the secondary coil of a transformer contains more turns of wire than the primary, the induced or secondary current will be of higher voltage than the primary current. On the other hand, if the secondary coil contains less turns of wire than the primary, the voltage of the induced current will be lower than that of the primary. A transformer in which the induced voltage is lower than the primary voltage is a *step-*

down transformer. A *step-up* transformer raises the voltage.

The currents induced in a wire or a coil by a neighboring wire or coil carrying a current are often objectionable in a radio circuit. The experienced radio designer takes every precaution to avoid this difficulty. It is avoided by arranging neighboring wires and coils at right angles to each other, plac-

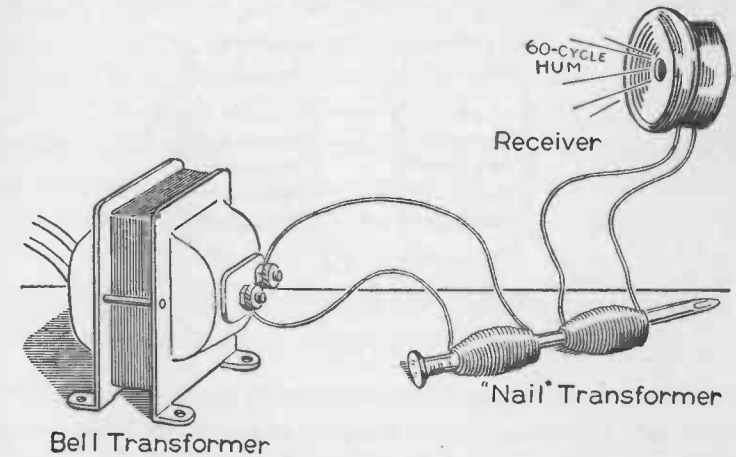

THE PRINCIPLE OF THE TRANSFORMER

The magnetic field produced by an alternating current flowing through a coil will induce an alternating current in a neighboring coil.

ing them as far apart as possible, and by "shielding." The magnetic field of a coil can be confined by placing the coil inside an iron shell.

AN IMPORTANT QUALITY OF AN ELECTRIC CIRCUIT CALLED SELF-INDUCTANCE

There is not enough space in this book to tell all the things that happen when an electric current flows through a coil of

wire, but it is important for the young experimenter to understand the quality of an electric circuit called *self-inductance*. Don't let the name frighten you. It is really quite simple.

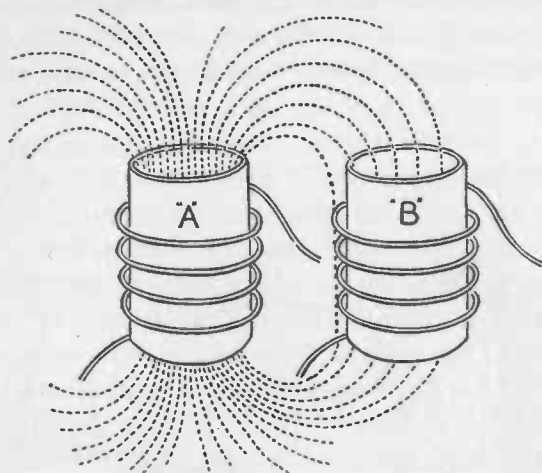

MUTUAL INDUCTANCE

If two coils (inductances) are so placed in relation to each other that the magnetic flux of one coil (A) is interlinked with the turns of the other (B) a voltage will be induced in the second coil (B). This effect of linking two inductances is called *mutual inductance*. Two circuits thus joined are said to be *inductively coupled*.

Another way of saying the same thing in different words is to define *mutual inductance* as the common property of two coils which gives transformer action, and energy is transferred from one coil to the other. Inductive coupling is employed in radio more frequently than any other form of coupling. The magnitude of the mutual inductance depends upon the shape and size of the two circuits, their distance apart and their relative positions. The coupling is greatest or closest when all the magnetic flux produced by one coil links with all the turns of the other coil.

As you already know, when a battery current flows through a wire or a coil of wire, the current builds up a magnetic field. When the current ceases, so does the magnetic field. That you can readily understand if you remember that when you shut

off the current from the nail electromagnet, the magnetic pull immediately disappeared.

But in ceasing, or *collapsing*—as the electrical engineer calls it—the magnetic field moves in toward the coil. In doing so, it induces a current of its own which flows in the *same direction* as the original battery current. This induced current, entirely created by the collapsing magnetic field, helps the battery current in its effort to continue to flow as the circuit is broken. It is largely responsible for the spark which is produced. This ability of a circuit to induce a current in itself is called *self-inductance*. It is very useful in radio circuits. A coil of wire has more self-inductance than a single wire. An iron core increases the self-inductance of a coil.

THE INTERESTING EFFECT OF SELF-INDUCTANCE IN AN ALTERNATING-CURRENT CIRCUIT

If an alternating current is sent through a coil of wire, the magnetic field which is produced will increase and decrease, first in one direction and then in the other. This varying field induces an alternating current in the coil which *opposes*, that is, flows in a direction opposite to the current which built up the field. As a result of self-inductance, a coil always tends to limit the amount of alternating current flowing through it. This tendency increases as the frequency of the current is increased. An iron core in the coil increases the self-inductance and aids the coil in limiting the current flow.

Wire coils, some with iron cores and some without, are often employed in radio circuits purposely to limit or “choke” the alternating current. They are called choke or impedance coils.

WHY IRON CORES ARE LAMINATED

The iron cores used in transformers, chokes, and other coils intended for use on alternating current are *laminated*. Laminated means made in layers. Solid cores are satisfactory for direct-current apparatus, but laminated cores are necessary in the case of alternating current for two reasons. A laminated iron core can become magnetized and demagnetized more rapidly than a solid core. Principally, however, because alternating

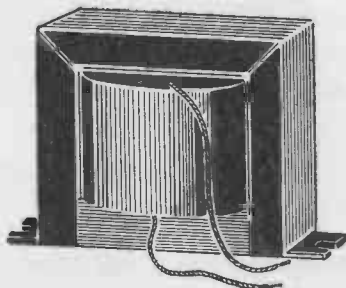

AN IRON-CORE CHOKE

Chokes are quite similar to transformers in general appearance but differ in that they consist of one winding only. The illustration shows a low-frequency choke.

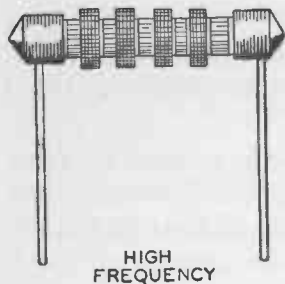
HIGH
FREQUENCY

SHIELDED

RADIO-FREQUENCY CHOKES

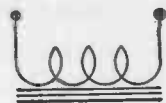

SYMBOL



RFC

SYMBOL

currents create (by electromagnetic induction) in the cores and frames of coils, currents called *eddy currents*, the magnetic parts of alternating-current devices are laminated.

INSIDE A RADIO RECEIVER

If you look into the cabinet of your home radio receiver, you will see that the tubes and various parts are assembled on a metal frame. This is called the *chassis base*. The assembled receiver exclusive of the cabinet is the *chassis*.

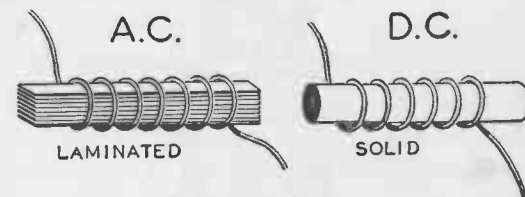

LAMINATED IRON CORES

The iron cores of coils or windings for use on low-frequency alternating currents are made in layers, or laminated to avoid the losses and heating effects of *eddy currents*. Eddy currents are created by electromagnetic induction.

The chassis base is easily removed from the cabinet if repairs or adjustments become necessary. The tubes, transformers, and tuning devices are mounted on the upper side of the chassis base and can be readily seen through an opening in the top or back of the cabinet. If the chassis is removed from the cabinet, there will be found on the underside of the base a bewildering maze of wires, coils, boxes, and cartridge-shaped devices. In spite of its disorderly appearance, there is "rhyme and reason" in this array. All of the wires are exactly where they belong. A few inches added to the length of some of these wires might throw the receiver out of adjustment.

The square boxes and small cylinders on the underside of

the chassis base usually contain condensers, resistances, and chokes, all necessary for the smooth working of a modern radio receiver.

ABOUT CONDENSERS OR CAPACITORS

Condensers are used in both radio receivers and radio transmitters. A condenser consists of two or more metal surfaces

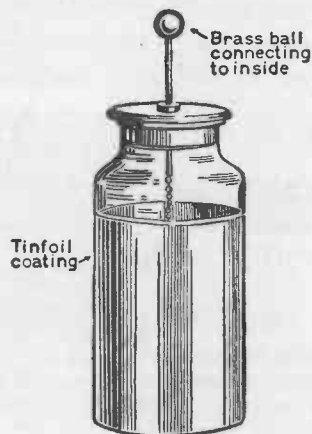

LEYDEN JAR

The first form of condenser. The tin-foil coatings on the inside and outside of the jar are the conducting surfaces. The glass walls of the jar are the dielectric.

separated from each other by a thin layer of insulating material called the *dielectric*. The dielectric is usually air, paper, mica, oil, wax, or certain chemical compounds. Smaller losses occur in condensers using air as the dielectric than in those employing paper, mica, and other materials. Therefore, "air-condensers" are used in those parts of a radio circuit where the currents are extremely weak, that is, in the radio-frequency portions.

The familiar Leyden jar is a condenser. It was the first form of condenser. The tin-foil coatings on the inside and outside of the jar are the metal surfaces. The glass walls of the jar are the dielectric.

Condensers are built in a great variety of types and sizes. The characteristic or quality which permits a condenser to be charged with electricity is called *capacity* or *capacitance*. The capacity of a condenser depends upon the size of the metal surfaces, the thickness of the dielectric, and the material used as the dielectric. Other things being equal, glass, mica, and paper give a greater capacity than air.

The "size" of a condenser is not its dimensions in inches or its weight, but its capacity. The unit of capacity is the *farad*, so called in honor of Michael Faraday. Actually, a condenser having a capacity of one farad would be so enormous that its construction would be impractical. A more useful unit for measuring condensers is therefore the *microfarad*. The microfarad is one-millionth of a farad. In circuits designed for short waves, some of the condensers are so small that their size is indicated in *micromicrofarads* or millionths of a microfarad.

VARIABLE CONDENSERS

There are two general types of condensers, called *fixed* and *variable*, accordingly as the capacity may be variable or not. The most common type of variable condenser is so constructed that the capacity may be gradually changed by turning a knob. Variable condensers are used for *tuning*. They consist of a number of movable, semi-circular, metal plates which rotate between another group of rigid or *fixed* plates so as to interleave. The air between the plates is the dielectric. Several variable condensers mounted so that all the movable plates are

on a common shaft are a "gang condenser," used in superheterodyne and tuned radio-frequency receivers.

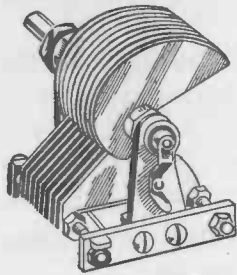

A VARIABLE CONDENSER

Variable condensers are used for tuning, and consist of a number of movable, semi-circular, metal plates which rotate between fixed plates. The air space between the plates is the dielectric.

FIXED CONDENSERS

Of fixed condensers there are no end. The catalogs of supply houses dealing in replacement and repair parts for radio receivers list hundreds of fixed condensers. They are of all sizes and varieties. Some have mica dielectrics, some have paper. Others are of the wet or dry electrolytic dielectric type. They may be enclosed in molded bakelite or paper boxes or sealed in metal cans.

ELECTROLYTIC CONDENSERS

Electrolytic condensers are enclosed in a metal can. One plate or surface of this type consists of sheets of aluminum immersed in a solution of borax. The borax solution is a conductor of electricity and serves as one of the conducting surfaces. The dielectric is a thin insulating film of aluminum oxide formed on the surface of the aluminum. The dry type of



SYMBOL

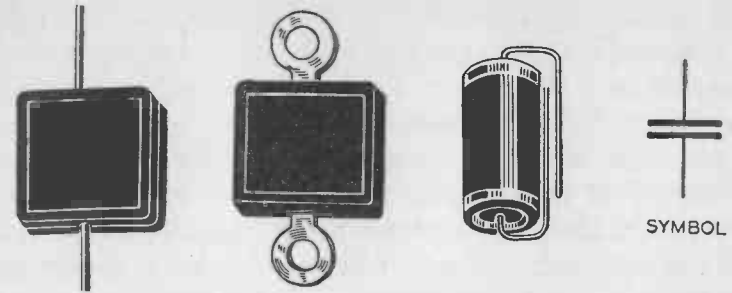

SMALL FIXED CONDENSERS

The size and form of fixed condensers varies widely but the electrical principle is always the same, *i.e.*, two conducting surfaces separated by a dielectric. Fixed condensers of the types shown above are used in radio receivers and amplifiers.

electrolytic condenser is similar in principle to the wet type but instead of containing a free liquid has its electrolyte soaked into a piece of gauze.

THE ACTION OF A CONDENSER

One of the "rules of a radio circuit" may be said to be the "right condenser in the right place." In diagrams of radio circuits it is usual to show whether a condenser is variable or fixed and to indicate its capacity.

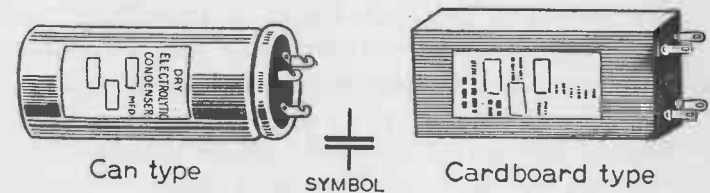

ELECTROLYTIC CONDENSERS

Condensers of the wet electrolytic type are enclosed usually in a metal container or can. A waxed cardboard box makes a satisfactory container for the dry electrolytic type.

A condenser acts as a sort of electrical spring. If you bend or compress a spring, it will fly back into its original position when released. If you apply a voltage to the surfaces of a condenser, the dielectric becomes strained just as a spring does if you bend, stretch, or compress it. The condenser is then "charged." If the charging current is removed and the two terminals of the condenser are connected together with a wire, the condenser will *discharge*. When a condenser is discharged, the strain on the dielectric is released. The dielectric "springs back" into its original condition and in doing so *gives out electricity*. The electric current is gone in a flash, but may be sufficient from a small condenser to give an uncomfortable or even dangerous shock. The shock from the condensers in a radio power pack can be fatal.

A direct current will flow into a condenser only so long as the condenser is charging, then it ceases. A condenser of small capacity is charged more quickly than a condenser of large capacity, other things being equal.

An alternating current charges a condenser, first in one direction and then the other; this rapidly changing charging current actually is the equivalent of a current passing through the condenser. Some of the condensers used in radio circuits are utilized so as to allow an alternating current to pass through a portion of the circuit but at the same time prevent the flow of any direct current. By using proper condensers and impedance coils, it is possible to arrange some very useful and interesting circuits called "filters." Direct currents will flow through portions of the filter circuit but not through others, because they are prevented by condensers. Alternating currents will flow where the direct current can not go, but by means of impedance coils are barred from places where direct current can pass.

CONDENSER DISCHARGE

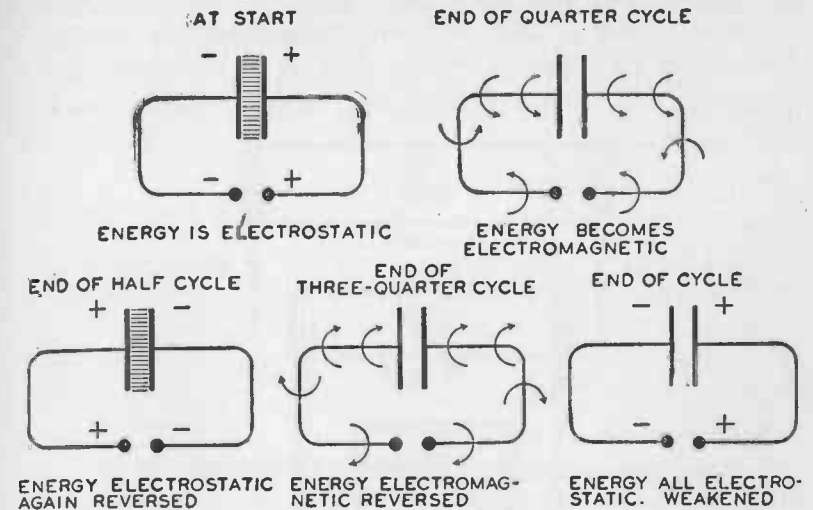

A RESERVOIR FOR ENERGY

A condenser does not store electricity; it stores energy. At the start of its discharge, the energy is all electrostatic, that is, the dielectric is under strain. This is indicated in the illustration by the shaded area between the condenser plates. As the condenser discharges and the strain in the dielectric is removed, a current moves through the circuit. The curved arrows in the illustration represent the magnetic field around the wires when a current flows and the energy has become electromagnetic. The condenser then becomes charged in a reverse direction, and again it discharges. Under the proper conditions, this swinging back and forth may occur several times. Thus a condenser releases its stored-up energy in the form of a rapidly alternating current.

RESISTORS

Resistance in various forms called resistors, rheostats, potentiometers, controls, and ballasts, is used in radio circuits. A resistor is usually a small tube or rod of carbon or a vitreous cylinder wound with Nichrome wire. Nichrome is an alloy made of nickel and chromium. It is drawn into wires which

have more than fifty times the resistance of a copper wire of the same size.

The resistance of radio resistors varies from 5 to 200,000 ohms. They are made in various sizes so as to handle from $\frac{1}{4}$ to 100 watts. Some resistors are marked with figures to

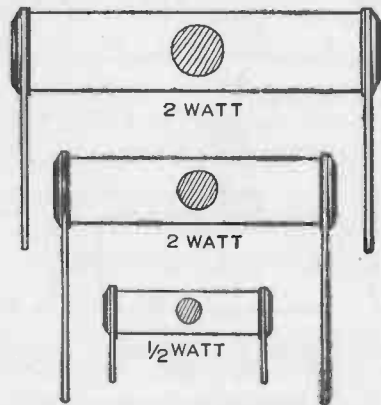

RESISTORS

Made in various sizes to handle from $\frac{1}{4}$ to 100 watts and in resistance from 5 to 200,000 ohms. The dot or circle on the body of the resistor is part of the manufacturers' color-code system indicating the resistance.

show their resistance in ohms. Others are "color coded," that is, marked with colors so as to indicate their resistance, according to a standard system adopted by the Radio Manufacturers Association. Three color indications are used. "Body" color is the color of the resistor itself. "End" color is the color at the end of the resistor, and "dot" color is the color of a dot on the resistor body.

The body color represents the first figure of the resistance value in ohms. End color represents the second figure, and dot color represents the number of zeros following the first two figures. For example, under the color-code system, a re-

sistor of 1,500 ohms would have a brown body, a green end, and a red dot. The table below shows the values represented by the various colors:

0—Black	3—Orange	7—Violet
1—Brown	4—Yellow	8—Gray
2—Red	5—Green	9—White
	6—Blue	

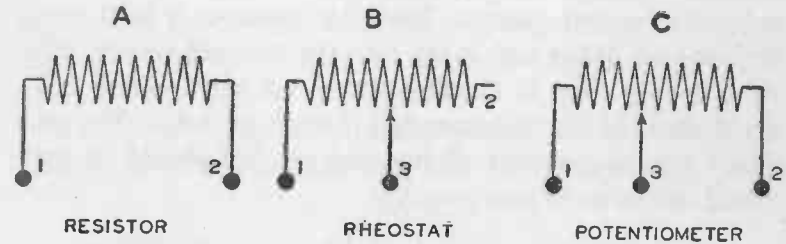

THE DIFFERENCE BETWEEN A RHEOSTAT AND A POTENTIOMETER

A resistor is a fixed resistance. Rheostats and potentiometers are adjustable resistances which can be varied by turning a knob. A rheostat has two terminals. A potentiometer has three terminals as shown in the diagram above. A rheostat is connected in series with the current source which it controls. A potentiometer is connected across or in shunt with the current source.

BALLASTS OR REGULATORS

The resistances used in some radio receivers operated on the 110-volt power line to control the current automatically are called *ballasts* or *regulators*. They are like the common detector or amplifier tube in appearance. If the voltage of the power line drops as low as 85 volts, the ballast tube automatically lowers its own resistance so as to let more current pass and keep the set operating properly. In case of a rise in voltage, up to 145 volts, the ballast tube will automatically increase its own resistance and cut down the current, thus protecting tubes, condensers, and resistors from burning out.

Receivers designed for operation either on 110-volt alternating or direct current can not use a power transformer, since a transformer will not work on direct current. In such case, low voltage for the tube filaments is usually obtained from the 110-volt line by connecting the filaments in series and using a suitable resistance between the filaments and one side of the line. Sometimes resistance is in the form of a resistor mounted inside the receiver cabinet. Often the resistance is built inside the line cord. When such is the case, the cord will become quite warm in operation. It should never be cut short, for to do so would decrease the resistance and damage the tubes. The cord should not be operated all bunched up, but should be kept spread out so as to cool properly.

POTENTIOMETERS, VOLUME CONTROLS, RHEOSTATS, AND VOLTAGE DIVIDERS

Potentiometers, volume controls, and rheostats are adjustable resistances which can be varied by turning a knob. A voltage divider is usually a resistance which is tapped at several points. It is part of the power-supply equipment used in radio receivers.

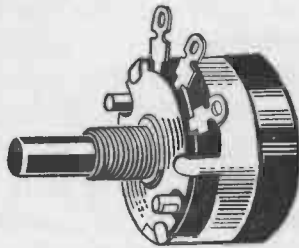

POTENTIOMETER OR VOLUME CONTROL

Potentiometers, volume controls, and rheostats are resistances which can be varied by turning a knob.



SYMBOL

TELEPHONE RECEIVERS

The purpose of telephone receivers and loud speakers (this last-named device is really a form of telephone receiver) as they are used in a radio receiving set is to make the signals audible.

A telephone receiver makes radio signals audible by changing some of the energy of the *rectified* high-frequency oscillations delivered by the detector or audio-amplifier into sound waves.

A telephone receiver is a simple device, yet it is one of the most sensitive of electrical instruments. An amazingly small

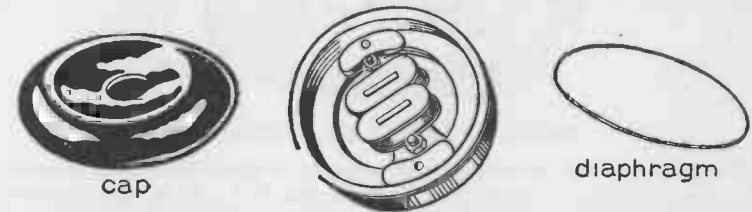

receiver with cap
and diaphragm removed

TELEPHONE RECEIVER

This is the type of receiver commonly used in radio work. In order to respond to very weak currents, the electromagnets are wound with a large number of turns of wire.

amount of energy flowing through the coils of a sensitive telephone receiver will produce sounds audible to the human ear. It consists of a pair of small electromagnets, a permanent magnet, and a thin sheet-iron diaphragm. The electromagnets are very close to the diaphragm but do not touch it. When current flows through the coils, the magnetic pull on the diaphragm varies, becoming stronger or weaker, depending upon whether the current in the windings is aiding or bucking the

pull of the permanent magnets. The diaphragm is like the head of a drum. It requires only a very small shock to make it respond loudly.

Telephone receivers will respond to audio-frequency currents only. There are several reasons why. Radio-frequency currents are "choked" by electromagnets in a receiver and do not pass through. Besides that, even if the currents could pass

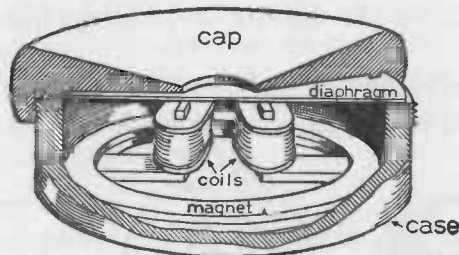

INSIDE A TELEPHONE RECEIVER

Telephone receivers are used in radio to make the signals audible by changing the energy of electric currents into sound waves. The coils or electromagnets in a telephone receiver are mounted upon the poles of a permanent magnet which exerts a pull upon the iron diaphragm. When a current is sent through the coils, the pull upon the diaphragm is weakened or strengthened depending upon the direction of the current. The change in pull moves the diaphragm and produces sound.

through, the metal diaphragm could not respond to such rapid vibrations as those of radio-frequency.

In radio work, it is desirable to have the telephone receivers held firmly to the operator's ears and leave both hands free to adjust the apparatus. The ordinary Bell telephone receiver is too large and cumbersome. Telephone receivers for radio use are small and light. They are the type commonly known as "watch-case" or "head-phones."

A complete headset consists of a pair of watch-case receivers

fitted with a head-band so that a receiver is closely held to each ear.

When used for radio work, telephone receivers are wound with much finer wire than for telephone work, usually No. 40 B. S. gage. This makes it possible to wind a great number of



RADIO HEADSET

A complete headset consists of a pair of receivers fitted with a head-band so that a receiver is held closely to each ear and all extraneous sounds are shut out. Telephone receivers will respond to weaker currents than a speaker.

turns in a comparatively small space and makes a receiver more sensitive to weak currents. It also increases the resistance. The Bell telephone receiver has a resistance of 75 ohms but radio receivers measure 1,000 ohms or more.

SPEAKER

In the early days of radio, telephone receivers made the signals audible. With the advent of broadcasting, the loud-speaker was born, this making it possible for a group of people to listen to the same receiving equipment. At that time, a

loud-speaker consisted merely of a telephone receiver placed at the small end of a cone-shaped horn. The young experimenter who likes to dabble and putter, can attach a telephone receiver to a megaphone, connect the receiver to the output of a radio receiver having one stage of audio-frequency amplification, and discover the failings of this arrangement. It will not reproduce the bass notes of the lower end of the sound range and will squawk and rattle on some of the high ones.

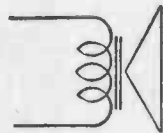
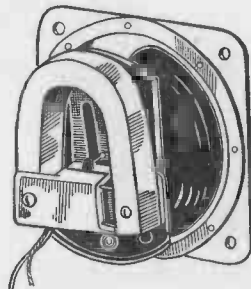

SYMBOL

SPEAKER WITH PERMANENT MAGNET FIELD

Quite similar to a telephone receiver in principle, a speaker produces sounds loud enough to fill a room or auditorium. The magnetic field, in which the coil or armature attached to the speaker diaphragm moves, is established by a coil or a powerful permanent magnet. The illustration shows a speaker having a permanent magnet field. This type is used in portable sets.

But, as is true of everything else connected with radio, the loud-speaker has been greatly improved. Even its name has changed. It is no longer a "loud" speaker. It is just plain "speaker."

In principle, it is still a telephone receiver, that is, a sound-producing diaphragm whose vibrations are the result of a varying magnetic field. The horn has been eliminated. It was made unnecessary by changing the flat, disklike telephone receiver diaphragm and giving it the shape of a cone. Increas-

ing the to and fro movement of a diaphragm sets in motion a larger volume of air and produces a greater volume of sound. A cone-shaped diaphragm will move farther without distorting sounds than a flat diaphragm.

The modern cone speaker may be one of two types—a "balanced armature magnetic" or a "dynamic." In the first, a

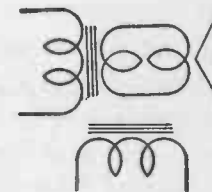
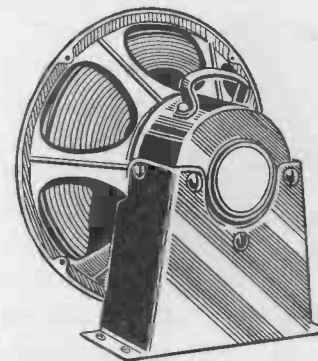

SYMBOL

DYNAMIC SPEAKER WITH ELECTROMAGNETIC FIELD

In the largest and most powerful speakers, the voice coil moves in a magnetic field established by an electromagnetic winding. The current which furnishes the field must be direct.

slender, stiff wire attached to the armature is fastened to the apex of the cone. The motions of the armature are imparted to the cone and the latter sends out corresponding sound waves. The motions of the armature are caused by changes in the magnetic flux of a coil of fine wire between the poles of a permanent magnet and connected to the output of the audio-frequency amplifier in the receiving set. From an electrical standpoint, the mechanism is practically that of a telephone receiver with the armature substituted for the diaphragm of the telephone receiver.

The dynamic is by far the most satisfactory type of speaker.

Its physical proportions are quite small, making it easy to place in a cabinet. It uses a relatively small cone diaphragm having a relatively great movement. There is no armature. A small coil of very fine wire, called the voice coil, is attached directly to the cone diaphragm. In this coil flows the varying signal current from the audio-amplifier. The coil is supported

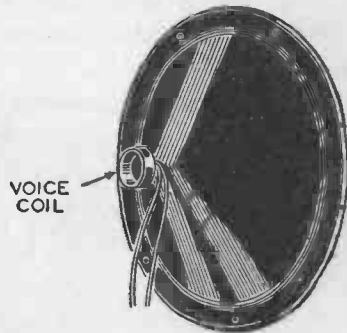

A SPEAKER CONE OR DIAPHRAGM

When an electric current flows through the voice coil it causes the coil to move. The coil is attached to the apex of the cone-shaped diaphragm and its motion is imparted to the diaphragm.

in a magnetic field established by a field winding or a powerful permanent magnet.

The most satisfactory method of mounting a speaker is to support it in a "baffle" or partition which will prevent sound waves from the back of the speaker diaphragm from canceling the sound waves at the front of the diaphragm.

RADIO ARITHMETIC

Every day, millions of people all over the world turn a knob on their radio receiving sets in order to find the correct wavelength for a certain broadcasting station. Dr. Michael I. Pupin,

Professor of Electromechanics at Columbia University, New York, was responsible for this operation. It was Dr. Pupin's knowledge and use of mathematics that enabled him to discover the principles of "electrical tuning" and set up the first resonant circuits. The results of this research were published in the *American Journal of Science* and also in the *Transactions of the American Institute of Electrical Engineers* for 1894. This was before Marconi commenced experimenting with Hertz's apparatus in Italy.

Ever since, there has been a growing partnership between mathematics and radio. When the trained radio engineer thinks of radio circuits he thinks of them in terms of mathematical equations. It makes his work much easier. A glance through a standard radio text-book will reveal page after page of equations and formulas, all of them "Greek" to any one who has not had an electrical engineer's training.

Fortunately, the beginner at radio experimenting can get along very well without quadratic equations, calculus, and logarithms. Simple arithmetic will serve his purposes when he has to "calculate" his circuits. There is always a small amount of figuring necessary in order to experiment with radio apparatus properly and intelligently. It is necessary to compute the proper length for an antenna, the amount of capacity in a circuit, the effect of resistance, and so on. None of these problems is difficult, however.

OHM'S LAW

Probably the most frequent electrical calculation is one involving the volts, amperes, or resistance in a circuit. For that purpose, Ohm's law is used.

Ohm's law, named after George Simon Ohm, a famous

scientist who contributed a great deal to our knowledge of electricity, is a simple statement of facts which shows the relationship between ohms, volts, and amperes in a *direct-current circuit*.

Ohm's law is the basis of design of almost all direct-current electrical instruments. It says: The current in amperes equals the voltage divided by the resistance. It may be expressed in symbols this way:

$$C = \frac{E}{R} \text{ or}$$

$$R = \frac{E}{C} \text{ or}$$

$$E = C \times R$$

C is the current in amperes; E is the potential in volts; and R the resistance in ohms.

By way of a simple illustration to show how Ohm's law may be used, we will suppose that a small incandescent lamp is connected to a battery and that the electromotive force of the battery is 3 volts. We will further suppose that the resistance of the battery itself and the connecting wires is 9 ohms. Knowing these two facts, it is easy to find out how many amperes are flowing through the circuit by substituting these values in the equation, as follows:

$$C = \frac{3}{9}$$

Dividing 3 by 9 gives the answer, namely, $\frac{1}{3}$ of an ampere. Thus, if you know the value of any two of the constants, you can find the value of the unknown by simple arithmetic.

When you know the current and resistance, it is only necessary to multiply them together to find the electromotive force in volts. Knowing the current and voltage, to find the re-

sistance, divide the electromotive force in volts by the current in amperes.

WHEN OHM'S LAW DOES NOT HOLD GOOD

Ohm's law does not hold good when the conductor is a gas or for alternating currents.

RESISTANCES IN SERIES

Whenever it is necessary to calculate the amount of resistance in a circuit for direct current or the effect of that resistance, Ohm's law holds good. If several resistances are connected in series, it is merely necessary to add up their total

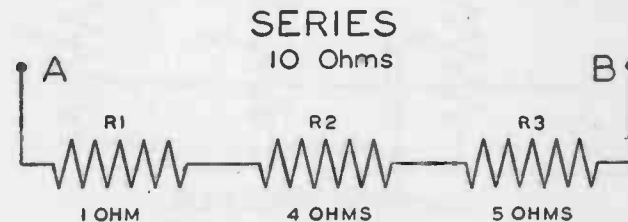

RESISTANCES IN SERIES

If several resistances are connected in series, their effect in a circuit is that of a single resistance equal to their sum.

resistance in ohms and consider the sum exactly as one resistance of that amount. The diagram shows three resistances, R₁, R₂, and R₃, connected in series. Their total resistance is 10 ohms and this figure should be used in calculating their effect in a circuit. For example, if an electromotive force of 20 volts is applied to the terminals A and B, since the resistance is 10 ohms, according to ohm's law, the current will be 2 amperes.

RESISTANCES CONNECTED IN PARALLEL

When the resistance in a circuit is made up of two or more resistances connected in parallel, it is an entirely different situation. The effective resistance is less than that of the smallest resistance. It is calculated by using "reciprocals." Reciprocals are the quotient obtained by dividing one, or unity, as a mathematician calls it, by any number.

PARALLEL

.62 Ohms

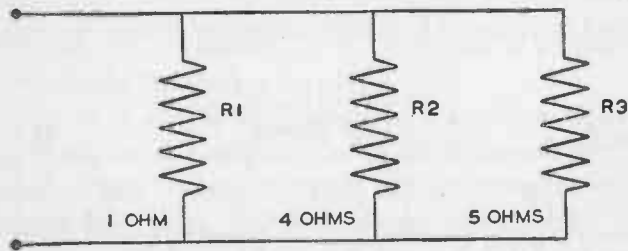

RESISTANCES IN PARALLEL

When the resistance in a circuit is made up of two or more resistances connected in parallel, their effect is calculated by using reciprocals. The effect of the three resistances which in series totaled 10 ohms is only .62 ohm when connected in parallel.

The diagram shows three resistances, R_1 , R_2 , and R_3 , respectively 1, 4, and 5 ohms, connected in parallel. They total 10 ohms but, however, they do not have the effect of 10 ohms in the circuit. Their effective resistance is found by the following equation:

$$\frac{1}{R} = \frac{1}{R_1} + \frac{1}{R_2} + \frac{1}{R_3}$$

When the values of the three resistances are substituted in the equation

$$\frac{1}{R} = \frac{1}{1} + \frac{1}{4} + \frac{1}{5} \text{ or } \frac{1}{R} = 1 + .25 + .20$$

Solving the problem shows R , or the resistance in ohms, to be .62 ohms.

CONDENSERS IN SERIES AND MULTIPLE

If a capacity of 4 microfarads is required, and condensers of only 1, 2, and 3 microfarads happen to be available, two

SERIES

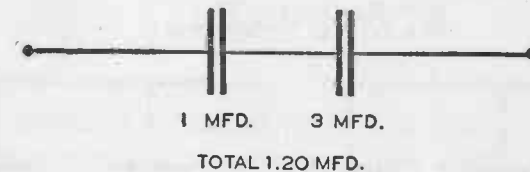

Condensers are sometimes connected in series in order to divide a high potential between them and avoid rupturing the dielectric. To calculate the effect of two condensers in series, employ the kind of equation used to calculate parallel resistances.

2 mfd., or a 1 mfd., and a 3 mfd. can be connected in *parallel* and the result will be a capacity of 4 mfd. When condensers are connected in *parallel*, the total capacity is equal to the sum of the separate capacities.

On the other hand, two condensers, connected in series, will act as a single condenser having less capacity than either of them separately. If we wish to calculate the capacities of two condensers connected in *series*, we must use an equation like

that used to calculate *parallel* resistances. The diagram shows two condensers, C_1 and C_2 , one of 3 mfd. capacity and the other 2 mfd., connected in series. The resulting capacity is expressed in mathematical form thus:

$$\frac{I}{\text{Total capacity}} = \frac{I}{C_1} + \frac{I}{C_2}$$

By substituting the values of C_1 and C_2 in the equation, we find

$$\frac{I}{\text{Total capacity}} = \frac{I}{3} + \frac{I}{2} \text{ or } \frac{I}{\frac{1}{3} + \frac{1}{2}} \text{ or } 1\frac{1}{5} \text{ mfd.}$$

Condensers are sometimes connected in series in order to divide a high potential between them, thus using them safely

PARALLEL

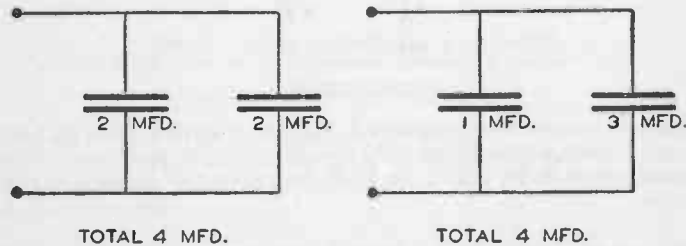

When condensers are connected in parallel, their effect is equal to that of a single condenser having a capacity equal to the sum of their capacities.

on a voltage which would rupture either one alone. For example, two condensers built for 500 volts could be used on 1,000 volts and would perform their duty safely if connected in series, but it would be necessary for them to have *twice* the capacity of a single 1,000-volt condenser.

IMPEDANCE MATCHING

In order to secure the maximum undistorted power from a vacuum-tube, its load must be designed to suit the tube. By load is meant the device or circuit to which the tube delivers its power. The resistance of the load must be in proper proportion to the internal resistance of the tube. To comply with this principle it is usual to employ what is termed *impedance matching* in designing radio circuits.

OUTPUT COUPLING

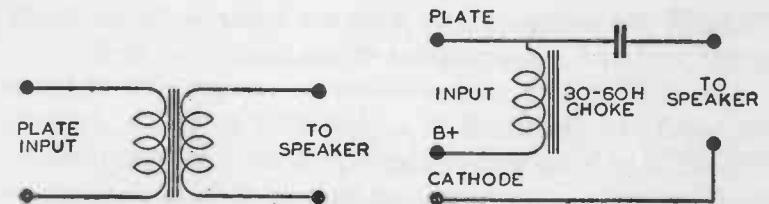

COUPLING AN AMPLIFIER TO THE SPEAKER

In order to transfer power efficiently from a power amplifier to a speaker of either the electromagnetic or dynamic type an output-coupling device is necessary. It may be a transformer, as shown at the left, or a choke-condenser, as shown in the circuit diagram at the right. An output-coupling transformer is constructed with two separate windings, a primary and a secondary, wound on an iron core. Choke-condenser output-coupling consists of an iron-core choke of 10 henries or more in series with the plate and B supply of the output tube, and 2 to 6 microfarad condenser in series with the speaker.

A good example of impedance matching is the use of an output transformer to connect the output circuit of an audio-frequency amplifier to a speaker. The voice coil in a speaker does not possess enough impedance to "match" the plate circuit of the amplifier tube, but a transformer does, and by its use the requirements of the circuit are satisfied.

THE DECIBEL

Sound is invisible and weightless, and for these and other reasons can not be measured by the quart or weighed by the pound. In radio it is frequently necessary to measure sound. The *decibel* is a unit used to compare sound levels. A decibel (abbreviation, db.) is one-tenth of the international unit known as the *bel*, in honor of Dr. Alexander Graham Bell, the inventor of the telephone. Actually it is a unit of amplification which may be converted into watts or vice versa.

A person with acute hearing is aware of a change in sound intensity when the level is varied *one* decibel but not before. Probably the average person does not notice a change in the sound level of a radio program of less than three decibels.

The purring of a cat represents an energy level of about 100 decibels; the sound of a typewriter is 10,000 decibels. The whine of a vacuum-cleaner represents 1,000,000 decibels, a police whistle 100,000,000, and the roar of an airplane engine 100,000,000,000 decibels.

HOW TO READ RADIO-CIRCUIT DIAGRAMS

To illustrate radio circuits, magazine articles, radio handbooks, and even beginner's manuals usually employ what are known as *schematic* diagrams. These consist of numerous symbols, circles, lines, and arrows.

Schematic diagrams are a sort of radio short-hand. They are employed because in that way a few simple lines can show any radio circuit and show it more clearly than any other method. A schematic circuit diagram which indicates the values of the various condensers, resistances, inductances, and so on, is like a blue-print in construction work. It shows how all the

SYMBOLS USED IN CIRCUIT DIAGRAMS

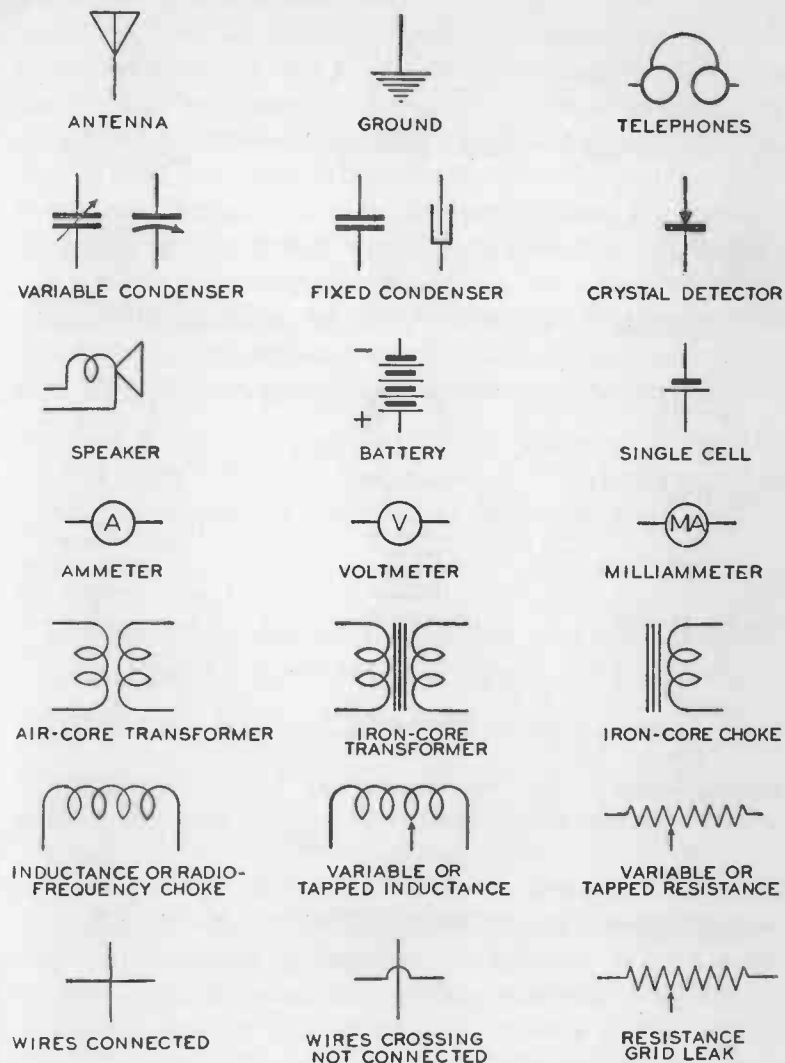

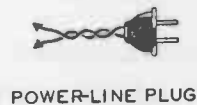
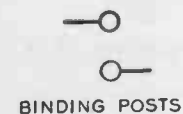
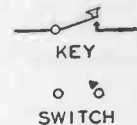
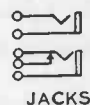
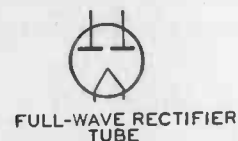
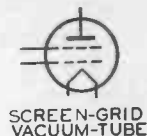
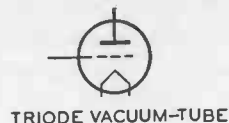

SYMBOLS USED IN CIRCUIT DIAGRAMS



parts fit together, and to the person well versed in radio it shows the purpose of each part.

Naturally, to the beginner in radio, schematic diagrams are at first bewildering. But it is essential to learn to "read" or understand these diagrams if you are interested in radio and wish to make progress in the field. It will be necessary to know how to read and draw schematic circuit diagrams to pass a license examination. The commonly used symbols are shown in the charts in this chapter. Study them until they are familiar and you can draw them yourself.

Schematic diagrams are really simple. For example, instead of showing a perspective drawing of a fixed condenser, every time that this part is used in a circuit a symbol which looks like this  is employed. If the condenser is variable,

it may be indicated in either of two ways, like this 

or 

Pictures require skill and time to draw. Not every one could draw a picture of an antenna or a resistor, yet it is simple to

draw a symbol like this  to represent an antenna or a

symbol like this  to indicate a ground. But a

schematic circuit diagram is simply a plan or drawing for a radio set in which the various parts and the manner in which they are connected is indicated by symbols. With a small amount of practise you can soon draw schematic diagrams.

There is another type of diagram, called a picture or pictorial diagram, which is often more easily understood by the

beginner. Since this is a book for beginners, you will find pictorial diagrams in it as well as schematic diagrams. Pictorial diagrams have been used to make things simple and schematic diagrams have been used in order that you may become familiar with them.

A	"A" Battery	NC	Neutralizing condenser
AC	Alternating current	OSC	Oscillator
AMP	Amperes	P	Plate
ANT	Antenna	R	Resistor
B	"B" Battery	RF	Radio-frequency transformer
C	Condenser	RFC	Radio-frequency choke
DC	Direct current	SWC	CH Swinging choke
F	Filament	V	Volts
G	Grid	VT	Vacuum tube
GND	Ground	W	Watts
IF	Intermediate frequency		
L	Inductance		
LS	Speaker		
MA	Milliamperes		
MEG	Megohms		

ABBREVIATIONS
USED IN
CIRCUIT DIAGRAMS

Receiving Radio Messages

YOU would hardly expect to secure a good radio detector by digging into the earth for it. Yet, for about ten years prior to the World War, the best detector was a small piece of such minerals as galena, iron pyrites, chalcopyrites, zincite, bornite, and molybdenite.

MINERAL OR CRYSTAL DETECTORS

Mineral, or "crystal" detectors, as they are popularly called, are obsolete in commercial work, having been superseded by the more easily adjusted and far more sensitive vacuum-tube, but they are still of interest to the young experimenter. A crystal is the simplest form of detector and offers the easiest way of becoming acquainted with radio. With nothing more than a suitable crystal and a telephone receiver connected to an antenna and ground (see diagram on page 108), you can receive radio messages. Such an arrangement is not efficient but will operate.

There are a number of substances which make satisfactory crystal detectors. Some are natural minerals, others are products of the electrical furnace and chemical laboratory. Galena is most commonly used. Not every piece of galena will prove to be a sensitive radio detector. Furthermore, the whole surface

of a piece of mineral is not always sensitive. There are definite spots on it which must be located by testing.

Tested crystals mounted in a small slug of low-temperature alloy are available in radio shops at small cost. A complete

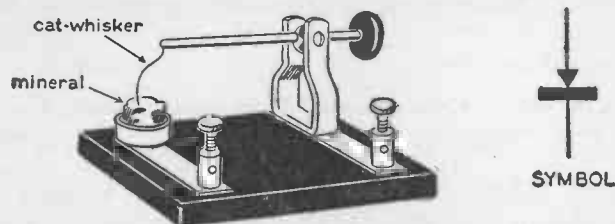

A CRYSTAL DETECTOR

The swivel arm moves in a ball and socket so that the "cat-whisker" can be brought into contact with any point on the crystal. A crystal detector rectifies the high-frequency currents produced in the antenna by incoming waves. The rectified currents produce sounds in the telephone receivers whereas the unrectified currents will not. A detector is a necessary part of every radio receiver. Vacuum-tube detectors have superseded crystal detectors.

detector stand with ball and socket swivel arm for making contact with any point on the crystal costs only fifteen cents.

If you live within twenty-five miles of a broadcast station, you can receive the programs with a crystal connected to an antenna and to the ground. A sensitive telephone receiver (1,000 ohms) or headset should be connected across the detector.

In such an arrangement you have the simplest radio receiver possible.

HOW A MINERAL RECEIVES RADIO MESSAGES

A sensitive mineral or crystal is a *rectifier*, that is, a current of electricity will flow through it better in one direction than the other. It acts as a sort of electrical valve and so can change

or rectify an alternating current into a direct current. When connected to the antenna and ground at a receiving station, a crystal detector rectifies the high-frequency alternating currents created in the antenna by the incoming waves. This rectifying process is the fundamental action required in order to *detect* the high-frequency currents. The rectified currents are able to produce sounds in a telephone receiver. Without a *detector* of some sort, no sound is produced by the high-frequency currents.

No satisfactory explanation has been found as to how or why certain crystals act as an electrical valve.

THE ESSENTIALS OF A RADIO RECEIVER

The simple receiving set shown in the top diagram on page 108 can be considerably improved by the addition of a "tuning"-coil as shown in the bottom diagram on the same page. A sliding contact on the tuning-coil enables any portion of the wire on the coil to be included in the circuit. Adding more wire "tunes" or alters the circuit so that it will receive waves of longer wave-length.

In order to be most efficient and to eliminate interference, a radio receiver must be tuned by a more elaborate arrangement than a tuning-coil in the antenna. But in the simple arrangement of an antenna, detector, telephone receiver, and ground connection, which have been shown, are embodied the fundamentals of a radio receiver. They are:

1. An antenna system to intercept the waves.
2. A detector to rectify the currents.
3. A tuning device.
4. A mechanism for changing the currents into sound.

Unfortunately, a receiving set can not be as simple as that

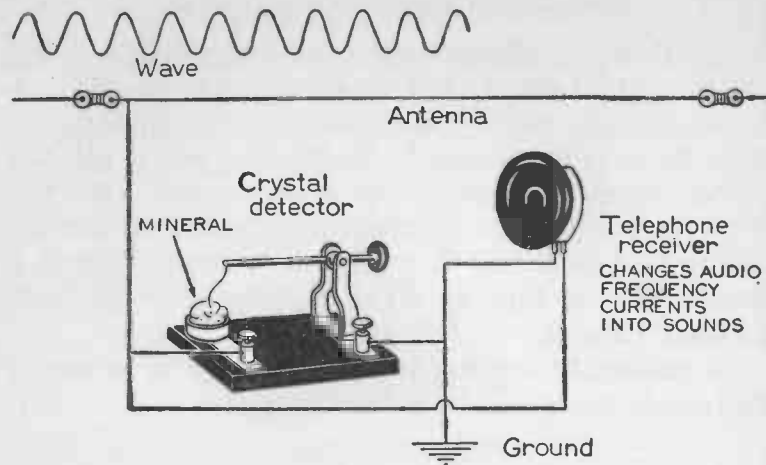

A SIMPLE UNTUNED RADIO RECEIVER

The incoming electromagnetic waves, striking the antenna, create high-frequency currents which pass through the detector. The mineral or crystal in the detector rectifies these currents, changing them into direct currents which are able to produce sounds in a telephone receiver.

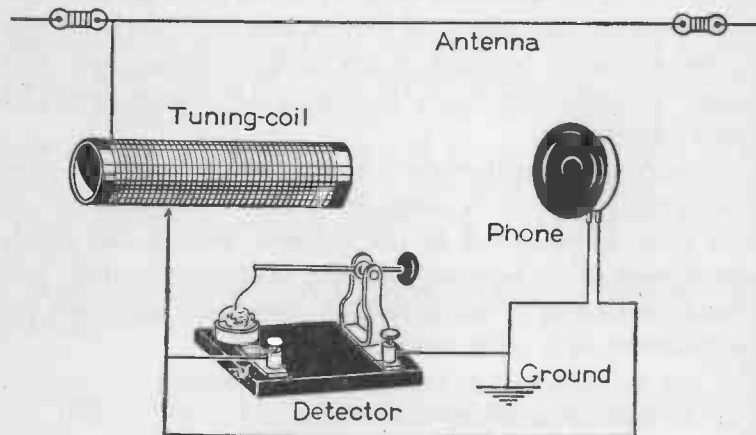

A SIMPLE TUNED RADIO RECEIVER

The simple untuned receiver is considerably improved by the addition of a tuning-coil to adjust the antenna circuit to the incoming waves.

shown in the diagrams on page 108 and still be practical. A more sensitive and stable detector and better selectivity are desirable. To accomplish these, a detector tube must be substituted for the crystal, and a transformer and variable condensers provided in place of the simple tuning-coil. These

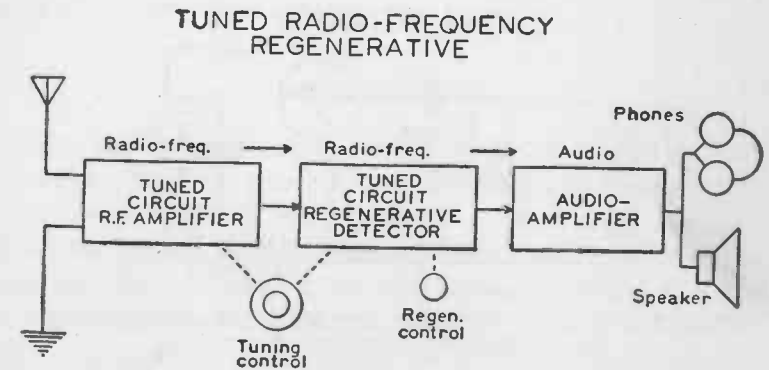
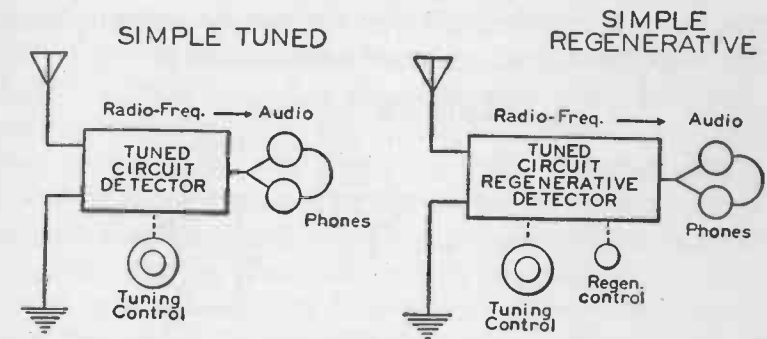

These are "block" diagrams. They show the essential units of three types of receiver. The simple tuned and simple regenerative were in use in the early days of radio, but have been superseded by more complicated and at the same time more selective and more sensitive receivers such as the tuned radio-frequency, regenerative, and the like.

changes also necessitate certain additional auxiliary apparatus such as batteries, filament control, and grid condenser. However, such a receiver would still be old-fashioned and unsatisfactory in these days of a crowded radio spectrum. It would be the equivalent of those used before Professor E. H. Armstrong discovered *regeneration*. The modern radio receiver is one of the four following types: regenerative, superregenerative, superheterodyne, or tuned radio-frequency.

PLATE DETECTION

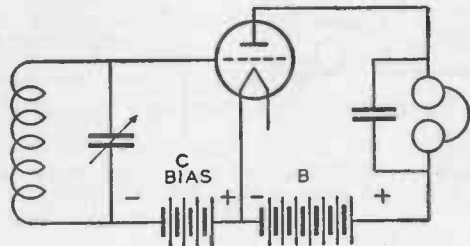

GRID DETECTION

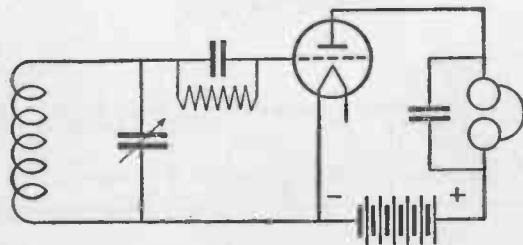

CIRCUIT DIAGRAMS SHOWING THE METHODS OF DETECTING OR RECTIFYING WITH TRIODE TUBES

By omitting the grid condenser and providing a bias battery, rectification is caused to take place in the plate circuit. By omitting the bias battery and providing a grid condenser and grid leak, rectification takes place in the grid circuit. It is not probable that the novice will understand these circuit diagrams until he has made further progress in his radio studies. The diagrams can be interpreted by referring to the symbols shown elsewhere on pages 101 and 102.

PLATE AND GRID DETECTION

The process of making signals intelligible is essentially the process of *rectification* or of converting the incoming radio-frequency currents into direct current. This direct current varies in accordance with the modulation of the carrier wave. Fleming valves, or diode tubes, will rectify in only one way, but triodes or multi-element tubes can be operated as either "grid" or "plate" detectors, depending upon where in the circuit the rectifying action takes place. If it occurs in that portion known as the grid circuit, the tube is operating as a "grid" detector. Arranged so that the rectifying action takes place in the plate circuit, the tube is a "plate" detector. Circuit diagrams showing these two methods of detection are illustrated. It is not expected, however, that you will understand how these circuits function differently until your knowledge of a radio tube has progressed farther than this book has taken you up to this point.

REGENERATION

The way to get the most out of a detector tube is to make it *regenerate*. It is possible to understand what regeneration means without going into the details of how a detector tube performs at this time. A three-electrode radio tube has three circuits called the *grid*, *plate*, and *filament* circuits. The grid circuit is an *input* circuit. The plate circuit is an *output* circuit. The current in the output circuit can be fed back into the input circuit and re-amplified a number of times. This action is called *regeneration* and brings about a tremendous increase in detector sensitivity.

The regenerative receiver is a favorite with beginners in

the radio field because of its low cost in its simple forms and because it is easy to construct and operate.

REGENERATIVE GRID DETECTION

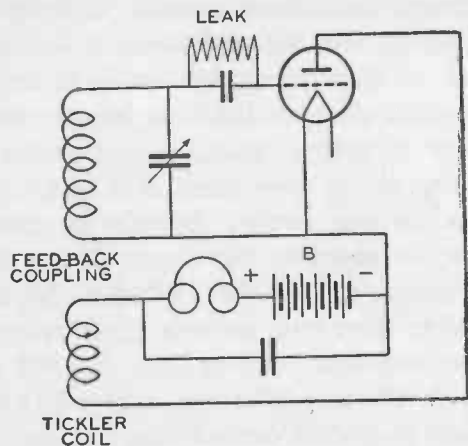

This is the schematic circuit diagram of a regenerative receiver in which the rectifying action of the detector takes place in the grid circuit. Notice the tickler coil by means of which energy in the plate circuit is fed back into the grid circuit thereby bringing about regeneration.

SUPER-REGENERATION

When regeneration is sufficiently great, a tube commences to oscillate. At this point the tube is acting as a generator of alternating currents and the limit to which its regenerative amplification can be carried has been reached. To overcome this limitation and secure still greater amplification, Professor Armstrong devised the super-regenerative circuit.

In principle, this clever and sensitive device consists of an ordinary regenerative detector provided with a *quench* to interrupt constantly the oscillations. The introduction of this

quench or interruption frequency permits the incoming signals to be built up to tremendous proportions by regeneration. The superregenerative receiver is extremely sensitive and provides a highly efficient circuit for the reception of ultra-high-frequencies.

SUPER-REGENERATION

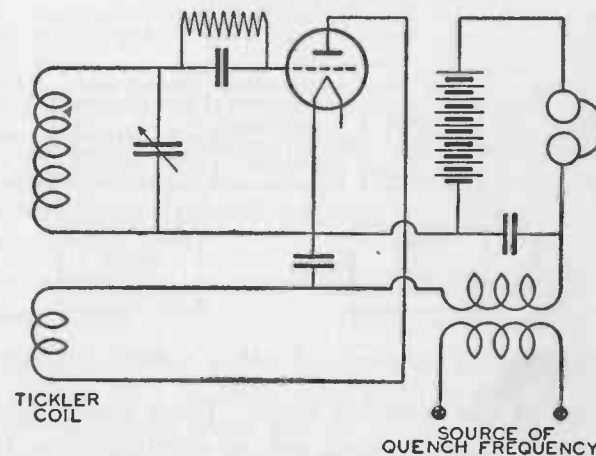

This is the schematic circuit diagram of a super-regenerative receiver. Super-regeneration is used on very short wave-lengths, such as the micro and ultra-high-frequency waves.

SUPERHETERODYNE RECEIVERS

Another type of receiver capable of a high order of performance is the superheterodyne. It was also invented by Armstrong.

The best broadcast receivers employ the superheterodyne circuit. The more experienced amateurs prefer it. Since a superheterodyne usually contains seven tubes or more, it is too complicated for the novice in radio to build.

The operation of a superheterodyne depends upon changing the frequency of the incoming currents before they are fed into the detector. The frequency change is brought about by heterodyne action, or the setting up of *beats*.

In the superheterodyne, one tube acts as a local oscillator and generates high-frequency currents of a frequency different

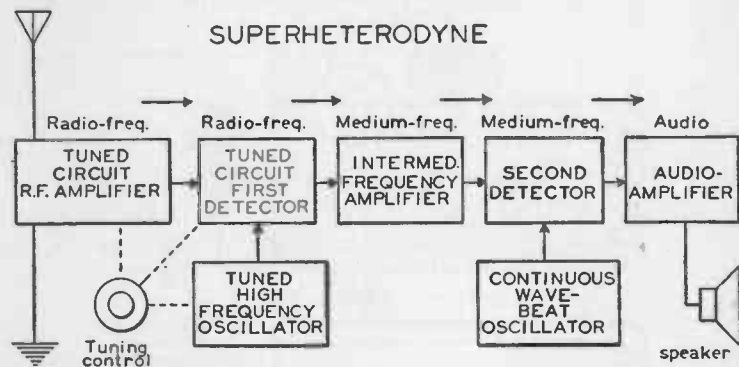

A block diagram of a superheterodyne receiver showing its essential units.

from those of the incoming signal. These local frequencies, produced in the receiver itself, are fed simultaneously with the incoming frequencies (from the antenna) to a detector called the *first detector* or *mixer*. As a result, the output of the first detector then contains not only the two original frequencies but a new beat frequency caused by their interaction. The resulting beat is then amplified by an intermediate-frequency amplifier (called the I. F. amplifier), and again rectified by a second detector.

When it is desirable to make continuous wave telegraph signals audible with a superheterodyne receiver, heterodyne action is again used at the second detector. This is accomplished by a second local oscillator called the C. W. beat oscillator.

Taking the Mystery out of Tuning

IN order to understand how radio circuits work, how and why they are adjusted, and how it is possible for dozens of radio stations to be "on the air" at the same time, it is necessary to become familiar with the very important subject of tuning.

To the engineer or the experienced radio experimenter who understands such terms as *capacitive reactance* and *inductive reactance*, tuning is simple. To the novice such terms means nothing. But by using analogies instead of technical terms, by comparing radio circuits to ropes, pipes, musical instruments, and so on, tuning can be freed of some of its mystery.

AN EXPERIMENT IN TUNING

Let us consider first a rope or a clothes-line hung between two supports about fifty feet apart and see how this rope can be made to behave like an electrical circuit and perhaps explain some of the principles of tuning. It is a simple experiment if you care to try it.

With your forefinger strike the rope a sharp, quick blow near one end. Watch what happens. Some of the energy that

is in your moving finger is given to the rope. The energy travels along the rope to the opposite end in the form of a wave and is reflected back again. The wave runs back and forth along the rope several times, becoming weaker and weaker until its energy is all used up and it disappears. If you could measure accurately the length of time that it takes for the wave to travel from one end of the rope to the other and back, you would find that the time is always the same no matter whether you tap the rope hard or gently.

Now try another experiment. Tighten the rope so that there is less slack and tap it again. The wave will travel from one end of the rope to the other and back more rapidly than it did before. Shortening the rope will produce the same effect. Lengthening or loosening the rope *increases* the time required for the wave to travel back and forth. Tightening or shortening the rope *decreases* the time. Here you have a method of *tuning a rope*.

CHANGING FREQUENCY

A wire which is struck by an electromagnetic wave is exactly like a rope struck by your finger. Energy runs along the wire, but it is not anything that you can see. It is an electric current. It travels along the wire to one end and then reverses its direction. It travels back and forth. *It is an alternating current*. Now a wire can be shortened, or lengthened, or tightened, or loosened just as a rope can. In other words, it can be tuned. If it is either shortened or tightened, the electric currents will run back and forth more rapidly. They will alternate at higher *frequency*. Lengthening and loosening the wire will both produce the opposite effect. They will lower the frequency of the alternating currents.

NATURAL FREQUENCY

The number of little waves that run back and forth along the rope in a second are called the *natural frequency* of the rope. The number of times that an electric current will surge back and forth along a wire *naturally*, that is, without being forced, is the *natural frequency* of the wire. This is not a literal definition of natural frequency as it is understood by a radio engineer but will serve for the time being to give you a conception of the meaning of natural frequency, a much used term in radio. Whenever we tune an electrical circuit we change its natural frequency.

Changing the physical length of a wire, that is, its length in feet and inches, changes its natural frequency. If the wire is an antenna, tightening or loosening it will change its natural period slightly. That is the reason why an antenna which sways in the wind is not desirable. But there are other ways of tightening or loosening a wire besides the mere physical taking in or letting out of slack. It may be *electrically* tightened or loosened, lengthened or shortened, by changing its *inductance* and *capacity*. A wire wound in the form of a coil has a different "tension" and a different "electrical length" than the same wire stretched out straight.

ANOTHER EXPERIMENT IN TUNING

Let us consider the rope again. Suppose for the moment that your finger is an electromagnetic wave carrying energy from a transmitting station and that the rope is the antenna of a radio receiver. Your frequency is five. You tap the rope five times per second. At the first tap the shock runs out along the rope. It reaches the end and is returning when *it meets* the

next outward-traveling shock sent out by the second tap of your finger. One shock cancels the other. Your waves do not have much effect on the rope antenna after the first shock. *The antenna is not in tune with the waves.*

But wait a moment. Suppose that you lengthen, shorten, tighten, or loosen the rope, in other words, *tune the rope*, so that each new outgoing shock set up by the taps of your finger falls in step with the one already traveling back and forth on the rope.

RESONANCE

An electrical engineer would say that the shocks are *in phase* and that the rope is tuned to *resonance* with the incoming waves. Your waves will have quite an effect on the rope antenna. The shocks will roll back and forth, or *oscillate*, without interference.

These same conditions and same events occur in a radio antenna. It is resonance which enables *tuning*—the process which selects the signals of only one radio station from all those which are on the air. In order for the incoming waves to have the most effect in producing currents in the antenna, the antenna must be tuned until it is in *resonance* with the incoming waves. It must be tuned to suit the frequency of the waves coming from the station to which it is desired to listen.

Every receiving antenna includes a small coil which couples or connects it to the receiving apparatus. A coil is also used to couple a transmitter to its antenna. This antenna coupling coil increases the electrical length of the antenna. A condenser placed in series will shorten it. In these two devices is a simple means of lengthening or shortening the electrical length of an

antenna, of bringing it into resonance with the incoming waves. In actual practice that is the way it is done. An adjustable coil, or "impedance," and a variable condenser, or "capaci-

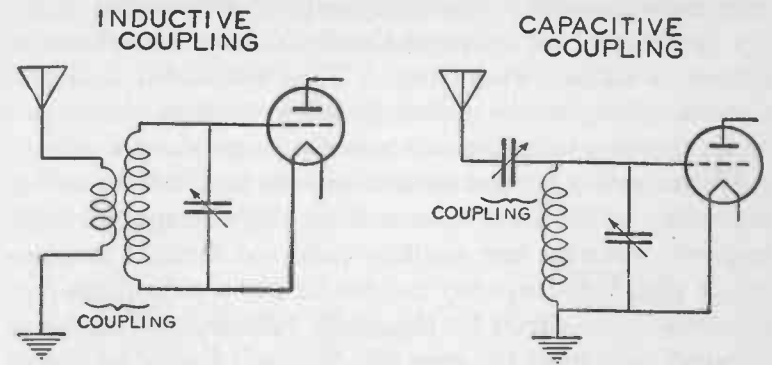

COUPLING

A single resonant circuit is seldom used in radio. It is usually associated with another circuit to which it is connected by coupling. It is by means of coupling that energy is transferred from one circuit to another. The coupling element may be inductance, capacitance, or resistance. Usually it is inductance in the form of a transformer.

The circuit diagrams above illustrate the two methods of coupling the antenna circuit to the input circuit of a receiver. The inductance coupling method employs two coils which are coupled closely together. A small condenser is used as coupling in the capacitive coupling arrangement.

tance," connected to a tuning knob tune the antenna to the desired signals.

One of the first things we learn about electricity is that in order for an electric current to flow in a circuit, the circuit must be complete; there must be two wires forming a loop so as to provide a return path. True enough, but since it is true, how then can an alternating current flow back and forth in a single wire such as an antenna?

Here is the explanation. A single wire, whether it is stretched out straight or in the form of an open coil, has two

remarkable properties. One is its inductance, which is the property that allows it to store up electrical energy in the form of a magnetic field. The other is its capacity, or ability to store up a certain amount of electrical energy by stressing or straining the space about it just as the dielectric in a condenser is stressed or strained when charged. This "distributed capacity," as it is called, is like a tiny invisible condenser connected across the ends of a wire or across the terminals of a coil.

When there is not too much resistance in a wire or coil in proportion to the inductance and distributed capacity, *high-frequency* currents can oscillate back and forth in an open coil or wire. Low-frequency currents or direct current can flow only in an open circuit for the merest infinitesimal fraction of a second, only while the open coil or wire is storing up energy in electromagnetic or electrostatic form.

The antenna circuit is not the only part of a radio station that must be tuned. Other circuits in the transmitter and in the receiver must be adjusted until they are in resonance. The transmitter circuits are tuned to resonance at the frequency at which it is desired to send. The receiving circuits are tuned to resonance with the frequency of the station which it is desired to receive.

TUNED CIRCUITS

All of the tuned circuits *in* a transmitter or a receiver are *closed* circuits. None of them is *open* like an antenna. All of them contain a certain amount of concentrated inductance in the form of a coil and a concentrated capacity in the form of a variable condenser.

There are two types of coil and condenser circuits employed in tuning. One is called a "parallel" tuned circuit and the other

is a "series"-tuned circuit. If you bear in mind what you learned about inductance and the action of condensers in the last chapter, you will understand how "parallel"- and "series"-tuned circuits work. It is useful knowledge. It will make clear to you exactly what happens when you tune your radio apparatus.

It should be remembered that when a source of alternating current is connected across a coil, the coil, because of its self-inductance, will not pass as much current as when an equal direct-current voltage is placed across the coil. The higher the

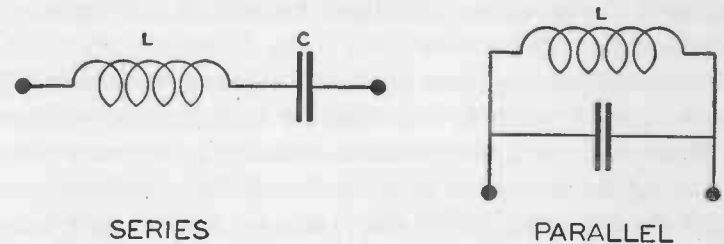

COIL AND CONDENSER ARRANGEMENTS EMPLOYED TO TUNE A CIRCUIT TO RESONANCE

When a source of alternating current is applied to the terminals of either of these arrangements, a certain frequency which depends upon the size of the coil and condenser will cause the maximum current to flow. This is called the resonance frequency. By varying the inductance in the coil and the capacity of the condenser the resonance frequency of the circuits can be varied at will. This is tuning.

frequency of the current the more the inductance will try to prevent its flow. The opposition to the current due to combined effect of frequency and inductance in coils is called *inductive reactance*.

The action of a condenser is just the opposite of an inductance. As frequency increases, more current—not less as in the case of an inductance—flows through a condenser. The opposition offered by the combined effect of frequency and

the capacity of a condenser is called the *capacitive reactance*.

Now let us look at a "parallel" coil-condenser circuit as shown in the illustration. If an alternating current of low frequency is applied to the circuit, practically all of the current will pass through the coil and very little will pass through the condenser. The reason is simple. At low frequencies, the reactance or opposition of the coil is low while that of the condenser is high. However, if an alternating current of high frequency is applied to the circuit, we find conditions reversed. The reactance of the coil is high and the condenser's is low. Practically all of the current will pass through the condenser and very little through the coil.

But somewhere between the low frequency—where all the current goes through the coil—and the high frequency—where it all passes through the condenser—there is a frequency which will cause the reactance of the coil and the condenser to be equal. At this point, called the *resonance frequency*, a maximum amount of current will flow through the circuit. Varying the size of the coil or the capacity of the condenser or tuning will raise or lower the point of resonance frequency.

The opposite effect takes place in a series coil-condenser circuit. In this, the current, in order to flow, must pass through both the coil and condenser. If an alternating current of low frequency is applied to the circuit, the reactance of the condenser will be high and will impede and limit the current. If the frequency is high, the reactance of the coil will be high and limit the current. However, at that frequency, where the reactance of the coil equals the reactance of the condenser, the maximum amount of current will flow. This frequency is also called the *resonance frequency*. If the coils and condensers in the series circuit are exactly like those in the parallel circuit, the resonance frequency will be the same in both cases.

When a circuit containing inductance and capacity is connected to a source of current and adjusted or tuned to the resonant frequency of the coil and condenser combination, the current surges back and forth in the circuit in *oscillation*. Both the coil and the condenser alternately store energy and discharge it back into the circuit.

First the condenser becomes charged and stores up electrostatic energy. Then it discharges through the coil and the energy is built up into a magnetic field about the coil. When substantially all of the energy has been stored in the field, the field starts to collapse and return the energy in the form of an electric current which again charges the condenser, *but in the opposite direction*. Then the sequence is repeated. Remember how the energy ran back and forth along the rope. The current would keep oscillating back and forth in the condenser and coil circuit if it were possible to make wires and coils and condensers without resistance. As it is, the resistance in the circuit causes part of the energy to be dissipated in the form of heat and the oscillations become weaker and weaker, or *damped*, until they die out entirely.

The fact that a coil and condenser circuit can be made to respond best to only one frequency—and if either the coil or condenser is made variable, any resonance frequency can be selected—is the secret of tuning. Tuning, after all, only means adjusting circuits to resonance so that they will give the best response to a desired frequency.

PIEZO-ELECTRICITY AND CRYSTAL-FREQUENCY CONTROL

Clocks, engines, generators, and various machines whose speed must be kept constant are equipped with a governor.

Radio transmitters are provided with a governor to keep the frequency constant. The governor in a radio-transmitting circuit is a "crystal" which controls the frequency by means of its *piezo-electric* action.

Certain crystals such as quartz, Rochelle salt, tourmaline, and cane sugar, when squeezed or compressed, will produce



MOUNTED PIEZO-ELECTRIC CRYSTAL

This is the type of quartz crystal used by amateurs to stabilize the oscillator of their transmitter and so keep the station on the frequency assigned by the Federal Communications Commission. The crystal is mounted in a Bakelite holder which fits in a standard 5-prong tube socket.

electricity. If two opposite edges of a quartz prism are pressed together, one becomes positive and the other negative. The electricity thus produced is called *piezo-electricity* and the crystal is a *piezo-electric* crystal. *Piezo* is a Greek word which means "pressure."

If a piezo-electric crystal is placed between two metal electrodes to which an alternating current is applied, the crystal will vibrate. Different crystals have different *natural* frequencies at which they vibrate. Their natural frequency is determined almost entirely by their mechanical dimensions. This interesting and useful characteristic makes piezo-electric crystals valuable for certain radio purposes. Grinding and mounting quartz crystals is part of the radio industry.



SYMBOL

Although the piece of quartz used is generally called a crystal, it is not a whole crystal but only a section of one cut to certain dimensions and specifications. A more accurate name is quartz plate.

A piezo-electric crystal mounted between metal electrodes is an electro-mechanical vibrator or oscillator and is the equivalent of the circuit illustrated below. It may be used for stabilizing oscillatory circuits or as a radio-frequency filter.

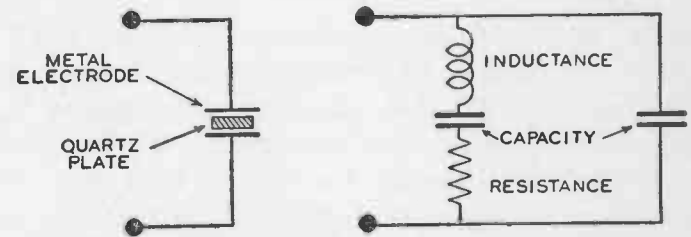

PIEZO-ELECTRIC CRYSTAL OSCILLATOR

A piezo-electric crystal suitably mounted between metal electrodes is an electro-mechanical vibrator or oscillator which is the equivalent of the electrical circuit shown at the right. This circuit consists of a condenser, shunted by an inductance, resistance, and capacity.

A quartz plate, carefully ground to the proper thickness to give it a certain natural frequency, may be used to hold a transmitter on that frequency. Broadcasting and amateur stations are kept on their assigned frequencies by "frequency-control" quartz plates.

Piezo-electric crystals are also used in the construction of microphones and phonograph pick-ups. The elements of a crystal microphone consist of a pair of Rochelle salts crystals cemented together. The crystal is mechanically connected to a diaphragm. Sound waves striking the diaphragm cause the crystal to vibrate mechanically and, due to the varying pres-

tures to which it is thus subjected, to generate a corresponding alternating voltage between its electrodes. This voltage is then fed into an amplifier and used to modulate the carrier wave of a radiophone.

What Your Radio Tube Does

SINCE the radio tube is actually "the heart" of every modern radio transmitter and receiver, it is essential to have a clear knowledge of how it works and what it does, if you wish to understand radio. In appearance a fragile affair constructed of glass and delicate metal parts, a radio tube is in reality a precisely made, rugged instrument—the product of the coördinated efforts of scientists, engineers, and craftsmen. Its use is world-wide. Its construction requires materials from every corner of the earth. Forty different elements enter into its manufacture.

Several interesting things happen inside a radio tube. These can not be witnessed but they can be visualized by the mind. First, it is necessary to know certain facts about electrons which are taught by the science of *physics*.

The radio and electrical arts are both branches of the science of physics. Physics is particularly concerned with the nature of things. In the attempt to explain the nature of what we call matter,* scientists have been able to devise a useful theory which fits all the facts and is now quite generally accepted. It ascribes to matter an electrical nature. The theory is called the *electron* theory.

* Matter is anything that occupies space and has weight. We can not always see matter. Some particles of matter are too small to be seen.

WHAT ARE ELECTRONS?

Are they imaginary things or are they realities? No one has ever seen any. No one has ever seen an electric current, either. But it is real; you can see its effects, the things that it does. So it is with electrons. Although the electrons themselves can not

HELTER-SKELTER

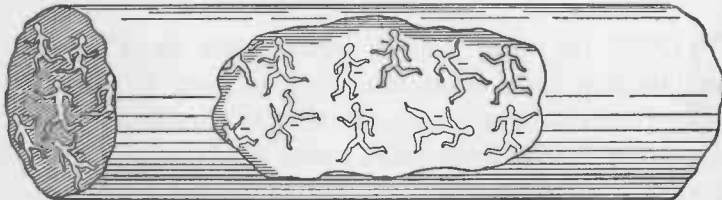

INSIDE A COPPER WIRE

By assuming that the tiny running figures shown in the illustration are electrons, you can better understand the nature of an electric current. If we could look into a copper wire through which no current is flowing and see electrons, we would ordinarily find them moving from atom to atom in such confusion as to make negligible the average motion in any one direction.

be seen, you can see their effects, the things they do. Electrons are probably not mythical, but are real existing things and in many ways the most interesting things we know anything about.

Electrons are tiny particles of *negative* electricity. They can travel at speeds of thousands of miles per second. Each electron is, of course, very small. It is estimated that these invisible bits of electricity weigh only $\frac{1}{46}$ billion, billion, billion, billionth of an ounce.

An electric current is a moving procession of electrons. Millions upon millions of electrons are required to form the current used to heat the filament of a single radio tube.

We are particularly interested in electrons because of the part they play in the workings of a radio tube. Electrons are put to work there. A radio tube is essentially a device to produce electrons and to utilize them.

THE ELECTRICAL NATURE OF MATTER

All substances, whether they be solids, liquids, gases, stars, men, mice, or puppy dogs; all matter—and that means everything in the universe—contain electricity.

All matter in the world is made up of ninety-two fundamental materials known as elements. The elements include

ELECTRON PARADE

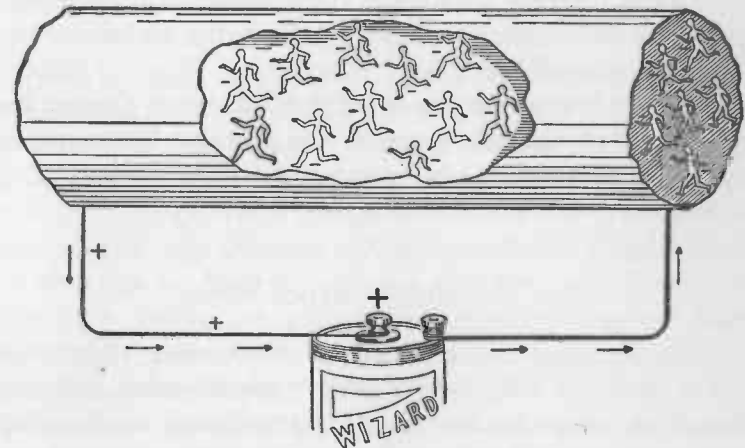

AN ELECTRIC CURRENT

If the ends of a copper wire are connected to the terminals of a battery, the electrons are caused to drift from atom to atom toward the end of the wire connected to the positive-battery terminal. This orderly parade of the electrons is an electric current. The arrows in the illustration show the direction of the current.

such familiar substances as oxygen, hydrogen, copper, gold, carbon, and many rare materials such as radium, yttrium, and helium. Combinations of the elements produce other substances. For example oxygen and hydrogen combined in proper proportion yield water.

The elements are differently arranged groups of tiny particles of positive and negative electricity, respectively protons and electrons. The tiny protons and electrons are constantly moving about. Unseen by our eyes, there is restless motion at ordinary temperatures in all matter. The groups of protons and electrons bump and bang against one another. When they move very fast, some of the electrons break loose. Heat speeds up the motion of electrons. If the temperature of a piece of metal is raised, the electrons moving around in it gain speed. If the metal becomes hot enough to glow, some of the electrons may move fast enough to break through the surface of the metal and jump off into space.

This principle is used in building radio tubes. One of the parts inside of the tube is called the cathode. The cathode, when heated, throws out large quantities of electrons. That is its purpose.

THE DIFFERENT RADIO TUBES

There are many different kinds of radio tubes. They range in size from the tiny "acorn" and "peanut" tubes built for ultra-short waves to the large water-jacketed transmitting tubes (nick-named bottles). The price varies from one dollar to several hundred dollars. One manufacturer makes more than three hundred types. Besides the various sorts of detectors, amplifiers, oscillators, and the like, tubes are divided into groups having such family names as *diode*, *triode*, *tetrode*,

and *pentode*. As soon as you know what these names mean, they will not be so fearsome.

Ordinarily a radio receiving tube consists of a cathode which supplies electrons and one or more additional electrodes which control the flight of the millions of tiny electrons thrown off by the cathode. These parts are enclosed in a sealed glass bulb or metal shell from which all the air has been pumped.

WHAT THE NAMES OF TUBES MEAN

Di, *tri*, *tetr*, and *pent* are from Greek words meaning respectively "two," "three," "four," and "five." *Diode* means "two electrodes," *triode* means "three electrodes," and so on, the name of the tube thus revealing how many electrodes are inside the glass bulb or metal shell.

A diode is a two-element or two-electrode tube with a cathode to supply the electrons and a plate to attract and receive them. Types 80, 5Z3, and 5Z4 are the common diode tubes. Diodes are used most frequently as rectifiers to change alternating into direct current in power-supply circuits or as special detectors. They are an electrical valve in which current can flow only from the cathode to the plate. Another name for this type of diode is *half-wave rectifier*, since current can flow only during one-half of the alternating-current cycle. The No. 81 and 12Z3 tubes used in some broadcast receivers are half-wave rectifiers.

Sometimes *two* plates and one or more cathodes are used in the same tube. This forms a modified diode called a *full-wave rectifier* and delivers a direct current obtained from both halves of the alternating current cycle. The 80, 82, 83 and 5Z3 are examples of this type.

The *triodes*, or three-electrode tubes, interest us most. The

three electrodes inside this type of tube are a *cathode*, a *grid*, and a *plate*. Originally, only the small, lamplike detector which De Forest called the audion, and amateur operators dubbed an "onion," it has developed into one of the most interesting

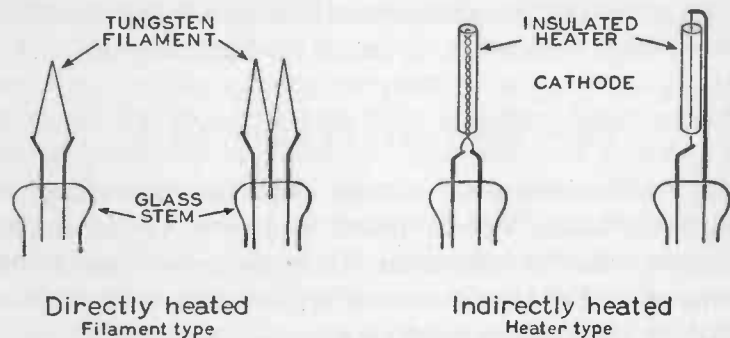

Courtesy of the Radio Corporation of America

TWO KINDS OF CATHODES

The directly heated type of cathode consists of a tungsten filament. The electrons are emitted directly from the filament. A tungsten filament responds very quickly to fluctuations in current and with each fluctuation there is a change in the number of electrons thrown out. The directly heated type of cathode requires direct current. It cannot be used on alternating current without producing a "hum" corresponding to the frequency of the current.

In the indirectly heated or heater-type cathode, the heat is supplied by a tungsten filament but this is surrounded by a chemically treated sleeve which supplies the electrons. The sleeve does not respond quickly to changes in the heat produced by the filament, and so does not produce any hum when the filament is operated on alternating current.

and useful inventions of the twentieth century. It will act as a detector, an amplifier or "increaser" of feeble currents, and as a generator of alternating currents ideal for producing *undamped* Hertzian waves.

WHY A VACUUM IS NECESSARY IN A RADIO TUBE

Since all air is pumped out of the bulb or envelope of a radio tube until the air pressure is only $\frac{1}{100,000,000}$ that of atmospheric pressure at sea level, the activity which occurs inside the tube when it is operating takes place in a vacuum. There are two important reasons for removing the air—to allow free movement of the electrons thrown off from the cathode and to prevent damage to the latter. For the cathode of a radio tube is like the filament of an incandescent lamp in that if it were exposed to the atmosphere while hot, it would burn up. In a vacuum, however, it will glow for a long time without damage.

The simplest form of cathode is a thin wire which, like a lamp filament, becomes heated when a current of electricity passes through it. Some cathodes must be heated to incandescence (white hot) for the best results, while others perform satisfactorily at a dull-red temperature.

THE ACTION INSIDE A RADIO TUBE

But no matter which type of cathode is used in a tube, its action is the same. When it is heated to operating temperature, a sort of invisible vapor or cloud forms in its immediate vicinity. This invisible cloud is made up of free electrons which have broken through the surface of the cathode; it is a swarm of tiny particles of negative electricity. A few of the electrons reach the plate, but most of them normally remain near the cathode.

One of the fundamental laws of electricity is that negative charges of electricity repel negative charges and positive

charges repel positive charges, but positive and negative charges *attract* each other. So, in obedience to this rule, if a positively charged body is placed in the vicinity of the cloud of electrons (negative), an attraction will result. In other words, electrons will move in the direction of the positive charge.

If we apply this knowledge to a radio tube, we will understand the fundamental action which takes place when the tube

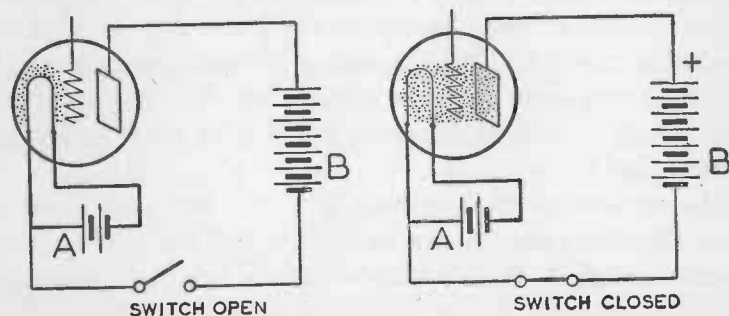

THE ACTION INSIDE A RADIO TUBE

The battery, marked A, heats the cathode and forms a cloud of electrons. The tiny dots clustered around the cathode in the left-hand cut represent electrons. The battery, marked B, is connected to the plate so as to place a positive charge on the latter when the switch is closed. At the right, the switch is shown closed. The plate is positive and electrons move from the cathode through the grid to the plate. This action is explained more fully in the text.

is operating. So, let us see what happens when the plate in a three-electrode tube is charged with positive electricity.

The illustration shows a tube with a battery (marked A) connected so as to heat the cathode and form a cloud of electrons. A second battery (marked B) is connected to the plate so as to place a positive charge on the latter when the switch is closed. When the switch is open and no positive charge is

applied to the plate, no electrons are attracted in that direction; they remain concentrated near the cathode. However, as soon as the switch is closed, the plate becomes positively charged and the electrons are attracted to the plate. They pass readily through the spaces in the grid and flow around through the circuit.

The grid in a radio tube usually consists of a very fine wire mesh or grating, the appearance of which suggests its name. A large portion of the electrons thrown out by the cathode can pass through the spaces in the grid on their way to the plate.

Since a positively charged plate will attract electrons, a grid placed between the cathode and the plate will also attract electrons when a positive charge is placed upon it. Moreover, since the grid is nearer to the cathode than the plate, a positive charge on the grid will have a much greater effect on the electron flow than an equal charge on the plate. In other words, the grid will cause a large number of electrons to flow toward the plate.

If, however, the grid is made negative, it will tend to repel electrons which would otherwise reach the plate. Very few electrons will reach the plate, and only a small amount of current will flow in the plate circuit.

Now, after a lot of explaining, we finally come to what actually happens in a tube when it is used as a detector and amplifier in a radio receiver. Incoming radio signals are of an alternating character, that is, alternately positive and negative. If the grid of a radio tube is connected to an antenna so that incoming signals are impressed upon it, the number of electrons passing from the cathode to the plate will vary in accordance with the signals. So will the current flowing in the plate circuit. Very feeble signal impulses on the grid will

produce relatively large variations in the current of the plate circuit. In this action lies the ability of the three-electrode radio tube to be a detector and to amplify radio signals.

For the purposes of the beginner in radio-set building and experimenting, this information about the inner workings of a radio tube is sufficient. It may not be understood at first, but

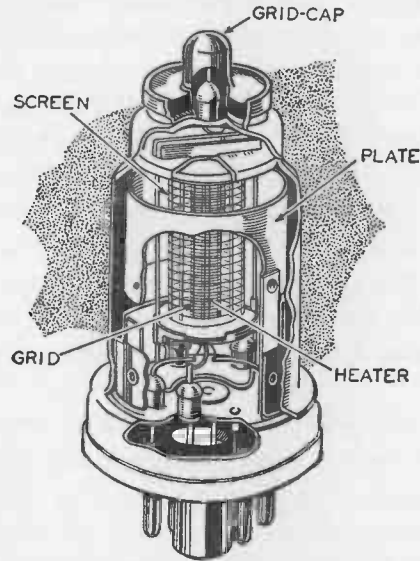

A MODERN VACUUM-TUBE

The modern vacuum-tube used in receiving sets as a detector and amplifier has its elements sealed in a steel "envelope." It may have a filament (cathode) grid and plate like its forerunner, the audion; or it may have as many as six elements. The illustration shows a four-element tube with the steel envelope cut away to reveal the heater, grid, screen-grid, and plate.

if you will patiently go over it several times and try to understand each statement before you go on to the next, you will finally master it.

Remember this much at least: The plate circuit is always

arranged so that the *plate* is *positive*. When a tube is used as a detector, the *antenna* is connected or coupled to the grid.

Now for some simpler facts regarding tubes:

Until about 1935, all radio tubes were manufactured with glass bulbs, or "envelopes" as they are technically called. In that year, tubes enclosed in a special steel shell which took the place of the glass bulb were introduced. The steel shell tends to reduce the hazard of breakage and to provide somewhat better operation because of the elimination of stray noise interference. The shell acts as an efficient shield against undesirable magnetic and electrical influences.

GRID VOLTAGE OR BIAS

Each manufacturer of radio tubes publishes a "Tube Manual" which gives the characteristics of the various types of detectors, amplifiers, and so forth. Since these manuals contain a great deal of useful information, they are well worth having. One of the characteristics given for many types of tubes is grid voltage. For example, under characteristics of the type 27 tube in the *RCA Receiving Tube Manual* you will find a grid voltage of -6 to -21 volts specified for this tube. The grid voltage varies with the plate voltage. You will notice that there is always a minus or negative sign in front of the figure indicating grid voltage.

Another name for grid voltage is *bias voltage* or just plain *bias*.

Bias is always negative and is applied to the grid. Its purpose is to keep the grid negative in respect to the filament. When the grid is properly negative, a tube will give more faithful reproduction, that is, the variations in the plate current will be identical reproductions (on a larger scale, of

course) of the variations in the signal voltages impressed upon the grid.

However, that is only one of the reasons why bias voltage is necessary. The whole explanation is rather complicated and would be confusing to the young radio enthusiast who does not know how to read graphs or curves. The reasons why bias is required can be explained only by the use of curves which show the "operating characteristics" and "operating points."

Some engines are fitted with governors which keep them operating within a narrow range of speed. Bias may be thought of as a sort of governor for a radio tube which keeps the tube operating in a certain range.

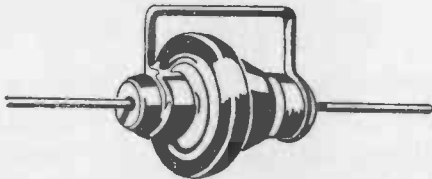

SMALL BIAS CELL

Used to bias first audio-amplifier tube in high-gain amplifiers. Also to furnish initial bias for radio-frequency, intermediate-frequency, and automatic volume-control circuits. Will last indefinitely if not overloaded. Provides 1 to 1¼ volts. Higher voltages are secured by connecting cells in series.

The necessary negative voltage for biasing the grid may be obtained from a separate "C" battery, or from taps on either the plate or cathode current supply. Exact details of bias voltage supply are given in a later chapter.

AMPLIFIERS

It has already been explained that very small amounts of electrical energy fed to the grid of a three-electrode radio tube produce relatively large variations in the plate current. In ad-

dition to their use as detectors, it is possible to employ three-electrode vacuum-tubes as amplifiers or "increasers." The word *amplifier* came from two Latin words which means "one or that which makes ample." A vacuum-tube amplifier is an extremely useful device. It will increase either the voltage, the amperage, or the power of a very small amount of electrical energy.

A radio-amplifier will increase the strength of feeble high-frequency currents generated in the antenna by the radio waves from a far-distant transmitter before they reach the detector; or it will again increase the strength of the signals after they have passed through the detector, adding enough energy to operate a loud speaker.

Because a detector alone does not supply enough energy to operate a loud speaker, without an amplifier it would be necessary to hold a telephone receiver to the ear in order to hear radio signals.

Amplifiers are used in other fields besides radio. They are employed on long-distance telephone lines, in making phonograph recordings, in talking moving pictures, and for a number of purposes outside the scope of this book.

TWO KINDS OF AMPLIFICATION

In radio, it is possible to make use of two kinds of amplification in order to intensify signals. An audio-frequency amplifier, a radio-frequency amplifier, or both, may be used. A radio-frequency amplifier amplifies the signals before they are fed into the detector. An audio-frequency amplifier boosts them after they have passed through the detector.

Both types of amplifier employ vacuum-tubes primarily to increase alternating-current voltages through the action of the

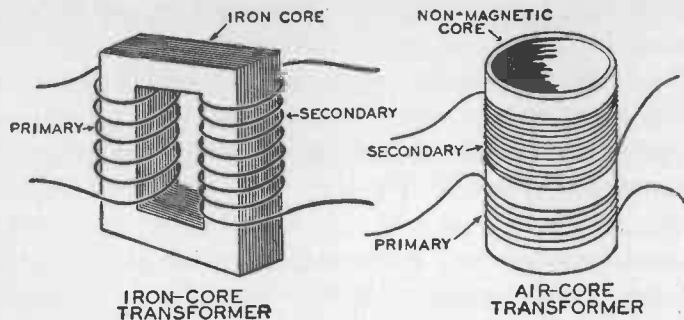

IRON CORES AND AIR CORES

In order to be efficient, transformers for low or audio-frequency currents must have iron cores. Transformers for radio-frequency currents sometimes have iron cores, but in general they consist of a primary and secondary winding upon a tube having an air core.

PUSH-PULL AMPLIFIER

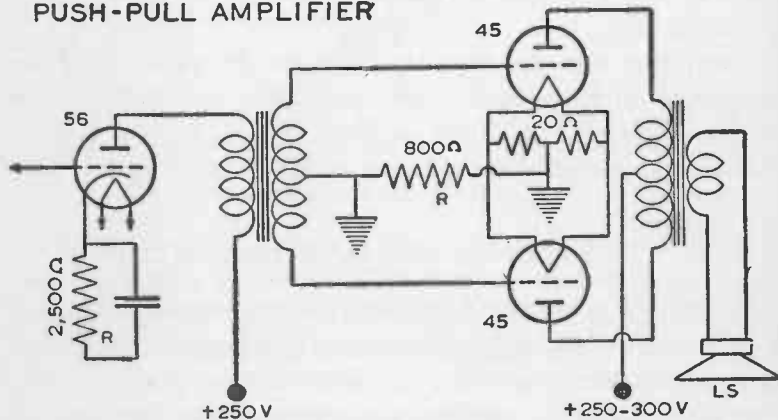

When it is desirable to obtain more power than one tube is capable of giving without distortion, two tubes can be connected together in push-pull. By means of two transformers having "center-taps" the grids and the plates of the two tubes are connected to opposite ends of the circuit. In such a circuit, the plate current of one tube is rising while the plate current of the other is falling.

grid in affecting the plate current. The names of the two types of amplifiers are a clue to the only difference between them. One amplifies low-frequency currents, the other amplifies high-frequency currents. In an audio-frequency transformer, the rate at which the current alternates varies between approximately 16 and 16,000 cycles per second, while in a radio-frequency amplifier, the currents may alternate from 20,000 to 60,000,000 or more times per second.

TRANSFORMER COUPLING

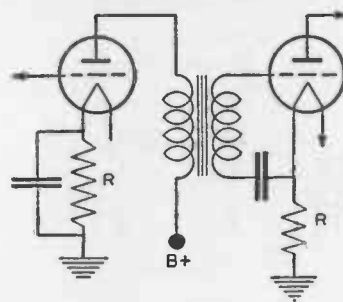

RESISTANCE COUPLING

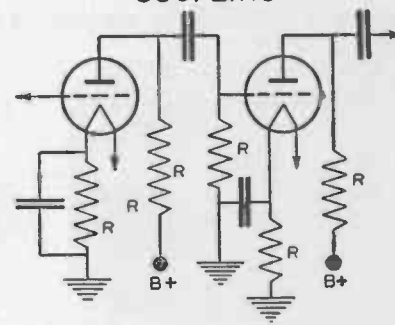

COMMON AUDIO-FREQUENCY INTERSTAGE COUPLING METHODS

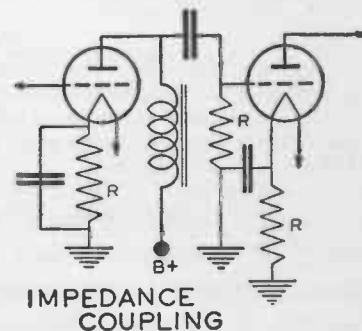

An amplifier may have more than one stage, that is, one amplifier may be used to increase the output of another. The means of transferring the output of one amplifier into the input circuit of another is termed *coupling*. Three common methods of coupling are shown above.

In the radio-frequency amplifiers used in receiving sets, it is generally the *voltage* of the energy forming the signal which is amplified. This is true also of the audio-frequency amplifier of a receiving set, except that when there is more than one stage, the amplification which takes place in the final stage is generally one of power or energy.

AMPLIFYING TRANSFORMERS

There are three different methods of "coupling" or connecting one amplifier to another or to a detector. One uses trans-

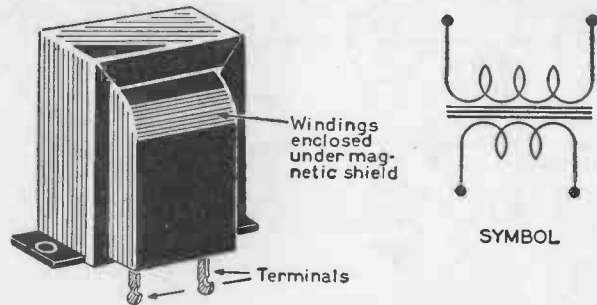

AUDIO-FREQUENCY TRANSFORMER

An audio-frequency transformer consists usually of two windings, a primary and a secondary, wound on an iron core. The secondary contains from 1½ to 3 times as many turns as the primary. The transformer may or may not be enclosed in a magnetic shield.

formers, one resistance units, and the other condensers or capacity. The capacity method is seldom used, the resistance method occasionally, and the transformer method generally.

Because of the great difference in the frequency of the currents passing through a radio-frequency amplifier and an audio-frequency amplifier, the coupling transformers used with these two types of amplifiers are quite different in construction.

There is also another reason for the considerable difference in design. An audio-frequency amplifier is an untuned or non-resonant circuit. On the other hand, a radio-frequency amplifier is usually associated with resonant circuits which may be

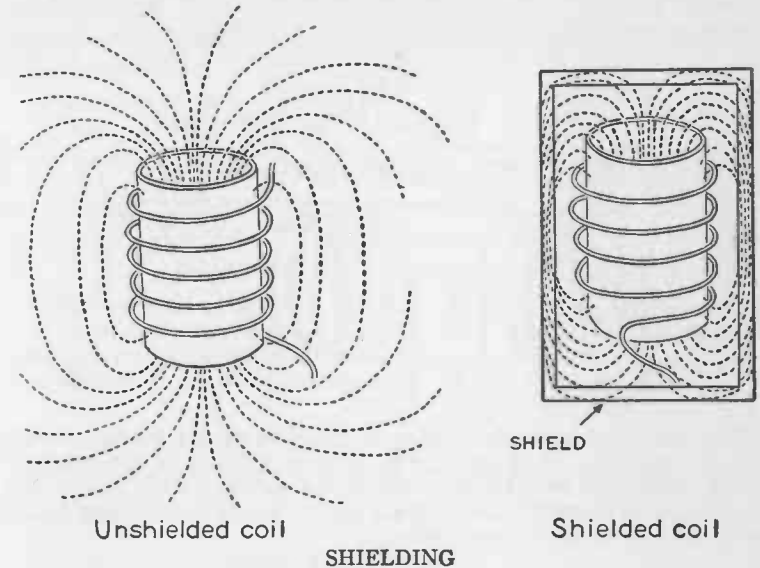

The currents induced in a wire or a coil by a neighboring wire or coil carrying a current are often objectionable in a radio circuit. The effect may be minimized by shielding. Enclosing a coil or a wire in an iron shell shields it magnetically. The lines of magnetic force are bent by the iron shield and do not curve out into space.

Coils and wires may be shielded electrostatically by enclosing in a metal shell or screen. The lines of electrostatic stress or strain are bent by the metal, and do not extend out into space.

tuned so as to respond most efficiently to some desired wavelength.

An audio-frequency transformer usually consists of an iron core upon which is wound a primary of fine wire. On top of this, a secondary of approximately three times as many turns

of fine wire is wound. Therefore an audio-frequency transformer is usually a step-up transformer, and the current delivered by the secondary has a higher voltage than the current fed into the primary.

Radio-frequency transformers sometimes have an iron core; but in general they consist of a primary and secondary wound

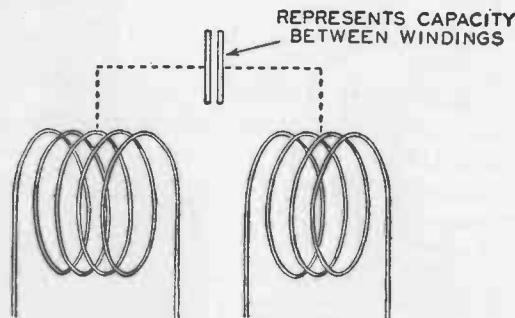

The primary and secondary windings of a transformer act like the coatings of a condenser to a small extent. This effect is negligible in low-frequency circuits but it must be taken into consideration in many radio circuits. The effect in a radio circuit is the same as if a small condenser (as indicated by the dotted lines) connected the two windings.

upon a tube of insulating material having an air core. They are enclosed in a metal "can" or shield to protect them from magnetism as well as to prevent their own magnetic field from "straying" into other coils and wires.

The primary and secondary windings of a transformer act, to a certain extent, like the conducting coatings of a condenser. Therefore in a radio-frequency transformer there is an "invisible condenser" or capacity (shown by dotted lines in the diagram), which connects or couples the windings. The magnetic coupling is consequently not the only coupling which exists between the primary and secondary. The capacity

coupling is a very important part of the coupling in practically all transformers operating at frequencies above 400,000 cycles.

Receivers, for home use in listening to broadcast programs, which employ several tubes and consequently have more than

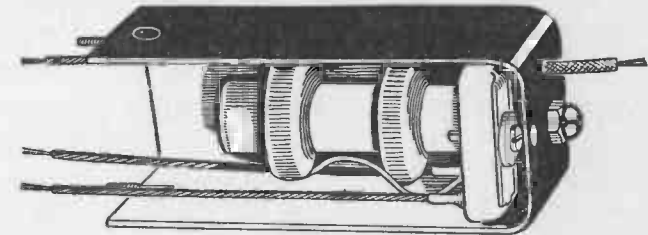

RADIO-FREQUENCY TRANSFORMER

A radio-frequency transformer sometimes has an iron core, but usually has an air core and is enclosed in a magnetic shield. The transformer illustrated above is shown with the front of the shield cut away so as to expose the windings and the trimmer condenser inside.

one tuned circuit, usually have a single dial control. Turning a single knob simultaneously tunes several circuits. This is done to make the receiver simple for the average person to use.

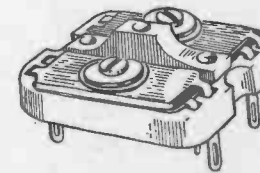

SYMBOL

A TRIMMER CONDENSER

The capacity can be changed by adjusting with a screwdriver. A trimmer condenser is a small adjustable condenser used principally in aligning radio-frequency transformers.

In order to make such receivers possible, it is necessary for the manufacturer to produce tuning condensers with several individual condenser sections on one shaft. At any point in the

VOLUME CONTROL

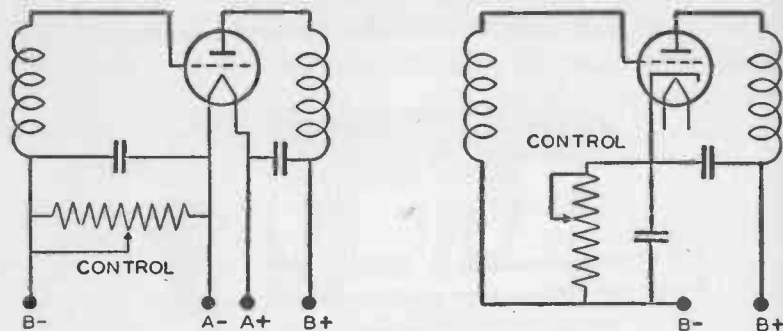

GRID-VOLTAGE VARIATION

A convenient and frequently used method for controlling receiver volume is to vary the grid voltage in the radio-frequency amplifier. The variable voltage supplied to the grid is usually obtained from a bleeder circuit by means of a potentiometer. The diagrams above show how to obtain volume control by varying the grid voltage with a potentiometer. The circuit at the left shows a directly heated (filament-type cathode) three-element tube. The tube in the circuit at the right is a three-element tube with a heater-type cathode.

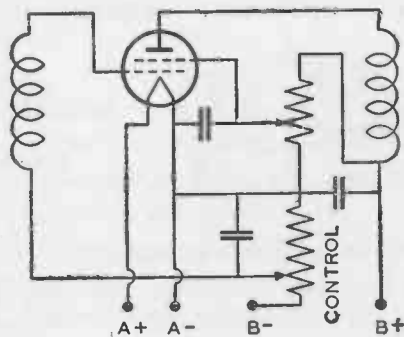

VOLUME CONTROL

This circuit shows how receiver volume may be controlled in the radio-frequency amplifier stage when a screen grid type of tube is used. The potentiometer marked "control" in the lower part of the circuit varies the grid voltage and consequently the volume.

rotation of the shaft, the several sections of the condenser are practically identical in capacity.

In order, however, to make the condensers and their coils all respond or tune to the same frequency at the same time (in the language of the radio man such circuits are said to "track") a certain amount of adjustment is necessary. This is called *alignment* and is accomplished by means of "trimmer" condensers with which certain types of radio-frequency transformers are fitted.

A trimmer condenser is a very small adjustable fixed condenser whose capacity can be altered with a screwdriver. The work of aligning a receiving set by adjusting the trimmer condensers requires skill and experience. None of the receivers described later in this book require alignment or make use of trimmer condensers. The subject has been mentioned because the novice who retains his interest in radio will eventually hear both these terms, or see them in print.

VOLUME CONTROL

Varying the grid voltage in the radio-frequency amplifier by means of a potentiometer or a variable resistance is a frequently used method for controlling receiver volume.

Another method is to connect a $\frac{1}{2}$ megohm potentiometer or "volume control" across the secondary of the input transformer of the audio-frequency amplifier.

About Antennas

THE IMPORTANCE OF THE ANTENNA

ONE of the most important parts of any radio station, transmitting or receiving, is the antenna. It is this part of the equipment which at the transmitting station radiates energy into space and at the receiving station intercepts the incoming waves.

A transmitter may send as much as 50 kilowatts of energy into its antenna. The antenna for such a station is necessarily large. Any transmitting antenna, either large or small, must be well designed and engineered in order to be efficient. Those used for sending out transatlantic radio-telephone messages are elaborate.

The amount of energy which reaches a receiving antenna is infinitesimal, probably only a few billionths of a watt. For that reason it is important for a receiving antenna to be erected so that it will collect and conserve as much energy as possible. The more energy picked up and fed to the receiver, the louder will be the signals.

A SIMPLE ANTENNA FOR THE NOVICE

The simplest form of antenna is a single horizontal wire having a "lead-in" wire connected to one end. This form of

antenna, if of proper length, is equally good for receiving or for transmitting *low power* except in the case of ultra-short waves. By ultra-short waves is meant waves of less than ten meters or frequencies of 30,000 kilocycles or more. All sorts of "fancy rigs" are used by amateurs such as the antennas

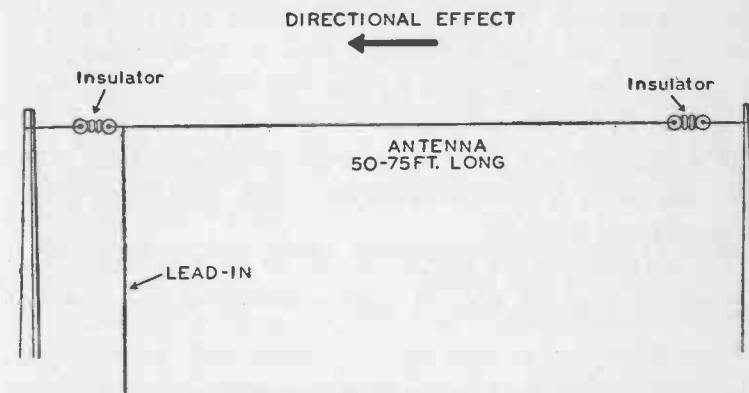

A SIMPLE ANTENNA FOR THE NOVICE

A single horizontal wire, insulated at both ends, is equally good for receiving or for transmitting low power except in the case of ultra-short waves.

called "cages," "arrays," and "doublets," but it requires some one more expert than the novice to erect one of these so that it will be any better than a single wire of proper length.

The ideal antenna is one carefully designed to transmit or receive a certain wave-length, and used only for waves of that particular length. Such is possible in the case of commercial stations, but an amateur is interested in a wide range of wave-lengths. Since it would not be practical for a station to have a separate antenna for each wave-length in the amateur and broadcast bands, the young experimenter must choose one which will respond to a wide range of wave-lengths, even

though it does not collect the maximum amount of energy from any of them.

For receiving, this is a wire 50-75 feet long, properly insulated and as high and clear of surrounding objects as possible. A height of 30-50 feet is desirable. The best supports for an antenna are two rigid poles, but it is not always that such an ideal arrangement is possible. Trees are not desirable because they sway in the wind. When they must be used, remember to let the antenna hang slack so that the branches can move without straining the antenna.

It is important to keep the antenna wire away from chimneys, tin roofs, gutters, drain-pipes, walls, telephones, power wires and tree branches.

The antenna and the lead-in should be one continuous piece of wire. If they are not, all connections should be carefully



PYREX GLASS ANTENNA INSULATOR

The short length ($3\frac{5}{8}$ in.) is used on receiving antennas and antennas for low-power transmitters. The medium length ($7\frac{1}{2}$ in.) is for antennas used with $\frac{1}{4}$ kilowatt transmitters.

soldered. Use stranded copper antenna wire, obtainable at any radio store.

Put at least one 3-inch glass antenna insulator at each end of a receiving antenna. Insulation for a transmitting antenna should be glass, or preferably glazed porcelain or isolantite. The insulation at the end of a transmitting antenna should be 8 to 12 inches in length.

THE DIRECTIONAL EFFECTS OF AN ANTENNA

A burning candle will throw its light equally in all directions, but if a suitable reflector is placed behind the candle, the light may be concentrated in a beam. Likewise, a vertical antenna, that is, a single perpendicular wire, radiates its waves equally in all directions, but by using an antenna system employing reflectors, the waves may be concentrated in a beam.

The high-powered long-distance short-wave stations which send signals half-way around the world, and aircraft beacon systems, use antennas called "arrays" which send out waves concentrated in a beam.

All antennas, except the vertical type consisting of a single perpendicular wire, have what is known as a *directional* effect. This means that they transmit and receive signals better in one direction than others. In the case of a horizontal wire, it will both transmit and receive best in a direction opposite to that in which the free end points. The free end is the one opposite to that to which the lead-in is attached. The antenna shown on page 149 will transmit to and receive from, most efficiently, stations lying in the direction to which the arrow points.

If you have a choice and can arrange your antenna to point in any direction, erect it so that its directional effect will be an advantage.

AN ANTENNA ON AN APARTMENT HOUSE

In cities, an antenna brings many problems not encountered in the country. Telephone wires running over the roofs, other antennas close by, steel-frame buildings, and man-made static are a few. Preferably, the antenna on an apartment house or city dwelling should be supported from two wooden poles at

least ten feet above the roof. It should be erected, if possible, at right angles to neighboring wires or antennas.

VERTICAL ANTENNAS

Where lack of space makes it necessary, a vertical antenna may be used. These are telescoping tubular metal masts made of steel, brass, or duralumin. The length varies from 12 to 24 feet and the mast is self-supporting, requiring no guy wires. The metal base is adjustable to any angle for mounting either on the roof or the side of a house. Ordinary lead-in wire may be run from the bottom of the aerial to the receiver. A lightning arrester is built into the base.

THE LEAD-IN

The lead-in from a single-wire horizontal antenna should be of the same sort of wire as the antenna. It should not approach the side of a building closer than six inches except at the point where it enters. The best method of bringing the lead-in into a building without causing leakage of energy is to pass it through a porcelain tube set in the wall or window frame. This is not always possible, and as an alternative an antenna lead-in strip may be used. This is a strip of copper insulated with waterproof lacquered webbing and is thin enough so that it may be laid on the window-sill and the window will close down on it.

THE GROUND

In towns and cities a good ground connection can be made to water-pipes where they enter the building. The second choice is a ground connection made to water-pipes inside the building or to a steam radiator. A ground on a steam radiator

will not always prove to be satisfactory. The pipes should be scraped clean and a firm, low-resistance connection made with a tightly fastened ground clamp. If no water-pipes are available, several galvanized iron pipes or ground rods six feet

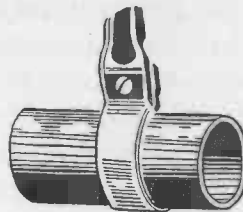

Pipe strip

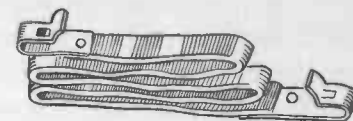

Lead-in strip

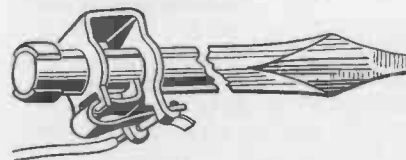

Ground-rod



Ground clamp

ANTENNA AND GROUND CONNECTION EQUIPMENT

long should be driven into the earth five or six feet apart and all connected together.

This type of ground will not prove satisfactory in dry or sandy soil and in that case a counterpoise will be necessary. A counterpoise is described later in this chapter.

DOES AN ANTENNA ATTRACT LIGHTNING?

The ordinary amateur antenna is usually comparatively close to the ground and does not attract lightning. Conse-

quently there is no more chance that lightning will strike your home if it has an antenna than there would be if it had none.

However, if lightning strikes in the vicinity, an antenna may pick up a considerable electrical charge which will damage radio apparatus. The National Board of Fire Insurance Underwriters requires that an antenna erected on insured property be protected by a suitable lightning arrester. An antenna without a lightning arrester is a violation of the Fire Insurance Code which can render an insurance policy worthless.

Some states and cities have adopted the National Code or have a strict code of their own which is enforced by inspectors.



LIGHTNING ARRESTERS

Inexpensive devices which should be connected to the antenna of every radio receiver on the outside of the building where the lead-in enters.

Before making installation of a radio transmitter it is well to find out if the equipment and wiring is subject to local laws. In any event, the installation should comply with the National Code. Any insurance broker will be glad to obtain a copy of the National Fire Insurance Electrical Code for you. The nearest radio shop will be able to advise you whether or not there are local or state requirements.

If a receiving set is operated from the lighting circuit, the wiring must comply with the national Electric Code. It is necessary to provide a lightning arrester.

A lightning arrester for the antenna of a radio receiver is an inexpensive device placed on the outside of the building where the lead-in enters. It is usually a small spark-gap sealed

in a vacuum so that the gap can be jumped by a charge of low voltage. One side of the arrester is connected to the lead-in, the other to the ground. This provides a path for the charge to pass harmlessly into the ground. A ground rod, for driving into the ground and connecting to the lightning arrester, is obtainable at a radio shop at small cost. It is a copper-plated steel rod four to six feet long, fitted with a connecting clamp.

A useful booklet called *Safety Rules for Radio Installations* may be obtained by sending ten cents (no stamps) to the Superintendent of Documents, Government Printing Office, Washington, D. C.

The small lightning arresters intended for receiving antennas are unsatisfactory for a transmitter. The antenna currents generated by a transmitter have sufficient potential to jump across the short gap in an ordinary lightning arrester and pass into the ground. To protect a transmitting station, a 100-ampere, 600-volt, single-pole, double-throw switch should be installed on the outside of the building close to the window where the lead-in enters. The switch should have an asbestos-board or bakelite base. Slate will not provide sufficient insulation for the transmitting current. The aerial should be connected to the knife or blade terminal. The lead-in is connected to one of the contacts and a No. 4 B.S. gage wire leading to the ground to the other contact. When the station is in operation, the switch is thrown so as to connect the antenna to the lead-in. At all other times, the switch is thrown so that the antenna is grounded.

INDOOR ANTENNAS

Because modern radio-frequency amplifier and detector tubes are highly sensitive, a large antenna is not always necessary for picking up signals. An indoor wire from 5 to 25 feet long

will often produce signals of good strength. Many amateurs use such an antenna.

The principal disadvantage of an indoor antenna is that it is entirely in the area where man-made static and stray noises originate. The volume of noise that it picks up may be large in proportion to the radio signals.

The various antenna eliminators, "spring," "window," and "under the rug" antennas, and other such devices, are worthless. An indoor antenna should be a copper wire running straight up from the receiver and then horizontally in a straight line. In other words, an indoor antenna should be an inverted "L" type. Often it can be concealed behind picture molding.

LOOP ANTENNA

Loop antennas are particularly used in direction finding both for ships at sea and for airplanes. They are also employed in portable sets.

A loop antenna is simply a coil of wire. The terminals of the loop are connected to a receiver in place of the usual antenna and ground. Some are circular in shape, others are in the form of a rectangle or square. Radio waves, reaching the loop, induce therein high-frequency alternating currents exactly as they do in the ordinary antenna. When used for direction finding, the loop is generally enclosed in a metal shield (except a short section).

A coil or loop antenna is highly directive. The signals from a distant station are of maximum strength when the plane of the loop is parallel to the line of direction taken by the signals. The signals are zero or weakest when the plane of the loop is at right angles to the line of direction from which the signals are coming.

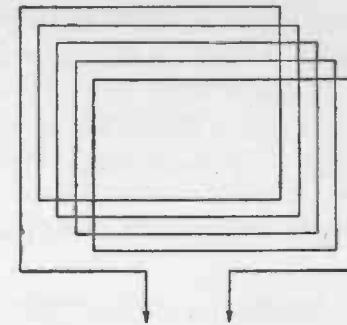

LOOP ANTENNA

A loop antenna is simply a coil of wire. Loops are employed in portable receivers and in radio direction finders. The signals from a distant station are of maximum intensity when the plane of the loop is parallel to the line of direction of the signals.

The efficiency of loop antennas is very low and they are used generally only for the special purposes already mentioned, direction finding and portable sets.

DOUBLET RECEIVING ANTENNA

Unquestionably it improves the operation of a receiver to have the antenna outside a building, and so away from the noise zone surrounding power and light wiring.

There is a disadvantage in the Marconi * type antenna. The lead-in picks up as well as the antenna. Even though the antenna is placed above the field of noises radiated by wiring, and so on, inside a building, the lead-in enters the zone where man-made static is prevalent, and it picks up noises which it feeds to the receiver. However, by using a radio-frequency transmission line to bring the signal from the antenna to the receiver, comparatively noise-free reception can be accom-

* For explanation of Marconi and Hertz antennas refer to Chapter XIV.

plished. A non-radiating transmission line picks up very little energy, and so can pass through the noise area without absorbing much interference.

In general, a good antenna for broadcast reception may not prove most satisfactory for short waves. On the other hand,

DOUBLET RECEIVING ANTENNA

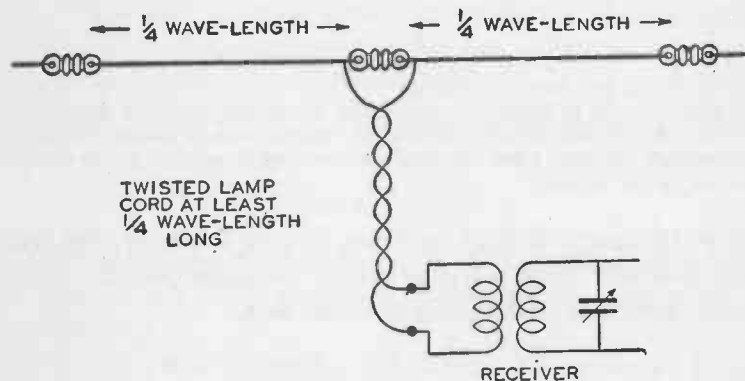

COMPARATIVELY NOISE FREE

This type of antenna gives excellent short-wave reception and satisfactory results on broadcast wave-lengths. Comparatively noise-free reception may be secured because the lead-in (twisted lamp cord) picks up very little energy. This type of lead-in is called a non-radiating transmission line. In order to secure noise-free reception the antenna must be elevated above the field of disturbances caused by wiring, electric refrigerators, and so on, inside the building.

an antenna which is suitable for short waves will give good broadcast reception.

A doublet or dipole antenna with a transposed or twisted "noise eliminating" transmission line leading to the receiver will give excellent short-wave reception and satisfactory results in picking up broadcasting.

A doublet is a Hertz* antenna divided into two equal sections or dipoles by an insulator. Each half of the antenna should be a quarter-wave long for the frequency band most used.

The transmission line may be ordinary twisted lamp cord, and may be of any convenient length provided it is at least a quarter of a wave-length long. The lower end of the antenna terminates in the antenna coil of the receiver.

THE "DOUBLE-DOUBLET"

There are many excellent types of short-wave receiving antennas available in kit form at reasonable prices. These are sold under various trade names such as "spider web," "double-doublet," "V-doublet," and "wave-master" antennas. They provide good reception over the entire broadcast and short-wave bands.

* For explanation of Marconi and Hertz antennas refer to Chapter XIV.

CHAPTER IX

Learning to Telegraph and Obtaining a License

NO LICENSE IS REQUIRED FOR A RADIO RECEIVER

NO license or permit of any sort is required to operate a radio receiving set.

However, there is a Federal law that no one can own or operate a *radio transmitter* without a license from the United States Government. All laws and regulations regarding radio are administered by the Federal Communications Commission in Washington, D. C. There are no state laws governing the operation of radio apparatus. The state or town where you live can not make laws regulating radio.

To own and operate an amateur radio transmitting station in the United States, it is necessary to have two licenses. For the transmitting equipment itself, a station license is required. For the operator, an operator's license is necessary. Heavy penalties are provided for operating an unlicensed station or operating without an operator's license—a maximum of two years in jail and a fine of \$10,000. No fee is required to obtain either form of license. It is necessary merely to pass a simple examination in elementary radio theory, the radio regulations and telegraph code.

There are many cities in the United States, one in Hawaii, and one in Porto Rico where examinations are held. Of these,

22 are district offices of the inspection division of the Federal Communications Commission. Examinations are given at these district offices once or twice a week. A list of them appears at the back of this book. Examinations are held occasionally in the following cities:

Albuquerque, N. M.	Nashville, Tenn.
Billings, Mont.	Oklahoma City, Okla.
Bismarck, N. D.	Phoenix, Ariz.
Boise, Idaho	Pittsburgh, Pa.
Butte, Mont.	Salt Lake City, Utah
Cincinnati, O.	San Antonio, Texas
Cleveland, O.	Schenectady, N. Y.
Columbus, O.	Spokane, Wash.
Jacksonville, Fla.	St. Louis, Mo.
Little Rock, Ark.	Winston-Salem, N. C.

Three classes of amateur licenses are issued, called respectively Class A, B, and C. Class A is the advanced grade. Classes B and C are beginners' licenses, identical in the privileges they grant but awarded under different circumstances. Class B licenses are issued only when the license examination has been taken in the presence of a radio inspector. Class C is issued to those who pass a mail examination.

Any of these three licenses will give you the right to communicate from your own home, on apparatus which you may build yourself or buy, with other amateurs similarly equipped. You may equip your station with a radio telephone, a radio-telegraph, or both. With experience and the proper equipment, you will be able to communicate with other amateurs all over the world.

Any one who wishes to obtain a Class A or B operator's license and who lives within 125 miles *airline* of an office of the Commission or a point where examinations are held, must travel to that point and take the examination there. Persons

who live more than 125 miles, airline, from an examining point may take the examinations by mail under the supervision of a licensed operator. In this event a Class C license will be issued. No one is obliged to qualify for a Class B just because he lives within 125 miles of an examination point. If travel is inconvenient, application may be made for a Class C license.

If application is made for a Class C amateur operator's license, the radio inspector in the district in which you live will send you Form 610, an instruction sheet and *sealed* envelop containing a set of examination questions. You must arrange to have a licensed operator give you a code test, and fill out and swear to a statement of your code speed before a notary public. If your code test is passed successfully, you may have an examiner-witness open the sealed examination questions and hand them to you. You proceed to answer the ten questions in the spaces provided. Your witness must remain present while you answer the questions and sign and swear to a statement that he opened the envelope and that you wrote the answers without any assistance whatsoever.

In either event, whether you take an examination by mail or travel to the examination office, the first step is to write to the Radio Inspector at the office listed at the back of this book which is nearest your home. Ask for an application blank for an amateur station and operator license, and for the date when examinations will be held if you are to appear personally. Fill out the application blank and mail it back to the inspector's office.

Neither the code test nor the written examination in simple radio theory and the essential parts of the radio laws and regulations is difficult. Tens of thousands of amateurs, many of whom were boys and girls, have passed them.* Coaching

* Boys of 10 and 12 have become licensed amateurs.

and preparing for the written examination is beyond the scope of this book. To pass the examination, it is necessary to have a general knowledge of radio principles. This does not mean an engineering training in the subject. Whatever you learn from these pages will be a great help. The information given here about radio and electrical principles is a sound basis upon which to build a more extensive knowledge. It will enable you to understand a standard radio text.

Assembling your own receiving sets, practicing the code, reading magazines and books dealing with radio will give you the skill and knowledge required to obtain a license for your station and for yourself as an operator. That is, it will if you undertake your new hobby in the spirit of finding out the "why" of everything as you proceed.

BECOMING A RADIO TELEGRAPH OPERATOR

Learning to send and receive telegraph signals is not at all difficult. It is mostly a matter of practice, and actually requires only a small amount of mental effort.

MEMORIZING THE CODE

The first step is to memorize the alphabet so that each character can be instantly called to mind at will. As is the case with many things, there is a right and a wrong way of doing this. Although the different characters are represented by dots and dashes, it will help if you think of them as sounds. A dot represents the sound *dit* and a dash the same *dah*. Think of *A* as the sound *dit-dah* and not as a dot and a dash. The letter *B* is *dah-dit-dit-dit*, not dash-dot-dot-dot. And so on

THE CONTINENTAL CODE

A	B	C	D	E	F
G	H	I	J	K	
L	M	N	O	P	
Q	R	S	T	U	
V	W	X	Y	Z	
1	2	3			
4	5	6	7		
8	9	0			
Call	Finish				
Period	Interrogation	Break			
Wait	End of message	End of transmission			
Received	Go ahead	Comma			

through the alphabet. The *dit-dah* sound is a close imitation of the actual sound of the letters as radio signals.

Some of the characters of the telegraph alphabet consist entirely of *dit* sounds. Some are entirely *dahs*. Others are combinations of *dit* and *dah*. Start by memorizing the letters of the alphabet. Disregard the numerals and punctuation marks at first. There are two systems of memorizing. One is to study the first four or five letters, then the next four or five, and so on. Notice that some letters are the reverse of others.

The other method is to arrange the letters in "memory groups," all the *dits* together, all the *dahs*, all the reverse letters, and so forth, as shown below.

When the letters of the alphabet have been memorized, learn

MEMORIZING GROUPS

E	T	K
I	M	X
S	O	C
H		Y
		Q
A	N	G
W	D	Z
J	B	P
R	U	
F	V	
L		

There are two systems of memorizing the telegraph alphabet or code. One is to study the first four or five letters, then the next four or five, and so on. The other is to study the characters, arranged in memory groups, as shown above.

the numerals. Notice that the numerals from 5 to 9 are the reverse of those from 1 to 4. Since they follow a definite system, you will probably store these away in your mind very quickly.

Only the first eight of the punctuation marks are important enough to memorize at first. You can acquire the others gradually after you have become an operator.

"LISTENING IN"

If you build a receiver which will cover the amateur wavelength bands, you will be able to get "on the air" and listen to actual radio telegraph signals.

Memorizing the code can be done while you are building your receiver. The operators of the commercial stations and most of the amateurs send too fast for you to read at first. But some of the amateurs send slowly enough so that you will be able to recognize letters now and then, and perhaps a whole word occasionally. Write down every letter or word that you can pick out, even if it is only an occasional one. Amateur radio operators are prone to use slang and abbreviations that will make their messages sound like gibberish to you at first.

The first letters that you are able to identify by listening-in will probably be the dot letters, *E*, *I*, *S*, and *H* and the letters *M*, *O* and *R*. The call signals identifying the station called and the calling station are usually repeated once or twice and so may be more easily identified by the beginner than characters that are heard only once.

CALL LETTERS

The United States Government assigns calls prefixed with the letter *W* to stations in this country and with *K* in United

States possessions. A letter and a numeral indicating the radio district where the station is located follow the prefix. Callbooks are published listing the calls of all the amateur stations in the United States and foreign countries, so that you can locate the stations that you hear.

It is amateur practice to call a station by sending the signal of the station called two or three times, followed by the letters *DE* and the signal of the station calling, thus:

W8CMP W8CMP W8CMP DE W8KKG W8KKG W8KKG

If station W8CMP hears station W8KKG and cares to answer, he would probably reply:

W8KKG DE W8CMP GE OM GA K

The abbreviations mean, "Good evening, old man, go ahead." The letter *K* is an invitation to transmit, used when answering or at the end of each transmission.

A signal which is frequently heard in the amateur band, and which you should be able to identify soon after you have started listening, is a series of *V*'s followed by the call signal of the transmitting station at frequent intervals. This is the testing signal sent while adjusting a transmitter or at the request of another station to enable the latter to adjust its receiver.

LEARNING TO SEND

Learning to send telegraph signals also helps in learning to receive them. Since you can not operate a transmitter without a license and you can not obtain a license until you have passed an examination in code sending and receiving, radio regulations, and elementary theory, your transmitting practice will have to be done with a key and buzzer.

Buy a telegraph key, a radio buzzer, and one or two dry cells. Connect them in series so that pressing the key will operate the buzzer. A radio buzzer is made so that it vibrates with a high-pitched sound similar to a radio signal. The telegraph key should be, if possible, the one which you will use later to operate your transmitting set when you build it.

Learn at the start to hold the key properly. Let the hand rest lightly on the key knob. Do not hold it tightly or jerky

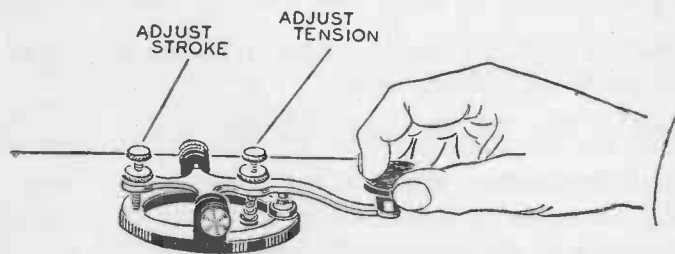

HOW TO HOLD A TELEGRAPH KEY

The thumb should be against the left side of the knob, and the first and second fingers should be partly on top and partly on the right side. The forearm should rest upon the table.

sending will result. The thumb should be against the left side of the knob and the first and second fingers should be partly on top and partly on the right side. Do not "tap," as the newspaper reporters and story-writers say. A telegraph operator never "taps." An operator's thumb and fingers never leave the key knob until he is through sending.

The key should be mounted on a table or "operating bench," far enough back from the edge so that there is room for the forearm to rest. Don't think about speed at first. That comes with practice. Keep your rate of sending down to that of your receiving; and take time to send slow, even, clean-cut signals.

A CODE-PRACTICE SET

You can arrange a code-practice set which will give a fairly good imitation of radio signals by adding a .001 mfd. fixed condenser and a pair of head-phones to the key and buzzer. The circuit is shown near-by. If the signals in the phones are too loud, they may be reduced by using a condenser of smaller capacity.

If you can get the assistance of an experienced operator to criticize and coach your sending, you will be in luck and will

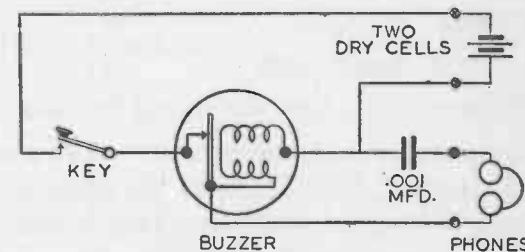

CODE-PRACTICE SET

When the telegraph code has been memorized, practice sending and receiving with a key and buzzer arranged as in the circuit above. The size of the condenser determines the strength of the signals heard in the phones. If a condenser of .001 mfd. produces a signal which is too loud, use an .0005 mfd. or smaller condenser.

progress more rapidly. Perhaps the best substitute for the assistance of an experienced operator is for two beginners to learn the code together and send to each other with the code-practice set. Write down—"copy" it is called—the signals sent you, in the form of letters, numerals, and punctuation marks. Do not copy them as dots and dashes. If you do not recognize a letter, do not think about it too long or you will miss the next signal. When you can send and receive 65 letters, numerals, and punctuation marks per minute and copy them ac-

curately, whether they make sense or not, you can pass the government code test.

“HAM” ABBREVIATIONS AND SLANG

The first time that you succeed in copying parts of an amateur conversation don't place all blame on yourself if it seems to be a lot of gibberish. In order to save time in talking to each other, most amateur operators abbreviate words and sentences. For example,

TKS OT CUL 73 CLD

merely means to a “ham's” ears:

Thanks old timer see you later best regards am closing station

It is quite common practice to omit the vowels from words, to substitute the letter *I* for *Y*, and to use a special brand of slang such as a “lid” or a “punk” for a poor operator, “brass-pounder” for amateur operator, “cans” for phones, and so on. Some of these “ham” abbreviations have become more or less standardized by constant use, not only in this country but in Canada, Great Britain, and Australia, in fact wherever English is spoken. There is no complete list of this “lingo” but some of the abbreviations frequently used are given.

It is not the purpose of this list to encourage the use of abbreviations. A reasonable use of shortcuts saves time but it is ridiculous to make wholesale use of them in a conversation of a few sentences.

THE “Q” CODE

In addition to the “ham abbreviations” used by amateurs there is the internationally recognized “Q” code formulated

HAM ABBREVIATIONS

ABT	About	GE	Good evening
AGN	Again	GM	Good morning
AHD	Ahead	GN	Good night
AUSSIE	Australian amateur	GND	Ground
BCL	Broadcast listener	GUD	Good
BD	Bad	HAM	Amateur
BN	Been	HI	Laughter
CANS	Phones	HRD	Heard
CD	Could	HV	Have
CK	Check	NM	No more
CKT	Circuit	NR	Number
CL	Call	OP	Operator
CLD	Closing station	OT	Old-timer
CONGRATS	Congratulations	OM	“Old Man”
CRD	Card	OW	A married woman operator
CUD	Could	PSE	Please
CUL	See you later	PUNK	Poor operator
CW	Continuous wave	R	O.K.
DNT	Don't	SED	Said
DX	Distance	SEZ	Says
FB	Fine business	SIG	Signature
FONE	Telephone	SIGS	Signals
FR	For	SKED	Schedule
FREQ	Frequency	VT	Vacuum-tube
GA	Go ahead	YL	Young lady
GB	Good-by	73	Best regards
GBA	Give better address		

and approved by the International Radiotelegraph Convention. There are a great many “Q” signals but most of them are useful only in commercial radio. Those suitable for amateur communication are listed. The abbreviations alone have the meanings shown in the column under “Answer,” but when an abbreviation is followed by the symbol for a question mark (...?) it has the meaning shown in the column under “Question.”

<i>Abbreviation</i>	<i>Question</i>	<i>Answer</i>
QRA	What is the name of your station?	This is
QRG	What is my exact frequency?	Your exact frequency is KCS.
QRH	Does my frequency vary?	Your frequency varies.
QRI	Does my note vary?	Your note varies.
QRJ	Do you receive me badly?	I cannot receive you.
QRK	Do you receive me well?	I receive you well.
QRL	Are you busy?	I am busy.
QRM	Are you being interfered with?	I am being interfered with.
QRN	Are you troubled by static?	I am troubled by static.
QRO	Shall I increase power?	Increase power.
QRP	Shall I decrease power?	Decrease power.
QRQ	Shall I send faster?	Send faster.
QRS	Shall I send slower?	Send slower.
QRT	Shall I stop sending?	Stop sending.
QRU	Have you anything for me?	I have nothing for you.
QRV	Are you ready?	I am ready.
QRX	Shall I wait?	Stand by. I will call you.
QRZ	Who is calling?	You are being called by
QSA	What is the strength of my signals (1 to 5)?	The strength is (1 to 5).
QSB	Does the strength of my signals vary?	The strength of your signals varies.
QSM	Shall I repeat the last message?	Repeat the last message you sent me.
QSZ	Shall I send each group or word twice?	Send each group or word twice.

CHAPTER X

How to Build Simple Radio Receivers

BUILDING a radio receiver or transmitter is largely a matter of assembling and connecting various parts which may be purchased ready made at small cost. Parts for every conceivable purpose are available and it is seldom necessary to build any of the component parts of a radio station, nor is it economical.

Apparatus may be assembled in the simple manner known as "breadboard" construction, or, more elaborately, on a metal chassis with a metal panel.

Simple breadboard construction, in which the parts are mounted on a wooden base, is the best method for the beginner. A pair of pliers, several drills, and a screw-driver are usually the only tools needed. The ability to solder is the only mechanical skill required. Dexterity in this simple process of joining metals together with a molten mixture of lead and tin is quickly acquired. All joints and connecting wires in a radio receiver must be well soldered to insure strong low-resistance connections. A well-soldered connection is permanent; does not become loosened until unsoldered.

SOLDERING

To solder, an "iron," flux, and solder are required. These, plus a bit of knowledge and ability to take pains, are all that are necessary. Satisfactory work can be done with any sort of soldering iron, whether heated by gas, electricity, or a torch, provided the iron is kept at the correct temperature and properly "tinned." The name soldering "iron" is somewhat of a misnomer. The "bit," or part of the "iron" that actually does the soldering, is made of copper. The only iron is in the shank which joins the bit to the handle. A small electric iron (not the dime-store variety) is inexpensive and useful in soldering the wiring in a radio set, but of course is impractical where electric power is not available. An ordinary soldering iron may be heated in a charcoal fire, in a gas flame, or blow-torch.

In order to do its work, a soldering iron must be properly "tinned." This means that the point of the copper must be coated with solder. To tin an iron, heat the copper until it will melt solder. Then file or scrape the four flat surfaces smooth and clean. This must be done quickly before the copper cools. Apply soldering paste and then solder before the cleaned surfaces have an opportunity to oxidize or discolor again. Rubbing the hot iron against a clean building brick will help to spread the molten solder evenly over the tip.

When a soldering iron is heated by a gas flame or blow-torch, the tinning on the copper point will remain longer if the tinned surface is kept out of the flame. Overheating oxidizes the tinning or "burns the iron," as a mechanic expresses it. The remedy is to re-tin the iron.

Solder will flow and stick only to bright, clean metal from which all grease, dirt, scale, and oxide have been removed. It is therefore necessary to prepare the surface to be soldered by

scraping it. Copper, brass, tin, and zinc are easily soldered. Iron and steel are more difficult. Aluminum can be soldered only with special aluminum solder and flux.

There are four steps in soldering:

1. Cleaning the metal
2. Applying the flux
3. Heating the metal
4. Applying the solder

It is almost impossible to solder without a flux. The purpose of the flux is to remove and prevent the formation of oxide on the surface of the metal during the soldering process. There are a number of different fluxes, but rosin is the only safe one to use in soldering radio connections. Never use soldering paste, acid, sal ammoniac, or any liquid flux for radio work because these are corrosive, attack the fine wires, and provide a conducting path through which currents can leak.

For small work, wire solder is most suitable. It may be purchased with a rosin core, making additional flux unnecessary.

The trick of soldering is to apply the hot iron to the surfaces to be joined and keep it there until they are hot enough to melt solder. Then apply some rosin-core solder, holding it against the tinned point of the iron so that it melts and flows into the joint. Remove the iron, and when the joint has cooled, test it by pulling and wiggling the connection. If the joint breaks or is not tight, solder it again.

HOW TO BUILD A RADIO RECEIVER WITH CRYSTAL DETECTOR

If you live within twenty-five to fifty miles of a broadcasting station, you can receive the program with a crystal

detector. You will be amazed at the clear natural tones produced in the phones by such a simple device. The crystal may be galena, silicon, or iron pyrites.

In order to operate efficiently, a crystal must be mounted in a detector "stand." There are innumerable ways of making a detector stand so that the surface of the crystal may be searched for the most sensitive spot by means of a fine wire or "cat-whisker," and the tension or pressure of the contact carefully regulated.

A piece of selected galena and a detector stand may be purchased at many radio shops for as little as twenty-five cents, and from the standpoint of economy it does not pay to build one. Usually, the stand can be improved by substituting a spring with less tension than that with which it comes equipped.

Tested crystals are usually mounted at the factory by imbedding with the sensitive side up in a small slug of low-temperature alloy. Solder should never be used for this purpose; its melting point is too high. It will oxidize the crystal. One of the alloys which will melt in boiling water is required. There are several of these. Wood's metal is the most well known and can be purchased from dealers in chemical supplies.

Formulas for making low-temperature alloys are given below. The lead should be melted first, then the bismuth added, and finally the tin.

LOW-TEMPERATURE ALLOYS

<i>Bismuth</i>	<i>Lead</i>	<i>Tin</i>	<i>Melting Point</i>
8	5	3	201 F
5	3	2	197 F

Metallic silicon was one of the first substances used as a crystal detector. It is not as sensitive as galena, but is more

rugged and does not get out of adjustment easily. It is a hard, rock-like, silver-gray substance made in electric furnaces by the Carborundum Company at Niagara Falls, New York. Silicon is not expensive and may be purchased from dealers in laboratory chemicals and supplies.

Iron pyrites, or "fools' gold," may be used as a detector crystal. All pieces of this mineral are not sensitive, however.

The mineral which makes the most sensitive crystal detector is galena, an ore of lead and sulphur. Like iron-pyrites, galena is not sensitive over its entire surface and must be "searched." When a sensitive piece is found, the best spot on it should be marked with white chalk and the dead area split away with a small chisel or knife blade.

A good piece of argentiferous galena, that is, galena containing silver, is usually sensitive over its entire surface.

If possible, avoid touching sensitive radio crystals with the fingers, as the slightest bit of oil and dirt, even if it can not be seen, reduces the sensitivity. Instead of the fingers, use a pair of forceps to handle the crystal.

In order to build the radio receiver shown on page 178, the following parts are required:

- 1 Wooden base 7¾" X 5" X ¾"
- 1 Variable condenser, 100 MMF.
- 1 Mica fixed condenser, .004 mfd.
- 1 Crystal detector
- 1 Coupler (homemade)
- 4 Binding posts
- 1 1,000-ohm telephone receiver or radio head-set

The coupler is the only one of the parts that it will be necessary to make. It consists of two separate windings, a primary and a secondary, of fine enameled magnet wire. The size of the wire is somewhat immaterial. Nos. 30-36 B.S. gage

may be used. The secondary consists of 100 turns of wire wound smoothly in a single layer around a cardboard or paper tube one inch in diameter and about two inches long. In place of a cardboard tube, a piece of one-inch wooden dowel may be

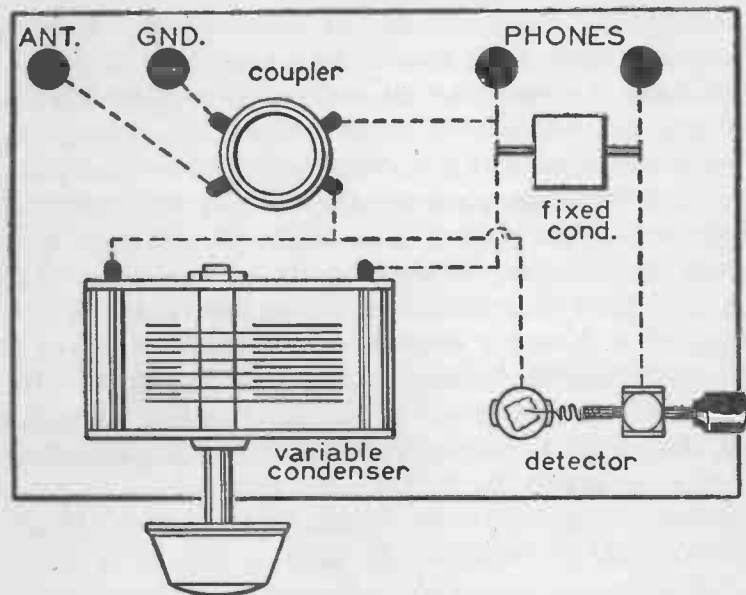

PLAN FOR RADIO RECEIVER WITH CRYSTAL DETECTOR

The coupler is the only one of the parts it is necessary to make. The others can be purchased at a radio shop. The dotted lines represent the wires which connect the parts.

used. This is often more convenient to procure than a cardboard tube of suitable size. The primary is wound over the secondary but is separated from the latter by two or three layers of paper. It consists of twelve turns of enameled wire of the same size as that used for the secondary. A coat of clear varnish or shellac will hold the windings in place.

If the secondary is wound on a piece of dowel, each end of the windings can be anchored by wrapping around a small brass or copper pin driven into the wood. The wire should be soldered to the pins. The enamel insulation can be removed from the wire for soldering by rubbing with a piece of very fine emery paper.

One of the illustrations shows a plan of the completed receiver and the location of the various parts on the base. It also shows the wiring.

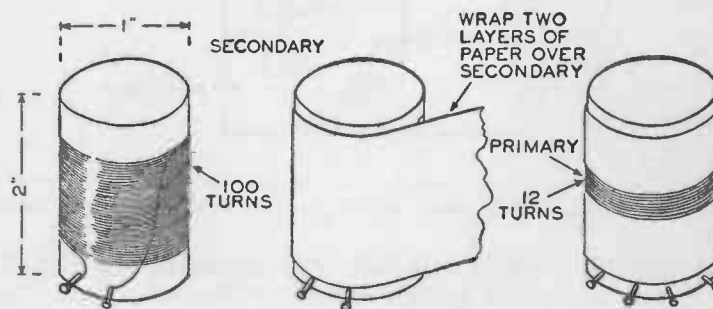

DETAILS OF THE COUPLER

The primary is wound over the secondary. The two coils are separated by two layers of paper.

The schematic diagram shows the circuit and will be of assistance in arranging the wiring. Use "push-back" wire and solder all the connections. The primary or antenna coil is connected to the two binding posts which lead to the aerial and ground. The secondary coil is connected directly across the terminals of the variable condenser. A wire leads from one terminal of the variable condenser to the crystal. The cat-whisker is connected to one side of the mica fixed condenser (by-pass condenser). The other side of the fixed condenser leads back to the variable condenser. The phone or head-set

is connected directly across the terminals of the fixed condenser.

To put the set in operation, first connect it to the antenna and ground. The antenna should be a carefully insulated horizontal wire from 50 to 75 feet long. If possible, the antenna

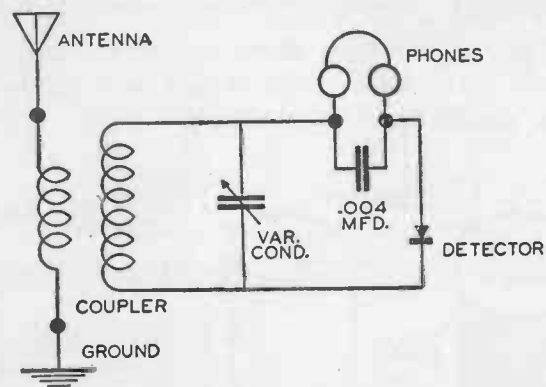

SCHMATIC CIRCUIT DIAGRAM FOR THE RADIO RECEIVER WITH CRYSTAL DETECTOR

The primary of the coupler is the coil which is connected to the antenna and ground. The secondary of the coupler is connected to the terminals of the variable condenser. The black dots represent binding posts.

should be erected in the open and as high as practical. It should be well insulated at each end and of fairly heavy wire (No. 14 B.S.), either insulated or bare.

Indoor antennas are sometimes very effective. The principal advantage of the outdoor antenna is to obtain a noise-free pick-up. A crystal detector is not nearly as sensitive as a radio tube and the noise that it picks up will usually not be noticeable. If an indoor antenna is erected, the same precautions as to insulation, and so on, should be observed.

After connecting the receiver to the aerial and ground, the next thing to do is to test the detector so as to insure that

the point of the "cat-whisker" is on a sensitive spot of the crystal. To do this, you need a small buzzer, a dry cell, and a switch. You can use a code-practice set for the purpose. Connect the buzzer, battery, and switch in series. Run a wire from the buzzer to the ground terminal of the crystal set. Close

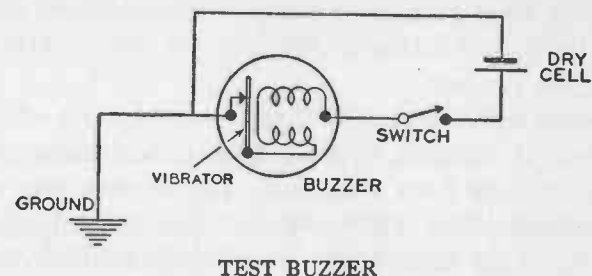

A small buzzer connected to a dry cell and a switch or push-button arranged as shown in the diagram above is used to adjust the crystal detector. Adjust the detector until the sound of the buzzer is loudest.

the switch so as to put the buzzer in operation, hold the phone to your ear, and move the cat-whisker around on the crystal and adjust the tension until the sound of the buzzer is loudest. When you have made this adjustment, open the switch to stop the buzzer and turn the variable condenser very slowly. Be careful not to jar the receiver and throw it out of adjustment.

You are now listening-in. Don't expect to hear many stations. Tune slowly by turning the variable condenser slowly. If your set is within receiving range of a broadcasting station, you will hear it.

HOW TO BUILD A ONE-TUBE ALL-WAVE REGENERATIVE BATTERY SET

To those whose sole experience as a radio constructor has been the assembly of a crystal receiver, even a single-tube

vacuum-tube receiver will seem much more complicated in appearance than it will actually prove to be if the assembling and wiring is undertaken slowly and patiently. All of the parts required may be purchased ready made with the exception of the baseboard and panel. All parts, not including the tube and battery, can be purchased at a cost of between four and five dollars. Any boy of twelve or older who has average ability can assemble the receiver.

The result will be a sensitive battery-operated set which will bring in police, amateur, aviation, ship, coastal telegraph, and broadcast stations from a distance. The receiver uses a type 30 vacuum-tube. This is a "low-drain" tube, which means that it uses very little current and is especially suited to battery operation. By means of plug-in coils, the receiver covers a range of 16 to 550 meters.

Coil forms for winding your own coils are available but it is advisable to purchase coils ready-wound. Plug-in coil forms are made of molded plastic and are provided with four prongs to fit the standard four-prong vacuum-tube socket. Each "coil" consists of two separate windings. The upper winding is the antenna and grid coil. The lower and smaller winding is the "tickler."

PARTS REQUIRED FOR ONE-TUBE ALL-WAVE SET

- 6 Binding posts
- 1 Wood base, $9\frac{3}{8}" \times 4\frac{1}{2}" \times \frac{3}{4}"$
- 1 Plywood panel, $9\frac{3}{8}" \times 4" \times \frac{1}{4}"$
- 1 Antenna control trimmer condenser, (1)
- 1 .00015 mfd. mica grid condenser, (2)
- 1 Wafer socket for No. 30 tube, (3)
- 1 Wafer socket for plug-in coils, (4)
- 1 Variable tuning condenser, (5)
- 1 Grid leak resistor, (6)

- 1 .0005 mfd. mica by-pass condenser, (7)
- 1 Regeneration control and potentiometer, (8)
- 1 Radio-frequency choke, (9)
- 1 Switch, part of No. 8, (10)
- 1 40 to 50 ohm filament rheostat, (11)
- 4 Plug-in coils to cover 16-217 meters
- 1 Plug-in coil to cover 190-300 meters
- 1 Plug-in coil to cover 300-550 meters
- 1 Type 30 vacuum-tube
- 1 45-90 volt "B" battery
- 2 No. 6 $1\frac{1}{2}$ volt "A" cells
- 1 2,000-ohm radio head-set

The numbers of the various parts in the above list will identify them in the plan and schematic diagram.

The parts should be arranged on the base as shown in the plan. The two sockets (3 and 4) are mounted on small bushings which raise them up from the base. The rheostat (11), the variable condenser (5), the potentiometer (8), and the switch are mounted on the back of the panel by means of the nut supplied with each. One of the illustrations shows the location of the holes through which the shafts project. If the shafts do not all project an equal amount through the panel, they may be evened by sawing off with a small hack-saw.

The set is now ready for wiring. The dotted lines in the plan show the connections. The schematic circuit diagram should also be consulted. Follow the connections with the utmost care. As each connection is made, check it on the diagram with a colored pencil. Then none will be overlooked. Have the soldering iron hot and keep it clean. Use only rosin-core solder and push-back wire. After completing the wiring, check it carefully. When all the connections have been made, the set is ready for testing.

Place a type 30 two-volt tube in socket 3 and one of the

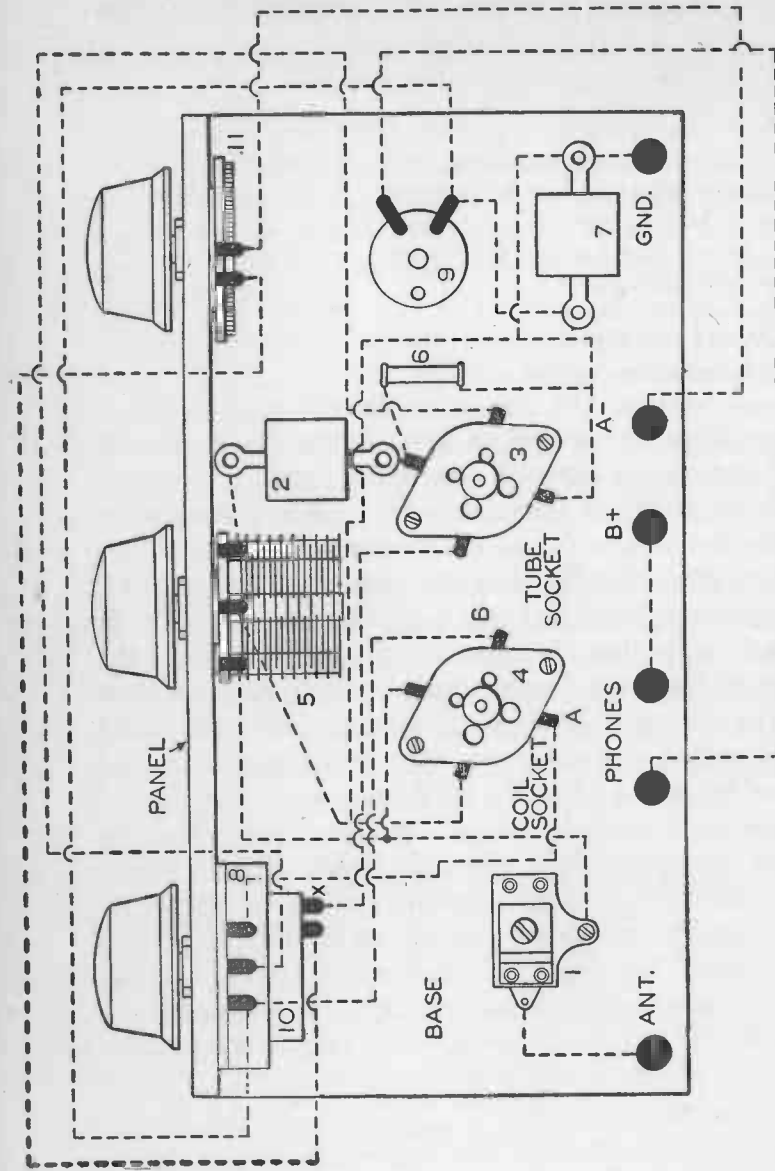

ONE-TUBE REGENERATIVE RECEIVER

The parts are all numbered so that they can be identified. The dotted lines represent connecting wires. For the sake of clearness some of them are shown outside of the base and panel. When wiring the receiver all wires are kept within the area of the base. When connecting the batteries to the receiver, the positive terminal of the "A" battery and the negative terminal of the "B" battery as well as the ground are connected to the binding post marked GND.

ONE-TUBE REGENERATIVE RECEIVER

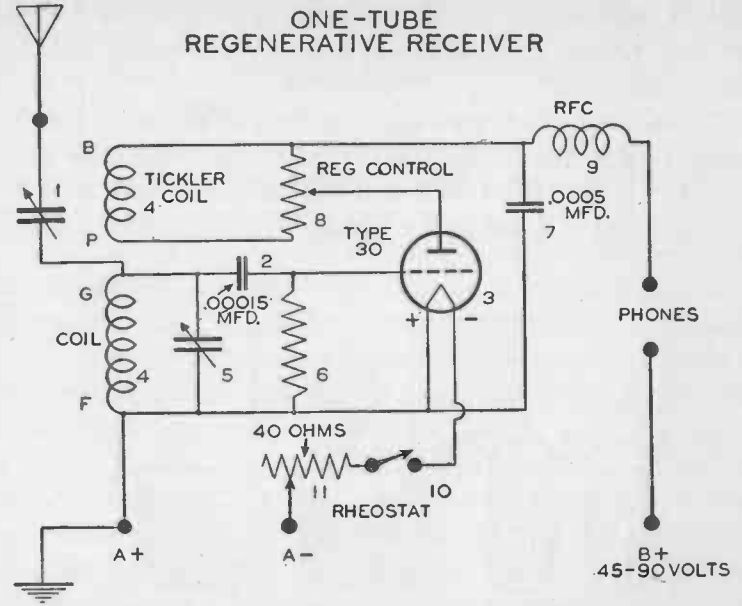

Schematic circuit diagram for the one-tube regenerative receiver. Consult this diagram when wiring the receiver. The various parts are numbered so that they can be identified with the parts shown in the plan for the receiver.

broadcasting coils in socket 4. Connect the antenna, ground, and "A" and "B" batteries to the proper binding posts. The "A" battery should consist of two 1½-volt dry cells connected in series. The "B" battery may be a single 45-volt unit or two 22½-volt batteries connected in series.

Turn the filament rheostat (11) all the way to the left. This opens the filament circuit. Turn the knob operating the potentiometer (B) and the switch (10) so that the switch is closed. Then turn the rheostat slowly in a clockwise direction until the tube filament lights. Using fresh "A" batteries, the two volts necessary to operate the tube will be obtained with the rheostat about half-way. As the batteries become older,

their voltage will drop, and in order to compensate for the loss, the rheostat knob will have to be turned further and further to the right.

Slip on the head-phones and tune in a broadcast station by slowly turning the center knob. Turn the potentiometer knob to control regeneration. At first it will be best to turn this until a distinct hiss is heard in the phones. When the hiss is heard,

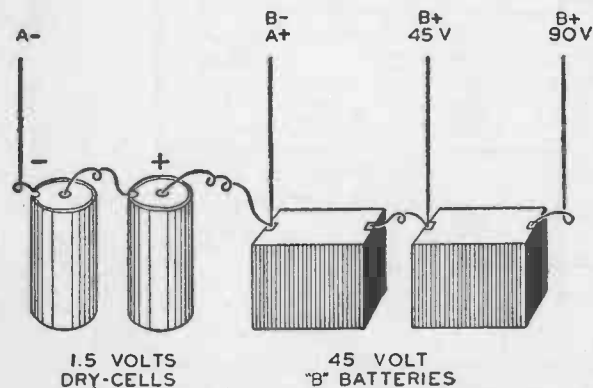

BATTERY CONNECTIONS

The proper way to connect the filament lighting "A" battery and the plate supplying "B" battery. Notice that the positive terminal of the "A" battery and the negative terminal of the "B" battery are common to each other.

the set is said to be "spilling over." With the set spilling over, adjust the antenna trimmer condenser (1) with a screwdriver, loosening it up approximately half-way. When the variable condenser is rotated slowly, a series of whistles and squeals will be heard, each indicating a different broadcast station. Starting with the trimmer condenser loosened up about half-way, adjust it until the hiss is loudest. The station-selector (variable condenser) knob should then be turned until a continuous whistle is heard and until it is loudest. The whistle can now be cleared

by a slight adjustment of the potentiometer, turning it back until the tube stops oscillating. The volume of the broadcasting program heard in the head-phones can be adjusted with the regeneration control.

When a station has been tuned in and the volume is adjusted by turning the potentiometer, a slight readjustment of the tuning control may be necessary.

After having adjusted the set to the broadcast band with the broadcast coil, the other coils may be tried, using the same procedure. The trimmer condenser must be adjusted for each coil. The adjustment is not critical except for the reception of very weak signals. Weak signals necessitate a very careful and close adjustment of all the controls.

If the set has been properly wired, no trouble should be experienced in getting it into satisfactory operation. In case no signals are heard, recheck all connections. Make certain that the filament of the tube lights and that both the "A" and "B" batteries are fresh and connected properly.

If no squeals are heard in the head-phones, it is an indication that the receiver is not regenerating. Check all connections and also check the batteries. Sometimes failure of the receiver to regenerate is due to the tickler-coil winding being reversed. In that case it will be necessary to reverse the connections which lead from the potentiometer to the coil socket. Unsolder the wires attached to the socket terminals marked *A* and *B* in the plan and solder to *B* the wire formerly connected to *A*. Likewise, the wire formerly attached to *B* should be soldered to *A*. Do not make this change, however, until it is certain that failure of the receiver to regenerate is not due to any other cause.

Objectionable noises in the receivers may be caused by loose contacts or by run-down "B" batteries. They can also be

caused by disturbances picked up by the antenna and lead-in.

An antenna which proves effective for receiving broadcast stations is not always satisfactory for short waves. Man-made static that is not annoying on broadcast wave-lengths will seriously interfere with reception on 30 meters or below.

Short-wave stations can not be found on all parts of the dial. Except in a few places, they are widely separated. Tune slowly, most distant stations tune very sharply. Weak signals can often be brought in clearly by careful tuning. Don't expect to hear stations all over the world the first day you have the set in operation. It requires some experience and skill to tune the receiver so as to get the most out of it. Don't expect to hear distant stations on wave-lengths above 33 meters in daylight or distant stations below 25 meters after dark.

HOW TO BUILD A WAVE-TRAP

Frequently, near-by broadcasting stations cause interference in an amateur receiver, especially when the longer wave coils are being used. The remedy for this difficulty is to add a rejector or wave-trap to the antenna circuit. This device is simply a coil and a variable condenser which may be tuned to the frequency of the interfering broadcast station.

The coil may be 32 feet of No. 22 double-cotton-covered magnet wire wound on a 3-inch (diameter) cardboard tube. This amount of wire will form 40 turns on a 3-inch tube. The diameter of the tube may vary slightly. It may be $2\frac{1}{2}$ inches in diameter or $3\frac{1}{2}$. Use the same length of wire in any case.

The variable condenser should have a capacity of at least .00035 mfd. In fact, any coil-condenser combination which will tune to the frequency of the interfering station will be satisfactory. The coil and condenser just described will cover

the entire broadcast band. The terminals of the condenser should be connected directly across the terminals of the coil and the trap inserted in the antenna lead-in, as shown in the diagram.

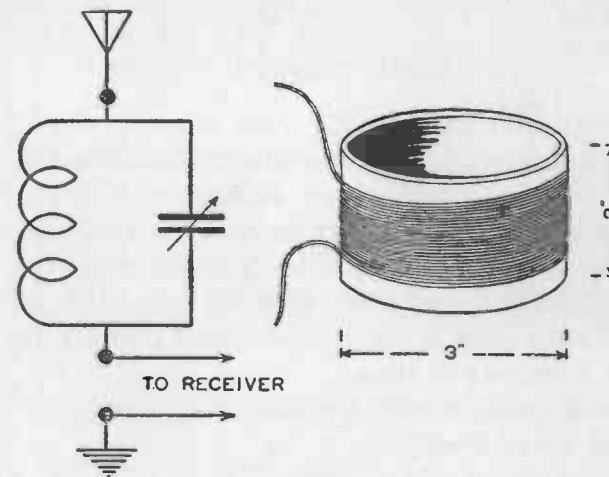

A WAVE-TRAP

This device is a coil and variable condenser connected as shown in the diagram above. It will help to eliminate interference from a near-by station.

HOW TO ADD AMPLIFICATION TO THE ONE-TUBE ALL-WAVE SET

The one-tube set which has just been described is the simplest possible form an all-wave receiver may take. It is possible to add both audio- and radio-frequency stages and greatly increase the power and range of the apparatus.

The tuned radio-frequency stage is placed between the antenna and the detector stage to amplify the radio-frequency currents before they are regenerated and rectified by the detector. The result is a great increase in volume.

Audio-frequency amplification is added to the detector to amplify the audio-frequency currents from the detector. The increase in power thus brought about will make it possible to replace the head-phones with a speaker.

THE RADIO-FREQUENCY STAGE

The circuit diagram for the radio-frequency stage is illustrated on page 193. It is very similar to the detector stage but there is no grid condenser, plate winding, or tickler. A plug-in coil is used and it is necessary to change two coils each time the wave band is changed, one in the amplifier and one in the detector. You will need a set of plug-in coils which are duplicates of those used in the detector circuit. Remove the lower winding from each of these.

To build a stage of radio-frequency amplification, the following parts are required:

- 1 Wooden base, 8" X 4½" X ¾"
- 1 Plywood panel, 8" X 4½" X ¼"
- 1 Antenna control trimmer condenser (15)
- 4 Plug-in coils for 16-217 meters
- 1 Plug-in coil for 190-300 meters
- 1 Plug-in coil for 300-550 meters
- 1 Wafer socket for type 30 tube (12)
- 1 Wafer socket for plug-in coils (13)
- 1 Variable tuning condenser (14)
- 1 40-60 M.H. radio-frequency choke (16)

The parts should be mounted on the base as shown in the plan. The two sockets (12 and 13) are raised off the base on small bushings. The variable condenser (14) is mounted on the back of the panel, with the shaft projecting through the front, and is fitted with a control knob.

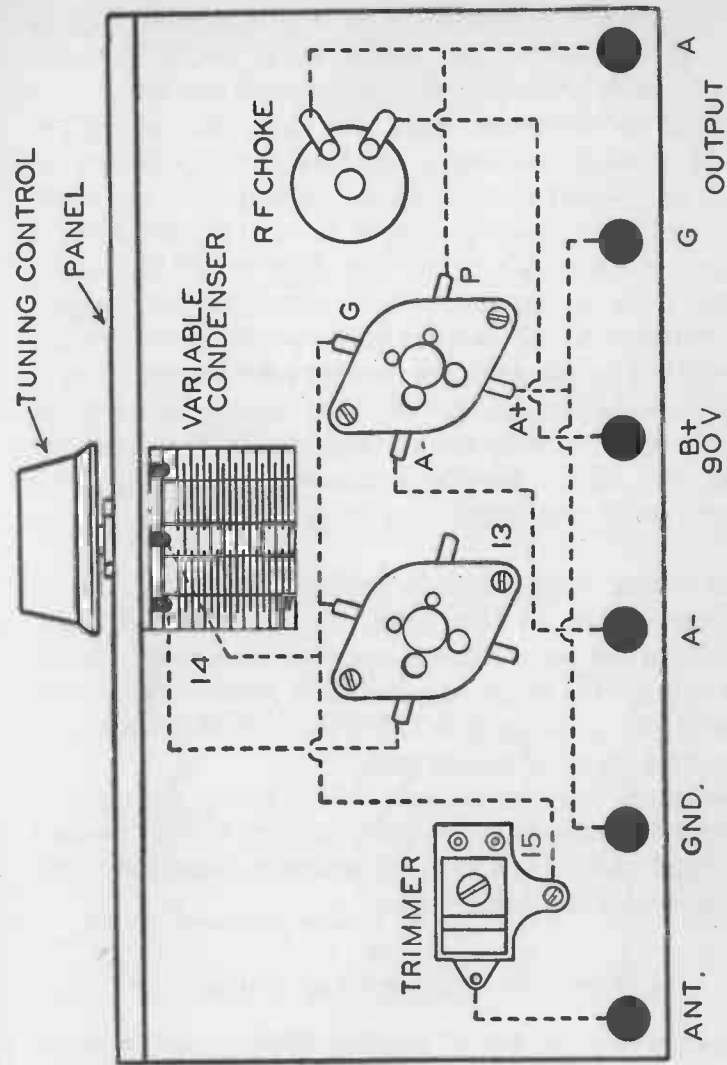

PLAN FOR RADIO-FREQUENCY AMPLIFIER

The variable condenser is mounted upon a wooden panel attached to the base-board. The dotted lines represent the wires which connect the various parts.

The plan shows the connections. The schematic diagram should also be consulted. Use push-back wire, and as each connection is made, check it on the diagram with a pencil.

When all the connections have been made and checked, the amplifier is ready to connect to the detector. Connect the antenna and ground to the terminals marked ANT and GND on the amplifier. Connect the output terminal marked A to the antenna terminal on the regenerative detector and the output terminal, G, to the ground-terminal on the detector. Connect the A- terminal on the amplifier to the terminal on the switch (10) which is connected to the detector-tube filament. This is marked X in the plan on page 183. The amplifier and detector tubes use the A and B batteries in common. By connecting the terminal, A- on the amplifier to the switch, the switch and rheostat control and amplifier tube, as well as the detector tube.

Place a type 30 vacuum-tube in its socket (12) and turn the switch so that the tube lights. Put a plug-in coil in the detector and the corresponding coil (secondary only) in the amplifier. The receiver should now operate. It will be necessary to adjust the antenna trimmer condensers for each set of plug-in coils.

Only by practice can you gain skill in tuning the receiver. After experimenting for a few days, you will be able to clear up the faint whistles and bring in short-wave broadcasts from the other side of the world.

THE AUDIO-FREQUENCY STAGE

There are two methods of coupling audio-frequency amplification to a detector. One is resistance coupling, and the other transformer coupling. When fine tone is the main consideration,

TUNED RADIO-FREQUENCY STAGE

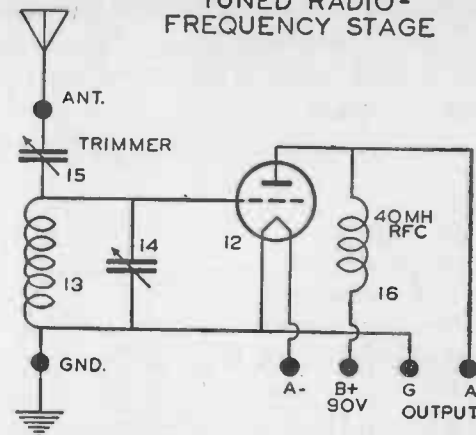

This is the schematic-circuit diagram for the radio-frequency stage of amplification. It should be consulted when wiring the amplifier. Instructions for connecting this amplifier to the regenerative detector are given in the text.

RESISTANCE COUPLED AUDIO-FREQUENCY

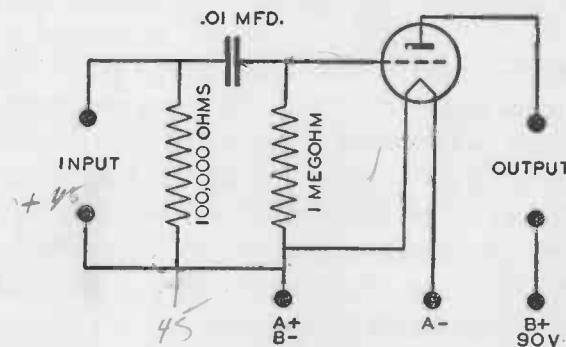

SINGLE-STAGE AMPLIFIER

Schematic circuit diagram for a single stage of resistance-coupled audio-frequency amplification. This may be used with the one-tube regenerative receiver described earlier in this chapter.

resistance coupling is used. If volume and distance are desired, transformer coupling is employed.

Circuits for a single stage of each type are shown and the parts required are listed:

Parts for a single-stage resistance-coupled amplifier:

- 1 Wafer socket
- 1 100,000-ohm resistor
- 1 megohm resistor
- 1 .01 mfd. fixed condenser
- 7 Binding posts or terminals
- 1 Wood base $4\frac{1}{2}'' \times 4\frac{1}{2}'' \times \frac{3}{4}''$
- 1 type 30 tube

Parts for a single-stage transformer-coupled amplifier:

- 1 3 to 1 ratio audio transformer
- 1 100,000-ohm resistor
- 7 Binding posts or terminals
- 1 Wafer socket
- 1 type 30 tube
- 1 Wood base $5'' \times 4\frac{1}{2}'' \times \frac{3}{4}''$

It is a simple matter to wire either one of these amplifiers by following the schematic circuit. The input terminals of the amplifier should be connected to the output posts of the detector, thus replacing the phones. The phones or a loud speaker are connected to the output terminals of the amplifier. If the A-terminal on the amplifier is connected to the switch terminal (marked X in the plan on page 183), the switch and rheostat will control the amplifier tube.

It is possible to mount all of the parts for a regenerative receiver with a single stage of radio-frequency and a single stage of audio-frequency on a wooden base $18'' \times 4\frac{1}{2}'' \times \frac{3}{4}''$. A schematic diagram of the circuit is given on another page.

It looks rather complicated but it is actually only a composite of the circuits shown on pages 185, 193, and 195.

TRANSFORMER-COUPLED AUDIO-FREQUENCY

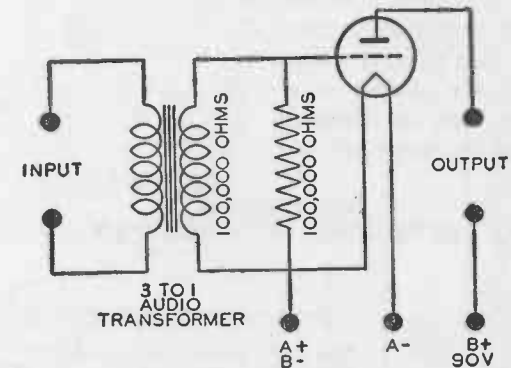

SINGLE-STAGE AMPLIFIER

Schematic circuit diagram for a single stage of transformer-coupled audio-frequency amplification. This may be used with the one-tube regenerative receiver described earlier in this chapter. Uses a type 30 tube.

HOW TO BUILD A TWO-STAGE AUDIO-FREQUENCY AMPLIFIER FOR THE ONE-TUBE ALL-WAVE RECEIVER

This amplifier, when connected to the one-tube receiver, will bring in signals with sufficient volume to operate a speaker. It comprises a stage of resistance-coupled amplification with a transformer-coupled audio amplifier.

The parts are mounted on a wooden base. Since the amplifier is designed for use with the one-tube regenerative receiver, the circuit is arranged so that the filament current for the

amplifier tubes is controlled by the rheostat on the receiver.

The following standard parts are required in order to assemble the amplifier:

- 1 Wood base 4" X 9" X 3/4"
- 2 4 prong wafer sockets, type 4 D (1 and 2)
- 1 3 to 1 ratio audio transformer (3)
- 1 .05 mfd. tubular condenser (4)
- 1 50,000 ohm 1/4-watt resistor (5)
- 1 500,000 ohm 1/2-watt resistor (6)
- 8 Binding posts or terminals
- 2 Type 30 vacuum-tubes

THREE-TUBE REGENERATIVE-RECEIVER

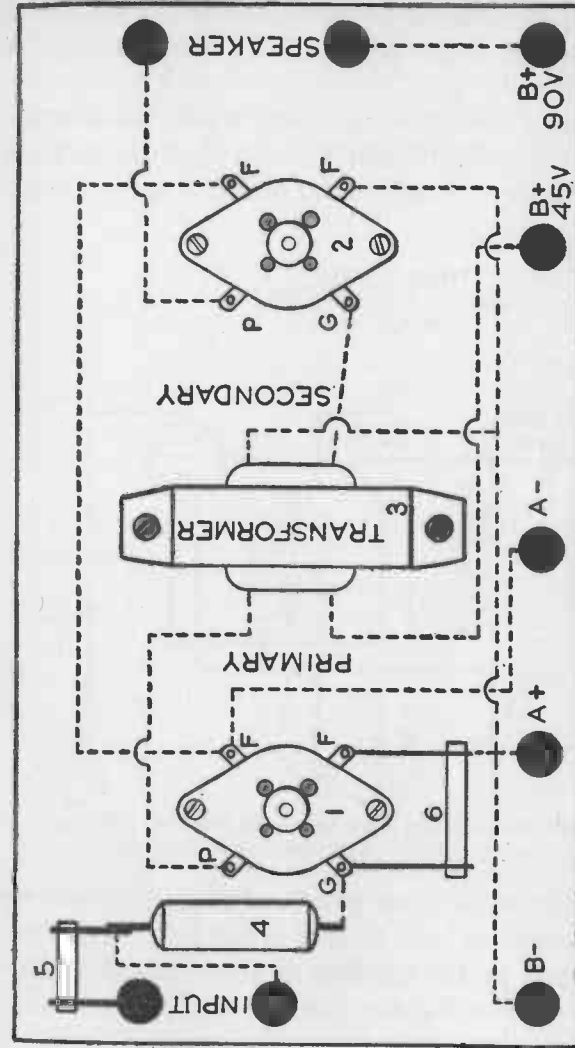
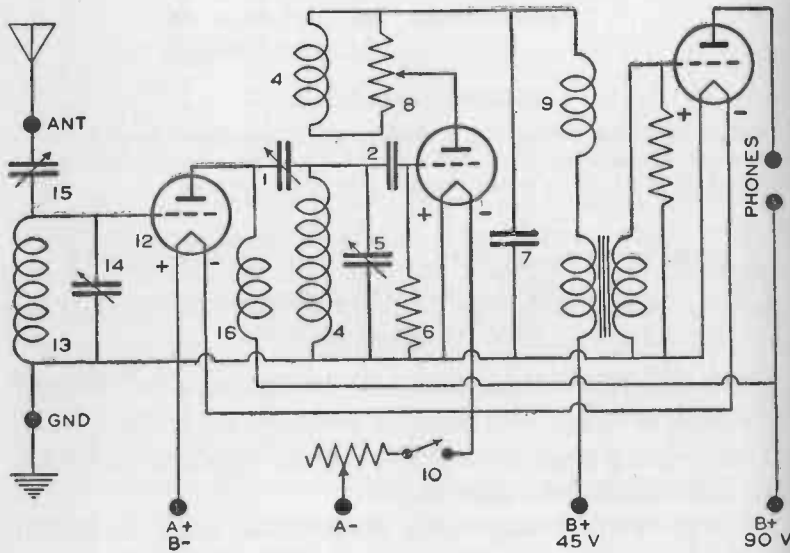

PLAN FOR A TWO-STAGE AUDIO-FREQUENCY AMPLIFIER

No panel is required. All the parts are mounted upon a wooden base. The first stage of this amplifier provides resistance coupling to the detector. The second stage is transformer coupled to the first stage. The dotted lines represent the wires which connect the parts. When wiring the amplifier, refer also to the schematic-circuit diagram.

When selecting the audio-transformer, choose one which has the terminals marked P (plate), G (grid), B+ and B— or C—.

Arrange the parts on the base as shown in the plan and wire with push-back wire. The dotted lines on the plan indicate the wires. Consult the schematic circuit diagram also and check each connection carefully.

TWO-STAGE AUDIO-FREQUENCY AMPLIFIER

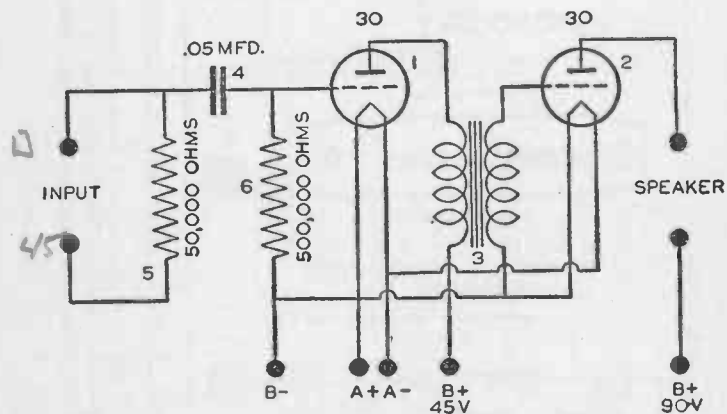

Circuit diagram for the two-stage audio-frequency amplifier. The parts are numbered so that they can be identified with the parts in the plan.

When the amplifier has been wired and checked, it is ready for use. Place a type 30 tube in each of the sockets. Connect the input terminals on the amplifier to the terminals marked PHONES on the receiver. Connect the phones or a small magnetic speaker to the SPEAKER posts on the amplifier.

Do not connect the terminals marked A+ and A— direct to the A battery, but connect them in parallel with the filament

terminals of the tube in the receiver. This is accomplished by connecting the A+ terminals on the receiver and amplifier together, and connecting the A— terminal on the amplifier to the switch terminal marked X in the plan on page 183. Then the rheostat on the receiver will control all the tubes.

The Transmitter and Its Apparatus

THE title of this chapter is more properly the title for a book. The subject of transmitters is a large one and can not be treated here at any great length both for lack of space and because the discussion would soon become too technical for the intended scope of this volume.

THE BASIS OF RADIO COMMUNICATION

Earlier in these pages it was explained that radio communication depends upon the fact that an alternating current of electricity flowing in a suitable circuit will throw off some of its energy in the form of invisible radio or electromagnetic waves. A radio transmitter is simply an apparatus which has been devised to generate and control alternating currents so that they will produce electromagnetic waves.

While every one is more or less familiar with a radio receiver, comparatively few have seen or operated a transmitter and the process of *sending* radio messages is not generally understood. However, it is neither complicated nor mysterious. Ordinary 60-cycle alternating current, the current used to light our homes, would radiate a large part of its energy in the form of radio waves if it were sent through a suitable circuit. But a suitable circuit for radiating energy at a frequency as low as

60 cycles would have physical dimensions which would make it impracticable; the circuit would have to be thousands of miles in length. Fortunately, as the frequency of an alternating current increases, the physical dimensions of a suitable circuit from which it can radiate its energy *decrease*. With the higher frequencies and consequently shorter wave-lengths, efficient radiating circuits become practicable in size. In fact, the extreme small dimensions of the circuits used in generating micro-waves bring difficult problems to the radio engineer.

The frequency of the generators employed to produce our house current can not be raised to the point where such machines would make suitable radio transmitters. Various methods have been used in the past to generate alternating currents of a frequency high enough so that radio waves could be radiated efficiently. But none of them were satisfactory. There was no satisfactory method until Armstrong discovered that a radio vacuum-tube could be made to generate high-frequency currents by feeding back some of the energy of the plate circuit into the grid circuit. A vacuum-tube can be made to generate alternating currents of a frequency as high as five hundred million cycles. The frequency of a vacuum-tube is easily controlled. The tube itself is a simple affair. So is the auxiliary apparatus. There are no moving parts. For these reasons, virtually all high-frequency alternating currents for radio transmitting are obtained to-day from vacuum-tube oscillators and amplifiers.

THE VACUUM-TUBE AS A REGENERATOR
AND OSCILLATOR

There is no "perpetual motion" about a vacuum-tube. It does not create energy. When used as a generator of high-

frequency currents, it *changes* direct current into alternating current. It is merely a "converter."

In order to change direct current into alternating current, oscillation must take place in the vacuum-tube. In order for oscillation to take place, *regeneration* must occur. To the uninitiated, oscillation and regeneration must be mystifying names. While they are technical terms, they actually are very appropriate names for two quite simple processes. The dictionary defines *oscillate* as "to cause to swing to and fro," and *regenerate* as "to produce again or renew by natural process."

In Chapter IV, alternating current was explained and we learned that an alternating current starts at a zero point, builds up to a maximum, decreases again to zero, builds up in the opposite direction and falls again to zero—thus completing one cycle. When the cycles or "swings to and fro" take place at a frequency of 20,000 or more per second, they are called *oscillations*.

Oscillations, "swings to and fro," or alternating currents, whichever you may prefer to call them, will occur in a vacuum-tube when given the right conditions. These right conditions permit regeneration to occur. A simple circuit, using a triode tube, is arranged so that power or energy is taken from the output or plate circuit of the tube and fed back into the input or grid circuit, amplified through the tube, and taken out of the plate circuit again. Each time the power is taken from the plate circuit and fed into the grid it is *regenerated*, "reborn," or "formed again" in the plate circuit.

The circuit diagram shows exactly how this occurs. Suppose that the filament of the vacuum-tube is lighted and the switch in the plate circuit is open. No current will flow in the plate circuit or in tickler coil A, which is part of the plate circuit. But when the switch is closed, current will immediately flow

in the plate circuit, through coil A, through RFC, and back to the filament.

Current flowing through a coil produces a magnetic field. Current flowing through coil A produces a magnetic field about

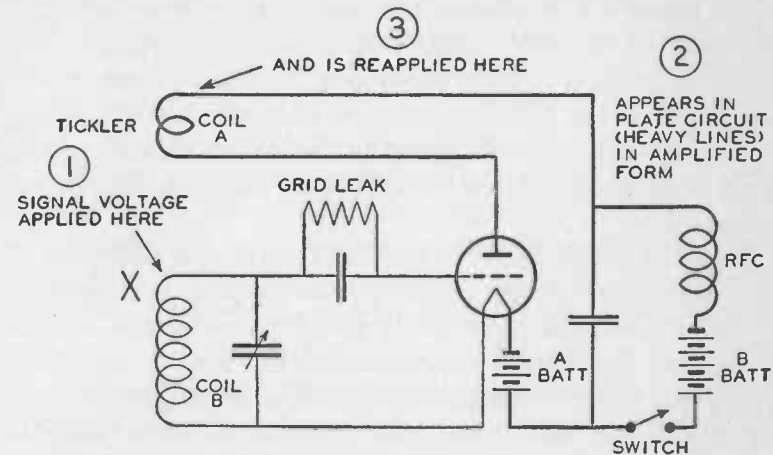

THE VACUUM-TUBE AS A REGENERATOR AND OSCILLATOR

E. H. Armstrong first discovered how to make a three-element vacuum-tube regenerate or oscillate. The process consists of feeding back energy from the plate circuit to the grid circuit. The frequency of the swings or oscillations depends upon the amount of inductance and capacity in the circuit.

The above diagram shows a regenerative circuit. Its action is as follows:

Current flowing through the tickler coil, A, creates a magnetic field. Any change in the strength of the magnetic field induces a current in coil, B, by magnetic induction and changes the charge upon the grid of the tube. Changes in the charge upon the grid produce changes in the current flowing in the plate circuit and through the tickler coil, A. This process repeats itself very rapidly, resulting in oscillations.

the coil. As this magnetism spreads out and passes through the turns of coil B, connected to the grid of the vacuum-tube, it *induces* a voltage in coil B. The voltage induced in coil B, if it applies a positive charge to the grid, causes an *increase* in plate-current flow which is above the normal value of the cur-

rent or the point at which it would rest if the grid were undisturbed. On the other hand, if the voltage induced in coil B applies a negative charge to the grid, it causes a decrease in plate-current flow. The effect of positive and negative charges upon the grid in producing changes in the current flowing in the plate circuit has already been explained in Chapter VII, but it is brought to mind again here so that you may follow the action of the tube, in producing oscillations, step by step.

Keep in mind also the fact that the energy induced in coil B by a current flowing in coil A is taken from the plate circuit or *feed-back*.

Now, let us see how and why oscillations will take place if the "feed-back" energy traveling from the plate to the grid to the plate and back again are in proper phase so that one impulse aids the other. The explanation can not be put into a few words. It is necessarily lengthy, but study it carefully, step by step. If you understand electromagnetic induction (Chapter IV), and how a vacuum-tube functions in a receiver (Chapter VII), you can understand this:

Assume that the first impulse of current flowing through coil A induces a current in coil B which applies a positive voltage to the grid. The current in the plate circuit is thereby caused to rise above its normal value. In so doing it *strengthens the magnetic field* around coil A and *increases* the current induced in coil B and the positive charge on the grid of the vacuum-tube. This build-up or increase in the plate current would continue indefinitely if it were not for the grid leak shunted around the grid condenser. The grid leak produces a voltage drop across its terminals; thus biases the grid and so controls the action that the plate current can not rise above a certain value. When the plate current ceases to increase, the magnetic field produced by coil A also ceases to increase. The

voltage induced in coil B by coil A is produced by a changing magnetic field. No voltage is induced by a stationary field. When the magnetic field ceases to increase, the voltage induced in coil B falls to zero. The current in the plate circuit then tends to decrease to its normal value. As it decreases, the magnetic field around coil A begins to recede and induces a voltage impulse in coil B which is of *opposite polarity* to that induced by the magnetic field when it was advancing and building up. The plate current immediately falls below its normal value.

However, as soon as the magnetic field about coil A has entirely collapsed, up goes the plate current to its normal value. A new field builds up around coil A, causing a positive voltage, the same as the original impulse, to be applied to the grid.

This "swinging to and fro" in the circuit is sustained oscillation and will continue indefinitely. The frequency of the swings or oscillations will depend upon the amount of inductance and capacity in the circuit.

There are other methods of arranging an oscillator circuit besides that just described. They are of two general types: "self-controlled" and "crystal-controlled."

SELF-CONTROLLED OSCILLATORS

The circuit which we have just considered is a self-controlled oscillator. There are several different self-controlled oscillator circuits which are more efficient as transmitting circuits. They are, however, not as simple to explain to the novice. A wide range of frequencies can be obtained from a self-controlled oscillator by merely turning the knob of the variable condenser, but the frequency *stability* can be poor under certain conditions. In other words, the frequency does not remain constant. Simplicity is the main virtue of a self-controlled oscillator.

SELF-EXCITED OSCILLATORS

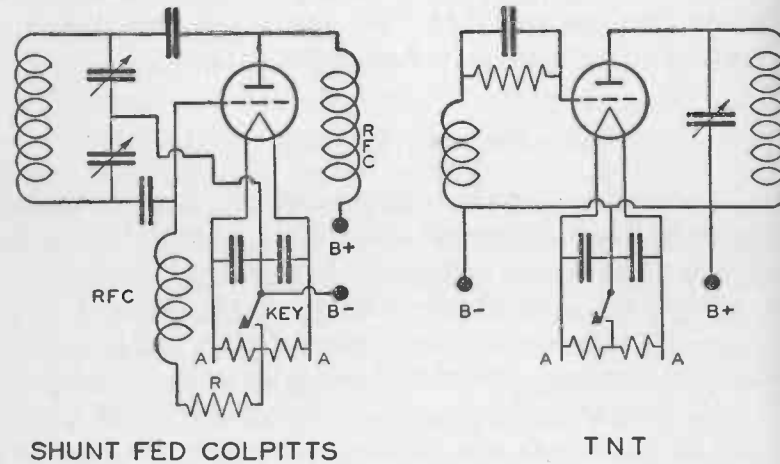
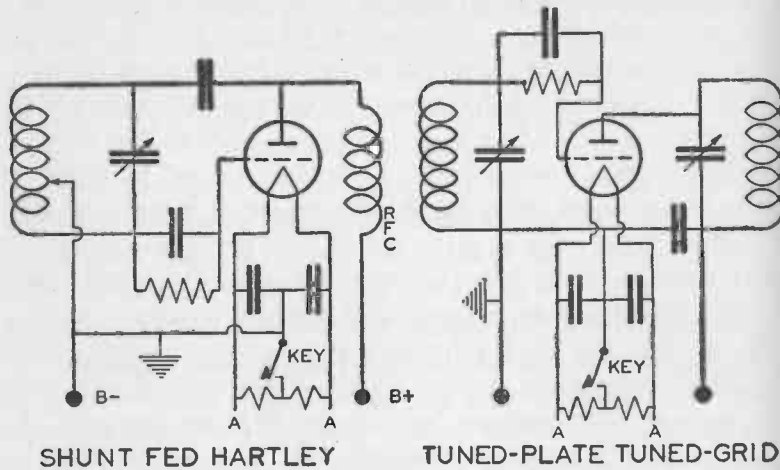

In the circuit on page 203 the feed-back or regeneration is of the tickler variety commonly used with regenerative detectors in short-wave receivers. Tickler feed-back is simply *inductive coupling* between the plate and grid. There are many varieties of this circuit. There are also two general divisions of self-controlled oscillator circuits—those employing induc-

HARTLEY OSCILLATOR CIRCUITS

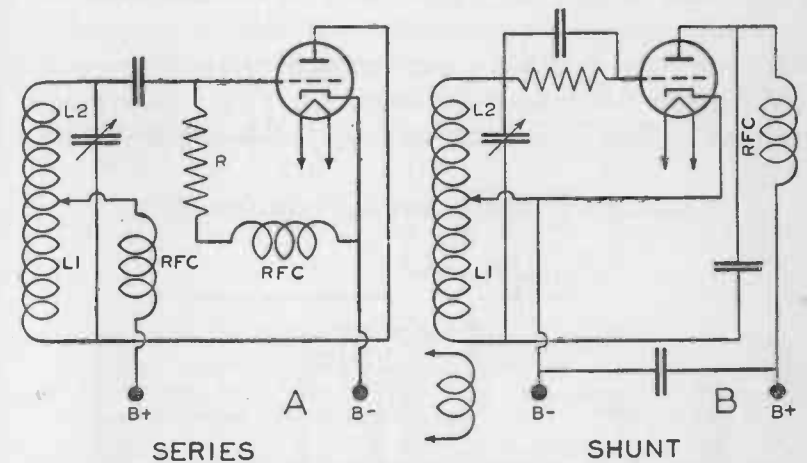

Circuit A has its plate voltage fed through the section of the coil marked L1 and is known as series feed. Circuit B has its plate voltage fed through a radio-frequency choke and is termed shunt feed.

tive coupling to feed back energy from the plate to the grid circuit and those which use capacitive coupling for the same purpose.

The Hartley, Colpitts, Tuned Plate and Tuned Grid, TNT, Electron-coupled, and Ultra-audion circuits, much discussed by amateur radio operators, are all self-controlled oscillators. To show how circuits can vary, two Hartley circuits are shown

on page 207. In circuit A the plate is "fed," that is, receives current through a section of the coil marked L_1 . This is known as *series* feed. In circuit B, also a Hartley, the plate is fed through a radio-frequency choke (R.F.C.). This is known as a parallel or *shunt* feed.

CRYSTAL-CONTROLLED OSCILLATORS

In order to keep the frequency of an oscillator constant, especially an oscillator employed in a transmitter operating in the short-wave spectrum, a quartz crystal-control is employed. Since quartz has piezo-electric properties, it will vibrate physically at a resonant frequency as long as some electrical stimu-

ELECTRON-COUPLED SELF-OSCILLATOR

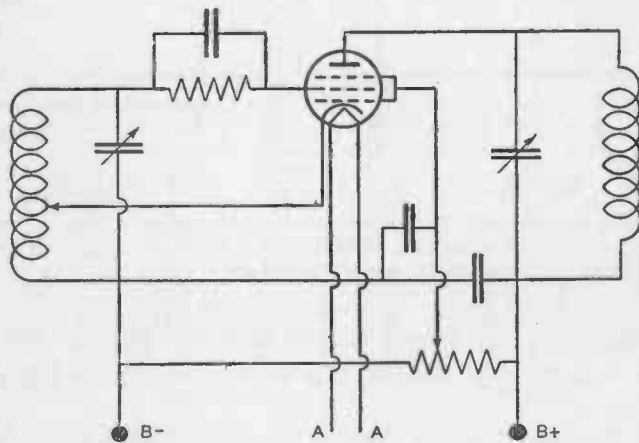

The circuit shown above is a common type of electron-coupled oscillator. Small variations in the power-supply voltage do not disturb the stability of this oscillator. It also has the advantage of a continuously variable range in frequency control.

lus is supplied to it. The frequency at which the quartz plate will vibrate is determined principally by its physical dimensions.* Each quartz plate for oscillator control is accurately ground to a certain thickness so that it will vibrate at a certain predesigned frequency. The stimulus which causes the quartz control to vibrate physically is obtained by radio-frequency feed-back from the oscillator tube. The physical vibrations of the plate generate piezo-electric charges which feed back into

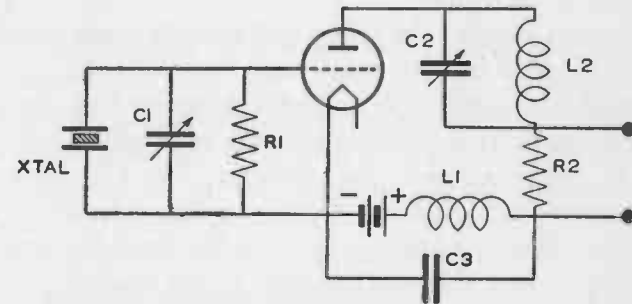

A CRYSTAL-CONTROLLED OSCILLATOR

This circuit shows a crystal-controlled tuned-plate, tuned-grid oscillator with three-element tube. Many circuits have been devised to utilize the stabilizing control of a piezo-electric crystal.

the tube at a frequency determined by the thickness of the crystal. In this way, the frequency of the oscillator is accurately controlled by the frequency of the quartz plate. A crystal-controlled oscillator has much better frequency stability than self-controlled oscillators.

The frequency of a transmitter utilizing a crystal-controlled oscillator may be changed only by changing the crystal or employing a frequency doubler. Frequency doublers are cir-

*Some quartz plates vibrate at more than one frequency and are known as crystals with "twin peaks." The circuit can, however, be arranged so as to prevent the crystal from oscillating at two frequencies.

uits which multiply the relatively low frequency of the crystal oscillator when higher frequency operation is desired.

RADIATION

A certain amount of energy is radiated in the form of radio waves from any circuit where oscillations are taking place. But in order to radiate efficiently, the power of an oscillator must be fed into an antenna.

If you bear in mind the things you already know about the inductive relation between two closely coupled coils, you will understand how simple it is to feed the power of an oscillator into an antenna. It is merely necessary to couple a coil, connected to the antenna, to the oscillator. The high-frequency alternating current in the tuned circuit will induce similar current in the coil coupled to it, and the power from the oscillator or a goodly part of it is thus radiated by the antenna.

EXCITER, OSCILLATOR AMPLIFIER, AND SELF-EXCITED TRANSMITTERS

That portion of a transmitter which supplies the actual control of frequency is called the *exciter*. The crystal oscillator and any frequency doublers are included in the exciter.

When an oscillator is used to feed the antenna directly, the transmitter is "self-excited." In order to increase the output of an oscillator before its energy is fed into the antenna circuit, an arrangement called an "oscillator-amplifier" is often used. In this, the oscillator drives one or more amplifier tubes which in turn feed the antenna.

C.W. AND PHONE

It is practicable to build oscillators to radiate waves ranging in frequency from 10,000 to more than 100,000,000 cycles, or in wave length from 30,000 meters to between one and two meters. The size and power of the apparatus may vary from that of the tiny equipment required to handle a fraction of a watt to that of the huge installation necessitated by 500,000 watts.

A transmitter may be arranged so as to be a continuous wave popularly called C.W., or radiotelegraph transmitter; or it may be a radiotelephone or voice transmitter. The waves of a C.W. transmitter are modulated with a telegraph key; those of a radiotelephone are modulated by sound waves through the medium of a microphone. When a transmitter is used to send pictures or television images, its waves are modulated by electrical impulses controlled by light.

The Power Supply for Amateur Radio

AN important part of any radio transmitter or receiver is the source of power or power-supply unit. All tube-equipped radio apparatus requires steady power for the filaments and direct current for the plates. The filament current may be either direct or alternating, depending on the type of service and the type of tube. The plate voltage must in all cases be direct. In most cases, power supply involves the use of only simple apparatus.

SOURCES OF CURRENT

Suitable current can be obtained from both dry and storage-batteries, the 110-volt power supply, and small generators. The popularity of automobile radios has caused the commercial development of a number of devices for obtaining a high-voltage direct current either from the car storage-battery or from a generator driven by the car's engine.

Receivers intended for operation on both direct and alternating current have the filament heaters connected in series with a suitable resistor and are supplied directly from the power line. A resistor is used frequently with a direct-current supply to compensate for variations in battery voltage or to adjust the tube voltage at the socket terminals to the correct

value. Usually, a step-down transformer is used with alternating current to supply the proper heater or filament voltage.

BATTERIES

Batteries are used chiefly for receivers where no other power is available and for both transmitters and receivers of the portable type, particularly with ultra-high-frequency equipment.

Current from dry-batteries or storage-batteries is ideal from one standpoint. It is steady, pure, direct current. However,

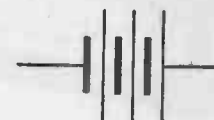
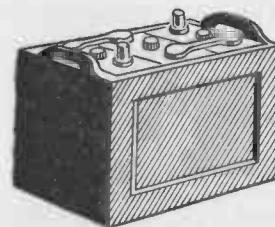

SYMBOL

SIX-VOLT STORAGE-BATTERY

Used to supply current for "farm," automobile and others radios where commercial power lines are not available. May be recharged from the power lines or a small generator driven by an engine or windmill.

the amount of current that can be taken from dry-batteries, especially B batteries, which are composed of a number of small cells, is extremely limited. Except for very low-power transmitters and small receivers, the cost of current from batteries is much greater than the cost of current from other sources.

Filament-lighting current for tubes designed for battery operation may be obtained from either dry-batteries, storage-batteries, or the patented Air Cell "A" Batteries.

Two 1½-volt dry cells connected in series with a ballast

tube to regulate the current automatically or a 2-volt storage cell may be used to operate tubes with a 2-volt filament. When a 2-volt storage-cell is used to replace three volts of dry-battery, the ballast tube is omitted.

Type 00-A and 01-A tubes are built with 5-volt filaments especially for operation on a 6-volt storage-battery. They are

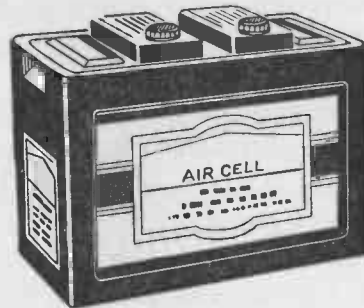

THE EVEREADY "AIR CELL"

This is a type of dry cell using activated carbon as a depolarizer. It is made to supply filament current for battery-operated radio sets and delivers two volts. The life is 1000 hours at 660 milliamperes, longer on smaller drain.

used principally for renewal purposes in old-type receivers.

It is possible to obtain 110-volt, 60-cycle alternating current from 6-volt storage-batteries by means of a rotary converter or by an inverter. Both of these devices may be operated also from 32-volt farm plants or 110-volt D.C. systems. A D.C.-A.C. inverter is a vibrating device similar in principle to the vibrators, "vibrapacks," and so on, commonly employed to furnish current for automobile radios.

OPERATING TUBES ON 110-VOLT D.C.

Where a 110-volt direct-current supply only is available, both the filament and plate circuits of receiving tubes may be

operated by including suitable resistance units. In the case of transmitters, it is advisable to use tubes designed especially for 110-volt D.C.

Perhaps the better method of operating radio apparatus, sound systems, and other equipment employing radio tubes, from the 110-volt direct current is to use a rotary converter to change the direct current into alternating current. A rotary converter is an electric motor equipped with generator coils on the armature which develop alternating current. Then by means of transformers the voltage of the alternating current is made suitable for the filament and plate circuits. After being raised to suitable voltage by a transformer, the current for the plate circuits is rectified through a diode tube and filtered in the usual manner.

HOW STORAGE-BATTERIES ARE RECHARGED

To recharge a storage-battery requires a *direct* current of at least $2\frac{1}{2}$ volts for each cell. Direct current of proper voltage and amperage may be secured from 110-volt A.C. by rectifying.

There are three types of small battery chargers on the market—the vibrator type, dry-disk rectifiers, and Tungar chargers. The dry-disk chargers utilize a number of copper oxide disks held together under pressure. These disks act as valves, permitting the current to flow in one direction but not in the other. The Tungar rectifiers are the type most frequently used in service stations for battery recharging. The Tungar rectifying device is a two-electrode vacuum-tube containing rarefied argon gas and connected to a step-down transformer. Inside the tube are a heavy filament of tungsten wire (cathode), and a small disk of graphite forming the anode or plate. When the filament is lighted, current will pass in one

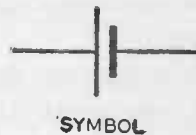

direction only across the space between the filament and plate. Two-volt storage-cells and six-volt storage-batteries are easily recharged with a windcharger or a small shunt-wound generator driven by a gasoline engine. A windcharger costs nothing to operate.

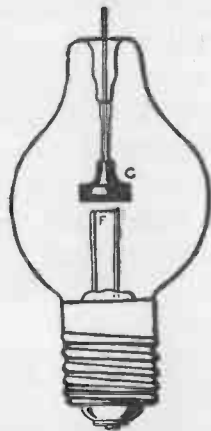

A TUNGAR RECTIFIER BULB

This is an interesting and useful tube development containing rarefied argon gas. Inside the tube are a heavy filament, F, of tungsten wire forming the cathode and a small disk of graphite forming the anode. Tungar tubes are used to rectify alternating current into direct current for battery charging.

OPERATING TUBES ON 110-VOLT A.C.

A very satisfactory high-voltage direct current for the plate circuits of either transmitting or receiving tubes can be built up from 110-volt or 220-volt alternating-current power by using a transformer, a rectifier, and a filter.

The power-supply equipment for A.C.-operated receivers and that used for transmitters does not differ materially except that the voltages required for receivers are lower. Trans-

formers, chokes, condensers, rectifier tubes, and resistors are the essentials of all A.C. power-supply systems.

When the apparatus for transforming, rectifying, and filtering A.C. current is assembled into a compact unit, it is usually termed a "power pack."

HOW 110-VOLT A.C. IS RECTIFIED FOR PLATE CIRCUITS

The rectifiers in use in receiving sets or employed by amateurs for supplying the plate circuits of transmitting tubes

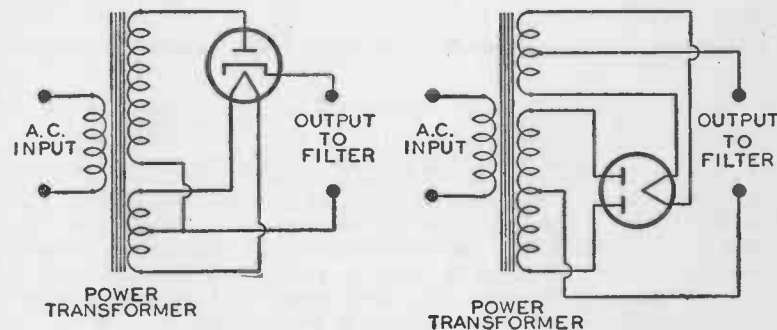

HALF-WAVE

FULL-WAVE

RECTIFIERS FOR PLATE-CIRCUIT SUPPLY

These circuits, using a single rectifier tube, show the difference between the half-wave and full-wave systems of rectifying the 110-volt A.C.

are usually the vacuum-tube type. They are "valves" or diodes very similar to receiving tubes in appearance and contain a cathode and either one or two plates. They will pass a current in one direction only across the space between the cathode and the plate and will rectify currents having a potential of several hundred volts. The tubes with a single plate are called *half-wave* rectifiers. Those with two plates are *full-wave* rectifiers.

A single half-wave tube will rectify only one-half of each alternating-current cycle and consequently produces a pulsating direct current. By using two half-wave tubes, or a single full-wave tube and what is called a "center-tapped" transformer,

POWER FILTERS

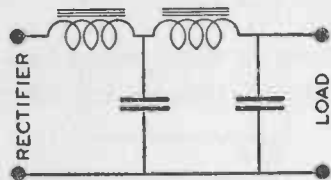

CHOKE-INPUT

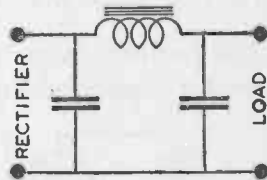

CONDENSER-INPUT

HOW A POWER FILTER OPERATES

A power filter is a simple arrangement for smoothing out ripples in a rectified current. Simple filter circuits consisting of reactance coils and condensers are shown above. The A.C. component or ripple of the rectified current tends to be impeded by the reactance or choke coils and short-circuited by the condensers in the filter. The direct current has an opposite action. It passes through the chokes but not through the condensers.

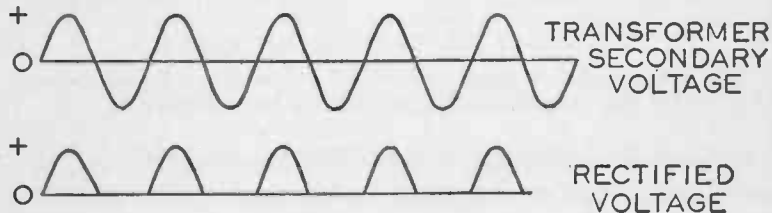

HALF-WAVE RECTIFICATION

An alternating current may be represented by a waving line as shown at the top. Each time the waving line crosses the straight line, it represents a reversal in the direction of the current. The effect of a half-wave rectifier is to eliminate every other alternation, as shown by the series of curved lines which are on one side of the straight line.

both halves of each alternating cycle may be utilized. This system produces a pulsating direct current also, but it does not have such prominent "ripples" as a single half-wave rectifier and so is easier to smooth out with a filter. Nothing is more annoying in a receiver than "ripples" in the plate current. They cause humming sounds. In the case of transmitters, a smooth, adequately filtered plate supply is necessary. The Federal Communications Commission requires it for all transmitters operating on frequencies below 30,000 kilocycles in order to insure pure, sharp signals.

HOW TO MAKE A POWER PACK FOR A RECEIVER

Power packs may be purchased completely assembled or in the form of kits for the radio experimenter to wire and finish. The kits usually include a steel base and all the fittings required to build a professional-looking job. A steel base is not essential and the radio experimenter can mount the various

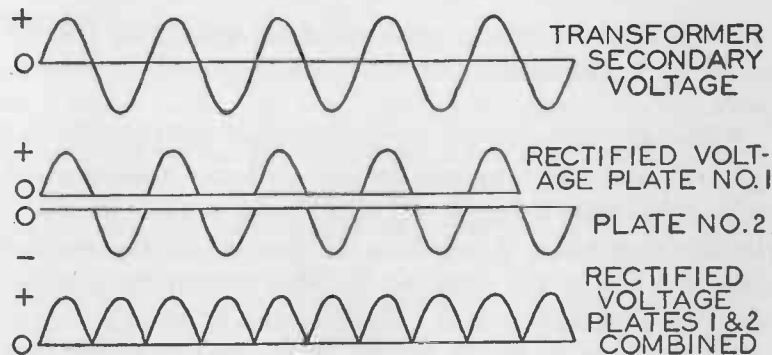

THE ACTION OF A FULL-WAVE RECTIFIER

A full-wave rectifier provides twice as many voltage impulses or ripples as a half-wave rectifier. Compare the representation of the rectified voltage shown above with that of the half-wave in the preceding illustration.

component parts of the pack on a wooden baseboard. It is not difficult to assemble and wire a power pack. The parts are not expensive. In fact, an old radio set which has been turned in for a small allowance on the purchase of a new receiver can

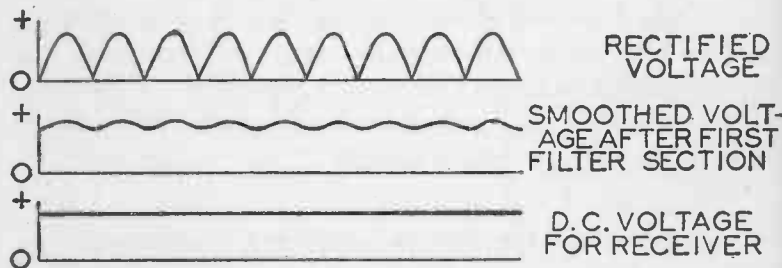

THE PURPOSE AND EFFECT OF THE POWER-SUPPLY FILTER

In order to make possible satisfactory reception, every trace of A. C. hum or ripple must be eliminated from the power supply. This is accomplished by passing the rectified current through a filter. The curves above show graphically the results of passing a fluctuating rectified voltage through a suitable filter.

often be obtained from a radio dealer for a dollar or two, its power pack dismantled and reassembled in more convenient form.

Power transformers for receiving tubes are built in two types—for 2.5-volt tubes and for 6.3-volt tubes. Windings and taps are provided to supply 2.5 volts for the cathode heaters in the receiving tubes, 5 volts for the filament of the rectifier tube, and 300 to 350 volts for the plate circuits. In a power pack for a transmitter it is a good practice to provide a separate transformer to supply current for the tube filaments. This is not necessary for low-power transmitters.

Several sizes of each type of power transformer are manufactured, the size varying according to the number of tubes to

be supplied. Transformers for four, five, six, seven, and eight to eleven tubes are standard sizes:

The various chokes, transformers, condensers, and resistors

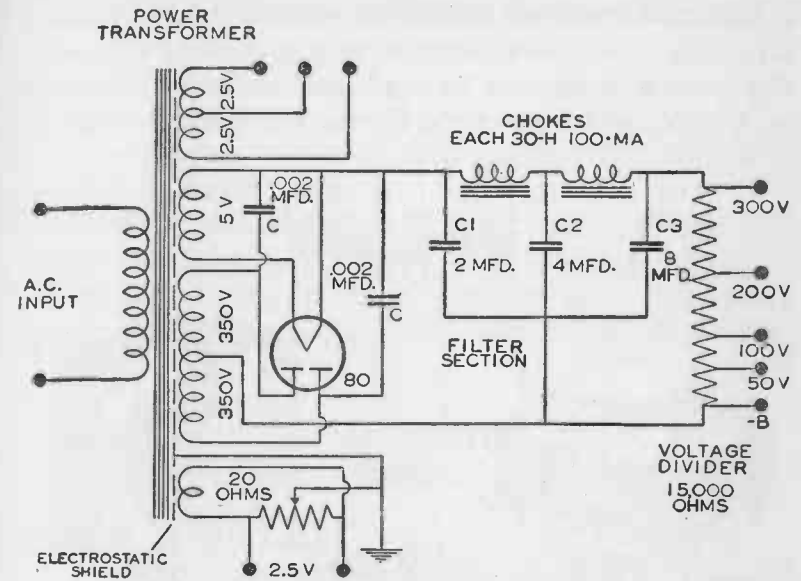

RECEIVER POWER SUPPLY

This diagram shows a complete receiver power supply with filter and voltage divider. A type 80 full-wave rectifier tube and a center-tapped power transformer with 700 volt secondary are used. A transformer with an electrostatic shield between the primary and secondary is desirable because if the shield is grounded it will help eliminate hum. The values of the various condensers and resistances are indicated in the diagram. The .002 mfd. condensers (C and C) connected across the plates and filaments of the rectifier tube should be mica condensers. Their purpose is to eliminate tunable hum. Tunable hum is caused by radio-frequency currents getting into the power supply and appears as a humming sound at certain frequencies when the detector is oscillating.

are all somewhat inexpensive items and are carried in stock by all radio stores catering to the needs of experimenters and radio-service men.

For power packs supplying up to 300 volts, the type 80 tube is recommended.* This is a full-wave rectifying tube which will deliver 350 volts per plate. It has a four-pin base to fit a standard four-contact socket. The socket should be mounted preferably to hold the tube in a vertical position. If it is necessary to place the tube in a horizontal position, the socket should be mounted with both of the filament-pin openings either at

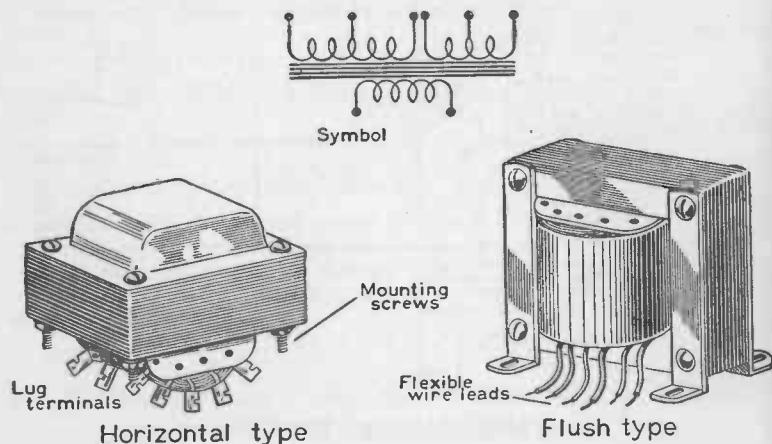

POWER TRANSFORMERS FOR PLATE AND FILAMENT SUPPLY

These transformers are made in great variety of sizes for supplying from 4 to 16 tubes.

the top or the bottom. This locates the plane of the filament vertically. Since a rectifier tube becomes quite hot during operation, provision should be made for free circulation of air around the bulb.

* For power potentials in the neighborhood of 500 volts, the type 5Z3 is suitable. There are several types of rectifier tubes for power packs. These are fully described in the *RCA Receiving Tube Manual* and the *RCA Transmitting Tube Manual*, obtainable from The Radio Corporation of America for 25 cents per copy.

A circuit diagram for a power pack designed for a receiving set is illustrated on page 221.

The transformer used in this pack is a standard power transformer with four separate secondary windings delivering 2.5, 5, and 700 volts. Two 5-volt secondaries are provided. One of these and the 700-volt winding are "center tapped" as shown in the diagram. The two condensers marked "C" should be mica condensers of .002 microfarad capacity. Their purpose is to eliminate tunable hums.

The three condensers marked C_1 , C_2 , and C_3 are the filter condensers. They, together with the chokes, comprise the filtering section of the power pack. The filter's action is to smooth out the ripple of the rectifier-tube output as shown in the illus-

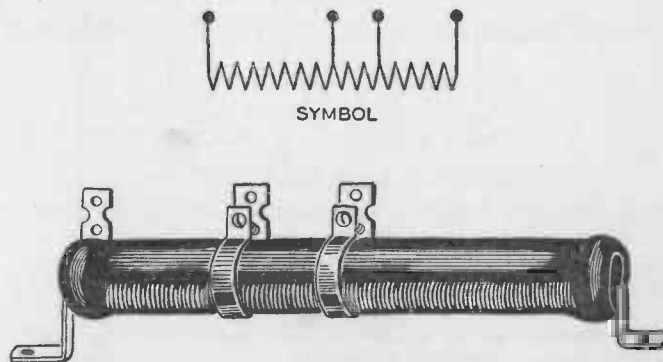

A VOLTAGE DIVIDER

A voltage divider makes it possible to obtain different voltages from the power supply. Regular voltage dividers are sold commercially for this purpose.

tration. The three filter condensers, C_1 , C_2 , and C_3 are respectively 2, 4, and 8 microfarads in capacity. Oil-impregnated paper condensers are really the best type, but for voltages below 500, electrolytic condensers may be used with the advantage of low cost.

There are two types of electrolytic condensers, *wet* and *dry*. The wet condenser, where the electrolyte is in the form of a liquid, may be overloaded and in such event is self-healing. The dry type, if overloaded, usually punctures and has to be replaced.

The two chokes or inductances used in the filter are standard "smoothing chokes" and should have an inductance of 30 henries each.

The resistance, marked "R₂," is a 15,000-ohm resistor, tapped every 3,000 ohms so as to act as a voltage divider and

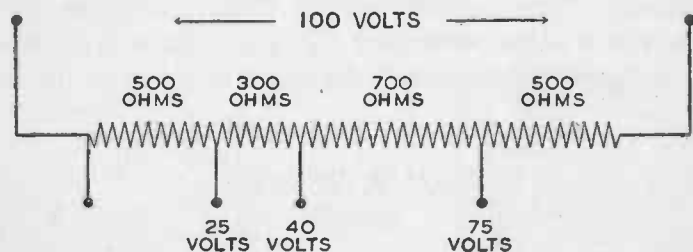

ADJUSTING A VOLTAGE DIVIDER

A voltage divider is actually a potentiometer connected across the output terminals of the power supply. By moving the metal contact bands or sliders, practically any desired voltage within range of the unit can be obtained. The diagram shows how approximately 25, 40, and 75 volts may be tapped from a resistance of 2,000 ohms having 100 volts across its terminals. The resistance values between the taps as indicated in the diagram are only approximate because the resistance needed between the taps actually depends upon the amount of current to be drawn at each of the taps.

cut down the output voltage to the values required by the plates, screens, and grids of the tubes in the receiver. One of the regular 15,000-ohm voltage dividers sold for this purpose may be used.

Resistance R₂ is a 20-ohm center-tapped resistor.

The various terminals will deliver approximately the voltages shown in the diagram. With modern receiving tubes, it is

not usually necessary for the voltages of the power pack to be nearer rated values than within 20 per cent.

VOLTAGE-DOUBLER RECTIFIERS

Some of the low-priced "universal" A.C.-D.C. broadcast receivers on the market are "transformerless," that is, they do not have a power transformer. Instead, to produce high poten-

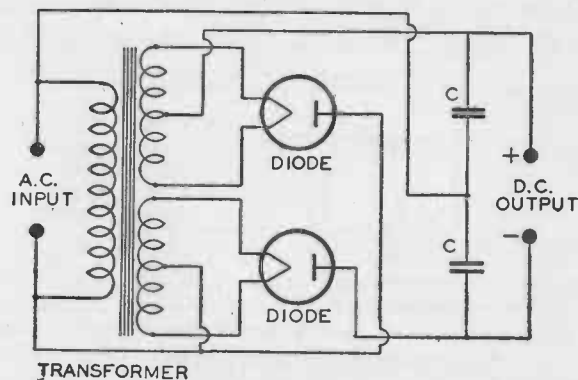

A VOLTAGE-DOUBLER RECTIFIER

This arrangement gives an output with a ripple frequency which is twice that of the A.C. supply line and makes filtering simpler. The direct current voltage output is approximately twice that obtained from a half-wave rectifier operated on the same current supply. This is brought about by the two condensers connected across the diodes. When one diode is rectifying, the condenser across the other diode is discharging. The output voltage is the sum of the output voltage of the conducting tube and the voltage of the discharging condenser.

tial for their plate circuits, they are provided with an arrangement of condensers and rectifier tube known as a *voltage-doubler rectifier*. The *no-load* direct-current voltage output of this ingenious device can be twice as high as the peak value of the alternating-current input voltage. This means that with-

out allowing for a small voltage drop which takes place in all rectifier tubes, a voltage-doubler rectifier operating on 110-volt A.C. can deliver 220 volts D.C. no-load. With a load—that is, when current is drawn at the output terminals of the rectifier—the output voltage drops below 220 by an amount that depends upon the size of the load and the capacity of the condensers.

A circuit diagram for a voltage-doubler of simple form using two half-wave rectifiers is illustrated. Briefly, the action of the circuit is as follows: When the upper side of the A.C. input

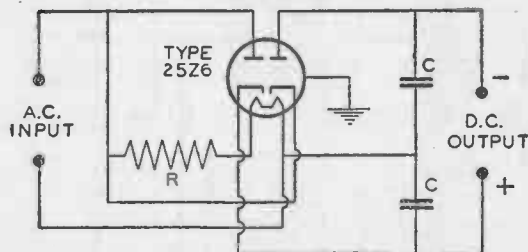

"TRANSFORMERLESS" PLATE SUPPLY

The circuit shows a "transformerless" plate supply utilizing the type 25Z6 tube. This tube contains two separate diodes in a single bulb. The resistance, R, represents the heaters of all the other tubes in the receiver, plus an appropriate voltage dropping resistor (if necessary). A filter of the condenser-input type is usually employed to smooth out the ripples in the output voltage. The condenser-input filter delivers the highest D.C. output.

line is positive, the upper rectifier (R_1) passes current and feeds a positive charge into the upper condenser C_1 . A positive voltage builds up across the condenser. On the next half-cycle of the A.C. input, when the upper side of the line is negative, the lower rectifier tube (R_2) passes current and feeds a negative charge into the lower condenser C_2 . A negative charge builds up across the lower condenser. If the input current is 110 volts A.C. and no current is drawn from the D.C. output

terminals, condenser C_1 can charge up to a voltage of approximately +110 and condenser C_2 can charge up to a voltage of approximately -110. The total voltage across the output terminals is therefore 220, the voltage doubler thus supplying a no-load direct-current output voltage twice as large as the peak alternating-current input voltage.

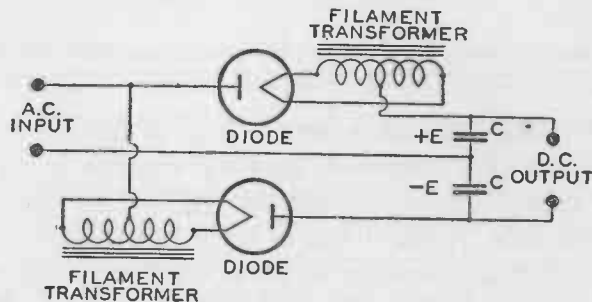

A SIMPLE FORM OF VOLTAGE-DOUBLER RECTIFIER

When the upper diode passes current (during the positive impulse of the A.C.) it builds up a positive charge in the upper condenser. On the next half-cycle of the A.C. input, the lower diode passes current and builds up a negative charge across the lower condenser. When no current is drawn from the output terminals, the voltage across the terminals is twice as large as the peak A.C. voltage. When current is drawn from the output terminals, the voltage drops, the amount of drop depending upon the capacity of the condensers and the amount of current drawn.

The Radio Corporation of America manufactures two rectifier tubes especially designed for use as voltage-doubler rectifiers. These tubes combine two separate diodes in one tube, or "envelope" as a radio engineer would say. The type 25Z6 is all metal and the 25Z5 is glass. The 25Z5 fits a standard six-contact socket and 25Z6 fits the standard octal socket.

In the accompanying diagram showing a type 25Z6 tube in a voltage-doubling rectifier circuit, the resistance R consists of the heaters of all the other tubes in series with an appropriate voltage-dropping resistor.

More About Radio Tubes

BEFORE radio tubes were brought to their present high state of development, there was only one type of tube on the market, the familiar triode. This was sold as all-purpose tube. It was a sort of radio jack-of-all-trades and served as a radio-frequency amplifier, oscillator, detector, or audio-frequency amplifier. One tube did not perform all these duties simultaneously, of course; it could be used for any of these purposes. In the 1920's, all the tubes in an eight-tube superheterodyne receiver were triodes. Quite naturally, one type of tube could not meet all these varied requirements to the best advantage. Research was begun to find out what characteristics a tube should have in order to fulfil best a particular purpose. The high degree of efficiency which modern receivers possess is largely due to the fact that there are many different types of tubes made to-day and that they each have been developed for some special duty or to combine in one bulb functions which formerly required two or three tubes. In this chapter, some of these special tubes and their applications are described. No one can be interested in radio long without hearing of screen grids, converters, mixers, and so on. At first acquaintance they are mysterious. Adding three or four more grids to a three-element tube makes things appear rather complicated. The four wheels on a cart make it appear more

complicated than a wheelbarrow, but the principle of each is simple. So it is with tubes; the multi-element tubes seem more perplexing than the three-element. Their principle is simple, however.

THE SCREEN-GRID VACUUM-TUBE

Triodes were never satisfactory as radio-frequency amplifiers. The plate and the grid of a triode or three-electrode tube form a tiny condenser which is troublesome in a radio-frequency amplifier. It is the reason for the tube's instability, for its tendency is to oscillate. Such devices as "neutralizers" and "lossers," used to prevent a triode radio-frequency amplifier from oscillating, waste valuable energy. Fortunately, this bothersome capacity between grid and plate can be made very small by mounting an additional electrode, called a screen-grid, in the tube. Consequently, the screen-grid type of tube has been highly developed and is now in almost universal use as a radio-frequency amplifier. Representative screen-grid tubes are Nos. 32 and 24-A.

With the addition of a screen-grid, a three-element tube has four electrodes and consequently becomes a tetrode. The screen grid is of coarser mesh than the grid itself and is mounted between the grid and the plate. It acts as an electrostatic shield, the effect of which is to make the grid-to-plate capacity of a tetrode very small. The effectiveness of this shielding action is further increased by connecting a small by-pass condenser across the screen and cathode. The result is a tube which is quite stable and will not oscillate.

The screen grid has another use besides reducing grid-to-plate capacity. If the plate voltage is kept higher than the screen voltage, the plate current is practically independent of

the plate voltage. This makes it possible to obtain much higher amplification with a tetrode than a triode, amplification which, on account of low grid-plate capacity, can be secured without instability.

SECONDARY EMISSION, SUPPRESSORS, AND THE PENTODE VACUUM-TUBE

Electrons moving at sufficient speed dislodge other electrons. In all radio tubes, electrons thrown off by the cathode may, if they strike the plate with sufficient velocity, dislodge other electrons called *secondary* electrons. Their release from the plate is called *secondary emission*. In a diode or triode, secondary electrons are eventually drawn back to the plate because there is no other positive electrode to attract them. Since that is where they belong, their short wandering does not cause any trouble. However, in a screen-grid tube it is a different story. Because the screen-grid is positive and is close to the plate, many of the vagrant secondary electrons are attracted to it. Their effect when drawn to the screen grid is to lower the plate current.

This troublesome effect of secondary emission in lowering the plate current of a screen-grid tube may be eliminated by adding a fifth electrode known as a *suppressor*. With five electrodes, the tube is called a *pentode*. The suppressor is similar to the screen-grid in construction and is located between the screen-grid and the plate. It is usually connected to the cathode and so is negative with respect to the plate. Consequently it repels the meandering secondary electrons in their attempt to move from the plate to the screen grid and drives them back to the plate where they cause no trouble.

When used as a radio-frequency, amplifier, the pentode tube

produces high-voltage amplification at moderate plate voltage. When used as an audio-frequency amplifier, it makes possible a large power output with high degree of amplification.

The positive voltage for the screen of a four-electrode or tetrode tube is usually obtained from the B-supply by connecting the screen either to the proper tap or to a potentiometer across the B supply. Varying the screen voltage of the tetrode tubes in the radio-frequency amplifier is a convenient means for controlling the volume of a receiver.

BEAM-POWER TUBES

There is still another method of effectually suppressing the wanderings of secondary electrons dislodged from the plate without using a suppressor screen. It is accomplished by a *beam-power* tube in which there are four electrodes, a cathode, grid screen, and plate. The electrodes are so spaced that electrons thrown off by the cathode and attracted to the plate slow down in a certain region near the plate where they form a space charge, a sort of stationary cloud of electrons which repels any secondary electrons emitted from the plate and compels them to return where they came from.

Type 6L6 is a beam power tube. It is an efficient, highly sensitive device capable of handling considerable power and is used as an amplifier tube in the output audio-amplifier stage of radio receivers.

The mechanical arrangement of a beam power tube is interesting and ingenious. It is a good illustration of how thoroughly the behavior of the invisible electrons is understood to-day. Two metal plates, partially enclosing the cathode, grid, and screen, force the electrons into a beam. The screen and grid are spiral wires. These are carefully spaced so that each turn

of the grid shades a corresponding turn of the screen from the electron beam emitted by the cathode. The electrons travel between the turns of the screen and very few of them actually touch it.

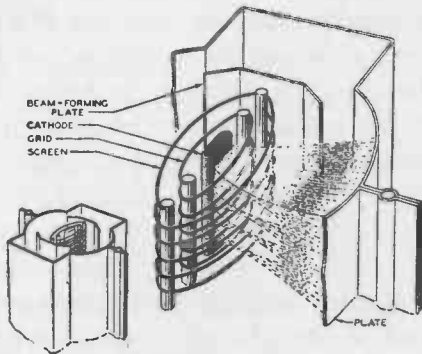

Courtesy of the Radio Corporation of America

THE BEAM-POWER TUBE

The construction of this tube effectually suppresses the wanderings of secondary electrons which are knocked out of the plate. The electrons are forced into a beam by the action of two plates partially enclosing the cathode, grid, and screen.

POWER DETECTION

The large amount of power fed to the detector by a screen-grid radio frequency amplifier makes necessary a detector which can handle this energy without distortion. The 201A- or 227-type tubes, used in the ordinary detector circuit, can not handle loud signals without distortion.

More power should mean better reproduction, and fortunately a way has been found to remedy the shortcomings of a detector tube. The strong signals furnished by screen-grid tubes in the radio-frequency amplifier make it possible to sacrifice some of the sensitivity of the detector circuit in order that more power may be handled without distortion. This is

accomplished by a circuit called *power detection* or *plate rectification*. At first glance, a power-detection circuit appears to be an ordinary radio-frequency amplifier. But due to the arrangement of the plate circuit, wherein are present a radio-frequency choke and a by-pass condenser, radio frequencies

AUTOMATIC VOLUME CONTROL "AVC"

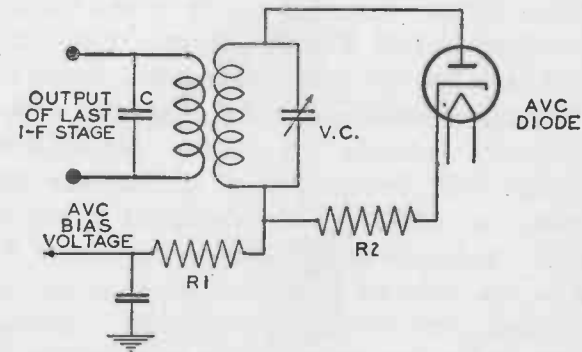

Automatic volume control prevents an unpleasant blast of sound from the speaker when tuning in a station. It is accomplished by means of the diode used as the second detector in a superheterodyne receiver. The current of the received signal is used to vary and control the negative bias on the radio-frequency and intermediate-frequency amplifier tubes and thereby regulate the volume. For further details of the operation of this circuit see text.

are eliminated from the detector's output and the tube's performance is that of a detector or rectifier.

ELECTRON-RAY TUBES AND AUTOMATIC VOLUME CONTROL

Radio engineers, like their younger brothers the "hams," have a lingo of their own. One of their expressions, unintelli-

gible to the layman, is AVC. AVC is *automatic volume control*. In a receiver, it prevents an unpleasant blast of sound from the loud speaker when tuning in a station with the volume control turned up high. It also eliminates fluctuations in tone volume when signals at the antenna are fading in and out. Modern broadcast receivers are usually provided with AVC.

Automatic volume control, or automatic gain control, as it is also called, is not accomplished by mechanical means. It is entirely electronic without a single moving mechanical part. It is attained by the diode used as the second detector in a superheterodyne receiver. The normal duty of this tube is to perform the same function as the detector in a simpler receiver, but as a by-product it will supply AVC. There is a wide variety of AVC circuits, including some using multi-element tubes which contain diode elements, but all are basically the same. They employ the rectified voltage developed by the received signal across a resistance in a detector circuit to vary the negative bias on the radio-frequency and intermediate-frequency amplified tubes. This voltage is practically proportional to the strength of the detector signal, so as the signal strength becomes greater so does the negative bias. When the negative bias is increased, the amplification in the radio-frequency and intermediate stages is decreased. When the signal at the antenna decreases, the AVC circuit acts in a reverse manner. It decreases the negative bias and increases the amplification. Thus, the AVC circuit acts to prevent change in the output of the last intermediate frequency stage and consequent change in loud-speaker volume.

Control of at least two stages of amplification by AVC is preferable. It is hardly worth while to employ it with a single stage.

Electron-ray tubes are often used as tuning indicators in

broadcast receivers with automatic volume control. Electron-ray tubes 6E5 and 6G5 are both triodes with a fluorescent target at the top of bulb. The target is kept positive and consequently attracts electrons from the cathode. When the

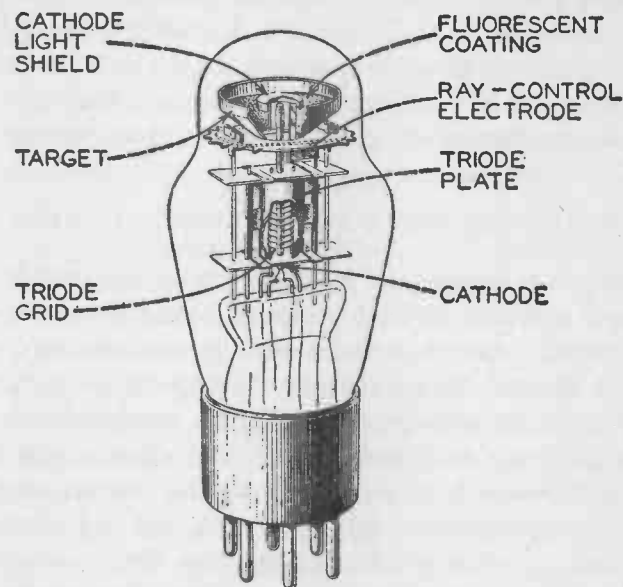

Courtesy of the Radio Corporation of America

ELECTRON-RAY TUBE

Used as a tuning-indicator in broadcast receivers with automatic volume control. The shadow on the fluorescent target is smallest when the set is tuned exactly to the desired station. See text for detailed explanation.

electrons strike the target, they produce a pink glow in the fluorescent coating. Between the cathode and target is a ray-control electrode which governs the electrons reaching the target. When this control electrode is at approximately the same potential as the target, all the electrons flow past it to the target and the latter has the appearance of a ring of light. But when

the potential of the control is less positive than the target, electrons do not reach that portion of the target behind the control and a shadow is cast upon the glowing target. The potential of the control electrode is determined by the potential on the grid of the triode section of the tube. AVC voltage is applied to the grid. The shadow is smallest when the set is tuned exactly to the desired station. In this way an electron-ray tube having AVC voltage applied to the grid of the tube's triode is a convenient visual indicator of correct tuning.

MULTI-ELECTRODE AND MULTI-UNIT TUBES

There are a number of "specialty" tubes designed to give maximum performance in a particular application or to combine actions in one tube which formerly required two or more tubes. In general, these tubes get their special characteristics by the proper arrangement of more than three electrodes and consequently may be broadly classed as multi-electrode tubes.

Tubes intended to give the best possible performance in a particular application are 6J7, 6L7, 6F6, and 6L6. Multi-unit tubes, that is, tubes which combine more than one function, are 6Q7, 6R7, 6B8, 6B7, 6N7 and 6A6. All of these types combine two or more separate tube units. 6Q7, for example, consists of two diodes and a triode in one bulb. It may be used as a combined detector, amplifier, and automatic-volume-control tube.

PENTAGRID CONVERTERS, PENTAGRID MIXERS, AND FREQUENCY CONVERSION

In a superheterodyne receiver, the incoming signal frequency is first converted to a fixed intermediate frequency and is then

amplified at the intermediate frequency prior to detection. The frequency converter is the heart of the superheterodyne receiver.

Extremely useful multi-element tubes utilizing five grids in their construction have been developed for superheterodynes. Type 6A8 and 1C6 are *pentagrid converters* combining an oscillator and a frequency mixer in one tube. Coupling between the oscillator and mixer circuits is obtained by means of the electron stream within the tube. The varying plate current which is produced is a combination of the oscillator and signal frequencies.

Still another method of frequency conversion particularly adapted for short-wave reception makes use of a *pentagrid mixer* and a separate oscillator tube. Type 6L7 is a *pentagrid mixer* tube having two separate control grids shielded from each other. Each grid acts independently on the electron stream. The tube is useful in circuits where dual control is desirable in a single stage and especially useful as a mixer in superheterodyne receivers having a separate oscillator stage. Radio-frequency signal voltage is applied to one of the control grids and oscillator voltage is applied to the other. The resulting variations in plate current are an intermediate frequency due to the combination of the oscillator and signal frequencies.

Amateur Transmitting Antennas

THERE are forms of antennas other than those described in Chapter VIII. An understanding of the principles involved in these systems is of great value to the radio amateur who endeavors to get the best performance from his equipment. It requires a knowledge of advanced mathematics and a great deal of special study to understand the fine points of antenna design and construction; but some of the most useful principles can be explained with the aid of simple arithmetic.

Few amateurs are fortunate enough to have sufficient clear space available to erect an ideal antenna system for transmitting. Usually there is only room enough to erect a half-wave antenna designed for the lowest frequency at which the station is to operate. In other words, at an amateur station, available space usually determines the most suitable antenna.

MARCONI AND HERTZ ANTENNAS

The antenna systems most favored by amateurs are the types called *Marconi* and *Hertz* antennas. They are named after the men who first employed them in transmitting and receiving electromagnetic waves.

The Hertz antenna is used by amateurs for short-wave work

except in the 160-200 meter band. The length of wire required to make an antenna system function efficiently on frequencies of 1,715-2,000 kilocycles (160-200 meter amateur band) makes

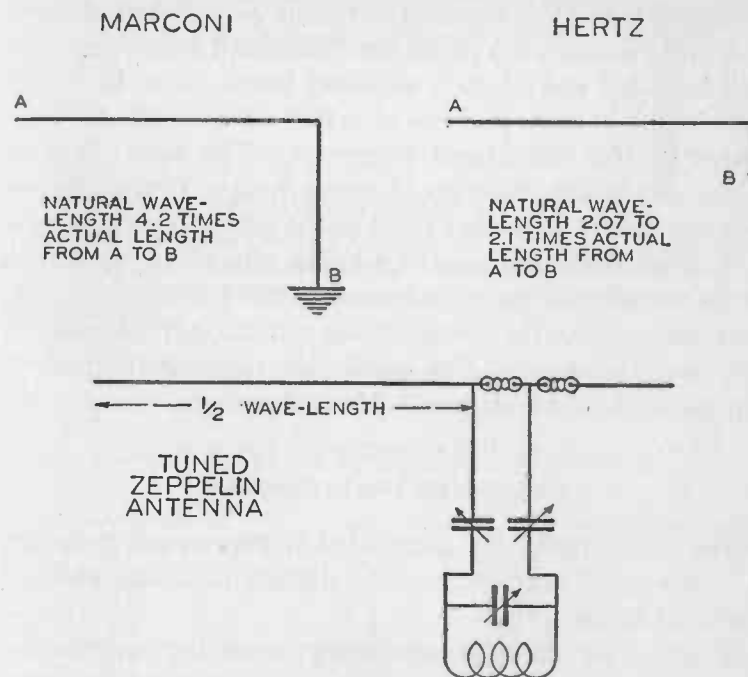

THREE COMMON TYPES OF ANTENNA

The Marconi, Hertz, and Zeppelin antennas are shown above in diagram. When employing a Hertz or a Zeppelin antenna no ground connection is used.

it impractical to erect an antenna system which would need to be 250 feet long for transmitting on 160 meters if of the Hertz type.

The Marconi antenna, or "grounded quarter-wave" antenna, is widely used on the 160-meter band. It is not as satisfactory for long-distance communication as the Hertz type. Its effi-

ciency is never quite as great, due to losses in the earth connection. Since a Marconi type antenna needs to be only half as long as a Hertz antenna in order to radiate the same wave-length, it is widely used in mobile 5-meter installations.

A Hertz antenna is a single wire suspended above the earth, well insulated and of such electrical length as to be a half wave-length or some multiple of a half wave-length. It is not connected with the ground in any way. The earth plays no direct part in the radiation of waves from a Hertz antenna, although it does have some effect on the practical performance.

A Marconi antenna may be a single wire, either vertical or partly vertical and partly horizontal, as the inverted "L" type. It is connected to the ground at the end through the coupling and tuning apparatus. The earth plays an essential part in the radiation of waves from a Marconi antenna.

PRACTICAL INSTALLATION

The best location for an antenna is over vacant property. A "back-yard" antenna is more efficient than one which is stretched across a roof.

There is no entirely satisfactory insulating material for short-wave transmitting antennas. Glass is the best compromise. Cheap glass insulators are satisfactory for receiving, but for transmitting, Pyrex glass insulators are advisable.

Insulators should be cleaned two or three times a year if they are exposed to much smoke and soot.

The ideal antenna wire is copper, of the largest size. The practical sizes are Nos. 6-14 B.S.-gauge enameled copper. Wires smaller than No. 14 B.S. gage are not strong enough to withstand being pulled taut.

The use of enameled wire is an amateur practice because

the insulating weather-proof enamel covering prevents the copper wire from corroding. Radio-frequency currents have a

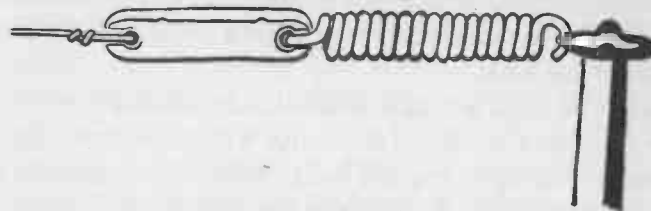

RELIEVING ANTENNA STRAIN

An antenna should be pulled up fairly taut so that it does not sway much. This causes considerable strain, especially when the wind blows. Some of the strain may be eased automatically by the action of a stiff spring in the antenna support.

tendency to travel on the surface of a wire. Bright new copper wire would be best if it were to retain its shiny finish; but

MARCONI TYPE ANTENNAS

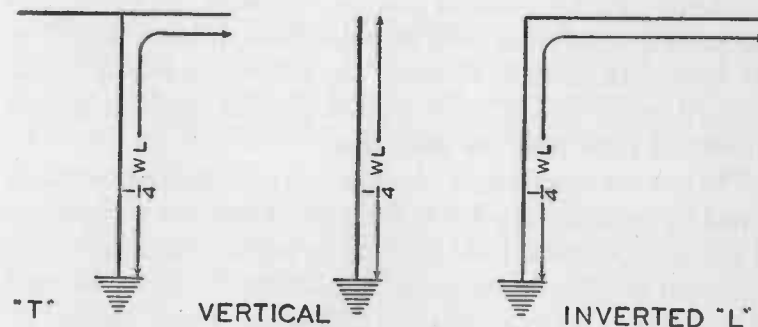

The arrows indicate the effective length which determines the natural wave-length of these antennas. The natural wave-length of a Marconi antenna is approximately four times its effective length.

it soon corrodes. (Theoretically, if it is sufficiently corroded, the corrosion is just as good an insulator as enamel.)

A short-wave antenna must be kept taut. This may be accomplished by a tension spring or a counterweight. When a counterweight is used, it is tied to the lower end of the antenna supporting rope. The rope runs over a pulley at the top of the supporting mast.

The length of an antenna determines its natural wave-length, or the frequency at which resonance will take place. Amateur antennas for transmitting are built so that their length is such that resonance will take place at the operating frequency of the transmitter. The efficiency of a resonant antenna is many times that of an antenna which is not resonant.

A Marconi antenna is usually one-quarter or three-quarters of a wave-length long. Thus it allows the use of half the wave-length of wire used for a Hertz antenna.

THE GROUNDED ANTENNA

When erecting a Marconi antenna, its length, its height, and the ground connection must be taken into consideration. For the system to be most efficient, the antenna must be of the proper length, it must be as high as possible, and the ground connection must have low resistance.

The natural wave-length of a Marconi antenna (not vertical)—and by natural wave-length is meant always the wave-length at which the antenna will resonate—is approximately 4.2 times its actual length. For example, an antenna for a wave-length of 160 meters (frequency 1,875 kilocycles) would be 160 divided by 4.2, or 38.9 meters, which is the equivalent of 127.6 feet. This length of an antenna is the *total length* from the free end of the antenna to the ground connection.

In installing a Marconi antenna intended to radiate a certain wave-length, it is not necessary to be highly accurate in cal-

culating and measuring the total length from free end to ground. The tuning devices incorporated in the transmitter will compensate any reasonable discrepancies between the natural wave-length of the antenna and the desired wave-length of the station.

In locations where it is impossible to secure good ground connections because no water pipes are available or the soil is dry or sandy, it is advisable to employ a counterpoise.

A counterpoise consists of a system of wires insulated from the ground and running horizontally above the earth over the area immediately under the antenna. The wires should be supported on insulators mounted on posts and be elevated about seven feet above ground. From three to five wires, about the same length as the antenna, may be used. They may run parallel to one another or spread out fanwise.

THE HERTZ OR HALF-WAVE ANTENNA

The natural wave-length of a Hertz antenna is double that of a Marconi antenna of the same physical length. A Hertz antenna which is well off the ground and reasonably clear of poles, guy wires, and other objects has a natural wave-length



STAND-OFF INSULATOR

Used in the construction of transmitters and to support antenna lead-ins. Made in various sizes, of isolantite, steatite, polystyrene, and other materials which reduce energy losses.

of between 2.07 and 2.1 times its actual length. The proximity of neighboring objects affects the ratio of natural wave-length to actual physical length so that an absolutely accurate calculation can not be made ahead of time. If it is desired to ascertain the actual natural wave-length, it can be measured with a frequency meter.

"FEEDING" THE ANTENNA

In order for an antenna to radiate, it must be supplied or "fed" with energy in the form of radio-frequency currents. Antennas are fed through a transmission line which leads from the transmitter to some point on the antenna. In the case of an inverted "L" Marconi-type antenna, the lead-in serves as the transmission line. The lead-in of a Marconi antenna radiates as well as the antenna.

Hertz antennas may be "directly" excited or fed by a non-radiating transmission line. A non-radiating transmission line often makes it possible to locate the transmitting apparatus more conveniently.

It is usual to connect the feeder to either end or to the center of an antenna of the directly excited type. When a Hertz antenna is center fed, the antenna is divided at the center so as to form two quarter-wave sections. When it is end fed, the length of the antenna should be exactly one-half wave-length, unless it is planned to operate on a harmonic.

HARMONICS OR MULTI-BAND OPERATION

For example, an end-fed Hertz antenna having a natural wave-length of 80 meters (it would have a physical length of 38.9 meters) could be used to transmit waves of 80, 40, 20, and

10 meters. The frequencies which produce waves 40, 20, and 10 meters long are harmonics of the frequency (3,750 kilocycles) which produces a wave 80 meters long. Eighty meters is the *fundamental* wave-length of such an antenna. Forty, 20, and 10 meters are respectively the *second*, *fourth*, and *eighth* harmonics of the antenna.

TRANSMISSION LINES

There are two types of transmission lines for connecting a transmitter to an antenna, the *tuned* and the *untuned*. Tuned lines are somewhat simpler to build and adjust than untuned lines and are more adaptable to multi-band operation.

Multi-band operation is possible with an untuned feeder, but only with such loss of efficiency that the untuned line is gen-

SINGLE WIRE FEEDER MATCHED IMPEDANCE

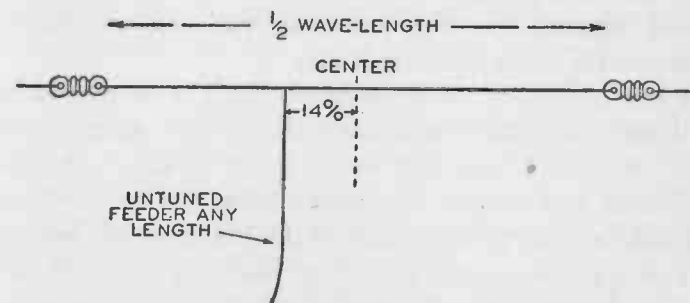

HERTZ ANTENNA WITH UNTUNED FEEDER

One method of feeding a Hertz antenna is with an untuned transmission line as shown above. The distance from the center of the antenna to the point where the feeder is attached is approximately 14 per cent of the total length of the horizontal wire. Its exact position must be determined experimentally. An antenna of this type is generally considered to be only a single wave-length arrangement. It is not suitable for multi-band operation.

erally considered to be only a single wave-length arrangement.

One method of feeding a Hertz antenna with an untuned line is called the *single-wire matched-impedance* system. This long name means simply a single wire attached to the horizontal antenna at a point slightly off center. The distance from the center of the antenna to the point where the feeder is attached is approximately 14 per cent of the total length of the horizontal wire. The distance varies slightly with the frequency, and has to be determined experimentally by testing with a low-reading thermo-ammeter. The position of the feeder is shifted slightly until the readings on the meter are practically the same all along the transmission line, and no points are found where the readings show pronounced increases or decreases.

A tuned line or feeder may seem at first to be a mysterious, complicated affair; but it is simply an antenna folded back on itself so that the radio-frequency currents flowing in each part are of the same strength but always of opposite polarity at the same instant. Thus they neutralize each other's radiation and none takes place from the feeder.

The two wires of a tuned feeder should both be exactly the same length, preferably an exact multiple of a quarter wave-length. However, if the line length is not exactly a multiple of a quarter wave-length, the tuning apparatus of the transmitter can be made to adjust electrically the difference between a quarter wave-length and the actual length of the wires. The two wires should run parallel and be spaced from 4 to 12 inches apart.

Any transmission-line fed antenna used for transmitting makes an excellent receiving antenna. A switch in the feeders inside the station can be arranged so that the antenna can be connected to either the transmitter or the receiver.

VOLTAGE FEED AND CURRENT FEED

When a Marconi antenna is supplied with power from a transmitter and is radiating, the current and voltage vary at different points along it. The point where the maximum voltage occurs is at the *ungrounded* end, while the point of greatest current is at the *grounded* end.

We find that the points of maximum voltage are at the ends of a Hertz half-wave antenna, while the point of greatest current is in the center.

When the transmission line is connected to the point of maximum voltage on the antenna, the antenna is said to be *voltage-fed*. When fed at the point of greatest current, the antenna is *current-fed*. Antennas fed at the center can be current-fed only when they are a half wave-length long.

THE ZEPPELIN ANTENNA

Undoubtedly the most popular type of Hertz antenna with tuned transmission line is the voltage-fed Zeppelin type antenna, popularly known as the "Zepp." The name was acquired by the early use of this antenna system on the Zeppelin airships. It is suitable for a station operating in several bands.

In the Zeppelin antenna, one wire of the tuned transmission line is connected to one end of the antenna. The other wire is left free, or "floating," as it is called.

The feeder wires may be separated by wooden dowels about twelve inches long, or by white-pine sticks $\frac{1}{2} \times \frac{1}{2} \times 12$ inches which have been boiled in paraffin. A slot one inch deep is cut in each end of each "spreader." The feeder wires are slipped into the slots and bound in place with wire.

A Zepp antenna may be any number of half waves long.

For transmitting the *fundamental* frequency or natural wave-length of the antenna, the transmission line is usually made an *odd* multiple of a quarter wave-length, that is, either one, three, or five quarter wave-lengths. A transmission line equal to an even multiple of a quarter wave-length is used for transmitting the *harmonics*.

The length of a half-wave antenna may be calculated from the following simple formula. It requires only arithmetic for its solution:

$$\text{Length in feet} = \frac{492,000 \times K}{F}$$

F is the frequency in kilocycles and K is a correction factor which varies with the frequency. For frequencies of

Less than 3,000 kilocycles, $K = .96$
 From 3,000 to 28,000 kilocycles, $K = .95$
 Above 28,000 kilocycles, $K = .94$

Here is an example of how the formula works in figuring the wave-length of a half-wave antenna for 160 meters. A wave of 160 meters has a frequency of 1,875 kilocycles.

$$\text{Length} = \frac{492,000 \times .96}{1875} = \frac{472,320}{1875} = 251.3 \text{ feet}$$

DIRECTIONAL EFFECTS

All of the half-wave Hertz antennas have considerable directional effect at right angles with the plane of the antenna. If a Hertz antenna points east and west, it will be directional north and south. A Zepp antenna, since it is end-fed, is somewhat less directive than the center-fed.

TWO-WIRE FEEDER SYSTEM

Two-wire transmission lines in which both wires actually feed energy into the antenna are somewhat preferable. They are no more difficult to erect and adjust. There is little to choose between the several types of two-wire systems and so only one will be described here. It is called

CENTER-FEED HALF-WAVE

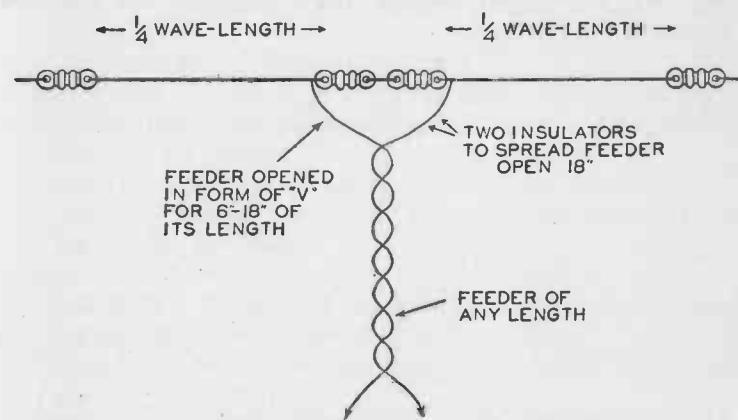

TWO-WIRE FEEDER SYSTEM

Each half of this type of antenna should be one-quarter wave long. Notice that the feeder is spread apart to form a V just before it reaches the antenna proper. The feeder is "twisted pair" sold by radio stores for this purpose.

A HALF-WAVE ANTENNA CENTER-FED BY A TWISTED PAIR LINE

The antenna should be one-half wave-length long. It is divided exactly at its center by two Pyrex glass insulators, so that each half of the antenna is exactly one-quarter wave-length long. The transmission line is a two-wire line and may

be the regular "twisted pair" sold by radio stores for this purpose; or it can be the No. 14 rubber-covered twisted wire used for house wiring. One end of each of the twisted wires is attached to each section of the antenna.

The twisted pair feeder may be almost any length. A slight adjustment of its impedance may be necessary. The purpose of the adjustment is to match the impedance of the feeder. This is accomplished by untwisting and spreading out the feeder wires slightly at the top where they join the antenna, as shown in the illustration.

Abbreviations and Definitions

- "A" BATTERY.** A battery which supplies current for the filament of a vacuum-tube.
- A.C.** Abbreviation for alternating current.
- ACORN TUBES.** Type 954 and 955 miniature tubes which function well at ultra-high-frequencies where tubes of ordinary construction will not operate.
- ACCELERATOR GRID.** A screen-grid in audio-power pentodes, the purpose of which is chiefly that of accelerating the electron flow rather than shielding.
- AERIAL.** An antenna.
- AIR CONDENSER.** A condenser having air as the dielectric or insulating material between plates.
- AIR CORE.** Some radio coils are wound over a hollow form in which air forms the core.
- ALTERNATING CURRENT.** An electric current that surges to and fro in a circuit.
- ALTERNATION.** One-half of an alternating current cycle or the rise and fall of an alternating current in one direction.
- ALTERNATOR.** An alternating current generator.
- AMMETER.** An instrument for measuring the strength of an electric current flowing in a circuit in terms of amperes.
- AMPERE.** The standard unit of electrical current. It is the current flowing in a circuit of one ohm resistance under a pressure of one volt.
- AMPERE HOUR.** The unit for measuring the volume of electricity passing in a circuit which takes into consideration the element of time. It is the quantity of electricity transferred by one ampere flowing for one hour.

- AMPERE-TURNS.** The product of the current in amperes times the number of turns of wire in a coil is called the ampere turns. An ampere flowing through one turn of a coil considered with reference to its electromagnet effect. A coil or electromagnet with 1,000 convolutions or turns and a current of 2 amperes would have 2,000 ampere turns.
- AMPLIFICATION, AUDIO-FREQUENCY.** The increase or augmentation of the energy of a current of audio-frequency by an amplifier tube or other means.
- AMPLIFICATION FACTOR.** The ratio between the plate voltage and grid voltage for constant plate current in an amplifier tube.
- AMPLIFICATION, RADIO-FREQUENCY.** The increase or augmentation of the energy of a current of radio-frequency by amplifier tube or other means.
- AMPLIFIER.** A device used to increase or augment electric currents of either audio or radio-frequency. It usually consists of one or more amplifier tubes coupled to a circuit by means of transformers, inductances, capacities, or combinations of these.
- AMPLIFYING TRANSFORMER.** A primary and a secondary winding, either with or without an iron core, used to couple an amplifier tube to a circuit.
- AMPLIFICATION, REGENERATIVE.** The amplification secured by coupling the plate circuit to the grid circuit so as to feed back part of the plate current to the grid. This increases the sensitiveness of a tube as a detector.
- AMPLITUDE.** The distance or measure of an electric wave from its zero line to its crest.
- AMPLITUDE MODULATION.** The impress of a signal on a radio wave by varying the amplitude of the wave.
- ANGLE OF RADIATION.** The angle in respect to the earth at which an antenna concentrates the energy of the waves which it radiates.
- ANODE.** A positively charged electrode toward which electrons flow in a vacuum-tube or a positively charged electrode by which a voltaic current enters an electrolyte or the like: opposed to cathode.
- ANTENNA.** A conductor intended to intercept or radiate radio waves.
- APERIODIC CIRCUIT.** An untuned circuit.
- ARMSTRONG CIRCUIT.** The "feed-back" circuit invented by E. H.

- ARMSTRONG** in which part of the plate circuit energy is fed back to the grid by coupling between the plate and grid circuits.
- ATMOSPHERICS.** Electrical disturbances in the atmosphere which cause noises in radio receivers. The same as static.
- ATOM.** The smallest particle of matter that can enter into combination.
- ATTENUATION.** The rejecting action of a band of frequencies by a filter.
- AUDIBILITY.** The ratio between the current producing a signal in a loud-speaker or telephone receiver and the current producing a signal which is just audible.
- AUDIO-FREQUENCY.** A frequency capable of producing sounds audible to the human ear.
- AUDIO-FREQUENCY AMPLIFIER.** See **AMPLIFICATION, AUDIO-FREQUENCY.**
- AUDIO-FREQUENCY CURRENT.** A current whose frequency is capable of producing sounds capable of being heard by the human ear. The currents of a radio signal after it has been rectified by a detector.
- AUTODYNE RECEIVER.** A self-heterodyne receiver. It has a regenerative circuit in which the same tube is used as a detector and as a generator of local oscillations, thus producing audio-frequency beats which render continuous wave signals audible.
- AUTOMATIC FREQUENCY CONTROL.** A circuit in a radio receiver which is designed so as to automatically bring the tuning circuits into resonance with a wave which is only partially tuned in.
- AUTOMATIC VOLUME CONTROL.** A circuit in a radio receiver so designed that it maintains received signals at approximately the same volume.
- AUTOTRANSFORMER.** A transformer having a single winding which is tapped to form a primary and a secondary.
- AVC.** Abbreviation for automatic volume control.
- "B" BATTERY.** A battery used to supply the plate circuit current in a vacuum-tube.
- BAFFLE.** A partition used in mounting speakers to "baffle" or prevent

- sound waves from the back of the speaker diaphragm from canceling the waves from the front of the diaphragm.
- BAKELITE.** A synthetic resin made from phenol and formaldehyde used as the basis of varnishes, plastics, cements, and insulating compounds.
- BALLAST.** An automatic current-control device consisting of a resistance wire which increases its resistance with an increase in current flow and decreases it when the current drops.
- BAND, WAVE-LENGTH.** A narrow band of radio wave-lengths containing "side" waves due to varying amplitude and frequencies caused by modulation. *See also* wave-length.
- BAND-PASS FILTER.** A filter circuit arranged to pass a single continuous band of frequencies and to block the passage of all frequencies above or below the band.
- BATTERY.** Two or more voltaic or storage cells connected together.
- BATTERY, PRIMARY.** A battery that produces current by chemical action in which the cathode is consumed. Dry cells connected together are the common form of primary battery.
- BATTERY, SECONDARY.** A storage battery. The current is generated by chemical action after the battery has first been charged by passing a current through it.
- BEAM POWER TUBE.** A radio tube of the pentode type of very high-power sensitivity, capable of giving considerably more output than ordinary tubes at moderate plate voltages.
- BEAT FREQUENCY.** The frequency which results when two different frequencies are brought together or heterodyned as in the regenerative, autodyne, and superheterodyne receivers.
- BEAT RECEPTION.** Reception by the beat method in which two different frequencies of constant amplitude act simultaneously in the same circuit.
- BIAS.** A potential applied to the grid of a vacuum-tube to cause operation to take place with a certain characteristic.
- BIASING BATTERY.** Also called a "C" battery. It furnishes the potential impressed upon the grid of a vacuum-tube to cause operation at a certain part of its characteristic curve.
- BIASING POTENTIAL.** The potential used to bias the grid.
- BIASING RESISTOR.** A resistor connected in a radio circuit so that the potential drop through the resistor is used as a biasing voltage.

- BLUE GLOW.** The blue light generated in a vacuum-tube when the vacuum is too low or the plate voltage is too high.
- BROADCAST.** The one-way transmission of news, music, entertainment, or other matter addressed to the public and not to individuals. Not point-to-point transmission.
- BROAD-WAVE.** A radio wave which can not be tuned sharply.
- BRUTE-FORCE FILTER.** A condenser-input filter, characterized by high voltage output, poor voltage regulation and high rectifier peak current.
- BUG KEYS.** High-speed keys which make dots automatically and save motion of the operator's wrist.
- BUZZER.** An electromagnetic signaling device with a vibrating armature which makes a buzzing sound.
- BUZZER MODULATION.** Variation, by means of a buzzer, of the output of a continuous wave generator.
- BY-PASS CONDENSER.** A fixed condenser which offers low impedance to radio-frequency currents but high impedance to audio-frequency currents and infinite resistance to direct current.
- "C" BATTERY.** A biasing battery used to impress a potential on the grid of a vacuum-tube.
- CAGE.** An antenna consisting of several wires arranged cylindrically.
- CAPACITATIVE REACTANCE.** The opposition offered to an alternating current by a condenser. The capacitive reactance changes with the frequency of the current.
- CAPACITY.** The ability or the measure of the ability of a condenser, coil, or wire to store up electrical energy. The unit of capacity measurement is the *farad*.
- CAPACITY, DISTRIBUTED.** Coils possess in addition to their inductance a small amount of capacity due to the proximity of the turns called the *distributed capacity*.
- CARBON MICROPHONE.** The conventional telephone transmitter or microphone in which sound waves are converted into pulsating electrical current by the variation in resistance with pressure between carbon granules in contact with a diaphragm which is caused to vibrate by sound waves.
- CARBORUNDUM.** A crystalline material (silicon carbide) made in the

- electric furnace for abrasive purposes. Once used as a radio detector.
- CARRIER FREQUENCY.** The radio-frequency generated by a radio telephone transmitter for the purpose of being modulated by an audio-frequency.
- CARRIER WAVE.** *See* CARRIER FREQUENCY.
- CASCADE AMPLIFIER.** An amplifier consisting of two or more amplifying tubes in which the current or potential to be amplified passes through successive tubes.
- CATHODE.** The heated element in a vacuum-tube which throws out electrons. A cathode may also be the negative electrode by which a voltaic current leaves an electrolyte: opposed to anode.
- CATHODE RAY.** An electron beam emitted by a cathode.
- CATHODE-RAY TUBE.** A tube used in television and in oscillographs in which a moving electron beam is focused on a fluorescent screen at one end of the tube.
- CAT-WHISKER.** A long, thin wire used to make contact with the sensitive surface of a detector crystal.
- CHANNEL.** A narrow band of radio wave-lengths.
- CHOKE.** An inductance coil with either an iron or air-core used to retard or impede certain frequencies.
- CHOKE COIL.** Same as choke.
- CIRCUIT.** A path through which an electric circuit may be established.
- CIRCULAR MIL.** One thousandths of a square inch. The measure of sectional area of a wire.
- CLICKS.** A form of static which causes a clicking noise in phones and loud-speakers.
- CLOSED CORE.** A transformer or reactance core in which the path of the magnetic flux is entirely through iron.
- COIL.** A number of turns of wire.
- COLPITTS CIRCUIT.** A fundamental system of connecting a radio tube so that it will oscillate in a manner suitable for creating radio waves. The filament is connected to the junction of two condensers which are placed in series with an inductance so that the grid and plate circuits share the voltage drop across the condensers.
- CONDENSER.** A device which stores up electrical energy consisting of

- two or more conducting surfaces separated by an insulating material called a dielectric.
- CONDENSER MICROPHONE.** A microphone which operates through changes in capacity caused by vibrations of a diaphragm forming one of the conducting surfaces of a condenser.
- CONDUCTIVITY.** The opposite of resistance. The measure of the current carrying ability of a substance.
- CONDUCTOR.** Generally a wire or a strip of metal. A conductor is a substance which offers a good path to an electric current.
- CONTINUOUS WAVE.** A wave of constant or unvarying amplitude.
- CONVERTER.** An electrical machine for changing A.C. to D.C. Also a radio tube in which the functions of oscillator and mixer are combined.
- COULOMB.** The unit of quantity in measuring electricity. The quantity of electricity transferred by a current of one ampere in one second.
- COUNTERPOISE.** A system of wires raised a few feet above the earth and insulated from it which is used to complete the capacity effect of the antenna in place of the usual ground connection.
- COUNTER ELECTROMOTIVE FORCE.** A voltage that is in the opposite direction and opposes the voltage causing it.
- COUPLER.** A device for furnishing coupling so as to transfer energy from one circuit to another.
- COUPLING.** The relation which permits the transfer of electrical energy between two circuits or two components of a circuit by means of a magnetic or electrostatic field.
- COUPLING, CAPACITIVE.** Coupling between two circuits or two components of a circuit by means of condensers.
- COUPLING, COEFFICIENT OF.** The measure of the amount of coupling between two circuits.
- COUPLING, INDUCTIVE.** Coupling between two circuits or two components of a circuit by means of the magnetic field produced by a wire or coil.
- COUPLING, RESISTANCE.** The coupling established between two circuits when they have a resistance in common.
- CRYSTAL.** Usually refers to the quartz crystal used to maintain the oscillations of a transmitter at a constant frequency.
- CRYSTAL DETECTOR.** A form of detector making use of the rectifying

properties of certain crystalline minerals such as galena, iron-pyrites, and so forth.

CRYSTAL MICROPHONE. A microphone which generates currents due to the action of a piezo-electric crystal subjected to the vibrations of the diaphragm.

CURRENT, ELECTRIC. A flow of electricity.

CURRENT FEED. A tuned transmission line connected to the center of a half-wave-length antenna.

CURRENT LAG. Delay in the rise of current in a circuit due to the electrical inertia presented by inductance. The current "lags" behind its voltage.

CURRENT LEAD. The opposite of *current lag*. In a circuit containing a preponderance of capacity, the current leads its voltage.

C. W. Abbreviation for continuous wave.

CYCLE. Two succeeding alternations in which the current changes from zero to maximum in one direction back to zero and to a maximum in the opposite direction and then to zero again.

DAMPED WAVE. A radio wave of decreasing amplitude.

DAMPING. The decreasing of the amplitude of radio waves or high frequency currents.

D.C. Abbreviation for direct current.

DECIBEL. The unit used in measuring increase or decrease of power. Used to measure gain of amplifiers.

DECREMENT. The rate of damping.

DEMODULATION. The same as **DETECTION**.

DETECTION. The process of extracting from a radio wave the signal imparted to it at the transmitting station.

DETECTOR. A sensitive device which converts radio-frequency oscillations into a form in which they will operate some sort of an indicator such as a telephone receiver or loud-speaker. The modern detector is a vacuum-tube.

DIAPHRAGM. The vibrating member in a microphone, telephone receiver, loud-speaker, or phonograph reproducer.

DIELECTRIC. The insulating material between the electrically charged plates of a condenser.

DIELECTRIC CONSTANT. The ratio of the capacity produced by a

condenser with a given dielectric and the capacity of the same condenser with air as the dielectric.

DIELECTRIC STRAIN. The stress or displacement taking place in the dielectric of a condenser when it is charged.

DIELECTRIC STRENGTH. The ability of an insulating material to resist the passage of electricity.

DIRECT CURRENT. A current of electricity which always flows in the same direction.

DIRECT COUPLING. The coupling produced between two circuits by having an inductance, condenser, or resistor in common or partly in common.

DIRECTIONAL ANTENNA. An antenna which radiates waves more strongly in one direction than another or which receives waves more readily from one direction than another.

DISTORTION. Unfaithful reproduction of signals.

DISTRIBUTED CAPACITY. See **CAPACITY, DISTRIBUTED**.

DOUBLET ANTENNA. A popular antenna of the Hertz type which may be used for either receiving or transmitting.

DRY CELL. A primary cell in which the electrolyte is in the form of a paste.

DUMMY ANTENNA. A non-radiating circuit coupled to a transmitter for the purpose of measuring the actual power output.

DYNAMIC SPEAKER. A loud-speaker having a diaphragm which is actuated by an attached coil suspended in a powerful magnetic field.

DYNAMOTOR. A direct-current machine having two sets of windings on one armature; one set acting as a motor and the other as a generator.

EARTH. A connection to the ground or earth.

EDISON STORAGE BATTERY. A storage battery developed by Thomas A. Edison which uses potassium hydroxide as the electrolyte and elements of nickel and iron.

EDISON EFFECT. The phenomenon discovered by Edison that a current will flow between the hot filament of an incandescent lamp and another electrode in the tube.

ELECTRODE. The elements of a voltaic cell or storage cell. The parts

of an apparatus which dip into an electrolyte and carry a current. The cathode, anode, grid, and screen are the electrodes in a radio tube.

ELECTROLYTE. A chemical solution which will conduct a current of electricity. More specifically it is the acid or alkaline solution used in batteries, chemical rectifiers, and a certain type of condenser.

ELECTROLYTIC CONDENSER. A fixed condenser in which one conducting surface is an electrolyte either in liquid or paste form and the other is aluminum foil.

ELECTROMAGNET. A magnet formed by passing an electric current through a coil of wire.

ELECTROMAGNETIC WAVES. The waves used in radiotelegraphy, radiotelephony, and television.

ELECTROMAGNETISM. Magnetism created by an electric current flowing through a conductor.

ELECTROMOTIVE FORCE. The voltage or electrical pressure that causes an electric current to flow along a conductor.

ELECTRON. A negative particle of electricity.

ELECTRON TUBE. A radio tube.

ELECTROSTATIC CHARGE. An electric charge at rest: "static" electricity.

ELECTROSTATIC COUPLING. The same as capacitive coupling.

E.M.F. Abbreviation for electromotive force.

ETHER. The medium which according to one theory pervades all matter and space and is the medium through which electromagnetic waves travel.

FADING. Variation in the strength of received radio signals when all the adjustments of both sending and receiving apparatus remain the same. Thought possibly to be caused by shifting of the Heaviside Layer, magnetic storms, and the like. The cause is unknown. Also called swinging.

FARAD. The practical unit of capacity. A condenser with a capacity of one farad when charged so as to have a potential of one volt contains one coulomb of electricity. The microfarad (one-millionth of a farad) is the practical unit.

FEED-BACK. The system of coupling the plate circuit to the grid circuit in regenerative circuits.

FIBER. An insulating material suitable for battery and 110-volt circuits but not suitable for high voltages.

FIDELITY. The proportionate response of a receiver throughout the audio-frequency range.

FIELD. Abbreviation for magnetic field. Also the name given to that portion of an electrical system or machine in which a magnetic field is set up.

FILAMENT. In a vacuum-tube, an electrically heated wire forming the cathode.

FILAMENT SUPPLY. The source of current which heats the filament or "heater" in a vacuum-tube.

FIXED CONDENSER. A condenser the capacity of which can not be adjusted.

FLAT TOP. An antenna consisting of one or more horizontal wires of the "T" or inverted "L" type.

FLEMING VALVE. The original radio tube, a two-element vacuum-tube containing filament and plate only and used as a detector.

FLICKER. The flickering of electric lights due to a voltage-drop on lines supplying radio transmitting sets due to the varying load when telegraphing.

FLUX. Magnetic lines of force.

FREQUENCY. The number of complete cycles of current occurring in one second. *See also* AUDIO-FREQUENCY, NATURAL FREQUENCY, and RADIO-FREQUENCY.

FREQUENCY CHANGER. A device for changing the frequency of an alternating current.

FULL-WAVE RECTIFIER. A rectifier which utilizes both halves of an alternating current cycle.

FUNDAMENTAL. The basic frequency generated by an oscillating circuit. The fundamental of an antenna is the lowest frequency of free alternating current in an unloaded antenna.

FUSE. A protective device designed to melt or fuse in case excessive current flows in a circuit.

- GALENA.** A crystalline lead ore (lead sulfide) used as a detector.
- GALVANOMETER.** A sensitive instrument used for detecting or measuring very weak currents.
- GAP.** An open space in a circuit.
- GAUSS.** The unit of magnetic intensity in terms of the number of lines of force per square centimeter in a magnetic field.
- GERMAN SILVER.** An alloy of copper, nickel, and zinc used in making resistance wire.
- GRID.** The metal gauze element in a vacuum-tube which controls the flow of electrons from the filament to the plate. Also one of the latticed lead-plates in a storage cell.
- GRID BATTERY.** Same as "C" BATTERY.
- GRID BIAS.** The voltage of a "C" or biasing battery applied to the grid of a radio tube.
- GRID CIRCUIT.** The circuit in which the grid of a vacuum-tube is connected.
- GRID CONDENSER.** A small condenser connected to the grid of a radio tube.
- GRID LEAK.** A high resistance sometimes connected from the grid to the filament of a radio tube to provide a leakage path and maintain the potential of the grid at a desired average value.
- GRID MODULATION.** The system of modulating the output of an oscillator tube by connecting the microphone transformer in the grid lead.
- GRID RESISTOR.** A resistor connected in the grid circuit to suppress radio-frequency currents.
- GRINDERS.** The most common form of static. It produces a grinding noise in phones and loud-speakers.
- GROUND.** An electrical connection to the earth or the frame, or core of an electrical device.
- GUY.** A wire or cable used to brace a radio mast.
- GROUND LEAD.** The wire or conductor leading to a ground connection.
- HALF-WAVE ANTENNA.** An antenna which is half as long in electrical length as the wave it receives or transmits.

- HALF-WAVE RECTIFIER.** A device which renders only one-half of an alternating current cycle available.
- HARD RUBBER.** An insulating material made of rubber and sulfur which has been largely replaced by Bakelite.
- HARD TUBES.** A vacuum-tube exhausted to a high degree.
- HARMONIC.** A frequency which is an even multiple of a fundamental frequency.
- HARTLEY CIRCUIT.** Used for generating oscillations in a transmitter. The tuned circuit has its ends connected to the grid and plate of the tube. The filament circuit of the tube is connected to the coil at a point between the grid end and the plate end. The coil is thus divided into two sections, one in the grid circuit and the other in the plate circuit.
- HEAT.** A form of energy consisting of electromagnetic waves of a frequency between that of light waves and radio waves.
- HEATER.** An electrical element in a vacuum-tube designed to operate on alternating current and to supply heat to an indirectly heated cathode.
- HEAVISIDE LAYER.** An area of ionized gas high above the earth which is thought to reflect radio waves.
- HELIX.** A coil of wire.
- HENRY.** The unit of inductance. A henry is the inductance in a circuit in which the electromotive force induced is 1 volt when the inducing current varies at the rate of one ampere per second.
- HERTZ ANTENNA.** A form of antenna consisting of a single ungrounded wire.
- HERTZIAN WAVE.** A name frequently given to radio waves.
- HETERODYNE RECEPTION.** The same as BEAT RECEPTION.
- HETEROTONE RECEPTION.** Tone modulation produced when receiving continuous-wave telegraph signals. It is accomplished by an audio-frequency oscillator or tone generator used to modulate one of the intermediate frequency amplifier tubes.
- HIGH FIDELITY.** When a wide band of audio-frequencies is transmitted and/or received.
- HIGH-FREQUENCY CURRENTS.** Radio-frequency currents.
- HIGH-PASS FILTER.** A filter circuit which passes frequencies *above* a certain limit and attenuates those below.
- HIGH-VOLTAGE.** Potential of considerable electromotive force.

HORSE-POWER. A unit of power which in electrical terms is equivalent to 746 watts.

HORSE-SHOE MAGNET. A magnet shaped like a horse-shoe.

HOT-WIRE AMMETER. A current-indicating meter which operates by the expansion of a wire when heated by the current being measured.

INDUCTANCE. The property of a circuit or of a coil by which it stores up electrical energy in electromagnetic form.

INDUCTANCE COIL. A coil included in a circuit for the express purpose of furnishing inductance.

INDUCTION. The transfer of energy from one conductor to another by magnetism, electromagnetism, or electrostatic stress.

INDUCTION COIL. An open-core high ratio step-up transformer.

INDUCTIVE COUPLING. The coupling of one circuit to another to bring about an energy transfer by means of induction.

IMPEDANCE. The total opposition of a circuit to the passage of an alternating current. The opposition is composed of reactance and resistance.

INPUT CIRCUIT. The primary of a transformer. The grid circuit of an electron tube.

INSULATION. Insulating material used to prevent current leakage.

INSULATORS. Substances which oppose the passage of an electric current to a high degree.

INTERFERENCE. Interruption in reception caused by static, transmitting stations, and so on.

INTERMEDIATE FREQUENCY TRANSFORMER. A transformer sharply tuned to a single frequency band designed to amplify the intermediate frequencies generated in a superheterodyne receiver.

INTERRUPTER. A device arranged to automatically make and break a circuit rapidly.

ION. An atom or a group of atoms bearing an electric charge. In a gas, a combination of a number of molecules with an electron. Ions impart conductivity to a gas or liquid.

IONIZATION. The process of charging atoms and molecules so that they become the carriers of positive and negative electricity called ions.

JACK. A device fitted with spring contacts into which a plug is inserted to complete the circuit through the apparatus connected to the plug.

JAMMING. The difficulty caused by interfering waves.

JOULE. The unit of electrical work or energy. The energy spent when a current of 1 ampere flows through a resistance of 1 ohm for one second.

JOULE'S LAW. The number of units of heat that develop in a circuit is proportional to its resistance, to the square of the strength of the current and to the time that the current lasts.

KENOTRON. The trade-marked name of a rectifier tube manufactured by the Radio Corporation of America.

KEY. A hand-operated switch arranged to make and break a circuit rapidly in accordance with the dots and dashes of the telegraph code.

KEY CHIRPS. Undesirable "chirpy" or "yooping" signals heard in a receiver due to frequency changes in a transmitter when the latter is modulated with a telegraph key.

KEY CLICK. Click sounds heard in a receiver caused by interfering radio frequency waves set up by "shock excitation" in opening and closing the circuit of a continuous wave transmitter.

KICK-BACK. Radio-frequency currents induced in the low-frequency side of a circuit.

KILO. A prefix meaning 1,000.

KILOCYCLE. 1,000 cycles.

KILO VOLT. 1,000 volts.

K.V.A. Abbreviation for kilovolt-ampere.

KILOVOLT-AMPERE. Unit used to rate alternating current generators. The product of kilovolts and amperes.

K.W. Abbreviation for kilowatt.

KILOWATT. 1,000 watts.

"L" ANTENNA. A flat-top antenna with the lead-in connected to one end.

LAGGING CURRENT. See CURRENT LAG.

- LAMBDA.** The Greek letter used as a symbol for wave-length.
- LAMINATIONS.** Thin sheets of iron or steel used as the cores of coils, transformers, motors, and other electrical apparatus.
- LEAD.** A wire or conductor that carries current to or from a piece of apparatus.
- LEAD-IN.** The conductor which connects a receiver or transmitter to the antenna.
- LEADING CURRENT.** *See* CURRENT LEAD.
- LEAKAGE CURRENT.** The small current which is lost through insulators, resistance or by brush discharge under certain circumstances.
- LECHER WIRES.** Two parallel wires coupled to an ultra-high frequency transmitter for the purpose of making a frequency measurement.
- LEYDEN JAR.** A type of condenser consisting of a glass jar coated with metal foil.
- LIGHTNING.** The discharge of atmospheric electricity from cloud to cloud or cloud to earth.
- LIGHTNING ARRESTER.** A device designed to provide a path to ground for atmospheric electricity.
- LIGHTNING SWITCH.** A protective switch used to ground the antenna during electrical storms.
- LINE DROP.** Electromotive force lost in sending current through a conductor.
- LINES OF FORCE.** The paths of the stress in magnetic or electrostatic fields.
- LINKAGE.** Same as COUPLING.
- LINK COUPLING.** An arrangement used for impedance matching radio-frequency circuits to transfer energy between circuits so separated by space that there is no direct mutual coupling between their coils.
- LITZ.** An abbreviated word for litzendraht.
- LITZENDRAHT.** A conductor formed by twisting together a number of fine insulated wires to form a low resistance radio-frequency conductor.
- LOAD FLICKER.** *See* FLICKER.
- LOADING COIL.** An inductance coil added to radio circuits to increase their wave-length or lower the frequency.

- LOOP ANTENNA.** One or more complete turns of wire both of which are connected to the input circuit of a radio receiver.
- LOOSE COUPLING.** Coupling in which only a small part of the energy flowing in one circuit is transferred to the other.
- LOUD-SPEAKER.** A device that changes electrical energy into sounds audible without the use of telephone receivers held to the ears.
- LOW-PASS FILTER.** A filter which passes frequencies below a certain frequency limit and attenuates frequencies of a higher frequency.
- MAGNET.** A piece of iron or steel capable of exerting magnetic force.
- MAGNET, ELECTRO.** *See* ELECTROMAGNET.
- MAGNETIC POLES.** The ends of a magnet where the magnetism is most concentrated.
- MAGNETISM.** The agency to which magnetic force is due.
- MARCONI ANTENNA.** An antenna which is grounded at its lower end.
- MECHANICAL RECTIFIER.** A vibrating device for rectifying an alternating current.
- MEG.** Prefix meaning 1,000,000. Alone it means 1,000,000 ohms.
- MEGACYCLE.** A million cycles.
- MEGOHM.** A resistance of 1,000,000 ohms.
- MERCURY VAPOR RECTIFIER.** A vacuum-type rectifier tube containing a small amount of mercury vapor to lower the internal resistance of the tube.
- METER.** A metric unit of length equal to 39.37 inches. Also an instrument for measuring the values of electrical energy.
- MHO.** The unit of conductance.
- MICA.** A transparent mineral insulating material which can be split into very thin sheets. It is widely used as dielectric in condensers.
- MICRO.** Prefix meaning one-millionth.
- MICROAMPERE.** One-millionth of an ampere.
- MICROHENRY.** One-millionth of a henry.
- MICROHM.** One-millionth of an ohm.
- MICROMICROFARAD.** One-millionth of a microfarad.
- MICROPHONE.** A device for changing sound vibrations into corresponding variations of an electric current.

- MICROVOLT.** One-millionth of a volt.
- MIKE.** A microphone.
- MIXER.** The first detector tube in a superheterodyne receiver in which the incoming carrier wave is combined with locally generated oscillations.
- MIL.** One-thousandth of an inch. A unit of length used in measuring the diameter of wire.
- MILLI.** Prefix meaning one-thousandth.
- MILLIAMMETER.** An instrument calibrated to measure current by one-thousandth of an ampere.
- MILLIAMPERE.** One-thousandth of an ampere.
- MILLIHENRY.** One-thousandth of a henry.
- MILLIVOLT.** One-thousandth of a volt.
- MILLIVOLTMETER.** An instrument calibrated to measure potential by one-thousandths of a volt.
- MODULATION.** The process by which signals or intelligence are impressed upon radio waves. The common method is to vary the amplitude of radio-frequency oscillations by impressing audio-frequency oscillations upon them.
- MODULATOR.** The circuit and apparatus used to modulate a radio wave.
- MONITOR.** A single-tube, miniature receiver for checking C. W. signals.
- MORSE.** The Morse telegraph alphabet or code.
- MOTOR.** A machine for tuning some form of energy into motion. An electrical motor converts electrical energy into mechanical energy.
- MOTOR-GENERATOR.** A motor and generator mechanically connected so that the motor drives the generator.
- MU.** The Greek letter used to designate the measure of amplification of which a tube is capable known as its amplification factor.
- MULTI-BAND ANTENNA.** An antenna designed to work efficiently over a wide-frequency range.
- MULTIPLIER, FREQUENCY.** A harmonic generator consisting of an amplifier whose plate circuit is tuned to a multiple of the driving frequency under conditions which produce a high harmonic output.

- MUTUAL CONDUCTANCE.** The ratio of current change in the plate circuit to the grid voltage change in a radio tube.
- MUTUAL INDUCTANCE.** The common property of two coils which gives transformer action.
- NATURAL FREQUENCY.** The frequency at which oscillations naturally take place in a circuit.
- NEGATIVE ELECTRICITY.** Electrons.
- NODES.** Points of zero current on an antenna.
- NON-CONDUCTORS.** Substances which do not conduct an electric current.
- OHM.** The unit of resistance. An ohm allows 1 ampere of current at a potential of 1 volt to pass.
- OHM'S LAW.** The relationship between current, electromotive force and resistance which states that the current in amperes in a direct-current circuit is equal to the electromotive force in volts divided by the resistance in ohms.
- OPEN-CORE.** A straight core in a transformer or reactance coil in which the path of the magnetic flux is partly through the air.
- OSCILLATIONS.** Alternating currents of high-frequency.
- OSCILLATION TRANSFORMER.** An air-core transformer used to transfer radio-frequency currents from one circuit to another.
- OSCILLATOR.** An apparatus for generating radio-frequency currents.
- OSCILLATOR TUBE.** A radio tube used to generate alternating currents.
- OSCILLATORY CIRCUIT.** A circuit in which oscillations occur.
- OSCILLOSCOPE.** A device employing a cathode-ray tube which produces a visible representation of an alternating current on a fluorescent screen. Oscillograph is another name.
- OVERMODULATION.** Distortion produced by variations of too great amplitude in the modulating audio-frequency currents.
- OXIDE.** A high resistance coating which forms on metal surfaces and must be removed in order to form a good electrical connection.
- PANCAKE COIL.** A flat, spiral inductance.
- PARAFFIN.** An insulating wax derived from petroleum frequently used in condensers and on wires.

- PARALLEL CONNECTION.** A circuit arranged so that the current divides between two or more devices. Also called a multiple connection.
- PEAK.** The point of maximum amplitude on a curve or graph. Also the points of maximum amplitude of a radio wave or alternating current.
- PEANUT TUBE.** A small radio tube.
- PENTODE.** A five-element radio tube. A pentode usually contains a filament (or cathode) grid, screen grid, suppressor grid and plate.
- PERIOD.** The time required for one cycle.
- PERMEABILITY, MAGNETIC.** The degree to which a substance can be magnetized.
- PHASE.** The time instant when the maximum, zero, or other relative value is attained by an electric wave or an alternating current.
- PHOTO-TUBE.** A photo-electric cell, sometimes popularly called an electric eye, in which an electron emission is produced by light falling upon a photo-sensitive element.
- PICK-UP, PHONOGRAPH.** A mechanism which converts the movements of a needle following the groove of a phonograph record, into audio-frequency currents or voltages.
- PIEZO-ELECTRIC CRYSTAL.** A crystal which generates current when subjected to mechanical stress or when subjected to electrical stress produces mechanical movement. Rochelle salts are common piezo-crystals.
- PLATE.** The common name given the anode in a radio tube.
- PLATE CIRCUIT.** The circuit in which the plate of a radio tube and the plate supply are included.
- PLATE CURRENT.** The current which passes between the plate and the hot cathode in a radio tube.
- PLATE MODULATION.** Modulation by varying the power impressed upon the plate.
- PLATE RESISTANCE.** The resistance to alternating current existing between the plate and cathode in a radio tube.
- PLATE SUPPLY.** The source of current in the plate circuit which gives the plate its positive charge. If a battery is used as the plate supply, it is termed a "B" battery.

- PLATE VOLTAGE.** The potential that is applied to the plate of a radio tube.
- POLARIZATION.** The formation of hydrogen gas on the positive element of certain types of primary cells which tends to reduce the output of the cell. Electric waves are said to be vertically polarized when the wave travels with its electric vector perpendicular to the earth and are horizontally polarized when the electric vector is parallel to the earth.
- POLES, BATTERY.** The positive and negative terminals of a battery.
- POLES, MAGNETIC.** See MAGNETIC POLES.
- POSITIVE ELECTRICITY.** The electrical charge on an atom which has lost some of its electrons. The opposite of negative electricity.
- POTENTIOMETER.** A resistance arranged across a current source so that the voltage may be subdivided by utilizing the voltage drop across a portion of the resistance.
- POWER FACTOR.** In computing the power in an A.C. circuit it is necessary to take into account any phase difference between current and voltage. This is made possible by a figure called the power factor. The power factor is equal to the resistance divided by the impedance in the circuit or the *actual* power in the circuit divided by the product of the voltage and current.
- POWER PACK.** The complete rectifying and filtering device used to supply filament, grid, and plate voltages to radio receivers.
- PRIMARY.** The input winding (the winding to which current is supplied) of a transformer.
- PRIMARY CELL.** A voltaic cell. Electricity is generated by chemical action in a primary cell and one of the electrodes is consumed in the process.
- PUSH-PULL AMPLIFIER.** A system of arranging a stage of amplification whereby two tubes have the load divided between them by utilizing a center tapped transformer. The arrangement permits increased capacity without an increase in distortion.
- PUSH-PULL OSCILLATOR.** When two tubes are to be used in an oscillator for the purpose of obtaining more power they should be connected in push-pull rather than simply in parallel.
- PYRANOL.** A synthetic non-inflammable insulating material.
- PYREX.** A brand of glass manufactured by the Corning Glass Works.

- Q.** A useful measure of coil efficiency in a tuned circuit is designated by the letter "Q." It is the ratio of the coil's reactance to its effective series resistance.
- "Q" ANTENNA.** A half-wave antenna having a two-wire line matched to its impedance at its center by the use of a quarter-wave line of special characteristics which acts as a matching transformer.
- QUARTER-WAVE ANTENNA.** An antenna whose electrical length is one-quarter that of the wave-length received or transmitted.
- QUARTZ CRYSTAL.** An accurately ground piezo-electric crystal mounted between a pair of metal electrodes and used in a receiving set to establish a selective radio-frequency circuit and in transmitting sets for stabilizing oscillators.
- QUENCH FREQUENCY.** A super-audible (above audibility) frequency utilized in a superregenerative receiver to vary the detector's operating point and interrupt its tendency to oscillate. In this way the regenerative action of the detector can build up signals to tremendous proportions.
- RADIATION.** The emission of energy—as of heat and light—from an incandescent wire and electromagnetic waves from an antenna.
- RADIATION RESISTANCE.** Energy radiated by an antenna is equivalent to energy dissipated in the form of heat in a resistor. The value of this equivalent resistance in ohms is the radiation resistance.
- RADIO COMPASS.** A receiving apparatus making use of the directional effect of a loop antenna for taking direction bearings.
- RADIO WAVES.** Electromagnetic waves produced by high-frequency currents for communication purposes.
- RADIO-FREQUENCY.** An arbitrary classification. Usually considered to be frequencies above 20,000 cycles.
- RADIO-FREQUENCY AMPLIFICATION.** Amplification of signals while oscillating at radio-frequencies.
- RADIO-FREQUENCY TRANSFORMER.** Usually an air-core transformer tuned by means of a variable condenser and designed to amplify voltages or currents which are alternating at radio frequencies.
- RADIO GONIOMETER.** A radio direction finder.
- RADIOPHONE.** Apparatus for sending and receiving speech and music via electromagnetic waves.

- REACTANCE.** The opposition offered to the flow of an alternating current due to the voltage induced by the variation of the current in any inductance and/or capacity present in the circuit.
- REACTANCE COIL.** A coil purposely wound to offer the retarding effect of self-inductance to an alternating current.
- REACTANCE DROP.** The drop in voltage caused by reactance as distinguished from that caused by the ohmic resistance of the circuit.
- REACTOR.** Same as REACTANCE COIL.
- RECEIVER.** A telephone receiver. Also the apparatus for receiving radio signals, speech, or music.
- RECEIVER, TELEPHONE.** A device for changing the variations of an electric current into sound.
- RECTIFIER.** An apparatus for converting alternating current into pulsating direct current.
- REFLECTED WAVES.** Radio waves, like light waves, can be reflected. Radio waves are reflected by conductors, such as wires, and by the ionized layers of the upper atmosphere.
- REFLEX CIRCUIT.** A system of receiving in which the signal is amplified at radio-frequencies, detected, and then amplified at audio-frequencies in the same tube.
- REGENERATIVE CIRCUIT.** Same as FEED-BACK. A tube circuit in which the plate current is fed back by coupling it to the grid circuit to amplify its powers.
- RELAY.** A sensitive device used to open or close another circuit. Radio tubes are termed "electron relays" when used as detectors or amplifiers.
- RELUCTANCE.** The quality of a magnetic circuit which is equivalent to resistance in a direct-current circuit. The effect of length, breadth and material of a magnetic circuit in determining what magnetic flux will be present.
- REMOTE CONTROL.** A system employing relays, and so on, to control and operate a radio transmitter or receiver from a distant point.
- RESISTANCE.** The opposition offered by a conductor to the passage of electric current, due to the length, area, and substance of the conductor.
- RESISTANCE, ANTENNA.** See RADIATION RESISTANCE.
- RESISTANCE COUPLING.** The coupling established between two cir-

cuits when they have a resistance in common. Sometimes employed in an amplifier.

RESISTOR. A unit designed to reduce the flow of current in a circuit.

RESONANCE. The condition that exists in a circuit when the reactance of its inductance and the reactance of its capacity are equal leaving only the resistance to impede the flow of current.

RESONANCE CURVE. A curve or graph drawn so as to show the current values in a circuit at resonance and when resonance conditions are departed from.

RHEOSTAT. A variable resistance device.

RIBBON MICROPHONE. Same as **VELOCITY MICROPHONE.**

RIPPLE. The output of the ordinary rectifier-filter system is considered to consist of two components, an assumed steady, "pure D.C." and a superimposed A.C. voltage called the *ripple*.

ROTARY CONVERTER. A rotating machine for converting D.C. to A.C. or vice versa.

ROTOR. The rotating coil of a variometer, vario-coupler, motor, or generator.

SATURATION, TUBE. The maximum current that the plate circuit will take. A condition existing when the space charge fully counteracts the influence of the positive charge on the grid.

SCHEMATIC DIAGRAMS. Diagrams which show the different parts of a circuit in skeleton form.

SCREEN GRID. An additional grid used in a vacuum-tube to reduce the capacity between the other electrodes and prevent the tube circuit from oscillating.

SECONDARY. The output winding of a transformer, that is, from which current or voltage is drawn.

SECONDARY CELL. A storage cell. The current is generated by chemical action after the battery has first been charged by passing a current through it.

SECONDARY EMISSION. Electrons striking the plate in a radio tube at high speeds dislodge other electrons. In a triode these cause no disturbance. In a screen grid tube this phenomenon known as "secondary emission" can cause a reverse current to flow between screen and plate unless suppressed.

SELECTIVITY. The ability of a receiver or a circuit to discriminate between signals of different frequencies.

SELF-HETERODYNE. A receiver for continuous wave signals by the beat method, by the use of an arrangement which is a radio-frequency generator and a detector of the audio-frequency beats produced.

SELF-INDUCTANCE. The property of electrical inertia in a circuit which tends to prevent any change in the current flowing therein.

SENSITIVITY. The minimum radio-frequency voltage input required in a receiver to give a specified useful output.

SHARP TUNING. In a transmitter sharp tuning is adjustment so that a pure wave with practically no harmonics is produced. In a receiver, it is the ability to select a signal and eliminate those of nearly identical frequencies.

SHARP WAVE. A wave which is pure, that is, has no harmonics or sidebands. A wave whose energy is in one wave-length.

SHELLAC. A material used as an insulating varnish.

SHIELDING. Shielding is accomplished by enclosing apparatus in a metal box. It confines the magnetic and electrostatic fields about coils and condensers. It prevents those fields from acting upon other apparatus, and external fields from acting upon them in turn.

SHUNT CIRCUIT. An arrangement in which the current is divided. A parallel circuit.

SIDE-BANDS. When the amplitude of a wave is changed by modulation, it has additional frequency components. The original frequency component is called the *carrier* frequency and the additional frequencies are the side-band frequencies.

SILICON STEEL. A steel containing a small amount of silicon used as the core for alternating current windings because of its desirable magnetic properties.

SKIN EFFECT. The tendency of high frequency currents to concentrate along the outer portion rather than pass through the center of a conductor.

SOCKET. A fixture designed to hold tubes, plug-in coils, and the like.

SOFT TUBE. A radio tube having a low vacuum.

SOLENOID. A hollow cylindrical coil.

- SPECIFIC INDUCTIVE CAPACITY.** The ability of a substance, used as a dielectric in a condenser, to store up energy.
- STABILITY.** A receiver's ability to maintain its output constant over a period of time with constant signal input. A transmitter's ability to maintain a constant frequency and output.
- STATIC.** Electrical disturbances which cause noises in the telephone receiver or loud-speaker.
- STATOR.** That part of an electrical device which remains fixed such as the fixed plates of a variable condenser, the fixed coil of a variocoupler, and so on.
- STEP-DOWN TRANSFORMER.** A transformer designed to give a lower voltage on the secondary or output side than the voltage impressed on the primary or input side.
- STEP-UP TRANSFORMER.** A transformer designed to give a higher voltage on the secondary or output side than the voltage impressed on the primary or input side.
- STORAGE CELL.** The same as **SECONDARY CELL**.
- STRAYS.** Man-made static.
- SUPERHETERODYNE.** A system of receiving in which the frequency of the incoming signal is first converted to an intermediate radio-frequency and then amplified prior to audio-frequency detection and amplification.
- SUPERREGENERATION.** A system of receiving similar to the ordinary regenerative type but having a superaudible (above audibility) signal introduced in such a way as to quench or interrupt the oscillations of the detector tube and permit the signal to build up to tremendous proportions.
- SUPPRESSOR GRID.** A third grid used in pentode tubes. It is connected to the cathode and overcomes the effects of secondary emission.
- SYMBOLS.** Abbreviations and Greek letters used to represent qualities of circuits and electrical apparatus. Also conventional drawings used in making schematic diagrams.
- TELEPHONE RECEIVER.** See **RECEIVER, TELEPHONE**.
- TELEVISION.** A branch of the radio art. Moving images are transmitted via radio waves and appear upon a fluorescent screen at the receiver.

- TETRODE.** A four-element vacuum-tube.
- TICKLER COIL.** A coupling coil used to feed-back part of the plate current to the grid in a regenerative receiver.
- TRACKING.** The condition achieved in single-dial control receivers by adjusting the condensers and coils so that the resonant frequencies of the several identical combinations will always be the same. It is the condition which makes single-dial control receivers possible.
- TRANSCEIVER.** Apparatus for sending and receiving radio messages which uses the same tubes for transmission as reception. This scheme is utilized for portable work. Only the audio part of the equipment is used in common for both transmitting and receiving.
- TRANSFORMER.** An electromagnetic device for transferring energy from one circuit to another.
- TRANSMISSION LINE.** Lines used for coupling between the transmitter and the radiating portion of the antenna system.
- TRIMMER CONDENSER.** A small condenser used to balance a circuit, compensate variations between sections of a gaged condenser, adjust radio-frequency transformers, and so on.
- TUNED CIRCUIT.** A circuit in which the capacity and inductance are adjusted to produce a desired period of oscillation.
- TUNING.** The adjustment in inductance or capacity which brings a circuit into resonance with a frequency.
- ULTRAUDION.** A form of Colpitts transmitting circuit seldom used except at the ultra-high frequencies.
- ULTRA-HIGH FREQUENCIES.** An arbitrary classification which usually means frequencies above 30 megacycles.
- UNDAMPED RADIO WAVES.** Waves of constant amplitude.
- VACUUM-TUBE.** The common name for the electron tube used in radio.
- VALVE.** See **FLEMING VALVE** and **VACUUM-TUBE**.
- VARIABLE CONDENSER.** A condenser whose capacity may be gradually increased or decreased.

- VARIABLE INDUCTANCE.** A coil, the inductance of which may be varied.
- VARIABLE RESISTOR.** A resistor, the resistance of which may be varied.
- VARIO COUPLER.** Two coils arranged so that when one is rotated, it will vary the coupling between the two.
- VELOCITY MICROPHONE.** An electrodynamic type of microphone in which a light corrugated ribbon of conductive material is suspended between the poles of an electromagnet so that its motion will be transverse to the magnetic field.
- VERNIER CONDENSER.** A small variable condenser for making fine adjustment of a circuit.
- VERNIER CONTROL.** A geared knob for obtaining fine adjustment of tuning controls.
- VIBRATOR.** A device used to rectify A.C. to D.C. by mechanical means. Also a device used in automobile receivers to change the D.C. from a storage battery to pulsating D.C. so that it may be stepped up by a transformer to provide plate current for the tubes.
- VICTRON.** A low loss insulating material.
- VOICE COIL.** A small coil of wire attached to the diaphragm of a dynamic speaker. It is connected to the audio-amplifier.
- VOLT.** The unit of electromotive force. It is the electromotive force which produces a current of one ampere when applied to a resistance of one ohm.
- VOLTAGE AMPLIFICATION.** Amplification whose chief purpose is to give a greatly magnified reproduction of the input signal without regard to the power delivered.
- VOLTAGE DIVIDER.** A tapped resistor. Generally employed in power packs. When a voltage is applied to its end terminals, intermediate voltages may be secured from its taps. A potentiometer is a voltage divider.
- VOLTAGE DROP.** That part of the electromotive force that is expended in overcoming the resistance or impedance of a circuit.
- VOLTMETER.** A device for measuring the voltage of an electric current.
- VULCANIZED FIBER.** See FIBER.

- WATCH-CASE RECEIVER.** A compact telephone receiver used with a head-band for radio reception.
- WATT.** The unit of electrical power representing the product of the amperage and voltage in a circuit. One watt is the power of one ampere at one volt.
- WAVE CHANGER.** A switching device for rapidly changing the radiated wave-length.
- WAVE-LENGTH.** The distance traveled by a wave during one complete cycle or the distance between peaks of an electromagnetic or other wave.
- WAVEMETER.** An instrument for measuring the frequency and wave-lengths set up in the circuits of sending and receiving sets.
- WAVE-TRAIN.** A group of waves.
- WAVE-TRAP.** A tuning device in the antenna circuit used to eliminate interference from a near-by source.
- WHEATSTONE BRIDGE.** An instrument for measuring resistances.
- WIRED RADIO.** A system in which conductors or wires act as guides for radio waves.
- WOOD'S METAL.** A low-temperature alloy which will melt in hot water, used for mounting crystals.
- "X" CUT.** A quartz crystal cut with its major surfaces perpendicular to its electric axis.
- "Y" CUT.** A quartz crystal cut with its major surfaces parallel to its electric axis.
- YOKE.** The cross-bar connecting the two coils of a horse-shoe electromagnet.
- ZEPPELIN ANTENNA.** A type of Hertz antenna originally developed for use on airships and now much favored by amateurs. Essentially, one wire of a tuned feed line is connected to one end of the antenna. The other feed wire is left floating.
- ZINCITE.** A mineral used as the sensitive element in a crystal detector.

Index

- Abbreviations, "ham," 170
 telegraph, 104
Air cell, 214
Alignment, 146
Alternation, 55
Alternator, 54
Amateur, license, 160
 spectrum, 38
Ammeters, 65
Ampere, 64
Ampère, André Marie, 64
Amplification, 139
 audio-frequency, 139
 radio-frequency, 139
Amplifiers, 138
 audio-frequency, 139
 how to build, 190
 push-pull, 140
 radio-frequency, 139
Amplitude modulation, 49
Antenna, amateur, 237
 directional effect, 151
 doublet, 157
 grounded, 242
 Hertz, 159, 239
 indoor, 155
 insulator, 150
 loop, 156
 Marconi, 239, 241
 vertical, 152
 Zeppelin, 239, 247
Arithmetic, radio, 93
Armstrong, Edwin H., 21, 24, 47, 49
Arnold, H. D., 26
Atlantic Ocean, crossed by radio, 12
Audio-frequencies, 46, 57
Audio-frequency amplifier, 139
 how to build, 193
Audion, 21, 23
Automatic volume control, 233
AVC. *See* Automatic volume control.
- Ballasts, 85
Batteries, 213
Beam-power tubes, 230
Bel, 100
Bias, 137
 battery, 138
Binns, Jack, 14
Block diagrams, 109
Branly coherer, 11, 21
Buzzer test, 181
- Call letters, 39, 166
Capacitance. *See* Capacity.
Capacitive coupling, 119
Capacity, 79
 between windings, 144
Carrier waves, 47
Cathode, 130, 132
Chassis, 77
Choke, iron core, 76
 radio-frequency, 76
Circuits, tuned, 120
Code, color, 84
 practice, 169
 "Q," 170
 telegraph, 163
 test, 162
Coherer, 12, 21

Color Code, 84
 Colpitts' oscillator, 206
 Condenser, action of, 81
 discharge, 83
 electrolytic, 80
 fixed, 79
 grid, 110
 parallel, 98
 series, 97
 trimmer, 145
 variable, 79
 Conductors, 61
 Cone, speaker, 89
 Continuous waves, 211
 Converters, 236
 Cores, 140
 Coupler, 179
 Coupling, 119
 impedance, 141
 output, 99
 resistance, 141
 transformer, 141
 Crystal, detector, 21, 105
 microphone, 125
 oscillator, 125
 piezo-electric, 124
 Crystal-frequency control, 123
 Current, Eddy, 77
 electric, 128
 feed, 247
 Cycle, 55

Decibel, 100
 De Forest, Lee, 21, 23, 26
 Demodulation, 49
 Detection, 49
 grid, 110
 plate, 110
 power, 232
 Detector, audion, 21
 crystal, 21, 105, 175
 electrolytic, 20
 microphonic, 21
 mineral, 21, 105
 Diaphragm, speaker, 92

Difference between radiotelegraph and
 radiotelephone, 4
 Diode, 131
 Directional effect of antenna, 151, 248
 Double-doublet antenna, 159
 Doublet antenna, 157
 Dynamic speaker, 91

Eddy currents, 77
 Edison, Thomas A., 21
 effect, 22
 Electric current, 51, 53
 alternating, 53
 direct, 53
 how measured, 64
 Electricity, nature of, 52
 Electrolytic condensers, 80
 detector, 20
 Electromagnet experiment, 57
 Electromagnetic, induction, 6, 69
 waves, 5, 28
 Electron theory, 127
 Electron-coupled oscillator, 208
 Electron-ray tubes, 233
 Electrons, 51, 128
 Ether theory, 29
 Examination, radio license, 161
 Exciter, 210
 Experiment, electromagnet, 57
 resistance, 62
 transformer, 70
 tuning, 115, 117

Farad, 79
 Faraday, Michael, 6, 68
 Feed-back, 24, 204
 Feeder, tuned, 245
 two-wire, 249
 untuned, 245
 Fessenden, Reginald, 18
 Filter, 218, 220
 First radiotelephone, 19
 Fleming, J. A., 21
 valve, 22

Frequency, 55, 56
 audio, 46, 57
 to calculate, 33
 conversion, 236
 effects of, 31
 modulation, 49
 natural, 117
 radio, 46, 57
 resonance, 122
 Full-wave rectification, 219

Grid, 132
 condenser, 110
 detection, 110
 leak, 110
 voltage, 137
 Ground, 152
 Ground-waves, 34

Half-wave rectification, 218
 Hartley oscillator, 206
 Headset, telephone, 89
 Hertz, Heinrich, 7
 antenna, 159, 239, 243
 oscillator and resonator, 10

Impedance, coupling, 141
 matching, 99
 Inductance, mutual, 74
 self, 73
 Induction, discovery of, 6
 electromagnetic, 69
 Inductive coupling, 119
 Insulators, 61
 antenna, 150
 stand-off, 243
 Iron cores, 77
 Ionosphere, 35

Key, how to hold, 169
 Kiloampere, 67
 Kilovolt, 67

Kilowatt, 67

Laminations, 76
 Langmuir, Irving, 21, 24
 Lead-in, 152
 Leak, grid, 110
 License, radio, 160
 Light, 31
 Lightning, 153
 Lightning arresters, 154
 Listening-in, 166
 Lodge, Sir Oliver, 17

Magnetic phantom, 68
 Magnetic speaker, 90
 Magnetism, 57
 produced by electricity, 69
 Marconi, Guglielmo, 10
 antenna, 157, 239, 241
 Matter, 127
 Maxwell, James Clerk, 7
 theory, 7
 Megohm, 67
 Messages, carried by electromagnetic
 waves, 5
 Microampere, 66
 Microfarad, 79
 Micro-microfarad, 79
 Microphone, crystal, 125
 Microphonic detector, 21
 Microvolt, 67
 Milliamperes, 66
 Millivolt, 67
 Mineral detectors, 105
 Mixers, 236
 Modulation, 48
 amplitude, 49
 frequency, 49
 Multi-electrode tubes, 236
 Mutual inductance, 74

Natural frequency, 117
 Nature's radio waves, 8

- Negative, 52
 Nichrome, 83
- Ohm, George Simon, 65, 93
 Ohm's law, 93
 Oscillations, 202
 Oscillator, crystal, 125
 crystal-controlled, 208
 Oscillators, 206
 Oscillograph, 56
 Output coupling, 99
- Pay-roll, radio, 15
 Pentode, 131
 Phantom, magnetic, 68
 Piezo-electricity, 123
 Plate, 132
 detection, 110
 Positive and negative, 52
 Potential, 64
 Potentiometer, 85
 Power detection, 232
 Power supply, 212
 Primary, 72
 Pupin, Michael, 17, 92
 Push-pull amplifier, 140
- "Q" Code, 170
 Quasi-optical waves, 43
- Radiation, 210
 Radio, beginning of, 4
 benefits of, 1
 what it is, 3
 Radio-frequency, 46, 57
 Radio-frequency amplifier, 139
 how to build, 190
 Radio receivers, 109
 how to build, 173
 Radio spectrum, 37
 Radiotelephone, 18
 Radio transmitter, essentials of, 47
- Radio vacuum-tube, 20, 127, 201, 228
 action of, 133
 Radio waves, long, 28, 43
 short, 43
 speed of, 33
 ultra-short, 43
 Receiving radio messages, 105
 Receivers, how to build, 173
 Rectification, 218, 219
 Rectifier, 131
 crystal, 106
 plate, 217
 Tungar, 215
 Regeneration, 25, 111, 202
 Regenerative receiver, how to build, 182
 Regulators, 85
 Relay, telephone, 26
 Republic disaster, 14
 Resistance, effect of, 62
 experiment, 62
 parallel, 95
 series, 96
 Resistance coupling, 141, 193
 Resistors, 83
 Resonance, 118
 frequency, 122
 Resonator, 9
 Rheostat, 85
 Ruhmkorff coil, 9
- Schematic diagrams, 100
 Screen-grid, 229
 Secondary, 72
 Self-controlled oscillator, 205
 Self-excitation, 210
 Self-inductance, 73, 75
 Send, learning to, 167
 Shielding, 73, 143
 Short-waves, 43
 Shunt-fed oscillator, 206
 Sidebands, 40
 Skin-effect, 57
 Skip-distance, 35
 Sky-waves, 34

- Solari, Lieutenant, 13
 Soldering, 174
 Sound, 60
 spectrum, 61
 waves, 60
 Speakers, 89
 Spectrum, amateur, 38
 radio, 37
 sound, 61
 Static, 40, 45
 Storage-batteries, recharging, 215
 Superheterodyne receivers, 113
 Super-regeneration, 112
 Suppressors, 230
 Symbols, 101
 Syntony, *see also* Tuning, 17
- Telegraph, learning to, 163
 Telephone, receivers, 87
 relay, 26
 Television, 211
 Temperature inversion, 44
 Test buzzer, 181
 Tetrode, 131
 Thomson, Elihu, 19
 TNT oscillator, 206
 Transformer, 70
 amplifying, 142
 coupling, 141, 194
 power supply, 222
 radio-frequency, 145
 Transmission lines, 245
 Transmitters, 46, 200
 Trap, wave, 188
 Trimmer condenser, 145
 Triode, 131
 Tubes, multi-electrode, 236, radio
 vacuum-, 228
 Tuned circuits, 120
- Tuned-plate tuned-grid oscillator, 206
 Tuned radio-frequency, 193
 Tungar rectifier, 215
 Tuning, 36
 experiment, 115, 117
 first, 17
- Ultra-short waves, 43
- Vacuum, 133
 Vacuum-tube, 20, 127, 201, 228
 beam-power, 231
 oscillator, 201
 screen-grid, 229
 suppressor, 230
 Volt, the, 44
 Volta, Alessandro, 65
 Voltage, 65
 Voltage divider, 225
 Voltage-doubler, 225
 Voltage feed, 247
 Voltmeter, 65
 Volume control, 146
- Watt, 67
 electromagnetic, 5, 28
 Wave-length, 30, 33
 Wave-trap, 189
 Waves, carrier, 47
 Wireless telegraphy, discovery of, 10
- X-rays, 32
- Zeppelin antenna, 239, 247

