

42<sup>ND</sup> EDITION • 1965

# The radio amateur's handbook

THE STANDARD MANUAL OF AMATEUR  
RADIO COMMUNICATION



\$4.00

*U.S.A. Proper*



---

PUBLISHED BY THE AMERICAN RADIO RELAY LEAGUE

---

# The Radio Amateur's Handbook

*James Peters  
227 Main St.  
Fairfield, Me.*

*By the* HEADQUARTERS STAFF

*of the*

AMERICAN RADIO RELAY LEAGUE

NEWINGTON, CONN., U.S.A.



Byron Goodman, W1DX  
*Editor*

1965

*Forty-second Edition*

COPYRIGHT 1965 BY

THE AMERICAN RADIO RELAY LEAGUE, INC.

*Copyright secured under the Pan-American Convention  
International Copyright secured*

This work is Publication No. 6 of The Radio Amateur's Library, published by the League. All rights reserved. No part of this work may be reproduced in any form except by written permission of the publisher. All rights of translation are reserved. Printed in U. S. A.

*Quedan reservados todos los derechos*

*Library of Congress Catalog Card Number: 41-3345*

*Forty-second Edition*

\$4.00 in U. S. A. proper. \$4.50 in U. S. Possessions and Canada. \$5.50 elsewhere.

Clothbound edition \$6.50 U.S.A., Possessions and Canada, \$7.00 Elsewhere.

# FOREWORD

The American Radio Relay League has completed fifty years of service to its membership of amateur radio operators, now numbering 100,000.

For nearly forty of those years, *The Radio Amateur's Handbook* has been a mainstay of the League's program to provide its member-amateurs with up-to-date, practical training and reference material.

The *Handbook* had its rather modest beginnings in 1925 when F. E. Handy, W1BDI, for many years the League's communications manager and now a vice-president as well, commenced work on a small manual of amateur operating procedure in which it was deemed desirable to include a certain amount of "technical" information. It was published in 1926 and enjoyed instant success. Increasing in size and scope with the growth of amateur radio itself, the *Handbook* soon required participation of numerous of the skilled amateurs at ARRL Hq., and became a family affair, the joint product of the staff. In recent years its content has been the primary responsibility of Byron Goodman, WIDX, a long-term member of the Hq. crew.

Virtually continuous modification is a feature of the *Handbook*, but always with the objective of presenting the soundest aspects of current practice rather than the merely new and novel. Written with the needs of the practical amateur constantly in mind, it has earned universal acceptance not only among amateurs but by all segments of the technical radio world. This wide dependence on the *Handbook* is founded on its practical utility, its treatment of radio communications problems in terms of how-to-do-it rather than by abstract discussion.

The *Handbook* has long been considered an indispensable part of the amateur's equipment. We earnestly hope that the present edition will succeed in bringing as much inspiration and assistance to amateurs and would-be amateurs as have its predecessors.

JOHN HUNTOON  
*General Manager, ARRL*

Newington, Conn.  
January, 1965





# CONTENTS

	The Amateur's Code . . . . .	6
<i>Chapter</i> 1	Amateur Radio . . . . .	7
2	Electrical Laws and Circuits . . . . .	15
3	Vacuum-Tube Principles . . . . .	59
4	Semiconductor Devices . . . . .	79
5	Receiving Systems . . . . .	86
6	Oscillators, Multipliers and Power Amplifiers .	144
7	Code Transmission . . . . .	224
8	Audio Amplifiers and Double-Sideband Phone .	232
9	Single-Sideband Phone . . . . .	273
10	Specialized Communications Systems . . . . .	291
11	Checking and Monitoring Transmissions . . . .	297
12	Power Supplies . . . . .	317
13	Transmission Lines . . . . .	341
14	Antennas . . . . .	359
15	Wave Propagation . . . . .	393
16	V.H.F. Receivers and Transceivers . . . . .	401
17	V.H.F. Transmitters . . . . .	423
18	V.H.F. Antennas . . . . .	452
19	Mobile and Portable-Emergency Equipment. .	464
20	Construction Practices . . . . .	500
21	Measurements . . . . .	511
22	Assembling a Station . . . . .	544
23	Interference With Other Services . . . . .	553
24	Operating a Station . . . . .	574
25	Vacuum Tubes and Semiconductors . . . . .	V1

Index

Catalog Section

# The Amateur's Code

## ONE

*The Amateur is Gentlemanly . . .* He never knowingly uses the air for his own amusement in such a way as to lessen the pleasure of others. He abides by the pledges given by the ARRL in his behalf to the public and the Government.

## TWO

*The Amateur is Loyal . . .* He owes his amateur radio to the American Radio Relay League, and he offers it his unswerving loyalty.

## THREE

*The Amateur is Progressive . . .* He keeps his station abreast of science. It is built well and efficiently. His operating practice is clean and regular.

## FOUR

*The Amateur is Friendly . . .* Slow and patient sending when requested, friendly advice and counsel to the beginner, kindly assistance and cooperation for the broadcast listener; these are marks of the amateur spirit.

## FIVE

*The Amateur is Balanced . . .* Radio is his hobby. He never allows it to interfere with any of the duties he owes to his home, his job, his school, or his community.

## SIX

*The Amateur is Patriotic . . .* His knowledge and his station are always ready for the service of his country and his community.

—PAUL M. SEGAL

# Amateur Radio

Amateur radio is a scientific hobby, a means of gaining personal skill in the fascinating art of electronics and an opportunity to communicate with fellow citizens by private short-wave radio. Scattered over the globe are over 350,000 amateur radio operators who perform a service defined in international law as one of "self-training, intercommunication and technical investigations carried on by . . . duly authorized persons interested in radio technique solely with a personal aim and without pecuniary interest."

From a humble beginning at the turn of the century, amateur radio has grown to become an established institution. Today the American followers of amateur radio number over 250,000, trained communicators from whose ranks will come the professional communications specialists and executives of tomorrow—just as many of today's radio leaders were first attracted to radio by their early interest in amateur radio communication. A powerful and prosperous organization now provides a bond between amateurs and protects their interests; an internationally respected magazine is published solely for their benefit. The military services seek the cooperation of the amateur in developing communications reserves. Amateur radio supports a manufacturing industry which, by the very demands of amateurs for the latest and best equipment, is always up-to-date in its designs and production techniques—in itself a national asset. Amateurs have won the gratitude of the nation for their heroic performances in times of natural disaster; traditional amateur skills in emergency communication are also the stand-by system for the nation's civil defense. Amateur radio is, indeed, a magnificently useful institution.

Although as old as the art of radio itself, amateur radio did not always enjoy such prestige. Its first enthusiasts were private citizens of an experimental turn of mind whose imaginations went wild when Marconi first proved that messages actually could be sent by wireless. They set about learning enough about the new scientific marvel to build homemade spark transmitters. By 1912 there were numerous Government and commercial stations, and hundreds of amateurs; regulation was needed, so laws, licenses and wavelength specifications appeared. There was then no amateur organization nor spokesman. The official viewpoint toward amateurs was something like this:

"Amateurs? . . . Oh, yes. . . . Well, stick 'em on 200 meters and below; they'll never get out of their backyards with that."

But as the years rolled on, amateurs found out how, and DX (distance) jumped from local to 500-mile and even occasional 1000-mile two-way contacts. Because all long-distance messages had to be relayed, relaying developed into a fine art—an ability that was to prove invaluable when the Government suddenly called hundreds of skilled amateurs into war service in 1917. Meanwhile U.S. amateurs began to wonder if there were amateurs in other countries across the seas and if, some day, we might not span the Atlantic on 200 meters.

Most important of all, this period witnessed the birth of the American Radio Relay League, the amateur radio organization whose name was to be virtually synonymous with subsequent amateur progress and short-wave development. Conceived and formed by the famous inventor, the late Hiram Percy Maxim, ARRL was formally launched in early 1914. It had just begun to exert its full force in amateur activities when the United States declared war in 1917, and by that act sounded the knell for amateur radio for the next two and a half years. There were then over 6000 amateurs. Over 4000 of them served in the armed forces during that war.

Today, few amateurs realize that World War I not only marked the close of the first phase of amateur development but came very near marking its end for all time. The fate of amateur radio was in the balance in the days immediately following the signing of the Armistice. The



HIRAM PERCY MAXIM  
President ARRL, 1914–1936

Government, having had a taste of supreme authority over communications in wartime, was more than half inclined to keep it. The war had not been ended a month before Congress was considering legislation that would have made it impossible for the amateur radio of old ever to be resumed. ARRL's President Maxim rushed to Washington, pleaded, argued, and the bill was defeated. But there was still no amateur radio; the war ban continued. Repeated representations to Washington met only with silence. The League's offices had been closed for a year and a half, its records stored away. Most of the former amateurs had gone into service; many of them would never come back. Would those returning be interested in such things as amateur radio? Mr. Maxim, determined to find out, called a meeting of the old Board of Directors. The situation was discouraging: amateur radio still banned by law, former members scattered, no organization, no membership, no funds. But those few determined men financed the publication of a notice to all the former amateurs that could be located, hired Kenneth B. Warner as the League's first paid secretary, floated a bond issue among old League members to obtain money for immediate running expenses, bought the magazine *QST* to be the League's official organ, started activities, and dunned officialdom until the wartime ban was lifted and amateur radio resumed again, on October 1, 1919. There was a headlong rush by amateurs to get back on the air. Gangway for King Spark! Manufacturers were hard put to supply radio apparatus fast enough. Each night saw additional dozens of stations crashing out over the air. Interference? It was bedlam!

But it was an era of progress. Wartime needs had stimulated technical development. Vacuum tubes were being used both for receiving and transmitting. Amateurs immediately adapted the new gear to 200-meter work. Ranges promptly increased and it became possible to bridge the continent with but one intermediate relay.

### TRANSATLANTICS

As DX became 1000, then 1500 and then 2000 miles, amateurs began to dream of transatlantic work. Could they get across? In December, 1921, ARRL sent abroad an expert amateur, Paul F. Godley, 2ZE, with the best receiving equipment available. Tests were run, and *thirty* American stations were heard in Europe. In 1922 another transatlantic test was carried out and 315 American calls were logged by European amateurs and one French and two British stations were heard on this side.

Everything now was centered on one objective: two-way amateur communication across the Atlantic! It must be possible—but somehow it couldn't quite be done. More power? Many already were using the legal maximum. Better receivers? They had superheterodynes. Another wavelength? What about those undisturbed wavelengths *below* 200 meters? The engineering world thought they were worthless—but they had

said that about 200 meters. So, in 1922, tests between Hartford and Boston were made on 130 meters with encouraging results. Early in 1923, ARRL-sponsored tests on wavelengths down to 90 meters were successful. Reports indicated that *as the wavelength dropped the results were better*. Excitement began to spread through amateur ranks.

Finally, in November, 1923, after some months of careful preparation, two-way amateur transatlantic communication was accomplished, when Fred Schnell, 1MO (now W4CF) and the late John Reinartz, 1XAM (later K6BJ) worked for several hours with Deloy, 8AB, in France, with all three stations on 110 meters! Additional stations dropped down to 100 meters and found that they, too, could easily work two-way across the Atlantic. The exodus from the 200-meter region had started. The "short-wave" era had begun!

By 1924 dozens of commercial companies had rushed stations into the 100-meter region. Chaos threatened, until the first of a series of national and international radio conferences partitioned off various bands of frequencies for the different services. Although thought still centered around 100 meters, League officials at the first of these frequency-determining conferences, in 1924, wisely obtained amateur bands not only at 80 meters but at 40, 20, and even 5 meters.

Eighty meters proved so successful that "forty" was given a try, and QSOs with Australia, New Zealand and South Africa soon became commonplace. Then how about 20 meters? This new band revealed entirely unexpected possibilities when 1XAM worked 6TS on the West Coast, direct, at high noon. The dream of amateur radio—daylight DX!—was finally true.

### PUBLIC SERVICE

Amateur radio is a grand and glorious hobby but this fact alone would hardly merit such wholehearted support as is given it by our Government at international conferences. There are other reasons. One of these is a thorough appreciation by the military and civil defense authorities of the value of the amateur as a source of skilled radio personnel in time of war. Another asset is best described as "public service."

About 4000 amateurs had contributed their skill and ability in '17-'18. After the war it was only natural that cordial relations should prevail between the Army and Navy and the amateur. These relations strengthened in the next few years and, in gradual steps, grew into cooperative activities which resulted, in 1925, in the establishment of the Naval Communications Reserve and the Army-Amateur Radio System (now the Military Affiliate Radio System). In World War II thousands of amateurs in the Naval Reserve were called to active duty, where they served with distinction, while many other thousands served in the Army, Air Forces, Coast Guard and Marine Corps. Altogether, more than 25,000 radio amateurs served in the armed forces of the United States. Other thousands were engaged in vital civilian electronic research, devel-

opment and manufacturing. They also organized and manned the War Emergency Radio Service, the communications section of OCD.

The "public-service" record of the amateur is a brilliant tribute to his work. These activities can be roughly divided into two classes, expeditions and emergencies. Amateur cooperation with expeditions began in 1923 when a League member, Don Mix, ITS, of Bristol, Conn. (now assistant technical editor of *QST*), accompanied MacMillan to the Arctic on the schooner *Bowdoin* with an amateur station. Amateurs in Canada and the U.S. provided the home contacts. The success of this venture was so outstanding that other explorers followed suit. During subsequent years a total of perhaps two hundred voyages and expeditions were assisted by amateur radio, the several explorations of the Antarctic being perhaps the best known.

Since 1913 amateur radio has been the principal, and in many cases the only, means of outside communication in several hundred storm, flood and earthquake emergencies in this country. The 1955 northeastern and west coast floods, the great Alaskan earthquake of early 1964 with its west coast tidal waves, and the southeast and Gulf of Mexico hurricanes in the fall of 1964 called for the amateur's greatest emergency effort. In these disasters and many others—tornadoes, sleet storms, forest fires, blizzards—amateurs played a major role in the relief work and earned wide commendation for their resourcefulness in effecting communication where all other means had failed. During 1938 ARRL inaugurated a new emergency-preparedness program, registering personnel and equipment in its Emergency Corps and putting into effect a comprehensive program of cooperation with the Red Cross, and in 1947 a National Emergency Coordinator was appointed to full-time duty at League headquarters.

The amateur's outstanding record of organized preparation for emergency communications and performance under fire has been largely responsible for the decision of the Federal Government to set up special regulations and set aside special frequencies for use by amateurs in providing auxiliary communications for civil defense purposes in the event of war. Under the banner, "Radio Amateur Civil Emergency Service," amateurs are setting up and manning community and area networks integrated with civil defense functions of the municipal governments. Should a war cause the shut-down of routine amateur activities, the RACES will be immediately available in the national defense, manned by amateurs highly skilled in emergency communication.

## TECHNICAL DEVELOPMENTS

Throughout these many years the amateur was careful not to slight experimental development in the enthusiasm incident to international DX. The experimenter was constantly at work on ever-higher frequencies, devising improved apparatus, and learning how to cram several stations where previously there was room for only

one! In particular, the amateur pressed on to the development of the very high frequencies and his experience with five meters is especially representative of his initiative and resourcefulness and his ability to make the most of what is at hand. In 1924, first amateur experiments in the vicinity of 56 Mc. indicated that band to be practically worthless for DX. Nonetheless, great "short-haul" activity eventually came about in the band and new gear was developed to meet its special problems. Beginning in 1934 a series of investigations by the brilliant experimenter, Ross Hull (later *QST*'s editor), developed the theory of v.h.f. wave-bending in the lower atmosphere and led amateurs to the attainment of better distances; while occasional manifestations of ionospheric propagation, with still greater distances, gave the band uniquely erratic performance. By Pearl Harbor thousands of amateurs were spending much of their time on this and the next higher band, many having worked hundreds of stations at distances up to several thousand miles. Transcontinental 6-meter DX is not uncommon; during solar peaks, even the oceans have been bridged! It is a tribute to these indefatigable amateurs that today's concept of v.h.f. propagation was developed largely through amateur research.

The amateur is constantly in the forefront of technical progress. His incessant curiosity, his eagerness to try anything new, are two reasons. Another is that ever-growing amateur radio continually overcrowds its frequency assignments, spurring amateurs to the development and adoption of new techniques to permit the accommodation of more stations. For examples, amateurs turned from spark to c.w., designed more selective receivers, adopted crystal control and pure d.c. power supplies. From the ARRL's own laboratory in 1932 came James Lamb's "single-signal" superheterodyne—the world's most advanced high-frequency radiotelegraph receiver—and, in 1936, the "noise-silencer" circuit. Amateurs are now turning to speech "clippers" to reduce bandwidths of phone transmissions and "single-sideband suppressed-carrier" systems as well as even more selectivity in receiving



A view of the ARRL laboratory.



equipment for greater efficiency in spectrum use.

During World War II, thousands of skilled amateurs contributed their knowledge to the development of secret radio devices, both in Government and private laboratories. Equally as important, the prewar technical progress by amateurs provided the keystone for the development of modern military communications equipment. Perhaps more important today than individual contributions to the art is the mass cooperation of the amateur body in Government projects such as propagation studies; each participating station is in reality a separate field laboratory from which reports are made for correlation and analysis. An outstanding example was varied amateur participation in several activities of the International Geophysical Year program. ARRL, with Air Force sponsorship, conducted an intensive study of v.h.f. propagation phenomena—DX transmissions via little-understood methods such as meteor and auroral reflections, and transequatorial scatter. ARRL-affiliated clubs and groups have operated precision receiving antennas and apparatus to help track earth satellites via radio. For volunteer astronomers searching visually for the satellites, other amateurs have manned networks to provide instant radio reports of sightings to a central agency so that an orbit might be computed.

From this work, amateurs have moved on to satellites of their own, launched piggyback on regular space shots at no cost to the taxpayer. The Project Oscar Association, an ARRL affiliate with headquarters in Sunnyvale, California, has designed and constructed the first two non-government satellites ever placed in orbit, Oscar I on December 12, 1961, and Oscar II on June 2, 1962. A beacon, transmitting the Morse code letters HI, was reported heard and tracked by more than 500 operators in 28 countries. A more sophisticated satellite which will receive and retransmit signals from the ground is planned for orbit early in 1965. The name Oscar is taken from the initials of the phrase, "Orbital Satellite Carrying Amateur Radio."

Another space-age field in which amateurs are

currently working is that of long-range communication using the moon as a passive reflector. The amateur bands from 144 to 1296 Mc. are being used for this work. . . . Moonbounce communications have been carried out between Finland and California on 144 Mc. and between Massachusetts and Hawaii on both 432 and 1296 Mc.

Emergency relief, expedition contact, experimental work and countless instances of other forms of public service—rendered, as they always have been and always will be, without hope or expectation of material reward—made amateur radio an integral part of our peacetime national life. The importance of amateur participation in the armed forces and in other aspects of national defense have emphasized more strongly than ever that amateur radio is vital to our national existence.

### THE AMERICAN RADIO RELAY LEAGUE

The ARRL is today not only the spokesman for amateur radio in the U.S. and Canada but it is the largest amateur organization in the world. It is strictly of, by and for amateurs, is noncommercial and has no stockholders. The members of the League are the owners of the ARRL and *QST*.

The League is pledged to promote interest in two-way amateur communication and experimentation. It is interested in the relaying of messages by amateur radio. It is concerned with the advancement of the radio art. It stands for the maintenance of fraternalism and a high standard of conduct. It represents the amateur in legislative matters.

One of the League's principal purposes is to keep amateur activities so well conducted that the amateur will continue to justify his existence. Amateur radio offers its followers countless pleasures and unending satisfaction. It also calls for the shouldering of responsibilities—the maintenance of high standards, a cooperative loyalty to the traditions of amateur radio, a dedication to its ideals and principles, so that the institution of amateur radio may continue to operate "in the public interest, convenience and necessity."

The operating territory of ARRL is divided into one Canadian and fifteen U. S. divisions. The affairs of the League are managed by a Board of Directors. One director is elected every two years by the membership of each U.S. division, and one by the Canadian membership. These directors then choose the president and three vice-presidents, who are also members of the Board. The secretary and treasurer are also appointed by the Board. The directors, as representatives of the amateurs in their divisions, meet annually to examine current amateur problems and formulate ARRL policies thereon. The directors appoint a general manager to supervise the operations of the League and its headquarters, and to carry out the policies and instructions of the Board.



The operating room at W1AW.

ARRL owns and publishes the monthly magazine, *QST*. Acting as a bulletin of the League's organized activities, *QST* also serves as a medium for the exchange of ideas and fosters amateur spirit. Its technical articles are renowned. It has grown to be the "amateur's bible," as well as one of the foremost radio magazines in the world. Membership dues include a subscription to *QST*.

ARRL maintains a model headquarters amateur station, known as the Hiram Percy Maxim Memorial Station, in Newington, Conn. Its call is W1AW, the call held by Mr. Maxim until his death and later transferred to the League station by a special government action. Separate transmitters of maximum legal power on each amateur band have permitted the station to be heard regularly all over the world. More important, W1AW transmits on regular schedules bulletins of general interest to amateurs, conducts code practice as a training feature, and engages in two-way work on all popular bands with as many amateurs as time permits.

At the headquarters of the League in Newington, Conn., is a well-equipped laboratory to assist staff members in preparation of technical material for *QST* and the *Radio Amateur's Handbook*. Among its other activities, the League maintains a Communications Department concerned with the operating activities of League members. A large field organization is headed by a Section Communications Manager in each of the League's seventy-three sections. There are appointments for qualified members in various fields, as outlined in Chapter 24. Special activities and contests promote operating skill. A special section is reserved each month in *QST* for amateur news from every section of the country.

## AMATEUR LICENSING IN THE UNITED STATES

Pursuant to the law, the Federal Communications Commission (FCC) has issued detailed regulations for the amateur service.

A radio amateur is a duly authorized person interested in radio technique solely with a personal aim and without pecuniary interest. Amateur operator licenses are given to U. S. citizens who pass an examination on operation and apparatus and on the provisions of law and regulations affecting amateurs, and who demonstrate ability to send and receive code. There are four available classes of amateur license—Novice, Technician, General (called "Conditional" if exam taken by mail), and Amateur Extra Class. Each has different requirements, the first two being the simplest and consequently conveying limited privileges as to frequencies available. Exams for Novice, Technician and Conditional classes are taken by mail under the supervision of a volunteer examiner. Station licenses are granted only to licensed operators and permit communication between such stations for amateur purposes, i.e., for personal noncommercial

aims flowing from an interest in radio technique. An amateur station may not be used for material compensation of any sort nor for broadcasting. Narrow bands of frequencies are allocated exclusively for use by amateur stations. Transmissions may be on any frequency within the assigned bands. All the frequencies may be used for c.w. telegraphy; some are available for radiotelephone, others for special forms of transmission such as teletype, facsimile, amateur television or radio control. The input to the final stage of amateur stations is limited to 1000 watts (with lower limits in some cases; see the table on page 13) and on frequencies below 144 Mc. must be adequately filtered direct current. Emissions must be free from spurious radiations. The licensee must provide for measurement of the transmitter frequency and establish a procedure for checking it regularly. A complete log of station operation must be maintained, with specified data. The station license also authorizes the holder to operate portable and mobile stations subject to further regulations. All radio licensees are subject to penalties for violation of regulations.

In the U.S., amateur licenses are issued only to citizens, without regard to age or physical condition. A fee of \$4.00 (payable to the Federal Communications Commission) must accompany applications for new and renewed licenses (except Novices: no fee). The fee for license modification is \$2.00. When you are able to copy code at the required speed, have studied basic transmitter theory and are familiar with the law and amateur regulations, you are ready to give serious thought to securing the Government amateur licenses which are issued you, after examination by an FCC engineer (or by a volunteer, depending on the license class), through the FCC Licensing Unit, Gettysburg, Pa., 17325. A complete up-to-the-minute discussion of license requirements, the FCC regulations for the amateur service, and study guides for those preparing for the examinations, are to be found in an ARRL publication, *The Radio Amateur's License Manual*, available from the American Radio Relay League, Newington, Conn. 06111, for 50¢, postpaid.

## AMATEUR LICENSING IN CANADA

The agency responsible for amateur radio in Canada is the Department of Transport, with its principal offices in Ottawa. Prospective amateurs, who must be at least 15 years old, and pay an examination fee of 50¢, may take the examination for an Amateur Radio Operator Certificate at one of the regional offices of the DOT. The test is in three parts: a Morse code test at ten words per minute, a written technical exam and an oral examination. Upon passing the examination, the amateur may apply for a station license, the fee for which is \$2.50 per year. At this point, the amateur is permitted to use c.w. on all authorized amateur bands (see table) and phone on those bands above 50 Mc.



After six months, during which the station has been operated on c.w. on frequencies below 29.7 Mc., the Canadian amateur may have his certificate endorsed for phone operation on the 26.96-27.0 Mc. and 28.0-29.7 Mc. bands. The amateur may take a 15 w.p.m. code test and more-difficult oral and written examinations, for the Advanced Amateur Radio Operator Certificate, which permits phone operations on portions of all authorized amateur bands. Holders of First or Second Class or Special Radio Operator's Certificates may enjoy the privileges of Advanced class without further examination. The maximum input power to the final stage of an amateur transmitter is limited to 750 watts.

Prospective amateurs living in remote areas may obtain a provisional station license after signing a statement that they can meet the technical and operating requirements. A provisional license is valid for a maximum of twelve consecutive months only; by that time, a provisional licensee should have had an opportunity to take the regular examination.

Licenses are available to citizens of Canada, to citizens of other countries in the British Commonwealth, and to non-citizens who qualify as "landed immigrants" within the meaning of Canadian immigration law. The latter status may be enjoyed for only six years, incidentally. A U.S. citizen who obtained a Canadian license as a "landed immigrant" would have to become a Canadian citizen at the end of six years or lose his Canadian license.

Copies of the Radio Act and of the General Radio Regulations may be obtained for a nominal fee from the Queen's Printer, Ottawa, and in other places where publications of the Queen's Printer are available. An extract of the amateur rules, Form AR-5-80, is available at DOT offices. A wealth of additional information on amateur radio in Canada can be found in the *Radio Amateur Licensing Handbook*, by Jim Kitchin, VE7KN, published by Radiotelephone Directories of Canada, Ltd., 119 West Pender Street, Vancouver 3, B.C., for \$2.00.

### RECIPROCAL OPERATING

U.S. amateurs may operate their amateur stations while visiting in Canada and Costa Rica, and vice versa. Reciprocal operating agreements are being negotiated with additional countries at press time; for the latest information on a specific country, write to ARRL headquarters.

### LEARNING THE CODE

In starting to learn the code, you should consider it simply another means of conveying information. The spoken word is one method, the printed page another, and typewriting and shorthand are additional examples. Learning the code is as easy—or as difficult—as learning to type.

The important thing in beginning to study code is to think of it as a language of *sound*, never as combinations of dots and dashes. It is easy to "speak" code equivalents by using "dit" and

"dah," so that A would be "didah" (the "t" is dropped in such combinations). The sound "di" should be staccato; a code character such as "5" should sound like a machinegun burst: didididit! Stress each "dah" equally; they are underlined or italicized in this text because they should be slightly accented and drawn out.

Take a few characters at a time. Learn them thoroughly in *didah* language before going on to new ones. If someone who is familiar with code can be found to "send" to you, either by whistling or by means of a buzzer or code oscillator, enlist his cooperation. Learn the code by *listening* to it. Don't think about speed to start; the first requirement is to learn the characters to the point where you can recognize each of them without hesitation. Concentrate on any difficult letters. Learning the code is not at all hard; a simple booklet treating the subject in detail is another of the beginner publications available from the League, and is entitled, *Learning the Radiotelegraph Code*, 50¢ postpaid.

Code-practice transmissions are sent by W1AW every evening at 0230 GMT (0130 May through October). See Chapter 24, "Code Proficiency."

### INTRODUCTION TO RADIO THEORY

As you start your studies for an amateur license, you may wish to have the additional help

<b>A</b> <u>didah</u>	<b>N</b> <u>dahit</u>
<b>B</b> <u>dahdidit</u>	<b>O</b> <u>dahdahdah</u>
<b>C</b> <u>dahdidahdit</u>	<b>P</b> <u>didahdahdit</u>
<b>D</b> <u>dahdidit</u>	<b>Q</b> <u>dahdahdidah</u>
<b>E</b> <u>dit</u>	<b>R</b> <u>didahdit</u>
<b>F</b> <u>dididahdit</u>	<b>S</b> <u>dididit</u>
<b>G</b> <u>dahdahdit</u>	<b>T</b> <u>dah</u>
<b>H</b> <u>didididit</u>	<b>U</b> <u>dididah</u>
<b>I</b> <u>didit</u>	<b>V</b> <u>didididah</u>
<b>J</b> <u>didahdahdah</u>	<b>W</b> <u>didahdah</u>
<b>K</b> <u>dahdidah</u>	<b>X</b> <u>dahdididah</u>
<b>L</b> <u>didahdidit</u>	<b>Y</b> <u>dahdidahdah</u>
<b>M</b> <u>dahdah</u>	<b>Z</b> <u>dahdahdidit</u>
<b>1</b> <u>didahdahdahdah</u>	<b>6</b> <u>dahdididit</u>
<b>2</b> <u>dididahdahdah</u>	<b>7</b> <u>dahdahdididit</u>
<b>3</b> <u>didididahdah</u>	<b>8</b> <u>dahdahdahdidit</u>
<b>4</b> <u>dididididah</u>	<b>9</b> <u>dahdahdahdahdit</u>
<b>5</b> <u>didididit</u>	<b>0</b> <u>dahdahdahdahdah</u>

Period : didahdidahdidah. Comma : dahdahdididahdah. Question mark : dididahdahdidit. Error : dididididididit. Double dash : dahdidididah. Wait : didahdididit. End of message : didahdidahdit. Invitation to transmit : dahdidah. End of work : didididahdidah. Fraction bar : dahdididahdit.

Fig. 1-1—The Continental (International Morse) code.

available in *How to Become a Radio Amateur* (\$1.00). It features an elementary description of radio theory and constructional details on a simple receiver and transmitter.

Another aid is *A Course in Radio Fundamentals* (\$1.00), a study guide using this *Handbook* as its text. There are experiments, discussions, and quizzes to help you learn radio fundamentals.

A new League publication, *Understanding Amateur Radio*, explains radio theory and practice in greater detail than is found in *How to Become a Radio Amateur*, but is at a more basic level than this *Handbook*. *Understanding Amateur Radio* contains 320 pages, and is priced at \$2.00.

These booklets are available postpaid from ARRL, Newington, Connecticut 06111.

## THE AMATEUR BANDS

Amateurs are assigned bands of frequencies at approximate harmonic intervals throughout the spectrum. Like assignments to all services, they

are subject to modification to fit the changing picture of world communications needs. Modifications of rules to provide for domestic needs are also occasionally issued by FCC and DOT, and in that respect each amateur should keep himself informed by WIAW bulletins, *QST* reports, or by communication with ARRL Hq. concerning a specific point.

On this page and page 14 are summaries of the Canadian and U.S. amateur bands on which operation is permitted as of our press date. Figures are megacycles. A $\emptyset$  means an unmodulated carrier, A1 means c.w. telegraphy, A2 is tone-modulated c.w. telegraphy, A3 is amplitude-modulated phone (n.f.m. may also be used in such bands, except on 1.8-2.0 Mc.), A4 is facsimile, A5 is television, n.f.m. designates narrow-band frequency- or phase-modulated radiotelephony, F1 is frequency-shift keying, F2 is frequency-modulated tone keying (Morse or teletype), F3 is f.m. phone, F4 is f.m. facsimile and F5 is f.m. television.

### CANADIAN AMATEUR BANDS

80 meters	3.500-3.725	3.725 Mc.	A1, F1,
	3.725-7.000	4.000 Mc.	A1, A3 <sup>1</sup> , F3 <sup>1</sup> ,
	7.000-7.150	7.150 Mc.	A1, F1,
40 m.	7.150-7.300	7.300 Mc.	A1, A3 <sup>1</sup> , F3 <sup>1</sup> ,
20 m.	14.000-14.100	14.100 Mc.	A1, F1,
	14.100-14.350	14.350 Mc.	A1, A3 <sup>1</sup> , F3 <sup>1</sup> ,
15 m.	21.000-21.100	21.100 Mc.	A1, F1,
	21.100-21.450	21.450 Mc.	A1, A3 <sup>1</sup> , F3 <sup>1</sup> ,
11 m.	26.960-27.000	27.000 Mc.	A1, A2, A3 <sup>2</sup> , F3 <sup>2</sup> ,
10 m.	28.000-28.100	28.100 Mc.	A1, F1,
	28.100-29.700	29.700 Mc.	A1, A3 <sup>2</sup> , F3 <sup>2</sup> ,
6 m.	50.000-51.000	51.000 Mc.	A1, A2, A3, F1, F2, F3
	51.000-54.000	54.000 Mc.	A $\emptyset$ , A1, A2, A3, F1, F2, F3,
2 m.	144.000-220.000	148.000 Mc. } 225.000 Mc. }	A $\emptyset$ , A1, A2, A3, F1,
	420.000-1215.000	450.000 Mc. }	F2, F3,
	1215.000-2300.000	1300.000 Mc. }	A $\emptyset$ , A1, A2,
	2300.000-3300.000	2450.000 Mc. }	A3, A5 <sup>3</sup> ,
	3300.000-5650.000	3500.000 Mc. }	F1, F2,
	5650.000-10000.000	5925.000 Mc. }	F3,
	10000.000-21000.000	10500.000 Mc. }	
	21000.000-22000.000	22000.000 Mc. }	

<sup>1</sup> Phone privileges are restricted to holders of Advanced Amateur Radio Operator Certificates, and of Commercial Certificates.

<sup>2</sup> Phone privileges are restricted as in footnote 1, and to holders of Amateur Radio Operators Certificates whose certificates have been endorsed for operation on phone in these bands; see text.

<sup>3</sup> Special endorsement required for amateur television transmission.

Operation in the frequency bands 1.800-1.825 Mc., 1.875-1.900 Mc., 1.900-1.925 Mc., and 1.975-2.000 Mc. shall be limited to the areas as indicated in the following table and shall be limited to the indicated maximum d.c. power input to the anode circuit of the final radio frequency stage of the transmitter during day and night hours respectively; for the purpose of the subsection, "day" means the hours between sunrise and sunset, and "night" means the hours between sunset and sunrise: A1, A3, and F3 emission are permitted.

Area	Authorized bands kc.	D.c. power input watts	
		day	night
The Provinces of Newfoundland, Nova Scotia, Prince Edward Island, New Brunswick, Quebec, Ontario, and the Districts of Keewatin, and Franklin.	1800-1825 1875-1900	375	150
The Provinces of Manitoba, Saskatchewan, Alberta, British Columbia, Yukon Territory, and the District of Mackenzie.	1900-1925 1975-2000	375	150

Except as otherwise specified, the maximum amateur power input is 750 watts.

U.S. AND POSSESSIONS AMATEUR BANDS

80 meters	3.500-4.000	Mc.—A1	220-225	Mc.	—A0, A1, A2, A3, A4, F0, F1, F2, F3, F4
	3.500-3.800	Mc.—F1			
	3.800-4.000	Mc.—A3	420-450 <sup>1</sup>	Mc.	A0, A1, A2, A3, A4, A5
40 m.	7.000-7.300	Mc.—A1	1,215-1,300	Mc.	F0, F1, F2, F3, F4, F5
	7.000-7.200	Mc.—F1	2,300-2,450	Mc.	
	7.200-7.300	Mc.—A3	3,300-3,500	Mc.	
	14.000-14.350	Mc.—A1	5,650-5,925	Mc.	A0, A1, A2, A3, A4, A5, F0, F1, F2, F3, F4, F5, pulse
20 m.	14.000-14.200	Mc.—F1	10,000-10,500 <sup>2</sup>	Mc.	
	14.200-14.350	Mc.—A3	21,000-22,000	Mc.	
	21.000-21.450	Mc.—A1	All above 40,000	Mc.	
15 m.	21.000-21.250	Mc.—F1			
	21.250-21.450	Mc.—A3			
	28.000-29.700	Mc.—A1			
10 m.	28.500-29.700	Mc.—A3			
	29.000-29.700	Mc.—F1, F3			
	50.0-50.1	Mc.—A1			
6 m.	50.1-54	Mc.—A1, A2, A3, A4			
	51-54	Mc.—A0			
	52.5-54	Mc.—F0, F1, F2, F3			
	144-147.9	Mc.—A0, A1, A2, A3, A4, F0, F1, F2, F3			
2 m.					
	147.9-148	Mc.—A1			

<sup>1</sup> Input power must not exceed 50 watts in Fla., Ariz., and parts of Ga., Ala., Miss., N. Mex., Tex., Nev., and Calif. See the *License Manual* or write ARRL for further details.

<sup>2</sup> No pulse permitted in this band.

NOTE: Frequencies from 3.9 to 4.0 Mc. are not available to amateurs on Baker, Canton, Enderbury, Guam, Howland, Jarvis, Palmyra, American Samoa, and Wake islands.

The bands 220 through 10,500 Mc. are shared with the Government Radio Positioning Service, which has priority.

In addition, A1 and A3 (except no n.f.m.) on portions of 1.800-2.000 Mc., as follows. Figures in the right columns are maximum d.c. plate power input.

Area	1800-1825 kc.		1875-1900 kc.		1900-1925 kc.		1975-2000 kc.	
	Day	Night	Day	Night	Day	Night	Day	Night
Alabama, Louisiana, Mississippi, Tennessee	200	50	No operation		No operation		100	25
Alaska	200	50	200	50	No operation		No operation	
Arizona, Utah	100	25	100	25	100	25	500	100
Arkansas	200	50	No operation		No operation		200	50
California	No operation		No operation		200	50	500	200
Colorado, New Mexico, Wyoming, Texas West of 103° W.	200	50	100	25	100	25	500	100
Connecticut, Delaware, D.C., Maryland, New Jersey, Pennsylvania, Rhode Island, Virginia, West Va., New York south of 42° N.	200	50	100	25	No operation		No operation	
Florida, Georgia, South Carolina	100	25	No operation		No operation		No operation	
Hawaii, Puerto Rico, Virgin Is.	No operation		No operation		100	25	100	25
Idaho, Montana west of 111° W.	100	25	200	50	200	50	500	100
Illinois, Missouri	200	50	100	25	100	25	200	50
Indiana, Kentucky, Ohio	200	50	100	25	100	25	100	25
Iowa, Kansas, Minnesota, Wisconsin, upper Michigan	500	100	100	25	100	25	200	50
Maine, Massachusetts, New Hampshire, Vermont, New York north of 42° N.	500	100	100	25	No operation		No operation	
Michigan, lower peninsula	500	100	100	25	100	25	100	25
Montana east of 111° W.	200	50	200	50	200	50	500	100
Nebraska, So. Dakota	500	100	100	25	100	25	500	100
Nevada	100	25	200	50	200	50	500	200
No. Carolina	200	50	No operation		No operation		No operation	
No. Dakota	500	100	200	50	200	50	500	100
Oklahoma, Texas east of 103° W.	500	100	No operation		No operation		200	50
Oregon, Washington	No operation		No operation		200	50	500	100
Navassa Is.	No operation		No operation		No operation		100	25
Swan Is., Serrana Bank, Roncador Key	500	100	No operation		No operation		100	25
Baker, Canton, Enderbury, Guam, Howland, Jarvis, Johnston, Midway & Palmyra Is.	No operation		No operation		500	100	500	100
American Samoa	500	200	500	200	500	200	500	200
Wake Is.	500	100	500	100	No operation		No operation	

Novice licensees may use the following frequencies, transmitters to be crystal-controlled and have a maximum power input of 75 watts.

3.700-3.750 Mc.	A1	21.100-21.250 Mc.	A1
7.150-7.200 Mc.	A1	145-147 Mc.	A1, A2, A3, f.m.

Technician licensees are permitted all amateur privileges in 50 Mc., 145-147 Mc. and in the bands 220 Mc. and above.

Except as otherwise specified, the maximum amateur power input is 1000 watts.

# Electrical Laws and Circuits

## ELECTRIC AND MAGNETIC FIELDS

When something occurs at one point in space because something else happened at another point, with no visible means by which the "cause" can be related to the "effect," we say the two events are connected by a **field**. In radio work, the fields with which we are concerned are the **electric** and **magnetic**, and the combination of the two called the **electromagnetic field**.

A field has two important properties, intensity (magnitude) and direction. The field exerts a **force** on an object immersed in it; this force represents potential (ready-to-be-used) energy, so the **potential** of the field is a measure of the **field intensity**. The **direction** of the field is the direction in which the object on which the force is exerted will tend to move.

An electrically charged object in an electric field will be acted on by a force that will tend to move it in a direction determined by the direction of the field. Similarly, a magnet in a magnetic field will be subject to a force. Everyone has seen demonstrations of magnetic fields with pocket magnets, so intensity and direction are not hard to grasp.

A "static" field is one that neither moves nor changes in intensity. Such a field can be set up by a stationary electric charge (**electrostatic field**) or by a stationary magnet (**magnetostatic field**). But if either an electric or magnetic field is moving in space or changing in intensity, the motion or change sets up the other kind of field. That is, a changing electric field sets up a magnetic field, and a changing magnetic field generates an electric field. This interrelationship between magnetic and electric fields makes possible such things as the electromagnet and the electric motor. It also makes possible the **electromagnetic waves** by which radio communication is carried on, for such waves are simply traveling fields in which the energy is alternately handed back and forth between the electric and magnetic fields.

### Lines of Force

Although no one knows what it is that composes the field itself, it is useful to invent a picture of it that will help in visualizing the forces and the way in which they act.

A field can be pictured as being made up of **lines of force**, or **flux lines**. These are purely imaginary threads that show, by the direction in which they lie, the direction the object on which the force is exerted will move. The **number**

of lines in a chosen cross section of the field is a measure of the **intensity** of the force. The number of lines per unit of area (square inch or square centimeter) is called the **flux density**.

## ELECTRICITY AND THE ELECTRIC CURRENT

Everything physical is built up of atoms, particles so small that they cannot be seen even through the most powerful microscope. But the atom in turn consists of several different kinds of still smaller particles. One is the **electron**, essentially a small particle of electricity. The quantity or **charge** of electricity represented by the electron is, in fact, the smallest quantity of electricity that can exist. The kind of electricity associated with the electron is called **negative**.

An ordinary atom consists of a central core called the **nucleus**, around which one or more electrons circulate somewhat as the earth and other planets circulate around the sun. The nucleus has an electric charge of the kind of electricity called **positive**, the amount of its charge being just exactly equal to the sum of the negative charges on all the electrons associated with that nucleus.

The important fact about these two "opposite" kinds of electricity is that they are strongly attracted to each other. Also, there is a strong force of repulsion between two charges of the **same** kind. The positive nucleus and the negative electrons are attracted to each other, but two electrons will be repelled from each other and so will two nuclei.

In a normal atom the positive charge on the nucleus is exactly balanced by the negative charges on the electrons. However, it is possible for an atom to lose one of its electrons. When that happens the atom has a little less negative charge than it should — that is, it has a net positive charge. Such an atom is said to be **ionized**, and in this case the atom is a **positive ion**. If an atom picks up an extra electron, as it sometimes does, it has a net negative charge and is called a **negative ion**. A positive ion will attract any stray electron in the vicinity, including the extra one that may be attached to a nearby negative ion. In this way it is possible for electrons to travel from atom to atom. The movement of ions or electrons constitutes the **electric current**.

The **amplitude** of the current (its intensity or magnitude) is determined by the rate at which electric charge — an accumulation of electrons or ions of the same kind — moves past a point in a circuit. Since the charge on a single electron or

ion is extremely small, the number that must move as a group to form even a tiny current is almost inconceivably large.

### Conductors and Insulators

Atoms of some materials, notably metals and acids, will give up an electron readily, but atoms of other materials will not part with any of their electrons even when the electric force is extremely strong. Materials in which electrons or ions can be moved with relative ease are called **conductors**, while those that refuse to permit such movement are called **nonconductors** or **insulators**. The following list shows how some common materials are classified:

<i>Conductors</i>	<i>Insulators</i>	
Metals	Dry Air	Glass
Carbon	Wood	Rubber
Acids	Porcelain	Resins
	Textiles	

### Electromotive Force

The electric force or potential (called **electromotive force**, and abbreviated **e.m.f.**) that causes current flow may be developed in several ways. The action of certain chemical solutions on dissimilar metals sets up an e.m.f.; such a combination is called a **cell**, and a group of cells forms an electric **battery**. The amount of current that such cells can carry is limited, and in the course of current flow one of the metals is eaten away. The amount of electrical energy that can be taken from a battery consequently is rather small. Where a large amount of energy is needed it is usually furnished by an electric **generator**, which develops its e.m.f. by a combination of magnetic and mechanical means.

### Direct and Alternating Currents

In picturing current flow it is natural to think of a single, constant force causing the electrons to move. When this is so, the electrons always move in the same direction through a path or circuit made up of conductors connected together in a continuous chain. Such a current is called a **direct current**, abbreviated **d.c.** It is the type of current furnished by batteries and by certain types of generators.

It is also possible to have an e.m.f. that periodically reverses. With this kind of e.m.f. the current flows first in one direction through the circuit and then in the other. Such an e.m.f. is called an **alternating e.m.f.**, and the current is called an **alternating current** (abbreviated **a.c.**). The reversals (alternations) may occur at any rate from a few per second up to several billion per second. Two reversals make a **cycle**; in one cycle the force acts first in one direction, then in the other, and then returns to the first direction to begin the next cycle. The number of cycles in one second is called the **frequency** of the alternating current.

The difference between direct current and alternating current is shown in Fig. 2-1. In these graphs the horizontal axis measures time, in-

creasing toward the right away from the vertical axis. The vertical axis represents the amplitude or strength of the current, increasing in either the up or down direction away from the horizontal axis. If the graph is *above* the horizontal axis the current is flowing in one direction through the circuit (indicated by the + sign) and if it is *below* the horizontal axis the current is flowing in the reverse direction through the circuit (indicated by the - sign). Fig. 2-1A shows that, if we close the circuit — that is, make the path for the current complete — at the time indicated by *X*, the current instantly takes the amplitude indicated by the height *A*. After that, the current continues at the same amplitude as time goes on. This is an ordinary **direct current**.

In Fig. 2-1B, the current starts flowing with the amplitude *A* at time *X*, continues at that amplitude until time *Y* and then instantly ceases. After an interval *YZ* the current again begins to flow and the same sort of start-and-stop performance is repeated. This is an **intermittent direct current**. We could get it by alternately closing and opening a switch in the circuit. It is a **direct current** because the *direction* of current flow does not change; the graph is always on the + side of the horizontal axis.

In Fig. 2-1C the current starts at zero, increases in amplitude as time goes on until it reaches the amplitude  $A_1$  while flowing in the + direction, then decreases until it drops to zero amplitude once more. At that time (*X*) the *direction* of the current flow reverses; this is indicated by the fact that the next part of the graph is below the axis. As time goes on the amplitude increases, with the current now flowing in the - direction, until it reaches amplitude  $A_2$ . Then

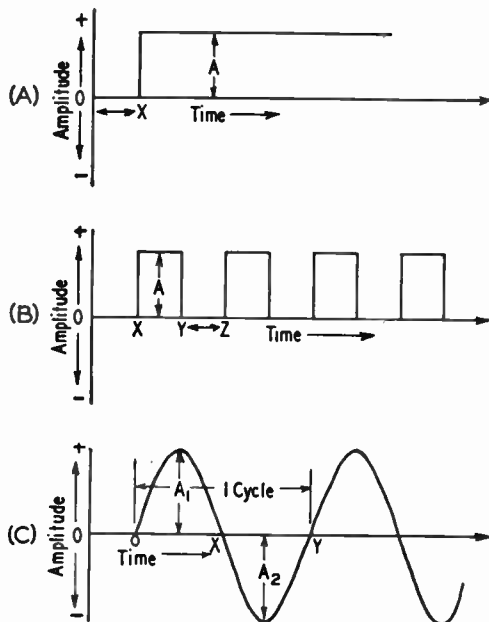

Fig. 2-1—Three types of current flow. A—direct current; B—intermittent direct current; C—alternating current.



the amplitude decreases until finally it drops to zero (*V*) and the direction reverses once more. This is an *alternating* current.

### Waveforms

The type of alternating current shown in Fig. 2-1C is known as a **sine wave**. The variations in many a.c. waves are not so smooth, nor is one half-cycle necessarily just like the preceding one in shape. However, these **complex waves** can be shown to be the sum of two or more sine waves of frequencies that are exact integral (whole-number) multiples of some lower frequency. The lowest frequency is called the **fundamental** frequency, and the higher frequencies (2 times, 3 times the fundamental frequency, and so on) are called **harmonics**.

Fig. 2-2 shows how a fundamental and a second harmonic (twice the fundamental) might add to form a complex wave. Simply by changing the relative amplitudes of the two waves, as well as the times at which they pass through zero amplitude, an infinite number of waveshapes can be constructed from just a fundamental and second harmonic. Waveforms that are still more complex can be constructed if more harmonics are used.

### Electrical Units

The unit of electromotive force is called the **volt**. An ordinary flashlight cell generates an e.m.f. of about 1.5 volts. The e.m.f. commonly supplied for domestic lighting and power is 115 volts, usually a.c. having a frequency of 60 cycles per second. The voltages used in radio receiving and transmitting circuits range from a few volts (usually a.c.) for filament heating to as high as several thousand d.c. volts for the operation of power tubes.

The flow of electric current is measured in **amperes**. One ampere is equivalent to the movement of many billions of electrons past a point in the circuit in one second. Currents in the neighborhood of an ampere are required for heating the filaments of small power tubes. The *direct* currents used in amateur radio equipment usually are not so large, and it is customary to measure such currents in **milliamperes**. One milliampere is equal to one one-thousandth of an ampere, or 1000 milliamperes equal one ampere.

A "d.c. ampere" is a measure of a *steady* current, but the "a.c. ampere" must measure a current that is continually varying in amplitude and periodically reversing direction. To put the two on the same basis, an a.c. ampere is defined as the current that will cause the same heating effect as one ampere of steady direct current. For sine-wave a.c., this **effective** (or **r.m.s.**, for *root mean square*, the mathematical derivation) value is equal to the **maximum** (or **peak**) amplitude ( $A_1$  or  $A_2$  in Fig. 2-1C) multiplied by 0.707. The **instantaneous value** is the value that the current (or voltage) has at any selected instant in the cycle. If all the instantaneous values in a sine wave are averaged over a *half-cycle*, the resulting figure is the **average** value. It is equal to 0.636 times the maximum amplitude.

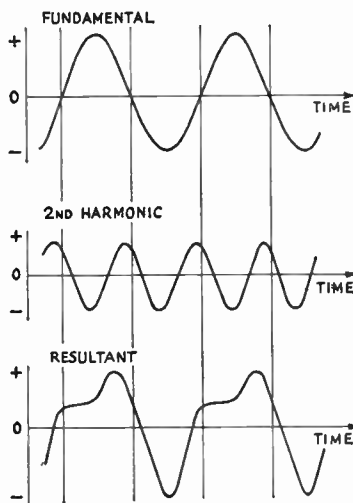

Fig. 2-2—A complex waveform. A fundamental (top) and second harmonic (center) added together, point by point at each instant, result in the waveform shown at the bottom. When the two components have the same polarity at a selected instant, the resultant is the simple sum of the two. When they have opposite polarities, the resultant is the *difference*; if the negative-polarity component is larger, the resultant is negative at that instant.

## FREQUENCY AND WAVELENGTH

### Frequency Spectrum

Frequencies ranging from about 15 to 15,000 cycles per second are called **audio frequencies**, because the vibrations of air particles that our ears recognize as sounds occur at a similar rate. Audio frequencies (abbreviated a.f.) are used to actuate loudspeakers and thus create sound waves.

Frequencies above about 15,000 cycles are called **radio frequencies (r.f.)** because they are useful in radio transmission. Frequencies all the way up to and beyond 10,000,000,000 cycles have been used for radio purposes. At radio frequencies the numbers become so large that it becomes convenient to use a larger unit than the cycle. Two such units are the **kilocycle**, which is equal to 1000 cycles and is abbreviated **kc.**, and the **megacycle**, which is equal to 1,000,000 cycles or 1000 kilocycles and is abbreviated **Mc.**

The various radio frequencies are divided off into classifications for ready identification. These classifications, listed below, constitute the **frequency spectrum** so far as it extends for radio purposes at the present time.

Frequency	Classification	Abbreviation
10 to 30 kc.	Very-low frequencies	v.l.f.
30 to 300 kc.	Low frequencies	l.f.
300 to 3000 kc.	Medium frequencies	m.f.
3 to 30 Mc.	High frequencies	h.f.
30 to 300 Mc.	Very-high frequencies	v.h.f.
300 to 3000 Mc.	Ultrahigh frequencies	u.h.f.
3000 to 30,000 Mc.	Superhigh frequencies	s.h.f.

### Wavelength

Radio waves travel at the same speed as light —300,000,000 meters or about 186,000 miles a

second in space. They can be set up by a radio-frequency current flowing in a circuit, because the rapidly changing current sets up a magnetic field that changes in the same way, and the varying magnetic field in turn sets up a varying electric field. And whenever this happens, the two fields move outward at the speed of light.

Suppose an r.f. current has a frequency of 3,000,000 cycles per second. The fields will go through complete reversals (one cycle) in 1/3,000,000 second. In that same period of time the fields—that is, the wave—will move 300,000,000/3,000,000 meters, or 100 meters. By the time the wave has moved that distance the next cycle has begun and a new wave has started out. The first wave, in other words, covers a distance of 100 meters before the beginning of the next, and so on. This distance is the **wavelength**.

The longer the time of one cycle—that is, the lower the frequency—the greater the distance occupied by each wave and hence the longer the wavelength. The relationship between wavelength and frequency is shown by the formula

$$\lambda = \frac{300,000}{f}$$

where  $\lambda$  = Wavelength in meters  
 $f$  = Frequency in kilocycles

or

$$\lambda = \frac{300}{f}$$

where  $\lambda$  = Wavelength in meters  
 $f$  = Frequency in megacycles

Example: The wavelength corresponding to a frequency of 3650 kilocycles is

$$\lambda = \frac{300,000}{3650} = 82.2 \text{ meters}$$

## RESISTANCE

Given two conductors of the same size and shape, but of different materials, the amount of current that will flow when a given e.m.f. is applied will be found to vary with what is called the **resistance** of the material. The lower the resistance, the greater the current for a given value of e.m.f.

Resistance is measured in **ohms**. A circuit has a resistance of one ohm when an applied e.m.f. of one volt causes a current of one ampere to flow. The **resistivity** of a material is the resistance, in ohms, of a cube of the material measuring one centimeter on each edge. One of the best conductors is copper, and it is frequently convenient, in making resistance calculations, to compare the resistance of the material under consideration with that of a copper conductor of the same size and shape. Table 2-I gives the ratio of the resistivity of various conductors to that of copper.

The longer the path through which the current flows the higher the resistance of that conductor. For direct current and low-frequency alternating

currents (up to a few thousand cycles per second) the resistance is *inversely* proportional to the cross-sectional area of the path the current must travel; that is, given two conductors of the same material and having the same length, but differing in cross-sectional area, the one with the larger area will have the lower resistance.

### Resistance of Wires

The problem of determining the resistance of a round wire of given diameter and length—or its opposite, finding a suitable size and length of wire to supply a desired amount of resistance—can be easily solved with the help of the copper-wire table given in a later chapter. This table gives the resistance, in ohms per thousand feet, of each standard wire size.

Example: Suppose a resistance of 3.5 ohms is needed and some No. 28 wire is on hand. The wire table in Chapter 20 shows that No. 28 has a resistance of 66.17 ohms per thousand feet. Since the desired resistance is 3.5 ohms, the length of wire required will be:

$$\frac{3.5}{66.17} \times 1000 = 52.89 \text{ feet.}$$

Or, suppose that the resistance of the wire in the circuit must not exceed 0.05 ohm and that the length of wire required for making the connections totals 14 feet. Then

$$\frac{14}{1000} \times R = 0.05 \text{ ohm}$$

where  $R$  is the maximum allowable resistance in ohms per thousand feet. Rearranging the formula gives

$$R = \frac{0.05 \times 1000}{14} = 3.57 \text{ ohms/1000 ft.}$$

Reference to the wire table shows that No. 15 is the smallest size having a resistance less than this value.

When the wire is not copper, the resistance values given in the wire table should be multiplied by the ratios given in Table 2-I to obtain the resistance.

Material	Resistivity Compared to Copper
Aluminum (pure) .....	1.6
Brass .....	3.7-4.9
Cadmium .....	4.4
Chromium .....	1.8
Copper (hard-drawn) .....	1.03
Copper (annealed) .....	1.00
Gold .....	1.4
Iron (pure) .....	5.68
Lead .....	12.8
Nickel .....	5.1
Phosphor Bronze .....	2.8-5.4
Silver .....	0.94
Steel .....	7.6-12.7
Tin .....	6.7
Zinc .....	3.4

Types of resistors used in radio equipment. Those in the foreground with wire leads are carbon types, ranging in size from  $\frac{1}{2}$  watt at the left to 2 watts at the right. The larger resistors use resistance wire wound on ceramic tubes; sizes shown range from 5 watts to 100 watts. Three are of the adjustable type, having a sliding contact on an exposed section of the resistance winding.

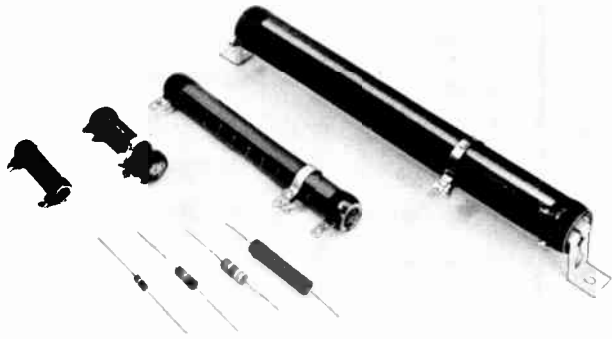

Example: If the wire in the first example were iron instead of copper the length required for 3.5 ohms would be

$$\frac{3.5}{66.17 \times 5.65} \times 1000 = 9.35 \text{ feet.}$$

### Temperature Effects

The resistance of a conductor changes with its temperature. Although it is seldom necessary to consider temperature in making resistance calculations for amateur work, it is well to know that the resistance of practically all metallic conductors increases with increasing temperature. Carbon, however, acts in the opposite way; its resistance *decreases* when its temperature rises. The temperature effect is important when it is necessary to maintain a constant resistance under all conditions. Special materials that have little or no change in resistance over a wide temperature range are used in that case.

### Resistors

A "package" of resistance made up into a single unit is called a **resistor**. Resistors having the same resistance value may be considerably different in size and construction. The flow of current through resistance causes the conductor to become heated; the higher the resistance and the larger the current, the greater the amount of heat developed. Resistors intended for carrying large currents must be physically large so the heat can be radiated quickly to the surrounding air. If the resistor does not get rid of the heat quickly it may reach a temperature that will cause it to melt or burn.

### Skin Effect

The resistance of a conductor is not the same for alternating current as it is for direct current. When the current is alternating there are internal effects that tend to force the current to flow mostly in the outer parts of the conductor. This decreases the effective cross-sectional area of the conductor, with the result that the resistance increases.

For low audio frequencies the increase in resistance is unimportant, but at radio frequencies this **skin effect** is so great that practically all the

current flow is confined within a few thousandths of an inch of the conductor surface. The r.f. resistance is consequently many times the d.c. resistance, and increases with increasing frequency. In the r.f. range a conductor of thin tubing will have just as low resistance as a solid conductor of the same diameter, because material not close to the surface carries practically no current.

### Conductance

The reciprocal of resistance (that is,  $1/R$ ) is called **conductance**. It is usually represented by the symbol  $G$ . A circuit having large conductance has low resistance, and vice versa. In radio work the term is used chiefly in connection with vacuum-tube characteristics. The unit of conductance is the **mho**. A resistance of one ohm has a conductance of one mho, a resistance of 1000 ohms has a conductance of 0.001 mho, and so on. A unit frequently used in connection with vacuum tubes is the **micromho**, or one-millionth of a mho. It is the conductance of a resistance of one megohm.

### OHM'S LAW

The simplest form of electric circuit is a battery with a resistance connected to its terminals, as shown by the symbols in Fig. 2-3. A complete circuit must have an unbroken path so current

Fig. 2-3—A simple circuit consisting of a battery and resistor.



can flow out of the battery, through the apparatus connected to it, and back into the battery. The circuit is **broken**, or **open**, if a connection is removed at any point. A **switch** is a device for making and breaking connections and thereby closing or opening the circuit, either allowing current to flow or preventing it from flowing.

The values of current, voltage and resistance in a circuit are by no means independent of each other. The relationship between them is known as **Ohm's Law**. It can be stated as follows: The



To change from	To	Divide by	Multiply by
Units	Micro-units	1,000,000	1,000,000
	Milli-units	1000	1000
	Kilo-units	1,000,000	
	Mega-units		
Micro-units	Milli-units	1000	
	Units	1,000,000	
Milli-units	Micro-units	1000	1000
	Units	1000	
Kilo-units	Units		1000
	Mega-units	1000	
Mega-units	Units	1,000,000	1,000,000
	Kilo-units	1000	1000

current flowing in a circuit is directly proportional to the applied e.m.f. and inversely proportional to the resistance. Expressed as an equation, it is

$$I \text{ (amperes)} = \frac{E \text{ (volts)}}{R \text{ (ohms)}}$$

The equation above gives the value of current when the voltage and resistance are known. It may be transposed so that each of the three quantities may be found when the other two are known:

$$E = IR$$

(that is, the voltage acting is equal to the current in amperes multiplied by the resistance in ohms) and

$$R = \frac{E}{I}$$

(or, the resistance of the circuit is equal to the applied voltage divided by the current).

All three forms of the equation are used almost constantly in radio work. It must be remembered that the quantities are in *volts, ohms* and *amperes*; other units cannot be used in the equations without first being converted. For example, if the current is in milliamperes it must be changed to the equivalent fraction of an ampere before the value can be substituted in the equations.

Table 2-II shows how to convert between the various units in common use. The prefixes attached to the basic-unit name indicate the nature of the unit. These prefixes are:

- micro — one-millionth (abbreviated  $\mu$ )
- milli — one-thousandth (abbreviated  $m$ )
- kilo — one thousand (abbreviated  $k$ )
- mega — one million (abbreviated  $M$ )

For example, one microvolt is one-millionth of a volt, and one megohm is 1,000,000 ohms. There are therefore 1,000,000 microvolts in one volt, and 0.000001 megohm in one ohm.

The following examples illustrate the use of Ohm's Law:

The current flowing in a resistance of 20,000 ohms is 150 milliamperes. What is the voltage? Since the voltage is to be found, the equation to use is  $E = IR$ . The current must first be converted from milliamperes to amperes, and reference to the table shows that to do so it is necessary to divide by 1000. Therefore,

$$E = \frac{150}{1000} \times 20,000 = 3000 \text{ volts}$$

When a voltage of 150 is applied to a circuit the current is measured at 2.5 amperes. What is the resistance of the circuit? In this case  $R$  is the unknown, so

$$R = \frac{E}{I} = \frac{150}{2.5} = 60 \text{ ohms}$$

No conversion was necessary because the voltage and current were given in volts and amperes.

How much current will flow if 250 volts is applied to a 5000-ohm resistor? Since  $I$  is unknown

$$I = \frac{E}{R} = \frac{250}{5000} = 0.05 \text{ ampere}$$

Milliamperes units would be more convenient for the current, and  $0.05 \text{ amp.} \times 1000 = 50$  milliamperes.

### SERIES AND PARALLEL RESISTANCES

Very few actual electric circuits are as simple as the illustration in the preceding section. Commonly, resistances are found connected in a

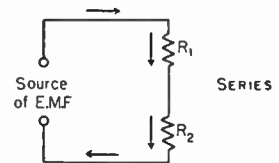
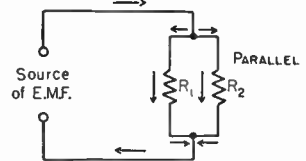

Fig. 2-4—Resistors connected in series and in parallel.



variety of ways. The two fundamental methods of connecting resistances are shown in Fig. 2-4. In the upper drawing, the current flows from the source of e.m.f. (in the direction shown by the arrow, let us say) down through the first resistance,  $R_1$ , then through the second,  $R_2$ , and then back to the source. These resistors are connected in **series**. The current everywhere in the circuit has the same value.

In the lower drawing the current flows to the common connection point at the top of the two resistors and then divides, one part of it flowing through  $R_1$  and the other through  $R_2$ . At the lower connection point these two currents again combine; the total is the same as the current that flowed into the upper common connection. In this case the two resistors are connected in **parallel**.

#### Resistors in Series

When a circuit has a number of resistances connected in series, the total resistance of the circuit is the sum of the individual resistances. If these are numbered  $R_1, R_2, R_3$ , etc., then

$R \text{ (total)} = R_1 + R_2 + R_3 + R_4 + \dots$  where the dots indicate that as many resistors as necessary may be added.

Example: Suppose that three resistors are connected to a source of e.m.f. as shown in Fig. 2-5. The e.m.f. is 250 volts,  $R_1$  is 5000 ohms,  $R_2$  is 20,000 ohms, and  $R_3$  is 8000 ohms. The total resistance is then

$$R = R_1 + R_2 + R_3 = 5000 + 20,000 + 8000 = 33,000 \text{ ohms}$$

The current flowing in the circuit is then

$$I = \frac{E}{R} = \frac{250}{33,000} = 0.00757 \text{ amp.} = 7.57 \text{ ma.}$$

(We need not carry calculations beyond three significant figures, and often two will suffice because the accuracy of measurements is seldom better than a few per cent.)

**Voltage Drop**

Ohm's Law applies to *any part* of a circuit as well as to the whole circuit. Although the current is the same in all three of the resistances in the example, the total voltage divides among them. The voltage appearing across each resistor (the **voltage drop**) can be found from Ohm's Law.

Example: If the voltage across  $R_1$  (Fig. 2-5) is called  $E_1$ , that across  $R_2$  is called  $E_2$ , and that across  $R_3$  is called  $E_3$ , then

$$\begin{aligned} E_1 &= IR_1 = 0.00757 \times 5000 = 37.9 \text{ volts} \\ E_2 &= IR_2 = 0.00757 \times 20,000 = 151.4 \text{ volts} \\ E_3 &= IR_3 = 0.00757 \times 8000 = 60.6 \text{ volts} \end{aligned}$$

The applied voltage must equal the sum of the individual voltage drops:

$$E = E_1 + E_2 + E_3 = 37.9 + 151.4 + 60.6 = 249.9 \text{ volts}$$

The answer would have been more nearly exact if the current had been calculated to more decimal places, but as explained above a very high order of accuracy is not necessary.

In problems such as this considerable time and trouble can be saved, when the current is small enough to be expressed in milliamperes, if the

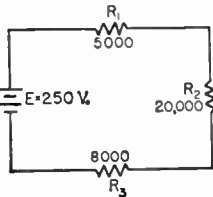

Fig. 2-5—An example of resistors in series. The solution of the circuit is worked out in the text.

resistance is expressed in kilohms rather than ohms. When resistance in kilohms is substituted directly in Ohm's Law the current will be in milliamperes if the e.m.f. is in volts.

**Resistors in Parallel**

In a circuit with resistances in parallel, the total resistance is *less* than that of the *lowest* value of resistance present. This is because the total current is always greater than the current in any individual resistor. The formula for finding the total resistance of resistances in parallel is

$$R = \frac{1}{\frac{1}{R_1} + \frac{1}{R_2} + \frac{1}{R_3} + \frac{1}{R_4} + \dots}$$

where the dots again indicate that any number

of resistors can be combined by the same method. For only two resistances in parallel (a very common case) the formula becomes

$$R = \frac{R_1 R_2}{R_1 + R_2}$$

Example: If a 500-ohm resistor is paralleled with one of 1200 ohms, the total resistance is

$$R = \frac{R_1 R_2}{R_1 + R_2} = \frac{500 \times 1200}{500 + 1200} = \frac{600,000}{1700} = 353 \text{ ohms}$$

It is probably easier to solve practical problems by a different method than the "reciprocal of reciprocals" formula. Suppose the three re-

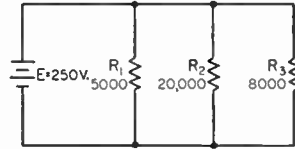

Fig. 2-6—An example of resistors in parallel. The solution is worked out in the text.

sistors of the previous example are connected in parallel as shown in Fig. 2-6. The same e.m.f., 250 volts, is applied to all three of the resistors. The current in each can be found from Ohm's Law as shown below,  $I_1$  being the current through  $R_1$ ,  $I_2$  the current through  $R_2$  and  $I_3$  the current through  $R_3$ .

For convenience, the resistance will be expressed in kilohms so the current will be in milliamperes.

$$I_1 = \frac{E}{R_1} = \frac{250}{5} = 50 \text{ ma.}$$

$$I_2 = \frac{E}{R_2} = \frac{250}{20} = 12.5 \text{ ma.}$$

$$I_3 = \frac{E}{R_3} = \frac{250}{8} = 31.25 \text{ ma.}$$

The total current is

$$I = I_1 + I_2 + I_3 = 50 + 12.5 + 31.25 = 93.75 \text{ ma.}$$

The total resistance of the circuit is therefore

$$R = \frac{E}{I} = \frac{250}{93.75} = 2.66 \text{ kilohms (} = 2660 \text{ ohms)}$$

**Resistors in Series-Parallel**

An actual circuit may have resistances both in parallel and in series. To illustrate, we use the same three resistances again, but now connected as in Fig. 2-7. The method of solving a circuit such as Fig. 2-7 is as follows: Consider  $R_2$  and  $R_3$  in parallel as though they formed a single resistor. Find their equivalent resistance. Then this resistance in series with  $R_1$  forms a simple series circuit, as shown at the right in Fig. 2-7. An example of the arithmetic is given under the illustration.

Using the same principles, and staying within the practical limits, a value for  $R_2$  can be computed that will provide a given voltage drop across  $R_3$  or a given current through  $R_1$ . Simple algebra is required.

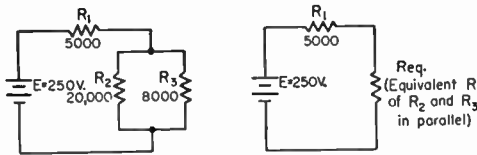

Fig. 2-7—An example of resistors in series-parallel. The equivalent circuit is on the right. The solution is worked out in the text.

Example: The first step is to find the equivalent resistance of  $R_2$  and  $R_3$ . From the formula for two resistances in parallel,

$$R_{eq} = \frac{R_2 R_3}{R_2 + R_3} = \frac{20 \times 8}{20 + 8} = \frac{160}{28} = 5.71 \text{ kilohms}$$

The total resistance in the circuit is then

$$R = R_1 + R_{eq} = 5 + 5.71 \text{ kilohms} = 10.71 \text{ kilohms}$$

The current is

$$I = \frac{E}{R} = \frac{250}{10.71} = 23.3 \text{ ma.}$$

The voltage drops across  $R_1$  and  $R_{eq}$  are

$$E_1 = IR_1 = 23.3 \times 5 = 117 \text{ volts}$$

$$E_2 = IR_{eq} = 23.3 \times 5.71 = 133 \text{ volts}$$

with sufficient accuracy. These total 250 volts, thus checking the calculations so far, because the sum of the voltage drops must equal the applied voltage. Since  $E_2$  appears across both  $R_2$  and  $R_3$ ,

$$I_2 = \frac{E_2}{R_2} = \frac{133}{20} = 6.65 \text{ ma.}$$

$$I_3 = \frac{E_2}{R_3} = \frac{133}{8} = 16.6 \text{ ma.}$$

where  $I_2$  = Current through  $R_2$   
 $I_3$  = Current through  $R_3$

The total is 23.25 ma., which checks closely enough with 23.3 ma., the current through the whole circuit.

**POWER AND ENERGY**

Power—the rate of doing work—is equal to voltage multiplied by current. The unit of electrical power, called the **watt**, is equal to one volt multiplied by one ampere. The equation for power therefore is

$$P = EI$$

where  $P$  = Power in watts

$E$  = E.m.f. in volts

$I$  = Current in amperes

Common fractional and multiple units for power are the **milliwatt**, one one-thousandth of a watt, and the **kilowatt**, or one thousand watts.

Example: The plate voltage on a transmitting vacuum tube is 2000 volts and the plate current is 350 milliamperes. (The current must be changed to amperes before substitution in the formula, and so is 0.35 amp.) Then

$$P = EI = 2000 \times 0.35 = 700 \text{ watts}$$

By substituting the Ohm's Law equivalents for  $E$  and  $I$ , the following formulas are obtained for power:

$$P = \frac{E^2}{R}$$

$$P = I^2 R$$

These formulas are useful in power calculations when the resistance and either the current or voltage (but not both) are known.

Example: How much power will be used up in a 4000-ohm resistor if the voltage applied to it is 200 volts? From the equation

$$P = \frac{E^2}{R} = \frac{(200)^2}{4000} = \frac{40,000}{4000} = 10 \text{ watts}$$

Or, suppose a current of 20 milliamperes flows through a 300-ohm resistor. Then

$$P = I^2 R = (0.02)^2 \times 300 = 0.0004 \times 300 = 0.12 \text{ watt}$$

Note that the current was changed from milliamperes to amperes before substitution in the formula.

Electrical power in a resistance is turned into heat. The greater the power the more rapidly the heat is generated. Resistors for radio work are made in many sizes, the smallest being rated to "dissipate" (or carry safely) about 1/4 watt. The largest resistors used in amateur equipment will dissipate about 100 watts.

**Generalized Definition of Resistance**

Electrical power is not always turned into heat. The power used in running a motor, for example, is converted to mechanical motion. The power supplied to a radio transmitter is largely converted into radio waves. Power applied to a loudspeaker is changed into sound waves. But in every case of this kind the power is completely "used up"—it cannot be recovered. Also, for proper operation of the device the power must be supplied at a definite ratio of voltage to current. Both these features are characteristics of resistance, so it can be said that any device that dissipates power has a definite value of "resistance." This concept of resistance as something that absorbs power at a definite voltage/current ratio is very useful, since it permits substituting a simple resistance for the load or power-consuming part of the device receiving power, often with considerable simplification of calculations. Of course, every electrical device has some resistance of its own in the more narrow sense, so a part of the power supplied to it is dissipated in that resistance and hence appears as heat even though the major part of the power may be converted to another form.

**Efficiency**

In devices such as motors and vacuum tubes, the object is to obtain power in some other form than heat. Therefore power used in heating is considered to be a loss, because it is not the *useful* power. The **efficiency** of a device is the useful power output (in its converted form) divided by the power input to the device. In a vacuum-tube transmitter, for example, the object is to convert power from a d.c. source into a.c. power at some radio frequency. The ratio of the r.f. power output to the d.c. input is the efficiency of the tube. That is,

$$Eff. = \frac{P_o}{P_i}$$

where *Eff.* = Efficiency (as a decimal)

$P_o$  = Power output (watts)

$P_i$  = Power input (watts)

Example: If the d.c. input to the tube is 100 watts and the r.f. power output is 60 watts, the efficiency is

$$Eff. = \frac{P_o}{P_i} = \frac{60}{100} = 0.6$$

Efficiency is usually expressed as a percentage; that is, it tells what per cent of the input power will be available as useful output. The efficiency in the above example is 60 per cent.

### Energy

In residences, the power company's bill is for electric **energy**, not for power. What you pay for is the *work* that electricity does for you, not the *rate* at which that work is done. Electrical work

is equal to power multiplied by time; the common unit is the **watt-hour**, which means that a power of one watt has been used for one hour. That is,

$$W = PT$$

where *W* = Energy in watt-hours

*P* = Power in watts

*T* = Time in hours

Other energy units are the **kilowatt-hour** and the **watt-second**. These units should be self-explanatory.

Energy units are seldom used in amateur practice, but it is obvious that a small amount of power used for a long time can eventually result in a "power" bill that is just as large as though a large amount of power had been used for a very short time.

## CAPACITANCE

Suppose two flat metal plates are placed close to each other (but not touching) and are connected to a battery through a switch, as shown in Fig. 2-8. At the instant the switch is closed, electrons will be attracted from the upper plate to the positive terminal of the battery, and the same number will be repelled into the lower plate from

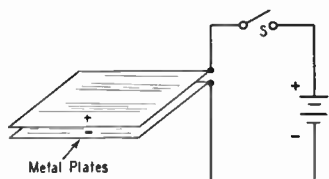

Fig. 2-8—A simple capacitor.

the negative battery terminal. Enough electrons move into one plate and out of the other to make the e.m.f. between them the same as the e.m.f. of the battery.

If the switch is opened after the plates have been **charged** in this way, the top plate is left with a deficiency of electrons and the bottom plate with an excess. The plates remain charged despite the fact that the battery no longer is connected. However, if a wire is touched between the two plates (**short-circuiting** them) the excess electrons on the bottom plate will flow through the wire to the upper plate, thus restoring electrical neutrality. The plates have then been **discharged**.

The two plates constitute an electrical **capacitor**; a capacitor possesses the property of storing electricity. (The energy actually is stored in the electric field between the plates.) During the time the electrons are moving—that is, while the capacitor is being charged or discharged—a current is flowing in the circuit even though the circuit is "broken" by the gap between the capacitor plates. However, the current flows only during the time of charge and discharge, and this time is usually very short. There can be no continuous flow of direct current "through" a capacitor, but an alternating current can pass through easily if the frequency is high enough.

The **charge** or quantity of electricity that can be placed on a capacitor is proportional to the applied voltage and to the **capacitance** of the capacitor. The larger the plate area and the smaller the spacing between the plates the greater the capacitance. The capacitance also depends upon the kind of insulating material between the plates; it is smallest with air insulation, but substitution of other insulating materials for air may increase the capacitance many times. The ratio of the capacitance with some material other than air between the plates, to the capacitance of the same capacitor with air insulation, is called the **dielectric constant** of that particular insulating material. The material itself is called a **dielectric**. The dielectric constants of a number of materials commonly used as dielectrics in capacitors are

Table 2-III

### Dielectric Constants and Breakdown Voltages

Material	Dielectric Constant *	Puncture Voltage **
Air	1.0	
Alsimag 196	5.7	240
Bakelite	4.4-5.4	300
Bakelite, mica-filled	4.7	325-375
Cellulose acetate	3.3-3.9	250-600
Fiber	5-7.5	150-180
Formica	4.6-4.9	450
Glass, window	7.6-8	200-250
Glass, Pyrex	4.8	335
Mica, ruby	5.4	3800-5600
Mycalex	7.4	250
Paper, Royalgrey	3.0	200
Plexiglass	2.8	990
Polyethylene	2.3	1200
Polystyrene	2.6	500-700
Porcelain	5.1-5.9	40-100
Quartz, fused	3.8	1000
Steatite, low-loss	5.8	150-315
Teflon	2.1	1000-2000

\* At 1 Mc. \*\* In volts per mil (0.001 inch)

given in Table 2-III. If a sheet of polystyrene is substituted for air between the plates of a capacitor, for example, the capacitance will be increased 2.6 times.

### Units

The fundamental unit of capacitance is the farad, but this unit is much too large for practical work. Capacitance is usually measured in **microfarads** (abbreviated  $\mu\text{f.}$ ) or **picofarads** ( $\text{pf.}$ ). The microfarad is one-millionth of a farad,

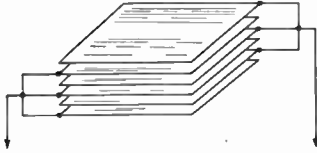

Fig. 2-9—A multiple-plate capacitor. Alternate plates are connected together.

and the picofarad (formerly micromicrofarad) is one-millionth of a microfarad. Capacitors nearly always have more than two plates, the alternate plates being connected together to form two sets as shown in Fig. 2-9. This makes it possible to attain a fairly large capacitance in a small space, since several plates of smaller individual area can be stacked to form the equivalent of a single large plate of the same total area. Also, all plates, except the two on the ends, are exposed to plates of the other group on *both sides*, and so are twice as effective in increasing the capacitance.

The formula for calculating capacitance is :

$$C = 0.224 \frac{KA}{d} (n - 1)$$

where  $C$  = Capacitance in pf.

$K$  = Dielectric constant of material between plates

$A$  = Area of one side of *one* plate in square inches

$d$  = Separation of plate surfaces in inches

$n$  = Number of plates

If the plates in one group do not have the same area as the plates in the other, use the area of the *smaller* plates.

### Capacitors in Radio

The types of capacitors used in radio work differ considerably in physical size, construction, and capacitance. Some representative types are shown in the photograph. In **variable capacitors** (almost always constructed with air for the dielectric) one set of plates is made movable with respect to the other set so that the capacitance can be varied. **Fixed capacitors**—that is, assemblies having a single, non-adjustable value of capacitance—also can be made with metal plates and with air as the dielectric, but usually are constructed from plates of metal foil with a thin solid or liquid dielectric sandwiched in between, so that a relatively large capacitance can be secured in a small unit. The solid dielectrics commonly used are mica, paper and special ceramics. An example of a liquid dielectric is mineral oil. The **electrolytic capacitor** uses aluminum-foil plates with a semiliquid conducting chemical compound between them; the actual dielectric is a very thin film of insulating material that forms on one set of plates through electrochemical action when a d.c. voltage is applied to the capacitor. The capacitance obtained with a given plate area in an electrolytic capacitor is very large, compared with capacitors having other dielectrics, because the film is so thin—much less than any thickness that is practicable with a solid dielectric.

The use of electrolytic and oil-filled capacitors is confined to power-supply filtering and audio bypass applications. Mica and ceramic capacitors are used throughout the frequency range from audio to several hundred megacycles.

### Voltage Breakdown

When a high voltage is applied to the plates of a capacitor, a considerable force is exerted on the electrons and nuclei of the dielectric. Because the dielectric is an insulator the electrons do not become detached from atoms the way they do in conductors. However, if the force is great enough the dielectric will "break down"; usually it will puncture and may char (if it is solid) and permit current to flow. The breakdown voltage depends upon the kind and thickness of the dielectric, as shown in Table 2-III. It is not directly proportional to the thickness; that is, doubling

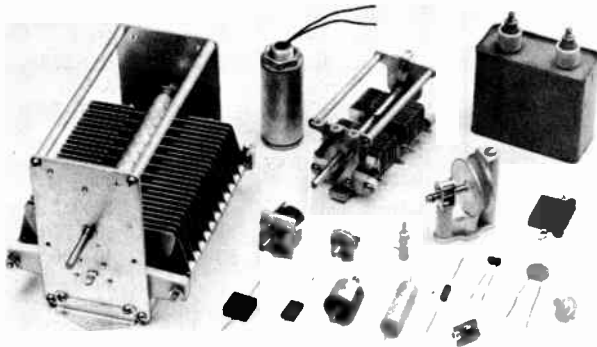

Fixed and variable capacitors. The large unit at the left is a transmitting-type variable capacitor for r.f. tank circuits. To its right are other air-dielectric variables of different sizes ranging from the midget "air padder" to the medium-power tank capacitor at the top center. The cased capacitors in the top row are for power-supply filters, the cylindrical can unit being an electrolytic and the rectangular one a paper-dielectric capacitor. Various types of mica, ceramic, and paper-dielectric capacitors are in the foreground.



the thickness does not quite double the breakdown voltage. If the dielectric is air or any other gas, breakdown is evidenced by a spark or arc between the plates, but if the voltage is removed the arc ceases and the capacitor is ready for use again. Breakdown will occur at a lower voltage between pointed or sharp-edged surfaces than between rounded and polished surfaces; consequently, the breakdown voltage between metal plates of given spacing in air can be increased by buffing the edges of the plates.

Since the dielectric must be thick to withstand high voltages, and since the thicker the dielectric the smaller the capacitance for a given plate area, a high-voltage capacitor must have more plate area than a low-voltage one of the same capacitance. High-voltage high-capacitance capacitors are physically large.

**CAPACITORS IN SERIES AND PARALLEL**

The terms "parallel" and "series" when used with reference to capacitors have the same circuit meaning as with resistances. When a number of capacitors are connected in parallel, as in Fig. 2-10, the total capacitance of the group is equal to the sum of the individual capacitances, so

$$C \text{ (total)} = C_1 + C_2 + C_3 + C_4 + \dots$$

However, if two or more capacitors are connected in series, as in the second drawing, the total capacitance is less than that of the smallest capacitor in the group. The rule for finding the capacitance of a number of series-connected capacitors is the same as that for finding the resistance of a number of parallel-connected resistors. That is,

$$C \text{ (total)} = \frac{1}{\frac{1}{C_1} + \frac{1}{C_2} + \frac{1}{C_3} + \frac{1}{C_4} + \dots}$$

and, for only two capacitors in series,

$$C \text{ (total)} = \frac{C_1 C_2}{C_1 + C_2}$$

The same units must be used throughout; that is, all capacitances must be expressed in either  $\mu\text{f.}$  or  $\mu\mu\text{f.}$ ; both kinds of units cannot be used in the same equation.

Capacitors are connected in parallel to obtain a larger total capacitance than is available in one unit. The largest voltage that can be applied safely to a group of capacitors in parallel is the voltage that can be applied safely to the one having the lowest voltage rating.

When capacitors are connected in series, the applied voltage is divided up among them; the situation is much the same as when resistors are in series and there is a voltage drop across each. However, the voltage that appears across each capacitor of a group connected in series is in

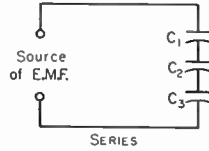
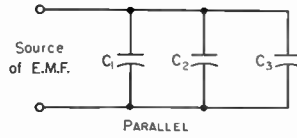

Fig. 2-10—Capacitors in parallel and in series.

inverse proportion to its capacitance, as compared with the capacitance of the whole group.

Example: Three capacitors having capacitances of 1, 2, and 4  $\mu\text{f.}$  respectively, are connected in series as shown in Fig. 2-11. The total capacitance is

$$C = \frac{1}{\frac{1}{C_1} + \frac{1}{C_2} + \frac{1}{C_3}} = \frac{1}{\frac{1}{1} + \frac{1}{2} + \frac{1}{4}} = \frac{1}{\frac{7}{4}} = \frac{4}{7} = 0.571 \mu\text{f.}$$

The voltage across each capacitor is proportional to the total capacitance divided by the capacitance of the capacitor in question, so the voltage across  $C_1$  is

$$E_1 = \frac{0.571}{1} \times 2000 = 1142 \text{ volts}$$

Similarly, the voltages across  $C_2$  and  $C_3$  are

$$E_2 = \frac{0.571}{2} \times 2000 = 571 \text{ volts}$$

$$E_3 = \frac{0.571}{4} \times 2000 = 286 \text{ volts}$$

totaling approximately 2000 volts, the applied voltage.

Capacitors are frequently connected in series to enable the group to withstand a larger voltage (at the expense of decreased total capacitance) than any individual capacitor is rated to stand. However, as shown by the previous example, the applied voltage does not divide equally among the capacitors (except when all the capacitances are the same) so care must be taken to see that the voltage rating of no capacitor in the group is exceeded.

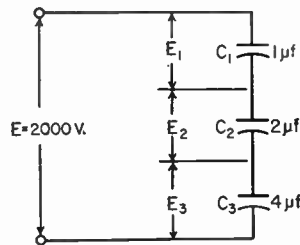

Fig. 2-11—An example of capacitors connected in series. The solution to this arrangement is worked out in the text.

**INDUCTANCE**

It is possible to show that the flow of current through a conductor is accompanied by magnetic

effects; a compass needle brought near the conductor, for example, will be deflected from its

normal north-south position. The current, in other words, sets up a magnetic field.

The transfer of energy to the magnetic field represents work done by the source of e.m.f. Power is required for doing work, and since power is equal to current multiplied by voltage, there must be a voltage drop in the circuit during the time in which energy is being stored in the field. This voltage "drop" (which has nothing to do with the voltage drop in any resistance in the circuit) is the result of an opposing voltage "induced" in the circuit while the field is building up to its final value. When the field becomes constant the induced e.m.f. or back e.m.f. disappears, since no further energy is being stored.

Since the induced e.m.f. opposes the e.m.f. of the source, it tends to prevent the current from rising rapidly when the circuit is closed. The amplitude of the induced e.m.f. is proportional to the rate at which the current is changing and to a constant associated with the circuit itself, called the **inductance** of the circuit.

Inductance depends on the physical characteristics of the conductor. If the conductor is formed into a coil, for example, its inductance is increased. A coil of many turns will have more inductance than one of few turns, if both coils are otherwise physically similar. Also, if a coil is placed on an iron core its inductance will be greater than it was without the magnetic core.

The polarity of an induced e.m.f. is always such as to oppose any change in the current in the circuit. This means that when the current in the circuit is increasing, work is being done against the induced e.m.f. by storing energy in the magnetic field. If the current in the circuit tends to decrease, the stored energy of the field returns to the circuit, and thus adds to the energy being supplied by the source of e.m.f. This tends to keep the current flowing even though the applied e.m.f. may be decreasing or be removed entirely.

The unit of inductance is the **henry**. Values of inductance used in radio equipment vary over a wide range. Inductance of several henrys is required in power-supply circuits (see chapter on

Power Supplies) and to obtain such values of inductance it is necessary to use coils of many turns wound on iron cores. In radio-frequency circuits, the inductance values used will be measured in **millihenrys** (a m.h., one one-thousandth of a henry) at low frequencies, and in **microhenrys** ( $\mu$ h., one one-millionth of a henry) at medium frequencies and higher. Although coils for radio frequencies may be wound on special iron cores (ordinary iron is not suitable) most r.f. coils made and used by amateurs are of the "air-core" type; that is, wound on an insulating support consisting of nonmagnetic material.

the conductor is not formed into a coil. The inductance of a short length of straight wire is small, but it may not be negligible because if the current through it changes its intensity rapidly enough the induced voltage may be appreciable. This will be the case in even a few inches of wire when an alternating current having a frequency of the order of 100 Mc. or higher is flowing. However, at much lower frequencies the inductance of the same wire could be left out of any calculations because the induced voltage would be negligibly small.

### Calculating Inductance

The approximate inductance of single-layer air-core coils may be calculated from the simplified formula

$$L (\mu\text{h.}) = \frac{a^2 n^2}{9a + 10b}$$

where  $L$  = Inductance in microhenrys

$a$  = Coil radius in inches

$b$  = Coil length in inches

$n$  = Number of turns

The notation is explained in Fig. 2-12. This

Fig. 2-12—Coil dimensions used in the inductance formula. The wire diameter does not enter into the formula.

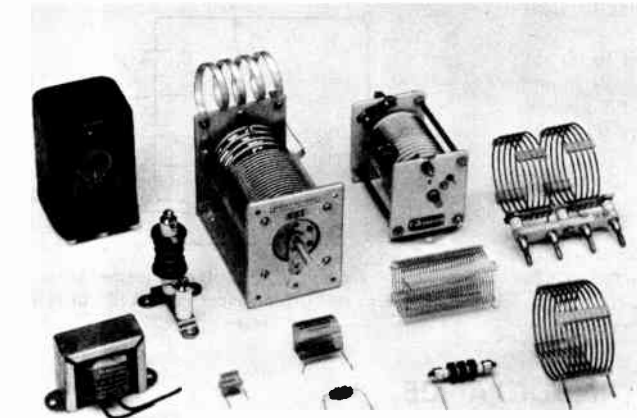
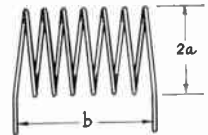

Inductors for power and radio frequencies. The two iron-core coils at the left are "chokes" for power-supply filters. The mounted air-core coils at the top center are adjustable inductors for transmitting tank circuits. The "pie-wound" coils at the left and in the foreground are radio-frequency choke coils. The remaining coils are typical of inductors used in r.f. tuned circuits, the larger sizes being used principally for transmitters.

formula is a close approximation for coils having a length equal to or greater than 0.8a.

Example: Assume a coil having 48 turns wound 32 turns per inch and a diameter of  $\frac{3}{4}$  inch. Thus  $a = 0.75 \div 2 = 0.375$ ,  $b = 48 \div 32 = 1.5$ , and  $n = 48$ . Substituting,

$$L = \frac{.375 \times .375 \times 48 \times 48}{(9 \times .375) + (10 \times 1.5)} = 17.6 \mu\text{h.}$$

To calculate the number of turns of a single-layer coil for a required value of inductance,

$$n = \sqrt{\frac{L(9a + 10b)}{a^2}}$$

Example: Suppose an inductance of  $10\mu\text{h.}$  is required. The form on which the coil is to be wound has a diameter of one inch and is long enough to accommodate a coil of  $1\frac{1}{4}$  inches. Then  $a = 0.5$ ,  $b = 1.25$ , and  $L = 10$ . Substituting,

$$n = \sqrt{\frac{10(4.5 + 12.5)}{.5 \times .5}} = \sqrt{680} = 26.1 \text{ turns}$$

A 26-turn coil would be close enough in practical work. Since the coil will be 1.25 inches long, the number of turns per inch will be  $26.1 \div 1.25 = 20.8$ . Consulting the wire table, we find that No. 17 enameled wire (or anything smaller) can be used. The proper inductance is obtained by winding the required number of turns on the form and then adjusting the spacing between the turns to make a uniformly-spaced coil 1.25 inches long.

Inductance Charts

Most inductance formulas lose accuracy when applied to small coils (such as are used in v.h.f. work and in low-pass filters built for reducing harmonic interference to television) because the conductor thickness is no longer negligible in comparison with the size of the coil. Fig. 2-13 shows the measured inductance of v.h.f. coils, and may be used as a basis for circuit design. Two curves are given: curve A is for coils wound to an inside diameter of  $\frac{1}{2}$  inch; curve B is for coils of  $\frac{3}{4}$ -inch inside diameter. In both curves the wire size is No. 12, winding pitch 8 turns to the inch ( $\frac{1}{8}$  inch center-to-center turn spacing). The inductance values given include leads  $\frac{1}{2}$  inch long.

The charts of Figs. 2-14 and 2-15 are useful for rapid determination of the inductance of coils of the type commonly used in radio-frequency circuits in the range 3-30 Mc. They are of sufficient accuracy for most practical work. Given the coil length in inches, the curves show the multiplying factor to be applied to the inductance value given in the table below the curve for a coil of the same diameter and number of turns per inch.

Example: A coil 1 inch in diameter is  $1\frac{1}{4}$  inches long and has 20 turns. Therefore it has 16 turns per inch, and from the table under Fig. 2-15 it is found that the reference inductance for a coil of this diameter and number of turns per inch is  $16.8 \mu\text{h.}$  From curve B in the figure the multiplying factor is 0.35, so the inductance is

$$16.8 \times 0.35 = 5.9 \mu\text{h.}$$

The charts also can be used for finding suitable dimensions for a coil having a required value of inductance.

Example: A coil having an inductance of  $12 \mu\text{h.}$  is required. It is to be wound on a form having a diameter of 1 inch, the length available for the winding being not more than  $1\frac{1}{4}$  inches. From Fig. 2-15, the multiplying factor for a 1-inch diameter coil (curve B) having the maximum possible length of  $1\frac{1}{4}$  inches is 0.35. Hence the number of turns per inch must be chosen for a reference inductance of at least  $12/0.35$ , or  $34 \mu\text{h.}$  From the Table under Fig. 2-15 it is seen that 16 turns per inch (reference inductance  $16.8 \mu\text{h.}$ ) is too small. Using 32 turns per inch, the multiplying factor is  $12/68$ , or 0.177, and from curve B this corresponds to a coil length of  $\frac{3}{4}$  inch. There will be 24 turns in this length, since the winding "pitch" is 32 turns per inch.

Machine-wound coils with the diameters and turns per inch given in the tables are available in many radio stores, under the trade names of "B&W Miniductor" and "Illumitronic Air Dux."

IRON-CORE COILS

Permeability

Suppose that the coil in Fig. 2-16 is wound on an iron core having a cross-sectional area of 2 square inches. When a certain current is sent through the coil it is found that there are 80,000 lines of force in the core. Since the area is 2 square inches, the flux density is 40,000 lines per square inch. Now suppose that the iron core is removed and the same current is maintained in the coil, and that the flux density without the iron core is found to be 50 lines per square inch. The ratio of the flux density with the given core material to the flux density (with the same coil and same current) with an air core is called the permeability of the material. In this case the permeability of the iron is  $40,000/50 = 800$ . The inductance of the coil is increased 800 times by inserting the iron core since, other things being equal, the inductance will be proportional to the magnetic flux through the coil.

The permeability of a magnetic material varies with the flux density. At low flux densities (or with an air core) increasing the current through

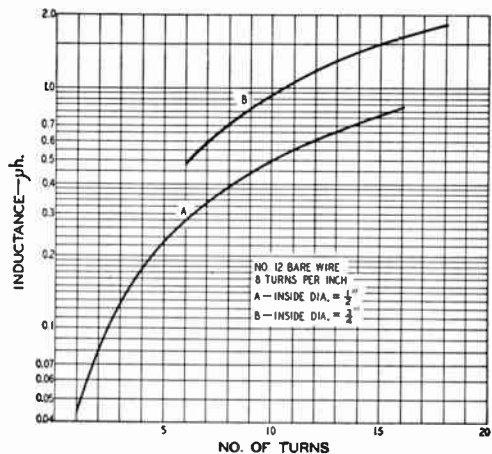

Fig. 2-13—Measured inductance of coils wound with No. 12 bare wire, 8 turns to the inch. The values include half-inch leads.



the coil will cause a proportionate increase in flux, but at very high flux densities, increasing the current may cause no appreciable change in the flux. When this is so, the iron is said to be **saturated**. Saturation causes a rapid decrease in permeability, because it decreases the ratio of flux lines to those obtainable with the same current and an air core. Obviously, the inductance of an iron-core inductor is highly dependent upon the current flowing in the coil. In an air-core coil, the inductance is independent of current because air does not saturate.

Iron core coils such as the one sketched in Fig. 2-16 are used chiefly in power-supply equipment. They usually have direct current flowing through the winding, and the variation in induct-

ance with current is usually undesirable. It may be overcome by keeping the flux density below the saturation point of the iron. This is done by opening the core so that there is a small "air gap," as indicated by the dashed lines. The magnetic "resistance" introduced by such a gap is so large—even though the gap is only a small fraction of an inch—compared with that of the iron that the gap, rather than the iron, controls the

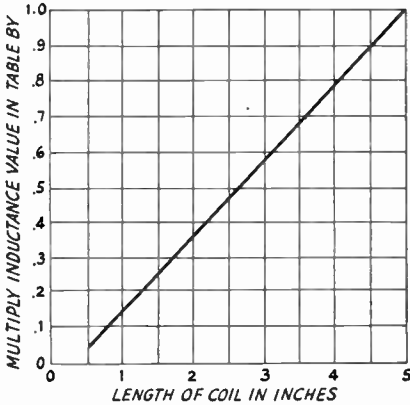

Fig. 2-14—Factor to be applied to the inductance of coils listed in the table below, for coil lengths up to 5 inches.

Coil diameter, Inches	No. of turns per inch	Inductance in $\mu$ h.
1¼	4	2.75
	6	6.3
	8	11.2
	10	17.5
	16	42.5
1½	4	3.9
	6	8.8
	8	15.6
	10	24.5
	16	63
1¾	4	5.2
	6	11.8
	8	21
	10	33
	16	85
2	4	6.6
	6	15
	8	26.5
	10	42
	16	108
2½	4	10.2
	6	23
	8	41
	10	64
3	4	14
	6	31.5
	8	56
	10	89

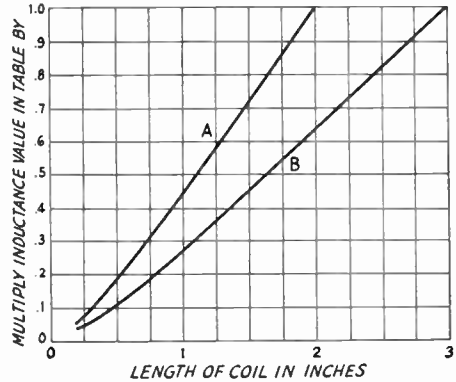

Fig. 2-15—Factor to be applied to the inductance of coils listed in the table below, as a function of coil length. Use curve A for coils marked A, curve B for coils marked B.

Coil diameter, Inches	No. of turns per inch	Inductance in $\mu$ h.
½ (A)	4	0.18
	6	0.40
	8	0.72
	10	1.12
	16	2.9
	32	12
¾ (A)	4	0.28
	6	0.62
	8	1.1
	10	1.7
	16	4.4
	32	18
¾ (B)	4	0.6
	6	1.35
	8	2.4
	10	3.8
	16	9.9
	32	40
1 (B)	4	1.0
	6	2.3
	8	4.2
	10	6.6
	16	16.8
	32	68

flux density. This reduces the inductance, but makes it practically constant regardless of the value of the current.

**Eddy Currents and Hysteresis**

When alternating current flows through a coil wound on an iron core an e.m.f. will be induced, as previously explained, and since iron is a conductor a current will flow in the core. Such currents (called **eddy currents**) represent a waste

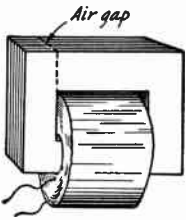

Fig. 2-16—Typical construction of an iron-core inductor. The small air gap prevents magnetic saturation of the iron and thus maintains the inductance at high currents.

of power because they flow through the resistance of the iron and thus cause heating. Eddy-current losses can be reduced by **laminating** the core; that is, by cutting it into thin strips. These strips or **laminations** must be insulated from each other by painting them with some insulating material such as varnish or shellac.

There is also another type of energy loss: the iron tends to resist any change in its magnetic state, so a rapidly-changing current such as a.c. is forced continually to supply energy to the iron to overcome this "inertia." Losses of this sort are called **hysteresis** losses.

Eddy-current and hysteresis losses in iron increase rapidly as the frequency of the alternating current is increased. For this reason, ordinary iron cores can be used only at power and audio frequencies—up to, say, 15,000 cycles. Even so, a very good grade of iron or steel is necessary if the core is to perform well at the higher audio frequencies. Iron cores of this type are completely useless at radio frequencies.

For radio-frequency work, the losses in iron cores can be reduced to a satisfactory figure by grinding the iron into a powder and then mixing it with a "binder" of insulating material in such a way that the individual iron particles are insulated from each other. By this means cores can be made that will function satisfactorily even through the v.h.f. range—that is, at frequencies up to perhaps 100 Mc. Because a large part of the magnetic path is through a nonmagnetic material, the permeability of the iron is low compared with the values obtained at power-supply frequencies. The core is usually in the form of a "slug" or cylinder which fits inside the insulating form on which the coil is wound. Despite the fact that, with this construction, the major portion of the magnetic path for the flux is in air, the slug is quite effective in increasing the coil inductance. By pushing the slug in and out of the coil the inductance can be varied over a considerable range.

**INDUCTANCES IN SERIES AND PARALLEL**

When two or more inductors are connected in series (Fig. 2-17, left) the total inductance is equal to the sum of the individual inductances, *provided the coils are sufficiently separated so that no coil is in the magnetic field of another.* That is,

$$L_{total} = L_1 + L_2 + L_3 + L_4 + \dots$$

If inductors are connected in parallel (Fig. 2-17, right)—and the coils are separated sufficiently,

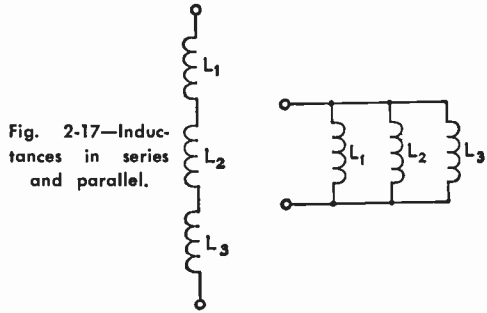

Fig. 2-17—Inductances in series and parallel.

the total inductance is given by

$$L_{total} = \frac{1}{\frac{1}{L_1} + \frac{1}{L_2} + \frac{1}{L_3} + \frac{1}{L_4} + \dots}$$

and for two inductances in parallel,

$$L = \frac{L_1 L_2}{L_1 + L_2}$$

Thus the rules for combining inductances in series and parallel are the same as for resistances, *if the coils are far enough apart so that each is unaffected by another's magnetic field.* When this is not so the formulas given above cannot be used.

**MUTUAL INDUCTANCE**

If two coils are arranged with their axes on the same line, as shown in Fig. 2-18, a current sent through Coil 1 will cause a magnetic field which "cuts" Coil 2. Consequently, an e.m.f. will be induced in Coil 2 whenever the field strength is changing. This induced e.m.f. is similar to the e.m.f. of self-induction, but since it appears in the *second* coil because of current flowing in the *first*, it is a "mutual" effect and results from the **mutual inductance** between the two coils.

If all the flux set up by one coil cuts all the turns of the other coil the mutual inductance has its maximum possible value. If only a small part of the flux set up by one coil cuts the turns of the other the mutual inductance is relatively small. Two coils having mutual inductance are said to be **coupled**.

The ratio of actual mutual inductance to the maximum possible value that could theoretically be obtained with two given coils is called the **coefficient of coupling** between the coils. It is frequently expressed as a percentage. Coils that

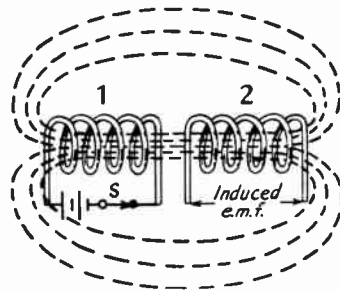

Fig. 2-18—Mutual inductance. When the switch, S, is closed current flows through coil No. 1, setting up a magnetic field that induces an e.m.f. in the turns of coil No. 2.

have nearly the maximum possible (coefficient = 1 or 100%) mutual inductance are said to be **closely**, or **tightly**, coupled, but if the mutual inductance is relatively small the coils are said to be **loosely** coupled. The degree of coupling depends upon the physical spacing between the coils and how they are placed with respect to each other. Maximum coupling exists when they have a common axis and are as close together as pos-

sible (one wound over the other). The coupling is least when the coils are far apart or are placed so their axes are at right angles.

The maximum possible coefficient of coupling is closely approached only when the two coils are wound on a closed iron core. The coefficient with air-core coils may run as high as 0.6 or 0.7 if one coil is wound over the other, but will be much less if the two coils are separated.

## TIME CONSTANT

### Capacitance and Resistance

Connecting a source of e.m.f. to a capacitor causes the capacitor to become charged to the full e.m.f. practically instantaneously, if there is no resistance in the circuit. However, if the circuit contains resistance, as in Fig. 2-19A, the resistance limits the current flow and an appreciable length of time is required for the e.m.f. between the capacitor plates to build up to the same value as the e.m.f. of the source. During this "building-up" period the current gradually decreases from its initial value, because the increasing e.m.f. stored on the capacitor offers increasing opposition to the steady e.m.f. of the source.

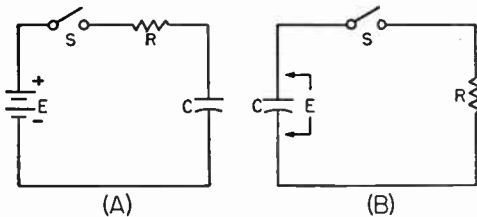

Fig. 2-19—Illustrating the time constant of an RC circuit.

Theoretically, the charging process is never really finished, but eventually the charging current drops to a value that is smaller than anything that can be measured. The **time constant** of such a circuit is the length of time, in seconds, required for the voltage across the capacitor to reach 63 per cent of the applied e.m.f. (this figure is chosen for mathematical reasons). The voltage across the capacitor rises with time as shown by Fig. 2-20.

The formula for time constant is

$$T = RC$$

where  $T$  = Time constant in seconds  
 $C$  = Capacitance in farads  
 $R$  = Resistance in ohms

If  $C$  is in microfarads and  $R$  in megohms, the time constant also is in seconds. These units usually are more convenient.

Example: The time constant of a 2- $\mu$ f. capacitor and a 250,000-ohm (0.25 megohm) resistor is

$$T = RC = 0.25 \times 2 = 0.5 \text{ second}$$

If the applied e.m.f. is 1000 volts, the voltage between the capacitor plates will be 630 volts at the end of  $\frac{1}{2}$  second.

If a charged capacitor is *discharged* through a

resistor, as indicated in Fig. 2-19B, the same time constant applies. If there were no resistance, the capacitor would discharge instantly when  $S$  was closed. However, since  $R$  limits the current flow the capacitor voltage cannot instantly go to zero, but it will decrease just as rapidly as the capacitor can rid itself of its charge through  $R$ . When the capacitor is discharging through a resistance, the time constant (calculated in the same way as above) is the time, in seconds, that it takes for the capacitor to *lose* 63 per cent of its voltage; that is, for the voltage to drop to 37 per cent of its initial value.

Example: If the capacitor of the example above is charged to 1000 volts, it will discharge to 370 volts in  $\frac{1}{2}$  second through the 250,000-ohm resistor.

### Inductance and Resistance

A comparable situation exists when resistance and inductance are in series. In Fig. 2-21, first consider  $L$  to have no resistance and also assume that  $R$  is zero. Then closing  $S$  would tend to

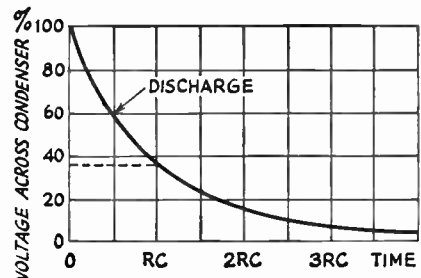
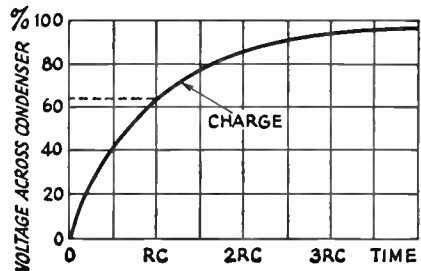

Fig. 2-20—How the voltage across a capacitor rises, with time, when charged through a resistor. The lower curve shows the way in which the voltage decreases across the capacitor terminals on discharging through the same resistor.

send a current through the circuit. However, the instantaneous transition from no current to a finite value, however small, represents a very rapid *change* in current, and a *back e.m.f.* is developed by the self-inductance of  $L$  that is practically equal and opposite to the applied e.m.f. The result is that the initial current is very small.

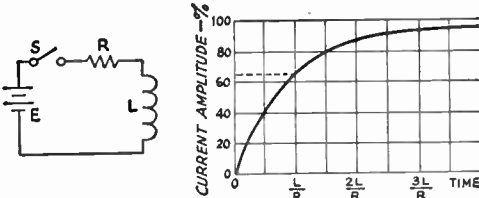

Fig. 2-21—Time constant of an LR circuit.

The back e.m.f. depends upon the *change* in current and would cease to offer opposition if the current did not continue to increase. With no resistance in the circuit (which would lead to an infinitely large current, by Ohm's Law) the current would increase forever, always growing just fast enough to keep the e.m.f. of self-induction equal to the applied e.m.f.

When resistance is in series, Ohm's Law sets a limit to the value that the current can reach. The back e.m.f. generated in  $L$  has only to equal the *difference* between  $E$  and the drop across  $R$ , because that difference is the voltage actually applied to  $L$ . This difference becomes smaller as the current approaches the final Ohm's Law value. Theoretically, the back e.m.f. never quite disappears and so the current never quite reaches the Ohm's Law value, but practically the difference becomes unmeasurable after a time. The time constant of an inductive circuit is the time in seconds required for the current to reach 63 per cent of its final value. The formula is

$$T = \frac{L}{R}$$

where  $T$  = Time constant in seconds

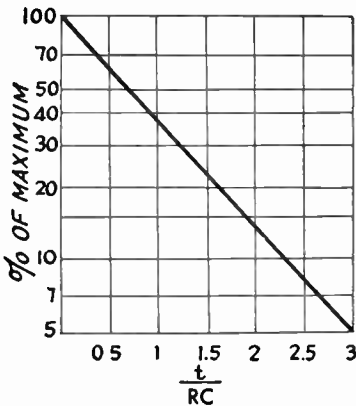

Fig. 2-22—Voltage across capacitor terminals in a discharging RC circuit, in terms of the initial charged voltage. To obtain time in seconds, multiply the factor  $t/RC$  by the time constant of the circuit.

$L$  = Inductance in henrys  
 $R$  = Resistance in ohms

The resistance of the wire in a coil acts as if it were in series with the inductance.

Example: A coil having an inductance of 20 henrys and a resistance of 100 ohms has a time constant of

$$T = \frac{L}{R} = \frac{20}{100} = 0.2 \text{ second}$$

If there is no other resistance in the circuit. If a d.c. e.m.f. of 10 volts is applied to such a coil, the final current, by Ohm's Law, is

$$I = \frac{E}{R} = \frac{10}{100} = 0.1 \text{ amp. or } 100 \text{ ma.}$$

The current would rise from zero to 63 milliamperes in 0.2 second after closing the switch.

An inductor cannot be "discharged" in the same way as a capacitor, because the magnetic field disappears as soon as current flow ceases. Opening  $S$  does not leave the inductor "charged." The energy stored in the magnetic field instantly returns to the circuit when  $S$  is opened. The rapid disappearance of the field causes a very large voltage to be induced in the coil—ordinarily many times larger than the voltage applied, because the induced voltage is proportional to the *speed* with which the field changes. The common result of opening the switch in a circuit such as the one shown is that a spark or arc forms at the switch contacts at the instant of opening. If the inductance is large and the current in the circuit is high, a great deal of energy is released in a very short period of time. It is not at all unusual for the switch contacts to burn or melt under such circumstances. The spark or arc at the opened switch can be reduced or suppressed by connecting a suitable capacitor and resistor in series across the contacts.

Time constants play an important part in numerous devices, such as electronic keys, timing and control circuits, and shaping of keying characteristics by vacuum tubes. The time constants of circuits are also important in such applications as automatic gain control and noise limiters. In nearly all such applications a resistance-capacitance ( $RC$ ) time constant is involved, and it is usually necessary to know the voltage across the capacitor at some time interval larger or smaller than the actual time constant of the circuit as given by the formula above. Fig. 2-22 can be used for the solution of such problems, since the curve gives the voltage across the capacitor, in terms of percentage of the initial charge, for percentages between 5 and 100, at any time after discharge begins.

Example: A 0.01- $\mu$ f. capacitor is charged to 150 volts and then allowed to discharge through a 0.1-megohm resistor. How long will it take the voltage to fall to 10 volts? In percentage,  $10/150 = 6.7\%$ . From the chart, the factor corresponding to 6.7% is 2.7. The time constant of the circuit is equal to  $RC = 0.1 \times 0.01 = 0.001$ . The time is therefore  $2.7 \times 0.001 = 0.0027$  second, or 2.7 milliseconds.

## ALTERNATING CURRENTS

## PHASE

The term *phase* essentially means "time," or the *time interval* between the instant when one thing occurs and the instant when a second related thing takes place. The later event is said to *lag* the earlier, while the one that occurs first is said to *lead*. In a.c. circuits the current amplitude changes continuously, so the concept of phase or time becomes important. Phase can be measured in the ordinary time units, such as the second, but there is a more convenient method: Since each a.c. cycle occupies exactly the same amount of time as every other cycle of the same frequency, we can use the cycle itself as the time unit. Using the cycle as the time unit makes the specification or measurement of phase independent of the frequency of the current, so long as only one frequency is under consideration at a time. When two or more frequencies are to be considered, as in the case where harmonics are present, the phase measurements are made with respect to the lowest, or fundamental, frequency.

The time interval or "phase difference" under consideration usually will be less than one cycle. Phase difference could be measured in decimal parts of a cycle, but it is more convenient to divide the cycle into 360 parts or **degrees**. A phase degree is therefore  $1/360$  of a cycle. The reason for this choice is that with sine-wave alternating current the value of the current at any instant is proportional to the sine of the angle that corresponds to the number of degrees—that is, length of time—from the instant the cycle began. There is no actual "angle" associated with an alternating current. Fig. 2-23 should help make this method of measurement clear.

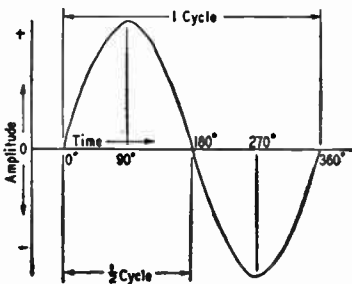

Fig. 2-23—An a.c. cycle is divided off into 360 degrees that are used as a measure of time or phase.

## Measuring Phase

The phase difference between two currents of the same frequency is the time or angle difference between corresponding parts of cycles of the two currents. This is shown in Fig. 2-24. The current labeled *A* leads the one marked *B* by 45 degrees, since *A*'s cycles begin 45 degrees earlier in time. It is equally correct to say that *B* lags *A* by 45 degrees.

Two important special cases are shown in

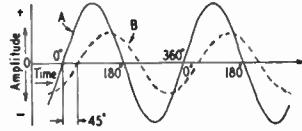

Fig. 2-24—When two waves of the same frequency start their cycles at slightly different times, the time difference or phase difference is measured in degrees. In this drawing wave *B* starts 45 degrees (one-eighth cycle) later than wave *A*, and so lags 45 degrees behind *A*.

Fig. 2-25. In the upper drawing *B* lags 90 degrees behind *A*; that is, its cycle begins just one-quarter cycle later than that of *A*. When one wave is passing through zero, the other is just at its maximum point.

In the lower drawing *A* and *B* are 180 degrees out of phase. In this case it does not matter which one is considered to lead or lag. *B* is always positive while *A* is negative, and vice versa. The two waves are thus *completely* out of phase.

The waves shown in Figs. 2-24 and 2-25 could represent current, voltage, or both. *A* and *B* might be two currents in separate circuits, or *A* might represent voltage and *B* current in the same circuit. If *A* and *B* represent two currents in the *same* circuit (or two voltages in the same circuit) the total or **resultant** current (or voltage) also is a sine wave, because adding any number of sine waves of the same frequency always gives a sine wave also of the same frequency.

## Phase in Resistive Circuits

When an alternating voltage is applied to a resistance, the current flows exactly in step with the voltage. In other words, the voltage and current are **in phase**. This is true at any frequency if the resistance is "pure"—that is, is free from the reactive effects discussed in the next section. Practically, it is often difficult to obtain a purely

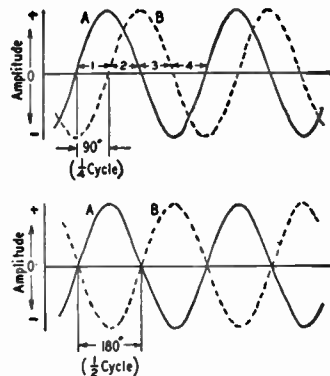

Fig. 2-25—Two important special cases of phase difference. In the upper drawing, the phase difference between *A* and *B* is 90 degrees; in the lower drawing the phase difference is 180 degrees.



resistive circuit at radio frequencies, because the reactive effects become more pronounced as the frequency is increased.

In a purely resistive circuit, or for purely resistive parts of circuits, Ohm's Law is just as valid for a.c. of any frequency as it is for d.c.

## REACTANCE

### Alternating Current in Capacitance

In Fig. 2-26 a sine-wave a.c. voltage having a maximum value of 100 volts is applied to a capacitor. In the period *OA*, the applied voltage increases from zero to 38 volts; at the end of this period the capacitor is charged to that voltage. In interval *AB* the voltage increases to 71 volts; that is, 33 volts additional. In this interval a smaller quantity of charge has been added than in *OA*, because the voltage rise during interval *AB* is smaller. Consequently the average current during *AB* is smaller than during *OA*. In the third interval, *BC*, the voltage rises from 71 to 92 volts, an increase of 21 volts. This is less than the voltage increase during *AB*, so the quantity of electricity added is less; in other words, the average current during interval *BC* is still smaller. In the fourth interval, *CD*, the voltage increases only 8 volts; the charge added is smaller than in any preceding interval and therefore the current also is smaller.

By dividing the first quarter cycle into a very large number of intervals it could be shown that the current charging the capacitor has the shape of a sine wave, just as the applied voltage does. The current is largest at the beginning of the cycle and becomes zero at the maximum value of the voltage, so there is a phase difference of 90 degrees between the voltage and current. During the first quarter cycle the current is flowing in the normal direction through the circuit, since the capacitor is being charged. Hence the current is positive, as indicated by the dashed line in Fig. 2-26.

In the second quarter cycle—that is, in the time from *D* to *H*, the voltage applied to the capacitor decreases. During this time the capacitor loses its charge. Applying the same reasoning, it is plain that the current is small in interval *DE* and continues to increase during each succeeding interval. However, the current is flowing against the applied voltage because the capacitor is discharging into the circuit. The current flows in

the *negative* direction during this quarter cycle. The third and fourth quarter cycles repeat the events of the first and second, respectively, with this difference—the polarity of the applied voltage has reversed, and the current changes to correspond. In other words, an alternating current flows in the circuit because of the alternate charging and discharging of the capacitance. As shown by Fig. 2-26, the current starts its cycle 90 degrees before the voltage, so the current in a capacitor leads the applied voltage by 90 degrees.

### Capacitive Reactance

The quantity of electric charge that can be placed on a capacitor is proportional to the applied e.m.f. and the capacitance. This amount of charge moves back and forth in the circuit once each cycle, and so the *rate* of movement of charge—that is, the current—is proportional to voltage, capacitance and frequency. If the effects of capacitance and frequency are lumped together, they form a quantity that plays a part similar to that of resistance in Ohm's Law. This quantity is called **reactance**, and the unit for it is the ohm, just as in the case of resistance. The formula for it is

$$X_c = \frac{1}{2\pi fC}$$

where  $X_c$  = Capacitive reactance in ohms  
 $f$  = Frequency in cycles per second  
 $C$  = Capacitance in farads  
 $\pi$  = 3.14

Although the unit of reactance is the ohm, there is no power dissipation in reactance. The energy stored in the capacitor in one quarter of the cycle is simply returned to the circuit in the next.

The fundamental units (cycles per second, farads) are too large for practical use in radio circuits. However, if the capacitance is in microfarads and the frequency is in megacycles, the reactance will come out in ohms in the formula.

Example: The reactance of a capacitor of 470  $\mu\text{f}$ . (0.00047  $\mu\text{f}$ .) at a frequency of 7150 kc. (7.15 Mc.) is

$$X = \frac{1}{2\pi fC} = \frac{1}{6.28 \times 7.15 \times 0.00047} = 47.4 \text{ ohms}$$

### Inductive Reactance

When an alternating voltage is applied to a pure inductance (one with no resistance—all practical inductors have resistance) the current is again 90 degrees out of phase with the applied voltage. However, in this case the current lags 90 degrees behind the voltage—the opposite of the capacitor current-voltage relationship.

The primary cause for this is the *back e.m.f.* generated in the inductance, and since the amplitude of the back e.m.f. is proportional to the rate at which the current changes, and this in turn is proportional to the frequency, the amplitude of the current is inversely proportional to the applied frequency. Also, since the back e.m.f. is proportional to inductance for a given rate of current change, the current flow is inversely propor-

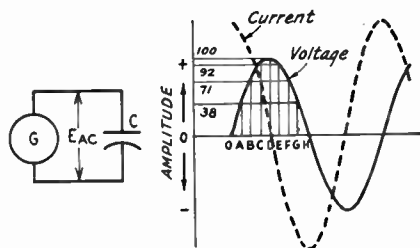

Fig. 2-26—Voltage and current phase relationships when an alternating voltage is applied to a capacitor.

tional to inductance for a given applied voltage and frequency. (Another way of saying this is that just enough current flows to generate an induced e.m.f. that equals and opposes the applied voltage.)

The combined effect of inductance and frequency is called **inductive reactance**, also expressed in ohms, and the formula for it is

$$X_L = 2\pi fL$$

where  $X_L$  = Inductive reactance in ohms  
 $f$  = Frequency in cycles per second  
 $L$  = Inductance in henrys  
 $\pi = 3.14$

Example: The reactance of a coil having an inductance of 8 henrys, at a frequency of 120 cycles, is

$$X_L = 2\pi fL = 6.28 \times 120 \times 8 = 6029 \text{ ohms}$$

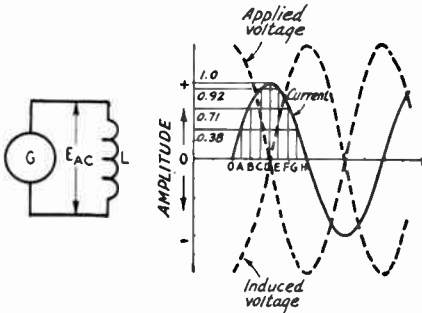

Fig. 2-27—Phase relationships between voltage and current when an alternating voltage is applied to an inductance.

In radio-frequency circuits the inductance values usually are small and the frequencies are large. If the inductance is expressed in millihenrys and the frequency in kilocycles, the conversion factors for the two units cancel, and the formula for reactance may be used without first converting to fundamental units. Similarly, no conversion is necessary if the inductance is in microhenrys and the frequency is in megacycles.

Example: The reactance of a 15-microhenry coil at a frequency of 14 Mc. is

$$X_L = 2\pi fL = 6.28 \times 14 \times 15 = 1319 \text{ ohms}$$

The resistance of the wire of which the coil is wound has no effect on the reactance, but simply acts as though it were a separate resistor connected in series with the coil.

**Ohm's Law for Reactance**

Ohn's Law for an a.c. circuit containing *only* reactance is

$$I = \frac{E}{X}$$

$$E = IX$$

$$X = \frac{E}{I}$$

where  $E$  = E.m.f. in volts  
 $I$  = Current in amperes  
 $X$  = Reactance in ohms

The reactance in the circuit may, of course, be

either inductive or capacitive.

Example: If a current of 2 amperes is flowing through the capacitor of the earlier example (reactance = 47.4 ohms) at 7150 kc., the voltage drop across the capacitor is

$$E = IX = 2 \times 47.4 = 94.8 \text{ volts}$$

If 400 volts at 120 cycles is applied to the 8-henry inductor of the earlier example, the current through the coil will be

$$I = \frac{E}{X} = \frac{400}{6029} = 0.0663 \text{ amp. (66.3 ma.)}$$

**Reactance Chart**

The accompanying chart, Fig. 2-28, shows the reactance of capacitances from 1  $\mu$ mf. to 100  $\mu$ f., and the reactance of inductances from 0.1  $\mu$ h. to 10 henrys, for frequencies between 100 cycles and 100 megacycles per second. The approximate value of reactance can be read from the chart or, where more exact values are needed, the chart will serve as a check on the order of magnitude of reactances calculated from the formulas given above, and thus avoid "decimal-point errors".

**Reactances in Series and Parallel**

When reactances of the same kind are connected in series or parallel the resultant reactance is that of the resultant inductance or capacitance. This leads to the same rules that are used when determining the resultant resistance when resistors are combined. That is, for series reactances of the same kind the resultant reactance is

$$X = X_1 + X_2 + X_3 + X_4$$

and for reactances of the same kind in parallel the resultant is

$$X = \frac{1}{\frac{1}{X_1} + \frac{1}{X_2} + \frac{1}{X_3} + \frac{1}{X_4}}$$

or for two in parallel,

$$X = \frac{X_1 X_2}{X_1 + X_2}$$

The situation is different when reactances of opposite kinds are combined. Since the current in a capacitance leads the applied voltage by 90 degrees and the current in an inductance lags the applied voltage by 90 degrees, the voltages at the terminals of opposite types of reactance are 180 degrees out of phase in a series circuit (in which the current has to be the same through all elements), and the currents in reactances of opposite types are 180 degrees out of phase in a parallel circuit (in which the same voltage is applied to all elements). The 180-degree phase relationship means that the currents or voltages are of opposite polarity, so in the series circuit of Fig. 2-29A the voltage  $E_L$  across the inductive reactance  $X_L$  is of opposite polarity to the voltage  $E_C$  across the capacitive reactance  $X_C$ . Thus if we call  $X_L$  "positive" and  $X_C$  "negative" (a common convention) the applied voltage  $E_{AC}$  is  $E_L - E_C$ . In the parallel circuit at B the total current,  $I$ , is equal to  $I_L - I_C$ , since the currents are 180 degrees out of phase.

In the series case, therefore, the resultant re-

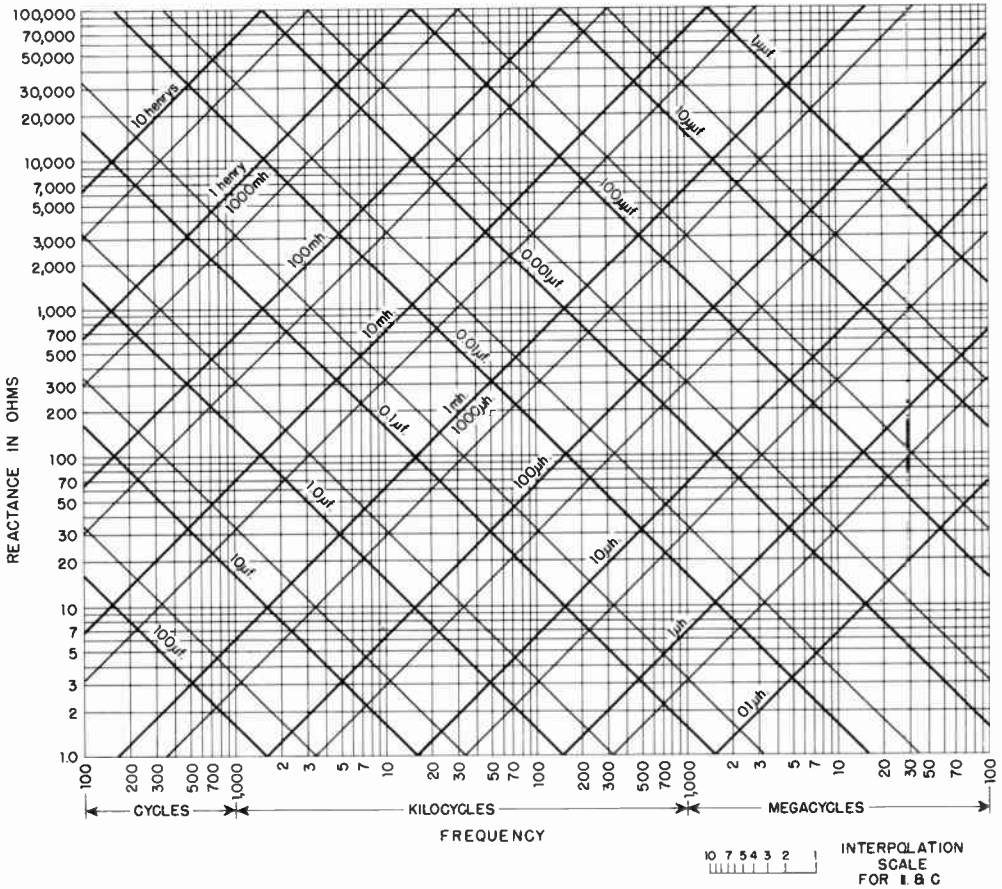

Fig. 2-28—Inductive and capacitive reactance vs. frequency. Heavy lines represent multiples of 10, intermediate light lines multiples of 5; e.g., the light line between 10  $\mu$ h. and 100  $\mu$ h. represents 50  $\mu$ h., the light line between 0.1  $\mu$ f. and 1  $\mu$ f. represents 0.5  $\mu$ f., etc. Intermediate values can be estimated with the help of the interpolation scale shown.

Reactances outside the range of the chart may be found by applying appropriate factors to values within the chart range. For example, the reactance of 10 henrys at 60 cycles can be found by taking the reactance to 10 henrys at 600 cycles and dividing by 10 for the 10-times decrease in frequency.

Reactance of  $X_L$  and  $X_C$  is

$$X = X_L - X_C$$

and in the parallel case

$$X = \frac{-X_L X_C}{X_L - X_C}$$

Note that in the series circuit the total reactance is negative if  $X_C$  is larger than  $X_L$ ; this indicates that the total reactance is capacitive in such a case. The resultant reactance in a series circuit is always smaller than the larger of the two individual reactances.

In the parallel circuit, the resultant reactance is negative (i.e., capacitive) if  $X_L$  is larger than  $X_C$ , and positive (inductive) if  $X_L$  is smaller than  $X_C$ , but in every case is always larger than the smaller of the two individual reactances.

In the special case where  $X_L = X_C$  the total reactance is zero in the series circuit and infinitely large in the parallel circuit.

**Reactive Power**

In Fig. 2-29A the voltage drop across the inductor is larger than the voltage applied to the circuit. This might seem to be an impossible condition, but it is not; the explanation is that while energy is being stored in the inductor's

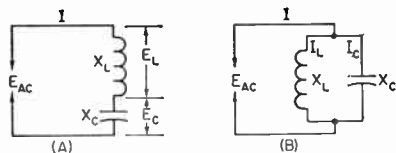

Fig. 2-29—Series and parallel circuits containing opposite kinds of reactance.

magnetic field, energy is being returned to the circuit from the capacitor's electric field, and



vice versa. This stored energy is responsible for the fact that the voltages across reactances in series can be larger than the voltage applied to them.

In a resistance the flow of current causes heating and a power loss equal to  $I^2R$ . The power in a reactance is equal to  $I^2X$ , but is not a "loss"; it is simply power that is transferred back and forth between the field and the circuit but not used up in heating anything. To distinguish this "nondissipated" power from the power which is actually consumed, the unit of reactive power is called the **volt-ampere-reactive**, or **var**, instead of the watt. Reactive power is sometimes called "wattless" power.

## IMPEDANCE

When a circuit contains both resistance and reactance the combined effect of the two is called **impedance**, symbolized by the letter  $Z$ . (Impedance is thus a more general term than either resistance or reactance, and is frequently used even for circuits that have only resistance or reactance, although usually with a qualification—such as "resistive impedance" to indicate that the circuit has only resistance, for example.)

The reactance and resistance comprising an impedance may be connected either in series or in parallel, as shown in Fig. 2-30. In these circuits the reactance is shown as a box to indicate that it may be either inductive or capacitive. In the series circuit the current is the same in both elements, with (generally) different voltages appearing across the resistance and reactance. In the parallel circuit the same voltage is applied to both elements, but different currents flow in the two branches.

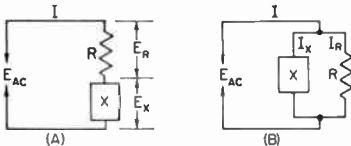

Fig. 2-30—Series and parallel circuits containing resistance and reactance.

Since in a resistance the current is in phase with the applied voltage while in a reactance it is 90 degrees out of phase with the voltage, the phase relationship between current and voltage in the circuit as a whole may be anything between zero and 90 degrees, depending on the relative amounts of resistance and reactance.

### Series Circuits

When resistance and reactance are in series, the impedance of the circuit is

$$Z = \sqrt{R^2 + X^2}$$

where  $Z$  = impedance in ohms

$R$  = resistance in ohms

$X$  = reactance in ohms.

The reactance may be either capacitive or inductive. If there are two or more reactances in the circuit they may be combined into a resultant

by the rules previously given, before substitution into the formula above; similarly for resistances.

The "square root of the sum of the squares" rule for finding impedance in a series circuit arises from the fact that the voltage drops across the resistance and reactance are 90 degrees out of phase, and so combine by the same rule that applies in finding the hypotenuse of a right-angled triangle when the base and altitude are known.

### Parallel Circuits

With resistance and reactance in parallel, as in Fig. 2-30B, the impedance is

$$Z = \frac{RX}{\sqrt{R^2 + X^2}}$$

where the symbols have the same meaning as for series circuits.

Just as in the case of series circuits, a number of reactances in parallel should be combined to find the resultant reactance before substitution into the formula above; similarly for a number of resistances in parallel.

### Equivalent Series and Parallel Circuits

The two circuits shown in Fig. 2-30 are equivalent if the same current flows when a given voltage of the same frequency is applied, and if the phase angle between voltage and current is the same in both cases. It is in fact possible to "transform" any given series circuit into an equivalent parallel circuit, and vice versa.

Transformations of this type often lead to simplification in the solution of complicated circuits. However, from the standpoint of practical work the usefulness of such transformations lies in the fact that the impedance of a circuit may be modified by the addition of *either* series or parallel elements, depending on which happens to be most convenient in the particular case. Typical applications are considered later in connection with tuned circuits and transmission lines.

### Ohm's Law for Impedance

Ohm's Law can be applied to circuits containing impedance just as readily as to circuits having resistance or reactance only. The formulas are

$$I = \frac{E}{Z}$$

$$E = IZ$$

$$Z = \frac{E}{I}$$

where  $E$  = E.m.f. in volts

$I$  = Current in amperes

$Z$  = Impedance in ohms

Fig. 2-31 shows a simple circuit consisting of a resistance of 75 ohms and a reactance of 100 ohms in series. From the formula previously given, the impedance is

$$Z = \sqrt{R^2 + X^2} = \sqrt{(75)^2 + (100)^2} = 125 \text{ ohms.}$$

If the applied voltage is 250 volts, then

$$I = \frac{E}{Z} = \frac{250}{125} = 2 \text{ amperes.}$$

This current flows through both the resistance and reactance, so the voltage drops are

$$E_R = IR = 2 \times 75 = 150 \text{ volts}$$

$$E_{X_L} = IX_L = 2 \times 100 = 200 \text{ volts}$$

The simple arithmetical sum of these two drops, 350 volts, is greater than the applied voltage because the two voltages are 90 degrees out of phase. Their actual resultant, when phase is taken into account, is

$$\sqrt{(150)^2 + (200)^2} = 250 \text{ volts.}$$

### Power Factor

In the circuit of Fig. 2-31 an applied e.m.f. of 250 volts results in a current of 2 amperes, giving an apparent power of  $250 \times 2 = 500$  watts. However, only the resistance actually consumes power. The power in the resistance is

$$P = I^2R = (2)^2 \times 75 = 300 \text{ watts}$$

The ratio of the power consumed to the apparent power is called the **power factor** of the circuit, and in this example the power factor would be  $300/500 = 0.6$ . Power factor is frequently expressed as a percentage; in this case, it would be 60 per cent.

“Real” or dissipated power is measured in watts; apparent power, to distinguish it from real power, is measured in volt-amperes. It is simply the product of volts and amperes and has no direct relationship to the power actually used up or dissipated unless the power factor of the circuit is known. The power factor of a purely resistive circuit is 100 per cent or 1, while the power factor of a pure reactance is zero. In this

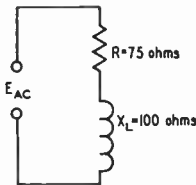

Fig. 2-31—Circuit used as an example for impedance calculations.

illustration, the reactive power is  $VAR = I^2X = (2)^2 \times 100 = 400$  volt-amperes.

### Reactance and Complex Waves

It was pointed out earlier in this chapter that a complex wave (a “nonsinusoidal” wave) can be resolved into a fundamental frequency and a series of harmonic frequencies. When such a complex voltage wave is applied to a circuit containing reactance, the current through the circuit will not have the same wave shape as the applied voltage. This is because the reactance of an inductor and capacitor depend upon the applied frequency. For the second-harmonic component of a complex wave, the reactance of the inductor is twice and the reactance of the capacitor one-half their respective values at the fundamental frequency; for the third harmonic the inductor reactance is three times and the capacitor reactance one-third, and so on. Thus the circuit impedance is different for each harmonic component.

Just what happens to the current wave shape depends upon the values of resistance and reactance involved and how the circuit is arranged. In a simple circuit with resistance and inductive reactance in series, the amplitudes of the harmonic currents will be reduced because the inductive reactance increases in proportion to frequency. When capacitance and resistance are in series, the harmonic current is likely to be accentuated because the capacitive reactance becomes lower as the frequency is raised. When both inductive and capacitive reactance are present the shape of the current wave can be altered in a variety of ways, depending upon the circuit and the “constants,” or the relative values of  $L$ ,  $C$ , and  $R$ , selected.

This property of nonuniform behavior with respect to fundamental and harmonics is an extremely useful one. It is the basis of “filtering,” or the suppression of undesired frequencies in favor of a single desired frequency or group of such frequencies.

## TRANSFORMERS FOR AUDIO FREQUENCIES

Two coils having mutual inductance constitute a **transformer**. The coil connected to the source of energy is called the **primary** coil, and the other is called the **secondary** coil.

The usefulness of the transformer lies in the fact that electrical energy can be transferred from one circuit to another without direct connection, and in the process can be readily changed from one voltage level to another. Thus, if a device to be operated requires, for example, 115 volts a.c. and only a 440-volt source is available, a transformer can be used to change the source voltage to that required. A transformer can be used only with a.c., since no voltage will be induced in the secondary if the magnetic field is not changing. If d.c. is applied to the primary of a transformer, a voltage will be induced in the secondary only at the instant of closing or open-

ing the primary circuit, since it is only at these times that the field is changing.

### THE IRON-CORE TRANSFORMER

As shown in Fig. 2-32, the primary and secondary coils of a transformer may be wound on a core of magnetic material. This increases the inductance of the coils so that a relatively small number of turns may be used to induce a given value of voltage with a small current. A **closed core** (one having a continuous magnetic path) such as that shown in Fig. 2-32 also tends to insure that practically all of the field set up by the current in the primary coil will cut the turns of the secondary coil. However, the core introduces a power loss because of hysteresis and eddy currents so this type of construction is normally practicable only at power and audio frequencies.

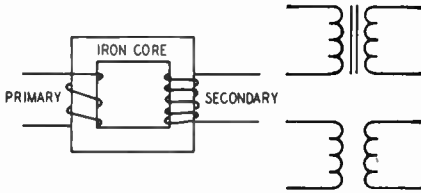

Fig. 2-32—The transformer. Power is transferred from the primary coil to the secondary by means of the magnetic field. The upper symbol of right indicates on iron-core transformer, the lower one on air-core transformer.

The discussion in this section is confined to transformers operating at such frequencies.

### Voltage and Turns Ratio

For a given varying magnetic field, the voltage induced in a coil in the field will be proportional to the number of turns in the coil. If the two coils of a transformer are in the same field (which is the case when both are wound on the same closed core) it follows that the induced voltages will be proportional to the number of turns in each coil. In the primary the induced voltage is practically equal to, and opposes, the applied voltage, as described earlier. Hence,

$$E_s = \frac{n_s}{n_p} E_p$$

where  $E_s$  = Secondary voltage

$E_p$  = Primary applied voltage

$n_s$  = Number of turns on secondary

$n_p$  = Number of turns on primary

The ratio  $n_s/n_p$  is called the secondary-to-primary turns ratio of the transformer.

Example: A transformer has a primary of 400 turns and a secondary of 2800 turns, and an e.m.f. of 115 volts is applied to the primary. The secondary voltage will be

$$E_s = \frac{n_s}{n_p} E_p = \frac{2800}{400} \times 115 = 7 \times 115 = 805 \text{ volts}$$

Also, if an e.m.f. of 805 volts is applied to the 2800-turn winding (which then becomes the primary) the output voltage from the 400-turn winding will be 115 volts.

Either winding of a transformer can be used as the primary, providing the winding has enough turns (enough inductance) to induce a voltage equal to the applied voltage without requiring an excessive current flow.

### Effect of Secondary Current

The current that flows in the primary when no current is taken from the secondary is called the magnetizing current of the transformer. In any properly-designed transformer the primary inductance will be so large that the magnetizing current will be quite small. The power consumed by the transformer when the secondary is "open"—that is, not delivering power—is only the amount necessary to supply the losses in the iron core and in the resistance of the wire with which the primary is wound.

When power is taken from the secondary winding, the secondary current sets up a magnetic

field that opposes the field set up by the primary current. But if the induced voltage in the primary is to equal the applied voltage, the original field must be maintained. Consequently, the primary must draw enough additional current to set up a field exactly equal and opposite to the field set up by the secondary current.

In practical calculations on transformers it may be assumed that the entire primary current is caused by the secondary "load." This is justifiable because the magnetizing current should be very small in comparison with the primary "load" current at rated power output.

If the magnetic fields set up by the primary and secondary currents are to be equal, the primary current multiplied by the primary turns must equal the secondary current multiplied by the secondary turns. From this it follows that

$$I_p = \frac{n_s}{n_p} I_s$$

where  $I_p$  = Primary current

$I_s$  = Secondary current

$n_p$  = Number of turns on primary

$n_s$  = Number of turns on secondary

Example: Suppose that the secondary of the transformer in the previous example is delivering a current of 0.2 ampere to a load. Then the primary current will be

$$I_p = \frac{n_s}{n_p} I_s = \frac{2800}{400} \times 0.2 = 7 \times 0.2 = 1.4 \text{ amp.}$$

Although the secondary voltage is higher than the primary voltage, the secondary current is lower than the primary current, and by the same ratio.

### Power Relationships; Efficiency

A transformer cannot create power; it can only transfer it and change the e.m.f. Hence, the power taken from the secondary cannot exceed that taken by the primary from the source of applied e.m.f. There is always some power loss in the resistance of the coils and in the iron core, so in all practical cases the power taken from the source will exceed that taken from the secondary. Thus,

$$P_o = nP_i$$

where  $P_o$  = Power output from secondary

$P_i$  = Power input to primary

$n$  = Efficiency factor

The efficiency,  $n$ , always is less than 1. It is usually expressed as a percentage; if  $n$  is 0.65, for instance, the efficiency is 65 per cent.

Example: A transformer has an efficiency of 85% at its full-load output of 150 watts. The power input to the primary at full secondary load will be

$$P_i = \frac{P_o}{n} = \frac{150}{0.85} = 176.5 \text{ watts}$$

A transformer is usually designed to have its highest efficiency at the power output for which it is rated. The efficiency decreases with either lower or higher outputs. On the other hand, the losses in the transformer are relatively small at low output but increase as more power is taken.

The amount of power that the transformer can handle is determined by its own losses, because these heat the wire and core. There is a limit to the temperature rise that can be tolerated, because too-high temperature either will melt the wire or cause the insulation to break down. A transformer can be operated at reduced output, even though the efficiency is low, because the actual loss also will be low under such conditions.

The full-load efficiency of small power transformers such as are used in radio receivers and transmitters usually lies between about 60 and 90 per cent, depending upon the size and design.

**Leakage Reactance**

In a practical transformer not all of the magnetic flux is common to both windings, although in well-designed transformers the amount of flux that "cuts" one coil and not the other is only a small percentage of the total flux. This leakage flux causes an e.m.f. of self-induction; consequently, there are small amounts of leakage inductance associated with both windings of the transformer. Leakage inductance acts in exactly the same way as an equivalent amount of ordinary inductance inserted in series with the circuit.

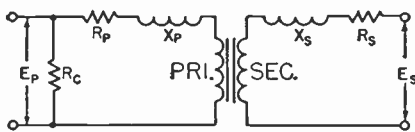

Fig. 2-33—The equivalent circuit of a transformer includes the effects of leakage inductance and resistance of both primary and secondary windings. The resistance  $R_c$  is an equivalent resistance representing the core losses, which are essentially constant for any given applied voltage and frequency. Since these are comparatively small, their effect may be neglected in many approximate calculations.

It has, therefore, a certain reactance, depending upon the amount of leakage inductance and the frequency. This reactance is called leakage reactance.

Current flowing through the leakage reactance causes a voltage drop. This voltage drop increases with increasing current, hence it increases as more power is taken from the secondary. Thus, the greater the secondary current, the smaller the secondary terminal voltage becomes. The resistances of the transformer windings also cause voltage drops when current is flowing; although these voltage drops are not in phase with those caused by leakage reactance, together they result in a lower secondary voltage under load than is indicated by the turns ratio of the transformer.

At power frequencies (60 cycles) the voltage at the secondary, with a reasonably well-designed transformer, should not drop more than about 10 per cent from open-circuit conditions to full load. The drop in voltage may be considerably more than this in a transformer operating at audio frequencies because the leakage reactance increases directly with the frequency.

**Impedance Ratio**

In an ideal transformer—one without losses or leakage reactance—the following relationship is true:

$$Z_p = Z_s N^2$$

where  $Z_p$  = Impedance looking into primary terminals from source of power

$Z_s$  = Impedance of load connected to secondary

$N$  = Turns ratio, primary to secondary

That is, a load of any given impedance connected to the secondary of the transformer will be transformed to a different value "looking into" the primary from the source of power. The impedance transformation is proportional to the square of the primary-to-secondary turns ratio.

Example: A transformer has a primary-to-secondary turns ratio of 0.6 (primary has 6/10 as many turns as the secondary) and a load of 3000 ohms is connected to the secondary. The impedance looking into the primary then will be

$$Z_p = Z_s N^2 = 3000 \times (0.6)^2 = 3000 \times 0.36 = 1080 \text{ ohms}$$

By choosing the proper turns ratio, the impedance of a fixed load can be transformed to any desired value, within practical limits. The transformed or "reflected" impedance has the same phase angle as the actual load impedance; thus if the load is a pure resistance the load presented by the primary to the source of power also will be a pure resistance.

The above relationship may be used in practical work even though it is based on an "ideal" transformer. Aside from the normal design requirements of reasonably low internal losses and low leakage reactance, the only requirement is that the primary have enough inductance to operate with low magnetizing current at the voltage applied to the primary.

The primary impedance of a transformer—as it appears to the source of power—is determined wholly by the load connected to the secondary and by the turns ratio. If the characteristics of the transformer have an appreciable effect on the impedance presented to the power source, the transformer is either poorly designed or is not suited to the voltage and frequency at which it is being used. Most transformers will operate quite well at voltages from slightly above to well below the design figure.

**Impedance Matching**

Many devices require a specific value of load resistance (or impedance) for optimum operation. The impedance of the actual load that is to dissipate the power may differ widely from this value, so a transformer is used to change the actual load into an impedance of the desired value. This is called impedance matching. From the preceding,

$$N = \sqrt{\frac{Z_p}{Z_s}}$$

where  $N$  = Required turns ratio, primary to secondary

$Z_p$  = Primary impedance required

$Z_s$  = Impedance of load connected to secondary

Example: A vacuum-tube a.f. amplifier requires a load of 5000 ohms for optimum performance, and is to be connected to a loud-speaker having an impedance of 10 ohms. The turns ratio, primary to secondary, required in the coupling transformer is

$$N = \sqrt{\frac{Z_p}{Z_s}} = \sqrt{\frac{5000}{10}} = \sqrt{500} = 22.4$$

The primary therefore must have 22.4 times as many turns as the secondary.

Impedance matching means, in general, adjusting the load impedance—by means of a transformer or otherwise—to a desired value. However, there is also another meaning. It is possible to show that any source of power will deliver its maximum possible output when the impedance of the load is equal to the internal impedance of the source. The impedance of the source is said to be “matched” under this condition. The efficiency is only 50 per cent in such a case; just as much power is used up in the source as is delivered to the load. Because of the poor efficiency, this type of impedance matching is limited to cases where only a small amount of power is available and heating from power loss in the source is not important.

### Transformer Construction

Transformers usually are designed so that the magnetic path around the core is as short as possible. A short magnetic path means that the transformer will operate with fewer turns, for a given applied voltage, than if the path were long.

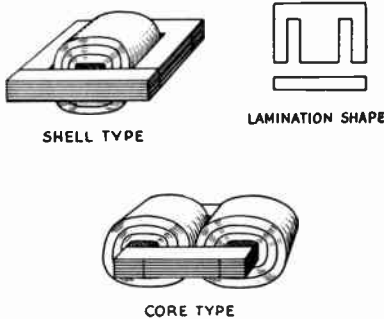

Fig. 2-34—Two common types of transformer construction. Core pieces are interleaved to provide a continuous magnetic path.

A short path also helps to reduce flux leakage and therefore minimizes leakage reactance.

Two core shapes are in common use, as shown in Fig. 2-34. In the shell type both windings are placed on the inner leg, while in the core type the primary and secondary windings may be placed on separate legs, if desired. This is some-

times done when it is necessary to minimize capacitive effects between the primary and secondary, or when one of the windings must operate at very high voltage.

Core material for small transformers is usually silicon steel, called “transformer iron.” The core is built up of laminations, insulated from each other (by a thin coating of shellac, for example) to prevent the flow of eddy currents. The laminations are interleaved at the ends to make the magnetic path as continuous as possible and thus reduce flux leakage.

The number of turns required in the primary for a given applied e.m.f. is determined by the size, shape and type of core material used, and the frequency. The number of turns required is inversely proportional to the cross-sectional area of the core. As a rough indication, windings of small power transformers frequently have about six to eight turns per volt on a core of 1-square-inch cross section and have a magnetic path 10 or 12 inches in length. A longer path or smaller cross section requires more turns per volt, and vice versa.

In most transformers the coils are wound in layers, with a thin sheet of treated-paper insulation between each layer. Thicker insulation is used between coils and between coils and core.

### Autotransformers

The transformer principle can be utilized with only one winding instead of two, as shown in Fig. 2-35; the principles just discussed apply

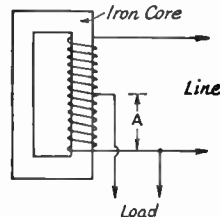

Fig. 2-35—The autotransformer is based on the transformer principle, but uses only one winding. The line and load currents in the common winding (A) flow in opposite directions, so that the resultant current is the difference between them. The voltage across A is proportional to the turns ratio.

equally well. A one-winding transformer is called an **autotransformer**. The current in the common section (A) of the winding is the difference between the line (primary) and the load (secondary) currents, since these currents are out of phase. Hence if the line and load currents are nearly equal the common section of the winding may be wound with comparatively small wire. This will be the case only when the primary (line) and secondary (load) voltages are not very different. The autotransformer is used chiefly for boosting or reducing the power-line voltage by relatively small amounts. Continuously-variable autotransformers are commercially available under a variety of trade names; “Variac” and “Powerstat” are typical examples.



## THE DECIBEL

In most radio communication the received signal is converted into sound. This being the case, it is useful to appraise signal strengths in terms of relative loudness as registered by the ear. A peculiarity of the ear is that an increase or decrease in loudness is responsive to the *ratio* of the amounts of power involved, and is practically independent of absolute value of the power. For example, if a person estimates that the signal is "twice as loud" when the transmitter power is increased from 10 watts to 40 watts, he will also estimate that a 400-watt signal is twice as loud as a 100-watt signal. In other words, the human ear has a *logarithmic* response.

This fact is the basis for the use of the relative-power unit called the decibel (abbreviated db.) A change of one decibel in the power level is just detectable as a change in loudness under ideal conditions. The number of decibels corresponding to a given power ratio is given by the following formula:

$$Db. = 10 \log \frac{P_2}{P_1}$$

Common logarithms (base 10) are used.

### Voltage and Current Ratios

Note that the decibel is based on *power* ratios. Voltage or current ratios can be used, but only when the impedance is the same for both values of voltage, or current. The gain of an amplifier cannot be expressed correctly in db. if it is based on the ratio of the output voltage to the input voltage unless both voltages are measured across the same value of impedance. When the impedance at both points of measurement is the same, the following formula may be used for voltage or current ratios:

$$Db. = 20 \log \frac{V_2}{V_1}$$

$$\text{or } 20 \log \frac{I_2}{I_1}$$

## RADIO-FREQUENCY CIRCUITS

### RESONANCE IN SERIES CIRCUITS

Fig. 2-37 shows a resistor, capacitor and inductor connected in series with a source of alternating current, the frequency of which can be varied over a wide range. At some *low* frequency the capacitive reactance will be much larger than the resistance of *R*, and the inductive reactance will be small compared with either the reactance of *C* or the resistance of *R*. (*R* is assumed to be the same at all frequencies.) On the other hand, at some very *high* frequency the reactance of *C* will be very small and the reactance of *L* will be very large. In either case the current will be small, because the net reactance is large.

### Decibel Chart

The two formulas are shown graphically in Fig. 2-36 for ratios from 1 to 10. Gains (increases) expressed in decibels may be added arithmetically; losses (decreases) may be subtracted. A power decrease is indicated by prefixing the decibel figure with a minus sign. Thus +6 db. means that the power has been multiplied by 4, while -6 db. means that the power has been divided by 4.

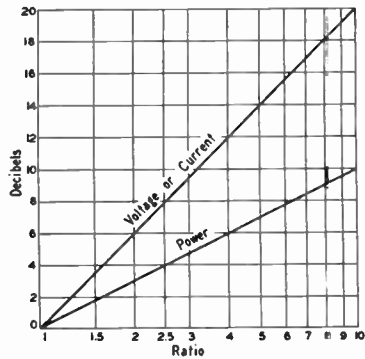

Fig. 2-36—Decibel chart for power, voltage and current ratios for power ratios of 1:1 to 10:1. In determining decibels for current or voltage ratios the currents (or voltages) being compared must be referred to the same value of impedance.

The chart may be used for other ratios by adding (or subtracting, if a loss) 10 db. each time the ratio scale is multiplied by 10, for power ratios; or by adding (or subtracting) 20 db. each time the scale is multiplied by 10 for voltage or current ratios. For example, a power ratio of 2.5 is 4 db. (from the chart). A power ratio of 10 times 2.5, or 25, is 14 db. (10 + 4), and a power ratio of 100 times 2.5, or 250, is 24 db. (20 + 4). A voltage or current ratio of 4 is 12 db., a voltage or current ratio of 40 is 32 db. (20 + 12), and one of 400 is 52 db. (40 + 12).

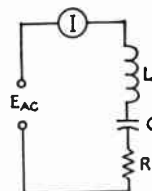

Fig. 2-37.—A series circuit containing *L*, *C* and *R* is "resonant" at the applied frequency when the reactance of *C* is equal to the reactance of *L*.



180 degrees out of phase. Therefore they cancel each other completely and the current flow is determined wholly by the resistance,  $R$ . At that frequency the current has its largest possible value, assuming the source voltage to be constant regardless of frequency. A series circuit in which the inductive and capacitive reactances are equal is said to be **resonant**.

The principle of resonance finds its most extensive application in radio-frequency circuits. The reactive effects associated with even small inductances and capacitances would place drastic limitations on r.f. circuit operation if it were not possible to "cancel them out" by supplying the right amount of reactance of the opposite kind—in other words, "tuning the circuit to resonance."

**Resonant Frequency**

The frequency at which a series circuit is resonant is that for which  $X_L = X_C$ . Substituting the formulas for inductive and capacitive reactance gives

$$f = \frac{1}{2\pi\sqrt{LC}}$$

where  $f$  = Frequency in cycles per second  
 $L$  = Inductance in henrys  
 $C$  = Capacitance in farads  
 $\pi = 3.14$

These units are inconveniently large for radio-frequency circuits. A formula using more appropriate units is

$$f = \frac{10^6}{2\pi\sqrt{LC}}$$

where  $f$  = Frequency in kilocycles (kc.)  
 $L$  = Inductance in microhenrys ( $\mu$ h.)  
 $C$  = Capacitance in micromicrofarads ( $\mu\mu$ f.)  
 $\pi = 3.14$

Example: The resonant frequency of a series circuit containing a 5- $\mu$ h. inductor and a 35- $\mu\mu$ f. capacitor is

$$f = \frac{10^6}{2\pi\sqrt{LC}} = \frac{10^6}{6.28 \times \sqrt{5 \times 35}}$$

$$= \frac{10^6}{6.28 \times 13.2} = \frac{10^6}{83} = 12,050 \text{ kc.}$$

The formula for resonant frequency is not affected by the resistance in the circuit.

**Resonance Curves**

If a plot is drawn of the current flowing in the circuit of Fig. 2-37 as the frequency is varied (the applied voltage being constant) it would look like one of the curves in Fig. 2-38. The shape of the **resonance curve** at frequencies near resonance is determined by the ratio of reactance to resistance.

If the reactance of either the coil or capacitor is of the same order of magnitude as the resistance, the current decreases rather slowly as the frequency is moved in either direction away from resonance. Such a curve is said to be **broad**. On the other hand, if the reactance is considerably larger than the resistance the current decreases

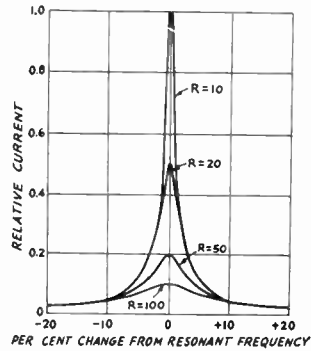

Fig. 2-38—Current in a series-resonant circuit with various values of series resistance. The values are arbitrary and would not apply to all circuits, but represent a typical case. It is assumed that the reactances (at the resonant frequency) are 1000 ohms. Note that at frequencies more than plus or minus ten per cent away from the resonant frequency the current is substantially unaffected by the resistance in the circuit.

rapidly as the frequency moves away from resonance and the circuit is said to be **sharp**. A sharp circuit will respond a great deal more readily to the resonant frequency than to frequencies quite close to resonance; a broad circuit will respond almost equally well to a group or band of frequencies centering around the resonant frequency.

Both types of resonance curves are useful. A sharp circuit gives good **selectivity**—the ability to respond strongly (in terms of current amplitude) at one desired frequency and discriminate against others. A broad circuit is used when the apparatus must give about the same response over a band of frequencies rather than to a single frequency alone.

**Q**

Most diagrams of resonant circuits show only inductance and capacitance; no resistance is indicated. Nevertheless, resistance is always present. At frequencies up to perhaps 30 Mc. this resist-

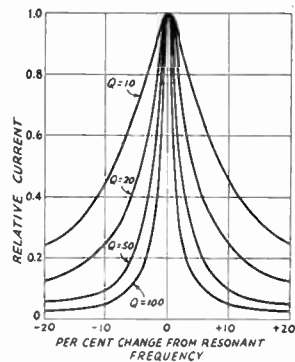

Fig. 2-39—Current in series-resonant circuits having different Qs. In this graph the current at resonance is assumed to be the same in all cases. The lower the Q, the more slowly the current decreases as the applied frequency is moved away from resonance.

ance is mostly in the wire of the coil. Above this frequency energy loss in the capacitor (principally in the solid dielectric which must be used to form an insulating support for the capacitor plates) also becomes a factor. This energy loss is equivalent to resistance. When maximum sharpness or selectivity is needed the object of design is to reduce the inherent resistance to the lowest possible value.

The value of the reactance of either the inductor or capacitor at the resonant frequency of a series-resonant circuit, divided by the resistance in the circuit, is called the  $Q$  (quality factor) of the circuit, or

$$Q = \frac{X}{R}$$

where  $Q$  = Quality factor

$X$  = Reactance of either coil or capacitor in ohms

$R$  = Series resistance in ohms

Example: The inductor and capacitor in a series circuit each have a reactance of 350 ohms at the resonant frequency. The resistance is 5 ohms. Then the  $Q$  is

$$Q = \frac{X}{R} = \frac{350}{5} = 70$$

The effect of  $Q$  on the sharpness of resonance of a circuit is shown by the curves of Fig. 2-39. In these curves the frequency change is shown in percentage above and below the resonant frequency.  $Q$ s of 10, 20, 50 and 100 are shown; these values cover much of the range commonly used in radio work.

### Voltage Rise at Resonance

When a voltage of the resonant frequency is inserted in series in a resonant circuit, the voltage that appears across either the inductor or capacitor is considerably higher than the applied voltage. The current in the circuit is limited only by the resistance and may have a relatively high value; however, the same current flows through the high reactances of the inductor and capacitor and causes large voltage drops. The ratio of the reactive voltage to the applied voltage is equal to the ratio of reactance to resistance. This ratio is also the  $Q$  of the circuit. Therefore, the voltage across either the inductor or capacitor is equal to  $QE$ , where  $E$  is the voltage inserted in series with the circuit.

Example: The inductive reactance of a circuit is 200 ohms, the capacitive reactance is 200 ohms, the resistance 5 ohms, and the applied voltage is 50. The two reactances cancel and there will be but 5 ohms of pure resistance to limit the current flow. Thus the current will be  $50/5$ , or 10 amperes. The voltage developed across either the inductor or the capacitor will be equal to its reactance times the current, or  $200 \times 10 = 2000$  volts. An alternate method: The  $Q$  of the circuit is  $X/R = 200/5 = 40$ . The reactive voltage is equal to  $Q$  times the applied voltage, or  $40 \times 50 = 2000$  volts.

### RESONANCE IN PARALLEL CIRCUITS

When a variable-frequency source of constant voltage is applied to a parallel circuit of the type shown in Fig. 2-40 there is a resonance effect

similar to that in a series circuit. However, in this case the "line" current (measured at the point indicated) is *smallest* at the frequency for which the inductive and capacitive reactances are equal. At that frequency the current through  $L$  is exactly canceled by the out-of-phase current through  $C$ , so that only the current taken by  $R$  flows in the line. At frequencies *below* resonance the current through  $L$  is larger than that through  $C$ , because the reactance of  $L$  is smaller and that of  $C$  higher at low frequencies; there is only partial cancellation of the two reactive currents and the line current therefore is larger than the current taken by  $R$  alone. At frequencies *above* resonance the situation is reversed and more current flows through  $C$  than through  $L$ , so the line current again increases. The current at resonance, being determined wholly by  $R$ , will be small if  $R$  is large and large if  $R$  is small.

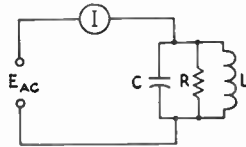

Fig. 2-40—Circuit illustrating parallel resonance.

The resistance  $R$  shown in Fig. 2-40 is not necessarily an actual resistor. In most cases it will be an "equivalent" resistance that represents the energy loss in the circuit. This loss can be inherent in the coil or capacitor, or may represent energy transferred to a load by means of the resonant circuit. (For example, the resonant circuit may be used for transferring power from a vacuum-tube amplifier to an antenna system.)

Parallel and series resonant circuits are quite alike in some respects. For instance, the circuits given at A and B in Fig. 2-41 will behave identically, when an external voltage is applied, if (1)  $L$  and  $C$  are the same in both cases; and (2)  $R_p$  multiplied by  $R_s$  equals the square of the reactance (at resonance) of either  $L$  or  $C$ . When these conditions are met the two circuits will have the same  $Q$ s. (These statements are approximate, but are quite accurate if the  $Q$  is 10 or more.) The circuit at A is a *series* circuit if it is viewed from the "inside"—that is, going around the loop formed by  $L$ ,  $C$  and  $R$ —so its  $Q$  can be found from the ratio of  $X$  to  $R_s$ .

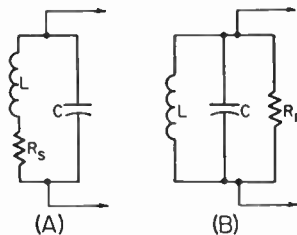

Fig. 2-41—Series and parallel equivalents when the two circuits are resonant. The series resistor,  $R_s$ , in A can be replaced by an equivalent parallel resistor,  $R_p$ , in B and vice versa.

Thus a circuit like that of Fig. 2-41A has an equivalent parallel impedance (at resonance) of  $R_p = \frac{X^2}{R_s}$ ;  $X$  is the reactance of either the inductor or the capacitor. Although  $R_p$  is not an actual resistor, to the source of voltage the parallel-resonant circuit "looks like" a pure resistance of that value. It is "pure" resistance because the inductive and capacitive currents are 180 degrees out of phase and are equal; thus there is no reactive current in the line. In a practical circuit with a high- $Q$  capacitor, at the resonant frequency the parallel impedance is

$$Z_r = QX$$

where  $Z_r$  = Resistive impedance at resonance  
 $Q$  = Quality factor of inductor  
 $X$  = Reactance (in ohms) of either the inductor or capacitor

Example: The parallel impedance of a circuit with a coil  $Q$  of 50 and having inductive and capacitive reactances of 300 ohms will be  
 $Z_r = QX = 50 \times 300 = 15,000$  ohms.

At frequencies off resonance the impedance is no longer purely resistive because the inductive and capacitive currents are not equal. The off-resonant impedance therefore is complex, and is lower than the resonant impedance for the reasons previously outlined.

The higher the  $Q$  of the circuit, the higher the parallel impedance. Curves showing the variation of impedance (with frequency) of a parallel circuit have just the same shape as the curves showing the variation of current with frequency in a series circuit. Fig. 2-42 is a set of such curves.

**Parallel Resonance in Low-Q Circuits**

The preceding discussion is accurate only for  $Q$ s of 10 or more. When the  $Q$  is below 10, resonance in a parallel circuit having resistance in series with the coil, as in Fig. 2-41A, is not so easily defined. There is a set of values for  $L$  and  $C$  that will make the parallel impedance a pure resistance, but with these values the impedance

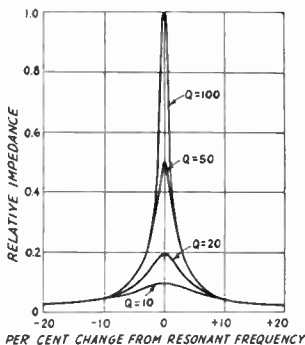

Fig. 2-42.—Relative impedance of parallel-resonant circuits with different  $Q$ s. These curves are similar to those in Fig. 2-39 for current in a series-resonant circuit. The effect of  $Q$  on impedance is most marked near the resonant frequency.

does not have its maximum possible value. Another set of values for  $L$  and  $C$  will make the parallel impedance a maximum, but this maximum value is not a pure resistance. Either condition could be called "resonance," so with low- $Q$  circuits it is necessary to distinguish between maximum impedance and resistive impedance parallel resonance. The difference between these  $L$  and  $C$  values and the equal reactances of a series-resonant circuit is appreciable when the  $Q$  is in the vicinity of 5, and becomes more marked with still lower  $Q$  values.

**Q of Loaded Circuits**

In many applications of resonant circuits the only power lost is that dissipated in the resistance of the circuit itself. At frequencies below 30 Mc. most of this resistance is in the coil. Within limits, increasing the number of turns in the coil increases the reactance faster than it raises the resistance, so coils for circuits in which the  $Q$  must be high may have reactances of 1000 ohms or more at the frequency under consideration.

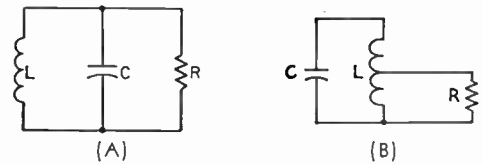

Fig. 2-43—The equivalent circuit of a resonant circuit delivering power to a load. The resistor  $R$  represents the load resistance. At B the load is tapped across part of  $L$ , which by transformer action is equivalent to using a higher load resistance across the whole circuit.

However, when the circuit delivers energy to a load (as in the case of the resonant circuits used in transmitters) the energy consumed in the circuit itself is usually negligible compared with that consumed by the load. The equivalent of such a circuit is shown in Fig. 2-43A, where the parallel resistor represents the load to which power is delivered. If the power dissipated in the load is at least ten times as great as the power lost in the inductor and capacitor, the parallel impedance of the resonant circuit itself will be so high compared with the resistance of the load that for all practical purposes the impedance of the combined circuit is equal to the load resistance. Under these conditions the  $Q$  of a parallel-resonant circuit loaded by a resistive impedance is

$$Q = \frac{R}{X}$$

where  $Q$  = Quality factor  
 $R$  = Parallel load resistance (ohms)  
 $X$  = Reactance (ohms) of either the inductor or capacitor

Example: A resistive load of 3000 ohms is connected across a resonant circuit in which the inductive and capacitive reactances are each 250 ohms. The circuit  $Q$  is then

$$Q = \frac{R}{X} = \frac{3000}{250} = 12$$

The "effective"  $Q$  of a circuit loaded by a parallel resistance becomes higher when the reactances are decreased. A circuit loaded with a relatively low resistance (a few thousand ohms) must have low-reactance elements (large capacitance and small inductance) to have reasonably high  $Q$ .

**Impedance Transformation**

An important application of the parallel-resonant circuit is as an impedance-matching device in the output circuit of a vacuum-tube r.f. power amplifier. As described in the chapter on vacuum tubes, there is an optimum value of load resistance for each type of tube and set of operating conditions. However, the resistance of the load to which the tube is to deliver power usually is considerably lower than the value required for proper tube operation. To transform the actual load resistance to the desired value the load may be tapped across part of the coil, as shown in Fig. 2-43B. This is equivalent to connecting a higher value of load resistance across the whole circuit, and is similar in principle to impedance transformation with an iron-core transformer. In high-frequency resonant circuits the impedance ratio does not vary exactly as the square of the turns ratio, because all the magnetic flux lines do not cut every turn of the coil. A desired reflected impedance usually must be obtained by experimental adjustment.

When the load resistance has a very low value (say below 100 ohms) it may be connected in series in the resonant circuit (as in Fig. 2-41A, for example), in which case it is transformed to an equivalent parallel impedance as previously described. If the  $Q$  is at least 10, the equivalent parallel impedance is

$$Z_r = \frac{X^2}{R}$$

where  $Z_r$  = Resistive parallel impedance at resonance

$X$  = Reactance (in ohms) of either the coil or capacitor

$R$  = Load resistance inserted in series

If the  $Q$  is lower than 10 the reactance will have to be adjusted somewhat, for the reasons given in the discussion of low- $Q$  circuits, to obtain a resistive impedance of the desired value.

**Reactance Values**

The charts of Figs. 2-44 and 2-45 show reactance values of inductances and capacitances in the range commonly used in r.f. tuned circuits for the amateur bands. With the exception of the 3.5-4 Mc. band, limiting values for which are shown on the charts, the change in reactance over a band, for either inductors or capacitors, is small enough so that a single curve gives the reactance with sufficient accuracy for most practical purposes.

**L/C Ratio**

The formula for resonant frequency of a circuit shows that the same frequency always will be obtained so long as the product of  $L$  and  $C$  is con-

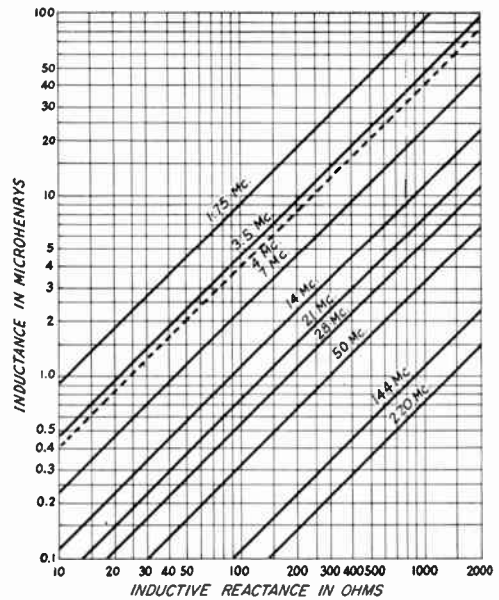

Fig. 2-44—Reactance chart for inductance values commonly used in amateur bands from 1.75 to 220 Mc.

stant. Within this limitation, it is evident that  $L$  can be large and  $C$  small,  $L$  small and  $C$  large, etc. The relation between the two for a fixed frequency is called the  $L/C$  ratio. A high- $C$  circuit is one that has more capacitance than "normal" for the frequency; a low- $C$  circuit one that has less than normal capacitance. These terms depend to a considerable extent upon the particular ap-

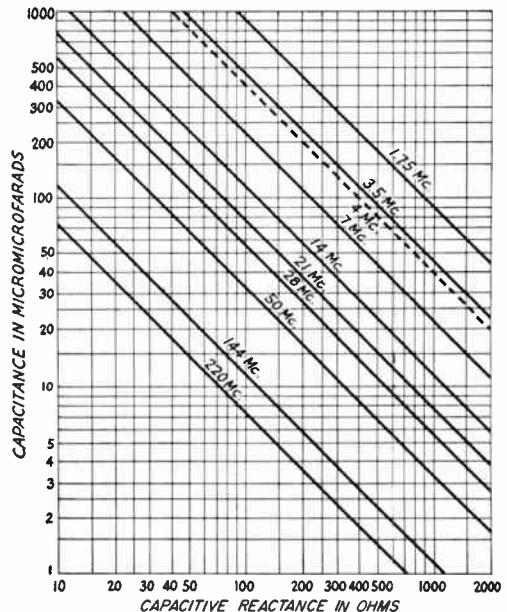

Fig. 2-45—Reactance chart for capacitance values commonly used in amateur bands from 1.75 to 220 Mc.



plication considered, and have no exact numerical meaning.

**LC Constants**

It is frequently convenient to use the numerical value of the **LC constant** when a number of calculations have to be made involving different  $L/C$  ratios for the same frequency. The constant for any frequency is given by the following equation:

$$LC = \frac{25,330}{f^2}$$

where  $L$  = Inductance in microhenrys ( $\mu\text{h.}$ )  
 $C$  = Capacitance in micromicrofarads ( $\mu\mu\text{f.}$ )  
 $f$  = Frequency in megacycles

Example: Find the inductance required to resonate at 3650 kc. (3.65 Mc.) with capacitances of 25, 50, 100, and 500  $\mu\mu\text{f.}$  The LC constant is

$$LC = \frac{25,330}{(3.65)^2} = \frac{25,330}{13.35} = 1900$$

- With 25  $\mu\mu\text{f.}$   $L = 1900/C = 1900/25 = 76 \mu\text{h.}$
- 50  $\mu\mu\text{f.}$   $L = 1900/C = 1900/50 = 38 \mu\text{h.}$
- 100  $\mu\mu\text{f.}$   $L = 1900/C = 1900/100 = 19 \mu\text{h.}$
- 500  $\mu\mu\text{f.}$   $L = 1900/C = 1900/500 = 3.8 \mu\text{h.}$

**COUPLED CIRCUITS**

**Energy Transfer and Loading**

Two circuits are **coupled** when energy can be transferred from one to the other. The circuit delivering power is called the **primary** circuit; the one receiving power is called the **secondary** circuit. The power may be practically all dissipated in the secondary circuit itself (this is usually the case in receiver circuits) or the secondary may simply act as a medium through which the power is transferred to a load. In the latter case, the coupled circuits may act as a radio-frequency impedance-matching device. The matching can be accomplished by adjusting the loading on the secondary and by varying the amount of coupling between the primary and secondary.

**Coupling by a Common Circuit Element**

One method of coupling between two resonant circuits is through a circuit element common to both. The three common variations of this type of coupling are shown in Fig. 2-46; the circuit element common to both circuits carries the subscript  $M$ . At A and B current circulating in  $L_1C_1$  flows through the common element, and the voltage developed across this element causes current to flow in  $L_2C_2$ . At C,  $C_M$  and  $C_2$  form a capacitive voltage divider across  $L_1C_1$ , and some of the voltage developed across  $L_1C_1$  is applied across  $L_2C_2$ .

If both circuits are resonant to the same frequency, as is usually the case, the value of coupling reactance required for maximum energy transfer can be approximated by the following, based on  $L_1 = L_2$ ,  $C_1 = C_2$  and  $Q_1 = Q_2$ :

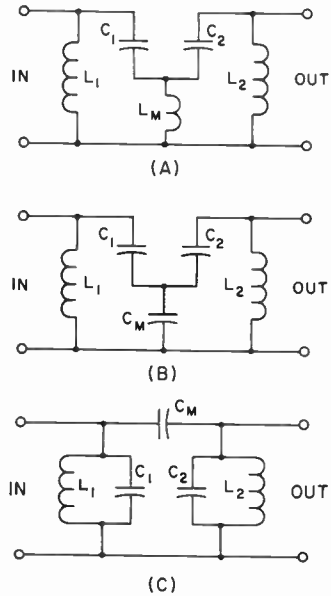

Fig. 2-46—Three methods of circuit coupling.

(A)  $L_M \approx L_1/Q_1$ ; (B)  $C_M \approx Q_1C_1$ ; (C)  $C_M \approx C_1/Q_1$ .

The coupling can be increased by increasing the above coupling elements in A and C and decreasing the value in B. When the coupling is increased, the resultant bandwidth of the combination is increased, and this principle is sometimes applied to "broad-band" the circuits in a transmitter or receiver. When the coupling elements in A and C are decreased, or when the coupling element in B is increased, the coupling between the circuits is decreased below the *critical coupling* value on which the above approximations are based. Less than critical coupling will decrease the bandwidth and the energy transfer; the principle is often used in receivers to improve the selectivity.

**Inductive Coupling**

Figs. 2-47 and 2-48 show inductive coupling, or coupling by means of the mutual inductance between two coils. Circuits of this type resemble the iron-core transformer, but because only a part of

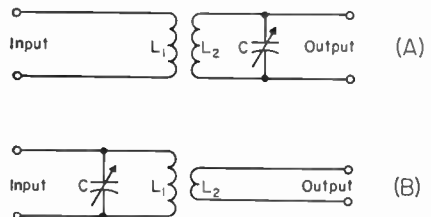

Fig. 2-47—Single-tuned inductively coupled circuits.

the magnetic flux lines set up by one coil cut the turns of the other coil, the simple relationships between turns ratio, voltage ratio and impedance



ratio in the iron-core transformer do not hold.

Two types of inductively-coupled circuits are shown in Fig. 2-47. Only one circuit is resonant. The circuit at A is frequently used in receivers for coupling between amplifier tubes when the tuning of the circuit must be varied to respond to signals of different frequencies. Circuit B is used principally in transmitters, for coupling a radio-frequency amplifier to a resistive load.

In these circuits the coupling between the primary and secondary coils usually is "tight"—that is, the coefficient of coupling between the coils is large. With very tight coupling either circuit operates nearly as though the device to which the untuned coil is connected were simply tapped across a corresponding number of turns on the tuned-circuit coil, thus either circuit is approximately equivalent to Fig. 2-43B.

By proper choice of the number of turns on the untuned coil, and by adjustment of the coupling, the parallel impedance of the tuned circuit may be adjusted to the value required for the proper operation of the device to which it is connected. In any case, the maximum energy transfer possible for a given coefficient of coupling is obtained when the reactance of the untuned coil is equal to the resistance of its load.

The  $Q$  and parallel impedance of the tuned circuit are reduced by coupling through an untuned coil in much the same way as by the tapping arrangement shown in Fig. 2-43B.

### Coupled Resonant Circuits

When the primary and secondary circuits are both tuned, as in Fig. 2-48, the resonance effects

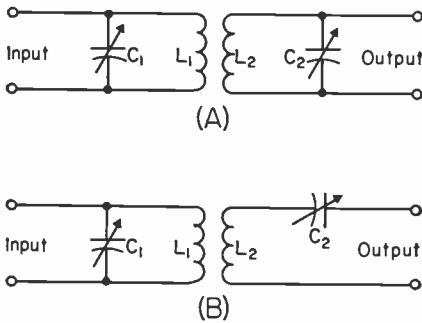

Fig. 2-48—Inductively-coupled resonant circuits. Circuit A is used for high-resistance loads (load resistance much higher than the reactance of either  $L_2$  or  $C_2$  at the resonant frequency). Circuit B is suitable for low resistance loads (load resistance much lower than the reactance of either  $L_2$  or  $C_2$  at the resonant frequency).

in both circuits make the operation somewhat more complicated than in the simpler circuits just considered. Imagine first that the two circuits are not coupled and that each is independently tuned to the resonant frequency. The impedance of each will be purely resistive. If the primary circuit is connected to a source of r.f. energy of the resonant frequency and the secondary is then loosely coupled to the primary, a current will flow in the

secondary circuit. In flowing through the resistance of the secondary circuit and any load that may be connected to it, the current causes a power loss. This power must come from the energy source through the primary circuit, and manifests itself in the primary as an increase in the equivalent resistance in series with the primary coil. Hence the  $Q$  and parallel impedance of the primary circuit are decreased by the coupled secondary. As the coupling is made greater (without changing the tuning of either circuit) the coupled resistance becomes larger and the parallel impedance of the primary continues to decrease. Also, as the coupling is made tighter the amount of power transferred from the primary to the secondary will increase to a maximum at one value of coupling, called **critical coupling**, but then decreases if the coupling is tightened still more (still without changing the tuning).

Critical coupling is a function of the  $Q$ s of the two circuits. A higher coefficient of coupling is required to reach critical coupling when the  $Q$ s are low; if the  $Q$ s are high, as in receiving applications, a coupling coefficient of a few per cent may give critical coupling.

With loaded circuits such as are used in transmitters the  $Q$  may be too low to give the desired power transfer even when the coils are coupled as tightly as the physical construction permits. In such case, increasing the  $Q$  of either circuit will be helpful, although it is generally better to increase the  $Q$  of the lower- $Q$  circuit rather than the reverse. The  $Q$  of the parallel-tuned primary (input) circuit can be increased by decreasing the  $L/C$  ratio because, as shown in connection with Fig. 2-43, this circuit is in effect loaded by a parallel resistance (effect of coupled-in resistance). In the parallel-tuned secondary circuit, Fig. 2-48A, the  $Q$  can be increased, for a fixed value of load resistance, either by decreasing the  $L/C$  ratio or by tapping the load down (see Fig. 2-43). In the series-tuned secondary circuit, Fig. 2-48B, the  $Q$  may be increased by increasing the  $L/C$  ratio. There will generally be no difficulty in securing sufficient coupling, with practicable coils, if the product of the  $Q$ s of the two tuned circuits is 10 or more. A smaller product will suffice if the coil construction permits tight coupling.

### Selectivity

In Fig. 2-47 only one circuit is tuned and the selectivity curve will be essentially that of a single resonant circuit. As stated, the effective  $Q$  depends upon the resistance connected to the untuned coil.

In Fig. 2-48, the selectivity is the same as that of a single tuned circuit having a  $Q$  equal to the product of the  $Q$ s of the individual circuits—if the coupling is well below critical (this is not the condition for optimum power transfer discussed immediately above) and both circuits are tuned to resonance. The  $Q$ s of the individual circuits are affected by the degree of coupling, because each couples resistance into the other; the

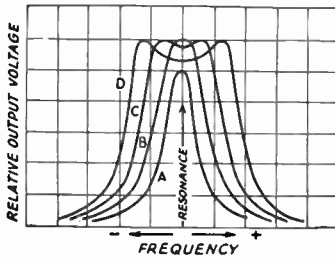

Fig. 2-49—Showing the effect on the output voltage from the secondary circuit of changing the coefficient of coupling between two resonant circuits independently tuned to the same frequency. The voltage applied to the primary is held constant in amplitude while the frequency is varied, and the output voltage is measured across the secondary.

tighter the coupling, the lower the individual  $Q$ s and therefore the lower the over-all selectivity.

If both circuits are independently tuned to resonance, the over-all selectivity will vary about as shown in Fig. 2-49 as the coupling is varied. With loose coupling, *A*, the output voltage (across the secondary circuit) is small and the selectivity is high. As the coupling is increased the secondary voltage also increases until critical coupling, *B*, is reached. At this point the output voltage at the resonant frequency is maximum but the selectivity is lower than with looser coupling. At still tighter couple, *C*, the output voltage at the resonant frequency decreases, but as the frequency is varied either side of resonance it is found that there are two "humps" to the curve, one on either side of resonance. With very tight coupling, *D*, there is a further decrease in the output voltage at resonance and the "humps" are farther away from the resonant frequency. Curves such as those at *C* and *D* are called **flat-topped** because the output voltage does not change much over an appreciable band of frequencies.

Note that the off-resonance humps have the same maximum value as the resonant output voltage at critical coupling. These humps are caused by the fact that at frequencies off resonance the secondary circuit is reactive and couples reactance as well as resistance into the primary. The coupled resistance decreases off resonance, and each hump represents a new condition of critical coupling at a frequency to which the primary is tuned by the additional coupled-in reactance from the secondary.

Fig. 2-50 shows the response curves for various degrees of coupling between two circuits tuned to a frequency  $f_0$ . Equals  $Q$ s are assumed in both circuits, although the curves are representative if the  $Q$ s differ by ratios up to 1.5 or even 2 to 1. In these cases, a value of  $Q = \sqrt{Q_1 Q_2}$  should be used.

**Band-Pass Coupling**

Over-coupled resonant circuits are useful where substantially uniform output is desired over a continuous band of frequencies, without read-

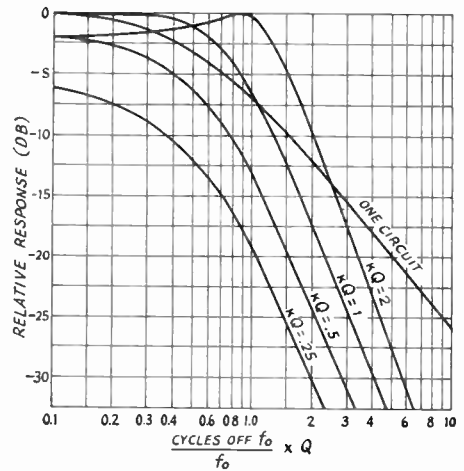

Fig. 2-50—Relative response for a single tuned circuit and for coupled circuits. For inductively-coupled circuits

(Figs. 2-46A and 2-48A),  $k = \frac{M}{\sqrt{L_1 L_2}}$  where  $M$  is the mutual inductance. For capacitance-coupled circuits (Figs. 2-46B and 2-46C),  $k \cong \frac{\sqrt{C_1 C_2}}{C_M}$  and  $k \cong \frac{C_M}{\sqrt{C_1 C_2}}$  respectively.

justment of tuning. The width of the flat top of the resonance curve depends on the  $Q$ s of the two circuits as well as the tightness of coupling; the frequency separation between the humps will increase, and the curve become more flat-topped, as the  $Q$ s are lowered.

Band-pass operation also is secured by tuning the two circuits to slightly different frequencies, which gives a double-humped resonance curve even with loose coupling. This is called **stagger tuning**. To secure adequate power transfer over the frequency band it is usually necessary to use tight coupling and experimentally adjust the circuits for the desired performance.

**Link Coupling**

A modification of inductive coupling, called **link coupling**, is shown in Fig. 2-51. This gives the effect of inductive coupling between two coils that have no mutual inductance; the link is simply a means for providing the mutual inductance. The total mutual inductance between two coils coupled by a link cannot be made as great as if the coils themselves were coupled. This is because the coefficient of coupling between air-

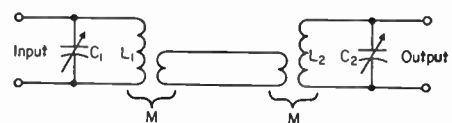

Fig. 2-51—Link coupling. The mutual inductances at both ends of the link are equivalent to mutual inductance between the tuned circuits, and serve the same purpose.

core coils is considerably less than 1, and since there are two coupling points the over-all coupling coefficient is less than for any pair of coils. In practice this need not be disadvantageous because the power transfer can be made great enough by making the tuned circuits sufficiently high- $Q$ . Link coupling is convenient when ordinary inductive coupling would be impracticable for constructional reasons.

The link coils usually have a small number of turns compared with the resonant-circuit coils. The number of turns is not greatly important, because the coefficient of coupling is relatively independent of the number of turns on either coil; it is more important that both link coils should have about the same inductance. The length of the link between the coils is not critical if it is very small compared with the wavelength, but if the length is more than about one-twentieth of a wavelength the link operates more as a transmission line than as a means for providing mutual inductance. In such case it should be treated by the methods described in the chapter on Transmission Lines.

### IMPEDANCE-MATCHING CIRCUITS

The coupling circuits discussed in the preceding section have been based either on inductive coupling or on coupling through a common circuit element between two resonant circuits. These are not the only circuits that may be used for transferring power from one device to another.

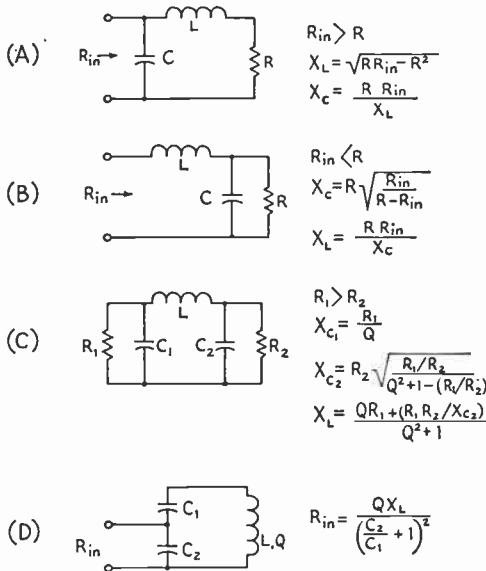

Fig. 2-52—Impedance-matching networks adaptable to amateur work. (A) L network for transforming to a lower value of resistance. (B) L network for transforming to a higher resistance value. (C) Pi network.  $R_1$  is the larger of the two resistors;  $Q$  is defined as  $R_1/X_{C1}$ . (D) Tapped tuned circuit used in some receiver applications. The impedance of the tuned circuit is transformed to a lower value,  $R_{in}$ , by the capacitive divider.

There is, in fact, a wide variety of such circuits available, all of them being classified generally as **impedance-matching networks**. Several networks frequently used in amateur equipment are shown in Fig. 2-52.

### The L Network

The L network is the simplest possible impedance-matching circuit. It closely resembles an ordinary resonant circuit with the load resistance,  $R$ , Fig. 2-52, either in series or parallel. The arrangement shown in Fig. 2-52A is used when the desired impedance,  $R_{in}$ , is larger than the actual load resistance,  $R$ , while Fig. 2-52B is used in the opposite case. The design equations for each case are given in the figure, in terms of the circuit reactances. The reactances may be converted to inductance and capacitance by means of the formulas previously given or taken directly from the charts of Figs. 2-44 and 2-45.

When the impedance transformation ratio is large—that is, one of the two impedances is of the order of 100 times (or more) larger than the other—the operation of the circuit is exactly the same as previously discussed in connection with impedance transformation with a simple LC resonant circuit.

The  $Q$  of an L network is found in the same way as for simple resonant circuits. That is, it is equal to  $X_L/R$  or  $R_{in}/X_C$  in Fig. 2-52A, and to  $X_L/R_{in}$  or  $R/X_C$  in Fig. 2-52B. The value of  $Q$  is determined by the ratio of the impedances to be matched, and cannot be selected independently. In the equations of Fig. 2-52 it is assumed that both  $R$  and  $R_{in}$  are pure resistances.

### The Pi Network

The pi network, shown in Fig. 2-52C, offers more flexibility than the L since the operating  $Q$  may be chosen practically at will. The only limitation on the circuit values that may be used is that the reactance of the series arm, the inductor  $L$  in the figure, must not be greater than the square root of the product of the two values of resistive impedance to be matched. As the circuit is applied in amateur equipment, this limiting value of reactance would represent a network with an undesirably low operating  $Q$ , and the circuit values ordinarily used are well on the safe side of the limiting values.

In its principal application as a "tank" circuit matching a transmission line to a power amplifier tube, the load  $R_2$  will generally have a fairly low value of resistance (up to a few hundred ohms) while  $R_1$ , the required load for the tube, will be of the order of a few thousand ohms. In such a case the  $Q$  of the circuit is defined as  $R_1/X_{C1}$ , so the choice of a value for the operating  $Q$  immediately sets the value of  $X_{C1}$  and hence of  $C_1$ . The values of  $X_{C2}$  and  $X_L$  are then found from the equations given in the figure.

Graphical solutions for practical cases are given in the chapter on transmitter design in the discussion of plate tank circuits. The  $L$  and  $C$  values may be calculated from the reactances or read from the charts of Figs. 2-44 and 2-45.

LOW-PASS FILTERS

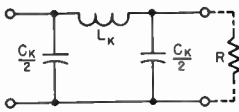

Constant-k pi section

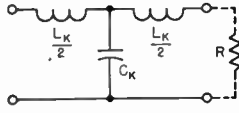

Constant-k T section

$$L_K = \frac{R}{\pi f_c} \quad C_K = \frac{1}{\pi f_c R}$$

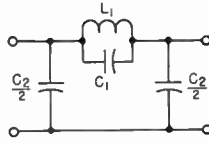

m-derived pi section

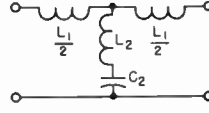

m-derived T section

$$L_1 = mL_K \quad C_1 = \frac{1-m^2}{4m} C_K$$

$$L_2 = \frac{1-m^2}{4m} L_K \quad C_2 = m C_K$$

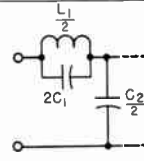

m-derived end sections for use with intermediate pi section

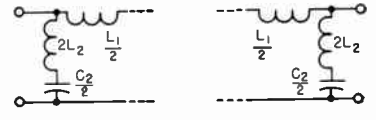
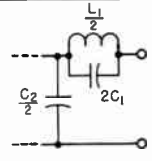

m-derived end sections for use with intermediate T section

$$L_1 = mL_K \quad C_1 = \frac{1-m^2}{4m} C_K$$

$$L_2 = \frac{1-m^2}{4m} L_K \quad C_2 = m C_K$$

HIGH-PASS FILTERS

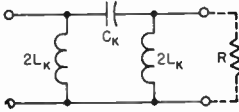

Constant-k pi section

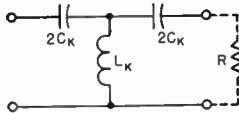

Constant-k T section

$$L_K = \frac{R}{4\pi f_c} \quad C_K = \frac{1}{4\pi f_c R}$$

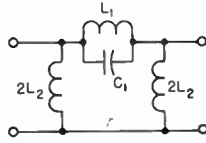

m-derived pi section

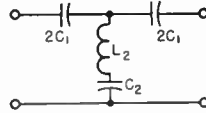

m-derived T section

$$L_1 = \frac{4m}{1-m^2} L_K \quad C_1 = \frac{C_K}{m}$$

$$L_2 = \frac{L_K}{m} \quad C_2 = \frac{4m}{1-m^2} C_K$$

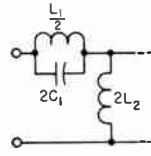

m-derived end sections for use with intermediate pi section

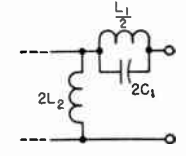

m-derived end section for use with intermediate T section

$$L_1 = \frac{4m}{1-m^2} L_K \quad C_1 = \frac{C_K}{m}$$

$$L_2 = \frac{L_K}{m} \quad C_2 = \frac{4m}{1-m^2} C_K$$

BANDPASS FILTERS

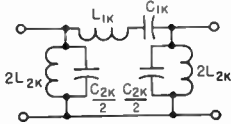

Constant-k pi section

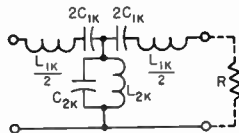

Constant-k T section

$$L_{1K} = \frac{R}{\pi(f_2 - f_1)} \quad C_{1K} = \frac{f_2 - f_1}{4\pi f_1 f_2 R}$$

$$L_{2K} = \frac{(f_2 - f_1)R}{4\pi f_1 f_2} \quad C_{2K} = \frac{1}{\pi(f_2 - f_1)R}$$

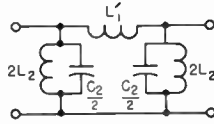

Three-element pi section

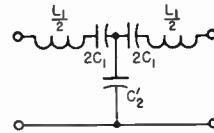

Three-element T section

$$L_1 = L_{1K} \quad L'_1 = \frac{R}{\pi(f_1 + f_2)}$$

$$C_1 = \frac{f_2 - f_1}{4\pi f_1^2 R} \quad L_2 = \frac{(f_2 - f_1)R}{4\pi f_1^2}$$

$$C_2 = C_{2K} \quad C'_2 = \frac{1}{\pi(f_1 + f_2)R}$$

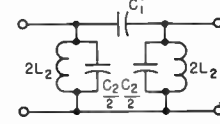

Three-element pi section

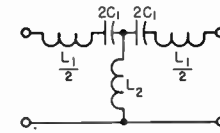

Three-element T section

$$L_1 = \frac{f_1 R}{\pi f_2 (f_2 - f_1)} \quad C_1 = C_{1K}$$

$$C'_1 = \frac{f_1 + f_2}{4\pi f_1 f_2 R} \quad L_2 = L_{2K}$$

$$L'_2 = \frac{(f_1 + f_2)R}{4\pi f_1 f_2} \quad C_2 = \frac{f_1}{\pi f_2 (f_2 - f_1)R}$$

Fig. 2-53—Basic filter sections and design formulas. In the above formulas R is in ohms, C in farads, L in henrys, and f in cycles per second.

### Tapped Tuned Circuit

The tapped tuned circuit of Fig. 2-52D is useful in some receiver applications, where it is desirable to use a high-impedance tuned circuit as a lower-impedance load. When the  $Q$  of the inductor has been determined, the capacitors can be selected to give the desired impedance transformation and the necessary resultant capacitance to tune the circuit to resonance.

### FILTERS

A filter is an electrical circuit configuration (network) designed to have specific characteristics with respect to the transmission or attenuation of various frequencies that may be applied to it. There are three general types of filters: low-pass, high-pass, and band-pass.

A low-pass filter is one that will permit all frequencies below a specified one called the **cut-off frequency** to be transmitted with little or no loss, but that will attenuate all frequencies above the cut-off frequency.

A high-pass filter similarly has a cut-off frequency, above which there is little or no loss in transmission, but below which there is considerable attenuation. Its behavior is the opposite of that of the low-pass filter.

A band-pass filter is one that will transmit a selected band of frequencies with substantially no loss, but that will attenuate all frequencies either higher or lower than the desired band.

The **pass band** of a filter is the frequency spectrum that is transmitted with little or no loss. The transmission characteristic is not necessarily perfectly uniform in the pass band, but the variations usually are small.

The **stop band** is the frequency region in which attenuation is desired. The attenuation may vary in the stop band, and in a simple filter usually is least near the cut-off frequency, rising to high values at frequencies considerably removed from the cut-off frequency.

Filters are designed for a specific value of purely resistive impedance (the **terminating impedance** of the filter). When such an impedance is connected to the output terminals of the filter, the impedance looking into the input terminals has essentially the same value, throughout most of the pass band. Simple filters do not give perfectly uniform performance in this respect, but the input impedance of a properly-terminated filter can be made fairly constant, as well as closer to the design value, over the pass band by using **m-derived** filter sections.

A discussion of filter design principles is beyond the scope of this *Handbook*, but it is not difficult to build satisfactory filters from the circuits and formulas given in Fig. 2-53. Filter circuits are built up from elementary sections as shown in the figure. These sections can be used alone or, if greater attenuation and sharper cut-off (that is, a more rapid rate of rise of attenuation with frequency beyond the cut-off frequency) are required, several sections can be connected in series. In the low- and high-pass filters,  $f_c$  repre-

sents the cut-off frequency, the highest (for the low-pass) or the lowest (for the high-pass) frequency transmitted without attenuation. In the band-pass filter designs,  $f_1$  is the low-frequency cut-off and  $f_2$  the high-frequency cut-off. The units for  $L$ ,  $C$ ,  $R$  and  $f$  are henrys, farads, ohms and cycles per second, respectively.

All of the types shown are "unbalanced" (one side grounded). For use in balanced circuits (e.g., 300-ohm transmission line, or push-pull audio circuits), the series reactances should be equally divided between the two legs. Thus the balanced constant- $k$   $\pi$ -section low-pass filter would use two inductors of a value equal to  $L_k/2$ , while the balanced constant- $k$   $\pi$ -section high-pass filter would use two capacitors each equal to  $2C_k$ .

If several low- (or high-) pass sections are to be used, it is advisable to use  $m$ -derived end sections on either side of a constant- $k$  center section, although an  $m$ -derived center section can be used. The factor  $m$  determines the ratio of the cut-off frequency,  $f_c$ , to a frequency of high attenuation,  $f_x$ . Where only one  $m$ -derived section is used, a value of 0.6 is generally used for  $m$ , although a deviation of 10 or 15 per cent from this value is not too serious in amateur work. For a value of  $m = 0.6$ ,  $f_x$  will be  $1.25f_c$  for the low-pass filter and  $0.8f_c$  for the high-pass filter. Other values can be found from

$$m = \sqrt{1 - \left(\frac{f_c}{f_\infty}\right)^2} \text{ for the low-pass filter and}$$

$$m = \sqrt{1 - \left(\frac{f_\infty}{f_c}\right)^2} \text{ for the high-pass filter.}$$

The output sides of the filters shown should be terminated in a resistance equal to  $R_l$ , and there should be little or no reactive component in the termination.

### PIEZOELECTRIC CRYSTALS

A number of crystalline substances found in nature have the ability to transform mechanical strain into an electrical charge, and *vice versa*. This property is known as the **piezoelectric effect**. A small plate or bar cut in the proper way from a quartz crystal and placed between two conducting electrodes will be mechanically strained when the electrodes are connected to a source of voltage. Conversely, if the crystal is squeezed between two electrodes a voltage will be developed between the electrodes.

Piezoelectric crystals can be used to transform mechanical energy into electrical energy, and *vice versa*. They are used in microphones and phonograph pick-ups, where mechanical vibrations are transformed into alternating voltages of corresponding frequency. They are also used in headsets and loudspeakers, transforming electrical energy into mechanical vibration. Crystals of Rochelle salts are used for these purposes.

### Crystal Resonators

Crystalline plates also are mechanical resonators that have natural frequencies of vibration



ranging from a few thousand cycles to tens of megacycles per second. The vibration frequency depends on the kind of crystal, the way the plate is cut from the natural crystal, and on the dimensions of the plate. The thing that makes the **crystal resonator** valuable is that it has extremely high  $Q$ , ranging from 5 to 10 times the  $Q$ s obtainable with good  $LC$  resonant circuits.

Analogies can be drawn between various mechanical properties of the crystal and the electrical characteristics of a tuned circuit. This leads to an "equivalent circuit" for the crystal. The electrical coupling to the crystal is through the holder plates between which it is sandwiched; these plates form, with the crystal as the dielectric, a small capacitor like any other capacitor constructed of two plates with a dielectric between. The crystal itself is equivalent to a series-resonant circuit, and together with the capacitance of the holder forms the equivalent circuit shown in Fig. 2-54. At frequencies of the order of

Fig. 2-54—Equivalent circuit of a crystal resonator.  $L$ ,  $C$  and  $R$  are the electrical equivalents of mechanical properties of the crystal;  $C_h$  is the capacitance of the holder plates with the crystal plate between them.

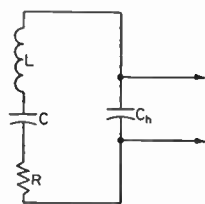

450 kc., where crystals are widely used as resonators, the equivalent  $L$  may be several henrys and the equivalent  $C$  only a few hundredths of a microfarad. Although the equivalent  $R$  is of the order of a few thousand ohms, the reactance at resonance is so high that the  $Q$  of the crystal likewise is high.

A circuit of the type shown in Fig. 2-54 has a series-resonant frequency, when viewed from the circuit terminals indicated by the arrowheads, determined by  $L$  and  $C$  only. At this frequency the circuit impedance is simply equal to  $R$ , providing the reactance of  $C_h$  is large compared with  $R$  (this is generally the case). The circuit also

has a parallel-resonant frequency determined by  $L$  and the equivalent capacitance of  $C$  and  $C_h$  in series. Since this equivalent capacitance is smaller than  $C$  alone, the parallel-resonant frequency is higher than the series-resonant frequency. The separation between the two resonant frequencies depends on the ratio of  $C_h$  to  $C$ , and when this ratio is large (as in the case of a crystal resonator, where  $C_h$  will be a few  $\mu\mu\text{f}$ . in the average case) the two frequencies will be quite close together. A separation of a kilocycle or less at 455 kc. is typical of a quartz crystal.

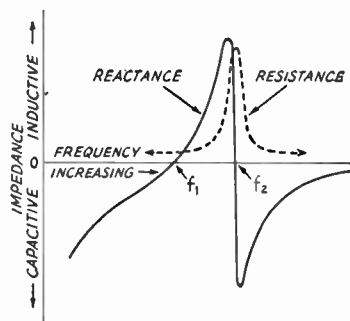

Fig. 2-55—Reactance and resistance vs. frequency of a circuit of the type shown in Fig. 2-54. Actual values of reactance, resistance and the separation between the series- and parallel-resonant frequencies,  $f_1$ , and  $f_2$ , respectively, depend on the circuit constants.

Fig. 2-55 shows how the resistance and reactance of such a circuit vary as the applied frequency is varied. The reactance passes through zero at both resonant frequencies, but the resistance rises to a large value at parallel resonance, just as in any tuned circuit.

Quartz crystals may be used either as simple resonators for their selective properties or as the frequency-controlling elements in oscillators as described in later chapters. The series-resonant frequency is the one principally used in the former case, while the more common forms of oscillator circuit use the parallel-resonant frequency.

## PRACTICAL CIRCUIT DETAILS

### COMBINED A.C. AND D.C.

Most radio circuits are built around vacuum tubes, and it is the nature of these tubes to require direct current (usually at a fairly high voltage) for their operation. They convert the direct current into an alternating current (and sometimes the reverse) at frequencies varying from well down in the audio range to well up in the super-high range. The conversion process almost invariably requires that the direct and alternating currents meet somewhere in the circuit.

In this meeting, the a.c. and d.c. are actually combined into a single current that "pulsates" (at the a.c. frequency) about an average value equal to the direct current. This is shown in Fig. 2-56. It is convenient to consider that the alter-

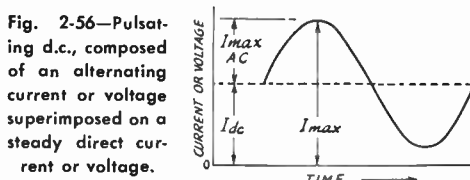

Fig. 2-56—Pulsating d.c., composed of an alternating current or voltage superimposed on a steady direct current or voltage.

nating current is **superimposed** on the direct current, so we may look upon the actual current as having two components, one d.c. and the other a.c.

In an alternating current the positive and negative alternations have the same average amplitude, so when the wave is superimposed on a direct current the latter is alternately increased and decreased by the same amount. There is thus

no *average* change in the direct current. If a d.c. instrument is being used to read the current, the reading will be exactly the same whether or not the a.c. is superimposed.

However, there is actually more power in such a combination current than there is in the direct current alone. This is because power varies as the square of the instantaneous value of the current, and when all the instantaneous squared values are averaged over a cycle the total power is greater than the d.c. power alone. If the a.c. is a sine wave having a peak value just equal to the d.c., the power in the circuit is 1.5 times the d.c. power. An instrument whose readings are proportional to power will show such an increase.

**Series and Parallel Feed**

Fig. 2-57 shows in simplified form how d.c. and a.c. may be combined in a vacuum-tube circuit. In this case, it is assumed that the a.c. is at radio frequency, as suggested by the coil-and-capacitor tuned circuit. It is also assumed that r.f. current can easily flow through the d.c. supply; that is, the impedance of the supply at radio frequencies is so small as to be negligible.

In the circuit at the left, the tube, tuned circuit, and d.c. supply all are connected in series. The direct current flows through the r.f. coil to get to the tube; the r.f. current generated by the tube

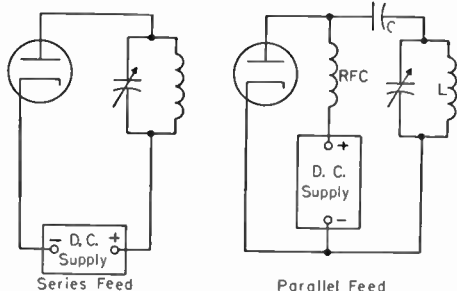

Fig. 2-57—Illustrating series and parallel feed.

flows through the d.c. supply to get to the tuned circuit. This is **series feed**. It works because the impedance of the d.c. supply at radio frequencies is so low that it does not affect the flow of r.f. current, and because the d.c. resistance of the coil is so low that it does not affect the flow of direct current.

In the circuit at the right the direct current does not flow through the r.f. tuned circuit, but instead goes to the tube through a second coil, **RFC (radio-frequency choke)**. Direct current cannot flow through *L* because a **blocking capacitance, C**, is placed in the circuit to prevent it. (Without *C*, the d.c. supply would be short-circuited by the low resistance of *L*.) On the other hand, the r.f. current generated by the tube can easily flow through *C* to the tuned circuit because the capacitance of *C* is intentionally chosen to have low reactance (compared with the impedance of the tuned circuit) at the radio frequency. The r.f. current cannot flow through the

d.c. supply because the inductance of *RFC* is intentionally made so large that it has a very high reactance at the radio frequency. The resistance of *RFC*, however, is too low to have an appreciable effect on the flow of direct current. The two currents are thus in *parallel*, hence the name **parallel feed**.

Either type of feed may be used for both a.f. and r.f. circuits. In parallel feed there is no d.c. voltage on the a.c. circuit, a desirable feature from the viewpoint of safety to the operator, because the voltages applied to tubes—particularly transmitting tubes—are dangerous. On the other hand, it is somewhat difficult to make an r.f. choke work well over a wide range of frequencies. Series feed is often preferred, therefore, because it is relatively easy to keep the impedance between the a.c. circuit and the tube low.

**Bypassing**

In the series-feed circuit just discussed, it was assumed that the d.c. supply had very low impedance at radio frequencies. This is not likely to be true in a practical power supply, partly because the normal physical separation between the supply and the r.f. circuit would make it necessary to use rather long connecting wires or leads. At radio frequencies, even a few feet of wire can have fairly large reactance—too large to be considered a really “low-impedance” connection.

An actual circuit would be provided with a **bypass capacitor**, as shown in Fig. 2-58. Capacitor *C* is chosen to have low reactance at the operating frequency, and is installed right in the circuit where it can be wired to the other parts with quite short connecting wires. Hence the r.f. current will tend to flow through it rather than through the d.c. supply.

To be effective, the reactance of the bypass

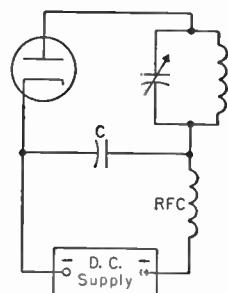

Fig. 2-58—Typical use of a bypass capacitor and r.f. choke in a series-feed circuit.

capacitor should not be more than one-tenth of the impedance of the bypassed part of the circuit. Very often the latter impedance is not known, in which case it is desirable to use the largest capacitance in the bypass that circumstances permit. To make doubly sure that r.f. current will not flow through a non-r.f. circuit such as a power supply, an r.f. choke may be connected in the lead to the latter, as shown in Fig. 2-58.

The same type of bypassing is used when audio frequencies are present in addition to r.f. Because

the reactance of a capacitor changes with frequency, it is readily possible to choose a capacitance that will represent a very low reactance at radio frequencies but that will have such high reactance at audio frequencies that it is practically an open circuit. A capacitance of 0.001  $\mu\text{f}$ . is practically a short circuit for r.f., for example, but is almost an open circuit at audio frequencies. (The actual value of capacitance that is usable will be modified by the impedances concerned.) Capacitors also are used in audio circuits to carry the audio frequencies around a d.c. supply.

### Distributed Capacitance and Inductance

In the discussions earlier in this chapter it was assumed that a capacitor has only capacitance and that an inductor has only inductance. Unfortunately, this is not strictly true. There is always a certain amount of inductance in a conductor of any length, and a capacitor is bound to have a little inductance in addition to its intended capacitance. Also, there is always capacitance between two conductors or between parts of the same conductor, and thus there is appreciable capacitance between the turns of an inductance coil.

This **distributed inductance** in a capacitor and the **distributed capacitance** in an inductor have important practical effects. Actually, every capacitor is in effect a series-tuned circuit, resonant at the frequency where its capacitance and inductance have the same reactance. Similarly, every inductor is in effect a parallel-tuned circuit, resonant at the frequency where its inductance and distributed capacitance have the same reactance. At frequencies well below these **natural resonances**, the capacitor will act like a capacitance and the coil will act like an inductor. Near the natural resonance points, the inductor will have its highest impedance and the capacitor will have its lowest impedance. At frequencies above resonance, the capacitor acts like an inductor and the inductor acts like a capacitor. Thus there is a limit to the amount of capacitance that can be used at a given frequency. There is a similar limit to the inductance that can be used. At audio frequencies, capacitances measured in microfarads and inductances measured in henrys are practicable. At low and medium radio frequencies, inductances of a few mh. and capacitances of a few thousand pf. are the largest practicable. At high radio frequencies, usable inductance values drop to a few  $\mu\text{h}$ . and capacitances to a few hundred pf.

Distributed capacitance and inductance are important not only in r.f. tuned circuits, but in bypassing and choking as well. It will be appreciated that a bypass capacitor that actually acts like an inductance, or an r.f. choke that acts like a low-reactance capacitor, cannot work as it is intended they should.

### Grounds

Throughout this book there are frequent references to **ground** and **ground potential**. When a connection is said to be "grounded" it does not

necessarily mean that it actually goes to earth. What it means is that an actual earth connection to that point in the circuit should not disturb the operation of the circuit in any way. The term also is used to indicate a "common" point in the circuit where power supplies and metallic supports (such as a metal chassis) are electrically tied together. It is general practice, for example, to "ground" the negative terminal of a d.c. power supply, and to "ground" the filament or heater power supplies for vacuum tubes. Since the cathode of a vacuum tube is a junction point for grid and plate voltage supplies, and since the various circuits connected to the tube elements have at least one point connected to cathode, these points also are "returned to ground." Ground is therefore a common reference point in the radio circuit. "Ground potential" means that there is no "difference of potential"—no voltage—between the circuit point and the earth.

### Single-Ended and Balanced Circuits

With reference to ground, a circuit may be either **single-ended** (unbalanced) or **balanced**. In a single-ended circuit, one side of the circuit (the cold side) is connected to ground. In a balanced circuit, the electrical midpoint is connected to ground, so that the circuit has two "hot" ends each at the same voltage "above" ground.

Typical single-ended and balanced circuits are shown in Fig. 2-59. R.f. circuits are shown in the upper row, while iron-core transformers

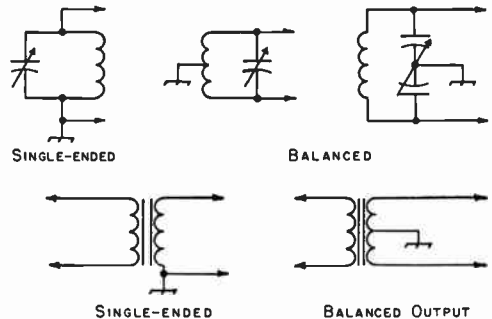

Fig. 2-59—Single-ended and balanced circuits.

(such as are used in power-supply and audio circuits) are shown in the lower row. The r.f. circuits may be balanced either by connecting the center of the coil to ground or by using a "balanced" or "split-stator" capacitor and connecting its rotor to r.f. ground. In the iron-core transformer, one or both windings may be tapped at the center of the winding to provide the ground connection.

### Shielding

Two circuits that are physically near each other usually will be coupled to each other in some degree even though no coupling is intended. The metallic parts of the two circuits form a small capacitance through which energy can be transferred by means of the electric field. Also, the magnetic field about the coil or wiring of

one circuit can couple that circuit to a second through the latter's coil and wiring. In many cases these unwanted couplings must be prevented if the circuits are to work properly.

Capacitive coupling may readily be prevented by enclosing one or both of the circuits in grounded low-resistance metallic containers, called **shields**. The electric field from the circuit components does not penetrate the shield. A metallic plate, called a **baffle shield**, inserted between two components also may suffice to prevent electrostatic coupling between them. It should be large enough to make the components invisible to each other.

Similar metallic shielding is used at radio frequencies to prevent magnetic coupling. The shielding effect for magnetic fields increases with frequency and with the conductivity and thickness of the shielding material.

A closed shield is required for good magnetic shielding; in some cases separate shields, one about each coil, may be required. The baffle shield is rather ineffective for magnetic shielding, al-

though it will give partial shielding if placed at right angles to the axes of, and between, the coils to be shielded from each other.

Shielding a coil reduces its inductance, because part of its field is canceled by the shield. Also, there is always a small amount of resistance in the shield, and there is therefore an energy loss. This loss raises the effective resistance of the coil. The decrease in inductance and increase in resistance lower the  $Q$  of the coil, but the reduction in inductance and  $Q$  will be small if the spacing between the sides of the coil and the shield is at least half the coil diameter, and if the spacing at the ends of the coil is at least equal to the coil diameter. The higher the conductivity of the shield material, the less the effect on the inductance and  $Q$ . Copper is the best material, but aluminum is quite satisfactory.

For good magnetic shielding at audio frequencies it is necessary to enclose the coil in a container of high-permeability iron or steel. In this case the shield can be quite close to the coil without harming its performance.

## U.H.F. CIRCUITS

### RESONANT LINES

In resonant circuits as employed at the lower frequencies it is possible to consider each of the reactance components as a separate entity. The fact that an inductor has a certain amount of self-capacitance, as well as some resistance, while a capacitor also possesses a small self-inductance, can usually be disregarded.

At the very-high and ultrahigh frequencies it is not readily possible to separate these components. Also, the connecting leads, which at lower frequencies would serve merely to join the capacitor and coil, now may have more inductance than the coil itself. The required inductance coil may be no more than a single turn of wire, yet even this single turn may have dimensions comparable to a wavelength at the operating frequency. Thus the energy in the field surrounding the "coil" may in part be radiated. At a sufficiently high frequency the loss by radiation may represent a major portion of the total energy in the circuit.

For these reasons it is common practice to utilize resonant sections of transmission line as tuned circuits at frequencies above 100 Mc. or so. A quarter-wavelength line, or any odd multiple thereof, shorted at one end and open at the other exhibits large standing waves, as described in the section on transmission lines. When a voltage of the frequency at which such a line is resonant is applied to the open end, the response is very similar to that of a parallel resonant circuit. The equivalent relationships are shown in Fig. 2-60. At frequencies off resonance the line displays qualities comparable with the inductive and capacitive reactances of a conventional tuned circuit, so sections of transmission line can be used in much the same manner as inductors and capacitors.

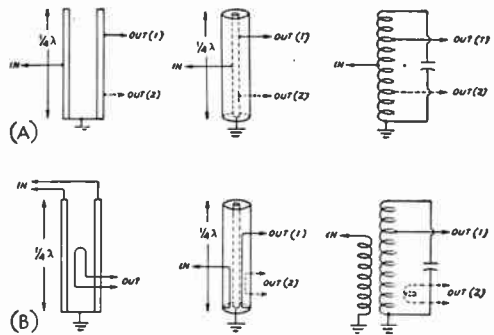

Fig. 2-60—Equivalent coupling circuits for parallel-line, coaxial-line and conventional resonant circuits.

To minimize radiation loss the two conductors of a parallel-conductor line should not be more than about one-tenth wavelength apart, the spacing being measured between the conductor axes. On the other hand, the spacing should not be less than about twice the conductor diameter because of "proximity effect," which causes eddy currents and an increase in loss. Above 300 Mc. it is difficult to satisfy both these requirements simultaneously, and the radiation from an open line tends to become excessive, reducing the  $Q$ . In such case the coaxial type of line is to be preferred, since it is inherently shielded.

Representative methods for adjusting coaxial lines to resonance are shown in Fig. 2-61. At the left, a sliding shorting disk is used to reduce the effective length of the line by altering the position of the short-circuit. In the center, the same effect is accomplished by using a telescoping tube in the end of the inner conductor to vary its length and thereby the effective length of the line. At the right, two possible methods of using



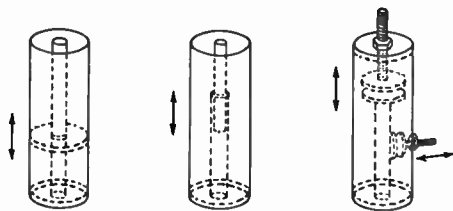

Fig. 2-61—Methods of tuning coaxial resonant lines.

parallel-plate capacitors are illustrated. The arrangement with the loading capacitor at the open end of the line has the greatest tuning effect per unit of capacitance; the alternative method, which is equivalent to tapping the capacitor down on the line, has less effect on the  $Q$  of the circuit. Lines with capacitive "loading" of the sort illustrated will be shorter, physically, than unloaded lines resonant at the same frequency.

Two methods of tuning parallel-conductor lines are shown in Fig. 2-62. The sliding short-

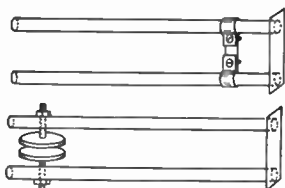

Fig. 2-62—Methods of tuning parallel-type resonant lines.

circuited strap can be tightened by means of screws and nuts to make good electrical contact. The parallel-plate capacitor in the second drawing may be placed anywhere along the line, the tuning effect becoming less as the capacitor is located nearer the shorted end of the line. Although a low-capacitance variable capacitor of ordinary construction can be used, the circular-plate type shown is symmetrical and thus does not unbalance the line. It also has the further advantage that no insulating material is required.

## WAVEGUIDES

A waveguide is a conducting tube through which energy is transmitted in the form of electromagnetic waves. The tube is not considered as carrying a current in the same sense that the wires of a two-conductor line do, but rather as a *boundary* which confines the waves to the enclosed space. Skin effect prevents any electromagnetic effects from being evident outside the guide. The energy is injected at one end, either through capacitive or inductive coupling or by radiation, and is received at the other end. The waveguide then merely confines the energy of the fields, which are propagated through it to the receiving end by means of reflections against its inner walls.

Analysis of waveguide operation is based on the assumption that the guide material is a perfect conductor of electricity. Typical distributions

of electric and magnetic fields in a rectangular guide are shown in Fig. 2-63. It will be observed that the intensity of the electric field is greatest (as indicated by closer spacing of the lines of force) at the center along the  $x$  dimension, Fig. 2-63(B), diminishing to zero at the end walls. The latter is a necessary condition, since the existence of any electric field parallel to the walls at the surface would cause an infinite current to flow in a perfect conductor. This represents an impossible situation.

### Modes of Propagation

Fig. 2-63 represents a relatively simple distribution of the electric and magnetic fields.

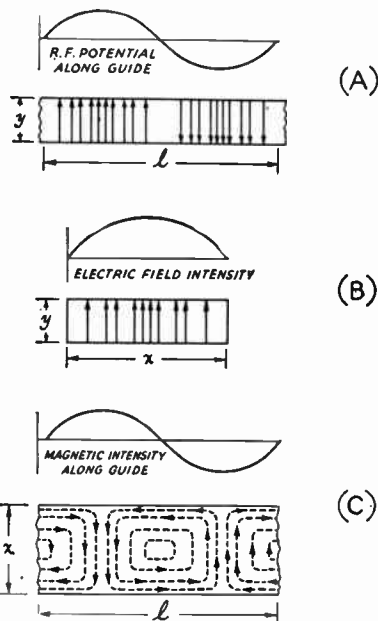

Fig. 2-63—Field distribution in a rectangular waveguide. The  $TE_{1,0}$  mode of propagation is depicted.

There is in general an infinite number of ways in which the fields can arrange themselves in a guide so long as there is no upper limit to the frequency to be transmitted. Each field configuration is called a *mode*. All modes may be separated into two general groups. One group, designated  $TM$  (*transverse magnetic*), has the magnetic field entirely transverse to the direction of propagation, but has a component of electric field in that direction. The other type, designated  $TE$  (*transverse electric*) has the electric field entirely transverse, but has a component of magnetic field in the direction of propagation.  $TM$  waves are sometimes called  $E$  waves, and  $TE$  waves are sometimes called  $H$  waves, but the  $TM$  and  $TE$  designations are preferred.

The particular mode of transmission is identified by the group letters followed by two subscript numerals; for example,  $TE_{1,0}$ ,  $TM_{1,1}$ , etc. The number of possible modes increases with



frequency for a given size of guide. There is only one possible mode (called the **dominant mode**) for the lowest frequency that can be transmitted. The dominant mode is the one generally used in practical work.

**Waveguide Dimensions**

In the rectangular guide the critical dimension is  $x$  in Fig. 2-63; this dimension must be more than one-half wavelength at the lowest frequency to be transmitted. In practice, the  $y$  dimension usually is made about equal to  $\frac{1}{2}x$  to avoid the possibility of operation at other than the dominant mode.

Other cross-sectional shapes than the rectangle can be used, the most important being the circular pipe. Much the same considerations apply as in the rectangular case.

Wavelength formulas for rectangular and circular guides are given in the following table, where  $x$  is the width of a rectangular guide and  $r$  is the radius of a circular guide. All figures are in terms of the dominant mode.

	Rectangular	Circular
Cut-off wavelength . . . . .	$2x$	$3.41r$
Longest wavelength transmitted with little attenuation . . . . .	$1.6x$	$3.2r$
Shortest wavelength before next mode becomes possible . . . . .	$1.1x$	$2.8r$

**Cavity Resonators**

Another kind of circuit particularly applicable at wavelengths of the order of centimeters is the **cavity resonator**, which may be looked upon as a section of a waveguide with the dimensions chosen so that waves of a given length can be maintained inside.

Typical shapes used for resonators are the cylinder, the rectangular box and the sphere, as shown in Fig. 2-64. The resonant frequency depends upon the dimensions of the cavity and the mode of oscillation of the waves (comparable to

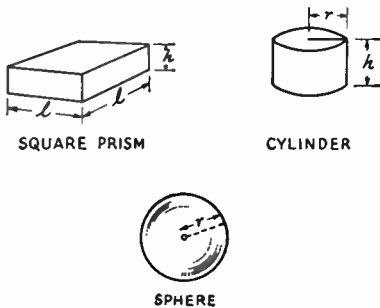

Fig. 2-64—Forms of cavity resonators.

the transmission modes in a waveguide). For the lowest modes the resonant wavelengths are as follows:

Cylinder . . . . .	$2.61r$
Square box . . . . .	$1.41l$
Sphere . . . . .	$2.28r$

The resonant wavelengths of the cylinder and square box are independent of the height when the height is less than a half wavelength. In other modes of oscillation the height must be a multiple of a half wavelength as measured inside the cavity. A cylindrical cavity can be tuned by a sliding shorting disk when operating in such a mode. Other tuning methods include placing adjustable tuning paddles or "slugs" inside the cavity so that the standing-wave pattern of the electric and magnetic fields can be varied.

A form of cavity resonator in practical use is the re-entrant cylindrical type shown in Fig. 2-65. In construction it resembles a concentric line closed at both ends with capacitive loading at the top, but the actual mode of oscillation may

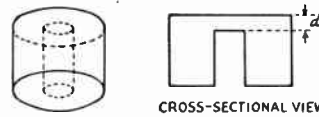

Fig. 2-65—Re-entrant cylindrical cavity resonator.

differ considerably from that occurring in coaxial lines. The resonant frequency of such a cavity depends upon the diameters of the two cylinders and the distance  $d$  between the cylinder ends.

Compared with ordinary resonant circuits, cavity resonators have extremely high  $Q$ . A value of  $Q$  of the order of 1000 or more is readily obtainable, and  $Q$  values of several thousand can be secured with good design and construction.

**Coupling to Waveguides and Cavity Resonators**

Energy may be introduced into or abstracted from a waveguide or resonator by means of either the electric or magnetic field. The energy transfer frequently is through a coaxial line, two methods for coupling to which are shown in Fig. 2-66. The probe shown at A is simply a short extension of the inner conductor of the coaxial line, so oriented that it is parallel to the electric lines of force. The loop shown at B is arranged so that it encloses some of the magnetic lines of force. The point at which maximum coupling will be secured depends upon the particular mode of propagation in the guide or cavity; the coupling will be maximum when the coupling device is in the most intense field.

Coupling can be varied by turning the probe or loop through a 90-degree angle. When the probe is perpendicular to the electric lines the coupling will be minimum; similarly, when the plane of the loop is parallel to the magnetic lines the coupling will have its minimum value.

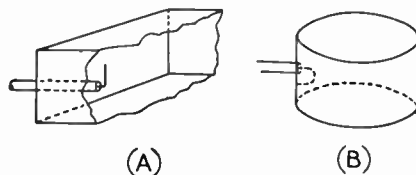

Fig. 2-66—Coupling to waveguides and resonators.

## MODULATION, HETERODYNING AND BEATS

Since one of the most widespread uses of radio frequencies is the transmission of speech and music, it would be very convenient if the audio spectrum to be transmitted could simply be shifted up to some radio frequency, transmitted as radio waves, and shifted back down to audio at the receiving point. Suppose the audio signal to be transmitted by radio is a pure 1000-cycle tone, and we wish to transmit it at 1 Mc. (1,000,000 cycles per second). One possible way might be to add 1,000 Mc. and 1 kc. together, thereby obtaining a radio frequency of 1.001 Mc. No simple method for doing this directly has been devised, although the *effect* is obtained and used in "single-sideband transmission."

When two different frequencies are present simultaneously in an ordinary circuit (specifically, one in which Ohm's Law holds) each be-

haves as though the other were not there. The total or resultant voltage (or current) in the circuit will be the sum of the instantaneous values of the two at every instant. This is because there can be only one value of current or voltage at any single point in a circuit at any instant. Figs. 2-67A and B show two such frequencies, and C shows the resultant. The amplitude of the 1-Mc. current is not affected by the presence of the 1-kc. current, but the axis is shifted back and forth at the 1-kc. rate. An attempt to transmit such a combination as a radio wave would result in only the radiation of the 1-Mc. frequency, since the 1-kc. frequency retains its identity as an audio frequency and will not radiate.

There are devices, however, which make it possible for one frequency to control the amplitude of the other. If, for example, a 1-kc. tone is used to control a 1-Mc. signal, the maximum r.f. output will be obtained when the 1-kc. signal is at the peak of one alternation and the minimum will occur at the peak of the next alternation. The process is called **amplitude modulation**, and the effect is shown in Fig. 2-67D. The resultant signal is now entirely at radio frequency, but with its amplitude varying at the modulation rate (1 kc.). Receiving equipment adjusted to receive the 1-Mc. r.f. signal can reproduce these changes in amplitude, and reveal what the audio signal is, through a process called **detection**.

It might be assumed that the only radio frequency present in such a signal is the original 1,000 Mc., but such is not the case. Two new frequencies have appeared. These are the sum ( $1.000 + .001$ ) and the difference ( $1.000 - .001$ ) of the two, and thus the radio frequencies appearing after modulation are 1.001, 1.000 and .999 Mc.

When an audio frequency is used to control the amplitude of a radio frequency, the process is generally called "amplitude modulation," as mentioned, but when a radio frequency modulates another radio frequency it is called **heterodyning**. The processes are identical. A general term for the sum and difference frequencies generated during heterodyning or amplitude modulation is "**beat frequencies**," and a more specific one is **upper side frequency**, for the sum, and **lower side frequency** for the difference.

In the simple example, the modulating signal was assumed to be a pure tone, but the modulating signal can just as well be a *band* of frequencies making up speech or music. In this case, the side frequencies are grouped into the **upper sideband** and the **lower sideband**. Fig. 2-67H shows the side frequencies appearing as a result of the modulation process.

Amplitude modulation (a.m.) is not the only possible type nor is it the only one in use. Such signal properties as phase and frequency can also be modulated. In every case the modulation process leads to the generation of a new set (or sets) of radio frequencies symmetrically disposed about the original radio (**carrier**) frequency.

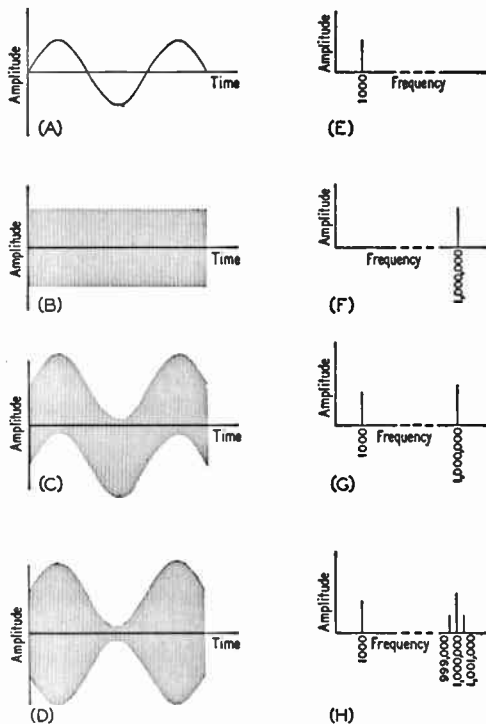

Fig. 2-67—Amplitude-vs.-time and amplitude-vs.-frequency plots of various signals. (A)  $1\frac{1}{2}$  cycles of an audio signal, assumed to be 1000 c.p.s. in this example. (B) A radio-frequency signal, assumed to be 1 Mc.; 1500 cycles are completed during the same time as the  $1\frac{1}{2}$  cycles in A, so they cannot be shown accurately. (C) The signals of A and B in the same circuit; each maintains its own identity. (D) The signals of A and B in a circuit where the amplitude of A can control the amplitude of B. The 1-Mc. signal is modulated by the 1000-cycle signal.

E, F, G and H show the spectrums for the signals in A, B, C and D, respectively. Note the new frequencies in H, resulting from the modulation process.

# Vacuum-Tube Principles

## CURRENT IN A VACUUM

The outstanding difference between the vacuum tube and most other electrical devices is that the electric current does not flow through a conductor but through empty space—a vacuum. This is only possible when “free” electrons—that is, electrons that are not attached to atoms—are somehow introduced into the vacuum. Free electrons in an evacuated space will be attracted to a positively charged object within the same space, or will be repelled by a negatively charged object. The movement of the electrons under the attraction or repulsion of such charged objects constitutes the current in the vacuum.

The most practical way to introduce a sufficiently large number of electrons into the evacuated space is by **thermionic emission**.

### Thermionic Emission

If a thin wire or filament is heated to incandescence in a vacuum, electrons near the surface are given enough energy of motion to fly off into the surrounding space. The higher the temperature, the greater the number of electrons emitted. A more general name for the filament is **cathode**.

If the cathode is the only thing in the vacuum, most of the emitted electrons stay in its immediate vicinity, forming a “cloud” about the cath-



Representative tube types. Transmitting tubes having up to 500-watt capability are shown in the back row. The tube with the top cap in the middle row is a low-power transmitting type. Others are receiving tubes, with the exception of the one in the center foreground which is a v.h.f. transmitting type.

ode. The reason for this is that the electrons in the space, being negative electricity, form a negative charge (**space charge**) in the region of the cathode. The space charge repels those electrons nearest the cathode, tending to make them fall back on it.

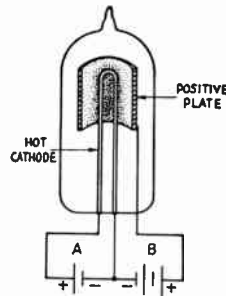

Fig. 3-1—Conduction by thermionic emission in a vacuum tube. The A battery is used to heat the filament to a temperature that will cause it to emit electrons. The B battery makes the plate positive with respect to the filament, thereby causing the emitted electrons to be attracted to the plate. Electrons captured by the plate flow back through the B battery to the filament.

Now suppose a second conductor is introduced into the vacuum, but not connected to anything else inside the tube. If this second conductor is given a positive charge by connecting a source of e.m.f. between it and the cathode, as indicated in Fig. 3-1, electrons emitted by the cathode are attracted to the positively charged conductor. An electric current then flows through the circuit formed by the cathode, the charged conductor, and the source of e.m.f. In Fig. 3-1 this e.m.f. is supplied by a battery (“B” battery); a second battery (“A” battery) is also indicated for heating the cathode or filament to the proper operating temperature.

The positively charged conductor is usually a metal plate or cylinder (surrounding the cathode) and is called an **anode** or **plate**. Like the other working parts of a tube, it is a **tube element** or **electrode**. The tube shown in Fig. 3-1 is a **two-element** or **two-electrode** tube, one element being the cathode or filament and the other the anode or plate.

Since electrons are negative electricity, they will be attracted to the plate *only* when the plate is positive with respect to the cathode. If the plate is given a negative charge, the

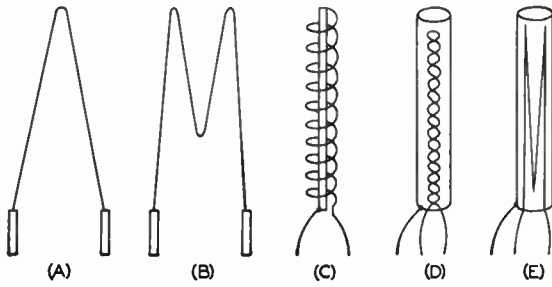

Fig. 3-2—Types of cathode construction. Directly heated cathodes or filaments are shown at A, B, and C. The inverted V filament is used in small receiving tubes, the M in both receiving and transmitting tubes. The spiral filament is a transmitting-tube type. The indirectly-heated cathodes at D and E show two types of heater construction, one a twisted loop and the other bunched heater wires. Both types tend to cancel the magnetic fields set up by the current through the heater.

electrons will be repelled back to the cathode and no current will flow. The vacuum tube therefore can conduct *only in one direction*.

### Cathodes

Before electron emission can occur, the cathode must be heated to a high temperature. However, it is not essential that the heating current flow through the actual material that does the emitting; the filament or heater can be electrically separate from the emitting cathode. Such a cathode is called **indirectly heated**, while an emitting filament is called **directly heated**. Fig. 3-2 shows both types in the forms in which they are commonly used.

Much greater electron emission can be obtained, at relatively low temperatures, by using special cathode materials rather than pure metals. One of these is **thoriated tungsten**, or tungsten in which thorium is dissolved. Still greater efficiency is achieved in the **oxide-coated cathode**, a cathode in which rare-earth oxides form a coating over a metal base.

Although the oxide-coated cathode has much the highest efficiency, it can be used successfully only in tubes that operate at rather low plate voltages. Its use is therefore confined to receiving-type tubes and to the smaller varieties of transmitting tubes. The thoriated filament, on the other hand, will operate well in high-voltage tubes.

### Plate Current

If there is only a small positive voltage on the plate, the number of electrons reaching it will be small because the space charge (which is negative) prevents those electrons nearest the cathode from being attracted to the plate. As the plate voltage is increased, the effect of the space charge is increasingly overcome and the number of electrons attracted to the plate becomes larger. That is, the **plate current** increases with increasing plate voltage.

Fig. 3-3 shows a typical plot of plate current *vs.* plate voltage for a two-element tube or **diode**. A curve of this type can be obtained with the circuit shown, if the plate voltage is increased in small steps and a current reading taken (by means of the current-indicating instrument—a milliammeter) at each voltage. The plate current is zero with no plate voltage and the curve rises until a **saturation point** is reached. This is where the positive charge on the plate has substantially overcome the space charge and almost all the electrons are going to the plate. At higher voltages the plate current stays at practically the same value.

The plate voltage multiplied by the plate current is the **power** input to the tube. In a circuit like that of Fig. 3-3 this power is all used in heating the plate. If the power input is large, the plate temperature may rise to a very high value (the plate may become red or even white hot). The heat developed in the plate is radiated to the bulb of the tube, and in turn radiated by the bulb to the surrounding air.

### RECTIFICATION

Since current can flow through a tube in only one direction, a diode can be used to change alternating current into direct current. It does this by permitting current to flow when the plate is positive with respect to the cathode, but by shutting off current flow when the plate is negative.

Fig. 3-4 shows a representative circuit. Alternating voltage from the secondary of the transformer, *T*, is applied to the diode tube in series with a **load resistor**, *R*. The voltage varies as is usual with a.c., but current flows through the tube and *R* only when the plate is positive with respect to the cathode—that is, during the half-cycle when the upper end of the transformer winding is positive. During the negative half-cycle there is simply a gap in the current flow. This **rectified** alternating current therefore is an **intermittent** direct current.

The load resistor, *R*, represents the actual circuit in which the rectified alternating current does work. All tubes work with a load of one type or another; in this respect a tube is much like a generator or transformer. A circuit that did not

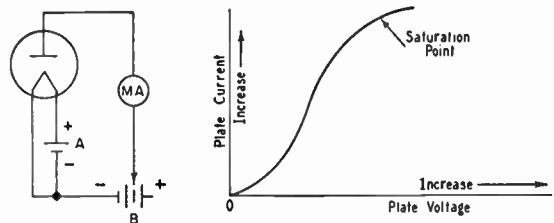

Fig. 3-3—The diode, or two-element tube, and a typical curve showing how the plate current depends upon the voltage applied to the plate.

provide a load for the tube would be like a short-circuit across a transformer; no useful purpose would be accomplished and the only result would be the generation of heat in the transformer. So it is with vacuum tubes; they must cause power to be developed in a load in order to serve a useful purpose. Also, to be *efficient* most of the power must do useful work in the load and not be used in heating the plate of the tube. Thus the voltage drop across the load should be much higher than the drop across the diode.

With the diode connected as shown in Fig. 3-4,

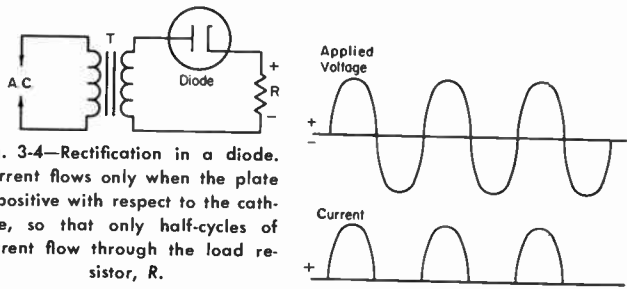

Fig. 3-4—Rectification in a diode. Current flows only when the plate is positive with respect to the cathode, so that only half-cycles of current flow through the load resistor,  $R$ .

the polarity of the current through the load is as indicated. If the diode were reversed, the polarity of the voltage developed across the load  $R$  would be reversed.

## VACUUM-TUBE AMPLIFIERS

### TRIODES

#### Grid Control

If a third element—called the **control grid**, or simply **grid**—is inserted between the cathode and plate as in Fig. 3-5, it can be used to control the effect of the space charge. If the grid is given a positive voltage with respect to the cathode, the positive charge will tend to neutralize the negative space charge. The result is that, at any

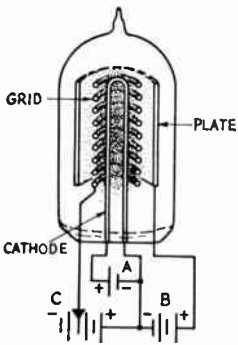

Fig. 3-5—Construction of an elementary triode vacuum tube, showing the directly-heated cathode (filament), grid (with an end view of the grid wires) and plate. The relative density of the space charge is indicated roughly by the dot density.

selected plate voltage, more electrons will flow to the plate than if the grid were not present. On the other hand, if the grid is made negative with respect to the cathode the negative charge on the grid will add to the space charge. This will reduce the number of electrons that can reach the plate at any selected plate voltage.

The grid is inserted in the tube to control the space charge and not to attract electrons to itself, so it is made in the form of a wire mesh or spiral. Electrons then can go through the open spaces in the grid to reach the plate.

#### Characteristic Curves

For any particular tube, the effect

of the grid voltage on the plate current can be shown by a set of **characteristic curves**. A typical set of curves is shown in Fig. 3-6, together with the circuit that is used for getting them. For each value of plate voltage, there is a value of negative grid voltage that will reduce the plate current to zero; that is, there is a value of negative grid voltage that will cut off the plate current.

The curves could be extended by making the grid voltage positive as well as negative. When the grid is negative, it repels electrons and therefore none of them reaches it; in other words, no current flows in the grid circuit. However, when the grid is positive, it attracts electrons and a current (**grid current**) flows, just as current flows to the positive plate. Whenever there is grid current there is an accompanying power loss in the grid circuit, but so long as the grid is negative no power is used.

It is obvious that the grid can act as a valve to control the flow of plate current. Actually, the grid has a much greater effect on plate current flow than does the plate voltage. A small change in grid voltage is just as effective in bringing about a given change in plate current as is a large change in plate voltage.

The fact that a small voltage acting on the grid

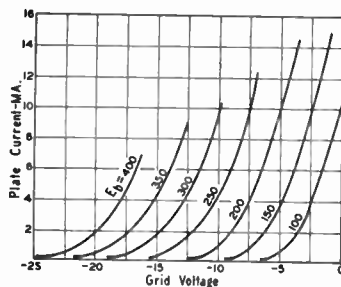
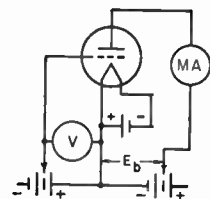

Fig. 3-6—Grid-voltage-vs.-plate-current curves at various fixed values of plate voltage ( $E_b$ ) for a typical small triode. Characteristic curves of this type can be taken by varying the battery voltages in the circuit at the right.





is equivalent to a large voltage acting on the plate indicates the possibility of **amplification** with the triode tube. The many uses of the electronic tube nearly all are based upon this amplifying feature. The amplified output is not obtained from the tube itself, but from the source of e.m.f. connected between its plate and cathode. The tube simply controls the power from this source, changing it to the desired form.

To utilize the controlled power, a load must be connected in the plate or "output" circuit, just as in the diode case. The load may be either a resistance or an impedance. The term "impedance" is frequently used even when the load is purely resistive.

### Tube Characteristics

The physical construction of a triode, determines the relative effectiveness of the grid and plate in controlling the plate current. If a very small change in the grid voltage has just as much effect on the plate current as a very large change in plate voltage, the tube is said to have a high **amplification factor**. Amplification factor is commonly designated by the Greek letter  $\mu$ . An amplification factor of 20, for example, means that if the grid voltage is changed by 1 volt, the effect on the plate current will be the same as when the plate voltage is changed by 20 volts. The amplification factors of triode tubes range from 3 to 100 or so. A high- $\mu$  tube is one with an amplification factor of perhaps 30 or more; **medium- $\mu$**  tubes have amplification factors in the approximate range 8 to 30, and **low- $\mu$**  tubes in the range below 7 or 8.

It would be natural to think that a tube that has a large  $\mu$  would be the best amplifier, but to obtain a high  $\mu$  it is necessary to construct the grid with many turns of wire per inch, or in the form of a fine mesh. This leaves a relatively small open area for electrons to go through to reach the plate, so it is difficult for the plate to attract large numbers of electrons. Quite a large change in the plate voltage must be made to effect a given change in plate current. This means that the resistance of the plate-cathode path—that is, the **plate resistance**—of the tube is high. Since this resistance acts in series with the load, the amount of current that can be made to flow through the load is relatively small. On the other hand, the plate resistance of a low- $\mu$  tube is relatively low.

The best all-around indication of the effectiveness of the tube as an amplifier is its **grid-plate transconductance**—also called **mutual conductance**. This characteristic takes account of both amplification factor and plate resistance, and therefore is a figure of merit for the tube. Transconductance is the change in plate current divided by the change in grid voltage that causes the plate-current change (the plate voltage being fixed at a desired value). Since current divided by voltage is conductance, transconductance is measured in the unit of conductance, the mho. Practical values of transconductance are very small, so the micromho (one-millionth of a mho)

is the commonly-used unit. Different types of tubes have transconductances ranging from a few hundred to several thousand. The higher the transconductance the greater the possible amplification.

### AMPLIFICATION

The way in which a tube amplifies is best shown by a type of graph called the **dynamic characteristic**. Such a graph, together with the circuit used for obtaining it, is shown in Fig. 3-7.

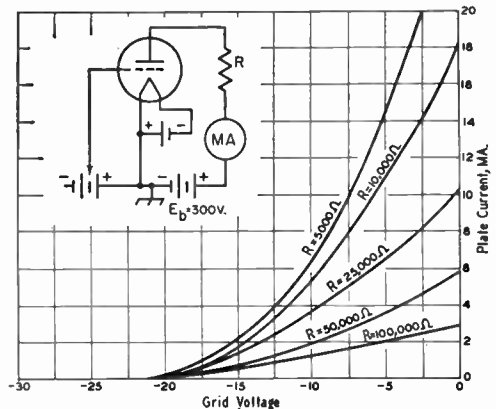

Fig. 3-7—Dynamic characteristics of a small triode with various load resistances from 5000 to 100,000 ohms.

The curves are taken with the plate-supply voltage fixed at the desired operating value. The difference between this circuit and the one shown in Fig. 3-6 is that in Fig. 3-7 a load resistance is connected in series with the plate of the tube. Fig. 3-7 thus shows how the plate current will vary, with different grid voltages, when the plate current is made to flow through a load and thus do useful work.

The several curves in Fig. 3-7 are for various values of load resistance. When the resistance is small (as in the case of the 5000-ohm load) the plate current changes rather rapidly with a given change in grid voltage. If the load resistance is high (as in the 100,000-ohm curve), the change in plate current for the same grid-voltage change is relatively small; also, the curve tends to be straighter.

Fig. 3-8 is the same type of curve, but with the circuit arranged so that a source of alternating voltage (**signal**) is inserted between the grid and the grid battery ("**C**" battery). The voltage of the grid battery is fixed at  $-5$  volts, and from the curve it is seen that the plate current at this grid voltage is 2 milliamperes. This current flows when the load resistance is 50,000 ohms, as indicated in the circuit diagram. If there is no a.c. signal in the grid circuit, the voltage drop in the load resistor is  $50,000 \times 0.002 = 100$  volts, leaving 200 volts between the plate and cathode.

When a sine-wave signal having a peak value of 2 volts is applied in series with the bias voltage in the grid circuit, the instantaneous voltage at the grid will swing to  $-3$  volts at the instant the

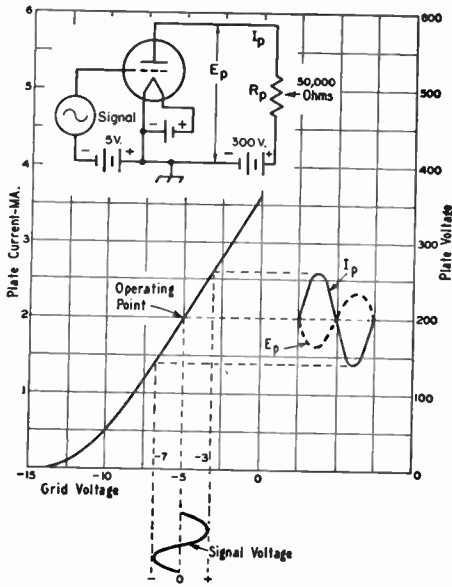

Fig. 3-8—Amplifier operation. When the plate current varies in response to the signal applied to the grid, a varying voltage drop appears across the load,  $R_p$ , as shown by the dashed curve,  $E_p$ .  $I_p$  is the plate current.

signal reaches its positive peak, and to  $-7$  volts at the instant the signal reaches its negative peak. The maximum plate current will occur at the instant the grid voltage is  $-3$  volts. As shown by the graph, it will have a value of 2.65 milliamperes. The minimum plate current occurs at the instant the grid voltage is  $-7$  volts, and has a value of 1.35 ma. At intermediate values of grid voltage, intermediate plate-current values will occur.

The instantaneous voltage between the plate and cathode of the tube also is shown on the graph. When the plate current is maximum, the instantaneous voltage drop in  $R_p$  is  $50,000 \times 0.00265 = 132.5$  volts; when the plate current is minimum the instantaneous voltage drop in  $R_p$  is  $50,000 \times 0.00135 = 67.5$  volts. The actual voltage between plate and cathode is the difference between the plate-supply potential, 300 volts, and the voltage drop in the load resistance. The plate-to-cathode voltage is therefore 167.5 volts at maximum plate current and 232.5 volts at minimum plate current.

This varying plate voltage is an a.c. voltage superimposed on the steady plate-cathode potential of 200 volts (as previously determined for no-signal conditions). The peak value of this a.c. output voltage is the difference between either the maximum or minimum plate-cathode voltage and the no-signal value of 200 volts. In the illustration this difference is  $232.5 - 200$  or  $200 - 167.5$ ; that is, 32.5 volts in either case. Since the grid signal voltage has a peak value of 2 volts, the voltage-amplification ratio of the amplifier is  $32.5/2$  or 16.25. That is, approximately 16 times as much voltage is obtained from

the plate circuit as is applied to the grid circuit.

As shown by the drawings in Fig. 3-8, the alternating component of the plate voltage swings in the *negative* direction (with reference to the no-signal value of plate-cathode voltage) when the grid voltage swings in the *positive* direction, and vice versa. This means that the alternating component of plate voltage (that is, the amplified signal) is 180 degrees out of phase with the signal voltage on the grid.

**Bias**

The fixed negative grid voltage (called **grid bias**) in Fig. 3-8 serves a very useful purpose. One object of the type of amplification shown in this drawing is to obtain, from the plate circuit, an alternating voltage that has the same wave-shape as the signal voltage applied to the grid. To do so, an **operating point** on the straight part of the curve must be selected. The curve must be straight in both directions from the operating point at least far enough to accommodate the maximum value of the signal applied to the grid. If the grid signal swings the plate current back and forth over a part of the curve that is not straight, as in Fig. 3-9, the shape of the a.c. wave in the plate circuit will not be the same as the shape of the grid-signal wave. In such a case the output wave shape will be **distorted**.

A second reason for using negative grid bias is that any signal whose peak positive voltage does not exceed the fixed negative voltage on the grid cannot cause grid current to flow. With no current flow there is no power consumption, so the tube will amplify without taking any power from the signal source. (However, if the positive peak of the signal does exceed the negative bias, current will flow in the grid circuit during the time the grid is positive.)

Distortion of the output wave shape that results

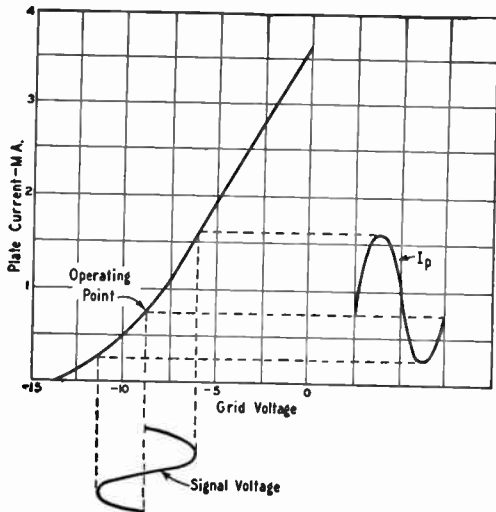

Fig. 3-9—Harmonic distortion resulting from choice of operating point on the curved part of the tube characteristic. The lower half-cycle of plate current does not have the same shape as the upper half-cycle.

from working over a part of the curve that is not straight (that is, a **nonlinear** part of the curve) has the effect of transforming a sine-wave grid signal into a more complex waveform. As explained in an earlier chapter, a complex wave can be resolved into a fundamental and a series of harmonics. In other words, distortion from nonlinearity causes the generation of harmonic frequencies—frequencies that are not present in the signal applied to the grid. Harmonic distortion is undesirable in most amplifiers, although there are occasions when harmonics are deliberately generated and used.

### Audio Amplifier Output Circuits

The useful output of a vacuum-tube amplifier is the *alternating* component of plate current or plate voltage. The d.c. voltage on the plate of the tube is essential for the tube's operation, but it almost invariably would cause difficulties if it were applied, along with the a.c. output voltage, to the load. The output circuits of vacuum tubes are therefore arranged so that the a.c. is transferred to the load but the d.c. is not.

Three types of coupling are in common use at audio frequencies. These are **resistance coupling**, **impedance coupling**, and **transformer coupling**. They are shown in Fig. 3-10. In all three cases the output is shown coupled to the grid circuit of a subsequent amplifier tube, but the same types of circuits can be used to couple to other devices than tubes.

In the resistance-coupled circuit, the a.c. voltage developed across the **plate resistor**  $R_p$  (that is, the a.c. voltage between the plate and cathode of the tube) is applied to a second resistor,  $R_g$ , through a **coupling capacitor**,  $C_c$ . The capacitor "blocks off" the d.c. voltage on the plate of the first tube and prevents it from being applied to the grid of tube  $B$ . The latter tube has negative grid bias supplied by the battery shown. No current flows on the grid circuit of tube  $B$  and there is therefore no d.c. voltage drop in  $R_g$ ; in other words, the full voltage of the bias battery is applied to the grid of tube  $B$ .

The **grid resistor**,  $R_g$ , usually has a rather high value (0.5 to 2 megohms). The reactance of the coupling capacitor,  $C_c$ , must be low enough compared with the resistance of  $R_g$  so that the a.c. voltage drop in  $C_c$  is negligible at the lowest frequency to be amplified. If  $R_g$  is at least 0.5 megohm, a 0.1- $\mu$ f. capacitor will be amply large for the usual range of audio frequencies.

So far as the alternating component of plate voltage is concerned, it will be realized that if the voltage drop in  $C_c$  is negligible then  $R_p$  and  $R_g$  are effectively in parallel (although they are quite separate so far as d.c. is concerned). The resultant parallel resistance of the two is therefore the actual load resistance for the tube. That is why  $R_g$  is made as high in resistance as possible; then it will have the least effect on the load represented by  $R_p$ .

The impedance-coupled circuit differs from that using resistance coupling only in the substitution of a high inductance (as high as several

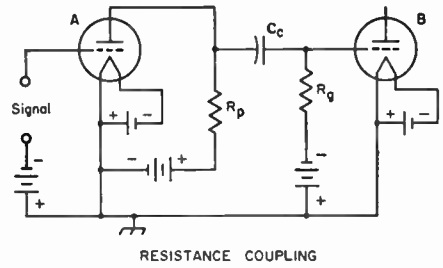

RESISTANCE COUPLING

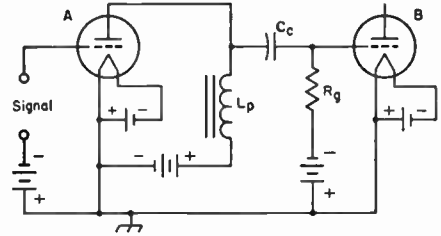

IMPEDANCE COUPLING

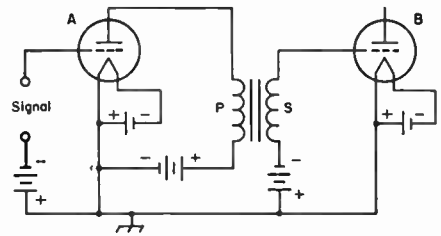

TRANSFORMER COUPLING

Fig. 3-10—Three basic forms of coupling between vacuum-tube amplifiers.

hundred henrys) for the plate resistor. The advantage of using an inductor rather than a resistor at this point is that the impedance of the inductor is high for audio frequencies, but its resistance is relatively low. Thus it provides a high value of load impedance for a.c. without an excessive d.c. voltage drop, and consequently the power-supply voltage does not have to be high for effective operation.

The transformer-coupled amplifier uses a transformer with its primary connected in the plate circuit of the tube and its secondary connected to the load (in the circuit shown, a following amplifier). There is no direct connection between the two windings, so the plate voltage on tube  $A$  is isolated from the grid of tube  $B$ . The transformer-coupled amplifier has the same advantage as the impedance-coupled circuit with respect to loss of d.c. voltage from the plate supply. Also, if the secondary has more turns than the primary, the output voltage will be "stepped up" in proportion to the turns ratio.

Resistance coupling is simple, inexpensive, and will give the same amount of amplification—or **voltage gain**—over a wide range of frequencies; it will give substantially the same amplification

at any frequency in the audio range, for example. Impedance coupling will give somewhat more gain, with the same tube and same plate-supply voltage, than resistance coupling. However, it is not quite so good over a wide frequency range; it tends to "peak," or give maximum gain, over a comparatively narrow band of frequencies. With a good transformer the gain of a transformer-coupled amplifier can be kept fairly constant over the audio-frequency range. On the other hand, transformer coupling in voltage amplifiers (see below) is best suited to triodes having amplification factors of about 20 or less, for the reason that the primary inductance of a practicable transformer cannot be made large enough to work well with a tube having high plate resistance.

### Class A Amplifiers

An amplifier in which voltage gain is the primary consideration is called a **voltage amplifier**. Maximum voltage gain is secured when the load resistance or impedance is made as high as possible in comparison with the plate resistance of the tube. In such a case, the major portion of the voltage generated will appear across the load.

Voltage amplifiers belong to a group called **Class A amplifiers**. A Class A amplifier is one operated so that the wave shape of the output voltage is the same as that of the signal voltage applied to the grid. If a Class A amplifier is biased so that the grid is always negative, even with the largest signal to be handled by the grid, it is called a **Class A<sub>1</sub> amplifier**. Voltage amplifiers are always Class A<sub>1</sub> amplifiers, and their primary use is in driving a following Class A<sub>1</sub> amplifier.

### Power Amplifiers

The end result of any amplification is that the amplified signal does some work. For example, an audio-frequency amplifier usually drives a loudspeaker that in turn produces sound waves. The greater the amount of a.f. power supplied to the speaker the louder the sound it will produce.

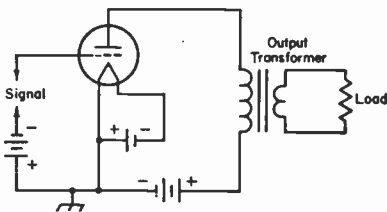

Fig. 3-11—An elementary power-amplifier circuit in which the power-consuming load is coupled to the plate circuit through an impedance-matching transformer.

Fig. 3-11 shows an elementary power-amplifier circuit. It is simply a transformer-coupled amplifier with the load connected to the secondary. Although the load is shown as a resistor, it actually would be some device, such as a loudspeaker, that employs the power usefully. Every power tube requires a specific value of load re-

sistance from plate to cathode, usually some thousands of ohms, for optimum operation. The resistance of the actual load is rarely the right value for "matching" this optimum load resistance, so the transformer turns ratio is chosen to reflect the proper value of resistance into the primary. The turns ratio may be either step-up or step-down, depending on whether the actual load resistance is higher or lower than the load the tube wants.

The **power-amplification ratio** of an amplifier is the ratio of the power output obtained from the plate circuit to the power required from the a.c. signal in the grid circuit. There is no power lost in the grid circuit of a Class A<sub>1</sub> amplifier, so such an amplifier has an infinitely large power-amplification ratio. However, it is quite possible to operate a Class A amplifier in such a way that current flows in its grid circuit during at least part of the cycle. In such a case power is used up in the grid circuit and the power amplification ratio is not infinite. A tube operated in this fashion is known as a **Class A<sub>2</sub> amplifier**. It is necessary to use a power amplifier to drive a Class A<sub>2</sub> amplifier, because a voltage amplifier cannot deliver power without serious distortion of the wave shape.

Another term used in connection with power amplifiers is **power sensitivity**. In the case of a Class A<sub>1</sub> amplifier, it means the ratio of power output to the grid signal voltage that causes it. If grid current flows, the term usually means the ratio of plate power output to grid power input.

The a.c. power that is delivered to a load by an amplifier tube has to be paid for in power taken from the source of plate voltage and current. In fact, there is always more power going into the plate circuit of the tube than is coming out as useful output. The difference between the input and output power is used up in heating the plate of the tube, as explained previously. The ratio of useful power output to d.c. plate input is called the **plate efficiency**. The higher the plate efficiency, the greater the amount of power that can be taken from a tube having a given plate-dissipation rating.

### Parallel and Push-Pull

When it is necessary to obtain more power output than one tube is capable of giving, two or more similar tubes may be connected in **parallel**. In this case the similar elements in all tubes are connected together. This method is shown in Fig. 3-12 for a transformer-coupled amplifier. The power output is in proportion to the number of tubes used; the grid signal or **exciting voltage** required, however, is the same as for one tube.

If the amplifier operates in such a way as to consume power in the grid circuit, the grid power required is in proportion to the number of tubes used.

An increase in power output also can be secured by connecting two tubes in **push-pull**. In this case the grids and plates of the two tubes are connected to opposite ends of a balanced circuit as shown in Fig. 3-12. At any instant the



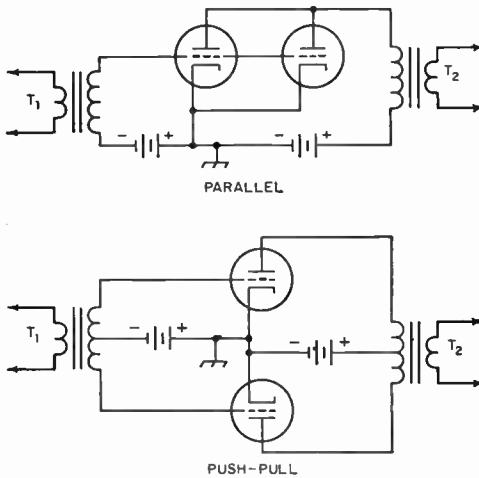

Fig. 3-12—Parallel and push-pull a.f. amplifier circuits.

ends of the secondary winding of the input transformer,  $T_1$ , will be at opposite polarity with respect to the cathode connection, so the grid of one tube is swung positive at the same instant that the grid of the other is swung negative. Hence, in any push-pull-connected amplifier the voltages and currents of one tube are out of phase with those of the other tube.

In push-pull operation the even-harmonic (second, fourth, etc.) distortion is balanced out in the plate circuit. This means that for the same power output the distortion will be less than with parallel operation.

The exciting voltage measured between the two grids must be twice that required for one tube. If the grids consume power, the driving power for the push-pull amplifier is twice that taken by either tube alone.

### Cascade Amplifiers

It is readily possible to take the output of one amplifier and apply it as a signal on the grid of a second amplifier, then take the second amplifier's output and apply it to a third, and so on. Each amplifier is called a **stage**, and stages used successively are said to be in **cascade**.

### Class B Amplifiers

Fig 3-13 shows two tubes connected in a push-pull circuit. If the grid bias is set at the point where (when no signal is applied) the plate current is just cut off, then a signal can cause plate current to flow in either tube only when the signal voltage applied to that particular tube is positive with respect to the cathode. Since in the balanced grid circuit the signal voltages on the grids of the two tubes always have opposite polarities, plate current flows only in one tube at a time.

The graphs show the operation of such an amplifier. The plate current of tube *B* is drawn inverted to show that it flows in the opposite direction, through the primary of the output transformer, to the plate current of tube *A*. Thus each

half of the output-transformer primary works alternately to induce a half-cycle of voltage in the secondary. In the secondary of  $T_2$ , the original waveform is restored. This type of operation is called **Class B amplification**.

The Class B amplifier has considerably higher plate efficiency than the Class A amplifier. Furthermore, the d.c. plate current of a Class B amplifier is proportional to the signal voltage on the grids, so the power input is small with small signals. The d.c. plate power input to a Class A amplifier is the same whether the signal is large, small, or absent altogether; therefore the maximum d.c. plate input that can be applied to a Class A amplifier is equal to the rated plate dissipation of the tube or tubes. Two tubes in a Class B amplifier can deliver approximately twelve times as much audio power as the same two tubes in a Class A amplifier.

A Class B amplifier usually is operated in such a way as to secure the maximum possible power output. This requires rather large values of plate current, and to obtain them the signal voltage must completely overcome the grid bias during at least part of the cycle, so grid current flows and the grid circuit consumes power. While the power requirements are fairly low (as compared with the power output), the fact that the grids are positive during only part of the cycle means that the load on the preceding amplifier or **driver stage** varies in magnitude during the cycle; the effective load resistance is high when the grids are not drawing current and relatively low when they do take current. This must be allowed for when designing the driver.

Certain types of tubes have been designed specifically for Class B service and can be operated without fixed or other form of grid bias (**zero-bias tubes**). The amplification factor is so high that the plate current is small without signal. Because there is no fixed bias, the grids start drawing current immediately whenever a

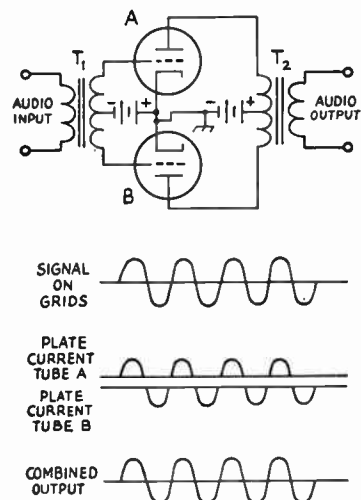

Fig. 3-13—Class B amplifier operation.



signal is applied, so the grid-current flow is continuous throughout the cycle. This makes the load on the driver much more constant than is the case with tubes of lower  $\mu$  biased to plate-current cut-off.

Class B amplifiers used at radio frequencies are known as **linear amplifiers** because they are adjusted to operate in such a way that the power output is proportional to the square of the r.f. exciting voltage. This permits amplification of a modulated r.f. signal without distortion. Push-pull is not required in this type of operation; a single tube can be used equally well.

### Class AB Amplifiers

A **Class AB amplifier** is a push-pull amplifier with higher bias than would be normal for pure Class A operation, but less than the cut-off bias required for Class B. At low signal levels the tubes operate practically as Class A amplifiers, and the plate current is the same with or without signal. At higher signal levels, the plate current of one tube is cut off during part of the negative cycle of the signal applied to its grid, and the plate current of the other tube rises with the signal. The plate current for the whole amplifier also rises above the no-signal level when a large signal is applied.

In a properly designed Class AB amplifier the distortion is as low as with a Class A stage, but the efficiency and power output are considerably higher than with pure Class A operation. A Class AB amplifier can be operated either with or without driving the grids into the positive region. A **Class AB<sub>1</sub> amplifier** is one in which the grids are never positive with respect to the cathode; therefore, no driving power is required—only voltage. A **Class AB<sub>2</sub> amplifier** is one that has grid-current flow during part of the cycle if the applied signal is large; it takes a small amount of driving power. The Class AB<sub>2</sub> amplifier will deliver somewhat more power (using the same tubes) but the Class AB<sub>1</sub> amplifier avoids the problem of designing a driver that will deliver power, without distortion, into a load of highly variable resistance.

### Operating Angle

Inspection of Fig. 3-13 shows that either of the two tubes actually is working for only half the a.c. cycle and idling during the other half. It is convenient to describe the amount of time during which plate current flows in terms of electrical degrees. In Fig. 3-13 each tube has "180-degree" excitation, a half-cycle being equal to 180 degrees. The number of degrees during which plate current flows is called the **operating angle** of the amplifier. From the descriptions given above, it should be clear that a Class A amplifier has 360-degree excitation, because plate current flows during the whole cycle. In a Class AB amplifier the operating angle is between 180 and 360 degrees (in each tube) depending on the particular operating conditions chosen. The greater the amount of negative grid bias, the smaller the operating angle becomes.

An operating angle of less than 180 degrees leads to a considerable amount of distortion, because there is no way for the tube to reproduce even a half-cycle of the signal on its grid. Using two tubes in push-pull, as in Fig 3-13, would merely put together two distorted half-cycles. An operating angle of less than 180 degrees therefore cannot be used if distortionless output is wanted.

### Class C Amplifiers

In power amplifiers operating at radio frequencies distortion of the r.f. wave form is relatively unimportant. For reasons described later in this chapter, an r.f. amplifier must be operated with tuned circuits, and the selectivity of such circuits "filters out" the r.f. harmonics resulting from distortion.

A radio-frequency power amplifier therefore can be used with an operating angle of less than 180 degrees. This is called **Class C** operation. The advantage is that plate efficiency is increased, because the loss in the plate is proportional, among other things, to the amount of time during which the plate current flows, and this time is reduced by decreasing the operating angle.

Depending on the type of tube, the optimum load resistance for a Class C amplifier ranges from about 1500 to 5000 ohms. It is usually secured by using tuned-circuit arrangements, of the type described in the chapter on circuit fundamentals, to transform the resistance of the actual load to the value required by the tube. The grid is driven well into the positive region, so that grid current flows and power is consumed in the grid circuit. The smaller the operating angle, the greater the driving voltage and the larger the grid driving power required to develop full output in the load resistance. The best compromise between driving power, plate efficiency, and power output usually results when the minimum plate voltage (at the peak of the driving cycle, when the plate current reaches its highest value) is just equal to the peak positive grid voltage. Under these conditions the operating angle is usually between 150 and 180 degrees and the plate efficiency lies in the range of 70 to 80 percent. While higher plate efficiencies are possible, attaining them requires excessive driving power and grid bias, together with higher plate voltage than is "normal" for the particular tube type.

With proper design and adjustment, a Class C amplifier can be made to operate in such a way that the power input and output are proportional to the square of the applied plate voltage. This is an important consideration when the amplifier is to be plate-modulated for radiotelephony, as described in the chapter on amplitude modulation.

### FEEDBACK

It is possible to take a part of the amplified energy in the plate circuit of an amplifier and insert it into the grid circuit. When this is done the amplifier is said to have **feedback**.

If the voltage that is inserted in the grid circuit is 180 degrees out of phase with the signal

voltage acting on the grid, the feedback is called **negative**, or **degenerative**. On the other hand, if the voltage is fed back in phase with the grid signal, the feedback is called **positive**, or **regenerative**.

### Negative Feedback

With negative feedback the voltage that is fed back opposes the signal voltage. This decreases the amplitude of the voltage acting between the grid and cathode and thus has the effect of reducing the voltage amplification. That is, a larger exciting voltage is required for obtaining the same output voltage from the plate circuit.

The greater the amount of negative feedback (when properly applied) the more independent the amplification becomes of tube characteristics and circuit conditions. This tends to make the frequency-response characteristic of the amplifier **flat**—that is, the amplification tends to be the same at all frequencies within the range for which the amplifier is designed. Also, any distortion generated in the plate circuit of the tube tends to “buck itself out.” Amplifiers with negative feedback are therefore comparatively free from harmonic distortion. These advantages are worth while if the amplifier otherwise has enough voltage gain for its intended use.

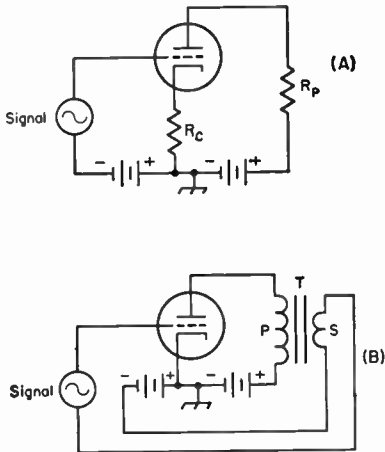

Fig. 3-14—Simple circuits for producing feedback.

In the circuit shown at A in Fig. 3-14 resistor  $R_c$  is in series with the regular plate resistor,  $R_p$ , and thus is a part of the load for the tube. Therefore, part of the output voltage will appear across  $R_c$ . However,  $R_c$  also is connected in series with the grid circuit, and so the output voltage that appears across  $R_c$  is in series with the signal voltage. The output voltage across  $R_c$  opposes the signal voltage, so the actual a.c. voltage between the grid and cathode is equal to the *difference* between the two voltages.

The circuit shown at B in Fig. 3-14 can be used to give either negative or positive feedback. The secondary of a transformer is connected back into the grid circuit to insert a desired amount of

feedback voltage. Reversing the terminals of either transformer winding (but not both simultaneously) will reverse the phase.

### Positive Feedback

Positive feedback increases the amplification because the feedback voltage adds to the original signal voltage and the resulting larger voltage on the grid causes a larger output voltage. The amplification tends to be greatest at one frequency (which depends upon the particular circuit arrangement) and harmonic distortion is increased. If enough energy is fed back, a self-sustaining oscillation—in which energy at essentially one frequency is generated by the tube itself—will be set up. In such case all the signal voltage on the grid can be supplied from the plate circuit; no external signal is needed because any small irregularity in the plate current—and there are always some such irregularities—will be amplified and thus give the oscillation an opportunity to build up. Positive feedback finds a major application in such “oscillators,” and in addition is used for selective amplification at both audio and radio frequencies, the feedback being kept below the value that causes self-oscillation.

### INTERELECTRODE CAPACITANCES

Each pair of elements in a tube forms a small capacitor, with each element acting as a capacitor “plate.” There are three such capacitances in a triode—that between the grid and cathode, that between the grid and plate, and that between the plate and cathode. The capacitances are very small—only a few micromicrofarads at most—but they frequently have a very pronounced effect on the operation of an amplifier circuit.

### Input Capacitance

It was explained perviously that the a.c. grid voltage and a.c. plate voltage of an amplifier having a resistive load are 180 degrees out of phase, using the cathode of the tube as a reference point. However, these two voltages are *in phase* going around the circuit from plate to grid as shown in Fig. 3-15. This means that their sum is acting between the grid and plate; that is, across the grid-plate capacitance of the tube.

As a result, a capacitive current flows around the circuit, its amplitude being directly proportional to the sum of the a.c. grid and plate

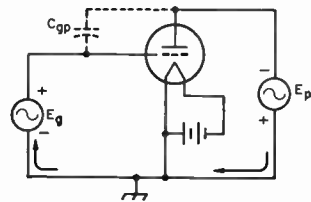

Fig. 3-15—The a.c. voltage appearing between the grid and plate of the amplifier is the sum of the signal voltage and the output voltage, as shown by this simplified circuit. Instantaneous polarities are indicated.

voltages and to the grid-plate capacitance. The source of grid signal must furnish this amount of current, in addition to the capacitive current that flows in the grid-cathode capacitance. Hence the signal source "sees" an effective capacitance that is larger than the grid-cathode capacitance. This is known as the **Miller Effect**.

The greater the voltage amplification the greater the effective input capacitance. The input capacitance of a resistance-coupled amplifier is given by the formula

$$C_{\text{input}} = C_{\text{gk}} + C_{\text{gp}}(A + 1)$$

where  $C_{\text{gk}}$  is the grid-to-cathode capacitance,  $C_{\text{gp}}$  is the grid-to-plate capacitance, and  $A$  is the voltage amplification. The input capacitance may be as much as several hundred micromicrofarads when the voltage amplification is large, even though the interelectrode capacitances are quite small.

### Output Capacitance

The principal component of the output capacitance of an amplifier is the actual plate-to-cathode capacitance of the tube. The output capacitance usually need not be considered in audio amplifiers, but becomes of importance at radio frequencies.

### Tube Capacitance at R.F.

At radio frequencies the reactances of even very small interelectrode capacitances drop to very low values. A resistance-coupled amplifier gives very little amplification at r.f., for example, because the reactances of the interelectrode "capacitors" are so low that they practically short-circuit the input and output circuits and thus the tube is unable to amplify. This is overcome at radio frequencies by using tuned circuits for the grid and plate, making the tube capacitances part of the tuning capacitances. In this way the circuits can have the high resistive impedances necessary for satisfactory amplification.

The grid-plate capacitance is important at radio frequencies because its reactance, relatively low at r.f., offers a path over which energy can be fed back from the plate to the grid. In practically every case the feedback is in the right phase and of sufficient amplitude to cause self-oscillation, so the circuit becomes useless as an amplifier.

Special "neutralizing" circuits can be used to prevent feedback but they are, in general, not too satisfactory when used in radio receivers. They are, however, used in transmitters.

## SCREEN-GRID TUBES

The grid-plate capacitance can be reduced to a negligible value by inserting a second grid between the control grid and the plate, as indicated in Fig. 3-16. The second grid, called the **screen grid**, acts as an electrostatic shield to prevent capacitive coupling between the control grid and plate. It is made in the form of a grid or coarse screen so that electrons can pass through it.

Because of the shielding action of the screen

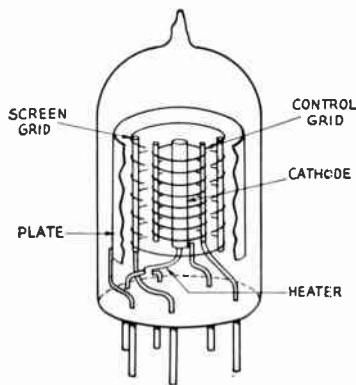

Fig. 3-16—Representative arrangement of elements in a screen-grid tetrode, with part of plate and screen cut away. This is "single-ended" construction with a button base, typical of miniature receiving tubes. To reduce capacitance between control grid and plate the leads from these elements are brought out at opposite sides; actual tubes probably would have additional shielding between these leads.

grid, the positively charged plate cannot attract electrons from the cathode as it does in a triode. In order to get electrons to the plate, it is necessary to apply a positive voltage (with respect to the cathode) to the screen. The screen then attracts electrons much as does the plate in a triode tube. In traveling toward the screen the electrons acquire such velocity that most of them shoot between the screen wires and then are attracted to the plate. A certain proportion do strike the screen, however, with the result that some current also flows in the screen-grid circuit.

To be a good shield, the screen grid must be connected to the cathode through a circuit that has low impedance at the frequency being amplified. A bypass capacitor from screen grid to cathode, having a reactance of not more than a few hundred ohms, is generally used.

A tube having a cathode, control grid, screen grid and plate (four elements) is called a **tetrode**.

### Pentodes

When an electron traveling at appreciable velocity through a tube strikes the plate it dislodges other electrons which "splash" from the plate into the interelement space. This is called **secondary emission**. In a triode the negative grid repels the secondary electrons back into the plate and they cause no disturbance. In the screen-grid tube, however, the positively charged screen attracts the secondary electrons, causing a reverse current to flow between screen and plate.

To overcome the effects of secondary emission, a third grid, called the **suppressor grid**, may be inserted between the screen and plate. This grid acts as a shield between the screen grid and plate so the secondary electrons cannot be attracted by the screen grid. They are hence attracted back to the plate without appreciably obstructing the regular plate-current flow. A five-element tube of this type is called a **pentode**.

Although the screen grid in either the tetrode or pentode greatly reduces the influence of the plate upon plate-current flow, the control grid still can control the plate current in essentially the same way that it does in a triode. Consequently, the grid-plate transconductance (or mutual conductance) of a tetrode or pentode will be of the same order of value as in a triode of corresponding structure. On the other hand, since a change in plate voltage has very little effect on the plate-current flow, both the amplification factor and plate resistance of a pentode or tetrode are very high. In small receiving pentodes the amplification factor is of the order of 1000 or higher, while the plate resistance may be from 0.5 to 1 or more megohms. Because of the high plate resistance, the actual voltage amplification possible with a pentode is very much less than the large amplification factor might indicate. A voltage gain in the vicinity of 50 to 200 is typical of a pentode stage.

In practical screen-grid tubes the grid-plate capacitance is only a small fraction of a micro-microfarad. This capacitance is too small to cause an appreciable increase in input capacitance as described in the preceding section, so the input capacitance of a screen-grid tube is simply the sum of its grid-cathode capacitance and control-grid-to-screen capacitance. The output capacitance of a screen-grid tube is equal to the capacitance between the plate and screen.

In addition to their applications as radio-frequency amplifiers, pentodes or tetrodes also are used for audio-frequency power amplification. In tubes designed for this purpose the chief function of the screen is to serve as an accelerator of the electrons, so that large values of plate current can be drawn at relatively low plate voltages. Such tubes have quite high power sensitivity compared with triodes of the same power output, although harmonic distortion is somewhat greater.

#### Beam Tubes

A **beam tetrode** is a four-element screen-grid tube constructed in such a way that the electrons are formed into concentrated beams on their way to the plate. Additional design features overcome the effects of secondary emission so that a suppressor grid is not needed. The "beam" construction makes it possible to draw large plate currents at relatively low plate voltages, and increases the power sensitivity.

For power amplification at both audio and radio frequencies beam tetrodes have largely supplanted the non-beam types because large power outputs can be secured with very small amounts of grid driving power.

#### Variable- $\mu$ Tubes

The mutual conductance of a vacuum tube decreases when its grid bias is made more negative, assuming that the other electrode voltages are held constant. Since the mutual conductance controls the amount of amplification, it is possible to adjust the gain of the amplifier by adjusting

the grid bias. This method of gain control is universally used in radio-frequency amplifiers designed for receivers.

The ordinary type of tube has what is known as a **sharp-cutoff** characteristic. The mutual conductance decreases at a uniform rate as the negative bias is increased. The amount of signal voltage that such a tube can handle without causing distortion is not sufficient to take care of very strong signals. To overcome this, some tubes are made with a **variable- $\mu$**  characteristic—that is, the amplification factor decreases with increasing grid bias. The variable- $\mu$  tube can handle a much larger signal than the sharp-cutoff type before the signal swings either beyond the zero grid-bias point or the plate-current cutoff point.

#### INPUT AND OUTPUT IMPEDANCES

The **input impedance** of a vacuum-tube amplifier is the impedance "seen" by the signal source when connected to the input terminals of the amplifier. In the types of amplifiers previously discussed, the input impedance is the impedance measured between the grid and cathode of the tube with operating voltages applied. At audio frequencies the input impedance of a Class  $A_1$  amplifier is for all practical purposes the input capacitance of the stage. If the tube is driven into the grid-current region there is in addition a resistance component in the input impedance, the resistance having an average value equal to  $E^2/P$ , where  $E$  is the r.m.s. driving voltage and  $P$  is the power in watts consumed in the grid. The resistance usually will vary during the a.c. cycle because grid current may flow only during part of the cycle; also, the grid-voltage/grid-current characteristic is seldom linear.

The **output impedance** of amplifiers of this type consists of the plate resistance of the tube shunted by the output capacitance.

At radio frequencies, when tuned circuits are employed, the input and output impedances are usually pure resistances; any reactive components are "tuned out" in the process of adjusting the circuits to resonance at the operating frequency.

#### OTHER TYPES OF AMPLIFIERS

In the amplifier circuits so far discussed, the signal has been applied between the grid and cathode and the amplified output has been taken from the plate-to-cathode circuit. That is, the cathode has been the meeting point for the input and output circuits. However, it is possible to use any one of the three principal elements as the common point. This leads to two additional kinds of amplifiers, commonly called the **grounded-grid amplifier** (or **grid-separation circuit**) and the **cathode follower**.

These two circuits are shown in simplified form in Fig. 3-17. In both circuits the resistor  $R$  represents the load into which the amplifier works; the actual load may be resistance-capacitance-coupled, transformer-coupled, may be a tuned circuit if the amplifier operates at radio



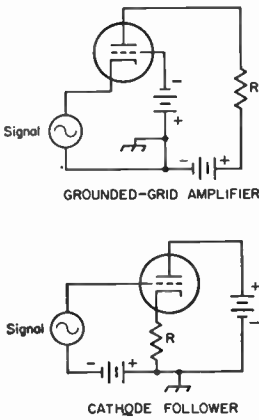

Fig. 3-17—In the upper circuit, the grid is the junction point between the input and output circuits. In the lower drawing, the plate is the junction. In either case the output is developed in the load resistor, R, and may be coupled to a following amplifier by the usual methods.

frequencies, and so on. Also, in both circuits the batteries that supply grid bias and plate power are assumed to have such negligible impedance that they do not enter into the operation of the circuits.

**Grounded-Grid Amplifier**

In the grounded-grid amplifier the input signal is applied between the cathode and grid, and the output is taken between the plate and grid. The grid is thus the common element. The a.c. component of the plate current has to flow through the signal source to reach the cathode. The source of signal is in series with the load through the plate-to-cathode resistance of the tube, so some of the power in the load is supplied by the signal source. In transmitting applications this fed-through power is of the order of 10 per cent of the total power output, using tubes suitable for grounded-grid service.

The input impedance of the grounded-grid amplifier consists of a capacitance in parallel with an equivalent resistance representing the power furnished by the driving source of the grid and to the load. This resistance is of the order of a few hundred ohms. The output impedance, neglecting the interelectrode capacitances, is equal to the plate resistance of the tube. This is the same as in the case of the grounded-cathode amplifier.

The grounded-grid amplifier is widely used at v.h.f. and u.h.f., where the more conventional amplifier circuit fails to work properly. With a triode tube designed for this type of operation, an r.f. amplifier can be built that is free from the type of feedback that causes oscillation. This requires that the grid act as a shield between the cathode and plate, reducing the plate-cathode capacitance to a very low value.

**Cathode Follower**

The cathode follower uses the plate of the tube as the common element. The input signal is applied between the grid and plate (assuming negligible impedance in the batteries) and

the output is taken between cathode and plate. This circuit is degenerative; in fact, all of the output voltage is fed back into the input circuit out of phase with the grid signal. The input signal therefore has to be larger than the output voltage; that is, the cathode follower gives a loss in voltage, although it gives the same power gain as other circuits under equivalent operating conditions.

An important feature of the cathode follower is its low output impedance, which is given by the formula (neglecting interelectrode capaci-

$$Z_{out} = \frac{r_p}{1 + \mu}$$

tances) where  $r_p$  is the tube plate resistance and  $\mu$  is the amplification factor. Low output impedance is a valuable characteristic in an amplifier designed to cover a wide band of frequencies. In addition, the input capacitance is only a fraction of the grid-to-cathode capacitance of the tube, a feature of further benefit in a wide-band amplifier. The cathode follower is useful as a step-down impedance transformer, since the input impedance is high and the output impedance is low.

**CATHODE CIRCUITS AND GRID BIAS**

Most of the equipment used by amateurs is powered by the a.c. line. This includes the filaments or heaters of vacuum tubes. Although supplies for the plate (and sometimes the grid) are usually rectified and filtered to give pure d.c. — that is, direct current that is constant and without a superimposed a.c. component — the relatively large currents required by filaments and heaters usually make a rectifier-type d.c. supply impracticable.

**Filament Hum**

Alternating current is just as good as direct current from the heating standpoint, but some of the a.c. voltage is likely to get on the grid and cause a low-pitched “a.c. hum” to be superimposed on the output.

Hum troubles are worst with directly-heated cathodes or filaments, because with such cathodes there has to be a direct connection between the source of heating power and the rest of the circuit. The hum can be minimized by either of

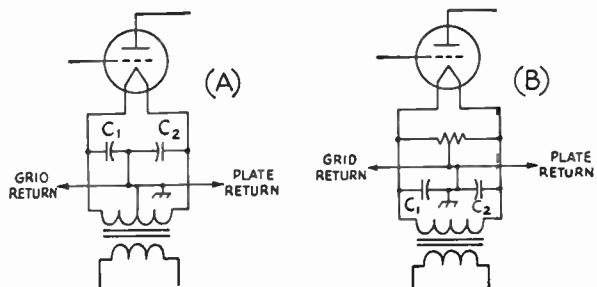

Fig. 3-18—Filament center-tapping methods for use with directly heated tubes.



the connections shown in Fig. 3-18. In both cases the grid- and plate-return circuits are connected to the electrical midpoint (**center tap**) of the filament supply. Thus, so far as the grid and plate are concerned, the voltage and current on one side of the filament are balanced by an equal and opposite voltage and current on the other side. The balance is never quite perfect, however, so filament-type tubes are never completely hum-free. For this reason directly-heated filaments are employed for the most part in power tubes, where the hum introduced is extremely small in comparison with the power-output level.

With indirectly heated cathodes the chief problem is the magnetic field set up by the heater. Occasionally, also, there is leakage between the heater and cathode, allowing a small a.c. voltage to get to the grid. If hum appears, grounding one side of the heater supply usually will help to reduce it, although sometimes better results are obtained if the heater supply is center-tapped and the center-tap grounded, as in Fig. 3-18.

### Cathode Bias

In the simplified amplifier circuits discussed in this chapter, grid bias has been supplied by a battery. However, in equipment that operates from the power line **cathode bias** is almost universally used for tubes that are operated in Class A (constant d.c. input).

The cathode-bias method uses a resistor (**cathode resistor**) connected in series with the cathode, as shown at  $R$  in Fig. 3-19. The direction of plate-current flow is such that the end of the resistor nearest the cathode is positive. The voltage drop across  $R$  therefore places a *negative* voltage on the grid. This negative bias is obtained from the steady d.c. plate current.

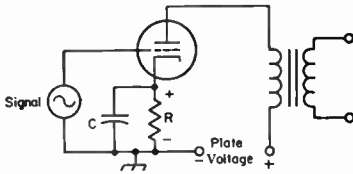

Fig. 3-19—Cathode biasing.  $R$  is the cathode resistor and  $C$  is the cathode bypass capacitor.

If the alternating component of plate current flows through  $R$  when the tube is amplifying, the voltage drop caused by the a.c. will be degenerative (note the similarity between this circuit and that of Fig. 3-14A). To prevent this the resistor is bypassed by a capacitor,  $C$ , that has very low reactance compared with the resistance of  $R$ . Depending on the type of tube and the particular kind of operation,  $R$  may be between about 100 and 3000 ohms. For good bypassing at the low audio frequencies,  $C$  should be 10 to 50 microfarads (electrolytic capacitors are used for this purpose). At radio frequencies, capacitances of about 100  $\mu\text{f}$ . to 0.1  $\mu\text{f}$ . are used; the small values are sufficient at very high frequencies and the largest at low and medium frequencies. In

the range 3 to 30 megacycles a capacitance of 0.01  $\mu\text{f}$ . is satisfactory.

The value of cathode resistor for an amplifier having negligible d.c. resistance in its plate circuit (transformer or impedance coupled) can easily be calculated from the known operating conditions of the tube. The proper grid bias and plate current always are specified by the manufacturer. Knowing these, the required resistance can be found by applying Ohm's Law.

Example: It is found from tube tables that the tube to be used should have a negative grid bias of 8 volts and that at this bias the plate current will be 12 milliamperes (0.012 amp.). The required cathode resistance is then

$$R = \frac{E}{I} = \frac{8}{0.012} = 667 \text{ ohms.}$$

The nearest standard value, 680 ohms, would be close enough. The power used in the resistor is

$$P = EI = 8 \times 0.012 = 0.096 \text{ watt.}$$

A  $\frac{1}{4}$ -watt or  $\frac{1}{2}$ -watt resistor would have ample rating.

The current that flows through  $R$  is the total cathode current. In an ordinary triode amplifier this is the same as the plate current, but in a screen-grid tube the cathode current is the sum of the plate and screen currents. Hence these two currents must be added when calculating the value of cathode resistor required for a screen-grid tube.

Example: A receiving pentode requires 3 volts negative bias. At this bias and the recommended plate and screen voltages, its plate current is 9 ma. and its screen current is 2 ma. The cathode current is therefore 11 ma. (0.011 amp.). The required resistance is

$$R = \frac{E}{I} = \frac{3}{0.011} = 272 \text{ ohms.}$$

A 270-ohm resistor would be satisfactory. The power in the resistor is

$$P = EI = 3 \times 0.011 = 0.033 \text{ watt.}$$

The cathode-resistor method of biasing is self-regulating, because if the tube characteristics vary slightly from the published values (as they do in practice) the bias will increase if the plate current is slightly high, or decrease if it is slightly low. This tends to hold the plate current at the proper value.

Calculation of the cathode resistor for a resistance-coupled amplifier is ordinarily not practicable by the method described above, because the plate current in such an amplifier is usually much smaller than the rated value given in the tube tables. However, representative data for the tubes commonly used as resistance-coupled amplifiers are given in the chapter on audio amplifiers, including cathode-resistor values.

### "Contact Potential" Bias

In the absence of any negative bias voltage on the grid of a tube, some of the electrons in the space charge will have enough velocity to reach the grid. This causes a small current (of the order of microamperes) to flow in the external

circuit between the grid and cathode. If the current is made to flow through a high resistance—a megohm or so—the resulting voltage drop in the resistor will give the grid a negative bias of the order of one volt. The bias so obtained is called contact-potential bias.

Contact-potential bias can be used to advantage in circuits operating at low signal levels (less than one volt peak) since it eliminates the cathode-bias resistor and bypass capacitor. It is principally used in low-level resistance-coupled audio amplifiers. The bias resistor is connected directly between grid and cathode, and must be isolated from the signal source by a blocking capacitor.

**Screen Supply**

In practical circuits using tetrodes and pentodes the voltage for the screen frequently is taken from the plate supply through a resistor. A typical circuit for an r.f. amplifier is shown in Fig. 3-20. Resistor *R* is the **screen dropping resistor**, and *C* is the **screen bypass capacitor**. In flowing through *R*, the screen current causes a voltage drop in *R* that reduces the plate-supply voltage to the proper value for the screen. When the plate-supply voltage and the screen current are known, the value of *R* can be calculated from Ohm's Law.

**Example:** An r.f. receiving pentode has a rated screen current of 2 milliamperes (0.002 amp.) at normal operating conditions. The rated screen voltage is 100 volts, and the plate supply gives 250 volts. To put 100 volts on the screen, the drop across *R* must be equal to the difference between the plate-supply

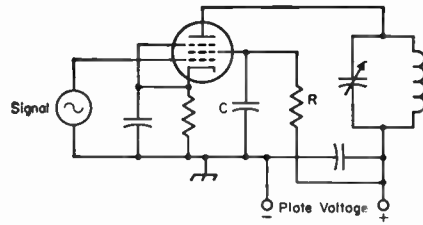

**Fig. 3-20**—Screen-voltage supply for a pentode tube through a dropping resistor, *R*. The screen bypass capacitor, *C*, must have low enough reactance to bring the screen to ground potential for the frequency or frequencies being amplified.

voltage and the screen voltage; that is, 250 — 100 = 150 volts. Then

$$R = \frac{E}{I} = \frac{150}{0.002} = 75,000 \text{ ohms.}$$

The power to be dissipated in the resistor is

$$P = EI = 150 \times 0.002 = 0.3 \text{ watt.}$$

A ½- or 1-watt resistor would be satisfactory.

The reactance of the screen bypass capacitor, *C*, should be low compared with the screen-to-cathode impedance. For radio-frequency applications a capacitance in the vicinity of 0.01 μf. is amply large.

In some vacuum-tube circuits the screen voltage is obtained from a voltage divider connected across the plate supply. The design of voltage dividers is discussed at length in Chapter 7 on Power Supplies.

**OSCILLATORS**

It was mentioned earlier that if there is enough positive feedback in an amplifier circuit, self-sustaining oscillations will be set up. When an amplifier is arranged so that this condition exists it is called an **oscillator**.

Oscillations normally take place at only one frequency, and a desired frequency of oscillation can be obtained by using a resonant circuit tuned to that frequency. For example, in Fig. 3-21A the circuit *LC* is tuned to the desired frequency of oscillation. The cathode of the tube is connected to a tap on coil *L* and the grid and plate are connected to opposite ends of the tuned circuit. When an r.f. current flows in the tuned circuit there is a voltage drop across *L* that increases progressively along the turns. Thus the point at which the tap is connected will be at an intermediate potential with respect to the two ends of the coil. The amplified current in the plate circuit, which flows through the bottom section of *L*, is in phase with the current already flowing in the circuit and thus in the proper relationship for positive feedback.

The amount of feedback depends on the position of the tap. If the tap is too near the grid end the voltage drop between grid and cathode is too small to give enough feedback to sustain oscillation, and if it is too near the plate end the im-

pedance between the cathode and plate is too small to permit good amplification. Maximum

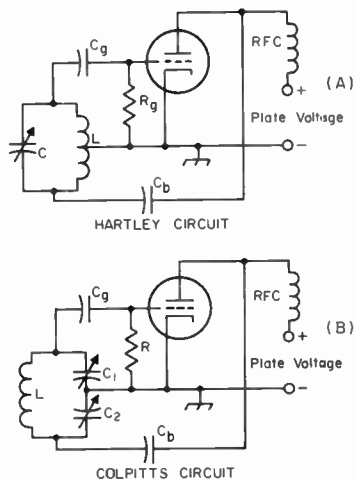

**Fig. 3-21**—Basic oscillator circuits. Feedback voltage is obtained by tapping the grid and cathode across a portion of the tuned circuit. In the Hartley circuit the tap is on the coil, but in the Colpitts circuit the voltage is obtained from the drop across a capacitor.

feedback usually is obtained when the tap is somewhere near the center of the coil.

The circuit of Fig. 3-21A is parallel-fed,  $C_b$  being the blocking capacitor. The value of  $C_b$  is not critical so long as its reactance is low (not more than a few hundred ohms) at the operating frequency.

Capacitor  $C_g$  is the **grid capacitor**. It and  $R_g$  (the **grid leak**) are used for the purpose of obtaining grid bias for the tube. In most oscillator circuits the tube generates its own bias. During the part of the cycle when the grid is positive with respect to the cathode, it attracts electrons. These electrons cannot flow through  $L$  back to the cathode because  $C_g$  "blocks" direct current. They therefore have to flow or "leak" through  $R_g$  to cathode, and in doing so cause a voltage drop in  $R_g$  that places a negative bias on the grid. The amount of bias so developed is equal to the grid current multiplied by the resistance of  $R_g$  (Ohm's Law). The value of grid-leak resistance required depends upon the kind of tube used and the purpose for which the oscillator is intended. Values range all the way from a few thousand to several hundred thousand ohms. The capacitance of  $C_g$  should be large enough to have low reactance (a few hundred ohms) at the operating frequency.

The circuit shown at B in Fig. 3-21 uses the voltage drops across two capacitors in series in the tuned circuit to supply the feedback. Other than this, the operation is the same as just described. The feedback can be varied by varying the ratio of the reactance of  $C_1$  and  $C_2$  (that is, by varying the ratio of their capacitances).

Another type of oscillator, called the **tuned-plate tuned-grid** circuit, is shown in Fig. 3-22.

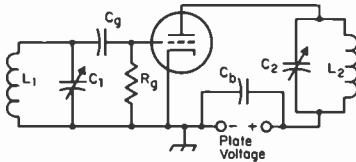

Fig. 3-22—The tuned-plate tuned-grid oscillator.

Resonant circuits tuned approximately to the same frequency are connected between grid and cathode and between plate and cathode. The two coils,  $L_1$  and  $L_2$ , are not magnetically coupled. The feedback is through the grid-plate capacitance of the tube, and will be in the right phase to be positive when the plate circuit,  $C_2L_2$ , is tuned to a slightly higher frequency than the grid circuit,  $L_1C_1$ . The amount of feedback can be adjusted by varying the tuning of either circuit. The frequency of oscillation is determined by the tuned circuit that has the higher  $Q$ . The grid leak and grid capacitor have the same functions as in the other circuits. In this case it is convenient to use series feed for the plate circuit, so  $C_b$  is a bypass capacitor to guide the r.f. current around the plate supply.

There are many oscillator circuits (examples

of others will be found in later chapters) but the basic feature of all of them is that there is positive feedback in the proper amplitude and phase to sustain oscillation.

### Oscillator Operating Characteristics

When an oscillator is delivering power to a load, the adjustment for proper feedback will depend on how heavily the oscillator is loaded — that is, how much power is being taken from the circuit. If the feedback is not large enough—**grid excitation** too small — a small increase in load may tend to throw the circuit out of oscillation. On the other hand, too much feedback will make the grid current excessively high, with the result that the power loss in the grid circuit becomes larger than necessary. Since the oscillator itself supplies this grid power, excessive feedback lowers the over-all efficiency because whatever power is used in the grid circuit is not available as useful output.

One of the most important considerations in oscillator design is **frequency stability**. The principal factors that cause a change in frequency are (1) temperature, (2) plate voltage, (3) loading, (4) mechanical variations of circuit elements. Temperature changes will cause vacuum-tube elements to expand or contract slightly, thus causing variations in the interelectrode capacitances. Since these are unavoidably part of the tuned circuit, the frequency will change correspondingly. Temperature changes in the coil or the tuning capacitor will alter the inductance or capacitance slightly, again causing a shift in the resonant frequency. These effects are relatively show in operation, and the frequency change caused by them is called **drift**.

A change in plate voltage usually will cause the frequency to change a small amount, an effect called **dynamic instability**. Dynamic instability can be reduced by using a tuned circuit of high effective  $Q$ . The energy taken from the circuit to supply grid losses, as well as energy supplied to a load, represent an increase in the effective resistance of the tuned circuit and thus lower its  $Q$ . For highest stability, therefore, the coupling between the tuned circuit and the tube and load must be kept as loose as possible. Preferably, the oscillator should not be required to deliver power to an external circuit, and a high value of grid leak resistance should be used since this helps to raise the tube grid and plate resistances as seen by the tuned circuit. Loose coupling can be effected in a variety of ways — one, for example, is by "tapping down" on the tank for the connections to the grid and plate. This is done in the "series-tuned" Colpitts circuit widely used in variable-frequency oscillators for amateur transmitters and described in a later chapter. Alternatively, the  $L/C$  ratio may be made as small as possible while sustaining stable oscillation (**high C**) with the grid and plate connected to the ends of the circuit as shown in Figs. 3-21 and 3-22. Using relatively high plate voltage and low plate current also is desirable.

In general, dynamic stability will be at maxi-

imum when the feedback is adjusted to the least value that permits reliable oscillation. The use of a tube having a high value of transconductance is desirable, since the higher the transconductance the looser the permissible coupling to the tuned circuit and the smaller the feedback required.

Load variations act in much the same way as plate-voltage variations. A temperature change in the load may also result in drift.

Mechanical variations, usually caused by vibration, cause changes in inductance and/or capacitance that in turn cause the frequency to "wobble" in step with the vibration.

Methods of minimizing frequency variations in oscillators are taken up in detail in later chapters.

### Ground Point

In the oscillator circuits shown in Figs. 3-21 and 3-22 the cathode is connected to ground. It is not actually essential that the radio-frequency circuit should be grounded at the cathode; in fact, there are many times when an *r.f.* ground on some other point in the circuit is desirable. The *r.f.* ground can be placed at any point so long as proper provisions are made for feeding the supply voltages to the tube elements.

Fig. 3-23 shows the Hartley circuit with the plate end of the circuit grounded. No *r.f.* choke is

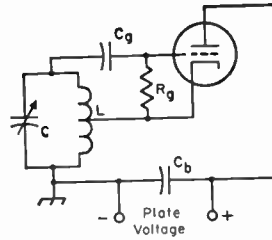

Fig. 3-23—Showing how the plate may be grounded for *r.f.* in a typical oscillator circuit (Hartley).

needed in the plate circuit because the plate already is at ground potential and there is no *r.f.* to choke off. All that is necessary is a bypass capacitor,  $C_b$ , across the plate supply. Direct current flows to the cathode through the lower part of the tuned-circuit coil,  $L$ . An advantage of such a circuit is that the frame of the tuning capacitor can be grounded.

Tubes having indirectly heated cathodes are more easily adaptable to circuits grounded at other points than the cathode than are tubes having directly heated filaments. With the latter tubes special precautions have to be taken to prevent the filament from being bypassed to ground by the capacitance of the filament-heating transformer.

## CLIPPING CIRCUITS

Vacuum tubes are readily adaptable to other types of operation than ordinary (without substantial distortion) amplification and the genera-

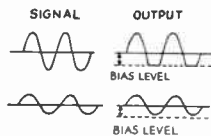
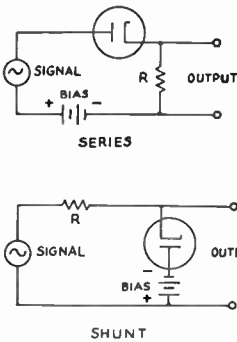

Fig. 3-24—Series and shunt diode clippers. Typical operation is shown at the right.

tion of single-frequency oscillations. Of particular interest is the clipper or limiter circuit, because of its several applications in receiving and other equipment.

### Diode Clipper Circuits

Basic diode clipper circuits are shown in Fig. 3-24. In the series type a positive d.c. bias voltage is applied to the plate of the diode so it is normally conducting. When a signal is applied the current through the diode will change proportionately during the time the signal voltage is positive at the diode plate and for that part of

the negative half of the signal during which the instantaneous voltage does not exceed the bias. When the negative signal voltage exceeds the positive bias the resultant voltage at the diode plate is negative and there is no conduction. Thus part of the negative half cycle is clipped as shown in the drawing at the right. The level at which clipping occurs depends on the bias voltage, and the proportion of signal clipping depends on the signal strength in relation to the bias voltage. If the peak signal voltage is below the bias level there is no clipping and the output wave shape is the same as the input wave shape, as shown in the lower sketch. The output voltage results from the current flow through the load resistor  $R$ .

In the shunt-type diode clipper negative bias is applied to the plate so the diode is normally nonconducting. In this case the signal voltage is fed through the series resistor  $R$  to the output circuit (which must have high impedance compared with the resistance of  $R$ ). When the negative half of the signal voltage exceeds the bias voltage the diode conducts, and because of the voltage drop in  $R$  when current flows the output voltage is reduced. By proper choice of  $R$  in relationship to the load on the output circuit the clipping can be made equivalent to that given by the series circuit. There is no clipping when the peak signal voltage is below the bias level.

Two diode circuits can be combined so that both negative and positive peaks are clipped.

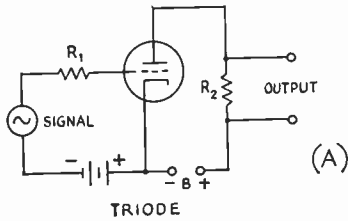
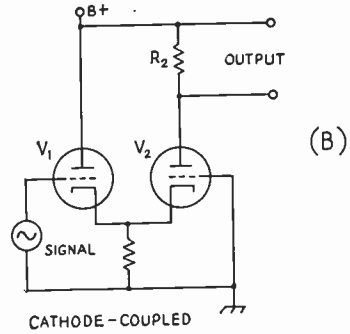

Fig. 3-25—Triode clippers. A—Single triode, using shunt-type diode clipping in the grid circuit for the positive peak and plate-current cut-off clipping for the negative peak. B—Cathode-coupled clipper, using plate-current cut-off clipping for both positive and negative peaks.



**Triode Clippers**

The circuit shown at A in Fig. 3-25 is capable of clipping both negative and positive signal peaks. On positive peaks its operation is similar to the shunt diode clipper, the clipping taking place when the positive peak of the signal voltage is large enough to drive the grid positive. The positive-clipped signal is amplified by the tube as a resistance-coupled amplifier. Negative peak clipping occurs when the negative peak of the signal voltage exceeds the fixed grid bias and thus cuts off the plate current in the output circuit.

In the cathode-coupled clipper shown at B in Fig. 3-25  $V_1$  is a cathode follower with its output circuit directly connected to the cathode of

$V_2$ , which is a grounded-grid amplifier. The tubes are biased by the voltage drop across  $R_1$ , which carries the d.c. plate currents of both tubes. When the negative peak of the signal voltage exceeds the d.c. voltage across  $R_1$  clipping occurs in  $V_1$ , and when the positive peak exceeds the same value of voltage  $V_2$ 's plate current is cut off. (The bias developed in  $R_1$  tends to be constant because the plate current of one tube increases when the plate current of the other decreases.) Thus the circuit clips both positive and negative peaks. The clipping is symmetrical, providing the d.c. voltage drop in  $R_2$  is small enough so that the operating conditions of the two tubes are substantially the same. For signal voltages below the clipping level the circuit operates as a normal amplifier with low distortion.

**U.H.F. AND MICROWAVE TUBES**

At ultrahigh frequencies, interelectrode capacitances and the inductance of internal leads determine the highest possible frequency to which a vacuum tube can be tuned. The tube usually will not oscillate up to this limit, however, because of dielectric losses, transit time and other effects. In low-frequency operation, the actual time of flight of electrons between the cathode and the anode is negligible in relation to the duration of the cycle. At 1000 kc., for example, transit time of 0.001 microsecond, which is typical of conventional tubes, is only 1/1000 cycle. But at 100 Mc., this same transit time represents 1/10 of a cycle, and a full cycle at 1000 Mc. These limiting factors establish about 3000 Mc. as the upper frequency limit for negative-grid tubes.

With most tubes of conventional design, the upper limit of useful operation is around 150 Mc. For higher frequencies tubes of special construction are required. About the only means available for reducing interelectrode capacitances is to reduce the physical size of the elements, which is practical only in tubes which do not have to handle appreciable power. However, it is possible to reduce the internal lead inductance very materially by minimizing the lead length and by using two or more leads in parallel from an electrode.

In some types the electrodes are provided with

up to five separate leads which may be connected in parallel externally. In double-lead types the plate and grid elements are supported by heavy single wires which run entirely through the envelope, providing terminals at either end of the

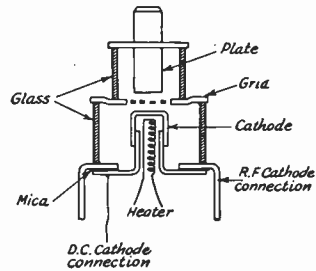

Fig. 3-26—Sectional view of the "lighthouse" tube's construction. Close electrode spacing reduces transit time while the disk electrode connections reduce lead inductance.

bulb. With linear tank circuits the leads become a part of the line and have distributed rather than lumped constants.

In "lighthouse" tubes or disk-seal tubes, the plate, grid and cathode are assembled in parallel planes, as shown in Fig. 3-26, instead of co-



axially. The disk-seal terminals practically eliminate lead inductance.

**Velocity Modulation**

In conventional tube operation the potential on the grid tends to reduce the electron velocity during the more negative half of the cycle, while on the other half cycle the positive potential on the grid serves to accelerate the electrons. Thus the electrons tend to separate into groups, those leaving the cathode during the negative half-cycle being collectively slowed down, while those leaving on the positive half are accelerated. After passing into the grid-plate space only a part of the electron stream follows the original form of the oscillation cycle, the remainder traveling to the plate at differing velocities. Since these contribute nothing to the power output at the operating frequency, the efficiency is reduced in direct proportion to the variation in velocity, the output reaching a value of zero when the transit time approaches a half-cycle.

This effect is turned to advantage in **velocity-modulated tubes** in that the input signal voltage on the grid is used to change the velocity of the electrons in a constant-current electron beam, rather than to vary the intensity of a constant-velocity current flow as is the method in ordinary tubes.

The velocity modulation principle may be used in a number of ways, leading to several tube designs. The major tube of this type is the "klystron."

**The Klystron**

In the **klystron** tube the electrons emitted by the cathode pass through an electric field established by two grids in a cavity resonator called the **buncher**, the high-frequency electric field between the grids is parallel to the electron stream.

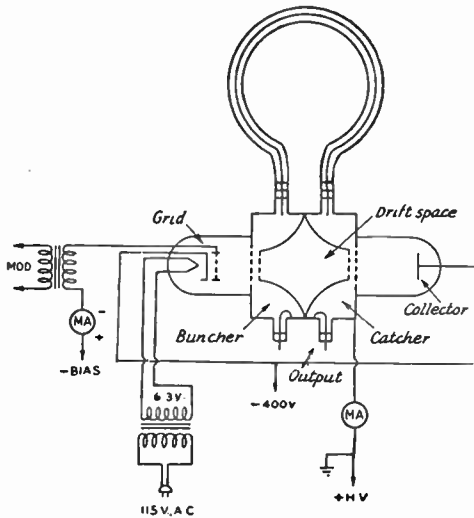

Fig. 3-27—Circuit diagram of the klystron oscillator, showing the feedback loop coupling the frequency-controlling cavities.

This field accelerates the electrons at one moment and retards them at another, in accordance with the variations of the r.f. voltage applied. The resulting velocity-modulated beam travels through a field-free "drift space," where the slower-moving electrons are gradually overtaken by the faster ones. The electrons emerging from the pair of grids therefore are separated into groups or "bunched" along the direction of motion. The velocity-modulated electron stream then goes to a **catcher** cavity where it again passes through two parallel grids, and the r.f. current created by the bunching of the electron beam induces an r.f. voltage between the grids. The catcher cavity is made resonant at the frequency of the velocity-modulated electron beam, so that an oscillating field is set up within it by the passage of the electron bunches through the grid aperture.

If a feedback loop is provided between the two cavities, as shown in Fig. 3-27, oscillations will occur. The resonant frequency depends on the electrode voltages and on the shape of the cavities, and may be adjusted by varying the supply voltage and altering the dimensions of the cavities. Although the bunched beam current is rich in harmonics the output wave form is remarkable pure because the high *Q* of the catcher cavity suppresses the unwanted harmonics.<sup>1</sup>

**Magnetrons**

A **magnetron** is fundamentally a diode with cylindrical electrodes placed in a uniform magnetic field, with the lines of magnetic force parallel to the axes of the elements. The simple cy-

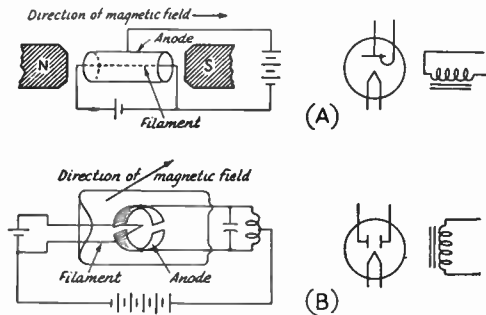

Fig. 3-28—Conventional magnetrons, with equivalent schematic symbols at the right. A, simple cylindrical magnetron. B, split-anode negative-resistance magnetron.

lindrical magnetron consists of a cathode surrounded by a concentric cylindrical anode. In the more efficient split-anode magnetron the cylinder is divided lengthwise.

Magnetron oscillators are operated in two

<sup>1</sup> A discussion of the operation of a three-cavity transmitting klystron operating above 1000 Mc. will be found in *QST* for August, 1961 (Badger, "An Introduction to the Klystron."). Practical information on klystron operation will be found in *QST* for August, 1960 (Prechtel, "An Experimental Transceiver for 5660 Mc.") and May, 1959 (Sharbaugh and Watters, "The World Above 20,000 Mc.").

different ways. Electrically the circuits are similar, the difference being in the relation between electron transit time and the frequency of oscillation.

In the negative-resistance or dynatron type of magnetron oscillator, the element dimensions and anode voltage are such that the transit time is short compared with the period of the oscillation frequency. Electrons emitted from the cathode are driven toward both halves of the anode. If the potentials of the two halves are unequal, the effect of the magnetic field is such that the majority of the electrons travel to the half of the anode that is at the lower potential. That is, a decrease in the potential of either half of the anode results in an increase in the electron current flowing to that half. The magnetron consequently exhibits negative-resistance characteristics. Negative-resistance magnetron oscillators are useful between 100 and 1000 Mc. Under the

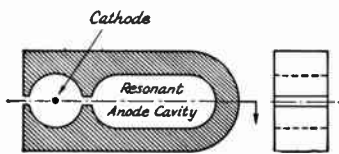

Fig. 3-29—Split-anode magnetron with integral resonant anode cavity for use at u.h.f.

best operating conditions efficiencies of 20 to 25 per cent may be obtained.

In the transit-time magnetron the frequency is determined primarily by the tube dimensions and by the electric and magnetic field intensities rather than by the tuning of the tank circuits. The intensity of the magnetic field is adjusted so that, under static conditions, electrons leaving the cathode move in curved paths which just fail to reach the anode. All electrons are therefore deflected back to the cathode, and the anode current is zero. An alternating voltage applied between the two halves of the anode will cause the potentials of these halves to vary about their

it. Meanwhile other electrons gain energy from the field and are returned to the cathode. Since those electrons that lose energy remain in the interelectrode space longer than those that gain energy, the net effect is a transfer of energy from the electrons to the electric field. This energy can be used to sustain oscillations in a resonant transmission line connected between the two halves of the anode.

Split-anode magnetrons for u.h.f. are constructed with a cavity resonator built into the tube structure, as illustrated in Fig. 3-29. The assembly is a solid block of copper which assists in heat dissipation. At extremely high frequencies operation is improved by subdividing the anode structure into 4 to 16 or more segments, the resonant cavities for each anode being coupled to the common cathode region by slots of critical dimensions.

The efficiency of multisegment magnetrons reaches 65 or 70 per cent. Slotted-anode magnetrons with four segments function up to 30,000 Mc. (1 cm.), delivering up to 100 watts at efficiencies greater than 50 per cent. Using larger multiples of anodes and higher-order modes, performance can be attained at 0.2 cm.

### Traveling-Wave Tubes

Gains as high as 50 db. over a bandwidth of 5000 Mc. at a center frequency of 7500 Mc. have been obtained through the use of a traveling-wave amplifier tube shown schematically in Fig. 3-30. An electromagnetic wave travels down the helix, and an electron beam is shot through the helix parallel to its axis, and in the direction of propagation of the wave. When the electron velocity is about the same as the wave velocity in the absence of the electrons, turning on the electron beam causes a power gain for wave propagation in the direction of the electron motion.

The portions of Fig. 3-30 marked "input" and "output" are coaxial lines to which the ends of

Fig. 3-30—Schematic drawing of a traveling-wave amplifier tube.

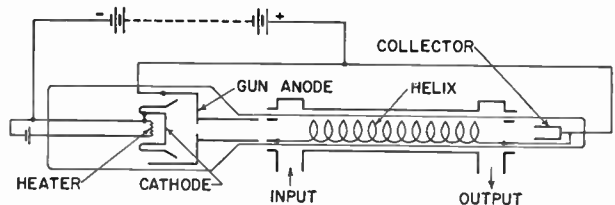

average positive values. If the period (time required for one cycle) of the alternating voltage is made equal to the time required for an electron to make one complete rotation in the magnetic field, the a.c. component of the anode voltage reverses direction twice with each electron rotation. Some electrons will lose energy to the electric field, with the result that they are unable to reach the cathode and continue to rotate about

the helix are coupled. The beam is focused electrically at the gun end, and magnetically along the helix by a series of opposing-polarity magnets stacked between ferrous pole pieces.

The outstanding features of the traveling-wave amplifier tube are its great bandwidth and large power gain. However, the efficiency is rather low. Typical power output is of the order of 3 watts.

# Semiconductor Devices

Certain materials whose resistivity is not high enough to classify them as good insulators, but is still high compared with the resistivity of common metals, are known as **semiconductors**. These materials, of which germanium and silicon are examples, have an atomic structure that normally is associated with insulators. However, when small amounts of impurities are introduced during the manufacture of germanium or silicon crystals, it is possible for free electrons to exist and to move through the crystals under the influence of an electric field. It is also possible for some of the atoms to be deficient in an electron, and these electron deficiencies or **holes** can move from atom to atom when urged to do so by an applied electric force. (The movement of a hole is actually the movement of an electron, the electron becoming detached from one atom, making a hole in that atom, in order to move into an existing hole in another atom.) The holes can be considered to be equivalent to particles carrying a positive electric charge, while the electrons of course have negative charges. Holes and electrons are called **charge carriers** in semiconductors.

## Electron and Hole Conduction

Material which conducts by virtue of a deficiency in electrons — that is, by **hole conduction** — is called **p-type** material. In **n-type** material, which has an excess of electrons, the conduction is termed "electronic." If a piece of p-type material is joined to a piece of n-type material as at A in Fig. 4-1 and a voltage is applied to the pair as at B, current will flow across the boundary or junction between the two (and also in the external circuit) when the battery has the polarity indicated. Electrons, indicated by the minus symbol, are attracted across the junction from the n material through the p material to the positive terminal of the battery, and holes, indicated by the plus symbol, are attracted in the opposite direction across the junction by the neg-

ative potential of the battery. Thus current flows through the circuit by means of electrons moving one way and holes the other.

If the battery polarity is reversed, as at C, the excess electrons in the n material are attracted away from the junction and the holes in the p material are attracted by the negative potential of the battery away from the junction. This leaves the junction region without any current carriers, consequently there is no conduction.

In other words, a junction of p- and n-type materials constitutes a rectifier. It differs from the tube diode rectifier in that there is a measurable, although comparatively very small, reverse current. The reverse current results from the presence of some carriers of the type opposite to those which principally characterize the material. The principal ones are called **majority carriers**, while the lesser ones are **minority carriers**.

The process by which the carriers cross the junction is essentially diffusion, and takes place comparatively slowly. This, together with the fact that the junction forms a capacitor with the two plates separated by practically zero spacing and hence has relatively high capacitance, places a limit on the upper frequency at which semiconductor devices of this construction will operate, as compared with vacuum tubes. Also, the number of excess electrons and holes in the material depends upon temperature, and since the conductivity in turn depends on the number of excess holes and electrons, the device is more temperature sensitive than is a vacuum tube.

Capacitance may be reduced by making the contact area very small. This is done by means of a **point contact**, a tiny p-type region being formed under the contact point during manufacture when n-type material is used for the main body of the device.

## SEMICONDUCTOR DIODES

Diodes of the point-contact type are used for many of the same purposes for which tube diodes

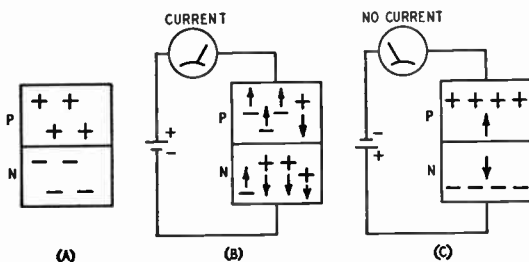

Fig. 4-1—A p-n junction (A) and its behavior when conducting (B) and non-conducting (C).

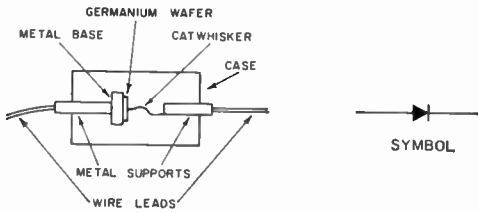

Fig. 4-2—Construction of a germanium-point-contact diode. In the circuit symbol for a contact rectifier the arrow points in the direction of minimum resistance measured by the conventional method—that is, going from the positive terminal of the voltage source through the rectifier to the negative terminal of the source. The arrow thus corresponds to the plate and the bar to the cathode of a tube diode.

are used. The construction of such a diode is shown in Fig. 4-2. Germanium and silicon are the most widely used materials, the latter principally in the u.h.f. region.

As compared with the tube diode for r.f. applications, the crystal diode has the advantages of very small size, very low interelectrode capacitance (of the order of 1  $\mu\text{mf.}$  or less) and requires no heater or filament power.

**Characteristic Curves**

The germanium crystal diode is characterized by relatively large current flow with small applied voltages in the “forward” direction, and small, although finite, current flow in the reverse or “back” direction for much larger applied voltages. A typical characteristic curve is shown in Fig. 4-3. The dynamic resistance in either the forward or back direction is determined by the change in current that occurs, at any given point on the curve, when the applied voltage is changed by a small amount. The forward resistance shows some variation in the region of very small applied voltages, but the curve is for the most part quite straight, indicating fairly constant dynamic resistance. For small applied voltages, the forward resistance is of the order of 200 ohms in most such diodes. The back resistance shows considerable variation, depending on the particular voltage chosen for the measurement. It may run from a few hundred thousand ohms to over a megohm. In applications such as meter rectifiers for r.f. indicating instruments (r.f. voltmeters, wavemeter indicators, and so on) where the load resistance may be small and the applied voltage of the order of several volts, the resistance vary with the value of the applied voltage and are considerably lower.

**Junction Diodes**

Junction-type diodes made of germanium or silicon are employed principally as power rectifiers, in applications similar to those where selenium rectifiers are used. Depending on the design of the particular diode, they are capable of rectifying currents up to several hundred milliamperes. The safe inverse peak voltage of a junction is relatively low, so an appropriate

number of rectifiers must be connected in series to operate safely on a given a.c. input voltage.

**Ratings**

Crystal diodes are rated primarily in terms of **maximum safe inverse voltage** and **maximum average rectified current**. Inverse voltage is a voltage applied in the direction opposite to that which causes maximum current flow. The average current is that which would be read by a d.c. meter connected in the current path.

It is also customary to specify standards of performance with respect to forward and back current. A minimum value of forward current is usually specified for one volt applied. The voltage at which the maximum tolerable back current is specified varies with the type of diode.

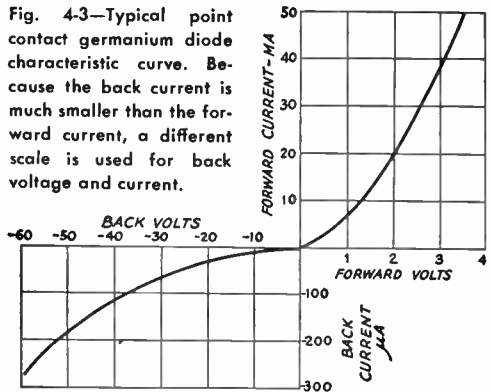

Fig. 4-3—Typical point contact germanium diode characteristic curve. Because the back current is much smaller than the forward current, a different scale is used for back voltage and current.

**Zener Diodes**

The “Zener diode” is a special type of silicon junction diode that has a characteristic similar to that shown in Fig. 4-4. The sharp break from non-conductance to conductance is called the Zener Knee; at applied voltages greater than this

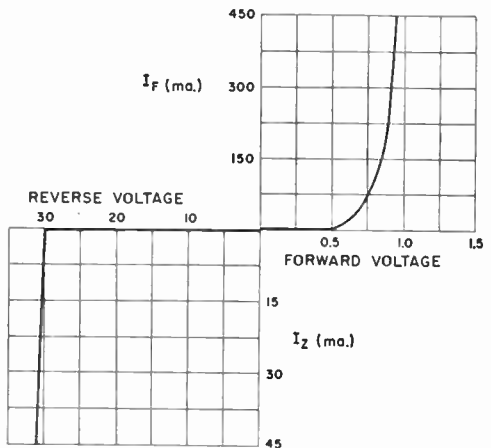

Fig. 4-4—Typical characteristic of a zener diode. In this example, the voltage drop is substantially constant at 30 volts in the (normally) reverse direction. Compare with Fig. 4-3. A diode with this characteristic would be called a “30-volt zener diode.”

breakdown point, the voltage drop across the diode is essentially constant over a wide range of currents. The substantially constant voltage drop over a wide range of currents allows this semiconductor device to be used as a constant voltage reference or control element, in a manner somewhat similar to the gaseous voltage-regulator tube. Voltages for Zener diode action range from a few volts to several hundred and power ratings run from a fraction of a watt to 50 watts.

Zener diodes can be connected in series to advantage; the temperature coefficient is improved over that of a single diode of equivalent rating and the power-handling capability is increased.

Two Zener diodes connected in opposition, Fig. 4-5, form a simple and highly effective clipper.

**Voltage-Variable Capacitors**

Voltage-variable capacitors are p-n junction diodes that behave as capacitors of reasonable  $Q$  (35 or more) up to 50 Mc. and higher. They are useful in many applications because the actual capacitance value is dependent upon the d.c. bias voltage that is applied. In a typical capacitor the capacitance can be varied over a 10-to-1 range with a bias change from 0 to -100 volts. The current demand on the bias supply is on the order of a few microamperes.

Typical applications include remote control of tuned circuits, automatic frequency control of

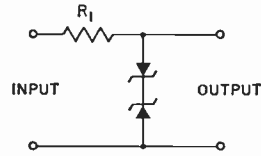

Fig. 4-5—Full-wave clipping action with two Zener diodes in opposition. The output level would be at a peak-to-peak voltage of twice the zener rating of a single diode.  $R_1$  should have a resistance value sufficient to limit the current to the zener diode rating.

receiver local oscillators, and simple frequency modulators for communications and for sweep-tuning applications.

**Tunnel Diode**

Much hope is held for the future use of the "tunnel diode," a junction semiconductor of special construction that has a "negative resistance" characteristic at low voltages. This characteristic (decrease of current with increase of voltage) permits the diode to be used as an oscillator and as an amplifier. Since electrical charges move through the diode with the speed of light, in contrast to the relatively slow motion of electrical charge carriers in other semiconductors, it has been possible to obtain oscillations at 2000 Mc. and higher.

**TRANSISTORS**

Fig. 4-6 shows a "sandwich" made from two layers of p-type semiconductor material with a thin layer of n-type between. There are in effect two p-n junction diodes back to back. If a positive bias is applied to the p-type material at the left, current will flow through the left-hand junction, the holes moving to the right and the electrons from the n-type material moving to the left. Some of the holes moving into the n-type material will combine with the electrons there and be neutralized, but some of them also will travel to the region of the right-hand junction.

If the p-n combination at the right is biased negatively, as shown, there would normally be no current flow in this circuit (see Fig. 4-1C). However, there are now additional holes available at the junction to travel to point B and electrons can travel toward point A, so a current

can flow even though this section of the sandwich considered alone is biased to prevent conduction. Most of the current is between A and B and does not flow out through the common connection to the n-type material in the sandwich.

A semiconductor combination of this type is called a **transistor**, and the three sections are known as the **emitter**, **base** and **collector**, respectively. The amplitude of the collector current depends principally upon the amplitude of the emitter current; that is, the collector current is controlled by the emitter current.

**Power Amplification**

Because the collector is biased in the back direction the collector-to-base resistance is high. On the other hand, the emitter and collector currents are substantially equal, so the power in the collector circuit is larger than the power in the emitter circuit ( $P = I^2 R$ , so the powers are proportional to the respective resistances, if the currents are the same). In practical transistors emitter resistance is of the order of a few hundred ohms while the collector resistance is hundreds or thousands of times higher, so power gains of 20 to 40 db. or even more are possible.

**Types**

The transistor may be one of the several types shown in Fig. 4-7. The assembly of p- and n-type materials may be reversed, so that p-n-p and n-p-n transistors are both possible.

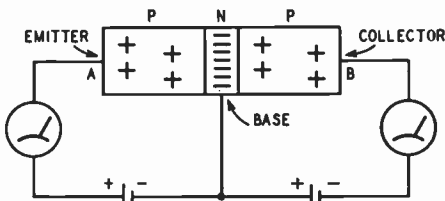

Fig. 4-6—The basic arrangement of a transistor. This represents a junction-type p-n-p unit.



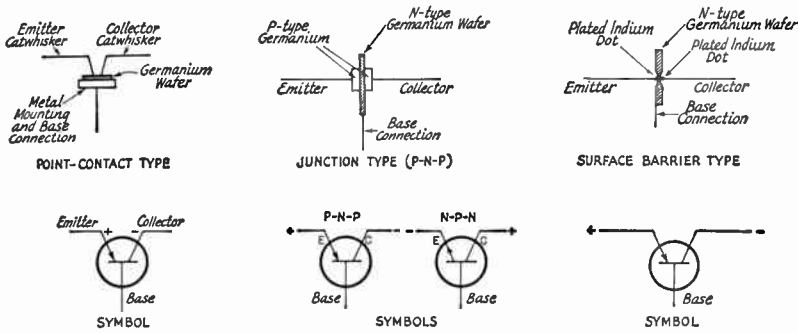

Fig. 4-7—Point-contact, junction-type and surface-barrier types of transistors with their circuit symbols. The plus and minus signs associated with the symbols indicate polarities of voltages, with respect to the base, to be applied to the elements.

### Point-Contact Transistors

The point-contact transistor, shown at the left in Fig. 4-7, has two "cat whiskers" placed very close together on the surface of a germanium wafer. It is principally of historical interest and is now superseded by the junction type. It is difficult to manufacture, since the two contact points must be extremely close together if good high-frequency characteristics are to be secured.

### Junction Transistors

The junction transistor, shown at the center in Fig. 4-7, has higher capacitances and higher power-handling capacity than the point-contact type. The "electrode" areas and thickness of the intermediate layer have an important effect on the upper frequency limit. Ordinary junction transistors may have cut-off frequencies (see next section) up to 50 Mc. or so. The types used for audio and low-radio frequencies usually have cut-off frequencies ranging from 500 to 1000 kc.

The upper frequency limit is extended considerably in the drift transistor. This type has a particular form of distribution of impurities in the base material resulting in the creation of an internal electric field that accelerates the carriers across the junction. Typical drift transistors have cut-off frequencies of the order of 100 Mc.

Another type of transistor useful in high-frequency work is the surface barrier transistor, using plated emitter and collector electrodes on a wafer of n-type material, as shown at the right in Fig. 4-7. Surface-barrier transistors will operate as amplifiers and oscillators at frequencies of 250 Mc. or higher.

## TRANSISTOR CHARACTERISTICS

An important characteristic of a transistor is its **current amplification factor**, usually designated by the symbol  $\alpha$ . This is the ratio of the change in collector current to a small change in emitter current, measured in the common-base circuit described later, and is comparable with the voltage amplification factor ( $\mu$ ) of a vacuum tube. The current amplification factor is almost, but not quite, 1 in a junction transistor. It is larger than 1 in the point-contact type, values in the neighborhood of 2 being typical.

The  $\alpha$  cut-off frequency is the frequency at

which the current amplification drops 3 db. below its low-frequency value. Cut-off frequencies range from 500 kc. to frequencies in the v.h.f. region. The cut-off frequency indicates in a general way the frequency spread over which the transistor is useful.

Each of the three elements in the transistor has a resistance associated with it. The emitter and collector resistances were discussed earlier. There is also a certain amount of resistance associated with the base, a value of a few hundred to 1000 ohms being typical of the base resistance.

The values of all three resistances vary with the type of transistor and the operating voltages. The collector resistance, in particular, is sensitive to operating conditions.

### Characteristic Curves

The operating characteristics of transistors can be shown by a series of characteristic curves. One such set of curves is shown in Fig. 4-8. It

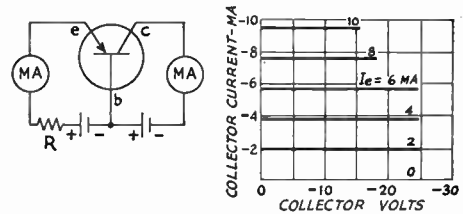

Fig. 4-8—A typical collector-current vs. collector-voltage characteristic of a junction-type transistor, for various emitter-current values. The circuit shows the setup for taking such measurements. Since the emitter resistance is low, a current-limiting resistor,  $R$ , is connected in series with the source of current. The emitter current can be set at a desired value by adjustment of this resistance.

shows the collector current *vs.* collector voltage for a number of fixed values of emitter current. Practically, the collector current depends almost entirely on the emitter current and is independent of the collector voltage. The separation between curves representing equal steps of emitter current is quite uniform, indicating that almost distortionless output can be obtained over the useful operating range of the transistor.

Another type of curve is shown in Fig. 4-9, together with the circuit used for obtaining it. This also shows collector current *vs.* collector

voltage, but for a number of different values of base current. In this case the emitter element is used as the common point in the circuit. The collector current is not independent of collector voltage with this type of connection, indicating that the output resistance of the device is fairly

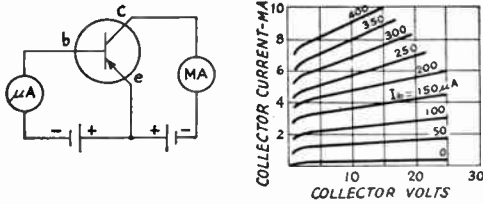

Fig. 4-9—Collector current vs. collector voltage for various values of base current, for a junction-type transistor. The values are determined by means of the circuit shown.

low. The base current also is quite low, which means that the resistance of the base-emitter circuit is moderately high with this method of connection. This may be contrasted with the high values of emitter current shown in Fig. 4-8.

**Ratings**

The principal ratings applied to transistors are maximum collector dissipation, maximum collector voltage, maximum collector current, and maximum emitter current. The voltage and current ratings are self-explanatory.

The collector dissipation is the power, usually expressed in milliwatts, that can safely be dissipated by the transistor as heat. With some types of transistors provision is made for transferring heat rapidly through the container, and such units usually require installation on a heat "sink," or mounting that can absorb heat.

The amount of undistorted output power that can be obtained depends on the collector voltage, the collector current being practically independent of the voltage in a given transistor. Increasing the collector voltage extends the range of linear operation, but must not be carried beyond the point where either the voltage or dissipation ratings are exceeded.

**TRANSISTOR AMPLIFIERS**

Amplifier circuits used with transistors fall into one of three types, known as the **grounded-base**, **grounded-emitter**, and **grounded-collector** circuits. These are shown in Fig. 4-10 in elementary form. The three circuits correspond approximately to the grounded-grid, grounded-cathode and cathode-follower circuits, respectively, used with vacuum tubes.

The important transistor **parameters** in these circuits are the **short-circuit current transfer ratio**, the **cut-off frequency**, and the **input and output impedances**. The short-circuit current transfer ratio is the ratio of a small change in output current to the change in input current that causes it, the output circuit being short-circuited. The cut-off frequency is the frequency

at which the amplification decreases by 3 db. from its value at some frequency well below that at which frequency effects begin to assume importance. The input and output impedances are, respectively, the impedance which a signal source working into the transistor would see, and the internal output impedance of the transistor (corresponding to the plate resistance of a vacuum tube, for example).

**Grounded-Base Circuit**

The input circuit of a grounded-base amplifier must be designed for low impedance, since the emitter-to-base resistance is of the order of  $25/I_e$  ohms, where  $I_e$  is the emitter current in milliamperes. The optimum output load impedance,  $R_L$ , may range from a few thousand ohms to 100,000, depending upon the requirements.

The current transfer ratio is  $\alpha$  and the cut-off frequency is as defined previously.

In this circuit the phase of the output (collector) current is the same as that of the input (emitter) current. The parts of these currents that flow through the base resistance are likewise in phase, so the circuit tends to be regenerative and will oscillate if the current amplification factor is greater than 1. A junction transistor is stable in this circuit since  $\alpha$  is less than 1, but a point-contact transistor will oscillate.

**Grounded-Emitter Circuit**

The grounded-emitter circuit shown in Fig. 4-10 corresponds to the ordinary grounded-cathode vacuum-tube amplifier. As indicated by the curves of Fig. 4-9, the base current is small and the input impedance is therefore fairly high—several thousand ohms in the average case. The collector resistance is some tens of thousands of ohms, depending on the signal source impedance. The current transfer ratio in the common-emitter circuit is equal to

$$\frac{\alpha}{1 - \alpha}$$

Since  $\alpha$  is close to 1 (0.98 or higher being representative), the short-circuit current gain in the grounded-emitter circuit may be 50 or more. The cut-off frequency is equal to the  $\alpha$  cut-off frequency multiplied by  $(1 - \alpha)$ , and therefore is relatively low. (For example a transistor with an  $\alpha$  cut-off of 1000 kc. and  $\alpha = 0.98$  would have a cut-off frequency of  $1000 \times 0.02 = 20$  kc. in the grounded-emitter circuit.)

Within its frequency limitations, the grounded-emitter circuit gives the highest power gain of the three.

In this circuit the phase of the output (collector) current is opposite to that of the input (base) current so such feedback as occurs through the small emitter resistance is negative and the amplifier is stable with either junction or point-contact transistors.

**Grounded-Collector Circuit**

Like the vacuum-tube cathode follower, the grounded-collector transistor amplifier has high

input impedance and low output impedance. The latter is approximately equal to the impedance of the signal input source multiplied by  $(1 - \alpha)$ . The input resistance depends on the load resistance, being approximately equal to the load resistance divided by  $(1 - \alpha)$ . The fact that input resistance is directly related to the load resistance is a disadvantage of this type of amplifier if the load is one whose resistance or impedance varies with frequency.

The current transfer ratio with this circuit is

$$\frac{1}{1 - \alpha}$$

and the cut-off frequency is the same as in the grounded-emitter circuit. The output and input currents are in phase.

### Practical Circuit Details

The transistor is essentially a low-voltage device, so the use of a battery power supply rather than a rectified-a.c. supply is quite common. Usually, it is more convenient to employ a single battery as a power source in preference to the two-battery arrangements shown in Fig. 4-10, so most circuits are designed for single-battery operation. Provision must be included, therefore, for obtaining proper biasing voltage for the emitter-base circuit from the battery that supplies the power in the collector circuit.

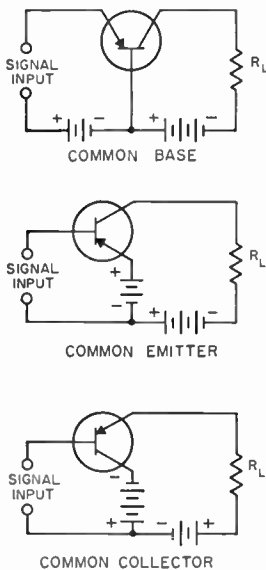

Fig. 4-10—Basic transistor amplifier circuits.  $R_L$ , the load resistance, may be an actual resistor or the primary of a transformer. The input signal may be supplied from a transformer secondary or by resistance-capacitance coupling. In any case it is to be understood that a d.c. path must exist between the base and emitter.

P-n-p transistors are shown in these circuits. If n-p-n types are used the battery polarities must be reversed.

Coupling arrangements for introducing the input signal into the circuit and for taking out the amplified signal are similar to those used with vacuum tubes. However, the actual component values will in general be quite different from those used with tubes. This is because the impedances associated with the input and output circuits of transistors may differ widely from the comparable impedances in tube circuits. Also, d.c. voltage drops in resistances may require more

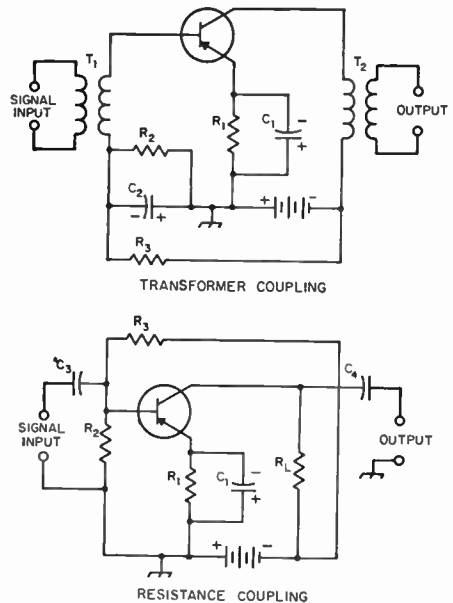

Fig. 4-11—Practical grounded-emitter circuits using transformer and resistance coupling. A combination of either also can be used—e.g., resistance-coupled input and transformer-coupled output. Tuned transformers may be used for r.f. and i.f. circuits.

With small transistors used for low-level amplification the input impedance will be of the order of 1000 ohms and the input circuit should be designed for an impedance step-down, if necessary. This can be done by appropriate choice of turns ratio for  $T_1$  or, in the case of tuned circuits, by tapping the base down on the tuned secondary circuit. In the resistance-coupled circuit  $R_2$  should be large compared with the input impedance, values of the order of 10,000 ohms being used.

In low-level circuits  $R_1$  will be of the order of 1000 ohms.  $R_3$  should be chosen to bias the transistor to the desired no-signal collector current; its value depends on  $R_1$  and  $R_2$  (see text).

careful attention with transistors because of the much lower voltage available from the ordinary battery power source. Battery economy becomes an important factor in circuit design, both with respect to voltage required and to overall current drain. A bias voltage divider, for example, easily may use more power than the transistor with which it is associated.

Typical single-battery grounded-emitter circuits are shown in Fig. 4-11.  $R_1$ , in series with the emitter, is for the purpose of "swamping out" the resistance of the emitter-base diode; this swamping helps to stabilize the emitter current. The resistance of  $R_1$  should be large compared with that of the emitter-base diode, which, as stated earlier, is approximately equal to 25 divided by the emitter current in ma.

Since the current in  $R_1$  flows in such a direction as to bias the emitter negatively with respect to the base (a p-n-p transistor is assumed), a base-emitter bias slightly greater than the drop in  $R_1$  must be supplied. The proper operating point is

achieved through adjustment of voltage divider  $R_2R_3$ , which is proportioned to give the desired value of no-signal collector current.

In the transformer-coupled circuit, input signal currents flow through  $R_1$  and  $R_2$ , and there would be a loss of signal power at the base-emitter diode if these resistors were not bypassed by  $C_1$  and  $C_2$ . The capacitors should have low reactance compared with the resistances across which they are connected. In the resistance-coupled circuit  $R_2$  serves as part of the bias voltage divider and also as part of the load for the signal-input source. As seen by the signal source,  $R_3$  is in parallel with  $R_2$  and thus becomes part of the input load resistance.  $C_3$  must have low reactance compared with the parallel combination of  $R_2, R_3$  and the base-to-emitter resistance of the transistor. The load impedance will determine the reactance of  $C_4$ .

The output load resistance in the transformer-coupled case will be the actual load as reflected at the primary of the transformer, and its proper value will be determined by the transistor characteristics and the type of operation (Class A, B, etc.). The value of  $R_L$  in the resistance-coupled case is usually such as to permit the maximum a.c. voltage swing in the collector circuit without undue distortion, since Class A operation is usual with this type of amplifier.

**Bias Stabilization**

Transistor currents are sensitive to temperature variations, and so the operating point tends to shift as the transistor heats. The shift in operating point is in such a direction as to increase the heating, leading to "thermal runaway" and possible destruction of the transistor. The heat developed depends on the amount of power dissipated in the transistor, so it is obviously advantageous in this respect to operate with as little internal dissipation as possible: i.e., the d.c. input should be kept to the lowest value that will permit the type of operation desired and should never exceed the rated value for the particular transistor used.

A contributing factor to the shift in operating point is the collector-to-base leakage current (usually designated  $I_{co}$ ) — that is, the current that flows from collector to base with the emitter connection open. This current, which is highly temperature sensitive, has the effect of increasing the emitter current by an amount much larger than  $I_{co}$  itself, thus shifting the operating point in such a way as to increase the collector current. This effect is reduced to the extent that  $I_{co}$  can be made to flow out of the base terminal rather than through the base-emitter diode. In the circuits of Fig. 4-11, bias stabilization is improved by making the resistance of  $R_1$  as large as possible and both  $R_2$  and  $R_3$  as small as possible, consistent with gain and battery economy.

**TRANSISTOR OSCILLATORS**

Since more power is available from the output circuit than is necessary for its generation in the input circuit, it is possible to use some of the output power to supply the input circuit and thus

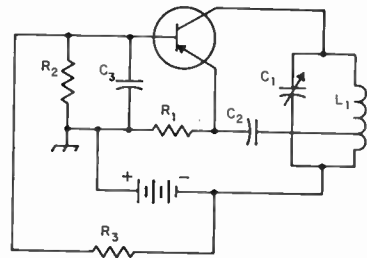

HARTLEY

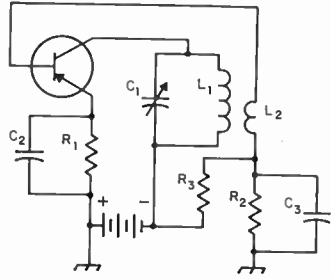

TICKLER

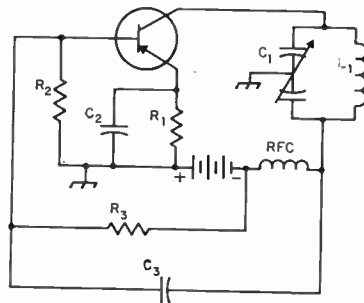

COLPITTS

Fig. 4-12—Typical transistor oscillator circuits. Component values are discussed in the text.

sustain self-oscillation. Representative oscillator circuits are shown in Fig. 4-12.

The upper frequency limit for oscillation is principally a function of the cut-off frequency of the transistor used, and oscillation will cease at the frequency at which there is insufficient amplification to supply the energy required to overcome circuit losses. Transistor oscillators usually will operate up to, and sometimes well beyond, the  $\alpha$  cut-off frequency of the particular transistor used.

The approximate oscillation frequency is that of the tuned circuit,  $L_1C_1$ .  $R_1, R_2$  and  $R_3$  have the same functions as in the amplifier circuits given in Fig. 4-11. Bypass capacitors  $C_2$  and  $C_3$  should have low reactances compared with the resistances with which they are associated.

Feedback in these circuits is adjusted in the same way as with tube oscillators: position of the tap on  $L_1$  in the Hartley, turns and coupling of  $L_2$  in the tickler, and ratio of the sections of  $C_1$  in the Colpitts.

# Receiving Systems

A good receiver in the amateur station makes the difference between mediocre contacts and solid QSOs, and its importance cannot be over-emphasized. In the less crowded v.h.f. bands, **sensitivity** (the ability to bring in weak signals) is the most important factor in a receiver. In the more crowded amateur bands, good sensitivity must be combined with **selectivity** (the ability to distinguish between signals separated by only a small frequency difference). To receive weak signals, the receiver must furnish enough **amplification** to amplify the minute signal power delivered by the antenna up to a useful amount of power that will operate a loudspeaker or set of headphones. Before the amplified signal can operate the speaker or phones, it must be converted to audio-frequency power by the process of **detection**. The sequence of amplification is not too important—some of the amplification can take place (and usually does) before detection, and some can be used after detection.

There are two basic considerations for any receiver for the several communications modes. Essentially the bandwidth (what the receiver will accept) must be consistent with the type of signal, and the detector must be suitable for recovering the intelligence. Double-sideband 'phone signals (a.m., f.m.) require more bandwidth (at least 6 to 8 kc.) than single-sideband 'phone (2 to 3 kc.), and A1, or c.w., requires the least of all (0.2 to 0.5 kc.). Since "narrow bandwidth" is synonymous with "high selectivity," maximum selectivity can be used with code and minimum selectivity with wide-band f.m. Greater-than-optimum bandwidth can, of course, be used with any mode, but

the price will be a reduction in selectivity.

Detectors fall into three categories: a.m., f.m. and heterodyne. A true a.m. detector depends upon the presence of a transmitted carrier-frequency signal to complete the detection process. A good f.m. detector will be insensitive to signal-amplitude changes and respond only to frequency changes. **Heterodyne** detectors are used for single-sideband 'phone or for code signals; they depend for their operation on the presence of a locally-generated steady signal. If the detector is made to oscillate and produce the steady signal, it is known as an **autodyne** detector. Modern superheterodyne receivers use a separate oscillator (**beat-frequency oscillator**, or "**b.f.o.**"). Summing up the differences, 'phone receivers can't use as much selectivity as code receivers, and code and s.s.b. receivers require a detector with a locally-generated steady frequency to give a readable signal. Entertainment receivers, of the type used for a.m. "broadcast" or f.m. "hi fi", can receive only a.m. or f.m. 'phone signals and not code and single-sideband signals because no beat-frequency oscillator is included with the detector circuit.

**Communications receivers** include a.m. and heterodyne detectors, and the better ones have some means for varying the selectivity, to match the mode being received. A single-sideband receiver or a highly-selective code receiver should have a slow tuning rate, for convenience and ease of operation. Without it, the sideband signals become difficult to tune in accurately, and one can tune right "through" a weak code signal without hearing it.

## RECEIVER CHARACTERISTICS

### Sensitivity

In commercial circles "sensitivity" is defined as the strength of the signal (in microvolts) at the input of the receiver that is required to produce a specified audio power output at the speaker or headphones. This is a satisfactory definition for broadcast and communications receivers operating below about 20 Mc., where atmospheric and man-made electrical noises normally mask any noise generated by the receiver itself.

Another commercial measure of sensitivity defines it as the signal at the input of the receiver required to give a signal-plus-noise output some stated ratio (generally 10 db.) above the noise output of the receiver. This is a more

useful sensitivity measure for the amateur, since it indicates how well a weak signal will be heard and is not merely a measure of the over-all amplification of the receiver. However, it is not an absolute method, because the bandwidth of the receiver plays a large part in the result.

The random motion of the molecules in the antenna and receiver circuits generates small voltages called **thermal-agitation noise** voltages. Thermal-agitation noise is independent of frequency and is proportional to the (absolute) temperature, the resistance component of the impedance across which the thermal agitation is produced, and the bandwidth. Noise is generated in vacuum tubes by random irregularities in the current flow within them; it is convenient to ex-



press this **shot-effect noise** as an equivalent resistance in the grid circuit of a noise-free tube. This **equivalent noise resistance** is the resistance (at room temperature) that placed in the grid circuit of a noise-free tube will produce plate-circuit noise equal to that of the actual tube. The equivalent noise resistance of a vacuum tube increases with frequency.

An ideal receiver would generate no noise in its tubes and circuits, and the minimum detectable signal would be limited only by the thermal noise in the antenna. In a practical receiver, the limit is determined by how well the amplified antenna noise overrides the other noise in the plate circuit of the input stage: (It is assumed that the first stage in any good receiver will be the determining factor; the noise contributions of subsequent stages should be insignificant by comparison.) At frequencies below 20 or 30 Mc. the site noise (atmospheric and man-made noise) is generally the limiting factor.

The degree to which a practical receiver approaches the quiet ideal receiver of the same bandwidth is given by the **noise figure** of the receiver. Noise figure is defined as the ratio of the signal-to-noise power ratio of the ideal receiver to the signal-to-noise power ratio of the actual receiver output. Since the noise figure is a ratio, it is usually given in decibels; it runs around 5 to 10 db. for a good communications receiver below 30 Mc. Although noise figures of 2 to 4 db. can be obtained, they are of little or no use below 30 Mc. except in extremely quiet locations or when a very small antenna is used. The noise figure of a receiver is not modified by changes in bandwidth. Measurement technique is described in Chapter 21.

**Selectivity**

Selectivity is the ability of a receiver to discriminate against signals of frequencies differing from that of the desired signal. The over-all selectivity will depend upon the selectivity and the number of the individual tuned circuits.

The selectivity of a receiver is shown graphically by drawing a curve that gives the ratio of signal strength required at various frequencies off resonance to the signal strength at resonance, to give constant output. A **resonance curve** of this type is shown in Fig. 5-1. The **bandwidth** is the width of the resonance curve (in cycles or kilocycles) of a receiver at a specified ratio; in the typical curve of Fig. 5-1 the bandwidths for response ratios of 2 and 1000 (described as “-6

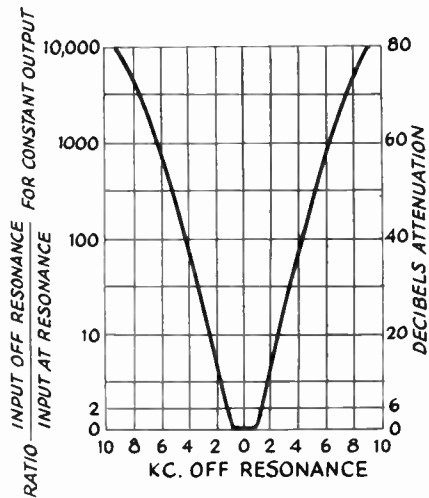

Fig. 5-1—Typical selectivity curve of a modern superheterodyne receiver. Relative response is plotted against deviations above and below the resonance frequency. The scale at the left is in terms of voltage ratios, the corresponding decibel steps are shown at the right.

db.” and “-60 db.”) are 2.4 and 12.2 kc. respectively.

The bandwidth at 6 db. down must be sufficient to pass the signal and its sidebands if faithful reproduction of the signal is desired. However, in the crowded amateur bands, it is generally advisable to sacrifice fidelity for intelligibility. The ability to reject adjacent-channel signals depends upon the **skirt selectivity** of the receiver, which is determined by the bandwidth at high attenuation. In a receiver with excellent skirt selectivity, the ratio of the 6-db. bandwidth to the 60-db. bandwidth will be about 0.25 for code and 0.5 for phone. The minimum usable bandwidth at 6 db. down is about 150 cycles for code reception and about 2000 cycles for phone.

**Stability**

The stability of a receiver is its ability to “stay put” on a signal under varying conditions of gain-control setting, temperature, supply-voltage changes and mechanical shock and distortion. The term “unstable” is also applied to a receiver that breaks into oscillation or a regenerative condition with some settings of its controls that are not specifically intended to control such a condition.

**DETECTION AND DETECTORS**

Detection is the process of recovering the modulation from a signal (see “Modulation, Heterodyning and Beats”, page 58). Any device that is “nonlinear” (i.e., whose output is not *exactly* proportional to its input) will act as an a.m. detector. It can be used as a detector if an impedance for the desired modulation frequency is connected in the output circuit.

Detector sensitivity is the ratio of desired detector output to the input. Detector linearity is a measure of the ability of the detector to reproduce the exact form of the modulation on the incoming signal. The resistance or impedance of the detector is the resistance or impedance it presents to the circuits it is connected to. The input resistance is important in receiver design, since if

it is relatively low it means that the detector will consume power, and this power must be furnished by the preceding stage. The signal-handling capability means the ability to accept signals of a specified amplitude without overloading or distortion.

**Diode Detectors**

The simplest detector for a.m. is the diode. A galena, silicon or germanium crystal is an imperfect form of diode (a small current can pass in the reverse direction), and the principle of detection in a crystal is similar to that in a vacuum-tube diode.

Circuits for both half-wave and full-wave diodes are given in Fig. 5-2. The simplified half-wave circuit at 5-2A includes the r.f. tuned circuit,  $L_2C_1$ , a coupling coil,  $L_1$ , from which the r.f. energy is fed to  $L_2C_1$ , and the diode,  $D$ ,

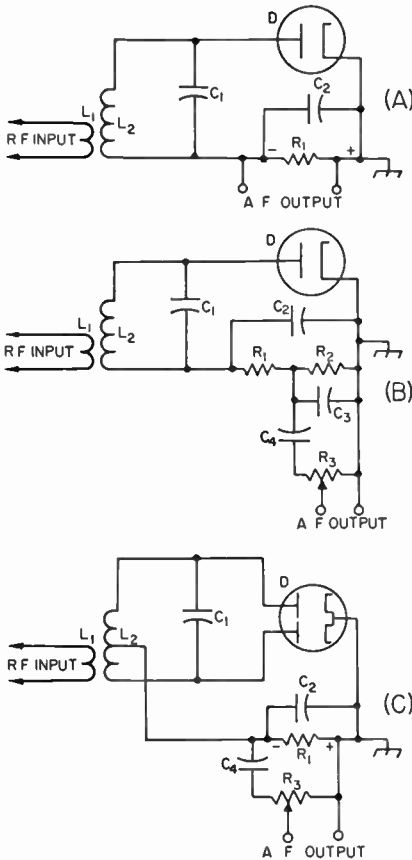

Fig. 5-2—Simplified and practical diode detector circuits. A, the elementary half-wave diode detector; B, a practical circuit, with r.f. filtering and audio output coupling; C, full-wave diode detector, with output coupling indicated. The circuit,  $L_2C_1$ , is tuned to the signal frequency; typical values for  $C_2$  and  $R_1$  in A and C are 250  $\mu\text{mf.}$  and 250,000 ohms, respectively; in B,  $C_2$  and  $C_3$  are 100  $\mu\text{mf.}$  each;  $R_1$ , 50,000 ohms; and  $R_2$ , 250,000 ohms.  $C_4$  is 0.1  $\mu\text{f.}$  and  $R_3$  may be 0.5 to 1 megohm.

with its load resistance,  $R_1$ , and bypass capacitor,  $C_2$ . The flow of rectified r.f. current causes a d.c. voltage to develop across the terminals of  $R_1$ . The  $-$  and  $+$  signs show the polarity of the voltage. The variation in amplitude of the r.f. signal with modulation causes corresponding variations in the value of the d.c. voltage across  $R_1$ . In audio work the load resistor,  $R_1$ , is usually 0.1 megohm or higher, so that a fairly large voltage will develop from a small rectified-current flow.

The progress of the signal through the detector or rectifier is shown in Fig. 5-3. A typical modulated signal as it exists in the tuned

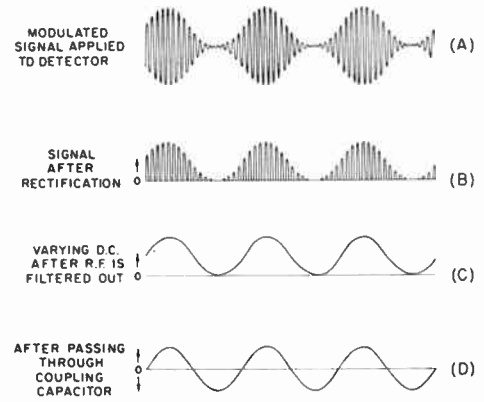

Fig. 5-3—Diagrams showing the detection process.

circuit is shown at A. When this signal is applied to the rectifier tube, current will flow only during the part of the r.f. cycle when the plate is positive with respect to the cathode, so that the output of the rectifier consists of half-cycles of r.f. These current pulses flow in the load circuit comprised of  $R_1$  and  $C_2$ , the resistance of  $R_1$  and the capacity of  $C_2$  being so proportioned that  $C_2$  charges to the peak value of the rectified voltage on each pulse and retains enough charge between pulses so that the voltage across  $R_1$  is smoothed out, as shown in C.  $C_2$  thus acts as a filter for the radio-frequency component of the output of the rectifier, leaving a d.c. component that varies in the same way as the modulation on the original signal. When this varying d.c. voltage is applied to a following amplifier through a coupling capacitor ( $C_4$  in Fig. 5-2), only the variations in voltage are transferred, so that the final output signal is a.c., as shown in D.

In the circuit at 5-2B,  $R_1$  and  $C_2$  have been divided for the purpose of providing a more effective filter for r.f. It is important to prevent the appearance of any r.f. voltage in the output of the detector, because it may cause overloading of a succeeding amplifier tube. The audio-frequency variations can be transferred to another circuit through a coupling capacitor,  $C_4$ , to a load resistor,  $R_3$ , which usually is a

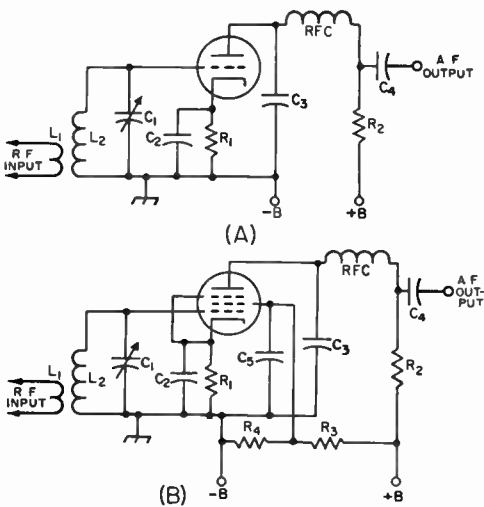

Fig. 5-4—Circuits for plate detection. A, triode; B, pentode. The input circuit,  $L_2C_1$  is tuned to the signal frequency. Typical values for the other components are:

Component	Circuit A	Circuit B
$C_2$	0.5 $\mu\text{f.}$ or larger.	0.5 $\mu\text{f.}$ or larger.
$C_3$	0.001 to 0.002 $\mu\text{f.}$	250 to 500 $\mu\text{f.}$
$C_4$	0.1 $\mu\text{f.}$	0.1 $\mu\text{f.}$
$C_5$		0.5 $\mu\text{f.}$ or larger.
$R_1$	25,000 to 150,000 ohms.	10,000 to 20,000 ohms.
$R_2$	50,000 to 100,000 ohms.	100,000 to 250,000 ohms.
$R_3$		50,000 ohms.
$R_4$		20,000 ohms.
RFC	2.5 mh.	2.5 mh.

Plate voltages from 100 to 250 volts may be used. Effective screen voltage in B should be about 30 volts.

“potentiometer” so that the audio volume can be adjusted to a desired level.

Coupling to the potentiometer (volume control) through a capacitor also avoids any flow of d.c. through the control. The flow of d.c. through a high-resistance volume control often tends to make the control noisy (scratchy) after a short while.

The full-wave diode circuit at 5-2C differs in operation from the half-wave circuit only in that both halves of the r.f. cycle are utilized. The full-wave circuit has the advantage that r.f. filtering is easier than in the half-wave circuit. As a result, less attenuation of the higher audio frequencies will be obtained for any given degree of r.f. filtering.

The reactance of  $C_2$  must be small compared to the resistance of  $R_1$  at the radio frequency being rectified, but at audio frequencies must be relatively large compared to  $R_1$ . If the capacity of  $C_2$  is too large, response at the higher audio frequencies will be lowered.

Compared with most other detectors, the gain of the diode is low, normally running around 0.8 in audio work. Since the diode consumes power, the  $Q$  of the tuned circuit is reduced,

bringing about a reduction in selectivity. The loading effect of the diode is close to one-half the load resistance. The detector linearity is good, and the signal-handling capability is high.

**Plate Detectors**

The plate detector is arranged so that rectification of the r.f. signal takes place in the plate circuit of the tube. Sufficient negative bias is applied to the grid to bring the plate current nearly to the cut-off point, so that application of a signal to the grid circuit causes an increase in average plate current. The average plate current follows the changes in signal in a fashion similar to the rectified current in a diode detector.

Circuits for triodes and pentodes are given in Fig. 5-4.  $C_3$  is the plate bypass capacitor, and, with RFC, prevents r.f. from appearing in the output. The cathode resistor,  $R_1$ , provides the operating grid bias, and  $C_2$  is a bypass for both radio and audio frequencies.  $R_2$  is the plate load resistance and  $C_4$  is the output coupling capacitor. In the pentode circuit at B,  $R_3$  and  $R_4$  form a voltage divider to supply the proper screen potential (about 30 volts), and  $C_5$  is a bypass capacitor.  $C_2$  and  $C_5$  must have low reactance for both radio and audio frequencies.

In general, transformer coupling from the plate circuit of a plate detector is not satisfactory, because the plate impedance of any tube is very high when the bias is near the plate-current cut-off point. Impedance coupling may be used in place of the resistance coupling shown in Fig. 5-4. Usually 100 henrys or more inductance is required.

The plate detector is more sensitive than the diode because there is some amplifying action in the tube. It will handle large signals, but is not so tolerant in this respect as the diode. Linearity, with the self-biased circuits, shown, is good. Up to the overload point the detector takes no power from the tuned circuit, and so does not affect its  $Q$  and selectivity.

**Infinite-Impedance Detector**

The circuit of Fig. 5-5 combines the high signal-handling capabilities of the diode detector

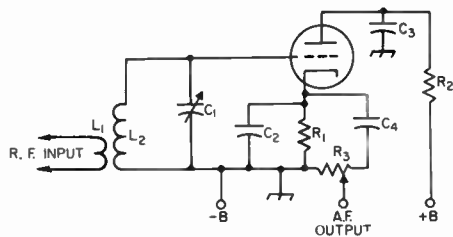

Fig. 5-5—The infinite-impedance detector. The input circuit,  $L_2C_1$ , is tuned to the signal frequency. Typical values for the other components are:

$C_2$ —250 $\mu\text{f.}$	$R_1$ —0.15 megohm.
$C_3$ —0.5 $\mu\text{f.}$	$R_2$ —25,000 ohms.
$C_4$ —0.1 $\mu\text{f.}$	$R_3$ —0.25-megohm volume control.

A tube having a medium amplification factor (about 20) should be used. Plate voltage should be 250 volts.

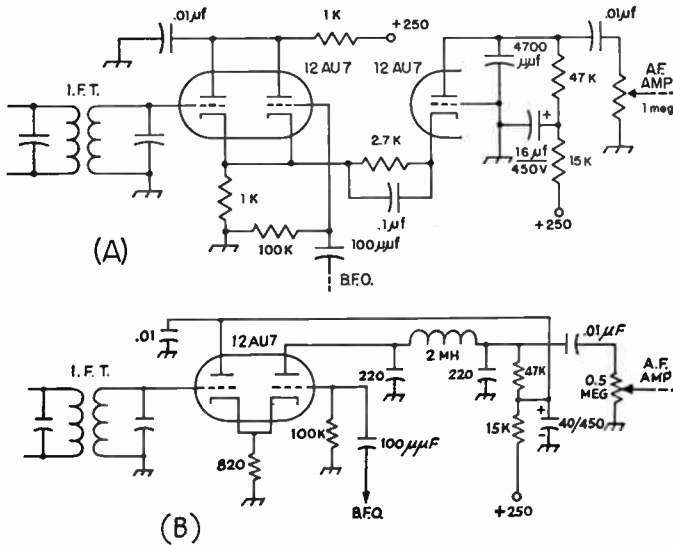

Fig. 5-6—Two versions of the "product detector" circuit. In the circuit at A separate tubes are used for the signal circuit cathode follower, the b.f.o. cathode follower and the mixer tube. In B the mixer and b.f.o. follower are combined in one tube, and a low-pass filter is used in the output.

with low distortion and, like the plate detector, does not load the tuned circuit it connects to. The circuit resembles that of the plate detector, except that the load resistance,  $R_1$ , is connected between cathode and ground and thus is common to both grid and plate circuits, giving negative feedback for the audio frequencies. The cathode resistor is bypassed for r.f. but not for audio, while the plate circuit is bypassed to ground for both audio and radio frequencies. An r.f. filter can be connected between the cathode and  $C_4$  to eliminate any r.f. that might otherwise appear in the output.

The plate current is very low at no signal, increasing with signal as in the case of the plate detector. The voltage drop across  $R_1$  consequently increases with signal. Because of this and the large initial drop across  $R_1$ , the grid usually cannot be driven positive by the signal, and no grid current can be drawn.

### Heterodyne and Product Detectors

Any of the preceding a.m. detectors becomes a heterodyne detector when a local-oscillator (b.f.o.) signal is added to it. The b.f.o. signal is normally coupled into the input circuit through a small capacitor. The b.f.o. signal amplitude should be large (5 to 20 times) compared with the strongest incoming code or s.s.b. signal, if distortion is to be minimized. Although any a.m. detector used with a b.f.o. much greater in amplitude than the incoming signal will give low distortion of the detected signal, the name "product detector" has been given to heterodyne-detector circuits in which particular attention is paid to maintaining low distortion and intermodulation products.

In the product-detector circuit of Fig. 5-6A, the first two triodes are used as cathode followers, for the signal and for the b.f.o. working into a common cathode resistor (1000 ohms). The third triode also shares this cathode resistor and

consequently the same signals, but it has an audio load in its plate circuit and it operates at a higher grid bias (by virtue of the 2700-ohm resistor in its cathode circuit). The signals and the b.f.o. mix in this third triode. If the b.f.o. is turned off, a modulated signal running through the signal cathode follower should yield little or no audio output from the detector, up to the overload point of the signal cathode follower. Turning on the b.f.o. brings in modulation, because now the detector output is the product of the two signals. The plates of the cathode followers are grounded and filtered for the i.f. and the 4700- $\mu\mu\text{f}$ . capacitor from plate to ground in the output triode furnishes a bypass at the i.f. The b.f.o. voltage should be about 2 r.m.s., and the signal should not exceed about 0.3 volts r.m.s.

The circuit in Fig. 5-6B is a simplification requiring one less triode. Its principle of operation is substantially the same except that the additional bias for the output tube is derived from rectified b.f.o. voltage across the 100,000-ohm resistor. More elaborate r.f. filtering is shown in the plate of the output tube (2-mh. choke and the 220- $\mu\mu\text{f}$ . capacitors), and the degree of plate filtering in either circuit will depend upon the frequencies involved. At low intermediate frequencies, more elaborate filtering is required.

### REGENERATIVE DETECTORS

By providing controllable r.f. feedback (regeneration) in a triode or pentode detector circuit, the incoming signal can be amplified many times, thereby greatly increasing the sensitivity of the detector. Regeneration also increases the effective  $Q$  of the circuit and thus the selectivity. The grid-leak type of detector is most suitable for the purpose.

The grid-leak detector is a combination diode rectifier and audio-frequency amplifier. In the circuit of Fig. 5-7A, the grid corresponds to the diode plate and the rectifying action is exactly

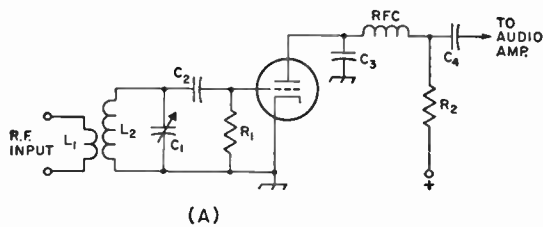
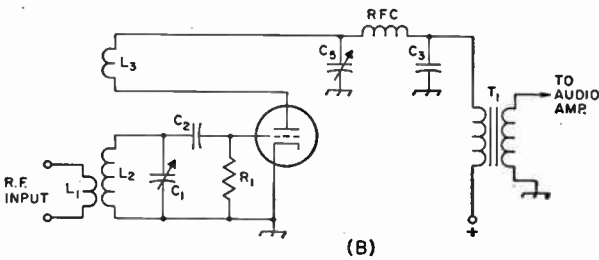

Fig. 5-7—(A) Triode grid-leak detector combines diode detection with triode amplification. Although shown here with resistive plate load,  $R_2$ , an audio choke coil or transformer could be used.



(B) Feeding some signal from the plate circuit back to the grid makes the circuit regenerative. When feedback is sufficient, the circuit will oscillate. Feedback is controlled here by varying reactance at  $C_5$ ; with fixed capacitor at that point regeneration could be controlled by varying plate voltage or coupling between  $L_2$  and  $L_3$ .

reducing  $R_1$  to 0.1 megohm, but the sensitivity will be decreased. The degree of antenna coupling is often critical.

### Tuning

For c.w. reception, the regeneration control is advanced until the detector breaks into a "hiss," which indicates that the detector is oscillating. Further advancing the regeneration control will result in a slight decrease in the hiss.

Code signals can be tuned in and will give a tone with each signal depending on the setting of the tuning control, as shown in Fig 5-8. A low-pitched beat-note cannot be obtained from a strong signal because the detector "pulls in" or "blocks."

The point just after the detector starts oscillating is the most satisfactory condition for code reception. Further advancing the regeneration control makes the receiver less prone to blocking, but also less sensitive to weak signals.

If the detector is in the oscillating condition and an a.m. phone signal is tuned in, a steady audible beat-note will result. While it is possible to listen to phone if the receiver can be tuned to exact zero beat, it is more satisfactory to reduce the regeneration to the point just before the receiver goes into oscillation. This is also the most sensitive operating point.

the same as in a diode. The d.c. voltage from rectified-current flow through the grid leak,  $R_1$ , biases the grid negatively, and the audio-frequency variations in voltage across  $R_1$  are amplified through the tube as in a normal a.f. amplifier. In the plate circuit,  $R_2$  is the plate load resistance and  $C_3$  and  $RFC$  a filter to eliminate r.f. in the output circuit.

A grid-leak detector has considerably greater sensitivity than a diode. The sensitivity is further increased by using a screen-grid tube instead of a triode. The operation is equivalent to that of the triode circuit. The screen bypass capacitor should have low reactance for both radio and audio frequencies.

The circuit in Fig. 5-7B is regenerative, the feedback being obtained by feeding some signal from the plate circuit back to the grid by inductive coupling. The amount of regeneration must be controllable, because maximum regenerative amplification is secured at the critical point where the circuit is just about to oscillate. The critical point in turn depends upon circuit conditions, which may vary with the frequency to which the detector is tuned. An oscillating detector can be detuned slightly from an incoming c.w. signal to give *autodyne* reception.

The circuit of Fig. 5-7B uses a variable bypass capacitor,  $C_5$ , in the plate circuit to control regeneration. When the capacitance is small the tube does not regenerate, but as it increases toward maximum its reactance becomes smaller until there is sufficient feedback to cause oscillation. If  $L_2$  and  $L_3$  are wound end-to-end in the same direction, the plate connection is to the outside of the plate or "tickler" coil,  $L_3$ , when the grid connection is to the outside end of  $L_2$ .

Although the regenerative grid-leak detector is more sensitive than any other type, its many disadvantages commend it for use only in the simplest receivers. The linearity is rather poor, and the signal-handling capability is limited. The signal-handling capability can be improved by

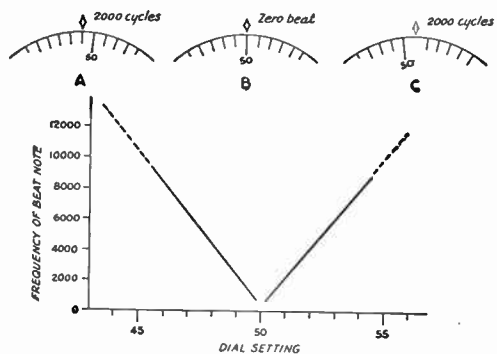

Fig. 5-8—As the tuning dial of a receiver is turned past a code signal, the beat-note varies from a high tone down through "zero beat" (no audible frequency difference) and back up to a high tone, as shown at A, B and C. The curve is a graphical representation of the action. The beat exists past 8000 or 10,000 cycles but usually is not heard because of the limitations of the audio system.



## TUNING AND BAND-CHANGING METHODS

### Tuning

The resonant frequency of a circuit can be shifted by changing either the inductance or the capacitance in the circuit. Panel control of inductance is used to tune a few commercial receivers, but most receivers depend upon panel-controlled variable capacitors for tuning.

### Tuning Rate

For ease in tuning a signal, it is desirable that the receiver have a tuning rate in keeping with the type of signal being received and also with the selectivity of the receiver. A tuning rate of 500 kc. per knob revolution is normally satisfactory for a broadcast receiver, but 100 kc. per revolution is almost too fast for easy s.s.b. reception—around 25 to 50 kc. being more desirable.

### Band Changing

The same coil and tuning capacitor cannot be used for, say, 3.5 to 14 Mc. because of the impracticable maximum-to-minimum capacitance ratio required. It is necessary, therefore, to provide a means for changing the circuit constants for various frequency bands. As a matter of convenience the same tuning capacitor usually is retained, but new coils are inserted in the circuit for each band.

One method of changing inductances is to use a switch having an appropriate number of contacts, which connects the desired coil and disconnects the others. The unused coils are some-

times short-circuited by the switch, to avoid undesirable self-resonances.

Another method is to use coils wound on forms that can be plugged into suitable sockets. These plug-in coils are advantageous when space is at a premium, and they are also very useful when considerable experimental work is involved.

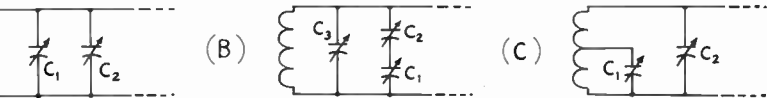

Fig. 5-9—Essentials of the three basic bandspread tuning systems.

times short-circuited by the switch, to avoid undesirable self-resonances.

Another method is to use coils wound on forms that can be plugged into suitable sockets. These plug-in coils are advantageous when space is at a premium, and they are also very useful when considerable experimental work is involved.

### Bandspreading

The tuning range of a given coil and variable capacitor will depend upon the inductance of the coil and the change in tuning capacitance. To cover a wide frequency range and still retain a suitable tuning rate over a relatively narrow frequency range requires the use of **bandspreading**. **Mechanical bandspreading** utilizes some mechanical means to reduce the tuning rate; a typical example is the two-speed planetary drive to be found in some receivers. **Electrical bandspreading** is obtained by using a suitable circuit configuration. Several of these methods are shown in Fig. 5-9.

In A, a small **bandspread capacitor**,  $C_1$  (15-

to 25-pf. maximum), is used in parallel with capacitor  $C_2$ , which is usually large enough (100 to 140 pf.) to cover a 2-to-1 frequency range. The setting of  $C_2$  will determine the minimum capacitance of the circuit, and the maximum capacitance for bandspread tuning will be the maximum capacitance of  $C_1$  plus the setting of  $C_2$ . The inductance of the coil can be adjusted so that the maximum-minimum ratio will give adequate bandspread. It is almost impossible, because of the non-harmonic relation of the various band limits, to get full bandspread on all bands with the same pair of capacitors.  $C_2$  is variously called the **band-setting** or **main tuning capacitor**. It must be reset each time the band is changed.

If the capacitance change of a tuning capacitor is known, the total fixed shunt capacitance (Fig. 5-9A) for covering a band of frequencies can be found from Fig. 5-10.

Example: What fixed shunt capacitance will allow a capacitor with a range of 5 to 30 pf. to tune 3.45 to 4.05 Mc.?  
 $(4.05 - 3.45) \div 4.05 = 0.148$ .

From Fig. 5-10, the capacitance ratio is 0.38, and hence the minimum capacitance is  $(30 - 5) \div 0.38 = 66$  pf. The 5-pf. minimum of the tuning capacitor, the tube capacitance and any stray capacitance must be included in the 66 pf.

The method shown at Fig. 5-9B makes use of capacitors in series. The tuning capacitor,  $C_1$ , may have a maximum capacitance of 100  $\mu\mu\text{f.}$  or

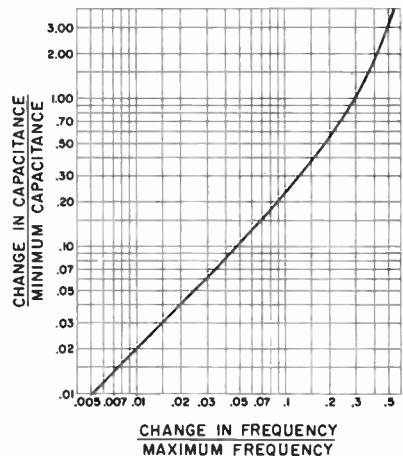

Fig. 5-10—Minimum circuit capacitance required in the circuit of Fig. 5-9A as a function of the capacitance change and the frequency change. Note that maximum frequency and minimum capacitance are used.

more. The minimum capacitance is determined principally by the setting of  $C_3$ , which usually has low capacitance, and the maximum capacitance by the setting of  $C_2$ , which is of the order of 25 to 50 pf. This method is capable of close adjustment to practically any desired degree of bandspread. Either  $C_2$  and  $C_3$  must be adjusted for each band or separate preadjusted capacitors must be switched in.

The circuit at Fig. 5-9C also gives complete spread on each band.  $C_1$ , the bandspread capacitor, may have any convenient value; 50 pf. is satisfactory.  $C_2$  may be used for continuous frequency coverage ("general coverage") and as a bandsetting capacitor. The effective maximum-minimum capacitance ratio depends upon  $C_2$  and the point at which  $C_1$  is tapped on the coil. The nearer the tap to the bottom of the coil, the greater the bandspread, and vice versa. For a given coil and tap, the bandspread will be greater if  $C_2$  is set at higher capacitance.  $C_2$  may be connected permanently across the individual inductor and preset, if desired. This requires a separate capacitor for each band, but eliminates the necessity for resetting  $C_2$  each time.

#### Ganged Tuning

The tuning capacitors of the several r.f. circuits may be coupled together mechanically and operated by a single control. However, this operating convenience involves more complicated construction, both electrically and mechanically. It becomes necessary to make the various circuits track—that is, tune to the same frequency for a given setting of the tuning control.

True tracking can be obtained only when the inductance, tuning capacitors, and circuit inductances and minimum and maximum capacitances

are identical in all "ganged" stages. A small trimmer or padding capacitor may be connected across the coil, so that various minimum capacitances can be compensated. The use of the trimmer necessarily increases the minimum circuit capacitance but is a necessity for satisfactory tracking. Midget capacitors having maximum capacitances of 15 to 30 pf. are commonly used.

The same methods are applied to bandspread circuits that must be tracked. The circuits are identical with those of Fig. 5-9. If both general-coverage and bandspread tuning are to be available, an additional trimmer capacitor must be connected across the coil in each circuit shown. If only amateur-band tuning is desired, however, the  $C_3$  in Fig. 5-9B, and  $C_2$  in Fig. 5-9C, serve as trimmers.

The coil inductance can be adjusted by starting with a larger number of turns than necessary and removing a turn or fraction of a turn at a time until the circuits track satisfactorily. An alternative method, provided the inductance is reasonably close to the correct value initially, is to make the coil so that the last turn is variable with respect to the whole coil.

Another method for trimming the inductance is to use an adjustable brass (or copper) or powdered-iron core. The brass core acts like a single shorted turn, and the inductance of the coil is decreased as the brass core, or "slug," is moved into the coil. The powdered-iron core has the opposite effect, and increases the inductance as it is moved into the coil. The  $Q$  of the coil is not affected materially by the use of the brass slug, provided the brass slug has a clean surface or is silverplated. The powdered-iron core will raise the  $Q$  of a coil, provided the iron is suitable for the frequency in use. Good powdered-iron cores can be obtained for use up to about 50 Mc.

## THE SUPERHETERODYNE

Years ago (until about 1932) practically the only type of receiver to be found in amateur stations consisted of a regenerative detector and one or more stages of audio amplification. Receivers of this type can be made quite sensitive but strong signals block them easily and, in our present crowded bands, they are seldom used except in emergencies. They have been replaced by **superheterodyne** receivers, generally called "superhets."

#### The Superheterodyne Principle

In a superheterodyne receiver, the frequency of the incoming signal is heterodyned to a new radio frequency, the **intermediate frequency** (abbreviated "i.f."), then amplified, and finally detected. The frequency is changed by modulating the output of a tunable oscillator (the **high-frequency**, or **local**, **oscillator**) by the incoming signal in a **mixer** or **converter** stage (**first detector**) to produce a side frequency equal to the intermediate frequency. The other side frequency is rejected by selective circuits. The

audio-frequency signal is obtained at the **second detector**. Code signals are made audible by autodyne or heterodyne reception at the second detector.

As a numerical example, assume that an intermediate frequency of 455 kc. is chosen and that the incoming signal is at 7000 kc. Then the high-frequency oscillator frequency may be set to 7455 kc., in order that one side frequency (7455 minus 7000) will be 455 kc. The high-frequency oscillator could also be set to 6545 kc. and give the same difference frequency. To produce an audible code signal at the second detector of, say, 1000 cycles, the autodyning or heterodyning oscillator would be set to either 454 or 456 kc.

The frequency-conversion process permits r.f. amplification at a relatively low frequency, the i.f. High selectivity and gain can be obtained at this frequency, and this selectivity and gain are constant. The separate oscillators can be designed for good stability and, since they are working at frequencies considerably removed from the signal frequencies, they are not normally "pulled" by the incoming signal.

### Images

Each h.f. oscillator frequency will cause i.f. response at two signal frequencies, one higher and one lower than the oscillator frequency. If the oscillator is set to 7455 kc. to tune to a 7000-kc. signal, for example, the receiver can respond also to a signal on 7910 kc., which likewise gives a 455-kc. beat. The undesired signal is called the **image**. It can cause unnecessary interference if it isn't eliminated.

The radio-frequency circuits of the receiver (those used before the signal is heterodyned to the i.f.) normally are tuned to the desired signal, so that the selectivity of the circuits reduces or eliminates the response to the image signal. The ratio of the receiver voltage output from the desired signal to that from the image is called the **signal-to-image ratio**, or **image ratio**.

The image ratio depends upon the selectivity of the r.f. tuned circuits preceding the mixer tube. Also, the higher the intermediate frequency, the higher the image ratio, since raising the i.f. increases the frequency separation between the signal and the image and places the latter further away from the resonance peak of the signal-frequency input circuits. Most receiver designs represent a compromise between economy (few input tuned circuits) and image rejection (large number of tuned circuits).

### Other Spurious Responses

In addition to images, other signals to which the receiver is not ostensibly tuned may be heard. Harmonics of the high-frequency oscillator may beat with signals far removed from the desired frequency to produce output at the intermediate frequency; such spurious responses can be reduced by adequate selectivity before the mixer stage, and by using sufficient shielding to prevent signal pick-up by any means other than the antenna. When a strong signal is received, the harmonics generated by rectification in the second detector may, by stray coupling, be introduced into the r.f. or mixer circuit and converted to the intermediate frequency, to go through the receiver in the same way as an ordinary signal. These "birdies" appear as a heterodyne beat on the desired signal, and are principally bothersome when the frequency of the incoming signal is not greatly different from the intermediate frequency. The cure is proper circuit isolation and shielding.

Harmonics of the beat oscillator also may be converted in similar fashion and amplified through the receiver; these responses can be reduced by shielding the beat oscillator and operating it at a low power level.

### The Double-Conversion Superheterodyne

At high and very-high frequencies it is difficult to secure an adequate image ratio when the intermediate frequency is of the order of 455 kc. To reduce image response the signal frequently is converted first to a rather high (1500, 5000, or even 10,000 kc.) intermediate frequency, and

then — sometimes after further amplification — reconverted to a lower i.f. where higher adjacent-channel selectivity can be obtained. Such a receiver is called a **double-conversion superheterodyne**.

### FREQUENCY CONVERTERS

A circuit tuned to the intermediate frequency is placed in the plate circuit of the mixer, to offer a high impedance load for the i.f. current that is developed. The signal- and oscillator-frequency voltages appearing in the plate circuit are rejected by the selectivity of this circuit. The i.f. tuned circuit should have low impedance for these frequencies, a condition easily met if they do not approach the intermediate frequency.

The **conversion efficiency** of the mixer is the ratio of i.f. output voltage from the plate circuit to r.f. signal voltage applied to the grid. High conversion efficiency is desirable. The mixer tube noise also should be low if a good signal-to-noise ratio is wanted, particularly if the mixer is the first tube in the receiver.

A change in oscillator frequency caused by tuning of the mixer grid circuit is called **pulling**. Pulling should be minimized, because the stability of the whole receiver depends critically upon the stability of the h.f. oscillator. Pulling decreases with separation of the signal and h.f.-oscillator frequencies, being less with high intermediate frequencies. Another type of pulling is caused by regulation in the power supply. Strong signals cause the voltage to change, which in turn shifts the oscillator frequency.

### Circuits

If the first detector and high-frequency oscillator are separate tubes, the first detector is called a "mixer." If the two are combined in one envelope (as is often done for reasons of economy or efficiency), the first detector is called a "converter." In either case the function is the same.

Typical mixer circuits are shown in Fig. 5-11. The variations are chiefly in the way in which the oscillator voltage is introduced. In 5-11A, a pentode functions as a plate detector; the oscillator voltage is capacitance-coupled to the grid of the tube through  $C_2$ . Inductive coupling may be used instead. The conversion gain and input selectivity generally are good, so long as the sum of the two voltages (signal and oscillator) impressed on the mixer grid does not exceed the grid bias. It is desirable to make the oscillator voltage as high as possible without exceeding this limitation. The oscillator power required is negligible. If the signal frequency is only 5 or 10 times the i.f., it may be difficult to develop enough oscillator voltage at the grid (because of the selectivity of the tuned input circuit). However, the circuit is a sensitive one and makes a good mixer, particularly with high-transconductance tubes like the 6AH6, 6AK5 or 6U8 (pentode section). Triode tubes can be used as mixers in grid-injection circuits, but they are commonly used at 50 Mc. and higher, where mixer noise may become a significant factor. The triode

Fig. 5-11—Typical circuits for separately excited mixers. Grid injection of a pentode mixer is shown at A, cathode injection at B, and separate excitation of a pentagrid converter is given in C. Typical values for C will be found in Table 5-1—the values below are for the pentode mixer of A and B.

- $C_1$ —10 to 50 pf.
- $C_2$ —5 to 10 pf.
- $C_3, C_4, C_5$ —0.001  $\mu$ f.
- $R_1$ —6800 ohms.
- $R_2$ —1.0 megohm.
- $R_3$ —0.47 megohm.
- $R_4$ —1500 ohms.

Positive supply voltage can be 250 volts with a 6AH6, 150 with a 6AK5.

mixer has the lowest inherent noise, the pentode is next, and the multigrad converter tubes are the noisiest.

The circuit in Fig. 5-11B shows cathode injection at the mixer. Operation is similar to the grid-injection case, and the same considerations apply.

It is difficult to avoid "pulling" in a triode or pentode mixer, and a pentagrid mixer tube provides much better isolation. A typical circuit is shown in Fig. 5-11C, and tubes like the 6SA7, 6BA7 or 6BE6 are commonly used. The oscillator voltage is introduced through an "injection" grid. Measurement of the rectified current flowing in  $R_2$  is used as a check for proper oscillator-voltage amplitude. Tuning of the signal-grid circuit can have little effect on the oscillator frequency because the injection grid is isolated from the signal grid by a screen grid that is at r.f. ground potential. The pentagrid mixer is much noisier than a triode or pentode mixer, but its isolating characteristics make it a very useful device.

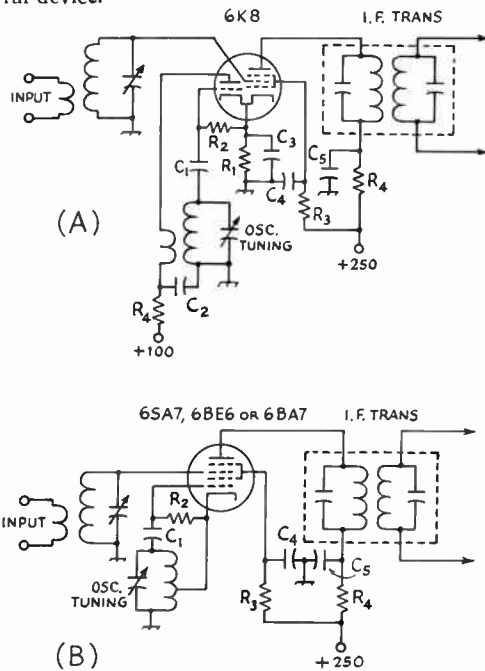
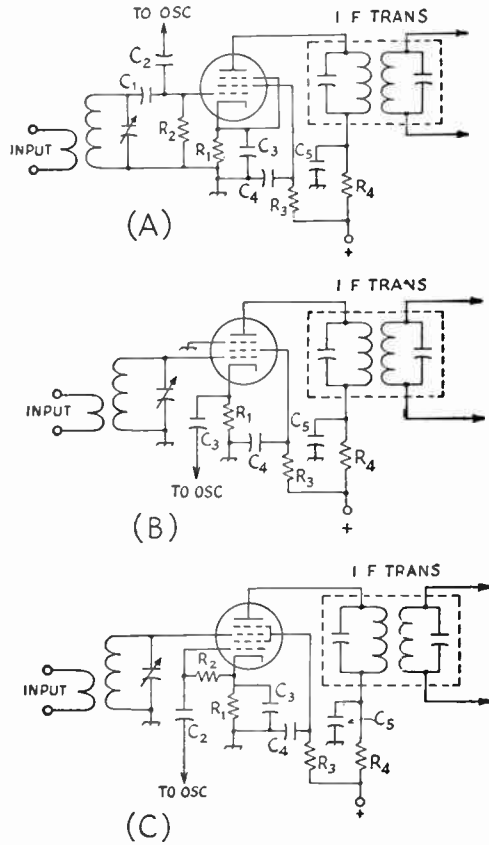

Many receivers use pentagrid converters, and two typical circuits are shown in Fig. 5-12. The circuit shown in Fig. 5-12A, which is suitable for the 6K8, is for a "triode-hexode" converter. A triode oscillator tube is mounted in the same envelope with a hexode, and the control grid of the oscillator portion is connected internally to an injection grid in the hexode. The isolation between oscillator and converter tube is reasonably good, and very little pulling results, except on signal frequencies that are quite large compared with the i.f.

The pentagrid-converter circuit shown in Fig. 5-12B can be used with a tube like the 6SA7, 6BA7 or 6BE6. Generally the only care necessary is to adjust the feedback of the oscillator circuit to give the proper oscillator r.f. voltage. The condition is checked by measuring the d.c. current flowing in grid resistor  $R_2$ .

A more stable receiver generally results, par-

Fig. 5-12—Typical circuits for triode-hexode (A) and pentagrid (B) converters. Values for  $R_1, R_2$  and  $R_3$  can be found in Table 5-1; others are given below.

- $C_1$ —47 pf.
- $C_2, C_4, C_5$ —0.001  $\mu$ f.
- $C_3$ —0.01  $\mu$ f.
- $R_4$ —1000 ohms.

**TABLE 5-1**  
**Circuit and Operating Values for Converter Tubes**  
 Plate voltage = 250    Screen voltage = 100, or through specified resistor from 250 volts

Tube	SELF-EXCITED				SEPARATE EXCITATION			
	Cathode Resistor	Screen Resistor	Leak Grid	Grid Current	Cathode Resistor	Screen Resistor	Grid Leak	Grid Current
6BA7 <sup>1</sup> . . . .	0	12,000	22,000	0.35 ma.	68	15,000	22,000	0.35 ma.
6BE6 <sup>1</sup> . . . .	0	22,000	22,000	0.5	150	22,000	22,000	0.5
6K8 <sup>2</sup> . . . . .	240	27,000	47,000	0.15-0.2	—	—	—	—
6SA7 <sup>2</sup> . . . .	0	18,000	22,000	0.5	150	18,000	22,000	0.5

<sup>1</sup> Miniature tube    <sup>2</sup> Octal base, metal.

ticularly at the higher frequencies, when separate tubes are used for the mixer and oscillator. Practically the same number of circuit components is required whether or not a combination tube is used, so that there is very little difference to be realized from the cost standpoint.

Typical circuit constants for converter tubes are given in Table 5-1. The grid leak referred to is the oscillator grid leak or injection-grid return,  $R_2$  of Figs. 5-11C and 5-12.

The effectiveness of converter tubes of the type just described becomes less as the signal frequency is increased. Some oscillator voltage will be coupled to the signal grid through "space-charge" coupling, an effect that increases with frequency. If there is relatively little frequency difference between oscillator and signal, as for example a 14- or 28-Mc. signal and an i.f. of 455 kc., this voltage can become considerable because the selectivity of the signal circuit will be unable to reject it. If the signal grid is not returned directly to ground, but instead is returned through a resistor or part of an a.g.c. system, considerable bias can be developed which will cut down the gain. For this reason, and to reduce image response, the i.f. following the first converter of a receiver should be not less than 5 or 10 per cent of the signal frequency.

#### Transistors in Mixers

Typical transistor circuitry for a mixer operating at frequencies below 20 Mc. is shown in Fig.

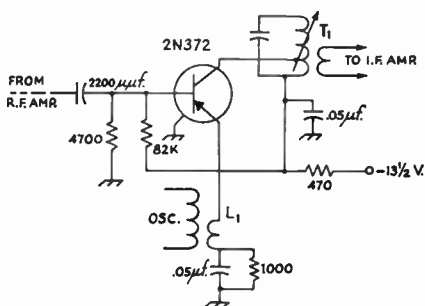

Fig. 5-13—Typical transistor mixer circuit.

$L_1$ —Low-impedance inductive coupling to oscillator.

$T_1$ —Transistor i.f. transformer. Primary impedance of 50,000 ohms, secondary impedance of 800 ohms (Miller 2066).

5-13. The local oscillator current is injected in the emitter circuit by inductive coupling to  $L_1$ ;  $L_1$  should have low reactance at the oscillator frequency. The input from the r.f. amplifier should be at low impedance, obtained by inductive coupling or tapping down on the tuned circuit. The output transformer  $T_1$  has the collector connection tapped down on the inductance to maintain a high  $Q$  in the tuned circuit.

#### Audio Converters

Converter circuits of the type shown in Fig. 5-12 can be used to advantage in the reception of code and s.s.b. signals, by introducing the local oscillator on the No. 1 grid, the signal on the No. 3 grid, and working the tube into an audio load. Its operation can be visualized as heterodyning the incoming signal into the audio range. The use of such circuits for audio conversion has been limited to selective i.f. amplifiers operating below 500 kc. and usually below 100 kc. An ordinary a.m. signal cannot be received on such a detector unless the tuning is adjusted to make the local oscillator zero-beat with the incoming carrier.

Since the beat oscillator modulates the electron stream completely, a large beat-oscillator component exists in the plate circuit. To prevent overload of the following audio amplifier stages, an adequate i.f. filter must be used in the output of the converter.

The "product detector" of Fig. 5-6 is also a converter circuit, and the statements above for audio converters apply to the product detector.

#### THE HIGH-FREQUENCY OSCILLATOR

Stability of the receiver is dependent chiefly upon the stability of the h.f. oscillator, and particular care should be given this part of the receiver. The frequency of oscillation should be insensitive to mechanical shock and changes in voltage and loading. Thermal effects (slow change in frequency because of tube or circuit heating) should be minimized. They can be reduced by using ceramic instead of bakelite insulation in the r.f. circuits, a large cabinet relative to the chassis (to provide for good radiation of developed heat), minimizing the number of high-wattage resistors in the receiver and putting them in the separate power supply, and not mounting the oscillator coils and tuning ca-



capacitor too close to a tube. Propping up the lid of the receiver will often reduce drift by lowering the terminal temperature of the unit.

Sensitivity to vibration and shock can be minimized by using good mechanical support for coils and tuning capacitors, a heavy chassis, and by not hanging any of the oscillator-circuit components on long leads. Tie points should be used to avoid long leads. Stiff *short* leads are excellent because they can't be made to vibrate.

Smooth tuning is a great convenience to the operator, and can be obtained by taking pains with the mounting of the dial and tuning capacitors. They should have good alignment and no backlash. If the capacitors are mounted off the chassis on posts instead of brackets, it is almost impossible to avoid some back-lash unless the posts have extra-wide bases. The capacitors should be selected with good wiping contacts to the rotor, since with age the rotor contacts can be a source of erratic tuning. All joints in the oscillator tuning circuit should be carefully soldered, because a loose connection or "rosin joint" can develop trouble that is sometimes hard to locate. The chassis and panel materials should be heavy and rigid enough so that pressure on the tuning dial will not cause torsion and a shift in the frequency.

In addition, the oscillator must be capable of furnishing sufficient r.f. voltage and power for the particular mixer circuit chosen, at all frequencies within the range of the receiver, and its harmonic output should be as low as possible to reduce the possibility of spurious responses.

The oscillator plate power should be as low as is consistent with adequate output. Low plate power will reduce tube heating and thereby lower the frequency drift. The oscillator and mixer circuits should be well isolated, preferably by shielding, since coupling other than by the intended means may result in pulling.

If the h.f.-oscillator frequency is affected by changes in plate voltage, a voltage-regulated plate supply (VR tube) can be used.

### Circuits

Several oscillator circuits are shown in Fig. 5-14. Circuits A and B will give about the same results, and require only one coil. However, in these two circuits the cathode is above ground potential for r.f., which often is a cause of hum modulation of the oscillator output at 14 Mc. and higher frequencies when a.c.-heated-cathode tubes are used. The circuit of Fig. 5-14C reduces hum because the cathode is grounded. It is simple to adjust, and it is also the best circuit to use with filament-type tubes. With filament-type tubes, the other two circuits would require r.f. chokes to keep the filament above r.f. ground.

Besides the use of a fairly high  $C/L$  ratio in the tuned circuit, it is necessary to adjust the feedback to obtain optimum results. Too much feedback may cause "squegging" of the oscillator and the generation of several frequencies simul-

taneously; too little feedback will cause the output to be low. In the tapped-coil circuits (A, B), the feedback is increased by moving the tap toward the grid end of the coil. In C, more feedback is obtained by increasing the number of turns on  $L_2$  or moving  $L_2$  closer to  $L_1$ .

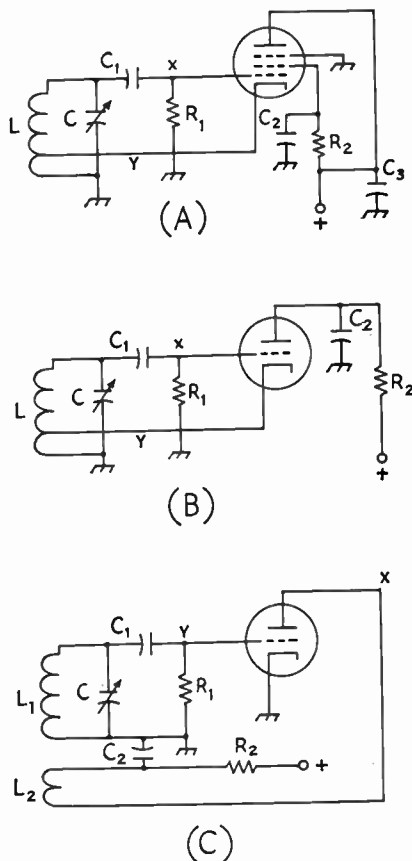

Fig. 5-14—High-frequency oscillator circuits. A, pentode grounded-plate oscillator; B, triode grounded-plate oscillator; C, triode oscillator with tickler circuit. Coupling to the mixer may be taken from points X and Y. In A and B, coupling from Y will reduce pulling effects, but gives less voltage than from X; this type is best adapted to mixer circuits with small oscillator-voltage requirements. Typical values for components are as follows:

Circuit A	Circuit B	Circuit C
$C_1$ —100 pf.	100 pf.	100 pf.
$C_2$ —0.01 $\mu$ f.	0.01 $\mu$ f.	0.01 $\mu$ f.
$C_3$ —0.01 $\mu$ f.		
$R_1$ —47,000 ohms.	47,000 ohms.	47,000 ohms.
$R_2$ —47,000 ohms.	10,000 to 25,000 ohms.	10,000 to 25,000 ohms.

The plate-supply voltage should be 250 volts. In circuits B and C,  $R_2$  is used to drop the supply voltage to 100–150 volts; it may be omitted if voltage is obtained from a voltage divider in the power supply.

## THE INTERMEDIATE-FREQUENCY AMPLIFIER

One major advantage of the superhet is that high gain and selectivity can be obtained by using a good i.f. amplifier. This can be a one-stage affair in simple receivers, or two or three stages in the more elaborate sets.

### Choice of Frequency

The selection of an intermediate frequency is a compromise between conflicting factors. The lower the i.f. the higher the selectivity and gain, but a low i.f. brings the image nearer the desired signal and hence decreases the image ratio. A low i.f. also increases pulling of the oscillator frequency. On the other hand, a high i.f. is beneficial to both image ratio and pulling, but the gain is lowered and selectivity is harder to obtain by simple means.

An i.f. of the order of 455 kc. gives good selectivity and is satisfactory from the standpoint of image ratio and oscillator pulling at frequencies up to 7 Mc. The image ratio is poor at 14 Mc. when the mixer is connected to the antenna, but adequate when there is a tuned r.f. amplifier between antenna and mixer. At 28 Mc. and on the very high frequencies, the image ratio is very poor unless several r.f. stages are used. Above 14 Mc., pulling is likely to be bad without very loose coupling between mixer and oscillator.

With an i.f. of about 1600 kc., satisfactory image ratios can be secured on 14, 21 and 28 Mc. with one r.f. stage of good design. For frequencies of 28 Mc. and higher, a common solution is to use double conversion, choosing one high i.f. for image reduction (5 and 10 Mc. are frequently used) and a lower one for gain and selectivity.

In choosing an i.f. it is wise to avoid frequencies on which there is considerable activity by the various radio services, since such signals may be picked up directly on the i.f. wiring. Shifting the i.f. or better shielding are the solutions to this interference problem.

### Fidelity; Sideband Cutting

Modulation of a carrier causes the generation of sideband frequencies numerically equal to the carrier frequency plus and minus the highest modulation frequency present. If the receiver is to give a faithful reproduction of modulation that contains, for instance, audio frequencies up to 5000 cycles, it must at least be capable of amplifying equally all frequencies contained in a band

extending from 5000 cycles above or below the carrier frequency. In a superheterodyne, where all carrier frequencies are changed to the fixed intermediate frequency, the i.f. amplification must be uniform over a band 5 kc. wide, when the carrier is set at one edge. If the carrier is set in the center, a 10-kc. band is required. The signal-frequency circuits usually do not have enough over-all selectivity to affect materially the "adjacent-channel" selectivity, so that only the i.f.-amplifier selectivity need be considered.

If the selectivity is too great to permit uniform amplification over the band of frequencies occupied by the modulated signal, some of the sidebands are "cut." While sideband cutting reduces fidelity, it is frequently preferable to sacrifice naturalness of reproduction in favor of communications effectiveness.

The selectivity of an i.f.-amplifier, and hence the tendency to cut sidebands, increases with the number of amplifier stages and also is greater the lower the intermediate frequency. From the standpoint of communication, sideband cutting is never serious with two-stage amplifiers at frequencies as low as 455 kc. A two-stage i.f. amplifier at 85 or 100 kc. will be sharp enough to cut some of the higher-frequency sidebands, if good transformers are used. However, the cutting is not at all serious, and the gain in selectivity is worthwhile in crowded amateur bands.

### Circuits

I.f. amplifiers usually consist of one or two stages. At 455 kc. two stages generally give all the gain usable, and also give suitable selectivity for phone reception.

A typical circuit arrangement is shown in Fig. 5-15. A second stage would simply duplicate the circuit of the first. The i.f. amplifier practically always uses a remote cut-off pentode-type tube operated as a Class-A amplifier. For maximum selectivity, double-tuned transformers are used for interstage coupling, although single-tuned circuits or transformers with untuned primaries can be used for coupling, with a consequent loss in selectivity. All other things being equal, the selectivity of an i.f. amplifier is proportional to the number of tuned circuits in it.

In Fig. 5-15, the gain of the stage is reduced by introducing a negative voltage to the lead marked "AGC" or a positive voltage to  $R_1$  at

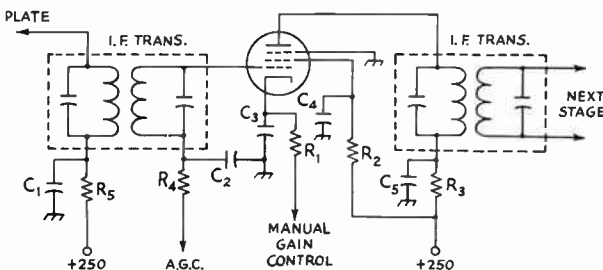

Fig. 5-15—Typical intermediate-frequency amplifier circuit for a superheterodyne receiver. Representative values for components are as follows:  $C_1, C_3, C_4, C_5$ —0.02  $\mu\text{f.}$  at 455 kc; 0.01  $\mu\text{f.}$  at 1600 kc. and higher.

$C_2$ —0.01  $\mu\text{f.}$

$R_1, R_2$ —See Table 5-II.

$R_3, R_5$ —1500 ohms.

$R_4$ —0.1 megohm.

the point marked "MANUAL GAIN CONTROL." In either case, the voltage increases the bias on the tube and reduces the mutual conductance and hence the gain. When two or more stages are used, these voltages are generally obtained from common sources. The decoupling resistor,  $R_3$ , helps to prevent unwanted interstage coupling.  $C_2$  and  $R_4$  are part of the automatic gain-control circuit (described later); if no a.g.c. is used, the lower end of the i.f.-transformer secondary is connected to chassis.

### Tubes for I.F. Amplifiers

Variable- $\mu$  (remote cut-off) pentodes are almost invariably used in i.f. amplifier stages, since grid-bias gain control is practically always applied to the i.f. amplifier. Tubes with high plate resistance will have least effect on the selectivity of the amplifier, and those with high mutual conductance will give greatest gain. The choice of i.f. tubes normally has no effect on the signal-to-noise ratio, since this is determined by the preceding mixer and r.f. amplifier.

Typical values of cathode and screen resistors for common tubes are given in Table 5-II. The 6BA6, 6BJ6 and 6BZ6 are recommended for i.f. work because they have desirable remote cut-off characteristics. The indicated screen resistors

**TABLE 5-II**  
Cathode and Screen-Dropping Resistors for R.F. or I.F. Amplifiers

Tube	Plate Volts	Screen Volts	Cathode Resistor	Screen R <sub>1</sub>	Resistor R <sub>2</sub>
6AC7 <sup>1</sup>	300		160		62,000
6AH6 <sup>2</sup>	300	150	160		62,000
6AK5 <sup>2</sup>	180	120	200		27,000
6AU6 <sup>2</sup>	250	150	68		33,000
6BA6 <sup>2*</sup>	250	100	68		33,000
6BH6 <sup>2</sup>	250	150	100		33,000
6BJ6 <sup>2*</sup>	250	100	82		47,000
6BZ6 <sup>2*</sup>	200	150	180		20,000
6CB6	200	150	180		56,000
6DC6 <sup>2</sup>	200	135	18		24,000
6SG7 <sup>1*</sup>	250	125	68		27,000
6SH7 <sup>1</sup>	250	150	68		39,000
6SJ7 <sup>1</sup>	250	100	820		180,000
6SK7 <sup>1*</sup>	250	100	270		56,000

<sup>1</sup> Octal base, metal.    <sup>2</sup> Miniature tube  
\* Remote cut-off type.

drop the plate voltage to the correct screen voltage, as  $R_2$  in Fig. 5-15.

When two or more stages are used the high gain may tend to cause instability and oscillation, so that good shielding, bypassing, and careful circuit arrangement to prevent stray coupling between input and output circuits are necessary.

When single-ended tubes are used, the plate and grid leads should be well separated. With these tubes it is advisable to mount the screen bypass capacitor directly on the bottom of the socket, crosswise between the plate and grid pins, to provide additional shielding. If a paper capacitor is used, the outside foil should be grounded to the chassis.

### I.F. Transformers

The tuned circuits of i.f. amplifiers are built up as transformer units consisting of a metal shield container in which the coils and tuning capacitors are mounted. Both air-core and powdered iron-core universal-wound coils are used, the latter having somewhat higher  $Q$ s and hence greater selectivity and gain. In universal windings the coil is wound in layers with each turn traversing the length of the coil, back and forth, rather than being wound perpendicular to the axis as in ordinary single-layer coils. In a straight multilayer winding, a fairly large capacitance can exist between layers. Universal winding, with its "criss-crossed" turns, tends to reduce distributed-capacitance effects.

For tuning, air-dielectric tuning capacitors are preferable to mica compression types because their capacity is practically unaffected by changes in temperature and humidity. Iron-core transformers may be tuned by varying the inductance (permeability tuning), in which case stability comparable to that of variable air-capacitor tuning can be obtained by use of high-stability fixed mica or ceramic capacitors. Such stability is of great importance, since a circuit whose frequency "drifts" with time eventually will be tuned to a different frequency than the other circuits, thereby reducing the gain and selectivity of the amplifier.

The normal interstage i.f. transformer is loosely coupled, to give good selectivity consistent with adequate gain. A so-called diode transformer is similar, but the coupling is tighter, to give sufficient transfer when working into the finite load presented by a diode detector. Using a diode transformer in place of an interstage transformer would result in loss of selectivity; using an interstage transformer to couple to the diode would result in loss of gain.

Besides the conventional i.f. transformers just mentioned, special units to give desired selectivity characteristics have been used. For higher-than-ordinary adjacent-channel selectivity, triple-tuned transformers, with a third tuned circuit inserted between the input and output windings, have been made. The energy is transferred from the input to the output windings via this tertiary winding, thus adding its selectivity to the over-all selectivity of the transformer.

A method of varying the selectivity is to vary the coupling between primary and secondary, overcoupling being used to broaden the selectivity curve. Special circuits using single tuned circuits, coupled in any of several different ways, have been used in some advanced receivers.

### Selectivity

The over-all selectivity of the i.f. amplifier will depend on the frequency and the number of stages. The following figures are indicative of the bandwidths to be expected with good-quality circuits in amplifiers so constructed as to keep regeneration at a minimum:

Fig. 5-16—Typical circuit for a two-stage transistor i.f. amplifier. The stages are neutralized by the 5- and 8.2- $\mu\text{mf.}$  capacitors. Unless specified otherwise, capacitances are in  $\mu\text{f.}$

- T<sub>1</sub>—50K to 800-ohm secondary (Miller 2066).
- T<sub>2</sub>—30K to 500-ohm secondary (Miller 2067).
- T<sub>3</sub>—20K to 5K secondary (Miller 2068).

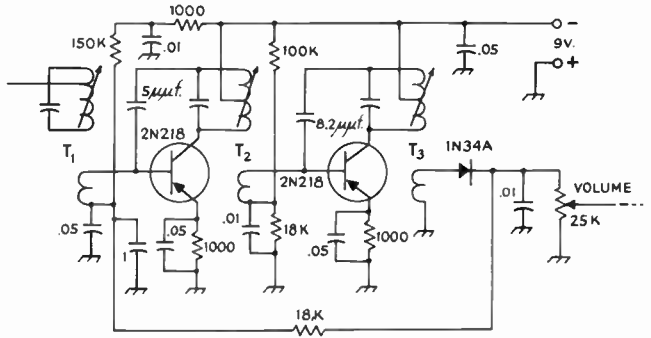

Tuned Circuits	Frequency	Circuit Q	Bandwidth, kc.		
			-6 db.	-20 db.	-60 db
4	50 kc.	60	0.5	0.95	2.16
4	455 kc.	75	3.6	6.9	16
6	1600 kc.	90	8.2	15	34

**Transistor I. F. Amplifier .**

A typical circuit for a two-stage transistor i.f. amplifier is shown in Fig. 5-16. Constants are given for a 455-kc. amplifier, but the same general circuitry applies to an amplifier at any frequency within the operating range of the transistors. When high frequencies are used, it is generally advisable to neutralize the amplifier to avoid overall oscillation; this is done by connecting the small capacitors of a few  $\mu\text{mf.}$  from base to primary, as shown in the diagram.

Automatic gain control is obtained by using

the developed d.c. at the 1N34A diode detector to modify the emitter bias current on the first stage. As the bias current changes, the input and output impedances change, and the resultant impedance mismatches causes a reduction in gain. Such a.g.c. assumes, of course, that the amplifier is set up initially in a matched condition.

**THE SECOND DETECTOR AND BEAT OSCILLATOR**

**Detector Circuits**

The second detector of a superheterodyne receiver performs the same function as the detector in the simple receiver, but usually operates at a higher input level because of the relatively great amplification ahead of it. Therefore, the ability

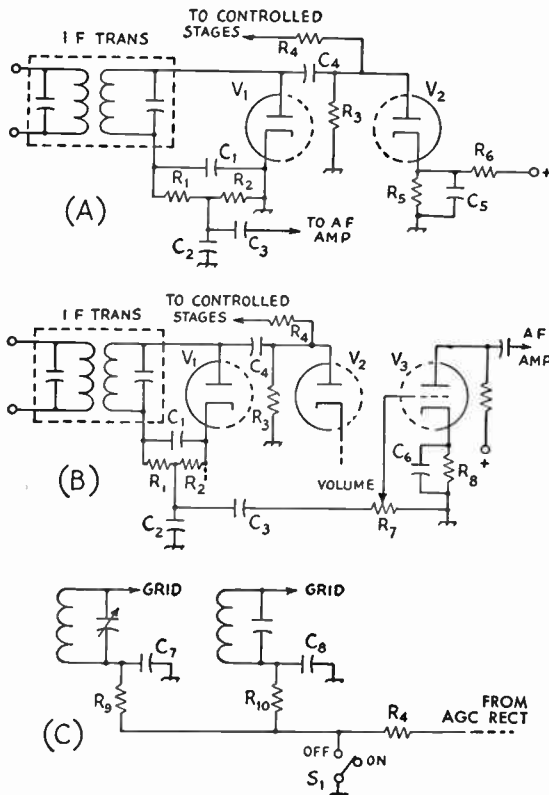

Fig. 5-17—Delayed automatic gain-control circuits using a twin diode (A) and a dual-diode triode. The circuits are essentially the same and differ only in the method of biasing the a.g.c. rectifier. The a.g.c. control voltage is applied to the controlled stages as in (C). For these circuits typical values are:

- C<sub>1</sub>, C<sub>2</sub>, C<sub>4</sub>—100  $\mu\text{mf.}$
- C<sub>3</sub>, C<sub>5</sub>, C<sub>7</sub>, C<sub>8</sub>—0.01  $\mu\text{f.}$
- C<sub>6</sub>—5- $\mu\text{f.}$  electrolytic.
- R<sub>1</sub>, R<sub>6</sub>, R<sub>10</sub>—0.1 megohm.
- R<sub>2</sub>—0.47 megohm.
- R<sub>3</sub>—2 megohms.
- R<sub>4</sub>—0.47 megohm.
- R<sub>5</sub>, R<sub>9</sub>—Voltage divider to give 2 to 10 volts bias at 1 to 2 ma. drain.
- R<sub>7</sub>—0.5-megohm volume control.
- R<sub>8</sub>—Correct bias resistor for triode section of dual-diode triode.

to handle large signals without distortion is preferable to high sensitivity. Plate detection is used to some extent, but the diode detector is most popular. It is especially adapted to furnishing automatic gain or volume control. The basic circuits have been described, although in many cases the diode elements are incorporated in a multipurpose tube that contains an amplifier section in addition to the diode.

Audio-converter circuits and product detectors are often used for code or s.s.b. detectors.

### The Beat Oscillator

Any standard oscillator circuit may be used for the beat oscillator required for heterodyne reception. Special beat-oscillator transformers are available, usually consisting of a tapped coil with adjustable tuning; these are most conveniently used with the circuits shown in Fig. 5-13A and B, with the output taken from  $Y$ . A variable capacitor of about 25- $\mu\text{mf}$ . capacitance can be connected between cathode and ground to provide fine adjustment of the frequency. The beat oscillator usually is coupled to the second-detector tuned circuit through a fixed capacitor of a few  $\mu\text{mf}$ .

The beat oscillator should be well shielded, to prevent coupling to any part of the receiver except the second detector and to prevent its harmonics from getting into the front end and being amplified along with desired signals. The b.f.o. power should be as low as is consistent with sufficient audio-frequency output on the strongest signals. However, if the beat-oscillator output is too low, strong signals will not give a proportionately strong audio signal. Contrary to some opinion, a weak b.f.o. is never an advantage.

## AUTOMATIC GAIN CONTROL

Automatic regulation of the gain of the receiver in inverse proportion to the signal strength is an operating convenience in phone reception, since it tends to keep the output level of the receiver constant regardless of input-signal strength. The average rectified d.c. voltage, developed by the received signal across a resistance in a detector circuit, is used to vary the bias on the r.f. and i.f. amplifier tubes. Since this voltage is proportional to the average amplitude of the signal, the gain is reduced as the signal strength becomes greater. The control will be more complete and the output more constant as the number of stages to which the a.g.c. bias is applied is increased. Control of at least two stages is advisable.

### Circuits

Although some receivers derive the a.g.c. voltage from the diode detector, the usual practice is to use a separate a.g.c. rectifier. Typical circuits are shown in Figs. 5-17A and 5-17B. The two rectifiers can be combined in one tube, as in the 6H6 and 6AL5. In Fig. 5-17A  $V_1$  is the diode detector; the signal is developed across  $R_1R_2$  and coupled to the audio stages through  $C_3$ .  $C_1$ ,  $R_1$  and  $C_2$  are included for r.f. filtering, to prevent

a large r.f. component being coupled to the audio circuits. The a.g.c. rectifier,  $V_2$ , is coupled to the last i.f. transformer through  $C_4$ , and most of the rectified voltage is developed across  $R_3$ .  $V_2$  does not rectify on weak signals, however; the fixed bias at  $R_5$  must be exceeded before rectification can take place. The developed negative a.g.c. bias is fed to the controlled stages through  $R_4$ .

The circuit of Fig. 5-17B is similar, except that a dual-diode triode tube is used. Since this has only one common cathode, the circuitry is slightly different but the principle is the same. The triode stage serves as the first audio stage, and its bias is developed in the cathode circuit across  $R_8$ . This same bias is applied to the a.g.c. rectifier by returning its load resistor,  $R_3$ , to ground. To avoid placing this bias on the detector,  $V_1$ , its load resistor  $R_1R_2$  is returned to cathode, thus avoiding any bias on the detector and permitting it to respond to weak signals.

The developed negative a.g.c. bias is applied to the controlled stages through their grid circuits, as shown in Fig. 5-17C.  $C_7R_9$  and  $C_8R_{10}$  serve as filters to avoid common coupling and possible feedback and oscillator. The a.g.c. is disabled by closing switch  $S_1$ .

The a.g.c. rectifier bias in Fig. 5-17B is set by the bias required for proper operation of  $V_3$ . If less bias for the a.g.c. rectifier is required,  $R_3$  can be tapped up on  $R_8$  instead of being returned to chassis ground. In Fig. 5-17A, proper choice of bias at  $R_5$  depends upon the over-all gain of the receiver and the number of controlled stages. In general, the bias at  $R_5$  will be made higher for receivers with more gain and more stages.

### Time Constant

The time constant of the resistor-capacitor combinations in the a.g.c. circuit is an important part of the system. It must be long enough so that the modulation on the signal is completely filtered from the d.c. output, leaving only an average d.c. component which follows the relatively slow carrier variations with fading. Audio-frequency variations in the a.g.c. voltage applied to the amplifier grids would reduce the percentage of modulation on the incoming signal. But the time constant must not be too long or the a.g.c. will be unable to follow rapid fading. The capacitance and resistance values indicated in Fig. 5-17 will give a time constant that is satisfactory for average reception.

### C.W. and S.S.B.

A.g.c. can be used for c.w. and s.s.b. reception but the circuit is usually more complicated. The a.g.c. voltage must be derived from a rectifier that is isolated from the beat-frequency oscillator (otherwise the rectified b.f.o. voltage will reduce the receiver gain even with no signal coming through). This is done by using a separate a.g.c. channel connected to an i.f. amplifier stage ahead of the second detector (and b.f.o.) or by rectifying the audio output of the detector. If the selectivity ahead of the a.g.c. rectifier isn't good, strong adjacent-channel signals may de-



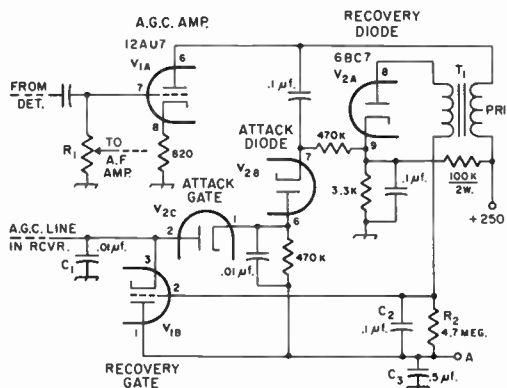

Fig. 5-18—Audio "hang" a.g.c. system. If manual control of gain is in i.f. and r.f. cathode circuits, point "A" is connected to chassis ground. If a negative supply is available, manual gain control can be negative bias applied between point "A" and ground.  $R_1$ —Normal audio volume control in receiver.  $T_1$ —1:3 step-up audio transformer.

The hang time can be adjusted by changing the value of the recovery diode time constant (4.7 megohms shown here). The a.g.c. line in the receiver must have no d.c. return to ground and the receiver should have good skirt selectivity.

velop a.g.c. voltages that will reduce the receiver gain while listening to weak signals. When clear channels are available, however, c.w. and s.s.b. a.g.c. will hold the receiver output constant over a wide range of signal inputs. A.g.c. systems designed to work on these signals should have fast-attack and slow-decay characteristics to work satisfactorily, and often a selection of time constants is made available.

The a.g.c. circuit shown in Fig. 5-18 is applicable to many receivers without too much modification. Audio from the receiver is amplified in  $V_{1A}$  and rectified in  $V_{2B}$ . The resultant voltage is applied to the a.g.c. line through  $V_{2C}$ . The capacitor  $C_1$  charges quickly and will remain charged until discharged by  $V_{1B}$ . This will occur some time after the signal has disappeared,

because the audio was stepped up through  $T_1$  and rectified in  $V_{2A}$ , and the resultant used to charge  $C_2$ . This voltage holds  $V_{1B}$  cut off for an appreciable time, until  $C_2$  discharges through the 4.7-megohm resistor. The threshold of compression is set by adjusting the bias on the diodes (changing the value of the 3.3K or 100K resistors). There can be no d.c. return to ground from the a.g.c. line, because  $C_1$  must be discharged only by  $V_{1B}$ . Even a v.t.v.m. across the a.g.c. line will be too low a resistance, and the operation of the system must be observed by the action of the S meter.

Occasionally a strong noise pulse may cause the a.g.c. to hang until  $C_2$  discharges, but most of the time the gain should return very rapidly to that set by the signal. A.g.c. of this type is very helpful in handling netted s.s.b. signals of widely varying strengths.

## NOISE REDUCTION

### Types of Noise

In addition to tube and circuit noise, much of the noise interference experienced in reception of high-frequency signals is caused by domestic or industrial electrical equipment and by automobile ignition systems. The interference is of two types in its effects. The first is the "hiss" type, consisting of overlapping pulses similar in nature to the receiver noise. It is largely reduced by high selectivity in the receiver, especially for code reception. The second is the "pistol-shot" or "machine-gun" type, consisting of separated impulses of high amplitude. The "hiss" type of interference usually is caused by commutator sparking in d.c. and series-wound a.c. motors, while the "shot" type results from separated spark discharges (a.c. power leaks, switch and key clicks, ignition sparks, and the like).

The only known approach to reducing tube and circuit noise is through better "front-end" design and through more over-all selectivity.

### Impulse Noise

Impulse noise, because of the short duration of the pulses compared with the time between them, must have high amplitude to contain much average energy. Hence, noise of this type strong enough to cause much interference generally has

an instantaneous amplitude much higher than that of the signal being received. The general principles of devices intended to reduce such noise is to allow the desired signal to pass through the receiver unaffected, but to make the receiver inoperative for amplitudes greater than that of the signal. The greater the amplitude of the pulse compared with its time of duration, the more successful the noise reduction.

Another approach is to "silence" (render inoperative) the receiver during the short duration time of any individual pulse. The listener will not hear the "hole" because of its short duration, and very effective noise reduction is obtained. Such devices are called "silencers" rather than "limiters."

In passing through selective receiver circuits, the time duration of the impulses is increased, because of the  $Q$  of the circuits. Thus the more selectivity ahead of the noise-reducing device, the more difficult it becomes to secure good pulse-type noise suppression.

### Audio Limiting

A considerable degree of noise reduction in code reception can be accomplished by amplitude-limiting arrangements applied to the audio-output circuit of a receiver. Such limiters also maintain the signal output nearly constant

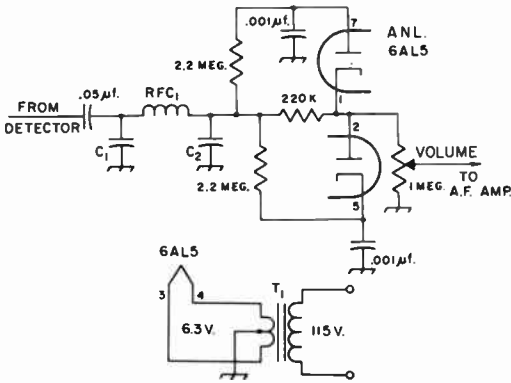

Fig. 5-19—Full-wave shunt limiter using contact-potential-biased diodes. A low-level limiter (½ volt), this circuit finds greatest usefulness following a product detector.

C<sub>1</sub>, C<sub>2</sub>—Part of low-pass filter with cutoff below i.f.  
 RFC<sub>1</sub>—Part of low-pass filter; see C<sub>1</sub>.  
 T<sub>1</sub>—Center-tapped heater transformer.

during fading. These output-limiter systems are simple, and they are readily adaptable to most receivers without any modification of the receiver itself. However, they cannot prevent noise peaks from overloading previous stages.

**SECOND-DETECTOR NOISE LIMITER CIRCUITS**

Most audio limiting circuits are based on one of two principles. In a series limiting circuit, a normally conducting element (or elements) is connected in the circuit in series and operated in such a manner that it becomes non-conductive above a given signal level. In a shunt limiting circuit, a non-conducting element is connected in shunt across the circuit and operated so that it becomes conductive above a given signal level, thus short-circuiting the signal and preventing its being transmitted to the remainder of the amplifier. The usual conducting element will be a forward-biased diode, and the usual non-conducting element will be a back-biased diode. In many applications the value of bias is set manually by the operator; usually the clipping level will be set at about 5 to 10 volts.

A full-wave clipping circuit that operates at a low level (approximately ½ volt) is shown in Fig. 5-19. Each diode is biased by its own contact potential, developed across the 2.2-megohm resistors. The .001-μf. capacitors become charged to close to this value of contact potential. A negative-going signal in excess of the bias will be shorted to ground by the upper diode; a positive-going signal will be conducted by the lower diode. The conducting resistance of the diodes is small by comparison with the 220,000 ohms in series with the circuit, and little if any of the excessive signal will appear across the 1-megohm volume control. In order that the clipping does not become excessive and cause distortion, the input signal must be held down by a gain control ahead of the detector. This circuit finds good application following a low-level detector.

To minimize hum in the receiver output, it is desirable to ground the center tap of the heater transformer, as shown, instead of the more common practice of returning one side of the heater circuit to chassis.

A circuit for a higher-level audio limiter is shown in Fig. 5-20. Because it operates at a higher level, it is ideal for use between receiver output and headphones, requiring no alteration to the receiver. The principle of operation is similar to that of the preceding limiter; when the signal level exceeds the level of the bias provided by the flashlight cells, the diodes conduct and short-circuit the signal.

Second-detector noise-limiting circuits that automatically adjust themselves to the received carrier level are shown in Fig. 5-21. In either circuit, V<sub>1</sub> is the usual diode second detector, R<sub>1</sub>R<sub>2</sub> is the diode load resistor, and C<sub>1</sub> is an r.f. bypass. A negative voltage proportional to the carrier level is developed across C<sub>2</sub>, and this voltage cannot change rapidly because R<sub>3</sub> and C<sub>2</sub> are both large. In the circuit at A, diode V<sub>2</sub> acts as a conductor for the audio signal up to the point where its anode is negative with respect to the cathode. Noise peaks that exceed the maximum carrier-modulation level will drive the anode negative instantaneously, and during this time the diode does not conduct. The long time constant of C<sub>2</sub>R<sub>3</sub> prevents any rapid change of the reference voltage. In the circuit at B, the diode V<sub>2</sub> is inactive until its cathode voltage exceeds its anode voltage. This condition will obtain under noise peaks and when it does, the diode V<sub>2</sub> short-circuits the signal and no voltage is passed on to the audio amplifier. Diode rectifiers such as the 6H6 and 6AL5 can be used for these types of noise limiters. Neither circuit is useful for c.w. or s.s.b. reception, but they are both quite effective for a.m. phone work. The series circuit (A) is slightly better than the shunt circuit.

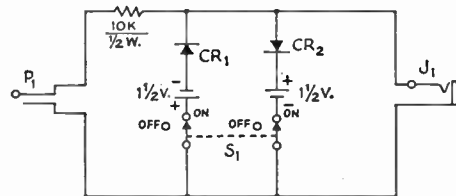

Fig. 5-20—Circuit diagram of a simple audio limiter, to be plugged into the headphone jack of a receiver. The flashlight cells draw very little current (it depends upon the back resistance of the crystal diodes), but it is advisable to open S<sub>1</sub> when the limiter is not in use. Crystal diodes can be 1N34As or similar.

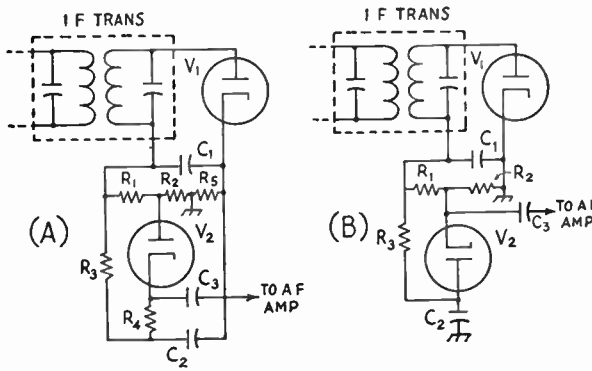

Fig. 5-21—Self-adjusting series (A) and shunt (B) noise limiters. The functions of  $V_1$  and  $V_2$  can be combined in one tube like the 6H6 or 6AL5.

- $C_1$ —100  $\mu\text{f}$ .
- $C_2, C_3$ —0.05  $\mu\text{f}$ .
- $R_1$ —0.27 meg. in A; 47,000 ohms in B.
- $R_2$ —0.27 meg. in A; 0.15 meg. in B.
- $R_3$ —1.0 megohm.
- $R_4$ —0.82 megohm.
- $R_5$ —6800 ohms.

**I.F. NOISE SILENCER**

The i.f. noise silencer circuit shown in Fig. 5-22 is designed to be used in a receiver as far along from the antenna stage as possible but ahead of the high-selectivity section of the receiver. Noise pulses are amplified and rectified, and the resulting negative-going d.c. pulses are used to cut off an amplifier stage during the pulse. A manual "threshold" control is set by the operator to a level that only permits rectification of the noise pulses that rise above the peak amplitude of the desired signal. The clamp diode,  $V_{1A}$ , short circuits the positive-going pulse "overshoots." Running the 6BE6 controlled i.f. amplifier at low screen voltage makes it possible for the No. 3 grid (pin 7) to cut off the stage at a lower voltage than if the screen were operated at the more-normal 100 volts, but it also reduces the available gain through the stage.

It is necessary to avoid i.f. feedback around the 6BE6 stage, and the closer  $RFC_1$  can be to self-resonant at the i.f. the better will be the filtering. The filtering cannot be improved by increasing the values of the 150- $\mu\text{f}$ . capacitors because this will tend to "stretch" the pulses and reduce the signal strength when the silencer is operative.

**SIGNAL-STRENGTH AND TUNING INDICATORS**

The simplest tuning indicator is a milliammeter connected in the d.c. plate lead of an a.g.c.-controlled r.f. or i.f. stage. Since the plate current is reduced as the a.g.c. voltage becomes higher with a stronger signal, the plate current is a measure of the signal strength. The meter can have a 0-1, 0-2 or 0-5 ma. movement, and it should be shunted by a 25-ohm rheostat which is

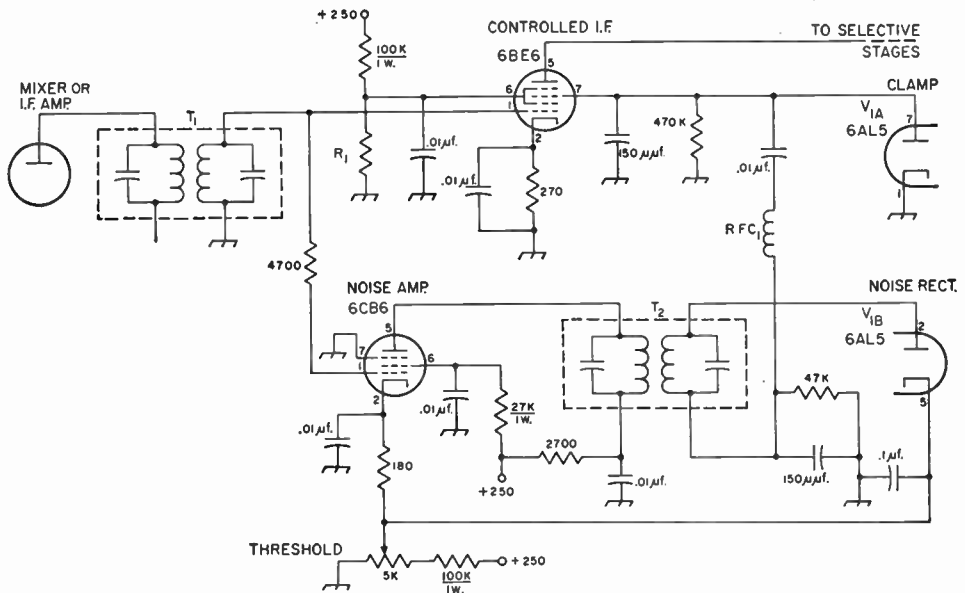

Fig. 5-22—Practical circuit diagram of an i.f. noise silencer. For best results the silencer should be used ahead of the high-selectivity portion of the receiver.

- $T_1$ —Interstage i.f. transformer
- $T_2$ —Diode i.f. transformer.
- $R_1$ —33,000 to 68,000 ohms, depending upon gain up to this stage.
- $RFC_1$ —R.f. choke, preferably self-resonant at i.f.

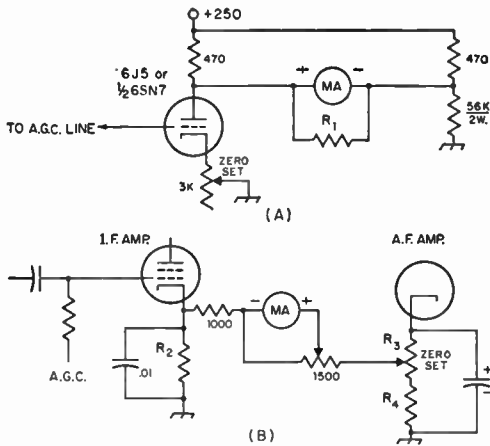

Fig. 5-23—Tuning indicator or S-meter circuits for super-heterodyne receivers.

MA—0.1 or 0.2 milliammeter.  $R_1$ — $R_4$ —See text.

used to set the no-signal reading to full scale on the meter. If a "forward-reading" meter is desired, the meter can be mounted upside down.

Two other S-meter circuits are shown in Fig. 5-23. The system at A uses a milliammeter in a bridge circuit, arranged so that the meter readings increase with the a.g.c. voltage and signal strength. The meter reads approximately in a linear decibel scale and will not be "crowded."

To adjust the system in Fig. 5-23A, pull the tube out of its socket or otherwise break the cathode circuit so that no plate current flows, and adjust the value of resistor  $R_1$  across the meter until the scale reading is maximum. The value of resistance required will depend on the internal resistance of the meter, and must be determined by trial and error (the current is approximately 2.5 ma.). Then replace the tube, allow it to warm up, turn the a.g.c. switch to "off" so the grid is shorted to ground, and adjust the 3000-ohm variable resistor for zero meter current. When the a.g.c. is "on," the meter will follow the signal variations up to the point where the voltage is high enough to cut off the meter tube's plate current. With a 6J5 or 6SN7GT this will occur in the neighborhood of 15 volts, a high-amplitude signal.

The circuit of Fig. 5-23B requires no additional tubes. The resistor  $R_2$  is the normal cathode resistor of an a.g.c.-controlled i.f. stage; its cathode resistor should be returned to chassis and not to the manual gain control. The sum of  $R_3$  plus  $R_4$  should equal the normal cathode resistor for the audio amplifier, and they should be proportioned so that the arm of  $R_3$  can pick off a voltage equal to the normal cathode voltage for the i.f. stage. In some cases it may be necessary to interchange the positions of  $R_3$  and  $R_4$  in the circuit.

The zero-set control  $R_3$  should be set for no reading of the meter with no incoming signal, and the 1500-ohm sensitivity control should be

set for a full meter reading with the i.f. tube removed from its socket.

Neither of these S-meter circuits can be "pinned," and only severe misadjustment of the zero-set control can injure the meter.

HEADPHONES AND LOUSPEAKERS

There are two basic types of headphones in common use, the magnetic and the crystal. A magnetic headphone uses a small electromagnet that attracts and releases a steel diaphragm in accordance with the electrical output of the radio receiver; this is similar to the "receiver" portion of the household telephone. A crystal headphone uses the piezoelectric properties of a pair of Rochelle-salt or other crystals to vibrate a diaphragm in accordance with the electrical output of the radio receiver. Magnetic headphones can be used in circuits where d.c. is flowing, such as the plate circuit of a vacuum tube, provided the current is not too heavy to be carried by the wire in the coils; the limit is usually a few milliamperes. Crystal headphones can be used only on a.c. (a steady d.c. voltage will damage the crystal unit), and consequently must be coupled to a tube through a device, such as a capacitor or transformer, that isolates the d.c. but passes the a.c. Most modern receivers have a.c. coupling to the headphones and hence either type of headphone can be used, but it is wise to look first at the circuit diagram in the instruction book and make sure that the headphone jack is connected to the secondary of the output transformer, as is usually the case.

In general, crystal headphones will have considerably wider and "flatter" audio response than will magnetic headphones (except those of the "hi-fi" type that sell at premium prices). The lack of wide response in the magnetic headphones is sometimes an advantage in code reception, since the desired signal can be set on the peak and be given a boost in volume over the undesired signals at slightly different frequencies.

Crystal headphones are available only in high-impedance values around 50,000 ohms or so, while magnetic headphones run around 10,000 to 20,000 ohms, although they can be obtained in values as low as 15 ohms. Usually the impedance of a headphone set is unimportant because there is more than enough power available from the radio receiver, but in marginal cases it is possible to improve the acoustic output through a better match of headphone to output impedance. When headphone sets are connected in series or in parallel they must be of similar impedance levels or one set will "hog" most of the power.

Loud speakers are practically always of the low-impedance permanent-field dynamic variety, and the loudspeaker output connections of a receiver can connect directly to the voice coil of the loudspeaker. Some receivers also provide a "500-ohm output" for connection to a long line to a remote loudspeaker. A loudspeaker requires mounting in a suitable enclosure if full low-frequency response is to be obtained.

## IMPROVING RECEIVER SELECTIVITY

### INTERMEDIATE-FREQUENCY AMPLIFIERS

As mentioned earlier in this chapter, one of the big advantages of the superheterodyne receiver is the improved selectivity that is possible. This selectivity is obtained in the i.f. amplifier, where the lower frequency allows more selectivity per stage than at the higher signal frequency. For phone reception, the limit to useful selectivity in the i.f. amplifier is the point where so many of the sidebands are cut that intelligibility is lost, although it is possible to remove completely one full set of sidebands without impairing the quality at all. Maximum receiver selectivity in phone reception requires good stability in both transmitter and receiver, so that they will both remain "in tune" during the transmission. The limit to useful selectivity in code work is around 100 or 200 *cycles* for hand-key speeds, but this much selectivity requires good stability in both transmitter and receiver, and a slow receiver tuning rate for ease of operation.

#### Single-Signal Effect

In heterodyne c.w. reception with a superheterodyne receiver, the beat oscillator is set to give a suitable audio-frequency beat note when the incoming signal is converted to the intermediate frequency. For example, the beat oscillator may be set to 454 kc. (the i.f. being 455 kc.) to give a 1000-cycle beat note. Now, if an interfering signal appears at 453 kc., or if the receiver is tuned to heterodyne the incoming signal to 453 kc., it will also be heterodyned by the beat oscillator to produce a 1000-cycle beat. Hence every signal can be tuned in at two places that will give a 1000-cycle beat (or any other low audio frequency). This **audio-frequency image** effect can be reduced if the i.f. selectivity is such that the incoming signal, when heterodyned to 453 kc., is attenuated to a very low level.

When this is done, tuning through a given signal will show a strong response at the desired beat note on one side of zero beat only, instead of the two beat notes on either side of zero beat characteristic of less-selective reception, hence the name: **single-signal reception**.

The necessary selectivity is not obtained with nonregenerative amplifiers using ordinary tuned circuits unless a low i.f. or a large number of circuits is used.

#### Regeneration

Regeneration can be used to give a single-signal effect, particularly when the i.f. is 455 kc. or lower. The resonance curve of an i.f. stage at critical regeneration (just below the oscillating point) is extremely sharp, a bandwidth of 1 kc. at 10 times down and 5 kc. at 100 times down being obtainable in one stage. The audio-frequency image of a given signal thus can be re-

duced by a factor of nearly 100 for a 1000-cycle beat note (image 2000 cycles from resonance).

Regeneration is easily introduced into an i.f. amplifier by providing a small amount of capacity coupling between grid and plate. Bringing a short length of wire, connected to the grid, into the vicinity of the plate lead usually will suffice. The feedback may be controlled by the regular cathode-resistor gain control. When the i.f. is regenerative, it is preferable to operate the tube at reduced gain (high bias) and depend on regeneration to bring up the signal strength. This prevents overloading and increases selectivity.

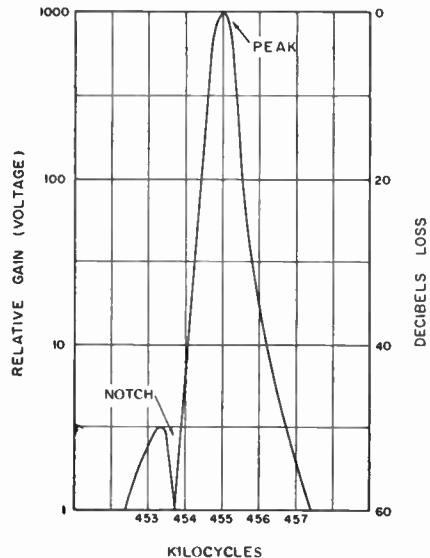

Fig. 5-24—Typical response curve of a crystal filter. The notch can be moved to the other side of the response peak by adjustment of the "phasing" control. With the above curve, setting the b.f.o. at 454 kc. would give good single-signal c.w. reception.

The higher selectivity with regeneration reduces the over-all response to noise generated in the earlier stages of the receiver, just as does high selectivity produced by other means, and therefore improves the signal-to-noise ratio. However, the regenerative gain varies with signal strength, being less on strong signals.

#### Crystal-Filters; Phasing

Probably the simplest means for obtaining high selectivity is by the use of a piezoelectric quartz crystal as a selective filter in the i.f. amplifier. Compared to a good tuned circuit, the  $Q$  of such a crystal is extremely high. The crystal is ground resonant at the i.f. and used as a selective coupler between i.f. stages.

Fig. 5-24 gives a typical crystal-filter reso-



nance curve. For single-signal reception, the audio-frequency image can be reduced by 50 db. or more. Besides practically eliminating the a.f. image, the high selectivity of the crystal filter provides good discrimination against adjacent signals and also reduces the noise.

Two crystal-filter circuits are shown in Fig. 5-25. The circuit at A (or a variation) is found in many of the current communications receivers. The crystal is connected in one side of a bridge circuit, and a phasing capacitor,  $C_1$  is connected in the other. When  $C_1$  is set to balance the crystal-holder capacitance, the resonance curve of the filter is practically symmetrical; the crystal acts as a series-resonant circuit of very high  $Q$  and allows signals over a narrow band of frequencies to pass through to the following tube. More or less capacitance at  $C_1$  introduces the "rejection notch" of Fig. 5-24 (at 453.7 kc. as drawn). The  $Q$  of the load circuit for the filter is adjusted by the setting of  $R_1$ , which in turn varies the bandwidth of the filter from "sharp" to a bandwidth suitable for phone reception. Some of the components of this filter are special and not generally available to amateurs.

## BAND-PASS FILTERS

A single high- $Q$  circuit (e.g., a quartz crystal or regenerative stage) will give adequate single-signal reception under most circumstances. For phone reception, however, either single-sideband or a.m., a band-pass characteristic is more desirable. A band-pass filter is one that passes without unusual attenuation a desired *band* of frequencies and rejects signals outside this band. A good band-pass filter for single-sideband reception might have a bandwidth of 2500 cycles at -6 db. and 10 kc. at -60 db.; a filter for a.m. would require twice these bandwidths if both sidebands were to be accommodated.

The simplest band-pass crystal filter is one using two crystals, as in Fig. 5-25B. The two crystals are separated slightly in frequency. If the frequencies are only a few hundred cycles apart the characteristic is a good one for c.w. reception. With crystals about 2 kc. apart, a reasonable phone characteristic is obtained. Fig. 5-1 shows a selectivity characteristic of an amplifier with a bandpass (at -6 db.) of 2.4 kc., which is typical of what can be expected from a two-crystal band-pass filter. Compare this with the single-crystal characteristic of Fig. 5-24.

More elaborate crystal filters, using four and six crystals, will give reduced bandwidth at -60 db. without decreasing the bandwidth at -6 db. The resulting increased "skirt selectivity" gives better rejection of adjacent-channel signals. "Crystal-lattice" filters of this type are available commercially for frequencies up to 10 Mc. or so, and they have also been built by amateurs from inexpensive transmitting-type crystals. (See Vester, "Surplus-Crystal High-Frequency Filters," *QST*, January, 1959; Healey, "High-Frequency Crystal Filters for S.S.B.," *QST*, October, 1960.)

"Mechanical" filters can be built at frequen-

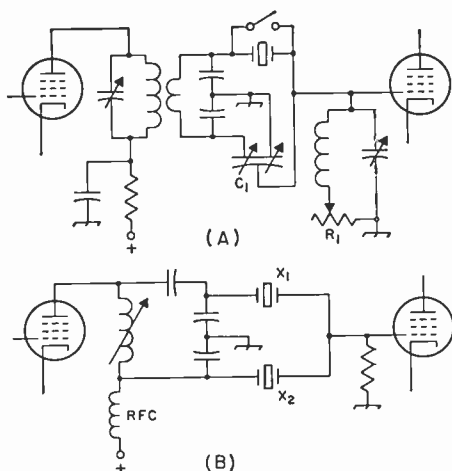

Fig. 5-25—A variable-selectivity crystal filter (A) and a band-pass crystal filter (B).

cies below 1 Mc. These are made up of three sections: an input transducer, a mechanically-resonant filter section, and an output transducer. The transducers use the principle of magnetostriction to convert the electrical signal to mechanical energy and back again. The mechanically-resonant section consists of carefully-machined metal disks supported and coupled by thin rods. Each disk has a resonant frequency dependent upon the material and its dimensions, and the effective  $Q$  of a single disk may be in excess of 2000. Consequently a mechanical filter can be built for either narrow or broad bandpass with a nearly rectangular curve. Mechanical filters are available commercially and are used in both receivers and single-sideband transmitters.

The signal-handling capability of a mechanical filter is limited by the magnetic circuits to from 2 to 15 volts r.m.s., a limitation that is of no practical importance provided it is recognized and provided for. Crystal filters are limited in their signal-handling ability only by the voltage breakdown limits, which normally would not be reached before the preceding amplifier tube was overloaded. A more serious practical consideration in the use of any high-selectivity component is the prevention of coupling "around" the filter (coupling from input to output outside the filter), which can only degrade the action of the filter.

Band-pass filters can also be made by using a number of high- $Q$  inductance-and-capacitance circuits, but their use is generally restricted to frequencies around 100 kc. At higher frequencies it is easier to get desirable selectivity by other means.

## Q Multiplier

The "Q Multiplier" is a stable regenerative stage that is connected in parallel with one of the i.f. stages of a receiver. In one condition it narrows the bandwidth and in the other condi-

tion it produces a sharp "null" or rejection notch. A "tuning" adjustment controls the frequency of the peak or null, moving it across the normal pass band of the receiver i.f. amplifier. The *shape* of the peak or null is always that of a single tuned circuit (Fig. 2-50) but the effective  $Q$  is adjustable over a wide range. A  $Q$  Multiplier is most effective at an i.f. of 500 kc. or less; at higher frequencies the rejection notch becomes wide enough (measured in cycles per second) to reject a major portion of a phone signal. Within its useful range, however, the  $Q$  Multiplier will reject an interfering carrier without degrading the quality of the desired signal.

In the "peak" condition the  $Q$  Multiplier can be made to oscillate by advancing the "peak" (regeneration) control far enough, and in this condition it can be made to serve as a beat-frequency oscillator. However, it cannot be made to serve as a selective element and as a b.f.o. at the same time. Some inexpensive receivers may combine either a  $Q$  Multiplier or some other form of regeneration with the b.f.o. function, and the reader is advised to check carefully any inexpensive receiver he intends to buy that offers a regenerative type of selectivity, in order to make sure that the selectivity is available when the b.f.o. is turned on.

Vacuum-tube versions of the  $Q$  Multiplier for 455-kc. i.f. amplifiers are available in kit form; a transistorized version is described later in this chapter. A  $Q$  Multiplier will be of no use on c.w. or s.s.b. reception when used with a receiver that employs an oscillating i.f. stage for the b.f.o. Some of the inexpensive "communications" receivers are of this type.

### Tee Notch Filter

At low intermediate frequencies (50–100 kc.) the T notch filter of Fig. 5-26 will provide a sharp tunable null.

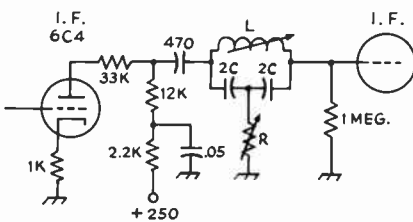

Fig. 5-26—Typical T-notch filter, to provide a sharp rejection notch at a low i.f. Adjustment of  $L$  changes the frequency of the notch; adjustment of  $R$  controls the depth.

The inductor  $L$  resonates with  $C$  at the rejection frequency, and when  $R = 4X_L/Q$  the rejection is maximum. ( $X_L$  is the coil reactance and  $Q$  is the coil  $Q$ ). In a typical 50-kc. circuit,  $C$  might be 3900  $\mu\text{mf.}$ , making  $L$  approximately 2.6 mh. When  $R$  is greater than the maximum-

attenuation value, the circuit still provides some rejection, and in use the inductor is detuned or shorted out when the rejection is not desired.

At higher frequencies, the T-notch filter is not sharp enough with available components to reject only a narrow band of frequencies.

### Additional I.F. Selectivity

Many commercial communications receivers, and particularly the older ones, do not have sufficient selectivity for amateur use, and their performance can be improved by additional i.f. selectivity. One method is to loosely couple a BC-453 aircraft receiver (war surplus, tuning 190 to 550 kc.) to the front end of the 455-kc. i.f. amplifier in the communications receiver and use the resultant output of the BC-453. The aircraft receiver uses an 85-kc. i.f. amplifier that is sharp for voice work (6.5 kc. wide at -60 db.) and it helps considerably in backing up single-crystal filters for improved c.w. reception.

The BC-453—sometimes called "The Poor Man's Q-Fiver"—uses 12-volt heater tubes and is designed for 24-volt operation. If a 24-volt transformer is available, no wiring changes will be necessary. If a 12-volt transformer is available, the heaters can be rewired. It is usually less expensive to obtain the proper transformer than it is to buy 6.3-volt tubes for the receiver. Any plate-voltage source of 125 to 250 volts at 40 to 80 ma. will be adequate for the B+ supply. A b.f.o. switch and audio and i.f. gain controls should be added to the BC-453 before it is used with the short-wave receiver. Its performance can be checked by tuning in aircraft beacons or low-frequency broadcast stations.

Maximum selectivity will be obtained from the BC-453 when the plungers in the i.f. cans, accessible by unscrewing the caps, are pulled up as far as they will go.

The BC-453 can be coupled to the receiver through a length of shielded wire or small coaxial line. The inner conductor is connected to the antenna post of the BC-453 and the shield is connected to the case. The shield should be connected at the other end to the short-wave receiver chassis, and the inner conductor, suitably insulated, should be wrapped once or twice around the plate pin of the first i.f. amplifier tube in the short-wave receiver. It may require a little experimentation before the proper coupling is obtained; the objective is enough coupling so that the short-wave receiver noise will mask any BC-453 noise, but not so much coupling that the BC-453 is overloaded. Reports of poor performance when using the BC-453 have practically always reduced to overload of the surplus aircraft receiver through too much coupling or coupling at a high-level point in the short-wave receiver.

If a BC-453 is not available, one can still enjoy the benefits of improved selectivity. It is only necessary to heterodyne to a lower frequency the 455-kc. signal existing in the receiver i.f. amplifier and then rectify it after passing it through

the sharp low-frequency amplifier. The J. W. Miller Company offers 50-kc. transformers for this application.

## RADIO-FREQUENCY AMPLIFIERS

While selectivity to reduce audio-frequency images can be built into the i.f. amplifier, discrimination against radio-frequency images can only be obtained in tuned circuits or other selective elements ahead of the first mixer or converter stage. These tuned circuits are usually used as the coupling networks for one or more vacuum tubes or transistors, and the combinations of circuits and amplifying devices are called radio-frequency amplifiers. The tuned circuits contribute to the r.f. image rejection and the amplifying device(s) determines the noise figure of the receiver.

Knowing the  $Q$  of the coil in each tuned circuit between the antenna and the first mixer or converter stage, the image rejection capability can be computed by using the chart in Fig. 2-50. The  $Q$  of the input tuned circuit (coupled to the antenna) should be taken as about one-half the unloaded  $Q$  of that circuit, and the  $Q$  of any other tuned circuit can be assumed to be the unloaded  $Q$  to a first approximation (the vacuum tubes will reduce the circuit  $Q$  to some extent, especially at 14 Mc. and higher).

In general, receivers with an i.f. of 455 kc. can be expected to have some noticeable image response at 14 Mc. and higher if there are only two tuned circuits (one r.f. stage) ahead of the mixer or converter. Regeneration in the r.f. amplifier will reduce image response, but regeneration usually requires frequent readjustment when tuning across a band. Regeneration is, however, a useful device for improving the selectivity of an r.f. amplifier without requiring a multiplicity of tuned circuits; a practical example will be found later in this chapter.

With three tuned circuits between the antenna and the first mixer, and an i.f. of 455 kc., no images should be encountered up to perhaps 25 Mc. Four tuned circuits or more will eliminate any images at 28 Mc. when an i.f. of 455 kc. is used.

Obviously, a better solution to the r.f. selectivity problem (elimination of image response) is to use an i.f. higher than 455 kc., and most modern receivers use an i.f. of 1600 kc. or higher. The owner of a receiver with a 455-kc i.f. amplifier can enjoy image-free reception on the higher frequencies by using a crystal-controlled converter ahead of the receiver and utilizing the receiver as a "tunable i.f. amplifier" at 3.5 or 7.0 Mc.

For best selectivity r.f. amplifiers should use high- $Q$  circuits and tubes with high input and output resistance. Variable- $\mu$  pentodes are practically always used, although triodes (neutralized or otherwise connected so that they won't oscillate) are often used on the higher frequencies because they introduce less noise. However, their lower plate resistance will load the tuned circuits. Pentodes are better where maximum im-

age rejection is desired, because they have less loading effect on the tuned circuits.

### Transistor R. F. Amplifier

A typical r.f. amplifier circuit using a 2N370 transistor is shown in Fig. 5-27. Since it is desirable to maintain a reasonable  $Q$  in the tuned circuits, to reduce r.f. image response, the base and collector are both tapped down on their tuned circuits. An alternative method, using low-impedance inductive coupling, is shown in Fig. 5-27B; this method is sometimes easier to adjust than the taps illustrated in Fig. 5-27A. The tuned circuits,  $L_1C_1$  and  $L_2C_2$ , should resonate at the operating frequency, and they should be mounted or shielded to eliminate inductive coupling between each other.

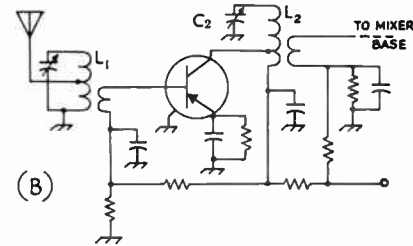
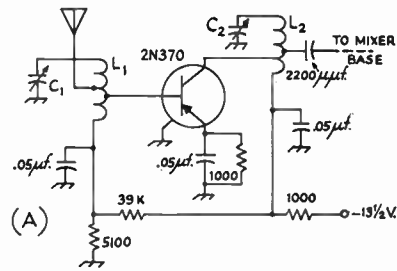

Fig. 5-27—Transistor r.f. amplifier circuit. The low-impedance connections to the base and collector can be (A) taps on the inductors or (B) low-impedance coupling links.  $L_1C_1$ ,  $L_2C_2$ —Resonant at signal frequency.

### FEEDBACK

Feedback giving rise to regeneration and oscillation can occur in a single stage or it may appear as an over-all feedback through several stages that are on the same frequency. To avoid feedback in a single stage, the output must be isolated from the input in every way possible, with the vacuum tube furnishing the only coupling between the two circuits. An oscillation can be obtained in an r.f. or i.f. stage if there is any undue capacitive or inductive coupling between output and input circuits, if there is too high an impedance between cathode and ground or screen and ground, or if there is any appreciable impedance through which the grid and plate currents can flow in common. This means

good shielding of coils and tuning capacitors in r.f. and i.f. circuits, the use of good bypass capacitors (mica or ceramic at r.f., paper or ceramic at i.f.), and returning all bypass capacitors (grid, cathode, plate and screen) for a given stage with short leads to one spot on the chassis. When single-ended tubes are used, the screen or cathode bypass capacitor should be mounted across the socket, to serve as shield between grid and plate pins. Less care is required as the frequency is lowered, but in high-impedance circuits, it is sometimes necessary to shield grid and plate leads and to be careful not to run them close together.

To avoid over-all feedback in a multistage amplifier, attention must be paid to avoid running any part of the output circuit back near the input circuit without first filtering it carefully. Since the signal-carrying parts of the circuit (the "hot" grid and plate leads) can't be filtered, the best design for any multistage amplifier is a straight line, to keep the output as far away from the input as possible. For example, an r.f. amplifier might run along a chassis in a straight line, run into a mixer where the frequency is changed, and then the i.f. amplifier could be run back parallel to the r.f. amplifier, provided there was a very large frequency difference between the r.f. and the i.f. amplifiers. However, to avoid any possible coupling, it would be better to run the i.f. amplifier off at right angles to the r.f.-amplifier line, just to be on the safe side. Good shielding is important in preventing over-all oscillation in high-gain-per-stage amplifiers, but it becomes less important when the stage gain drops to a low value. In a high-gain amplifier, the power leads (including the heater circuit) are common to all stages, and they can provide the over-all coupling if they aren't properly filtered. Good bypassing and the use of series isolating resistors will generally eliminate any possibility of coupling through the power leads. R.f. chokes, instead of resistors, are used in the heater leads where necessary.

## CROSS-MODULATION

Since a one- or two-stage r.f. amplifier will have a bandwidth measured in hundreds of kc. at 14 Mc. or higher, strong signals will be amplified through the r.f. amplifier even though it is not tuned exactly to them. If these signals are strong enough, their amplified magnitude may be measurable in volts after passing through several r.f. stages. If an undesired signal is strong enough after amplification in the r.f. stages to shift the operating point of a tube (by driving the grid into the positive region), the undesired signal will modulate the desired signal. This effect is called **cross-modulation**, and is often encountered in receivers with several r.f. stages working at high gain. It shows up as a superimposed modulation on the signal being listened to, and often the effect is that a signal can be tuned in at several points. It can be reduced or eliminated by greater selectivity in the antenna and r.f. stages (difficult to obtain), the

use of variable- $\mu$  tubes in the r.f. amplifier, reduced gain in the r.f. amplifier, or reduced antenna input to the receiver. The 6BJ6, 6BA6 and 6DC6 are recommended for r.f. amplifiers where cross-modulation may be a problem.

A receiver designed for minimum cross-modulation will use as little gain as possible ahead of the high-selectivity stages, to hold strong unwanted signals below the cross-modulation point. Cross-modulation often takes place in double-conversion superheterodynes at the *second* converter stage because there is insufficient selectivity up to this point and at this point the signals have quite appreciable amplitudes. Whenever interference drops out quite suddenly with a reduction in the setting of the gain control, cross-modulation should be suspected. Normally, of course, the interference would reduce in amplitude in proportion to the desired signal as the gain setting is reduced.

## Gain Control

To avoid cross-modulation and other overload effects in the mixer and r.f. stages, the gain of the r.f. stages is usually made adjustable. This is accomplished by using variable- $\mu$  tubes and varying the d.c. grid bias, either in the grid or cathode circuit. If the gain control is automatic, as in the case of a.g.c., the bias is controlled in the grid circuit. Manual control of r.f. gain is generally done in the cathode circuit. A typical r.f. amplifier stage with the two types of gain control is shown in schematic form in Fig. 5-28. The a.g.c. control voltage (negative) is derived from rectified carrier or signal at the detector before the audio amplifier, or in the case of a c.w. or s.s.b. receiver it can be derived from rectified audio. The manual gain control voltage (positive with respect to chassis) is usually derived from a potentiometer across the B+ supply, since the bias can be changed even though little plate current is being drawn.

## Tracking

In a receiver with no r.f. stage, it is no incon-

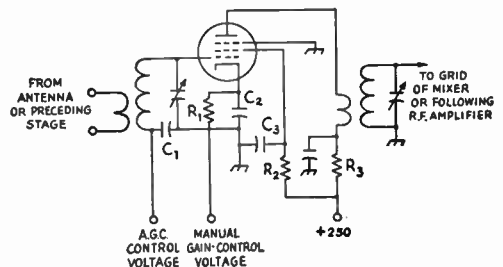

Fig. 5-28—Typical radio-frequency amplifier circuit for a superheterodyne receiver. Representative values for components are as follows:

$C_1$  to  $C_4$ —0.01  $\mu$ f. below 15 Mc., 0.001  $\mu$ f. at 30 Mc.  
 $R_1$ ,  $R_2$ —See Table 5-II.  
 $R_3$ —1800 ohms.



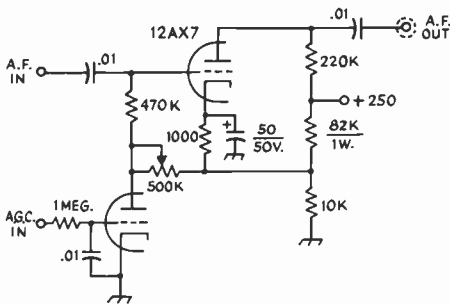

Fig. 5-29—A practical squelch circuit for cutting off the receiver output when no signal is present.

venience to adjust the high-frequency oscillator and the mixer circuit independently, because the mixer tuning is broad and requires little attention over an amateur band. However, when r.f. stages are added ahead of the mixer, the r.f. stages and mixer will require retuning over an entire amateur band. Hence most receivers with one or more r.f. stages gang all of the tuning controls to give a single-tuning-control receiver. Obviously there must exist a constant difference in frequency (the i.f.) between the oscillator and the mixer/r.f. circuits, and when this condition is achieved the circuits are said to **track**.

In amateur-band receivers, tracking is simplified by choosing a bandspread circuit that gives practically straight-line-frequency tuning (equal frequency change for each dial division), and then adjusting the oscillator and mixer tuned circuits so that both cover the same total number of kilocycles. For example, if the i.f. is 455 kc. and the mixer circuit tunes from 7000 to 7300 kc. between two given points on the dial, then the oscillator must tune from 7455 to 7755 kc. between the same two dial readings. With

the bandspread arrangement of Fig. 5-9A, the tuning will be practically straight-line-frequency if  $C_2$  (bandset) is 4 times or more the maximum capacitance of  $C_1$  (bandspread), as is usually the case for strictly amateur-band coverage.  $C_1$  should have semicircular plates.

### Squelch Circuits

An audio squelch circuit is one that cuts off the receiver output when no signal is coming through the receiver. It is useful in mobile or net work where the no-signal receiver noise may be as loud as the signal, causing undue operator fatigue during no-signal periods.

A practical squelch circuit is shown in Fig. 5-29. A dual triode (12AX7) is used as an amplifier and as a control tube. When the a.g.c. voltage is low or zero, the lower (control) triode draws plate current. The consequent voltage drop across the adjustable resistor in the plate circuit cuts off the upper (amplifier) triode and no signal or noise is passed. When the a.g.c. voltage rises to the cut-off value of the control triode, the tube no longer draws current and the bias on the amplifier triode is now only its normal operating bias, furnished by the 1000-ohm resistor in the cathode circuit. The tube now functions as an ordinary amplifier and passes signals. The relation between the a.g.c. voltage and the signal turn-on point is adjusted by varying the resistance in the plate circuit of the control triode.

Connections to the receiver consist of two a.f. lines (shielded), the a.g.c. lead, and chassis ground. The squelch circuit is normally inserted between detector output and the audio volume control of the receiver. Since the circuit is used in the low-level audio point, its plate supply must be free from a.c. or objectionable hum will be introduced.

## IMPROVING RECEIVER SENSITIVITY

The sensitivity (signal-to-noise ratio) of a receiver on the higher frequencies above 20 Mc. is dependent upon the band width of the receiver and the noise contributed by the "front end" of the receiver. Neglecting the fact that image rejection may be poor, a receiver with no r.f. stage is generally satisfactory, from a sensitivity point, in the 3.5- and 7-Mc. bands. However, as the frequency is increased and the atmospheric noise becomes less, the advantage of a good "front end" becomes apparent. Hence at 14 Mc. and higher it is worth while to use at least one stage of r.f. amplification ahead of the first detector for best sensitivity as well as image rejection. The multigrid converter tubes have very poor noise figures, and even the best pentodes and triodes are three or four times noisier when used as mixers than they are when used as amplifiers.

If the purpose of an r.f. amplifier is to improve the receiver noise figure at 14 Mc. and higher, a high- $g_m$  pentode or triode should be used. Among the pentodes, the best tubes are the

6AH6, 6AK5 and the 6BZ6, in the order named. The 6AK5 takes the lead around 30 Mc. The 6J4, 6J6, and triode-connected 6AK5 are the best of the triodes. For best noise figure, the antenna circuit should be coupled a little heavier than optimum. This cannot give best selectivity in the antenna circuit, so it is futile to try to maximize sensitivity *and* selectivity in this circuit.

When a receiver is satisfactory in every respect (stability and selectivity) except sensitivity on 14 through 30 Mc., the best solution for the amateur is to add a **preamplifier**, a stage of r.f. amplification designed expressly to improve the sensitivity. If image rejection is lacking in the receiver, some selectivity should be built into the preamplifier (it is then called a **preselector**). If, however, the receiver operation is poor on the higher frequencies but is satisfactory on the lower ones, a "converter" is the best solution.

Some commercial receivers that appear to lack sensitivity on the higher frequencies can be im-



proved simply by tighter coupling to the antenna. This can be accomplished by changing the antenna feed line to the right value (as determined from the receiver instruction book) or by using a simple matching device as described later in this chapter. Overcoupling the input circuit will often improve sensitivity but it will, of course, always reduce the image-rejection contribution of the antenna circuit.

#### Regeneration

Regeneration in the r.f. stage of a receiver (where only one stage exists) will often improve the sensitivity because the greater gain it provides serves to mask more completely the first-mixer noise, and it also provides a measure of automatic matching to the antenna through tighter coupling. However, accurate ganging becomes a problem, because of the increased selectivity of the regenerative r.f. stage, and the receiver almost invariably becomes a two-handed-tuning device. Regeneration should not be overlooked as an expedient, however, and amateurs have used it with considerable success.

High- $g_m$  tubes are the best as regenerative amplifiers, and the feedback should not be controlled by changing the operating voltages (which should be the same as for the tube used in a high-gain amplifier) but by changing the loading or the feedback coupling. This is a tricky process and another reason why regeneration is not too widely used.

#### Gain Control

In a receiver front end designed for best signal-to-noise ratio, it is advantageous in the reception of weak signals to eliminate the gain control from the first r.f. stage and allow it to run "wide open" all of the time. If the first stage is controlled along with the i.f. (and other r.f. stages, if any), the signal-to-noise ratio of the receiver will suffer. As the gain is reduced, the  $g_m$  of the first tube is reduced, and its noise figure becomes higher. A good receiver might well have two gain controls, one for the first r.f. stage and another for the i.f. (and any other r.f.) stages. The first r.f. stage gain would be reduced only for extremely strong signals.

## TUNING A RECEIVER

### C.W. Reception

For making code signals audible, the beat oscillator should be set to a frequency slightly different from the intermediate frequency. To adjust the beat-oscillator frequency, first tune in a moderately weak but steady carrier with the beat oscillator turned off. Adjust the receiver tuning for maximum signal strength, as indicated by maximum hiss. Then turn on the beat oscillator and adjust its frequency (leaving the receiver tuning unchanged) to give a suitable beat note. The beat oscillator need not subsequently be touched, except for occasional checking to make certain the frequency has not drifted from the initial setting. The b.f.o. may be set on either the high- or low-frequency side of zero beat.

The best receiver condition for the reception of code signals will have the first r.f. stage running at maximum gain, the following r.f., mixer and i.f. stages operating with just enough gain to maintain the signal-to-noise ratio, and the audio gain set to give comfortable headphone or speaker volume. The audio volume should be controlled by the audio gain control, not the i.f. gain control. Under the above conditions, the selectivity of the receiver is being used to best advantage, and cross-modulation is minimized. It precludes the use of a receiver in which the gains of the r.f. and i.f. stages are controlled simultaneously.

#### Tuning with the Crystal Filter

If the receiver is equipped with a crystal filter the tuning instructions in the preceding paragraph still apply, but more care must be used both in the initial adjustment of the beat oscillator and in tuning. The beat oscillator is set as

described above, but with the crystal filter set at its sharpest position, if variable selectivity is available. The initial adjustment should be made with the phasing control in an intermediate position. Once adjusted, the beat oscillator should be left set and the receiver tuned to the other side of zero beat (audio-frequency image) on the same signal to give a beat note of the same tone. This beat will be considerably weaker than the first, and may be "phased out" almost completely by careful adjustment of the phasing control. This is the adjustment for normal operation; it will be found that one side of zero beat has practically disappeared, leaving maximum response on the other.

An interfering signal having a beat note differing from that of the a.f. image can be similarly phased out, provided its frequency is not too near the desired signal.

Depending upon the filter design, maximum selectivity may cause the dots and dashes to lengthen out so that they seem to "run together." It must be emphasized that, to realize the benefits of the crystal filter in reducing interference, it is necessary to do *all* tuning with it in the circuit. Its high selectivity often makes it difficult to find the desired station quickly, if the filter is switched in only when interference is present.

### A.M. Phone Reception

In reception of a.m. phone signals, the normal procedure is to set the r.f. and i.f. gain at maximum, switch on the a.g.c., and use the audio gain control for setting the volume. This insures maximum effectiveness of the a.g.c. system in compensating for fading and maintaining constant audio output on either strong or weak signals. On occasion a strong signal close to the

frequency of a weaker desired station may take control of the a.g.c., in which case the weaker station may disappear because of the reduced gain. In this case better reception may result if the a.g.c. is switched off, using the manual r.f. gain control to set the gain at a point that prevents "blocking" by the stronger signal.

When receiving an a.m. signal on a frequency within 5 to 20 kc. from a single-sideband signal it may also be necessary to switch off the a.g.c. and resort to the use of manual gain control, unless the receiver has excellent skirt selectivity. No ordinary a.g.c. circuit can handle the syllabic bursts of energy from the sideband station, but there are special circuits that will.

A crystal filter will help reduce interference in phone reception. Although the high selectivity cuts sidebands and reduces the audio output at the higher audio frequencies, it is possible to use quite high selectivity without destroying intelligibility. As in code reception, it is advisable to do all tuning with the filter in the circuit. Variable-selectivity filters permit a choice of selectivity to suit interference conditions.

An undesired carrier close in frequency to a desired carrier will heterodyne with it to produce a beat note equal to the frequency difference. Such a heterodyne can be reduced by adjustment of the phasing control in the crystal filter.

A tone control often will be of help in reducing the effects of high-pitched heterodynes, sideband splatter and noise, by cutting off the higher audio frequencies. This, like sideband cutting with high selectivity circuits, reduces naturalness.

### Spurious Responses

Spurious responses can be recognized without a great deal of difficulty. Often it is possible to identify an image by the nature of the transmitting station, if the frequency assignments applying to the frequency to which the receiver is tuned are known. However, an image also can be recognized by its behavior with tuning. If the signal causes a heterodyne beat note with the desired signal and is actually on the same frequency, the beat note will not change as the receiver is tuned through the signal; but if the interfering signal is an image, the beat will vary in pitch as the receiver is tuned. The beat oscillator in the receiver must be turned off for this test. Using a crystal filter with the beat oscillator on, an image will peak on the side of zero beat opposite that on which desired signals peak.

Harmonic response can be recognized by the "tuning rate," or movement of the tuning dial required to give a specified change in beat note. Signals getting into the i.f. via high-frequency oscillator harmonics tune more rapidly (less dial movement) through a given change in beat note than do signals received by normal means.

Harmonics of the beat oscillator can be recognized by the tuning rate of the beat-oscillator pitch control. A smaller movement of the control will suffice for a given change in beat note than that necessary with legitimate signals. In poorly-designed or inadequately-shielded and -filtered receivers it is often possible to find h.f.o. harmonics below 2 Mc., but they should be very weak or non-existent at higher frequencies.

## ALIGNMENT AND SERVICING OF SUPERHETERODYNE RECEIVERS

### I.F. Alignment

A calibrated signal generator or test oscillator is a useful device for alignment of an i.f. amplifier. Some means for measuring the output of the receiver is required. If the receiver has a tuning meter, its indications will serve. Lacking an S meter, a high-resistance voltmeter or a vacuum-tube voltmeter can be connected across the second-detector load resistor, if the second detector is a diode. Alternatively, if the signal generator is a modulated type, an a.c. voltmeter can be connected across the primary of the transformer feeding the speaker, or from the plate of the last audio amplifier through a 0.1- $\mu$ f. blocking capacitor to the receiver chassis. Lacking an a.c. voltmeter, the audio output can be judged by ear, although this method is not as accurate as the others. If the tuning meter is used as an indication, the a.g.c. of the receiver should be turned on, but any other indication requires that it be turned off. Lacking a test oscillator, a steady signal tuned through the input of the receiver (if the job is one of just touching up the

i.f. amplifier) will be suitable. However, with no oscillator and tuning an amplifier for the first time, one's only recourse is to try to peak the i.f. transformers on "noise," a difficult task if the transformers are badly off resonance, as they are apt to be. It would be much better to haywire together a simple oscillator for test purposes.

Initial alignment of a new i.f. amplifier is as follows: The test oscillator is set to the correct frequency, and its output is coupled through a capacitor to the grid of the last i.f. amplifier tube. The trimmer capacitors of the transformer feeding the second detector are then adjusted for maximum output, as shown by the indicating device being used. The oscillator output lead is then clipped on to the grid of the next-to-the-last i.f. amplifier tube, and the second-from-the-last transformer trimmer adjustments are peaked for maximum output. This process is continued, working back from the second detector, until all of the i.f. transformers have been aligned. It will be necessary to reduce the output of the test oscillator as more of the i.f. amplifier is brought into use. It is desirable in all cases to use the

minimum signal that will give useful output readings. The i.f. transformer in the plate circuit of the mixer is aligned with the signal introduced to the grid of the mixer. Since the tuned circuit feeding the mixer grid may have a very low impedance at the i.f., it may be necessary to boost the test generator output or to disconnect the tuned circuit temporarily from the mixer grid.

If the i.f. amplifier has a crystal filter, the filter should first be switched out and the alignment carried out as above, setting the test oscillator as closely as possible to the crystal frequency. When this is completed, the crystal should be switched in and the oscillator frequency varied back and forth over a small range either side of the crystal frequency to find the exact frequency, as indicated by a sharp rise in output. Leaving the test oscillator set on the crystal peak, the i.f. trimmers should be realigned for maximum output. The necessary readjustment should be small. The oscillator frequency should be checked frequently to make sure it has not drifted from the crystal peak.

A modulated signal is not of much value for aligning a crystal-filter i.f. amplifier, since the high selectivity cuts sidebands and the results may be inaccurate if the audio output is used as the tuning indication. Lacking the a.g.c. tuning meter, the transformers may be conveniently aligned by ear, using a weak unmodulated signal adjusted to the crystal peak. Switch on the beat oscillator, adjust to a suitable tone, and align the i.f. transformers for maximum audio output.

An amplifier that is only slightly out of alignment, as a result of normal drift or aging, can be realigned by using any steady signal, such as a local broadcast station, instead of the test oscillator. One's 100-kc. standard makes an excellent signal source for "touching up" an i.f. amplifier. Allow the receiver to warm up thoroughly, tune in the signal, and trim the i.f. for maximum output.

If you bought your receiver instead of making it, be sure to read the instruction book carefully before attempting to realign the receiver. Most instruction books include alignment details, and any little special tricks that are peculiar to the receiver will also be described in detail.

### R.F. Alignment

The objective in aligning the r.f. circuits of a gang-tuned receiver is to secure adequate tracking over each tuning range. The adjustment may be carried out with a test oscillator of suitable frequency range, with harmonics from your 100-kc. standard or other known oscillator, or even on noise or such signals as may be heard. First set the tuning dial at the high-frequency end of the range in use. Then set the test oscillator to the frequency indicated by the receiver dial. The test-oscillator output may be connected to the antenna terminals of the receiver for this test. Adjust the oscillator trimmer capacitor in the receiver to give maximum response on the test-oscillator signal, then reset the receiver

dial to the low-frequency end of the range. Set the test-oscillator frequency near the frequency indicated by the receiver dial and tune the test oscillator until its signal is heard in the receiver. If the frequency of the signal as indicated by the test-oscillator calibration is higher than that indicated by the receiver dial, more inductance (or more capacity in the tracking capacitor) is needed in the receiver oscillator circuit; if the frequency is lower, less inductance (less tracking capacity) is required in the receiver oscillator. Most commercial receivers provide some means for varying the inductance of the coils or the capacity of the tracking capacitor, to permit aligning the receiver tuning with the dial calibration. Set the test oscillator to the frequency indicated by the receiver dial, and then adjust the tracking capacity or inductance of the receiver oscillator coil to obtain maximum response. After making this adjustment, recheck the high-frequency end of the scale as previously described. It may be necessary to go back and forth between the ends of the range several times before the proper combination of inductance and capacity is secured. In many cases, better overall tracking will result if frequencies near but not actually at the ends of the tuning range are selected, instead of taking the extreme dial settings.

After the oscillator range is properly adjusted, set the receiver and test oscillator to the high-frequency end of the range. Adjust the mixer trimmer capacitor for maximum hiss or signal, then the r.f. trimmers. Reset the tuning dial and test oscillator to the low-frequency end of the range, and repeat; if the circuits are properly designed, no change in trimmer settings should be necessary. If it is necessary to increase the trimmer capacity in any circuit, more inductance is needed; conversely, if less capacity resonates the circuit, less inductance is required.

Tracking seldom is perfect throughout a tuning range, so that a check of alignment at intermediate points in the range may show it to be slightly off. Normally the gain variation will be small, however, and it will suffice to bring the circuits into line at both ends of the range. If most reception is in a particular part of the range, such as an amateur band, the circuits may be aligned for maximum performance in that region, even though the ends of the frequency range as a whole may be slightly out of alignment.

### Oscillation in R.F. or I.F. Amplifiers

Oscillation in high-frequency amplifier and mixer circuits shows up as squeals or "birdies" as the tuning is varied, or by complete lack of audible output if the oscillation is strong enough to cause the a.g.c. system to reduce the receiver gain drastically. Oscillation can be caused by poor connections in the common ground circuits. Inadequate or defective bypass capacitors in cathode, plate and screen-grid circuits also can cause such oscillation. A metal tube with an ungrounded shell may cause trouble. Improper

screen-grid voltage, resulting from a shorted or too-low screen-grid series resistor, also may be responsible for such instability.

Oscillation in the i.f. circuits is independent of high-frequency tuning, and is indicated by

a continuous squeal that appears when the gain is advanced with the c.w. beat oscillator on. It can result from defects in i.f.-amplifier circuits. Inadequate screen or plate bypass capacitance is a common cause of such oscillation.

## IMPROVING THE PERFORMANCE OF RECEIVERS

Frequently amateurs unjustly criticize a receiver's performance when actually part of the trouble lies with the operator, in his lack of knowledge about the receiver's operation or in his inability to recognize a readily curable fault. The best example of this is a complaint about "lack of selectivity" when the receiver contains an i.f. crystal filter and the operator hasn't bothered to learn how to use it properly. "Lack of sensitivity" may be nothing more than poor alignment of the r.f. and mixer tuning. The cures for these two complaints are obvious, and the details are treated both in this chapter and in the receiver instruction book.

However, many complaints about selectivity, sensitivity, and other points are justified. Inexpensive, and most second-hand, receivers cannot be expected to measure up to the performance standards of some of the current and top-priced receivers. Nevertheless, many amateurs overlook the possibility of improving the performance of these "bargains" (they may or may not be bargains) by a few simple additions or modifications. From time to time articles in *QST* describe improvements for specific receivers, and it may repay the owner of a newly-acquired second-hand receiver to examine past issues and see if an applicable article was published. The annual index in each December issue is a help in this respect.

Where no applicable article can be found, a few general principles can be laid down. If the complaint is the inability to separate stations, better i.f. (and occasionally audio) selectivity is indicated. The answer is not to be found in better bandspread tuning of the dial as is sometimes erroneously concluded. For code reception the addition of a "Q Multiplier" to the i.f. amplifier is a simple and effective attack; a Q Multiplier is at its best in the region 100 to 900 kc., and higher than this its effectiveness drops off. The Selectoject is a selective audio device based on similar principles. For phone reception the addition of a Q Multiplier will help to reject an interfering carrier, and the use of a BC-453 as a "Q5-er" will add adjacent-channel selectivity.

With the addition of more i.f. selectivity, it may be found that the receiver's tuning rate (number of kc. tuned per dial revolution) is too high, and consequently the tuning with good i.f. selectivity becomes too critical. If this is the case, a 5-to-1 reduction planetary dial drive mechanism may be added to make the tuning rate more favorable. These drives are sold by the larger supply houses and can usually be added to the receiver if a suitable mounting bracket is

made from sheet metal. If there is already some backlash in the dial mechanism, the addition of the planetary drive will magnify its effect, so it is necessary to minimize the backlash before attempting to improve the tuning rate. While this is not possible in all cases, it should be investigated from every angle before giving up. Replacing a small tuning knob with a larger one will add to ease of tuning; in many cases after doing so it will then be desirable or necessary to raise the receiver higher above the table.

If the receiver appears to lack the ability to bring in the weak signals, particularly on the higher-frequency bands, the performance can often be improved by the addition of an antenna coupler (described elsewhere in this chapter); it will always be improved by the addition of a preselector (also described elsewhere in this chapter).

If the receiver shortcoming is inadequate r.f. selectivity, as indicated by r.f. "images" on the higher-frequency bands, a simple antenna coupler will often add sufficient selectivity to cure the trouble. However, if the images are severe, it is likely that a preselector will be required, preferably of the regenerative type. The preselector will also add to the ability of the receiver to detect weak signals at 14 Mc. and higher.

In many of the inexpensive receivers the frequency calibration of the dial is not very accurate. The receiver's usefulness for determining band limits will be greatly improved by the addition of a 100-kc. crystal-controlled frequency standard. These units can be built or purchased complete at very reasonable prices, and no amateur station worthy of the name should be without one.

Some receivers that show a considerable frequency drift as they are warming up can be improved by the simple expedient of furnishing more ventilation, by propping up the lid or by drilling extra ventilation holes. In many cases the warm-up drift can be cut in half. A 7-watt 115-volt lamp mounted under the receiver chassis and wired so that it is turned on when the receiver is turned off will maintain the receiver temperature above the room temperature and will reduce the warm-up drift. The auxiliary heat source is also of help in reducing or eliminating the ill effects of condensation in the receiver, where the receiver is used in a damp location.

Receivers that show frequency changes with line-voltage or gain-control variations can be greatly improved by the addition of regulated voltage on the oscillators (high-frequency and b.f.o.) and the screen of the mixer tube. There is usually room in any receiver for the addition of a VR tube of the right rating.



## RECEIVER PROTECTION AND MUTING

Receiver protection means preventing injury to the receiver during transmission periods. A basic method is to remove the receiver from the antenna and simultaneously short-circuit the input terminals; this is an excellent method, and suitable coaxial relays are available for the purpose. If a high-powered transmitter is used, the receiver may still be overloaded by the leakage signal, and some means for simultaneous gain reduction must be provided. In many installations one of the operator's hands is adequate.

When a separate receiving antenna is used, connected to the receiver at all times, the receiver will be overloaded by the transmitted signal unless suitable protection is provided. This can be input protection or gain reduction. When an electronic t.r. switch is used (see Chapter 22) simultaneous gain reduction must be provided if receiver overload is to be avoided.

If the receiver is protected against injury, the easiest method for protecting the operator's ears is to short circuit (or disconnect) the audio output. This is usually done with a relay; it can be the same relay that provides a transmitter function, since the armature can be grounded. Other methods include providing gain reduction through additional bias, or r.f. keyed audio amplifiers that transfer from receiver to a monitoring signal.

The muting system shown in Fig. 5-30 can be used with any grid-block or tube-keyed transmitter, and it is particularly applicable to the VR-tube differential keying circuit of Chap. 7. Referring to Fig. 5-30,  $R_1$ ,  $R_2$  and  $C_1$  have the same values and functions that the similar components of any grid-block system have. When the key is open, a small current will flow through  $R_3$ , the 0A2 and  $R_2$ , and the voltage drop across  $R_4$  will be sufficient to cut off the 6C4. With the 6C4 cut off, there is no current through  $R_4$  and consequently no voltage appearing across  $R_4$ .

When the key is closed, there is insufficient voltage across the 0A2 to maintain conduction, and consequently there is no current flow through  $R_3$ . With zero voltage between grid and cathode, the 6C4 passes current. The drop across  $R_4$ , and thus the negative voltage applied to the a.g.c. line

in the receiver, is determined by the value of  $R_4$ . Thus the key-down gain of the receiver can be adjusted to permit listening to one's own signal, by increasing the value of  $R_4$  until the receiver output level is a comfortable one. To utilize the same antenna for transmitting and receiving, and thus benefit during receiving from any directional properties of the antenna, an electronic transmit-receive switch can be used.

The receiver a.g.c. bus can be located by reference to the receiver instruction manual, and connection be made to it through a length of shielded wire. The a.g.c. switch in the receiver must be turned to ON for the muter to be effective.

If desired, the muting circuit can be built into the transmitter, or it can be mounted on a shelf or small chassis behind the receiver. The two negative voltages can be furnished by one supply and a reasonably heavy voltage divider; the main requirement of the supply is that the nominal -125 volts remain below the normal voltage drop of the 0A2 (150 volts). Installation of the muting circuits should have little or no effect on the keying characteristic of the transmitter; if it does the characteristic can be restored by proper values for  $R_1$ ,  $R_2$  and  $C_1$ .

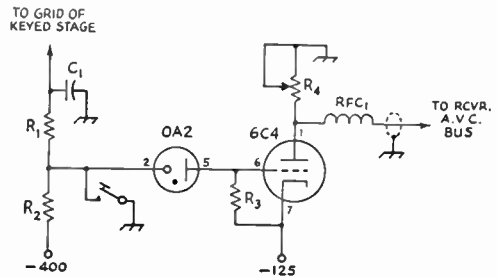

Fig. 5-30—Circuit diagram of a receiver muter for use with grid-block or tube keying.

$C_1$ —Shaping capacitor, see text.

$R_1$ ,  $R_2$ —Shaping resistors, see text.

$R_3$ —0.1 megohm.

$R_4$ —15,000-ohm 2-watt potentiometer.

## RECEPTION OF F.M. AND P.M. SIGNALS

Receivers for f.m. and p.m. signals differ from others principally in two features — there is no need for linearity preceding detection (in fact, it is advantageous if amplitude variations in signal and background noise can be "washed out"), and the detector must be capable of converting frequency variations in the incoming signal into amplitude variations.

Frequency- or phase-modulated signals can be received after a fashion on any ordinary receiver. The receiver is tuned to put the carrier frequency part-way down on one side of the selectivity curve. When the frequency of the sig-

nal varies with modulation it swings as indicated in Fig. 5-31A, resulting in an a.m. output varying between  $X$  and  $Y$ . This is then rectified as an a.m. signal.

With receivers having steep-sided selectivity curves, the method is not very satisfactory because the distortion is quite severe unless the frequency deviation is small, since the frequency deviation and output amplitude is linear over only a small part of the selectivity curve.

A detector designed expressly for f.m. or p.m. has a characteristic similar to that shown in Fig. 5-31B. The output is zero when the unmodulated



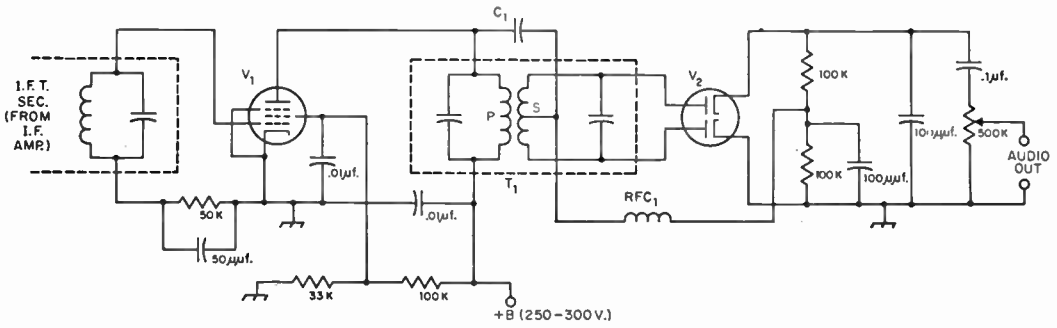

Fig. 5-32—Limiter-discriminator circuit.

$C_1$ —About 500 ohms reactance at i.f.  
 $T_1$ —Discriminator transformer for i.f. used. Push-pull diode transformer may be substituted.

$RFC_1$ —High reactance at i.f.  
 $V_1$ —6AU6 or equivalent.  
 $V_2$ —6AL5 or equivalent.

carrier is tuned to the center,  $\theta$ , of the characteristic. When the frequency swings higher, the rectified output amplitude increases in the positive direction (as chosen in this example), and when the frequency swings lower the output amplitude increases in the negative direction. Over the range in which the characteristic is a straight line the conversion from f.m. to a.m. is linear and there is no distortion. One type of detector that operates in this way is the **frequency discriminator**, which combines the f.m.-

to-a.m. conversion with rectification to give an a.f. output from the f.m. signal.

**Limiter and Discriminator**

A practical discriminator circuit is shown in Fig. 5-32. The f.m.-to-a.m. conversion takes place in transformer  $T_1$ , which operates at the intermediate frequency of a superheterodyne receiver. The voltage induced in the transformer secondary,  $S$ , is 90 degrees out of phase with the primary current. The primary voltage is introduced at the center tap on the secondary through  $C_1$  and combines with the secondary voltages on each side of the center tap so that the resultant voltage on one side of the secondary leads the primary voltage and the voltage on the other side lags by the same phase angle, when the circuits are resonated to the unmodulated carrier frequency. When rectified, these two voltages are equal and of opposite polarity. If the frequency changes, there is a shift in the relative phase of the voltage components that results in an increase in output amplitude on one side of the secondary and a corresponding decrease in amplitude on the other side. Thus the voltage applied to one diode of  $V_2$  increases while the voltage applied to the other diode decreases. The difference between these two voltages, after rectification, is the audio-frequency output of the detector.

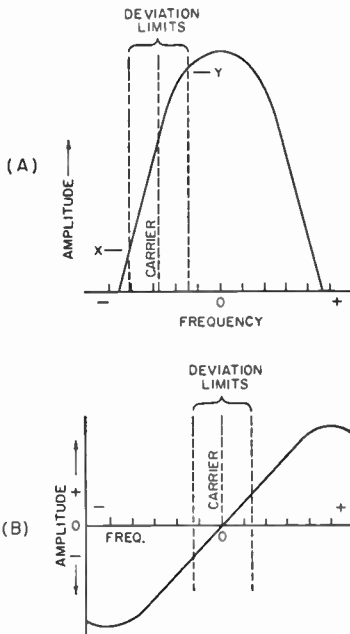

Fig. 5-31—F.m. or p.m. detection characteristics. A—"Slope detection," using the sloping side of the receiver's selectivity curve to convert f.m. or p.m. to a.m. for subsequent rectification. B—Typical discriminator characteristic. The straight portion of this curve between the two peaks is the useful region. The peaks should always lie outside the pass band of the receiver's selectivity curve.

The output amplitude of a simple discriminator depends on the amplitude of the input r.f. signal, which is undesirable because the noise-reducing benefits of f.m. are not secured if the receiving system is sensitive to amplitude variations. A discriminator is always preceded by some form of amplitude limiting, therefore. The conventional type of limiter also is shown in Fig. 5-32. It is simply a pentode i.f. amplifier,  $V_1$ , with its operating conditions chosen so that it "saturates" on a relatively small signal voltage. The limiting action is aided by grid rectification, with grid-leak bias developed in the 50,000-ohm resistor in the grid circuit. Another contributing factor is low screen voltage, the screen voltage-divider constants being chosen to result in about 50 volts on the screen.

## THE "SimpleX Super Mark II" THREE-TUBE RECEIVER

The name of the receiver shown in Figs. 5-33 and 5-36 derives from "simple," "X" for crystal (filter) and "super" for superheterodyne; hence a "simple crystal-filter superheterodyne." It is an improved version of an earlier model (*QST*, December, 1958), hence the "Mark II." For less than fifty dollars and a few nights at the workbench, this little receiver will allow you to copy practically any c.w. or s.s.b. signal in the 40- or 80-meter band that a much more expensive receiver might bring in. By the throw of a switch you can tune in WWV on 5.0 Mc. for time signals and standard-frequency transmissions.

Referring to the circuit diagram in Fig. 5-34, the receiver is a superheterodyne with an intermediate frequency of 1700 kc. With the h.f. oscillator tuning 5.2. to 5.7 Mc., the 3.5- or 7-Mc. amateur bands can be tuned merely by retuning the input circuit. Since  $C_2$  is large enough to hit the two bands without a coil change, the band-changing process consists of turning  $C_2$  to the low- or high-capacitance end of its range. To copy WWV at 5 Mc., the oscillator must be tuned to 3.3 Mc., and this is done by switching in (via  $S_{2A}$ ) a preset capacitor,  $C_5$ , across the oscillator circuit.

The advantage of a two-band receiver of this type is that the absence of coil switching makes it easy to build a stable high-frequency oscillator, and the stability of this oscillator then determines the stability of the receiver. Higher-frequency bands (14, 21 and 28 Mc.) can be listened to by adding a crystal-controlled converter; the construction of such a converter is described later in this chapter.

Selectivity at the i.f. is obtained through the use of a single crystal. This, in conjunction with the regeneration provided by the detector, is sharp enough to provide a fair degree of single-signal c.w. reception and yet is broad enough for copy of an s.s.b. phone signal.

In the detector stage, the pentode section of a 6U8A is used as a regenerative detector, and the triode section serves as the b.f.o. Stray coupling at the socket and in the tube provides adequate injection. The regeneration control is not mounted on the panel because, once set below the threshold of oscillation, it is not touched. The

regeneration is not essential to good c.w. or s.s.b. reception, but it helps considerably on a.m. reception. Audio amplification is obtained from the two triode sections of a 6CG7. The primary of a small output transformer,  $T_1$ , serves as the coupling for high-impedance headphone output, and a small loudspeaker or low-impedance headphones can be connected to the secondary.

The power supply uses a small transformer and two selenium rectifiers in a full-wave voltage-doubling circuit. This is about as inexpensive a power supply as can be built, and it also has the advantages of not occupying much space and not generating much heat.

A switch,  $S_{1A}$ , at the input of the receiver is included so that the receiver can be used to listen to one's own transmitter without too severe blocking. Another section of the same switch,  $S_{1B}$ , shifts the mixer screen voltage from its operating value to zero, to reduce further the sensitivity of the receiver while one is transmitting. If it reduces it so much that the receiver has too little gain, this section of the switch can be omitted from the circuit and the mixer operated at full screen voltage at all times.

An  $8 \times 12 \times 3$ -inch aluminum chassis takes all of the parts without crowding, and the location of the components can be seen in the photographs. The receiver is shown with a 7-inch high standard relay-rack panel, which leaves room at one end of the panel for auxiliary equipment or a small transmitter. If desired, a shorter panel of  $\frac{3}{8}$ -inch aluminum can be used. The panel is held to the chassis by the two switches and the headphones jack. The tuning capacitor,  $C_3$ , is mounted on a small aluminum bracket, and the capacitor is driven by a Jackson Brothers Planetary Vernier (Arrow Electronics, N.Y.C.) via a Millen 39016 coupling. Before the bracket is finally fastened to the chassis the capacitor and bracket should be used to locate the center for the vernier hole. It pays to take care in mounting the tuning capacitor and its drive, since a smooth tuning drive is essential to any receiver. A National HRT knob is used to turn the vernier, and a paper scale is made as can be seen in one of the photographs.

Tie points are used liberally throughout the

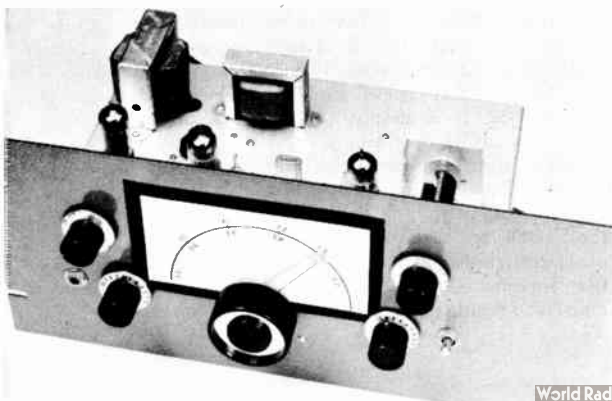

Fig. 5-33—The SimpleX Super receiver uses three dual tubes and a crystal filter to cover the 80- and 40-meter bands, and it can tune to 5 Mc. for copying WWV. The dial scale is made from white paper held to the panel by black tape; the index is clear plastic.

Extra panel space is provided for control circuits or a small transmitter.

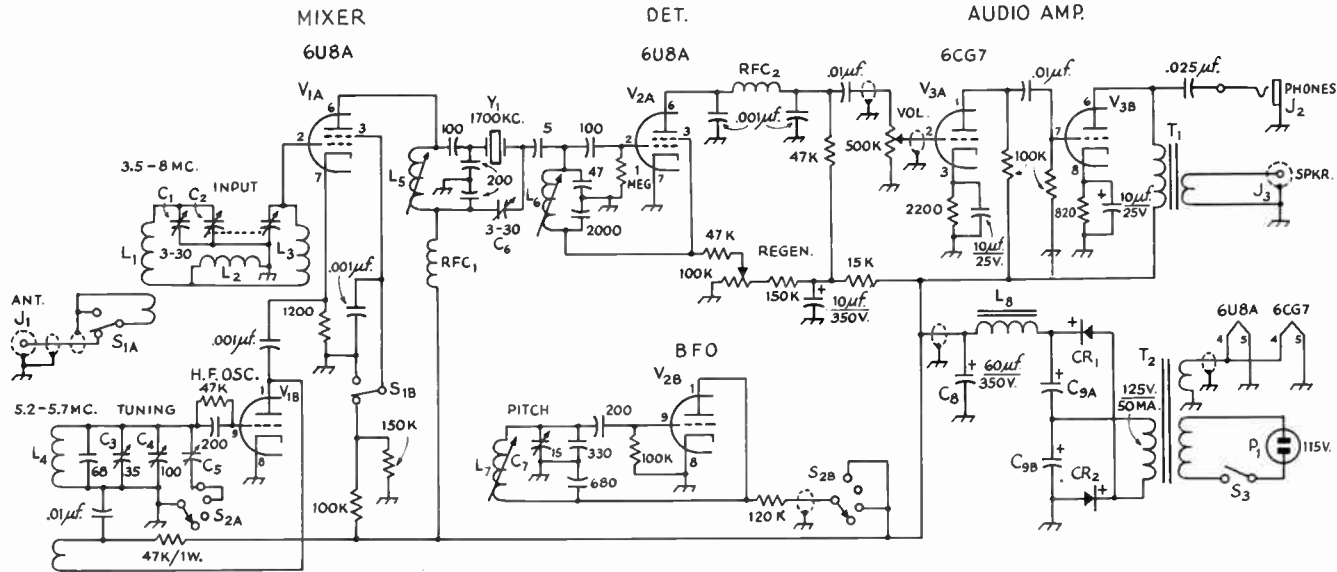

Fig. 5-34—Circuit diagram of the Simplex Super receiver. Unless otherwise indicated, capacitances are in  $\mu\text{f.}$ , resistances are in ohms, resistors are  $\frac{1}{2}$  watt. Polarity is shown on electrolytic capacitors, 680  $\mu\text{f.}$  or less are silver mica or NPO ceramic, 2000- $\mu\text{f.}$  fixed capacitor is mica. Capacitors specified in decimal- $\mu\text{f.}$  values are ceramic.

C<sub>1</sub>—3- to 30- $\mu\text{f.}$  mica compression trimmer.  
 C<sub>2</sub>—140-140 dual variable (Hammarlund HFD-140).  
 C<sub>3</sub>—35- $\mu\text{f.}$  midget variable (Hammarlund HF-35).  
 C<sub>4</sub>—100- $\mu\text{f.}$  midget trimmer (Hammarlund MAPC-100).  
 C<sub>5</sub>—180- $\mu\text{f.}$  silver mica in parallel with 150- $\mu\text{f.}$  mica-compression trimmer (Arco 424).  
 C<sub>6</sub>—3- to 30- $\mu\text{f.}$  mica compression trimmer with adjustment screw removed.  
 C<sub>7</sub>—15- $\mu\text{f.}$  midget variable (Hammarlund HF-15).  
 C<sub>8</sub>—60- $\mu\text{f.}$  350-v. electrolytic (Mallory TC-68 or equiv.).  
 C<sub>9</sub>—40-40- $\mu\text{f.}$  150-v. electrolytic, negative not common (Mallory TCS-48 or equiv.).  
 CR<sub>1</sub>, CR<sub>2</sub>—400 p.i.v. 200 ma. silicon rectifier

J<sub>1</sub>, J<sub>3</sub>—Phono jack.  
 J<sub>2</sub>—Phone jack.  
 L<sub>1</sub>, L<sub>3</sub>, L<sub>4</sub>—See Fig. 5-32.  
 L<sub>2</sub>—18 t. No. 22 enam., closewound on  $\frac{1}{4}$ -diam. form (1-watt resistor, 100K or more).  
 L<sub>5</sub>, L<sub>6</sub>—105-200  $\mu\text{h.}$  shielded inductor (North Hills SE-120-H).  
 L<sub>7</sub>—36-64  $\mu\text{h.}$  shielded inductor (North Hills SE-120-F).  
 L<sub>8</sub>—16-henry 50-ma. filter choke (Knight 62G137 or equiv.).  
 P<sub>1</sub>—A.c. line plug, preferably fused.  
 S<sub>1</sub>—D.p.d.t. toggle.  
 S<sub>2</sub>—Two-pole 6-position (4 used) rotary switch (Centrablab PA-2003 or equiv.).

S<sub>3</sub>—S.p.s.t. toggle  
 RFC<sub>1</sub>, RFC<sub>2</sub>—1-mh. r.f. choke (Millen J300-1000).  
 T<sub>1</sub>—Small output transformer, 10K plate to voice coil (Stancor A-3879 or equiv.).  
 T<sub>2</sub>—125-v. 50-ma. and 6.3-v. 2-amp. power transformer (Knight 61G411 or equiv.).  
 Y<sub>1</sub>—1700-kc. crystal (International Crystal FA-5 or equiv.) (All radio stores do not handle all of the above components. North Hills coils and cans are available from Arrow Electronics, N.Y.C. Knight is handled by Allied Radio, 100 N. Western Ave., Chicago 80, Ill.)

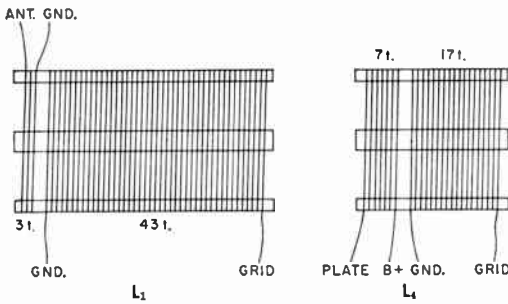

Fig. 5-35—Details of the coil construction. Each one is made from B & W 3012 Miniductor or Illumintronic 632 stock, which is wound 32 t.p.i. and  $\frac{3}{4}$ -inch diameter. The separation between coils in  $L_1$  is  $1\frac{1}{2}$  turns; the separation between coils in  $L_4$  is 1 turn.  $L_3$  is 43 turns of the same stock.

It is important that the coils be connected as indicated. The coil stock can be cut to the required lengths by pushing in a turn, cutting it inside the coil and then pushing the newly cut ends through to outside the coil. Once outside, the wire can be peeled away with the help of long-nose pliers. When sufficient turns have been removed, the support bars can be cut with a fine saw.

receiver, as junctions for components and interconnecting wires. The coils  $L_3$  and  $L_4$  are mounted on tie points, using short leads, and  $L_1$  is mounted on  $S_{1A}$ . If the leads from  $L_4$  are too long, the coil will be "floppy" and the receiver may be unstable. Fig. 5-35 shows how the coils are constructed and connected. The leads from  $C_2$  are brought through the chassis in insulating rubber grommets. The 3- to 30- $\mu\text{f}$ . mica compression trimmer across  $L_1$  is soldered to the associated section of  $C_2$ .  $C_2$  is mounted on top of the chassis and surrounded by a Bud CU-3002-A Minibox, which serves as a dust cover. The partition between the two sections of  $C_2$  should be grounded to the chassis, to prevent capacitive coupling between the two sections. The coil  $L_2$  is wound on a high-resistance 1-watt resistor; the ends of the coil are soldered to the leads of the resistor, and the winding will stay in place readily if the resistor is notched at each end before the winding is started.

The receiver is wired with shielded wire for many of the leads, in an effort to minimize hum

in the audio and feedthrough around the crystal filter. The shielded leads are marked in Fig. 5-34 where feasible; the simple rule to follow is to shield all B+ leads along with those shown shielded in Fig. 5-34. For ease of wiring, these shielded leads should be installed first or at least early in the construction. As the wiring progresses, a neat-looking unit can be obtained by dressing the leads and components in parallel lines or at right angles. D.c. and a.c. leads can be tucked out of the way along the edges of the chassis, while r.f. leads should be as direct as is reasonable.

If this is a first receiver or construction job, there are several pitfalls to be avoided. When installing a tube socket, orient the socket so the grid and plate leads will be direct and not cross over the socket.

Another thing is to avoid stranded wire for making connections throughout the receiver. Where stranded wire must be used, be careful to avoid wild strands that stray over to an adjacent socket terminal. No. 20 or 22 insulated solid tinned copper wire should be used for connections wherever no shielding is used. Long bare leads from resistors or capacitors should be covered with insulating tubing unless they go to chassis grounds.

The final bugaboo is a poorly-soldered connection. If this is first venture, by all means practice soldering before starting to wire this receiver. Read an article or two on how to solder, or get a friend to demonstrate. A good soldering iron is an essential; there have been instances of a first venture having been "soldered" with an iron that would just barely melt the solder; the iron was incapable of heating the solder and work to where the solder would flow properly.

When the wiring has been completed and checked once more against the circuit diagram, plug in the tubes and the line cord and turn on the receiver through  $S_3$ . The tube heaters should light up and nothing should start to smoke or get hot. If you have a voltmeter you should measure about 270 volts on the B+ line.

With headphones plugged in the receiver, you should be able to hear a little hum when the volume control is advanced all the way. If you can't hear any hum, touching a screwdriver to Pin 2 of  $V_{3A}$  should produce hum and a loud click. This shows that the detector and audio amplifier are working. The 100K regeneration control should be set at mid range.

The next step is to tune  $L_5$ ,  $L_6$  and  $L_7$  to 1700 kc., the crystal frequency. If you have or can

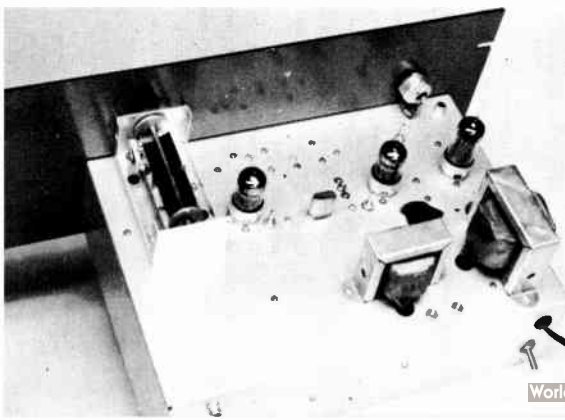

Fig. 5-36—Top view of the SimpleX Super. The tube at the left is the mixer-oscillator 6U8A; the 6CG7 audio amplifier is at the far right. The black knob is on the regeneration control. Toggle switch under the a.c. line cord is the a.c. line switch,  $S_3$ . Phono jack at left is the antenna terminal; phono jack at right near volume control is speaker jack,  $J_s$ .



borrow a signal generator, put 1700-kc. r.f. in at the control grid of the 6U8A mixer and peak  $L_5$  and  $L_6$ . Lacking a signal generator, you may be lucky enough to find a strong signal by tuning around with  $C_3$ , but it isn't likely. Your best bet is to tune a broadcast receiver to around 1245 kc.; if the receiver has a 455-kc. i.f. the oscillator will then be on 1700 kc. Don't depend upon the calibration of the broadcast receiver; make your own by checking known stations. The oscillator of the broadcast receiver will furnish a steady carrier that can be picked up by running a wire temporarily from the grid of the 6U8A mixer to a point near the chassis of the b.c. receiver. Adjust  $L_7$  until you get a beat with the 1700-kc. signal, and then peak  $L_5$  and  $L_6$ . If the signal gets too loud, reduce the signal by moving the wire away from the b.c. receiver. Now slowly swing the signal frequency back and forth with the b.f.o. turned off; a spot should be found where the noise rushes up quickly and then drops off. This is the crystal frequency, and  $L_5$  and  $L_6$  should be peaked again on this frequency.

An antenna connected to the receiver should now permit the reception of signals. With  $C_2$  nearly unmeshed, the input tuning will be in the region of the 7-Mc. band, and with  $C_2$  almost completely meshed, the input circuits will be near 3.5 Mc. Do the tuning with the  $C_4$  in the oscillator circuit, until a known frequency is found (it can be a signal from the station transmitter). Let's say the transmitter has a crystal at 3725 kc. Set  $C_3$  at half capacitance and tune with  $C_4$  until the transmitter is heard. No antenna should be needed on the receiver for this test. Once  $C_4$  is set, put the antenna on the receiver and look around for other known signals. (CHU, the Canadian standard-frequency station at 7335 kc., is a good marker.) With luck the tuning should just be able to cover the 80-meter band; if it covers one end but not the other, a minor readjustment of the trimmer is indicated.

Once the receiver is aligned to receive signals, switch  $S_2$  so that the b.f.o. is turned off. Advance the regeneration control (turn arm away from grounded end) and a point will be found where the noise increases and a slight "thump" is heard. This is the point where the detector oscil-

lates; just below this is the most sensitive condition for the reception of a.m. phone signals. Set the regeneration control at this point.

Turn the b.f.o. back on and tune in a c.w. signal. Tuning through the signal with the tuning knob on  $C_3$ , note that the signal is louder on one side of zero beat than on the other. Experiment with the setting of the PITCH control until the maximum single-signal effect (louder one side than the other) is obtained. It may be necessary to pull up the plate of  $C_6$  and to retune  $L_6$  and  $L_5$  before this is accomplished. After a little adjustment, however, the single-signal effect should be quite apparent.

All that remains is to install the dial scale and calibrate it. A 100-kc. oscillator is ideal for this job; lacking one or the ability to borrow one, other signals must be used. If the crystal filter is 1700 kc. exactly, the 80- and 40-meter calibrations will coincide as they do on the scale shown in Fig. 5-30; if not, the calibration marks will be offset on the two bands.

To find WWV at 5 Mc., set  $S_2$  so that  $C_5$  is switched in and the b.f.o. is on and adjust  $C_5$  so that WWV falls on scale.

It may be noticed that tuning  $C_2$  has a slight effect on the tuning of the signal. In other words, tuning  $C_2$  "pulls" the oscillator slightly. To remedy this would have made the receiver more complicated, and the simple solution is merely to first peak  $C_2$  on noise and then tune with  $C_3$ . If two peaks of noise are found in the 80- or 40-meter bands, adjust  $C_1$  until they coincide.

This will be found to be a practical receiver in every way for the c.w. (or s.s.b.) operator. The tuning rate is always the same on 80 or 40, or 15 with a converter, and 21-Mc. s.s.b. signals tune as easily as those on 3.9 Mc. The warm-up drift is negligible, and the oscillator is surprisingly insensitive to voltage changes. Whether or not the oscillator is insensitive to shock and vibration will depend upon the care with which the components are anchored to their respective tie points.

Fig. 5-37—Shielded wire, used for most of the d.c. and 60-cycle leads, lends to the clean appearance underneath the chassis. Toggle switch at the left shorts the input of the receiver, and the adjacent rotary switch handles the b.f.o. and the padding capacitor for WWV. The pitch control,  $C_7$ , is at the right, next to the headphone jack. Power supply components ( $C_8$ ,  $C_9$  and  $CR_1$ ,  $CR_2$ ) are mounted on or near rear wall of chassis.

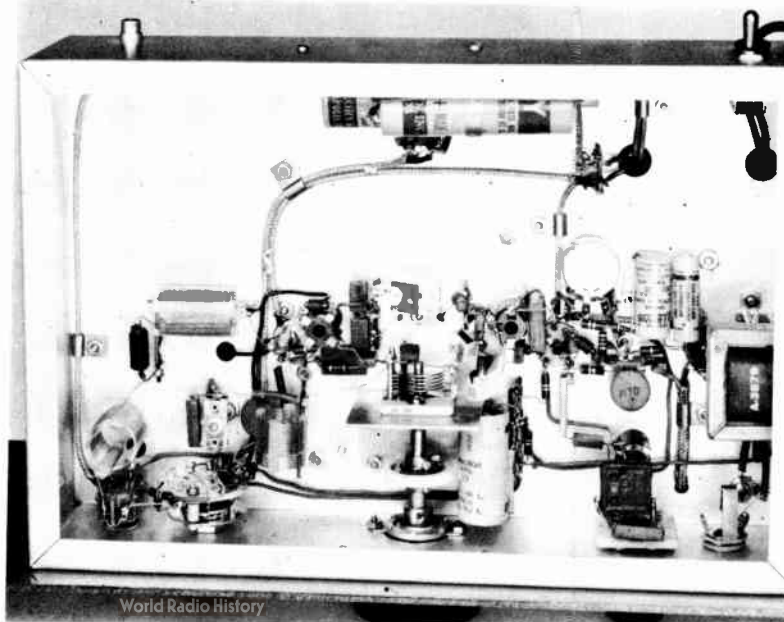



## THE 2X4 + SUPERHETERODYNE

The receiver shown in Figs. 5-38, 5-39 and 5-41 is a two-band (80 and 40 meters) four-tube (2X4) receiver plus (+) provision for receiving WWV at 5 Mc. A dual-crystal filter provides good adjacent-channel selectivity, and two tuned circuits between the antenna and mixer give image rejection of greater than 70 db. on both bands. The receiver can be used on other bands by the addition of a crystal-controlled converter.

Referring to the circuit in Fig. 5-40, the pentode portion of a 6EA8 is used as a mixer, with the triode portion of the same tube serving as the oscillator. The i.f. is 1700 kc. and the oscillator tunes 5.2 to 5.7 Mc.; tuning the input circuit to the 80-meter band brings in 80-meter signals, and all that is required to hear 40-meter signals is to swing the input tuning,  $C_1$ , to the low-capacitance end of its range. Although, e.g., a 7.0-Mc. (5.3 + 1.7) and a 3.6-Mc. (5.3 - 1.7) signal will appear at the same setting of the tuning dial, the two signals cannot be received simultaneously because the double-tuned circuit between antenna and mixer grid provides the necessary rejection. Coupling between the two circuits is provided by a small common inductor,  $L_4$ . A series inductor in the antenna lead makes the coupling more nearly constant on the two bands (reduced antenna coupling at 7 Mc. compensates for increased  $Q$  of  $L_5$ ). For the reception of WWV at 5 Mc., a small relay,  $K_1$ , cuts in addi-

tional capacitance across the oscillator and brings its frequency to 3.3 Mc.

The mixer is followed by the dual crystal filter at 1700 kc. and a stage of amplification. I.f. gain is manually controlled by a variable bias control in the cathode circuit of the 6BA6 i.f. amplifier stage. One end of the gain control is brought to a jack,  $J_2$ , for possible use of the break-in or muting circuit of Fig. 7-9, if the circuit is not utilized the end of the gain control is grounded by using a shorting plug in  $J_2$ .

One triode of a 6CG7,  $V_{3A}$ , serves as a grid-leak detector and the other is used as the b.f.o. A two-stage audio amplifier follows, providing low-impedance output for low-impedance phones or speaker when connected as shown; if high-impedance phones are used they should be coupled to the plate of  $V_{4B}$  through a 0.02- $\mu$ f. capacitor, as shown by the dashed lines. The audio power is sufficient to give more than enough headphone volume and quite adequate loudspeaker volume in a quiet room.

The power supply uses silicon diodes in a bridge rectifier circuit, and a 0B2 provides stabilized +105 volts for the high-frequency and beat oscillators. Capacitor  $C_{5A}$  appears to be in an unusual place in the circuit, but it is required to eliminate a slight hum that is present without it. No a.c. line switch is included because it is assumed that the receiver will be turned on by a

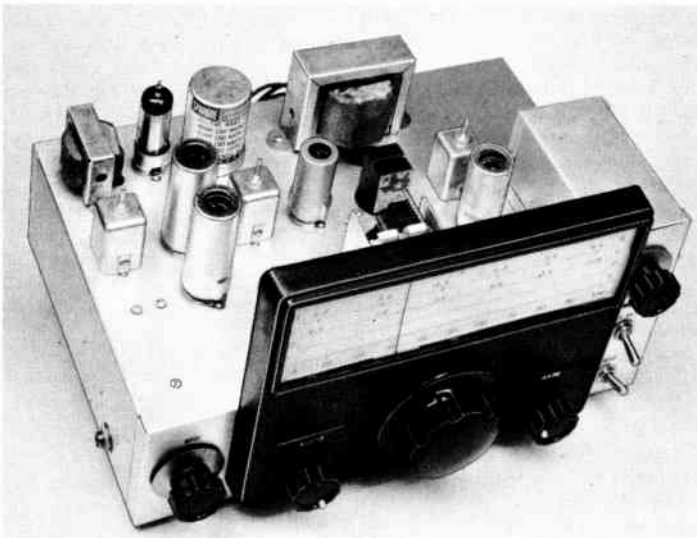

Fig. 5-38—The 2X4+ receiver uses four tubes and tunes 3.5 to 4.0 Mc. and 6.9 to 7.4 Mc; the range is selected by the setting of a two-section input tuning capacitor housed in a Minibox (extreme right). The toggle switches under the input tuning knob turn on (top) a 5-Mc. range for reception of WWV and (bottom) the b.f.o. Knobs either side of the central main tuning knob control (left) audio gain and (right) i.f. gain. B.f.o. frequency is set by the knob at the left.

Power-supply components, including an unshielded VR tube, are mounted along the rear of the chassis. The mixer/oscillator 6EA8 tube is at the right, near the input tuning housing, and the audio amplifier 6CG7 is at the left, nearer the front of the chassis than the 6CG7 detector/b.f.o.

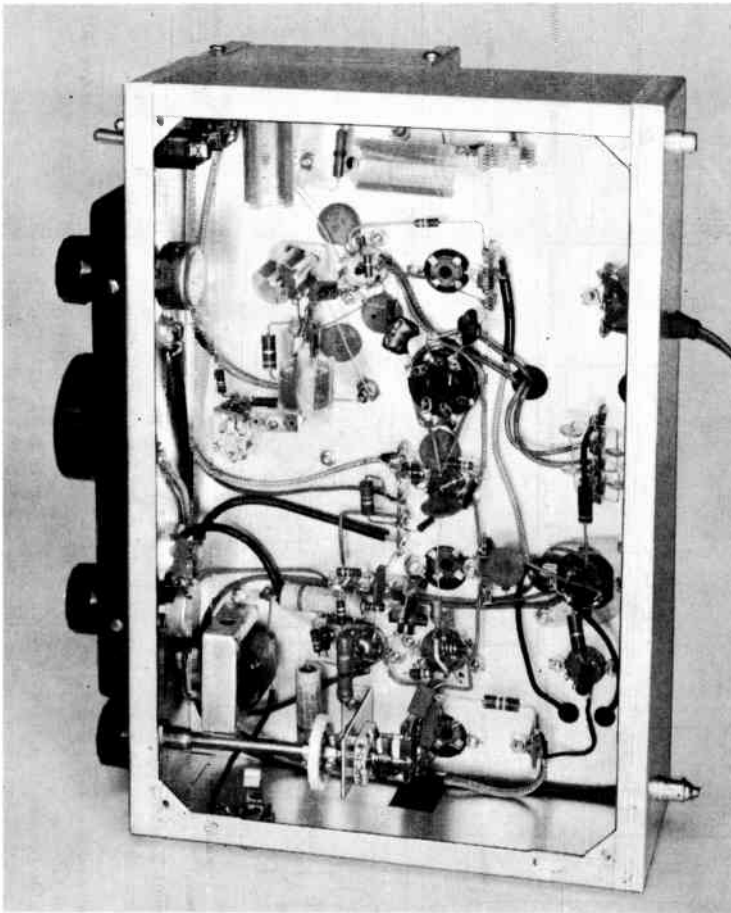

Fig. 5-39—This view underneath the chassis of the 2X4+ receiver shows how the input circuit coils (top) are mounted at right angles to each other. The small variable capacitor near the i.f. gain control is in the oscillator circuit; the oscillator inductor is below this capacitor. The mica-compression trimmer visible at the bottom end of the oscillator inductor trims the circuit for WWV reception; it is supported at the left-hand side by the small relay.

The audio output transformer is visible at the bottom, between the audio gain control and the extension shaft for the b.f.o. capacitor.

Along the rear wall (right-hand side in this view), the four silicon diodes of the power supply are mounted on a multiple tie point. The two phono jacks are (upper) antenna and (lower) break-in control.

wall or other switch. The receiver is fused in the line plug,  $P_1$ .

### Construction

One of the objectives of the receiver design was to make it as simple to construct as possible, and to this end the conventional panel-and-cabinet construction was eliminated by using a dial (Millen 10035) that is easy to mount on one side of the  $8 \times 12 \times 3$ -inch chassis. Aluminum chassis vary with the manufacturer; in the interests of maximum mechanical strength a chassis with welded corner gusset plates (Premier ACH-430) was used. The dial is held to the chassis by three 6-32 screws and the gain and audio controls. If the dial-drive action is stiff, it can be freed somewhat by carefully prying the "crimp" drive with a heavy screwdriver blade.

The most exacting job in the construction of the receiver is the mounting of the tuning capacitor,  $C_4$ . It is supported by a three-sided aluminum bracket fashioned from scrap aluminum, and it should be carefully aligned with the dial to minimize the torque requirements of the dial. The specified capacitor is one requiring relatively low torque, and its use is recommended over some of the "stiffer" capacitors of the same range. A National T1B bushing mounted near the end of the stator support bar carries the stator connection through the chassis.

The location of most of the components can be determined from the photographs. An L-shaped bracket that supports the b.f.o. tuning capacitor,  $C_7$ , is the only other bit of metal fabrication other than the bracket mentioned above and the drilling and punching of the chassis. A

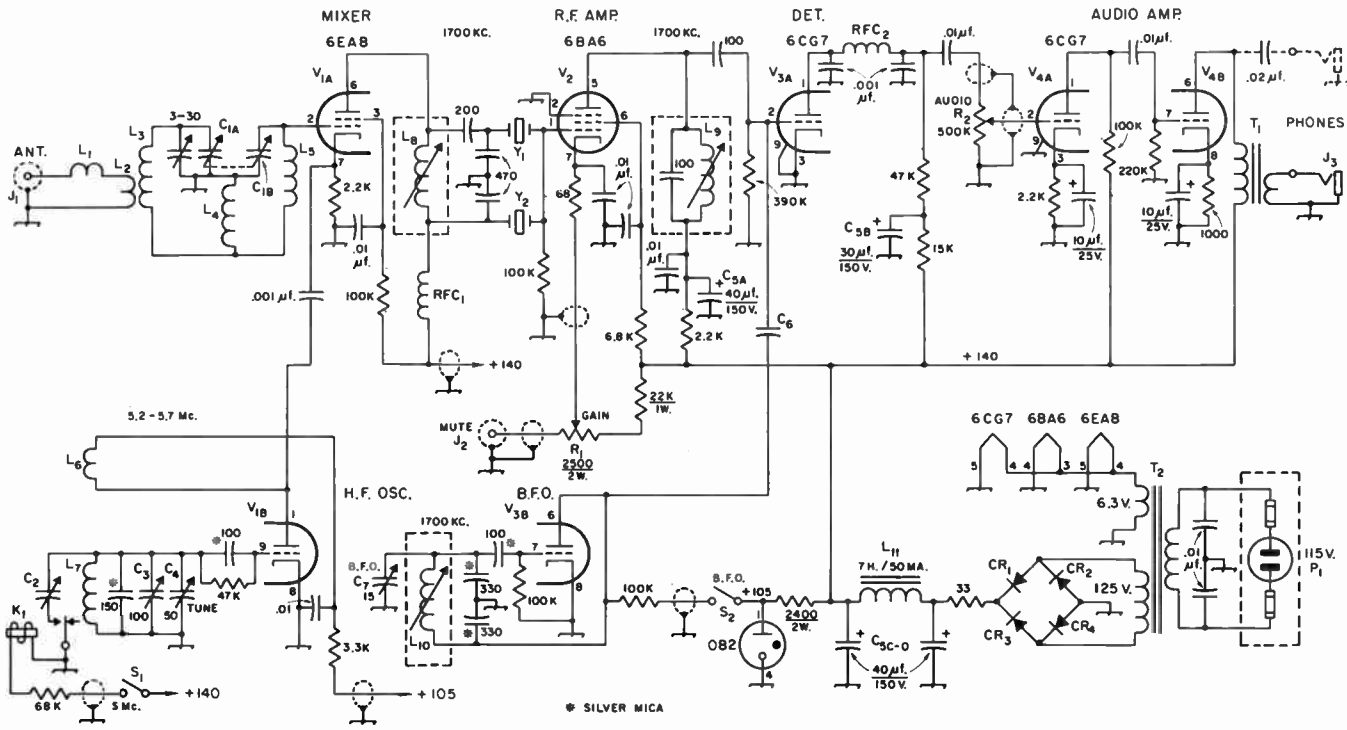

Fig. 5-40—Circuit diagram of the 2X4 receiver. Unless otherwise indicated, capacitances are in pf. (picofarads or  $\mu\mu\text{f.}$ ), resistances are in ohms, resistors are  $\frac{1}{2}$ -watt. Capacitors marked with polarity are electrolytic; those marked with asterisk are silver mica.

- C<sub>1</sub>—Dual 140-pf. variable (Hammarlund HFD-140). 3- to 30-pf. mica compression trimmer mounted across C<sub>1A</sub>.
- C<sub>2</sub>—300 pf. mica compression trimmer (Arco 427) and 270-pf. silver mica in parallel.
- C<sub>3</sub>—100-pf. variable (Hammarlund MAPC-100).
- C<sub>4</sub>—50-pf. variable (Johnson 167-3).
- C<sub>5</sub>—40-, 40-, 40-, 30- $\mu\text{f.}$  150-volt electrolytic (Sprague TVL 4441).

- C<sub>6</sub>—Insulated wire soldered to Pin 6 of V<sub>3</sub> and laid near Pin 2 of V<sub>3</sub>.
- C<sub>7</sub>—15-pf. variable (Hammarlund MAPC-15-B).
- CR<sub>1</sub>—CR<sub>4</sub>—400 p.i.v. 200-ma. silicon rectifier (International Rectifier 2E4)
- J<sub>1</sub>, J<sub>2</sub>—Phono jack.
- J<sub>3</sub>—Phono jack.
- K<sub>1</sub>—5000-ohm 1.5-ma. miniature relay (Lafayette Radio, N.Y.C., F-260).

- L<sub>1</sub>—3 turns No. 20, 16 t.p.i.,  $\frac{3}{4}$ " diam. (B&W 3011 Miniductor)
- L<sub>2</sub>, L<sub>3</sub>, L<sub>4</sub>, L<sub>5</sub>, L<sub>7</sub>—See Fig. 5-38.
- L<sub>4</sub>—0.1- $\mu\text{h.}$  choke (Miller 4580).
- L<sub>6</sub>, L<sub>0</sub>—64 to 105  $\mu\text{h.}$ , adjustable (North Hills 120-G in North Hills S-120 shield can).
- L<sub>10</sub>—36 to 64  $\mu\text{h.}$ , adjustable (North Hills 120-F in North Hills S-120 shield can).
- L<sub>11</sub>—7-henry 50-ma. choke (Knight 61 G 408)

- P<sub>1</sub>—Fused (1-amp.) line plug.
- R<sub>1</sub>—2500-ohm 2-watt potentiometer (Ohmite CU 2521).
- R<sub>2</sub>—500K volume control, audio taper (IRC Q13-133).
- RFC<sub>1</sub>—R.f. choke self-resonant around 1700 kc. (Millen J300-1000)
- RFC<sub>2</sub>—1-mh. r.f. choke (Millen 34300-1000).
- S<sub>1</sub>, S<sub>2</sub>—S.p.s.t. toggle.
- T<sub>1</sub>—10K to 4-ohm output transformer, 4 watts (Knight 61 G 404).
- T<sub>2</sub>—125 v. at 50 ma., 6.3 v. at 2 amp. (Knight 61 G 411).
- Y<sub>1</sub>—1700.0 kc., 0.005% tolerance, FT-243 holder (Texas Crystals).
- Y<sub>2</sub>—1700.5 kc., 0.005% tolerance, FT-243 holder (Texas Crystals). 200- and 470-pf. capacitors associated with L<sub>4</sub> and 100-pf. capacitor across L<sub>9</sub>
- C-D Royal Blue or Arco Dur-Mica, North Hills coils and cans available from Arrow Electronics, N.Y.C. Knight transformers available from Allied Radio, Chicago.

4 × 2¼ × 2¼ "Minibox" (Bud CU-3003) is used as a dust cover and shield for C<sub>1</sub>; the leads from the stators are brought through clearance holes in the chassis. The input and oscillator coils are supported by multiple tie-point strips, as are the four silicon diodes of the power supply and many of the other components. The insulated couplings for C<sub>4</sub> and C<sub>7</sub> are Millen 39006. Capacitor C<sub>2</sub> is supported at one end by a tie point and at the other by a contact on relay K<sub>1</sub>. This relay is one used in radio-controlled model airplane work but it is ideal in this receiver application because it is so small and inexpensive.

Shielded wire is used in several places in the receiver, as indicated in Fig. 5-40. The leads to the audio control, R<sub>2</sub>, are made from audio wire, which is a shielded wire with an insulating outer covering. This type of audio wire is also used for the long shielded lead running from R<sub>1</sub> to J<sub>2</sub> and the short lead from J<sub>1</sub> to L<sub>1</sub>.

The two crystals, Y<sub>1</sub> and Y<sub>2</sub>, mount in an octal socket (Amphenol 77M1P8) from which pins 2 and 6 have been removed. The crystals plug into 1 and 3 and into 5 and 7, and pins 4 and 8 are grounded.

In the b.f.o. section, the rotor of C<sub>7</sub> is grounded to a tie point held in place by one of the mounting screws of L<sub>10</sub>. The two 330-pf. capacitors are supported by tie points on the same strip.

The shield on C<sub>1</sub> is grounded to a lug under the head of the screw that holds the tie-point strip supporting L<sub>5</sub>. The grounding of this shield is important because if it is omitted the input circuits will be overcoupled. The 3- to 30-pf. mica trimmer across C<sub>1A</sub> is soldered directly to the terminals of the capacitor section. The 100-pf. capacitor across L<sub>9</sub> is mounted on the inductor inside the shield can.

**Alignment**

The alignment procedure can be expedited if a short-wave receiver or a signal generator can be

borrowed. The receiver can be used to listen for the signals from the 2 × 4 + b.f.o. and high-frequency oscillator, and the signal generator can be used to provide signals for aligning the i.f. circuits and the input. Lacking these, a grid-dip meter can be used to provide a signal source and to check the resonances of the tuned circuits. If a 100-kc. oscillator is available, it can be used to align the receiver. A last desperate measure is to use a broadcast receiver as a signal generator; when the b.c. receiver is tuned to 1245 kc. its oscillator will be on 1700 kc. if the i.f. is 455 kc., as is usually the case. A wire from around the b.c. receiver to the 2 × 4 + should provide sufficient signal.

The audio amplifier of the receiver should be checked first, by turning on the receiver and listening to the headphones as the audio control, R<sub>2</sub>, is advanced. When it is full clockwise a low-pitched hum should be just audible in the headphones. A further check can be made by touching the center terminal of R<sub>2</sub> with the tip of a screwdriver, which should result in a click in the output.

If a signal generator is available, the i.f. can be aligned by introducing a modulated 1700-kc. signal at the control grid of V<sub>1A</sub> and peaking L<sub>8</sub> and L<sub>9</sub> for maximum audio output. As the inductors are peaked the signal-generator output should be reduced simultaneously, to avoid overloading the receiver. When the circuits are peaked on what the signal generator says is 1700 kc., "rock" the generator frequency slightly. If the output increases sharply at something other than the nominal 1700-kc. setting of the generator, it indicates that the calibration is slightly off, since this sudden peak in response is the crystal-filter frequency. Trim L<sub>8</sub> and L<sub>9</sub> on the

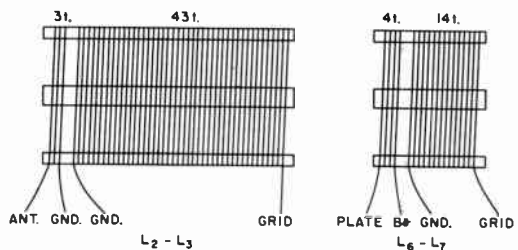

Fig. 5-41—Details of the coil construction. Each one is made from B & W 3012 Miniductor or Illumitronic 632 stock, which is wound 32 t.p.i. and ¾-inch diameter. The separation between L<sub>2</sub> and L<sub>3</sub> is 1 turn; the separation between L<sub>6</sub> and L<sub>7</sub> is 1 turn. L<sub>8</sub> is 43 turns of the same stock.

It is important that the coils be connected as indicated. The coil stock can be cut to the required lengths by pushing in a turn, cutting it inside the coil and then pushing the newly cut ends through to outside the coil. Then the wire can be peeled away with the help of long-nose pliers. When sufficient turns have been removed, the support bars can be cut with a fine saw.

crystal-filter frequency. Turn off the modulation of the generator signal, switch on  $S_2$  and tune  $L_{10}$  for a beat note. Setting the b.f.o. to one side or the other of the crystal-filter frequency should result in good single-signal c.w. reception, with little or no response on the "other side" of zero beat.

If a borrowed receiver is used to align the receiver, use the borrowed receiver to set the  $2 \times 4 +$  b.f.o. on 1700 kc. and the high-frequency oscillator on 5.2 Mc. Then feed a 3.5-Mc. signal from a v.f.o. or exciter into the  $2 \times 4 +$  and peak  $L_8$  and  $L_9$  for loudest signal with the b.f.o. on. As with a signal generator, the signal should be kept at a low level, by reducing power or coupling to the v.f.o. or by detuning  $C_1$ . After the i.f. has been aligned roughly, the crystal-filter frequency can be found by minor tuning excursions, looking for a sudden peak in signal response.

Most grid-dip oscillators have enough modulation on the signal so that the signal can be used in the same way as the output from a modulated signal generator. If the g.d.o. calibration can be trusted, the  $2 \times 4$  h.f. oscillator can be set on 5.2 Mc. (and left) and a 3.5-Mc. g.d.o. signal introduced at the  $2 \times 4$  input. Inductors  $L_8$  and  $L_9$  should then be peaked for maximum signal, after which  $S_2$  can be closed and  $L_{10}$  brought to tune. If the g.d.o. tunes to 1700 kc., the i.f. can be aligned without regard for the setting of the h.f. oscillator.

Once the i.f. and b.f.o. have been aligned, all that remains is proper setting of the h.f. oscillator range by the setting of  $C_3$ . When correctly set, the 3.5- to 4.0-Mc. band will tune roughly from 5 to 95 on the tuning dial (as will 6.9 to 7.4 Mc.). All that is necessary to go from one band to the other is to set  $C_1$  in the maximum capacitance end (80 meters) or the low-capacitance end (40 meters). With an antenna having a coaxial feed line (for which the receiver is designed), the 80- and 40-meter resonance peaks will be quite sharp and the background noise will come up sharply at these points. If two peaks are found close to-

gether, adjustment of the 30-pf. trimmer across  $C_{1A}$  is indicated. When the receiver is working properly on 40 and 80 meters,  $S_1$  can be closed and  $C_2$  adjusted to bring in WWV (5 Mc.) at the center (or any preferred spot) of the tuning dial.  $C_1$  should be set around half scale (noise peak) when receiving WWV. Since  $K_1$  is mounted upside down, it may be necessary to reduce the spring tension slightly, to enable the relay to close.

When the receiver is properly aligned and with no antenna connected, turning on the b.f.o. by closing  $S_2$  should produce an increase in background noise in the output of the receiver. If this rushing noise is just barely audible, increase the capacitance at  $C_6$  by moving the free end of the wire closer to Pin 2 of  $V_{3A}$ . With a v.t.v.m. the d.c. voltage to chassis at the output end of  $RFC_2$  should go from about +30 to about +35 or +36 when  $S_2$  is closed.

To check operation of the h.f. oscillator, connect a voltmeter across the 3300-ohm resistor in the plate lead (— terminal to end connected to 0.01- $\mu$ f. capacitor). The voltage should jump from about 15 to 35 when the stator of  $C_3$  or  $C_4$  is momentarily shorted to chassis (use a screwdriver with an insulated handle to avoid a shock). If the oscillator doesn't work, it may be because the outside turns of  $L_6$  and  $L_7$  are not connected to plate and grid respectively.

The crystal filter should give good rejection of the "other side of zero beat" in c.w. reception. If it doesn't, try dressing the 470-pf. and the 200-pf. capacitors across  $L_8$  as close to the chassis as feasible, to minimize leakage around the crystal. The selectivity of the receiver is such that the reception of s.s.b. phone signals is quite normal, but turning off the b.f.o., for the reception of a.m. phone signals, will result in a "boomy" sound to the signal. This is an inescapable result of the selectivity; it can be reduced by tuning slightly to one side or the other of the "center" of the a.m. signal.

Best reception will be obtained when the regular transmitting antenna is used with the receiver.

## ADAPTOR PLUG

The sketch below shows an exploded view of an adaptor plug which adapts a conventional u.h.f. series connector for mating with a phono jack. To assemble the plug, solder a 1-inch length of No. 12 copper wire to the center conductor of an SO-239 connector. Next sweat-solder the cap end of a phono plug into the small end of an 83-1H hood. Slip the hood and plug assembly onto the SO-239 connector so that the No. 12 wire inserts in the center conductor of the phono plug. Attach the hood to the connector

with machine screws and solder the wire that is in the tip of the phono plug.

—Robert J. Jarnutowski, K9ITS

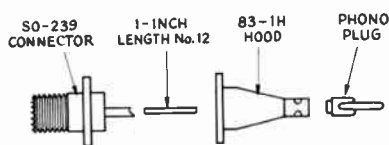

U.h.f. series-to-phono-plug adaptor.



## A SELECTIVE CONVERTER FOR 80 AND 40 METERS

Many inexpensive "communications" receivers are lacking in selectivity and bandspread. The 80- and 40-meter performance of such a receiver can be improved considerably by using ahead of it the converter shown in Figs. 5-42 and 5-44. This converter is not intended to be used ahead of a broadcast receiver except for phone reception, because the b.c. set has no b.f.o. or manual gain control, and both of these features are necessary for good c.w. reception. The converter can be built for less than \$20, and that cost can be cut

appreciably if the power can be "borrowed" from another source.

The converter uses the tuning principle employed in the two-band superheterodynes described earlier in this chapter. A double-tuned input circuit with large capacitors covers both 80 and 40 meters without switching, and the oscillator tunes from 5.2 to 5.7 Mc. Consequently with an i.f. of 1700 kc. the tuning range of the converter is 3.5 to 4.0 Mc. and 6.9 to 7.4 Mc. Which band is being heard will depend upon the setting of the input circuit tuning ( $C_1$  in Fig. 5-40). The converter output is amplified in the receiver, which must of course be set to 1700 kc. To add selectivity, a 1700-kc. quartz crystal is used in series with the output connection. A small power supply is shown with the converter, and some expense can be eliminated if 300 volts d.c. at 15 ma. and 6.3 volts a.c. at 0.45 ampere is available from an existing supply.

### Construction

The unit is built on a  $7 \times 11 \times 2$ -inch aluminum chassis. The front panel is made from a  $6 \times 7$ -inch piece of aluminum. The power supply is mounted to the rear of the chassis and the converter components are in the center and front. The layout shown in the bottom view should be followed, at least for the placement of  $L_1$ ,  $L_2$ ,  $L_3$  and  $L_4$ .

The input and oscillator coils are made from a single length of B & W Miniductor stock, No. 3016. Count off 31 turns of the coil stock and

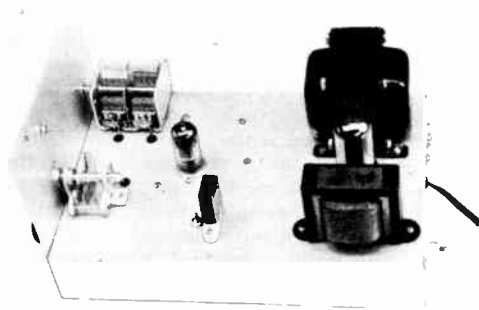

Fig. 5-42—Used ahead of a small receiver that tunes to 1700 kc., this converter will add tuning ease and selectivity on the 80- and 40-meter bands. The input capacitor is the dual-section unit at the upper left-hand corner. The crystal and the tuning slug for  $L_6$  are near the center at the foreground edge.

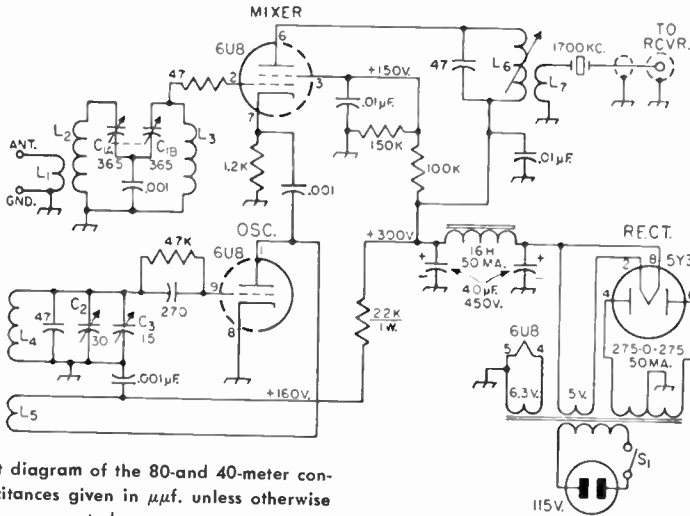

Fig. 5-43—Circuit diagram of the 80- and 40-meter converter. All capacitances given in  $\mu\text{mf.}$  unless otherwise noted.

$C_1$ —365- $\mu\text{mf.}$  dual variable, t.r.f. type.

$C_2$ —3-30- $\mu\text{mf.}$  trimmer.

$C_3$ —15- $\mu\text{mf.}$  variable (Bud 1850, Cardwell ZR-15AS, Millen 20015).

$L_1$ ,  $L_2$ ,  $L_3$ ,  $L_4$ ,  $L_5$ —B & W No. 3016 Miniductor, 1-inch diameter, 32 turns per inch, No. 22 wire, cut as below.

$L_1$ —8 turns separated from  $L_2$  by one turn (see text).  
 $L_2$ ,  $L_3$ —19 turns.

$L_4$ —21 turns separated from  $L_5$  by one turn.  
 $L_5$ —8 turns.

$L_6$ —92-187  $\mu\text{h.}$  slug-tuned coil (Miller 42A 154 CBI)

$L_7$ —See text.

Crystal—1700 kc. (E. B. Lewis Co. Type EL-3).

bend the 32nd turn in toward the axis of the coil. Cut the wire at this point and then unwind the 32nd turn from the support bars. Using a hacksaw blade, carefully cut the polystyrene support bars and separate the 31-turn coil from the original stock. Next, count off 9 turns from the 31-turn coil and cut the wire at the 9th turn. At the cut unwind a half turn from each coil, and also unwind a half turn at the outside ends. This will leave two coils on the same support bars, with half-turn leads at their ends. One coil has 21 turns and the other has 8 turns, and they are separated by the space of one turn. These coils are  $L_4$  and  $L_5$ .

The input coils  $L_1$  and  $L_2$  are made up in the same manner. Standard bakelite tie points are used to mount the coils. Two 4-terminal tie points are needed for  $L_1L_2$  and  $L_4L_5$ , and a one-terminal unit is required for  $L_3$ . The plate load inductance  $L_6$  is a 105-200  $\mu\text{h}$ . variable-inductance coil (North Hills 120H). The coupling coil  $L_7$  is 45 turns of No. 32 enam. scramble-wound adjacent to  $L_6$ . If the constructor should have difficulty in obtaining No. 32 wire, any size small enough to allow 45 turns on the coil form can be substituted.

The input capacitor,  $C_1$ , is a 2-gang t.r.f. variable, 365  $\mu\text{mf}$ . per section. As both the stators and rotor must be insulated from the chassis, extruded fiber washers should be used with the screws that hold the unit to the chassis. The panel shaft hole should be made large enough to clear the rotor shaft.

A National type O dial assembly is used to tune  $C_3$ . One word of advice when drilling the holes for the dial assembly: the template furnished with the unit is in error on the 2-inch dimension (it is slightly short) so use a ruler to measure the hole spacing.

It is important that the output lead from the crystal socket be run in shielded wire. A phono jack is mounted on the back of the chassis, and a piece of shielded lead connects from the jack to the crystal socket terminal. The leads from the stators of  $C_1$  and  $C_3$  are insulated from the chassis by means of rubber grommets.

### Testing and Adjustment

A length of shielded wire is used to connect the converter to the receiver: the inner conductor of the wire is connected to one antenna terminal; the shield is connected to the other terminal and grounded to the receiver chassis. The use of shielded wire helps to prevent pickup of unwanted 1700-kc. signals. Turn on the converter and receiver and allow them to warm up. Tune the receiver to the 5.2-Mc. region and listen for the oscillator of the converter. The b.f.o. in the receiver should be turned on. Tune around until the oscillator is heard. Once you spot it, tune  $C_3$  to maximum capacitance and the receiver to as close to 5.2 Mc. as you can. Adjust the oscillator trimmer capacitor,  $C_2$ , until you hear the oscillator signal. Put your receiving antenna on the converter, set the receiver to 1700 kc., and tune the input capacitor,  $C_1$ , to near maximum capacitance. At one point you'll hear the background noise come up. This is the 80-meter tuning. The point near minimum capacitance—where the noise is loudest—is the 40-meter tuning.

With the input tuning set to 80 meters, turn on your transmitter and tune in the signal. By spotting your crystal-controlled frequency you'll have one sure calibration point for the dial. By listening in the evening when the band is crowded you should be able to find the band edges.

You'll find by experimenting that there is one point at or near 1700 kc. on your receiver where the background noise is the loudest. Set the receiver to this point and adjust the slug on  $L_6$  for maximum noise or signal. When you have the receiver tuned *exactly* to the frequency of the crystal in the converter, you'll find that you have quite a bit of selectivity. Tune in a c.w. signal and tune slowly through zero beat. You should notice that on one side of zero beat the signal is strong, and on the other side you won't hear the signal or it will be very weak (if it isn't, off-set the b.f.o. a bit). This is single-signal c.w. reception.

When listening to phone signals, it may be found that the use of the quartz crystal destroys some of the naturalness of the voice signal. If this is the case, the crystal should be unplugged and replaced by a 10- or 20- $\mu\text{mf}$ . capacitor.

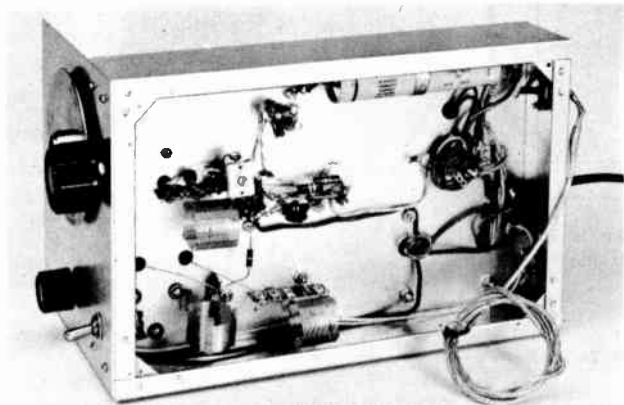

Fig. 5-44—Bottom view of the converter showing placement of parts. The coil at the lower left is  $L_3$ , and the input coil,  $L_1L_2$ , is just to the right of  $L_3$ . The oscillator coil  $L_4L_5$ , is at the left near the center. The output coil,  $L_6$ , is near the top center.

## A CRYSTAL-CONTROLLED CONVERTER FOR 20, 15 AND 10 METERS

The cure for most of the high-frequency ills of many receivers is the installation of a good crystal-controlled converter between the antenna and the receiver. The converter shown in Figs. 5-45 and 5-47 is intended to be used ahead of a receiver that tunes from 3.5 to 4.0 Mc., although its output range can be modified merely by changing the crystal frequencies. Used with a receiver tuning the 80-meter band only, the 14- and 21-Mc. bands are covered with something left over, but only 500-kc. segments of the 28-Mc. band can be covered without switching crystals. If complete coverage without switching is desired, a wider-range receiver can be used; e.g., the BC-454 surplus receiver, which tunes 3 to 6 Mc.

Referring to Fig. 5-46, the converter consists of an r.f. amplifier, mixer and oscillator stages, and an inexpensive power supply. A cathode-bias control ( $R_1$ ) on the r.f. stage determines the stage gain and prevents overloading on strong signals. The signal circuits, tuned by  $C_1$  and  $C_2$ , cover 14 to 30 Mc. and are peaked by the operator for the band in use. The selector switch,  $S_2$ , is used to switch to the required crystal and output circuit; on 10 meters the same output circuit is used for several crystals. No tuned output from the mixer is included; the tuned circuit (s) of the receiver following the converter being all that is necessary.

The converter is built on a  $4 \times 7 \times 2$ -inch chassis and is housed in a  $5 \times 9 \times 6$  grey hamertone aluminum utility cabinet. Although the construction is straightforward and should present no particular problems, there are places where caution should be exercised. For example, r.f. leads and bypassing at the 6BZ6 socket should be made as short and direct as possible, to minimize the chance for oscillation of this high-gain stage. Grounding should be done with soldering lugs to the screws that hold the socket to the chassis. Generous use of tie points is advisable, so that both ends of resistors and capacitors will be supported.

Coils  $L_1$  and  $L_2$  are made from a single piece of B&W 3011 Miniductor stock. Start with a 20-turn length of stock. With a pin or knife push in the 6th turn from one end and cut it. Push the cut ends back out and unwind each approximately a half turn to the support bar. Unwind the ends to give the specified turns in each coil (see Fig. 5-43). The coils are supported by standard tie-point strips; on  $L_1$  the outside ends go to antenna (small coil) and grid, and on  $L_2$  the outside ends go to plate (small coil) and grid. When

the coils are mounted, they should be positioned at least  $\frac{1}{2}$  inch away from the chassis or panel.

Ceramic or mica capacitors can be used across  $L_3$ ,  $L_4$  and  $L_5$ . The  $3\text{-}\mu\text{f.}$  coupling capacitor between pins 1 and 2 of the 6U8A can be a small ceramic or it can be made from two 1-inch lengths of plastic-covered wire twisted together.

When the wiring has been completed and checked, plug the tubes into their sockets and turn the adjustment screws of  $L_3$ ,  $L_4$  and  $L_5$  until the screws are out of the coil ends as far as they will go. Use a length of coaxial line and suitable plugs to connect the output of the converter to the antenna terminals of the receiver, and connect an antenna to the antenna terminals of the converter. Plug in the line plug (fused with  $\frac{1}{2}$ -ampere fuses) and turn on  $S_1$ . The tube heaters should light up. With  $S_2$  switched to the 20-meter position, screw in the slug of  $L_3$  as the knob of  $C_2$  is rocked back and forth about the maximum-capacitance end of its range. When an increase in noise is heard as  $C_2$  is rocked through a particular point, hold up on the adjustment of  $L_3$  and turn the knob of  $C_1$ . Peak  $C_1$  on noise and tune around with the receiver for any signals. If for any reason the crystal or oscillator is suspected of not operating properly, it can be checked by connecting a voltmeter across the 1000-ohm resistor running to the arm of  $S_{2A}$  (+ side of meter to power-supply side). If the oscillator is functioning properly, when  $Y_1$  is removed from its socket the voltage measured across the 1000-ohm resistor should increase.

The slugs in  $L_4$  and  $L_5$  are adjusted in a similar manner, with  $S_2$  in the proper position. After one slug has been adjusted, it may be necessary to touch up the others slightly. A compromise setting will be found for  $L_5$  that allows good operation of either  $Y_3$  or  $Y_4$ .

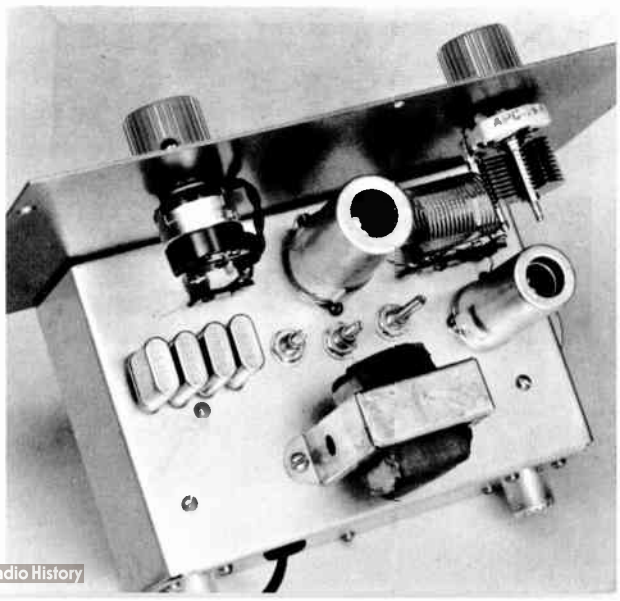

Fig. 5-45—A 3-band crystal-controlled converter, to be used ahead of a receiver tuning the 80-meter band. The converter is shown out of its cabinet. Mixer tuning control at right, gain control and line switch at left. The tube in the center is the 6U8A mixer-oscillator.

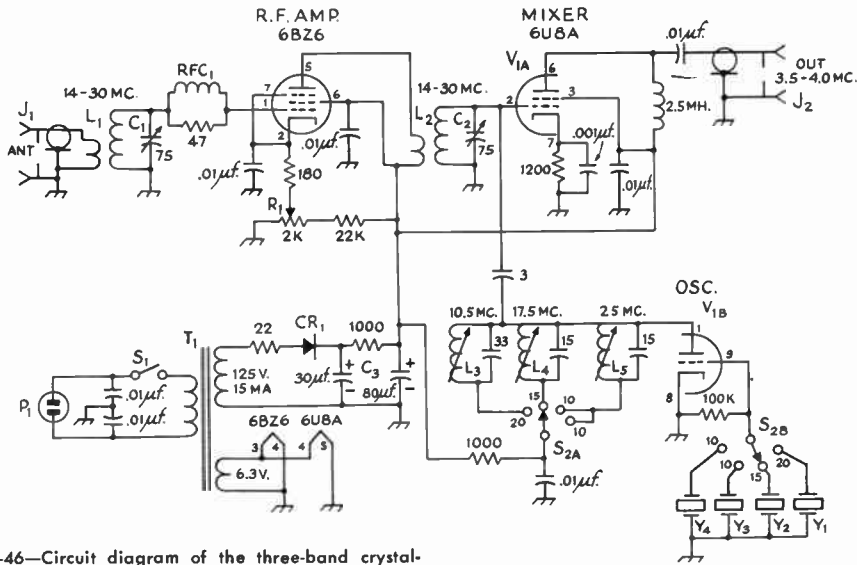

Fig. 5-46—Circuit diagram of the three-band crystal-controlled converter. Unless indicated otherwise, capacitances are in  $\mu\text{f.}$ , resistors are  $\frac{1}{2}$  watt.

$C_1, C_2$ —75- $\mu\text{f.}$  variable (Hammarlund APC-75-B).

$C_3$ —30-80- $\mu\text{f.}$  dual electrolytic, 150-volt, common negative.

$CR_1$ —50-ma. 130-v. selenium rectifier (International Rectifier TO65).

$J_1, J_2$ —Chassis-mounting coaxial connector (SO-239).

$L_1, L_2$ —12 turns No. 20, 16 t.p.i.,  $\frac{3}{4}$ -inch diam. (See text). Primary on  $L_1$  is 3 turns, 4 turns on  $L_2$ . Separation of  $\frac{1}{16}$  inch between primary and secondary.

$L_3$ —3.1- to 6.8- $\mu\text{h.}$ , slug-tuned (Miller 4405).

$L_4, L_5$ —1.5- to 3.2- $\mu\text{h.}$ , slug-tuned (Miller 4404).

$P_1$ —Fused plug (El Menco).

$R_1$ —2000-ohm 1-watt potentiometer, with switch (CTS-IRC Q11-110 with IRC 76-1 switch).

$S_1$ —Part of  $R_1$ , see above.

$S_2$ —2-pole 5-position (4 used) rotary switch (Centralab PA-2003).

$RFC_1$ —7 turns No. 20 wound on 47-ohm  $\frac{1}{2}$ -watt resistor.

$T_1$ —125 v. at 15 ma., 6.3 v. at 0.6 amp. (Allied Radio's Knight 61 G 410 or equiv.)

$Y_1$ —10.5-Mc. crystal (International Crystal Co., Type FA-9).

$Y_2$ —17.5-Mc. crystal.

$Y_3$ —24.5-Mc. crystal.

$Y_4$ —25.0-Mc. crystal.

Fairly sharp tuning of  $C_1$  and  $C_2$  is normal, and it may be found that any given settings will suffice for a receiver tuning range of only a portion of an amateur band. If the gain control cannot be advanced to the maximum-gain position (arm at chassis end of  $R_1$ ) without oscillation, take a second look at the wiring of the 6BZ6 socket. The grid and plate leads should not be able to "see" each other, and the center post of the socket should be grounded to the chassis by a short length of wire.

With this converter, the 80-meter receiver is serving as a tunable i.f. system. The signal frequency is the indicated receiver frequency plus the crystal frequency; e.g., on 20 meters a 14.1-Mc. signal will appear at 3.6 Mc. ( $3.6 + 10.5 = 14.1$ ) on the receiver. The over-all system becomes a double-conversion superheterodyne with a crystal-controlled "front end," a popular arrangement found in many high-priced receivers.

Fig. 5-47—A view underneath the chassis of the three-band converter. Input tuned circuit at left, oscillator coils at center, and band switch and output connector at right. The selenium rectifier is hidden by the lip of the  $4 \times 6 \times 2$ -inch chassis.

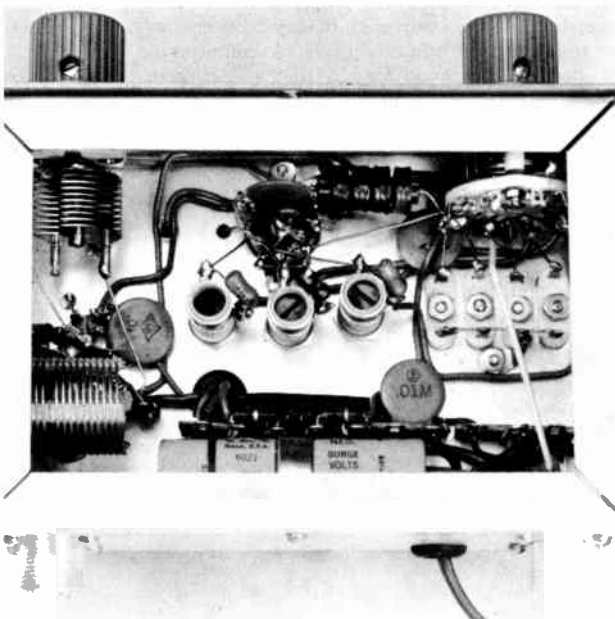



## THE "SELECTOJECT"

The Selectoject is a receiver adjunct that can be used as a sharp amplifier or as a single-frequency rejection filter. The frequency of operation may be set to any point in the audio range by turning a single knob. The degree of selectivity (or depth of the null) is continuously adjustable and is independent of tuning. In phone work, the rejection notch can be used to reduce or eliminate a heterodyne. In c.w. reception, interfering signals may be rejected or, alternatively, the desired signal may be picked out and amplified. The Selectoject may also be operated as a low-distortion variable-frequency audio oscillator suitable for amplifier frequency-response measurements, modulation tests, and the like, by advancing the "selectivity" control far enough in the selective-amplifier condition. The Selectoject is connected in a receiver between the detector and the first audio stage. Its power requirements are 4 ma. at 150 volts and 6.3 volts at 0.6 ampere. For proper operation, the 150 volts should be obtained from across a VR-150 or from a supply with an output capacity of at least 20  $\mu$ f.

The wiring diagram of the Selectoject is shown in Fig. 5-48. Resistors  $R_2$  and  $R_3$ , and  $R_4$  and  $R_5$ , can be within 10 per cent of the nominal value but

they should be as close to each other as possible. An ohmmeter is quite satisfactory for doing the matching. One-watt resistors are used because the larger ratings are usually more stable over a long period of time.

If the station receiver has an "accessory socket" on it, the cable of the Selectoject can be made up to match the connections to the socket, and the numbers will not necessarily match those shown in Fig 5-48. The lead between the second detector and the receiver gain control should be broken and run in shielded leads to the two pins of the socket corresponding to those on the plug marked "A.F. Input" and "A.F. Output." If the receiver has a VR-150 included in it for voltage stabilization there will be no problem in getting the plate voltage—otherwise a suitable voltage divider should be incorporated in the receiver, with a 20- to 40- $\mu$ f. electrolytic capacitor connected from the +150-volt tap to ground.

In operation, overload of the receiver or the Selectoject should be avoided, or all of the possible selectivity may not be realized.

The Selectoject is useful as a means for obtaining much of the performance from a "Q Multiplier" from a receiver lacking one.

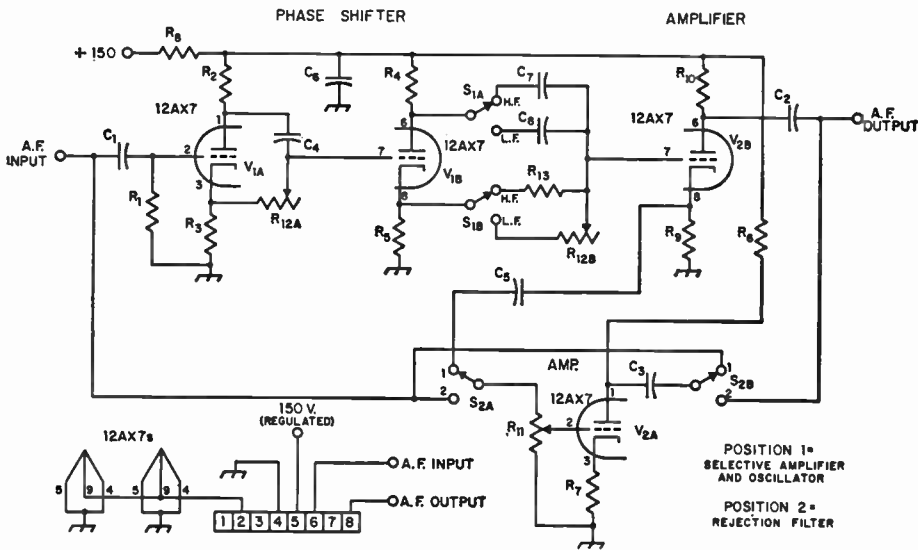

Fig. 5-48—Complete schematic of Selectoject using 12AX7 tubes.

- $C_1$ —0.01- $\mu$ f. mica, 400 volts.
- $C_2, C_3$ —0.1- $\mu$ f. paper, 200 volts.
- $C_4, C_8$ —0.002- $\mu$ f. paper, 400 volts.
- $C_5$ —0.05- $\mu$ f. paper, 400 volts.
- $C_6$ —16- $\mu$ f. 150-volt electrolytic.
- $C_7$ —0.0002- $\mu$ f. mica.
- $R_1$ —1 megohm,  $\frac{1}{2}$  watt.
- $R_2, R_3$ —1000 ohms, 1 watt, matched as closely as possible (see text).
- $R_4, R_5$ —2000 ohms, 1 watt, matched as closely as possible (see text).
- $R_6$ —20,000 ohms,  $\frac{1}{2}$  watt.
- $R_7$ —2000 ohms,  $\frac{1}{2}$  watt.
- $R_8$ —10,000 ohms, 1 watt.
- $R_9$ —6000 ohms,  $\frac{1}{2}$  watt.
- $R_{10}$ —20,000 ohms,  $\frac{1}{2}$  watt.
- $R_{11}$ —0.5-megohm  $\frac{1}{2}$ -watt potentiometer (selectivity).
- $R_{12}$ —Ganged 5-megohm potentiometers (tuning control) (IRC PQ11-141 with IRC M11-141.)
- $R_{13}$ —0.12 megohm,  $\frac{1}{2}$  watt.
- $S_1, S_2$ —D.p.d.t. toggle (can be ganged).



## ANTENNA COUPLER FOR RECEIVING

In many instances reception can be improved by the addition of an antenna coupler between the antenna feedline and the receiver, and in all cases the r.f. image rejection will be increased. The unit shown on this page consists of one series-tuned circuit and one parallel-tuned circuit; usually its best performance is obtained with the parallel-tuned circuit connected to the receiver input, as indicated in Fig. 5-49. However, the coupler should also be tried with the connections reversed, to see which gives the better results. The desired connection is the one that gives the sharper peak or louder signals when the circuits are resonated.

The coupler is built on one section of a  $5 \times 4 \times 3$ -inch Minibox (Bud CU-2105A). Tuning capacitors  $C_1$  and  $C_2$  are mounted directly on the Minibox face, since there is no need to insulate the rotors. The arrangement of the components can be seen in Fig 5-50.

The coils  $L_1$  and  $L_2$  are made from a single length of B & W 3011 Miniductor. The wire is snipped at the center of the coil and unwound in both directions until there are three empty spaces on three support bars and two empty spaces on the bar from which the snipped ends project. These inner ends run to the connectors  $J_1$  and  $J_2$ . (Fig. 5-46). Unwind turns at the ends of the coils until each coil has a total of 22 turns. When soldering the leads to the 3rd, 6th, 8th and 12th turns from the inside ends of the coils, protect the adjacent turns from solder and flux by placing strips of aluminum cooking foil between the turns. An iron with a sharp point will be required for the soldering.

The "panel" side of the box can be finished off with decals indicating the knob functions and switch positions.

The antenna coupler should be mounted within a few feet of the receiver, to minimize the length of RG-59/U between coupler and receiver. In crowded quarters, the use of M-359A right-angle adapters (Amphenol 83-58) at  $J_1$  and  $J_2$  will

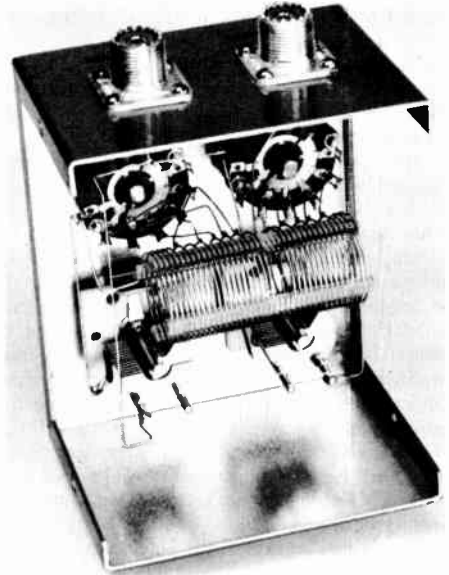

Fig. 5-50—Receiver antenna coupler, with cover removed from case. Unit tunes 6 to 30 Mc. The coil is supported by the leads to the capacitors and switches.

make it easier to bring out the cables neatly.

Normally the coupler will be adjusted for optimum coupling or maximum image rejection, but by detuning the coupler it can be used as an auxiliary gain control to reduce the overloading effects of strong local signals. The coupler circuits do not resonate below 6 Mc., but a coupler of this type is seldom if ever used in the 80-meter band; its major usefulness will be found at the higher frequencies.

As shown, the coupler is designed for use with an antenna fed with coaxial line. If a simple wire antenna is used, try connecting the antenna to  $J_2$  and the receiver to  $J_1$ .

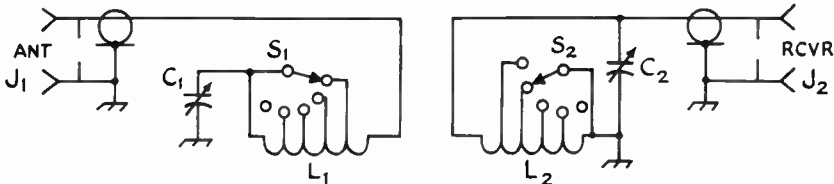

Fig. 5-49—Circuit diagram of the receiver antenna coupler.

$C_1, C_2$ —100- $\mu\text{f.}$  midget variable (Hammarlund HF-100).

$J_1, J_2$ —Coaxial cable connector, SO-239.

$L_1, L_2$ —22 turns No. 20,  $\frac{3}{4}$ -inch diameter, 16 t.p.i. Tapped 3, 6, 8 and 12 turns from inside end. See text

on spacing and tapping.

$S_1, S_2$ —Single-pole 11-position switch (5 used) rotary switch (Centralab PA-1000).

## A REGENERATIVE PRESELECTOR FOR 7 TO 30 Mc.

The performance of many receivers begins to drop off at 14 Mc. and higher. The signal-to-noise ratio is reduced, and unless double conversion is used in the receiver there is likely to be increased trouble with r.f. images at the higher frequencies. The preselector shown in Figs. 5-51 and 5-52 can be added ahead of any receiver without making any changes within the receiver, and a self-contained power supply eliminates the problem of furnishing heater and plate power. The poorer the receiver is at the higher frequencies, the more it needs the preselector.

A truly good receiver at 28 Mc. will show little or no improvement when the preselector is added, but a mediocre receiver or one without an r.f. stage will be improved greatly through the use of the preselector.

A 6CG7 dual triode is used in the preselector, one triode as a bandswitched regenerative r.f. stage and the other as a cathode follower. A conventional neutralizing circuit is used in the amplifier; by upsetting this circuit enough the stage can be made to oscillate. Smooth control of regeneration up to this point is obtained by varying one of the capacitances in the neutralizing circuit.

If and when it becomes necessary to reduce gain (to avoid overloading the receiver), the regeneration control can be retarded. One position of the bandswitch permits straight-through operation, so the preselector unit can be left connected to the receiver even during low-frequency reception.

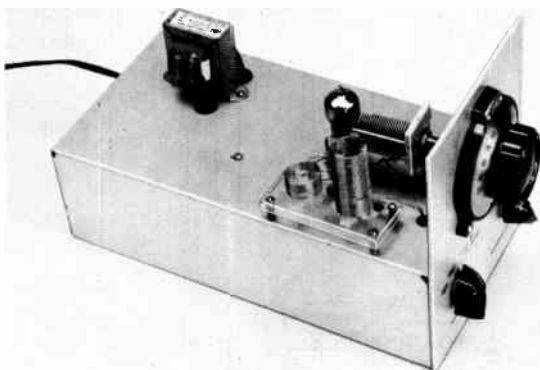

Fig. 5-51—The regenerative preselector covers the range 7 to 30 Mc.; it can be used ahead of any receiver to improve gain, image rejection and, in many cases, sensitivity. A dual triode 6CG7 is used as r.f. amplifier and cathode follower.

The preselector is built on a  $5 \times 10 \times 3$ -inch chassis (Bud AC-404). A  $5 \times 6\frac{1}{2}$ -inch aluminum panel is held to the chassis by the extension-shaft bushing for the regeneration-control capacitor,  $C_3$ , and the bushing for the rotary switch. The coils,  $L_1$  and  $L_2$ , are supported on a small staging of  $1\frac{1}{4} \times 3$ -inch clear plastic. (It can be made from the lid of the box that the Sprague 5GA-S1 .01- $\mu$ f. disk ceramic capacitors come in.) All coils can be made from a single length of B&W 3011 Miniductor. They are cemented to the plastic staging with Duco cement.

The rotor of  $C_1$  can be insulated from the chassis by mounting the capacitor bracket on insulating bushings (National XS-6 or Millen 37201); its shaft is extended through the use of an insulated extender shaft (Allied Radio No.

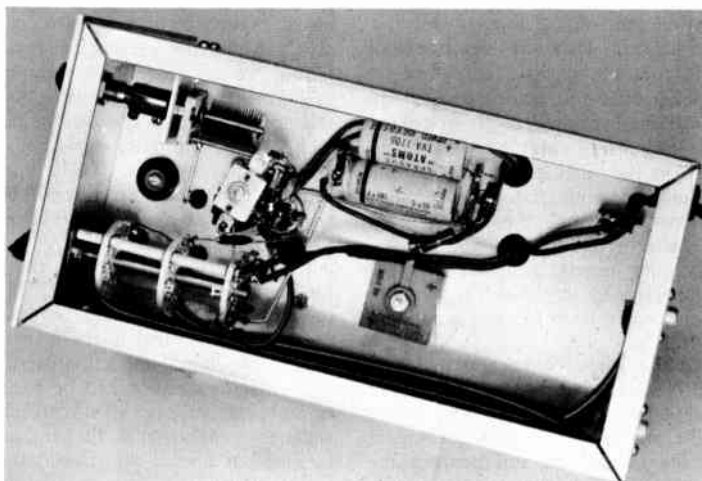

Fig. 5-52—The r.f. components are bunched around the 9-pin miniature tube socket. Power supply components are supported by screws and tie points.

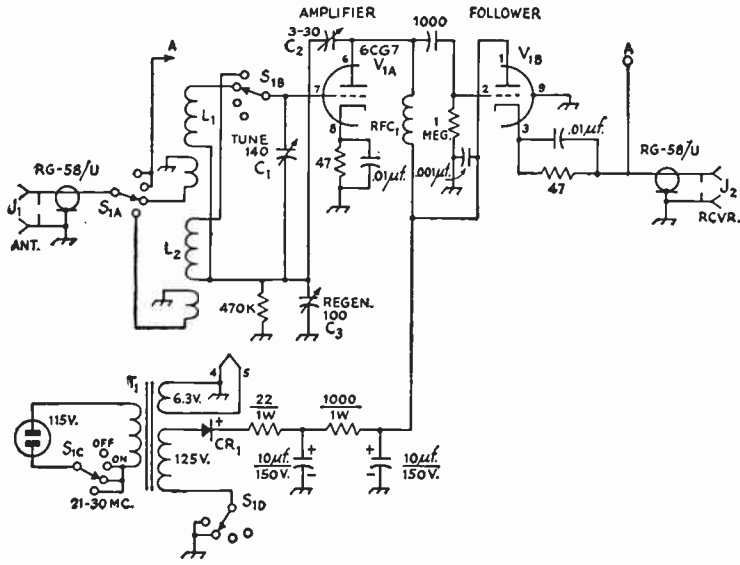

Fig. 5-53—Circuit diagram of the regenerative preselector. Unless otherwise specified, resistors are ½ watt, capacitors are in pf., capacitors marked in polarity are electrolytic.

- C<sub>1</sub>—140-pf. midget variable (Hammarlund HF-140).
- C<sub>2</sub>—3- to 30-pf. mica compression trimmer.
- C<sub>3</sub>—100-pf. variable (Hammarlund MAPC-100-B).
- CR<sub>1</sub>—50-ma. selenium (International Rectifier TO50).
- J<sub>1</sub>, J<sub>2</sub>—Phono jack.
- L<sub>1</sub>—19 turns, 7-turn primary.
- L<sub>2</sub>—5 turns, 2-turns primary. Coils are ¾-inch diameter, 16 t.p.i., No. 20 Wire (B & W 3011 Miniductor). One-turn spacing between coils and primaries.

- S<sub>1</sub>—Three-wafer rotary switch. S<sub>1A</sub> and S<sub>1B</sub> are 1-pole 12-position (4 used) sections (Centralab PA-1); S<sub>1C</sub> and S<sub>1D</sub> are 2-pole 6-position (4 used) sections (Centralab PA-3), all mounted on Centralab PA-301 index assembly.
- T<sub>1</sub>—125 v. at 15 ma., 6.3 v. at 0.6 amp. (Stancor PS-8415 or Knight 61G410).
- RFC<sub>1</sub>—100-μh. r.f. choke (National R-33).

60 H 355). The bandswitch S<sub>1</sub> is made from the specified sections (see Fig. 5-53). The first section is spaced ¾ inch from the indexing head, there is 1-inch separation between this and the next section (S<sub>1B</sub>), and the next section (S<sub>1C</sub>, S<sub>1D</sub>) is spaced 2½ inches from S<sub>1B</sub>.

The regeneration control, C<sub>3</sub>, is mounted on a small aluminum bracket. Its shaft does not have to be insulated from the chassis, so either an insulated or a solid shaft connector can be used. The small neutralizing capacitor, C<sub>2</sub>, is supported by soldering one lead of it to a stator bar of C<sub>3</sub> and running a wire from the other lead to pin 6 of the tube socket. The rotor and stator connections from C<sub>1</sub> are brought through the chassis deck through small rubber grommets.

Power supply components, resistors and capacitors are supported by suitable lugs and tie points. Phono jacks are used for the input and output connectors.

Assuming that the wiring is correct and that the coils have been constructed properly and cover the required ranges, the only preliminary adjustment is the proper setting of C<sub>2</sub>. Connect an antenna to the input jack and connect the receiver to the output jack through a suitable length of RG-58/U. Turn on the receiver b.f.o. and tune to 28 Mc. with S<sub>1</sub> in the ON position.

Now turn S<sub>1</sub> to the 21- to 30-Mc. range. Swing the TUNE capacitor, C<sub>1</sub>, and listen for a loud rough signal which indicates that the preselector is oscillating. If nothing is heard, advance the regeneration control toward the minimum capacitance end and repeat. If no oscillation is heard, it may be necessary to change the setting of C<sub>2</sub>. Once the oscillating condition has been found, set the regeneration control at minimum capacitance and slowly adjust C<sub>2</sub> until the preselector oscillates only when the regeneration control is set at minimum capacitance. You can now swing the receiver to 21 Mc. and peak the preselector tuning capacitor. It will be found that the regeneration capacitance will have to be increased to avoid oscillation.

Check the performance on the lower range by tuning in signals at 14 and 7 Mc. and peaking the preselector. It should be possible to set the regeneration control in these two ranges to give both an oscillating and a non-oscillating condition.

A little experience will be required to get the best performance out of the preselector. Learn to set the regeneration so that the preselector is selective, but not so selective that it must be retuned every 10 kc. or so. Changing to another antenna may modify the best regeneration setting because the loading is changed.

## A TRANSISTORIZED Q MULTIPLIER

A "Q multiplier" is an electronic device that boosts the Q of a tuned circuit many times beyond its normal value. In this condition the single tuned circuit has much greater selectivity than normal, and it can be utilized to reject or amplify a narrow band of frequencies. There are vacuum-tube versions of the Q-multiplier circuit, but the transistorized Q multiplier to be described has the advantage that it eliminates a power-supply problem and is very compact.

### Circuit and Theory

Parallel-tuned circuits have been used for years as "suck-out" trap circuits. Properly coupling a parallel-tuned circuit loosely to a vacuum-tube amplifier stage, it will be found that the amplifier stage has no gain at the frequency to which the trap circuit is tuned. The additional tuned circuit puts a "notch" in the response of the amplifier. The principle is used in TV and other amplifiers to minimize response to a narrow band of frequencies. Increasing the Q of the trap circuit reduces the width of the rejection notch.

The transistorized Q multiplier makes use of the above effect for its operation. A tuned circuit is made regenerative to increase its Q and is coupled into the i.f. stage of a receiver. By changing the frequency of the regenerative circuit, the sharp notch can be moved about across the pass-band of the receiver. The width of the notch is changed by controlling the amount of regeneration.

Although it seems paradoxical, the transistorized Q multiplier with no change in circuitry will also permit "peaking" an incoming signal the way a vacuum-tube Q multiplier does. The mode of operation is selected by adjustment of the regeneration control, and this then usually requires a slight readjustment of the frequency control. The peaking effect is not quite as pronounced as the notch, but it is still adequate to give fairly good single-signal c.w. reception with a receiver of otherwise inadequate selectivity.

The regenerative circuit builds up the signal and feeds it back to the amplifier at a higher level and in the proper phase to add to the original signal. The notch effect described earlier works in a similar manner except that the tuning of the

regenerative circuit is such that it feeds back the signal out of phase.

The schematic diagram of the Q multiplier is shown in Fig. 5-54. The inductor  $L_1$  furnishes coupling from the receiver to the Q multiplier, and  $C_4$  is required to prevent short-circuiting the receiver's plate supply. The multiplier proper consists of the tunable circuit  $C_1C_3L_2$  connected to a transistor in the collector-tuned common-base oscillator circuit using capacitive feedback via  $C_2$ . Regeneration is controlled by varying the d.c. operating voltage through dropping resistor  $R_1$ .

### Layout

The unit and power supply are built in a small aluminum "Minibox" measuring  $5 \times 2\frac{1}{4} \times 2\frac{1}{4}$  inches (Bud CU-3004) and the operating controls are mounted on a lucite or aluminum subpanel. All parts of the unit are built on one half of the box. This feature not only simplifies construction but makes a battery change a simple job, even if this is required only a couple of times a year.

All major components, such as the two slug-tuned coils, tie point, battery holder, regeneration and tuning controls, are mounted directly on the box and subpanel. The remaining resistors, capacitors and the single transistor are supported by their connections to the above parts.

The two slug-tuned coils,  $L_1$  and  $L_2$ , are centered on the box and spaced one inch apart on centers. Operating controls  $C_1$  and  $R_1$  are placed  $1\frac{1}{4}$  inches from the ends of the subpanel and centered. The tie point mounts directly behind tuning control  $C_1$ .

Power for the unit is supplied by four penlight cells (type 912) which are mounted in the battery holder (Lafayette Radio Co. Stock No. MS-170) directly behind regeneration control  $R_1$ . Total drain on the battery never exceeds 0.2 ma.

Connection to the receiver is made with a three-foot length of RG-58/U cable brought through the rear wall of the Minibox. A rubber grommet should be placed in the hole to prevent chafing of the cable insulation.

When soldering the transistor in place, be sure to take the usual precautions against heat damage.

Fig. 5-54—Circuit diagram of the 455-kc. transistorized Q multiplier. Unless otherwise indicated, capacitances are in pf., resistances are in ohms, resistors are  $\frac{1}{2}$  watt.

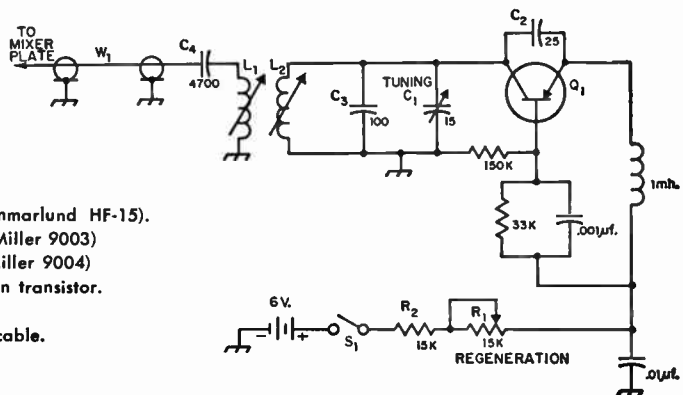

- $C_1$ —15-pf. variable capacitor (Hammarlund HF-15).
- $L_1$ —1000-2000- $\mu$ h. slug-tuned coil (Miller 9003)
- $L_2$ —500-1000- $\mu$ h. slug-tuned coil (Miller 9004)
- $Q_1$ —2N1264 or 2N274 PNP junction transistor.
- $S_1$ —Part of  $R_1$ .
- $W_1$ —Three-foot length of RG-58/U cable.



### Alignment

After completing the wiring (and double-checking it) connect the open end of the three-foot cable to the plate circuit of the receiver mixer tube. This can be done in a permanent fashion by soldering the inner conductor of the cable to the plate pin on the tube socket or any point that is connected directly to this pin, and by soldering the shield to any convenient nearby ground point. If you are one of those people who is afraid to take the bottom plate off his receiver, and you have a receiver with octal tubes, a "chicken connection" can be made by removing the mixer tube and wrapping a short piece of small wire around the plate pin. Reinsert the tube in its socket and solder the center conductor of the coax to the small wire coming from the plate pin. Now ground the coax shield to the receiver chassis. It is important to keep the lead from the tube pin to the coax as short as possible, to prevent stray pickup.

Check the schematic diagram of the receiver for help in locating the above receiver connections.

Turn on the receiver and tune in a signal strong enough to give an S-meter reading. Any decent signal on the broadcast band will do. Next, tune the slug on  $L_1$  until the signal peaks up. You are tuning out the reactance of the connecting cable, and effectively peaking up the i.f. If the receiver has no S meter, use an a.c. voltmeter across the audio output. When this step has been successfully completed the  $Q$  multiplier is properly connected to the receiver and when switched to "off" ( $S_1$  opened) will not affect normal receiver operation.

The next step is to bring the multiplier into oscillation, and to adjust its frequency to a useful range. Set the tuning control to half capacity and advance the regeneration control to about half open. This latter movement also turns the power on. Tune the receiver to a clear spot and set the receiver b.f.o. to the center of the pass-band.

Fig. 5-56—The  $Q$  multiplier and its battery supply are combined in one small Minibox. The single transistor is visible near the top right corner.

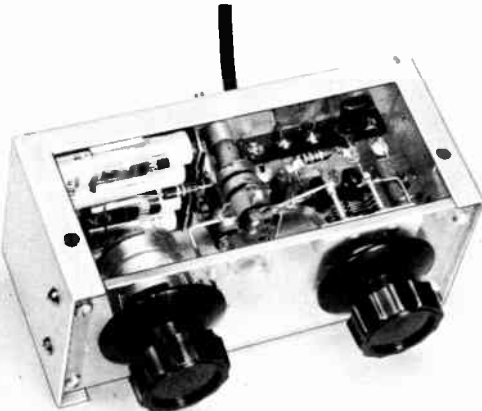

Fig. 5-55—View of the  $Q$  multiplier showing its single connecting cable to the receiver. The box can be placed in any convenient spot on or around the receiver.

Now adjust the slug of  $L_2$ . The multiplier should be oscillating, and somewhere in the adjustment of  $L_2$  a beat note will be heard from the receiver. This indicates the frequency of oscillation is somewhere on or near the i.f. Swing this into zero beat with the b.f.o.

### Final Adjustment

One of the best ways to make final alignment is to simulate an unwanted heterodyne in the receiver and adjust the  $Q$  multiplier for maximum attenuation of the unwanted signal. To do this, tune in a moderately weak signal with the b.f.o. on. A broadcast station received with the antenna disconnected will do. The b.f.o. will beat with the incoming signal, producing an audio tone. Adjust the b.f.o. for a tone of about 1 kc. or so.

Back off on control  $R_1$  until the oscillator becomes regenerative. By alternately adjusting the tuning control,  $C_1$ , and the regeneration control,  $R_1$ , a point can be found where the audio tone disappears, or at least is attenuated. Some slight retouching of  $L_2$  may have to be done in the above alignment, since the movement of any one control tends to "pull" the others. The optimum situation is to have the tuning control  $C_1$  set at about half capacity when the notch is in the center of the passband.

If you happen to get a super active transistor and the regeneration control does not have the range to stop oscillator action, increase the value of the series resistor  $R_2$ . Conversely, if the unit fails to oscillate, reduce the value of  $R_2$ .

Note that the audio tone can be peaked as well as nulled. If it can not be peaked, a little more practice with the controls should produce this condition. In the unit shown here, the best null was produced with the regeneration control turned only a few degrees. Optimum peak position was obtained with the regeneration control almost at the point of oscillation.



## THE HB-65 FIVE-BAND RECEIVER

The receiver shown in Figs. 5-57 through 5-61 is actually a receiver and a crystal-controlled converter on the same chassis. The receiver section tunes 3.5 to 4.1 or 6.9 to 7.5 Mc. without changing coils. This is made possible by a first i.f. of 1700 kc. and an oscillator that tunes 5.2 to 5.8 Mc. When the double-tuned input circuit is tuned to 80 meters, signals in that band may be received; when the input circuits are tuned to 40 meters, signals in that band may be received. The rejection of the undesired band is better than 80 db.

Following the frequency change to 1700 kc., a crystal-controlled converter (crystal oscillator on 1600 kc.) converts the signal to 100 kc. A two-stage 100-kc. amplifier, with eight tuned circuits, provides adequate gain and selectivity. On a.m. a germanium diode detector is used for detection and a.g.c.; a double-diode detector plus b.f.o. provide product detection for c.w. and s.s.b. reception. A two-stage audio amplifier delivers 200 mw. before appreciable distortion takes place, more than enough output for headphone operation. A.g.c. for c.w. and s.s.b. is obtained from an audio-derived a.g.c. system using a full-wave silicon rectifier circuit. Both manual and automatic gain control are applied through the grid circuits of three stages; the a.g.c. action can be monitored by a voltmeter reading across the cathode of an i.f. stage, and a test point is provided for this purpose. The negative voltage for the manual gain control is obtained from a small filament transformer (used as a step-up transformer) and a half-wave rectifier. A slight economy might be affected here by the use of a voltage-doubling circuit taken from the 6.3-volt heater line.

The crystal-controlled converter section has a double-tuned input circuit that tunes 14 through 30 Mc. The mixer circuit is a variation of one of the product detectors normally used at i.f. A high- $g_m$  triode serves as a cathode follower to

drive a high- $g_m$  tetrode through the cathode circuit, and the oscillator voltage (crystal-controlled) is introduced at the control grid of the tetrode. A fixed-tuned circuit in the plate circuit of the tetrode increases its conversion gain, and a triode cathode follower transforms the impedance to a low level suitable for the antenna input circuit of the tunable receiver section.

Although the receiver has no r.f. stages ahead of the mixers, the sensitivity is adequate with all but the poorest antennas. The elimination of r.f. stages simplifies construction. As mentioned before, band-changing between 3.5 and 7 Mc. involves only retuning of the input circuit, a simple operation. For operation on 14, 21 or 28 Mc., it is necessary to unplug the antenna lead from the low-frequency antenna input and plug in a lead from the converter output. Throwing a switch then applies plate voltage to the converter section and it is ready to go. On 14 Mc. the converter output is in the 3.5-Mc. range; on 21 and 28 Mc. it is at 7 Mc. Thus band changing among the higher-frequency bands involves turning a switch and touching up one or two knobs.

### Construction

Prime objectives in the design of the receiver were economy and simplicity of construction. The receiver is built on a  $10 \times 12 \times 3$ -inch aluminum chassis, and the panel is a  $12\frac{1}{2}$ -inch length cut from a 7-inch high relay rack panel (Bud SFA-1934). A rectangular hole must be cut in the chassis for the power transformers, and smaller rectangular holes are needed for the i.f. transformers. The i.f. transformers are held to the chassis with two spade-bolt assemblies (Miller part 183). If a suitable punch is lacking, a "nibbler" is the best tool for cutting the rectangular holes. The panel is held to the chassis by the controls and shaft extensions. (If the audio control shank is too short for this purpose, the panel hole must clear the nut on the volume-control shank.)

Fig. 5-57—The HB-65 receiver is a two-band (80 and 40 meters) receiver plus a crystal-controlled converter (20, 15 and 10 meters). The large tuning knob turns a two-speed drive for the tunable oscillator; the small knob to its right selects the 3.5- or 7-Mc. range by peaking two tuned circuits. The knob to the left of the main tuning peaks two input circuits on 14, 21 and 28 Mc.

Controls along the bottom, from left to right, are BFO, converter crystal-selector switch, MAN-AUTO gain control switch, AM-HET detector switch, AUDIO and (i.f.) GAIN.

The 6BK7B oscillator is just visible above the dial. The (shielded) tube at the extreme right is the 7360 mixer; tubes in the i.f. chain across chassis, from right to left, are 6KE8 crystal-controlled converter, 6BA6 i.f. Two tubes near panel on left are 6GK5 and (right) 6FV6. A 12AT7 close to the panel is not visible. At the left rear there are two 6CG7s; the tube in front of the filter choke is a 0B2 regulator.

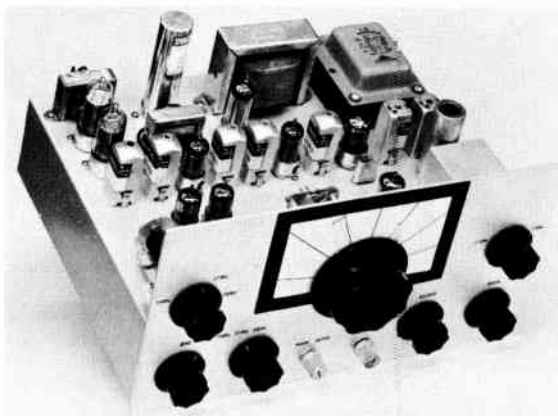



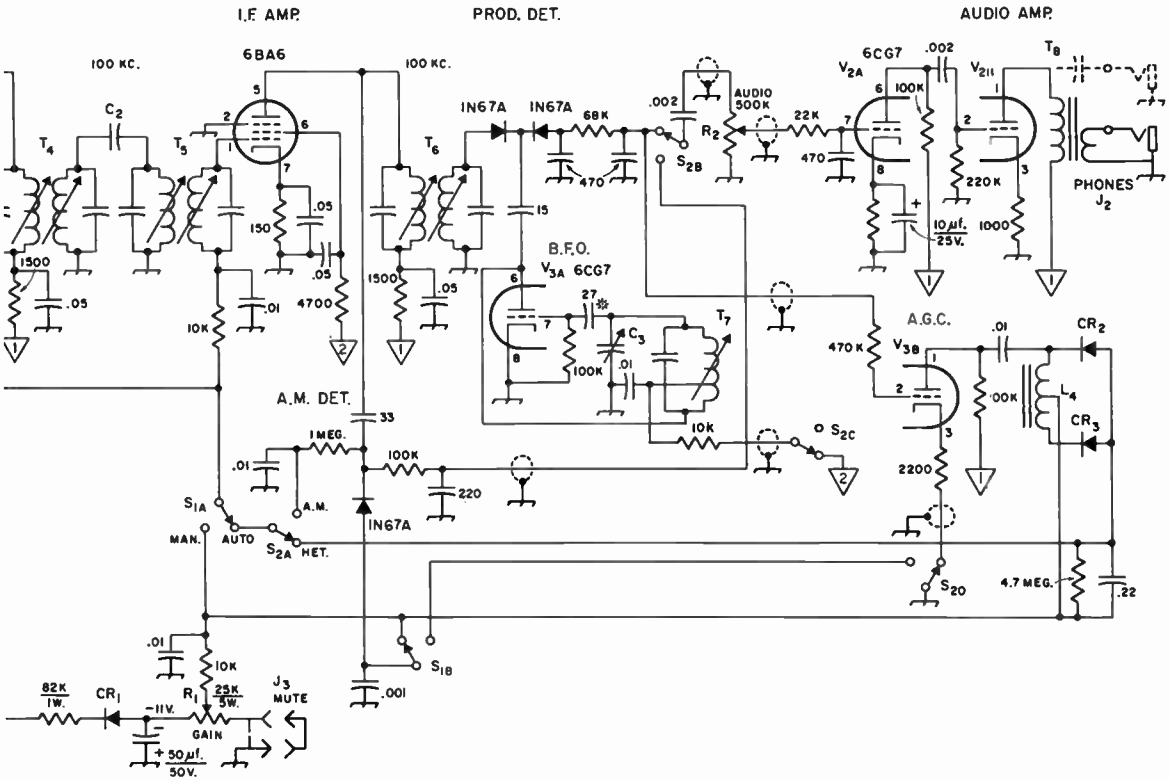

- L<sub>4</sub>—Secondary of 5-watt p.p. output transformer (Stancor A-3857 or equiv.).
- R<sub>1</sub>—25,000-ohm 5-watt potentiometer (Mallory VW-25K).
- R<sub>2</sub>—0.5-megohm volume control, audio taper.
- RFC<sub>1</sub>, RFC<sub>2</sub>—0.33 μh. (Miller 4586).
- RFC<sub>3</sub>, RFC<sub>4</sub>—0.75 mh. (Miller 4651).
- S<sub>1</sub>—D.p.d.t. rotary switch (Centralab 1462).
- S<sub>2</sub>—Four-pole 2-position rotary, non-shorting (Centralab PA-1011).
- T<sub>1</sub>, T<sub>2</sub>—1650-kc. i.f. transformer, tuned to 1700 kc. (Miller 1732).

- T<sub>3</sub>—T<sub>6</sub>—100-kc. i.f. transformer (Miller 1709).
  - T<sub>7</sub>—100-kc. b.f.o. assembly (Miller 1711).
  - T<sub>8</sub>—10K to voice coil output transformer (Stancor A-3879).
  - T<sub>9</sub>—6.3-v. 0.3-a. filament transformer.
  - Y<sub>1</sub>—1700-kc. crystal (International Crystal FA-5).
- Capacitors not marked with polarity or asterisk are tubular or disc ceramic, except 0.22 μf. (Sprague 2PS-P22). Polar capacitor, C<sub>1</sub>, available from British Radio Electronics Ltd., 1742 Wisconsin Ave., N.W., Washington 7, D.C.

is used; it is held in place by the nuts holding L<sub>1</sub> and L<sub>2</sub> and by two bolts on the side of the chassis. These same two bolts hold another shield in place under the chassis (see Fig. 5-60) that adds to the overall stability of the receiver. The two holes are required for access to the 1700-kc. i.f. transformers, for alignment.

A third small shield is mounted between the 1600-kc. crystal socket and the tunable oscillator, to eliminate a spurious response from the second harmonic of the tunable oscillator and the 6th harmonic of the crystal. The remaining piece of sheet aluminum is a bracket for mounting the b.f.o. capacitor, C<sub>3</sub>.

Wiring can be kept clean by using small Teflon-covered wire instead of the thicker plastic-covered material. Liberal use of tie points is required, since every component should be anchored at each end. In a few instances this may be awkward or difficult, and one end of a small component may be anchored to a stiff wire. This is true of audio or d.c. wiring; it is definitely not true of any self-controlled oscillator circuit, as the high-frequency oscillator or the b.f.o. Shielded wire should be used where shown in the circuit diagrams, except in the audio volume control circuit where audio wire (plastic coating over shielding) is preferable. Coaxial line is used for the two antenna input leads and for the converter output lead.

If low-impedance headphones are used, the phone jack J<sub>2</sub> should be wired as shown, to the secondary of the output transformer. A small

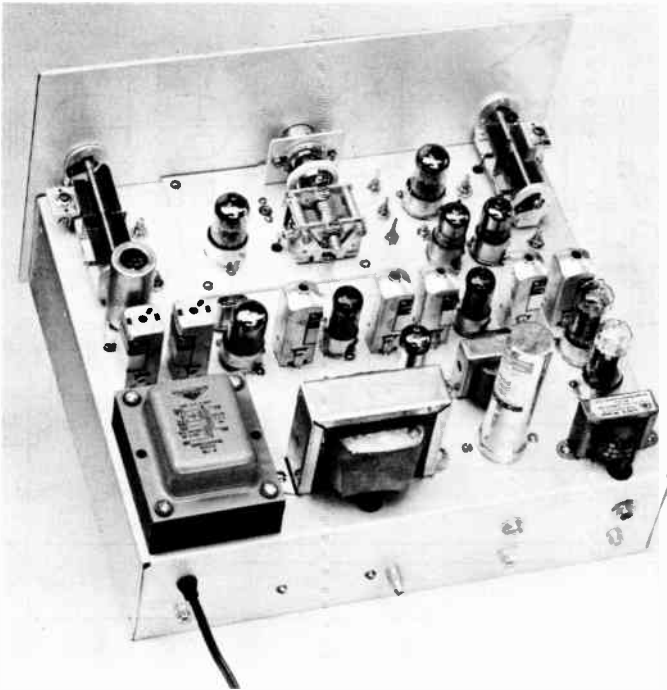

Fig. 5-59—Another view of the top of the receiver. The shield has been removed from the input tuning capacitor (left) disclosing the 3-30 mica trimmer mounted on section  $C_{1A}$ . A hole in the shield cover makes adjustment possible with the shield in place. Note the reinforcing plate for the oscillator section, and the tip jack (visible over filter choke) used as an a.g.c. monitoring point. On the rear of the chassis, the phone jack and the h.f. antenna jack can be seen below the audio output transformer (right). To the left: converter switch  $S_1$ , with converter output jack  $J_5$  directly below; mute jack (shorted if mute feature not used) and, at left under a.c. line cord, the low-frequency antenna jack,  $J_1$ .

The tube nearest the panel on the right is the 12A7 crystal oscillator and cathode follower; the three coils to the left are the crystal-oscillator plate coils.

speaker can be used with the same connection, but it must be in a reasonably quiet room. If high-impedance phones are to be used, connect the primary of  $T_8$  to the jack via a 0.05- $\mu$ f. capacitor, as shown by the dashed lines.

### Alignment

As in any receiver, initial alignment is most readily accomplished by working from the output stages toward the input. Plug in the headphones and  $V_2$  and the 0B2, and plug  $P_1$  into a live a.c. outlet. The power supply should deliver about 180 volts, and with  $K_2$  at maximum volume, touching the arm of  $R_2$  with a pencil should result in a hum or a click. Plug in  $V_3$  and the two i.f. amplifier tubes (6BA6). B.f.o. oscillation can be checked by connecting a voltmeter across the 10,000 ohm resistor in the lead to the tap on  $T_7$ . With  $S_2$  turned to HET, momentarily short to ground the grid of  $V_{3A}$ . The voltage across the 10,000 ohm resistor should increase, proving that the b.f.o. is oscillating.

If a 100-kc. oscillator is available (you may have to borrow one), feed its output through a capacitor to the secondary of  $T_6$ . Adjust the core of  $T_7$  for a beat note (zero beat with  $C_3$  set at mid range). Move the lead from the 100-kc. oscillator to the grid of the 6BA5 and peak the cores in  $T_6$  for maximum signal. As with all alignment, as you move toward the antenna, the signal input will have to be reduced or the gain of the receiver will have to be decreased, or both. Move the signal source to the grid of the first

6BA6 and finally to the grid pin of the 6KE8 socket. If the i.f. amplifier is in tune, it won't take much signal at this point to give a strong signal in the output. The bandwidth of the i.f. amplifier can be increased by using more capacitance at  $C_2$ ; with the  $\frac{1}{2}$  pf. as shown the bandwidth is good for s.s.b. and single-signal c.w.; it is a little sharp (but perfectly usable) for a.m.

If an r.f. probe is available, the h.f.o. output voltage can be measured at the plate of  $V_{3A}$ ; it should run about 15 volts. The 1600-kc. oscillator can also be checked with an r.f. probe; it should be about 5 volts at the plate of the oscillator. No coupling is shown to the mixer; it is obtained by stray coupling within the tube. With the 6KE8 stage operative, background noise should be audible with the gain control toward maximum (minimum grid bias), and the gain control action can be checked.

It will simplify matters if the high-frequency oscillator range can be checked on a receiver or grid-dip meter. If not, it will have to be found by a little experimentation and listening to signals of known frequency. If a signal near 3500 kc. is available (as from a v.f.o. or crystal oscillator) set the tuning capacitor near maximum and couple the signal in at  $J_1$ . With the 7360 and 6BK7B plugged in, tune  $C_5$  for the test signal. The cores should be nearly full in at  $L_1$  and  $L_2$ , and  $C_1$  should be near maximum. When the test signal is found, reduce its level and peak the cores in  $T_1$  and  $T_2$ . If a 7-Mc. signal is available, turn  $C_1$  to near minimum and



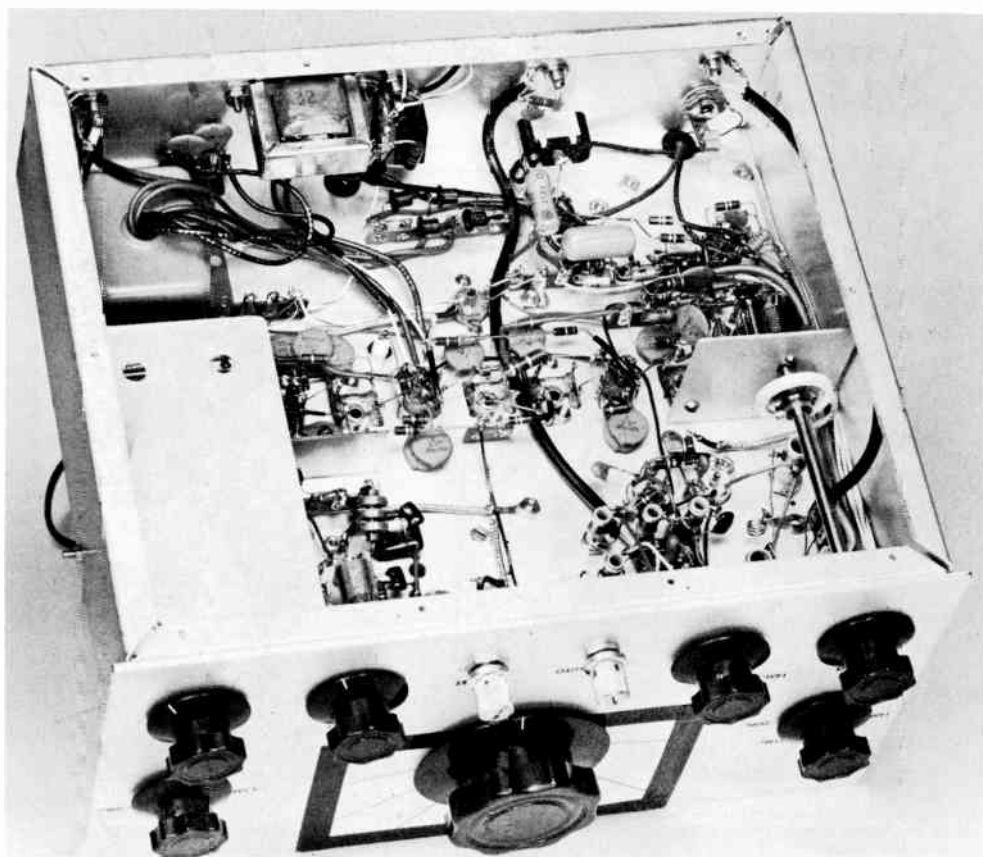

Fig. 5-60—This view under the chassis has the shield in place over the low-frequency mixer section. Visible on the rear wall of the chassis are the bias-supply transformer,  $T_8$ , with its rectifier and capacitor mounted on a tie strip to the right. The dropping resistor to the OB2 can be seen near the converter switch at the rear wall. The capacitor near the resistor is the 0.22- $\mu$ f. unit in the a.g.c. circuit; it is mounted on a tie strip that also supports the silicon a.g.c. diodes.

tune in the 7-Mc. signal with  $C_4$ . "Rock"  $C_1$  and it is likely that two peaks will be found, fairly close together. Judicious adjustment of the trimmer across  $C_{1A}$  will bring these points close together. Go back to the 3.5-Mc. signal ( $C_1$  near maximum) and adjust the cores of  $L_1$  and  $L_2$  for a single peak.

The receiver should be in operating condition after these tests, provided the high-frequency oscillator is set properly. Either 3.5 or 6.9 Mc. should be tuned with  $C_1$  near maximum, and either 4.1 or 7.5 Mc. should be tuned near minimum. Whichever is heard depends upon the setting of  $C_1$ . It will be found that the setting of  $C_1$  is fairly sharp. The r.f. potential at pin 9 of the 7360 mixer should be about 4 volts.

A.g.c. action can be checked by measuring the voltage across the 68-ohm cathode resistor in the 6BA6 i.f. stage. As a signal is tuned in, the cathode voltage will decrease. On c.w. and s.s.b. the voltage will increase slowly as the signal is removed (long time-constant a.g.c.) while on a.m. the action is faster. On a.m. with no signal

and reduced gain there will be a slight hum in the output, the result of insufficient filter in the bias supply. However, the hum disappears with a.m. signals of reasonable strength. The manual gain control is operative even with a.g.c., on both a.m. and product detection.

It may be noticed that when the b.f.o. is set to the middle of the i.f. pass band (lowest-pitched hiss) that full i.f. gain permits the i.f. to oscillate. This is a result of b.f.o. voltage getting into the front end of the i.f. amplifier. It is not the way the receiver should be operated, however; the b.f.o. is offset for either s.s.b. or c.w. reception.

### Converter

Crystal-controlled converter alignment consists of first checking crystal oscillation and then peaking the signal circuits. Inductors  $L_9$ ,  $L_{10}$  and  $L_{11}$  should be set with the cores as far out as they will go (minimum inductance). Clipping a voltmeter across the 47,000 ohm resistor in the oscillator plate lead, the reading should increase when the  $V_{4A}$  grid is momentarily grounded. If an r.f.



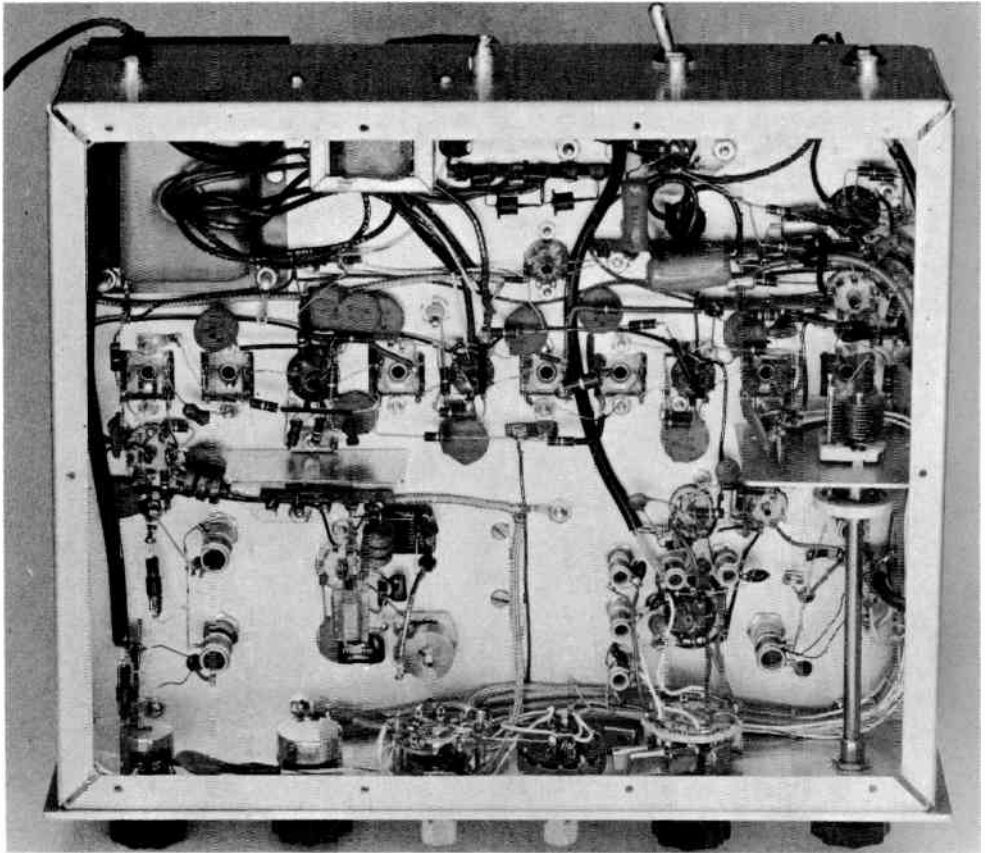

Fig. 5-61—Another view under the chassis, with a shield removed to show the mixer section. The crystals in the high-frequency converter section are soldered to the switch,  $S_8$ , at bottom right, supported by their wire leads.

probe is available, the r.f. potential at pin 6 of  $V_{4A}$  should be about 4 to 6 volts. The cores of the inductors can be screwed in if the r.f. voltage is not enough. However, do not make the mistake of overdriving the mixer, since this will result in spurious signals as a result of the harmonics being generated.

When  $S_3$  is in the 14-Mc. setting,  $C_1$  should

be set for 3.5-Mc. reception and  $L_7$  should be peaked on an incoming signal.  $L_5$  and  $L_6$  are adjusted as for the low-frequency input circuit; the inductors are peaked at 14 Mc. and the 3-30-pf. trimmer adjusted on 28 Mc. With  $S_3$  on 21 or 28 Mc., the low-frequency tuning,  $C_1$ , should be set for 7 Mc. and  $L_8$  should be peaked on a signal.

There is a good possibility that under certain

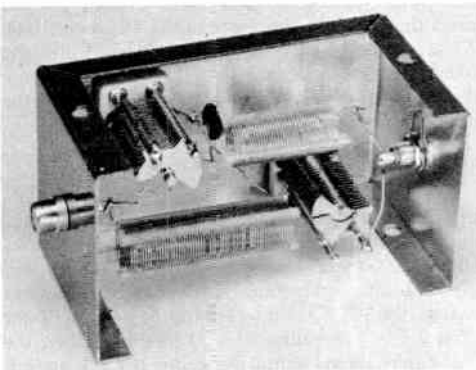
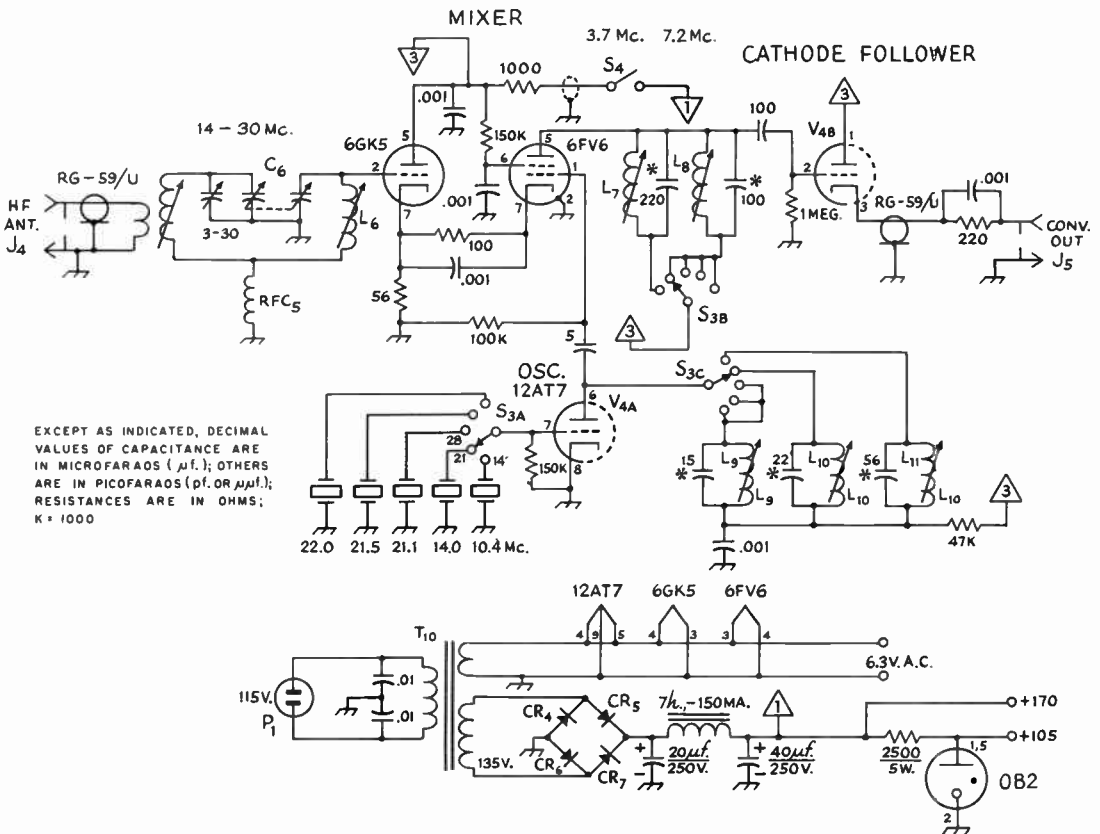

Fig. 5-62—Severe cases of converter feedthrough on 80 and 40 meters can be alleviated by using a simple wavetraps such as this in the high-frequency antenna lead. It is built in a  $2\frac{1}{4} \times 2\frac{1}{4} \times 4$ -inch Minibox.



EXCEPT AS INDICATED, DECIMAL VALUES OF CAPACITANCE ARE IN MICROFARADS ( $\mu$ f.); OTHERS ARE IN PICOFARADS (pf. OR  $\mu\mu$ f.); RESISTANCES ARE IN OHMS; K = 1000

Fig. 5-63—Circuit diagram of the crystal-controlled converter and the power supply. Capacitors marked with polarity are electrolytic; capacitors marked with asterisk are dipped silver mica. Resistors are 1/2-watt unless specified otherwise.

- C<sub>6</sub>—Dual 100-pf. variable (Hammarlund HFD-100).
- J<sub>4</sub>, J<sub>5</sub>—Phono jack.
- L<sub>5</sub>—Approximately 1.3  $\mu$ h. Primary is 2 turns No. 24 enam. closewound 1/8 inch from "cold" end (Miller 4403).
- L<sub>6</sub>—Approximately 1.3  $\mu$ h. (Miller 4403).
- L<sub>7</sub>—Approximately 7.5  $\mu$ h. (Miller 4505).
- L<sub>8</sub>—Approximately 4.2  $\mu$ h. (Miller 4504).

- L<sub>9</sub>—1.6  $\mu$ h. (Miller 4503).
- L<sub>10</sub>, L<sub>11</sub>—2.8  $\mu$ h. (Miller 4504).
- P<sub>1</sub>—Fused plug, 2-ampere fuses.
- S<sub>3</sub>—Three-pole 5-position ceramic rotary switch (Centralab 2007).
- S<sub>4</sub>—S.p.s.t. toggle.
- T<sub>10</sub>—135 v. at 200 ma., 6.3 v. at 5.5 amp. (Triad R-73B).
- Y<sub>5</sub>-Y<sub>6</sub>—As indicated (International Crystal FA-9).

conditions, 3.5- or 7-Mc. signals will leak through the converter when it is set for 14, 21 or 28 Mc. These signals can be from loud, local amateurs or from strong commercial signals. This is not a shortcoming of this particular receiver; it is basic, arising from trying to accomplish things in the simplest manner. The interference can be

attenuated by using a wave trap in the antenna lead to J<sub>4</sub>. If an antenna coupler is used in the station, the wave trap may not be necessary, but with a "random" wire it is likely to be required at some time. A spurious response of this type is readily detected; its strength will not change with the setting of C<sub>8</sub> or the setting of S<sub>3</sub>.

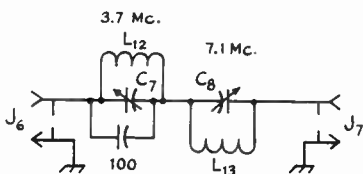

Fig. 5-64—Circuit of the 80- and 40-meter rejection filter.

- C<sub>7</sub>, C<sub>8</sub>—100-pf. midget variable (Hammarlund MAPC-100-B).
- L<sub>12</sub>—60 turns No. 24, 32 t.p.i., 1/2-inch diam. (B&W 3004).
- L<sub>13</sub>—36 turns No. 24, 32 t.p.i., 1/2-inch diam. (B&W 3004).
- J<sub>6</sub>, J<sub>7</sub>—Phono jack.

# Oscillators, Multipliers and Power Amplifiers

Regardless of the transmission mode—code, a.m., single sideband, radioteletype, amateur TV—vacuum tubes and semiconductors are common elements to the transmitters. They are used as oscillators, amplifiers, frequency multipliers and frequency converters. These four building blocks, plus suitable power supplies, are basically all that is required to make any of the popular transmission systems.

The simplest code transmitter is a keyed oscillator working directly into the antenna; a more elaborate (and practical) code transmitter will include one or more frequency-multiplication stages and one or more power-amplifier stage. Any code transmitter will obviously require a means for keying it. The bare skeleton is shown in Fig. 6-1A. The r.f. generating and amplifying sections of a double-sideband 'phone transmitter (a.m. or f.m.) are similar to those of a code transmitter.

The over-all design depends primarily upon the bands in which operation is desired, and the power output. A simple oscillator with satisfactory frequency stability may be used as a transmitter at the lower frequencies, but the power output obtainable is small. As a general rule, the output of the oscillator is fed into one or more amplifiers to bring the power fed to the antenna up to the desired level.

An amplifier whose output frequency is the same as the input frequency is called a **straight amplifier**. A **buffer amplifier** is the term sometimes applied to an amplifier stage to indicate that its primary purpose is one of isolation, rather than power gain.

Because it becomes increasingly difficult to maintain oscillator frequency stability as the frequency is increased, it is most usual practice in working at the higher frequencies to operate the oscillator at a low frequency and follow it with one or more frequency multipliers as required to arrive at the desired output frequency. A frequency multiplier is an amplifier that delivers output at a multiple of the exciting frequency. A doubler is a multiplier that gives output at twice the exciting frequency; a tripler multiplies the exciting frequency by three, etc. From the viewpoint of any particular stage in a transmitter, the preceding stage is its driver.

As a general rule, frequency multipliers should not be used to feed the antenna system directly, but should feed a straight amplifier which, in turn, feeds the antenna system.

Good frequency stability is most easily obtained through the use of a crystal-controlled oscillator, although a different crystal is needed

for each frequency desired (or multiples of that frequency). A self-controlled oscillator or v.f.o. (variable-frequency oscillator) may be tuned to any frequency with a dial in the manner of a receiver, but requires great care in design and construction if its stability is to compare with that of a crystal oscillator.

In all types of transmitter stages, screen-grid tubes have the advantage over triodes that they require less driving power. With a lower-power exciter, the problem of harmonic reduction is made easier.

The best stage or stages to key in a code transmitter is a problem by itself, to be discussed in a later chapter. An f.m. transmitter (Fig. 6-1B) can only be modulated in the oscillator stage; a closely-allied type of transmitter (phase-modulated) can be modulated in a multiplier or amplifier stage. An a.m. 'phone transmitter, Fig. 6-1C, can only be modulated in the output stage, unless the modulated stage is followed by a linear amplifier. However, following an amplitude-modulated stage by a linear amplifier is an inefficient process, convenient as an expedient but not recommended for best efficiency.

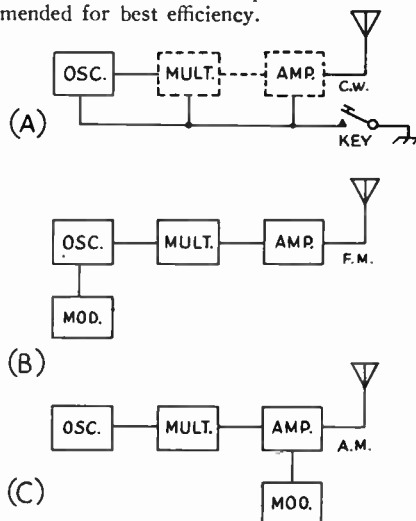

Fig. 6-1—Block diagrams showing the types of transmitters that typically use frequency multipliers followed by power amplifiers. The code transmitter (A) may or may not include multipliers and amplifiers. An f.m. transmitter must be modulated in the oscillator stage and is usually followed by several multiplier stages before the output amplifier. An a.m. 'phone transmitter is most efficient when modulated in the output stage, although it can be modulated in the driver stage and use a following linear amplifier on the same frequency.

Following the generation of a single-sideband 'phone signal, its frequency can be changed only by frequency conversion (not multiplication), in exactly the same manner that signals in a receiver are heterodyned to a different frequency.

### CRYSTAL OSCILLATORS

The frequency of a crystal-controlled oscillator is held constant to a high degree of accuracy by the use of a quartz crystal. The frequency depends almost entirely on the dimensions of the crystal (essentially its thickness); other circuit values have comparatively negligible effect. However, the power obtainable is limited by the heat the crystal will stand without fracturing. The amount of heating is dependent upon the r.f. crystal current which, in turn, is a function of the amount of feedback required to provide proper excitation. Crystal heating short of the danger point results in frequency drift to an extent depending upon the way the crystal is cut. Excitation should always be adjusted to the minimum necessary for proper operation.

#### Crystal-Oscillator Circuits

The simplest crystal-oscillator circuit is shown in Fig. 6-2A. An equivalent circuit is shown in Fig. 6-2B, where  $C_4$  represents the grid-

the oscillator itself is not entirely independent of adjustments made in the plate tank circuit when the latter is tuned near the fundamental frequency of the crystal, the effects can be satisfactorily minimized by proper choice of the oscillator tube.

The circuit of Fig. 6-3A is known as the Tritet. The oscillator circuit is that of Fig. 6-2C. Excitation is controlled by adjustment of the tank  $L_1C_1$ , which should have a low  $L/C$  ratio, and be tuned considerably to the high-frequency side of the crystal frequency (approximately 5 Mc. for a 3.5-Mc. crystal) to prevent over-excitation and high crystal current. Once the proper adjustment for average crystals has been found,  $C_1$  may be replaced with a fixed capacitor of equal value.

The oscillator circuit of Fig. 6-3B is that of Fig. 6-2A. Excitation is controlled by  $C_9$ .

The oscillator of the grid-plate circuit of Fig. 6-3C is the same as that of Fig. 6-3B, except that the ground point has been moved from the cathode to the plate of the oscillator (in other words, to the screen of the tube). Excitation is adjusted by proper proportioning of  $C_6$  and  $C_7$ .

When most types of tubes are used in the circuits of Fig. 6-3, oscillation will stop when the output plate circuit is tuned to the crystal fre-

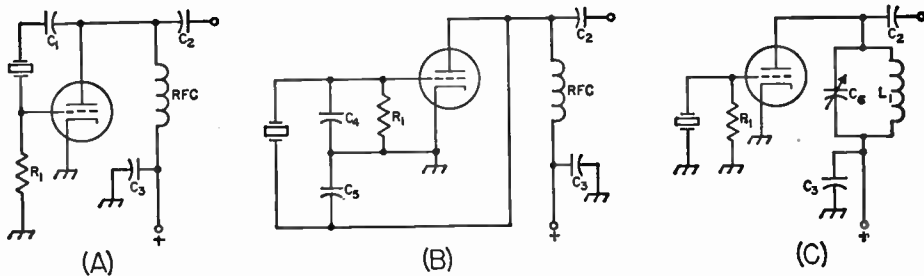

Fig. 6-2—Simple crystal oscillator circuits. A—Pierce. B—Equivalent of circuit A. C—Simple triode oscillator.  $C_1$  is a plate blocking capacitor,  $C_2$  an output coupling capacitor, and  $C_3$  a plate bypass.  $C_4$  and  $C_5$  are discussed in the text.  $C_6$  and  $L_1$  should tune to the crystal fundamental frequency.  $R_1$  is the grid leak.

cathode capacitance and  $C_5$  indicates the plate-cathode, or output capacitance. The ratio of these capacitors controls the excitation for the oscillator, and good practice generally requires that both of these capacitances be augmented by external capacitors, to provide better control of the excitation.

The circuit shown in Fig. 6-2C is the equivalent of the tuned-grid tuned-plate circuit discussed in the chapter on vacuum-tube principles, the crystal replacing the tuned grid circuit.

The most commonly used crystal-oscillator circuits are based on one or the other of these two simple types, and are shown in Fig. 6-3. Although these circuits are somewhat more complicated, they combine the functions of oscillator and amplifier or frequency multiplier in a single tube. In all of these circuits, the screen of a tetrode or pentode is used as the plate in a triode oscillator. Power output is taken from a separate tuned tank circuit in the actual plate circuit. Although

frequency, and it is necessary to operate with the plate tank circuit critically detuned for maximum output with stability. However, when the 6AG7, 5763, or the lower-power 6AH6 is used with proper adjustment of excitation, it is possible to tune to the crystal frequency without stopping oscillation. The plate tuning characteristic should then be similar to Fig. 6-4. These tubes also operate with less crystal current than most other types for a given power output, and less frequency change occurs when the plate circuit is tuned through the crystal frequency (less than 25 cycles at 3.5 Mc.).

Crystal current may be estimated by observing the relative brilliance of a 60-ma. dial lamp connected in series with the crystal. Current should be held to the minimum for satisfactory output by careful adjustment of excitation. With the operating voltages shown, satisfactory output should be obtained with crystal currents of 40 ma. or less.



In these circuits, output may be obtained at multiples of the crystal frequency by tuning the plate tank circuit to the desired harmonic, the output dropping off, of course, at the higher har-

monics. Especially for harmonic operation, a low- $C$  plate tank circuit is desirable.

For best performance with a 6AG7 or 5763, the values given under Fig. 6-3 should be followed closely.

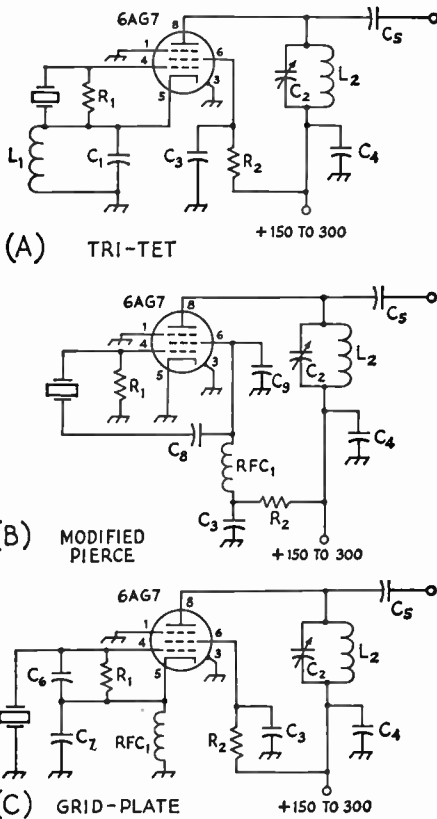

Fig. 6-3—Commonly used crystal-controlled oscillator circuits. Values are those recommended for a 6AG7 or 5763 tube. (See reference in text for other tubes.)

- $C_1$ —Feedback-control capacitor—3.5-Mc. crystals—approx. 220-pf. mica—7-Mc. crystals—approx. 150-pf. mica.
- $C_2$ —Output tank capacitor—100-pf. variable for single-band tank; 250-pf. variable for two-band tank.
- $C_3$ —Screen bypass—0.001- $\mu$ f. disk ceramic.
- $C_4$ —Plate bypass—0.001- $\mu$ f. disk ceramic.
- $C_5$ —Output coupling capacitor—50 to 100 pf.
- $C_6$ —Excitation-control capacitor—30-pf. trimmer.
- $C_7$ —Excitation capacitor—220-pf. mica for 6AG7; 100-pf. for 5763.
- $C_8$ —D.c. blocking capacitor—0.001- $\mu$ f. mica.
- $C_9$ —Excitation-control capacitor—220-pf. mica.
- $R_1$ —Grid leak—0.1 megohm,  $\frac{1}{2}$  watt.
- $R_2$ —Screen resistor—47,000 ohms, 1 watt.
- $L_1$ —Excitation-control inductance—3.5-Mc. crystals—approx. 4  $\mu$ h.; 7-Mc. crystals—approx. 2  $\mu$ h.
- $L_2$ —Output-circuit coil—single band:—3.5 Mc.—17  $\mu$ h., 7 Mc.—8  $\mu$ h.; 14 Mc.—2.5  $\mu$ h.; 28 Mc.—1  $\mu$ h. Two-band operation: 3.5 & 7 Mc.—7.5  $\mu$ h.; 7 & 14 Mc.—2.5  $\mu$ h.
- $RFC_1$ —2.5-mh. 50-ma. r.f. choke.

## VARIABLE-FREQUENCY OSCILLATORS

The frequency of a v.f.o. depends entirely on the values of inductance and capacitance in the circuit. Therefore, it is necessary to take careful steps to minimize changes in these values not under the control of the operator. As examples, even the minute changes of dimensions with temperature, particularly those of the coil, may result in a slow but noticeable change in frequency called drift. The effective input capacitance of the oscillator tube, which must be connected across the circuit, changes with variations in electrode voltages. This, in turn, causes a change in the frequency of the oscillator. To make use of the power from the oscillator, a load, usually in the form of an amplifier, must be coupled to the oscillator, and variations in the load may reflect on the frequency. Very slight mechanical movement of the components may result in a shift in frequency, and vibration can cause modulation.

### V.F.O. Circuits

Fig. 6-5 shows the most commonly used circuits. They are all designed to minimize the effects mentioned above. All are similar to the crystal oscillators of Fig. 6-3 in that the screen of a tetrode or pentode is used as the oscillator plate. The oscillating circuits in Figs. 6-5A and B are the Hartley type; those in C and D are Colpitts circuits. (See chapter on vacuum-tube principles.) In the circuits of A, B and C, all of the above-mentioned effects, except changes in inductance, are minimized by the use of a high- $Q$  tank circuit obtained through the use of large tank capacitances. Any uncontrolled changes in capacitance thus become a very small percentage of the total circuit capacitance.

In the series-tuned Colpitts circuit of Fig. 6-5D (sometimes called the Clapp circuit), a high- $Q$  circuit is obtained in a different manner. The tube is tapped across only a small portion of the oscillating tank circuit, resulting in very loose coupling between tube and circuit. The taps are provided by a series of three capacitors across the coil. In addition, the tube capacitances are shunted by large capacitors, so the effects of the tube—changes in electrode voltages and loading—are still further reduced. In contrast to the preceding circuits, the resulting tank circuit has a high  $L/C$  ratio and therefore the

Fig. 6-4—Plate tuning characteristic of circuits of Fig. 6-3 with preferred types (see text). The plate-current dip at resonance broadens and is less pronounced when the circuit is loaded.



tank current is much lower than in the circuits using high-*C* tanks. As a result, it will usually be found that, other things being equal, drift will be less with the low-*C* circuit.

For best stability, the ratio of  $C_{12}$  or  $C_{13}$  (which are usually equal) to  $C_{10} + C_{11}$  should be as high as possible without stopping oscillation. The permissible ratio will be higher the higher the *Q* of the coil and the mutual conductance of the tube. If the circuit does not oscillate over the desired range, a coil of higher *Q* must be used or the capacitance of  $C_{12}$  and  $C_{13}$  reduced.

**Load Isolation**

In spite of the precautions already discussed, the tuning of the output plate circuit will cause a noticeable change in frequency, particularly in

the region around resonance. This effect can be reduced considerably by designing the oscillator for half the desired frequency and doubling frequency in the output circuit.

It is desirable, although not a strict necessity if detuning is recognized and taken into account, to approach as closely as possible the condition where the adjustment of tuning controls in the transmitter, beyond the v.f.o. frequency control, will have negligible effect on the frequency. This can be done by substituting a fixed-tuned circuit in the output of the oscillator, and adding isolating stages whose tuning is fixed between the oscillator and the first tunable amplifier stage in the transmitter. Fig. 6-6 shows such an arrangement that gives good isolation. In the first stage, a 6C4 is connected as a cathode follower. This

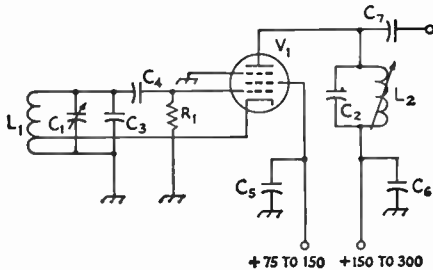

(A) HARTLEY

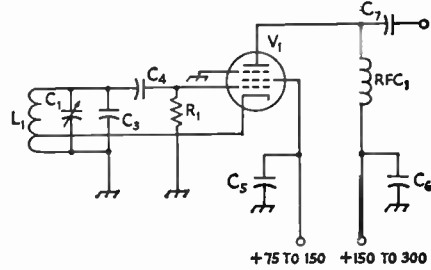

(B) HARTLEY - UNTUNED OUTPUT

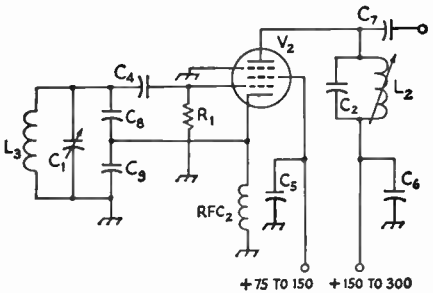

(C) COLPITTS

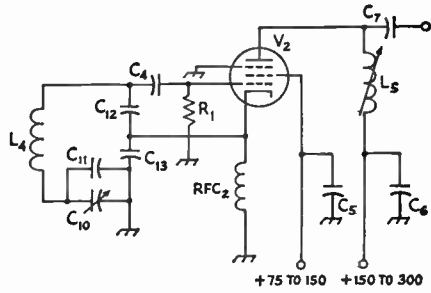

(D) SERIES - TUNED COLPITTS

Fig. 6-5—V.f.o. circuits. Approximate values for 3.5-4.0-Mc. output are given below. Grid circuits are tuned to half frequency (1.75 Mc.).

- C<sub>1</sub>—Oscillator bandsread tuning capacitor—200- $\mu$ mf. variable.
- C<sub>2</sub>—Output-circuit tank capacitor—47- $\mu$ mf.
- C<sub>3</sub>—Oscillator tank capacitor—600- $\mu$ mf. zero-temperature-coefficient mica.
- C<sub>4</sub>—Grid coupling capacitor—100- $\mu$ mf. zero-temperature-coefficient mica.
- C<sub>5</sub>—Screen bypass—0.001- $\mu$ f. disk ceramic.
- C<sub>6</sub>—Plate bypass—0.001- $\mu$ f. disk ceramic.
- C<sub>7</sub>—Output coupling capacitor—50 to 100- $\mu$ mf. mica.
- C<sub>8</sub>—Oscillator tank capacitor—750- $\mu$ mf. zero-temperature-coefficient mica.
- C<sub>9</sub>—Oscillator tank capacitor—0.0033- $\mu$ f. zero-temperature-coefficient mica.
- C<sub>10</sub>—Oscillator bandsread padder—100- $\mu$ mf. variable air.

- C<sub>11</sub>—Oscillator bandsread tuning capacitor—50- $\mu$ mf. variable.
- C<sub>12</sub>, C<sub>13</sub>—Tube-coupling capacitor—0.002- $\mu$ f. zero-temperature-coefficient mica.
- R<sub>1</sub>—47,000 ohms, 1/2 watt.
- L<sub>1</sub>—Oscillator tank coil—10  $\mu$ h., tapped about one-third-way from grounded end.
- L<sub>2</sub>—Output-circuit tank coil—20-40  $\mu$ h., adjustable.
- L<sub>3</sub>—Oscillator tank coil—10  $\mu$ h.
- L<sub>4</sub>—Oscillator tank coil—70  $\mu$ h.
- L<sub>5</sub>—Output coil—100-140  $\mu$ h., adjustable.
- RFC—100  $\mu$ h. r.f. choke.
- V<sub>1</sub>—6AG7, 5763 or 6AH6 preferred; other types usable.
- V<sub>2</sub>—6AG7, 5763 or 6AH6 required for feedback capacitances shown.

drives a 5763 buffer amplifier whose input circuit is fixed-tuned to the v.f.o. output band. For best isolation, the 6C4 should not be driven into grid current. This can be achieved by adding a 100-pf. capacitor from 6C4 grid to ground (to form, with the coupling capacitor, a voltage divider) or by reducing the oscillator supply voltages.

### Chirp, Pulling and Drift

Any oscillator will change frequency with an extreme change in plate and screen voltages, and the use of stabilized sources for both is good practice. But steady source voltages cannot alter the fact of the extreme voltage changes that take place when an oscillator is keyed or heavily amplitude-modulated. Consequently some chirp or f.m. is the inescapable result of oscillator keying or heavy amplitude modulation.

A keyed or amplitude-modulated amplifier presents a variable load to the driving stage. If the driving stage is an oscillator, the keyed or modulated stage (the variable load) may "pull" the oscillator frequency during the keying or modulation. This may cause a "chirp" on c.w. or incidental f.m. on a.m. phone. In either case the cure is to provide one or more "buffer" or isolating stages between the oscillator stage and the varying load. If this is not done, the keying or modulation may be little better than when the oscillator itself is keyed or modulated.

Frequency drift is minimized by limiting the temperature excursions of the frequency-determining components to a minimum. This calls for good ventilation and a minimum of heat-generating components.

Variable capacitors should have ceramic insulation, good bearing contacts and should preferably be of the double bearing type. Fixed capacitors should have zero temperature coefficients. The tube socket should have ceramic insulation.

### Temperature Compensation

If, despite the observance of good oscillator construction practice, the warm-up drift of an oscillator is too high, it is caused by high-temperature operation of the oscillator. If the ventilation cannot be improved (to reduce the ultimate temperature), the frequency drift of the oscillator can be reduced by the addition of a "temperature-coefficient capacitor". These are available in negative and positive coefficients, in contrast to the zero-coefficient "NPO" types.

Most uncorrected oscillators will drift to a lower frequency as the temperature rises. Such

an oscillator can be corrected (at a frequency  $f$ ) by adding an N750-type capacitor (-750 parts per million per °C) of a value determined by making two sets of measurements. Measure the drift  $f_1$  from cold to stability (e.g., 1½ hours). To the cold (cooled-off) oscillator, add a trial N750 capacitor (e.g., 50 pf.) and retune the cold oscillator to frequency  $f$  (by retuning a padder capacitor or the tuning capacitor). Measure the new warm-up drift  $f_2$  over the same period (e.g., 1½ hours). The required corrective N750 capacitor is then

$$\text{Corrective } C = C_{\text{trial}} \frac{f_1}{f_1 - f_2}$$

If the trial capacitor results in a drift to a higher frequency, the denominator becomes  $f_1 + f_2$ .

### Oscillator Coils

The  $Q$  of the tank coil used in the oscillating portion of any of the circuits under discussion should be as high as circumstances (usually space) permit, since the losses, and therefore the heating, will be less. With recommended care in regard to other factors mentioned previously, most of the drift will originate in the coil. The coil should be well spaced from shielding and other large metal surfaces, and be of a type that radiates heat well, such as a commercial air-

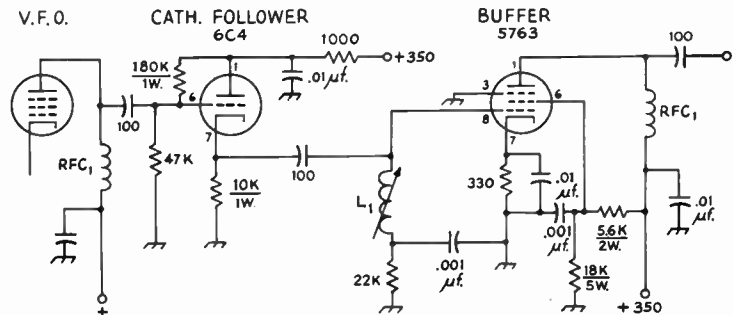

Fig. 6-6—Circuit of an isolating amplifier for use between v.f.o. and first tunable stage. Unless otherwise specified, all capacitances are in picofarads, all resistors are ½ watt.  $L_1$ , for the 3.5-Mc. band, consists of 100-140  $\mu$ h. adjustable inductor.  $RFC_1$  is 100  $\mu$ h. All capacitors are disk ceramic.

wound type, or should be wound tightly on a threaded ceramic form so that the dimensions will not change readily with temperature. The wire with which the coil is wound should be as large as practicable, especially in the high- $C$  circuits.

### Mechanical Vibration

To eliminate mechanical vibration, components should be mounted securely. Particularly in the circuit of Fig. 6-5D, the capacitor should preferably have small, thick plates and the coil braced, if necessary, to prevent the slightest mechanical movement. Wire connections between tank-circuit components should be as short as possible and flexible wire will have less tendency to vibrate than solid wire. It is advisable to cushion the entire oscillator unit by mounting on sponge rubber or other shock mounting.

**Tuning Characteristic**

If the circuit is oscillating, touching the grid of the tube or any part of the circuit connected to it will show a change in plate current. In tuning the plate output circuit without load, the plate current will be relatively high until it is tuned near resonance where the plate current will dip to a low value, as illustrated in Fig. 6-4. When the output circuit is loaded, the dip should still be found, but broader and much less pronounced as indicated by the dashed line. The circuit should not be loaded beyond the point where the dip is still recognizable.

**Checking V.F.O. Stability**

A v.f.o. should be checked thoroughly before it is placed in regular operation on the air. Since succeeding amplifier stages may affect the signal characteristics, final tests should be made with the complete transmitter in operation. Almost any v.f.o. will show signals of good quality and stability when it is running free and not connected to a load. A well-isolated monitor is a necessity. Perhaps the most convenient, as well as one of the most satisfactory, well-shielded monitoring arrangements is a receiver combined with a crystal oscillator, as shown in Fig. 6-7. (See "Crystal Oscillators," this chapter.) The crystal frequency should lie in the band of the lowest frequency to be checked and in the frequency range where its harmonics will fall in the higher-frequency bands. The receiver b.f.o. is turned off and the v.f.o. signal is tuned to beat with the signal from the crystal oscillator instead. In this way any receiver instability caused by overloading of the input circuits, which may result in "pulling" of the h.f. oscillator in the receiver, or by a change in line voltage to the receiver when the transmitter is keyed, will not

affect the reliability of the check. Most crystals have a sufficiently low temperature coefficient to give a check on drift as well as on chirp and signal quality if they are not overloaded.

Harmonics of the crystal may be used to beat with the transmitter signal when monitoring at the higher frequencies. Since any chirp at the lower frequencies will be magnified at the higher frequencies, accurate checking can best be done by monitoring at a harmonic.

The distance between the crystal oscillator and receiver should be adjusted to give a good beat between the crystal oscillator and the transmitter signal. When using harmonics of the crystal oscillator, it may be necessary to attach a piece

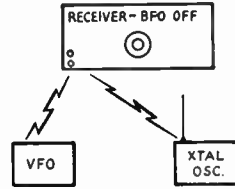

Fig. 6-7—Setup for checking v.f.o. stability. The receiver should be tuned preferably to a harmonic of the v.f.o. frequency. The crystal oscillator may operate somewhere in the band in which the v.f.o. is operating. The receiver b.f.o. should be turned off.

of wire to the oscillator as an antenna to give sufficient signal in the receiver. Checks may show that the stability is sufficiently good to permit oscillator keying at the lower frequencies, where break-in operation is of greater value, but that chirp becomes objectionable at the higher frequencies. If further improvement does not seem possible, it would be logical in this case to use oscillator keying at the lower frequencies and amplifier keying at the higher frequencies.

**R.F. POWER-AMPLIFIER TANKS AND COUPLING**

In the remainder of this chapter the vacuum tubes will be shown, for the most part, with indirectly-heated cathodes. However, many transmitting tubes used directly-heated filaments for the cathodes; when this is done the filament "center-tap" connection will be used, as shown in Fig. 6-8.

**PLATE TANK Q**

R.f. power amplifiers used in amateur transmitters are operated under Class-C or -AB conditions (see chapter on tube fundamentals). The main objective, of course, is to deliver as much fundamental power as possible into a load,  $R$ , without exceeding the tube ratings. The load resistance  $R$  may be in the form of a transmission line to an antenna, or the grid circuit of another amplifier. A further objective is to minimize the harmonic energy (always generated by a Class C amplifier) fed into the load circuit. In attaining these objectives, the  $Q$  of the tank circuit is of importance. When a load is coupled inductively, as in Fig. 6-10, the  $Q$  of the tank circuit

will have an effect on the coefficient of coupling necessary for proper loading of the amplifier. In respect to all of these factors, a tank  $Q$  of 10 to 20 is usually considered optimum. A much lower  $Q$  will result in less efficient operation of the amplifier tube, greater harmonic output, and greater difficulty in coupling inductively to a load. A much higher  $Q$  will result in higher tank current with increased loss in the tank coil.

The  $Q$  is determined (see chapter on electrical

Fig. 6-8—Filament center-tap connections to be substituted in place of cathode connections shown in diagrams when filament-type tubes are substituted.  $T_1$  is the filament transformer. Filament bypasses,  $C_1$ , should be 0.01- $\mu$ f. disk ceramic capacitors. If a self-biasing (cathode) resistor is used, it should be placed between the center tap and ground.

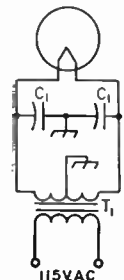

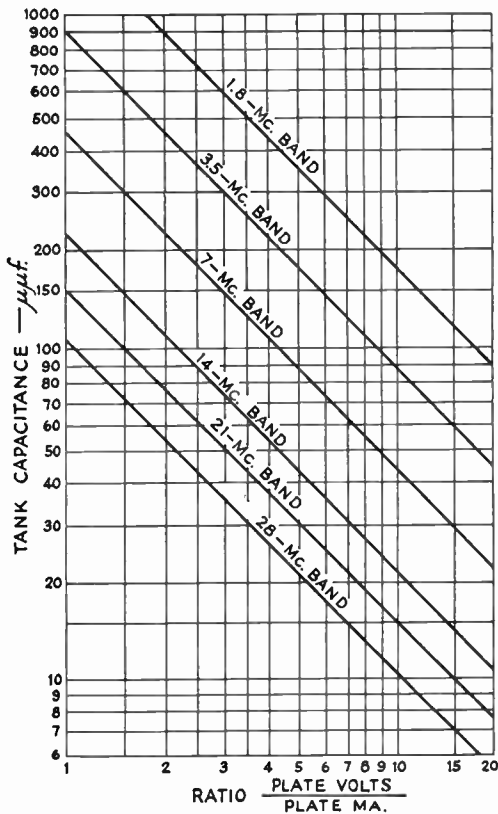

Fig. 6-9—Chart showing plate tank capacitance required for a  $Q$  of 10. Divide the tube plate voltage by the plate current in milliamperes. Select the vertical line corresponding to the answer obtained. Follow this vertical line to the diagonal line for the band in question, and thence horizontally to the left to read the capacitance. For a given ratio of plate-voltage/plate current, doubling the capacitance shown doubles the  $Q$ , etc. When a split-stator capacitor is used in a balanced circuit, the capacitance of each section may be one half of the value given by the chart.

laws and circuits) by the  $L/C$  ratio and the load resistance at which the tube is operated. The tube load resistance is related, in approximation, to the ratio of the d.c. plate voltage to d.c. plate current at which the tube is operated.

The amount of  $C$  that will give a  $Q$  of 10 for various ratios is shown in Fig. 6-9. For a given plate-voltage/plate-current ratio, the  $Q$  will vary directly as the tank capacitance, twice the capacitance doubles the  $Q$ , etc. For the same  $Q$ , the capacitance of each section of a split-stator capacitor in a balanced circuit should be half the value shown.

These values of capacitance include the output capacitance of the amplifier tube, the input capacitance of a following amplifier tube if it is coupled capacitively, and all other stray capacitances. At the higher plate-voltage/plate-current ratios, the chart may show values of capacitance,

for the higher frequencies, smaller than those attainable in practice. In such a case, a tank  $Q$  higher than 10 is unavoidable.

In low-power exciter stages, where capacitive coupling is used, very low- $Q$  circuits, tuned only by the tube and stray circuit capacitances are sometimes used for the purpose of "broadbanding" to avoid the necessity for retuning a stage across a band. Higher-order harmonics generated in such a stage can usually be attenuated in the tank circuit of the final amplifier.

## INDUCTIVE-LINK COUPLING

### Coupling to Flat Coaxial Lines

When the load  $R$  in Fig. 6-10 is located for convenience at some distance from the amplifier, or when maximum harmonic reduction is desired, it is advisable to feed the power to the load through a low-impedance coaxial cable. The shielded construction of the cable prevents radiation and makes it possible to install the line in any convenient manner without danger of unwanted coupling to other circuits.

If the line is more than a small fraction of a wavelength long, the load resistance at its output end should be adjusted, by a matching circuit if necessary, to match the impedance of the cable. This reduces losses in the cable and makes the coupling adjustments at the transmitter independent of the cable length. Matching circuits for use between the cable and another transmission line are discussed in the chapter on transmission lines, while the matching adjustments when the load is the grid circuit of a following

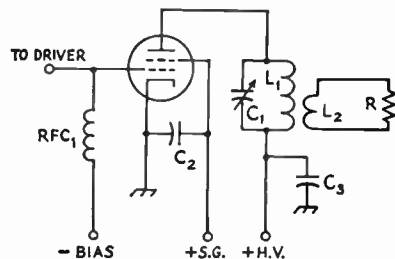

Fig. 6-10—Inductive-link output coupling circuits.  
 $C_1$ —Plate tank capacitor—see text and Fig. 6-9 for capacitance, Fig. 6-33 for voltage rating.  
 $C_2$ —Screen bypass—voltage rating depends on method of screen supply. See paragraphs on screen considerations. Voltage rating same as plate voltage will be safe under any condition.  
 $C_3$ —Plate bypass—0.001- $\mu$ f. disk ceramic or mica. Voltage rating same as  $C_1$ , plus safety factor.  
 $L_1$ —To resonate at operating frequency with  $C_1$ . See LC chart and inductance formula in electrical-laws chapter, or use ARRL Lightning Calculator.  
 $L_2$ —Reactance equal to line impedance. See reactance chart and inductance formula in electrical-laws chapter, or use ARRL Lightning Calculator.  
 $R$ —Representing load.

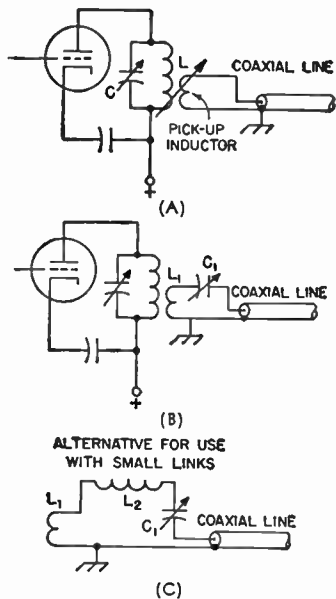

Fig. 6-11—With flat transmission lines, power transfer is obtained with looser coupling if the line input is tuned to resonance.  $C_1$  and  $L_1$  should resonate at the operating frequency. See table for maximum usable value of  $C_1$ . If circuit does not resonate with maximum  $C_1$  or less, inductance of  $L_1$  must be increased, or added in series as  $L_2$ .

amplifier are described elsewhere in this chapter.

Assuming that the cable is properly terminated, proper loading of the amplifier will be assured, using the circuit of Fig. 6-11A, if

- 1) The plate tank circuit has reasonably high value of  $Q$ . A value of 10 is usually sufficient.
- 2) The inductance of the pick-up or link coil is close to the optimum value for the frequency and type of line used. The optimum coil is one whose self-inductance is such that its reactance at the operating frequency is equal to the characteristic impedance,  $Z_0$ , of the line.
- 3) It is possible to make the coupling between the tank and pick-up coils very tight.

The second in this list is often hard to meet. Few manufactured link coils have adequate inductance even for coupling to a 50-ohm line at low frequencies.

Capacitance in pf. Required for Coupling to Flat Coaxial Lines with Tuned Coupling Circuit <sup>1</sup>		
Frequency Band	Characteristic Impedance of Line	
Mc.	ohms	ohms
3.5	450	300
7	230	150
14	115	75
21	80	50
28	60	40

<sup>1</sup> Capacitance values are maximum usable.  
 Note: Inductance in circuit must be adjusted to resonate at operating frequency.

If the line is operating with a low s.w.r., the system shown in Fig. 6-11A will require tight coupling between the two coils. Since the secondary (pick-up coil) circuit is not resonant, the leakage reactance of the pick-up coil will cause some detuning of the amplifier tank circuit. This detuning effect increases with increasing coupling, but is usually not serious. However, the amplifier tuning must be adjusted to resonance, as indicated by the plate-current dip, each time the coupling is changed.

**Tuned Coupling**

The design difficulties of using "untuned" pick-up coils, mentioned above, can be avoided by using a coupling circuit tuned to the operating frequency. This contributes additional selectivity as well, and hence aids in the suppression of spurious radiations.

If the line is flat the input impedance will be essentially resistive and equal to the  $Z_0$  of the line. With coaxial cable, a circuit of reasonable  $Q$  can be obtained with practicable values of inductance and capacitance connected in series with the line's input terminals. Suitable circuits are given in Fig. 6-11 at B and C. The  $Q$  of the coupling circuit often may be as low as 2, without running into difficulty in getting adequate coupling to a tank circuit of proper design. Larger values of  $Q$  can be used and will result in increased ease of coupling, but as the  $Q$  is increased the frequency range over which the circuit will operate without readjustment becomes smaller. It is usually good practice, therefore, to use a coupling-circuit  $Q$  just low enough to permit operation, over as much of a band as is normally used for a particular type of communication, without requiring retuning.

Capacitance values for a  $Q$  of 2 and line impedances of 52 and 75 ohms are given in the accompanying table. These are the *maximum* values that should be used. The inductance in the circuit should be adjusted to give resonance at the operating frequency. If the link coil used for a particular band does not have enough inductance to resonate, the additional inductance may be connected in series as shown in Fig. 6-11C.

**Characteristics**

In practice, the amount of inductance in the circuit should be chosen so that, with somewhat loose coupling between  $L_1$  and the amplifier tank coil, the amplifier plate current will increase when the variable capacitor,  $C_1$  is tuned through the value of capacitance given by the table. The coupling between the two coils should then be increased until the amplifier loads normally, without changing the setting of  $C_1$ . If the transmission line is flat over the entire frequency band under consideration, it should not be necessary to readjust  $C_1$  when changing frequency, if the values given in the table are used. However, it is unlikely that the line actually will be flat over such a range, so some readjustment of  $C_1$  may be needed to compensate for changes in the input impedance of the line. If the input impedance



variations are not large,  $C_1$  may be used as a loading control, no changes in the coupling between  $L_1$  and the tank coil being necessary.

The degree of coupling between  $L_1$  and the amplifier tank coil will depend on the coupling-circuit  $Q$ . With a  $Q$  of 2, the coupling should be tight—comparable with the coupling that is typical of “fixed-link” manufactured coils. With a swinging link it may be necessary to increase the  $Q$  of the coupling circuit in order to get sufficient power transfer. This can be done by increasing the  $L/C$  ratio.

**PI-SECTION OUTPUT TANK**

A pi-section tank circuit may also be used in coupling to an antenna or transmission line, as shown in Fig. 6-12. The optimum values of capacitance for  $C_1$  and  $C_2$ , and inductance for  $L_1$  are dependent upon values of tube power input and output load resistance.

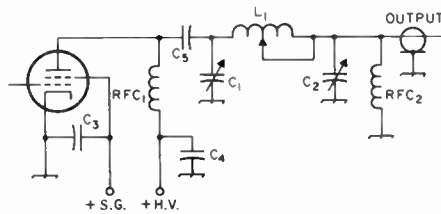

Fig. 6-12—Pi-section output tank circuit.

- $C_1$ —Input or plate tuning capacitor. See text or Fig. 6-13 for reactance. Voltage rating equal to d.c. plate voltage; twice this for plate modulation.
- $C_2$ —Output or loading capacitor. See text or Fig. 6-15 for reactance. See text for voltage rating.
- $C_3$ —Screen bypass. See Fig. 6-10.
- $C_4$ —Plate bypass. See Fig. 6-10.
- $C_5$ —Plate blocking capacitor—0.001- $\mu$ f. disk ceramic or mica. Voltage rating same as  $C_1$ .
- $L_1$ —See text or Fig. 6-14 for reactance.
- RFC<sub>1</sub>—See later paragraph on r.f. chokes.
- RFC<sub>2</sub>—2.5-mh. receiving type (to reduce peak voltage across both  $C_1$  and  $C_2$  and to blow plate power supply fuse if  $C_5$  fails).

Values of reactance for  $C_1$ ,  $L_1$  and  $C_2$  may be taken directly from the charts of Figs. 6-13, 6-14 and 6-15 if the output load resistance is the usual 52 or 72 ohms. It should be borne in mind that these values apply only where the output load is resistive, i.e., where the antenna and line have been matched.

**Output-Capacitor Ratings**

The voltage rating of the output capacitor will depend upon the s.w.r. If the load is resistive, receiving-type air capacitors should be adequate for amplifier input powers up to 1 kw. with plate modulation when feeding 52- or 72-ohm loads. In obtaining the larger capacitances re-

**PI-NETWORK DESIGN CHARTS FOR FEEDING 52- OR 72-OHM COAXIAL TRANSMISSION LINES**

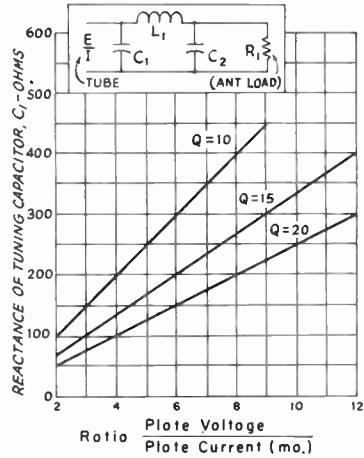

Fig. 6-13—Reactance of input capacitor,  $C_1$ , as a function the ratio of plate voltage to plate current.

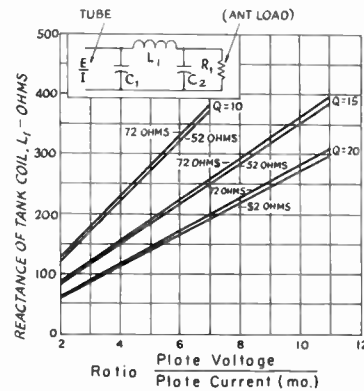

Fig. 6-14—Reactance of tank coil,  $L_1$ , as a function of plate voltage and current, for pi networks.

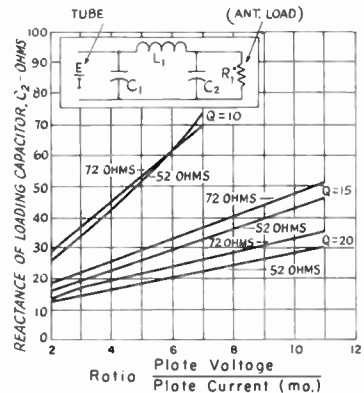
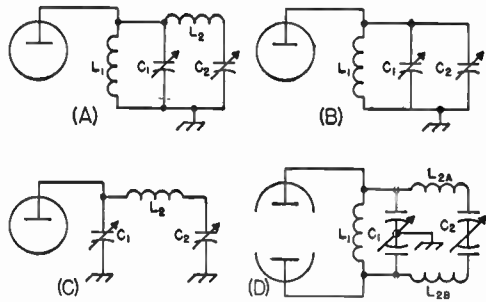

Fig. 6-15—Reactance of loading capacitor,  $C_2$ , as a function of plate voltage and current, for pi networks.

Fig. 6-16—Multiband tuner circuits. In the unbalanced circuit of A,  $C_1$  and  $C_2$  are sections of a single split-stator capacitor. In the balanced circuit of D, the two split-stator capacitors are gonged to a single control with an insulated shaft coupling between the two. In D, the two sections of  $L_2$  are wound on the same form, with the inner ends connected to  $C_2$ . In A, each section of the capacitor should have a voltage rating the same as Fig. 6-33A. In D,  $C_1$  should have a rating the same as Fig. 6-33H (or Fig. 6-33E if the feed system corresponds).  $C_2$  may have the rating of Fig. 6-33E so long as the rotor is not grounded or bypassed to ground.



quired for the lower frequencies, it is common practice to switch fixed capacitors in parallel with the variable air capacitor. While the voltage rating of a mica or ceramic capacitor may not be exceeded in a particular case, capacitors of these types are limited in current-carrying capacity. Postage-stamp silver-mica capacitors should be adequate for amplifier inputs over the range from about 70 watts at 28 Mc. to 400 watts at 14 Mc. and lower. The larger mica capacitors (CM-45 case) having voltage ratings of 1200 and 2500 volts are usually satisfactory for inputs varying from about 350 watts at 28 Mc. to 1 kw. at 14 Mc. and lower. Because of these current limitations, particularly at the higher frequencies, it is advisable to use as large an air capacitor as practicable, using the micas only at the lower frequencies. Broadcast-receiver replacement-type capacitors can be obtained very reasonably. They are available in triple units totaling about 1100 pf., or dual units totaling about 900 pf. Their insulation should be sufficient for inputs of 500 watts or more. Air capacitors have the additional advantage that they are seldom permanently damaged by a voltage break-down.

### Neutralizing with Pi Network

Screen-grid amplifiers using a pi-network output circuit may be neutralized by the system shown in Figs. 6-23 B and C.

### MULTIBAND TANK CIRCUITS

Multiband tank circuits provide a convenient means of covering several bands without the need for changing coils. Tuners of this type consist essentially of two tank circuits, tuned simultaneously with a single control. In a tuner designed to cover 80 through 10 meters, each circuit has a sufficiently large capacitance variation to assure an approximately 2-to-1 frequency range. Thus, one circuit is designed so that it covers 3.5 through 7.3 Mc., while the other covers 14 through 29.7 Mc.

## R.F. AMPLIFIER-TUBE OPERATING CONDITIONS

In addition to proper tank and output-coupling circuits discussed in the preceding sections, an r.f. amplifier must be provided with suitable electrode voltages and an r.f. driving or excitation voltage (see vacuum-tube chapter).

A single-ended, or unbalanced, circuit of this type is shown in Fig. 6-16A. In principle, the reactance of the high-frequency coil,  $L_2$ , is small enough at the lower frequencies so that it can be largely neglected, and  $C_1$  and  $C_2$  are in parallel across  $L_1$ . Then the circuit for low frequencies becomes that shown in Fig. 6-16B. At the high frequencies, the reactance of  $L_1$  is high, so that it may be considered simply as a choke shunting  $C_1$ . The high-frequency circuit is essentially that of Fig. 6-16C,  $L_2$  being tuned by  $C_1$  and  $C_2$  in series.

In practice, the effect of one circuit on the other cannot be neglected entirely.  $L_2$  tends to increase the effective capacitance of  $C_2$ , while  $L_1$  tends to decrease the effective capacitance of  $C_1$ . This effect, however, is relatively small. Each circuit must cover somewhat more than a 2-to-1 frequency range to permit staggering the two ranges sufficiently to avoid simultaneous responses to a frequency in the low-frequency range, and one of its harmonics lying in the range of the high-frequency circuit.

In any circuit covering a frequency range as great as 2 to 1 by capacitance alone, the circuit  $Q$  must vary rather widely. If the circuit is designed for a  $Q$  of 12 at 80, the  $Q$  will be 6 at 40, 24 at 20, 18 at 15, and 12 at 10 meters. The increase in tank current as a result of the increase in  $Q$  toward the low-frequency end of the high-frequency range may make it necessary to design the high-frequency coil with care to minimize loss in this portion of the tuning range. It is generally found desirable to provide separate output coupling coils for each circuit.

Fig. 6-16D shows a similar tank for balanced circuits. The same principles apply.

Series or parallel feed may be used with either balanced or unbalanced circuits. In the balanced circuit of Fig. 6-16D, the series feed point would be at the center of  $L_1$ , with an r.f. choke in series.

(For further discussion see *QST*, July, 1954.)

All r.f. amplifier tubes require a voltage to operate the filament or heater (a.c. is usually permissible), and a positive d.c. voltage between the plate and filament or cathode (plate voltage). Most tubes also require a negative d.c. voltage

(biasing voltage) between control grid (Grid No. 1) and filament or cathode. Screen-grid tubes require in addition a positive voltage (screen voltage or Grid No. 2 voltage) between screen and filament or cathode.

Biasing and plate voltages may be fed to the tube either in series with or in parallel with the associated r.f. tank circuit as discussed in the chapter on electrical laws and circuits.

It is important to remember that true plate, screen or biasing voltage is the voltage between the particular electrode and filament or cathode. Only when the cathode is directly grounded to the chassis may the electrode-to-chassis voltage be taken as the true voltage.

The required r.f. driving voltage is applied between grid and cathode.

#### Power Input and Plate Dissipation

Plate power input is the d.c. power input to the plate circuit (d.c. plate voltage  $\times$  d.c. plate current).—Screen power input likewise is the d.c. screen voltage  $\times$  the d.c. screen current.

Plate dissipation is the difference between the r.f. power delivered by the tube to its loaded plate tank circuit and the d.c. plate power input. The screen, on the other hand, does not deliver any output power, and therefore its dissipation is the same as the screen power input.

#### TRANSMITTING-TUBE RATINGS

Tube manufacturers specify the maximum values that should be applied to the tubes they produce. They also publish sets of typical operating values that should result in good efficiency and normal tube life.

Maximum values for all of the most popular transmitting tubes will be found in the tables of transmitting tubes in the last chapter. Also included are as many sets of typical operating values as space permits. However, it is recommended that the amateur secure a transmitting-tube manual from the manufacturer of the tube or tubes he plans to use.

#### CCS and ICAS Ratings

The same transmitting tube may have different ratings depending upon the manner in which the tube is to be operated, and the service in which it is to be used. These different ratings are based primarily upon the heat that the tube can safely dissipate. Some types of operation, such as with grid or screen modulation, are less efficient than others, meaning that the tube must dissipate more heat. Other types of operation, such as c.w. or single-sideband phone are intermittent in nature, resulting in less average heating than in other modes where there is a continuous power input to the tube during transmissions. There are also different ratings for tubes used in transmitters that are in almost constant use (CCS—Continuous Commercial Service), and for tubes that are to be used in transmitters that average only a few hours of daily operation (ICAS—Intermittent Commercial and Amateur Service). The latter are the ratings used by amateurs who

wish to obtain maximum output with reasonable tube life.

#### Maximum Ratings

Maximum ratings, where they differ from the values given under typical operating values, are not normally of significance to the amateur except in special applications. No single maximum value should be used unless all other ratings can simultaneously be held within the maximum values. As an example, a tube may have a maximum plate-voltage rating of 2000, a maximum plate-current rating of 300 ma., and a maximum plate-power-input rating of 400 watts. Therefore, if the maximum plate voltage of 2000 is used, the plate current should be limited to 200 ma. (instead of 300 ma.) to stay within the maximum power-input rating of 400 watts.

#### SOURCES OF ELECTRODE VOLTAGES

##### Filament or Heater Voltage

The heater voltage for the indirectly heated cathode-type tubes found in low-power classifications may vary 10 per cent above or below rating without seriously reducing the life of the tube. But the voltage of the higher-power filament-type tubes should be held closely between the rated voltage as a minimum and 5 per cent above rating as a maximum. Make sure that the plate power drawn from the power line does not cause a drop in filament voltage below the proper value when plate power is applied.

Thoriated-type filaments lose emission when the tube is overloaded appreciably. If the overload has not been too prolonged, emission sometimes may be restored by operating the filament at rated voltage with all other voltages removed for a period of 10 minutes, or at 20 per cent above rated voltage for a few minutes.

##### Plate Voltage

D.c. plate voltage for the operation of r.f. amplifiers is most often obtained from a transformer-rectifier-filter system (see power-supply chapter) designed to deliver the required plate voltage at the required current. However, batteries or other d.c.-generating devices are sometimes used in certain types of operation (see portable-mobile chapter).

##### Bias and Tube Protection

Several methods of obtaining bias are shown in Fig. 6-17. In A, bias is obtained by the voltage drop across a resistor in the grid d.c. return circuit when rectified grid current flows. The proper value of resistance may be determined by dividing the required biasing voltage by the d.c. grid current at which the tube will be operated. Then, so long as the r.f. driving voltage is adjusted so that the d.c. grid current is the recommended value, the biasing voltage will be the proper value. The tube is biased only when excitation is applied, since the voltage drop across the resistor depends upon grid-current flow. When excitation is removed, the bias falls to

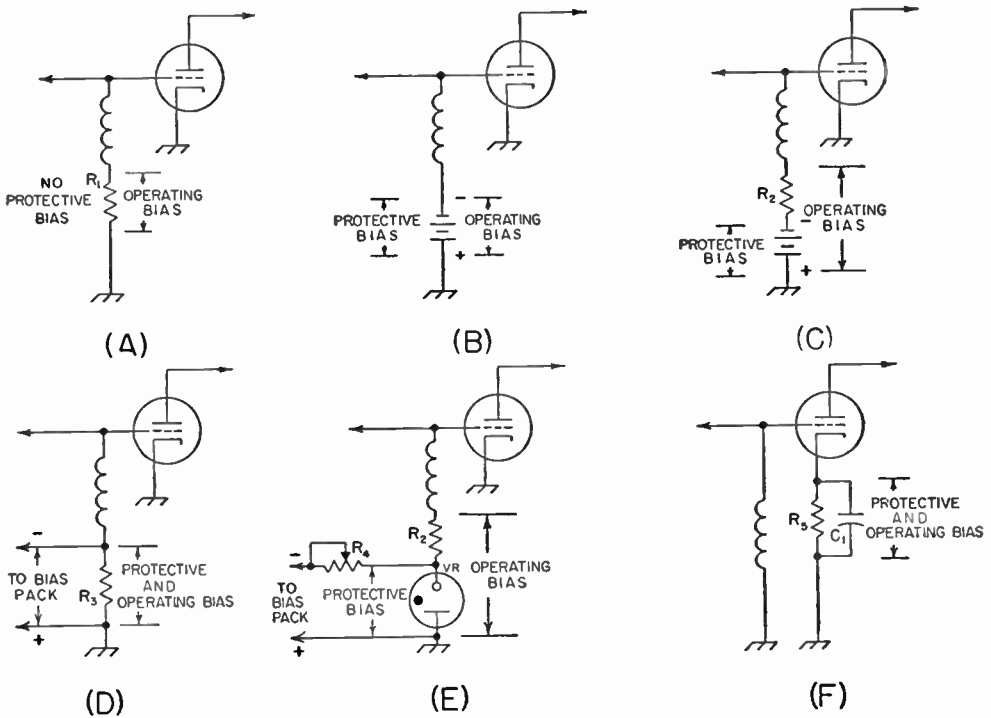

Fig. 6-17—Various systems for obtaining protective and operating bias for r.f. amplifiers. A—Grid-leak. B—Battery. C—Combination battery and grid leak. D—Grid leak and adjusted-voltage bias pack. E—Combination grid leak and voltage-regulated pack. F—Cathode bias.

zero. At zero bias most tubes draw power far in excess of the plate-dissipation rating. So it is advisable to make provision for protecting the tube when excitation fails by accident, or by intent as it does when a preceding stage in a c.w. transmitter is keyed.

If the maximum c.w. ratings shown in the tube tables are to be used, the input should be cut to zero when the key is open. Aside from this, it is not necessary that plate current be cut off completely but only to the point where the rated dissipation is not exceeded. In this case plate-modulated phone ratings should be used for c.w. operation, however.

With triodes this protection can be supplied by obtaining all bias from a source of fixed voltage, as shown in Fig. 6-17B. It is preferable, however, to use only sufficient fixed bias to protect the tube and obtain the balance needed for operating bias from a grid leak, as in C. The grid-leak resistance is calculated as above, except that the fixed voltage is subtracted first.

Fixed bias may be obtained from dry batteries or from a power pack (see power-supply chapter). If dry batteries are used, they should be checked periodically, since even though they may show normal voltage, they eventually develop a high internal resistance. Grid-current flow through this battery resistance may increase the bias considerably above that anticipated. The life of batteries in bias service will be approximately the same as though they were subject to a drain equal to the grid current, despite the fact that the

grid-current flow is in such a direction as to charge the battery, rather than to discharge it.

In Fig. 6-17F, bias is obtained from the voltage drop across a resistor in the cathode (or filament center-tap) lead. Protective bias is obtained by the voltage drop across  $R_5$  as a result of plate (and screen) current flow. Since plate current must flow to obtain a voltage drop across the resistor, it is obvious that cut-off protective bias cannot be obtained. When excitation is applied, plate (and screen) current increases and the grid current also contributes to the drop across  $R_5$ , thereby increasing the bias to the operating value. Since the voltage between plate and cathode is reduced by the amount of the voltage drop across  $R_5$ , the over-all supply voltage must be the sum of the plate and operating-bias voltages. For this reason, the use of cathode bias usually is limited to low-voltage tubes when the extra voltage is not difficult to obtain.

The resistance of the cathode biasing resistor  $R_5$  should be adjusted to the value which will give the correct operating bias voltage with rated grid, plate and screen currents flowing with the amplifier loaded to rated input. When excitation is removed, the input to most types of tubes will fall to a value that will prevent damage to the tube, at least for the period of time required to remove plate voltage. A disadvantage of this biasing system is that the cathode r.f. connection to ground depends upon a bypass capacitor. From the consideration of v.h.f. harmonics and stability with high-perveance tubes, it is preferable



to make the cathode-to-ground impedance as close to zero as possible.

### Screen Voltage

For c.w. operation, and under certain conditions of phone operation (see amplitude-modulation chapter), the screen may be operated from a power supply of the same type used for plate supply, except that voltage and current ratings should be appropriate for screen requirements. The screen may also be operated through a series resistor or voltage-divider from a source of higher voltage, such as the plate-voltage supply, thus making a separate supply for the screen unnecessary. Certain precautions are necessary, depending upon the method used.

It should be kept in mind that screen current varies widely with both excitation and loading. If the screen is operated from a fixed-voltage source, the tube should never be operated without plate voltage and load, otherwise the screen may be damaged within a short time. Supplying the screen through a series dropping resistor from a higher-voltage source, such as the plate supply, affords a measure of protection, since the resistor causes the screen voltage to drop as the current increases, thereby limiting the power drawn by the screen. However, with a resistor, the screen voltage may vary considerably with excitation, making it necessary to check the voltage at the screen terminal under actual operating conditions to make sure that the screen voltage is normal. Reducing excitation will cause the screen current to drop, increasing the voltage; increasing excitation will have the opposite effect. These changes are in addition to those caused by changes in bias and plate loading, so if a screen-grid tube is operated from a series resistor or a voltage divider, its voltage should be checked as one of the final adjustments after excitation and loading have been set.

An approximate value for the screen-voltage dropping resistor may be obtained by dividing the voltage *drop* required from the supply voltage (difference between the supply voltage and rated screen voltage) by the rated screen current in decimal parts of an ampere. Some further adjustment may be necessary, as mentioned above, so an adjustable resistor with a total resistance above that calculated should be provided.

### Protecting Screen-Grid Tubes

Screen-grid tubes cannot be cut off with bias unless the screen is operated from a fixed-voltage supply. In this case the cut-off bias is approximately the screen voltage divided by the amplification factor of the screen. This figure is not always shown in tube-data sheets, but cut-off voltage may be determined from an inspection of tube curves, or by experiment.

When the screen is supplied from a series dropping resistor, the tube can be protected by the use of a clamper tube, as shown in Fig. 6-18. The grid-leak bias of the amplifier tube with excitation is supplied also to the grid of the clamper tube. This is usually sufficient to cut off

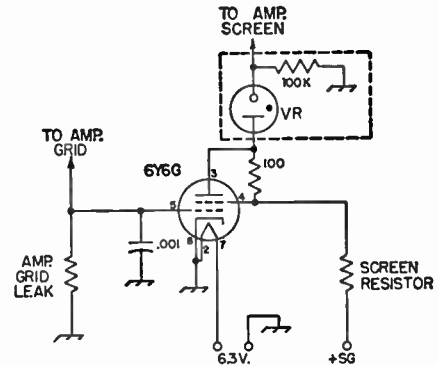

Fig. 6-18—Screen clamper circuit for protecting screen-grid power tubes. The VR tube is needed only for complete screen-voltage cut-off.

the clamper tube. However, when excitation is removed, the clamper-tube bias falls to zero and it draws enough current through the screen dropping resistor usually to limit the input to the amplifier to a safe value. If complete screen-voltage cut-off is desired, a VR tube may be inserted in the screen lead as shown. The VR-tube voltage rating should be high enough so that it will extinguish when excitation is removed.

### FEEDING EXCITATION TO THE GRID

The required r.f. driving voltage is supplied by an oscillator generating a voltage at the desired frequency, either directly or through intermediate amplifiers or frequency multipliers.

As explained in the chapter on vacuum-tube fundamentals, the grid of an amplifier operating under Class C conditions must have an exciting voltage whose peak value exceeds the negative biasing voltage over a portion of the excitation cycle. During this portion of the cycle, current will flow in the grid-cathode circuit as it does in a diode circuit when the plate of the diode is positive in respect to the cathode. This requires that the r.f. driver supply power. The power required to develop the required peak driving voltage across the grid-cathode impedance of the amplifier is the r.f. driving power.

The tube tables give approximate figures for the grid driving power required for each tube under various operating conditions. These figures, however, do not include circuit losses. In general, the driver stage for any Class C amplifier should be capable of supplying at least three times the driving power shown for typical operating conditions at frequencies up to 30 Mc., and from three to ten times at higher frequencies.

Since the d.c. grid current relative to the biasing voltage is related to the peak driving voltage, the d.c. grid current is commonly used as a convenient indicator of driving conditions. A driver adjustment that results in rated d.c. grid current when the d.c. bias is at its rated value, indicates proper excitation to the amplifier when it is fully loaded.

In coupling the grid input circuit of an amplifier to the output circuit of a driving stage the



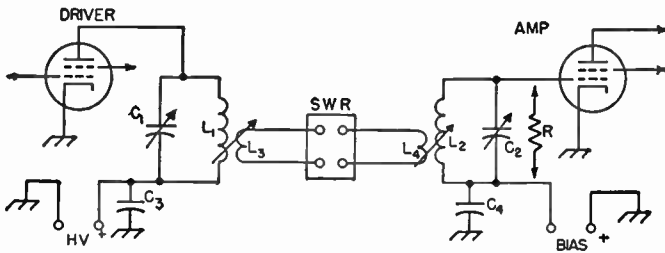

Fig. 6-19—Coupling excitation to the grid of an r.f. power amplifier by means of a low-impedance coaxial line.

C<sub>1</sub>, C<sub>2</sub>, L<sub>1</sub>, L<sub>3</sub>—See corresponding components in Fig. 6-10.

C<sub>2</sub>—Amplifier grid tank capacitor—see text and Fig. 6-20 for capacitance, Fig. 6-34 for voltage rating.

C<sub>4</sub>—0.001- $\mu$ f. disk ceramic.

L<sub>2</sub>—To resonate at operating frequency with C<sub>2</sub>. See LC chart inductance formula in electrical-laws chapter, or use ARRL *Lightning Calculator*.

L<sub>4</sub>—Reactance equal to line impedance—see reactance chart and inductance formula in electrical-laws chapter, or use ARRL *Lightning Calculator*.

R is used to simulate grid impedance of the amplifier when a low-power s.w.r. indicator, such as a resistance bridge, is used. See formula in text for calculating value. Standing-wave indicator SWR is inserted only while line is made flat.

objective is to load the driver plate circuit so that the desired amplifier grid excitation is obtained without exceeding the plate-input ratings of the driver tube.

**Driving Impedance**

The grid-current flow that results when the grid is driven positive in respect to the cathode over a portion of the excitation cycle represents an average resistance across which the exciting voltage must be developed by the driver. In other words, this is the load resistance into which the driver plate circuit must be coupled. The approximate grid input resistance is given by :

$$\text{Input impedance (ohms)} = \frac{\text{driving power (watts)}}{\text{d.c. grid current (ma.)}^2} \times 620,000$$

For normal operation, the driving power and grid current may be taken from the tube tables.

Since the grid input resistance is a matter of a few thousand ohms, an impedance step-down is necessary if the grid is to be fed from a low-impedance transmission line. This can be done by the use of a tank as an impedance-transforming device in the grid circuit of the amplifier as shown in Fig. 6-19. This coupling system may be considered either as simply a means of obtaining mutual inductance between the two tank coils, or as a low-impedance transmission line. If the line is longer than a small fraction of a wave length, and if a s.w.r. bridge is available, the line is more easily handled by adjusting it as a matched transmission line.

**Inductive Link Coupling with Flat Line**

In adjusting this type of line, the object is to make the s.w.r. on the line as low as possible over as wide a band of frequencies as possible so that power can be transferred over this range without retuning. It is assumed that the output coupling considerations discussed earlier have been observed in connection with the driver plate

circuit. So far as the amplifier grid circuit is concerned, the controlling factors are: the Q of the tuned grid circuit, L<sub>2</sub>C<sub>2</sub>, (see Fig. 6-20) the inductance of the coupling coil, L<sub>4</sub>, and the degree of coupling between the coils is convenient, but not strictly necessary if one or both of the other factors can be varied. An s.w.r. indicator (shown as "SWR" in the drawing) is essential. An indi-

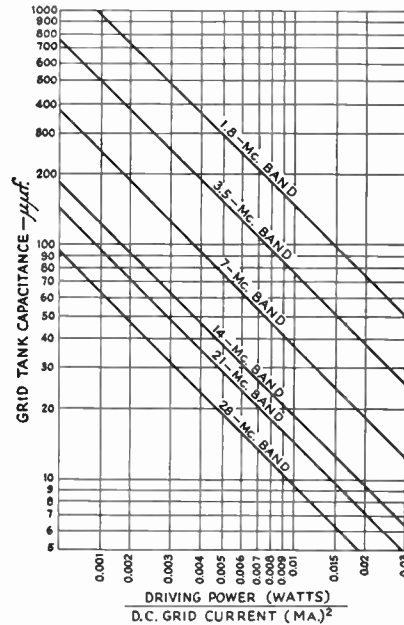

Fig. 6-20—Chart showing required grid tank capacitance for a Q of 12. To use, divide the driving power in watts by the square of the d.c. grid current in milliamperes and proceed as described under Fig-6-9. Driving power and grid current may be taken from the tube tables. When a split-stator capacitor is used in a balanced grid circuit, the capacitance of each section may be half that shown.

cator such as the "Micromatch" (a commercially available instrument) may be connected as shown and the adjustments made under actual operating conditions; that is, with full power applied to the amplifier grid.

Assuming that the coupling is adjustable, start with a trial position of  $L_4$  with respect to  $L_2$ , and adjust  $C_2$  for the lowest s.w.r. Then change the coupling slightly and repeat. Continue until the s.w.r. is as low as possible; if the circuit constants are in the right region it should not be difficult to get the s.w.r. down to 1 to 1. The  $Q$  of the tuned grid circuit should be designed to be at least 10, and if it is not possible to get a very low s.w.r. with such a grid circuit the probable reason is that  $L_4$  is too small. Maximum coupling, for a given degree of physical coupling will occur when the inductance of  $L_4$  is such that its reactance at the operating frequency is equal to the characteristic impedance of the link line. The reactance can be calculated as described in the chapter on electrical fundamentals if the inductance is known; the inductance can either be calculated from the formula in the same chapter or measured as described in the chapter on measurements.

Once the s.w.r. has been brought down to 1 to 1, the frequency should be shifted over the band so that the variation in s.w.r. can be observed, without changing  $C_2$  or the coupling between  $L_2$  and  $L_4$ . If the s.w.r. rises rapidly on either side of the original frequency the circuit can be made "flatter" by reducing the  $Q$  of the tuned grid circuit. This may be done by decreasing  $C_2$  and correspondingly increasing  $L_2$  to maintain resonance, and by tightening the coupling between  $L_2$  and  $L_4$ , going through the same adjustment process again. It is possible to set up the system so that the s.w.r. will not exceed 1.5 to 1 over, for example, the entire 7-Mc. band and proportionately on other bands. Under these circumstances a single setting will serve for work anywhere in the band, with essentially constant power transfer from the line to the power-amplifier grids.

If the coupling between  $L_2$  and  $L_4$  is not adjustable the same result may be secured by varying the  $L/C$  ratio of the tuned grid circuit—that is, by varying its  $Q$ . If any difficulty is encountered it can be overcome by changing the number of turns in  $L_4$  until a match is secured. The two coils should be tightly coupled.

When a resistance-bridge type s.w.r. indicator (see measurements chapter) is used it is not possible to put the full power through the line when making adjustments. In such case the operating conditions in the amplified grid circuit can be simulated by using a carbon resistor ( $\frac{1}{2}$  or 1 watt size) of the same value as the calculated amplifier grid impedance, connected as indicated by the arrows in Fig. 6-19. In this case the amplifier tube *must* be operated "cold"—without filament or heater power. The adjustment process is the same as described above, but with the driver power reduced to a value suitable for operating the s.w.r. bridge.

When the grid coupling system has been ad-

justed so that the s.w.r. is close to 1 to 1 over the desired frequency range, it is certain that the power put into the link line will be delivered to the grid circuit. Coupling will be facilitated if the line is tuned as described under the earlier section on output coupling systems.

#### Link Feed with Unmatched Line

When the system is to be treated without regard to transmission-line effects, the link line must not offer appreciable reactance at the operating frequency. Any appreciable reactance will in effect reduce the coupling, making it impossible to transfer sufficient power from the driver to the amplifier grid circuit. Coaxial cables especially have considerable capacitance for even short lengths and it may be more desirable to use a spaced line, such as Twin-Lead, if the radiation can be tolerated.

The reactance of the line can be nullified only by making the link resonant. This may require changing the number of turns in the link coils, the length of the line, or the insertion of a tuning capacitance. Since the s.w.r. on the link line may be quite high, the line losses increase because of the greater current, the voltage increase may be sufficient to cause a breakdown in the insulation of the cable and the added tuned circuit makes adjustment more critical with relatively small changes in frequency.

These troubles may not be encountered if the link line is kept very short for the highest frequency. A length of 5 feet or more may be tolerable at 3.5 Mc., but a length of a foot at 28 Mc. may be enough to cause serious effects on the functioning of the system.

Adjusting the coupling in such a system must necessarily be largely a matter of cut and try. If the line is short enough so as to have negligible reactance, the coupling between the two tank circuits will increase within limits by adding turns to the link coils, or by coupling the link coils more tightly, if possible, to the tank coils. If it is impossible to change either of these, a variable capacitor of 300  $\mu\text{mf.}$  may be connected in series with or in parallel with the link coil at the driver end of the line, depending upon which connection is the most effective.

If coaxial line is used, the capacitor should be connected in series with the inner conductor. If the line is long enough to have appreciable reactance, the variable capacitor is used to resonate the entire link circuit.

The size of the link coils and the length of the line, as well as the size of the capacitor, will affect the resonant frequency, and it may take an adjustment of all three before the capacitor will show a pronounced effect on the coupling.

When the system has been made resonant, coupling may be adjusted by varying the link capacitor.

#### Simple Capacitive Interstage Coupling

The capacitive system of Fig. 6-21A is the simplest of all coupling systems. In this circuit, the plate tank circuit of the driver,  $C_1L_1$ , serves

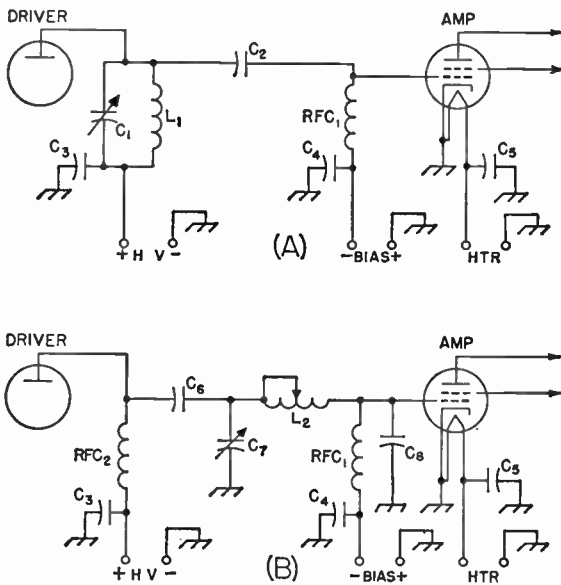

Fig. 6-21—Capacitive-coupled amplifiers. A—Simple capacitive coupling. B—Pi-section coupling.

- C<sub>1</sub>—Driver plate tank capacitor—see text and Fig. 6-9 for capacitance, Fig. 6-33 for voltage rating.
- C<sub>2</sub>—Coupling capacitor—50 to 150 pf. mica, as necessary for desired coupling. Voltage rating sum of driver plate and amplifier biasing voltages, plus safety factor.
- C<sub>3</sub>—Driver plate bypass capacitor—0.001- $\mu$ f. disk ceramic or mica. Voltage rating same as plate voltage.
- C<sub>4</sub>—Grid bypass—0.001- $\mu$ f. disk ceramic.
- C<sub>5</sub>—Heater bypass—0.001- $\mu$ f. disk ceramic.
- C<sub>6</sub>—Driver plate blocking capacitor—0.001- $\mu$ f. disk ceramic or mica. Voltage rating same as C<sub>3</sub>.
- C<sub>7</sub>—Pi-section input capacitor—see text referring to Fig. 6-12 for capacitance. Voltage rating—see Fig. 6-33A.
- C<sub>8</sub>—Pi-section output capacitor—100-pf. mica. Voltage rating same as driver plate voltage plus safety factor.
- L<sub>1</sub>—To resonate at operating frequency with C<sub>1</sub>. See LC chart and inductance formula in electrical-laws chapter, or use ARRL Lightning Calculator.
- L<sub>2</sub>—Pi-section inductor—See Fig. 6-12. Approx. same as L<sub>1</sub>.
- RFC<sub>1</sub>—Grid r.f. choke—2.5-mh.
- RFC<sub>2</sub>—Driver plate r.f. choke—2.5 mh.

also as the grid tank of the amplifier. Although it is used more frequently than any other system, it is less flexible and has certain limitations that must be taken into consideration.

The two stages cannot be separated physically any appreciable distance without involving loss in transferred power, radiation from the coupling lead and the danger of feedback from this lead. Since both the output capacitance of the driver tube and the input capacitance of the amplifier are across the single circuit, it is sometimes difficult to obtain a tank circuit with a sufficiently low  $Q$  to provide an efficient circuit at the higher frequencies. The coupling can be varied by altering the capacitance of the coupling capacitor, C<sub>2</sub>. The driver load impedance is the sum of the amplifier grid resistance and the reactance of the coupling capacitor in series, the coupling capacitor serving simply as a series reactor. The driver load resistance increases with a decrease in the capacitance of the coupling capacitor.

When the amplifier grid impedance is lower than the optimum load resistance for the driver, a transforming action is possible by tapping the grid down on the tank coil, but this is not recom-

mended because it invariably causes an increase in v.h.f. harmonics and sometimes sets up a parasitic circuit.

So far as coupling is concerned, the  $Q$  of the circuit is of little significance. However, the other considerations discussed earlier in connection with tank-circuit  $Q$  should be observed.

### Pi-Network Interstage Coupling

A pi-section tank circuit, as shown in Fig. 6-21B, may be used as a coupling device between screen-grid amplifier stages. The circuit can also be considered a coupling arrangement with the grid of the amplifier tapped down on the circuit by means of a capacitive divider. In contrast to the tapped-coil method mentioned previously, this system will be very effective in reducing v.h.f. harmonics, because the output capacitor, C<sub>8</sub>, provides a direct capacitive shunt for harmonics across the amplifier grid circuit.

To be most effective in reducing v.h.f. harmonics, C<sub>8</sub> should be a mica capacitor connected directly across the tube-socket terminals. Tapping down on the circuit in this manner also helps to stabilize the amplifier at the operating frequency because of the grid-circuit loading

provided by  $C_8$ . For the purposes both of stability and harmonic reduction, experience has shown that a value of 100 pf. for  $C_8$  usually is sufficient. In general,  $C_7$  and  $L_2$  should have values approximating the capacitance and inductance used in a conventional tank circuit. A reduction in the inductance of  $L_2$  results in an increase in coupling because  $C_7$  must be increased to retune the circuit to resonance. This changes the ratio of  $C_7$  to  $C_8$  and has the effect of

moving the grid tap up on the circuit. Since the coupling to the grid is comparatively loose under any condition, it may be found that it is impossible to utilize the full power capability of the driver stage. If sufficient excitation cannot be obtained, it may be necessary to raise the plate voltage of the driver, if this is permissible. Otherwise a larger driver tube may be required. As shown in Fig. 6-21B, parallel driver plate feed and amplifier grid feed are necessary.

## R.F. POWER AMPLIFIER CIRCUITRY

### STABILIZING AMPLIFIERS

A straight amplifier operates with its input and output circuits tuned to the same frequency. Therefore, unless the coupling between these two circuits is brought to the necessary minimum, the amplifier will oscillate as a tuned-plate tuned-grid circuit. Care should be used in arranging components and wiring of the two circuits so that there will be negligible opportunity for coupling external to the tube itself. Complete shielding between input and output circuits usually is required. All r.f. leads should be kept as short as possible and particular attention should be paid to the r.f. return paths from plate and grid tank circuits to cathode. In general, the best arrangement is one in which the cathode connection to ground, and the plate tank circuit are on the same side of the chassis or other shielding. The "hot" lead from the grid tank (or driver plate tank) should be brought to the socket through a hole in the shielding. Then when the grid tank capacitor or bypass is grounded, a return path through the hole to cathode will be encouraged, since transmission-line characteristics are simulated.

A check on external coupling between input and output circuits can be made with a sensitive indicating device, such as the one diagrammed in Fig. 6-22. The amplifier tube is removed from its socket and if the plate terminal is at the

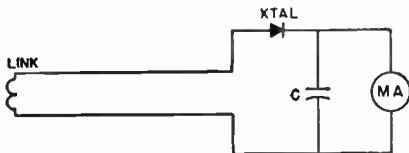

Fig. 6-22—Circuit of sensitive neutralizing indicator. *Xtal* is a 1N34 crystal detector, *MA* a 0-1 direct-current milliammeter and *C* a 0.001- $\mu$ f. mica bypass capacitor.

socket, it should be disconnected. With the driver stage running and tuned to resonance, the indicator should be coupled to the output tank coil and the output tank capacitor tuned for any indication of r.f. feedthrough. Experiment with shielding and rearrangement of parts will show whether the isolation can be improved.

### Screen-Grid Tube Neutralizing Circuits

The plate-grid capacitance of screen-grid tubes is reduced to a fraction of a micromicrofarad by

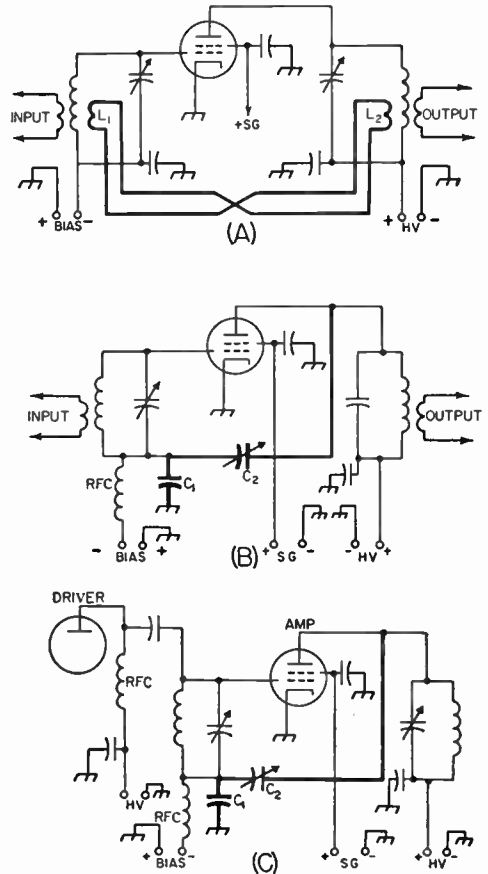

Fig. 6-23—Screen-grid neutralizing circuits. A—Inductive neutralizing. B—C—Capacitive neutralizing.

$C_1$ —Grid bypass capacitor—approx. 0.001- $\mu$ f. mica. Voltage rating same as biasing voltage in B, same as driver plate voltage in C.

$C_2$ —Neutralizing capacitor—approx. 2 to 10  $\mu$ mf.—see text. Voltage rating same as amplifier plate voltage for c.w., twice this value for plate modulation.

$L_1, L_2$ —Neutralizing link—usually a turn or two will be sufficient.

the interposed grounded screen. Nevertheless, the power sensitivity of these tubes is so great that only a very small amount of feedback is necessary to start oscillation. To assure a stable amplifier, it is usually necessary to load the grid circuit, or to use a neutralizing circuit.

Fig. 6-23A shows how a screen-grid amplifier may be neutralized by the use of an inductive link line coupling the input and output tank circuits in proper phase. If the initial connection proves to be incorrect, connections to one of the link coils should be reversed. Neutralizing is adjusted by changing the distance between the link coils and the tank coils.

A capacitive neutralizing system for screen-grid tubes is shown in Fig. 6-23B.  $C_2$  is the neutralizing capacitor. The capacitance should be chosen so that at some adjustment of  $C_2$ ,

$$\frac{C_2}{C_1} = \frac{\text{Tube grid-plate capacitance (or } C_{gp})}{\text{Tube input capacitance (or } C_{in})}$$

The grid-cathode capacitance must include all strays directly across the tube capacitance, including the capacitance of the tuning-capacitor stator to ground. This may amount to 5 to 20  $\mu\text{f}$ . In the case of capacitance coupling, as shown in Fig. 6-23C, the output capacitance of the driver tube must be added to the grid-cathode capacitance of the amplifier in arriving at the value of  $C_2$ .

### Neutralizing a Screen-Grid Amplifier Stage

There are two general procedures available for indicating neutralization in a screen-grid amplifier stage. If the screen-grid tube is operated with or without grid current, a sensitive output indicator can be used. If the screen-grid tube is operated with grid current, the grid-current reading can be used as an indication of neutralization. When the output indicator is used, both screen and plate voltages must be removed from the tubes, but the d.c. circuits from plate and screen to cathode must be completed. If the grid-current reading is used, the plate voltage may remain on but the screen voltage must be zero, with the d.c. circuit completed between screen and cathode.

The immediate objective of the neutralizing process is reducing to a minimum the r.f. driver voltage fed from the input of the amplifier to its output circuit through the grid-plate capacitance of the tube. This is done by adjusting carefully, bit by bit, the neutralizing capacitor or link coils until an r.f. indicator in the output circuit reads minimum, or the reaction of the unloaded plate-circuit tuning on the grid-current value is minimized.

The device shown in Fig. 6-22 makes a sensitive neutralizing indicator. The link should be coupled to the output tank coil at the low-potential or "ground" point. Care should be taken to make sure that the coupling is loose enough at all times to prevent burning out the meter or the rectifier. The plate tank capacitor should be re-adjusted for maximum reading after each change in neutralizing.

When the grid-current meter is used as a neutralizing indicator, the screen should be grounded for r.f. and d.c., as mentioned above. There will be a change in grid current as the unloaded plate tank circuit is tuned through resonance. The neutralizing capacitor (or inductor) should be adjusted until this deflection is brought to a minimum. As a final adjustment, screen voltage should be returned and the neutralizing adjustment continued to the point where minimum plate current, maximum grid current and maximum screen current occur simultaneously. An increase in grid current when the plate tank circuit is tuned slightly on the high-frequency side of resonance indicates that the neutralizing capacitance is too small. If the increase is on the low-frequency side, the neutralizing capacitance is too large. When neutralization is complete, there should be a slight decrease in grid current on either side of resonance.

### Grid Loading

The use of a neutralizing circuit may often be avoided by loading the grid circuit if the driving stage has some power capability to spare. Loading by tapping the grid down on the grid tank coil (or the plate tank coil of the driver in the case of capacitive coupling), or by a resistor from grid to cathode is effective in stabilizing an amplifier, but either device may increase v.h.f. harmonics. The best loading system is the use of a pi-section filter, as shown in Fig. 6-21B. This circuit places a capacitance directly between grid and cathode. This not only provides the desirable loading, but also a very effective capacitive short for v.h.f. harmonics. A 100-pf. mica capacitor for  $C_8$ , wired directly between tube terminals, will usually provide sufficient loading to stabilize the amplifier.

### V.H.F. Parasitic Oscillation

Parasitic oscillation in the v.h.f. range will take place in almost every r.f. power amplifier. To test for v.h.f. parasitic oscillation, the grid tank coil (or driver tank coil in the case of ca-

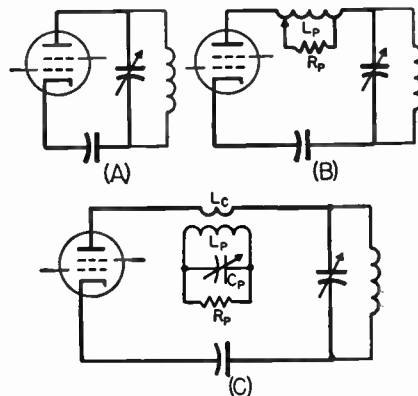

Fig. 6-24—A—Usual parasitic circuit. B—Resistive loading of parasitic circuit. C—Inductive coupling of loading resistance into parasitic circuit.



capacitive coupling) should be short-circuited with a clip lead. This is to prevent any possible t.g.t.p. oscillation at the operating frequency which might lead to confusion in identifying the parasitic. Any fixed bias should be replaced with a grid leak of 10,000 to 20,000 ohms. All load on the output of the amplifier should be disconnected. Plate and screen voltages should be reduced to the point where the rated dissipation is not exceeded. If a Variac is not available, voltage may be reduced by a 115-volt lamp in series with the primary of the plate transformer.

With power applied only to the amplifier under test, a search should be made by adjusting the input capacitor to several settings, including minimum and maximum, and turning the plate capacitor through its range for each of the grid-capacitor settings. Any grid current, or any dip or flicker in plate current at any point, indicates oscillation. This can be confirmed by an indicating absorption wavemeter tuned to the frequency of the parasitic and held close to the plate lead of the tube.

The heavy lines of Fig. 6-24A show the usual parasitic tank circuit, which resonates, in most cases, between 150 and 200 Mc. For each type of tetrode, there is a region, usually below the parasitic frequency, in which the tube will be self-neutralized. By adding the right amount of inductance to the parasitic circuit, its resonant frequency can be brought down to the frequency at which the tube is self-neutralized. However, the resonant frequency should not be brought down so low that it falls close to TV Channel 6 (88 Mc.). From the consideration of TVI, the circuit may be loaded down to a frequency not lower than 100 Mc. If the self-neutralizing frequency is below 100 Mc., the circuit should be loaded down to somewhere between 100 and 120 Mc. with inductance. Then the parasitic can be suppressed by loading with resistance, as shown in Fig. 6-24B. A coil of 4 or 5 turns,  $\frac{1}{4}$  inch in diameter, is a good starting size. With the tank capacitor turned to maximum capacitance, the circuit should be checked with a g.d.o. to make sure the resonance is above 100 Mc. Then, with the shortest possible leads, a noninductive 100-ohm 1-watt resistor should be connected across the entire coil. The amplifier should be tuned up to its highest-frequency band and operated at low voltage. The tap should be moved a little at a time to find the minimum number of turns required to suppress the parasitic. Then voltage should be increased until the resistor begins to feel warm after several minutes of operation, and the power input noted. This input should be compared with the normal input and the power rating of the resistor increased by this proportion; i.e., if the power is half normal, the wattage rating should be doubled. This increase is best made by connecting 1-watt carbon resistors in parallel to give a resultant of about 100 ohms. As power input is increased, the parasitic may start up again, so power should be applied only momentarily until it is made certain that the parasitic is still suppressed. If the parasitic starts

up again when voltage is raised, the tap must be moved to include more turns. So long as the parasitic is suppressed, the resistors will heat up only from the operating-frequency current.

Since the resistor can be placed across only that portion of the parasitic circuit represented by  $L_p$ , the latter should form as large a portion of the circuit as possible. Therefore, the tank and bypass capacitors should have the lowest possible inductance and the leads shown in heavy lines should be as short as possible and of the heaviest practical conductor. This will permit  $L_p$  to be of maximum size without tuning the circuit below the 100-Mc. limit.

Another arrangement that has been used successfully is shown in Fig. 6-24C. A small turn or two is inserted in place of  $L_p$  and this is coupled to a circuit tuned to the parasitic frequency and loaded with resistance. The heavy-line circuit should first be checked with a g.d.o. Then the loaded circuit should be tuned to the same frequency and coupled in to the point where the parasitic ceases. The two coils can be wound on the same form and the coupling varied by sliding one of them. Slight retuning of the loaded circuit may be required after coupling. Start out with low power as before, until the parasitic is suppressed. Since the loaded circuit in this case carries much less operating-frequency current, a single 100-ohm 1-watt resistor will often be sufficient and a 30-pf. mica trimmer should serve as the tuning capacitor,  $C_p$ .

#### Low-Frequency Parasitic Oscillation

The screening of most transmitting screen-grid tubes is sufficient to prevent low-frequency parasitic oscillation caused by resonant circuits set up by r.f. chokes in grid and plate circuits. Should this type of oscillation (usually between 200 and 1200 kc.) occur, see paragraph under triode amplifiers.

#### PARALLEL AND PUSH-PULL AMPLIFIERS

The circuits for parallel-tube amplifiers are the same as for a single tube, similar terminals of the tubes being connected together. The grid impedance of two tubes in parallel is half that of a single tube. This means that twice the grid tank capacitance shown in Fig. 6-20 should be used for the same  $Q$ .

The plate load resistance is halved so that the plate tank capacitance for a single tube (Fig. 6-10) also should be doubled. The total grid current will be doubled, so to maintain the same grid bias, the grid-leak resistance should be half that used for a single tube. The required driving power is doubled. The capacitance of a neutralizing capacitor, if used, should be doubled and the value of the screen dropping resistor should be cut in half.

In treating parasitic oscillation, it is often necessary to use a choke in each plate lead, rather than one in the common lead to avoid building in a push-pull type of v.h.f. circuit, a factor in obtaining efficient operation at higher frequencies.

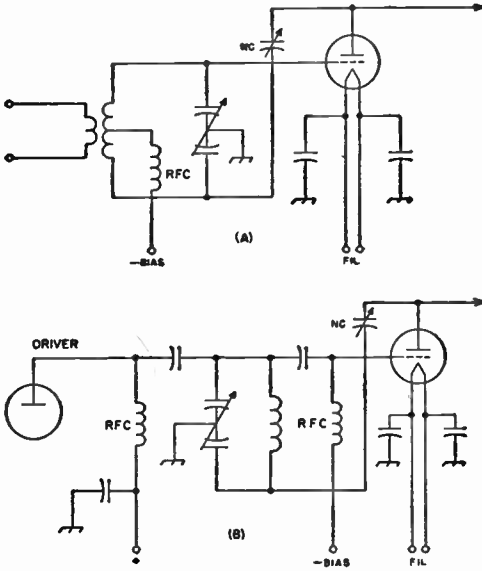

Fig. 6-25—When a pi-network output circuit is used with a triode, a balanced grid circuit must be provided for neutralizing. A—Inductive-link input. B—Capacitive input coupling.

Basic push-pull circuits are shown in Fig. 6-26C and D. Amplifiers using this circuit are cumbersome to bandswitch and consequently are not very popular below 30 Mc. However, since the push-pull configuration places tube input and output capacitances in series, the circuit is widely used at 50 Mc. and higher.

**TRIODE AMPLIFIERS**

Circuits for triode amplifiers are shown in Fig. 6-26. All triode straight amplifiers (not multipliers) must be neutralized. From the tube tables, it will be seen that triodes require considerably more driving power than screen-grid tubes. However, they also have less power sensitivity, so that greater feedback can be tolerated without the danger of instability.

Triode amplifiers can be neutralized using either the sensitive output rectifier or the grid-current meter as an indicator. In either case, the plate voltage must be zero and the d.c. circuit complete between plate and cathode.

**Low-Frequency Parasitic Oscillation**

When r.f. chokes are used in both grid and plate circuits of a triode amplifier, the split-stator tank capacitors combine with the r.f. chokes to form a low-frequency parasitic circuit,

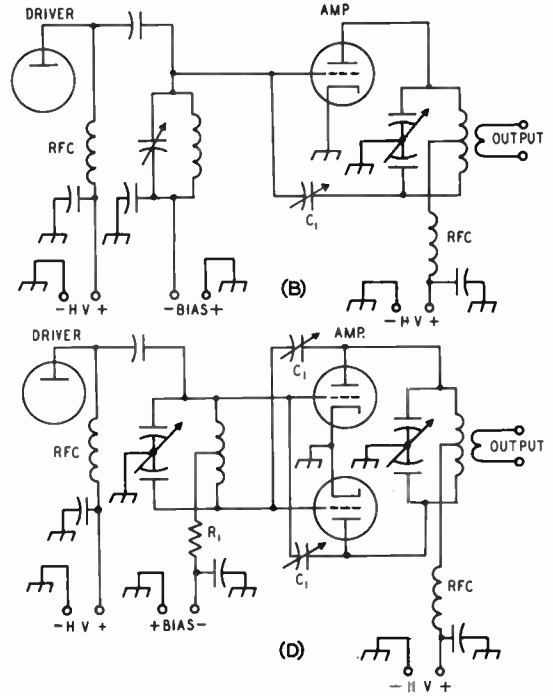
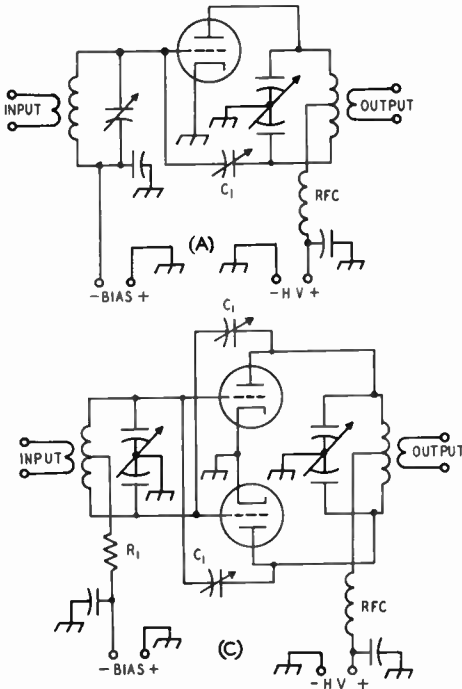

Fig. 6-26—Triode amplifier circuits. A—Link coupling, single tube. B—Capacitive coupling, single tube. C—Link coupling, push-pull. D—Capacitive coupling, push-pull. Aside from the neutralizing circuits, which are mandatory with triodes, the circuits are the same as for screen-grid tubes, and should have the same values throughout. The neutralizing capacitor,  $C_1$ , should have a capacitance somewhat greater than the grid-plate capacitance of the tube. Voltage rating should be twice the d.c. plate voltage for c.w., or four times for plate modulation, plus safety factor. The resistance  $R_1$  should be at least 100 ohms and it may consist of part or preferably all of the grid leak. For other component values, see similar screen-grid diagrams.

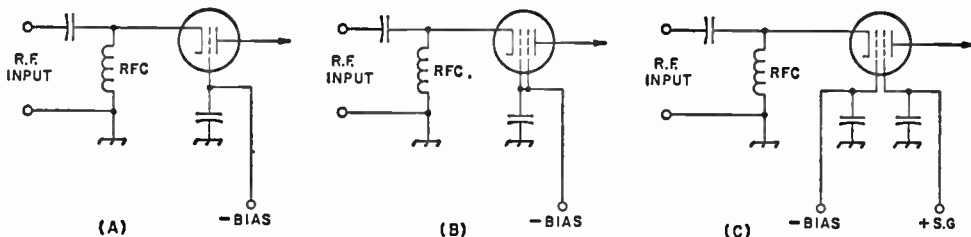

Fig. 6-27—A—Grounded-grid triode input circuit. B—Tetrode input circuit with grid and screen directly in parallel. C—Tetrode circuit with d.c. voltage applied to the screen. Plate circuits are conventional.

unless the amplifier circuit is arranged to prevent it. In the circuit of Fig. 6-26B, the amplifier grid is series fed and the driver plate is parallel fed. For low frequencies, the r.f. choke in the driver plate circuit is shorted to ground through the tank coil. In Figs. 6-26C and D, a resistor is substituted for the grid r.f. choke. This resistance should be at least 100 ohms. If any grid-leak resistance is used for biasing, it should be substituted for the 100-ohm resistor.

#### Triode Amplifiers with Pi-Network Output

Pi-network output tanks, designed as described earlier for screen-grid tubes, may also be used with triodes. However, in this case, a balanced input circuit must be provided for neutralizing. Fig. 6-25A shows the circuit when inductive-link input coupling is used, while B shows the circuit to be used when the amplifier is coupled capacitively to the driver. Pi-network circuits cannot be used in both input and output circuits, since no means is provided for neutralizing.

#### GROUNDING-GRID AMPLIFIERS

Fig. 6-27A shows the input circuit of a grounded-grid triode amplifier. In configuration it is similar to the conventional grounded-cathode circuit except that the grid, instead of the cathode, is at ground potential. An amplifier of this type is characterized by a comparatively low input impedance and a relatively high driver-power requirement. The additional driver power is not consumed in the amplifier but is "fed through" to the plate circuit where it combines with the normal plate output power. The total r.f. power output is the sum of the driver and amplifier output powers less the power normally required to drive the tube in a grounded-cathode circuit.

Positive feedback is from plate to cathode through the plate-cathode capacitance of the tube. Since the grounded grid is interposed between the plate and cathode, this capacitance is small, and neutralization usually is not necessary.

In the grounded-grid circuit the cathode must be isolated for r.f. from ground. This presents a practical difficulty especially in the case of a filament-type tube whose filament current is large. In plate-modulated phone operation the driver power fed through to the output is not modulated.

The chief application for grounded-grid ampli-

fiers in amateur work below 30 Mc. is in the case where the available driving power far exceeds the power that can be used in driving a conventional grounded-cathode amplifier.

D.c. electrode voltages and currents in grounded-grid triode-amplifier operation are the same as for grounded-cathode operation. Approximate values of driving power, driving impedance, and total power output in Class C operation can be calculated as follows, using information normally provided in tube data sheets. R.m.s. values are of the fundamental components:

$$E_D = \frac{\text{r.m.s. value of r.f. plate voltage}}{\text{d.c. plate volts} + \text{d.c. bias volts} - \text{peak r.f. grid volts}} \\ = \frac{\quad}{1.41}$$

$$I_D = \frac{\text{r.m.s. value of r.f. plate current}}{\text{rated power output watts}} \\ = \frac{\quad}{E_D}$$

$$E_g = \frac{\text{r.m.s. value of grid driving voltage}}{\text{peak r.f. grid volts}} \\ = \frac{\quad}{1.41}$$

$$I_g = \frac{\text{r.m.s. value of r.f. grid current}}{\text{rated driving power watts}} \\ = \frac{\quad}{E_g}$$

$$\text{Driving power (watts)} = E_g (I_D + I_g)$$

$$\text{Driving impedance (ohms)} = \frac{E_g}{I_g + I_D}$$

$$\text{Power fed through from driver stage (watts)} = E_g I_D$$

$$\text{Total power output (watts)} = I_D (E_g + E_D)$$

Screen-grid tubes are also used sometimes in grounded-grid amplifiers. In some cases, the screen is simply connected in parallel with the grid, as in Fig. 6-27B, and the tube operates as a high- $\mu$  triode. In other cases, the screen is bypassed to ground and operated at the usual d.c. potential, as shown at C. Since the screen is still in parallel with the grid for r.f., operation is very much like that of a triode except that the positive voltage on the screen reduces driver-power requirements. Since the information usually furnished in tube-data sheets does not apply to triode-type operation, operating conditions are usually determined experimentally. In general, the bias is adjusted to produce maximum output (within the tube's dissipation rating) with the driving power available.

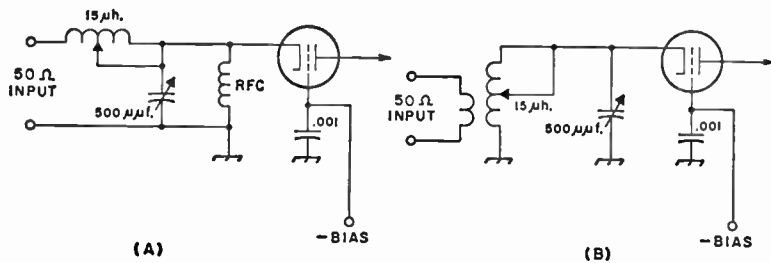

Fig. 6-28—Two ways to couple a low-impedance driver to a grounded-grid input. A—L network. B—Link-coupled tank circuit.

Fig. 6-28 shows two methods of coupling a grounded-grid amplifier to the 50-ohm output of an existing transmitter. At A an L network is used, while a conventional link-coupled tank is shown at B. The values shown will be approximately correct for most triode amplifiers operating at 3.5 Mc. Values should be cut in half each time frequency is doubled, i.e., 250 μμf. and 7.5 μh. for 7 Mc., etc.

**Filament Isolation**

In indirectly-heated cathode tubes, the low heater-to-cathode capacitance will often provide enough isolation to keep r.f. out of the heater transformer and the a.c. lines. If not, the heater voltage must be applied through r.f. chokes.

In a directly-heated cathode tube, the filament must be maintained above r.f. ground. This can be done by using a pair of filament chokes or by using the input tank circuit, as shown in Fig. 6-29. In the former method, a double solenoid (often wound on a ferrite core) is generally used, although separate chokes can be used. When the tank circuit is used, the tank inductor is wound from two (insulated) conductors in parallel or from an insulated conductor inside a tubing outer conductor.

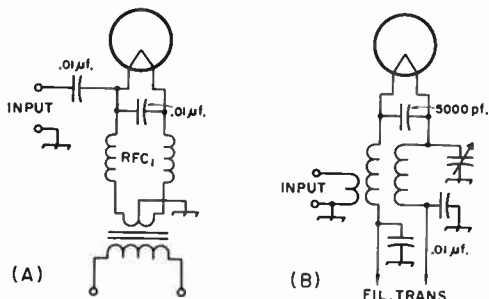

Fig. 6-29—Methods of isolating filament from ground. A—R.f. chokes in filament circuit. B—Filament fed through input tank inductor.

**POWER AMPLIFIERS FOR TRANSMITTERS**

C.w. or F.M.: In a c.w. or f.m. transmitter, any class of amplifier can be used as an output or intermediate amplifier. (For reasonable efficiency, a frequency multiplier *must* be operated Class C.) Class-C operation of the amplifier gives the highest efficiency (65 to 75 per cent), but it is likely to be accompanied by appreciable

harmonics and consequent TVI possibilities. If the excitation is keyed in a c.w. transmitter, Class-C operation of subsequent amplifiers will, under certain conditions, introduce key clicks not present on the keyed excitation (see chapter on "Keying"). The *peak envelope power* (p.e.p.) input or output of any c.w. (or f.m.) transmitter is the "key-down" input or output.

A.M.: In an amplitude-modulated phone transmitter, plate modulation of a Class-C output amplifier results in the highest output for a given input to the output stage. The efficiency is the same as for c.w. or f.m. with the same amplifier, from 65 to 75 per cent. (In most cases the manufacturer rates the *maximum allowable input* on plate-modulated phone at about 2/3 that of c.w. or f.m.). A plate-modulated stage running 100 watts input will deliver a carrier output of from 65 to 75 watts, depending upon the tube, frequency and circuit factors. The p.e.p. output of any a.m. signal is four times the carrier output power, or 260 to 300 watts for the 100-watt input example.

Grid- (control or screen) modulated amplifiers in a.m. operation run at a carrier efficiency of 30 to 35 per cent, and a grid-modulated stage with 100 watts input has a carrier output of 30 to 35 watts. (The p.e.p. output, four times the carrier output, is 120 to 140 watts.

Running the legal input limit in the United States, a plate-modulated output stage can deliver a carrier output of 650 to 750 watts, while a screen- or control-grid-modulated amplifier can deliver only a carrier of 300 to 350 watts.

S.S.B.: Only *linear* amplifiers can be used to amplify s.s.b. signals without distortion, and this limits the choice of amplifier operation to Classes A, AB<sub>1</sub>, AB<sub>2</sub> and B. The efficiency of operation of these amplifiers runs from about 20 to 65 per cent. In all but Class-A operation the indicated (by plate-current meter) input will vary with the signal, and it is not possible to talk about relative inputs and outputs as readily as it is with other modes. Therefore linear amplifiers are rated by p.e.p. (input or output) at a given distortion level, which indicates not only how much s.s.b. signal they will deliver but also how effective they will be in amplifying an a.m. signal.

LINEAR AMPLIFIERS FOR A.M.: In considering the practicality of adding a linear amplifier to an existing a.m. transmitter, it is necessary to know the carrier output of the a.m. transmitter and the p.e.p. output rating of the linear amplifier. Since the p.e.p. output of an a.m. signal is



four times the carrier output, it is obvious that a linear with a p.e.p. output rating of only four times the carrier output of the a.m. transmitter is a poor investment. If the linear amplifier has a p.e.p. output rating of 8 times the a.m. transmitter carrier output, the output power will be doubled and a 3-db. improvement will be obtained. In most cases a 3-db. change is *just discernible* by the receiving operator.

By comparison, a linear amplifier with a p.e.p. output rating of four times an existing s.s.b., c.w. or f.m. transmitter will *quadruple* the output, a 6-db. improvement. It should be noted that the linear amplifier must be rated for the mode (s.s.b., c.w. or f.m.) with which it is to be used.

**GROUNDING-GRID AMPLIFIERS:** The preceding discussion applies to vacuum-tube amplifiers connected in grounded-cathode or grounded-grid circuits. However, there are a few points that apply only to grounded-grid amplifiers.

A tube operated in a given class ( $AB_1$ , B, C) will require more driving power as a grounded-grid amplifier than as a grounded-cathode amplifier. This is not because the grid losses run higher in the grounded-grid configuration but because some of the driving power is coupled directly through the tube and appears in the plate load circuit. Provided enough driving power is available, this increased requirement is of no concern in c.w. or linear operation. In a.m. operation, however, the fed-through power prevents the grounded-grid amplifier from being fully modulated (100 per cent).

## FREQUENCY MULTIPLIERS

### Single-Tube Multiplier

Output at a multiple of the frequency at which it is being driven may be obtained from an amplifier stage if the output circuit is tuned to a harmonic of the exciting frequency instead of to the fundamental. Thus, when the frequency at the grid is 3.5 Mc., output at 7 Mc., 10.5 Mc., 14 Mc., etc., may be obtained by tuning the plate tank circuit to one of these frequencies. The circuit otherwise remains the same as that for a straight amplifier, although some of the values and operating conditions may require change for maximum multiplier efficiency.

A practical limit to efficiency and output within normal tube ratings is reached when the multiplier is operated at maximum permissible plate voltage and maximum permissible grid current. The plate current should be reduced as necessary to limit the dissipation to the rated value by increasing the bias.

Multiplications of four or five sometimes are used to reach the bands above 28 Mc. from a lower-frequency crystal, but in the majority of lower-frequency transmitters, multiplication in a single stage is limited to a factor of two or three. Screen-grid tubes make the best multipliers because their high power-sensitivity makes them easier to drive properly than triodes.

Since the input and output circuits are not

tuned close to the same frequency, neutralization usually will not be required. Instances may be encountered with tubes of high trans-conductance, however, when a doubler will oscillate in t.g.t.p. fashion. The link neutralizing system of Fig. 6-23A is convenient in such a contingency.

### Push-Push Multipliers

A two-tube circuit which works well at even harmonics, but not at the fundamental or odd harmonics, is shown in Fig. 6-30. It is known as the **push-push** circuit. The grids are connected in push-pull while the plates are connected in parallel. The efficiency of a doubler using this circuit approaches that of a straight amplifier.

This arrangement has an advantage in some applications. If the heater of one tube is turned off, its grid-plate capacitance, being the same as that of the remaining tube, serves to neutralize

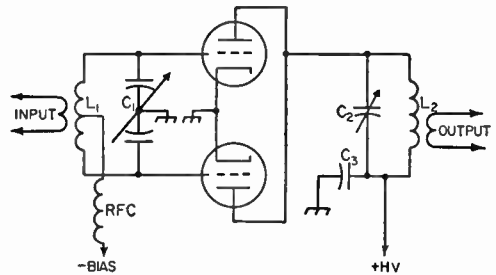

Fig. 6-30—Circuit of a push-push frequency multiplier for even harmonics.

$C_1, L_1$  and  $C_2, L_2$ —See text.

$C_3$ —Plate by-pass—0.001- $\mu$ f. disk ceramic or mica.

the circuit. Thus provision is made for either straight amplification at the fundamental with a single tube, or doubling frequency with two tubes.

The grid tank circuit is tuned to the frequency of the driving stage and should have the same constants as indicated in Fig. 6-20 for balanced grid circuits. The plate tank circuit is tuned to an even multiple of the exciting frequency, and should have the same values as a straight amplifier for the harmonic frequency (see Fig. 6-10), bearing in mind that the total plate current of both tubes determines the  $C$  to be used.

### Push-Pull Multiplier

A single- or parallel-tube multiplier will deliver output at either even or odd multiples of the exciting frequency. A push-pull stage does not work as a doubler or quadrupler but it will work as a tripler.

## METERING

Fig. 6-31 shows how a voltmeter and milliammeter should be connected to read various voltages and currents. Voltmeters are seldom installed permanently, since their principal use is in preliminary checking. Also, milliammeters are not normally installed permanently in all of the positions shown. Those most often used are the



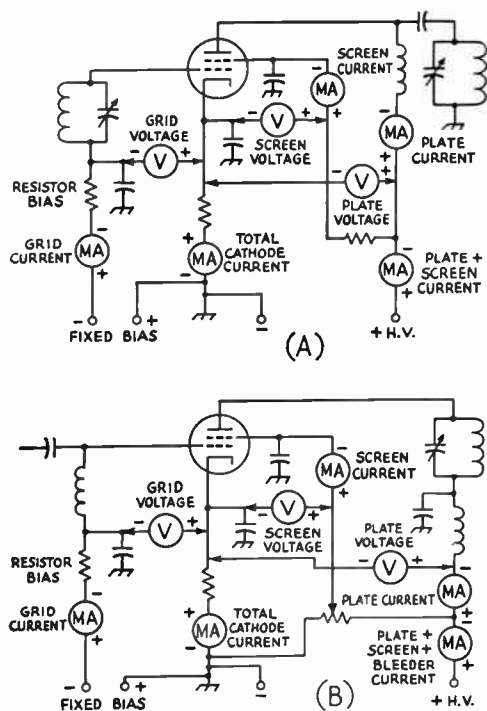

Fig. 6-31—Diagrams showing placement of voltmeter and milliammeter to obtain desired measurements. A—Series grid feed, parallel plate feed and series screen voltage-dropping resistor. B—Parallel grid feed, series plate feed and screen voltage divider.

ones reading grid current and plate current, or grid current and cathode current.

Milliammeters come in various current ranges. Current values to be expected can be taken from the tube tables and the meter ranges selected accordingly. To take care of normal overloads and pointer swing, a meter having a current range of about twice the normal current to be expected should be selected.

Grid-current meters connected as shown in Fig. 6-31 and meters connected in the cathode circuit need no special precautions in mounting on the transmitter panel so far as safety is concerned. However, milliammeters having zero-adjusting screws on the face of the meter should be recessed behind the panel so that accidental contact with the adjusting screw is not possible, if the meter is connected in any of the other positions shown in Fig. 6-31. The meter can be mounted on a small subpanel attached to the front panel with long screws and spacers. The meter opening should be covered with glass or celluloid. Illuminated meters make reading easier. Reference should also be made to the TVI chapter of this *Handbook* in regard to wiring and shielding of meters to suppress TVI.

**Meter Switching**

Milliammeters are expensive items and therefore it is seldom feasible to provide metering of

grid, screen and plate currents of all stages. The exciter stages in a multistage transmitter often do not require metering after initial adjustments. It is common practice to provide a meter-switching system by which a single milliammeter may be switched to read currents in as many circuits as desired. Two such meter-switching circuits are shown in Fig. 6-32. In Fig. 6-32A the resistors *R* (there could be more, of course) are connected in the various circuits in place of the milliammeters shown in Fig. 6-31. If the resistance of *R* is much higher than the internal resistance of the milliammeter, it will have no practical effect upon the reading of the meter. Care should be taken to observe proper polarity in making the connections between the resistors and the switch, and the switch should have adequate insulation and be of the "non-shorting" type. The circuit is used when the currents to be metered are of the same order.

When the meter must read currents of widely differing values, a low-current meter should be used as a voltmeter to measure the voltage drop across a resistor of, say, 10 to 100 ohms. An example of this circuit is shown in Fig. 6-32B; the resistor in series with the meter serves as the voltmeter multiplier (see chapter on measurements). Both the line resistor and the higher multiplier can be varied, to give a wide range for the single meter. Standard values of resistors can usually be found for any desired range.

**AMPLIFIER ADJUSTMENT**

Earlier sections in this chapter have dealt with the design and adjustment of input (grid) and

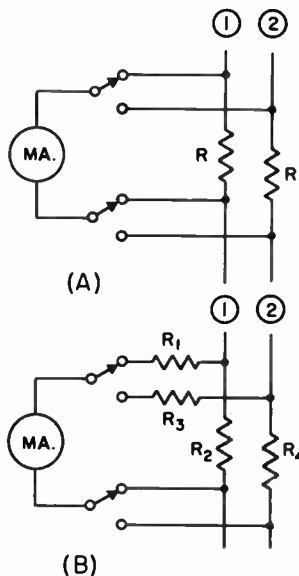

Fig. 6-32—Two circuits for switching a single milliammeter. (A) Where all currents are of the same order, the single meter is switched across resistors having 10 to 20 times the internal resistance of the meter. (B) Where a wide range of currents is to be metered, a low-current meter is used as a voltmeter.

output (plate) coupling systems, the stabilization of amplifiers, and the methods of obtaining the required electrode voltages. Reference to these sections should be made as necessary in following a procedure of amplifier adjustment.

The objective in the adjustment of an intermediate amplifier stage is to secure adequate excitation to the following stage. In the case of the output or final amplifier, the objective is to obtain maximum power output to the antenna. The adjustment must be consistent with the tube's voltage, current and dissipation ratings.

Adequate drive to a following amplifier is normally indicated when rated grid current in the following stage is obtained with the stage operating at rated bias, the stage loaded to rated plate current, and the driver stage tuned to resonance. In a final amplifier, maximum output is normally indicated when the output coupling is adjusted so that the amplifier tube draws rated plate current when it is tuned to resonance.

Resonance in the plate circuit is normally indicated by the dip in plate-current reading as the plate tank capacitor is tuned through its range. When the stage is unloaded, or lightly loaded, this dip in plate current will be quite pronounced. As the loading is increased, the dip will become less noticeable. See Fig. 6-4. However, in the base of a screen-grid tube whose screen is fed through a series resistor, maximum output may not be simultaneous with the dip in plate current. The reason for this is that the screen current varies widely as the plate circuit is tuned through resonance. This variation in screen current causes a corresponding variation in the voltage drop across the screen resistor. In this case, maximum output may occur at an adjustment that results in an optimum combination of screen voltage and nearness to resonance. This effect will seldom be observed when the screen is operated from a fixed voltage source.

The first step in the adjustment of an amplifier is to stabilize it, both at the operating frequency by neutralizing it if necessary, and at parasitic frequencies by introducing suppression circuits.

If "flat" transmission-line coupling is used, the output end of the line should be matched, as described in this chapter for the case where the amplifier is to feed the grid of a following stage, or in the transmission-line chapter if the ampli-

fier is to feed an antenna system. After proper match has been obtained, all adjustments in coupling should be made at the *input* end of the line.

Until preliminary adjustments of excitation have been made, the amplifier should be operated with filament voltage on and fixed bias, if it is required, but screen and plate voltages off. With the exciter coupled to the amplifier, the coupling to the driver should be adjusted until the amplifier draws rated grid current, or somewhat above the rated value. Then a load (the antenna grid of the following stage, or a dummy load) should be coupled to the amplifier.

With screen and plate voltages (preferably reduced) applied, the plate tank capacitor should be adjusted to resonance as indicated by a dip in plate current. Then, with full screen and plate voltages applied, the coupling to the load should be adjusted until the amplifier draws rated plate current. Changing the coupling to the load will usually detune the tank circuit, so that it will be necessary to readjust for resonance each time a change in coupling is made. An amplifier should not be operated with its plate circuit off reso-

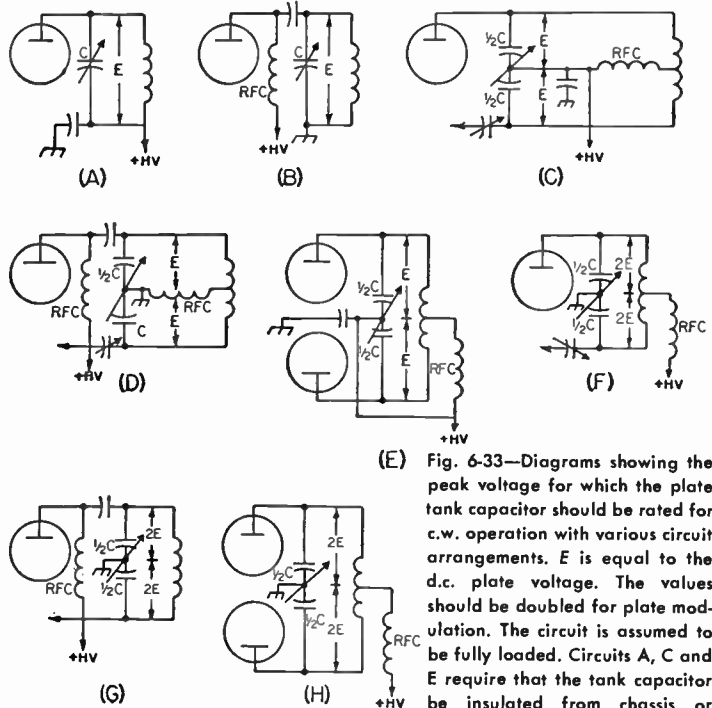

Fig. 6-33—Diagrams showing the peak voltage for which the plate tank capacitor should be rated for c.w. operation with various circuit arrangements.  $E$  is equal to the d.c. plate voltage. The values should be doubled for plate modulation. The circuit is assumed to be fully loaded. Circuits A, C and E require that the tank capacitor be insulated from chassis or ground, and from the control.

nance for any except the briefest necessary time, since the plate dissipation increases greatly when the plate circuit is not at resonance. Also, a screen-grid tube should not be operated without normal load for any appreciable length of time, since the screen dissipation increases.

It is normal for the grid current to decrease when the plate voltage is applied, and to decrease again as the amplifier is loaded more heavily. As the grid current falls off, the coupling to the

driver should be increased to maintain the grid current at its rated value.

## COMPONENT RATINGS AND INSTALLATION

### Plate Tank-Capacitor Voltage

In selecting a tank capacitor with a spacing between plates sufficient to prevent voltage breakdown, the peak r.f. voltage across a tank circuit under load, but without modulation, may be taken conservatively as equal to the d.c. plate voltage. If the d.c. plate voltage also appears across the tank capacitor, this must be added to the peak r.f. voltage, making the total peak voltage twice the d.c. plate voltage. If the amplifier is to be plate-modulated, this last value must be doubled to make it four times the d.c. plate voltage, because both d.c. and r.f. voltages double with 100-per-cent plate modulation. At the higher plate voltages, it is desirable to choose a tank circuit in which the d.c. and modulation voltages do not appear across the tank capacitor, to permit the use of a smaller capacitor with less plate spacing. Fig. 6-33 shows the peak voltage, in terms of d.c. plate voltage, to be expected across the tank capacitor in various circuit arrangements. These peak-voltage values are given assuming that the amplifier is loaded to rated plate current. Without load, the peak r.f. voltage will run much higher.

The plate spacing to be used for a given peak voltage will depend upon the design of the variable capacitor, influencing factors being the mechanical construction of the unit, the insulation used and its placement in respect to intense fields, and the capacitor plate shape and degree of polish. Capacitor manufacturers usually rate their products in terms of the peak voltage between plates. Typical plate spacings are shown in the following table.

Typical Tank-Capacitor Plate Spacings					
Spacing (In.)	Peak Voltage	Spacing (In.)	Peak Voltage	Spacing (In.)	Peak Voltage
0.015	1000	0.07	3000	0.175	7000
0.02	1200	0.08	3500	0.25	9000
0.03	1500	0.125	4500	0.35	11000
0.05	2000	0.15	6000	0.5	13000

Plate tank capacitors should be mounted as close to the tube as temperature considerations will permit, to make possible the shortest capacitive path from plate to cathode. Especially at the higher frequencies where minimum circuit capacitance becomes important, the capacitor should be mounted with its stator plates well spaced from the chassis or other shielding. In circuits where the rotor must be insulated from ground, the capacitor should be mounted on ceramic insulators of size commensurate with the plate voltage involved and — most important of all, from the viewpoint of safety to the operator — a well-insulated coupling should be used between the capacitor shaft and the dial. *The sec-*

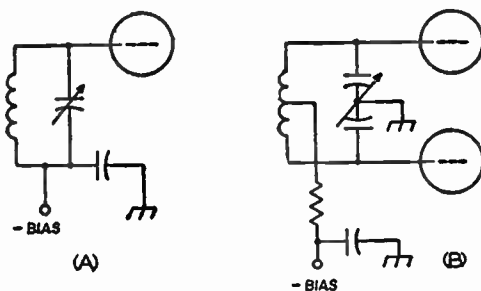

Fig. 6-34—The voltage rating of the grid tank capacitor in A should be equal to the biasing voltage plus about 20 per cent of the plate voltage.

*tion of the shaft attached to the dial should be well grounded.* This can be done conveniently through the use of panel shaft-bearing units.

### Grid Tank Capacitors

In the circuit of Fig. 6-34A, the grid tank capacitor should have a voltage rating approximately equal to the biasing voltage plus 20 per cent of the plate voltage. In the balanced circuit of B, the voltage rating of *each section* of the capacitor should be this same value.

The grid tank capacitor is preferably mounted with shielding between it and the tube socket for isolation purposes. It should, however, be mounted close to the socket so that a short lead can be passed through a hole to the socket. The rotor ground lead or bypass lead should be run directly to the nearest point on the chassis or other shielding. In the circuit of Fig. 6-34A, the same insulating precautions mentioned in connection with the plate tank capacitor should be used.

### Plate Tank Coils

The inductance of a manufactured coil usually is based upon the highest plate-voltage/plate-current ratio likely to be used at the maximum power level for which the coil is designed. Therefore in the majority of cases, the capacitance shown by Figs. 6-9 and 6-20 will be greater than that for which the coil is designed and turns must be removed if a *Q* of 10 or more is needed. At 28 Mc., and sometimes 21 Mc., the value of capacitance shown by the chart for a high plate-voltage/plate-current ratio may be lower than that attainable in practice with the components available. The design of manufactured coils usually takes this into consideration also and it may be found that values of capacitance greater than those shown (if stray capacitance is included) are required to tune these coils to the band.

Manufactured coils are rated according to the plate-power input to the tube or tubes when the stage is loaded. Since the circulating tank current is much greater when the amplifier is unloaded, care should be taken to operate the amplifier conservatively when unloaded to prevent damage to the coil as a result of excessive heating.

Tank coils should be mounted at least their diameter away from shielding to prevent a marked loss in  $Q$ . Except perhaps at 28 Mc., it is not important that the coil be mounted quite close to the tank capacitor. Leads up to 6 or 8 inches are permissible. It is more important to keep the tank capacitor as well as other components out of the immediate field of the coil. For this reason, it is preferable to mount the coil so that its axis is parallel to the capacitor shaft, either alongside the capacitor or above it.

There are many factors that must be taken into consideration in determining the size of wire that should be used in winding a tank coil. The considerations of form factor and wire size that will produce a coil of minimum loss are often of less importance in practice than the coil size that will fit into available space or that will handle the required power without excessive heating. This is particularly true in the case of screen-grid tubes where the relatively small driving power required can be easily obtained even if the losses in the driver are quite high. It may be considered preferable to take the power loss if the physical size of the exciter can be kept down by making the coils small.

The accompanying table shows typical conductor sizes that are usually found to be adequate for various power levels. For powers under 25 watts, the minimum wire sizes shown are largely a matter of obtaining a coil of reasonable  $Q$ . So far as the power is concerned, smaller wire could be used.

Wire Sizes for Transmitting Coils		
Power Input (Watts)	Band (Mc.)	Wire Size
1000	28-21	6
	14-7	8
	3.5-1.8	10
500	28-21	8
	14-7	12
	3.5-1.8	14
150	28-21	12
	14-7	14
	3.5-1.8	18
75	28-21	14
	14-7	18
	3.5-1.8	22
25 or less*	28-21	18
	14-7	24
	3.5-1.8	28

\*Wire size limited principally by consideration of  $Q$ .

Space-winding the turns invariably will result in a coil of higher  $Q$ , especially at frequencies above 7 Mc., and a form factor in which the turns spacing results in a coil length between 1 and 2 times the diameter is usually considered satisfactory. Space winding is especially desirable at the higher power levels because the heat developed is dissipated more readily. The power lost in a tank coil that develops appreciable heat

at the higher-power levels does not usually represent a serious loss percentagewise. A more serious consequence, especially at the higher frequencies, is that coils of the popular "air-wound" type supported on plastic strips may deform. In this case, it may be necessary to use wire (or copper tubing) of sufficient size to make the coil self-supporting. Coils wound on tubular forms of ceramic or mica-filled bakelite will also stand higher temperatures.

#### Plate-Blocking and Bypass Capacitors

Plate-blocking and bypass capacitors should have low inductance. Between 3.5 and 30 Mc. a capacitance of 0.001  $\mu$ f. is commonly used. The voltage rating should be 50% above the peak supply voltage.

Disk ceramic capacitors are to be preferred as bypass capacitors, since when they are applied correctly (see TVI chapter), they are series resonant in the TV range and thus very useful in filtering power leads.

#### R. F. Chokes

The characteristics of any r.f. choke will vary with frequency, from characteristics resembling those of a parallel-resonant circuit, of high impedance, to those of a series-resonant circuit, where the impedance is lowest. In between these extremes, the choke will show varying amounts of inductive or capacitive reactance.

In series-feed circuits, these characteristics are of relatively small importance because the r.f. voltage across the choke is negligible. In a parallel-feed circuit, however, the choke is shunted across the tank circuit, and is subject to the full tank r.f. voltage. If the choke does not present a sufficiently high impedance, enough power will be absorbed by the choke to cause it to burn out.

To avoid this, the choke must have a sufficiently high reactance to be effective at the lowest frequency, and yet have no series resonances near the higher-frequency bands.

Universal pie-wound chokes of the "receiver" type (2.5 mh., 125 ma.) are usually satisfactory if the plate voltage does not exceed 750. For higher voltages, a single-layer solenoid-type choke of correct design has been found satisfactory. The National type R-175A and Raypar RL-100, RL-101 and RL-102 are representative manufactured types.

Since the characteristics of a choke will be affected by any metal in its field, it should be checked when mounted in the position in which it is to be used, or in a temporary set-up simulating the same conditions. The plate end of the choke should not be connected, but the power-supply end should be connected directly, or bypassed, to the chassis. The g.d.o. should be coupled as close to the ground end of the choke as possible. Series resonances, indicating the frequencies of greatest loss, should be checked with the choke short-circuited with a short piece of wire. Parallel resonances, indicating frequencies of least loss, are checked with the short removed.



## A THREE-BAND OSCILLATOR TRANSMITTER FOR THE NOVICE

The novice transmitter shown in Figs. 6-35-6-38, inclusive, is easy to build and get working. It is a crystal-controlled, one-tube oscillator capable of running at 30 watts input on the 3.5-, 7-, and 21-Mc. Novice bands. A special feature of the transmitter is a built-in keying monitor which permits the operator to listen to his own sending.

Regulated voltage is used on the screen of the oscillator. This minimizes frequency shift of the oscillator with keying, which is the cause of chirp. In addition, a small amount of cathode bias ( $R_4$ ) is used on the oscillator. This also tends to improve the keying characteristics in a cathode-keyed simple-oscillator transmitter.

### Circuit Details

The oscillator circuit used is the grid-plate type, and the tube is a 6DQ6A pentode. The power output is taken from the plate circuit of the tube. On 80 meters, an 80-meter crystal is needed. On 40, either 80- or 40-meter crystals can be used, although slightly more output will be obtained by using 40-meter crystals. To operate on 15 meters, a 40-meter crystal is used.

The tank circuit is a pi network. The plate tank capacitor is the variable  $C_6$ , and the tank inductance is  $L_2L_3$ .  $C_8$  is a two-section variable, approximately 365  $\mu\mu\text{f}$ . per section, with the stators connected together to give a total capacitance of about 730  $\mu\mu\text{f}$ . This range of capacitance is adequate for coupling to 50 or 75 ohms on 7 and 21 Mc. When operating on 3.5 Mc., an additional 1000  $\mu\mu\text{f}$ . ( $C_7$ ) is added to furnish the needed range of capacitance.  $L_1$  and  $R_2$  are essential for suppressing v.h.f. parasitic oscillations.

The keying-monitor circuit uses a neon bulb (type NE-2) audio-frequency oscillator connected to the cathode of the 6DQ6A at the key jack,  $J_1$ . The headphones are plugged into  $J_2$ , a jack mounted on the back of the transmitter chassis. Another jack,  $J_3$ , is used as a terminal for the leads that go to the headphone jack on the receiver.

### Power Supply

The power supply uses a 5U4G in a full-wave circuit. A capacitor-input filter is used and the output voltage is approximately 370 volts with a cathode current of 90 milliamperes. A 0-150 milliammeter reads cathode current. The screen and grid currents are approximately 4 ma. when the oscillator is loaded.

### Construction

All of the components, including the power supply, are mounted on a  $2 \times 7 \times 13$ -inch aluminum chassis that is in turn enclosed in a  $7 \times 9 \times 15$ -inch aluminum box. (Premier AC-1597). One of the removable covers of the box is used as the front panel, as shown in Fig. 6-35. The box has a  $\frac{1}{2}$ -inch lip around both openings, so the bottom edge of the chassis should be placed one inch from the bottom of the panel. The sides of the chassis are also one inch from the sides of the panel. The chassis is held to the panel by  $S_2$ ,  $J_1$ , and the mounting screws for the crystal socket, so both the front edge of the chassis and the panel must be drilled alike for these components.  $S_1$ , at the left in the front view, is one inch from the edge of the chassis (that is, two inches from the edge of the panel) and centered vertically on the chassis edge. Thus it is one inch from the bottom of the chassis edge and two inches from the bottom edge of the panel. The hole for  $J_1$  is centered on the chassis edge and the holes for the crystal socket are drilled at the right-hand end of the chassis to correspond with the position of  $S_1$  at the left.

There is nothing critical about the placement of the meter or the shafts for  $C_6$ ,  $C_8$  and  $S_1$ . As shown in Fig. 6-38,  $C_6$  is mounted directly above  $J_1$  and approximately two inches from the top of the panel.  $C_8$  similarly is above the crystal socket and on the same horizontal line as  $C_6$ .  $S_1$  is about at the middle of the square formed by these four components.

Fig. 6-35—This 30-watt three-band Novice transmitter is enclosed in a  $7 \times 9 \times 15$ -inch aluminum box. A group of  $\frac{1}{4}$ -inch-diameter holes should be drilled in the top of the box over the oscillator tube, as shown, to provide ventilation. A similar set of holes should be drilled in the back cover behind the oscillator circuit.

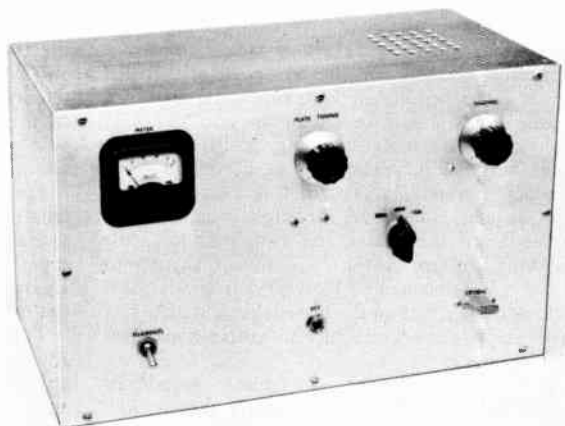



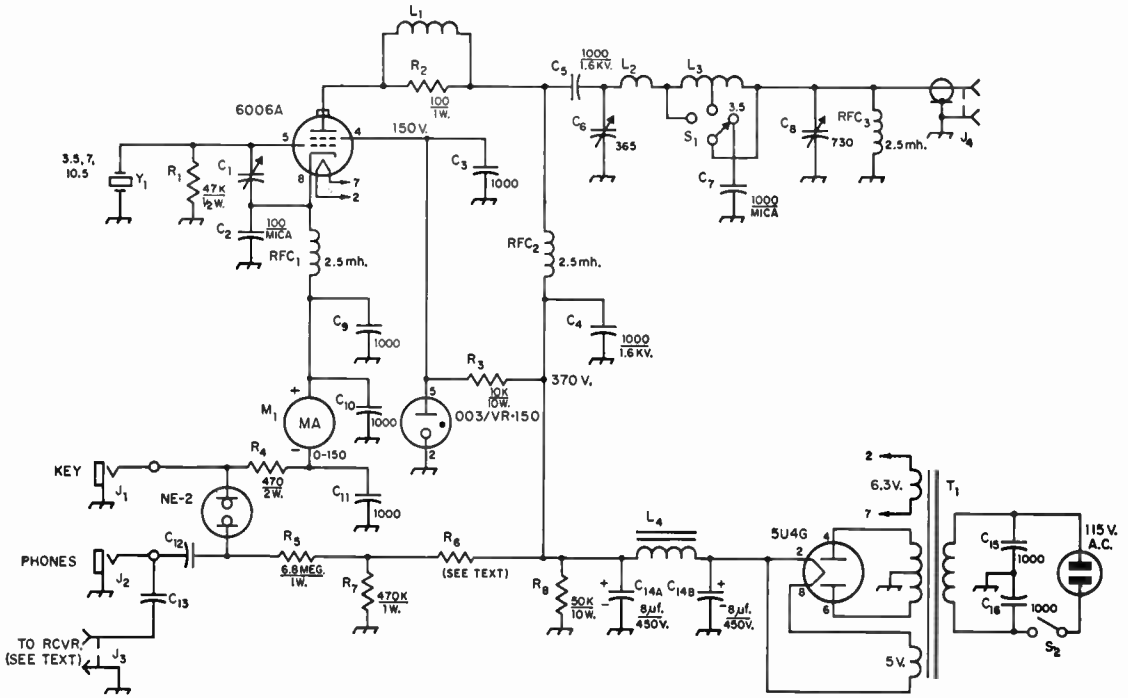

Fig. 6-36—Circuit diagram of the three-band transmitter. Unless otherwise specified, capacitances are in  $\mu\text{f}$ . Resistances are in ohms ( $K=1000$ ).

$C_1$ —3-30- $\mu\text{f}$ . trimmer.

$C_2$ —100- $\mu\text{f}$ . mica.

$C_3, C_9, C_{10}, C_{11}, C_{15}, C_{16}$ —0.001- $\mu\text{f}$ . disk ceramic.

$C_4, C_5$ —0.001- $\mu\text{f}$ . 1600-volt disk ceramic.

$C_6$ —365- $\mu\text{f}$ . variable capacitor, single section, broadcast-replacement type.

$C_7$ —0.001- $\mu\text{f}$ . 600-volt mica.

$C_8$ —365- $\mu\text{f}$ . variable capacitor, dual section, broadcast-replacement type.

$C_{12}$ —500- $\mu\text{f}$ . mica or ceramic.

$C_{13}$ —0.01- $\mu\text{f}$ . disk ceramic.

$C_{14}$ —8-8- $\mu\text{f}$ . 450-volt dual electrolytic capacitor.

$J_1, J_2$ —Open-circuit phone jack.

$J_3$ —Phono jack, RCA type.

$J_4$ —Coaxial chassis connector, SO-239.

$L_1$ —10 turns No. 18 wire space-wound on  $R_2$ .

$L_2$ —6 turns No. 16 wire, 8 turns per inch,  $1\frac{1}{4}$  inches diam. (B & W 3018).

$L_3$ —23 turns No. 16 wire, 8 turns per inch,  $1\frac{1}{4}$  inches diam. (B & W 3018). The 7-Mc. tap is 18 turns from the junction of  $L_2$  and  $L_3$ .

$L_4$ —8-h. 150-ma. filter choke (Thordarson 20C54).

$M_1$ —0-150 ma (Shurite 950).

$R_1$ — $R_8$  inc.—As specified.

$RFC_1, RFC_2, RFC_3$ —2.5-mh. r.f. choke (National R-50 or similar).

$S_1$ —Single-pole 3-position switch (Centralab 1461).

$S_2$ —Single-pole single-throw toggle switch.

$T_1$ —Power transformer: 360-0-360 volts, 120 ma.; 6.3 volts, 3.5 amp.; 5 volts, 3 amp. (Stancor PM-8410).

$Y_1$ —Crystal (see text).

The holes on the rear edge of the chassis for the coaxial connector  $J_4$ , phone jack  $J_2$ , receiver connector  $J_3$ , and for the a.c. cord are drilled at the same height as those on the front edge. Access holes should be cut in the rear cover of the box at the corresponding positions; these holes may be large enough to clear the components, but not larger than is necessary for this purpose. The cover fits tightly against the rear edge of the chassis and thus maintains the shielding for preventing radiation of harmonics in the television bands. However, it is advisable to fasten the cover to the chassis edge with a few sheet-metal screws, in order to insure good electrical contact.

There are several different types of broadcast-replacement variable capacitors on the market.

Some of these have holes tapped in the front of the frame, and this type can be mounted directly on the panel using machine screws and spacers. Others have mounting holes only in the bottom. In this case, the capacitor can be mounted on a pair of L-shaped brackets made from strips of aluminum.

Both  $L_2$  and  $L_3$  are supported by their leads. One end of  $L_3$  is connected to the stator of  $C_8$  and the other end is connected to a junction on top of a one-inch-long steatite stand-off insulator.  $L_2$  has one end connected to the stator of  $C_6$  and the other end to one of the terminals on  $S_1$ .

The voltage-dividing network consisting of  $R_6$  and  $R_7$  provides the correct voltage for operating the keying monitor,  $R_6$  is 1.65 megohms, a value obtained by using two 3.3-megohm 1-watt



Fig. 6-37—Rear view of the transmitter showing the placement of components above chassis. The loading capacitor,  $C_5$ , is at the left,  $L_3$  is the vertical coil and  $L_2$  the horizontal one. Rubber grommets are used to prevent chafing and to furnish additional insulation on the leads coming from below chassis.

resistors in parallel. These resistors and other small components may be mounted on standard bakelite tie points.

#### Adjustment and Testing

When the unit is ready for testing, a 15- or 25-watt electric light will serve as a dummy load. One side of the lamp should be connected to the output lead and the other side to chassis ground. A crystal appropriate for the band to be used should be plugged into the crystal socket, and a key connected to the key jack.  $S_1$  should be set to the proper band.  $S_2$  may then be closed and the transmitter allowed to warm up.

Set  $C_8$  at maximum capacitance (plates completely meshed) and close the key. Quickly tune  $C_6$  to resonance, as indicated by a dip in the cathode-current reading. Gradually decrease the capacitance of  $C_8$ , while retouching the tuning of  $C_6$  as the loading increases. Increased loading will be indicated by increasing lamp brightness and by larger values of cathode current. Tune

for maximum lamp brilliance. The cathode current should read between 90 and 100 milliamperes when the oscillator is fully loaded.

$C_1$  should be adjusted for the best keying characteristics consistent with reasonably good power output. It is not advisable to attempt to adjust  $C_1$  with a lamp dummy load, since the lamp resistance will change during the heating and cooling that take place during keying, and this will affect the keying characteristic of the oscillator. Use a regular antenna, with or without an antenna coupler or matching network as the antenna system may require, and listen to the keying on the station receiver. Remove the antenna from the receiver to prevent overloading, and adjust the r.f. gain control for a signal level comparable with that at which signals on that band are normally heard. Further details on checking keying will be found in the chapter on keying and break-in.

(Originally described in *QST* December, 1957.)

Fig. 6-38—Below-chassis view. Power-supply components are mounted in the left-hand side and the oscillator section is at the right-hand side. Mounted on the back wall of the chassis is the keying monitor. Although not visible in this view, the monitor components are mounted on a four-terminal tie point.

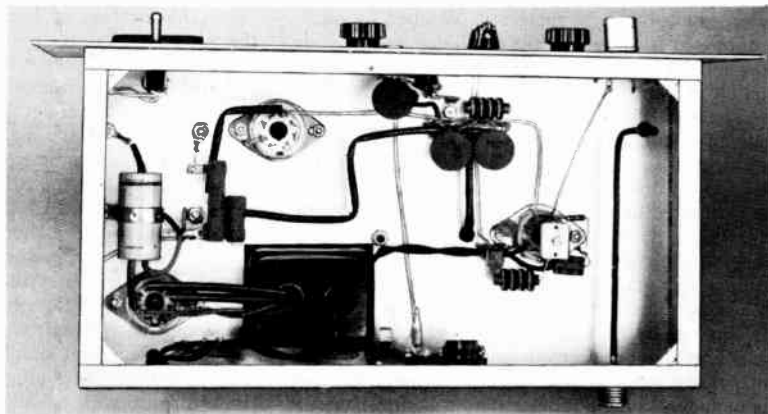

## AN INEXPENSIVE 75-WATT TRANSMITTER

The transmitter shown in Figs. 6-39 and 6-41 combines the efficiency and flexibility of plug-in coils with good shielding for TVI prevention. It is a two-stage transmitter using a 12BY7 crystal oscillator and an inexpensive 1625 tetrode amplifier. The latter tube is quite inexpensive in surplus and probably represents the least "dollars per watt" of any available tube. Provision is included for crystal-controlled operation, and terminals are provided for connecting a v.f.o. Construction has been simplified by holding the metal work to a minimum.

Referring to the circuit diagram of the transmitter, Fig. 6-40, a 12BY7 grid-plate type crystal-controlled oscillator is used. The output can be tuned to the crystal frequency or to multiples of it, depending upon the coil plugged in at  $L_1$ .

the inductance of a small coil, since any coil of sufficient turns (without the ferrite) would of necessity be wound of wire too small to handle the r.f. current adequately.

Two methods of keying are provided. The oscillator and amplifier can be keyed simultaneously with switch  $S_2$  in the "break-in" position, or the amplifier only can be keyed, with the oscillator running all the time, turned on by a switch connected at  $J_4$ . The latter keying system should be used if reports of a chirpy signal are received (a possibility on 10 and 15 meters with some crystals). However, good keying is provided for in the break-in condition through the inclusion of a 4- $\mu$ f. "shaping" capacitor across the keyed circuit.

The switch  $S_1$  provides "CAL" ("calibrate")



Fig. 6-39—The inexpensive 75-watt transmitter is a two-tube five-band crystal-controlled transmitter; v.f.o. control can be added at any time. To simplify construction and testing, plug-in coils are used, housed in the two shield cans (Millen 80011 or Miller S-42 with S-42C base). The crystal-oscillator tube, a 12BY7, is housed in the black tube shield at the left; the 1625 amplifier tube is mounted under the chassis.

Two toggle switches under the meter select (left) remote oscillator control or break-in keying and (right) grid or cathode current of the 1625. Two voltage regulator tubes can be seen at the rear of the chassis; the key jack, antenna jack, remote oscillator control jack and line-cord outlet are at the rear of the chassis (not visible).

Both 80- and 40-meter crystals are used; 80-meter crystals for 80- or 40-meter operation, and 40-meter crystals for 40-, 20-, 15- and 10-meter work. Output on 10 meters is obtained by quadrupling to 10 meters in the oscillator and running the amplifier at reduced input because the excitation is marginal.

The amplifier tank circuit is a pi network designed primarily for working into a low impedance (50 to 75 ohms). A 140-pf. capacitor,  $C_2$ , is used for plate tuning on all bands; on 80 meters it is shunted by an additional 100 pf. This is done automatically by a jumper connection in the coil. The loading capacitor is a 3-section broadcast-tuning type capacitor (365 pf. per section) with all stators connected in parallel. On 80 meters it is shunted by an additional 470-pf. mica capacitor. The coils are ready-wound coil stock mounted in polystyrene coil forms. A piece of ferrite rod is mounted in the 80-meter output coil to increase

and "TUNE" positions as well as the normal "OP" ("operate") condition. At CAL only the oscillator is turned on, so that listening in the receiver will show the location of the signal in the band. In the TUNE position, the oscillator and amplifier are both turned on, but the amplifier is operated at reduced input by grounding the screen grid. This allows tuning  $C_1$  and  $C_2$  without putting much of a signal out on the air.

A 0-1 milliammeter can be switched to either the grid or cathode circuit of the 1625; switched to the grid the meter has a full-scale deflection of 10 ma., and to the cathode the full-scale deflection is 200 ma. The meter is mounted outside the chassis, but the leads are bypassed by two small feedthrough capacitors, to minimize stray radiation from the transmitter.

For economy and simplification, no a.c. switch is included. The a.c. plug contains the fuses for the transmitter.

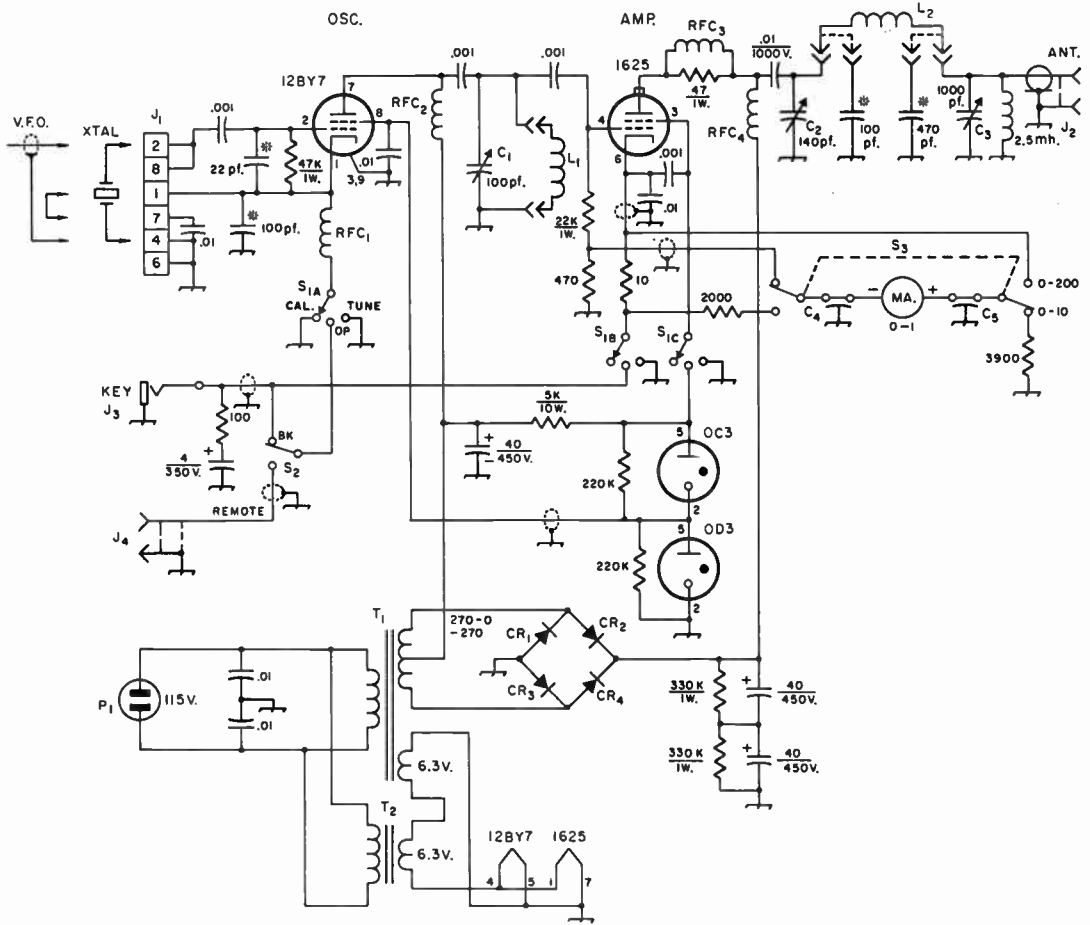

Fig. 6-40—Circuit diagram of the inexpensive 75-watt transmitter. Unless indicated otherwise, all resistors are 1/2-watt, all resistances are in ohms, all capacitances are in  $\mu\text{f}$ . Electrolytic capacitors are marked with polarity, mica capacitors are marked with \*, other fixed capacitors under 0.1  $\mu\text{f}$ . are ceramic.

- C<sub>1</sub>—100-pf. variable (Hammarlund HF-100).
- C<sub>2</sub>—140-pf. variable (Hammarlund HFA-140-A).
- C<sub>3</sub>—1100-pf. variable—triple b.c. capacitor (J. W. Miller 2113).
- C<sub>4</sub>, C<sub>5</sub>—500-pf. feedthrough (Centralab FT-500).
- CR<sub>1</sub>—CR<sub>4</sub>—1000 p.i.v. 300-ma. silicon (1N3563).
- J<sub>1</sub>—Octal socket (Amphenol 77MIPB).
- J<sub>2</sub>—Coaxial chassis receptacle, SO-239.
- J<sub>3</sub>—Standard phone jack.
- J<sub>4</sub>—Phono jack.
- L<sub>1</sub>, L<sub>2</sub>—See coil table.

- P<sub>1</sub>—Fused line plug, 5-ampere fuses.
- RFC<sub>1</sub>, RFC<sub>2</sub>—1-mh. 135-ma. r.f. choke (National R-50).
- RFC<sub>3</sub>—7 turns No. 20 space-wound on 47-ohm 1-watt resistor.
- RFC<sub>4</sub>—2.5-mh. 115-ma. r.f. choke (National R-100U).
- S<sub>1</sub>—3-pole 3-position rotary switch (Centralab PA-1007).
- S<sub>2</sub>—D.p.d.t. toggle (one pole used, see text).
- S<sub>3</sub>—D.p.d.t. toggle.
- T<sub>1</sub>—540 v.c.f. at 120 ma., 5 v. at 3 amp. (not used), 6.3 v. at 3.5 amp. (Knight 61 G 466 or equiv.).
- T<sub>2</sub>—6.3 v. at 1 amp.

### CONSTRUCTION DETAILS

Before drilling any holes for the components, it would be wise to study the arrangement of parts on the 10 × 12 × 3-inch aluminum chassis. While the location of components is not critical, some initial planning will permit leads to be made direct and as short as possible.

Two brackets of sheet aluminum are required, one for the 1625 socket and one for the meter. The bracket for the tube socket is held to the chassis by the 4-pin socket for L<sub>1</sub>, and the tube socket is centered 1 1/2 inches from the chassis. The meter panel is held to the chassis by the two feedthrough capacitors at the rear and by a 6-32 screw and nut at the front.

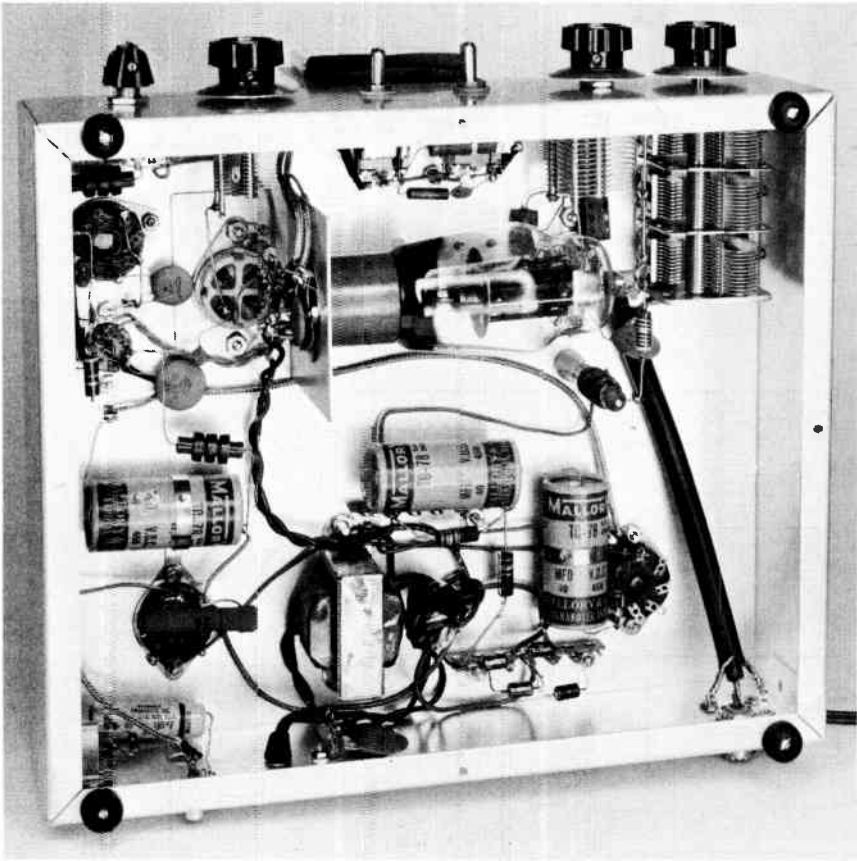

Fig. 6-41—A view underneath the chassis of the 75-watt transmitter with the perforated-metal bottom plate removed. The four silicon rectifiers are mounted on a multiple tie point strip (lower right); the center electrolytic filter capacitor has its metal strap removed, and the capacitor is supported by its two leads and another multiple tie point strip. The small electrolytic capacitor at the lower left is across the keying circuit. Ventilation of the chassis is obtained through the holes above the 1625 (see Fig. 6-39) and by raising the chassis above the table by the height of the rubber feet. The rubber feet and several sheetmetal screws normally hold the perforated-metal bottom plate in place.  $C_3$  must have the three stators connected together to give the full 1100-pf. capacitance (upper right). A pair of the 8-32 mounting screws for  $T_1$  also anchor  $T_2$  (bottom center).

All other construction is straightforward assembly on the chassis, with 4-40 hardware for the 12BY7 socket and 6-32 hardware for everything else but the transformers, which are big enough to require 8-32 hardware. Multiple tie-point strips are used at several points to furnish mounting terminals for the silicon rectifiers and some filter and bypass capacitors, and chassis connections are made to soldering lugs held in place by the tube-socket hardware. The metal mounting strap around one of the 40- $\mu$ f. filter capacitors is removed, and the capacitor is supported by its two leads and tie-points. This is the 40- $\mu$ f. capacitor in Fig. 6-40 that has neither terminal grounded to the chassis. Pin 5 on the 1625 socket is used as a tie-point for the junction of the 22K and 470-ohm resistors, and an unused terminal on  $S_2$  is used as a tie-point for the 10-

and 2000-ohm resistors in the 1625 cathode circuit. Screen and cathode bypass capacitors are mounted and grounded close to their respective tube sockets.

The 6.3-volt windings of  $T_1$  and  $T_2$  must be connected "aiding" to furnish the 12.6 volts for the tube heaters. Connect the primary leads in parallel first, and then try the 6.3-volt windings connected in series, with one of the tubes connected across the "12.6-volt" leads. If the secondaries are aiding, the tube heater will light when the primaries are connected to the 115-volt line. If not, reverse the connections of *one* of the secondaries.

The construction of the coils is straightforward, and the only precaution one should take is to hold the pin of the coil form with a pair of pliers (to form a "heat sink") when soldering



Fig. 6-42—The normal coil is simply a section of coil stock mounted inside a polystyrene coil form (left). The 80-meter amplifier inductor uses a length of ferrite rod within the coil to increase the inductance (right). Rod is held in place with transparent tape.

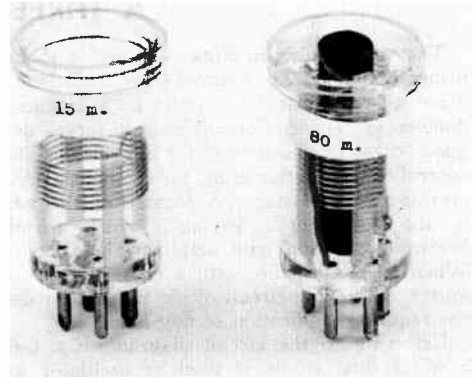

the end of the coil. If this is not done, the hot pin may move around in the softened polystyrene. It makes the soldering easier if the pins of the coil forms are cleaned out first with a suitable drill. The ferrite rod can be brought to size by first filing a notch around it with a three-cornered file, and then splitting it over the sharp edge of a cold chisel held upright in a vise. A sharp hammer blow on the ferrite while the rod is pressed against the cold chisel will usually result in a fairly clean break. The rod can be brought to exact size with a grindstone.

**Tune-Up Procedure**

For the initial testing, a 60-watt lamp bulb will make a suitable dummy load. Connect it at  $J_2$  through a short length of cable or wires and a plug. Plug in an 80-meter crystal at Pins 2 and 4 (or 6 and 8) of  $J_1$ , and plug in a telegraph key at  $J_3$ . Plug in the 80-meter  $L_1$  and  $L_2$ , and set  $C_1$  at minimum capacitance. Plug in the tubes and set  $S_1$  at  $\infty$ . When the a.c. is turned on (by a wall switch or by plugging in  $P_1$  to a "live" socket) the voltage-regulator tubes should glow immediately and the tube heaters should light. After a minute, turn  $S_1$  to TUNE. With  $S_3$  set to read grid current, turn  $C_1$  through its range. If the crystal is oscillating, grid current will be indicated, and the amount can be controlled by the setting of  $C_1$ . Set for about  $2\frac{1}{2}$  ma., on the low-capacitance side of the setting that gives maximum reading. Flip  $S_3$  to read cathode current and, with  $C_3$  set at maximum capacitance, tune  $C_2$  while watching the cathode current. A sudden dip in the current indicates resonance; leave  $C_2$  at this position momentarily. Turn  $S_1$  to  $\infty$  and load the amplifier to a cathode current of about 120 ma. (0.6 on the meter) by reducing capacitance in  $C_3$  and retuning to resonance (dip) with  $C_2$ . The plate voltage should be about 680, so with a screen current of about 10 ma. the plate input to the 1625 under these conditions is  $0.11 \times 680 = 74.8$  watts. With the amplifier loaded, recheck the grid current; it should be about 2.5 ma. (0.25 on the meter). Observe the VR tubes when the key is closed; if the glow goes out entirely it indicates heavy screen current caused by excessive excitation, and the grid cur-

rent should be reduced slightly by detuning  $C_1$ .

Operation on the other bands is similar. With an 80-meter crystal, 40-meter output is obtained with 40-meter coils at  $L_1$  and  $L_2$ . With a 40-meter crystal, output can be obtained on 40, 20, 15 or 10 meters by the proper selection of coils and tuning. It will be found that the same coil at  $L_1$  can tune to either 20 meters (near maximum capacitance) or 15 meters (near minimum capacitance). Be careful when first tuning to be certain the right band is tuned. When quadrupling in the oscillator for 10-meter operation, it will not be possible to obtain the  $2\frac{1}{2}$  ma. grid current required for high-efficiency operation. However, with  $\frac{3}{4}$  ma. or so the input to the 1625 can be reduced to 100 ma. cathode current, for an output of about 20 watts. The tuning on 15 and 10 meters becomes a little critical, and an output indicator (r.f. ammeter or voltmeter) is a useful device for getting the most output for a given input.

The keying can be made "softer" by adding more capacitance across the 4- $\mu$ f. capacitor in the key circuit, if it becomes desirable to do so.

**Coil Table for the 75-Watt Transmitter**

The  $L_1$  coils are mounted inside 4-pin polystyrene coil form (Allied Radio 71 H 713);  $L_2$  coils are mounted inside 5-pin form (Allied Radio 71 H 714). Coil stocks are (A) 1-inch diameter 32 t.p.i. No. 24, (B) 1-inch diameter 16 t.p.i. No. 20, and (C)  $\frac{3}{4}$ -inch diameter 16 t.p.i. No. 20. (B & W 3016, 3015 and 3011.)

Band	$L_1$	$L_2$
80 m.	42½ turns A	16½ turns C*
40 m.	20½ turns B	24½ turns B
20 m.	6½ turns B	12½ turns B
15 m.	Same as 20 m.	6½ turns B
10 m.	3½ turns B	5½ turns B

\* With 2-inch length of  $\frac{1}{2}$ -inch diameter ferrite rod (Lafayette MS-333). See text. Jumper leads to connect 100- and 470-pf. capacitors are also included in this coil.

## A THREE-BAND V.F.O.

The v.f.o. shown in Figs. 6-43 and 6-46 furnishes output on 3.5, 7 and 14 Mc. sufficient to drive a crystal-oscillator stage as a frequency doubler or tripler. Consequently it serves as a good "crystal replacement" for a former crystal-controlled transmitter using, for example, a 6AG7 crystal-oscillator stage. A feature of the v.f.o. is the "differential keying", which permits break-in operation with amplifier-stage keying. When using the v.f.o. with a subsequent transmitter, the keying circuit of the transmitter does not require modification of any kind.

Referring to the circuit diagram, Fig. 6-44, a 6CG7 dual triode is used as oscillator and cathode-follower buffer. The plate-tickler oscillator circuit has two tuning ranges, selected by  $S_1$ . In the 2 position, the tuning range is 1.75 to 2.0 Mc., giving full coverage of the 3.5- to 4.0-Mc. band. In the 1 position of  $S_1$ , the oscillator tunes 1.75 to 1.86 Mc., and the harmonics cover the remaining amateur bands through 28 Mc. The two tuning ranges provide a more favorable tuning rate at 28 Mc. than if the basic range were 1.75 to 2.0 Mc. only.

Following the buffer stage, a 6AG7 doubles to 3.5 Mc. and provides output on that band. The 6AG7 is followed by 6AC5 doubler stages, switched in by  $S_2$  when needed.  $S_2$  also selects the output coupling link for the output stage in use. The lack of grid-leak bias in the two 6AC5 stages is deliberate; in this application these tubes furnish more output when the grid-leak bias is omitted.

The power-supply maximum drain is 75 ma., and the power transformer is capable of furnishing considerably more than this. However, it was the only one available in the voltage range desired. A filament transformer,  $T_2$ , is required for the tube heaters, and another filament trans-

former,  $T_3$ , is used as a step-up transformer for the bias and relay supply.

The keying relay is a fast one that keys the transmitter following the v.f.o. It is quiet and makes less noise than a semi-automatic "bug" key. The differential-keying circuit for the oscillator consists of the control dual triode 6CG7 and the 0C2 voltage-regulator tube used as a switch. The big advantage of the circuit is that it will work with any keyed amplifier.

## Construction

The mechanical stability of the v.f.o. is greatly enhanced by reinforcing the chassis with a strip of  $\frac{1}{8}$ -inch aluminum. A 12-inch length of a  $5\frac{1}{4}$ -inch unpainted aluminum rack panel (Bud SFA-1833) is bolted to the front top of the  $8 \times 12 \times 3$ -inch aluminum chassis used for the v.f.o. It is necessary to remove a  $\frac{1}{4}$ -inch strip at the right rear of the panel strip to leave room for the power transformer.

The panel for the unit is  $7\frac{1}{4}$  inches high and is formed from  $\frac{1}{16}$ -inch aluminum. Lips are bent at the top and sides to provide attachment area for the perforated-metal covering. The back panel is similarly made but has a  $2\frac{1}{4}$ -inch high opening for ventilation. The front and rear panels are tied together with doubled strips of the  $\frac{1}{16}$ -inch aluminum. The perforated-metal covering (Reynolds aluminum) is held to the panel lips and chassis with sheet-metal screws.

Leads to the tuning capacitor,  $C_1$ , are brought through the chassis and reinforcing strip by the use of National FTB feedthrough bushings. The installation of the Jackson Bros. (England) 6-36 two-speed dial drive (available from Arrow Electronics, N.Y.C.) is altered slightly. Instead of tying the planetary to the panel by two pillars furnished with the dial, the pillars are discarded

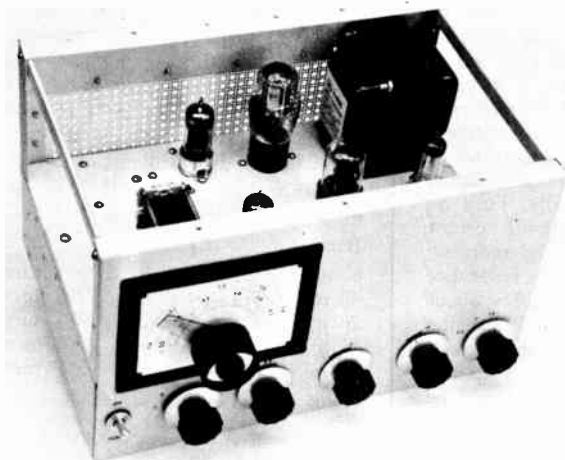

Fig. 6-43—The three-band v.f.o. with cane-metal cover removed. The v.f.o. delivers output on 3.5, 7 or 14 Mc. and includes its own differential-keying circuit. For improved mechanical stability, the front top of the chassis is reinforced with a length of  $\frac{1}{8}$ -inch thick panel material.

SPOT-OP switch at lower left. Continuing toward right the knobs control range switch, 3.5-, 7- and 14-Mc. tuning, output band.

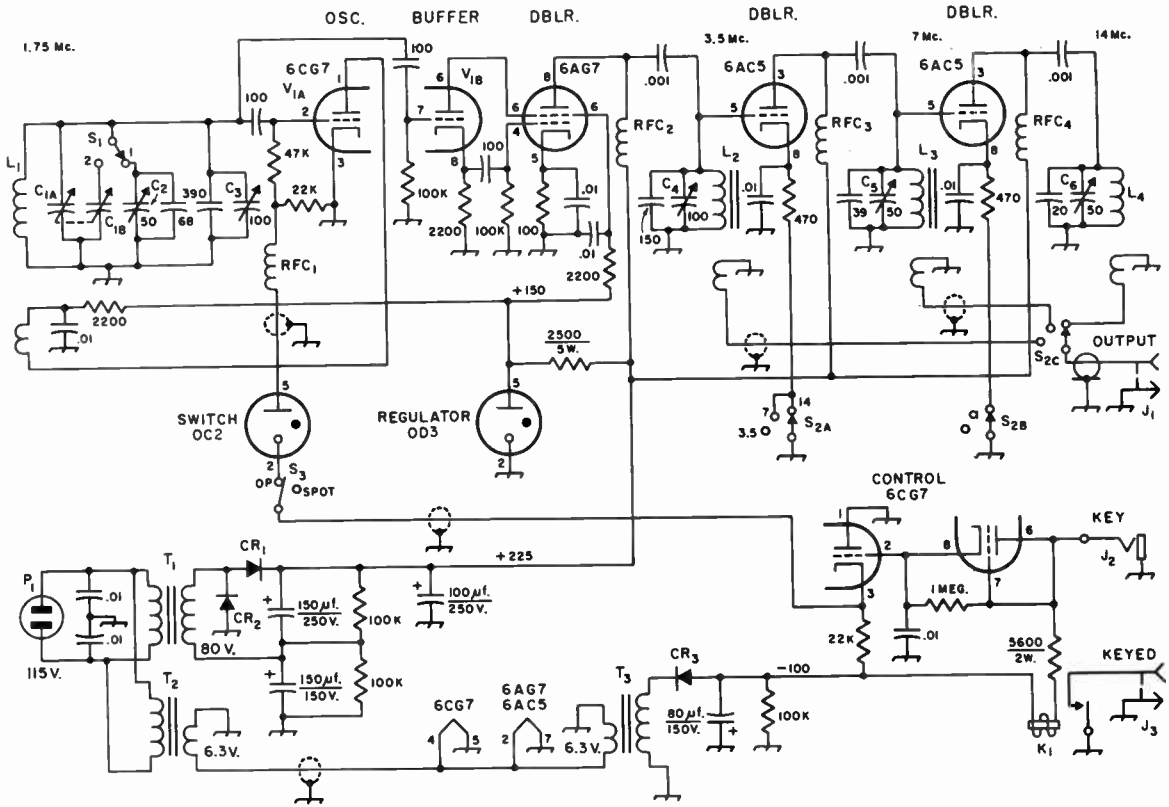

Fig. 6-44—Circuit diagram of the three-band v.f.o. Fixed capacitors under 400 pf. are dipped silver mica; 0.01 and 0.001  $\mu$ f. are disk ceramic.

- C<sub>1</sub>—Modified dual 100-pf. variable. (Johnson 167-53 type 100LD15. C<sub>1A</sub> has three rotor plates removed.)
- C<sub>2</sub>—50-pf. trimmer (Hammarlund APC-50).
- C<sub>3</sub>—100-pf. trimmer (Hammarlund APC-100).
- C<sub>4</sub>—100-pf. midget variable (Hammarlund HF-100).
- C<sub>5</sub>, C<sub>6</sub>—50-pf. midget variable (Hammarlund HF-50).
- CR<sub>1</sub>, CR<sub>2</sub>, CR<sub>3</sub>—400 p.i.v. 750-ma. silicon.
- J<sub>1</sub>, J<sub>3</sub>—Phono jack.
- J<sub>2</sub>—Phone jack.
- K<sub>1</sub>—High-speed keying relay, 2000 ohms, 9 ma. (Sigma 41F-2000FK-TUN).
- L<sub>1</sub>—27 turns No. 18, 16 t.p.i., 1/4 diam. (B&W 3019). Plate coil 5 turns same, spaced 1 turn.
- L<sub>2</sub>—15 turns No. 20, 16 t.p.i., 3/8 diam. (B&W 3007). Link 3 turns same, adjacent. Ferrite rod, 1/2

- diam., 1 1/4 long, extends down to link. (Lafayette Radio MS-333).
- L<sub>3</sub>—15 turns same as L<sub>2</sub>; link is 2 turns spaced 1 turn. Ferrite rod, 1 inch long, extends down to link.
- L<sub>4</sub>—14 turns same as L<sub>2</sub>; link is 2 turns, adjacent.
- P<sub>1</sub>—Fused line plug, 2-ampere fuses.
- RFC<sub>1</sub>—1-mh. low-current choke (Millen J300-1000).
- RFC<sub>2</sub>, RFC<sub>3</sub>, RFC<sub>4</sub>—1-mh. 135-ma. (National R-50).
- S<sub>1</sub>—1-pole 12-position (2 used) rotary ceramic switch (Centralab PA-2001).
- S<sub>2</sub>—3-pole 5-position (3 used) rotary ceramic switch (Centralab PA-2007).
- S<sub>3</sub>—S.p.s.t. toggle switch.
- T<sub>1</sub>—80-volt 1200-ma. transformer (Stancor P-8196).
- T<sub>2</sub>—6.3-volt 3-ampere transformer.
- T<sub>3</sub>—6.3-volt 0.6-ampere transformer.

and the planetary is mounted on an aluminum bracket mounted on the top of the chassis and reinforcing strip.

The oscillator coil, L<sub>1</sub>, is supported on a strip of 1/4-inch thick Lucite, which in turn is mounted on two 1 1/16-inch long insulators (National GS-1). Leads throughout the oscillator circuit were made with copper strip, although heavy wire should suffice.

Coils L<sub>2</sub> and L<sub>3</sub> use cores of ferrite rod to increase their inductance. To cut the core material,

first scribe a 1/16-inch deep notch around the rod with a triangular file. Then place a cold chisel in a vise, sharp edge up, and have an assistant hold the rod on the chisel, notch against the sharp edge. Hold a knife blade on the top of the rod at the notch and hit the knife blade with a hammer. It doesn't take more than a sharp tap to crack the rod through at the notch. The lengths of rod are inserted in the coil material and held in place by force or a little coil cement.

For acoustic insulation of the relay, to prevent

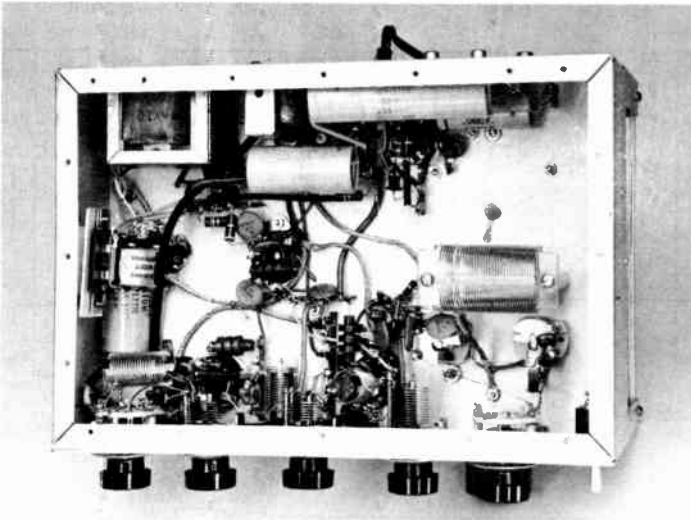

Fig. 6-45—Bottom view of the v.f.o. with its cover plate removed. The oscillator coil (right) is held in place by a Lucite strip mounted on standoff insulators. The 3.5- and 7-Mc. coils (near front panel, center) have lengths of ferrite rod inserted in them to increase the inductance. Keying relay (left) is mounted on block of sponge rubber (see text).

the chassis from serving as a sounding board, two strips of aluminum are cemented with epoxy cement to a small block of sponge rubber. The relay is mounted on one strip of aluminum and the assembly is held to the side wall of the chassis by the other and machine screws. Use sloppy wire leads to the relay, to minimize the acoustic coupling through the leads.

The remainder of the construction work is conventional. Tie points are used wherever required to secure components.

#### Adjustment

To test the oscillator, use a 6-volt 250-ma. dial lamp for a dummy load. When the v.f.o. is working properly, the lamp will light at about half brilliance on 14 Mc. and slightly less than that at the two lower frequencies.

After checking the circuit and determining that the power supply is working and the tubes are lit, turn  $S_1$  to 2, the tuning dial to a few degrees from fully-meshed  $C_1$ , and  $S_3$  to SPOT. Tune a receiver around 3.5 Mc. and find the v.f.o. signal. It will require some adjustment of  $C_3$  to

bring the signal to exactly 3.500 Mc. Then switch  $S_1$  to 1 and trim  $C_2$  so that the signal is again exactly on 3.500 Mc. The high-frequency limits can now be checked; 4.0 Mc. and 3.7 Mc. should both appear at about 90 on the dial, depending on whether the 1 or 2 range is in use.

The output can be checked by switching  $S_2$  to 3.5 and peaking  $C_4$ . Next switch on 7 and peak  $C_5$ , and finally switch to 14 and peak  $C_6$ .

Next check the hold-in time of the differential keying by plugging in a key at  $J_2$ . Turn  $S_3$  to ON and send a series of slow dots (about 5 w.p.m.). The oscillator should follow but the dots will be heavy. Increasing the speed to 10 or 15 w.p.m. should result in a steady signal from the oscillator. If the hold-in time is too long, it can be shortened by decreasing the value of the 1-meg-ohm resistor in the control-tube circuit. However, don't decrease it too much or you will be right back to oscillator keying. Note: the keying of this unit *should* have key clicks on it, on both make and break. The shaping of the keying (elimination of the key clicks) is done in the amplifier stage or stages keyed by the relay through  $J_3$ .

Fig. 6-46—Tap view of the three-band v.f.o. Miniature tube next to the tuning capacitor is the 6CG7 oscillator-buffer. The metal tube is the 6AG7, and the two large glass tubes are the 6AC5 multiplier stages. Miniature tube next to the transformer is the 6CG7 control tube; remaining tubes are OD3 regulator and OC2 switch.

Jacks at rear of chassis (bottom) are for output, amplifier keying and key.

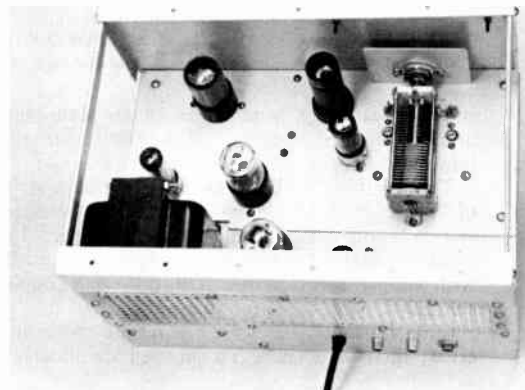



## A 75- TO 120-WATT 6146B TRANSMITTER

The transmitter shown in Fig. 6-47 is designed to satisfy the requirements of either a Novice or General Class licensee. With one combination of voltage-regulator tubes in the power supply it will operate normally at 75 watts input, with crystal switching, band switching, and other operating features. The General license holder can run 120 watts input normally by changing to another combination of voltage-regulator tubes. He can also use v.f.o. control and, by means of the modulator unit included in the transmitter, screen-modulated phone. Crystal switching is a convenience for rapidly shifting frequency within a band to dodge QRM, and a SPOT position on the operate switch permits identifying one's frequency relative to others in a band.

Referring to Fig. 6-48, the circuit diagram of the transmitter, the crystal selector switch,  $S_1$ , is used to choose the desired crystal. In one position it switches to  $J_1$ , where an external v.f.o. signal can be introduced, and it also switches a 0.01- $\mu$ f. capacitor to the cathode of the oscillator tube to prevent self oscillation.

The crystal oscillator stage uses a 6AG7 pentode, working "straight through" or frequency multiplying in its plate circuit. In other words, an 80-meter crystal in the grid will develop 80- or 40-meter energy in the subsequent 6146B grid circuit, depending upon the settings of  $S_3$  and  $C_1$ . Similarly, a 40-meter crystal will give drive to the 6146B on 40, 20, 15 and 10 meters. Since the excitation will vary with the degree of frequency multiplication, a screen-voltage drive control,  $R_1$ , is included.

For maximum stability, the 6146B amplifier is neutralized. This is done simply by using the capacitive neutralizing circuit of Fig. 6-23B. The adjustable capacitor,  $C_2$ , consists of a doubled length of No. 16 wire running from the 150-pf. mica capacitor through a National FTB feed-through bushing to a position alongside the 6146B envelope (see Fig. 6-49). The capacitance

between the length of wire and the plate of the tube is adjusted as described later.

Provision is included for measuring grid current or cathode current of the amplifier stage. To facilitate construction and reduce the chances for TVI, the leads to the meter switch  $S_4$  are brought out through Centralab FT-500 feed-through capacitors. The 0-5 milliammeter reads directly in the GRID position; in the PLATE position full-scale deflection represents 250 ma. cathode current.

The plate tank circuit of the 6146B uses the pi configuration for simple band switching. It will be noted that the same inductance is retained on both the 10- and 15-meter bands. This was done for convenience in construction.

Two transformers in parallel are used in the power supply because this is the most economical way to get the power until special transformers are available. Silicon rectifiers are used in the "economy" supply circuit. Depending upon the line voltage, the high-voltage supply will run about 750 volts, key up, dropping to about 700 under load. If the line voltage is near 120, these figures will be increased by about 50 volts.

Fig. 6-48 shows a 0B3 and a 0C3 in the voltage-regulator positions. This is for 120-watt operation. By using two 0B3's, or a single 0D3, the operation is more normal for 75 watts input.

The function switch,  $S_5$ , turns on the transmitter and also selects the c.w. or phone mode. On phone the modulator is turned on and connected to the screen of the 6146B, and at the same time the screen voltage is dropped to a lower value. Switch  $S_2$  is used to spot one's frequency in the band (oscillator only) and to tune at reduced input (zero screen voltage on amplifier). In the operate position, the oscillator and amplifier are keyed simultaneously, in the cathode circuit. A 10- $\mu$ f. capacitor across the key line is included to shape the keying and reduce key clicks.



Fig. 6-47—This 75-watt transmitter can be increased to 120 watts by changing voltage-regulator tubes in the power supply; an audio section is included for screen-grid modulation of the amplifier.

The toggle switch under the meter puts the meter in the grid or the cathode circuit of the 6146B amplifier. Small knobs under the switch control speech-amplifier GAIN (left) and OFF-CW-PH functions. Continuing at this level, knobs control crystal-selection switch, GRID tuning, grid band switch, and SPOT-OP-TUNE switch. Knob in center of panel controls DRIVE to amplifier stage; the amplifier plate-circuit band switch and P.A. (upper) and LOADING controls are to the right.



## Construction

A 10 × 14 × 3-inch aluminum chassis is used as the base of the transmitter, with a standard 8¾-inch rack panel trimmed to 15 inches serving as the panel. The panel is held to the chassis by the various switches and panel bushings common to the chassis and panel. A good idea of the relative location of the parts can be obtained from the photographs. (Scaled down templates for the panel and chassis are available from A.R.R.L. for 50 cents.) The rear panel for the r.f. compartment is made from a sheet of aluminum. Three-quarter-inch lips are bent along the four sides to give a finished size of 5 × 10½ inches. This rear panel is held to the chassis by 6-32 hardware, and the cane-metal screen is fastened to it with sheet-metal (self-tapping) screws. The cane-metal shield has lips bent out from it where it makes up to the front panel and to the top (not the side) of the chassis. The rear panel mounts 65⁄8 inches from the front panel, leaving about 3⁄8-inch clearance between it and the power transformer(s).

On the chassis, three of the four leads running to the meter switch are brought out through feedthrough capacitors. These capacitors mount in the three holes under the switch. The fourth

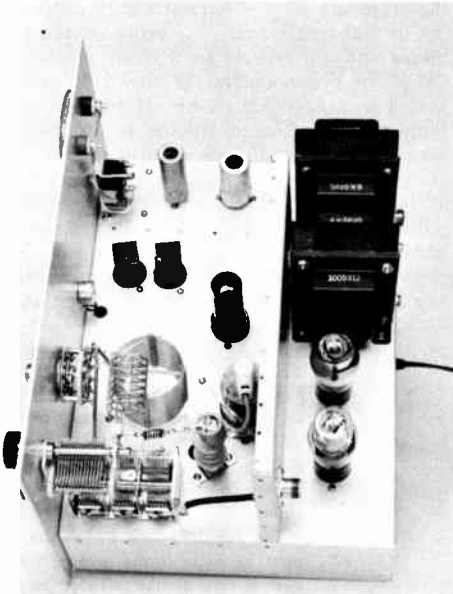

Fig. 6-49—Top view of the 6146B transmitter, with the cane-metal covering removed. Tube shields are used on the 12AX7 (right) and 6DS5 tubes in the modulator section. The double piece of bare wire between the 6146B and the r.f. choke is the neutralizing capacitor, C<sub>2</sub>. Octal sockets are used of crystal sockets, visible to the right of the panel-mounted DRIVE control.

Fig. 6-48—Circuit diagram of the 614B transmitter. Unless specified otherwise, resistance is in ohms, resistors are ½ watt, decimal capacitance values are in μf, whole number capacitances are in pf. (μμf.). Capacitors marked with polarity are electrolytic.

- C<sub>1</sub>—100-pf. variable (Hammarlund APC-100-B).  
 C<sub>2</sub>—Neutralizing capacitor, see text.  
 C<sub>3</sub>—200-pf. variable (Hammarlund MC-200-M).  
 C<sub>4</sub>—1095-pf. variable. 3-section, 365pf. per section, broadcast-type variable, stator sections connected in parallel, compression trimmers removed (Miller 2113 or equivalent).  
 CR—CR<sub>1</sub>—1000 p.i.v. 300-ma. silicon (1N3563 or equiv.)  
 J<sub>1</sub>—Phone jack.  
 J<sub>2</sub>—Open circuit phone jack.  
 J<sub>3</sub>—Coaxial receptacle, SO-239.  
 J<sub>4</sub>—Audio receptacle (Amphenol 75 PC1M).  
 L<sub>1</sub>—7½ turns No. 18, 8 t.p.i., 3⁄8-inch diam. (B&W 300G).  
 10-meter tap 5½ turns from grid end.
- L<sub>2</sub>—40 turns No. 24, 32 t.p.i., 1-inch diam. (B&W 3016).  
 Tapped 7 t. and 15 t. from L<sub>2</sub> end.  
 L<sub>3</sub>—7 turns No. 16, 4 t.p.i., 1-inch diam. (B&W 3013).  
 L<sub>4</sub>—21 t. No. 16, 10 t.p.i., 2-inch diam. (B&W 3907-1).  
 Tapped 4 t. and 9 t. from L<sub>4</sub> end.  
 P<sub>1</sub>—Fused plug, 3-ampere fuse.  
 R<sub>1</sub>—25,000-ohm 5-watt wirewound potentiometer (Molloy VW-25K).  
 R<sub>2</sub>—0.25-megohm volume control audio taper.  
 RFC<sub>1</sub>, RFC<sub>2</sub>, RFC<sub>3</sub>—1-mh. 135-ma. r.f. choke (National R-50).  
 RFC<sub>4</sub>—1-mh. 500-ma. r.f. choke (Johnson 102-752).  
 RFC<sub>5</sub>—6 turns No. 18 spacewound, 1⁄4-inch diam. Wound on 22-ohm 1-watt composition resistor.
- S<sub>1</sub>—2-pole 5-position non-shorting rotary switch (Centralab 2505).  
 S<sub>2</sub>—3-pole 3-position non-shorting rotary switch (Centralab 1407).  
 S<sub>3</sub>, S<sub>4</sub>—1-pole 6-position (5 used) non-shorting rotary switch (Centralab 2501).  
 S<sub>5</sub>—D.p.d.t. toggle switch.  
 T<sub>1</sub>, T<sub>2</sub>—540 v.c.t., 120 ma; 5 v., 3 a. (not used); 6.3 v., 3.5 ampere (Knight 61G466).  
 T<sub>3</sub>—10,000 primary, 8000-ohm secondary (Triod M-1X).  
 The 500-pf. feedthrough capacitors in meter leads are Centralab FT-500. The meter is a Parker S-25. Knight transformers available from Allied Radio, Chicago, Ill.



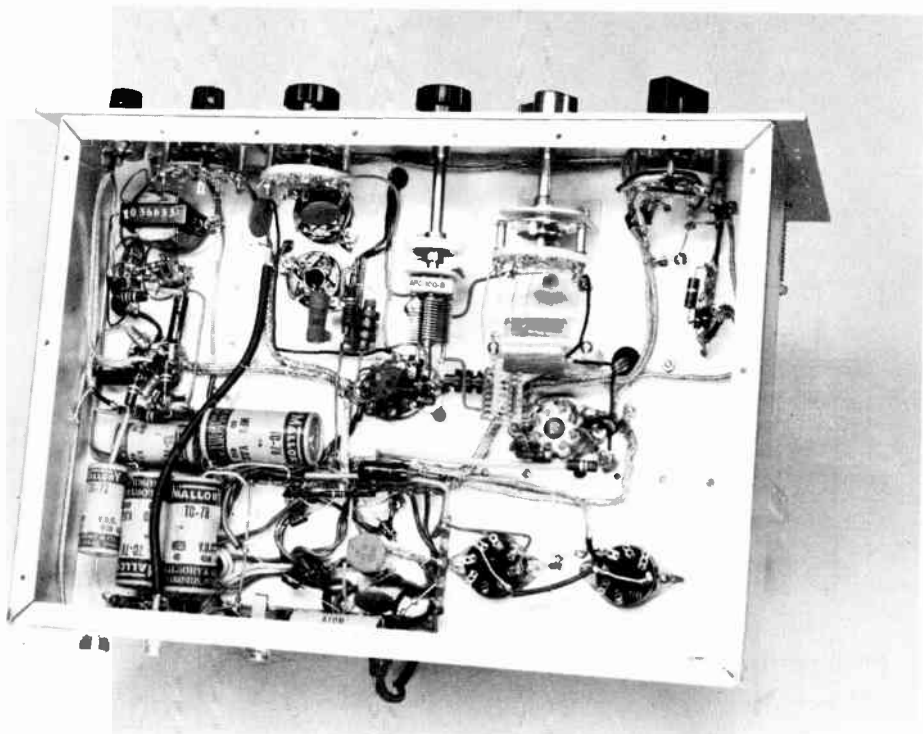

Fig. 6-50—Bottom view of the 6146B transmitter, with rubber feet and cane-metal cover removed. Microphone jack  $J_4$ , v.f.o. jack  $J_1$ , and key jack  $J_2$  are mounted on rear wall of chassis (bottom in this view).

lead (connected to chassis) runs to a solder lug held in place by a feedthrough capacitor. As mentioned earlier, the neutralizing lead is a double length of No. 16 wire soldered to an FTB feedthrough bushing. The lead to the base of  $RFC_3$  is brought up through a rubber grommet, as are the leads running to  $R_1$ . As indicated in Fig. 6-48, non-r.f. leads, such as heater, control and power, are run in shielded wire, to reduce chances for TVI.  $L_4$  is supported by a strip of  $\frac{1}{8}$ -inch Lucite force-fitted into the coil and fastened to the chassis by a small bracket. Other metal brackets (under the chassis) support capacitor  $C_1$  and switch  $S_3$ . The 500-pf. 1-kv. plate blocking capacitor is supported on the top of  $RFC_3$ .

The two octal sockets (Amphenol MIP-8) used for crystal sockets should have every other contact pin removed. This is done easily by twisting the pin and pushing it through. Since the rotor of  $C_1$  is "above ground" for r.f. and d.c., it must be insulated. This is done by using the capacitor specified (or one of similar construction) and by using an insulated shaft coupling between its shaft and the shaft of the panel bearing shaft assembly.

When wiring the power supply, it is necessary to connect the high-voltage windings correctly

to each other. First connect the primaries in parallel, then trial connect two secondary leads. If correct, no voltage can be measured between the other two leads. The 6.3-volt windings are used independently and require no attention; the 5-volt windings are not used and can have their leads taped to avoid accidental contact with the chassis. The four silicon diodes are mounted to tie points to space them from the chassis. Filter capacitors and associated bleeder resistors are also mounted on tie points. Don't omit the "spike-prevention" 0.01- $\mu$ f. capacitor across the high-voltage secondary.

### Adjustments

When the transmitter has been wired and checked against the schematic diagram, it is ready for test. The two voltage-regulator tubes should be plugged in their sockets and, with  $S_5$  at OFF, the plug  $P_1$  inserted in a 115-volt outlet.  $P_1$  should have fuses in it. When  $S_5$  is turned to CW, the voltage-regulator tubes should glow. If a d.c. voltmeter is available, the high voltage at  $RFC_3$  should measure about +750 to +800 (depending upon the line voltage), and the lower voltage (pin 8 of the 6AG7 socket) just less than half of this. *Both of these voltages are dangerous!* Turn off the rig at  $S_5$  and check with the volt-

meter that the voltage drops to zero at  $RFC_3$  and the 6AG7 socket. (It will take at least a minute for the high-voltage supply to drop to 50 volts.)

Pull  $P_1$  out of the outlet. (Never work on the transmitter with the a.c. plug in the outlet.) Plug in the 6AG7 and the 6146B, connecting the plate cap of the latter tube. Insert an 80-meter crystal and set  $S_1$  to the corresponding point. Set  $S_2$  in the TUNE position.

Replace  $P_1$  in the a.c. outlet, switch  $S_5$  to cw and  $S_4$  to GRID. Switch  $S_3$  to 80 and set the drive control at minimum. As the tubes warm up, swing  $C_1$  through its range. If the crystal oscillator stage is oscillating, grid-current readings will be obtained on the meter, and it should be possible, for a given setting of  $C_1$  to control the grid current by the setting of the drive control. If the meter is driven off scale, as is likely, the reading can also be reduced by detuning  $C_1$  (preferably to the low-capacitance side of resonance). Switch  $S_3$  to the 40-meter position and confirm that the second harmonic of the crystal can be tuned.

With a 40-meter crystal in place and  $S_1$  set to correspond, it should be possible to obtain grid current with  $S_3$  at 40, 20, 15 or 10 meters. The maximum grid current obtainable will be less on the shorter-wavelength bands, but with an active crystal  $2\frac{1}{2}$  ma. grid current should be available on 15 meters and about 1 ma. on 10. While this latter value will not be enough for full excitation, it is sufficient for operation. If an absorption wavemeter is available, the setting of  $C_1$  should be confirmed (and recorded) for each band, to insure on-frequency operation. With  $S_3$  in either of the two highest-frequency bands, it is possible to tune two harmonics of the crystal, and it is essential to know which is which. Lacking the wavemeter, a receiver with a 6-inch-or-so antenna can be used to check the bands. Leave  $S_2$  on TUNE.

With  $S_3$  and  $S_6$  set for 15 meters, tune  $C_1$  for maximum grid current (on 15 meters) and set the value to about  $1\frac{1}{2}$  or 2 ma. with the DRIVE control. Set  $C_4$  at about half scale and slowly tune  $C_3$  while watching the meter. At the point where  $C_3$  tunes through resonance a sharp dip in grid current will be seen, unless by pure chance the amplifier is already neutralized perfectly. Slow tuning is required because the meter is fairly well damped and will not respond instantly. When the dip has been found, try pushing the wire forming  $C_2$  nearer to or farther from the 6146B envelope, in an effort to reduce the dip to less than a meter division (0.1 ma.). The minute dip indicates that the amplifier is reasonably well neutralized. If a neutralizing indicator is available (see Index), it can be used instead of the grid-current dip. In this case the high voltage must be temporarily removed by unsoldering the lead between rectifiers and capacitor (marked "+750" in the circuit diagram). When neutralization has been completed and all circuits are normal, con-

nect a load to the transmitter. Preferably this is a 50-ohm dummy load. Second choice is a 100-watt lamp. If an output indicator is available, so much the better, although the lamp is a fair indicator on its own. On 80 or 40 meters, use an 80-meter crystal. With  $S_3$  and  $S_6$  set for the desired band, and with  $S_1$  set for the desired crystal, set  $S_2$  on TUNE and turn on the transmitter. With  $C_1$  and the drive control, adjust the grid current to  $2\frac{1}{2}$  ma. With a key plugged in at  $J_2$ , set  $S_2$  on OP. Set  $C_4$  at three-quarters meshed, and switch  $S_4$  to read plate current. Watching the meter, close the key and swing  $C_3$  for a plate-current dip. The dip indicates resonance. If the plate current dips below 170 ma. (indicated 3.4 ma.), decrease the capacitance in  $C_4$  and again tune  $C_3$  for resonance. The objective is to set the loading capacitor so that the plate current dips down to 170 ma. at resonance. Check the grid current after the plate circuit is tuned; if it isn't  $2\frac{1}{2}$  ma. correct it by retuning  $C_1$ .

Operation on 20 meters, with a 40-meter crystal, follows substantially the same procedure, except that  $S_1$ ,  $S_3$  and  $S_6$  are set for the corresponding crystal and bands. On 21 and 28 Mc., where the efficiencies are not quite as good and full grid current may not always be available, slightly different procedures are required. On 21 Mc. the amplifier stage should be loaded to about 160 ma., even if  $2\frac{1}{2}$  ma. grid current is available, as it should be. On 28 Mc. (7-Mc. crystal) the transmitter should be used with  $S_5$  switched to PH, to reduce the screen voltage on the 6146B. (The modulator is not necessary; if it hasn't been installed treat the transformer  $T_3$  secondary as a straight-through connection.) On this band, the plate-current dip should be 75 ma., with the grid current about 0.9 ma. If a v.f.o. with 20-meter output is used with the transmitter, the higher screen voltage can be used on the 6146B on 10 meters.

On phone,  $S_5$  is turned to PH and the transmitter tuning procedure is similar to that on c.w. However, on 3.8 through 14 Mc. the grid current should be set at 3 ma., and the plate-current resonance dip should be 100 ma. The setting of the gain control can be found by experience and the help of others if no oscilloscope is available. Do not advance the gain control any farther than where just a slight waver of the plate-current meter can be detected. On 21 Mc. the plate-current dip should be 90 ma., with grid current of 2 ma., and on 28 Mc. (crystal controlled with 7-Mc. crystal) one must compromise with 85 ma. plate current and 1 ma. grid current.

When used on 3.5, 7 and 21 Mc. at 75 watts input (Novice bands), a 0D3 should be substituted for the 0B3, and a jumper soldered between pins 5 and 2 of the 0C3 socket. This allows the 6146B to operate with 150 volts on the screen grid, and cuts down the screen dissipation when running a plate current of 100 ma. (75 watts input).

## A 90-WATT ALL-PURPOSE AMPLIFIER

The amplifier shown in Figs. 6-51 through 6-54 will serve as a Class-AB<sub>1</sub> linear amplifier or as a Class-C power amplifier with no changes other than the proper adjustment of excitation and loading. To accomplish this, a stabilized bias supply provides proper Class-AB<sub>1</sub> bias; the bias increases to the correct value for Class-C operation when the excitation is brought up to the point that yields normal grid current. A stabilized screen supply is included to insure good linear operation.

Referring to the amplifier circuit in Fig. 6-53, excitation on the desired band is introduced at  $J_1$ . The grid circuit is a commercial assembly,  $Z_1$ , that can be switched to the correct band by  $S_1$  and tuned by  $C_1$ . A pi-network coupler is used in the output, switched by  $S_2$  and tuned by  $C_3$ . Proper loading is obtained by adjustment of  $C_4$ ; to provide sufficient output capacitance in the 80-meter band an additional 680  $\mu\text{f.}$  is added. A neutralizing circuit,  $C_2$  and a 680- $\mu\text{f.}$  capacitor, adds to the fundamental stability at the higher frequencies. Parasitic suppressors were found to be necessary in the grid and plate circuits.

Overload protection is provided by a 250-ma. fuse in the cathode circuit. The grid, plate or screen current can be metered by a suitable setting of  $S_3$ ; with the resistances shown the meter provides a full-scale reading 5 ma. on grid current, 25 ma. on screen current, and 250 ma. on plate current.

If it is desired to plate- or screen-modulate the amplifier for a.m. operation, the necessary audio power can be introduced at  $J_3$ .



Fig. 6-51—Front view of the 6146 all-purpose amplifier. The upper panel is part of an 8 × 6 × 3½-inch Minibox (Bud CU-2109); the ventilated shielding of Reynolds Aluminium cane metal is fastened to the Minibox and base with sheet-metal screws.

Plate-circuit tuning controls and switch are mounted on the Minibox, and the grid-circuit controls, power switches and meter are mounted on the end of the 8 × 12 × 3-inch aluminum chassis that serves as a base.

The power-supply circuit is shown separately (Fig. 6-55) for convenience only, since the amplifier and power supply are all built on the same 8 × 12 × 3-inch chassis. High voltage for the plate of the 6146 is provided by a bridge rectifier using a 5U4-GB and two 6DE4 rectifiers; stabilized screen voltage is obtained from the same supply and two voltage-regulator tubes.



Fig. 6-52—Rear view of the 90-watt all-purpose amplifier with the cane-metal cover removed. One voltage-regulator tube has been removed from its socket (right edge of transformer) to allow the neutralizing capacitor and plate blocking capacitor to be seen. The plate r.f. choke (RFC<sub>3</sub> in Fig. 6-49) is mounted on one side wall, and the load capacitor and safety choke (C<sub>1</sub> and RFC<sub>1</sub> in Fig. 6-53) are mounted on the far side wall.

The rear apron of the chassis (foreground) carries the input and output coaxial-connector jacks, the 6146 cathode fuse, and the socket for the a.m. modulator connections. A shorting plug is shown in the socket.



## Construction

Most of the components can be identified in Figs. 6-51, 6-52 and 6-54, but a few construction notes are in order. The octal socket for the 6146 is mounted on two 1/2-inch-long collars above the usual 1 1/8-inch diameter hole in the chassis. The three .001- $\mu$ f. ceramic capacitors connected to the cathode pins (1, 4 and 6) ground to the chassis at lugs under the nuts holding the socket-mounting screws. The .001- $\mu$ f. ceramic capacitors in the screen and heater circuits ground to their respective wire shields which in turn are connected to the same ground lugs as the cathode circuit. The grounded side of the 680- $\mu$ f. capacitor in the grid-circuit return should also be soldered to one of the ground lugs.

The neutralizing capacitor,  $C_2$ , has its rotor

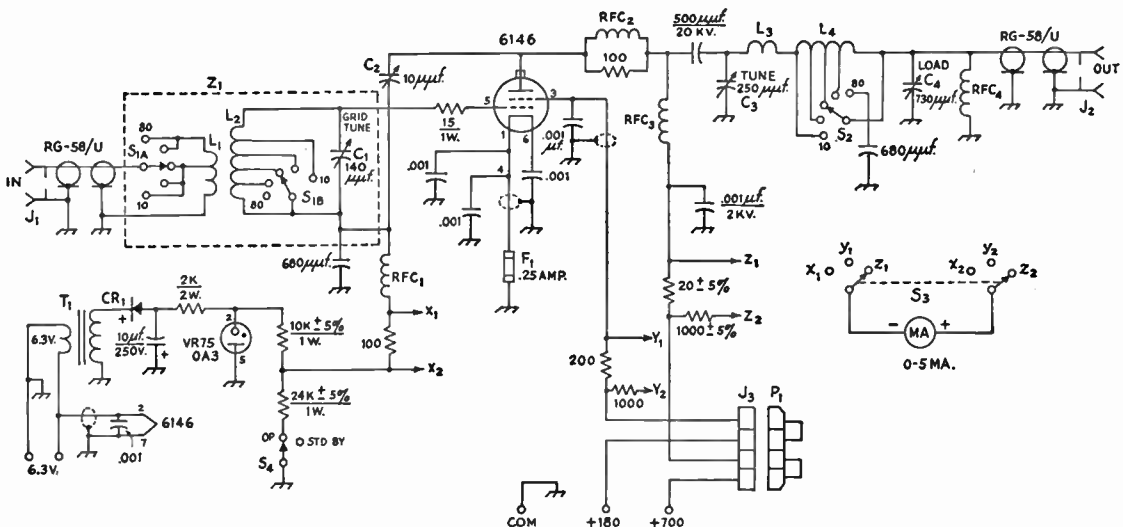

Fig. 6-53—Circuit diagram of the all-purpose amplifier and its bias supply. Unless otherwise indicated, resistors are 1/2 watt.

$C_1$ —140- $\mu$ f. midget variable (Hammarlund APC-140-B).

$C_2$ —10- $\mu$ f. midget variable (Hammarlund HF-15X with one stator plate removed).

$C_3$ —250- $\mu$ f. variable (Hammarlund MC-250M).

$C_4$ —730- $\mu$ f. variable (Broadcast receiver replacement, 365  $\mu$ f. each section, connected in parallel).

$CR_1$ —20-ma. 130-volt selenium rectifier.

$J_1, J_2$ —Coaxial cable connector, SO-239.

$J_3$ —4-pin tube socket.

$L_1$ —3 3/4 turns No. 18 at grid end of  $L_2$ , tapped 2 turns from ground end.

$L_2$ —50 turns No. 24, 1 3/4 inches long on 3/4-inch diameter threaded ceramic form. Tapped at 5, 8, 13 and 25 turns from grid end.

$L_3$ —4 1/4 turns No. 14, 1 3/8 inch diam., 3/8 inch long.

$L_4$ —18 turns No. 16, 2-inch diameter, 10 t.p.i. Tapped at 1 1/2, 5 1/2 and 11 1/2 turns from plate end. (B&W 3907-1).

$P_1$ —4-prong plug, with jumper connections as shown.

$RFC_1$ —2.5-mh. 100-ma. r.f. choke (National R-50).

$RFC_2$ —5 turns No. 16 wire, wound on 100-ohm 1-watt resistor.

$RFC_3$ —1-mh. 500-ma. r.f. choke (Johnson 102-752).

$RFC_4$ —2.5-mh. 125-ma. r.f. choke (National R-100S).

$S_1$ —2-pole 6-position (5 used) miniature ceramic switch (Centralab PA-2002).

$S_2$ —1-pole 6-position (5 used) ceramic switch (Centralab 2501).

$S_3$ —2-pole 6-position (5 used) non-shorting miniature ceramic switch. (Centralab PA-2003). Alternate contacts used only, to increase voltage rating.

$S_4$ —S.p.s.t. toggle switch.

$T_1$ —6.3-volt filament transformer (Stancor P-6134).

$Z_1$ , comprising  $C_1, L_2$  and  $S_1$ , is Harrington Electronics OP-20L unit. Capacitors showing polarity are electrolytic; 680- $\mu$ f. capacitors are silver mica, .001- $\mu$ f. are ceramic.

insulated from the chassis by mounting it in extruded fiber washers and a suitable hole in the chassis. Connection to the rotor should be made under the chassis by using a suitable soldering lug under the nut on the threaded sleeve bearing. (Old volume controls are a good source for this lug.)

The high-voltage lead from the base of  $RFC_3$  is run in well-insulated wire to a feed-through bushing that runs through the chassis and to the meter switch terminal  $T_1$ . A high-voltage bypass capacitor is connected between the bushing and the chassis.

A simple clamp, Fig. 6-56, holds the length of RG-58/U from  $C_4$  in place and at the same time insures that the r.f. leaves the compartment via the inside of the cable and not the outside. Aluminum cane metal is available in many

hardware stores, and it is an easy matter to bend a piece of it to form the cover. Make the cover with lips on the vertical portion that slip tightly over the sides of the Minibox, and with a bend at the bottom that can be fastened to the chassis. Another piece of cane metal should be cut to serve as a bottom cover; mounting the chassis on rubber feet lifts it above the table and permits good air circulation through the unit.

The self-supported inductor  $L_3$  can be wound on the envelope of one of the 6DE4 rectifiers, removed and pulled apart slightly to give the specified winding length. The taps on  $L_4$  are made by first bending inward the wire on either side of the turn to be tapped, then looping the tap wire around the turn and soldering it securely in place. Both  $L_3$  and  $L_4$  are supported only by their leads.

### Testing and Adjustment

With all tubes in their sockets except the 6146, the line cord should be plugged in and the power switch turned on. The bias-supply 0A3 should glow immediately and the rectifier filament and

heaters should light up. The screen-supply regulators should glow. If a voltmeter is available, the high-voltage supply should show first around 400 volts, and then rise slowly to about 950 volts. Switch off the power; the plate supply voltage should decay to less than 100 in under 20 seconds, indicating that the 40,000-ohm resistors are "bleeding" the supply. Note also how long it takes for the voltage to reach a value of only a few volts: this will demonstrate forcefully how long it takes to discharge a high-capacitance filter.

When the power supply has discharged, plug in the 6146, connect the plate cap, and set  $S_4$  to STAND BY. Set the neutralizing capacitor  $C_2$  at half capacitance and the band switches on 80 meters. Turn on the power and set the meter switch,  $S_3$ , to read plate current. The 6146 heater should warm up. Now flip  $S_4$  to operate; the meter should read 10–20 ma. (.2–.4 on the scale). Switching to read screen current, the meter should show under 1 ma. (2 divisions on the meter). There should be no grid current.

Turn off the power and remove the three

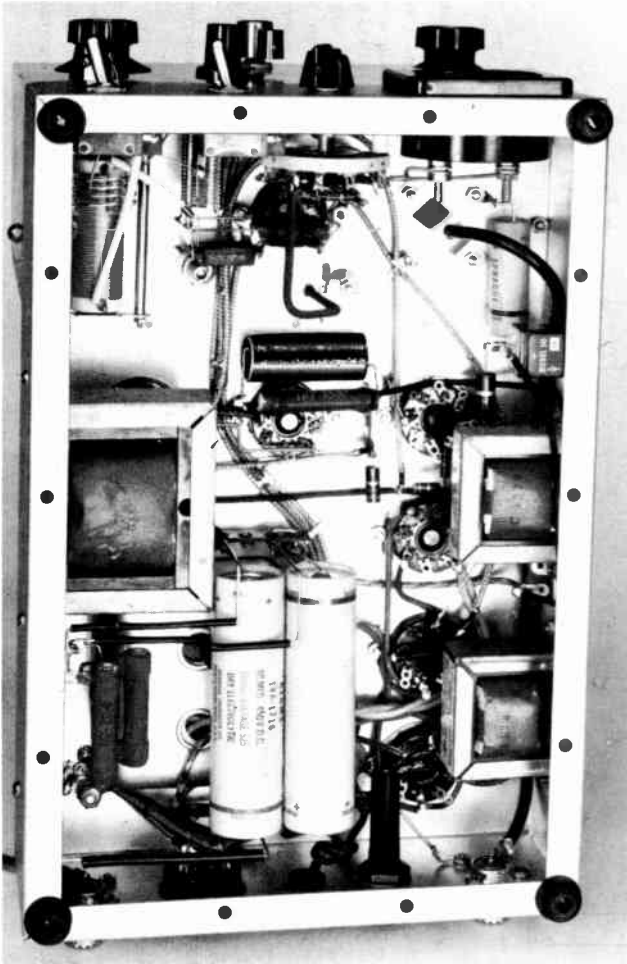

Fig. 6-54—Bottom view of the all-purpose amplifier. The 150-ma. filter choke is mounted on the left-hand wall; the smaller filter choke, the small filament transformer ( $T_1$  in Fig. 6-53) and the selenium rectifier are mounted on the right-hand wall. The strap of aluminum, visible below the meter at the top right, provides additional support for the length of RG-58/U cable that runs to the output coaxial connector. All power leads except the high voltage to the plate are run in shielded wire.

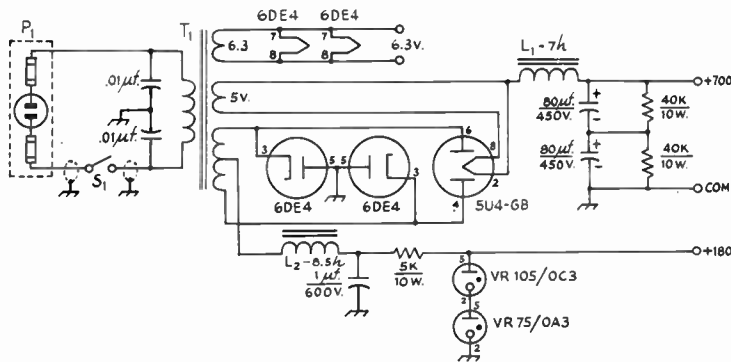

Fig. 6-55—Power supply section of the all-purpose amplifier.

- L<sub>1</sub>—7-henry 150-ma. choke (Stancor C-1710).
- L<sub>2</sub>—8½-henry 50-ma. choke (Stancor C-1279).
- P<sub>1</sub>—Fused line plug, 3-ampere fuses.
- S<sub>1</sub>—S.p.s.t. toggle.
- T<sub>1</sub>—800 v.c.t. at 200 ma., 6.3 v. at 5 amp., 5 v. at 3 amp. (Allied Radio Knight 62 G 033).

rectifier tubes. Connect at *J*<sub>1</sub> the driver or excitation source to be used—less than a watt is required for linear operation, and only a shade more for Class C. Use the drive at a high frequency, such as 21 or 28 Mc. Turn on the amplifier and switch the band switches to the band corresponding to the excitation-source frequency. Adjust the grid tuning capacitor for a show of grid current; peak the tuning and (if necessary) adjust the excitation for a half-scale reading of grid current. With the loading capacitor *C*<sub>4</sub> set at half scale, swing the tuning capacitor *C*<sub>3</sub> through its range. Watch carefully for a slight flicker in grid current. If one is found, adjust the neutralizing capacitor *C*<sub>2</sub> until the flicker is minimized. The amplifier is now neutralized. Alternatively, a sensitive detector of r.f. can be coupled at the output connector, *J*<sub>2</sub>, and used instead of the grid-current flicker. Adjust *C*<sub>2</sub> for minimum r.f. in the output when the plate circuit is tuned through resonance. Turn off the power switch and disconnect the excitation source.

Remove the sensitive detector, if used, and replace the rectifier tubes. Turn on the power and switch the meter to read plate current. With the grid and plate circuits switched to the same band (10, 15, 20 or 40) it should be possible to swing the grid and plate tuning to any combination of settings with no change in plate current reading. This indicates that the amplifier is stable and free from oscillation. (The amplifier can be made to oscillate on 80 meters with no grid or plate loading, but in loaded operation it will be stable.)

The antenna and excitation can now be connected and the amplifier used in normal fashion. Used as a linear amplifier, the excitation should be adjusted just below the level that would kick the grid-current indication on signal peaks. Proper loading will be obtained when a steady carrier just under the grid-current level is used for drive and the loading at resonance is set for

about 100 ma. plate current. Under these conditions of loading, a sideband signal will kick the plate current to about 40 or 50 ma. on peaks. Measured p.e.p. input before clipping should be 60 to 70 watts.

When used as a Class-C amplifier, the drive should be increased to where about 2 to 3 ma. grid current is drawn, and the loading to where the 6146 draws about 125 ma. If the amplifier is plate modulated, the plate current should be reduced to 95 ma., to stay within the tube ratings.

Since the amplifier uses a fixed and "stiff" screen supply, it is good practice always to bring up the excitation and loading together, while checking to see that the screen current never exceeds about 15 ma. In normal Class-C operation the screen current will run around 10 ma.

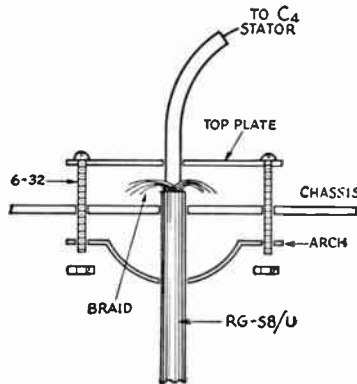

Fig. 6-56—Exploded view of the cable clamp used to hold the coaxial cable running to *J*<sub>2</sub>. The top plate is a 1½-inch square of sheet aluminum with holes at the four corners for 6-32 screws. The arch is a ⅜-inch wire strap that mounts diagonally under the chassis. When tightened, the top plate clamps the cable braid to the chassis; the arch lends support to the cable.

## AN 811-A 200-WATT GROUNDED-GRID LINEAR AMPLIFIER

The amplifier shown in Figs. 6-57, 6-59 and 6-60 requires about 15 watts of excitation power to drive it to full peak input (200 watts) on 3.5 through 30 Mc. For convenience and compactness, the amplifier is completely self-contained; silicon-diode rectifiers in the plate and bias supplies contribute materially to the small size.

Referring to the circuit diagram in Fig. 6-58, the input impedance of the grounded-grid 811-A amplifier (about 300 ohms) is stepped down through an "L" network to offer approximately 50 ohms as a load for the driver. The network makes for little or no complication, since the circuits are fixed-tuned and, once adjusted, need not be touched again. It will be noted that on the 15- and 10-meter bands no lumped capacitance is used in the network; this is because the capacitance of the length of RG-58/U running from  $S_{1B}$  is sufficient.

The filament choke,  $RFC_1$ , is an inexpensive homemade one (described later). Since the filament winding of the power transformer has no center tap, two 22-ohm resistors are used to provide a center tap for the filament circuit. In the band-switched plate circuit, a commercial inductor (with two winding pitches) is used, and because the output capacitor is not large enough on 80 meters, on that band an additional 500 pf. is switched in by  $S_2$ .

To meter grid or plate current, a 0-1 milliammeter is used as a 0-1 voltmeter to measure the drop across 10 ohms in the grid circuit or 2.5 ohms in the plate circuit, giving 0-100 and 0-400 ma. full-scale readings respectively.

A panel operate-standby switch,  $S_4$ , removes the fixed grid bias during operate periods. If an external control is available, is in a VOX-controlled s.s.b. exciter,  $S_4$  is left open and the external circuit connected through  $J_2$ .

All of the power is derived from a single husky TV power transformer. The plate power is derived from a voltage-doubling circuit using inexpensive silicon diodes and 450-volt electrolytic capacitors. The filament voltage for the 811-A is obtained from one transformer secondary, and another 6.3-volt secondary is utilized in a voltage-doubling circuit to provide cut-off bias for the 811-A, to avoid diode-noise problems if an electronic t.r. switch is used. High-voltage filtering is furnished by four 40- $\mu$ f. capacitors connected in series.

### Construction

The amplifier is built on a 10 × 12 × 3-inch aluminum chassis, with a panel and back panel of 0.063-inch aluminum measuring 9 × 12 inches. One-inch aluminum angle stock is used to make side and top lips that take the perforated-

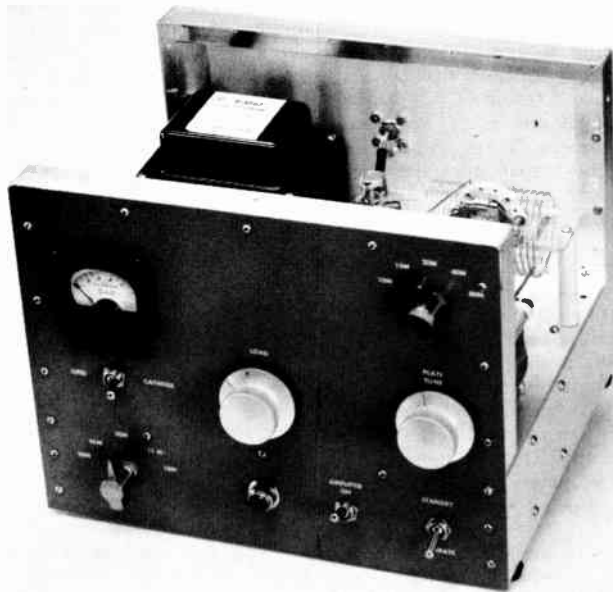

Fig. 6-57—The 200-watt grounded-grid amplifier with its perforated-metal cover removed. This compact amplifier uses an 811-A and a simple 1300-volt power supply. To simplify construction, two bandswitches are used (input at lower left, plate at upper right). The single meter can be switched to read either grid or plate current.

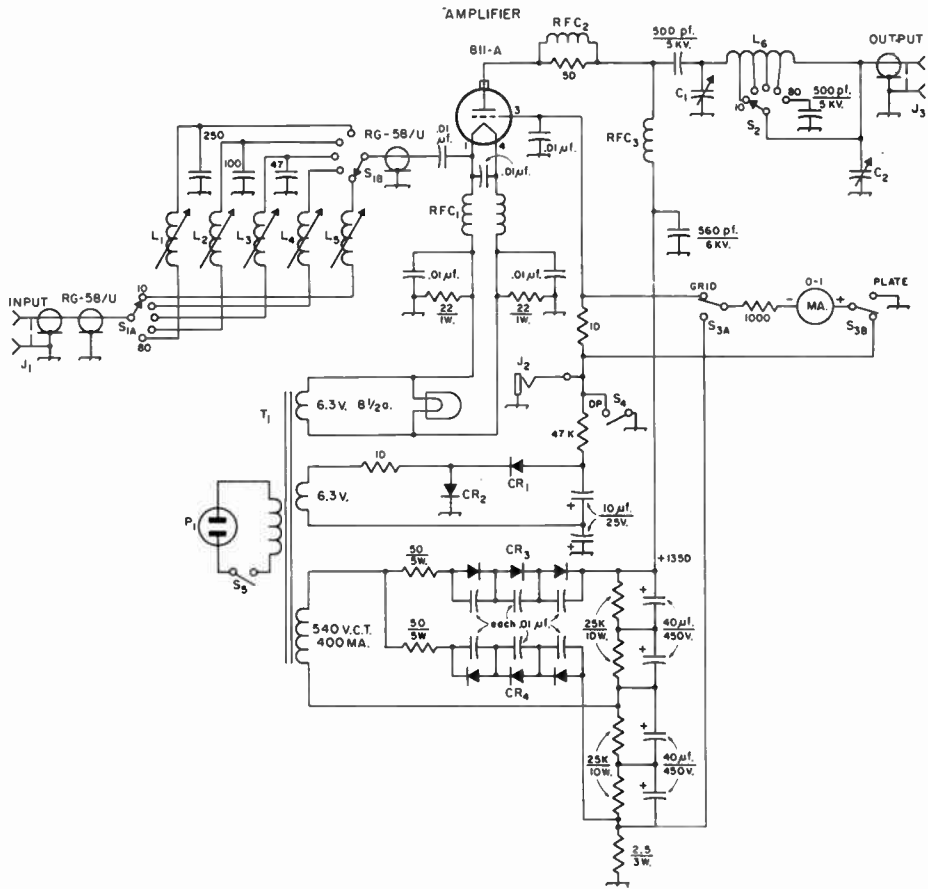

Fig. 6-58—Circuit diagram of the 200-watt grounded-grid linear amplifier. Unless specified, all capacitances are in picofarads (pf. or  $\mu\text{f.}$ ), all resistors are  $\frac{1}{2}$  watt, all resistances are in ohms. Capacitors marked with polarity are electrolytic; 0.01- $\mu\text{f.}$  capacitors are 1200-volt disk ceramic.

- C<sub>1</sub>—250-pf. variable, 0.045-inch spacing (Johnson type 154-1).
- C<sub>2</sub>—3-gang capacitor, 365 pf. each section (Allied Radio 60 L 726).
- CR<sub>1</sub>, CR<sub>2</sub>—200 p.i.v. 750 ma. silicon (RCA 1N3253 or equiv.).
- CR<sub>3</sub>, CR<sub>4</sub>—Each three 600-p.i.v. 500-ma. silicon diodes in series (RCA 1N3195 or equiv.).
- J<sub>1</sub>, J<sub>3</sub>—Coaxial receptacle, chassis type (SO-239).
- J<sub>2</sub>—Open-circuit jack.
- L<sub>1</sub>—5-9- $\mu\text{h.}$ , adjustable (Miller 4505).
- L<sub>2</sub>—3-5- $\mu\text{h.}$ , adjustable (Miller 4504).
- L<sub>3</sub>, L<sub>4</sub>—1-1.6- $\mu\text{h.}$ , adjustable (Miller 4502).
- L<sub>5</sub>—0.4-0.8- $\mu\text{h.}$ , adjustable (Miller 4501).
- L<sub>6</sub>—22 turns No. 14, 2-inch diam., 8 t.p.i. tapped 2, 3, 5, and 10 turns from C<sub>1</sub> end (Air-Dux PI 1608D6).

- P<sub>1</sub>—Mounting plate a.c. plug (Amphenol 61-M1).
  - RFC<sub>1</sub>—Dual winding, 29 turns No. 14 Formvar or Nylclad, spacewound on ferrite rod. See text.
  - RFC<sub>2</sub>—4 turns No. 14,  $\frac{3}{8}$ -inch diam.,  $1\frac{1}{4}$  inch long, wound outside two 100-ohm 1-watt resistors in parallel.
  - RFC<sub>3</sub>—1-mh. r.f. choke (National R-154U).
  - S<sub>1</sub>—2-pole 6-position rotary ceramic (Centralab PA-2003).
  - S<sub>2</sub>—1-pole 6-position rotary ceramic (Centralab PA-2001).
  - S<sub>3</sub>—D.p.d.t. toggle.
  - S<sub>4</sub>, S<sub>5</sub>—S.p.s.t. toggle.
  - T<sub>1</sub>—560 v.c.t. 400 ma.; 6.3 v. 8.5 a.; 6.3 v. 4.5 a. (Stancor P-8167).
- Knobs are Barker & Williamson 901; bar knobs are National HRB.



aluminum cover. The cover, not shown in the photographs, is a single piece 10 inches wide bent in a broad "U" shape; it is held to the lips by sheet-metal screws.

Capacitors  $C_1$  and  $C_2$  are fastened to the top of the chassis by 6-32 hardware;  $C_1$  is located far enough in from the edge so that its stator will clear the cane-metal side by  $\frac{1}{4}$  inch or better. The plate bandswitch,  $S_2$ , is supported by an aluminum bracket that is fastened to the rear of  $C_1$ . The 500-pf. plate-blocking capacitor and the  $RFC_2$  assembly are supported by the top of  $RFC_3$ , and the 500-pf. 80-meter output padding capacitor is bolted to the chassis below  $S_2$ . Plate coil  $L_6$  is supported by two  $2\frac{1}{2}$ -inch ceramic pillars. To reduce the height taken by the 811-A above the chassis, the 811-A socket is supported below the chassis by mounting it (Amphenol 49RSS4) in a recessed shell (Amphenol 61-61).

Underneath the chassis, the two toggle switches, the 6.3-volt pilot lamp, and the bandswitch  $S_1$  are mounted on the front lip of the chassis. The input inductors,  $L_1$  through  $L_5$ , are clustered around the bandswitch, as are the sev-

eral capacitors associated with this circuit. Lengths of RG-58/U run from the arms of  $S_1$  to the input jack,  $J_1$ , and the 811-A socket. The unused socket pin (No. 2) is used as a tie point for the coaxial line and the 0.01- $\mu$ f. coupling capacitor.

The filament choke,  $RFC_1$ , is made by winding No. 14 Formvar or Nylclad wire on a  $7\frac{1}{2}$ -inch length of  $\frac{1}{2}$ -inch diameter ferrite antenna core (Lafayette Radio, N.Y.C., MS-333). To obtain a high- $Q$  coil, the two windings are wound parallel but spaced by lacing twine to give 29 turns in each coil. The coil is wound by securing the two ends and the length of spacing twine in a vise, securing the other wire ends to a 2-terminal strip held in place by a  $\frac{1}{2}$ -inch diameter nylon cable clamp, and then winding the coils as the wires are stretched taut. Each turn of the core winds two turns of wire and one of twine. The twine is left on the coil, and no insulation is required between wires and core when the recommended surface covering (Formvar or Nylclad) is used. The choke assembly is supported below the chassis by 1-inch ceramic posts and the nylon cable clamps.

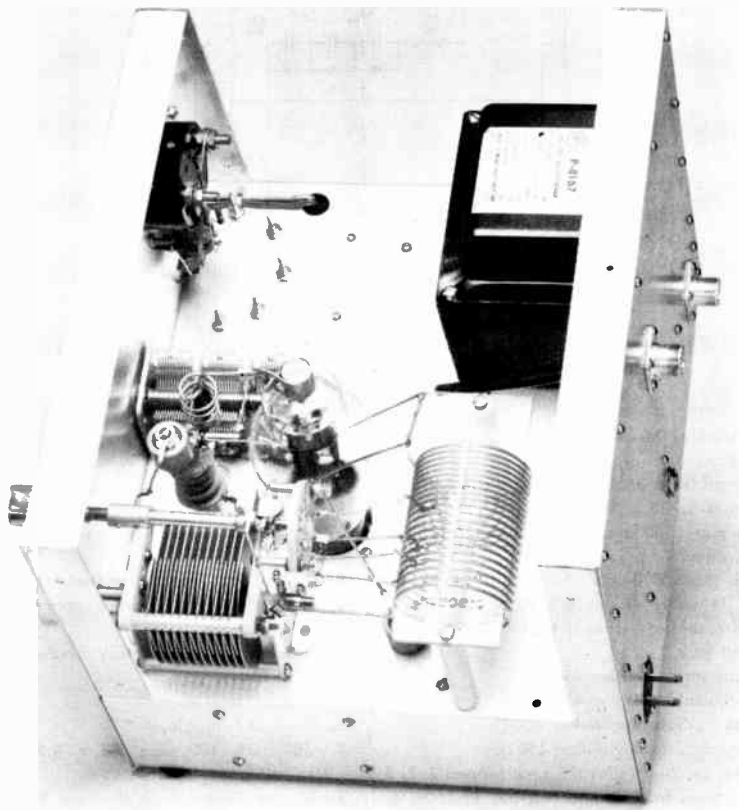

Fig. 6-59—A top view of the 811-A amplifier. The adjusting screws for the five switched input circuits project through the chassis under the meter. A bracket fastened to the back plate of the plate tuning capacitor (lower left) supports the plate bandswitch.

The bias-supply rectifiers, resistors and capacitors or mounted on a multiple tie-point strip. In the high-voltage supply, the diodes and capacitors are mounted on a  $4 \times 7$ -inch piece of  $\frac{1}{16}$ -inch thick prepunched phenolic terminal board (Vector 85G24E1P) with push-in terminals (Vector T-28). The resistors, both 50-ohm 5-watt and 25,000-ohm 10-watt, are mounted on tie points or narrow strips of terminal board located several inches from the diode and capacitor board. The reason for this is simple: the resistors become hot and might damage the diodes if mounted too close to them. The 2.5-ohm 3-watt resistor consists of three 7.5-ohm 1-watt resistors connected in parallel.

### Tuning

When the wiring has been completed and the power supply checked (+1500 volts no-load, about 1450 with the 811-A drawing idling current of 30 ma.), the amplifier can be checked on a band

with a driver capable of delivering a peak signal of 15 watts or so. A dummy load should be used during initial tests, and an output indicator (r.f. ammeter or voltmeter) is very useful. Using a c.w. signal to drive the amplifier, it should be found possible to load the amplifier so that at plate-circuit resonance the plate current is 160 ma. and the grid current is about 27 ma. As the drive is reduced the grid and plate currents should drop back at roughly the same rate. If the amplifier is not loaded heavily enough, the grid current will run proportionately higher than the plate current. There is, of course, no real substitute for a two-tone linearity test, as outlined in Chapter Eleven, but the above figures will serve as a rough guide. When the amplifier has been loaded to the figures above with a c.w. driving source, an s.s.b. signal driving it to peak output will kick the plate meter to about 80 ma. (0.2 on meter) or the grid meter to 15 ma. (0.15 on meter).

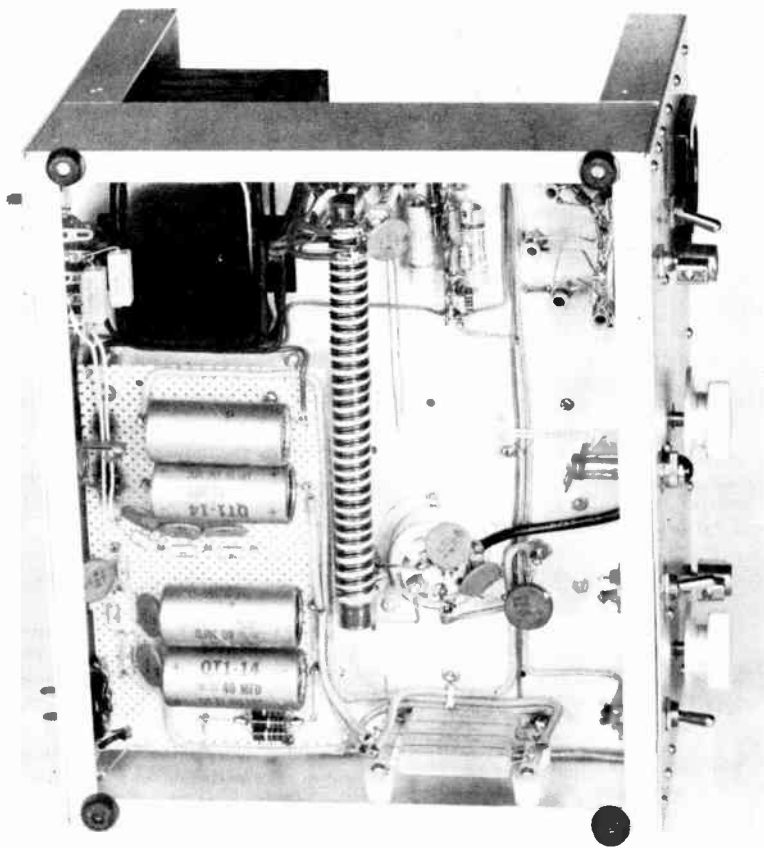

Fig. 6-60—The 811-A socket is mounted below the chassis in a recessed shell. One end of the homemade filament choke is supported near the socket, and the other end is mounted near the transformer. Four 25,000-ohm bleeder resistors (bottom) and two 50-ohm resistors (upper left) are mounted well away from the plate-supply diodes (left) and bias diodes (top center, to right of filament choke).

## A SELF-CONTAINED 450-WATT C.W. TRANSMITTER

The 450-watt c.w. transmitter shown in Figs. 6-61 through 6-67 is completely self-contained including a 2500-volt semi-conductor power supply. Using an external s.s.b. exciter, the driver and final can be run as Class AB<sub>1</sub> linears with a final input of about 275 watts. Only a few volts of excitation is required.

Referring to Fig. 6-63, the oscillator is a high-C Colpitts using a 6BQ7A dual triode, with both sections connected in parallel. The v.f.o. operates in the 1.75 to 2.0 Mc. range for complete coverage of the 3.5 to 28 Mc. bands. Small coupling capacitance, high resistance grid leak and temperature compensation keep drift at a minimum.

A 6CX8 triode-pentode operates as a buffer-doubler stage on 3.5 Mc. On 80 meters its output is fed directly to the 2E26 driver,  $V_8$ ; on the other bands it drives a 12BH7A doubler,  $V_3$ , to 7.0 Mc.  $V_3$  drives  $V_8$  on 40 meters, a 12BH7A doubler,  $V_{4A}$ , to 14 Mc. on 20 and 10 meters and a 12BH7A tripler,  $V_{4B}$ , to 21 Mc. on 15 meters.  $V_{4A}$  feeds the driver on 20 meters and  $V_{4B}$ , now a doubler, on 10 meters.  $V_{4B}$  drives the 2E26 on 15 and 10 meters; it doubles or triples depending upon whether  $L_5$  or  $L_6$  is switched into its plate circuit by  $S_1$ . The tuning capacitors of the multiplier stages are ganged to one control.  $V_2$ ,  $V_3$  and  $V_4$  are cathode biased to prevent excessive plate dissipation when they are not being driven.

The 2E26 driver is neutralized and operates straight through on all bands. A potentiometer in its grid circuit serves as a drive control.

The final is a 4E27A/125-B and requires no neutralization. Under some conditions the amplifier can be made to oscillate when unloaded, but in normal loaded operation it will be quite stable. An unusually high plate voltage-to-current ratio (2450 volts, 185 ma.) requires a pi-L configuration in the output for reasonable components to be used and good efficiency to be obtained. Plate tuning capacitor,  $C_{17}$ , is tapped down on the pi coil,  $L_8$ ; otherwise, the loaded Q of  $L_8$  would be too high and large circulating currents would

overheat it on 10 and 15 meters. The high plate impedance of the final necessitates the use of two r.f. chokes in the high voltage line to keep r.f. out of the power supply.

The 2E26 screen is keyed by cathode follower  $V_{6A}$ , and shaping is obtained from  $C_{13}$  and the various circuit resistances. The manual key leads are made non-lethal by the addition of a switch tube,  $V_7$ , a circuit borrowed from the *Radio Handbook*.  $V_5$  and  $V_{6B}$  make up the oscillator switching circuit for smooth differential keying.

A switchable 0-5 milliammeter is used to meter the driver and final stages. Appropriate multipliers provide full scale readings of 10 ma. for the 2E26 grid, 100 ma. for the 2E26 plate, 25 ma. for the final grid and 50 ma. for the final screen. Final plate current and voltage are metered in the power supply.

Referring to Fig. 6-62, the plate supply uses a 2340-volt transformer followed by a semiconductor bridge rectifier and a capacitive-input filter. Eight 1N1764 diodes are used in each leg of the bridge. A 30-uf. filter is furnished by eight 240-uf. electrolytics in series. Final plate current is measured in the negative high-voltage lead; a 10-ohm resistor provides a full scale reading of 500 ma. Final plate voltage is determined by measuring the voltage across  $C_1$  through two multiplier resistors; full scale reading is 5000 volts.

The low-voltage supply uses three 1N1764 diodes in each leg of a full-wave rectifier. Five hundred volts for the plate of the driver and the screen of the final amplifier are provided at the output of a capacitor-input filter. Voltage regulator tubes supply suitable voltages for the exciter and for the screen of the driver. A half-wave rectifier of three 1N1764 diodes and a capacitor input filter furnishes 500 volts of bias for the keyer; a voltage regulator tube supplies 150 volts of bias for the driver and final.

Separate filament windings are used for the keyer tubes so as not to exceed their heater-to-cathode voltage ratings.



Fig. 6-61—The 450-watt c.w. transmitter is mounted on I beams of Reynolds T-shaped aluminum to allow air to be drawn in at the bottom and cool the 4E27A/5-125B final by convection. Controls along the bottom, from left to right, are the power switch and associated pilot light, driver plate tuning, exciter band switch, exciter tuning and final band switch. Above, from left to right, are the meter switch, spot-operate control, v.f.o. tuning, final drive control and final loading. Final plate tuning control is at the upper right. The v.f.o. dial is an Eddystone 898, the pointer knobs are National, and all other dials are Johnson. (Built by Walter Lange, W1YDS, West Hartford, Conn.)



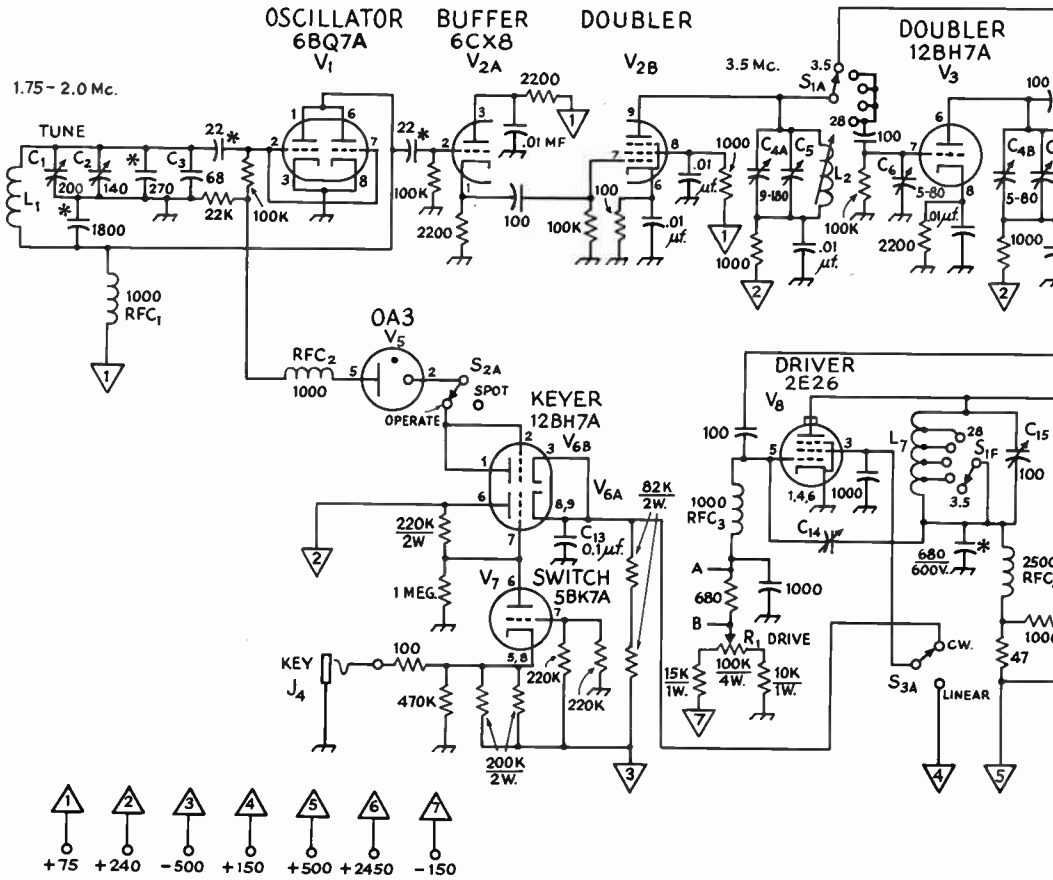

Fig. 6-63—Circuit diagram of the 450-watt self-contained transmitter. Unless otherwise specified, all capacitances are in picofarads (pf. or uuf.), all resistors are 1/2 watt, all resistances are in ohms. Except as noted below, 100-pf. fixed capacitors are mica or ceramic, 1000-pf. and .01-uf. capacitors are disc ceramic, and those marked with asterisk are silver mica. R.f. chokes are in uh. For simplicity, the power supply is shown in a separate diagram (Fig. 6-62).

- C<sub>1</sub>—200-pf. variable (Johnson 167-12).
- C<sub>2</sub>—140-pf. variable (Hammarlund APC-140).
- C<sub>3</sub>—68-pf. negative coefficient ceramic (Centralab N750, type TCN).
- C<sub>4</sub>—52-pf., 33-pf. dual variable (Hammarlund HFD-50 with three rotor and two stator plates removed from C4B section).
- C<sub>5</sub>—9-180-pf. mica compression trimmer.
- C<sub>6</sub>, C<sub>7</sub>—5-80-pf. mica compression trimmer.
- C<sub>8</sub>, C<sub>10</sub>, C<sub>11</sub>—3-30-pf. mica compression trimmer.
- C<sub>9</sub>—33-pf., 48-pf. dual variable (Hammarlund HFD-50 with three rotor and two stator plates removed from C<sub>8A</sub> section and one rotor plate removed from C<sub>9B</sub> section).
- C<sub>12</sub>—1.5-15-pf. mica compression trimmer.
- C<sub>13</sub>—0.1-pf. 600-volt paper.
- C<sub>14</sub>—9-pf. variable (Hammarlund APC-15B with one rotor and one stator plate removed).

- C<sub>15</sub>—100-pf. variable (Hammarlund APC-100B).
- C<sub>16</sub>, C<sub>18</sub>—1000-pf. 5000-volt ceramic (Centralab 858S-1000).
- C<sub>17</sub>—75-pf. 4500-volt variable (Johnson 154-13).
- C<sub>19</sub>, C<sub>20</sub>, C<sub>21</sub>—100-pf. 5000-volt ceramic (Centralab 850S-100N).
- C<sub>22</sub>—320-pf. variable (Hammarlund MC-325-M).
- J<sub>1</sub>, J<sub>2</sub>, J<sub>3</sub>—Coaxial chassis receptacle, SO-239.
- J<sub>4</sub>—Open-circuit phone jack.
- L<sub>1</sub>—Approx. 18 μh.—32 turns No. 22 Nylclad or Formvar, closewound on 1-inch diam., 1 1/4-inch high ceramic form (National XR-60 with iron slug removed).
- L<sub>2</sub>—14.8-31-μh. adjustable (Miller 4407).
- L<sub>3</sub>—6.7-15-μh. adjustable (Miller 4406).
- L<sub>4</sub>—1.5-3.2-μh. adjustable (Miller 4404).

the divider, allows the 3 × 4 × 5-inch utility box (Premier AC-453) in the final to be mounted flush to the driver compartment. Both the exciter and power supply are built on 3 × 7 × 17-inch aluminum chassis (Premier ACH-409).

Generous use of 3/4 × 3/4 × 1/8-inch aluminum angle is made throughout the unit. The transmitter is mounted on two I beams of Reynolds T-shaped aluminum. Two sections of T material, bolted side to side, form each I beam. A 19-inch





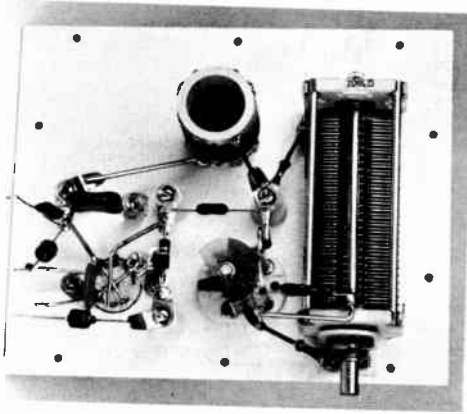

Fig. 6-64—V.f.o. components are mounted on a 5 x 6 x 1/8-inch aluminum plate. Tie-points are 3/4 x 1/2-inch cone insulators. Free leads at the left side of the plate connect to the rest of the circuitry via National TPB threaded polystyrene bushings. Although not shown in the photograph, temperature-compensating capacitor  $C_3$  should be soldered parallel to the silver mica capacitor located between the two variable capacitors.

one of the side panels of a 4 x 5 x 6-inch utility box (Premier AC-564). Tuning capacitor,  $C_1$ , is positioned so that its shaft lines up with that of the v.f.o. dial. Once the oscillator plate is mounted,  $C_1$  can be connected to the tuning dial with a Millen 39016 flexible coupling. With the correct position located, the box can be bolted permanently to the exciter chassis. Five 1/4-inch holes are drilled through the exciter chassis and v.f.o. box. National TPB threaded polystyrene bushings are installed in the holes and connected to the oscillator circuitry. Attaching the other side plate to the utility box completes the v.f.o. construction.

The exciter chassis is divided into two compartments by an aluminum plate that runs the width of the chassis. This plate is mounted 4 1/2 inches from the rear panel (see Fig. 6-65). Multiplier tube sockets are mounted in a line, 2-1/8 inches from the right edge of the exciter chassis. The 80, 40, 20 and 15 meter coils are lined up 2 1/2 inches to the right of the same edge. Two Hammarlund HFD-50 dual-section variable capacitors are mounted back-to-back and insulated from the chassis with extruded fibre washers. Millen 39016 insulated flexible couplings are used to insulate the two capacitors from each other and to connect them to a front panel shaft. Trimmer capacitors  $C_5$ ,  $C_7$ ,  $C_{10}$  and  $C_{12}$  are mounted directly on the four-section variable. Holes are drilled above the trimmers to permit their adjustment from the top of the chassis.

Band switch,  $S_1$ , is assembled from six Centralab XD wafers and a P-272 index. Its sections are arranged so that the majority of contacts on the first five sections face the left and the majority of contacts on the last wafer (in the driver compartment) face the right (see Fig. 6-65).  $S_1$

is supported by a small bracket at the front and a chassis divider plate at the rear. Trimmer  $C_6$  is mounted to the right of the third wafer between the 40 and 20 meter coils.  $C_8$  is mounted between the second and third wafers,  $C_{11}$  between the third and fourth wafers and the 10 meter coil between the fourth and fifth. Small holes are drilled above the trimmer capacitors to permit their adjustment from the top side of the chassis. Driver neutralization capacitor,  $C_{14}$ , is insulated from the chassis and is mounted in line and to the rear of the 80 through 15 meter coils.

The c.w.-LINEAR switch is mounted just to the left of the band switch; its shaft is spaced about 1/8-inch from wafer  $S_{1F}$ . A long shaft on the left side of the exciter chassis connects to the driver plate tuning capacitor,  $C_{15}$ , which is insulated from the chassis. Behind this capacitor on the rear panel is the final cathode fuse holder.

The 2E26 socket is mounted just to the right of wafer  $S_{1F}$ . Driver plate coil,  $L_7$ , supported by two small plexiglas bars and metal spacers, is mounted between the shaft of  $S_3$  and the 2E26. Small holes are drilled in the exciter chassis above the 2E26 to permit ventilation of the driver stage.

The drive potentiometer,  $R_1$ , is mounted on the front panel above the exciter chassis (see Fig. 6-67).

S.s.b. energy is introduced at a SO-239 coaxial connector on the rear panel. A length of RG-58/U coaxial cable takes it through two UG-177/U coaxial hoods, one mounted above and one mounted below the chassis, to the c.w.-LINEAR switch.

The voltage regulator and keyer tubes are mounted in a line 1/8-inch from the left side of the chassis (see Fig. 6-65). A 10 x 2 3/4-inch bracket to the right of the tubes supports the electrolytic capacitors in the low-voltage and bias supplies. The power supply diodes and associated capacitors and resistors are mounted on 1 3/16-inch strips of prepunched terminal board (Vector 85G24EP) with push-in terminals (Vector T-28). Diodes and resistors are on one side of the board and capacitors on the other. Small 2 1/2 x 1/2-inch brackets support the diode strips above the chassis and away from each other. Filament transformers  $T_2$  and  $T_4$  are located near the back of the chassis with the low-voltage supply diodes to their right.

The power switch and pilot lamp are mounted at the front of the chassis; the key jack, a.c. connector, screen and high-voltage primary fuse holders and final bias potentiometer are mounted at the rear. Both the low-voltage and plate transformers are mounted at the back of the power supply chassis, with the plate transformer overlapping the exciter chassis by 1 inch (see Fig. 6-67). Filament transformer,  $T_1$ , and filter choke,  $L_1$ , are mounted on the exciter chassis in line with the plate transformer.  $L_1$  is also in line with the 80 through 15 meter coils and  $C_{14}$ .

Three 8 x 10 1/4-inch sheets of plexiglas are used in the construction of the high-voltage filter. A 4 x 4 1/4-inch piece is removed from the corner

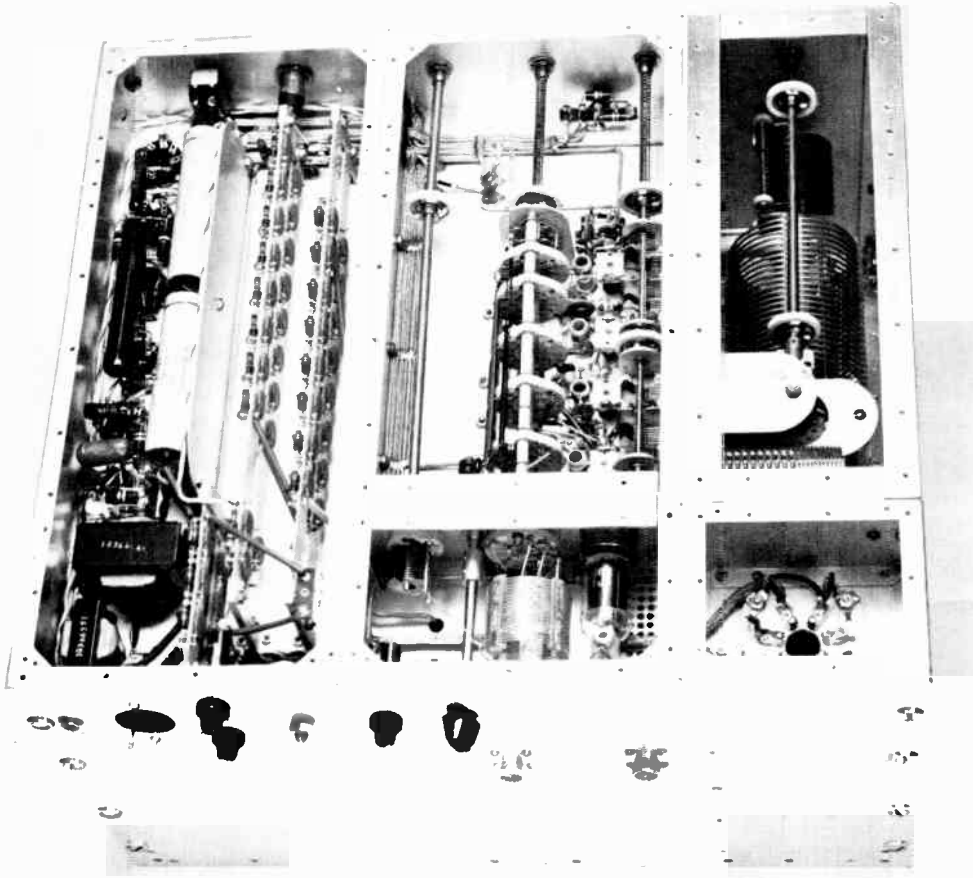

Fig. 6-65—Bottom view of the 450-watt transmitter with the perforated aluminum shielding removed. Two  $10\frac{1}{2} \times 19$ -inch rack panels are separated by two  $3 \times 7 \times 17$ -inch chassis, one  $3 \times 4 \times 5$ -inch utility box and several lengths of  $\frac{3}{4} \times \frac{3}{4} \times \frac{1}{8}$ -inch aluminum angle. Power supply diodes and associated protective capacitors and balancing resistors are mounted on pre-punched terminal boards in the chassis at the left. Electrolytic capacitors in the low voltage supply are mounted on an aluminum bracket to the left of the diodes. The center chassis is divided into two compartments, the smaller one containing the 2E26 driver tube and its companion plate circuit components. Small holes drilled above the 2E26 allow air to circulate around the tube. A shaft passing through the driver compartment connects to the C.W.-LINEAR switch in the exciter section. The four-section variable capacitor in the exciter compartment is insulated from the chassis with extruded fibre washers. All leads entering the center chassis are shielded.

of each sheet, for clearance of the v.f.o. box. The bottom sheet is  $\frac{1}{4}$ -inch thick and insulates the filter capacitors from the chassis. A second sheet, also  $\frac{1}{4}$ -inch thick, has clearance holes to hold the capacitors in position. The top plexiglas plate,  $\frac{1}{8}$ -inch thick, is spaced from the other two with  $2 \times \frac{1}{16}$ -inch standoff insulators (Millen 31003). Output of the filter is fed to the final through a short piece of RG-8/U coaxial cable.

The meter, OPERATE-SPOT switch and meter switch are mounted on the front panel at the head of the power supply chassis.

A Johnson 122-237-200 socket, incorporating a ventilating hole, is used in the final amplifier.

It is mounted below the chassis with pins 1 and 7 facing towards the front panel (see Fig. 6-65). Spring fingers are located under each mounting screw and make contact with the metal base shell of the tube (see Fig. 6-66).  $RFC_6$  (B & W 800) mounts on a short piece of angle aluminum in line with the center of the tube socket and the back panel. Bypass capacitor  $C_{18}$  is located behind this choke and to the right.  $RFC_7$  (National R-300U) is threaded into  $C_{18}$  and connects to the plate supply through a UG-106/U coaxial hood with a short length of RG-8/U coaxial cable.  $L_{10}$  mounts half way up the utility box on  $1 \times \frac{3}{8}$ -inch standoff insulators (Millen

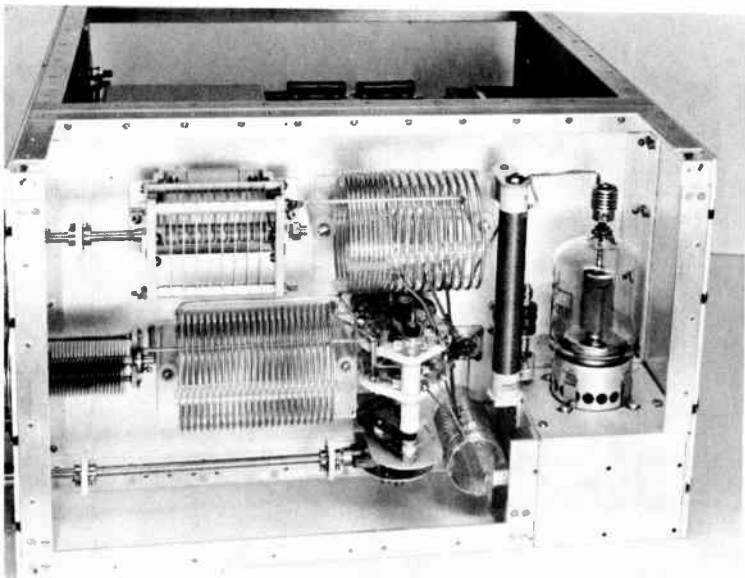

Fig. 6-66—A  $10\frac{1}{2} \times 17 \times \frac{1}{8}$ -inch aluminum panel separates the 4E27A/5-125B amplifier from the rest of the transmitter. The final uses a pi-L network; the two large coils are in the pi and the smaller coil is in the L. Plate tuning capacitor  $C_{17}$  is at top left, and below it and to the left is loading capacitor  $C_{22}$ . Note that  $L_8$ , the pi coil above the band switch, connects to the other pi coil  $L_9$  at the  $C_{22}$  end of the coil. Two chokes are used in the plate circuit, a B & W 800 mounted on a short section of angle aluminum, and a National R-300U that is threaded into the 1000-pf. 5-kv. bypass capacitor to the rear left of the 4E27A. Two of the three additional loading capacitors required on 3.5 and 7 Mc. are barely visible just behind the switch. A 1000-pf. 5-kv. coupling capacitor is mounted on the small bracket at the top of the B & W r.f. choke.

31007). The output end of the coil connects to a SO-239 coaxial receptacle,  $J_2$ , mounted on the side wall of the final compartment. A right angle coaxial plug,  $P_1$ , connects to  $J_2$  at a point just above the exciter chassis in line with  $C_{14}$  (see Fig. 6-67). A length of RG-8/U coaxial cable with a PL-259 coaxial plug,  $P_2$ , on one end is attached to  $P_1$ . The other end of the cable connects to a SO-239 coaxial receptacle on the rear panel.

Controls in the final amplifier are mounted in a line,  $2\frac{1}{2}$ -inches from the right edge of the transmitter (see Fig. 6-61). From the top,  $C_{17}$  is spaced  $2\frac{5}{8}$ -inches,  $C_{22}$  is spaced 6 inches and  $S_4$  is spaced 9 inches.

$L_9$  is mounted immediately behind  $C_{22}$  on a scrap of plexiglas and two  $2\frac{1}{2} \times \frac{1}{2}$ -inch stand-off insulators (Millen 31002) (see Fig. 6-66).  $C_{17}$  is mounted above  $L_9$  on short sections of angle aluminum.  $L_8$  is supported on two  $2 \times 1\frac{1}{16}$ -inch stand-off insulators (Millen 31003) in line with  $C_{17}$ . The wide spaced end of  $L_8$  connects to  $C_{16}$  which is mounted on a small aluminum bracket at the top of  $RFC_6$ .

In order to install  $S_4$  in the limited space available it must be modified slightly. The rear shaft bearing is removed and the two  $\frac{3}{4}$ -inch long ceramic insulators are replaced by suitable insulators,  $\frac{1}{2}$ -inch long. After the shaft bearing is replaced, supporting brackets are mounted on each end of  $S_4$ . A right-angle drive (National RAD) is attached to a third bracket and mounted as close as possible to the body of the switch. The drive shaft is lined up with the front panel control and the switch brackets are bolted to the amplifier panel. All metal parts of  $S_4$  should be at least  $\frac{1}{4}$  inch away from  $L_8$ ; if they are not, the shaft bearing and supporting screws should be filed down to a suitable height. The fixed

loading capacitors,  $C_{19}$ ,  $C_{20}$ ,  $C_{21}$ , are mounted on the amplifier panel in back of the switch sections.

### Adjustment

All tubes should be inserted in their respective sockets with the exception of the final amplifier. Disconnect the coaxial cable from the plate supply filter. Set the meter switch to read high voltage and turn on the power switch. After settling down, the meter should indicate approximately 2900 volts, with only a bleeder load on the plate supply. With  $S_2$  in the operate position, the voltage regulator tubes should all glow. Once the power switch is turned off, the high voltage reading should slowly decay to zero. After the high-voltage primary fuse is removed, transmitter alignment can commence.

$S_2$  should be set in the SPOR position and  $S_1$  turned to 80 meters. With the v.f.o. dial set at 10,  $C_2$  should be adjusted until a signal is heard at 1.75 Mc. on a calibrated receiver. 2.0 Mc. should now occur at about 445 on the tuning dial.

Install a 0-100 dial (Johnson 116-222-6) on  $C_4$  so that 0 indicates maximum capacitance. Set the v.f.o. at 1.75 Mc.,  $C_4$  at a dial setting of 20, the meter switch,  $S_5$ , in the driver grid position and  $R_1$  for maximum drive. Adjust  $L_2$  for maximum grid current. Move the v.f.o. to 2.0 Mc. and retune  $C_4$ .  $C_4$  should peak at a dial setting of 72; if not, set  $C_4$  at 72 and peak  $C_5$ . Now, turn the v.f.o. back to 1.75 Mc.,  $C_4$  back to 20 and tune  $L_2$  for maximum drive. Return the v.f.o. to 2.0 Mc. and again check the position at which  $C_4$  peaks; if this doesn't occur at 72, set  $C_4$  at 72 and repeak  $C_5$ . Continue the above procedure until  $C_4$  peaks at 20 when the v.f.o. is on 1.75 Mc. and at 72 when the v.f.o. is on 2.0 Mc.

Turn  $S_1$  to 40 meters and set the v.f.o. at 1.75 Mc. With  $C_4$  at a dial setting of 20, tune  $C_6$  and



Fig. 6-67—A view of the transmitter showing the exciter, power supply and back panel. The v.f.o. is contained within the 4 x 5 x 6-inch aluminum utility box. A 6CX8 cathode-follower doubler stage is nearest the v.f.o., with the two 12BH7A frequency multiplier stages following it. The knob next to the last 12BH7A adjusts the driver neutralization capacitor. Rubber grommets in the vicinity of the multiplier tubes cover below-deck trimmer capacitors and keep them from being shorted to the chassis while they are screwdriver adjusted. High voltage is brought into the compartment through a UG-106/U coaxial hood with a short section of RG-8/U coaxial cable. The voltage regulator and keyer tubes are mounted in a line to the right of the meter.

On the rear panel, from left to right, are output and input connectors, C.W.-LINEAR switch, final cathode fuse holder, final bias potentiometer, high-voltage primary and final screen fuse holders, a.c. connector and key jack.

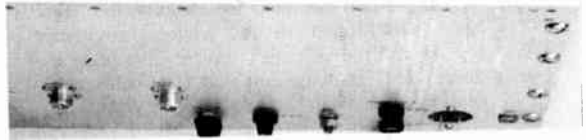
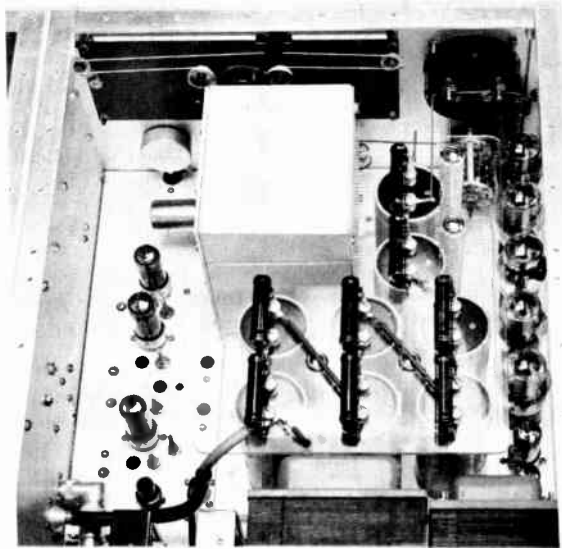

$L_3$  for maximum grid drive. Tune the oscillator to 2.0 Mc. (approximately 445 on the v.f.o. dial).  $C_4$  should now peak at a dial setting of 72; if not, set  $C_4$  at 72 and peak  $C_7$ . Turn the v.f.o. back to 1.75 Mc.,  $C_4$  back to 20 and tune  $L_3$  for maximum drive. Return the v.f.o. to 2.0 Mc. and again check the position at which  $C_4$  peaks; if this doesn't occur at 72, set  $C_4$  at 72 and repeak  $C_7$ . Continue the above procedure until  $C_4$  peaks at 20 when the v.f.o. is on 1.75 Mc. and at 72 when the v.f.o. is on 2.0 Mc.

The exciter should be adjusted on 20 and 10 meters in a manner similar to the 40 meter alignment described above. On 20 meters, with the v.f.o. set at 1.75 Mc and  $C_4$  at 20, peak  $C_8$  and  $L_4$ ; with the v.f.o. set at 2.0 Mc. and  $C_4$  at 72, peak  $C_{10}$ . Go back and forth until  $C_4$  peaks at the correct settings (same as on 40 meters) on both ends of the v.f.o. range. On 10 meters, peak  $C_{11}$  and  $L_6$  with the v.f.o. at 1.75 Mc. and  $C_4$  at 20; peak  $C_{12}$  with the v.f.o. at 2.0 Mc. and  $C_4$  at 72. Repeat until  $C_4$  peaks at the proper dial settings. To align the exciter on 15 meters, turn  $S_1$  initially to 10 meters, the v.f.o. to 1.875 Mc. and peak  $C_4$  for maximum grid drive. Switch  $S_1$  to 15 meters and peak  $L_5$ . This completes the exciter alignment.

Now insert the 4E27A/125-B in its socket and neutralize the 2E26 as described earlier in this chapter. After this has been accomplished, recheck the exciter, as it might have been thrown out of adjustment. Retune if necessary.

Reconnect the coaxial power cable from the final amplifier to the plate supply filter and reinsert the high-voltage primary fuse. Attach a 500-watt 50-ohm dummy load to  $J_3$ . Turn both band switches to 80 meters, set  $S_2$  in the spot position and  $S_3$  in the c.w. position. Attach a key to  $J_4$  and apply power. With  $S_5$  in the driver grid position, peak  $C_4$  for maximum drive. Switch the meter to indicate 2E26 plate current, key the transmitter and tune  $C_{15}$  for minimum. Turn  $S_5$  to the final grid position and adjust  $R_1$  for a reading of 10 ma. Switch  $S_2$  to the operate position and the meter to indicate final plate

current. Open the loading capacitor,  $C_{22}$ , approximately 25 per cent. Key the transmitter while quickly resonating the final tuning capacitor,  $C_{17}$ . Switch the meter to read screen current and adjust  $R_1$  for an indication of approximately 20 ma. The final may now be loaded to a maximum rated plate current of 185 ma. Be sure the screen current is 20 ma; if it isn't, readjust the drive with  $R_1$ . Tuning up on the higher bands is done in a similar manner.

For linear operation of the driver and final using an external s.s.b. exciter, switch  $S_3$  to the LINEAR position and  $S_2$  to the OPERATE position. Attach the s.s.b. source to  $J_1$  with a length of 50-ohm coaxial cable. The s.s.b. exciter should be set up to develop no more than 7 volts across the 100-ohm input resistor. A 1-volt signal will easily drive the amplifiers to full output. With the exciter turned off and  $M_1$  set to read final plate current, adjust  $R_2$  for a zero signal reading of approximately 32 ma. Apply excitation and resonate the driver plate circuit. With the drive control,  $R_1$ , advanced so that the final is drawing grid current, quickly tune  $C_{17}$  and  $C_{22}$  for maximum output. Back off  $R_1$  until the final is drawing zero grid current. Driver plate current should now be from 12 to 15 ma. with zero grid current. If it is greater, repeat the previous steps using more excitation; if smaller, repeat using less. Maximum signal plate current should be 110 ma., maximum signal screen current, 4 to 5 ma. and maximum signal grid current, 0 ma. The final plate should glow no brighter than cherry red while operating at maximum input (275 watts).



## A COMPACT 3-400Z GROUNDED-GRID AMPLIFIER

The amplifier shown in Figs. 6-68 through 6-71 easily handles a kilowatt p.e.p. input at 3000 volts. It has been designed with ease of construction and operation in mind, and to this end as few special parts and machine operations as possible are required. Probably the major operation is adding an arm to the band switch, to ground a plate padding capacitor in the 3.5-Mc. position. This enables a smaller plate tuning capacitor to be used than would be the case if the variable were required to furnish all of the capacitance on this lowest-frequency band.

Referring to the wiring diagram in Fig. 6-69, the circuit is about as simple as it could be made. No tuned input circuit is used, since it was found that any of the s.s.b. units in the 75- to 100-watts output class could drive it without any trouble. If drive were marginal, as when only 35 watts peak were available, a coupling network might offer a slight advantage. Two r.f. chokes and a 1000-pf. bypass are used in the high-voltage lead because a high-impedance circuit like this is harder to filter than one where the current is higher and the voltage is lower. The plate coil is a standard 500-watt unit that runs cold at a kilowatt c.w. or s.s.b.

The 50,000-ohm resistor in the center tap of the filament transformer biases the tube to cut-off during "stand-by" periods and eliminates the "diode noise" caused by the static plate current. Leads to  $J_4$  and  $J_5$  from the VOX or other control short the resistor during transmit periods.

The connections on  $J_6$  are similar to those on the 3-1000Z amplifier shown later in this chapter, with the exception of the lead marked "VM". This variation permits mounting the voltmeter on the transmitter panel instead of in the power supply. The power supply can be the same as that

shown for the larger amplifier, with the exception of the power transformer. A smaller 600-v.a. unit (BTC-6181) has the same voltage ratings and 60 per cent of the price of the larger transformer; it is heartily recommended unless one plans some day to move up to the 3-1000Z amplifier.

Front and back panels and base plate are all standard unfinished  $\frac{1}{8}$ -inch thick aluminum rack panels. They are trimmed to 15 inches. The angle stock holding the pieces together, and furnishing the faces for support of the cover, are 1 x 1 x  $\frac{1}{16}$ -inch Reynolds stock. A short piece is also used for supporting the fan, cut away as shown in Fig. 6-71.

The tube socket (Johnson 122-275-200) is supported 1 inch above the base on rods threaded into the base. Its three grid pins are bonded together with a  $\frac{3}{8}$ -inch wide strap of copper; the strap in turn is bolted to the base.

To conserve space, the filament transformer must be modified so that the leads come out the side. This is done by removing the end bells and drilling a hole in the side through which the leads can be threaded.

To modify switch  $S_1$ , first remove the rear shaft bearing and replace the ceramic insulators with shorter ( $\frac{1}{2}$ -inch) ones. Fiber washers or any suitable insulating material can be used here to expose the end of the switch shaft. A brass shaft coupling, cut to a length of  $\frac{7}{16}$  inch, is drilled and tapped 6-32 at right angles to the normal set-screw hole. The spring stock (0.20 x  $\frac{3}{8}$  silver solder) is wrapped half around the coupling and fastened at two points with short 6-32 screws through the new hole. The original set screw is left exposed. (Silver solder is available at welding supply houses; the type used here is called "Handy Harmon Easy Flow"). The

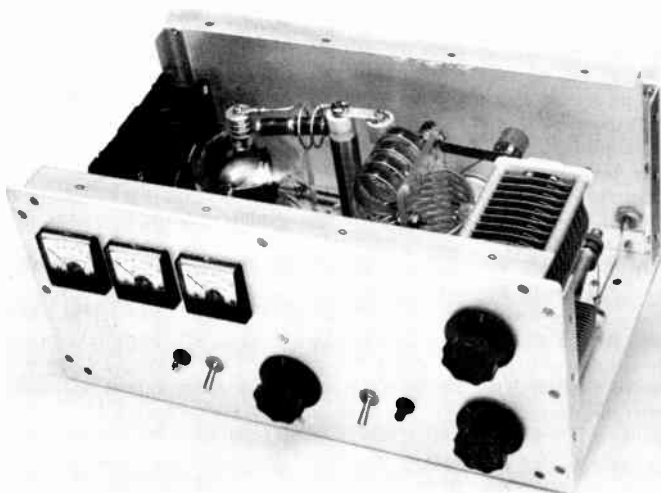

Fig. 6-68—The compact kilowatt amplifier with its perforated-metal cover removed. Using a 3-400Z in a grounded-grid circuit, it handles a kilowatt p.e.p. input at 3000 volts with ease. The (2-inch) meters monitor plate voltage, grid current and plate current. Panel is 7 x 15 inches; the bottom plate is  $\frac{3}{8}$  inches wide. (Built by Robert Smith, WILLF, Simsbury, Conn.)



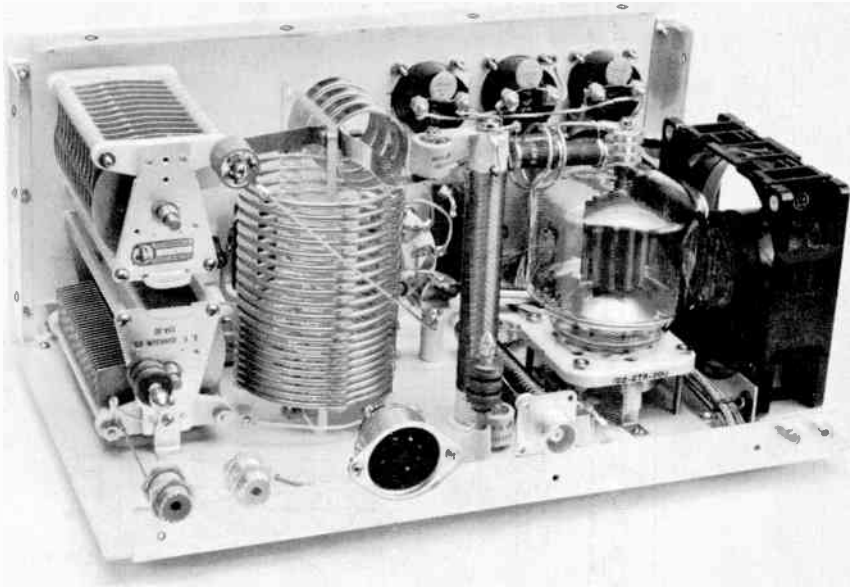

Fig. 6-70—The rear wall of the compact kilowatt has been removed to reveal the "works." Coaxial receptacles at left are output and input jacks; receptacle at center (near tube) is high-voltage connector. A 50-pf. 3.5-Mc. plate loading capacitor can be seen mounted on the plate tuning capacitor (upper left); the 500-pf. 3.5-Mc. output loading capacitor is mounted on the base behind the coil (just visible to right of variable loading capacitor).

Note heavy copper strap from socket to base, grounding grid pins. The fan is mounted on a piece of ¼-inch foam rubber and held in position by two screws through rubber grommets in the vertical plate.

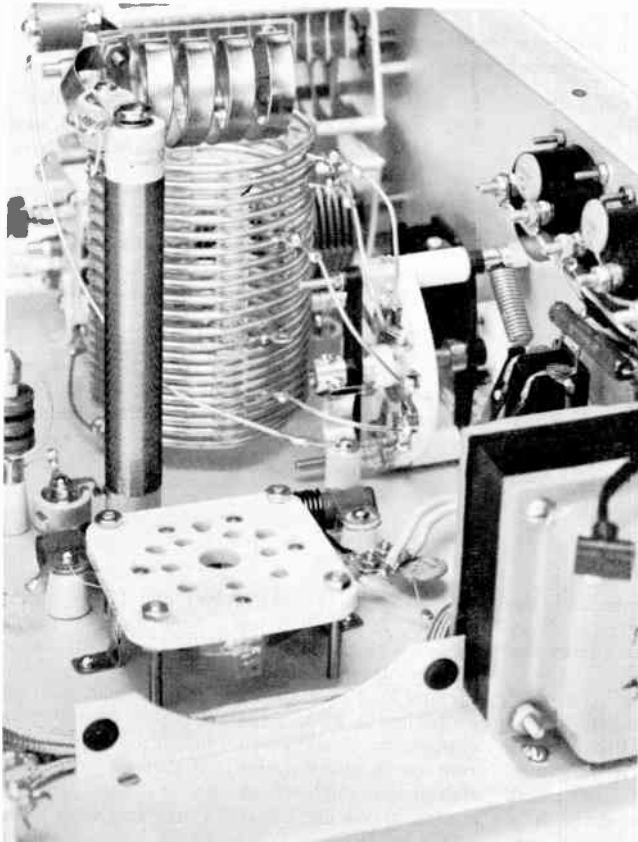

Fig. 6-71—Close-up view with the tube and fan removed discloses details of switch  $S_{1B}$ . It is made from a brass shaft coupling and a length of silver solder; in the 3.5-Mc. position it contacts a fixed arm and grounds the 50-pf. fixed capacitor (upper left).

Mounting plate for fan is trimmed away for maximum ventilation under tube socket.

## A KILOWATT 4-400A AMPLIFIER

Any transmitter delivering about ten watts will drive the amplifier shown in Figs. 6-72 through 6-77. When used as a Class AB<sub>1</sub> linear for sideband, a peak driving voltage of about 150 is required. The plate tank circuit of the amplifier is homemade from readily available parts.

Referring to Fig. 6-73, the amplifier uses the conventional neutralized grounded-cathode amplifier circuit. Switch  $S_{1B}$  shorts out the unused part of grid coil  $L_2$ , and  $S_{1A}$  modifies the input link coupling. A Harrington Electronics GP-20L subassembly is shown, but an equivalent circuit can be built from standard parts. The output circuit is a shunt-fed pi network for the amateur bands 3.5 to 30 Mc. The smaller tuning capacitor,  $C_{10}$ , is used on 20, 15 and 10 meters, and the larger  $C_{11}$  is added for tuning on 40 and 80 meters. Having two tuning capacitors allows the optimum  $L/C$  ratio to be maintained on all bands without resorting to an expensive vacuum variable.

A 17-c.f.m. blower supplies adequate forced air cooling for the 4-400A base and plate seals. The blower is connected across the 4-400A filament transformer primary and operates whenever the filament is energized.

All required control and metering circuits are mounted on a separate chassis. Meters are provided for amplifier grid current, screen current, cathode current and plate voltage, to comply with the FCC rule regarding measurement of input powers over 900 watts.

The amplifier is fixed biased at -225 volts for Class C and -150 volts for Class-AB<sub>1</sub> operation. The full-wave rectifiers in the bias supply are silicon diodes, with no warm-up time, and full operating bias is applied as soon as the power switch,  $S_6$ , is closed. Time-delay relay  $K_1$  operates  $K_2$ , which is in series with the screen supply primary. Thus there is a 60-second delay before screen potential can be applied to the amplifier tube.

The accessory a.c. socket,  $J_8$ , and the high-voltage filament transformer socket,  $J_9$ , are energized as soon as power switch  $S_1$  is closed. The h.v. plate transformer is turned on by a relay plugged into  $J_{10}$  and controlled by the time-delay relay. With this arrangement, it is impossible to apply a.c. to the h.v. rectifier plates before their filaments have had a chance to warm up.

A variable autotransformer in series with the screen-supply primary allows the screen voltage to be adjusted from zero to about 800 volts under load. This makes a convenient arrangement for setting the screen voltage when changing from Class C to Class AB<sub>1</sub> or vice versa, and for adjusting the power input of the amplifier.

A screen overload protection circuit is included. If excessive screen current flows,  $K_3$  is energized and is kept energized by the current

through  $R_8$ . To reset the relay the screen voltage must be momentarily disconnected so that the relay will return to its unenergized condition. This can be done by opening  $S_7$ . The current at which the overload relay throws is set with shunt resistor  $R_7$ ; maximum allowable screen dissipation is 35 watts.

## Construction

The amplifier is built on a 4 × 13 × 17-inch chassis and uses a 14-inch rack panel. All major components are visible in the photographs. The Harrington grid circuit, output loading capacitors and switch, and filament transformer are all below the chassis.

An insulated coupling must be used between the rotor of  $C_1$  and the shaft going to the grid tuning knob. Leads from the grid circuit are brought out through the 3 × 5-inch aluminum back plate via a feed-through capacitor and bushings. The input link is connected to the coax receptacle through a length of RG-58/U. The flanged cover of a 5 × 4 × 3-inch Minibox is slipped over the grid assembly, and this cover is secured to the back plate with four self-tapping screws and to the main chassis with four 6-32 spade bolts.

The ganged loading capacitors ( $C_{12}$ ) are mounted off the chassis on 1-inch spacers. Connections in the output circuit are made with



Fig. 6-72—The kilowatt 4-400A amplifier and its control unit are mounted in a 21-inch gray hammer-tone rack cabinet (Bud CR 1727). Shelf brackets (Bud SA-1350) are mounted on both sides of the cabinet to hold the amplifier chassis. Below the meters, from left to right: filament pilot light, key-type a.c. switch, Class AB<sub>1</sub> C bias switch, screen autotransformer, plate switch and plate pilot light.

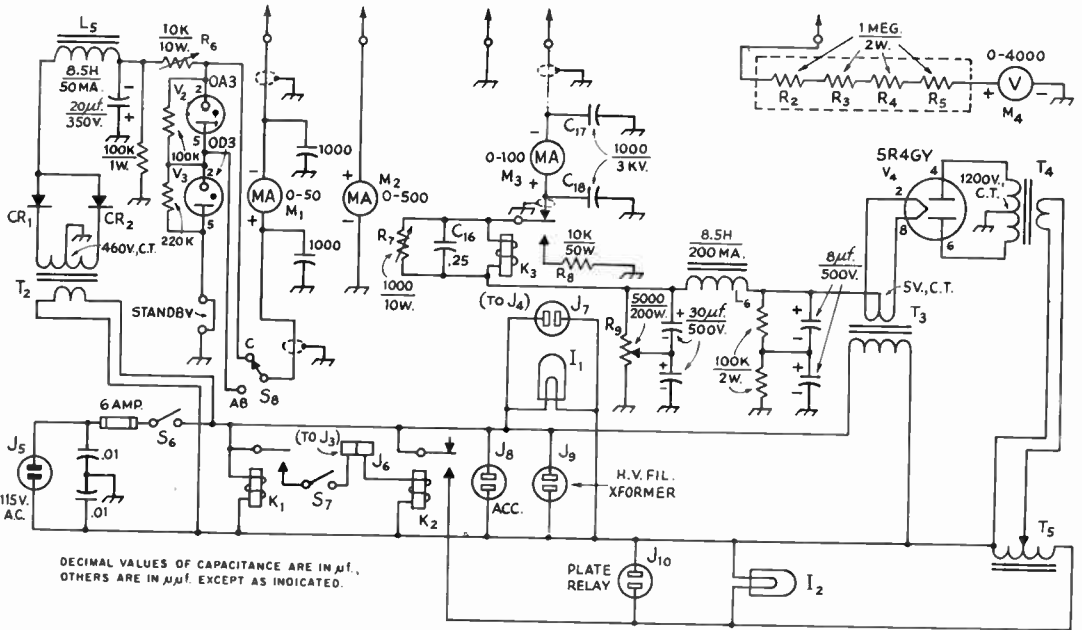
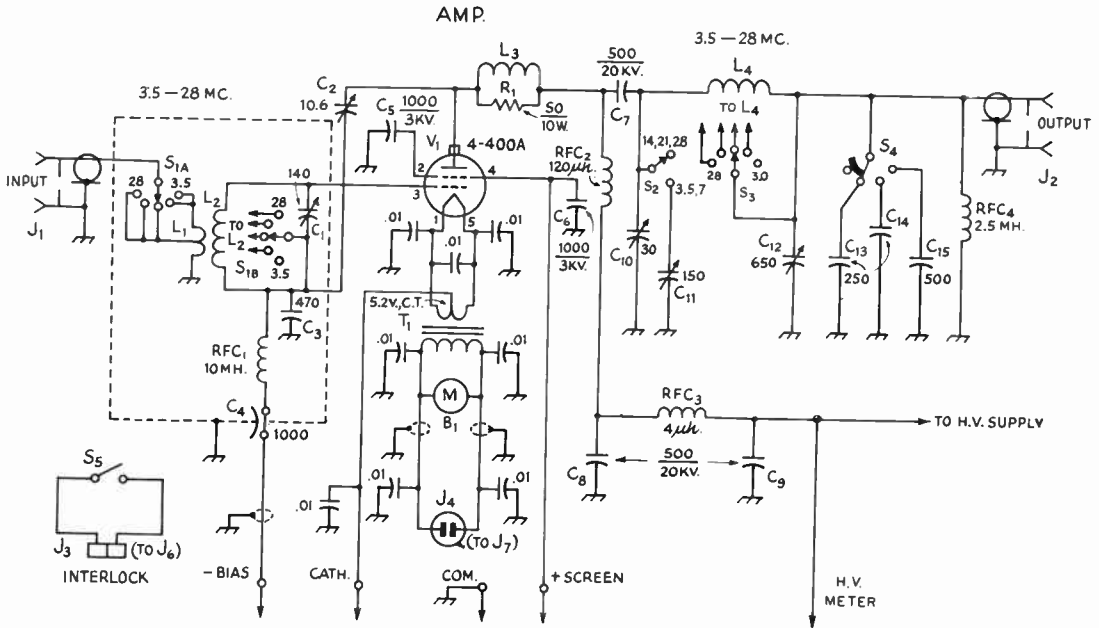

DECIMAL VALUES OF CAPACITANCE ARE IN  $\mu\text{f}$ .  
OTHERS ARE IN  $\mu\text{m}\text{f}$ . EXCEPT AS INDICATED.

Fig. 6-73—Circuit diagram of the 4-400A amplifier (above the dashed line) and power supply/control unit. Resistances are in ohms, and resistors are 1/2-watt unless otherwise indicated. Capacitors not listed are 600-volt disk ceramic except for those marked with polarity, which are electrolytic.



copper or brass strapping to provide low-inductance leads.

The blower is mounted on the rear apron of the chassis by four 6-32 spade lugs attached to the walls of the blower output housing. A  $1\frac{1}{4} \times 1\frac{1}{8}$ -inch hole cut in the rear apron of the chassis accommodates the blower; a cork gasket is used between the plastic blower housing and the amplifier chassis.

The chassis should be as airtight as possible to provide maximum air flow to the 4-400A tube, and any small holes should be sealed by covering them with tape.

### Plate Tank and Enclosure

The plate tank coil,  $L_4$ , band switch,  $S_3$ , and plate tuning capacitor switch,  $S_2$ , are mounted on two Lucite plates in the center of the chassis. The tank coil comes prewound on one Lucite plate which is positioned  $\frac{3}{2}$  inches above the chassis on ceramic spacers. Hard rubber washers (the type used for packing faucets) are inserted between the ceramic spacers and the Lucite plates to provide a tight fit.

Counting from the blocking capacitor end, the

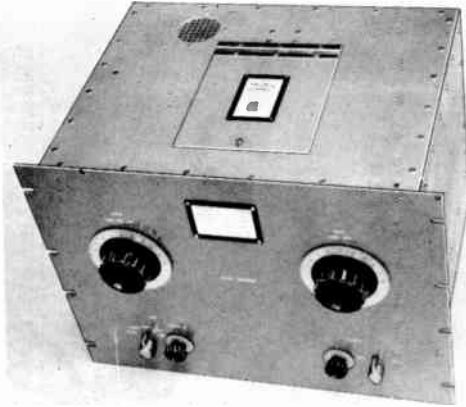

Fig. 6-74—This view of the amplifier shows the band-switch trap door, air-exhaust port and hole for adjusting neutralization, all in the top of the shielding enclosure. The large knob on the left of the panel is for the 20/15/10-meter plate tuning capacitor, and the matching knob adjusts the capacitor used on 80 and 40. Farther down, from left to right: grid BAND switch, grid TUNING control, variable LOADING adjustment and LOADING switch.

- $B_1$ —Blower-motor assembly, 17 c.f.m. (Ripley, Inc., Middletown, Conn., type 8433).
- $C_1$ —140- $\mu$ f. midget variable (Hammarlund APC-140-B). See  $L_2$ .
- $C_2$ —10.6- $\mu$ f. neutralizing (Johnson N250).
- $C_3$ —500-volt mica.
- $C_4$ —0.001- $\mu$ f. feed-through (Centralab FT-1000).
- $C_6, C_8, C_{17}, C_{18}$ —0.001- $\mu$ f., 3000-volt disk ceramic (Centralab DD30-120).
- $C_7, C_9, C_{10}$ —500- $\mu$ f., 20,000-volt ceramic (Centralab TV-207).
- $C_{10}$ —30- $\mu$ f. variable, 0.25-inch spacing (Barker & Williamson CX-45-C butterfly, one section used), or Johnson 50D90 with two stator plates removed).
- $C_{11}$ —150- $\mu$ f. variable, 0.25-inch spacing (Johnson 150D90).
- $C_{12}$ —650- $\mu$ f. variable (two Hammarlund MC-325M ganged and paralleled).
- $C_{13}, C_{14}, C_{15}$ —2500-volt mica (Aerovox 1652L).
- $C_{16}$ —200-volt molded paper.
- $CR_1, CR_2$ —500-ma. 600-volt peak inverse silicon diode (Sarkes Tarzian F-6).
- $J_1, J_2$ —Coaxial receptacle, chassis mounting (SO-239).
- $J_3, J_6$ —2-contact socket (Cinch-Jones S-202-B).
- $J_4, J_5$ —115-volt plug, chassis mounting (Amphenol 61-M1).
- $J_7$ — $J_{10}$ , incl.—115-volt socket (Amphenol 61-F1).
- $K_1$ —115-volt 60-second time-delay, normally open (Amperite 115N060).
- $K_2$ —S.p.d.t. relay, 115-volt a.c. coil (Potter & Brumfield KA5AY).
- $K_3$ —S.p.d.t. relay, 2500-ohm 7.2-ma. coil (Advance GHE/1C/2500).
- $L_1$ —3 $\frac{3}{4}$  turns No. 18 insulated wire on cold end of  $L_2$ ; tapped 2 turns from ground end.
- $L_2$ —50 turns No. 24 tinned,  $1\frac{3}{4}$  inches long on  $\frac{3}{4}$ -inch diam. ceramic form; tapped 5, 8, 13 and 25 turns from grid end. ( $C_2, L_2$  and  $S_1$  make

- Harrington GP-20L assembly; available Harrington Electronics, Box 189, Topsfield, Mass.)
- $L_3$ —3 turns No. 10 tinned,  $\frac{5}{8}$ -inch diam., 1 inch long, mounted on  $R_1$ .
- $L_4$ —Pi-network coil assembly (Air Dux 195-2 available from Illumitronics Engineering, Sunnydale, Calif.); see text.
- $P_1$ —2-contact plug (Cinch-Jones P-202-CCT).
- $R_1$ —50-ohm 5-watt wire-wound (Sprague 5KT).
- $R_6, R_7$ —10-watt adjustable.
- $R_8$ —200-watt adjustable; set tap at midpoint.
- $RFC_1$ —10-mh. r.f. choke (National R-50-1).
- $RFC_2$ —120- $\mu$ h. plate r.f. choke (Raypar RI-101).
- $RFC_3$ —4- $\mu$ h. r.f. choke (National R-60).
- $RFC_4$ —2.5 mh. r.f. choke (National R-50).
- $S_1$ —Miniature ceramic rotary, 2 poles, 6 positions, 1 section, shorting, 5 positions used (Centralab PA-2002). See  $L_2$ .
- $S_2, S_3$ —Homemade, see text and Fig. 6-72
- $S_4$ —Ceramic rotary, 9 positions, 1 section, progressively shorting, 4 positions used (Centralab PISD section and P-270 index assembly).
- $S_5$ —S.p.d.t. microswitch (Unimax 2HBW-1).
- $S_6$ —Lock switch (Arrow-Hart & Hegeman 81715-L).
- $S_7$ —S.p.s.t. toggle.
- $S_8$ —S.p.d.t. toggle
- $T_1$ —Filament transformer, 5.2 volts, c.t., 24 amp. (Triad F-11U).
- $T_2$ —Power transformer, 460 volts, c.t., 50 ma. (Stancor PC-8418).
- $T_3$ —Filament transformer, 5 volts c.t., 3 amp. (Thor-darson 21F03).
- $T_4$ —Power transformer, 1200 volts, c.t., 200 ma. (Thor-darson 22R36).
- $T_5$ —Variable autotransformer, 0-132 volts, 1.75 amp. (Superior 10B).

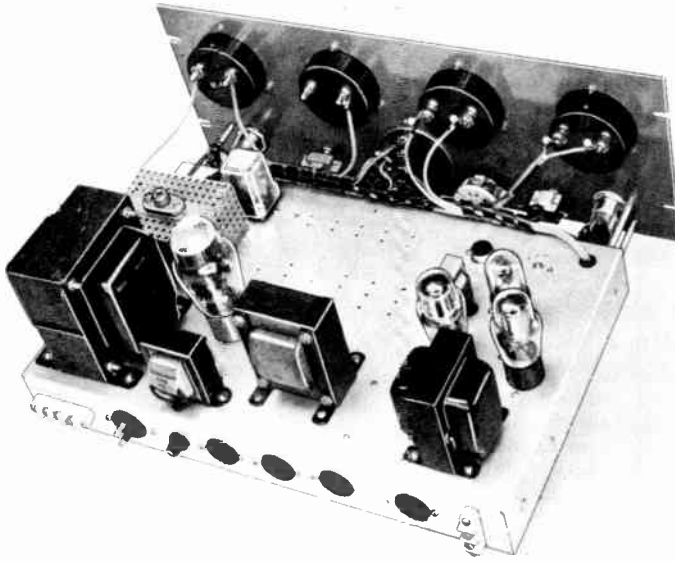

Fig. 6-75—Top view of the control unit. The voltmeter multiplier resistors are housed in a cone-metal protective shield (upper left). Resistors  $R_8$  and  $R_9$  are mounted under the sets of ventilation holes (center near panel).

plate coil is tapped at 4 turns ( $0.4 \mu\text{h.}$ ) for 10 meters; 7.5 turns ( $1 \mu\text{h.}$ ) for 15 meters; 10.5 turns ( $2.33 \mu\text{h.}$ ) for 20 meters, 14 turns ( $5.2 \mu\text{h.}$ ) for 40 meters, and 24 turns ( $16.4 \mu\text{h.}$ ) for 80 meters. (All the figures include the 4-turn coil made of  $\frac{3}{8}$ -inch strap.) The lugs provided with the tank coil assembly should be securely soldered to the coil at these points. Strapping should then be run from these taps to the appropriate band-switch terminals. It should be noted that the

band-switch terminals do not progress in consecutive order, but are arranged to provide the shortest possible lead lengths.

Be sure no iron or steel hardware is used in the band-switch assembly, or for that matter, anywhere in the plate tank circuitry of the amplifier. Each piece of hardware should be checked first with a magnet to insure that it is neither iron nor steel before being used in the plate circuit.

In order to get to the band switch and capacitor

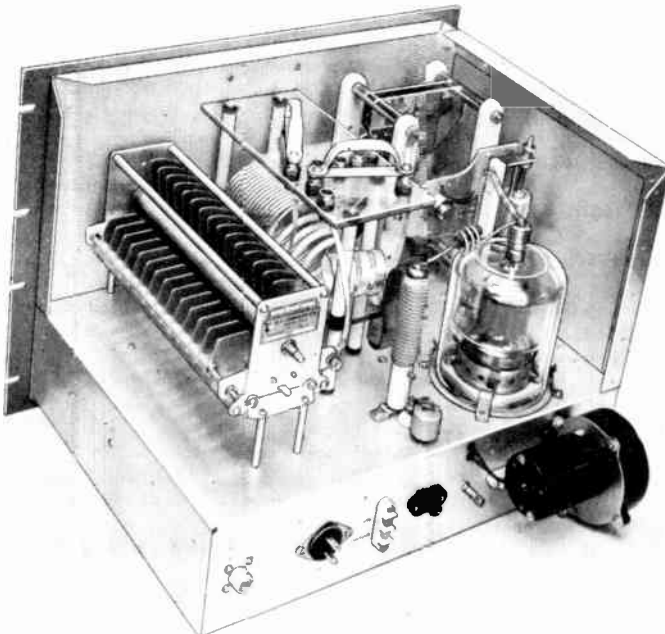
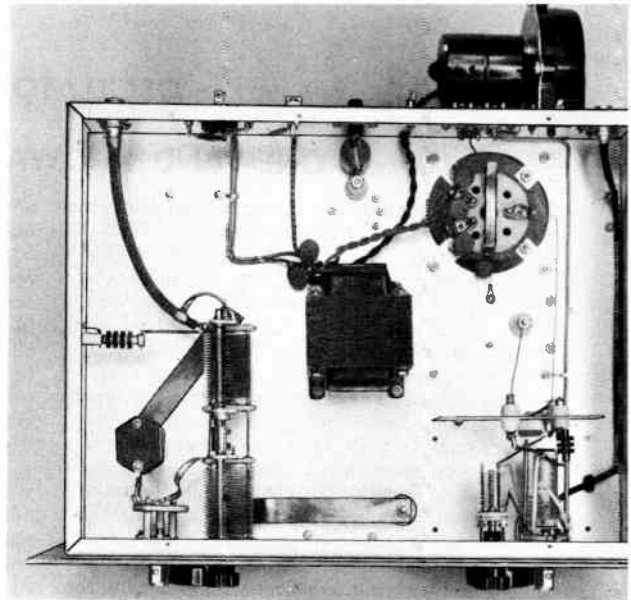

Fig. 6-76—Most of the enclosure has been removed to show the low- and high-frequency plate tuning capacitors, the coil and band-switch assembly (center) and the 4-400A in its glass chimney (Eimac SK-406). The neutralizing capacitor is behind the tube in this view. A cork gasket is used between chimney and chassis. Across the rear apron: output jack, filament a.c. plug, cathode and ground terminals, high-voltage connector, ground post and blower. The blower hides another terminal strip (for bias and screen connections) and the input jack. The band switch is made from a  $4\frac{1}{8} \times 8$ -inch strip of  $\frac{1}{4}$ -inch thick Lucite and Johnson 108-760 jacks and 108-770 plugs. The plugs are mounted on two  $\frac{3}{8}$ -inch utility handles (Bud UH-71A) strengthened by straps of aluminum.

Fig. 6-77—Bottom view of the amplifier. The Minibox shield has been removed from the grid circuit (lower right). Loading capacitors, switch and "safety" choke are at the left. The filament transformer is in the center. Amplifier tube socket is mounted on four tabs spaced evenly around the circular cutout.



switch, a trap door is provided in the top of the enclosure. Microswitch  $S_5$  is installed so that it is actuated by the trap door. The leads from  $S_5$  are brought out to a jack,  $J_3$ , located on the back wall of the enclosure, and from there to  $J_6$  on the control unit. The trap door measures  $6\frac{1}{4}$  by 7 inches and the rectangular cutout in the top of the enclosure is  $4\frac{3}{8}$  by  $6\frac{1}{4}$  inches. This provides adequate overlap to prevent any leakage of r.f.

#### Adjustment and Operation

First, determine that the control unit is operating correctly. Apply 115 volts to  $J_5$ , insert the tubes, and turn on the key switch,  $S_6$ . The green filament pilot light should go on immediately. There should also be power at receptacles  $J_7$ ,  $J_8$  and  $J_9$ .  $J_7$  and  $J_9$  are for the amplifier and plate supply filament transformers;  $J_8$ , an accessory socket, is provided so that external equipment such as the station receiver can be controlled by  $S_6$ . There should be no power at  $J_{10}$ , the plate transformer control socket.

Next, adjust  $R_6$  until the VR tubes just begin to glow. Be sure the standby terminal jumper from Pin 5 of  $V_3$  to ground is in place. Turning  $S_5$  should change the bias from  $-150$  volts in the Class- $AB_1$  position to  $-225$  volts for Class C in the other. With  $S_8$  in the linear position (AB), and leaving a voltmeter on the output of the bias supply, temporarily lift the standby jumper from ground. The output voltage should rise from  $-150$  to approximately  $-300$  volts. The standby terminals provide a convenient way to bias the 4-400A beyond cutoff during standby and receiving periods. This will prevent any annoying diode noise generation.

Open  $S_6$  and again connect an a.c. voltmeter to  $J_{10}$ . Put a temporary jumper between the two contacts of  $J_6$ . Close  $S_6$  and  $S_7$ , and after 60 seconds there should be power at  $J_{10}$  and the red plate pilot lamp should light. Replace the jumper across  $J_6$  with the leads from the micro-switch interlock. Lifting the trap door should

deenergize  $J_{10}$ , and the plate pilot bulb should extinguish.

Next, connect a d.c. voltmeter to the output of the screen supply. By adjusting  $T_5$  it should be possible to vary the output from 0 to approximately 850 volts. Finally, adjust  $R_7$  so that  $K_3$  trips when 40 ma. is drawn from the screen supply. This can be checked by connecting a resistor (620 ohms or less, 1 watt) across the supply output and running the voltage up from zero until the drain is 40 ma. This completes the testing of the control unit.

The amplifier must now be neutralized. Set the grid and plate band switches for 28 Mc., and disconnect the screen and plate leads at the amplifier terminals. Couple a sensitive indicating wavemeter to the output end of the plate tank circuit and apply the required  $-225$  volts of bias. Apply drive, resonate the grid circuit and adjust the output of the exciter for rated 4-400A grid current. Neutralizing capacitor  $C_2$  should then be adjusted for minimum r.f. in the plate tank circuit. The plate tuning capacitor should be retuned for maximum wavemeter reading after each change of  $C_2$ . After rated plate and screen voltages have been applied and the amplifier loaded, the neutralizing capacitor should be touched up so that minimum plate current and maximum grid and screen currents occur simultaneously as the plate tank is tuned through resonance.

If the amplifier is to be used for s.s.b., the h.v. power supply should have a minimum output capacitance of  $8 \mu f$ . For best voltage regulation the plate transformer should have a 220-volt primary. The output of the h.v. power supply should include a  $\frac{1}{2}$ -ampere fuse to protect the supply from excessive overloads.

If the amplifier is to be plate modulated, a choke, approximately 10 hy. at 50 or 100 ma., should be inserted in series with the screen lead of the 4-400A. An external switch can be used to short out the choke when using the amplifier for c.w. or s.s.b.

## ONE-BAND KILOWATT AMPLIFIERS

Separate kilowatt amplifiers on each of the bands 80 through 10 meters has always been the *ne plus ultra* of transmitter construction. However, space limitations and cost are the two key factors that have prevented many from realizing this goal. The amplifiers to be described are compact and are constructed economically; the builder may wish to construct one amplifier for his favorite band or the group of five for versatile all-band operation. Advantages of the separate-amplifier philosophy include optimum circuit  $Q$  for every band, simplified construction and band switching, less chance for tube failure because each amplifier is pretuned, and fast band changing for the contest-minded. The supply voltages remain on all the amplifiers; only the filament and excitation power are switched to the desired final amplifier.

The availability and proven dependability of the 813 make a pair of them the logical choice for the kilowatt amplifier. A shrewd amateur should have no trouble procuring the tubes through surplus channels or by bartering with local hams.

Referring to the circuit diagram, Fig. 6-79, the

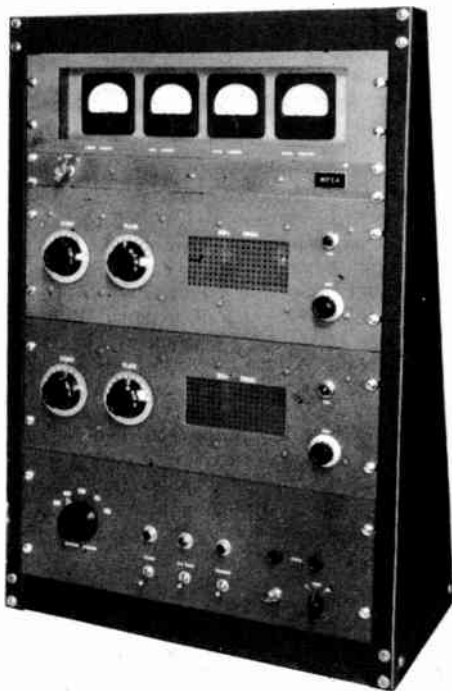

Fig. 6-78—Individual kilowatt amplifiers for two bands plus complete metering and all control circuits and power supplies (except plate) fit handily into a table rack. Amplifiers for five bands plus the plate supply will mount in floor rack. Bond switch at lower left ( $S_6$  in Fig. 6-79) switches filament supply, excitation and output connections to all amplifiers in use; screen and plate supplies are connected to all amplifiers at all times.

amplifier control unit contains the filament, bias and screen supplies. A 3-position mode switch,  $S_2$ , selects the bias for either Class-AB<sub>1</sub> or -C operation, and in the third position grounds the screen grids, to limit the plate current during initial tuning. Another 3-position switch,  $S_1$ , allows the total or individual screen currents to be read. The latter position is useful in matching tubes. The high-voltage supply should furnish from 1750 to 2250 volts.

## Construction

Each amplifier is assembled on a  $13 \times 17$ -inch aluminum bottom plate. Two  $5 \times 13 \times 3$ -inch aluminum chassis are used as the sides of the enclosure. The paint is removed from the back of a 7-inch aluminum rack panel, and a piece of Reynolds cane metal is sandwiched between the panel and the two chassis. A rectangular window in the panel provides additional ventilation and a means for inspecting the color of the tube plates. The top and back of the enclosure are formed from a single piece of cane metal, bent to fit the chassis rear and top. Three lengths of  $1 \times 1 \times \frac{1}{8}$ -inch aluminum angle stock are used in the corners of the enclosure, as can be seen in Figs. 6-81 and 6-82.

The variable tank capacitors,  $C_4$ , are mounted on 1-inch stand-off insulators, to bring the shafts to the proper panel height. In the 10-meter amplifier the capacitor shaft must remain above r.f. ground, and a suitable insulated shaft coupling is used. On the other bands, the rotors of the capacitors are grounded to the chassis through metal straps.

On 20, 15 and 10 meters the tank coils are wound self-supporting of  $\frac{1}{4}$ -inch diameter soft-drawn copper tubing, and they are supported by their leads. On 80 and 40 the coils are lengths of Air-Dux stock, and they are supported by small ceramic insulators.

The special plate r.f. chokes,  $RFC_2$ , are constructed by close-winding No. 24 enameled wire on  $\frac{3}{4}$ -inch diameter ceramic insulators. Four-inch long insulators (National GS-4) are used on the 80- and 40-meter bands, and 2-inch long insulators (National GS-3) are used on the other bands. In each case the original base of the insulator is removed and the insulator is mounted on a stand-off (Johnson 135-20). The high-voltage lead and the "cold" end of the choke are connected to a soldering lug mounted between the two insulators.

Bridge neutralization is included in the 20-, 15- and 10-meter amplifiers. The neutralizing capacitors are made from two  $\frac{1}{2}$ -inch wide aluminum strips 5 inches long. One strip is connected directly to the plate lead at  $C_3$  and the other is supported by a ceramic feed-through insulator that connects to the rotor of  $C_1$ . The amplifiers are neutralized by adjusting the spacing between the aluminum strips.

The metal ring surrounding the base of the 813



10-METER TANK DETAIL

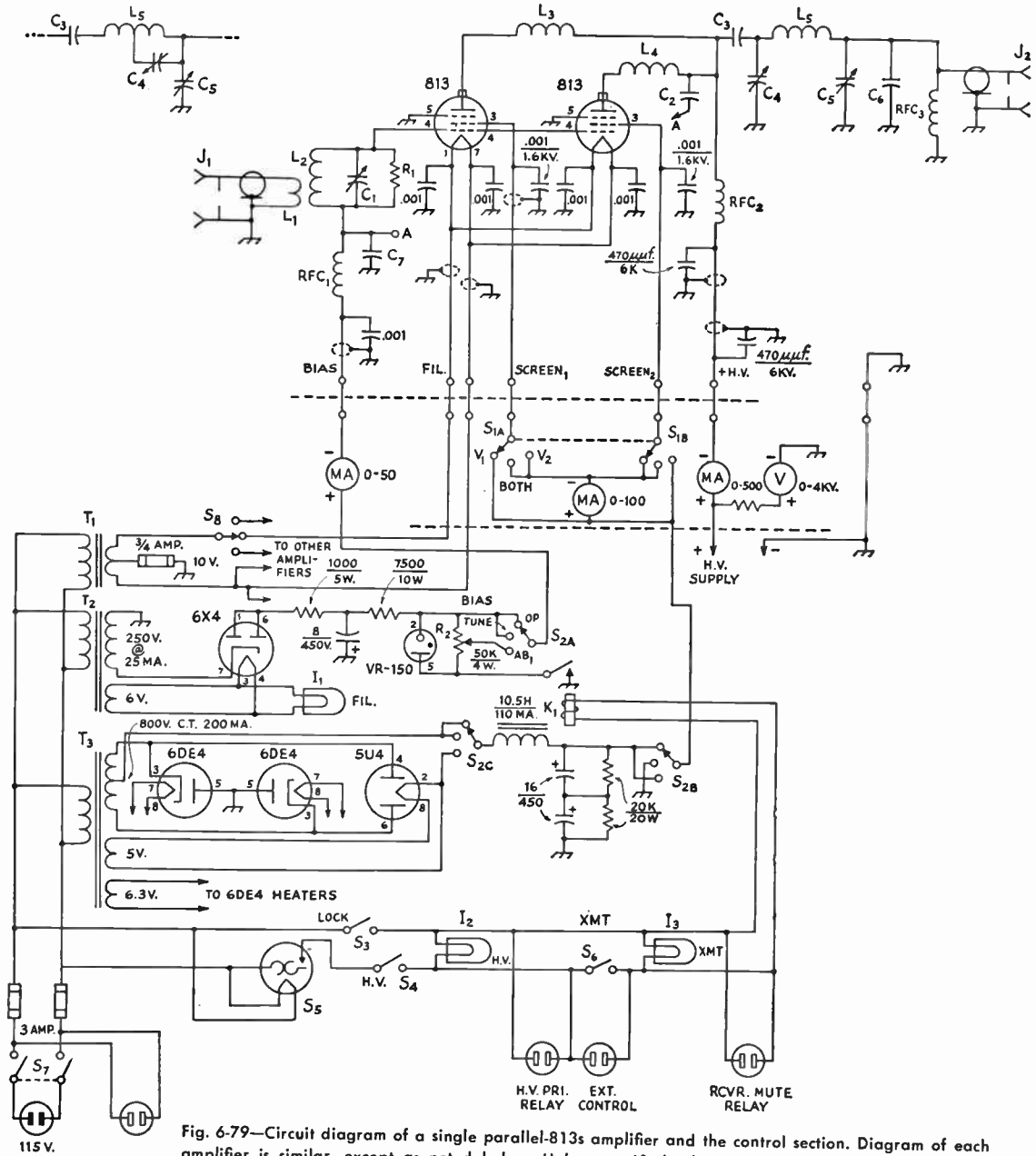

Fig. 6-79—Circuit diagram of a single parallel-813s amplifier and the control section. Diagram of each amplifier is similar, except as noted below. Unless specified otherwise, capacitances are in  $\mu\text{f.}$ , capacitors marked with polarity are electrolytic, fixed capacitors are ceramic, resistances are in ohms.

C<sub>2</sub>—Not used on 80 or 40 meters; see text.

C<sub>3</sub>—Two 500- $\mu\text{f.}$  20-kv. ceramic (Centralab TV-207) in parallel on 80 m.; single 500- $\mu\text{f.}$  20-kv. ceramic on other bands.

C<sub>7</sub>—0.001- $\mu\text{f.}$  1-kv. ceramic on 80 and 40 m.; 240- $\mu\text{f.}$  silver mica on other bands.

I<sub>1</sub>—6-v. pilot lamp.

I<sub>2</sub>, I<sub>3</sub>—115-v. pilot lamp.

J<sub>1</sub>, J<sub>2</sub>—Coaxial cable receptacle.

K<sub>1</sub>—S.p.d.t. relay, 115-v. a.c. coil.

L<sub>3</sub>, L<sub>4</sub>—Not required on 80 or 40 m.; 6 turns No. 14 on 1/4-inch diam.

R<sub>1</sub>—10,000 ohms, 2 watts, composition.

R<sub>2</sub>—50,000 ohms, 4 watts (Mallory M50MPK).

RFC<sub>1</sub>—2.5-mh. 75-ma. r.f. choke.

RFC<sub>2</sub>—See text.

RFC<sub>3</sub>—2.5-mh. 300-ma. r.f. choke.

S<sub>1</sub>—Two-pole 3-position rotary switch, shorting type.

S<sub>2</sub>—Two-pole 3-position rotary switch, non-shorting type.

S<sub>3</sub>—S.p.s.t. lock switch (AHH 81715-L).

S<sub>4</sub>, S<sub>5</sub>—S.p.s.t. toggle.

S<sub>6</sub>—Time delay relay (Amperite 115N060).

S<sub>7</sub>—Heavy duty d.p.s.t. toggle.

T<sub>1</sub>—10-volt 10-ampere filament transformer.

T<sub>2</sub>—250-volt 25-ma. transformer (Stancor PS-8416).

T<sub>3</sub>—800-v.c.t. 200-ma., 5- and 6.3-v. heater windings.



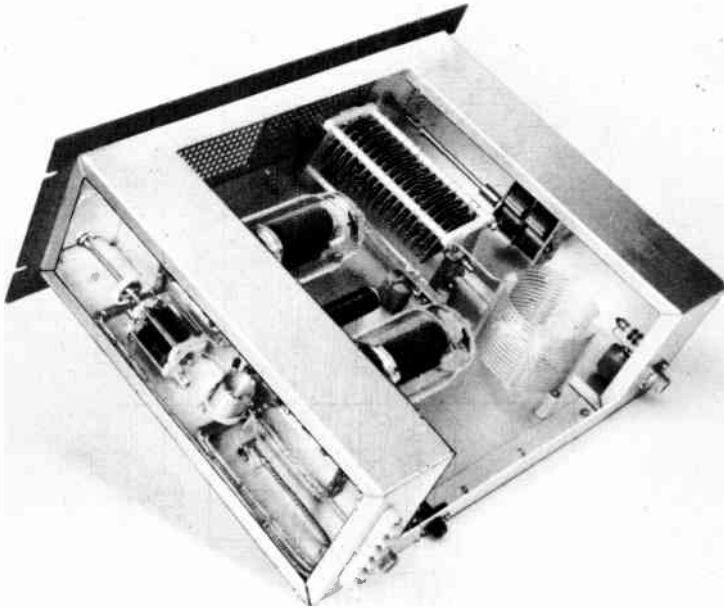

Fig. 6-80—View of the 80-meter amplifier with its cane-metal covering removed. As in each amplifier, the chassis is made from two 5 × 13 × 3-inch chassis and a 13 × 17-inch base plate. Input and low-voltage leads make up to terminals and jack in center foreground.

should be grounded to the chassis. A piece of Eimac Finger Stock or a homemade contact can be used for the purpose.

All power wiring is done with shielded wire and bypassed as described in Chapter Twenty-three. The filament leads should be made from No. 14 (or heavier) shielded wire.

The screen and bias supplies plus station control circuits are built on a rack-mounting chassis (Bud CB-1373) behind a 7-inch panel. In the

Class-C position of  $S_2$ , +400 volts is applied to the screens and —150 is connected to the grids. In the Class-AB<sub>1</sub> position, the screen voltage is increased to 700 and the grid bias is dropped to a value determined by the setting of  $R_2$ . This latter setting should be one that gives best linearity without exceeding a no-signal plate input of 150 watts for the two 813s; it depends on the plate voltage available. A heavy bleed on the screen supply helps the regulation.

Coil and Capacitor Table					
Band	80	40	20	15	10
$C_1$	100 $\mu\text{f.}$ (Johnson 100L15)	100 $\mu\text{f.}$ (Johnson 100L15)	50 $\mu\text{f.}$ (Johnson 50L15)	50 $\mu\text{f.}$ (Johnson 50L15)	50 $\mu\text{f.}$ (Johnson 50L15)
$C_4$	150 $\mu\text{f.}$ (Johnson 150E45)	150 $\mu\text{f.}$ (Johnson 150E45)	35 $\mu\text{f.}$ (Johnson 35E45)	35 $\mu\text{f.}$ (Johnson 35E45)	50 $\mu\text{f.}$ (Hammarlund MC-50-MX)
$C_5$	710 $\mu\text{f.}$ (2-gang 365 $\mu\text{f.}$ )	325 $\mu\text{f.}$ (Hammarlund MC-325-M)	325 $\mu\text{f.}$ (Hammarlund MC-325-M)	325 $\mu\text{f.}$ (Hammarlund MC-325-M)	325 $\mu\text{f.}$ (Hammarlund MC-325-M)
$C_6$	500 $\mu\text{f.}$ (Centralab TV-207)	100 $\mu\text{f.}$ (CRL 850S-100N)	—	—	—
$L_1$	4 t. No. 22*	3 t. No. 22*	2 t. No. 22*	1 t. No. 22*	1 t. No. 22*
$L_2$	32 t.p.i. No. 24, 1 inch long, 1 inch diam. (B&W 3016)	16 t.p.i. No. 20 1 1/4 inch long, 1 inch diam. (B&W 3015)	8 t.p.i. No. 18 1 3/4 inch long, 1 inch diam. (B&W 3014)	8 t.p.i. No. 18 3/4 inch long 1 inch diam. (B&W 3014)	8 t.p.i. No. 18 1/2 inch long, 1 inch diam. (B&W 3014)
$L_5$	6 t.p.i. No. 12, 3 inch long, 3 inch diam. (Air Dux 2406)	4 t.p.i. No. 12, 3 3/4 inch long, 2 1/2 inch diam. (Air Dux 2004)	2 t.p.i. 1/4-inch copper tubing, 4 1/2 inch long, 2 1/2 i.d.	2 t.p.i. 1/4-inch Copper tubing, 3 inch long, 2 1/2 i.d.	2 t.p.i. 1/4-inch copper tubing, 2 inch long, 2 1/2 i.d. $C_4$ tap 2 turns.

\* Insulated hookup wire, wound over  $C_1$  end of  $L_2$ .

The unit shown in Fig. 6-78 uses an Ohmite Model 111 switch at *S*<sub>8</sub>. This is ganged with antenna and excitation switches to permit one-control bandswitching. The relay *K*<sub>1</sub> is actuated

when the plate supply is turned on; when the relay is open a high bias is applied to the 813s to reduce the plate current to 0 ma. and eliminate receiver noise caused by static plate current.

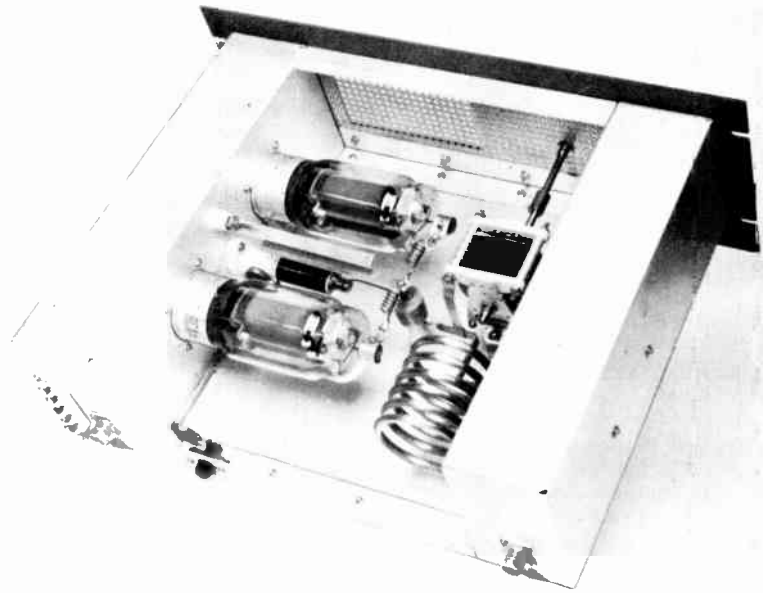

Fig. 6-81—Top view of the 15-meter amplifier. The neutralizing capacitor consists of two strips of aluminum, supported by the plate-blocking capacitor and a feedthrough insulator. It is mounted over the r.f. choke between the two 813 tubes.

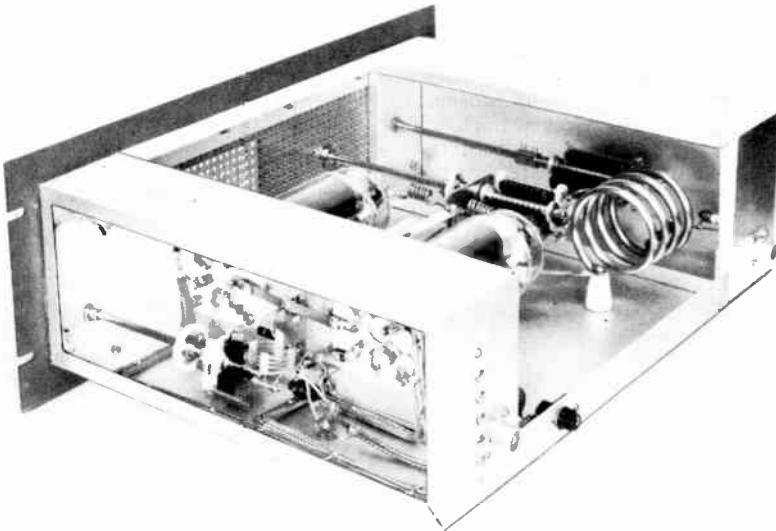

Fig. 6-82—As in the other amplifiers, the 10-meter final uses shielded wires in the filament, screen, and grid-return circuits. For tuning this amplifier uses a small variable capacitor connected across half of the plate coil, to maintain a favorable *L/C* ratio.

## A HIGH-POWER GROUNDED-GRID AMPLIFIER AND POWER SUPPLY

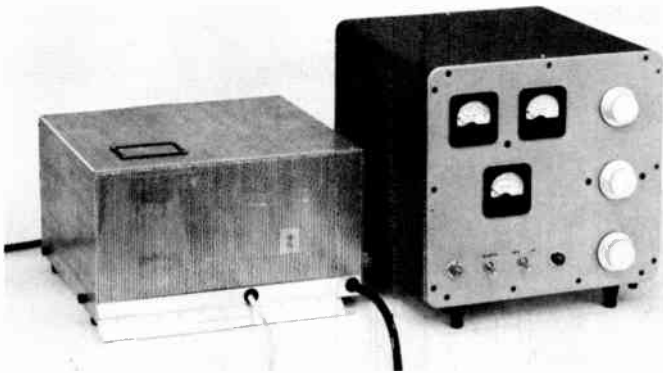

Fig. 6-83—The 3-1000Z grounded-grid linear and its solid-state power supply are shown here with a 12-inch ruler to show the relative sizes of the units. The chart frame on the top of the power-supply housing holds the clear plastic through which the voltmeter can be read. (Built by Bob Smith, WILLF.)

The grounded-grid linear amplifier and power supply shown in Fig. 6-83 are designed for the amateur power limit in single-sideband operation. The amplifier uses a 3-1000Z triode in Class B to handle a p.e.p. input of 2 kw. on peaks. The amplifier and supply each occupy just over 1 cubic foot and are made from readily available components. The 3-1000Z requires a driver capable of supplying at least 65 watts p.e.p.

Referring to the amplifier circuit diagram in Fig. 6-85, the grid of the triode is grounded for both r.f. and d.c. The cathode is maintained above r.f. ground by feeding it through a homemade filament choke wound on a ferrite rod. The input impedance of the grounded-grid 3-1000Z is close to 50 ohms, and it provides a good match for a driver with fixed-impedance output or any other driver that can be properly loaded with 50 ohms.

The plate tank circuit uses a commercial coil assembly (Air Dux 195-2) that has been rearranged to conserve space and fit better into the

compact package. The single-pole bandswitch is modified slightly, as described later, to permit the switching in of a plate loading capacitor on 75 meters.

During "receive" periods a 50,000-ohm resistor in the filament-transformer center tap practically cuts off the plate current; leads from it are brought to two phone jacks so that the resistor can be shorted out during "transmit" by a set of contacts on the antenna transfer relay (or by the VOX control if an electronic t.r. switch is used).

Three meters are used in the amplifier. The grid and plate currents are read separately by a 0-500 milliammeter and a 0-1 ammeter. The third meter is a relative-output indicator metering the r.f. voltage at the output. D.c. for the meter is derived from a germanium-diode rectifier connected to a resistive r.f. voltage divider.

Panel switches and associated neon indicators are provided for control of the filament (and blower) and high-voltage power.

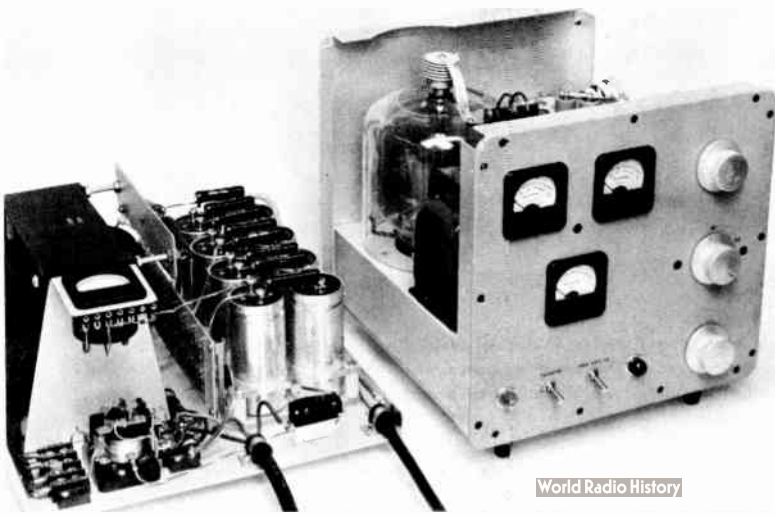

Fig. 6-84—The 3-1000Z grounded-grid linear is mounted on short legs to allow air to be drawn in at the bottom and blown up past the tube. The meters indicate grid (left) and plate current and relative output (below). Knobs at right (B & W 901) control plate (top), band switching and loading.

Two layers of the heat-radiating plate cap have been removed to allow clearance of the perforated-metal cover.

The companion power supply uses silicon diodes in a voltage-doubling circuit.



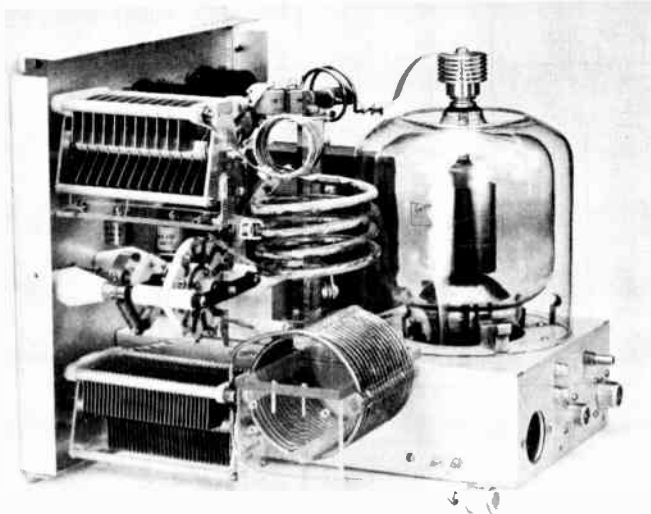

Fig. 6-86—Rear view of the 3-1000Z amplifier with the back wall and SK-516 chimney removed. Note the two ceramic capacitors mounted on the plastic strip below the plate tuning capacitor (top left). The left-hand capacitor is cut into the circuit on 3.5 Mc. by the spring arm on the switch shaft (see text).

circuitry, consisting of the 22,000- and 470-ohm resistors, the 1N34A rectifier and the 0.001- $\mu$ f. capacitor, is also mounted on the chassis (see Fig. 6-90). These are mounted on a multiple tie-point strip fastened to the top edge of the chassis near  $C_4$ . The assembly is shielded by a  $2\frac{3}{4} \times 2\frac{1}{8} \times 1\frac{5}{8}$ -inch "Minibox" (Bud CU-3000-A).

To provide an extra grounding contact, switch S1 must be modified. A brass collar that will fit the shaft is required. It is drilled and tapped to fasten to the shaft and also to hold a strap made of spring material (silver solder ribbon,  $0.020 \times \frac{3}{4}$  inch was used, trimmed to the width of the collar). The strap is located on the shaft so that in the 3.5-Mc. position it will contact the 100-pf. 5 kv. ceramic capacitor supported by a strip of plexiglas hung from C1 (see Fig. 6-86). The switch is supported on the panel by four 1-inch high ceramic cone insulators (Johnson 135-501) mounted base-to-base. On the panel, shaft bearings are used for the switch shaft and the two capacitor shafts.

The tank coil assembly is modified by first removing the strap coil and the copper tubing coil from the polystyrene strip that supports them.

Then saw a 3-inch long strip from one end and mount it at right angles to the original strip with cement or brass screws (see Fig. 6-86). Coil  $L_4$ , the wire coil, is supported by the polystyrene strip, which rests on the bottom plate at the outside and on the basic chassis on the inside. The inside end of  $L_4$  is bent up and a loop formed in the end. Coil  $L_3$  is bolted to this loop with a brass 8-32 machine screw, and the tap running to the 20-meter pin on the switch is taken off at the same junction. All coil taps were made of  $\frac{3}{16}$ -inch wide straps cut from copper flashing. The coil  $L_2$  is supported at one end by an end of  $L_3$  and at the other by a copper strap fastened to the stator of  $C_3$  (see Fig. 6-90).

Two 1000-pf. 5-kv. capacitors and the parasitic suppressor,  $RFC_2R_1$ , are supported by the top of  $RFC_3$ , and a flexible strap runs from the other end of the parasitic suppressor to the plate cap. To avoid contact between the cap and the amplifier cover, two layers must be cut off the top of the plate connector (Eimac HR-8).

Fig. 6-87—A view under the sub chassis of the amplifier. The filament choke can be seen supported off the side wall by ceramic stand-off insulators and plastic cable clamps. A lip on the tube socket (right foreground) has been removed to provide more space and better air flow; the three grid pins of the socket are grounded to the chassis by short straps. Don't try to bend the terminals out of the way before sawing off the lip; remove them entirely.

The resistor mounted on a tie-point strip and visible under the left end of the filament choke is the 50,000-ohm cathode resistor used for stand-by bias; leads from it run in shielded wire to  $J_4$  and  $J_5$ . Wires and plug dangling over the side run to the blower (see Fig. 6-88).

The jack on the rear wall closest to the near side (foreground) is  $J_3$ , the high-voltage cable jack. A 1000-pf. 5-kv. capacitor is mounted on the chassis just inside this point.

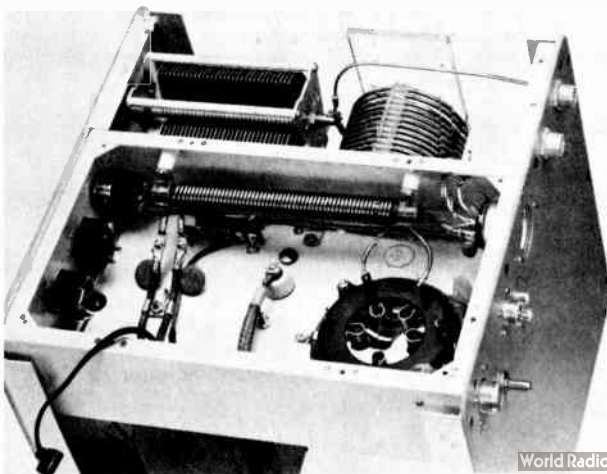



The chimney (Eimac SK-516) is held in place around the 3-1000Z by four metal clips, and the socket (Eimac SK-510) is modified slightly as mentioned in the caption for Fig. 6-87. The blower is mounted on the  $12 \times 11\frac{1}{4} \times \frac{1}{8}$ -inch bottom plate so that it is not directly under the tube socket but near the front panel. Rubber (they could be turned wooden) feet attached to the bottom plate support the amplifier above the operating table and allow the free flow of air into the blower. The a.c. connector for the blower is a stock item (Rotron 16415).

To conserve space, the filament transformer  $T_1$  must be modified so that the leads come out the bottom. This is done by removing the end bells, blocking the original holes with paper and drilling new holes for the leads.

There is a little trick to winding the filament choke,  $RFC_1$ , primarily because the wire is so heavy that it cannot be wound directly on the ferrite rod without springing out. To overcome this, the dual winding of the choke is wound first on a length of  $\frac{7}{16}$ -inch wooden dowel. When it is released it will spring out slightly, enough to permit it to be slipped off the dowel and on to the ferrite core. One-half inch nylon cable clamps mounted on  $\frac{5}{8}$ -inch standoff insulators hold the core in place on the inside wall of the chassis (see Fig. 6-87). Formvar or Nylclad wire is recommended for the choke because with it there is very little chance that the insulation will be chipped off as the core is inserted in the coils.

It will be noted that the three grid leads are connected directly to the chassis. There are slots in the SK-510 socket especially provided to allow low-inductance ground terminations to be made to each of the grid terminals. The grounding straps are slipped through the slots and soldered to the socket pins.

The  $7 \times 7 \times 2$ -inch chassis that shields the three meters is held to the panel by a single screw that threads into a metal stud. To clear the shielded wires running up to the meters from the hole in the main chassis, a suitable slot is cut on one side of the shield chassis.

### Power Supply

A power supply delivering 2500 to 3000 volts at 400 to 350 ma. will be suitable for use with the amplifier. The power supply shown in Figs. 6-84 and 6-89 is built with sixteen silicon diodes costing 84 cents each (a total of \$13.50), although rectifier units having a p.i.v. rating of 4000 (and a price of \$18 each) are available.

Referring to the circuit diagram of the supply, Fig. 6-91, a transformer with a dual primary is used, to permit operation from either a 115- or a 230-volt line. The higher voltage is recommended. No fuses are shown; it is expected that the supply will be protected by the fuses (or circuit breakers) in the wall outlet box.

The filter capacitors are called "computer grade" capacitors; the 25K resistors across them serve both as the bleeder resistor and the equalizing resistors. In operation, the idling current of the amplifier (180 ma.) further bleeds the supply.

The 0-5000 voltmeter is included to comply with the FCC regulations. It is a good idea to get into the habit of watching the voltage decay when the power supply is turned off; in this way you are less likely to get mixed up with a residual charge in the capacitors. An interlock switch in series with the relay makes it necessary to replace the cover before turning on the supply.

The 10-ohm resistor between the negative terminal and chassis allows plate-current metering in the negative lead with no difference in potential between power-supply and amplifier chassis.

The power supply construction is not critical, and the main considerations are adequate insulation and safety precautions. The string of silicon diodes and their associated capacitors and resistors are mounted on a  $3 \times 9\frac{1}{4}$ -inch strip of pre-punched terminal board (Vector 85G24EP), with push-in terminals (Vector T28) serving as tie points. The rectifiers are mounted on one side of the board, the resistors and capacitors on the other. The strip is mounted on the  $12 \times 13 \times \frac{1}{8}$ -

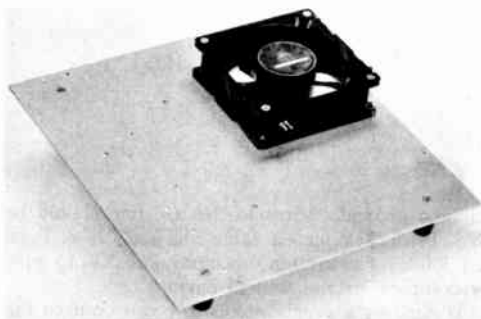

Fig. 6-88—Blower is mounted on bottom plate of amplifier near the front panel (not directly under the tube). A.c. power connector for blower is stock item mentioned in text.

inch aluminum base plate with a pair of panel brackets (Raytheon MB-128).

The pair of 50-ohm resistors is mounted on a  $7\frac{1}{2} \times 1\frac{3}{4}$ -inch strip of pre-punched terminal board, supported by two  $\frac{1}{4}$ -20 bolts, 5 inches long, that replace two of the original transformer bolts. This strip also serves as a stop to prevent the cover and the resistors coming in contact.

The bank of eight 240- $\mu$ f. capacitors is insulated from the base plate by a sheet of  $4\frac{3}{4} \times 9 \times \frac{1}{4}$ -inch clear plastic (Lucite or Plexiglas). A similar sheet with clearance holes is mounted higher and holds the capacitors in place. The 25K bleeder resistors mount on the capacitor terminals.

The high-voltage cable running to the amplifier is a length of RG-8/U terminated in a high-voltage coaxial plug (UG-59B/U). At the power supply end, the braid is peeled back for about a foot on the insulating material, to provide a suitably long leakage path. Disregard of this small point may result in voltage breakdown along the surface of the insulating material. The shield braid is connected to the base plate, which serves as the

Fig. 6-89—In this view of the power supply, four filter capacitors have been removed to show how the silicon diodes are mounted on one side of the terminal board; equalizing resistors and capacitors are mounted on the other side. The meter mounting bracket is held to the base plate by two of the bolts that run through the feet of the transformer. Small switch in the foreground is the interlock; control relay is mounted on base plate to left of terminal block.

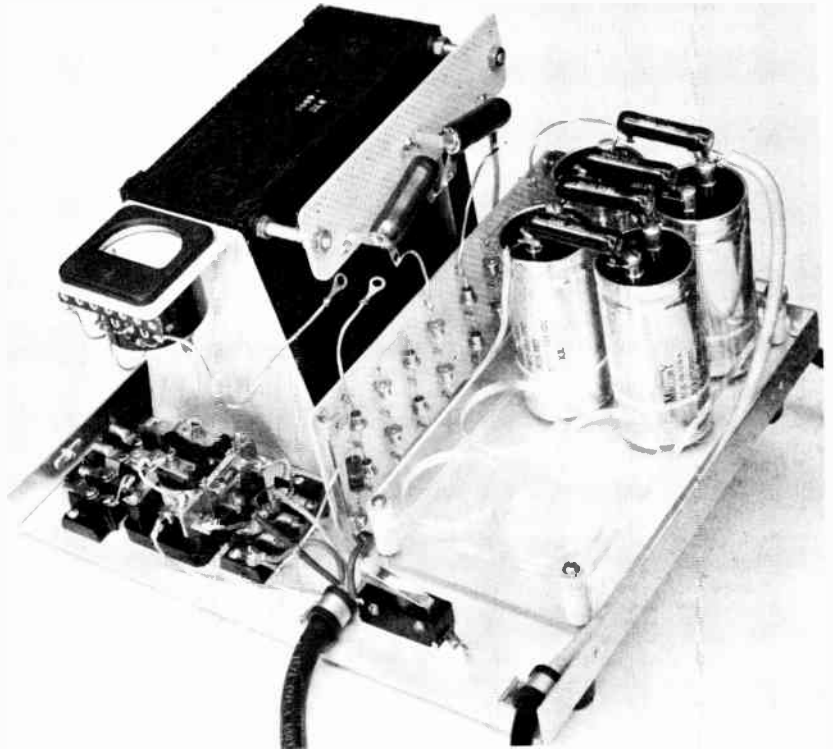

chassis ground. Wires to the a.c. line should be No. 14 or heavier (a cable marked "14-3 Type SJ 300 V" was used in this unit), and No. 16 wire will suffice for the control wiring.

If desired, a precision resistor can be used for  $R_3$ , the voltmeter multiplier. However, selected standard 20-percent resistors will serve as well.

#### Safety Precautions

A 3000-volt power supply with a 30- $\mu$ f. filter capacitor is a lethal device. There is no such thing as a "slight electrical shock" from a power supply like this one. Make absolutely certain that the voltmeter indication has coasted down to zero before removing the protective cover or touching anything remotely connected to the high-voltage lead. Even then it is a good idea to use a "shorting stick" across the output as a double check.

#### Adjustment of the Amplifier

An amplifier of this quality and power level

deserves the best of treatment, and to that end it is recommended that the operator familiarize himself with its operation by using a dummy load, an oscilloscope and some method of "pulsing" the drive (see Goodman, "Linear Amplifiers and Power Ratings," *QST*, August, 1957). This will enable the operator to work the amplifier at its maximum legal capability with a minimum of spurious radiation.

Lacking the equipment mentioned above, it is possible to approach proper operating conditions by the following rules of thumb. They are intended, however, to serve only as rough guides.

With a sideband exciter set for c.w. operation, feed its output to the amplifier at input jack  $J_1$ , through a length of RG-58/U or RG-8/U terminated in a PL-259 coaxial plug. With the filament of the amplifier turned on, but with the plate voltage turned off, tune the sideband exciter at low output level, using the grid-current indication in the grounded-grid amplifier as the out-

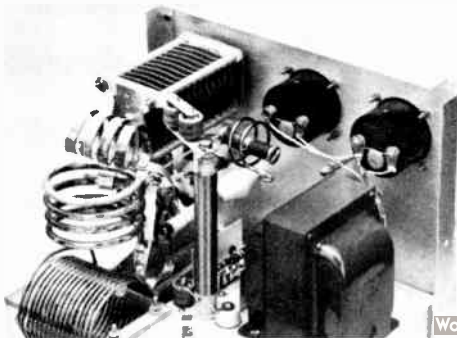

Fig. 6-90—Another view of the grounded-grid amplifier, showing the output voltmeter (shield cover removed) components mounted on a multiple tie point strip. The metal stud between the meters receives the screw that holds down the meter shield (7 x 7 x 2-inch chassis).



## CONVERTING SURPLUS TRANSMITTERS FOR NOVICE USE

War-surplus radio equipment, available in many radio stores, is a good source of radio parts. Some of the transmitters and receivers can be made to operate in the amateur bands with little or no modification. It would be hard to find a more economical way for a Novice to get started on 40 or 80 meters than by adapting a normally-v.f.o.-controlled surplus "Command Set" to crystal control.

The "Command Sets" are parts of the SCR-274N and AN/ARC-5 equipments, transmitters and receivers designed for use in military aircraft. The two series are substantially identical in circuit and construction. Of the transmitters, two are of particular interest to the Novice. These are the BC-696 (part of 274N) or T19 (ARC-5) covering 3 to 4 Mc., and the BC-459 or T22, 7 to 9.1 Mc. The transmitter circuit consists of a 1626 triode variable-frequency oscillator that drives a pair of 1625s in parallel, which for Novice use can be run at 75 watts input. In addition to the 1626 and 1625s the transmitters include a 1629 magic-eye tube, which was used as a resonance indicator with a crystal for checking the dial calibration. The tubes have 12-volt heaters connected in series-parallel for 24-volt battery operation. The BC-696 and 459 are available from surplus dealers at prices ranging from five to fifteen dollars each, depending on condition.

Several methods have been described for converting the transmitters to crystal control for Novice use, but they don't consider the reversion required to change back to v.f.o. when the Novice gains his General-Class license.

In the modification to be described, the Novice requirement for crystal control is met by using a separate crystal-controlled oscillator. The output of the external oscillator is fed into the transmitter through a plug that fits into the 1626 oscillator socket. The 1626 is not used. The transmitter modifications are such that when it is desired to restore the transmitter to v.f.o. operation the external oscillator is unplugged and the 1626 is put back in its socket. No wiring changes are needed to go from crystal control to v.f.o.

In addition to the external oscillator, a power supply is required for the oscillator and transmitter (Fig. 6-93), and certain wiring changes are needed to make the transmitter itself suitable for amateur use. These changes consist primarily of removing two relays, changing the tube heater circuit for operation on 12 volts instead of 24 volts, and the addition of a power plug.

### Transmitter Modifications

The 80- and 40-meter transmitters are practically identical except for frequency range, and the modifications are the same in both. Remove the top cover and bottom plate. Remove the tubes and crystal from their sockets so there will be no danger of breaking them as you work on the transmitter. If the sockets are not marked by tube types, mark them yourself so you'll know which tube goes where.

The following modifications are required:

- 1) Remove the antenna relay (front panel) and control relay (side of chassis) and unsolder and remove all wires that were connected to the relays with the exception of the wire going to Pin 4 on the oscillator socket.
- 2) Remove the wire-wound resistor mounted on the rear wall of the transmitter.
- 3) Unsolder the wire from Pin 7 of the 1629 socket and move it to Pin 2. Ground Pin 7.
- 4) Unsolder the wires from Pin 1 of the 1625 closest to the drive shaft for the variable capacitors and solder the wires to Pin 7. Run a lead from the same Pin 1 to the nearest chassis ground.
- 5) Unsolder all leads from the power socket at the rear of the chassis and remove the socket. The socket can be pried off with a screwdriver.
- 6) Unsolder the end of the 20-ohm resistor (red-black-black) that is connected to Pin 4 on the oscillator socket and connect it to Pin 6

Fig. 6-92—The complete Novice setup, in this case using the 80-meter (BC-696) transmitter. Note the key jack at the lower-left corner of the transmitter panel. The crystal oscillator is connected to the transmitter oscillator-tube socket with a short length of cable terminating in an octal plug. A small notch should be cut in the transmitter cover to provide clearance for the cable when the cover is installed.

The power transformer, rectifier, and choke are mounted on top of the power-supply chassis at the rear, and the control switches are mounted on the wall as shown. Remaining components are underneath.









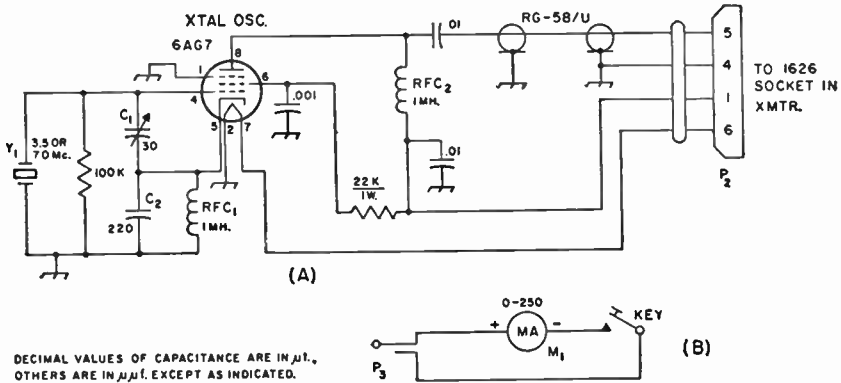

Fig. 6-94—(A) Circuit diagram of external crystal-controlled oscillator. Unless otherwise specified, resistances are in ohms, resistors are 1/2 watt. The 0.01- and 0.001- $\mu\text{f}$ . capacitors are disk ceramic. (B) Method of connecting the milliammeter in series with the key.

- C<sub>1</sub>—3.30- $\mu\text{f}$ . trimmer.
- C<sub>2</sub>—220- $\mu\text{f}$ . fixed mica.
- M<sub>1</sub>—0-250 d.c. milliammeter.
- P<sub>2</sub>—Octal plug, male (Amphenol 86-PM8).
- P<sub>3</sub>—Phone plug.
- RFC<sub>1</sub>, RFC<sub>2</sub>—1-mh. r.f. chokes.
- Y<sub>1</sub>—3.5- or 7-Mc. Novice-band crystal, as required.

provide 6.3 volts for the heater of the 6AG7. Current requirement for the 6AG7 heater is 0.65 amp and for the 1625s, 0.9 amp. total.

To turn off the plate voltages on the transmitter during stand-by periods, the center tap of  $T_1$  is opened. This can be done in two ways; by  $S_2$ , or by a remotely-mounted switch whose leads are connected in parallel with  $S_2$ . A two-terminal strip is mounted on the power-supply chassis, the terminals being connected to  $S_2$  which is also on the chassis. The remotely-mounted switch can be installed in any convenient location at the operating position. A single-pole, single-throw switch can be used for this purpose or, if desired, a multicontact switch can be used to perform simultaneously this and other functions, such as controlling an antenna-changeover relay.

The high-voltage and heater leads are brought out in a cable to an octal plug,  $P_1$ , that connects to  $J_1$  on the transmitter. The length of the cable will, of course, depend on where you want to install the power supply. Some amateurs prefer to have the supply on the floor under the operating desk rather than have it take up room at the operating position.

The supply shown here was constructed on a 3 x 6 x 10-inch chassis. The layout is not critical, nor are there any special precautions to take during construction other than to observe polarity in wiring the electrolytic capacitors and to see that the power leads are properly insulated. Never have  $P_1$  unplugged from  $J_1$  when the power supply is turned on; there is danger of electrical shock at several pins of  $P_1$ . Interchanging the inserts of  $P_1$  and  $J_1$  will remove this hazard.

When wiring  $P_1$  don't connect the B-plus lines to Pins 2 or 3, the amplifier plates and screens, at first. It is more convenient to test the oscillator without plate and screen voltages on the amplifier.

When the supply is completed, check between

chassis ground and the 12.6-volt lead with an a.c. voltmeter to see if the two 6.3-volt windings are connected correctly. If you find that the voltage is zero, reverse one of the windings. If you don't have an a.c. meter you can check by observing the heaters in the 1625s. They will light up if you have the windings connected correctly. Incidentally, leave B plus off, by opening  $S_2$ , for this check.

Next, set the slider on the bleeder resistor,  $R_1$ , at about one-quarter of the total resistor length, measured from the B-plus end of the bleeder. Be sure to turn off the power when making this adjustment. With the tap set about one-quarter of the way from the B-plus end of the bleeder the oscillator plate and amplifier screen voltages will be approximately 250 volts.

**Testing the Transmitter**

A key and meter connected as shown in Fig. 6-94 are needed for checking the transmitter. When  $P_3$  is plugged into the jack in the transmitter it will measure the cathode current of the 1625s. The cathode current is the sum of the plate, screen and control-grid currents. Some amateurs prefer to install the meter in the plate lead so it reads plate current only. This can be done by opening the B-plus line at the point marked "X" in Fig. 6-93, and inserting the meter in series with the line. However, unless more than one meter is available, don't install it in the power supply setup in this way until after the tests described below have been made.

Insert the external oscillator plug,  $P_2$ , into the 1626 socket and connect  $P_1$  to the transmitter. Plug  $P_1$  into the key jack on the front panel of the transmitter. With  $S_2$  open, turn on the power and allow a minute or two for the tubes to warm up. Next, close the center-tap connection,  $S_2$ , on the power transformer. Set the transmitter dial to the same frequency as that of the crystal in

use and close the key. A slight indication of grid current should show on the meter. There is no plate or screen current because there are no screen or plate voltages on the amplifier. If no grid current is obtained, adjust  $C_1$  until grid current shows, or try another crystal.

The next step is to peak the amplifier grid circuit — that is, the 1626 v.f.o tank — for maximum grid-current reading. The v.f.o. trimmer capacitor is in an aluminum box on the top of the chassis at the rear. There is a 1/2-inch diameter hole in the side of the box; loosen the small screw visible through this hole, thus unlocking the rotor shaft of the trimmer capacitor. Move the rotor-arm shaft in either direction, observing the meter reading, and find the position that gives the highest reading. This should be something more than 10 ma.

Now connect the plate and screen voltage leads to  $P_1$ . Be sure to turn off the power supply before making the connections!

The first test of the rig should be with a dummy load; a 115-volt, 60-watt light bulb can be used for this purpose. The lamp should be connected between the antenna terminal and chassis ground. However, to make the lamp take power it may be necessary to add capacitance in parallel with it. A receiving-type variable capacitor having 250  $\mu\text{f.}$  or more maximum capacitance will be adequate for the job.

Turn on the power and allow the tubes to warm up, but leave the key open. Set the antenna coupling control on the transmitter to 7 or 8, and set the variable capacitor connected across the dummy load to about maximum capacitance. Next, close the key and adjust the antenna inductance control for an increase in cathode current. Turn the frequency control for a dip in current reading. The indicated frequency will probably differ from that of the crystal in use, but don't worry about it.

Adjust the three transmitter controls, antenna inductance, antenna coupling, and frequency, along with the variable capacitor across the lamp load, until the lamp lights up to apparently full brilliance. The cathode current should be between 150 and 200 ma. With the transmitter fully loaded, adjust  $C_1$  in the crystal oscillator so that the lamp brilliance just starts to decrease. This is the optimum setting for  $C_1$  and no further adjustments are required.

If a d.c. voltmeter is available, check the different voltages in the setup. Using the power supply shown here, the plate voltage on the 1625s is approximately 400 with the amplifier fully loaded. With the plate voltage on the oscillator and screen voltage on the 1625s adjusted to 250 volts (tap on  $R_1$ ), the oscillator screen voltage is 160 volts. The oscillator takes approximately 30 ma. and the 1625 amplifier screens about 10 ma. when the amplifier is fully loaded.

### Getting on the Air

To put the transmitter on the air, it is necessary only to connect an antenna to the antenna post and connect a ground lead from the transmitter

chassis to a water-pipe ground or to a metal stake driven in the ground. Almost any length of antenna will work, but for best results the minimum length should not be less than about 1/4 wavelength for the band in use. This is approximately 33 feet for 80 meters and 16 feet for 40 meters. It is of course better to make the antenna longer — and to be sure to get the far end as high as possible.

An output indicator will prove to be a handy device for knowing when power is actually going into the antenna. For this purpose use a 6.3-volt, 150-ma. dial lamp. Connect two leads, each about one foot long, to the shell and base of the bulb, respectively. Clip one lead to the antenna post and the other lead on the antenna wire two feet from antenna post. A small amount of power will go through the bulb and this will provide a visual indication of output. Follow the same tuning procedure as outlined above for the dummy antenna. If the bulb gets so bright that it is in danger of burning out, move the leads closer together to reduce the pickup.

It may be found that certain antenna lengths won't work — that is, the amplifier won't load — no matter where the antenna coupling and inductance are set. In such a case, connect a variable capacitor — like the one used with the lamp dummy — between the antenna post and the transmitter chassis. Adjust the capacitor and antenna inductance for maximum brilliance of the output indicator.

A superior antenna system uses a two-wire feeder system and an antenna coupler; examples are given in Chapters 13 and 14. If a coupler is used, the transmitter and coupler should be connected together with coax line. The inner conductor of the coax should be connected to the antenna terminal and the outer braid to the transmitter case, as close to the antenna terminal as possible. If desired, the antenna terminal can be removed and a coax fitting substituted.

When the coveted General Class ticket is obtained, it is only necessary to unplug the crystal oscillator, put the original tube back in the rig, and move out of the Novice band.

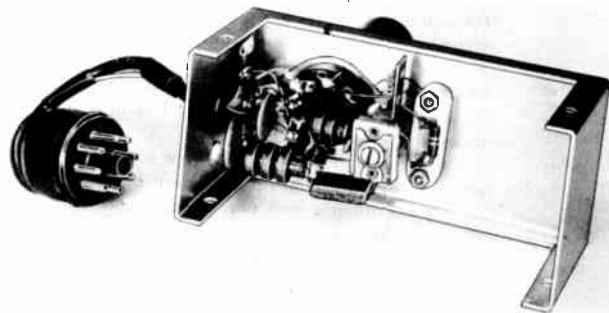

Fig. 6-95—This bottom view of the crystal oscillator shows the arrangement of components. Terminal strips are used for the cable connections and also as support for  $C_1$ , the feedback capacitor.

# Code Transmission

Keying a transmitter properly involves much more than merely turning it on and off with a fast manually-operated switch (the key). If the output is permitted to go from zero to full instantaneously (zero "rise" time), side frequencies, or **key clicks**, will be generated for many kilocycles either side of the transmitter frequency, at the instant the key is closed. Similarly, if the output drops from full to zero instantaneously (zero "decay" time), side frequencies will be generated at the instant of opening the key. The amplitude of the side-frequency energy decreases with the frequency separation from the transmitter frequency. To avoid key clicks and thus to comply with the FCC regulations covering spurious radiations, the transmitter output must be "shaped" to provide finite rise and decay times for the envelope. The longer the rise and decay times, the less will be the side-frequency energy and extent.

Since the FCC regulations require that "... the frequency of the emitted wave shall be as

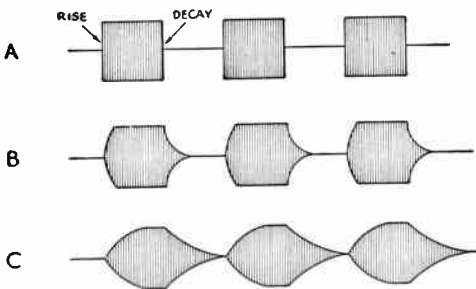

Fig. 7-1—Typical oscilloscope displays of a code transmitter. The rectangular-shaped dots or dashes (A) have serious key clicks extending many kc. either side of the transmitter frequency. Using proper shaping circuits increases the rise and decay times to give signals with the envelope form of B. This signal would have practically no key clicks. Carrying the shaping process too far, as in C, results in a signal that is too "soft" and is not easy to copy.

Oscilloscope displays of this type are obtained by coupling the transmitter r.f. to the vertical plates (Chapter 11) and using a slow sweep speed synchronized to the dot or dash speed of an automatic key.

constant as the state of the art permits", there should be no appreciable change in the transmitter frequency while energy is being radiated. A *slow* change in frequency, taking place over minutes of time, is called a frequency "drift"; it is usually the result of thermal effects on the oscillator. A *fast* frequency change, observable

during each *dit* or *dah* of the transmission, is called a chirp. Chirp is usually caused by a non-constant load on the oscillator or by d.c. voltage changes on the oscillator during the keying cycle. Chirp may or may not be accompanied by drift.

If the transmitter output is not reduced to zero when the key is up, a backwave (sometimes called a "spacing wave") will be radiated. A backwave is objectionable to the receiving operator if it is readily apparent; it makes the signal slightly harder to copy. However, a slight backwave, 40 db. or more below the key-down signal, will be discernible only when the signal-to-noise ratio is quite high. Some operators lis-

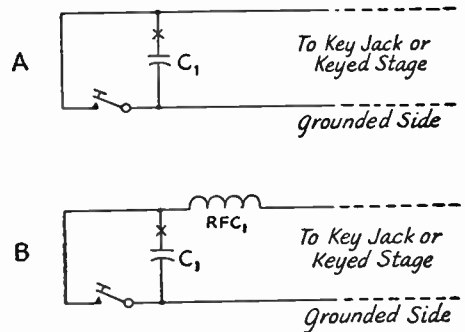

Fig. 7-2—Typical filter circuits to apply at the key (and relay, if used) to minimize r.f. clicks. The simplest circuit (A) is a small capacitor mounted at the key. If this proves insufficient, an r.f. choke can be added to the ungrounded lead (B). The value of  $C_1$  is .001 to .01  $\mu\text{f.}$ ,  $\text{RFC}_1$  can be 0.5 to 2.5 mh., with a current-carrying ability sufficient for the current in the keyed circuit. In difficult cases another small capacitor may be required on the other side of the r.f. choke. In all cases the r.f. filter should be mounted right at the key or relay terminals; sometimes the filter can be concealed under the key. When cathode or center-tap keying is used, the resistance of the r.f. choke or chokes will add cathode bias to the keyed stage, and in this case a high-current low-resistance choke may be required, or compensating reduction of the grid-leak bias (if it is used) may be needed. Shielded wire or coaxial cable makes a good keying lead.

A visible spark on "make" can often be reduced by the addition of a small (10 to 100 ohms) resistor in series with  $C_1$  (inserted at point "x"). Too high a value of resistor reduces the arc-suppressing effect on "break."

tending in the shack to their own signals and hearing a backwave think that the backwave can be heard on the air. It isn't necessarily so, and the best way to check is with an amateur a

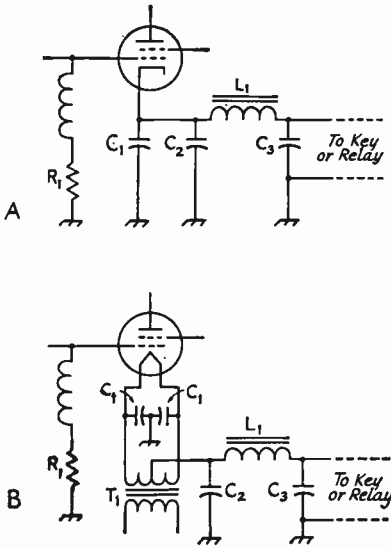

Fig. 7-3—The basic cathode (A) and center-tap (B) keying circuits. In either case  $C_1$  is the r.f. return to ground, shunted by a larger capacitor,  $C_2$ , for shaping. Voltage ratings at least equal to the cut-off voltage of the tube are required.  $T_1$  is the normal filament transformer.  $C_1$  and  $C_2$  can be about  $0.01 \mu\text{f}$ .

The shaping of the signal is controlled by the values of  $L_1$  and  $C_2$ . Increased capacitance at  $C_2$  will make the signal softer on break; increased inductance at  $L_1$  will make the signal softer on make. In many cases the make will be satisfactory without any inductance.

Values at  $C_2$  will range from 0.5 to  $4 \mu\text{f}$ ., depending upon the tube type and operating conditions. The value of  $L_1$  will also vary with tube type and conditions, and may range from a fraction of a henry to several henrys. When tetrodes or pentodes are keyed in this manner, a smaller value can sometimes be used at  $C_2$  if the screen-voltage supply is fixed and not obtained from the plate supply through a dropping resistor.

Oscillators keyed in the cathode circuit cannot be softened on break indefinitely by increasing the value of  $C_2$  because the grid-circuit time constant enters into the action.

mile or so away. If he doesn't find the backwave objectionable on the S9+ signal, you can be sure that it won't be when the signal is weaker.

When any circuit carrying d.c. or a.c. is closed or opened, the small or large spark (depending

upon the voltage and current) generates r.f. during the instant of make or break. This r.f. click covers a frequency range of many megacycles. When a transmitter is keyed, the spark at the key (and relay, if one is used) causes a click in the receiver. This click has no effect on the transmitted signal.

Since it occurs at the same time that a click (if any) appears on the transmitter output, it must be eliminated if one is to listen critically to his own signal within the shack. A small r.f. filter is required at the contacts of the key (and relay); typical circuits and values are shown in Fig. 7-2. To check the effectiveness of the r.f. filter, listen on a band lower in frequency than the one the transmitter is tuned to, with a short receiving antenna and the receiver gain backed off.

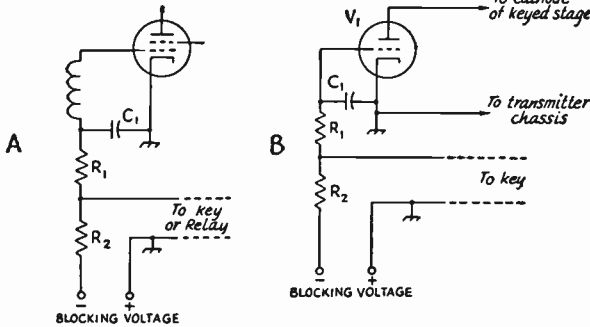

Fig. 7-4—The basic circuit for blocked-grid keying is shown at A.  $R_1$  is the normal grid leak, and the blocking voltage must be at least several times the normal grid bias. The click on make can be reduced by making  $C_1$  larger, and the click on break can be reduced by making  $R_2$  larger. Usually the value of  $R_2$  will be 5 to 20 times the resistance of  $R_1$ . The power-supply current requirement depends upon the value of  $R_2$ , since closing the key circuit places  $R_2$  across the blocking voltage supply.

An allied circuit is the vacuum-tube keyer of B. The tube  $V_1$  is connected in the cathode circuit of the stage to be keyed. The values of  $C_1$ ,  $R_1$  and  $R_2$  determine the keying envelope in the same way that they do for blocked-grid keying. Values to start with might be  $0.47 \text{ megohm}$  for  $R_1$ ,  $4.7 \text{ megohm}$  for  $R_2$  and  $0.0047 \mu\text{f}$ . for  $C_1$ .

The blocking voltage supply must deliver several hundred volts, but the current drain is very low. The 2A3 or other low plate-resistance triode is suitable for  $V_1$ . To increase the current-carrying ability of a tube keyer, several tubes can be connected in parallel.

A vacuum-tube keyer adds cathode bias and drops the supply voltages to the keyed stage and will reduce the output of the stage. In oscillator keying it may be impossible to use a v.t. keyer without changing the oscillator d.c. grid return from ground to cathode.

### What Transmitter Stage To Key

A satisfactory c.w. signal, free from chirp and key clicks, can be amplified by a linear amplifier without affecting the keying characteristics in any way. If, however, the satisfactory signal is amplified by one or more non-linear stages (e.g., a Class-C multiplier or amplifier), the signal envelope will be modified. The rise and decay times will be decreased, possibly introducing significant key clicks that were not present on the signal before amplification. It is possible to compensate for the effect by using longer-than-normal rise and decay times in the excitation and letting the amplifier(s) modify the signal to an acceptable one.

Many two-, three- and even four-stage v.f.o.-controlled transmitters are



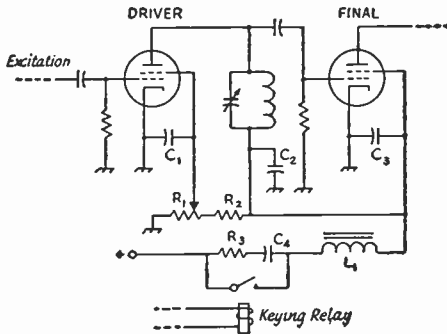

Fig. 7-5—When the driver-stage plate voltage is roughly the same as the screen voltage of a tetrode final amplifier, combined screen and driver keying is an excellent system. The envelope shaping is determined by the values of  $L_1$ ,  $C_4$ , and  $R_3$ , although the r.f. bypass capacitors  $C_1$ ,  $C_2$  and  $C_3$  also have a slight effect.  $R_1$  serves as an excitation control for the final amplifier, by controlling the screen voltage of the driver stage. If a triode driver is used, its plate voltage can be varied for excitation control.

The inductor  $L_1$  will not be too critical, and the secondary of a spare filament transformer can be used if a low-inductance choke is not available. The values of  $C_4$  and  $R_3$  will depend upon the inductance and the voltage and current levels, but good starting values are 0.1  $\mu$ f. and 50 ohms.

To minimize the possibility of electrical shock, it is recommended that a keying relay be used in this circuit, since both sides of the circuit are "hot." As in any transmitter, the signal will be chirp-free only if keying the driver stage has no effect on the oscillator frequency.

(The Sigma 41FZ-35-ACS-SIL 6-volt a.c. relay is well-suited for keying applications.)

incapable of chirp-free output-amplifier keying because keying the output stage has an effect on the oscillator frequency and "pulls" it. Keying the amplifier presents a variable load to its driver stage, which in turn is felt as a variable load on the previous stage, and so on back to the oscillator. Chances of "pulling" are especially high when the oscillator is on the same frequency as the keyed output stage, but frequency multiplication is no guarantee against pulling. Another source of reaction is the variation in oscillator supply voltage under keying conditions, but this can usually be handled by stabilizing the oscillator supply with a VR tube. If the objective is a completely chirp-free transmitter, the first step is to make sure that keying the amplifier stage

(or stages) has no effect on the oscillator frequency. This can be checked by listening on the oscillator frequency while the amplifier stage is keyed. Listen for chirp on either side of zero beat, to eliminate the possibility of a chirpy receiver (caused by line-voltage changes or b.f.o. pulling).

An amplifier can be keyed by any method that reduces the output to zero. Neutralized stages can be keyed in the cathode circuit, although where powers over 50 or 75 watts are involved it is often desirable to use a keying relay or vacuum tube keyer, to minimize the chances for electrical shock. Tube keying drops the supply voltages and adds cathode bias, points to be considered where maximum output is required. Blocked-grid keying is applicable to many neutralized stages, but it presents problems in high-powered amplifiers and requires a source of negative voltage. Output stages that aren't neutralized such as many of the tetrodes and pentodes in widespread use, will usually leak a little and show some backwave regardless of how they are keyed. In a case like this it may be necessary to key two stages to eliminate backwave. They can be keyed in the cathodes, with blocked-grid keying, or in the screens. When screen keying is used, it is not always sufficient to reduce the screen voltage to zero; it may have to be pulled to some negative value to bring the key-up plate current to zero, unless fixed negative control-grid bias is used. It should be apparent that where two stages are keyed, keying the earlier stage must have no effect on the oscillator frequency if completely chirp-free output is the goal.

Shaping of the keying is obtained in several ways. Blocked-grid and vacuum-tube keyers get suitable shaping with proper choice of resistor and capacitor values, while cathode and screen-grid keying can be shaped by using inductors and capacitors. Sample circuits are shown in Figs. 7-3, 7-4 and 7-5, together with instructions for their adjustment. There is no "best" adjustment, since this is a matter of personal preference and what you want your signal to sound like. Most operators seem to like the make to be heavier than the break. All of the circuits shown here are capable of a wide range of adjustment.

If the negative supply in a grid-block keyed stage fails, the tube will draw excessive key-up current. To protect against tube damage in this eventuality, an overload relay can be used or, more simply, a fast-acting fuse can be included in the cathode circuit.

## VACUUM-TUBE KEYERS

The practical tube-keyer circuit of Fig. 7-6 can be used for keying any stage of any transmitter. Depending upon the power level of the keyed stage, or more or fewer type 2A3 tubes can be connected in parallel to handle the necessary current. The voltage drop through a single 2A3 varies from about 60 volts at 50 ma. to 40 volts at 25 ma. Tubes added in parallel will reduce the drop in proportion to the number of tubes used.

When connecting the output terminals of the keyer to the circuit to be keyed, the grounded output terminal of the keyer must be connected to the transmitter ground. Thus the keyer can be used only in negative-lead or cathode keying. When used in cathode keying, it will introduce cathode bias to the stage and reduce the output. This can be compensated for by a reduction in the grid-leak bias of the stage. If an oscillator



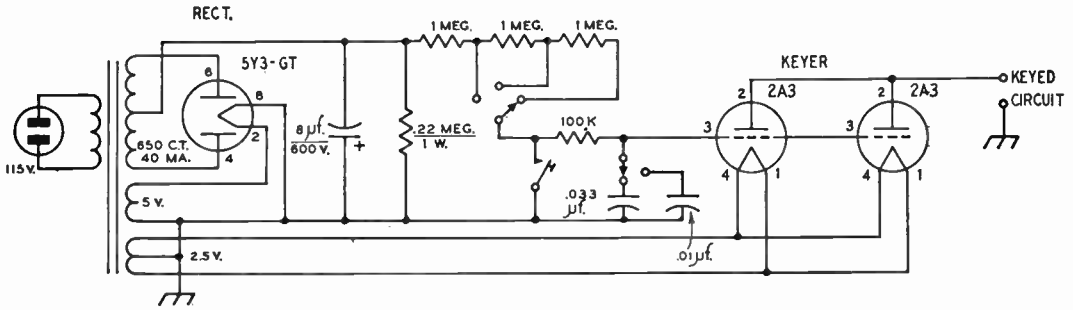

Fig. 7-6—Wiring diagram of a practical vacuum-tube keyer.

stage is keyed, the keyer should be connected in the negative lead, not the cathode.

The negative-voltage supply can be eliminated if a negative voltage is available from some other source, such as a bias supply. A simplified version of this circuit could eliminate the switches and

associated resistors and capacitors, since they are incorporated only to allow the operator to select the combination he prefers. But once the values have been selected, they can be soldered permanently in place. Adjustment of the keying characteristic is the same as with blocked-grid keying.

## OSCILLATOR KEYING

One may wonder why oscillator keying hasn't been mentioned earlier, since it is widely used. A sad fact of life is that excellent oscillator keying is infinitely more difficult to obtain than is excellent amplifier keying. If the objective is no detectable chirp, it is probably impossible to obtain with oscillator keying, particularly on the higher frequencies. The reasons are simple. Any keyed-oscillator transmitter requires shaping at the oscillator, which involves changing the operating conditions of the oscillator over a significant period of time. The output of the oscillator doesn't rise to full value immediately so the drive on the following stage is changing, which in turn may reflect a variable load on the oscillator. No oscillator has been devised that has no change in frequency over its entire operating voltage range and with a changing load. Furthermore, the shaping of the keyed-oscillator envelope usually has to be exaggerated, because the following stages will tend to sharpen up the keying and introduce clicks unless they are operated as linear amplifiers.

Acceptable oscillator keying can be obtained on the lower-frequency bands, and the methods used to key amplifiers can be used, but chirp-free clickless oscillator keying is probably not possible at the higher frequencies. Often some additional shaping of the signal will be introduced on "make" through the use of a clamp tube in the output amplifier stage, because the time constant of the screen bypass capacitor plus screen dropping resistor increases the screen-voltage rise time, but it is of no help on the "break" portion of the signal.

### Break-In Keying

The usual argument for oscillator keying is that it permits break-in operation (see below, also Chapter 22). If break-in operation is not contemplated and as near perfect keying as possible

is the objective, then keying an amplifier or two by the methods outlined earlier is the solution. For operating convenience, an automatic transmitter "turner-onner" (see Campbell, *QST*, Aug., 1956), which will turn on the power supplies and switch antenna relays and receiver muting devices, can be used. The station switches over to the complete "transmit" condition where the first dot is sent, and it holds in for a length of time dependent upon the setting of the delay. It is equivalent to voice-operated phone of the type commonly used by s.s.b. stations. It does not permit hearing the other station whenever the key is up, as does full break-in.

Full break-in with excellent keying is not easy to come by, but it is easier than many amateurs think. Many use oscillator keying and put up with a second-best signal.

### Differential Keying

The principle behind "differential" keying is to turn the oscillator on fast before a keyed amplifier stage can pass any signal and turn off the oscillator fast after the keyed amplifier stage has cut off. A number of circuits have been devised for accomplishing the action. One of the simplest can be applied to any grid-block keyed amplifier or tube-keyed stage by the addition of a triode and a VR tube, as in Fig. 7-7. Using this keying system for break-in, the keying will be chirp-free if it is chirp-free with the VR tube removed from its socket, to permit the oscillator to run all of the time. If the transmitter can't pass this test, it indicates that more isolation is required between keyed stage and oscillator.

Another VR-tube differential keying circuit, useful when the screen-grid circuit of an amplifier is keyed, is shown in Fig. 7-8. The normal screen keying circuit is made up of the shaping capacitor  $C_1$ , the keying relay (to remove dangerous voltages from the key), and the resistors  $R_1$  and  $R_2$ .

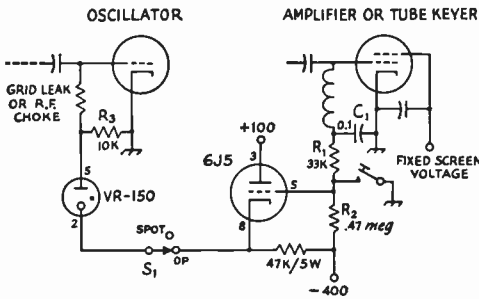

Fig. 7-7—When satisfactory blocked-grid or tube keying of an amplifier stage has been obtained, this VR-tube break-in circuit can be applied to the transmitter to furnish differential keying. The constants shown here are suitable for blocked-grid keying of a 6146 amplifier; with a tube keyer the 6J5 and VR tube circuitry would be the same.

With the key up, sufficient current flows through  $R_3$  to give a voltage that will cut off the oscillator tube. When the key is closed, the cathode voltage of the 6J5 becomes close to ground potential, extinguishing the VR tube and permitting the oscillator to operate. Too much shunt capacity on the leads to the VR tube, and too large a value of grid capacitor in the oscillator, may slow down this action, and best performance will be obtained when the oscillator (turned on and off this way) sounds "clicky." The output envelope shaping is obtained in the amplifier, and it can be made softer by increasing the value of  $C_1$ . If the keyed amplifier is a tetrode or pentode, the screen voltage should be obtained from a fixed voltage source or stiff voltage divider, not from the plate supply through a dropping resistor.

The + supply should be 50 to 100 volts higher than the normal screen voltage, and the - voltage should be sufficient to ignite the VR tube,  $V_2$ , through the drop in  $R_2$  and  $R_3$ . Current through  $R_2$  will be determined by voltage required to cut off oscillator; if 10 volts will do it the current will be 1 ma. For a desirable keying characteristic,  $R_2$  will usually have a higher value than  $R_1$ . Increasing the value of  $C_1$  will soften both "make" and "break."

The tube used at  $V_2$  will depend upon the available negative supply voltage. If it is between 120 and 150, a 0A3/VR75 is recommended. Above this a 0C3/VR105 can be used. The diode,  $V_1$ , can be any diode operated within ratings. A 6AL5 will suffice with screen voltages under 250 and bleeder currents under 5 ma. For maximum life a separate heater transformer should be used for the diode, with the cathode connected to one side of the heater winding.

#### Clicks in Later Stages

It was mentioned earlier that key clicks can be generated in amplifier stages following the keyed stage or stages. This can be a puzzling problem to an operator who has spent considerable time adjusting the keying in his exciter unit for clickless keying, only to find that the clicks are bad

when the amplifier unit is added. There are two possible causes for the clicks: low-frequency parasitic oscillations and amplifier "clipping."

Under some conditions an amplifier will be momentarily triggered into low-frequency parasitic oscillations, and clicks will be generated when the amplifier is driven by a keyed exciter. If these clicks are the result of low-frequency parasitic oscillations, they will be found in "groups" of clicks occurring at 50- to 150-kc. intervals either side of the transmitter frequency. Of course low-frequency parasitic oscillations can be generated in a keyed stage, and the operator should listen carefully to make sure that the output of the exciter is clean before he blames a later amplifier. Low-frequency parasitic oscillations are usually caused by poor choice in r.f. choke values, and the use of more inductance in the plate choke than in the grid choke for the same stage is recommended.

When the clicks introduced by the addition of an amplifier stage are found only near the transmitter frequency, amplifier "clipping" is indicated. It is quite common when fixed bias is used on the amplifier and the bias is well past the "cut-off" value. The effect can usually be minimized by using a combination of fixed and grid-leak bias for the amplifier stage. The fixed bias should be sufficient to hold the key-up plate current only to a low level and not to zero.

A linear amplifier (Class AB<sub>1</sub>, AB<sub>2</sub> or B) will amplify the excitation without adding any clicks, and if clicks show up a low-frequency parasitic oscillation is probably the reason.

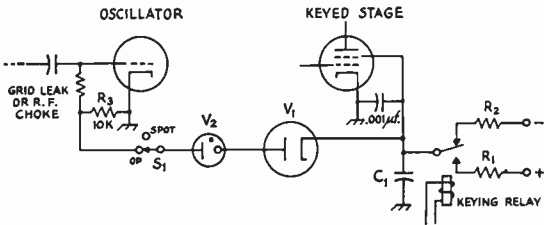

Fig. 7-8—VR-tube differential keying in an amplifier screen circuit.

With key up and current flowing through  $V_1$  and  $V_2$ , the oscillator is cut off by the drop through  $R_3$ . The keyed stage draws no current because its screen grid is negative.  $C_1$  is charged negatively to the value of the - source. When the relay is energized,  $C_1$  charges through  $R_1$  to a + value. Before reaching zero (on its way +) there is insufficient voltage to maintain ionization in  $V_2$ , and the current is broken in  $R_3$ , turning on the oscillator stage. As the screen voltage goes positive, the VR tube,  $V_2$ , cannot reignite because the diode,  $V_1$ , will not conduct in that direction. The oscillator and keyed stage remain on as long as the relay is closed. When the relay opens, the voltage across  $C_1$  must be sufficiently negative for  $V_2$  to ionize before any bleeder current will pass through  $R_3$ . By this time the screen of the keyed stage is so far negative that the tube has stopped conducting. (See Fig. 7-5 for suitable relay.)

## SPEED KEYS

The average operator finds that a speed of 20 to 25 words per minute is the limit of his ability with a straight hand key. However, he can increase his speed to 30 to 40 w.p.m. by the use of a "speed key." The mechanical speed keys, available in most radio stores, give additional speed by making strings of dots when the key lever is pushed to the right; dashes are made manually by closing the key to the left. After practicing with the speed key, the operator obtains the correct "feel" for the key, which allows him to release the dot lever at exactly the right time to make the required number of dots. A speed key can deliver practically perfect code characters

when used by an operator who knows what good code sounds like; however, one will not compensate for an operator's poor code ability.

An electronic speed key will not compensate for an operator's poor sending ability, either. However, the electronic speed key has the feature that it makes strings of both dots and dashes, by proper manipulation of the key lever, and in current designs the dashes are *self-completing*. This means that it is impossible to send anything but the correct length of dash when the key lever is closed on the dash side. It is, of course, possible to send an incorrect number of dashes through poor operator timing.

## KEYING SPEEDS

In radio telegraphy the basic code element is the dot, or unit pulse. A dot and space is two unit pulses, and a dash is three unit pulses long. The space between letters is three unit pulses, and the space between words is seven unit pulses. A speed of one baud is one pulse per second.

Assuming that a speed key is adjusted to give

the proper dot, space and dash values mentioned above, the code speed can be found from

$$\text{Speed (w.p.m.)} = \frac{\text{dots/min.}}{25}$$

E.g.: A properly adjusted electronic key gives a string of dots that counts to 10 dots per second. Speed =  $(60 \times 10) \div 25 = 24$  w.p.m.

## AN ELECTRONIC SPEED KEY

The unit shown in Figs. 7-9 and 7-11 represents one of the simpler designs of an electronic key. The total cost of the key, in dollars and construction time, is quite low. The keying lever is made from parts taken from two straight telegraph keys; these are available at less than a dollar each in the war-surplus version (J-38). A more elegant keying lever can be built from a (more-expensive) war-surplus mechanical speed key.

Referring to Fig. 7-10, the timing of the key is provided by the oscillator  $V_{1A}$ . When the key is closed, a sawtooth wave is generated by the fast charge and slow discharge of the .25- $\mu$ f. capacitor in the cathode circuit. The rate of discharge is set by the total resistance across the capacitor, and the voltage to which the capacitor is charged is determined by the setting of  $R_1$ . The sawtooth wave, applied to the grid of  $V_{2A}$ , cannot drive the grid very positive because the 3.3-megohm resistor limits the current; the effect is to "clip the tops" of the sawtooth cycles. The voltage at which  $V_{2A}$  passes enough current to close the relay is set by the position of the arm of  $R_3$ .

Except for the tubes, the keyer circuit is housed in a grey Hammertone 6  $\times$  5  $\times$  4-inch Minibox (Bud CU-2107), as shown in Fig. 7-11. The tube sockets are mounted so that the two tubes project outside at the rear of the unit. The power transformer is mounted on the rear wall, and the toggle switch and the three controls are mounted on the "front" panel. The power line to  $P_2$ , the two-wire cable to  $P_1$ , and the three-wire cable to the key leave the cabinet at the rear through

individual rubber grommets. Use multiple tie points generously for the support of the fixed resistors and capacitors.

To make the key, first remove the keys from their bases and strip the bases of their remaining hardware. The four support legs for the key are formed from the original tie strips and shorting switch arms. At the front they bolt to the key frame at the countersunk holes; at the rear they make up to the binding posts. The three-wire cable connects to two binding posts and a sup-

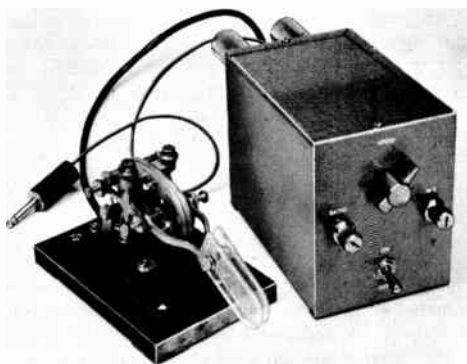

Fig. 7-9—This electronic speed key has a range of approximately 8 to 35 w.p.m., set by the speed control at top center. It has relay output and can be used with any transmitter that can be keyed by a hand key. The key (left) is made from two telegraph keys and a pair of 1/8-inch thick sheet plastic paddles.

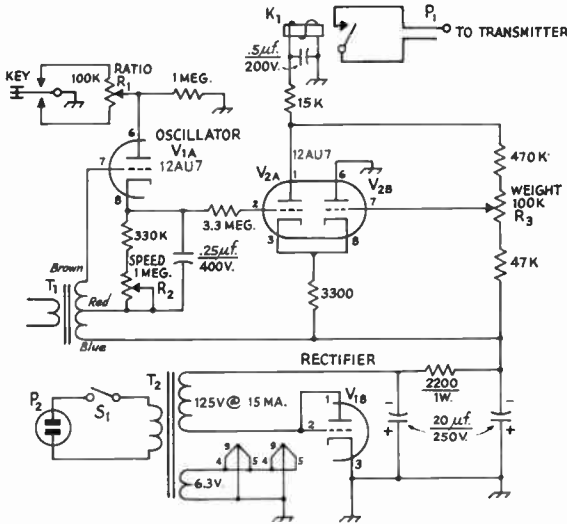

Fig. 7-10—Circuit diagram of the electronic speed key. Unless otherwise specified, resistors are ½ watt. Polarity-marked capacitors are electrolytic, others are tubular paper.

K<sub>1</sub>—5000-ohm 3-ma. relay (Sigma 41F-5000S-S1L).

P<sub>1</sub>—Phone plug.

P<sub>2</sub>—A.c. line plug.

R<sub>1</sub>, R<sub>3</sub>—100,000-ohm potentiometer, linear taper.

R<sub>2</sub>—1-megohm potentiometer, linear taper.

S<sub>1</sub>—S.p.s.f. toggle.

T<sub>1</sub>—5-watt 25,000-to-4-ohm output transformer, secondary not used (Stancor A-3857).

T<sub>2</sub>—125-v. 15-ma. and 6.3-v. 0.6-amp. transformer (Stancor PS-8415 or similar).

porting leg. A heavy base of ½-inch thick steel adds weight to the structure, and rubber or cork feet glued to the steel prevent its scratching the table.

#### Adjustment of Electronic Speed Key

In operation, the three controls will serve as their labels indicate. There is a unique (but not highly critical) combination of settings of the weight and ratio controls that will give automatic dots and dashes at the same speed; this setting can only be determined by ear and will be dependent on how well the operator can recognize good code. If the operator taps his foot to count groups of four dots or two dashes, the dots and dashes will have the same speed when the beat is the same. It is easy to determine whether dots or dashes are too heavy or too light. Connect an ohmmeter to P<sub>1</sub>; holding the dot lever closed should make the ohmmeter needle hover around half scale, and holding the dash lever closed should make the ohmmeter hover around 75 per cent of the short-circuit reading. Lacking an

ohmmeter, the transmitter plate milliammeter can be used; dots and dashes should give 50 per cent and 75 per cent of the key-down value when the keyer controls have been properly adjusted.

*QST* articles describing other types of electronic speed keys include:

Bartlett, "Compact Automatic Key Design," Dec., 1951.

Brann, "In Search of the Ideal Electronic Key," Feb., 1951.

Kanda, "The Ultimatic—Transistorized," Sept., Oct., 1960.

Kaye, "The Ultimatic—The Key with a Memory," Feb., 1953.

Kaye, "The All-Electronic Automatic Keyer," April, 1955.

MacFarlane, "A Monitored Electronic Key and Keyer," Dec., 1962; July, 1963.

Muir, "The Penultimate Electronic Key," March, 1962.

Old, "Transistorized Electronic Key and Monitor," May, 1959.

Fig. 7-11—Components for the electronic speed key are mounted on the three walls of a Minibox section, with the tubes projecting out the back. Keep wires away from screw holes, to prevent short circuits when the box is assembled.

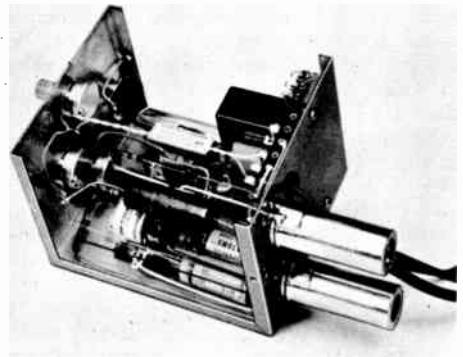

**BREAK-IN OPERATION**

Smooth c.w. break-in operation involves protecting the receiver from permanent damage by the transmitter power and insurance that the receiver will "recover" fast enough to be sensitive between dots and dashes, or at least between letters and words. None of the available antenna transfer relays is fast enough to follow keying, so the simplest break-in system is the use of a separate receiving antenna. If the transmitter power is low (25 or 50 watts) and the isolation between transmitting and receiving antennas is good, this method can be satisfactory. Best isolation is obtained by mounting the antennas as far apart as possible and at right angles to each other. Feedline pick-up should be minimized, through the use of coaxial cable or 300-ohm Twin-Lead. If the receiver recovers fast enough but the transmitter clicks are bothersome (they may be caused by the receiver overload and so exist only in the receiver) their effect on the operator can be minimized through the use of an output limiter (see Chapter Five).

When powers above 25 or 50 watts are used, or where two antennas are not available, special treatment is required for quiet break-in on the transmitter frequency. A means must be provided for limiting the power that reaches the receiver input; this can be either a direct short-circuit or a limiting device like an electronic TR switch (see Chapter Twenty two). Further, a

means must be provided for momentarily reducing the gain through the receiver, which enables the receiver to "recover" faster.

The system shown in Fig. 7-12 permits quiet break-in operation of high-powered stations. It may require a simple operation on the receiver, although many commercial receivers already provide the connection and require no internal modification. The circuit for use with a separate receiving antenna is shown in Fig. 7-12A; the slight change for use with a TR switch and a single antenna is shown in B.  $R_1$  is the regular receiver r.f. and i.f. gain control. The ground lead is run to chassis ground through a rheostat,  $R_2$ . A wire from the junction runs to the keying relay,  $K_1$ . When the key is up, the ground side of  $R_1$  is connected to ground through the relay arm, and the receiver is in its normal operating condition. When the key is closed the relay closes, which breaks the ground connection from  $R_1$  and applies additional bias to the tubes in the receiver. This bias is controlled by  $R_2$ . When the relay closes, it also closes the circuit to the transmitter keying circuit. A simple r.f. filter at the key suppresses the local clicks caused by the relay current. This circuit is superior to any working on the a.g.c. line of the receiver because the cathode circuit(s) have shorter time constants than the a.g.c. circuits and will recover faster.

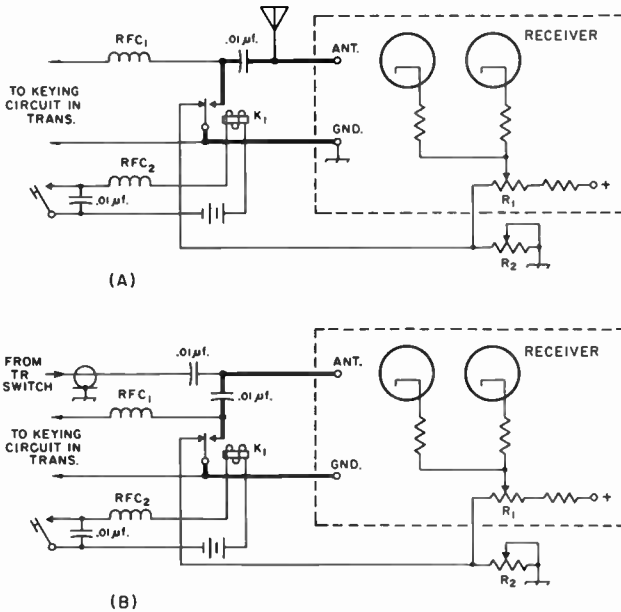

Fig. 7-12—Two variations of a circuit for smooth break-in operation, using (A) separate receiving antenna or (B) an electronic TR switch. The leads shown as heavy lines should be kept as short as possible, to minimize direct transmitter pick-up.

$R_1$ —Receiver manual gain control.  
 $R_2$ —5000- or 10,000-ohm wire-wound potentiometer.

$RFC_1, RFC_2$ —1- to 2½-mh. r.f. choke, current rating adequate for application.

$K_1$ —S.p.d.t. keying relay (Sigma 41FZ-35-ACS-SIL or equiv.). Although battery and d.c. relay are shown, any suitable a.c. or d.c. relay and power source can be used.



# Audio Amplifiers and Double-Sideband Phone

The audio amplifiers used in radiotelephone transmitters operate on the principles outlined earlier in this book in the chapter on vacuum tubes. The design requirements are determined principally by the type of modulation system to be used and by the type of microphone to be employed. It is necessary to have a clear understanding of modulation principles before the problem of laying out a speech system can be approached successfully. Those principles are discussed under appropriate headings.

The present chapter deals with the design of audio amplifier systems for communication purposes. In voice communication the primary objective is to obtain the most *effective* transmission; i.e., to make the message be understood at the receiving point in spite of adverse conditions created by noise and interference. The methods used to accomplish this do not necessarily coincide with the methods used for other purposes,

such as the reproduction of music or other program material. In other words, "naturalness" in reproduction is distinctly secondary to intelligibility.

The fact that satisfactory intelligibility can be maintained in a relatively narrow band of frequencies is particularly fortunate, because the width of the channel occupied by a phone transmitter is directly proportional to the width of the audio-frequency band. If the channel width is reduced, more stations can occupy a given band of frequencies without mutual interference.

In speech transmission, amplitude distortion of the voice wave has very little effect on intelligibility. The importance of such distortion in communication lies almost wholly in the fact that many of the audio-frequency harmonics caused by it lie outside the channel needed for intelligible speech, and thus will create unnecessary interference to other stations.

## SPEECH EQUIPMENT

In designing speech equipment it is necessary to know (1) the amount of audio power the modulation system must furnish and (2) the output voltage developed by the microphone when it is spoken into from normal distance (a few inches) with ordinary loudness. It then becomes possible to choose the number and type of amplifier stages needed to generate the required audio power without overloading or undue distortion anywhere in the system.

### MICROPHONES

The level of a microphone is its electrical output for a given sound intensity. Level varies greatly with microphones of different types, and depends on the distance of the speaker's lips from the microphone. Only approximate values based on averages of "normal" speaking voices can be given. The values given later are based on close talking; that is, with the microphone about an inch from the speaker's lips.

The **frequency response** or **fidelity** of a microphone is its relative ability to convert sounds of different frequencies into alternating current. For understandable speech transmission only a limited frequency range is necessary, and intelligible speech can be obtained if the output of the microphone does not vary more than a few decibels at any frequency within a range of about 200 to 2500 cycles. When the variation expressed in terms of decibels is small between two fre-

quency limits, the microphone is said to be flat between those limits.

In general, microphones are designed either to respond equally well in most directions or to have poor response in one direction. This latter type is called **uni-directional** and is useful in solving acoustic-feedback problems.

### Carbon Microphones

The carbon microphone consists of a metal diaphragm placed against an insulating cup containing loosely-packed carbon granules (**microphone button**). When used with a vacuum-tube amplifier, the microphone is connected in the cathode circuit of a triode, as shown in Fig. 8-1A.

Sound waves striking the diaphragm cause it to vibrate in accordance with the sound, and the pressure on the granules alternately increases and decreases, causing a corresponding decrease and increase in the electrical resistance of the microphone. The instantaneous value of this resistance determines the instantaneous value of plate current through the tube, and as a consequence the voltage drop across the plate load resistor increases and decreases with the increases and decreases in granule pressure.

The carbon microphone finds its major amateur application in mobile and portable work; a good microphone in the circuit of Fig. 8-1A will deliver 20 to 30 volts peak output at the transformer secondary.

**Crystal Microphones**

The **crystal microphone** makes use of the piezoelectric properties of Rochelle-salt crystals. This type of microphone requires no battery or transformer and can be connected directly to the grid of an amplifier tube. It is a popular type of microphone among amateurs; it has good frequency response and is available in inexpensive models. The input circuit is shown in Fig. 8-1B.

Although the level of crystal microphones varies with different models, an output of 0.03 volt or so is representative for communication types. The level is affected by the length of the cable connecting the microphone to the first amplifier stage; the above figure is for lengths of 6 or 7 feet. The frequency characteristic is unaffected by the cable, but the load resistance (amplifier grid resistor) does affect it; the lower frequencies are attenuated as the value of load resistance is lowered. A grid-resistor value of at least 1 megohm should be used.

The **ceramic microphone** utilizes the piezoelectric effect in certain types of ceramic materials to achieve performance very similar to that of the crystal microphone. It is less affected by temperature and humidity. Output levels are similar to those of crystal microphones for the same type of frequency response.

**Dynamic Microphones**

The **dynamic microphone** somewhat resembles a dynamic loud-speaker. A lightweight voice coil is rigidly attached to a diaphragm, the coil being suspended between the poles of a permanent magnet. Sound causes the diaphragm to vibrate, thus moving the coil between the magnet poles and generating an alternating voltage.

Dynamic microphones are inherently low-impedance devices, but they are supplied as straight low-impedance microphones or with a built-in transformer to raise the impedance level. Used with the high-impedance output the microphone is suitable for working directly into the grid of the input amplifier stage. If the connecting cable must be unusually long, a low-impedance microphone should be used, with a step-up transformer at the speech-amplifier end of the cable.

In general, the dynamic microphones have the smoothest peak-free response and widest frequency range, and they are also the least susceptible to damage from shock and extremes of temperature and humidity.

**Miscellaneous Microphones**

Two other types of microphones, now rarely used in amateur radio, are the **condenser** and the **ribbon** (or **velocity**) microphone. The condenser microphone uses a tightly-stretched metal diaphragm as one plate of a capacitor, and the sound vibrations move the diaphragm and change the capacitance. The condenser microphone requires a polarizing voltage of several hundred volts, and a one- or two-stage pre-amplifier is usually included in the microphone housing. The condenser microphone is noted for its low distortion and excellent frequency response.

In a ribbon microphone, the element acted upon by the sound waves is a thin corrugated metallic ribbon suspended between the poles of a magnet. The microphone has a bi-directional (figure-8) pattern and good frequency response.

**THE SPEECH AMPLIFIER**

The a.f. amplifier stage that causes the r.f. output to be varied is called the **modulator**, and all the amplifier stages preceding it comprise the **speech amplifier**. Depending on the modulator used, the speech amplifier may be called upon to deliver power ranging from zero (only voltage required) to 20 or 30 watts.

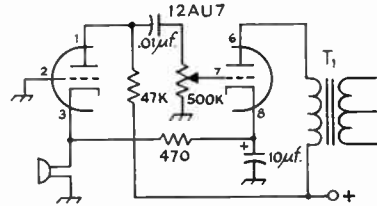

(A) CARBON

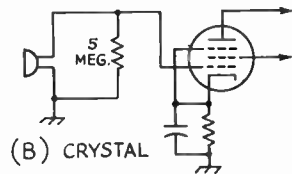

(B) CRYSTAL

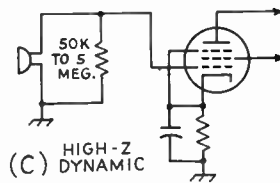

(C) HIGH-Z DYNAMIC

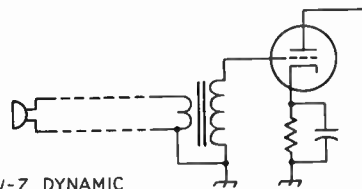

(D) LOW-Z DYNAMIC

Fig. 8-1—Speech input circuits used with various types of microphones.

Before starting the design of a speech amplifier, therefore, it is necessary to have selected a suitable modulator for the transmitter. This selection must be based on the power required to modulate the transmitter; this power in turn is determined by the mode of transmission and the particular method of modulation. With the modulator determined, its **driving-power** requirements (audio power required to excite the modulator to full output) can be determined from the tube tables in a later chapter. Generally speaking, it is **advisable** to choose a tube or tubes for the

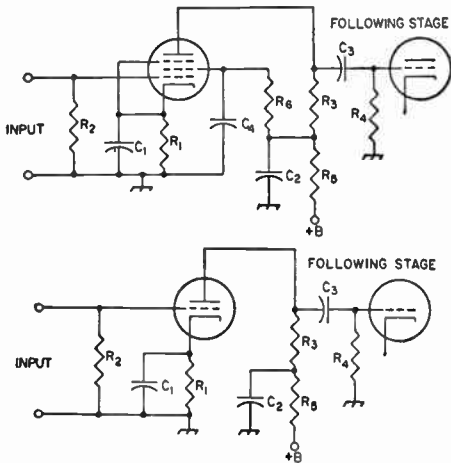

Fig. 8-2—Resistance-coupled voltage-amplifier circuits. A, pentode; B, triode. Designations are as follows:

- C<sub>1</sub>—Cathode bypass capacitor.
- C<sub>2</sub>—Plate bypass capacitor.
- C<sub>3</sub>—Output coupling capacitor (blocking capacitor).
- C<sub>4</sub>—Screen bypass capacitor.
- R<sub>1</sub>—Cathode resistor.
- R<sub>2</sub>—Grid resistor.
- R<sub>3</sub>—Plate resistor.
- R<sub>4</sub>—Next-stage grid resistor.
- R<sub>5</sub>—Plate decoupling resistor.
- R<sub>6</sub>—Screen resistor.

Values for suitable tubes are given in Table 9-1. Values in the decoupling circuit, C<sub>2</sub>, R<sub>5</sub> are not critical. R<sub>5</sub> may be about 10% of R<sub>3</sub>; an 8- or 10- $\mu$ f. electrolytic capacitor is usually large enough at C<sub>2</sub>.

last stage of the speech amplifier that will be capable of developing at least 50 per cent more power than the rated driving power of the modulator. This will provide a factor of safety so that losses in coupling transformers, etc., will not upset the calculations.

### Voltage Amplifiers

If the last stage in the speech amplifier is a Class AB<sub>2</sub> or Class B amplifier, the stage ahead of it must be capable of sufficient power output to drive it. However, if the last stage is a Class AB<sub>1</sub> or Class A amplifier the preceding stage can be simply a voltage amplifier. From there on back to the microphone, all stages are voltage amplifiers.

The important characteristics of a voltage amplifier are its voltage gain, maximum undistorted output voltage, and its frequency response. The voltage gain is the voltage-amplification ratio of the stage. The output voltage is the maximum a.f. voltage that can be secured from the stage without distortion. The amplifier frequency response should be adequate for voice reproduction; this requirement is easily satisfied.

The voltage gain and maximum undistorted output voltage depend on the operating conditions of the amplifier. Data on the popular types

of tubes used in speech amplifiers are given in Table 8-1, for resistance-coupled amplification. The output voltage is in terms of *peak* voltage rather than r.m.s.; this makes the rating independent of the waveform. Exceeding the peak value causes the amplifier to distort, so it is more useful to consider only peak values in working with amplifiers.

### Resistance Coupling

Resistance coupling generally is used in voltage-amplifier stages. It is relatively inexpensive, good frequency response can be secured, and there is little danger of hum pick-up from stray magnetic fields associated with heater wiring. It is the most satisfactory type of coupling for the output circuits of pentodes and high- $\mu$  triodes, because with transformers a sufficiently high load impedance cannot be obtained without considerable frequency distortion. Typical circuits are given in Fig. 8-2 and design data in Table 8-1.

### Transformer Coupling

Transformer coupling between stages ordinarily is used only when power is to be transferred (in such a case resistance coupling is very inefficient), or when it is necessary to couple between a single-ended and a push-pull stage. Triodes having an amplification factor of 20 or less are used in transformer-coupled voltage amplifiers. With transformer coupling, tubes should be operated under the Class A conditions given in the tube tables at the end of this book.

Representative circuits for coupling single-ended to push-pull stages are shown in Fig. 8-3.

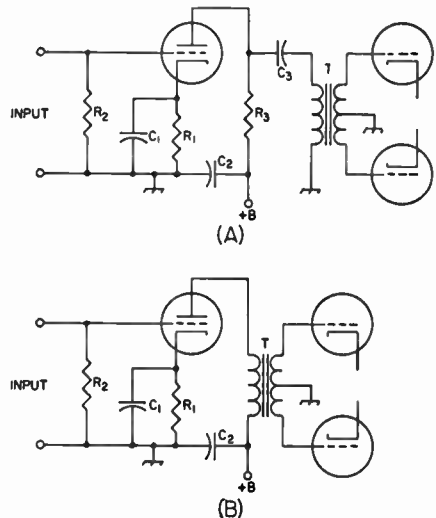

Fig. 8-3—Transformer-coupled amplifier circuits for driving a push-pull amplifier. A is for resistance-transformer coupling; B for transformer coupling. Designations correspond to those in Fig. 9-2. In A, values can be taken from Table 9-1. In B, the cathode resistor is calculated from the rated plate current and grid bias as given in the tube tables for the particular type of tube used.

TABLE 8-1—RESISTANCE-COUPLED VOLTAGE-AMPLIFIER DATA

Data are given for a plate supply of 300 volts. Departures of as much as 50 per cent from this supply voltage will not materially change the operating conditions or the voltage gain, but the output voltage will be in proportion to the ratio of the new voltage to 300 volts. Voltage gain is measured at 400 cycles. Capacitor values given are based on 100-cycle cutoff. For increased low-frequency response, all capacitors may be made larger than specified (cut-off frequency in inverse proportion to capacitor values provided all are changed in the same proportion). A variation of 10 per cent in the values given has negligible effect on the performance.

	Plate Resistor Megohms	Next-Stage Grid Resistor Megohms	Screen Resistor Megohms	Cathode Resistor Ohms	Screen Bypass $\mu$ f.	Cathode Bypass $\mu$ f.	Blocking Capacitor $\mu$ f.	Output Volts (Peak) <sup>1</sup>	Voltage Gain <sup>2</sup>
6SJ7, 12SJ7	0.1	0.1	0.35	500	0.10	11.6	0.019	72	67
		0.25	0.37	530	0.09	10.9	0.016	96	98
		0.5	0.47	590	0.09	9.9	0.007	101	104
	0.25	0.25	0.89	850	0.07	8.5	0.011	79	139
		0.5	1.10	860	0.06	7.4	0.004	88	167
		1.0	1.18	910	0.06	6.9	0.003	98	185
0.5	0.5	2.0	1300	0.06	6.0	0.004	64	200	
	1.0	2.2	1410	0.05	5.8	0.002	79	238	
	2.0	2.5	1530	0.04	5.2	0.0015	89	263	
6J7, 7C7, 12J7-GT	0.1	0.1	0.44	500	0.07	8.5	0.02	55	61
		0.25	0.5	450	0.07	8.3	0.01	81	82
		0.5	0.53	600	0.06	8.0	0.006	96	94
	0.25	0.25	1.18	1100	0.04	5.5	0.008	81	104
		0.5	1.18	1200	0.04	5.4	0.005	104	140
		1.0	1.45	1300	0.05	5.8	0.005	110	185
0.5	0.5	2.45	1700	0.04	4.2	0.005	75	161	
	1.0	2.9	2200	0.04	4.1	0.003	97	200	
	2.0	2.95	2300	0.04	4.0	0.0025	100	230	
6AU6, 6SH7, 12AU6, 12SH7	0.1	0.1	0.2	500	0.13	18.0	0.019	76	109
		0.22	0.24	600	0.11	16.4	0.011	103	145
		0.47	0.26	700	0.11	15.3	0.006	129	168
	0.22	0.22	0.42	1000	0.1	12.4	0.009	92	164
		0.47	0.5	1000	0.098	12.0	0.007	108	230
		1.0	0.55	1100	0.09	11.0	0.003	122	262
0.47	0.47	1.0	1800	0.075	8.0	0.0045	94	248	
	1.0	1.1	1900	0.065	7.6	0.0028	105	318	
	2.2	1.2	2100	0.06	7.3	0.0018	122	371	
6AQ6, 6AT6, 6SL7-GT, 6T8-A, 12AT6, 12SL7-GT (one triode)	0.1	0.1	—	1500	—	4.4	0.027	40	34
		0.22	—	1800	—	3.6	0.014	54	38
		0.47	—	2100	—	3.0	0.0065	63	41
	0.22	0.22	—	2600	—	2.5	0.013	51	42
		0.47	—	3200	—	1.9	0.0065	65	46
		1.0	—	3700	—	1.6	0.0035	77	48
0.47	0.47	—	5200	—	1.2	0.006	61	48	
	1.0	—	6300	—	1.0	0.0035	74	50	
	2.2	—	7200	—	0.9	0.002	85	51	
6AV6, 12AV6, 12AX7 (one triode)	0.1	0.1	—	1300	—	4.6	0.027	43	45
		0.22	—	1500	—	4.0	0.013	57	52
		0.47	—	1700	—	3.6	0.006	66	57
	0.22	0.22	—	2200	—	3.0	0.013	54	59
		0.47	—	2800	—	2.3	0.006	69	65
		1.0	—	3100	—	2.1	0.003	79	68
0.47	0.47	—	4300	—	1.6	0.006	62	69	
	1.0	—	5200	—	1.3	0.003	77	73	
	2.2	—	5900	—	1.1	0.002	92	75	
6SC7, <sup>3</sup> 12SC7 <sup>3</sup> (one triode)	0.1	0.1	—	750	—	—	0.033	35	29
		0.25	—	930	—	—	0.014	50	34
		0.5	—	1040	—	—	0.007	54	36
	0.25	0.25	—	1400	—	—	0.012	45	39
		0.5	—	1680	—	—	0.006	55	42
		1.0	—	1840	—	—	0.003	64	45
0.5	0.5	—	2330	—	—	0.006	50	45	
	1.0	—	2980	—	—	0.003	62	48	
	2.0	—	3280	—	—	0.002	72	49	
6CG7, 6J5, 7A4, 7N7, 6SN7-GT <sup>3</sup> , 12J5-GT, 12SN7-GT (one triode)	0.047	0.047	—	1300	—	3.6	0.061	59	14
		0.1	—	1580	—	3.0	0.032	73	15
		0.22	—	1800	—	2.5	0.015	83	16
	0.1	0.1	—	2500	—	1.9	0.031	68	16
		0.22	—	3130	—	1.4	0.014	82	16
		0.47	—	3900	—	1.2	0.0065	96	16
0.22	0.22	—	4800	—	0.95	0.015	68	16	
	0.47	—	6500	—	0.69	0.0065	85	16	
	1.0	—	7800	—	0.58	0.0035	96	16	
6C4, 12AU7-A (one triode)	0.047	0.047	—	870	—	4.1	0.065	38	12
		0.1	—	1200	—	3.0	0.034	52	12
		0.22	—	1500	—	2.4	0.016	68	12
	0.1	0.1	—	1900	—	1.9	0.032	44	12
		0.22	—	3000	—	1.3	0.016	68	12
		0.47	—	4000	—	1.1	0.007	80	12
0.22	0.22	—	5300	—	0.9	0.015	57	12	
	0.47	—	8800	—	0.52	0.007	82	12	
	1.0	—	11000	—	0.46	0.0035	92	12	

<sup>1</sup> Voltage across next-stage grid resistor at grid-current point.

<sup>2</sup> At 5 volts r.m.s. output.

<sup>3</sup> Cathode-resistor values are for phase-inverter service.

The circuit at A combines resistance and transformer coupling, and may be used for exciting the grids of a Class A or  $AB_1$  following stage. The resistance coupling is used to keep the d.c. plate current from flowing through the transformer primary, thereby preventing a reduction in primary inductance below its no-current value; this improves the low-frequency response. With medium- $\mu$  triodes (6C5, 6J5, etc.), the gain is equal to that with resistance coupling multiplied by the secondary-to-primary turns ratio of the transformer.

In B the transformer primary is in series with the plate of the tube, and thus must carry the tube plate current. When the following amplifier operates without grid current, the voltage gain of the stage is practically equal to the  $\mu$  of the tube multiplied by the transformer ratio. This circuit also is suitable for transferring power

(within the capabilities of the tube) to a following Class  $AB_2$  or Class B stage.

### Phase Inversion

Push-pull output may be secured with resistance coupling by using **phase-inverter** or **phase-splitter** circuits as shown in Fig. 8-4.

The circuits shown in Fig. 8-4 are of the "self-balancing" type. In A, the amplified voltage from  $V_1$  appears across  $R_5$  and  $R_7$  in series. The drop across  $R_7$  is applied to the grid of  $V_2$ , and the amplified voltage from  $V_2$  appears across  $R_6$  and  $R_7$  in series. This voltage is 180 degrees out of phase with the voltage from  $V_1$ , thus giving push-pull output. The part that appears across  $R_7$  from  $V_2$  opposes the voltage from  $V_1$  across  $R_7$ , thus reducing the signal applied to the grid of  $V_2$ . The negative feedback so obtained tends to regulate the voltage applied to the phase-inverter tube so that the output voltages from both tubes are substantially equal. The gain is slightly less than twice the gain of a single-tube amplifier using the same operating conditions.

In the single-tube circuit shown in Fig. 9-4B the plate load resistor is divided into two equal parts,  $R_9$  and  $R_{10}$ , one being connected to the plate in the normal way and the other between cathode and ground. Since the voltages at the plate and cathode are 180 degrees out of phase, the grids of the following tubes are fed equal a.f. voltages in push-pull. The grid return of  $V_3$  is made to the junction of  $R_8$  and  $R_{10}$  so normal bias will be applied to the grid. This circuit is highly degenerative because of the way  $R_{10}$  is connected. The voltage gain is less than 2 even when a high- $\mu$  triode is used at  $V_3$ .

### Gain Control

A means for varying the over-all gain of the amplifier is necessary for keeping the final output at the proper level for modulating the transmitter. The common method of gain control is to adjust the value of a.c. voltage applied to the grid of one of the amplifiers by means of a voltage divider or potentiometer.

The gain-control potentiometer should be near the input end of the amplifier, at a point where the signal voltage level is so low there is no danger that the stages ahead of the gain control will be overloaded by the full microphone output. With carbon microphones the gain control may be placed directly across the microphone-transformer secondary. With other types of microphones, however, the gain control usually will affect the frequency response of the microphone when connected directly across it. Also, in a high-gain amplifier it is better to operate the first tube at maximum gain, since this gives the best signal-to-hum ratio. The control therefore is usually placed in the grid circuit of the second stage.

### DESIGNING THE SPEECH AMPLIFIER

The steps in designing a speech amplifier are as follows:

1) Determine the power needed to modulate

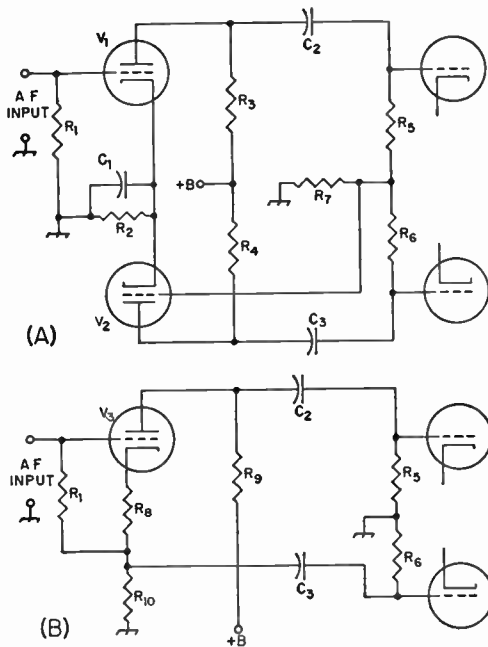

Fig. 8-4—Self-balancing phase-inverter circuits.  $V_1$  and  $V_2$  may be a double triode such as the 12AU7 or 12AX7.  $V_3$  may be any of the triodes listed in Table 9-1, or one section of a double triode.

$R_1$ —Grid resistor (1 megohm or less).

$R_2$ —Cathode resistor; use one-half value given in Table 9-1 for tube and operating conditions chosen.

$R_3, R_4$ —Plate resistor; select from Table 9-1.

$R_5, R_6$ —Following-stage grid resistor (0.22 to 0.47 megohm).

$R_7$ —0.22 megohm.

$R_8$ —Cathode resistor; select from Table 9-1.

$R_9, R_{10}$ —Each one-half of plate load resistor given in Table 9-1.

$C_1$ —10- $\mu$ f. electrolytic.

$C_2, C_3$ —0.01- to 0.1- $\mu$ f. paper.



the transmitter and select the modulator. In the case of plate modulation, a Class B amplifier may be required. Select a suitable tube type and determine from the tube tables at the end of this book the grid driving power required, if any.

2) As a safety factor, multiply the required driver power by at least 1.5.

3) Select a tube, or pair of tubes, that will deliver the power determined in the second step. This is the last or output stage of the speech-amplifier. Receiver-type power tubes can be used (beam tubes such as the 6L6 may be needed in some cases) as determined from the receiving-tube tables. If the speech amplifier is to drive a Class B modulator, use a Class A or AB<sub>1</sub> amplifier.

4) If the speech-amplifier output stage is also the modulator and must operate Class AB<sub>2</sub> to develop the required power output, use a low- or medium- $\mu$  triode to drive it. If more power is needed than can be obtained from one tube, use two in push-pull, in the driver. In either case transformer coupling will have to be used, and transformer manufacturers' catalogs should be consulted for a suitable type.

5) If the speech-amplifier output stage operates Class A or AB<sub>1</sub>, it may be driven by a voltage amplifier. If the output stage is push-pull, the driver may be a single tube coupled through a transformer with a balanced secondary, or may be a dual-triode phase inverter. Determine the signal voltage required for full output from the last stage. If the last stage is a single-tube Class A amplifier, the peak signal is equal to the grid-bias voltage; if push-pull Class A, the peak-to-peak signal voltage is equal to twice the grid bias; if Class AB<sub>1</sub>, twice the bias voltage when fixed bias is used; if cathode bias is used, twice the bias figured from the cathode resistance and the maximum-signal cathode current.

6) From Table 8-I, select a tube capable of giving the required output voltage and notes its rated voltage gain. A double-triode phase inverter (Fig. 8-4A) will have approximately twice the output voltage and twice the gain of one triode operating as an ordinary amplifier. If the driver is to be transformer-coupled to the last stage, select a medium- $\mu$  triode and calculate the gain and output voltage as described earlier in this chapter.

7) Divide the voltage required to drive the output stage by the gain of the preceding stage. This gives the peak voltage required at the grid of the next-to-the-last stage.

8) Find the output voltage, under ordinary conditions, of the microphone to be used. This information should be obtained from the manufacturer's catalog. If not available, the figures given in the section on microphones in this chapter will serve.

9) Divide the voltage found in (7) by the output voltage of the microphone. The result is the over-all gain required from the microphone to the grid of the next-to-the-last stage. To be on the safe side, double or triple this figure.

10) From Table 8-I, select a combination of

tubes whose gains, when multiplied together, give approximately the figure arrived at in (9). These amplifiers will be used in cascade. If high gain is required, a pentode may be used for the first speech-amplifier stage, but it is *not* advisable to use a second pentode because of the possibility of feedback and self-oscillation. In most cases a triode will give enough gain, as a second stage, to make up the total gain required. If not, a medium- $\mu$  triode may be used as a third stage.

A high- $\mu$  double triode with the sections in cascade makes a good low-level amplifier, and will give somewhat greater gain than a pentode followed by a medium- $\mu$  triode. With resistance-coupled input to the first section the cathode of that section may be grounded (contact potential bias), which is helpful in reducing hum.

## SPEECH-AMPLIFIER CONSTRUCTION

Once a suitable circuit has been selected for a speech amplifier, the construction problem resolves itself into avoiding two difficulties — excessive hum, and unwanted feedback. For reasonably humless operation, the hum voltage should not exceed about 1 per cent of the maximum audio output voltage — that is, the hum and noise should be at least 40 db. below the output level.

Unwanted feedback, if negative, will reduce the gain below the calculated value; if positive, is likely to cause self-oscillation or "howls." Feedback can be minimized by isolating each stage with decoupling resistors and capacitors, by avoiding layouts that bring the first and last stages near each other, and by shielding of "hot" points in the circuit, such as grid leads in low-level stages.

Speech-amplifier equipment, especially voltage amplifiers, should be constructed on steel chassis, with all wiring kept below the chassis to take advantage of the shielding afforded. Exposed leads, particularly to the grids of low-level high-gain tubes, are likely to pick up hum from the electric field that usually exists in the vicinity of house wiring. Even with the chassis, additional shielding of the input circuit of the first tube in a high-gain amplifier usually is necessary. In addition, such circuits should be separated as much as possible from power-supply transformers and chokes and also from any audio transformers that operate at fairly high power levels; this will minimize magnetic coupling to the grid circuit and thus reduce hum or audio-frequency feedback. It is always safe, although not absolutely necessary, to separate the speech amplifier and its power supply, building them on separate chassis.

If a low-level microphone such as the crystal type is used, the microphone, its connecting cable, and the plug or connector by which it is attached to the speech amplifier, all should be shielded. The microphone and cable usually are constructed with suitable shielding; this should be connected to the speech-amplifier chassis, and it is advisable — as well as necessary — to connect

the chassis to a ground such as a water pipe. With the top-cap tubes, complete shielding of the grid lead and grid cap is a necessity.

Heater wiring should be kept as far as possible from grid leads, and either the center-tap or one side of the heater-transformer secondary winding should be connected to the chassis. If the center-tap is grounded, the heater leads to each tube should be twisted together to reduce the magnetic field from the heater current. With either type of connection; it is advisable to lay heater leads in the corner formed by a fold in the chassis, bringing them out from the corner to the tube socket by the shortest possible path.

When metal tubes are used, always ground the shell connection to the chassis. Glass tubes used in the low-level stages of high-gain amplifiers

must be shielded; tube shields are obtainable for that purpose. It is a good plan to enclose the entire amplifier in a metal box, or at least provide it with a cane-metal cover, to avoid feedback difficulties caused by the r.f. field of the transmitter. R.f. picked up on exposed wiring, leads or tube elements causes overloading, distortion, and self-oscillation of the amplifier.

When using paper capacitors as bypasses, be sure that the terminal marked "outside foil" is connected to ground. This utilizes the outside foil of the capacitor as a shield around the "hot" foil. When paper capacitors are used for coupling between stages, always connect the outside foil terminal to the side of the circuit having the lowest impedance to ground. Usually, this will be the plate side rather than the following-grid side.

## AMPLITUDE MODULATORS AND THEIR DRIVERS

### CLASS AB AND B MODULATORS

Class AB or B modulator circuits are basically identical no matter what the power output of the modulator. The diagrams of Fig. 8-5 therefore will serve for any modulator of this type that the amateur may elect to build. The triode circuit is given at A and the circuit for tetrodes at B. When small tubes with indirectly heated cath-

odes are used, the cathodes should be connected to ground.

#### Modulator Tubes

The audio ratings of various types of transmitting tubes are given in the chapter containing the tube tables. Choose a pair of tubes that is capable of delivering sine-wave audio power equal to somewhat more than half the d.c. input to the modulated Class C amplifier. It is sometimes convenient to use tubes that will operate at the same plate voltage as that applied to the Class C stage, because one power supply of adequate current capacity may then suffice for both stages.

In estimating the output of the modulator, remember that the figures given in the tables are for the tube output only, and do not include output-transformer losses. To be adequate for modulating the transmitter, the modulator should have a theoretical power capability 15 to 25 per cent greater than the actual power needed for modulation.

#### Matching to Load

In giving audio ratings on power tubes, manufacturers specify the plate-to-plate load impedance into which the tubes must operate to deliver the rated audio power output. This load impedance seldom is the same as the modulating impedance of the Class C r.f. stage, so a match must be brought about by adjusting the turns ratio of the coupling transformer. The required turns ratio, primary to secondary, is

$$N = \sqrt{\frac{Z_p}{Z_m}}$$

where  $N$  = Turns ratio, primary to secondary

$Z_m$  = Modulating impedance of

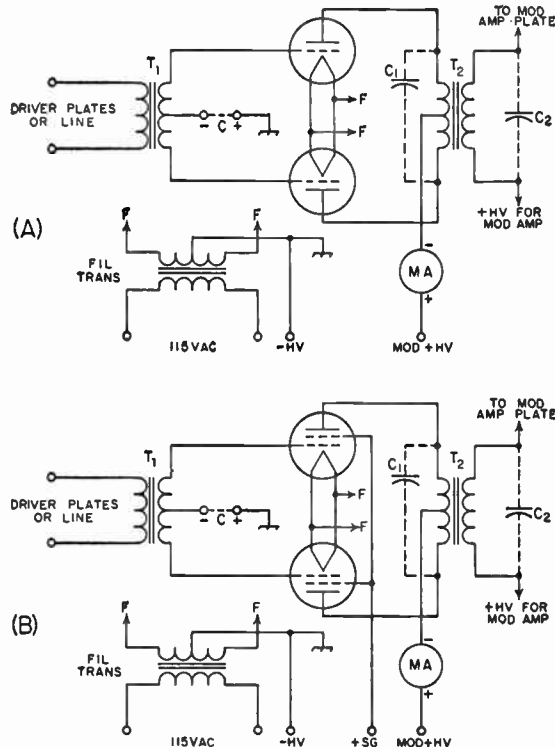

Fig. 8-5—Amplitude-modulator circuit diagrams. Tubes and circuit considerations are discussed in the text.

Class C r.f. amplifier

$Z_p$  = Plate-to-plate load impedance for Class B tubes

*Example:* The modulated r.f. amplifier is to operate at 1250 volts and 300 ma. The power input is

$$P = EI = 1250 \times 0.3 = 375 \text{ watts}$$

so the modulating power required is  $375/2 = 188$  watts. Increasing this by 25% to allow for losses and a reasonable operating margin gives  $188 \times 1.25 = 236$  watts. The modulating impedance of the Class C stage is

$$Z_m = \frac{E}{I} = \frac{1250}{0.3} = 4167 \text{ ohms.}$$

From the *RCA Transmitting Tube Manual* a pair of 811As at 1250 plate volts will deliver 235 watts to a load of 12,400 ohms, plate-to-plate. The primary-to-secondary turns ratio of the modulation transformer therefore should be

$$\sqrt{\frac{Z_p}{Z_m}} = \sqrt{\frac{12,400}{4170}} = \sqrt{2.97} = 1.72:1.$$

The required transformer ratios for the ordinary range of impedances are shown graphically in Fig 8-6.

Many modulation transformers are provided with primary and secondary taps, so that various turns ratios can be obtained to meet the requirements of particular tube combinations. However, it may be that the exact turns ratio required cannot be secured, even with a tapped modulation transformer. *Small* departures from the proper turns ratio will have no serious effect if the modulator is operating well within its capabilities; if the actual turns ratio is within 10 per cent of the ideal value, the system will operate satisfactorily. Where the discrepancy is larger, it is usually possible to choose a new set of operating conditions for the Class C stage to give a modulating impedance that can be matched by the turns ratio of the available transformer. This may require operating the Class C amplifier at higher voltage and less plate current, if the modulating impedance must be increased, or at lower voltage and higher current if the modulating impedance must be decreased. However, this process cannot be carried very far without exceeding the ratings of the Class C tubes for either plate voltage or plate current, even though the power input is kept at the same figure.

### Suppressing Audio Harmonics

Distortion in either the driver or Class B modulator will cause a.f. harmonics that may lie outside the frequency band needed for intelligible speech transmission. While it is almost impossible to avoid some distortion, it is possible to cut down the amplitude of the higher-frequency harmonics.

The purpose of capacitors  $C_1$  and  $C_2$  across the primary and secondary, respectively, of the Class B output transformer in Fig. 9-5 is to reduce the strength of harmonics and unnecessary

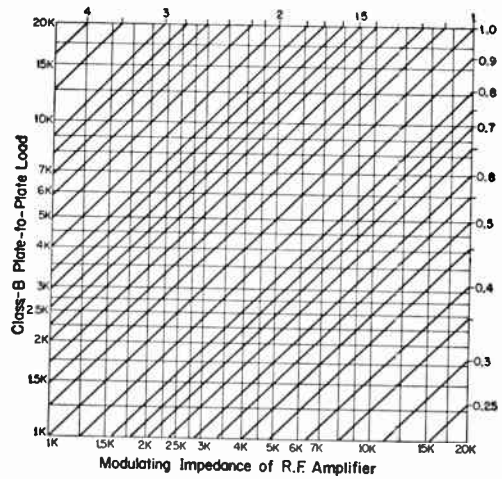

Fig. 8-6—Transformer ratios for matching a Class C modulating impedance to the required plate-to-plate load for the Class B modulator. The ratios given on the curves are from total primary to secondary. Resistance values are in kilohms.

high-frequency components existing in the modulation. The capacitors act with the leakage inductance of the transformer winding to form a rudimentary low-pass filter. The values of capacitance required will depend on the load resistance (modulating impedance of the Class C amplifier) and the leakage inductance of the particular transformer used. In general, capacitances between about 0.001 and 0.01  $\mu$ f. will be required; the larger values are necessary with the lower values of load resistance. The voltage rating of each capacitor should at least be equal to the d.c. voltage at the transformer winding with which it is associated. In the case of  $C_2$ , part of the total capacitance required will be supplied by the plate bypass or blocking capacitor in the modulated amplifier.

A still better arrangement is to use a low-pass filter as shown later, even though clipping is not deliberately employed.

### Grid Bias

Certain triodes designed for Class B audio work can be operated without grid bias. Besides eliminating the grid-bias supply, the fact that grid current flows over the whole audio cycle means that the load resistance for the driver is fairly constant. With these tubes the grid-return lead from the center-tap of the input transformer secondary is simply connected to the filament center-tap or cathode.

When the modulator tubes require bias, it should always be supplied from a *fixed* voltage source. Cathode bias or grid-leak bias cannot be used with a Class-B amplifier. When only a small amount of bias is required it can be obtained conveniently from a few dry cells. The battery is charged by the grid current rather than discharged, but nevertheless it will deteriorate with time. It should be replaced if the voltage meas-

ured across it varies with the signal by more than 10 per cent or so.

As an alternative to batteries, a regulated bias supply may be used. This type of supply is described in the power supply chapter.

### Plate Supply

In addition to adequate filtering, the voltage regulation of the plate supply should be as good as it can be made. If the d.c. output voltage of the supply varies with the load current, the voltage at *maximum* current determines the amount of power that can be taken from the modulator without distortion. A supply whose voltage drops from 1500 at no load to 1250 at the full modulator plate current is a 1250-volt supply, so far as the modulator is concerned, and any estimate of the power output available should be based on the lower figure.

Good dynamic regulation—i.e., with suddenly applied loads—is equally as important as good regulation under steady loads, since an instantaneous drop in voltage on voice peaks also will limit the output and cause distortion. The output capacitor of the supply should have as much capacitance as conditions permit. A value of at least 10  $\mu$ f. should be used, and still larger values are desirable. It is better to use all the available capacitance in a single-section filter rather than to distribute it between two sections.

It is particularly important, in the case of a tetrode Class B stage, that the screen-voltage power-supply source have excellent regulation, to prevent distortion. The screen voltage should be set as exactly as possible to the recommended value for the tube. The audio impedance between screen and cathode also must be low.

### Overexcitation

When a Class B amplifier is overdriven in an attempt to secure more than the rated power, distortion increases rapidly. The high-frequency harmonics which result from the distortion modulate the transmitter, producing spurious sidebands which can cause serious interference over a band of frequencies several times the channel width required for speech. (This can happen even though the modulation percentage, as defined in the chapter on amplitude modulation, is less than 100 per cent, if the modulator is incapable of delivering the audio power required to modulate the transmitter.)

As shown later, such a condition may be reached by deliberate design, in case the modulator is to be adjusted for peak

clipping. But whether it happens by accident or intention, the splatter and spurious sidebands can be eliminated by inserting a low-pass filter (Fig. 8-13) between the modulator and the modulated amplifier, and then taking care to see that the actual modulation of the r.f. amplifier does not exceed 100 per cent.

### Operation Without Load

Excitation should never be applied to a Class B modulator until after the Class C amplifier is turned on and is drawing the value of plate current required to present the rated load to the modulator. With no load to absorb the power, the primary impedance of the transformer rises to a high value and excessive audio voltages may be developed in the primary—frequently high enough to break down the transformer insulation.

### DRIVERS FOR CLASS-B MODULATORS

Class AB<sub>2</sub> and Class B amplifiers are driven into the grid-current region, so power is consumed in the grid circuit. The preceding stage or driver must be capable of supplying this power at the required peak audio-frequency grid-to-grid voltage. Both of these quantities are given in the manufacturer's tube ratings. The grids of the

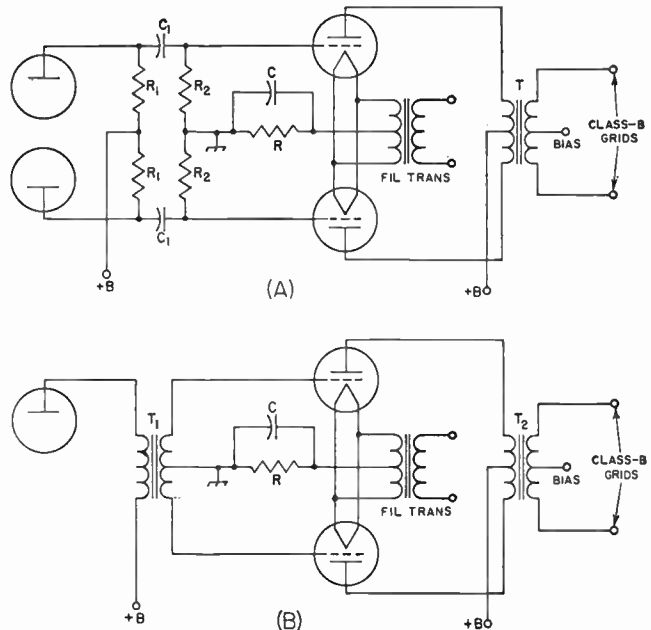

Fig. 8-7—Triade driver circuits for Class B modulators. A, resistance coupling to grids; B, transformer coupling.  $R_1$  in A is the plate resistor for the preceding stage, value determined by the type of tube and operating conditions as given in Table 8-1. C and  $R_2$  are the coupling capacitor and grid resistor, respectively; values also may be taken from Table 8-1.

In both circuits the output transformer, ( $T_1T_2$ ) should have the proper turns ratio to couple between the driver tubes and the Class B grids.  $T_1$  in B is usually a 2:1 transformer, secondary to primary.  $R$ , the cathode resistor, should be calculated for the particular tubes used. The value of C, the cathode bypass, is determined as described in the text.



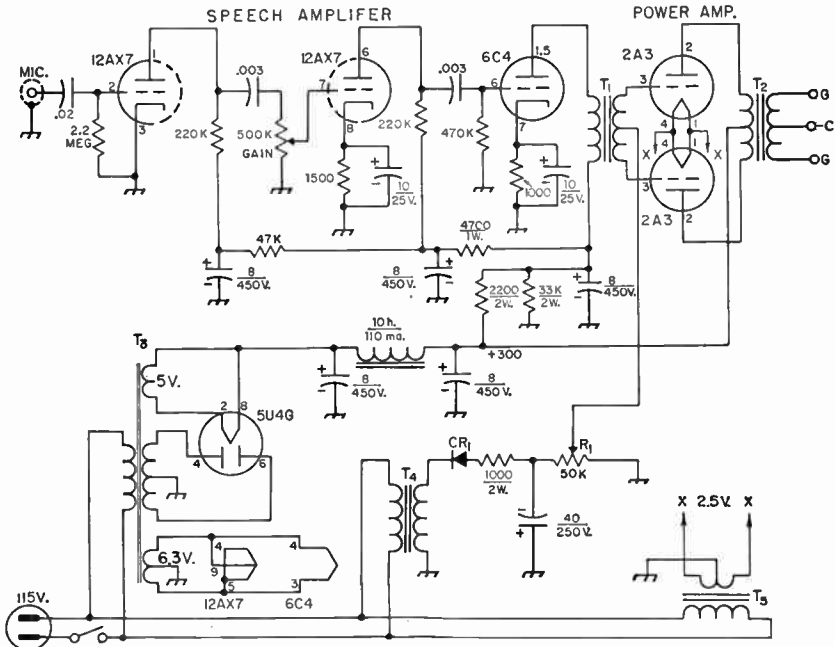

Fig. 8-8—Typical speech-amplifier driver for 10-15 watts output. Capacitances are in  $\mu\text{f}$ . Resistors are  $\frac{1}{2}$  watt unless specified otherwise. Capacitors with polarity indicated are electrolytic.

CR<sub>1</sub>—Selenium rectifier, 20 ma.

R<sub>1</sub>—50,000-ohm potentiometer, preferably wire wound.

T<sub>1</sub>—Interstage audio transformer, single plate to push-pull grids, turns ratio 2 to 1 or 3 to 1, total secondary to primary.

T<sub>2</sub>—Class-B driver transformer, 3000 ohms plate-to-plate; secondary impedance as required by

Class-B tubes used; 15-watt rating.

T<sub>3</sub>—Power transformer, 700 volts c.t., 110 ma.; 5 volts, 3 amp.; 6.3 volts, 4 amp.

T<sub>4</sub>—Power transformer, 125 volts, 20 ma.; 6.3 volts, 0.6 amp.

T<sub>5</sub>—2.5-volt 5-ampere filament transformer (Thordarson 21F00).

Class B tubes represent a varying load resistance over the audio-frequency cycle, because the grid current does not increase directly with the grid voltage. To prevent distortion, therefore, it is necessary to have a driving source that will maintain the wave form of the signal without distortion even though the load varies. That is, the driver stage must have good regulation. To this end, it should be capable of delivering somewhat more power than is consumed by the Class B grids, as previously described in the discussion on speech amplifiers.

**Driver Tubes**

To secure good voltage regulation the internal impedance of the driver, as seen by the modulator grids, must be low. The principal component of this impedance is the plate resistance of the driver tube or tubes as reflected through the driver transformer. Hence for low driving-source impedance the effective plate resistance of the driver tubes should be low and the turns ratio of the driver transformer, primary to secondary, should be as large as possible. The maximum turns ratio that can be used is that value which just permits developing the modulator grid-to-grid a.f. voltage required for the desired power output. The rated tube output as shown by the

tube tables should be reduced by about 20 per cent to allow for losses in the Class B input transformer.

Low- $\mu$  triodes such as the 2A3 have low plate resistance and are therefore good tubes to use as drivers for Class AB<sub>2</sub> or Class B modulators. Tetrodes such as the 6V6 and 6L6 make very poor drivers in this respect when used without negative feedback, but with such feedback the effective plate resistance can be reduced to a value comparable with low- $\mu$  triodes.

Fig. 8-7 shows representative circuits for a push-pull triode driver using cathode bias. If the amplifier operates Class A the cathode resistor need not be bypassed, because the a.f. currents from each tube flowing in the cathode resistor are out of phase and cancel each other. However, in Class AB operation this is not true; considerable distortion will be generated at high signal levels if the cathode resistor is not bypassed. The bypass capacitance required can be calculated by a simple rule: the cathode resistance in ohms multiplied by the bypass capacitance in microfarads should equal at least 25,000. The voltage rating of the capacitor should be equal to the maximum bias voltage. This can be found from the maximum-signal plate current and the cathode resistance.



*Example:* A pair of 2A3s is to be used in Class AB<sub>1</sub> self-biased. From the tube tables, the cathode resistance should be 780 ohms and the maximum-signal plate current 100 ma. From Ohm's Law,

$$E = RI = 780 \times 0.10 = 78.6 \text{ volts}$$

From the rule mentioned previously, the bypass capacitance required is

$$C = 25,000/R = 25,000/780 = 32 \mu\text{f.}$$

A 40- or 50- $\mu\text{f.}$  100-volt electrolytic capacitor would be satisfactory.

Fig. 8-8 is a typical circuit for a speech amplifier suitable for use as a driver for a Class AB<sub>2</sub> or Class B modulator. An output of about 13 watts can be realized with the power supply circuit shown (or any similar well-filtered supply delivering 300 volts under load). This is sufficient for driving any of the power triodes commonly used as modulators. The 2A3s in the output stage are operated Class AB<sub>1</sub>. The circuit provides several times the voltage gain needed for crystal or ceramic microphones.

The two sections of a 12AX7 tube are used in the first two stages of the amplifier. These are resistance coupled, the gain control being in the grid circuit of the second stage. Although the cathode of the first stage is grounded and there is no separate bias supply for the grid, the grid bias actually is about one volt because of "contact potential."

The third stage uses a medium- $\mu$  triode which is coupled to the 2A3 grids through a transformer having a push-pull secondary. The ratio may be of the order of 2 to 1 (total secondary to

primary) or higher; it is not critical since the gain is sufficient without a high step-up ratio.

The turns ratio of transformer  $T_2$ , for the primary to one-half secondary, is approximated by

$$N = \sqrt{\frac{PZ}{0.35 E_s}}$$

where  $P$  = driving power required by modulator tubes

$Z$  = plate load impedance of driver tube(s)

$E_s$  = peak grid-to-grid voltage for driven tubes

(This approximation is useful for any driver tube, or tubes, driving Class AB<sub>2</sub> or Class B modulators. Select driver tube(s) capable of delivering 1½ times the grid-driving power required.)

In the case of AB<sub>1</sub> 2A3s with fixed bias and 300 plate volts,  $Z = 3000$  ohms.

Grid bias for the 2A3s is furnished by a separate supply using a small selenium rectifier and a TV "booster" transformer,  $T_4$ . The bias should be set to -62 volts or to obtain a total plate current of 80 ma.

In building an amplifier of this type the constructional precautions outlined earlier should be observed. The Class AB<sub>1</sub> modulators described subsequently in this chapter are representative of good constructional practice.

**Negative Feedback**

Whenever tetrodes or pentodes are used as drivers for Class B modulators, negative feedback should be used in the driver stage, for the reason already discussed.

Suitable circuits for single-ended and push-pull tetrodes are shown in Fig. 8-9. Fig. 8-9A shows resistance coupling between the preceding stage and a single tetrode, such as the 6V6, that operates at the same plate voltage as the preceding stage. Part of the a.f. voltage across the primary of the output transformer is fed back to the grid of the tetrode,  $V_2$ , through the plate resistor of the preceding tube,  $V_1$ . The total resistance of  $R_4$  and  $R_5$  in series should be ten or more times the rated load resistance of  $V_2$ . Instead of the voltage divider, a tap on the transformer primary can be used to supply the feedback voltage, if such a tap is available.

The amount of feedback voltage that appears at the grid of tube  $V_2$  is determined by  $R_1$ ,  $R_2$  and the plate resistance of  $V_1$ , as well as by the relationship between  $R_4$  and  $R_5$ . Circuit values for typical tube combinations are given in detail in Fig. 8-9.

The push-pull circuit in Fig. 8-9B requires an audio transformer with a split secondary. The feedback

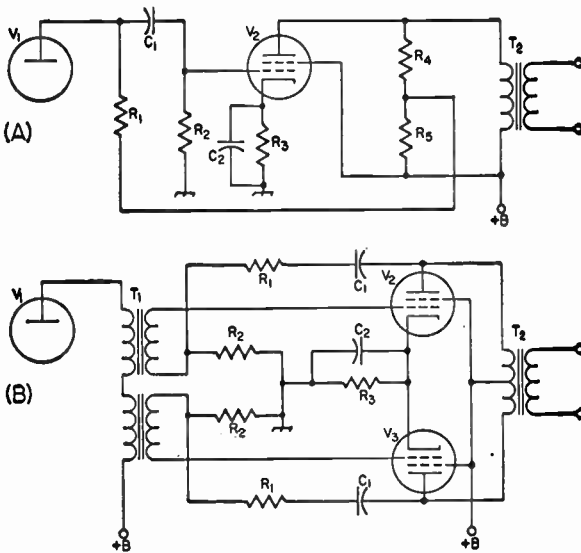

Fig. 8-9—Negative-feedback circuits for drivers for Class B modulators. A—Single-ended beam-tetrode driver. If  $V_1$  and  $V_2$  are a 6J5 and 6V6, respectively, or one section of a 6CG7 and a 6AQ5, the following values are suggested:  $R_1$ , 47,000 ohms;  $R_2$ , 0.47 megohm;  $R_3$ , 250 ohms;  $R_4$ ,  $R_5$ , 22,000 ohms;  $C_1$ , 0.01  $\mu\text{f.}$ ;  $C_2$ , 50  $\mu\text{f.}$

B—Push-pull beam-tetrode driver. If  $V_1$  is a 6J5 or 6CG7 and  $V_2$  and  $V_3$  6L6s, the following values are suggested:  $R_1$ , 0.1 megohm;  $R_2$ , 22,000 ohms;  $R_3$ , 250 ohms;  $C_1$ , 0.1  $\mu\text{f.}$ ;  $C_2$ , 100  $\mu\text{f.}$

voltage is obtained from the plate of each output tube by means of the voltage divider,  $R_1, R_2$ . The blocking capacitor,  $C_1$ , prevents the d.c. plate voltage from being applied to  $R_1, R_2$ ; the reactance of this capacitor should be low, compared with the sum of  $R_1$  and  $R_2$ , at the lowest audio frequency to be amplified. Also, the sum of  $R_1$  and  $R_2$  should be high (ten times or more) compared with the rated load resistance for  $V_2$  and  $V_3$ .

In this circuit the feedback voltage that is developed across  $R_2$  appears at the grid of  $V_2$  (or  $V_3$ ) through the transformer secondary and grid-cathode circuit of the tube, provided the tubes are not driven to grid current. The per cent feedback is

$$n = \frac{R_2}{R_1 + R_2} \times 100$$

where  $n$  is the feedback percentage, and  $R_1$  and

$R_2$  are connected as shown in the diagram. The higher the feedback percentage, the lower the effective plate resistance. However, if the percentage is made too high the preceding tube,  $V_1$ , may not be able to develop enough voltage, through  $T_1$ , to drive the push-pull stage to maximum output without itself generating harmonic distortion. Distortion in  $V_1$  is not compensated for by the feedback circuit.

If  $V_2$  and  $V_3$  are 6L6s operated self-biased in Class AB<sub>1</sub> with a load resistance of 4000 ohms,  $V_1$  is a 6J5 or similar triode, and  $T_1$  has a turns ratio of 2-to-1, total secondary to primary, it is possible to use over 30 per cent feedback without going beyond the output-voltage capabilities of the triode. Twenty per cent feedback will reduce the effective plate resistance to the point where the output voltage regulation is better than that of 2A3s without feedback. The power output under these conditions is about 20 watts.

## INCREASING THE EFFECTIVENESS OF THE PHONE TRANSMITTER

The effectiveness of a double-sideband transmitter can be increased to a considerable extent by taking advantage of speech characteristics. Measures that may be taken to make the modulation more effective include band compression (filtering), volume compression, and speech clipping.

### Compressing the Frequency Band

Most of the intelligibility in speech is contained in the medium band of frequencies; that is, between about 500 and 2500 cycles. On the other hand, a large portion of speech power is normally found below 500 cycles. If these low frequencies are attenuated, the frequencies that carry most of the actual communication can be increased in amplitude without exceeding 100-per cent modulation, and the effectiveness of the transmitter is correspondingly increased.

One simple way to reduce low-frequency response is to use small values of coupling capacitance between resistance-coupled stages, as shown in Fig. 8-10A. A time constant of 0.0005 second for the coupling capacitor and following-stage grid resistor will have little effect on the amplification at 500 cycles, but will practically halve it at 100 cycles. In two cascaded stages the gain will be down about 5 db. at 200 cycles and 10 db. at 100 cycles. When the grid resistor is  $\frac{1}{2}$  megohm a coupling capacitor of 0.001  $\mu$ f. will give the required time constant.

The high-frequency response can be reduced by using "tone control" methods, utilizing a capacitor in series with a variable resistor connected across an audio impedance at some point in the speech amplifier. The best spot for the tone control is across the primary of the output transformer of the speech amplifier, as in Fig. 9-10B. The capacitor should have a reactance at 1000 cycles about equal to the load resistance required by the amplifier tube or tubes, while the variable resistor in series may have a value equal to four

or five times the load resistance. The control can be adjusted while listening to the amplifier, the object being to cut the high-frequency response without unduly sacrificing intelligibility.

Restricting the frequency response not only puts more modulation power in the optimum frequency band but also reduces hum, because the low-frequency response is reduced, and helps reduce the width of the channel occupied by the transmission, because of the reduction in the amplitude of the high audio frequencies.

### Volume Compression

Although it is obviously desirable to modulate the transmitter as completely as possible, it is

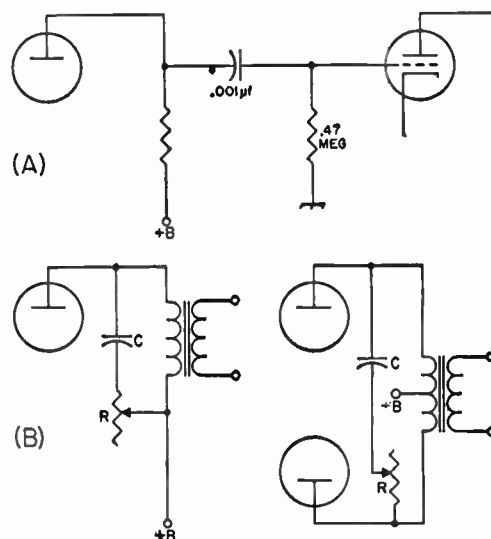

Fig. 8-10—A, use of a small coupling capacitor to reduce low-frequency response; B, tone-control circuits for reducing high-frequency response. Values for C and R are discussed in the text; 0.01  $\mu$ f. and 25,000 ohms are typical.

difficult to maintain constant voice intensity when speaking into the microphone. To overcome this variable output level, it is possible to use automatic gain control that follows the *average* (not instantaneous) variations in speech amplitude. This can be done by rectifying and filtering some of the audio output and applying the rectified and filtered d.c. to a control electrode in an early stage in the amplifier.

A practical circuit for this purpose is shown in Fig. 8-11.  $V_1$ , a medium- $\mu$  triode, has its grid connected in parallel with the grid of the last speech amplifier tube (the stage preceding the power stage) through the gain control  $R_1$ . The amplified output is coupled to a full-wave rectifier,  $V_2$ . The rectified audio output develops a negative d.c. voltage across  $C_1R_3$ , which has a sufficiently long time constant to hold the voltage at a reasonably steady value between syllables and words. The negative d.c. voltage is applied as control bias to the suppressor grid of the first tube in the speech amplifier (this circuit requires a pentode first stage), effecting a reduction in gain. The gain reduction is substantially proportional to the average microphone output and thus tends to hold the amplifier output at a constant level.

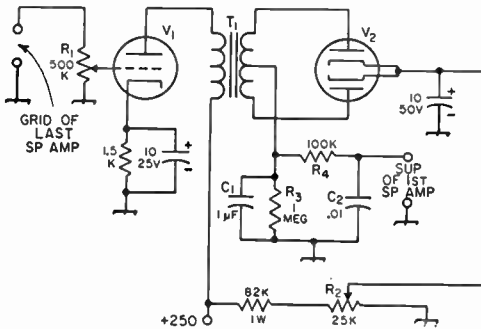

Fig. 8-11—Speech-amplifier output compression circuit.  
 $V_1$ —6C4, 6C5, 6CG7, 6J5, 12AU7, etc.  
 $V_2$ —6H6, 6AL5, etc.  
 $T_1$ —Interstage audio, single plate to p.p. grids.

An adjustable bias is applied to the cathodes of  $V_2$  to cut off the tube at low levels and thus prevent rectification until a desired output level is reached.  $R_2$  is the "threshold control" which sets this level.  $R_1$ , the gain control, determines the rate at which the gain is reduced with increasing signal level.

The hold-in time can be increased by increasing the resistance of  $R_3$ .  $C_2$  and  $R_4$  may not be necessary in all cases; their function is to prevent too-rapid gain reduction on a sudden voice peak. The "rise time" of this circuit can be increased by increasing  $C_2$  or  $R_4$ , or both.

The over-all gain of the system must be high enough so that full output can be secured at a moderately low voice level.

### Speech Clipping and Filtering

In speech wave forms the average power content is considerably less than in a sine wave of the same peak amplitude. Since modulation per-

centage is based on peak values, the modulation or sideband power in a transmitter modulated 100 per cent by an ordinary voice wave form will be considerably less than the sideband power in the same transmitter modulated 100 per cent by a sine wave. In other words, the modulation percentage with voice wave forms is determined by peaks having relatively low average power content.

If the low-energy peaks are clipped off, the remaining wave form will have a considerably higher ratio of average power to peak amplitude. More sideband power will result, therefore, when such a clipped wave is used to modulate the transmitter 100 per cent. Although clipping distorts the wave form and the result therefore does not sound exactly like the original, it is possible to secure a worth-while increase in modulation power without sacrificing intelligibility. Once the system is properly adjusted it *will be impossible to overmodulate the transmitter* because the maximum output amplitude is fixed.

By itself, clipping generates the same high-order harmonics that overmodulation does, and therefore will cause splatter. To prevent this, the audio frequencies above those needed for intelligible speech must be filtered out, *after* clipping and *before* modulation. The filter required for this purpose should have relatively little attenuation at frequencies below about 2500 cycles, but high attenuation for all frequencies above 3000 cycles.

It is possible to use as much as 25 db. of clipping before intelligibility suffers; that is, if the original peak amplitude is 10 volts, the signal can be clipped to such an extent that the resulting maximum amplitude is less than one volt. If the original 10-volt signal represented the amplitude that caused 100-per-cent modulation on peaks, the clipped and filtered signal can then be amplified up to the same 10-volt peak level for modulating the transmitter.

There is a loss in naturalness with "deep" clipping, even though the voice is highly intelligible. With moderate clipping levels (6 to 12 db.) there is almost no change in "quality" but the voice power is increased considerably.

Before drastic clipping can be used, the speech signal must be amplified several times more than is necessary for normal modulation. Also, the hum and noise must be much lower than the tolerable level in ordinary amplification, because the noise in the output of the amplifier increases in proportion to the gain.

One type of clipper-filter system is shown in Fig. 8-12. The clipper is a peak-limiting rectifier of the same general type that is used in receiver noise limiters. It must clip both positive and negative peaks. The gain or clipping control sets the amplitude at which clipping starts. Following the low-pass filter for eliminating the harmonic distortion frequencies is a second gain control, the "level" or modulation control. This control is set initially so that the amplitude-limited output of the clipper-filter cannot cause more than 100 per cent modulation.

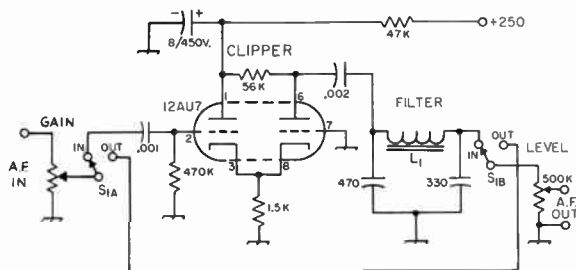

Fig. 8-12—Practical speech clipper circuit with low-pass filter. Capacitances below 0.001  $\mu\text{f.}$  are in  $\mu\mu\text{f.}$  Resistors are  $\frac{1}{2}$  watt.  $L_1$ —20 henrys, 900 ohms (Stancor C-1515).  $S_1$ —D.p.d.t. toggle or rotary.

It should be noted that the peak amplitude of the audio wave form actually applied to the modulated stage in the transmitter is not necessarily held at the same relative level as the peak amplitude of the signal coming out of the clipper stage. When the clipped signal goes through the filter, the relative phases of the various frequency components that pass through the filter are shifted, particularly those components near the cut-off frequency. This may cause the peak amplitude out of the filter to exceed the peak amplitude of the clipped signal applied to the filter input terminals. Similar phase shifts can occur in amplifiers following the filter, especially if these amplifiers, including the modulator, do not have good low-frequency response. With poor low-frequency response the more-or-less "square" waves resulting from clipping tend to be changed into triangular waves having higher peak amplitude. Best practice is to cut the low-frequency response *before* clipping and to make all amplifiers following the clipper-filter as flat and distortion-free as possible.

The best way to set the modulation control in such a system is to check the actual modulation percentage with an oscilloscope connected as described in the section on modulation. With the gain control set to give a desired clipping level with normal voice intensity, the level control should be adjusted so that the maximum modulation does not exceed 100 per cent no matter how much sound is applied to the microphone.

The practical clipper-filter circuit shown in Fig. 8-12 may be inserted between two speech-amplifier stages (but after the one having the gain control) where the level is normally a few volts. The cathode-coupled clipper circuit gives some over-all voltage gain in addition to performing the clipping function. The filter constants are such as to give a cut-off characteristic that combines reasonably good fidelity with adequate high-frequency suppression.

**High-Level Clipping and Filtering**

Clipping and filtering also can be done at high level—that is, at the point where the modulation is applied to the r.f. amplifier—instead of in the lowlevel stages of the speech amplifier. In one rather simple but effective arrangement of this type the clipping takes place in the Class-B modulator itself. This is accomplished by carefully adjusting the plate-to-plate load resistance for the

modulator tubes so that they saturate or clip peaks at the amplitude level that represents 100 per cent modulation. The load adjustment can be made by choice of output transformer ratio or by adjusting the plate-voltage/plate-current ratio of the modulated r.f. amplifier. It is best done by examining the output wave form with an oscilloscope.

The filter for such a system consists of a choke coil and capacitors as shown in Fig. 9-13. The values of  $L$  and  $C$  should be chosen to form a low-pass filter section having a cut-off frequency of about 2500 cycles, using the modulating impedance of the r.f. amplifier as the load resistance. For this cut-off frequency the formulas are

$$L_1 = \frac{R}{7850} \text{ and } C_1 = C_2 = \frac{63.6}{R}$$

where  $R$  is in ohms,  $L_1$  in henrys, and  $C_1$  and  $C_2$  in microfarads. For example, with a plate-modulated amplifier operating at 1500 volts and 200 ma. (modulating impedance 7500 ohms)  $L_1$  would be  $7500/7850 = 0.96$  henry and  $C_1$  or  $C_2$  would be  $63.6/7500 = 0.0085 \mu\text{f.}$  Bypass capacitors in the plate circuit of the r.f. amplifier should be included in  $C_2$ . Voltage ratings for  $C_1$  and  $C_2$  when connected as shown must be the same as for the plate blocking capacitor—i.e., at least twice the d.c. voltage applied to the plate of the modulated amplifier.  $L$  and  $C$  values can vary 10 per cent or so without seriously affecting the operation of the filter.

Besides simplicity, the high-level system has the advantage that high-frequency components

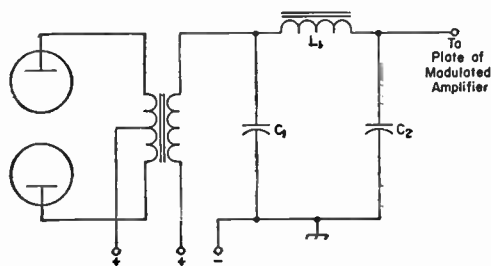

Fig. 8-13—Splatter-suppression filter for use at high level, shown here connected between a Class B modulator and plate-modulated r.f. amplifier. Values for  $L_1$ ,  $C_1$  and  $C_2$  are determined as described in the text.



of the audio signal fed to the modulator grids, whether present legitimately or as a result of amplitude distortion in lower-level stages, are suppressed along with the distortion components that arise in clipping. Also, the undesirable effects of poor low-frequency response following clipping and filtering, mentioned in the preceding

section, are avoided. Phase shifts can still occur in the high-level filter, however, so adjustments preferably should be made by using an oscilloscope to check the actual modulation percentage under all conditions of speech intensity. (For further discussion see Bruene, "High-Level Clipping and Filtering," *QST*, November, 1951.)

## A LOW-POWER MODULATOR

A modulator suitable for plate modulation of low-power transmitters or for screen or control-grid modulation of high-power amplifiers is pictured in Figs. 8-14 and 8-16. As shown in Fig. 8-15, it uses a pair of Class A<sub>1</sub> 6AQ5's in push-pull in the output stage. These are driven by a 6C4 phase inverter. A two-stage preamplifier using a 12AX7 brings the output voltage of a crystal or ceramic microphone up to the proper level for the 6C4 grid. A power supply is included on the same chassis.

The undistorted audio output of the amplifier is 7-8 watts. This is sufficient for modulating the plate of an r.f. amplifier running 10 to 15 watts input, or for modulating the control grids or screens of r.f. amplifiers using tubes having plate-dissipation ratings up to 250 watts. When screen modulation is used the screen power for the modulated amplifier (up to 250 volts) can be taken from the modulator power supply. The wiring shown in Fig. 8-15 provides for this, through an adjustable tap on the 25,000-ohm bleeder resistor,  $R_5$ , in the power supply. If a separate screen supply is used, or if the modulator is used for grid-bias or plate modulation of an r.f. amplifier, the d.c. circuit should be opened at point "X" in Fig. 8-15.

The amplifier uses resistance coupling up to the output-stage grids. The first section,  $V_{1A}$ , of the 12AX7 has "contact-potential" bias. The gain control,  $R_1$ , is in the grid circuit of the second section,  $V_{1B}$ , of the 12AX7. Negative feedback from the secondary of the output transformer,  $T_1$ , is introduced at the cathode of this tube section. The feedback voltage is dependent on the

ratio of  $R_2$  to  $R_3$ , approximately, and with the constants given is sufficient to result in a considerable reduction in distortion along with improved regulation of the audio output voltage. The latter is important when the unit is used for modulating a screen or control grid, as described in the chapter on amplitude modulation.

The phase inverter is of the split-load type described earlier in this chapter. It drives the push-pull 6AQ5's in the power amplifier. The output transformer used in the power stage is a multitap modulation transformer suitable for any of the types of modulation mentioned above.

Capacitor  $C_1$  across the secondary of the output transformer,  $T_1$ , is used to reduce the high-frequency response of the amplifier. Without it, self-oscillation is likely to occur at a high audio frequency (usually above audibility) because phase shift in the output transformer at the end of its useful frequency range causes the feedback to become positive.

The power supply uses a replacement-type transformer and choke with a capacitor-input filter. Voltage under the modulator and speech-amplifier load is 250. The decoupling resistance-capacitance networks in the plate circuits of  $V_{1A}$  and  $V_{1B}$  contribute additional smoothing of the d.c. for these low-level stages.

The unit includes provision for send-receive switching,  $S_1$  being used for that purpose.  $S_{1B}$  can be used to control the r.f. section — for example, by being connected in parallel with the key used for c.w. operation. Simultaneously  $S_{1A}$  short-circuits the secondary of  $T_1$  so the transformer will not be damaged by being left without

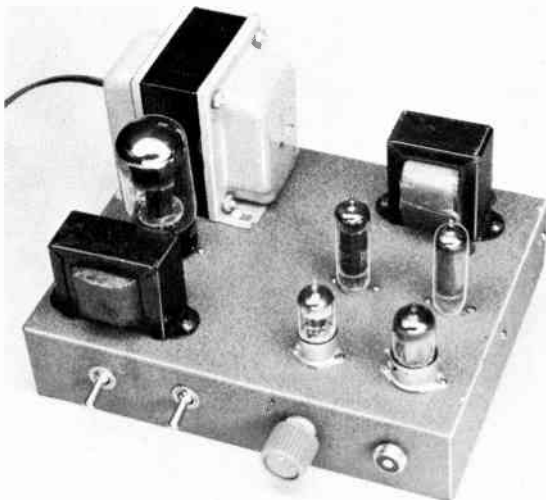

Fig. 8-14—Speech amplifier and low-power modulator suitable for screen or control-grid modulation of high-power amplifiers, or for plate modulation of an r.f. stage with up to 15 watts plate input. It is assembled on a 7 × 9 × 2-inch steel chassis, with the power supply occupying the left-hand section and the audio circuits the right. The 12AX7 preamplifier is at the lower right-hand corner, the 6C4 phase inverter is to its left, and the 6AQ5 power amplifiers are behind the two. Controls along the chassis edge are, left to right, the power switch, send-receive switch, gain control, and microphone jack.



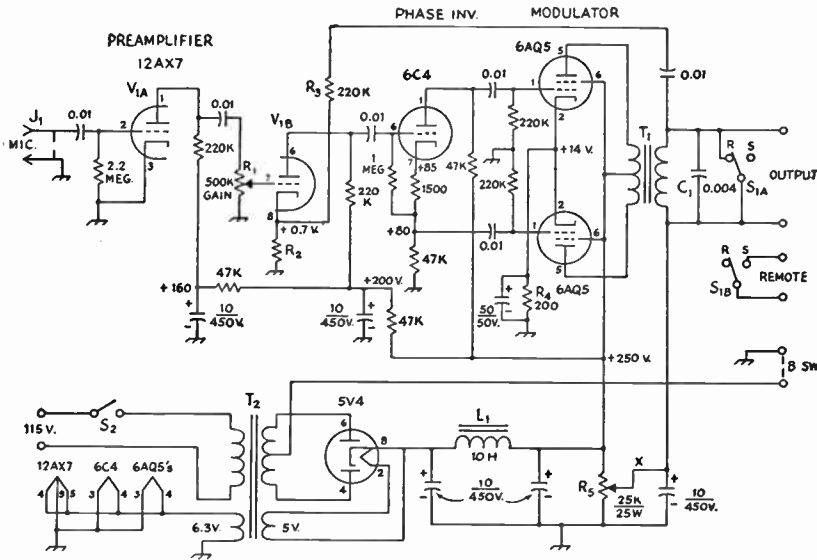

Fig. 8-15—Circuit of the speech amplifier and modulator. All capacitances are in  $\mu$ f.; capacitors with polarities marked are electrolytic, others are ceramic. Resistors are  $\frac{1}{2}$  watt except as noted below. Voltages measured to chassis with v.t. voltmeter.

- J<sub>1</sub>—Microphone connector (Amphenol 75-PC1M).
- L<sub>1</sub>—10 henrys, 90 ma. (Triad C-7X).
- S<sub>1</sub>—D.p.d.t. toggle.
- S<sub>2</sub>—S.p.s.t. toggle.
- T<sub>1</sub>—Modulation transformer, tapped secondary, primary 10,000 ohms plate to plate (Thordar-

- son 21M68).
- T<sub>2</sub>—Power transformer, 525 v.c.t., 90 ma.; 6.3 v., 5 amp.; 5 v., 2 amp. (Triad R-10A).
- R<sub>2</sub>—1500 ohms,  $\frac{1}{2}$  watt.
- R<sub>4</sub>—App. 200 ohms, 2 watts (two 390-ohm 1-watt resistors in parallel).

load. If S<sub>1B</sub> is connected across the transmitter key, S<sub>1</sub> also can be used as a phone-c.w. switch, being left in the "R" position for c.w. operation.

The terminals marked "B Switch" should be short circuited (indicated by the dashed line) if S<sub>1</sub> is used as a send-receive. If a switch on the transmitter is used for send-receive, these terminals may be used for turning the plate voltage in the modulator on and off through an extra pair of contacts on the transmitter send-receive

switch. In that case S<sub>1</sub> should be left in the "send" position for phone operation.

The proper secondary taps to use on T<sub>1</sub> will depend on the impedance of the load to which the amplifier is connected. Methods for determining the modulating impedance with various types of modulation are given in the section on amplitude modulation, together with information on connecting the modulator to the r.f. stage.

Fig. 8-16—Below-chassis view of the modulator. The rectifier tube socket and electrolytic filter capacitors are at the right in this view. The 12AX7 socket is at the lower left. Bleeder resistor R<sub>5</sub> is at the upper left, near the 6-terminal connection strip on the rear edge of the chassis. Placement of components is not critical, but the leads in the first two stages should be kept short and close to the chassis to minimize hum troubles.

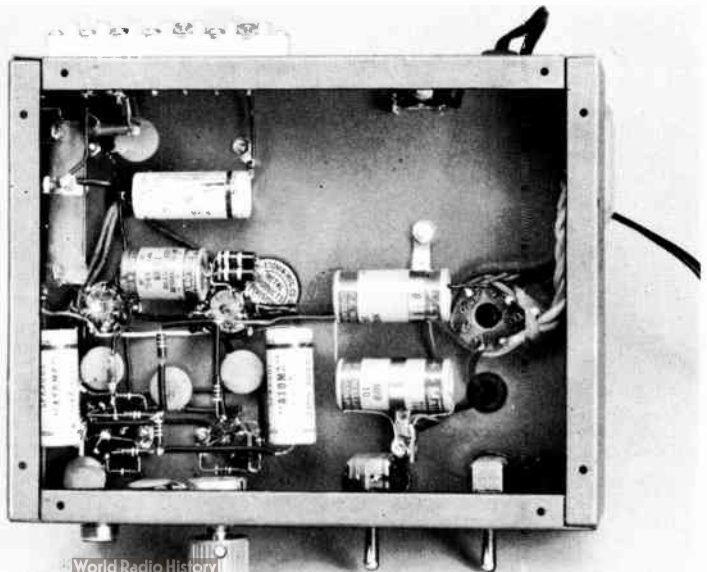

## A 25-WATT MODULATOR USING PUSH-PULL 6BQ6GT<sub>s</sub>

The speech amplifier-modulator shown in Figs. 8-17 to 8-19, inclusive, can be used for plate modulation of low-power transmitters running 25 to 50 watts input to the final stage. The circuit as shown is capable of an audio output of 25 watts, but this can be increased to 30 watts by a simple modification. The 6BQ6s in the output stage are operated in Class AB<sub>1</sub>. Inexpensive receiver-type replacement components are used throughout, except for the modulation transformer.

### Circuit

The speech amplifier uses a pentode first stage resistance-coupled to a triode second stage. This combination gives sufficient gain for a crystal microphone. The pentode and triode are the two sections of a dual tube, the 6AN8. Transformer coupling is used between the triode and the modulator tubes, in order to get push-pull voltage for the 6BQ6GT grids. Cathode bias is used on the final stage.

The coupling capacitance between the first and second stages is purposely made small to reduce the low-frequency response, and the primary of the output transformer is shunted by C<sub>2</sub> to reduce the amplification at the high-frequency end. C<sub>1</sub>, on the first stage, also tends to reduce high-frequency response in addition to bypassing any r.f. that might be picked up on the microphone cord. These measures confine the frequency response to the most useful portion of the voice range.

S<sub>2</sub> is the "send-receive" switch. One section opens the power transformer center tap, thus cutting off the plate voltage during receiving periods. The other section can be connected to the key terminals on the transmitter, as indicated in the circuit diagram, to turn the transmitter on and off along with the modulator. If the transmitter is one in which the oscillator is not keyed, S<sub>2B</sub> may be used to control the trans-

mitter plate voltage, usually by being connected in the 115-volt circuit to the plate-supply transformer.

The "phone-c.w." switch, S<sub>3</sub>, short-circuits the secondary of the modulation transformer, T<sub>3</sub>, when the transmitter is to be keyed, and also opens the center-tap of T<sub>1</sub> so plate voltage cannot be applied to the modulator.

The power supply uses a receiver replacement-type transformer with a capacitor-input filter. Additional filtering for the speech-amplifier stages is provided by the 10- $\mu$ f. capacitors and the series resistors in the plate circuits. Hum is also reduced by the VR-150 used to regulate the modulator screen voltage. Note that the regulator tube is connected between the screens and cathodes so that the actual screen voltage is 150 and is not reduced by the drop in the cathode bias resistor. Maintaining full screen voltage is important if the rated output is to be secured.

### Operating

The 6BQ6GT amplifier requires a plate-to-plate load of 4000 ohms, and the output transformer ratio must be chosen to reflect this load to the plates (see later section on matching a modulator to its load). For most small transmitters running 30 to 50 watts input to the final stage a 1-to-1 transformer ratio will be satisfactory, since the modulating impedance of such transmitters usually is in the neighborhood of 4000 ohms. The secondary of T<sub>3</sub> is connected in series with the d.c. lead to the plate (and screen, if a screen-grid tube) of the Class C amplifier to be modulated. For further details, see the chapter on amplitude modulation.

For checking the modulator operation a milliammeter (0-200 range satisfactory) may be connected in the lead to the center-tap of the primary of T<sub>3</sub>. Without voice input to the microphone the plate current should be approximately



Fig. 8-17—A modulator for transmitters operating at plate inputs up to 50 watts. The speech amplifier and modulator are on the left in this view; power supply components are on the right. The chassis is 7 × 11 × 2 inches.

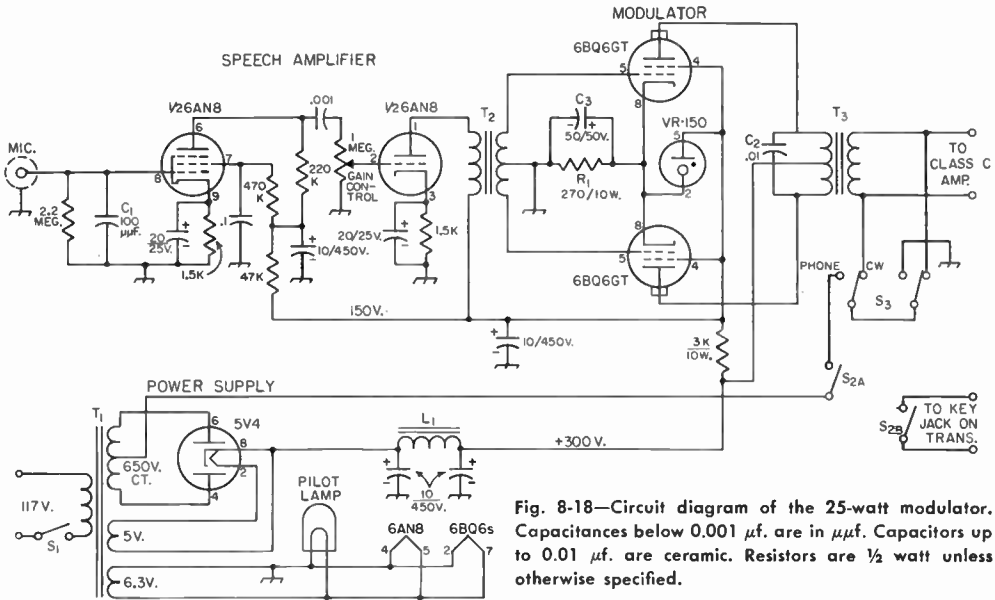

Fig. 8-18—Circuit diagram of the 25-watt modulator. Capacitances below 0.001  $\mu\text{f.}$  are in  $\mu\text{m.f.}$  Capacitors up to 0.01  $\mu\text{f.}$  are ceramic. Resistors are  $\frac{1}{2}$  watt unless otherwise specified.

- T<sub>1</sub>—8 henrys, 150 ma.
- S<sub>1</sub>—S.p.s.t. toggle.
- S<sub>2</sub>—D.p.s.t. toggle.
- S<sub>3</sub>—2-pole 2-position rotary (Centralab PA-2003).

- T<sub>1</sub>—Power transformer, 650 volts c.t., 150 ma. 5 volts 3 amp.; 6.3 volts, 5 amp.
- T<sub>2</sub>—Interstage audio, single plate to p.p. grids, pri. to total sec. ratio 1 to 3.
- T<sub>3</sub>—Modulation transformer, multimatch type (UTC S-19).

50 ma. When modulating the transmitter, the current should "kick" to 60 or 70 ma.; this will usually represent 100 per cent modulation. If the amplifier can be tested with a single-tone signal replacing the microphone, the plate current will be about 165 ma. at full output. The audio power output can be increased to about 30 watts, sufficient for modulating an 807

at its full phone rating, if the 6BQ6GT cathodes are grounded and bias of about 30 volts from a fixed source such as a small battery is applied to the grids. The battery may be substituted for the cathode resistor if the ground connection is moved from the center tap of the secondary of T<sub>2</sub> to the cathodes of the 6BQ6GTs. (From QST, December, 1955.)

Fig. 8-19—Under-chassis view of the 6BQ6GT modulator. The two large capacitors at the right are the filter capacitors in the power supply. The modulator bias resistor and bypass capacitor (R<sub>1</sub>C<sub>3</sub>) are at lower left. Leads from the modulation transformer go through the three holes in the chassis. Shielded wire is used for heater, microphone input, and gain-control leads.

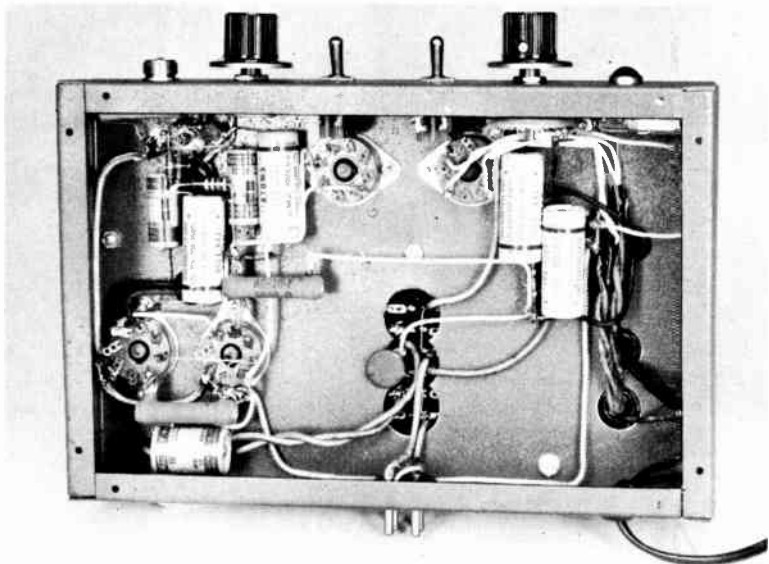

## A 50-WATT CLASS AB<sub>1</sub> MODULATOR

Four type 1625 tubes were used in the output stage of the modulator shown in Figs. 8-20 and 8-22 for several good reasons. These tubes, 12-volt heater versions of the popular 807, are widely available on the surplus market at attractive prices. With the economical power supply shown here, four 1625s will deliver up to 50 watts of audio, sufficient to modulate a 100-watt transmitter. At higher plate voltages, four 1625s in Class AB<sub>1</sub> will furnish up to 140 watts (at 750 plate volts), sufficient to modulate a 280-watt transmitter.

Referring to the circuit diagram, the speech amplifier consists of a 6AV6 triode and the two triodes of a 6CG7. Transformer coupling between  $V_{1B}$  and the modulator tubes gives adequate signal for the 1625s at any rated plate voltage. A built-in bias supply, using a voltage-tripling circuit and selenium rectifiers  $CR_1$ ,  $CR_2$  and  $CR_3$ , furnishes operating bias that can be set to the proper value by  $R_2$ . During standby conditions, the modulator is turned off by opening the circuit at  $J_3$  or by adding additional bias through

$J_4$ . Since connecting four tetrodes in push-pull parallel can often yield parasitic oscillations, resistors are connected in both control and screen grid circuits of the modulator tubes. With these resistors present, there should be no instabilities of any kind. The low- and high-frequency responses are restricted to good communications levels by proper proportioning of the coupling capacitors and the shunt capacitors. The 0.004- $\mu$ f. capacitor across the secondary of  $T_2$  will have a greater effect on restricting high-frequency response if a high-voltage low-current amplifier is being modulated than if a low-voltage high-current r.f. stage is used. The 0.004- $\mu$ f. value was selected for use with a 400-volt 200-ma. amplifier.

Provision for connecting an external modulation monitor (see Chapter 12) is included, as well as a power outlet,  $J_5$ , for the monitor or other auxiliary equipment.

### Construction

The modulator is built on a 17 × 10 × 3-inch steel chassis, although an aluminum chassis would



Fig. 8-20—A 50-watt modulator, using four 1625-type tubes in Class AB<sub>1</sub>. With higher plate voltage and a larger modulation transformer, the tubes can deliver up to 140 watts of audio power.

Speech amplifier tubes and coupling transformer are at the right, in front of the four 1625s. The two voltage-regulator tubes in the center, in front of the modulation transformer, stabilize the screen voltage on the 1625s.

Power-supply filter choke is at the upper left-hand corner, and the small choke to the immediate right is connected in the screen circuit if a screen-grid r.f. amplifier is used. If desired, a cane-metal housing can be used over the modulator, but the use of high-voltage wire and insulated plate caps practically eliminates the danger of electrical shock when the unit is in its normal position.



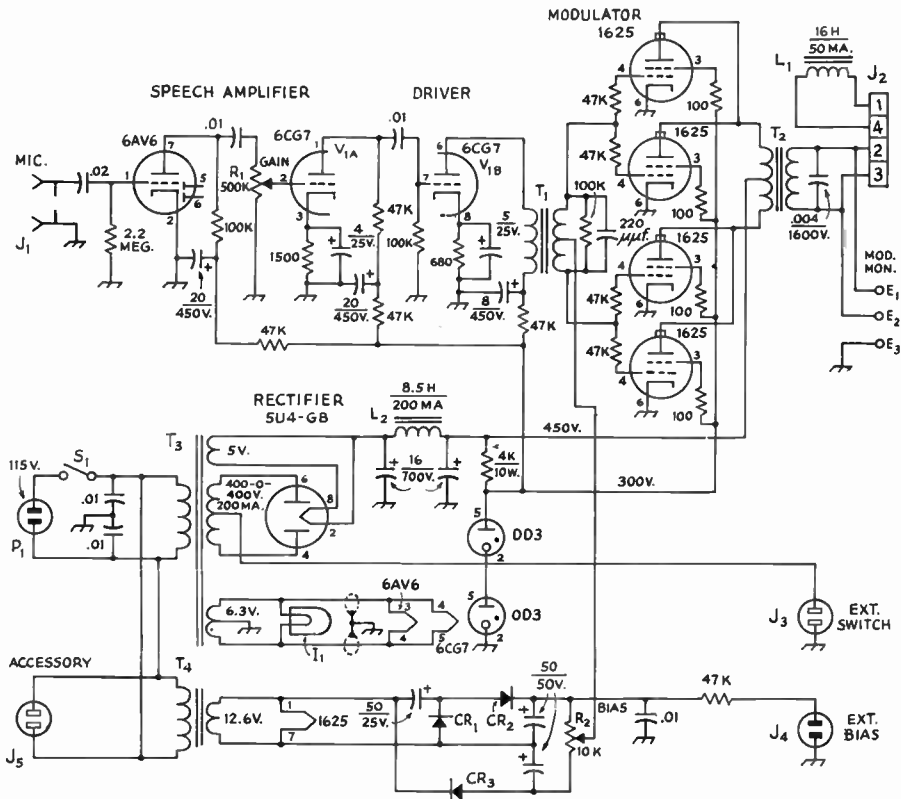

Fig. 8-21—Circuit diagram of the 50-watt modulator. Unless specified otherwise, capacitances are in  $\mu\text{f.}$ , resistances are in ohms, resistors are  $\frac{1}{2}$  watt.

- C<sub>1</sub>—0.004  $\mu\text{f.}$ , but subject to modification. See text.
- CR<sub>1</sub>, CR<sub>2</sub>, CR<sub>3</sub>—20-ma. 130-v. selenium rectifier.
- E<sub>1</sub>, E<sub>2</sub>, E<sub>3</sub>—Nylon tip jacks (Johnson 105-601, 105-602 105-603).
- L<sub>1</sub>—6.3-volt pilot lamp.
- J<sub>1</sub>—Microphone connector (Amphenol 75-PC1M).
- J<sub>2</sub>—4-prong tube socket.
- J<sub>3</sub>, J<sub>5</sub>—2-pin chassis-mounting a.c. receptacle (Amphenol 61-F1).
- J<sub>4</sub>—Phono jack.
- L<sub>2</sub>—Screen choke, used when modulating tetrode amplifier.

- L<sub>2</sub>—8.5-henry 200-ma. filter choke (Knight 61 G 409 or equiv.).
- P<sub>1</sub>—A.c. line plug.
- R<sub>1</sub>—Volume control, audio taper.
- R<sub>2</sub>—2-watt wire-wound control, linear taper.
- S<sub>1</sub>—S.p.s.t. toggle switch.
- T<sub>1</sub>—1:3 ratio interstage transformer (Triad A-31X).
- T<sub>2</sub>—60-watt modulation transformer (Stancor A-3893).
- T<sub>3</sub>—400-0-400 v, at 200 ma., 5 v. at 3 a., 6.3 v. at 5 a. (Knight 61 G 414 or equiv.).
- T<sub>4</sub>—12.6 v. at 2 a. (Knight 61 G 420 or equiv.).

probably be almost as strong and would be definitely easier to drill and punch. The components were arranged to keep a.c. leads a reasonable distance away from the speech-amplifier circuits, and the heater leads to the 6AV6 and 6CG7 were run in shielded wire. These shielded leads, and the shielded leads carrying 115 v. a. c., were run along the folded corners of the chassis. Another precaution in wiring the modulator is to keep the leads to and from T<sub>2</sub> away from the speech-amplifier portion of the modulator, to reduce the chances for feedback and consequent audio oscillation. The leads to and from T<sub>2</sub> should be made with well-insulated wire, and wherever they pass through the chassis rubber grommets should be used.

The connections to T<sub>2</sub> will depend upon the voltage-to-current ratio of the d.c. input to the

modulated stage. With the power supply shown, the modulator is well suited to work with some of the smaller transmitters and amplifiers described in Chapter Six. The proper load for the four 1625s, with 450 volts on the plates, is 3800 ohms, rising to 6000 ohms with 750 volts on the plates. An instruction sheet is furnished with the transformer; to determine the transformer taps to be used, first measure the plate voltage and current of the modulated stage. Divide the voltage by the current in amperes, to determine the secondary load. From the instruction sheet select the connections that most nearly give the same resistance ratio, primary to secondary. It is not likely that the exact values of resistance will be available but this is unimportant; it is the ratio that matters. If there is a choice, use as much of the windings as possible.



### Operation

When the modulator is completed, connect a key or other external switch temporarily at  $J_3$ , and short-circuit  $J_4$ . Plug  $P_1$  into an a.c. outlet, plug in the 5U4-GB and the 0D3s, and turn on  $S_1$ . The filament of the 5U4-GB should glow. Close the key or switch at  $J_3$ ; the 0D3s should light. Open the external switch and plug in the speech amplifier tubes. After allowing time for the 6AV6 and 6CG7 to warm up, as indicated by the heater glow, turn on the external switch and turn off  $S_1$ . Allow a half minute for the filter capacitors to be discharged by the speech amplifier tubes, and then check with a voltmeter that no charge is left in the filter. Open the external switch, plug in the 1625s, and close  $S_1$ . After the heaters warm up, set the arm of  $R_2$  to give a voltage of  $-32$  between arm and chassis. Connect the transmitter or a dummy load to the modulator output (never operate the modulator without a load; the modulation transformer insulation may break down). Set the volume control at minimum (arm of  $R_1$  at chassis end) and close  $J_3$ . With a microphone connected at  $J_1$ , speaking into the mike and slowly opening  $R_1$  should deliver audio output from the modulator.

To obtain more power from the four 1625s, it is necessary to use a higher-powered modulation transformer at  $T_2$  and to raise the plate voltage and grid bias. At 750 volts on the plates, the bias should be  $-35$  volts.

The modulator should be turned on and off with the transmitter, so that a load is always furnished for the transformer. The modulator can be placed on standby by opening the circuit at  $J_3$ , or by adding additional negative voltage at  $J_4$ , depending upon the basic station control circuitry.

If a number of 1625s are available, it is desirable to select four that have substantially the same plate current (28 ma.) for the  $-32$  volts bias. The plate currents of the individual tubes can be measured between insulating plate cap and the tube plate cap, connecting the  $+$  terminal of the milliammeter to the transformer lead. Turn off the equipment between measurements to avoid the possibility of a dangerous electrical shock.

As with any modulator using an output transformer, the secondary winding should be short-circuited (or the modulator disconnected) when the r.f. amplifier is used for c.w. or as a linear amplifier.

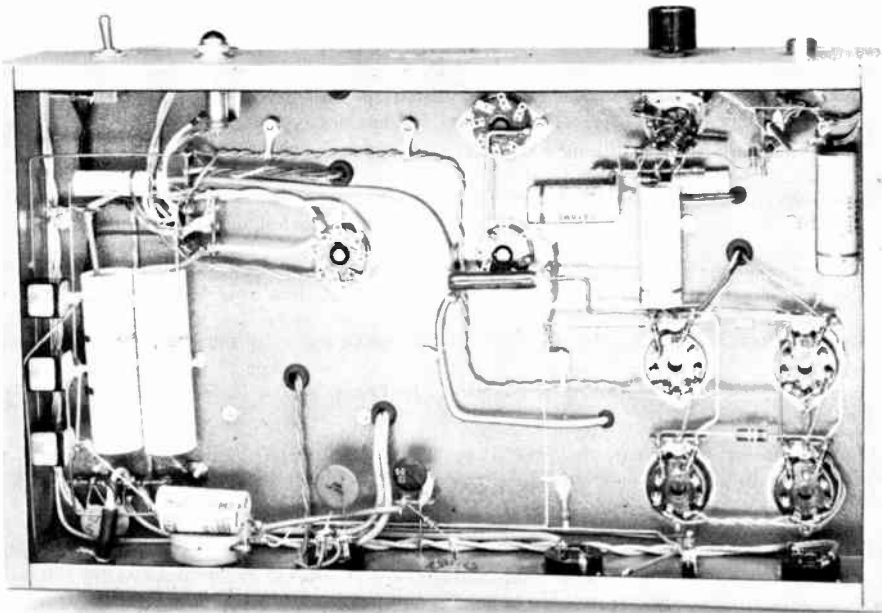

Fig. 8-22—Under the chassis of the 50-watt modulator. Three selenium rectifiers in the bias supply are mounted on the left-hand wall of the chassis. Associated components are grouped around the speech-amplifier sockets (upper right).

Components mounted on the rear apron of the chassis, from left to right, are bias potentiometer, audio power socket  $J_2$ , external bias connection  $J_4$ , external switch connection  $J_3$ , modulation monitor terminals  $E_1$ ,  $E_2$  and  $E_3$ , and the accessory socket  $J_5$ .

Shielded wire is used on 60-cycle a.c. leads in the power transformer primaries and secondaries to reduce the possibility of hum pick-up in the speech amplifier section.

## A 6146 MODULATOR AND SPEECH AMPLIFIER

The modulator shown in Figs. 8-23 to 8-25, inclusive, uses a pair of 6146s in AB<sub>1</sub>, and is complete with power and bias supplies on a 10 × 17 × 3-inch chassis. The modulator also is equipped with an audio take-off for scope monitoring.

The audio power that can be obtained (based on measurements) is as follows:

Nominal Plate Voltage	Power Output	Plate-to-Plate Load Resistance
500 volts	75 watts	4200 ohms
600 volts	95 watts	5200 ohms
750 volts	120 watts	6700 ohms

Suitable sets of components for all three of the voltages listed above are readily available, so the power level can be selected to suit the Class C amplifier to be modulated. The modulator shown in the photographs is set up for 750-volt operation, but aside from the power and modulation transformers all components are the same regardless of the voltage level.

## Audio Circuits

As shown in the circuit diagram, Fig. 8-24, the audio system consists of a 12AX7 preamplifier with the two tube sections in cascade, followed by a 6C4 voltage amplifier which is transformer-coupled to the grids of the Class AB<sub>1</sub> modulator tubes. The combination provides ample gain for a communications-type crystal, ceramic, or dynamic microphone.

The first stage of the amplifier is "contact-potential" biased, and is resistance-coupled to the second stage. The gain control,  $R_1$ , is in the grid circuit of the second stage. Decoupling resistors and capacitors are included in the plate-supply circuits of these two stages; these decoupling circuits also provide additional plate-supply hum filtering for the two low-level stages.

The secondary of  $T_1$ , the transformer coupling the third speech stage to the modulator grids, is shunted by a 470- $\mu$ f. capacitor to reduce high-

frequency response. The optimum value of capacitance will depend on the particular type of audio transformer selected, as well as on the high-frequency characteristics of the microphone employed. Different values should be tried, to reduce the high-frequency response as much as possible, consistent with intelligibility.

The modulation transformer is of the multi-match type, and the taps should be selected to reflect the proper plate-to-plate load impedance, as given earlier, for the desired power output. The impedance ratio, secondary to primary, will depend on the modulating impedance of the modulated r.f. amplifier, as described earlier in this chapter. The secondary of the modulation transformer is shunted by  $C_1$  to reduce output at the higher audio frequencies, particularly for attenuating high-frequency harmonics that might be generated in the modulator at high output levels. The value suggested (0.005  $\mu$ f.) is an average figure and should be modified according to the modulating impedance of the Class-C stage as discussed earlier in this chapter.

## Power Supply

Plate power for all tubes in the unit is supplied by a single power transformer. Mercury-vapor rectifiers are used because good voltage regulation is desirable. The filter is a single section with choke input and a large (over 25  $\mu$ f.) output capacitance. The filter capacitor consists of three 80- $\mu$ f. 450-volt electrolytic capacitors in series for 750-volt d.c. output. If the output voltage is 600 or less only two capacitors in series will be needed. These capacitors are shunted by 0.1-megohm resistors to help equalize the d.c. voltages across them.

The 200-volt (approximately) supply for the 6146 screens and the plates of the speech-amplifier tubes is taken from the main supply through a dropping resistor, and is regulated by two 0B2 voltage-regulator tubes in series. A 20- $\mu$ f. capacitor is connected across the VR tubes to im-

Fig. 8-23—Class-AB<sub>1</sub> modulator using 6146s, complete with speech amplifier and power supply. The relay-rack panel is 10½-inches high. Plate- and filament-supply primary switches, each with its own pilot lamp, are near the lower edge of the panel. The gain control is at lower center. Along the front of the chassis, just behind the panel, are the plate power transformer, filter choke, and modulation transformer, going from left to right. The tubes at the left are the 816 rectifiers, with the 6146s at the right. Along the rear edge are the two voltage-regulator tubes, the 12AX7 and 6C4 speech amplifier tubes, and the inter-stage audio transformer,  $T_1$ .



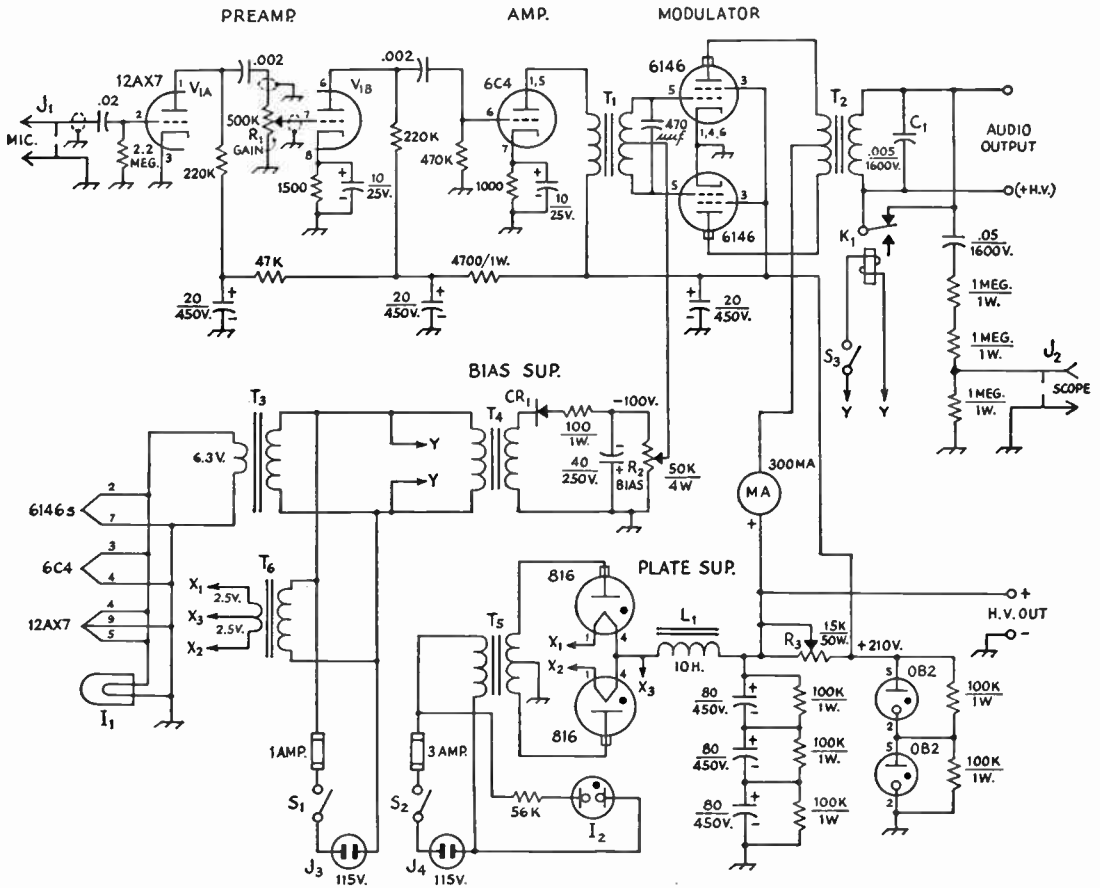

Fig. 8-24—Circuit diagram of the 6146 modulator and power supply. Capacitances are in  $\mu\text{f.}$  unless indicated otherwise; capacitors marked with polarity are electrolytic, others may be paper or ceramic as convenient. Resistances are in ohms; resistors are  $\frac{1}{2}$  watt except as indicated.

- C<sub>1</sub>—See text.
- CR<sub>1</sub>—Selenium rectifier, 20 ma. or higher, 130 volts.
- I<sub>1</sub>—6.3-volt pilot lamp.
- I<sub>2</sub>—Neon lamp, NE-51.
- J<sub>1</sub>—Microphone connector (Amphenol 75-PC1M).
- J<sub>2</sub>—Phana jack.
- J<sub>3</sub>, J<sub>4</sub>—115-volt chassis-mounting plug (Amphenol 61-M1).
- K<sub>1</sub>—Antenna changeover relay, 115-volt coil (Advance AH/2C/115VA; type AM also suitable).
- L<sub>1</sub>—Filter choke, 10 henrys, 300 ma. (Triad C-19A).
- R<sub>1</sub>—0.5-megohm control, audio taper.
- R<sub>2</sub>—50,000-ohm wire-wound control, 4 watts.
- R<sub>3</sub>—15,000-ohm adjustable, 50 watts.
- S<sub>1</sub>, S<sub>2</sub>—S.p.s.t. toggle.
- S<sub>3</sub>—S.p.s.t. mounted on R<sub>1</sub>.

- T<sub>1</sub>—Interstage audio, single plate to p.p. grids, 3-to-1 secondary-to-primary ratio (Stancor A-63-C).
- T<sub>2</sub>—Multimatch modulation transformer, 125 watts (Triad M-12AL).
- T<sub>3</sub>—Filament transformer, 6.3 volts at 4 amp. (Triad F-53X).
- T<sub>4</sub>—Power transformer, 117 volts at 20 ma.; 6.3-volt winding unused (Thordarson 26R32).
- T<sub>5</sub>—Plate transformer. For 500 volts d.c.: 1235 volts c.t., 310 ma. (Triad P-7A); for 600 volts d.c.: 1455 volts c.t., 310 ma (Triad P-11A). Transformer shown is for either 600 or 750 volts d.c. output at 310 ma.; sec. voltage 1780 c.t. for 750 volts (Triad P-14A).
- T<sub>6</sub>—Filament transformer, 5 volts at 3 amp., 2500-volt insulation (Stancor P-4088).

prove the dynamic regulation in the 6146 screen circuit, since the peak instantaneous screen current exceeds the regulating capacity (30 ma.) of the VR tubes when the modulator is driven to maximum output.

Fixed bias for the 6146 grids is taken from a built-in bias supply using a TV "booster" transformer with a selenium rectifier. This bias is

adjustable by means of R<sub>2</sub>. The bias supply and filament transformer are on the same a.c. circuit so that bias is applied to the modulator grids whenever the tube heaters are energized.

**Control and Auxiliary Circuits**

The modulator includes an oscilloscope take-off circuit consisting of the 0.05- $\mu\text{f.}$  capacitor and

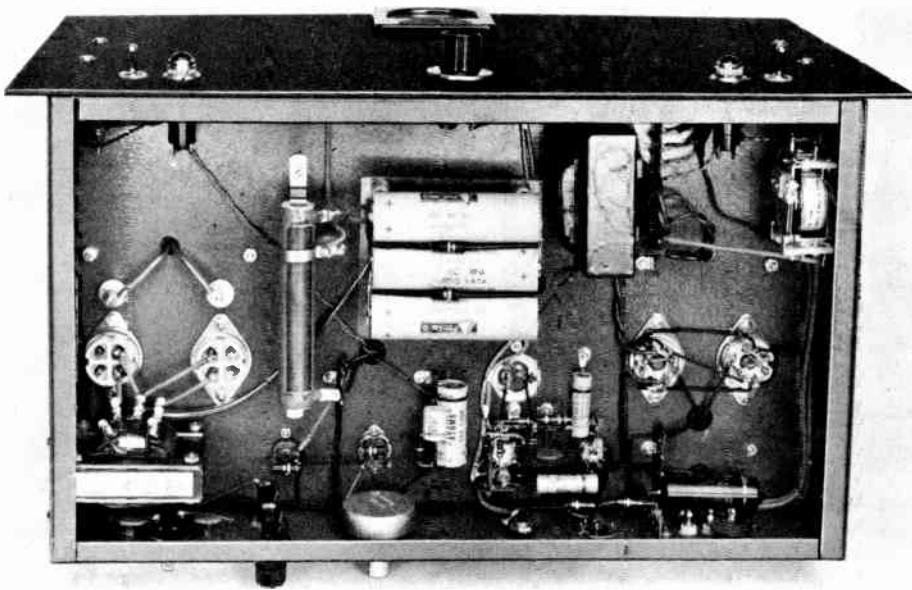

Fig. 8-25—Below-chassis view of the 6146 modulator. The 816 sockets and filament transformer ( $T_0$ ) are at the lower left. The chassis wall at the bottom has on it, left to right, the 115-volt a.c. plugs, fuse holders, bias control ( $R_2$ ), microphone input connector ( $J_1$ ), scope take-off connector ( $J_2$ ) and a three-terminal strip (Millen 37303) for audio output and positive high voltage connections. The high-voltage filter capacitor bank is in the center, mounted on a plate of plastic insulation which is supported away from the chassis on small pillars. The 6.3-volt transformer ( $T_1$ ) is to the right of the capacitors. The antenna changeover relay used for shorting the modulation-transformer secondary is on the right-hand chassis wall.

three 1-megohm resistors in series. This can be used for horizontal deflection of a c.r. tube to give the trapezoidal modulation pattern (see chapter on amplitude modulation). Usually, it will be necessary to use an external control for adjusting the amplitude of the sweep voltage so obtained. If desired, a 1-megohm control can be substituted for the fixed resistor at the bottom of the string, thus avoiding the necessity for an external control.

The normally closed contacts of an antenna-type relay,  $K_1$ , are used to short-circuit the secondary of the modulation transformer when the transmitter is to be used for c.w. work. The switch,  $S_3$ , that controls the relay is mounted on the gain control,  $R_1$ , so that when the gain is turned all the way off, thus opening the switch, the relay contacts close. This insures that the modulator is inoperative and cannot be driven by accidental voice input (which would result in excessive plate current) when the transformer secondary is short-circuited.

Separate a.c. inputs are provided for the filament-bias and plate power circuits. The plate supply can thus be controlled by an external switch without disturbing the operation of the filament circuits or requiring a modification of the 115-volt wiring.

Terminals are provided for taking out high-voltage d.c. for an external unit. The power-supply equipment has more capacity than is needed by the modulator unit itself (the rating

for amateur-type service is somewhat over 300 ma.) and may in some cases be sufficient for operation of the modulated r.f. amplifier as well. At least 200 ma. should be available for this purpose, since the average plate-supply current in the modulator unit alone is less than 100 ma., including the speech-amplifier and VR-tube drain.

#### Operating Data

The dropping resistor in the screen-supply circuit should be adjusted so that the current through  $6B2s$  is 30 ma. with the bias on the 6146 grids adjusted so that the no-signal plate current is approximately 50 ma. The current through the VR tubes may be measured by opening the lead to the upper  $6B2$  at pin 5 and inserting a milliammeter of appropriate range.

If a sine-wave signal is used for testing the modulator, full output should be secured with a modulator plate current of approximately 240 ma. This value will be the same for all plate voltages, provided the screen voltage is maintained at approximately 200 volts and the values of plate-to-plate load resistance as specified earlier are used. With voice input the plate current will kick up to about 100 ma. on peaks, depending on the characteristics of the speaker's voice and those of the microphone used. This peak value should be determined under actual operating conditions with an oscilloscope, after which the plate milliammeter can be used as a modulation indicator.



## AUDIO AMPLIFIERS AND DOUBLE-SIDEBAND PHONE CLASS B MODULATOR WITH FILTER

Representative Class B modulator construction is illustrated by the unit shown in Figs. 8-26 and 8-28. This modulator includes a splatter filter

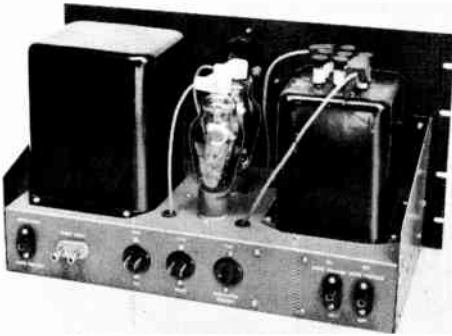

Fig. 8-26—A typical Class B modulator arrangement. This unit uses a pair of 811As, capable of an audio power output of 340 watts, and includes a splatter filter. The modulation transformer is at the left and the splatter choke at the right. All high-voltage terminals are covered so they cannot be touched accidentally.

filter,  $C_1C_2L_1$  in the circuit diagram, Fig. 8-27, and also has provision for short-circuiting the modulation transformer secondary when c.w. is to be used.

The audio input transformer is not built into

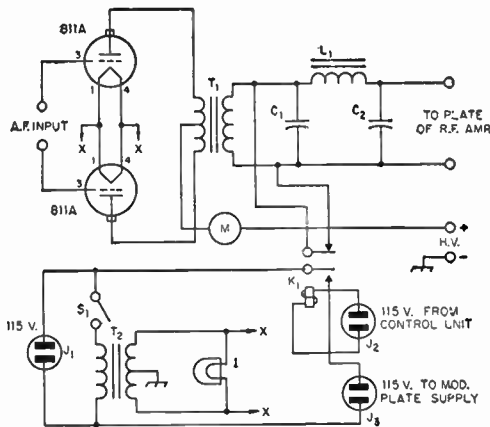

Fig. 8-27—Circuit diagram of the Class B modulator.  $C_1$ ,  $C_2$ ,  $L_1$ —See text. ( $L_1$  is Chicago Transformer type SR-300).

$K_1$ —D.p.d.t. relay, high-voltage insulation (Advance type 400).

$M$ —0-500 d.c. milliammeter, bakelite case.

$T_1$ —Variable-ratio modulation transformer (Chicago Transformer type CMS-1).

$T_2$ —Filament transformer, 6.3 v., 8 amp.

$I_1$ —6.3-volt pilot light.

$X_1$ ,  $X_2$ —Chassis-type 115-volt plugs, male.

$X_3$ —Chassis-type 115-volt receptacle, female.

$S_1$ —S.p.s.t. toggle.

this unit, it being assumed that this transformer will be included in the driver assembly as is customary. If the modulator and speech amplifier-driver are mounted in the same rack or cabinet, the length of leads from the driver to the modulator grids presents no problem. The bias required by the modulator tubes at their higher plate-voltage ratings should be fed through the center tap on the secondary of the driver transformer. At a plate voltage of 1250 or less no bias is needed and the center-tap connection on the transformer can be grounded.

The values of  $C_1$ ,  $C_2$  and  $L_1$  depend on the modulating impedance of the Class C r.f. amplifier. They can be determined from the formulas given in this chapter in the section on high-level clipping and filtering. The splatter filter will be effective regardless of whether the modulator operating conditions are chosen to give high-level clipping, but it is worth while to design the system for clipping at 100 per cent modulation if the tube curves are available for that purpose. The voltage ratings for  $C_1$  and  $C_2$  should at least equal the d.c. voltage applied to the modulated r.f. amplifier.

A relay with high-voltage insulation is used to short-circuit the secondary of  $T_1$  when the

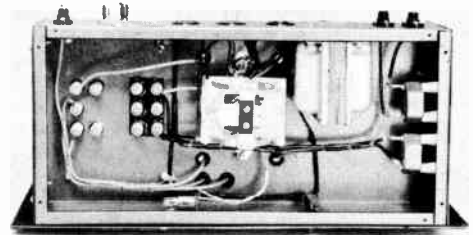

Fig. 8-28—The relay and filament transformer are mounted below the chassis.  $C_1$ ,  $C_2$  and  $K_1$  are mounted on small stand-off insulators.

relay coil is not energized. A normally closed contact is used for this purpose. The other arm is used to close the primary circuit of the modulator plate supply when the relay is energized. Shorting the transformer secondary is necessary when the r.f. amplifier is keyed, to prevent an inductive discharge from the transformer winding that would put "tails" on the keyed characters and, with cathode keying of the amplifier, would cause excessive sparking at the key contacts. The control circuit should be arranged in such a way that  $K_1$  is not energized during c.w. operation but is energized by the send-receive switch during phone operation.

Careful attention should be paid to insulation since the instantaneous voltages in the secondary circuit of the transformer will be at least twice the d.c. voltage on the r.f. amplifier. If a "hi-fi" amplifier of 10 watts or more output is available, it can be used as the driver for the 811As by coupling as shown in Fig. 8-29.



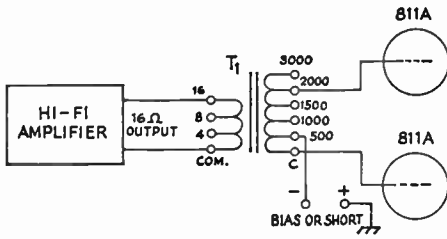

Fig. 8-29—A “hi-fi” audio amplifier will drive a Class-B modulator; a suitable coupling transformer is required. The connections shown here are for a pair of 811As. The amplifier should have an output rating of at least 10 watts.

T<sub>1</sub>—10-watt line-to-voice-coil transformer (Stancor A-8104).

## AMPLITUDE MODULATION

As described in the chapter on circuit fundamentals, the process of modulation sets up groups of frequencies called **sidebands**, which appear symmetrically above and below the frequency of the unmodulated signal or **carrier**. If the instantaneous values of the amplitudes of all these separate frequencies are added together, the result is called the **modulation envelope**. In **amplitude modulation (a.m.)** the modulation envelope follows the amplitude variations of the signal that is used to modulate the wave.

For example, modulation by a 1000-cycle tone will result in a modulation envelope that varies in amplitude at a 1000-cycle rate. The actual r.f. signal that produces such an envelope consists of three frequencies—the carrier, a side frequency 1000 cycles higher, and a side frequency 1000 cycles lower than the carrier. These three frequencies easily can be separated by a receiver having high selectivity. In order to reproduce the original modulation the receiver must have enough bandwidth to accept the carrier and the sidebands simultaneously. This is because an a.m. detector responds to the modulation envelope rather than to the individual signal components, and the envelope will be distorted in the receiver unless all the frequency components in the signal go through without change in their amplitudes.

In the simple case of tone modulation the two side frequencies and the carrier are constant in amplitude—it is only the envelope amplitude that varies at the modulation rate. With more complex modulation such as voice or music the amplitudes and frequencies of the side frequencies vary from instant to instant. The amplitude of the modulation envelope varies from instant to instant in the same way, as the complex audio-frequency signal causing the modulation. Even in this case the *carrier* amplitude is constant if the transmitter is properly modulated.

### A.M. Sidebands and Channel Width

Speech can be electrically reproduced, with high intelligibility, in a band of frequencies lying between approximately 100 and 3000 cycles. When these frequencies are combined with a radio-frequency carrier, the sidebands occupy the frequency spectrum from about 3000 cycles below the carrier frequency to 3000 cycles above—a total band or **channel** of about 6 kilocycles.

Actual speech frequencies extend up to 10,000 cycles or more, so it is possible to occupy a 20-kc.

channel if no provision is made for reducing its width. For communication purposes such a channel width represents a waste of valuable spectrum space, since a 6-kc. channel is fully adequate for intelligibility. Occupying more than the minimum channel creates unnecessary interference. Thus speech equipment design and transmitter adjustment and operation should be pointed toward minimum channel width.

### THE MODULATION ENVELOPE

In Fig. 8-30 the drawing at A shows the unmodulated r.f. signal, assumed to be a sine wave of the desired radio frequency. The graph can be taken to represent either voltage or current.

In B, the signal is assumed to be modulated by the audio frequency shown in the small drawing above. This frequency is much lower than the carrier frequency, a necessary condition for good modulation. When the modulating voltage is “positive” (above its axis) the envelope amplitude is increased *above* its unmodulated amplitude; when the modulating voltage is “negative” the envelope amplitude is *decreased*. Thus the envelope grows larger and smaller with the polarity and amplitude of the modulating voltage.

The drawings at C shows what happens with stronger modulation. The envelope amplitude is doubled at the instant the modulating voltage reaches its positive peak. On the negative peak of the modulating voltage the envelope amplitude just reaches zero.

### Percentage of Modulation

When a modulated signal is detected in a receiver, the detector output follows the modulation envelope. The stronger the modulation, therefore, the greater is the useful receiver output. Obviously, it is desirable to make the modulation as strong or “heavy” as possible. A wave modulated as in Fig. 8-30C would produce more useful audio output than the one shown at B.

The “depth” of the modulation is expressed as a percentage of the unmodulated carrier amplitude. In either B or C, Fig 8-30, X represents the unmodulated carrier amplitude, Y is the maximum envelope amplitude on the modulation up-peak, and Z is the minimum envelope amplitude on the modulation downpeak.

In a properly operating modulation system the modulation envelope is an accurate reproduction of the modulating wave, as can be seen in Fig.

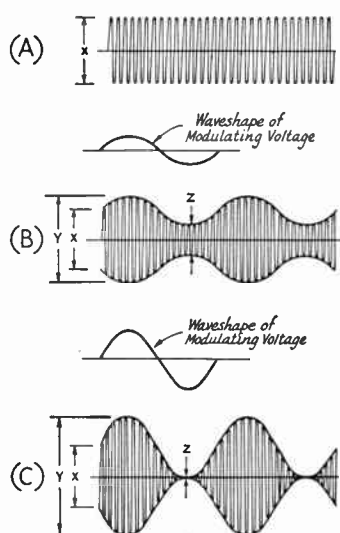

Fig. 8-30—Graphical representation of (A) r.f. output unmodulated, (B) modulated 50%, (C) modulated 100%. The modulation envelope is shown by the thin outline on the modulated wave.

8-30 at B and C by comparing one side of the outline with the shape of the modulating wave. (The lower outline duplicates the upper, but simply appears upside down in the drawing.)

The **percentage of modulation** is

$$\% \text{ Mod.} = \frac{Y-X}{X} \times 100 \text{ (upward modulation), or}$$

$$\% \text{ Mod.} = \frac{X-Z}{X} \times 100 \text{ (downward modulation)}$$

If the wave shape of the modulation is such that its peak positive and negative amplitudes are equal, then the modulation percentage will be the same both up and down. If the two percentages differ, the larger of the two is customarily specified.

#### Power in Modulated Wave

The amplitude values shown in Fig. 8-30 correspond to current or voltage, so the drawings may be taken to represent instantaneous values of either. The power in the wave varies as the *square* of either the current or voltage, so at the peak of the modulation up-swing the instantaneous power in the envelope of Fig. 8-30 is four times the unmodulated carrier power (because the current and voltage both are doubled). At the peak of the down-swing the power is zero, since the amplitude is zero. These statements are true of 100 per cent modulation no matter what the wave form of the modulation. The instantaneous envelope power in the modulated signal is proportional to the square of its envelope amplitude at every instant. This fact is highly important in the operation of every method of amplitude modulation.

It is convenient, and customary, to describe the operation of modulation systems in terms of

sine-wave modulation. Although this wave shape is seldom actually used in practice (voice wave shapes depart very considerably from the sine form) it lends itself to simple calculations and its use as a standard permits comparison between systems on a common basis. With sine-wave modulation the *average* power in the modulated signal over any number of full cycles of the modulation frequency is found to be  $1\frac{1}{2}$  times the power in the unmodulated carrier. In other words, the power output increases 50 per cent with 100 per cent modulation by a sine wave.

This relationship is very useful in the design of modulation systems and modulators, because any such system that is capable of increasing the *average* power output by 50 per cent with sine-wave modulation automatically fulfills the requirement that the *instantaneous* power at the modulation up-peak be four times the carrier power. Consequently, systems in which the additional power is supplied from outside the modulated r.f. stage (e.g., plate modulation) usually are designed on a sine-wave basis as a matter of convenience. Modulation systems in which the additional power is secured from the modulated r.f. amplifier (e.g., grid modulation) usually are more conveniently designed on the basis of peak envelope power rather than average power.

The extra power that is contained in a modulated signal goes entirely into the sidebands, half in the upper sideband and half into the lower. As a numerical example, full modulation of a 100-watt carrier by a sine wave will add 50 watts of sideband power, 25 in the lower and 25 in the upper sideband. Supplying this additional power for the sidebands is the object of all of the various systems devised for amplitude modulation.

No such simple relationship exists with complex wave forms. Complex wave forms such as speech do not, as a rule, contain as much average power as a sine wave. Ordinary speech wave forms have about half as much average power as a sine wave, for the same peak amplitude in both wave forms. Thus for the same modulation percentage, the sideband power with ordinary speech will average only about half the power with sine-wave modulation, since it is the peak envelope amplitude, not the average power, that determines the percentage of modulation.

#### Unsymmetrical Modulation

In an ordinary electric circuit it is possible to increase the amplitude of current flow indefinitely, up to the limit of the power-handling capability of the components, but it cannot very well be decreased to less than zero. The same thing is true of the amplitude of an r.f. signal; it can be modulated *upward* to any desired extent, but it cannot be modulated *downward* more than 100 per cent.

When the modulating wave form is unsymmetrical it is possible for the upward and downward modulation percentages to be different. A simple case is shown in Fig. 8-31. The positive peak of the modulating signal is about 3 times the amplitude of the negative peak. If, as shown

in the drawing, the modulating amplitude is adjusted so that the peak downward modulation is just 100 per cent ( $Z = 0$ ) the peak upward modulation is 300 per cent ( $Y = 4X$ ). The carrier amplitude is represented by  $X$ , as in Fig. 10-1. The modulation envelope reproduces the wave form of the modulating signal accurately, hence there is no distortion. In such a modulated signal the increase in power output with modulation is considerably greater than it is when the modulation is symmetrical and therefore has to be limited to 100 per cent both up and down.

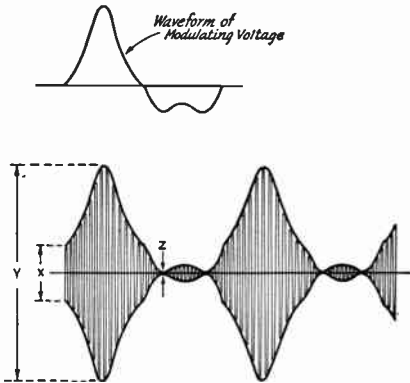

Fig. 8-31—Modulation by an unsymmetrical wave form. This drawing shows 100% downward modulation along with 300% upward modulation. There is no distortion, since the modulation envelope is an accurate reproduction of the wave form of the modulating voltage.

In Fig. 10-2 the peak envelope amplitude,  $Y$ , is four times the carrier amplitude,  $X$ , so the peak-envelope power is 16 times the carrier power. When the upward modulation is more than 100 per cent the power capacity of the modulating system obviously must be increased sufficiently to take care of the much larger peak amplitudes.

### Overmodulation

If the amplitude of the modulation on the

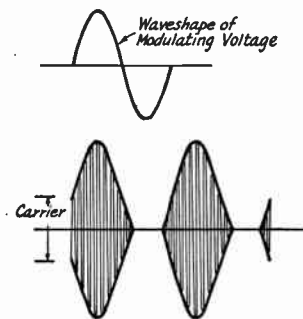

Fig. 8-32—An overmodulated signal. The modulation envelope is not an accurate reproduction of the wave form of the modulating voltage. This or any type of distortion occurring during the modulation process generates spurious sidebands or "splatter."

downward swing becomes too great, there will be a period of time during which the r.f. output is entirely cut off. This is shown in Fig. 8-32. The shape of the downward half of the modulating wave is no longer accurately reproduced by the modulation envelope, consequently the modulation is distorted. Operation of this type is called **overmodulation**. The distortion of the modulation envelope causes new frequencies (harmonics of the modulating frequency) to be generated. These combine with the carrier to form new side frequencies that widen the channel occupied by the modulated signal. These spurious frequencies are commonly called "splatter."

It is important to realize that the channel occupied by an amplitude-modulated signal is dependent on the shape of the modulation envelope. If this wave shape is complex and can be resolved into a wide band of audio frequencies, then the channel occupied will be correspondingly large. An overmodulated signal splatters and occupies a much wider channel than is necessary because the "clipping" of the modulating wave that occurs at the zero axis changes the envelope wave shape to one that contains high-order harmonics of the original modulating frequency. These harmonics appear as side frequencies separated by, in some cases, many kilocycles from the carrier frequency.

Because of this clipping action at the zero axis, it is important that care be taken to prevent applying too large a modulating signal in the downward direction. Overmodulation downward results in more splatter than is caused by most other types of distortion in a phone transmitter.

### GENERAL REQUIREMENTS

For proper operation of an amplitude-modulated transmitter there are a few general requirements that must be met no matter what particular method of modulation may be used. Failure to meet these requirements is accompanied by distortion of the modulation envelope. This in turn increases the channel width as compared with that required by the legitimate frequencies contained in the original modulating wave.

#### Frequency Stability

For satisfactory amplitude modulation, the carrier frequency must be entirely unaffected by modulation. If the application of modulation causes a change in the carrier frequency, the frequency will wobble back and forth with the modulation. This causes distortion and widens the channel taken by the signal. Thus unnecessary interference is caused to other transmissions.

In practice, this undesirable frequency modulation is prevented by applying the modulation to an r.f. amplifier stage that is isolated from the frequency-controlling oscillator by a buffer amplifier. Amplitude modulation applied directly to an oscillator always is accompanied by frequency modulation. Under existing FCC regulations amplitude modulation of an oscillator is permitted only on frequencies above 144 Mc. Below that frequency the regulations require that

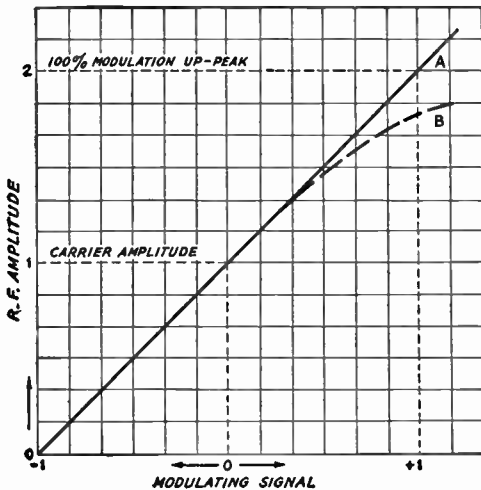

Fig. 8-33—The modulation characteristic shows the relationship between the instantaneous envelope amplitude of the r.f. output (or voltage) and the instantaneous amplitude of the modulating voltage. The ideal characteristic is a straight line, as shown by curve A.

an amplitude-modulated transmitter be completely free from frequency modulation.

### Linearity

At least up to the limit of 100 per cent upward modulation, the amplitude of the r.f. output should be directly proportional to the amplitude of the modulating wave. Fig. 10-4 is a graph of an ideal modulation characteristic, or curve showing the relationship between r.f. output amplitude and instantaneous modulation amplitude. The modulation swings the r.f. amplitude back and forth along the curve A, as the modulating voltage alternately swings positive and negative. Assuming that the negative peak of the modulating wave is just sufficient to reduce the r.f. output to zero (modulating voltage equal to -1 in the drawing), the same modulating voltage peak in the positive direction (+1) should cause the r.f. amplitude to reach twice its unmodulated value. The ideal is a straight line, as shown by curve A. Such a modulation characteristic is perfectly linear.

A nonlinear characteristic is shown by curve B. The r.f. amplitude does not reach twice the unmodulated carrier amplitude when the modu-

lating voltage reaches its positive peak. A modulation characteristic of this type gives a modulation envelope that is "flattened" on the up-peak; in other words, the modulation envelope is not an exact reproduction of the modulating wave. It is therefore distorted and harmonics are generated, causing the transmitted signal to occupy a wider channel than is necessary. A nonlinear modulation characteristic can easily result when a transmitter is not properly designed or is misadjusted.

The modulation capability of the transmitter is the maximum percentage of modulation that is possible without objectionable distortion from nonlinearity. The maximum capability can never exceed 100 per cent on the down-peak, but it is possible for it to be higher on the up-peak. The modulation capability should be as close to 100 per cent as possible, so that the most effective signal can be transmitted.

### Plate Power Supply

The d.c. power supply for the plate or plates of the modulated amplifier should be well filtered; if it is not, plate-supply ripple will modulate the carrier and cause annoying hum. The ripple voltage should not be more than about 1 per cent of the d.c. output voltage.

In amplitude modulation the plate current of the modulated r.f. amplifier varies at an audio-frequency rate; in other words, an alternating current is superimposed on the d.c. plate current. The output filter capacitor in the plate supply must have low reactance, at the lowest audio frequency in the modulation, if the transmitter is to modulate equally well at all audio frequencies. The capacitance required depends on the ratio of d.c. plate current to plate voltage in the modulated amplifier. The requirements will be met satisfactorily if the capacitance of the output capacitor is at least equal to

$$C = 25 \frac{I}{E}$$

where  $C$  = Capacitance of output capacitor in  $\mu\text{f}$ .

$I$  = D.c. plate current of modulated amplifier in milliamperes

$E$  = Plate voltage of modulated amplifier

Example: A modulated amplifier operates at 1250 volts and 275 ma. The capacitance of the output capacitor in the plate-supply filter should be at least

$$C = 25 \frac{I}{E} = 25 \times \frac{275}{1250} = 25 \times 0.22 = 5.5 \mu\text{f}.$$

## AMPLITUDE MODULATION METHODS

### MODULATION SYSTEMS

As explained in the preceding section, amplitude modulation of a carrier is accompanied by an increase in power output, the additional power being the "useful" or "talk power" in the sidebands. This additional power may be supplied from an external source in the form of audio-

frequency power. It is then added to the unmodulated power input to the amplifier to be modulated, after which the combined power is converted to r.f. This is the method used in plate modulation. It has the advantage that the r.f. power is generated at the high efficiency characteristic of Class C amplifiers—of the order of 65 to 75 per cent—but has the accom-



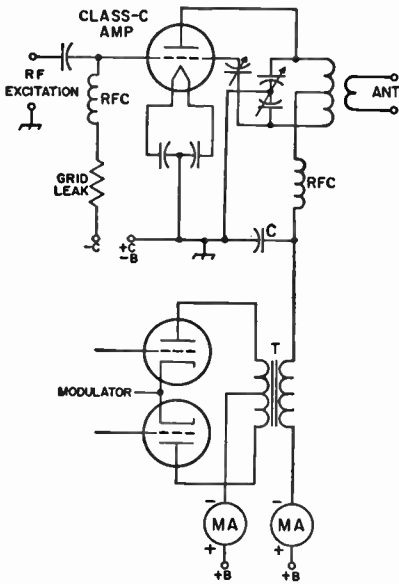

Fig. 8-34—Plate modulation of a Class C r.f. amplifier. The r.f. plate bypass capacitor, C, in the amplifier stage should have reasonably high reactance at audio frequencies. A value of the order of 0.001  $\mu$ f. to 0.005  $\mu$ f. is satisfactory in practically all cases. (See chapter on modulators.)

panying disadvantage that generating the audio-frequency power is rather expensive.

An alternative that does not require relatively large amounts of audio-frequency power makes use of the fact that the power output of an amplifier can be controlled by varying the potential of a tube element — such as a control grid or a screen grid — that does not, in itself, consume appreciable power. In this case the additional power during modulation is secured by sacrificing carrier power; in other words, a tube is capable of delivering only so much total power within its ratings, and if more must be delivered at full modulation, then less is available for the unmodulated carrier. Systems of this type must of necessity work at rather low efficiency at the unmodulated carrier level. As a practical working rule, the efficiency of the modulated r.f. amplifier is of the order of 30 to 35 per cent, and the unmodulated carrier power output obtainable with such a system is only about one-fourth to one-third that obtainable from the same amplifier with plate modulation.

It is well to appreciate that no simple modulation scheme that purports to get around this limitation of grid modulation ever has actually done so. Methods have been devised that have resulted in modulation at high over-all efficiency, without requiring audio power, by obtaining the necessary additional power from an auxiliary r.f. amplifier. This leads to circuit and operating complexities that make the systems unsuitable for amateur work, where rapid frequency change

and simplicity of operation are almost always essential.

The method discussed in this section are the basic ones. Variants that from time to time attain passing popularity can readily be appraised on the basis of the preceding paragraphs. A simple grid modulation system that claims high efficiency should be looked upon with suspicion, since it is almost certain that the high efficiency, if actually achieved, is obtained by sacrificing the linear relationship between modulating signal and modulation envelope that is the first essential of a good modulation method.

**PLATE MODULATION**

Fig. 8-34 shows the most widely used system of plate modulation, in this case with a triode r.f. tube. A balanced (push-pull Class A, Class AB or Class B) modulator is transformer-coupled to the plate circuit of the modulated r.f. amplifier. The audio-frequency power generated by the modulator is combined with the d.c. power in the modulated-amplifier plate circuit by transfer through the coupling transformer, T. For 100 per cent modulation the audio-frequency power output of the modulator and the turns ratio of the coupling transformer must be such that the voltage at the plate of the modulated amplifier varies between zero and twice the d.c. operating plate voltage, thus causing corresponding variations in the amplitude of the r.f. output.

**Audio Power**

As stated earlier, the average power output of the modulated stage must increase during modulation. The modulator must be capable of supplying to the modulated r.f. stage sine-wave audio power equal to 50 per cent of the d.c. plate input. For example, if the d.c. plate power input to the r.f. stage is 100 watts, the sine-wave audio power output of the modulator must be 50 watts.

**Modulating Impedance; Linearity**

The modulating impedance, or load resistance presented to the modulator by the modulated r.f. amplifier, is equal to

$$Z_m = \frac{E_b}{I_p} \times 1000 \text{ ohms}$$

where  $E_b$  = D.c. plate voltage

$I_p$  = D.c. plate current (ma.)

$E_b$  and  $I_p$  are measured without modulation.

The power output of the r.f. amplifier must vary as the square of the instantaneous plate voltage (the r.f. output voltage must be proportional to the plate voltage) for the modulation to be linear. This will be the case when the amplifier operates under Class C conditions. The linearity depends upon having sufficient grid excitation and proper bias, and upon the adjustment of circuit constants to the proper values.

**Adjustment of Plate-Modulated Amplifiers**

The general operating conditions for Class C operation are described in the chapter on transmitters. The grid bias and grid current required



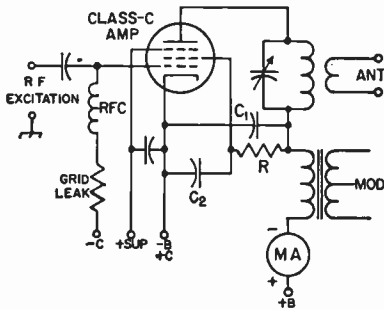

Fig. 8-35—Plate and screen modulation of a Class C r.f. amplifier using a screen-grid tube. The plate r.f. bypass capacitor,  $C_1$ , should have reasonably high reactance at all audio frequencies; a value of 0.001 to 0.005  $\mu\text{f.}$  is generally satisfactory. The screen bypass,  $C_2$ , should not exceed 0.002  $\mu\text{f.}$  in the usual case.

When the modulated amplifier is a beam tetrode the suppressor connection shown in this diagram may be ignored. If a base terminal is provided on the tube for the beam-forming plates, it should be connected as recommended by the tube manufacturer.

for plate modulation usually are given in the operating data supplied by the tube manufacturer; in general, the bias should be such as to give an operating angle of about 120 degrees at the d.c. plate voltage used, and the grid excitation should be great enough so that the amplifier's plate efficiency will stay constant when the plate voltage is varied over the range from zero to twice the unmodulated value. For best linearity, the grid bias should be obtained from a fixed-bias source of about the cut-off value, supplemented by enough grid-leak bias to bring the total up to the required operating bias.

The maximum permissible d.c. plate power input for 100 per cent modulation is twice the sine-wave audio-frequency power output available from the modulator. This input is obtained by varying the loading on the amplifier (keeping its tank circuit tuned to resonance) until the product of d.c. plate voltage and plate current is the desired power. The modulating impedance

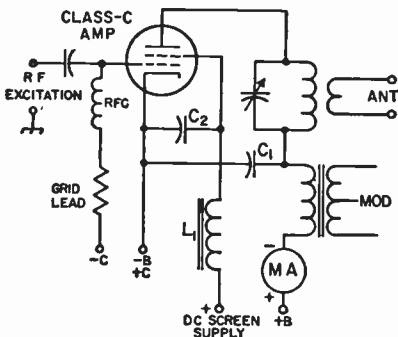

Fig. 8-36—Plate modulation of a beam tetrode, using an audio impedance in the screen circuit. The value of  $L_1$  discussed in the text. See Fig. 8-35 for data on bypass capacitors  $C_1$  and  $C_2$ .

under these conditions must be transformed to the proper value for the modulator by using the correct output-transformer turns ratio. This point is considered in detail in the chapter on modulator design.

Neutralization, when triodes are used, should be as nearly perfect as possible, since regeneration may cause nonlinearity. The amplifier also must be completely free from parasitic oscillations.

Although the total power input (d.c. plus audio-frequency a.c.) increases with modulation, the d.c. plate current of a plate-modulated amplifier should not change when the stage is modulated. This is because each increase in plate voltage and plate current is balanced by an equivalent decrease in voltage and current on the next half-cycle of the modulating wave. D.c. instruments cannot follow the a.f. variations, and since the average d.c. plate current and plate voltage of a properly operated amplifier do not change, neither do the meter readings. A change in plate current with modulation indicates nonlinearity. On the other hand, a thermocouple r.f. ammeter connected in the antenna or transmission line will show an increase in r.f. current with modulation, because instruments of this type respond to power rather than to current or voltage.

#### Screen-Grid Amplifiers

Screen-grid tubes of the pentode or beam-tetrode type can be used as Class C plate-modulated amplifiers by applying the modulation to both the plate and screen grid. The usual method of feeding the screen grid with the necessary d.c. and modulation voltages is shown in Fig. 8-35. The dropping resistor,  $R$ , should be of the proper value to apply normal d.c. voltage to the screen under steady carrier conditions. Its value can be calculated by taking the difference between plate and screen voltages and dividing it by the rated screen current.

The modulating impedance is found by dividing the d.c. plate voltage by the sum of the plate and screen currents. The plate voltage multiplied by the sum of the two currents gives the power input to be used as the basis for determining the audio power required from the modulator.

Modulation of the screen along with the plate is necessary because the screen voltage has a much greater effect on the plate current than the plate voltage does. The modulation characteristic is nonlinear if the plate alone is modulated. However, some beam tetrodes can be modulated satisfactorily by applying the modulating power to the plate circuit alone, provided the screen is connected to its d.c. supply through an audio impedance. Under these conditions the screen becomes self-modulating, because of the variations in screen current that occur when the plate voltage is varied. The circuit is shown in Fig. 8-36. The choke coil  $L_1$  is the audio impedance in the screen circuit; its inductance should be large enough to have a reactance (at the lowest desired audio frequency) that is not less than the impedance of the screen. The screen impedance

can be taken to be approximately equal to the d.c. screen voltage divided by the d.c. screen current in amperes.

**Choke-Coupled Modulator**

The choke-coupled Class A modulator is shown in Fig. 8-37. Because of the relatively low power output and plate efficiency of a Class A amplifier, this method is seldom used except for a few special applications. There is considerably less freedom in adjustment, since no transformer is available for matching impedances.

The modulating impedance of the r.f. amplifier must be adjusted to the value of load impedance required by the particular modulator tube used, and the power input to the r.f. stage should not exceed twice the rated a.f. power output of the modulator for 100 per cent modulation. The plate voltage on the modulator must be higher than the plate voltage on the r.f. amplifier, for

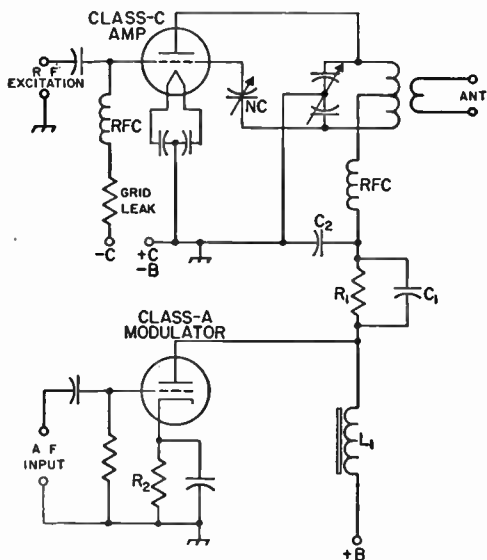

Fig. 8-37—Choke-coupled Class A modulator. The cathode resistor,  $R_2$ , should have the normal value for operation of the modulator tube as a Class A power amplifier. The modulation choke,  $L_1$ , should be 5 henrys or more. A value of 0.001 to 0.005  $\mu$ f. is satisfactory at  $C_2$ , the r.f. amplifier plate bypass capacitor. See text for discussion of  $C_1$  and  $R_1$ .

100 per cent modulation, because the a.f. voltage developed by the modulator cannot swing to zero without a great deal of distortion.  $R_1$  provides the necessary d.c. voltage drop between the modulator and r.f. amplifier. The d.c. voltage drop through  $R_1$  must equal the minimum instantaneous plate voltage on the modulator tube under normal operating conditions.  $C_1$ , an audio-frequency bypass across  $R_1$ , should have a capacitance such that its reactance at 100 cycles is not more than about one-tenth the resistance of  $R_1$ . Without  $R_1C_1$  the percentage of modulation is limited to 70 to 80 per cent in the average case.

**GRID MODULATION**

The principal disadvantage of plate modulation is that a considerable amount of audio power is necessary. This requirement can be avoided by applying the modulation to a grid element in the modulated amplifier. However, serious disadvantages of grid modulation are the reduction in the carrier power output obtainable from a given r.f. amplifier tube and the more rigorous operating requirements and more complicated adjustment.

The term "grid modulation" as used here applies to all types—control grid, screen, or suppressor—since the operating principles are exactly the same no matter which grid is actually modulated. With grid modulation the plate voltage is constant, and the increase in power output with modulation is obtained by making both the plate current and plate efficiency vary with the modulating signal as shown in Fig. 10-9. For 100 per cent modulation, both plate current and efficiency must, at the peak of the modulation up-swing, be twice their carrier values. Thus at the modulation-envelope peak the power input is doubled, and since the plate efficiency also is doubled at the same instant the peak envelope

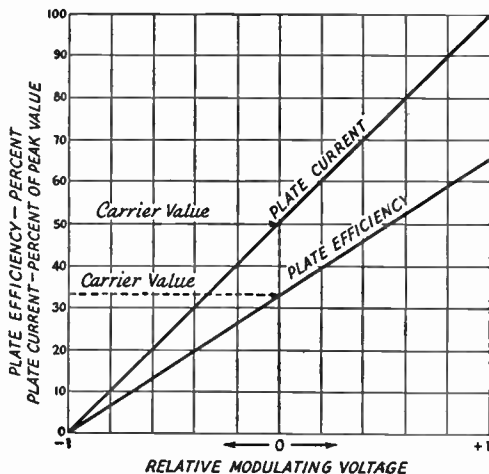

Fig. 8-38—In a perfect grid-modulated amplifier both plate current and plate efficiency would vary with the instantaneous modulating voltage as shown. When this is so the modulation characteristic is as given by curve A in Fig. 8-33, and the peak envelope output power is four times the unmodulated carrier power. The variations in plate current with modulation, indicated above, do not register on a d.c. meter, so the plate meter shows no change when the signal is modulated.

output power will be four times the carrier power. The efficiency obtainable at the envelope peak depends on how carefully the modulated amplifier is adjusted, and sometimes can be as high as 80 per cent. It is generally less when the amplifier is adjusted for good linearity, and under average conditions a round figure of  $\frac{2}{3}$ , or 66

per cent, is representative. The efficiency without modulation is only half the peak efficiency, or about 33 per cent. This low average efficiency reduces the permissible carrier output to about one-fourth the power obtainable from the same tube in c.w. operation, and to about one-third the carrier output obtainable from the tube with plate modulation.

The modulator is required to furnish only the audio power dissipated in the modulated grid under the operating conditions chosen. A speech amplifier capable of delivering 3 to 10 watts is usually sufficient.

Grid modulation does not give quite as linear a modulation characteristic as plate modulation, even under optimum operating conditions. When misadjusted the nonlinearity may be severe, resulting in bad distortion and splatter.

### Plate-Circuit Operating Conditions

The d.c. plate power input to the grid-modulated amplifier, assuming a round figure of  $\frac{1}{2}$  (33 per cent) for the plate efficiency, should not exceed  $1\frac{1}{2}$  times the plate dissipation rating of the tube or tubes used in the modulated stage. Use the maximum plate voltage permitted by the manufacturer's ratings, because the optimum operating conditions are more easily achieved with high plate voltage and the linearity also is improved.

Example: Two tubes having plate dissipation ratings of 55 watts each are to be used with grid modulation.

The maximum permissible power input, at 33% efficiency, is

$$P = 1.5 \times (2 \times 55) = 1.5 \times 110 = 165 \text{ watts}$$

The maximum recommended plate voltage for these tubes is 1500 volts. Using this figure, the average plate current for the two tubes will be

$$I = \frac{P}{E} = \frac{165}{1500} = 0.11 \text{ amp.} = 110 \text{ ma.}$$

At 33% efficiency, the carrier output to be expected is 55 watts.

The plate-voltage/plate-current ratio at twice carrier plate current is

$$\frac{1500}{220} = 6.8$$

The tank-circuit  $L/C$  ratio should be chosen on the basis of twice the average or carrier plate current. If the  $L/C$  ratio is based on the plate voltage/plate current ratio under carrier conditions the  $Q$  may be too low for good coupling to the output circuit.

### Screen Grid Modulation

Screen modulation is probably the simplest form of grid modulation and the least critical of adjustment. The most satisfactory way to apply the modulating voltage to the screen is through a transformer, as shown in Fig. 8-39. With practical tubes it is necessary to drive the screen somewhat negative with respect to the cathode to get complete cut-off of r.f. output. For this reason the peak modulating voltage required for 100 per cent modulation is usually 10 per cent or so greater than the d.c. screen voltage. The latter, in turn, is approximately half the rated screen voltage recommended by the manufacturer under

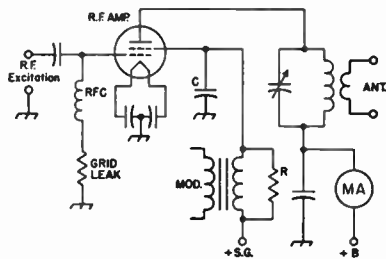

Fig. 8-39—Screen-grid modulation of beam tetrode. Copocitor C is on r.f. bypass capacitor and should have high reactance of audio frequencies. A value of 0.002  $\mu$ f. is satisfactory. The grid leak can have the same value that is used for c.w. operation of the tube.

maximum ratings for radiotelegraph operation.

The audio power required for 100 per cent modulation is approximately one-fourth the d.c. power input to the screen in c.w. operation, but varies somewhat with the operating conditions. A receiving-type audio power amplifier will suffice as the modulator for most transmitting tubes. The relationship between screen voltage and screen current is not linear, which means that the load on the modulator varies over the audio-frequency cycle. It is therefore highly advisable to use negative feedback in the modulator circuit. If excess audio power is available, it is also advisable to load the modulator with a resistance ( $R$  in Fig. 8-39) its value being adjusted to dissipate the excess power. There is no simple way to determine the proper resistance except experimentally, by observing its effect on the modulation envelope with the aid of an oscilloscope.

On the assumption that the modulator will be fully loaded by the screen plus the additional load resistor  $R$ , the turns ratio required in the coupling transformer may be calculated as follows:

$$N = \frac{E_d}{2.5\sqrt{PR_L}}$$

where  $N$  is the turns ratio, secondary to primary;  $E_d$  is the rated screen voltage for c.w. operation;  $P$  is the rated audio power output of the modulator; and  $R_L$  is the rated load resistance for the modulator.

### Adjustment

A screen-modulated amplifier should be adjusted with the aid of an oscilloscope connected to give a trapezoid pattern (see later in chapter). A tone source for modulating the transmitter is a convenience, since a steady tone will give a steady pattern on the oscilloscope. A steady pattern is easier to study than one that flickers with voice modulation.

Having determined the permissible carrier plate current as previously described, apply r.f. excitation and d.c. plate and screen voltages. Without modulation, adjust the plate loading to give the required plate current, keeping the plate

tank circuit tuned to resonance. Next, apply modulation and increase the modulating voltage until the modulation characteristic shows curvature (see later in this chapter for use of the oscilloscope). If curvature occurs well below 100 per cent modulation, the plate efficiency is too high at the carrier level. Increase the plate loading slightly and readjust the r.f. grid excitation to maintain the same plate current; then apply modulation and check the characteristic again. Continue until the characteristic is as linear as possible from zero to twice the carrier amplitude.

In general, the amplifier should be heavily loaded. Under proper operating conditions the plate-current dip as the amplifier plate circuit is tuned through resonance will be little more than just discernible. Operate with the grid current as low as possible, since this reduces the screen current and thus reduces the amount of power required from the modulator.

With proper adjustment the linearity is good up to about 90 per cent modulation. When the screen is driven negative for 100 per cent modulation there is a kink in the modulation characteristic at the zero-voltage point. This introduces a small amount of envelope distortion. The kink can be removed and the over-all linearity improved by applying a small amount of modulating voltage to the control grid simultaneously with screen modulation.

In an alternative adjustment method not requiring an oscilloscope the r.f. amplifier is first tuned up for maximum output without modulation and the rated d.c. screen voltage (from a fixed-voltage supply) for c.w. operation applied. Use heavy loading and reduce the grid excitation until the output just starts to fall off, at which point the resonance dip in plate current should be small. Note the plate current and, if possible,

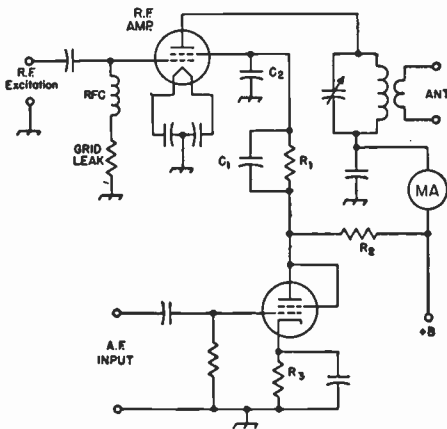

Fig. 8-40—Screen modulation by a "clamp" tube. The grid leak is the normal value for c.w. operation and  $C_2$  should be 0.002  $\mu\text{f.}$  or less. See text for discussion of  $C_1$ ,  $R_1$ ,  $R_2$  and  $R_3$ .  $R_2$  should have the proper value for Class A operation of the modulator tube, but cannot be calculated unless triode curves for the tube are available.

the r.f. output current, and then reduce the d.c. screen voltage until the plate current is one-half its previous value. The r.f. output current should also be one-half its previous value at this screen voltage. The amplifier is then ready for modulation, and the modulating voltage may be increased until the plate current just starts to shift upward, which indicates that the amplifier is modulated 100 per cent. With voice modulation the plate current should remain steady, or show just an occasional small upward kick on intermittent peaks.

### "Clamp-Tube" Modulation

A method of screen-grid modulation that is convenient in transmitters provided with a screen protective tube ("clamp" tube) is shown in Fig. 8-40. An audio-frequency signal is applied to the grid of the clamp tube, which then becomes a modulator. The simplicity of the circuit is somewhat deceptive, since it is considerably more difficult from a design standpoint than the transformer-coupled arrangement of Fig. 8-39.

For proper modulation the clamp tube must be operated as a triode Class A amplifier; the method is essentially identical with the choke-coupled Class A plate modulator of Fig. 8-37 except that a resistance,  $R_2$ , is substituted for the choke.  $R_2$ , in the usual case, is the screen dropping resistor normally used for c.w. operation. Its value should be at least two or three times the load resistance required by the Class A modulator tube for optimum audio-frequency output.

Like the choke-coupled modulator, the clamp-tube modulator is incapable of modulating the r.f. stage 100 per cent unless the dropping resistor,  $R_1$ , and audio bypass,  $C_1$ , are incorporated in the circuit. The same design considerations hold, with the addition of the fact that the screen must be driven negative, not just to zero voltage, for 100 per cent modulation. The modulator tube must thus be operated at a voltage ranging from 20 to 40 per cent higher than the modulated screen.

Adjustment with this system, once the design voltages have been determined, is carried out in the same way as with transformer-coupled screen modulation, preferably with the oscilloscope. Without the oscilloscope, the amplifier may first be adjusted for c.w. operation as described earlier, but with the modulator tube removed from its socket. The modulator is then replaced, and the cathode resistance,  $R_3$ , adjusted to reduce the amplifier plate current to one-half its c.w. value. The amplifier plate current should remain constant with modulation, or show just a small upward flicker on occasional voice peaks.

### Controlled Carrier

As explained earlier, a limit is placed on the output obtainable from a grid-modulation system by the low r.f. amplifier plate efficiency (approximately 33 per cent) under unmodulated carrier conditions. The plate efficiency increases with modulation, since the output increases while the d.c. input remains constant, and reaches a maxi-



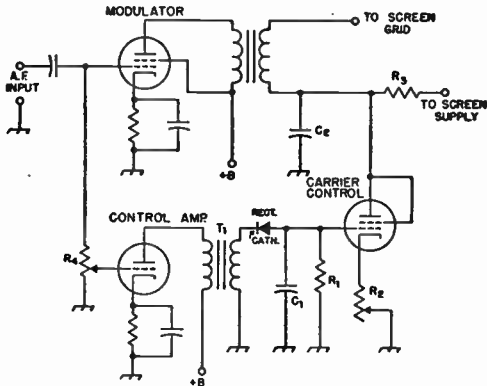

Fig. 8-41—Circuit for carrier control with screen modulation. A small triode such as the 6C4 can be used as the control amplifier and a 6Y6G is suitable as a carrier-control tube.  $T_1$  is an interstage audio transformer having a 1-to-1 or larger turns ratio.  $R_4$  is a 0.5-megohm volume control and also serves as the grid resistor for the modulator. A germanium crystal may be used as the rectifier. Other values are discussed in the text.

imum in the neighborhood of 50 per cent with 100 per cent sine-wave modulation. If the power input to the amplifier can be reduced during periods when there is little or no modulation, thus reducing the plate loss, advantage can be taken of the higher efficiency at full modulation to obtain higher effective output. This can be done by varying the d.c. power input to the modulated stage in accordance with *average* variations in voice intensity, in such a way as to maintain just sufficient carrier power to keep the modulation high, but not exceeding 100 per cent, under all conditions. Thus the carrier amplitude is controlled by the average voice intensity. Properly utilized, controlled carrier permits increasing the carrier output at maximum level to a value about equal to the rated plate dissipation of the tube, twice the output obtainable with constant carrier.

It is desirable to control the power input just enough so that the plate loss, without modulation, is safely below the tube rating. Excessive control is disadvantageous because the distant receiver's a.v.c. system must continually follow the variations in average signal level. The circuit of Fig. 8-41 permits adjustment of both the maximum and minimum power input, and although somewhat more complicated than some circuits that have been used is actually simpler to operate because it separates the functions of modulation and carrier control. A portion of the audio voltage at the modulator grid is applied to a Class A "control amplifier" which drives a rectifier circuit to produce a d.c. voltage negative with respect to ground.  $C_1$  filters out the audio variations, leaving a d.c. voltage proportional to the average voice level. This voltage is applied to the grid of a "clamp" tube to control the d.c. screen voltage and thus the r.f. carrier level. Maximum output is obtained when the carrier-

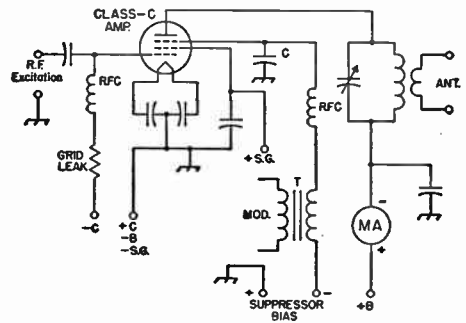

Fig. 8-42—Suppressor-grid modulation of an r.f. amplifier using a pentode-type tube. The suppressor-grid r.f. bypass capacitor,  $C$ , should be the same as the grid bypass capacitor in control-grid modulation.

control tube grid is driven to cut-off, the voice level at which this occurs being determined by the setting of  $R_4$ . The input without modulation is set to the desired level (usually about equal to the plate dissipation rating of the modulated stage) by adjusting  $R_2$ .  $R_3$  may be the normal screen-dropping resistor for the modulated beam tetrode, but in case a separate screen supply is used the resistance need be just large enough to give sufficient voltage drop to reduce the no-modulation power input to the desired value.

$C_1R_1$  and  $C_2R_3$  should have a time constant of about 0.1 second. An oscilloscope is required for proper adjustment.

### Suppressor Modulation

Pentode-type tubes do not, in general, modulate well when the modulating voltage is applied to the screen grid. However, a satisfactory modulation characteristic can be obtained by applying the modulation to the suppressor grid. The circuit arrangement for suppressor-grid modulation of a pentode tube is shown in Fig. 8-42.

The method of adjustment closely resembles that used with screen-grid modulation. If an oscilloscope is not available, the amplifier is first adjusted for optimum c.w. output with zero bias on the suppressor grid. Sufficient negative bias is then applied to the suppressor to drop the plate current and r.f. output current to half their original values. The amplifier is then ready for modulation.

Since the suppressor is always negatively biased, the modulator is not required to furnish any power and a voltage amplifier can be used. The suppressor bias will vary with the type of pentode and the operating conditions, but usually will be of the order of  $-100$  volts. The peak a.f. voltage required from the modulator is equal to the suppressor bias.

### Control-Grid Modulation

Although control-grid modulation may be used with any type of r.f. amplifier tube, it is seldom used with tetrodes and pentodes because screen or suppressor modulation is generally





## CATHODE MODULATION

## Circuit

The fundamental circuit for cathode modulation is shown in Fig. 8-44. It is a combination of the plate and grid methods, and permits a carrier efficiency midway between the two. Audio power is introduced in the cathode circuit, and both grid bias and plate voltage are modulated.

Because part of the modulation is by the control-grid method, the plate efficiency of the modulated amplifier must vary during modulation. The carrier efficiency therefore must be lower than the efficiency at the modulation peak. The required reduction in efficiency depends upon the proportion of grid modulation to plate modulation; the higher the percentage of plate modulation, the higher the permissible carrier efficiency, and vice versa. The audio power required from the modulator also varies with the percentage of plate modulation, being greater as this percentage is increased.

The way in which the various quantities vary is illustrated by the curves of Fig. 10-16. In these curves the performance of the cathode-modulated r.f. amplifier is plotted in terms of the tube ratings for plate-modulated telephony, with the percentage of plate modulation as a base. As the percentage of plate modulation is decreased, it is assumed that the grid modulation is increased to make the over-all modulation reach 100 per cent. The limiting condition, 100 per cent plate modulation and no grid modulation, is at the right (*A*); pure grid modulation is represented by the left-hand ordinate (*B* and *C*).

## Modulating Impedance

The modulating impedance of a cathode-modulated amplifier is approximately equal to

$$m \frac{E_b}{I_b}$$

where  $m$  = Percentage of plate modulation (expressed as a decimal)

$E_b$  = D.c. plate voltage on modulated amplifier

$I_b$  = D.c. plate current of modulated amplifier

The modulating impedance is the load into which the modulator must work, just as in the case of pure plate modulation. This load must be matched to the load required by the modulator tubes by proper choice of the turns ratio of the modulation transformer.

## Conditions for Linearity

R.f. excitation requirements for the cathode-modulated amplifier are midway between those for plate modulation and control-grid modulation. More excitation is required as the percentage of plate modulation is increased. Grid bias should be considerably beyond cut-off; fixed bias from a supply having good voltage regulation is preferred, especially when the percentage of plate modulation is small and the amplifier is operating more nearly like a grid-bias modulated stage. At the higher percentages of plate modulation a combination of fixed and grid-leak bias can be used, since the variation in rectified grid current is smaller. The grid leak should be bypassed for audio frequencies. The percentage of grid modulation may be regulated by choice of a suitable tap on the modulation-transformer secondary.

The cathode circuit of the modulated stage must be independent of other stages in the transmitter. When directly heated tubes are modulated their filaments must be supplied from a separate transformer. The filament bypass capacitors should not be larger than about 0.002  $\mu$ f., to avoid bypassing the a.f. modulation.

In most respects, the adjustment procedure is similar to that for grid-bias modulation. The critical adjustments are antenna loading, grid bias, and excitation.

Adjustments should be made with the aid of an oscilloscope connected in the same way as for grid-bias modulation. With proper antenna loading and excitation, the normal wedge-shaped pattern will be obtained at 100 per cent modulation. As in the case of grid-bias modulation, too light antenna loading will cause flattening of the upward peaks of modulation as also will too high excitation. The cathode current will be practically constant with or without modulation under the proper operating conditions.

## FREQUENCY AND PHASE MODULATION

It is possible to convey intelligence by modulating any property of a carrier, including its frequency and phase. When the frequency of the carrier is varied in accordance with the variations in a modulating signal, the result is **frequency modulation (f.m.)**. Similarly, varying the phase of the carrier current is called **phase modulation (p.m.)**.

Frequency and phase modulation are not independent, since the frequency cannot be varied without also varying the phase, and vice versa. The difference is largely a matter of definition.

The effectiveness of f.m. and p.m. for communication purposes depends almost entirely on the receiving methods. If the receiver will respond to frequency and phase changes but is insensitive to amplitude changes, it will discriminate against most forms of noise, particularly impulse noise such as is set up by ignition systems and other sparking devices. Special methods of detection are required to accomplish this result.

Modulation methods for f.m. and p.m. are simple and require practically no audio power.

There is also the advantage that, since there is no amplitude variation in the signal, interference to broadcast reception resulting from rectification of the transmitted signal in the audio circuits of the BC receiver is substantially eliminated. These two points represent the principal

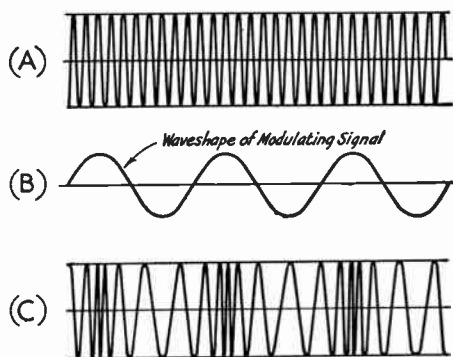

Fig. 8-46—Graphical representation of frequency modulation. In the unmodulated carrier at A, each r.f. cycle occupies the same amount of time. When the modulating signal, B, is applied, the radio frequency is increased and decreased according to the amplitude and polarity of the modulating signal.

reasons for the use of f.m. and p.m. in amateur work.

### Frequency Modulation

Fig. 8-46 is a representation of frequency modulation. When a modulating signal is applied, the carrier frequency is increased during one half-cycle of the modulating signal and decreased during the half-cycle of opposite polarity. This is indicated in the drawing by the fact that the r.f. cycles occupy less time (higher frequency) when the modulating signal is positive, and more time (lower frequency) when the modulating signal is negative. The change in the carrier frequency (frequency deviation) is proportional to the instantaneous amplitude of the modulating signal, so the deviation is small when the instantaneous amplitude of the modulating signal is small, and is greatest when the modulating signal reaches its peak, either positive or negative.

As shown by the drawing, the amplitude of the signal does not change during modulation.

### Phase Modulation

If the phase of the current in a circuit is changed there is an instantaneous frequency change during the time that the phase is being shifted. The amount of frequency change, or deviation, depends on how rapidly the phase shift is accomplished. It is also dependent upon the total amount of the phase shift. In a properly operating p.m. system the amount of phase shift is proportional to the instantaneous amplitude of the modulating signal. The rapidity of the phase shift is directly proportional to the frequency of the modulating signal. Conse-

quently, the frequency deviation in p.m. is proportional to both the amplitude and frequency of the modulating signal. The latter represents the outstanding difference between f.m. and p.m., since in f.m. the frequency deviation is proportional only to the amplitude of the modulating signal.

### Modulation Depth

Percentage of modulation in f.m. and p.m. has to be defined differently than for a.m. Practically, "100 per cent modulation" is reached when the transmitted signal occupies a channel just equal to the bandwidth for which the receiver is designed. If the frequency deviation is greater than the receiver can accept, the receiver distorts the signal. However, on another receiver designed for a different bandwidth the same signal might be equivalent to only 25 per cent modulation.

In amateur work "narrow-band" f.m. or p.m. (frequently abbreviated n.f.m.) is defined as having the same channel width as a properly modulated a.m. signal. That is, the effective channel width does not exceed twice the highest audio frequency in the modulating signal. N.f.m. transmissions based on an upper audio limit of 3000 cycles therefore should occupy a channel not significantly wider than 6 kc.

### F.M. and P.M. Sidebands

The sidebands set up by f.m. and p.m. differ from those resulting from a.m. in that they occur at integral multiples of the modulating frequency on either side of the carrier rather than, as in a.m., consisting of a single set of side frequencies for each modulating frequency. An f.m. or p.m. signal therefore inherently occupies a wider channel than a.m.

The number of "extra" sidebands that occur in f.m. and p.m. depends on the relationship between the modulating frequency and the frequency deviation. The ratio between the frequency deviation, in cycles per second, and the modulating frequency, also in cycles per second, is called the modulation index. That is,

$$\text{Modulation index} = \frac{\text{Carrier frequency deviation}}{\text{Modulating frequency}}$$

*Example:* The maximum frequency deviation in an f.m. transmitter is 3000 cycles either side of the carrier frequency. The modulation index when the modulating frequency is 1000 cycles is

$$\text{Modulation index} = \frac{3000}{1000} = 3$$

At the same deviation with 3000-cycle modulation the index would be 1; at 100 cycles it would be 30, and so on.

In p.m. the modulation index is constant regardless of the modulating frequency; in f.m. it varies with the modulating frequency, as shown in the above example. In an f.m. system the ratio of the maximum carrier-frequency deviation to the highest modulating frequency used is called the deviation ratio.

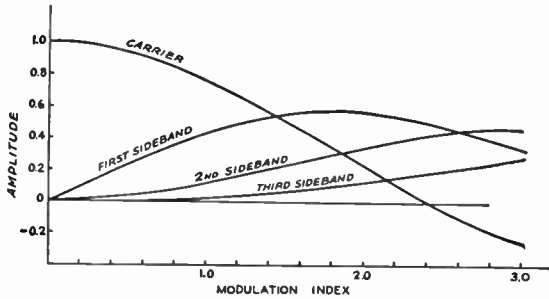

Fig. 8-47—How the amplitude of the pairs of sidebands varies with the modulation index in an f.m. or p.m. signal. If the curves were extended for greater values of modulation index it would be seen that the carrier amplitude goes through zero at several points. The same statement also applies to the sidebands.

Fig. 8-47 shows how the amplitudes of the carrier and the various sidebands vary with the modulation index. This is for single-tone modulation; the first sideband (actually a pair, one above and one below the carrier) is displaced from the carrier by an amount equal to the modulating frequency, the second is twice the modulating frequency away from the carrier, and so on. For example, if the modulating frequency is 2000 cycles and the carrier frequency is 29,500 kc., the first sideband pair is at 29,498 kc. and 29,502 kc., the second pair is at 29,496 kc. and 29,504 kc., the third at 29,494 kc. and 29,506 kc., etc. The amplitudes of these sidebands depend on the modulation index, not on the frequency deviation.

Note that, as shown by Fig. 8-47, the carrier strength varies with the modulation index. (In amplitude modulation the carrier strength is constant; only the sideband amplitude varies.) At a modulation index of approximately 2.4 the carrier disappears entirely. It then becomes "negative" at a higher index, meaning that its phase is reversed as compared to the phase without modulation. In f.m. and p.m. the energy that goes into the sidebands is taken from the carrier, the total power remaining the same regardless of the modulation index.

Since there is no change in amplitude with modulation, an f.m. or p.m. signal can be amplified without distortion by an ordinary Class C amplifier. The modulation can take place in a very low-level stage and the signal can then be amplified by either frequency multipliers or straight amplifiers.

If the modulated signal is passed through one or more frequency multipliers, the modulation index is multiplied by the same factor that the carrier frequency is multiplied. For example, if modulation is applied on 3.5 Mc. and the final output is on 28 Mc. the total frequency multiplication is 8 times, so if the frequency deviation is 500 cycles at 3.5 Mc. it will be 4000 cycles at 28 Mc. Frequency multiplication offers a means for obtaining practically any desired amount of frequency deviation, whether or not the modulator itself is capable of giving that much deviation without distortion.

#### Narrow-Band F.M. and P.M.

"Narrow-band" f.m. or p.m., the only type that is authorized by FCC for use on the lower frequencies where the phone bands are crowded,

is defined as f.m. or p.m. that does not occupy a wider channel than an a.m. signal having the same audio modulating frequencies.

If the modulation index (with single-tone modulation) does not exceed 0.6 or 0.7, the most important extra sideband, the second, will be at least 20 db. below the unmodulated carrier level, and this should represent an effective channel width about equivalent to that of an a.m. signal. In the case of speech, a somewhat higher modulation index can be used. This is because the energy distribution in a complex wave is such that the modulation index for any one frequency component is reduced, as compared to the index with a sine wave having the same peak amplitude as the voice wave.

The chief advantage of narrow-band f.m. or p.m. for frequencies below 30 Mc. is that it eliminates or reduces certain types of interference to broadcast reception. Also, the modulating equipment is relatively simple and inexpensive. However, assuming the same unmodulated carrier power in all cases, narrow-band f.m. or p.m. is not as effective as a.m. *with the methods of reception used by most amateurs.* As shown by Fig. 8-47, at an index of 0.6 the amplitude of the first sideband is about 25 per cent of the unmodulated-carrier amplitude; this compares with a sideband amplitude of 50 per cent in the case of a 100 per cent modulated a.m. transmitter. When copied on an a.m. receiver, a narrow-band f.m. or p.m. transmitter is about equivalent to a 100 per cent modulated a.m. transmitter operating at one-fourth the carrier power. On a suitable (f.m.) receiver, f.m. is as good or better than a.m., watt for watt.

#### Comparison of F.M. and P.M.

Frequency modulation cannot be applied to an amplifier stage, but phase modulation can; p.m. is therefore readily adaptable to transmitters employing oscillators of high stability such as the crystal-controlled type. The amount of phase shift that can be obtained with good linearity is such that the maximum practicable modulation index is about 0.5. Because the phase shift is proportional to the modulating frequency, this index can be used only at the highest frequency present in the modulating signal, assuming that all frequencies will at one time or another have equal amplitudes. Taking 3000 cycles as a suitable upper limit for voice work, and setting the modulation index at 0.5 for 3000



cycles, the frequency response of the speech-amplifier system above 3000 cycles must be sharply attenuated, to prevent sideband splatter. Also, if the "tinny" quality of p.m. as received on an f.m. receiver is to be avoided, the p.m. must be changed to f.m., in which the modulation index decreases in inverse proportion to the modulating frequency. This requires shaping the speech-amplifier frequency-response curve in such a way that the output voltage is inversely proportional to frequency over most of the voice range. When this is done the maximum modulation index can only be used at some relatively low audio frequency, perhaps 300 to 400 cycles in voice transmission, and must decrease in proportion to the increase in fre-

quency. The result is that the maximum linear frequency deviation is only one or two hundred cycles, when p.m. is changed to f.m. To increase the deviation for n.f.m. requires a frequency multiplication of 8 times or more.

It is relatively easy to secure a fairly large frequency deviation when a self-controlled oscillator is frequency-modulated directly. (True frequency modulation of a crystal-controlled oscillator results in only very small deviations and so requires a great deal of frequency multiplication.) The chief problem is to maintain a satisfactory degree of carrier stability, since the greater the inherent stability of the oscillator the more difficult it is to secure a wide frequency swing with linearity.

## METHODS OF FREQUENCY AND PHASE MODULATION

A simple and satisfactory device for producing f.m. in the amateur transmitter is the reactance modulator. This is a vacuum tube connected to the r.f. tank circuit of an oscillator in such a way as to act as a variable inductance or capacitance.

Fig. 8-48 is a representative circuit. The control grid of the modulator tube,  $V_2$ , is connected across the oscillator tank circuit,  $C_1L_1$ , through resistor  $R_1$  and blocking capacitor  $C_2$ .  $C_8$  represents the input capacitance of the modulator tube. The resistance of  $R_1$  is made large compared to the reactance of  $C_8$ , so the r.f. current through  $R_1C_8$  will be practically in phase with the r.f. voltage appearing at the terminals of the tank circuit. However, the voltage across  $C_8$  will lag the current by 90 degrees. The r.f. current in the plate circuit of the modulator will be in phase with the grid voltage, and consequently is 90 degrees behind the current through  $C_8$ , or 90 degrees behind the r.f. tank voltage. This lagging current is drawn through the oscillator tank, giving the same effect as though an inductance were connected across the tank. The frequency increases in proportion to the amplitude of the lagging plate current of the modulator. The audio voltage, introduced through a radio-frequency choke,  $RFC_1$ , varies the transconductance of the tube and thereby varies the r.f. plate current.

The modulated oscillator usually is operated on a relatively low frequency, so that a high order of carrier stability can be secured. Frequency multipliers are used to raise the frequency to the final frequency desired.

A reactance modulator can be connected to a crystal oscillator as well as to the self-controlled type. However, the resulting signal is more phase-modulated than it is frequency-modulated, for the reason that the frequency deviation that can be secured by varying the tuning of a crystal oscillator is quite small.

The sensitivity of the modulator (frequency change per unit change in grid voltage) depends on the transconductance of the modulator tube.

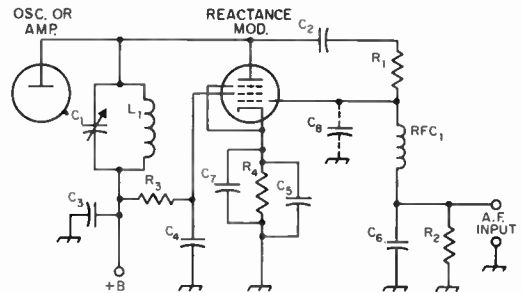

Fig. 8-48—Reactance modulator using a high-transconductance pentode (6BA6, 6CL6, etc.).

- $C_1$ —R.f. tank capacitance (see text).
- $C_2, C_3$ —0.001- $\mu$ f. mica.
- $C_4, C_5, C_6$ —0.0047- $\mu$ f. mica.
- $C_7$ —10- $\mu$ f. electrolytic.
- $C_8$ —Tube input capacitance.
- $R_1$ —47,000 ohms.
- $R_2$ —0.47 megohm.
- $R_3$ —Screen dropping resistor; to give proper screen voltage on modulator tube.
- $R_4$ —Cathode bias resistor; Class-A operation.
- $L_1$ —R.f. tank inductance.
- $RFC_1$ —2.5-mh. r.f. choke.

It increases when  $R_1$  is made smaller in comparison with  $C_8$ . It also increases with an increase in  $L/C$  ratio in the oscillator tank circuit. However, for highest carrier stability it is desirable to use the largest tank capacitance that will permit the desired deviation to be secured while keeping within the limits of linear operation.

A change in any of the voltages on the modulator tube will cause a change in r.f. plate current, and consequently a frequency change. Therefore it is advisable to use a regulated power supply for both modulator and oscillator. At the low voltage used (250 volts or less) the required stabilization can be secured by means of gaseous regulator tubes.



### Speech Amplification

The speech amplifier preceding the modulator follows ordinary design, except that no power is taken from it and the a.f. voltage required by the modulator grid usually is small — not more than 10 or 15 volts, even with large modulator tubes. Because of these modest requirements, only a few speech stages are needed; a two-stage amplifier consisting of a pentode followed by a triode, both resistance-coupled, will more than suffice for crystal microphones.

### PHASE MODULATION

The same type of reactance-tube circuit that is used to vary the tuning of the oscillator tank in f.m. can be used to vary the tuning of an amplifier tank and thus vary the phase of the tank current for p.m. Hence the modulator circuit of Fig. 8-48 can be used for p.m. if the reactance tube works on an amplifier tank instead of directly on a self-controlled oscillator.

The phase shift that occurs when a circuit is detuned from resonance depends on the amount of detuning and the  $Q$  of the circuit. The higher the  $Q$ , the smaller the amount of detuning needed to secure a given number of degrees of phase shift. If the  $Q$  is at least 10, the relationship between phase shift and detuning (in kilocycles either side of the resonant frequency) will be substantially linear over a phase-shift range of about 25 degrees. From the standpoint of modulator sensitivity, the  $Q$  of the tuned circuit on which the modulator operates should

be as high as possible. On the other hand, the effective  $Q$  of the circuit will not be very high if the amplifier is delivering power to a load since the load resistance reduces the  $Q$ . There must therefore be a compromise between modulator sensitivity and r.f. power output from the modulated amplifier. An optimum figure for  $Q$  appears to be about 20; this allows reasonable loading of the modulated amplifier and the necessary tuning variation can be secured from a reactance modulator without difficulty. It is advisable to modulate at a low power level, as in a stage where receiving-type tubes are used.

Reactance modulation of an amplifier stage usually also results in simultaneous amplitude modulation because the modulated stage is detuned from resonance as the phase is shifted. This must be eliminated by feeding the modulated signal through an amplitude limiter or one or more "saturating" stages — that is, amplifiers that are operated Class C and driven hard enough so that variations in the amplitude of the grid excitation produce no appreciable variations in the final output amplitude.

For the same type of reactance modulator, the speech-amplifier gain required is the same for p.m. as for f.m. However, as pointed out earlier, the fact that the actual frequency deviation increases with the modulating audio frequency in p.m. makes it necessary to cut off the frequencies above about 3000 cycles before modulation takes place. If this is not done, unnecessary sidebands will be generated at frequencies considerably away from the carrier.

# Single-Sideband Phone

A fully modulated a.m. signal has two-thirds of its power in the carrier and only one-third in the sidebands. The sidebands carry the intelligence to be transmitted; the carrier "goes along for the ride" and serves only to demodulate the signal at the receiver. By eliminating the carrier and transmitting only the sidebands or just one sideband, the available transmitter power is used to greater advantage. To recover the intelligence being transmitted, the carrier must be reinserted at the receiver, but this is no great problem with a proper detector circuit.

Assuming that the same final-amplifier tube or tubes are used either for normal a.m. or for single sideband, carrier suppressed, it can be shown that the use of s.s.b. can give an effective gain of up to 9 db. over a.m. — equivalent to increasing the transmitter power 8 times. Eliminating the carrier also eliminates the heterodyne interference that so often spoils communication in congested phone bands.

## DOUBLE-SIDEBAND GENERATORS

The carrier can be suppressed or nearly eliminated by an extremely sharp filter or by using a **balanced modulator**. The basic principle in any balanced modulator is to introduce the carrier in such a way that it does not appear in the output but so that the sidebands will. This requirement is satisfied by introducing the audio in push-pull and the r.f. drive in parallel, and connecting the output in push-pull. Balanced modulators can also be connected with the r.f. drive and audio inputs in push-pull and the output in parallel with equal effectiveness. The choice of a balanced modulator circuit is generally determined by constructional considerations and the method of modulation preferred by the builder. Vacuum-tube balanced modulators can be operated at high power levels and the double-sideband output can be used directly into the antenna. A d.s.b. signal can be copied by the same methods that are used for single-sideband signals, provided the receiver has sufficient selectivity to reject one of the sidebands.

In any balanced-modulator circuit there will be no output with no audio signal. When audio is applied, the balance is upset, and one branch will conduct more than the other. Since any modulation process is the same as "mixing" in receivers, sum and difference frequencies (sidebands) will be generated. The modulator is not balanced for the sidebands, and they will appear in the output.

In the rectifier-type balanced modulators

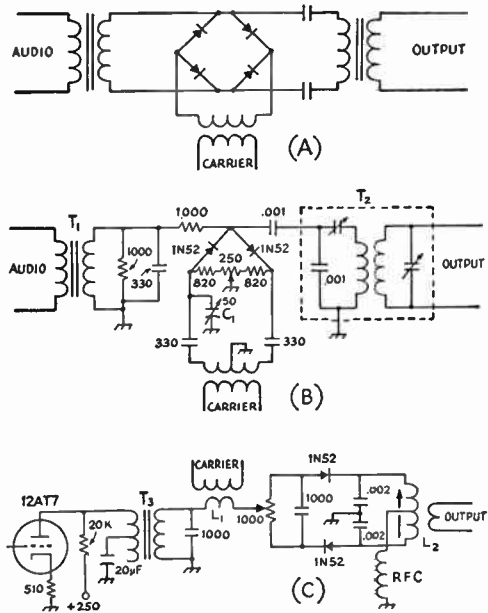

Fig. 9-1—Typical rectifier-type balanced modulators.

The circuit at A is called a "bridge" balanced modulator and has been widely used in commercial work.

The balanced modulator at B is shown with constants suitable for operation at 450 kc. It is useful for working into a crystal bandpass filter.  $T_1$  is a transformer designed to work from the audio source into a 600-ohm load, and  $T_2$  is an ordinary i.f. transformer with the trimmer reconnected in series with a 0.001- $\mu$ f. capacitor, for impedance-matching purposes from the modulator. The capacitor  $C_1$  is for carrier balance and may be found unnecessary in some instances—it should be tried connected on either side of the carrier input circuit and used where it is more effective. The 250-ohm potentiometer is normally all that is required for carrier balance. The carrier input should be sufficient to develop several volts across the resistor string.

The circuit at C is shown with constants suitable for operation at 3.9 Mc.  $T_3$  is a step-down output transformer (Stancor A3250, 10,000 to 200 ohms), shunt-fed to eliminate d.c. from the windings.  $L_1$  can be a small coupling coil wound on the "cold" end of the carrier-oscillator tank coil, with sufficient coupling to give two or three volts of r.f. across its output.  $L_2$  is a slug-tuned coil that resonates to the carrier frequency with the effective 0.001  $\mu$ f. across it. The 1000-ohm potentiometer is for carrier balance.

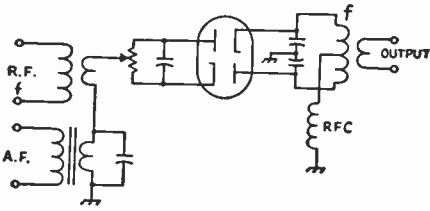

Fig. 9-2—A twin-diode balanced-modulator circuit. This is essentially the same as the circuit in Fig. 9-1C, and differs only in that a twin diode is used instead of dry rectifiers. The heater circuit for the twin diode can be connected in the usual way (one side grounded or center tap grounded).

shown in Fig. 9-1, the diode rectifiers are connected in such a manner that, if they have equal forward resistances, no r.f. can pass from the carrier source to the output circuit via either of the two possible paths. The net effect is that no r.f. energy appears in the output. When audio is applied, it unbalances the circuit by biasing the diode (or diodes) in one path, depending upon the instantaneous polarity of the audio, and hence some r.f. will appear in the output. The r.f. in the output will appear as a double-sideband suppressed-carrier signal. (For a more complete description of diode-modulator operation, see "Diode Modulators," *QST*, April, 1953, p. 39.)

In any diode modulator, the r.f. voltage should be at least 6 or 8 times the peak audio voltage, for minimum distortion. The usual operation involves a fraction of a volt of audio and several volts of r.f. The diodes should be matched as closely as possible — ohmmeter measurements of their forward resistances is the usual test.

(The circuit of Fig. 9-1B is described more fully in Weaver and Brown, "Crystal Lattice Filters for Transmitting and Receiving," *QST*, August, 1951. The circuit of Fig. 9-1C is suitable for use in a double-balanced-modulator circuit and is so described in "SSB, Jr.," *General Electric Ham News*, September, 1950.)

Vacuum-tube diodes can also be used in the two- and four-diode balanced-modulator circuits, and many operators consider them superior to the dry rectifier circuits. A typical balanced modulator circuit using a twin diode (6AL5, 6H6, etc.) is shown in Fig. 9-2. In phasing-type s.s.b. generators (described later) two of these modulators are required, and they are usually worked into a common output circuit. (For a description of a complete s.s.b. exciter using 6AL5 balanced modulators, see Vitale, "Cheap and Easy S.S.B.," *QST*, March, 1956, and May, 1958.)

Another form of balanced modulator uses the type 7360 "beam-deflection" tube, and it is capable of a high order of carrier suppression (60 db.) with good output (4 volts peak-to-peak) and low distortion (45 db.). A typical

application is shown in the s.s.b. generators described later in this chapter.

### SINGLE-SIDEBAND GENERATORS

Two basic systems for generating s.s.b. signals are shown in Fig. 9-3. One involves the use of a bandpass filter having sufficient selectivity to pass one sideband and reject the other. Inductor-capacitor filters having suitable characteristics can only be constructed for relatively low frequencies (below 1 Mc.). "Mechanical" filters are available in the same frequency range. From 0.2 to 10 Mc., good sideband rejection can be obtained with filters using four or more quartz crystals. Oscillator output at the filter frequency is combined with the audio signal in a balanced modulator, and only the upper and lower sidebands appear in the output. One of the sidebands is passed by the filter and the other rejected, so that an s.s.b. signal is fed to the mixer. The signal is there mixed with the output of a high-frequency r.f. oscillator to produce the desired output frequency. For additional amplification a linear r.f. amplifier (Class A or Class B) must be used. When the s.s.b. signal is generated around 500 kc. it may be necessary to convert twice to reach the operating frequency, since this simplifies the problem of rejecting the "image" frequencies resulting from the heterodyne process. The problem of image frequencies in the frequency conversions of s.s.b. signals differs from the problem in receivers because the beating-oscillator frequency becomes important. Either balanced modulators or sufficient selectivity must be used to attenuate these frequencies in the output and hence minimize the possibility of unwanted radiations. (Examples of filter-type exciters can be found in various issues of *QST* and in *Single Sideband for the Radio Amateur*.)

The second system is based on the phase relationships between the carrier and sidebands in a modulated signal. As shown in the diagram, the audio signal is split into two components that are identical except for a phase difference of 90 degrees. The output of the r.f. oscillator (which may be at the operating frequency, if desired) is likewise split into two separate components having a 90-degree phase difference. One r.f. and one audio component are combined in each of two separate balanced modulators. The carrier is suppressed in the modulators, and the relative phases of the sidebands are such that one sideband is balanced out and the other is augmented in the combined output. If the output from the balanced modulators is high enough, such an s.s.b. exciter can work directly into the antenna, or the power level can be increased in a following amplifier.

Properly adjusted, either system is capable of good results. Arguments in favor of the filter system are that it is somewhat easier to adjust without an oscilloscope, since it requires only a receiver and a v.t.v.m. for alignment, and it is more likely to remain in adjustment over a long period of time. The chief argument against it,

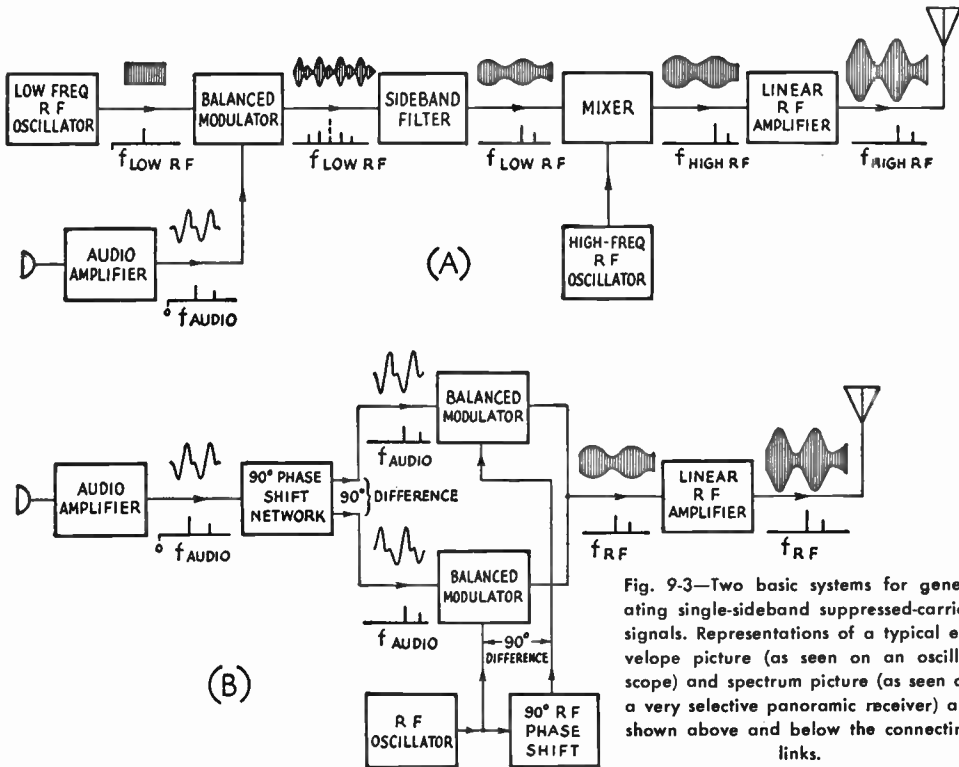

Fig. 9-3—Two basic systems for generating single-sideband suppressed-carrier signals. Representations of a typical envelope picture (as seen on an oscilloscope) and spectrum picture (as seen on a very selective panoramic receiver) are shown above and below the connecting links.

from the amateur viewpoint, is that it requires quite a few stages and at least one frequency conversion after modulation. The phasing system requires fewer stages and can be designed to require no frequency conversion, but its alignment and adjustment are often considered to be a little "trickier" than that of the filter system. This probably stems from lack of familiarity with the system rather than any actual difficulty, and now that commercial pre-adjusted audio-phasing networks are available,

most of the alignment difficulty has been eliminated. In most cases the phasing system will cost less to apply to an existing transmitter.

Regardless of the method used to generate a s.s.b. signal of 5 or 10 watts, the minimum cost will be found to be higher than for an a.m. transmitter of the same low power. However, as the power level is increased, the s.s.b. transmitter becomes more economical than the a.m. rig, both initially and from an operating standpoint.

## FILTER-TYPE S.S.B. EXCITERS

The basic configuration of a filter-type s.s.b. exciter was shown in Fig. 9-3. Suitable filters, sharp enough to reject the unwanted side frequencies a few hundred cycles and above from the carrier frequency, can be built in the range 20 kc. to 10 Mc. The low-frequency filters generally use iron-cored inductors, and the new toroid forms find considerable favor at frequencies up to 50 or 60 kc. These filters are of normal band-pass constant- $k$  and  $m$ -derived configuration. In the range 450 to 500 kc., either crystal-lattice or electro-mechanical filters are used. Low-frequency filters are manufactured by Barker & Williamson and by Burnell & Co., and electro-mechanical filters are made by the Collins Radio Co. Crystal filters are available from International Crystal and McCoy Electronics in the megacycles range; homemade

filters generally utilize war-surplus crystals.

The frequency of the filter determines how many conversions must be made before the operating frequency is reached. If the filter frequency is 30 kc. or so, it is wise to convert first to 500 or 600 kc. and then convert to the 3.9-Mc. band, to avoid the image that would almost surely result if the conversion from 30 to 3900 kc. were made without the intermediate step. When a filter at 500 kc. is used, only one conversion is necessary to operate in the 3.9-Mc. band, but 14-Mc. and higher-frequency operation would require at least two conversions to hold down the images (and local-oscillator signals if balanced mixers aren't used) and make them easy to eliminate.

The choice of converter circuit depends largely on the frequencies involved and the im-

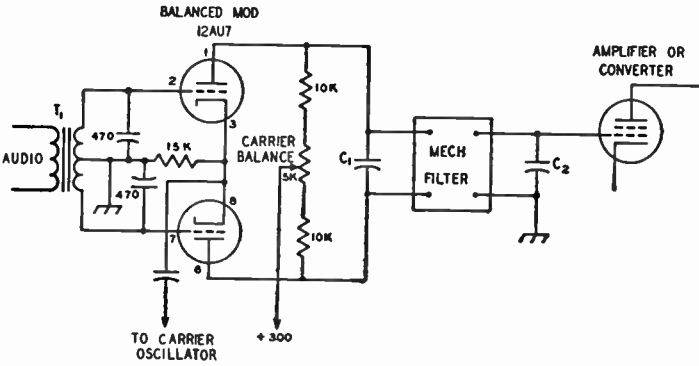

Fig. 9-4—One type of balanced-modulator circuit that can be used with a mechanical filter (Collins F455-31 or F500-31 series) in the i.f. range. The filters are furnished in various types of mountings, and the values of  $C_1$  and  $C_2$  will depend upon the type of filter selected.  
 $T_1$ —Plate-to-push-pull-grids audio transformer.

pedance level. At low frequencies (up to 500 kc.) and low impedances, rectifier-type balanced modulators are often used for mixers, because the balanced modulator does not show the local-oscillator frequency in its output and one source of spurious signal is minimized. At high impedance levels, and at the higher frequencies, vacuum tubes are generally used, in straight converter or balanced-modulator circuits, depending upon the need for minimizing the local-oscillator frequency in the output.

Sideband filters in the 30- to 50-kc. range are usually low-impedance devices, and rectifier-type balanced modulators are common practice. Sideband filters in the i.f. range are higher-impedance circuits and vacuum-tube balanced modulators are the rule in this case. An example of one that can be used with the high-impedance (15,000 ohms) mechanical filter is shown in Fig. 9-4. The filter can be followed by a converter or amplifier tube, depending upon the signal level. Some models of the mechanical filters have a 23-db. insertion loss, while others have only 10.

Crystal-lattice filters are also used to reject the unwanted sideband. These filters can be made from crystals in the i.f. range — many of these are still available from stores selling military surplus. A popular configuration is the "cascaded half lattice" shown in Fig. 9-5. The crystals used in this filter can be obtained at frequencies in the i.f. range, and ones that are within the ranges of the modified i.f. transformers will be satisfactory. Two 100- $\mu$ f. capacitors are connected across the secondary winding of two of the transformers to give push-pull output. The crystals should be obtained in pairs 1.8 kc. apart. The i.f. trans-

formers can be either capacitor-tuned as shown, or they can be slug-tuned.

A variable-frequency signal generator of some kind is required for alignment of the filter, but this can be nothing more elaborate than a shielded b.f.o. unit. The signal should be introduced at the balanced modulator, and an output indicator connected to the plate circuit of the vacuum tube following the filter. With the crystals out of the circuit, the transformers can be brought close to frequency by plugging in small capacitors (2 to 5  $\mu$ f.) in one crystal socket in each stage and then tuning the transformers for peak output at one of the two crystal frequencies. The small capacitors can then be removed and the crystals replaced in their sockets.

Tuning the signal source slowly across the pass band of the filter and watching the output indicator will show the selectivity characteristic of the filter. The objective is a fairly flat response for about two kc. and a rapid drop-off outside this range. It will be found that small changes in the tuning of the transformers will change the shape of the selectivity characteristic, so it is wise to make a small adjustment of one trimmer, swing the frequency across the band, and observe the characteristic. After a little experimenting it will be found which way the trimmers must be moved to compensate for the peaks that will rise when the filter is out of adjustment.

The (suppressed) carrier frequency must be adjusted so that it falls properly on the slope of the filter characteristic. If it is too close to the filter mid-frequency the sideband rejection will be poor; if it is too far away there will be a lack of "lows" in the signal.

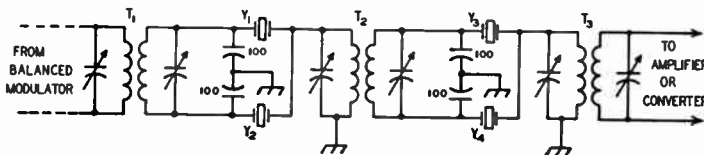

Fig. 9-5—A cascaded half-lattice crystal filter that can be used for sideband selection. The crystals are surplus type in FT-243A holders.  $Y_1$  and  $Y_3$  should be the same frequency and  $Y_2$  and  $Y_4$  should be 1.8 kc. higher.  $T_1, T_2, T_3$ —450-kc. i.f. transformers.



**AMPLIFICATION OF S.S.B. SIGNALS**

When an s.s.b. signal is generated at some frequency other than the operating frequency, it is necessary to change frequency by heterodyne methods. These are exactly the same as those used in receivers, and any of the normal mixer or converter circuits can be used. One exception to this is the case where the heterodyning oscillator frequency is close to the desired output frequency. In this case, a balanced mixer should be used, to minimize the heterodyning oscillator frequency in the output.

To increase the power level of an s.s.b. signal, a **linear amplifier** must be used. A linear amplifier is one that operates with low distortion, and the low distortion is obtained by the proper choice of tube and operating conditions. Physically there is little or no difference between a linear amplifier and any other type of r.f. amplifier stage. The circuit diagram of a tetrode r.f. amplifier is shown in Fig. 9-6; it is no different basically than the similar ones in Chapter Six. The practical differences can be found in the supply voltages for the tube and their special requirements. The proper voltages for a number of suitable tubes can be found in Table 9-1; filament-type tubes will require the addition of the filament bypass capacitors  $C_9$  and  $C_{10}$  and the completion of the filament circuit by grounding the filament-transformer center tap. The grid bias,  $E_1$ , is furnished through an r.f. choke, although a resistor can be used if the tube is operated in Class  $AB_1$  (no grid current). The screen voltage,  $E_2$ , must be supplied from a "stiff" source (little or no voltage change with current change) which eliminates the use of a dropping resistor from the plate supply unless a voltage-regulator tube is used.

Any r.f. amplifier circuit can be adapted to

linear operation through the proper selection of operating conditions. For example, the tetrode circuit in Fig. 9-6 might be modified by the use of another neutralizing scheme, but the resultant amplifier would still be linear if the proper operating conditions were observed. A triode or pentode amplifier circuit would differ only in detail; typical circuits can be found in Chapter Six.

The simplest linear amplifier is the Class-A amplifier, which is used almost without exception throughout receivers and low-level speech amplifiers. (See Chapter Three for an explanation of the classes of amplifier operation.) While its linearity can be made relatively good, it is inefficient. The theoretical limit of efficiency is 50 per cent, and most practical amplifiers run about 25 per cent at full output. At low levels this is not worth worrying about, but when the 2- to 10-watt level is exceeded the efficiency should be considered, in view of the tube, power-supply and operating costs.

Class- $AB_1$  operation provides excellent linear amplifiers if suitable tubes are used. Primary advantages of Class- $AB_1$  amplifiers are that they give greater output than straight Class-A amplifiers using the same tubes, and they too do not require any grid driving power (no grid current drawn at any time). Triodes can be used in Class  $AB_1$  but tetrodes or pentodes are to be preferred. Class- $AB_1$  operation requires high peak plate current without grid current, which is easier to obtain with multigrid tubes (tetrodes and pentodes) than with triodes.

Maximum linear output is obtained from tetrodes, pentodes and most triodes when they are operated class  $AB_2$ . This operation, however, increases the driving-power requirements and,

Fig. 9-6—Circuit diagram of a tetrode linear amplifier using link-coupled input tuning and pi network output coupling. The grid, screen and plate voltages ( $E_1$ ,  $E_2$  and  $E_3$ ) are given in Table 11-1 for a number of tubes. Although the circuit is shown for an indirectly-heated cathode tube, the only change required when a filament type tube is used is the addition of the filament bypass capacitors  $C_9$  and  $C_{10}$ .

Minimum voltage ratings for the capacitors are given in terms of the power supply voltages.

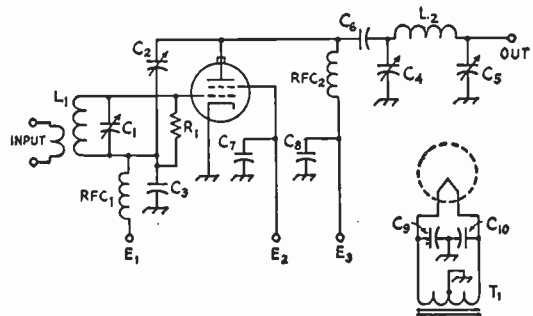

- $C_1$ —Grid tuning capacitor,  $3E_1$ .
- $C_2$ —Neutralizing capacitor,  $2E_3$ .
- $C_3$ —Grid-circuit bypass capacitor, part of neutralizing circuit,  $3E_1$ .
- $C_4$ —Plate tuning capacitor,  $1.5E_3$ .
- $C_5$ —Output loading capacitor. 0.015 spacing for kilowatt peak.
- $C_6$ —Plate coupling capacitor,  $2E_3$ .
- $C_7$ —Screen bypass capacitor,  $2E_3$ .

- $C_8$ —H.v. bypass capacitor,  $2E_3$ .
- $C_9, C_{10}$ —Filament bypass capacitor.
- $L_1$ —Grid inductor.
- $L_2$ —Plate inductor.
- $R_1$ —Grid circuit swamping resistor, required for  $AB_2$ .  
See text.
- $RFC_1$ —Grid-circuit r.f. choke.
- $RFC_2$ —Plate r.f. choke.
- $T_1$ —Filament transformer.

TABLE 9-I—LINEAR-AMPLIFIER TUBE-OPERATION DATA FOR SINGLE SIDEBAND—GROUNDED-CATHODE CIRCUIT

Unless otherwise noted, ratings are manufacturers' for audio operation. Values given are for one tube. Driving powers represent tube losses only—circuit losses will increase the figures.

Tube	Class	Plate Voltage	Screen Voltage	D.C. Grid Voltage <sup>1</sup>	Zero-Sig. D.C. Plate Current	Max.-Sig. D.C. Plate Current	Zero-Sig. D.C. Screen Current	Max.-Sig. D.C. Screen Current	Peak R.F. Grid Voltage	Max.-Sig. D.C. Grid Current	Max.-Sig. Driving Power	Max.-Rated Screen Dissipation	Max.-Rated Grid Dissipation	Avg. Plate Dissipation	Max.-Sig. Useful Power Output
2E26	AB <sub>1</sub>	500	200	— 25	9	45	—	10	25	0	0	2.5	—	—	15
6146	AB <sub>1</sub>	600	200	— 50	14	115	.5	14	50	0	0	3	—	25	47
6883		750	195	— 50	12	110	.5	13	50	0	0	3	—	25	60
807	AB <sub>1</sub>	600	300	— 34	18	70	.3	8	34	—	0	3.5	—	25	28
1625		750	300	— 35	15	70	.3	8	35	—	0	3.5	—	30	36
811-A	B	1000	—	0	22	175	—	—	93	—	3.8	—	—	65	124
		1250	—	0	27	175	—	—	88	13	3.0	—	—	65	155
		1500	—	— 4.5	16	157	—	—	85	—	2.2	—	—	65	170
4-65A <sup>2</sup>	AB <sub>1</sub>	1500	500	— 90	30	83	—	5	70	—	—	10	—	—	60
		2000	500	— 105	20	75	—	3	80	—	—	10	—	—	85
		2500	400	— 85	15	66	—	3	77	—	—	10	—	—	100
		3000	400	— 90	15	60	—	3	77	—	—	10	—	—	120
PL-177A <sup>2</sup> PL-177VA <sup>2</sup>	AB <sub>1</sub>	1500	600	— 110	30	175	0	8	108	0	0	10	—	110	140
		2000	600	— 115	25	175	0	7	112	0	0	10	—	125	210
7094	AB <sub>1</sub>	2000	400	— 65	30	200	—	35	60	0	4 <sup>3</sup>	20	—	—	250
		2500	750 <sup>4</sup>	— 95	25	145	—	27	90	0	0	—	—	—	245
813	AB <sub>2</sub>	2250	750 <sup>4</sup>	— 90	23	158	.8	29	115	—	.1	22	—	100	258
		2500	750 <sup>4</sup>	— 95	18	180	.6	28	118	—	.2	22	—	125	325
		2000	615	— 105	40	135 (100) <sup>4</sup>	—	14 (4.0) <sup>4</sup>	105	0	0	20	—	—	150
4-125A	AB <sub>1</sub>	2500	555	— 100	35	120 (85) <sup>4</sup>	—	10 (3.0) <sup>4</sup>	100	0	0	20	—	—	180
		3000	510	— 95	30	105 (75) <sup>4</sup>	—	6.0 (1.5) <sup>4</sup>	95	0	0	20	—	—	200
		1500	350	— 41	44	200	0	17	141	9	1.25	20	5	125	175
	AB <sub>2</sub>	2000	350	— 45	36	150	0	3	105	7	.7	20	5	125	175
		2500	350	— 43	47	130	0	3	89	6	.5	20	5	122	200
		7034/ 4X150A	1000	300	— 50	50	225	0	11	50	0	0	12	—	—
4-250A	AB <sub>1</sub>	1500	300	— 50	50	225	0	11	50	0	0	12	—	—	200
		1800	300	— 50	50	225	0	11	50	0	0	12	—	—	250
		2500	600	— 115	65	230 (170) <sup>4</sup>	—	15 (3.5) <sup>4</sup>	115	0	0	35	—	—	335
		3000	600	— 110	55	210 (150) <sup>4</sup>	—	12 (2.5) <sup>4</sup>	110	0	0	35	—	—	400
4-250A	AB <sub>1</sub>	3500	555	— 105	45	185 (130) <sup>4</sup>	—	9.5 (2.0) <sup>4</sup>	105	0	0	35	—	—	425
		4000	510	— 100	40	165 (115) <sup>4</sup>	—	7.5 (1.5) <sup>4</sup>	100	0	0	35	—	—	450
		1500	300	— 48	50	243	0	17	96	11	1.1	35	10	150	214
		2000	300	— 48	60	255	0	13	99	12	1.2	35	10	185	325
	AB <sub>2</sub>	2500	300	— 51	60	250	0	12	100	11	1.1	35	10	205	420
		3000	300	— 53	63	237	0	17	99	10	1	35	10	190	520
304TL	AB <sub>1</sub>	1500	—	— 118	135	286	—	—	118	0	0	—	—	—	128
		2000	—	— 170	100	273	—	—	170	0	0	—	—	—	245
		2500	—	— 230	80	242	—	—	230	0	0	—	—	—	305
		3000	—	— 290	65	222	—	—	290	0	0	—	—	—	365
PL-175A <sup>2</sup>	AB <sub>1</sub>	2500	750	— 143	100	350	1	35	143	0	0	25	—	265	570
		3000	750	— 150	80	350	1	29	150	0	0	25	—	305	680
		3500	750	— 160	75	350	1	24	160	0	0	25	—	345	790
PL-8295/172 PL-8432	AB <sub>1</sub>	2000	500 <sup>4</sup>	— 110	200	800	12	43	110	0	0	30	—	—	1040
		2500	500 <sup>4</sup>	— 115	200	800	11	40	115	0	0	30	—	—	1260
		3000	500 <sup>4</sup>	— 115	220	800	11	39	115	0	0	30	—	—	1590
4CX1000A	AB <sub>1</sub>	2000	325	— 60	250	1000	— 2	35	60	—	0	12	0	—	1020
		3000	325	— 60	250	900	— 2	35	60	—	0	12	0	—	1680

<sup>1</sup>Approximate; adjust to give stated zero-signal plate current.  
<sup>2</sup>Single-sideband suppressed-carrier ratings, voice signal.

<sup>3</sup>60 Mc.  
<sup>4</sup>Values in parentheses are with two-tone test signal.

<sup>5</sup>0 v. suppressor grid  
<sup>6</sup>+35 v. suppressor grid.

TABLE 9-II—CLASS-B LINEAR-AMPLIFIER TUBE-OPERATION DATA FOR SINGLE SIDEBAND—GROUNDED-GRID CIRCUIT

Tube	Plate Voltage	D.C. Grid Voltage	Zero-Sig. D.C. Plate Current	Max.-Sig. D.C. Plate Current	Peak R.F. Grid Voltage	Max.-Sig. D.C. Grid Current	Max.-Sig. Driving Power	Max.-Sig. Useful Power Output
811-A	1500	0	13	151	85	28	12	170
	2000	0	24	124	87	20	10	158
813 <sup>1</sup>	2500	0	30	133	91	23	11	219
	2000	0	10	105 (30) <sup>2</sup>	—	55	16	145
4-125A <sup>1</sup>	2500	0	15	110 (30) <sup>2</sup>	—	55	16	190
	3000	0	20	115 (30) <sup>2</sup>	—	55	16	240
4-400A <sup>1</sup>	2000	0	70	265 (55) <sup>2</sup>	—	100	38	325
	2500	0	80	270 (55) <sup>2</sup>	—	100	39	435
3-400Z	3000	0	90	280 (55) <sup>2</sup>	—	100	40	555
	2000	0	62	400 (265) <sup>2</sup>	—	148 (87) <sup>2</sup>	—	445 <sup>1</sup>
PL-6569	2500	0	73	400 (274) <sup>2</sup>	—	142 (82) <sup>2</sup>	—	560 <sup>2</sup>
	3000	0	100	333	—	120	32	655
PL-6580	2500	60 <sup>6</sup>	40	300	180	80	70 <sup>7</sup>	550
	3000	—	30	270	220	68	75 <sup>7</sup>	760
3-1000Z	4000	—	24	250	205	42	60 <sup>7</sup>	800
	2500	50	60	350	195	95	75 <sup>7</sup>	610
3-1000Z	3500	—	45	300	210	65	68 <sup>7</sup>	765
	4000	—	40	300	230	65	72 <sup>7</sup>	910
3-1000Z	2500	0	162	800 (550) <sup>2</sup>	—	254 (147) <sup>2</sup>	—	1050 <sup>1</sup>
	3000	0	240	670	—	300	65	1360

<sup>1</sup>Grid and screen connected together. <sup>2</sup>Two-tone signal. <sup>3</sup>Minimum distortion products at 1 k.w. p.e.p. input. <sup>4</sup>Minimum distortion products. <sup>5</sup>Approximate; adjust to give stated zero-signal plate current. <sup>6</sup>Minimum distortion products. <sup>7</sup>Includes bias loss, grid dissipation, and feed-through power.

what is more important, requires that driver regulation (ability to maintain wave form under varying load) be good or excellent. This is not an easy requirement to meet, and the current trend is to use tetrodes or pentodes in AB<sub>1</sub> or zero-bias Class-B triodes.

Class-B amplifiers are theoretically capable of 78.5 per cent efficiency at full output, and practical amplifiers run at 60–70 per cent efficiency at full output. Triodes normally designed for Class-B audio work can be used in r.f. linear amplifiers and will operate at the same power rating and efficiency provided, of course, that the tube is capable of operation at the radio frequency. The operating conditions for r.f. are substantially the same as for audio work—the only difference is that the input and output transformers are replaced by suitable r.f. tank circuits. Further, in r.f. circuits it is readily possible to operate only one tube if only half the power is wanted—push-pull is not a necessity in Class-B r.f. work.

For proper operation of grounded-cathode Class-B amplifiers, and to reduce harmonics and facilitate coupling, the input and output circuits should not have a low C-to-L ratio. A good guide to the proper size of tuning capacitor will be found in Chapter Six; use the voltage-to-current ratio of p.e.p. conditions. It is essential that the amplifier be so constructed, wired and neutralized that no trace of regeneration or parasitic instability remains. Needless to say, this also applies to the preceding stages.

In a Class-AB<sub>1</sub> amplifier, the control-grid bias supply can be anything. However, the screen supply should have good regulation; its voltage should remain constant under the varying current demands. If the maximum screen current does not exceed 30 or 35 ma., a string of VR tubes in series can be used to regulate the screen voltage. If the current demand is higher, it may be necessary to use an electronically regulated power supply or a heavily bled power supply with a current capacity of several times the current demand of the screen circuit.

Where VR tubes are used to regulate the screen supply, they should be selected to give a regulated voltage as close as possible to the tube's rated voltage, but it does not have to be exact. Minor differences in idling plate current can be made up by readjusting the grid bias.

The plate voltage applied to the linear amplifier should be held as constant as possible under the varying current-demand conditions. This condition can be met by using low-resistance transformers and inductors and by using a large value of output capacitor in the power-supply filter. An output capacitor value three or four times the minimum required for normal filtering is reasonable.

**Grounded-grid** operation of zero-bias triodes is finding increasing popularity among s.s.b. operators. A zero-bias triode that requires 10 or 15 watts driving power in a grounded-cathode circuit will need several times this for full output in the grounded-grid configuration. This is not because the grid losses increase—they don't

—but in grounded-grid operation a large portion of the input signal finds its way to the output. Since many of the sideband-exciter designs that one starts with are in the 50- to 100-watt output class, a grounded-grid amplifier makes better use of the exciter output than would a Class-AB<sub>1</sub> amplifier.

It is not necessary to use indirectly-heated cathode type tubes in grounded-grid circuits; filament-type tubes can be used just as effectively. However, it is necessary to raise the filament above r.f. ground with filament chokes between the filament transformer and the tube socket. The inductance of the r.f. chokes does not have to be very high, and 5 to 10  $\mu$ h. will usually suffice from 80 meters on down. The current-carrying capacities of the r.f. chokes must be adequate for the tube or tubes in use, and if the resistance of the chokes is too high the filament voltage at the tube socket may be too low and the tube life will be endangered. In such a case, a higher-voltage filament transformer can be used, with its primary voltage cut down until the voltage at the tube socket is within the proper limits.

Although filament chokes can be wound on wooden or ceramic forms (e.g., large cylindrical ceramic antenna insulators), they can be made more compact and with lower resistance (less voltage drop) by winding them on ferrite rods. Individual chokes for each side of the filament are desirable if they must be wound on wood or ceramic, but when wound on ferrite a dual winding is satisfactory. The single winding choke(s) should be wound with heavy wire spaced (with string) one-half to one wire diameter. In the ferrite-cored choke the two parallel enameled wires are treated as one wire; see Chapter Six for two examples of homemade filament chokes.

When considerable power is available for driving the grounded-grid stage, the matching between driver stage and the amplifier is not too important. However, when the driving power is marginal or when the driver and amplifier are to be connected by a long length of coaxial cable, a matching circuit can be used in the input of the grounded-grid amplifier. The input impedance of a grounded-grid amplifier is in the range of 50 to 400 ohms, depending upon the tube or tubes and their operating conditions. When data for grounded-grid operation is available (see Table 9-II), the input impedance can be computed from

$$Z = \frac{(\text{peak r.f. driving voltage})^2}{2 \times \text{driving power}}$$

From this and the equations for a pi or L network, a suitable matching circuit can be devised. It should have a low  $Q$ , about 2 or 3.

Tables 9-I and 9-II list a few of the more popular tubes commonly used for s.s.b. linear-amplifier operation. Except where otherwise noted, these ratings are those given by the manufacturer for audio work and as such are based on a sine-wave signal. These ratings are adequate ones for use in s.s.b. amplifier design, but they

are conservative for such work and hence do not necessarily represent the maximum powers that can be obtained from the tubes in voice-signal s.s.b. service. In no case should the average plate dissipation be exceeded for any considerable length of time, but the nature of a s.s.b. signal is such that the average plate dissipation of the tube will run well below the peak plate dissipation.

Getting the most out of a linear amplifier is done by increasing the peak power without exceeding the average plate dissipation over any appreciable length of time. This can be done by raising the plate voltage or the peak current (or both), provided the tube can withstand the increase. However, the manufacturers have not released any data on such operation, and any extrapolation of the audio ratings is at the risk of the amateur. A 35- to 50-per cent increase above plate-voltage ratings should be perfectly safe in most cases. In a tetrode or pentode, the peak plate current can be boosted some by raising the screen voltage. In all instances there will be an optimum set of driving and loading conditions for any given set of plate and grid (and screen) voltages, but the tube manufacturer can obviously give only a few (and they are likely to be conservative). The *only* dependable approach to determining the proper conditions for an "unknown" linear (one operating at other than manufacturer's ratings) is by using an oscilloscope and dummy load.

When running a linear amplifier at considerably higher than the audio ratings, the "two-tone test signal" should never be applied at full amplitude for more than a few seconds at any one time. The above statements about working tubes above ratings apply only when a voice signal is used—a prolonged whistle or two-tone test signal may damage the tube. It is possible, however, to "key" or "pulse" the two-tone test signal so that the linearity of an amplifier can be checked at high peak-to-average plate dissipation ratios. For example, an electronic "bug" key can be used to switch the two-tone test signal on and off at a rapid rate (a string of "dots"). This will reduce the average-to-peak plate-dissipation ratio to a low figure. (For another method of adjusting linear amplifiers safely at high input, see Goodman, "Linear amplifiers and Power Ratings," *QST*, August, 1957.)

Linear amplifiers are rated in "p.e.p. input" or "p.e.p. output." The "p.e.p." stands for **peak envelope power**. P.e.p. input is not indicated by the maximum reading the plate milliammeter kicks to; it is the input that would be indicated by the plate milliammeter and voltmeter if the amplifier were driven continuously by a single r.f. signal of the peak amplitude the amplifier can handle within its allowable distortion limits. In other words, it is the "key-down input" within the allowable distortion limits. The p.e.p. output is the r.f. output under these same conditions. As implied in the preceding paragraph, it may be impossible to measure the p.e.p. input or output directly without injuring the tube or tubes.



## A HIGH-FREQUENCY CRYSTAL-FILTER SIDEBAND EXCITER

When a sideband signal is generated at 500 kc. or below, several frequency conversions are usually required to move the signal to the 14-Mc. band without danger of "image" signals. By generating the sideband signal at a high frequency, only one frequency conversion is required. The sideband transmitter shown in Figs. 9-7 through 9-10 is built around a commercial 9-Mc. crystal filter and, with a 6DQ5 in the output stage, it will deliver 50 watts p.e.p. on 75, 40 and 20 meters. The crystal filter is furnished with two matching crystals for the oscillator, so that upper or lower sideband can be obtained by shifting the (suppressed) carrier frequency to one side or the other of the crystal-filter pass band.

To facilitate construction and adjustment, the exciter has none of the "frills" to be found in some commercial equipment, although they can of course be added by the experienced amateur. Plug-in coils and crystal control are used, although there is provision for "pulling" the crystal frequency by means of a "VXO" circuit. Voice-controlled break-in has been omitted in the interests of simplicity (and perhaps a better type of operation), and the transmitter is turned on or off by a foot switch or key. No operating conveniences have been omitted, however, other than the ability to make sudden large frequency changes. A "calibrate" position of the mode switch permits accurate setting of one's frequency at a level that does not block the receiver, and in the "standby" condition a bias voltage of -100 is available to be applied to any subsequent amplifier that might generate undesirable diode noise without the additional bias.

Referring to the wiring diagram in Fig. 9-8, the two triode sections of a 6CG7 are used in cascade for the speech amplifier, to bring the voice signal up to the desired level of about 1 volt. This is used to modulate the beam of the 7360 balanced-modulator stage. The 7360 is also used as the (suppressed) carrier oscillator, by raising its cathode above r.f. ground and connecting the carrier-frequency crystal between control grid and ground. Two crystals are furnished with the crystal filter; in this case they have nominal frequencies of 8.998500 and 9.001500 Mc. The 12- $\mu\text{f}$ . adjustable ceramic capacitors (Centralab 827-B) in shunt with the crystals are used to pull the frequencies into correct relationship to the filter pass band. Since the good linearity of the 7360 is destroyed if the grid is driven positive, a 1N34A diode is used to provide bias in addition to that produced by the cathode resistor. Carrier balance is obtained through adjustment of the relative positive biases (about +20 volts) on the deflection plates, and also through the capacitive balance made possible by the range of  $C_1$ . Upsceting the balance by changing the bias on one deflection plate provides a "calibration" signal or, by changing the unbalance still more by closing  $S_2$ , sufficient carrier for c.w. operation.

The 9-Mc. crystal filter,  $FL_1$ , is a low-impedance device (560 ohms), and the double-sideband signal appearing in  $L_1$  is coupled to  $FL_1$  through a low-impedance winding. A suitable termination for the filter is obtained by the properly-transformed self impedance of the circuit made up of  $L_2$  and the 47- $\mu\text{f}$ . capacitor; since the correct

Fig. 9-7—This single-sideband exciter unit uses a 9-Mc. crystal filter and a choice of oscillator frequencies to obtain the upper or lower sideband. The output tube (right) is a 6DQ5. For simplicity, plug-in coils are used, and two of them are shielded by grocery-store products painted gray (center).

One side has been removed for the photograph; the top plate is "plug on" at the four corners through jacks mounted on the four corners of the top plate.

The frequency control for the unit is a "VXO," a crystal-controlled oscillator that can be pulled several kc. by a panel control (large knob under meter). The crystal in use is plugged in at the lower right, just above a small CAL control knob that sets the signal level into the receiver when the function switch (left, below VXO control) is on "calibrate." Small knob at lower left is sideband-selector switch. Switch to left of meter switches meter to grid or cathode of output tube or to r.f. voltmeter on output line; knob just below adjusts sensitivity of r.f. voltmeter.

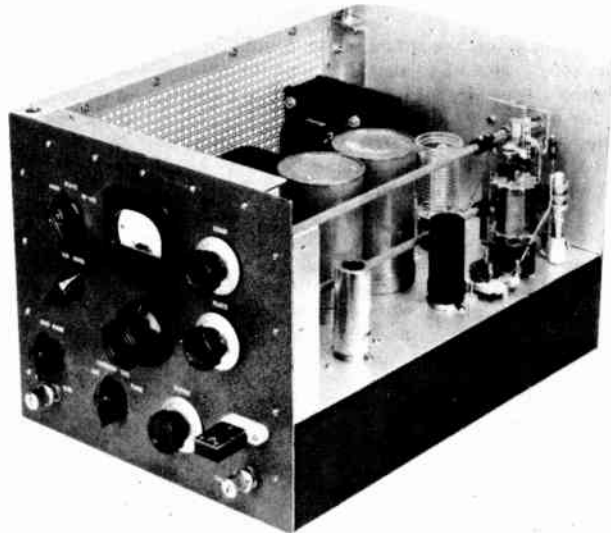





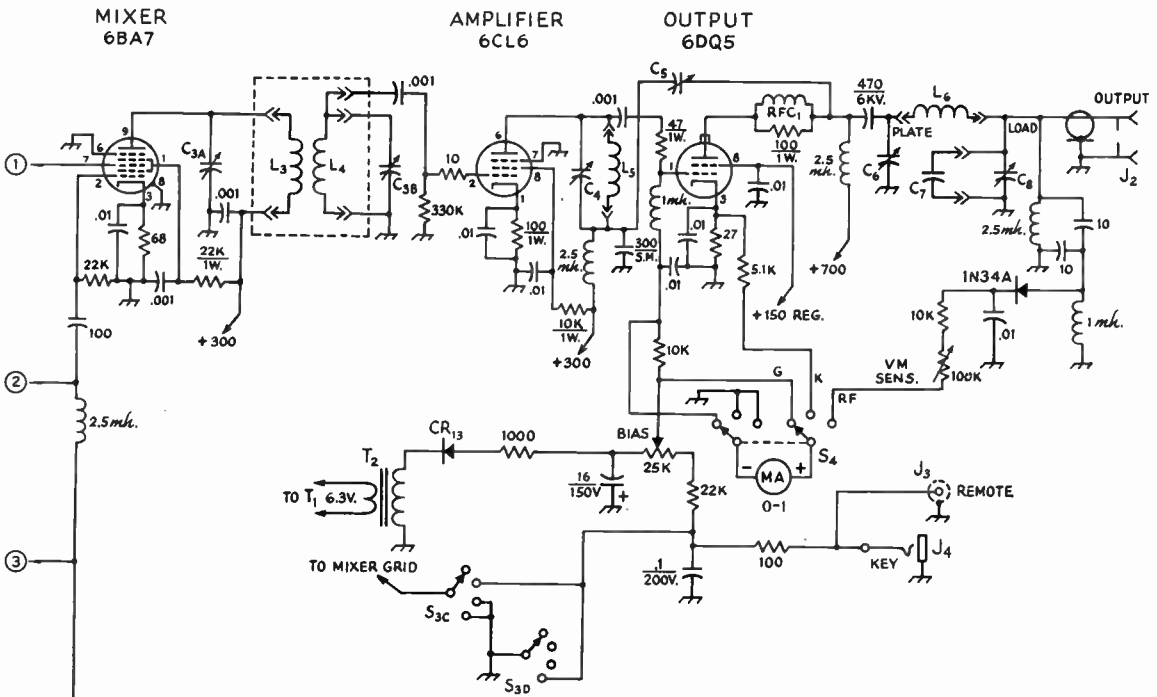

Fig. 9-8—Circuit diagram of the crystal-filter sideband generator. Unless specified otherwise, capacitances are in  $\mu\text{f.}$ , decimal capacitances are in  $\mu\text{f.}$ , resistors are  $\frac{1}{2}$  watt, resistances are in ohms. Capacitors marked with polarity are electrolytic.

- C<sub>1</sub>—15- $\mu\text{f.}$  differential capacitor (Johnson 160-308).
- C<sub>2</sub>—Dual 50- $\mu\text{f.}$  variable (Johnson 167-52).
- C<sub>3</sub>—Dual 50- $\mu\text{f.}$  variable (Hammarlund HFD-50). Each section has 30- $\mu\text{f.}$  mica compression trimmer in parallel.
- C<sub>4</sub>—50- $\mu\text{f.}$  miniature variable (Hammarlund APC-50B).
- C<sub>5</sub>—11- $\mu\text{f.}$  variable (Johnson 167-1).
- C<sub>6</sub>—100- $\mu\text{f.}$  variable (Hammarlund HFA-100A).
- C<sub>7</sub>—Mounted in L<sub>5</sub> form. See coil table.
- C<sub>8</sub>—365- $\mu\text{f.}$  midget variable (Allied Radio 61 H 009 or Lafayette Radio MS-214).
- CR<sub>1</sub>-CR<sub>15</sub>—400 p.i.v. 500-ma. silicon (Lafayette Radio SP-196).
- FL<sub>1</sub>—9.0-Mc. crystal filter (McCoy Electronics 32 B1).
- J<sub>1</sub>—Microphone jack (Amphenol 75 PC-1M).
- J<sub>2</sub>—Coaxial receptacle (SO-239).
- J<sub>3</sub>—Phono jack.
- J<sub>4</sub>—Open-circuit phone jack.

- L<sub>1</sub>, L<sub>2</sub>—3.1-6.8- $\mu\text{h.}$  variable inductor (Miller M-4405). Coupling coils are 4 t. No. 22 enam. close-wound over center of L<sub>1</sub> and "cold" end of L<sub>2</sub>.
- L<sub>3</sub>-L<sub>7</sub>—See coil table, next page.
- L<sub>8</sub>—5-henry 100-ma. choke (Stancor C-2305).
- L<sub>9</sub>—2-henry 200-ma. choke (Stancor C-2325).
- P<sub>1</sub>—Line plug, preferably fused, 1 $\frac{1}{2}$  amp.
- RFC<sub>1</sub>—5 t. No. 22 spacewound on 100-ohm 1-watt resistor.
- S<sub>1</sub>—2-pole 6-pos. (2 used) rotary (Centralob PA-2003).
- S<sub>2</sub>—S.p.s.t. toggle.
- S<sub>3</sub>—4-pole 5-position (4 used) 2-section rotary switch (Centralab PA-1013).
- T<sub>1</sub>—800 v.c.t. 200-ma. power transformer with 6.3- and 5-v. filament windings (Knight 61 G 414).
- T<sub>2</sub>—6.3-v.0.6-amp. fil. transformer (Knight 61 G 416).
- Y<sub>1</sub>—See coil table, next page.

provides 700 volts for the output stage, 300 volts for the low-level stages, and regulated 150 volts for the oscillators. Inexpensive silicon rectifiers are used in a combination circuit that provides a basic 700 and 300 volts under load. A small filament transformer, T<sub>2</sub>, is connected to the (otherwise) unused 5-volt winding of the power transformer, and the resulting 90 volts at the secondary is rectified to furnish the bias voltage for the output stage.

The mode switch, S<sub>3</sub>, turns on the power supply, and places the transmitter in readiness to be controlled at J<sub>4</sub>. In its third position, S<sub>3</sub> unbal-

ances the balanced modulator but keeps the output stage biased off, for calibration purposes, and in the fourth position it unbalances the modulator and turns on the final, for tune-up purposes.

**Construction**

The transmitter is built on a 10 × 14 × 3-inch aluminum chassis, with front and rear panels made of sturdy sheet aluminum 9 inches high. The cane-metal sides are bolted to aluminum angle stock that is bolted to the panels; this can be seen in Figs. 9-7 and 9-9. A lip bent inward

on the bottom of each side plate of cane metal rests on the chassis; see Fig. 9-9. The top plate of cane metal has a banana jack set in each corner, which engages a corresponding banana plug mounted on the angle stock (see Fig. 9-7).

The placement of most of the major components can be seen in the several photographs. The 7360 beam-deflection modulator tube should be mounted well away from transformers or chokes that might be surrounded by an a.c. field, because the tube is sensitive to these a.c. fields and low-frequency sidebands can be generated by these stray fields. Aluminum brackets made of scrap sheet material will be required to mount  $C_6$  and  $C_8$ ,  $C_3$  and  $C_4$ , and the tie-point strips supporting  $CR_1$  through  $CR_{12}$ . The bracket supporting  $C_3$  has two National TPB feedthrough bushings mounted on the side to shorten the leads between stators and related tube sockets. The neutralizing capacitor,  $C_5$ , must be insulated from the chassis, and another National TPB feedthrough is used from the rotor terminal to the underside of the chassis.

The coil shield cans are made from baking-powder (Calumet) cans emptied and sprayed on the outside with grey lacquer. A hole is cut in

the cover and the cover is held to the chassis by the same screws that secure the socket. The two black tube shields visible in one of the pictures are ordinary tube shields sprayed with flat black.

### Alignment

During the first stages of testing the transmitter, it is suggested that the 27- and 5100-ohm resistors be disconnected from Pin 3 of the 6DQ5 socket. This will open the cathode circuit for d.c. and the tube will be inactive in the socket. At the same time, open the lead from  $L_9$  to the rectifiers.

With the tubes in place, and coils and crystals for a band plugged in, the unit should first be tuned as a c.w. transmitter. First checks for output and resonance can be made with  $S_3$  in the "calibrate" position, using the 500,000-ohm CALIBRATE LEVEL control as an excitation control. A useful tool at this point is a pick-up loop and a shielded lead to a receiver. Checking at  $L_5$  should show r.f. of the desired frequency that is controllable in amplitude by the setting of the CALIBRATE LEVEL control. With an insulated screwdriver on the padder across  $C_{3A}$ , adjust the ganged shafts of  $C_3$  and  $C_4$  and the screwdriver on the padder for maximum output as indicated

Band (Mc.)	3.8-4.0	7.2-7.3	14.2-14.35
Crystal $Y_1$	5.2-5.0	16.2-16.3	5.2-5.35
$L_3$	46 t.*	22 t.**	10 t.**
Shunt	10,000 ohms	10,000 ohms	None
$L_4$	None	None	10 t.** $\frac{1}{2}$ inch from $L_3$
$L_5$	46 t.*	22 t.**	10 t.**
Shunt	4700 ohms	4700 ohms	47,000 ohms
$L_6$	46 t.**	24 t.**	12 t.***
$L_7$	72 t.*	20 t.**	Same as 3.8 Mc.
$C_7$ ( $\mu\text{mf.}$ )	1000	330	—

\*No. 24, 32 t.p.i., 1-inch diam. (B&W 3016).

\*\*No. 20, 16 t.p.i., 1-inch diam. (B&W 3015).

\*\*\*No. 18, 8 t.p.i., 1-inch diam. (B&W 3014).

Coils are mounted in  $1\frac{1}{4}$ -inch o.d. polystyrene plug-in coil forms (Allied Radio 24-4P and 24-5P).

Shunt resistors are  $\frac{1}{2}$ -watt except 4700 ohms, which are 1-watt.

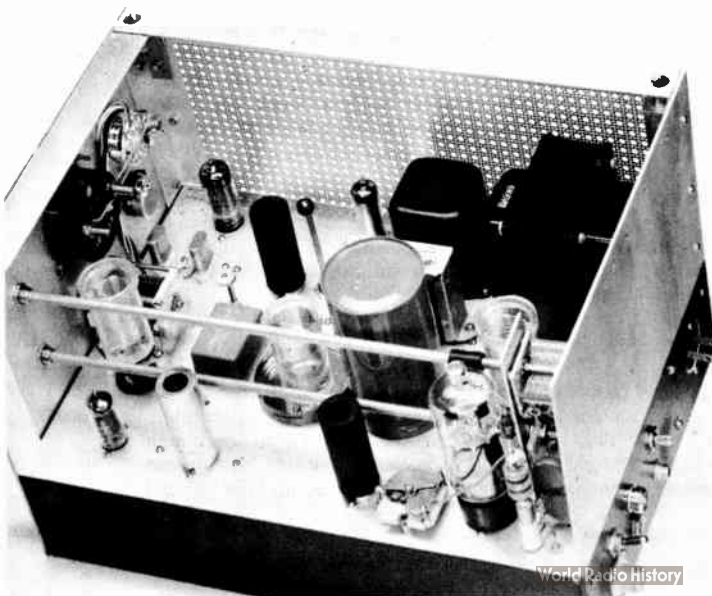

Fig. 9-9—Another view of the top of the filter sideband exciter. The variable capacitor in the Vxo circuit is under the meter; the small box to the right of this capacitor is the crystal filter, and the two matched oscillator crystals supplied with the filter are near the panel. The 7360 beam-deflection modulator is in the black tube shield near the filter; a grommet on the shaft (next to the 7360) of the balance potentiometer serves as a knob.

Tubes in the foreground, from left to right, are 6AU6 Vxo, 6BA7 mixer, 6CL6 (black shield) amplifier and 6DQ5 output stage. The long extension shafts behind the tubes control plate tuning and output loading capacitors.

by the receiver. The object is to set the padder so that its capacitance is equal to the circuit capacitance across  $L_5$ , thus enabling the circuits to track. If this alignment is done on 20 meters (preferable), the padder across  $C_{3B}$  will also have to be adjusted at the same time.

If  $S_4$  is set to the position for measuring the r.f. output, resonating the output circuit may show a slight amount of r.f. even though the cathode circuit is open. If r.f. is indicated, the stage can be roughly neutralized by setting  $C_3$  for minimum output under these conditions. The receiver, connected at  $J_2$  or coupled to  $L_6$ , is a much more sensitive neutralization indicator, however.

Switching now to OPERATE, it should be found that there is a setting of the 5000-ohm "balance" control that gives very low output. Test this first with  $C_1$  set at equal capacitances; after finding the minimum setting for the potentiometer try adjusting the capacitor. If the wiring is reasonably symmetrical, it may be found that  $C_1$  has little effect, but this is nothing to worry about. If the tone of the (apparently) suppressed carrier suddenly changes as the potentiometer reaches the null point, it indicates the presence of 60- or 120-cycle residual sidebands, stemming from a.c. at the deflection plates or a magnetic field around the tube.

If the two crystals in the 7360 balanced modulator had exactly the same activity, it might be possible to set their frequencies by adjusting the trimmers across the crystals until, in the testing in the "calibrate" setting of  $S_3$ , exactly the same output was obtained for either setting of  $S_1$ . Since this equal-output condition is not necessarily the case, it becomes necessary to adjust the two trimmers, until, judging by ear, the sideband signal sounds the same for either setting of  $S_1$  (and proper tuning of the receiver). A more sophisticated and accurate approach is to borrow an audio oscillator (if one is lacking) and measure the relative outputs at various audio frequencies for the two settings of  $S_1$ . The output should start to fall off fast below about 400 cycles and above about 3000; the exact figures will be determined by the filter characteristics and by personal preferences of the operator.

When an acceptable sideband signal can be obtained, the transmitter can be turned off long enough to reconnect  $L_9$  and also the resistors in the 6DQ5 cathode circuit. Before turning on the power, a dummy load should be connected at  $J_2$

and the 25,000-ohm bias control should be set to give maximum bias (arm closest to capacitor side). Set  $S_4$  to read cathode current (full scale is 200 ma.) and turn on the transmitter. With a key plugged in at  $J_4$ , close the key and turn the bias potentiometer arm until a cathode current of about 30 ma. (reading of 0.15) is obtained. Swinging  $C_6$  around should give no change in cathode current; if the cathode current suddenly kicks up it means the stage is not completely neutralized and needs touching up.

Switching to the "tune" position and using the "calibrate level" control for an excitation control, it should be possible to drive the 5DQ5 into grid current on any of the three bands. With the excitation backed off just below the point of grid current, the output stage should be loaded to draw about 120 ma. cathode current. Switching to "operate" and speaking into the microphone, the gain should be set to where voice peaks kick the cathode current to peaks of 50 ma. (0.25) or so. A much finer adjustment of loading conditions and a better control of speech level before distortion can be obtained by using an oscilloscope to observe the effects of tuning, loading and level.

No values are given for 10- and 15-meter operation because full output cannot be obtained on these bands without an additional stage of amplification.

Fig. 9-10—Underneath the chassis of the sideband exciter. The twelve silicon rectifiers of the power supply are hung between tie points mounted on an aluminum bracket (upper right). The ganged capacitors,  $C_3$ ,  $C_4$  that tune the excitation stages are mounted on an aluminum bracket (lower left center); the shaft of  $C_4$  is insulated to keep it above ground potential.

Controls and outlets along the back panel (top) are, left to right:  $S_2$ , output jack, microphone jack, key jack, bias control, remote jack  $J_3$ , and the a.c. line connection.

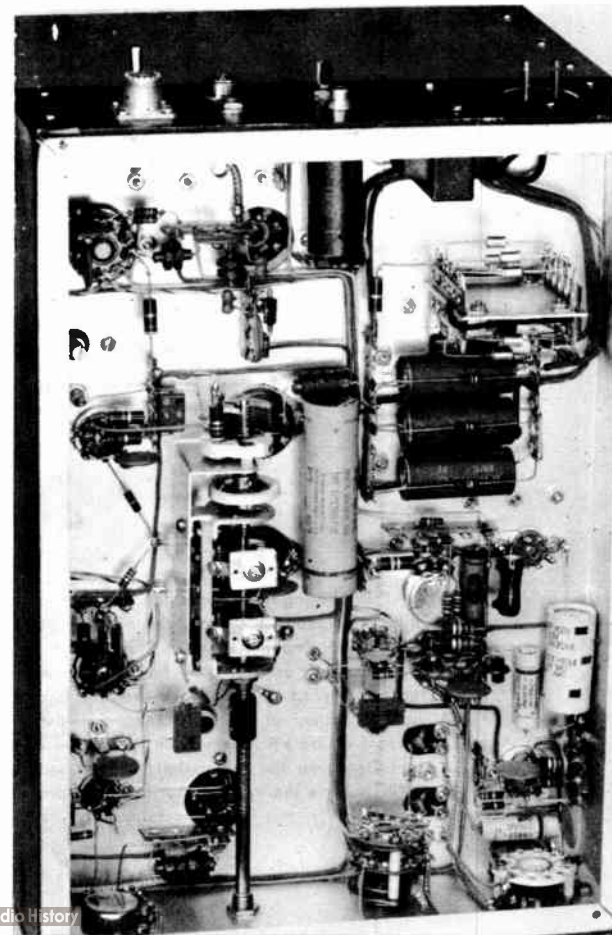



## A PHASED SINGLE-SIDEBAND EXCITER

The sideband generator shown in Figs. 9-11 and 9-12 uses the phasing principle outlined earlier (Fig. 9-3B) to produce an upper or lower single-sideband signal. It will also generate a double-sideband signal, with or without carrier. The generator features the new beam-deflection 7360 tube in the balanced modulator portion of the circuit, and it is complete (with power supply) except for the frequency-controlling source. A watt or two of r.f. from a v.f.o. or crystal-controlled oscillator is sufficient for the unit.

Referring to the circuit diagram in Fig. 9-13, a 12AT7 twin triode serves as the speech amplifier. An audio phase-shift network (Barker & Williamson Model 350 2Q4) plugs in the octal socket  $J_2$ . This preadjusted network has the property of delivering two audio signals differing in phase by 90 degrees  $\pm$  1.5 degrees over the range 300 to 3000 cycles. The audio network is protected against low- and high-frequency components outside this range by the coupling-capacitance values and the low-pass filter  $C_1C_2L_1L_2$ . The two audio signals from the network are equalized by the PHASE control and amplified by  $V_{2A}$  and  $V_{2B}$  and applied to the deflection plates of the 7360 balanced modulators. The r.f. introduced at  $J_4$  is split and shifted +

and - 45 degrees in the r.f. phase-shift network to give a net difference of 90 degrees.

The output of the balanced modulators is amplified by a Class-A 6CL6, which has sufficient output to drive two or three 6146s in Class AB<sub>1</sub>. The tube complement and power supply shown in the circuit diagram are such that the 6CL6 can be overdriven on 75, 40 and 20 meters (but Class-A operation demands that the tube never be driven into grid current). On 15 and 10 meters this reserve gain is lacking, and consequently inductor and phase-shift values for these bands are not given.

For ease of adjustment the grid, screen and plate currents of the 6CL6 can be measured, by proper settings of  $S_4$ . Further, the input and output r.f. voltages can be metered, for convenience in setting the excitation and the output tuning.

To simplify the construction and adjustment, plug-in coils and r.f. phase-shift networks are used (Fig. 9-14). The r.f. network is made up of 100-ohm resistors and suitable capacitors (100-ohms reactance at the operating frequency); once adjusted it will hold sufficiently over an amateur band.

The mode switch,  $S_1$ , shifts from one sideband output to another by shifting the deflection

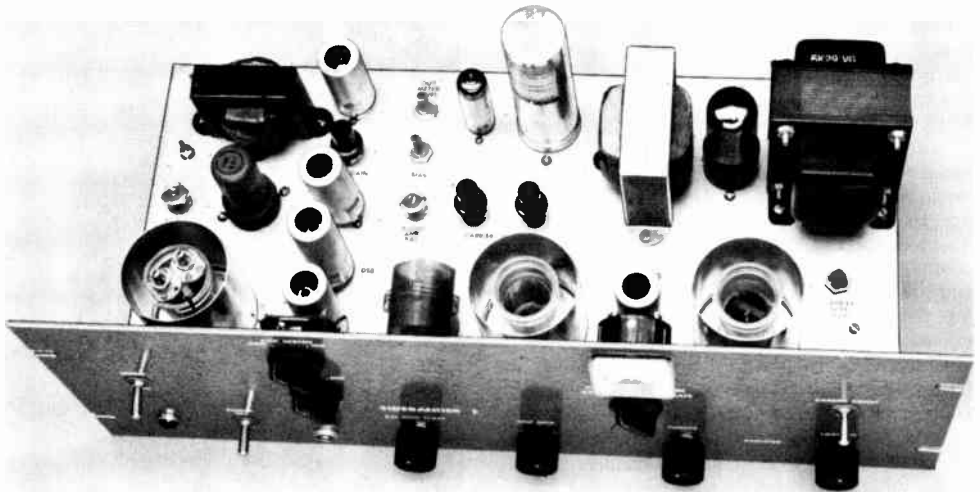

Fig. 9-11—This phasing-type single (and double) sideband generator features the 7360 beam-deflection tube in the balanced-modulator section. The 6CL6 output amplifier (behind meter) delivers sufficient output to drive one or more 6146 amplifier tubes in Class AB<sub>1</sub>. Plug-in coils are used to simplify construction.

The r.f. phase-shift network (coil form at extreme left, with two capacitor shafts visible) is plug-in for each band. The audio phase-shift network (B & W Type 2Q4 No. 350) is housed in the tube envelope in front of the audio transformer at rear left. The unshielded tube at rear center is a voltage-regulator tube; two black knobs in front of the VR tube are on the carrier balance controls.

Toggle switches on the panel, left to right, are transmit-receive, power and spotting (carrier insert). Two knobs at left, above the microphone jack, turn the mode (lower) and the tune-operate switches. Knob under the meter is on the 5-position meter switch.



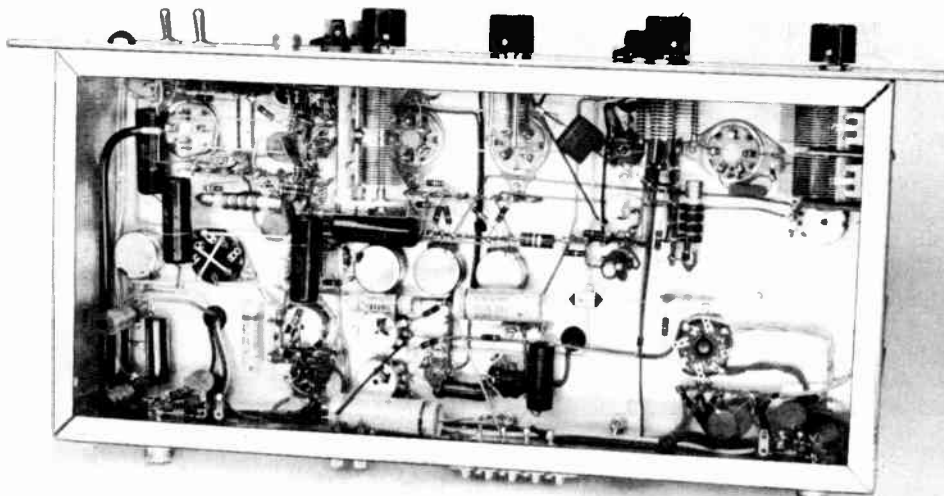

Fig. 9-12—View underneath the chassis of the sideband generator. Tuning capacitors are mounted close under the sockets for the associated plug-in coils. At rear of the chassis (bottom in this view), two terminals are used for bias measurement, and the 4-terminal barrier strip is for making connection to remote control and v.f.o. on-off circuits. Two inductors, part of the low-pass audio filter that protects the audio phase-shift network, are mounted near the r.f. input jack (lower left).

plate to which the audio is applied in one of the balanced modulators. A third position of the switch disables one of the balanced modulators, resulting in double-sideband output from the generator. A spotting switch,  $S_2$ , is used to momentarily unbalance a balanced modulator and allow r.f. to feed through in an amount sufficient to be heard in the receiver. The amount of unbalance is determined by the setting of the SPOT LEVEL resistor. A second circuit of  $S_2$  is available to turn on the external oscillator at the same time. The TUNE-OPERATE switch,  $S_3$ , is used to ground the 6CL6 screen during tune-up procedures.

The power supply includes a bias supply for the 6CL6 amplifier stage. When switch  $S_6$  is closed, normal operating bias is applied to the 6CL6, but when it is opened the bias will rise to the power-supply level and reduce the 6CL6 plate current to zero. This is useful if the 6CL6 generates "diode noise" on standby that is audible in the receiver. Remote connections allow the same bias to be applied to a following amplifier during standby, or they can be used to open and close the circuit normally controlled by  $S_6$ .

### Construction

The physical arrangement of the major components is shown in Figs. 9-11 and 9-13. The generator is built on an  $8 \times 17 \times 3$ -inch aluminum chassis, with a 7-inch high relay rack panel held to it by the components along the bottom front. Milfen 80008  $2\frac{1}{8}$ -inch diameter aluminum shields are used at the sockets for  $L_4$ ,  $L_5$  and the r.f. phase-shift network. A minor departure

from convention is the location of the AUDIO GAIN control on the chassis instead of the front panel, but the control is used so seldom that the location is justified.

No special considerations are required in wiring the audio section other than the usual precautions against hum pickup. Before installing  $L_1$  and  $L_2$  they should be set to their correct value of 25 mh. An impedance bridge or  $Q$  meter can be used for the purpose, if available. If not, they can be set with an audio oscillator and v.t.v.m. (or oscilloscope). Connect an inductor in parallel with one of the 0.1- $\mu$ f. capacitors, and connect the combination to the audio oscillator output through a high resistance (100K or so). Connect the v.t.v.m. (or scope) across the parallel-tuned circuit, and adjust the inductor for maximum voltage across the combination when the audio oscillator is set at 3200 cycles. Repeat for the other inductor and capacitor, and do not change the slug settings again. The filter will have a cut-off frequency of 3200 cycles.

R.f. wiring should be made short and direct wherever possible. Input and output are run to jacks  $J_3$  and  $J_4$  in RG-58/U coaxial cable. Try to maintain symmetry of leads in the balanced-modulator portion of the circuit.

Coil and r.f. phase-shift network dimensions are given in the coil table.  $L_3$  is a manufactured product used as is;  $L_4$  and  $L_5$  are made from coil stock and mounted inside the polystyrene plug-in coil forms. The  $L_5$  form also carries padding capacitors for  $C_7$  (these aren't shown in Fig. 9-13). A 39- $\mu$ f. padder for  $C_6$ , used only on 75 meters, can be connected to a spare

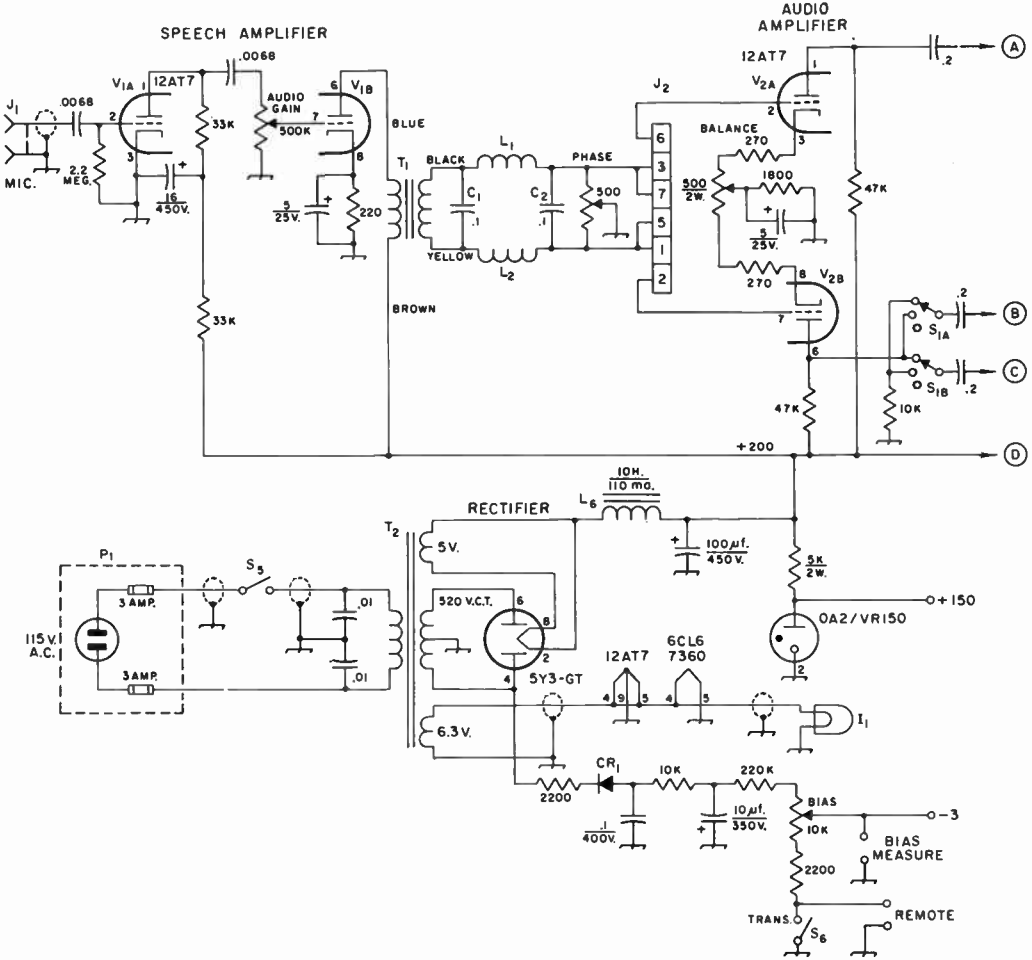

Fig. 9-13—Schematic diagram of the sideband generator. Unless specified otherwise, resistors are 1/2-watt, .01- and .002- $\mu$ f. capacitors are disk ceramic, 600 volts; .1- and .2- $\mu$ f. capacitors are tubular paper, 400 volts; capacitors marked with polarities are electrolytic.

- C<sub>1</sub>, C<sub>2</sub>—0.1- $\mu$ f. 200-v. paper  $\pm$  10 per cent (Sprague 2TM-P1).
- C<sub>3</sub>—Dual 100- $\mu$ f. variable (Hammarlund HFD-100).
- C<sub>4</sub>—15- $\mu$ f. variable (Hammarlund MAPC-15).
- C<sub>5</sub>—100- $\mu$ f. variable (Hammarlund APC-100B).
- C<sub>6</sub>—100- $\mu$ f. variable (Hammarlund HFA-100A).
- C<sub>7</sub>—Dual 365- $\mu$ f. variable, stators in parallel (broadcast replacement type).
- C<sub>8</sub>, C<sub>10</sub>—See coil table.
- C<sub>9</sub>, C<sub>11</sub>—32- $\mu$ f. variable (Johnson 30M8 160-130).
- CR<sub>1</sub>—360 p.i.v. 200-ma. silicon (Sarkes-Tarzian K-200).
- I<sub>1</sub>—6.3-v. panel light.
- J<sub>1</sub>—Microphone connector (Amphenol 75-PC1M).
- J<sub>2</sub>—Octal tube socket, for phase-shift network.

- J<sub>3</sub>, J<sub>4</sub>—Coaxial-plug receptacle (SO-239).
- L<sub>1</sub>, L<sub>2</sub>—4–30 mh. slug-tuned coil (Miller 6315) adjusted to 25 mh. See text.
- L<sub>3</sub>, L<sub>4</sub>, L<sub>5</sub>—See coil table.
- L<sub>6</sub>—10-henry 110-ma. filter choke (Knight 62G139).
- P<sub>1</sub>—Fuse plug.
- S<sub>1</sub>—3-pole 3-position rotary switch.
- S<sub>2</sub>—D.p.d.t. toggle.
- S<sub>3</sub>—Single-pole 2-position non-shorting rotary switch.
- S<sub>4</sub>—Two-pole 5-position rotary switch, non-shorting.
- S<sub>5</sub>, S<sub>6</sub>—S.p.s.t. toggle.
- T<sub>1</sub>—20,000-to-600 ohms tube-to-line transformer (Thordarson 22S91).
- T<sub>2</sub>—520 v.c.t. at 90 ma., 5 v., 6.3 v. (Knight 61G412).

pin on the socket for L<sub>5</sub>, with the other capacitor terminal connected to the chassis. A jumper in the 75-meter L<sub>6</sub> will then connect the padder across C<sub>8</sub>.

By cutting a small notch in each side of the coil form, the two trimmer capacitors C<sub>9</sub> and C<sub>11</sub> can be mounted side by side in the coil form.

Since the rotor terminals of C<sub>9</sub> and C<sub>11</sub> would normally touch each other when the two capacitors are in place, each terminal must be snipped off close to the ceramic. A piece of tinned wire is then soldered to the remaining portion of the terminal and led across the ceramic and up through the hole that will be farther from the

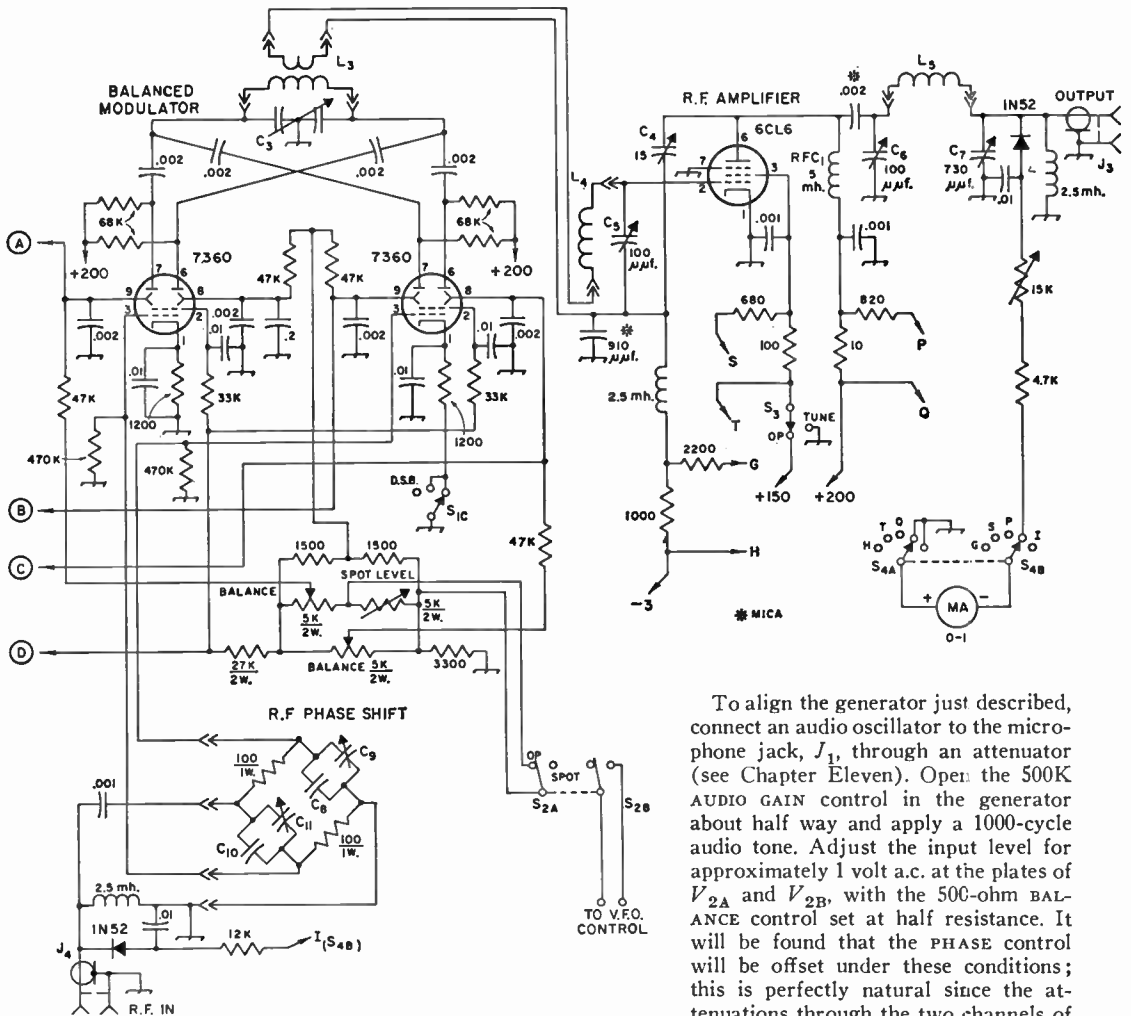

other trimmer capacitor when the two are in place. The connections to  $C_9$ ,  $C_{10}$  and the two 100-ohm 1-watt (composition, not wirewound) resistors must be made before the wires are snaked through the coil-form pins and soldered. Before soldering to the coil-form pins, the lengths of leads to the stators of  $C_9$  and  $C_{11}$  can be measured and soldered. The leads to the rotors from the coil-form pins are long leads that are led up from the pins through the holes in the ceramic end supports. When these long leads have been soldered to the leads from the rotors they will serve to hold  $C_9$  and  $C_{11}$  in place.

**Adjustment**

An audio oscillator or other source of low-distortion single-tone audio is a necessity in the preliminary adjustment of the sideband generator. An oscilloscope is also very useful, but it is possible to adjust the generator with only the source of single-tone a.f., a selective receiver and a v.t.v.m.

To align the generator just described, connect an audio oscillator to the microphone jack,  $J_1$ , through an attenuator (see Chapter Eleven). Open the 500K AUDIO GAIN control in the generator about half way and apply a 1000-cycle audio tone. Adjust the input level for approximately 1 volt a.c. at the plates of  $V_{2A}$  and  $V_{2B}$ , with the 500-ohm BALANCE control set at half resistance. It will be found that the PHASE control will be offset under these conditions; this is perfectly natural since the attenuations through the two channels of the audio phase-shift network are not equal. If a good oscilloscope is available (identical phase shifts through vertical and horizontal amplifiers), the outputs from  $V_{2A}$  and  $V_{2B}$  should give a circle on the scope face when the vertical and horizontal gains are equalized.

Apply r.f. from the v.f.o. or crystal-controlled oscillator at  $J_4$ , and increase its amplitude until the meter shows full scale with  $S_4$  turned full clockwise. A full-scale reading will be close to 3½ volts peak at the No. 3 pins of the 7360 balanced-modulator tubes. With  $S_3$  in the TUNE position, and  $S_5$  switched to read the grid current of the 6CL6, it should be possible to tune  $C_3$  and  $C_5$  and get an indication of grid current. Turn off the generator by pulling the line plug and temporarily open one side of the 10-ohm resistor in the plate-voltage lead to the 6CL6. The 6CL6 stage can now be neutralized, using for an indicator a receiver connected to the output jack  $J_3$ . Use a length of coaxial cable from  $J_3$  to the receiver, and install an attenuator network at the receiver antenna terminals. Adjust



Fig. 11-14—Plug-in coils and r.f. phase-shift networks for the sideband generator. Output tank coils (right) include additional padding capacitor for  $C_7$ , as given in the coil table. Polystyrene coil forms are 4-pin (Allied Radio 24-4P) and 5-pin (Allied Radio 24-5P).

the neutralizing capacitor for minimum signal at the receiver, with all circuits resonated,  $S_3$  on TUNE, and the signal backed off below the grid-current level.

Turn off the power, reconnect the 10-ohm resistor, and connect a dummy load to the output of the sideband generator. Couple the scope and/or receiver to the dummy load or  $L_5$ .

With the oscillator running, tune the balanced modulator and 6CL6 circuits for maximum output—this resonates these circuits. Next adjust the 5K BALANCE potentiometers for minimum output. Then introduce a single audio tone of around 1000 cycles at the microphone terminal. Here again it may be necessary to use a resistance voltage divider to hold the signal down and prevent overload. Advance the gain control and look at or listen to the output signal from the 6CL6. It is most likely to be a heavily modulated signal. Try various settings of  $C_9$  and  $C_{11}$  until the modulation is minimized, and experiment as well with slight touches on the BALANCE and PHASE controls.  $S_2$  should be in the OPERATE positions during these adjustments. With the

v.t.v.m. check the r.f. voltages at the No. 3 pins of the 7360s—they should be the same within a few per cent. If not, they can be brought into this condition by readjustment of  $C_9$  and  $C_{11}$ , consistent with minimum modulation on the output signal.

The s.s.b. signal with single-tone audio input is a steady unmodulated signal. While it may not be possible to eliminate the modulation entirely, it will be possible to get it down to a satisfactorily low level. Conditions that will prevent this are improper r.f. phasing, lack of carrier balance (suppression), distortion in the audio signal (at the source or through overload in the speech amplifier), and lack of audio balance at the 12AT7 audio amplifier.

A final check on the signal can be made with the receiver in its most selective condition. Examining the spectrum near the signal, the side signals other than the main one (carrier, unwanted sidebands, and sidebands from audio harmonics) should be at least 30 db. down from the desired signal.

The bias potentiometer for the 6CL6 amplifier should be set initially for a bias of about—3 volts (plate and screen currents of about 30 and 7 ma.). Under-maximum-signal conditions, just short of running into grid current, the plate current will kick up slightly. The best indicator is the output meter.

SIDEBAND GENERATOR COIL TABLE

Band (meters)	$L_s$	$L_4$	$L_5$	$C_7$ pad***	$C_8, C_{10}$ ***
75	47 t. No. 24, 32 t.p.i., 1½ diam.; 3 turn link (B & W 80 MCL)	41 turns*	27 turns*	910 $\mu$ f.	390 $\mu$ f.
40	25 t. No. 22, 16 t.p.i., 1½ diam.; 3 turn link (B & W 40 MCL)	20 turns*	19 turns*	470 $\mu$ f.	200 $\mu$ f.
20	13 t. No. 18, 8 t.p.i., 1½ diam.; 2 turn link (B & W 20 MCL)	17 turns**	16 turns**	270 $\mu$ f.	91 $\mu$ f.

\*32 t.p.i. No. 24, 1 inch diam. (B & W 3016 Miniductor).  
 \*\*16 t.p.i. No. 20, ¾ inch diam. (B & W 3D11 Miniductor).  
 \*\*\*Silver mica,  $\pm$  5 per cent tolerance.

# Specialized Communications Systems

The field of specialized amateur communications systems includes radioteletype, amateur television, amateur facsimile, and repeaters (fixed and mobile). Radio control of models is not a "communications" system in the amateur (two-way) sense. The specialized hobby of radio control has a large following, but "citizen-band" provisions for frequency allocations and operator registrations divorce it from the strictly ham-radio field (unless one wishes to avoid the QRM). By far the greatest activity in the specialized fields is to be found in radioteletype (RTTY).

Activity in amateur TV (ATV) can be found primarily in a number of population centers around the country. Most of the work is based on converted entertainment receivers and manufacturer's-surplus camera tubes (Vidicons). ATV is permitted on the amateur bands above 420 Mc., and this and the broadband nature of the transmissions precludes extensive DX work. (See *QST*, November, 1962).

"Slow-scan TV" is essentially facsimile and a narrow-band system that is permitted in any of the 'phone bands. It is a completely electronic system, however; no photographic techniques are required. Depending upon the definition (number of lines) and the bandwidth, pictures can be transmitted in 6 seconds or less. (See *QST*, Aug., 1958; Jan., 1961; March, 1964).

Hilltop-located unmanned repeater stations make extended-range v.h.f. contacts readily possible with normal equipment. Ten or so such stations are scattered around the country. Each one is a special problem, involving satisfying the FCC that all legal requirements (no unauthorized access, log-keeping, master control) be met. (See Green, *QST*, July, 1962.)

Extensive work has already been done on an earth-orbiting satellite repeater station ("OSCAR III"), and it should be in space shortly after this book is off the press. *QST* carries up-to-date reports on its progress.

## RADIOTELETYPE

Radioteletype (abbreviated RTTY) is a form of telegraphic communication employing typewriter-like machines for 1) generating a coded set of electrical impulses when a typewriter key corresponding to the desired letter or symbol is pressed, and 2) converting a received set of such impulses into the corresponding printed character. The message to be sent is typed out in much the same way that it would be written on a typewriter, but the printing is done at the distant receiving point. The teletypewriter at the sending point also prints the same material, for checking and reference.

The machines used for RTTY are far too complex mechanically for home construction, and if purchased new would be highly expensive. However, used teletypewriters in good mechanical condition are available at quite reasonable prices. These are machines retired from commercial service but capable of entirely satisfactory operation in amateur work. They may be obtained from several sources on condition that they will be used purely for amateur purposes and will not be resold for commercial use. Information on prices and availability of teletype equipment may be obtained from:

RTTY Society of Southern California  
Attn: M. L. Swan, W6AEE  
372 Warren Way  
Arcadia, Calif. 91007



The Model 15 page printer, shown here with table, is used in a great many RTTY stations.



(W6AEE publishes a monthly bulletin, "RTTY", at nominal cost, that includes technical and operating information.)

RTTY Society of Northern Calif. (NCARTS)  
Attn: Art Sloper, W6MXJ  
436 Madrid St.  
San Francisco 12, Calif.

(NCARTS has available a 14-page pamphlet on RTTY, with circuits. Write for information.)

Chicago Amateur Radio-Teletypewriter Society.  
Attn: Ray E. Morrison, W9GRW  
8029 Keeler Avenue  
Skokie, Ill.

### Types of Machines

There are two general types of machines. the **page printer** and the **tape printer**. The former prints on a paper roll about the same width as a business letterhead. The latter prints on paper tape, usually gummed on the reverse side so it may be cut to letter-size width and pasted on a sheet of paper in a series of lines. The page printer is the more common type in the equipment available to amateurs.

The operating speed of most machines is such that characters are sent at the rate of about 60 words per minute. Ordinary teletypewriters are of the **start-stop** variety, in which the pulse-forming mechanism (motor driven) is at rest until a typewriter key is depressed. At this time it begins operating, forms the proper pulse sequence, and then comes to rest again before the next key is depressed to form the following



The Model 32 page printer is one of the newer types; it can be obtained directly from the manufacturer at a price that is reasonably attractive to the amateur.

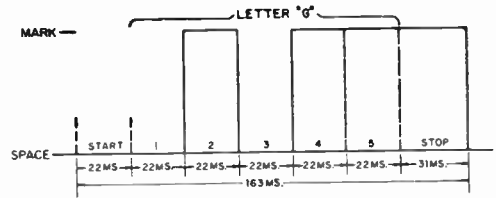

Fig. 10-1—Pulse sequence in the teletype code. Each character begins with a start pulse, always a "space," and ends with a "stop" pulse, always a "mark." The distribution of marks and spaces in the five elements between start and stop determines the particular character transmitted.

character. The receiving mechanism operates in similar fashion, being set into operation by the first pulse of the sequence from the transmitter. Thus, although the actual transmission speed cannot exceed about 60 w.p.m. it can be considerably slower, depending on the typing speed of the operator.

It is also possible to transmit by using perforated tape. This has the advantage that the complete message may be typed out in advance of actual transmission, at any convenient speed; when transmitted, however, it is sent at the machine's normal maximum speed. A special transmitting head and tape perforator are required for this process. A **reperforator** is a device that may be connected to the conventional teletypewriter for punching tape when the machine is operated in the regular way. It may thus be used either for an original message or for "taping" an incoming message for retransmission.

### Teletype Code

In the special code used for teletype every character has five "elements" sent in sequence. Each element has two possible states, either "mark" or "space," which are indicated by different types of electrical impulses (i.e., mark might be indicated by a negative voltage and space by a positive voltage). In customary practice each element occupies a time of 22 milliseconds. In addition, there is an initial "start" element (space), also 22 milliseconds long, to set the sending and receiving mechanisms in operation, and a terminal "stop" element (mark) 31 milliseconds long, to end the operation and ready the machine for the next character.

This sequence is illustrated in Fig. 10-1, which shows the letter G with its start and stop elements. The letter code as it would appear on perforated tape is shown in Fig. 10-2, where the black dots indicate marking pulses. Figures and arbitrary signs — punctuation, etc. — use the same set of code impulses as the alphabet, and are selected by shifting the carriage as in the case of an ordinary typewriter. The carriage shift is accomplished by transmitting

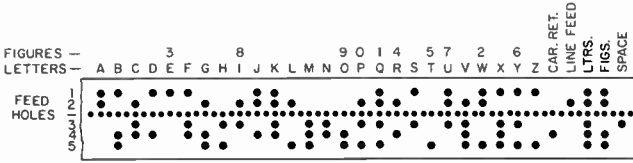

Fig. 10-2—Teletype letter code as it appears on perforated tape. Start and stop elements do not appear on tape. Elements are numbered from top to bottom, and dots indicate marking pulses. Numerals, punctuation signs, and other arbitrary symbols are secured by carriage shift.

There are no lower-case letters on a teletypewriter. Where blanks appear in the above chart in the "FIGS" line, characters may differ on different machines.

either the "LTRS" or "FIGS" code symbol as required. There is also a "carriage return" code character to bring the carriage back to the starting position after the end of the line is reached on a page printer, and a "line feed" character to advance the page to the next line after a line is completed.

**Additional System Requirements**

To be used in radio communication, the pulses (d.c.) generated by the teletypewriter must be utilized in some way to key a radio transmitter so they may be sent in proper sequence and usable form to a distant point. At the receiving end the incoming signal must be converted into d.c. pulses suitable for operating the printer. These functions, shown in block form in Fig. 10-3, are performed by electronic units known respectively as the **keyer** and **receiving converter**.

The radio transmitter and receiver are quite conventional in design. Practically all the special features needed can be incorporated in the keyer and converter, so that any ordinary amateur equipment is suitable for RTTY with little modification.

**Transmission Methods**

It is quite possible to transmit teletype signals by ordinary "on-off" or "make-break" keying such as is used in regular hand-keyed c.w. transmission. In practice, however, **frequency-shift keying** is preferred because it gives definite pulses on both mark and space, which is an advantage in printer operation. Also, since f.s.k. can be received by methods similar to those used for f.m. reception, there is considerable discrimination against noise, both natural and man-made, distributed uniformly across the receiver's pass band, when the received signal is not too weak. Both factors make for increased reliability in printer operation.

**Frequency-Shift Keying**

General practice with f.s.k. is to use a frequency shift of 850 cycles per second, although FCC regulations permit the use of any value of frequency shift up to 900 cycles. The smaller values of shift have been shown to have a signal-to-noise-ratio advantage in commercial circuits, and are currently being experimented with by amateurs. At present, however, the major part of amateur RTTY work is done with the 850-cycle shift. This figure also is used in much commercial work. The nominal transmitter frequency is the mark condition and the frequency is shifted 850 cycles (or whatever shift may be chosen) lower for space.

On the v.h.f. bands where A2 transmission is permitted **audio frequency-shift keying (a.f.s.k.)** is generally used. In this case the r.f. carrier is transmitted continuously, the pulses being transmitted by frequency-shifted tone modulation. The audio frequencies used have been more-or-less standardized at 2125 and 2975 cycles per second, the shift being 850 cycles as in the case of straight f.s.k. (These frequencies are the 5th and 7th harmonics, respectively, of 425 cycles, which is half the shift frequency, and thus are convenient for calibration and alignment purposes.) With a.f.s.k. the lower audio frequency is customarily used for mark and the higher for space.

**THE RECEIVING CONVERTER**

In receiving an f.s.k. teletype signal, the receiver's beat-frequency oscillator is turned on as for ordinary c.w. reception and the receiver tuning is then adjusted so that the mark and space signals produce audio beat tones of 2125 and 2975 cycles. Either frequency can be used for either mark or space, but no matter which may be used at the transmitter, the mark and space frequencies can be reversed at the receiver simply by tuning to the "other side of zero beat." (This cannot be done with a.f.s.k., of course, but the reversal can be accomplished quite simply, if necessary, by interchanging the outputs from the two frequencies as applied to the printer.) The audio-frequency tones are applied to separate rectifiers to convert them into d.c. impulses, which may then be further amplified to the power level required to operate the printer.

The receiving converter which performs these functions generally will include means

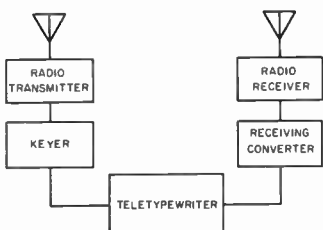

Fig. 10-3—Radioteletype in block form.

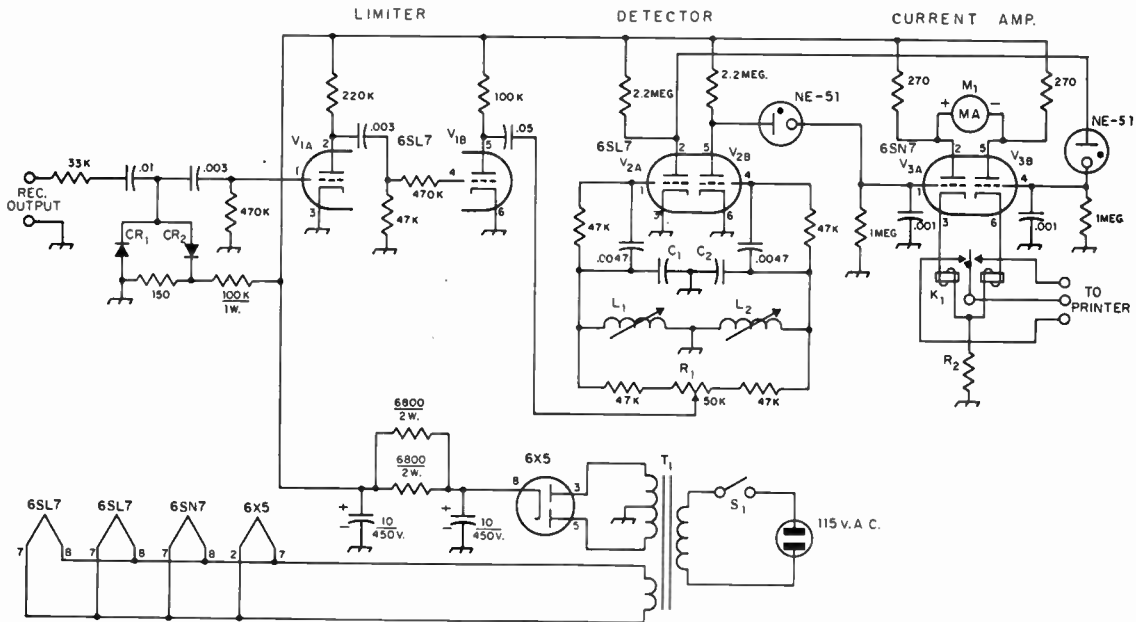

Fig. 10-4—Receiving converter for f.s.k. teletype signals (W2PAT). Unless otherwise indicated, capacitances are in  $\mu\text{f}$ , resistances are in ohms, resistors are  $\frac{1}{2}$  watt. Capacitors of 0.01  $\mu\text{f}$ . or less may be mica or ceramic; larger values may be paper. Capacitors with polarities indicated are electrolytic.

$C_1$ —0.15- $\mu\text{f}$ . paper.

$C_2$ —0.1- $\mu\text{f}$ . paper.

$CR_1$ ,  $CR_2$ —1N34 or equivalent.

$K_1$ —Polar relay, to operate on 20 ma.

$L_1$ —36 mh. (TV width control, GE type RLD-019).

$L_2$ —29 mh. (TV width control, GE type RLD-014).

$M_1$ —Zero-center d.c. milliammeter, 20 ma. or more full scale (may be a 100-0-100 microammeter ap-

propriately shunted).

$R_1$ —50,000-ohm volume control, linear taper.

$R_2$ —1000 ohms, 1 watt.

$S_1$ —S.p.s.t. toggle.

$T_1$ —Power transformer, 500 volts c.t., 30 ma.; 6.3 volts 3 amp.

$V_1$ ,  $V_2$ —6SL7 (or 12AX7).

$V_3$ —6SN7GT (or 12AU7).

for clipping or limiting the signals so they are held at constant amplitude, and may also include provision for some shaping of the pulses to overcome distortion that occurs in transmission. There are many ways by which these results can be accomplished, and the higher the order of performance the more complicated the circuits become. However, satisfactory results under reasonably good receiving conditions can be secured with relatively simple equipment, and the "basic" circuit shown in Fig. 10-4 has proved to be quite successful in practice. It operates as follows:

When audio output from the receiver is applied, the two diodes,  $CR_1$  and  $CR_2$ , which are biased with approximately 0.3 volt, limit the peak voltage at the grid of the limiter tube,  $V_{1A}$ , to 0.6 volt or less for signal voltages up to 30 volts or more. Additional limiting in  $V_{1A}$  further stabilizes the voltage level.  $V_{1B}$  is primarily an amplifier, and delivers approximately 15 volts output, constant to within 1 db. for receiver output voltages varying between about 0.5 volt and more than 30 volts.

The two tones, thus limited in amplitude, are

applied to two simple filter circuits,  $L_1C_1$  and  $L_2C_2$ , tuned to 2125 and 2975 cycles, respectively. The two tones are thus separated, one being applied to the grid of  $V_{2A}$  and the other to the grid of  $V_{2B}$ .  $V_{2A}$  and  $V_{2B}$  operate as grid-leak detectors, and when a signal is applied to, say,  $V_{2A}$ , the flow of grid current causes the grid to be driven practically to plate-current cutoff. As a result the plate voltage on  $V_{2A}$ , normally 15 volts with no signal, rises to 50 volts. This is sufficient to ignite the neon lamp connected between the plate of  $V_{2A}$  and the grid of  $V_{3B}$ , and a positive bias of about 25 volts is applied to the grid of  $V_{3B}$ .  $V_{3B}$  then takes a plate current of about 20 ma. and a bias of 20 volts is developed across the common cathode resistor,  $R_2$ . This is sufficient to cut off the plate current of  $V_{3A}$ , hence the left-hand magnet of the polarized relay,  $K_1$ , is inoperative while the right-hand magnet closes the contacts on its side. A similar action takes place when a signal is applied to the grid of  $V_{2B}$  but not to  $V_{2A}$ ; in this case the relay contacts are pulled to the left. The relay thus keys the mark and space voltages applied to the printer.

Fig. 10-5—Modification of converter circuit for use with single-magnet printers. Unless otherwise indicated, capacitances are in  $\mu\text{f.}$ , resistances in ohms, resistors are  $\frac{1}{2}$  watt.

$M_1$ —Zero-center d.c. milliammeter, 100 ma. full scale (may be microammeter with appropriate shunt).

$R_1$ —50,000-ohm volume control.

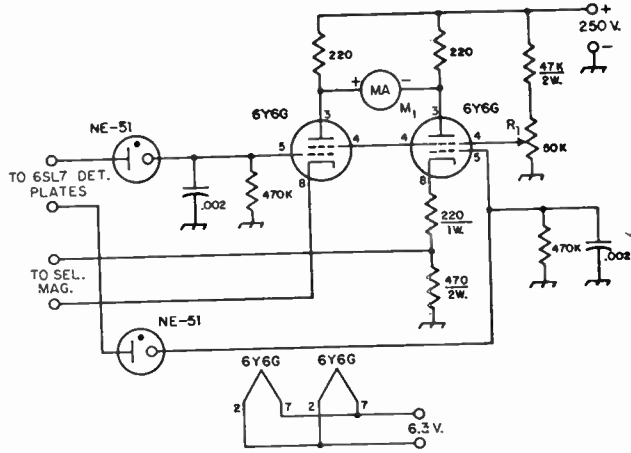

Potentiometer  $R_1$  is adjusted so that incoming noise (which will affect both channels equally) is balanced out and does not cause  $K_1$  to operate. The neon lamps improve the operation of the circuit by acting as switches, making for sharp demarcation between mark and space pulses.

The zero-center meter,  $M_1$ , is not a necessity but is a convenience in making adjustments.  $R_1$  should be adjusted on receiver noise for zero reading. With a 2125-cycle tone the pointer will swing to the left and  $L_1$  should be adjusted for maximum deflection. With a 2975-cycle tone the pointer will swing to the right and  $L_2$  should be adjusted for maximum deflection. Equal deflections should be obtained from both channels.

The keying circuit shown in Fig. 10-4 is for use with the Model 12 machine which requires an external power supply. For machines having a single selector magnet the modification shown in Fig. 10-5 may be used so the printer may be operated directly. These machines usually require a current of 60 ma., which will be furnished by this circuit and may be adjusted to the correct value by means of  $R_1$ . Note that a heavier power supply is required than that of Fig. 10-4.

**FREQUENCY-SHIFT KEYERS**

The keyboard contacts of the teletypewriter actuate a direct-current circuit that operates the printer magnets, and a pair of terminals is provided at which a keyed d.c. signal of the order of 100 volts is available. (Some machines, such as the Model 12, require an external d.c. power supply for this purpose; others have self-contained power supplies.) In the "resting" condition the contacts are closed (mark) and the voltage at the terminals, which are in parallel with the contacts, is zero. In operation, the contacts open for "space" and the full voltage appears across the terminals. As normally connected, the spacing signal has positive polarity.

This keyed d.c. voltage may be used to operate a keyer circuit for the radio transmitter, provided it is not "loaded" to such an extent that it affects the operation of the printer. Alternatively, the keyed current, rather than the voltage, may be used for external keying. This can be done by using an auxiliary keying relay with its coil connected in series with the printer magnet or relay circuit. A fast-acting relay

must be used, and the coil must be one that will operate satisfactorily on the current available in the printer circuit. This will usually be either 20 or 60 milliamperes, depending on the type of machine.

**F.S.K. with Variable-Frequency Oscillators**

Perhaps the simplest satisfactory circuit for frequency-shift keying a v.f.o. is the one shown in Fig. 10-6A. This operates from the voltage available at the keyboard contact terminals and uses a reactance tube to obtain the required frequency shift.

The frequency shift is obtained by changing the plate resistance of the reactance tube,  $V_2$ , so that in effect the variable capacitor  $C_2$  is alternately disconnected or connected in parallel with the tuning capacitor in the v.f.o. tank circuit. With no voltage applied to the grid,  $V_2$  is biased so that the plate current is low and the effect of  $C_2$  on the oscillator frequency is small. When a positive voltage from the keyboard contacts is applied to the grid the plate resistance is low and the oscillator frequency becomes lower because of the greater effect of  $C_2$ . The amount of frequency shift depends on the capacitance of  $C_2$  and the amplitude of the positive voltage applied to the grid of  $V_2$ . The latter can be controlled by  $R_1$ .

$C_1$ , the associated 20,000-ohm resistor, and the neon bulb,  $V_1$ , constitute a filter for removing clicks generated at the keyboard contacts. The value of  $C_1$  depends somewhat on the machine, and values up to 0.25  $\mu\text{f.}$  can be used, if necessary, without objectionable distortion of the keying pulses. The capacitance should be adjusted for clickless keying.

The frequency-shift circuit should be initially adjusted at the lowest radio frequency to be used, since the shift will be smallest in this case. If  $C_2$  is set so a shift of 850 cycles is obtained at this frequency, further adjustment of the shift may be made by means of  $R_1$ . If the transmitter output is on a higher-frequency

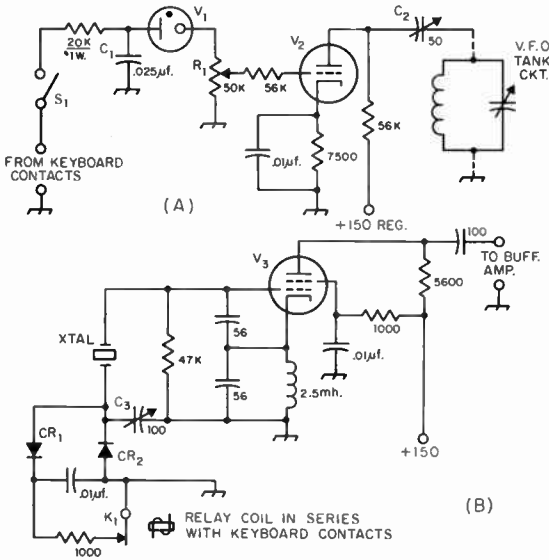

Fig. 10-6—Frequency-shift keyer circuits. Unless otherwise indicated, capacitances are in  $\mu\text{mf.}$ , resistances are in ohms, resistors are  $\frac{1}{2}$  watt. A—Reactance-tube keyer for use with variable-frequency oscillator (W6OWP). B—Crystal oscillator circuit (W2PAT). It is essential that all leads associated with the crystal portion of the circuit be held to a small fraction of an inch in length if maximum shift is desired.

- $C_1$ —Paper (see text).
- $C_2$ —50pf. midget variable.
- $C_3$ —100pf. midget variable.
- $CR_1, CR_2$ —1N34 or equivalent.
- $K_1$ —Normally closed relay, fast operating, coil current according to printer magnet or relay current.
- $R_1$ —Volume control.
- $S_1$ —S.p.s.t. toggle.
- $V_1$ —1-watt neon bulb without base resistor.
- $V_2$ —6C4 or equivalent.
- $V_3$ —6AK5 or equivalent.

band than that on which the v.f.o. operates, the shift at the v.f.o. fundamental frequency must be reduced accordingly.

#### F.S.K. With Crystal Oscillators

Fig. 10-6B is a circuit which has been found to give a frequency shift of 850 cycles or more with crystals of the type ordinarily used for frequencies of the order of 3.5 Mc. and higher. This is an oscillator of the "grid-plate" type

discussed in Chapter 6, with the addition of a variable capacitor,  $C_3$ , in series with the crystal.  $C_3$  reduces the total capacitance across the crystal and thus raises the oscillation frequency. When it is shorted out the capacitance across the crystal is higher and the resulting frequency is lower.

Although relay contacts could be used for shorting the capacitor, the diode arrangement shown in Fig. 10-6B is more reliable in practice. With the contacts of  $K_1$  open there is no d.c. path through  $CR_2$  and it acts simply as a small capacitance (about  $1 \mu\text{mf.}$ ) in parallel with  $C_3$ . When the contacts of  $K_1$  are closed there is a d.c. circuit through  $CR_1, CR_2$  and the 1000-ohm resistor. Thus there is a path for direct current flow as a result of rectification of the r.f. voltage across  $CR_2$ . Because of the d.c. bias the resistance of  $CR_2$  drops to a low value and  $C_3$  is effectively shorted out.

Adjustment of the circuit consists simply of determining the setting of  $C_3$  at which the operating frequency is 850 cycles (or the desired shift) higher with the contacts of  $K_1$  open than the frequency when the relay contacts are closed. A normally closed relay is used in order to make the mark frequency lower than the space frequency, in accordance with usual practice.

#### Frequency Adjustment

The frequency shift, whatever the type of circuit, should be made as nearly exact as available equipment will permit, since the shift must match the frequency difference between the filters in the receiving converter if the signals are to be usable at the receiving end. An accurately calibrated audio oscillator is useful for this purpose. To check, the mark frequency should be tuned in on the station receiver, with the b.f.o. on, and the receiver set to exact zero beat (see Chapter 21 on measurements for identification of exact zero beat). The space frequency should then be adjusted to exactly the desired shift. This may be done by adjusting for an auditory zero beat between the beat tone from the receiver and the tone from the audio oscillator. If an oscilloscope is available, the frequency adjustment may be accomplished by feeding the receiver tone to the vertical plates and the audio-oscillator tone to the horizontal plates, and then adjusting the space frequency for the elliptical pattern that indicates the two frequencies are the same.



# Testing and Monitoring Transmissions

Testing and measuring of power output and frequency are not treated in this chapter, since they are treated elsewhere. It should be pointed out, however, that the fine points of frequency measurement become increasingly important as one operates closer to a band edge.

A little knowledge of how to test one's own equipment is worth more than most of the solicited reports obtained over the air during a lifetime. *Unsolicited adverse* criticism is something else again; it usually indicates a signal

so bad that it is a menace to the welfare of the band!

"Testing" involves the checking of new or modified equipment, to determine if it is working as it should. "Monitoring" is the continuous checking during every transmission, to insure that nothing has failed or that inherent limits have not been exceeded. Obviously the fields are overlapping, and "checking" procedures may be used for continuous monitoring.

## TESTING KEYING

The easiest way to find out what your keyed signal sounds like on the air is to trade stations with a near-by ham friend some evening for a short QSO. If he is a half mile or so away, that's fine, but any distance where the signals are still S9 will be satisfactory.

After you have found out how to work his rig, make contact and then have him send slow dashes, with dash spacing. (The letter "T" at about 5 w.p.m.) With minimum selectivity, cut the r.f. gain back just enough to avoid receiver overloading (the condition where you get crisp signals instead of mushy ones) and tune slowly from out of beat-note range on one side of the signal through to zero and out the other side. Knowing the tempo of the dashes, you can readily identify any clicks in the vicinity as yours or someone else's. A good signal will have a thump on "make" that is perceptible only where you can also hear the beat note, and the click on "break" should be practically negligible at any point. If your signal is like that, it will sound good, provided there are no chirps. Then have your friend run off a string of fast dots with the bug — if they are easy to copy, your signal has no "tails" worth worrying about and is a good one for any speed up to the limit of manual keying. Make one last check with the selectivity in, to see that the clicks off the signal frequency are negligible even at high signal level.

If you don't have any friends with whom to trade stations, you can still check your keying, although you have to be a little more careful. The first step is to get rid of the r.f. click at the key. This requires an r.f. filter (see Chapter 7).

With no click from a spark at the key, disconnect the antenna from your receiver and short the antenna terminals with a short piece of wire. Tune in your own signal and reduce the r.f. gain to the

point where your receiver doesn't overload. Detune any antenna trimmer the receiver may have. If you can't avoid overload within the r.f. gain-control range, pull out the r.f. amplifier tube and try again. If you still can't avoid overload, listen to the second harmonic as a last resort. An overloaded receiver can generate clicks.

Describing the volume level at which you should set your receiver for these "shack" tests is a little difficult. The r.f. filter should be effective with the receiver running wide open and with an antenna connected. When you turn on the transmitter and take the steps mentioned to reduce the signal in the receiver, run the audio up and the r.f. down to the point where you can just hear a little "rushing" sound with the b.f.o. off and the receiver tuned to the signal. This is with the selectivity in. At this level, a properly adjusted keying circuit will show no clicks off the rushing-sound range. With the b.f.o. on and the same gain setting, there should be no clicks outside the beat-note range. When observing clicks, make the slow-dash and dot tests outlined previously.

Now you know how your signal sounds on the air, with one possible exception. If keying your transmitter makes the lights blink, you may not be able to tell too accurately about the chirp on your signal. However, if you are satisfied with the absence of chirp when tuning *either side of zero beat*, it is safe to assume that your receiver isn't chirping with the light flicker and that the observed signal is a true representation. No chirp either side of zero beat is fine. Don't try to make these tests without first getting rid of the r.f. click at the key, because clicks can mask a chirp.

The least satisfactory way to check your keying is to ask another ham on the air how your keying sounds. It is the least satisfactory because

most hams are reluctant to be highly critical of another amateur's signal. In a great many cases

they don't actually know what to look for or how to describe any aberrations they may observe.

## MONITORING OF KEYING

In general, there are two common methods for monitoring one's "fist" and signal. The first type involves the use of an audio oscillator that is keyed simultaneously with the transmitter.

The second method is one that permits receiving the signal through one's receiver, and this generally requires that the receiver be tuned to the transmitter (not always convenient unless working on the same frequency) and that some method be provided for preventing overloading

of the receiver, so that a good replica of the transmitted signal will be received. Except where quite low power is used, this usually involves a relay for simultaneously shorting the receiver input terminals and reducing the receiver gain. Methods are shown in Chapter 5.

An alternative is to use an r.f.-powered audio oscillator. This follows the keying very closely (but tells nothing about the quality—chirps or clicks—of the signal).

## THE "MATCHTONE"

The "Matchtone" is a c.w. tone-generating monitor using a transistor audio oscillator. A diode rectifier in the antenna circuit or the d.c. from a "Monimatch" (see Chap. 13) serves as the keyed source of d.c. power. In addition to the usual function it can be used by the sightless amateur as an audible transmitter-antenna tuning indicator.

While direct monitoring of c.w. transmissions via the receiver is a preferred method because it can reveal much about the keying characteristics, transmissions offset from the receiving frequency call for a separate monitor. The self-powered transistorized monitor fills the bill nicely. The use of the r.f. bridge, already connected in the r.f. transmission line, as a source of power for the monitor is a logical choice.

The circuit of the Matchtone and the connections to the Monimatch and the receiver are shown in Fig. 11-1. A small 2- or 3-to-1 push-pull grid-to-plate audio interstage transformer is used for feedback as well as for coupling to the receiver. If a transformer having a p.p. grid winding is not available from the junk box, the audio coupling to the receiver can be obtained by connecting  $C_2$  to the ungrounded end of  $R_1$ . While use of a low value of capacitance for  $C_2$  is necessary to avoid excessive shunting of the high impedance receiver audio circuit, the value shown will provide sufficient coupling for a good audio tone level from the monitor. A third possibility for the audio output connection from the monitor is to substitute the headphones for  $R_1$ , together with a single-pole double-throw switch or relay to switch the phones between the monitor and the receiver. The on-off switch,  $S_1$ , can be made a part of  $R_2$  by use of a volume control switch attachment.

The value shown for  $C_1$  gives an audio pitch in the 500-1000 cycle range, depending somewhat on the particular transformer, the setting of  $R_2$  and the transmitter output power. Other values of  $C_1$  can be used to adjust the pitch to the

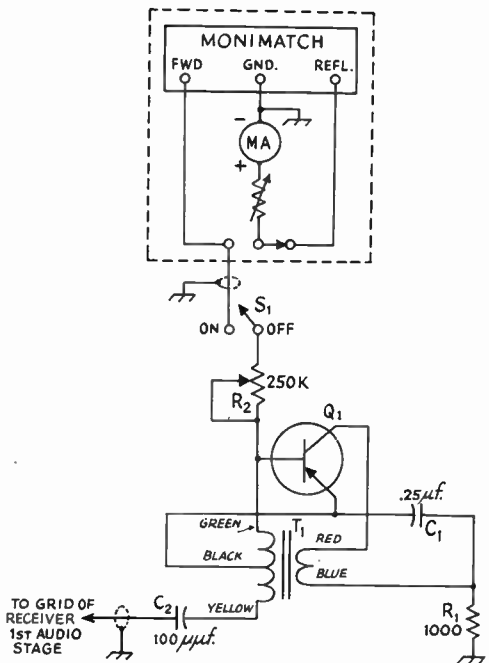

Fig. 11-1—Circuit of the Matchtone. Section enclosed in dashed line is the Monimatch and its indicating circuit; a simple r.f. rectifier will also serve as the d.c. source. Braid of shielded lead to audio grid should connect to receiver chassis.

$C_1$ —Paper.

$C_2$ —Mica or ceramic.

$Q_1$ —2N109, CK722 or similar.

$R_1$ —1000 ohms, ½ watt.

$R_2$ —0.25-megohm volume control.

$S_1$ —S.p.s.t. toggle.

$T_1$ —Push-pull interstage audio transformer, 2:1 or 3:1 total grid to plate.

operator's individual preference.  $R_2$  may be adjusted to compensate for the changes in the d.c. current from the rectifier or Monimatch caused by a change in transmitter frequency band or power. Using a 2N109 transistor, the circuit should oscillate with usable audio level with as little as 0.1 ma. d.c. flowing to ground through the monitor. Other low-cost transistors such as the 2N107 and the 2N170 should work equally well in the circuit.

Because the pitch of the audio tone is to some degree dependent upon the d.c. voltage obtained from the source, the pitch gives a reasonably accurate indication of correct final amplifier plate circuit tuning (maximum power output) and, if an antenna tuner is used, will also indicate resonance of the tuner to the transmitter output frequency. This characteristic of the Matchtone should be of considerable aid to sightless amateurs. (From *QST*, January, 1958.)

## CHECKING AUDIO AMPLIFIER OPERATION

An adequate job of checking speech equipment can be done with equipment that is neither elaborate nor expensive. A typical setup is shown in Fig. 11-2. The construction of a simple audio oscillator is described in the chapter on measurements. The voltmeter can be either a v.t.v.m. or a volt-ohmmeter with a rectifier-type a.c. range. The headset is included for aural checking.

An audio oscillator usually will have an output control, but if the maximum output voltage is in excess of a volt or so the output setting may be rather critical when a high-gain speech amplifier is being tested. In such cases an attenuator such as is shown in Fig. 11-2 is a convenience.

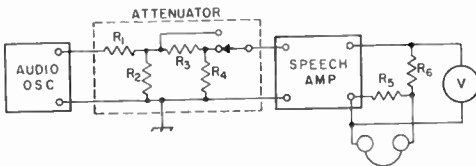

Fig. 11-2—Simple oscillator-attenuator test setup for checking a speech amplifier. It is not necessary that the frequency range of the audio oscillator be continuously variable; one or more "spot frequencies" will be satisfactory. Suitable resistor values are:  $R_1$  and  $R_3$ , 10,000 ohms;  $R_2$  and  $R_4$ , 1000 ohms.

Each of the two voltage dividers reduces the voltage by a factor of roughly 10 to 1, so that the over-all attenuation is about 100 to 1. The relatively low value of resistance,  $R_4$ , connected across the input terminals also will minimize stray hum pickup on the connecting leads.

The output of a power amplifier such as a modulator or driver for a Class B stage may be checked by using a resistance load of the rated value for the amplifier. A useful circuit arrangement is shown in Fig. 11-3. The load resistance,  $R_1$ , may be a single adjustable unit of appropriate power rating or may be made up of several resistors in series or parallel to give the required resistance. If measurement of the resistance is necessary an ohmmeter will be sufficiently accu-

rate. In the case of a multimatch output transformer the taps should be those that will actually be used with the Class C amplifier with which the modulator is intended to work.  $R_1$  then should have a value equal to the modulating impedance of the r.f. amplifier.

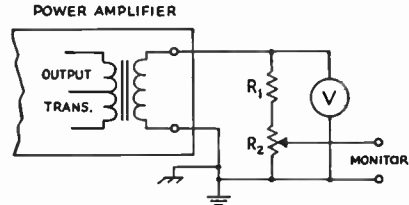

Fig. 11-3—Circuit for measuring power and making qualitative checks of the amplifier output. Values to be used for  $R_1$  and  $R_2$  are discussed in the text. The secondary winding of the output transformer in the amplifier should be disconnected from any d.c. source in the unit and one end connected to chassis as shown. An earth ground should be used on the system.

If an audio oscillator generating a good sine wave is used as the signal source the output power of the amplifier may be measured by an audio-frequency voltmeter as indicated by  $V$ . Either a vacuum-tube voltmeter on its a.c. scale or a rectifier-type a.c. voltmeter will be satisfactory, the principal requirements being relatively high impedance (1000 ohms per volt or more) and a reasonably accurate calibration. The power output will be equal to  $E^2/R_1$ , where  $E$  is the r.m.s. value of the voltage across the resistor (a.c. instruments usually are calibrated in r.m.s. values). This assumes that the distortion generated in the amplifier is small; if distortion is high, the voltmeter reading will be inaccurate.

If the amplifier is a driver for a Class B modulator, the value of  $R_1$  should be calculated from  $R/N^2$ , where  $N$  is the turns ratio, primary to total secondary, of the class B input transformer, and  $R$  is the rated plate-to-plate load for the driver tube or tubes.  $R_1$  should of course be connected across the total secondary in this case.

For a qualitative check on distortion, provision is made in Fig. 11-3 for monitoring the out-

put of the amplifier.  $R_2$  should be a wire-wound potentiometer having a resistance of 10 or 20 ohms. A headset may be connected to the "Monitor" terminals. Using the audio oscillator as a signal source, start with the gain control at minimum and then advance it slowly while listening carefully to the tone signal in the headset. When it begins to sound like a musical octave instead of a single tone, or when higher harmonically related tones can be heard along with the desired one, distortion is starting to become appreciable. This effect usually will be detectable, but not serious, at full output of the amplifier as indicated by the voltmeter reading. Keep the signal in the headset at a moderate level by adjusting  $R_2$  when necessary. If the amplifier passes the distortion test satisfactorily, reduce the audio input to zero and note whether any hum is audible in the headset. There should be none, if the tone level in the headset at full sine-wave output was no more than moderately high.

After completing these checks with satisfactory results, substitute the microphone for the oscillator input to the amplifier and have someone speak into it at a moderate level. The headset will serve to indicate the speech quality at various output levels. A tape recorder, if available, is useful at this stage since it can be substituted for the headset and will provide a means for comparing the effect of changes and adjustments in the amplifier as well as giving a better over-all check on speech quality than the average headset. The effect of measures taken to attenuate high- or low-frequency response in the amplifier is readily observed by comparing recordings made before and after changes. The output quality of the amplifier also can be compared with the original output of the microphone as registered on the recorder. In using a recorder care must be taken to set  $R_2$  so that the first stage in the recorder amplifier is not overloaded. Use the normal gain setting of the recorder and adjust  $R_2$  to give normal level indications.

#### Amplifier Troubles

If the hum level is too high, the amplifier stage that is causing the trouble can be located by temporarily short-circuiting the grid of each tube to ground, starting with the output amplifier.

When shorting a particular grid makes a marked decrease in hum, the hum presumably is coming from a *preceding* stage, although it is possible that it is getting its start in that particular grid circuit. If shorting a grid does *not* decrease the hum, the hum is originating either in the plate circuit of that tube or the grid circuit of the next. Aside from wiring errors, a defective tube, or inadequate plate-supply filtering, objectionable hum usually originates in the first stage of the amplifier.

If distortion occurs below the point at which the expected power output is secured the stage in which it is occurring can be located by working from the last stage toward the front end of the amplifier, applying a signal to each grid in turn from the audio oscillator and adjusting the signal voltage for maximum output. In the case of push-pull stages, the signal may be applied to the primary of the interstage transformer—*after* disconnecting it from the plate-voltage source and the amplifier tube. Assuming that normal design principles have been followed and that all stages are theoretically working within their capabilities, the probable causes of distortion are wiring errors (such as accidental short-circuit of a cathode resistor), defective components, or use of wrong values of resistance in cathode and plate circuits.

#### Using the Oscilloscope

Speech-amplifier checking is facilitated considerably if an oscilloscope of the type having amplifiers and a linear sweep circuit is available. A typical setup for using the oscilloscope is shown in Fig. 11-4. With the connections shown, the sweep circuit is not required but horizontal and vertical amplifiers are necessary. Audio voltage from the oscillator is fed directly to one oscilloscope amplifier (horizontal in this case) and the output of the speech amplifier is connected to the other. The scope amplifier gains should be adjusted so that each signal gives the same line length with the other signal shut off.

Under these conditions, when the input and output signals are applied simultaneously they are compared directly. If the speech amplifier is distortion-free and introduces no phase shift, the resulting pattern is simply a straight line, as

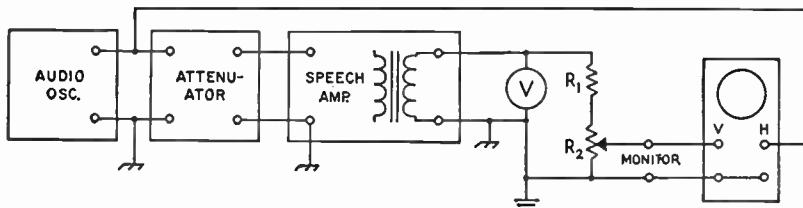

Fig. 11-4—Test setup using the oscilloscope to check for distortion. These connections will result in the type of pattern shown in Fig. 11-5, the horizontal sweep being provided by the audio input signal. For waveform patterns, omit the connection between the audio oscillator and the horizontal amplifier in the scope, and use the horizontal linear sweep.

shown at the upper left in Fig. 11-5, making an angle of about 45 degrees with the horizontal and vertical axes. If there is no distortion but there is phase shift, the pattern will be a smooth ellipse, as shown at the upper right. The greater the phase shift the greater the tendency of the ellipse to grow into a circle. When there is even-harmonic distortion in the amplifier one end of the line or ellipse becomes curved, as shown in the second row in Fig. 11-5. With odd-harmonic distortion such as is characteristic of overdriven push-pull stages, the line or ellipse is curved at both ends.

Patterns such as these will be obtained when the input signal is a fairly good sine wave. They will tend to become complicated if the input wave form is complex and the speech amplifier introduces appreciable phase shifts. It is therefore advisable to test for distortion with an input signal that is as nearly as possible a sine wave. Also, it is best to use a frequency in the 500-1000 cycle range, since improper phase shift in the amplifier is usually least in this region. Phase shift in itself is not of great importance in an audio amplifier of ordinary design because it does not change the character of speech so far as the ear is concerned. However, if a complex signal is used for testing, phase shift may make it difficult to detect distortion in the oscilloscope pattern.

Since the oscilloscope amplifiers themselves may introduce phase shift and possibly distortion as well, it is advisable to check the scope before attempting to make checks on the speech amplifier. Apply the signal from the audio oscillator simultaneously to the horizontal and vertical amplifier input terminals. If both amplifiers have the same phase characteristics and negligible distortion the pattern, after suitable adjustment of the gains, will be a straight line as shown at the upper left in Fig. 11-5. If distortion is visible, note whether it changes when the scope gain controls are reduced; if not, the signal voltage from the audio oscillator is too great and should be reduced to the point where the input amplifiers are not overloaded. After finding the proper settings for signal input and scope gains, leave the latter alone in making checks on the speech equipment and adjust the input to the scope by means of  $R_2$  and the output of the audio oscillator. Phase shift in the scope itself is not serious since the presence of distortion in the speech amplifier can be detected by the patterns shown at the right in Fig. 11-5.

In amplifiers having negative feedback, excessive phase shift within the feedback loop may cause self-oscillation, since the signal feedback may arrive at the grid in phase with the applied signal voltage instead of out of phase with it. Such a phase shift is most likely to be associated with the output transformer. Oscillation usually occurs at some frequency above 10,000 cycles, although occasionally it will occur at a very low frequency. If the pass band in the stage in which the phase shift occurs is deliberately restricted to the optimum voice range, as

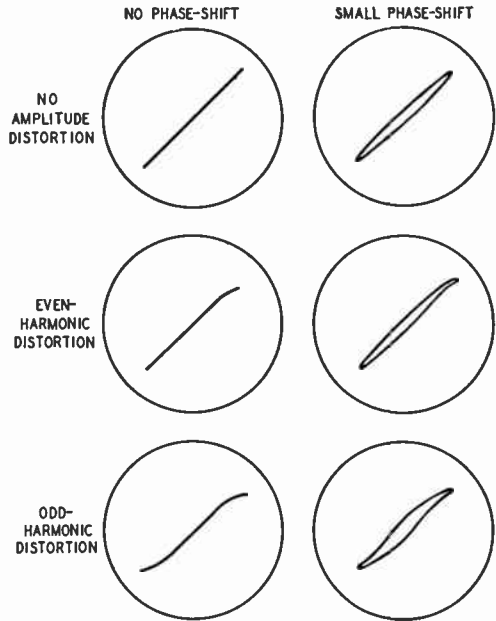

Fig. 11-5—Typical patterns obtained with the connections shown in Fig. 11-4. Depending on the number of stages in the amplifier, the pattern may slope upward to the right, as shown, or upward to the left. Also, depending on where the distortion originates, the curvature in the second row may appear either at the top or bottom of the line or ellipse.

described earlier, the gain at both very high and very low frequencies will be so low that self-oscillation is unlikely, even with large amounts of feedback.

Generally speaking, it is easier to detect small amounts of distortion with the type of pattern shown in Fig. 11-5 than it is with the wave-form pattern obtained by feeding the output signal to the vertical plates and making use of the linear sweep in the scope. However, the wave-form pattern can be used satisfactorily if the signal from the audio oscillator is a reasonably good sine wave. One simple method is to examine the output of the oscillator alone and trace the pattern on a sheet of transparent paper. The pattern given by the output of the amplifier can then be compared with the "standard" pattern by adjusting the oscilloscope gains to make the two patterns coincide as closely as possible. The pattern discrepancies are a measure of the distortion.

In using the oscilloscope care must be taken to avoid introducing hum voltages that will upset the measurements. Hum pickup on the scope leads or other exposed parts such as the amplifier load resistor or the voltmeter can be detected by shutting off the audio oscillator and speech amplifier and connecting first one and then the other to the vertical plates of the scope, setting



the internal horizontal sweep to an appropriate width. The trace should be a straight horizontal line when the vertical gain control is set at the position used in the actual measurements. Waviness in the line indicates hum. If the hum is not in the scope itself (check by disconnecting the leads at the instrument) make sure that there is a good ground connection on all the equipment and, if necessary, shield the hot leads.

The oscilloscope can be used to good advantage in stage-by-stage testing to check wave forms at the grid and plate of each stage and thus to determine rapidly where a source of trouble may be located. When the scope is connected to circuits that are not at ground potential for d.c., a capacitor of about  $0.1 \mu\text{f.}$  should be connected in series with the hot oscilloscope lead. The probe lead should be shielded to prevent hum pickup.

## CHECKING A.M. PHONE OPERATION

### USING THE OSCILLOSCOPE

Proper adjustment of a phone transmitter is aided immeasurably by the oscilloscope. The scope will give more information, more accurately, than almost any collection of other instruments that might be named. Furthermore, an oscilloscope that is entirely satisfactory for the purpose is not necessarily an expensive instrument; the cathode-ray tube and its power supply are about all that are needed. Amplifiers and linear sweep circuits are by no means necessary.

In the simplest scope circuit, radio-frequency voltage from the modulated amplifier is applied to the vertical deflection plates of the tube, usually through blocking capacitors as shown in the oscilloscope circuit in the chapter on measurements, and audio-frequency voltage from the modulator is applied to the horizontal deflection plates. As the instantaneous amplitude of the audio signal varies, the r.f. output of the transmitter likewise varies, and this produces a wedge-shaped pattern or trapezoid on the screen. If the oscilloscope has a built-in horizontal sweep, the r.f. voltage can be applied to the vertical plates as before (never through an amplifier) and the sweep will produce a pattern that follows the modulation envelope of the transmitter output, provided the sweep frequency is lower than the modulation frequency. This produces a wave-envelope modulation pattern.

#### The Wave-Envelope Pattern

The connections for the wave-envelope pattern are shown in Fig. 11-6A. The vertical deflection plates are coupled to the amplifier tank coil (or an antenna coil) through a low-impedance (coax, twisted pair, etc.) line and pick-up coil. As shown in the alternative drawing, a resonant circuit tuned to the operating frequency may be connected to the vertical plates, using link coupling between it and the transmitter. This will eliminate r.f. harmonics, and the tuning control is a means for adjustment of the pattern height.

If it is inconvenient to couple to the final tank coil, as may be the case if the transmitter is tightly shielded, the pick-up loop may be coupled to the tuned tank of a matching circuit or antenna coupler. Any method (even a short antenna

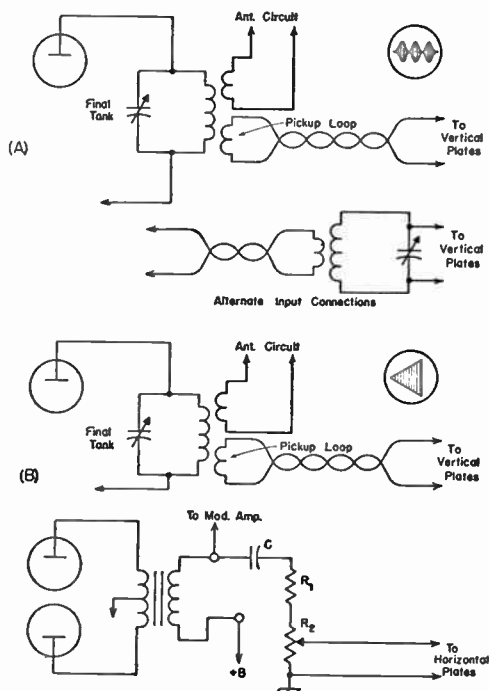

Fig. 11-6—Methods of connecting the oscilloscope for modulation checking. A—connections for wave-envelope pattern with any modulation method; B—connections for trapezoidal pattern with plate or screen modulation.

coupled to the tuned circuit shown in the "alternate input connections" of Fig. 11-6A) that will pick up enough r.f. to give a suitable pattern height may be used.

The position of the pick-up coil should be varied until an unmodulated carrier pattern, Fig. 11-7B, of suitable height is obtained. The horizontal sweep voltage should be adjusted to make the width of the pattern somewhat more than half the diameter of the screen. When voice modulation is applied, a rapidly changing pattern of varying height will be obtained. When the

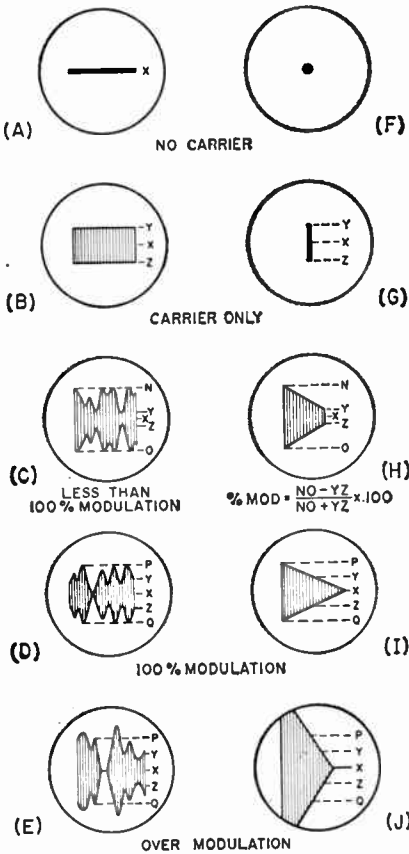

Fig. 11-7—Wave-envelope and trapezoidal patterns representing different conditions of modulation.

maximum height of this pattern is just twice that of the carrier alone, the wave is being modulated 100 per cent. This is illustrated by Fig. 11-7D, where the point X represents the horizontal sweep line (reference line) alone, YZ is the carrier height, and PQ is the maximum height of the modulated wave.

If the height is greater than the distance PQ, as illustrated in E, the wave is overmodulated in the upward direction. Overmodulation in the downward direction is indicated by a gap in the pattern at the reference axis, where a single bright line appears on the screen. Overmodulation in either direction may take place even when the modulation in the other direction is less than 100 per cent.

**The Trapezoidal Pattern**

Connections for the trapezoid or wedge pattern as used for checking a.m. are shown in Fig. 11-6B. The vertical plates of the c.r. tube are coupled to the transmitter tank through a pick-up loop, preferably using a tuned circuit, as shown in the upper drawing, adjustable to the operating frequency. Audio voltage from the modulator is applied to the horizontal plates through a voltage divider,  $R_1R_2$ . This voltage should be

adjustable so a suitable pattern width can be obtained; a 0.25-megohm volume control can be used at  $R_2$  for this purpose.

The resistance required at  $R_1$  will depend on the d.c. voltage on the modulated element. The total resistance of  $R_1$  and  $R_2$  in series should be about 0.25 megohm for each 100 volts. For example, if a plate-modulated amplifier operates at 1500 volts, the total resistance should be 3.75 megohms, 0.25 megohm at  $R_2$  and the remainder, 3.5 megohms, in  $R_1$ .  $R_1$  should be composed of individual resistors not larger than 0.5 megohm each, in which case 1-watt resistors will be satisfactory.

For adequate coupling at 100 cycles the capacitance, in microfarads, of the blocking capacitor, C, should be at least  $0.05/R$ , where R is the total resistance ( $R_1 + R_2$ ) in megohms. In the example above, where R is 3.75 megohms, the capacitance should be  $0.05/3.75 = 0.013 \mu f.$  or

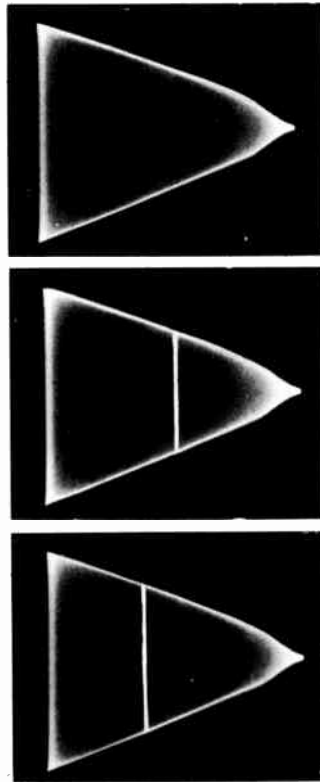

Fig. 11-8—Top—A typical trapezoidal pattern obtained with screen modulation adjusted for optimum conditions. The sudden change in slope near the point of the wedge occurs when the screen voltage passes through zero. Center—if there is no audio distortion, the unmodulated carrier will have the height and position shown by the white line superimposed on the sine-wave modulation pattern. Bottom—Even-harmonic distortion in the audio system, when the audio signal applied to the speech amplifier is a sine wave, is indicated by the fact that the modulation pattern does not extend equal horizontal distances on both sides of the unmodulated carrier.

more. The voltage rating of the capacitor should be at least twice the d.c. voltage applied to the modulated element.

Trapezoidal patterns for various conditions of modulation are shown in Fig. 11-7 at F to J, each alongside the corresponding wave-envelope pattern. With no signal, only the cathode-ray spot appears on the screen. When the unmodulated carrier is applied, a vertical line appears; the length of the line should be adjusted, by means of the pick-up coil coupling, to a convenient value. When the carrier is modulated, the wedge-shaped pattern appears; the higher the modulation percentage, the wider and more pointed the wedge becomes. At 100 per cent modulation it just makes a point on the axis, X, at one end, and the height, PQ, at the other end is equal to twice the carrier height, YZ. Over-modulation in the upward direction is indicated by an extension along the axis X at the pointed end.

### CHECKING A.M. TRANSMITTER PERFORMANCE

The trapezoidal pattern is generally more useful than the wave-envelope pattern for checking the operation of a phone transmitter. However, both types of patterns have their special virtues, and the best test setup is one that makes both available. The trapezoidal pattern is better adapted to showing the performance of a modulated amplifier from the standpoint of inherent linearity, without regard to the wave form of the audio modulating signal, than is the wave-envelope pattern. Distortion in the audio signal also can be detected in the trapezoidal pattern, although experience in analyzing scope patterns is required to recognize it.

If the wave-envelope pattern is used with a

sine-wave audio modulating signal, distortion in the modulation envelope is easily recognizable; however, it is difficult to determine whether the distortion is caused by lack of linearity of the r.f. stage or by a.f. distortion in the modulator. If the trapezoidal pattern shows good linearity in such a case the trouble obviously is in the audio system. It is possible, of course, for both defects to be present simultaneously. If they are, the r.f. amplifier should be made linear first; then any distortion in the modulation envelope will be the result of improper operation in the speech amplifier or modulator, or in coupling the modulator to the modulated r.f. stage.

### R. F. Linearity

The trapezoidal pattern is a graph of the modulation characteristic of the modulated amplifier. The sloping sides of the wedge show the r.f. amplitude for every value of instantaneous modulating voltage. If these sides are perfectly straight lines, as drawn in Fig. 11-7 at H and I, the modulation characteristic is linear. If the sides show curvature, the characteristic is non-linear to an extent shown by the degree to which the sides depart from perfect straightness. This is true regardless of the modulating wave form.

### Audio Distortion

If the speech system can be driven by a good audio sine-wave signal instead of a microphone, the trapezoidal pattern also will show the presence of even-harmonic distortion (the most common type, especially when the modulator is overloaded) in the speech amplifier or modulator. If there is no distortion in the audio system, the trapezoid will extend horizontally equal distances on each side of the vertical line representing the unmodulated carrier. If there is even-harmonic

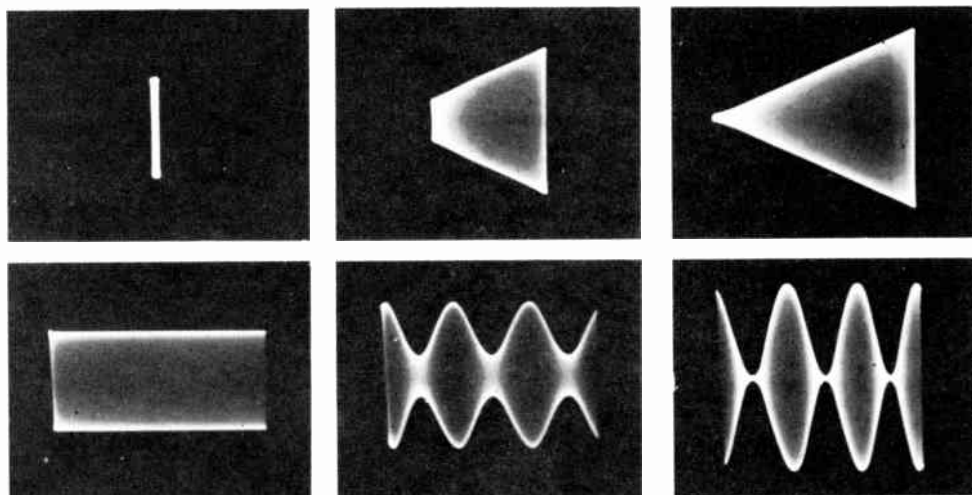

Unmodulated carrier.

Approximately 50 per cent modulation.

100 per cent modulation.

Fig. 11-9—Oscilloscope patterns showing proper modulation of a plate-and-screen modulated tetrode r.f. amplifier. Upper row, trapezoidal patterns; lower row, corresponding wave-envelope patterns. In the latter a linear sweep having a frequency one-third that of the sine-wave audio modulating frequency was used, so that three cycles of the modulation envelope show in the pattern.

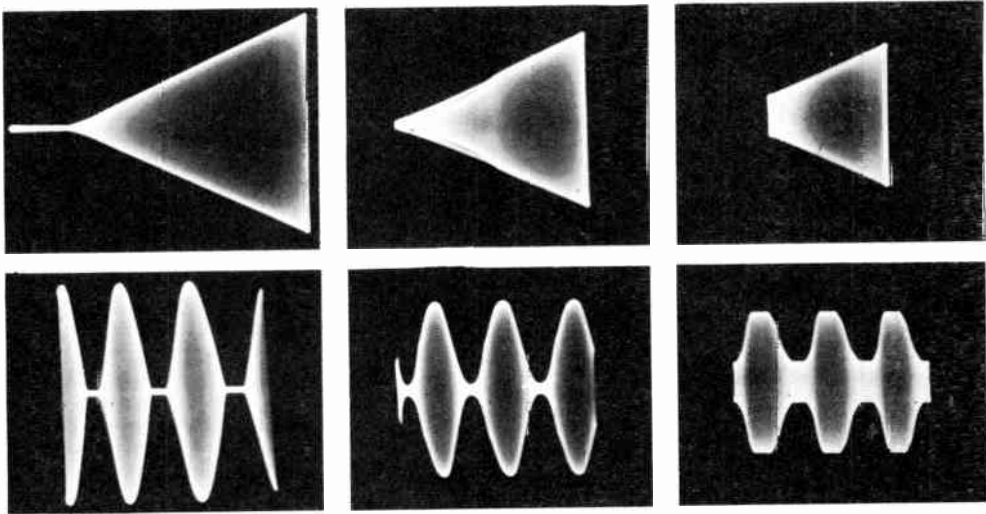

Modulation over 100 per cent. Improper screen-circuit time constant. Insufficient audio power.

Fig. 11-10—Improper operation or design. These pictures are to the same scale as those in Fig. 20-20, on the same transmitter and with the same test setup.

distortion the trapezoid will extend farther to one side of the unmodulated-carrier position than to the other. This is shown in Fig. 11-8. The probable cause is inadequate power output from the modulator, or incorrect load on the modulator.

An audio oscillator having reasonably good sine-wave output is highly desirable for testing both speech equipment and the phone transmitter as a whole. With an oscillator and the scope, the pattern is steady and can be studied closely to determine the effects of adjustments.

In the case of the wave-envelope pattern, distortion in the audio system will show up in the modulation envelope (with a sine-wave input signal) as a departure from the sine-wave form, and may be checked by comparing the envelope with a drawing of a sine-wave. Attributing any such distortion to the audio system assumes, of course, that a check has been made on the linearity of the modulated r.f. amplifier, preferably by use of the trapezoidal pattern.

**Typical Patterns**

Figs. 11-8, 11-9 and 11-10 show some typical scope patterns of modulated signals for different conditions of operation. The screen-modulation patterns, Fig. 11-8, also show how the presence of even-harmonic audio distortion can be detected in the trapezoidal pattern. The pattern to be sought in adjusting the transmitter is the one at the top in Fig. 11-9, where the top and bottom edges of the pattern continue in straight lines up to the point representing 100 per cent modulation. If these edges tend to bend over toward the horizontal at the maximum height of the wedge the amplifier is "flattening" on the modulation up-peaks. This is usually caused by attempting to get too large a carrier output, and can be corrected by tighter coupling to the antenna or by a decrease in the d.c. screen voltage.

Fig. 11-9 shows patterns indicating proper operation of a plate-and-screen modulated tetrode r.f. amplifier. The slight "tailing off" at the modulation down peak (point of the wedge) can be minimized by careful adjustment of excitation and plate loading.

Several types of improper operation are shown in Fig. 11-10. In the photos at the left the linearity of the r.f. stage is good but the amplifier is being modulated over 100 per cent. This is shown by the maximum height of the pattern (compare with the unmodulated carrier of Fig. 10-20) and by the bright line extending from the point of the wedge (or between sections of the envelope).

The patterns in the center, Fig. 11-10, show the effect of a too-long time constant in the screen circuit, in an amplifier getting its screen voltage through a dropping resistor, both plate and screen being modulated. The "double-edged" pattern is the result of audio phase shift in the screen circuit combined with varying screen-to-cathode resistance during modulation. The overall effect is to delay the rise in output amplitude during the up-sweep of the modulation cycle, slightly distorting the modulation envelope as shown in the wave-envelope pattern. This effect, which becomes more pronounced as the audio modulating frequency is increased, is usually absent at low modulation percentages but develops rapidly as the modulation approaches 100 per cent. It can be reduced by reducing the screen bypass capacitance, and also by connecting resistance (to be determined experimentally, but of the same order as the screen dropping resistance) between screen and cathode.

The right-hand pictures in Fig. 11-10 show the effect of insufficient audio power. Although the trapezoidal pattern shows good linearity in the r.f. amplifier, the wave-envelope pattern shows flattened peaks (both positive and negative) in



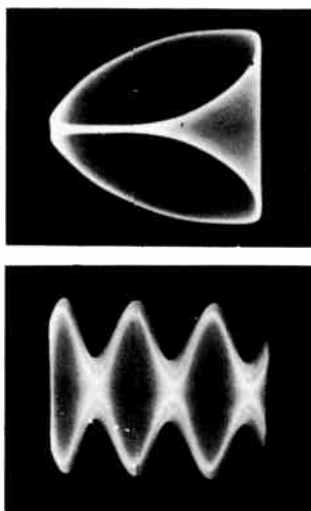

Fig. 11-11—Upper photo—Audio phase shift in coupling circuit between transmitter and horizontal deflection plates. Lower photo—Hum on vertical deflection plates.

the modulation envelope even though the audio signal applied to the amplifier was a sine wave. More speech-amplifier gain merely increases the flattening without increasing the modulation percentage in such a case. The remedy is to use a larger modulator or less input to the modulated r.f. stage. In some cases the trouble may be caused by an incorrect modulation-transformer turns ratio, causing the modulator to be overloaded before its maximum power output capabilities are reached.

#### Faulty Patterns

The pattern defects shown in Fig. 11-10 are only a few out of many that might be observed in the testing of a phone transmitter, all capable of being interpreted in terms of improper operation in some part of the transmitter. However, it is not always the transmitter that is at fault when the scope shows an unusual pattern. The trouble may be in some defect in the test setup.

Patterns representative of two common faults of this nature are shown in Fig. 11-11. The upper picture shows the trapezoidal pattern when the audio voltage applied to the horizontal plates of the c.r. tube is not exactly in phase with the modulation envelope. The normal straight edges of the wedge are transformed into ellipses which in the case of 100 per cent modulation (shown) touch at the horizontal axis and reach maximum heights equal to the height of the normal wedge at the modulation up-peak. Such a phase shift can occur (and usually will) if the audio voltage applied to the c.r. tube deflection plates is taken from any point in the audio system other than where it is applied to the modulated r.f. stage. The coupling capacitor shown in Fig. 11-6 must have very low reactance compared with the resistance of  $R_1$  and  $R_2$  in series — not larger than

a few per cent of the sum of the two resistances.

The wave-envelope pattern in Fig. 11-11 shows the effect of hum on the vertical deflection plates. This may actually be on the carrier or may be introduced in some way from the a.c. line through stray coupling between the scope and the line or because of poor grounding of the scope, transmitter or modulator.

It is important that r.f. from the *modulated stage only* be coupled to the oscilloscope, and then only to the vertical plates. If r.f. is present also on the horizontal plates, the pattern will lean to one side instead of being upright. If the oscilloscope cannot be moved to a position where the unwanted pick-up disappears, a small bypass capacitor (10  $\mu\mu\text{f.}$  or more) should be connected across the horizontal plates as close to the cathode-ray tube as possible. An r.f. choke (2.5 mh. or smaller) may also be connected in series with the ungrounded horizontal plate.

#### MODULATION CHECKING WITH THE PLATE METER

The plate milliammeter of the modulated amplifier provides a simple and fairly reliable means for checking the performance of a phone transmitter, although it does not give nearly as definite information as the oscilloscope does. If the modulated amplifier is perfectly linear, its plate current will not change when modulation is applied if

- 1) the upward modulation percentage does not exceed the modulation capability of the amplifier,
- 2) the downward modulation does not exceed 100 per cent, and
- 3) there is no change in the d.c. operating voltages on the transmitter.

The plate current should be constant, ideally, with any of the methods of modulation discussed in this chapter, with the single exception of the controlled-carrier system. The plate meter cannot give a reliable check on the performance of the latter system because the plate current increases with the intensity of modulation.

#### Plate Modulation

With plate modulation, a downward shift in plate current may indicate one or more of the following:

- 1) Insufficient excitation.
- 2) Insufficient grid bias.
- 3) R.f. amplifier not loaded properly.
- 4) Insufficient output capacitance in the filter of the modulated-amplifier plate supply.
- 5) Excessive d.c. input to the r.f. amplifier, under carrier conditions. Alternately, the cathode emission of the amplifier tubes may be low.
- 6) In plate-and-screen modulation of tetrodes or pentodes, the screen is not being sufficiently modulated along with the plate. If the d.c. screen voltage is obtained through a dropping resistor, a dip in plate current may occur if the screen bypass capacitance is large enough to bypass audio frequencies.
- 7) Poor voltage regulation of the modulated-



amplifier plate supply. It is readily checked by measuring the voltage with and without modulation. Poor line regulation will be shown by a drop in filament voltage with modulation.

Any of the following may cause an upward shift in plate current:

- 1) Overmodulation (excessive audio power, audio gain too high).
- 2) Incomplete neutralization of the modulated amplifier.
- 3) Parasitic oscillation in the modulated amplifier.

### Grid Modulation

With any type of grid modulation, any of the following may cause a downward shift in modulated-amplifier plate current:

- 1) Too much r.f. excitation.
- 2) Insufficient grid bias with control-grid modulation. Grid bias is usually not critical with screen and suppressor modulation.
- 3) With control-grid modulation, excessive resistance in the bias supply.
- 4) Insufficient output capacitance in plate-supply filter.
- 5) Amplifier is not loaded heavily enough.

Because grid modulation is not perfectly linear, (always less so than plate modulation) an amplifier that is properly designed and operated may show a small upward plate-current shift with modulation, 10 per cent or less with sine-wave modulation and amounting to an occasional upward flicker with voice. An upward plate current shift in excess of this may be caused by

- 1) Overmodulation (excessive modulating voltage).
- 2) Regeneration (incomplete neutralization).
- 3) With control-grid or suppressor modulation, bias too great.
- 4) With screen modulation, d.c. screen voltage too low.
- 5) Audio distortion in modulator.

In grid-modulation systems the modulator is not necessarily operating linearly if the plate current stays constant with or without modulation. It is readily possible to arrive at a set of operating conditions in which flattening of the up-peaks is just balanced by overmodulation downward. The oscilloscope provides the only certain check on grid modulation.

## COMMON TROUBLES IN THE PHONE TRANSMITTER

### Noise and Hum on Carrier

Noise and hum may be detected by listening to the signal on a receiver, provided the receiver is far enough away from the transmitter to avoid overloading. The hum level should be low compared with the voice at 100 per cent modulation. Hum may come either from the speech amplifier and modulator or from the r.f. section of the transmitter. Hum from the r.f. section can be detected by completely shutting off the modulator; if hum remains, the power-supply filters

for one or more of the r.f. stages have insufficient smoothing. With a hum-free carrier, hum introduced by the modulator can be checked by turning on the modulator but leaving the speech amplifier off; power-supply filtering is the likely source of such hum. If carrier and modulator are both clean, connect the speech amplifier and observe the increase in hum level. If the hum disappears with the gain control at minimum, the hum is being introduced in the stage or stages preceding the gain control. The microphone also may pick up hum, a condition that can be checked by removing the microphone from the circuit but leaving the first speech-amplifier grid circuit otherwise unchanged. A good ground (to a cold water pipe, for example) on the microphone and speech system usually is essential to hum-free operation.

### Spurious Sidebands

A superheterodyne receiver having good selectivity (bandwidth of less than 1 kc.) is needed for checking spurious sidebands outside the normal communication channel. The r.f. input to the receiver must be kept low enough, by removing the antenna or by adequate separation from the transmitter, to avoid overloading and consequent spurious receiver responses. An "S"-meter reading of about half scale is satisfactory. With the selectivity at its sharpest, tune through the region outside the normal channel limits (3 to 4 kilocycles each side of the carrier) while another person talks into the microphone. Spurious sidebands will be observed as intermittent "clicks" or crackles well away from the carrier frequency. Sidebands more than 3 to 4 kc. from the carrier should be of negligible strength, compared with the carrier, in a properly modulated phone transmitter. The causes are overmodulation or nonlinear operation.

With sine-wave modulation the relative intensities of sidebands can be observed if a tone of 1000 cycles or so is used. The "S"-meter will show how the spurious side frequencies (those spaced more than the modulating frequency from the carrier) compare with the carrier itself. Without an "S"-meter, the a.v.c. should be turned off and the b.f.o. turned on; then the r.f. gain should be set to give a moderately strong beat note with the carrier. The intensity of the side frequencies can be estimated from their relative strengths as the receiver is tuned through them.

Receivers having steep-sided band-pass filters for single-sideband reception can be used, but the technique is more difficult. If the band pass is, say, 3 kc., the signal should first be tuned in with the carrier placed at one edge of the pass band. If it is placed at the low edge, for example, the receiver should then be tuned 3 kc. higher so its response will be in the region just outside the normal spectrum space occupied by one sideband. Any "crackles" heard in this region represent the results of nonlinearity of over-modulation. This assumes that the precautions mentioned above with respect to receiver overloading have been carefully observed.

**R.F. in Speech Amplifier**

A small amount of r.f. current in the speech amplifier — particularly in the first stage, which is most susceptible to such r.f. pickup — will cause overloading and distortion in the low-level stages. Frequently also there is a regenerative effect which causes an audio-frequency oscillation or "howl" to be set up in the audio system. In such cases the gain control cannot be advanced very far before the howl builds up, even though the amplifier may be perfectly stable when the r.f. section of the transmitter is not turned on.

Complete shielding of the microphone, microphone cord, and speech amplifier is necessary to

prevent r.f. pickup, and a ground connection separate from that to which the transmitter is connected is advisable.

If the transmitter is "hot" with r.f., the cause usually is to be found in the method of coupling to the antenna. Any form of coupling that involves either a direct or capacitive connection between the transmitter and the transmission line is likely to cause the transmitter chassis to assume an r.f. potential above ground because of "parallel" type currents on the line. An earth connection to the transmitter does not always help in such a case. The best remedy is to use inductive coupling between the transmitter and line.

**MODULATION MONITORING**

It is always desirable to modulate as fully as possible, but 100 per cent modulation should not be exceeded — particularly in the downward direction — because harmonic distortion will be generated and the channel width increased. This causes unnecessary interference to other stations. The oscilloscope is the best instrument for continuously checking the modulation. However, simpler indicators may be used for the purpose, once calibrated.

A convenient indicator, when a Class B modulator is used, is the plate milliammeter in the Class B stage, since the plate current of the modulator fluctuates with the voice intensity. Using the oscilloscope, determine the gain-control setting and voice intensity that give 100 per cent modulation on voice peaks, and simultaneously observe the maximum Class B plate-milliammeter reading on the peaks. When this maximum reading is obtained, it will suffice to adjust the gain so that it is not exceeded.

A high-resistance (1000-ohms-per-volt or more) rectifier-type voltmeter (copper-oxide or germanium type) also can be used for modulation monitoring. It should be connected across the output circuit of an audio driver stage where the power level is a few watts, and similarly calibrated against the oscilloscope to determine the reading that represents 100 per cent modulation.

The plate milliammeter of the modulated r.f. stage also is of value as an indicator of over-modulation, as explained earlier.

**A. M. MODULATION MONITOR**

The modulation monitor shown in Figs. 11-12 and 11-14 uses two magic-eye tubes and a dual diode. One eye closes whenever the modulation reaches 50 per cent or more, and the second eye closes when the modulation hits 85 per cent or more. In operation, the operator controls his speech to close the "50%" eye much of the time without closing the "85%" eye except on rare occasions. No adjustment of the monitor is required other than the setting of two intensity controls for the ambient light condition. The monitor, with the constants to be described, will work with any plate-modulated amplifier at volt-

ages between 300 and 500; with a slight modification it can be extended to 750 volts.

The circuit diagram is shown in Fig. 11-13. A voltage divider, consisting of  $R_1$ ,  $R_2$  plus  $R_3$ , and  $R_4$ , is connected across the plate supply of the modulated stage. The cathodes of two diodes are connected to the modulated voltage applied to the r.f. amplifier, and the anodes of the two diodes are connected through 100K resistors to the junctions on the voltage divider. The voltage divider is proportioned so that the cathode of  $V_1$  is at approximately 50 per cent of the plate supply voltage and the cathode of  $V_2$  is at 15 per cent of the voltage. When the instantaneous voltage is 50 per cent or less of the idling plate voltage, as during the negative portion of a modulation cycle, the upper diode of  $V_3$  will conduct and the voltage drop across the associated 100K resistor will close the eye of  $V_1$ . If during the negative portion of the cycle the instantaneous



Fig. 11-12—An a.m. modulation indicator using two inexpensive magic eye tubes. It is to be connected to the plate supply and modulation transformer of the plate-modulated transmitter stage. The monitor is built in one half of a Minibox and the entire assembly is supported by a cane-metal housing. Heater transformers hang down from the Minibox, inside the housing.

voltage goes as low as 15 per cent of the supply voltage, the lower diode of  $V_3$  will conduct and the drop across the associated 100K resistor will close the eye of  $V_2$ . Capacitors at the grids of  $V_1$  and  $V_2$  make the edges of the closing eyes readily visible.

Type 1629 magic eye tubes are used because they are common tubes in radio surplus stores and are quite inexpensive. Because they have a limited cathode-to-heater voltage rating, it is necessary to use a separate heater transformer with its center tap connected to a midpoint on the voltage divider. For similar insulation reasons, a separate heater transformer is used for the twin diode,  $V_3$ .

**Construction**

With the exception of the transformers, all components are mounted inside a 5 × 7 × 3-inch Minibox. A supporting housing for the chassis is made from a small piece of Reynolds No. 33 aluminum mesh, available in many hardware stores. A 3/8-inch lip bent in on the bottom edge provides greater rigidity for the structure and a surface to which four rubber feet can be attached. The monitor is built within one half of the Minibox and the two transformers are mounted on the other side of this half. Two Amphenol 58-MEA8 assemblies are used to support the magic eye tubes; these include the mounting brackets, the sockets and wires, the light shields and the metal escutcheons. The 6H6 socket is supported off the chassis by two 3/4-inch ceramic insulators.

**Operation**

When using the monitor with a transmitter, the only adjustment necessary is that of the two 100K intensity controls. The "50%" eye will start to close at about 50 per cent modulation and will be completely closed at around 70 per cent. The "85%" eye will start to close at about

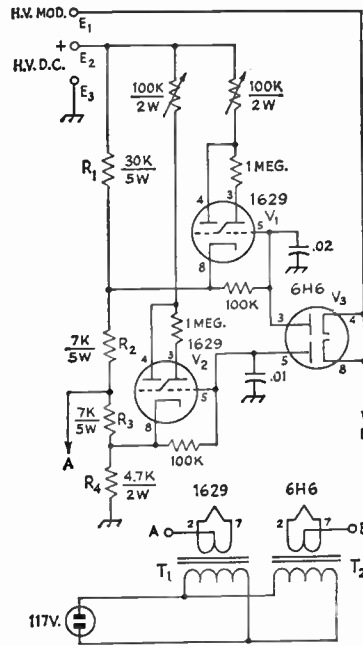

Fig. 11-13—Circuit diagram of the modulation monitor. Unless specified otherwise, resistors are 1/2 watt, resistances are in ohms, capacitances are in  $\mu$ f. C<sub>1</sub>, C<sub>2</sub>—Disk ceramic. E<sub>1</sub>, E<sub>2</sub>, E<sub>3</sub>—Insulated tip jacks (Johnson 105-601, -602, -603) T<sub>1</sub>—12.6-v. 2-a. transformer (Knight 61 G 420) T<sub>2</sub>—6.3-v. 0.6-a. transformer (Knight 61 G 416)

85 per cent and be completely closed at 100 per cent modulation.

**Higher Voltages**

If the monitor is to be used at supply voltages between 500 and 750, several alterations are required. Either the "50%" eye must be eliminated or a second 12.6-volt transformer must be added (so that each 1629 has its own heater supply). At the higher voltage, additional 47K 2-watt resistors should be connected in series with the intensity controls. The voltage divider R<sub>1</sub> through R<sub>4</sub> must be modified for the higher dissipation.

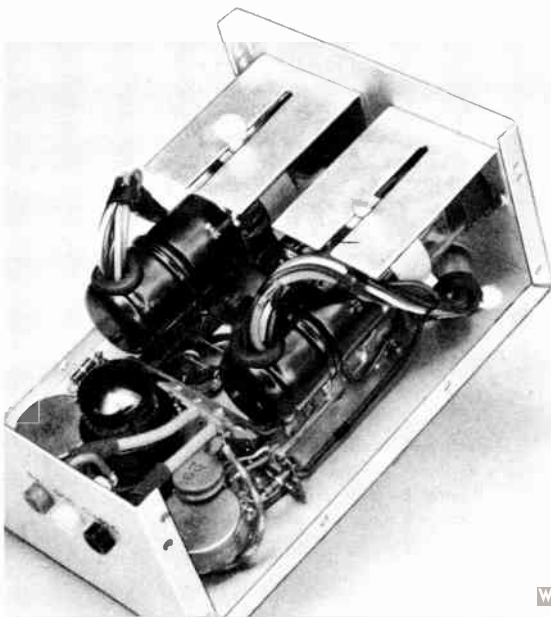

Fig. 11-14—Modulation monitor with housing and case removed. Tie strips and adequately-insulated wire are required. Cable clamps hold the wires from the magic-eye sockets, to avoid strain on the tubes. Transformers cannot be seen in this view because they are on the other side of the assembly. Note ventilation holes at right-hand corner.

## CHECKING AND MONITORING TRANSMISSIONS

### CHECKING F.M. AND P.M. TRANSMITTERS

Accurate checking of the operation of an f.m. or p.m. transmitter requires different methods than the corresponding checks on an a.m. set. This is because the common forms of measuring devices either indicate amplitude variations only (a d.c. milliammeter, for example), or because their indications are most easily interpreted in terms of amplitude. There is no simple measuring instrument that indicates frequency deviation directly.

However, there is one favorable feature in f.m. or p.m. checking. The modulation takes place at a very low level and the stages following the one that is modulated do not affect the linearity of modulation so long as they are properly tuned. Therefore the modulation may be checked *without putting the transmitter on the air*, or even on a dummy antenna. The power is simply cut off the amplifiers following the modulation stage. A selective receiver is an essential part of the checking equipment of an f.m. or p.m. transmitter, particularly for narrow-band f.m. or p.m.

The quantities to be checked in an f.m. or p.m. transmitter are the linearity and frequency deviation. The methods of checking differ in detail.

#### Reactance-Tube F.M.

It is possible to calibrate a reactance modulator by applying an adjustable d.c. voltage to the modulator grid and noting the change in oscillator frequency as the voltage is varied. A suitable circuit for applying the adjustable voltage is shown in Fig. 11-15. The battery

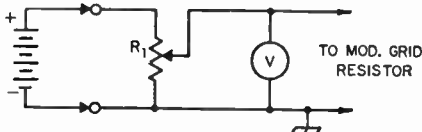

Fig. 11-15—D.c. method of checking frequency deviation.  $R_1$  is 500 to 1000 ohms.

voltage is 3 to 6 volts (two or more dry cells in series). The arrows indicate clip connections so that the battery polarity can be reversed.

The oscillator frequency deviation should be measured by using a receiver in conjunction with an accurately calibrated frequency meter, or by any means that will permit accurate measurement of frequency differences of a few hundred cycles. One simple method is to tune in the oscillator on the receiver (disconnecting the receiving antenna, if necessary, to keep the signal strength well below the overload point) and then set the receiver b.f.o. to zero beat. Then increase the d.c. voltage applied to the modulator grid from zero in steps of about  $\frac{1}{2}$  volt and note the beat frequency at each change. Then reverse the battery terminals and repeat. The frequency of the beat note may be measured by comparison with a calibrated

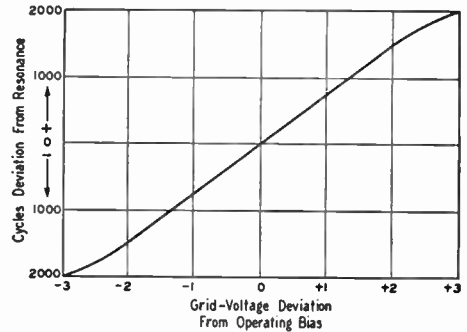

Fig. 11-16—A typical curve of frequency deviation vs. modulator grid voltage.

audio-frequency oscillator. Note that with the battery polarity positive with respect to ground the radio frequency will move in one direction when the voltage is increased, and in the other direction when the polarity is reversed. When several readings have been taken a curve may be plotted to show the relationship between grid voltage and frequency deviation.

A sample portion of the curve is the center part which is essentially a straight line. The bending at the ends indicates that the modulator is no longer linear; this departure from linearity will cause harmonic distortion and will broaden the channel occupied by the signal. In the example, the characteristic is linear 1.5 kc. on either side of the center or carrier frequency.

A good modulation indicator is a "magic-eye" tube such as the 6E5. This should be connected across the grid resistor of the reactance modulator as shown in Fig. 11-17. Note its deflection (using the d.c. voltage method as in Fig. 11-15) at the maximum deviation to be used. For narrow-band f.m. the proper deviation is approximately 2000 cycles (this maximum deviation is based on an upper a.f. limit of 3000 cycles and a deviation ratio of 0.7) at the *output* frequency. This deflection represents "100 per cent modulation" and with speech input the gain should be kept at the point where it is just reached on voice peaks. If the transmitter is used on more than one band, the gain control should be marked at the proper setting

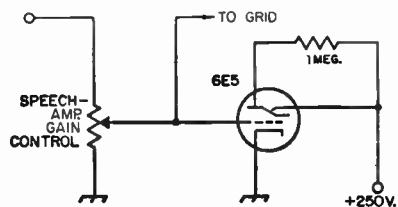

Fig. 11-17—6E5 modulation indicator for f.m. or p.m. modulators. To insure sufficient grid voltage for a good deflection, it may be necessary to connect the gain control in the modulator grid circuit.



for each band, because the signal amplitude that gives the correct deviation on one band will be either too great or too small on another.

**Checking with a Selective Receiver**

With p.m. the d.c. method of checking just described cannot be used, because the frequency deviation at zero frequency (d.c.) also is zero. For narrow-band p.m. it is necessary to check the actual width of the channel occupied by the transmission. (The same method also can be used to check f.m.) For this purpose it is necessary to have a selective receiver and a 3000-cycle audio oscillator or generator.

Keeping the signal intensity in the receiver at a medium level, tune in the carrier at the *output* frequency. Do not use the a.v.c. Switch on the beat oscillator, and set the receiver filter at its sharpest. Peak the signal on the crystal and adjust the b.f.o. for any convenient beat note. Then apply the 3000-cycle tone to the speech amplifier (through an attenuator, if necessary, to avoid overloading) and increase the audio gain until there is a small amount of modulation. Tuning the receiver near the carrier frequency will show the presence of sidebands 3 kc. from the carrier. With low input, these two should be the only sidebands detectable.

Now increase the audio gain and tune the receiver over a range of about 10 kc. on both sides of the carrier. When the gain becomes high enough, a second set of sidebands spaced 6 kc. on either side of the carrier will be detected. The signal amplitude at which these

sidebands become detectable is the maximum speech amplitude that should be used.

When this method of checking is used with a reactance-tube-modulated f.m. (not p.m.) transmitter, the linearity of the system can be checked by observing the *carrier* as the a.f. gain is slowly increased. The beat-note frequency will stay constant so long as the modulator is linear, but nonlinearity will be accompanied by a shift in the average carrier frequency that will cause the beat note to change in frequency. If such a shift occurs at the same time that the 6-kc. sidebands appear, the extra sidebands may be caused by modulator distortion rather than by an excessive modulation index.

**R.F. Amplifiers**

The r.f. stages in the transmitter that follow the modulated stage may be adjusted as for c.w. operation. All tank circuits should be carefully tuned to resonance. With f.m. or p.m., all r.f. stages in the transmitter can be operated at the manufacturer's maximum c.w. ratings.

The output power of the transmitter should be checked for amplitude modulation. It should not change from the unmodulated-carrier value when the transmitter is modulated. If no output indicator is available, a flashlight lamp and loop can be coupled to the final tank coil to serve as a current indicator. If the carrier amplitude is constant, the lamp brilliance will not change with modulation. If a.m. is indicated, the cause is almost certain to be nonlinearity in the modulator.

**TESTING AN S.S.B. EXCITER**

Any acceptable testing of an s.s.b. exciter requires the use of an audio oscillator, and a *selective* receiver or an oscilloscope. The audio oscillator should be capable of furnishing a signal with low distortion. The receiver should have good

skirt selectivity, if it is to be of value, since it must be capable of separating the desired signal from the carrier and from the unwanted sideband.

Detailed instructions on the test procedure to be followed with specific pieces of equipment will be

Fig. 11-18—Fundamental arrangement for using an oscilloscope and/or receiver when testing an s.s.b. exciter or transmitter. An audio oscillator is required to furnish the audio signal, and its output is best controlled by the external control  $R_1$ . The audio volume control in the s.s.b. exciter should not be turned on too far, or it should be set at the normal position if you know that position, and all volume controlling should then be done with  $R_1$  and the output attenuator of the audio oscillator. This will reduce the chances of overloading the audio and other amplifier stages in the exciter, a common cause of distortion.

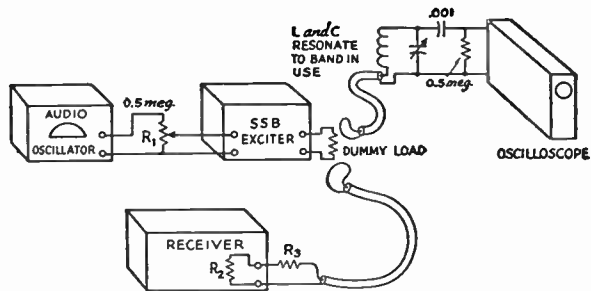

The oscilloscope is coupled to the dummy load through a loop, length of coaxial line, and an L-C circuit tuned to the operating frequency. It is necessary to go directly to the vertical deflection plates of the oscilloscope.

The receiver is coupled to the dummy load through a loop and a length of shielded line. If too much signal is obtained this way, an attenuator,  $R_2R_3$ , can be added to the input terminals of the receiver. Small values of  $R_2$  and large values of  $R_3$  give the most attenuation: in some cases  $R_2$  might be merely a few inches of solid wire.



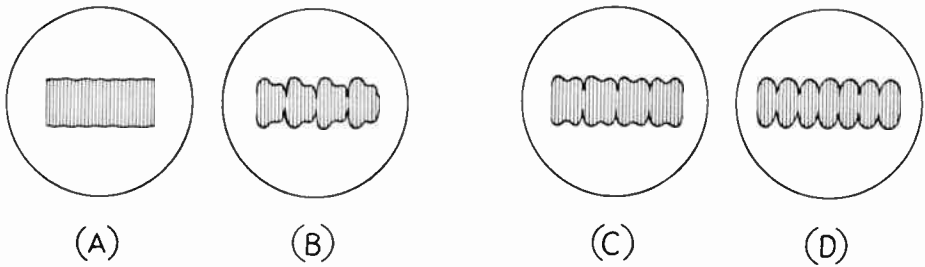

Fig. 11-19—Sketches of the oscilloscope face showing different conditions of adjustment of the exciter unit. (A) shows the substantially clean carrier obtained when all adjustments are at optimum and a sine-wave signal is fed to the audio input. (B) shows improper r.f. phase and unbalance between the outputs of the two balanced modulators. (C) shows improper r.f. phasing but outputs of the two balanced modulators equal. (D) shows proper r.f. phasing but unbalance between outputs of two balanced modulators.

found in their descriptions; the general test arrangement is shown in Fig. 11-18. When using a receiver to check an s.s.b. exciter, two points must be kept in mind. 1) The receiver must always be operated well below an overload point, and 2) care must be taken to insure that the signal is picked up directly from the tuned circuit under study, and *not* picked up by radiation. To this end, an attenuator at the receiver input and a shielded pick-up loop as shown in Fig. 11-18, are mandatory.

When an oscilloscope is used, a tuned circuit is required for two reasons. First, it will help to increase the voltage applied to the vertical de-

flexion plates and, second, it will help to reject harmonics that might be present.

The oscilloscope presentation is especially useful when adjusting a phasing-type s.s.b. exciter. While such an exciter can be adjusted by using only a receiver, it requires good understanding of the basic theory (and an ability to visualize what the 'scope pattern would look like, by listening to the modulation). The changes in envelope ripple content in the output from a phasing-type exciter are shown in Fig. 11-19. (For a treatment of the alignment of commercial phasing-type s.s.b. exciters, see Ehrlich, "How to Adjust Phasing-Type S.S.B. Exciters," *QST*, November, 1956.)

## ADJUSTMENT OF LINEAR AMPLIFIERS

One of the more important features of the linear amplifier is that the ordinary plate and grid meters are at best only a poor indicator of what is going on. As the meters bounce back and forth, even a person who is thoroughly familiar with this kind of amplifier would be hard put to sense whether the input power registered is attributable to (a) overdrive and underload, which yield distortion, splatter, TVI, etc., or (b) underdrive and too-heavy loading, resulting in inefficiency and loss of output.

The simplest and best way to get the whole story is to make a linearity test; that is, to send through the amplifier a signal whose amplitude varies from zero up to the peak level in a certain known manner and then observe, by means of an oscilloscope, whether this same waveform comes out of the amplifier at maximum ratings.

### Test Equipment

Even the simplest type of cathode-ray oscilloscope can be used for linearity tests, so long as it has the regular internal sweep circuit. If this instrument is not already part of the regular station equipment, it might be well to purchase one of the several inexpensive kits now on the market, so that it will be on hand not only to make initial tests but also as a permanent monitor during all operation. Barring a purchase, it is recommended at least that a scope be borrowed to make the linearity checks; the regular plate and

grid meters can serve thereafter to indicate roughly changes in operating conditions.

All linearity tests require that the vertical plates of the scope be supplied with r.f. from the amplifier output. To avoid interaction within the instrument, it is usually best to connect directly to the cathode-ray tube terminals at the back of the cabinet. A pick-up device and its connections to the oscilloscope are shown in Fig. 11-18. Normally, the pick-up loop should be coupled to the dummy load, antenna tuner, or transmission line; i.e., to a point in the system beyond where any tuning adjustments are to be made.

The only other piece of test equipment will be an audio oscillator. Since only one frequency

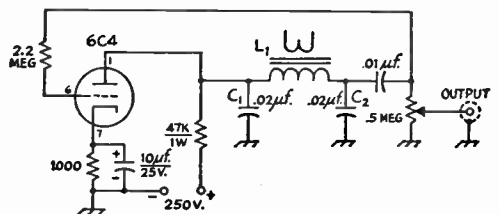

Fig. 11-20—Fixed-frequency audio oscillator having good output waveform. The frequency can be varied by changing the values of  $C_1$  and  $C_2$ .

$L_1$ —Small speaker output transformer, secondary not used.

is needed, the simple circuit of Fig. 11-20 works quite well. Some equipment has a circuit similar to this one built right into the exciter audio system.

### Two-Tone Test

The two-tone test involves sending through the amplifier or the system a pair of r.f. signals of equal amplitude and a thousand cycles or so apart in frequency. The combined envelope of two such signals looks like two sine waves folded on one another. If this waveform comes out of the final, well and good; if not, there is work to do.

There are two commonly used ways to generate the two-tone signal, and the choice of which to use depends on the particular type of exciter available.

#### Method A — for Filter or Phasing Exciters:

1) Turn up the carrier insertion until a carrier is obtained at about half the expected output amplitude.

2) Connect an audio oscillator to the microphone input and advance audio gain until (when the carrier and the one sideband are equal) the scope pattern takes on the appearance of full modulation; i.e., the cusps just meet at the center line. See Fig. 11-21, photo No. 1.

3) To change the drive through the system, increase or decrease the carrier and audio settings together, maintaining equality of the two signals.

#### Method B — for Phasing Exciters:

1) Disable the audio input to one balanced modulator, by removing a tube or by temporarily short-circuiting an audio transformer.

2) Connect the audio oscillator and advance audio gain to get the desired drive. Note that with one balanced modulator cut out, the resultant signal will be double-sideband with no carrier, hence two equal r.f. signals.

### Double-Trapezoid Test

When Method B can be used with phasing exciters, it is possible to derive a somewhat more informative pattern by making a connection from the exciter audio system to the horizontal signal input of the oscilloscope and using this audio signal, instead of the regular internal sweep, to cause the horizontal deflection. Those who are familiar with the regular trapezoid test for a.m. transmitters will recognize this set-up as being the same, except that instead of one trapezoid, this test produces two triangles pointing toward each other.

Each individual triangle is subject to the same analysis as the regular trapezoid pattern; i.e., the sloping sides of the pattern should be straight lines for proper operation. Since it is much easier to tell whether a line is straight or not than to judge the correctness of a sine curve, the double trapezoid has the advantage of being somewhat more positive and sensitive to slight departures from linearity than is the regular two-tone pattern.

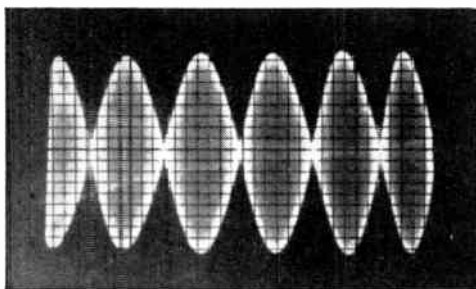

(1)

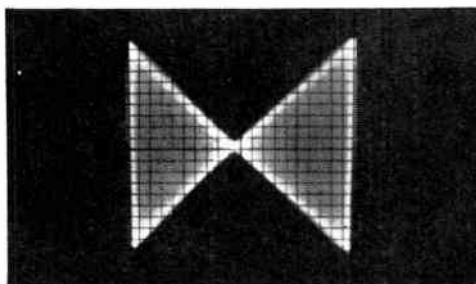

(2)

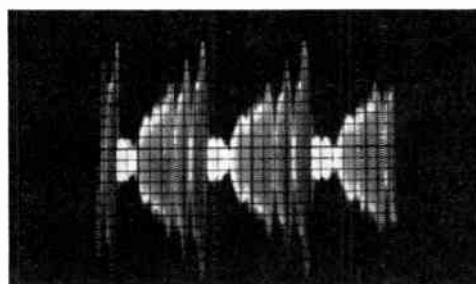

(3)

Fig. 11-21—Correct Patterns. 1—Desired two-tone test pattern. 2—Desired double-trapezoid test pattern. 3—Typical voice pattern in a correctly adjusted amplifier, scope set for 30-cycle sweep. Note that peaks are clean and sharp.

If the audio can be picked off at the plate of the audio modulator tube that is still working, the input signal need not be a pure sine wave; merely whistling or talking into the microphone should produce the appropriate pattern. If, because of the exciter layout, it is necessary to pick up the audio signal ahead of the phase-shift network, it will then be necessary to use a good sine-wave audio oscillator as before. Also, with the latter set-up, the pattern will probably have a loopy appearance at first, and phase correction will be needed to make the figure close up. This can be done either by varying the audio frequency or by putting a phaser in series with the horizontal input to the scope, as shown in Fig. 11-22.

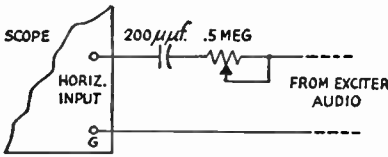

Fig. 11-22—"Phaser" circuit for the oscilloscope.

**Ratings**

Before proceeding with linearity tests, it is well to have in mind the current and power levels to expect. A suppressed-carrier signal is exactly like an audio signal, except for its frequency, so the audio ratings for any tube are

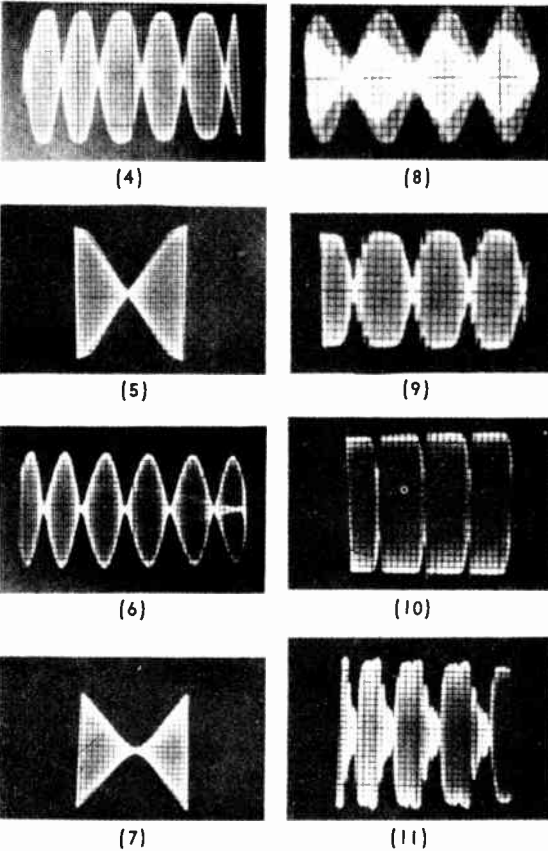

Fig. 11-23—Improper Amplifier Operation. 4—Overdrive, indicated by flattening of peaks. 5—Same as 4, double-trapezoid test. 6—Too much bias, causing cross-over to become pinched together rather than cutting straight across center line. 7—Same as 6, double-trapezoid test. 8—Two-tone test with v.h.f. parasitics. Note fuzzy halo or fringe. In milder cases the fuzziness will appear just at the peaks. 9—Two-tone test with fundamental frequency parasitics, accompanied by overdrive. 10—Severe overdrive and parasitics. 11—Voice pattern showing flattening of peaks due to overdrive. When flattening is apparent on the voice pattern, the case is a severe one.

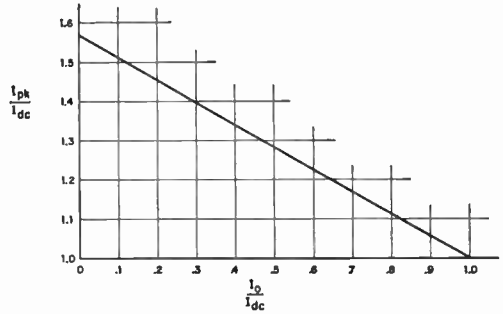

Fig. 11-24—When the two-tone test signal is used for checking the linearity of an amplifier, the peak current is higher than the current indicated by the plate meter. The ratio of these values depends upon the ratio of the idling (no-signal) current to the indicated current.

The graph shows the relationship.

$I_o$  = no-signal (idling) current,

$I_{ac}$  = meter reading with two-tone test signal,

$I_{pk}$  = actual peak current.

perfectly applicable for linear r.f. service where no carrier is involved. On the other hand, the ratings sometimes shown for Class B r.f. telephony are *not* what is wanted, because they are for conventional a.m. transmission with carrier.

If audio ratings are not given for the desired tube type, it will be safe to assume that the maximum-signal input for Class-B or -AB<sub>2</sub> service is about 10 per cent less than the key-down Class-C c.w. conditions. The input will have to be held somewhat lower in Class-AB<sub>1</sub> operation because the average efficiency is lower and, also, the tube can draw only a limited amount of current at zero grid voltage.

The maximum-signal conditions determined from tube data correspond in s.s.b. work to the very peak of the r.f. envelope; when a two-tone test signal (or voice) is used, the plate milliammeter does not indicate the peak plate current. The relationship between peak current and indicated current is variable with voice signals, but with the two-tone test signal applied there is a definite relationship between indicated (d.c.) current and peak current. This relationship is plotted in Fig. 11-24. Knowing the ratio of the idling current to the plate current with the two-tone test signal,  $I_o/I_{ac}$ , one can find the factor that can be applied to give the peak current. For example, an amplifier draws 50 ma. with no signal and 250 ma. (before flattening) with the two-tone test signal.  $I_o/I_{ac} = 0.2$ , and  $I_{pk}/I_{ac} = 1.45$ , from Fig. 11-21. Thus  $I_{pk} = 1.45 \times 250 = 363$  ma.

Should the resulting peak input (0.363 × plate voltage) be different than the design value for the particular amplifier tube, the drive and loading adjustments can be changed in the proper directions (always adjusting the loading so that the peaks of the envelope are on the verge of flattening) and the proper value reached.

Using the Linearity Tests

The photos (Figs. 11-21, 11-23 and 11-25) have been taken to show many of the typical patterns that may be encountered with either of the test arrangements described previously. They are classified separately as to those representing correct conditions (Fig. 11-21), faulty operation of the r.f. amplifier (Fig. 11-23), and various other patterns that look irregular but which really represent a peculiarity in the test set-up or the exciter but not in the final (Fig. 11-25).

Aside from the problem of parasitics, which may or may not be a difficult one, it should be possible without much difficulty to achieve the correct linearity pattern by taking action as indicated by the captions accompanying the photos. It can then be assumed that the amplifier is not contributing any distortion to the signal so long as the peak power level indicated by the test is not exceeded. It is entirely possible, however, that good linearity will be obtained only by holding the power down to a level considerably below what is expected, or conversely that there will be signs of excessive plate dissipation at a level that the tubes should handle quite easily. In such cases, some attention should be given to the plate loading, as discussed below.

The several patterns of Fig. 11-26 show how loading affects the output and efficiency of a linear amplifier. In the first two, loading is relatively light and limiting takes place in the final plate circuit. Reserve power is still available in the driver, evidenced by the fact that heavier loading on the final allows the peak output to increase up to the optimum level of the third pattern. With still heavier loading the output ceases to increase but in fact drops somewhat; even though the input power goes up all the time, the efficiency goes down rapidly. In the last two patterns, the driver is the limiting element in the system, and the extra power-handling capability of the final, due to heavier loading, is wasted by inability of the driver to do it justice.

1) For good efficiency, the final itself must be the limiting element in the power-handling capability of the system.

2) If the final is not being driven to its limit, it should be loaded less heavily until such is the case.

3) If the power level obtained above is less than should be expected, more driving power is needed.

There are several ways to tell whether or not the final is being driven to its limit. One way is to advance the drive until peak limiting is apparent in the output, then move the oscilloscope coupling link over to the driver plate tank and see whether or not the same limiting appears there. Another way is to decrease or increase the final loading slightly and note whether the limiting output level increases or decreases correspondingly. If it does not, the final is not controlling the system. Still another but similar

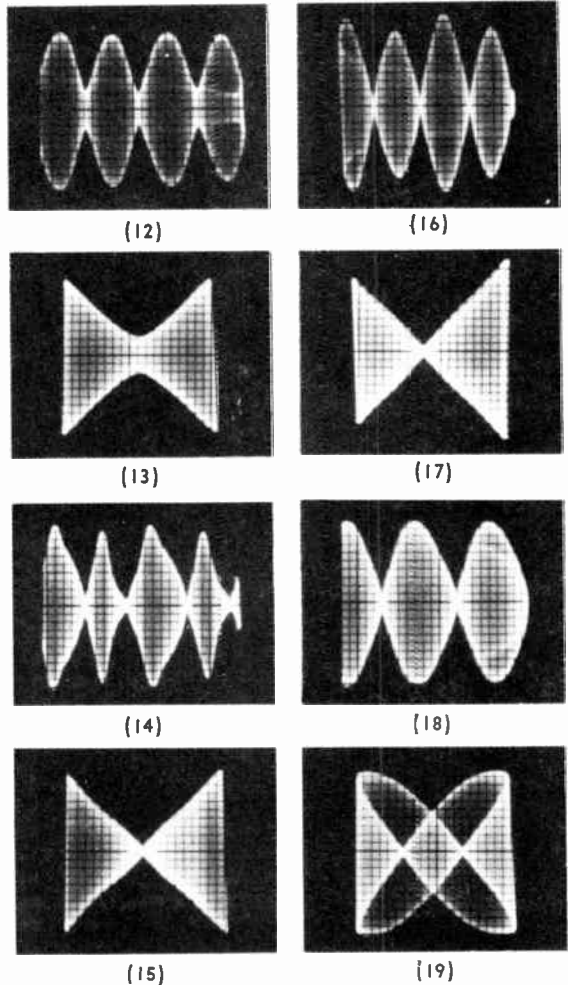
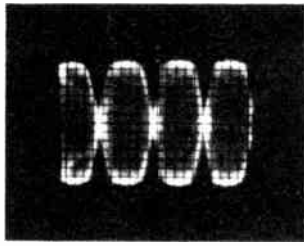

Fig. 11-25—Improper Test Setup. 12—Two r.f. signals unequal. In Method A, caused by improper settings of either carrier or audio control. Method B, either carrier leakage through disabled modulator or unequal sidebands due to selective action of same high-Q circuit off resonance. 13—Same as 12, double-trapezoid test (Method B). 14—Distorted audio. A clue to this defect is that successive waves are not identical. 15—Same distortion as 14, but switched to double trapezoid test pattern. Note that correct pattern prevails regardless of poor audio signal. 16—Carrier leakage through working modulator (Method B only). 17—Same as 16, double trapezoid. 18—(Note tilt to left.) Caused by incomplete suppression of unwanted sideband (Method A) or by r.f. leakage into horizontal circuits of scope. 19—Double trapezoid with audio phase shift in test setup.

method is to detune the final slightly while limiting is apparent, and if proper drive conditions prevail the pattern will improve when the amplifier plate is detuned.

The intermediate and driver stages will follow the same laws, except that what is called "load-





(20)

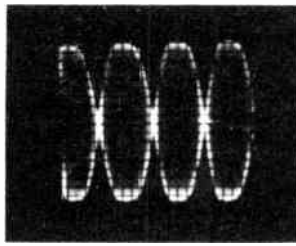

(21)

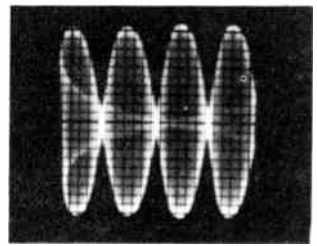

(22)

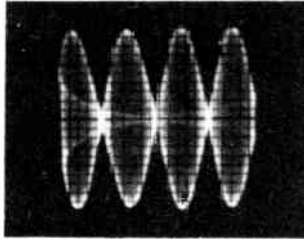

(23)

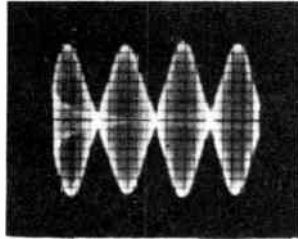

(24)

Fig. 11-26—Amplifier Loading Characteristics. Two-tone patterns taken at the output of a Class-B linear amplifier with constant drive and successively heavier loading. Measured input power: 20—90 watts; 21—135 watts; 22—250 watts; 23—330 watts; 24—400 watts.

ing" on a final is often referred to as "impedance matching" when going between tubes. More often than not, an apparent lack of power transfer from a driver to its succeeding stage is due to a poor match. In Class-AB<sub>2</sub> or -B service, a step-down type of coupling is required between power stages, and a person accustomed to the conventional plate-to-grid coupling capacitor technique will be surprised to find how effective it is to tap the driven stage down on its tank — or otherwise to decouple the system. For example, an 807 driving a pair of 811s requires a voltage step-down of about 3 or 4 to 1 from plate to each grid.

#### Dummy Load

For the sake of everyone concerned, linearity tests should be kept off the air as much as possible. They make quite a racket and serious signals are plentiful in earlier stages of misadjustment. Ordinary lamp bulbs make a fine dummy load so long as it is recognized that their impedance is not exactly the same as the antenna and that this impedance changes somewhat as the bulbs light up. These factors can be taken into account by making careful note of plate and grid currents after the transmitter has

been adjusted and is operating with a linearity test signal at maximum linear output into the lamp load. Then, having reconnected the regular antenna, the same loading conditions for the final will be reproduced by adjusting its tuning and loading until the identical combination of plate and grid currents can be obtained. This process will require only a few moments of on-the-air operation.

When the final on-the-air checks are made, it will be convenient to make a few reference marks on the oscilloscope screen to indicate the peak height of the pattern. The scope will then serve as a permanent output monitor for all operations. For best results the sweep should be set for about 30 cycles, in which case the voice patterns will stand out clearly and can easily be kept just within the reference lines. Incidentally, the pattern is really fascinating to watch.

Don't be a "meter bender." Input power isn't everything. If you have to cut your input in half to avoid overload, the fellow at the other end will hardly notice the difference in level. At the same time, your neighbors, both those on the ham band and those next door trying to watch TV, will appreciate the difference right away.



# Power Supplies

The electrical power required to operate amateur radio equipment is usually taken from the a.c. lines when the equipment is operated where this power is available; in mobile operation the prime source of power is usually the storage battery.

The high-voltage d.c. for the plates of vacuum tubes used in receivers and transmitters is derived from the commercial a.c. by the use of a transformer-rectifier-filter system. The transformer changes the voltage of the a.c. to a suitable value, the rectifier(s) converts it to pulsating d.c., and the filter reduces the pulsations to a suitably low level. Essentially pure direct current is required to prevent hum in the output of receivers, speech amplifiers, modulators and transmitters. In the case of transmitters, pure d.c. plate supply is also dictated by government regulations.

When the prime power source is d.c. (battery), the d.c. is first changed to a.c. and is then followed by the transformer-rectifier-filter system.

The cathode-heating power can be a.c. or d.c. in the case of indirectly-heated cathode tubes, and a.c. or d.c. for filament-type tubes if the tubes are operated at a high power level (high-powered audio and r.f. applications). Low-level operation of filament-type tubes generally requires d.c. on the filaments if undue hum is to be avoided.

Power-supply filters are low-pass devices using series inductors and shunt capacitors. A configuration in which the first element following the rectifier is an inductor is called a "choke-input filter," to distinguish it from a "capacitor-input filter." The type of filter (choke or capacitor input) has a large effect on the peak current through the rectifiers and upon the output voltage.

## RECTIFIER CIRCUITS

### Half-Wave Rectifier

Fig. 12-1 shows three rectifier circuits covering most of the common applications in amateur equipment. Fig. 12-1A is the circuit of a half-wave rectifier. The rectifier is a device that will conduct current in one direction but not in the other. During one half of the a.c. cycle the rectifier will conduct and current will flow through the rectifier to the load. During the other half of the cycle the rectifier does not conduct and no current flows to the load. The shape of the output wave is shown in (A) at the right. It shows that the current always flows in the same direction but that the flow of current is not continuous and is pulsating in amplitude.

The average output voltage—the voltage read by the usual d.c. voltmeter—with this circuit (no filter connected) is 0.45 times the r.m.s. value of the a.c. voltage delivered by the transformer secondary. Because the frequency of the pulses is relatively low (one pulsation per cycle), considerable filtering is required to provide adequately smooth d.c. output, and for this reason this circuit is usually limited to applications where the current involved is small, such as supplies for cathode-ray tubes and for protective bias in a transmitter.

The *peak reverse voltage*, the voltage the rectifier must withstand when it isn't conducting, varies with the load. With a resistive load it is the peak a.c. voltage ( $1.4 E_{\text{RMS}}$ ) but with a capacitor load drawing little or no current it can

rise to  $2.8 E_{\text{RMS}}$ .

Another disadvantage of the half-wave rectifier circuit is that the transformer must have a considerably higher primary volt-ampere rating (approximately 40 per cent greater), for the same d.c. power output, than in other rectifier circuits.

### Full-Wave Center-Tap Rectifier

The most universally used rectifier circuit is shown in Fig. 12-1B. Essentially an arrangement in which the outputs of two half-wave rectifiers are combined, it makes use of both halves of the a.c. cycle. A transformer with a center-tapped secondary is required with the circuit.

The average output voltage is 0.9 times the r.m.s. voltage of half the transformer secondary; this is the maximum voltage that can be obtained with a suitable choke-input filter. The peak output voltage is 1.4 times the r.m.s. voltage of half the transformer secondary; this is the maximum voltage that can be obtained from a capacitor-input filter (at little or no load).

The peak reverse voltage across a rectifier unit is 2.8 times the r.m.s. voltage of half the transformer secondary.

As can be seen from the sketches of the output wave form in (B) to the right, the frequency of the output pulses is twice that of the half-wave rectifier. Therefore much less filtering is required. Since the rectifiers work alternately, each handles half of the load current, and the load-current rat-

Fig. 12-1—Fundamental rectifier circuits. A—Half-wave ( $E_{PRV} = 1.4 E_{RMS}$  with resistive load,  $= 2.8 E_{RMS}$  with capacitor-input filter). B—Full-wave. C—Full-wave bridge. Output voltage values do not include rectifier voltage drops.

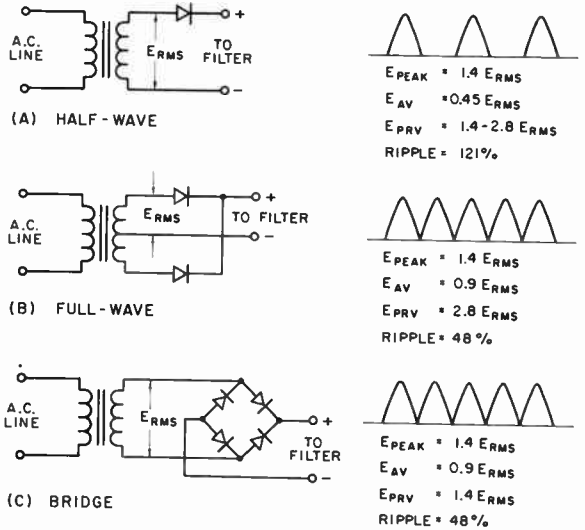

ing of each rectifier need be only half the total load current drawn from the supply.

Two separate transformers, with their primaries connected in parallel and secondaries connected in series (with the proper polarity) may be used in this circuit. However, if this substitution is made, the primary volt-ampere rating must be reduced to about 40 per cent less than twice the rating of one transformer.

**Full-Wave Bridge Rectifier**

Another full-wave rectifier circuit is shown in Fig. 12-1C. In this arrangement, two rectifiers operate in series on each half of the cycle, one rectifier being in the lead to the load, the other being in the return lead. The current flows through two rectifiers during one half of the cycle and through the other two rectifiers during the other half of the cycle. The output wave shape (C), to the right, is the same as that from the simple center-tap rectifier circuit. The maximum output voltage into a resistive load or a properly-designed choke-input filter is 0.9 times the r.m.s. voltage delivered by the transformer secondary; with a capacitor-input filter and a very light load the output voltage is 1.4 times the secondary r.m.s. voltage. The peak reverse voltage per rectifier is 1.4 times the secondary r.m.s. voltage. Each rectifier in a bridge circuit should have a minimum load-current rating of one-half the total load current to be drawn from the supply.

**Other Rectifier Circuits**

The basic rectifier circuits shown in Fig. 12-1 are the ones generally encountered. Variations of these, and a family of "voltage-multiplying" circuits, will be treated later in this chapter.

**Semiconductor Rectifiers**

Selenium and silicon rectifiers are finding increasing application in power supplies for amateur equipment, and they will eventually supplant high-vacuum and mercury-vapor rectifiers. The semiconductors have the advantages of compact-

ness, low internal voltage drop, low operating temperature and high current-handling capability. Also, no filament transformers are required.

In general, selenium rectifiers find their primary application at relatively low voltages (130 r.m.s. or less) and for load currents up to about one ampere.

Silicon rectifiers are available in a wide range of voltage and current ratings. In peak inverse voltage (p.i.v.) ratings of 600 and less, silicon rectifiers carry current ratings as high as 40 amperes, and at 800 p.i.v. the current ratings may be 500 ma. or so. The extreme compactness of silicon types makes feasible the stacking of several units in series for higher voltages. Standard stacks are available that will handle up to 10,000 p.i.v. at a d.c. load current of 500 ma., although they are comparatively expensive and the amateur can do much better by stacking the rectifiers himself. To equalize the p.i.v. drops and to guard against transient voltage spikes, it is good practice to shunt each rectifier with a half-megohm resistor and a 0.01- $\mu$ f. capacitor, as shown in Fig. 12-2. Silicon rectifiers carry surge-current ratings, and

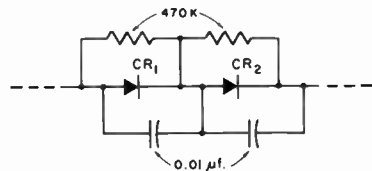

Fig. 12-2—When silicon rectifiers are connected in series for high-voltage operation, the reverse voltage drops can be equalized by using equalizing resistors of about one-half megohm. To protect against voltage "spikes" that may injure an individual rectifier, each rectifier should be bypassed by a 0.01- $\mu$ f. capacitor. Connected as shown, two 400-p.i.v. silicon rectifiers can be used as an 800-p.i.v. rectifier, although it is preferable to include a safety factor and call it a "750-p.i.v." rectifier. The rectifiers, CR<sub>1</sub> and CR<sub>2</sub>, should be the same type (same type number and ratings).

series limiting resistors are required if the transformer winding resistance and reactance are too low to limit the current to a suitable value.

High-Vacuum Rectifiers

High-vacuum rectifiers depend entirely upon the thermionic emission from a heated filament and are characterized by a relatively high internal resistance. For this reason, their application usually is limited to low power, although there are a few types designed for medium and high power in cases where the relatively high internal voltage drop may be tolerated. This high internal resistance make them less susceptible to damage from temporary overload and they are free from the bothersome electrical noise sometimes associated with other types of rectifiers.

Some rectifiers of the high-vacuum full-wave type in the so-called receiver-tube class will handle up to 275 ma. at 400 to 500 volts d.c. output. Those in the higher-power class can be used to handle up to 500 ma. at 2000 volts d.c. in full-wave circuits. Most low-power high-vacuum rectifiers are produced in the full-wave type, while those for greater power are invariably of the half-wave type, two tubes being required for a full-wave rectifier circuit. A few of the lower-voltage types have indirectly heated cathodes, but are limited in heater-to-cathode voltage rating.

Mercury-Vapor Rectifiers

The voltage drop through a mercury-vapor rectifier is practically constant regardless of the load current. It ranges from 10 to 15 volts, depending upon the tube type. Rectifiers of this type, however, have a tendency toward a type of oscillation which produces noise in nearby receivers, sometimes difficult to eliminate. R.f. filtering in the primary circuit and at the rectifier plates as well as shielding may be required. As with high-vacuum rectifiers, full-wave types are available in the lower-power ratings only. For higher power, two tubes are required in a full-wave circuit.

Rectifier Ratings

All rectifiers are subject to limitations as to breakdown voltage and current-handling capability. Some tube types are rated in terms of the maximum r.m.s. voltage that should be applied to the rectifier plate. This is sometimes dependent on whether a choke- or capacitive-input filter is used. Others, particularly mercury-vapor and semiconductor types, are rated according to maximum peak inverse voltage (p.i.v.)—the peak voltage between anode and cathode while the rectifier is not conducting.

Rectifiers are rated also as to maximum d.c. load current, and some may carry peak-current ratings in addition. To assure normal life, all ratings should be carefully observed.

Operation of Hot-Cathode Rectifiers

In operating rectifiers requiring filament or cathode heating, as shown in Fig. 12-3, care should be taken to provide the correct filament voltage at

the tube terminals. Low filament voltage can cause excessive voltage drop in high-vacuum rectifiers and a considerable reduction in the inverse peak-voltage rating of a mercury-vapor tube. Filament connections to the rectifier socket should be firmly soldered, particularly in the case of the larger mercury-vapor tubes whose filaments operate at low voltage and high current. The socket should be selected with care, not only as to contact surface but also as to insulation, since the filament usually is at full output voltage to ground. Bakelite sockets will serve at voltages up to 500 or so, but ceramic sockets, well spaced from the chassis, always should be used at the

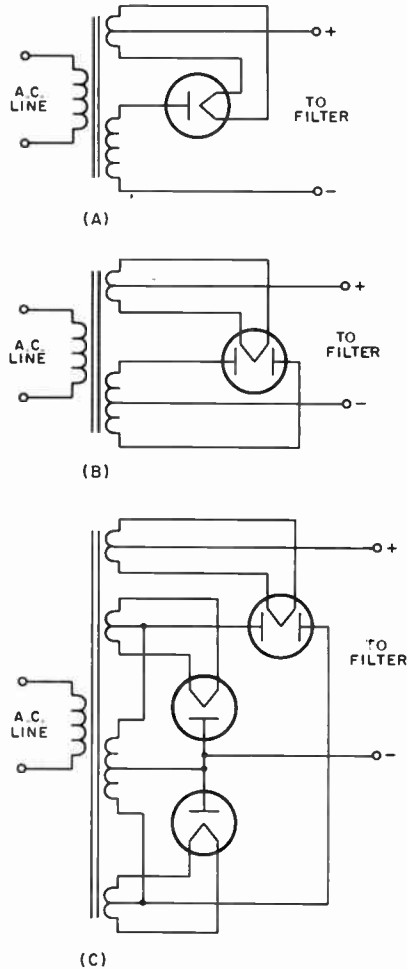

Fig. 12-3—The fundamental rectifier circuits of Fig. 12-1 redrawn for the use with hot-cathode rectifiers. In many applications the filament transformer would be separate from the high-voltage transformer, and in many applications the full-wave rectifier in a single envelope would be replaced by two half-wave rectifiers. Low-voltage bridge circuits sometimes use rectifiers with indirectly-heated cathodes that have high heater-to-cathode voltage ratings; this reduces the number of cathode-heating windings required for the power supply.

higher voltages. Special filament transformers with high-voltage insulation between primary and secondary are required for rectifiers operating at potentials in excess of 1000 volts inverse peak. In a supply furnishing a + voltage with respect to ground, the insulation must at least be able to withstand any possible voltage, plus 1000 or 2000 volts safety factor. Most rectifier filament transformers intended for high-voltage service carry 5000- or 10,000-volt insulation ratings.

The rectifier tubes should be placed in the equipment with adequate space surrounding them to provide for ventilation. When mercury-vapor tubes are first placed in service, and each time after the mercury has been disturbed, as by removal from the socket to a horizontal position, they should be run with filament voltage only for 30 minutes before applying high voltage. After that, a delay of 30 seconds is recommended each time the filament is turned on.

Hot-cathode rectifiers may be connected in

Fig. 12-4—Connecting mercury-vapor rectifiers in parallel for heavier currents.  $R_1$  and  $R_2$  should have the same value, between 50 and 100 ohms, and corresponding filament terminals should be connected together.

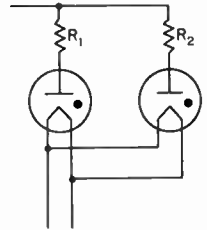

parallel for current higher than the rated current of a single unit. This includes the use of the sections of a double diode for this purpose. With mercury-vapor types, equalizing resistors of 50 to 100 ohms should be connected in series with each plate, as shown in Fig. 12-4, to maintain an equal division of current between the two rectifiers. If one tube tends to "hog" the current, the increased voltage drop across its resistor will decrease the voltage applied to the tube.

## FILTERS

The pulsating d.c. waves from the rectifiers shown in Fig. 12-1 are not sufficiently constant in amplitude to prevent hum corresponding to the pulsations. Filters consisting of capacitances and inductances are required between the rectifier and the load to smooth out the pulsations to an essentially constant d.c. voltage. Also, upon the design of the filter depends to a large extent the d.c. voltage output, the *voltage regulation* of the power supply and the maximum load current that can be drawn from the supply without exceeding the peak-current rating of the rectifier.

### Load Resistance

In discussing the performance of power-supply filters, it is sometimes convenient to express the load connected to the output terminals of the supply in terms of resistance. The load resistance is equal to the output voltage divided by the total current drawn, including the current drawn by the bleeder resistor.

### Type of Filter

Power-supply filters fall into two classifications, capacitor input and choke input. Capacitor-input filters are characterized by relatively high output voltage in respect to the transformer voltage. Advantage of this can be taken when silicon rectifiers are used or with any rectifier when the load resistance is high. Silicon rectifiers have a higher allowable peak-to-d.c. ratio than do thermionic rectifiers. This permits the use of capacitor-input filters at ratios of input capacitor to load resistance that would seriously shorten the life of a thermionic rectifier system. When the series resistance through a rectifier and filter system is appreciable, as when high-vacuum rectifiers are used, the voltage regulation (see subsequent section) of a capacitor-input power supply is poor.

The output voltage of a properly-designed choke-input power supply is less than would be

obtained with a capacitor-input filter from the same transformer.

### Voltage Regulation

The output voltage of a power supply always decreases as more current is drawn, not only because of increased voltage drops on the transformer, filter chokes and the rectifier (if high-vacuum rectifiers are used) but also because the output voltage at light loads tends to soar to the peak value of the transformer voltage as a result of charging the first capacitor. By proper filter design the latter effect can be eliminated. The change in output voltage with load is called *voltage regulation* and is expressed as a percentage.

$$\text{Per cent regulation} = \frac{100 (E_1 - E_2)}{E_2}$$

Example: No-load voltage =  $E_1 = 1550$  volts.

Full-load voltage =  $E_2 = 1230$  volts.

$$\text{Percentage regulation} = \frac{100 (1550 - 1230)}{1230}$$

$$= \frac{32,000}{1230} = 26 \text{ per cent.}$$

A steady load, such as that represented by a receiver, speech amplifier or unkeyed stages of a transmitter, does not require good (low) regulation so long as the proper voltage is obtained under load conditions. However, the filter capacitors must have a voltage rating safe for the highest value to which the voltage will soar when the external load is removed.

A power supply will show more (higher) regulation with long-term changes in load resistance than with short temporary changes. The regulation with long-term changes is often called the **static regulation**, to distinguish it from the **dynamic regulation** (short temporary load changes). A load that varies at a syllabic or keyed rate, as represented by some audio and r.f. amplifiers, usually requires good dynamic regulation (15 per cent or less) if distortion products are



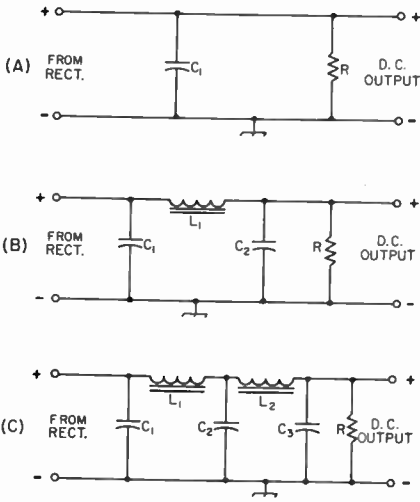

Fig. 12-5.—Capacitive-input filter circuits. A—Simple capacitive. B—Single-section. C—Double-section.

to be held to a low level. The dynamic regulation of a power supply is improved by increasing the value of the output capacitor.

When essentially constant voltage, regardless of current variation is required (for stabilizing an oscillator, for example), special voltage-regulating circuits described elsewhere in this chapter are used.

**Bleeder**

A bleeder resistor is a resistance connected across the output terminals of the power supply. Its functions are to discharge the filter capacitors as a safety measure when the power is turned off and to improve voltage regulation by providing a minimum load resistance. When voltage regulation is not of importance, the resistance may be as high as 100 ohms per volt. The resistance value to be used for voltage-regulating purposes is discussed in later sections. From the consideration of safety, the power rating of the resistor should be as conservative as possible, since a burned-out

bleeder resistor is more dangerous than none at all!

**Ripple Frequency and Voltage**

The pulsations in the output of the rectifier can be considered to be the resultant of an alternating current superimposed upon a steady direct current. From this viewpoint, the filter may be considered to consist of shunting capacitors which short-circuit the a.c. component while not interfering with the flow of the d.c. component, and series chokes which pass d.c. readily but which impede the flow of the a.c. component.

The alternating component is called the ripple. The effectiveness of the filter can be expressed in terms of per cent ripple, which is the ratio of the r.m.s. value of the ripple to the d.c. value in terms of percentage. For c.w. transmitters, the output ripple from the power supply should not exceed 5 per cent. The ripple in the output of supplies for voice transmitters should not exceed 1 per cent. Class B modulators require a ripple reduction to about 0.25%, while v.f.o.'s, high-gain speech amplifiers, and receivers may require a reduction in ripple to 0.01%.

Ripple frequency is the frequency of the pulsations in the rectifier output wave—the number of pulsations per second. The frequency of the ripple with half-wave rectifiers is the same as the frequency of the line supply—60 cycles with 60-cycle supply. Since the output pulses are doubled with a full-wave rectifier, the ripple frequency is doubled—to 120 cycles with 60-cycle supply.

The amount of filtering (values of inductance and capacitance) required to give adequate smoothing depends upon the ripple frequency, more filtering being required as the ripple frequency is lowered.

**Transformer Winding Resistance**

The effective transformer winding resistance is given by

$$R_{tr} = N^2 R_{pr1} + R_{scc}$$

where  $N$  is the transformer turns ratio, primary to secondary (voltage ratio at no load), and  $R_{pr1}$  and  $R_{scc}$  are the primary and secondary resistances respectively. In the case of a full-wave rectifier circuit,  $N$  is the ratio of primary to

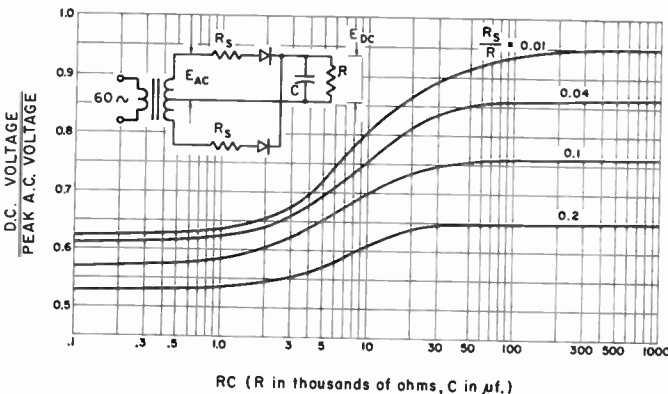

Fig. 12-6—D.c. output voltages from a full-wave rectifier circuit as a function of the filter capacitance and load resistance.  $R_s$  includes transformer winding resistance and rectifier forward resistance. For the ratio  $R_s/R$ , both resistances are in ohms; for the RC product, R is in thousands of ohms.

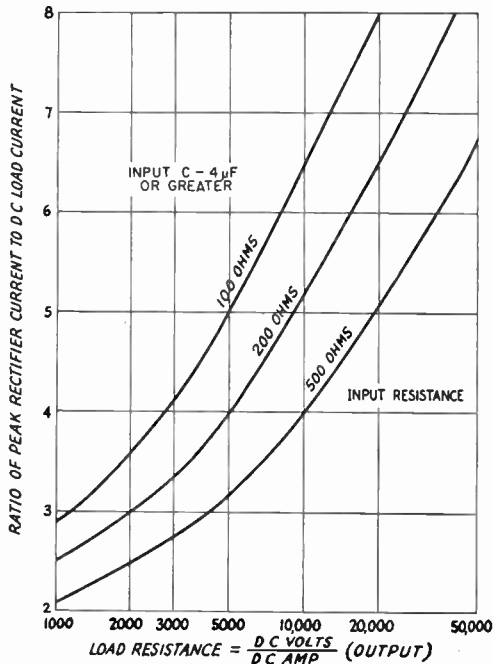

Fig. 12-7—Graph showing the relationship between the d.c. load current and the rectifier peak plate current with capacitive input for various values of load and input resistance.

one-half secondary and  $R_{s.e.}$  is the resistance of half of the secondary winding.

### CAPACITIVE-INPUT FILTERS

Capacitive-input filter systems are shown in Fig. 12-5. Disregarding voltage drops in the chokes, all have the same characteristics except in respect to ripple. Better ripple reduction will be obtained when  $LC$  sections are added, as shown in Figs. 12-5B and C.

#### Output Voltage

To determine the approximate d.c. voltage output when a capacitive-input filter is used, reference should be made to the graph of Fig. 12-6.

Example:

Transformer r.m.s. voltage—350  
 Peak a.c. voltage =  $1.4 \times 350 = 495$   
 Load resistance—2000 ohms  
 Series resistance—200 ohms  
 $200 \div 2000 = 0.1$   
 Input capacitor  $C = 20 \mu\text{f.}$   
 $R \text{ (thousands)} \times C = 2 \times 20 = 40$   
 From curve 0.1 and  $RC = 40$ , d.c. voltage  
 =  $495 \times 0.75 = 370$

#### Regulation

If a bleeder resistance of 20,000 ohms is used in the example above, when the load is removed and  $R$  becomes 20,000, the d.c. voltage will rise to 470. For best regulation with a capacitor-input filter, the bleeder resistor should be as low as possible, or the series resistance should be low and the filter capacitance high, without exceeding the transformer or rectifier ratings.

### Maximum Rectifier Current

The maximum current that can be drawn from a supply with a capacitive-input filter without exceeding the peak-current rating of the rectifier may be estimated from the graph of Fig. 12-7. Using values from the preceding example, the ratio of peak rectifier current to d.c. load current for 2000 ohms, as shown in Fig. 12-7 is 3. Therefore, the maximum load current that can be drawn without exceeding the rectifier rating is  $\frac{1}{3}$  the peak rating of the rectifier. For a load current of 185 ma., as above, the rectifier peak current rating should be at least  $3 \times 185 = 555$  ma.

With bleeder current only, Fig. 12-7 shows that the ratio will increase to  $7\frac{1}{2}$ . But since the bleeder draws 23.5 ma. d.c., the rectifier peak current will be only 176 ma.

### Ripple Filtering

The approximate ripple percentage after the simple capacitive filter of Fig. 12-5A may be determined from Fig. 12-8. With a load resistance of 2000 ohms, for instance, the ripple will be approximately 10% with an 8- $\mu\text{f.}$  capacitor or 20% with a 4- $\mu\text{f.}$  capacitor. For other capacitances, the ripple will be in inverse proportion to the capacitance, e.g., 5% with 16  $\mu\text{f.}$ , 40% with 2  $\mu\text{f.}$ , and so forth.

The ripple can be reduced further by the addition of  $LC$  sections as shown in Figs. 12-5B and C. Fig. 12-9 shows the factor by which the ripple from any preceding section is reduced depending on the product of the capacitance and inductance added. For instance, if a section composed of a choke of 5 h. and a capacitor of 4  $\mu\text{f.}$  were to be added to the simple capacitor of Fig. 12-5A, the product is  $4 \times 5 = 20$ . Fig. 12-9 shows that the original ripple (10% as above with 8  $\mu\text{f.}$  for example) will be reduced by a factor of about 0.09. Therefore the ripple percentage after the new section will be approximately  $0.09 \times 10 = 0.9\%$ . If another section is added to the filter, its reduc-

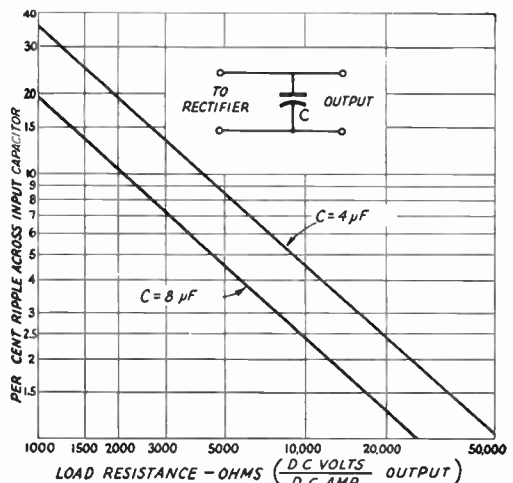

Fig. 12-8—Showing approximate 120-cycle percentage ripple across filter input capacitor for various loads.

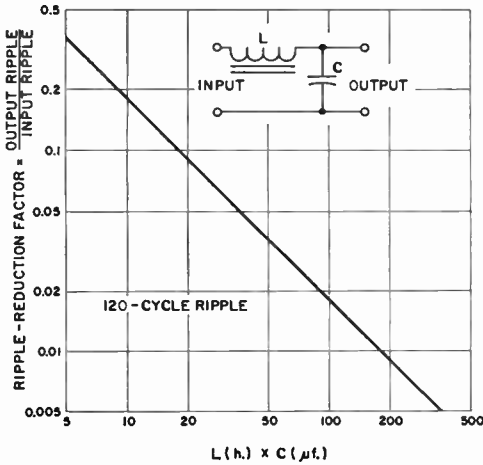

Fig. 12-9—Ripple-reduction factor for various values of  $L$  and  $C$  in filter section. Output ripple = input ripple  $\times$  ripple factor.

tion factor from Fig. 12-9 will be applied to the 0.9% from the preceding section;  $0.9 \times 0.09 = 0.081\%$  (if the second section has the same  $LC$  product as the first).

**CHOKE-INPUT FILTERS**

With thermionic rectifiers better voltage regulations results when a choke-input filter, as shown in Fig. 12-10, is used. Choke input permits better utilization of the thermionic rectifier, since a higher load current usually can be drawn without exceeding the peak current rating of the rectifier.

**Minimum Choke Inductance**

A choke-input filter will tend to act as a capacitive-input filter unless the input choke has at least a certain minimum value of inductance called the **critical value**. This critical value is given by

$$L_{crit} \text{ (henries)} = \frac{E \text{ (volts)}}{I \text{ (ma.)}}$$

where  $E$  is the output voltage of the supply, and

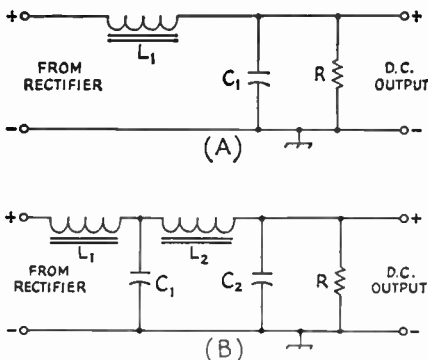

Fig. 12-10—Choke-input filter circuits. A—Single-section. B—Double-section.

$I$  is the current being drawn through the filter.

If the choke has at least the critical value, the output voltage will be limited to the average value of the rectified wave at the input to the choke (see Fig. 12-1) when the current drawn from the supply is small. This is in contrast to the capacitive-input filter in which the output voltage tends to soar toward the peak value of the rectified wave at light loads. Also, if the input choke has at least the critical value, the rectifier peak current will be limited to about twice the d.c. current drawn from the supply. Most thermionic rectifiers have peak-current ratings of three to four times their maximum d.c. output-current ratings. Therefore, with an input choke of at least critical inductance, current up to the maximum output-current rating of the thermionic rectifier may be drawn from the supply without exceeding the peak-current rating of the rectifier.

**Minimum-Load—Bleeder Resistance**

From the formula above for critical inductance, it is obvious that if no current is drawn from the supply, the critical inductance will be infinite. So that a practical value of inductance may be used, some current must be drawn from the supply at all times the supply is in use. From the formula we find that this minimum value of current is

$$I \text{ (ma.)} = \frac{E \text{ (volts)}}{L_{crit}}$$

Thus, if the choke has an inductance of 20 h., and the output voltage is 2000, the minimum load current should be 100 ma. This load may be provided, for example, by transmitter stages that draw current continuously (stages that are not keyed). However, in the majority of cases it will be most convenient to adjust the bleeder resistance so that the bleeder will draw the required minimum current. In the above example, the bleeder resistance should be  $2000/0.1 = 20,000$  ohms.

From the formula for critical inductance, it is seen that when more current is drawn from the supply, the critical inductance becomes less. Thus, as an example, when the total current, including the 100 ma. drawn by the bleeder, rises to 400 ma., the choke need have an inductance of only 5 h. to maintain the critical value. This is fortunate, because chokes having the required inductance for the bleeder load only and that will maintain this value of inductance for much larger currents are very expensive.

**Swinging Chokes**

Less costly chokes are available that will maintain at least critical value of inductance over the range of current likely to be drawn from practical supplies. These chokes are called **swinging chokes**. As an example, a swinging choke may have an inductance rating of 5/25 h. and a current rating of 200 ma. If the supply delivers 1000 volts, the minimum load current should be  $1000/25 = 40$  ma. When the full load current of 200 ma. is drawn from the supply, the inductance

Fig. 12-11—Diagram showing various voltage drops that must be taken into consideration in determining the required transformer voltage to deliver the desired output voltage.

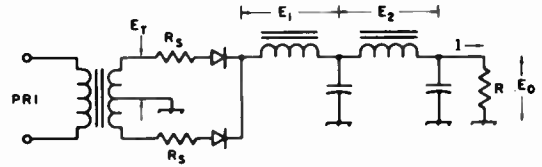

will drop to 5 h. The critical inductance for 200 ma. at 1000 volts is  $1000/200 = 5$  h. Therefore the 5/25-h. choke maintains the critical inductance at the full current rating of 200 ma. At all load currents between 40 ma. and 200 ma., the choke will adjust its inductance to the approximate critical value.

Table 12-I shows the maximum supply output voltage that can be used with commonly-available swinging chokes to maintain critical inductance at the maximum current rating of the choke. These chokes will also maintain critical inductance for any lower values of voltage, or current down to the required minimum drawn by a proper bleeder as discussed above.

In the case of supplies for higher voltages in particular, the limitation on maximum load re-

**Output Voltage**

Provided the input-choke inductance is at least the critical value, the output voltage may be calculated quite closely by the following equation:

$$E_o = 0.9E_t - (I_B + I_L) (R_1 + R_2) - E_r$$

where  $E_o$  is the output voltage;  $E_t$  is the r.m.s. voltage applied to the rectifier (r.m.s. voltage between center-tap and one end of the secondary in the case of the center-tap rectifier);  $I_B$  and  $I_L$  are the bleeder and load currents, respectively, in amperes;  $R_1$  and  $R_2$  are the resistances of the first and second filter chokes; and  $E_r$  is the voltage drop across the rectifier. The various voltage drops are shown in Fig. 12-11. At no load  $I_L$  is zero, hence the no-load voltage may be calculated on the basis of bleeder current only. The voltage regulation may be determined from the no-load and full-load voltages using the formula previously given.

**Ripple with Choke Input**

The percentage ripple output from a single-section filter may be determined to a close approximation from Fig. 12-12.

Example:  $L = 5$  h.,  $C = 4 \mu f.$ ,  $LC = 20$ .  
From Fig. 12-12, percentage ripple = 7 per cent.

Example:  $L = 5$  h. What capacitance is needed to reduce the ripple to 1 per cent? Following the 1-per-cent line to its intersection with the diagonal, thence down to the  $LC$  scale, read  $LC = 120$ .  $120/5 = 24 \mu f.$

$L_h$	Max. ma.	Max. volts	Max. $R^1$	Min. ma. <sup>2</sup>
3.5/13.5	150	525	13.5K	39
2/12	200	400	12K	33
5/25	200	1000	25K	40
2/12	250	500	12K	42
4/20	300	1200	20K	60
5/25	300	1500	25K	60
4/20	400	1600	20K	80
5/25	500	2500	25K	100

<sup>1</sup> Maximum bleeder resistance for critical inductance.  
<sup>2</sup> Minimum current (bleeder) for critical inductance.

sistance may result in the wasting of an appreciable portion of the transformer power capacity in the bleeder resistance. Two input chokes in series will permit the use of a bleeder of twice the resistance, cutting the wasted current in half. Another alternative that can be used in a c.w. transmitter is to use a very high-resistance bleeder for protective purposes and only sufficient fixed bias on the tubes operating from the supply to bring the total current drawn from the supply, when the key is open, to the value of current that the required bleeder resistance should draw from the supply. Operating bias is brought back up to normal by increasing the grid-leak resistance. Thus the entire current capacity of the supply (with the exception of the small drain of the protective bleeder) can be used in operating the transmitter stages. With this system, it is advisable to operate the tubes at phone, rather than c.w., ratings, since the average dissipation is increased.

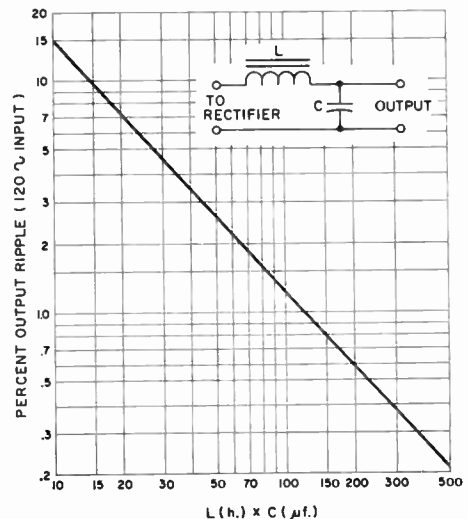

Fig. 12-12—Graph showing combinations of inductance and capacitance that may be used to reduce 120-cycle ripple with a single-section choke-input filter.



In selecting values for the first filter section, the inductance of the choke should be determined by the considerations discussed previously. Then the capacitor should be selected that when combined with the choke inductance (minimum inductance in the case of a swinging choke) will bring the ripple down to the desired value. If it is found impossible to bring the ripple down to the desired figure with practical values in a single section, a second section can be added, as shown in Fig. 12-10B and the reduction factor from Fig. 12-9 applied as discussed under capacitive-input filters. The second choke should not be of the swinging type, but one having a more or less constant inductance with changes in current (smoothing choke).

### OUTPUT CAPACITOR

If the supply is intended for use with a Class-A a.f. amplifier, the reactance of the output capacitor should be low for the lowest audio frequency; 8  $\mu\text{f.}$  or more is usually adequate. When the supply is used with a Class-B amplifier (for modulation or for s.s.b. amplification) or a c.w. transmitter, increasing the output capacitance will result in improved dynamic regulation of the supply. However, a region of diminishing returns can be reached, and 10 to 20  $\mu\text{f.}$  will usually suffice for any supply subjected to large changes at a syllabic (or keying) rate.

### RESONANCE

Resonance effects in the series circuit across the output of the rectifier which is formed by the first choke and first filter capacitor must be avoided, since the ripple voltage would build up to large values. This not only is the opposite action to that for which the filter is intended, but also may cause excessive rectifier peak currents and abnormally high inverse peak voltages. For full-wave rectification the ripple frequency will be 120 cycles for a 60-cycle supply, and resonance will occur when the product of choke inductance in henrys time capacitor capacitance in microfarads is equal to 1.77. The corresponding figure for 50-cycle supply (100-cycle ripple frequency) is 2.53, and for 25-cycle supply (50-cycle ripple frequency) 13.5. At least twice these products of inductance and capacitance should be used to ensure against resonance effects. With a swinging choke, the minimum rated inductance of the choke should be used.

### RATINGS OF FILTER COMPONENTS

In a power supply using a choke-input filter and properly-designed choke and bleeder resistor, the no-load voltage across the filter capacitors will be about nine-tenths of the a.c. r.m.s. voltage. Nevertheless, it is advisable to use capacitors rated for the *peak* transformer voltage. This large safety factor is suggested because the voltage across the capacitors can reach this peak value if the bleeder should burn out and there is no load on the supply.

In a capacitive-input filter, the capacitors should have a working-voltage rating at least

as high, and preferably somewhat higher, than the peak-voltage rating of the transformer. Thus, in the case of a center-tap rectifier having a transformer delivering 550 volts each side of the center-tap, the minimum safe capacitor voltage rating will be  $550 \times 1.41$  or 775 volts. An 800-volt capacitor should be used, or preferably a 1000-volt unit.

### Filter Capacitors in Series

Filter capacitors are made in several different types. Electrolytic capacitors, which are available for peak voltages up to about 800, combine high capacitance with small size, since the dielectric is an extremely thin film of oxide on aluminum foil. Capacitors of this type may be connected in series for higher voltages, although the filtering capacitance will be reduced to the resultant of the two capacitances in series. If this arrangement is used, it is important that *each* of the capacitors be shunted with a resistor of about 100 ohms per volt of supply voltage, with a power rating adequate for the total resistor current at that voltage. These resistors may serve as all or part of the bleeder resistance (see choke-input filters). Capacitors with higher-voltage ratings usually are made with a dielectric of thin paper impregnated with oil. The **working voltage** of a capacitor is the voltage that it will withstand continuously.

### Filter Chokes

The input choke may be of the swinging type, the required minimum no-load and full-load inductance values being calculated as described above. For the second choke (**smoothing choke**) values of 4 to 20 henrys ordinarily are used. When filter chokes are placed in the positive leads, the negative being grounded, the windings should be insulated from the core to withstand the full d.c. output voltage of the supply and be capable of handling the required load current.

Filter chokes or inductances are wound on iron cores, with a small gap in the core to prevent magnetic saturation of the iron at high currents. When the iron becomes saturated its permeability decreases, consequently the inductance also decreases. Despite the air gap, the inductance of a choke usually varies to some extent with the direct current flowing in the winding; hence it is necessary to specify the inductance at the current which the choke is intended to carry. Its inductance with little or no direct current flowing in the winding will usually be considerably higher than the value when full load current is flowing.

### NEGATIVE-LEAD FILTERING

For many years it has been almost universal practice to place filter chokes in the positive leads of plate power supplies. This means that the insulation between the choke winding and its core (which should be grounded to chassis as a safety measure) must be adequate to withstand the output voltage of the supply. This voltage require-

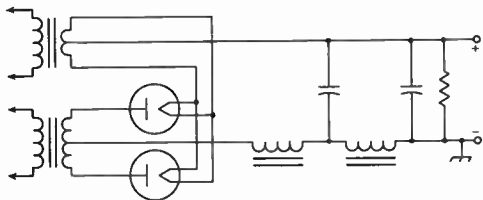

Fig. 12-13—In most applications, the filter chokes may be placed in the negative instead of the positive side of the circuit. This reduces the danger of a voltage breakdown between the choke winding and core.

ment is removed if the chokes are placed in the negative lead as shown in Fig. 12-13. With this connection, the capacitance of the transformer

secondary to ground appears in parallel with the filter chokes tending to bypass the chokes. However, this effect will be negligible in practical application except in cases where the output ripple must be reduced to a very low figure. Such applications are usually limited to low-voltage devices such as receivers, speech amplifiers and v.f.o.'s where insulation is no problem and the chokes may be placed in the positive side in the conventional manner. In higher-voltage applications, there is no reason why the filter chokes should not be placed in the negative lead to reduce insulation requirements. Choke terminals, negative capacitor terminals and the transformer center-tap terminal should be well protected against accidental contact, since these will assume full supply voltage to chassis should a choke burn out or the chassis connection fail.

## PLATE AND FILAMENT TRANSFORMERS

### Output Voltage

The output voltage which the plate transformer must deliver depends upon the required d.c. load voltage and the type of filter circuit.

With a choke-input filter, the required r.m.s. secondary voltage (each side of center-tap for a center-tap rectifier) can be calculated by the equation:

$$E_t = 1.1 \left[ E_o + I(R_1 + R_2 + R_s) \right]$$

where  $E_o$  is the required d.c. output voltage,  $I$  is the load current (including bleeder current) in amperes,  $R_1$  and  $R_2$  are the d.c. resistances of the chokes, and  $R_s$  is the series resistance (transformer and rectifier) rectifier.  $E_t$  is the open-circuit r.m.s. voltage.

The approximate transformer output voltage required to give a desired d.c. output voltage with a given load with a capacitive-input filter system can be calculated with Fig. 12-11.

Example:

Required d.c. output volts — 500

Load current to be drawn — 100 ma. (0.1 amp)

Load resistance =  $\frac{500}{0.1} = 5000$  ohms.

Input capacitor — 10  $\mu$ f.

If the series resistance is 200 ohms, Fig. 12-6 shows that the ratio of d.c. volts to the required transformer peak voltage is 0.85. The ratio to the r.m.s. voltage is  $0.85 \times 1.414 = 1.2$ .

The required transformer terminal voltage under load with chokes of 200 and 300 ohms is

$$E_t = \frac{E_o + I(R_1 + R_2 + R_s)}{1.2}$$

$$= \frac{500 + 0.1(200 + 300 + 200)}{1.2}$$

$$= \frac{570}{1.2} = 475 \text{ volts.}$$

### Volt-Ampere Rating

The volt-ampere rating of the transformer depends upon the type of filter (capacitive or choke input). With a capacitive-input filter the heating effect in the secondary is higher because of the high ratio of peak to average current, consequently the volt-amperes handled by the transformer may be several times the watts delivered to the load. With a choke-input filter, provided the input choke has at least the critical inductance, the secondary volt-amperes can be calculated quite closely by the equation:

$$\text{Sec. V.A.} = 0.00075EI$$

where  $E$  is the total r.m.s. voltage of the secondary (between the outside ends in the case of a center-tapped winding) and  $I$  is the d.c. output current in milliamperes (load current plus bleeder current). The primary volt-amperes will be 10 to 20 per cent higher because of transformer losses.

### Broadcast & Television Replacement Transformers in Amateur Transmitter Service

Small power transformers of the type sold for replacement in broadcast and television receivers are usually designed for service in terms of use for several hours continuously with capacitor-input filters. In the usual type of amateur transmitter service, where most of the power is drawn intermittently for periods of several minutes with equivalent intervals in between, the published ratings can be exceeded without excessive transformer heating.

With capacitor input, it should be safe to draw 20 to 30 per cent more current than the rated value. With a choke-input filter, an increase in current of about 50 per cent is permissible. If a bridge rectifier is used (with a choke-input filter) the output voltage will be approximately doubled. In this case, it should be possible in amateur transmitter service to draw the rated current, thus obtaining about twice the rated output power from the transformer.

This does not apply, of course, to amateur transmitter plate transformers which are usually already rated for intermittent service.

**Filament Supply**

Except for tubes designed for battery operation, the filaments or heaters of vacuum tubes used in both transmitters and receivers are universally operated on alternating current obtained from the power line through a step-down transformer delivering a secondary voltage equal to the rated voltage of the tubes used. The transformer should be designed to carry the current taken by the number of tubes which may be con-

nected in parallel across it. The filament or heater transformer generally is center-tapped, to provide a balanced circuit for eliminating hum.

For medium- and high-power r.f. stages of transmitters, and for high-power audio stages, it is desirable to use a separate filament transformer for each section of the transmitter, installed near the tube sockets. This avoids the necessity for abnormally large wires to carry the total filament current for all stages without appreciable voltage drop. Maintenance of rated filament voltage is highly important, especially with thoriated-filament tubes, since under- or over-voltage may reduce filament life.

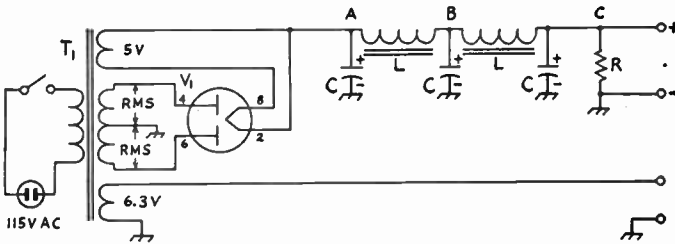

Fig. 12-14—Typical a.c. power-supply circuit for receivers, exciters, or low-power transmitters. Representative values will be found in Table 12-11. The 5-volt winding of  $T_1$  should have a current rating of at least 2 amp. for types 5Y3-GT and 5V4-GA, and 3 amp. for 5U4-GB.

**TYPICAL POWER SUPPLIES**

Figs. 12-14 and 12-15 show typical power-supply circuits. Fig. 12-14 is for use with transformers commonly listed as broadcast or television re-

placement power transformers. In addition to the high-voltage winding for plate supply, these transformers have windings that supply filament

TABLE 12-11

Capacitor-Input Power Supplies

$T_1$ Rating		$V_1$ Tube Type	C		L		R		Approximate Full-load d.c. Volts at			Approximate Ripple % at			Approx. Output Useful Bleeder Load	Ma.*
Total Volts R.M.S.	Ma. D.C.		uf.	Volts	H.	Ohms	Ohms	Watts	A	B	C	A	B	C		
650	40	5Y3-GT	8	600	8	400	90K	5	375	360	345	2.5	0.08	0.002	450	36
650	40	5V4-GA	8	600	8	400	90K	5	410	395	375	2.5	0.08	0.002	450	36
700	90	5Y3-GT	8	600	10	225	46K	10	370	350	330	6	0.1	0.002	460	82
700	90	5V4-GA	8	600	10	225	46K	10	410	390	370	6	0.1	0.002	460	82
750	150	5U4-GB	8	700	8	145	25K	10	375	350	330	9	0.2	0.006	500	136
750	150	5V4-GA	8	700	8	145	25K	10	425	400	380	9	0.2	0.006	500	136
800	200	5U4-GB	8	700	8	120	22K	20	375	350	325	12	0.3	0.008	550	184

Choke-Input Power Supplies

650	40	5Y3-GT	8	450	15	420	18K	10	—	240	225	—	0.8	0.01	265	25
650	40	5V4-GA	8	450	15	420	18K	10	—	255	240	—	0.8	0.01	280	25
700	90	5Y3-GT	8	450	10	225	11K	10	—	240	220	—	1.25	0.02	250	68
700	90	5V4-GA	8	450	10	225	11K	10	—	270	250	—	1.25	0.02	280	68
750	150	5Y3-GT	8	450	12	150	13K	20	—	265	245	—	1	0.015	325	125
750	150	5V4-GA	8	450	12	150	13K	20	—	280	260	—	1	0.015	340	125
800	200	5U4-GB	8	450	12	140	14K	20	—	275	250	—	1	0.015	350	175

\* Balance of transformer current capacity consumed by bleeder resistor.

**TABLE 12-III**

Approx. D.C. Output		Transformer Rating		$L_2$ H.	Voltage Rating $C_1, C_2$	R Watts	Approx. Bleeder-Load Output Volts
Volts	Ma. <sup>1</sup>	Approx. V.R.M.S.	Ma.				
400/500	230	520/615	250	4	700	20	440/540
600/750	260	750/950	300	8	1000	50	650/800
1250/1500	240	1500/1750	300	8	2000	150	1300/1600
1250/1500	440	1500/1750	500	6	2000	150	1315/1615
2000/2500	200	2400/2900	300 <sup>4</sup>	8	3000	320 <sup>2</sup>	2050/2550
2000/2500	400	2400/2900	500	6	3000	320 <sup>2</sup>	2065/2565
2500/3000	380	2900/3450	500 <sup>5</sup>	6	4000	500 <sup>3</sup>	2565/3065

<sup>1</sup> Balance of transformer current rating consumed by bleeder resistor.  
<sup>2</sup> Use two 160-watt, 12,500-ohm units in series.  
<sup>3</sup> Use five 100-watt, 5000-ohm units in series.  
<sup>4</sup> Regulation will be somewhat better with a 400- or 500-ma. choke.  
<sup>5</sup> Regulation will be somewhat better with a 550-ma. choke.

volages for the rectifier and other tubes in the receiver or low-power transmitter. Transformers are available with ratings to 1200 volts at 200 ma.

Fig. 12-14 shows a two-section filter with capacitor input. However, depending upon the maximum hum level that may be allowable for a particular application, the last capacitor and choke may not be needed. In some low-current applications, the first capacitor alone may provide adequate filtering. Table 12-II shows the approximate full-load and bleeder-load output volages and a.c. ripple percentages for several representative sets of components. Voltage and ripple values are given for three points in the circuit—Point A (first capacitor only used), Point B (last capacitor and choke omitted), and Point C (complete two-section filter in use). In each case, the bleeder resistor  $R$  should be used across the output.

Table 12-II also shows approximate output volages and ripple percentages for choke-input filters (first filter capacitor omitted), for Point

B (last capacitor and choke omitted), and Point C (two-section filter, first capacitor omitted).

Actual full-load output volages may be somewhat lower than those shown in the table, since the voltage drop through the resistance of the transformer secondary has not been included.

Table 12-III shows typical values for representative higher-voltage supplies, based on commonly available components. A full-wave rectifier circuit and two-section filter with swing-choke input are assumed. A pair of 816 rectifiers could be used in the 400/500-volt supply; the others would require 866A or 3B28 rectifiers.  $L_2$  is the smoothing choke,  $C_1$  and  $C_2$  the filter capacitors, and  $R$  the bleeder resistor. Ripple in the output of the first filter section will be approximately 5 per cent with a 4- $\mu$ f. capacitor, or 10 per cent with a 2- $\mu$ f. capacitor. Transformers made for amateur service are predominantly designed for choke-input filters; the d.c. output current rating of such transformers should be decreased about 30 per cent when used with capacitor-input filters.

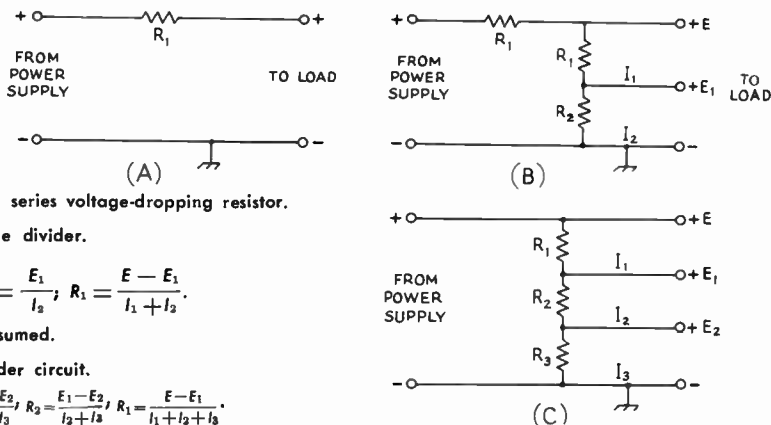

Fig. 12-15—A—A series voltage-dropping resistor.

B—Simple voltage divider.

$$R_2 = \frac{E_1}{I_2}; R_1 = \frac{E - E_1}{I_1 + I_2}$$

$I_2$  must be assumed.

C—Multiple divider circuit.

$$R_3 = \frac{E_2}{I_3}; R_2 = \frac{E_1 - E_2}{I_2 + I_3}; R_1 = \frac{E - E_1}{I_1 + I_2 + I_3}$$

$I_3$  must be assumed.



VOLTAGE CHANGING

Series Voltage-Dropping Resistor

Certain plates and screens of the various tubes in a transmitter or receiver often require a variety of operating voltages differing from the output voltage of an available power supply. In most cases, it is not economically feasible to provide a separate power supply for each of the required voltages. If the current drawn by an electrode, or combination of electrodes operating at the same voltage, is reasonably constant under normal operating conditions, the required voltage may be obtained from a supply of higher voltage by means of a voltage-dropping resistor in series, as shown in Fig. 12-15A. The value of the series resistor,  $R_1$ , may be obtained from Ohm's Law,  $R = \frac{E_d}{I}$ , where  $E_d$  is the voltage drop required from the supply voltage to the desired voltage and  $I$  is the total rated current of the load.

Example: The plate of the tube in one stage and the screens of the tubes in two other stages require an operating voltage of 250. The nearest available supply voltage is 400 and the total of the rated plate and screen currents is 75 ma. The required resistance is

$$R = \frac{400 - 250}{0.075} = \frac{150}{0.075} = 2000 \text{ ohms.}$$

The power rating of the resistor is obtained from  $P$  (watts) =  $I^2R = (0.075)^2 (2000) = 11.2$  watts. A 20-watt resistor is the nearest safe rating to be used.

Voltage Dividers

The regulation of the voltage obtained in this manner obviously is poor, since any change in current through the resistor will cause a directly proportional change in the voltage drop across the resistor. The regulation can be improved somewhat by connecting a second resistor from the low-voltage end of the first to the negative power-supply terminal, as shown in Fig. 12-15B. Such an arrangement constitutes a **voltage divider**. The second resistor,  $R_2$ , acts as a constant load for the first,  $R_1$ , so that any variation in current from the tap becomes a smaller percentage of the total current through  $R_1$ . The heavier the current drawn by the resistors when they alone are connected across the supply, the better will be the voltage regulation at the tap.

Such a voltage divider may have more than a single tap for the purpose of obtaining more than one value of voltage. A typical arrangement is shown in Fig. 12-15C. The terminal voltage is  $E$ , and two taps are provided to give lower voltages,  $E_1$  and  $E_2$ , at currents  $I_1$  and  $I_2$  respectively. The smaller the resistance between taps in proportion to the total resistance, the lower the voltage between the taps. For convenience, the voltage divider in the figure is considered to be made up of separate resistances  $R_1, R_2, R_3$ , between taps.  $R_3$  carries only the bleeder current,  $I_3$ ;  $R_2$  carries  $I_2$  in addition to  $I_3$ ;  $R_1$  carries  $I_1, I_2$  and  $I_3$ . To

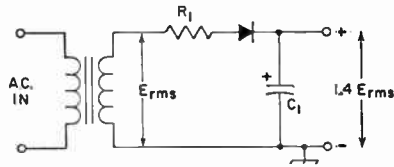

Fig. 12-16—If the current demand is low, a simple half-wave rectifier will deliver a voltage increase. Typical values, for  $E_{rms} = 117$  and a load current of 1 ma.:  $C_1$ —50- $\mu$ f., 250-v. electrolytic.  $E_{output}$ —160 volts.  $R_1$ —22 ohms.

calculate the resistances required, a bleeder current,  $I_3$ , must be assumed; generally it is low compared with the total load current (10 per cent or so). Then the required values can be calculated as shown in the caption of Fig. 12-15C,  $I$  being in decimal parts of an ampere.

The method may be extended to any desired number of taps, each resistance section being calculated by Ohm's Law using the needed voltage drop across it and the total current through it. The power dissipated by each section may be calculated by multiplying  $I$  and  $E$  or  $I^2$  and  $R$ .

The "Economy" Power Supply

In many transmitters of the 100-watt class, an excellent method for obtaining plate and screen voltages without excessive loss of power in dropping resistors is through the use of the "economy" circuit for full-wave use (center-tapped secondary) with a bridge-rectified configuration. The voltage at  $E_1$  is the normal voltage obtained with the full-wave circuit, and the voltage at  $E_2$  is that obtained with the full-wave circuit (see Fig. 12-1). The total d.c. power obtained from the transformer is, of course, the same as when the transformer is used in its normal manner. In c.w. and s.s.b. applications, additional power can usually be drawn without excessive heating, especially if the transformer has a rectifier filament winding that isn't being used.

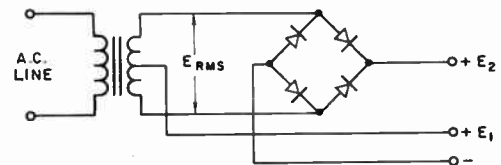
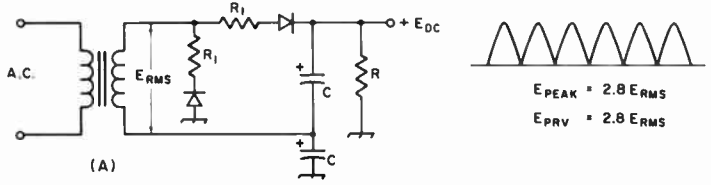

Fig. 12-17—The "economy" power supply circuit is a combination of the full-wave and bridge-rectifier circuits.

Fig. 12-18—Full-wave voltage-doubling circuit. Values of limiting resistors,  $R_1$ , depend upon allowable surge currents of rectifiers.



**VOLTAGE-MULTIPLYING CIRCUITS**

Although vacuum-tube rectifiers can be used in voltage-multiplying circuits, semiconductor rectifiers are usually more convenient. Selenium can be used in the low-voltage ranges; silicon rectifiers singly or in series are used at the higher voltages.

A simple half-wave rectifier circuit is shown in Fig. 12-16. Strictly speaking this is not a voltage-multiplying circuit. However, if the current demand is low (a milliampere or less), the d.c. output voltage will be close to the peak voltage of the source, or  $1.4E_{rms}$ . A typical application of the circuit would be to obtain a low bias voltage from a heater winding; the + side of the output can be grounded by reversing the polarity of the rectifier and capacitor. As with all half-wave rectifiers, the output voltage drops quickly with increased current demand.

The resistor  $R_1$  in Fig. 12-16 is included to limit the current through the rectifier, in accordance with the manufacturer's rating for the diode. If the resistance of the transformer winding is sufficient,  $R_1$  can be omitted.

Several types of voltage-doubling circuits are in common use. Where it is not necessary that one side of the transformer secondary be at ground potential, the voltage-doubling circuit of Fig. 12-18 is used. This circuit has several ad-

vantages over the voltage-doubling circuit to be described later. For a given output voltage, compared to the full-wave rectifier circuit (Fig. 12-1B), this full-wave doubler circuit requires only half the p.i.v. rating. Again for a given output voltage, compared to a full-wave bridge circuit (Fig. 12-1C) only half as many rectifiers (of the same p.i.v. rating) are required.

Resistors  $R_1$  in Fig. 12-18 are used to limit the surge currents through the rectifiers. Their values are based on the transformer voltage and the rectifier surge-current rating, since at the instant the power supply is turned on the filter capacitors look like a short-circuited load. Provided the limiting resistors can withstand the surge current, their current-handling capacity is based on the maximum load current from the supply.

Output voltages approaching twice the peak voltage of the transformer can be obtained with the voltage-doubling circuit of Fig. 12-18. Fig. 12-19 shows how the voltage depends upon the ratio of the series resistance to the load resistance, and the product of the load resistance times the filter capacitance.

When one side of the transformer secondary must be at ground potential, as when the a.c. is derived from a heater winding, the voltage-multiplying circuits of Fig. 12-20 can be used. In the voltage-doubling circuit at A,  $C_1$  charges through the left-hand rectifier during one half

Fig. 12-19—D.c. output voltages from a full-wave voltage-doubling circuit as a function of the filter capacitances and load resistance. For the ratio  $R_s/R$ , both resistances are in ohms; for the RC product, R is in thousands of ohms.

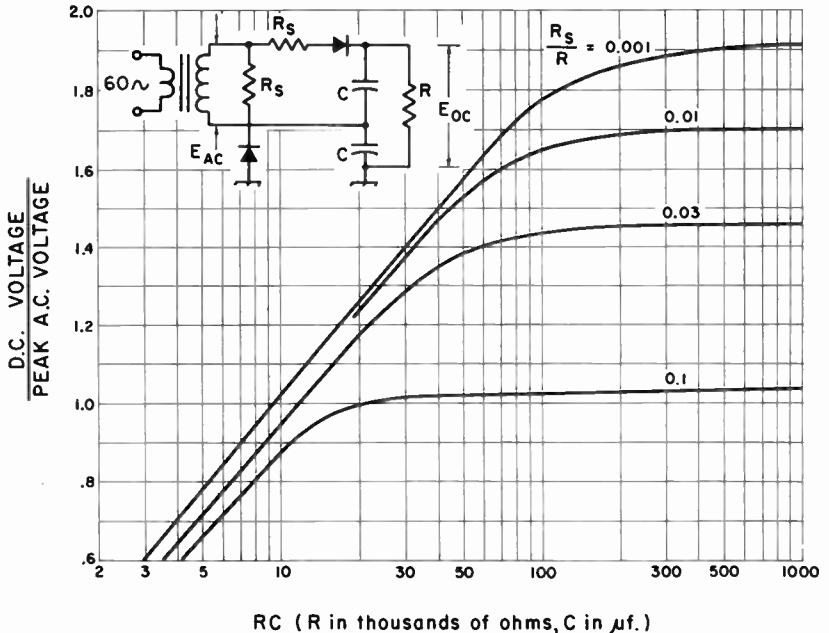

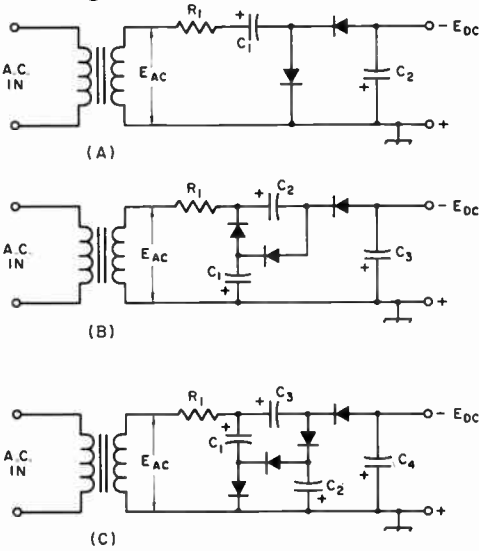

Fig. 12-20—Voltage-multiplying circuits with one side of transformer secondary grounded. (A) Voltage doubler (B) Voltage tripler (C) Voltage quadrupler.

Capacitances are typically 20 to 50  $\mu\text{f.}$ , depending upon output current demand. D.c. ratings of capacitors are related to  $E_{\text{peak}}$  (1.4  $E_{\text{ac}}$ ):

- $C_1$ —Greater than  $E_{\text{peak}}$
- $C_2$ —Greater than  $2E_{\text{peak}}$
- $C_3$ —Greater than  $3E_{\text{peak}}$
- $C_4$ —Greater than  $4E_{\text{peak}}$

of the a.c. cycle; the other rectifier is nonconductive during this time. During the other half of the cycle the right-hand rectifier conducts and  $C_2$  becomes charged; they see as the source the transformer plus the voltage in  $C_1$ . By reversing the polarities of the capacitors and rectifiers, the - side of the output can be grounded.

A voltage-tripling circuit is shown in Fig. 12-

20B. On one half of the a.c. cycle  $C_1$  is charged to the source voltage through the left-hand rectifier. On the opposite half of the cycle the middle rectifier conducts and  $C_2$  is charged to twice the source voltage, because it sees the transformer plus the charge in  $C_1$  as the source. At the same time the right-hand rectifier conducts and, with the transformer and the charge in  $C_2$  as the source,  $C_3$  is charged to three times the transformer voltage. The - side of the output can be grounded if the polarities of all of the capacitors and rectifiers are reversed.

The voltage-quadrupling circuit of Fig. 12-20C works in substantially similar fashion.

In any of the circuits of Fig. 12-20, the output voltage will approach an exact multiple (2, 3 or 4, depending upon the circuit) of the peak a.c. voltage when the output current drain is low and the capacitance values are high.

## VOLTAGE STABILIZATION

### Gaseous Regulator Tubes

There is frequent need for maintaining the voltage applied to a low-voltage low-current circuit at a practically constant value, regardless of the voltage regulation of the power supply or variations in load current. In such applications, gaseous regulator tubes (0C3/VR105, 0D3/VR150, etc.) can be used to good advantage. The voltage drop across such tubes is constant over a moderately wide current range. Tubes are available for regulated voltages near 150, 105, 90 and 75 volts.

The fundamental circuit for a gaseous regulator is shown in Fig. 12-21A. The tube is connected in series with a limiting resistor,  $R_1$ , across a source of voltage that must be higher than the starting voltage. The starting voltage is about 30 to 40 per cent higher than the operating voltage. The load is connected in parallel

with the tube. For stable operation, a minimum tube current of 5 to 10 ma. is required. The maximum permissible current with most types is 40 ma.; consequently, the load current cannot exceed 30 to 35 ma. if the voltage is to be stabilized over a range from zero to maximum load current.

The value of the limiting resistor must lie between that which just permits minimum tube current to flow and that which just passes the maximum permissible tube current when there is no load current. The latter value is generally used. It is given by the equation:

$$R = \frac{(E_s - E_r)}{I}$$

where  $R$  is the limiting resistance in ohms,  $E_s$  is the voltage of the source across which the tube and resistor are connected,  $E_r$  is the rated voltage drop across the regulator tube, and  $I$  is the maximum tube current in amperes, (usually 40 ma., or 0.04 amp.).

Fig. 12-21B shows how two tubes may be used in series to give a higher regulated voltage than is obtainable with one, and also to give two values of regulated voltage. The limiting resistor may be calculated as above, using the sum of the voltage drops across the two tubes for  $E_r$ . Since the upper tube must carry more current than the lower, the load connected to the low-voltage tap must take small current. The total current taken

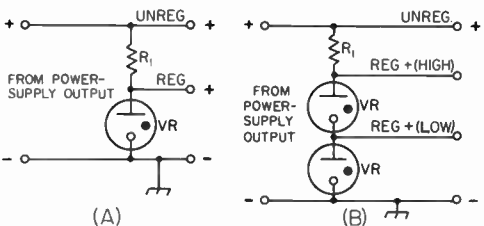

Fig. 12-21—Voltage-stabilizing circuits using VR tubes.

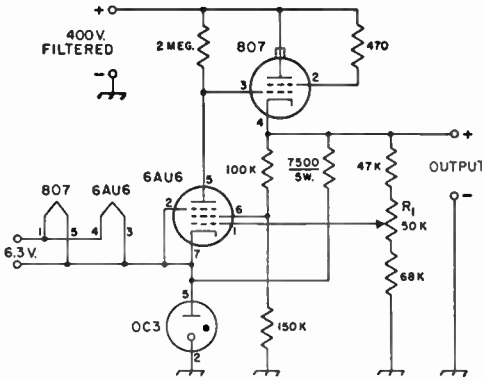

Fig. 12-22—Electronic voltage-regulator circuit. Resistors are 1/2 watt unless specified otherwise.

by the loads on both taps should not exceed 30 to 35 ma. Regulation of the order of 1 per cent can be obtained with these regulator circuits.

The capacitance in shunt with a VR tube should be limited to 0.1  $\mu$ f. or less. Larger values may cause the tube drop to oscillate between the operating and starting voltages.

A single VR tube may also be used to regulate the voltage to a load current of almost any value so long as the variation in the current does not exceed 30 to 35 ma. If, for example, the average load current is 100 ma., a VR tube may be used to hold the voltage constant provided the current does not fall below 85 ma. or rise above 115 ma. In this case, the resistance should be calculated to drop the voltage to the VR-tube rating at the maximum load current to be expected plus

5 ma. Under constant load, effects of line-voltage changes may be eliminated by basing the resistance on load current plus 15 ma.

**Electronic Voltage Regulation**

Several circuits have been developed for regulating the voltage output of a power supply electronically. While more complicated than the VR-tube circuits, they will handle higher voltages currents and the output voltage may be varied continuously over a wide range. In the circuit of Fig. 12-22, the 0C3 regulator tube supplies a reference of approximately +105 volts for the 6AU6 control tube. When the load connected across the output terminals increases, the output voltage tends to decrease. This makes the voltage on the control grid of the 6AU6 less positive, causing the tube to draw less current through the 2-megohm plate resistor. As a consequence the grid voltage on the 807 series regulator becomes more positive and the voltage drop across the 807 decreases, compensating for the reduction in output voltage. With the values shown, adjustment of  $R_1$  will give a regulated output from 150 to 250 volts, at up to 60 or 70 ma. A 6L6-GB can be substituted for the type 807; the available output current can be increased by adding tubes in parallel with the series regulator tube. When this is done, 100-ohm resistors should be wired to each control grid and plate terminal, to reduce the chances for parasitic oscillations.

Another similar regulator circuit is shown in Fig. 12-23. The principal difference is that screen-grid regulator tubes are used. The fact that a screen-grid tube is relatively insensitive to changes in plate voltage makes it possible to ob-

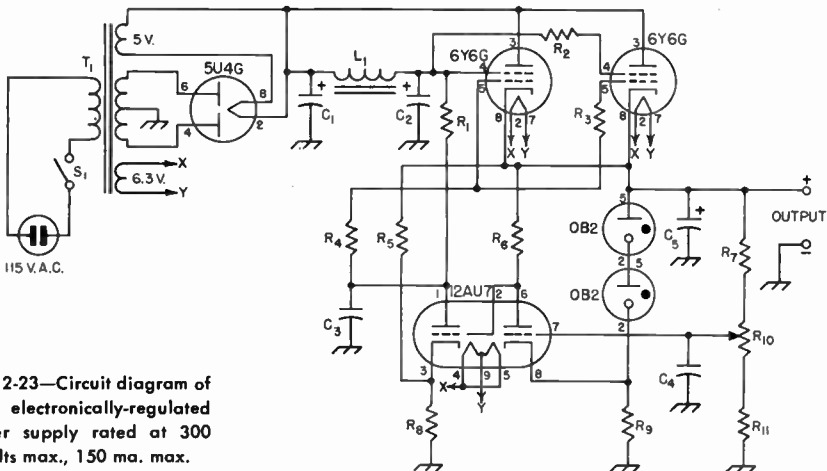

Fig. 12-23—Circuit diagram of an electronically-regulated power supply rated at 300 volts max., 150 ma. max.

- C<sub>1</sub>, C<sub>2</sub>, C<sub>5</sub>—16- $\mu$ f. 600-volt electrolytic.
- C<sub>3</sub>—0.015- $\mu$ f. paper.
- C<sub>4</sub>—0.1- $\mu$ f. paper.
- R<sub>1</sub>—0.3 megohm, 1/2 watt.
- R<sub>2</sub>, R<sub>3</sub>—100 ohms, 1/2 watt.
- R<sub>4</sub>—510 ohms, 1/2 watt.
- R<sub>5</sub>, R<sub>6</sub>—30,000 ohms, 2 watts.
- R<sub>8</sub>—0.24 megohm, 1/2 watt.
- R<sub>7</sub>—0.15 megohm, 1/2 watt.

- R<sub>9</sub>—9100 ohms, 1 watt.
- R<sub>10</sub>—0.1-megohm potentiometer.
- R<sub>11</sub>—43,000 ohms, 1/2 watt.
- L<sub>1</sub>—8-hy., 40-ma. filter choke.
- S<sub>1</sub>—S.p.s.t. toggle.
- T<sub>1</sub>—Power transformer: 375-375 volts r.m.s., 160 ma.; 6.3 volts, 3 amps.; 5 volts, 3 amps. (Thor. 22R33).

tain a reduction in ripple voltage adequate for many purposes simply by supplying filtered d.c. to the screens with a consequent saving in weight and cost. The accompanying table shows the performance of the circuit of Fig. 12-23. Column I shows various output voltages, while Column II shows the maximum current that can be drawn at that voltage with negligible variation in output voltage. Column III shows the measured ripple at the maximum current. The second part of the table shows the variation in ripple with load current at 300 volts output.

I	II	III	Output voltage — 300	
450 v.	22 ma.	3 mv.	150 ma.	2.3 mv.
425 v.	45 ma.	4 mv.	125 ma.	2.8 mv.
400 v.	72 ma.	6 mv.	100 ma.	2.6 mv.
375 v.	97 ma.	8 mv.	75 ma.	2.5 mv.
350 v.	122 ma.	9.5 mv.	50 ma.	3.0 mv.
325 v.	150 ma.	3 mv.	25 ma.	3.0 mv.
300 v.	150 ma.	2.3 mv.	10 ma.	2.5 mv.

### High-Voltage Regulators

Regulated screen voltage is required for screen-grid tubes used as linear amplifiers in single-side-band operation. Figs. 12-24 through 12-27 show various different circuits for supplying regulated voltages up to 1200 volts or more.

In the circuit of Fig. 12-24, gas-filled regulator tubes are used to establish a fixed reference voltage to which is added an electronically regulated variable voltage. The design can be modified to give any voltage from 225 volts to 1200 volts, with each design-center voltage variable by plus or minus 60 volts.

The output voltage will depend upon the number and voltage ratings of the VR tubes in the string between the 991 and ground. The total VR-tube voltage rating needed can be determined by subtracting 250 volts from the desired output voltage. As examples, if the desired output voltage is 350, the total VR-tube voltage rating should be  $350 - 250 = 100$  volts. In this case, a VR-105 would be used. For an output voltage of 1000, the VR-tube voltage rating should be

$1000 - 250 = 750$  volts. In this case, five VR-150s would be used in series.

The maximum voltage output that can be obtained is approximately equal to 0.7 times the r.m.s. voltage of the transformer  $T_1$ . The current rating of the transformer must be somewhat above the load current to take care of the voltage dividers and bleeder resistances.

A single 6L6 will handle 90 ma. For larger currents, 6L6s may be added in parallel.

The heater circuit supplying the 6L6 and 6SJ7 should *not* be grounded. The shaft of  $R_1$  should be grounded. When the output voltage is above 300 or 400, the potentiometer should be provided with an insulating mounting, and should be controlled from the panel by an extension shaft with an insulated coupling and grounded control.

In some cases where the plate transformer has sufficient current-handling capacity, it may be desirable to operate a screen regulator from the plate supply, rather than from a separate supply. This can be done if a regulator tube is used that can take the required voltage drop. In Fig. 12-25, a type 211 or 812A is used, the control tube being a 6AQ5. With an input voltage of 1800 to 2000, an output voltage of 500 to 700 can be

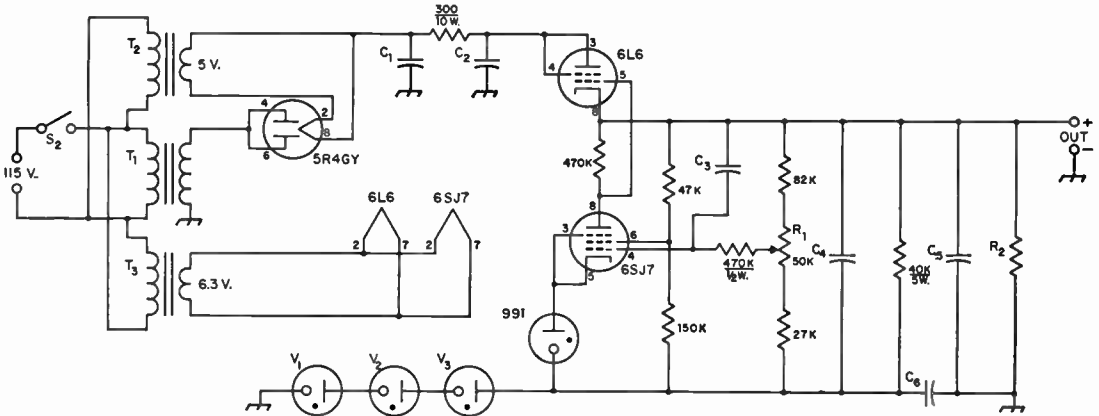
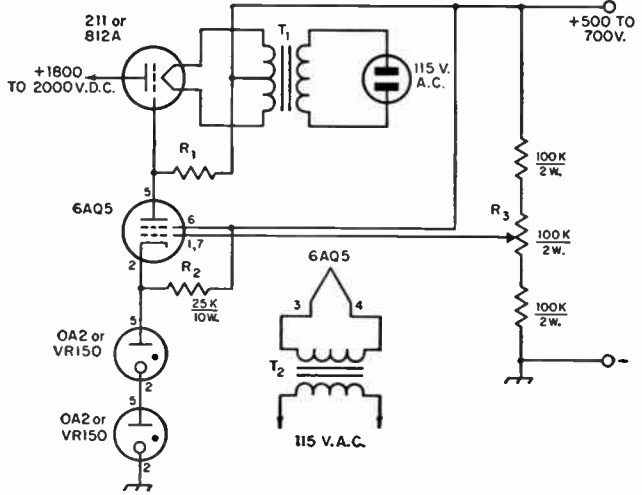

**Fig. 12-24—High-voltage regulator circuit by W4PRM.** Resistors are 1 watt unless indicated otherwise.  
 C<sub>1</sub>, C<sub>2</sub>—4- $\mu$ f. paper, voltage rating above peak-voltage output of  $T_1$ .  
 C<sub>3</sub>—0.1- $\mu$ f. paper, 600 volts.  
 C<sub>4</sub>—12- $\mu$ f. electrolytic, 450 volts.  
 C<sub>5</sub>—40 $\mu$ f., voltage rating above d.c. output voltage. Can be made up of a combination of electrolytics in series, with equalizing resistor. (See section on ratings of filter components.)  
 C<sub>6</sub>—4- $\mu$ f. paper, voltage rating above voltage rating of VR string.  
 R<sub>1</sub>—50,000-ohm, 4-watt potentiometer.  
 R<sub>2</sub>—Bleeder resistor, 50,000 to 100,000 ohms, 25 watts (not needed if equalizing resistors mentioned above are used).  
 T<sub>1</sub>—See text.  
 T<sub>2</sub>—Filament transformer; 5 volts, 2 amp.  
 T<sub>3</sub>—Filament transformer; 6.3 volts, 1.2 amp.  
 V<sub>1</sub>, V<sub>2</sub>, V<sub>3</sub>—See text.



Fig. 12-25—Screen regulator circuit designed by W9OKA. Resistances are in ohms (K = 1000).

- R<sub>1</sub>—6000 ohms for 211; 2300 ohms for 812A, 20 watts.
- R<sub>2</sub>—25,000 ohms, 10 watts.
- R<sub>3</sub>—Output voltage control, 0.1-megohm, 2-watt potentiometer.
- T<sub>1</sub>—Filament transformer: 10 volts, 3.25 amp. for 211; 6.3 volts, 4 amp. for 812A.
- T<sub>2</sub>—Filament transformer: 6.3 volts, 1 amp.



obtained with a regulation better than 1 per cent over a current range of 0 to 100 ma.

In the circuit of Fig. 12-26, a V-70D (or 8005) is used as the regulator, and the control tube is an 807 which can take the full output voltage, making it unnecessary to raise it above ground with VR tubes. If taps are switched on R<sub>1</sub>, the output voltage can be varied over a wide range. Increasing the screen voltage decreases the output voltage. For each position of the tap on R<sub>1</sub>, decreasing the value of R<sub>3</sub> will lower the minimum output voltage as R<sub>2</sub> is varied, and decreasing

the value of R<sub>4</sub> will raise the maximum output voltage. However, if these values are made too small, the 807 will lose control.

At 850 volts output, the variation over a current change of 20 to 80 ma. should be negligible. At 1500 volts output with the same current change, the variation in output voltage should be less than three per cent. Up to 88 volts of grid bias for a Class A or Class AB<sub>1</sub> amplifier may be taken from the potentiometer across the reference-voltage source. This bias cannot, of course, be used for biasing a stage that is drawing grid current.

Fig. 12-26—This regulator circuit used by W1SUN operates from the plate supply and requires no VR string. A small supply provides screen voltage and reference bias for the control tube.

- Unless otherwise marked, resistances are in ohms. (K = 1000). Capacitors are electrolytic.
- R<sub>1</sub>—50,000-ohm, 50-watt adjustable resistor.
- R<sub>2</sub>—0.1-megohm 2-watt potentiometer.
- R<sub>3</sub>—4.7 megohms, 2 watts.
- R<sub>4</sub>—0.1 megohm, ½ watt.
- T<sub>1</sub>—Power transformer: 470 volts center tapped, 40 ma.; 5 volts, 2 amps.; 6.3 volts, 2 amps.
- T<sub>2</sub>—Filament transformer: 7.5 volts, 3.25 amp. (for V-70D).

A somewhat different type of regulator is the shunt regulator shown in Fig. 12-27. The VR tubes and R<sub>2</sub> in series are across the output. Since the voltage drop across the VR tubes is constant, any change in output voltage appears across R<sub>2</sub>. This causes a change in grid bias on the 811-A grid, causing it to draw more or less current in inverse proportion to the current being drawn by

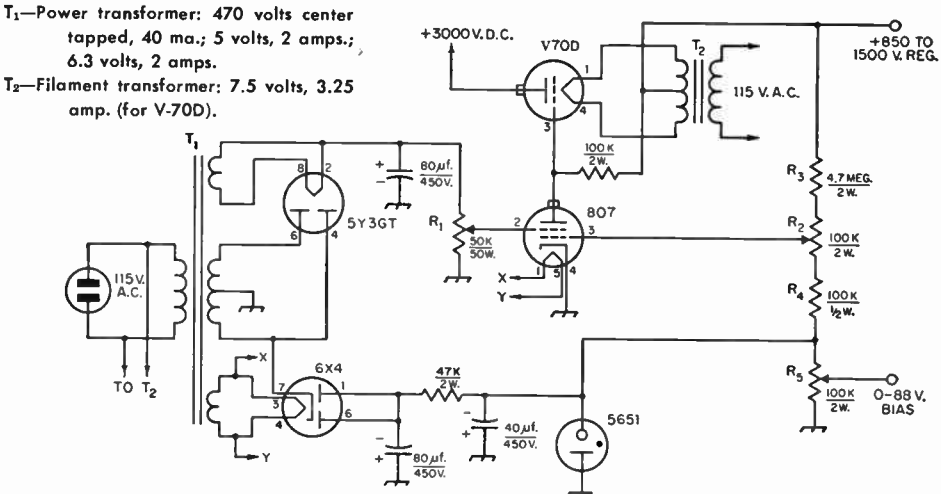

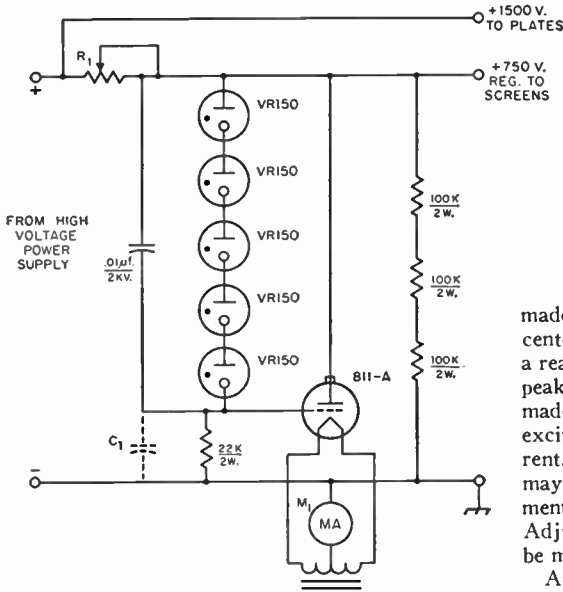

Fig. 12-27—Shunt screen regulator used by W2AZW.

$C_1$ —0.01  $\mu$ f., 400 volts if needed to suppress oscillation.

$M_1$ —See text.

$R_1$ —Adjustable wire-wound resistor, resistance and wattage as required.

the amplifier screen. This provides a constant load for the series resistor  $R_1$ .

The output voltage is equal to the sum of the VR drops plus the grid-to-ground voltage of the 811-A. This varies from 5 to 20 volts between full load and no load. The initial adjustment is

made by placing a milliammeter in the filament center-tap lead, as shown, and adjusting  $R_1$  for a reading of 15 to 20 ma. higher than the normal peak screen current. This adjustment should be made with the amplifier connected but with no excitation, so that the amplifier draws idling current. After the adjustment is complete, the meter may be removed from the circuit and the filament center tap connected directly to ground. Adjustment of the tap on  $R_1$  should, of course, be made with the high voltage turned off.

Any number of VR tubes may be used to provide a regulated voltage near the desired value. The maximum current through the 811-A should be limited to the maximum plate-current rating of the tube. If larger currents are necessary, two 811-As may be connected in parallel. Over a current range of 5 to 60 ma., the regulator holds the output voltage constant within 10 or 15 volts.

### BIAS SUPPLIES

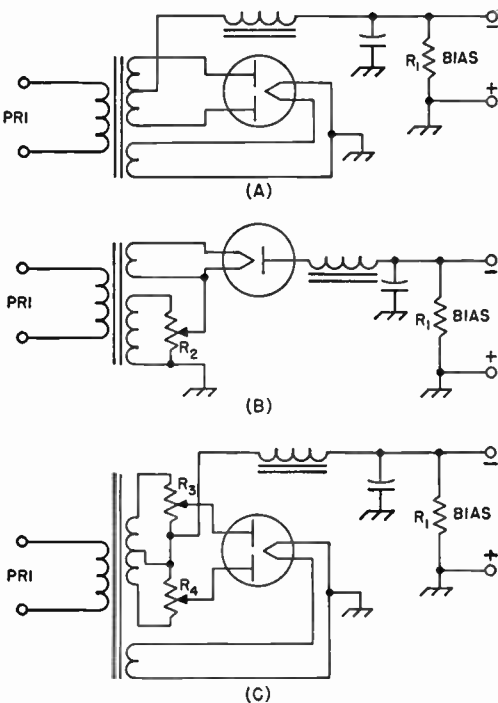

As discussed in Chapter 6 on high-frequency transmitters, the chief function of a bias supply for the r.f. stages of a transmitter is that of providing protective bias, although under certain circumstances, a bias supply, or pack, as it is sometimes called, can provide the operating bias if desired.

#### Simple Bias Packs

Fig. 12-28A shows the diagram of a simple bias supply.  $R_1$  should be the recommended grid leak for the amplifier tube. No grid leak should be used in the transmitter with this type of supply. The output voltage of the supply, when amplifier grid current is not flowing, should be some value between the bias required for plate-current cut-off and the recommended operating bias for the amplifier tube. The transformer peak voltage (1.4 times the r.m.s. value) should not exceed the recommended operating-bias value, otherwise the output voltage of the pack will soar above the operating-bias value with rated grid current.

Fig. 12-28—Simple bias-supply circuits. In A, the peak transformer voltage must not exceed the operating value of bias. The circuits of B (half-wave) and C (full-wave) may be used to reduce transformer voltage to the rectifier.  $R_1$  is the recommended grid-leak resistance.

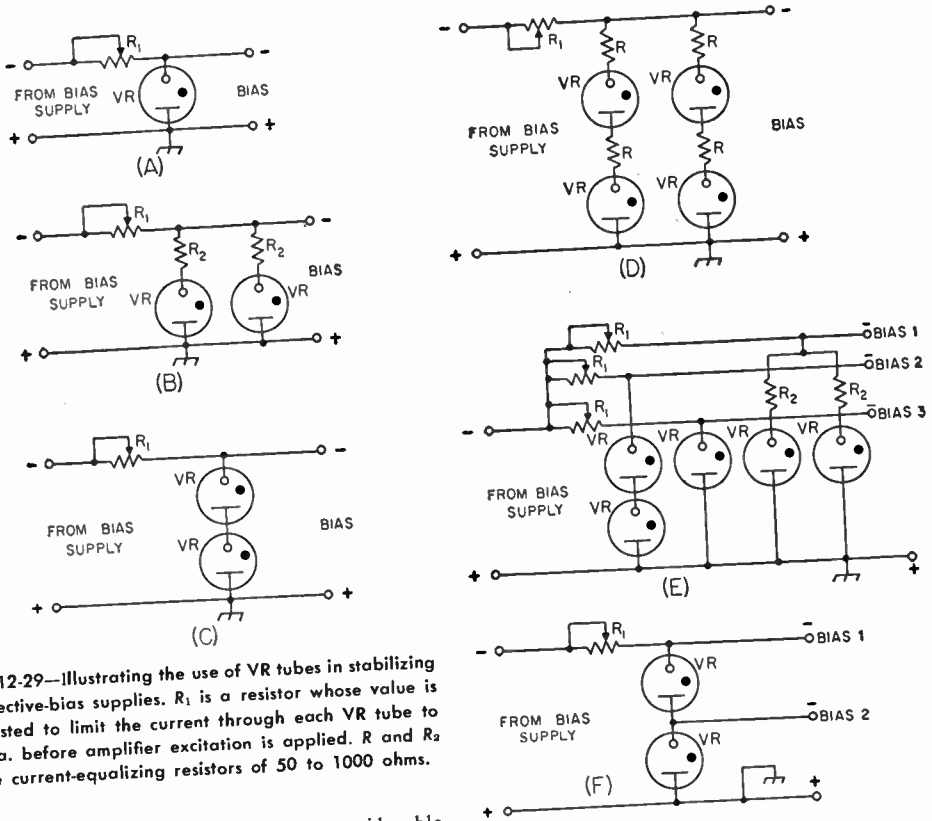

Fig. 12-29—Illustrating the use of VR tubes in stabilizing protective-bias supplies.  $R_1$  is a resistor whose value is adjusted to limit the current through each VR tube to 5 ma. before amplifier excitation is applied.  $R$  and  $R_2$  are current-equalizing resistors of 50 to 1000 ohms.

This soaring can be reduced to a considerable extent by the use of a voltage divider across the transformer secondary, as shown at B. Such a system can be used when the transformer voltage is higher than the operating-bias value. The tap on  $R_2$  should be adjusted to give amplifier cut-off bias at the output terminals. The lower the total value of  $R_2$ , the less the soaring will be when grid current flows.

A full-wave circuit is shown in Fig. 12-28C.  $R_3$  and  $R_4$  should have the same total resistance and the taps should be adjusted symmetrically. In all cases, the transformer must be designed to furnish the current drawn by these resistors plus the current drawn by  $R_1$ .

**Regulated Bias Supplies**

The inconvenience of the circuits shown in Fig. 12-28 and the difficulty of predicting values in practical application can be avoided in most cases by the use of gaseous voltage-regulator tubes across the output of the bias supply, as shown in Fig. 12-29A. A VR tube with a voltage rating anywhere between the biasing-voltage value which will reduce the input to the amplifier to a safe level when excitation is removed, and the operating value of bias, should be chosen.  $R_1$  is adjusted, without amplifier excitation, until the VR tube ignites and draws about 5 ma. Additional voltage to bring the bias up to the operating value when excitation is applied can be obtained from a grid leak resistor, as discussed in the transmitter chapter.

Each VR tube will handle 40 ma. of grid current. If the grid current exceeds this value under any condition, similar VR tubes should be added in parallel, as shown in Fig. 12-29B, for each 40 ma., or less, of additional grid current. The resistors  $R_2$  are for the purpose of helping to maintain equal currents through each VR tube, and should have a value of 50 to 1000 ohms or more.

If the voltage rating of a single VR tube is not sufficiently high for the purpose, other VR tubes may be used in series (or series-parallel if required to satisfy grid-current requirements) as shown in the diagrams of Fig 12-29C and D.

If a single value of fixed bias will serve for more than one stage, the biasing terminal of each such stage may be connected to a single supply of this type, provided only that the total grid current of all stages so connected does not exceed the current rating of the VR tube or tubes. Alternatively, other separate VR-tube branches may be added in any desired combination to the same supply, as in Fig. 12-29E, to adapt them to the needs of each stage.

Providing the VR-tube current rating is not exceeded, a series arrangement may be tapped for lower voltage, as shown at F.

The circuit diagram of an electronically regulated bias-supply is shown in Fig. 12-30. The output voltage may be adjusted to any value between 20 volts and 80 volts and the unit will handle grid currents up to 200 ma. over the range

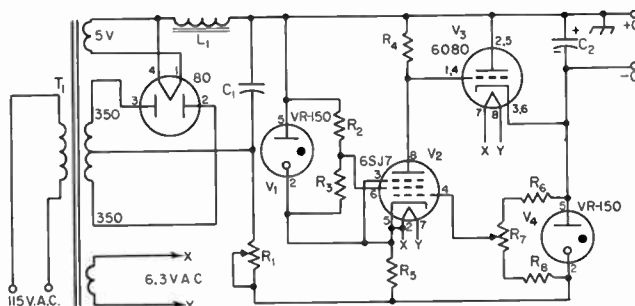

Fig. 12-30—Circuit diagram of an electronically regulated bias supply.

- C<sub>1</sub>—20- $\mu$ f. 450-volt electrolytic.
- C<sub>2</sub>—20- $\mu$ f. 150-volt electrolytic.
- R<sub>1</sub>—5000 ohms, 25 watts.
- R<sub>2</sub>—22,000 ohms, 1/2 watt.
- R<sub>3</sub>—68,000 ohms, 1/2 watt.
- R<sub>4</sub>—0.27 megohm, 1/2 watt.
- R<sub>5</sub>—3000 ohms, 5 watts.
- R<sub>6</sub>—0.12 megohm, 1/2 watt.
- R<sub>7</sub>—0.1-megohm potentiometer.
- R<sub>8</sub>—27,000 ohms, 1/2 watt.
- L<sub>1</sub>—20-hy. 50-ma. filter choke.
- T<sub>1</sub>—Power transformer: 350 volts r.m.s. each side of center 50 ma.; 5 volts, 2 amp.; 6.3 volts, 3 amp.

of 30 to 80 volts, and 100 ma. over the remainder of the range. If higher current-handling capacity is required, more 6080s can be connected in parallel with V<sub>3</sub>. The regulation will hold to about 0.001 volt per milliamper of grid current. The regulator operates as follows: Since the voltage

drop across V<sub>3</sub> and V<sub>4</sub> is in parallel with the voltage drop across V<sub>1</sub> and R<sub>5</sub>, any change in voltage across V<sub>3</sub> will appear across R<sub>5</sub> because the voltage drops across both VR tubes remain constant. R<sub>5</sub> is a cathode biasing resistor for V<sub>2</sub>, so any voltage change across it appears as a grid-voltage change on V<sub>2</sub>. This change in grid voltage is amplified by V<sub>2</sub> and appears across R<sub>4</sub> which is connected to the plate of V<sub>2</sub> and the grids of V<sub>3</sub>. This change in voltage swings the grids of V<sub>3</sub> more positive or negative, and thus varies the internal resistance of V<sub>3</sub>, maintaining the voltage drop across V<sub>3</sub> practically constant.

**Other Sources of Biasing Voltage**

In some cases, it may be convenient to obtain the biasing voltage from a source other than a separate supply. A half-wave rectifier may be connected with reversed polarization to obtain biasing voltage from a low-voltage plate supply, as shown in Fig. 12-31A. In another arrangement, shown at B, a spare filament winding can be used to operate a filament transformer of similar voltage rating in reverse to obtain a voltage of about 130 from the winding that is customarily the primary. This will be sufficient to operate a VR75 or VR90 regulator tube.

A bias supply of any of the types discussed requires relatively little filtering, if the output-terminal peak voltage does not approach the operating-bias value, because the effect of the supply is entirely or largely "washed out" when grid current flows.

**POWER-LINE CONSIDERATIONS**

**POWER LINE CONNECTIONS**

If the transmitter is rated at much more than 100 watts, special consideration should be given to the a.c. line running into the station. In some residential systems, three wires are brought in

from the outside to the distribution board, while in other systems there are only two wires. In the three-wire system, the third wire is the neutral which is grounded. The voltage between the other two wires normally is 230, while half of this voltage (115) appears between each of these

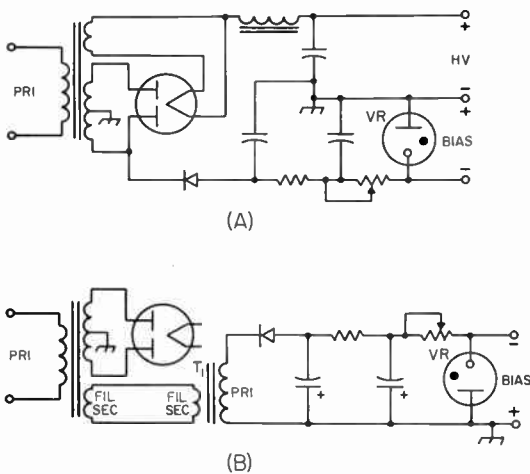

Fig. 12-31—Convenient means of obtaining biasing voltage. A—From a low-voltage plate supply. B—From spare filament winding. T<sub>1</sub> is a filament transformer, of a voltage output similar to that of the spare filament winding, connected in reverse to give 115 volts r.m.s. output.

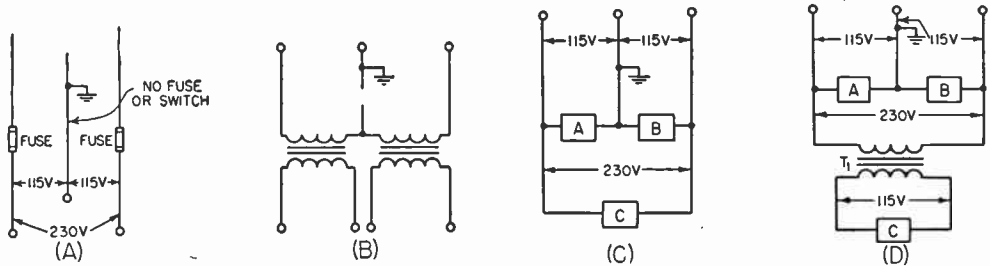

Fig. 12-32—Three-wire power-line circuits. A—Normal 3-wire-line termination. No fuse should be used in the grounded (neutral) line. B—Showing that a switch in the neutral does not remove voltage from either side of the line. C—Connections for both 115- and 230-volt transformers. D—Operating a 115-volt plate transformer from the 230-volt line to avoid light blinking.  $T_1$  is a 2-to-1 step-down transformer.

wires and neutral, as indicated in Fig. 12-32A. In systems of this type, usually it will be found that the 115-volt household load is divided as evenly as possible between the two sides of the circuit, half of the load being connected between one wire and the neutral, while the other half of the load is connected between the other wire and neutral. Heavy appliances, such as electric stoves and heaters, normally are designed for 230-volt operation and therefore are connected across the two ungrounded wires. While both ungrounded wires should be fused, a fuse should never be used in the wire to the neutral, nor should a switch be used in this side of the line. The reason for this is that opening the neutral wire does not disconnect the equipment. It simply leaves the equipment on one side of the 230-volt circuit in series with whatever load may be across the other side of the circuit, as shown in Fig. 12-32B. Furthermore, with the neutral open, the voltage will then be divided between the two sides in inverse proportion to the load resistance, the voltage on one side dropping below normal, while it soars on the other side, unless the loads happen to be equal.

The usual line running to baseboard outlets is rated at 15 amperes. Considering the power consumed by filaments, lamps, modulator, receiver and other auxiliary equipment, it is not unusual to find this 15-ampere rating exceeded by the requirements of a station of only moderate power. It must also be kept in mind that the same branch may be in use for other household purposes through another outlet. For this reason, and to minimize light blinking when keying or modulating the transmitter, a separate heavier line should be run from the distribution board to the station whenever possible. (A three-volt drop in line voltage will cause noticeable light blinking.)

If the system is of the three-wire type, the three wires should be brought into the station so that the load can be distributed to keep the line balanced. The voltage across a fixed load on one side of the circuit will increase as the load current on the other side is increased. The rate of increase will depend upon the resistance introduced by the neutral wire. If the resistance of the neutral is low, the increase will be corre-

spondingly small. When the currents in the two circuits are balanced, no current flows in the neutral wire and the system is operating at maximum efficiency.

Light blinking can be minimized by using transformers with 230-volt primaries in the power supplies for the keyed or intermittent part of the load, connecting them across the two ungrounded wires with no connection to the neutral, as shown in Fig. 12-32C. The same can be accomplished by the insertion of a step-down transformer whose primary operates at 230 volts and whose secondary delivers 115 volts. Conventional 115-volt transformers may be operated from the secondary of the step-down transformer (see Fig. 7-32D).

When a special heavy-duty line is to be installed, the local power company should be consulted as to local requirements. In some localities it is necessary to have such a job done by a licensed electrician, and there may be special requirements to be met in regard to fittings and the manner of installation. Some amateurs terminate the special line to the station at a switch box, while others may use electric-stove receptacles as the termination. The power is then distributed around the station by means of conventional outlets at convenient points. All circuits should be properly fused.

### Fusing

All transformer primary circuits should be properly fused. To determine the approximate current rating of the fuse to be used, multiply each current being drawn from the supply in amperes by the voltage at which the current is being drawn. Include the current taken by bleeder resistances and voltage dividers. In the case of series resistors, use the source voltage, not the voltage at the equipment end of the resistor. Include filament power if the transformer is supplying filaments. After multiplying the various voltages and currents, add the individual products. Then divide by the line voltage and add 10 or 20 per cent. Use a fuse with the nearest larger current rating.

### LINE-VOLTAGE ADJUSTMENT

In certain communities trouble is sometimes experienced from fluctuations in line voltage.



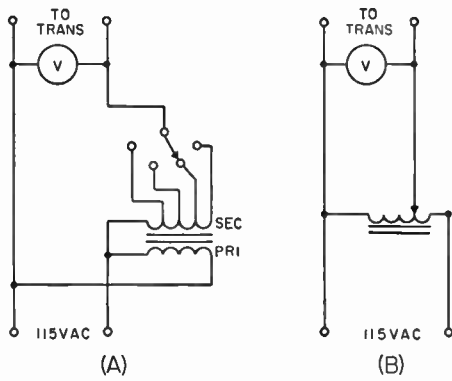

Fig. 12-33—Two methods of transformer primary control. At A is a tapped toy transformer which may be connected so as to boost or buck the line voltage as required. At B is indicated a variable transformer or autotransformer (Variac) which feeds the transformer primaries.

Usually these fluctuations are caused by a variation in the load on the line and, since most of the variation comes at certain fixed times of the day or night, such as the times when lights are turned on at evening, they may be taken care of by the use of a manually operated compensating device. A simple arrangement is shown in Fig. 12-33A. A toy transformer is used to boost or buck the line voltage as required. The transformer should have a tapped secondary varying between 6 and 20 volts in steps of 2 or 3 volts and its secondary should be capable of carrying the full load current.

The secondary is connected in series with the line voltage and, if the phasing of the windings is correct, the voltage applied to the primaries of the transmitter transformers can be brought up to the rated 115 volts by setting the toy-transformer tap switch on the right tap. If the phasing of the two windings of the toy transformer happens to be reversed, the voltage will be reduced instead of increased. This connection may be used in cases where the line voltage may be above 115 volts. This method is preferable to using a resistor in the primary of a power transformer since it does not affect the voltage regulation as seriously. The circuit of 12-33B illustrates the use of a variable autotransformer (Variac) for adjusting line voltage.

Another scheme by which the primary voltage of each transformer in the transmitter may be adjusted to give a desired secondary voltage, with a master control for compensating for changes in line voltage, is shown in the autotransformer circuit of Fig. 12-34.

This arrangement has the following features:

- 1) Adjustment of the switch  $S_1$  to make the voltmeter read 105 volts adjusts all transformer primaries to the predetermined correct voltages.
- 2) The necessity for having all primaries work at the same voltage is eliminated. Thus, 110 volts can be applied to the primary of one transformer, 115 to another, etc.
- 3) Independent control of the plate transformer is afforded by the tap switch  $S_2$ . This permits power-input control and does not require an extra autotransformer.

**Constant-Voltage Transformers**

Although comparatively expensive, special transformers called **constant-voltage transformers** are available for use in cases where it is necessary to hold line voltage and/or filament voltage constant with fluctuating supply-line voltage. They are rated over a range of 17 v.a. at 6.3 volts output up to several thousand v.a. at 115 or 230 volts. On the average they will hold their output voltages within one per cent under an input-voltage variation of 30 per cent.

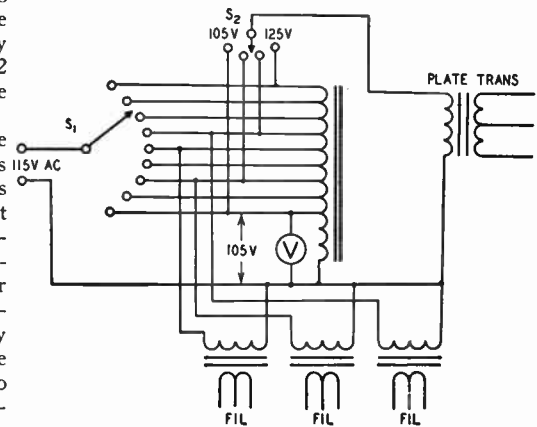

Fig. 12-34—With this circuit, a single adjustment of the tap switch  $S_1$  places the correct primary voltage on all transformers in the transmitter.

**CONSTRUCTION OF POWER SUPPLIES**

The length of most leads in a power supply is unimportant, so that the arrangement of components from this consideration is not a factor in construction. More important are the points of good high-voltage insulation, adequate conductor size for filament wiring, proper ventilation for rectifier tubes and — most important of all — safety to the operator. Exposed high-

voltage terminals or wiring which might be bumped into accidentally should not be permitted to exist. They should be covered with adequate insulation or placed inaccessible to contact during normal operation and adjustment of the transmitter. Power-supply units should be fused individually. All negative terminals of plate supplies and positive terminals of bias sup-

plies should be securely grounded to the chassis, and the chassis connected to a waterpipe or radiator ground. All transformer, choke, and capacitor cases should also be grounded to the chassis. A.c. power cords and chassis connectors should be arranged so that exposed contacts are never "live." Starting at the conventional a.c. wall outlet which is female, one end of the cord should be fitted with a male plug. The other end of the cord should have a female receptacle. The input connector of the power supply should have a male receptacle to fit the female receptacle of the cord. The power-output connector on the power supply should be a female socket. A male plug to fit this socket should be connected to the cable going to the equipment. The opposite end of the cable should be fitted with a female connector, and the series should terminate with a male connector on the equipment. There should be no "live" exposed contacts at any point, regardless of where a disconnection may be made.

Rectifier filament leads should be kept short to assure proper voltage at the rectifier socket. Through a metal chassis, grommet-lined clearance holes will serve for voltages up to 500 or 750, but ceramic feed-through insulators should be used for higher voltages. Bleeder and voltage-dropping resistors should be placed where they are open to air circulation. Placing them in confined space reduces the rating.

For operating convenience it is desirable to have separate filament transformers for the rectifier tubes, rather than to use combination filament and plate transformers. If a combination power transformer is used, the high voltage may be turned off by using a switch between the transformer center tap and chassis. The switch should be of the rotary type with good insulation between contacts. The shaft of the switch *must* be grounded.

### SAFETY PRECAUTIONS

All power supplies in an installation should be fed through a single main power-line switch so that all power may be cut off quickly, either before working on the equipment, or in case of an accident. Spring-operated switches or relays are not sufficiently reliable for this important service. Foolproof devices for cutting off all power to the transmitter and other equipment are shown in Fig. 12-35. The arrangements shown in Fig. 12-35A and B are similar circuits for two-wire (115-volt) and three-wire (230-volt) systems. *S* is an enclosed double-throw knife switch of the sort usually used as the entrance switch in house installations. *J* is a standard a.c. outlet and *P* a shorted plug to fit the outlet. The switch should be located prominently in plain sight and members of the household should be instructed in its location and use. *I* is a red lamp located alongside the switch. Its purpose is not so much to serve as a warning that the power is on as it is to help in identifying and quickly locating the switch should it become necessary for someone else to cut the power off in an emergency.

The outlet *J* should be placed in some corner out of sight where it will not be a temptation for children or others to play with. The shorting plug can be removed to open the power circuit if there are others around who might inadvertently throw the switch while the operator is working on the rig. If the operator takes the plug with him, it will prevent someone from turning on the power in his absence and either injuring themselves or the equipment or perhaps starting a fire. Of utmost importance is the fact that the outlet *J* *must* be placed in the *ungrounded* side of the line.

Those who are operating low power and feel that the expense or complication of the switch isn't warranted can use the shorted-plug idea as the main power switch. In this case, the outlet should be located prominently and identified by a signal light, as shown in Fig 12-35C.

The test bench ought to be fed through the main power switch, or a similar arrangement at the bench, if the bench is located remote from the transmitter.

A bleeder resistor with a power rating giving a considerable margin of safety should be used across the output of all transmitter power supplies so that the filter capacitors will be discharged when the high-voltage transformer is turned off.

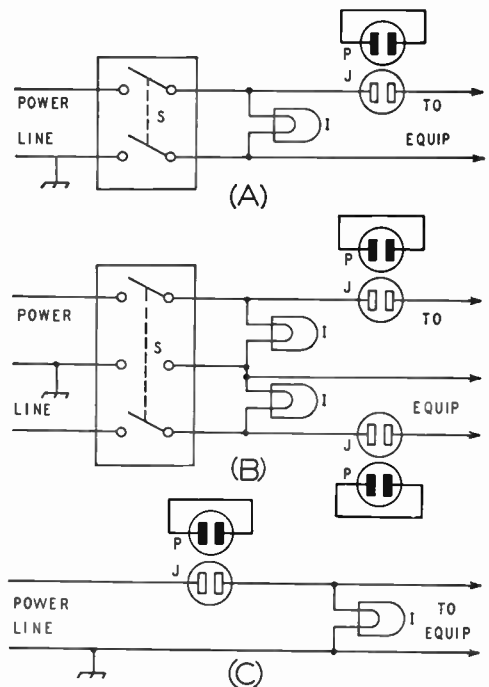

Fig. 12-35—Reliable arrangements for cutting off all power to the transmitter. *S* is an enclosed double-pole knife-type switch, *J* a standard a.c. outlet, *P* a shorted plug to fit the outlet and *I* a red lamp.

*A* is for a two-wire 115-volt line, *B* for a three-wire 230-volt system, and *C* a simplified arrangement for low-power stations.

# Transmission Lines

The place where r.f. power is generated is very frequently not the place where it is to be utilized. A transmitter and its antenna are a good example: The antenna, to radiate well, should be high above the ground and should be kept clear of trees, buildings and other objects that might absorb energy, but the transmitter itself is most conveniently installed indoors where it is readily accessible.

The means by which power is transported from point to point is the r.f. transmission line.

At radio frequencies a transmission line exhibits entirely different characteristics than it does at commercial power frequencies. This is because the speed at which electrical energy travels, while tremendously high as compared with mechanical motion, is not infinite. The peculiarities of r.f. transmission lines result from the fact that a time interval comparable with an r.f. cycle must elapse before energy leaving one point in the circuit can reach another just a short distance away.

## OPERATING PRINCIPLES

If a source of e.m.f.—a battery, for example—is connected to the ends of a pair of insulated parallel wires that extend outward for an infinite distance, electric currents will immediately become detectable in the wires near the battery terminals. The electric field of the battery will cause free electrons in the wire connected to the positive terminal to be attracted to the battery, and an equal number of free electrons in the wire connected to the negative terminal will be repelled from the battery. These currents do not flow instantaneously throughout the length of the wires; the electric field that causes the electron movement cannot travel faster than the speed of light, so a measurable interval of time elapses before the currents become evident even a relatively short distance away.

For example, the currents would not become detectable 300 meters (nearly 1000 feet) from the battery until at least a microsecond (one millionth of a second) after the connection was made. By ordinary standards this is a very short length of time, but in terms of radio frequency it represents the time of one

between the two wires. However, the conductors of this “linear” capacitor also have appreciable inductance. The line may be thought of as being composed of a whole series of small inductances and capacitances connected as shown in Fig. 13-1, where each coil is the inductance of a very short section of one wire and each capacitor is the capacitance between two such short sections.

### Characteristic Impedance

An infinitely long chain of coils and capacitors connected as in Fig. 13-1, where the small inductances and capacitances all have the same values, respectively, has an important property. To an electrical impulse applied at one end, the combination appears to have an impedance—called the **characteristic impedance** or **surge impedance**—approximately equal to  $\sqrt{L/C}$  where  $L$  and  $C$  are the inductance and capacitance per unit length. This impedance is purely resistive.

In defining the characteristic impedance as  $\sqrt{L/C}$ , it is assumed that the conductors have no inherent resistance—that is, there is no  $I^2R$  loss in them—and that there is no power loss in the dielectric surrounding the conductors. There is thus no power loss in or from the line no matter how great its length. This may not seem consistent with calling the characteristic impedance a pure resistance, which implies that the power supplied is all dissipated in the line. But in an infinitely long line the effect, so far as the source of power is concerned, is exactly the same as though the power were dissipated in a resistance, because the power leaves the source and travels outward forever along the line.

The characteristic impedance determines the amount of current that can flow when a

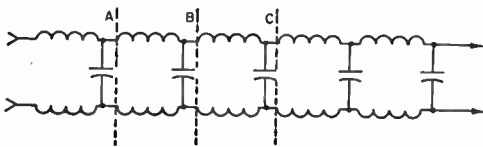

Fig. 13-1—Equivalent of a transmission line in lumped circuit constants.

complete cycle of a 1000-kilocycle current—a frequency considerably lower than those with which amateurs communicate.

The current flows to charge the capacitance

given voltage is applied to an infinitely long line, in exactly the same way that a definite value of actual resistance limits current flow when a voltage is applied.

The inductance and capacitance per unit length of line depend upon the size of the conductors and the spacing between them. The closer the two conductors and the greater their diameter, the higher the capacitance and the lower the inductance. A line with large conductors closely spaced will have low impedance, while one with small conductors widely spaced will have relatively high impedance.

### "Matched" Lines

Actual transmission lines do not extend to infinity but have a definite length and are connected to, or terminate in, a load at the "output" end, or end to which the power is delivered. If the load is a pure resistance of a value equal to the characteristic impedance of the line, the line is said to be *matched*. To current traveling along the line such a load just looks like still more transmission line of the same characteristic impedance.

In other words, a short line terminated in a purely resistive load equal to the characteristic impedance of the line acts just as though it were infinitely long. In a matched transmission line, power travels outward along the line from the source until it reaches the load, where it is completely absorbed.

### R.F. on Lines

The principles discussed above, although based on direct-current flow from a battery, also hold when an r.f. voltage is applied to the line. The difference is that the alternating voltage causes the amplitude of the current at the input terminals of the line to vary with the voltage, and the direction of current flow also periodically reverses when the polarity of the applied voltage reverses. The current at a given instant at any point along the line is the result of a voltage that was applied at some *earlier* instant at the input terminals. Since the distance traveled by the electromagnetic fields in the time of one cycle is equal to one wavelength (Chapter 2), the instantaneous amplitude of the current is different at all points in a one-wavelength section of line. In fact, the current flows in opposite directions in the same wire in successive half-wavelength sections. However, at any given point along the line the current goes through similar variations with time that the current at the input terminals did.

Thus the current (and voltage) travels along the wire as a series of waves having a length equal to the speed of travel divided by the frequency of the a.c. voltage. On an infinitely long line, or one properly matched by its load, an ammeter inserted anywhere in the line will show the same current, because the ammeter averages out the variations in

current during a cycle. It is only when the line is not properly matched that the wave motion becomes apparent through observations made with ordinary instruments.

### STANDING WAVES

In the infinitely long line (or its matched counterpart) the impedance is the same at any point on the line because the ratio of voltage to current is always the same. However, the impedance at the end of the line in Fig. 13-2 is zero—or at least extremely small—because the line is short-circuited at the end. The outgoing power, on meeting the short-circuit, reverses its direction of flow and goes back along the transmission line toward the input end. There is a large current in the short-circuit, but substantially no voltage across the line at this point. We now have a voltage and current representing the power going outward (*incident power*) toward the short-circuit, and a second voltage and current representing the *reflected power* traveling back toward the source.

The reflected current travels at the same speed as the outgoing current, so its instantaneous value will be different at every point along the line, in the distance represented by the time of one cycle. At some points along

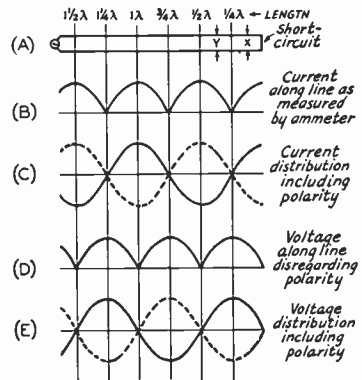

Fig. 13-2—Standing waves of voltage and current along short-circuited transmission line.

the line the phase of the incident and reflected currents will be such that the currents cancel each other while at others the amplitude will be doubled. At in-between points the amplitude is between these two extremes. The points at which the currents are in and out of phase depend only on the *time* required for them to travel and so depend only on the *distance* along the line from the point of reflection.

In the short-circuit at the end of the line the two current components are in phase and the total current is large. At a distance of one-half wavelength back along the line from the short-circuit the outgoing and reflected components will again be in phase and the re-

sultant current will again have its maximum value. This is also true at any point that is a multiple of a half wavelength from the short-circuited end of the line.

The outgoing and reflected currents will cancel at a point one-quarter wavelength, along the line, from the short-circuit. At this point, then, the current will be zero. It will also be zero at all points that are an *odd* multiple of one-quarter wavelength from the short-circuit.

If the current along the line is measured at successive points with an ammeter, it will be found to vary about as shown in Fig. 13-2B. The same result would be obtained by measuring the current in either wire, since the ammeter cannot measure phase. However, if the phase could be checked, it would be found that in each successive half-wavelength section of the line the currents at any given instant are flowing in opposite directions, as indicated by the solid line in Fig. 13-2C. Furthermore, the current in the second wire is flowing in the opposite direction to the current in the adjacent section of the first wire. This is indicated by the broken curve in Fig. 13-2C. The variations in current intensity along the transmission line are referred to as **standing waves**. The point of maximum line current is called a **current loop** or **current antinode** and the point of minimum line current is called a **current node**.

**Voltage Relationships**

Since the end of the line is short-circuited, the voltage at that point has to be zero. This can only be so if the voltage in the outgoing wave is met, at the end of the line, by a reflected voltage of equal amplitude and opposite polarity. In other words, the phase of the voltage wave is *reversed* when reflection takes place from the short-circuit. This reversal is equivalent to an extra half cycle or half wavelength of travel. As a result, the outgoing and returning voltages are in phase a quarter wavelength from the end of the line, and again out of phase a half wavelength from the end. The standing waves of voltage, shown at D in Fig. 13-2, are therefore displaced by one-quarter wavelength from the standing waves of current. The drawing at E shows the voltages on both wires when phase is taken into account. The polarity of the voltage on each wire reverses in each half wavelength section of transmission line. A voltage maximum is called a **voltage loop** or **antinode** and a voltage minimum is called a **voltage node**.

**Open-Circuited Line**

If the end of the line is open-circuited instead of short-circuited, there can be no current at the end of the line but a large voltage can exist. Again the incident power is reflected back toward the source. The incident and reflected components of current must be equal and opposite in phase at the open circuit in

order for the total current at the end of the line to be zero. The incident and reflected components of voltage are in phase and add together. The result is again that there are standing waves, but the conditions are reversed as compared with a short-circuited line. Fig. 13-3 shows the open-circuited line case.

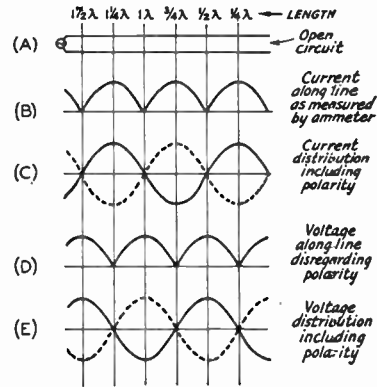

Fig. 13-3—Standing waves of current and voltage along an open-circuited transmission line.

**Lines Terminated in Resistive Load**

Fig. 13-4 shows a line terminated in a resistive load. In this case at least part of the incident power is absorbed in the load, and so is not available to be reflected back toward the source. Because only part of the power is reflected, the reflected components of voltage and current do not have the same magnitude as the incident components. Therefore neither voltage nor current cancel completely at any point along the line. However, the *speed* at which the incident and reflected components travel is not affected by their amplitude, so the phase relationships are similar to those in open- or short-circuited lines.

It was pointed out earlier that if the load resistance,  $Z_R$ , is equal to the characteristic impedance,  $Z_0$ , of the line all the power is absorbed in the load. In such a case there is no reflected power and therefore no standing waves of current and voltage. This is a special case that represents the change-over point

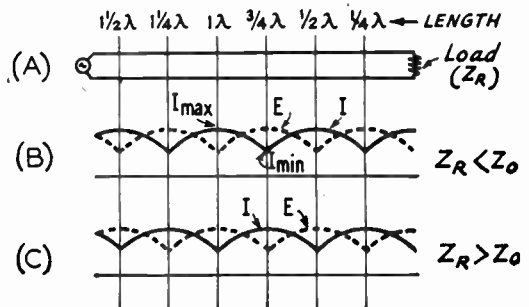

Fig. 13-4—Standing waves on a transmission line terminated in a resistive load.



between "short-circuited" and "open-circuited" lines. If  $Z_R$  is less than  $Z_0$ , the current is largest at the load, while if  $Z_R$  is greater than  $Z_0$  the voltage is largest at the load. The two conditions are shown at B and C, respectively, in Fig. 13-4.

The resistive termination is an important practical case. The termination is seldom an actual resistor, the most common terminations being resonant circuits or resonant antenna systems, both of which have essentially resistive impedances. If the load is reactive as well as resistive, the operation of the line resembles that shown in Fig. 13-4, but the presence of reactance in the load causes two modifications: The loops and nulls are shifted toward or away from the load; and the amount of power reflected back toward the source is increased, as compared with the amount reflected by a purely resistive load of the same total impedance. Both effects become more pronounced as the ratio of reactance to resistance in the load is made larger.

**Standing-Wave Ratio**

The ratio of maximum current to minimum current along a line, Fig. 13-5, is called the **standing-wave ratio**. The same ratio holds for maximum voltage and minimum voltage. It is a measure of the mismatch between the load and the line, and is equal to 1 when the line is perfectly matched. (In that case the "maximum" and "minimum" are the same, since the current and voltage do not vary along the line.) When the line is terminated in a purely resistive load, the standing-wave ratio is

$$S.W.R. = \frac{Z_R}{Z_0} \text{ or } \frac{Z_0}{Z_R} \quad (13-A)$$

Where *S.W.R.* = Standing-wave ratio

$Z_R$  = Impedance of load (must be pure resistance)

$Z_0$  = Characteristic impedance of line

Example: A line having a characteristic impedance of 300 ohms is terminated in a resistive load of 25 ohms. The s.w.r. is

$$S.W.R. = \frac{Z_0}{Z_R} = \frac{300}{25} = 12 \text{ to } 1$$

It is customary to put the larger of the two quantities,  $Z_R$  or  $Z_0$ , in the numerator of the

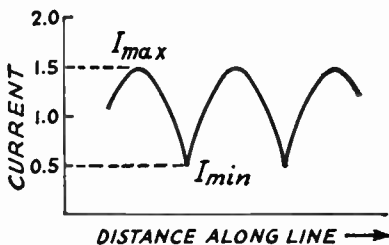

Fig. 13-5—Measurement of standing-wave ratio. In this drawing,  $I_{max}$  is 1.5 and  $I_{min}$  is 0.5, so the s.w.r. =  $I_{max} / I_{min} = 1.5 / 0.5 = 3$  to 1.

fraction so that the s.w.r. will be expressed by a number larger than 1.

It is easier to measure the standing-wave ratio than some of the other quantities (such as the impedance of an antenna) that enter into transmission-line computations. Consequently, the s.w.r. is a convenient basis for work with lines. The higher the s.w.r., the greater the mismatch between line and load. In practical lines, the power loss in the line itself increases with the s.w.r., as shown later.

**INPUT IMPEDANCE**

The input impedance of a transmission line is the impedance seen looking into the sending-end or input terminals; it is the impedance into which the source of power must work when the line is connected. If the load is perfectly matched to the line the line appears to be infinitely long, as stated earlier, and the input impedance is simply the characteristic impedance of the line itself. However, if there are standing waves this is no longer true; the input impedance may have a wide range of values.

This can be understood by referring to Figs. 13-2, 13-3, or 13-4. If the line length is such that standing waves cause the voltage at the input terminals to be high and the current low, then the input impedance is higher than the  $Z_0$  of the line, since impedance is simply the ratio of voltage to current. Conversely, low voltage and high current at the input terminals mean that the input impedance is lower than the line  $Z_0$ . Comparison of the three drawings also shows that the range of input impedance values that may be encountered is greater when the far end of the line is open- or short-circuited than it is when the line has a resistive load. In other words, the higher the s.w.r. the greater the range of input impedance values when the line length is varied.

In addition to the variation in the absolute value of the input impedance with line length, the presence of standing waves also causes the input impedance to contain both reactance and resistance, even though the load itself may be a pure resistance. The only exceptions to this occur at the exact current loops or nodes, at which points the input impedance is a pure resistance. These are the only points at which the outgoing and reflected voltages and currents are exactly in phase: At all other distances along the line the current either leads or lags the voltage and the effect is exactly the same as though a capacitance or inductance were part of the input impedance.

The input impedance can be represented either by a resistance and a capacitance or by a resistance and an inductance. Whether the impedance is inductive or capacitive depends on the characteristics of the load and the length of the line. It is possible to represent the input impedance by an equivalent circuit having resistance and reactance either in ser-

ies or parallel, so long as the total impedance and phase angle are the same in either case.

The magnitude and character of the input impedance is quite important, since it determines the method by which the power source must be coupled to the line. The calculation of input impedance is rather complicated and its measurement is not feasible without special equipment. Fortunately, in amateur work it is unnecessary either to calculate or measure it. The proper coupling can be achieved by relatively simple methods described later in this chapter.

**Lines Without Load**

The input impedance of a short-circuited or open-circuited line not an exact multiple of one-quarter wavelength long is practically a pure reactance. This is because there is very little power lost in the line. Such lines are frequently used as "linear" inductances and capacitances.

If a shorted line is less than a quarter-wave long, as at X in Fig. 13-2, it will have inductive reactance. The reactance increases with the line length up to the quarter-wave point. Beyond that, as at Y, the reactance is capacitive, high near the quarter-wave point and becoming lower as the half-wave point is approached. It then alternates between inductive and capacitive in successive quarter-wave sections. Just the reverse is true of the open-circuited line.

At exact multiples of a quarter wavelength the impedance is purely resistive. It is apparent, from examination of B and D in Fig. 13-2, that at points that are a multiple of a half wavelength—i.e., 1/2, 1, 1 1/2 wavelengths, etc.—from the short-circuited end of the line the current and voltage have the same values that they do at the short circuit. In other words, if the line were an exact multiple of a half wavelength long the generator or source of power would "look into" a short circuit. On the other hand, at points that are an odd multiple of a quarter wavelength—i.e., 1/4, 3/4, 1 1/4, etc.—from the short circuit the voltage is maximum and the current is zero. Since  $Z = E/I$ , the impedance at these points is theoretically infinite. (Actually it is very high, but not infinite. This is because the current does not actually go to zero when there are losses in the line. Losses are always present, but usually are small.)

**Impedance Transformation**

The fact that the input impedance of a line depends on the s.w.r. and line length can be used to advantage when it is necessary to transform a given impedance into another value.

Study of Fig. 13-4 will show that, just as in the open- and short-circuited cases, if the line is one-half wavelength long the voltage and current are exactly the same at the input terminals as they are at the load. This is also

true of lengths that are integral multiples of a half wavelength. It is also true for all values of s.w.r. Hence the input impedance of any line, no matter what its  $Z_0$ , that is a multiple of a half wavelength long is exactly the same as the load impedance. Such a line can be used to transfer the impedance to a new location without changing its value.

When the line is a quarter wavelength long, or an odd multiple of a quarter wavelength, the load impedance is "inverted." That is, if the current is low and the voltage is high at the load, the input impedance will be such as to require high current and low voltage. The relationship between the load impedance and input impedance is given by

$$Z_s = \frac{Z_0^2}{Z_R} \tag{13-B}$$

where  $Z_s$  = Impedance looking into line (line length an odd multiple of one-quarter wavelength)

$Z_R$  = Impedance of load (must be pure resistance)

$Z_0$  = Characteristic impedance of line

Example: A quarter-wavelength line having a characteristic impedance of 500 ohms is terminated in a resistive load of 75 ohms. The impedance looking into the input or sending end of the line is

$$Z_s = \frac{Z_0^2}{Z_R} = \frac{(500)^2}{75} = \frac{250,000}{75} = 3333 \text{ ohms}$$

If the formula above is rearranged, we have

$$Z_0 = \sqrt{Z_s Z_R} \tag{13-C}$$

This means that if we have two values of impedance that we wish to "match," we can do so if we connect them together by a quarter-wave transmission line having a characteristic impedance equal to the square root of their product. A quarter-wave line, in other words, has the characteristics of a transformer.

**Resonant and Nonresonant Lines**

The input impedance of a line operating with a high s.w.r. is critically dependent on the line length, and resistive only when the length is some integral multiple of one-quarter wavelength. Lines cut to such a length and operated with a high s.w.r. are called "tuned" or "resonant" lines. On the other hand, if the s.w.r. is low the input impedance is close to the  $Z_0$  of the line and does not vary a great deal with the line length. Such lines are called "flat," or "untuned," or "nonresonant."

There is no sharp line of demarcation between tuned and untuned lines. If the s.w.r. is below 1.5 to 1 the line is essentially flat, and the same input coupling method will work with all line lengths. If the s.w.r. is above 3 or 4 to 1 the type of coupling system, and its adjustment, will depend on the line length and such lines fall into the "tuned" category.

It is usually advantageous to make the s.w.r. as low as possible. A resonant line becomes necessary only when a considerable

mismatch between the load and the line has to be tolerated. The most important practical example of this is when a single antenna is operated on several harmonically related frequencies, in which case the antenna impedance will have widely different values on different harmonics.

### RADIATION

Whenever a wire carries alternating current the electromagnetic fields travel away into space with the velocity of light. At power-line frequencies the field that "grows" when the current is increasing has plenty of time to return or "collapse" about the conductor when the current is decreasing, because the alternations are so slow. But at radio frequencies fields that travel only a relatively short distance do not have time to get back to the conductor before the next cycle commences. The consequence is that some of the electromagnetic energy is prevented from being restored to the conductor; in other words, energy is radiated into space in the form of electromagnetic waves.

The lines previously considered have consisted of two parallel conductors of the same diameter. Provided there is nothing in the system to destroy symmetry, at every point along the line the current in one conductor has the same intensity as the current in the other conductor at that point, but the currents

flow in opposite directions. This was shown in Figs. 13-2C and 13-3C. It means that the fields set up about the two wires have the same intensity, but *opposite directions*. The consequence is that the total field set up about such a transmission line is zero; the two fields "cancel out." Hence no energy is radiated.

Practically, the fields do not quite cancel out because for them to do so the two conductors would have to occupy the same space, whereas they are actually slightly separated. However, the cancellation is substantially complete if the distance between the conductors is very small compared to the wavelength. Transmission line radiation will be negligible if the distance between the conductors is 0.01 wavelength or less, provided the currents in the two wires are balanced.

The amount of radiation also is proportional to the current flowing in the line. Because of the way in which the current varies along the line when there are standing waves, the effective current, for purposes of radiation, becomes greater as the s.w.r. is increased. For this reason the radiation is least when the line is flat. However, if the conductor spacing is small and the currents are balanced, the radiation from a line with even a high s.w.r. is inconsequential. A small unbalance in the line currents is far more serious—and is just as serious when the line is flat as when the s.w.r. is high.

## PRACTICAL LINE CHARACTERISTICS

The foregoing discussion of transmission lines has been based on a line consisting of two parallel conductors. The parallel-conductor line is but one of two general types, the other being the coaxial or concentric line. The coaxial line consists of a conductor placed in the center of a tube. The inside surface of the tube and the outside surface of the smaller inner conductor form the two conducting surfaces of the line.

In the coaxial line the fields are entirely inside the tube, because the tube acts as a shield to prevent them from appearing out-

side. This reduces radiation to the vanishing point. So far as the electrical behavior of coaxial lines is concerned, all that has previously been said about the operation of parallel-conductor lines applies. There are, however, practical differences in the construction and use of parallel and coaxial lines.

### PARALLEL-CONDUCTOR LINES

A type of parallel-conductor line sometimes used in amateur installations is one in which two wires (ordinarily No. 12 or No. 14) are supported a fixed distance apart by means of insulating rods called "spacers." The spacings used vary from two to six inches, the smaller spacings being necessary at frequencies of the order of 28 Mc. and higher so that radiation will be minimized. The construction is shown in Fig. 13-6. Such a line is said to be **air-insulated**. The characteristic impedance of such "open-wire" lines is between 400 and 600 ohms, depending on the wire size and spacing.

Parallel-conductor lines also are occasionally constructed of metal tubing of a diameter of  $\frac{1}{4}$  to  $\frac{1}{2}$  inch. This reduces the characteristic impedance of the line. Such lines are mostly used as quarter-wave transformers, when different values of impedance are to be matched.

Prefabricated parallel-conductor line with

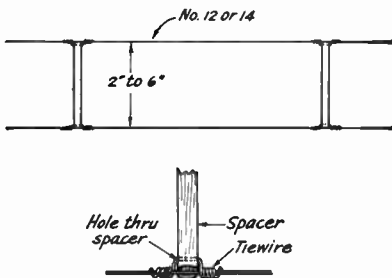

Fig. 13-6—Typical construction of open-wire line. The line conductor fits in a groove in the end of the spacer, and is held in place by a tie-wire anchored in a hole near the groove.

air insulation, developed for television reception, can be used in transmitting applications. This line consists of two conductors separated one-half to one inch by molded-on spacers. The characteristic impedance is 300 to 450 ohms, depending on the wire size and spacing.

A convenient type of manufactured line is one in which the parallel conductors are imbedded in low-loss insulating material (polyethylene). It is commonly used as a TV lead-in and has a characteristic impedance of about 300 ohms. It is sold under various names, the most common of which is "Twin-Lead." This type of line has the advantages of light weight, close and uniform conductor spacing, flexibility and neat appearance. However, the losses in the solid dielectric are higher than in air, and dirt or moisture on the line tends to change the characteristic impedance. Moisture effects can be reduced by coating the line with silicone grease. A special form of 300-ohm Twin-Lead for transmitting uses a polyethylene tube with the conductors molded diametrically opposite; the longer dielectric path in such line reduces moisture troubles.

In addition to 300-ohm line, Twin-Lead is obtainable with a characteristic impedance of 75 ohms for transmitting purposes. Lightweight 75- and 150-ohm Twin-Lead also is available.

**Characteristic Impedance**

The characteristic impedance of an air-insulated parallel-conductor line is given by:

$$Z_0 = 276 \log \frac{b}{a} \quad (13-D)$$

- where  $Z_0$  = Characteristic impedance
- $b$  = Center-to-center distance between conductors
- $a$  = Radius of conductor (in same units as  $b$ )

It does not matter what units are used for  $a$  and  $b$  so long as they are the same units. Both quantities may be measured in centimeters, inches, etc. Since it is necessary to have a table of common logarithms to solve practical problems, the solution is given in graphical form in Fig. 13-7 for a number of common conductor sizes.

In solid-dielectric parallel-conductor lines such as Twin-Lead the characteristic impedance cannot be calculated readily, because part of the electric field is in air as well as in the dielectric.

**Unbalance in Parallel-Conductor Lines**

When installing parallel-conductor lines care should be taken to avoid introducing electrical unbalance into the system. If for some reason the current in one conductor is higher than in the other, or if the currents in the two wires are not exactly out of phase with each other, the electromagnetic fields will not cancel completely and a considerable amount of power may be radiated by the line.

Maintaining good line balance requires, first of all, a balanced load at its end. For this reason the antenna should be fed, whenever possible, at a point where each conductor "sees" exactly the same thing. Usually this means that the antenna system should be fed at its electrical center. However, even though the antenna appears to be symmetrical physically, it can be unbalanced electrically if the part connected to one of the line conductors is coupled to something (such as house wiring or a metal pole or roof) that is not duplicated on the other part of the antenna. Every effort should be made to keep the antenna as far as possible from other wiring or sizable metallic objects. The transmission line itself will cause some unbalance if it is not brought away from the antenna at right angles to it for a distance of at least a quarter wavelength.

In installing the line conductors take care to see that they are kept away from metal. The minimum separation between either con-

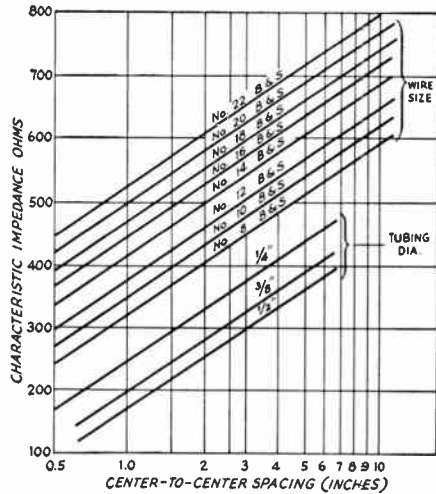

Fig. 13-7—Chart showing the characteristic impedance of spaced-conductor parallel transmission lines with air dielectric. Tubing sizes given are for outside diameters.

ductor and all other wiring should be at least four or five times the conductor spacing. The shunt capacitance introduced by close proximity to metallic objects can drain off enough current (to ground) to unbalance the line currents, resulting in increased radiation. A shunt capacitance of this sort also constitutes a reactive load on the line, causing an impedance "bump" that will prevent making the line actually flat.

**COAXIAL LINES**

The most common form of coaxial line consists of either a solid or stranded-wire inner conductor surrounded by polyethylene dielectric. Copper braid is woven over the dielectric



to form the outer conductor, and a waterproof vinyl covering is placed on top of the braid. This cable is made in a number of different diameters. It is moderately flexible, and so is convenient to install. This solid coaxial cable is commonly available in impedances approximating 50 and 70 ohms.

Air-insulated coaxial lines have lower losses than the solid-dielectric type, but are rarely used in amateur work because they are expensive and difficult to install as compared with the flexible cable. The common type of air-insulated coaxial line uses a solid-wire conductor inside a copper tube, with the wire held in the center of the tube by means of insulating "beads" placed at regular intervals.

travel more slowly in material dielectrics than they do in free space. In air the velocity is practically the same as in empty space, but a practical line always has to be supported in some fashion by solid insulating materials. The result is that the fields are slowed down; the currents travel a shorter distance in the time of one cycle than they do in space, and so the wavelength along the line is less than the wavelength would be in free space at the same frequency.

Whenever reference is made to a line as being so many wavelengths (such as a "half wavelength" or "quarter wavelength") long, it is to be understood that the *electrical* length of the line is meant. Its actual physical length as measured by a tape always will be somewhat less. The physical length corresponding to an electrical wavelength is given by

$$Length \text{ in feet} = \frac{984V}{f} \tag{13-F}$$

where  $f$  = Frequency in megacycles  
 $V$  = Velocity factor

The **velocity factor** is the ratio of the actual velocity along the line to the velocity in free space. Values of  $V$  for several common types of lines are given in Table 13-I.

Example: A 75-foot length of 300-ohm Twin-Lead is used to carry power to an antenna at a frequency of 7150 kc. From Table 13-I,  $V$  is 0.82. At this frequency (7.15 Mc.) a wavelength is

$$Length \text{ (feet)} = \frac{984V}{f} = \frac{984}{7.15} \times 0.82$$

$$= 137.6 \times 0.82 = 112.8 \text{ ft.}$$

The line length is therefore  $75/112.8 = 0.665$  wavelength.

Because a quarter-wavelength line is frequently used as a linear transformer, it is convenient to calculate the length of a quarter-wave line directly. The formula is

$$Length \text{ (feet)} = \frac{246V}{f} \tag{13-G}$$

where the symbols have the same meaning as above.

**LOSSES IN TRANSMISSION LINES**

There are three ways by which power may be lost in a transmission line: by radiation, by heating of the conductors ( $I^2R$  loss), and by heating of the dielectric, if any. Radiation losses are in general the result of "antenna currents" on the line, resulting from undesired coupling to the radiating antenna. They cannot readily be estimated or measured, so the following discussion is based only on conductor and dielectric losses.

Heat losses in both the conductor and the dielectric increase with frequency. Conductor losses also are greater the lower the charac-

**TABLE 13-I**

**Transmission-Line Data**

Type	Description or Type Number	Charac-teristic Impedance	Velocity Factor	Capacitance per foot at 30 Mc. pf.	Power Rating <sup>1</sup> Watts
Coaxial	RG-8A/U	53	0.66	29.5	1700
	RG-58A/U	53	0.66	28.5	430
	RG-17A/U	50	0.66	30	5600
	621-1111 <sup>1</sup>	50	—	26.0	3500 <sup>2</sup>
	RG-11A/U	75	0.66	20.5	1700
	RG-59A/U	73	0.66	21.0	680
Parallel Conductor	621-1001 <sup>1</sup>	75	—	16.5	3000 <sup>2</sup>
	Air-insulated	200-600	0.975 <sup>3</sup>	—	—
	214-023 <sup>1</sup>	75	0.71	20.0	1000
	214-056 <sup>1</sup>	300	0.82	5.8	—
	214-076 <sup>1</sup>	300	0.84	3.9	1000
	214-022 <sup>1</sup>	300	0.85	3.0	—

<sup>1</sup>Amphenol type numbers and data. Similar lines may be made by other manufacturers but losses and maximum ratings may differ. Type 214-056 is standard receiving "Twin-Lead"; 214-022 has No. 16 Copperweld conductors for extra strength.

<sup>2</sup>Maximum operating volts, r.m.s.

<sup>3</sup>Average figure for lines insulated with ceramic spacers at intervals of a few feet.

**Characteristic Impedance**

The characteristic impedance of an air-insulated coaxial line is given by the formula

$$Z_0 = 138 \log \frac{b}{a} \tag{13-E}$$

where  $Z_0$  = Characteristic impedance  
 $b$  = Inside diameter of outer conductor  
 $a$  = Outside diameter of inner conductor (in same units as  $b$ )

The formula for coaxial lines is approximately correct for lines in which bead spacers are used, provided the beads are not too closely spaced. When the line is filled with a solid dielectric, the characteristic impedance as given by the formula should be multiplied by  $1/\sqrt{K}$ , where  $K$  is the dielectric constant of the material.

**ELECTRICAL LENGTH**

In the discussion of line operation earlier in this chapter it was assumed that currents traveled along the conductors at the speed of light. Actually, the velocity is somewhat less, the reason being that electromagnetic fields



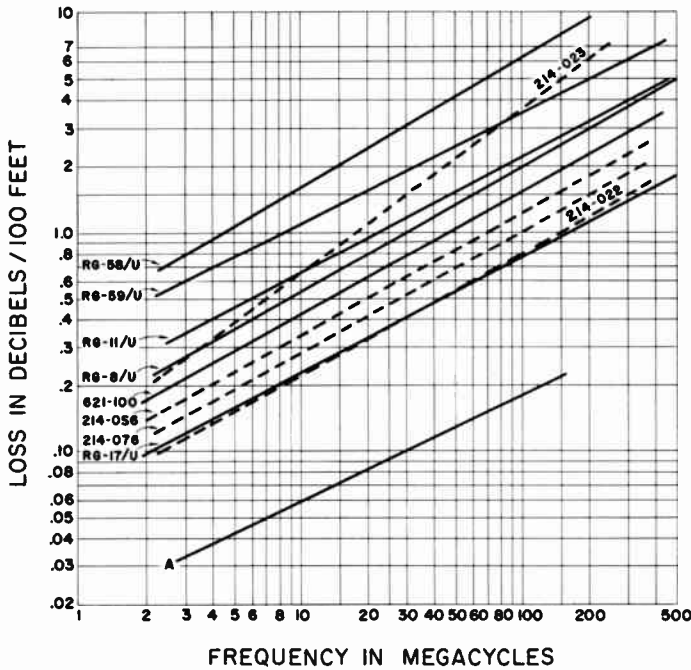

Fig. 13-8—Attenuation data for common types of transmission lines. Curve A is the nominal attenuation of 600-ohm open-wire line with No. 12 conductors, not including dielectric loss in spacers nor possible radiation losses. Additional line data are given in Table 13-1.

teristic impedance of the line, because a higher current flows in a low-impedance line for a given power input. The converse is true of dielectric losses because these increase with the voltage, which is greater on high-impedance lines. The dielectric loss in air-insulated lines is negligible (the only loss is in the insulating spacers) and such lines operate at high efficiency when radiation losses are low.

It is convenient to express the loss in a transmission line in decibels per unit length, since the loss in db. is directly proportional to the line length. Losses in various types of lines operated without standing waves (that is, terminated in a resistive load equal to the characteristic impedance of the line) are given in graphical form in Fig. 13-8. In these curves the radiation loss is assumed to be negligible.

When there are standing waves on the line the power loss increases as shown in Fig. 13-

9. Whether or not the increase in loss is serious depends on what the original loss would have been if the line were perfectly matched. If the loss with perfect matching is very low, a large s.w.r. will not greatly affect the efficiency of the line — i.e., the ratio of the power delivered to the load to the power put into the line.

Example: A 150-foot length of RG-11/U cable is operating at 7 Mc. with a 5-to-1 s.w.r. If perfectly matched, the loss from Fig. 13-8 would be  $1.5 \times 0.4 = 0.6$  db. From Fig. 13-9 the additional loss because of the s.w.r. is 0.73 db. The total loss is therefore  $0.6 + 0.73 = 1.33$  db.

An appreciable s.w.r. on a solid-dielectric line may result in excessive loss of power at the higher frequencies. Such lines, whether of the parallel-conductor or coaxial type, should be operated as nearly flat as possible, particularly when the line length is more than 50 feet.

## LOADS AND BALANCING DEVICES

The most important practical load for a transmission line is an antenna which, in most cases, will be "balanced"—that is, symmetrically constructed with respect to the feed point. Aside from considerations of matching the actual impedance of the antenna at the feed point to the characteristic impedance of the line (if such matching is attempted) a balanced antenna should be fed through a balanced transmission line in order to preserve symmetry with respect to ground and thus avoid difficulties with unbalanced currents on the line and consequent undesirable radiation from the transmission line itself.

If, as is often the case, the antenna is to be fed through coaxial line (which is inherently unbalanced) some method should be used for connecting the line to the antenna without upsetting the symmetry of the antenna itself. This requires a circuit that will isolate the balanced load from the unbalanced line while providing efficient power transfer. Devices for doing this are called baluns. The types used between the antenna and transmission line are generally "linear," consisting of transmission-line sections as described in Chapter 14.

The need for baluns also arises in coupling a transmitter to a balanced transmission line,

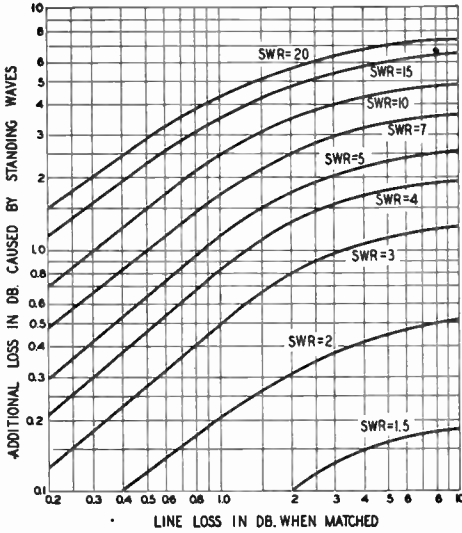

Fig. 13-9—Effect of standing-wave ratio on line loss. The ordinates give the additional loss in decibels for the loss, under perfectly matched conditions, shown on horizontal scale.

since the output circuits of most transmitters have one side grounded. (This type of output circuit is desirable for a number of reasons, including TVI reduction.) The most flexible type of balun for this purpose is the inductively coupled matching network described in a subsequent section in this chapter. This combines impedance matching with balanced-to-unbalanced operation, but has the disadvantage that it uses resonant circuits and thus can work over only a limited band of frequencies without readjustment. However, if a fixed impedance ratio in the balun can be tolerated, the coil balun described below can be used without adjustment over a frequency range of about 10 to 1 — 3 to 30 Mc., for example. Alternatively, a similarly wide band can be covered by a properly designed transformer (with the same impedance limitation) but the design principles and materials used in such transformers are quite specialized. Their

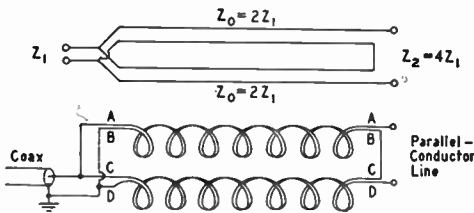

Fig. 13-10—Baluns for matching between push-pull and single-ended circuits. The impedance ratio is 4 to 1 from the push-pull side to the unbalanced side. Coiling the lines (lower drawing) increases the frequency range over which satisfactory operation is obtained.

construction is beyond the scope of this Handbook.

**Coil Baluns**

The type of balun known as the “coil balun” is based on the principles of a linear transmission-line balun as shown in the upper drawing of Fig. 13-10. Two transmission lines of equal length having a characteristic impedance  $Z_0$  are connected in series at one end and in parallel at the other. At the series-connected end the lines are balanced to ground and will match an impedance equal to  $2Z_0$ . At the parallel-connected end the lines will be matched by an impedance equal to  $Z_0/2$ . One side may be connected to ground at the parallel-connected end, provided the two lines have a length such that, considering each line as a single wire, the balanced end is effectively decoupled from the parallel-connected end. This requires a length that is an odd multiple of  $1/4$  wavelength. The impedance transformation from the series-connected end to the parallel-connected end is 4 to 1.

A definite line length is required only for decoupling purposes, and so long as there is adequate decoupling the system will act as a 4-to-1 impedance transformer regardless of line length. If each line is wound into a coil, as in the lower drawing, the inductances so formed will act as choke coils and will tend to isolate the series-connected end from any ground connection that may be placed on the parallel-connected end. Balun coils made in this way will operate over a wide frequency range, since the choke inductance is not critical. The lower frequency limit is where the coils are no longer effective in isolating one end from the other; the length of line in each coil should be about equal to a quarter wavelength at the lowest frequency to be used.

The principal application of such coils is in going from a 300-ohm balanced line to a 75-ohm coaxial line. This requires that the  $Z_0$  of the lines forming the coils be 150 ohms. Commercial (B&W) coils are available.

A balun of this type is simply a fixed-ratio transformer, when matched. It cannot compensate for inaccurate matching elsewhere in the system. With a “300-ohm” line on the balanced end, for example, a 75-ohm coax cable will not be matched unless the 300-ohm line actually is terminated in a 300-ohm load.

**NONRADIATING LOADS**

Typical examples of nonradiating loads for a transmission line are the grid circuit of a power amplifier (considered in the chapter on transmitters), the input circuit of a receiver, and another transmission line. This last case includes the “antenna tuner”—a misnomer because it is actually a device for coupling a transmission line to the transmitter. Because of its importance in amateur installations, the antenna coupler is considered separately in a later part of this chapter.

A good match between an antenna and its transmission line does not guarantee a low standing-wave ratio on the line when the antenna system is used for receiving. The s.w.r. is determined wholly by what the line "sees" at the receiver's antenna-input terminals. For minimum s.w.r. the receiver input circuit must be matched to the line. The rated input impedance of a receiver is a nominal value that

varies over a considerable range with frequency. Methods for bringing about a proper match are discussed in the chapter on receivers.

The most desirable condition is that in which the receiver is matched to the line  $Z_0$  and the line in turn is matched to the antenna. This transfers maximum power from the antenna to the receiver with the least loss in the transmission line.

## COUPLING THE TRANSMITTER TO THE LINE

The type of coupling system that will be needed to transfer power adequately from the final r.f. amplifier to the transmission line depends almost entirely on the input impedance of the line. As shown earlier in this chapter, the input impedance is determined by the standing-wave ratio and the line length. The simplest case is that where the line is terminated in its characteristic impedance so that the s.w.r. is 1 to 1 and the input impedance is equal to the  $Z_0$  of the line, regardless of line length.

Coupling systems that will deliver power into a flat line are readily designed. For all practical purposes the line can be considered to be flat if the s.w.r. is no greater than about 1.5 to 1. That is, a coupling system designed to work into a pure resistance equal to the line  $Z_0$  will have enough leeway to take care of the small variations in input impedance that will occur when the line length is changed, if the s.w.r. is higher than 1 to 1 but no greater than 1.5 to 1.

Current practice in transmitter design is to provide an output circuit that will work into such a line, usually a coaxial line of 50 to 75 ohms characteristic impedance. The design of such output circuits is discussed in the chapter on high-frequency transmitters. If the input impedance of the transmission line that is to be connected to the transmitter differs appreciably from the value of impedance into which the transmitter output circuit is designed to operate, an impedance-matching network must be inserted between the transmitter and the line input terminals.

### IMPEDANCE-MATCHING CIRCUITS FOR TRANSMISSION LINES

As shown earlier in this chapter, the input impedance of a line that is operating with a high standing-wave ratio can vary over quite wide limits. The simplest type of circuit that will match such a range of impedances to 50 to 75 ohms is a simple series- or parallel-tuned circuit, approximately resonant at the operating

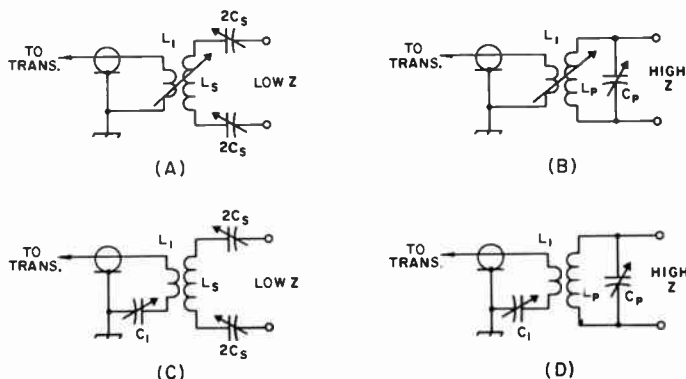

Fig. 13-11—Simple circuits for coupling a transmitter to a balanced line that presents a load different than the transmitter design output impedance. (A) and (B) are respectively series- and parallel-tuned circuits using variable inductive coupling between coils, and (C) and (D) are similar but use fixed inductive coupling and a variable series capacitor,  $C_1$ . A series-tuned circuit works well with a low-impedance load; the parallel circuit is better with high-impedance loads (several hundred ohms or more).

frequency. If the load presented by the line at the operating frequency is low (below a few hundred ohms), a series-tuned circuit should be used. When the load is higher than this, the parallel-tuned circuit is easier to use.

Typical simple circuits for coupling between the transmitter with 50- to 75-ohm coaxial-line output and a balanced transmission line are shown in Fig. 13-11. The inductor  $L_1$  should have a reactance of about 60 ohms (see Fig. 2-44) when adjustable inductive coupling is used (Figs. 13-11A and 13-11B). When a variable series capacitor is used,  $L_1$  should have a reactance of about 120 ohms. The variable capacitor,  $C_1$ , should have a reactance at maximum capacitance of about 100 ohms.

On the secondary side,  $L_2$  and  $C_2$  should be capable of being tuned to resonance at about 80 percent of the operating frequency. In the series-tuned circuits, for a given low-impedance load looser coupling can be used between  $L_1$  and  $L_2$  as the  $L_2$ -to- $C_2$  ratio is increased. In the parallel-tuned circuits, for a given high-impedance load looser coupling can be used between  $L_1$  and  $L_2$  as the  $C_2$ -to- $L_2$  ratio is in-

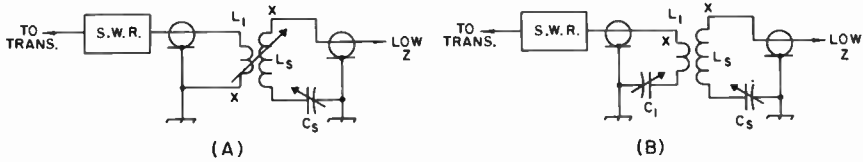

Fig. 13-12—Coupling from a transmitter designed for 50- to 75-ohm output to a coaxial line with a 3- or 4-to-1 s.w.r. is readily accomplished with these circuits. Essential difference between the circuits is (A) adjustable inductive coupling and (B) fixed inductive coupling with variable series capacitor.

In either case the circuit can be adjusted to give a 1-to-1 s.w.r. on the meter in the line to the transmitter. The coil ends marked "x" should be adjacent, for minimum capacitive coupling.

increased. The constants are not critical; the rules of thumb are mentioned to assist in correcting a marginal condition where sufficient transmitter loading cannot be obtained.

Coupling to coaxial lines that have a high s.w.r., and consequently may present a transmitter with a load it cannot couple to, is done with an unbalanced version of the series-tuned circuit, as shown in Fig. 13-12. The rule given above for coupling ease and  $L_s$ -to- $C_s$  ratio applies to these circuits as well.

The most satisfactory way to set up initially any of the circuits of Figs. 13-11 or 13-12 is to connect a coaxial s.w.r. bridge in the line to the transmitter, as shown in Fig. 13-12. The "Monimatch" type of bridge, which can handle the full transmitter power and may be left in the line for continuous monitoring, is excellent for this purpose. However, a simple resistance bridge such as is described in the chapter on measurements is perfectly adequate, requiring only that the transmitter output be reduced to a very low value so that the bridge will not be overloaded. To adjust the circuit, make a trial setting of the coupling (coil spacing in Figs. 13-11A and B and 13-12A,  $C_1$  setting in others)

and adjust  $C_s$  or  $C_p$  for minimum s.w.r. as indicated by the bridge. If the s.w.r. is not close to 1 to 1, readjust the coupling and retune  $C_s$  or  $C_p$ , continuing this procedure until the s.w.r. is practically 1 to 1. The settings may then be logged for future reference.

In the series-tuned circuits of Figs. 13-11A and 13-11C, the two capacitors should be set at similar settings. The " $2C_s$ " indicates that a balanced series-tuned coupler requires twice the capacitance in each of two capacitors as does an unbalanced series-tuned circuit, all other things being equal.

It is possible to use circuits of this type without initially setting them up with an s.w.r. bridge. In such a case it is a matter of cut-and-try until adequate power transfer between the amplifier and main transmission line is secured. However, this method frequently results in a high s.w.r. in the link, with consequent power loss, "hot spots" in the coaxial cable, and tuning that is critical with frequency. The bridge method is simple and gives the optimum operating conditions quickly and with certainty.

## COUPLER OR MATCHING-CIRCUIT CONSTRUCTION

The design of matching or "antenna coupler" circuits has been covered in the preceding section, and the adjustment procedure also has been outlined. When circuits of this type are used for transferring power from the transmitter to a parallel-conductor transmission line, a principal point requiring attention is that of maintaining good balance to ground. If the coupler circuit is appreciably unbalanced the currents in the two wires of the transmission line will also be unbalanced, resulting in radiation from the line.

In most cases the matching circuit will be built on a metal chassis, following common practice in the construction of transmitting units. The chassis, because of its relatively large area, will tend to establish a "ground"—even though not actually grounded—particularly if it is assembled with other units of the transmitter in a rack or cabinet. The components used in the coupler, therefore, should be placed so that they are electrically symmetrical with respect to the chassis

and to each other if a parallel-conductor transmission line is to be used.

In general, the construction of a coupler circuit for parallel lines should physically resemble the tank layouts used with push-pull amplifiers. In parallel-tuned circuits a split-stator capacitor should be used. The capacitor frame should be insulated from the chassis because, depending on line length and other factors, harmonic reduction and line balance may be improved in some cases by grounding and in others by not grounding. It is therefore advisable to adopt construction that permits either. Provision also should be made for grounding the center of the coil, for the same reason. The coil in a parallel-tuned circuit should be mounted so that its hot ends are symmetrically placed with respect to the chassis and other components. This equalizes stray capacitances and helps maintain good balance.

When the coupler is of the type that can be shifted to series or parallel tuning as required,



two separate single-ended capacitors will be satisfactory. As described earlier, they should be connected so that both frames go to corresponding parts of the circuit — i.e., either to the coil or to the line — for series tuning, and when used in parallel for parallel tuning should be connected frame-to-stator.

A coupler designed and adjusted so that the connecting link acts as a matched transmission line may be placed in any convenient location. Some amateurs prefer to install the coupler at the point where the main transmission line enters the station. This helps maintain a tidy station layout when an air-insulated parallel-conductor transmission line is used. With solid-dielectric lines, which lend themselves well to neat installation indoors, it is probably more desirable to install the coupler where it can be reached easily for adjustment and band-changing.

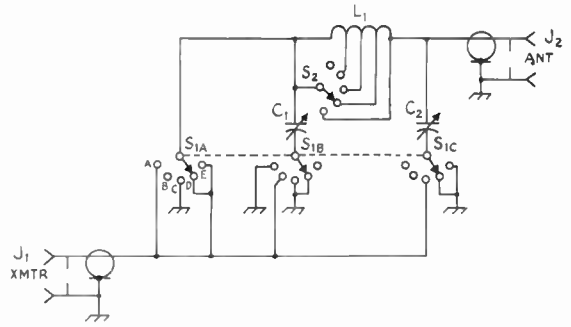

Fig. 13-13—Circuit diagram of an antenna coupler for "random" antennas. All contacts of  $S_2$  are not shown.

$C_1, C_2$ —150 pf. See text for spacing.

$J_1, J_2$ —Coaxial receptacles (SO-239).

$L_1$ —20 turns No. 12 bare, 2½ inch diam., 6 t.p.i. (B&W 3905-1). Tapped every other turn.

$S_1$ —Three-pole 5-position ceramic rotary switch.

$S_2$ —Single-pole 11-position ceramic rotary switch.

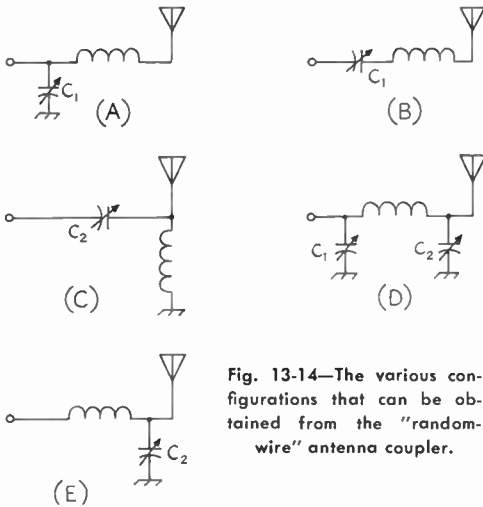

Fig. 13-14—The various configurations that can be obtained from the "random-wire" antenna coupler.

can be enclosed in a metal cabinet or chassis. If it is built breadboard, it may be more convenient to use a small clip instead of  $S_2$  to vary the inductance of  $L_1$ . An elaborate version can be made with a built-in Monimatch and output indicator.

The several configurations that can be obtained from the coupler are shown in Fig. 13-14. The letters correspond to those on the switch  $S_1$ .

When first using this tuner with an antenna, try various positions of  $C_1, C_2, S_1$  and  $S_2$  in order to find the point at which maximum output is obtained (maintaining a constant transmitter input). When the correct settings have been found for each frequency band, and these settings have been noted for future reference, it is an easy matter to hop from band to band. With certain settings and configurations it will be pos-

## MATCHING TO "RANDOM" ANTENNAS

In many cases it is impractical or impossible to install a conventional antenna complete with transmission line. Under these conditions, the only solution may be to string a wire to an existing support or between two supports and run one end to the transmitter. Such a "random" antenna will not couple conveniently to the low-impedance output of most transmitters unless its length happens to be an odd multiple of a quarter wavelength. In cases where a random antenna must be used, the antenna-coupler circuit of Fig. 13-13 provides a simple solution. Although specific values are given for  $C_1, C_2$  and  $L_1$ , they are not critical.  $C_1$  and  $C_2$  should be at least 150 pf. The spacing of  $C_1$  and  $C_2$  should be 0.025 inch for transmitter inputs of 100 watts or less.  $L_1$  may be a convenient length of any of the two-to three-inch diameter air inductors, or it can be a homemade coil on a ceramic form. It should be tapped every two or three turns. The tuner may be built in an open "breadboard" style, or it

Fig. 13-15—An example of how the antenna coupler can be built. In this case the components are installed in a 10 × 17 × 3-inch aluminum chassis that serves as the support for the transmitter. An r.f. ammeter (right) is used as an output indicator. (W4UWA/DL4, QST, November, 1958).

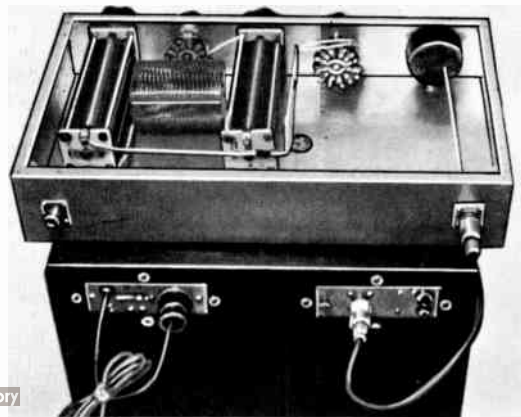



sible to dissipate a large part of the transmitter output in the tuner itself, and for this reason an output indicator is highly desirable, at least for the initial tune-up. Either an r.f. ammeter in the output lead or an r.f. voltmeter from it to chassis will be satisfactory. Under some conditions a neon bulb will serve as an r.f. voltmeter.

If TVI is a problem, the low-pass filter should be installed in the line between coupler and transmitter.

**A WIDE-RANGE COUPLER FOR ANY ANTENNA**

The coupler shown in Figs. 13-16 and 13-18 will match a transmitter's 50- or 70-ohm output to antenna loads as low as 10 ohms and as high as 4000, balanced or unbalanced. For load changes it uses a capacitive voltage divider. Referring to Fig. 13-17, the capacitors  $C_2$ ,  $C_3$  and  $C_4$ , connected in series across the inductance  $L_1$  form the divider.

To simplify construction and duplication, a single length of coil stock is used for the inductance. The link,  $L_2L_3$ , is actually two coils. For 80 and 40 meters, the two coils are connected in series to provide an 8-turn link. On 20, 15 and 10 the coils are connected in parallel, resulting in the equivalent of a two-turn link. Using the two coils in this fashion provides tighter coupling to  $L_1$  than would be obtained if a single link

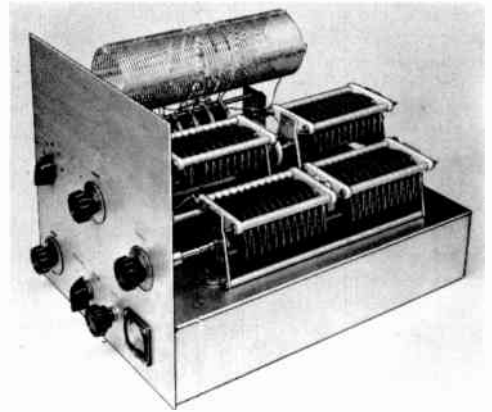

Fig. 13-16—This wide-range antenna coupler can be used with parallel-line or coaxial transmission lines, as well as with a wire of random length. The capacitors at the center of the chassis are insulated from the chassis and from each other; the near capacitor is a normal split-stator capacitor and is mounted on the chassis. The coil at the far side is supported by its leads above the band switch.

Controls along the bottom, from left to right, are the link capacitor, the Monimatch FORWARD-REFLECTED switch and the Monimatch SENSITIVITY control.

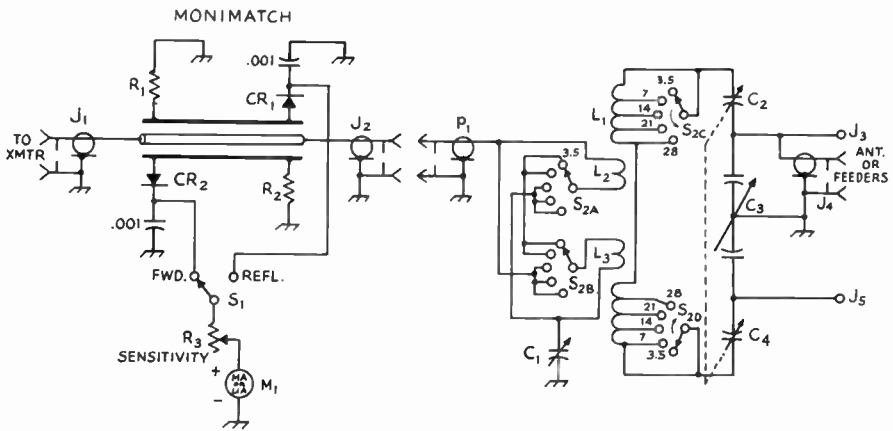

Fig. 13-17—Circuit diagram of the antenna coupler and Monimatch.

- $C_1$ —250- $\mu$ mf. variable, 0.045-inch spacing for high power (Jahnsan 250E20); 0.025-inch spacing for low power (Hammarlund MC-250-M).
- $C_2$ ,  $C_4$ —100- $\mu$ mf. variable, 0.125-inch spacing for high power (Jahnsan 100E45); 0.025-inch spacing for low power (Hammarlund MC-100-M).
- $C_3$ —100- $\mu$ mf.-per-section, dual variable, 0.125-inch spacing for high power (Jahnsan 100ED45); 0.025-inch spacing for low power (Hammarlund MCD-100-M).
- $CR_1$ ,  $CR_2$ —1N34A germanium diodes.
- $J_1$ ,  $J_2$ ,  $J_4$ —Chassis-type caax receptacles, type SO-239.

- $J_3$ ,  $J_5$ —Feedthrough insulators.
- $L_1$ ,  $L_2$ ,  $L_3$ ,  $L_4$ —See Fig. 13-19 and text.
- $M_1$ —0-1 ma. or less; see text.
- $P_1$ —Caax plug, type PL-259.
- $R_1$ ,  $R_2$ —For 50-ohm bridge, 150 ohms, 1/2-watt composition; for 70-ohm bridge, 100-ohms, 1/2-watt composition.
- $R_3$ —20,000-ohm central, linear taper.
- $S_1$ —Rotary, 1 pole, 2 positions (Centralab type 1460).
- $S_2$ —Ceramic rotary, 4 poles, 5 positions, 1 pole per section, 4 sections (Centralab index type P-272 with type "TD" or "XD" sections).

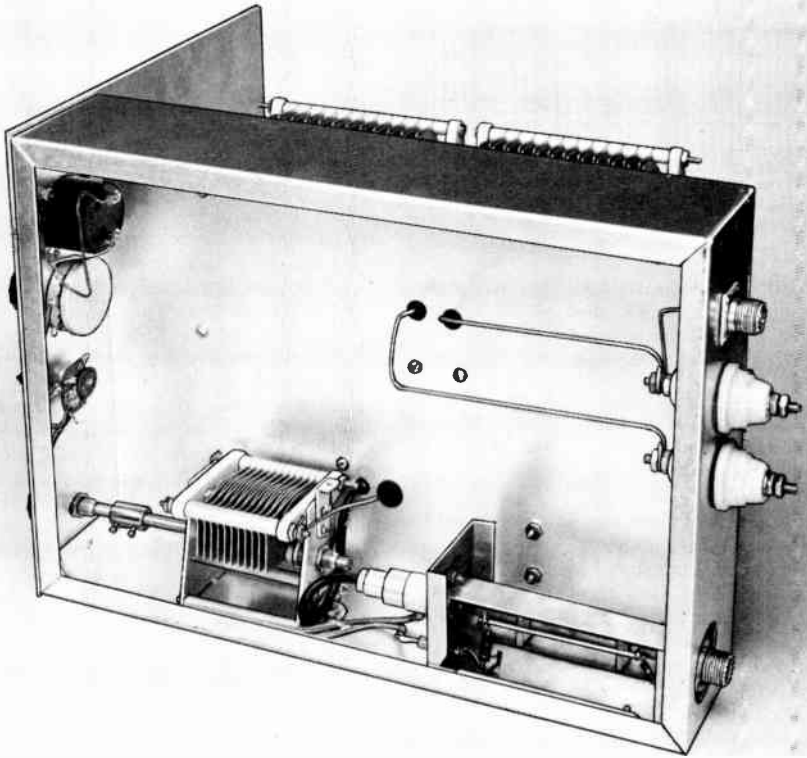

Fig. 13-18—The link capacitor and the Monimatch are mounted underneath the chassis.

were tapped, and it maintains symmetry with respect to the large coil.

A Monimatch is included as a tuning indicator. Some form of indicator is required to show when the unit is correctly adjusted. If a Monimatch or similar indicator is already available, this part of Fig. 13-17 can be eliminated.

As designed and shown, this unit will handle about 500 watts on c.w. or s.s.b. and about half that power on a.m. phone. For amateurs using less power (in the 50- to 100-watt level), the capacitor spacings can be reduced at a saving in cost, and suitable capacitors are specified in Fig. 13-17. The coil remains the same for either power level—there isn't enough difference in coil cost to warrant using a different coil unless space is at a premium.

If substitutions for the specified capacitors are contemplated, no harm will be done if higher-capacitance units are substituted. However, if lower capacitance values are used they will limit the range over which a match can be obtained.

The complete coupler, including the Monimatch, is built on a  $3 \times 10 \times 14$ -inch aluminum chassis. The front panel is made from a  $10 \times 10$ -inch piece of aluminum sheet stock. The link capacitor,  $C_1$ , is mounted under the chassis, as is the Monimatch. The loading capacitor,  $C_3$ , is mounted directly on the chassis top along the

right-hand side; the ganged capacitors,  $C_2$  and  $C_4$  are supported off the chassis by one-inch ceramic stand-off insulators and their shafts are connected together and to the panel shaft by suitable insulated shaft couplings. The two output leads that go to  $J_3$  and  $J_5$  are taken off the rotor mounting points between the two capacitors. These leads run down below chassis to the connectors through two rubber grommets. If suitable feed-through insulators are available they can be used to mount  $C_2$  and  $C_4$  and the under-chassis leads taken from them.

Fig. 13-19 shows how to make  $L_1$ ,  $L_2$ ,  $L_3$  and  $L_4$ . Cut a total of 67 turns from a length of coil stock, making sure to leave enough lead length at each end of the coil for connections to the switch. At  $28\frac{1}{2}$  turns from each end of the coil cut the wire and unwind  $\frac{1}{2}$  turn from the support bars. This will give two coils of 28 turns and another of 9 turns. Cut the 9-turn coil at the center and unwind the half turns, leaving two coils of 4 turns each. The two 28-turn coils are connected together at the center by soldering the two inside leads together.

The coil assembly is supported by its own leads, and it is mounted over  $S_2$ . The switch is made from a Centralab P-272 index and four single-pole five-position rotary ceramic switch sections (Centralab TD or XD). Two switch-

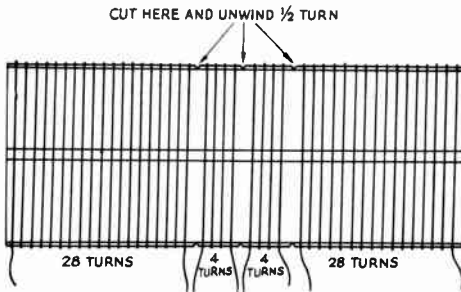

Fig. 13-19—Details of the coil assembly. Not shown are the taps needed for changing bands. The tap points listed below all are counted from the outside ends of the coil.

7 Mc.—12 turns.                      21 Mc.—25 turns.  
 14 Mc.—23 turns.                     28 Mc.—26 turns.  
 The coil stock is 3 inches in diam., No. 14, 8 turns per inch (Illumintron, Air Dux 2408T).

mounting brackets of sheet aluminum are used to support the switch assembly.

The Monimatch is mounted in a  $2\frac{1}{4} \times 2\frac{1}{4} \times 5$ -inch aluminum box (Bud Minibox CU-3004A). Chassis-type coax fittings (SO-239) are mounted in the center of each end of the box. A piece of  $\frac{1}{4}$ -inch o.d. copper tubing,  $4\frac{5}{8}$  inches long, is connected between the two inner pins of the coax fittings. The two pick-up leads for the bridge are made from No. 14 solid wire held in the proper position by two insulating spacers. Details of the spacers are shown in Fig. 13-20. The spacers can be made from  $\frac{1}{8}$ - to  $\frac{1}{4}$ -inch thick polystyrene or bakelite.

Two flat strips of copper,  $\frac{5}{8}$  inch wide by  $4\frac{7}{8}$  inches long, are installed as shown in Fig. 13-18. The method of mounting the strips is quite simple. Solder a lug to each end of each strip, allowing the end of the lug with the screw hole to project beyond the edge. Bend this part of the lug up at right angles to the strip. The strips are then mounted by using the top and bottom screws and nuts of the coax fittings.

When soldering the germanium diodes to the pickup wires, hold the lead of the diode with a pair of pliers between the point of soldering and the body of the diode. This will keep excess heat from reaching the diodes and ruining them.

For a 50-ohm bridge  $R_1$  and  $R_2$  should be 150-ohm,  $\frac{1}{2}$ -watt resistors. For 70-ohm bridge use 100 ohms,  $\frac{1}{2}$  watt. The resistors used should be composition or carbon, *not wire-wound*.

## THE "MONIMATCH"

The "Monimatch," shown in Figs. 13-21 and 13-23, is an s.w.r. monitoring bridge that can be used continuously in the transmission line at power levels up to the legal limit.

It makes use of the combined effects of inductive and capacitive coupling between the center conductor of a coaxial line and a length of wire

The leads to  $S_1$  are brought out of the Monimatch box through two feedthrough insulators and run from there to the switch in shielded wire.  $M_1$  as shown is a 500- $\mu$ a. meter, but a 0-1 milliammeter can be used.

### Adjustment Procedure

The coupler can be used with practically any antenna system. With a balanced line (open-wire or Twin-Lead), the conductors should be connected to terminals  $J_3$  and  $J_5$ . A coax line from the antenna should be connected to  $J_4$ . For single-wire feed, such as a wire fed at the end, the wire should be connected to  $J_3$  and the coupler chassis grounded to an earth ground.

Connect a length of coax between the transmitter and the coupler, using either 50- or 70-ohm coax, depending on which value the Monimatch was built to handle. Feed some power through the system and set  $S_1$  to read forward power. Adjust  $R_3$  for a full-scale meter deflection. Next, set  $S_1$  to read reflected power and tune  $C_1$  and  $C_2C_4$  for minimum reading. If it is impossible to get the reading down to zero (the object of the adjustment), try a different setting of  $C_3$  and again adjust the other two controls. Once the zero reading is obtained, the coupler is correctly adjusted for that particular frequency. Make a note of the settings and proceed to the next band. If an accurate record is kept it will be simple to change bands quickly.

If an antenna system is encountered that cannot be matched, although this is unlikely, the simplest thing to do is to increase or decrease the length of the feed line. A little experimentation will quickly set up a "matched" condition.

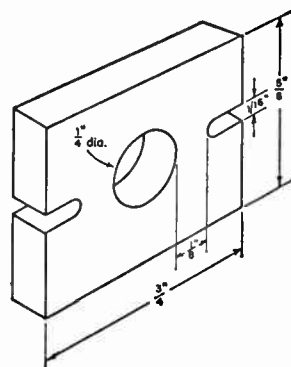

Fig. 13-20—Dimensions of the insulating spacers used to hold the pick-up wires in place in the Monimatch.

parallel to it. When the coupled wire is properly terminated in a resistance, the voltage induced in it by power travelling along the line in one direction will be balanced out in the crystal-rectifier r.f. voltmeter circuit, but power travelling along the line in the opposite direction will cause a voltmeter indication.

If the bridge is adjusted to match the  $Z_0$  of the coaxial line being used, the voltmeter will respond only to the reflected voltage, just as in the case of the resistance-type bridges. The power consumed in the bridge is below one watt, even at the maximum power permitted amateur transmitters.

The circuit of Fig. 21-22 uses a d.p.d.t. switch to exchange the voltmeter and the terminating resistance, so that either the forward or reflected voltage can be measured. The sensitivity of this type of bridge is proportional to frequency, so higher power is required for a given voltmeter deflection at low than at high frequencies. The sensitivity also increases with an increase in pickup length, but this should not be longer than about  $1/20$  wavelength, to avoid standing-wave effects in the pick-up circuit. For higher frequencies the length should be decreased in proportion to the wavelength. This reduces the sensitivity considerably at the lower frequencies, so it is advisable to make separate units for v.h.f. and the frequencies below 30 Mc.

The additional conductor in the bridge shown in the photographs is a length of No. 20 enameled wire running under 8 inches of the RG-8/U shield. The length of the RG-8/U is 14 inches. To insert the No. 20 wire under the cable shield, first loosen the braid by bunching it from the ends toward the center. Punch the two small holes for the wire and then snake the wire through one hole, under the braid, and out the other hole. Next, smooth out the braid to its original length, being careful not to apply so much pressure that the enamel on the wire is scratched. Check with an ohmmeter to make sure the wire and braid are not short circuited. There are several types of enameled wire (e.g., Formvar, Nylclad) that have an extremely tough covering, and the use of one of these is recommended. The covering is somewhat difficult to remove for soldering, but the use of the wire will insure against an inadvertent



Fig. 13-21—The Monimatch, an s.w.r. monitor that can be left in the line at all times. The unit shown here will handle a kilowatt.

short-circuit to the outer conductor of the coaxial line.

It is important when assembling and wiring the Monimatch that good symmetry be maintained. Each end of the length of RG-8/U should be connected in the same way, with at least two connections made between the outer conductor and the coaxial connectors (see Fig. 13-23). The ground connection for  $R_1$  and for the 0.001- $\mu$ f. capacitor should be the midpoint on the outer conductor of the RG-8/U. The outer conductor is connected to the chassis only at  $J_1$  and  $J_2$ ; the cable is

Fig. 13-22—Wiring diagram of the Monimatch.

- $J_1, J_2$ —SO-239 coaxial receptacle.
- $R_1$ —Nominally 33 ohms. See text for adjustment procedure.
- $S_1$ —4.p.d.t. rotary switch (2 poles used). (Centralab 1409)
- $W_1$ —14-inch length of RG-8/U with length of No. 20 enam. inserted under outer conductor. See text.

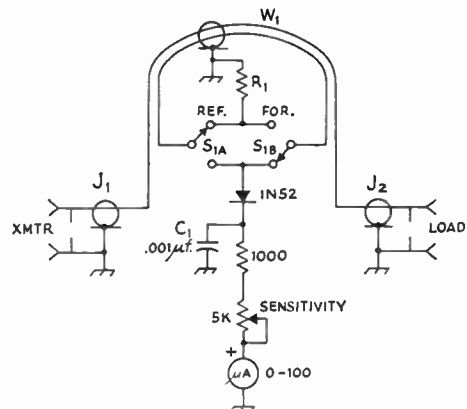

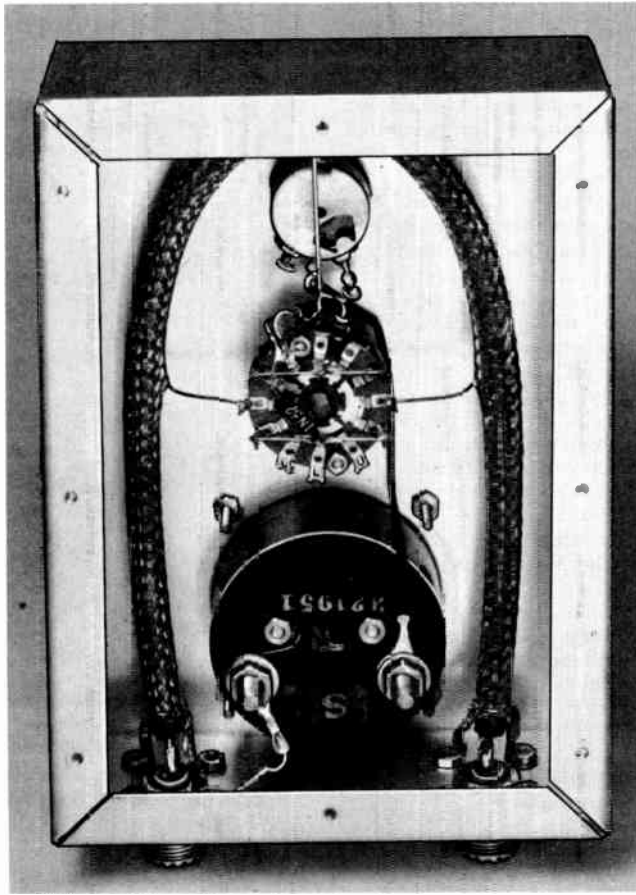

Fig. 13-23—Rear view of Monimatch with cane-metal cover removed. To maintain symmetry, the terminating resistor  $R_1$  and the crystal diode are connected to the midpoints of the leads between  $S_{1A}$  and  $S_{1B}$ , and  $R_1$  and  $C_1$  are grounded to the center of the coaxial-line outer conductor via the heavy wire running across the variable resistor. The outer conductor of the coaxial line is connected to the chassis only at  $J_1$  and  $J_2$ , and two connections are made in each case.

The Monimatch is built in a 5 x 7 x 2-inch aluminum chassis.

stiff enough to be self-supporting and can be dressed away from the chassis at other points.

A dummy antenna of the same resistance as the  $Z_0$  of the line should be used to adjust  $R_1$  (Fig. 13-22). Make the connecting leads as short as possible. Only 30 or 40 watts will be required at 21 and 28 Mc. to give close to full-scale deflection, and a dummy load capable of handling this power for a short time can be made from 13 680-ohm 1-watt resistors in parallel. (See "V.H.F. Dummy Loads." *QST*, March, 1960.) Try several different 33-ohm resistors (with slightly different d.c. resistances) at  $R_1$ , and use the one that gives

a minimum reading with  $S_1$  at "REF" when nearly a full-scale reading can be obtained with  $S_1$  at FOR. A final test on the Monimatch is to reverse the transmitter and load connections; a good minimum should be obtained with  $S_1$  at FOR.

It is possible to generate harmonics in the voltmeter of sufficient intensity to cause television interference. If TVI is a problem, a low-pass filter should be connected in the line between the Monimatch and the antenna coupler or antenna. In many cases the antenna coupler alone will have sufficient selectivity to reject the harmonics generated by the voltmeter diode.



# Antennas

An *antenna system* can be considered to include the antenna proper (the portion that radiates the r.f. energy), the feed line, and any coupling devices used for transferring power from the transmitter to the line and from the line to the antenna. Some simple systems may omit the transmission line or one or both of the coupling devices. This chapter will describe the antenna proper, and in many cases will show popular types of lines, as well as line-to-antenna couplings where they are required. However, it should be kept in mind that *any* antenna proper can be used with *any* type of feedline if a suitable coupling is used between the antenna and the line. Changing the line does not change the type of antenna.

## Selecting an Antenna

In selecting the type of antenna to use, the majority of amateurs are somewhat limited through space and structural limitations to simple antenna systems, except for v.h.f. operation where the small space requirements make the use of multielement beams readily possible. This chapter will consider antennas for frequencies as high as 30 Mc.—a later chapter will describe the popular types of v.h.f. antennas. However, even though the available space may be limited, it is well to consider the propagation characteristics of the frequency band or bands to be used, to insure that best possible use is made of the available facilities. The propagation characteristics of the amateur-band frequencies are described in Chapter Fifteen. In general, antenna construction and location become more critical and important on the higher frequencies. On the lower frequencies (3.5 and 7 Mc.) the vertical angle of radiation and the plane of polarization may be of relatively little importance; at 28 Mc. they may be all-important.

## Definitions

The **polarization** of a straight-wire antenna is determined by its position with respect to the earth. Thus a vertical antenna radiates vertically polarized waves, while a horizontal antenna radiates horizontally polarized waves in a direction broadside to the wire and vertically polarized waves at high vertical angles off the ends of the wire. The wave from an antenna in a slanting position, or from the horizontal antenna in directions other than mentioned above, contains components of both horizontal and vertical polarization.

The vertical angle of maximum radiation of an antenna is determined by the free-space

pattern of the antenna, its height above ground, and the nature of the ground. The angle is measured in a vertical plane with respect to a tangent to the earth at that point, and it will usually vary with the horizontal angle, except in the case of a simple vertical antenna. The **horizontal angle of maximum radiation** of an antenna is determined by the free-space pattern of the antenna.

The **impedance** of the antenna at any point is the ratio of the voltage to the current at that point. It is important in connection with feeding power to the antenna, since it constitutes the load to the line offered by the antenna. It can be either resistive or complex, depending upon whether or not the antenna is resonant.

The **field strength** produced by an antenna is proportional to the current flowing in it. When there are standing waves on an antenna, the parts of the wire carrying the higher current have the greater radiating effect. All resonant antennas have standing waves—only terminated types, like the terminated rhombic and terminated “V,” have substantially uniform current along their lengths.

The ratio of power required to produce a given field strength with a “comparison” antenna to the power required to produce the same field strength with a specified type of antenna is called the **power gain** of the latter antenna. The field is measured in the optimum direction of the antenna under test. The comparison antenna is generally a half-wave antenna at the same height and having the same polarization as the antenna under consideration. Gain usually is expressed in decibels.

In unidirectional beams (antennas with most of the radiation in only one direction) the **front-to-back ratio** is the ratio of power radiated in the maximum direction to power radiated in the opposite direction. It is also a measure of the reduction in received signal when the beam direction is changed from that for maximum response to the opposite direction. Front-to-back ratio is usually expressed in decibels.

The **bandwidth** of an antenna refers to the frequency range over which a property falls within acceptable limits. The **gain bandwidth**, the **front-to-back-ratio bandwidth** and the **standing-wave-ratio bandwidth** are of prime interest in amateur work. The gain bandwidth is of interest because, generally, the higher the antenna gain is the narrower the gain bandwidth will be. The s.w.r. bandwidth is of interest because it is an indication of the transmission-line efficiency over the useful frequency range of the antenna.

GROUND EFFECTS

The radiation pattern of any antenna that is many wavelengths distant from the ground and all other objects is called the **free-space pattern** of that antenna. The free-space pattern of an antenna is almost impossible to obtain in practice, except in the v.h.f. and u.h.f. ranges. Below 30 Mc., the height of the antenna above ground is a major factor in determining the radiation pattern of the antenna.

When any antenna is near the ground the free-space pattern is modified by reflection of radiated waves from the ground, so that the actual pattern is the resultant of the free-space pattern and ground reflections. This resultant is dependent upon the height of the antenna, its position or orientation with respect to the surface of the ground, and the electrical characteristics of the ground. The effect of a perfectly reflecting

frequencies. It is advantageous, therefore, to erect the antenna at a height that will take advantage of ground reflection in such a way as to reinforce the space radiation at the most desirable angle. Since low angles usually are most effective, this generally means that the antenna should be high—at least one-half wavelength at 14 Mc., and preferably three-quarters or one wavelength, and at least one wavelength, and preferably higher, at 28 Mc. The physical height required for a given height in wavelengths decreases as the frequency is increased, so that good heights are not impracticable; a half wavelength at 14 Mc. is only 35 feet, approximately, while the same height represents a full wavelength at 28 Mc. At 7 Mc. and lower frequencies the higher radiation angles are effective, so that again a useful antenna height is not difficult of attainment. Heights between 35 and 70 feet are suitable for all bands, the higher figures being preferable.

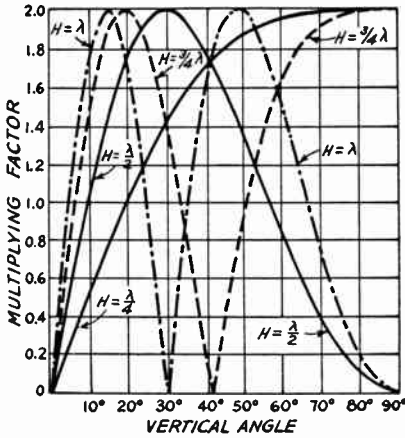

Fig. 14-1—Effect of ground on radiation of horizontal antennas at vertical angles for four antenna heights. This chart is based on perfectly conducting ground.

ground is such that the original free-space field strength may be multiplied by a factor which has a maximum value of 2, for complete reinforcement, and having all intermediate values to zero, for complete cancellation. These reflections only affect the radiation pattern in the vertical plane—that is, in directions upward from the earth's surface—and not in the horizontal plane, or the usual geographical directions.

Fig. 14-1 shows how the multiplying factor varies with the vertical angle for several representative heights for horizontal antennas. As the height is increased the angle at which complete reinforcement takes place is lowered, until for a height equal to one wavelength it occurs at a vertical angle of 15 degrees. At still greater heights, not shown on the chart, the first maximum will occur at still smaller angles.

Radiation Angle

The vertical angle of maximum radiation is of primary importance, especially at the higher

Imperfect Ground

Fig. 14-1 is based on ground having perfect conductivity, whereas the actual earth is not a perfect conductor. The principal effect of actual ground is to make the curves inaccurate at the lowest angles; appreciable high-frequency radiation at angles smaller than a few degrees is practically impossible to obtain over horizontal ground. Above 15 degrees, however, the curves are accurate enough for all practical purposes, and may be taken as indicative of the result to be expected at angles between 5 and 15 degrees.

The effective ground plane—that is, the plane from which ground reflections can be considered to take place—seldom is the actual surface of the ground but is a few feet below it, depending upon the character of the soil.

Impedance

Waves that are reflected directly upward from the ground induce a current in the antenna in

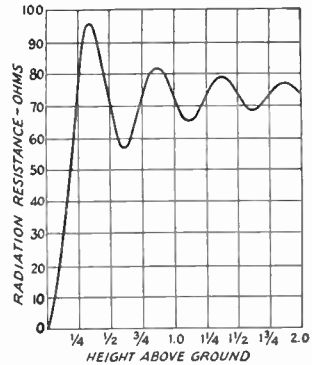

Fig. 14-2—Theoretical curve of variation of radiation resistance for a very thin half-wave horizontal antenna as a function of height in wavelength above perfectly reflecting ground.

passing, and, depending on the antenna height, the phase relationship of this induced current to the original current may be such as either to increase or decrease the total current in the antenna. For the same power input to the antenna, an increase in current is equivalent to a decrease in impedance, and vice versa. Hence, the impedance of the antenna varies with height. The theoretical curve of variation of radiation resistance for a very thin half-wave antenna above perfectly reflecting ground is shown in Fig. 14-2. The impedance approaches the free-space value as the height becomes large, but at low heights may differ considerably from it.

**Choice of Polarization**

Polarization of the transmitting antenna is generally unimportant on frequencies between 3.5 and 30 Mc. However, the question of whether

the antenna should be installed in a horizontal or vertical position deserves consideration for other reasons. A vertical half-wave or quarter-wave antenna will radiate equally well in all *horizontal* directions, so that it is substantially nondirectional, in the usual sense of the word. If installed horizontally, however, the antenna will tend to show directional effects, and will radiate best in the direction at right angles, or broadside, to the wire. The radiation in such a case will be least in the direction toward which the wire points.

The vertical angle of radiation also will be affected by the position of the antenna. If it were not for ground losses at high frequencies, the vertical half-wave antenna would be preferred because it would concentrate the radiation horizontally, and this low-angle radiation is preferable for practically all work.

**THE HALF-WAVE ANTENNA**

A fundamental form of antenna is a single wire whose length is approximately equal to half the transmitting wavelength. It is the unit from which many more-complex forms of antennas are constructed. It is known as a **dipole antenna**.

The length of a half-wave in space is:

$$\text{Length (feet)} = \frac{492}{\text{Freq. (Mc.)}} \quad (14-A)$$

The actual length of a half-wave antenna will not be exactly equal to the half-wave in space, but depends upon the thickness of the conductor in relation to the wavelength as shown in Fig. 14-3, where *K* is a factor that must be multiplied by the half wavelength in free space to obtain the resonant antenna length. An additional shortening effect occurs with wire antennas supported by insulators at the ends because of the capacitance added to the system by the insulators (end effect). The following formula is sufficiently accurate for wire antennas at frequencies up to 30 Mc.:

$$\text{Length of half-wave antenna (feet)} = \frac{492 \times 0.95}{\text{Freq. (Mc.)}} = \frac{468}{\text{Freq. (Mc.)}} \quad (14-B)$$

Example: A half-wave antenna for 7150 kc. (7.15 Mc.) is  $\frac{468}{7.15} = 65.45$  feet, or 65 feet 5 inches.

Above 30 Mc. the following formulas should be used, particularly for antennas constructed from rod or tubing. *K* is taken from Fig. 14-3.

$$\text{Length of half-wave antenna (feet)} = \frac{492 \times K}{\text{Freq. (Mc.)}} \quad (14-C)$$

$$\text{or length (inches)} = \frac{5905 \times K}{\text{Freq. (Mc.)}} \quad (14-D)$$

Example: Find the length of a half wavelength antenna at 28.7 Mc., if the antenna is made of 1/2-inch diameter tubing. At 28.7 Mc., a half wavelength in space is  $\frac{492}{28.7} = 17.14$  feet, from Eq. 14-A. Ratio of half wavelength to conductor diameter (changing wavelength to inches) is  $\frac{(17.14 \times 12)}{0.5} = 411$ . From Fig. 14-3, *K* = 0.97 for this ratio. The length of the antenna, from Eq. 14-C, is  $\frac{(492 \times 0.97)}{28.7} = 16.63$  feet, or 16 feet 7 1/2 inches. The answer is obtained directly in inches by substitution in Eq. 14-D:  $\frac{(5905 \times 0.97)}{28.7} = 199.6$  inches.

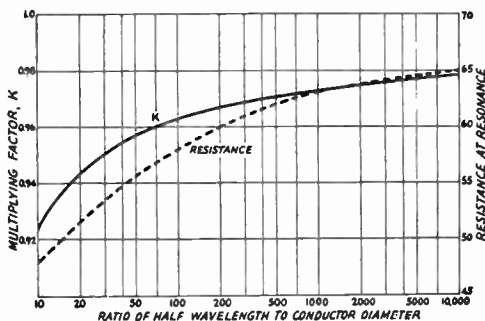

Fig. 14-3—Effect of antenna diameter on length for half-wave resonance, shown as a multiplying factor, *K*, to be applied to the free-space half wavelength (Equation 14-A). The effect of conductor diameter on the center impedance also is shown.

**Current and Voltage Distribution**

When power is fed to an antenna, the current and voltage vary along its length. The current is maximum (**loop**) at the center and nearly zero (**node**) at the ends, while the opposite is true of the r.f. voltage. The current does not actually reach zero at the current nodes, because of the end effect; similarly, the voltage is not

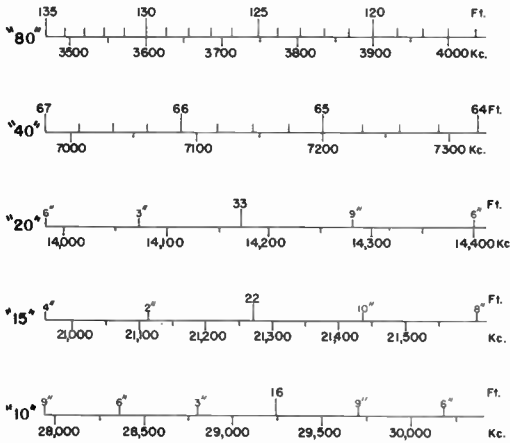

Fig. 14-4—The above scales, based on Eq. 14-B, can be used to determine the length of a half-wave antenna of wire.

zero at its node because of the resistance of the antenna, which consists of both the r.f. resistance of the wire (*ohmic resistance*) and the **radiation resistance**. The radiation resistance is an *equivalent* resistance, a convenient conception to indicate the radiation properties of an antenna. The radiation resistance is the equivalent resistance that would dissipate the power the antenna radiates, with a current flowing in it equal to the antenna current at a current loop (maximum). The ohmic resistance of a half wavelength antenna is ordinarily small enough, compared with the radiation resistance, to be neglected for all practical purposes.

**Impedance**

The radiation resistance of an infinitely-thin half-wave antenna in free space is about 73 ohms. The value under practical conditions is commonly taken to be in the neighborhood of 60 to 70 ohms, although it varies with height in the manner of Fig. 14-2. It increases toward the ends. The actual value at the ends will depend on a number of factors, such as the height, the physical construction, the insulators at the ends, and the position with respect to ground.

**Conductor Size**

The impedance of the antenna also depends upon the diameter of the conductor in relation to the wavelength, as indicated in Fig. 14-3. If the diameter of the conductor is increased the capacitance per unit length increases and the inductance per unit length decreases. Since the radiation resistance is affected relatively little, the decreased *L/C* ratio causes the *Q* of the antenna to decrease, so that the resonance curve becomes less sharp. Hence, the antenna is capable of working over a wide frequency range. This effect is greater as the diameter is increased, and is a property of some importance at the very-high frequencies where the wavelength is small.

**Radiation Characteristics**

The radiation from a dipole antenna is not uniform in all directions but varies with the angle with respect to the axis of the wire. It is most intense in directions perpendicular to the wire and zero along the direction of the wire,

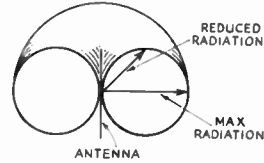
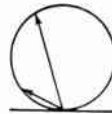

Fig. 14-5—The free-space radiation pattern of a half-wave antenna. The antenna is shown in the vertical position, and the actual "doughnut" pattern is cut in half to show how the line from the center of the antenna to the surface of the pattern varies. In practice this pattern is modified by the height above ground and if the antenna is vertical or horizontal. Fig. 14-1 shows some of the effects of height on the vertical angle of radiation.

with intermediate values at intermediate angles. This is shown by the sketch of Fig. 14-5, which represents the radiation pattern in free space. The relative intensity of radiation is proportional to the length of a line drawn from the center of the figure to the perimeter. If the antenna is vertical, as shown, then the field strength will be uniform in all horizontal directions; if the antenna is hori-

Fig. 14-6—Illustrating the importance of vertical angle of radiation in determining antenna directional effects. Off the end, the radiation is greater at higher angles. Ground reflection is neglected in this drawing of the free-space pattern of a horizontal antenna.



zontal, the relative field strength will depend upon the direction of the receiving point with respect to the direction of the antenna wire. The variation in radiation at various vertical angles from a half wavelength horizontal antenna is indicated in Figs. 14-6 and 14-7.

**FEEDING A DIPOLE ANTENNA**

Since the impedance at the center of a dipole is in the vicinity of 70 ohms, it offers a good match for 75-ohm two-wire transmission lines. Several types are available on the market, with different power-handling capabilities. They can be connected in the center of the antenna, across a small strain insulator to provide a convenient connection point. Coaxial line of 75 ohms impedance can also be used, but it is heavier and thus not as convenient. In either case, the transmission line should be run away at right angles to the antenna for at least one-quarter wavelength, if possible, to avoid current unbalance in the line caused by pick-up from the antenna. The antenna



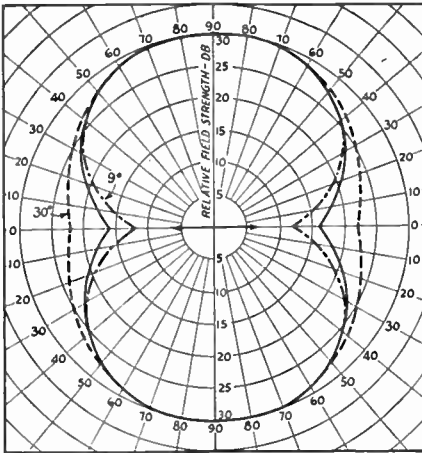

Fig. 14-7—Horizontal pattern of a horizontal half-wave antenna at three vertical radiation angles. The solid line is relative radiation at 15 degrees. Dotted lines show deviation from the 15-degree pattern for angles of 9 and 30 degrees. The patterns are useful for shape only, since the amplitude will depend upon the height of the antenna above ground and the vertical angle considered. The patterns for all three angles have been proportioned to the same scale, but this does not mean that the maximum amplitudes necessarily will be the same. The arrow indicates the direction of the horizontal antenna wire.

length is calculated from Equation 14-B, for a half wavelength antenna. When No. 12 or No. 14 enameled wire is used for the antenna, as is generally the case, the length of the wire is the overall length measured from the loop through the insulator at each end. This is illustrated in Fig. 14-8.

The use of 75-ohm line results in a "flat" line over most of any amateur band. However, by making the half-wave antenna in a special manner, called the **two-wire** or **folded dipole**, a good match is offered for a 300-ohm line. Such an antenna is shown in Fig. 14-9. The open-wire line shown in Fig. 14-9 is made of No. 12 or No. 14 enameled wire, separated by lightweight spacers of Lucite or other material (it doesn't have to be a *low-loss* insulating material), and the spacing can be on the order of from 4 to 8 inches, depending upon what is convenient and what the operating frequency is. At 14 Mc., 4-inch separation is satisfactory, and 8-inch spacing can be used at 3.5 Mc.

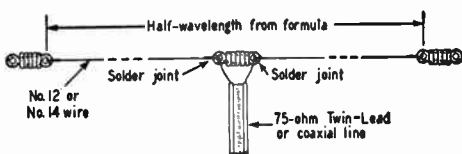

Fig. 14-8—Construction of a dipole fed with 75-ohm line. The length of the antenna is calculated from Equation 14-B or Fig. 14-4.

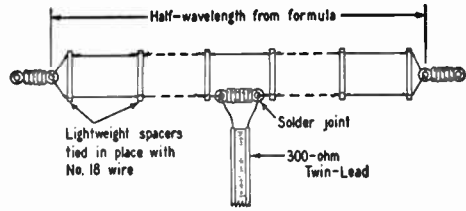

Fig. 14-9—The construction of an open-wire folded dipole fed with 300-ohm line. The length of the antenna is calculated from Equation 14-B or Fig. 14-4.

The half wavelength antenna can also be made from the proper length of 300-ohm line, opened on one side in the center and connected to the feedline. After the wires have been soldered together, the joint can be strengthened by molding some of the excess insulating material (polyethylene) around the joint with a hot iron, or a suitable lightweight clamp of two pieces of Lucite can be devised.

Similar in some respects to the two-wire folded dipole, the three-wire folded dipole of Fig. 14-10 offers a good match for a 600-ohm line. It is favored by amateurs who prefer to use an open-wire line instead of the 300-ohm insulated line.

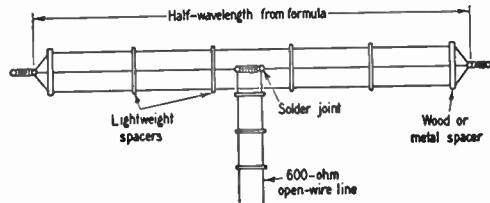

Fig. 14-10—The construction of a 3-wire folded dipole is similar to that of the 2-wire folded dipole. The end spacers may have to be slightly stronger than the others because of the greater compression force on them. The length of the antenna is obtained from Equation 14-B or Fig. 14-4. A suitable line can be made from No. 14 wire spaced 5 inches, or from No. 12 wire spaced 6 inches.

The three wires of the antenna proper should all be of the same diameter.

Another method for offering a match to a 600-ohm open-wire line with a half wavelength antenna is shown in Fig. 14-11. The system is called a **delta match**. The line is "fanned" as it approaches the antenna, to have a gradually increasing impedance that equals the antenna impedance at the point of connection. The dimensions are fairly critical, but careful measurement before installing the antenna and matching section is generally all that is necessary. The length of the antenna, *L*, is calculated from Equation 14-B or Fig. 14-4. The length of section *C* is computed from:

$$C \text{ (feet)} = \frac{118}{\text{Freq. (Mc.)}} \quad (14-E)$$



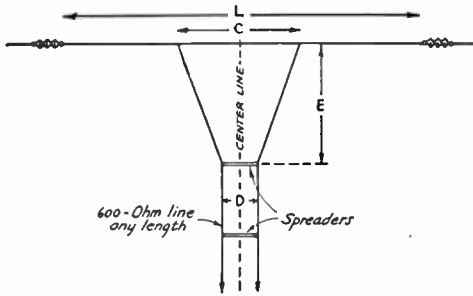

Fig. 14-11—Delta-matched antenna systems. The dimensions *C*, *D*, and *E* are found by formulas given in the text. It is important that the matching section, *E*, come straight away from the antenna.

The feeder clearance, *E*, is found from

$$E \text{ (feet)} = \frac{148}{\text{Freq. (Mc.)}} \quad (14-F)$$

Example: For a frequency of 7.1 Mc., the length

$$L = \frac{468}{7.1} = 65.91 \text{ feet, or } 65 \text{ feet } 11 \text{ inches.}$$

$$C = \frac{118}{7.1} = 16.62 \text{ feet, or } 16 \text{ feet } 7 \text{ inches.}$$

$$E = \frac{148}{7.1} = 20.84 \text{ feet, or } 20 \text{ feet } 10 \text{ inches.}$$

Since the equations hold only for 600-ohm line, it is important that the line be close to this value. This requires 5-inch spaced No. 14 wire, 6-inch spaced No. 12 wire, or 3¾-inch spaced No. 16 wire.

If a half wavelength antenna is fed at the center with other than 75-ohm line, or if a two-wire dipole is fed with other than 300-ohm line, standing waves will appear on the line and coupling to the transmitter may become awkward for some line lengths, as described in Chapter 13. How-

ever, in many cases it is not convenient to feed the half-wave antenna with the correct line (as is the case where multiband operation of the same antenna is desired), and sometimes it is not convenient to feed the antenna at the center. Where multiband operation is desired (to be discussed later) or when the antenna must be fed at one end by a transmission line, an open-wire line of from 450 to 600 ohms impedance is generally used. The impedance at the end of a half wavelength antenna is in the vicinity of several thousand ohms, and hence a standing-wave ratio of 4 or 5 is not unusual when the line is connected to the end of the antenna. It is advisable, therefore, to keep the losses in the line as low as possible. This requires the use of ceramic or Micalex feeder spacers, if any appreciable power is used. For low-power installations in dry climates, dry wood spacers boiled in paraffin are satisfactory. Mechanical details of half wavelength antennas fed with open-wire lines are given in Fig. 14-12. Regardless of the power level, solid-dielectric Twin-Lead is not recommended for this use.

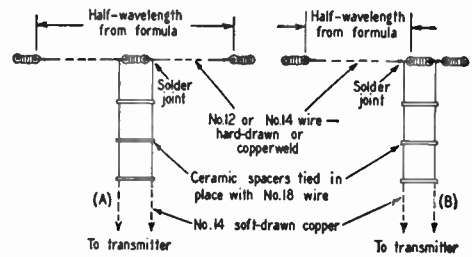

Fig. 14-12—The half-wave antenna can be fed at the center or at the end with an open-wire line. The antenna length is obtained from Equation 14-B or Fig. 14-4.

### THE "INVERTED V" ANTENNA

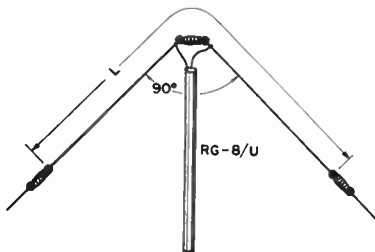

Fig. 14-13—The inverted V antenna is a dipole with the ends lower than the center. It is convenient to use because it requires only one high support, which also supports the weight of the coaxial transmission line. Shown here in its simplest form, with a glass insulator in the center, a deluxe version can be made with a waterproof fitting (Cesco Dri-Fit).

A popular and effective antenna on 40 and 80 meters is the so-called "inverted V" antenna. Actually it is a half-wave dipole with the ends lower than the center; a true "V" antenna is usually several wavelengths long. However, the convenience of installation of the antenna (only one high support is required) makes it a useful low-frequency antenna.

Referring to Fig. 14-13, an inverted V antenna with the wires at 45 degrees to the vertical will require a support about 60 feet high for an 80-meter antenna and about 35 feet for a 40-meter version, if the ends are to be no closer than 10 feet from the ground. As with any antenna, additional height is an advantage.

The length of the wire in an inverted V antenna is slightly longer than that required when the dipole is strung in a straight line, and the overall length can be approximated by

$$\text{Length (feet)} = \frac{490}{\text{Freq. (Mc.)}}$$

Example: For a frequency of 3.9 Mc., the length equals  $490 \div 3.9 = 125.5 = 125$  feet 6 inches.

The impedance of the inverted V antenna is lower than that of a linear dipole, and 50-ohm coaxial cable is recommended for the transmission line. Since the exact angle of the wires, the presence of nearby objects and the height

above ground will all affect the impedance and the frequency of resonance, it is desirable to cut the antenna a little long at first and check for resonance by finding the frequency of minimum s.w.r. If the minimum s.w.r. occurs at a frequency well below the desired operating frequency, trim small equal amounts off of each end of the inverted V and repeat the test.

## LONG-WIRE ANTENNAS

An antenna will be resonant so long as an integral number of standing waves of current and voltage can exist along its length; in other words, so long as its length is some integral multiple of a half wavelength. When the antenna is more than a half-wave long it usually is called a long-wire antenna, or a harmonic antenna.

### Current and Voltage Distribution

Fig. 14-14 shows the current and voltage distribution along a wire operating at its fundamental frequency (where its length is equal to a

standing wave is opposite to that in the adjacent standing waves. This is shown in the figure by drawing the current and voltage curves successively above and below the antenna (taken as a zero reference line), to indicate that the polarity reverses when the current or voltage goes through zero. Currents flowing in the same direction are *in phase*; in opposite directions, *out of phase*.

It is evident that one antenna may be used for harmonically-related frequencies, such as the various amateur bands. The long-wire or harmonic antenna is the basis of multiband operation with one antenna.

### Physical Lengths

The length of a long-wire antenna is not an exact multiple of that of a half-wave antenna because the end effects operate only on the end sections of the antenna; in other parts of the wire these effects are absent, and the wire length is approximately that of an equivalent portion of the wave in space. The formula for the length of a long-wire antenna, therefore, is

$$\text{Length (feet)} = \frac{492 (N - 0.05)}{\text{Freq. (Mc.)}} \quad (14-G)$$

where *N* is the number of *half-waves* on the antenna.

Example: An antenna 4 half-waves long at 14.2 Mc. would be  $\frac{492 (4 - 0.05)}{14.2} = \frac{492 \times 3.95}{14.2} = 136.7$  feet, or 136 feet 8 inches.

It is apparent that an antenna cut as a half-wave for a given frequency will be slightly off resonance at exactly twice that frequency (the second harmonic), because of the decreased influence of the end effects when the antenna is more than one-half wavelength long. The effect is not very important, except for a possible unbalance in the feeder system and consequent radiation from the feedline. If the antenna is fed in the exact center, no unbalance will occur at any frequency, but end-fed systems will show an unbalance on all but one frequency in each harmonic range.

### Impedance and Power Gain

The radiation resistance as measured at a current loop becomes higher as the antenna length is increased. Also, a long-wire antenna radiates more power in its most favorable direction than does a half-wave antenna in its most favorable

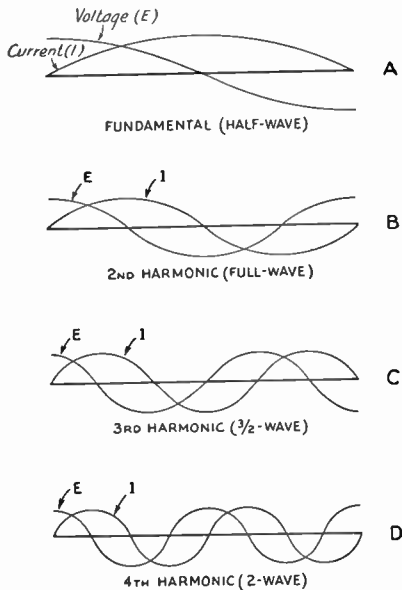

Fig. 14-14—Standing-wave current and voltage distribution along an antenna when it is operated at various harmonics of its fundamental resonant frequency.

half wavelength) and at its second, third and fourth harmonics. For example, if the fundamental frequency of the antenna is 7 Mc., the current and voltage distribution will be as shown at A. The same antenna excited at 14 Mc. would have current and voltage distribution as shown at B. At 21 Mc., the third harmonic of 7 Mc., the current and voltage distribution would be as in C; and at 28 Mc., the fourth harmonic, as in D. The number of the harmonic is the number of half waves contained in the antenna at the particular operating frequency.

The polarity of current or voltage in each

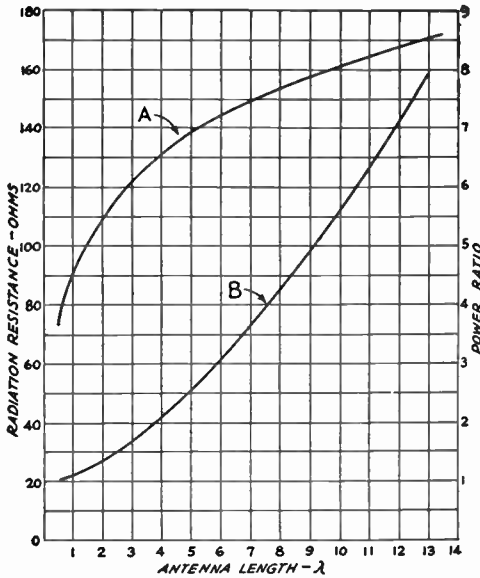

Fig. 14-15—Curve A shows variation in radiation resistance with antenna length. Curve B shows power in lobes of maximum radiation for long-wire antennas as a ratio to the maximum radiation for a half-wave antenna.

direction. This power gain is secured at the expense of radiation in other directions. Fig. 14-15 shows how the radiation resistance and the power in the lobe of maximum radiation vary with the antenna length.

**Directional Characteristics**

As the wire is made longer in terms of the number of half wavelengths, the directional ef-

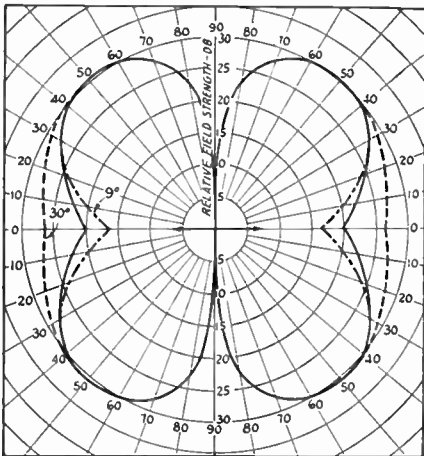

Fig. 14-16—Horizontal patterns of radiation from a full-wave antenna. The solid line shows the pattern for a vertical angle of 15 degrees; dotted lines show deviation from the 15-degree pattern at 9 and 30 degrees. All three patterns are drawn to the same relative scale; actual amplitudes will depend upon the height of the antenna.

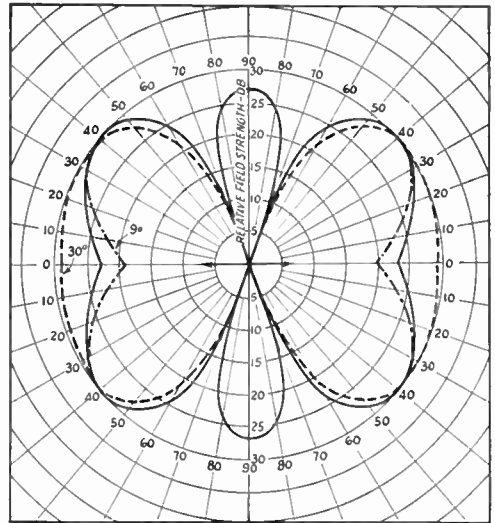

Fig. 14-17—Horizontal patterns of radiation from an antenna three half-waves long. The solid line shows the pattern for a vertical angle of 15 degrees; dotted lines show deviation from the 15-degree pattern at 9 and 30 degrees. Minor lobes coincide for all three angles.

fects change. Instead of the "doughnut" pattern of the half-wave antenna, the directional characteristic splits up into "lobes" which make various angles with the wire. In general, as the length of the wire is increased the direction in which maximum radiation occurs tends to approach the line of the antenna itself.

Directional characteristics for antennas one wavelength, three half-wavelengths, and two wavelengths long are given in Figs. 14-16,

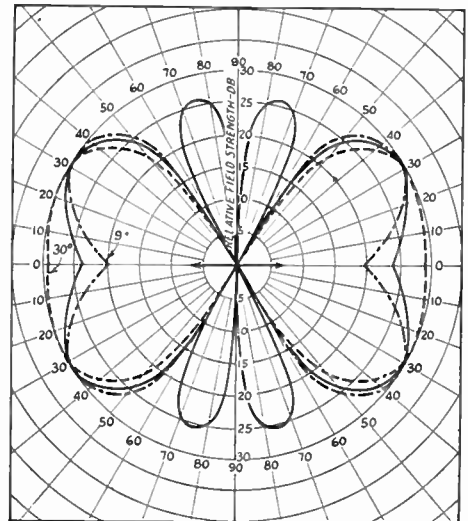

Fig. 14-18—Horizontal patterns of radiation from an antenna two wavelengths long. The solid line shows the pattern for a vertical angle of 15 degrees; dotted lines show deviation from the 15-degree pattern at 9 and 30 degrees. The minor lobes coincide for all three angles.

14-17 and 14-18, for three vertical angles of radiation. Note that, as the wire length increases, the radiation along the line of the antenna becomes more pronounced. Still longer antennas can be considered to have practically "end-on" directional characteristics, even at the lower radiation angles.

**Methods of Feeding**

In a long-wire antenna, the currents in adja-

cent half-wave sections must be out of phase, as shown in Fig. 14-14. The feeder system must not upset this phase relationship. This is satisfied by feeding the antenna at either end or at any current loop. A two-wire feeder cannot be inserted at a current node, however, because this invariably brings the currents in two adjacent half-wave sections in phase. A long wire antenna is usually made a half wavelength at the lowest frequency and fed at the end.

**MULTIBAND ANTENNAS**

As suggested in the preceding section, the same antenna may be used for several bands by operating it on harmonics. When this is done it is necessary to use tuned feeders, since the impedance matching for nonresonant feeder operation can be accomplished only at one frequency unless means are provided for changing the length of a matching section and shifting the point at which the feeder is attached to it.

A dipole antenna that is center-fed by a solid-dielectric line is useless for even harmonic operation; on all even harmonics there is a voltage maximum occurring right at the feed point, and the resultant impedance mismatch causes a large standing-wave ratio and consequently high losses arise in the solid dielectric. It is wise not to attempt to use on its even harmonics a half-wave antenna center-fed with coaxial cable. On odd harmonics, as between 7 and 21 Mc., a current loop will appear in the center of the antenna and a fair match can be obtained. High-impedance solid-dielectric lines such as 300-ohm Twin-Lead may be used in an emergency, provided the power does not exceed a few hundred watts, but it is an inefficient feed method.

When the same antenna is used for work in several bands, the directional characteristics will vary with the band in use.

**Simple Systems**

The most practical simple multiband antenna is one that is a half wavelength long at the lowest frequency and is fed either at the center or one end with an open-wire line. Although the standing wave ratio on the feedline will not approach 1.0 on any band, if the losses in the line are low the system will be efficient. From the standpoint of reduced feedline radiation, a center-fed system is superior to one that is end-fed, but the end-fed arrangement is often more convenient and should not be ignored as a possibility. The center-fed antenna will not have the same radiation pattern as an end-fed one of the same length, except on frequencies where the length of the antenna is a half wavelength. The end-fed antenna acts like a long-wire antenna on all bands (for which it is longer than a half wavelength), but the center-fed one acts like two antennas of half that length fed in phase. For example, if a full-wavelength antenna is fed at one end, it will have a radiation pattern as shown in Fig. 14-16, but if it is fed in the center the pat-

tern will be somewhat similar to Fig. 14-7, with the maximum radiation broadside to the wire. Either antenna is a good radiator, but if the radiation pattern is a factor, the point of feed must be considered.

Since multiband operation of an antenna does not permit matching of the feedline, some attention should be paid to the length of the feedline if convenient transmitter-coupling arrangements are to be obtained. Table 14-I gives some suggested antenna and feeder length for multiband operation. In general, the length of the feedline can be other than that indicated, but the type of coupling circuit may change.

Open-wire line feed is recommended for an antenna of this type, since the losses will run too high in solid-dielectric line. For low-power applications up to a few hundred watts, open-wire TV line is convenient and satisfactory to use. However, for high-power installations up to the kilowatt limit, an open-wire line with No. 14 or No.

**TABLE 14-I**  
**Multiband Tuned-Line-Fed Antennas**

<i>Antenna Length (Ft.)</i>	<i>Feeder Length (Ft.)</i>	<i>Band.</i>	<i>Type of Coupling Circuit</i>
<i>With end feed:</i>			
135	45	3.5 - 21 28	Series Parallel
67	45	7 - 21 28	Series Parallel
<i>With center feed:</i>			
135	42	3.5 - 21 28	Parallel Series
135	77½	3.5 - 28	Parallel
67	42½	3.5 7 - 28	Series Parallel
67	65½	3.5, 14, 28 7, 21	Parallel Series

Antenna lengths for end-fed antennas are approximate and should be cut to formula length at favorite operating frequency.

Where parallel tuning is specified, it will be necessary in some cases to tap in from the ends of the coil for proper loading — see Chapter 13 for examples of antenna couplers.



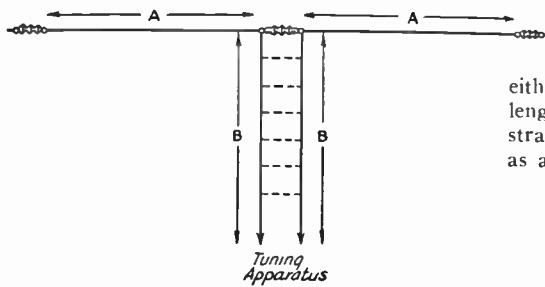

Fig. 14-19—Practical arrangement of a shortened antenna. When the total length,  $A + B + B + A$ , is the same as the antenna length plus twice the feeder length of the center-fed antennas of Table 14-1, the same type of coupling circuit will be used. When the feeder length or antenna length, or both, makes the sum different, the type of coupling circuit may be different but the effectiveness of the antenna is not changed, unless  $A + A$  is less than a quarter wavelength.

12 conductors should be used. This can be built from soft-drawn wire and ceramic or other suitable spacers, or it can be bought ready-made.

#### Antennas for Restricted Space

If the space available for the antenna is not large enough to accommodate the length necessary for a half wave at the lowest frequency to be used, quite satisfactory operation can be secured by using a short antenna and making up the missing length in the feeder system. The antenna itself may be as short as a quarter wavelength and will radiate fairly well, although of course it will not be as effective as one a half wave long. Nevertheless such a system is useful where operation on the desired band otherwise would be impossible.

Tuned feeders are a practical necessity with such an antenna system, and a center-fed antenna will give best all-around performance. With end feed the feeder currents become badly unbalanced.

With center feed, practically any convenient length of antenna can be used. If the total length of antenna plus twice feedline is the same as in Table 14-1, the type of tuning will be the same as stated. This is illustrated in Fig. 14-19. If the total length is not the same, different tuning conditions can be expected on some bands. This should not be interpreted as a fault in the antenna, and any tuning system (series or parallel) that works well without any trace of heating is quite satisfactory. Heating may result when the taps with parallel tuning are made too close to the center of the coil—it can often be corrected by using less total inductance and more capacitance.

#### Bent Antennas

Since the field strength at a distance is proportional to the current in the antenna, the high-current part of a dipole antenna (the center quarter wave, approximately) does most of the radiating. Advantage can be taken of this

fact when the space available does not permit building an antenna a half-wave long. In this case the ends may be bent, either horizontally or vertically, so that the total length equals a half wave, even though the straightway horizontal length may be as short as a quarter wave. The operation is illustrated

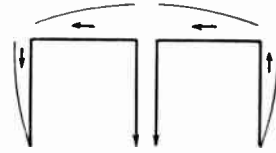

Fig. 14-20—Folded arrangement for shortened antennas. The total length is a half-wave, not including the feeders. The horizontal part is made as long as convenient and the ends dropped down to make up the required length. The ends may be bent back on themselves like feeders to cancel radiation partially. The horizontal section should be at least a quarter wave long.

in Fig. 14-20. Such an antenna will be a somewhat better radiator than a quarter wavelength antenna on the lowest frequency, but is not so desirable for multiband operation because the ends play an increasingly important part as the frequency is raised. The performance of the system in such a case is difficult to predict, especially if the ends are vertical (the most convenient arrangement) because of the complex combination of horizontal and vertical polarization which results as well as the dissimilar directional characteristics. However, the fact that the radiation pattern is incapable of prediction does not detract from the general usefulness of the antenna. For one-band operation with a "flat" line, end-loading with coils (5 feet or so in from each end) is practical and efficient.

#### "Windom" or Off-Center-Fed Antenna

A multiband antenna that enjoyed considerable popularity in the 1930s is the "off-center feed" of "Windom," named after the amateur who wrote a comprehensive article about it. Shown in Fig. 14-21A, it consists of a half wavelength antenna on the lowest-frequency band to be used, with a *single-wire* feeder connected 14% off center. The antenna will operate satisfactorily on the even-harmonic frequencies, and thus a single antenna can be made to serve on the 80-, 40-, 20-, and 10-meter bands. The single-wire feeder shows an impedance of approximately 600 ohms to ground, and consequently the antenna coupling system must be capable of matching this value to the transmitter. A tapped parallel-tuned circuit or a properly-proportioned pi-network coupler is generally used. Where TVI is a problem, the antenna coupler is required, so that a low-pass filter can be used in the connecting link of coaxial line.

Although theoretically the feed line can be of any length, some lengths will tend to give trouble with "too much r.f. in the shack," with the consequence that r.f. sparks can be drawn from



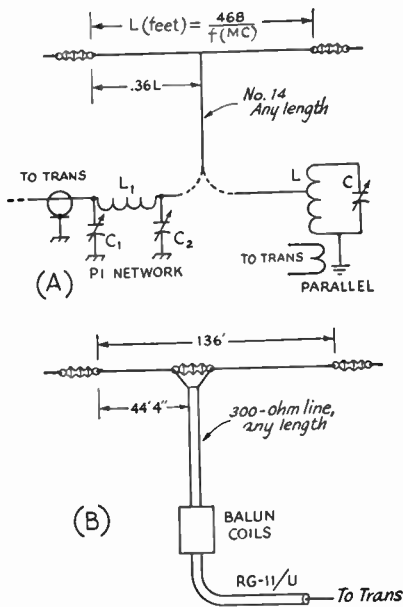

Fig. 14-21—Two versions of the off-center-fed antenna.

(A) Single-wire feed shows approximately 600 ohms impedance to ground and is most conveniently coupled to the transmitter as shown. The pi-network coupling will require more capacity at  $C_1$  than at  $C_2$ .  $L_1$  is best found by experiment—an inductance of about the same size as that used in the output stage is a good starting point. The parallel-tuned circuit will be a tuned circuit that resonates at the operating frequency with  $L$  and  $C$  close to those used in the output stage. The tap is found by experiment, and it should be as near the top of  $L$  as it can and still give good loading of the transmitter.

(B) Two-wire off-center feed uses 300-ohm TV line. Although the 300-ohm line can be coupled directly to some transmitters, it is common practice to step down the impedance level to 75 ohms through a pair of "balun" coils.

the transmitter's metal cabinet and/or v.f.o. notes will develop serious modulation. If such is found to be the case, the feeder length should be changed.

A newer version of the off-center-fed antenna uses 300-ohm TV Twin-Lead to feed the antenna, as shown in Fig. 14-21B. It is claimed that the antenna offers a good match for the 300-ohm line on four bands and, although this is more wishful thinking than actual truth, the system is widely used and does work satisfactorily. It is subject to the same feed line length and "r.f.-in-the-shack" troubles that the single-wire version enjoys. However, in this case a pair of "balun" coils can be used to step down the impedance level to 75 ohms and at the same time alleviate some of the feedline troubles. This antenna system is popular among amateurs using multiband transmitters with pi-network-tuned output stages.

With either of the off-center-fed antenna systems, the feedline should run away from the an-

tenna at right angles for as great a distance as possible before bending. No sharp bends should be allowed anywhere in the line.

**Multiband Operation with Coaxial Line Feed**

The proper use of coaxial line requires that the standing-wave ratio be held to a low value, preferably below 2:1. Since the impedance of an ordinary antenna changes widely from band to band, it is not possible to feed a simple antenna with coaxial line and use it on a number of bands without tricks of some kind. The single exception to this is the use of 75-ohm coaxial line to feed a 7-Mc. half-wave antenna, as in Fig. 14-19; this antenna can also be used on 21 Mc. and the s.w.r. in the line will not run too high.

One multiband antenna system that can be used by anyone without much trouble is shown in Fig. 14-22. Here separate dipoles are connected to one feedline. The 7-Mc. dipole also serves on 21 Mc. A low s.w.r. will appear on the feedline in each band if the dipoles are of the proper length. The antenna system can be built by suspending one set of elements from the one above, using insulator-terminated wood spreaders about one foot long. An alternative is to let one antenna droop several feet under the other, bring ropes attached to the insulators back to a common support point. It has been found that a separation of only an inch or two between dipoles is satisfactory. By using a length of the Twin-Lead used for folded dipoles (one Copperweld conductor and one soft-drawn), the strong wire can be used for the low-frequency dipole. The soft-drawn wire is then used on a higher band, supported by the solid dielectric.

A vertical antenna can be operated on several bands and fed with a single length of coaxial line provided the antenna is no longer than 0.6 wavelength at the highest frequency and that a suitable matching network for each band is used at the base. A good radial or ground system is required. The matching sections can be housed in a

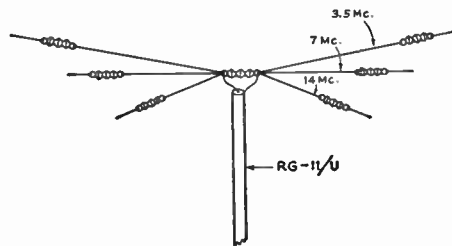

Fig. 14-22—An effective "all-band" antenna fed with a single length of coaxial line can be constructed by joining several half wavelength antennas at their centers and feeding them at the common point. In the example above, a low s.w.r. will be obtained on 80, 40, 20 and 15 meters. (The 7-Mc. antenna also works at 21 Mc.) If a 28-Mc. antenna were added, 10-meter operation could also be included. The antenna lengths can be computed from formula 14-B. The shorter antennas can be suspended a foot or two below the longest one or fanned out in the same horizontal plane.

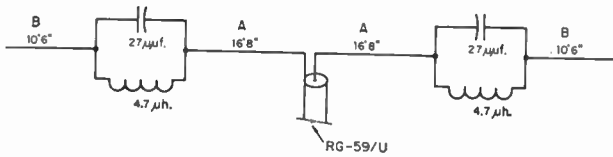

Fig. 14-23—Sketch showing dimensions of a trap dipole covering the 40-, 20- and 10-meter bands. The total span is less than 60 feet.

weatherproof box and changed manually or by stepping relays; their form will vary from parallel-tuned circuits to L sections. (See McCoy, *QST*, December, 1955, for description of L-section coupler.)

### Multiband "Trap" Antennas

Another approach to the problem of multiband operation with a single untuned feedline is the use of parallel-tuned circuits installed in the antenna at the right points to "divorce" the remainder of the antenna from the center section (part fed by coaxial line) as the transmitter is changed to a higher-frequency band. This principle of the divorcing circuits is utilized in a commercial "all-band" vertical antenna, and a 5-band kit for horizontal antennas is also available commercially. The divorcing circuits are also used in several commercial multiband beams for the 14-, 21- and 28-Mc. bands.

The multiband antenna system shown in Fig. 14-23 may be of interest to the ham who wishes to work on several bands but doesn't have sufficient space for an 80-meter antenna and consequently is limited to 40 meters and below. (A five-band antenna requires more than a 100-foot span; see Greenberg, *QST*, October, 1956.)

On 40 meters the traps serve as inductors to load the system to 7 Mc. On 20, the traps (resonant to 14.1 Mc.) divorce the B sections from the antenna proper. On 28 Mc. the entire antenna becomes approximately a  $5/2$ -wavelength radiator.

As shown in Fig. 14-24, each trap is literally built around an "egg" or "strain" insulator. In this type of insulator, the hole at one end is at right angles to the hole at the other end, and the wires are fastened as in Fig. 14-25. These insulators have greater compressive strength than tensile strength and will not permit the antenna to fall should the insulator break, since the two interlooped wires prevent it. There is ample space within the inductor for both the insulator and capacitor. The plastic covers are not essential but are considered desirable because they provide mechanical pro-

tection and prevent the accumulation of ice or soot and tars which may not wash off the traps when it rains.

Electrically, each trap consists of a 25- $\mu$ f. capacitor shunted by 4.7  $\mu$ h. of inductance. A Centralab ceramic transmitting capacitor 857-25Z, rated at 15,000 volts d.c., is shown and will safely handle a kilowatt. Other ceramic capacitors rated at approximately 6000 volts would be satisfactory, as well as cheaper. The inductors are made of No. 12 wire,  $2\frac{1}{2}$  inches in diameter, 6 turns per inch (B & W 3905-1 coil stock).

One may wish to choose a different frequency in the 20-meter band for which optimum results are desired; for example, 14.05 Mc. for c.w. operation, 14.25 Mc. for phone operation, or perhaps 14.175 Mc. for general coverage. In any case, the number of inductor turns is adjusted accordingly.

### Trap Adjustment

As a preliminary step, loops of No. 12 wire are fitted to one of the egg insulators in the normal manner (see Fig. 14-25), except that after the wraps are made, the end leads are snipped off close to the wraps. A capacitor is then placed in position and bridged with short leads across the insulator and soldered sufficiently to provide temporary support. The combination is then slipped inside about 10 turns of the inductor, one end of which should be soldered to an insulator-capacitor lead.

Adjustment to the resonant frequency can now proceed, using a grid-dip meter.

Coupling between the g.d.o. and the trap should be very loose. To insure accuracy, the station receiver should be used to check the g.d.o. frequency. The inductance should be reduced  $1/4$  turn at a time. If one is careful, the resonant fre-

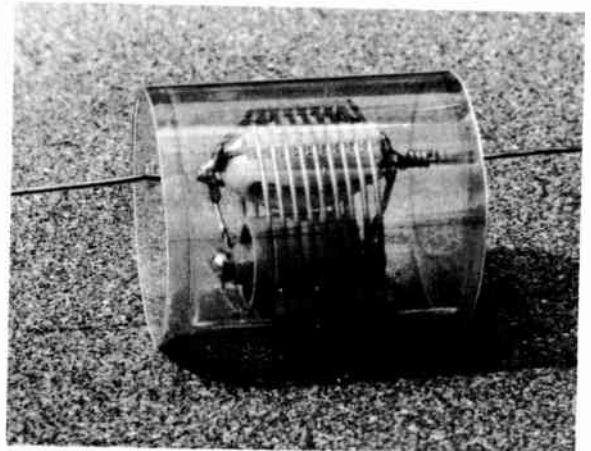
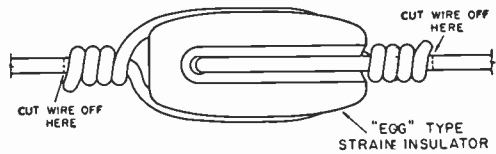

Fig. 14-24—The 14-Mc. trap is enclosed in a weatherproof cover made of plastic sheet. The ceramic capacitor and strain insulator are inside the coil.

Fig. 14-25—Method of connecting the antenna wire to the strain insulator. The antenna wire is cut off close to the wrap before checking the resonant frequency of the trap.



quency can easily be set to within a few kilocycles of the chosen figure.

The reason for snipping the end leads close to the wraps and the inclusion of the loops through the egg insulator soon becomes apparent. The resonant frequency of the capacitor and inductor alone is reduced about 20 kc. per inch of end lead length and about 350 kc. by the insulator loops. The latter add approximately 2  $\mu\text{f.}$  to the fixed capacitor value and account for the total of 27  $\mu\text{f.}$  shown in Fig. 14-23.

**Assembly**

Having determined the exact number of inductor turns, the trap is taken apart and reassembled with leads of any convenient length. One may, of course, connect the entire lengths of sections A and B to the trap at this time, if desired. But, if more convenient, a foot or two of wire can be fastened and the remaining lengths soldered on just before the antenna is raised.

The protective covers are most readily formed by wrapping two turns (plus an overlap of 1/2 inch) of 0.020-inch polystyrene or lucite sheeting around a 3-inch plastic disk held at the center of the cylinder so formed. The length of the cover should be about 4 inches. A very small amount of plastic solvent (a cohesive cement that actually softens the plastic surfaces) should then be applied under the edge of the overlap and the joint held firmly for about two minutes to insure a strong, tight seal. The disk is pushed out and the inner seam of the sheeting sealed.

The trap is then placed in the plastic cylinder and the end disks marked where the antenna

wires are to pass through. After drilling these holes, the disks are slipped over the leads, pressed into the ends of the cylinder and a small amount of solvent applied to the periphery to obtain a good seal. Some air can flow in and out of the trap through the antenna-wire holes, and this will prevent the accumulation of condensation.

**Length Adjustment**

Standing-wave ratios are not uniform throughout the band or bands for which an antenna is designed. In a trap antenna, the choice of frequencies for best performance is a compromise. After making the traps resonant at 14.1 Mc., sections A are adjusted for resonance. Sections B are then adjusted for resonance at approximately 7.2 Mc. For the dimensions shown, with the antenna about 250 ft. above street level and 35 ft. above electrical ground, an s.w.r. of virtually 1 to 1 was obtained at 7.2 Mc., with maximums of 1.3 and 1.1 at 7.0 and 7.3 Mc., respectively. In the 20-meter band, the s.w.r. was also 1 to 1 at 14.1 Mc., 1.1 at 14.0 Mc. and 1.3 at 14.3 Mc. In the 10-meter band, the s.w.r. was 1.3 to 1 at 28.0 Mc., 1.1 at 28.4 Mc., 1.5 at 29 Mc., and only 2.4 at the upper extreme of the band. The s.w.r. on 21 Mc. will be high because the antenna is not resonant in that band.

RG-59/U cable forms the transmission line and is connected to the antenna through a Continental Electronic & Sound Co. "Dipole Dri-Fit Connector." After connecting the cable and antenna wires, the connector should be coated with several layers of insulating varnish to make certain that the junction is watertight.

**VERTICAL ANTENNAS**

A vertical quarter-wavelength antenna is often used in the low-frequency amateur bands to obtain low-angle radiation. It is also used when there isn't enough room for the supports for a horizontal antenna. For maximum effectiveness is should be located free of nearby objects and it should be operated in conjunction with a good ground system, but it is still worth trying where these ideal conditions cannot be obtained.

Four typical examples and suggested methods for feeding a vertical antenna are shown in Fig. 14-26. The antenna may be wire or tubing supported by wood or insulated guy wires. When tubing is used for the antenna, or when guy wires (broken up by insulators) are used to reinforce the structure, the length given by the formula is likely to be long by a few per cent. A check of the standing-wave ratio on the line will indicate the frequency at which the s.w.r. is minimum,

and the antenna length can be adjusted accordingly.

A good ground connection is necessary for the most effective operation of a vertical antenna (other than the ground-plane type). In some cases a short connection to the cold-water system of the house will be adequate. But maximum performance usually demands a separate ground system. A single 4- to 6-foot ground rod driven into the earth at the base of the antenna is usually not sufficient, unless the soil has exceptional conductivity. A minimum ground system that can be depended upon is 6 to 12 quarter wavelength radials laid out as the spokes of a wheel from the base of the antenna. These radials can be made of heavy aluminum wire, of the type used for grounding TV antennas, buried at least 6 inches in the ground. This is normally done by slitting the earth with a spade and pushing the

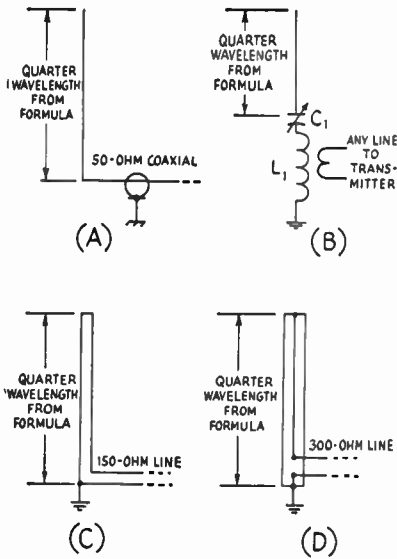

Fig. 14-26—A quarter-wavelength antenna can be fed directly with 50-ohm coaxial line (A) with a low standing-wave ratio, or a coupling network can be used (B) that will permit a line of any impedance to be used. In (B),  $L_1$  and  $C_2$  should resonate to the operating frequency, and  $L_1$  should be larger than is normally used in a plate tank circuit at the same frequency. By using multiwire antennas, the quarter-wave vertical can be fed with (C) 150- or (D) 300-ohm line.

wire into the slot, after which the earth can be tamped down.

The examples shown in Fig. 14-26 all require an antenna insulated from the ground, to provide for the feed point. A grounded tower or pipe can be used as a radiator by employing "shunt feed," which consists of tapping the inner conductor of the coaxial-line feed up on the tower until the best match is obtained, in much the same manner as the "gamma match" (described later) is used on a horizontal element. If the antenna is not an electrical quarter wavelength long, it is necessary to tune out the reactance by adding capacity or inductance between the coaxial line and the shunting conductor. A metal tower supporting a TV antenna or rotary beam can be shunt-fed only if all of the wires and leads from the supported antenna run down the center of the tower and underground away from the tower.

## THE GROUND-PLANE ANTENNA

A ground-plane antenna is a vertical quarter-wavelength antenna using an artificial metallic ground, usually consisting of four rods or wires perpendicular to the antenna and extending radially from its base. Unlike the quarter-wavelength vertical antennas without an artificial ground, the ground-plane antenna will give low-angle radiation regardless of the height above actual ground. However, to be a true ground-plane antenna, the plane of the radials should be at least

a quarter wavelength above ground. Despite this on limitation, the antenna is useful for DX work in any band below 30 Mc.

The vertical portion of the ground-plane antenna can be made of self-supported aluminum tubing, or a top-supported wire depending upon the necessary length and the available supports. The radials are also made of tubing or heavy wire depending upon the available supports and necessary lengths. They need not be exactly symmetrical about the base of the vertical portion.

The radiation resistance of a ground-plane antenna varies with the diameter of the vertical element. The radiation resistance is usually in the vicinity of 30 ohms, and the antenna can be fed with 75-ohm coaxial line with a quarter-wavelength section of 50-ohm line between line and antenna. For multiband operation, a ground-plane antenna can be fed with tuned open-wire

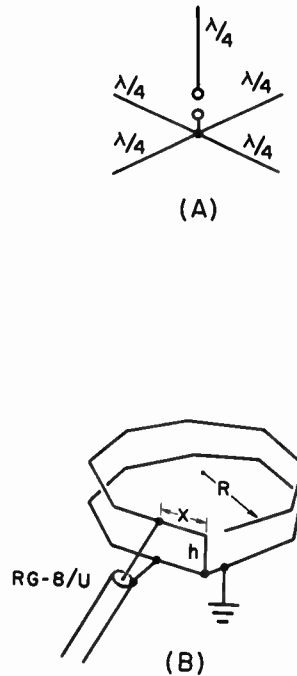

Fig. 14-27—(A) Basic ground-plane antenna. The practical antenna usually is fed by coaxial line; the vertical section is tubing or wire, and the radials are also tubing or wire. Radials may slope down (and be actual guy wires for support).

(B) The unusual DDRR vertically-polarized antenna. Length around top (open) wire or bottom (closed) wire, in feet, =  $252/f$  (Mc.) (E.g., 64.7 feet for 3.9 Mc.). Height  $h = 8.5/f$  (Mc.) (E.g., 2.2 feet at 3.9 Mc.) The feedpoint distance,  $x$ , is given approximately by  $x = 28/f$  (Mc.) (E.g., 7.2 feet at 3.9 Mc.)



line, or the vertical section can be quarter-wavelength pieces for each band. The radials should be a quarter wavelength at the lowest frequency.

### The DDRR Antenna

A new (and controversial) vertically-polarized antenna is the DDRR (directional-discontinuity ring radiator) shown in Fig. 14-27B. (See *Elec-*

*tronics*, January, 1963). If an excellent ground is available, the bottom wire would not be required, otherwise it should be laid on the ground or the roof or whatever flat plane the DDRR is placed over. The antenna shown is the version tried by WØMOX, which is simpler to construct than the original circular configuration. This is an antenna that merits further investigation by experimentally-inclined amateurs.

## ANTENNAS FOR 160 METERS

Results on 1.8 Mc. will depend to a large extent on the antenna system and the time of day or night. Almost any random long wire that can be tuned to resonance will work during the night but it will generally be found very ineffective during the day. A vertical antenna—or rather an antenna from which the radiation is predominantly vertically polarized—is probably the best for 1.8-Mc. operation. A horizontal antenna (horizontally-polarized radiation) will give better results during the night than the day. The vertically-polarized radiator gives a strong ground wave that is effective day or night, and it is to be preferred on 1.8 Mc.

The low-angle radiation from a horizontal antenna  $\frac{1}{8}$  or  $\frac{1}{4}$  wavelength above ground is almost insignificant. Any reasonable height is small in terms of wavelength, so that a horizontal antenna on 160 meters is a poor radiator at angles useful for long distances ("long," that is, for this band). Its chief usefulness is over relatively short distances at night.

### Bent Antennas

Since ideal vertical antennas are generally out of the question for practical amateur work, the best compromise is to bend the antenna in such a way that the high-current portions of the antenna run vertically. It is advisable to place the antenna so that the highest currents in the antenna occur at the highest points above actual ground. Two antenna systems designed along these lines are shown in Fig. 14-28. The antenna of Fig. 14-28B uses a full half wavelength of wire but is bent so that the high-current portion runs vertically. The horizontal portion running to  $L_1C_1$  should run 8 or 10 feet above ground.

### Grounds

A good ground connection is generally important on 160 meters. The ideal system is a number of wire radials buried a foot or two underground and extending 50 to 100 feet from the central connection point. The use of any less than six or eight radials is inadvisable.

If the soil is good (not rocky or sandy) and generally moist, a low-resistance connection to the cold-water pipe system in the house will often serve as an adequate ground system. The connection should be made close to where the pipe enters the ground, and the surface of the pipe should be scraped shiny before tightening the

clean ground clamp around the cold-water pipe.

A 6- or 8-foot length of 1-inch water pipe, driven into the soil at a point where there is considerable natural moisture, can be used for the ground connection. Three or four pipes driven into the ground 8 or 10 feet apart and all joined

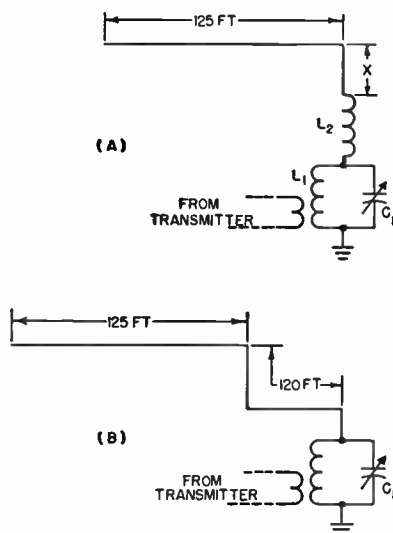

Fig. 14-28—Bent antenna for the 160-meter band. In the system at A, the vertical portion (length X) should be made as long as possible. In either antenna system,  $L_1C_1$  should resonate at 1900 kc., roughly. To adjust  $L_2$  in antenna A, resonate  $L_1C_1$  alone to the operating frequency, then connect it to the antenna system and adjust  $L_2$  for maximum loading. Further loading can be obtained by increasing the coupling between  $L_1$  and the link.

together at the top with heavy wire are more effective than the single pipe.

The use of a counterpoise is recommended where a buried system is not practicable or where a pipe ground cannot be made to have low resistance because of poor soil conditions. A counterpoise consists of a number of wires supported from 6 to 10 feet above the surface of the ground. Generally the wires are spaced 10 to 15 feet apart and located to form a square or polygonal configuration under the vertical portion of the antenna.



## LONG-WIRE DIRECTIVE ARRAYS

As the length (in wavelengths) of an antenna is increased, the lobes of maximum radiation make a more acute angle with the wire. Two long wires can be combined in the form of a horizontal "V", in the form of a horizontal rhombus, or in parallel, to provide a long-wire directive array. In the "V" and rhombic antennas the main lobes reinforce along a line bisecting the acute angle between the wires; in the parallel antenna the reinforcement is along the line of the lobe. This reinforcement provides both gain and directivity along the line, since the lobes in other directions tend to cancel. When the proper configuration for a given length and height above ground is used, the power gain depends upon the length (in wavelengths) of the wires.

Rhombic and "V" antennas are normally bi-

directional along the bisector line mentioned above. They can be made unidirectional by terminating the ends of the wires away from the feed point in the proper value of resistance. When properly terminated, "V" and rhombic antennas of sufficient length work well over a three-to-one or four-to-one frequency range and hence are useful for multiband operation.

Antenna gains of the order of 10 to 15 db. can be obtained with properly-constructed long-wire arrays. However, the pattern is rather sharp with gains of this order, and rhombic and "V" beams are not used by amateurs as commonly as they were, having been displaced by the rotatable multi-element Yagi beam. Further information on these antennas can be found in *The ARRL Antenna Book*.

## BEAMS WITH DRIVEN ELEMENTS

By combining individual half-wave antennas into an array with suitable spacing between the antennas (called **elements**) and feeding power to them simultaneously, it is possible to make the radiation from the elements add up along a single direction and form a beam. In other directions the radiation tends to cancel, so a power gain is obtained in one direction at the expense of radiation in other directions. There are several methods of arranging the elements. If they are strung end to end, so that all lie on the same straight line, the elements are said to be **collinear**. If they are parallel and all lying in the same plane, the elements are said to be **broadside** when the phase of the current is the same in all, and **end-fire** when the currents are not in phase.

### Collinear Arrays

Simple forms of collinear arrays, with the current distribution, are shown in Fig. 14-29. The

shown will result in an "X"-shaped pattern that no longer has the maximum radiation at right angles to the wire.

Collinear arrays may be mounted either horizontally or vertically. Horizontal mounting gives increased horizontal directivity, while the vertical directivity remains the same as for a single element at the same height. Vertical mounting gives the same horizontal pattern as a single element.

### Broadside Arrays

Parallel antenna elements with currents in phase may be combined as shown in Fig. 14-30 to form a **broadside** array, so named because the direction of maximum radiation is broadside to the plane containing the antennas. Again the gain and directivity depend upon the spacing of the elements.

Broadside arrays may be suspended either with the elements all vertical or with them horizontal

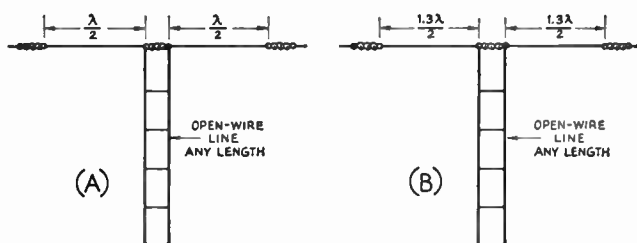

Fig. 14-29—Collinear antennas in phase. The system at A is known as "two half waves in phase" and has a gain of 1.8 db. over a half-wave antenna. By lengthening the antenna slightly, as in B, the gain can be increased to 3 db. Maximum radiation is at right angles to the antenna. The antenna at A is sometimes called a "double Zepp" antenna, and that at B is known as an "extended double Zepp."

two-element array at A is popularly known as "two half-waves in phase" or a **double Zepp** antenna. It will be recognized as simply a center-fed dipole operated at its second harmonic.

By extending the antenna, as at B, the additional gain of an **extended double Zepp** antenna can be obtained. Carrying the length beyond that

and one above the other (**stacked**). In the former case the horizontal pattern becomes quite sharp, while the vertical pattern is the same as that of one element alone. If the array is suspended horizontally, the horizontal pattern is equivalent to that of one element while the vertical pattern is sharpened, giving low-angle radiation.

Fig. 14-30—Simple broadside array using horizontal elements. By making the spacing  $S$  equal to  $\frac{3}{8}$  wavelength, the antenna at A can be used at the corresponding frequency and up to twice that frequency. Thus when designed for 14 Mc. it can also be used on 21 and 28 Mc. The antenna at B can be used on only the design band. This array is bidirectional, with maximum radiation "broadside" or perpendicular to the antenna plane (perpendicularly through this page). Gain varies with the spacing  $S$ , running from  $2\frac{1}{2}$  to almost 5 db. (See Fig. 14-32).

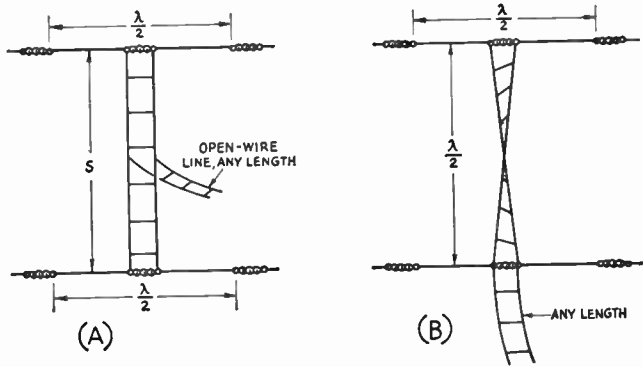

Broadside arrays may be fed either by tuned open-wire lines or through quarter-wave matching sections and flat lines. In Fig. 14-30B, note the "crossing over" of the phasing section, which is necessary to bring the elements into proper phase relationship.

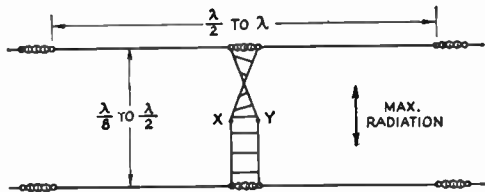

Fig. 14-31—Top view of a horizontal end-fire array. The system is fed with an open-wire line at  $x$  and  $y$ ; the line can be of any length. Feed points  $x$  and  $y$  are equidistant from the two insulators, and the feed line should drop down vertically from the antenna. The gain of the system will vary with the spacing, as shown in Fig. 14-32, and is a maximum at  $\frac{1}{8}$  wavelength. By using a length of 33 feet and a spacing of 8 feet, the antenna will work on 20, 15 and 10 meters.

**End-Fire Arrays**

Fig. 14-31 shows a pair of parallel half-wave elements with currents out of phase. This is

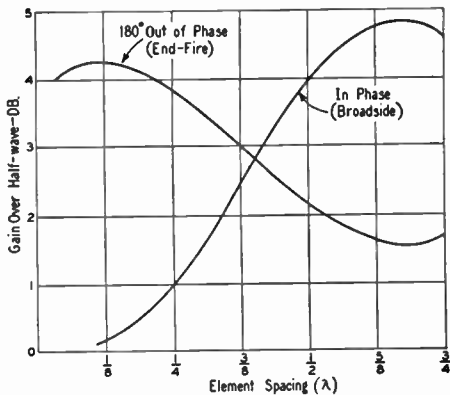

Fig. 14-32—Gain vs. spacing for two parallel half-wave elements combined as either broadside or end-fire arrays.

known as an **end-fire array** because it radiates best along the plane of the antennas, as shown.

The end-fire array may be used either vertically or horizontally (elements at the same height), and is well adapted to amateur work because it gives maximum gain with relatively close element spacing. Fig. 14-32 shows how the gain varies with spacing. End-fire elements may be combined with additional collinear and broadside elements to give a further increase in gain and directivity.

Either tuned or untuned lines may be used with this type of array. Untuned lines preferably are matched to the antenna through a quarter-wave matching section or phasing stub.

**Combined Arrays**

Broadside, collinear and end-fire arrays may be combined to give both horizontal and vertical directivity, as well as additional gain. The lower angle of radiation resulting from stacking elements in the vertical plane is desirable at the higher frequencies. In general, doubling the number of elements in an array by stacking will raise the gain from 2 to 4 db.

Although arrays can be fed at one end as in Fig. 14-30B, it is not especially desirable in the case of large arrays. Better distribution of energy between elements, and hence better overall performance will result when the feeders are attached as nearly as possible to the center of the array.

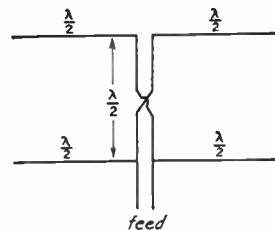

Fig. 14-33—A four-element combination broadside-collinear array, popularly known as the "lazy-H" antenna. A closed quarter-wave stub may be used at the feed point to match into an untuned transmission line, or tuned feeders may be attached at the point indicated. The gain over a half-wave antenna is 5 to 6 db.

A four-element array, known as the "lazy-H" antenna, has been quite frequently used. This arrangement is shown, with the feed point indicated, in Fig. 14-33. (Compare with Fig. 14-30B). For best results, the bottom section should be at least a half wavelength above ground.

It will usually suffice to make the length of each element that given by Equations 14-B or 14-C. The phasing line between the parallel elements should be of open-wire construction, and its length can be calculated from:

$$\text{Length of half-wave line (feet)} =$$

$$\frac{480}{\text{Freq. (Mc.)}} \quad (14-H)$$

Example: A half-wavelength phasing line for 28.8 Mc. would be  $\frac{480}{28.8} = 16.66 \text{ feet} = 16 \text{ feet } 8 \text{ inches.}$

The spacing between elements can be made equal to the length of the phasing line. No special adjustments of line or element length or spacing are needed, provided the formulas are followed closely.

## DIRECTIVE ARRAYS WITH PARASITIC ELEMENTS

### Parasitic Excitation

The antenna arrays previously described are bidirectional; that is, they will radiate in directions both to the "front" and to the "back" of the antenna system. If radiation is wanted in only one direction, it is necessary to use different element arrangements. In most of these arrangements the additional elements receive power by induction or radiation from the driven element generally called the "antenna," and reradiate it in the proper phase relationship to achieve the desired effect. These elements are called *parasitic* elements, as contrasted to the driven elements which receive power directly from the transmitter through the transmission line.

The parasitic element is called a **director** when

it reinforces radiation on a line pointing to it from the antenna, and a **reflector** when the reverse is the case. Whether the parasitic element is a director or reflector depends upon the parasitic-element tuning, which usually is adjusted by changing its length.

### Gain vs. Spacing

The gain of an antenna with parasitic elements varies with the spacing and tuning of the elements and thus for any given spacing there is a tuning condition that will give maximum gain at this spacing. The maximum front-to-back ratio seldom if ever, occurs at the same condition that gives maximum forward gain. The impedance of the driven element also varies with the tuning and spacing, and thus the antenna system must be tuned to its final condition before the match between the line and the antenna can be completed. However, the tuning and matching may interlock to some extent, and it is usually necessary to run through the adjustments several times to insure that the best possible tuning has been obtained.

### Two-Element Beams

A 2-element beam is useful where space or other considerations prevent the use of the larger structure required for a 3-element beam. The general practice is to tune the parasitic element as a reflector and space it about 0.15 wavelength from the driven element, although some successful antennas have been built with 0.1-wavelength spacing and director tuning. Gain *vs.* element spacing for a 2-element antenna is given in Fig. 14-34, for the special case where the parasitic element is resonant. It is indicative of the performance to be expected under maximum-gain tuning conditions.

### Three-Element Beams

A theoretical investigation of the 3-element case (director, driven element and reflector) has indicated a maximum gain of slightly more than 7 db. A number of experimental investigations have shown that the optimum spacing between the driven element and reflector is in the region of 0.15 to 0.25 wavelength, with 0.2 wavelength representing probably the best over-all choice.

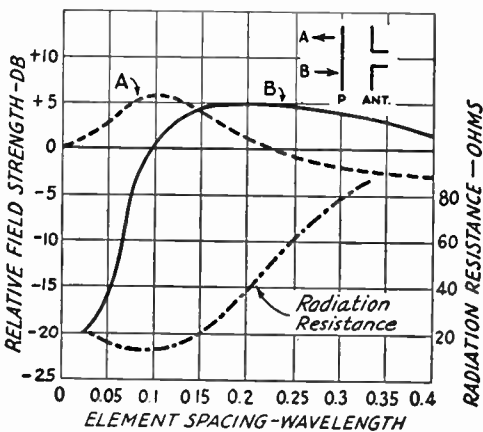
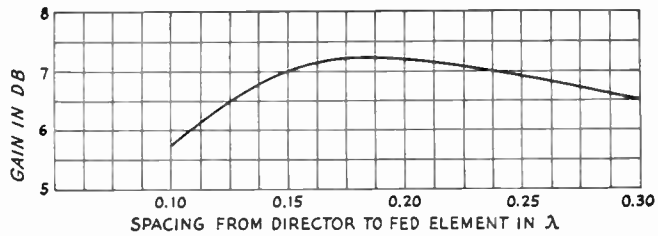

Fig. 14-34—Gain vs. element spacing for an antenna and one parasitic element. The reference point, 0 db., is the field strength from a half-wave antenna alone. The greatest gain is in direction A at spacings of less than 0.14 wavelength, and in direction B at greater spacings. The front-to-back ratio is the difference in db. between curves A and B. Variation in radiation resistance of the driven element also is shown. These curves are for a self-resonant parasitic element. At most spacings the gain as a reflector can be increased by slight lengthening of the parasitic element; the gain as a director can be increased by shortening. This also improves the front-to-back ratio.

Fig. 14-35—Gain of 3-element Yagi versus director spacing, the reflector being fixed at 0.2 wavelength.



With 0.2 wavelength reflector spacing, Fig. 14-35 shows the gain variation with director spacing. It is obvious that the director spacing is not especially critical, and that the over-all length of the array (boom length in the case of a rotatable antenna) can be anywhere between 0.35 and 0.45 wavelength with no appreciable difference in gain.

Wide spacing of both elements is desirable not only because it results in high gain but also because adjustment of tuning or element length is less critical and the input resistance of the driven element is higher than with close spacing. The latter feature improves the efficiency of the antenna and makes a greater band width possible. However, a total antenna length, director to reflector, of more than 0.3 wavelength at fre-

quencies of the order of 14 Mc. introduces considerable difficulty from a constructional standpoint, so lengths of 0.25 to 0.3 wavelength are frequently used for this band, even though they are less than optimum.

In general, the gain of the antenna drops off less rapidly when the reflector length is increased beyond the optimum value than it does for a corresponding decrease below the optimum value. The opposite is true of a director. It is therefore advisable to err, if necessary, on the long side for a reflector and on the short side for a director. This also tends to make the antenna performance less dependent on the exact frequency at which it is operated, because an increase above the design frequency has the same effect as increasing the length of both parasitic elements, while a decrease in frequency has the same effect as shortening both elements. By making the director slightly short and the reflector slightly long, there will be a greater spread between the upper and lower frequencies at which the gain starts to show a rapid decrease.

When the over-all length has been decided upon, the element lengths can be found by referring to Fig. 14-36. The lengths determined by these charts will vary slightly in actual practice with the element diameter and the method of supporting the elements, and the tuning of a beam should always be checked after installation. However, the lengths obtained by the use of the charts will be close to correct in practically all cases, and they can be used without checking if the beam is difficult of access.

The preferable method for checking the beam is by means of a field-strength meter or the S-meter of a communications receiver, used in conjunction with a dipole antenna located at least 10 wavelengths away and as high as or higher than the beam that is being checked. A few watts of power fed into the antenna will give a useful signal at the observation point, and the power input to the transmitter (and hence the antenna) should be held constant for all of the readings. Beams tuned on the ground and then lifted into place are subject to tuning errors and cannot be depended upon. The impedance of the driven element will vary with the height above ground, and good practice dictates that all final matching between antenna and line be done with the antenna in place at its normal height above ground.

Simple Systems: the Rotary Beam

Two- and 3-element systems are popular for rotary-beam antennas, where the entire antenna

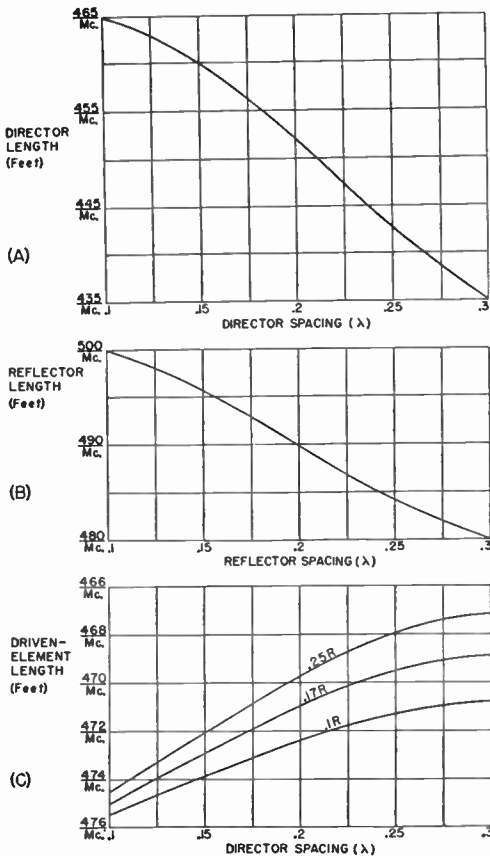

Fig. 14-36—Element lengths for a 3-element beam. These lengths will hold closely for tubing elements supported at or near the center.

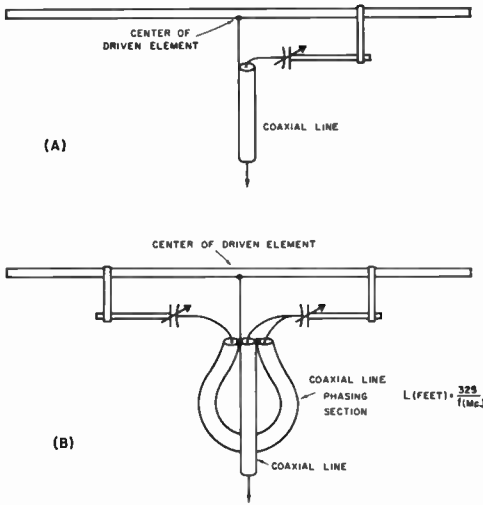

Fig. 14-37—The most popular methods of feeding the driven element of a beam antenna are (A) the gamma match and (B) the T match. The aluminum tubing or rod used for the matching section is usually of smaller diameter than the antenna element; its length will vary somewhat with the spacing and number of elements in the beam. The coaxial line in the phasing section can be coiled in a 2- or 3-foot diameter coil instead of hanging as shown.

system is rotated, to permit its gain and directivity to be utilized for any compass direction. They may be mounted either horizontally (with the plane containing the elements parallel to the earth) or vertically.

A 4-element beam will give still more gain than a 3-element one, provided the support is sufficient for about 0.2 wavelength spacing between elements. The tuning for maximum gain involves many variables, and complete gain and tuning data are not available.

The elements in close-spaced (less than one-quarter wavelength element spacing) arrays preferably should be made of tubing of one-half to one-inch diameter. A conductor of large diameter not only has less ohmic resistance but also

has lower  $Q$ ; both these factors are important in close-spaced arrays because the impedance of the driven element usually is quite low compared to that of a simple dipole antenna. With 3- and 4-element close-spaced arrays the radiation resistance of the driven element may be so low that ohmic losses in the conductor can consume an appreciable fraction of the power.

**Feeding the Rotary Beam**

Any of the usual methods of feed (described later under "Matching the Antenna to the Line") can be applied to the driven element of a rotary beam. Tuned feeders are not recommended for lengths greater than a half wavelength unless open lines of copper-tubing conductors are used. The popular choices for feeding a beam are the gamma match with series capacitor and the T match with series capacitors and a half-wavelength phasing section, as shown in Fig. 14-37. These methods are preferred over any others because they permit adjustment of the matching and the use of coaxial line feed. The variable capacitors can be housed in small plastic cups for weatherproofing; receiving types with close spacing can be used at powers up to a few hundred watts. Maximum capacity required is usually 140  $\mu\text{f.}$  at 14 Mc. and proportionately less at the higher frequencies.

If physically possible, it is better to adjust the matching device after the antenna has been installed at its ultimate height, since a match made with the antenna near the ground may not hold for the same antenna in the air.

**Sharpness of Resonance**

Peak performance of a multielement parasitic array depends upon proper phasing or tuning of the elements, which can be exact for one frequency only. In the case of close-spaced arrays, which because of the low radiation resistance usually are quite sharp-tuning, the frequency range over which optimum results can be secured is only of the order of 1 or 2 per cent of the resonant frequency, or up to about 500 kc. at 28 Mc. However, the antenna can be made to work satisfactorily over a wider frequency range by

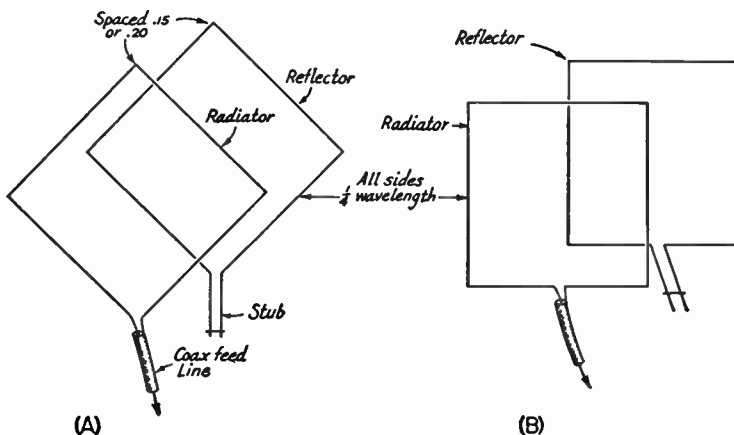

Fig. 14-38—The cubical quad antenna, consisting of two square loops one of which is driven and the other is used as a parasitic reflector. The planes of the loops are parallel, and the loops are coaxial although shown offset in these drawings for clarity. Note the difference in feed points in A and B; the shift in feed point is necessary if both loop orientations are to transmit signals of the same polarization (horizontal in both cases shown here).



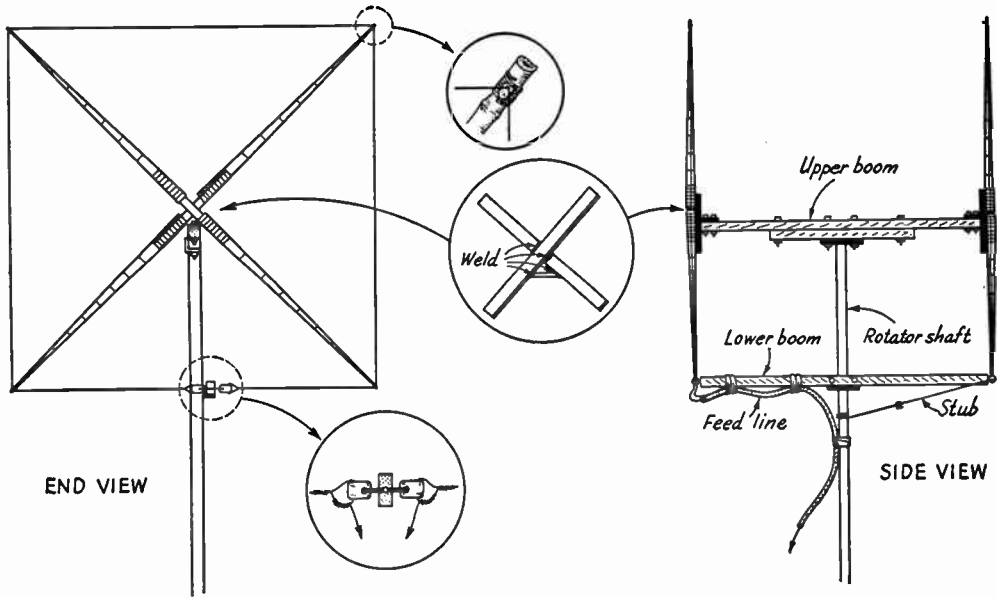

Fig. 14-39—End and side views of a quad. Upper insert shows method of fastening antenna wire to support arms. Center insert shows construction of support-arm mounting bracket. Lower insert shows method of attaching feed line and stub to the center insulators. Two small egg insulators are used, fastened to end of lower boom as shown with a small nail.

$$\text{The length of one side is found from } L \text{ (feet)} = \frac{251}{f(\text{Mc.})}$$

adjusting the director or directors to give maximum gain at the *highest* frequency to be covered, and by adjusting the reflector to give optimum gain at the *lowest* frequency. This sacrifices some gain at all frequencies, but maintains more uniform gain over a wider frequency range.

The use of large-diameter conductors will broaden the response curve of an array because the larger diameter lowers the *Q*. This causes the reactances of the elements to change rather slowly with frequency, with the result that the tuning stays near the optimum over a considerably wider frequency range than is the case with wire conductors.

**Combination Arrays**

It is possible to combine parasitic elements with driven elements to form arrays composed of collinear driven and parasitic elements and combination broadside-collinear-parasitic elements. Thus two or more collinear elements might be provided with a collinear reflector or director set, one parasitic element to each driven element. Or both directors and reflectors might be used. A broadside-collinear array can be treated in the same fashion.

**THE "QUAD" ANTENNA**

The "cubical quad" or, simply, "quad" antenna

consists of a pair of square loops, one-quarter wavelength on a side or one-wavelength around the periphery, one loop being driven and the other used as a parasitic reflector. The separation between the two is usually of the order of 0.15 to 0.2 wavelength, with the planes of the loops parallel.

Fig. 14-38 shows typical quad arrangements, that at B being the more frequently used. The reflector is tuned by means of a stub to a lower frequency than the one at which the fed loop is driven, just as is done with the conventional straight elements in a driven element-reflector array of the parasitic type. With the reflector in place and properly tuned the impedance of the driven element at the feed point is of the same order as the characteristic impedance of coaxial cable, so ordinarily the standing-wave ratio on

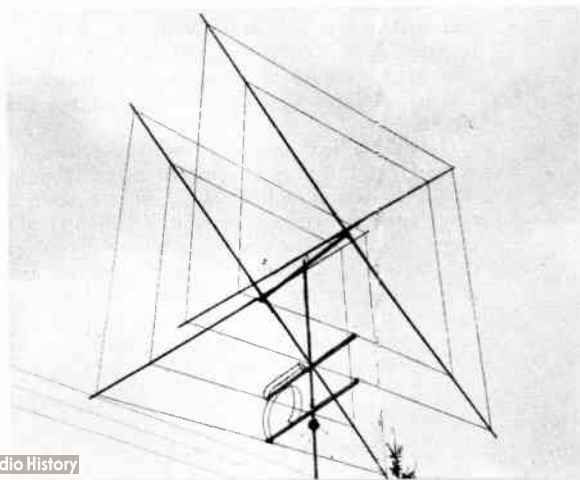

Fig. 14-40—A 15/10-meter quad. Tuning stubs for the reflectors are looped back along the tie bars. Total weight of this assembly, not including the mast, is 13 pounds.

the transmission line will be low enough so that no special means need be included for matching.

A few measurements on the quad have indicated that its gain is roughly comparable with that of a three-element Yagi of ordinary design. Early quads consisted only of driven element and parasitic reflector; recent designs have included two parasitic directors, with consequent improved gain. (See Bergren, *QST*, May, 1963.). The two-element quad is, however, the one most commonly in use.

The quad is a more cumbersome structure than an ordinary parasitic beam, but is light in weight and relatively inexpensive. Diagonal spreaders, usually of bamboo (fiberglass poles are also available) are used to support the corners of the loop, the loop itself being made of ordinary antenna wire. The spreaders usually are mounted on a boom which in general is similar to the booms used with Yagi antennas and is also similarly mounted on the mast or tower and rotated. The light weight permits rotation by a TV rotator. Constructional details of a typical quad are given in Fig. 14-39.

If the fishing poles are well treated with a weatherproofing compound they will last several years. Weatherproofing compounds are available at all lumber dealers. Get straight poles with no splits in them. No insulators are necessary, the poles themselves acting as long insulators. The easiest way to mount the antenna wire on the arms is to lay a long length of wire on the ground

and mark it at the approximate quarter-wave intervals, and use these marks to indicate where the wire fastens to the pole.

Dual and triple quads can be built for the bands 20 through 10 meters. One such antenna is shown in Fig. 14-40, a dual quad for 15 and 10 meters. The same supporting structure is used for the two antennas, making the boom length equal to 0.15 to 0.2 wavelengths at the lower-frequency band. Separate coaxial cable feed lines are brought down from the two driven elements. In a two-band quad (20/15 or 15/10) the length of one side is obtained from

$$L \text{ (feet)} = 250 \div (\text{Mc.})$$

In the case of any quad or combination of quads, each quad should be tuned up separately for maximum forward gain by adjusting the stub length on the reflector element and checking the field strength with a nearby ham. If accessible, the reflector element can be resonated with a grid-dip meter to a frequency just below the lowest to be used; this is a good starting place for further adjustment. The resonance of the antenna system can be checked by finding the frequency that gives the lowest s.w.r. on the feed line; this lowest s.w.r. is not necessarily 1.0. If the resonant frequency is higher than the desired frequency, lengthen the driven element; shorten the element if the resonant frequency is too low. In the dual antennas that have been constructed, there has been little or no evidence of interaction of tuning.

## MATCHING THE ANTENNA TO THE LINE

The load for a transmission line may be any device capable of dissipating r.f. power. When lines are used for transmitting applications the most common type of load is an antenna. When a transmission line is connected between an antenna and a receiver, the receiver input circuit (not the antenna) is the load, because the power taken from a passing wave is delivered to the receiver.

Whatever the application, the conditions existing at the load, and *only* the load, determine the standing-wave ratio on the line. If the load is purely resistive and equal in value to the characteristic impedance of the line, there will be no standing waves. If the load is not purely resistive, and/or is not equal to the line  $Z_0$ , there will be standing waves. No adjustments that can be made at the input end of the line can change the s.w.r., nor is it affected by changing the line length.

Only in a few special cases is the load inherently of the proper value to match a practicable transmission line. In all other cases it is necessary either to operate with a mismatch and accept the s.w.r. that results, or else to take steps to bring about a proper match between the line and load by means of transformers or similar devices. Impedance-matching transformers may take a variety of physical forms, depending on the circumstances.

Note that it is essential, if the s.w.r. is to be made as low as possible, that the load at the point of connection to the transmission line be purely resistive. In general, this requires that the load be tuned to resonance. If the load itself is not resonant at the operating frequency the tuning sometimes can be accomplished in the matching system.

## THE ANTENNA AS A LOAD

Every antenna system, no matter what its physical form, will have a definite value of impedance at the point where the line is to be connected. The problem is to transform this **antenna input impedance** to the proper value to match the line. In this respect there is no one "best" type of line for a particular antenna system, because it is possible to transform impedances in any desired ratio. Consequently, any type of line may be used with any type of antenna. There are frequently reasons other than impedance matching that dictate the use of one type of line in preference to another, such as ease of installation, inherent loss in the line, and so on, but these are not considered in this section.

Although the input impedance of an antenna system is seldom known very accurately, it is often possible to make a reasonably close estimate of its value. The information earlier in this chapter can be used as a guide.

Matching circuits may be constructed using ordinary coils and capacitors, but are not used very extensively because they must be supported at the antenna and must be weatherproofed. The systems to be described use **linear transformers**.

### The Quarter-Wave Transformer or "Q" Section

As mentioned previously (Chapter 13), a quarter-wave transmission line may be used as an impedance transformer. Knowing the antenna impedance and the characteristic impedance of the

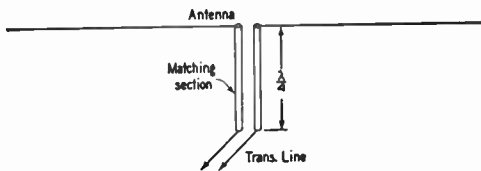

Fig. 14-41—"Q" matching section, a quarter-wave impedance transformer.

transmission line to be matched, the required characteristic impedance of a matching section such as is shown in Fig. 14-41 is

$$Z = \sqrt{Z_1 Z_0} \quad (14-I)$$

where  $Z_1$  is the antenna impedance and  $Z_0$  is the characteristic impedance of the line to which it is to be matched.

Example: To match a 600-ohm line to an antenna presenting a 72-ohm load, the quarter-wave matching section would require a characteristic impedance of  $\sqrt{72 \times 600} = \sqrt{43,200} = 208$  ohms.

The spacings between conductors of various sizes of tubing and wire for different surge impedances are given in graphical form in the chapter on "Transmission Lines." (With 1/2-inch tubing, the spacing in the example above should be 1.5 inches for an impedance of 208 ohms.)

The length of the quarter-wave matching section may be calculated from

$$\text{Length (feet)} = \frac{246 V}{f} \quad (14-J)$$

where  $V$  = Velocity factor  
 $f$  = Frequency in Mc.

Example: A quarter-wave transformer of RG-11/U is to be used at 28.7 Mc. From the table in Chapter Thirteen,  $V = 0.66$ .

$$\text{Length} = \frac{246 \times 0.66}{28.7} = 5.67 \text{ feet} \\ = 5 \text{ feet } 8 \text{ inches}$$

The antenna must be resonant at the operating frequency. Setting the antenna length by formula is amply accurate with single-wire antennas, but in other systems, particularly close-spaced arrays, the antenna should be adjusted to resonance before the matching section is connected.

When the antenna input impedance is not known accurately, it is advisable to construct the matching section so that the spacing between conductors can be changed. The spacing then

may be adjusted to give the lowest possible s.w.r. on the transmission line.

### Folded Dipoles

A half-wave antenna element can be made to match various line impedances if it is split into two or more parallel conductors with the transmission line attached at the center of only one of them. Various forms of such "folded dipoles" are shown in Fig. 14-42. Currents in all conductors are in phase in a folded dipole, and since the conductor spacing is small the folded dipole is equivalent in radiating properties to an ordinary single-conductor dipole. However, the current flowing into the input terminals of the antenna from the line is the current in one conductor only, and the entire power from the line is delivered at this value of current. This is equivalent to saying that the input impedance of the antenna has been raised by splitting it up into two or more conductors.

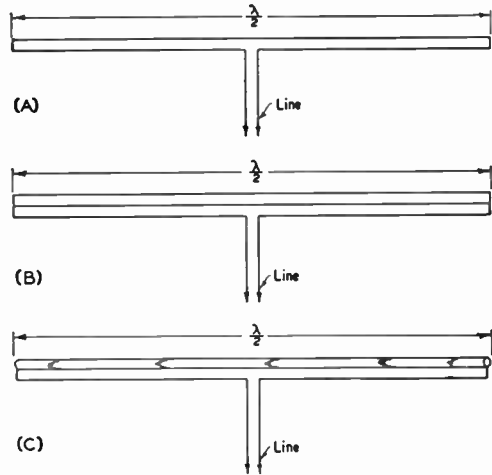

Fig. 14-42—The folded dipole, a method for using the antenna element itself to provide an impedance transformation.

The ratio by which the input impedance of the antenna is stepped up depends not only on the number of conductors in the folded dipole but also on their relative diameters, since the distribution of current between conductors is a function of their diameters. (When one conductor is larger than the other, as in Fig. 14-42C, the larger one carries the greater current.) The ratio also depends, in general, on the spacing between the conductors, as shown by the graphs of Figs. 14-43 and 14-44. An important special case is the 2-conductor dipole with conductors of equal diameter; as a simple antenna, not a part of a directive array, it has an input resistance close enough to 300 ohms to afford a good match to 300-ohm Twin-Lead.

The required ratio of conductor diameters to give a desired impedance ratio using two conductors may be obtained from Fig. 14-43. Similar information for a 3-conductor dipole is given

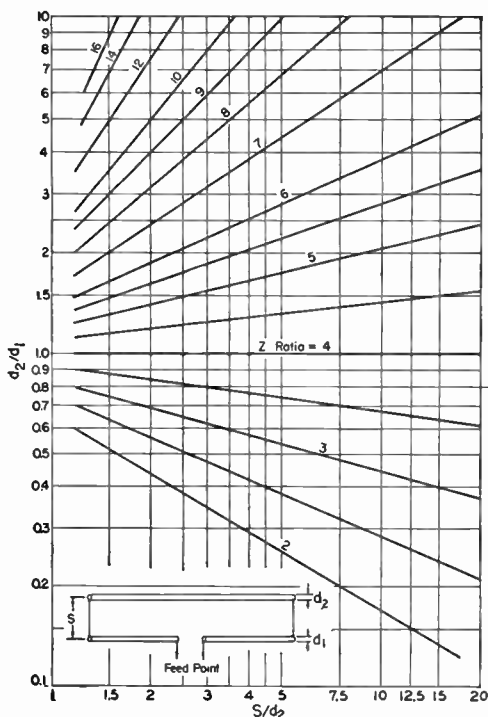

Fig. 14-43—Impedance transformation ratio, two-conductor folded dipole. The dimensions  $d_1$ ,  $d_2$  and  $s$  are shown on the inset drawing. Curves show the ratio of the impedance (resistive) seen by the transmission line to the radiation resistance of the resonant antenna system.

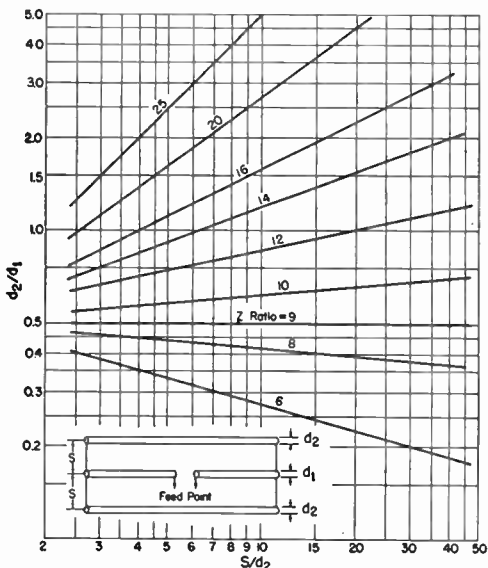

Fig. 14-44—Impedance transformation ratio, three-conductor folded dipole. The dimensions  $d_1$ ,  $d_2$  and  $s$  are shown on the inset drawing. Curves show the ratio of the impedance (resistive) seen by the transmission line to the radiation resistance of the resonant antenna system.

in Fig. 14-44. This graph applies where all three conductors are in the same plane. The two conductors not connected to the transmission line must be equally spaced from the fed conductor, and must have equal diameters. The fed conductor may have a different diameter, however. The unequal-conductor method has been found particularly useful in matching to low-impedance antennas such as directive arrays using close-spaced parasitic elements.

The length of the antenna element should be such as to be approximately self-resonant at the median operating frequency. The length is usually not highly critical, because a folded dipole tends to have the characteristics of a "thick" antenna and thus has a relatively broad frequency-response curve.

**"T" and "Gamma" Matching Sections**

The method of matching shown in Fig. 14-45A is based on the fact that the impedance between any two points along a resonant antenna is resistive, and has a value which depends on the spacing between the two points. It is therefore possible to choose a pair of points between which the impedance will have the right value to match a transmission line. In practice, the line cannot be connected directly at these points because the distance between them is much greater than the conductor spacing of a practicable transmission line. The "T" arrangement in Fig. 14-45A overcomes this difficulty by using a second conductor paralleling the antenna to form a matching section to which the line may be connected.

The "T" is particularly suited to use with a parallel-conductor line, in which case the two points along the antenna should be equidistant from the center so that electrical balance is maintained.

The operation of this system is somewhat complex. Each "T" conductor ( $y$  in the drawing) forms with the antenna conductor opposite it a short section of transmission line. Each of these transmission-line sections can be considered to be terminated in the impedance that exists at the point of connection to the antenna. Thus the part of the antenna between the two points carries a transmission-line current in addition to the normal antenna current. The two transmission-line

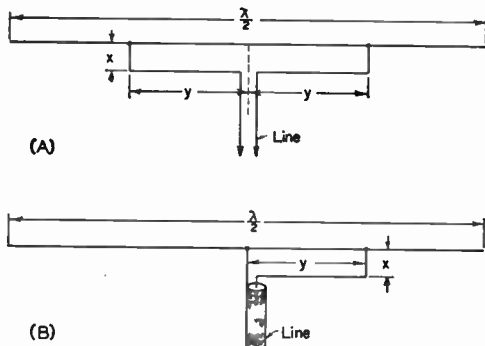

Fig. 14-45—The "T" match and "gamma" match.

matching sections are in series, as seen by the main transmission line.

If the antenna by itself is resonant at the operating frequency its impedance will be purely resistive, and in such case the matching-section lines are terminated in a resistive load. However, since these sections are shorter than a quarter wavelength their input impedance—i.e., the impedance seen by the main transmission line looking into the matching-section terminals—will be reactive as well as resistive. This prevents a perfect match to the main transmission line, since its load must be a pure resistance for perfect matching. The reactive component of the input impedance must be tuned out before a proper match can be secured.

One way to do this is to detune the antenna just enough, by changing its length, to cause reactance of the opposite kind to be reflected to the input terminals of the matching section, thus cancelling the reactance introduced by the latter. Another method, which is considerably easier to adjust, is to insert a variable capacitor in series with the matching section where it connects to the transmission line, as shown in Fig. 14-37. The capacitor must be protected from the weather.

The method of adjustment commonly used is to cut the antenna for approximate resonance and then make the spacing  $x$  some value that is convenient constructionally. The distance  $y$  is then adjusted, while maintaining symmetry with respect to the center, until the s.w.r. on the transmission line is as low as possible. If the s.w.r. is not below 2 to 1 after this adjustment, the antenna length should be changed slightly and the matching-section taps adjusted again. This process may be continued until the s.w.r. is as close to 1 to 1 as possible.

When the series-capacitor method of reactance compensation is used (Fig. 14-37), the antenna should be the proper length to be resonant at the operating frequency. Trial positions of the matching-section taps are taken, each time adjusting the capacitor for minimum s.w.r., until the standing waves on the transmission line are brought down to the lowest possible value.

The unbalanced ("gamma") arrangement in Fig. 14-45B is similar in principle to the "T," but is adapted for use with single coax line. The method of adjustment is the same.

## BALANCING DEVICES

An antenna with open ends, of which the half-wave type is an example, is inherently a balanced radiator. When opened at the center and fed with a parallel-conductor line this balance is maintained throughout the system, so long as the causes of unbalance discussed in the transmission-line chapter are avoided.

If the antenna is fed at the center through a coaxial line, as indicated in Fig. 14-46A, this balance is upset because one side of the radiator is connected to the shield while the other is connected to the inner conductor. On the side connected to the shield, a current can flow down

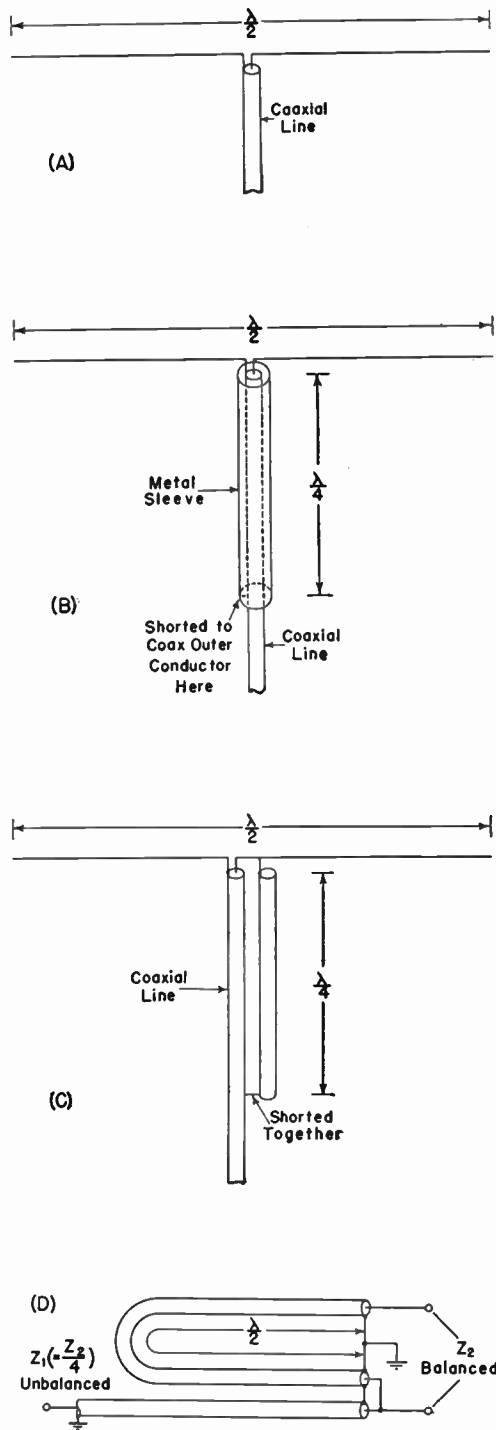

Fig. 14-46—Radiator with coaxial feed (A) and methods of preventing unbalance currents from flowing on the outside of the transmission line (B and C). The half-wave phasing section shown at D is used for coupling between an unbalanced and a balanced circuit when a 4-to-1 impedance ratio is desired or can be accepted.



over the *outside* of the coaxial line, and the fields thus set up cannot be canceled by the fields from the inner conductor because the fields *inside* the line cannot escape through the shielding afforded by the outer conductor. Hence these "antenna" currents flowing on the outside of the line will be responsible for radiation.

### Linear Baluns

Line radiation can be prevented by a number of devices whose purpose is to detune or decouple the line for "antenna" currents and thus greatly reduce their amplitude. Such devices generally are known as **baluns** (a contraction for "balanced to unbalanced"). Fig. 14-46B shows one such arrangement, known as a **bazooka**, which uses a sleeve over the transmission line to form, with the outside of the outer line conductor, a shorted quarter-wave line section. As described earlier in this chapter, the impedance looking into the open end of such a section is very high, so that the end of the outer conductor of the coaxial line is effectively insulated from the part of the line below the sleeve. The length is an *electrical* quarter wave, and may be physically shorter if the insulation between the sleeve and the line is other than air. The bazooka has no effect on the impedance relationships between the antenna and the coaxial line.

Another method that gives an equivalent effect is shown at C. Since the voltages at the antenna terminals are equal and opposite (with reference to ground), equal and opposite currents flow on the surfaces of the line and second conductor. Beyond the shorting point, in the direction of the transmitter, these currents combine to cancel out. The balancing section "looks like" an open circuit to the antenna, since it is a quarter-wave parallel-conductor line shorted at the far end, and thus has no effect on the normal antenna operation. However, this is not essential to the line-balancing function of the device, and baluns of this type are sometimes made shorter than a quarter wavelength in order to provide the shunt inductive reactance required in certain types of matching systems.

Fig. 14-46D shows a third balun, in which equal and opposite voltages, balanced to ground, are taken from the inner conductors of the main transmission line and half-wave phasing section. Since the voltages at the balanced end are in series while the voltages at the unbalanced end are in parallel, there is a 4-to-1 step-down in impedance from the balanced to the unbalanced side. This arrangement is useful for coupling between a balanced 300-ohm line and a 75-ohm coaxial line, for example.

### RECEIVING ANTENNAS

Nearly all of the properties possessed by an antenna as a radiator also apply when it is used for reception. Current and voltage distribution, impedance, resistance and directional characteristics are the same in a receiving antenna as if it were used as a transmitting antenna. This reciprocal behavior makes possible the design of a

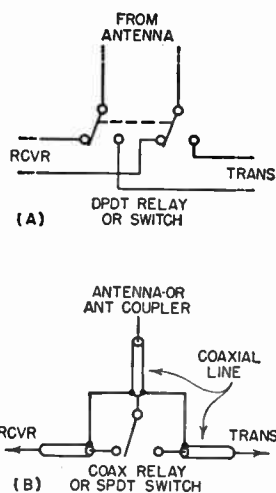

Fig. 14-47—Antenna changeover for receiving and transmitting in two-wire (A) and coaxial line (B). The low-pass filter for TVI reduction should be connected between switch or relay and the transmitter.

receiving antenna of optimum performance based on the same considerations that have been discussed for transmitting antennas.

The simplest receiving antenna is a wire of random length. The longer and higher the wire, the more energy it abstracts from the wave. Because of the high sensitivity of modern receivers, sometimes only a short length of wire strung around the room is used for a receiving antenna, but such an antenna cannot be expected to give good performance, although it is adequate for loud signals on the 3.5- and 7-Mc. bands. It will serve in emergencies, but a longer wire outdoors is always better.

The use of a tuned antenna improves the operation of the receiver, because the signal strength is greater than with a wire of random length. Where local electrical noise is a problem, as from an electrical appliance, a measure of relief can often be obtained by locating the antenna as high above and as far as possible from the noise source and power lines. The lead-in wire, from the center of the antenna, should be a coaxial line or shielded twin-conductor cable (RG-62/U). If the twin-conductor cable is used, the conductors connect to the antenna binding posts and the shield to the ground binding post of the receiver.

### Antenna Switching

Switching of the antenna from receiver to transmitter is commonly done with a changeover relay, connected in the antenna leads or the coupling link from the antenna tuner. If the relay is one with a 115-volt a.c. coil, the switch or relay that controls the transmitter plate power will also control the antenna relay. If the convenience of a relay is not desired, porcelain knife switches can be used and thrown by hand.

Typical arrangements are shown in Fig. 14-47. If coaxial line is used, a coaxial relay is recom-

mended, although on the lower-frequency bands a regular switch or change-over relay will work almost as well. The relay or switch contacts should be rated to handle at least the maximum power of the transmitter.

An additional refinement is the use of an electronic transmit-receive switch, which permits full break-in operation even when using the transmitting antenna for receiving. For details and circuitry on t.r. switches, see Chapter Eight.

### ANTENNA CONSTRUCTION

The use of good materials in the antenna system is important, since the antenna is exposed to wind and weather. To keep electrical losses low, the wires in the antenna and feeder system must have good conductivity and the insulators must have low dielectric loss and surface leakage, particularly when wet.

For short antennas, No. 14 gauge hard-drawn enameled copper wire is a satisfactory conductor. For long antennas and directive arrays, No. 14 or No. 12 enameled copper-clad steel wire should be used. It is best to make feeders and matching stubs of ordinary soft-drawn No. 14 or No. 12 enameled copper wire, since hard-drawn or copper-clad steel wire is difficult to handle unless it is under considerable tension at all times. The wires should be all in one piece; where a joint cannot be avoided, it should be carefully soldered. Open-wire TV line is excellent up to several hundred watts.

In building a two-wire open line, the spacer insulation should be of as good quality as in the antenna insulators proper. For this reason, good ceramic spacers are advisable. Wooden dowels boiled in paraffin may be used with untuned lines, but their use is not recommended for tuned lines. The wooden dowels can be attached to the feeder wires by drilling small holes and binding them to the feeders.

At points of maximum voltage, insulation is most important, and Pyrex glass or ceramic insulators with long leakage paths are recommended for the antenna. Insulators should be cleaned once or twice a year, especially if they are subjected to much smoke and soot.

In most cases poles or masts are desirable to lift the antenna clear of surrounding buildings, although in some locations the antenna will be sufficiently in the clear when strung from one chimney to another or from a housetop to a tree. Small trees usually are not satisfactory as points of suspension for the antenna because of their movement in windy weather. If the antenna is strung from a point near the center of the trunk of a large tree, this difficulty is not so serious. Where the antenna wire must be strung from one of the smaller branches, it is best to tie a pulley firmly to the branch and run a rope through the pulley to the antenna, with the other end of the rope attached to a counterweight near the ground. The counterweight will keep the tension on the antenna wire reasonably constant even when the branches sway or the rope tightens and stretches with varying climatic conditions.

Telephone poles, if they can be purchased and installed economically, make excellent supports because they do not ordinarily require guying

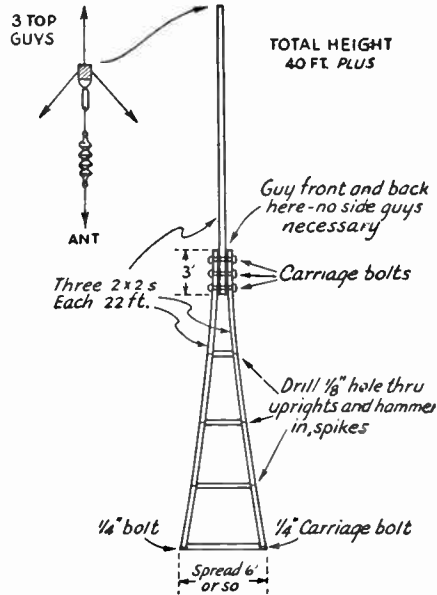

Fig. 14-48—Details of a simple 40-foot "A"-frame mast suitable for erection in locations where space is limited.

in heights up to 40 feet or so. Many low-cost television-antenna supports are now available, and they should not be overlooked as possible antenna aids.

### "A"-FRAME MAST

The simple and inexpensive mast shown in Fig. 14-48 is satisfactory for heights up to 35 or 40 feet. Clear, sound lumber should be selected. The completed mast may be protected by two or three coats of house paint.

If the mast is to be erected on the ground, a couple of stakes should be driven to keep the bottom from slipping and it may then be "walked up" by a pair of helpers. If it is to go on a roof, first stand it up against the side of the building and then hoist it from the roof, keeping it vertical. The whole assembly is light enough for two men to perform the complete operation—lifting the mast, carrying it to its permanent berth, and fastening the guys—with the mast vertical all the while. It is entirely practicable, therefore, to erect this type of mast on any small, flat area of roof.

By using 2 x 3s or 2 x 4s, the height may be extended up to about 50 feet. The 2 x 2 is too flexible to be satisfactory at such heights.

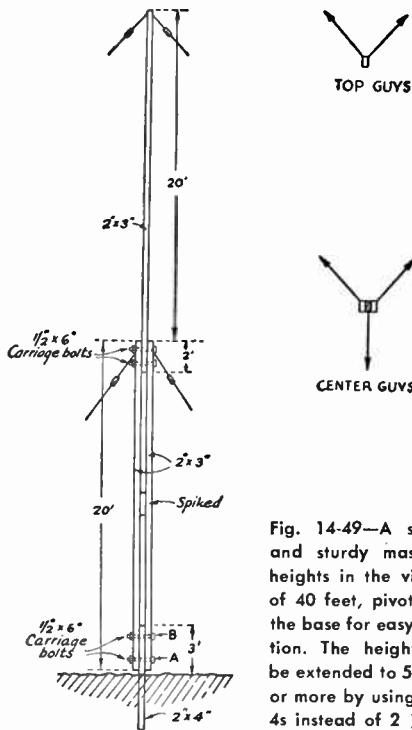

Fig. 14-49—A simple and sturdy mast for heights in the vicinity of 40 feet, pivoted at the base for easy erection. The height can be extended to 50 feet or more by using  $2 \times 4$ s instead of  $2 \times 3$ s.

### SIMPLE 40-FOOT MAST

The mast shown in Fig. 14-49 is relatively strong, easy to construct, readily dismantled, and costs very little. Like the "A"-frame, it is suitable for heights of the order of 40 feet.

The top section is a single  $2 \times 3$ , bolted at the bottom between a pair of  $2 \times 3$ s with an overlap of about two feet. The lower section thus has two legs spaced the width of the narrow side of a  $2 \times 3$ . At the bottom the two legs are bolted to a length of  $2 \times 4$  which is set in the ground. A short length of  $2 \times 3$  is placed between the two legs about halfway up the bottom section, to maintain the spacing.

The two back guys at the top pull against the antenna, while the three lower guys prevent buckling at the center of the pole.

The  $2 \times 4$  section should be set in the ground so that it faces the proper direction, and then made vertical by lining it up with a plumb bob. The holes for the bolts should be drilled beforehand. With the lower section laid on the ground, bolt *A* should be slipped in place through the three pieces of wood and tightened just enough so that the section can turn freely on the bolt. Then the top section may be bolted in place and the mast pushed up, using a ladder or another 20-foot  $2 \times 3$  for the job. As the mast goes up, the slack in the guys can be taken up so that the whole structure is in some measure continually supported. When the mast is vertical, bolt *B* should be slipped in place and both *A* and *B* tightened. The lower guys can then be given a final tightening, leaving those at the top a little slack until the antenna is pulled up, when they

should be adjusted to pull the top section into line.

### GUYS AND GUY ANCHORS

For masts or poles up to about 50 feet, No. 12 iron wire is a satisfactory guy-wire material. Heavier wire or stranded cable may be used for taller poles or poles installed in locations where the wind velocity is likely to be high.

More than three guy wires in any one set usually are unnecessary. If a horizontal antenna is to be supported, two guy wires in the top set will be sufficient in most cases. These should run to the rear of the mast about 100 degrees apart to offset the pull of the antenna. Intermediate guys should be used in sets of three, one running in a direction opposite to that of the antenna, while the other two are spaced 120 degrees either side. This leaves a clear space under the antenna. The guy wires should be adjusted to pull the pole slightly back from vertical before the antenna is hoisted so that when the antenna is pulled up tight the mast will be straight.

When raising a mast that is big enough to tax the available facilities, it is some advantage to know nearly exactly the length of the guys. Those on the side on which the pole is lying can then be fastened temporarily to the anchors beforehand, which assures that when the pole is raised, those holding opposite guys will be able to pull it into nearly vertical position with no danger of its getting out of control. The guy lengths can be figured by the right-angled-triangle rule that "the sum of the squares of the two sides is equal to the square of the hypotenuse." In other words, the distance from the base of the pole to the anchor should be measured and squared. To this should be added the square of the pole length to the point where the guy is fastened. The square root of this sum will be the length of the guy.

Guy wires should be broken up by strain insulators, to avoid the possibility of resonance at the transmitting frequency. Common practice is to insert an insulator near the top of each guy, within a few feet of the pole, and then cut each section of wire between the insulators to a length which will not be resonant either on the fundamental or harmonics. An insulator every 25 feet will be satisfactory for frequencies up to 30 Mc. The insulators should be of the "egg" type with the insulating material under compression, so that the guy will not part if the insulator breaks.

Twisting guy wires onto "egg" insulators may be a tedious job if the guy wires are long and of large gauge. A simple time- and finger-saving device (piece of heavy iron or steel) can be made by drilling a hole about twice the diameter of the guy wire about a half inch from one end of the piece. The wire is passed through the insulator, given a single turn by hand, and then held with a pair of pliers at the point shown in Fig. 14-50. By passing the wire through the hole in the iron and rotating the iron as shown, the wire may be quickly and neatly twisted.

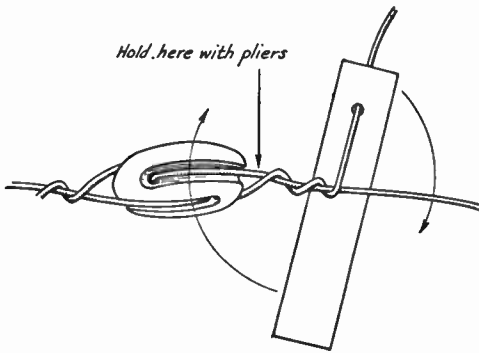

Fig. 14-50—Using a lever for twisting heavy guy wires.

Guy wires may be anchored to a tree or building when they happen to be in convenient spots. For small poles, a 6-foot length of 1-inch pipe driven into the ground at an angle will suffice.

**HALYARDS AND PULLEYS**

Halyards or ropes and pulleys are important items in the antenna-supporting system. Particular attention should be directed toward the choice of a pulley and halyards for a high mast since replacement, once the mast is in position, may be a major undertaking if not entirely impossible.

Galvanized-iron pulleys will have a life of only a year or so. Especially for coastal-area installations, marine-type pulleys with hardwood blocks and bronze wheels and bearings should be used.

For short antennas and temporary installations, heavy clothesline or window-sash cord may be used. However, for more permanent jobs, 3/8-inch or 1/2-inch waterproof hemp rope should be used. Even this should be replaced about once a year to insure against breakage.

It is advisable to carry the pulley rope back up to the top in "endless" fashion in the manner of a flag hoist so that if the antenna breaks close to the pole, there will be a means for pulling the hoisting rope back down.

**BRINGING THE ANTENNA OR FEED LINE INTO THE STATION**

The antenna or transmission line should be anchored to the outside wall of the building, as shown in Fig. 14-52, to remove strain from the

lead-in insulators. Holes cut through the walls of the building and fitted with feed-through insulators are undoubtedly the best means of bringing the line into the station. The holes should have plenty of air clearance about the conducting rod, especially when using tuned lines that develop high voltages. Probably the best place to go through the walls is the trimming board at the top or bottom of a window frame which provides flat surfaces for lead-in insulators. Cement or rubber gaskets may be used to waterproof the exposed joints.

Where such a procedure is not permissible,

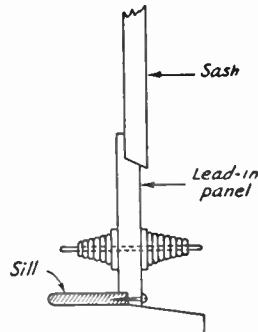
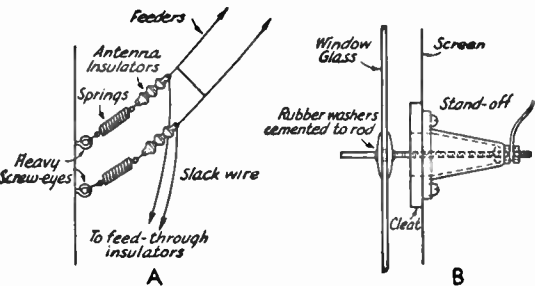

Fig. 14-51—An antenna lead-in panel may be placed over the top sash or under the lower sash of a window. Substituting a smaller height sash in half the window will simplify the weatherproofing problem where the sash overlaps.

the window itself usually offers the best opportunity. One satisfactory method is to drill holes in the glass near the top of the upper sash. If the glass is replaced by plate glass, a stronger job will result. Plate glass may be obtained from automobile junk yards and drilled before placing in the frame. The glass itself provides insulation and the transmission line may be fastened to bolts fitting the holes. Rubber gaskets will render the holes waterproof. The lower sash should be provided with stops to prevent damage when it is raised. If the window has a full-length screen, the scheme shown in Fig. 14-52B may be used.

As a less permanent method, the window may be raised from the bottom or lowered from the top to permit insertion of a board which carries the feed-through insulators. This lead-in arrangement can be made weatherproof by making an overlapping joint between the board and win-

Fig. 14-52—A—Anchoring feeders takes the strain from feed-through insulators or window glass. B—Going through a full-length screen, a cleat is fastened to the frame of the screen on the inside. Clearance holes are cut in the cleat and also in the screen.



dow sash, as shown in Fig. 14-51, or by using weatherstrip material where necessary.

Coaxial line can be brought through clearance holes without additional insulation.

## ROTARY-BEAM CONSTRUCTION

It is a distinct advantage to be able to shift the direction of a beam antenna at will, thus securing the benefits of power gain and directivity in any desired compass direction. A favorite method of doing this is to construct the antenna so that it can be rotated in the horizontal plane. The use of such rotatable antennas is usually limited to the higher frequencies—14 Mc. and above—and to the simpler antenna-element combinations if the structure size is to be kept within practicable bounds. For the 14-, 21- and 28-Mc. bands such antennas usually consist of two to four elements and are of the parasitic-array type described earlier in this chapter. At 50 Mc. and higher it becomes possible to use more elaborate arrays because of the shorter wavelength and thus obtain still higher gain. Antennas for these bands are described in another chapter.

The problems in rotary-beam construction are those of providing a suitable mechanical support for the antenna elements, furnishing a means of rotation, and attaching the transmission line so that it does not interfere with the rotation of the system.

### Elements

The antenna elements usually are made of metal tubing so that they will be at least partially self-supporting, thus simplifying the sup-

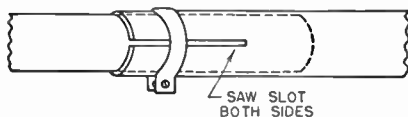

Fig. 14-53—Details of telescoping tubing for beam elements.

porting structure. The large diameter of the conductor is beneficial also in reducing resistance,

which becomes an important consideration when close-spaced elements are used.

Aluminum alloy tubes are generally used for the elements. The elements frequently are constructed of sections of telescoping tubing making length adjustments for tuning quite easy. Electrician's thin-walled conduit also is suitable for rotary-beam elements. Regardless of the tubing used, the ends should be plugged up with corks sealed with glyptal varnish.

The element lengths are made adjustable by sawing a 6- to 12-inch slot in the ends of the larger-diameter tubing and clamping the smaller tubing inside. Homemade clamps of aluminum can be built, or hose clamps of suitable size can be used. An example of this construction is shown in Fig. 14-53. If steel clamps are used, they should be cadmium- or zinc-plated before installation.

### Supports

Metal is commonly used to support the elements of the rotary beam. For 28 Mc., a piece of 2-inch diameter duraluminum tubing makes a good "boom" for supporting the elements. The elements can be made to slide through suitable holes in the boom, or special clamps and brackets can be fashioned to support the elements. Fittings for TV antennas can often be used on 21- and 28-Mc. beams. "Irrigation pipe" is a good source of aluminum tubing up to diameters of 6 inches and lengths of 20 feet. Muller clamps can be used to hold beam elements to a boom.

Most of the TV antenna rotators are satisfactory for turning the smaller beams.

With all-metal construction, delta, "gamma" or "T"-match are the only practical matching methods to use to the line, since anything else requires opening the driven element at the center, and this complicates the support problem for that element.

## "PLUMBER'S-DELIGHT" CONSTRUCTION

The lightest beam to build is the so-called "plumber's delight", an array constructed entirely of metal, with no insulating members between the elements and the supporting structure. Some suggestions for the constructional details are given in Figs. 14-54, 14-55 and 14-56. These show portions of a 4-element 10-meter beam, but the same principles hold for 15- and 20-meter beams.

Boom material can be the irrigation pipe suggested earlier (available from Sears Roebuck). Muller clamps and homemade brackets (aluminum or cadmium-plated steel) can be used to hold the parasitic elements to the boom, as shown in Fig. 14-54. The muller clamps and all hard-

ware should be cadmium-plated to forestall corrosion; the plating can be done at a plating shop and will not be very expensive if it is all done at the same time.

Muller clamps and a steel plate can be used to hold the boom to the supporting mast, as shown in Fig. 14-55. For maximum strength, the mast section should be a length of galvanized iron pipe. The plate thickness should run from  $\frac{3}{16}$  inch for a 10-meter beam to  $\frac{1}{2}$  inch or more for a 20-meter beam. Steel plates of this thickness are best cut in a welding shop, where it can be done quickly for a nominal fee. After the plate has been cut and the muller-clamp holes drilled, the plate, clamps and hardware should be plated.



The photograph in Fig. 14-56 shows one way a T-matched driven element can be assembled with its half-wave balun. Three coaxial chassis receptacles are fastened to a ¼-inch thick sheet of phenolic that is supported below the driven element by three aluminum straps. The two T rods are also supported by the phenolic sheet at the inner ends and by suitable straps at the outer ends where they make up to the driven element.

### Rotation

It is convenient but not essential to use a motor to rotate the beam. If a rope-and-pulley arrangement can be brought into the operating room or if the pole can be mounted near a window in the operating room, hand rotation will work.

If the use of a rope and pulleys is impracticable, motor drive is about the only alternative. There are several complete motor driven rotators on the market, and they are easy to mount, convenient to use, and require little or no maintenance. Generally speaking, light-weight units are better because they reduce the tower load.

The speed of rotation should not be too great—one or 1½ r.p.m. is about right. This requires a considerable gear reduction from the usual 1750-r.p.m. speed of small induction motors; a large reduction is advantageous because the gear train will prevent the beam from turning in weather-vane fashion in a wind. The usual beam does not require a great deal of power for rotation at slow speed, and a ⅛-hp. motor will be ample. A reversible motor should be used. War-surplus "prop pitch" motors have found wide application for rotating 14-Mc. beams, while TV rotators can be used with many 28-Mc. lightweight beams.

Driving motors and gear housings will stand the weather better if given a coat of aluminum paint followed by two coats of enamel and a coat of glyptal varnish. Even commercial units will last longer if treated with glyptal varnish. Be sure that the surfaces are clean and free from grease before painting. Grease can be removed by brushing with kerosene and then squirting the surface with a solid stream of water. The work can then be wiped dry with a rag.

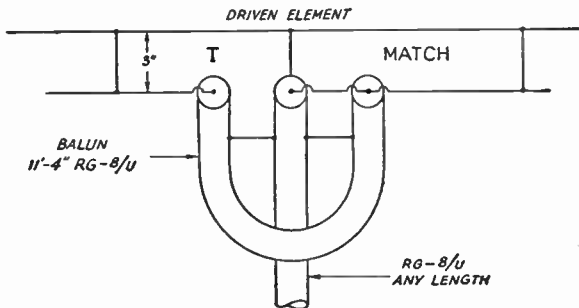

Fig. 14-56—(Diagram, above) Details of a coaxial-line termination board and T-match support for a 10-meter beam. The balun of a half-wavelength of coaxial line is coiled and then fastened to the boom with tape (right).

The power and control leads to the rotator should be run in electrical conduit or in lead covering, and the metal should be grounded.

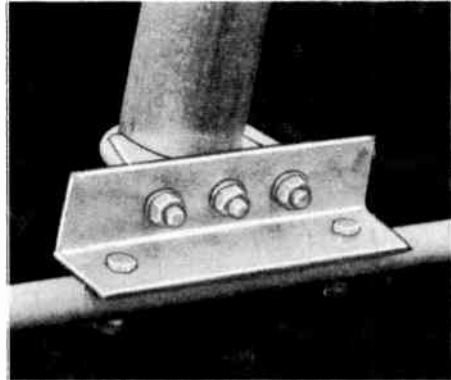

Fig. 14-54—Muffer clamps can be used to hold beam elements to the boom. The angle can be aluminum angle or angle iron; if iron is used it should be cadmium plated. This example shows a ¾-inch-diameter element held to a 2-inch diameter boom.

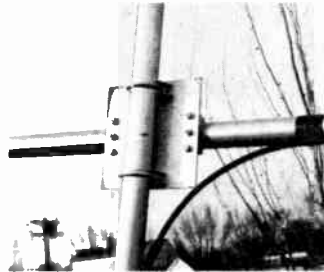
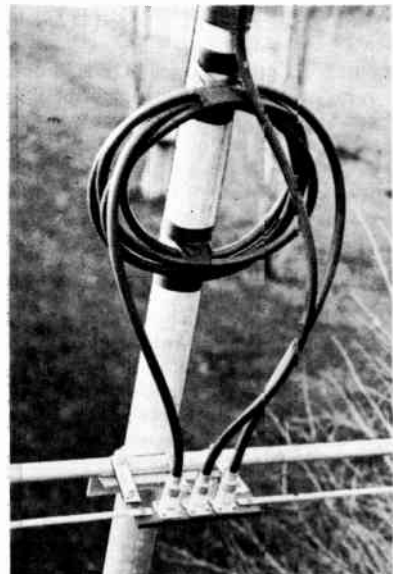

Fig. 14-55—The boom can be tied to the mast with muffer clamps and a steel plate. The coaxial line from the driven element is taped to the boom and mast.



### A COMPACT 14-Mc. 3-ELEMENT BEAM

A 20-meter beam no larger than the usual 10-meter beam can be made by using center-loaded elements and close spacing. Such an antenna will show good directivity and can be rotated with a TV-antenna rotator.

Constructional details of the elements are shown in Figs. 14-57 and 14-58. The loading coils are space-wound by interwinding plumb line (sometimes known as chalk line) with the No. 12 wire coils. The coil ends are secured by drilling small holes through the polystyrene bar, as shown in Fig. 14-60. The coils should be sprayed or painted with Krylon before installing the protective Lucite tubes.

The beam will require 4-foot lengths of the

clamps can be used for this purpose. The boom is a 12-foot length of 1½-inch o.d. 61ST aluminum tubing, with 0.125-inch wall.

The line is coupled and matched at the center of the driven element through adjustment of the link wound on the outside of the Lucite tubing. To check the adjustment of the elements, first resonate the driven element to the desired frequency in the 14-Mc. band with a grid-dip oscillator. Then resonate the director to approximately 14.8 Mc., and the reflector to approximately 13.6 Mc. This is not critical and only serves as rough point for the final tuning, which is done by use of a conventional field-strength indicator. Check the transmitter load-

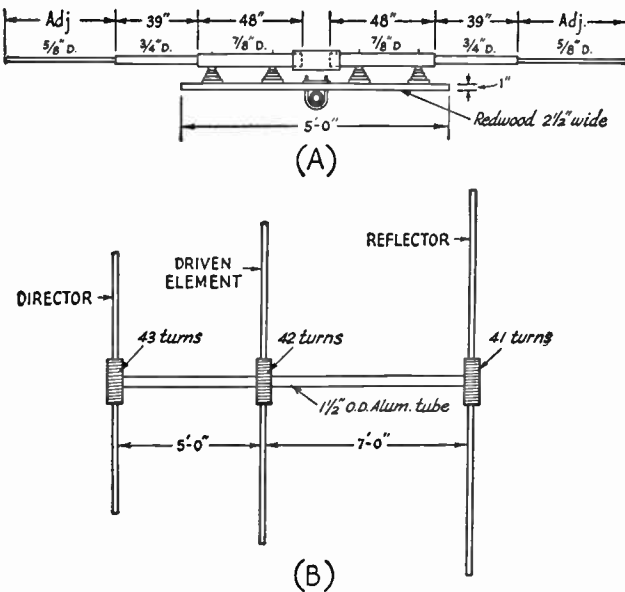
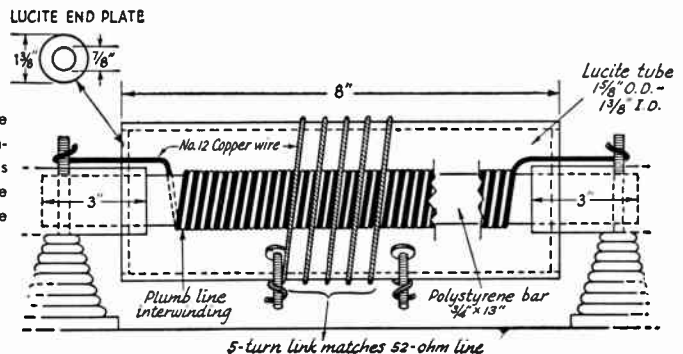

Fig. 14-57—Dimensions of a compact 14-Mc. beam. A—Side view of a typical element. TV-antenna "U" clamps hold the support arms to the boom. Birnbach 4176 insulators support the elements. B—Top plan of the beam showing element spacing and loading-coil dimensions. Elements are made of aluminum tubing. Construction of the loading coils and adjustment of the elements are discussed in the text. End-section lengths of 41 inches for the reflector, 40 inches for the driven element, and 10 inches for the director will be close to optimum.

tubings indicated in Fig. 14-57A. For good telescoping, element-wall thickness of 0.058 inch is recommended. The ends of the tubing sections should be slotted to permit adjustment, and secured with clamps, so that the joints will not work loose in the wind. Perforated ground

ing and readjust if necessary. Adjust the director for maximum forward gain, and then adjust the reflector for maximum forward gain. At this point, check the driven element for resonance and readjust if necessary. Turn the reflector toward the field-strength indicator and adjust for

Fig. 14-58—Detailed sketch of the loading and coupling coils at the center of the driven element, and its mounting. Similar loading coils (see text) are used at the centers of the director and reflector.



back cut-off. This must be done in small steps. Do not expect the attenuation off the sides of a short beam to be as high as that obtained with full-length elements. The s.w.r. of the line feeding the antenna can be checked with a bridge, and after the elements have been tuned, a final

adjustment of the s.w.r. can be made by adjusting the coupling at the antenna loading coil turns and spacing. As in any beam, the s.w.r. will depend upon this adjustment and not on any that can be made at the transmitter. Transmitter coupling is the usual for any coaxial line.

## A "ONE-ELEMENT ROTARY" FOR 21 Mc.

The directional properties of a simple half-wavelength antenna become more apparent at higher frequencies, and it is possible to take advantage of this fact to build a "one-element rotary" for 21 or 28 Mc. To take advantage of the directional properties of the antenna, it is only

wise or by laying the end of the tubing on a hard surface and then hammering it flat. This will provide enough space to accommodate the coax fitting (Amphenol type 83-1R). A 5/8-inch hole will be needed in the flat section to clear the shell of the coax fitting.

Fig. 14-59—(A) Diagram of the 21-Mc. antenna and mounting. The U-bolts that hold the 2 by 2 to the floor flange are standard 2-inch TV mast type bolts. (B) A more detailed drawing of the coil and coax-fitting mountings. The 1/4-inch spacing between turns is not critical, and they can vary as much as 1/16 inch without any apparent harm to the match.

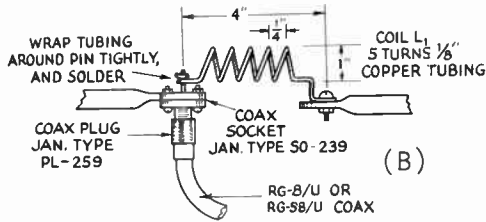
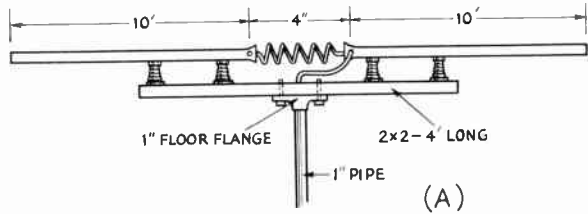

necessary to rotate it 180 degrees. It can be rotated by hand, as will be described, or by a small TV antenna rotator. A 28-Mc. antenna should be made full size (14-C) and fed at the center with RG-11/U.

The 21-Mc. antenna is made from two pieces of 1/2-inch diameter electrical thin-wall steel tubing or conduit. This tubing is readily available at any electric supply shop. It comes in 10-foot lengths and, while 20 feet is short for a half-wave antenna at 21-Mc., with loading the length is just about right for 52-ohm line feed. (A half-wavelength antenna would normally be fed with 72-ohm cable, since the antenna offers a good match for this impedance value. In this antenna system, the shorter elements, plus the small coil, offer a good match for 52-ohm cable.) If aluminum tubing is available, it can be used in place of the conduit, and the antenna will be lighter in weight. As shown in Figs. 14-59 and 14-60, the two pieces of tubing are supported by four stand-off insulators on a four-foot-long 2 by 2. The coax fitting for the feed line is mounted on the end of one of the lengths of tubing. A mounting point is made by flattening the end of the tubing for a length of about 1 1/2 inches. The tubing can be flattened by squeezing it in a

The coil,  $L_1$ , is made from 1/8-inch diameter copper tubing. It consists of 5 turns spaced 1/4 inch apart and is 1 inch inside diameter. The coil is connected in series with the inner conductor pin on the coax fitting and the other half of the antenna. To secure a good connection at the coax fitting, the coil lead should be wound around the inner-conductor pin and soldered. The other end of the coil can be connected with a screw and nut.

### Mounting

The antenna can be mounted on a 1-inch floor flange and held in place by two 2-inch bolts, as shown in Fig. 14-61. The floor flange can be connected to a 12-foot length of 1-inch pipe which will serve as a mast. Television antenna wall mounts can be used to support the mast.

In the installation shown in Fig. 14-61, 19-inch wall mounts were used in order to clear the eaves of the house. A 2-inch long piece of 1 1/4-inch pipe was used as a sleeve, and it was clamped in the U bolt on the bottom wall mount. A 1/4-inch hole was drilled through the mast pipe approximately 6 inches from the bottom. Then a 1 1/2-inch bolt was slipped through the hole and the mast was then mounted in the sleeve on the bottom wall mount. The bolt acted as a

Fig. 14-60—A close-up of the coil and coax fitting mountings. Be sure that the coil doesn't short out to the outer conductor when soldering the coil end to the inner conductor pin on the coax fitting.

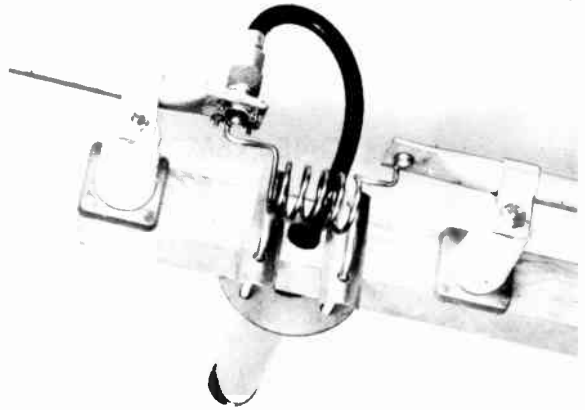

bearing point against the top of the sleeve. Another  $\frac{1}{4}$ -inch hole was drilled through the mast about three feet above the bottom wall mount. A piece of  $\frac{1}{4}$ -inch metal rod, six inches long, was forced through the hole so that the rod projected on each side of the mast. To turn the mast, a piece of rope was attached to each end

of the rod and the rope was brought into the shack, so that the antenna could be rotated by the "arm-strong" method. Obviously, one could spend more money for a "de luxe" version and use a TV antenna rotator and mast.

RG-8/U 52-ohm coax cable is recommended to feed the antenna. For power inputs up to 100 watts, the smaller and less expensive RG-58/U can be used. However, when you buy RG-58/U, be sure that the line is made by a reputable manufacturer (such as Amphenol or Belden). Some of the line made for TV installations is of inferior quality and is likely to have higher losses. The feedline was fed up through the mast pipe and through a  $\frac{3}{4}$ -inch hole in the 2 by 2. An Amphenol 83-1SP fitting on the end of the coax line connects to the female fitting on the antenna.

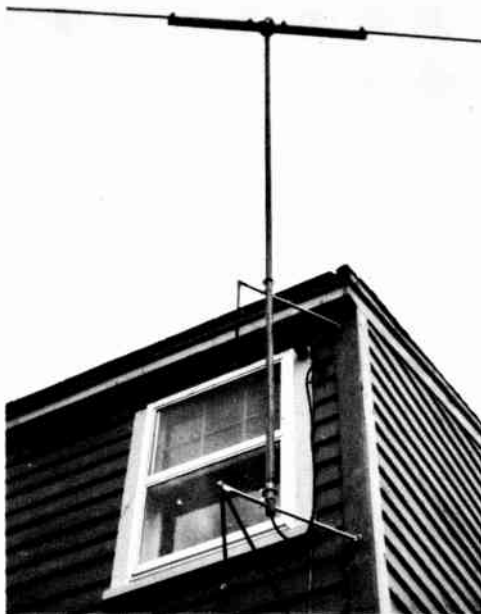

Fig. 14-61—Over-all view of the antenna and mounting. The feedline comes out of the bottom of the mast and through the wall into the shack.

#### Coupling to the Transmitter

It may be found that, when the feed line is coupled to the transmitter, the antenna won't take power. Since the line is terminated at the antenna in its characteristic impedance of 52 ohms, the output of the final r.f. amplifier must be adjusted to couple into a 52-ohm load. Where the output coupling device is a variable link, all that may be needed is the correct setting of the link. If the link is fixed, one end of the link can be grounded to the transmitter chassis and the other end of the link connected in series with a small variable capacitor to the inner conductor of the feed line. The outer conductor of the coax is grounded to the transmitter chassis. The capacitor is tuned to the point where the final amplifier is properly loaded. For transmitters having a pi-network output circuit, it is merely a matter of adjusting the network to the point where the amplifier is properly loaded.

# Wave Propagation

Much of the appeal of amateur communication lies in the fact that the results are not always predictable. Transmission conditions on the same frequency vary with the year, season and with the time of day. Although these variations usually follow certain established patterns, many peculiar effects can be observed from time to time. Every radio amateur should have some understanding of the known facts about radio wave propagation so that he will stand some chance of interpreting the unusual conditions

when they occur. The observant amateur is in an excellent position to make worthwhile contributions to the science, provided he has sufficient background to understand his results. He may discover new facts about propagation at the very-high frequencies or in the microwave region, as amateurs have in the past. In fact, it is through amateur efforts that most of the extended-range possibilities of various radio frequencies have been discovered, both by accident and by long and careful investigation.

## CHARACTERISTICS OF RADIO WAVES

Radio waves, like other forms of electromagnetic radiation such as light, travel at a speed of 300,000,000 meters per second in free space, and can be reflected, refracted, and diffracted.

An electromagnetic wave is composed of moving fields of electric and magnetic force. The lines of force in the electric and magnetic fields are at right angles, and are mutually per-

pendicular to the direction of travel. A simple representation of a wave is shown in Fig. 15-1.

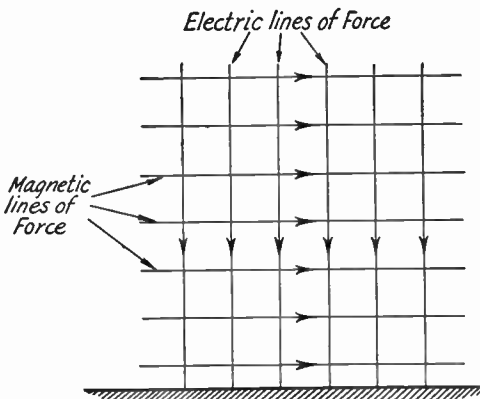

Fig. 15-1—Representation of electric and magnetic lines of force in a radio wave. Arrows indicate instantaneous directions of the fields for a wave traveling toward the reader. Reversing the direction of one set of lines would reverse the direction of travel.

pendicular to the direction of travel. A simple representation of a wave is shown in Fig. 15-1. In this drawing the electric lines are perpendicular to the earth and the magnetic lines are horizontal. They could, however, have any position with respect to earth so long as they remain perpendicular to each other.

The plane containing the continuous lines of electric and magnetic force shown by the grid-

or mesh-like drawing in Fig. 15-1 is called the wave front.

The medium in which electromagnetic waves travel has a marked influence on the speed with which they move. When the medium is empty space the speed, as stated above, is 300,000,000 meters per second. It is almost, but not quite, that great in air, and is much less in some other substances. In dielectrics, for example, the speed is inversely proportional to the square root of the dielectric constant of the material.

When a wave meets a good conductor it cannot penetrate it to any extent (although it will travel through a dielectric with ease) because the electric lines of force are practically short-circuited.

### Polarization

The polarization of a radio wave is taken as the direction of the lines of force in the electric field. If the electric lines are perpendicular to the earth, the wave is said to be **vertically polarized**; if parallel with the earth, the wave is **horizontally polarized**. The longer waves, when traveling along the ground, usually maintain their polarization in the same plane as was generated at the antenna. The polarization of shorter waves may be altered during travel, however, and sometimes will vary quite rapidly.

### Spreading

The field intensity of a wave is inversely proportional to the distance from the source. Thus if in a uniform medium one receiving point is twice as far from the transmitter as another, the field strength at the more distant point will be just half the field strength at the nearer point. This results from the fact that the energy in the wave front must be distributed over a greater area as the wave moves away from the source. This **inverse-distance law** is based on the assumption that there is nothing in the



medium to absorb energy from the wave as it travels. This is not the case in practical communication along the ground and through the atmosphere.

### Types of Propagation

According to the altitudes of the paths along which they are propagated, radio waves may be classified as **ionospheric waves**, **tropospheric waves** or **ground waves**.

The ionospheric or **sky wave** is that part of the total radiation that is directed toward the ionosphere. Depending upon variable conditions in that region, as well as upon transmitting wave length, the ionospheric wave may or may not be returned to earth by the effects of refraction and reflection.

The tropospheric wave is that part of the total radiation that undergoes refraction and reflection in regions of abrupt change of dielectric constant in the troposphere, such as may

occur at the boundaries between air masses of differing temperature and moisture content.

The ground wave is that part of the total ra-

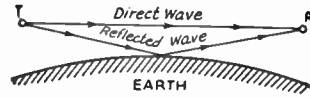

Fig. 15-2—Showing how both direct and reflected waves may be received simultaneously.

diation that is directly affected by the presence of the earth and its surface features. The ground wave has two components. One is the **surface wave**, which is an earth-guided wave, and the other is the **space wave** (not to be confused with the ionospheric or sky wave). The space wave is itself the resultant of two components — the **direct wave** and the **ground-reflected wave**, as shown in Fig. 15-2.

## IONOSPHERIC PROPAGATION

### PROPERTIES OF THE IONOSPHERE

Except for distances of a few miles, nearly all amateur communication on frequencies below 30 Mc. is by means of the sky wave. Upon leaving the transmitting antenna, this wave travels upward from the earth's surface at such an angle that it would continue out into space were its path not bent sufficiently to bring it back to earth. The medium that causes such bending is the **ionosphere**, a region in the upper atmosphere, above a height of about 60 miles, where free ions and electrons exist in sufficient quantity to have an appreciable effect on wave travel.

The ionization in the upper atmosphere is believed to be caused by ultraviolet radiation from the sun. The ionosphere is not a single region but is composed of a series of layers of varying densities of ionization occurring at different heights. Each layer consists of a central region of relatively dense ionization that tapers off in intensity both above and below.

### Refraction

The greater the intensity of ionization in a layer, the more the path of the wave is bent. The bending, or refraction (often also called reflection), also depends on the wavelength; the longer the wave, the more the path is bent for a given degree of ionization. Thus low-frequency waves are more readily bent than those of high frequency. For this reason the lower frequencies — 3.5 and 7 Mc. — are more "reliable" than the higher frequencies — 14 to 28 Mc.; there are times when the ionization is of such low value that waves of the latter frequency range are not bent enough to return to earth.

### Absorption

In traveling through the ionosphere the wave gives up some of its energy by setting the ionized particles into motion. When the moving

ionized particles collide with others this energy is lost. The **absorption** from this cause is greater at lower frequencies. It also increases with the intensity of ionization, and with the density of the atmosphere in the ionized region.

### Virtual Height

Although an ionospheric layer is a region of considerable depth it is convenient to assign to it a definite height, called the **virtual height**. This is the height from which a simple reflection would give the same effect as the gradual

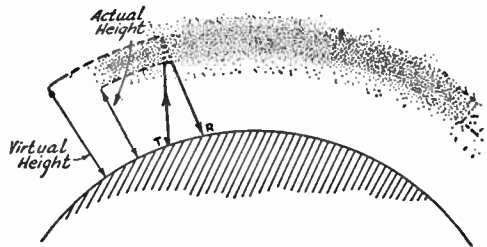

Fig. 15-3—Bending in the ionosphere, and the echo or reflection method of determining virtual height.

bending that actually takes place, as illustrated in Fig. 15-3. The wave traveling upward is bent back over a path having an appreciable radius of turning, and a measurable interval of time is consumed in the turning process. The virtual height is the height of a triangle having equal sides of a total length proportional to the time taken for the wave to travel from T to R.

### Normal Structure of the Ionosphere

The lowest useful ionized layer is called the **E layer**. The average height of the region of maximum ionization is about 70 miles. The air at this height is sufficiently dense so that the ions and electrons set free by the sun's radiation

do not travel far before they meet and recombine to form neutral particles, so the layer can maintain its normal intensity of ionization only in the presence of continuing radiation from the sun. Hence the ionization is greatest around local noon and practically disappears after sundown.

In the daytime there is a still lower ionized area, the *D* region. *D*-region ionization is proportional to the height of the sun and is greatest at noon. The lower amateur-band frequencies (1.8 and 3.5 Mc.) are almost completely absorbed by this layer, and only the high-angle radiation is reflected by the *E* layer. (Lower-angle radiation travels farther through the *D* region and is absorbed.)

The second principal layer is the *F* layer, which has a height of about 175 miles at night. At this altitude the air is so thin that recombination of ions and electrons takes place very slowly. The ionization decreases after sundown, reaching a minimum just before sunrise. In the daytime the *F* layer splits into two parts, the *F*<sub>1</sub> and *F*<sub>2</sub> layers, with average virtual heights of, respectively, 140 miles and 200 miles. These layers are most highly ionized at about local noon, and merge again at sunset into the *F* layer.

## SKY-WAVE PROPAGATION

### Wave Angle

The smaller the angle at which a wave leaves the earth, the less the bending required in the ionosphere to bring it back. Also, the smaller the angle the greater the distance between the point where the wave leaves the earth and that at which it returns. This is shown in Fig. 15-4. The vertical angle that the wave makes with a tangent to the earth is called the **wave angle** or **angle of radiation**.

### Skip Distance

More bending is required to return the wave to earth when the wave angle is high, and at times the bending will not be sufficient unless the wave angle is smaller than some critical value. This is illustrated in Fig. 15-4, where *A* and smaller angles give useful signals while waves sent at higher angles penetrate the layer and are not returned. The distance between *T* and *R*<sub>1</sub> is, therefore, the shortest possible distance, at that particular frequency, over which communication by ionospheric refraction can be accomplished.

The area between the end of the useful ground wave and the beginning of ionospheric-wave reception is called the **skip zone**, and the distance from the transmitter to the nearest point where the sky wave returns to earth is called the **skip distance**. The extent of the skip zone depends upon the frequency and the state of the ionosphere, and also upon the height of the layer in which the refraction takes place. The

higher layers give longer skip distances for the same wave angle. Wave angles at the transmitting and receiving points are usually, although not always, approximately the same for any given wave path.

### Critical and Maximum Usable Frequencies

If the frequency is low enough, a wave sent vertically to the ionosphere will be reflected back down to the transmitting point. If the frequency is then gradually increased, eventually a frequency will be reached where this vertical reflection just fails to occur. This is the **critical frequency** for the layer under consideration. When the operating frequency is below the critical value there is no skip zone.

The critical frequency is a useful index to the highest frequency that can be used to transmit over a specified distance—the **maximum usable frequency (m.u.f.)**. If the wave leaving the transmitting point at angle *A* in Fig. 15-4 is, for example, at a frequency of 14 Mc., and if a higher frequency would skip over the receiving point *R*<sub>1</sub>, then 14 Mc. is the m.u.f. for the distance from *T* to *R*<sub>1</sub>.

The greatest possible distance is covered when the wave leaves along the tangent to the earth; that is, at zero wave angle. Under average conditions this distance is about 4000 kilometers or 2500 miles for the *F*<sub>2</sub> layer, and 2000 km. or 1250 miles for the *E* layer. The distances vary with the layer height. Frequencies above these limiting m.u.f.'s will not be returned to earth at any distance. The 4000-km. m.u.f. for the *F*<sub>2</sub> layer is approximately 3 times the critical frequency for that layer, and for the *E* layer the 2000-km. m.u.f. is about 5 times the critical frequency.

Absorption in the ionosphere is least at the maximum usable frequency, and increases very rapidly as the frequency is lowered below the m.u.f. Consequently, best results with low power always are secured when the frequency is as close to the m.u.f. as possible.

It is readily possible for the ionospheric wave to pass through the *E* layer and be refracted back to earth from the *F*, *F*<sub>1</sub> or *F*<sub>2</sub> layers. This

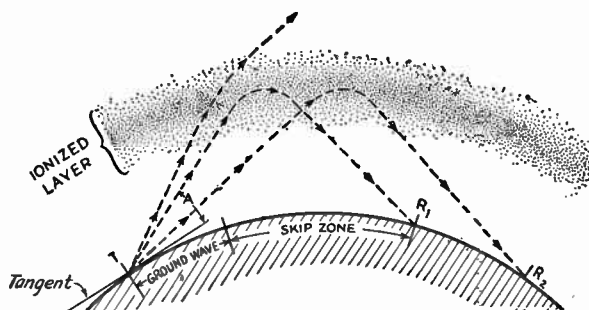

Fig. 15-4—Refraction of sky waves, showing the critical wave angle and the skip zone. Waves leaving the transmitter at angles above the critical (greater than *A*) are not bent enough to be returned to earth. As the angle is decreased, the waves return to earth at increasingly greater distances.

is because the critical frequencies are higher in the latter layers, so that a signal too high in frequency to be returned by the *E* layer can still come back from one of the others, depending upon the time of day and the existing conditions.

### Multihop Transmission

On returning to the earth the wave can be reflected upward and travel again to the ionosphere. There it may once more be refracted, and again bent back to earth. This process may be repeated several times. **Multihop** propagation of this nature is necessary for transmission over great distances because of the limited heights of the layers and the curvature of the earth, which restrict the maximum one-hop distance to the values mentioned in the preceding section. However, ground losses absorb some of the energy from the wave on each reflection (the amount of the loss varying with the type of ground and being least for reflection from sea water), and there is also absorption in the ionosphere at each reflection. Hence the smaller the number of hops the greater the signal strength at the receiver, other things being equal.

### Fading

Two or more parts of the wave may follow slightly different paths in traveling to the receiving point, in which case the difference in path lengths will cause a phase difference to exist between the wave components at the receiving antenna. The total field strength will be the sum of the components and may be larger or smaller than one component alone, since the phases may be such as either to aid or oppose. Since the paths change from time to time, this causes a variation in signal strength called **fading**. Fading can also result from the combination of single-hop and multihop waves, or the combination of a ground wave with an ionospheric or tropospheric wave.

Fading may be either rapid or slow, the former type usually resulting from rapidly-changing conditions in the ionosphere, the latter occurring when transmission conditions are relatively stable. Severe changes in signal strength of 10 to 20 db: or more are called "deep" fades, in contrast to the more normal "shallow" fades of a few db.

It frequently happens that transmission conditions are different for waves of slightly different frequencies, so that in the case of voice-modulated transmission, involving sidebands differing slightly from the carrier in frequency, the carrier and various sideband components may not be propagated in the same relative amplitudes and phases they had at the transmitter. This effect, known as **selective fading**, causes severe distortion of the signal. The distortion is most marked on amplitude-modulated signals and at high percentages of modulation; it is possible to reduce the effects considerably by using "exalted-carrier reception" and "single-sideband" techniques that, in effect, reduce the modulation percentage at the receiver.

### Back Scatter

Even though the operating frequency is above the m.u.f. for a given distance, it is usually possible to hear signals from within the skip zone. This phenomenon, called **back scatter**, is caused by reflections from distances beyond the skip zone. Such reflections can occur when the transmitted energy strikes the earth at a distance and some of it is reflected back into the skip zone to the receiver. Such scatter signals are weaker than those normally propagated, and also have a rapid fade or "flutter" that makes them easily recognizable.

A certain amount of scattering of the wave also takes place in the ionosphere because the ionized region is not completely uniform. Scattering in the normal propagation direction is called **forward scatter**, and is responsible for extending the range of transmission beyond the distance of a regular hop, and for making communication possible on frequencies greater than the actual m.u.f.

## OTHER FEATURES OF IONOSPHERIC PROPAGATION

### Cyclic Variations in the Ionosphere

Since ionization depends upon ultraviolet radiation, conditions in the ionosphere vary with changes in the sun's radiation. In addition to the daily variation, seasonal changes result in higher critical frequencies in the *E* layer in summer, averaging about 4 Mc. as against a winter average of 3 Mc. The *F* layer critical frequency is of the order of 4 to 5 Mc. in the evening. The *F*<sub>1</sub> layer, which has a critical frequency near 5 Mc. in summer, usually disappears entirely in winter. The daytime maximum critical frequencies for the *F*<sub>2</sub> are highest in winter (10 to 12 Mc.) and lowest in summer (around 7 Mc.). The virtual height of the *F*<sub>2</sub> layer, which is about 185 miles in winter, averages 250 miles in summer. These values are representative of latitude 40 deg. North in the Western hemisphere, and are subject to considerable variation in other parts of the world.

Very marked changes in ionization also occur in step with the **11-year sunspot cycle**. Although there is no apparent direct correlation between sunspot activity and critical frequencies on a given day, there is a definite correlation between *average* sunspot activity and critical frequencies. The critical frequencies are highest during sunspot maxima and lowest during sunspot minima. During the period of minimum sunspot activity, the lower frequencies—7 and 3.5 Mc.—frequently are the only usable bands at night. At such times the 28-Mc. band is seldom useful for long-distance work, while the 14-Mc. band performs well in the daytime but is not ordinarily useful at night.

### Ionosphere Storms

Certain types of sunspot activity cause considerable disturbances in the ionosphere (iono-

sphere storms) and are accompanied by disturbances in the earth's magnetic field (magnetic storms). Ionosphere storms are characterized by a marked increase in absorption, so that radio conditions become poor. The critical frequencies also drop to relatively low values during a storm, so that only the lower frequencies are useful for communication. Ionosphere storms may last from a few hours to several days. Since the sun rotates on its axis once every 28 days, disturbances tend to recur at such intervals, if the sunspots responsible do not become inactive in the meantime. Absorption is usually low, and radio conditions good, just preceding a storm.

#### Sporadic-E Ionization

Scattered patches or clouds of relatively dense ionization occasionally appear at heights approximately the same as that of the *E* layer, for reasons not yet known. This sporadic-*E* ionization is most prevalent in the equatorial regions, where it is substantially continuous. In northern latitudes it is most frequent in the spring and early summer, but is present in some degree a fair percentage of the time the year 'round. It accounts for much of the night-time short distance work on the lower frequencies (3.5 and 7 Mc.) and, when more intense, for similar work on 14 to 28 Mc. Exceptionally intense sporadic-*E* ionization permits work over distances exceeding 400 or 500 miles on the 50-Mc. band.

There are indications of a relationship between sporadic-*E* ionization and average sunspot activity, but it does not appear to be directly related to daylight and darkness since it may occur at any time of the day. However, there is an apparent tendency for the ionization to peak at mid-morning and in the early evening.

#### Tropospheric Propagation

Changes in temperature and humidity of air masses in the lower atmosphere often permit work over greater than normal ground-wave distances on 28 Mc. and higher frequencies. The effect can be observed on 28 Mc., but it is generally more marked on 50 and 144 Mc. The subject is treated in detail later.

### PREDICTION CHARTS

The Central Radio Propagation Laboratory of National Bureau of Standards offers prediction charts, by means of which it is possible to predict with considerable accuracy the maximum usable frequency that will hold over any path on the earth during a monthly period. The charts can be obtained from the Superintendent of Documents, U. S. Government Printing Office, Washington 25, D.C. for 15 cents per copy or \$1.50 per year (\$2.00 foreign). They are called "*CRPL Ionospheric Predictions*." The use of the charts is explained in Handbook 90, "*Handbook for CRPL Ionospheric Predictions*," available for 40 cents from the same address.

Predictions on *E*-layer propagation may be obtained from information included in Handbook 90.

### PROPAGATION IN THE BANDS BELOW 30 MC.

The 1.8-Mc., or "160-meter," band offers reliable working over ranges up to 25 miles or so during daylight. On winter nights, ranges up to several thousand miles are not impossible. Only small sections of the band are currently available to amateurs, because of the loran (navigation) service in that part of the spectrum.

The 3.5-Mc., or "80-meter," band is a more useful band during the night than during the daylight hours. In the daytime, one can seldom hear signals from a distance of greater than 200 miles or so, but during the darkness hours distances up to several thousand miles are not unusual, and transoceanic contacts are regularly made during the winter months. During the summer, the static level is high.

The 7-Mc., or "40-meter," band has many of the same characteristics as 3.5, except that the distances that can be covered during the day and night hours are increased. During daylight, distances up to a thousand miles can be covered under good conditions, and during the dawn and dusk periods in winter it is possible to work stations as far as the other side of the world, the signals following the darkness path. The winter months are somewhat better than the summer ones. In general, summer static is much less of a problem than on 80 meters, although it can be serious in the semitropical zones.

The 14-Mc., or "20-meter," band is probably the best one for long-distance work. During the high portion of the sunspot cycle it is open to some part of the world during practically all of the 24 hours, while during a sunspot minimum it is generally useful only during daylight hours and the dawn and dusk periods. There is practically always a skip zone on this band.

The 21-Mc., or "15-meter," band shows highly variable characteristics depending on the sunspot cycle. During sunspot maxima it is useful for long-distance work during a large part of the 24 hours, but in years of low sunspot activity it is almost wholly a daytime band, and sometimes unusable even in daytime. However, it is often possible to maintain communication over distances up to 1500 miles or more by sporadic-*E* ionization which may occur either day or night at any time in the sunspot cycle.

The 28-Mc. ("10-meter") band is generally considered to be a DX band during the daylight hours (except in summer) and good for local work during the hours of darkness, for about half the sunspot cycle. At the very peak of the sunspot cycle, it may be "open" into the late evening hours for DX communication. At the sunspot minimum the band is usually "dead" for long-distance communication, by means of the  $F_2$  layer, in the northern latitudes. Nevertheless, sporadic-*E* propagation is likely to occur at any time, just as in the case of the 21-Mc. band.

There will often be exceptions to the general conditions described above, and their observation is a very interesting facet of amateur radio.



## PROPAGATION ABOVE 50 MC.

The importance to the amateur of having some knowledge of wave propagation was stressed at the beginning of this chapter. An understanding of the means by which his signals reach their destination is an even greater aid to the v.h.f. worker. Each of his bands shows different characteristics, and knowledge of their peculiarities is as yet far from complete. The observant user of the amateur v.h.f. assignments has a good opportunity to contribute to that knowledge, and his enjoyment of his work will be greatly enhanced if he knows when to expect unusual propagation conditions.

### CHARACTERISTICS OF THE V.H.F. BANDS

An outstanding feature of our bands from 50 Mc. up is their ability to provide consistent and interference-free communication within a limited range. All lower frequencies are subject to varying conditions that impair their effectiveness for work over distances of 100 miles or less at least part of the time, and the heavy occupancy they support results in severe interference problems in areas of dense population. The v.h.f. bands, being much wider, can handle many times the amateur population without crowding, and their characteristics for local work are more stable. It is thus to the advantage of amateur radio as a whole to make use of 50 Mc. and higher bands for short-range communication wherever possible.

In addition to reliable local coverage, the v.h.f. bands also exhibit several forms of long-distance propagation at times, and use of 50 and 144 Mc. has been taken up in recent years by many isolated amateurs who must depend on these propagation peculiarities for all or most of their contacts. It is particularly important to these operators that they understand common propagation phenomena. The material to follow supplements information presented earlier in this chapter, but deals with wave propagation only as it affects the occupants of the world above 50 Mc. First let us consider each band.

*50 to 54 Mc.:* This band is borderline territory between the DX frequencies and those normally employed for local work. Thus just about every form of wave propagation found throughout the radio spectrum appears, on occasion, in the 50-Mc. region. This has contributed greatly to the popularity of the 50-Mc. band.

During the peak years of a sunspot cycle it is occasionally possible to work 50-Mc. DX of world-wide proportions, by reflection of signals from the  $F_2$  layer. Sporadic-E skip provides contacts over distances from 400 to 2500 miles or so during the early summer months, regardless of the solar cycle. Reflection from the aurora regions allows 100- to 1000-mile work during pronounced ionospheric disturbances. The ever-changing weather pattern offers extension of the normal coverage to as much as 300 to 500 miles.

This develops most often during the warmer months, but may occur at any season. In the absence of any favorable propagation, the average well-equipped 50-Mc. station should be able to work regularly over a radius of 75 to 100 miles or more, depending on local terrain.

*144 to 148 Mc.:* Ionospheric effects are greatly reduced at 144 Mc.  $F_2$ -layer reflection is unlikely, and sporadic-E skip is rare. Aurora DX is fairly common, but signals are generally weaker than on 50 Mc. Tropospheric effects are more pronounced than on 50 Mc., and distances covered during favorable weather conditions are greater than on lower bands. Air-mass boundary bending has been responsible for communication on 144 Mc. over distances in excess of 2500 miles, and 500-mile work is fairly common in the warmer months. The reliable range under normal conditions is slightly less than on 50 Mc., with comparable equipment.

*220 Mc. and Higher:* Ionospheric propagation is unlikely at 220 Mc. and up, but tropospheric bending is more prevalent than on lower bands. Amateur experience on 220 and 420 Mc. is showing that they can be as useful as 144 Mc., when comparable equipment is used. Under minimum conditions the range may be slightly shorter, but when signals are good on 144 Mc., they may be better on 220 or 420. Even above 1000 Mc. there is evidence of tropospheric DX.

### PROPAGATION PHENOMENA

The various known means by which v.h.f. signals may be propagated over unusual distances are discussed below.

*$F_2$ -Layer Reflection:* Most contacts made on 28 Mc. and lower frequencies are the result of reflection of the wave by the  $F_2$  layer, the ionization density of which varies with solar activity, the highest frequencies being reflected at the peak of the 11-year solar cycle. The maximum usable frequency (m.u.f.) for  $F_2$  reflection also follows other well-defined cycles, daily, monthly, and seasonal, all related to conditions on the sun and its position with respect to the earth.

At the low point of the 11-year cycle, such as in the early '50s, the m.u.f. may reach 28 Mc. only during a short period each spring and fall, whereas it may go to 60 Mc. or higher at the peak of the cycle. The fall of 1946 saw the first authentic instances of long-distance work on 50 Mc. by  $F_2$ -layer reflection, and as late as 1950 contacts were made in the more favorable areas of the world by this medium. The rising curve of the current solar cycle again made  $F_2$  DX on 50 Mc. possible in the low latitudes in the winter of 1955-6. DX was worked over much of the earth in the years 1956 through 1959, falling off in 1960. Loss of the 50-Mc. band to television in some countries will limit the scope of 50-Mc. DX in years to come.

The  $F_2$  m.u.f. is readily determined by observation, and it may be estimated quite accu-



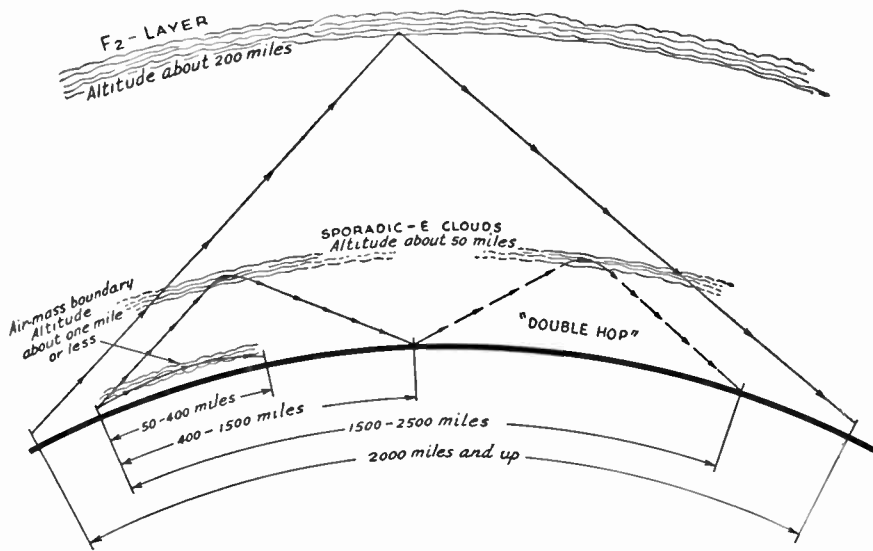

Fig. 15-5—The principal means by which v.h.f. signals may be returned to earth, showing the approximate distances over which they are effective. The  $F_2$  layer, highest of the reflecting layers, may provide 50-Mc. DX at the peak of the 11-year sunspot cycle. Such communication may be world-wide in scope. Sporadic ionization of the E region produces the familiar "short skip" on 28 and 50 Mc. It is most common in early summer and in late December, but may occur at any time, regardless of the sunspot cycle. Refraction of v.h.f. waves also takes place at air-mass boundaries, making possible communication over distances of several hundred miles on all v.h.f. bands. Normally it exhibits no skip zone.

ately for any path at any time. It is predictable for months in advance, enabling the v.h.f. worker to arrange test schedules with distant stations at propitious times. As there are numerous commercial signals, both harmonics and fundamental transmissions, on the air in the range between 28 and 50 Mc., it is possible to determine the approximate m.u.f. by careful listening in this range. Daily observations will show if the m.u.f. is rising or falling, and once the peak for a given month is determined it can be assumed that another will occur about 27 days later, this cycle coinciding with the turning of the sun on its axis. The working range, via  $F_2$  skip, is roughly comparable to that on 28 Mc., though the *minimum* distance is somewhat longer. Two-way work on 50 Mc. by reflection from the  $F_2$  layer has been accomplished over distances from 2200 to 12,000 miles. The maximum frequency for  $F_2$  reflection is believed to be about 70 Mc.

**Sporadic-E Skip:** Patchy concentrations of ionization in the E-layer region are often responsible for reflection of signals on 28 and 50 Mc. This is the popular "short skip" that provides fine contacts on both bands in the range between 400 and 1300 miles. It is most common in May, June and July, during morning and early evening hours, but it may occur at any time or season. Multiple-hop effects may appear, making possible work over more than 2500 miles.

The upper limit of frequency for sporadic-E skip is not positively known, but scattered instances of 144-Mc. propagation over distances in excess of 1000 miles indicate that E-layer reflection, possibly aided by tropospheric effects, may be responsible.

**Aurora Effect:** Low-frequency communication is occasionally wiped out by absorption in the ionosphere, when ionospheric storms, associated with variations in the earth's magnetic field, occur. During such disturbances, however, v.h.f. signals may be reflected back to earth, making communication possible over distances not normally workable in the v.h.f. range. Magnetic storms may be accompanied by an aurora-borealis display, if the disturbance occurs at night and visibility is good. Aiming a beam at the auroral curtain will bring in signals strongest, regardless of the direction to the transmitter.

Aurora-reflected signals are characterized by a rapid flutter, which lends a "dribbling" sound to 28-Mc. carriers and may render modulation on 50- and 144-Mc. signals completely unreadable. The only satisfactory means of communication then becomes straight c.w. The effect may be noticeable on signals from any distance other than purely local, and stations up to about 1000 miles in any direction may be worked at the peak of the disturbance. Unlike the two methods of propagation previously described, aurora effect exhibits no skip zone. It is observed frequently on 50 and 144 Mc. in northeastern U. S. A., usually in the early evening hours or after midnight. The highest frequency for auroral reflection is not yet known, but pronounced disturbances have permitted work by this medium in the 220-Mc. band.

**Tropospheric Bending:** The most common form of v.h.f. DX is the extension of the normal operating range associated with easily observed weather phenomena. It is the result of the change in refractive index of the atmosphere at the boundary between air masses of differing

temperature and humidity characteristics. Such boundaries usually lie along the western or southern edges of a stable slow-moving area of high barometric pressure (fair, calm weather) in the period prior to the arrival of a storm.

A typical upper-air sounding showing temperature and water-vapor gradients favorable to v.h.f. DX is shown in Fig. 15-6. An increase in temperature and a sharp drop in water-vapor gradient are seen at about 4000 feet.

Such a favorable condition develops most often in the late summer or early fall, along the junction between air masses that may have come together from such widely separated points as the Gulf of Mexico and Northern Canada. Under

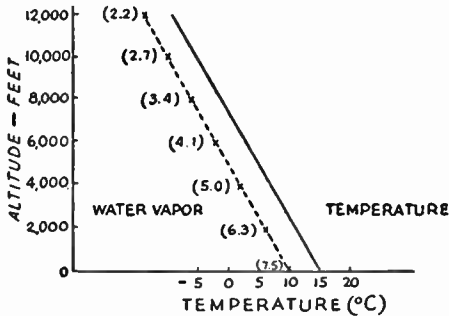

the 144-Mc. band may show strong signals from far beyond visual distances when lower frequencies are relatively inactive. It is probable that this tendency continues on up through the microwave range, and there is good evidence to indicate that our assignments in the u.h.f. and s.h.f. portions of the frequency spectrum may someday support communication over distances far in excess of the optical range.

*Scatter:* Forward scatter, both ionospheric and tropospheric, may be used for marginal communication in the v.h.f. bands. Both provide very weak but consistent signals over distances that were once thought impossible on frequencies higher than about 30 Mc.

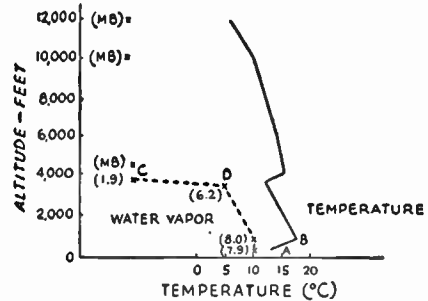

Fig. 15-6—Upper-air conditions that produce extended-range communication on the v.h.f. bands. At the left is shown the U. S. Standard Atmosphere temperature curve. The humidity curve (dotted) is that which would result if the relative humidity were 70 per cent from the ground level to 12,000 feet elevation. There is only slight refraction under this standard condition. At the right is shown a sounding that is typical of marked refraction of v.h.f. waves. Figures in parentheses are the "mixing ratio"—grams of water vapor per kilogram of dry air. Note the sharp break in both curves at about 4000 feet. (From Collier, "Upper-Air Conditions for 2-Meter DX," QST, September, 1955.)

stable weather conditions the two air masses may retain their original character for several days at a time, usually moving slowly eastward across the country. When the path between two v.h.f. stations separated by fifty to several hundred miles lies along such a boundary, signal levels run far above the average value.

Many factors other than air-mass movement of a continental character provide increased v.h.f. operating range. The convection along coastal areas in warm weather is a good example. The rapid cooling of the earth after a hot day in summer, with the air aloft cooling more slowly, is another, producing a rise in signal strength in the period around sundown. The early morning hours, when the sun heats the air aloft, before the temperature of the earth's surface begins to rise, may be the best of the day for extended v.h.f. range, particularly in clear, calm weather.

The v.h.f. enthusiast soon learns to correlate various weather manifestations with radio-propagation phenomena. By watching temperature, barometric pressure, changing cloud formations, wind direction, visibility, and other easily-observed weather signs, he can tell with a reasonable degree of accuracy what is in prospect on the v.h.f. bands.

The responsiveness of radio waves to varying weather conditions increases with frequency. The 50-Mc. band is more sensitive to weather variations than is the 28-Mc. band, and

Tropospheric scatter is prevalent all through the v.h.f. and microwave regions, and is usable over distances up to about 400 miles. Ionospheric scatter, augmented by meteor bursts, usually brings in signals over 600 to 1300 miles, on frequencies up to about 100 Mc. Either form of scatter requires high power, large antennas and c.w. technique to provide useful communication.

Back scatter, of the type heard on lower bands, is also heard occasionally on 50 Mc., when  $F_2$  or sporadic-E skip is present.

*Reflections from Meteor Trails:* Probably the least-known means of v.h.f. wave propagation is that resulting from the passage of meteors across the signal path. Reflections from the ionized meteor trails may be noted as a Doppler-effect whistle on the carrier of a signal already being received, or they may cause bursts of reception from stations not normally receivable. Ordinarily such reflections are of little value in communication, since the increases in signal strength are of short duration, but meteor showers of considerable magnitude and duration may provide fluttery signals from distances up to 1500 miles on both 50 and 144 Mc.

As meteor-burst signals are relatively weak, their detection is greatly aided if high power and high-gain antennas are used. Two-way communication of sorts has been carried on by this medium on 50 and 144 Mc. over distances of 600 to 1300 miles.

# V.H.F. Receivers and Transceivers

Good receiving facilities are all-important in v.h.f. work. High sensitivity, adequate stability and good signal-to-noise ratio, necessary attributes in a receiving system for 50 Mc. and higher frequencies, are most readily attained through the use of a converter working into a communications receiver designed for lower frequencies. Though receivers and converters for the v.h.f. bands are available on the amateur market, the amateur worker can build his own with fully as good results, usually at a considerable saving in cost.

Basically, modern v.h.f. receiving equipment is little different from that employed on lower frequencies. The same order of selectivity may be used on all amateur frequencies up to at least 450 Mc. The greatest practical selectivity should be employed in v.h.f. reception, as it not only allows more stations to operate in a given band, but is an important factor in improving the signal-to-noise ratio. All else equal, the effective sensitivity of a receiver having "communication" selectivity is much better than with a broadband system.

This rules out converted radar-type receivers and others using broad i.f. amplifiers. The superregenerative receiver, a simple but broadband device that was popular in the early days of v.h.f. work, is now used principally for portable operation, or for other applications where high sensitivity and selectivity are not of prime importance. It is capable of surprising performance, for a given number of tubes and components, but its lack of selectivity, its poor signal-to-noise ratio, and its tendency to radiate a strong interfering signal have eliminated the superregenerator as a fixed-station receiver in areas where there is appreciable v.h.f. activity.

## R. F. AMPLIFIER DESIGN

The noise generated within the receiver itself is an important factor in the effectiveness of v.h.f. receiving gear. At lower frequencies, and to a considerable extent on 50 Mc., external noise is a limiting factor. At 144 Mc. and higher the receiver noise figure, gain and selectivity determine the ability of the system to respond to weak signals. Proper selection of r.f. amplifier tubes and appropriate circuit design aimed at low noise figure are more important in the v.h.f. receiver "front end" than mere gain.

### Triode or Pentode?

Certain triode tubes have been developed with this end in view. Their superiority over

pentode types is more pronounced as we go higher in frequency. Because of the limitation on sensitivity imposed by external noise at that frequency, triode or pentode r.f. amplifiers give about the same results at 50 Mc. Thus the pentode types, which offer the advantages of better selectivity and simpler circuitry, are often used for 50-Mc. work. But at 144 Mc. and higher, the newer triodes designed for r.f. amplifier service give fully as much gain as the pentodes, and with lower internal noise. With the exception of a transceiver, the equipment described in the following pages incorporates low-noise r.f. amplifier techniques.

### Neutralizing Methods

When triodes are used as r.f. amplifiers some form of neutralization of the grid-plate capacitance is required. The alternative to neutralization is the use of grounded-grid circuitry which, unfortunately, does not usually permit as good selectivity through the r.f. stages. Circuits for v.h.f. triode r.f. amplifier stages are given in Figs. 16-1 through 16-4. Any transmitting neutralizing circuit may be utilized, provided it is suitable for the frequency.

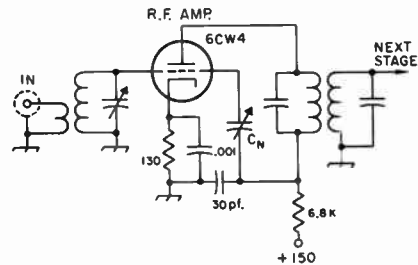

Fig. 16-1—Schematic diagram of a single-ended triode r.f. amplifier for v.h.f. applications. Although shown with a 6CW4 tube, it can be utilized with any suitable tube.

CN—1 to 3.5-pf. ceramic adjustable.

The single-ended neutralized triode amplifier shown in Fig. 16-1 gives typical values for use with a 6CW4 "Nuvistor" tube. A prime consideration is that both ends of the output tuned circuit be "above ground"; to this end it is important that the series dropping resistor (6.8K in Fig. 16-1) be at least 1000 ohms in any application of the circuit. Other tube types might take other

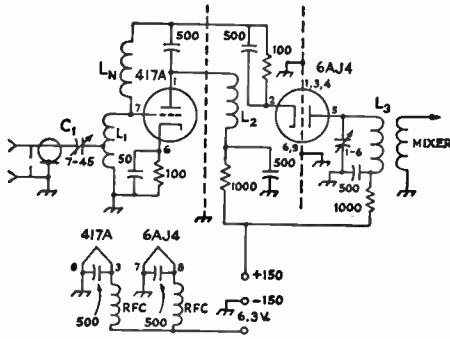

Fig. 16-2—Circuit of the cascode r.f. amplifier. Coupling capacitor,  $C_1$ , may be omitted if spurious receiver responses are not a problem. Neutralizing winding,  $L_N$  should resonate at the signal frequency with the grid-plate capacitance of the first tube. Base connections are for 417A and 6AJ4, but other small triodes may be used.

ratios of the capacitors in the neutralizing circuit (the 3.5-pf. adjustable and the 30-pf. fixed).

A triode amplifier having excellent noise figure and broadband characteristics is shown in Fig. 16-2. Commonly called the cascode, it uses a triode or triode-connected pentode followed by a triode grounded-grid stage. This circuit is extremely stable and uncritical in adjustment. At 50 Mc. and higher its over-all gain is at least equal to the best single-stage pentode amplifier and its noise figure is far lower.

Neutralization is accomplished by the coil  $L_N$ , whose value is such that it resonates at the signal frequency with the grid-plate capacitance of the tube. Its inductance is not critical; it may be omitted from the circuit without the stage going into oscillation, but neutralization results in a lower noise figure than is possible without it. Any of several v.h.f. tubes may be used in the cascode circuit. The example shown in Fig. 16-2 uses the 417A (5842), followed by a 6AJ4. Two 6AJ4s would work almost equally well, as would the 6AM4, 6AN4 and 6BC4. Pin connections in Fig. 16-2 should be changed to suit the tubes selected.

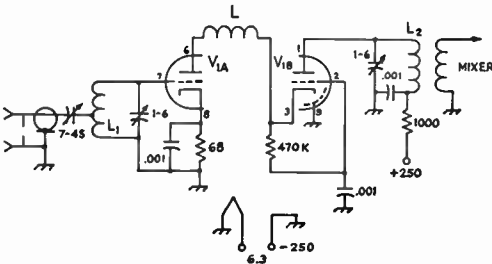

Fig. 16-3—Simplified cascode circuit for use with dual triodes having separate cathodes. Coil and capacitance values not given depend on frequency. Bifilar r.f. chokes are occasionally used in heater leads.  $L$  matches impedances between tubes and improves overall noise figure.

A simplified version of the cascode, using a dual triode tube designed especially for this application, is shown in Fig. 16-3. By reducing stray capacitance, through direct coupling between the two triode sections, this circuit makes for improved performance at the frequencies above 100 Mc. The two sections of the tube are in series, as far as plate voltage is concerned, so it requires higher voltage than the other circuits shown.

The neutralization process for the cascode and neutralized-triode amplifiers is somewhat similar. With the circuit operating normally the neutralizing adjustments (capacitance of  $C_N$  in Fig. 16-1; inductance of  $L_N$  in Fig. 16-2) can be set for best signal-to-noise ratio. The best results are obtained using a noise generator, adjusting for lowest noise figure, but careful adjustment on a weak signal provides a fair approximation. Noise generators and their use in v.h.f. receiver adjustment are treated in July, 1953, *QST*, p. 10, and in this *Handbook*, Chapter 21.

Grounded-grid r.f. amplifier technique is illustrated in Figs. 16-4 and 16-25. Here the input is in the cathode lead, with the grid of the tube grounded, to act as a shield between cathode and plate. The grounded-grid circuit is stable and easily adjusted, and is well adapted to broadband applications. The gain per stage is low, so that two or more stages may be required.

Tubes well-suited to grounded-grid amplifier service include the 6J4, 6AN4, 6AJ4, 6AM4, 6BC4, 417A and 416B. Disk-seal tubes such as the "lighthouse" and "pencil tube" types are often used as r.f. amplifiers above 500 Mc., and the new ceramic tubes show great possibilities for r.f. amplifier service in the u.h.f. range.

Great care should be used in adjusting the r.f. portion of a v.h.f. receiver, whatever circuit is used. If it is working properly it will control the noise figure of the entire system.

### Reducing Spurious Responses

In areas where there is a high level of v.h.f. activity or extensive use of other frequencies in the v.h.f. range, the ability of the receiver to operate properly in the presence of strong signals may be an important consideration. Special tube types, otherwise similar to older numbers, have been developed for low overload and cross-modulation susceptibility. The 6BC8, which may be used as a replacement for the 6BQ7A or 6BZ7, is one of these.

Modification of the converter design can also improve performance in these respects. In general, the gain ahead of the mixer stage should be made no more than is necessary to achieve good noise figure characteristics. The plate voltage on the r.f. amplifier should be kept as high as practical, to prevent easy overloading.

Rejection of signals outside the desired frequency range can be improved by the use of high- $Q$  tuned circuits ahead of the first r.f. amplifier stage. Television transmitters are particularly troublesome in this respect, and one or



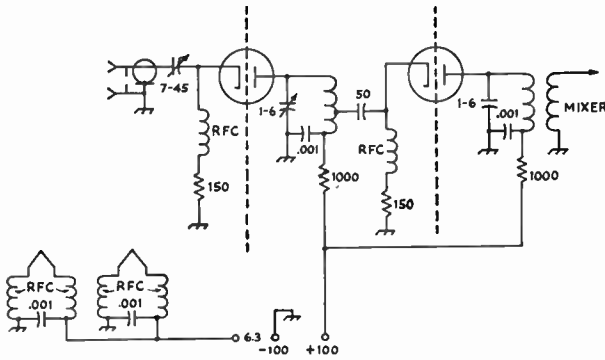

Fig. 16-4—Grounded-grid amplifier. Position of tap on plate coil should be adjusted for lowest noise figure. Low gain with this circuit makes two stages necessary for most applications. R.f. choke and coil values depend on frequency.

more coaxial-type circuits inserted in the lead from the antenna to the converter may be necessary to keep such signals from interfering with normal reception.

A common cause of unwanted signals appearing in the tuning range is the presence of oscillator harmonics in the energy being fed to the mixer of a crystal-controlled converter. This may be prevented by using a high oscillator frequency, to keep down the number of multiplications, and by shielding the oscillator and multiplier stages from the rest of the converter.

Signals at the intermediate frequency may ride through a converter. This can be prevented by keeping down capacitive interstage coupling in the r.f. circuitry, and by shielding the converter and the receiver antenna terminals. The problem of receiver responses is dealt with in *QST* for April, 1955, p. 56, and February, 1958, p. 27.

**MIXER CIRCUITS**

The mixer in a v.h.f. converter may be either a pentode or a triode tube. Pentodes give generally higher output, and may require less injection. When used without a preceding r.f. amplifier stage, the triode mixer may provide a better noise figure. With either tube, the grid circuit is tuned to the signal frequency, and the plate circuit to the intermediate frequency.

A simple triode mixer is shown in Fig. 16-5A, with a pentode mixer at B. A dual-triode version (push-push mixer) is shown at C. The push-push mixer is well adapted to use at 420 Mc., and may, of course, be used at any lower frequency. Dual tubes may be used as both mixer and oscillator, combining the circuits of Figs. 16-5 and 16-6. A 6U8 could use its pentode as a mixer (16-5B) and the oscillator portion (16-6A) would be a triode. Dual-triode tubes (6J6, 12AT7 and many others) would combine 16-5A and 16-6A. In dual triodes having separate cathodes some external coupling may be required, but the common cathode of the 6J6 will provide sufficient injection in most cases. If the injection is more than necessary it can be reduced by drop-

ping the oscillator plate voltage, either directly or by increasing the value of the dropping resistor.

A pentode mixer is less subject to oscillator pulling than a triode, and it will probably require less injection voltage. In a pentode mixer with no r.f. amplifier, plate current should be held to the lowest usable value, to reduce tube noise. This may be controlled by varying the mixer screen voltage. When a good r.f. amplifier is used the mixer plate current may be run higher, for better operation with strong signals.

Occasionally oscillation near the signal frequency may be encountered in v.h.f. mixers. This usually results from stray lead inductance in the mixer plate circuit, and is most common with triode mixers. It may be corrected by connecting a small capacitance from plate to cathode, *directly* at the tube socket. Ten to 25  $\mu\mu\text{f.}$  will be sufficient, depending on the signal frequency.

**OSCILLATOR STABILITY**

When a high-selectivity i.f. system is employed in v.h.f. reception, the stability of the oscillator is extremely important. Slight variations in oscillator frequency that would not be noticed when a broadband i.f. amplifier is used become intolerable when the passband is reduced to crystal-filter proportions.

One satisfactory solution to this problem is the use of a crystal-controlled oscillator, with frequency multipliers if needed, to supply the

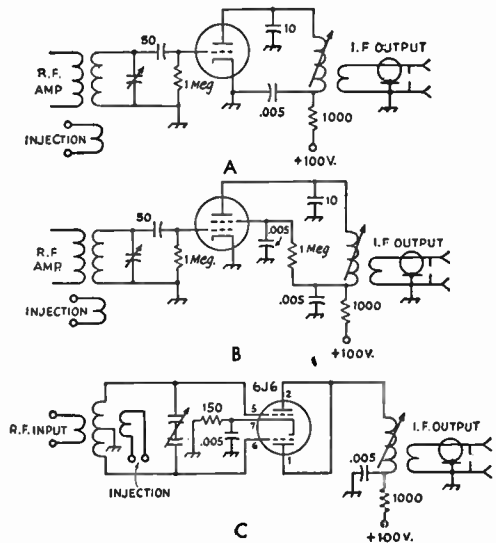
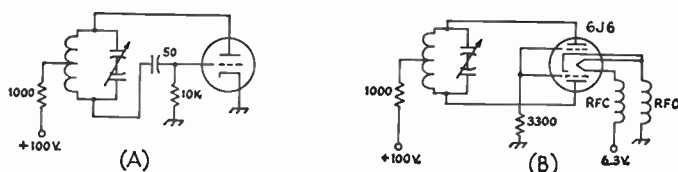

Fig. 16-5—Typical v.h.f. mixer circuits for triode (A), pentode (B) and push-push triode (C). Circuits A and B may be used with one portion of various dual-purpose tubes. Plate current of pentode (B) should be held at lowest usable value if no r.f. stage is used.



Fig. 16-6—Recommended circuits for tunable v.h.f. oscillators. (A) Single-ended, and (B) push-pull. R.f. choke coil inductance depends on frequency.



injection voltage. Such a converter usually employs one or more broadband r.f. amplifier stages, and tuning is done by tuning the receiver with which the converter is used to cover the desired intermediate frequency range.

When a tunable oscillator and a fixed intermediate frequency are used, special attention must be paid to the oscillator design, to be sure that it is mechanically and electrically stable. The tuning capacitor should be solidly built, preferably of the double-bearing type. Split-stator capacitors specifically designed for v.h.f. service, usually having ball-bearing end plates and special construction to insure short leads, are well worth their extra cost. Leads should be made with stiff wire, to reduce vibration effects. Mechanical stability of air-wound coils can be improved by tying the turns together with narrow strips of household cement at several points.

Recommended oscillator circuits for v.h.f. work are shown in Fig. 16-6. The single-ended oscillator may be used for 50 or 144 Mc. with good results. It works well with almost any small triode, or one section of a 6J6 or 12AT7. The push-pull version is best suited for tubes worked near their frequency limit, since the apparent parallel grid circuit is actually push-pull, utilizing the inductance of the grid leads. The 6J6 will oscillate at 420 Mc. in this circuit.

### THE I.F. AMPLIFIER

Superheterodyne receivers for 50 Mc. and up should have fairly high intermediate frequencies, to reduce both oscillator pulling and image response. Approximately 10 per cent of the signal frequency is commonly used, with 10.7 Mc. being set up as the standard i.f. for commercially-built f.m. receivers. This particular frequency has a disadvantage for 50-Mc. work, in that it makes the receiver subject to image response from 28-Mc. signals, if the oscillator is on the low side of the signal frequency. A spot around 7 Mc. is favored for amateur converter service, as practically all communications receivers are capable of tuning this range.

For selectivity with a reasonable number of i.f. stages, double conversion is usually employed in complete receivers for the v.h.f. range. A 7-Mc. intermediate frequency, for instance, is changed to 455 kc., by the addition of a second mixer-oscillator. This procedure is, of course, inherent in the use of a v.h.f. converter ahead of a communications receiver.

If the receiver so used is lacking in sensitivity, the over-all gain of the converter-receiver combination may be inadequate. This can be cor-

rected by building an i.f. amplifier stage into the converter itself. Such a stage is useful even when the gain of the system is adequate without it, as the gain control can be used to permit operation of the converter with receivers of widely different performance. If the receiver has an S-meter, its adjustment may be left in the position used for lower frequencies, and the converter gain set so as to make the meter read normally on v.h.f. signals.

Where reception of wide-band f.m. or unstable signals of modulated oscillators is desired, a converter may be used ahead of an f.m. broadcast receiver. A superregenerative detector operating at the intermediate frequency, with or without additional i.f. amplifier stages, also may serve as an i.f. and detector system for reception of wide-band signals. By using a high i.f. (10 to 30 Mc. or so) and by resistive loading of the i.f. transformers, almost any desired degree of bandwidth can be secured, providing good voice quality on all but the most unstable signals. Any of these methods may be used for reception in the microwave region, where stabilized transmission is extremely difficult at the current state of the art.

### THE SUPERREGENERATIVE RECEIVER

The simplest type of v.h.f. receiver is the superregenerator. It affords fair sensitivity with few tubes and elementary circuits, but its weaknesses, listed earlier, have relegated it to applications where small size and low power consumption are important considerations.

Its sensitivity results from the use of an alternating quenching voltage, usually in the range between 20 and 200 kc., to interrupt the normal oscillation of a regenerative detector. The regeneration can thus be increased far beyond the amount usable in a straight regenerative circuit. The detector itself can be made to furnish the quenching voltage, or a separate oscillator tube can be used. Regeneration is usually controlled by varying the plate voltage in triode detectors, or the screen voltage in the case of pentodes. A typical circuit is shown in Fig. 16-7.

Fig. 16-7—Superregenerative detector circuit for self-quenched detector. Pentode tube may be used, varying screen voltage by means of the potentiometer to control regeneration.

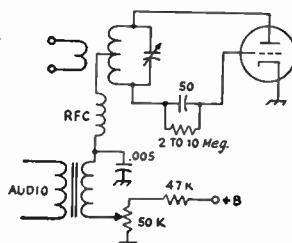

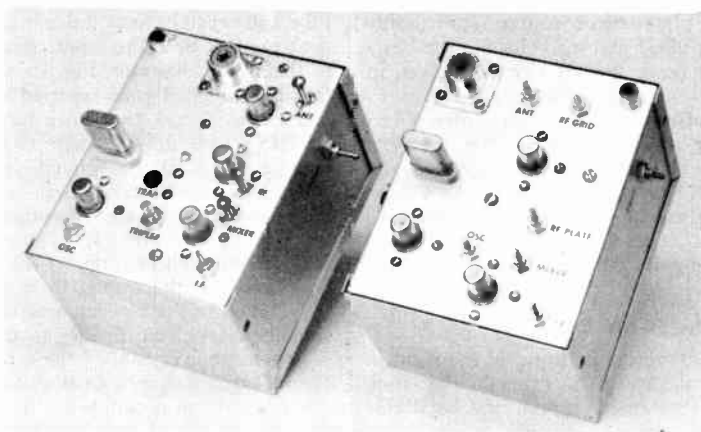

Fig. 16-8—The 50- and 144-Mc. crystal-controlled converters are built in 3 × 4 × 5-inch Miniboxes and are designed to work into a receiver that tunes 14 to 18 Mc. Plate voltage required is +150, and use of a OD3-stabilized supply is suggested.

**CRYSTAL-CONTROLLED CONVERTERS FOR 50, 144 AND 220 Mc.**

The three converters shown in Figs. 16-8 through 16-15 are designed to be used with a receiver that tunes 14 to 18 Mc. (14 to 19 Mc. for the 220-Mc. converter.). Designed around

the “Nuvistor” miniature triode and a crystal-controlled local-oscillator signal, they offer low noise figures and high stability on the three bands. The power-supply requirement is 150

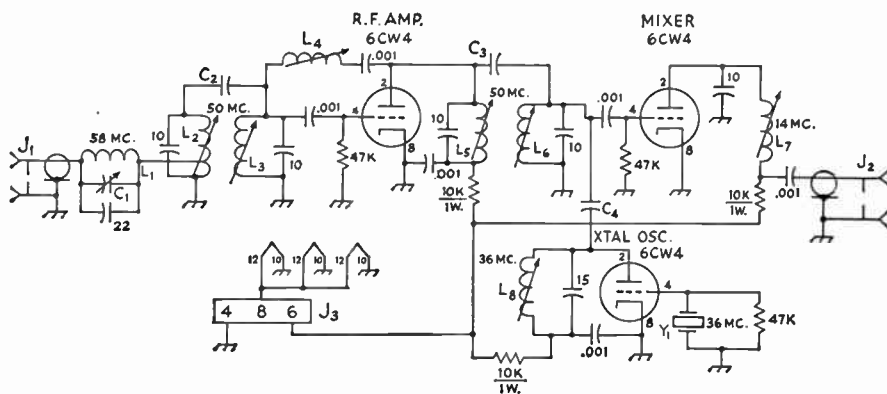

Fig. 16-9—Schematic diagram and parts information for the 50-Mc. converter. Resistors ½ watt unless specified. Fixed capacitors are ceramic; decimal values in  $\mu\text{f.}$ , others in  $\mu\mu\text{f.}$

- C<sub>1</sub>—3—30- $\mu\mu\text{f.}$  mica trimmer.
- C<sub>2</sub>, C<sub>3</sub>—No. 22 insulated hookup wires 2 inches long, twisted together for approximately 1¼ inches.
- C<sub>4</sub>—Same, but 1-inch wires twisted for ½ inch.
- J<sub>1</sub>—Coaxial connector, SO-239.
- J<sub>2</sub>—Phono jack.
- J<sub>3</sub>—8-pin plug (Amphenol 86-RCP8).
- L<sub>1</sub>—5 turns No. 18, ½-inch diam., 8 t.p.i. (B & W No. 3002).
- L<sub>2</sub>—10 turns No. 28 enam., close-wound on ¼-inch iron-slug phenolic form, tapped at 3 turns; 0.65 to 1.3  $\mu\text{h.}$  (Miller form No. 20A000RB1).
- L<sub>3</sub>, L<sub>4</sub>, L<sub>5</sub>—8 turns No. 28 enam., close-wound on ¼-inch iron-slug phenolic form. Range 0.43 to 0.85

- $\mu\text{h.}$  L<sub>3</sub> set for 0.64  $\mu\text{h.}$ , L<sub>4</sub> for 0.66, L<sub>5</sub> for 0.73  $\mu\text{h.}$  (Miller coils No. 20A687RB1). L<sub>3</sub> and L<sub>5</sub> are ⅞ inch apart c. to c. L<sub>4</sub> to L<sub>5</sub> is ¾ inch; L<sub>6</sub> to L<sub>8</sub> is ⅞ inch.
- L<sub>4</sub>—No. 32 enam., close-wound ⅛ inch on ¼-inch iron-slug phenolic form; 3.8 to 8.5  $\mu\text{h.}$ , set for 6.9  $\mu\text{h.}$  (Miller coil No. 20A686RB1).
- L<sub>7</sub>—Universal-wound coil, 4.7 to 10  $\mu\text{h.}$ , set for 7.9  $\mu\text{h.}$  (Miller coil No. 20A826RB1).
- L<sub>8</sub>—8 turns No. 32 enam., close-wound on ¼ inch iron-slug phenolic form; 0.67 to 1.25  $\mu\text{h.}$ , set for 0.94  $\mu\text{h.}$  (Miller coil No. 20A106RB1).
- Y<sub>1</sub>—36-Mc. crystal (International Crystal Mfg. Co. FA-5).

volts for the plate-power source (preferably stabilized, by a 0D3) and 6.3 volts for the heaters. A suitable power-supply circuit is given in Fig. 16-16.

At 50 Mc. noise coming in on the antenna is a limiting factor, even in the quietest location. This antenna noise is much lower on 144 and 220 Mc. At 50 Mc. one r.f. stage gives all the sensitivity that can be used, but at 144 and 220 Mc. a "cascode" stage using two tubes is needed to approach the point where antenna noise is the limiting factor.

#### The 50-Mc. Converter

The 50-Mc. converter is shown at the right in Fig. 16-8, and the circuit is given in Fig. 16-9. Referring to Fig. 16-8 (right), the oscillator

tube and crystal are at the left, and the r.f. stage is at the top, near the input connector. Turning to the circuit diagram, Fig. 16-9, it will be seen that two tuned circuits are used between antenna and r.f. grid, and two more tuned circuits are used to couple the r.f. stage to the mixer. The trap circuit,  $L_1C_1$  is optional. Its purpose is to reject Channel-2 video signals that might cause interference to 50-Mc. reception, as the result of the second harmonic of the oscillator (72 Mc.) beating with a Channel-2 TV signal. There is no need for the trap if there is no Channel-2 TV station in the vicinity, and the lead from  $J_1$  should then be run directly to the tap on  $L_2$ .

An overtone crystal of the type that needs no special circuit is used in the oscillator, and the oscillator signal is coupled to the mixer through

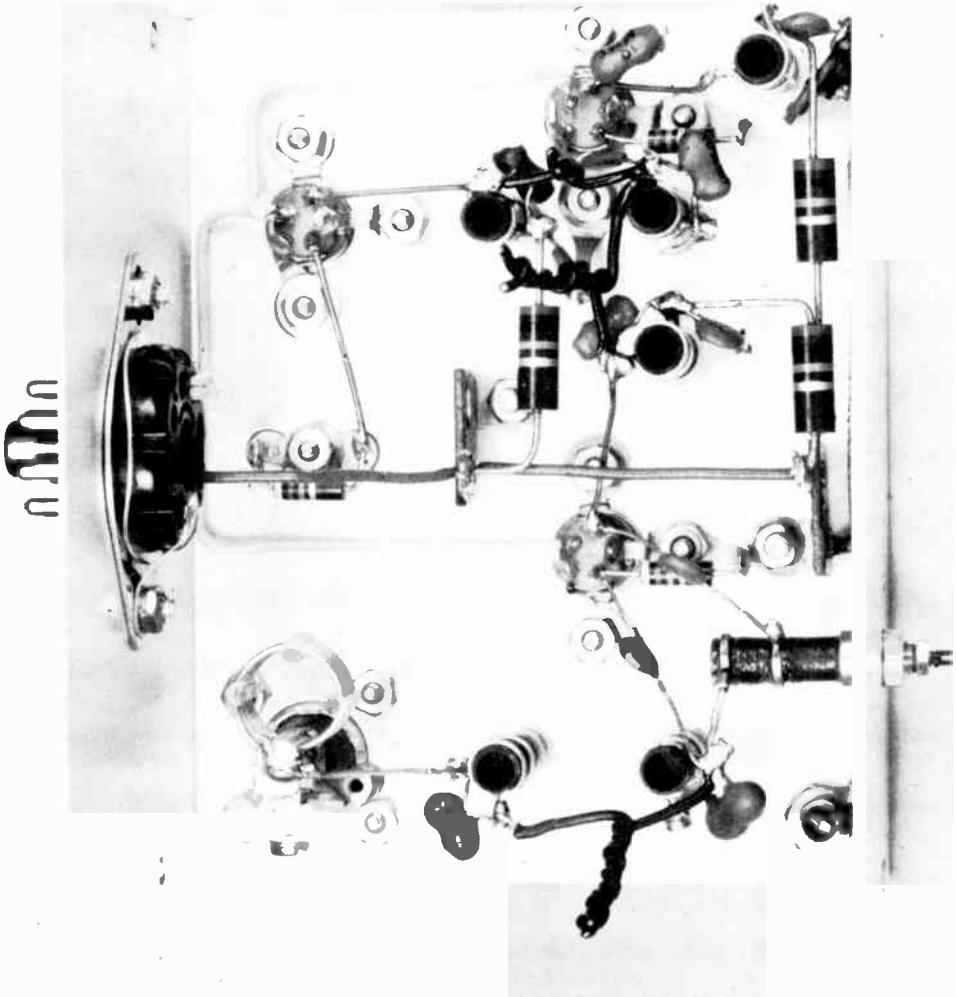

Fig. 16-10—Bottom view of the 50-Mc. converter. The antenna connector and trap circuit are in the lower left corner. The neutralizing coil,  $L_4$ , is mounted horizontally at lower right.



good signal generator. For any except the last, connect some kind of antenna to  $J_1$ . A short piece of wire will do at first, and the length can be varied to suit the strength of the signal. Set the stud in  $L_4$  at about the middle of its range. Next, peak the screws in  $L_2$ ,  $L_3$ ,  $L_5$ ,  $L_6$  and  $L_7$  for maximum signal strength. Now disable the r.f. amplifier stage by disconnecting the 10,000-ohm resistor from  $L_5$ , or by removing the heater lead from Pin 12 of the socket. Adjust  $L_4$  for *minimum* signal. Replace the heater or plate voltage and readjust all coils except  $L_4$  for maximum signal again.

The converter should be close to optimum performance if everything has been done properly to this point. If the Channel 2 trap is used, adjust it so that no interference is heard from the local TV station. If the station is very near by,

it may still be heard as long as the cover is off the converter case. It should disappear when the case is assembled. Recheck the adjustment of  $L_2$  and  $L_3$  after final adjustment of the trap.

Further work to improve weak-signal reception should be done with a noise generator, though satisfactory results can be obtained on weak signals if the work is done with care. The aim should be better signal-to-noise ratio, rather than merely greater signal strength. Using the receiver S meter, or the audio sound of a weak signal, tune for maximum signal *with respect to noise*.

As a final check, put a 50-ohm resistor across  $J_1$ . Observe the noise level. Now remove the resistor and put on an antenna system with 50-ohm feed. If the noise rises appreciably, this external noise is the limiting factor in v.h.f. recep-

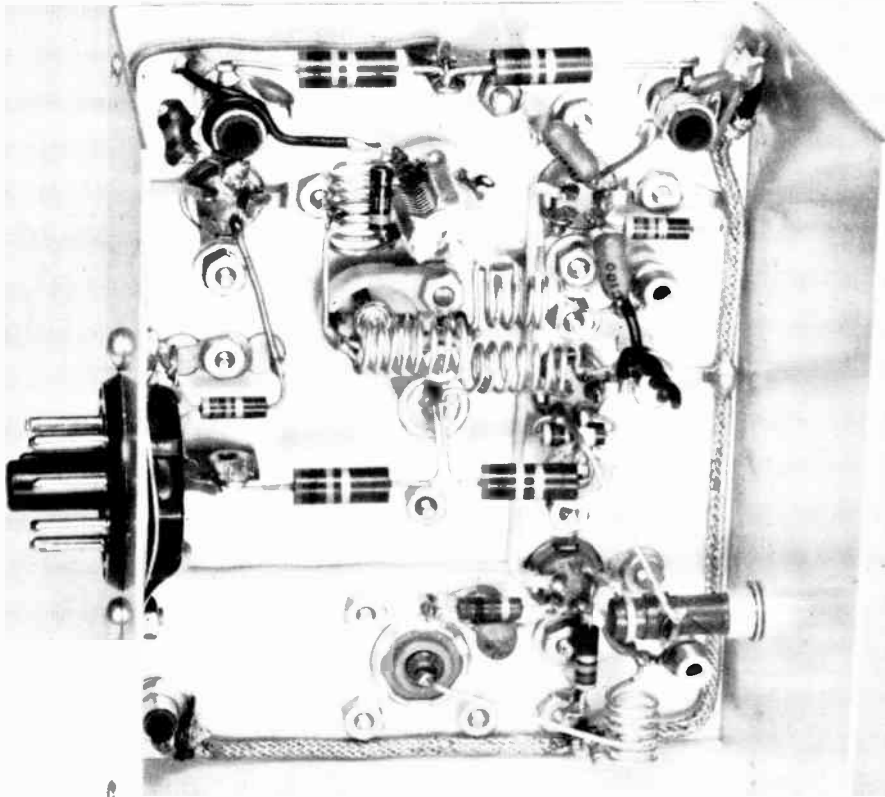

Fig. 16-12—Interior of the 144-Mc. converter. Details of parts arrangement are given in the text. The i.f. output from the mixer plate coil,  $L_4$ , (upper right) is brought through a shielded lead down the side and across the bottom to the output connector,  $J_2$ , at the lower left.



tion, and the only improvement one can make from here on is to put up a bigger or higher antenna, or move to a quieter location.

#### The 144-Mc. Converter

The 144-Mc. converter, Figs. 16-8 and 16-12, uses a two-tube "cascode" r.f. amplifier ahead of the mixer, and a frequency-multiplying system is required to provide the desired 130-Mc. local-oscillator signal. Handwound coils are used in the r.f. circuits, instead of slug-tuned coils, with the exception of the matching reactance ( $L_2$  in Fig. 16-11) which must be adjusted for best noise figure. The crystal oscillator works on 43.333 Mc. and drives a crystal-diode frequency tripler to 130 Mc. A trap circuit tuned to the second harmonic rejects the second harmonic and another circuit accentuates the third harmonic and provides a "clean" local-oscillator signal at 130 Mc. As with the 50-Mc. converter, the second-harmonic trap circuit ( $L_9C_4$ ) can be omitted if no local interference problem exists. In the case of the converter pictured, a local f.m. station at 100.8 Mc. gave an output signal at 14.2 Mc. by beating against the 86.6-Mc. second harmonic of the oscillator. A trap in the antenna circuit was not as effective, since it caused some deterioration of the 144-Mc. noise figure.

Referring to Fig. 16-12, the construction is similar to that of the 50-Mc. converter, with a few exceptions. The coils can be wound to speci-

fication on a  $\frac{1}{4}$ -inch diameter drill and then mounted on associated tuning capacitors, tie points or ground lugs. In the photograph, the r.f. amplifier input circuit is in the lower right-hand corner. The coil above it is  $L_2$ , the matching reactance, mounted on the side of the box. The two air-wound coils side by side and just to the right of center are for the amplifier plate and the mixer grid ( $L_3$  and  $L_4$ ). The second-harmonic trap circuit is to their left, just below the third harmonic tank circuit,  $L_8C_5$ . The oscillator plate coil and the output coil are in the upper left and right corners, respectively.

Adjustment of the 144-Mc. converter is similar, except that the multiplier tank circuit,  $L_8C_5$ , should be adjusted for maximum signal. External noise may not be discernible in quiet locations on 144 Mc., and the antenna check outlined for 50 Mc. may be inconclusive. Adjustment of all r.f. circuits should be made carefully for greatest margin of signal over noise, using weak signals. The minimum-signal method of adjusting coil  $L_2$  may be followed initially, but readjustment for optimum signal-to-noise ratio (or lowest noise figure, using a noise generator) should produce a worthwhile improvement. Do not use the second-harmonic trap,  $L_9C_4$ , unless it is necessary to eliminate f.m. interference, as this circuit introduces one more variable to complicate the adjustment procedure.

In most areas 2-meter activity is spread over

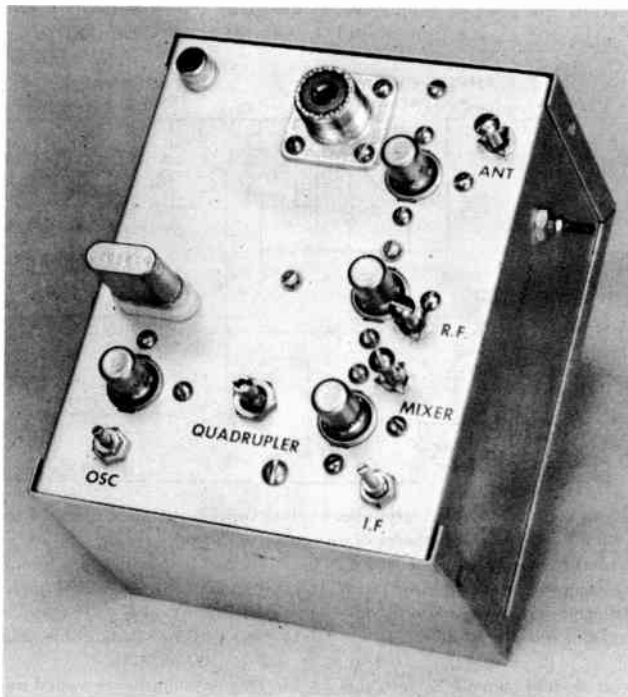

Fig. 16-13—The 220-Mc. converter uses four 6CW4 tubes and a semi-conductor frequency quadrupler. Screw on the side is neutralization adjustment.

more of the band than is the case with 50 Mc. The converter response can be made uniform across most or all of the band by tuning the i.f. output coil,  $L_5$ , for maximum response near the high end or middle of the band. This coil affects only the gain of the converter; detuning it does not reduce the signal-to-noise ratio. The r.f. amplifier plate and mixer grid circuits,  $C_2-L_3$  and  $C_3-L_4$  have only a minor effect on noise figure, so they can also be "stagger-tuned" to some extent to achieve uniform response.

A fair final check on the 144-Mc. converter performance is to detune the diode multiplier circuit,  $L_8C_5$ , and note its effect on the signal-to-noise ratio. If the r.f. amplifier is working properly it should be possible to detune this circuit so that the gain drops an S unit or two, before there is any effect on the signal-to-noise ratio observable on weak signals.

### The 220-Mc. Converter

The 220-Mc. converter, Figs. 16-13 and 16-15, is similar to the 144-Mc. converter in both construction and circuitry. A cascode r.f. stage is used ahead of the mixer, and a diode frequency quadrupler is used to furnish a 206-Mc. local-oscillator signal from a 51.5-Mc. crystal oscillator. Two tuned circuits are used between r.f. stage and mixer, coupled by a small capacitance. Because the 220-Mc. band is 5 Mc. wide, the receiver following this converter must tune from 14 to 19 Mc.

As can be seen in Fig. 16-15, the construction is quite similar to that of the 144-Mc. converter. The inductors  $L_1$ ,  $L_3$ ,  $L_4$  and  $L_8$  are first wound

on a  $\frac{1}{4}$ -inch diameter rod or drill and then spaced to meet the specifications. They are supported by soldering the ends directly to tube pins, ground lugs or capacitor terminals. The Nuvistor sockets are set in  $\frac{1}{2}$ -inch diameter holes in which two notches have been filed to accept the tabs; the tabs are then bent over and held to the chassis by washers and 4-40 hardware. The two 0.001- $\mu$ f. capacitors bypassing the grid of the second 6CW4 and the bottom end of  $L_3$  are mica "button" capacitors (Centralab ZA-102). When mounting the tubular trimmer capacitors that are used to tune the signal circuits, it will be necessary to notch the holes slightly to clear the mounting.

The adjustment of the converter is quite similar to that of the 144-Mc. converter, and the instructions given earlier apply equally as well to the 220-Mc. band. Depending upon the local operating habits, it may be desirable to peak the circuits for a particular portion of the band. In areas where TV sets are tuned to Channel 7, there may be substantial TV-receiver local-oscillator radiation that will mess up the first megacycle or two of the band, and consequently the amateur activity will peak around 222 or 223 Mc. Both a grid-dip oscillator or signal generator, and a noise generator will be found to be very useful in getting best results from the converter.

### Power Supply

The circuit for a suitable power supply is given in Fig. 16-16. Any power supply of 180 volts or more (enough to fire a 0D3) will be

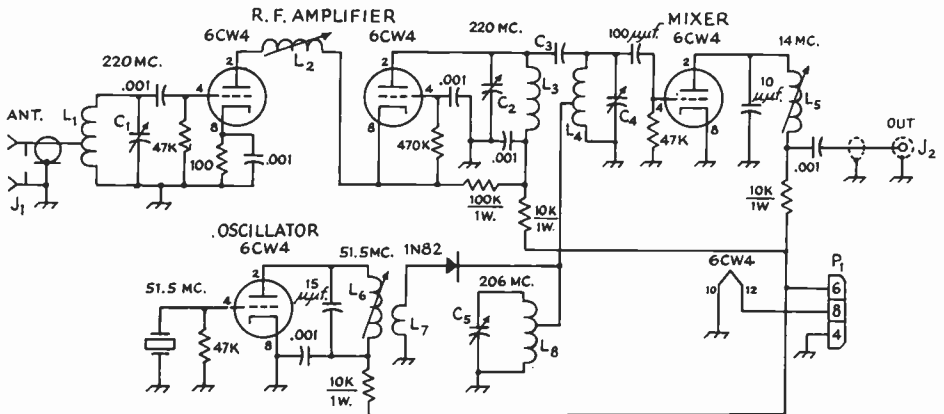

Fig. 16-14—Circuit diagram of the 220-Mc. crystal-controlled converter. Unless specified otherwise, resistors are  $\frac{1}{2}$  watt, resistances are in ohms, capacitances in  $\mu$ f.

- $C_1$ ,  $C_2$ ,  $C_4$ —1-6  $\mu$ f. tubular trimmer (Centralab 829-6).
- $C_3$ —2  $\mu$ f., made by twisting two insulated wires 1 inch.
- $C_5$ —15- $\mu$ f. variable (Hammarlund MAC-15).
- $J_1$ —Chassis-mounting coaxial receptacle (SO-239).
- $J_2$ —Phono jack.
- $L_1$ —2 $\frac{1}{4}$  t. No. 18 spaced wire diam.,  $\frac{1}{4}$  inch i.d., tapped  $\frac{3}{4}$  t. from ground end.
- $L_2$ —0.12 - 0.19  $\mu$ h. adjustable inductor (Miller 20A157RBI).
- $L_3$ —2 $\frac{3}{4}$  t. No. 18 spaced twice wire diam.,  $\frac{1}{4}$  inch i.d.

- $L_4$ —4 t. as  $L_3$ , tapped 1 turn from ground end.
- $L_5$ —4.7 - 10.0  $\mu$ h. adjustable inductor (Miller 20A826RBI).
- $L_6$ —0.43 - 0.85  $\mu$ h. adjustable inductor (Miller 20A687RBI).
- $L_7$ —1 $\frac{1}{2}$  t. insulated wire wound on ground end of  $L_6$ .
- $L_8$ —4 t. No. 18 spaced three times wire diam.,  $\frac{1}{4}$  inch i.d., tapped  $1\frac{1}{4}$  t. from ground end.
- $P_1$ —Chassis-mounting octal plug (Amphenol 86-CP8).

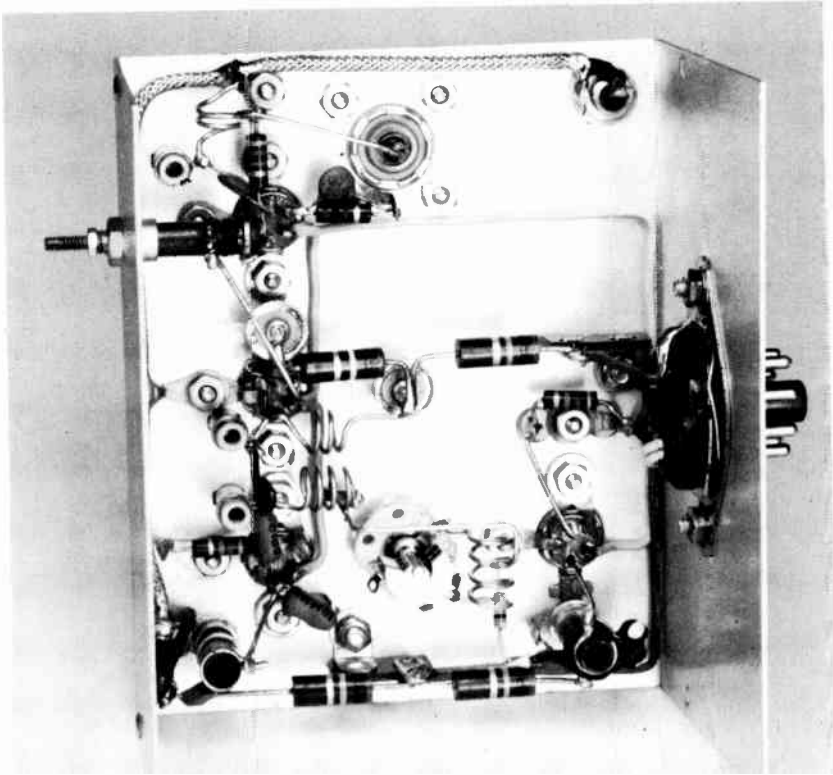

Fig. 16-15—View underneath the chassis of the 220-Mc. converter. The long shielded wire runs from  $L_5$  at the lower left to the output jack. Silver-button mica capacitors (Centralab ZA-102) that bypass the plate coil and the control grid of the second 6CW4 (center left) are also used to support several resistors. Coil  $L_5$  is supported by the terminals of  $C_5$  (bottom center). Chassis is part of 3 × 4 × 5-inch Minibox.

suitable; depending upon the voltage available the value of  $R_1$  may have to be changed.  $R_1$  should have a value such that with no current being taken from terminal 6 the current through the 0D3 is between 30 and 40 ma.

**Using Other Intermediate Frequencies**

The i.f. tuning range beginning at 14 Mc. was selected as the most desirable for most receivers. Other ranges may be preferred, and the i.f. can be altered easily enough. The injection frequency is lower than the signal frequency by whatever i.f. you intend to use. For example, a 50-Mc. converter with a 7-Mc. i.f. would have a crystal and injection frequency of 50-7, or 43 Mc. The 144-Mc. converter would have a 137-Mc. injection frequency, and the crystal would be one-third of this, or 45.667 Mc.

Generally speaking, single-conversion communications receivers (most inexpensive types, and all older receivers) work best with low intermediate frequencies, such as 7 Mc. or lower. Double-conversion receivers will be satisfactory in the 14-Mc. range in almost every case, and

some are stable enough to do well around 30 Mc. At least one communications receiver, the NC-300, has a range designed especially for v.h.f. converter use, starting at 30.5 Mc.

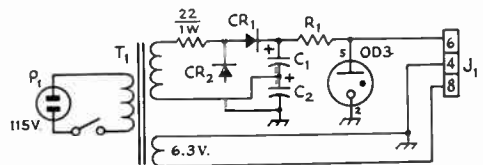

Fig. 16-16—Typical power supply for the 50-, 144- or 220-Mc. converter.

- $C_1, C_2$ —40- $\mu$ f. separate section dual capacitor (Sprague TCS-48).
- $CR_1, CR_2$ —400 p.i.v. silicon rectifier (1N1763 or equiv.)
- $J_1$ —Octal socket.
- $P_1$ —Line plug, preferably fused.
- $R_1$ —3000 ohms, 5-watt wirewound.
- $S_1$ —S.p.s.t. toggle.
- $T_1$ —125 v. at 50 ma., 6.3 v. at 2.0 amp. (Knight 61 G 411 or equiv.).

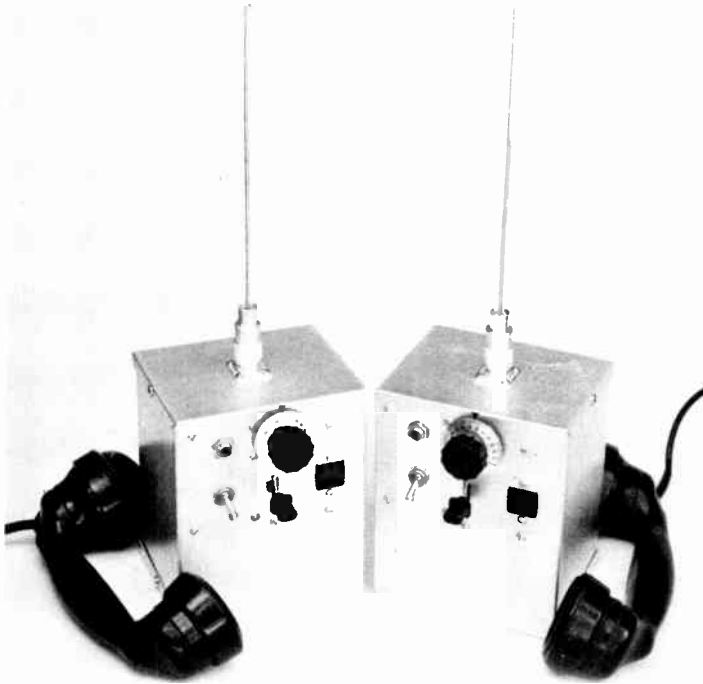

Fig. 16-17—This pair of 420-Mc. transceivers will be all ready to go as soon as the handset connectors are plugged in the panel sockets. Each handful is a complete station, built around the 6CW4 Nuvistor and a pair of transistors.

## A SIMPLE 420-MC. TRANSCIVER

A transceiver is a compact radio station that uses some (or all) of the components for both transmitting and receiving. In the 1930s, transceivers were very popular for portable and mobile work in the 5- and 2½-meter bands (forerunners of the present 50- and 144-Mc. assignments). In a transceiver, one tube is used as a modulated oscillator while transmitting and as a superregenerative detector for receiving, and the audio system is used as modulator and as audio amplifier. The broad signal from the modulated oscillator is readily received with good audio quality by the superregenerative detector, and the inherent a.g.c. action of the detector allows the receiver to handle a wide range of signal levels without attention to a gain control.

The transceiver shown in Figs. 16-17 and 16-20 is a simple self-contained unit that is readily portable and will furnish communication up to 25 or 30 miles over line-of sight ranges, and less than that over masked routes, depending upon the terrain. It can be built for just over \$25.

### The Circuit

The 420-Mc. transceiver circuit, Fig. 16-18, is similar to an old stand-by of the 1930s except for the transistors in the audio system. The 6CW4,  $V_1$ , is used as either a superregenerative

detector or modulated oscillator. When transmitting, a 2N107 with a microphone in the emitter circuit serves as a speech amplifier, and a 2N270 is used as the modulator. During receiving, the transistors amplify the output of the superregenerative detector. The value of 470 ohms for  $R_3$  may seem small, but it worked out best in terms of smooth operation of the detector, and the two-stage transistor amplifier provides plenty of audio output.

An inexpensive power transformer,  $T_1$ , is used as a combination audio output and modulation transformer. The impedance ratio of the transformer is not optimum for the handset headphone, but the two transistor amplifiers provide enough gain for adequate audio. A 3.2-ohm loudspeaker is a better impedance match for the transistor through  $T_1$ , and will give ample volume for fixed-station operation when plugged into  $J_2$ .

Considerable time was spent in trying various r.f. chokes in the circuit, and maximum transmitter output was obtained when the values shown in Fig. 16-18 were used.

### Construction

Parts placement can be quite critical. Unless the constructor has had previous u.h.f. experience, it is best to wire the transceiver exactly as

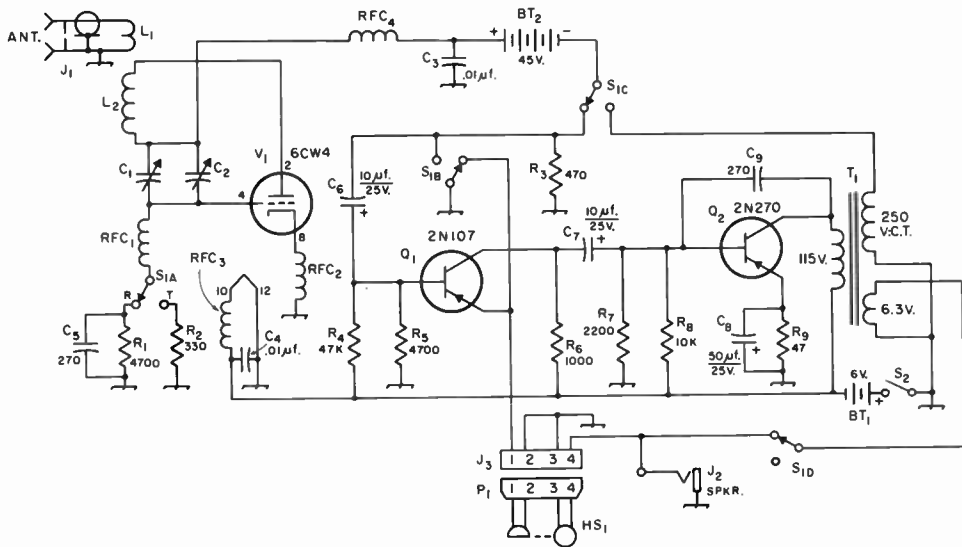

Fig. 16-18—Circuit diagram of the 420-Mc. transceiver. Unless specified otherwise, capacitances are in picofarads (pf. or  $\mu\text{mf.}$ ), resistances are in ohms, resistors are  $\frac{1}{2}$  watt. Capacitors marked with polarity are electrolytic.

BT<sub>1</sub>—6-volt "A" battery (Burgess F4P1).

BT<sub>2</sub>—45-volt miniature "B" battery (Burgess XX30).

C<sub>1</sub>—8.7-pf. midget tuning capacitor (Hammarlund MAC-10 or Johnson 160-104).

C<sub>2</sub>—7.3-pf. subminiature variable (Johnson 189-3).

HS<sub>1</sub>—Western Electric E1, available through many surplus outlets.

J<sub>1</sub>—Coaxial connector, SO-239.

J<sub>2</sub>—Open-circuit phone jack.

J<sub>3</sub>—4-conductor connector (Cinch-Jones S-304-AB).

L<sub>1</sub>, L<sub>2</sub>—See text and Fig. 16-19.

P<sub>1</sub>—4-conductor plug (Cinch-Jones P-304-CCT).

RFC<sub>1</sub>—1.0- $\mu\text{h.}$  r.f. choke (Stancor RTC-8515 or Miller 4602).

RFC<sub>2</sub>, RFC<sub>4</sub>—10- $\mu\text{h.}$  r.f. choke (Stancor RTC-8522 or Miller 4612).

RFC<sub>3</sub>—2.4- $\mu\text{h.}$  r.f. choke (Stancor RTC-8517 or Miller 4606).

S<sub>1</sub>—4-pole 2-position lever switch (Centralab 1458).

S<sub>2</sub>—S.p.s.t. toggle switch.

T<sub>1</sub>—Small power transformer, 115-v. primary, 250-v. c.t. and 6.3-v. secondary (Knight, Allied Radio 62 G 008).

described and with the parts specified. Once the builder has gained some experience with a working unit, he will be in a much better position to experiment and make changes if he so desires.

Construction of the transceiver is started by cutting and drilling a piece of  $3 \times 3 \times \frac{1}{8}$ -inch Plexiglas or polystyrene to the dimensions shown in Fig. 16-19A. Seven one-inch tapped spacers are mounted on the Plexiglas sheet with  $6-32 \times \frac{1}{4}$ -inch screws. Using Figs. 16-20 and 16-21 as guides, mount terminal strips under three of these screws. Insert the 6CW4 in its socket. Push the Nuvistor through the  $\frac{7}{16}$ -inch hole so that its socket rests on top of the Plexiglas sheet. Make sure no part of the Nuvistor socket comes in contact with any other metal part near it. Position the socket so that Pin 4 is on the left, as shown in Fig. 16-21.

Solder the small trimmer capacitor, C<sub>2</sub>, to the main tuning capacitor, C<sub>1</sub>, and then mount C<sub>1</sub> in the  $\frac{1}{4}$ -inch hole next to the Nuvistor socket. Put two soldering lugs under the screw labeled A in Fig. 16-21. Connect a wire from Pin 12 of the

Nuvistor socket to one of these lugs. Position this lug so that one end of the coupling loop, L<sub>1</sub>, can later be soldered to it.

Next mount the three electrolytics, C<sub>6</sub>, C<sub>7</sub>, and C<sub>8</sub>, on the Plexiglas board. On the middle terminal strip, solder a one-inch piece of bare wire to the ground lug and a two-inch piece of insulated wire to the next terminal. On the bottom terminal strip, solder a two-inch insulated wire to the center lug.

In sequence R<sub>5</sub>, R<sub>9</sub>, R<sub>7</sub>, R<sub>6</sub>, R<sub>4</sub>, and R<sub>8</sub> can now be soldered in place. Q<sub>1</sub> is mounted on the middle terminal strip and Q<sub>2</sub> on the lower. Solder the oscillator coil (dimensions shown in Fig. 16-19B) in place and then the three r.f. chokes, RFC<sub>2</sub>, RFC<sub>3</sub>, and RFC<sub>4</sub>. Mount two 0.01- $\mu\text{f.}$  disk-ceramic capacitors, C<sub>3</sub> and C<sub>4</sub>, on the top terminal strip. Assembly of components on the Plexiglas board is now complete.

Drill the front panel of the Minibox, using Figs. 16-17 and 16-22 as a guide. Make a strap from a  $7 \times \frac{3}{4}$ -inch piece of scrap aluminum to secure the batteries to the lower half of the Mini-





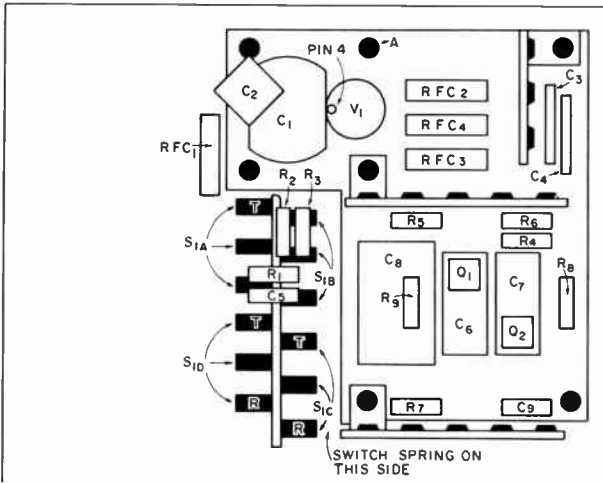

Fig. 16-21—Location of components on the clear plastic sheet. One 3-terminal and two 5-terminal tie-point strips are required.

the main tuning capacitor plates half way and set  $C_2$  to minimum capacitance. Position a 0-100 knob on the insulated shaft extender so that the dial reads 50. Using a 432-Mc. signal source, adjust  $C_2$  until 432 Mc. is heard at a dial setting of 50. Vary the coupling between the oscillator coil and output loop for maximum sensitivity, retuning  $C_2$  to keep the dial at a mid-scale. Units adjusted in such a manner should cover about 415 to 455 Mc. and be able to detect a modulated signal of 2 microvolts. An unmodulated carrier of 50 to 100  $\mu$ v. or more should silence the receiver hiss.

A good signal source for calibrating the re-

ceiver is a 2-meter transmitter. Its 3rd harmonics should provide accurate calibration points from 432 to 444 Mc. Also useful, but normally not as accurate, are grid-dipper and signal-generator harmonics.

To see if the receiver is working at its best, it is advisable to try different values of  $R_1$  and also to try smaller values for  $C_9$ . This experimentation is necessary because minor variations in wiring, the transistor and tube characteristics may cause differences in performance. Of the two units shown in the first photograph, the receiver of one required no capacitance at  $C_9$  to give the same performance and sensitivity as the receiver requiring a  $C_9$  of 270 pf.

Because of different tube operating conditions, the transmitter operates at a slightly higher frequency than the receiver. This can be corrected with a compensating circuit; however, too much power is lost in the process to make it worth while. If only one of the transceiver operators will retune his dial to the same setting after each transmission, this deficiency should prove to be no great handicap. The plate power input to the transmitter should be about 0.2 to 0.25 watt.

For maximum transmitter output it is important that the A battery be up to par. As the filament battery deteriorates, power output drops off rapidly. However, the receiver will perform satisfactorily with low battery voltage.

**Operation**

In field testing two of these units, it was found that at all times horizontal polarization was equal to or better than vertical polarization. The greatest DX so far has been a 30-mile line-of-sight contact between Glastonbury, Conn., and Westfield, Mass. Since only simple whips were used for antennas, much greater range should be possible with beams at both ends. Non-line-of-sight contacts will, of course, be over much shorter distances, the maximum range depending upon the size of the obstructions and the antennas in use.

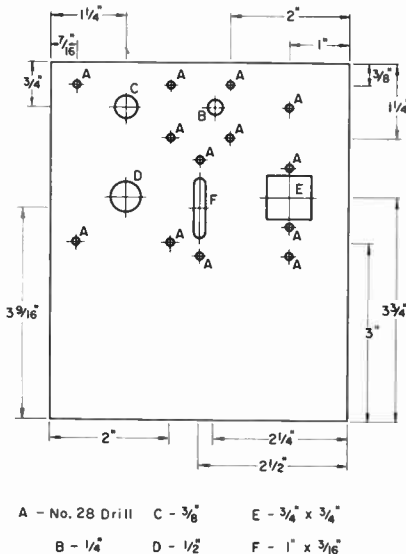

Fig. 16-22—Location of holes on the panel. The panel is part of a 4 x 5 x 6-inch Minibox (Bud CU-3007A). The square hole, E, takes the 4-pin connector (Cinch-Jones S-304-AB) used to connect the handset to the transceiver.

## A CRYSTAL-CONTROLLED CONVERTER FOR 432 Mc.

The crystal-controlled converter shown in Figs. 16-23 and 16-25 uses two grounded-grid r.f. stages and a grounded-grid mixer. This proved to be a more stable arrangement and easier to duplicate than one with grounded-cathode stages. A major source of over-all feedback is the heater connections, and more elaborate heater-line filtering will be found in this unit than is usually the case. The local-oscillator signal at 418 Mc. is obtained by tripling twice from a 46.44-Mc. crystal oscillator, once in a triode section of a 6J6 and once through a 1N82 diode.

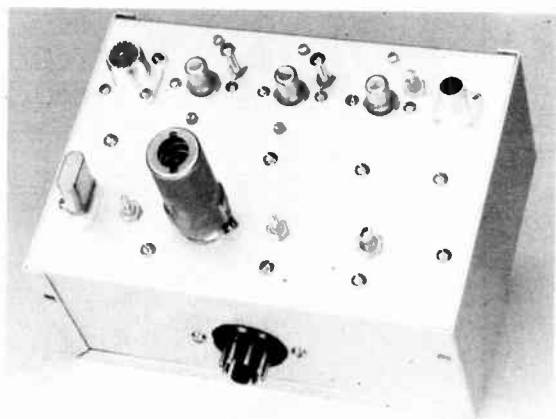

Fig. 16-23—The 432-Mc. converter is built in a 5 X 7 X 3-inch Minibox. At the top in this view, from left to right: input jack, r.f. amplifier, r.f. amplifier, mixer, output jack. The tube (shielded) is a 6J6, used as crystal oscillator and frequency multiplier.

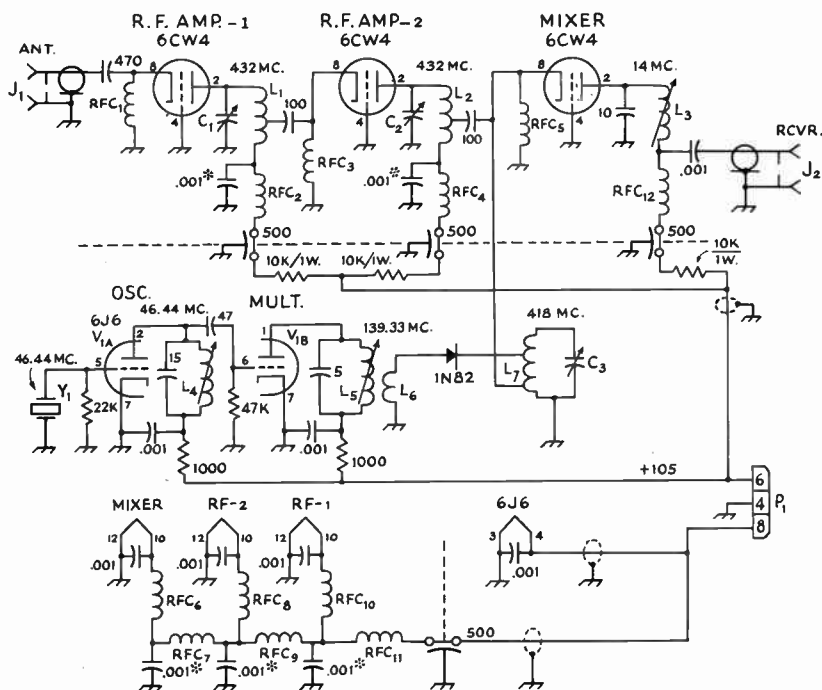

Fig. 16-24—Wiring diagram of the 432-Mc. converter. Capacitance values are in  $\mu\text{f.}$ , except decimal values which are in  $\mu\text{f.}$  Resistors are  $\frac{1}{2}$  watt unless specified otherwise. All 0.001- $\mu\text{f.}$  capacitors marked \* are button-type (Centralab ZA-102); other 0.001- $\mu\text{f.}$  capacitors are disk ceramic. All 500- $\mu\text{f.}$  feedthrough capacitors are Centralab FT-500.

$C_1, C_2$ —6- $\mu\text{f.}$  ceramic variable (Centralab 829-6)

$C_3$ —15- $\mu\text{f.}$  variable (Hammarlund MAC-15)

$L_1, L_2, L_7$ —See Fig. 16-26.

$L_3$ —4.7–10.0- $\mu\text{h.}$  adjustable inductor (Miller 20A826RBI).

$L_4$ —0.43–0.85- $\mu\text{h.}$  adjustable inductor (Miller 20A687RBI).

$L_6$ —0.119–0.187- $\mu\text{h.}$  adjustable inductor (Miller 20A157RBI).

$L_5$ —2 t. No. 20 insulated, wound around ground end of  $L_5$ .

RFC<sub>1</sub>–RFC<sub>11</sub>—8 inches No. 22 enam. cleaned  $\frac{1}{2}$  inch each end and wound on 10K or higher  $\frac{1}{2}$ -watt resistor.

RFC<sub>12</sub>—50- $\mu\text{h.}$  r.f. choke (Millen 34300-50).

J<sub>1</sub>—Coaxial chassis receptacle (SO-239).

J<sub>2</sub>—Coaxial chassis receptacle (UG-290A/U).

P<sub>1</sub>—Octal plug (Amphenol 86-CP8).

Y<sub>1</sub>—46.44-Mc. crystal (International Crystal FA-9).

Referring to the circuit diagram in Fig. 16-24, the circuitry through the oscillator-multiplier chain is similar to that shown for the lower-frequency converters described earlier in this chapter. Adjustable inductors tune the circuits on the lower frequencies, and at 418 Mc. a variable capacitor,  $C_3$ , tunes in half-turn coil,  $L_7$  (see Figs. 16-25 and 16-26). In the signal channel, 6CW4s are used as grounded-grid amplifiers and mixer, and the coupling circuits are ceramic trimmers and half-turn inductors. The B+ leads are filtered heavily as are the heater leads. For over-all good stability, numerous ceramic feed-

through and button bypass capacitors are used. Study of Figs. 16-23 and 16-25 will give a good idea of the location of the various components. The shield partition is built from a 3/4-inch wide strip of aluminum, and a 3/8-inch lip is bent on one edge for mounting on the chassis. The line of screws holding the chassis bisects the chassis.

Practically all of the components will be supported by tube-socket pins, button or feedthrough capacitors, ground lugs or tie points. The exception is the diode multiplier, which is supported at one end by the point on  $L_7$  to which

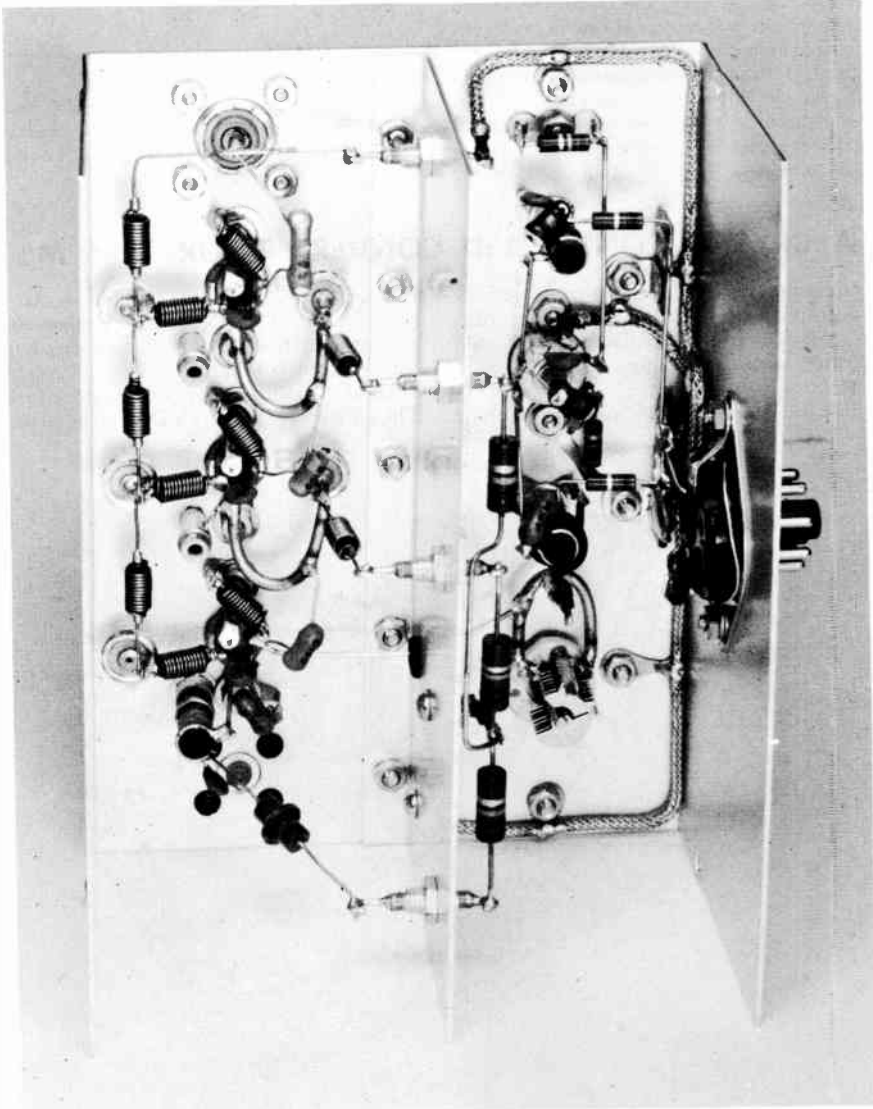

Fig. 16-25—View underneath the 432-Mc. converter shows the partition separating the oscillator and multiplier (right) from the r.f. and mixer. R.f. chokes mounted on button bypass capacitors (left) provide filtering for heater wiring. Feedthrough bypass capacitors in partition are 2 inches from chassis, except heater feedthrough (top) which is 1/2 inch from chassis. Oscillator injection lead from  $L_7$  to the cathode of the mixer runs through rubber grommet in partition.

it is soldered and at the other by an end of  $L_6$ .

A regulated 105-volt power supply is recommended for use with the converter. The crystal oscillator should be checked first, by measuring the voltage drop across the 1000-ohm resistor to  $L_4$ . The drop across this resistor will be greater when the stage is not oscillating than when it is, and the slug of  $L_4$  should be set at a lower-inductance value than that which gives minimum voltage drop across the resistor, to insure proper starting and operation. If a wavemeter is available, the frequency of output should be checked. The slug of  $L_5$  should be set for minimum voltage drop across the 1000-ohm resistor connected to  $L_5$ , and again the frequency should be checked with a wavemeter if one is available. The third harmonic of a 144-Mc. signal source can be used to align the r.f. stages, after which  $C_3$  and  $L_5$  should be peaked for maximum signal.

If any instability is experienced in the signal circuits, as evidenced by regeneration or oscillations at some setting of  $C_1$  and  $C_2$ , look for

poor connections or poor grounds. In some cases the instability may also be caused by having the mixer tap too high above ground on  $L_7$ .

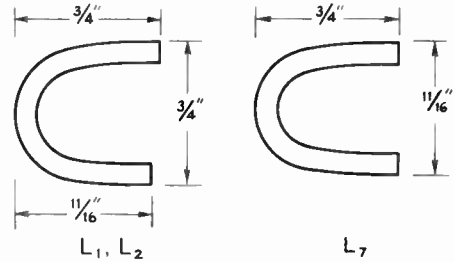

Fig. 16-26—Details of "coils"  $L_1$ ,  $L_2$  and  $L_7$ . Material is No. 10 tinned copper wire. Taps on  $L_1$  and  $L_2$  are  $\frac{1}{3}$  up from ground end; taps on  $L_7$  are  $\frac{1}{3}$  and  $\frac{1}{2}$  up from ground end.

## A CRYSTAL-CONTROLLED CONVERTER FOR 1296 Mc.

The converter described is the result of an effort to simplify circuits and construction of a converter for 1296 Mc. to a point where it could be duplicated with a minimum of effort, and a limited amount of equipment.

Only five tubes are used, and one of these is a

voltage regulator for the crystal oscillator. One half of a 12AT7,  $V_{1A}$ , is an overtone oscillator at approximately 53.4 Mc. The second half,  $V_{1B}$ , doubles to 106.8 Mc. A 6CY5,  $V_2$ , doubles to 213.6 Mc. and drives a 6AK5 doubler to 427 Mc. The output of  $V_3$  drives a DR303 diode multiplier

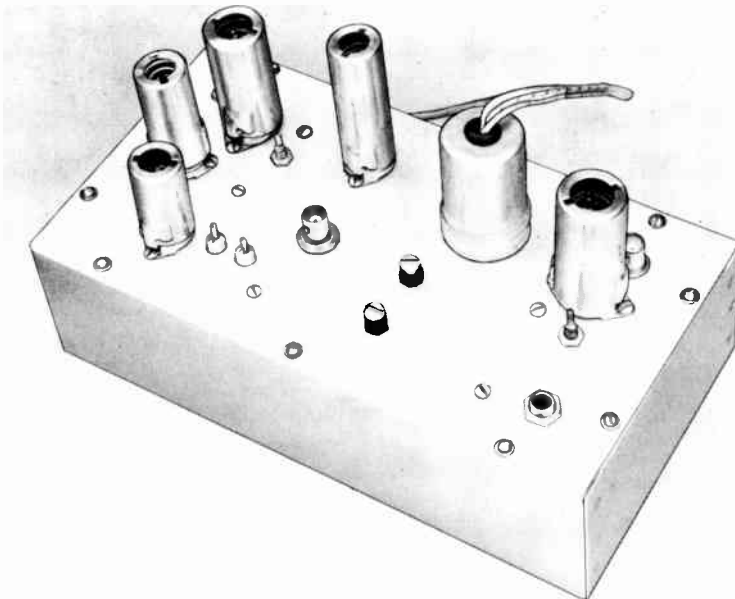

Fig. 16-27—From the top, the 1296-Mc. converter looks much like conventional designs for the v.h.f. bands. Across the lower portion of the chassis are the cascode i.f. amplifier stage and its output jack, left, the power connections shielded by means of an aluminum film can, the voltage regulator tube, and the 12AT7 crystal oscillator. In the upper right are the 6CY5 and 6AK5 frequency multipliers. The black nuts, left center, are used for tension on the adjusting screws for the u.h.f. circuits.





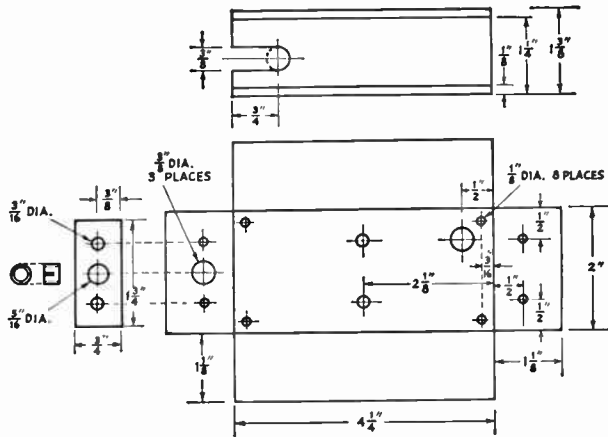

Fig. 16-29—Details of the sheet-metal parts of the trough-line tank circuits. The small plate at the left is insulated from the end of the trough assembly with thin sheet teflon. Slot in the partition, upper portion of drawing, provides space for the mixer crystal, as shown in Figs. 16-30 and 16-31.

soldering a  $\frac{1}{4}$ -inch length of  $\frac{1}{4}$ -inch i.d.,  $\frac{5}{16}$ -inch o.d. brass tubing in the  $\frac{5}{16}$ -inch hole in the mixer bypass plate, then making two saw cuts across the end of the tubing at 90-degree angles to form fingers. These are bent in until they grip the large end of the crystal firmly. The mixer bypass plate is insulated by covering the side away from the crystal holder with cellophane tape, and is mounted on the end of the trough lines with 4-40 screws and insulating shoulder washers. The holder for the small end of the crystal is a contact removed from an octal tube socket.

The antenna input connector is a UG 1094/U BNC fitting. It must be spaced up with a few  $\frac{3}{8}$ -inch i.d. washers so that the threads will just reach through the chassis and the trough line with enough length for the nut. The center con-

nection of the fitting should be cut down so that it clears the  $\frac{1}{4}$ -inch rod that is the trough line center conductor. If desired, a type N fitting could be used by drilling out the hole for the larger fitting. The input loop is soldered to the end of the trough line about  $\frac{3}{16}$  inch up from the bottom, and run straight over to the input fitting. The coupling loop to the mixer crystal is soldered to the end of the trough line between the mixer crystal and the center conductor. The entire u.h.f. portion of the converter can be silver plated, if means are available, but this is not mandatory.

#### Filtering

The power to the converter should be filtered to prevent signals in the i.f. range from getting into the converter and back into the receiver.

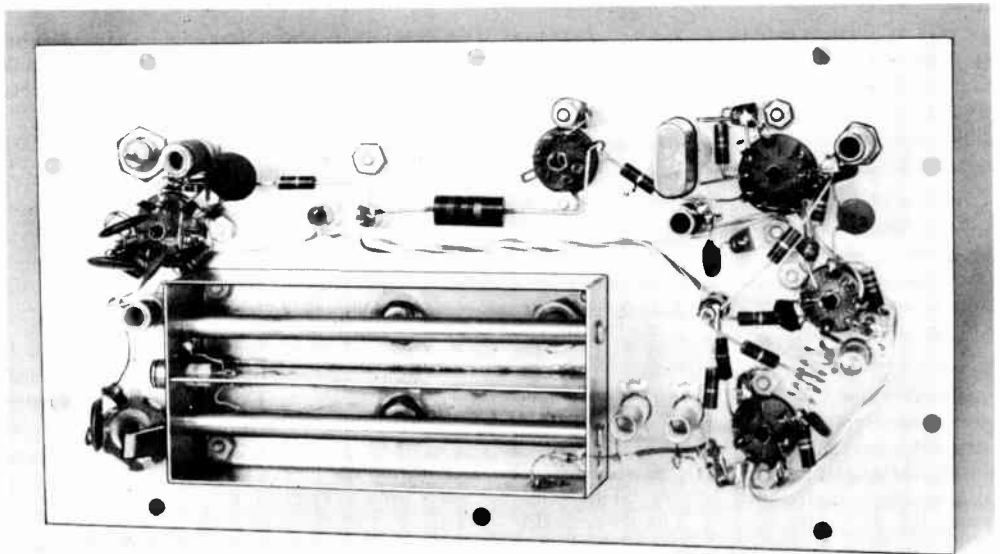

Fig. 16-30—Bottom view of the 1296-Mc. converter. Oscillator multiplier components are at the right. Note the diode multiplier in the lower right corner of the 1282-Mc. tank circuit. The mixer crystal is at the left end of the tank circuits.

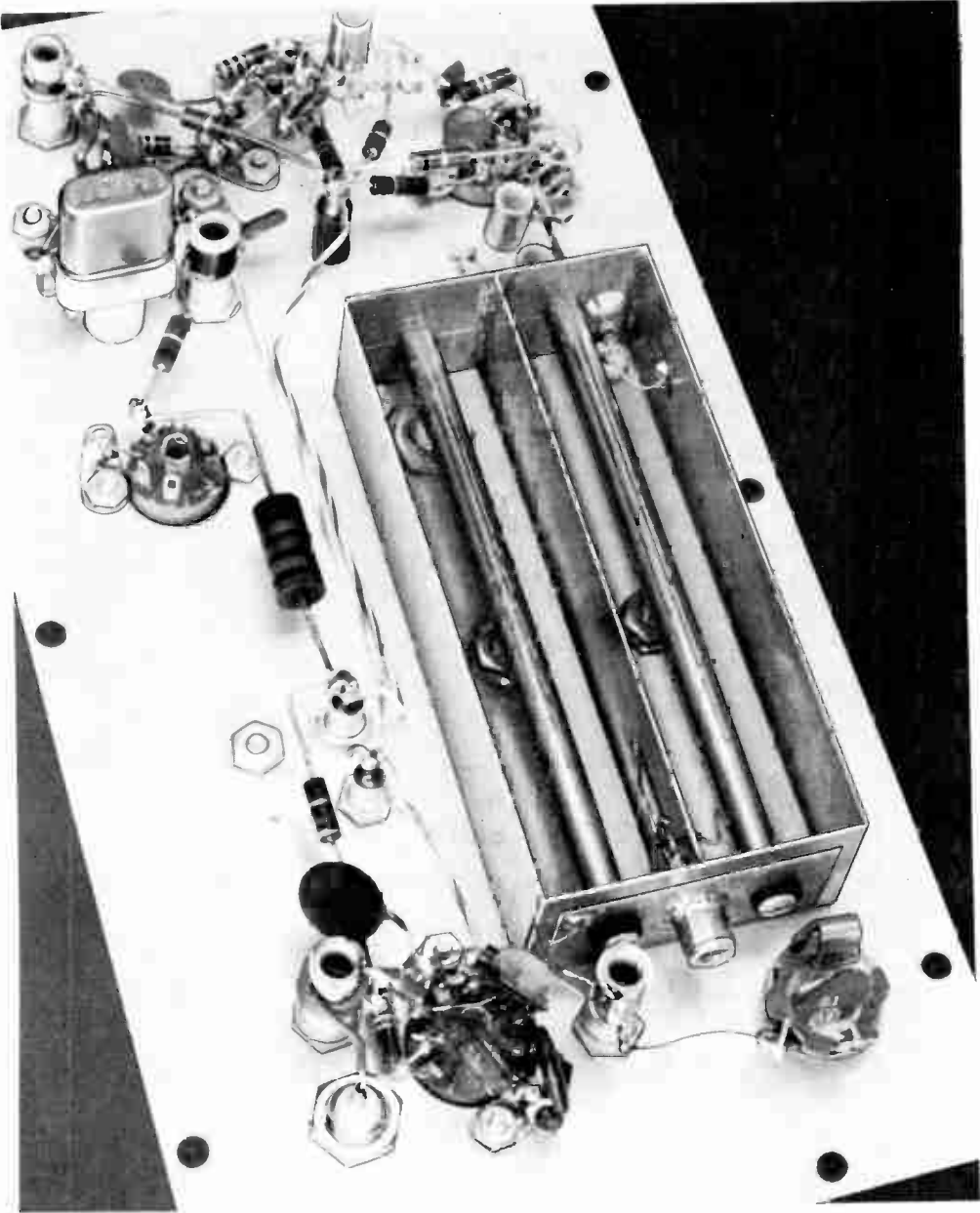

Fig. 16-31—Close-up view of the u.h.f. circuits. These are halfwave lines, tuned at their midpoints. The mixer crystal is held in place by a slotted brass sleeve, soldered to a capacitor plate on the outside of the trough. Though it is not visible in the picture, the capacitor plate is insulated from the trough end with a thin film of plastic. Screws that hold the inner conductors in position are insulated from the capacitor plate by fiber washers.

This is accomplished by bringing in B+ through a 47-ohm resistor and a feed-through bypass capacitor. The filament power comes through a choke wound on a 1-watt resistor and through a feed-through bypass. To cover the exposed terminals on top of the converter, an aluminum can that 35-mm. film is packaged in was used. The top was flattened by placing the

top over a large dowel and hammering out the bulge. The top is then drilled for the feed-through capacitors and the terminal strip mounting screw. The top is held in place on the top of the chassis with these components. The power cable is brought in through a grommet in the bottom of the film can. The paint can be removed from the film can with lacquer thinner.

### Adjustment

The oscillator and multiplier stages can be checked out as in any converter, using a grid-dip meter to tune circuits, up to the 213-Mc. stage. The output of the 427-Mc. stage can be checked by temporarily disconnecting the multiplier diode where it connects to the side of the trough line and putting a meter in series with the diode to ground. Current here should be 6 ma. or more. If insufficient current is obtained, try increasing the value of grid leak for the 6AK5 stage from 15K to 33K or 47K. The diode should then be reconnected and a 0-1-ma. meter connected to the mixer current jack. The tuning screw in the 1282-Mc. trough line should be adjusted until crystal current is obtained. If the crystal current is less than 0.2 ma., solder a 1/2-inch long piece of wire to the contact at the small end of the mixer crystal and bend the other end near the center conductor of 1282-Mc. line, and readjust the tuning.

Next, adjust the tuning of the 1296-Mc. line until the crystal current dips. This indicates that the input circuit is tuned to 1282 Mc. Back the screw out slightly, and you will be near 1296 Mc. Connect the converter to a receiver tuned to 14 Mc. and adjust the i.f. amplifier coils for maximum noise in the receiver. At this point you can listen for the harmonic of a 144- or 432-Mc. transmitter and peak up the input on that

signal. For further improvement a crystal diode noise generator will be required.

With a noise generator, experiment with size and shape of input coupling and mixer coupling loops, and local oscillator injection. It may be worthwhile, also, to try different taps on the i.f. input coil. When changing mixer crystals, do not decide which is best until you have optimized these adjustments for the particular crystal in question. A 1N21E may seem no better than the 1N21B you started with, until things are peaked up for the new crystal. Then there is a difference.

It is important that the shortest possible feed-line be used at this frequency. RG-8/U is commonly used, but has about 9-db. loss per 100 feet. The converter has a BNC input connector as RG-55/U cable is used between the converter and the antenna relay, a distance of three feet. From the relay to the antenna, RG-8/U is used. Double-shielded cables such as RG-71/U 93-ohm or RG-55/U 53-ohm cable should be used between converters and the receiver to keep signals at the intermediate frequency from leaking to the receiver.

(From March, 1961, *QST*.)

K6AXN provided a drawing of the converter top plate which can be used as a template for drilling. Copies of this template will be sent free of charge upon receipt of a stamped self-addressed envelope. Address ARRL Technical Dept., Newington, Connecticut 06111.

## 1215 Mc. and higher

The September, 1960, issue of *QST* carried an article on the conversion of the war-surplus APX-6 transponder to a 1215-Mc. transmitter receiver. Anyone interested in this frequency will do well to consider the unit, since it is an inexpensive way to get started on the band.

The August, 1960, issue of *QST* described an

experimental transceiver for 5650 Mc. based on using the 2K26 reflex klystron as transmitter and receiver local oscillator. Elementary waveguide techniques are used with a horn antenna.

An account of experimental two-way communication above 20 kMc. was carried in the May, 1959, issue of *QST*.

# V.H.F. Transmitters

Transmitter stability regulations for the 50-Mc. band are the same as for lower bands, and proper design may make it possible to use the same rig for 50, 28, 21, and even 14 Mc., but incorporation of 144 Mc. and higher in the usual multiband transmitter is generally not feasible. Rather, it is usually more satisfactory to combine 50 and 144 Mc., since the two bands are close to a third-harmonic relationship. At least the exciter portion of the transmitter may be made to cover both bands very readily.

Though no stability restrictions are imposed by law on amateur operation at 144 Mc. and higher, the use of stabilized narrow-band systems pays off in improved effectiveness in both transmitter and receiver. It is this factor, more than the interference potentialities of the wide-band systems, which makes it desirable to employ advanced techniques at 144, 220 and 420 Mc.

The low-power stages of a transmitter for the v.h.f. bands need not be greatly different in design from those used for lower bands, and the techniques of Chapter Six can be used. The constructor has the choice of starting at some lower frequency, usually around 6, 8 or 12 Mc., multiplying to the operating frequency in one or more additional stages, or he can use a high initial frequency and thus reduce the number of multiplier stages. The first approach has the virtue of using low-cost crystals, but h.f. crystals may effect an economy in power consumption, an important factor in portable or emergency-powered gear.

## CRYSTAL OSCILLATORS

Crystal oscillator stages for v.h.f. transmitters may make use of any of the circuits shown in Chapter Six when crystals up to 12 Mc. are used, but certain variations are helpful for higher frequencies. Crystals for 12 Mc. or higher are usually of the overtone variety. Their frequency of oscillation is an approximate odd multiple of some lower frequency, for which the crystal is actually ground. Thus 24-Mc. crystals commonly used in 144-Mc. work are 8-Mc. cuts, specially treated for overtone characteristics. The overtone crystals currently being supplied are nearly as stable as those designed for fundamental operation, and they are easy to handle in properly designed circuits.

Manufacturers usually provide recommended circuits with their overtone crystals. These may be nothing more than a conventional triode circuit, or they may involve additional feedback.

Overtone operation is possible with standard fundamental-type crystals, using regenerative circuits. Practically all will oscillate on their third overtones, and fifth and higher odd overtones may be possible. Adjustment of regeneration is more critical, however, if the crystals are not ground for overtone characteristics. The frequency may not be an exact multiple of that marked on the crystal holder, so care should be used in working with crystals that are near a band edge.

Crystals ground for overtone service can be made to oscillate on other overtones than the one marked on the holder. For more discussion of overtone oscillator techniques, see *QST* for March, 1955, page 16.

Crystals are now available for frequencies up to around 100 Mc. They are somewhat more expensive and more critical in operation than those for 30 Mc. and lower, however. Use of 50-Mc. crystals is made occasionally as a means of preventing radiation of the harmonics from lower frequency crystals that might cause TVI.

## FREQUENCY MULTIPLIERS

Frequency multiplying stages in a v.h.f. transmitter follow standard practice, the principal precaution being arrangement of components for short lead length and minimum stray capacitance. This is particularly important at 144 Mc. and higher. To reduce the possibility of radiation of oscillator harmonics on frequencies that might interfere with television or other services, the lowest satisfactory power level should be used. Low-powered stages are easier to shield or filter, in case such steps become necessary.

Common practice in v.h.f. exciter design is to make the tuned circuits capable of operation over the whole range from 48 to 54 Mc., so that the output stage can drive either an amplifier at 50 to 54 Mc. or a tripler from 48 to 144 Mc. Tripling is often done with push-pull stages, particularly when the output frequency is to be 144 Mc. or higher.

## AMPLIFIERS

Most transmitting tubes now used by amateurs will work on 50 Mc., but for 144 Mc. and higher the tube types are limited to those having low input and output capacitances and compact physical structure. Leads must be as short as possible, and soldered connections should be avoided in high-powered circuits, where heating may be great enough to melt the solder.

Plug-in coils and their associated sockets or jack bars are generally unsatisfactory for use at



144 Mc. and higher because of the stray inductance and capacitance they introduce. One way around this trouble is the use of a dual tank circuit in which the inductor for 144 Mc. is a conventional tuned line, with its shorting bar made as a removable plug. When the stage is to be used on another band the short is removed and a coil is plugged into the jack, the line then serving as a pair of plate leads. Such an arrangement will operate as efficiently on 144 Mc. as if it were designed for that band alone.

At 220 Mc. and higher it may be necessary to employ half-wave lines as tuned circuits, as shown later in a 432-Mc. unit.

Neutralization of triode amplifiers for 50 and 144 Mc. can follow standard practice, but the stray inductance and capacitance introduced by the neutralizing circuits may be excessive for 220 Mc. and higher. In such instances grounded-grid amplifiers may be used. Driving power is applied to the cathode circuit, with the grid acting as a shield. Some of the drive appears in the output, so both the driver and amplifier must be modulated when a.m. is used. For this reason the grounded-grid amplifier is used mainly in f.m. transmitters or linear amplifiers.

Instability shows up frequently in tetrode amplifiers as the result of ineffective screen bypassing. The solution lies in series-resonating the screen circuits to ground. The r.f. choke and capacitor values vary with frequency, so screen neutralization is essentially a one-band device.

## FREQUENCY MODULATION

Though f.m. has not enjoyed great popularity in v.h.f. operation, probably because of lack of suitable receivers in most v.h.f. stations, its possibilities should not be overlooked, particularly for the higher bands. At 420 Mc., for instance, the efficiency of most amplifiers is so low that it is often difficult to develop sufficient grid drive for proper a.m. service. With f.m. any amount of grid drive may be used without affecting the audio quality of the signal, and the modulation process adds nothing to the plate dissipation. Thus considerably higher power can be run with f.m. than with a.m. before damage to the tubes develops or the signal is of poor quality.

Frequency modulation also simplifies transmitter design. The principal obstacle to greater use of f.m. in v.h.f. work is the wide variation in selectivity of v.h.f. receivers, making it difficult for the operator to set up his deviation so that it will be satisfactory for all listeners.

## V.H.F. TVI PREVENTION AND CURE

The principal causes of TVI from v.h.f. transmitters are as follows:

- 1) Adjacent-channel interference in Channel 2 from 50 Mc.
- 2) Fourth harmonic of 50 Mc. in Channels 11, 12 or 13, depending on the operating frequency.
- 3) Radiation of unused harmonics of the oscillator or multiplier stages. Examples are 9th harmonic of 6 Mc., and 7th harmonic of 8 Mc. in Channel 2; 10th harmonic of 8 Mc. in Channel

6; 7th harmonic of 25-Mc. stages in Channel 7; 4th harmonic of 48-Mc. stages in Channel 9 or 10; and many other combinations. This may include i.f. pickup, as in the cases of 24-Mc. interference in receivers having 21-Mc. i.f. systems, and 48-Mc. trouble in 45-Mc. i.f.'s.

4) Fundamental blocking effects, including modulation bars, usually found only in the lower channels, from 50-Mc. equipment.

5) Image interference in Channel 2 from 144 Mc., in receivers having a 45-Mc. i.f.

6) Sound interference (picture clear in some cases) resulting from r.f. pickup by the audio circuits of the TV receiver.

There are many other possibilities, and u.h.f. TV in general use will add to the list, but nearly all can be corrected completely, and the rest can be substantially reduced.

Items 1, 4 and 5 are receiver faults, and nothing can be done at the transmitter to reduce them, except to lower the power or increase separation between the transmitting and TV antenna systems. Item 6 is also a receiver fault, but it can be alleviated at the transmitter by using f.m. or c.w. instead of a.m. phone.

Treatment of the various harmonic troubles, Items 2 and 3, follows the standard methods detailed elsewhere in this *Handbook*. It is suggested that the prospective builder of new v.h.f. equipment familiarize himself with TVI prevention techniques, and incorporate them in new construction projects.

Use as high a starting frequency as possible, to reduce the number of harmonics that might cause trouble. Select crystal frequencies that do not have harmonics in TV channels in use locally. Example: The 10th harmonic of 8-Mc. crystals used for operation in the low part of the 50-Mc. band falls in Channel 6, but 6-Mc. crystals for the same band have no harmonic in that channel.

If TVI is a serious problem, use the lowest transmitter power that will do the job at hand. Much interesting work can be done on the v.h.f. bands with but a few watts output, particularly if a good antenna system is used.

Keep the power in the multiplier and driver stages at the lowest practical level, and use link coupling in preference to capacitive coupling.

Plan for complete shielding and filtering of the r.f. sections of the transmitter, should these steps become necessary.

Use coaxial line to feed the antenna system, and locate the radiating portion as far as possible from TV receivers and their antenna systems.

Some v.h.f. TV tuners have removable strips that can be replaced with double-conversion inserts for u.h.f. reception. For a number of channels the first conversion frequency may then fall in or near the 144-Mc. band. Where this method is employed for u.h.f. reception the receiver is very sensitive to 144-Mc. interference. The cure is to replace the strips with others having a different conversion frequency, or use a conventional u.h.f. converter for reception of the channels from 14 up.

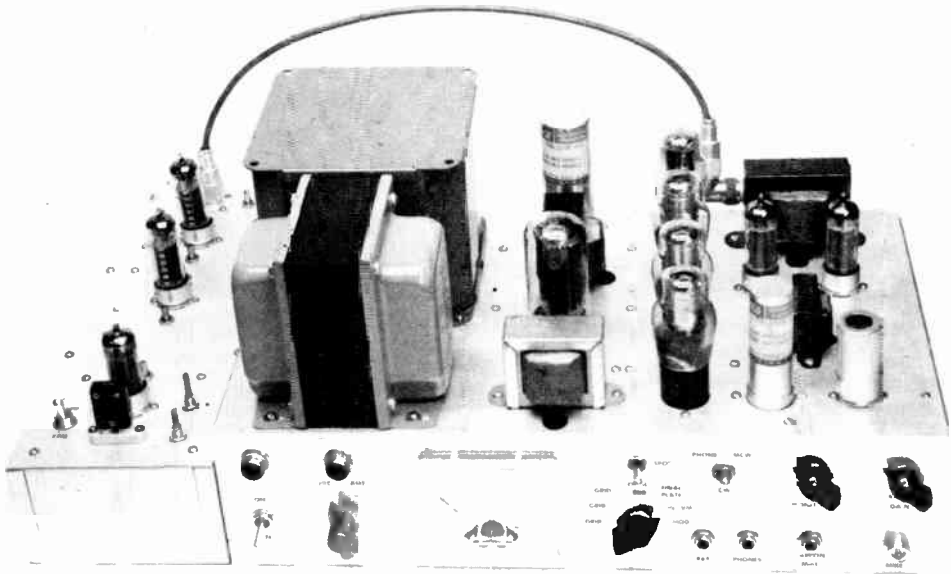

Fig. 17-1—A complete 50-, 144-, 220- and 432-Mc. transmitter, set up for 144-Mc. operation. The large chassis houses the power supply, modulation equipment and control circuits. The unit at the left is the 144-Mc. transmitter/driver.

## A COMPLETE 50- THROUGH 432-MC. TRANSMITTER

The transmitter pictured in Figs. 17-1 through 17-14 includes complete r.f. sections, modulator, power supply and control circuits for phone, c.w. and m.c.w. operation on 50 through 432 Mc. Modular construction of the r.f. sections is incorporated, and the amateur requiring only a 50- or 144-Mc. transmitter, for example, will not build any unused r.f. sections. If later operation is extended to the higher frequencies, a minimum of additional equipment is required.

Separate plug-in transmitters are provided for the 50-, 144- and 220-Mc. bands. On 432 Mc., the 144-Mc. unit is used as an exciter to drive a plug-in tripler/amplifier. All of the transmitters can be crystal- or v.f.o.-controlled. The phone (a.m.) carrier output is 10 to 15 watts on all bands except 432 Mc., where it drops to about 5 watts.

A single 0-1 milliammeter is used; with switching it is possible to meter the grid currents, the amplifier and modulator cathode currents, and the r.f. output voltage. Other accessories provided in the unit include an antenna changeover relay, a c.w. monitor, and a spotting switch. Either a carbon or a crystal microphone can be used with the modulator.

### 50-Mc. Transmitter

The 50-Mc. transmitter, Figs. 17-2 and 17-3, uses a 6CX8 pentode-triode to drive a 6360 output stage. Referring to Fig. 17-4, the pentode section of the 6CX8 is connected to be used in the grid-plate crystal-oscillator circuit or, by closing  $S_1$ , as the input amplifier for a v.f.o. Various ranges of crystals may be used: 6.25 to 6.75 Mc., 8.33 to 9.0 Mc., 12.5 to 13.5 Mc., and 25 to 27 Mc. For stability with line-voltage changes, both the screen and plate voltages are regulated. When the pentode is converted to multiplier operation for use with a v.f.o., the cathode is brought down to r.f. ground. V.f.o. drive on any of the above crystal ranges can be used.

Link coupling is used between the oscillator plate coil and the triode section of the 6CX8. In the triode the signal is doubled to the 50-Mc. band and then inductively coupled to the final grids. To maintain balance and to help couple the maximum drive from the doubler stage to the push-pull output stage, a small balancing capacitor,  $C_2$ , is used to compensate for the triode's output capacitance.

For phone operation, the 6360 output stage is

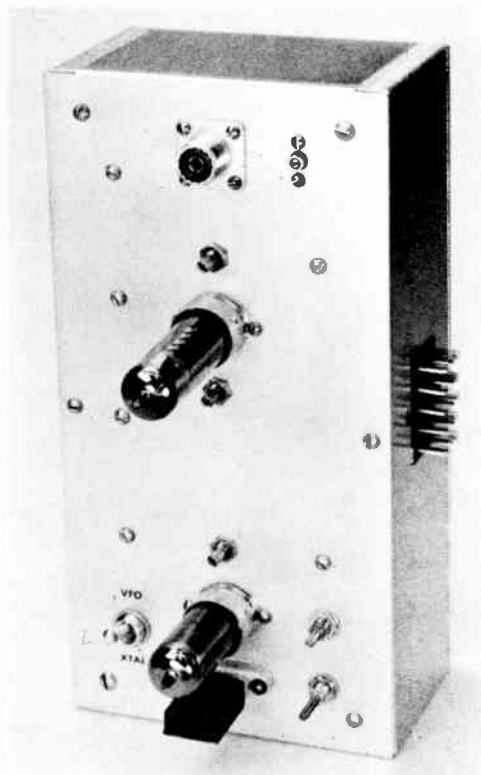

Fig. 17-2—Top view of the 50-Mc. transmitter. The toggle switch at the lower left changes the input circuit for crystal or v.f.o. operation; when used, the v.f.o. output is introduced at the crystal socket.

plate and screen modulated. The cathode of the amplifier stage is keyed during c.w. operation. The meter can be switched to read the 6360 grid or cathode current. On grid current the full-scale meter indicates 5 ma., and on cathode current it is 100 ma.

### Construction

The 50-Mc. transmitter is built on a  $5 \times 10$ -inch sheet of aluminum, which is held by sheet-metal screws to a  $5 \times 10 \times 3$ -inch chassis that serves as a case. The power and metering leads within the transmitter run first to multiple tie points and then by flexible leads to a 15-pin plug ( $P_1$  in Fig. 17-4) mounted on the side of the case (chassis). The transmitter is plugged into a matching receptacle on the left side of the power supply/ control unit (see Fig. 17-1).

As can be seen in Fig. 17-3, the tube sockets, input and output connectors, and three of the tuning capacitors are mounted along the center line of the aluminum plate. The two adjustable inductors,  $L_1$  and  $L_3$ , are mounted 1 inch apart, center to center, and coupled together by a  $\frac{3}{4}$ -turn link around each one at the "cold" (grounded) end. Capacitor  $C_2$  is soldered to the

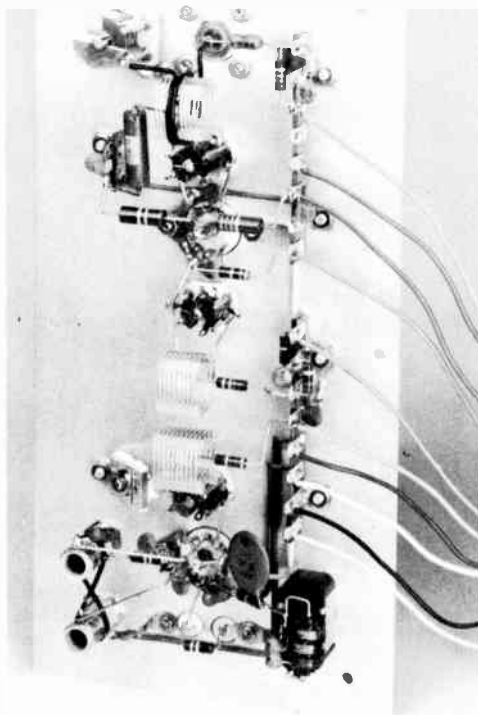

Fig. 17-3—Bottom view of the 50-Mc. transmitter. The oscillator/doubler circuitry is at the bottom of the aluminum plate. All power leads are terminated at the tie points along the right-hand side, and flexible leads run from the tie points to the 15-pin plug on the side of the chassis (not visible).

appropriate stator of  $C_1$  and bolted to the base plate; the adjustment-screw side of  $C_2$  is connected to the base. Coils  $L_4$  and  $L_5$  are mounted 1 inch apart, center to center, supported by their leads.

The cathode and screen bypass capacitors in the 6360 stage are mounted at the tube socket with leads as short as possible. The r.f. voltmeter components can be seen in Fig. 17-3 at the upper right, bunched together on the upper end of the terminal strip.

Leads from the terminal strip to plug  $P_1$  should be made long enough to permit working on the transmitter plate when it is unfastened from the case. When the plate is replaced, the leads should be bent against the side wall of the chassis away from the coils or other components.

### Adjustment

The adjustment procedure to be outlined applies to the unit when used with the power supply and control circuits described later. All pre-

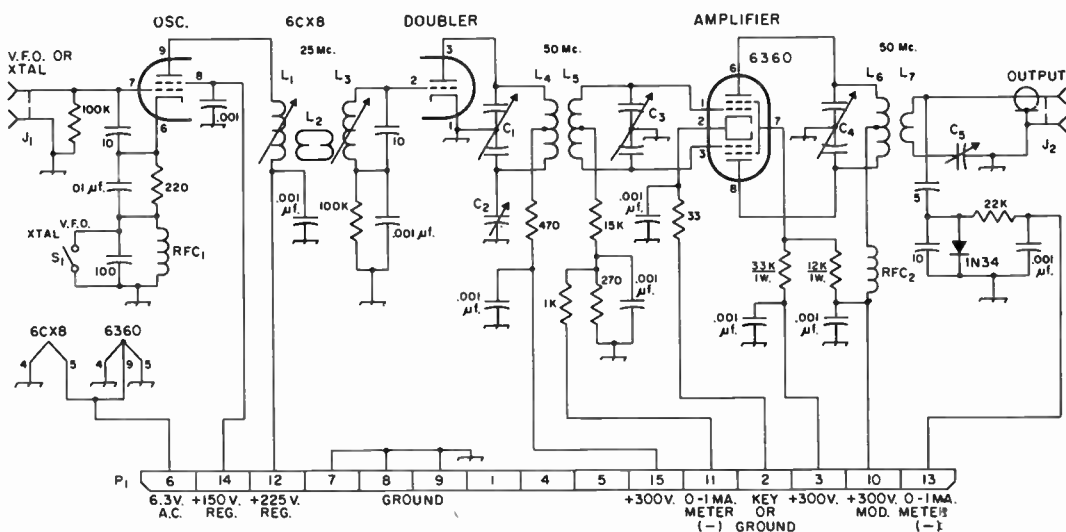

Fig. 17-4—Circuit diagram of the 50-Mc. transmitter. Unless specified otherwise, capacitances are in picafarads (pf. or  $\mu\mu\text{f.}$ ), resistances, are in ohms, resistors are  $\frac{1}{2}$  watt. Fixed capacitors are ceramic.

$C_1$ —8-pf. miniature butterfly variable (Johnson 160-208).

$C_2$ —3-30-pf. mica compression trimmer.

$C_3$ —5-pf. miniature butterfly variable (Johnson 160-205).

$C_4$ —11-pf. miniature butterfly variable (Johnson 160-211).

$C_5$ —50-pf. miniature variable (Hammarlund MAPC-50).

$J_1$ —Crystal socket.

$J_2$ —Coaxial receptacle, SO-239.

$L_1$ —3.1–6.8- $\mu\text{h.}$  variable inductor (Miller 4405).

$L_2$ — $\frac{3}{4}$ -turn link of insulated hook-up wire around cold

ends of  $L_1$  and  $L_3$ . See Fig. 17-4.

$L_3$ —1.5–3.2- $\mu\text{h.}$  variable inductor (Miller 4404).

$L_4$ —10 t. No. 20,  $\frac{3}{4}$ -inch diam., 16 t.p.i., center-tapped (B & W 3011).

$L_5$ —8 turns, same material as  $L_4$ .

$L_6$ —9 turns, same material as  $L_4$ .

$L_7$ —2 turns insulated wire around center of  $L_4$ .

$P_1$ —15-contact plug with brackets (Cinch-Jones P-315-AB).

$\text{RFC}_1$ —750- $\mu\text{h.}$  r.f. choke.

$\text{RFC}_2$ —7- $\mu\text{h.}$  r.f. choke (Ohmite Z-50).

$S_1$ —S.p.s.t., toggle.

liminary adjustments are made with the mode switch ( $S_4$  in Fig. 17-14) in the phone position and with the audio gain control,  $R_1$ , set at minimum. The meter when switched to the r.f. voltmeter position indicates relative output; it is not calibrated.

With the 50-Mc. transmitter plugged into the power supply and the aluminum plate turned upside down (and the power off), temporarily disconnect the +300-volt lead to  $L_4$  and to the plate and screen of the 6360. Make an output indicator from 2 or 3 turns of insulated hook-up wire,  $\frac{1}{2}$ -inch in diameter, with the ends soldered to the terminals of a pink-bead (type 48 or 49) flashlight bulb. Apply power to the oscillator while carefully coupling the indicator coil to  $L_1$ . Adjust the core in  $L_1$  for maximum brilliance of the flashlight bulb. Couple the indicator to  $L_3$  and tune  $L_1$  and  $L_3$  for maximum brilliance. Apply plate voltage to the triode by reconnecting the lead to  $L_4$  (with power off, of course) and, with power on, adjust  $C_1$  and  $C_2$  for maximum output indicated at  $L_4$ .

Once an indication has been obtained, switch the meter switch to read grid current in the 6360

and adjust  $C_3$  for maximum grid current. Juggle the settings of  $C_1$  and  $C_2$  until the combination is found that gives the maximum grid current. A maximum of 5 ma. or more should be readily attainable, if all is working well.

A 50-ohm load should now be connected to  $J_2$  and the plate and screen supply should be reconnected to the output stage. With the meter switched to read final plate and screen current, turn on the transmitter and quickly adjust  $C_4$  for the dip in current. Then switch the meter to read output voltage and alternately adjust  $C_4$  and  $C_5$  until a maximum indication is obtained.

The aluminum plate can now be screwed to the case (chassis) and all controls again peaked for maximum output, as indicated by the output voltmeter. Loaded for maximum output on phone, the plate and screen current of the output stage should be about 75 ma., and the grid current should run 3 to 4 ma.

The 6360 dual pentode is internally neutralized and should be completely stable. To check the stability, pull out the crystal briefly and check grid and output-voltage readings. They should both be zero.

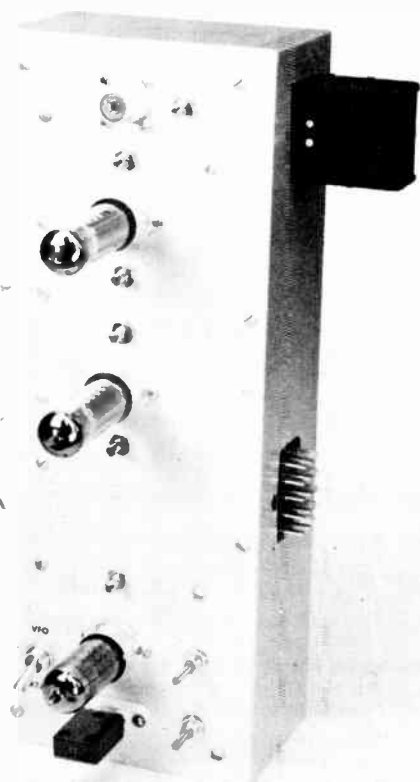

Fig. 17-5—Top view of the 144-Mc. transmitter/driver. The power socket (upper right) with jumper plug in place, is used with the 432-Mc. tripler amplifier.

### The 144-Mc. Transmitter

The 144-Mc. transmitter/driver is shown in Figs. 17-5 and 17-6. As can be seen from the circuit diagram, Fig. 17-7, the oscillator-doubler circuitry is about the same as that of the 50-Mc. unit. The frequency ranges are different; inputs (crystal or v.f.o.) can be 6.000 to 6.164 Mc., 8.000 to 8.222 Mc., 12.000 to 12.333 Mc., and 24.000 to 24.666 Mc.

The output of the doubler stage, working in the range 48.000 to 49.333 Mc., is inductively coupled to a push-pull 6360 tripler. Omitting the screen bypass capacitor is not an error; it follows a recommendation of the tube manufacturer. Inductive coupling is used between the tripler and the 6360 final amplifier. As on 50 Mc., the final is plate and screen modulated for a.m. operation. On c.w., the cathodes of the final and the driver stages are both keyed, to minimize chances for a backwave.

Many of the connections in the 144-Mc. transmitter are made through a jumper plug,  $P_2-J_3$  in Fig. 17-7. This is done so that removal of  $P_2$  permits connecting the 432-Mc. unit via  $J_3$ . If no 432-Mc. operation is contemplated, the con-

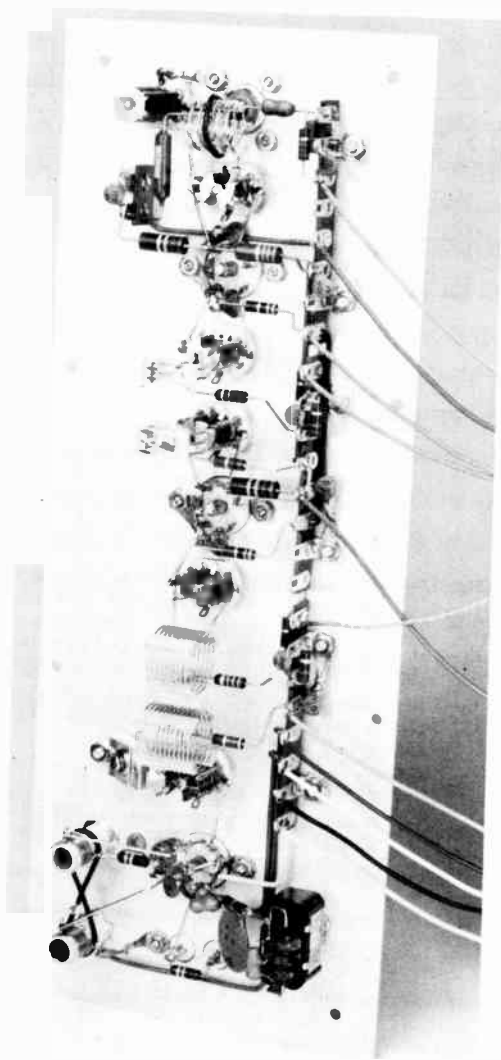

Fig. 17-6—Bottom view of the 144-Mc. transmitter. Oscillator-doubler circuitry is at the bottom, tripler circuitry in the center and the final at the top. Bypass capacitors have very short leads; all power leads are brought to the string of tie points on right, and from there lead to the chassis-mounted plug and receptacle.

struction of the 144-Mc. unit can be simplified (and a few dollars can be saved) by eliminating  $P_2$  and  $J_3$ .

### Construction

The 144-Mc. transmitter is built on a  $5 \times 13$ -inch aluminum plate, which is fastened by sheet-metal screws to a  $5 \times 13 \times 3$ -inch chassis that serves as a case. The two 15-contact connectors are mounted on one side of the chassis.

As in the 50-Mc. unit, the major transmitter components are mounted on the long center line



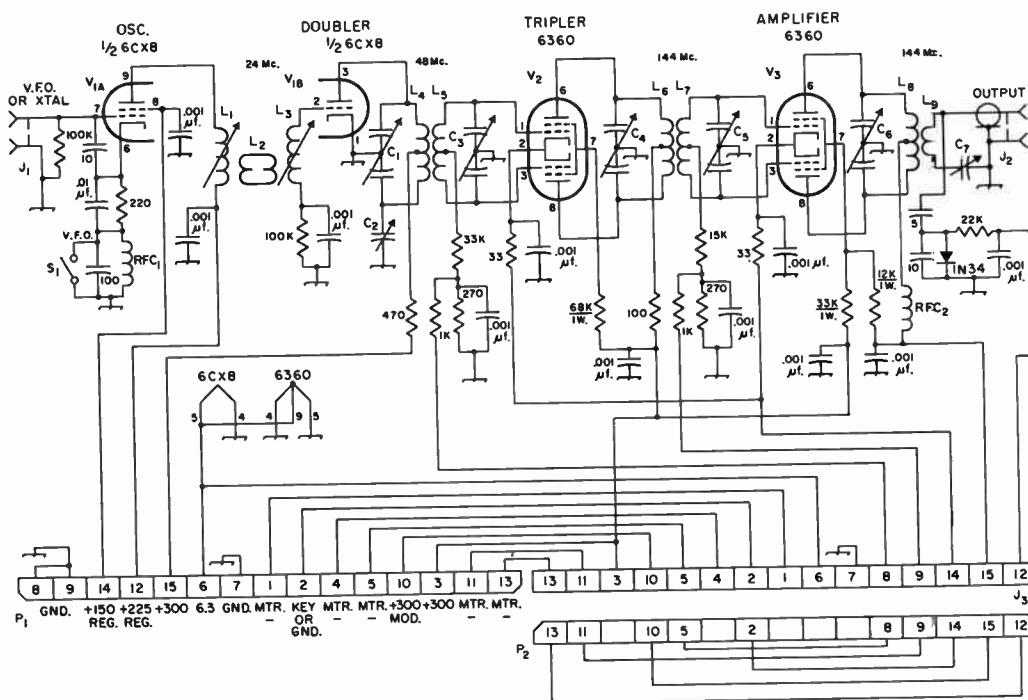

Fig. 17-7—Circuit diagram of the 144-Mc. transmitter. Unless specified otherwise, capacitances are in picofarads (pf. or  $\mu\text{m.f.}$ ), resistances are in ohms, resistors are  $\frac{1}{2}$  watt.  $P_2$  plugs into  $J_3$  for 144-Mc. operation.

- $C_1, C_4, C_5$ —8-pf. miniature butterfly variable (Johnson 160-208).
- $C_2$ —3-30-pf. mica compression trimmer.
- $C_3, C_6$ —5-pf. miniature butterfly variable (Johnson 160-205).
- $C_7$ —30-pf. miniature variable (Johnson 160-130).
- $J_1$ —Crystal socket.
- $J_2$ —Coaxial receptacle, SO-239.
- $J_3$ —15-contact socket with brackets (Cinch-Jones S-315-AB).
- $L_1, L_3$ —3.1–6.8- $\mu\text{h.}$  adjustable inductor (Miller 4405).
- $L_2$ — $\frac{3}{4}$ -turn link of insulated hook-up wire around cold ends of  $L_1$  and  $L_3$ . See Fig. 17-7.
- $L_4$ —12 t. No. 20,  $\frac{3}{4}$ -inch diam., 16 t.p.i., c.t. (B&W 3011).

- $L_5$ —9 t. same stock as  $L_4$ .
- $L_6$ — $2\frac{3}{4}$  t. No. 18,  $\frac{3}{4}$ -inch diam., 8 t.p.i., c.t. (B&W 3010).
- $L_7$ — $1\frac{1}{4}$  t. same stock as  $L_6$ .
- $L_8$ —5 t. No. 18,  $\frac{1}{2}$ -inch diam., 8 t.p.i., c.t. (B&W 3002).
- $L_9$ —1 t. insulated wire around center of  $L_8$ .
- $P_1$ —15-contact male chassis fitting (Cinch-Jones P-315-AB).
- $P_2$ —15-contact male plug (Cinch-Jones P-315-CCT).
- RFC<sub>1</sub>—750- $\mu\text{h.}$  r.f. choke.
- RFC<sub>2</sub>—1.8- $\mu\text{h.}$  r.f. choke (Ohmite Z-144).
- $S_1$ —S.p.s.t. toggle.

of the aluminum plate. The two adjustable inductors,  $L_1$  and  $L_3$  (Fig. 17-7), are spaced  $1\frac{1}{4}$  inches apart, center to center. They are coupled by  $\frac{3}{4}$ -turn links wound around the "cold" (ground) ends. Inductors  $L_4$  and  $L_5$  are mounted by their leads on  $C_1$  and  $C_3$  respectively; their centers are 1 inch apart.  $L_6$  and  $L_7$  are also mounted on their respective capacitors, with their adjacent ends  $\frac{5}{8}$  inch apart.

Screen and cathode bypass capacitors are mounted at the appropriate tube sockets with very short leads. All power wiring is made to the terminal strips along one edge of the base plate; these terminal strips also support the various

resistors and components associated with the metering circuits.

### Adjustment

The adjustment procedure for the 144-Mc. transmitter is similar to that for the 50-Mc. unit, except that there is also a push-pull tripler stage to adjust.

With the  $P_2$  jumper plug in place (if  $P_2$  and  $J_3$  are incorporated) and with the B+ disconnected from all stages except the pentode oscillator, peak  $L_1$  and  $L_3$  by using a pilot-bulb pickup loop, as described for the 50-Mc. unit. Then apply B+ to the triode doubler stage and peak it as described

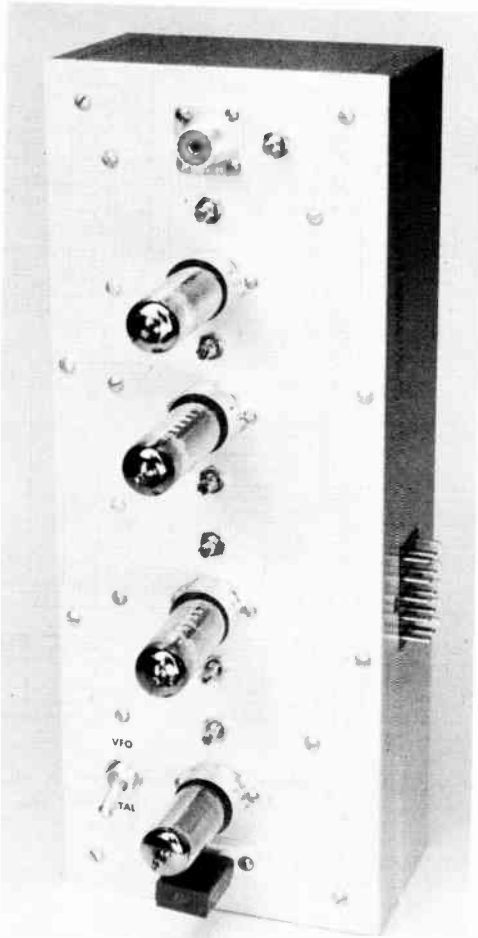

Fig. 17-8—Top view of the 220-Mc. transmitter. Major components are arranged in a line down the middle of the aluminum plate. The output loading capacitor is mounted to the right of the output connector (top).

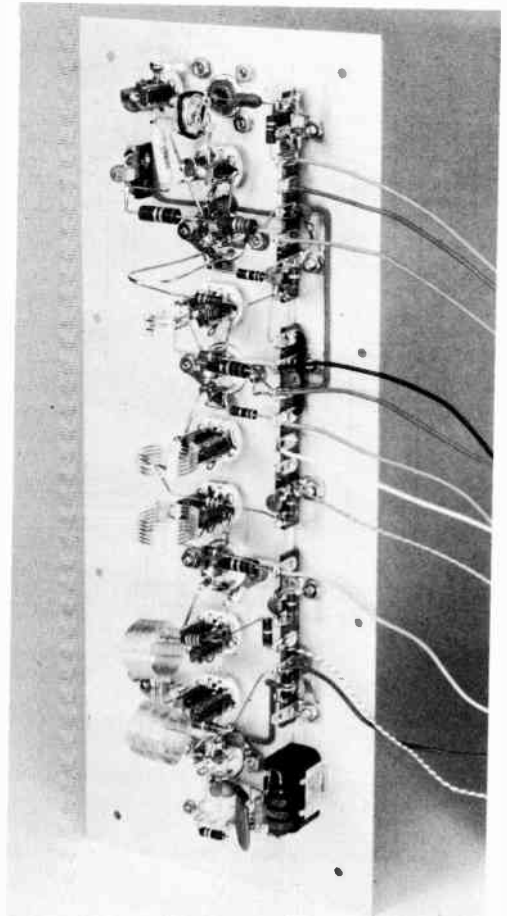

Fig. 17-9—Bottom view of the 220-Mc. transmitter. Circuit runs from bottom to top.

earlier. Switch the meter to the tripler grid-current position, adjust  $C_3$  and then alternately  $C_1$  and  $C_2$  for maximum grid current. Switch the meter to read final grid current, apply B+ to the tripler, and adjust  $C_4$  and  $C_5$  for maximum final grid current.

Attach a 50-ohm load to the output connector, apply final plate and screen voltage, and adjust the final for maximum output indication. Typical readings for a.m. phone operation should be: tripler grid current,  $1\frac{1}{2}$  ma.; final grid current, 3 ma., and final plate (and screen) current, 75 ma.

#### 220-Mc. Transmitter

In the 220-Mc. transmitter shown in Figs. 17-8 and 17-9, a 6CL6 pentode is used in the crystal-oscillator stage. As can be seen in Fig. 17-10, the oscillator stage is connected so that it can also take v.f.o. input. For 220-Mc. operation, the

crystals (or v.f.o. output) should fall in one of the following ranges: 6.11 to 6.25 Mc., 8.149 to 8.333 Mc., 12.22 to 12.50 Mc., or 24.44 to 25.00 Mc.

The plate circuit of the oscillator is inductively-coupled to a push-pull tripler, which drives another 6360 push-pull tripler to 220 Mc. To complete the chain, a 6360 is operated straight-through on 220 Mc. No tuning capacitor is used in the grid circuit of the final, since the grid coil,  $L_6$ , tunes to 220 Mc. with only the input capacitance of the final stage.

For phone, combined plate and screen modulation of the final stage is used. On c.w., the driver and final cathodes are keyed simultaneously.

#### Construction

The 220-Mc. transmitter is built on a  $5 \times 13$ -inch aluminum plate, which is fastened with sheet-metal screws to a  $5 \times 13 \times 3$ -inch chassis that serves as a case. A 15-pin plug on one side of the case is used for power and meter connections.

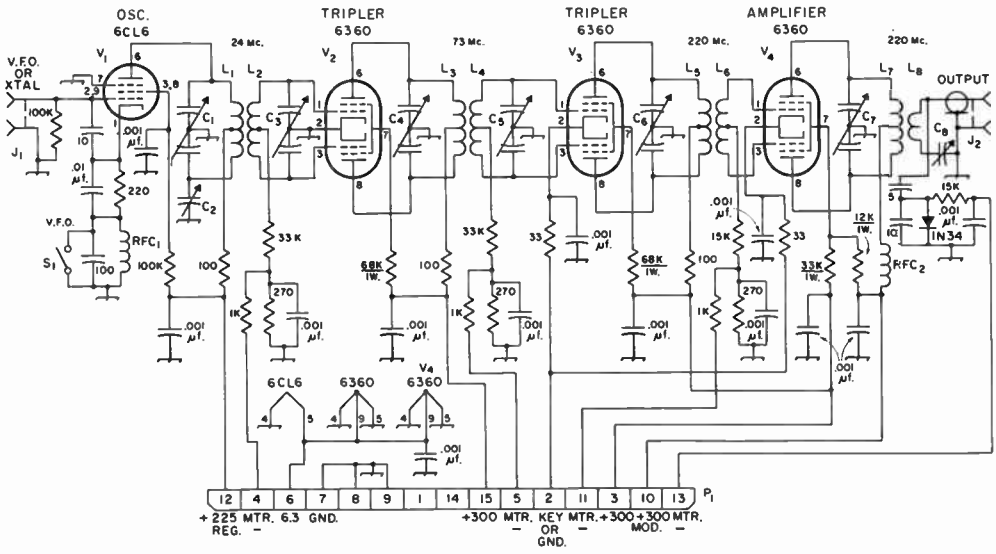

Fig. 17-10—Circuit diagram of the 220-Mc. transmitter. Unless specified otherwise, capacitances are in picofarads (pf. or  $\mu\text{mf.}$ ), resistances are in ohms, resistors are  $\frac{1}{2}$  watt.

- $C_1, C_8$ —11-pf. miniature butterfly (Johnson 160-211).
- $C_2$ —3-30-pf. mica compression trimmer.
- $C_4, C_5, C_6$ —8-pf. miniature butterfly (Johnson 160-208).
- $C_7$ —5-pf. miniature butterfly (Johnson 160-205).
- $C_8$ —15-pf. miniature variable (Johnson 160-107).
- $J_1$ —Crystal socket.
- $J_2$ —Coaxial receptacle, SO-239.
- $L_1$ —18 t. No. 24,  $\frac{3}{4}$ -inch diam., 32 t.p.i., c.t. (B&W 3012).
- $L_2$ —16 turns same stock as  $L_1$ .
- $L_3$ — $6\frac{1}{4}$  t. No. 20,  $\frac{3}{4}$ -inch diam., 16 t.p.i., c.t. (B&W 3011).

- $L_4$ — $4\frac{3}{4}$  turns, same stock as  $L_3$ .
- $L_5$ — $1\frac{3}{4}$  t. No. 18,  $\frac{1}{2}$ -inch diam., 8 t.p.i., c.t. (B&W 3002).
- $L_6$ —Hairpin loop No. 18, 2 inches long, tapered from  $11/16$  to  $\frac{3}{8}$  inch wide.
- $L_7$ — $2\frac{1}{4}$  turns, same stock as  $L_5$ .
- $L_8$ —1 turn insulated wire around center of  $L_7$ .
- $P_1$ —15-contact male chassis plug (Cinch-Jones P-315-AB).
- RFC $_1$ —750- $\mu\text{h.}$  r.f. choke.
- RFC $_2$ —0.84- $\mu\text{h.}$  r.f. choke (Ohmite Z-235).
- $S_1$ —S.p.s.t. toggle.

As in the other units, the major components are mounted on the long center line of the aluminum plate. The two coils,  $L_1$  and  $L_2$ , in the oscillator plate and first tripler grid circuits, are spaced  $1\frac{1}{4}$  inches apart, center to center.  $L_3$  and  $L_4$  are mounted on their respective capacitors and spaced  $\frac{5}{8}$  inches apart, edge to edge. (This slightly unbalanced arrangement gives a bit more drive than the more-normal parallel-axis arrangement.) Coil  $L_5$  and hairpin loop  $L_6$  are mounted  $\frac{5}{8}$  inches apart, loop to nearest edge of coil.

All bypass capacitors in this transmitter should be mounted with very short leads. Note that the heater of the output stage is bypassed in this unit. These capacitors should be grounded to the chassis at the appropriate tube sockets. As in the other units, all power and meter leads are brought to tie points along the edge and then in flexible leads to the 15-prong plug.

**Adjustment**

The 220-Mc. tune-up procedure is quite similar

to that for the 144-Mc. transmitter. With B+ applied only to the oscillator, couple the flashlight bulb indicator to  $L_1$  and adjust  $C_1$  and/or  $C_2$  for maximum output. Now switch the meter to the first tripler grid position and adjust  $C_3$  for maximum grid current. Go back and readjust  $C_1$  and  $C_2$  alternately until the settings are obtained that give maximum grid current.

Switch the meter to the second tripler grid and apply plate and screen voltage to the first tripler. Adjust  $C_4$  and  $C_5$  for maximum grid current. Then switch the meter to the output amplifier grid and apply power to the plate and screen of the second tripler. Adjust  $C_6$  for maximum grid current. With no plate or screen voltage on the output amplifier, the grid current should be at least 3 ma. It can be peaked by adjustment of  $C_6$ , slight changes in spacing between  $L_5$  and  $L_6$ , and by pinching or spreading the sides of the loop,  $L_6$ .

Before plate and screen voltages are applied to the output stage, connect a 50-ohm dummy load to  $J_2$  and switch the meter to read final plate cur-

rent. Apply high voltage and quickly adjust  $C_7$  for minimum plate current. Then replace the plate on the case (chassis) and peak all controls for maximum meter indication in the r.f. voltmeter position. With the 220-Mc. transmitter adjusted for maximum output on phone, typical meter readings should be: first tripler grid current, 2 ma.; second tripler grid current,  $2\frac{1}{4}$  ma.; final grid current  $2\frac{3}{4}$  ma., and final plate current, 80 ma.

#### 432-Mc. Tripler/Amplifier

The 432-Mc. tripler/amplifier shown in Figs. 17-11 and 17-13 is designed to be driven by the 144-Mc. unit described earlier. As can be seen in the circuit diagram, Fig. 17-12, the first stage is a 6939 push-pull tripler stage. Its input circuit tunes to the 144-Mc. band with the input capacitance of the tube and the inductance of  $L_2$ ; it is not at all critical because there is an abundance of drive available. The input to the tripler can be anything from 140 to 150 Mc., to cover the entire  $\frac{3}{4}$ -meter band. However, since almost all crystal-controlled transmitters in this band are operated between 432- and 436 Mc., the following crystal ranges for the 144-Mc. transmitter will prove most useful: 6.000 to 6.055 Mc., 8.000 to 8.074 Mc., 12.00 to 12.11 Mc., and 24.00 to 24.22 Mc.

The plate circuit of the tripler is a quarter-wavelength tuned line,  $L_3$ . It is inductively coupled to the half-wavelength tuned line,  $L_4$ , in the grid circuit of the push-pull 6939 output amplifier. This amplifier uses a quarter-wavelength line in its plate circuit, inductively coupled to a series-tuned output loop,  $L_6$ . Note that the plate tuning capacitor,  $C_3$ , does not have its rotor grounded as might seem normal; it was found that a parasitic oscillation disappeared when the rotor was lifted.

A shield is mounted across the socket of the output amplifier to minimize coupling between the grid and plate circuits. Small unbypassed resistors are included in the screen leads of both tubes to discourage parasitic oscillations. Suitable r.f. chokes and bypass capacitors are used in the heater circuit to prevent r.f. loss.

As in the other units, the final screen and plate are modulated for phone work, and for c.w. operation the cathodes of both stages are keyed. It was found necessary to shield the r.f. voltmeter (output indicator) circuitry to avoid false readings. Since this unit uses lower B+ voltages than the other three transmitters, suitable dropping resistors are included in the unit. In the interests of good modulation, the resistor to the output amplifier is bypassed for audio by a large capacitor.

#### Construction

The 432-Mc. tripler/amplifier is built on a  $5 \times 10$ -inch aluminum plate that is held to a 3-inch chassis by sheet-metal screws. A 15-pin chassis-mounted plug is mounted at the end of the chassis so that it can engage the mating unit on the 144-Mc. case (see Fig. 17-13).

The major components are mounted along the center line of the aluminum plate. The input jack,  $J_1$ , is mounted 1 inch from the tripler socket, and

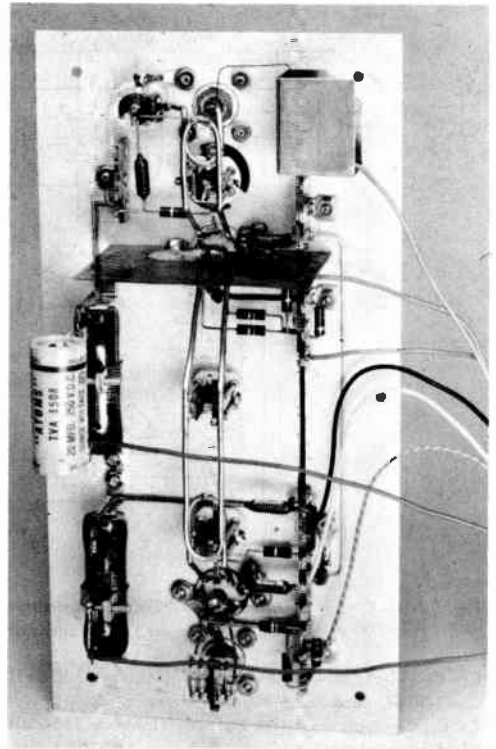

Fig. 17-11—Bottom view of the 432-Mc. tripler/amplifier. A small shield of flashing copper crosses the final tube socket, and a box (upper right) of the same material houses the r.f. voltmeter on the output terminal.

$C_1$  is mounted 1 inch away on the other side. The output amplifier socket is mounted 4 inches from  $C_1$ .  $C_2$  is mounted midway between  $C_1$  and the output amplifier, and  $C_3$  and  $J_2$  are mounted 1 and 2 inches respectively from the output tube socket.  $C_3$  is insulated from the chassis by mounting it on a small phenolic disk; some radio stores carry extruded fibre washers that can be pressed into service. If none can be found, the phenolic disk from an RCA phono jack can be used.

Dimensions for the inductors  $L_1$  through  $L_6$  are given in Fig. 17-12. A  $2 \times 3$ -inch shield of flashing copper is mounted across the socket of the output amplifier. It passes over the spaces between pins 4 and 5 and pins 1 and 9. Pins 4 and 5 are soldered to the copper shield, as are the soldering lugs held by the tube socket's mounting screws and the central shield pin of the socket.

The components for the r.f. voltmeter circuit are mounted with very short leads on a three-terminal strip and enclosed in a small four-sided box made of flashing copper. The voltmeter is wired to the output connector with a short length of hook-up wire.

The several bypass capacitors should be wired with very short leads. When the aluminum plate is fastened to the case (chassis), the power wiring

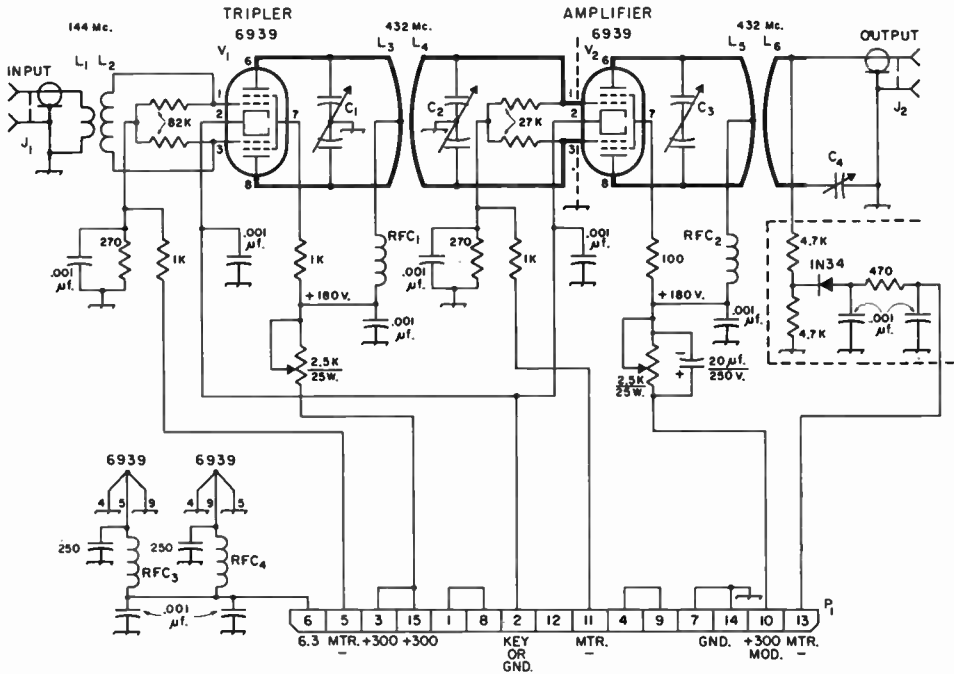

Fig. 17-12—Circuit diagram of the 432-Mc. tripler/amplifier shown in Fig. 17-13. Unless specified otherwise, capacitances are in picofarads, resistances are in ohms, resistors are 1/2 watt.

- C<sub>1</sub>—8-pf. miniature butterfly (Johnson 160-208).
- C<sub>2</sub>—11-pf. miniature butterfly (Johnson 160-211).
- C<sub>3</sub>—5-pf. miniature butterfly, insulated from chassis (Johnson 160-205).
- C<sub>4</sub>—5-pf. miniature variable (Johnson 160-102).
- J<sub>1</sub>, J<sub>2</sub>—Coaxial receptacle, SO-239.
- L<sub>1</sub>—1 turn of insulated wire around center of L<sub>2</sub>.
- L<sub>2</sub>—5 t. No. 18, 1/2-inch diam., 8 t.p.i., c.t. (B&W 3002).
- L<sub>3</sub>—Hairpin loop No. 12, 1 7/8-inch long, 1/2-inch wide, bent 1 inch from closed end, C<sub>1</sub> center 3/4 inch from closed end.
- L<sub>4</sub>—Hairpin loop No. 12, 4 inches long and 1/2 inch

- wide, bent 2 3/8 inches from closed end, C<sub>2</sub> center 2-1/16 inches from closed end. Space 1/8 inch below L<sub>3</sub>.
- L<sub>5</sub>—Hairpin loop No. 12, 2-1/16 inches long and 1/2 inch wide, bent 1/4 inches from closed end, C<sub>3</sub> center 15/16 inch from closed end.
- L<sub>6</sub>—Hairpin loop No. 12, 1 3/8 inches long and 1/2 inch wide, bent 7/8 inch from closed end. Space 1/16 inch above L<sub>5</sub>.
- P<sub>1</sub>—15-contact male chassis plug (Cinch-Jones P-315-AB).
- RFC<sub>1</sub>—RFC<sub>4</sub>—0.2µh. r.f. choke (Ohmite Z-460).

running from the terminal strips and resistors to the 15-pin plug, should be dressed flat against the sides of the case, away from the r.f. coils and components.

**Adjustment**

First, the 144-Mc. transmitter should be tuned for maximum output, as described earlier. With the power turned off, the jumper plug should be removed from the 144-Mc. unit and the 432-Mc. tripler/amplifier plugged in. A coaxial cable with suitable plugs should be used to connect the 144-Mc. drive to the tripler input jack. When the two units are connected together, the meter in the control unit will read 144-Mc. tripler grid current in position 1, 144-Mc. final grid current in position 2, 432-Mc. tripler grid current in position 3, and 432-Mc. final grid current in position 4.

With the meter switch in position 3 and no

B+ applied to the 432-Mc. unit, turn on the 2-meter transmitter and adjust C<sub>6</sub> and C<sub>7</sub> in the 144-Mc. unit for a 432-Mc. tripler grid current of 3 to 4 ma. Do not try to get more grid drive. If the meter reading is too high, reduce it by detuning C<sub>7</sub> in the 2-meter unit or by loosening the coupling between L<sub>1</sub> and L<sub>2</sub> in the 432-Mc. unit. Do not reduce drive by detuning C<sub>6</sub> in the 144-Mc. transmitter. Always adjust this control for maximum drive to the 432-Mc. transmitter.

Set the resistor in the tripler high-voltage lead to maximum resistance and switch the meter switch to position 4. Apply B+ to the tripler stage and adjust C<sub>1</sub> and C<sub>2</sub> (Fig. 17-12) alternately until maximum grid current is obtained. Then carefully adjust the slider on the resistor until the voltage measured at the bypassed end of RFC<sub>1</sub> is about +180.

Connect a 50-ohm dummy load to the output connector, J<sub>2</sub>. Set the adjustable resistor in the





Fig. 17-13—Rear view of the power supply and modulator, with the 144- and 432-Mc. units in place, for 432-Mc. operation. The 432-Mc. unit is in the foreground; its power plug plugs into a socket on the 144-Mc. driver. The six-prong plug to the right of the antenna changeover relay is an outlet for v.f.o. power and control, and the phono jack to the right is  $J_5$ , for receiver output. Socket on the side of the chassis is  $J_4$ , for converter power. The fourth VR tube, visible here but not shown in Fig. 17-14, is for possible use with a receiver/converter power supply.

B+ lead to the output stage to maximum resistance, and switch the meter switch to read amplifier plate and screen current. Apply B+ to the output stage and quickly adjust  $C_3$  for minimum plate current. Then switch the meter to the r.f. voltmeter position and adjust  $C_3$  and  $C_4$  alternately until maximum output is indicated. Then adjust the resistor in the B+ lead until the voltage measured at the bypassed end of  $RFC_2$  is +180.

Next, go back and repeak all adjustments for maximum r.f. voltmeter indication. Check occasionally to insure that the B+ applied to either stage does not exceed +180 volts; if it does, increase the resistance of the appropriate resistor. The 432-Mc. unit may now be installed in its case and all controls touched up for maximum output. Typical meter readings when the transmitter is properly adjusted for phone operation will be: 144-Mc. tripler grid, 1½ ma.; 144-Mc. final grid, 3 ma.; 432-Mc. tripler grid, 3 ma.; 432-Mc. final grid, 2¾ ma.; and 432-Mc. amplifier plate and screen, 55 ma.

#### The Modulator/Power Supply Unit

In the modulator section (see Fig. 17-14), a 6AN8 is used as the speech amplifier, driving a pair of 6GK6s in Class AB<sub>1</sub>. The pentode section of the 6AN8 serves as the input stage; a high-impedance microphone can be coupled into the

grid circuit via  $J_1$ , or a carbon microphone can be plugged in at  $J_2$ ; in this latter case the pentode operates as a grounded-grid amplifier. The triode section of the 6AN8 is transformer-coupled to the grids of the 6GK6s.

A switch,  $S_{4A}$ , in the secondary circuit of the modulation transformer, short-circuits the transformer secondary during c.w. operation and also removes B+ from the modulator plates and screens at the same time. A second half of the same switch,  $S_{4B}$ , transfers the keyed circuit(s), the cathode(s), from ground to the key. The keyed circuit also controls a neon-tube oscillator that is used to monitor the sending on c.w. and to furnish the modulation for an m.c.w. (modulated c.w.) signal. A 0.001- $\mu$ f. capacitor across the primary of the modulation transformer,  $T_2$ , reduces the high-frequency responses and eliminates a parasitic audio oscillation that occurs under some conditions. A position of the meter switch,  $S_5$ , permits metering the modulator cathode current as well as the other currents mentioned previously.

A 5V3 full-wave rectifier is used in the power supply. To stabilize the voltages on the crystal oscillators, a 0A3 and a 0D3 are included. A third regulator tube, a 0C3, is shown, to furnish stabilized voltage for a crystal-controlled converter that could pick up its power at  $J_4$ .

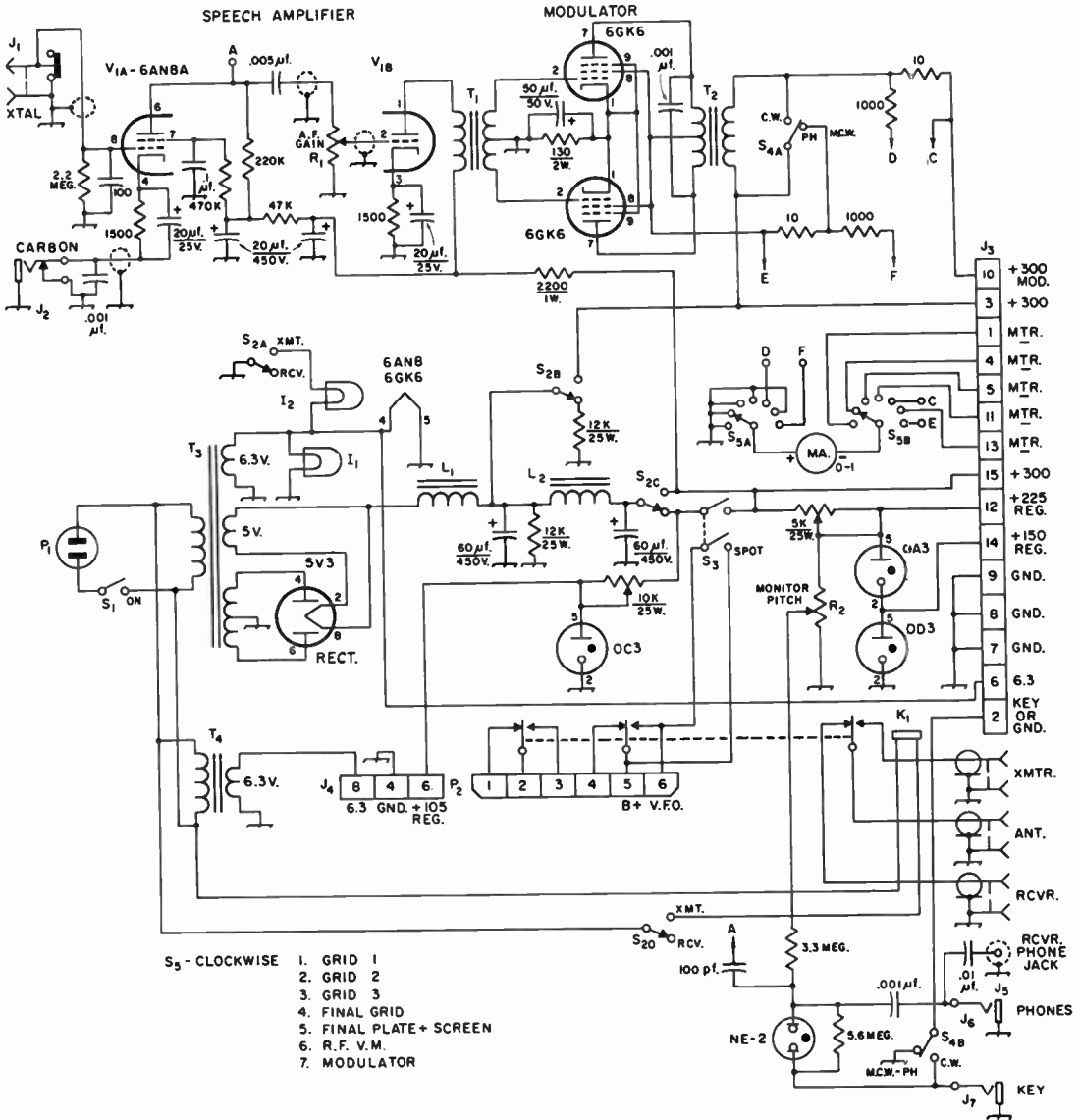

Fig. 17-14—Circuit diagram of the power supply, modulator and control unit. Unless specified otherwise, resistances are in ohms, resistors are 1/2 watt, capacitors marked with polarity are electrolytic.

- I<sub>1</sub>, I<sub>2</sub>—6.3-v. pilot lamp.
- J<sub>1</sub>—Microphone connector, shorting type (Amphenol 75 CL PC1M).
- J<sub>2</sub>—Closed-circuit phone jack.
- J<sub>3</sub>—15-contact female chassis fitting (Cinch-Jones S-315-AB).
- J<sub>4</sub>—Octal socket (Amphenol 78-RS8).
- J<sub>5</sub>—Phono jack.
- J<sub>6</sub>, J<sub>7</sub>—Open-circuit phone jack.
- K<sub>1</sub>—Coaxial antenna relay with d.p.d.t. external contacts, 115 volts a.c. (Dow-Key DK60-G2C).
- L<sub>1</sub>—8-henry 400-ma. filter choke (UTC S-35).
- L<sub>2</sub>—10-henry 90-ma. filter choke (Triad C-7X).
- P<sub>1</sub>—Chassis-mounting line plug (Amphenol 61-M1).
- P<sub>2</sub>—Chassis-mounting 6-pin plug (Amphenol 86-RCP6).

- R<sub>1</sub>, R<sub>2</sub>—1-megohm volume control, audio taper.
- S<sub>1</sub>—S.p.s.t. toggle.
- S<sub>2</sub>—Rotary switch, 4-pole 2-position, shorting type (Mallory 1212L).
- S<sub>3</sub>—D.p.s.t. toggle.
- S<sub>4</sub>—D.p.d.t. toggle.
- S<sub>5</sub>—Rotary switch, 2-pole 11-position (7 used), non-shorting (Mallory 1212L).
- T<sub>1</sub>—1:3 plate to push-pull grids (Triad A-31X).
- T<sub>2</sub>—20-watt modulation transformer, 10,000-to-5000 ohms (Triad M-3X).
- T<sub>3</sub>—800 v.c.t., 380 ma.; 5 v. at 6 a., 6.3 v. at 6 a. (Triad R-24A).
- T<sub>4</sub>—6.3 v. at 3 a. (Knight 62 G 031).

The send-receive switch,  $S_2$ , controls the antenna changeover relay,  $K_1$ , and the B+ voltages to the transmitter in use. Auxiliary contacts on the relay can be used to turn on a v.f.o. or turn off receiver circuits, through  $P_2$ . Although the receiver regulated +105 (at  $J_4$ ) is shown turned off during transmit periods, in some cases it might be found desirable to retain this voltage on the converter oscillator, to minimize drift.

### Construction

The power supply and modulator are built on a  $4 \times 17 \times 10$ -inch aluminum chassis. As can be seen in Fig. 17-1, the power supply components (including regulator tubes) occupy most of the chassis, and the speech amplifier and modulator fill out the remainder, along the right-hand side. The transmitters plug in on the left-hand side, and the converter power outlet is at the right. The coaxial antenna changeover relay is mounted at the rear of the unit, as can be seen in Fig. 17-13. Note that the external contacts of the relay are exposed; if they are used to transfer high voltage they should be protected from accidental contact by a suitable cover.

As in any power supply, the wiring is not critical and the only caution is the usual observation of good insulating practices. In the speech section, several shielded leads should be used; these are indicated in Fig. 17-14.

### Adjustment

The voltage regulator tubes will pass differing amounts of current, depending upon which equipment is plugged into the control unit. Their series-dropping resistors should be set so that the tubes draw at least 5 ma. but not more than 40

ma. when the VR tubes are lit. Further information on setting up voltage-stabilized circuits is given in the Power Supplies chapter.

One of the transmitters should be plugged into the power-supply-modulator-control unit and adjusted as described earlier. A crystal microphone can be connected at  $J_1$  or a carbon microphone plugged into  $J_2$ . Set the GAIN control,  $R_1$ , to minimum and switch  $S_5$  to the modulator current position. A reading between 75 to 85 ma. should be obtained, depending upon which transmitter is used. The higher frequency units put a greater demand on the power supply resulting in lower voltages and consequently lower current readings. The gain control should be advanced until voice peaks cause the meter to kick up 10 or 15 ma. at a normal speaking level.

A visual indication of modulation at the transmitter can be obtained by using a lamp dummy load. None are too good above 50 Mc., but six blue-bead, No. 44 or 46 pilot bulbs, connected in parallel, will give a fair indication of transmitter output. If all is working well, modulation should cause the bulbs to brighten; however, the final may tune differently than when a matched antenna or 50-ohm dummy load is used.

For c.w. operation, plug headphones into  $J_6$ , a key into  $J_7$ , and switch  $S_4$  to the c.w. position. The neon-bulb oscillator will be keyed simultaneously with the transmitter and should be heard in the headphones. The pitch of the monitor can be varied by adjusting  $R_2$ . M.c.w. is accomplished by keying the monitor with  $S_4$  in the PHONE position. The modulator current should kick-up when the key is depressed. The monitor can be keyed for off-the-air code practice by leaving  $S_2$  in the receive position while  $S_3$  is in the SPOT position.

## USING THE 80-METER V.F.O. ON 2 METERS

The circuit at the right (*QST*, May, 1960) allows v.f.o. operation in the v.h.f. range with substantially the stability available on 80 meters. In this example the 80-meter v.f.o. output is heterodyned to 24 Mc., but other combinations can be used. To minimize the generation of spurious signals, the signal from the v.f.o. should be held to the lowest value possible consistent with useful output, by using loose coupling between  $L_1$  and  $L_2$ . If the transmitter crystal-oscillator tube is a triode, it should be neutralized or operated as a frequency multiplier.

Conversion circuit for obtaining 24-Mc. output with 3.5-Mc. input. Capacitances are in picofarads (pf. or  $\mu\mu\text{f.}$ ), resistors are  $\frac{1}{2}$  watt. Bypass capacitors are disk ceramic; other fixed capacitors should be NPO ceramic or mica.

$C_1$ —25-pf. miniature variable.

$L_1$ —50 turns No. 26 enam. on  $\frac{1}{4}$ -inch iron-slug form (Stancor WC-1 TV width control with turns removed leaving single layer, full length, approx. 40  $\mu\text{h.}$ ).

$L_2$ —Single turn insulated wire loosely coupled to ground end of  $L_1$ .

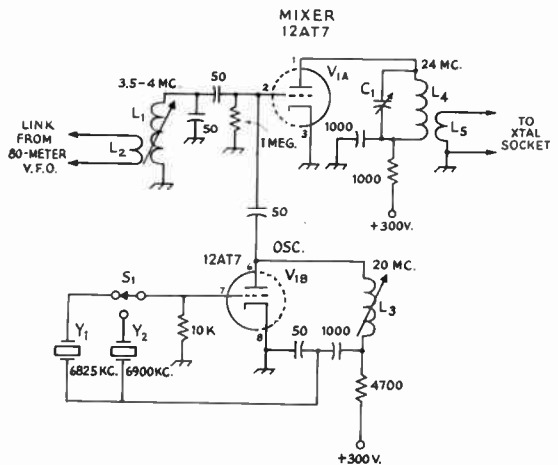

$L_3$ —12 turns No. 32 enam.,  $\frac{3}{16}$  inch long on  $\frac{3}{8}$ -inch iron-slug form, approx 5  $\mu\text{h.}$

$L_4$ —15 turns No. 20,  $\frac{3}{8}$ -inch diam., 1-inch long, approx. 1.8  $\mu\text{h.}$  (B&W 3007 Miniductor).

$L_5$ —2 or 3 turn link at ground end of  $L_4$ .

$S_1$ —S.p.d.t. rotary switch.

## HIGH-POWER TRANSMITTER FOR 50 AND 144 Mc.

The gear described in the next several pages shows how transmitting equipment for two v.h.f. bands can be coordinated in design so as to work from a single exciter. If the builder so desires, the station may be operated from one set of power supplies and speech equipment, with a single set of meters measuring the important currents in both transmitters. Each item can be used by itself, or they combine readily to cover both 50 and 144 Mc., at a power level approaching the legal limit.

In order of their description they are an exciter capable of delivering up to 40 watts output at 48 to 54 Mc., a companion amplifier for the 50-Mc. band, a tripler-driver-amplifier for 144 Mc., and a dual antenna coupler for feeding 50- and 144-Mc. antennas having balanced lines. Their physical appearance is such that they combine neatly for rack mounting, as seen in Fig. 17-15.

## THE EXCITER

Though it is shown mounted on the same panel as the 50-Mc amplifier in Fig. 17-16, the exciter unit might well be used alone, as a versatile 50-Mc. transmitter capable of running up to about 65 watts input. Provision is made for taking off 48-Mc. output at two power levels, through  $J_3$  or  $J_2$ , the latter being used for driving the 144-Mc. tripler to be described later.

The exciter is completely shielded, and its power leads are filtered to prevent radiation of harmonics by the power cable. In addition, there are built-in traps to absorb unwanted oscillator harmonics that might otherwise be passed on to the amplifier, or to the antenna. Harmonics of this kind are particularly troublesome when they fall in Channel 2, which is so close to the operating frequency that a filter in the antenna line is relatively ineffective against them.

The interstage coupling circuits are of band-pass design. Once they are properly adjusted they require no further tuning, when the frequency is changed over a 4-Mc. range. Thus only the crystal switch and the output plate circuit need be adjusted when changing frequency.

## Circuit Details

The oscillator is a 5763, using crystals above 6, 8, 12, or 24 Mc. for 144-Mc. operation, or 6.25, 8.34, 12.5 or 25 Mc. for 50 Mc. Its plate circuit tunes 24 to 27 Mc., quadrupling, tripling or doubling the crystal frequency. (Crystals at 24 to 27 Mc. are overtone cuts that oscillate at one-third the marked frequency in this circuit.) A series-

Fig. 17-15—A high-power r.f. section for a 50- and 144-Mc. station. Equipment includes a band-pass exciter for both bands, a 50-Mc. r.f. amplifier built on the same panel, a tripler-driver-amplifier for 144 Mc., and a dual antenna coupler for both frequencies. Units can be operated with a single set of power supplies, and with common speech equipment and meters.

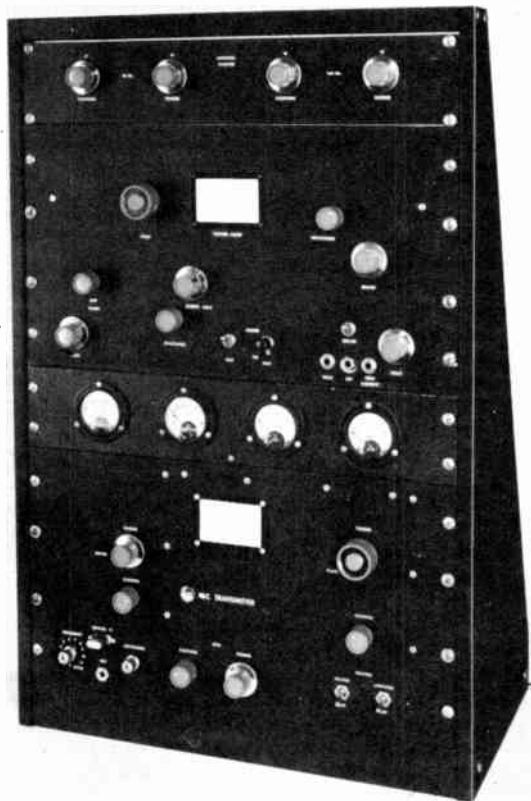



Fig. 17-16—The 50-Mc. r.f. unit. Exciter, left portion on the assembly, also serves on 144 Mc. Amplifier utilizes a 4-125A, 4-250A or 4-400A.

tuned trap,  $L_1C_1$ , in the oscillator plate circuit absorbs the third harmonic of 6-Mc. crystals. This 18-Mc. energy otherwise would pass on to the next stage, where it would be tripled to a frequency in Channel 2. This harmonic has been found to be a common cause of 50-Mc. TVI in Channel 2 areas.

The doubler is also a 5763. A second trap,  $C_3L_3$ , in the grid circuit, is tuned to the 7th harmonic of 8-Mc. crystals. The two traps thus prevent radiation of energy in Channel 2, the most critical transmitter problem a 6-meter man is likely to encounter in correcting TVI. They can be modified for other frequencies to suit local problems. An example is the 10th harmonic of 8-Mc. crystals, that falls in Channel 6. A trap for the 5th harmonic of the crystal frequency should take care of this.

The 6146 amplifier stage has a shunt-fed pi-network plate circuit. For best stability over the entire operating range the stage is neutralized. The choke,  $RFC_4$ , is provided to short out the d.c. voltage that would appear on the output circuit if  $C_9$  should break down. The choke in the plate lead,  $RFC_5$ , is for parasitic oscillation suppression. Note that each of the three cathode leads is bypassed separately at the socket. The exciter may be keyed in the 6146 cathode jack,  $J_4$ .

Double-tuned band-pass circuits between the oscillator and doubler, and between the doubler and final, provide essentially flat response from 48 to 52 Mc., or 50 to 54 Mc. A potentiometer in the doubler screen circuit provides excitation control for the 6146, and may be used to compensate for variations in drive that may appear at some spots in the band.

The link winding on the doubler plate circuit,  $L_8$ , is for the purpose of taking off low-level 48-Mc. output to drive the tripler in the 144-Mc. r.f. unit. Note that the keying jack in the 6146 cathode circuit is the open-circuit type. Removing the key thus disables the 6146 stage, when the first two stages are being used in this way. Separate heater and filament switches on all units

allow them to be operated separately. High-voltage supplies may be left connected to all r.f. units, energizing only the filaments and heaters in the ones being used.

#### Construction

The exciter is built on a  $5 \times 10 \times 3$ -inch aluminum chassis, with a bottom plate and a perforated aluminum cage to complete the shielding. The small knobs at the lower left of the front view are for the crystal switch and the excitation control. The crystal switch has 12 positions. Ten are for the crystals on the multiple crystal socket (Johnson No. 126-120-1). One more crystal position is provided on the front panel (a convenience if you want to use a frequency not covered by the 10 crystals in the multiple socket), and the 12th switch position is for an external v.f.o. It connects the 5763 grid to the coaxial v.f.o. input fitting, and shorts out  $RFC_1$ , and its parallel capacitor. The stage then functions as a frequency multiplier. The output frequency of the v.f.o. could thus be in the 6-, 8- or 12-Mc. range. Above the excitation control may be seen the knobs for the 6146 plate and output coupling capacitors.

Three coaxial connectors are on the rear wall of the exciter. The one at the outside edge is for v.f.o. input. The others are the doubler and 6146 output fittings. Two 4-terminal seatite strips handle the various power and metering leads. Adjacent to each terminal except the ground connection is a feed-through bypass capacitor to take the power lead through the chassis.

TVI that might result from radiation of harmonics by the power leads is prevented by filtering of each lead. The feed-through bypasses are connected to the exciter circuits through r.f. chokes, the inner ends of which are again bypassed with small disk ceramic capacitors. All power leads are made with shielded wire, bonded at intervals to the chassis.

The side view shows the multiple crystal socket at the front of the chassis. Separate crystal sockets may be used if desired. The oscillator and



doubler tubes are in the foreground. The trap capacitors,  $C_1$  and  $C_4$ , are adjacent to these tubes, while  $C_2$  and  $C_3$ , are between them, a bit off their center line. To the rear of the 5763 doubler are  $C_5$  and  $C_7$ . The grid tuning capacitor for the 6146,  $C_6$ , is just visible inside the amplifier compartment.

A separate lead is provided for each power circuit. Fixed bias for the 6146 is brought in from the bias supply that is part of the high-power amplifier assembly. This bias is desirable to prevent the plate current from rising too high when the excitation is backed off. If the exciter is used alone, fixed bias is unnecessary. External meters can be connected in any of the circuits at the terminal strips.

The sides, back and top of the amplifier cage are Reynolds "Do-It-Yourself" perforated aluminum sheet, now available in many hardware stores. The pieces are joined together at the corners with lengths of  $\frac{3}{8}$ -inch aluminum angle which can be bought or bent up from sheet stock. The tuning and loading capacitors are mounted on the front of the cage, so this part should be a piece of solid sheet stock rather than the perforated material. The dimensions of the cage are not critical. The original is  $5\frac{3}{4}$  inches deep,  $2\frac{5}{8}$  inches across, and  $4\frac{1}{4}$  inches high. Make provision for removing the top and outside sheets of perforated stock for convenience in servicing, when the exciter is mounted against the amplifier unit. Extension shafts and couplings bring out the amplifier controls to the panel.

Inside the cage, the 6146 can be seen with its socket mounted above the chassis on  $\frac{1}{2}$ -inch metal sleeves. The cathode and screen bypasses should connect to separate ground lugs on the top of the chassis, with the shortest possible leads. This wiring can be done conveniently before the socket is mounted on the chassis if nuts are used temporarily to hold the ground lugs in place over the socket mounting screws. The neutralizing adjustment,  $C_8$ , is mounted on the rear wall of the cage, and wired to the 6146 plate clip and the feed-through bushing with  $\frac{3}{8}$ -inch wide strips of thin copper. A ceramic insulator mounted on the wall near the 6146 plate cap supports the junction of  $RFC_5$ ,  $RFC_3$ , and  $C_9$ . An ordinary tie point supports the other end of  $RFC_3$  and the shielded power lead. The plate coil,  $L_8$ , can be seen in back of the 5763 doubler tube, wired between the stators of  $C_{10}$  and  $C_{11}$ .  $C_{12}$  and  $RFC_4$  are mounted near  $C_{11}$ , and hooked between its stator bar and a ground lug. A short length of RG-58/U coax runs down

through a hole in the chassis from  $C_{11}$  over to  $J_3$ .

Most of the parts visible in the chassis view can be identified from our description of the panel, rear, and topside layouts. The oscillator cathode choke,  $RFC_1$ , can be seen mounted upright near the oscillator tube and crystal sockets. Both 5763 sockets should be oriented so that Pins 4 and 5 are adjacent to the outside chassis wall.  $L_1$  is visible between  $C_1$  and the oscillator tube socket.  $L_2$  and  $L_3$  run between this socket and that of the doubler. These coils are made from a single length of Miniductor stock with the specified number of turns removed to provide spacing between them. The same applies to  $L_5$  and  $L_7$ . These are to the left of the 6146 socket.  $L_4$  is between the doubler socket and  $C_4$ . The trap coils are mounted with their axes vertical, to minimize coupling to the band-pass coils.  $L_6$  is wound around and cemented to the bypassed end of  $L_5$ .

The power lead r.f. chokes are mounted between single-terminal tie points on the rear lip of the chassis and the feed-through capacitors. The disk ceramic bypasses are then applied to the tie points. A single-terminal tie point mounted under  $RFC_1$  holds one end of the 3300-ohm doubler screen resistor and the lead over to the terminal strip at the rear. A double tie point is mounted between the two 5763 sockets to support the bypassed ends of  $L_2$  and  $L_3$ . Another over nearer the rear of the chassis supports the cold end of  $L_5$  and the bottom of the doubler grid resistor.

Wiring will be simplified by the following procedure. Before mounting the crystal switch, ground one terminal of each crystal socket through a bus wire. Connect short lengths of tinned wire to the other terminal of each socket

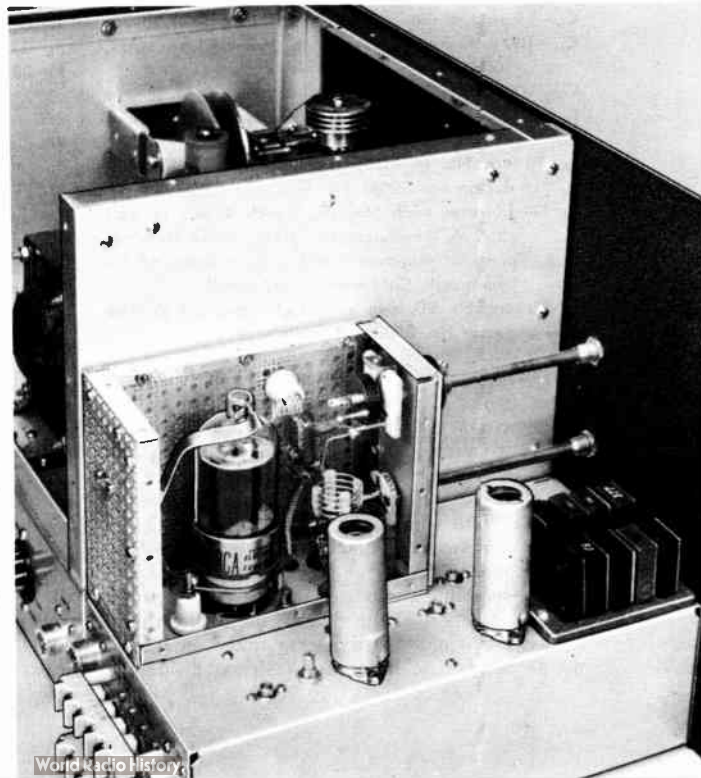

Fig. 17-17—Side view of the exciter, with cover removed. Band-pass coupling circuits eliminate front-panel tuning controls except for crystal switch and output stage tuning.

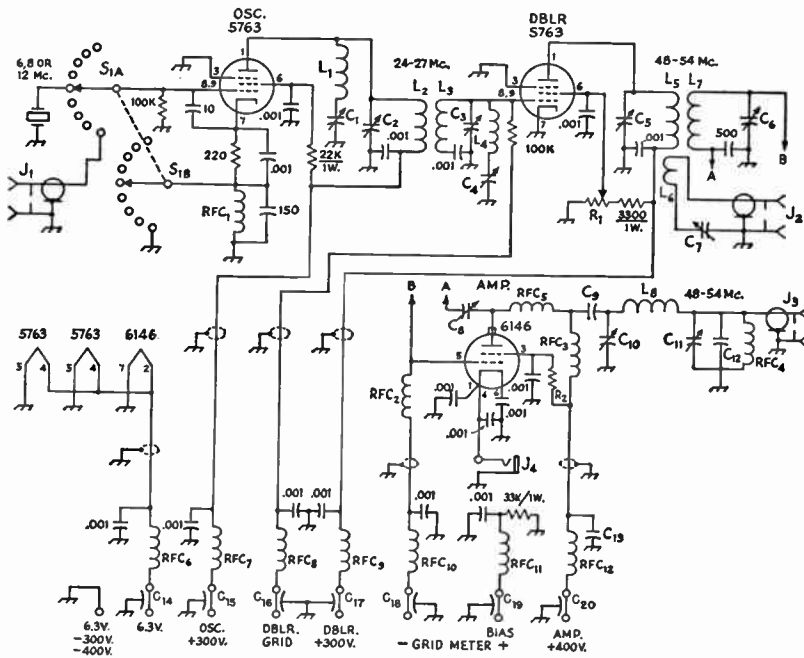

Fig. 17-18—Schematic diagram of 48-54-Mc. exciter. All capacitances less than  $.001 \mu\text{f.}$  are in  $\mu\text{mfd.}$  All  $.001\text{-}\mu\text{f.}$  capacitors are disk ceramic. All resistors are  $\frac{1}{2}$  watt unless otherwise specified.

$C_1, C_2, C_3$ — $35\text{-}\mu\text{mfd.}$  miniature trimmer (Hammarlund MAPC-35).

$C_4$ — $10\text{-}\mu\text{mfd.}$  miniature variable (Hammarlund MAC-10).

$C_5, C_6$ — $20\text{-}\mu\text{mfd.}$  miniature variable (Hammarlund MAC-20).

$C_7$ — $50\text{-}\mu\text{mfd.}$  miniature trimmer (Hammarlund MAPC-50).

$C_8$ — $15\text{-}\mu\text{mfd.}$  miniature trimmer (Hammarlund MAPC-15).

$C_9, C_{13}$ — $.001\text{-}\mu\text{f.}$  3000-volt disk ceramic.

$C_{10}$ — $35\text{-}\mu\text{mfd.}$  miniature variable (Hammarlund HF-35).

$C_{11}$ — $100\text{-}\mu\text{mfd.}$  miniature variable (Hammarlund MAPC-100B).

$C_{12}$ — $100\text{-}\mu\text{mfd.}$  1000-volt mica.

$C_{14}$ — $C_{20}$ — $.001\text{-}\mu\text{mfd.}$  feedthrough-type ceramic (Centralab FT-1000).

$L_1$ —16 turns No. 24,  $\frac{5}{8}$ -inch diam., 32 t.p.i. (B & W Miniductor No. 3008).

$L_2, L_3$ —12 turns each No. 20,  $\frac{5}{8}$ -inch diam., 16 t.p.i. (B & W Miniductor No. 3007). Make from one piece of Miniductor with 5 turns removed between coils. Cold ends are adjacent.

$L_4$ —10 turns No. 20,  $\frac{1}{2}$ -inch diam., 16 t.p.i. (B & W Miniductor No. 3003).

$L_5, L_7$ —6 turns No. 20,  $\frac{1}{2}$ -inch diam., 16 t.p.i. (B & W Miniductor No. 3003). Make from one piece of Miniductor with 3 turns removed between coils.

$L_6$ —2 turns hookup wire wound around cold end of  $L_5$  and cemented in place.

$L_8$ —4 turns No. 18,  $\frac{3}{4}$ -inch diam., 8 t.p.i. (B & W Miniductor No. 3010).

$J_1, J_2, J_3$ —Coaxial chassis fitting (Amphenol 83-1R).

$J_4$ —Open-circuit phone jack.

$R_1$ —25,000-ohm 4-watt pot.

$R_2$ —33,000-ohm 3-watt (3 100,000-ohm 1-watt in parallel).

$RFC_1$ —2.5-mh. r.f. choke (National R-100S).

$RFC_2, RFC_3, RFC_4$ — $7\text{-}\mu\text{h.}$  solenoid v.h.f. choke (Ohmite Z-50).

$RFC_5$ —6 turns No. 22 tinned wire,  $\frac{1}{4}$ -inch diam., spaced one-wire diam.

$RFC_6$ — $RFC_{12}$ —15 turns No. 24 enam. close-wound on high-value 1-watt resistor.

$S_1$ —2-pole 12-position miniature ceramic rotary (Centralab PA-2005).

that will be under the switch. Then when the latter is installed, the wires can be run to the proper contacts and soldered in place. Note that the front wafer of the switch is used for shorting out  $RFC_1$ , while the crystal socket connections are made to the rear wafer, which is more accessible. The v.f.o. input socket is connected to the proper switch contact with a length of RG-58/U coax.

In assembling the power lead filtering components at the rear of the chassis, the disk ceramic bypasses can most easily be mounted on the tie points before the latter are fastened inside the

chassis. Wiring up the power leads should be done before the r.f. chokes are mounted in place.

### THE 50-MC. AMPLIFIER

Though the exciter and amplifier are pictured on a single panel, the possibility of using either by itself should not be overlooked. The exciter will make a fine low-powered transmitter, and the final amplifier may be used with any exciter delivering 15 watts or more.

It will take up to the legal limit of power with a 4-400A tube, 750 watts with a 4-250A, or 400 watts with a 4-125A.

The plate circuit is a larger version of the one used in the 6146 stage of the exciter, a shunt-fed pi-network. Operation is completely stable without neutralization, probably because the natural neutralized frequency of the tubes is close to 50 Mc. Provision was originally made for neutralization, but it was found to be unnecessary. Parasitic suppression devices were not required, but if the layout is varied appreciably from that shown, the builder should check for both types of instability with great care.

The jack in the filament center-tap lead is for keying, or for insertion of a grid-bias modulator. A bias supply that delivers about 50 volts negative for the 6146 and 150 for the final amplifier is included in the final stage assembly. Filament transformers for the exciter and final are also part of this unit. Separate filament switches are included; one for the exciter and the other for the final tube and the blower motor. Power leads, except the high voltage, are brought in on an 8-pin plug.

### Building the Amplifier

A 12 × 10 × 3-inch aluminum chassis is used for the amplifier unit. Thus, it may be combined with the exciter on a 10½-inch rack panel, if desired. The amplifier controls mounted near the panel bottom are, left to right, the input link reactance capacitor,  $C_1$ ; the grid tuning capacitor,  $C_2$ ; and  $S_1$  and  $S_2$ .  $S_1$  applies a.c. to the transformer for the exciter heaters and to the bias

supplies.  $S_2$  applies a.c. to the filament transformer of the amplifier and starts the cooling fan. Above the switches on the panel are the amplifier plate tuning and loading controls.

On the rear of the chassis, coaxial connectors for r.f. input and output are mounted at either end. Between them are the high-voltage connector for the plate supply, the cathode circuit jack, and a fitting for the remaining power and meter leads.

Above the chassis, the 4-250A tube is seen near the front of the chassis. Note that its socket is mounted on ½-inch sleeves. Holes ⅜-inch in diameter are drilled in the chassis directly underneath those provided in the socket for the passage of cooling air. Holes are also drilled adjacent to the cathode, grid, and screen pins to pass their leads. Bypassing of cathode and screen is done above the chassis. The heat radiating plate connector for the 4-250A was cut down to four fins to reduce the over-all height requirement. The filament transformer,  $T_3$ , and the screen modulation choke,  $L_4$ , are also topside.

The amplifier plate circuit components are to the left of the tube. The tuning capacitor,  $C_7$ , originally a neutralizing capacitor, is mounted on the side wall of the shielding assembly. Two modifications should be made to the neutralizing unit before mounting. The circular plates supplied should be replaced with larger ones, 3 inches in diameter, to increase the available tuning range. The bearing assembly of the rotor disk must be temporarily removed, and a strap of copper run between the screw holding the bearing in place and the opposite (grounded) end of the square ceramic insulating pillar, grounding the capacitor rotor. Two copper straps must be inserted between the stator disk and its insulator, to connect the stator with the blocking capacitor,  $C_5$ , and with  $L_3$ .

The blocking capacitor, the shunt-feed r.f. choke,  $RFC_2$ , and the high-voltage bypass,  $C_6$ , are assembled into one unit before mounting in the amplifier. This is done with the aid of the hardware supplied with the TV-type high-voltage capacitors. The bypass capacitor, on the bottom of the stack, is equipped with one terminal threaded and one tapped. The latter is on the bottom end, for fastening the assembly to the chassis. The threaded terminal screws into the 2½-inch ceramic insulator upon which  $RFC_2$  is wound.

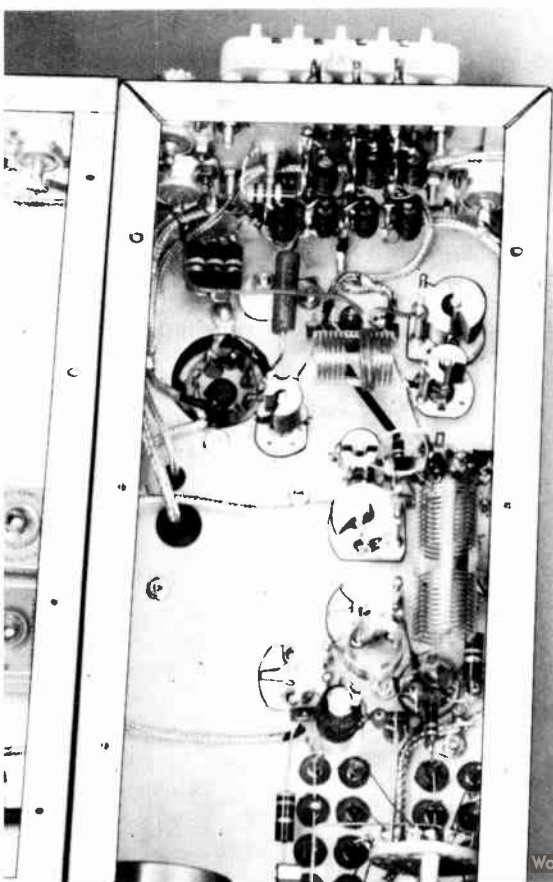

Fig. 17-19—Bottom view of the 50-Mc. exciter, showing band-pass circuits and TVI protective measures.

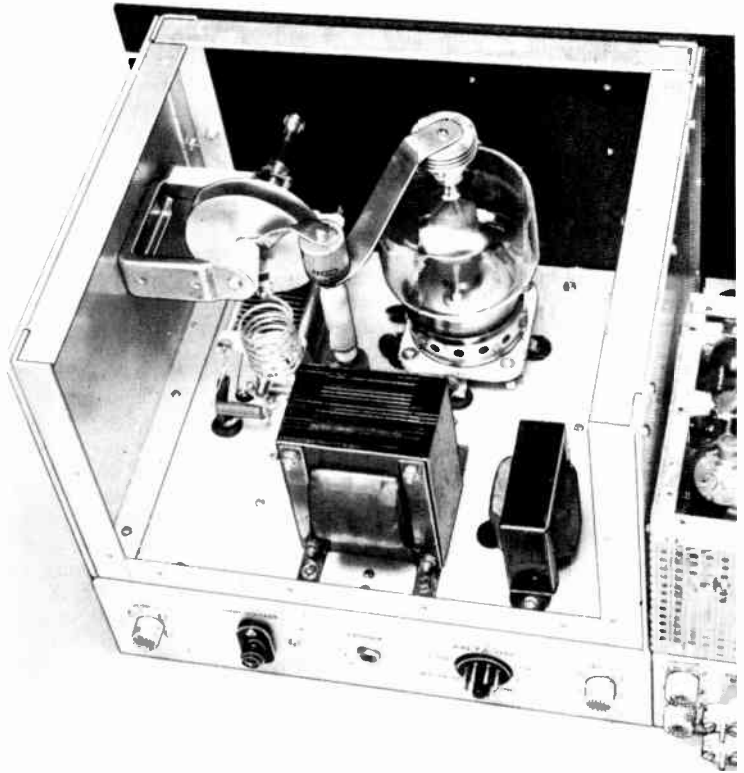

Fig. 17-20—Interior of the 50-Mc. final amplifier. Plate tuning capacitor is modified neutralizing unit, left.

The ends of the choke winding are secured by lugs at each end of the insulator.  $C_5$  should be fitted with a threaded terminal at the lower end for screwing into the top of the insulator. This also serves to fasten the  $\frac{3}{4}$ -inch wide strip of copper which runs up to the 4-250A plate cap. Finally, the longer of the two copper strips coming from the stator of  $C_7$  is screwed to the top of  $C_5$ . A  $\frac{1}{2}$ -inch feedthrough bushing brings the high-voltage up to the hot side of  $C_6$ . The loading capacitor,  $C_8$ , is mounted on the chassis directly underneath  $C_7$ . The plate coil,  $L_3$ , gets rather warm when the rig is operated at high power level, so both of its ends must be bolted in place rather than soldered. One end is bent around and fastened under a nut provided on the stator of  $C_8$ . The other is bolted to the short length of copper strap previously fastened to the stator of  $C_7$ . A length of RG-8/U coaxial cable is run between  $C_8$  and  $J_2$ . At the capacitor end, this cable is connected to lugs under the stator and frame mounting screws.

Solid sheet aluminum is used for the enclosure of this unit, as it must be reasonably airtight except for holes directly above the tube itself. The side that supports  $C_7$  must be of fairly heavy stock for rigidity. Home-bent  $\frac{3}{4}$ -inch angle stock was used to hold the assembly together. If the over-all height of the unit is kept to just about that of the  $10\frac{1}{2}$ -inch rack panel, there will be enough clearance above the tube plate connector.

Most of the under-chassis components are visible in the bottom view. The grid circuit is near the front edge of the chassis. Copper strap connects the tube socket grid pin with the stator of  $C_2$ .  $L_2$  then is soldered between this strap and a tie point.  $L_1$  is slid inside the cold end of  $L_2$ , and cemented lightly in place.

The cooling fan sucks air in from the side of the amplifier near the back corner. The motor is mounted on an aluminum bracket. The fan as supplied will blow, rather than suck, so the blades must be bent back to reverse their pitch. A small piece of aluminum window screening shields the hole cut in the chassis side for the fan.

Bias supply components occupy the lower left quarter of the bottom view. Layout and wiring of this portion of the rig is anything but critical. Shielded wire was used for all power leads. Bypassing at the power connector should be done with very short leads, and  $C_{14}$  should be mounted as close as possible to the high-voltage connector.

#### Adjustment and Operation

An initial setting of the exciter controls can be made before power is applied, if a grid-dip meter is available. The series traps,  $L_1C_1$  and  $L_4C_4$ , introduce varying amounts of reactance across the tuned circuits when they are adjusted, so some further adjustment will be needed after these are set up finally, but the following



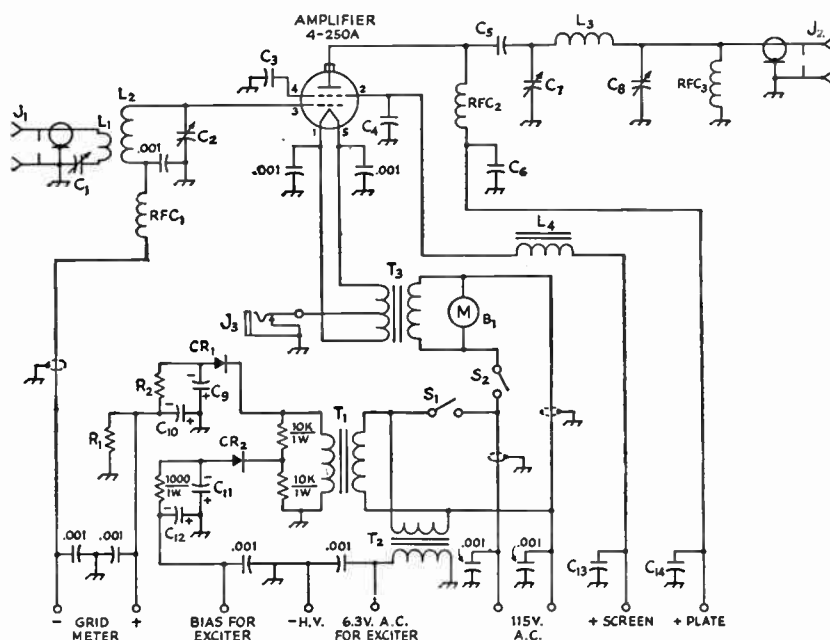

Fig. 17-21—Schematic diagram and parts list for the 4-250 A amplifier. All capacitors marked .001  $\mu\text{f}$ . are 600-volt disk ceramic.

$C_1$ —50- $\mu\text{f}$ . miniature variable (Hammarlund HF-50).  
 $C_2$ —15- $\mu\text{f}$ . miniature variable, double-spaced (Hammarlund HF-15X).  
 $C_3, C_4, C_{13}$ —.001- $\mu\text{f}$ . 1000-volt disk ceramic.  
 $C_5, C_6, C_{14}$ —500- $\mu\text{f}$ . 20,000-volt ceramic (Cornell-Dubilier MM120T5).  
 $C_7$ —Disk-type capacitor with 3-inch diam. plates (made from Millen 15011).  
 $C_8$ —250- $\mu\text{f}$ . variable, double-spaced (Johnson 250-F20).  
 $C_9, C_{10}, C_{11}, C_{12}$ —12- $\mu\text{f}$ . 250-volt electrolytic.  
 $J_1, J_2$ —Coaxial chassis fitting (Amphenol 83-1R).  
 $J_3$ —Closed-circuit phone jack.  
 $CR_1$ —65-ma. selenium rectifier (Federal 1002A).  
 $CR_2$ —20-ma. selenium rectifier (Federal 1159).  
 $L_1$ —5 turns No. 24,  $\frac{1}{2}$ -inch diam., 32 t.p.i. (B & W Mini-inductor No. 3004).  
 $L_2$ —4 turns No. 18,  $\frac{3}{4}$ -inch diam., 8 t.p.i. (B & W Mini-inductor No. 3010).

$L_3$ —6 turns No. 12 tinned wire, 1-inch diam., spaced twice wire diam.  
 $L_4$ —Filter choke, about 10-hy. 100-ma. (Triad C-10X).  
 $B_1$ —Blower motor and fan (Allied cat. No. 72P715).  
 $R_1$ —20,000 ohms, 10 watts.  
 $R_2$ —500 ohms 2 watts (2 1000-ohm 1-watt resistors in parallel).  
 $RFC_1, RFC_3$ —7- $\mu\text{h}$ . solenoid choke (Ohmite Z-50).  
 $RFC_2$ —Solenoid choke, 42 turns No. 24 d.c.c. close-wound on  $\frac{1}{2}$ -inch diam.,  $2\frac{1}{2}$ -inch long insulator (National GS-2).  
 $S_1, S_2$ —Single-pole single-throw toggle switch.  
 $T_1$ —Power transformer, 135 volts at 50 ma. (Triad R-30X).  
 $T_2$ —Filament transformer, 6.3 volts at 3 amp. (Triad F-16X).  
 $T_3$ —Filament transformer, 5.2 volts c.t. at 15 am. (Triad F-11U).

procedure will result in a close approximation.

Disconnect one end of  $L_3$ , Fig. 17-18. Couple the grid-dip meter to  $L_2$  and tune it with  $C_2$  to about 24.5 Mc. Leaving the setting of  $C_2$  at that position, lift one end of  $L_2$ . Reconnect  $L_3$  and resonate  $C_3L_3$  to about 25.5 Mc. Reconnect  $L_2$ , and the circuits should be set for operation on 48 to 52 Mc. For 50 to 54 Mc., the frequencies should be 25.5 and 26.5 Mc.

Procedure for the second band-pass circuit is similar except for the frequencies involved. For 48 to 52 Mc., disconnect  $L_7$  and tune  $C_5L_5$  to 49 Mc. Reconnect  $L_7$  and disconnect  $L_5$ , tuning  $L_7C_6$  to 51 Mc. Reconnect  $L_5$ . For the 50- to 54-Mc. range these frequencies would be about 51 and 53 Mc.

Connect a source of 6.3 volts a.c. at 2.5 amperes or more between the ground and heater terminals, and a low-range meter from the doubler grid return terminal to ground. Insert crystals for the desired frequency range. Apply about 200 volts d.c. to the oscillator plate-screen terminal through a 50- or 100-ma. meter. Current should be 20 to 30 ma., and grid current in the following stage should be about 0.5 ma., when the voltage is increased to the normal 300 volts. Touch up the tuning of the band-pass circuit, if necessary, to get uniform response across the desired range.

The trap circuits can be adjusted at this point, tuning for minimum signal at the frequency to be attenuated in each case. A receiver tuning to the harmonic frequencies is helpful. These will be



about 18 to 20.25 Mc. for the first trap and 56 to 60 Mc. for the second, if they are for Channel 2. A TV receiver on the channels to be protected may also be used, merely tuning the traps for minimum TVI. Some slight readjustment of the band-pass circuit may be needed after the final trap tuning is done.

Now remove the grid current meter and ground the metering terminal in the doubler grid circuit. Connect a meter (0 to 5 ma. or more) between the terminals provided for measuring the 6146 grid current. Set the screen potentiometer,  $R_1$ , to about the middle of its range and apply about 200 volts to the doubler plate-screen input terminal. Adjust the band-pass circuit,  $L_5C_5$ ,  $L_7C_6$  for nearly uniform response across the desired range, using the 6146 grid current as the output indication. There should be at least 2 ma. across a 4-Mc. range when the doubler plate voltage is raised to 300. Note that the screen potentiometer controls the input to the doubler, and through it the excitation to the 6146.

The 48-Mc. output coupling adjustment,  $L_6C_7$ , may be checked at this time. The line to a 144-Mc. tripler stage should be connected to  $J_2$ , and the series capacitor,  $C_7$ , adjusted for maximum grid current in the driven stage. Recheck the adjustment of the band-pass circuit after this is done.

The 6146 amplifier stage had to be neutralized for stable operation. Its adjustment was not critical, however, and  $C_8$  could be set anywhere near minimum capacitance with good results. Start out with its plates meshed about  $\frac{1}{8}$ -inch. With grid drive applied but no plate or screen voltage, tune the 6146 plate circuit through resonance, trying various settings of  $C_8$  until there is no grid current dip at resonance.

A load for the 6146 output circuit is now required. This can be a 40- or 60-watt lamp, with a 50- $\mu$ f. capacitor in series to tune out its reactance. Adjust it for minimum reflected power, as indicated on an s.w.r. bridge. With the load connected and grid drive on, apply 300 to 400 volts to the amplifier plate and screen terminal. Tune  $C_{10}$  for maximum indicated output. Loading can

be adjusted by varying  $C_{11}$ , returning  $C_{10}$  after each movement of  $C_{11}$ .

Recheck for neutralization at this point, working for a setting of  $C_8$  at which minimum plate current, maximum grid current, and maximum output all occur at the same setting of the plate tuning capacitor,  $C_{10}$ . The input can be run up to about 65 watts with plate modulation and 35-40 watts output should be obtained. Higher input can be run on c.w. Plate voltage should not exceed about 400 with plate modulation, though it can be somewhat more for c.w.

Now make a final check on the trap circuits, if necessary. In case TVI is experienced, adjust the traps while someone watches the TV screen, and see whether any improvement is possible. Remember that the traps shown were designed primarily to reduce Channel 2 interference. Where the trouble is with other channels, the traps can be modified to reduce the offending harmonic as required. A low-pass filter or a 4th harmonic trap will be needed if there is harmonic interference in Channels 11-13.

The amplifier as shown furnishes heater voltage and protective bias for the exciter. Hook together the 6.3-volt and ground terminals of the two units, and connect the bias output pin on the amplifier to the 6146 grid return in the exciter. Apply 115 volts a.c. to the appropriate pins on the amplifier power plug. When  $S_1$ , Fig. 17-21, is closed, the exciter heaters and the bias supplies are energized. The bias voltages are about 50 and 150 negative for the driver and amplifier, respectively. Closing  $S_2$  lights the amplifier filament and starts the fan motor.

For the initial testing of the amplifier disconnect its fixed bias supply, by lifting the connection between  $R_1$  and  $R_2$ , so that instability will be more evident. Connect the output of the exciter through a length of coaxial cable to  $J_1$ . Hook a 0-25- or 0-50-ma. meter to the terminals provided for measuring grid current. Turn on the exciter and adjust the driver output and amplifier input for maximum grid current. Set this current between 10 and 15 ma. with the excitation control,  $R_1$ , in the exciter. To insure proper

Fig. 17-22—Bottom view of 50-Mc. exciter and amplifier. Note that the two units are built separately, though they mount together on a single panel. Amplifier unit includes bias and filament supplies for both.

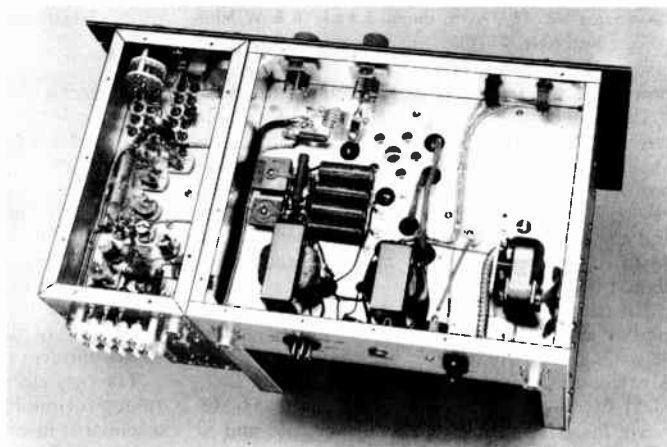

adjustment of the amplifier grid circuit, insert an s.w.r. bridge unit such as a Micromatch in the coax connecting the driver and amplifier, and tune  $C_1$  and  $C_2$  in the amplifier alternately for minimum reflected power. Adjust the driver tuning for maximum forward power.

Never apply screen voltage without having the plate voltage on also, and do not operate the amplifier without load. Either will result in excessive screen dissipation, and almost certain tube failure if continued for any length of time. A usable dummy load for testing can be made by connecting two or more 100-watt lamps in parallel. A variable series capacitor, 50  $\mu\text{mf}$ . or more, will be helpful in making the lamp load something like 50 ohms, resistive, at this frequency.

It is well to start with something less than maximum voltages in testing. If the plate voltage is under 1000 and the screen voltage about 200 to 300 volts, little harm can result if something is not quite right. With the dummy load connected, apply plate and screen voltages. Set  $C_8$  near the middle of its range and tune  $C_7$  for maximum output. If this occurs at or close to the end of the tuning range of  $C_7$ , adjust the spacing of the turns in the plate coil accordingly. Adjust  $C_8$  for maximum output, returning  $C_7$  as required. If the grid current dropped below 10 ma. under load, increase the drive with the doubler screen potentiometer in the exciter.

Check now for stability. Briefly cut off the drive and see if the amplifier grid current drops to zero. If it doesn't, the amplifier either needs neutralization, or it has a parasitic oscillation. If no grid current shows with drive removed, note whether, when drive is applied and the amplifier is tuned properly, maximum output, minimum plate current and maximum grid current all occur at the same plate tuning. If they do, the amplifier is operating satisfactorily.

If oscillation does show up, check its frequency. If it is much higher than the operating frequency (probably over 150 Mc.) v.h.f. parasitic suppres-

sion measures are in order. If it is in the 50-Mc. region, neutralization will be required. These troubles are most common in multiband designs, and unlikely in a layout of this sort. Neutralization of the capacity-bridge type, like that in the exciter, can be incorporated readily, and parasitic suppression is covered in detail elsewhere in this *Handbook*. Neutralization may require *additional* grid-plate capacitance in some layouts. Provision was made for neutralization in the original layout (explaining the plugged hole in the front panel), but it was found to be unnecessary.

When the amplifier is operating stably, the plate and screen voltages may be increased in accordance with the tube manufacturer's ratings, for the type of operation intended. Operating conditions are different for the three tubes which can be used and they should follow the manufacturer's recommendations. This is not to say that variations from the published data are unsafe or undesirable. Any of the values can be varied over quite a range if the maximum rating for each tube element concerned is not exceeded. In this connection, it is highly desirable to provide continuous metering for the grid, screen, and plate currents. This, with a knowledge of the applied voltages, will help insure proper operation and make correct adjustment a simple matter.

#### A 144-MC. DRIVER-AMPLIFIER

The unit shown in Figs. 17-23 through 17-28 is a three-stage tripler-driver-amplifier that may be used with the exciter just described. Driving power at 48 Mc. may be taken from the doubler stage (by connecting to  $J_2$  in Fig. 17-18) or from the output stage, running at low power. Almost any 50-Mc. transmitter of 3 to 5 watts output could be used by substituting a suitable crystal and retuning the stages for operation at 48 to 49.3 Mc. If a small 144-Mc. transmitter is available, the tripler stage may be dispensed with, in which case about 5 watts of drive on 144 Mc. is required.

This section of the station is built in two parts. The tripler and driver stages are in the small portion at the right of Fig. 17-23, with the final stage at the left. All are push-pull stages, the tripler and driver using dual tetrodes. The tripler is an Amperex 6360, followed by an RCA 6524 straight-through amplifier. This drives a pair of 4-125As in the final stage.



Fig. 17-23—The high-power 2-meter rig, with shielding enclosures in place. The small unit at the right houses the tripler and driver stages.

Input to the 4-125As can be up to 600 watts on a.m. phone, or 800 watts on c.w. or f.m. By suitable adjustment of screen and plate voltages the power can be dropped as low as 150 watts input and still maintain good efficiency. Some means of reducing power is highly desirable, as most operation on 144 Mc. can be carried on satisfactorily with low power.

### The Driver Portion

The tripler and driver stages, Figs. 17-25 and 17-26, both operate well below their maximum ratings. Self-tuned grid circuits are used in each stage. This simplifies construction, and in the case of the driver stage, reduces the possibility of self-oscillation. With a surplus of drive available, the grid circuit of the 6524 may be resonated as low as 130 Mc. There is little tendency to tuned-plate tuned-grid oscillation, therefore, and neutralization is not required.

Tripler and driver are built on a standard  $5 \times 10 \times 3$ -inch aluminum chassis, with the tripler at the back. Its plate circuit is tuned from the front panel by an extension shaft. Omission of the screen bypass on the tripler is intentional as the stage works satisfactorily without screen bypassing.

The 6524 is easily over-driven. This may be corrected by squeezing the driver grid coil turns closer together, lowering the resonant frequency until the desired 2.5 to 3.5 ma. is obtained across the band. The farther it can be resonated below 144 Mc. the less likelihood there is of self-oscillation in the driver stage.

The 6524 is mounted horizontally, and holes are drilled in the chassis under the tube to allow for air circulation. Plate leads are made of thin phosphor bronze or copper, bent into a semicircle, connecting the butterfly capacitor and the heat-dissipating connectors. This allows the latter to be removed for changing tubes, without putting undue strain on the plate pins. The connectors have to be sawed or filed down on the insides to fit on the 6524 pins. The coupling link at the driver plate circuit is tuned, to provide efficient transfer of energy to the amplifier grids.

Small feedthrough bypasses are used in the driver screen circuit.  $C_5$  is mounted in the aluminum plate that supports the 6524 socket, and  $C_6$  is in the chassis surface.

### Amplifier Features

Design of the 4-125A grid circuit is important in achieving

Fig. 17-24—Rear view of the 4-125A final stage. The split-stator capacitor near the middle of the picture is the screen neutralizing adjustment. The plate line is tuned with a capacitor made from parts of a neutralizing unit, mounted on ceramic stand-offs.

efficient transfer of energy from the driver stage. The input capacitance of the large tetrodes is so high that a tuned grid circuit of conventional design cannot be used at 144 Mc., so a half-wave line is substituted, as shown in Figs. 17-27 and 17-28. The input coupling link is series tuned, permitting adjustment for minimum standing wave ratio on the coaxial line connecting it to the driver stage output link. The grid line,  $L_1L_2$ , is made of  $\frac{1}{4}$ -inch copper tubing, to reduce heat losses.

Maintaining the 4-125A screens and filament leads at ground potential for r.f. is necessary for stability. To this end, the tube sockets are mounted above the chassis, rather than below. They are elevated only enough to allow the socket contacts to clear the chassis, and are mounted corner to corner, with the inner corners almost touching. The grid line is brought up through  $\frac{1}{2}$ -inch chassis holes and soldered directly to the grid contacts. This determines the line spacing, about  $1\frac{1}{2}$ -inches center to center.

The inner filament terminals on each socket are grounded to the chassis. The others connect to feedthrough bypasses with the shortest possible leads. These are joined under the chassis with a shielded wire and tied to the filament transformer. The r.f. chokes in the screen leads are under the chassis, their wire leads coming up through Millen type 32150 feedthrough bushings inserted in chassis holes under the screen terminals. The two screen terminals on each socket are strapped together with a  $\frac{3}{8}$ -inch wide strip of flashing copper. The screen neutralizing capacitor is mounted as close to the sockets as possible and still leave room for the shaft coupling on its rotor. Leads to its stators are about one half inch long.

More compact and symmetrical design is possible if a modified single-section capacitor is used for  $C_6$ . It should be the type having supports at both ends of the rotor shaft. The Millen 19140 and Hammarlund MC-140 are suitable units for the purpose. The stator bars are sawed at each side of the center stator plate. The front rotor plate is removed, making a split-stator variable with 4 plates on each stator and 8 on the

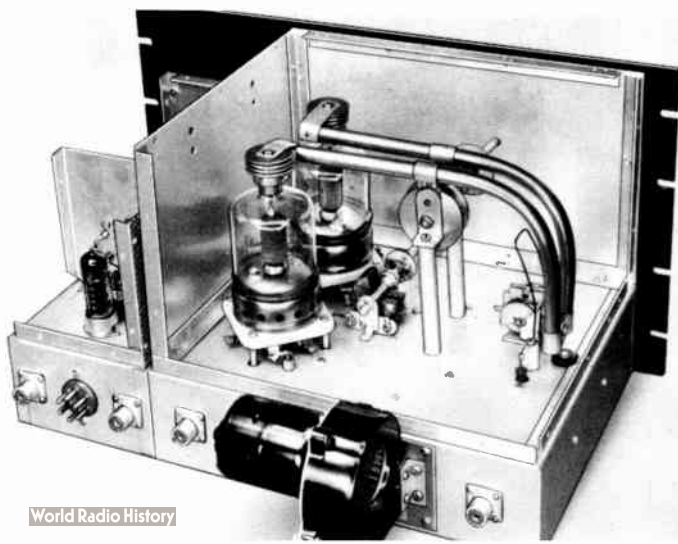

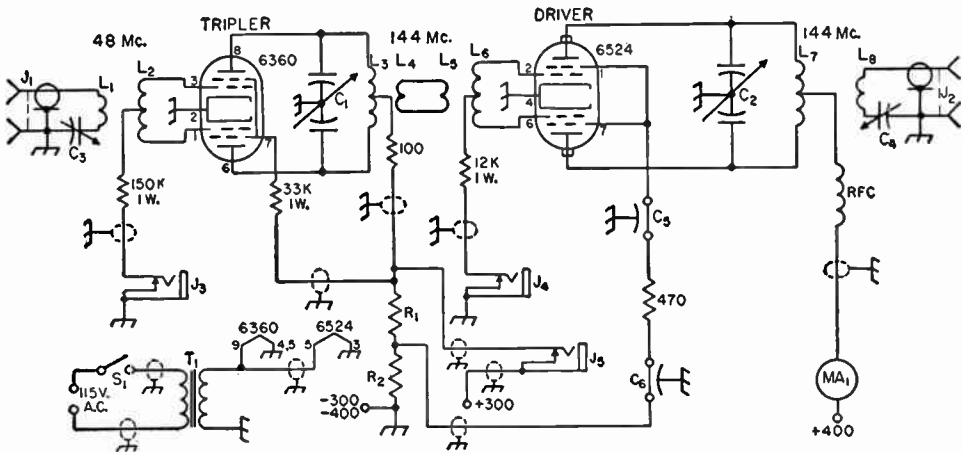

Fig. 17-25—Schematic diagram of the tripler and driver stages of the high-powered 2-meter transmitter.

C<sub>1</sub>, C<sub>2</sub>—10.5  $\mu$ f.-per-section butterfly variable (Johnson 10LB15).  
 C<sub>3</sub>—25- $\mu$ f. screwdriver-adjustment variable (Hammarlund APC-25).  
 C<sub>4</sub>—25- $\mu$ f. miniature variable (Bud LC-1642).  
 C<sub>5</sub>, C<sub>6</sub>—500- $\mu$ f. feed-through bypass (Centralab FT-500).  
 R<sub>1</sub>—11,000 ohms 2 watts (two 22,000-ohm 1-watt resistors in parallel).  
 R<sub>2</sub>—50,000 ohms 2 watts (two 100,000-ohm 1-watt resistors in parallel).  
 L<sub>1</sub>—2 turn insulated wire around center of L<sub>2</sub>. Twist leads to J<sub>1</sub> and C<sub>3</sub>.  
 L<sub>2</sub>—13 turns No. 20,  $\frac{3}{8}$ -inch diam.,  $\frac{7}{8}$ -inch long, center tapped (B & W Miniductor No. 3007).  
 L<sub>3</sub>—3 turns No. 14 enamel,  $\frac{3}{4}$ -inch diam., spaced  $\frac{1}{16}$  inch center-tapped.  
 L<sub>4</sub>—2 turns No. 18 enamel, same as L<sub>3</sub>, inserted at center.  
 L<sub>5</sub>—2 turns No. 18 enamel, same as L<sub>4</sub>, inserted at center.  
 L<sub>6</sub>—4 turns No. 14 enamel,  $\frac{1}{2}$ -inch diam., turns spaced wire diameter.  
 L<sub>7</sub>—2 turns No. 14 enamel, 1-inch diam., spaced  $\frac{1}{4}$ -inch.  
 L<sub>8</sub>—1 turn No. 14 enamel between turns of L<sub>7</sub>.  
 J<sub>1</sub>, J<sub>2</sub>—Coaxial fitting, female (Amphenol 83-1R).  
 J<sub>3</sub>, J<sub>4</sub>, J<sub>5</sub>—Closed-circuit jack. Insulate J<sub>5</sub> from panel and chassis.  
 MA<sub>1</sub>—External meter not shown in photo, 200 ma.  
 S<sub>1</sub>—Toggle switch.  
 T<sub>1</sub>—Filament transformer, 6.3 volts, 3 amp. (UTC S-55).

rotor. This procedure may not be applicable to all 140- $\mu$ f. capacitors, but any method that results in a balanced unit having about 50  $\mu$ f. per section should do.

Construction of the final plate circuit should be clear from Fig. 17-24. Tuning is done with parts of a disk-type neutralizing capacitor (Millen 15011) mounted on ceramic stand-offs 3 $\frac{1}{2}$ -inches high. These are made of one 1-inch and one 2 $\frac{1}{2}$ -inch stand off each, fastened together with a threaded insert. Connection to the lines is made with copper or silver strap, 4 $\frac{1}{2}$  inches from the plate end. Silver plating of all tank circuit parts is a worthwhile investment, though it should not be considered a necessity. A shaft coupling designed for high-voltage service is at-

tached to the threaded shaft of the movable plate, and this is rotated with a shaft of insulating material brought out to the front panel.

A word about the extension shafts is in order at this point. If they are of metal they may have a serious detuning effect in some circuits, even though they are connected through insulating couplings. Bakelite rod is fine, but since the insulating qualities are of no importance,  $\frac{1}{4}$ -inch wooden doweling will do the job just as well. Lucite or polystyrene rod will not stand the heat and should not be used.

Fig. 17-26—Side view of the tripler and driver stages. Coil adjacent to the 6360 tripler tube is the grid coil for the 6524 driver. Plate leads for the driver tube are flexible copper straps, to permit removal of the tube from its socket. Screwdriver adjustment at the lower right is the reactance tuning capacitor for the tripler input link.

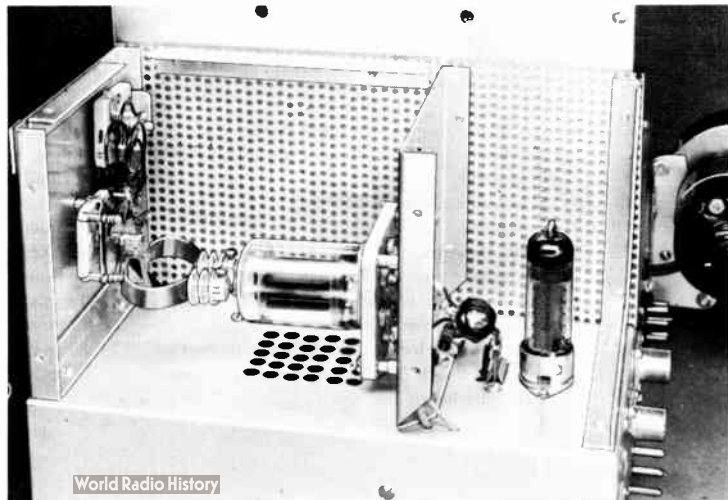



The final chassis is aluminum, 10 by 12 by 3 inches, matching up with the driver chassis to fit into a standard 10½-inch rack panel. Complete enclosure is a must for TVI prevention, and it pays dividends in improved stability by providing effective isolation of circuits that tend to give trouble in open layouts.

The enclosures were made by mounting ½-inch aluminum angle stock around the edges of the chassis of both units and cutting the sides and covers to fit. It was not intended to cool the driver unit originally, so the enclosure was made of perforated aluminum. The blower for the final provided plenty of air, however, so three holes are made in the walls of the two chassis to allow some of the air flow to go through the driver enclosure as well. The chassis are bolted together where the vent holes are drilled. The main flow is up through the amplifier chassis, around the 4-125As, and out through the ¼-inch holes drilled in the top cover above the tubes. Holes in the amplifier chassis are drilled to line up with the ventilating holes in the 4-125A sockets. All

other holes and cracks are sealed with household cement to confine the air to the desired paths, and bottom covers are fitted tightly to both units.

The somewhat random appearance of the front panel is the result of the development of the unit in experimental form. A slight rearrangement of some of the noncritical components could be made to achieve a symmetrical panel layout readily enough.

### Operation

The two units have their own filament transformers. Plate supply requirements are 300 volts at 50 ma. for the tripler, 400 volts at 100 ma. for the driver, 300 to 400 volts at 75 ma. for the final screens and 1000 to 2500 volts at 400 ma. for the final plates. The driver plates and final screens may be run from the same supply, but more flexibility is possible if they are supplied separately. A variable-voltage supply for final screens is a fine way to control the power level.

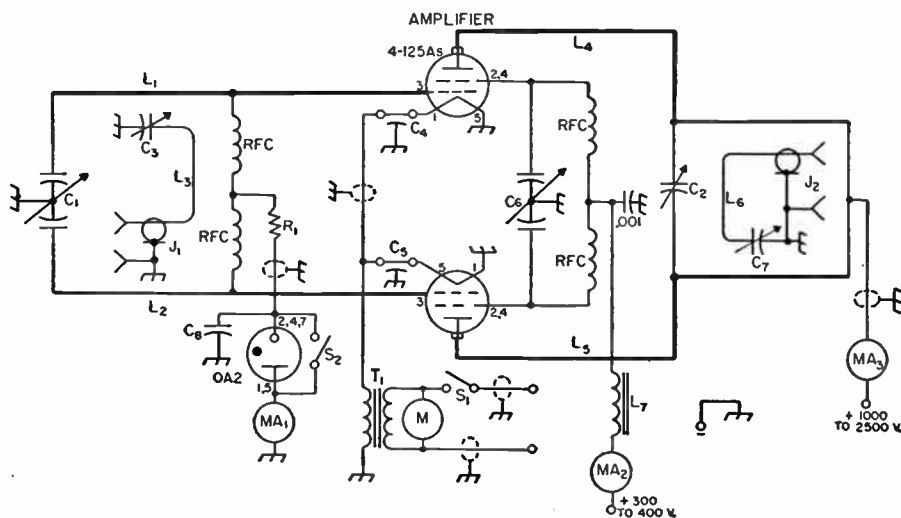

Fig. 17-27—Schematic diagram of the 4-125A amplifier for 144 Mc.

C<sub>1</sub>—30- $\mu$ f.-per-section split-stator variable (Hammarlund HFD-30X).

C<sub>2</sub>—Plate tuning capacitor made from Millen 15011 neutralizing unit; see text and photo.

C<sub>3</sub>—25- $\mu$ f. miniature variable (Bud LC-1642).

C<sub>4</sub>, C<sub>5</sub>—500- $\mu$ f. feedthrough bypass (Centralab FT-500).

C<sub>6</sub>—Approx. 50- $\mu$ f.-per-section split-stator variable. Make from Millen 19140 or Hammarlund MC-140; see text.

C<sub>7</sub>—25- $\mu$ f. variable (Johnson 25L15).

C<sub>8</sub>—0.25- $\mu$ f. tubular.

R<sub>1</sub>—5000 ohms, 10 watts.

L<sub>1</sub>, L<sub>2</sub>—¼-inch copper tubing, 12 inches long, spaced 1½ inches center to center. Bend around 1½-inch radius, 1 inch from grid end.

L<sub>3</sub>—Loop made from 5 inches No. 14 enamel. Portion coupled to line is 1 inch long each side, about ⅜ inch from line.

L<sub>4</sub>, L<sub>5</sub>—½-inch copper tubing 12 inches long, spaced 1½ inches center to center. Bend around 2-inch radius to make line 4 inches high. Attach C<sub>2</sub> 4½ inches from plate end.

L<sub>6</sub>—Loop made from 7 inches No. 14 enamel. Sides spaced 1¼ inches.

L<sub>7</sub>—5-h. (min.) 100-ma. rating filter choke.

J<sub>1</sub>, J<sub>2</sub>—Coaxial fitting, female (Amphenol 83-1R).

MA<sub>1</sub>, MA<sub>2</sub>, MA<sub>3</sub>—External meters, not shown; 100, 200 and 500 ma.

M—Motor-blower assembly, 17 c.f.m. (Ripley Inc., Middletown, Conn., Type 8433).

RFC—V.h.f. solenoid choke (Ohmite Z-144). Four required.

S<sub>1</sub>—Toggle Switch.

S<sub>2</sub>—Rotary jack-type switch (Mallory 720).

T<sub>1</sub>—Filament transformer, 5-volt 13-amp. (Chicago FO-513).



In putting the rig on the air the stages are fired up separately, beginning with the tripler. A jack ( $J_3$ , in Fig. 17-25) is provided on the front panel for measuring the 6360 grid current. About 1 ma. through the 150,000-ohm grid resistor is plenty of drive. The series capacitor,  $C_3$ , in the link can be used as a drive adjustment, if more than necessary is available.

Next plug the grid meter into the 6524 grid current jack,  $J_4$ , and tune the 6360 plate circuit for maximum grid current. If it is higher than 3 to 4 ma. increase the inductance of the grid coil,  $L_6$ , by squeezing its turns closer together. Now apply plate and screen voltage to the 6524, and check for signs of self-oscillation. If the plate circuit is tuned down to the same frequency as that at which the grid coil resonates with the tube capacitance, the stage may oscillate, but if it is stable across the intended tuning range there should be no operating difficulty resulting from a tendency to oscillate lower in frequency, and no neutralization should be needed.

Connect a coaxial line between the driver output and the final grid input preferably with a standing-wave bridge connected to indicate the standing-wave ratio on this line. Tune the driver plate circuit and its series-tuned link for maximum grid current in the final amplifier. Adjust the final grid tuning,  $C_1$ , for maximum grid current, and the series capacitor,  $C_3$ , in the link for minimum reflected power on the s.w.r. bridge. Adjust the coupling loop position for maximum transfer of power, using the least coupling that will achieve this end.

Adjust the screen neutralizing capacitor,  $C_6$ , for maximum final grid current, with the plate and screen voltages off. Do not attempt to run the final stage without load. With a fixed screen supply the screen dissipation goes very high when the plate load is removed or made too light. It is important to meter the screen current at all times. With 4-125As danger to the plates can be detected by their color, but the screen current is the only indication of possible damage to that element.

There is no suitable inexpensive dummy load

for testing a v.h.f. rig of this power level. The best load is probably an antenna. This can be an indoor gamma-matched dipole, fed with coax. Its series capacitor should be adjusted for a standing-wave ratio close to 1:1. The Micro-match can be used in this operation, but adjustments should be made at less than full power. Watch for any sign of heating in the bridge unit.

The position of the coupling loop,  $L_7$ , should be adjusted for maximum transfer of energy to the antenna, keeping the coupling as loose as possible. The series capacitor,  $C_7$ , can be used as a loading adjustment thereafter. If the screen voltage is continuously variable it will be found that there is an optimum value around 325 to 350 volts.

Below are some conditions under which the rig has been operated experimentally:

Stage	$E_p$	$I_p$	$E_{sc}$	$I_{sc}$	$I_g$
Tripler	300 v.	35 ma.	—	—	1.5 ma.
Driver	400 v.	92 ma.	—	8 ma.	3-4 ma.
Final	1000 v.	300 ma.	400 v.	60 ma.	22 ma.
Final	2000 v.	350 ma.	350 v.	45 ma.	20 ma.
Final	2500 v.	400 ma.	320 v.	40 ma.	18 ma.

The first and third conditions given for the final stage represent extremes, both exceeding the tubes' ratings in some way, so they are not recommended. At low plate voltages the screen has to be run above recommended ratings to make the tubes draw their full rated plate current and operate efficiently. At high plate voltages the screen dissipation drops markedly. The use of 4-125As at a full kilowatt input exceeds the manufacturer's maximum ratings, and is done at the user's risk. To operate safely, the maximum plate voltage for voice work at 144 Mc. should probably not go over 2000. At this level the tubes will handle 600 watts input on voice, and 750 watts on c.w. easily.

### Modulation and Keying

Keying is done in the screen circuit of the driver stage, and in the screen and plate circuits of the tripler. Cathode keying of the driver was attempted, but it caused instability troubles, so was abandoned. The screen method makes the

Fig. 17-28—Under-chassis view of the 2-meter transmitter. Tripler grid and plate circuits are at the upper left. Only two of the three jacks on the front panel show in the lower left. The half-wave line used in the 4-125A grid circuit is the main item of interest in the amplifier section. Both units are fitted with bottom covers, to provide shielding and confine the flow of cooling air to the desired areas.

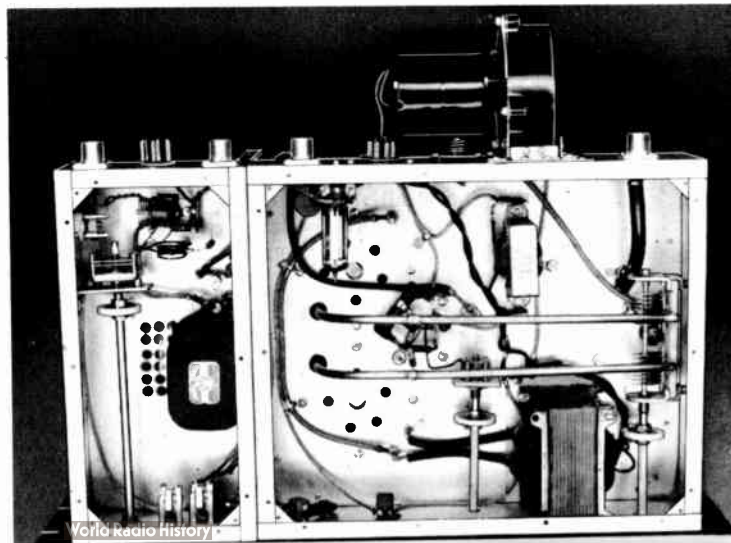

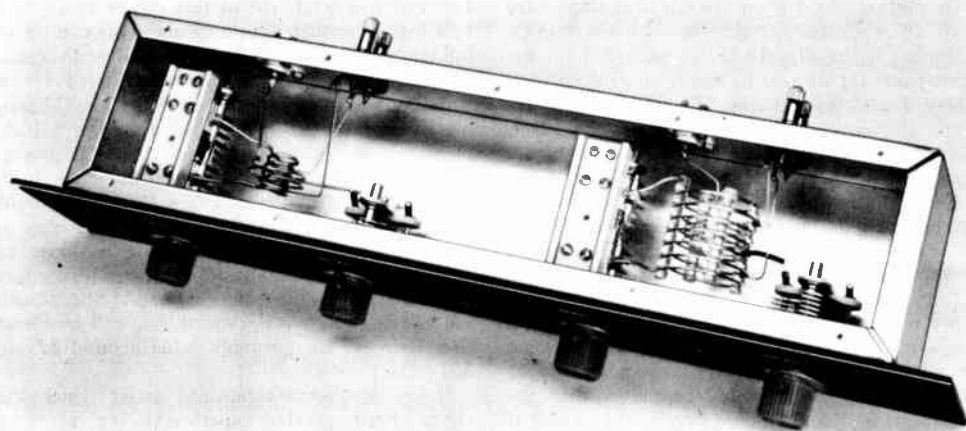

Fig. 17-29—Antenna couplers for 50 and 144 Mc. designed for use with the high-power transmitters on the previous pages.

key hot, so an insulated key or a keying relay must be used in the interest of safety. The keying jack must be insulated from the panel.

Fixed bias for the final amplifier is provided by the VR-tube method. When the tube ignites the grids. The effectiveness of this system requires a at the application of drive, the capacitor  $C_g$  charges. Removing excitation stops the flow through the VR tube and leaves the negative charge in the capacitor applied to the amplifier low-leakage capacitor for  $C_g$ .

Modulation is applied to the plates only. A choke of about 10 henrys is connected in the screen lead, or the modulation can be supplied through a screen winding on the modulation transformer. The bypass value in the screen circuit should be low enough to avoid affecting the higher audio frequencies. Occasionally audio resonance in the screen choke may cause a singing effect on the modulation. If this develops, the choke may be shunted with a resistor. Use the highest value that will stop the singing.

In neutralizing the 4-125As it may be found that what appears to be the best setting of the screen capacitor will result in a very large drop in grid current when plate voltage is applied. The setting may be altered slightly, raising the full-load grid current, without adversely affecting the stability of the amplifier. The final check for neutralization is twofold. There should be no oscillation when drive is removed; and maximum grid current, minimum plate current and maximum output should all show at one setting of the plate tuning capacitor. The latter condition may be observed only when the amplifier is operated without fixed bias.

### ANTENNA COUPLERS FOR 50 AND 144 MC.

The antenna couplers shown in Figs. 17-29, and at the top of Fig. 17-15, can be used with 52-ohm or 75-ohm coaxial line, and with balanced lines of any impedance from 200 to 600 ohms or

more. They were designed for use with the high-power transmitters described previously, but may be used at any power level.

#### Construction

The two couplers are identical circuitwise. They are built inside a standard 3 by 4 by 17-inch aluminum chassis, with a bottom plate to complete the shielding. The panel is  $3\frac{1}{2}$  inches high. If only one coupler is required, a 3 by 4 by 6-inch utility box can be used. Terminals on the back of the chassis include a coaxial input fitting and a two-post output fitting for each coupler. The circuit diagram, Fig. 17-30, serves for both.

The 50-Mc. coils are cut from commercially

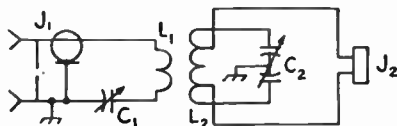

Fig. 17-30—Circuit and parts information for the v.h.f. antenna couplers.

$C_1$ —100- $\mu$ mf. variable for 50 Mc., 50- $\mu$ mf. for 144 Mc. (Hammarlund MC-100 and MC-50).

$C_2$ —35- $\mu$ mf. per-section split-stator variable, 0.07-inch spacing (Hammarlund MCD-35SX). Reduce to 4 stator and 4 rotor plates in each section in 144-Mc. coupler for easier tuning; see text.

$J_1$ —Coaxial fitting, female.

$J_2$ —Two-post terminal assembly (National FWH).

$L_1$ —50 Mc.: 4 turns No. 18 tinned, 1 inch diameter,  $\frac{1}{8}$ -inch spacing (Air-Dux No. 808T).

114 Mc.: 2 turns No. 14 enam., 1 inch diameter,  $\frac{1}{8}$ -inch spacing. Slip over  $L_2$  before mounting.

$L_2$ —50 Mc.: 7 turns No. 14 tinned,  $1\frac{1}{2}$  inch diameter,  $\frac{1}{4}$  inch spacing (Air Dux No. 1204). Tap  $1\frac{1}{2}$  turns from each end.

144 Mc.: 5 turns No. 12 tinned,  $\frac{1}{2}$  inch diameter,  $\frac{7}{8}$  inch long. Tap  $1\frac{1}{2}$  turns from each end.

available stock, though they can be made by hand if desired. The coupling winding,  $L_1$ , is inserted inside the tuned circuit. The polyethylene strips on which the coils are wound keep the two coils from making electrical contact, so no support other than the wire leads is needed.

Leads to  $L_1$  are brought out between the turns of  $L_2$ , and are insulated from them by two sleeves of spaghetti, one inside the other. Do not use the soft vinyl type of sleeving, as it will melt too readily if, through an accident to the antenna system, the coil should run hot. In the 144-Mc. coupler the positions of the coils are reversed, with the tuned circuit,  $L_2$ , at the center, and the coupling coil outside it.

Similar tuning capacitors are used in both couplers, but some of the plates are removed from the one in the 144-Mc. circuit. This provides easier tuning, though it has little effect on the minimum capacitance, and therefore on the size of the coil.

### Adjusting the Couplers

An antenna coupler can be adjusted properly only if some form of standing-wave bridge is connected in the line between the transmitter and the coupler. If it is a power-indicating type, so much the better, as it then can be used for adjusting the transmitter loading, and the work can be done at normal transmitter power.

With the bridge set to read forward power, adjust the coupler capacitors and the transmitter tuning roughly for maximum indication. Now set the bridge to read reflected power, and adjust the antenna coupler capacitors, first one and then the other, until minimum reflected power is achieved. Unless the line input impedance is very highly reactive, it should be possible to get the reflected power down to zero, or very close to it. Adjustment of the coupler is now complete. Tuning for maximum transfer of power from the transmitter is done *entirely* at the transmitter.

# V.H.F. Antennas

While the basic principles of antenna design remain the same at all frequencies where conventional elements and transmission lines are used, certain aspects of v.h.f. work call for changes in antenna techniques above 50 Mc. Here the physical size of arrays is reduced to the point where some form of antenna having gain over a simple halfwave dipole can be used in almost any location, and the rotatable high-gain directional array has become a standard feature of all well-equipped v.h.f. stations. The importance of antenna gain in v.h.f. work cannot be over-emphasized. By no other means can so large a return be obtained from a small investment as results from the erection of a good directional array.

## DESIGN CONSIDERATIONS

At 50 Mc. and higher it is usually important to have the antenna work well over all or most of the band in question, and as the bands are wider than at lower frequencies the attention of the designer must be focused on broad frequency response. This may be attained in some instances through sacrificing other qualities such as high front-to-back ratio.

The loss in a given length of transmission line rises with frequency. V.h.f. feedlines should be kept as short as possible, therefore. Matching of the impedances of the antenna and transmission line should be done with care, and in open locations a high-gain antenna at relatively low height may be preferable to a low-gain system at great height. Wherever possible, however, the

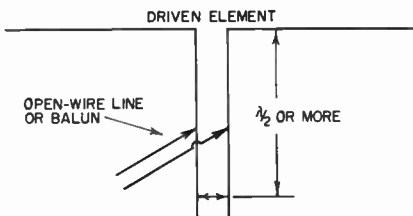

Fig. 18-1—Combination tuning and matching stub for v.h.f. arrays. Sliding short is used to tune out reactance of the driven element or phasing system. Transmission line, either balanced or coax, is connected at the point of lowest standing-wave ratio. Adjustment procedure is outlined in text.

v.h.f. array should be well above heavy foliage, buildings, power lines or other obstructions.

The physical size of a v.h.f. array is usually more important than the number of elements. A 4-element array for 432 Mc. may have as much

gain over a dipole as a similarly designed array for 144 Mc., but it will intercept only one-third as much energy in receiving. Thus to be equal in communication, the 432-Mc. array must equal the 144-Mc. antenna in *capture area*, requiring three times as many elements, if similar element configurations are used in both.

## Polarization

Early v.h.f. work was done with simple antennas, and since the vertical dipole gave as good results in all directions as its horizontal counterpart offered in only two directions, vertical polarization became the accepted standard. Later when high-gain antennas came into use it was only natural that these, too, were put up vertical in areas where v.h.f. activity was already well established.

When the discovery of various forms of long-distance propagation stirred interest in v.h.f. operation in areas where there was no previous experience, many newcomers started in with horizontal arrays, these having been more or less standard practice on frequencies with which these operators were familiar. As use of the same polarization at both ends of the path is necessary for best results, this lack of standardization resulted in a conflict that, even now, has not been completely resolved.

Tests have shown no large difference in results over long paths though evidence points to a slight superiority for horizontal in certain kinds of terrain, but vertical has other factors in its favor. Horizontal arrays are generally easier to build and rotate. Where ignition noise and other forms of man-made interference are present, horizontal systems usually provide better signal-to-noise ratio. Simple 3- or 4-element arrays are more effective horizontal than vertical, as their radiation patterns are broad in the plane of the elements and sharp in a plane perpendicular to them.

Vertical systems can provide uniform coverage in all directions, a feature that is possible only with fairly complex horizontal arrays. Gain can be built up without introducing directivity, an important feature in net operation, or in locations where the installation of rotatable systems is not possible. Mobile operation is simpler with vertical antennas. Fear of increased TVI has kept v.h.f. men in some densely populated areas from adopting horizontal as a standard.

The factors favoring horizontal have been predominant on 50 Mc., and today we find it the standard for that band, except for emergency net operation involving mobile units. The slight

advantage it offers in DX work has accelerated the trend to horizontal on 144 Mc. and higher bands, though vertical polarization is still widely used. The picture on 144, 220 and 420 Mc. is still confused, the tendency being to follow the local trend. The newcomer should check with local amateurs to see which polarization is in general use in the area he expects to cover. Eventual standardization should be a major objective, and to this end it is recommended that horizontal polarization be established in areas where activity is developing for the first time.

### IMPEDANCE MATCHING

Because line losses increase with frequency it is important that v.h.f. antenna systems be matched to their transmission lines carefully. Lines commonly used in v.h.f. work include open-wire, usually 300 to 500 ohms impedance, spaced  $\frac{1}{2}$  to two inches; polyethylene-insulated flexible lines, available in 300, 150 and 72 ohms impedance; and coaxial lines of 50 to 90 ohms impedance.

The various methods of matching antenna and line impedance are described in detail in Chapter 14. Matching devices commonly used in v.h.f. arrays fed with balanced lines include the folded dipole in its various forms, Fig. 14-42, the "T" Match, Fig. 14-45, the "Q" section, Fig. 14-41, and the adjustable stub, Fig. 18-1. The gamma match, useful for feeding the driven element of a parasitic array with coaxial line, is shown in schematic form in Fig. 14-45. Balanced loads such as a split dipole or a folded dipole can be fed with coax through a balun, as shown in Fig. 14-46. Practical examples of the use of these devices are shown in the following pages. The principles upon which their operation depends are explained in Chapter 14, with the exception of the adjustable stub of Fig. 18-1.

#### The Corrective Stub

The adjustable stub shown in Fig. 18-1 provides a means of matching the antenna to the transmission line and also tuning out reactance in the driven element. It is, in effect, a tuning device to which the transmission line may be connected at the point where impedances match. Both the shorting stub and the point of connection are made adjustable, though once the proper points are found the connections may be made permanent.

For antenna experiments the stub may be made of tubing, and the connections made with sliding clips. In a permanent installation a stub of open-wire line, with all connections soldered, may be more satisfactory mechanically. The transmission line may be open-wire or Twin-Lead, connected directly to the stub, or coaxial line of any impedance, which should be connected through a balun.

To adjust the stub start with the short at a point about a half wavelength below the antenna, moving the point of connection of the transmission line up and down the stub until the lowest standing-wave ratio is achieved. Then

move the shorting stub a small amount and re-adjust the line connection for lowest s.w.r. again. If the minimum s.w.r. is lower than at the first point checked the short was moved in the right direction. Continue in that direction, readjusting the line connection each time, until the s.w.r. is as close to 1:1 as possible. When adjustments are completed the portion of the stub below the short can be cut off, if this is desirable mechanically.

### TYPES OF V.H.F. ARRAYS

Directional antenna systems commonly used in amateur v.h.f. work are of three general types, the collinear, the Yagi, and the plane reflector

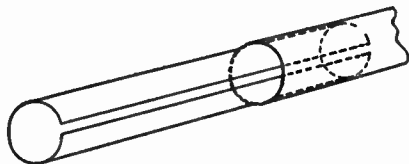

Fig. 18-2—Inserts for the ends of the elements in a v.h.f. array provide a means of adjustment of length for optimum performance. Short pieces of the element material are sawed lengthwise and compressed to fit inside the element ends.

array. Collinear systems have two or more driven elements end to end, fed in phase, usually backed up by parasitic reflectors. The Yagi has a single driven element, with one or more parasitic elements in front and in back of the driven element, all in the same plane. The plane-reflector array has a large reflecting surface in back of its driven element or elements. This may be a sheet of metal, a metal screen, or closely spaced rods or wires. The reflector may be a flat plane, or it can be bent into several forms, such as the corner and the parabola.

Examples of all three types are described, and each has points in its favor. The collinear systems such as the 12- and 16-element arrays of Figs. 18-14 and 18-15 require little or no adjustment and they present few feed problems. They work well over a wide band of frequencies. Yagi, or parasitic, arrays, Figs. 18-5 to 18-10, depend on fairly precise tuning of their elements for gain, and thus work over a narrower frequency range. They are simple mechanically, however, and usually offer more gain for a given number of elements than do the collinear systems. Plane- and corner-reflector arrays are broadband devices, having broad forward lobes and high front-to-back ratio. They are easily adjusted, but somewhat cumbersome mechanically.

### ELEMENT LENGTHS AND SPACINGS

Designing a v.h.f. array presents both mechanical and electrical problems. The electrical problems are basic, and their solution involves choosing the type of performance most desired. Mechanical design, on the other hand, can be subject to almost endless variations, and the form that the array will take can usually be



**TABLE 18-I**  
Dimensions for V.H.F. Arrays in Inches

Freq. (Mc.)	52*	146*	222.5*	435*
Driven Element	106.5	38	24 $\frac{1}{2}$	12 $\frac{3}{4}$
Change per Mc.*	2	0.25	0.12	0.03
Reflector	111 $\frac{1}{2}$	40	26 $\frac{1}{2}$	13 $\frac{3}{4}$
1st Director	101 $\frac{1}{2}$	36	23 $\frac{3}{4}$	12 $\frac{1}{2}$
2nd Director	99 $\frac{1}{2}$	35 $\frac{3}{4}$	23 $\frac{3}{4}$	12
3rd Director	97 $\frac{1}{2}$	35	23	11 $\frac{7}{8}$
1.0 Wavelength	234	81	53	27
0.625 Wavelength	147	50 $\frac{1}{2}$	33 $\frac{1}{2}$	16 $\frac{3}{4}$
0.5 Wavelength	117	40 $\frac{1}{2}$	26 $\frac{1}{2}$	13.5
0.25 Wavelength	58 $\frac{1}{2}$	20 $\frac{1}{4}$	13 $\frac{1}{4}$	6 $\frac{3}{4}$
0.2 Wavelength	47	16	10 $\frac{1}{2}$	5 $\frac{3}{4}$
0.15 Wavelength	35	12	8	4
Balun loop (coax)	76	26.5	17 $\frac{1}{4}$	8 $\frac{3}{4}$

\*Dimensions given for element lengths are for the middle of each band. For other frequencies adjust lengths as shown in the third line of table. Example: A dipole for 50.0 Mc. would be 106.5 + 4 = 110.5 inches.

Apply change figure to parasitic elements as well. For phasing lines or matching sections, and for spacing between elements, the midband figures are sufficiently accurate. They apply only to open-wire lines.

Parasitic-element lengths are optimum for 0.2 wavelength spacing.

decided by the materials and tools available. One common source of materials for amateur arrays is commercially built TV antennas. They can often be revamped for the amateur v.h.f. bands with a minimum of effort and expense.

Dimensions for Yagi or collinear arrays and their matching devices can be taken from Table 18-I. The driven element is usually cut to the formula:

$$Length \text{ (in inches)} = \frac{5540}{Freq. \text{ (Mc.)}}$$

This is the basis of the lengths in Table 18-I, which are suitable for the tubing or rod sizes commonly used. Arrays for 50 Mc. usually have  $\frac{1}{2}$  to 1-inch elements. For 144 Mc.  $\frac{3}{4}$  to  $\frac{1}{2}$ -inch stock is common. Rod or tubing  $\frac{1}{8}$  to  $\frac{3}{8}$  inch in diameter is suitable for 220 and 420 Mc. Note that the element lengths in the table are for the middle of the band concerned. For peaked performance at other frequencies the element

lengths should be altered according to the figures in the third line of the table.

Reflector elements are usually about 5 per cent longer than the driven element. The director nearest the driven element is 5 per cent shorter, and others are progressively shorter, as shown in the table. Parasitic elements should also be adjusted according to Line 3 of the table, if peak performance is desired at some frequency other than midband.

Parasitic element lengths of Table 18-I are based on element spacings of 0.2 wavelength. This is most often used in v.h.f. arrays, and is suitable for up to 4 or 5 elements. Other spacings can be used, however. If the element lengths are adjusted properly there is little difference in gain with reflector spacings of 0.15 to 0.25 wavelength. The closer the reflector is to the driven

**Fig. 18-3—Omnidirectional vertical array for 144 Mc. Elements of aluminum clothesline wire are mounted on ceramic standoff insulators screwed to a wooden pole. Feedline shown is 52-ohm coax, with a balun at the feedpoint. Twin-Lead or other 300-ohm balanced line may also be used, but it should be brought away horizontally from the supporting pole and elements for at least a quarter wavelength. Coax may be taped to the support.**

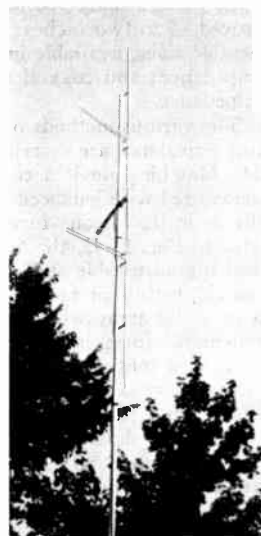

element, the shorter it must be for optimum forward gain, and the greater will be its effect on the driven element impedance.

Directors may also be spaced over a similar range. Closer spacing than 0.2 wavelength for arrays of two or three elements will require a longer director than shown in Table 18-I. Thus it can be seen that close-spaced arrays tend to work over a narrower frequency range than wide-spaced ones, when they are tuned for best performance. They also result in lower driven-element impedance, making them more difficult to feed properly. Spacings less than 0.15 wavelength are not commonly used in v.h.f. arrays for these reasons.

## PRACTICAL DESIGNS FOR V.H.F. ARRAYS

The antenna systems pictured and described herewith are examples of ways in which the information in Table 18-I can be used in arrays of proven performance. Dimensions can be taken from the table, except where otherwise noted. If the builder wishes to experiment with element

adjustment, a simple method is shown in Fig. 18-2. With elements  $\frac{1}{2}$ -inch or larger diameter a piece of the element material can be used. It is sawed lengthwise and then compressed to make a tight fit inside the end of the element.

A readily available material often used for

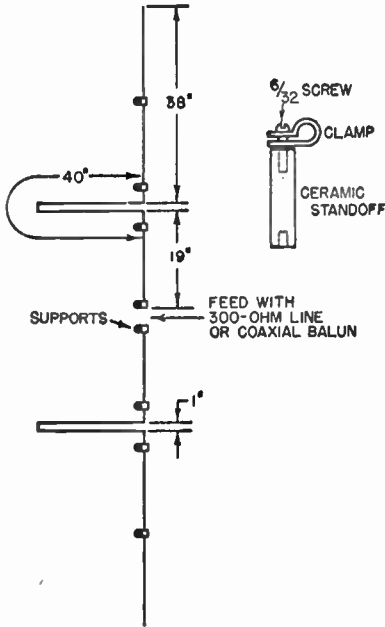

Fig. 18-4—Dimensions and supporting method for the 144-Mc. vertical array.

elements in arrays for 144 Mc. and higher is aluminum clothesline wire. This is a stiff hard-drawn wire about 1/8 inch in diameter. It should be used in preference to a similar-appearing wire commonly sold for TV grounding purposes. The latter is too soft to make satisfactory elements if the length is more than about two feet.

**A Collinear Array for 144 Mc.**

Where a vertically-polarized array having some gain over a dipole is needed, yet directivity is undesirable, collinear half wave elements may be mounted vertically and fed in phase, as shown in Figs. 18-3 and 18-4. Such an array may have 3 elements, as shown, or 5. The impedance at the center is approximately 300 ohms, permitting it to be fed directly with TV-type line, or through a coaxial balun, as in the model shown. Either 52- or 72-ohm line may be employed without serious mismatch.

The array is made from two pieces of aluminum clothesline wire about 97 inches long overall. These are bent to provide a 38-inch top section, a folded-back 40-inch phasing loop, and a 19-inch center section. These elements are mounted on ceramic pillars, which are fastened to a round wooden pole. Small clamps of sheet aluminum are wrapped around the elements and screwed to the stand-offs. A cheaper but somewhat less desirable method of mounting is to use TV screw-eye insulators to hold the elements in place.

Feeding the array at the center with a coaxial balun makes a neat arrangement. The balun loop may be taped to the vertical support, and the coaxial line likewise taped at intervals down the mast. The same type of construction can be ap-

plied to a 220-Mc. vertical collinear array, using the lengths for that band given in Table 18-I.

**PARASITIC ARRAYS**

Single-bay arrays of 2 to 5 elements are widely used in 50-Mc. work. These may be built in many different ways, using the dimensions given in the table. Probably the strongest and lightest structure results from use of aluminum, or dural tubing (usually 1 1/4 to 1 1/2 inches in diameter) for the boom, though wood is also usable. If the elements are mounted at their midpoints there is no need to use insulating supports. Usually the elements are run through the boom and clamped in place in a manner similar to that shown in Fig. 18-12. Where a metal boom is used the joints between it and the elements must be tight, as any movement at this point will result in noisy reception.

**2-Element 50-Mc. Array**

The 2-element antenna of Fig. 18-5 was designed for portable use, but it is also suitable for fixed-station work with minor modification. The 2-meter array above it is described later. The elements are made in three sections, for portability, using inserts similar to that shown in Fig. 18-2. The driven element is gamma matched for coax feed, and the parasitic element is a 0.15-wavelength spaced director. Details of the gamma section, the boom and its supporting clamp are shown in Fig. 18-6. The arm is about 12 inches long, and the capacitor is a 50-μf.



Fig. 18-5—Two-element 50-Mc. and four-element 144-Mc. arrays designed for portable use. Support is sectional TV masting clamped to car door handle. Elements of 50-Mc. array are made in three sections, for stowing in back of car. Antenna for 144 Mc. is cut-down TV array. Both use gamma match, as shown in Fig. 18-6.

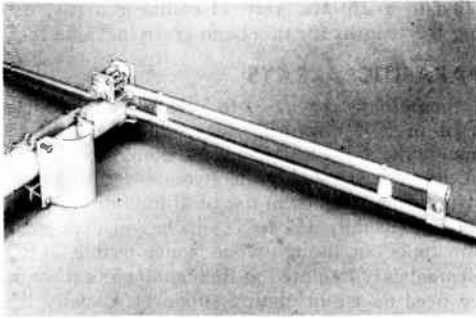

Fig. 18-6—Details of the gamma match for the 50-Mc. portable array. In a permanent installation the variable capacitor should be mounted in an inverted plastic cup or other device to protect it from the weather. The gamma arm is about 12 inches long for 50 Mc., 5 inches for 144 Mc.

variable. Clean, tight connections between the arm and element are important. Where the array is to be mounted permanently outdoors the capacitor may be protected from the weather by mounting it in an inverted plastic cup or other covering.

### 3-Element Lightweight Array

The 3-element 50-Mc. array of Fig. 18-7 weighs only 5 pounds. It uses the closest spacing that is practical for v.h.f. applications, in order to make an antenna that could be used individually or stacked in pairs without requiring a cumbersome support. The elements are half-inch aluminum tubing of 1/16-inch wall thickness, attached to the 1/4-inch dural boom with aluminum castings made for the purpose. (Dick's, 62 Cherry Ave., Tiffin, Ohio, Type HASL.) By limiting the element spacing to 0.15 wavelength the boom is only 6 feet long. Two booms for a stacked array (Fig. 18-11) can thus be cut from a single 12-foot length of tubing.

The folded-dipole driven element has No. 12 wire for the feed portions. These are mounted on 3/4-inch cone standoff insulators and joined to the outer ends of the main portion by means of metal pillars and 6-32 screws and nuts. When the wires are pulled up tightly and wrapped around the screw, solder should be sweated over the nuts and screw ends to seal the whole against weather corrosion. The same treatment should be used at each stand-off. Mount a soldering lug on the ceramic cone and wrap the end of the lug around the wire and solder the whole assembly together. These joints and other portions of the array may be sprayed with clear lacquer as an additional protection.

The inner ends of the folded dipole are 1 1/2 inches apart. Slip the dipole into its aluminum casting, and then

drill through both element and casting with a No. 36 drill, and tap with 6-32 thread. Suitable inserts for mounting the stand-offs can be made by cutting the heads off 6-32 screws. Taper the cut end of the screw slightly with a file and it will screw into the standoff readily.

Cut the dipole length according to Table 18-I, for the middle of the frequency range you expect to use most. The reflector and director will be approximately 4 per cent longer and shorter, respectively. The closer spacing of the parasitic elements (0.15 wavelength) makes this deviation from the dimensions of the table desirable.

The single 3-element array has a feed impedance of about 200 ohms at its resonant frequency. Thus it may be fed with 52-ohm coax and a balun. A gamma-matched dipole may also be used, as in the 2-element array. If the gamma match and 72-ohm coax are used, a balun will convert to 300-ohm balanced feed, if Twin-Lead or 300-ohm open-wire TV line feed is desired. If the dimensions are selected for optimum performance at 50.5 Mc. the array will show good performance and fairly low standing-wave ratio over the range from 50 to 51.5 Mc.

A closeup of a mounting method for this or any other array using a round boom is shown in Fig. 18-8. Four TV-type U bolts clamp the horizontal and vertical members together. The metal plate is about 6 inches square. If 1/4-inch sheet aluminum is available it may be used alone, though the photograph shows a sheet of 1/16-inch stock backed up by a piece of wood of the same size for stiffening.

### High-Performance 4-Element Array

The 4-element array of Fig. 18-9 was designed for maximum forward gain, and for direct feed with 300-ohm balanced transmission line. The parasitic elements may be any diameter from 1/2 to 1 inch, but the driven element should be made as shown in the sketch. The same general arrangement may be used for a 3-element array, except that the solid portion of the dipole should

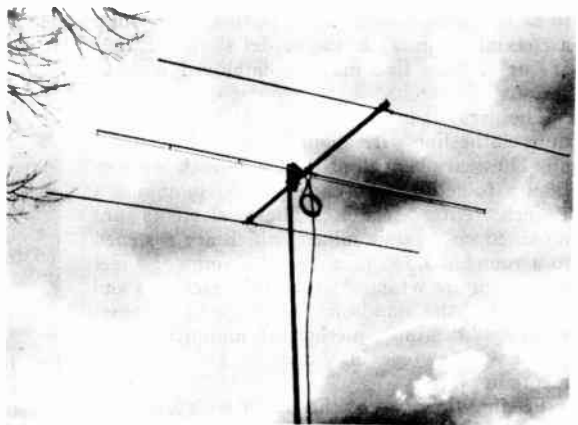

Fig. 18-7—Lightweight 3-element 50-Mc. array. Feedline is 52-ohm coax, with a balun for connection to the folded-dipole driven element. Balun may be coiled as shown or taped to supporting pipe.

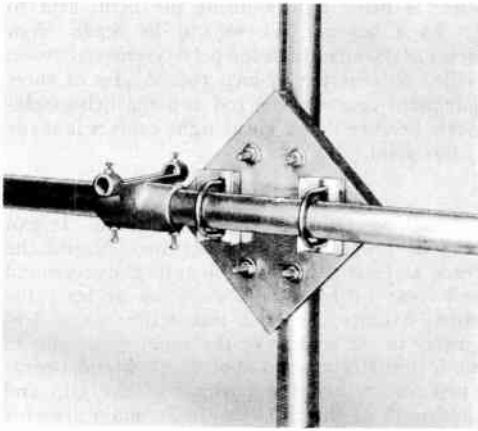

Fig. 18-8—Closeup photograph of the boom mounting for the 50-Mc. array. A sheet of aluminum 6 inches square is backed up by a piece of wood of the same size. TV-type U clamps hold the boom and vertical support together at right angles. At the left of the mounting assembly is one of the aluminum castings for holding the beam elements.

be  $\frac{3}{4}$ -inch tubing instead of 1-inch. With the element lengths given the array will give nearly uniform response from 50 to 51.5 Mc., and usable gain to above 52 Mc. It may be peaked for any portion of the band by using the information in Table 18-I.

If a shorter boom is desired, the reflector spacing can be reduced to 0.15 wavelength and both directors spaced 0.2 or even 0.15 wavelength, with only a slight reduction in forward gain and bandwidth.

**5-Element 50-Mc. Array**

As aluminum or dural tubing is usually sold in 12-foot lengths this dimension imposes a practical limitation on the construction of a 50-Mc. beam. A 5-element array that makes optimum use of a 12-foot boom may be built according to Table 18-I. If the aluminum casting method of mounting elements shown for the 3-element array is employed the weight of a 5-element beam can be held to under 10 pounds. The gamma match and coaxial line are recommended for feeding such an array, though a balun and 72-ohm coax can be used for the rotating portion of the line, converting to balanced feed at the anchor point.

Elements should be spaced 0.15 wavelength, or about 36 inches. With 5 or more elements, good bandwidth can be secured by tapering the element lengths properly. A dipole 110 inches long, with a 116-inch reflector, and directors of 105, 103 and 101 inches respectively will work

Fig. 18-10—A 6-element long Yagi for 50 Mc. and a 16-element collinear array for 144 Mc. Both are all-metal construction. Each has its own vertical member, which is clamped to the rotating vertical pipe that runs down through the tower bearing.

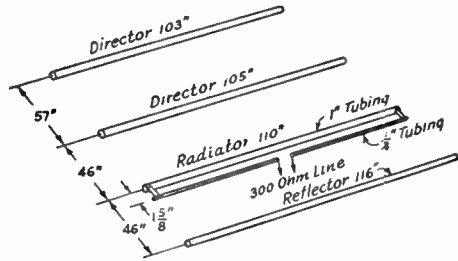

Fig. 18-9—Details of a 4-element 50-Mc. array designed for 300-ohm balanced feed. Element lengths and spacings were derived experimentally for optimum performance over the first 1.5 megacycles of the band.

well over the first two megacycles of the band, provided that the s.w.r. is adjusted for optimum at 51 Mc.

**Long Yagis for 50 Mc.**

With boom lengths greater than about 12 feet and with more elements than 4, somewhat better performance can be obtained by using gradually increasing spacing between the directors. The 6-element array in Fig. 18-10 is an example of this approach. It also employs a variation of the gamma match that has mechanical advantages. The long boom and wide-spaced elements give a sharpness of horizontal pattern that is not obtainable with the same number of elements in a stacked array.

The long Yagi is not a broadband device. This one works well over the first megacycle of the band with the following dimensions. Sub-

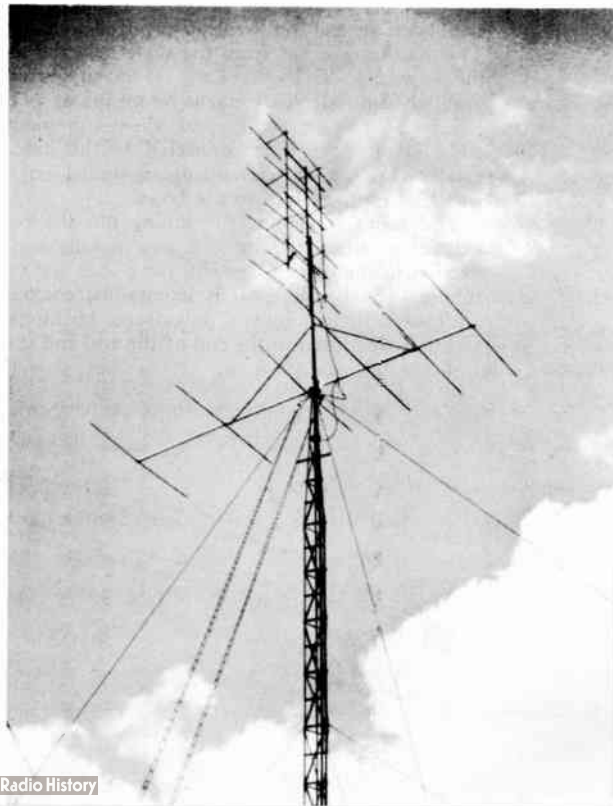



tract 2 inches from each element for each megacycle higher. Reflector — 116 inches. Driven element — 110.5. First director — 105.5. Second director — 104. Third director — 102.75. Fourth director — 101.5. Spacings are, from back forward: 36, 36, 42, 59 and 70 inches. If a longer array is to be built each additional director should be 70 inches from the last.

### Construction

The long Yagi is built similar to the 3-element array of Fig. 18-7 and 18-8, using those same castings for mounting the elements. The gusset plate for fastening the boom to the vertical support is made larger, and four U bolts are used on each member instead of two. The array is mounted at its center of gravity, rather than at its physical center. The boom is braced to prevent drooping, at points about 5 feet out from the mounting point. Braces are aluminum tubing, flattened at the ends, and clamped to the boom and the vertical member. Suspension bracing, as shown in Fig. 18-10, provides strength with lightweight supports.

The dimensions given require a boom slightly more than 20 feet long. This was made up by splicing, but if a 20-foot length is available in one piece the spacings of the two forward directors can be made slightly less, in order to avoid splicing. Element spacing is not particularly critical, but lengths are fairly so.

### The Gamma Match

The gamma match is ideal for matching arrays fed with coax. The arrangement shown in Fig. 18-11 combines the adjustable arm with the series capacitor, and provides a rugged assembly that can be weather-proofed readily. The main arm is cut from the same material as the elements, 15 inches long. It is supported parallel to the driven element by means of two 1-inch ceramic standoffs and sheet-aluminum clips. Its inner end is connected to the inner conductor of a coaxial fitting, mounted on a small bracket screwed to the boom.

The series capacitor, for tuning out the reactance of the matching arm and making connection to the driven element, is  $\frac{1}{4}$ -inch rod or tubing 14 inches long. It is maintained coaxial with the main arm by two polystyrene bushings. One is force-fitted to the end of the rod and the

other is fitted tightly inside the main arm to act as a bearing. These can be made from pieces of  $\frac{3}{8}$ -inch diameter polystyrene rod stock, drilled to pass the  $\frac{1}{4}$ -inch rod. A clip of sheet aluminum connects the rod and the driven element. Be sure that a clean tight contact is made at this point.

### Adjustment

Matching requires an s.w.r. bridge. It can be done properly in no other way. Mount the beam at least a half wavelength above ground and clear of trees and wires by at least the same distance. Set the transmitter at a frequency in the middle of the range you want to work (50.3 is a good spot for low-end operation) and adjust the position of the clip and the length of the rod outside the main arm for minimum s.w.r. Move first one variable and then the other until zero reflected power is indicated. Tighten the clip solidly, tape over the junction between the arm and the rod with waterproof tape, and the array is ready for use.

### 144-Mc. PARASITIC ARRAYS

The main features of the arrays described above can be adapted to 144-Mc. antennas, but the small physical size of arrays for this frequency makes it possible to use larger numbers of elements with ease. Few 2-meter antennas have less than 4 or 5 elements, and most stations use more, either in a single bay or in stacked systems.

Parasitic arrays for 144 Mc. can be made readily from TV antennas for Channels 4, 5 or 6. The relatively close spacing normally used in TV arrays makes it possible to approximate the recommended 0.2 wavelength at 144 Mc., though the element spacing is not a critical factor. A 4-element array for 144 Mc. made from a Channel 6 TV Yagi is shown in Fig. 18-5. It is fed with a gamma match and 52-ohm coax, and was designed primarily for portable work. As most TV antennas are designed for 300-ohm feed the same feed system can be employed for the 2-meter array that is made from them.

If one wishes to build his own Yagi antennas from available tubing sizes, the boom of a 2-meter antenna should be  $\frac{3}{4}$  to 1 inch aluminum or dural. Elements can be  $\frac{1}{4}$  to  $\frac{1}{2}$ -inch stock, fastened to the boom as shown in Fig. 18-12.

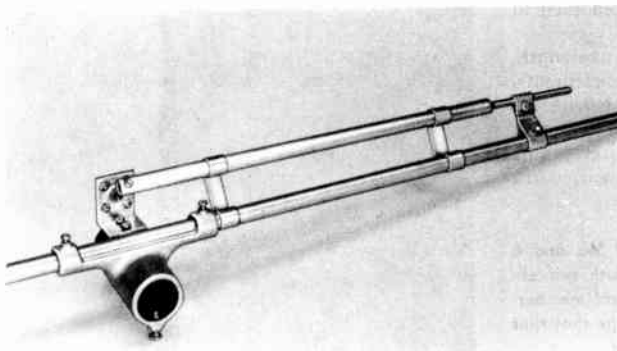

Fig. 18-11 — Details of the gamma match used on the 6-element 50-Mc. array. Series capacitor is formed by sliding a rod or tube inside the main arm.



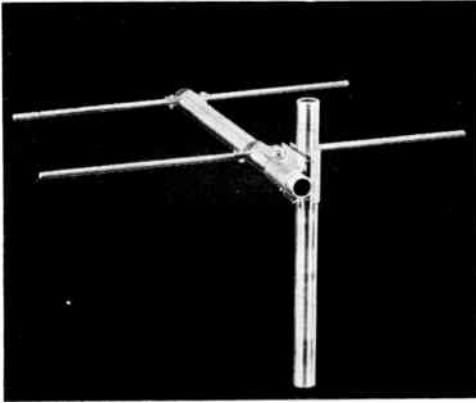

Fig. 18-12—Model showing method of assembling all-metal arrays for 144 Mc. and higher frequencies. Dimensions of clamps are given in Fig. 18-16.

Recommended spacing for up to 6 elements is 0.2 wavelength, though this is not too critical. Gamma match feed is recommended for coax, or a folded dipole and balun may be used. If balanced line is to be used the folded dipole is recommended, the 4 to 1 ratio of conductor sizes being about right for most designs.

Very high gain can be obtained with long Yagi-type arrays for 144 Mc. and higher frequencies, though the bandwidth of such antennas is considerably narrower than for those having up to 4 or 5 elements. The first two directors in long Yagis are usually spaced about 0.1 wavelength. The third is spaced about 0.2, increasing to 0.4 wavelength or so for the forward directors. Highest gain is obtained when all directors are made the same length, but better front-to-back ratio and lower side lobe content results if the director lengths are tapered  $\frac{1}{8}$  to  $\frac{1}{4}$  inch per director. Tapering the element lengths also widens the effective bandwidth. There is more on long Yagis in *QST* for January and September, 1956.

### STACKED YAGI ARRAYS

The gain (in power) obtainable from a single Yagi array can be more than doubled by stacking two or more of them vertically and feeding them in phase. This refers to horizontal systems, of course. Vertically-polarized bays are usually stacked side by side. The principles to follow apply in either case.

The spacing between bays should be at least one-half wavelength, and more is desirable. For dipoles or Yagis of up to three elements optimum spacing between bays is about  $\frac{5}{8}$  wavelength, but with longer Yagis the spacing can be increased to one wavelength or more. Bays of 5 elements or more, spaced one wavelength, are commonly used in antennas for 144 Mc. and higher frequencies. Optimum spacing for long Yagis is about two wavelengths.

Where half-wave stacking is to be employed, the phasing line between bays can be treated as a double "Q" section. If two bays, each de-

signed for 300-ohm feed, are to be stacked a half wavelength apart and fed at the midpoint between them, the phasing line should have an impedance of about 380 ohms. No. 12 wire spaced one inch will do for this purpose. The midpoint then can be fed either with 300-ohm line, or with 72-ohm coax and a balun.

When a spacing of  $\frac{3}{8}$  wavelength between bays is employed, the phasing lines can be coax. (The velocity factor of coax makes a full wavelength of line actually about  $\frac{5}{8}$  wavelength physically.) The impedance at the midpoint between two bays is slightly less than half the impedance of either bay alone, due to the coupling between bays. This effect decreases with increased spacing.

When two bays are spaced a full wavelength the coupling is relatively slight. The phasing line can be any open-wire line, and the impedance at the midpoint will be approximately half that of the individual bays. Predicting what it will be with a given set of dimensions is difficult, as many factors come into play. It will usually be of a value that can be fed through the combination of a "Q" section and a transmission line of 300 to 450 ohms impedance. An adjustable "Q" section, or an adjustable stub like the one shown in Fig. 18-1, may be used when the antenna impedance is not known.

The stacked 3-over-3 for 50 Mc., Fig. 18-13, uses a coaxial phasing line and an additional section of coax to provide for the flexible por-

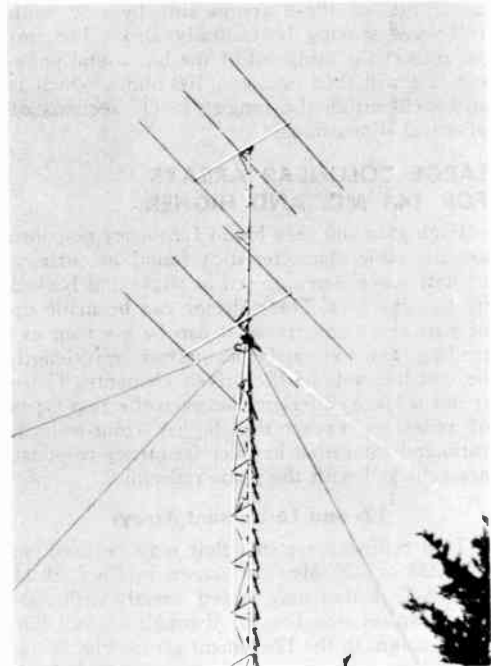

Fig. 18-13—Stacked array for 50 Mc. using two of the 3-element bays of Fig. 18-7. Phasing system and flexible section for rotation are of coaxial line. A "Q" section matches this to 450-ohm open-wire line for run to the station.

tion of the feedline. Each bay is fed with a balun and halfwave section of RG-8/U cable. These are joined at the center between bays with a Tee fitting. As each bay has an impedance of 200 ohms, two 50-ohm leads are paralleled at the center, resulting in an impedance of about 20 ohms, when the coupling effect between bays is included. A flexible section of 50-ohm coax one wavelength long, with a balun at the end, steps this up to about 80 ohms. A "Q" section of  $\frac{1}{4}$ -inch tubing  $\frac{3}{4}$  inch center to center steps this up to the point where it can be fed with 450-ohm open-wire TV line.

#### The "Twin-Five" for 144 Mc.

A popular stacked array for 144-Mc. work is the Twin-Five, originally developed by W2PAU.<sup>1</sup> In this design two 5-element arrays of standard design are stacked a full wavelength apart. If the folded-dipole driven elements are constructed so that the individual bays have a feed impedance of about 400 ohms the midpoint of the open-wire phasing line can be fed with 52-ohm coax and a balun. Where open-wire line is desired, the impedances can be matched through a "Q" section of about 300 ohms impedance. If the constructor is in doubt as to the actual feed impedance to be matched, the stub arrangement of Fig. 18-1 will take care of a wide range of impedances and lines to be matched. Dimensions can be taken from Table 18-1.

An effective 20-element array can be made by using two of these arrays side by side, with full-wave spacing horizontally also. The impedance at the midpoint of the horizontal phasing line will then be about 100 ohms, which is still well within the range of "Q" sections of practical dimensions.

#### LARGE COLLINEAR ARRAYS FOR 144 MC. AND HIGHER

High gain and very broad frequency response are desirable characteristics found in curtains of half-wave elements fed in phase and backed up by reflectors. The reflector can be made up of parasitic elements, or it can be a screen extending approximately a quarter wavelength beyond the ends of the driven elements. There is not a large difference between the two types of reflectors, except that higher front-to-back ratio and somewhat broader frequency response are achieved with the plane reflector.

#### 12- and 16-Element Arrays

Two collinear systems that may be used on 144, 220 or 420 Mc. are shown in Figs. 18-14 and 18-15. Either may be fed directly with 300-ohm transmission line, or through coaxial line and a balun. In the 12-element array, Fig. 18-14, the reflectors are spaced 0.15 wavelength in back of the driven elements, while the 16-element array, Figs. 18-15 and 18-10, uses 0.2 wave-

length spacing. Dimensions may be taken from Table 18-I, and figures for the middle of the band will give good performance across either band.

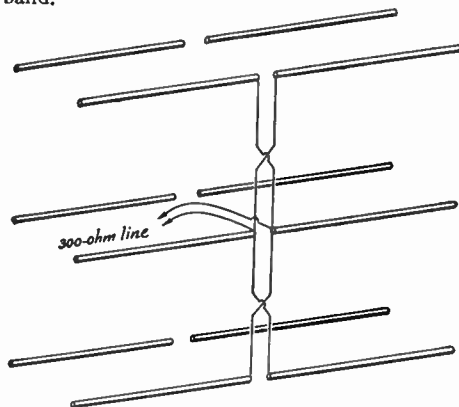

Fig. 18-14—Element arrangement and feed system of the 12-element array. Reflectors are spaced 0.15 wavelength behind the driven elements.

The supporting frame for either array may be made of wood or metal. Details of a metal support for the 12-element array are shown in Figs. 18-16 and 18-17. Note that all elements are mounted at their midpoints, and that no insulators are used. The elements are mounted in front of the supporting frame, to keep metal out of the field of the array. This method is preferable to that wherein mechanical balance is maintained through mounting the driven ele-

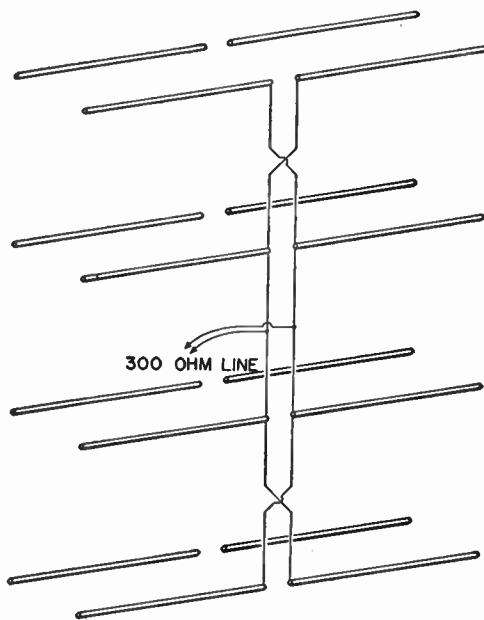

Fig. 18-15—Schematic drawing of a 16-element array. A variable "Q" section may be inserted at the feed point if accurate matching is desired. Reflector spacing is 0.2 wavelength.

<sup>1</sup> Brown—"The Wide-Spread Twin-Five" *CQ*, March, 1950.

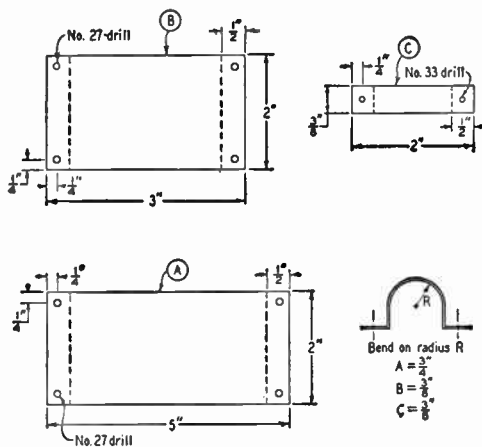

Fig. 18-16—Detail drawings of the clamps used to assemble the all-metal 2-meter array. A, B and C are before bending into "U" shape. The right-angle bends should be made first, along the dotted lines as shown, then the plates may be bent around a piece of pipe of the proper diameter. Sheet stock should be 1/16-inch or heavier aluminum.

ments in front and the reflectors in back of the supporting structure.

Combination of collinear arrays may be carried further. Pairs of 16-element systems fed in

phase are common, and even 64-element arrays (4 16-element beams fed in phase) are used in some leading stations on 144 Mc. Configurations of 32 to 64 elements are not difficult to build and support at 220 or 420 Mc. An example of two 16-element beams mounted on the same support is pictured in Fig. 18-18.

**ARRAYS FOR 220 AND 420 MC.**

The use of high-gain antenna systems is almost a necessity if work is to be done over any great distance on 220 and 420 Mc. Experimentation with antenna arrays for these frequencies is fascinating indeed, as their small size permits trying various element arrangements and feed systems with ease. Arrays for 420 Mc., particularly, are convenient for study and demonstration of antenna principles, as even high-gain systems may be of table-top proportions.

In some instances a good arrangement is obtained by mounting beams "back to back" on a single rotator. For example, a 16-element 220-Mc. array might be mounted with a 24-element 420-Mc. array (two 12-element assemblies mounted one above the other) and fed with separate transmission lines.

(For an example of stacking several commercial 220-Mc. beams, see Tilton, "A 66-Element Stacked-Yagi Array for 220 Mc.," *QST*, January, 1959.)

**Plane-Reflector Arrays**

At 220 Mc. and higher, where their dimensions become practicable, plane-reflector arrays are widely used. Except as it affects the impedance of the system, as shown in Fig. 18-19, the spacing between the driven elements and the reflecting plane is not particularly critical. Maximum gain occurs around 0.1 to 0.15 wavelength, which is also the region of lowest impedance. Highest impedance appears at about 0.3 wavelength. A plane reflector spaced 0.22 wavelength in back of the driven elements has no effect on their feed impedance. As the gain of a plane-reflector array is nearly constant at spacings from 0.1 to 0.25 wavelength, it may be seen that the spacing may be varied to achieve an impedance match.

An advantage of the plane reflector is that it may be used with two driven element systems, one on each side of the plane, providing for two-band operation, or the incorporation of horizontal and vertical polarization in a single structure. The gain of a plane-reflector array is slightly higher than that of a similar number of driven elements backed up by parasitic reflectors. It also has a broader frequency response and higher front-to-back ratio. To achieve these ends, the reflecting plane must be larger than the area of the driven elements, extending at least a quarter wavelength on all sides. Chicken wire on a wood or metal frame makes a good plane reflector. Closely spaced wires or rods may be substituted, with the spacing between them running up to 0.1 wavelength without reduction in effectiveness.

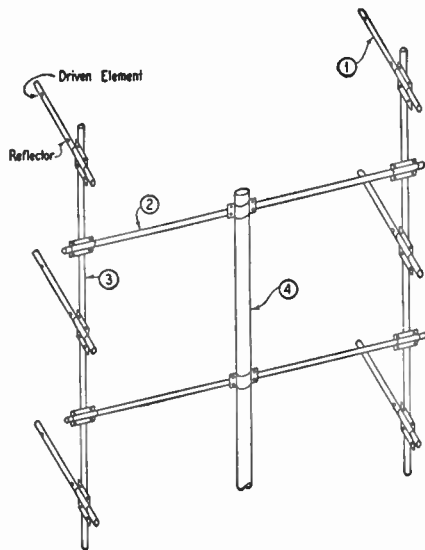

Fig. 18-17—Supporting framework for a 12-element 144-Mc. array of all-metal design. Dimensions are as follows: element supports (1) 3/4 by 16 inches; horizontal members (2) 3/4 by 46 inches; vertical members (3) 3/4 by 86 inches; vertical support (4) 1 1/2-inch diameter, length as required; reflector-to-driven-element spacing 12 inches. Parts not shown in sketch: driven elements 1/4 by 38 inches; reflectors 1/4 by 40 inches; phasing lines No. 18 spaced 1 inch, 80 inches long, fanned out to 3 1/2 inches at driven elements (transpose each half-wave section).

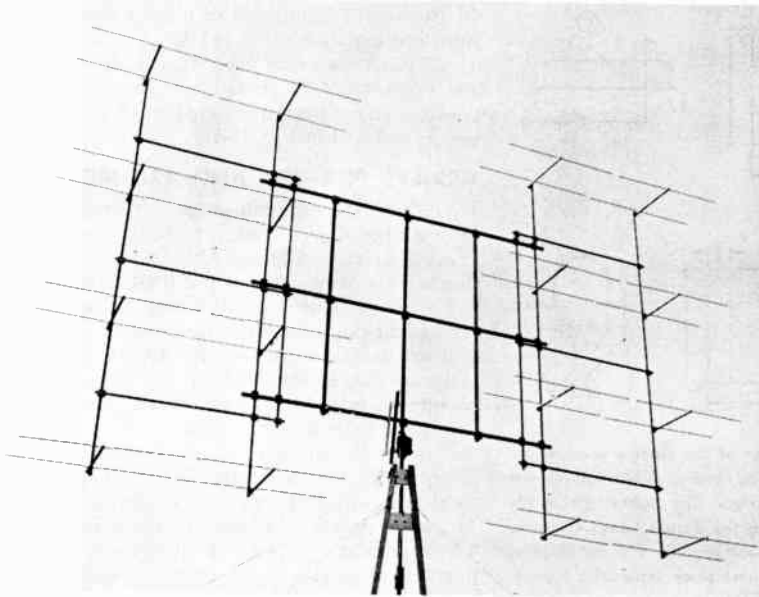

Fig. 18-18—Two 16-element arrays spaced  $1\frac{1}{2}$  wavelength and fed in phase.

**Corner Reflectors**

In the corner reflector two plane surfaces are set at an angle, usually between 45 and 90 degrees, with the antenna on a line bisecting this angle. Maximum gain is obtained with the antenna 0.5 wavelength from the vertex, but compromise designs can be built with closer spacings. There is no focal point, as would be the case for a parabolic reflector. Corner angles greater than 90 degrees can be used at some sacrifice in gain. At less than 90 degrees the

gain increases, but the size of the reflecting sheets must be increased to realize this gain.

At a spacing of 0.5 wavelength from the vertex, the impedance of the driven element is approximately twice that of the same dipole in free space. The impedance decreases with smaller spacings and corner angles, as shown in Fig. 18-19. The gain of a corner-reflector array with a 90-degree angle, 0.5 wavelength spacing and sides one wavelength long is approximately 10 db. Principal advantages of the corner reflector are broad frequency response and high front-to-back ratio.

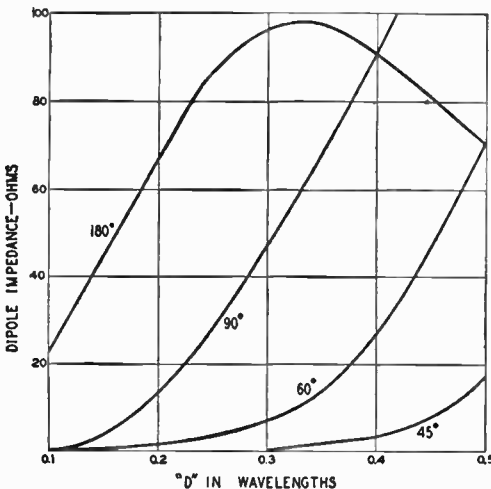

Fig. 18-19—Feed impedance of the driven element in a corner-reflector array for corner angles of 180 (flat sheet), 90, 60 and 45 degrees. "D" is the dipole-to-vertex spacing.

**Parabolic Reflectors**

A plane sheet may be formed into the shape of a parabolic curve and used with a driven radiator situated at its focus, to provide a highly directive antenna system. If the parabolic reflector is sufficiently large so that the distance to the focal point is a number of wavelengths, optical conditions are approached and the wave across the mouth of the reflector is a plane wave. However, if the reflector is of the same order of dimensions as the operating wavelength, or less, the driven radiator is appreciably coupled to the reflecting sheet and minor lobes occur in the pattern. With an aperture of 10 to 20 wavelengths, a practical size for microwave work, a beam width of approximately 5 degrees may be achieved.

A reflecting paraboloid must be carefully designed and constructed to obtain ideal performance. The antenna must be located at the focal point. The most desirable focal length of the parabola is that which places the radiator along the plane of the mouth; this length is equal to one-half the mouth radius.

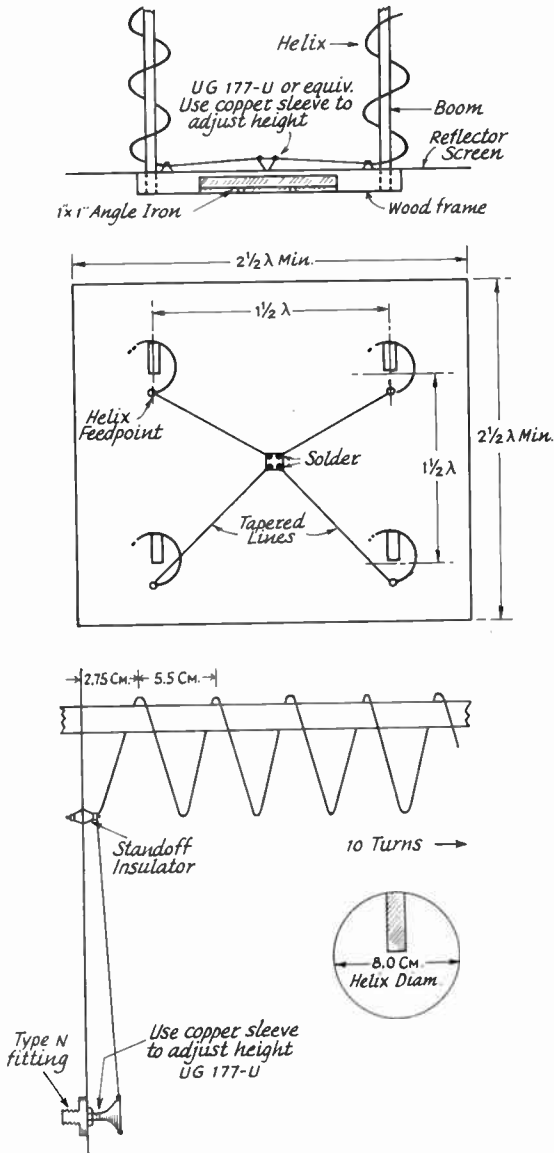

Fig. 18-21—Mechanical details of the quadhelix antenna. Top two views show overall dimensions; bottom view is detail of one helix. 5.5 cm. is  $2\frac{1}{8}$  in., 8 c.m. is  $3\frac{5}{32}$  in. Other dimensions are found from Eq. 14-D.

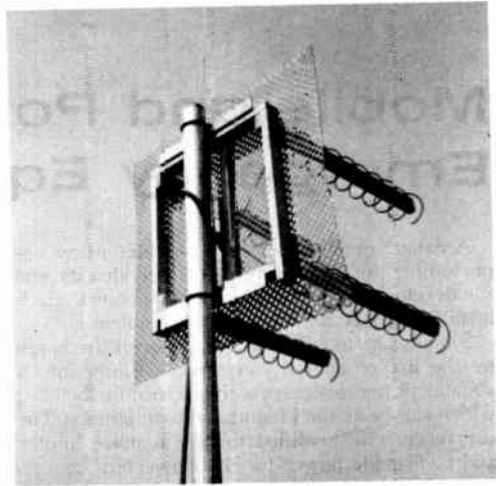

Fig. 18-20—Rear view of the helical array at K6UQH, showing the wooden frame and angle irons used for mounting the frame to the vertical support. (QST, August, 1963)

**A 1215-Mc. Quadhelix Antenna**

The helical antenna represents the transition point between linear antennas and the loop. In the axial mode (as used here) the radiation is circularly polarized. The helix is a broadband antenna, on the order of 1.7 to 1 in frequency. The impedance of a single helix varies from 120 to 160 ohms over this range. A gain of nearly 20 db. is claimed for the quadhelix shown here.

The quadhelix consists of four 10-turn helices wound clockwise from No. 10 copper wire. The helices are mounted on 1x2-inch smooth lumber booms, and held in place by metal horseshoe brads. The booms are attached by screws and glue to a wooden frame, to which is also fastened the 2-foot square perforated-aluminum reflector. Eight-inch lengths of 1-inch angle iron screwed to the frame provide anchorages for the U-bolts holding the antenna to the mast.

The 140-ohm impedance of each helix is transformed to 200 ohms through tapering lines, made of No. 10 wire running from a standoff insulator at the end of the helix to a UG-177/U hood used as a junction. The four 200-ohm loads offer 50 ohms to the coaxial line. The match can be adjusted by raising or lowering the center terminus above the ground-plane reflector. Calculated heights for the line are 0.254 inches at the helix ends and 0.717 at the junction ends.



# Mobile and Portable-Emergency Equipment

Amateur mobile operation provides many opportunities for exercising one's individuality and for developing original ideas in equipment. Each installation has its own special problems.

Simple a.m. mobile receiving systems are based on the use of an h.f. converter working into a standard car broadcast receiver tuned to 1500 kc., which serves as the i.f. and audio amplifiers. The car receiver is modified to take a noise limiter and to provide power for the converter.

While a few mobile a.m. transmitters may run final-amplifier powered inputs of 100 watts or more, an input of 30 to 50 watts is a more usual figure, unless the car is equipped with a special battery-charging system. Transistor amplifiers for modulator stages (instead of vacuum tubes) reduce the power-supply requirements.

S.s.b. *transceivers* offer the most effective use of the total available power.

Mobile c.w. operation has been accomplished by a few hardy driver-operators, but never with the best wishes of highway safety agencies. "Portable" c.w. operation (from a *parked* car), or mobile operation by a passenger, are worthy considerations for emergency work.

If the mobile station is a single package, such as an s.s.b. transceiver, it will usually be mounted under the dashboard over the transmission tunnel.

The power supply is best mounted in the engine compartment or in the trunk. If the station consists of several units (exclusive of power supply), tuning dials requiring observation should be mounted where they can be seen by the operator with a minimum of acrobatics. Power-control switches, which can be operated without direct observation, are not subject to this restriction. Common spots for the location of tunable converters or receivers are on top or bottom of the instrument panel, or attached to the steering post.

The send-receive switch, which usually controls a heavy-duty relay (to avoid having to carry heavy current), can be incorporated in the unit mounted closest to the driver-operator.

Frequency within any of the phone bands sometimes is changed remotely by means of a stepping-switch system that switches crystals. In most cases, however, extensive frequency excursions within a band, and band-changing, require stopping the car to make the necessary transmitter and antenna changes.

When a mobile a.m. transmitter is used, only the frequency-control unit (v.f.o. or crystal-selector switch) need be readily available to the operator. The transmitter proper can be mounted anywhere if small, and in the trunk if large.

Most mobile antennas consist of a vertical whip with some system of adjustable loading for the lower frequencies. Power supplies are of the vibrator, motor-generator, or transistor type operating from the car storage battery.

Units intended for use in mobile installations should be assembled with greater than ordinary care, since they will be subject to considerable vibration. Soldered joints should be well made and wire wrap-arounds should be used to avoid dependence upon the solder for mechanical strength. Self-tapping screws should be used wherever feasible, otherwise lock-washers should be provided. Any shafts that are normally operated at a permanent or semi-permanent setting should be provided with shaft locks so they cannot jar out of adjustment. Where wires pass through metal, the holes should be fitted with rubber grommets to prevent chafing. Any cabling or wiring between units should be securely clamped in place where it cannot work loose to interfere with the operation of the car.

## NOISE ELIMINATION

Electrical-noise interference to reception in a car arise from several different sources. Trouble may be experienced with ignition noise, generator and voltage-regulator hash, or wheel static.

A noise limiter added to the car broadcast receiver will go far in reducing some types, especially ignition noise from passing cars as well as your own. But for the satisfactory reception of weaker signals, some treatment of the car's electrical system will be necessary.

### Tire Static

The traditional cure for tire static is to inject

"antistatic powder" into the tire tubes. However, few garages or other suppliers stock such a powder these days, and the injector (for getting the antistatic powder into the tubes) is even harder to find.

"Antistatic powder" is nothing more than the graphite powder used for lubricating locks. The dry graphite powder is packaged in a small plastic tube similar to a small toothpaste tube. To use it for eliminating tire static, deflate the tires, squeeze the graphite into the tubes and re-inflate the tires. Tire men state that the powder has no adverse effect on the tube.

## Ignition Interference

Fig. 19-1 indicates the measures that may be taken to suppress ignition interference. The capacitor at the primary of the ignition coil should be of the coaxial type; ordinary types are not effective. It should be placed as close to the coil terminal as possible. In stubborn cases, two of these capacitors with an r.f. choke between them may provide additional suppression. The size of the choke must be determined experimentally. The winding should be made with wire heavy enough to carry the coil primary current. A 10,000-ohm suppressor resistor should be inserted at the center tower of the distributor, a 5000-ohm suppressor at each spark-plug tower on the distributor, and a 10,000 ohm suppressor

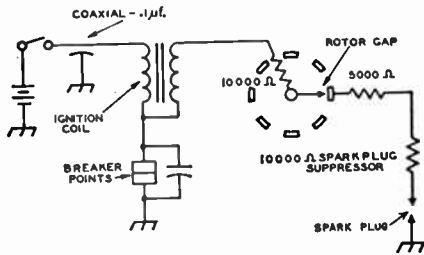

Fig. 19-1—Ignition system with recommended suppression methods.

at each spark plug. The latter may be built-in or external. A good suppressor element should be molded of material having low capacitance. Several concerns manufacture satisfactory suppressors. In extreme cases, it may be necessary to use shielded ignition wire. Suppressor ignition wire kits having the resistance distributed throughout the length of the wire are available from some automobile supply dealers. Distributed resistance of this type is somewhat superior to lumped resistance and may be used if the lead lengths are right to fit your car. They should not be cut, but used as they are sold.

## D.C. Generator Noise

Generator hash is caused by sparking at the commutator. The pitch of the noise varies with the speed of the motor. This type of noise may be eliminated by using a 0.1- to 0.25  $\mu\text{f}$ . coaxial capacitor in the generator armature circuit. This capacitor should be mounted as near the armature terminal as possible and directly on the frame of the generator.

To reduce the noise at 28 Mc., it may be necessary to insert a parallel trap, tuned to the middle of the band, in series with the generator output lead. The coil should have about 8 turns of No. 10 wire, space-wound on a 1-inch diameter and should be shunted with a 30-p.f. mica trimmer. It can be pretuned by putting it in the antenna lead to the home-station receiver tuned to the middle of the band, and adjusting the trap to the point of minimum noise. The tuning may need to be peaked up after installing in the car, since it is fairly critical.

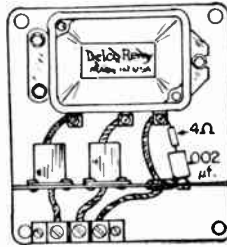

Fig. 19-2—Bypasses installed to reduce regulator interference. A capacitor should never be connected across the generator field lead without the small series resistor indicated.

Practically all of the newer cars use alternators (generators of a.c.) in conjunction with silicon-diode rectifiers for battery charging. The system provides better battery charging and less head-light-intensity variation at low engine speeds. However, normal care and maintenance is required for minimum radio noise. Alternator noise will be caused by dirty collector rings, and the rings and brushes should be cleaned every 10,000 miles for best radio performance.

## Voltage-Regulator Interference

In eliminating voltage-regulator noise, the use of two coaxial capacitors, and a resistor-mica-capacitor combination, as shown in Fig. 19-2, are effective. A 0.1- to 0.25- $\mu\text{f}$ . coaxial capacitor should be placed between the battery terminal of the regulator and the battery, with its case well grounded. Another capacitor of the same size and type should be placed between the generator terminal of the regulator and the generator. A 0.002- $\mu\text{f}$ . mica capacitor with a 4-ohm carbon resistor in series should be connected between the field terminal of the regulator and ground. Never use a capacitor across the field contacts or between field and ground without the resistor in series, since this greatly reduces the life of the regulator. In some cases, it may be necessary to pull double-braid shielding over the leads between the generator and regulator. It will be advisable to run new wires, grounding the shielding well at both ends. If regulator noise persists, it may be necessary to insulate the regulator from the car body. The wire shielding is then connected to the regulator case at one end and the generator frame at the other.

## Wheel Static

Wheel static shows up as a steady popping in the receiver at speeds over about 15 m.p.h. on smooth dry streets. Front-wheel static collectors are available on the market to eliminate this variety of interference. They fit inside the dust cap and bear on the end of the axle, effectively grounding the wheel at all times. Those designated particularly for your car are preferable, since the universal type does not always fit well. They are designed to operate without lubrication and the end of the axle and dust cap should be cleaned of grease before the installation is made. These collectors require replacement about every 10,000 miles.

Rear-wheel collectors have a brush that bears against the inside of the brake drum. It may be

necessary to order these from the factory through your dealer.

### Tracing Noise

To determine if the receiving antenna is picking up all of the noise, the shielded lead-in should be disconnected at the point where it connects to the antenna. The motor should be started with the receiver gain control wide open. If no noise is heard, all noise is being picked up via the antenna. If the noise is still heard with the antenna disconnected, even though it may be reduced in strength, it indicates that some signal from the ignition system is being picked up by the antenna transmission line. The

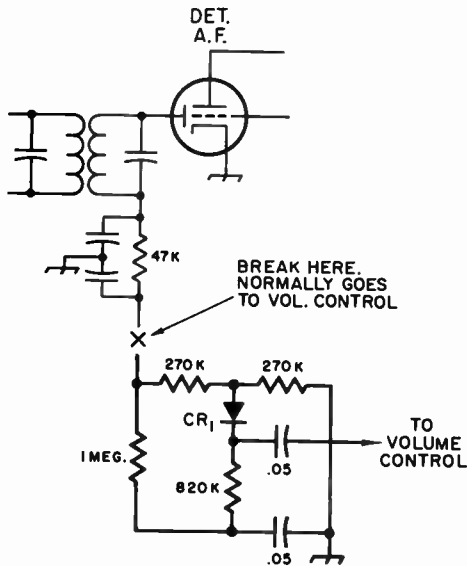

Fig. 19-3—Diagram showing addition (heavy lines) of series noise limiter to car radio receiver. A high back-resistance silicon diode is required (see text) but a vacuum-tube diode may be substituted if there is sufficient room in the receiver. A switch across the diode will remove the noise-limiting action, but leads to the switch must be short and shielded.

lead-in may not be sufficiently well shielded, or the shield not properly grounded. Noise may also be picked up through the battery circuit, although this does not normally happen if the receiver is provided with the usual r.f.-choke-and-bypass capacitor filter.

In case of noise from this source, a direct wire from the "hot" battery terminal to the receiver is recommended.

Ignition noise varies in repetition rate with engine speed and usually can be recognized by that characteristic in the early stages. Later, however, it may resolve itself into a popping noise that does not always correspond with

engine speed. In such a case, it is a good idea to remove all leads from the generator so that the only source left is the ignition system.

Regulator and generator noise may be detected by racing the engine and cutting the ignition switch. This eliminates the ignition noise. Generator noise is characterized by its musical whine contrasted with the ragged raspy irregular noise from the regulator.

With the motor running at idling speed, or slightly faster, checks should be made to try to determine what is bringing the noise into the field of the antenna. It should be assumed that any control rod, metal tube, steering post, etc., passing from the motor compartment through an insulated bushing in the firewall will carry noise to a point where it can be radiated to the antenna. All of these should be bonded to the firewall with heavy wire or braid. Insulated wires can be stripped of r.f. by bypassing them to ground with 0.5- $\mu$ f. metal-case capacitors. The following should not be overlooked: battery lead at the ammeter, gasoline gauge, ignition switch, headlight, backup and taillight leads and the wiring of any accessories running from the motor compartment to the instrument panel or outside the car.

The firewall should be bonded to the frame of the car and also to the motor block with heavy braid. If the exhaust pipe and muffler are insulated from the frame by rubber mountings, they should likewise be grounded to the frame with flexible copper braid.

### Noise Limiting

Fig. 19-3 shows the alterations that may be made in the existing car-receiver circuit to provide for a noise limiter. The dark lines show the additional circuitry for a self-adjusting series limiter. It is important that the diode CR<sub>1</sub> be silicon and of the high back-resistance type. Some silicon diodes will give only fair results and germanium diodes will not work at all. The 1N658 computer diode works well in this application and its performance can be compared to that of a vacuum tube. The limiter can be switched out of the circuit by shorting the diode CR<sub>1</sub>, but the leads to the switch should be as short as possible and must be shielded.

The switch that cuts the limiter in and out of the circuit may be located for convenience on or near the converter panel. Regardless of its placement, however, the leads to the switch should be shielded to prevent hum pick-up.

Several other noise limiter circuits are described in ARRL's publication, *The Mobile Manual For Radio Amateurs*. The *Mobile Manual* also describes a combination noise limiter and audio squelch circuit. Squelch circuits are designed to suppress receiver background noise in the absence of signals (see Chapter 5); their chief use is in fixed-frequency (net) operation.

At least one manufacturer (Gonset) produces a complete noise limiter unit. The unit is mounted external to the main chassis and takes operating voltages from the receiver.

## A MOBILE CONVERTER FOR 3.5 THROUGH 28 MC.

Figures 19-4 through 19-7 show a crystal-controlled converter, covering 3.5 through 28 Mc. without complex band switching or gang-tuned circuits. Plug-in coil assemblies provide rapid band changing and allow construction for either single-band or multiband operation. The converter uses the car broadcast receiver as a tunable i.f. amplifier.

Plate power requirements for the converter are approximately 20 milliamperes at 200 to 250 volts. This means that the unit can be supplied from the car-receiver power pack without overloading it.

### The Circuit

The circuit diagram of the converter is shown in Fig. 19-5. A 6BZ6 is used in the r.f. amplifier, and a 12AT7 operates as a mixer-oscillator. The oscillator is crystal-controlled and works on the low-frequency side of the signal frequency.  $J_1$ ,  $J_2$ , and  $J_3$  are the antenna-input, mixer-output and power jacks, respectively.  $S_1$  performs the switching in changing over from ham-band to broadcast input.  $S_{1A}$  and  $S_{1B}$  shift the antenna from the converter input circuit to the car receiver, and  $S_{1C}$  is the heater on-off switch.

Since the tuning of the converter is fixed, the circuits of the r.f. amplifier and the mixer must be broadbanded to pass all frequencies in any ham band. A slug-tuned coil,  $L_3$ , is used in the amplifier plate circuit, and  $RFC_1$  provides a broad-band plate load for the mixer tube  $V_{2A}$ . The grid circuit of the amplifier also uses a slug-tuned coil and includes a trimmer capacitor,  $C_1$ , that permits peaking the input for the antenna in use, or in tuning completely across a band. A slug-cored coil is used at  $L_4$  to facilitate resonating the circuit near the crystal frequency.

The frequency of the oscillator must differ from the frequency of the received signal by the frequency of the tunable i.f. amplifier. With the car broadcast receiver following the converter, the i.f. range will be from approximately 550 to 1550 kc. Since the tunable i.f. range is thus limited to a band 1000 kc. wide, the tuning

range of the system with any single crystal will be restricted to 1 Mc. This is sufficient for all except the 28-Mc. band. Two crystals are required to cover the entire 10-meter band. The first of these gives a tuning range of 28 to 28.9 Mc. and the second permits tuning 28.8 to 29.7 Mc. An accompanying frequency chart lists the crystal frequencies and the ranges over which the broadcast receiver must be tuned to cover the amateur bands.

### Construction

The input-tuning capacitor,  $C_1$ , the pilot lamp and the switch are in line across the panel of the converter as shown in Fig. 19-4. Each of these components is centered  $\frac{3}{4}$  inch down from the top of the case and each is separated from the other in horizontal plane by  $1\frac{3}{4}$  inches. The male jacks for the grid, plate and oscillator coils are below  $C_1$ ,  $I_1$  and  $S_1$  in that order. Each jack is centered  $1\frac{1}{8}$  inches up from the bottom of the cabinet.

The chassis, shown in Fig. 19-7, may be made of thin aluminum sheet and should be fastened to the side walls of the cabinet with homemade brackets, or angle stock. The sockets for  $V_{11}$  (at the right as seen in the rear view) and  $V_{22}$  are centered  $1\frac{5}{8}$  inches in from the right and left edges of the chassis, respectively.  $J_3$  is centered on the rear wall of the chassis with  $J_1$  and  $J_2$  to the right and left.

A bottom view of the converter clearly shows the components mounted below deck.

The exterior and the interior of the coil box are shown in Figs. 19-4 and 19-7. Wind the antenna coupling coils,  $L_1$  in Fig. 19-5, around the ground ends of the grid coils before the latter are soldered in place. Wind the coupling coils rather snugly but not so tightly as to prevent adjustment of the coupling to  $L_2$  during testing of the converter.



Fig. 19-4—The aluminum case for the converter measures  $3 \times 4 \times 5$  inches (Bud CU-3005 or Premier AMC-1005). Amphenol type 86-CP4 male jacks mounted on the front of the box mate with MIP 4-prong sockets mounted on the rear of the coil compartment shown in the foreground. Knobs for  $C_1$  and  $S_1$  are to the left and right, respectively, of the pilot lamp. The coil box measures  $2\frac{1}{4} \times 2\frac{1}{4} \times 5$  inches (Bud CU-3004 or Premier AMC-1004). Slug-adjustment screws for  $L_2$ ,  $L_3$  and  $L_4$  protrude through rubber grommets mounted on the front wall of the plug-in coil assembly.



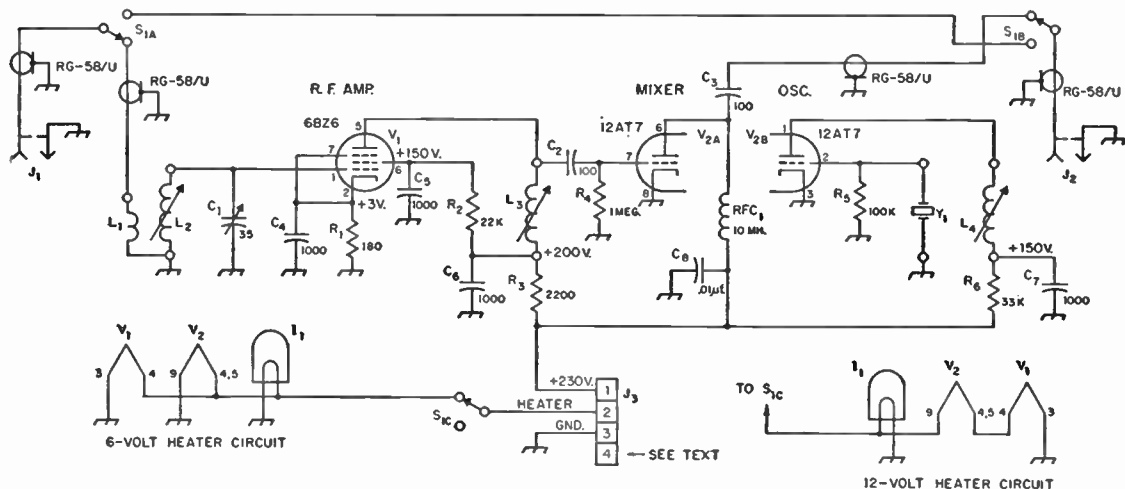

Fig. 19-5—Circuit diagram of the crystal-controlled mobile converter. Unless otherwise indicated, capacitances are in  $\mu\text{mf.}$ , resistances are in ohms, resistors are  $\frac{1}{2}$  watt.

$C_1$ —35- $\mu\text{mf.}$  midget variable (Hammarlund MAPC-35-B).

$C_2, C_3$ —100- $\mu\text{mf.}$  ceramic tubular.

$C_4, C_5, C_6, C_7$ —1000- $\mu\text{mf.}$  disk ceramic.

$C_8$ —0.01- $\mu\text{f.}$  disk ceramic.

$I_1$ —Pilot-light assembly [Johnson 147-503 with No. 44 (6-volt) or No. 1815 (12-volt) lamp].

$J_1, J_2$ —Motorola-type shielded jack (ICA 2378).

$J_3$ —4-prong male chassis connector (Cinch-Jones P-304-AB).

$L_1, L_2, L_3, L_4$ —See coil chart.

$R_1$ —180 ohms,  $\frac{1}{2}$  watt.

$R_2$ —22,000 ohms,  $\frac{1}{2}$  watt.

$R_3$ —2200 ohms,  $\frac{1}{2}$  watt.

$R_4$ —1 megohm,  $\frac{1}{2}$  watt.

$R_5$ —0.1 megohm,  $\frac{1}{2}$  watt.

$R_6$ —33,000 ohms,  $\frac{1}{2}$  watt.

RFC<sub>1</sub>—10-mh. r.f. choke (National R-100S).

$S_1$ —3-pole 3-position (used as 3 p.d.t.) selector switch (Centralab PA-1007).

$Y_1$ —See text and frequency chart (International Crystals type FA-9).

An a.c. transformer may be used for the filaments while testing the converter. The plate supply should deliver 20 milliamperes at 200 to 250 volts. A modulated-signal generator covering the bands for which the converter has been constructed is extremely helpful. To be most effective, the generator should have a 50-ohm output termination. A grid-dip meter for preliminary adjustment of the slug-tuned coils is useful, but not essential to alignment. If at all possible, the car receiver that is to be used as the tunable i.f. should be used during the testing.

Using coaxial-cable leads, connect the signal generator and the broadcast receiver to  $J_1$  and  $J_2$ , respectively. Switch  $S_1$  to the ham-band

position, and apply heater power. The receiver need not be turned on at this time, and plate power for the converter does not have to be applied. Now, rotate  $C_1$  to approximately half capacitance and then adjust  $L_2$  to resonance (use the grid-dip meter as the indicator) at the low end of the band. Move the grid-dipper over to the plate circuit of the amplifier and peak  $L_3$  at the center of the band. Next, couple the meter to  $L_4$  of the oscillator and tune the coil to the frequency of the crystal in use.

After these initial adjustments, plate power may be applied to the converter and a frequency-indicating device used to detect oscillation of  $V_{2B}$ . If the grid-dip meter is the self-rectifying type it may be used for the check. An absorption-type wavemeter with indicator or a

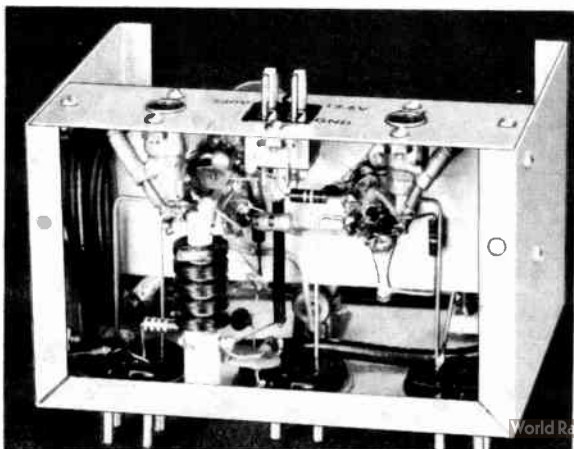

Fig. 19-6—A bottom view of the mobile converter. The amplifier tube socket at the right is mounted with Pin 7 facing toward the rear wall of the chassis.  $R_1$  and  $R_3$  are to the right and left of the socket, respectively. The socket for  $V_2$  is mounted with Pins 4 and 5 facing toward the rear of the unit.  $C_2$  is to the lower left of  $R_2$ , and RFC<sub>1</sub> is mounted on the front wall of the housing.  $C_7$  and  $R_6$  are to the left of the base of the choke.  $C_8, C_9$  and  $R_5$  are to the right of RFC<sub>1</sub>. The output coupling capacitor  $C_3$  is supported between Terminal 4 of  $J_3$  and Pin 6 of the socket for  $V_2$ .  $R_4$  and  $R_8$  are partially visible to the right and left, respectively, of the  $V_2$  socket.



Coil Chart for the Mobile Converter							
Band	Turns	Ind. Range, $\mu$ h.				Type No.	
Mc.	$L_1$	$L_2$	$L_3$	$L_4$	$L_2$	$L_3$	$L_4$
3.5-4	14	36-64	64-105	105-200	120-F	120-G	120-H
7-7.3	7	9-18	18-36	36-64	120-D	120-E	120-F
14-14.35	4	3-5	5-9	9-18	120-B	120-C	120-D
21-21.45	3	2-3	3-5	3-5	120-A	120-B	120-B
28-28.9	3	1-1.6	1.6-2.7	2.7-4.5	1000-A	1000-B	1000-C
28.8-29.7	3	1-1.6	1.6-2.7	2.7-4.5	1000-A	1000-B	1000-C

Note:  $L_1$  is wound with No. 28 d.c.c. wire at grounded end of  $L_2$ .  $L_2$ ,  $L_3$  and  $L_4$  are slug-tuned coils manufactured by North Hills Electric Co., Inc. (Mineola, L.I.)

receiver tuned to the crystal frequency (with the b.f.o. on) may also be used for the purpose.  $L_4$  should be tuned through resonance to the high-frequency side of the crystal frequency until the crystal oscillates reliably as indicated by rapid starting when plate power is turned on.

With the converter and the i.f. amplifier both turned on, and with the signal generator tuned to the center of the band, tune the receiver until the test signal is heard. Peak  $L_3$  and  $L_4$  for best response and then peak  $L_2$  with  $C_1$  set at half capacitance. The coupling between  $L_1$  and  $L_2$  may now be adjusted for optimum performance.

If the aforementioned test equipment is not available, the converter may be aligned while using a strong local of known frequency as the signal source. Of course, the signal frequency

must be in the band for which the converter is to be aligned. In using this system, first set the broadcast receiver as closely as possible to the proper i.f. frequency (see the frequency chart) and then tune  $L_4$  until the crystal oscillates. It is advisable to tune the receiver through a narrow range as the oscillator coil is being adjusted to assure that the test signal will be heard as soon as the crystal breaks into oscillation. After the signal is detected, the grid, plate and oscillator circuits may be adjusted for maximum gain.

The mobile antenna should be resonant and tightly coupled to the converter. Traps for suppressing interference caused by strong local broadcast signals that feed in through the converter to the tunable i.f. have not been included in the converter because the need for them will be entirely dependent on local broadcast-station power and frequency assignments.

(Originally described in *QST*, Nov. 1957).

(For a description of a bandswitching crystal-controlled converter, see *QST*, January, 1955, or *The Mobile Manual for Radio Amateurs*.)

Frequency Chart for the Mobile Converter		
Band Mc.	Crystal Freq., Mc.	I.F. Range Kc.
3.5-4	2.9	650-1100
7-7.3	6.4	600-900
14-14.35	13.4	600-950
21-21.45	20.4	600-1050
28-28.9	27.4	600-1500
28.8-29.7	28.2	600-1500

Note: I.f. range indicates broadcast receiver tuning range necessary for covering the associated amateur frequencies.

Fig. 19-7—Homemade L-shaped chassis, mounted on small brackets fastened to the side walls of the converter housing, is  $4\frac{15}{16}$  inches long, 2 inches wide and  $1\frac{1}{2}$  inches deep.  $V_1$  is mounted on the chassis to the right of  $V_2$  as seen in this rear view.  $J_1$ ,  $J_3$  and  $J_2$  are in line in that order from right to left across the rear wall of the chassis. An interior view of a coil compartment is shown in the foreground. Terminals of the coils are soldered directly to the socket terminals. Notice that the crystal for the oscillator is mounted adjacent to  $L_4$ .



## "HYBRID" CRYSTAL-CONTROLLED CONVERTER

The converter shown in Figs. 19-8 and 19-9 combines a 12-volt r.f. pentode and two transistors in a circuit that requires only a 12-volt d.c. source for all power requirements. As a result, it is admirably suited for use with any of the newer hybrid receivers. ("Hybrid" receivers combine tubes and transistors; the tubes are special in that they operate with only 12 volts on plate and screen.) The oscillator is crystal-controlled, and stations are tuned in by adjustment of the b.c. receiver used as a tunable i.f. amplifier.

Referring to the circuit diagram, Fig. 19-8, the r.f. stage uses a 12EK6 pentode with a fixed-tune input circuit,  $L_1L_2$ , and a plate circuit tuned from the panel through  $C_1$ . Mixer and oscillator stages both use the 2N274 transistor; the mixer input is "tapped down" on the coupling circuit to provide a good match and to maintain selectivity. In the oscillator section, crystals and plate coil are switched. It will be noted that, for simplicity in presenting the diagram, all of the coils at  $L_1$  and  $L_2$  and all of the taps on  $L_3$  are not shown. Further, all of the crystals are not shown. However, after a little study it should be apparent to anyone contemplating construction of the unit where the missing coils, taps and crystals are connected.

All of the components fit comfortably in and on a  $3 \times 4 \times 5$ -inch Minibox. Referring to Fig. 19-9, the components are mounted on the U-shaped half of the Minibox. It is intended that

the other half of the Minibox, the portion with the guide lips, be mounted under the dashboard of the car. It is then a simple matter to remove or replace the "working" portion of the converter. The crystals plug in at the back of the box and are covered by a small aluminum box that prevents their accidental damage and eliminates a source of broadcast feedthrough.

Two 3-pole 5-position ceramic rotary switch sections provide all of the necessary switching. The poles  $S_{1A}$ ,  $S_{1B}$  and  $S_{1E}$  make up the rear section. The r.f. chokes used at  $L_6$  and  $L_7$  mount directly on the front section ( $S_{1F}$  and the others).

Coil and Crystal Table for the Hybrid Converter

Range	Crystal	B.C. Receiver	$L_1$	$L_2$
3.5-4.0	2.5 Mc.	1000-1500	3 t. No. 28	68-130 $\mu$ h. (Miller 4409)
7.0-7.5	6.0 Mc.	1000-1500	2 t. No. 28	14.8-31 $\mu$ h. (Miller 4407)
14.0-14.5	13.0 Mc.	1000-1500	1½ t. No. 18	6.7-15 $\mu$ h. (Miller 4406)
21.0-21.5	20.0 Mc.	1000-1500	1 t. No. 18	3.1-6.8 $\mu$ h. (Miller 4405)
28.54-29.5	28.0 Mc.	540-1500	1 t. No. 18	1.5-3.2 $\mu$ h. (Miller 4404)

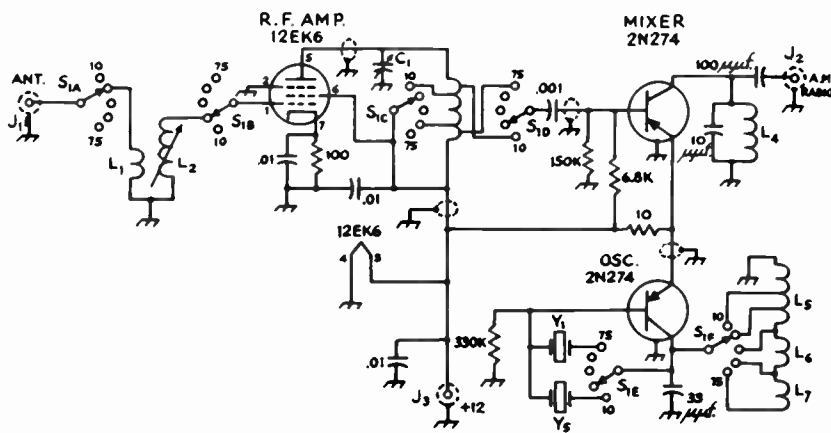

Fig. 19-8—Circuit diagram of the hybrid crystal-controlled converter. Unless specified otherwise, capacitances are in  $\mu$ f., resistances are in ohms, resistors are  $\frac{1}{2}$  watt.

$C_1$ —100- $\mu$ f. midget variable (Hammarlund HF-100).

$J_1, J_2, J_3$ —Phono jacks.

$L_1, L_2$ —See table.

$L_3$ —47 turns No. 20, 16 t.p.i., 1-inch diam. (B&W 3015 Miniductor).  $S_{1C}$  taps 5, 7, 12 and 25 turns from plate end;  $S_{1D}$  taps 4, 6, 11, 19 and 30 turns from plate end.

$L_4$ —1-mh. r.f. choke (Millen J300-1000).

$L_5$ —31 turns No. 20, 16 t.p.i.,  $\frac{5}{8}$ -inch diam. (B&W 3007

Miniductor).  $S_{1F}$  taps 9½ and 16½ turns from grounded end.

$L_6$ —25  $\mu$ h. r.f. choke (Millen J300-25)

$L_7$ —100- $\mu$ h. r.f. choke. (Millen 34300-100)

$S_1$ —Six-pole 5-position rotary ceramic switch, 3 poles per section. (Centralab PA-5 sections on PA-301 index assembly. Sections spaced  $\frac{1}{2}$  inch and  $2\frac{1}{4}$  inch from index.)

$Y_1, Y_2$ —See crystal table.

All of the input coils,  $L_1L_2$ , are mounted on the rear apron, just above the tube socket. To minimize coupling from the coils to  $L_3$ ,  $L_3$  is mounted parallel to the front panel, supported at one end by a tie point and at the other by a 1-inch ceramic insulator. Further to isolate the coils, an aluminum shield is placed between  $L_3$  and the set of input coils. The remaining coil,  $L_5$ , is mounted alongside the switch.

Tie points are used generously throughout the converter, to support components that might otherwise vibrate loose. The transistor leads are all soldered to tie points. While soldering, hold the wire in pliers or other form of "heat sink," to minimize the heat that reaches the transistor.

Note in Fig. 19-8 that some of the leads use shielded wire. These include the plate lead of the r.f. stage, the lead from  $S_{11}$  to the base of the mixer transistor and the emitter lead to the oscillator transistor. In wiring the converter, it is advisable to plan the wiring in advance, since

of necessity some wires will eventually interfere with others. If the switched leads to  $L_1$  and  $L_2$  are wired before the shield and  $L_3$  are installed, the construction will be easier than if the leads to  $L_1$  and  $L_2$  were left to the last.

With the 12EK6 removed from its socket, the converter should not draw more than 3 ma. or so. The oscillator can be checked for oscillation by listening for it on a communications receiver. If the oscillator should fail to work on 15 or 10 meters, the taps on  $L_5$  may have to be moved.

Replace the tube in its socket and adjust the input coils,  $L_2$ , to resonance with a grid-dip meter. With the car radio tuned to the middle of its range, touch up  $L_2$  on each band for maximum noise. Peak  $C_1$  for maximum gain while listening to a weak signal, and once more check the tuning of  $L_2$ . On the higher frequencies it will be possible to hear "image" signals on occasion. This is an inescapable result of using a low i.f. (the b.c. receiver) and not an indication that the converter isn't working properly.

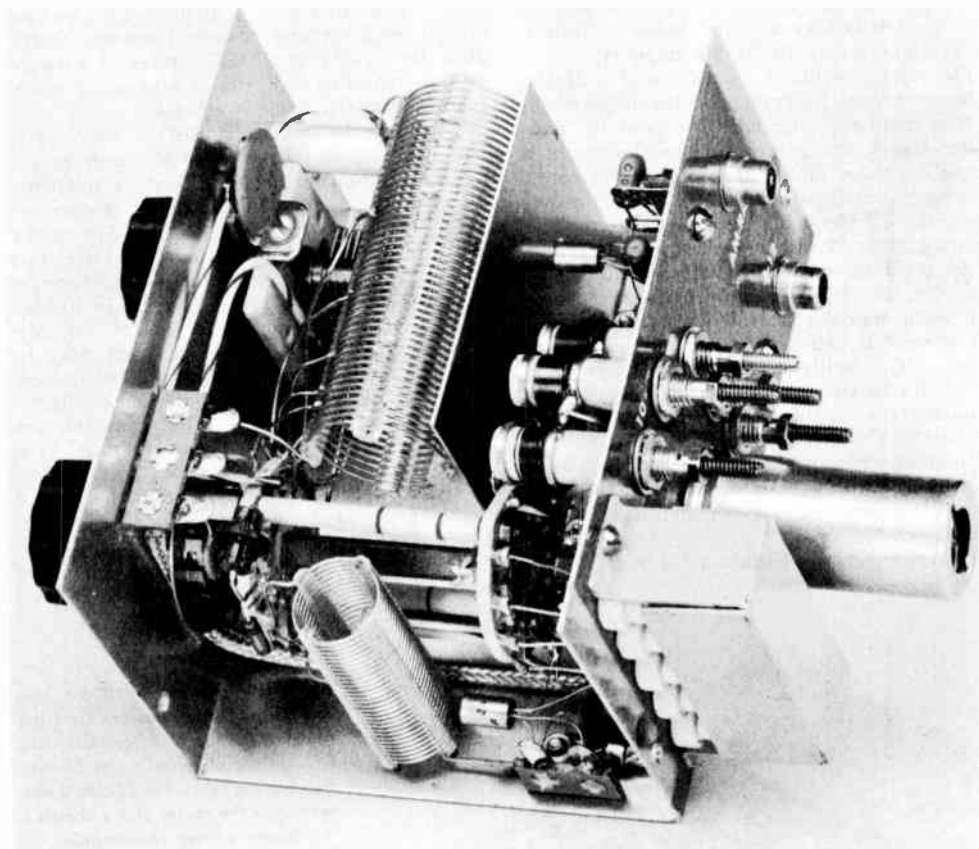

Fig. 19-9—The 12-volt hybrid crystal-controlled converter with the housing removed. The large coil (center) is the interstage coupling coil between r.f. tube and mixer transistor. The tube and crystals plug in at the rear, and the input tuning slugs project out the rear. The antenna jack cannot be seen; it is below the tube socket. The only panel controls are interstage tuning and band switch.

## CRYSTAL-CONTROLLED CONVERTERS FOR 50 AND 144 MC.

The mobile converters shown in Figs. 19-10 through 19-13 combine simplicity with good v.h.f. design practice. Although only two tubes are used in each, the converters include a stage of r.f. amplification plus crystal-controlled oscillators. Ten meters was chosen as the i.f. because when the broadcast receiver is used as the tunable i.f. for v.h.f. converters images are a problem, and only 1 Mc. at a time could be tuned. The converters described here, therefore, are designed to work into a 10-meter converter or receiver. This can be a tunable converter which in turn works into the broadcast receiver, or a complete self-contained 10-meter receiver.

### The 50-Mc. Unit

The circuit diagram for the 50-Mc. unit is shown in Fig. 19-11. A 6AK5 is used as an r.f. amplifier. The same gain with lower noise can be obtained with a cascode-type dual-triode amplifier, but the performance of this pentode stage is satisfactory and its design is considerably simpler than the triode amplifier.

The crystal oscillator makes use of a 22-Mc. overtone crystal. A crystal on the required injection frequency eliminates the need for multiplier stages, and makes possible the use of a simple oscillator circuit. The 10-meter receiver or converter is tuned from 28 to 30 Mc. in covering 50 to 52 Mc. If a general coverage receiver covering 26 to 30 Mc. is used, a 24-Mc. crystal in the oscillator will allow tuning 50 to 54 Mc. However, any injection frequency may be used to cover a desired portion of the band.

The pentode half of the 6U8 tube is used as a mixer. The oscillator and mixer sections are in the same tube envelope so there is enough stray coupling between the two for adequate oscillator injection.

The diagram shows the heaters connected for 12 volts. If 6-volt operation is desired, the heaters are connected in parallel and  $R_1$  is disregarded.

The converters are built in a  $5\frac{1}{4} \times 3 \times 2\frac{1}{8}$ -

inch Minibox. All of the parts are mounted on the bottom half of the box while the upper half (the one with lips) is fastened under the car dash. The bottom half containing all the components can be slid in and out for easy servicing.

Fig. 19-10 shows the placement of most of the components. The output peaking control  $C_1$  and switch  $S_1$  are mounted on one side of the chassis to form the front panel. The tubes, slug-tuned inductances, crystal socket and antenna connectors are mounted directly opposite on the back wall. Two tie-points are bolted to the base of the box for connecting and supporting leads and components. When wiring, make the r.f. leads as short and direct as possible.

### The 144-Mc. Unit

The circuit diagram for the 144-Mc. converter is shown in Fig. 19-13. Two 6U8 tubes are used with the pentode section of one tube acting as the r.f. amplifier followed by the triode-section mixer. The other 6U8 is used as an overtone crystal oscillator and pentode frequency multiplier. By combining all the features of a 4-tube crystal-controlled converter in a two-tube model space-saving simplicity is achieved.

The same basic circuit used in the 50-Mc. model is followed in the 144-Mc. unit except for the addition of a multiplier stage following the crystal oscillator. The oscillator operates at 38,666 Mc. and is multiplied to 116 Mc. in the tripler stage. As in the 50-Mc. converter, this unit is designed to work into a 10-meter receiver or converter. If the i.f. tunes from 27 to 30 Mc., the converter will tune from 144 to 147 Mc. However, any segment of the band may be tuned by choosing the proper crystal frequency.

Unlike the 50-Mc. converter, the oscillator-multiplier stages of the 144-Mc. converter are physically separated from the mixer stage. It is necessary, therefore, to couple the 116-Mc. energy from the multiplier stage to the grid of the mixer. Capacitor  $C_2$  is used for this purpose. It consists of a pair of twisted hook-up wires with one end of one lead connected to the mixer

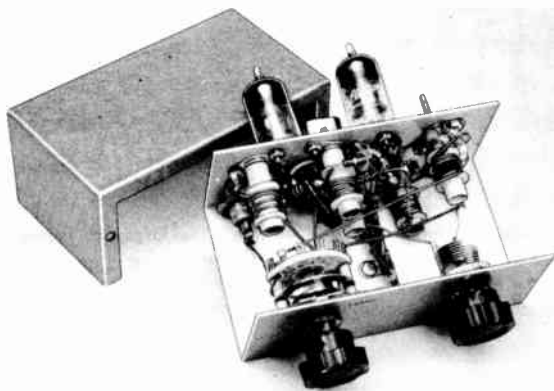

Fig. 19-10—View of the 50-Mc. converter. The inductances are from left to right: (bottom)  $L_7$ , (top)  $L_{5L6}$ ,  $L_{3L4}$ ,  $L_1L_2$ . The top of crystal  $Y_1$  can be seen between the tubes. The 22-ohm 2-watt resistor in the center of the chassis is the heater current compensating resistor, used for 12-volt operation. Input and output antenna connectors are mounted on opposite ends of the back wall. Power is fed to the unit through the twisted power cable running in from the left side of the photograph.



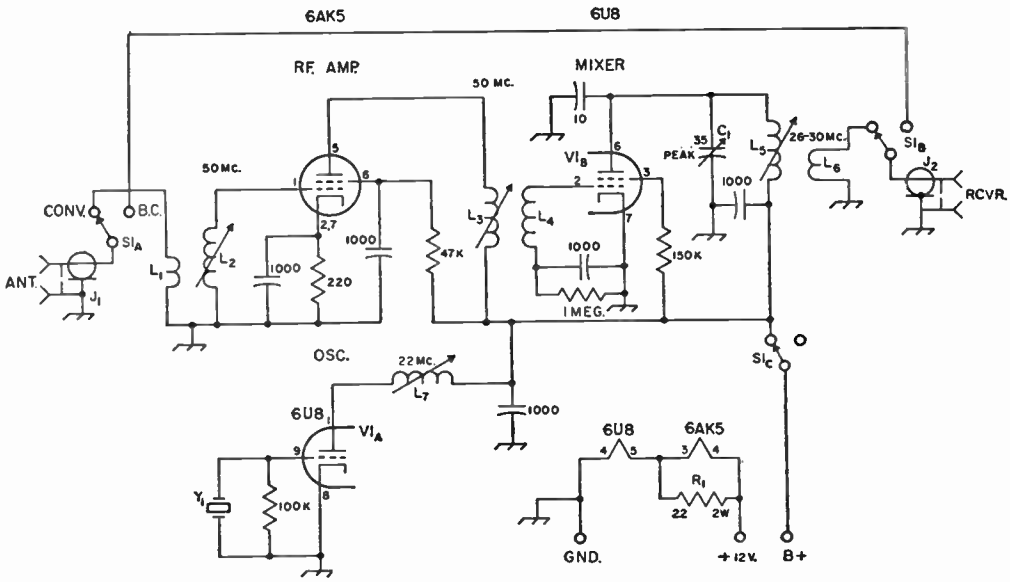

Fig. 19-11—Schematic diagram for the 50-Mc. mobile converter. All resistors 1/2 watt unless otherwise specified. Capacitor values below 0.001  $\mu\text{f.}$  are in  $\mu\text{f.}$  All 0.001  $\mu\text{f.}$  capacitors are disk ceramic. Other fixed capacitors are tubular ceramic.

- $C_1$ —35- $\mu\text{f.}$  midget variable capacitor (Hammarlund MAPC-35-B).
- $J_1, J_2$ —Automobile type antenna connectors.
- $L_1$ —3 turns No. 20 insulated wire, close-wound over cold end of  $L_2$ .
- $L_2$ —14 turns No. 20 enam. wire, close-wound on 1/2 inch slug tuned coil.
- $L_3$ —16 turns No. 20 enam. wire, close-wound on 1/2 inch slug tuned coil form.
- $L_4$ —2 turns No. 20 insulated wire, close-wound over cold end of  $L_5$
- $L_5$ —9 turns No. 20 enam. wire, close-wound on 1/2 inch

- slug tuned coil form.
- $L_6$ —2 turns No. 20 insulated wire, close-wound over cold end of  $L_5$ .
- $L_7$ —28 turns No. 30 enam. wire, close-wound on 1/2 inch slug tuned coil.
- $R_1$ —22-ohm 2-watt resistor (used for 12-volt heater operation only).
- $S_1$ —Three-pole two-position rotary switch (Centralab PA-2007).
- $Y_1$ —22 Mc. overtone crystal. (International Crystal type FA-5 for miniature socket, FA-9 for standard socket).

grid and the end of the other lead connected to the multiplier plate.

The circuit diagram shows the heaters connected for 12-volt operation. For 6 volts, the heaters should be connected in parallel.

The same basic outline of construction used in the 50-Mc. converter is followed in the 144-Mc. unit. Fig. 19-12 shows how output peaking

control  $C_1$  and the control switch  $S_1$  are mounted on the front wall of the chassis while most of the remaining parts are secured to the rear surface. A single tie point is mounted on the bottom of the chassis for connecting and supporting various leads. The input and output antenna connectors are mounted at opposite ends of the back wall of the chassis.

Fig. 19-12—View of the 144-Mc. converter. The inductances from left to right are: (top)  $L_1, L_2, L_3, L_4, L_5, L_6$ , (bottom)  $L_7$  and  $L_8$ . All components except  $S_1$  and  $C_1$  are mounted on the back wall of the chassis. A single tie point in the bottom of the channel supports various leads and provides junctions for sundry connections. The input and output antenna connectors are placed near the bottom right and left of the back panel. The crystal  $Y_1$  is between the two tubes. Converter power is fed through the twisted cable which passes through a hole and grommet in the back wall of the chassis.

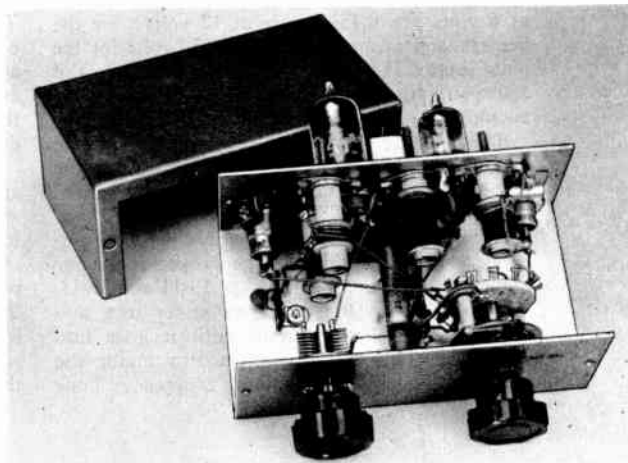



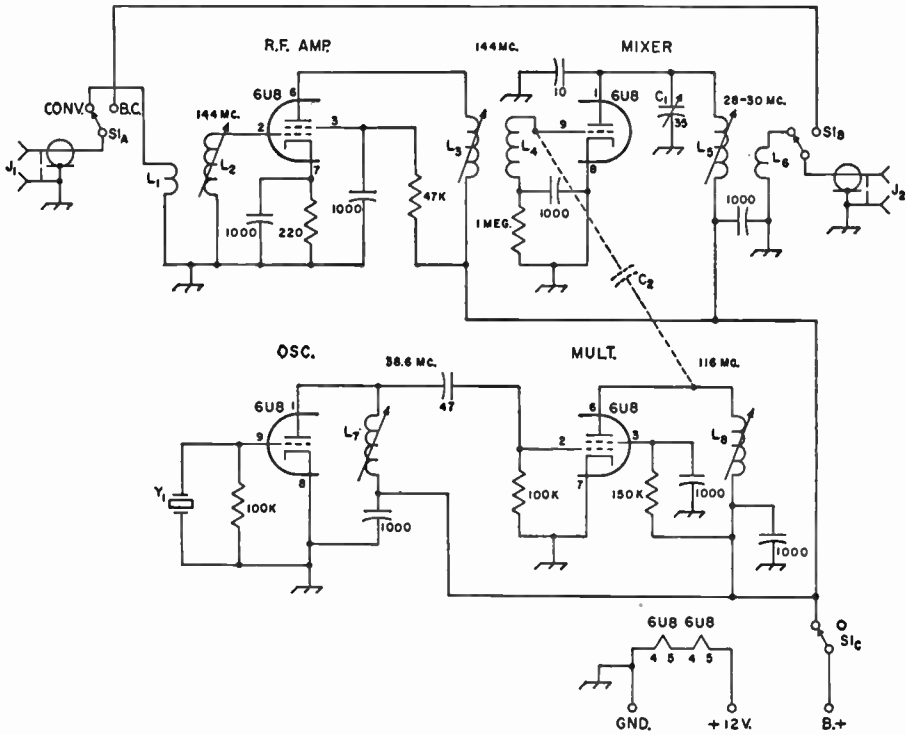

Fig. 19-13—Schematic diagram for the 144-Mc. converter. All resistors ½ watt unless otherwise specified. Capacitor values below 0.001  $\mu\text{f.}$  are in  $\mu\text{f.}$  All 1000- $\mu\text{f.}$  capacitors are disk ceramic. Other fixed capacitors are tubular ceramic.

C<sub>1</sub>—35- $\mu\text{f.}$  midget variable capacitor (Hammarlund MAPC-35-B).

C<sub>2</sub>—Oscillator injection capacitor (see text).

J<sub>1</sub>, J<sub>2</sub>—Automobile type antenna connectors.

L<sub>1</sub>—2 turns No. 18 enam., ¾ inches long, on ½ inch slug tuned coil form.

L<sub>2</sub>—2 turns No. 20 insulated wire, close wound over cold end of L<sub>1</sub>.

L<sub>3</sub>—2 turns No. 18 enam., ¾ inches long, on ½ inch slug tuned coil form.

L<sub>4</sub>—2 turns No. 20 insulated wire, close wound over cold end of L<sub>3</sub>.

L<sub>5</sub>—9 turns No. 24 enam., close wound on ½ inch slug tuned coil form.

L<sub>6</sub>—2 turns No. 20 insulated wire, close wound over cold end of L<sub>5</sub>.

L<sub>7</sub>—10 turns No. 24 enam., close wound on ½ inch slug tuned coil form.

L<sub>8</sub>—5 turns No. 18 enam., ½ inches long, on ½ inch slug tuned coil form.

S<sub>1</sub>—Three-pole two-position rotary switch (Centralab PA-2007).

Y<sub>1</sub>—38.666 Mc. overtone crystal (International Crystal Co. type FA-5 for miniature socket, FA-9 for standard socket).

**Testing the Converters**

The 50-Mc. converter requires 0.625 ampere at 6 volts (or 0.45 ampere at 12 volts) for the heaters, and around 15 to 20 at 150 volts for the plate supply. If the car radio delivers in excess of 180 volts, the plate voltage on the converter should be dropped by a series resistor.

The 144-Mc. converter requires 0.9 ampere at 6 volts (or 0.45 ampere at 12 volts) for the heaters. A plate voltage of 150 volts is required at about 30 ma.

All tuned circuits should be checked for resonance with a grid-dipper. The proper frequency for each circuit is given in Figs. 19-11 and 19-13. Apply power to the converter under test, and adjust the oscillator circuit until it goes into oscillation. This can be confirmed by tuning the home receiver to the oscillator frequency. Tune

the oscillator inductance until the maximum oscillator signal is obtained. Now feed a 50 or 144-Mc. signal into the converter under test. This signal may come from a signal generator or a grid-dip meter, it may be a harmonic from a low-frequency transmitter stage, or it may be an actual signal from the antenna. Go through the converter stage by stage, adjusting the inductances for peak output.

After the first run the converter should be spot-checked through the entire band to make sure that the over-all response is fairly uniform.

The output capacitor C<sub>1</sub> is used to peak the output circuit during normal operation, and during the preliminary tune-up it must be peaked at each frequency on which the converter is checked. L<sub>6</sub> is adjusted so that C<sub>1</sub> peaks at mid-capacitance in the center of the i.f. tuning range.

## A 40-WATT "EXTENDED-BAND" MOBILE TRANSMITTER

The mobile transmitter shown in Figs. 19-14 through 19-20 is capable of 40 watts input on any band from 160 to 6 meters. It is not band-switched; coil data are given for each band, and it is only a matter of a few minutes to unsolder the coils and substitute those for another band. This single-band construction permits maximum efficiency with minimum expenditure.

Referring to the circuit diagram in Fig.

19-16, only two tubes are used in the r.f. section. The pentode portion of a 6CX8 is used as a crystal-controlled oscillator which, on bands 160 through 40 meters, drives the 12GJ5 output amplifier directly. On the higher frequency bands, the triode section of the 6CX8 is used as a frequency multiplier. To modify the diagram for low-frequency operation, break the two plate leads at the points marked "x"

Fig. 19-14—Front view of the "extended-band" mobile transmitter, removed from its case. The transmitter uses a transistor modulator and a separate semiconductor power supply. Panel controls, counterclockwise from the meter, are meter switch, operating switch, gain control, power switch, grid tuning, output loading and plate tuning. An L-shaped shield of perforated aluminum normally covers the center (amplifier) compartment.

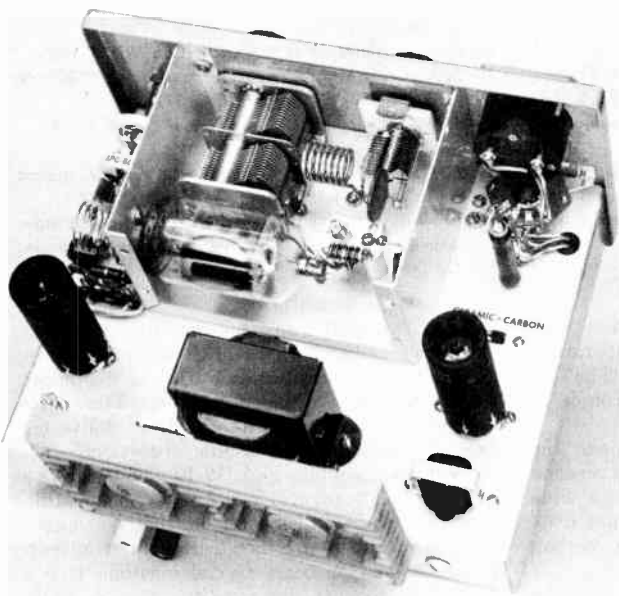
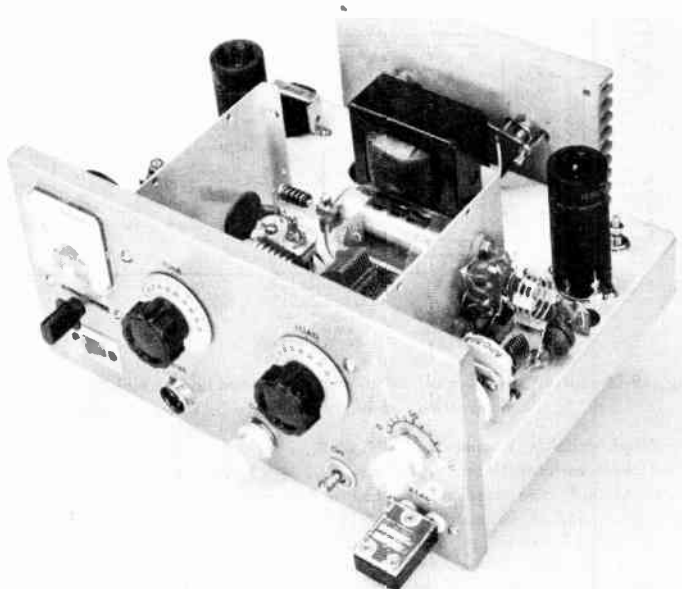

Fig. 19-15—Rear view of the transmitter with coils for 6-meter operation in place. The cast-aluminum transistor heat sink, at bottom of photograph, is a Cesco type HS-4. A slot is cut in the rear of the cabinet to clear the heat sink. All transistors are mounted using mica spacers (furnished with transistors) smeared with silicone heat-conducting grease.

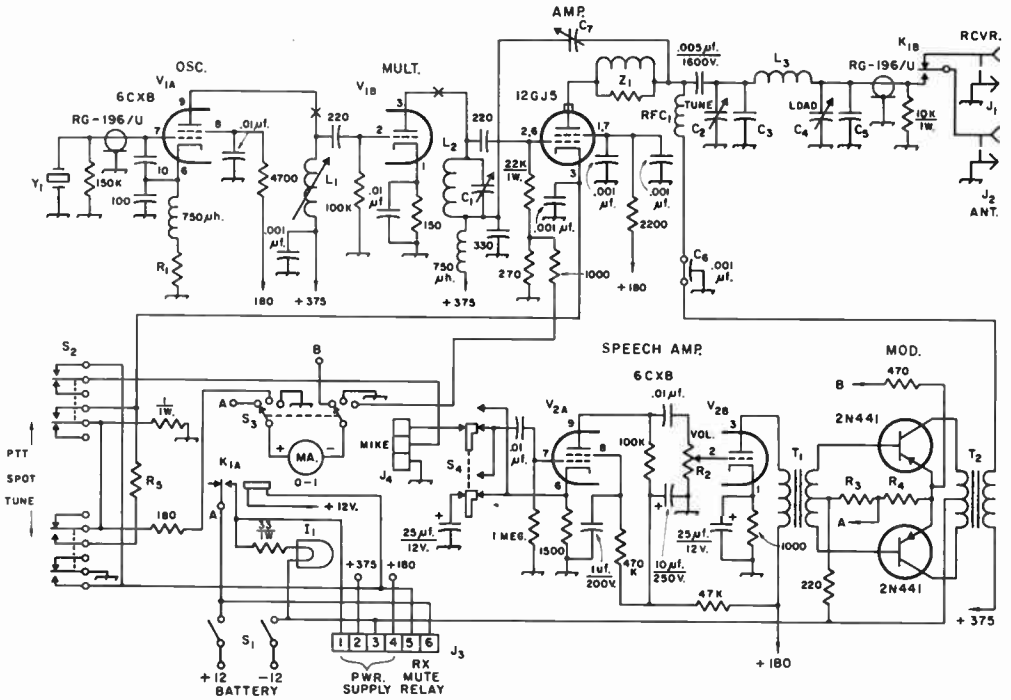

Fig. 19-16—Circuit diagram of the 40-watt "extended-band" mobile transmitter. Unless noted otherwise, resistances are in ohms, resistors are 1/2 watt, capacitances are in picofarads.

- C<sub>1</sub>—50-pf. variable (Hammarlund APC-50-B).
- C<sub>2</sub>—100-pf. variable (Hammarlund HF-100).
- C<sub>3</sub>, C<sub>5</sub>—470-pf. mica, used only on 160 and 80 meters.
- C<sub>4</sub>—2-gang 365-pf. variable (Miller 2112), sections in parallel except on 6 meters where only one section used.
- C<sub>6</sub>—0.003 μf. on 160 meters, 470 pf. on 80 meters.
- C<sub>0</sub>—0.001-μf. feedthrough (Centralab FT-1000).
- C<sub>7</sub>—2.9-pf. variable (Johnson 9M11).
- I<sub>1</sub>—6-v. lamp, part of S<sub>2</sub> (GE 1768).
- J<sub>1</sub>—Phono jack.
- J<sub>2</sub>—Broadcast antenna connector (Cinch-Jones 81F).
- J<sub>3</sub>—Six-connector chassis socket (Cinch-Jones AB S-306).
- J<sub>4</sub>—Two-pin microphone receptacle (Amphenol 80 PC2F).
- K<sub>1</sub>—D.p.d.t. relay, 12-v. coil (Potter & Brumfield KT 11D).
- L<sub>1</sub>, L<sub>2</sub>, L<sub>3</sub>—See table.
- R<sub>1</sub>—1000 ohms; required on 80 and 40 meters only.
- R<sub>2</sub>—0.5-megohm volume control.
- R<sub>3</sub>—3.3-ohm ±5%, 1 watt.

- R<sub>4</sub>—0.1-ohm ±5% 5-watt wirewound (IRC AS-5).
  - R<sub>5</sub>—500 ohms, 10-watt wirewound.
  - RFC<sub>1</sub>—160 through 10 meters: 2.5-mh, 125-ma. (Millen 34300-2500). Six meters: 8.2 μh., 300-ma. (Miller RFC-50).
  - S<sub>1</sub>—D.p.s.t. toggle, 6 amp. at 125 v.a.c. (C-H 8370-K7).
  - S<sub>2</sub>—Three-position illuminated lever switch (Switchcraft 25312).
  - S<sub>3</sub>—Three-position double-pole lever switch (Centralab PA-7001).
  - S<sub>4</sub>—D.p.d.t. miniature slide switch (Con Wirt G126).
  - T<sub>1</sub>—300 mw. transistor output transformer, 3000 to 16/8/4 ohms (Knight 62 G 371).
  - T<sub>2</sub>—6.3-v. 3-amp. filament transformer (Triad F-16X).
  - Y<sub>1</sub>—See table.
  - Z<sub>1</sub>—Five turns No. 20 on 47-ohm 1-watt resistor, spaced to occupy full length.
- (Knight transformer carried by Allied Radio, Chicago. Milliammeter is TM-400, carried by Lafayette Radio, N.Y.C.)

and connect the plate of V<sub>1A</sub> to the "hot" end of the C<sub>1</sub>L<sub>2</sub> tank circuit. For stable operation, the 12GJ5 amplifier is neutralized. The pi-network output circuit is designed to couple to a load on the order of 50 ohms.

The speech amplifier uses a 6CX8, and the input circuit is designed to take either a ceramic (or crystal) or a carbon microphone; a slide switch, S<sub>4</sub>, makes the changeover a simple matter. When switched for use with a carbon microphone, the grid of the input stage is grounded and the microphone works into the

cathode. A small transistor output transformer drives the bases of a pair of 2N441 modulators, and a filament transformer is used as the output transformer back to the r.f. amplifier. The simple yet versatile modulator is capable of delivering over 20 watts of audio at low distortion.

The power supply, Figs. 19-19 and 19-20, is a separate unit housed in a 3 × 4 × 5-inch Mini-box mounted at a distance from the transmitter.

Control circuits are mounted on the transmitter panel, and S<sub>2</sub> bears special mention. It is a 3-position, locking, lever switch that is back-

illuminated (by  $I_1$ , Fig. 19-16). Depending upon the position of the switch, however, the color of the illumination changes. The switch offers a number of colors; this particular one was set up to be red on PTT (push-to-talk), blue on SPOT (frequency setting) and orange on TUNE. In the SPOT position an external receiver-muting relay is disabled along with the amplifier so that the oscillator can be heard in the receiver. In the TUNE position the amplifier is cathode-biased by  $R_5$  to limit the off-resonance plate current and prevent the power supply from dropping out of oscillation during mistuning conditions.

The meter switch,  $S_3$ , allows the single meter to indicate grid, cathode or modulator current. With the resistors shown, the full-scale readings are 10 ma., 200 ma. and 5 amperes, respectively.

**Construction**

The transmitter is built on the aluminum chassis that is included with the  $4\frac{7}{16} \times 9\frac{1}{4} \times 7\frac{1}{4}$ -inch cabinet (California Chassis LTC-464). The amplifier section is enclosed in a modified section of a  $3 \times 4 \times 5$ -inch Minibox, as shown in Figs. 19-14 and 19-15. A  $\frac{1}{4}$ -inch strip is removed from the Minibox to allow it to fit in the cabinet, and a cover of perforated aluminum is bolted in place at the top and rear.

Fig. 19-15 shows the  $1\frac{1}{2} \times \frac{3}{8}$ -inch strip of copper, mounted on a 1-inch long ceramic insulator, that serves as a support for  $C_7$  and a tie-point for  $Z_1$ ,  $RFC_1$  and the 0.005- $\mu$ f. plate-blocking capacitor.

Referring to Fig. 19-14, the grid tuning capacitor,  $C_1$ , is mounted on a small aluminum bracket. The capacitor is insulated from the panel shaft by a small shaft coupling (Millen 39001). "Hot" r.f. leads passing through the chassis, as the lead from  $K_{1B}$  to  $C_4$  (visible in Fig. 19-17), were made with feed-through bushings (National TPB).

COIL TABLE				
Band	$L_1$	$L_2$	$L_3$	$Y_1$
160	Not used, pentode tuned by $C_1$	50- $\mu$ h. choke (Millen 34300-50)	18 turns A, <sup>1</sup> 2-inch ferrite <sup>2</sup>	1.8 Mc.
80	As above	24- $\mu$ h. choke (Miller 4626)	14 turns A, 1½-inch ferrite	1.8 or 3.5
40	As above	10- $\mu$ h. choke (Miller 4612)	11 turns A, 1-inch ferrite	3.5 or 7 Mc.
20	7 Mc. : 20 $\mu$ h. approx. (Miller 4407)	2.4- $\mu$ h. choke (Miller 4606)	18 turns A	3.5 or 7 Mc.
15	As above	1.5- $\mu$ h. choke (Miller 4604)	12 turns A	7 Mc.
10	14 Mc. : 7½ $\mu$ h. approx. (Miller 4406)	0.75- $\mu$ h. choke (Miller 4592)	9 turns B <sup>3</sup>	7 Mc.
6	25 Mc. : 2½ $\mu$ h. approx. (Miller 4404)	3 turns B	7 turns No. 11, ½ diam., 8 t.p.i.	8.3 Mc.

<sup>1</sup> Material A is No. 20 wound 16 t.p.i., ⅜ diam. (B & W 3007).  
<sup>2</sup> Ferrite rod is ½-inch diameter (Lafayette Radio, N.Y.C., MS-333)  
<sup>3</sup> Material B is No. 18 wound 8 t.p.i., ⅜ diam. (B & W 3010).

Fig. 19-17—Bottom view of the mobile transmitter. The binding posts at the rear of the unit are for the 12-volt connections (Johnson 111 series). Shielded wire is used to the microphone connector and to the gain control.

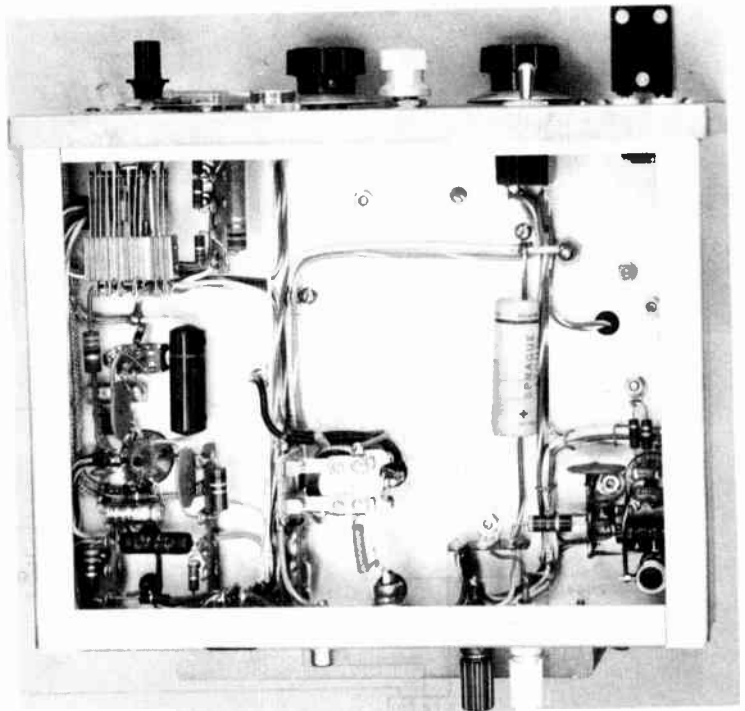
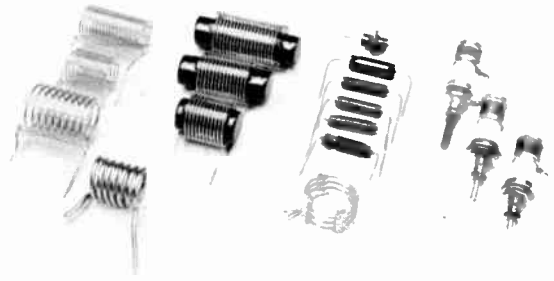

Fig. 19-18—Coils used in the transmitter. Ferrite rod used in coils on lower frequencies raises inductance and Q without sacrificing space.



**Testing**

The power supply should deliver voltages of approximately 375 and 180. If any difficulty is experienced with lack of oscillation, check the wiring on the primary side of  $T_1$  (Fig. 19-20).

Recommended crystal frequencies for operation in the various bands are given in the coil

table. Coils and padder capacitor should be selected from the table to suit the band to be used.

Coils  $L_1$  and  $L_2$  can be resonated to the proper frequency with a grid-dip meter, or they can be adjusted for maximum deflection on an absorption wavemeter with  $S_2$  in the spot position. The amplifier should be resonated in the TUNE position with  $C_4$  at maximum capacitance and with grid drive applied. The final can then be loaded in the PRT condition to a cathode-current condition of 100 to 120 ma. The grid current should run about 2 ma.

Under idling conditions the modulator current should be about  $\frac{1}{4}$  ampere, kicking up on voice peaks to about 2 amperes.

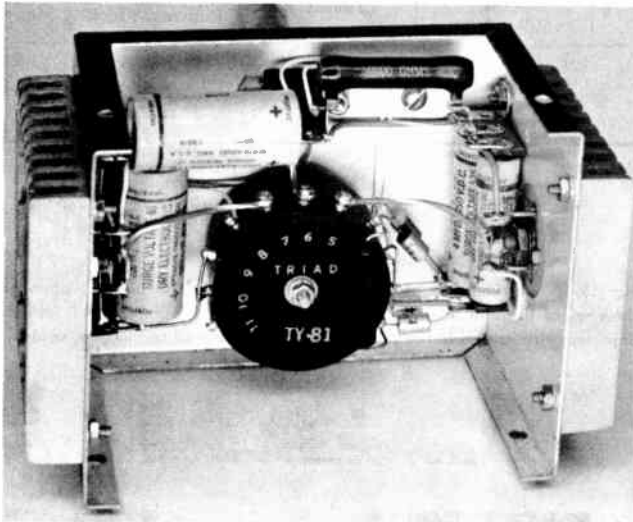

Fig. 19-19—Power supply for the 40-watt mobile transmitter. The two 12-volt leads between the transmitter and this supply (in the homemade 4-wire connecting cable) should be no smaller than No. 14. The homemade cable is shielded by a length of  $\frac{3}{8}$ -inch copper braid (Belden 8672) and covered with plastic tubing. Each end of the braid is connected to the corresponding chassis through a spade lug.

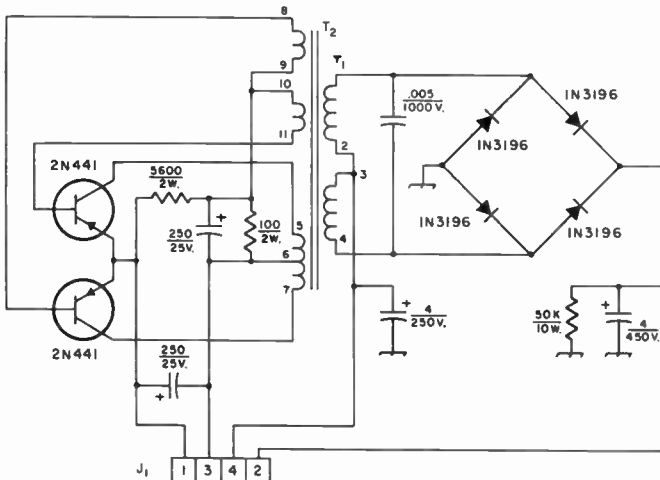

Fig. 19-20—Circuit diagram of the power supply. Capacitances are in  $\mu$ f., resistances are in ohms.

$J_1$ —Four-connector chassis socket (Cinch-Jones AB S-304).

$T_1$ —Transistor power transformer, 375 v.c.t. at 200 ma., 12-v. input (Triad TY-81).

Plugs on connecting cable between power supply and transmitter are Cinch-Jones CCT P-304 and CCT P-306. Muting relay in receiver is s.p.d.t. miniature, 12-v.d.c. coil (Potter & Brumfield RS 5D).



## A 65-WATT MOBILE TRANSMITTER

The transmitter shown in Figs. 19-21 through 19-27 is a compact (14 inches wide,  $11\frac{3}{4}$  deep and  $3\frac{1}{2}$  inches high) self-contained unit featuring a transistorized modulator and power supply. The output stage is a plate-modulated 6883 (12.6-volt heater version of the 6146). When the transmitter is being used the front section drops down, as shown in Fig. 19-21, to reveal the panel controls. Latches on either side secure the hinged section and prevent its rattling.

Referring to the circuit diagram, Fig. 19-24, a Nuvistor v.f.o. in the 160-meter band is followed by a 12BA6 stage driven at 80 meters. This in turn is followed by a 12AU6 frequency

multiplier that works "straight through" when the output frequency is 80 or 40 meters; it doubles to 40 meters when the output frequency is 20 or 15 meters, and it quadruples to 20 when the output band is 10 meters. A 6417 driver works "straight through" on all bands except 10 meters, when it is operated as a doubler. The output stage uses a Harrington Electronics GP-50 tank circuit for coupling to the antenna; this prefabricated unit is intended for use with link coupling, but in this application a pin-network circuit is used and the coupling link is put to work with a germanium diode in an output-indication circuit. The loading control drives a dual capacitor, and a loading switch,  $S_3$ , allows one or two sections of the variable to be used or for additional fixed capacitors to be connected.

In the modulator circuit, a two-stage speech amplifier is used ahead of the 2N242 driver to bring the carbon-microphone signal to a useful level. The driver transformer,  $T_1$ , is actually a transistor output transformer, but it has the right ratio to give proper push-pull drive for the 2N41 modulators. The microphone jack has provision for a push-to-talk switch on the microphone; the push-to-talk circuit is used to control a relay,  $K_1$ , that doubles as antenna changeover relay and power switch.

The power supply has two transistors that oscillate at several hundred c.p.s.; this a.c. is



Fig. 19-21—The 65-watt mobile transmitter has a Nuvistor v.f.o., a 6146 output stage and transistors in the modulator and power supply. In this view the sheet-metal top and sides have been removed to show the arrangement of parts. The panel carrying the meter and switches (see Fig. 19-23) is recessed in a  $3\frac{1}{2}$  high  $\times$   $2\frac{3}{4}$  deep by 14-inch box; the box is hinged and folds up when the transmitter is not in use. Major chassis is built from  $\frac{3}{8}$ -inch wide by  $\frac{1}{8}$ -inch thick aluminum angle and a  $9 \times 14$ -inch sheet of aluminum. A ventilation hole covered with cane metal is partially visible below the 6146 (center).

The 6883 socket is mounted on a  $2 \times 4\frac{1}{2} \times 3\frac{1}{4}$ -inch miniature chassis (Bud CB-1625) that houses the multiplier and driver plate coils; see Fig. 19-26. Controls (upper panel) from left to right are v.f.o. tuning, band-switch (upper) and driver tune, output loading switch, loading, plate tuning and plate bandswitch. Toggle switch just visible under the plate tuning control is the on-off switch in the 12-volt line.

Controls on the bottom panel, from left to right, are gain (above the microphone jack), tune switch, zero switch, and meter switch above the key jack.

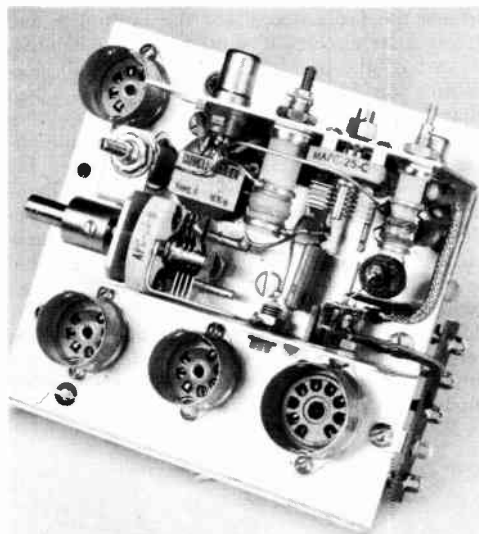

Fig. 19-22—The v.f.o. section is built in the U-shaped portion of a  $3\frac{1}{4} \times 2\frac{1}{2} \times 1\frac{1}{2}$ -inch Minibox (Bud CU-2101-A) mounted on a sheet of aluminum; the other half of the Minibox serves as the cover. The Nuvistor socket and the oscillator coils are mounted on one side of the Minibox. Jack  $J_1$  is mounted on the other side of the Minibox and is visible between the two right-hand tube sockets.

$C_1$ —25- $\mu$ f. variable (Hammarlund APC-25-B).  
 $C_2$ —200- $\mu$ f. variable (Part of Harrington Electronics\* GP-50 tank assembly).  
 $C_3$ —Dual variable capacitor, 365  $\mu$ f. per section (Miller 2112).  
 $CR_1, CR_2$ —600 p.i.v. 750-ma. silicon rectifier (Sarkes Tarzian 1N2484).  
 $J_1, J_2$ —Phono jack.  
 $J_3$ —Coaxial chassis receptacle (SO-239).  
 $J_4$ —Three-conductor phone jack.  
 $J_5$ —Closed-circuit phone jack.  
 $K_1$ —D.p.d.t. antenna relay, 12-volt coil (Advance AH/C2/12VD).  
 $L_1$ —40  $\mu$ h. (Miller 4408, 30 to 69  $\mu$ h.).  
 $L_2$ —16–24- $\mu$ h. adjustable inductor (Miller 4507).  
 $L_3$ —68–130- $\mu$ h. adjustable inductor (Miller 4409).  
 $L_4$ —9–16- $\mu$ h. adjustable inductor (Miller 4506).  
 $L_5$ —24–35- $\mu$ h. adjustable inductor (Miller 4508).  
 $L_6$ —100- $\mu$ h. r.f. choke (Millen 34300-100).  
 $L_7$ —0.9–1.6- $\mu$ h. adjustable inductor (Miller 4403).  
 $L_8$ —1.5–3.2- $\mu$ h. adjustable inductor (Miller 4404).  
 $L_9$ —3.1–6.8- $\mu$ h. adjustable inductor (Miller 4405).  
 $L_{10}$ —15–31- $\mu$ h. adjustable inductor (Miller 4407).  
 $L_{11}$ —68–130- $\mu$ h. adjustable inductor (Miller 4409).

\*Harrington Electronics, Box 189, Topsfield, Mass. v. at 200 ma. output (Triad TY-84).

$L_{12}$ —Part of Harrington Electronics\* GP-50 tank assembly.  
 $P_1$ —Phono plug.  
 $R_1$ —One to two feet of heavy (No. 12 or so) wire, adjusted to give 10-ampere full-scale reading. See text.  
 $S_1$ —3-pole 5-position rotary switch, two sections. (Made from two Centralab PA-3 sections and one PA-301 index assembly).  
 $S_2$ —Part of Harrington Electronics GP-50 tank assembly.  
 $S_3$ —10-position single pole, progressively unshorting (Centralab PA-13 section and PA-301 index assembly).  
 $S_4$ —S.p.s.t. toggle switch.  
 $S_5$ —Two-pole 6-position (4 used) rotary ceramic, non-shorting (Centralab PA-2003).  
 $S_6$ —15-ampere 125-volt toggle switch (Cutler-Hammer 7361K5).  
 $T_1$ —48-ohm c.t. to 3.2/8/16-ohm secondary. 3.2-ohm tap used as center tap for secondary. (Thordarson TR-61).  
 $T_2$ —40-watt output transformer, 6-ohm c.t. primary to 6000-ohm secondary (Triad TY-66A).  
 $T_3$ —Toroidal power transformer, 12.6 v. input, 300/600

stepped up through  $T_3$  and rectified in a dual circuit that provides 600- and 300-volt outputs.

To eliminate mechanical linkages, two band switches are used. One,  $S_1$ , switches a padding capacitor across the v.f.o. on all bands but 80 meters (to restrict the tuning range) and also selects the proper coils for the multiplier and driver plate circuits. The other band switch,  $S_2$ , is part of the pre-fabricated tank circuit. Remembering to turn two band switches when changing bands is no great trick.

The meter switch,  $S_5$ , allows the 0-1 milliammeter to be used as a 0-10 milliammeter for measuring grid current and as a 0-200 milliammeter for measuring cathode current. The resistance of  $R_1$  was beyond the limits of measurement of the lab equipment, but it was adjusted to give a 0-10 ampere range to the meter when switched to the MOD position. If the builder does not have access to an ammeter in this range, he can guess at the value of  $R_1$  and use anything that holds the meter on scale during modulation peaks.

When a transistor power supply is overloaded it stops working. This means that under normal conditions a transistor power supply would not continue to function if the final amplifier were off resonance, and tuning the transmitter would be a touchy cut-and-try process. To facilitate tune-up, a 500-ohm resistor is cut into the 6883 cathode circuit when  $S_4$  is opened. This limits the off-resonance plate current to a low value.

The cabinet for the transmitter is special and made from  $\frac{3}{4}$ -inch-wide aluminum angle and 18-gauge (0.040) sheet stock. The cover and sides are not shown in any of the illustrations; they are made from one piece of sheet stock bent in the shape of a shallow U. The transmitter is hung under the instrument panel of the car by two brackets that make up to the sides of the transmitter. Whether or not a ventilation hole (covered with cane metal) is placed in the cover will depend upon whether the car leaks.

The front compartment that drops down is also made of sheet stock and angle stock. The

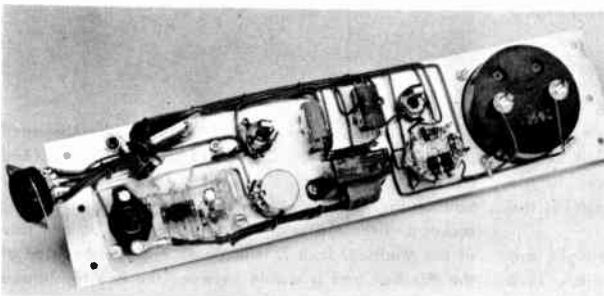

Fig. 19-23—Rear view of the meter panel. Leads from this unit terminate in the 11-pin socket, which is mounted on the back of the housing opposite this panel. A jumper cable plugs into this socket and into a similar socket in the bottom of the major unit.

The first three stages of the speech-amplifier section are mounted on a plastic plate (lower left) next to the gain control. Transformer  $T_1$  can be seen at the center of the panel.

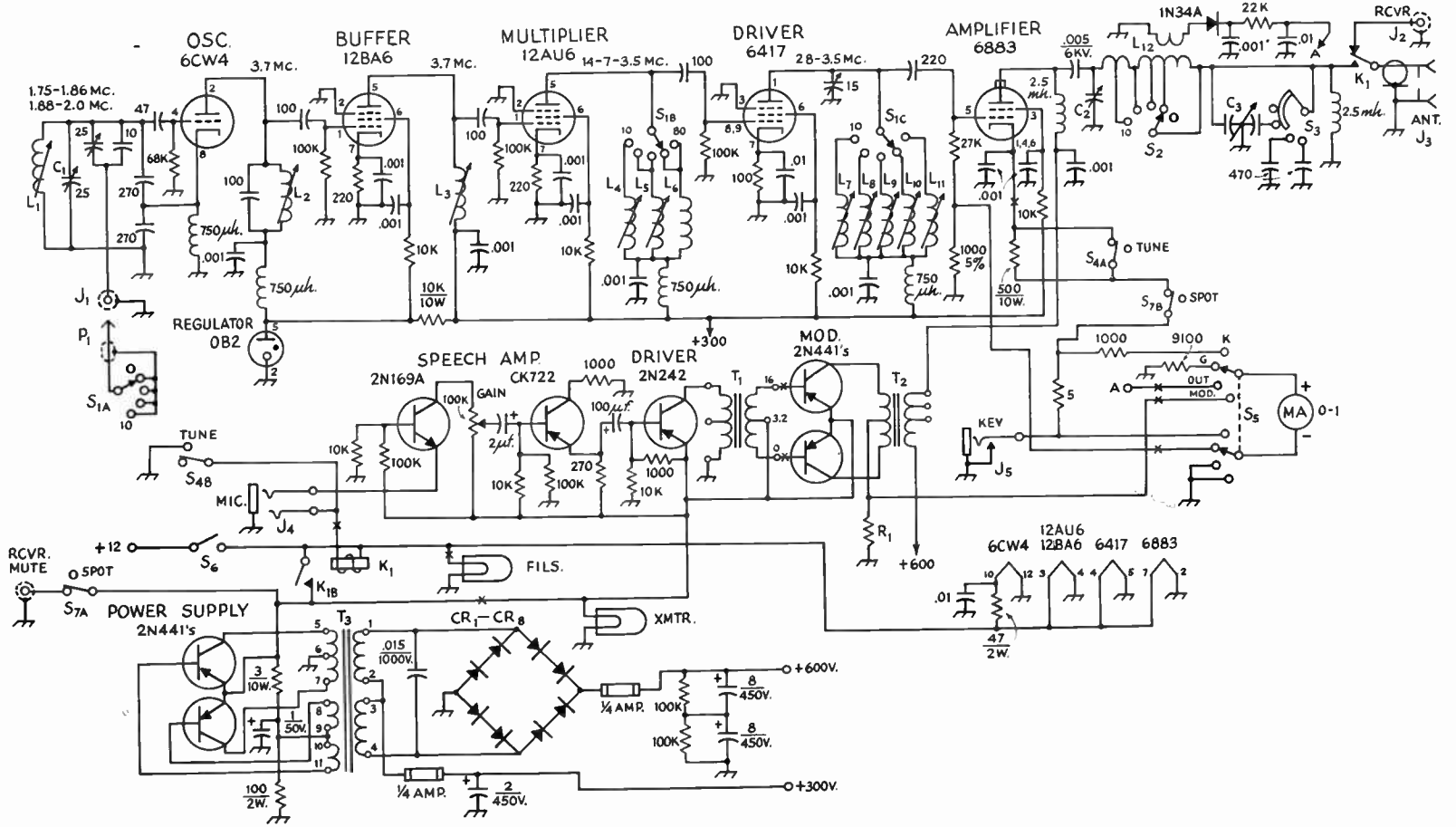

Fig. 19-26—Circuit diagram of the mobile transmitter. Unless specified otherwise, capacitances are in  $\mu\text{f.}$ , decimal values are in  $\mu\text{f.}$ , resistances are in ohms, resistors are  $\frac{1}{2}$  watt.

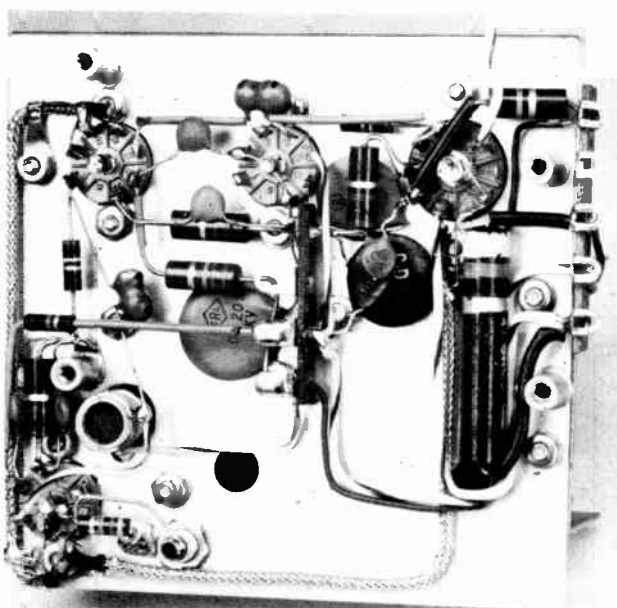

Fig. 19-25—View underneath the v.f.o./multiplier section. The plate is supported by four tapped pillars. 12BA6 socket at lower right; sockets on left, from the top, are 6417, OB2 and 12AU6. Phone jack at upper left receives cable from phono jack at upper right in Fig. 19-22, carrying output of 6CW4 to 12BA6 grid.

panel of this section makes up to angle stock on the sides; Fig. 19-21 suggests the location of these strips by the visible heads of screws on the right-hand end past the meter.

Also not visible in any of the pictures is the socket that picks up the leads from the dropped panel (see Fig. 19-23). This socket is located under the two horizontally-mounted power transistors at the rear center of the transmitter; the socket is an Amphenol 77MIP11 and the mating cable plug is an Amphenol 86-FM11. A small

Fig. 19-26—View into the 6883 socket housing; the v.f.o. section has been removed. The short length of coaxial cable running from the front section of the switch is terminated in  $P_1$ . Coils  $L_4$ ,  $L_5$  and  $L_6$  are visible between the two switch wafers; the other coils are the driver plate-circuit inductors. The driver plate tuning capacitor is mounted on a small bracket.

Planetary drive for the v.f.o. capacitor (right) is English and distributed in the U.S. (Arrow Electronics).

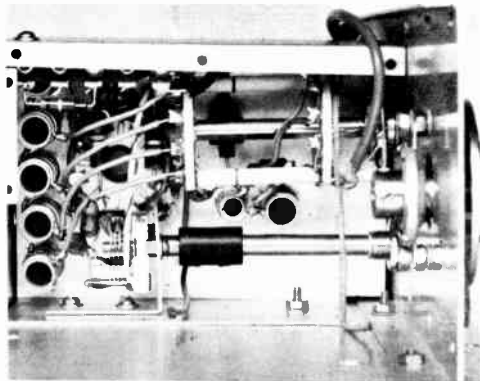

“x” is shown in Fig. 19-24 in each lead that is run through these plugs and sockets. The 11th lead is a ground lead, not necessary when everything is bolted together but useful during the testing stage.

Many of the sections of the transmitter can be tested before their final placement in the unit, and this will make the initial testing easier. The power supply can be tested as a unit before installation, as can the speech amplifier and driver and modulator. The oscillator can be tested out of the transmitter, but its final adjustment must be made in the transmitter because  $P_1$  and  $J_1$  must be connected. The high-frequency range is adjusted first by setting  $S_1$  to the 80-meter position and setting  $C_1$  at minimum capacitance. The slug in  $L_1$  is then set for a frequency of 2.005 Mc. (4.010 Mc. if the receiver is tuned to 75 meters).  $S_1$  is then switched to another band and  $C_1$  is turned to maximum capacitance. The 25- $\mu$ hf. trimmer capacitance should then be set to give an oscillator frequency of 1.745 Mc. (3.490 Mc.).

The cores of the various inductors are adjusted for maximum drive in the various bands; in some cases it may be found advantageous to “stagger tune” two stages. In operation, the 6883 is run with a grid current of 3 to 4 ma. and a cathode current of 120 ma.

Fig. 19-27—Power supply and modulator of the mobile transmitter. The bridge-rectifier diodes,  $CR_1$  through  $CR_4$ , are mounted on a plastic sheet above the power transformer  $T_3$  (left). Modulator transistors are mounted on vertical plate (insulated by mica washers). The entire section, including the modulation transformer (right), is supported by tapped pillars.

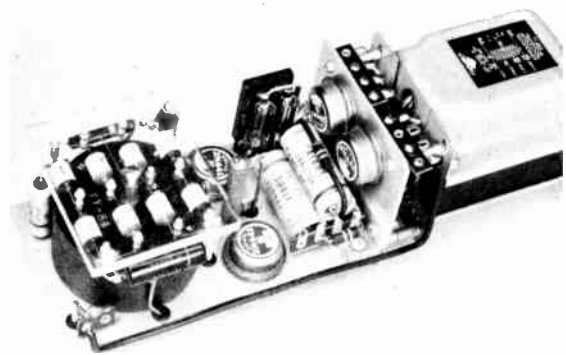



## MOBILE MODULATORS

Vacuum-tube modulators for mobile operation are in general similar to those used in fixed-station installations. Equipment shown in the section on modulators may be modified for use with almost any mobile transmitter. As in fixed station work, the mobile modulator must be capable of supplying to the plate-modulated r.f. stage sine-wave audio power equal to 50 per cent of the d.c. plate input for 100 per cent modulation.

For several reasons a transistorized modulator is the logical choice for mobile work. It will work directly from the 12-volt car battery, without the need for a high-voltage power supply. The overall efficiency is high because there is no heater power demand, and the small size makes for a compact design. The major precaution in using a transistorized modulator is to be sure

that the transistors will not be subjected to excessive heat.

There are two main constructional precautions to be observed when building a modulator for mobile work. The input circuits should be well-shielded and protected against r.f. pick-up or audio feedback, and the chassis grounds should be arranged to avoid the possibility of introducing power-supply noise into the microphone or low-level audio circuits. The second precaution is to locate the audio output transformer far enough away from the audio input circuits to insure the complete lack of audio feedback.

In any mobile installation, the modulator may be separated from the r.f. assembly by any convenient distance. The cable connecting the modulator to the r.f. section should be made with individually shielded leads.

### A 25-WATT TRANSISTOR MODULATOR

The circuit shown in Fig. 19-28 is that of a complete transistor modulator; it is a 12-volt 25-watt Class-B modulator. The advantages of a transistor modulator of this type are the compactness (25 watts of audio from a unit readily housed in a 3 × 4 × 5-inch utility cabinet), high over-all efficiency, no warm-up time and low idling current. Further, by requiring only the 12 volts from the battery, it allows full use of the high-voltage supply by the r.f. section. The modulator will modulate an r.f. stage input of between 45 and 50 watts, at an impedance level of 4000 ohms with the output transformer listed (about 450 volts and 110 ma.). Suitable 12-volt heater tubes for the modulated output stage include the 1625 (similar to 807) and the 6883 (similar to the 6146). The exciter portion of the transmitter can be made up of 6417s (similar to the 5763) or of 12V6-GTs or 12L6-GTs. Maximum economy will be obtained with a transistorized power supply.

For a modulation transformer the unit uses a 6.3-volt filament transformer,  $T_3$ . To obtain a true center tap for the driver transformer, a transformer having taps at 4 and 16 ohms is used. Since the impedance varies as the square of the turns ratio, the 4-ohm tap provides a center tap.

It may be found necessary to add an input filter on the 12-volt line to prevent hash from getting into the microphone circuit and adding noise.

#### Transistor Mounting

Because the collector connection is common with the case of the transistor, mica spacers must be used between the transistor cases and ground. (Insulator package No. 1221264). These can be obtained in a special mounting kit from Delco distributors.

Be careful to apply as little heat as possible when soldering any transistor connections.

Either G.E. 2N190 or RCA 2N109 can be used for the input transistors. Although several other types could be used for the output transistors, the specified 2N278 (Delco DS-501) should be easier to obtain than some since it is sold as a replacement in car-radio service.

It is not likely that a 0.1-ohm 1-watt resistor (see Fig. 19-28) can be purchased at any radio store. A satisfactory substitute is to wind a suitable length of resistance wire over a 2-watt resistor used as a form, or three 0.33-ohm ½-watt resistors can be wired in parallel to obtain a value sufficiently close.

#### Testing

After wiring and construction of the unit is completed, testing for proper operation can be done in several ways. One method is simply to connect a 4000-ohm 10-watt resistor across the modulation transformer output connections and then place a d.c. ammeter in series with the 12-volt line, and watch the current variation while talking into the microphone. The idling current should be around 700 ma., kicking up to above 2 amperes on peaks. Do not, under any circumstances, try to operate the unit without a load of some sort on the output terminals as this may damage the output transistors.

Another method of testing is to place another 6.3-volt filament transformer back-to-back with the modulation transformer, to bring the impedance down to a low level, and then connect a p.m. speaker to the 6.3-volt winding.

A scope test can be made after the unit is connected to the transmitter. The Class-C load level can be adjusted for impedance matching.

An F1 carbon microphone is suitable for use with this unit. Although not shown in Fig. 19-28, the unit should be connected so that it is turned on only while the transmit-receive switch is in the transmit position. An inexpensive 12-volt automobile-horn relay (e.g., Echlin HR



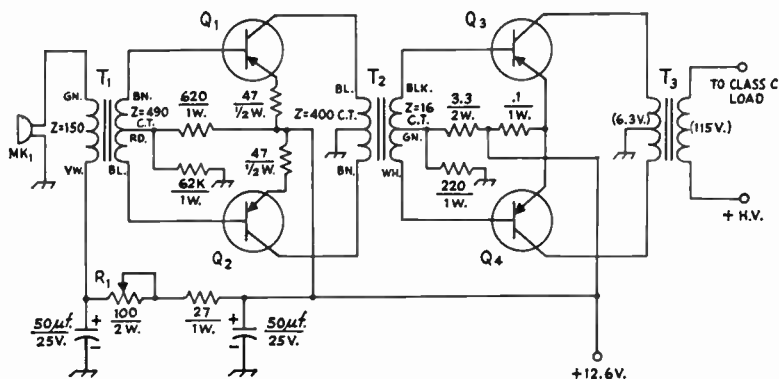

Fig. 19-28—Circuit of the 25-watt transistor modulator. Resistances are in ohms. Capacitors are electrolytic.

- MK<sub>1</sub>—Single-button carbon microphone.
- Q<sub>1</sub>, Q<sub>2</sub>—2N190 (GE) or 2N109 (RCA).
- Q<sub>3</sub>, Q<sub>4</sub>—2N278 (Delco DS-501).
- R<sub>1</sub>—100-ohm 2-watt potentiometer.
- T<sub>1</sub>—150 ohms c.t. (c.t. not used) to 490 ohms c.t. (Thor-darson TR-5).

- T<sub>2</sub>—400 ohms c.t. to 16 ohms, c.t. (see text), Stancor TA-41).
- T<sub>3</sub>—6.3-volt c.t., 3-amp. filament transformer used as modulation transformer (see text) (Stancor P-5014). 5-volt c.t. 3-amp. transformer for 6500-ohm load.

101), available at most filling stations or automobile parts distributors, should be used to close and open the circuit. The relay arm and contact should be connected in the +12.6-volt lead from the battery and fuse. If excessive sparking is noted at the relay contacts it may be reduced by moving the 50-µf. 25-volt capacitor to the fuse side of the relay contacting circuit.

Concerning placement of the unit in the car: Try to find a location away from high-temperature spots and in a well-ventilated area. The trunk is not recommended since there is little ventilation; this area can become quite hot in the summertime and damage to the transistors could result. The engine compartment makes a

convenient place to mount the unit but this space is not adequately ventilated except possibly while the car is in motion. The most favorable spot is on the fire wall in the passenger compartment, or under the front seat. These areas are usually well ventilated, or at least cooler than any other enclosed section of the car. As in any mobile installation where the modulator is some distance from the r.f. section, good practice demands that the audio leads from the secondary of the modulation transformer to the modulated r.f. stage should be made with individually-shielded leads.

(Original description appeared in *QST* for November, 1959.)

### THE MOBILE ANTENNA

For mobile operation in the range between 1.8 and 30 Mc., the vertical whip antenna is almost universally used. Since longer whips present mechanical difficulties, the length is usually limited to a dimension that will resonate as a quarter-wave antenna in the 10-meter band. The car body serves as the ground connection. This antenna length is approximately 8 feet.

With the whip length adjusted to resonance in the 10-meter band, the impedance at the feed point, X, Fig. 19-29, will appear as a pure resistance at the resonant frequency. This resistance will be composed almost entirely of radiation resistance (see index), and the efficiency will be high. However, at frequencies lower than the resonant frequency, the antenna will show an increasingly large capacitive reactance and a decreasingly small radiation resistance.

The equivalent circuit is shown in Fig. 19-30. For the average 8-ft. whip, the reactance of the

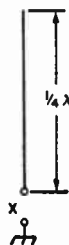

Fig. 19-29—The quarterwave whip at resonance will show a pure resistance at the feed point X.

capacitance, C<sub>a</sub>, may range from about 150 ohms at 21 Mc. to as high as 8000 ohms at 1.8 Mc., while the radiation resistance, R<sub>r</sub>, varies from about 15 ohms at 21 Mc. to as low as 0.1 ohm at 1.8 Mc. Since the resistance is low, considerable power is to be dissipated as radiation in the resistance. Yet it is apparent that little current

can be made to flow in the circuit so long as the comparatively high series reactance remains.

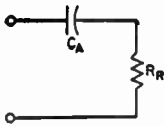

Fig. 19-30—At frequencies below the resonant frequency, the whip antenna will show capacitive reactance as well as resistance.  $R_R$  is the radiation resistance, and  $C_A$  represents the capacitive reactance.

**Eliminating Reactance**

The capacitive reactance can be canceled out by connecting an equivalent inductive reactance,  $L_L$ , in series, as shown in Fig. 19-31, thus tuning the system to resonance.



Fig. 19-31 — The capacitive reactance at frequencies lower than the resonant frequency of the whip can be canceled out by adding an equivalent inductive reactance in the form of a loading coil in series with the antenna.

Unfortunately, all coils have resistance, and this resistance will be added in series, as indicated at  $R_C$  in Fig. 19-32. While a large coil may

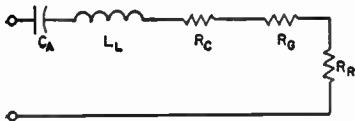

Fig. 19-32—Equivalent circuit of a loaded whip antenna.  $C_A$  represents the capacitive reactance of the antenna,  $L_L$  an equivalent inductive reactance.  $R_C$  is the loading-coil resistance,  $R_G$  the ground-loss resistance, and  $R_R$  the radiation resistance.

radiate some energy, thus adding to the radiation resistance, the latter will usually be negligible compared to the loss resistance introduced. However, adding the coil makes it possible to feed power to the circuit.

**Ground Loss**

Another element in the circuit dissipating power is the ground-loss resistance. Fundamentally, this is related to the nature of the soil in the area under the antenna. Little information is available on the values of resistance to be expected in practice, but some measurements have shown that it may amount to as much as 10 or 12 ohms at 4 Mc. At the lower frequencies, it may constitute the major resistance in the circuit.

Fig. 19-32 shows the circuit including all of the elements mentioned above. Assuming  $C_A$  lossless and the loss resistance of the coil to be represented by  $R_C$ , it is seen that the power output of the transmitter is divided among three resistances— $R_C$ , the coil resistance;  $R_G$ , the ground-loss resistance; and  $R_R$ , the radiation resistance. Only the power dissipated in  $R_R$  is radiated. The power developed in  $R_C$  and  $R_G$  is dissipated in heat. Therefore, it is important that the latter two resistances be minimized.

**MINIMIZING LOSSES**

There is little that can be done about the nature of the soil. However, poor electrical contact between large surfaces of the car body, and especially between the point where the feed line is grounded and the rest of the body, can add materially to the ground-loss resistance. For example, the feed line, which should be grounded as close to the base of the antenna as possible, may be connected to the bumper, while the bumper may have poor contact with the rest of the body because of rust or paint.

**Loading Coils**

The accompanying tables show the approximate loading-coil inductance required for the

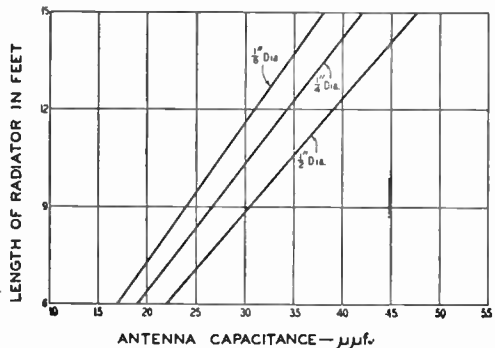

Fig. 19-33—Graph showing the approximate capacitance of short vertical antennas for various diameters and lengths, at 3.9 Mc. These values should be approximately halved for a center-loaded antenna.

various bands. The graph of Fig. 19-33 shows the approximate capacitance of whip antennas of various average diameters and lengths. For 1.8, 4 and 7 Mc., the loading-coil inductance required (when the loading coil is at the base) will be approximately the inductance required to resonate in the desired band with the whip capacitance taken from the graph. For 14 and 21 Mc., this rough calculation will give more than the required inductance, but it will serve as a starting point for final experimental adjustment that must always be made.

Also shown in table 19-I are approximate values of radiation resistance to be expected with an 8-ft. whip, and the resistances of loading coils — one group having a  $Q$  of 50, the other a  $Q$  of 300. A comparison of radiation and coil

TABLE 19-I

Approximate Values for 8-ft. Mobile Whip						
Base Loading						
<i>f</i> <sub>kc.</sub>	Loading L <sub>uh.</sub>	<i>R</i> <sub>C</sub> (Q50) Ohms	<i>R</i> <sub>C</sub> (Q300) Ohms	<i>R</i> <sub>R</sub> Ohms	<i>F</i> <sub>cc'd</sub> <i>R</i> <sup>*</sup> Ohms	Matching L <sub>uh.</sub> *
1800	345	77	13	0.1	23	3
3800	77	37	6.1	0.35	16	1.2
7200	20	18	3	1.35	15	0.6
14,200	4.5	7.7	1.3	5.7	12	0.28
21,250	1.25	3.4	0.5	14.8	16	0.28
29,000	....	....	....	....	36	0.23
Center Loading						
1800	700	158	23	0.2	34	3.7
3800	150	72	12	0.8	22	1.4
7200	40	36	6	3	19	0.7
14,200	8.6	15	2.5	11	19	0.35
21,250	2.5	6.6	1.1	27	29	0.29

*R*<sub>C</sub> = Loading-coil resistance; *R*<sub>R</sub> = Radiation resistance.  
 \* Assuming loading coil *Q* = 300, and including estimated ground-loss resistance.  
 Suggested coil dimensions for the required loading inductances are shown in a following table.

resistances will show the importance of reducing the coil resistance to a minimum, especially on the three lower-frequency bands.

To minimize loading-coil loss, the coil should have a high ratio of reactance to resistance, i.e., high *Q*. A 4-Mc. loading coil wound with small wire on a small-diameter solid form of poor quality, and enclosed in a metal protector, may have a *Q* as low as 50, with a resistance of 50 ohms or more. High-*Q* coils require a large conductor, "air-wound" construction, turns spaced, the best insulating material available, a diameter not less than half the length of the coil (not always mechanically feasible), and a minimum of metal in the field. Such a coil for 4 Mc. may show a *Q* of 300 or more, with a resistance of 12 ohms or less. This reduction in loading-coil resistance may be equivalent to increasing the transmitter power by 3 times or more. Most low-loss transmitter plug-in coils of the 100-watt size or larger, commercially produced, show a *Q* of this order. Where larger inductance values are required, lengths of low-loss space-wound coils are available.

#### Center Loading

The radiation resistance of the whip can be approximately doubled by placing the loading coil at the center of the whip, rather than at the base, as shown in Fig. 19-34. (The optimum position varies with ground resistance. The center is optimum for average ground resist-

ance.) However, the inductance of the loading coil must be approximately doubled over the value required at the base to tune the system to resonance. For a coil of the same *Q*, the coil resistance will also be doubled. But, even if this

TABLE 19-II

Suggested Loading-Coil Dimensions					
Req'd L <sub>uh.</sub>	Turns	Wire Size	Diam. In.	Length In.	Form or B & W Type
700	190	22	3	10	Polystyrene
345	135	18	3	10	Polystyrene
150	100	16	2½	10	Polystyrene
77	75	14	2½	10	Polystyrene
77	29	12	5	4¼	160T
40	28	16	2½	2	80B less 7 t.
40	34	12	2½	4¼	80T
20	17	16	2½	1¼	80B less 18 t.
20	22	12	2½	2¾	80T less 12 t.
8.6	16	14	2	2	40B less 4 t.
8.6	15	12	2½	3	40T less 5 t.
4.5	10	14	2	1¼	40B less 10 t.
4.5	12	12	2½	4	40T
2.5	8	12	2	2	15B
2.5	8	6	2¾	4½	15T
1.25	6	12	1¾	2	10B
1.25	6	6	2¾	4½	10T



Fig. 19-34—Placing the loading coil at the center of the whip antenna, instead of at the base, increases the radiation resistance, although a larger coil must be used.

is the case, center loading represents a gain in antenna efficiency, especially at the lower frequencies. This is because the ground-loss resistance remains the same, and the increased radiation resistance becomes a larger portion of the total circuit resistance, even though the coil resistance also increases. However, as turns are added to a loading coil (other factors being equal) the inductance (and therefore the reactance) increases at a greater rate than the resistance, and the larger coil will usually have a higher  $Q$ .

**Top Loading Capacitance**

Since the coil resistance varies with the inductance of the loading coil, the coil resistance can be reduced by reducing the number of turns. This can be done, while still maintaining resonance, by adding capacitance to the portion of the antenna above the coil. This capacitance can be provided by attaching a capacitive surface as high up on the antenna as is mechanically feasible. Capacitive "hats," as they are usually called, may consist of a light-weight metal ball,



Fig. 19-35—The top-loaded 4-Mc. antenna designed by W6SCX. The loading coil is a B & W transmitting coil. The coil can be tuned by the variable link which is connected in series with the two halves of the coil.

cylinder, disk, or wheel structure as shown in Fig. 19-35. This should be added to the capacitance of the whip above the loading coil (from Fig. 19-33) in determining the approximate inductance of the loading coil.

When center loading is used, the amount of capacitance to be added to permit the use of the same loading inductance required for base loading is not great, and should be seriously considered, since the total gain made by moving the coil to the center of the antenna may be quite marked.

**Tuning the Band**

Especially at the lower frequencies, where the resistance in the circuit is low compared to the coil reactance, the antenna will represent a very high- $Q$  circuit, making it necessary to retune for relatively small changes in frequency. While many methods have been devised for tuning the whip over a band, one of the simplest is shown in Fig. 19-36. In this case, a standard B & W plug-in coil is used as the loading coil. A length of large-diameter polystyrene rod is drilled and tapped to fit between the upper and lower sections of the antenna. The assembly also serves to clamp a pair of metal brackets on each side

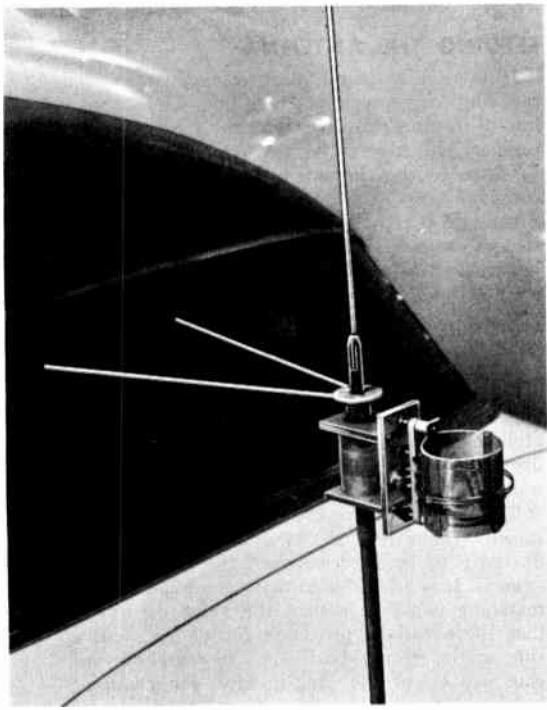

Fig. 19-36—W8AUN's adjustable capacity hat for tuning the whip antenna over a band. The coil is a B & W type B 160-meter coil, with a turn or two removed. Spreading the rods apart increases the capacitance. This simple top loader has sufficient capacitance to permit the use of approximately the same loading-coil inductance at the center of the antenna as would normally be required for base loading.

of the polystyrene block that serve both as support and connections to the loading-coil jack bar.

A 1/8-inch steel rod, about 15 inches long, is brazed to each of two large-diameter washers with holes to pass the threaded end of the upper section. The rods form a loading capacitance that varies as the upper rod is swung away from the lower one, the latter being stationary. Enough variation in tuning can be obtained to cover the 80-meter band. (Original description appeared in *QST*, September, 1953.)

**REMOTE ANTENNA RESONATING**

Fig. 19-37 shows circuits of two remote-control resonating systems for mobile antennas. As shown, they make use of surplus d.c. motors driving a loading coil removed from a surplus ARC-5 transmitter. A standard coil and motor may be used in either installation at increased expense.

The control circuit shown in Fig. 19-37A is a three-wire system (the car frame is the fourth conductor) with a double-pole double-throw switch and a momentary (normally off) single-pole single-throw switch.  $S_2$  is the motor reversing switch. The motor runs so long as  $S_1$  is closed.

The circuit shown in Fig. 19-37B uses a latching relay, in conjunction with microswitches, to automatically reverse the motor when the roller reaches the end of the coil.  $S_3$  and  $S_5$  operate

the relay,  $K_1$ , which reverses the motor.  $S_4$  is the motor on-off switch. When the tuning coil roller reaches one end or the other of the coil, it closes  $S_6$  or  $S_7$ , as the case may be, operating the relay and reversing the motor.

The procedure in setting up the system is to prune the center loading coil to resonate the antenna on the highest frequency used without the base loading coil. Then, the base loading coil is used to resonate at the lower frequencies. When the circuit shown in Fig. 19-37A is used for control,  $S_1$  is used to start and stop the motor, and  $S_2$ , set at the "up" or "down" position, will determine whether the resonant frequency is raised or lowered. In the circuit shown in Fig. 19-37B,  $S_4$  is used to control the motor.  $S_3$  or  $S_5$  is momentarily closed (to activate the latching relay) for raising or lowering the resonant frequency. The broadcast antenna is used with a wavemeter to indicate resonance.

(Originally described in *QST*, Dec., 1953.)

Several companies offer motor tuning for getting optimum performance over a low-frequency band. (For a complete description of the commercially available remotely-tuned systems, see Goodman, "Frequency Changing and Mobile Antennas," *QST*, Dec., 1957.)

**Automatic Mobile Antenna Tuning**

A somewhat more complex antenna tuning system for 75 and 40 meters is one that automatically tunes the antenna as the transmitter frequency is shifted. After initial adjustments, the radiator is kept in resonance without attention from the operator. (For a description of the automatic system, see Hargrave, "Automatic Mobile Antenna Tuning," *QST*, May, 1955.)

**FEEDING THE ANTENNA**

It is usually found most convenient to feed the whip antenna with coax line. Unless very low- $Q$  loading coils are used, the feed-point impedance will always be appreciably lower than 52 ohms — the characteristic impedance of the commonly-used coax line, RG-8/U or RG-58/U. Since the length of the transmission line will seldom exceed 10 ft., the losses involved will be negligible, even at 29 Mc., with a fairly-high s.w.r. However, unless a line of this length is made reasonably flat, difficulty may be encountered in obtaining sufficient coupling with a link to load the transmitter output stage.

One method of obtaining a match is shown in Fig. 19-38. A small inductance,  $L_M$ , is inserted at the base of the antenna, the loading-coil inductance being reduced correspondingly to maintain resonance. The line is then tapped on the coil at a point where the desired loading is obtained. Table 19-I shows the approximate inductance to be used between the line tap and ground. It is advisable to make the experimental matching coil larger than the value shown, so that there will be provision for varying either side of the proper position. The matching coil can also be of the plug-in type for changing bands.

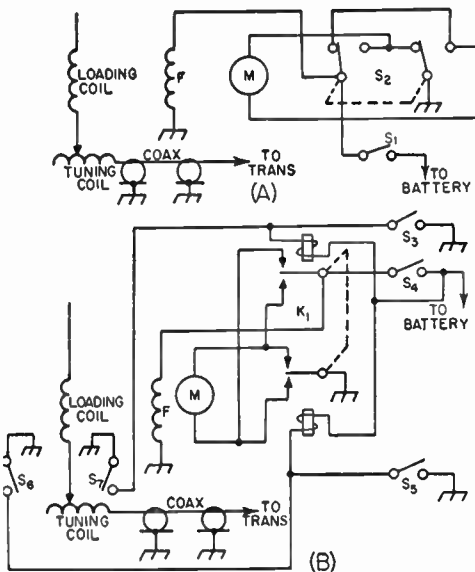
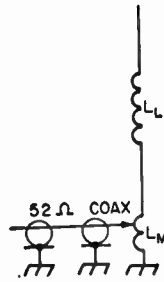

Fig. 19-37—Circuit of the remote mobile-whip tuning systems.

- $K_1$ —D.p.d.t. latching relay.
- $S_1, S_2, S_4, S_5$ —Momentary-contact s.p.s.t., normally open.
- $S_2$ —D.p.d.t. toggle.
- $S_6, S_7$ —S.p.s.t. momentary-contact microswitch, normally open.



Fig. 19-38 — A method of matching the loaded whip to 52-ohm coax cable.  $L_L$  is the loading coil and  $L_M$  the matching coil.



**Adjustment**

For operation in the bands from 29 to 1.8 Mc., the whip should first be resonated at 29 Mc. with the matching coil inserted; but the line disconnected, using a grid-dip oscillator coupled to the matching coil. Then the line should be attached, and the tap varied to give proper loading, using a link at the transmitter end of the line whose reactance is approximately 52 ohms at the operating frequency, tightly coupled to the output tank circuit. After the proper position for the tap has been found, it may be necessary to readjust the antenna length slightly for resonance. This can be checked on a field-strength meter several feet away from the car.

The same procedure should be followed for each of the other bands, first resonating, with the g.d.o. coupled to the matching coil, by adjusting the loading coil.

After the position of the matching tap has been found, the size of the matching coil can be reduced to only that portion between the tap and ground, if desired. If turns are removed here, it will be necessary to reresonate with the loading coil.

If an entirely flat line is desired, a s.w.r. indicator should be used while adjusting the line tap. With a good match, it should not be necessary to readjust for resonance after the line tap has been set.

It should be emphasized that the figures shown in the table are only approximate and may be altered considerably depending on the type of car on which the antenna is mounted and the spot at which the antenna is placed.

**ANTENNAS FOR 50 AND 144 MC.**

**A Simple Vertical Antenna**

The most convenient type of antenna for mobile v.h.f. work is the quarter-wave vertical radiator, fed with 50-ohm coaxial line. The antenna, which may be a flexible telescoping "fish pole," can be mounted in any of several places on the car. An ideal mounting spot is on top of the car, though rear-deck mounting presents a better spot for esthetic reasons. Tests have shown that with the car in motion there is no observable difference in average performance of the antennas, regardless of their mounting positions. There may be more in the way of directional effects with the rear-deck mount, but the over-all advantage of the roof mount is slight.

A good match may be obtained by feeding the simple vertical with 50-ohm line. However, it is well to provide some means for tuning the system, so that all variables can be taken care of. The simplest tuning arrangement consists of a variable capacitor connected between the low side of the transmitter coupling coil and ground, as shown in Fig. 19-39. This capacitor should

Fig. 19-39—Method of feeding quarter-wave mobile antennas with coaxial line.  $C_1$  should have a maximum capacitance of 75 to 100  $\mu\text{f.}$  for 28- and 50-Mc. work.  $L_1$  is an adjustable link.

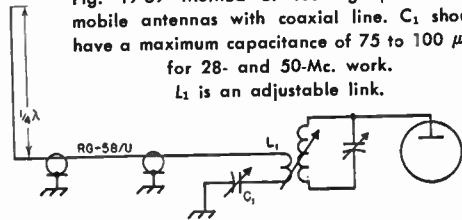

have a maximum capacitance of 75 to 100  $\mu\text{f.}$  for 50 Mc., and should be adjusted for maximum loading with the least coupling to the transmitter. Some method of varying the coupling to the transmitter should be provided.

**Horizontal Polarization**

Horizontally polarized antennas have a considerable advantage over the vertical whip under usual conditions of mobile operation. This is particularly true when horizontal polarization is used at both ends of a line-of-sight circuit, or on a longer circuit over reasonably flat terrain. An additional advantage, especially on 6 meters, is a marked reduction in ignition noise from neighboring cars as well as from the station car.

**A Horizontally Polarized Two-Band Antenna for V.H.F.**

One type of horizontally-polarized antenna, called the "halo," is shown in Fig. 19-40. It is a dipole bent into a circle, with the ends capacitively loaded to reduce the circumference. Since the 50- and 144-Mc. bands are almost in third harmonic relationship, it is possible to build a single halo that will work on both bands. The antenna is changed from one band to another by changing the spacing between the end loading plates and adjusting the matching mechanism.

**Mechanical Details**

The halo is made of 7/16-inch aluminum fuel-line tubing. This material is both strong and very light, but any tubing of about 1/2-inch diameter could be used equally well. The loop is 67 inches in circumference and the capacitor plates are 2 1/4 inches square, with the corners rounded off.

To fasten the capacitor plates to the ends of the tubing, aluminum rod stock is turned down on a lathe to make a tight fit into the ends. This is tapped for 6-32 thread, and then forced into the tubing ends. Holes are drilled through tubing and inserts, at each end of the halo, and a screw run through each to keep the inserts from turning around or slipping out. The binding-

head screws that hold the plates to the inserts are equipped with lock washers. The holes for mounting the ceramic cone spacer are drilled directly below the center, midway between the center and the edge of the capacitor plates.

The halo is set into a slot cut in the vertical support. This slot should be just big enough to permit the halo to be forced into it. The halo has to be stiffened, so cut it at the center and insert about 2 inches of aluminum rod, again turned down on a lathe to fit tightly inside the tubing. The two pieces of tubing are then pushed together, over the insert, and drilled each side of center to pass 6-32 screws. The halo and insert are also drilled at the midpoint, to pass the mounting screw. This is an 8-32 screw, 1¼ inches long. If lathe facilities are not available, the mounting of the capacitor plates and the securing of the halo to the vertical support can be handled with angle brackets.

Mechanical stability is important so straps of aluminum ½ inch wide are wrapped around the halo either side of the mounting post. These are bent at right angles and the ends pulled together with a bolt.

The matching arm is 14½ inches long, of the same material as the halo itself. It is mounted below the halo on two ¾-inch cone standoffs. For convenience in detaching the feed line a coaxial fitting is mounted on an L bracket bolted to the vertical support. The stator bar of the 25- $\mu$ f. variable capacitor (Johnson 167-2) is soldered directly to the coaxial fitting. The rotor of the capacitor is connected to the gamma arm through a piece of stiff wire. For further stiffening an aluminum angle bracket is screwed to the lower mounting stud of the capacitor and the other end mounted under the screw that holds the first cone standoff in place. Contact between the arm and the halo proper is made through a strap of ½-inch wide aluminum bent to form a sliding clip. Be sure that a clean tight contact is made between the tubing and the clip, as high current flows at this point. A poor or varying contact will ruin the effectiveness of the antenna.

#### Adjustment

The capacity-loaded halo is a high- $Q$  device so

it must be tuned on-the-nose, or it will not work properly. The only reliable method for adjusting a halo is to use a standing-wave bridge, making tuning and matching adjustments for minimum reflected power. Using a field-strength meter and attempting to adjust for maximum radiated power can give confusing indications, and is almost certain to result in something less than maximum effectiveness.

The adjustment process with this design can be simplified if the halo is first resonated approximately to the desired frequency ranges with the aid of a grid-dip meter. Set the clip at about one inch in from the end of the arm, and the series capacitor at the middle of its range. Check the resonant frequency of the loop with the grid-dip meter, with the ¾-inch spacer between the capacitor plates. It should be close to 50 Mc. If the frequency is too low, trimming the corners of the plates or putting shims under the ceramic spacer will raise it somewhat. If the frequency is too high already, make new and slightly larger capacitor plates.

Next, insert an s.w.r. bridge between the antenna and the transmission line. Apply power and swing the capacitor through its range, noting whether there is a dip in reflected power at any point. If the reflected power will not drop to zero, slide the clip along the gamma arm and retune the capacitor, until the lowest reading possible is obtained. If this is still not zero, the halo is not resonant. If the halo capacitance is on the low side, moving the hands near the plates will cause the reflected power to drop. Closer spacing of the plates, larger plates or a longer halo loop are possible solutions.

These adjustments should be made on a frequency near the middle of the range you expect to use. Adjusting for optimum at 50.25 Mc., for example, will result in usable operation over the first 500 kc. of the band, and a good match (below 1.5 to 1) from 50.1 to 50.4. The s.w.r. will rise rapidly either side of this range.

To tune up on 144 Mc., insert the ½-inch cone between the capacitor plates. Slide the clip back on the gamma arm about 3 to 4 inches and repeat the adjustment for minimum reflected power, using a frequency at the middle of a 2-Mc. range.

Fig. 19-40—The 2-band halo as it appears when set up for 50-Mc. operation. Changing to 144 Mc. involves decreasing the plate spacing by swapping cone insulators, and resetting the gamma-matching clip and series capacitor.

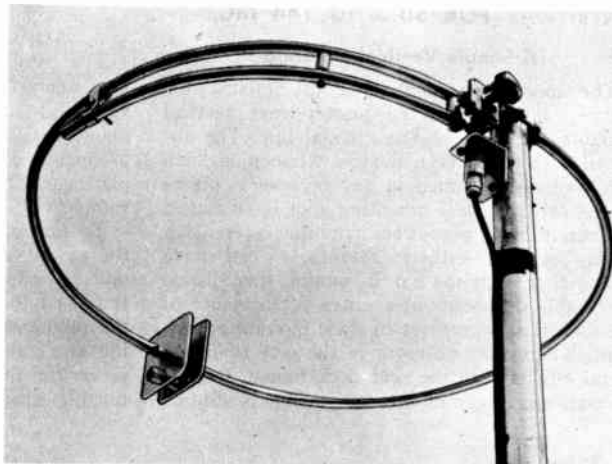

Tuning up at 145 Mc., for example, will give quite satisfactory operation from the low end to 146 Mc., the halo being much broader in frequency response when it is operated on its third harmonic. In this model the series capacitor in the gamma arm was at about the middle of its range for 50 Mc., and near minimum for 144 Mc. Slight differences in mechanical construction may change the value of capacitance required, so these settings should not be taken as important.

The photograph, Fig. 19-40, shows a method used to avoid running the chance that the second ceramic cone would be missing when a band change was to be made. The head was cut from a 6-32 screw, leaving a threaded stud about 1/2 inch long. This is screwed into one of the ceramic cones. The other cone then serves as a nut, to tighten down the capacitor plate. In changing bands merely swap cones. (Original description appeared in *QST*, Sept., 1958.)

Commercial versions of the one- and two-band halo antennas are available.

Bibliography

Swafford, "Improved Coax Feed for Low-Frequency Mobile Antennas." *QST*, December, 1951.  
 Roberge McConnell, "Let's Go High Hat!," *QST*, January, 1952.  
 Belrose, "Short Antennas for Mobile Operation," *QST*, September, 1953.  
 Dinsmore, "The 'Hot-Rod' Mobile Antenna," *QST*, September, 1953.  
 Picken & Wambsgans, "Remote Mobile-Antenna Resonating," *QST*, December, 1953.  
 Webster, "Mobile Loop Antennas," *QST*, Jun., 1954.  
 Tilton, "Have you Tried V.H.F. Mobile?" *QST*, September, 1954.  
 Hargrave, "Automatic Mobile Antenna Tuning," *QST*, May, 1955.  
 Morgan, "Tuning the Mobile Antenna from the Driver's Seat," *QST*, October, 1955.  
 Braschwitz, "Directional Antenna for the Transmitter Hunter," *QST*, April, 1956.  
 Tilton, "Polarization Effects in V.H.F. Mobile," *QST*, December, 1956.  
 Bretz, "A Simple Halo for 2-Meter Mobile Use," *QST*, August, 1957.  
 Harris, "Continuously Loaded Whip Antennas," *QST*, May, 1958.  
 Mellen and Milner, "Big Wheel on Two," *QST*, Sept., 1961. Also "Big Wheel Performance Tests," *QST*, Oct., 1961.

A FIELD-STRENGTH METER FOR PORTABLE-MOBILE USE

The field-strength meter of Figs. 19-41 through 19-43 can be used in a mobile station as an antenna-resonance indicator or as a continuous output indicator showing that the transmitting system is actually radiating. It is designed to be inserted between the automobile broadcast receiving antenna, which acts as the r.f. pick-up, and the broadcast receiver. Small magnets or



Fig. 19-41—A front view of the field-strength meter. Sensitivity control  $R_1$  is to the right of the 0-1 indicating meter. Antenna input and output connectors are mounted on the right end of the box.

- Fig. 19-42—Circuit of the field-strength meter.
- CR<sub>1</sub>—Crystal diode (1N34A).
- M<sub>1</sub>—High-resistance 0-1 milliammeter (Emico or Shurite)
- RFC<sub>1</sub>—2.5 mh. r.f. choke.
- R<sub>1</sub>—500 ohm potentiometer (Mallory U-2).
- S<sub>2</sub>—S.p.d.t. switch for above potentiometer.

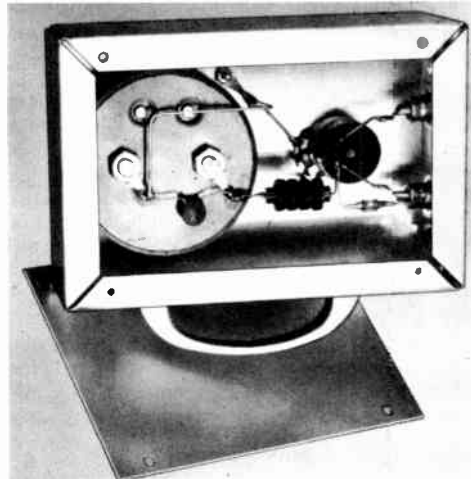
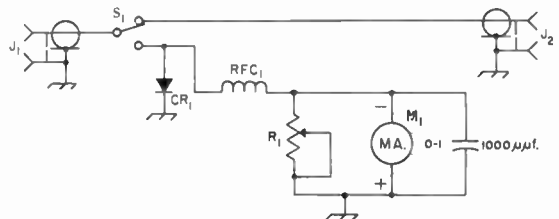

Fig. 19-43—Inside view of the meter. The back plate shown in the photograph is used as a cover for the box.

rubber suction cups on the back plate will hold the meter securely on top of the car dash. Although in this position the meter will be face up in most cases, it can nevertheless usually be read from the driver position.



A handle can be mounted on the meter box so that the meter can easily be carried about for portable measurements. The same basic layout less the handle can be used if the box is to be mounted under the dash or in the glove compartment.

The circuit for the field-strength meter is shown in Fig. 19-42. The values shown are not critical. Nearly any type of crystal detector can be used and the meter movement can be anything from 100  $\mu$ a. to 2 ma. or more, depending upon the size and placement of the antenna and the power output of the transmitter. All components, including the 3-inch indicating meter, are housed in a 2  $\times$  6  $\times$  4-inch aluminum

chassis. If a smaller meter is used, the box could be reduced in size accordingly. However, in mobile operation a large meter is more convenient to read while in motion. An illuminated meter could be substituted for the one shown in the photograph for use at night. A switch,  $S_1$ , is used in the circuit to switch the antenna to the field-strength meter position or straight through to the broadcast set. For portable or temporary mobile operation, a short pick-up wire can be used instead of the automobile receiving antenna. The pick-up antenna lead comes into a connector mounted on one end of the box. There is a second connector for attaching the lead to the broadcast receiver.

## MOBILE POWER SUPPLY

By far the majority of amateur mobile installations depend upon the car storage battery as the source of power. The tube types used in equipment are chosen so that the filaments or heaters may be operated directly from the battery. High voltage may be obtained from a supply of the vibrator-transformer-rectifier type, a small motor generator or a transistor-transformer-rectifier system operating from the car battery.

### Filaments

Because tubes with directly heated cathodes (filament-type tubes) have the advantage that they can be turned off during receiving periods and thereby reduce the average load on the battery, they are preferred by some for transmitter applications. However, the choice of types with direct heating is limited and the saving may not always be as great as anticipated, because directly heated tubes may require greater filament power than those of equivalent rating with indirectly heated cathodes. In most cases, the power required for transmitter filaments will be quite small compared to the total power consumed.

### Plate Power

Under steady running conditions, the vibrator-transformer-rectifier system and the motor-generator-type plate supply operate with approximately the same efficiency. However, for the same power, the motor-generator's over-all efficiency may be somewhat lower because it draws a heavier starting current. On the other hand, the output of the generator requires less filtering and sometimes trouble is experienced in eliminating interference from the vibrator.

Transistor-transformer-rectifier plate supplies currently available operate with an efficiency of approximately 80 per cent. These compact, lightweight supplies use no moving parts (vibrator or armature) or vacuum tubes, and draw no starting surge current. Most transistorized supplies are designed to operate at 12 volts d.c. and some units deliver 125 watts or more.

Converter units, both in the vibrator and rotating types, are also available. These operate at 6 or 12 volts d.c. and deliver 115 volts a.c. This permits operating standard a.c.-powered equipment in the car. Although these systems have the advantage of flexibility, they are less efficient than the previously mentioned systems because of the additional losses introduced by the transformers used in the equipment.

### Mobile Power Considerations

Since the car storage battery is a low-voltage source, this means that the current drawn from the battery for even a moderate amount of power will be large. Therefore, it is important that the resistance of the battery circuit be held to a minimum by the use of heavy conductors and good solid connections. A heavy-duty relay should be used in the line between the battery and the plate-power unit. An ordinary toggle switch, located in any convenient position, may then be used for the power control. A second relay may sometimes be advisable for switching the filaments. If the power unit must be located at some distance from the battery (in the trunk, for instance) the 6- or 12-volt cable should be of the heavy military type.

A complete mobile installation may draw 30 to 40 amperes or more from the 6-volt battery or better than 20 amperes from a 12-volt battery. This requires a considerably increased demand from the car's battery-charging generator. The voltage-regulator systems on cars of recent years will take care of a moderate increase in demand if the car is driven fair distances regularly at a speed great enough to insure maximum charging rate. However, if much of the driving is in urban areas at slow speed, or at night, it may be necessary to modify the charging system. Special communications-type generators, such as those used in police-car installations, are designed to charge at a high rate at slow engine speeds. The charging rate of the standard system can be increased within limits by tightening up



slightly on the voltage-regulator and current-regulator springs. This should be done with caution, however, checking for excessive generator temperature or abnormal sparking at the commutator. The average 6-volt car generator has a rating of 35 amperes, but it may be possible to adjust the regulator so that the generator will at least hold even with the transmitter, receiver, lights, etc., all operating at the same time.

If higher transmitter power is used, it may be necessary to install an a.c. charging system. In this system, the generator delivers a.c. and works into a rectifier. A charging rate of 75 amperes is easily obtained. Commutator trouble often experienced with d.c. generators at high

current is avoided, but the cost of such a system is rather high.

Some mobile operators prefer to use a separate battery for the radio equipment. Such a system can be arranged with a switch that cuts the auxiliary battery in parallel with the car battery for charging at times when the car battery is lightly loaded. The auxiliary battery can also be charged at home when not in use.

A tip: many mobile operators make a habit of carrying a pair of heavy cables five or six feet long, fitted with clips to make a connection to the battery of another car in case the operator's battery has been allowed to run too far down for starting.

## THE AUTOMOBILE STORAGE BATTERY

The success of any mobile installation depends to a large extent upon intelligent use and maintenance of the car's battery.

The storage battery is made up of units consisting of a pair of coated lead plates immersed in a solution of sulphuric acid and water. Cells, each of which delivers about 2 volts, can be connected in series to obtain the desired battery voltage. A 6-volt battery therefore has three cells, and a 12-volt battery has 6 cells. The average stock car battery has a rated capacity of 600 to 800 watt-hours, regardless of whether it is a 6-volt or 12-volt battery.

### Specific Gravity and the Hydrometer

As power is drawn from the battery, the acid content of the electrolyte is reduced. The acid content is restored to the electrolyte (meaning that the battery is recharged) by passing a current through the battery in a direction opposite to the direction of the discharge current.

Since the acid content of the electrolyte varies with the charge and discharge of the battery, it is possible to determine the state of charge by measuring the *specific gravity* of the electrolyte.

An inexpensive device for checking the s.g. is the hydrometer which can be obtained at any automobile supply store. In checking the s.g., enough electrolyte is drawn out of the cell and into the hydrometer so that the calibrated bulb floats freely without leaning against the wall of the glass tube.

While the readings will vary slightly with batteries of different manufacture, a reading of 1.275 should indicate full charge or nearly full charge, while a reading below 1.150 should indicate a battery that is close to the discharge point. More specific values can be obtained from the car or battery dealer.

Readings taken immediately after adding water, or shortly after a heavy discharge period will not be reliable, because the electrolyte will not be uniform throughout the cell. Charging will speed up the equalizing, and some mixing can be done by using the hydrometer to withdraw and return some of the electrolyte to the cell several times.

A battery should not be left in a discharged condition for any appreciable length of time. This is especially important in low temperatures when there is danger of the electrolyte freezing and ruining the battery. A battery discharged to an s.g. of 1.100 will start to freeze at about 20 degrees F., at about 5 degrees when the s.g. is 1.150 and at 16 below when the s.g. is 1.200.

If a battery has been run down to the point where it is nearly discharged, it can usually be fast-charged at a battery station. Fast-charging rates may be as high as 80 to 100 amperes for a 6-volt battery. Any 6-volt battery that will accept a charge of 75 amperes at 7.75 volts during the first 3 minutes of charging, or any 12-volt battery that will accept a charge of 40 to 45 amperes at 15.5 volts, may be safely fast-charged up to the point where the gassing becomes so excessive that electrolyte is lost or the temperature rises above 125 degrees.

A normal battery showing an s.g. of 1.150 or less may be fast-charged for 1 hour. One showing an s.g. of 1.150 to 1.175 may be fast-charged for 45 minutes. If the s.g. is 1.175 to 1.200, fast-charging should be limited to 30 minutes.

### Care of the Battery

The battery terminals and mounting frame should be kept free from corrosion. Any corrosive accumulation may be removed by the use of water to which some household ammonia or baking soda has been added, and a stiff-bristle brush. Care should be taken to prevent any of the corrosive material from falling into the cells. Cell caps should be rinsed out in the same solution to keep the vent holes free from obstructing dirt. Battery terminals and their cable clamps should be polished bright with a wire brush, and coated with mineral grease.

The hold-down clamps and the battery holder should be checked occasionally to make sure that they are tight so the battery will not be damaged by pounding when the car is in motion.

### Voltage Checks

Although the readings of s.g. are quite reliable as a measure of the state of charge of a normal



battery, the necessity for frequent use of the hydrometer is an inconvenience and will not always serve as a conclusive check on a defective battery. Cells may show normal or almost normal s.g. and yet have high internal resistance that ruins the usefulness of the battery under load.

When all cells show satisfactory s.g. readings and yet the battery output is low, service stations check each cell by an instrument that measures the voltage of each cell under a heavy load. Under a heavy load the cell voltages should not differ by more than 0.15 volt.

A load-voltage test can also be made by measuring the voltage of each cell while closing the starter switch with the ignition turned off. In many cars it is necessary to pull the central dis-

tributor wire out to prevent the motor starting.

### Electrolyte Level

Water is evaporated from the electrolyte, but the acid is not. Therefore water must be added to each cell from time to time so that the plates are always completely covered. The level should be checked at least once per week, especially during hot weather and constant operation.

Distilled water is preferred for replenishing, but clear drinking water is an acceptable substitute. Too much water should not be added, since the gassing that accompanies charging may force electrolyte out through the vent holes in the caps of the cells. The electrolyte expands with temperature. (From *QST*, August, 1955.)

## EMERGENCY AND INDEPENDENT POWER SOURCES

Emergency power supply which operates independently of a.c. lines is available, or can be built in a number of different forms, depending upon the requirements of the service for which it is intended.

The most practical supply for the average individual amateur is one that operates from a car storage battery. Such a supply may take the form of a small motor generator (often called a dynamotor), a rotary converter, a vibrator-transformer-rectifier combination, or transistor supply.

### Dynamotors

A dynamotor differs from a motor generator in that it is a single unit having a double armature winding. One winding serves for the driving motor, while the output voltage is taken from the other. Dynamotors usually are operated from 6-, 12-, 28- or 32-volt storage batteries and deliver from 300 to 1000 volts or more at various current ratings.

Successful operation of dynamotors requires heavy direct leads, mechanical isolation to reduce vibration, and thorough r.f. and ripple filtration. The shafts and bearings should be thoroughly "run in" before regular operation is attempted, and thereafter the tension of the bearings should be checked occasionally to make certain that no looseness has developed.

In mounting the dynamotor, the support should be in the form of rubber mounting blocks, or equivalent, to prevent the transmission of vibration mechanically. The frame of the dynamotor should be grounded through a heavy flexible connector. The brushes on the high-voltage end of the shaft should be bypassed with 0.002  $\mu$ f. mica capacitors to a common point on the dynamotor frame, preferably to a point inside the end cover close to the brush holders. Short leads are essential. It may prove desirable to shield the entire unit, or even to remove the unit to a distance of three or four feet from the receiver and antenna lead.

When the dynamotor is used for receiving, a filter should be used similar to that described

for vibrator supplies. A 0.01- $\mu$ f. 600-volt (d.c.) paper capacitor should be connected in shunt across the output of the dynamotor, followed by a 2.5-mh. r.f. choke in the positive high-voltage lead. From this point the output should be run to the receiver power terminals through a smoothing filter using 4- to 8- $\mu$ f. capacitors and a 15- or 30-henry choke having low d.c. resistance.

### Vibrator Power Supplies

The vibrator type of power supply consists of a special step-up transformer combined with a vibrating interrupter (vibrator). When the unit is connected to a storage battery, plate power is obtained by passing current from the battery through the primary of the transformer. The circuit is made and reversed rapidly by the vibrator contacts, interrupting the current at regular intervals to give a changing magnetic field which induces a voltage in the secondary. The resulting square-wave d.c. pulses in the primary of the transformer cause an alternating voltage to be developed in the secondary. This high-voltage a.c. in turn is rectified, either by a vacuum-tube rectifier or by an additional synchronized pair of vibrator contacts. The rectified output is pulsating d.c., which may be filtered by ordinary means. The smoothing filter can be a single-section affair, but the output capacitance should be fairly large — 16 to 32  $\mu$ f.

Fig. 19-44 shows the two types of circuits. At A is shown the nonsynchronous type of vibrator. When the battery is disconnected the reed is midway between the two contacts, touching neither. On closing the battery circuit the magnet coil pulls the reed into contact with one contact point, causing current to flow through the lower half of the transformer primary winding. Simultaneously, the magnet coil is short-circuited, de-energizing it, and the reed swings back. Inertia carries the reed into contact with the upper point, causing current to flow through the upper half of the transformer primary. The magnet coil again is energized, and the cycle repeats itself.

The synchronous circuit of Fig. 19-44B is provided with an extra pair of contacts which

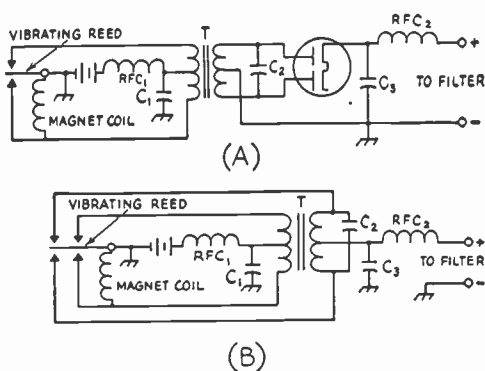

Fig. 19-44—Basic types of vibrator power-supply circuits. A—Nonsynchronous. B—Synchronous.

rectifies the secondary output of the transformer, thus eliminating the need for a separate rectifier tube. The secondary center-tap furnishes the positive output terminal when the relative polarities of primary and secondary windings are correct. The proper connections may be determined by experiment.

The buffer capacitor,  $C_2$ , across the transformer secondary, absorbs the surges that occur on breaking the current, when the magnetic field collapses practically instantaneously and hence causes very high voltages to be induced in the secondary. Without this capacitor excessive sparking occurs at the vibrator contacts, shortening the vibrator life. Correct values usually lie between 0.005 and 0.03  $\mu\text{f.}$ , and for 250-300-volt supplies the capacitor should be rated at 1500 to 2000 volts d.c. The exact capacitance is critical, and should be determined experimentally. The optimum value is that which results in least battery current for a given rectified d.c. output from the supply. In practice the value can be determined by observing the degree of vibrator sparking as the capacitance is changed. When the system is operating properly there should be practically no sparking at the vibrator contacts. A 5000-ohm resistor in series with  $C_2$  will limit the secondary current to a safe value should the capacitor fail.

Vibrator-transformer units are available in a variety of power and voltage ratings. Representative units vary from one delivering 125 to 200 volts at 100 ma. to others that have a 400-volt output rating at 150 ma. Most units come supplied with "hash" filters, but not all of them have built-in ripple filters. The requirements for ripple filters are similar to those for a.c. supplies. The usual efficiency of vibrator packs is in the vicinity of 70 per cent, so a 300-volt 200-ma. unit will draw approximately 15 amperes from a 6-volt storage battery. Special vibrator transformers are also available from transformer manufacturers so that the amateur may build his own supply if he so desires. These have d.c. output ratings varying from 150 volts at 40 ma. to 330 volts at 135 ma.

Vibrator-type supplies are also available for

operating standard a.c. equipment from a 6- or 12-volt storage battery in power ratings up to 100 watts continuous or 125 watts intermittent.

### "Hash" Elimination

Sparking at the vibrator contacts causes r.f. interference ("hash," which can be distinguished from hum by its harsh, sharper pitch) when used with a receiver. To minimize this, r.f. filters are incorporated, consisting of  $RFC_1$  and  $C_1$  in the battery circuit, and  $RFC_2$  with  $C_3$  in the d.c. output circuit.

Equally as important as the hash filter is thorough shielding of the power supply and its connecting leads, since even a small piece of wire or metal will radiate enough r.f. to cause interference in a sensitive amateur receiver.

The power supply should be built on a metal chassis, with all unshielded parts underneath. A bottom plate to complete the shielding is advisable. The transformer case, vibrator cover and the metal shell of the tube all should be grounded to the chassis. If a glass tube is used it should be enclosed in a tube shield. The battery leads should be evenly twisted, since these leads are more likely to radiate hash than any other part of a well-shielded supply. Experimenting with different values in the hash filters should come *after* radiation from the battery leads has been reduced to a minimum. Shielding the leads is not often found to be particularly helpful.

### UNIVERSAL POWER SUPPLY

A vibrator-type power supply may be designed to operate from a storage battery only, or from either a battery or 115 volts a.c. Most late-model cars use 12-volt batteries, but there are still many cars with 6-volt systems in operation — a point to consider where emergency operation is an objective.

The circuit of a universal power supply for emergency, mobile, or home-station use is shown in Fig. 19-45. The unit furnishes a d.c. output of 300 volts at 160 ma. and can be operated from any of the above-mentioned sources. Shifting from one power source to another is accomplished by plugging  $P_1$  or  $P_2$ , connected to the selected source, into one of the two chassis connectors  $J_1$  or  $J_2$ . The vibrator-primary current is 11.6 amperes with 6-volt input under loaded conditions, and 6.8 amperes with 12-volt input.

To adapt equipment for optional 6- or 12-volt operation, 6-volt tubes must be used with their heaters in series-parallel. Fig. 19-46 shows a typical example of connections.

Battery input connections are made through  $P_3$  which plugs into a cigar-lighter socket in mobile service.

For 6-volt operation  $P_1$  is plugged into  $J_1$ . For 12-volt operation  $P_1$  is plugged into  $J_2$ . For 115-volt a.c. operation  $P_2$  is plugged into  $J_2$ .

Positive high-voltage output from the supply is fed to Pins 3 on output connectors  $J_3$  and  $J_4$ . The three heater connections are made through Pins 1, 2 and 6. The cable for transmitter plug  $P_3$  has provision for connecting to a transmit-

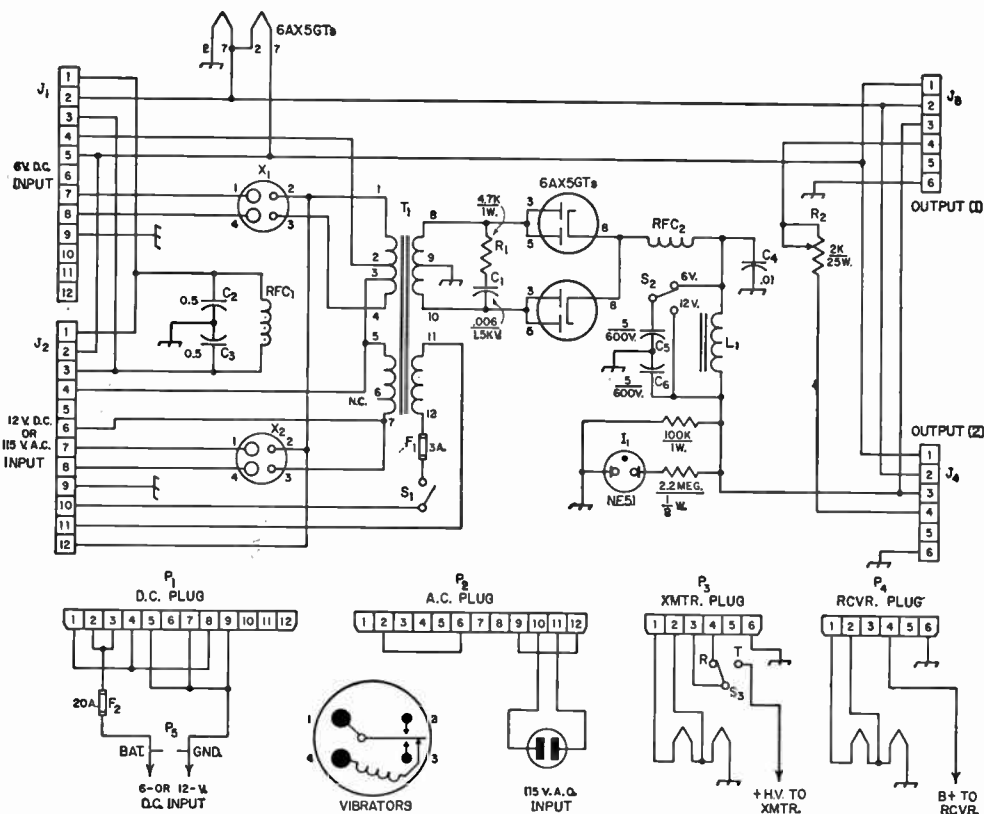
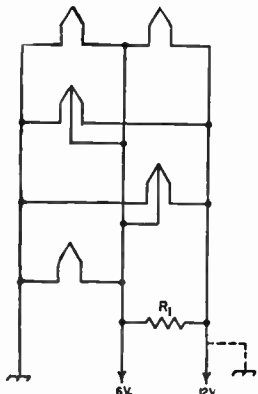

Fig. 19-45—Circuit of the universal power supply. All capacitances are in  $\mu$ f.

- F<sub>1</sub>—3-amp. cartridge fuse.
- F<sub>2</sub>—20-amp. cartridge fuse.
- J<sub>1</sub>, J<sub>2</sub>—12-contact male chassis connector (Cinch-Jones P-312-AB).
- J<sub>3</sub>, J<sub>4</sub>—6-contact female chassis connector (Cinch-Jones S-306-AB).
- L<sub>1</sub>—5-h. 200-ma. 80-ohm filter choke (Merit C-1396, Stancor C-1411).
- P<sub>1</sub>, P<sub>2</sub>—12-contact female cable connector (Cinch-Jones S-312-CCT).
- P<sub>3</sub>, P<sub>4</sub>—6-contact male cable connector (Cinch-Jones P-306-CCT).

- P<sub>5</sub>—Cigar-Lighting plug (Mallory R-675).
- RFC<sub>1</sub>—30 turns No. 14 enam., 1/2-inch diam., close-wound.
- RFC<sub>2</sub>—1-mh. r.f. choke (National R-300-U, Millen 34106).
- T<sub>1</sub>—Combination power transformer: 6-volt d.c. vibrator or 115 v a.c. input; 300 volts, 160 ma.; 6.3 volts 3 amp.; 6.3-volt 4.5-amp. tap on vibrator primary (Merit P-3176).
- X<sub>1</sub>—4-prong tube socket for 6-volt vibrator (Mallory 4501 vibrator).
- X<sub>2</sub>—4-prong tube socket for 12-volt vibrator (Mallory G4501 vibrator).

Fig. 19-46 — Circuit showing typical series-parallel heater connections for 6-volt and 6/12-volt tubes. Resistor R<sub>1</sub> is used when necessary to balance the currents in the two branches. The dashed line shows how the switching system connects all tubes in parallel for 6-volt operation by grounding.



receive switch (S<sub>3</sub>) at the transmitter. In the transmit position the plate voltage is fed to the transmitter. In the receive position the switch feeds the plate voltage, via Pin 4, through series voltage-dropping resistor R<sub>2</sub> to Pin 4 on the other output jack and thence to the receiver. It will be noticed that the same circuit results with P<sub>3</sub> and P<sub>4</sub> in either output jack.

(Originally described in *QST*, Oct., 1957.)

### TRANSISTOR POWER SUPPLIES

A mobile or portable power supply using transistors has high over-all efficiency at its rated power output. Since there are no moving parts there are few maintenance problems. Capacitors and resistors may occasionally need

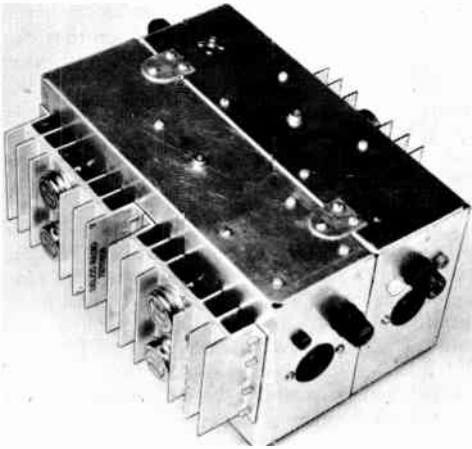

Fig. 19-47—Triple transistor power supply delivers +600, +250 and -300 volts. Ribbed aluminum heat sinks are standard item, were painted black after picture was taken. Tube sockets are used as jacks for output and control circuits, tip jacks are voltage test points. Two chassis are hinged on underside, locked together on top by two tabs of aluminum and sheet-metal screws.

replacement, but if the transistors are operated within their electrical and thermal ratings, their life expectancy is in terms of years rather than hours.

In a transistor power supply, the transistors operate as electronic switches to interrupt the d.c. through the primary of the power transformer much like the mechanical vibrator does in a vibrator supply.

When voltage is applied to the power supply circuit, current will flow through the transistors; however, since no two transistors are precisely alike electrically, initially one will con-

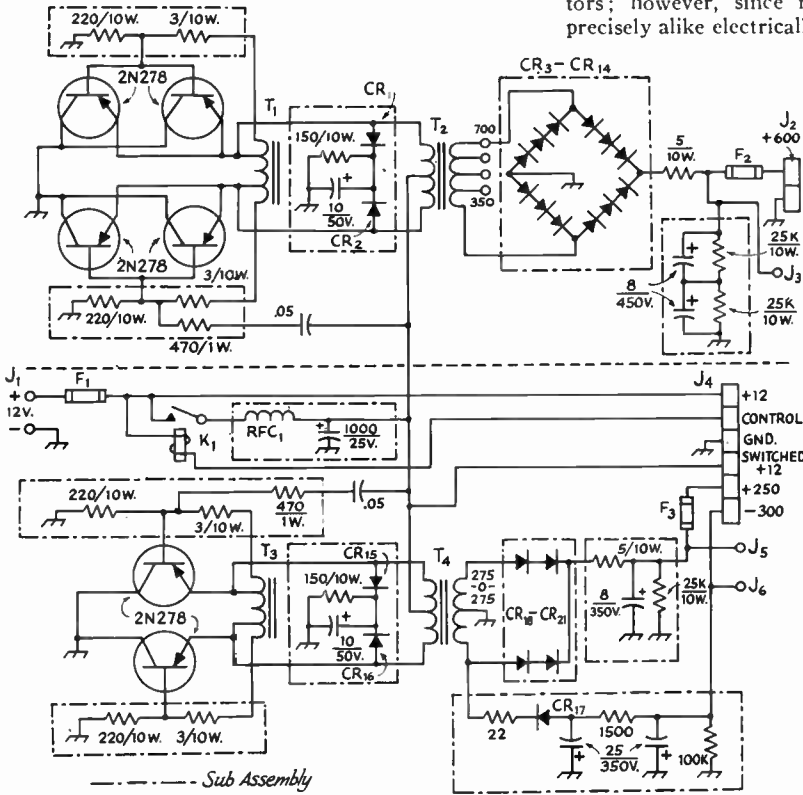

Fig. 19-48—Circuit diagram of the triple transistorized power supply. Capacitances are in  $\mu\text{f.}$ , resistors are  $\frac{1}{2}$  watt unless specified otherwise. Capacitors marked with polarity are electrolytic; others are paper.

CR<sub>1</sub>—CR<sub>17</sub>—400 p.i.v. 350-ma. silicon rectifier (International Rectifier 5E4).

CR<sub>18</sub>—CR<sub>21</sub>—400 p.i.v. 600-ma. silicon rectifier (G. E. 1N1695).

F<sub>1</sub>—30-ampere fuse.

F<sub>2</sub>— $\frac{1}{4}$ -ampere fuse.

F<sub>3</sub>— $\frac{1}{8}$ -ampere fuse.

J<sub>1</sub>—Insulated terminal (Millen 37001).

J<sub>2</sub>, J<sub>1</sub>—Tube socket.

J<sub>3</sub>, J<sub>5</sub>, J<sub>6</sub>—Insulated tip jack.

K<sub>1</sub>—S.p.s.t. relay, 60-amp. contacts, 12-volt coil (Potter & Brumfield MB3D).

RFC<sub>1</sub>—20 turns No. 10 enamel close-wound on  $\frac{1}{2}$ -inch diameter.

T<sub>1</sub>—Toroid feedback transformer (Osborne 2709).

T<sub>2</sub>—Power transformer with Hypersil core, 295 v.a. Secondary tapped for 700, 650, 550 or 350 volts. (Osborne 16553-12).

T<sub>3</sub>—Toroid feedback transformer (Osborne 716).

T<sub>4</sub>—Power transformer with Hypersil core, 120 v.a. Secondary 550 v.c.t. (Osborne 14572A-12). (T<sub>1</sub> - T<sub>4</sub> available from Osborne Transformer Co., 3834 Mitchell, Detroit 7, Mich.)



## MOBILE EQUIPMENT

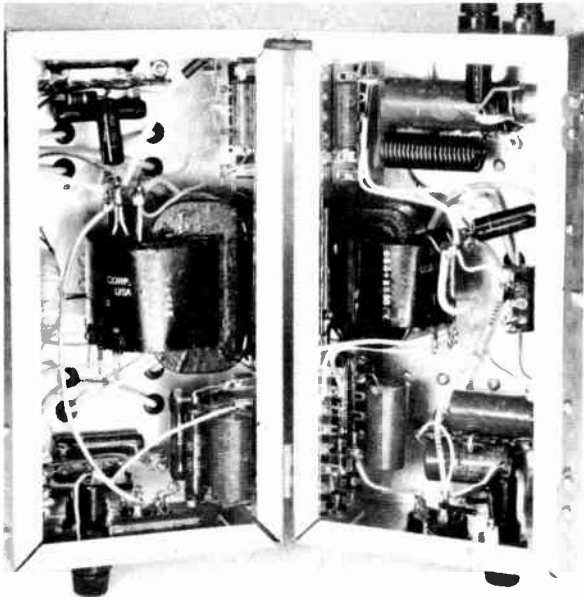

Fig. 19-49—Only electrical connections between the two chassis are through fastenings and the +12-volt lead (top center). Construction of the units is simplified by generous use of sub-assemblies (outlined in dot-and-dash lines in Fig. 19-50). The sub-assemblies are made up on multiple tie-point strips, wired and put in place. Bridge rectifier section, CR<sub>3</sub> through CR<sub>14</sub>, is made on four tie-point strips arranged in a square (lower left). The insulated terminal on the low-voltage supply (upper right) receives the +12 volts from the battery.

duct a little more current than the other. This difference current or "starting" current will cause a small voltage to be induced in the transformer winding connected to the bases of the transistors. The polarity is such that the conducting transistor is biased to conduct even more heavily while the base of the other transistor is biased to cutoff. This process continues until the increasing current causes magnetic saturation of the transformer core, at which time the induced voltage drops to zero and there is no longer enough base bias to maintain the collector current. When this happens the current decreases, causing an induced voltage of opposite polarity. The process then reverses so that the previously nonconducting transistor starts to conduct and the previously conducting transistor becomes cut off. The result is an alternating current of square-wave form through the transformer primary. This in turn induces a stepped-up voltage in the h.v. secondary of the transformer.

The transistor supply is self-protecting against overload because if a short circuit or heavy overload occurs oscillations cease and the input current drops to a low value. The output voltage regulation is extremely good making the transistor supply especially useful as a source of plate or screen power for a single-sideband mobile or portable rig.

In a transistor power supply that has not been properly designed, small spikes may appear on the leading edges of the square wave gener-

ated in the transistor power oscillator. Even though the spikes are of short duration they can cause punch-through of the transistor junction if the total voltage exceeds the transistor collector-to-emitter rating. The amplitudes of these spikes can be held to a safe value if the primary and secondary coils on the power transformer are tightly coupled and a large capacitor is connected across the low-voltage supply.

Transistor power transformers are available in both conventional and toroidal construction, with outputs ranging up to 150 watts. The supply shown in Figs. 19-47 and 19-49 has three outputs: 590 volts at 120 ma. (dropping to 570 volts at 225-ma. peaks), 250 volts at 125 ma., and a 300-volt negative supply for bias purposes. The high-voltage section uses silicon diodes in series in a bridge rectifier circuit, and the low-voltage section uses a center-tapped transformer and silicon diodes in series in a full-wave rectifier circuit. The transistors are mounted on ribbed aluminum heat sinks (Delco 7270606).

The wiring diagram, Fig. 19-48, is drawn with a horizontal dashed line that separates the high-voltage supply from the other two. This dashed line also represents the distribution of the components between the two 5 × 9½ × 3-inch aluminum chassis that make up the cabinet. A single heavy wire carries the +12 volts from one chassis to the other. Provision is included for remote control of the power (and +12 volts) through the heavy-duty relay.

It is very important to provide good heat transfer from the mounting bases of the transistors to the heat sinks, and a small amount of silicone lubricant should be spread on the transistor when it is bolted to the sink.

Matched pairs of 2N278 transistors were used in the high-voltage supply. If matched pairs were not used in parallel, it would be necessary to include 0.1-ohm current-equalizing resistors in series with each emitter.

Since heat is the prime limiting factor in transistor power supply operation, placement of the unit in the car should have some special consideration. Try to find a location away from high-temperature spots and in a well-ventilated area.

## GASOLINE-ENGINE DRIVEN GENERATORS

For higher-power installations, such as for communications control centers during emergencies, the most practical form of independent power supply is the gasoline-engine driven generator which provides standard 115-volt 60-cycle supply.

Such generators are ordinarily rated at a minimum of 250 or 300 watts. They are available up to ten kilowatts, or big enough to handle the highest-power amateur rig. Most are arranged to charge automatically an auxiliary 6- or 12-volt battery used in starting. Fitted with self-starters and adequate mufflers and filters,



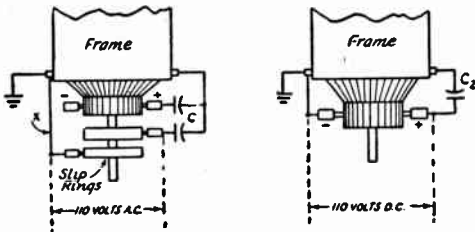

Fig. 19-50—Connections used for eliminating interference from gas-driven generator plants. C should be 1  $\mu$ f., 300 volts, paper, while C<sub>2</sub> may be 1  $\mu$ f. with a voltage rating of twice the d.c. output voltage delivered by the generator. X indicates an added connection between the slip ring on the grounded side of the line and the generator frame.

they represent a high order of performance and efficiency. Many of the larger models are liquid-cooled, and they will operate continuously at full load.

The output frequency of an engine-driven generator must fall between the relatively narrow limits of 50 to 60 cycles if standard 60-cycle transformers are to operate efficiently from this source. A 60-cycle electric clock provides a means of checking the output frequency with a fair degree of accuracy. The clock is connected across the output of the generator and the second hand is checked closely against the second hand of a watch. The speed of the engine is adjusted until the two second hands are in synchronism.

Output voltage should be checked with a voltmeter since a standard 115-volt lamp bulb, which is sometimes used for this purpose, is very inaccurate.

**Noise Elimination**

Electrical noise which may interfere with receivers operating from engine-driven a.c. generators may be reduced or eliminated by taking proper precautions. The most important point is that of grounding the frame of the generator and one side of the output. The ground lead should be short to be effective, otherwise grounding may actually increase the noise. A water pipe may be used if a short connection can be made near the point where the pipe enters the ground, otherwise a good separate ground should be provided.

The next step is to loosen the brush-holder locks and slowly shift the position of the brushes while checking for noise with the receiver. Usually a point will be found (almost always different from the factory setting) where there is a marked decrease in noise.

From this point on, if necessary, bypass capacitors from various brush holders to the frame, as shown in Fig. 19-50, will bring the hash down to within 10 to 15 per cent of its original intensity, if not entirely eliminating it. Most of the remaining noise will be reduced still further if the high-power audio stages are cut out and a pair of headphones is connected into the second detector.

**DRY CELL BATTERIES**

Dry-cell batteries are a practical source of power for supplying portables or equipment which must be transported on foot. However, they are costly and have limited current capability. The zinc-carbon cells lose their power even when not in use, if allowed to stand idle for periods of a year or more. This makes them uneconomical if not used more or less continuously.

The mercury cell has a much higher ratio of ampere-hour capacity to volume at higher current densities than are obtainable from the conventional dry cell. Mercury batteries are well suited for emergency portable operation even after many months of storage.

Typical service life data for several types of zinc-carbon cells and batteries is given in Table 19-III. The figures show length of service time before the cell terminal voltage drops to 1.0 volt (in B-batteries, when individual cells reach 1.0 volt).

Mercury batteries and cells are available in several sizes and shapes. Some may be operated at current drains up in the ampere range and others are available in potentials in the hundreds of volts. A typical 1.35-volt mercury cell measuring only 2 3/4 x 2 3/4 x 2 3/4 inches, has a capacity of 43 ampere hours (maximum current 3 amperes). Cells of this type would be useful for filament or heater applications. A representative mercury B-battery has a voltage of 67.5 volts and a capacity of 3.6 ampere hours (maximum current 250 ma.). It measures about 3 3/8 x 1 1/2 x 10 1/8 inches.

**TABLE 19-III**  
Service life of some typical zinc-carbon cells and batteries

Cell or Battery	ASA Cell Size	Continuous service		4 hours per day service	
		ma.	hrs.	ma.	hrs.
1.5 v. penlite cell 1.5 v. flashlight cell 1.5 v. ignition cell	AA	30	14	20	33
	D	160	9	130	21
	#6	500	43	500	80
45 v., 67.5 v., 90 v. B-battery	F30	18	9	16	14
	F40	19	15	17	24
	F70	20	35	24	47

# Construction Practices

## TOOLS AND MATERIALS

While an easier, and perhaps a better, job can be done with a greater variety of tools available, by taking a little thought and care it is possible to turn out a fine piece of equipment with only a few of the common hand tools. A list of tools which will be indispensable in the construction of radio equipment will be found on this page. With these tools it should be possible to perform any of the required operations in preparing panels and metal chassis for assembly and wiring.

### INDISPENSABLE TOOLS

Long-nose pliers, 6-inch.  
 Diagonal cutting pliers, 6-inch.  
 Wire stripper.  
 Screwdriver, 6- to 7-inch,  $\frac{1}{4}$ -inch blade.  
 Screwdriver, 4- to 5-inch,  $\frac{1}{8}$ -inch blade.  
 Scratch awl or scriber for marking lines.  
 Combination square, 12-inch, for laying out work.  
 Hand drill,  $\frac{1}{4}$ -inch chuck or larger, 2-speed type preferable.  
 Electric soldering iron, 100 watts,  $\frac{1}{4}$ -in. tip.  
 Hack saw, 12-inch blades.  
 Center punch for marking hole centers.  
 Hammer, ball-peen, 1-lb. head.  
 Heavy knife.  
 Yardstick or other straightedge.  
 Carpenter's brace with adjustable hole cutter or socket-hole punches (see text).  
 Large, coarse, flat file.  
 Large round or rat-tail file,  $\frac{1}{2}$ -inch diameter.  
 Three or four small and medium files—flat, round, half-round, triangular.  
 Drills, particularly  $\frac{1}{4}$ -inch and Nos. 18, 28, 33, 42 and 50.  
 Combination oil stone for sharpening tools.  
 Solder, rosin-core.  
 Medium-weight machine oil.

### ADDITIONAL TOOLS

Bench vise, 4-inch jaws.  
 Tin shears, 10-inch, for cutting thin sheet metal.  
 Taper reamer,  $\frac{1}{2}$ -inch, for enlarging small holes.  
 Taper reamer, 1-inch, for enlarging holes.  
 Countersink for brace.  
 Carpenter's plane, 8- to 12-inch, for woodworking.  
 Carpenter's saw, crosscut.  
 Motor-driven emery wheel for grinding.  
 Phillips screwdriver.  
 Long-shank screwdriver with screw-holding clip for tight places.  
 Set of "Spintite" socket wrenches for hex nuts.  
 Set of small, flat, open-end wrenches for hex nuts.  
 Set of Allen wrenches.  
 Set of spline wrenches.  
 Wood chisel,  $\frac{1}{2}$ -inch.  
 Cold chisel,  $\frac{1}{2}$ -inch.  
 Wing dividers, 8-inch, for scribing circles.  
 Set of machine-screw taps and dies.  
 Dusting brush.  
 Socket punches, esp.  $\frac{3}{8}$ ",  $\frac{1}{4}$ ",  $1\frac{1}{8}$ " and  $1\frac{1}{4}$ ".

It is an excellent idea for the amateur who does constructional work to add to his supply of tools from time to time as finances permit.

Radio-supply houses, mail-order retail stores and most hardware stores carry the various tools required when building or servicing amateur radio equipment. While power tools (electric drill or drill press, grinding wheel, etc.) are very useful and will save a lot of time, they are not essential.

### Twist Drills

Twist drills are made of either high-speed steel or carbon steel. The latter type is more common and will usually be supplied unless specific request is made for high-speed drills. The carbon drill will suffice for most ordinary equipment construction work and costs less than the high-speed type.

While twist drills are available in a number of sizes, those listed in bold-faced type in Table 20-I will be most commonly used in construction of amateur equipment. It is usually desirable to purchase several of each of the commonly used sizes rather than a standard set, most of which will be used infrequently if at all.

### Care of Tools

The proper care of tools is not alone a matter of pride to a good workman. He also realizes the energy which may be saved and the annoyance which may be avoided by the possession of a full kit of well-kept sharp-edged tools.

Drills should be sharpened at frequent intervals so that grinding is kept at a minimum each time. This makes it easier to maintain the rather critical surface angles required for best cutting with least wear. Occasional oilstoning of the cutting edges of a drill or reamer will extend the time between grindings.

The soldering iron can be kept in good condition by keeping the tip well tinned with solder and not allowing it to run at full voltage for long periods when it is not being used. After each period of use, the tip should be removed and cleaned of any scale which may have accumulated. An oxidized tip may be cleaned by dipping it in sal ammoniac while hot and then wiping it clean with a rag. If the tip becomes pitted it should be filed until smooth and bright, and then tinned immediately by dipping it in solder.

Useful Materials

Small stocks of various miscellaneous materials will be required in constructing radio apparatus, most of which are available from hardware or radio-supply stores. A representative list follows:

Sheet aluminum, solid and perforated, 16 or 18 gauge, for brackets and shielding.

1/2 x 1/2-inch aluminum angle stock.

1/4-inch diameter round brass or aluminum rod for shaft extensions.

Machine screws: Round-head and flat-head, with nuts to fit. Most useful sizes: 4-40, 6-32 and 8-32, in lengths from 1/4 inch to 1 1/2 inches. (Nickel-plated iron will be found satisfactory except in strong r.f. fields, where brass should be used.)

Bakelite, lucite and polystyrene scraps.

Soldering lugs, panel bearings, rubber grommets, terminal-lug wiring strips, varnished-cambrie insulating tubing.

Shielded and unshielded wire.

Tinned bare wire, Nos. 22, 14 and 12.

Machine screws, nuts, washers, soldering lugs, etc., are most reasonably purchased in quantities of a gross. Many of the radio-supply stores sell small quantities and assortments that come in handy.

CHASSIS WORKING

With a few essential tools and proper procedure, it will be found that building radio gear on a metal chassis is a relatively simple matter. Aluminum is to be preferred to steel, not only because it is a superior shielding material, but because it is much easier to work and to provide good chassis contacts.

The placing of components on the chassis is shown quite clearly in the photographs in this Handbook. Aside from certain essential dimensions, which usually are given in the text, exact duplication is not necessary.

Much trouble and energy can be saved by spending sufficient time in planning the job. When all details are worked out beforehand the actual construction is greatly simplified.

Cover the top of the chassis with a piece of wrapping paper or, preferably, cross-section

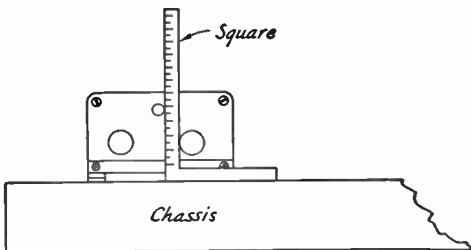

Fig. 20-1—Method of measuring the heights of capacitor shafts, etc. If the square is adjustable, the end of the scale should be set flush with the face of the head.

TABLE 20-1  
Numbered Drill Sizes

Number	Diameter (mils)	Will Clear Screw	Drilled for Tapping Iron, Steel or Brass*
1	228.0	—	—
2	221.0	12-24	—
3	213.0	—	14-24
4	209.0	12-20	—
5	205.0	—	—
6	204.0	—	—
7	201.0	—	—
8	199.0	—	—
9	196.0	—	—
10	193.5	10-32	—
11	191.0	10-24	—
12	189.0	—	—
13	185.0	—	—
14	182.0	—	—
15	180.0	—	—
16	177.0	—	12-24
17	173.0	—	—
18	169.5	8-32	—
19	166.0	—	12-20
20	161.0	—	—
21	159.0	—	10-32
22	157.0	—	—
23	154.0	—	—
24	152.0	—	—
25	149.5	—	10-24
26	147.0	—	—
27	144.0	—	—
28	140.0	6-32	—
29	136.0	—	8-32
30	128.5	—	—
31	120.0	—	—
32	116.0	—	—
33	113.0	4-40	—
34	111.0	—	—
35	110.0	—	6-32
36	106.5	—	—
37	104.0	—	—
38	101.5	—	—
39	99.5	3-48	—
40	99.0	—	—
41	99.0	—	—
42	99.5	—	4-40
43	98.0	2-56	—
44	98.0	—	—
45	98.2	—	3-48
46	98.1	—	—
47	97.8	—	—
48	97.8	—	—
49	97.3	—	2-56
50	97.0	—	—
51	96.7	—	—
52	96.5	—	—
53	95.9	—	—
54	95.0	—	—

\*Use one size larger for tapping bakelite and phenolics.

paper, folding the edges down over the sides of the chassis and fastening with adhesive tape. Then assemble the parts to be mounted on top of the chassis and move them about until a satisfactory arrangement has been found, keeping in mind any parts which are to be mounted underneath, so that interferences in mounting may be avoided. Place capacitors and other parts with shafts extending through the panel first, and arrange them so that the controls will form the desired pattern on the panel. Be sure to line up the shafts

squarely with the chassis front. Locate any partition shields and panel brackets next, and then the tube sockets and any other parts, marking the mounting-hole centers of each accurately on the paper. Watch out for capacitors whose shafts are off center and do not line up with the mounting holes. Do not forget to mark the centers of socket holes and holes for leads under i.f. transformers, etc., as well as holes for wiring leads. The small holes for socket-mounting screws are best located and center-punched, using the socket itself as a template, after the main center hole has been cut.

By means of the square, lines indicating accurately the centers of shafts should be extended to the front of the chassis and marked on the panel at the chassis line, the panel being fastened on temporarily. The hole centers may then be punched in the chassis with the center punch. After drilling, the parts which require mounting underneath may be located and the mounting holes drilled, making sure by trial that no interferences exist with parts mounted on top. Mounting holes

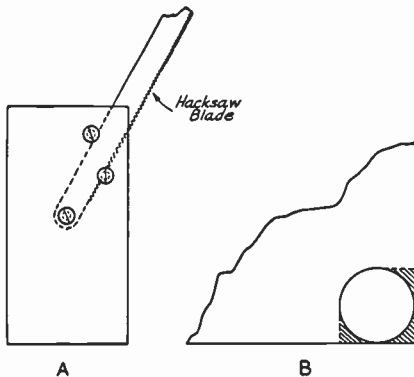

Fig. 20-2—To cut rectangular holes in a chassis corner, holes may be filed out as shown in the shaded portion of B, making it possible to start the hack-saw blade along the cutting line. A shows how a single-ended handle may be constructed for a hack-saw blade.

along the front edge of the chassis should be transferred to the panel, by once again fastening the panel to the chassis and marking it from the rear.

Next, mount on the chassis the capacitors and any other parts with shafts extending to the panel, and measure accurately the height of the center of each shaft above the chassis, as illustrated in Fig. 20-1. The horizontal displacement of shafts having already been marked on the chassis line on the panel, the vertical displacement can be measured from this line. The shaft centers may now be marked on the back of the panel, and the holes drilled. Holes for any other panel equipment coming above the chassis line may then be marked and drilled, and the remainder of

the apparatus mounted. Holes for terminals etc., in the rear edge of the chassis should be marked and drilled at the same time that they are done for the top.

### Drilling and Cutting Holes

When drilling holes in metal with a hand drill it is important that the centers first be located with a center punch, so that the drill point will not "walk" away from the center when starting the hole. When the drill starts to break through, special care must be used. Often it is an advantage to shift a two-speed drill to low gear at this point. Holes more than  $\frac{1}{4}$  inch in diameter should be started with a smaller drill and reamed out with the larger drill.

The chuck on the usual type of hand drill is limited to  $\frac{1}{4}$ -inch drills. Although it is rather tedious, the  $\frac{1}{4}$ -inch hole may be filed out to larger diameters with round files. Another method possible with limited tools is to drill a series of small holes with the hand drill along the inside of the diameter of the large hole, placing the holes as close together as possible. The center may then be knocked out with a cold chisel and the edges smoothed up with a file. Taper reamers which fit into the carpenter's brace will make the job easier. A large rat-tail file clamped in the brace makes a very good reamer for holes up to the diameter of the file.

For socket holes and other large holes in an aluminum chassis, socket-hole punches should be used. They require first drilling a guide hole to pass the bolt that is turned to squeeze the punch through the chassis. The threads of the bolt should be oiled occasionally.

Large holes in steel panels or chassis are best cut with an adjustable circle cutter. Occasional application of machine oil in the cutting groove will help. The cutter first should be tried out on a block of wood, to make sure that it is set for the right diameter.

The burrs or rough edges which usually result after drilling or cutting holes may be removed with a file, or sometimes more conveniently with a sharp knife or chisel. It is a good idea to keep an old wood chisel sharpened and available for this purpose.

### Rectangular Holes

Square or rectangular holes may be cut out by making a row of small holes as previously described, but is more easily done by drilling a  $\frac{1}{2}$ -inch hole inside each corner, as illustrated in Fig. 20-2, and using these holes for starting and turning the hack saw. The socket-hole punch and the square punches which are now available also may be of considerable assistance in cutting out large rectangular openings.

### CONSTRUCTION NOTES

If a control shaft must be extended or insulated, a flexible shaft coupling with ad-

equate insulation should be used. Satisfactory support for the shaft extension, as well as electrical contact for safety, can be provided by means of a metal panel bearing made for the purpose. These can be obtained singly for use with existing shafts, or they can be bought with a captive extension shaft included. In either case the panel bearing gives a "solid" feel to the control.

The use of fiber washers between ceramic insulation and metal brackets, screws or nuts will prevent the ceramic parts from breaking.

edge of the sheet may become bent. A pair of iron bars or pieces of heavy angle stock, as long or longer than the width of the sheet, to hold it in the vise will make the job easier. "C" clamps may be used to keep the bars from spreading at the ends. The rough edges may be smoothed with a file or by placing a large piece of emery cloth or sandpaper on a flat surface and running the edge of the metal back and forth over the sheet.

Bends may be made similarly.

**Finishing Aluminum**

Aluminum chassis, panels and parts may be given a sheen finish by treating them in a caustic bath. An enamelled or plastic container, such as a dishpan or infant's bathtub, should be used for the solution. Dissolve ordinary household lye in cold water in a proportion of 1/4 to 1/2 can of lye per gallon of water. The stronger solution will do the job more rapidly. Stir the solution with a stick of wood until the lye crystals are completely dissolved. Be very careful to avoid any skin contact with the solution. It is also harmful to clothing. Sufficient solution should be prepared to cover the piece completely. When the aluminum is immersed, a very pronounced bubbling takes place and ventilation should be provided to disperse the escaping gas. A half hour to two hours in the solution should be sufficient, depending upon the strength of the solution and the desired surface.

Remove the aluminum from the solution with sticks and rinse thoroughly in cold water while swabbing with a rag to remove the black deposit. When dry, finish by spraying on a light coat of clear lacquer.

**Soldering**

The secret of good soldering is allowing time for the joint, as well as the solder, to attain sufficient temperature. Enough heat should be applied so that the solder will melt when it comes in contact with the wires being joined, without touching the solder to the iron. Always use rosin-core solder, never acid-core. Solders have different melting points, depending upon the ratio of tin to lead. A 50-50 solder melts at 425° F, while 60-40 melts at 371° F. (A less-common solder, 63-37, melts at 361° F.) When it is desirable to protect from excessive heat the components being soldered, the 60-40 solder is preferable.

When soldering transistors, crystal diodes or small resistors, the lead should be gripped with a pair of pliers up close to the unit so that the heat will be conducted away. Overheating of a transistor or diode while soldering can cause permanent damage. Also, mechanical stress will have a similar effect, so that a small unit should be mounted so that there is no appreciable mechanical strain on the leads.

Trouble is sometimes experienced in soldering to the pins of coil forms or male cable plugs. It helps if the pins are first cleaned on the inside

**STANDARD METAL GAUGES**

Gauge No.	American or B. & S. <sup>1</sup>	U. S. Standard <sup>2</sup>	Birmingham or Stubs <sup>3</sup>
1	.2893	.28125	.300
2	.2576	.265625	.284
3	.2294	.25	.259
4	.2043	.234375	.238
5	.1819	.21875	.220
6	.1620	.203125	.203
7	.1443	.1875	.180
8	.1285	.171875	.165
9	.1144	.15625	.148
10	.1019	.140625	.134
11	.09074	.125	.120
12	.08081	.109375	.109
13	.07196	.09375	.095
14	.06408	.078125	.083
15	.05707	.0703125	.072
16	.05082	.0625	.065
17	.04526	.05625	.058
18	.04030	.05	.049
19	.03589	.04375	.042
20	.03196	.0375	.035
21	.02846	.034375	.032
22	.02535	.03125	.028
23	.02257	.028125	.025
24	.02010	.025	.022
25	.01790	.021875	.020
26	.01594	.01875	.018
27	.01420	.0171875	.016
28	.01264	.015625	.014
29	.01126	.0140625	.013
30	.01003	.0125	.012
31	.008928	.0109375	.010
32	.007950	.01015625	.009
33	.007080	.009375	.008
34	.006350	.00859375	.007
35	.005615	.0078125	.005
36	.005000	.00703125	.004
37	.004453	.006640626	....
38	.003965	.00625	....
39	.003531	.....	....
40	.003145	.....	....

<sup>1</sup> Used for aluminum, copper, brass and non-ferrous alloy sheets, wire and rods.

<sup>2</sup> Used for iron, steel, nickel and ferrous alloy sheets, wire and rods.

<sup>3</sup> Used for seamless tubes; also by some manufacturers for copper and brass.

**Cutting and Bending Sheet Metal**

If a sheet of metal is too large to be cut conveniently with a hack saw, it may be marked with scratches as deep as possible along the line of the cut on both sides of the sheet and then clamped in a vise and worked back and forth until the sheet breaks at the line. Do not carry the bending too far until the break begins to weaken; otherwise the



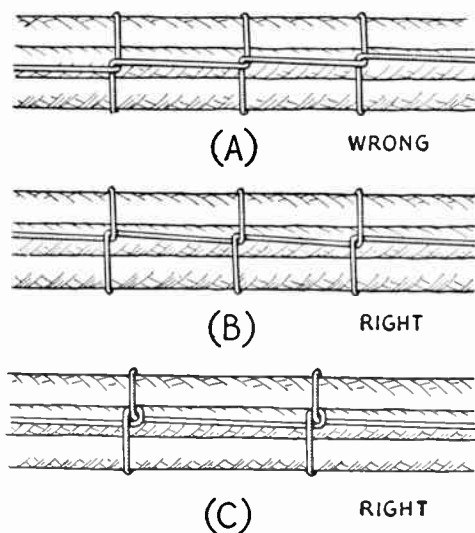

Fig. 20-3—Methods of lacing cables. The method shown at C is more secure, but takes more time than the method of B. The latter is usually adequate for most amateur requirements.

with a suitable twist drill and then tinned by flowing rosin-core solder into them. Immediately clear the surplus solder from each hot pin by a whipping motion or by blowing through the pin from the inside of the form or plug. Before inserting the wire in the pin, file the nickel plate from the tip. After soldering, round the solder tip off with a file.

When soldering to the pins of polystyrene coil forms, hold the pin to be soldered with a pair of heavy pliers, to form a "heat sink" and insure that the pin does not heat enough in the coil form to loosen and become misaligned.

### Wiring

The wire used in connecting amateur equipment should be selected considering both the maximum current it will be called upon to handle and the voltage its insulation must stand without breakdown. Also, from the consideration to TVI, the power wiring of all transmitters should be done with wire that has a braided shielding cover. Receiver and audio circuits may also require the use of shielded wire at some points for stability, or the elimination of hum.

No. 20 stranded wire is commonly used for most receiver wiring (except for the high-frequency circuits) where the current does not exceed 2 or 3 amperes. For higher-current heater circuits, No. 18 is available. Wire with cellulose acetate insulation is good for voltages up to about 500. For higher voltages, thermoplastic-insulated wire should be used. Inexpensive wire strippers that make the removal of insulation from hook-up wire an easy job are available on the market.

When power leads have several branches in the chassis, it is convenient to use fiber-insulated

multiple tie points as anchorages or junction points. Strips of this type are also useful as insulated supports for resistors, r.f. chokes and capacitors. High-voltage wiring should have exposed points held to a minimum; those which cannot be avoided should be made as inaccessible as possible to accidental contact or short-circuit.

Where shielded wire is called for and capacitance to ground is not a factor, Belden type 8885 shielded grid wire may be used. If capacitance must be minimized, it may be necessary to use a piece of car-radio low-capacitance lead-in wire, or coaxial cable.

For wiring high-frequency circuits, rigid wire is often used. Bare soft-drawn tinned wire, sizes 22 to 12 (depending on mechanical requirements), is suitable. Kinks can be removed by stretching a piece 10 or 15 feet long and then cutting into short lengths that can be handled conveniently. R.f. wiring should be run directly from point to point with a minimum of sharp bends and the wire kept well spaced from the chassis or other grounded metal surfaces. Where the wiring must pass through the chassis or a partition, a clearance hole should be cut and lined with a rubber grommet. In case insulation becomes necessary, varnished cambric tubing (spaghetti) can be slipped over the wire.

In transmitters where the peak voltage does not exceed 2500 volts, the shielded grid wire mentioned above should be satisfactory for power circuits. For higher voltages, Belden type 8656, Birnbach type 1820, or shielded ignition cable can be used. In the case of filament circuits carrying heavy current, it may be necessary to use No. 10 or 12 bare or enameled wire, slipped through spaghetti, and then covered with copper braid pulled tightly over the spaghetti. The chapter on TVI shows the manner in which shielded wire should be applied. If the shielding is simply slid back over the insulation and solder flowed into the end of the braid, the braid usually will stay in place without the necessity for cutting it back or binding it in place. The braid should be cleaned first so that solder will take with a minimum of heat.

R.f. wiring in transmitters usually follows the method described above for receivers with due respect to the voltages involved.

Where power or control leads run together for more than a few inches, they will present a better appearance when bound together in a single cable. The correct technique is illustrated in Fig. 20-3; both plastic and waxed-linen lacing cords are available. Plastic cable clamps are available to hold the laced cable.

To give a "commercial look" to the wiring of any unit, run any cabled leads along the edge of the chassis. If this isn't possible, the cabled leads should then run parallel to an edge of the chassis. Further, the generous use of tie points (mounted parallel to an edge of the chassis), for the support of one or both ends of a resistor or fixed capacitor, will add to the ap-

BNC Connectors

1.—Cut end of cable even.

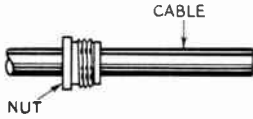

2.—Remove vinyl jacket  $\frac{1}{2}$ "—don't nick braid.

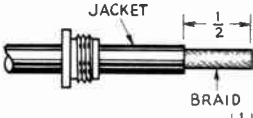

3.—Push braid back and remove  $\frac{1}{8}$ " of insulation and conductor.

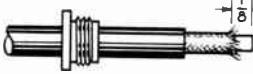

4.—Taper braid.



5.—Slide sleeve over tapered braid. Fit inner shoulder or sleeve squarely against end of jacket.

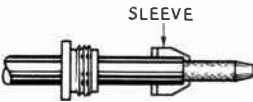

6.—With sleeve in place, comb out braid, fold back smooth as shown, and trim  $\frac{3}{32}$ ".

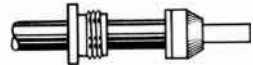

7.—Bare center conductor  $\frac{1}{8}$ "—don't nick conductor.

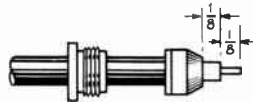

8.—Tin center conductor of cable. Slip female contact in place and solder. Remove excess solder. Be sure cable dielectric is not heated excessively and swollen so as to prevent dielectric entering body.

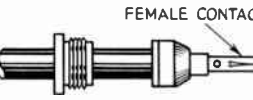

9.—Push into body as far as it will go. Slide nut into body and screw into place, with wrench, until it is moderately tight. Hold cable and shell rigidly and rotate nut.

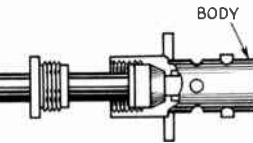

10.—This assembly procedure applies to BNC jacks. The assembly for plugs is the same except for the use of male contacts and a plug body.

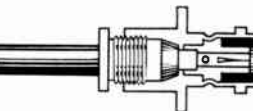

83-1SP Plug

1.—Cut end of cable even. Remove vinyl jacket  $\frac{1}{4}$ "—don't nick braid.



2.—Bare  $\frac{3}{4}$ " of center conductor—don't nick conductor. Trim braided shield  $\frac{1}{16}$ " and tin. Slide coupling ring on cable.

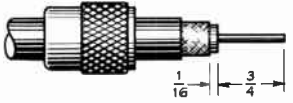

3.—Screw the plug assembly on cable. Solder plug assembly to braid through solder holes. Solder conductor to contact sleeve.

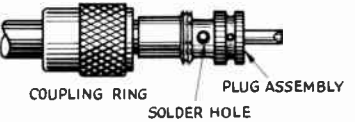

4.—Screw coupling ring on assembly.

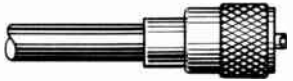

83-1SP Plug with Adapters

1.—Cut end of cable even. Remove vinyl jacket  $\frac{21}{32}$ "—don't nick braid. Slide coupling ring and adapter on cable.

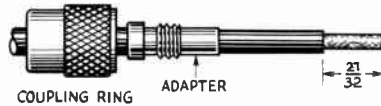

2.—Fan braid slightly and fold back over cable.



3.—Compress braid around cable. Position adapter to dimension shown. Press braid down over body of adapter to dimension shown. Press braid down over body of adapter and trim.



4.—Bare  $\frac{1}{4}$ " of center conductor—don't nick conductor. Pre-tin exposed center conductor.

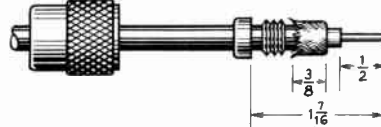

5, 6.—Same as 3 and 4 under 83-1SP Plug.

Fig. 20-4—Cable-stripping dimensions and assembly instructions for several popular coaxial-cable plugs. This material courtesy Amphenol Connector Division, Amphenol-Borg Electronics Corp.

**TABLE 20-II**  
**Standard Component Values**

20% Tolerance	10% Tolerance	5% Tolerance
10	10	10
	12	11
		12
15	15	13
		15
	18	16
		18
22	22	20
		22
	27	24
		27
		30
33	33	33
		36
	39	39
		43
47	47	47
		51
	56	56
		62
68	68	68
		75
	82	82
		91
100	100	100

pearance of the finished unit. In a similar manner, "dress" the small components so that they are parallel to the panel or sides of the chassis.

**Winding Coils**

Close-wound coils are readily wound on the specified form by anchoring one end of a length of wire (in a vise or to a doorknob) and the other end to the coil form. Straighten any kinks in the wire and then pull to keep the wire under slight tension. Wind the coil to the required number of turns while walking toward the anchor, always maintaining a slight tension on the wire.

To space-wind the coil, wind the coil simultaneously with a suitable spacing medium (heavy thread, string or wire) in the manner described above. When the winding is complete, secure the end of the coil to the coil-form terminal and then carefully unwind the spacing material. If the coil is wound under suitable tension, the spacing material can be easily removed without disturbing the winding. Finish the space-wound coil by judicious applications of Duco cement, to hold the turns in place.

The "cold" end of a coil is the end at or close to chassis or ground potential. Coupling links should be wound on the cold end of a coil, to minimize capacitive coupling.

**COMPONENT VALUES**

Values of composition resistors and small capacitors (mica and ceramic) are specified throughout this *Handbook* in terms of "preferred values." In the preferred-number system, all values represent (approximately) a constant-percentage increase over the next lower value. The base of the system is the

number 10. Only two significant figures are used. Table 20-II shows the preferred values based on tolerance steps 20, 10 and 5 per cent. All other values are expressed by multiplying or dividing the base figures given in the table by the appropriate power of 10. (For example, resistor values of 33,000 ohms, 6800 ohms, and 150 ohms are obtained by multiplying the base figures by 1000, 100, and 10, respectively.)

"Tolerance" means that a variation of plus or minus the percentage given is considered satisfactory. For example, the actual resistance of a "4700-ohm" 20-per-cent resistor can lie anywhere between 3700 and 5600 ohms, approximately. The permissible variation in the same resistance value with 5-per-cent tolerance would be in the range from 4500 to 4900 ohms, approximately.

Only those values shown in the first column of Table 20-II are available in 20-per-cent tolerance. Additional values, as shown in the second column, are available in 10-per-cent tolerance; still more values can be obtained in 5-per-cent tolerance.

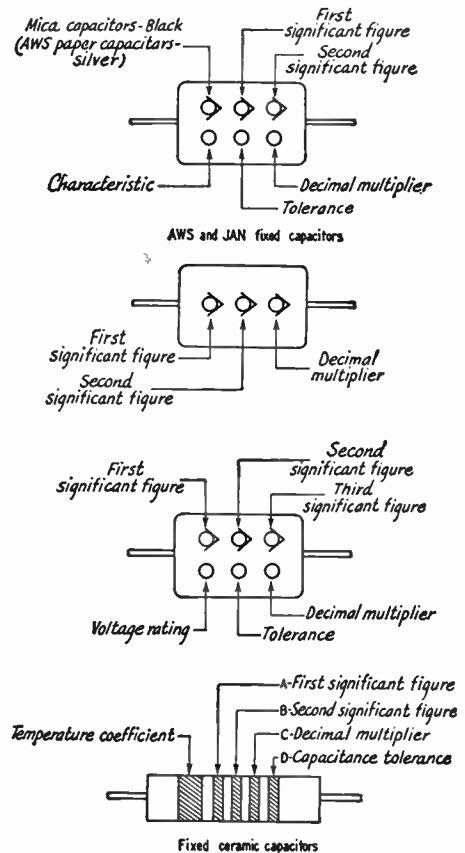

Fig. 20-5—Color coding of fixed mica, molded paper and tubular ceramic capacitors. The color code for mica and molded paper capacitors is given in Table 20-III. Table 20-IV gives the color code for tubular ceramic capacitors.

In the component specifications in this *Handbook*, it is to be understood that when no tolerance is specified the *largest* tolerance available in that value will be satisfactory.

Values that do not fit into the preferred-number system (such as 500, 25,000, etc.) easily can be substituted. It is obvious, for example, that a 5000-ohm resistor falls well within the tolerance range of the 4700-ohm 20-per-cent resistor used in the example above. It would not, however, be usable if the tolerance were specified as 5 per cent.

**COLOR CODES**

Standardized color codes are used to mark values on small components such as composition resistors and mica capacitors, and to identify leads from transformers, etc. The resistor-capacitor number color code is given in Table 20-III.

**Fixed Capacitors**

The methods of marking "postage-stamp" mica capacitors, molded paper capacitors, and tubular ceramic capacitors are shown in Fig. 20-5. Capacitors made to American War Standards or Joint Army-Navy specifications are marked with the 6-dot code shown at the top. Practically all surplus capacitors are in this category. The 3-dot EIA code is used for capacitors having a rating of 500 volts and  $\pm 20\%$  tolerance only; other ratings and tolerances are covered by the 6-dot EIA code.

Examples: A capacitor with a 6-dot code has the following markings: Top row, left to right, black, yellow, violet; bottom row, right to left, brown, silver, red. Since the first color in the top row is black (significant figure zero) this is the AWS code and the capacitor has mica dielectric. The significant figures are 4 and 7, the decimal multiplier 10 (brown, at right of second row), so the capacitance is 470  $\mu\text{f}$ . The tolerance is  $\pm 10\%$ . The final color, the characteristic, deals with temperature coefficients and methods of testing (see Table 20-V on page 510).

A capacitor with a 3-dot code has the following colors, left to right: brown, black, red. The significant figures are 1, 0 (10) and the

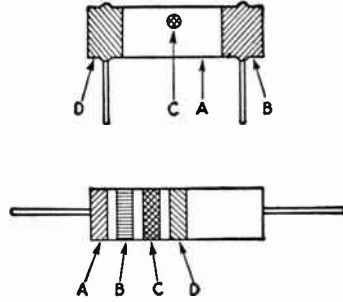

Fig. 20-6—Color coding of fixed composition resistors. The color code is given in Table 20-III. The colored areas have the following significance:

- A—First significant figure of resistance in ohms.
- B—Second significant figure.
- C—Decimal multiplier.
- D—Resistance tolerance in per cent. If no color is shown the tolerance is  $\pm 20\%$ .

multiplier is 100. The capacitance is therefore 1000  $\mu\text{f}$ .

A capacitor with a 6-dot code has the following markings: Top row, left to right, brown, black, black; bottom row, right to left, black, gold, blue. Since the first color in the top row is neither black nor silver, this is the EIA code. The significant figures are 1, 0, 0 (100) and the decimal multiplier is 1 (black). The capacitance is therefore 100  $\mu\text{f}$ . The gold dot shows that the tolerance is  $\pm 5\%$  and the blue dot indicates 600-volt rating.

**Ceramic Capacitors**

Conventional markings for ceramic capacitors are shown in the lower drawing of Fig. 20-5. The colors have the meanings indicated in Table 20-IV. In practice, dots may be used instead of the narrow bands indicated in Fig. 20-5.

Example: A ceramic capacitor has the following markings: Broad band, violet; narrow bands or dots, green, brown, black, green. The significant figures are 5, 1 (51) and the decimal multiplier is 1, so the capacitance is 51  $\mu\text{f}$ . The temperature coefficient is  $-750$  parts per million per degree C., as given by the broad band, and the capacitance tolerance is  $\pm 5\%$ .

**TABLE 20-III**  
Resistor-Capacitor Color Code

Color	Significant Figure	Decimal Multiplier	Tolerance (%)	Voltage Rating*
Black	0	1	—	—
Brown	1	10	1*	100
Red	2	100	2*	200
Orange	3	1,000	3*	300
Yellow	4	10,000	4*	400
Green	5	100,000	5*	500
Blue	6	1,000,000	6*	600
Violet	7	10,000,000	7*	700
Gray	8	100,000,000	8*	800
White	9	1,000,000,000	9*	900
Gold	—	0.1	5	1000
Silver	—	0.01	10	2000
No color	—	—	20	500

\* Applies to capacitors only.

**TABLE 20-IV**  
Color Code for Ceramic Capacitors

Color	Significant Figure	Decimal Multiplier	Capacitance Tolerance		Temp. Coeff. p.p.m./deg. C.
			More than 10 $\mu\text{f}$ (in %)	Less than 10 $\mu\text{f}$ (in $\mu\text{f}$ .)	
Black	0	1	$\pm 20$	2.0	0
Brown	1	10	$\pm 1$		$-30$
Red	2	100	$\pm 2$		$-80$
Orange	3	1000			$-150$
Yellow	4				$-220$
Green	5		$\pm 5$	0.5	$-330$
Blue	6				$-470$
Violet	7				$-750$
Gray	8	0.01		0.25	30
White	9	0.1	$\pm 10$	1.0	500

PILOT-LAMP DATA					
Lamp No.	Bead Color	Base (Miniature)	Bulb Type	RATING	
				Volts	Amp.
40	Brown	Screw	T-3¼	6-8	0.15
40A <sup>1</sup>	Brown	Bayonet	T-3¼	6-8	0.15
41	White	Screw	T-3¼	2.5	0.5
42	Green	Screw	T-3¼	3.2	**
43	White	Bayonet	T-3¼	2.5	0.5
44	Blue	Bayonet	T-3¼	6-8	0.25
45	*	Bayonet	T-3¼	3.2	**
46 <sup>2</sup>	Blue	Screw	T-3¼	6-8	0.25
47 <sup>1</sup>	Brown	Bayonet	T-3¼	6-9	0.15
48	Pink	Screw	T-3¼	2.0	0.06
49 <sup>3</sup>	Pink	Bayonet	T-3¼	2.0	0.06
49A <sup>3</sup>	White	Bayonet	T-3¼	2.1	0.12
50	White	Screw	G-3½	6-8	0.2
51 <sup>3</sup>	White	Bayonet	G-3½	6-8	0.2
53	—	Bayonet	G-3½	14.4	0.12
55	White	Bayonet	G-4¼	6-8	0.4
292 <sup>5</sup>	White	Screw	T-3¼	2.9	0.17
292A <sup>5</sup>	White	Bayonet	T-3¼	2.9	0.17
1455	Brown	Screw	G-5	18.0	0.25
1455A	Brown	Bayonet	G-5	18.0	0.25
1487	—	Screw	T-3¼	12-16	0.20
1488	—	Bayonet	T-3¼	14	0.15
1813	—	Bayonet	T-3¼	14.4	0.10
1815	—	Bayonet	T-3¼	12-16	0.20

<sup>1</sup> 40A and 47 are interchangeable.  
<sup>2</sup> Have frosted bulb.  
<sup>3</sup> 49 and 49A are interchangeable.  
<sup>4</sup> Replace with No. 48.  
<sup>5</sup> Use in 2.5-volt sets where regular bulb burns out too frequently.  
\* White in G.E. and Sylvania; green in National Union, Raytheon and Tung-Sol.  
\*\* 0.35 in G.E. and Sylvania; 0.5 in National Union, Raytheon and Tung-Sol.

**Fixed Composition Resistors**

Composition resistors (including small wire-wound units molded in cases identical with the composition type) are color-coded as shown in Fig. 20-6. Colored bands are used on resistors having axial leads; on radial-lead resistors the colors are placed as shown in the drawing. When bands are used for color

Color Sixth Dot	Temperature Coefficient p.p.m./deg. C.	Capacitance Drift
Black	± 1000	± 5% +1 μf.
Brown	± 500	± 3% +1 μf.
Red	+200	± 0.5%
Orange	+100	± 0.3%
Yellow	-20 to +100	± 0.1% +0.1 μf.
Green	0 to +70	± 0.05% +0.1 μf.

coding the body color has no significance.

Examples: A resistor of the type shown in the lower drawing of Fig. 20-6 has the following color bands: A, red; B, red; C, orange; D, no color. The significant figures are 2, 2 (22) and the decimal multiplier is 1000. The value of resistance is therefore 22,000 ohms and the tolerance is ± 20%.

A resistor of the type shown in the upper drawing has the following colors: body (A), blue; end (B), gray; dot, red; end (D), gold. The significant figures are 6, 8 (68) and the decimal multiplier is 100, so the resistance is 6800 ohms. The tolerance is ± 5%.

**I.F. Transformers**

- Blue — plate lead.
- Red — "B" + lead.
- Green — grid (or diode) lead.
- Black — grid (or diode) return.

NOTE: If the secondary of the i.f.t. is center-tapped, the second diode plate lead is green-and-black striped, and black is used for the center-tap lead.

**A.F. Transformers**

- Blue — plate (finish) lead of primary.
- Red — "B" + lead (this applies whether the primary is plain or center-tapped).
- Brown — plate (start) lead on center-tapped primaries. (Blue may be used for this lead if polarity is not important.)
- Green — grid (finish) lead to secondary.
- Black — grid return (this applies whether the secondary is plain or center-tapped).
- Yellow — grid (start) lead on center-tapped secondaries. (Green may be used for this lead if polarity is not important.)

NOTE: These markings apply also to line-to-grid and tube-to-line transformers.

**Power Transformers**

- 1) Primary Leads .....Black  
 If tapped:  
 Common .....Black  
 Tap.....Black and Yellow Striped  
 Finish.....Black and Red Striped
- 2) High-Voltage Plate Winding.....Red  
 Center-Tap.....Red and Yellow Striped
- 3) Rectifier Filament Winding.....Yellow  
 Center-Tap.....Yellow and Blue Striped
- 4) Filament Winding No. 1.....Green  
 Center-Tap.....Green and Yellow Striped
- 5) Filament Winding No. 2.....Brown  
 Center-Tap.....Brown and Yellow Striped
- 6) Filament Winding No. 3.....Slate  
 Center-Tap.....Slate and Yellow Striped

No.	Breaking Load (Pounds)		Copperweld (40% conduct)
	Hard Drawn	Soft Drawn	
18	85		150
16	135		250
14	215	125	400
12	335	200	710
10	530	315	1130

Breaking load for plastic clothesline is about 250 pounds.



COPPER-WIRE TABLE

Wire Size A.W.G. (B&S)	Diam. in Mils <sup>1</sup>	Circular Mil Area	Turns per Linear Inch <sup>2</sup>			Cont.-duty current <sup>3</sup> single wire in open air	Cont.-duty current <sup>3</sup> wires or cables in conduits or bundles	Feet per Pound, Bare	Ohms per 1000 ft. 25° C.	Current Carrying Capacity <sup>4</sup> at 700 C.M. per Amp.	Diam. in mm.	Nearest British S.W.G. No.
			Enamel	S.C.E.	D.C.C.							
1	289.3	83690	—	—	—	—	3.947	.1264	119.6	7.348	1	
2	257.6	66370	—	—	—	—	4.977	.1593	94.8	6.544	3	
3	229.4	52640	—	—	—	—	6.276	.2009	75.2	5.827	4	
4	204.3	41740	—	—	—	—	7.914	.2533	59.6	5.189	5	
5	181.9	33100	—	—	—	—	9.980	.3195	47.3	4.621	7	
6	162.0	26250	—	—	—	—	12.58	.4028	37.5	4.115	8	
7	144.3	20820	—	—	—	—	15.87	.5080	29.7	3.665	9	
8	128.5	16510	7.6	—	7.1	73	20.01	.6405	23.6	3.264	10	
9	114.4	13090	8.6	—	7.8	—	25.23	.8077	18.7	2.906	11	
10	101.9	10380	9.6	9.1	8.9	55	31.82	1.018	14.8	2.588	12	
11	90.7	8234	10.7	—	9.8	—	40.12	1.284	11.8	2.305	13	
12	80.8	6530	12.0	11.3	10.9	41	50.59	1.619	9.33	2.053	14	
13	72.0	5178	13.5	—	12.8	—	63.80	2.042	7.40	1.828	15	
14	64.1	4107	15.0	14.0	13.8	32	80.44	2.575	5.87	1.628	16	
15	57.1	3257	16.8	—	14.7	—	101.4	3.247	4.65	1.450	17	
16	50.8	2583	18.9	17.3	16.4	22	127.9	4.094	3.69	1.291	18	
17	45.3	2048	21.2	—	18.1	—	161.3	5.163	2.93	1.150	18	
18	40.3	1624	23.6	21.2	19.8	16	203.4	6.510	2.32	1.024	19	
19	35.9	1288	26.4	—	21.8	—	256.5	8.210	1.84	.912	20	
20	32.0	1022	29.4	25.8	23.8	11	323.4	10.35	1.46	.812	21	
21	28.5	810.1	33.1	—	26.0	—	407.8	13.05	1.16	.723	22	
22	25.3	642	37.0	31.3	30.0	—	514.2	16.46	.918	.644	23	
23	22.6	510	41.3	—	37.6	—	648.4	20.76	.728	.573	24	
24	20.1	404	46.3	37.6	35.6	—	817.7	26.17	.577	.511	25	
25	17.9	320	51.7	—	38.6	—	1031	33.00	.458	.455	26	
26	15.9	254	58.0	46.1	41.8	—	1300	41.62	.363	.405	27	
27	14.2	202	64.9	—	45.0	—	1639	52.48	.288	.361	29	
28	12.6	160	72.7	54.6	48.5	—	2067	66.17	.228	.321	30	
29	11.3	127	81.6	—	51.8	—	2607	83.44	.181	.286	31	
30	10.0	101	90.5	64.1	55.5	—	3287	105.2	.144	.255	33	
31	8.9	80	101	—	59.2	—	4145	132.7	.114	.227	34	
32	8.0	63	113	74.1	62.6	—	5227	167.3	.090	.202	36	
33	7.1	50	127	—	66.3	—	6591	211.0	.072	.180	37	
34	6.3	40	143	86.2	70.0	—	8310	266.0	.057	.160	38	
35	5.6	32	158	—	73.5	—	10480	335	.045	.143	38-39	
36	5.0	25	175	103.1	77.0	—	13210	423	.036	.127	39-40	
37	4.5	20	198	—	80.3	—	16660	533	.028	.113	41	
38	4.0	16	224	116.3	83.6	—	21010	673	.022	.101	42	
39	3.5	12	248	—	86.6	—	26500	848	.018	.090	43	
40	3.1	10	282	131.6	89.7	—	33410	1070	.014	.080	44	

<sup>1</sup> A mil is 0.001 inch. <sup>2</sup> Figures given are approximate only; insulation thickness varies with manufacturer. <sup>3</sup> Max. wire temp. of 212° F and max. ambient temp. of 135° F. <sup>4</sup> 700 circular mils per ampere is a satisfactory design figure for small transformers, but values from 500 to 1000 c.m. are commonly used.

## SEMICONDUCTOR DIODE COLOR CODE

The "1N" prefix is omitted. A double-width band, which also identifies the cathode terminal end of the diode, is usually used as the first band. (An alternative method uses equal band widths with the set clearly grouped toward the cathode end.) The code is read starting at the cathode end.













































































Diodes having two-digit numbers are coded with a black band followed by second and third bands. A suffix letter is indicated by a fourth band.

Diodes with three-digit numbers are coded with the sequence numbers in the first, second and third bands. Any suffix letter is indicated by a fourth band.

Diodes with four-digit numbers are coded by four bands followed by a black band. A suffix letter is indicated by a fifth band replacing the black band.

The color code (numbers) is the same as the resistor-capacitor code. The suffix-letter code is A—brown, B—red, C—orange, D—yellow, E—green, and F—blue.

**SCHEMATIC SYMBOLS USED IN CIRCUIT DIAGRAMS**

 <b>ANTENNA</b>	 Single cell  Multicell <b>BATTERIES</b>		 Electrolytic  Fixed		 Variable  Split-stator		 Feedthrough <b>CAPACITORS</b>						
Male → Fem. ← Contacts		 Multiple, Movable Coaxial Receptacle  Multiple, Fixed Coaxial Plug		 Female 115V.  Male 115V.		 230V.		 Phono Jack  Phone Jack  Phone Plug  Mic. Jack <b>CONNECTORS</b>					
 <b>CRYSTAL QUARTZ</b>		 <b>FUSE</b>	 <b>GROUND</b>	 <b>HEADSET</b>		 R.F. Choke  Air Core		 Iron Core		 Tapped		 Adjustable <b>INDUCTORS</b>	
 Hand  Foot <b>KEYS</b>		 Pilot  Neon (A.C.) <b>LAMPS</b>		* Insert Appropriate Designations  A - Ammeter  V - Voltmeter  MA - Milliammeter etc. <b>METERS</b>		 <b>MICROPHONE</b>		  <b>RECTIFIER</b>					
 S.P.  D.P.  S.P.D.T. <b>RELAYS</b>			 Fixed  Tapped  Adjustable <b>RESISTORS</b>			 Rectifier  PNP  NPN <b>SEMI CONDUCTORS</b>			 Zener Diode  Voltage Dependent Capacitor  Tunnel Diode				
 General  Enclosure  Shielded Wire  Shielded Multiconductor  Coaxial Cable <b>SHIELDING</b>					 <b>SPEAKER</b>		 S.P.S.T.  S.P.D.T.  Multipoint <b>SWITCHES</b>						
 Air Core  Iron Core  Adjustable Inductance  Adjustable Coupling  With Link <b>TRANSFORMERS</b>					 <b>VIBRATOR</b>		 Terminal  Crossing Conductors not joined  Conductors joined  Chassis Connections <b>WIRING</b>						
 Heater or Filament  Indirectly Heated Cathode  Cold Cathode  Grid  Plate  Deflection Plates  Gas Filled <b>ELECTRON TUBE ELEMENTS</b>						 Triode  Pentode  Voltage Regulator <b>COMPLETE TUBES</b>							

Where it is necessary or desirable to identify the electrodes or capacitors, the curved element represents the *outside* electrode (marked "outside foil," "ground," etc.) in fixed paper- and ceramic-dielectric capacitors, and the *negative* electrode in electrolytic capacitors. In variable or adjustable capacitors (regardless

of dielectric), the curved line indicates the moving element (rotor plates).

In the case of switches, jacks, etc., only the basic combinations are shown. Any combination of these symbols may be assembled as required, following the elementary forms shown.

# Measurements

It is practically impossible to operate an amateur station without making measurements at one time or another. Although quite crude measurements often will suffice, more refined equipment and methods will yield more and better information. With adequate information at hand it becomes possible to adjust a piece of equipment for optimum performance quickly and surely, and to design circuits along established principles rather than depending on cut-and-try.

Measuring and test equipment is valuable during construction, for testing components before installation. It is practically indispensable in the initial adjustment of radio gear, not only for establishing operating values but also for tracing possible errors in wiring. It is likewise needed for locating breakdowns and defective components in existing equipment.

The basic measurements are those of current, voltage, and frequency. Determination of the values of circuit elements—resistance, inductance and capacitance — are almost equally important. The inspection of waveform in audio-frequency circuits is highly

useful. For these purposes there is available a wide assortment of instruments, both complete and in kit form; the latter, particularly, compare very favorably in cost with strictly home-built instruments and are frequently more satisfactory both in appearance and calibration. The home-built instruments described in this chapter are ones having features of particular usefulness in amateur applications, and not ordinarily available commercially.

In using any instrument it should always be kept in mind that the accuracy depends not only on the inherent accuracy of the instrument itself (which, in the case of commercially built units is usually within a few per cent, and in any event should be specified by the manufacturer) but also the conditions under which the measurement is made. Large errors can be introduced by failing to recognize the existence of conditions that affect the instrument readings. This is particularly true in certain types of r.f. measurements, where stray effects are hard to eliminate, and in the measurement of d.c. and a.c. voltages across extremely high-impedance circuits.

## VOLTAGE, CURRENT, AND RESISTANCE

### D.C. MEASUREMENTS

A direct-current instrument — voltmeter, ammeter, milliammeter or microammeter — is a device using electromagnetic means to deflect a pointer over a calibrated scale in proportion to the current flowing. In the **D'Arsonval** type a coil of wire, to which the pointer is attached, is pivoted between the poles of a permanent magnet, and when current flows through the coil it causes a magnetic field that interacts with that of the magnet to cause the coil to turn. The design of the instrument is usually such as to make the pointer deflection directly proportional to the current.

A less expensive type of instrument is the **moving-vane** type, in which a pivoted soft-iron vane is pulled into a coil of wire by the magnetic field set up when current flows through the coil. The farther the vane extends into the coil the greater the magnetic pull on it, for a given change in current, so this type of instrument does not have "linear" deflection—the intervals of equal current are crowded together at the low-current end and

spread out at the high-current end of the scale.

The same basic instrument is used for measuring either current or voltage. Good-quality instruments are made with fairly high **sensitivity** — that is, they give full-scale pointer deflection with very small currents — when intended to be used as voltmeters. The sensitivity of instruments intended for measuring large currents can be lower, but a highly sensitive instrument can be, and frequently is, used for measurement of currents much greater than needed for full-scale deflection.

Panel-mounting instruments of the D'Arsonval type will give a smaller deflection when mounted on iron or steel panels than when mounted on nonmagnetic material. Readings may be as much as ten per cent low. Specially calibrated meters should be obtained for mounting on such panels.

### VOLTMETERS

Only a fraction of a volt is required for full-scale deflection of a sensitive instrument (1 milliamperere or less full scale) so for meas-

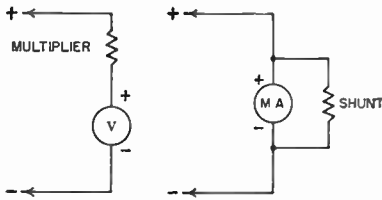

Fig. 21-1—How voltmeter multipliers and milliammeter shunts are connected to extend the range of a d.c. meter.

uring voltage a high resistance is connected in series with it, Fig. 21-1. Knowing the current and the resistance, the voltage can easily be calculated from Ohm's Law. The meter is calibrated in terms of the voltage drop across the series resistor or **multiplier**. Practically any desired full-scale voltage range can be obtained by proper choice of multiplier resistance, and voltmeters frequently have several ranges selected by a switch.

The sensitivity of the voltmeter is usually expressed in "ohms per volt." A sensitivity of 1000 ohms per volt means that the resistance

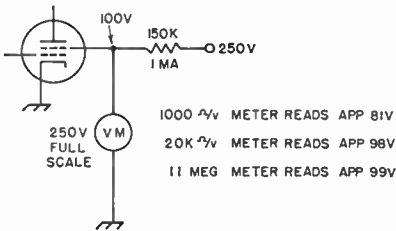

Fig. 21-2—Effect of voltmeter resistance on accuracy of readings. It is assumed that the d.c. resistance of the screen circuit is constant at 100 kilohms. The actual current and voltage without the voltmeter connected are 1 ma. and 100 volts. The voltmeter readings will differ because the different types of meters draw different amounts of current through the 150-kilohm resistor.

of the voltmeter is 1000 times the full-scale voltage, and by Ohm's Law the current required for full-scale deflection is 1 milliampere. A sensitivity of 20,000 ohms per volt, another commonly used value, means that the instrument is a 50-microampere meter. The higher the resistance of the voltmeter the more accurate the measurements in high-resistance circuits. This is because the current flowing through the voltmeter will cause a change in the voltage between the points across which the meter is connected, compared with the voltage with the meter absent, as shown in Fig. 21-2.

### Multipliers

The required multiplier resistance is found by dividing the desired full-scale voltage by the current, in amperes, required for full-scale deflection of the meter alone. Strictly,

the internal resistance of the meter should be subtracted from the value so found, but this is seldom necessary (except perhaps for very low ranges) because the meter resistance will be negligibly small compared with the multiplier resistance. An exception is when the instrument is already provided with an internal multiplier, in which case the multiplier resistance required to extend the range is

$$R = R_m(n - 1)$$

where  $R$  is the multiplier resistance,  $R_m$  is the total resistance of the instrument itself, and  $n$  is the factor by which the scale is to be multiplied. For example, if a 1000-ohms-per-volt voltmeter having a calibrated range of 0-10 volts is to be extended to 1000 volts,  $R_m$  is  $1000 \times 10 = 10,000$  ohms,  $n$  is  $1000/10 = 100$ , and  $R = 10,000(100 - 1) = 990,000$  ohms.

If a milliammeter is to be used as a voltmeter, the value of series resistance can be found by Ohm's Law:

$$R = \frac{1000E}{I}$$

where  $E$  is the desired full-scale voltage and  $I$  the full-scale reading of the instrument in milliamperes.

### Accuracy

The accuracy of a voltmeter depends on the calibration accuracy of the instrument itself and the accuracy of the multiplier resistors. Good-quality instruments are generally rated for an accuracy within plus or minus 2 per cent. This is also the usual accuracy rating of the basic meter movement.

When extending the range of a voltmeter or converting a low-range milliammeter into a voltmeter the rated accuracy of the instrument is retained only when the multiplier resistance is precise. Precision wire-wound resistors are used in the multipliers of high-quality instruments. These are relatively expensive, but the home constructor can do quite well with 1% tolerance composition resistors. They should be "derated" when used for this purpose—that is, the actual power dissipated in the resistor should not be more than  $\frac{1}{4}$  to  $\frac{1}{2}$  the rated dissipation—and care should be used to avoid overheating the body of the resistor when soldering to the leads. These precautions will help prevent permanent change in the resistance of the unit.

Ordinary composition resistors are generally furnished in 10% or 5% tolerance ratings. If possible errors of this order can be accepted, resistors of this type may be used as multipliers. They should be operated below the rated power dissipation figure, in the interests of long-time stability.

### MILLIAMMETERS AND AMMETERS

A microammeter or milliammeter can be used to measure currents larger than its full-scale reading by connecting a resistance

shunt across its terminals as shown in Fig. 21-1. Part of the current flows through the shunt and part through the meter. Knowing the meter resistance and the shunt resistance, the relative currents can easily be calculated.

The value of shunt resistance required for a given full-scale current range is given by

$$R = \frac{R_m}{n - 1}$$

where  $R$  is the shunt,  $R_m$  is the internal resistance of the meter, and  $n$  is the factor by which the original meter scale is to be multiplied. The internal resistance of a milliammeter is preferably determined from the manufacturer's catalog, but if this information is not available it can be measured by the method shown in Fig. 21-3. Do not attempt to use an ohmmeter to measure the internal

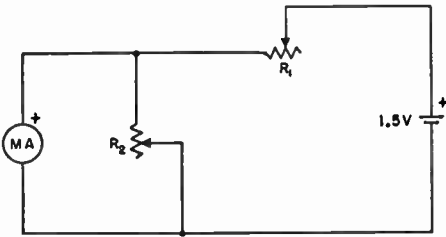

Fig. 21-3—Determining the internal resistance of a milliammeter or microammeter.  $R_1$  is an adjustable resistor having a maximum value about twice that necessary for limiting the current to full scale with  $R_2$  disconnected; adjust it for exactly full-scale reading. Then connect  $R_2$  and adjust it for exactly half-scale reading. The resistance of  $R_2$  is then equal to the internal resistance of the meter, and the resistor may be removed from the circuit and measured separately. Internal resistances vary from a few ohms to several hundred ohms, depending on the sensitivity of the instrument.

resistance of a milliammeter; the instrument may be ruined by doing so.

Homemade milliammeter shunts can be constructed from any of the various special kinds of resistance wire, or from ordinary copper wire if no resistance wire is available. The Copper Wire Table in this *Handbook* gives the resistance per 1000 feet for various sizes of copper wire. After computing the resistance required, determine the smallest wire size that will carry the full-scale current (250 circular mils per ampere is a satisfactory figure for this purpose). Measure off enough wire to provide the required resistance. Accuracy can be checked by causing enough current to flow through the meter to make it read full scale without the shunt; connecting the shunt should then give the correct reading on the new range.

**Current Measurement with a Voltmeter**

A current-measuring instrument should have very low resistance compared with the resistance of the circuit being measured;

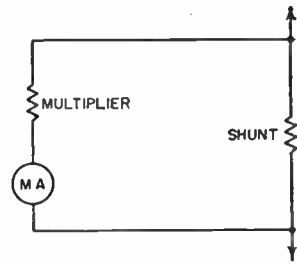

Fig. 21-4—Voltmeter method of measuring current. This method permits using relatively large values of resistance in the shunt, standard values of fixed resistors frequently being usable. If the multiplier resistance is 20 (or more) times the shunt resistance, the error in assuming that all the current flows through the shunt will not be of consequence in most practical applications.

otherwise, inserting the instrument will cause the current to differ from its value with the instrument out of the circuit. (This may not matter if the instrument is left permanently in the circuit.) However, the resistance of many circuits in radio equipment is quite high and the circuit operation is affected little, if at all, by adding as much as a few hundred ohms in series. In such cases the voltmeter method of measuring current, shown in Fig. 21-4, is frequently convenient. A voltmeter — or low-range milliammeter provided with a multiplier and operating as a voltmeter — having a full-scale voltage range of a few volts, is used to measure the voltage drop across a comparatively high resistance acting as a shunt. The formula previously given is used for finding the proper value of shunt resistance for a given scale-multiplying factor,  $R_m$  in this case being the multiplier resistance.

**D.C. Power**

Power in direct-current circuits is determined by measuring the current and voltage. When these are known, the power is equal to the voltage in volts multiplied by the cur-

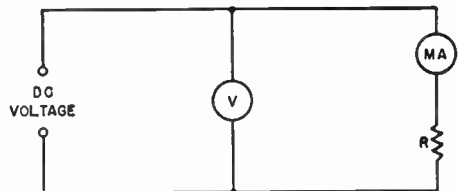

Fig. 21-5—Measuring resistance with a voltmeter and milliammeter. If the approximate resistance is known the voltage can be selected to cause the milliammeter, MA, to read about half scale. If not, additional resistance should be first connected in series with  $R$  to limit the current to a safe value for the milliammeter. The set-up then measures the total resistance, and the value of  $R$  can be found by subtracting the known additional resistance from the total.



rent in amperes. If the current is measured with a milliammeter, the reading of the instrument must be divided by 1000 to convert it to amperes.

**RESISTANCE MEASUREMENTS**

Measurement of d.c. resistance is based on measuring the current through the resistance when a known voltage is applied, then using Ohm's Law. A simple circuit is shown in Fig. 21-5. The internal resistance of the ammeter or milliammeter, *MA*, should be low compared with the resistance, *R*, being measured, since the voltage read by the voltmeter, *V*, is the voltage across *MA* and *R* in series. The instruments and the d.c. voltage should be chosen so that the readings are in the upper half of the scale, if possible, since the percentage error is less in this region.

An ohmmeter is an instrument consisting fundamentally of a voltmeter (or milliammeter, depending on the circuit used) and a small dry battery as a source of d.c. voltage, calibrated so the value of an unknown resistance can be read directly from the scale. Typical ohmmeter circuits are shown in Fig. 21-6. In the simplest type, shown in Fig. 21-6A, the meter and battery are connected in series with the unknown resistance. If a given deflection is obtained with terminals *A-B* shorted, inserting the resistance to be measured will cause the meter reading to decrease. When the resistance of the voltmeter is known, the following formula can be applied:

$$R = \frac{eR_m}{E} - R_m$$

where *R* is the resistance under measurement, *e* is the voltage applied (*A-B* shorted), *E* is the voltmeter reading with *R* connected, and *R<sub>m</sub>* is the resistance of the voltmeter.

The circuit of Fig. 21-6A is not suited to measuring low values of resistance (below a hundred ohms or so) with a high-resistance voltmeter. For such measurements the circuit of Fig. 21-6B can be used. The milliammeter should be a 0-1 ma. instrument, and *R<sub>1</sub>* should be equal to the battery voltage, *e*, multiplied by 1000. The unknown resistance is

$$R = \frac{I_2 R_m}{I_1 - I_2}$$

where *R* is the unknown, *R<sub>m</sub>* is the internal resistance of the milliammeter, *I<sub>1</sub>* is the current in ma. with *R* disconnected from terminals *A-B*, and *I<sub>2</sub>* is the current in ma. with *R* connected.

The formula is approximate, but the error will be negligible if *e* is at least 3 volts so that *R<sub>1</sub>* is at least 3000 ohms.

A third circuit for measuring resistance is shown in Fig. 21-6C. In this case a high-resistance voltmeter is used to measure the

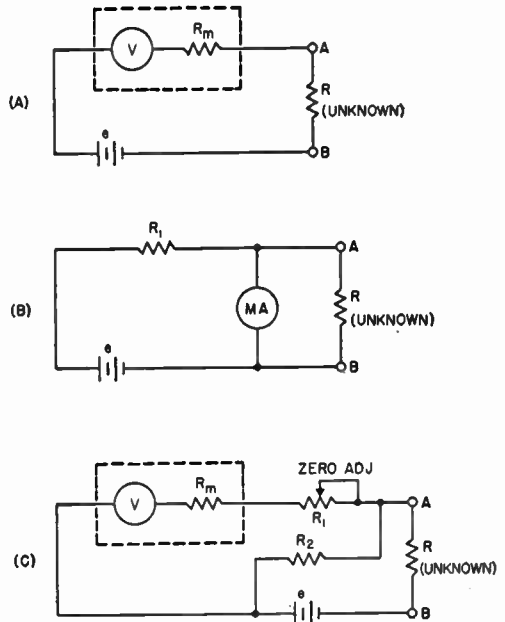

Fig. 21-6—Ohmmeter circuits. Values are discussed in the text.

voltage drop across a reference resistor, *R<sub>2</sub>*, when the unknown resistor is connected so that current flows through it, *R<sub>2</sub>* and the battery in series. By suitable choice of *R<sub>2</sub>* (low values for low resistance, high values for high-resistance unknowns) this circuit will give equally good results on all resistance values in the range from one ohm to several megohms, provided that the voltmeter resistance, *R<sub>m</sub>*, is always very high (50 times or more) compared with the resistance of *R<sub>2</sub>*. A 20,000-ohms-per-volt instrument (50- $\mu$ amp. movement) is generally used. Assuming that the current through the voltmeter is negligible compared with the current through *R<sub>2</sub>*, the formula for the unknown is

$$R = \frac{eR_2}{E} - R_2$$

where *R* and *R<sub>2</sub>* are as shown in Fig. 21-6C, *e* is the voltmeter reading with *A-B* shorted, and *E* is the voltmeter reading with *R* connected.

The "zero adjuster," *R<sub>1</sub>*, is used to set the voltmeter reading exactly to full scale when the meter is calibrated in ohms. A 10,000-ohm variable resistor is suitable with a 20,000-ohms-per-volt meter. The battery voltage is usually 3 volts for ranges up to 100,000 ohms or so and 6 volts for higher ranges.

**A. C. Measurements**

Several types of instruments are available for measurement of low-frequency alternating currents and voltages. The better-grade panel

instruments for power-line frequencies are of the dynamometer type. This compares with the D'Arsonval movement used for d.c. measurements, but instead of a permanent magnet the dynamometer movement has a field coil which, together with the moving coil, is connected to the a.c. source. Thus the moving coil is urged to turn in the same direction on both halves of the a.c. cycle.

Moving-vane type instruments, described earlier, also are used for a.c. measurements. This is possible because the pull exerted on the vane is in the same direction regardless of the direction of current through the coil. The calibration of a moving-vane instrument on a.c. will, in general, differ from its d.c. calibration.

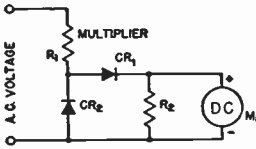

Fig. 21-7—Rectifier-type a.c. voltmeter circuit, with "linearizing" resistor and diode for back-current correction.

For measurements in the audio-frequency range, and in applications where high impedance is required, the rectifier-type a.c. instrument is generally used. This is essentially a sensitive d.c. meter, of the type previously described, provided with a rectifier for converting the a.c. to d.c. A typical rectifier-type voltmeter circuit is shown in Fig. 21-7. The half-wave meter rectifier,  $CR_1$ , is frequently of the copper-oxide type, but crystal diodes can be used. Such a rectifier is not "perfect"

— that is, the application of a voltage of reversed polarity will result in a small current flow — and so  $CR_2$  is used for eliminating the effect of reverse current in the meter circuit. It does this by providing a low-resistance path across  $CR_1$  and the meter during the a.c. alternations when  $CR_1$  is not conducting.

Resistor  $R_2$  shunted across  $M_1$  is used for improving the linearity of the circuit. The effective resistance of the rectifier decreases with increasing current, leading to a calibration scale with nonuniform divisions. This is overcome to a considerable extent by "bleeding" several times as much current through  $R_2$  as flows through  $M_1$  so the rectifier is always carrying a fairly large current.

Because of these expedients and the fact that with half-wave rectification the average current is only 0.45 times the r.m.s. value of a sine wave producing it, the impedance of a rectifier-type voltmeter is rather low compared with the resistance of a d.c. voltmeter using the same meter. Values of 1000 ohms per volt are representative, when the d.c. instrument is a 0-200 microammeter.

The d.c. instrument responds to the average value of the rectified alternating current. This average current will vary with the shape of the a.c. wave applied to the rectifier, and so the meter reading will not be the same for different wave forms having the same maximum values or the same r.m.s. values. Hence a "wave-form error" is always present unless the a.c. wave is very closely sinusoidal. The actual calibration of the instrument usually is in terms of the r.m.s. value of a sine wave.

Modern rectifier-type a.c. voltmeters are capable of good accuracy, within the wave-form limitations mentioned above, throughout the audio-frequency range.

Fig. 21-8—Vacuum-tube voltmeter circuit.

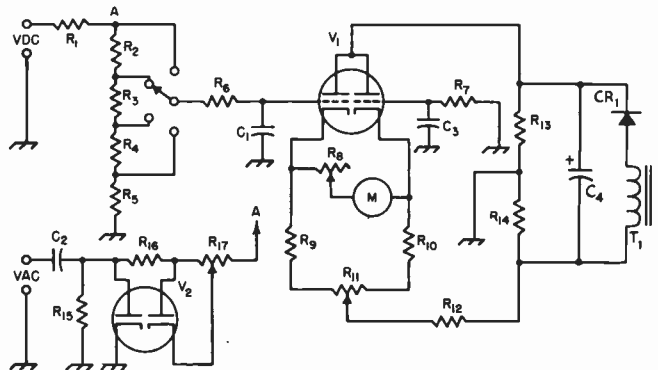

- $C_1, C_3$ —0.002- to 0.005- $\mu$ f. mica.
- $C_2$ —0.01  $\mu$ f., 1000 to 2000 volts, paper or mica.
- $C_4$ —16  $\mu$ f. electrolytic, 150 volts.
- $CR_1$ —400 p.i.v. rectifier.
- $R_1$ —1 megohm,  $\frac{1}{2}$  watt.
- $R_2$  to  $R_6$ , inc.—To give desired voltage ranges, totaling 10 megohms.
- $R_6, R_7$ —2 to 3 megohms.
- $R_8$ —10,000-ohm variable.
- $R_9, R_{10}$ —2000 to 3000 ohms.
- $R_{11}$ —5000- to 10,000-ohm control.
- $R_{12}$ —10,000 to 50,000 ohms.
- $R_{13}, R_{14}$ —App. 25,000 ohms. A 50,000-ohm slider-type wire-wound can be used.

- $R_{15}$ —10 megohms.
- $R_{16}$ —3 megohms.
- $R_{17}$ —10-megohm variable.
- $T_1$ —130-volt 15-ma. transformer (only secondary shown).
- $M$ —0-200  $\mu$ amp. to 0.1 ma. range.
- $V_1$ —Dual triode, 12AU7.
- $V_2$ —Dual diode, 6AL5.

### COMBINATION INSTRUMENTS— THE V.O.M.

Since the same basic instrument is used for measuring current, voltage and resistance, the three functions can readily be combined in one unit using a single meter. Various models of the "v.o.m." (volt-ohm-milliammeter) are available commercially, both completely assembled and in kit form. The less expensive ones use a 0-1 milliammeter as the basic instrument, providing voltmeter ranges at 1000 ohms per volt. The more elaborate meters of this type use a microammeter—0-50 microamperes, frequently—with voltmeter resistances of 20,000 ohms per volt. With the more sensitive instruments it is possible to make resistance measurements in the megohms range. A.c. voltmeter scales also are frequently included.

The v.o.m., even a very simple one, is among the most useful instruments for the amateur. Besides current and voltage measurements, it can be used for checking continuity in circuits, for finding defective components before installation — shorted capacitors, open or otherwise defective resistors, etc. — shorts or opens in wiring, and many other checks that, if applied during the construction of a piece of equipment, save much time and trouble. It is equally useful for servicing, when a component fails during operation.

### THE VACUUM-TUBE VOLTMETER

The usefulness of the vacuum-tube voltmeter (v.t.v.m.) is based on the fact that a vacuum tube can amplify without taking power from the source of voltage applied to its grid. It is therefore possible to have a voltmeter of extremely high resistance, and thus take negligible current from the circuit under measurement, without using a d.c. instrument of exceptional sensitivity.

The v.t.v.m. has the disadvantage that it requires a source of power for its operation, as compared with a regular d.c. instrument. Also, it is susceptible to r.f. pick-up when working around an operating transmitter, unless well shielded and filtered. The fact that one of its terminals is grounded is also disadvantageous in some cases, since a.c. readings in particular may be inaccurate if an attempt is made to measure a circuit having both sides "hot" with respect to ground. Nevertheless, the high resistance of the v.t.v.m. more than compensates for these disadvantages, especially since in the majority of measurements they do not apply.

While there are several possible circuits, the one commonly used is shown in Fig. 21-8. A dual triode,  $V_1$ , is arranged so that, with no voltage applied to the left-hand grid, equal currents flow through both sections. Under this condition the two cathodes are at the same potential and no current flows through  $M$ . The currents can be adjusted to balance

by potentiometer  $R_{11}$ , which takes care of variations in the tube sections and in the values of cathode resistors  $R_9$  and  $R_{10}$ . When a positive d.c. voltage is applied to the left-hand grid the current through that tube section increases, so the current balance is upset and the meter indicates. The sensitivity of the meter is regulated by  $R_8$ , which serves to adjust the calibration.  $R_{12}$ , common to the cathodes of both tube sections, is a feed back resistor that stabilizes the system and makes the readings linear.  $R_6$  and  $C_1$  form a filter for any a.c. component that may be present, and  $R_6$  is balanced by  $R_7$  connected to the grid of the second tube section.

To stay well within the linear range of operation the scale is limited to 3 volts or less in the average commercial instrument. Higher ranges are obtained by means of the voltage divider formed by  $R_1$  to  $R_5$ , inclusive. As many ranges as desired can be used. Common practice is to use 1 megohm at  $R_1$ , and to make the sum of  $R_2$  to  $R_5$ , inclusive, 10 megohms, thus giving a total resistance of 11 megohms, constant for all voltage ranges.  $R_1$  should be at the probe end of the d.c. lead to minimize capacitive loading effects when measuring d.c. voltages in r.f. circuits.

Values to be used in the circuit depend considerably on the supply voltage and the sensitivity of the meter,  $M$ .  $R_{12}$ , and  $R_{13}$ – $R_{14}$ , should be adjusted by trial so that the voltmeter circuit can be brought to balance, and to give full-scale deflection on  $M$  with about 3 volts applied to the left-hand grid. The meter connections can be reversed to read voltages that are negative with respect to ground.

### A.C. Voltage

For measuring a.c. voltages up to 4 Mc., the rectifier circuit in the lower left of Fig. 21-8 is used. One diode of  $V_2$  is a half-wave rectifier and the other acts as a balancing device, adjustable by  $R_{17}$ , against contact potential effects that would cause a residual d.c. voltage to appear at the v.t.v.m. grid.

The rectifier output voltage is proportional to the peak amplitude of the a.c. wave, rather than to the average or r.m.s. values. Since the positive and negative peaks of a complex wave may not have equal amplitudes, a different reading may be obtained on such wave forms when the voltmeter probe terminals are reversed. This "turnover" effect is inherent in any peak-indicating device, but is not necessarily a disadvantage. The fact that the readings are not the same when the voltmeter connections are reversed is an indication that the wave form under measurement is unsymmetrical. In some measurements, as in audio amplifiers, a peak measurement is more useful than an r.m.s. or average-value measurement because amplifier capabilities are based on the peak amplitudes.

The scale calibration usually is based on the r.m.s. value of a sine wave,  $R_8$  being set so

that the same scale can be used either for a.c. or d.c. The r.m.s. reading can easily be converted to a peak reading by multiplying by 1.41.

## INSTRUMENT CALIBRATION

When extending the range of a d.c. instrument, calibration usually is necessary — although resistors for voltmeter multipliers often can be purchased to close-enough tolerances so that the new range will be accurately known. However, in calibrating an instrument such as a v.t.v.m. a known voltage must be available to provide a starting point. Fresh dry cells have an open-circuit terminal voltage of approximately 1.6 volts, and one or more of them may be connected in series to provide several calibration points on the low range. Gas regulator tubes in a power supply, such as the 0C3, 0D3, etc., also provide a stable source of voltage whose value is known within a few per cent. Once a few such points are determined the voltmeter ranges may be

extended readily by adding multipliers or a voltage divider as appropriate.

Shunts for a milliammeter may be adjusted by first using the meter alone in series with a source of voltage and a resistor selected to limit the current to full scale. For example, a 0-1 milliammeter may be connected in series with a dry cell and a 2000-ohm variable resistor, the latter being adjusted to allow exactly 1 milliampere to flow. Then the shunt is added across the meter and its resistance adjusted to reduce the meter reading by exactly the scale factor,  $n$ . If  $n$  is 5, the shunt would be adjusted to make the meter read 0.2 milliampere, so the full-scale current will be 5 ma. Using the new scale, the second shunt is added to give the next range, the same procedure being followed. This can be carried on for several ranges, but it is advisable to check the meter on the highest range against a separate meter used as a standard, since the errors in this process tend to be cumulative.

## MEASUREMENT OF FREQUENCY

### ABSORPTION FREQUENCY METERS

The simplest possible frequency-measuring device is a resonant circuit, tunable over the desired frequency range and having its tuning dial calibrated in terms of frequency. It operates by extracting a small amount of energy from the oscillating circuit to be measured, the frequency being determined by the tuning setting at which the energy absorption is maximum (Fig. 21-9).

Such an instrument is not capable of very

tent and change each others' tuning. Nevertheless, the absorption frequency meter or "wavemeter" is a highly useful instrument. It is compact, inexpensive, and requires no power supply. There is no ambiguity in its indications, as is frequently the case with the heterodyne-type instruments.

When an absorption meter is used for checking a transmitter, the plate current of the tube connected to the circuit being checked can provide the necessary resonance indication. When the frequency meter is loosely coupled to the tank circuit the plate current will give a slight upward flicker as the meter is tuned through resonance. The accuracy is greatest when the loosest possible coupling is used.

A receiver oscillator may be checked by tuning in a steady signal and heterodyning it to give a beat note as in ordinary c.w. reception. When the frequency meter is coupled to the oscillator coil and tuned through resonance the beat note will change. Again, the coupling should be made loose enough so that a just-perceptible change in beat note is observed.

An approximate calibration for the meter, adequate for most purposes, may be obtained by comparison with a calibrated receiver. The usual receiver dial calibration is sufficiently accurate. A simple oscillator circuit covering the same range as the frequency meter will be useful in calibration. Set the receiver to a given frequency, tune the oscillator to zero beat at the same frequency, and adjust the frequency meter to resonance with the oscillator as described above. This gives one calibration point. When a sufficient number of such points has been obtained a graph may be

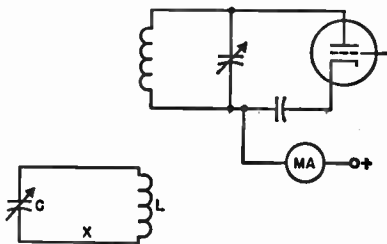

Fig. 21-9—Absorption frequency meter and a typical application. The meter consists simply of a calibrated resonant circuit LC. When coupled to an amplifier or oscillator the tube plate current will rise when the frequency meter is tuned to resonance. A flashlight lamp may be connected in series at X to give a visual indication, but it decreases the selectivity of the instrument and makes it necessary to use rather close coupling to the circuit being measured.

high accuracy, because the  $Q$  of the tuned circuit cannot be high enough to avoid uncertainty as to the exact dial setting and because any two coupled circuits interact to some ex-



drawn to show frequency *vs.* dial settings on the frequency meter.

### INDICATING FREQUENCY METERS

The plain absorption meter requires fairly close coupling to the oscillating circuit in order to affect the plate current of a tube sufficiently to give a visual indication. However, by adding a rectifier and d.c. microammeter or milliammeter, the sensitivity of the instrument can be increased to the point where very loose coupling will suffice for a good reading. A typical circuit for this purpose is given in Fig. 21-10.

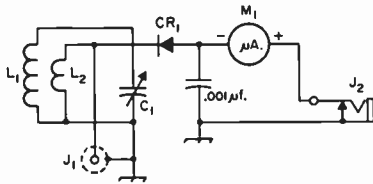

Fig. 21-10—Circuit of typical wavemeter with built-in indicator. The circuit responds to the frequency for which  $L_1C_1$  is resonant; a small amount of energy is coupled to  $L_2$ , rectified by  $CR_1$  and indicated by the meter. By plugging in a pair of headphones at  $J_1$ , any modulation on the signal will be heard.

$L_2$ —1 to 2 turns or 10 percent of  $L_1$ , whichever is greater.

Wound adjacent to or over grounded end of  $L_1$ .  
MA—Microammeter or 0.1 milliammeter.

The rectifier, a crystal diode, is coupled to the tuned circuit  $L_1C_1$  through a coupling coil,  $L_2$ , having a relatively small number of turns. The step-down transformer action from  $L_1$  to  $L_2$  provides for efficient energy transfer from the high-impedance tuned circuit to the low-impedance rectifier circuit. The number of turns on  $L_2$  can be adjusted for maximum reading on the d.c. milliammeter; when doing this, use a fixed value of coupling between  $L_1$  and the source of energy. The proper number of turns for this purpose will depend on the sensitivity of  $M_1$ . Less than optimum coupling is preferable, in most cases, since heavy loading lowers the  $Q$  of the tuned circuit  $L_1C_1$  and makes it less selective. The coupling is reduced by reducing the number of turns on  $L_2$ .

The meter can be used with a pick-up loop and coaxial line connected to  $J_1$ . Energy picked up by the loop is fed through the cable to  $L_2$  and thence coupled to  $L_1C_1$ . This is a convenient method of coupling to circuits where it would be physically difficult to secure inductive coupling to  $L_1$ . The pick-up cable should not be self-resonant, as a transmission-line section, at any frequency within the range in which it is to be used. A 5-foot length of RG-58/U is useful up to about 30 Mc.; a one-foot length is good to about 200 Mc.

By plugging a headset into the output jack,  $J_2$ , (phones having 2000 ohms or greater resistance should be used for greatest sensitivity)

the frequency meter can be used as a monitor for modulated transmissions.

### Sensitive Wavemeter

If a v.t.v.m. is available, its sensitivity can be used to provide good resonance indications in a wavemeter when very low power levels are involved. At normal power levels very loose coupling will suffice for a good reading. A typical circuit for this purpose is given in Fig. 21-11, and Fig. 21-12 shows most of the details of construction. By using manufactured stock B & W "Miniductor") for the coils, it is possible to duplicate the wavemeter fairly closely and thus use the same calibration. Starting with a few known points, the calibration can be completed as harmonics of an oscillator are identified.

The tuning capacitor,  $C_1$ , is mounted in a hole in the center of one end of the Minibox cover. When the capacitor is installed, a small pointer of wire or scrap aluminum should be put under the mounting nut and adjusted to come just above the edge of the tuning knob (Johnson 116-222-1). The knob should read "0" at minimum capacitance. A two-terminal screw-type strip (screws spaced  $\frac{1}{2}$  inch) is mounted at the center of the opposite end of the Minibox cover, raised above the cover by the thickness of a 4-40 nut. The two terminal lugs pass through 5/16-inch clearance holes; one is grounded to a soldering lug held by one of the 4-40 screws that secure the strip, and the other is connected to the stator of  $C_1$  by a piece of wire (No. 24) unwound from the coil stock. One end of the 1N34A diode is soldered to the appropriate terminal lug and the other is soldered to an insulated tie point located near the insulated terminal for the v.t.v.m., which is mounted near the center of the large wall of the Minibox cover.

The "plugs" for the coils (except the highest-frequency range) are made from three-terminal tie points. By trimming two adjacent terminals, as shown in Fig. 21-12, it will be found that the "plug" will just slip under the two screws of the strip used as a socket. One altered terminal fits under one screw, and the other two terminals "straddle" the other screw. The coil ends are soldered to the two active terminals and, in the case of the larger coils, the coils are cemented to the strip with Duco cement for additional support. The "hairpin" coil made from the paper clip has its ends bent past the active portion at an angle of about 80 degrees, as can be seen in Fig. 21-12.

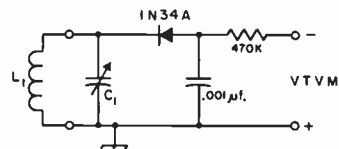

Fig. 21-11—Circuit diagram of the simple wavemeter.  $C_1$ —100- $\mu\text{f}$ . variable (Hammarlund MC-100-M).

$L_1$ —Made from 1-inch diameter, No. 24 wire, 32 t.p.i. coil stock (B&W 3016). See coil table.



Fig. 21-12—This simple wavemeter is useful for checking the frequency of a transmitter, to insure that it is properly tuned in an amateur band. It also serves to identify the correct harmonic when frequency-multiplying in a transmitter or crystal-controlled converter.

Housed in a 4×2¼×2¼-inch "Minibox" (Bud CU-3003A), the wavemeter has a range of 2.5 to 160 Mc. through the use of five coils. The coils "plug" into a 2-contact screw-type terminal strip; the "coil" shown in place covers 50 to 160 Mc. and is made from a paper clip. The other coils (two shown) use 3-terminal insulated mounting strips for plugs and coil supports.

The v.t.v.m. indicator connects to the terminals on the back wall: one is the screw holding the tie point, and the other is an insulated terminal (Johnson 105-602 nylon tip jack).

When using the wavemeter, connect the v.t.v.m. to the two terminals and set the v.t.v.m. to its lowest voltage range. Normally it will be necessary only to couple the wavemeter coil very loosely to the circuit under test, if it is a transmitter circuit; the wavemeter has sufficient sensitivity to measure the r.f. in a receiver oscillator circuit.

With reasonable care, the frequency limits for the various coils will fall within 5 per cent of those given in the coil table. With this as a starting point, it is a simple matter to find additional (and accurate) calibration points from receiver oscillators and crystal oscillators and their harmonics.

WAVEMETER COIL TABLE

Coil (turns) <sup>1</sup>	Range (Mc.)	Amateur Band	Dial <sup>2</sup>
64	2.35-6.1	80	40-53
21	4.9-13.0	40	37-39
6	12.5-33.0	20	14-16
		15	51-53
		10	78-84
2	28.5-81.0	6	54-60
Hairpin <sup>3</sup>	49-160	2	89-91

<sup>1</sup> B&W 3016 coil stock plus lead length.

<sup>2</sup> 0-100 for 180-degree rotation. 100 = minimum capacitance.

<sup>3</sup> Made from paper clip. Active loop is 5/16 inch wide, 3/4 inch long.

## THE SECONDARY FREQUENCY STANDARD

The secondary frequency standard is a highly stable low-power oscillator generating a fixed frequency, usually 100 kc. It is nearly always crystal-controlled, and inexpensive 100-kc. crystals are available for the purpose. Since the harmonics are multiples of 100 kc. throughout the spectrum, some of them can be compared directly with the standard frequencies transmitted by WWV.

The edges of most amateur bands also are exact multiples of 100 kc., so it becomes pos-

sible to determine the band edges very accurately. This is an important consideration in amateur frequency measurement, since the only regulatory requirement is that an amateur transmission be inside the assigned band, not on a specific frequency.

### Frequency Standard with Harmonic Amplifier

The frequency standard circuit shown in Fig. 21-13 includes a tuned amplifier to increase the strength of the higher harmonics, and incorporates a crystal-diode sawtooth generator to make the harmonic strength reasonably uniform throughout the usable frequency spectrum of the instrument. It will produce useful calibration signals at 100-kc. intervals up to about 60 Mc. The strength of a particular harmonic may be peaked up by selecting the proper amplifier tuning range with  $S_2$  and adjusting  $C_4$ .

The 100-kc. oscillator uses the triode section of a 6AN8, while the amplifier uses the pentode section of the same tube. Power required for the unit is 150 volts at 10 ma. and 6.3 volts at 0.45 amp. This may be taken from the accessory socket of a receiver, or a special supply easily can be made using a TV "booster" transformer (such as the Merit P-3046 or equivalent).

The standard is built in a 4 × 5 × 6 inch chassis-type box (Fig. 21-14).  $R_2$  and  $S_2$  are mounted on the panel, with the amplifier plate coils mounted on  $S_2$ . The remaining components are mounted on the chassis,  $C_4$  being insulated from it because its plates are above ground for d.c. For the same reason, an insulated shaft extension is used for front-panel control of  $C_4$ .

Connection between the standard and the receiver can be made through a wire from the hot terminal of  $J_1$  to the antenna input post on the receiver. Depending on how well the receiver is shielded, such a wire may not be needed at the lower-frequency end of the range.

### Adjusting to Frequency

The frequency can be adjusted exactly to

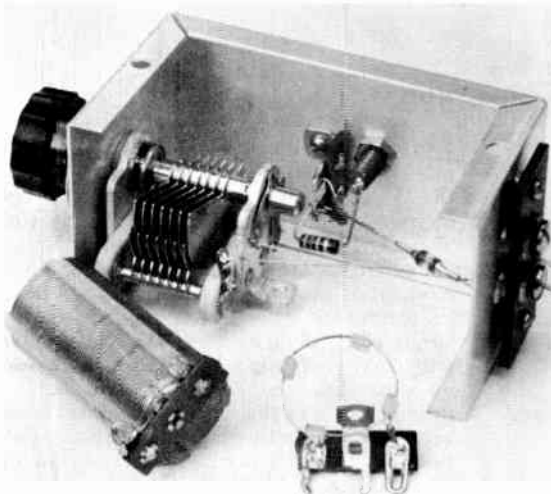

100 kc. by making use of the WWV transmissions tabulated later in this chapter. Select the WWV frequency that gives a good signal at your location at the time of day most convenient. Tune it in with the receiver b.f.o. off and wait for the period during which the modulation is absent. Then switch on the 100-kc. oscillator and adjust its frequency, by means of  $C_1$  until its harmonic is in zero beat with WWV. The exact setting is easily found by observing the slow pulsation in background noise as the harmonic comes close to zero beat, and adjusting to where the pulsation disappears or occurs at a very slow rate. The pulsation can be observed even more readily by switching on the receiver's b.f.o., after approximate zero beat has been secured, and observing the rise and fall in intensity (not frequency) of the beat tone. For best results the WWV signal and the signal from the 100-kc. oscillator should be about the same strength. It is advisable not to try to set the 100-kc. oscillator during the periods when the WWV signal is tone-modulated, since it is difficult to tell whether the harmonic is being adjusted to zero beat with the carrier or with a sideband.

#### Using the Standard

Basically, the 100-kc. standard provides a means for indicating the exact receiver dial settings at which frequencies that are multiples of 100 kc. are to be found. The harmonics of the standard can thus be used to check the dial calibration of a receiver, and many of the better-grade communications receivers either include a 100-kc. oscillator for this purpose or have provision for installing one as an accessory. The actual frequency of at

least one 100-kc. point in a given amateur band must be known, of course, but this is generally an easy matter since the activity in amateur bands usually makes identification of the band-edge "marker signal" quite simple. After one frequency is known, the consecutive 100-kc. harmonic signals are simply counted off from it.

Although the 100-kc. standard does not make possible the exact measurement of a frequency, it is readily possible to determine whether or not the signal is in a particular 100-kc. segment. If the unknown signal tunes in between, say, 21,200 and 21,300 kc., as indicated by the marker signals in the receiver, its frequency obviously lies between those two figures. For purposes of complying with the amateur regulations it is usually sufficient to know that the signal is above, or below, some specified 100-kc. point, since the edges of the amateur bands or sub-bands usually are at such points. If a closer measurement is desired a fairly good estimate usually can be made by counting the number of dial divisions between two 100-kc. points and dividing the number into 100 to find how many kilocycles there are per dial division.

In using the receiver to check one's own transmitting frequency it is necessary to take special precautions to reduce the strength of the signal from the transmitter to the point where it does not overload the receiver nor create spurious responses that could be taken for the actual signal. This invariably means that the receiving antenna must be disconnected from the receiver, and it may be necessary, in addition, to short-circuit the receiver's antenna input terminals. Try to reduce stray pickup to such an extent that the transmit-

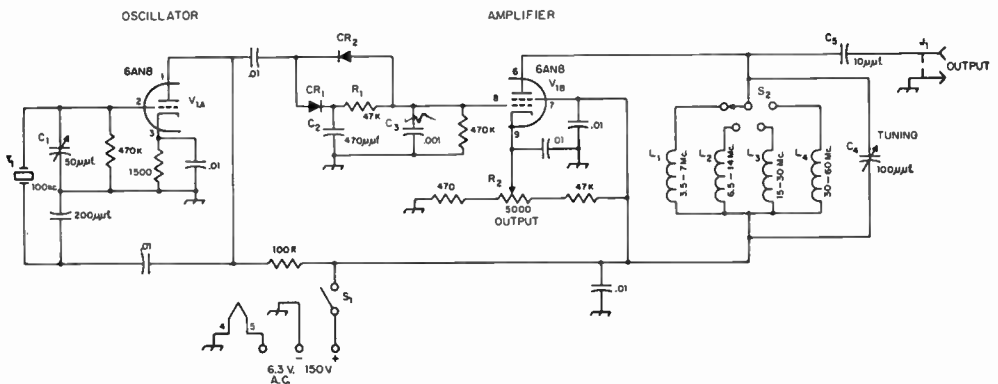

Fig. 21-13—Circuit of the 100-kc. crystal calibrator. Unless otherwise indicated, capacitances are in  $\mu\text{f.}$ , resistances are in ohms, resistors are  $\frac{1}{2}$  watt.

$C_1$ —50- $\mu\text{f.}$  midget variable (Hammarlund MAPC-50).

$C_4$ —100- $\mu\text{f.}$  variable (Hammarlund HF-100).

$CR_1, CR_2$ —1N34A.

$J_1$ —Phono jack.

$L_1$ —3.5-7 Mc., 10  $\mu\text{h.}$  (National R-33 r.f. choke).

$L_2$ —6.5-14 Mc., 4.7  $\mu\text{h.}$  (IRC type CL-1 r.f. choke).

$L_3$ —15-30 Mc., 1.0  $\mu\text{h.}$  (IRC type CL-1 r.f. choke).

$L_4$ —30-60 Mc., 0.22  $\mu\text{h.}$ ; 4 turns No. 20 plastic-insulated wire,  $\frac{3}{8}$ -inch diam.

$R_2$ —5000-ohm potentiometer (Mallory U-14).

$S_1$ —S.p.s.t., mounted on  $R_2$  (Mallory US-26).

$S_2$ —1-section, 1-pole, 4-position miniature phenolic rotary switch (Centralab PA-1000).

$Y_1$ —100-kc. crystal.

STANDARD FREQUENCIES AND TIME SIGNALS

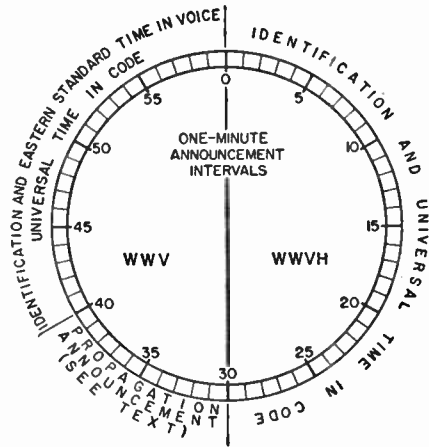
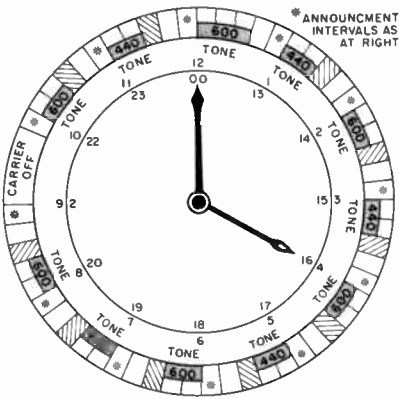

The Central Radio Propagation Laboratory of the National Bureau of Standards maintains two radio transmitting stations, WWV near Washington, D.C., and WWVH at Puunene, Hawaii, for broadcasting standard radio frequencies of high accuracy. WWV broadcasts are on 2.5, 5, 10, 15, 20 and 25 megacycles per second, and those from WWVH are on 5, 10, and 15 Mc. The radio-frequency signals are modulated by pulses at 1 cycle per second, and also by standard audio frequencies alternating between 440 and 600 c.p.s.

Transmissions are continuous, with the following exceptions: The WWV transmissions are interrupted for a 4-minute period beginning at approximately 45 minutes after the hour, as indicated above; the

WWVH transmissions are interrupted for a 4-minute period beginning 15 minutes after the hour.

WWVB and WWVL near Fort Collins, Colorado, transmit standard frequency signals at 60 and 20 kc., respectively.

Transmitted frequencies are accurate to within 2 parts in 100 billion, according to the Bureau of Standards. The WWV transmissions are generally stable to 1 part in a billion in any given day, although this is not guaranteed. Frequencies are based on an atomic standard, and daily corrections to the transmitted frequencies are subsequently published each month in the *Proceedings of the IEEE*.

Time Signals

The 1-c.p.s. modulation is a 5-millisecond pulse at intervals of precisely one second, and is heard as a tick. The pulse transmitted by WWV consists of 5 cycles of 1000-cycle tone; that transmitted by WWVH consists of 6 cycles of 1200-cycle tone. On the WWV transmissions, the 440- or 600-cycle tone is blanked out beginning 10 milliseconds before and ending 25 milliseconds after the pulse. On the WWVH transmissions, the pulse is superimposed on the tone. The pulse on the 59th second is omitted, and for additional identification the zero-second pulse is followed by another 100 milliseconds later. On WWV during the minutes identified by coarse cross-hatching (above) a high-speed pulse code is transmitted, giving the time of day and the accuracy of the time. It sounds like an erratic "buzz."

Propagation Notices

Following the announcement intervals every 5 minutes, propagation notices applying to transmission paths over the North Atlantic are transmitted from WWV on 2.5, 5, 10, 15, 20, and 25 Mc. Similar forecasts for the North Pacific are transmitted from WWVH.

These notices, in telegraphic code, consist of the letter N, W, or U followed by a number. The letter designations apply to propagation conditions as of the time of the broadcast, and have the following significance:

- W — Ionospheric disturbance in progress or expected.
- U — Unstable conditions, but communication possible with high power.
- N — No warning.

The number designations apply to expected propagation conditions during the subsequent 12 hours and have the following significance:

- 1 — impossible; 2 — very poor; 3 — poor; 4 — fair to poor; 5 — fair; 6 — fair to good; 7 — good; 8 — very good; 9 — excellent.

CHU

CHU, the Canadian time-signal station, transmits on 3330.0, 7335.0 and 14,670.0 kc. Voice announcement of the minute is made each minute; the 29th second time tick is omitted. Voice announcements are made in English and French.

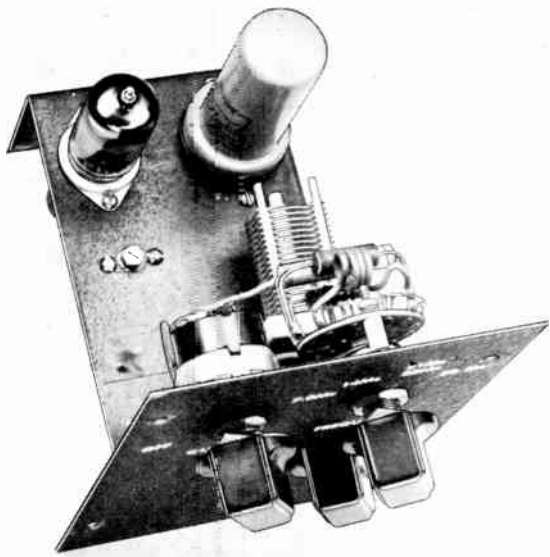

Fig. 21-14—A 100-kc. frequency standard and harmonic amplifier. The crystal in this unit is in the metal-tube type envelope. Power and r.f. output connections are taken through the rear chassis lip.

The crystal diodes,  $CR_1$  and  $CR_2$ , are mounted on a tie-point strip underneath the chassis. The shaft of  $C_1$  can be seen in front of the vacuum tube.

ter's signal is no stronger than normal incoming signals at the regular gain-control settings. With some receivers this may require additional shielding around the signal-frequency circuits, and perhaps filtering of the

a.c. and speaker leads where they leave the chassis, to prevent energy picked up on these leads from getting into the front end of the receiver.

### More Precise Methods

The methods described above are quite adequate for the primary purpose of amateur frequency measurements—that is, determining whether or not a transmitter is operating inside the limits of an amateur band, and the approximate frequency inside the band. For measurement of an unknown frequency to a high degree of accuracy more advanced methods can be used. Accurate signals at closer intervals can be obtained by using a multi-vibrator in conjunction with the 100-kc. standard, and thus obtaining signals at intervals of, say, 10 kc. or some other integral divisor of 100. Temperature control is frequently used on the 100-kc. oscillator to give a high order of stability (Collier, "What Price Precision?", *QST*, September and October, 1952). Also, the secondary standard can be used in conjunction with a variable-frequency interpolation oscillator to fill in the standard intervals (Woodward, "A Linear Beat-Frequency Oscillator for Frequency Measurement," *QST*, May, 1951). An interpolation oscillator and standard can be combined in one instrument to give signals throughout the spectrum. One application of this type was described in *QST* for May, 1949 (Grammer, "The Additive Frequency Meter").

## TEST OSCILLATORS AND SIGNAL GENERATORS

### THE GRID-DIP METER

The grid-dip meter is a simple vacuum-tube oscillator to which a microammeter or low-range milliammeter has been added for reading the oscillator grid current. A 0-1 milliammeter is sensitive enough in most cases. The grid-dip meter is so called because if the oscillator is coupled to a tuned circuit the grid current will show a decrease or "dip" when the oscillator is tuned through resonance with the unknown circuit. The reason for this is that the external circuit will absorb energy from the oscillator when both are tuned to the same frequency; the loss of energy from the oscillator circuit causes the feed-back to decrease and this in turn is accompanied by a decrease in grid current. The dip in grid current is quite sharp when the circuit to which the oscillator is coupled has reasonably high  $Q$ .

The grid-dip meter is most useful when it covers a wide frequency range and is compactly constructed so that it can be coupled to circuits in hard-to-reach places such as in a transmitter or receiver chassis. It can thus be used to check tuning ranges and to find unwanted resonances

of the type described in the chapter on TVI. Since it is its own source of r.f. energy it does not require the circuit being checked to be energized. In addition to resonance checks, the grid-dip meter also can be used as a signal source for receiver alignment and, as described later in this chapter, is useful in measurement of inductance and capacitance in the range of values used in r.f. circuits.

The grid-dip meter shown in Fig. 21-15 is representative, although this particular unit has a higher frequency limit than similar inexpensive units. It uses the 6CW4 (Nuvistor) triode for the oscillator, and it can be used with the power supply and metering circuit shown in Fig. 21-18.

Referring to the circuit in Fig. 21-16, a resistor,  $R_2$ , is plugged in with each coil (the resistor is mounted in the coil form). It forms a voltage divider with the normal grid leak,  $R_1$ , and brings the metering circuit into the best range for the transistor booster.

The construction of the meter is straightforward; a small aluminum bracket supports the



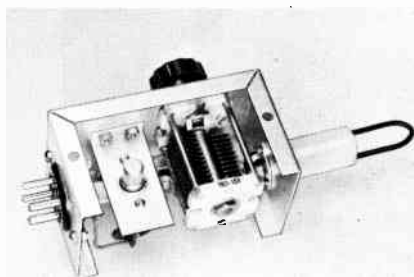

Fig. 21-15—Grid-dip meter covering the range 1.7 to 275 Mc., with the 90-165 Mc. coil in place. The power supply and transistor meter booster are a separate unit (see Fig. 21-17). The split-stator tuning capacitor is made from a single-stator variable. The Nuvistor tube socket is mounted on a small bracket, and a tie point under the bracket supports associated copocitors and resistors that aren't supported by socket and tuning-capacitor terminals.

Nuvisor socket within the 2¼ × 2¼ × 4-inch Minibox that is used as a housing. A 5-pin socket (Amphenol 78-S5S) is mounted at one end of the Minibox, and the variable capacitor stator leads are soldered directly to two of the pins. Coils in the low-frequency ranges are wound with enameled wire on ¾-inch diameter forms. In the intermediate ranges coil stock (B&W Miniductor) is mounted inside the coil forms, with one end of the coil close to the open end of the form, for ease in coupling. The two highest-range coils are hairpin loops of No. 14 wire, covered with insulation as a safety precaution. In every case the associated R<sub>2</sub> is mounted in the coil form. The highest range requires that only the base of the coil form be used, since the loop is shorter than the form.

The power supply for the grid-dip meter may be included with the oscillator, but since this increases the bulk and weight a separate supply is often desirable. The power supply shown in Fig. 21-18 uses a miniature power transformer with a silicon rectifier and a simple filter to give approximately 120 volts for the oscillator plate. It also uses a transistor booster for the meter because it was designed for use with a u.h.f. grid-dip meter. A supply to be used with only the unit of Fig. 21-15 could eliminate the transistor by using a 0-1 milliammeter between lead 3 of P<sub>1</sub> and chassis ground. In this case R<sub>2</sub> could also be eliminated, and the B+ for pin 4 of P<sub>1</sub> should be derived from the arm of a 0.1-megohm potentiometer connected across the power supply. The adjustable plate voltage source is necessary to bring the grid current into the range of the meter.

The instrument may be calibrated by listening to its output with a calibrated receiver. The calibration should be as accurate as possible, although "frequency-meter accuracy" is not required in the applications for which a grid-dip meter is useful.

The grid-dip meter may be used as an indicating-type absorption wavemeter by removing the plate voltage and using the grid and cathode of the tube as a diode. However, this type of circuit is not as sensitive as the crystal-detector type shown earlier in this chapter, because of the high-resistance grid leak in series with the meter.

In using the grid-dip meter for checking the resonant frequency of a circuit the coupling should be set to the point where the dip in grid current is just perceptible. This reduces interaction between the two circuits to a minimum and gives the highest accuracy. With too-close coupling the oscillator frequency may be "pulled" by the circuit being checked, in which case different readings will be obtained when resonance is approached from the high-frequency side as compared with approaching from the low side.

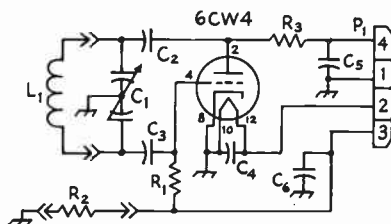

Fig. 21-16—Circuit diagram of the grid-dip meter. C<sub>1</sub>—50 μmf. per section (Johnson 167-11 with stator bars sowed between 6th and 7th plates). C<sub>2</sub>, C<sub>3</sub>—100-μmf. ceramic. C<sub>4</sub>, C<sub>5</sub>, C<sub>6</sub>—0.001-μf. disk ceramic. P<sub>1</sub>—4-pin chassis plug (Amphenol 86-CP4). R<sub>1</sub>—47,000 ohms, ½ watt. R<sub>2</sub>—See table below. R<sub>3</sub>—10,000 ohms.

Range	L <sub>1</sub>	R <sub>2</sub>
1.7-3.2 Mc.	195 turns No. 34 enam.*	680
2.7-5.0	110 turns No. 30 enam.*	470
4.4-7.8	51½ turns No. 30 enam.*	470
7.5-13.2	24½ turns No. 30 enam.*	470
12-22	31 t. No. 24 (B&W 3004)**	1000
20-36	14 t. No. 24 (B&W 3004)**	680
33-60	8½ t. No. 20 (B&W 3003)***	680
54-99	3¾ t. No. 20 (B&W 3003)***	1000
90-165	3¾-inch loop No. 14, ½-inch separation	1500
150-275	1¼-inch loop No. 14, ¼-inch separation	3300

\*Wound on ¾-inch diameter polystyrene form (Allied Radio 71 H 723).  
\*\*32 t.p.i.      \*\*\*16 t.p.i.

### U.H.F. Grid-Dip Oscillator

The range of the grid-dip meter shown in Fig. 21-17 is from 275 to 725 Mc., a higher range than any of the inexpensive meters now available. It is able to cover these high frequencies by virtue of the 6CW4 (Nuvistor) tube and the series-tuned circuit. Unfortunately the series-tuned circuit becomes impractical with



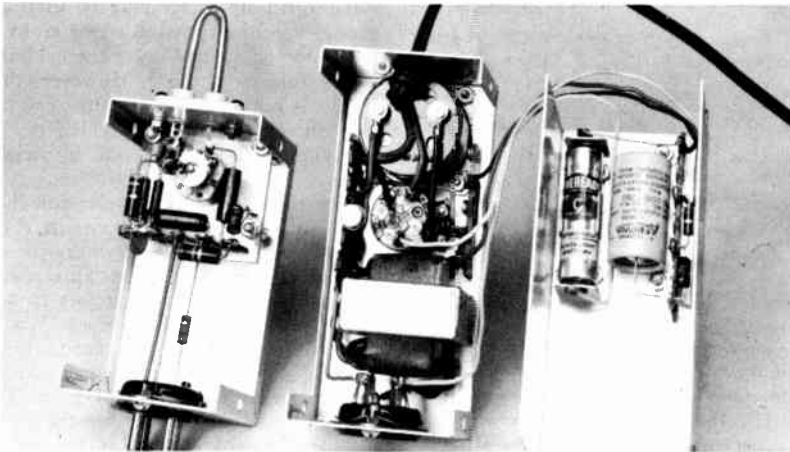

Fig. 21-17—Grid-dip meter for the 300- to 700-Mc. range. The oscillator section is at the left in its own case, and the power supply plus transistorized indicator is at the center and right. In the oscillator section, the 6CW4 (Nuvistor) socket is to the left of the tuning capacitor.

this tube at lower frequencies, and to cover the lower frequencies the circuit of Fig. 21-16 must be used. The u.h.f. grid-dip oscillator uses a transistor amplifier to amplify the changes across the unusually-low value of grid resistor. The low value of grid resistor is required because higher values will cause the oscillator to “squegg.”

The grid-dip meter is built in a  $2\frac{1}{4} \times 2\frac{1}{4} \times 4$ -inch Minibox, and the power supply and meter circuit is built in a similar enclosure. In use the two Miniboxes are connected by a short length of four-conductor cable.

The “heart” of the meter is the oscillator section, which is built on a  $1\frac{3}{4} \times 1\frac{7}{8}$ -inch piece of  $\frac{1}{8}$ -inch thick polystyrene. The Nuvistor

socket is mounted in one corner and the tuning capacitor is mounted a little above center. The coil socket, a National CS-6, is mounted on the end of the Minibox. The polystyrene sheet is supported by four 1-inch 6-32 screws, and the sockets and variable capacitor are positioned so that direct connections can be made between plate pin and coil socket, capacitor rotor and coil socket, and capacitor stator and grid pin. The various resistors and r.f. chokes are supported at one end by a multiple-terminal tie strip mounted on the polystyrene sheet and at the other end by the socket pins and other terminals.

The coils are made from No. 10 tinned copper wire; as a safety precaution they are covered

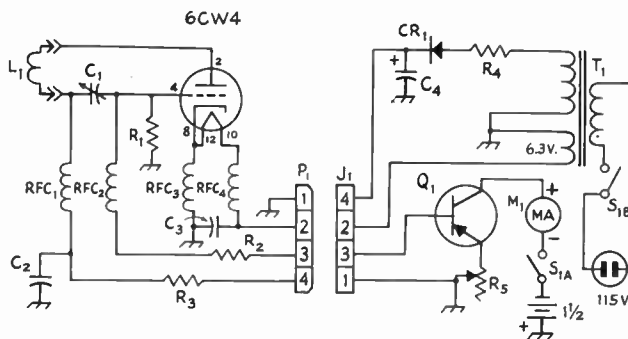

Fig. 21-18—Circuit diagram of the u.h.f. grid-dip meter.

$C_1$ —8- $\mu$ f. midget variable (Hammarlund MAC-10 with one rotor plate removed).

$C_2$ —150- $\mu$ f. ceramic.

$C_3$ —0.001- $\mu$ f. ceramic.

$C_4$ —20- $\mu$ f., 250-volt electrolytic.

$CR_1$ —400 p.i.v. rectifier (Sarkes Tarzian 2F4).

$J_1$ —4-pin tube socket.

$M_1$ —0-500 microammeter.

$P_1$ —4-pin plug (Amphenol 86-CP4).

$Q_1$ —2N1264 transistor.

$R_1$ —330 ohms, 1 watt.

$R_2$ —47,000 ohms,  $\frac{1}{2}$  watt.

$R_3$ —10,000 ohms.

$R_4$ —22 ohms,  $\frac{1}{2}$  watt.

$R_5$ —10,000-ohm potentiometer.

$RFC_1$ ,  $RFC_2$ —22- $\mu$ h. r.f. choke (Millen 34300-22).

$RFC_3$ ,  $RFC_4$ —0.82- $\mu$ h. r.f. choke (Millen 34300-82).

$S_{1A}$ ,  $S_{1B}$ —D.p.s.t., part of  $R_5$ . Switches should be open when  $R_5$  at maximum resistance.

$T_1$ —6.3- and 125-v. transformer (Knight 61 G 410).

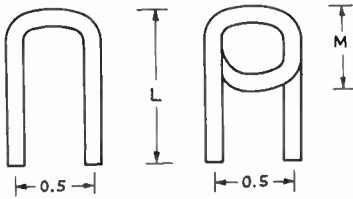

Fig. 21-19—Details of the coils used in the u.h.f. grid dip meter. The material is No. 10 tinned-copper wire. One turn in end of low-frequency coil.

Range	Dimension "L"	"M"
271-324 Mc.	2¾	1¼
312-378	3½	—
372-463	2	—
413-519	1¾	—
446-565	1¼	—
544-730	½*	—

\*Shape closed end to be nearly square.

except at the tips by clear plastic insulation. Details are given in Fig. 21-19.

Frequency calibration of the meter can be started by reference to u.h.f. TV stations in the area, if any, or by reference to 420-Mc. amateur gear.

**AUDIO-FREQUENCY OSCILLATORS**

A useful accessory for testing audio-frequency amplifiers and modulators is an audio-frequency signal generator or oscillator. Checks for distortion, gain, and the troubles that occur in such amplifiers do not require elaborate equipment; the principal requirement is a source of one or more audio tones having a good sine wave form, at a voltage level adjustable from a few volts down to a few millivolts so the oscillator can be substituted for the type of microphone to be used.

An easily constructed oscillator of this type is shown in Figs. 21-20 to 21-22, inclusive.

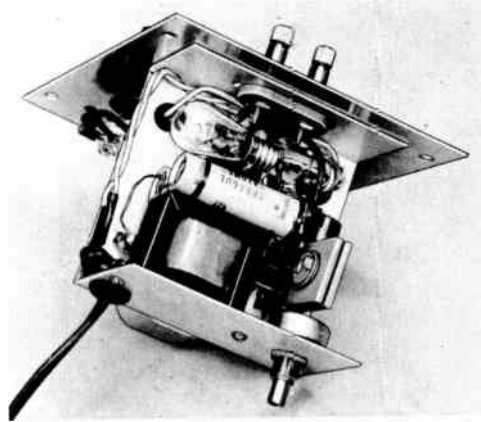

Fig. 21-20—Bottom view of the audio oscillator, showing the power-supply components and amplitude-control lamp, *I*<sub>1</sub>. The lamp is mounted by wires soldered to its base. The selenium rectifier is supported by a tie-point strip. Placement of resistors, which are hidden by the other components, is not critical. The unit fits in a 4 × 5 × 6 inch box.

Three audio frequencies are available, approximately 200, 900 and 2500 cycles. These three frequencies are sufficient for testing the frequency response of an amplifier over the range needed for voice communication.

The circuit uses a double triode as a cathode-coupled oscillator, the second section of the tube providing the feedback necessary for oscillation through the common cathode connection. The 3-watt lamp in this feedback loop acts as a variable resistance to control the oscillation amplitude and thus maintain the operating conditions at the point where the best wave form is generated. This operating point is set by the "oscillation control," *R*<sub>1</sub>. The frequency is determined by the resistance and capacitance in

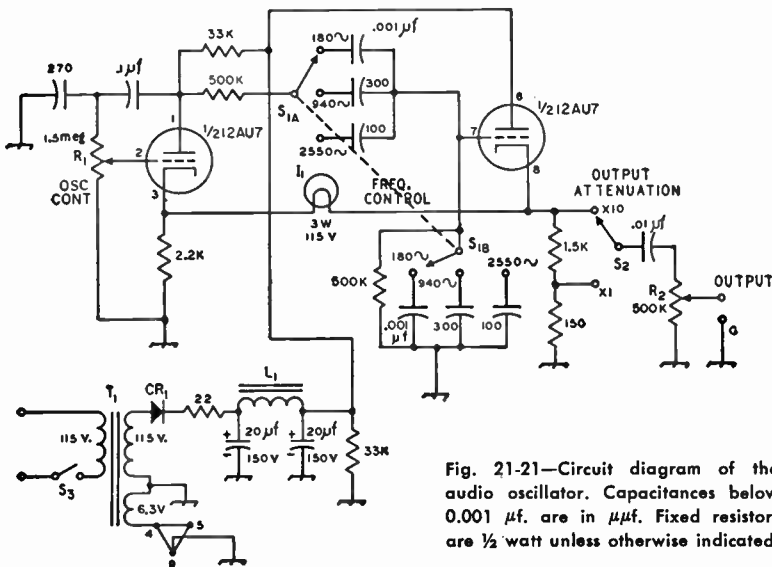

Fig. 21-21—Circuit diagram of the audio oscillator. Capacitances below 0.001 μf. are in μf. Fixed resistors are ½ watt unless otherwise indicated.

- CR<sub>1</sub>—20-ma. selenium rectifier.
- I<sub>1</sub>—3-watt, 115-volt lamp (G.E. 3S6).
- L<sub>1</sub>—8 henrys, 40 ma. (Thoradson 20C-52).
- R<sub>1</sub>, R<sub>2</sub>—Volume controls.
- S<sub>1</sub>—2-pole 5-position (3 used) rotary switch.
- S<sub>2</sub>—S.p.d.t. toggle.
- S<sub>3</sub>—S.p.s.t. toggle (mounted on R<sub>1</sub>).
- T<sub>1</sub>—Power transformer, 150 volts, 25 ma.; 6.3 volts 0.5 amp. (Merit P-3046).

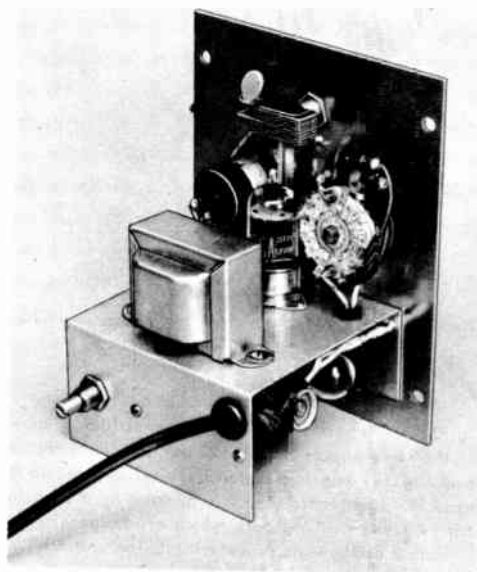

Fig. 21-22—Inside view of the audio oscillator. The a.c. switch,  $S_2$ , is mounted on the OUTPUT control at the left on the panel. The ceramic capacitors in the frequency-determining circuits are mounted on the rotary switch,  $S_1$ , at the right.  $S_2$  is above the tube, and  $T_1$  is on the near edge of the chassis, which is a U-shaped piece of aluminum  $3\frac{1}{2}$  inches deep with  $1\frac{1}{2}$ -inch lips.  $R_1$  is mounted on the near lip at the left.

the coupling circuit between the first-section plate and second-section grid. Various values of capacitance can be selected by means of  $S_1$  to set the frequency. The actual frequencies measured in the unit shown in the photographs are given on the diagram. They may be either increased or decreased by using smaller or larger capacitances, respectively.

Output is taken from the cathode of the second triode section. Either the full output, 1.5 volts, or approximately one-tenth of it, can be selected by  $S_2$ . On either of these two ranges smooth control of output is provided by  $R_2$ .

The built-in power supply uses a small transformer and a selenium rectifier to develop approximately 150 volts. Hum is reduced to a negligible level by the filter consisting of the 8-henry choke and 20- $\mu$ f. capacitors.

An oscilloscope is useful for preliminary checking of the oscillator since it will show wave form.  $R_1$  should be set at the point that will ensure oscillation on all three frequencies when switching from one to the other.

## DIODE NOISE GENERATORS

A noise generator is a device for creating a controllable amount of r.f. noise ("hiss"-type noise) evenly distributed throughout the spectrum of interest. The simplest type of noise gen-

erator is a diode, either vacuum-tube or crystal, with d.c. flowing through it. The current is also made to flow through a load resistance which usually is chosen to equal the characteristic impedance of the transmission line to be connected to the receiver's input terminals. The resistance then substitutes for the line, and the amount of r.f. noise fed to receiver input is controlled by varying the d.c. through the diode.

The noise generator is useful for adjusting the "front-end" circuits of a receiver for best noise figure (see Chapter Five), and it is actually more effective for this purpose than a laboratory-type signal generator. A simple circuit using a crystal diode is shown in Fig. 21-23. The unit can be built into a small metal box; the main consideration is that the circuit from  $C_1$  through to  $P_1$  be as compact as possible. By mounting  $P_1$  at one end of the box, the unit can be readily attached to the receiver under test. A calibrated knob on  $R_1$  will permit

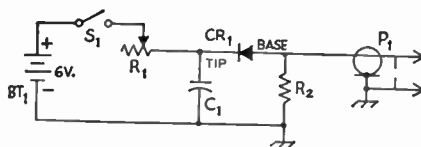

Fig. 21-23—Circuit of a simple crystal-diode noise generator.

$BT_1$ —Dry-cell battery, any convenient type.

$C_1$ —500- $\mu$ f. ceramic, disk or tubular.

$CR_1$ —Silicon diode, 1N21 or 1N23. Diodes with "R" suffix have reversed polarity. (Do not use ordinary germanium diodes).

$P_1$ —Coaxial fitting, cable type.

$R_1$ —50,000-ohm control, counterclockwise logarithmic taper.

$R_2$ —51 or 75 ohms,  $\frac{1}{2}$ -watt composition.

$S_1$ —S.p.s.t. toggle (may be mounted on  $R_1$ ).

resetting the generator to roughly the same spot each time, for making comparisons. If the leads are short, the generator can be used through the 144-Mc. band for receiver comparisons.

To use the generator, screw the coaxial fitting on the receiver's input fitting, open  $S_1$ , and measure the noise output of the receiver using an a.c. vacuum-tube voltmeter or similar a.f. voltage indicator. Make sure that the receiver's r.f. and audio gain controls are set well within the linear range, and do not use a.g.c. Then turn on the noise generator and set  $R_1$  for an appreciable increase in output, say twice the original noise voltage, and note the dial setting. Receiver front-end adjustments may then be made with the object of attaining the same noise increase with the lowest possible direct current through the diode—that is, with the largest possible resistance at  $R_1$ .

While the simple crystal-diode noise generator is a useful device within the shack for evaluating receiver performance, it does not permit good comparisons with other receivers measured

Fig. 21-24—Two diode noise generators and (left) their power supply. Useful generator range is (right) 7 to 90 Mc. and (center) 90 to 450 Mc.



with other noise generators. Diode noise generators that allow the noise figure to be measured are shown in Figs. 21-24 and 21-26. Referring to the circuit diagram in Fig 21-25, a 5722 noise diode is used in place of the crystal diode. A power supply that can be used with either generator unit (which differ only in their filtering and plug connector) is shown in Fig. 21-27. The heart of the supply is a heavy-duty filament rheostat,  $R_3$ , that is used to control the diode filament temperature. With  $S_2$  in the N.F. position, the 0-1 milliammeter reads the current through the diode by measuring the voltage across the 100-ohm resistor. Full-scale reading is 10 ma. or 50 ma., depending upon the position of  $S_3$ . The meter also serves as an output indicator for the receiver when  $S_2$  is in the OUT position. Terminals are provided for connecting the meter mounted in the power supply to the

receiver speaker terminals, so that the receiver output can be monitored.

An important part of the design of the noise-generator power supply is the resistor  $R_1$ . This tapped resistor serves as an output load for the receiver. With  $S_1$  in the OFF position, and  $S_2$  in the OUT position, the receiver output is rectified by the 1N34A and a suitable meter indication can be obtained by variation of the receiver volume control. When  $S_1$  is switched to ON, only a fraction of the receiver noise output is rectified and, at the same time, the diode noise generator is turned on. If the meter now reads half the receiver output noise power, and the re-

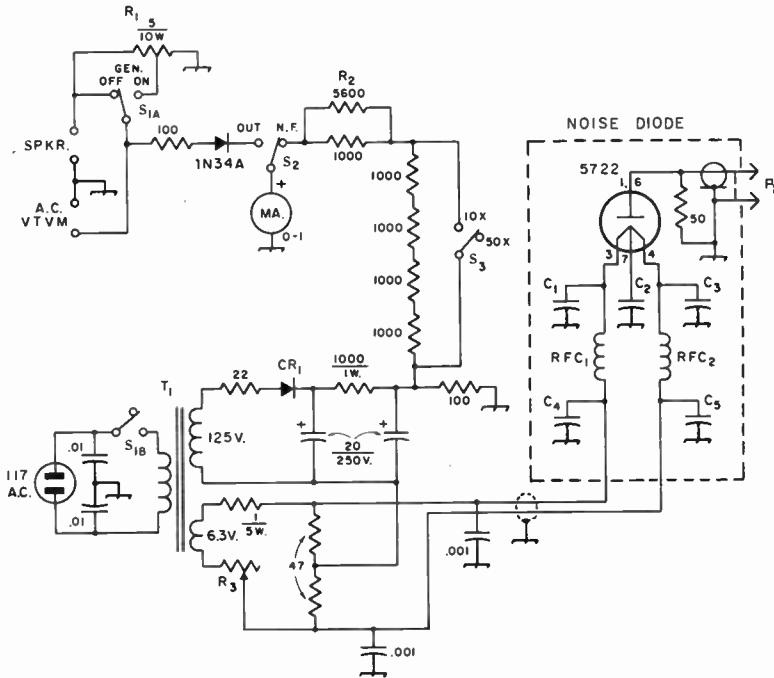

Fig. 21-25—Circuit diagram of the diode noise generators and power supply. Unless indicated otherwise, resistances are in ohms, resistors are 1/2-watt, capacitances are in  $\mu$ f.

- $C_1$ - $C_8$ —0.001- $\mu$ f. disk ceramic in 7-90 Mc.; button (Centralab ZA-102) in 90-450 Mc.
- $C_4$ ,  $C_8$ —0.001- $\mu$ f. disk ceramic
- $CR_1$ —400 p.i.v. silicon rectifier.
- $P_1$ —PL-259 in 7-90 Mc.; UG-260B/U in 90-450 Mc.
- $R_1$ —5-ohm 10-watt adjustable, tap set at about 3 1/2 ohms to ground. See text.

- $R_2$ —Approximately 5600 ohms. See text.
- $R_3$ —4-ohm 50-watt rheostat (Ohmite 0311).
- $RFC_1$ ,  $RFC_2$ —7-90 Mc.: Approximately 9  $\mu$ h. 38 turns No. 22 Nylclad on 1/2-inch diameter form (Millen 69046), slug set for maximum inductance. 90-450 Mc.: 0.22  $\mu$ h. (Miller RFC-420).
- $T_1$ —125 volts at 50 ma., 6.3 v. at 2 a. (Knight 61 G 411).



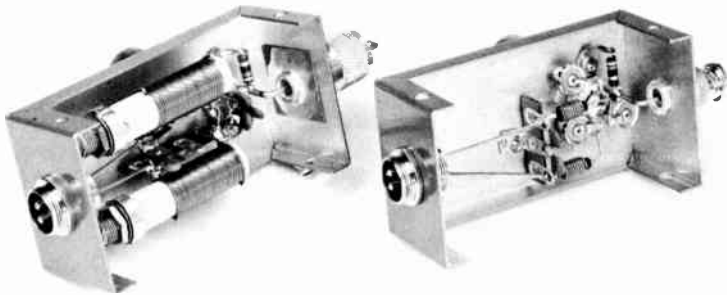

Fig. 21-26—Each diode noise generator is housed in a  $4 \times 2\frac{1}{8} \times 1\frac{1}{8}$ -inch "Minibox" (Bud CU-2102-A). Power connections are made through double-pin male receptacles (Amphenol 80 PC2M), and the r.f. connection is made to the receiver or converter by a suitable plug. The plug on the 7- to 90-Mc. generator (left) is a PL-259 held to the face of the "Minibox" by a small copper plate and a UG-176/U reducing adapter.

ceiver noise output has been doubled by the noise from the diode noise generator, the meter reading will remain the same for either position of  $S_2$ . Since the meter needle will "wobble" back and forth about a mean reading, it is much easier to match readings that are made at the same point on the meter scale than it is to "read" the meter at two different points on the scale.

The tap on  $R_1$  is set to 70.7 per cent of the full resistance. If the "5-ohm" resistor is exactly 5.00 ohms, the tap should be set to read 3.54 ohms ( $0.707 \times 5.00 = 3.54$ ) to ground.

The resistor  $R_2$  may not have a value of exactly 5.6K, as shown in Fig. 21-25. It should be considered as an adjustment of the voltmeter multiplier for the meter in the N.F. position. By proper selection of  $R_2$ , opening  $S_3$  will give a

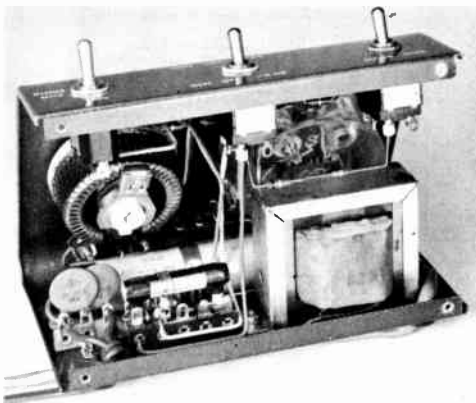

Fig. 21-27—Power supply for the noise generators is housed in a 7-inch wide sloping-panel cabinet (Bud AC-1613). Switches, from left to right, are (referring to Fig. 21-25)  $S_3$ ,  $S_1$  and  $S_2$ .

meter reading of  $1/5$  the reading when  $S_3$  is closed. Check this for several points on the meter, obtaining various values of current by changing the setting of  $R_3$ .

To measure the noise figure of a receiver, connect the applicable noise-diode unit to the input of the receiver to be checked. Connect the output of the receiver to the SPKR terminals. With  $S_1$  in the OFF position, and  $S_2$  in the OUT position, run the gain controls of the receiver up to get a suitable reading on the meter. A "suitable" reading is one that is somewhat less than the maximum that can be obtained; it is very important that the receiver be operated at all times well below any overload or limiting point. Note the reading of the meter and throw  $S_1$  to ON. Slowly decrease the value at  $R_3$  and watch the meter. When the meter reading matches the previous reading (when  $S_1$  was at OFF), flip  $S_2$  to read the diode current. It is good practice to do this the first time with  $S_3$  at 50X, to avoid possible injury to the meter. When the process has been repeated several times, and a reasonably "firm" figure for the diode current has been obtained, the noise figure can be found from

$$\text{Noise figure} = 20IR$$

where  $I$  = diode current in amperes

$R$  = generator resistance in ohms

Thus if the diode current is 5 ma. and the resistance is 50 ohms, the noise figure is 5.0 ( $20 \times 0.005 \times 50 = 5.0$ ). The noise figure is often expressed in db. above a perfect receiver; in the example it would be 7 db. ( $10 \log 5 = 10 \times 0.7 = 7$ ).

It should be appreciated that the current through the 100-ohm resistor must be measured with a reasonable degree of accuracy, and the accuracy of this circuit should be confirmed by comparison with another meter or by the use of low-tolerance components.

## R.F. MEASUREMENTS

### R.F. CURRENT

R.f. current-measuring devices use a thermocouple in conjunction with an ordinary d.c. instrument. The thermocouple is made of two dissimilar metals which, when heated, generate a small d.c. voltage. The thermocouple is

heated by a resistance wire through which the r.f. current flows, and since the d.c. voltage developed is proportional to the heating, which in turn is proportional to the power used by the heating element, the deflections of the d.c. instrument are proportional to power rather than to current. This causes the calibrated



scale to be compressed at the low-current end and spread out at the high-current end. The useful range of such an instrument is about 3 or 4 to 1; that is, an r.f. ammeter having a full-scale reading of 1 ampere can be read with satisfactory accuracy down to about 0.3 ampere, one having a full scale of 5 amperes can be read down to about 1.5 amperes, and so on. No single instrument can be made to handle a wide range of currents. Neither can the r.f. ammeter be shunted satisfactorily, as can be done with d.c. instruments, because even a very small amount of reactance in the shunt will cause the readings to be highly dependent on frequency.

Fig. 21-28 shows a convenient way of using



Fig. 21-28—R.f. ammeter mounted for connecting into a coaxial line for measuring power. A "2-inch" instrument will fit into a 2 × 4 × 4 metal box.

an r.f. ammeter for measuring current in a coaxial line. The instrument is simply mounted in a metal box with a short lead from each terminal to a coaxial fitting. The shunt capacitance of an ammeter mounted in this way has only a negligible effect on accuracy at frequencies as high as 30 Mc. if the instrument has a bakelite case. Metal-cased meters should be mounted on a bakelite panel which in turn can be mounted behind a cut-out that clears the meter case by ¼ inch or so.

R.F. VOLTAGE

An r.f. voltmeter is a rectifier-type instrument in which the r.f. is converted to d.c., which is then measured with a d.c. instrument. The best type of rectifier for most applications is a crystal diode, such as the 1N34 and similar types, because its capacitance is so low as to have little effect on the behavior of the r.f. circuit to which it is connected. The principal limitation of these rectifiers is their rather low value of safe inverse peak voltage. Vacuum-tube diodes are considerably better in this respect, but their size, shunt capacitance, and the fact that power is required for heating the cathode constitute serious disadvantages in many applications.

One of the principal uses for such voltmeters is as null indicators in r.f. bridges, as described later in this chapter. Another useful application is in measurement of the voltage between the conductors of a coaxial line, to show when a transmitter is adjusted for optimum output. In either case the voltmeter impedance should be high compared with that of the circuit under measurement, to avoid

taking appreciable power, and the relationship between r.f. voltage and the reading of the d.c. instrument should be as linear as possible—that is, the d.c. indication should be directly proportional to the r.f. voltage at all points of the scale.

All rectifiers show a variation in resistance with applied voltage, the resistance being highest when the applied voltage is small. These variations can be fairly well "swamped out" by using a high value of resistance in the d.c. circuit of the rectifier. A resistance of at least 10,000 ohms is necessary for reasonably good linearity with a 0-1 milliammeter. High resistance in the d.c. circuit also raises the impedance of the r.f. voltmeter and reduces its power consumption.

The basic voltmeter circuit is shown in Fig. 21-29. It is simply a half-wave rectifier with a meter and a resistor,  $R_1$ , for improving the linearity. The time constant of  $C_1R_1$  should be large compared with the period of the lowest radio frequency to be measured—a condition that can easily be met if  $R_1$  is at least 10,000 ohms and  $C_1$  is 0.001  $\mu$ f. or more—so  $C_1$  will stay charged near the peak value of the r.f. voltage. The radio-frequency choke may be omitted if there is a low-resistance d.c. path through the circuit being measured.  $C_2$  provides additional r.f. filtering for the d.c. circuit.

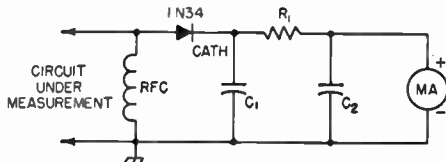

Fig. 21-29—R.f. voltmeter circuit using a crystal rectifier and d.c. microammeter or 0-1 milliammeter.

The simple circuit of Fig. 21-29 is useful for voltages up to about 20 volts, a limitation imposed by the inverse-peak voltage ratings of crystal diodes. A dual range voltmeter circuit, 0-20 and 0-100 volts, is shown in Fig. 21-30.

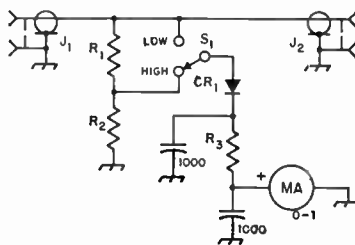

Fig. 21-30—Dual-range r.f. voltmeter circuit. Capacitances are in  $\mu$ f.; capacitors are disk ceramic.

- CR<sub>1</sub>—1N34 or equivalent.
- J<sub>1</sub>, J<sub>2</sub>—Coaxial connectors, chassis-mounting type.
- R<sub>1</sub>—1000 ohms, 1 watt.
- R<sub>2</sub>—3300 ohms, 2 watts.
- R<sub>3</sub>—App. 22,000 ohms (see text), ½ watt.
- S<sub>1</sub>—S.p.d.t. rotary switch (Centralab 1460).

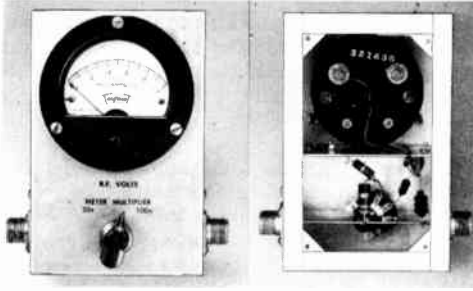

Fig. 21-31—Dual-range r.f. voltmeter for use in coaxial line, using a 0-1 d.c. milliammeter. The voltage-divider resistors,  $R_1$  and  $R_2$  (Fig. 21-30) are at the center in the lower compartment. The bypass capacitors and  $R_3$  are mounted on a tie-point strip at the right. The unit is built in a  $4 \times 6 \times 2$  inch aluminum chassis, with an aluminum partition connecting the two sides of the box to form a shielded space. A bottom plate, not shown, is used to complete the shielding.

A voltage divider,  $R_1R_2$ , is used for the higher range. An instrument using this circuit is shown in Fig. 21-31. It is designed for connection into a coaxial line. The principal constructional precautions are to keep leads short, and to mount the components in such a way as to minimize stray coupling between them and to keep them fairly well separated from metal surfaces.

For accurate calibration (the power method described below may be used)  $R_3$  should be adjusted, by selection of resistors or using two in series to obtain the desired value, so that the meter reads full scale, with  $S_1$  set for the low range, with 20 volts r.m.s. on the line. A frequency in the vicinity of 14 Mc. should be used. Then, with  $S_1$  set for the high range, various resistors should be tried at  $R_1$  or  $R_2$  until with the same voltage the meter reads 20 per cent of full scale. The resistance variations usually will be within the range of 10 per cent tolerance resistors of the values specified. The readings at various other voltages should be observed in order to check the linearity of the scale.

**Calibration**

Calibration is not necessary for purely comparative measurements. A calibration in actual voltage requires a known resistive load and an r.f. ammeter. The setup is the same as for r.f. power measurement as described later.

**V.T.V.M. R.F. PROBE**

R.f. up to about 30 volts peak and a frequency of 200 Mc. is most conveniently measured with a v.t.v.m. (Fig. 21-8) and an r.f. probe. An r.f. probe is merely a rectifier that uses a v.t.v.m. to indicate the magnitude of the rectified voltage. The resultant d.c. voltage is very nearly equal to the peak value of the r.f. voltage.

The unit shown in Figs. 21-32 and 21-34 and schematically in Fig. 21-33 is similar in circuitry to most of the conventional peak-indicating, shunt-type commercial r.f. probes. However, it can be constructed for considerably less than the cost of a commercial unit. If all parts, including the shielded wire, alligator clip, tie point, resistor, phone plug, tube socket, tube shield, capacitor, and diode are purchased new, the total cost of the unit is approximately \$2.25.

Fig. 21-32—The r.f. probe is used in conjunction with a vacuum-tube voltmeter. The case of the probe is constructed from a 7-pin ceramic tube socket and a 2¼-inch tube shield. A half-inch grommet at the top of the tube shield prevents the output lead of the probe from chafing. The flexible copper-braid grounding lead and alligator clip provide a low-inductance return path from the test circuit. The d.c. output of the probe goes to the phone plug, which plugs into the d.c. input jack of the v.t.v.m.



The isolation capacitor, crystal diode, and resistor are mounted on a bakelite 5-lug terminal strip, as shown in Fig. 21-35. One end lug should be rotated 90 degrees so that it extends off the end of the strip. All other lugs should be cut off flush with the edge of the strip. Where the inner conductor connects to the terminal lug, unravel the shield three-quarters of an inch, slip a piece of spaghetti over it, and then solder the braid to the ground lug on the terminal strip. Remove the spring from the tube shield, slide it over the cable, and crimp it to the remaining quarter inch of shield braid. Solder both the spring and a 12-inch length of flexible copper braid to the shield.

Next, cut off the pins on a seven-pin miniature ceramic or mica shield-base tube socket. Use a socket with a cylindrical center post,

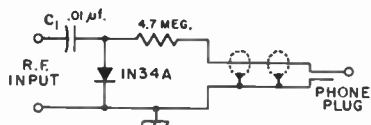

Fig. 21-33—The r.f. probe circuit.

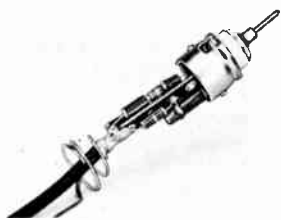

Fig. 21-34—Close-up of the inside of the probe. The 1N34A crystal diode rectifier, calibrating resistor, and input capacitor are mounted tight to the terminal strip with shortest leads possible. Spaghetti tubing is placed on the diode leads to prevent accidental short circuits. The tube-shield spring and Rextible-copper grounding lead are soldered to the cable braid (the cable is RG-58/U coax). The tip can be either a phone tip or a short pointed piece of heavy wire.

such as the Johnson 120-277. Crimp the terminal lug previously bent out at the end of the strip and insert it into the center post of the tube socket from the top. Insert the end of a phone tip or a pointed piece of heavy wire into the bottom of the tube socket center post, and solder the lug and tip to the center post. Insert a half-inch grommet at the top of the tube shield, and slide the shield over the cable and flexible braid down onto the tube socket. The spring should make good contact with the tube shield to insure that the tube shield (probe case) is grounded. Solder an alligator clip to the other end of the flexible braid and mount a phone plug on the free end of the shielded wire.

Mount components close to the terminal strip, to keep lead lengths as short as possible and minimize stray capacitance. Use spaghetti over all wires to prevent accidental shorts. When soldering the crystal diode, hold the end to be soldered with a pair of long-nose pliers, to conduct damaging heat away from the diode.

The a.c. input voltage that the probe can handle safely is limited to about 21 volts r.m.s. or 30 volts peak, as a result of the 60-volt peak-inverse rating of the 1N34A crystal diode. The phone plug on the probe cable plugs into the d.c. input jack of the v.t.v.m., and r.m.s. voltages are read on the vacuum-tube voltmeter's negative d.c. scale. When using the probe be sure that any d.c. voltage on the circuit being checked does not exceed the d.c. voltage rating of  $C_1$ .

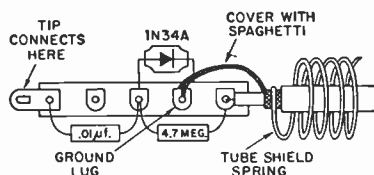

Fig. 21-35—Component mounting details.

The accuracy of the probe is approximately  $\pm 10$  per cent from 50 kc. to 250 Mc. For example, if the error of the v.t.v.m. used with the probe is  $\pm 5$  per cent, then the over-all error of the measuring system is  $\pm 15$  per cent. At low values of input voltage, below a volt or so, the accuracy of the probe is somewhat poorer because of the nonlinearity of the 1N34A crystal diode. At these lower input voltages the output of the probe more closely approaches a square-law relationship than a linear one.

The approximate input impedance of a probe of this type is 6000 ohms shunted by  $1.75 \mu\text{f.}$  (at 200 Mc.), and the amount of error introduced because of circuit loading by the probe is dependent on the impedance of the source of the a.c. voltage being measured. If r.m.s. values are desired rather than peak, the peak values can be divided by 1.41. This is true only for a sine waveform, it does not hold for waves with harmonic content.

## R.F. POWER

Measurement of r.f. power requires a resistive load of known value and either an r.f. ammeter or a calibrated r.f. voltmeter. The power is then either  $I^2R$  or  $E^2/R$ , where  $R$  is the load resistance in ohms.

The simplest method of obtaining a load of known resistance is to use an antenna system with coax-coupled matching circuit of the type described in the chapter on transmission lines. When the circuit is adjusted, by means of an s.w.r. bridge, to bring the s.w.r. down to 1 to 1 the load is resistive and of the value for which the bridge was designed (52 or 75 ohms).

The r.f. ammeter should be inserted in the line in place of the s.w.r. bridge after the matching has been completed, and the transmitter then adjusted—without touching the matching circuit—for maximum current. A 0-1 ammeter is useful for measuring the approximate range 5-50 watts in 52-ohm line, or 7.5-75 watts in 75-ohm line; a 0-3 instrument can be used for 13-450 watts in 52-ohm line and 20-675 watts in 75-ohm line. The accuracy is usually greatest in the upper half of the scale.

An r.f. voltmeter of the type described in the preceding section also can be used for power measurement in a similar setup. It has the advantage that, because its scale is substantially linear, a much wider range of powers can be measured with one instrument.

## INDUCTANCE AND CAPACITANCE

The ability to measure inductance and capacitance saves time that might otherwise be spent in cut-and-try. A convenient instrument for this purpose is the grid-dip oscillator, described earlier in this chapter.

For measuring inductance, use is made of a capacitance of known value as shown at A in

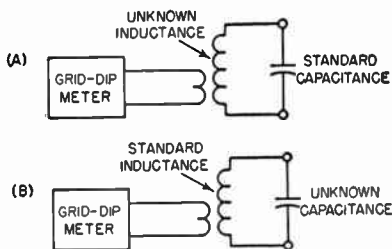

Fig. 21-36—Setups for measuring inductance and capacitance with the grid-dip meter.

Fig. 21-36. With the unknown coil connected to the standard capacitor, couple the grid-dip meter to the coil and adjust the oscillator frequency for the grid-current dip, using the loosest coupling that gives a detectable indication. The inductance is then given by the formula

$$L_{\mu h.} = \frac{25,330}{C_{\mu\mu f.} \cdot f^2 \text{ Mc.}}$$

The reverse procedure is used for measuring capacitance—that is, a coil of known inductance is used as a standard as shown at B. The unknown capacitance is

$$C_{\mu\mu f.} = \frac{25,330}{L_{\mu h.} \cdot f^2 \text{ Mc.}}$$

The accuracy of this method depends on the accuracy of the grid-dip meter calibration and the accuracy with which the standard values of *L* and *C* are known. Postage-stamp silver-mica capacitors make satisfactory ca-

pacitance standards, since their rated tolerance is  $\pm 5$  per cent. Equally good inductance standards can be made from commercial machine-wound coil material.

A single pair of standards will serve for measuring the *L* and *C* values commonly used in amateur equipment. A good choice is 100  $\mu\mu f.$  for the capacitor and 5  $\mu h.$  for the coil. Based on these values the chart of Fig. 21-38 will give the unknown directly in terms of the resonant frequency registered by the grid-dip meter. In measuring the frequency the coupling between the grid-dip meter and resonant circuit should be kept at the

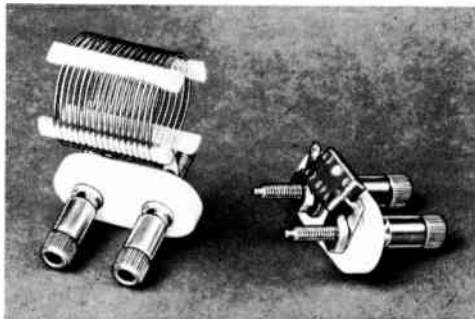

Fig. 21-37—A convenient mounting, using binding-post plates, for *L* and *C* standards made from commercially-available parts. The capacitor is a 100- $\mu\mu f.$  silver mica unit, mounted so the lead length is as nearly zero as possible. The inductance standard, 5  $\mu h.$ , is 17 turns of No. 3015 B & W Miniductor, 1-inch diameter, 16 turns per inch.

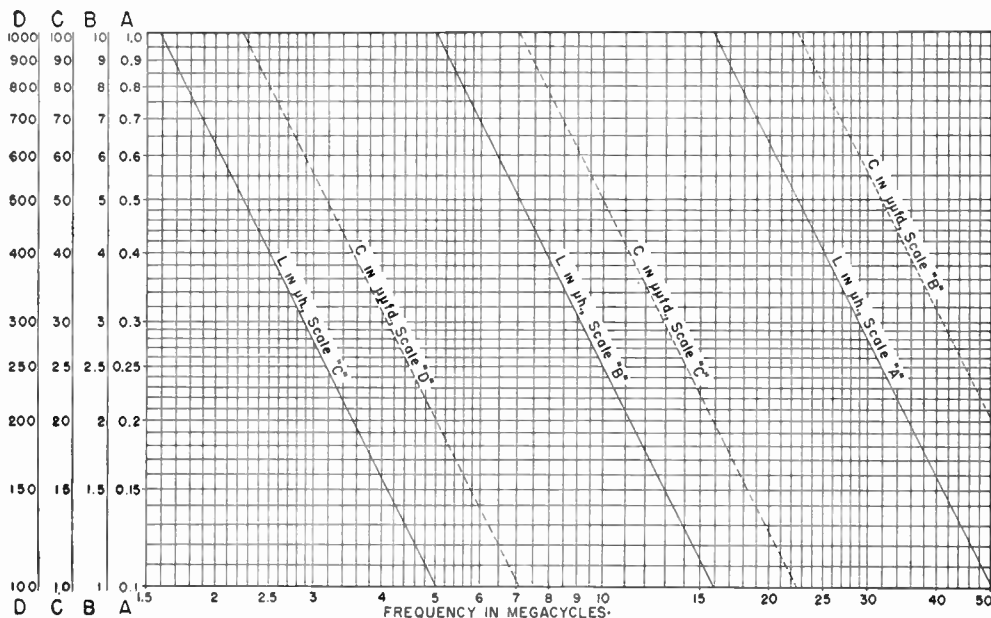

Fig. 21-38—Chart for determining unknown values of *L* and *C* in the range 0.1 to 100  $\mu h.$  and 2 to 1000  $\mu\mu f.$ , using standards of 100  $\mu\mu f.$  and 5  $\mu h.$



smallest value that gives a definite indication.

A correction should be applied to measurements of very small values of  $L$  and  $C$  to include the effects of the shunt capacitance of the mounting for the coil, and for the inductance of the leads to the capacitor. These amount to approximately  $1 \mu\mu\text{f.}$  and  $0.03 \mu\text{h.}$ , respectively, with the method of mounting shown in Fig. 21-37.

#### Coefficient of Coupling

The same equipment can be used for measurement of the coefficient of coupling between two coils. This simply requires two measurements of inductance (of *one* of the coils) with the coupled coil first open-circuited and then short-circuited. Connect the  $100\text{-}\mu\mu\text{f.}$  standard capacitor to one coil and measure the inductance with the terminals of the second coil open. Then short the terminals of the second coil and again measure the inductance of the first. The coefficient of coupling is given by

$$k = \sqrt{1 - \frac{L_2}{L_1}}$$

where  $k$  = coefficient of coupling

$L_1$  = inductance of first coil with terminals of second coil open

$L_2$  = inductance of first coil with terminals of second coil shorted.

#### R.F. RESISTANCE

Aside from the bridge methods used in transmission-line work, described later, there

is relatively little need for measurement of r.f. resistance in amateur practice. Also, measurement of resistance by fundamental methods is not practicable with simple equipment. Where such measurements are made, they are usually based on known characteristics of available resistors used as standards.

Most types of resistors have so much inherent reactance and skin effect that they do not act like "pure" resistance at radio frequencies, but instead their effective resistance and impedance vary with frequency. This is especially true of wire-wound resistors. Composition (carbon) resistors of 25 ohms or more as a rule have negligible inductance for frequencies up to 100 Mc. or so. The skin effect also is small, but the shunt capacitance cannot be neglected in the higher values of these resistors, since it reduces their impedance and makes it reactive. However, for most purposes the capacitive effects can be considered to be negligible in composition resistors of values up to 1000 ohms, for frequencies up to 50 to 100 Mc., and the r.f. resistance of such units is practically the same as their d.c. resistance. Hence they can be considered to be practically pure resistance in such applications as r.f. bridges, etc., provided they are mounted in such a way as to avoid magnetic coupling to other circuit components, and are not so close to grounded metal parts as to give an appreciable increase in shunt capacitance.

## ANTENNA AND TRANSMISSION-LINE MEASUREMENTS

Two principal types of measurements are made on antenna systems: (1) the standing-wave ratio on the transmission line, as a means for determining whether or not the antenna is properly matched to the line (alternatively, the input resistance of the line or antenna may be measured); (2) the comparative radiation field strength in the vicinity of the antenna, as a means for checking the directivity of a beam antenna and as an aid in adjustment of element tuning and phasing. Both types of measurements can be made with rather simple equipment.

#### FIELD-STRENGTH MEASUREMENTS

The radiation intensity from an antenna is measured with a device that is essentially a very simple receiver equipped with an indicator to give a visual representation of the comparative signal strength. Such a **field-strength meter** is used with a "pick-up antenna" which should always have the same polarization as the antenna being checked — e.g., the pick-up antenna should be horizontal if the transmitting antenna is. Care should be taken to prevent stray pickup by the field-strength meter or by any transmission line that may connect it to the pickup antenna.

Field-strength measurements preferably should be made at a distance of several wavelengths from the transmitting antenna being tested. Measurements made within a wavelength of the antenna may be misleading, because of the possibility that the measuring equipment may be responding to the combined induction and radiation fields of the antenna, rather than to the radiation field alone. Also, if the pick-up antenna has dimensions comparable with those of the antenna under test it is likely that the coupling between the two antennas will be great enough to cause the pick-up antenna to tend to become part of the radiating system and thus result in misleading field-strength readings.

A desirable form of pick-up antenna is a dipole installed at the same height as the antenna being tested, with low-impedance line such as 75-ohm Twin-Lead connected at the center to transfer the r.f. signal to the field-strength meter. The length of the dipole need only be great enough to give adequate meter readings. A half-wave dipole will give high sensitivity, but such length will not be needed unless the distance is several wavelengths and a relatively insensitive meter is used.



### Field-Strength Meters

The crystal-detector wavemeter described earlier in this chapter may be used as a field-strength meter. It may be coupled to the transmission line from the pick-up antenna through the coaxial-cable jack,  $J_1$ .

The indications with a crystal wavemeter connected as shown in Fig. 21-10 will tend to be "square law"—that is, the meter reading will be proportional to the square of the r.f.

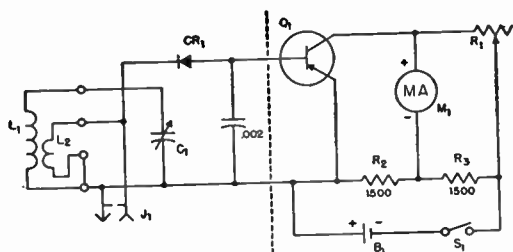

Fig. 21-39—Transistor d.c. amplifier applied to the wavemeter of Fig. 21-10 to increase sensitivity. Components not listed below are the same as in Fig. 21-10.  $B_1$ —Small flashlight cell.  $M_1$ —0-1 d.c. milliammeter (see text).  $Q_1$ —2N107, CK722, etc.  $R_1$ —10,000-ohm control.

voltage. This exaggerates the effect of relatively small adjustments to the antenna system and gives a false impression of the improvement secured. The meter reading can be made more linear by connecting a fairly large resistance in series with the milliammeter (or microammeter). About 10,000 ohms is required for good linearity. This considerably reduces the sensitivity of the meter, but the lower sensitivity can be compensated for by making the pick-up antenna sufficiently large.

### Transistorized Wavemeter and Field-Strength Meter

A sensitive field-strength meter can be made by using a transistor as a d.c. amplifier following the crystal rectifier of a wavemeter. A circuit of this type is shown in Fig. 21-39. Depending on the characteristics of the particular transistor used, the amplification of current may be 10 or more times, so that a 0-1 milliamper d.c. instrument becomes the equivalent of a sensitive microammeter.

The circuit to the left of the dashed line in Fig. 21-39 is the same as the wavemeter circuit of Fig. 21-10, and the transistor amplifier can easily be accommodated in the case housing the wavemeter.

The transistor is connected in the common-emitter circuit with the rectified d.c. from the crystal diode flowing in the base-emitter circuit. Since there is a small residual current in the collector circuit with no current flowing in the base-emitter circuit, the d.c. meter

is connected in a bridge arrangement so the residual current can be balanced out. This is accomplished, in the absence of any signal input to the transistor base, by adjusting  $R_1$  so that the voltage drop across it is equal to the voltage drop from collector to emitter in the transistor.  $R_2$  and  $R_3$ , being of the same resistance, have equal voltage drops across them and so there is no difference of potential across the meter terminals until the collector current increases because of current flow in the base-emitter circuit.

The collector current in a circuit of this type is not strictly proportional to the base current, particularly for low values of base current. The meter readings are not directly proportional to the field strength, therefore, but tend toward "square law" response just as in the case of a simple diode with little or no resistance in its d.c. circuit. For this reason the d.c. meter,  $M_1$ , should not have too-high sensitivity if reasonably linear response is desired. A 0-1 milliammeter will be satisfactory.

The zero balance should be checked at intervals while the instrument is in use, since the residual current of the transistor is sensitive to temperature changes.

### IMPEDANCE AND STANDING-WAVE RATIO

Adjustment of antenna matching systems requires some means either of measuring the input impedance of the antenna or transmission line, or measuring the standing-wave ratio. "Bridge" methods are suitable for either measurement.

There are many varieties of bridge circuits, the two shown in Fig. 21-40 being among the most popular for amateur purposes. The simple resistance bridge of Fig. 21-40A consists essentially of two voltage dividers in parallel across a source of voltage. When the voltage drop across  $R_1$  equals that across  $R_3$  the drops across  $R_2$  and  $R_L$  are likewise equal and

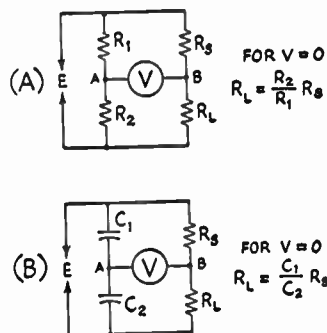

Fig. 21-40—Basic bridge circuits. (A) Resistance bridge; (B) resistance-capacitance bridge. The latter circuit is used in the "Micromatch," with  $R_3$  a very low resistance (1 ohm or less) and the ratio  $C_1/C_2$  adjusted accordingly for a desired line impedance.

there is no difference of potential between points *A* and *B*. Hence the voltmeter reading is zero and the bridge is said to be "balanced." If the drops across  $R_1$  and  $R_8$  are not equal, points *A* and *B* are at different potentials and the voltmeter will read the difference. The operation of the circuit of Fig. 21-40B is similar, except that one of the voltage dividers is capacitive instead of resistive.

Because of the characteristics of practical components at radio frequencies, the circuit of Fig. 21-40A is best suited to applications where the ratio  $R_1/R_2$  is fixed; this type of bridge is particularly well suited to measurement of standing-wave ratio. The circuit of Fig. 21-40B is well adapted to applications where a variable voltage divider is essential (since  $C_1$  and  $C_2$  may readily be made variable) as in measurement of unknown values of  $R_L$ .

**S.W.R. Bridge**

In the circuit of Fig. 21-40A, if  $R_1$  and  $R_2$  are made equal, the bridge will be balanced when  $R_L = R_S$ . This is true whether  $R_L$  is an actual resistor or the input resistance of a perfectly matched transmission line, provided  $R_S$  is chosen to equal the characteristic impedance of the line. Even if the line is not properly matched, the bridge will still be balanced for power traveling outward on the line, since outward-going power sees only the  $Z_0$  of the line until it reaches the load. However, power reflected back from the load does not "see" a bridge circuit and the reflected voltage registers on the voltmeter. From the known relationship between the outgoing or "forward" voltage and the reflected voltage, the s.w.r. is easily calculated:

$$S.W.R. = \frac{V_o + V_r}{V_o - V_r}$$

where  $V_o$  is the forward voltage and  $V_r$  is the reflected voltage. The forward voltage is equal to  $E/2$  since  $R_S$  and  $R_L$  (the  $Z_0$  of the line) are equal. It may be measured either by disconnecting  $R_L$  or shorting it.

**Measuring Voltages**

For the s.w.r. formula above to apply with reasonable accuracy (particularly at high standing-wave ratios) the current taken by the voltmeter must be inappreciable compared with the currents through the bridge "arms." The voltmeter used in bridge circuits employs a crystal diode rectifier (see discussion earlier in this chapter) and in order to meet the above requirement — as well as to have linear response, which is equally necessary for calibration purposes — should use a resistance of at least 10,000 ohms in series with the milliammeter or microammeter.

Since the voltage applied to the line is measured by shorting or disconnecting  $R_L$  (that is, the line input terminals), while the

reflected voltage is measured with  $R_L$  connected, the load on the source of voltage  $E$  is different in the two measurements. If the regulation of the voltage source is not perfect, the voltage  $E$  will not remain the same under these two conditions. This can lead to large errors. Such errors can be avoided by using a second voltmeter to maintain a check on the voltage applied to the bridge, readjusting the coupling to the voltage source to maintain constant applied voltage during the two measurements. Since the "input" voltmeter is simply used as a reference, its linearity is not important, nor does its reading have to bear any definite relationship to that of the "bridge" voltmeter, except that its range has to be at least twice that of the latter.

A practical circuit incorporating these features is given in Fig. 21-41.

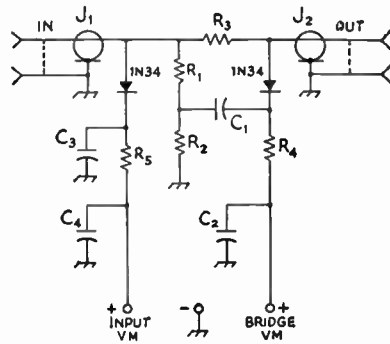
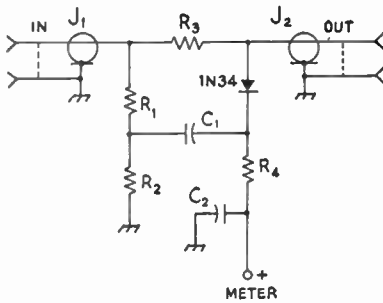

Fig. 21-41—Bridge circuit for s.w.r. measurements. This circuit is intended for use with a d.c. voltmeter, range 5 to 10 volts, having a resistance of 10,000 ohms per volt or greater.

- $C_1, C_2, C_3, C_4$ —0.005- or 0.01- $\mu$ f. disk ceramic.
- $R_1, R_2$ —47-ohm composition, 1/2 or 1 watt.
- $R_3$ —52- or 75-ohm (depending on line impedance) composition, 1/2 or 1 watt; precision type preferred.
- $R_4, R_5$ —10,000 ohms, 1/2 watt.
- $J_1, J_2$ —Coaxial connectors.

Meter connects to either "input" or "bridge" position as required.

If the bridge is to be used merely for antenna adjustment, where the object is to secure the lowest possible s.w.r. rather than to measure the s.w.r. accurately, the voltmeter requirements are not stringent. In this case the object is to get as close to a "null" or balance (that is, zero reading) as possible. At or near exact balance the voltmeter impedance is not important. Neither is it necessary to maintain constant input voltage to the bridge. This simplifies the bridge circuit considerably, Fig. 21-42 being a practical example. The construction of a bridge of this type suitable for antenna and transmission line adjustments is shown in Fig. 21-43.



### Bridge Construction

A principal point in the construction of an s.w.r. bridge is to avoid coupling between the resistors forming the bridge arms, and between the arms and the voltmeter circuit. This can be done by keeping the resistance arms separated and at right angles to each other, and by placing the crystal and its connecting leads so that the loop so formed is not in inductive relationship with any loops formed by the bridge arms. Shielding between the bridge arms and the crystal circuit is helpful in reducing such couplings, although it is not always necessary. The two resistors forming the "ratio arms,"  $R_1$  and  $R_2$ , should have identical relationships with metal parts, to keep the shunt capacitances equal, and also should have the same lead lengths so the in-

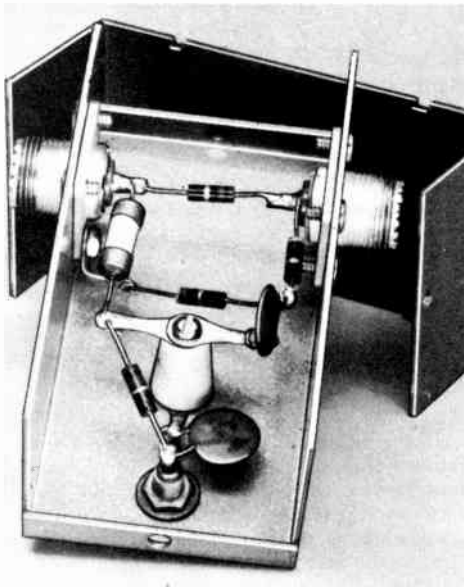

Fig. 21-43—An inexpensive bridge for matching adjustments using the circuit of Fig. 21-42. It is built in a  $1\frac{1}{2} \times 2\frac{1}{8} \times 4$ -inch "Channel-lock" box. The standard resistor,  $R_3$ , bridges the two coax connectors. A pin jack is provided for connection to the d.c. meter, 0-1 ma. or 0-500  $\mu$ a.; the meter negative can be connected to the case or to one of the coax fittings.

Fig. 21-42—A simple bridge circuit useful for impedance-matching in coaxial lines.

$C_1, C_2$ —0.005- or 0.01- $\mu$ f. disk ceramic.

$R_1, R_2$ —47-ohm composition,  $\frac{1}{2}$  watt.

$R_3$ —52- or 75-ohm (depending on line impedance) composition,  $\frac{1}{2}$  watt; precision type preferred.

$R_4$ —1000-ohm composition,  $\frac{1}{2}$  watt.

$J_1, J_2$ —Coaxial connector.

The meter may be a 0-1 milliammeter or d.c. voltmeter of any type having a sensitivity of 1000 ohm per volt or greater, and a full-scale range of 5 to 10 volts. Negative side of meter connects to ground.

ductances will balance. Leads should be kept as short as possible.

### Testing and Calibration

In a bridge intended for s.w.r. measurement (Fig. 21-41) rather than simple matching, the first check is to apply just enough r.f. voltage, at the highest frequency to be used, so that the bridge voltmeter reads full scale with the load terminals open. Observe the input voltage, then short-circuit the load terminals and readjust the input to the same voltage. The bridge voltmeter should again register full scale. If it does not, the ratio arms,  $R_1$  and  $R_2$ , probably are not exactly equal. These two resistors should be carefully matched, although their actual value is not critical. If a similar test at a low frequency shows better balance, the probable cause is stray inductance or capacitance in one arm not balanced by equal strays in the other.

After the "short" and "open" readings have been equalized, the bridge should be checked for null balance with a "dummy" resistance, equal to the line impedance, connected to the load terminals. It is convenient to mount a half- or 1-watt resistor of the proper value in a coax connector, keeping it centered in the connector and using the minimum lead length. The bridge voltmeter should read zero at all frequencies. A reading above zero that remains constant at all frequencies indicates that the "dummy" resistor is not matched to  $R_3$ , while readings that vary with frequency indicate stray reactive effects or stray coupling between parts of the bridge.

When the operation is satisfactory on the two points just described, the null should be checked with the dummy resistor connected to the bridge through several different lengths of transmission line, to ensure that  $R_3$  actually matches the line impedance. If the null is not complete in this test both the dummy resistor and  $R_3$  will have to be adjusted until a good match is obtained. With care, composition resistors can be filed down to raise the resistance, so it is best to start with resistors somewhat low in value. With each change in  $R_3$ , adjust the dummy resistor to give a good null when connected directly to the bridge, then try it at the end of several different lengths of line, continuing until the null is satis-

factory under all conditions of line length and frequency.

With a high-impedance voltmeter, the s.w.r. readings will closely approximate the theoretical curve of Fig. 21-44. The calibration can

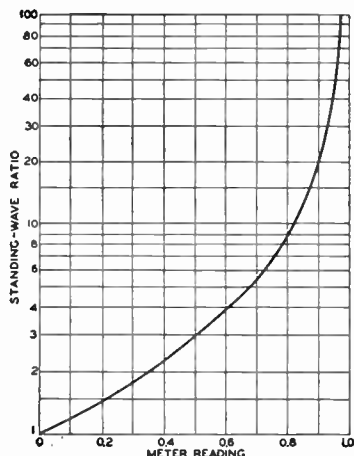

Fig. 21-44—Standing-wave ratio in terms of meter reading (relative to full scale) after setting forward voltage to full scale.

be checked by using composition resistors as loads. Adjust the transmitter coupling so that the bridge voltmeter reads full scale with the output terminals open, and then check the input voltage. Connect various values of resistance across the output terminals, making sure that the input voltage is readjusted to be the same in each case, and note the reading with the meter in the bridge position. This check should be made at a low frequency such as 3.5 Mc. in order to minimize the effect of reactance in the resistors. The s.w.r. is given by

$$S.W.R. = \frac{R_L}{R_0} \text{ or } \frac{R_0}{R_L}$$

where  $R_0$  is the line impedance for which the bridge has been adjusted to null, and  $R_L$  is the resistance used as a load. Use the formula that places the larger of the two resistances in the numerator. If the readings do not correspond exactly for the same s.w.r. when appropriate resistors above and below the line impedance for which the bridge is designed are used, a possible reason is that the current taken by the voltmeter is affecting the measurements.

#### Using the Bridge

The operating procedure is the same whether the bridge is used for matching or for s.w.r. measurement. Apply power with the load terminals either open or shorted, and adjust the input until the bridge voltmeter reads full scale. Because the bridge operates a very low power level it may be necessary

to couple it to a low-power driver stage rather than to the final amplifier. Alternatively, the plate voltage and excitation for the final amplifier may be reduced to the point where the power output is of the order of a few watts. Then connect the load and observe the voltmeter reading. For matching, adjust the matching network until the best possible null is obtained. For s.w.r. measurement, note the r.f. input voltage to the bridge after adjusting for full-scale with the load terminals open or shorted, then connect the load and readjust the transmitter for the same input voltage. The bridge voltmeter then indicates the standing-wave ratio as given by Fig. 21-44.

Antenna systems are in general resonant systems and thus exhibit a purely-resistive impedance at only one frequency or over a small band of frequencies. In making bridge measurements, this will cause errors if the r.f. energy used to operate the bridge is not free from harmonics and other spurious components, such as frequencies lower than the desired operating frequency that may be fed through the final amplifier from a frequency-doubler stage. When a good null cannot be secured in, for example, the course of adjusting a matching section for 1-to-1 s.w.r., a check should be made to ensure that only the desired measurement frequency is present. An indicating-type absorption frequency meter coupled to the load usually will show whether energy on undesired frequencies is present in significant amounts. If so, additional selectivity must be used between the source of power and the measuring circuit.

#### IMPEDANCE BRIDGE

The bridge shown in Figs. 21-45 to 21-47, inclusive, uses the basic circuit of Fig. 21-37B and incorporates a "differential" capacitor to obtain an adjustable ratio. When a resistive load of unknown value is connected in place of  $R_L$ , the  $C_1/C_2$  ratio may be varied to attain a balance, as indicated by a null reading. The capacitor settings can be calibrated in terms of resistance at  $R_L$ , so the unknown value can be read off the calibration.

The differential capacitor consists of two identical capacitors on the same shaft, arranged so that when the shaft is rotated to increase the capacitance of one unit, the capacitance of the other decreases. The practical circuit of the bridge is given in Fig. 21-46. Satisfactory operation hinges on observing the same constructional precautions as in the case of the s.w.r. bridge. Although a high-impedance voltmeter is not essential, since the bridge is always adjusted for a null, the use of such a voltmeter is advisable because its better linearity makes the actual null settings more accurately observable.

With the circuit arrangement and capacitor



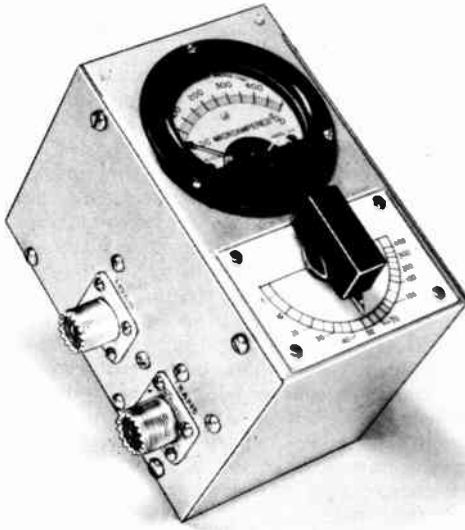

Fig. 21-45—An RC bridge for measuring unknown values of impedance. The bridge operates at an r.f. input voltage level of about 5 volts. The aluminum box is 3 by 4 by 5 inches.

shown, the useful range of the bridge is from about 5 ohms to 400 ohms. The calibration is such that the percentage accuracy of reading is approximately constant at all parts of the scale. The midscale value is in the range 50–75 ohms, to correspond to the  $Z_0$  of coaxial cable. The reliable frequency range of the bridge includes all amateur bands from 3.5 to 54 Mc.

#### Checking and Calibration

A bridge constructed as shown in the photographs should show a complete null at all frequencies within the range mentioned above when a 50-ohm "dummy" load of the type

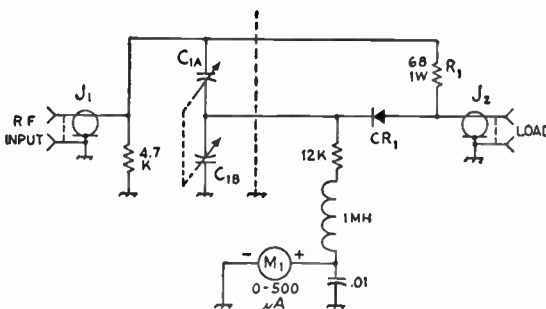

Fig. 21-46—Circuit of the impedance bridge. Resistors are composition,  $\frac{1}{2}$  watt except as noted. Fixed capacitors are ceramic.

$C_1$ —Differential capacitor, 11-161  $\mu\text{mf.}$  per section (Millen 28801).

$CR_1$ —Germanium diode (1N34, 1N48, etc.).

$J_1, J_2$ —Coaxial connectors, chassis type.

$M_1$ —0-500 microammeter.

described earlier in connection with the s.w.r. bridge is connected to the load terminals. The bridge may be calibrated by using a number of  $\frac{1}{2}$ -watt 5% tolerance composition resistors of different values in the 5–400 ohm range as loads, in each case balancing the bridge by adjusting  $C_1$  for a null reading on the meter. The leads between the test resistor and  $J_2$  should be as short as possible, and the calibration preferably should be done in the 3.5-Mc. band where stray inductance and capacitance will have the least effect.

#### Using the Bridge

Strictly speaking, a simple bridge can measure only purely resistive impedances. When the load is a pure resistance, the bridge can be balanced to a good null (meter reading zero). If the load has a reactance component the null will not be complete; the higher the ratio of reactance to resistance in the load the poorer the null reading. The operation of the bridge is such that when an exact null cannot be secured, the readings approximate the resistive component of the load for very low values of impedance, and approximate the total impedance at very high values of impedance. In the mid-range the approximation

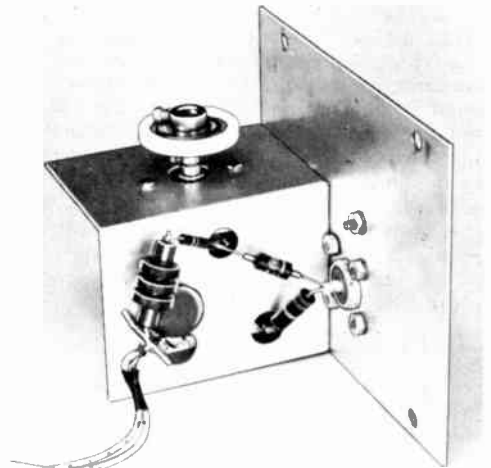

Fig. 21-47—All components except the meter are mounted on one of the removable sides of the box. The variable capacitor is mounted on an L-shaped piece of aluminum (with half-inch lips on the inner edge for bolting to the box side) 2 inches wide,  $2\frac{1}{4}$  inches high and  $2\frac{3}{4}$  inches deep, to shield the capacitor from the other components. The terminals project through holes as shown, with associated components mounted directly on them and the load connector,  $J_2$ . Since the rotor of  $C_1$  must not be grounded, the capacitor is operated by an extension shaft and insulated coupling.

The lead from  $J_1$  to  $C_{1A}$  should go directly from the input connector to the capacitor terminal (lower right) to which the 68-ohm resistor is attached. The 4700-ohm resistor is soldered across  $J_2$ .



to either is poor, for loads having considerable reactance.

In using the bridge for adjustment of matching networks  $C_1$  is set to the desired value (usually the  $Z_0$  of the coaxial line) and the matching network is then adjusted for the best possible null.

**PARALLEL-CONDUCTOR LINES**

Bridge measurements made directly on parallel-conductor lines are frequently subject to considerable error because of "antenna" currents flowing on such lines. These currents, which are either induced on the line by the field around the antenna or coupled into the line from the transmitter by stray capacitance, are in the same phase in both line wires and hence do not balance out like the true transmission-line currents. They will nevertheless actuate the bridge voltmeter, causing an indication that has no relationship to the standing-wave ratio.

**S.W.R. Measurements**

The effect of "antenna" currents on s.w.r. measurements can be largely overcome by using a coaxial bridge and coupling it to the parallel-conductor line through a properly designed impedance-matching circuit. A suitable circuit is given in Fig. 21-48. An antenna coupler can be used for the purpose. In the balanced tank circuit the "antenna" or parallel components on the line tend to balance out and so are not passed on to the s.w.r. bridge. It is essential that  $L_1$  be coupled to a "cold" point on  $L_2$  to minimize capacitive coupling, and also desirable that the center of  $L_2$  be grounded to the chassis on which the circuit is mounted. Values should be such that  $L_2C_2$  can be tuned to the operating frequency and that  $L_1$  provides sufficient coupling, as described in the transmission-line chapter. The measurement procedure is as follows:

Connect a noninductive ( $\frac{1}{2}$ - or 1-watt carbon) resistor, having the same value as the characteristic impedance of the parallel-conductor line, to the "line" terminals. Apply r.f. to the bridge, adjust the taps on  $L_2$  (keeping them equidistant from the center), while varying the capacitance of  $C_1$  and  $C_2$ , until the bridge shows a null. After the null is obtained, do not touch any of the circuit adjustments. Next, short-circuit the "line" terminals and

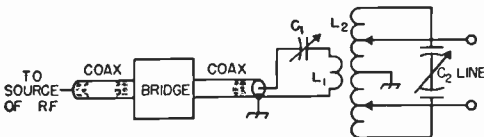

Fig. 21-48—Circuit for using coaxial s.w.r. bridge for measurements on parallel-conductor lines. Values of circuit components are identical with those used for the similar "antenna-coupler" circuit discussed in the chapter on transmission lines.

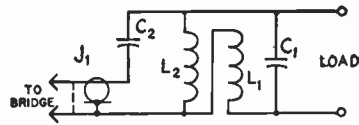

Fig. 21-49—Tuned balun for coupling between balanced and unbalanced lines.  $L_1$  and  $L_2$  should be built as a bifilar winding to get as tight coupling as possible between them. Typical constants are as follows:

Freq., Mc.	$L_1, L_2$	$C_1$	$C_2$
28	3 turns each on 2-inch form, equally spaced over $\frac{3}{16}$ inch, total.	4 $\mu\text{f.}$	420 $\mu\text{f.}$
14	Same as 28 Mc.	39 $\mu\text{f.}$	0.0015 $\mu\text{f.}$
7	8 turns of 150-ohm Twin-Lead, no spacing between turns, on $2\frac{3}{4}$ -inch dia. form.	None	0.001 $\mu\text{f.}$
3.5	Same as 7 Mc.	62 $\mu\text{f.}$	0.0045 $\mu\text{f.}$

Capacitors in unit shown in Fig. 21-50 are NPO disk ceramic. Units may be paralleled to obtain proper capacitance.

adjust the r.f. input until the bridge voltmeter reads full scale. Remove the short-circuit and test resistor, and connect the regular transmission line. The bridge will then indicate the standing-wave ratio on the line.

The circuit requires rematching, with the test resistor, whenever the frequency is changed appreciably. It can, however, be used over a portion of an amateur band without readjustment, with negligible error.

**Impedance Measurements**

Measurements on parallel-conductor lines and other balanced loads can be made with the impedance bridge previously described by using a balun of the type shown schematically in Fig. 21-49. This is an autotransformer having a 2-to-1 turns ratio and thus provides a 4-to-1 step-down in impedance from a balanced load to the output circuit of the bridge, one side of which is grounded.  $L_1$  and  $L_2$  must be as tightly coupled as possible, and so should be constructed as a bifilar winding. The circuit is resonated to the operating frequency by  $C_1$ , and  $C_2$  serves to tune out any residual reactance that may be present because the coupling between the two coils is not quite perfect.

Fig. 21-50 shows one method of constructing such a balun. The two interwound coils are made as nearly identical as possible, the "finish" end of the first being connected to the "start" end of the second through a short



Fig. 21-50 — Balun construction (W2ZE). 150-ohm Twin-Lead may be used for the bifilar winding in place of the ordinary wire shown. Symmetrical construction with tight coupling between the two coils is essential to good performance.

lead running under the winding inside the form. The center of this lead is tapped to give the connection to the shell side of the coax connector.  $C_1$  should be chosen to resonate the circuit at the center of the band for which the balun is designed with  $J_1$  open, and  $C_2$  should resonate the circuit to the same frequency with both  $J_1$  and the "load" terminals shorted. The frequency checks may be made

with a grid-dip meter. (For further details, see *QST* for August, 1955.)

With the balun in use the bridge is operated in the same way as previously described, except that all impedance readings must be multiplied by 4. The balun also may be used for s.w.r. measurements on 300-ohm line in conjunction with a resistance bridge designed for 75-ohm coaxial line.

## THE OSCILLOSCOPE

The cathode-ray oscilloscope gives a visual representation of signals at both audio and radio frequencies and can therefore be used for many types of measurements that are not possible with instruments of the types discussed earlier in this chapter. In amateur work, one of the principal uses of the scope is for displaying an amplitude-modulated signal so a phone transmitter can be adjusted for proper modulation and continuously monitored to keep the modulation percentage within proper limits. For this purpose a very simple circuit will suffice, and a typical circuit is described later in this section.

The versatility of the scope can be greatly increased by adding amplifiers and linear deflection circuits, but the design and adjustment of such circuits tends to be complicated if optimum performance is to be secured, and is somewhat outside the field of this section. Special components are generally required. Oscilloscope kits for home assembly are available from a number of suppliers, and since their cost compares very favorably with that of a home-built instrument of comparable design, they are recommended for serious consideration by those who have need for or are interested in the wide range of measurements that is possible with a fully-equipped scope.

### CATHODE-RAY TUBES

The heart of the oscilloscope is the cathode-ray tube, a vacuum tube in which the electrons emitted from a hot cathode are first accelerated to give them considerable velocity, then formed into a beam, and finally allowed to strike a special translucent screen

which *fluoresces*, or gives off light at the point where the beam strikes. A beam of moving electrons can be moved laterally, or deflected, by electric or magnetic fields, and since its weight and inertia are negligibly small, it can be made to follow instantly the variations in periodically-changing fields at both audio and radio frequencies.

The electrode arrangement that forms the electrons into a beam is called the **electron gun**. In the simple tube structure shown in Fig. 21-51, the gun consists of the cathode, grid, and anodes Nos. 1 and 2. The intensity of the electron beam is regulated by the grid in the same way as in an ordinary tube. Anode No. 1 is operated at a positive potential with respect to the cathode, thus accelerating the electrons that pass through the grid, and is provided with small apertures through which the electron stream passes. On emerging from the apertures the electrons are traveling in practically parallel straight-line paths. The electrostatic fields set up by the potentials on anode No. 1 and anode No. 2 form an **electron lens** system which makes the electron paths converge or focus to a point at the fluorescent screen. The potential on anode No. 2 is usually fixed, while that on anode No. 1 is varied to bring the beam into focus. Anode No. 1 is, therefore, called the **focusing electrode**.

Electrostatic deflection, the type generally used in the smaller tubes, is produced by **deflecting plates**. Two sets of plates are placed at right angles to each other, as indicated in Fig. 21-51. The fields are created by applying suitable voltages between the two plates of each pair. Usually one plate of each pair is

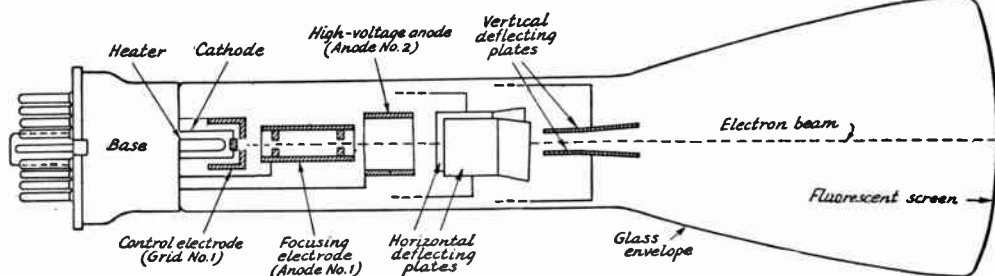

Fig. 21-51—Typical construction for a cathode-ray tube of the electrostatic-deflection type.

connected to anode No. 2, to establish the polarities of the vertical and horizontal fields with respect to the beam and to each other.

**Formation of Patterns**

When periodically-varying voltages are applied to the two sets of deflecting plates, the path traced by the fluorescent spot forms a pattern that is stationary so long as the amplitude and phase relationships of the voltages remain unchanged. Fig. 21-52 shows how one such pattern is formed. The horizontal sweep voltage is assumed to have the "sawtooth" waveshape indicated. With no voltage applied to the vertical plates the trace simply sweeps from left to right across the screen along the horizontal axis  $X-X'$  until the instant  $H$  is reached, when it reverses direction and snaps back to the starting point. The sine-wave voltage applied to the vertical plates similarly would trace a line along the axis  $Y-Y'$  in the absence of any deflecting voltage on the horizontal plates. However, when both voltages are present the position of the spot at any instant depends upon the voltages on both sets of plates at that instant. Thus at time  $B$  the horizontal voltage has moved the spot a short distance to the right and the vertical voltage has similarly moved it upward, so that it reaches the actual position  $B'$  on the screen. The resulting trace is easily followed from the other indicated positions, which are taken at equal time intervals.

**Types of Sweeps**

A sawtooth sweep-voltage wave shape, such as is shown in Fig. 21-52, is called a **linear sweep**, because the deflection in the horizontal direction is directly proportional to time. If the sweep were perfect the fly-back time, or time taken for the spot to return from the end ( $H$ ) to the beginning ( $I$  or  $A$ ) of the horizontal trace, would be zero, so that the line  $HI$  would be perpendicular to the axis  $Y-Y'$ . Although the fly-back time cannot be made zero in practicable sweep-voltage generators it can be made quite small in comparison to the time of the desired trace  $AH$ , at least at most frequencies within the audio range. The line  $H'I'$  is called the **return trace**;

with a linear sweep it is less brilliant than the pattern, because the spot is moving much more rapidly during the fly-back time than during the time of the main trace.

The linear sweep shows the shape of the wave in the same way that it is usually represented graphically. If the period of the a.c. voltage applied to the vertical plates is considerably less than the time taken to sweep horizontally across the screen, several cycles of the vertical or "signal" voltage will appear in the pattern.

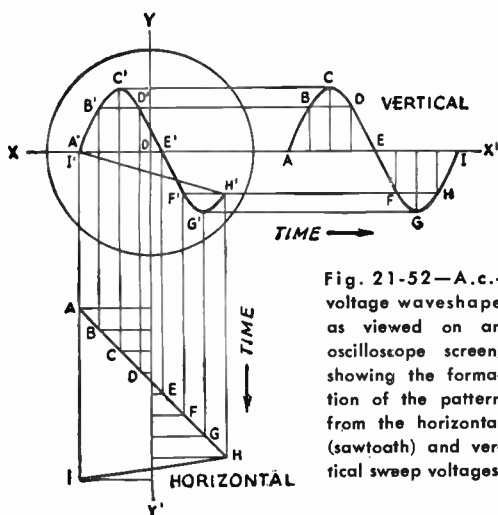

Fig. 21-52—A.c. voltage waveshape as viewed on an oscilloscope screen, showing the formation of the pattern from the horizontal (sawtooth) and vertical sweep voltages.

For many amateur purposes a satisfactory horizontal sweep is simply a 60-cycle voltage of adjustable amplitude. In modulation monitoring (described in the chapter on amplitude modulation) audio-frequency voltage can be taken from the modulator to supply the horizontal sweep. For examination of audio-frequency wave forms, the linear sweep is essential. Its frequency should be adjustable over the entire range of audio frequencies to be inspected on the oscilloscope.

**Lissajous Figures**

When sinusoidal a.c. voltages are applied to the two sets of deflecting plates in the

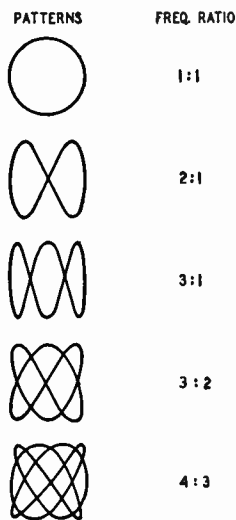

Fig. 21-53—Lissajous figures and corresponding frequency ratios for a 90-degree phase relationship between the voltages applied to the two sets of deflecting plates.

oscilloscope the resultant pattern depends on the relative amplitudes, frequencies and phase of the two voltages. If the ratio between the two frequencies is constant and can be expressed in integers a stationary pattern will be produced. This makes it possible to use the oscilloscope for determining an unknown frequency, provided a variable frequency standard is available, or for determining calibration points for a variable-frequency oscillator if a few known frequencies are available for comparison.

The stationary patterns obtained in this way are called **Lissajous figures**. Examples of some of the simpler Lissajous figures are given in Fig. 21-53. The frequency ratio is

found by counting the number of loops along two adjacent edges. Thus in the third figure from the top there are three loops along a horizontal edge and only one along the vertical, so the ratio of the vertical frequency to the horizontal frequency is 3 to 1. Similarly, in the fifth figure from the top there are four loops along the horizontal edge and three along the vertical edge, giving a ratio of 4 to 3. Assuming that the known frequency is applied to the horizontal plates, the unknown frequency is

$$f_2 = \frac{n_2}{n_1} f_1$$

where  $f_1$  = known frequency applied to horizontal plates,  
 $f_2$  = unknown frequency applied to vertical plates,  
 $n_1$  = number of loops along a vertical edge, and  
 $n_2$  = number of loops along a horizontal edge.

An important application of Lissajous figures is in the calibration of audio-frequency signal generators. For very low frequencies the 60-cycle power-line frequency is held accurately enough to be used as a standard in most localities. The medium audio-frequency range can be covered by comparison with the 440- and 600-cycle modulation on the WWV transmissions. An oscilloscope having both horizontal and vertical amplifiers is desirable, since it is convenient to have a means for adjusting the voltages applied to the deflection plates to secure a suitable pattern size. It is possible to calibrate over a 10-to-1 range, both upwards and downwards, from each of the latter frequencies and thus cover the audio range useful for voice communication.

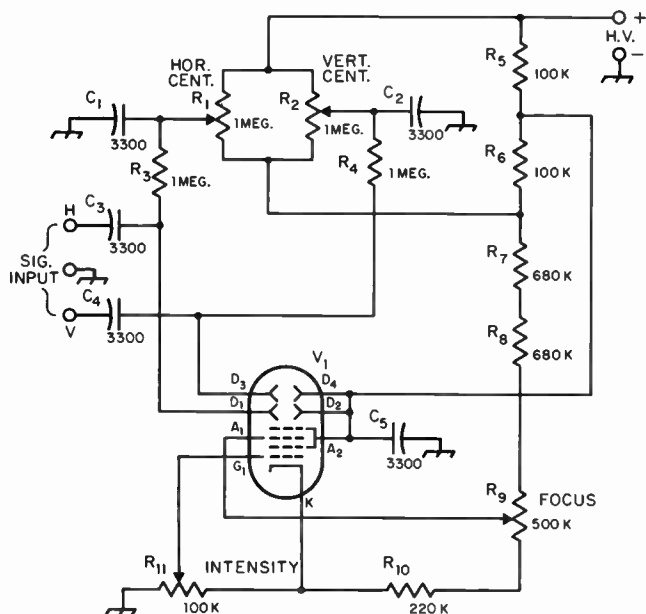

Fig. 21-54—Oscilloscope circuit for modulation monitoring. Constants are for 1500- to 2500-volt high-voltage supply. For 1000 to 1500 volts, omit  $R_5$  and connect the bottom end of  $R_7$  to the top end of  $R_6$ .  $C_1$ - $C_5$ , inc.—3000-volt disk ceramic.  $R_1$ ,  $R_2$ ,  $R_6$ ,  $R_{11}$ —Volume-control type, linear taper.  $R_3$ ,  $R_4$ ,  $R_5$ ,  $R_8$ ,  $R_{10}$ — $\frac{1}{2}$  watt.  $R_7$ ,  $R_9$ —1 watt.  $V_1$ —Electrostatic-deflection cathode-ray tube, 2- to 5-inch. See tube tables for base connections and heater ratings of type chosen.

### Basic Oscilloscope Circuit

The essential oscilloscope circuit is shown in Fig. 21-54. The minimum requirements are supplying the various electrode potentials, plus controls for focusing and centering the spot on the face of the tube and adjusting the spot intensity. The circuit of Fig. 21-54 can be used with electrostatic-deflection tubes from two to five inches in face diameter, with voltages up to 2500. This includes practically all the types popular for small oscilloscopes.

The circuit has provision for introducing signal voltages to the two sets of deflecting plates. Either set of deflecting electrodes ( $D_1D_2$ , or  $D_3D_4$ ) may be used for either horizontal or vertical deflection, depending on how the tube is mounted.

The high voltage may be taken from a transmitter power supply if desired. The current is only a millianpere or so. The voltage preferably should be constant, such as is obtained from a supply having a constant load — e.g., the supply for the Class C amplifier in an a.m. transmitter.

In the circuit of Fig. 21-54 the centering controls are at the full supply voltage above ground and therefore should be carefully insulated by being mounted on bakelite or similar material rather than directly on a metal panel or chassis. Insulated couplings or extension shafts should be used. The focusing control is also several hundred volts above ground and should be similarly insulated.

The tube should be protected from stray magnetic fields, either by enclosing it in an iron or steel box or by using one of the special c.r. tube shields available. If the heater transformer (or other transformer) is mounted in the same cabinet, care must be used to place it so the stray field around it does not deflect the spot. The spot cannot be focussed to a fine point when influenced by a transformer field.

### Modulation Monitoring

The addition of Fig. 21-55 to the basic circuit of Fig. 21-54 provides all that is necessary for modulation checking. The r.f. from the transmitter is applied to the vertical plates through a tuned circuit  $L_1C_1$  and link  $L_2$ . When adjusted to the transmitter operating frequency the tuned circuit furnishes ample deflection voltage even from a low-power transmitter, and  $C_1$  can be used to control the pattern height.

Deflection voltage for the horizontal plates can be taken from the modulation transformer secondary of an a.m. transmitter, or 60-cycle deflection can be used to give a wave-envelope type pattern. In either case a maximum of about 200 volts r.m.s. will give full-width deflection. This voltage is almost independent of the size of c.r. tube used. Methods of using such a scope for modulation checking are described in the chapter on amplitude modulation.

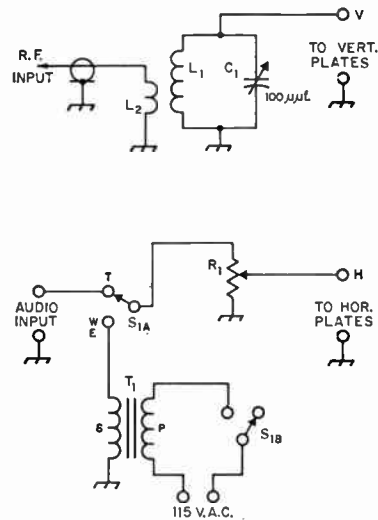

Fig. 21-55—Circuits for supplying r.f., audio, and a.c. voltages to oscilloscope deflection plates for modulation monitoring.

$C_1$ —100- $\mu$ f. variable, receiving type.

$L_1$ —1.75 Mc.: 30 enam. close-wound on 1-inch form, coil length  $\frac{3}{4}$  inch.

3.5-8 Mc.: 30 turns No. 22 enam., close-wound on 1-inch form.

13-30 Mc.: 7 turns No. 22, spread to  $\frac{3}{4}$  inch length on 1-inch form.

$L_2$ —2 or more turns, as required for sufficient coupling, at cold end of  $L_1$ .

$R_1$ —Volume control, 0.25 megohm or more.

$S_1$ —D.p.d.t. switch.

$T_1$ —Interstage audio transformer, any type. Use secondary-to-primary turns ratio of 1-to-1 to 2-to-1.

### Frequency Limitations of Oscilloscopes

Most commercial or kitted oscilloscopes include vacuum-tube amplifiers between the input terminals and the deflection plates, to increase the sensitivity and usefulness of the instrument. Depending upon the construction of the amplifiers, their useful frequency range may be only as high as several hundred kc., although more expensive instruments will include amplifiers that work in the megacycle range. The operator should acquaint himself with the frequency limitations of the 'scope through study of the specifications, since attempts to pass, e.g., a 450-kc. i.f. signal through an amplifier that cuts off at 100 kc. are doomed to failure. No such frequency limits apply when the connection is made directly to the deflection plates, and consequently r.f. at 20 to 30 Mc. can be applied by the method shown in Fig. 21-55. A practical limitation will be found when r.f. from the vertical plates is (stray) capacitively coupled to the horizontal-deflection plates; this will show as a thickening of the trace. In some instances it can be reduced by r.f. bypassing of the horizontal deflection plates.



# Assembling a Station

The actual location inside the house of the “shack”—the room where the transmitter and receiver are located—depends, of course, on the free space available for amateur activities. Fortunate indeed is the amateur with a separate room that he can reserve for his hobby, or the few who can have a special small building separate from the main house. However, most amateurs must share a room with other domestic activities, and amateur stations will be found tucked away in a corner of the living room, a bedroom, or even in a large closet! A spot in the cellar or the attic can almost be classed as a separate room, although it may lack the “finish” of a normal room.

Regardless of the location of the station, however, it should be designed for maximum operating convenience and safety. It is foolish to have the station arranged so that the throwing of several switches is required to go from “receive” to “transmit,” just as it is silly to have the equipment arranged so that the operator is in an uncomfortable and cramped position during his operating hours. The reason for building the station as safe as possible is obvious, if you are interested in spending a number of years with your hobby!

## CONVENIENCE

The first consideration in any amateur station is the operating position, which includes the operator's table and chair and the pieces of equipment that are in constant use (the receiver, send-receive switch, and key or microphone). The table should be as large as possible, to allow sufficient room for the receiver or receivers, transmitter frequency control, frequency-measuring equipment, monitoring equipment, control switches, and keys and microphones, with

enough space left over for the logbook, a pad and pencil, and perhaps a *large* ash tray. Suitable space should be included for radiogram blanks and a call book, if these accessories are in frequent use. If the table is small, or the number of pieces of equipment is large, it is often necessary to build a shelf or rack for the auxiliary equipment, or to mount it in some less convenient location in or under the table. If one has the facilities, a semicircular “console” can be built of wood, or a simpler solution is to use two small wooden cabinets to support a table top of wood or Masonite. A flush-type door will make an excellent table top. Home-built tables or consoles can be finished in any of the available oil stains, varnishes, paints or lacquers. Many operators use a large piece of plate glass over part of their table, since it furnishes a good writing surface and can cover miscellaneous charts and tables, prefix lists, operating aids, calendar, and similar accessories.

If the major interests never require frequent band changing, or frequency changing within a band, the transmitter can be located some distance from the operator, in a location where the meters can be observed from time to time. If frequent band or frequency changes are a part of the usual operating procedure, the transmitter should be mounted close to the operator, either along one side or above the receiver, so that the controls are easily accessible without the need for leaving the operating position.

A compromise arrangement would place the v.f.o. or exciter at the operating position and the transmitter proper in some convenient location not adjacent to the operator. Since it is usually possible to operate over a portion of a band without retuning the transmitter stages, an

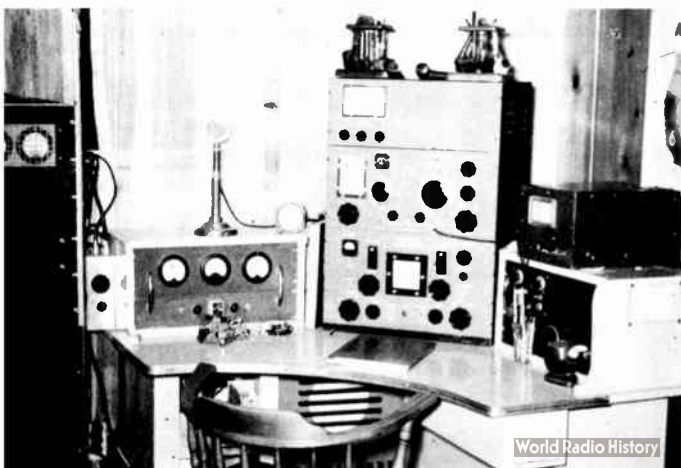

Here is a station that is completely home-built. At the left is a linear amplifier and power supply in a floor-mounted rack. On the console, at the left, are an antenna patch box and t.r. switch and the station control panel. In center of the console is a three-tiered rack containing a ham-bands only receiver at the bottom, a sideband exciter in the middle, and above that a converter for frequencies outside the ham bands. At the far right is a frequency meter and monitor. The console is also home-built, in a shape that provides good operating convenience. (W2TBZ/4, Springfield, Va.)

operating position of this type is an advantage over one in which the operator must leave his position to change frequency.

### Controls

The operator has an excellent chance to exercise his ingenuity in the location of the operating controls. The most important controls in the station are the receiver tuning dial and the send-receive switch. The receiver tuning dial should be located four to eight inches above the operating table, and if this requires mounting the receiver off the table, a small shelf or bracket will do the trick. With the single exception of the amateur whose work is almost entirely in traffic or rag-chew nets, which require little or no attention to the receiver, it will be found that the operator's hand is on the receiver tuning dial most of the time. If the tuning knob is too high or too low, the hand gets cramped after an extended period of operating, hence the importance of a properly located receiver. The majority of c.w. operators tune with the left hand, preferring to leave the right hand free for copying messages and handling the key, and so the receiver should be mounted where the knob can be reached by the left hand. Phone operators aren't tied down this way, and tune the communications receiver with the hand that is more convenient.

The hand key should be fastened securely to the table, in a line just outside the right shoulder and far enough back from the front edge of the table so that the elbow can rest on the table. A good location for the semiautomatic or "bug" key is right next to the hand-key, although some operators prefer to mount the automatic key in front of them on the left, so that the right forearm rests on the table parallel to the front edge.

The best location for the microphone is directly in front of the operator, so that he doesn't have to shout across the table into it, or run up the speech-amplifier gain so high that all manner of external sounds are picked up. If the microphone is supported by a boom or by a flexible "goose neck," it can be placed in front of the operator without its base taking up valuable table space.

In any amateur station worthy of the name, it should be necessary to throw no more than one switch to go from the "receive" to the "transmit" condition. In phone stations, this switch should be located where it can be easily reached by the hand that isn't on the receiver. In the case of c.w. operation, this switch is most conveniently located to the right or left of the key, although some operators prefer to have it mounted on the left-hand side of the operating position and work it with the left hand while the right hand is on the key. Either location is satisfactory, of course, and the choice depends upon personal preference. Some operators use a foot- or knee-controlled switch, which is a convenience but doesn't allow too much freedom of position during long operating periods.

If the microphone is hand-held during phone

operation, a "push-to-talk" switch on the microphone is convenient, but hand-held microphones tie up the use of one hand and are not too desirable, although they are widely used in mobile and portable work.

The location of other switches, such as those used to control power supplies, and phone/c.w. change-over, is of no particular importance, and they can be located on the unit with which they are associated. This is not strictly true in the case of the phone/c.w. DX man, who sometimes has need to change in a hurry from c.w. to phone. In this case, the change-over switch should be at the operating table, although the actual change-over may be done by a relay controlled by the switch.

If a rotary beam is used the control of the beam should be convenient to the operator. The direction indicator, however, can be located anywhere within sight of the operator, and does not have to be located on the operating table unless it is included with the control.

### Frequency Spotting

The operator should be able to turn on only the oscillator of his transmitter, so that he can spot accurately his location in the band with respect to other stations. This allows him to see if he has anything like a clear channel, or to see what his frequency is with respect to another station. Such a provision can be part of the "send-receive" switch. Switches are available with a center "off" position, a "hold" position on one side, for turning on the oscillator only, and a "lock" position on the other side for turning on the transmitter and antenna relay. If oscillator keying is used, the key serves the same purpose, provided a "send-receive" switch is available to disable the rest of the transmitter and prevent a signal going out on the air during adjustment of the oscillator frequency.

For phone operation, the telegraph key or an auxiliary switch can control the transmitter oscillator, and the "send-receive" switch can then be wired into the control system so as to control the oscillator as well as the other circuits.

### Comfort

Of prime importance is the comfort of the operator. If you find yourself getting tired after a short period of operating, examine your station to find what causes the fatigue. It may be that the chair is too soft or hasn't a straight back or is the wrong height for you. The key or receiver may be located so that you assume an uncomfortable position while using them. If you get sleepy fast, the ventilation may be at fault. (Or you may need sleep!)

### POWER CONNECTIONS AND CONTROL

Following a few simple rules in wiring your power outlets and control circuits will make it an easy job to change units in the station. If the station is planned in this way from the start, or if the rules are recalled when you are re-

building, you will find it a simple matter to revise your station from time to time without a major rewiring job.

It is neater and safer to run a single pair of wires from the outlet over to the operating table or some central point, rather than to use a number of adapters at the wall outlet.

#### Interconnections

The a.c. wiring of most stations will entail little more than finding sufficient wall outlets to accept the power-cable plugs from the several units. However, a more sophisticated station would provide the various outlets at some inconspicuous area at the operating table or console. If the transmitter power is in excess of 500 watts it is advisable to provide 230 volts for its power supply (if it will work from 230 volts) rather than the more common 115-volt source. The higher voltage source will provide better regulation, and the house lights are less likely to "blink" with keying or modulation. A single switch, either on the wall of the "shack" or at the operating position, should control all of the 115- and/or 230-volt outlets; this makes it a simple matter to turn on the station to the "standby" condition.

The nature of the send-receive control circuitry depends so much upon the equipment in use that it is impossible to give anything but the broadest principles to follow. With commercial equipment, the instruction books usually provide some suggestions. In some cases the antenna-transfer relay is provided also, so that the antenna is connected to the transmitter and a cable from the transmitter is connected to the receiver. Normally the receiver is connected to the antenna through this relay. When the transmitter is "on" the relay transfers the antenna to the transmitter output circuit.

A near ultimate for a compact station is achieved by housing a commercial transceiver (Callins KWM-1), an s.w.r. bridge assembled from a kit (Heath), and an antenna beam-rotator control box (CDR AR-22) in a homemade cabinet that blends into the room furnishing. The operation is made possible by the fan (Rotron Muffin) in the cabinet and the power supply in the cellar. Cabinet is made from heavy plywood, step-joined at corners, with a full-length piano hinge for the cover. (W1HAC, Manchester, Conn.)

Lacking a built-in antenna transfer relay, many amateurs make do with a short separate wire for the receiving antenna. While this is acceptable in many instances, it is seldom as effective (on receiving) as using the same antenna for transmitting and receiving. A separate antenna relay can be used; several models are available, for use with coaxial or open-wire line. Models are available for use with 115-volt a.c. or 12-volt d.c. Some have an auxiliary set of contacts that can be used to control the transmitter "on" function and/or the receiver "mute" circuit.

#### Break-In and Push-To-Talk

In c.w. operation, "break-in" is any system that allows the transmitting operator to hear the other station's signal during the "key-up" periods between characters and letters. This allows the sending station to be "broken" by the receiving station at any time, to shorten calls, ask for "fills" in messages, and speed up operation in general. With present techniques, it requires the use of a separate receiving antenna or an electronic "t.r." switch and, with high power, some means for protecting the receiver from the transmitter when the key is "down." If the transmitter is low-powered (50 watts or so), no special equipment is required except the separate receiving antenna and a receiver that "recovers" fast. Where break-in operation is used, the output stage should be disabled when adjusting the oscillator to a new frequency, to avoid radiating an unnecessary signal.

"Push-to-talk" is an expression derived from the "PUSH" switch on some microphones, and it means a phone station with a single control for

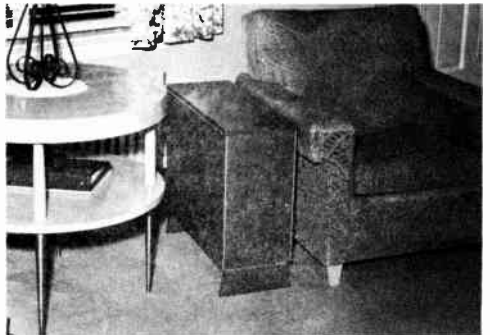

all change-over functions. Strictly speaking, it should apply only to a station where this single send-receive switch must be held in place during transmission periods, but any fast-acting switch will give practically the same effect. A control switch with a center "OFF" position, and one "HOLD" and one "LOCK" position, will give more flexibility than a straight "push" switch. The one switch must control the transmitter, the receiver "on-off" circuit and, if one is used, the antenna change-over relay. The receiver control is necessary to disable its output during transmit periods, to avoid acoustic feedback. A "foot switch" on the floor at the operating position is a convenient control.

Many s.s.b. transmitters provide for "VOX" (voice-controlled operation), where the transmitter is turned on automatically at the first voice syllable and is held on for a half second or more after the voice stops. Operation with a VOX-operated s.s.b. transmitter is similar to c.w. break-in, in that a separate receiving antenna or an antenna transfer relay or an electronic t.r. switch is required. Several examples of electronic t.r. switches are given at the end of this chapter.

#### Switches and Relays

It is dangerous to use an overloaded switch in the power circuits. After it has been used for some time, it may fail, leaving the power on the circuit even after the switch is thrown to the "OFF" position. For this reason, large switches, or relays with adequate ratings, should be used to control the plate power. Relays are rated by coil voltages (for their control circuits) and by their contact current and voltage ratings. Any switch or relay for the power-control circuits of an amateur station should be conservatively rated; overloading a switch or relay is very poor economy. Switches rated at 20 amperes at 125 volts will handle the switching of circuits at the kilowatt level, but the small toggle switches rated 3 amperes at 125 volts should be used only in circuits up to about 150 watts.

When relays are used, the send-receive switch closes the circuits to their coils. The energized relays close the heavy-duty relay contacts. Since the relay contacts are in the power circuit being controlled, the switch handles only the relay-coil current. As a consequence, this switch can have a low current rating.

#### SAFETY

Of prime importance in the layout of the station is the personal safety of the operator and of visitors, invited or otherwise, during normal operating practice. If there are small children in the house, every step must be taken to prevent their accidental contact with power leads of any voltage. A locked room is a fine idea, if it is possible, otherwise housing the transmitter and power supplies in metal cabinets is an excellent, although expensive, solution. Lacking a metal cabinet, a wooden cabinet or a wooden framework covered with wire screen is the next best solution. Many stations have the power supplies housed in metal cabinets in the operating room or in a closet or basement, and this cabinet or entry is kept locked—with the key out of reach of everyone but the operator. The power leads are run through conduit to the transmitter, using ignition cable for the high-voltage leads. If the power supplies and transmitter are in the same cabinet, a lock-type main switch for the incoming line power is a good precaution.

A simple substitute for a lock-type main switch is an ordinary line plug with a short connecting wire between the two pins. By wiring a female receptacle in series with the main power line in the transmitter, the shorting plug will act as the main safety lock. When the plug is removed and hidden, it will be impossible to energize the transmitter, and a stranger or child isn't likely to spot or suspect the open receptacle.

An essential adjunct to any station is a **shorting stick** for discharging any high voltage to ground before any work is done in the transmitter. Even if interlocks and power-supply bleeders are used, the failure of one or more of these



This neat "built-in" installation features separate filaments and exciters for each band, along with room for receiver, frequency meter, oscilloscope, Q multiplier and v.h.f. converter. All units are mounted on the three large panels; the panels are hinged at the bottom so that they can be lowered for service work on the individual units. A common power supply is used, and band-changing consists of turning on the filaments in the desired r.f. section.

(W9OVO, Sturgeon Bay, Wisc.)



components may leave the transmitter in a dangerous condition. The shorting stick is made by mounting a small metal hook, of wire or rod, on one end of a dry stick or bakelite rod. A piece of ignition cable or other well-insulated wire is then run from the hook on the stick to the chassis or common ground of the transmitter, and the stick is hung alongside the transmitter. Whenever the power is turned off in the transmitter to permit work on the rig, the shorting stick is first used to touch the several high-voltage leads (plate r.f. choke, filter capacitor, tube plate connection, etc.) to insure that there is no high voltage at any of these points. This simple device has saved many a life. Use it!

### Fusing

A minor hazard in the amateur station is the possibility of fire through the failure of a component. If the failure is complete and the component is large, the house fuses will generally blow. However, it is unwise and inconvenient to depend upon the house fuses to protect the lines running to the radio equipment, and every power supply should have its primary circuit individually fused, at about 150 to 200 per cent of the maximum rating of the supply. Circuit breakers can be used instead of fuses if desired.

### Wiring

Control-circuit wires running between the operating position and a transmitter in another part of the room should be hidden, if possible. This can be done by running the wires under the floor or behind the base molding, bringing the wires out to terminal boxes or regular wall fixtures. Such construction, however, is generally only possible in elaborate installations, and the average amateur must content himself with trying to make the wires as inconspicuous as possible. If several pairs of leads must be run from the operating table to the transmitter, as is generally the case, a single piece of rubber- or vinyl-covered multiconductor cable will always look neater than several pieces of rubber-covered

lamp cord, and it is much easier to sweep around or dust.

Solid or stranded wire connected to a screw terminal (a.c. plug, antenna binding posts, etc.) should either be "hooked" around a *clockwise* direction or, better yet, be terminated in a soldering lug. If the wire is hooked in a counter-clockwise position, it will tend to move out from under the screw head as the screw is tightened.

The antenna wires always present a problem, unless coaxial-line feed is used. Open-wire line from the point of entry of the antenna line should always be arranged neatly, and it is generally best to support it at several points. Many operators prefer to mount any antenna-tuning assemblies right at the point of entry of the feedline, together with an antenna changeover relay (if one is used), and then the link from the tuning assembly to the transmitter can be made of inconspicuous coaxial line. If the transmitter is mounted near the point of entry of the line, it simplifies the problem of "What to do with the feeders?"

### Lightning and Fire Protection

The National Electrical Code (NFPA No. 70) adopted by the National Fire Protection Association, although purely advisory as far as the NFPA is concerned, is of interest because it is widely used in law and for legal regulatory purposes. Article 810 deals with radio and television equipment, and Section C treats specifically amateur transmitting and receiving stations. Pertinent paragraphs are reprinted below:

810-11. Material. Antenna and lead-in conductors shall be of hard-drawn copper, bronze, aluminum alloy, copper-clad steel or other high-strength, corrosion-resistant material. Soft-drawn or medium-drawn copper may be used for lead-in conductors where the maximum span between points of support is less than 35 feet.

810-12. Supports. Outdoor antenna and lead-in conductors shall be securely supported. They shall not be attached to poles or similar structures carrying electric light or power wires or trolley wires of more than 250 volts between conductors. Insulators supporting the antenna conductors shall have sufficient mechanical strength to safely support the conductors.

A neat operating bench can be built from wood and covered with linoleum. There is enough room on the table shown here to house the transmitter, receiver, and numerous adjuncts and accessories. Interconnecting wiring is run behind the units or underneath the table. (W3AQN, York, Pa.)





Lead-in conductors shall be securely attached to the antenna.

810-13. Avoidance of Contacts with Conductors of Other Systems. Outdoor antenna and lead-in conductors from an antenna to a building shall not cross over electric light or power circuits and shall be kept well away from all such circuits so as to avoid the possibility of accidental contact. Where proximity to electric light and power service conductors of less than 250 volts between conductors cannot be avoided, the installation shall be such as to provide a clearance of at least two feet. It is recommended that antenna conductors be so installed as not to cross under electric light or power conductors.

810-14. Splices. Splices and joints in antenna span shall be made with approved splicing devices or by such other means as will not appreciably weaken the conductors.

Soldering may ordinarily be expected to weaken the conductor. Therefore, the joint should be mechanically secure before soldering.

810-15. Grounding. Masts and metal structures supporting antennas shall be permanently and effectively grounded, without intervening splice or connection.

810-52. Size of Antenna. Antennas for amateur transmitting and receiving stations shall be of a size not less than given in Table 810-52.

Material	Minimum Size of Conductors	
	When Maximum Open Span Length Is	
	Less than 150 feet	Over 150 feet
Hard-drawn copper	14	10
Copper-clad steel, bronze or other high-strength material	14	12

810-53. Size of Lead-In Conductors. Lead-in conductors for transmitting stations shall, for various maximum span lengths, be of a size at least as great as that of conductors for antenna specified in 810-52.

810-54. Clearance on Building. Antenna conductors for transmitting stations, attached to buildings, shall be firmly mounted at least 3 inches clear of the surface of the building on nonabsorptive insulating supports, such as treated pins or brackets, equipped with insulators having not less than 3-inch creepage and airgap distances. Lead-in conductors attached to buildings shall also conform to these requirements, except when they are enclosed in a continuous metal shield which is permanently and effectively grounded. In this latter case the metallic shield may also be used as a conductor.

810-55. Entrance to Building. Except where protected with a continuous metal shield which is permanently and effectively grounded, lead-in conductors for transmitting stations shall enter building by one of the following methods:

(a) Through a rigid, noncombustible, nonabsorptive insulating tube or bushing.

(b) Through an opening provided for the purpose in which the entrance conductors are firmly secured so as to provide a clearance of at least 2 inches.

(c) Through a drilled window pane.

810-56. Protection Against Accidental Contact. Lead-in conductors to radio transmitters shall be so located or installed as to make accidental contact with them difficult.

810-57. Lightning Arrestors—Transmitting Stations. Each conductor of a lead-in for outdoor antenna shall be provided with a lightning arrester or other suitable means which will drain static charges from the antenna system.

*Exception No. 1. When protected by a continuous metallic shield which is permanently and effectively grounded.*

*Exception No. 2. Where the antenna is permanently and effectively grounded.*

810-21. Grounding Material. The grounding conductor shall, unless otherwise specified, be of copper, aluminum, copper-clad steel, bronze, or other corrosion-resistant material.

810-22. Insulation. The grounding conductors may be uninsulated.

810-23. Supports. The grounding conductors shall be securely fastened in place and may be directly attached to the surface wired over without the use of insulating supports. Where proper support cannot be provided the size of the grounding conductor shall be increased proportionately.

810-24. Mechanical Protection. The grounding conductor shall be protected where exposed to physical damage or the size of the grounding conductor shall be increased proportionately to compensate for the lack of protection.

810-25. Run in Straight Line. The grounding conductor shall be run in as straight a line as practicable from the antenna mast and/or lightning arrester to the grounding electrode.

810-26. Grounding Electrode. The grounding conductor shall be connected to a metallic underground water piping system. Where the building is not supplied with a (suitable) water system (one buried deeper than ten feet) the connection shall be made to the metal frame of the building when effectively grounded or to a grounding electrode. At a penthouse or similar location the ground conductor may be connected to a water pipe or rigid conduit.

810-27. Grounding Conductor. The grounding conductor may be run either inside or outside the building.

810-59. Size of Protective Ground. The protective ground conductor for transmitting stations shall be as large as the lead-in, but not smaller than No. 10 copper, bronze or copper-clad steel.

810-60. Size of Operating Grounding Conductor. The operating grounding conductor for transmitting stations shall be not less than No. 14 copper or its equivalent.

810-70. Clearance from Other Conductors. All conductors inside the building shall be separated at least 4 inches from the conductors of other light or signal circuit unless separated therefrom by conduit or some firmly fixed non-conductor such as porcelain tubes or flexible tubing.

810-71. General. Transmitters shall comply with the following:

(a) Enclosing. The transmitter shall be enclosed in a metal frame or grille, or separated from the operating space by a barrier or other equivalent means, all metallic parts of which are effectually connected to ground.

(b) Grounding of Controls. All external metallic handles and controls accessible to the operating personnel shall be effectually grounded.

No circuit in excess of 150 volts between conductors should have any parts exposed to direct contact. A complete dead-front type of switchboard is preferred.

(c) Interlocks on Doors. All access doors shall be provided with interlocks which will disconnect all voltages in excess of 350 volts between conductors when any access door is opened.

(d) Audio Amplifiers. Audio amplifiers which are located outside the transmitter housing shall be suitably housed and shall be so located as to be readily accessible and adequately ventilated.

If coaxial line is used, compliance with 810-57 above is readily achieved by grounding the shield of the coax at the point where it is nearest to the ground outside the house. Use a heavy wire—the aluminum wire sold for grounding TV antennas is good. If the cable can be run underground, one or more grounding stakes should be located

at the point where the cable enters the ground, at the antenna end. A grounding stake, to be effective in soils of average conductivity, should

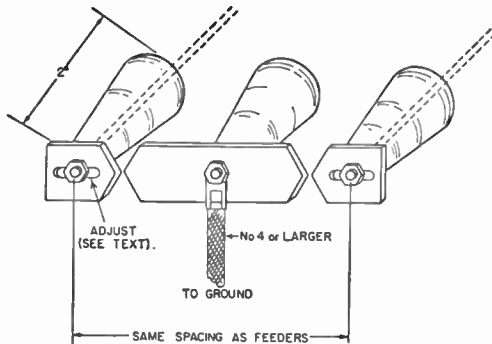

Fig. 22-1—A simple lightning arrester made from three stand-off or feed-through insulators and sections of brass or copper strap. It should be installed in the open-wire or Twin-Lead line at the point where it is nearest the ground outside the house. The heavy ground lead should be as short and direct as possible.

be not less than 8 feet long. Galvanized  $\frac{3}{4}$ -inch iron pipe is acceptable, as is  $\frac{5}{8}$ -inch steel rod or  $\frac{1}{2}$ -inch non-ferrous rod. Making connection to the outside of the outer conductor of the coaxial line will normally have no effect on the s.w.r. in the line, and consequently it can be done at any point or points. A commercial model of a lightning arrester for coaxial line is available.

Open-wire or Twin-Lead transmission lines can comply with 810-57 above through the use of a spark gap such as the one sketched in Fig. 22-1. The center contact should be grounded with a

No. 4 or larger wire. The gaps can be made from  $\frac{1}{8} \times \frac{1}{2}$ -inch flat brass rod shaped as shown, and the gaps should be set sufficiently far apart to prevent flash-over during normal operation of the transmitter. Depending upon the power of the transmitter and the s.w.r. pattern on the line, the gap may run anything from  $\frac{1}{32}$  to  $\frac{3}{16}$  inch. It may spark intermittently when a thunderstorm is building up or is in the general area.

Rotary beams using a T or gamma match and with each element connected to the boom will usually be grounded through the supporting metal tower. If the antenna is mounted on a wooden pole or on the top of the house, a No. 4 or larger wire should be connected from the beam to the ground by the shortest and most direct route possible, using insulators where the wire comes close to the building. From a lightning-protection standpoint, it is desirable to run the coaxial and control lines from a beam down a metal tower and underground to the shack. If the tower is well grounded and the antenna is higher than any surrounding objects, the combination will serve well as a lightning rod.

The sole purpose of lightning rods or grounded roofs is to protect a building in case a lightning stroke occurs; there is no accepted evidence that any form of protection can prevent a stroke.\*

Experiments have indicated that a high vertical conductor will generally divert to itself direct hits that might otherwise fall within a cone-shaped space of which the apex is the top of the conductor and the base a circle of radius approximately two times the height of the conductor. Thus a radio mast may afford some protection to low adjacent structures, but only when low-impedance grounds are provided.

\* See "Code for Protection Against Lightning," *National Bureau of Standards Handbook 46*, for sale by the Superintendent of Documents, Washington 25, D.C.



This homemade console, built of plywood and finished with light tan speckled spray paint, effectively conceals all power and antenna leads. The top of the console lifts off for access to the equipment.

Cherry-finished Formica is used for the desk top; there is a wooden top at the same height behind the console face, and the receiver and transmitters rest on wooden runners that elevate the equipment for greater convenience. A central control unit (behind the microphone) carries power switches, pilot lamps and beam-heading indicator. (K3NCN, Philadelphia, Pa.)

## ELECTRONIC TRANSMIT-RECEIVE SWITCHES

No antenna relay is fast enough to switch an antenna from transmitter to receiver and back at normal keying speeds. As a consequence, when it is desired to use the same antenna for transmitting and receiving (a "must" when directional antennas are used) and to operate c.w. break-in or voice-controlled sideband, and electronic switch is used in the antenna. The word "switch" is a misnomer in this case; the transmitter is connected to the antenna at all times and the t.r. "switch" is a device for preventing burn-out of the receiver by the transmitter.

One of the simplest approaches is the circuit shown in Fig. 22-2. The 6C4 cathode follower couples the incoming signal on the line to the receiver input with only a slight reduction in gain. When the transmitter is "on," the grid of the 6C4 is driven positive and the rectified current biases the 6C4 so that it can pass very little power on to the receiver. The factors that limit the r.f. voltage the circuit can handle are the voltage break-down rating of the 47- $\mu$ f. capacitor and the voltage that may be safely applied between the grid and cathode of the tube.

To avoid stray pick-up on the lead between the cathode and the antenna terminal of the receiver, this lead should be well-shielded. Further, the entire unit should be shielded and mounted at the transmitter antenna terminals. In wiring the tube socket, input and output cir-

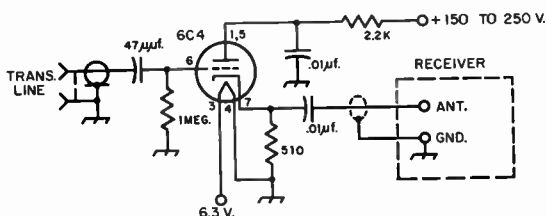

Fig. 22-2—Schematic diagram of cathode-follower t.r. switch. Resistors are  $\frac{1}{2}$ -watt. The unit should be assembled in a small chassis or shield can and mounted on or very close to the receiver antenna terminals. The transmitter transmission line can be connected at the coaxial jack with an M-358 Tee adapter.

The heater and plate power can be "borrowed" from the receiver in most cases.

cuit components should be separated to reduce feed-through by stray coupling.

The cable run to the receiver can be any convenient length, but if the t.r. switch is not located at or quite near to the transmitter there may be conditions where a loss of received signal will be noticed, caused by resonant conditions in the cable and the transmitter output circuit. This effect is more likely to be observed as one moves higher in frequency (to 21 and 28 Mc.).

## SELF-CONTAINED ALL-BAND ELECTRONIC T.R. SWITCH



The t.r. switch shown in Fig. 22-3 differs in several ways from the preceding example. It contains its own power supply and consequently can be used with any transmitter/receiver combination without "borrowing" power. It will add gain and front-end selectivity to the receiver. A commercial switch-coil-capacitor is shown in the unit, although the constructor could build his own.

Referring to the circuit diagram in Fig. 22-4, one triode of a 12AU7 is used as an amplifier stage, followed by the other triode as a cathode-follower stage to couple between the tuned circuit and the receiver. As in the simpler switch, the triodes are biased during transmission periods by rectified grid current, and insufficient power is fed to the receiver to injure its input circuit.

The t.r. switch is intended to mount behind the transmitter near its output terminal, so that the connecting cable is short. The lead from the t.r. switch to the receiver can be any reasonable length. Components are mounted on the sides and walls of the chassis, although a small bracket will be needed to support the tube socket and another is required to hold the far end of the coil  $L_1$ . The single coil bracket, aided by panel bushings for

Fig. 22-3—The electronic t.r. switch is built in a  $5 \times 9 \times 2\frac{1}{2}$ -inch chassis. Although two receiver outlets are shown on the near face (a phono jack and a coaxial receptacle), only one is required, depending upon one's choice of cable termination.

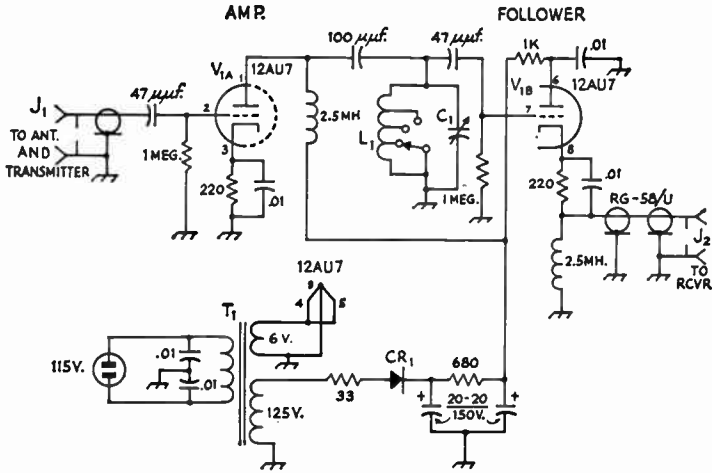

Fig. 22-4—Circuit diagram of the electronic t.r. switch. Unless otherwise specified, resistances are in ohms, resistors are 1/2 watt, capacitances are in μf.

- C<sub>1</sub>—140-μf. variable (part of Harrington GP-20 tuner).
- CR<sub>1</sub>—200-ma. 360-p.i.v. silicon rectifier (Sarkes Tarzian K-200).
- J<sub>1</sub>—Coaxial receptacle and tee fitting (SO-239 and M-358).
- J<sub>2</sub>—Coaxial receptacle or phono jack.

- L<sub>1</sub>—52 turns No. 24 on 3/4-inch diam. form, 28 t.p.i. Tapped at 46 1/2, 43 1/2, 39 and 28 turns from grounded end. (Part of Harrington GP-20 tuner).
- T<sub>1</sub>—125-v. 15-ma., 6-v. 0.6-amp. transformer (Stancor PS-8415) (GP-20 tuner available from Harrington Electronics, Box 189 Topsfield, Mass.).

the switch and capacitor C<sub>1</sub> shafts, is sufficient support for the coil-and-capacitor assembly. In wiring the switch, a length of RG-58/U should be used between the cathode-follower load (resistor and r.f. choke) and the output jack J<sub>2</sub>, to minimize "feedthrough" around the tube. A pair of 0.01 μf. capacitors across the a.c. line where it enters the chassis helps to hold down the r.f. that might otherwise ride in on the a.c. line.

In operation, it is only necessary to switch the unit to the band in use and peak capacitor C<sub>1</sub> for maximum signal or background noise. A significant increase in signal or background noise should be observed on any band within the range of the coil/capacitor combination.

A simple t.r. switch that has been used successfully for fast break-in operation with a 100-watt transmitter was described by Quick, W8EUJ, in *QST* (September, 1958). The circuit, shown in Fig. 22-5, uses a dual triode. A grounded-grid input stage (switched by grid rectification) R-C coupled to a cathode-follower output stage, pro-

vides a broad-band low-impedance t.r. switch suitable for use with coaxial cable. The unit has some gain but, if needed, more gain can be had by increasing the plate load resistance of the first stage to 6800 ohms or more.

The switch can be built as a separate unit with its own booster-type transformer, selenium rectifier and other components built on a 3 1/2 x 5-inch aluminum sheet chassis and housed in a 4 x 4 x 5-inch sheet metal can. A phono jack in the transmitter end of the low-pass filter will provide a convenient point for connection to the r.f. line.

**TVI and T.R. Switches**

The preceding t.r. switches generate harmonics when their grid circuits are driven positive, and these harmonics can cause TVI if steps are not taken to prevent it. Either switch should be well-shielded and used in the antenna transmission line between transmitter and low-pass filter.

Fig. 22-5—Circuit diagram of W8EUJ's t.r. switch. Unless otherwise indicated, capacitances are in μf. Resistances are in ohms, resistors are 1/2 watt. L<sub>1</sub> and L<sub>2</sub> are each wound with 30 turns No. 24 wire to a diameter of 3/16 inch.

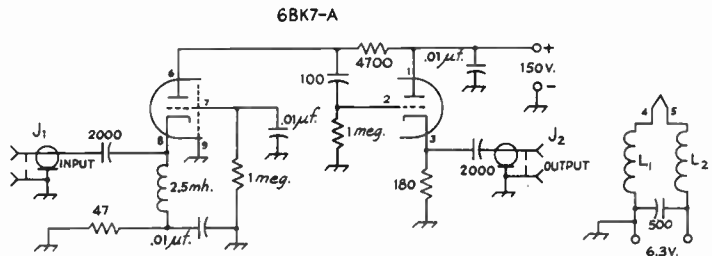



# INTERFERENCE WITH OTHER SERVICES

Every amateur has the obligation to make sure that the operation of his station does not, because of any shortcomings in equipment, cause interference with other radio and audio services. It is unfortunately true that much of the interference that amateurs cause to broadcast and television reception is directly the fault of b.c. and TV receiver construction. Nevertheless, the amateur can and should help to alleviate interference even though the responsibility for it does not lie with him.

Successful handling of interference cases requires winning the listener's cooperation. Here are a few pointers on how to go about it.

## Clean House First

The first step obviously is to make sure that the transmitter has no radiations outside the bands assigned for amateur use. The best check on this is your own a.m. or TV receiver. It is always convincing if you can demonstrate that you do not interfere with reception in your own home.

## Don't Hide Your Identity

Whenever you make equipment changes — or shift to a hitherto unused band or type of emission — that might be expected to change the interference situation, check with your neighbors. If no one is experiencing interference, so much the better; it does no harm to keep the neighborhood aware of the fact that you are operating without bothering anyone.

Should you change location, announce your presence and conduct occasional tests on the air, requesting anyone whose reception is being spoiled to let you know about it so steps may be taken to eliminate the trouble.

## Act Promptly

The average person will tolerate a limited amount of interference, but the sooner you take steps to eliminate it, the more agreeable the listener will be; the longer he has to wait for you, the less willing he will be to cooperate.

## Present Your Story Tactfully

When you interfere, it is natural for the complainant to assume that your transmitter is at fault. If you are certain that the trouble is not in your transmitter, explain to the listener that the reason lies in the receiver design, and that some modifications may have to be made in the receiver if he is to expect interference-free reception.

## Arrange for Tests

Most listeners are not very competent observers of the various aspects of interference. If at all possible, enlist the help of another amateur and have him operate your transmitter while you see for yourself what happens at the affected receiver.

## In General

In this "public relations" phase of the problem a great deal depends on your own attitude. Most people will be willing to meet you half way, particularly when the interference is not of long standing, if you as a person make a good impression. Your personal appearance is important. So is what you say about the receiver — no one takes kindly to hearing his possessions derided. If you discuss your interference problems on the air, do it in a constructive way — one calculated to increase listener cooperation, not destroy it.

## INTERFERENCE WITH STANDARD BROADCASTING

Interference with a.m. broadcasting usually falls into one or more rather well-defined categories. An understanding of the general types of interference will avoid much cut-and-try in finding a cure.

### Transmitter Defects

Out-of-band radiation is something that must be cured at the transmitter. Parasitic oscillations are a frequently unsuspected source of such radiations, and no transmitter can be considered satisfactory until it has been thoroughly checked for both low- and high-frequency par-

asitics. Very often parasitics show up only as transients, causing key clicks in c.w. transmitters and "splashes" or "burps" on modulation peaks in a.m. transmitters. Methods for detecting and eliminating parasitics are discussed in the transmitter chapter.

In c.w. transmitters the sharp make and break that occurs with unfiltered keying causes transients that, in theory, contain frequency components through the entire radio spectrum. Practically, they are often strong enough in the immediate vicinity of the transmitter to cause serious interference to broadcast reception. Key



clicks can be eliminated by the methods detailed in the chapter on keying.

A distinction must be made between clicks generated in the transmitter itself and those set up by the mere opening and closing of the key contacts when current is flowing. The latter are of the same nature as the clicks heard in a receiver when a wall switch is thrown to turn a light on or off, and may be more troublesome nearby than the clicks that actually go out on the signal. A filter for eliminating them usually has to be installed as close as possible to the key contacts.

Overmodulation in a.m. phone transmitters generates transients similar to key clicks. It can be prevented either by using automatic systems for limiting the modulation to 100 per cent, or by continuously monitoring the modulation. Methods for both are described in the chapter on amplitude modulation.

BCI is frequently made worse by radiation from the power wiring or the r.f. transmission line. This is because the signal causing the interference, in such cases, is radiated from wiring that is nearer the broadcast receiver than the antenna itself. Much depends on the method used to couple the transmitter to the antenna, a subject that is discussed in the chapters on transmission lines and antennas. If it is at all possible the antenna itself should be placed so that it is not in close proximity to house wiring, telephone and power lines, and similar conductors.

#### Image and Oscillator-Harmonic Responses

Most present-day broadcast receivers use a built-in loop antenna as the grid circuit for the mixer stage. The selectivity is not especially high at the signal frequency. Furthermore, an appreciable amount of signal pick-up usually occurs on the a.c. line to which the receiver is connected, the signal so picked up being fed to the mixer grid by stray means.

As a result, strong signals from nearby transmitters, even though the transmitting frequency is far removed from the broadcast band, can force themselves to the mixer grid. They will normally be eliminated by the i.f. selectivity, except in cases where the transmitter frequency is the image of the broadcast signal to which the receiver is tuned, or when the transmitter frequency is so related to a harmonic of the broadcast receiver's local oscillator as to produce a beat at the intermediate frequency.

These image and oscillator-harmonic responses tune in and out on the broadcast receiver dial just like a broadcast signal, except that in the case of harmonic response the tuning rate is more rapid. Since most receivers use an intermediate frequency in the neighborhood of 455 kc., the interference is a true image only when the amateur transmitting frequency is in the 1800-kc. band. Oscillator-harmonic responses occur from 3.5- and 7-Mc. transmissions, and sometimes even from higher frequencies.

Since images and harmonic responses occur

at definite frequencies on the receiver dial, it is possible to choose operating frequencies that will avoid putting such a response on top of the broadcast stations that are favored in the vicinity. While your signal may still be heard when the receiver is tuned off the local stations, it will at least not interfere with program reception.

There is little that can be done to most receivers to cure interference of this type except to reduce the amount of signal getting into the set through the a.c. line. A line filter such as is shown in Fig. 23-1 often will help accomplish this. The values used for the coils and capacitors are in general not critical. The effectiveness of the filter may depend considerably on the ground connection used, and it is advisable to use a short ground lead to a cold-water pipe if at all possible. The line cord from the set should be bunched up, to minimize the possibility of pick-up on the cord. It may be necessary to install the filter inside the receiver, so that the filter is connected between the line cord and the set wiring, in order to get satisfactory operation.

#### Cross-Modulation

With phone transmitters, there are occasionally cases where the voice is heard whenever the broadcast receiver is tuned to a b.c. station, but there is no interference when tuning between stations. This is cross-modulation, a result of rectification in one of the early stages of the receiver. Receivers that are susceptible to this trouble usually also get a similar type of interference from regular broadcasting if there is a strong local b.c. station and the receiver is tuned to some *other* station.

The remedy for cross-modulation in the receiver is the same as for images and oscillator-harmonic response — reduce the strength of the amateur signal at the receiver by means of a line filter.

The trouble is not always in the receiver, since cross modulation can occur in any nearby rectifying circuit — such as a poor contact in water or steam piping, gutter pipes, and other conductors in the strong field of the transmitting antenna — external to both receiver and transmitter. Locating the cause may be difficult, and is best attempted with a battery-operated portable broadcast receiver used as a "probe" to find the spot where the interference is most intense. When such a spot is located, inspection of the metal structures in the vicinity should indicate the cause. The remedy is to make a good electrical bond between the two conductors having the poor contact.

#### Audio-Circuit Rectification

The most frequent cause of interference from operation at 21 Mc. and higher frequencies is rectification of a signal that by some means gets into the audio system of the receiver. In the milder cases an amplitude-modulated signal will be heard with reasonably good quality, but is not tunable — that is, it is present no matter what the frequency to which the receiver dial

is set. An unmodulated carrier may have no observable effect in such cases beyond causing a little hum. However, if the signal is very strong there will be a reduction of the audio output level of the receiver whenever the carrier is thrown on. This causes an annoying "jumping" of the program when the interfering signal is keyed. With phone transmission the change in audio level is not so objectionable because it occurs at less frequent intervals. Rectification ordinarily gives no audio output from a frequency-modulated signal, so the interference can be made almost unnoticeable if f.m. or p.m. is used instead of a.m.

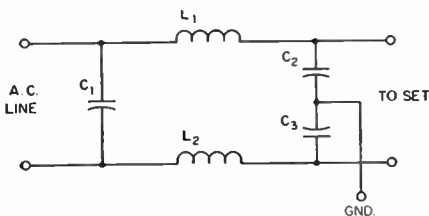

Fig. 23-1—"Brute-force" a.c. line filter for receivers. The values of C<sub>1</sub>, C<sub>2</sub> and C<sub>3</sub> are not generally critical; capacitances from 0.001 to 0.01  $\mu$ f. can be used. L<sub>1</sub> and L<sub>2</sub> can be a 2-inch winding of No. 18 enameled wire on a half-inch diameter form. In making up such a unit for use external to the receiver, make sure that there are no exposed conductors to offer a shock hazard.

Interference of this type usually results from a signal on the power line being coupled by some means into the audio circuits, although the pickup also may occur on the set wiring itself. A "brute-force" line filter as described above may or may not be completely effective, but in any event is the simplest thing to try. If it does not do the job, some modification of the receiver will be necessary. This usually takes the form of a simple filter connected in the grid circuit of the tube in which the rectification is occurring. Usually it will be the first audio amplifier, which is commonly a diode-triode type tube.

Filter circuits that have proved to be effective are shown in Fig. 23-2. In A, the value of the grid leak in the combined detector/first audio tube is reduced to 2 to 3 megohms and the grid is bypassed to chassis by a 250- $\mu$ f. mica or ceramic capacitor. A somewhat similar method that does not require changing the grid resistor is shown at B. In C, a 75,000-ohm (value not

critical) resistor is connected between the grid pin on the tube socket and all other grid connections. In combination with the input capacitance of the tube this forms a low-pass filter to prevent r.f. from reaching the grid. In some cases, simply bypassing the heater of the detector/first audio tube to chassis with a 0.001- $\mu$ f. or larger capacitor will suffice. In all cases, check to see that the a.c. line is bypassed to chassis; if it is not, install bypass capacitors (0.001 to 0.01  $\mu$ f.).

Handling BCI Cases

Assuming that your transmitter has been checked and found to be free from spurious radiations, get another amateur to operate your station, if possible, while you make the actual check on the interference yourself. The following procedure should be used.

Tune the receiver through the broadcast band, to see whether the interference tunes like a regular b.c. station. If so, image or oscillator-harmonic response is the cause. If there is interference only when a b.c. station is tuned in, but not between stations, the cause is cross modulation. If the interference is heard at all settings of the tuning dial, the trouble is pickup in the audio circuits. In the latter case, the receiver's volume control may or may not affect the strength of the interference, depending on the means by which your signal is being rectified.

Having identified the cause, explain it to the set owner. It is a good idea to have a line filter with you, equipped with enough cord to replace the set's line cord, so it can be tried then and there. If it does not eliminate the interference, explain to the set owner that there is nothing further that can be done without modifying the receiver. Recommend that the work be done by a competent service technician, and offer to advise the service man on the cause and remedy. Don't offer to work on the set yourself, but if you are asked to do so use your own judgment about complying; set owners sometimes complain about the over-all performance of the receiver afterward, often without justification. If you work on it, take it to your station so the effect of changes you make can be seen. Return the receiver promptly when you have finished.

MISCELLANEOUS TYPES OF INTERFERENCE

The operation of amateur phone transmitters occasionally results in interference on telephone lines and in audio amplifiers used in public-address work and for home music reproduction.

Fig. 23-2—Methods of eliminating r.f. from the grid of a combined detector/first-audio stage. At A, the value of the grid leak is reduced to 2 or 3 megohms, and a bypass capacitor is added. At B, both grid and cathode are bypassed.

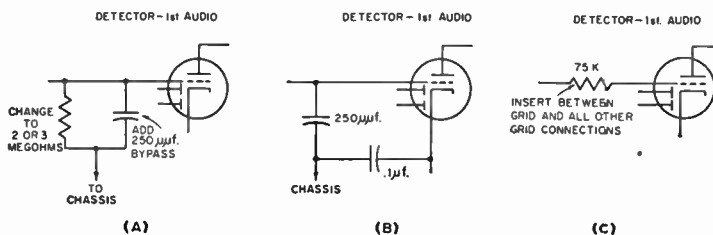

The cause is rectification of the signal in an audio circuit.

### Telephone Interference

Telephone interference can be cured by connecting a bypass capacitor (about 0.001  $\mu$ f.) across the microphone unit in the telephone handset. The telephone companies have capacitors for this purpose. When such a case occurs, get in touch with the repair department of the phone company, giving the particulars. Section C38.025 of the Bell System Practices *Station Operations Manual* gives detailed instructions. Do not try to work on the telephone yourself.

### Hi-Fi and P. A. Systems

In interference to public-address and "hi-fi" installations the principal sources of signal pick-

up are the a.c. line or a line from the power amplifier to a speaker. All amplifier units should be bonded together and connected to a good ground such as a cold-water pipe. Make sure that the a.c. line is bypassed to chassis in each unit with capacitors of about 0.01  $\mu$ f. at the point where the line enters the chassis. The speaker line similarly should be bypassed to the amplifier chassis with about 0.001  $\mu$ f.

If these measures do not suffice, the shielding on the amplifiers may be inadequate. A shield cover and bottom pan should be installed in such cases.

The spot in the system where the rectification is occurring often can be localized by seeing if the interference is affected by the volume control setting; if not, the cause is in a stage following the volume control.

## TELEVISION INTERFERENCE (See also Chap. 17)

Interference with the reception of television signals usually presents a more difficult problem than interference with a.m. broadcasting. In BCI cases the interference almost always can be attributed to deficient selectivity or spurious responses in the b.c. receiver. While similar deficiencies exist in many television receivers, it is also true that amateur transmitters generate harmonics that fall inside many or all tele-

vision channels. These spurious radiations cause interference that ordinarily cannot be eliminated by anything that may be done at the receiver, so must be prevented at the transmitter itself.

The over-all situation is further complicated by the fact that television broadcasting is in three distinct bands, two in the v.h.f. region and one in the u.h.f.

## V.H.F. TELEVISION

For the amateur who does most of his transmitting on frequencies below 30 Mc. the TV band of principal interest is the low v.h.f. band between 54 and 88 Mc. If harmonic radiation can be reduced to the point where no interference is caused to Channels 2 to 6, inclusive, it is almost certain that any harmonic troubles with channels above 174 Mc. will disappear also.

The relationship between the v.h.f. television channels and harmonics of amateur bands from 14 through 28 Mc. is shown in Fig. 23-3. Harmonics of the 7- and 3.5-Mc. bands are not shown because they fall in every television channel. However, the harmonics above 54 Mc. from these bands are of such high order that they are usually rather low in amplitude, although they may be strong enough to interfere if the television receiver is quite close to the amateur transmitter. Low-order harmonics — up to about the sixth — are usually the most difficult to eliminate.

Of the amateur v.h.f. bands, only 50 Mc. will have harmonics falling in a v.h.f. television chan-

nel (channels 11, 12 and 13). However, a transmitter for any amateur v.h.f. band may cause interference if it has multiplier stages either operating in or having harmonics in one or more of the v.h.f. TV channels. The r.f. energy on such

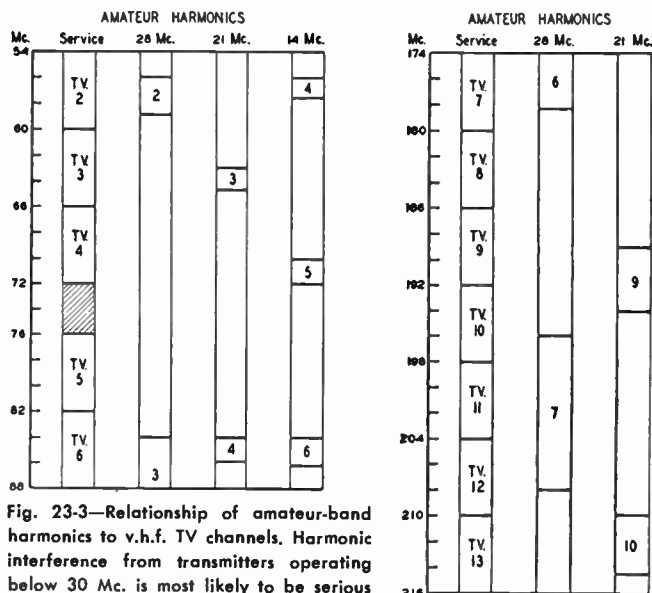

Fig. 23-3—Relationship of amateur-band harmonics to v.h.f. TV channels. Harmonic interference from transmitters operating below 30 Mc. is most likely to be serious in the low-channel group (54 to 88 Mc.).

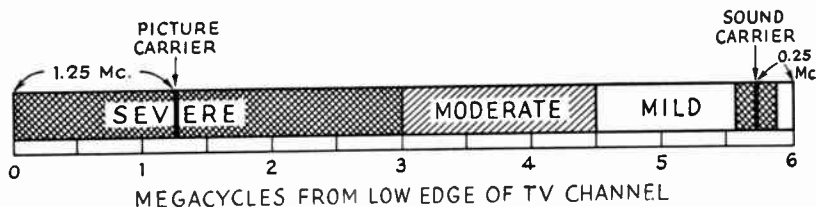

Fig. 23-4—Location of picture and sound carriers in a monochrome television channel, and relative intensity of interference as the location of the interfering signal within the channel is varied without changing its strength. The three regions are not actually sharply defined as shown in this drawing, but merge into one another gradually.

frequencies can be radiated directly from the transmitting circuits or coupled by stray means to the transmitting antenna.

### Frequency Effects

The degree to which transmitter harmonics or other undesired radiation actually in the TV channel must be suppressed depends principally on two factors, the strength of the TV signal on the channel or channels affected, and the relationship between the frequency of the spurious radiation and the frequencies of the TV picture and sound carriers within the channel. If the TV signal is very strong, interference can be eliminated by comparatively simple methods. However, if the TV signal is very weak, as in "fringe" areas where the received picture is visibly degraded by the appearance of set noise or "snow" on the screen, it may be necessary to go to extreme measures.

In either case the intensity of the interference depends very greatly on the exact frequency of the interfering signal. Fig. 23-4 shows the placement of the picture and sound carriers in the standard TV channel. In Channel 2, for example, the picture carrier frequency is  $54 + 1.25 = 55.25$  Mc. and the sound carrier frequency is  $60 - 0.25 = 59.75$  Mc. The second harmonic of 28,010 kc. (56,020 kc. or 56.02 Mc.) falls  $56.02 - 54 = 2.02$  Mc. above the low edge of the channel and is in the region marked "Severe" in Fig. 23-4. On the other hand, the second harmonic of 29,500 kc. (59,000 kc. or 59 Mc.) is  $59 - 54 = 5$  Mc. from the low edge of the channel and falls in the region marked "Mild." Interference at

this frequency has to be about 100 times as strong as at 56,020 kc. to cause effects of equal intensity. Thus an operating frequency that puts a harmonic near the picture carrier requires about 40 db. more harmonic suppression in order to avoid interference, as compared with an operating frequency that puts the harmonic near the upper edge of the channel.

For a region of 100 kc. or so either side of the sound carrier there is another "Severe" region where a spurious radiation will interfere with reception of the sound program, and this region also should be avoided. In general, a signal of intensity equal to that of the picture carrier will not cause noticeable interference if its frequency is in the "Mild" region: shown in Fig. 23-4, but the same intensity in the "Severe" region will utterly destroy the picture.

### Interference Patterns

The visible effects of interference vary with the type and intensity of the interference. Complete "blackout," where the picture and sound disappear completely, leaving the screen dark, occurs only when the transmitter and receiver are quite close together. Strong interference ordinarily causes the picture to be broken up, leaving a jumble of light and dark lines, or turns the picture "negative" — the normally white parts of the picture turn black and the normally black parts turn white. "Cross-hatching" — diagonal bars or lines in the picture — accompanies the latter, usually, and also represents the most common type of less-severe interference. The bars are the result of the beat between the harmonic frequency and the picture carrier frequency. They are broad and relatively few in number if the beat frequency is comparatively low — near the picture carrier — and are numerous and very fine if the beat frequency is very high — toward the upper end of the channel. Typical cross-hatching is shown in Fig. 23-5. If the frequency falls in the "Mild" region in Fig. 23-4 the cross-hatching may be so fine as to be visible only on close inspection of the picture, in which case it may simply cause the apparent brightness of the screen to change when the transmitter carrier is thrown on and off.

Whether or not cross-hatching is visible, an amplitude-modulated transmitter may cause "sound bars" in the picture. These look about



Fig. 23-5—"Cross-hatching," caused by the beat between the picture carrier and an interfering signal inside the TV channel.



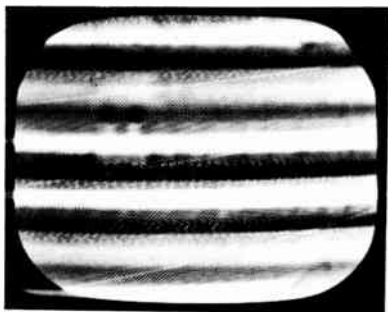

Fig. 23-6—"Sound bars" or "modulation bars" accompanying amplitude modulation of an interfering signal. In this case the interfering carrier is strong enough to destroy the picture, but in mild cases the picture is visible through the horizontal bars. Sound bars may accompany modulation even though the unmodulated carrier gives no visible cross-hatching.

as shown in Fig. 23-6. They result from the variations in the intensity of the interfering signal when modulated. Under most circumstances modulation bars will not occur if the amateur transmitter is frequency- or phase-modulated. With these types of modulation the cross-hatching will "wiggle" from side to side with the modulation.

Except in the more severe cases, there is seldom any effect on the sound reception when interference shows in the picture, unless the frequency is quite close to the sound carrier. In the latter event the sound may be interfered with even though the picture is clean.

Reference to Fig. 23-3 will show whether or not harmonics of the frequency in use will fall in any television channels that can be received in the locality. It should be kept in mind that not only harmonics of the final frequency may interfere, but also harmonics of any frequencies that may be present in buffer or frequency-multiplier stages. In the case of 144-Mc. transmitters, frequency-multiplying combinations that require a doubler or tripler stage to operate on a frequency actually in a low-band v.h.f. channel in use in the locality should be avoided.

### Harmonic Suppression

Effective harmonic suppression has three separate phases:

- 1) Reducing the amplitude of harmonics generated in the transmitter. This is a matter of circuit design and operating conditions.
- 2) Preventing stray radiation from the transmitter and from associated wiring. This requires adequate shielding and filtering of all circuits and leads from which radiation can take place.
- 3) Preventing harmonics from being fed into the antenna.

It is impossible to build a transmitter that will not generate *some* harmonics, but it is obviously advantageous to reduce their strength, by circuit design and choice of operating conditions, by as large a factor as possible before attempt-

ing to prevent them from being radiated. Harmonic radiation from the transmitter itself or from its associated wiring obviously will cause interference just as readily as radiation from the antenna, so measures taken to prevent harmonics from reaching the antenna will not reduce TVI if the transmitter itself is radiating harmonics. But once it has been found that the transmitter itself is free from harmonic radiation, devices for preventing harmonics from reaching the antenna can be expected to produce results.

### REDUCING HARMONIC GENERATION

Since reasonably efficient operation of r.f. power amplifiers always is accompanied by harmonic generation, good judgment calls for operating all frequency-multiplier stages at a very low power level—plate voltages not exceeding 250 or 300. When the final output frequency is reached, it is desirable to use as few stages as possible in building up to the final output power level, and to use tubes that require a minimum of driving power.

#### Circuit Design and Layout

Harmonic currents of considerable amplitude flow in both the grid and plate circuits of r.f. power amplifiers, but they will do relatively little harm if they can be effectively bypassed to the cathode of the tube. Fig. 23-7 shows the paths followed by harmonic currents in an amplifier circuit; because of the high reactance of the tank coil there is little harmonic current in it, so the harmonic currents simply flow through the tank capacitor, the plate (or grid) blocking capacitor, and the tube capacitances. The lengths of the leads forming these paths is of great importance, since the inductance in this circuit will resonate with the tube capacitance at some frequency in the v.h.f. range (the tank and blocking capacitances usually are so large compared with the tube capacitance that they have little effect on the resonant frequency). If such a resonance happens to occur at or near the same frequency as one of the transmitter harmonics, the effect is just the same as though a harmonic tank circuit had been deliberately introduced; the harmonic at that frequency will be tremendously increased in amplitude.

Such resonances are unavoidable, but by keeping the path from plate to cathode and from

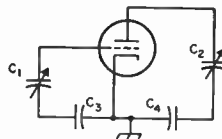

Fig. 23-7—A v.h.f. resonant circuit is formed by the tube capacitance and the leads through the tank and blocking capacitors. Regular tank coils are not shown, since they have little effect on such resonances.  $C_1$  is the grid tuning capacitor and  $C_2$  is the plate tuning capacitor.  $C_3$  and  $C_4$  are the grid and plate blocking or bypass capacitors, respectively.



grid to cathode as short as is physically possible, the resonant frequency usually can be raised above 100 Mc. in amplifiers of medium power. This puts it between the two groups of television channels.

It is easier to place grid-circuit v.h.f. resonances where they will do no harm when the amplifier is link-coupled to the driver stage, since this generally permits shorter leads and more favorable conditions for bypassing the harmonics than is the case with capacitive coupling. Link coupling also reduces the coupling between the driver and amplifier at harmonic frequencies, thus preventing driver harmonics from being amplified.

The inductance of leads from the tube to the tank capacitor can be reduced not only by shortening but by using flat strip instead of wire conductors. It is also better to use the chassis as the return from the blocking capacitor or tuned circuit to cathode, since a chassis path will have less inductance than almost any other form of connection.

The v.h.f. resonance points in amplifier tank circuits can be found by coupling a grid-dip meter covering the 50–250 Mc. range to the grid and plate leads. If a resonance is found in or near a TV channel, methods such as those described above should be used to move it well out of the TV range. The grid-dip meter also should be used to check for v.h.f. resonances in the tank coils, because coils made for 14 Mc. and below usually will show such resonances. In making the check, disconnect the coil entirely from the transmitter and move the grid-dip meter coil along it while exploring for a dip in the 54–88 Mc. band. If a resonance falls in a TV channel that is in use in the locality, changing the number of turns will move it to a less-troublesome frequency.

### Operating Conditions

Grid bias and grid current have an important effect on the harmonic content of the r.f. currents in both the grid and plate circuits. In general, harmonic output increases as the grid bias and grid current are increased, but this is not necessarily true of a particular harmonic. The third and higher harmonics, especially, will go through fluctuations in amplitude as the grid current is increased, and sometimes a rather high value of grid current will minimize one harmonic as compared with a low value. This characteristic can be used to advantage where a particular harmonic is causing interference, remembering that the operating conditions that minimize one harmonic may greatly increase another.

For equal operating conditions, there is little or no difference between single-ended and push-pull amplifiers in respect to harmonic generation. Push-pull amplifiers are frequently trouble-makers on even harmonics because with such amplifiers the even-harmonic voltages are in phase at the ends of the tank circuit and hence appear with equal amplitude across the whole

tank coil, if the center of the coil is not grounded. Under such circumstances the even harmonics can be coupled to the output circuit through stray capacitance between the tank and coupling coils. This does not occur in a single-ended amplifier having an inductively coupled tank, if the coupling coil is placed at the cold end, or with a pi-network tank.

### Harmonic Traps

If a harmonic in only one TV channel is particularly bothersome—frequently the case when the transmitter operates on 28 Mc.—a trap tuned to the harmonic frequency may be installed in the plate lead as shown in Fig. 23-8. At the harmonic frequency the trap represents a very high impedance and hence reduces the amplitude of the harmonic current flowing through the tank circuit. In the push-pull circuit both traps have the same constants. The  $L/C$  ratio is not critical but a high- $C$  circuit usually will have least effect on the performance of the plate circuit at the normal operating frequency.

Since there is a considerable harmonic voltage across the trap, radiation may occur from the trap unless the transmitter is well shielded. Traps should be placed so that there is no coupling between them and the amplifier tank circuit.

A trap is a highly selective device and so is useful only over a small range of frequencies.

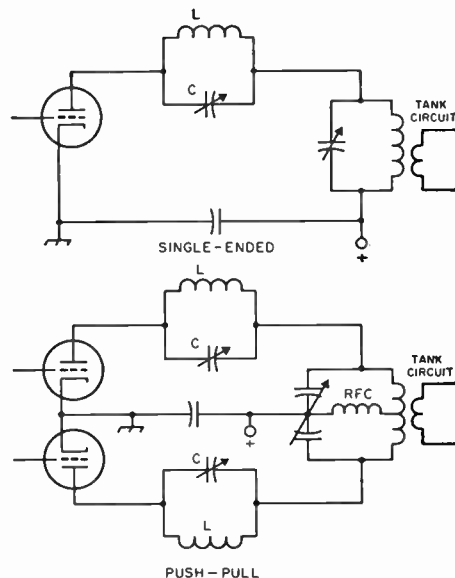

Fig. 23-8—Harmonic traps in an amplifier plate circuit.  $L$  and  $C$  should resonate at the frequency of the harmonic to be suppressed.  $C$  may be a 25- to 50- $\mu\text{f}$ . midget, and  $L$  usually consists of 3 to 6 turns about  $\frac{1}{2}$  inch in diameter for Channels 2 through 6. The inductance should be adjusted so that the trap resonates at about half capacitance of  $C$  before being installed in the transmitter. The frequency may be checked with a grid-dip meter. When in place, the trap should be adjusted for minimum interference to the TV picture.

A second- or third-harmonic trap on a 28-Mc. tank circuit usually will not be effective over more than 50 kc. or so at the fundamental frequency, depending on how serious the interference is without the trap. Because they are critical of adjustment, it is better to prevent TVI by other means, if possible, and use traps only as a last resort.

### PREVENTING RADIATION FROM THE TRANSMITTER

The extent to which interference will be caused by direct radiation of spurious signals depends on the operating frequency, the transmitter power level, the strength of the television signal, and the distance between the transmitter and TV receiver. Transmitter radiation can be a very serious problem if the TV signal is weak, if the TV receiver and amateur transmitter are close together, and if the transmitter is operated with high power.

#### Shielding

Direct radiation from the transmitter circuits and components can be prevented by proper shielding. To be effective, a shield must completely enclose the circuits and parts and must have no openings that will permit r.f. energy to escape. Unfortunately, ordinary metal boxes and cabinets do not provide good shielding, since such openings as louvers, lids, and holes for running in connections allow far too much leakage.

A primary requisite for good shielding is that all joints must make a good electrical connection along their entire length. A small slit or crack will let out a surprising amount of r.f. energy; so will ventilating louvers and large holes such as those used for mounting meters. On the other hand, small holes do not impair the shielding very greatly, and a limited number of ventilating holes may be used if they are small — not over  $\frac{1}{4}$  inch in diameter. Also, wire screen makes quite effective shielding if the wires make good electrical connection at each crossover. Perforated aluminum such as the "do-it-yourself" sold at hardware stores also is good, although not very strong mechanically. If perforated material is used, choose the variety with the smallest openings. The leakage through large openings can be very much reduced by covering such openings with screening or perforated aluminum, well bonded to all edges of the opening.

The intensity of r.f. fields about coils, capacitors, tubes and wiring decreases very rapidly with distance, so shielding is more effective, from a practical standpoint, if the components and wiring are not too close to it. It is advisable to have a separation of several inches, if possible, between "hot" points in the circuit and the nearest shielding.

For a given thickness of metal, the greater the conductivity the better the shielding. Copper is best, with aluminum, brass and steel following in that order. However, if the thickness is adequate for structural purposes (over 0.02

inch) and the shield and a "hot" point in the circuit are not in close proximity, any of these metals will be satisfactory. Greater separation should be used with steel shielding than with the other materials not only because it is considerably poorer as a shield but also because it will cause greater losses in near-by circuits than would copper or aluminum at the same distance. Wire screen or perforated metal used as a shield should also be kept at some distance from high-voltage or high-current r.f. points, since there is considerably more leakage through the mesh than through solid metal.

Where two pieces of metal join, as in forming a corner, they should overlap at least a half inch and be fastened together firmly with screws or bolts spaced at close-enough intervals to maintain firm contact all along the joint. The contact surfaces should be clean before joining, and should be checked occasionally — especially steel, which is almost certain to rust after a period of time.

The leakage through a given size of aperture in shielding increases with frequency, so such points as good continuous contact, screening of large holes, and so on, become even more important when the radiation to be suppressed is in the high band — 174-216 Mc. Hence 50- and 144-Mc. transmitters, which in general will have frequency-multiplier harmonics of relatively high intensity in this region, require special attention in this respect if the possibility of interfering with a channel received locally exists.

#### Lead Treatment

Even very good shielding can be made completely useless when connections are run to external power supplies and other equipment from the circuits inside the shield. Every such conductor leaving the shielding forms a path for the escape of r.f., which is then radiated by the connecting wires. Hence a step that is essential

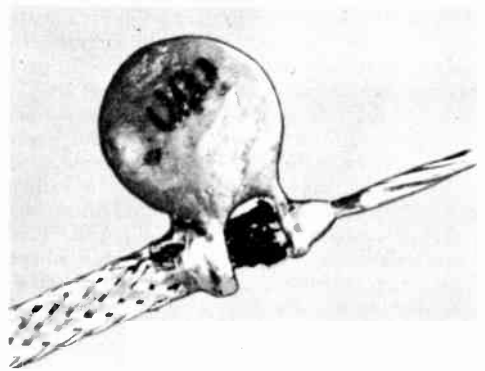

Fig. 23-9—Proper method of bypassing the end of a shielded lead using disk ceramic capacitor. The 0.001- $\mu$ f. size should be used for 1600 volts or less; 500  $\mu$ f. at higher voltages. The leads are wrapped around the inner and outer conductors and soldered, so that the lead length is negligible. This photograph is about four times actual size.

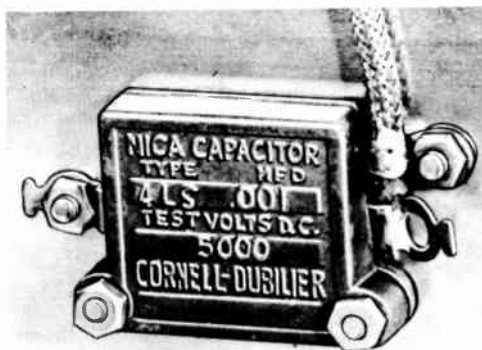

Fig. 23-10—Bypassing with a mica capacitor the end of a high-voltage lead. The end of the shield braid is soldered to a lug fastened to the chassis directly underneath. The other terminal of the capacitor is similarly bolted directly to the chassis. When the bypass is used at a terminal connection block the "hot" lead should be soldered directly to the terminal, if possible, but in any event connected to it by a very short lead.

in every case is to prevent harmonic currents from flowing on the leads leaving the shielded enclosure.

Harmonic currents always flow on the d.c. or a.c. leads connecting to the tube circuits. A very effective means of preventing such currents from being coupled into other wiring, and one that provides desirable bypassing as well, is to use shielded wire for all such leads, maintaining the shielding from the point where the lead connects to the tube or r.f. circuit right through to the point where it leaves the chassis. The shield braid should be grounded to the chassis at both ends and at frequent intervals along the path.

Good bypassing of shielded leads also is essential. Bearing in mind that the shield braid about the conductor confines the harmonic currents to the *inside* of the shielded wire, the object of bypassing is to prevent their escape. Figs. 23-9 and 23-10 show the proper way to bypass. The small-type 0.001- $\mu$ f. ceramic disk capacitor, when mounted on the end of the shielded wire as shown in Fig. 23-9, actually forms a series-resonant circuit in the 54-88-Mc. range and thus represents practically a short-circuit for low-band TV harmonics. The exposed wire to the connection terminal should be kept as short as is physically possible, to prevent any possible harmonic pickup exterior to the shielded wiring. Disk capacitors of this

Fig. 23-11—Additional r.f. filtering of supply leads may be required in regions where the TV signal is very weak. The r.f. choke should be physically small, and may consist of a 1-inch winding of No. 26 enameled wire on a 1/4-inch form, close-wound. Manufactured single-layer chokes having an inductance of a few microhenries also may be used.

capacitance are available in several voltage ratings up to 3000 volts. For higher voltages, the maximum capacitance available is approximately 500  $\mu$ f., which is large enough for good bypassing of harmonics. Alternatively, mica capacitors may be used as shown in Fig. 23-10, mounting the capacitor flat against the chassis and grounding the end of the shield braid directly to chassis, keeping the exposed part as short as possible. Either 0.001- $\mu$ f. or 470- $\mu$ f. (500  $\mu$ f.) capacitors should be used. The larger capacitance is series-resonant in Channel 2 and the smaller in Channel 6.

These bypasses are essential at the connection-block terminals, and desirable at the tube ends of the leads also. Installed as shown with shielded wiring, they have been found to be so effective that there is usually no need for further harmonic filtering. However, if a test shows that additional filtering is required, the arrangement shown in Fig. 23-11 may be used. Such an r.f. filter should be installed at the tube end of the shielded lead, and if more than one circuit is filtered care should be taken to keep the r.f. chokes separated from each other and so oriented as to minimize coupling between them. This is necessary for preventing harmonics present in one circuit from being coupled into another.

In difficult cases involving Channels 7 to 13—i.e., close proximity between the transmitter and receiver, and a weak TV signal—additional lead-filtering measures may be needed to prevent radiation of interfering signals by 50- and 144-Mc. transmitters. A recommended method is shown in Fig. 23-12. It uses a shielded lead bypassed with a ceramic disk as described above, with the addition of a low-inductance feed-through type capacitor and a small r.f. choke, the capacitor being used as a terminal for the external connection. For voltages above 400, a capacitor of compact construction (as indicated in the caption) should be used, mounted so that there is a very minimum of exposed lead, inside the chassis, from the capacitor to the connection terminal.

As an alternative to the series-resonant bypassing described above, feed-through type capacitors such as the Sprague "Hypass" type may be used as terminals for external connections. The ideal method of installation is to mount them so they protrude through the chassis, with thorough bonding to the chassis all around the hole in which the capacitor is mounted. The principle is illustrated in Fig. 23-13.

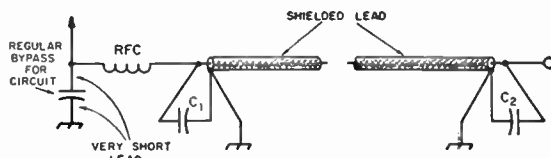

Meters that are mounted in an r.f. unit should be enclosed in shielding covers, the connections being made with shielded wire with each lead bypassed as described above. The shield braid should be grounded to the panel or chassis immediately outside the meter shield, as indicated in Fig. 23-14. A bypass may also be connected across the meter terminals, principally to prevent any fundamental current that may be present from flowing through the meter itself. As an alternative to individual meter shielding the meters may be mounted entirely behind the panel, and the panel holes needed for observation may be covered with wire screen that is carefully bonded to the panel all around the hole.

Care should be used in the selection of shielded wire for transmitter use. Not only should the insulation be conservatively rated for the d.c.

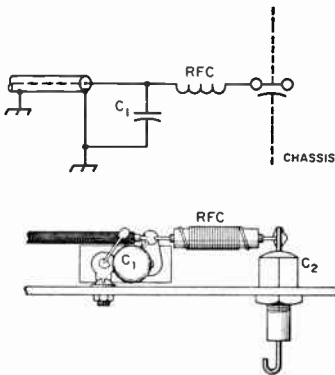

Fig. 23-12—Additional lead filtering for harmonics or other spurious frequencies in the high v.h.f. TV band (174-216 Mc.)

$C_1$ —0.001- $\mu$ f. disk ceramic.

$C_2$ —0.001- $\mu$ f. feed-through bypass (Erie Style 326). (For 500-2000-volt lead, substitute Plasticon Glass mike, LSG-251, for  $C_2$ .)

RFC—14 inches No. 26 enamel close-wound on  $\frac{3}{16}$ -inch diam. form or resistor.

voltage in use, but the insulation should be of material that will not easily deteriorate in soldering. The r.f. characteristics of the wire are not especially important, except that the attenuation of harmonics in the wire itself will be greater if the insulating material has high losses at radio frequencies; in other words, wire intended for use at d.c. and low frequencies is preferable to cables designed expressly for carrying r.f. The attenuation also will increase with the length of the wire; in general, it is better to make the leads as long as circumstances permit rather than to follow the more usual practice of using no more lead than is actually necessary. Where wires cross or run parallel, the shields should be spot-soldered together and connected to the chassis. For high voltages, automobile ignition cable covered with shielding braid is recommended.

Proper shielding of the transmitter requires that the r.f. circuits be shielded entirely from

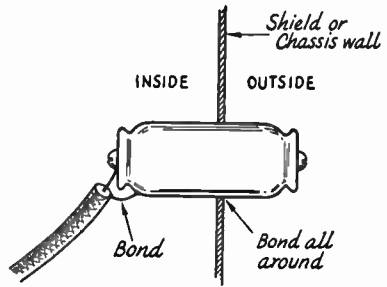

Fig. 23-13—The best method of using the "Hypass" type feed-through capacitor. Capacitances of 0.01 to 0.1  $\mu$ f. are satisfactory. Capacitors of this type are useful for high-current circuits, such as filament and 115-volt leads, as a substitute for the r.f. choke shown in Fig. 23-11, in cases where additional lead filtering is needed.

the external connecting leads. A situation such as is shown in Fig. 23-15, where the leads in the r.f. chassis have been shielded and properly filtered but the chassis is mounted in a large shield, simply invites the harmonic currents to travel over the chassis and on out over the leads outside the chassis. The shielding about the r.f. circuits should make complete contact with the chassis on which the parts are mounted.

#### Checking Transmitter Radiation

A check for transmitter radiation always should be made before attempting to use low-pass filters or other devices for preventing harmonics from reaching the antenna system. The only really satisfactory indicating instrument is a television receiver. In regions where the TV signal is strong an indicating wavemeter such as one having a crystal or tube detector may be useful; if it is possible to get any indication at all from harmonics either on supply leads or

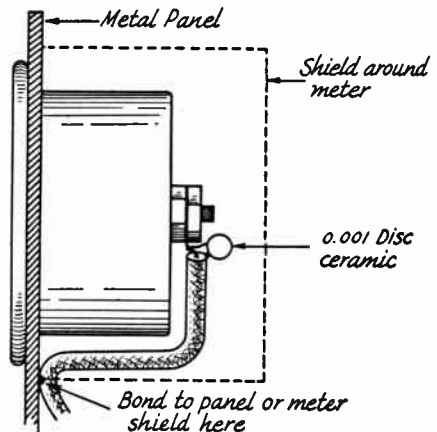

Fig. 23-14—Meter shielding and bypassing. It is essential to shield the meter mounting hole since the meter will carry r.f. through it to be radiated. Suitable shields can be made from 2½- or 3-inch diameter metal cans or small metal chassis boxes.



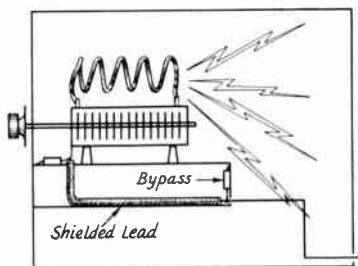

Fig. 23-15—A metal cabinet can be an adequate shield, but there will still be radiation if the leads inside can pick up r.f. from the transmitting circuits.

around the transmitter itself, the harmonics are probably strong enough to cause interference. However, the absence of any such indication does not mean that harmonic interference will not be caused. If the techniques of shielding and lead filtering described in the preceding section are followed, the harmonic intensity on any external leads should be far below what any such instruments can detect.

Radiation checks should be made with the transmitter delivering full power into a dummy antenna, such as an incandescent lamp of suitable power rating, preferably installed inside the shielded enclosure. If the dummy must be external, it is desirable to connect it through a coax-matching circuit such as is shown in Fig. 23-16. Shielding the dummy antenna circuit is also desirable, although it is not always necessary.

Make the radiation test on all frequencies that are to be used in transmitting, and note whether or not interference patterns show in the received picture. (These tests must be made while a TV signal is being received, since the beat patterns will not be formed if the TV picture carrier is not present.) If interference exists, its source can be detected by grasping the various external leads (by the insulation, not the live wire!) or bringing the hand near meter faces, louvers, and other possible points where harmonic energy might escape from the transmitter. If any of these tests cause a *change*—

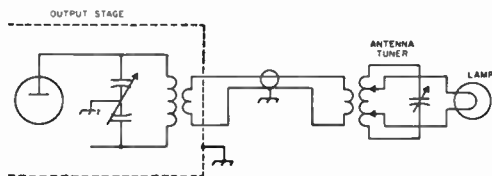

Fig. 23-16—Dummy-antenna circuit for checking harmonic radiation from the transmitter and leads. The matching circuit helps prevent harmonics in the output of the transmitter from flowing back over the transmitter itself, which may occur if the lamp load is simply connected to the output coil of the final amplifier. See transmission-line chapter for details of the matching circuit. Tuning must be adjusted by cut-and-try, as the bridge method described in the transmission-line chapter will not work with lamp loads because of the change in resistance when the lamps are hot.

not necessarily an *increase*—in the intensity of the interference, the presence of harmonics at that point is indicated. The location of such "hot" spots usually will point the way to the remedy. If the TV receiver and the transmitter can be operated side-by-side, a length of wire connected to one antenna terminal on the receiver can be used as a probe to go over the transmitter enclosure and external leads. This device will very quickly expose the spots from which serious leakage is taking place.

As a final test, connect the transmitting antenna or its transmission line terminals to the outside of the transmitter shielding. Interference created when this test is applied indicates that weak currents are on the outside of the shield and can be conducted to the antenna when the normal antenna connections are used. Currents of this nature represent interference that is conducted *over* low-pass filters, and hence cannot be eliminated by such filters.

### PREVENTING HARMONICS FROM REACHING THE ANTENNA

The third and last step in reducing harmonic TVI is to keep the spurious energy generated in or passed through the final stage from traveling over the transmission line to the antenna. It is seldom worthwhile even to attempt this until the radiation from the transmitter and its connecting leads has been reduced to the point where, with the transmitter delivering full power into a dummy antenna, it has been determined by actual testing with a television receiver that the radiation is below the level that can cause interference. If the dummy antenna test shows enough radiation to be seen in a TV picture, it is a practical certainty that harmonics will be coupled to the antenna system no matter what preventive measures are taken.

In inductively coupled output systems, some harmonic energy will be transferred from the final amplifier through the mutual inductance between the tank coil and the output coupling coil. Harmonics of the output frequency transferred in this way can be greatly reduced by providing sufficient selectivity between the final tank and the transmission line. A good deal of selectivity, amounting to 20 to 30 db. reduction of the second harmonic and much higher reduction of higher-order harmonics, is furnished by a matching circuit of the type shown in Fig. 23-16 and described in the chapter on transmission lines. An "antenna coupler" is therefore a worthwhile addition to the transmitter.

In 50- and 144-Mc. transmitters, particularly, harmonics not directly associated with the output frequency—such as those generated in low-frequency early stages of the transmitter—may get coupled to the antenna by stray means. For example, a 144-Mc. transmitter might have an oscillator or frequency multiplier at 48 Mc., followed by a tripler to 144 Mc. Some of the 48-Mc. energy will appear in the plate circuit of the tripler, and if passed on to the grid of the final amplifier will appear as a 48-Mc. modula-

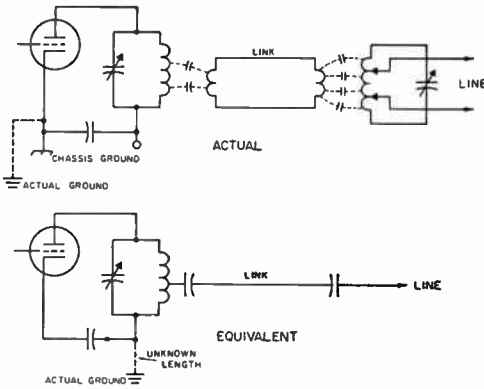

Fig. 23-17—The stray capacitive coupling between coils in the upper circuit leads to the equivalent circuit shown below, for v.h.f. harmonics.

tion on the 144-Mc. signal. This will cause a spurious signal at 192 Mc., which is in the high TV band, and the selectivity of the tank circuits may not be sufficient to prevent its being coupled to the antenna. Spurious signals of this type can be reduced by using link coupling between the driver stage and final amplifier (and between earlier stages as well) in addition to the suppression afforded by using an antenna coupler.

**Capacitive Coupling**

The upper drawing in Fig. 23-17 shows a parallel-conductor link as it might be used to couple into a parallel-conductor line through a matching circuit. Inasmuch as a coil is a sizable metallic object, there is capacitance between the final tank coil and its associated link coil, and between the matching-circuit coil and its link. Energy coupled through these capacitances travels over the link circuit and the transmission line as though these were merely single conductors. The tuned circuits simply act as masses of metal and offer no selectivity at all for capacitively-coupled energy. Although the actual capacitances are small, they offer a good coupling medium for frequencies in the v.h.f. range.

Capacitive coupling can be reduced by coupling to a "cold" point on the tank coil—the end connected to ground or cathode in a single-ended stage. In push-pull circuits having a split-stator capacitor with the rotor grounded for r.f., all parts of the tank coil are "hot" at even har-

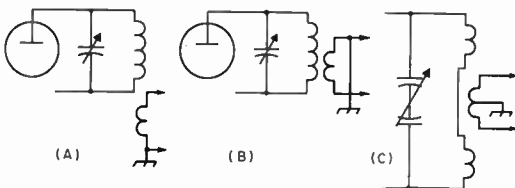

Fig. 23-18—Methods of coupling and grounding link circuits to reduce capacitive coupling between the tank and link coils. Where the link is wound over one end of the tank coil the side toward the hot end of the tank should be grounded, as shown at B.

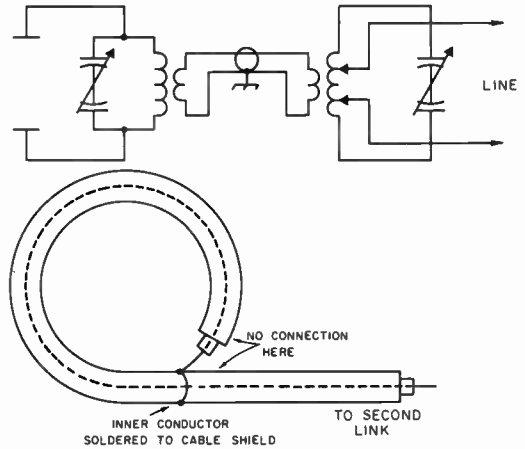

Fig. 23-19—Shielded coupling coil constructed from coaxial cable. The smaller sizes of cable such as RG-59/U are most convenient when the coil diameter is 3 inches or less, because of greater flexibility. For larger coils RG-8/U or RG-11/U can be used.

monics, but the center of the coil is "cold" at the fundamental and odd harmonics. If the center of the tank coil, rather than the rotor of the tank capacitor, is grounded through a bypass capacitor the center of the coil is "cold" at all frequencies, but this arrangement is not very desirable because it causes the harmonic currents to flow through the coil rather than the tank capacitor and this increases the harmonic transfer by pure inductive coupling.

With either single-ended or balanced tank circuits the coupling coil should be grounded to the chassis by a short, direct connection as shown in Fig. 23-18. If the coil feeds a balanced line or link, it is preferable to ground its center, but if it feeds a coax line or link one side may be grounded. Coaxial output is much preferable to balanced output, because the harmonics have to stay *inside* a properly installed coax system and tend to be attenuated by the cable before reaching the antenna coupler.

At high frequencies—and possibly as low as 14 Mc.—capacitive coupling can be greatly reduced by using a shielded coupling coil as shown in Fig. 23-19. The inner conductor of a length of coaxial cable is used to form a one-turn coupling coil. The outer conductor serves as an open-circuited shield around the turn, the shield being grounded to the chassis. The shielding has no effect on the inductive coupling. Because this construction is suitable only for one turn, the coil is not well adapted for use on the lower frequencies where many turns are required for good coupling. Shielded coupling coils having a larger number of turns are available commercially. A shielded coil is particularly useful with push-pull amplifiers when the suppression of even harmonics is important.

A shielded coupling coil or coaxial output will not prevent stray capacitive coupling to the an-

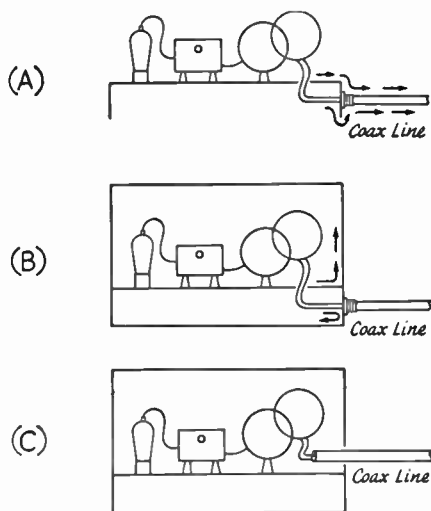

Fig. 23-20—Right (B) and wrong (A and C) ways to connect a coaxial line to the transmitter. In A or C, harmonic energy coupled by stray capacitance to the outside of the cable will flow without hindrance to the antenna system. In B the energy cannot leave the shield and can flow out only through, not over, the cable.

antenna if harmonic currents can flow over the *outside* of the coax line. In Fig. 23-20, the arrangement at either A or C will allow r.f. to flow over the outside of the cable to the antenna system. The proper way to use coaxial cable is to shield the transmitter completely, as shown at B, and make sure that the outer conductor of the cable is a continuation of the transmitter shielding. This prevents r.f. inside the transmitter from getting out by any path except the *inside* of the cable. Harmonics flowing *through* a coax line can be stopped by an antenna coupler or low-pass filter installed in the line.

**Low-Pass Filters**

A low-pass filter properly installed in a coaxial line, feeding either a matching circuit (antenna coupler) or feeding the antenna directly, will provide very great attenuation of harmonics. When the main transmission line is of the parallel-conductor type, the coax-coupled matching-circuit arrangement is highly recommended as a means for using a coax low-pass filter.

A low-pass filter will transmit power at the fundamental frequency without appreciable loss if the line in which it is inserted is properly terminated (has a low s.w.r.). At the same time it has large attenuation for all frequencies above the "cut-off" frequency.

Low-pass filters of simple and inexpensive construction for use with transmitters operating below 30 Mc. are shown in Figs. 23-21 and 23-23. The former is designed to use mica capacitors of readily available capacitance values, for compactness and low cost. Both use the same circuit, Fig. 23-22, the only difference being in the

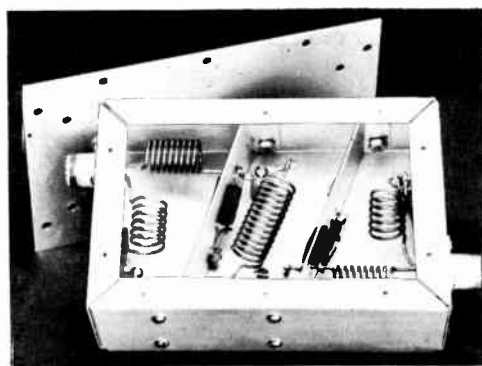

Fig. 23-21—An inexpensive low-pass filter using silver-mica postage-stamp capacitors. The box is a 2 by 4 by 6 aluminum chassis. Aluminum shields, bent and folded at the sides and bottom for fastening to the chassis, form shields between the filter sections. The diagonal arrangement of the shields provides extra room for the coils and makes it easier to fit the shields in the box, since bending to exact dimensions is not essential. The bottom plate, made from sheet aluminum, extends a half inch beyond the ends of the chassis and is provided with mounting holes in the extensions. It is held on the chassis with sheet-metal screws.

*L* and *C* values. Technically, they are three-section filters having two full constant-*k* sections and two *m*-derived terminating half-sections, and their attenuation in the 54-88-Mc. range varies from over 50 to nearly 70 db., depending on the frequency and the particular set of values used. At high frequencies the ultimate attenuation will depend somewhat on internal resonant conditions associated with component lead lengths. These leads should be kept as short as possible.

The power that filters using mica capacitors can handle safely is determined by the voltage and current limitations of the capacitors. The power capacity is least at the highest frequency. The unit using postage-stamp silver mica capacitors is capable of handling approximately 50 watts in the 28-Mc. band, when working into a properly-matched line, but is good for about 150 watts at 21 Mc. and 300 watts at 14 Mc. and lower frequencies. A filter with larger mica capacitors (case type CM-45) will carry about 250 watts safely at 21 Mc., this rating increasing to 500 watts at 21 Mc. and a kilowatt at 14 Mc. and lower. If there is an appreciable mismatch between the filter and the line into which it works, these ratings will be considerably decreased, so in order to avoid capacitor failure it is highly essential that the line on the output side of the filter be carefully matched.

The power capacity of these filters can be increased considerably by substituting r.f. type fixed capacitors (such as the Centralab 850 series) or variable air capacitors, in which event the power capability will be such as to handle the maximum amateur power on any band. The construction can be modified to accommodate

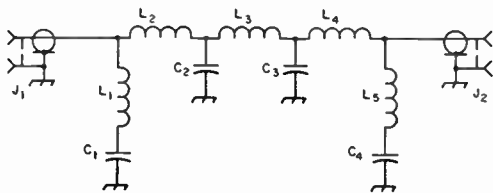

Fig. 23-22—Low-pass filter circuit.  $J_1$  and  $J_2$  are chassis-type coaxial connectors. In the table below the letters refer to the following:

- A—Using 100- and 70- $\mu\text{f}$ . 500-volt silver mica capacitors in parallel for  $C_2$  and  $C_3$ .
- B—Using 70- and 50- $\mu\text{f}$ . silver mica capacitors in parallel for  $C_2$  and  $C_3$ .
- C—Using 100- and 50- $\mu\text{f}$ . mica capacitors, 1200-volt (case-style CM-45) in parallel for  $C_2$  and  $C_3$ .
- D and E—Using variable air capacitors, 500- to 1000-volt rating, adjusted to values given.

	A	B	C	D	E	
$Z_0$	52	75	52	52	75	ohms
$f_c$	36	35.5	41	40	40	Mc.
$f_{00}$	44.4	47	54	50	50	Mc.
$f_1$	25.5	25.2	29	28.3	28.3	Mc.
$f_2$	32.5	31.8	37.5	36.1	36.1	Mc.
$C_1, C_4$	50	40	50	46	32	$\mu\text{f}$ .
$C_2, C_3$	170	120	150	154	106	$\mu\text{f}$ .
$L_1, L_5$	5½	6	4	5	6½	turns*
$L_2, L_4$	8	11	7	7	9½	turns*
$L_3$	9	13	8	8½	11½	turns*

\*No. 12 or No. 14 wire, ½-inch inside diameter, 8 turns per inch.

variable air capacitors as shown in Fig. 23-23.

Using fixed capacitors of standard tolerances, there should be little difficulty in getting proper filter operation. A grid-dip meter with an accurate calibration should be used for adjustment of the coils. First, wire up the filter without  $L_2$  and  $L_4$ . Short-circuit  $J_1$  at its inside end with a screwdriver or similar conductor, couple the grid-dip meter to  $L_1$  and adjust the inductance of  $L_1$ , by varying the turn spacing, until the circuit resonates at  $f_2$  as given in the table. Do the same thing at the other end of the filter with  $L_5$ . Then couple the meter to the circuit formed by  $L_3, C_2$  and  $C_3$ ,

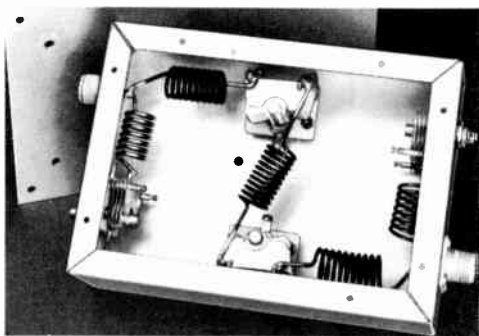

Fig. 23-23—Low-pass filter using variable air capacitors. The box is a 2 by 5 by 7 aluminum chassis, fitted with a bottom plate of similar construction to the one used in Fig. 23-21.

and adjust  $L_3$  to resonate at the frequency  $f_1$  as given by the table. Then remove  $L_3$ , install  $L_2$  and  $L_4$  and adjust  $L_2$  to make the circuit formed by  $L_1, L_2, C_1$  and  $C_2$  (without the short across  $J_1$ ) resonate at  $f_2$  as given in the table. Do the same with  $L_4$  for the circuit formed by  $L_4, L_5, C_3$  and  $C_4$ . Then replace  $L_3$  and check with the grid-dip meter at any coil in the filter; a distinct resonance should be found at or very close to the cut-off frequency,  $f_c$ .

The filter constants suggested at D and E in Fig. 23-22 are based on the optimum design for good impedance characteristics—that is, with  $m = 0.6$  in the end sections—and a cut-off frequency below the standard i.f. for television receivers (sound carrier at 41.25 Mc.; picture carrier at 45.75 Mc.). This is to avoid possible harmonic interference from 21 Mc. and below to the receiver's intermediate amplifier. The other designs similarly cut off at 41 Mc. or below, but  $m$  in these cases is necessarily based on the capacitances available in standard fixed capacitors.

**Filters for 50- and 144-Mc. Transmitters**

Since a low-pass filter must have a cut-off frequency above the frequency on which the transmitter operates, a filter for a v.h.f. transmitter cannot be designed for attenuation in all television channels. This is no handicap for v.h.f. work but means that the filter will not be effective when used with lower-frequency transmit-

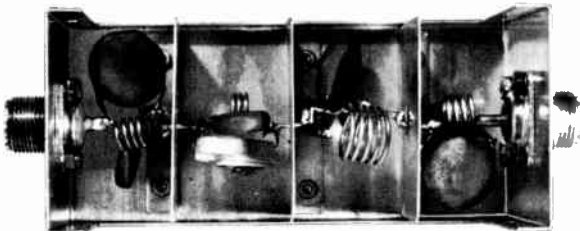
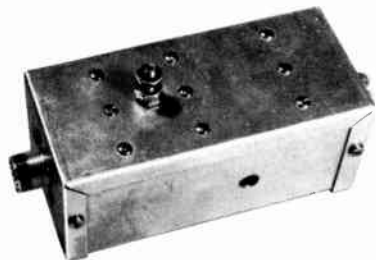

Fig. 23-24—Low-pass filter for use with 50-Mc. transmitters at powers up to about 300 watts. The housing is a 2¼-inches square by 5-inches long Minibox. Connections between the various sections of the filter are made through 5/16-inch clearance holes cut in the centers of the shielding partitions.



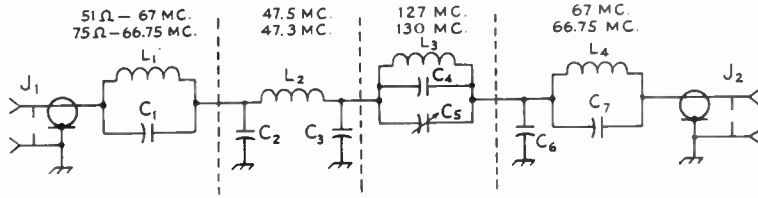

Fig. 23-25—Circuit of the 6-meter low-pass filter. See table for capacitance and inductance values.  $C_1, C_2, C_3, C_4, C_6, C_7$ —6000-volt disk ceramic (Centralab DD60, Sprague 60GA, Erie HD6 or similar).  $C_5$ —45- $\mu$ f. ceramic trimmer (Centralab 822BN).  $J_1, J_2$ —Chassis-mounting coax receptacle (SO-239). Resonant frequencies refer to the following independent combinations:  $L_1C_1, L_2C_2C_3, L_3C_3C_6$  and  $L_4C_7$ .

Capacitance ( $\mu$ f.) and Inductance ( $\mu$ h.) Values for the 6-Meter Low-Pass Filter			
	50 ohms	75 ohms	
$C_1, C_3, C_7$	68	47	
$C_2$	82	56	
$C_4$	100	68	
$C_5$	7-45	7-45	
$C_6$	39	25	
$L_1, L_4$	0.0825	0.121	
$L_2$	0.3	0.441	
$L_3$	0.0622	0.0915	
Coil Dimensions (All No. 16 Wire)			
$L$ ( $\mu$ h.)	Turns	I.D.	Turns Spacing
0.441	7	$\frac{1}{2}$ inch	$\frac{1}{16}$ inch
0.3	5	$\frac{1}{2}$ inch	$\frac{1}{16}$ inch
0.121	4	$\frac{3}{8}$ inch	$\frac{3}{32}$ inch
0.0915	4	$\frac{1}{4}$ inch	1 turn
0.0825	4	$\frac{1}{4}$ inch	$\frac{1}{16}$ inch
0.0622	3	$\frac{5}{16}$ inch	1 turn

ground lug. The only stand-off insulators are the two supporting  $L_3, C_4$  and  $C_5$ . Leads should be centered in the middle of the holes through the shields, and excess solder resin cleaned from capacitor bodies and stand-off insulators.

The filter will have about 0.3 db. attenuation up to 51 Mc. and about 3 to 4 db. at 53 Mc. At 55.25 and above the attenuation should never be less than 25 or 30 db.

A filter for low-power 144-Mc. transmitters is shown in Fig. 23-26. It is designed for maximum attenuation in the 190-215 Mc. region to suppress the spurious radiations in that range that frequently occur with 144-Mc. transmitters, but also has good attenuation for all frequencies above 170 Mc. Optimum capacitance values are given in Fig. 23-27. If possible, several units of the nearest standard values available should be measured and those having values closest to the optimum used. Adjust the filter as follows:

First, mount  $L_1$  and  $C_1$ , short  $J_1$  temporarily at its inner terminals, and adjust  $L_1$  until the combination resonates at 200 Mc. as shown by a grid-dip meter. Next, remove the short from  $J_1$  and connect  $L_2$  and  $C_2$ , adjusting  $L_2$  until the circuit formed by  $L_1L_2C_1C_2$  resonates at 144 Mc. Then disconnect  $L_2$  and mount  $L_3$  between  $C_2$  and  $C_3$ . Adjust  $L_3$  until the circuit  $L_3C_2C_3$  resonates at 112 Mc. Next, disconnect  $L_3$  and follow a similar procedure starting from the other end with  $L_5$  and  $C_4$ . Finally, reconnect all coils; a check at any point in the filter should show resonance at 160 Mc.

**Filter Installation**

To be effective, a low-pass filter must be installed so that all the output of the transmitter flows through it. If harmonic currents are permitted to flow on the outside of the connecting coaxial cables, they will simply flow over the filter and on up to the antenna, and the filter does not have an opportunity to stop them.

Fig. 23-28 shows the proper way to install a filter between a shielded transmitter and a matching circuit. The coax, together with the

ters, unless it happens that no local TV channels fall inside the pass band of the filter.

Fig. 23-24 shows a filter for 50- or 75-ohm coax suitable for a 50-Mc. transmitter of any power up to about 300 watts. The circuit diagram is given in Fig. 23-25. If the values of inductance and capacitance can be measured, the components can be preset and assembled without further adjustment. Alternatively, the grid-dip meter method described earlier may be used. The resonant frequencies are checked for the following combinations (see Fig. 23-25):  $L_1C_1, L_2C_2C_3$  ( $L_3$  and associated capacitors lifted),  $L_3C_3C_6$  ( $L_2$  lifted from  $C_3, L_4$  lifted from  $C_6, C_4$  and  $C_5$  lifted), and  $L_4C_7$ . Coil turns are spread apart or squeezed together during adjustment. When sections have been resonated, the filter is reconnected and, with a suitable termination,  $C_5$  is adjusted for minimum response at 55.25 Mc.

In constructing the filter, the coils are supported by the coax connectors and by the short capacitor leads, one of which is soldered to a

Fig. 23-26—A 52-ohm low-pass filter for 144-Mc. Transmitters. Case is made from flashing copper and is  $1\frac{1}{4}$  inches square by  $7\frac{1}{2}$  inches long. Cover slips on flanges folded out at the bottom; ends are folded down and soldered.

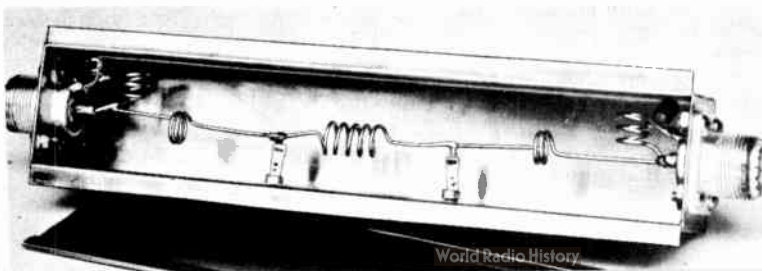

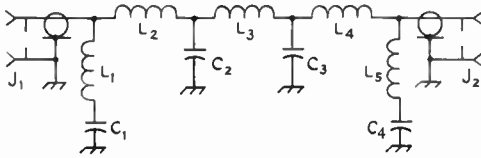

Fig. 23-27—Low-pass filter for 144-Mc. operation through 50-ohm coaxial line.

$C_1, C_4$ —10- $\mu\text{mf.}$  ceramic (Sprague 10TS-Q10).

$C_2, C_3$ —39- $\mu\text{mf.}$  ceramic (Sprague 10TS-Q39).

$J_1, J_2$ —Coaxial fitting (SO-239).

$L_1, L_5$ —3 turns,  $\frac{1}{4}$ -inch long, leads  $\frac{1}{4}$ -inch long each end.

$L_2, L_4$ —2 turns  $\frac{1}{8}$ -inch long, leads 1 inch long each end.

$L_3$ —5 turns  $\frac{3}{4}$ -inch long, leads  $\frac{3}{8}$ -inch long each end.

All coils of No. 18 tinned copper,  $\frac{1}{4}$ -inch diam.

shields about the transmitter and filter, forms a continuous shield to keep all the r.f. inside. The r.f. forced to flow through the filter and the harmonics are attenuated. If there is no harmonic energy left after passing through the filter, shielding from that point on is not necessary. However, the antenna-coupler chassis arrangement shown in Fig. 23-28 is desirable because it will tend to prevent fundamental-frequency energy from flowing from the matching circuit back over the transmitter; this helps eliminate feed-back troubles in audio systems.

When a filter does not seem to give the harmonic attenuation of which it should be capable, the probable reason is that harmonics are bypassing it because of improper installation and inadequate transmitter shielding, including lead filtering. However, occasionally there are cases where the circuits formed by the cables and the apparatus to which they connect become resonant at a harmonic frequency. This greatly increases the harmonic output at that frequency. Such troubles can be completely overcome by substituting a slightly different cable length. The most critical length is that connecting the transmitter to the filter. Checking with a grid-dip meter at the final amplifier output coil usually will show whether an unfavorable resonance of this type exists.

## SUMMARY

The methods of harmonic elimination outlined in this chapter have been proved beyond doubt to be effective even under highly unfavorable conditions. It must be emphasized once more, however, that the problem must be solved one step at a time, and the procedure must be in logical order. It cannot be done properly without two items of simple equipment: a grid-dip meter and wavemeter covering the TV bands, and a dummy antenna.

To summarize:

- 1) Take a critical look at the transmitter on

the basis of the design considerations outlined under "Reducing Harmonic Generation".

- 2) Check all circuits, particularly those connected with the final amplifier, with the grid-dip meter to determine whether there are any resonances in the TV bands. If so, rearrange the circuits so the resonances are moved out of the critical frequency region.

- 3) Connect the transmitter to the dummy antenna and check with the wavemeter for the presence of harmonics on leads and around the transmitter enclosure. Seal off the weak spots in the shielding and filter the leads until the wavemeter shows no indication at any harmonic frequency.

- 4) At this stage, check for interference with a TV receiver. If there is interference, determine the cause by the methods described previously and apply the recommended remedies until the interference disappears.

- 5) When the transmitter is completely clean on the dummy antenna, connect it to the regular antenna and check for interference on the TV receiver. If the interference is not bad, an antenna coupler or matching circuit installed as previously described should clear it up. Alternatively, a low-pass filter may be used. If neither the antenna coupler nor filter makes any difference in the interference, the evidence is strong that the interference, at least in part, is being caused by receiver overloading because of the strong fundamental-frequency field about the TV antenna and receiver. (See later section for identification of fundamental-frequency interference.) A coupler and/or filter, installed as described above, will invariably make a difference in the intensity of the interference if the interference is caused by transmitter harmonics alone.

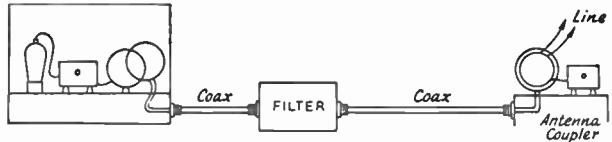

Fig. 23-28—The proper method of installing a low-pass filter between the transmitter and antenna coupler or matching circuit. If the antenna is fed through coax the antenna coupler may be omitted but the same construction should be used between the transmitter and filter. The filter should be thoroughly shielded.

- 6) If there is still interference after installing the coupler and/or filter, and the evidence shows that it is probably caused by a harmonic, more attenuation is needed. A more elaborate filter may be necessary. However, it is well at this stage to assume that part of the interference may be caused by receiver overloading, and take steps to alleviate such a condition before trying highly-elaborate filters, traps, etc., on the transmitter.

## HARMONICS BY RECTIFICATION

Even though the transmitter is completely free from harmonic output it is still possible for interference to occur because of harmonics

generated outside the transmitter. These result from rectification of fundamental-frequency currents induced in conductors in the vicinity of the transmitting antenna. Rectification can take place at any point where two conductors are in poor electrical contact, a condition that frequently exists in plumbing, downspouting, BX cables crossing each other, and numerous other places in the ordinary residence. It also can occur in any exposed vacuum tubes in the station, in power supplies, speech equipment, etc., that may not be enclosed in the shielding about the r.f. circuits. Poor joints anywhere in the antenna system are especially bad, and rectification also may take place in the contacts of antenna changeover relays. Another common cause is overloading the front end of the communications receiver when it is used with a separate antenna (which will radiate the harmonics generated in the first tube) for break-in.

Rectification of this sort will not only cause harmonic interference but also is frequently responsible for cross-modulation effects. It can be detected in greater or less degree in most locations, but fortunately the harmonics thus generated are not usually of high amplitude. However, they can cause considerable interference in the immediate vicinity in fringe areas, especially when operation is in the 28-Mc. band. The amplitude decreases rapidly with the order of the harmonic, the second and third being the worst. It is ordinarily found that even in cases where destructive interference results from 28-Mc. operation the interference is comparatively mild from 14 Mc., and is negligible at still lower frequencies.

Nothing can be done at either the transmitter or receiver when rectification occurs. The remedy is to find the source and eliminate the poor contact either by separating the conductors or bonding them together. A crystal wavemeter (tuned to the fundamental frequency) is useful for hunting the source, by showing which conductors are carrying r.f. and, comparatively, how much.

Interference of this kind is frequently intermittent since the rectification efficiency will vary with vibration, the weather, and so on. The possibility of corroded contacts in the TV receiving antenna should not be overlooked, especially if it has been up a year or more.

## TV RECEIVER DEFICIENCIES

### Front-End Overloading

When a television receiver is quite close to the transmitter, the intense r.f. signal from the transmitter's fundamental may overload one or more of the receiver circuits to produce spurious responses that cause interference.

If the overload is moderate, the interference is of the same nature as harmonic interference; it is caused by harmonics generated in the early stages of the receiver and, since it occurs only on channels harmonically related to the transmitting frequency, is difficult to distinguish

from harmonics actually radiated by the transmitter. In such cases additional harmonic suppression at the transmitter will do no good, but any means taken at the receiver to reduce the strength of the amateur signal reaching the first tube will effect an improvement. With very severe overloading, interference also will occur on channels *not* harmonically related to the transmitting frequency, so such cases are easily identified.

### Cross-Modulation

Upon some circumstances overloading will result in cross-modulation or mixing of the amateur signal with that from a local f.m. or TV station. For example, a 14-Mc. signal can mix with a 92-Mc. f.m. station to produce a beat at 78 Mc. and cause interference in Channel 5, or with a TV station on Channel 5 to cause interference in Channel 3. Neither of the channels interfered with is in harmonic relationship to 14 Mc. Both signals have to be on the air for the interference to occur, and eliminating either at the TV receiver will eliminate the interference.

There are many combinations of this type, depending on the band in use and the local frequency assignments to f.m. and TV stations. The interfering frequency is equal to the amateur fundamental frequency either added to or subtracted from the frequency of some local station, and when interference occurs in a TV channel that is not harmonically related to the amateur transmitting frequency the possibilities in such frequency combinations should be investigated.

### I. F. Interference

Some TV receivers do not have sufficient selectivity to prevent strong signals in the intermediate-frequency range from forcing their way through the front end and getting into the i.f. amplifier. The once-standard intermediate frequency of, roughly, 21 to 27 Mc., is subject to interference from the fundamental-frequency output of transmitters operating in the 21-Mc. band. Transmitters on 28 Mc. sometimes will cause this type of interference as well.

A form of i.f. interference peculiar to 50-Mc. operation near the low edge of the band occurs with some receivers having the standard "41-Mc." i.f., which has the sound carrier at 41.25 Mc. and the picture carrier at 45.75 Mc. A 50-Mc. signal that forces its way into the i.f. system of the receiver will beat with the i.f. picture carrier to give a spurious signal on or near the i.f. sound carrier, even though the interfering signal is not actually in the nominal passband of the i.f. amplifier.

There is a type of i.f. interference unique to the 144-Mc. band in localities where certain u.h.f. TV channels are in operation, affecting only those TV receivers in which double-conversion type plug-in u.h.f. tuning strips are used. The design of these strips involves a first intermediate frequency that varies with the TV channel to be received and, depending on the particular strip design, this first i.f. may be in

or close to the 144-Mc. amateur band. Since there is comparatively little selectivity in the TV signal-frequency circuits ahead of the first i.f., a signal from a 144-Mc. transmitter will "ride into" the i.f., even when the receiver is at a considerable distance from the transmitter. The channels that can be affected by this type of i.f. interference are:

<p><i>Receivers with 21-Mc. second i.f.</i></p> <p>Channels 14-18, inc. Channels 41-48, inc. Channels 69-77, inc.</p>	<p><i>Receivers with 41-Mc. second i.f.</i></p> <p>Channels 20-25, inc. Channels 51-58, inc. Channels 82 and 83.</p>
---	--

If the receiver is not close to the transmitter, a trap of the type shown in Fig. 23-31 will be effective. However, if the separation is small the 144-Mc. signal will be picked up directly on the receiver circuits and the best solution is to readjust the strip oscillator so that the first i.f. is moved to a frequency not in the vicinity of the 144-Mc. band. This has to be done by a competent technician.

I.f. interference is easily identified since it occurs on all channels—although sometimes the intensity varies from channel to channel—and the cross-hatch pattern it causes will rotate when the receiver's fine-tuning control is varied. When the interference is caused by a harmonic, overloading, or cross modulation, the structure of the interference pattern does not change (its intensity may change) as the fine-tuning control is varied.

### High-Pass Filters

In all of the above cases the interference can be eliminated if the fundamental signal strength can be reduced to a level that the receiver can handle. To accomplish this with signals on bands below 30 Mc., the most satisfactory device is a high-pass filter having a cut-off frequency between 30 and 54 Mc., installed at the tuner input terminals of the receiver. Circuits

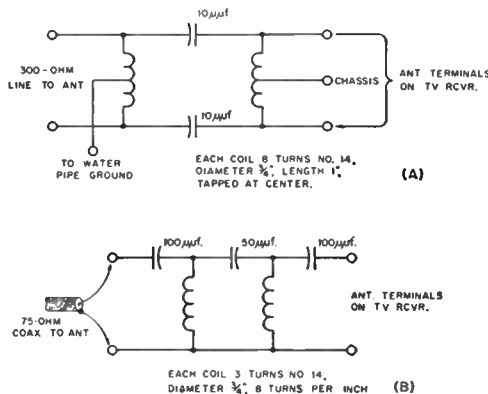

Fig. 23-29—High-pass filters for installation at the TV receiver antenna terminals. A—balanced filter for 300-ohm line, B—for 75-ohm coaxial line. Important: Do not use a direct ground on the chassis of a transformerless receiver. Ground through a 0.001-μf. mica capacitor.

that have proved effective are shown in Figs. 23-29 and 23-30. Fig. 23-30 has one more section than the filters of Fig. 23-29 and as a consequence has somewhat better cut-off characteristics. All the circuits given are designed to have little or no effect on the TV signals but will attenuate all signals lower in frequency than about 40 Mc. These filters preferably should be constructed in some sort of shielding container, although shielding is not always necessary. The dashed lines in Fig. 23-30 show how individual filter coils can be shielded from each other. The capacitors can be tubular ceramic units centered in holes in the partitions that separate the coils.

Simple high-pass filters cannot always be applied successfully in the case of 50-Mc. transmissions, because they do not have sufficiently-sharp cut-off characteristics to give both good attenuation at 50-54 Mc. and no attenuation above 54 Mc. A more elaborate design capable of giving the required sharp cut-off has been described (Ladd, "50-Mc. TVI—Its Causes and Cures," *QST*, June and July, 1954). This article

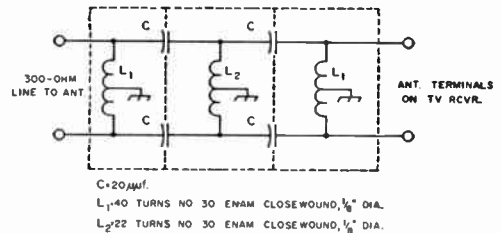

Fig. 23-30—Another type of high-pass filter for 300-ohm line. The coils may be wound on 1/8-inch diameter plastic knitting needles. Important: Do not use a direct ground on the chassis of a transformerless receiver. Ground through a 0.001-μf. mica capacitor.

also contains other information useful in coping with the TVI problems peculiar to 50-Mc. operation. As an alternative to such a filter, a high-Q wave trap tuned to the transmitting frequency may be used, suffering only the disadvantage that it is quite selective and therefore will protect a receiver from overloading over only a small range of transmitting frequencies in the 50-Mc. band. A trap of this type using quarter-wave sections of Twin-Lead is shown in Fig. 23-31. These "suck-out" traps, while absorbing energy at the frequency to which they are tuned, do not affect the receiver operation otherwise. The assembly should be slid along the TV antenna lead-in until the most effective position is found, and then fastened securely in place with Scotch Tape. An insulated tuning tool should be used for adjustment of the trimmer capacitor, since it is at a "hot" point and will show considerable body-capacitance effect.

High-pass filters are available commercially at moderate prices. In this connection, it should be understood by all parties concerned that while an amateur is responsible for harmonic radiation from his transmitter, it is no part of his



Fig. 23-31—Absorption-type wave trap using sections of 300-ohm line tuned to have an electrical length of  $\frac{1}{4}$  wavelength at the transmitter frequency. Approximate physical lengths (dimension A) are 40 inches for 50 Mc. and 11 inches for 144 Mc., allowing for the loading effect of the capacitance at the open end. Two traps are used in parallel, one on each side of the line to the receiver.

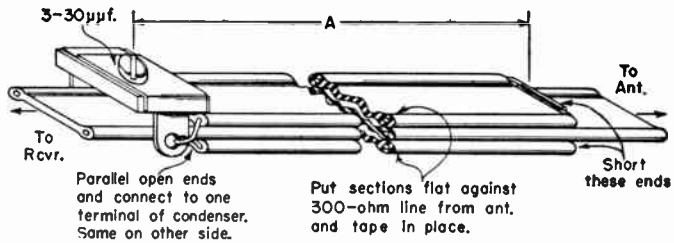

responsibility to pay for or install filters, wave traps, etc. that may be required at the receiver to prevent interference caused by his *fundamental* frequency. The set owner should be advised to get in touch with the organization from which he purchased the receiver or which services it, to make arrangements for proper installation. Proper installation usually requires that the filter be installed right at the input terminals of the r.f. tuner of the TV set and not merely at the external antenna terminals, which may be at a considerable distance from the tuner. The question of cost is one to be settled between the set owner and the organization with which he deals.

Some of the larger manufacturers of TV receivers have instituted arrangements for cooperating with the set dealer in installing high-pass filters at no cost to the receiver owner. FCC-sponsored TVI Committees, now operating in many cities, have all the information necessary for effectuating such arrangements. To find out whether such a committee is functioning in your community, write to the FCC field office having jurisdiction over your location. A list of the field offices is contained in *The Radio Amateur's License Manual*, published by ARRL.

If the fundamental signal is getting into the receiver by way of the line cord a line filter such as that shown in Fig. 23-1 may help. To be most effective it should be installed inside the receiver chassis at the point where the cord enters, making the ground connections directly to chassis at this point. It may not be so helpful if placed between the line plug and the wall socket unless the r.f. is actually picked up on the house wiring rather than on the line cord itself.

### Antenna Installation

Usually, the transmission line between the TV receiver and the actual TV antenna will pick up a great deal more energy from a nearby transmitter than the television receiving antenna itself. The currents induced on the TV transmission line in this case are of the "parallel" type, where the phase of the current is the same in both conductors. The line simply acts like two wires connected together to operate as one. If the receiver's antenna input circuit were perfectly balanced it would reject these "parallel" or "unbalance" signals and respond only to the

true transmission-line ("push-pull") currents; that is, only signals picked up on the actual antenna would cause a receiver response. However, no receiver is perfect in this respect, and many TV receivers will respond strongly to such parallel currents. The result is that the signals from a nearby amateur transmitter are much more intense at the first stage in the TV receiver than they would be if the receiver response were confined entirely to energy picked up on the TV antenna alone. This situation can be improved by using shielded transmission line—coax or, in the balanced form, "twinax"—for the receiving installation. For best results the line should terminate in a coax fitting on the receiver chassis, but if this is not possible the shield should be grounded to the chassis right at the antenna terminals.

The use of shielded transmission line for the receiver also will be helpful in reducing response to harmonics actually being radiated from the transmitter or transmitting antenna. In most receiving installations the transmission line is very much longer than the antenna itself, and is consequently far more exposed to the harmonic fields from the transmitter. Much of the harmonic pickup, therefore, is on the receiving transmission line when the transmitter and receiver are quite close together. Shielded line, plus relocation of either the transmitting or receiving antenna to take advantage of directive effects, often will result in reducing overloading, as well as harmonic pickup, to a level that does not interfere with reception.

### U.H.F. TELEVISION

Harmonic TVI in the u.h.f. TV band is far less troublesome than in the v.h.f. band. Harmonics from transmitters operating below 30 Mc. are of such high order that they would normally be expected to be quite weak; in addition, the components, circuit conditions and construction of low-frequency transmitters are such as to tend to prevent very strong harmonics from being generated in this region. However, this is not true of amateur v.h.f. transmitters, particularly those working in the 144-Mc. and higher bands. Here the problem is quite similar to that of the low v.h.f. TV band with respect to transmitters operating below 30 Mc.

There is one highly favorable factor in u.h.f.

TABLE 23-I

## Harmonic Relationship—Amateur V.H.F. Bands and U.H.F. TV Channels

<i>Amateur Band</i>	<i>Harmonic</i>	<i>Fundamental Freq. Range</i>	<i>Channel Affected</i>	<i>Amateur Band</i>	<i>Harmonic</i>	<i>Fundamental Freq. Range</i>	<i>Channel Affected</i>	
144 Mc.	4th	144.0-144.5	31	220 Mc.	3rd	220-220.67	45	
		144.5-146.0	32			220.67-222.67	46	
		146.0-147.5	33			222.67-224.67	47	
		147.5-148.0	34			224.67-225	48	
	5th	144.0-144.4	55		420 Mc.	2nd	220-221	82
		144.4-145.6	56				221-222.5	83
		145.6-146.8	57				420-421	75
		146.8-148	58				421-424	76
	6th	144-144.33	79	424-427	77			
		144.33-145.33	80	427-430	78			
		145.33-147.33	81	430-433	79			
		147.33-148	82	433-436	80			

TV that does not exist in the most of the v.h.f. TV band: If harmonics are radiated, it is possible to move the transmitter frequency sufficiently (within the amateur band being used) to avoid interfering with a channel that may be in use in the locality. By restricting operation to a portion of the amateur band that will not result in harmonic interference, it is possible to avoid the necessity for taking extraordinary precautions to prevent harmonic radiation.

The frequency assignment for u.h.f. television consists of seventy 6-megacycle channels (Nos. 14 to 83, inclusive) beginning at 470 Mc. and ending at 890 Mc. The harmonics from amateur bands above 50 Mc. span the u.h.f. channels as shown in Table 23-I. Since the assignment plan calls for a minimum separation of six channels between any two stations in one locality, there is ample opportunity to choose a fundamental frequency that will move a harmonic out of range of a local TV frequency.

### COLOR TELEVISION

The color TV signal includes a subcarrier spaced 3.58 megacycles from the regular picture carrier (or 4.83 Mc. from the low edge of the channel) for transmitting the color information. Harmonics which fall in the color subcarrier region can be expected to cause break-up of color in the received picture. This modifies the chart of Fig. 23-3 to introduce another "severe" region centering around 4.8 Mc. measured from the low-frequency edge of the channel. Hence with color television reception there is less opportunity to avoid harmonic interference by choice of operating frequency. In other respects the problem of eliminating interference is the same as with black-and-white television.

### INTERFERENCE FROM TV RECEIVERS

The TV picture tube is swept horizontally by the electron beam 15,750 times per second, using a wave shape that has very high harmonic content. The harmonics are of appreciable amplitude even at frequencies as high as 30 Mc., and when radiated from the receiver can cause

considerable interference to reception in the amateur bands. While measures to suppress radiation of this nature are required by FCC in current receivers, many older sets have had no such treatment. The interference takes the form of rather unstable, a.c.-modulated signals spaced at intervals of 15.75 kc.

Studies have shown that the radiation takes place principally in three ways, in order of their importance: (1) from the a.c. line, through stray coupling to the sweep circuits; (2) from the antenna system, through similar coupling; (3) directly from the picture tube and sweep-circuit wiring. Line radiation often can be reduced by bypassing the a.c. line cord to the chassis at the point of entry, although this is not completely effective in all cases since the coupling may take place outside the chassis beyond the point where the bypassing is done. Radiation from the antenna is usually suppressed by installing a high-pass filter on the receiver. The direct radiation requires shielding of high-potential leads and, in some receivers, additional bypassing in the sweep circuit; in severe cases, it may be necessary to line the cabinet with screening or similar shielding material.

Incidental radiation of this type from TV and broadcast receivers, when of sufficient intensity to cause serious interference to other radio services (such as amateur), is covered by Part 15 of the FCC rules. When such interference is caused, the user of the receiver is obligated to take steps to eliminate it. The owner of an offending receiver should be advised to contact the source from which the receiver was purchased for appropriate modification of the receiving installation. TV receiver dealers can obtain the necessary information from the set manufacturer.

It is usually possible to reduce interference very considerably, without modifying the TV receiver, simply by having a good amateur-band receiving installation. The principles are the same as those used in reducing "hash" and other noise — use a good antenna, such as the

transmitting antenna, for reception; install it as far as possible from a.c. circuits; use a good feeder system such as a properly balanced two-wire line or coax with the outer conductor grounded; use coax input to the receiver, with a matching circuit if necessary; and check the receiver to make sure that it does not pick up signals or noise with the antenna disconnected.

### TRANSMITTING ANTENNA CONSIDERATIONS

When a well-shielded transmitter is used in conjunction with an effective low-pass filter, and there is no incidental rectification in the area, it is impossible to have "harmonic-type" TVI, regardless of the type of transmitting antenna. However, the type of transmitting antenna in use can be responsible for "fundamental-overload" TVI.

To minimize the chances of TVI, the trans-

mitting antenna should be located as far as possible from the receiving antenna. The chances of fundamental overload at the television receiver are reduced when a horizontal transmitting antenna or beam is mounted higher than the TV antenna. Other things being equal, fundamental overload is more likely to occur with a vertical transmitting antenna than with a horizontal one, because the vertical antenna has a stronger field at a low angle. If a ground-plane antenna can be located well above the height of the TV receiving antenna, there is less likelihood of fundamental overload than when it is at the same height or below the television antenna.

The s.w.r. on the line to the transmitting antenna has no effect on TVI. However, when the line to the antenna passes near the TV antenna, radiation from the line can be a source of TVI. Methods for minimizing radiation from the line are discussed in the chapter on transmission lines.

# Operating a Station

The enjoyment of our hobby comes mostly from the operation of our station once we have finished its construction. Upon the *station* and its *operation* depend the communication records that are made. The standing of individuals as amateurs and respect for the capabilities of the whole institution of amateur radio depend to a considerable extent on the practical communications established by amateurs, the aggregate of all our station efforts.

An operator with a slow, steady, clean-cut method of sending has a big advantage over the poor operator. The technique of speaking in connected thoughts and phrases is equally important for the voice operator. Good sending is partly a matter of practice but patience and judgment are just as important qualities of an operator as a good "fist."

Operating knowledge embracing standard procedures, development of skill in employing c.w. to expand the station range and operating effectiveness at minimum power levels and some net know-how are all essentials in achieving a triumphant amateur experience with top station records, personal results, and demonstrations of what our stations can do in practical communications.

## OPERATING COURTESY AND TOLERANCE

Normal operating interests in amateur radio vary considerably. Public service is of course the most important activity (more about this later) and other interests include rag-chewing, handling casual message traffic, working DX, contest operating, award-seeking, or experimenting on the air. Inevitably, amateurs in pursuit of their own favorite activity often get into each other's hair.

Interference is one of the things we amateurs have to live with. However, we can conduct our operating in a way designed to alleviate it as

much as possible. *Before putting the transmitter on the air, listen on your own frequency.* If you hear stations engaged in communication on that frequency, stand by until you are sure no interference will be caused by your operations, or *shift to another frequency.* No amateur or any group of amateurs has any *exclusive* claim to any frequency in any band. We must work together, each respecting the rights of others. Remember, those other chaps can cause you as much interference as you cause them, sometimes more!

In this chapter we'll recount some fundamentals of operating success, cover major procedures for successful general work and include proper forms to use in message handling and other fields. Note also the sections on special activities, awards and organization. These permit us all to develop through our organization more success together than we could ever attain by separate uncoordinated efforts.

## C.W. PROCEDURE

The best operators, *both* those using voice and c.w., observe certain operating procedures regarded as "standard practice."

1) *Calls.* Calling stations may call efficiently by transmitting the call signal of the station called three times, the letters DE, followed by one's own station call sent three times. (Short calls with frequent "breaks" to listen have proved to be the best method.) Repeating the call of the station called three times and signing not more than two or three times has proved excellent practice, thus: W0BY W0BY W0BY DE W1AW W1AW AR.

*CQ.* The general-inquiry call (CQ) should be sent not more than five times without interspersing one's station identification. The length of repeated calls is *carefully limited* in intelligent amateur operating. (CQ is not to be used when testing or when the sender is not expecting or looking for an answer. Never send a CQ "blind." Listen on the transmitting frequency first.)

The directional CQ: The best way to find some specific state, country or place is to *listen* and *call* when what you are looking for is heard. Directional or selective CQ's just cause unnecessary interference. However, occasionally they work, and it is preferable to call a selective CQ than to call a general one and not answer if the station answering is not what you want. Never send a CQ, or any other transmission, "blind." Listen on the frequency first. *Example:* A station looking for Vermont might call: CQ VT CQ VT CQ VT DE W4IA W4IA W4IA K.





Hams who do not raise stations readily may find that their sending is poor, their calls ill-timed or their judgment in error. When conditions are right to bring in signals from the desired locality, you can call them. Short calls, at about the same frequency, with breaks to listen, will raise stations with minimum time and trouble.

2) *Answering a Call*: Call three times (or less); send DE; sign three times (or less); after contact is established decrease the use of the call signals of both stations to *once or twice*. When a station receives a call but does not receive the call letters of the station calling, QRZ? may be used. It means "By whom am I being called?" QRZ should not be used in place of CQ.

3) *Ending Signals and Sign-Off*: The proper use of AR, K, KN, SK and CL ending signals is as follows:

**AR**—End of transmission. Recommended after call to a specific station before contact has been established.

*Example*: W6ABC W6ABC W6ABC  
DE W9LMN W9LMN AR. Also at the end of transmission of a radiogram, immediately following the signature, preceding identification.

**K**—Go ahead (any station). Recommended after CQ and at the end of each transmission during QSO when there is no objection to others breaking in.

*Example*: CQ CQ CQ DE W1ABC W1ABC  
K or W9XYZ DE W1ABC K.

**KN**—Go ahead (specific station), all others keep out. Recommended at the end of each transmission during a QSO, or after a call, when calls from other stations are not desired and will not be answered.

*Example*: W4FGH DE EL4A KN.

**SK**—End of QSO or communication. Recommended before signing *last* transmission at end of a QSO.

*Example*: ... SK W8LMN DE W5BCD.

**CL**—I am closing station. Recommended when a station is going off the air, to indicate that it will not listen for any further calls.

*Example*: ... SK W7HIJ DE W2JKL  
CL.

4) *Testing*. When it is necessary for a station to make test signals they must not continue for more than 10 seconds and must be composed of a series of VVV followed by the call sign of the station emitting the test signals. *Always listen first* to find a clear spot if possible, to avoid causing unwarranted QRM of a QSO in progress.

5) *Receipting* for conversation or traffic: Never receipt for a transmission until it has been entirely received. "R" means "transmission received as sent." Use R *only* when *all* is received correctly.

6) *Repeats*. When part of a transmission is lost, a call should be followed by correct abbreviations to ask for repeats. When a few words on the end of a transmission are lost, the *last word*

*received correctly* is given after ?AA, meaning "all after." When a few words at the beginning of a transmission are lost, ?AB for "all before" a stated word should be used. The quickest way to ask for a fill in the middle of a transmission is to send the last word received correctly, a question mark, then the next word received correctly. Or send "?BN [word] and [word]."

Do not send words twice (QSZ) unless it is requested. Send single. Do not fall into the bad habit of sending double *without a request* from fellows you work. Don't say "QRM" or "QRN" when you mean "QRS." Don't CQ unless there is definite reason for so doing. When sending CQ, use judgment.

### General Practices

When a station has receiving trouble, the operator asks the transmitting station to "QSV." The letter "R" is often used in place of a decimal point (e.g., "3R5 Mc.") or the colon in time designation (e.g., "2R30 PM"). A long dash is sometimes sent for "zero."

The law concerning superfluous signals should be noted. If you *must* test, disconnect the antenna system and use an equivalent "dummy" antenna. Send your call frequently when operating. Pick a time for adjusting the station apparatus when few stations will be bothered.

The up-to-date amateur station uses "break-in." For best results send at a medium speed. Send evenly with proper spacing. The standard-type telegraph key is best for all-round use. Regular daily practice periods, two or three periods a day, are best to acquire real familiarity and proficiency with code.

No excuse can be made for "garbled" copy. Operators should copy what is sent and refuse to acknowledge a whole transmission until every word has been received correctly. *Good operators do not guess*. "Swing" in a fist is *not* the mark of a good operator. Unusual words are sent twice, the word repeated following the transmission of "?". If not *sure*, a good operator systematically asks for a fill or repeat. Sign your call frequently, interspersed with calls, and at the end of all transmissions.

### On Good Sending

Assuming that an operator has learned sending properly, and comes up with a precision "fist" — not fast, but clean, steady, making well-formed rhythmical characters and spacing beautiful to listen to — he then becomes subject to outside pressures to his own possible detriment in everyday operating. He will want to "speed it up" because the operator at the other end is going faster, and so he begins, unconsciously, to run his words together or develops a "swing."

Perhaps one of the easiest ways to get into bad habits is to do too much playing around with special keys. Too many operators spend only enough time with a straight key to acquire "passable" sending, then subject their newly-developed "fists" to the entirely different movements of bugs, side-swipers, electronic keys, or

what-have-you. All too often, this results in the ruination of what might have become a very good "fist."

Think about your sending a little. Are you satisfied with it? You should not be—ever. Nobody's sending is perfect, and therefore every operator should continually strive for improvement. Do you ever run letters together — like Q for MA, or P for AN — especially when you are in a hurry? Practically everybody does at one time or another. Do you have a "swing"? Any recognizable "swing" is a deviation from perfection. Strive to send like tape sending; copy a WIAW Bulletin and try to send it with the same spacing using a local oscillator on a subsequent transmission.

Check your spacing in characters, between characters and between words occasionally by making a recording of your fist on an inked tape recorder. This will show up your faults as nothing else will. Practice the correction of faults.

### USING A BREAK-IN SYSTEM

Break-in avoids unnecessarily long calls, prevents QRM, gives more communication per hour of operating. Brief calls with frequent short pauses for reply can approach (but not equal) break-in efficiency.

A separate receiving antenna facilitates break-in operation. It is only necessary with break-in to pause just a moment with the key up (or to cut the carrier momentarily and pause in a phone conversation) to listen for the other station. The click when the carrier is cut off is as effective as the word "break."

*C.w. telegraphy* break-in is usually simple to arrange. With break-in, ideas and messages to be transmitted can be pulled right through the holes in the QRM. Snappy, efficient amateur work with break-in usually requires a separate receiving antenna and arrangement of the transmitter and receiver to eliminate the necessity for throwing switches between transmissions.

In calling, the transmitting operator sends the letters "BK" at intervals during his call so that stations hearing the call may know that break-in is in use and take advantage of the fact. *He pauses at intervals* during his call, to listen for a moment for a reply. If the station being called does not answer, the call can be continued.

With a tap of the key, the man on the receiving end can interrupt (if a word is missed). The other operator is constantly monitoring, awaiting just such directions. It is not necessary that you have perfect facilities to take advantage of break-in when the stations you work are break-in-equipped. After an invitation to *break* is given (and at each pause) press your key—and contact can start *immediately*.

### VOICE OPERATING

The use of proper procedure to get best results is just as important as in using code. In telegraphy words must be spelled out letter by letter. It is therefore but natural that abbreviations and shortcuts should have come into widespread use.

#### Voice-Operating Hints

- 1) Listen before calling.
- 2) Make short calls with breaks to listen. Avoid long CQs; do not answer over-long CQs.
- 3) Use push-to-talk or voice control. Give essential data concisely in first transmission.
- 4) Make reports honest. Use definitions of strength and readability for reference. Make your reports informative and useful. Honest reports and full word description of signals save amateur operators from FCC trouble.
- 5) Limit transmission length. Two minutes or less will convey much information. When three or more stations converse in round tables, brevity is essential.
- 6) Display sportsmanship and courtesy. Bands are congested . . . make transmissions meaningful . . . give others a break.
- 7) Check transmitter adjustment . . . avoid a.m. overmodulation and splatter. On s.s.b. check carrier balance carefully. Do not radiate when moving v.f.o. frequency or checking n.f.m. swing. Use receiver b.f.o. to check stability of signal. Complete testing before busy hours!

In voice work, however, abbreviations are not necessary, and should have less importance in our operating procedure.

The letter "K" has been agreed to in telegraphic practice so that the operator will not have to pound out the separate letters that spell the words "go ahead." The voice operator can say the words "go ahead" or "over," or "come in please."

One laughs on c.w. by spelling out HI. On phone use a laugh when one is called for. Be natural as you would with your family and friends.

The matter of reporting *readability* and *strength* is as important to phone operators as to those using code. With telegraph nomenclature, it is necessary to spell out words to describe signals or use abbreviated signal reports. But on voice, we have the ability to "say it with words." "Readability four, strength eight" is the best way to give a quantitative report. Reporting can be done so much more meaningfully with ordinary words: "You are weak but in the clear and I can understand you, so go ahead," or "Your signal is strong but you are buried under local interference." Why not say it with words?

#### Voice Equivalents to Code Procedure

Voice	Code	Meaning
Go ahead; over	K	Self-explanatory
Wait; stand by	AS	Self-explanatory
Received	R	Receipt for a correctly-transcribed message or for "solid" transmission with no missing portions

#### Phone-Operating Practice

Efficient voice communication, like good c.w. communication, demands good operating. Adherence to certain points "on getting results" will go a long way toward improving our phone-band operating conditions.

Use *push-to-talk technique*. Where possible arrange on-off switches, controls or voice-con-

trolled break-in for fast back-and-forth exchanges. This will help reduce the length of transmissions and keep brother amateurs from calling you a "monologist" — a guy who likes to hear himself talk!

*Listen with care.* Keep noise and "backgrounds" out of your operating room to facilitate good listening. It is natural to answer the strongest signal, but take time to listen and give some consideration to the *best* signals, regardless of strength. Every amateur cannot run a kilowatt transmitter, but there is no reason why every amateur cannot have a signal of good quality, and utilize uniform operating practices to aid in the understandability and ease of his own communications.

*Interpose your call regularly and at frequent intervals.* Three short calls are better than one long one. In calling CQ, one's call should certainly appear at least once for every five or six CQs. Calls with frequent breaks to listen will save time and be most productive of results. In identifying, always transmit your *own* call last. *Don't* say "This is W1ABC standing by for W2DEF"; say "W2DEF, this is W1ABC, over." FCC regulations show the call of the transmitting station sent last.

*Monitor your own frequency.* This helps in timing calls and transmissions. Transmit only when the frequency is clear and there is a chance of being copied successfully—not when you are merely "more QRM." Timing transmissions is an art to cultivate.

*Keep modulation constant.* By turning the gain "wide open" you are subjecting anyone listening to the diversion of whatever noises are present in or near your operating room, to say nothing of the possibility of feedback, echo due to poor acoustics, and modulation excesses due to sudden loud noises. Speak near the microphone, and don't let your gaze wander all over the station causing sharply-varying input to your speech amplifier; at the same time, keep far enough from the microphone so your signal is not modulated by your breathing. Change distance to the microphone or gain only as necessary to insure uniform transmitter performance without splatter or distortion.

*Make connected thoughts and phrases.* Don't mix disconnected ideas or subjects. Ask questions consistently. Pause for a moment and then get the answers.

*Have a pad of paper handy.* It is convenient and desirable to jot down questions as they come, in order not to miss any. It will help you to make intelligent to-the-point replies.

*Steer clear of inanities and soap-opera stuff.* Our amateur radio and personal reputation as serious communications workers depend on us.

*Avoid repetition.* Don't repeat back what the other fellow has just said. Too often we hear: "Okay on your new antenna there, okay on receiving me okay, okay on the trouble you're having with your receiver, okay on the company who just came in with some ice cream and cake, okay ... [etc.]." Just say you received everything

O.K. Don't try to prove it.

*Use phonetics only as required.* When clarifying genuinely doubtful expressions and in getting your call identified positively we suggest use of the ARRL Phonetic List or the International Civil Aviation Organization list. The ARRL list was designed for amateur use (no confusion between phonetics and station location). Whichever you learn, don't overdo its use.

The speed of radiotelephone transmission (with perfect accuracy) depends almost entirely upon the skill of the two operators involved. One must learn to speak at a rate allowing perfect understanding as well as permitting the receiving operator to copy down the message text, if that is necessary. Because of the similarity of many English speech sounds, the use of word lists has been found necessary. All voice-operated stations should use a *standard* list as needed to identify call signals or unfamiliar expressions.

### WORD LISTS FOR VOICE WORK

ARRL	ICAO	ARRL	ICAO
A — ADAM	ALFA	N — NANCY	NOVEMBER
B — BAKER	BRavo	O — OTTO	OSCAR
C — CHARLIE	CHARLIE	P — PETER	PAPA
D — DAVID	DELTA	Q — QUEEN	QUEBEC
E — EDWARD	ECHO	R — ROBERT	ROMEO
F — FRANK	FOXTROT	S — SUSAN	SIERRA
G — GEORGE	GOLF	T — THOMAS	TANGO
H — HENRY	HOTEL	U — UNION	UNIFORM
I — IDA	INDIA	V — VICTOR	VICTOR
J — JOHN	JULIETT	W — WILLIAM	WHISKEY
K — KING	KILO	X — X-RAY	X-RAY
L — LEWIS	LIMA	Y — YOUNG	YANKEE
M — MARY	MIKE	Z — ZEBRA	ZULU

Example: W1AW . . . W 1 ADAM WILLIAM . . . W1AW

*Round Tables.* The round table has many advantages if run properly. It clears frequencies of interference, especially if all stations involved are on the same frequency, while the enjoyment value remains the same, if not greater. By use of push-to-talk, the conversation can be kept lively and interesting, giving each station operator ample opportunity to participate without waiting overlong for his turn.

Round tables can become very unpopular if they are not conducted properly. The monologist, off on a long spiel about nothing in particular, cannot be interrupted; *make your transmissions short and to the point.* "Butting in" is discourteous and unsportsmanlike; *don't enter a round table, or any contact between two other amateurs, unless you are invited.* It is bad enough trying to copy through prevailing interference without the added difficulty of poor voice quality; *check your transmitter adjustments frequently.* In general, follow the precepts as hereinbefore outlined for the most enjoyment in round tables as well as any other form of radiotelephone communication.

### WORKING DX

Most amateurs at one time or another make "working DX" a major aim. As in every other phase of amateur work, there are right and wrong ways to go about getting best results in

working foreign stations, and it is the intention of this section to outline a few of them.

The ham who has trouble raising DX stations readily may find that poor transmitter efficiency is not the reason. He may find that his sending is poor, or his calls ill-timed, or his judgment in error. When conditions are right to bring in the DX, and the receiver sensitive enough to bring in several stations from the desired locality, the way to work DX is to use the appropriate frequency and timing and *call these stations*, as against the common practice of calling "CQ DX."

The call CQ DX means slightly different things to amateurs in different bands:

a) On v.h.f., CQ DX is a general call ordinarily used only when the band is open, under favorable "skip" conditions. For v.h.f. work, such a call is used for looking for new states and countries, also for distances beyond the customary "line-of-sight" range on most v.h.f. bands.

b) CQ DX on our 7-, 14-, 21- and 28-Mc. bands may be taken to mean "General call to any foreign station." The term "foreign station" usually refers to any station in a foreign continent. (*Experienced amateurs in the U. S. A. and Can-*

ada do *not* use this call, but *answer* such calls made by foreign stations.)

c) CQ DX used on 3.5 Mc. under winter-night conditions may be used in this same manner. At other times, under average 3.5-Mc. propagation conditions, the call may be used in domestic work when looking for new states or countries in one's own continent, usually applying to stations located over 1000 miles distant from you.

The way to work DX is not to use a CQ call at all (in our continent). Instead, use your best tuning skill — and listen — and listen — and listen. *You have to hear them before you can work them.* Hear the desired stations first; time your calls well. Use your utmost skill. A sensitive receiver is often more important than the power input in working foreign stations. If you can hear stations in a particular country or area, chances are that you will be able to work someone there.



"...DO A LOT OF SNOODING"

#### DX OPERATING CODE

(For W/VE Amateurs)

Some amateurs interested in DX work have caused considerable confusion and QRM in their efforts to work DX stations. The points below, if observed by all W/VE amateurs, will go a long way toward making DX more enjoyable for everybody.

1. Call DX only after he calls CQ, QRZ?, signs SK, or phone equivalents thereof
2. Do *not* call a DX station:
  - a. On the frequency of the station he is working until you are *sure* the QSO is over. This is indicated by the ending signal SK on c.w. and any indication that the operator is listening, on phone
  - b. Because you hear someone else calling him
  - c. When he signs KN, AR, CL, or phone equivalents
  - d. Exactly on his frequency
  - e. After he calls a directional CQ, unless of course you are in the right direction or area.
3. Keep within frequency-band limits. Some DX stations operate outside. Perhaps they can get away with it, but you cannot
4. Observe calling instructions of DX stations. "10U" means call ten kc. *up* from his frequency, "15D" means 15 kc. *down*, etc.
5. Give honest reports. Many foreign stations *depend* on W and VE reports for adjustment of station and equipment
6. Keep your signal clean. Key clicks, chirps, hum or splatter give you a bad reputation and may get you a citation from FCC.
7. *Listen* for and *call* the station you want. Calling CQ DX is not the best assurance that the *rare* DX will reply.
8. When there are several W or VE stations waiting to work a DX station, avoid asking him to "listen for a friend." Let your friend take his chances with the rest. Also avoid engaging DX stations in rag-chews against their wishes.

One of the most effective ways to work DX is to know the operating habits of the DX stations sought. Doing too much transmitting on the DX bands is not the way to do this. Again, *listening* is effective. Once you know the operating habits of the DX station you are after you will know when and where to call, and when to remain silent waiting your chance.

Some DX stations indicate where they will tune for replies by use of "10U" or "15D." (See point 4 of the DX Operating Code.) In voice work the overseas operator may say "listening on 14,225 kc." or "tuning upward from 28,500 kc." Many a DX station will not reply to a call on his exact frequency.

ARRL has recommended some operating procedures to DX stations aimed at controlling some of the thoughtless operating practices sometimes used by W/VE amateurs. A copy of these recommendations (Operating Aid No. 5) can be obtained free of charge from ARRL Headquarters.

In any band, particularly at line-of-sight frequencies, when directional antennas are used, the directional CQ such as CQ W5, CQ north, etc., is the preferable type of call. Mature amateurs agree that CQ DX is a wishful rather than a practical type of call for most stations in the North Americas looking for foreign contacts. Ordinarily, it is a cause of unnecessary QRM.

Conditions in the transmission medium often make it possible for the signals from low-powered transmitters to be received at great distances. In general, the higher the frequency band the less important power considerations become, for occasional DX work. This accounts in part



DATE TIME	STATION CALLED	CALLED BY	MIS FREQ. OR DIAL	MIS SIGNALS RST	MV SIGNALS RST	FREQ. MC	EMIS- SION TYPE	POWER INPUT WATTS	TIME OF ENDING QSO	OTHER DATA
11-16-53										
1815	WØTQD	X	3.65	589	569X	3.5	A1	250	1843	Tfc-rec'd 6, sent 10
1920	CQ	X				7	"	"		
1921	X	W4TWI	7.16	369	579		"	"	1932	Vy heavy QRM on me
21 25	W8UKS	X	3.83	59	47	3.9	A3	100	2205	Sam
11-18-53										
0705	VK4EL	X	14.03			14	A1	250		Answered a W6
0709	ZL2ACV	X	14.07	339	559X		"	"	0720	
0721	X	KA2KW	14.07	469X	349		"	"	0733	First KA
0736	CQ	X					"	"		
0737	X	W6TH	14.01	589	589C		"	"	0812	

**KEEP AN ACCURATE AND COMPLETE STATION LOG AT ALL TIMES. F.C.C. REQUIRES IT.**

A page from the official ARRL log is shown above, answering every Government requirement in respect to station records. Bound logs made up in accord with the above form can be obtained from Headquarters for a nominal sum or you can prepare your own, in which case we offer this form as a suggestion. The ARRL log has a special wire binding and lies perfectly flat on the table.

for the relative popularity of the 14-, 21- and 28-Mc. bands among amateurs who like to work DX.

### KEEPING AN AMATEUR STATION LOG

The FCC requires every amateur to keep a complete station operating record. It may also contain records of experimental tests and adjustment data. A stenographer's notebook can be ruled with vertical lines in any form to suit the user. The Federal Communications Commission requirements are that a log be maintained that shows (1) the date and time of *each* transmission, (2) *all calls* and transmissions made (whether

two-way contacts resulted or not), (3) the input power to the last stage of the transmitter, (4) the frequency band used, (5) the time of *ending* each QSO and the operator's identifying signature for responsibility for each session of operating. Messages may be written in the log or separate records kept—but record must be retained for one year as required by the FCC. For the convenience of amateur station operators ARRL stocks both logbooks and message blanks, and if one uses the official log he is sure to comply fully with the Government requirements if the precautions and suggestions included in the log are followed.

## PUBLIC SERVICE OPERATING

Amateurs interested in rendering public service in operating are "closing ranks" in the Amateur Radio Public Service Corps, a new name for a very old concept. ARPSC combines two time-honored ARRL operating entities, the Amateur Radio Emergency Corps (AREC) and the National Traffic System (NTS); the former now becomes the "Emergency Division" or ARPSC while the latter becomes the "Traffic Division."

Practically speaking, little change has been made in either the AREC or the NTS. Both continue as before, AREC to provide communications in time of emergency, NTS to handle amateur traffic on a daily basis. The big difference is that AREC now conducts regular liaison with nets of NTS so that in an emergency long-haul traffic can be handled with efficiency and dispatch through the System's facilities; and that NTS now embraces an emergency communication plan making provision for special extended operation of the system during time of emergency.

The detailed workings of the AREC and NTS are fully explained in separate ARRL publications available without charge to amateurs interested. This section of the Handbook will be re-

stricted to basics regarding each and some details of message-handling and emergency operations.

### MESSAGE HANDLING

Amateur operators in the United States and a few other countries enjoy a privilege not available to amateurs in most countries—that of handling third-party message traffic. In the early history of amateur radio in this country, some amateurs who were among the first to take advantage of this privilege formed an extensive relay organization which became the ARRL.

Thus, amateur message-handling has had a long and honorable history and, like most services, has gone through many periods of development and change. Those amateurs who handled traffic in 1914 would hardly recognize it the way some of us do it today, just as equipment in those days was far different from that in use now. Progress has been made and new methods have been developed in step with advancement in communication techniques of all kinds. Amateurs who handled a lot of traffic found that organized operating schedules were more effective than random relays, and as techniques advanced and

messages increased in number, trunk lines were organized, spot frequencies began to be used, and there came into existence a number of traffic nets in which many stations operated on the same frequency to effect wider coverage in less time with fewer relays; but the old methods are still available to the amateur who handles only an occasional message.

Although message handling is as old an art as is amateur radio itself, there are many amateurs who do not know how to handle a message and have never done so. As each amateur grows older and gains experience in the amateur service, there is bound to come a time when he will be called upon to handle a written message, during a communications emergency, in casual contact with one of his many acquaintances on the air, or as a result of a request from a non-amateur friend. Regardless of the occasion, if it comes to you, you will want to rise to it! Considerable embarrassment is likely to be experienced by the amateur who finds he not only does not know the form in which the message should be prepared, but does not know how to go about putting it on the air.

Traffic work need not be a complicated or time-consuming activity for the casual or occasional message-handler. Amateurs may participate in traffic work to whatever extent they wish, from an occasional message now and then to becoming a part of organized traffic systems. This chapter explains some principles so the reader may know where to find out more about the subject and may exercise the message-handling privilege to best effect as the spirit and opportunity arise.

### Responsibility

Amateurs who originate messages for transmission or who receive messages for relay or delivery should first consider that in doing so they are accepting the responsibility of clearing the message from their station on its way to its destination in the shortest possible time. Forty-eight hours after filing or receipt is the generally-accepted rule among traffic-handling amateurs, but it is obvious that if every amateur who relayed the message allowed it to remain in his station this long it might be a long time reaching its destination. Traffic should be relayed or delivered as quickly as possible.

### Message Form

Once this responsibility is realized and accepted, handling the message becomes a matter of following generally-accepted standards of form and transmission. For this purpose, each message is divided into four parts: the preamble, the address, the text and the signature. Some of these parts themselves are subdivided. It is necessary in preparing the message for transmission and in actually transmitting it to know not only what each part is and what it is for, but to know in what *order* it should be transmitted, and to know the various procedure signals used with it when sent by c.w. If you are going to send a message, you may as well send it right.

Standardization is important! There is a great deal of room for expressing originality and individuality in amateur radio, but there are also times and places where such expression can only cause confusion and inefficiency. Recognizing the need for standardization in message form and message transmitting procedures, ARRL has long since recommended such standards, and most traffic-interested amateurs have followed them. In general, these recommendations, and the various changes they have undergone from

THE AMERICAN RADIO RELAY LEAGUE					
RADIOGRAM					
TO	FROM	STATION	DATE	TIME	FILE
		EL CAJON CALIF	2330		APR 18
To: DANIEL JOHNSON 29 WEST MULBERRY ST CANTON OHIO					

PLEASE LET US KNOW YOUR PLANS FOR SUMMER VISIT STOP LOVE

RITA

REC'D	BY	FOR	FILED	DATE	TIME
SENT	98AC	CANTON OHIO	4/19	1910	158

Here is an example of a plain-language message in correct ARRL form. The preamble is always sent as shown: number, station of origin, check, place of origin, time filed, date.

year to year, have been at the request of amateurs participating in this activity, and they are completely outlined and explained in *Operating an Amateur Radio Station*, a copy of which is available upon request or by use of the coupon at the end of this chapter.

### Clearing a Message

The best way to clear a message is to put it into one of the many organized traffic networks, or to give it to a station who can do so. There are many amateurs who make the handling of traffic their principal operating activity, and many more still who participate in this activity to a greater or lesser extent. The result is a system of traffic nets which spreads to all corners of the United States and covers most U. S. possessions and Canada. Once a message gets into one of these nets, regardless of the net's size or coverage, it is systematically routed toward its destination in the shortest possible time.

Amateurs not experienced in message handling should depend on the experienced message-handler to get a message through, if it is important; but the average amateur can enjoy operating with a message to be handled either through a local traffic net or by free-lancing. The latter may be accomplished by careful listening for an amateur station at desired points, directional CQs, use of the National Calling and Emergency frequencies, or by making and keeping a schedule with another amateur for regular work between specified points. He may well aim at learning and enjoying through doing. The joy and accomplishment in thus developing one's operating skill to

the peak of perfection has a reward all its own.

If you decide to "take the bull by the horns" and put the message into a traffic net yourself (and more power to you if you do!), you will need to know something about how traffic nets operate, and the special Q signals and procedure they use to dispatch all traffic with a maximum of efficiency. The frequency and operating time of the net in your section, or of other nets into which your message can go, is given in ARRL's Net Directory. This annually-revised publication is available on request. Listening for a few minutes at the time and frequency indicated should acquaint you with enough fundamentals to enable you to report into the net and indicate your traffic. From that time on you follow the instructions of the net control station, who will tell you when and to whom (and on what frequency, if different from the net frequency) to send your message. Since c.w. nets use the special "QN" signals, it is helpful to have a list of these before you (available from ARRL Hq., Operating Aid No. 9).

### Network Operation

About this time, you may find that you are enjoying this type of operating activity and want to know more about it and increase your proficiency. Many amateurs are happily "addicted" to traffic handling after only one or two brief exposures to it. Much traffic is at present being conducted by c.w., since this mode of communication seems to be popular for record purposes—but this does not mean that high code speed is a necessary prerequisite to working in traffic networks. There are many nets organized specifically for the slow-speed amateur, and most of the so-called "fast" nets are usually glad to slow down to accommodate slower operators.

It is a significant operating fact that code speed or word speed alone does *not* make for efficiency—sometimes the contrary! A high-speed operator who does not know procedure can "foul up" a net much more completely and more quickly than can a slow operator. It is a proven fact that a bunch of high-speed operators who are not "savvy" in net operation cannot accomplish as much during a specified period as an equal number of slow operators who *know* net procedure. Don't let low code speed deter you from getting into traffic work. Given a little time, your speed will reach the point where you can easily hold your own. Concentrate first on learning the net procedures.

Much traffic is also handled on phone. This mode is exceptionally well suited to short-range traffic work and requires knowledge of phonetics and procedure peculiar to voice operation. Procedure is of paramount importance on phone, since the public may be listening.

*Teamwork* is the theme of net operation. The net which functions most efficiently is the net in which all participants are thoroughly familiar with the procedure used, and in which operators refrain from transmitting except at the direction of the net control station, and do not occupy time

with extraneous comments, even the exchange of pleasantries. There is a time and place for everything. When a net is in session it should concentrate on handling traffic until all traffic is cleared. Before or after the net is the time for rag-chewing and discussion. Some details of net operation are included in *Operating an Amateur Radio Station*, mentioned earlier, but there is no substitute for actual participation.

### The National Traffic System

To facilitate and speed the movement of message traffic, there is in existence an integrated national system by means of which originated traffic can normally reach its destination area the same day the message is originated. This system uses the local section net as a basis. Each section net sends a representative to a "region" net (normally covering a call area) and each "region" net sends a representative to an "area" net (normally covering a time zone). After the area net has cleared all its traffic, its members then go back to their respective region nets, where they clear traffic to the various section net representatives. By means of connecting schedules between the area nets, traffic can flow both ways so that traffic originated on the West Coast reaches the East Coast with a maximum of dispatch, and vice versa. In general local section nets function at 1900, region nets at 1945, area nets at 2030 and the same or different regional personnel again at 2130. Some section nets conduct a late session at 2200 to effect traffic delivery the same night. Local standard time is referred to in each case.

The NTS plan somewhat spreads traffic opportunity so that casual traffic may be reported into nets for efficient handling one or two nights per week, early or late; or the ardent traffic man can operate in *both* early and late groups and in between to roll up impressive totals and speed traffic reliably to its destination. Old-time traffic men who prefer a high degree of organization and teamwork have returned to the traffic game as a result of the new system. Beginners have shown more interest in becoming part of a system nationwide in scope, in which *anyone* can participate. The National Traffic System has vast and intriguing possibilities as an amateur service. It is open to any amateur who wishes to participate.

The above is but the briefest résumé of what is of necessity a rather complicated arrangement of nets and schedules. Complete details of the System and its operation are available to anyone interested. Just drop a line to ARRL.

### EMERGENCY COMMUNICATION

One of the most important ways in which the amateur serves the public, thus making his existence a national asset, is by his preparation for and his participation in communications emergencies. Every amateur, regardless of the extent of his normal operating activities, should give some thought to the possibility of his being the only means of communication should his com-

munity be cut off from the outside world. It has happened many times, often in the most unlikely places; it has happened without warning, finding some amateurs totally unprepared; it can happen to *you*. Are you ready?

There are two principal ways in which any amateur can prepare himself for such an eventuality. One is to provide himself with equipment capable of operating on any type of emergency power (i.e., either a.c. or d.c.), and equipment which can readily be transported to the scene of disaster. Mobile equipment is especially desirable in most emergency situations.

Such equipment, regardless of how elaborate or how modern, is of little use, however, if it is not used properly and at the right times; and so another way for an amateur to prepare himself for emergencies, by no means less important than the first, is to *learn to operate efficiently*. There are many amateurs who feel that they know how to operate efficiently but who find themselves considerably handicapped at the crucial time by not knowing proper procedure, by being unable, due to years of casual amateur operation, to adapt themselves to snappy, abbreviated transmissions, and by being unfamiliar with message form and procedures. It is dangerous to overrate your ability in this; it is better to assume you have things to learn.

In general it can be said that there is more emergency equipment available than there are operators who know properly how to operate during emergency conditions, for such conditions require clipped, terse procedure with complete break-in on c.w. and fast push-to-talk on phone. The casual rag-chewing aspect of amateur radio, however enjoyable and worth-while in its place, must be forgotten at such times in

favor of the business at hand. There is only one way to gain experience in this type of operation, and that is by practice. During an emergency is no time for practice; it should be done beforehand, as often as possible, on a regular basis.

This leads up to the necessity for emergency organization and preparedness. ARRL has long recognized this necessity and has provided for it. The Section Communications Manager (whose address appears on page 6 of every issue of *QST*) is empowered to appoint certain qualified amateurs in his section for the purpose of coordinating emergency communication organization and preparedness in specified areas or communities. This appointee is known as an Emergency Coordinator for the city or town. One should be specified for each community. For coordination and promotion at section level a Section Emergency Coordinator arranges for and recommends the appointments of various Emergency Coordinators at activity points throughout the section. Emergency Coordinators organize amateurs in their communities according to local needs for emergency communication facilities.

The community amateurs taking part in the local organization are members of the Amateur Radio Emergency Corps (AREC). *All* amateurs are invited to register in the AREC, whether they are able to play an active part in their local organization or only a supporting role. Application blanks are available from your EC, SEC, SCM or direct from ARRL Headquarters. In the event that inquiry reveals no Emergency Coordinator appointed for your community, your SCM would welcome a recommendation either from yourself or from a radio club of which you are a member. By holding an amateur operator license, you have the respon-

#### Before Emergency

PREPARE yourself by providing a transmitter-receiver setup together with an emergency power source upon which you can depend.

TEST both the dependability of your emergency equipment and your own operating ability in the annual ARRL Simulated Emergency Test and the several annual on-the-air contests, especially Field Day.

REGISTER your facilities and your availability with your local ARRL Emergency Coordinator. If your community has no EC, contact your local civic and relief agencies and explain to them what the Amateur Service offers the community in time of disaster.

#### In Emergency

LISTEN before you transmit. Never violate this principle.

REPORT at once to your Emergency Coordinator so that he will have up-to-the-minute data on the facilities available to him. Work with local civic and relief agencies as the EC suggests, offer these agencies your services directly in the absence of an EC.

RESTRICT all on-the-air work in accordance with FCC regulations, Sec. 12.156, whenever FCC "declares" a state of communications emergency.

QRRR is the official ARRL "land SOS," a distress call for emergency only. It is for use *only* by a station seeking assistance.

RESPECT the fact that the success of the amateur effort in emergency depends largely on circuit discipline. The established Net Control Station should be the supreme authority for priority and traffic routing.

COOPERATE with those we serve. Be ready to help, but stay off the air unless there is a specific job to be done that you can handle more efficiently than any other station.

COPY all bulletins from WIAW. During time of emergency special bulletins will keep you posted on the latest developments.

#### After Emergency

REPORT to ARRL Headquarters as soon as possible and as fully as possible so that the Amateur Service can receive full credit. Amateur Radio has won glowing public tribute in many major disasters since 1919. Maintain this record.



sibility to your community and to amateur radio to uphold the traditions of the service.

Among the League's publications is a booklet entitled *Emergency Communications*. This booklet, while small in size, contains a wealth of information on AREC organization and functions and is invaluable to any amateur participating in emergency or civil defense work. It is free to AREC members and should be in every amateur's shack. Drop a line to the ARRL Communications Department if you want a copy, or use the coupon at the end of this chapter.

#### The Radio Amateur Civil Emergency Service

In order to be prepared for any eventuality, FCC and the Office of Civil Defense (OCD), in collaboration with ARRL, have promulgated the Radio Amateur Civil Emergency Service. RACES is a temporary amateur service, intended primarily to serve civil defense and to continue operation during any extreme national emergency, such as war. It shares certain segments of frequencies with the regular Amateur Service on a nonexclusive basis. Its regulations have been made a sub-part of the familiar amateur regulations and are included in the latest edition of the ARRL *License Manual*.

If every amateur participated, we would still be far short of the total operating personnel required properly to implement RACES. As the service which bears the responsibility for the successful implementation of this important function, we face not only the task of installing

(and in some cases building) the necessary equipment, but also of the training of thousands of additional people. This can and should be a function of the local unit of the Amateur Radio Emergency Corps under its EC and his assistants, working in close collaboration with the local civil defense organization.

The first step in organizing RACES locally is the appointment of a Radio Officer by the local civil defense director, possibly on the recommendation of his communications officer. A complete and detailed communications plan must be approved successively by local, state and OCD regional directors, by the OCD National office, and by FCC. Once this has been accomplished, applications for station authorizations under this plan can be submitted direct to FCC. *QST* carries further information from time to time, and ARRL will keep its field officials fully informed by bulletins as the situation requires. A complete bibliography of *QST* articles dealing with the subject of civil defense and RACES is available upon request from the ARRL Communications Department.

In the event of war, civil defense will place great reliance on RACES for radio communications. RACES is an Amateur Service. Its implementation is logically a function of the Amateur Radio Emergency Corps—an *additional* function in peacetime, but probably an exclusive function in wartime. Therefore, your best opportunity to be of service will be to register with your local EC, and to participate *actively* in the local AREC/RACES program.

## ARRL OPERATING ORGANIZATION

Amateur operation must have point and constructive purpose to win public respect. Each individual amateur is the ambassador of the entire fraternity in his public relations and attitude toward his hobby. ARRL field organization adds point and purpose to amateur operating.

The Communications Department of the League is concerned with the practical operation of stations in all branches of amateur activity. Appointments or awards are available for rag-chewer, traffic enthusiast, phone operator, DX man and experimenter.

There are seventy-three ARRL Sections in the League's field organization, which embraces the United States, Canada and certain other territory. Operating affairs in each Section are supervised by a Section Communications Manager elected by members in that section for a two-year term of office. Organization appointments are made by the section managers, elected as provided in the Rules and Regulations of the Communications Department, which accompany the League's By-Laws and Articles of Association. Section Communications Managers' addresses for all sections are given in full in each issue of *QST*. SCMs welcome monthly activity reports from all stations in their jurisdiction.

Whether your activity embraces phone or

telegraphy, or both, there is a place for you in the League organization.

### LEADERSHIP POSTS

To advance each type of station work and group interest in amateur radio, and to develop practical communications plans with the greatest success, appointments of leaders and organizers in particular single-interest fields are made by SCMs. Each leadership post is important. Each provides activities and assistance for appointee groups and individual members along the lines of natural interest. Some posts further the general ability of amateurs to communicate efficiently at all times, by pointing activity toward networks and round tables, others are aimed specifically at establishment of provisions for organizing the amateur service as a stand-by communications group to serve the public in disaster, civil defense need or emergency of any sort. The SCM appoints the following in accordance with section needs and individual qualifications:

- PAM Phone Activities Manager. Organizes activities for OPSs and voice operators in his section. Promotes phone nets and recruits OPSs. The appointment of VHF-PAM is open to both general and technician licensees.
- RM Route Manager. Organizes and coordinates c.w.

- traffic activities. Supervises and promotes nets and recruits ORSs.
- SEC Section Emergency Coordinator. Promotes and administers section emergency radio organization.
- EC Emergency Coordinator. Organizes amateurs of a community or other local area for emergency radio service; maintains liaison with officials and agencies served, also with other local communication facilities. Sponsors tests, recruits for AREC and encourages alignment with RACES.

## STATION APPOINTMENTS

ARRL's field organization has a place for every active amateur who has a station. The Communications Department organization exists to increase individual enjoyment and station effectiveness in amateur radio work, and we extend a cordial invitation to every amateur to participate fully in the activities, to report results monthly, and to apply to the SCM for one of the following station appointments. ARRL membership and the General Class license or VE equivalent is prerequisite to all appointments, except where otherwise indicated.

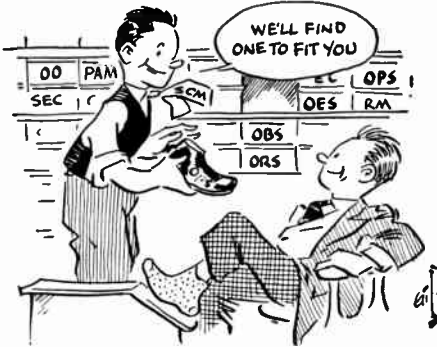

- OFS Official Phone Station. Sets high voice operating standards and procedures, furthers phone nets and traffic.
- ORS Official Relay Station. Traffic service, operates c.w. nets; noted for 15 w.p.m. and procedure ability.
- OBS Official Bulletin Station. Transmits ARRL and FCC bulletin information to amateurs. Open to Technician licensees.
- OES Official Experimental Station. Collects and reports v.h.f.-u.h.f.-s.h.f. propagation data, may engage in facsimile, TT, TV, work on 50 Mc. and/or above. Takes part as feasible in v.h.f. traffic work, reports same, supports v.h.f. nets, observes procedure standards. Open to both Novice and Technician licensees.
- OO Official Observer. Sends cooperative notices to amateurs to assist in frequency observance, insures high-quality signals, and prevents FCC trouble.

### Emblem Colors

Members wear the ARRL emblem with black-enamel background. A red background for an emblem will indicate that the wearer is SCM. SECs, ECs, RMs, and PAMs may wear the emblem with green background. Observers and all *station* appointees are entitled to wear blue emblems.

## SECTION NETS

Amateurs gain experience and pleasure and add much accomplishment to the credit of all of

amateur radio, when organized into effective nets interconnecting cities and towns.

The successful operation of a net depends a lot on the Net Control Station. This station should be chosen carefully and be one that will not hesitate to enforce each and every net rule and set the example in his own operation.

A progressive net grows, obtaining new members both directly and through other net members. Bulletins may be issued at intervals to keep in direct contact with the members regarding general net activity, to keep tab on net procedure, make suggestions for improvement, keep track of active members and weed out inactive ones.

A National Traffic System is sponsored by ARRL to facilitate the over-all expeditious relay and delivery of message traffic. The system recognizes the need for handling traffic beyond the section-level networks that have the popular support of both phone and c.w. groups (OPS and ORS) throughout the League's field organization. Area and regional provisions for NTS are furthered by Headquarters correspondence. The ARRL Net Directory, revised each fall, includes the frequencies and times of operation of the hundreds of different nets operating on amateur band frequencies.

### Radio Club Affiliation

ARRL is pleased to grant affiliation to any amateur society having (1) at least 51% of the voting club membership as full members of the League, and (2) at least 51% of members government-licensed radio amateurs. In high school radio clubs *bearing the school name*, the first above requirement is modified to require one full member of ARRL in the club. Where a society has common aims and wishes to add strength to that of other club groups and strengthen amateur radio by affiliation with the national amateur organization, a request addressed to the Communications Manager will bring the necessary forms and information to initiate the application for affiliation. Such clubs receive field-organization bulletins and special information at intervals for posting on club bulletin boards or for relay to their memberships. A travel plan providing communications, technical and secretarial contact from the Headquarters is worked out seasonally to give maximum benefits to as many as possible of the twelve hundred active *affiliated* radio clubs. Papers on club work, suggestions for organizing, for constitutions, for radio courses of study, etc., are available on request.

### Club Training Aids

One section of the ARRL Communications Department handles the Training Aids Program. This program is a service to ARRL affiliated clubs. Material is aimed at education, training and entertainment of club members. Interesting quiz material is available.

Training Aids include such items as motion-picture films, film strips, slides, audio tapes and lecture outlines. Bookings are limited to ARRL-

affiliated clubs, since the visual aids listings are not sufficiently extensive to permit such services to other groups.

All Training Aids materials are loaned free (except for shipping charges) to ARRL affiliated clubs. Numerous groups use this ARRL service to good advantage. If your club is affiliated but has not yet taken advantage of this service, you are missing a good chance to add the available features to your meeting programs and general club activities. Watch club bulletins and *QST* or write the ARRL Communications Department for TA-21.

## W1AW

The Maxim Memorial Station, W1AW, is dedicated to fraternity and service. Operated by the League headquarters, W1AW is located adjacent to the Headquarters offices on a seven-acre site. The station is on the air daily, except holidays, and available time is divided between the different bands and modes. Telegraph and



phone transmitters are provided for all bands from 1.8 to 144 Mc. The normal frequencies in each band for voice and c.w. transmissions are as follows:

1805, 1820, 3555, 3945, 7080, 7255, 14,100, 14,280, 21,075, 21,330, 28,080, 29,000, 50,700 and 145,800 kc. Operating-visiting hours and the station schedule are listed every other month in *QST*.

Operation is roughly proportional to amateur interest in different bands and modes, with one kw. except on 160 and v.h.f. bands. W1AW's daily bulletins and code practice aim to give operational help to the largest number.

All amateurs are invited to visit W1AW, as well as to work the station from their own shacks. The station was established to be a living memorial to Hiram Percy Maxim, to carry on the work and traditions of amateur radio.

## OPERATING ACTIVITIES

Within the ARRL field organization there are several special activities. During six months of the year, the first week end is an occasion for ARRL officials, officers, and directors to get together over the air. This activity is known to the gang as the LO (League officials) party. For all appointees, quarterly CD parties are scheduled additionally to develop operating ability and a spirit of fraternalism.

In addition to those for appointees and officials, ARRL sponsors various other activities open to all amateurs. The DX-minded amateur may participate in the Annual ARRL International DX competition during February and March. This popular contest may bring you the thrill of work-

ing new countries and building up your DXCC totals; certificate awards are offered to top scorers in each country and ARRL section (see page 6 of any *QST*) and to club leaders. Then there is the ever-popular Sweepstakes in November. Of domestic scope, the SS affords the opportunity to work new states for that WAS award. A Novice activity is planned annually. The interests of v.h.f. enthusiasts are also provided for in contests held in January, June and September of each year. Where enough logs (three) are received to constitute minimum "competition" a certificate in spot activities, such as the "SS" and v.h.f. party, is awarded the leading newcomer for his work considered only in competition with other newcomers.

As in all our operating, the idea of having a good time is combined in the Annual Field Day with the more serious thought of preparing ourselves to render public service in times of emergency. A premium is placed on the use of equipment without connection to commercial power sources. Clubs and individual groups always enjoy themselves in the "FD," and learn much about the requirements for operating under knockabout conditions afield.

ARRL contest activities are diversified to appeal to all operating interests, and will be found announced in detail in issues of *QST* preceding the different events.

## AWARDS

The League-sponsored operating activities heretofore mentioned have useful objectives and provide much enjoyment for members of the fraternity. Achievement in amateur radio is recognized by various certificates offered through the League and detailed below.

### WAS Award

WAS means "Worked All States." This award is available regardless of affiliation or nonaffiliation with any organization. Here are the simple rules to follow in going after your WAS:

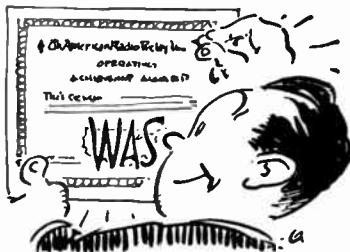

1) Two-way communication must be established on the amateur bands with each of the states; any and all amateur bands may be used. A card from the District of Columbia may be submitted in lieu of one from Maryland.

2) Contacts with all states must be made from the same location. Within a given community one location may be defined as from places no two of which are more than 25 miles apart.

3) Contacts may be made over any period of years, provided only that all contacts are from the same location, and except that only contacts with Alaska dated



January 3, 1959, or later count, and only contacts with Hawaii dated August 21, 1959, or later count.

4) QSL cards, or other written communications from stations worked confirming the necessary two-way contacts, must be submitted by the applicant to ARRL headquarters.

5) Sufficient postage must be sent with the confirmations to finance their return. No correspondence will be returned unless sufficient postage is furnished.

6) The WAS award is available to all amateurs. It is required that the confirmations submitted be placed *alphabetically in order by states*.

7) Address all applications and confirmations to the Communications Department, ARRL, 225 Main St., Newington, Conn., 06111.

### DX Century Club Award

Here are the rules under which the DX Century Club Award will be issued to amateurs who have worked and confirmed contact with 100 countries in the postwar period.

1) The DX Century Club Award Certificate for confirmed contacts with 100 or more countries is available to all amateurs everywhere in the world.

2) Confirmations must be submitted direct to ARRL headquarters for all countries claimed. Claims for a total of 100 countries must be included with first application. Confirmation from foreign contest logs may be requested in the case of the ARRL International DX Competition only, subject to the following conditions:

a) Sufficient confirmations of other types must be submitted so that these, plus the DX Contest confirmations, will total 100. In every case, Contest confirmations must not be requested for any countries from which the applicant has regular confirmations. That is, contest confirmations will be granted only in the case of countries from which applicants have no regular confirmations.

b) Logs are available for the last five contests *only*.

c) Look up the contest results as published in *QST* to see if your man is listed in the foreign scores. If he isn't, he did not send in a log and no confirmation is possible.

d) Give year of contest, date and time of QSO.

e) In future DX Contests, do not request confirmations until after the final results have been published, usually in one of the early fall issues. Requests before this time must be ignored.

3) The ARRL Countries List, will be used in determining what constitutes a "country." This chapter contains the Postwar Countries List.

4) Confirmations must be accompanied by a list of claimed countries and stations to aid in checking and for future reference.

5) Confirmations from additional countries may be submitted for credit each time ten additional confirmations are available. Endorsements for affixing to certificates and showing the new confirmed total (110, 120, 130, etc.) will be awarded as additional credits are granted. ARRL DX Competition logs from foreign stations may be utilized for these endorsements, subject to conditions stated under (2).

6) All contacts must be made with amateur stations working in the authorized amateur bands or with other stations licensed to work amateurs.

7) In cases of countries where amateurs are licensed in the normal manner, credit may be claimed only for stations using regular government-assigned call letters. No credit may be claimed for contacts with stations in any countries in which amateurs have been temporarily closed down by special government edict where amateur licenses were formerly issued in the normal manner.

8) All stations contacted must be "land stations" . . . contacts with ships, anchored or otherwise, and aircraft, cannot be counted.

9) All stations must be contacted from the same call area, where such areas exist, or from the same country in cases where there are no call areas. One exception is allowed to this rule: where a station is moved from one call area to another, or from one country to another, all contacts must be made from within a radius of 150 miles of the initial location.

10) Contacts may be made over any period of years from November 15, 1945, provided only that all contacts

be made under the provisions of Rule 9, and by the same station licensee; contacts may have been made under different call letters in the same area (or country), if the licensee for all was the same.

11) Any altered or forged confirmations submitted for CC credit will result in disqualification of the applicant. The eligibility of any DXCC applicant who was ever barred from DXCC to reapply, and the conditions for such application, shall be determined by the Awards Committee. Any holder of the Century Club Award submitting forged or altered confirmations must forfeit his right to be considered for further endorsements.

12) Operating ethics: Fair play and good sportsmanship in operating are required of all amateurs working toward the DX Century Club Award. In the event of specific objections relative to continued poor operating ethics an individual may be disqualified from the DXCC by action of the ARRL Awards Committee.

13) Sufficient postage for the return of confirmations must be forwarded with the application. In order to insure the safe return of large batches of confirmations, it is suggested that enough postage be sent to make possible their return by first-class mail, registered.

14) Decisions of the ARRL Awards Committee regarding interpretation of the rules as here printed or later amended shall be final.

15) Address all applications and confirmations to the Communications Department, ARRL, 225 Main St., Newington, Conn., 06111.

### WAC Award

The WAC award, Worked All Continents, is issued by the International Amateur Radio Union (IARU) upon proof of contact with each of the six continents. Amateurs in the U.S.A., Possessions and Canada should apply for the award through ARRL, headquarters society of the IARU. Those elsewhere must submit direct to their own IARU member-society. Residents of countries not represented in the Union may apply directly to ARRL for the award. Two basic types of WAC certificates are issued. One contains no endorsements and is awarded for c.w. or a combination of c.w. and phone contacts; the other is awarded when all work is done on phone. There is a special endorsement to the phone WAC when all of the confirmations submitted clearly indicate that the work was done on two-way s.s.b. The *only* special band endorsements are for 3.5 and 50 Mc.

### Code Proficiency Award

Many hams can follow the general idea of a contact "by ear" but when pressed to "write it down" they "muff" the copy. The Code Proficiency Award permits each amateur to prove himself as a proficient operator, and sets up a





system of awards for step-by-step gains in copying proficiency. It enables every amateur to check his code proficiency, to better that proficiency, and to receive a certification of his receiving speed.

This program is a whale of a lot of fun. The League will give a certificate to any licensed radio amateur who demonstrates that he can copy perfectly, for at least one minute, plain-language Continental code at 10, 15, 20, 25, 30 or 35 words per minute, as transmitted during special monthly transmissions from WIAW and W6OWP.

As part of the ARRL Code Proficiency program WIAW transmits plain-language practice material each evening at speeds from 5 to 35 w.p.m. All amateurs are invited to use these transmissions to increase their code-copying ability. Non-amateurs are invited to utilize the lower speeds, 5, 7½ and 10 w.p.m., which are transmitted for the benefit of persons studying the code in preparation for the amateur license examination. Refer to any issue of *QST* for details of the practice schedule.

#### Rag Chewers Club

The Rag Chewers Club is designed to encourage friendly contacts and discourage the "hello-good-by" type of QSO. It furthers fraternalism through amateur radio. Membership certificates are awarded.

How To Get in: (1) Chew the rag *with a member of the club* for at least a solid half hour. This does not mean a half hour spent in trying to get a message over through bad QRM or QRN, but a solid half hour of conversation or message handling. (2) Report the conversation by card to The Rag Chewers Club, ARRL, Communications Department, West Hartford, Conn., and ask the member station you talk with to do the same. When *both reports* are received you will be sent a membership certificate entitling you to all the privileges of a Rag Chewer.

How To Stay in: (1) Be a conversationalist on the air instead of one of those tongue-tied infants who don't know any words except "cuagn" or "cul," or "QRU" or "nil." Talk to the fellows you work with and get to know them. (2) Operate your station in accordance with the radio laws and ARRL practice. (3) Observe rules of courtesy on the air. (4) Sign "RCC" after each call so that others may know you can talk as well as call.

#### A-1 Operator Club

The A-1 Operator Club should include in its ranks every good operator. To become a member, one must be nominated by at least two operators who already belong. General keying or voice technique, procedure, copying ability, judgment and courtesy all count in rating candidates under the club rules detailed at length in

*Operating an Amateur Radio Station*. Aim to make yourself a fine operator, and one of these days you may be pleasantly surprised by an invitation to belong to the A-1 Operator Club, which carries a worth-while certificate in its own right.

#### Brass Pounders League

Every individual reporting more than a specified minimum in official monthly traffic totals is given an honor place in the *QST* listing known as the Brass Pounders League and a certificate to recognize his performance is furnished by the SCM. In addition, a *BPL Traffic Award* (medallion) is given to individual amateurs working at their own stations after the third time they "make BPL" provided it is duly reported to the SCM and recorded in *QST*.

The value to amateurs in operator training, and the utility of amateur message handling to the members of the fraternity itself as well as to the general public, make message-handling work of prime importance to the fraternity. Fun, enjoyment, and the feeling of having done something really worth while for one's fellows is accentuated by pride in message files, records, and letters from those served.

#### Old Timers Club

The Old Timers Club is open to anyone who holds an amateur call at the present time, and who held an amateur license (operator or station) 20-or-more years ago. Lapses in activity during the intervening years are permitted.

If you can qualify as an "Old Timer," send an outline of your ham career. Indicate the date of your first amateur license and your present call. If eligible for the OTC, you will be added to the roster and will receive a membership certificate.

#### INVITATION

Amateur radio is capable of giving enjoyment, self-training, social and organization benefits in proportion to what the individual amateur puts into his hobby. All amateurs are invited to become ARRL members, to work toward awards, and to accept the challenge and invitation of field-organization appointments. Drop a line to ARRL Headquarters for the booklet *Operating an Amateur Radio Station*, which has detailed information on the field-organization appointments and awards. Accept today the invitation to take full part in all League activities and organization work.

## OPERATING ABBREVIATIONS AND PREFIXES

## Q SIGNALS

Given below are a number of Q signals whose meanings most often need to be expressed with brevity and clearness in amateur work. (Q abbreviations take the form of questions only when each is sent followed by a question mark.)

- QRG Will you tell me my exact frequency (or that of.....)? Your exact frequency (or that of.....)is.....kc.
- QRH Does my frequency vary? Your frequency varies.
- QRI How is the tone of my transmission? The tone of your transmission is.....(1. Good; 2. Variable; 3. Bad).
- QRK What is the intelligibility of my signals (or those of...)? The intelligibility of your signals (or those of...) is..(1. bad; 2. poor; 3. fair; 4. good; 5. excellent.
- QRL Are you busy? I am busy (or I am busy with.....). Please do not interfere.
- QRM Are you being interfered with? I am being interfered with..(1. nil; 2. slightly; 3. moderately; 4. severely; 5. extremely).
- QRN Are you troubled by static? I am troubled by static..(1-5 as under QRM).
- QRO Shall I increase power? Increase power.
- QRP Shall I decrease power? Decrease power.
- QRQ Shall I send faster? Send faster (....w.p.m.).
- QRS Shall I send more slowly? Send more slowly (.... w.p.m.).
- QRT Shall I stop sending? Stop sending.
- QRU Have you anything for me? I have nothing for you.
- QRV Are you ready? I am ready.
- QRW Shall I inform.....that you are calling him on ....kc.? Please inform.....that I am calling on....kc.
- QRX When will you call me again? I will call you again at.....hours (on.....kc.).
- QRY What is my turn? Your turn is Number...
- QRZ Who is calling me? You are being called by..... (on.....kc.).
- QSA What is the strength of my signals (or those of.....)? The strength of your signals (or those of.....) is.....(1. Scarcely perceptible; 2. Weak; 3. Fairly good; 4. Good; 5. Very good).
- QSB Are my signals fading? Your signals are fading.
- QSD Is my keying defective? Your keying is defective.
- QSG Shall I send.....messages at a time? Send..... messages at a time.
- QSK Can you hear me between your signals and if so can I break in on your transmission? I can hear you between my signals; break in on my transmission.
- QSL Can you acknowledge receipt? I am acknowledging receipt.
- QSM Shall I repeat the last message which I sent you, or some previous message? Repeat the last message which you sent me [or message(s) number(s).....].
- QSN Did you hear me (or...) on...kc.? I did hear you (or...) on...kc.
- QSO Can you communicate with....direct or by relay? I can communicate with....direct (or by relay through.....).
- QSP Will you relay to.....? I will relay to....

- QSU Shall I send or reply on this frequency (or on...kc.)? Send or reply on this frequency (or on...kc.)
- QSV Shall I send a series of Vs on this frequency (or...kc.)? Send a series of Vs on this frequency (or....kc.).
- QSW Will you send on this frequency (or on...kc.)? I am going to send on this frequency (or on....kc.).
- QSX Will you listen to....on....kc.? I am listening to....on....kc.
- QSY Shall I change to transmission on another frequency? Change to transmission on another frequency (or on....kc.).
- QSZ Shall I send each word or group more than once? Send each word or group twice (or...times).
- QTA Shall I cancel message number....as if it had not been sent? Cancel message number.... as if it had not been sent.
- QTB Do you agree with my counting of words? I do not agree with your counting of words; I will repeat the first letter or digit of each word or group.
- QTC How many messages have you to send? I have ....messages for you (or for.....).
- QTH What is your location? My location is.....
- QTR What is the correct time? The time is.....
- QUA Have you news of...(call sign)? Here is news of...(call sign).

Special abbreviations adopted by ARRL:

- QST General call preceding a message addressed to all amateurs and ARRL members. This is in effect "CQ ARRL."
- QRRR Official ARRL "land SOS." A distress call for emergency use only by a station in an emergency situation.

### The R-S-T System READABILITY

- 1 — Unreadable.
- 2 — Barely readable, some words distinguishable.
- 3 — Readable with considerable difficulty.
- 4 — Readable with practically no difficulty.
- 5 — Perfectly readable.

### SIGNAL STRENGTH

- 1 — Faint signals, barely perceptible.
- 2 — Very weak signals.
- 3 — Weak signals.
- 4 — Fair signals.
- 5 — Fairly good signals.
- 6 — Good signals.
- 7 — Moderately strong signals.
- 8 — Strong signals.
- 9 — Extremely strong signals.

### TONE

- 1 — Extremely rough hissing note.
- 2 — Very rough a.c. note, no trace of musicality.
- 3 — Rough low-pitched a.c. note, slightly musical.
- 4 — Rather rough a.c. note, moderately musical.
- 5 — Musically-modulated note.
- 6 — Modulated note, slight trace of whistle.
- 7 — Near d.c. note, smooth ripple.
- 8 — Good d.c. note, just a trace of ripple.
- 9 — Purest d.c. note.

If the signal has the characteristic stability of crystal control, add the letter X to the RST report. If there is a chirp, the letter C may be added to so indicate. Similarly for a click, add K.

This reporting system is used on both c.w. and voice, leaving out the "tone" report on voice.

AC3	.....	Sikkim	KG4	.....	Guantanamo Bay	VK	.....	Lord Howe Island
AC4	.....	Tibet	KG6	.....	Guam	VK	.....	Willis Islands
AC5, 7	.....	Bhutan	KG6	.....	Marcus Island	VK9	.....	Christmas Island
AP	.....	East Pakistan	KG6	.....	Mariana Islands	VK9	.....	Cocos Islands
AP	.....	West Pakistan	KG6I	.....	Bonin & Volcano Islands	VK9	.....	Nauru Island
BV	.....	Formosa	KH6	.....	Hawaiian Islands	VK9	.....	Norfolk Island
BY	.....	China	KH6	.....	Kure Island	VK9	.....	Papua Territory
CE	.....	Chile	KJ6	.....	Johnston Island	VK9	.....	Territory of New Guinea
CE9	.....	VP8, ZL5, etc.	KL7	.....	Alaska	VK0	.....	(See CE9)
CE9	.....	(See VP8)	KM6	.....	Midway Islands	VK0	.....	Heard Island
CE0A	.....	Easter Island	KP4	.....	Puerto Rico	VK0	.....	Macquarie Island
CE0Z	.....	Juan Fernandez Archipelago	KP6	.....	Palmyra Group, Jarvis Island	VO	.....	(See VE)
CM, CO	.....	Cuba	KR6	.....	Ryukyu Islands	VP1	.....	British Honduras
CN2, 8, 9	.....	Morocco	KS4B	.....	Serrana Bank & Roncador Cay	VP2K	.....	Anguilla
CP	.....	Bolivia	KS4	.....	Swan Islands	VP2A	.....	Antigua, Barbuda
CR4	.....	Cape Verde Islands	KS6	.....	American Samoa	VP2V	.....	British Virgin Islands
CR5	.....	Portuguese Guinea	KV4	.....	Virgin Islands	VP2D	.....	Dominica
CR5	.....	Principe, Sao Thome	KW6	.....	Wake Island	VP2G	.....	Granada & Dependencies
CR6	.....	Angola	KX6	.....	Marshall Islands	VP2M	.....	Montserrat
CR7	.....	Mozambique	KZ5	.....	Canal Zone	VP2K	.....	St. Kitts, Nevis
CR8	.....	Portuguese Timor	LA	.....	Bouvet Island	VP2L	.....	St. Lucia
CR9	.....	Macao	LA	.....	Jan Mayen	VP2S	.....	St. Vincent & Dependencies
CT1	.....	Portugal	LA	.....	Norway	VP3	.....	British Guiana
CT2	.....	Azores	LA	.....	Svalbard	VP4	.....	Trinidad & Tobago
CT3	.....	Madeira Islands	LU	.....	Argentina	VP5	.....	Cayman Islands
CX	.....	Uruguay	LU-Z	.....	(See CE9, VP8)	VP5	.....	Turks & Caicos Islands
DJ, DL, DM	.....	Germany	LX	.....	Luxembourg	VP6	.....	Barbados
DU	.....	Philippine Islands	LZ	.....	Bulgaria	VP7	.....	Bahama Islands
EA	.....	Spain	M1, 9A1	.....	San Marino	VP8	.....	(See CE9)
EA6	.....	Balearic Islands	MP4	.....	Bahrain	VP8	.....	Falkland Islands
EA8	.....	Canary Islands	MP4	.....	Qatar	VP8, LU-Z	.....	South Georgia Islands
EA9	.....	Ifni	MP4M, VS9	.....	Sultanate of Muscat & Oman	VP8, LU-Z	.....	South Orkney Islands
EA9	.....	Rio de Oro	MP4	.....	Trucial Oman	VP8, LU-Z	.....	South Sandwich Islands
EA9	.....	Spanish Morocco	OA	.....	Peru	VP8, LU-Z, CE9	.....	South Shetland Islands
EA0	.....	Spanish Guinea	OD5	.....	Lebanon	VP9	.....	Bermuda Islands
EI	.....	Republic of Ireland	OE	.....	Austria	VQ1	.....	Zanzibar
EL	.....	Liberia	OH	.....	Finland	VQ2	.....	Northern Rhodesia
EP	.....	Iran	OH0	.....	Aland Islands	VQ8	.....	Agalega & St. Brandon
ET3	.....	Ethiopia	OK	.....	Czechoslovakia	VQ8	.....	Chagos Islands
F	.....	France	ON4, 5	.....	Belgium	VQ8	.....	Mauritius
FB8	.....	Amsterdam & St. Paul Islands	OX, KG1	.....	Greenland	VQ8	.....	Rodriguez Island
FB8	.....	Crozet Island	OY	.....	Faroe Islands	VQ9	.....	Aldabra Islands
FB8	.....	Kerguelen Islands	OZ	.....	Denmark	VQ9	.....	Seychelles
FC (unofficial)	.....	Corsica	PA0, PI1	.....	Netherlands	VR1	.....	British Phoenix Islands
FG7	.....	Guadeloupe	PJ	.....	Netherlands Antilles	VR1	.....	Gilbert & Ellice Islands & Ocean Island
FH8	.....	Comoro Islands	PJ2M	.....	Sint Maarten	VR2	.....	Fiji Islands
FK8	.....	New Caledonia	PK	.....	Indonesia	VR3	.....	Fanning & Christmas Islands
FL8	.....	French Somaliland	PX	.....	Andorra	VR4	.....	Solomon Islands
FM7	.....	Martinique	PY	.....	Brazil	VR5	.....	Tonga Islands
FO8	.....	Clipperton Island	PY0	.....	Fernando de Noronha	VR6	.....	Pitcairn Island
FO8	.....	French Oceania	PZ1	.....	Trindade & Martim Vaz Islands	VS4	.....	Sarawak
FP8	.....	St. Pierre & Miquelon Islands	SL, SM	.....	Sweden	VS5	.....	Brunei
FR7	.....	Gloriosos Islands	SP	.....	Poland	VS6	.....	Hong Kong
FR7	.....	Juan de Nova	ST2	.....	Sudan	VS9	.....	Aden & Socotra
FR7	.....	Reunion	SU	.....	Egypt	VS9K	.....	Kamran Islands
FR7	.....	Tromelin	SV	.....	Crete	VS9H	.....	Kuria Muria Islands
FS7	.....	Saint Martin	SV	.....	Dodecanese	VS9M	.....	Maldiv Islands
FU8, YJ1	.....	New Hebrides	TA	.....	Turkey	VU	.....	Andaman and Nicobar Islands
FW8	.....	Wallis & Futuna Islands	TF	.....	Iceland	VU	.....	Laccadive Islands
FY7	.....	French Guiana & Inini	TG	.....	Guatemala	W	.....	(See K)
G	.....	England	TI	.....	Costa Rica	XE, XF	.....	Mexico
GC	.....	Guernsey & Dependencies	TI9	.....	Cocos Island	XF4	.....	Revilla Gigedo
GC	.....	Jersey Island	TJ	.....	Cameroun	XT	.....	Voltaic Rep.
GD	.....	Isle of Man	TL	.....	Central African Republic	XW8	.....	Laos
GI	.....	Northern Ireland	TN	.....	Congo Republic	XZ2	.....	Burma
GM	.....	Scotland	TR	.....	Gabon Republic	YA	.....	Afghanistan
GW	.....	Wales	TT	.....	Chad Republic	YI	.....	Iraq
HA	.....	Hungary	TU	.....	Ivory Coast	YJ	.....	(See FU8)
HB0	.....	Liechtenstein	TZ	.....	Dahomey Republic	YK	.....	Syria
HB	.....	Switzerland	UA1, 6, UN1	.....	Mali Republic	YN, YN0	.....	Nicaragua
HC	.....	Ecuador	UA1	.....	European Russian Socialist Federal Soviet Republic	YO	.....	Rumania
HC8	.....	Galapagos Islands	UA2	.....	Franz Josef Land	YS	.....	Salvador
HI	.....	Haiti	UA9, 0	.....	Kaliningradsk	YU	.....	Yugoslavia
HK	.....	Dominican Republic	UB5, UT5	.....	Asiatic Russian S.F.S.R.	YV	.....	Venezuela
HK0	.....	Colombia	UC2	.....	Ukraine	YV0	.....	Aves Islands
HK0	.....	Bajo Nuevo	UD6	.....	White Russian S.S.R.	ZB1	.....	Malta
HK0	.....	Malpelo Island	UG6	.....	Azerbaijan	ZB2	.....	Gibraltar
HK0, HM	.....	San Andres and Providencia	UH8	.....	Georgia	ZC5	.....	North Borneo
HL	.....	Korea	UG6	.....	Armenia	ZC6	.....	Palestine
HP	.....	Panama	UH8	.....	Turkoman	ZD3	.....	Gambia
HR	.....	Honduras	UI8	.....	Uzbek	ZD7	.....	St. Helena
HS	.....	Thailand	UJ8	.....	Tadzhik	ZD8	.....	Ascension Island
HV	.....	Vatican	UL7	.....	Kazakh	ZD9	.....	Tristan da Cunha & Gough Islands
HZ, 7Z	.....	Saudi Arabia	UM8	.....	Kirghiz	ZE	.....	Southern Rhodesia
II, IT1	.....	Italy	UO5	.....	Moldavia	ZK1	.....	Cook Islands
IS1	.....	Sardinia	UP2	.....	Lithuania	ZK1	.....	Manihiki Islands
JA, KA	.....	Japan	UQ2	.....	Latvia	ZK2	.....	Niue
JT1	.....	Mongolia	UR2	.....	Estonia	ZL	.....	Auckland Isl. & Campbell Isl.
JY	.....	Jordan	VE, VO	.....	Canada	ZL	.....	Chatham Islands
K, W	.....	United States of America	VK	.....	Australia	ZL	.....	Kermadec Islands
KB6	.....	Baker, Howland & American Phoenix Islands			(including Tasmania)			
KC4	.....	(See CE9)						
KC4	.....	Navassa Island						
KC6	.....	Eastern Caroline Islands						
KC6	.....	Western Caroline Islands						
KG1	.....	(See OX)						

ZL	.....New Zealand	4X4	.....Israel	7Z	.....(See HZ)
ZL5	.....(See CE9)	5A	.....Libya	8Z4	.....Saudi Arabia/Iraq
ZM6	.....Western Samoa	5B4	.....Cyprus		Neutral Zone
ZM7	.....Tokelau (Union) Islands	5H3	.....Tanganyika	8Z5	.....(See 9K3)
ZP	.....Paraguay	5N2	.....Nigeria	9A1	.....(See M1)
ZS1, 2, 4, 5, 6	.....South Africa	5R8	.....Malagasy Rep.	9G1	.....Ghana
ZS2	.....Prince Edward & Marion Islands	5T	.....Mauritania	9K2	.....Kuwait
ZS3	.....Southwest Africa	5U7	.....Niger Rep.	9K3, 8Z5	.....Kuwait/Saudia Arabia
ZS7	.....Swaziland	5V	.....Togo		Neutral Zone
ZS8	.....Basutoland	5X5	.....Uganda	9L1	.....Sierra Leone
ZS9	.....Bechuanaland	5Z4	.....Kenya	9M2	.....Malaya
3A	.....Monaco	6O1, 2, 6	.....Somali Rep.	9M4	.....Singapore
3V8	.....Tunisia	6W8	.....Senegal Rep.	9N1	.....Nepal
3W8	.....Vietnam	6Y	.....Jamaica	9O5	.....Rep. of Congo
4S7	.....Ceylon	7G1	.....Rep. of Guinea	9U5	.....Burundi
4U1	.....I.T.U. Geneva	7Q	.....Nyasaland	9X5	.....Rwanda
4W1	.....Yemen	7X	.....Algeria		.....Cambodia

## INTERNATIONAL PREFIXES

AAA-ALZ	United States of America	QAA-QZZ	(Service abbreviations)
AMA-AOZ	Spain	RAA-RZZ	Union of Soviet Socialist Republics
APA-ASZ	Pakistan	SAA-SMZ	Sweden
ATA-AWZ	India	SNA-SRZ	People's Republic of Poland
AXA-AXZ	Commonwealth of Australia	SSA-SSM	Egypt
AYA-AZZ	Argentine Republic	SSN-STZ	Sudan
BAA-BZZ	China	SUA-SUZ	Egypt
CAA-CEZ	Chile	SVA-SZZ	Greece
CFA-CKZ	Canada	TAA-TCZ	Turkey
CLA-CMZ	Cuba	TDA-TDZ	Guatemala
CNA-CNZ	Morocco	TEA-TEZ	Costa Rica
COA-COZ	Cuba	TFA-TFZ	Iceland
CPA-CPZ	Bolivia	TGA-TGZ	Guatemala
CQA-CRZ	Portuguese Overseas Provinces	THA-THZ	France and French Community
CSA-CUZ	Portugal	TIA-TIZ	Costa Rica
CVA-CXZ	Uruguay	TJA-TJZ	Republic of Cameroon
CYA-CZZ	Canada	TKA-TKZ	France, and Community
DAA-DTZ	Germany	TLA-TLZ	Central African Republic
DUA-DZZ	Republic of the Philippines	TMA-TMZ	France, French Community
EAA-EHZ	Spain	TNA-TNZ	Republic of the Congo (Brazzaville)
EIA-EJZ	Ireland	TOA-TOZ	France, French Community
EKA-EKZ	Union of Soviet Socialist Republics	TRA-TRZ	Republic of Gabon
ELA-ELZ	Liberia	TSA-TSZ	Tunisia
EMA-EOZ	Union of Soviet Socialist Republics	TTA-TTZ	Republic of Chad
EPA-EQZ	Iran	TUA-TUZ	Republic of the Ivory Coast
ERA-ERZ	Union of Soviet Socialist Republics	TVA-TXZ	France, French Community
ESA-ESZ	Estonia	TYA-TYZ	Republic of Dahomey
ETA-ETZ	Ethiopia	TZA-TZZ	Republic of Mali
EUA-EVZ	Bielorussian Soviet Socialist Republic	UAA-UQZ	Union of Soviet Socialist Republics
EXA-FZZ	Union of Soviet Socialist Republics	URA-UTZ	Ukrainian Soviet Socialist Republic
FAA-FZZ	France and French Community	UUA-UZZ	Union of Soviet Socialist Republics
GAA-GZZ	Great Britain	VAA-VGZ	Canada
HAA-HAZ	Hungarian People's Republic	VHA-VNZ	Commonwealth of Australia
HBA-HBZ	Switzerland	VOA-VOZ	Canada
HCA-HDZ	Ecuador	VPA-VSZ	British Overseas Territories
HEA-HEZ	Switzerland	VTA-VWZ	India
HFA-HFZ	People's Republic of Poland	VXA-VYZ	Canada
HGA-HGZ	Hungarian People's Republic	VZA-VZZ	Commonwealth of Australia
HHA-HHZ	Republic of Haiti	WAA-WZZ	United States of America
HIA-HIZ	Dominican Republic	XAA-XIZ	Mexico
HJA-HKZ	Republic of Colombia	XJA-XOZ	Canada
HLA-HMZ	Korea	XPA-XPZ	Denmark
HNA-HNZ	Iraq	XQA-XRZ	Chile
HOA-HPZ	Republic of Panama	XSA-XSZ	China
HQA-HRZ	Republic of Honduras	XTA-XTZ	Republic of the Upper Volta
HSA-HSZ	Thailand	XUA-XUZ	Cambodia
HTA-HTZ	Nicaragua	XVA-XVZ	Viet-Nam
HUA-HUZ	Republic of El Salvador	XWA-XWZ	Laos
HVA-HVZ	Vatican City State	XXA-XXZ	Portuguese Overseas Provinces
HWA-HYZ	France and French Community	XYA-XXZ	Burma
HZA-HZZ	Saudi Arabia	YAA-YAZ	Afghanistan
IAA-IZZ	Italy and Mandated Territories	YBA-YHZ	Republic of Indonesia
JAA-JSZ	Japan	YIA-YIZ	Iraq
JTA-JVZ	Mongolian People's Republic	YJA-YJZ	New Hebrides
JWA-JXZ	Norway	YKA-YKZ	Syria
JYA-JYZ	Jordan	YLA-YLZ	Latvia
JZA-JZZ	West New Guinea	YMA-YMZ	Turkey
KAA-KZZ	United States of America	YNA-YNZ	Nicaragua
LAA-LNZ	Norway	YOA-YZZ	Roumanian People's Republic
LOA-LWZ	Argentine Republic	YSA-YSZ	Republic of El Salvador
LXA-LXZ	Luxembourg	YTA-YUZ	Yugoslavia
LYA-LYZ	Lithuania	YVA-YYZ	Venezuela
LZA-LZZ	People's Republic of Bulgaria	YZA-YZZ	Yugoslavia
MAA-MZZ	Great Britain	ZAA-ZAZ	Albania
NAA-NZZ	United States of America	ZBA-ZJZ	British Overseas Territories
OAA-OCZ	Peru	ZKA-ZMZ	New Zealand
ODA-ODZ	Lebanon	ZNA-ZOZ	British Overseas Territories
OEA-OEZ	Austria	ZPA-ZPZ	Paraguay
OFA-OJZ	Finland	ZQA-ZQZ	British Overseas Territories
OKA-OMZ	Czechoslovakia	ZRA-ZUZ	Republic of South Africa
ONA-OTZ	Belgium	ZVA-ZZZ	Brazil
OQA-OZZ	Denmark	2AA-2ZZ	Great Britain
PAA-PIZ	Netherlands	3AA-3AZ	Monaco
PJA-PJZ	Netherlands Antilles		



PKA-POZ	Republic of Indonesia	6AA-6BZ	Egypt
PPA-PYZ	Brazil	6CA-6CZ	Syria
PZA-PZZ	Surinam	6DA-6JZ	Mexico
3VA-3VZ	Tunisia	6KA-6NZ	Korea
3WA-3WZ	Viet-Nam	6OA-6OZ	Somalia
3XA-3XZ	Guinea	6PA-6SZ	Pakistan
3YA-3YZ	Norway	6TA-6UZ	Sudan
3ZA-3ZZ	People's Republic of Poland	6VA-6WZ	Republic of the Senegal
4AA-4CZ	Mexico	6XA-6XZ	Malagasy Republic
4DA-4IZ	Republic of the Philippines	6YA-6YZ	Jamaica
4JA-4LZ	Union of Soviet Socialist Republics	6ZA-6ZZ	Liberia
4MA-4MZ	Venezuela	7AA-7IZ	Indonesia
4NA-4OZ	Yugoslavia	7JA-7NZ	Japan
4PA-4SZ	Ceylon	7QA-7OZ	Malawi
4TA-4TZ	Peru	7RA-7RZ	Algeria
4UA-4UZ	United Nations	7SA-7SZ	Sweden
4VA-4VZ	Republic of Haiti	7TA-7YZ	Algeria
4WA-4WZ	Yemen	7ZA-7ZZ	Saudi Arabia
4XA-4XZ	State of Israel	8AA-8IZ	Indonesia
4YA-4YZ	International Civil Aviation Organization	8JA-8NZ	Japan
4ZA-4ZZ	State of Israel	8SA-8SZ	Sweden
5AA-5AZ	Libya	8TA-8YZ	India
5BA-5BZ	Republic of Cyprus	8ZA-8ZZ	Saudi Arabia
5CA-5GZ	Morocco	9AA-9AZ	San Marino
5HA-5IZ	Tanganyika	9BA-9DZ	Iran
5JA-5KZ	Colombia	9EA-9FZ	Ethiopia
5LA-5MZ	Liberia	9GA-9GZ	Ghana
5NA-5OZ	Nigeria	9HA-9HZ	Malta
5PA-5QZ	Denmark	9IA-9JZ	Zambia
5RA-5SZ	Malagasy Republic	9KA-9KZ	Kuwait
5TA-5TZ	Islamic Republic of Mauretania	9LA-9LZ	Sierra Leone
5UA-5UZ	Republic of the Niger	9MA-9MZ	Malaysia
5VA-5VZ	Togolese Republic	9NA-9NZ	Nepal
5WA-5WZ	Western Samoa	9OA-9TZ	Republic of the Congo (Leopoldville)
5XA-5XZ	Uganda	9UA-9UZ	Burundi
5YA-5YZ	Kenya	9VA-9WZ	Malaysia
3BA-3FZ	Canada	9XA-9XZ	Rwanda
3GA-3GZ	Chile	9VA-9ZZ	Trinidad and Tobago
3HA-3UZ	China		

## ABBREVIATIONS FOR C.W. WORK

Abbreviations help to cut down unnecessary transmission. However, make it a rule not to abbreviate unnecessarily when working an operator of unknown experience:

AA	All after	NW	Now; I resume transmission
AB	All before	OB	Old boy
ABT	About	OM	Old man
ADR	Address	OP-OPR	Operator
AGN	Again	OT	Old timer; old top
ANT	Antenna	PBL	Preamble
BCI	Broadcast interference	PSE	Please
BCL	Broadcast listener	PWR	Power
BK	Break; break me; break in	PX	Press
BN	All between; been	R	Received as transmitted; are
C	Yes	RCD	Received
CFM	Confirm; I confirm	RCVR (RX)	Receiver
CK	Check	REF	Refer to; referring to; reference
CL	I am closing my station; call	RIG	Station equipment
CLD-CLG	Called; calling	RPT	Repeat; I repeat
CUD	Could	SED	Said
CUL	See you later	SIG	Signature; signal
CUM	Come	SINE	Operator's personal initials or nickname
CW	Continuous wave	SKED	Schedule
DI.D-DLVD	Delivered	SRI	Sorry
DX	Distance, foreign countries	SVC	Service; prefix to service message
ES	And, &	TFC	Traffic
FB	Fine business; excellent	TMW	Tomorrow
GA	Go ahead (or resume sending)	TNX-TKS	Thanks
GB	Good-by	TT	That
GBA	Give better address	TU	Thank you
GE	Good evening	TVI	Television interference
GG	Going	TXT	Text
GM	Good morning	UR-URS	Your; you're; yours
GN	Good night	VFO	Variable-frequency oscillator
GND	Ground	VY	Very
GUD	Good	WA	Word after
HI	The telegraphic laugh; high	WB	Word before
HR	Here; hear	WD-WDS	Word; words
HV	Have	WKD-WKG	Worked; working
HW	How	WL	Well; will
LID	A poor operator	WUD	Would
MA, MILS	Milliamperes	WX	Weather
MSG	Message; prefix to radiogram	XMTR (TX)	Transmitter
N	No	XTAL	Crystal
ND	Nothing doing	XYL (YF)	Wife
NIL	Nothing; I have nothing for you	YL	Young lady
NM	No more	73	Best regards
NR	Number	88	Love and kisses



► *Operating an Amateur Radio Station* covers the details of practical amateur operating. In it you will find information on Operating Practices, Emergency Communication, ARRL Operating Activities and Awards, the ARRL Field Organization, Handling Messages, Network Organization, "Q" Signals and Abbreviations used in amateur operating, important extracts from the FCC Regulations, and other helpful material. It's a handy reference that will serve to answer many of the questions concerning operating that arise during your activities on the air.

► *Emergency Communications* is the "bible" of the Amateur Radio Emergency Corps. Within its eight pages are contained the fundamentals of emergency communication which every amateur interested in public service work should know, including a complete diagrammatical plan adaptable for use in any community, explanation of the role of the American Red Cross and FCC's regulations concerning amateur operation in emergencies. The Radio Amateur Civil Emergency Service (RACES) comes in for special consideration, including a table of RACES frequencies.

The two publications described above may be obtained without charge by any *Handbook* reader. Either or both will be sent upon request.

---

**AMERICAN RADIO RELAY LEAGUE**  
 225 Main Street  
 Newington, Conn. 06111

Please send me, without charge, the following:  
 OPERATING AN AMATEUR RADIO STATION  
 EMERGENCY COMMUNICATIONS

Name .....  
 (Please Print)

Address .....

# Vacuum Tubes and Semiconductors

For the convenience of the designer, the receiving-type tubes listed in this chapter are grouped by filament voltages and construction types (glass, metal, miniature, etc.). For example, all miniature tubes are listed in Table I, all metal tubes are in Table II, and so on.

Transmitting tubes are divided into triodes and tetrodes-pentodes, then listed according to rated plate dissipation. This permits direct comparison of ratings of tubes in the same power classification.

For quick reference, all tubes are listed in numerical-alphabetical order in the index. Types having no table reference are either obsolete or of little use in amateur equipment. Base diagrams for these tubes are listed.

## Tube Ratings

Vacuum tubes are designed to be operated within definite maximum (and minimum) ratings. These ratings are the maximum safe operating voltages and currents for the electrodes, based on inherent limiting factors such as permissible cathode temperature, emission, and power dissipation in electrodes.

In the transmitting-tube tables, maximum ratings for electrode voltage, current and dissipation are given separately from the typical operating conditions for the recommended classes of operation. In the receiving-tube tables, ratings and operating data are combined. Where only one set of operating conditions appears, the positive electrode voltages shown (plate, screen, etc.) are, in general, also the maximum rated voltages.

For certain air-cooled transmitting tubes, there are two sets of maximum values, one designated as CCS (Continuous Commercial Service) ratings, the other ICAS (Intermittent Commercial and Amateur Service) ratings. Continuous Commercial Service is defined as that type of service in which long tube life and reliability of performance under continuous operating conditions are the prime consideration. Intermittent Commercial and Amateur Service is defined to include the

many applications where the transmitter design factors of minimum size, light weight, and maximum power output are more important than long tube life. ICAS ratings are considerably higher than CCS ratings. They permit the handling of greater power, and although such use involves some sacrifice in tube life, the period over which tubes give satisfactory performance in intermittent service can be extremely long.

The plate dissipation values given for transmitting tubes should not be exceeded during normal operation. In plate modulated amplifier applications, the maximum allowable carrier-condition plate dissipation is approximately 66 per cent of the value listed and will rise to the maximum value under 100 per cent sinusoidal modulation.

## Typical Operating Conditions

The typical operating conditions given for transmitting tubes represent, in general, maximum ICAS ratings where such ratings have been given by the manufacturer. They do not represent the *only* possible method of operation of a particular tube type. Other values of plate voltage, plate current, etc., may be used so long as the maximum ratings for a particular voltage or current are not exceeded.

Detailed information and characteristic curves are available from tube and semiconductor manufacturers, in books sold through radio dealers or direct from the factory.

## Equivalent Tubes

The equivalent tubes listed in Table VII are used occasionally in amateur service. In addition to the types listed, other equivalents are available for special purposes such as series-heater string operation in TV receivers. These types require unusual values of heater voltage (3.15, 4.2, etc.), and have controlled warm-up time characteristics to minimize voltage unbalance during starting. Except for heater design, these types correspond electrically and mechanically to 6-volt prototypes.

## INDEX TO TUBE TABLES

I — Miniature Receiving Tubes.....	V16	VIII — Control and Regulator Tubes....	V25
II — 6.3-Volt Metal Receiving Tubes....	V21	IX — Rectifiers .....	V25
III — 6.3-Volt Glass Tubes, Octal Bases.	V22	X — Triode Transmitting Tubes.....	V26
IV — 6.3-Volt Lock-In Base Tubes.....	V22	XI — Multigridded Transmitting Tubes....	V30
V — 1.5-Volt Battery Tubes.....	V23	XII — Cathode-Ray Tubes .....	V32
VI — Special Receiving Tubes.....	V23	XIII — Transistors .....	V33
VII — Equivalent Tubes .....	V23	XIV — Crystal Diodes .....	V34

INDEX TO VACUUM-TUBE TYPES  
Base-diagram section pages V5-V15. Classified data pages V16-V34.

Type	Page	Base	Type	Page	Base	Type	Page	Base	Type	Page	Base	Type	Page	Base
00-A	4D		2C43	V27	Fig. 11	6A78	16	7BW	6A78	16	7BW	6A78	16	7BW
00-B	V25	5B0	2C52	8B1		6A79	16	7CW	6A79	16	7CW	6A79	16	7CW
00-C	V25	4AJ	2D21	V28	7B1	6A80	16	7D	6A80	16	7D	6A80	16	7D
00-D	V25	5B0	2E22	V30	5F	6A81	16	7E	6A81	16	7E	6A81	16	7E
00-E	V25	4AJ	2E23	V30	7CL	6A82	16	7F	6A82	16	7F	6A82	16	7F
00-F	V25	4AJ	2E24	V30	7CL	6A83	16	7G	6A83	16	7G	6A83	16	7G
00-G	V25	4AJ	2E25	V30	5B1	6A84	16	7H	6A84	16	7H	6A84	16	7H
00-H	V25	4AJ	2E26	Ch. 11	7CK	6A85	16	7I	6A85	16	7I	6A85	16	7I
00-I	V25	4AJ	2E27	Ch. 11	7CK	6A86	16	7J	6A86	16	7J	6A86	16	7J
00-J	V25	4AJ	2E28	Ch. 11	7CK	6A87	16	7K	6A87	16	7K	6A87	16	7K
00-K	V25	4AJ	2E29	Ch. 11	7CK	6A88	16	7L	6A88	16	7L	6A88	16	7L
00-L	V25	4AJ	2E30	Ch. 11	7CK	6A89	16	7M	6A89	16	7M	6A89	16	7M
00-M	V25	4AJ	2E31	Ch. 11	7CK	6A90	16	7N	6A90	16	7N	6A90	16	7N
00-N	V25	4AJ	2E32	Ch. 11	7CK	6A91	16	7O	6A91	16	7O	6A91	16	7O
00-O	V25	4AJ	2E33	Ch. 11	7CK	6A92	16	7P	6A92	16	7P	6A92	16	7P
00-P	V25	4AJ	2E34	Ch. 11	7CK	6A93	16	7Q	6A93	16	7Q	6A93	16	7Q
00-Q	V25	4AJ	2E35	Ch. 11	7CK	6A94	16	7R	6A94	16	7R	6A94	16	7R
00-R	V25	4AJ	2E36	Ch. 11	7CK	6A95	16	7S	6A95	16	7S	6A95	16	7S
00-S	V25	4AJ	2E37	Ch. 11	7CK	6A96	16	7T	6A96	16	7T	6A96	16	7T
00-T	V25	4AJ	2E38	Ch. 11	7CK	6A97	16	7U	6A97	16	7U	6A97	16	7U
00-U	V25	4AJ	2E39	Ch. 11	7CK	6A98	16	7V	6A98	16	7V	6A98	16	7V
00-V	V25	4AJ	2E40	Ch. 11	7CK	6A99	16	7W	6A99	16	7W	6A99	16	7W
00-W	V25	4AJ	2E41	Ch. 11	7CK	6A00	16	7X	6A00	16	7X	6A00	16	7X
00-X	V25	4AJ	2E42	Ch. 11	7CK	6A01	16	7Y	6A01	16	7Y	6A01	16	7Y
00-Y	V25	4AJ	2E43	Ch. 11	7CK	6A02	16	7Z	6A02	16	7Z	6A02	16	7Z
00-Z	V25	4AJ	2E44	Ch. 11	7CK	6A03	16	8A	6A03	16	8A	6A03	16	8A
01-A	V25	4AJ	2E45	Ch. 11	7CK	6A04	16	8B	6A04	16	8B	6A04	16	8B
01-B	V25	4AJ	2E46	Ch. 11	7CK	6A05	16	8C	6A05	16	8C	6A05	16	8C
01-C	V25	4AJ	2E47	Ch. 11	7CK	6A06	16	8D	6A06	16	8D	6A06	16	8D
01-D	V25	4AJ	2E48	Ch. 11	7CK	6A07	16	8E	6A07	16	8E	6A07	16	8E
01-E	V25	4AJ	2E49	Ch. 11	7CK	6A08	16	8F	6A08	16	8F	6A08	16	8F
01-F	V25	4AJ	2E50	Ch. 11	7CK	6A09	16	8G	6A09	16	8G	6A09	16	8G
01-G	V25	4AJ	2E51	Ch. 11	7CK	6A10	16	8H	6A10	16	8H	6A10	16	8H
01-H	V25	4AJ	2E52	Ch. 11	7CK	6A11	16	8I	6A11	16	8I	6A11	16	8I
01-I	V25	4AJ	2E53	Ch. 11	7CK	6A12	16	8J	6A12	16	8J	6A12	16	8J
01-J	V25	4AJ	2E54	Ch. 11	7CK	6A13	16	8K	6A13	16	8K	6A13	16	8K
01-K	V25	4AJ	2E55	Ch. 11	7CK	6A14	16	8L	6A14	16	8L	6A14	16	8L
01-L	V25	4AJ	2E56	Ch. 11	7CK	6A15	16	8M	6A15	16	8M	6A15	16	8M
01-M	V25	4AJ	2E57	Ch. 11	7CK	6A16	16	8N	6A16	16	8N	6A16	16	8N
01-N	V25	4AJ	2E58	Ch. 11	7CK	6A17	16	8O	6A17	16	8O	6A17	16	8O
01-O	V25	4AJ	2E59	Ch. 11	7CK	6A18	16	8P	6A18	16	8P	6A18	16	8P
01-P	V25	4AJ	2E60	Ch. 11	7CK	6A19	16	8Q	6A19	16	8Q	6A19	16	8Q
01-Q	V25	4AJ	2E61	Ch. 11	7CK	6A20	16	8R	6A20	16	8R	6A20	16	8R
01-R	V25	4AJ	2E62	Ch. 11	7CK	6A21	16	8S	6A21	16	8S	6A21	16	8S
01-S	V25	4AJ	2E63	Ch. 11	7CK	6A22	16	8T	6A22	16	8T	6A22	16	8T
01-T	V25	4AJ	2E64	Ch. 11	7CK	6A23	16	8U	6A23	16	8U	6A23	16	8U
01-U	V25	4AJ	2E65	Ch. 11	7CK	6A24	16	8V	6A24	16	8V	6A24	16	8V
01-V	V25	4AJ	2E66	Ch. 11	7CK	6A25	16	8W	6A25	16	8W	6A25	16	8W
01-W	V25	4AJ	2E67	Ch. 11	7CK	6A26	16	8X	6A26	16	8X	6A26	16	8X
01-X	V25	4AJ	2E68	Ch. 11	7CK	6A27	16	8Y	6A27	16	8Y	6A27	16	8Y
01-Y	V25	4AJ	2E69	Ch. 11	7CK	6A28	16	8Z	6A28	16	8Z	6A28	16	8Z
01-Z	V25	4AJ	2E70	Ch. 11	7CK	6A29	16	9A	6A29	16	9A	6A29	16	9A
02-A	V25	4AJ	2E71	Ch. 11	7CK	6A30	16	9B	6A30	16	9B	6A30	16	9B
02-B	V25	4AJ	2E72	Ch. 11	7CK	6A31	16	9C	6A31	16	9C	6A31	16	9C
02-C	V25	4AJ	2E73	Ch. 11	7CK	6A32	16	9D	6A32	16	9D	6A32	16	9D
02-D	V25	4AJ	2E74	Ch. 11	7CK	6A33	16	9E	6A33	16	9E	6A33	16	9E
02-E	V25	4AJ	2E75	Ch. 11	7CK	6A34	16	9F	6A34	16	9F	6A34	16	9F
02-F	V25	4AJ	2E76	Ch. 11	7CK	6A35	16	9G	6A35	16	9G	6A35	16	9G
02-G	V25	4AJ	2E77	Ch. 11	7CK	6A36	16	9H	6A36	16	9H	6A36	16	9H
02-H	V25	4AJ	2E78	Ch. 11	7CK	6A37	16	9I	6A37	16	9I	6A37	16	9I
02-I	V25	4AJ	2E79	Ch. 11	7CK	6A38	16	9J	6A38	16	9J	6A38	16	9J
02-J	V25	4AJ	2E80	Ch. 11	7CK	6A39	16	9K	6A39	16	9K	6A39	16	9K
02-K	V25	4AJ	2E81	Ch. 11	7CK	6A40	16	9L	6A40	16	9L	6A40	16	9L
02-L	V25	4AJ	2E82	Ch. 11	7CK	6A41	16	9M	6A41	16	9M	6A41	16	9M
02-M	V25	4AJ	2E83	Ch. 11	7CK	6A42	16	9N	6A42	16	9N	6A42	16	9N
02-N	V25	4AJ	2E84	Ch. 11	7CK	6A43	16	9O	6A43	16	9O	6A43	16	9O
02-O	V25	4AJ	2E85	Ch. 11	7CK	6A44	16	9P	6A44	16	9P	6A44	16	9P
02-P	V25	4AJ	2E86	Ch. 11	7CK	6A45	16	9Q	6A45	16	9Q	6A45	16	9Q
02-Q	V25	4AJ	2E87	Ch. 11	7CK	6A46	16	9R	6A46	16	9R	6A46	16	9R
02-R	V25	4AJ	2E88	Ch. 11	7CK	6A47	16	9S	6A47	16	9S	6A47	16	9S
02-S	V25	4AJ	2E89	Ch. 11	7CK	6A48	16	9T	6A48	16	9T	6A48	16	9T
02-T	V25	4AJ	2E90	Ch. 11	7CK	6A49	16	9U	6A49	16	9U	6A49	16	9U
02-U	V25	4AJ	2E91	Ch. 11	7CK	6A50	16	9V	6A50	16	9V	6A50	16	9V
02-V	V25	4AJ	2E92	Ch. 11	7CK	6A51	16	9W	6A51	16	9W	6A51	16	9W
02-W	V25	4AJ	2E93	Ch. 11	7CK	6A52	16	9X	6A52	16	9X	6A52	16	9X
02-X	V25	4AJ	2E94	Ch. 11	7CK	6A53	16	9Y	6A53	16	9Y	6A53	16	9Y
02-Y	V25	4AJ	2E95	Ch. 11	7CK	6A54	16	9Z	6A54	16	9Z	6A54	16	9Z
02-Z	V25	4AJ	2E96	Ch. 11	7CK	6A55	16	0A	6A55	16	0A	6A55	16	0A
03-A	V25	4AJ	2E97	Ch. 11	7CK	6A56	16	0B	6A56	16	0B	6A56	16	0B
03-B	V25	4AJ	2E98	Ch. 11	7CK	6A57	16	0C	6A57	16	0C	6A57	16	0C
03-C	V25	4AJ	2E99	Ch. 11	7CK	6A58	16	0D	6A58	16	0D	6A58	16	0D
03-D	V25	4AJ	2E00	Ch. 11	7CK	6A59	16	0E	6A59	16	0E	6A59	16	0E
03-E	V25	4AJ	2E01	Ch. 11	7CK	6A60	16	0F	6A60	16	0F	6A60	16	0F
03-F	V25	4AJ	2E02	Ch. 11	7CK	6A61	16	0G	6A61	16	0G	6A61	16	0G
03-G	V25	4AJ	2E03	Ch. 11	7CK	6A62	16	0H	6A62	16	0H	6A62	16	0H
03-H	V25	4AJ	2E04	Ch. 11	7CK	6A63	16	0I	6A63	16	0I	6A63	16	0I
03-I	V25	4AJ	2E05	Ch. 11	7CK	6A64	16	0J	6A64	16	0J	6A64	16	0J
03-J														



Type	Page	Base	Type	Page	Base	Type	Page	Base	Type	Page	Base	Type	Page	Base	Type	Page	Base
6J7	V21	7R	7B6	V24	8W	12D77	V19	9A	25C8	V24	7CV	117FGT	V26	8AV			
6J8	V22	8W	7B7	V24	8X	12D78	V20	9A	25C9	V24	7C	117GOT	V26	8AA			
6J9	V23	12BW	7B8	V24	8Y	12D79	V20	9X	25CA	V24	7C	117ZAGT	V26	8A			
6J0	V23	9PM	7C4	V24	9A	12D80	V20	9Y	25CB	V24	7C	117ZAGT	V26	8A			
6J1	V19	9FA	7C5	V24	9A	12D81	V20	9Z	25CC	V24	7C	117ZAGT	V26	8A			
6J2	V23	9AM	7C6	V24	9A	12D82	V20	9A	25CD	V24	7C	117ZAGT	V26	8A			
6J3	V23	9AM	7C7	V24	9A	12D83	V20	9A	25CE	V24	7C	117ZAGT	V26	8A			
6J4	V23	9AM	7C8	V24	9A	12D84	V20	9A	25CF	V24	7C	117ZAGT	V26	8A			
6J5	V19	9FA	7C9	V24	9A	12D85	V20	9A	25CG	V24	7C	117ZAGT	V26	8A			
6J6	V19	9FA	7D0	V24	9A	12D86	V20	9A	25CH	V24	7C	117ZAGT	V26	8A			
6J7	V19	9FA	7D1	V24	9A	12D87	V20	9A	25CI	V24	7C	117ZAGT	V26	8A			
6J8	V19	9FA	7D2	V24	9A	12D88	V20	9A	25CJ	V24	7C	117ZAGT	V26	8A			
6J9	V19	9FA	7D3	V24	9A	12D89	V20	9A	25CK	V24	7C	117ZAGT	V26	8A			
6K0	V22	8R	7E4	V24	9A	12D90	V20	9A	25CL	V24	7C	117ZAGT	V26	8A			
6K1	V22	8R	7E5	V24	9A	12D91	V20	9A	25CM	V24	7C	117ZAGT	V26	8A			
6K2	V22	8R	7E6	V24	9A	12D92	V20	9A	25CN	V24	7C	117ZAGT	V26	8A			
6K3	V22	8R	7E7	V24	9A	12D93	V20	9A	25CO	V24	7C	117ZAGT	V26	8A			
6K4	V22	8R	7E8	V24	9A	12D94	V20	9A	25CP	V24	7C	117ZAGT	V26	8A			
6K5	V22	8R	7E9	V24	9A	12D95	V20	9A	25CQ	V24	7C	117ZAGT	V26	8A			
6K6	V22	8R	7F0	V24	9A	12D96	V20	9A	25CR	V24	7C	117ZAGT	V26	8A			
6K7	V21	7T	7F1	V24	9A	12D97	V20	9A	25CS	V24	7C	117ZAGT	V26	8A			
6K8	V21	7T	7F2	V24	9A	12D98	V20	9A	25CT	V24	7C	117ZAGT	V26	8A			
6K9	V21	7T	7F3	V24	9A	12D99	V20	9A	25CU	V24	7C	117ZAGT	V26	8A			
6L0	V23	7B2	7F4	V24	9A	12D100	V20	9A	25CV	V24	7C	117ZAGT	V26	8A			
6L1	V23	7B2	7F5	V24	9A	12D101	V20	9A	25CW	V24	7C	117ZAGT	V26	8A			
6L2	V23	7B2	7F6	V24	9A	12D102	V20	9A	25CX	V24	7C	117ZAGT	V26	8A			
6L3	V23	7B2	7F7	V24	9A	12D103	V20	9A	25CY	V24	7C	117ZAGT	V26	8A			
6L4	V23	7B2	7F8	V24	9A	12D104	V20	9A	25CZ	V24	7C	117ZAGT	V26	8A			
6L5	V23	7B2	7F9	V24	9A	12D105	V20	9A	25D0	V24	7C	117ZAGT	V26	8A			
6L6	V23	7B2	7F0	V24	9A	12D106	V20	9A	25D1	V24	7C	117ZAGT	V26	8A			
6L7	V21	7T	7F1	V24	9A	12D107	V20	9A	25D2	V24	7C	117ZAGT	V26	8A			
6L8	V21	7T	7F2	V24	9A	12D108	V20	9A	25D3	V24	7C	117ZAGT	V26	8A			
6L9	V21	7T	7F3	V24	9A	12D109	V20	9A	25D4	V24	7C	117ZAGT	V26	8A			
6M0	V21	7T	7F4	V24	9A	12D110	V20	9A	25D5	V24	7C	117ZAGT	V26	8A			
6M1	V21	7T	7F5	V24	9A	12D111	V20	9A	25D6	V24	7C	117ZAGT	V26	8A			
6M2	V21	7T	7F6	V24	9A	12D112	V20	9A	25D7	V24	7C	117ZAGT	V26	8A			
6M3	V21	7T	7F7	V24	9A	12D113	V20	9A	25D8	V24	7C	117ZAGT	V26	8A			
6M4	V21	7T	7F8	V24	9A	12D114	V20	9A	25D9	V24	7C	117ZAGT	V26	8A			
6M5	V21	7T	7F9	V24	9A	12D115	V20	9A	25DA	V24	7C	117ZAGT	V26	8A			
6M6	V21	7T	7F0	V24	9A	12D116	V20	9A	25DB	V24	7C	117ZAGT	V26	8A			
6M7	V21	7T	7F1	V24	9A	12D117	V20	9A	25DC	V24	7C	117ZAGT	V26	8A			
6M8	V21	7T	7F2	V24	9A	12D118	V20	9A	25DD	V24	7C	117ZAGT	V26	8A			
6M9	V21	7T	7F3	V24	9A	12D119	V20	9A	25DE	V24	7C	117ZAGT	V26	8A			
6N0	V23	12CA	7A4	V24	9A	12D120	V20	9A	25DF	V24	7C	117ZAGT	V26	8A			
6N1	V23	12CA	7A5	V24	9A	12D121	V20	9A	25DG	V24	7C	117ZAGT	V26	8A			
6N2	V23	12CA	7A6	V24	9A	12D122	V20	9A	25DH	V24	7C	117ZAGT	V26	8A			
6N3	V23	12CA	7A7	V24	9A	12D123	V20	9A	25DI	V24	7C	117ZAGT	V26	8A			
6N4	V23	12CA	7A8	V24	9A	12D124	V20	9A	25DJ	V24	7C	117ZAGT	V26	8A			
6N5	V23	12CA	7A9	V24	9A	12D125	V20	9A	25DK	V24	7C	117ZAGT	V26	8A			
6N6	V23	12CA	7B0	V24	9A	12D126	V20	9A	25DL	V24	7C	117ZAGT	V26	8A			
6N7	V21	7F	7V1	V24	9A	12D127	V20	9A	25DM	V24	7C	117ZAGT	V26	8A			
6N8	V21	7F	7V2	V24	9A	12D128	V20	9A	25DN	V24	7C	117ZAGT	V26	8A			
6N9	V21	7F	7V3	V24	9A	12D129	V20	9A	25DO	V24	7C	117ZAGT	V26	8A			
6O0	V21	7F	7V4	V24	9A	12D130	V20	9A	25DP	V24	7C	117ZAGT	V26	8A			
6O1	V21	7F	7V5	V24	9A	12D131	V20	9A	25DQ	V24	7C	117ZAGT	V26	8A			
6O2	V21	7F	7V6	V24	9A	12D132	V20	9A	25DR	V24	7C	117ZAGT	V26	8A			
6O3	V21	7F	7V7	V24	9A	12D133	V20	9A	25DS	V24	7C	117ZAGT	V26	8A			
6O4	V21	7F	7V8	V24	9A	12D134	V20	9A	25DT	V24	7C	117ZAGT	V26	8A			
6O5	V21	7F	7V9	V24	9A	12D135	V20	9A	25DU	V24	7C	117ZAGT	V26	8A			
6O6	V21	7F	7V0	V24	9A	12D136	V20	9A	25DV	V24	7C	117ZAGT	V26	8A			
6O7	V21	7F	7V1	V24	9A	12D137	V20	9A	25DW	V24	7C	117ZAGT	V26	8A			
6O8	V21	7F	7V2	V24	9A	12D138	V20	9A	25DX	V24	7C	117ZAGT	V26	8A			
6O9	V21	7F	7V3	V24	9A	12D139	V20	9A	25DY	V24	7C	117ZAGT	V26	8A			
6P0	V21	7F	7V4	V24	9A	12D140	V20	9A	25DZ	V24	7C	117ZAGT	V26	8A			
6P1	V21	7F	7V5	V24	9A	12D141	V20	9A	25E0	V24	7C	117ZAGT	V26	8A			
6P2	V21	7F	7V6	V24	9A	12D142	V20	9A	25E1	V24	7C	117ZAGT	V26	8A			
6P3	V21	7F	7V7	V24	9A	12D143	V20	9A	25E2	V24	7C	117ZAGT	V26	8A			
6P4	V21	7F	7V8	V24	9A	12D144	V20	9A	25E3	V24	7C	117ZAGT	V26	8A			
6P5	V21	7F	7V9	V24	9A	12D145	V20	9A	25E4	V24	7C	117ZAGT	V26	8A			
6P6	V21	7F	7V0	V24	9A	12D146	V20	9A	25E5	V24	7C	117ZAGT	V26	8A			
6P7	V21	7F	7V1	V24	9A	12D147	V20	9A	25E6	V24	7C	117ZAGT	V26	8A			
6P8	V21	7F	7V2	V24	9A	12D148	V20	9A	25E7	V24	7C	117ZAGT	V26	8A			
6P9	V21	7F	7V3	V24	9A	12D149	V20	9A	25E8	V24	7C	117ZAGT	V26	8A			
6Q0	V21	7F	7V4	V24	9A	12D150	V20	9A	25E9	V24	7C	117ZAGT	V26	8A			
6Q1	V21	7F	7V5	V24	9A	12D151	V20	9A	25EA	V24	7C	117ZAGT	V26	8A			
6Q2	V21	7F	7V6	V24	9A	12D152	V20	9A	25EB	V24	7C	117ZAGT	V26	8A			
6Q3	V21	7F	7V7	V24	9A	12D153	V20	9A	25EC	V24	7C	117ZAGT	V26	8A			
6Q4	V21	7F	7V8	V24	9A	12D154	V20	9A	25ED	V24	7C	117ZAGT	V26	8A			
6Q5	V21	7F	7V9	V24	9A	12D155	V20	9A	25EE	V24	7C	117ZAGT	V26	8A			
6Q6	V21	7F	7V0	V24	9A	12D156	V20	9A	25EF	V24	7C	117ZAGT	V26	8A			
6Q7	V21	7F	7V1	V24	9A	12D157	V20	9A	25EG	V24	7C	117ZAGT	V26	8A			
6Q8	V21	7F	7V2	V24	9A	12D158	V20	9A	25EH	V24	7C	117ZAGT	V26	8A			
6Q9	V21	7F	7V3	V24	9A	12D159	V20	9A	25EI	V24	7C	117ZAGT	V26	8A			
6R0	V21	7F	7V4	V24	9A	12D160	V20	9A	25EJ	V24	7C	117ZAGT	V26	8A			
6R1	V21	7F	7V5	V24	9A	12D161	V20	9A	25EK	V24	7C	117ZAGT	V26	8A			
6R2	V21	7F	7V6	V24	9A	12D162	V20	9A	25EL	V24	7C	117ZAGT	V26	8A			
6R3	V21	7F	7V7	V24	9A	12D163	V20	9A	25EM	V24	7C	117ZAGT	V26	8A			
6R4	V21	7F	7V8	V24	9A	12D164	V20	9A	25EN	V24	7C						

Type	Page	Base	Type	Page	Base	Type	Page	Base	Type	Page	Base	Type	Page	Base
879	5683	V25 4AB	6262	V30 Fig. 7	9002	PL172/8295	9003	V27 7B8	PK11	Ch. 11	PK11	Ch. 11	Ch. 11	
884	5670	V24 6CJ	6263	V27	9004	PL172/8295	9005	V27 7BD	PK12	Ch. 11	PK12	Ch. 11	Ch. 11	
885	5679	V24 7CX	6265	V24 7CM	9006	PL172/8295	9007	V28 5BC	PK13	Ch. 11	PK13	Ch. 11	Ch. 11	
886	5686	V30 9C	6267	V24 9CT	9008	PL172/8295	9009	V28 6B8	PK14	Ch. 11	PK14	Ch. 11	Ch. 11	
887	5687	V20 9H	6300	V25 8EK	9010	PL172/8295	9011	V28 5BK	PK15	Ch. 11	PK15	Ch. 11	Ch. 11	
888	5690	V24 8BD	6302	V24 8BD	9012	PL172/8295	9013	V28 5BK	PK16	Ch. 11	PK16	Ch. 11	Ch. 11	
889	5692	V24 8BD	6304	V25 9A	9014	PL172/8295	9015	V28 5BK	PK17	Ch. 11	PK17	Ch. 11	Ch. 11	
890	5693	V21 8CB	6306	V20 9E	9016	PL172/8295	9017	V28 5BK	PK18	Ch. 11	PK18	Ch. 11	Ch. 11	
891	5694	V25 7BN	6308	V20 9K	9018	PL172/8295	9019	V28 5BK	PK19	Ch. 11	PK19	Ch. 11	Ch. 11	
892	5722	V20 9CB	6417	V24 7BK	9020	PL172/8295	9021	V28 5BK	PK20	Ch. 11	PK20	Ch. 11	Ch. 11	
893	5726	V24 7BN	6445	V24 7BK	9022	PL172/8295	9023	V28 5BK	PK21	Ch. 11	PK21	Ch. 11	Ch. 11	
894	5727	V24 7BN	6445	V24 7BK	9024	PL172/8295	9025	V28 5BK	PK22	Ch. 11	PK22	Ch. 11	Ch. 11	
895	5731	V24 7BC	6524	V20 Fig. 76	9026	PL172/8295	9027	V28 5BK	PK23	Ch. 11	PK23	Ch. 11	Ch. 11	
896	5732	V24 7BC	6524	V20 Fig. 76	9028	PL172/8295	9029	V28 5BK	PK24	Ch. 11	PK24	Ch. 11	Ch. 11	
897	5750	V24 7CH	6660	V24 7CM	9030	PL172/8295	9031	V28 5BK	PK25	Ch. 11	PK25	Ch. 11	Ch. 11	
898	5751	V24 9A	6661	V24 7CM	9032	PL172/8295	9033	V28 5BK	PK26	Ch. 11	PK26	Ch. 11	Ch. 11	
899	5751	V24 9A	6661	V24 7CM	9034	PL172/8295	9035	V28 5BK	PK27	Ch. 11	PK27	Ch. 11	Ch. 11	
900	5752	V24 9A	6663	V24 6BT	9036	PL172/8295	9037	V28 5BK	PK28	Ch. 11	PK28	Ch. 11	Ch. 11	
901	5766	V20 9K	6664	V24 5CE	9038	PL172/8295	9039	V28 5BK	PK29	Ch. 11	PK29	Ch. 11	Ch. 11	
902	5766	V20 9K	6664	V24 5CE	9040	PL172/8295	9041	V28 5BK	PK30	Ch. 11	PK30	Ch. 11	Ch. 11	
903	5768	V20 9K	6677	V24 9AB	9042	PL172/8295	9043	V28 5BK	PK31	Ch. 11	PK31	Ch. 11	Ch. 11	
904	5794	V20 9K	6677	V24 9AB	9044	PL172/8295	9045	V28 5BK	PK32	Ch. 11	PK32	Ch. 11	Ch. 11	
905	5812	V20 9K	6680	V25 9A	9046	PL172/8295	9047	V28 5BK	PK33	Ch. 11	PK33	Ch. 11	Ch. 11	
906	5814	V25 4CK	6681	V25 9A	9048	PL172/8295	9049	V28 5BK	PK34	Ch. 11	PK34	Ch. 11	Ch. 11	
907	5823	V24 7B	6681	V25 9A	9050	PL172/8295	9051	V28 5BK	PK35	Ch. 11	PK35	Ch. 11	Ch. 11	
908	5824	V24 7B	6681	V25 9A	9052	PL172/8295	9053	V28 5BK	PK36	Ch. 11	PK36	Ch. 11	Ch. 11	
909	5824	V24 7B	6681	V25 9A	9054	PL172/8295	9055	V28 5BK	PK37	Ch. 11	PK37	Ch. 11	Ch. 11	
910	5824	V24 7B	6681	V25 9A	9056	PL172/8295	9057	V28 5BK	PK38	Ch. 11	PK38	Ch. 11	Ch. 11	
911	5824	V24 7B	6681	V25 9A	9058	PL172/8295	9059	V28 5BK	PK39	Ch. 11	PK39	Ch. 11	Ch. 11	
912	5824	V24 7B	6681	V25 9A	9060	PL172/8295	9061	V28 5BK	PK40	Ch. 11	PK40	Ch. 11	Ch. 11	
913	5824	V24 7B	6681	V25 9A	9062	PL172/8295	9063	V28 5BK	PK41	Ch. 11	PK41	Ch. 11	Ch. 11	
914	5824	V24 7B	6681	V25 9A	9064	PL172/8295	9065	V28 5BK	PK42	Ch. 11	PK42	Ch. 11	Ch. 11	
915	5824	V24 7B	6681	V25 9A	9066	PL172/8295	9067	V28 5BK	PK43	Ch. 11	PK43	Ch. 11	Ch. 11	
916	5824	V24 7B	6681	V25 9A	9068	PL172/8295	9069	V28 5BK	PK44	Ch. 11	PK44	Ch. 11	Ch. 11	
917	5824	V24 7B	6681	V25 9A	9070	PL172/8295	9071	V28 5BK	PK45	Ch. 11	PK45	Ch. 11	Ch. 11	
918	5824	V24 7B	6681	V25 9A	9072	PL172/8295	9073	V28 5BK	PK46	Ch. 11	PK46	Ch. 11	Ch. 11	
919	5824	V24 7B	6681	V25 9A	9074	PL172/8295	9075	V28 5BK	PK47	Ch. 11	PK47	Ch. 11	Ch. 11	
920	5824	V24 7B	6681	V25 9A	9076	PL172/8295	9077	V28 5BK	PK48	Ch. 11	PK48	Ch. 11	Ch. 11	
921	5824	V24 7B	6681	V25 9A	9078	PL172/8295	9079	V28 5BK	PK49	Ch. 11	PK49	Ch. 11	Ch. 11	
922	5824	V24 7B	6681	V25 9A	9080	PL172/8295	9081	V28 5BK	PK50	Ch. 11	PK50	Ch. 11	Ch. 11	
923	5824	V24 7B	6681	V25 9A	9082	PL172/8295	9083	V28 5BK	PK51	Ch. 11	PK51	Ch. 11	Ch. 11	
924	5824	V24 7B	6681	V25 9A	9084	PL172/8295	9085	V28 5BK	PK52	Ch. 11	PK52	Ch. 11	Ch. 11	
925	5824	V24 7B	6681	V25 9A	9086	PL172/8295	9087	V28 5BK	PK53	Ch. 11	PK53	Ch. 11	Ch. 11	
926	5824	V24 7B	6681	V25 9A	9088	PL172/8295	9089	V28 5BK	PK54	Ch. 11	PK54	Ch. 11	Ch. 11	
927	5824	V24 7B	6681	V25 9A	9090	PL172/8295	9091	V28 5BK	PK55	Ch. 11	PK55	Ch. 11	Ch. 11	
928	5824	V24 7B	6681	V25 9A	9092	PL172/8295	9093	V28 5BK	PK56	Ch. 11	PK56	Ch. 11	Ch. 11	
929	5824	V24 7B	6681	V25 9A	9094	PL172/8295	9095	V28 5BK	PK57	Ch. 11	PK57	Ch. 11	Ch. 11	
930	5824	V24 7B	6681	V25 9A	9096	PL172/8295	9097	V28 5BK	PK58	Ch. 11	PK58	Ch. 11	Ch. 11	
931	5824	V24 7B	6681	V25 9A	9098	PL172/8295	9099	V28 5BK	PK59	Ch. 11	PK59	Ch. 11	Ch. 11	
932	5824	V24 7B	6681	V25 9A	9100	PL172/8295	9101	V28 5BK	PK60	Ch. 11	PK60	Ch. 11	Ch. 11	
933	5824	V24 7B	6681	V25 9A	9102	PL172/8295	9103	V28 5BK	PK61	Ch. 11	PK61	Ch. 11	Ch. 11	
934	5824	V24 7B	6681	V25 9A	9104	PL172/8295	9105	V28 5BK	PK62	Ch. 11	PK62	Ch. 11	Ch. 11	
935	5824	V24 7B	6681	V25 9A	9106	PL172/8295	9107	V28 5BK	PK63	Ch. 11	PK63	Ch. 11	Ch. 11	
936	5824	V24 7B	6681	V25 9A	9108	PL172/8295	9109	V28 5BK	PK64	Ch. 11	PK64	Ch. 11	Ch. 11	
937	5824	V24 7B	6681	V25 9A	9110	PL172/8295	9111	V28 5BK	PK65	Ch. 11	PK65	Ch. 11	Ch. 11	
938	5824	V24 7B	6681	V25 9A	9112	PL172/8295	9113	V28 5BK	PK66	Ch. 11	PK66	Ch. 11	Ch. 11	
939	5824	V24 7B	6681	V25 9A	9114	PL172/8295	9115	V28 5BK	PK67	Ch. 11	PK67	Ch. 11	Ch. 11	
940	5824	V24 7B	6681	V25 9A	9116	PL172/8295	9117	V28 5BK	PK68	Ch. 11	PK68	Ch. 11	Ch. 11	
941	5824	V24 7B	6681	V25 9A	9118	PL172/8295	9119	V28 5BK	PK69	Ch. 11	PK69	Ch. 11	Ch. 11	
942	5824	V24 7B	6681	V25 9A	9120	PL172/8295	9121	V28 5BK	PK70	Ch. 11	PK70	Ch. 11	Ch. 11	
943	5824	V24 7B	6681	V25 9A	9122	PL172/8295	9123	V28 5BK	PK71	Ch. 11	PK71	Ch. 11	Ch. 11	
944	5824	V24 7B	6681	V25 9A	9124	PL172/8295	9125	V28 5BK	PK72	Ch. 11	PK72	Ch. 11	Ch. 11	
945	5824	V24 7B	6681	V25 9A	9126	PL172/8295	9127	V28 5BK	PK73	Ch. 11	PK73	Ch. 11	Ch. 11	
946	5824	V24 7B	6681	V25 9A	9128	PL172/8295	9129	V28 5BK	PK74	Ch. 11	PK74	Ch. 11	Ch. 11	
947	5824	V24 7B	6681	V25 9A	9130	PL172/8295	9131	V28 5BK	PK75	Ch. 11	PK75	Ch. 11	Ch. 11	
948	5824	V24 7B	6681	V25 9A	9132	PL172/8295	9133	V28 5BK	PK76	Ch. 11	PK76	Ch. 11	Ch. 11	
949	5824	V24 7B	6681	V25 9A	9134	PL172/8295	9135	V28 5BK	PK77	Ch. 11	PK77	Ch. 11	Ch. 11	
950	5824	V24 7B	6681	V25 9A	9136	PL172/8295	9137	V28 5BK	PK78	Ch. 11	PK78	Ch. 11	Ch. 11	
951	5824	V24 7B	6681	V25 9A	9138	PL172/8295	9139	V28 5BK	PK79	Ch. 11	PK79	Ch. 11	Ch. 11	
952	5824	V24 7B	6681	V25 9A	9140	PL172/8295	9141	V28 5BK	PK80	Ch. 11	PK80	Ch. 11	Ch. 11	
953	5824	V24 7B	6681	V25 9A	9142	PL172/8295	9143	V28 5BK	PK81	Ch. 11	PK81	Ch. 11	Ch. 11	
954	5824	V24 7B	6681	V25 9A	9144	PL172/8295	9145	V28 5BK	PK82	Ch. 11	PK82	Ch. 11	Ch. 11	
955	5824	V24 7B	6681	V25 9A	9146	PL172/8295	9147	V28 5BK	PK83	Ch. 11	PK83	Ch. 11	Ch. 11	
956	5824	V24 7B	6681	V25 9A	9148	PL172/8295	9149	V28 5BK	PK84	Ch. 11	PK84	Ch. 11	Ch. 11	
957	5824	V24 7B	6681	V25 9A	9150	PL172/8295	9151	V28 5BK	PK85	Ch. 11	PK85	Ch. 11	Ch. 11	
958	5824	V24 7B	6681	V25 9A	9152	PL172/8295	9153	V28 5BK	PK86	Ch. 11	PK86	Ch. 11	Ch. 11	
959	5824	V24 7B	6681	V25 9A	9154	PL172/8295	9155	V28 5BK	PK87	Ch. 11	PK87	Ch. 11	Ch. 11	
960	5824	V24 7B	6681	V25 9A	9156	PL172/8295	9157	V28 5BK	PK88	Ch. 11	PK88	Ch. 11	Ch. 11	
961	5824	V24 7B	6681	V25 9A	9158	PL172/8295	9159	V28 5BK	PK89	Ch. 11	PK89	Ch. 11	Ch. 11	
962	5824	V24 7B	6681	V25 9A	9160	PL172/8295	9161	V28 5BK	PK90	Ch. 11	PK90	Ch. 11	Ch. 11	
963	5824	V24 7B	6681	V25 9A	9162	PL172/8295	9163	V28 5BK	PK91	Ch. 11	PK91	Ch. 11	Ch. 11	
964	5824	V24 7B	6681	V25 9A	9164	PL172/8295	9165	V28 5BK	PK92	Ch. 11	PK92	Ch. 11	Ch. 11	
965	5824	V24 7B	6681	V25 9A	9166	PL172/8295	9167	V28 5BK	PK93	Ch. 11	PK93	Ch. 11	Ch. 11	
966	5824	V24 7B	6681	V25 9A	9168	PL172/8295	9169	V28 5BK	PK94	Ch. 11	PK94	Ch. 11	Ch. 11	
967	5824	V24 7B	6681	V25 9A	9170	PL172/8295	9171	V28 5BK	PK95	Ch. 11	PK95	Ch. 11	Ch. 11	
968	5824	V24 7B	6681	V25 9A	9172	PL172/8295	9173	V28 5BK	PK96	Ch. 11	PK96	Ch. 11	Ch. 11	
969	5824	V24 7B	6681	V25 9A	9174	PL172/8295	9175	V28 5BK	PK97	Ch. 11	PK97	Ch. 11	Ch. 11	
970	5824	V24 7B	6681	V25 9A	91									

E.I.A. VACUUM-TUBE BASE DIAGRAMS

Socket connections correspond to the base designations given in the column headed "Base" in the classified tube-data tables. Bottom views are shown throughout. Terminal designations are as follows:

- |                  |                      |                                |                            |
|------------------|----------------------|--------------------------------|----------------------------|
| A = Anode        | D = Deflecting Plate | IS = Internal Shield           | RC = Ray-Control Electrode |
| B = Beam         | F = Filament         | K = Cathode                    | Ref = Reflector            |
| BP = Bayonet Pin | FE = Focus Elect.    | NC = No Connection             | S = Shell                  |
| BS = Base Sleeve | G = Grid             | P = Plate (Anode)              | TA = Target                |
| C = Ext. Coating | H = Heater           | P <sub>1</sub> = Starter-Anode | U = Unit                   |
| CL = Collector   | IC = Internal Con.   | P <sub>2</sub> F = Beam Plates | • = Gas-Type Tube          |

Alphabetical subscripts D, P, T and HX indicate, respectively, diode unit, pentode unit, triode unit or hexode unit in multi-unit types. Subscript CT indicates filament or heater tap.

Generally when the No. 1 pin of a metal-type tube in Table 11, with the exception of all triodes, is shown connected to the shell, the No. 1 pin in the glass (G or GT) equivalent is connected to an internal shield.

\* On 12AQ, 12AS and 12CT: index = large lug; • = pin cut off

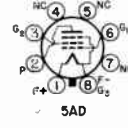
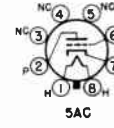
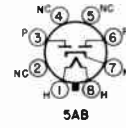
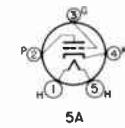
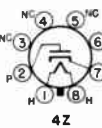
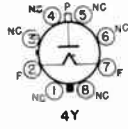
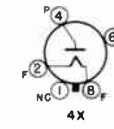
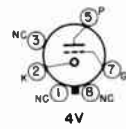
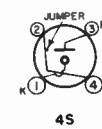
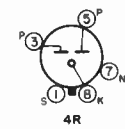
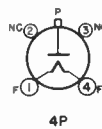
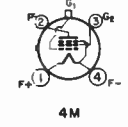
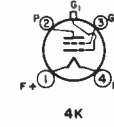
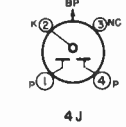
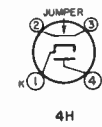
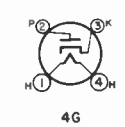
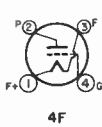
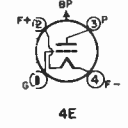
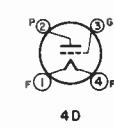
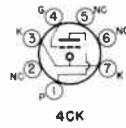
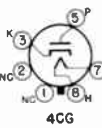
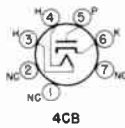
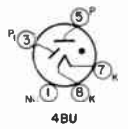
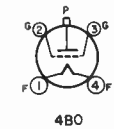
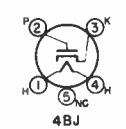
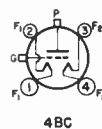
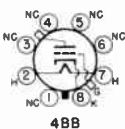
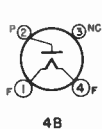
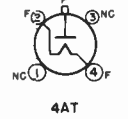
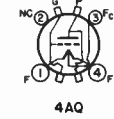
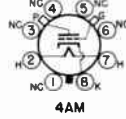
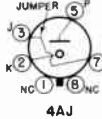
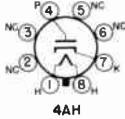
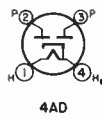
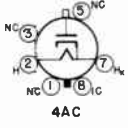
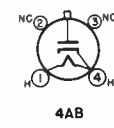
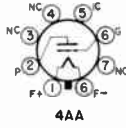
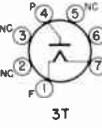
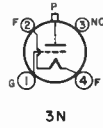
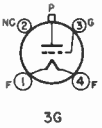
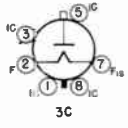
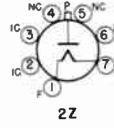
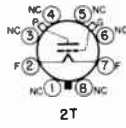
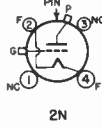
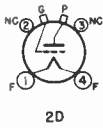
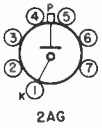

TUBE BASE DIAGRAMS

Bottom views are shown. Terminal designations on sockets are given on page V5.

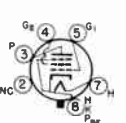
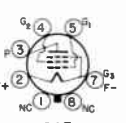
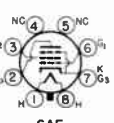
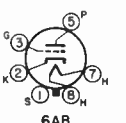
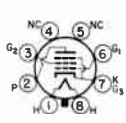
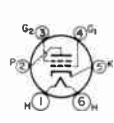
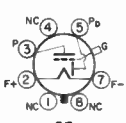
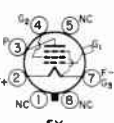
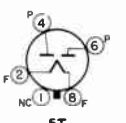
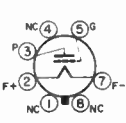
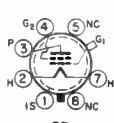
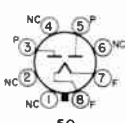
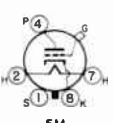
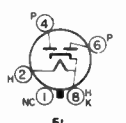
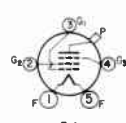
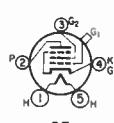
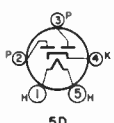
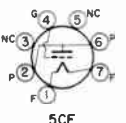
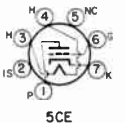
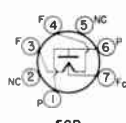
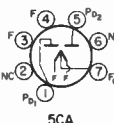
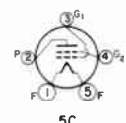
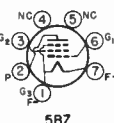
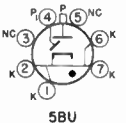
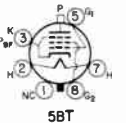
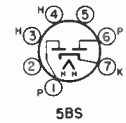
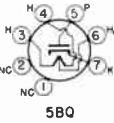
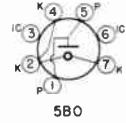
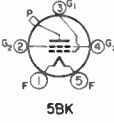
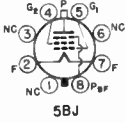
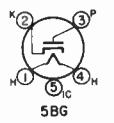
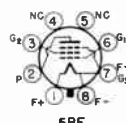
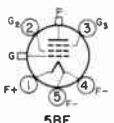
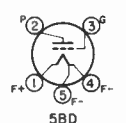
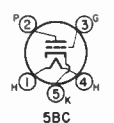
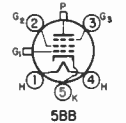
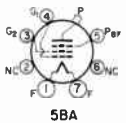
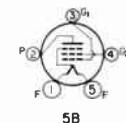
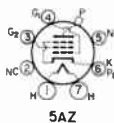
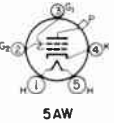
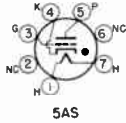
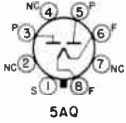
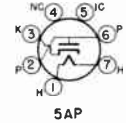
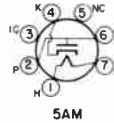
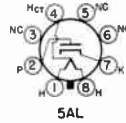
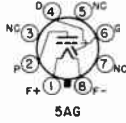
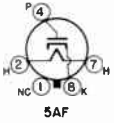



TUBE BASE DIAGRAMS

Bottom views are shown. Terminal designations on sockets are given on page V5.

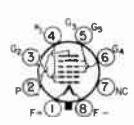
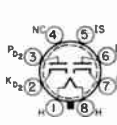
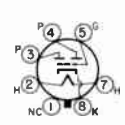
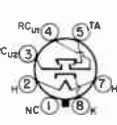
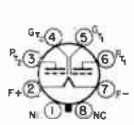
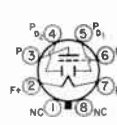
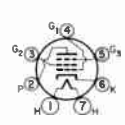
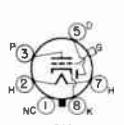
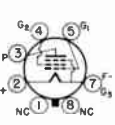
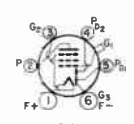
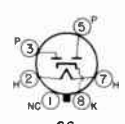
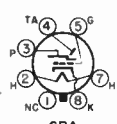
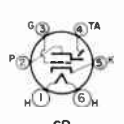
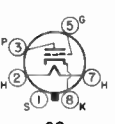
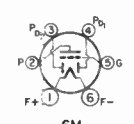
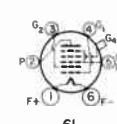
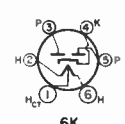
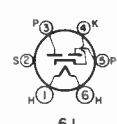
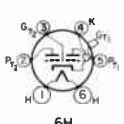
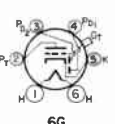
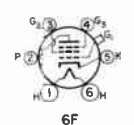
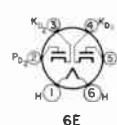
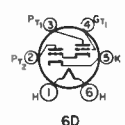
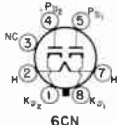
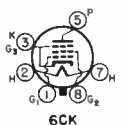
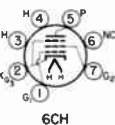
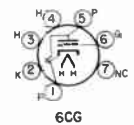
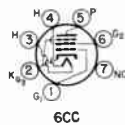
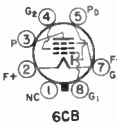
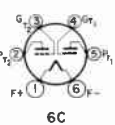
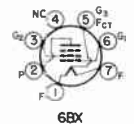
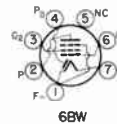
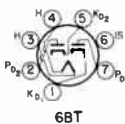
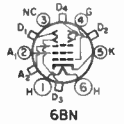
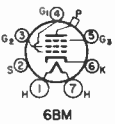
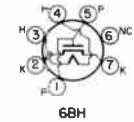
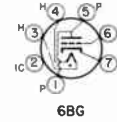
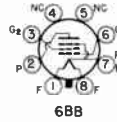
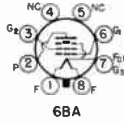
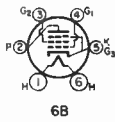
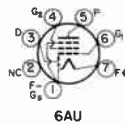
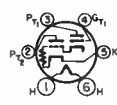
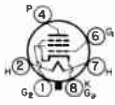

TUBE BASE DIAGRAMS

Bottom views are shown. Terminal designations on sockets are given on page V5

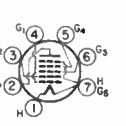
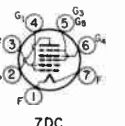
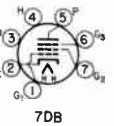
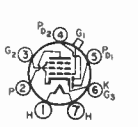
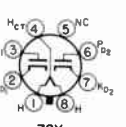
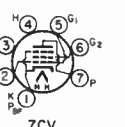
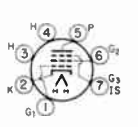
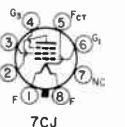
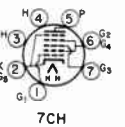
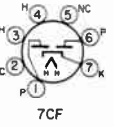
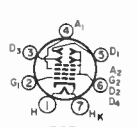
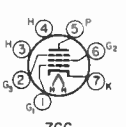
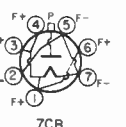
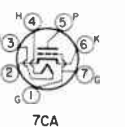
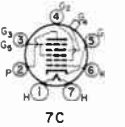
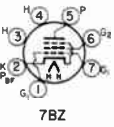
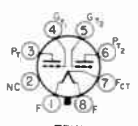
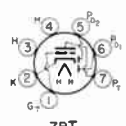
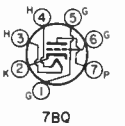
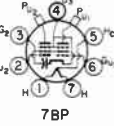
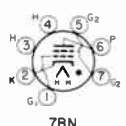
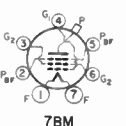
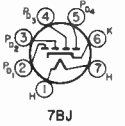
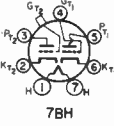
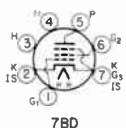
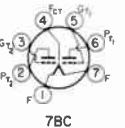
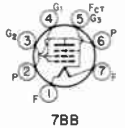
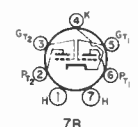
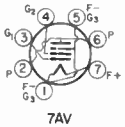
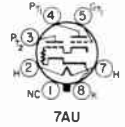
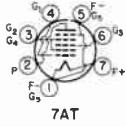
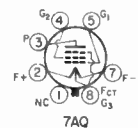
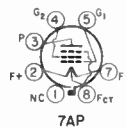
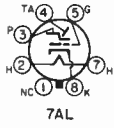

TUBE BASE DIAGRAMS

Bottom views are shown. Terminal designations on sockets are given on page V5.

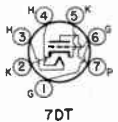

7DT

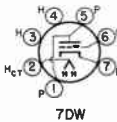

7DW

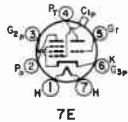

TUBE BASE DIAGRAMS

Bottom views are shown. Terminal designations on sockets are given on page V5.

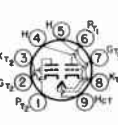
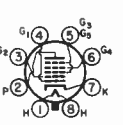
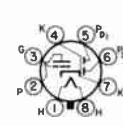
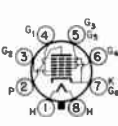
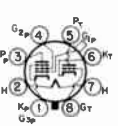
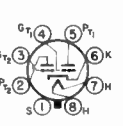
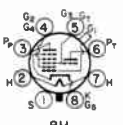
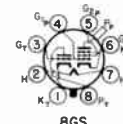
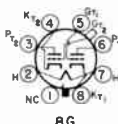
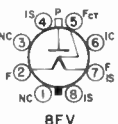
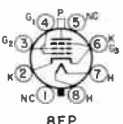
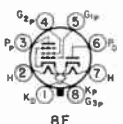
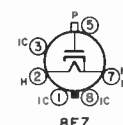
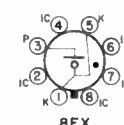
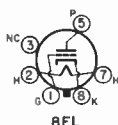
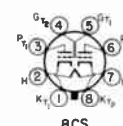
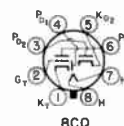
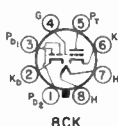
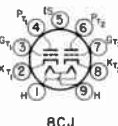
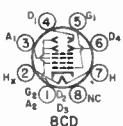
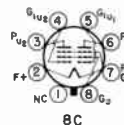
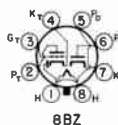
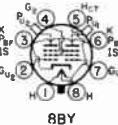
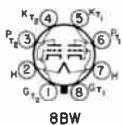
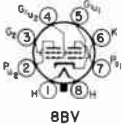
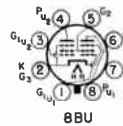
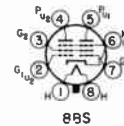
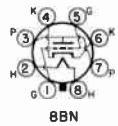
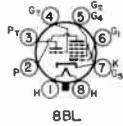



TUBE BASE DIAGRAMS

Bottom views are shown. Terminal designations on sockets are given on page V5.



9AC



9AD

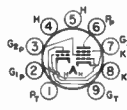

9AE

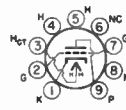

9AG

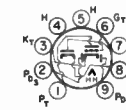

9AH

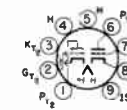

9AJ



9AK



9AM

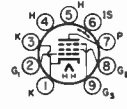

9AQ

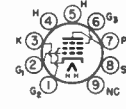

9AR



9AS

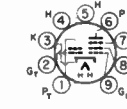

9AT



9AX



9AZ



9BA



9BB



9BC

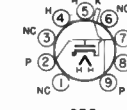

9BD



9BF



9BG



9BJ



9BK



9BL



9BM



9BP



9BQ

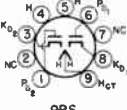

9BS



9BU



9BV

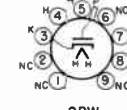

9BW

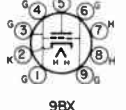

9BX

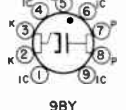

9BY



9BZ

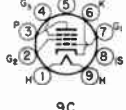

9C

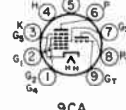

9CA

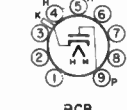

9CB

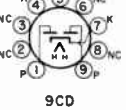

9CD

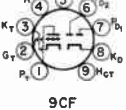

9CF



9CG



9CK



9CT



9CV

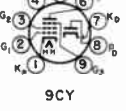

9CY



9CZ



9DA



9DC

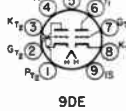

9DE



9DJ



9DP

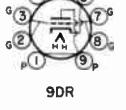

9DR

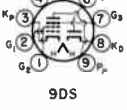

9DS

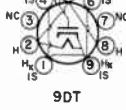

9DT



9DW

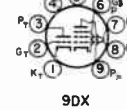

9DX

TUBE BASE DIAGRAMS

Bottom views are shown. Terminal designations on sockets are given on page V5

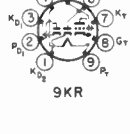
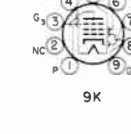
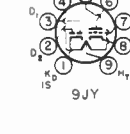
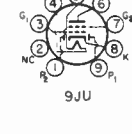
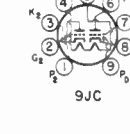
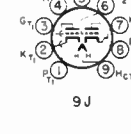
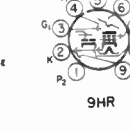
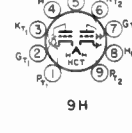
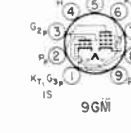
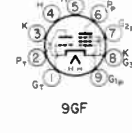
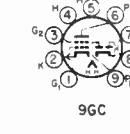
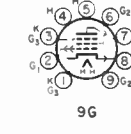
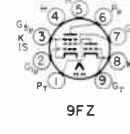
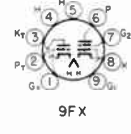
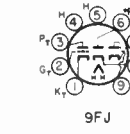
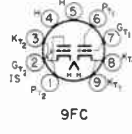
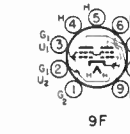
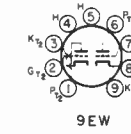
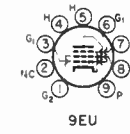
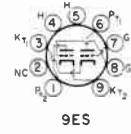
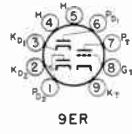
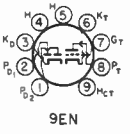
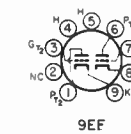
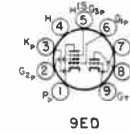
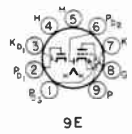
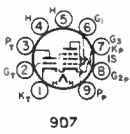

Bottom views are shown. Terminal designations on sockets and \* meaning are given on page V5.



9LS



9KV



9LW



9LY

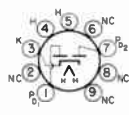

9M

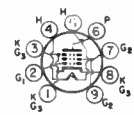

9MS



9N



9NM

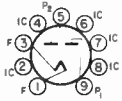

9NT



9NZ

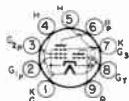

9PA



9PB



9PM



9PU



9PX



9Q



9QA



9CL



9R



9S



9T



9U



9V



9X



9Y



9Z



11A



11B



11C



11J



11L



11M



11N



11S



11T



11V



12AQ



12AS



12BF



12BJ



12BM

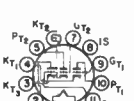

12BQ



12BY



12FB



12BW



12CA



12CT



12E



12EA



12A



12EU



12F

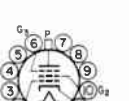

12J



12T

TUBE BASE DIAGRAMS

Bottom views are shown. Terminal designations on sockets are given on page V5.



14A



14B



14E



14G

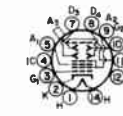

14J



14K



14P



14R



14S



14U



14V



FIG. 1

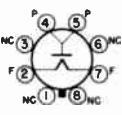

FIG. 2

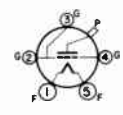

FIG. 3





## TUBE BASE DIAGRAMS

Bottom views are shown. Terminal designations on sockets are given on page V5.

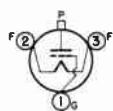

FIG. 44

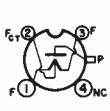

FIG. 45

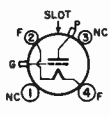

FIG. 46

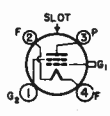

FIG. 47

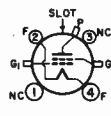

FIG. 48

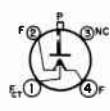

FIG. 49

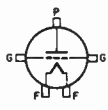

FIG. 50

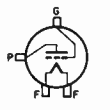

FIG. 51

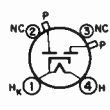

FIG. 52

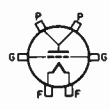

FIG. 53

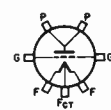

FIG. 54

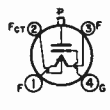

FIG. 55

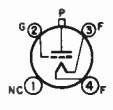

FIG. 56

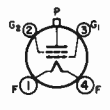

FIG. 57

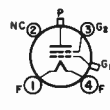

FIG. 58

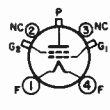

FIG. 59

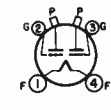

FIG. 60

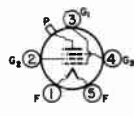

FIG. 61

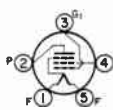

FIG. 62

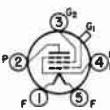

FIG. 63

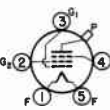

FIG. 64

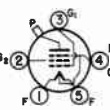

FIG. 65

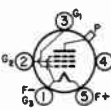

FIG. 66

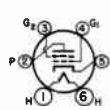

FIG. 67

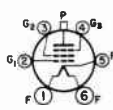

FIG. 68

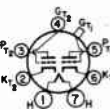

FIG. 69

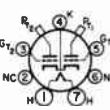

FIG. 70

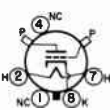

FIG. 71

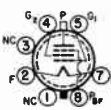

FIG. 72

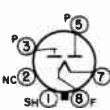

FIG. 73



FIG. 74



FIG. 75

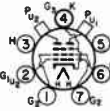

FIG. 76

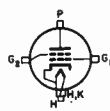

FIG. 77

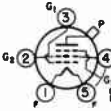

FIG. 78

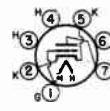

FIG. 79

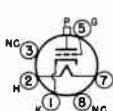

FIG. 80

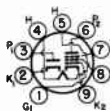

FIG. 81



FIG. 82



FIG. 84



FIG. 85

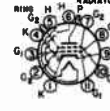

FIG. 86

TABLE I—MINIATURE RECEIVING TUBES

Type	Name	Base	Fil. or Heater		Capacitances pf.			Plate Supply V.	Grid Bias	Screen Volts	Screen Wren.	Plate Mb.	Plate Res. Ohms.	Transcon- ductance <sup>1</sup>	Amp. Factor <sup>2</sup>	Load Res. Ohms	Watts Output	
			V.	Amp.	C <sub>in</sub>	C <sub>out</sub>	C <sub>sp</sub>											
1A3	H.f. Diode	5AP	1.4	0.15	—	—	—	Max. a.c. voltage per plate — 117. Max. output current — 0.5 ma.										
1L4	Sharp Cut-off Pent.	6AR	1.4	0.05	3.6	7.5	0.008	90	0	90	2.0	4.5	350K	1025	—	—	—	
1L6	Pentagrid Conv.	7DC	1.4	0.05	7.5	12.0	0.3	90	0	45	0.6	0.5	650K	300	—	—	—	
1R5	Pentagrid Conv.	7AT	1.4	0.05	7.0	12.0	0.3	90	0	67.5	3.5	1.5	400K	280	Grid No. 1 100K			
1S4	Pentagrid Pwr. Amp.	7AV	1.4	0.1	—	—	—	90	-7.0	67.5	1.4	7.4	100K	1575	—	8K	0.270	
1S5	Diode — Pentode	A <sub>1</sub> Amp. R.f. Amp.	6AU	1.4	0.05	—	—	67.5	0	67.5	0.4	1.6	600K	625	—	—	—	
								90	0	90	Screen Resistor 3 meg., grid 10 meg.		1 meg.	0.050				
1T4	Variable- $\mu$ Pent.	6AR	1.4	0.05	3.6	7.5	0.01	90	0	67.5	1.4	3.5	500K	900	—	—	—	
1U4	Sharp Cut-off Pent.	6AR	1.4	0.05	3.6	7.5	0.01	90	0	90	0.5	1.6	1 meg.	900	—	—	—	
1U5	Diode Pentode	6BW	1.4	0.05	—	—	—	67.5	0	67.5	0.4	1.6	600K	625	—	—	—	
2E30	Beam Pwr. Pent.	A <sub>1</sub> Amp. A <sub>2</sub> Amp. <sup>2</sup> AB <sub>1</sub> Amp. <sup>3</sup> AB <sub>2</sub> Amp. <sup>3</sup>	7CQ	6.0	0.65	9.5	6.6	0.2	250	450*	250	3.3/7.4	44 <sup>2</sup>	63K	3700	40 <sup>3</sup>	4.5K	4.5
									250	225*	250	6.6/14.8	88 <sup>2</sup>	—	—	80 <sup>3</sup>	9K <sup>6</sup>	9
									250	-25	250	3/13.5	82 <sup>2</sup>	—	—	48 <sup>3</sup>	8K <sup>6</sup>	12.5
									250	-30	250	4/20	120 <sup>2</sup>	—	—	40 <sup>3</sup>	3.8 <sup>6</sup>	17
2EA5 <sup>1</sup>	Sharp Cut-off Pent.	7EW	2.4	0.60	3.8	2.3	0.06	250	-1	150	—	10	150K	8000	—	—	—	
2EN5 <sup>1</sup>	Dual Diode	7FL	2.1	0.45	—	—	—	Max. a.c. voltage per plate — 200. Max. output current — 5.0 ma.										
								1.4	0.2	—	—	135	-7.5	90	2.6	14.9 <sup>2</sup>	90K	1900
3A4	Pwr. Amp. Pent.	7BB	2.8	0.1	4.8	4.2	0.34	150	-8.4	90	2.2	14.1 <sup>2</sup>	100K	—	—	—	—	
																		1.4
3A5	H.f. Dual Triode <sup>10</sup>	7BC	2.8	0.11	0.9	1.0	3.2	90	-2.5	—	—	3.7	8.3K	1800	15	—	—	
3DK6 <sup>1</sup>	Sharp Cut-off Pent.	7CM	3.15	0.6	6.3	1.9	0.02	300	-6.5	150	3.8	12	—	9800	—	—	—	
3Q4	Pwr. Amp. Pent.	7BA	1.4	0.1	5.5	3.8	0.2	90	-4.5	90	1.7	7.7	120K	2000	—	10K	0.27	
																	2.8	0.05
3S4	Pwr. Amp. Pent.	7BA	1.4	0.1	—	—	—	90	-7	67.5	1.4	7.4	100K	1575	—	8K	0.27	
																	2.8	0.05
4EW6 <sup>1</sup>	Sharp Cut-off Pent.	7CM	4.2	0.6	10.0	2.4	0.04	300	-3.5	180	3.2	11	—	1400	—	—	—	
6AB4	U.h.f. Triode	5CE	6.3	0.15	2.2	0.5	1.5	250	200*	—	—	10	10.9K	5500	60	—	—	
6AF4A	U.h.f. — Triode	A <sub>1</sub> Amp. Osc. 950 Mc.	7DK	6.3	0.225	2.2	0.45	1.9	80	150*	—	—	16	2.27K	6600	15	—	
									100	10K $\Omega$	—	—	0.4 <sup>8</sup>	22	—	—	—	
6AG5	Sharp Cut-off Pent.	7BD	6.3	0.3	6.5	1.8	0.03	250	180*	150	2.0	6.5	800K	5000	—	—	—	
6AH6	Sharp Cut-off Pent.	Pent. Amp. Triode Amp.	7BK	6.3	0.45	10.0	2.0	0.03	300	160*	150	2.5	10	500K	9600	—	—	
									150	160*	—	—	12.5	3.6K	11K	40	—	—
6AJ4	U.h.f. Triode	9BX	6.3	0.225	4.4	0.18	2.4	125	68*	—	—	16	4.2K	10K	42	—	—	
6AK5	Sharp Cut-off Pent.	7BD	6.3	0.175	4.0	2.8	0.02	180	200*	120	2.4	7.7	690K	5100	—	—	—	
								150	330*	140	2.2	7	420K	4300	—	—		
6AK6	Pwr. Amp. Pent.	7BK	6.3	0.15	3.6	4.2	0.12	120	200*	120	2.5	7.5	340K	5000	—	—	—	
								180	-9	180	2.5	15	200K	2300	—	10K	1.1	
6AL5	Dual Diode <sup>10</sup>	6BT	6.3	0.3	—	—	—	Max. r.m.s. voltage — 117. Max. d.c. output current — 9 ma. <sup>1</sup>										
6AM4	U.h.f. Triode	9BX	6.3	0.225	4.4	0.16	2.4	150	100*	—	—	7.5	10K	9000	90	—	—	
6AMB4 <sup>1</sup>	Diode — Sharp Cut-off Pent.	9CY	6.3	0.45	6.0	2.6	0.015	200	120*	150	2.7	11.5	600K	7000	—	—	—	
6AN4	U.h.f. Triode	7DK	6.3	0.225	2.8	0.28	1.7	200	100*	—	—	13	—	10K	70	—	—	
6AN5	Beam Pwr. Pent.	7BD	6.3	0.45	9.0	4.8	0.075	120	120*	120	12.0	35	12.5K	8000	—	2.5K	1.3	
6AN8A <sup>1</sup>	Medium- $\mu$ Triode	9DA	6.3	0.45	2.0	2.7	1.5	200	-6	—	—	13	5.75K	3300	—	—	—	
																		200
6AQ5A <sup>1</sup>	Beam Pwr. Pent.	7BZ	6.3	0.45	8.3	8.2	0.35	180	-8.5	180	3/4	30 <sup>2</sup>	58K	3700	29 <sup>3</sup>	5.5K	2.0	
								250	-12.5	250	4.5/7	47 <sup>2</sup>	52K	4100	45 <sup>3</sup>	5K	4.5	
6AQ6	Dual Diode — High- $\mu$ Triode	7BT	6.3	0.15	1.7	1.5	1.8	100	-1	—	—	0.8	61K	1150	70	—	—	
6AQ8	High- $\mu$ Twin Triode	9AJ	6.3	0.435	0.3	1.2	1.5	250	-2	—	—	10	9.7K	6000	—	—	—	
6AR5	Pwr. Amp. Pent.	6CC	6.3	0.4	—	—	—	250	-16.5	250	5.7/10	35 <sup>2</sup>	65K	2400	34 <sup>3</sup>	7K	3.2	
6AR8	Sheet Beam	9DP	6.3	0.3	—	—	—	250	-18	250	5.5/10	33 <sup>2</sup>	68K	2300	32 <sup>3</sup>	7.6K	3.4	
								TV Color Ckts. — Synchronizer Detector — Burst Gate										
6AS5	Beam Pwr. Amp.	7CV	6.3	0.8	12	6.2	0.6	150	-8.5	110	2/6.5	36 <sup>2</sup>	—	5600	35 <sup>3</sup>	4.5K	2.2	
6AS6	Sharp Cut-off Pent.	7CM	6.3	0.175	4	3	0.2	120	-2	120	3.5	5.2	110K	3200	—	—	—	
6AS8	Diode — Sharp Cut-off Pent.	9DS	6.3	0.45	7	2.2	0.04	200	180*	150	3	9.5	300K	6200	—	—	—	
6AT6	Duplex Diode — High- $\mu$ Triode	7BT	6.3	0.3	2.3	1.1	2.1	250	-3	—	—	1	58K	1200	70	—	—	
6AT8A <sup>1</sup>	Medium- $\mu$ Triode	9DW	6.3	0.45	2	0.5	1.5	100	100*	—	—	8.5	6.9K	5800	40	—	—	
																		250
6AU6A <sup>1</sup>	Sharp Cut-off Pent.	7BK	6.3	0.3	5.5	5	0.0035	250	68*	150	4.3	10.6	1 meg.	5200	—	—	—	
6AU8A <sup>1</sup>	Medium- $\mu$ Triode	9DX	6.3	0.6	2.6	0.34	2.2	150	150*	—	—	9	8.2K	4900	40	—	—	
																		250
6AV6	Dual Diode — High- $\mu$ Triode	7BT	6.3	0.3	7.5	3.4	0.06	200	-2	—	—	1.2	62.5K	1600	100	—	—	
6AW8A <sup>1</sup>	High- $\mu$ Triode	9DX	6.3	0.6	3.2	0.32	2.2	200	-2	—	—	4	17.5K	4000	70	—	—	
																		200
6AX8	Medium- $\mu$ Triode	9AE	6.3	0.45	2.5	1	1.8	150	56*	—	—	18	5K	8500	40	—	—	
																		250
6AZ8	Semiremote Cut-off Pent.	9ED	6.3	0.45	2	1.7	1.7	200	-6	—	—	13	5.75K	3300	19	—	—	
																		200
6BA6	Remote Cut-off Pent.	7BK	6.3	0.3	5.5	5	0.0035	250	68*	100	4.2	11	1 meg.	4400	—	—	—	
6BA7	Pentagrid Conv.	8CT	6.3	0.3	Osc. 20K $\Omega$			250	-1	100	10	3.8	1 meg.	950	—	—	—	
6BA8A <sup>1</sup>	Medium- $\mu$ Triode	9DX	6.3	0.6	2.5	0.7	2.2	200	-8	—	—	8	6.7K	2700	18	—	—	
																		200
6BC4	U.h.f. Medium- $\mu$ Triode	9DR	6.3	0.225	2.9	0.26	1.6	150	100*	—	—	14.5	4.8K	10K	48	—	—	
6BC5	Sharp Cut-off Pent.	7BD	6.3	0.3	6.5	1.8	0.03	250	180*	150	2.1	7.5	800K	5700	—	—	—	
6BC7	Triple Diode	9AX	6.3	0.45	Max. diode current per plate = 12 Ma. Max. htr. cath. volts = 200													
6BC8	Medium- $\mu$ Dual Triode <sup>10</sup>	9AJ	6.3	0.4	2.5	1.3	1.4	150	220*	—	—	10	—	—	—	—	—	
																		100
6BD6	Remote Cut-off Pent.	7BK	6.3	0.3	4.3	5.0	0.005	250	-3	100	3	9	800K	2000	—	—		

TABLE 1—MINATURE RECEIVING TUBES—Continued

Type	Name	Base	Fil. or Heater		Capacitances pf.			Plate Supply V.	Grid Bias	Screen Volts	Screen Ma.	Plate Ma.	Plate Res. Ohms	Transcon-ductance <sup>1</sup>	Amp. Factor	Load Res. Ohms	Watts Output	
			V.	Amp.	C <sub>in</sub>	C <sub>out</sub>	C <sub>sp</sub>											
1BE6	Pentagrid Conv.	7CH	6.3	0.3	Osc. 20K $\mu$			250	-1.5	100	6.8	2.9	1 meg.	475	—	—	—	
1BE8A <sup>2</sup>	Medium- $\mu$ Triode	9EG	6.3	0.45	2.8	1.5	1.8	150	56*	—	—	18	5K	8500	40	—	—	
	Sharp Cut-off Pent.				4.4	2.6	0.04	250	68*	110	3.5	10	400K	5200	—	—	—	
1BF5	Beam Pwr. Amp.	7BZ	6.3	1.2	14	6	0.65	110	-7.5	110	4, 10.5	39 <sup>2</sup>	12K	7500	36 <sup>3</sup>	2.5K	1.9	
1BF6	Dual Diode — Medium- $\mu$ Triode	7BT	6.3	0.3	1.8	0.8	2	250	-9	—	—	9.5	8.5K	1900	16	10K	0.3	
1BH6	Sharp Cut-off Pent.	7CM	6.3	0.15	5.4	4.4	0.0035	250	-1	150	2.9	7.4	1.4 meg.	4600	—	—	—	
	Medium- $\mu$ Triode				2.6	0.38	2.4	150	-5	—	9.5	5.15K	3300	17	—	—		
1BH8 <sup>2</sup>	Sharp Cut-off Pent.	9DX	6.3	0.6	7	2.4	0.046	200	82*	125	3.4	15	150K	7000	—	—	—	
	Remote Cut-off Pent.				4.5	5.5	0.0035	250	-1	100	3.3	9.2	1.3 meg.	3800	—	—	—	
1BJ6A	Remote Cut-off Pent.	7CM	6.3	0.15	4.5	5.5	0.0035	250	-1	100	3.3	9.2	1.3 meg.	3800	—	—	—	
1BJ7	Triple Diode	9AX	6.3	0.45	Max. peak inverse plate voltage = 330 V. Max d.c. plate current each diode = 1.0 Ma.													
1BJ8 <sup>2</sup>	Dual Diode — Medium- $\mu$ Triode	9ER	6.3	0.6	2.8	0.38	2.6	250	-9	—	8	7.15K	2800	20	—	—	—	
1BK5	Beam Pwr. Pent.	9BQ	6.3	1.2	13	5	0.6	250	-5	250	3.5/10	37 <sup>2</sup>	100K	8500	35 <sup>3</sup>	6.5K	3.5	
1BK6	Dual Diode — High- $\mu$ Triode	7BT	6.3	0.3	—	—	—	250	-2	—	—	1.2	62.5K	1600	100	—	—	
1BK7B	Medium- $\mu$ Dual Triode <sup>10</sup>	9AJ	6.3	0.4	3	1	1.8	150	56*	—	—	18	4.6K	9300	43	—	—	
1BL0	Triode Pentode	Fig. 83	6.3	0.43	2.5	1.8	1.5	250	-1.3	—	—	14	—	5000	20	—	—	
	Medium- $\mu$ Triode				5.2	3.4	0.025	250	-1.3	175	2.8	10	400K	6200	47	—	—	
1BN4A	Medium- $\mu$ Triode	7EG	6.3	0.2	3.2	1.4	1.2	150	220*	—	—	9	6.3K	6800	43	—	—	
1BN6	Gated-Beam Pent.	7DF	6.3	0.3	4.2	3.3	0.004	80	-1.3	60	5	0.23	—	—	—	68K	—	
1BN8 <sup>2</sup>	Dual Diode — High- $\mu$ Triode	9ER	6.3	0.6	3.6	0.25	2.5	250	-3	—	—	1.6	28K	2500	70	—	—	
1BQ5	Pwr. Amp. Pent.	9CV	6.3	0.76	10.8	6.5	0.5	300	-7.3	200	10.8	49.5 <sup>2</sup>	38K	—	—	5.2K	17 <sup>3</sup>	
1BQ7A	Medium- $\mu$ Dual Triode <sup>10</sup>	9AJ	6.3	0.4	2.85	1.35	1.15	150	220*	—	—	9	6.1K	6400	39	—	—	
1BR8A <sup>2</sup>	Medium- $\mu$ Triode	9FA	6.3	0.45	2.5	0.4	1.8	150	56*	—	—	18	5K	8500	40	—	—	
	Sharp Cut-off Pent.				5	2.6	0.015	250	68*	110	3.5	10	400K	5200	—	—	—	
1BS5	Low-Noise Dual Triode <sup>10</sup>	9AJ	6.3	0.4	2.6	1.35	1.15	150	220*	—	—	10	5K	7200	36	—	—	
1BT6	Dual Diode — High- $\mu$ Triode	7BT	6.3	0.3	—	—	—	250	-3	—	—	1	58K	1200	70	—	—	
1BT8	Dual Diode — Pent.	9FE	6.3	0.45	7	2.3	0.04	200	180*	150	2.8	9.5	300K	6200	—	—	—	
1BU6	Dual Diode — Low- $\mu$ Triode	7BT	6.3	0.3	—	—	—	250	-9	—	—	9.5	8.5K	1900	16	10K	0.3	
1BU8	Dual Pent. <sup>10</sup>	9FG	6.3	0.3	6	3 <sup>1</sup>	—	100 <sup>1</sup>	—	67.5	3.3	2.2	—	—	—	—	—	
1BV8 <sup>2</sup>	Dual Diode — Medium- $\mu$ Triode	9FJ	6.3	0.6	3.6	0.4	2	200	330*	—	—	11	5.9K	5600	33	—	—	
1BW8	Dual Diode — Pent.	9HK	6.3	0.45	4.8	2.6	0.02	250	68*	110	3.5	10	250K	5200	—	—	—	
1BX8	Dual Triode <sup>10</sup>	9AJ	6.3	0.4	—	—	—	65	-1	—	—	9	—	6700	25	—	—	
1BY6	Pentagrid Amp.	7CH	6.3	0.3	5.4	7.6	0.08	250	-2.5	100	9	6.5	E <sub>c1</sub> = -2.5 V.	1900	—	—	—	
1BY8 <sup>2</sup>	Diode — Sharp Cut-off Pent.	9FN	6.3	0.6	5.5	5	0.0035	250	68*	150	4.3	10.6	1 meg.	5200	—	—	—	
1BZ6	Semiremote Cut-off Pent.	7CM	6.3	0.3	7.5	1.8	0.02	200	180*	150	2.6	11	600K	6100	—	—	—	
1BZ7	Medium- $\mu$ Dual Triode <sup>10</sup>	9AJ	6.3	0.4	2.5	1.35	1.15	150	220*	—	—	10	5.6K	6800	38	—	—	
1BZ8	Dual Triode <sup>10</sup>	9AJ	6.3	0.4	—	—	—	125	100*	—	—	10 <sup>1</sup>	5.6K	8000	45	—	—	
1C4	Medium- $\mu$ Triode	6BG	6.3	0.15	1.8	1.3	1.6	250	-8.5	—	—	10.5	7.7K	2200	17	—	—	
1CA5	Beam Pent.	7CV	6.3	1.2	15	9	0.5	125	-4.5	125	4, 11	36 <sup>2</sup>	15K	9200	37 <sup>3</sup>	4.5K	1.5	
1CB6A <sup>2</sup>	Sharp Cut-off Pent.	7CM	6.3	0.3	6.5	1.9	0.02	200	180*	150	2.8	9.5	600K	6200	—	—	—	
1CE5 <sup>1</sup>	R.I. Pent.	7BD	6.3	0.3	6.5	1.9	0.03	200	180*	150	2.8	9.5	600K	6200	—	—	—	
1CF6	Sharp Cut-off Pent.	7CM	6.3	0.3	6.3	1.9	0.02	200	180*	150	2.8	9.5	600K	6200	—	—	—	
1CG6	Semiremote Cut-off Pent.	7BK	6.3	0.3	5	5	0.008	250	-8	150	2.3	9	720K	2000	—	—	—	
1CG7 <sup>2</sup>	Medium- $\mu$ Dual Triode <sup>10</sup>	9AJ	6.3	0.6	2.3	2.2	4	250	-8	—	—	9	7.7K	2600	20	—	—	
1CG8A <sup>2</sup>	Medium- $\mu$ Triode	9AF	6.3	0.45	2.6	0.05	1.5	100	100*	—	—	8.5	6.9K	5800	40	—	—	
	Sharp Cut-off Pent.				4.8	0.9	0.03	250	200*	150	1.6	7.7	750K	4600	—	—	—	
1CH8	Medium- $\mu$ Triode	9FT	6.3	0.45	1.9	1.6	1.6	200	-6	—	—	13	5.75K	3300	19	—	—	
	Sharp Cut-off Pent.				7	2.25	0.025	200	180*	150	2.8	9.5	300K	6200	—	—	—	
1CL6	Pwr. Amp. Pent.	9BV	6.3	0.65	11	5.5	0.12	250	-3	150	7, 7.2	31 <sup>2</sup>	150K	11K	30 <sup>3</sup>	7500	2.8	
1CL8A <sup>2</sup>	Medium- $\mu$ Triode	9FX	6.3	0.45	2.7	0.4	1.8	300	—	—	—	15	5K	8000	40	—	—	
	Sharp Cut-off Tetrode				5	0.02	0.02	300	-1	300	4	12	100K	6400	—	—	—	
1CM6	Beam Pwr. Amp.	9CK	6.3	0.45	8	8.5	0.7	315	-13	225	2.2/6	35 <sup>2</sup>	80K	3750	34 <sup>3</sup>	8.5K	5.5	
1CM7 <sup>2</sup>	Medium- $\mu$ Triode No. 1	9ES	6.3	0.6	2	0.5	3.8	200	-7	—	—	5	11K	2000	20	—	—	
	Dual Triode No. 2				3.5	0.4	3	250	-8	—	10	4.1K	4400	18	—	—		
1CM8 <sup>2</sup>	High- $\mu$ Triode	9FZ	6.3	0.45	1.6	0.22	1.9	250	-2	—	—	1.8	50K	2000	100	—	—	
	Sharp Cut-off Pent.				6	2.6	0.02	200	180*	150	2.8	9.5	300K	6200	—	—	—	
1CN7 <sup>2</sup>	Dual Diode — High- $\mu$ Triode	9EN	6.3	0.3	1.5	0.5	1.8	100	-1	—	—	0.8	54K	1300	70	—	—	
	Medium- $\mu$ Triode				3.15	0.6	—	250	-3	—	1	58K	1200	70	—	—	—	
1CQ8 <sup>2</sup>	Medium- $\mu$ Triode	9GE	6.3	0.45	2.7	0.4	1.8	125	56*	—	—	15	5K	8000	40	—	—	
	Sharp Cut-off Tetrode				5	2.5	0.019	125	-1	125	4.2	12	140K	5800	—	—	—	
1CR6	Diode — Remote Cut-off Pent.	7EA	6.3	0.3	—	—	—	250	-2	100	3	9.5	200K	1950	—	—	—	
1CS5	Beam Pwr. Pent.	9CK	6.3	1.2	15	9	0.5	200	180*	125	2.2	47 <sup>2</sup>	28K	8000	—	4K	3.8	
1CS6	Pentagrid Amp.	7CM	6.3	0.3	5.5	7.5	0.05	100	-1	30	1.1	0.75	1 meg.	950	E <sub>c2</sub> = 0 V.	—	—	
1CS7 <sup>2</sup>	Medium- $\mu$ Triode No. 1	9EF	6.3	0.6	1.8	0.5	2.6	250	-8.5	—	—	10.5	7.7K	2200	17	—	—	
	Dual Triode No. 2				3.0	0.5	2.6	250	-10.5	—	19	3.45K	4500	15.5	—	—		
1CU5	Beam Pwr. Pent.	7CV	6.3	1.2	13.2	8.8	0.7	120	-8	110	4, 8.5	50 <sup>2</sup>	10K	7500	—	2.5K	2.3	
1CW4	Triode	12AQ	6.3	0.13	4.1	1.7	0.92	70	0	—	—	8	5.44K	12.5K	68	—	—	
1CW5	Pentode	9CV	6.3	0.76	12	6	0.6	170	-12.5	170	5	70	—	—	—	2.4K	5.6	
1CX8	Medium- $\mu$ Triode	9DX	6.3	0.75	2.2	0.38	4.4	150	150*	—	—	9.2	8.7K	4600	40	—	—	
	Sharp Cut-off Pent.				9	4.4	0.06	200	68*	125	5.2	24	70K	10K	—	—	—	
1CY5	Sharp Cut-off Tetrode	7EW	6.3	0.2	4.5	3	0.03	125	-7	80	1.5	10	100K	8000	—	—	—	
1CY7	Dissimilar — Dual Triode	9EF	6.3	0.75	1.5 <sup>2</sup>	0.3 <sup>2</sup>	1.8 <sup>1</sup>	250 <sup>1</sup>	-3 <sup>1</sup>	—	—	—	1.2 <sup>2</sup>	52K <sup>2</sup>	1300 <sup>2</sup>	68 <sup>2</sup>	—	—
	Medium- $\mu$ Triode				5 <sup>1</sup>	1 <sup>1</sup>	4.4 <sup>1</sup>	150 <sup>1</sup>	620 <sup>1</sup> *	—	—	30 <sup>1</sup>	920 <sup>1</sup>	5400				

TABLE I—MINIATURE RECEIVING TUBES—Continued

Type	Name	Base	Fil. or Heater		Capacitances pf.			Plate Supply V.	Grid Bias	Screen Volts	Screen Ma.	Plate Ma.	Plate Res. Ohms	Transcon- ductance <sup>1</sup>	Amp. Factor	Load Res. Ohms	Watts Output	
			V.	Amp.	C <sub>in</sub>	C <sub>out</sub>	C <sub>sp</sub>											
6DE8	Sharp Cut-off Pent.	7CM	6.3	0.3	6.3	1.9	0.02	200	180*	150	2.8	9.5	600K	6200	—	—	—	
6DE7	Dissimilar — Dual Triode	9HF	6.3	0.9	2.2 <sup>2</sup> 5.5 <sup>4</sup>	0.52 <sup>7</sup> 1 <sup>8</sup>	4 <sup>7</sup> 8.5 <sup>8</sup>	250 <sup>7</sup> 150 <sup>8</sup>	-11 <sup>7</sup> -17.5 <sup>8</sup>	—	—	5.5 <sup>7</sup> 35 <sup>8</sup>	8.75K <sup>7</sup> 925 <sup>8</sup>	2000 <sup>7</sup> 6500 <sup>8</sup>	17.5 <sup>7</sup> 6 <sup>8</sup>	—	—	
6DJ8	Twin Triode	9AJ	6.3	0.365	3.3	1.8	1.4	90	-1.3	—	—	15	—	12.5K	33	—	—	
6DK6	Sharp Cut-off Pent.	7CM	6.3	0.3	6.3	1.9	0.02	300	-6.5	150	3.8	12	—	9800	—	—	—	
6DR7	Dissimilar — Dual Triode	9HF	6.3	0.9	2.2 5.5	0.34 1.0	4.5 8.5	330 275	-3 -17.5	—	—	1.4 35	—	1600 6500	68 <sup>7</sup> 6 <sup>8</sup>	—	—	
6DS4	High- $\mu$ Triode	12AQ	6.3	0.135	4.1	1.7	.92	70	0	—	—	8	5.44K	12.5K	68	—	—	
6DS5	Beam Pwr. Amp.	7BZ	6.3	0.8	9.5	6.3	0.19	250 250	-8.5 270*	200	3/10	32 <sup>2</sup>	28K	5800	32 <sup>5</sup>	8K	3.8	
6DT5	Pwr. Amp. Pent.	9HN	6.3	0.76	10.8	6.5	0.5	300	-7.3	200	10.8	49.5 <sup>2</sup>	28K	5800	27 <sup>5</sup>	8K	3.6	
6DT6	Sharp Cut-off Pent.	7EN	6.3	0.3	5.8	—	—	150	560*	100	2.1	1.1	150K	615	—	—	5.2K	
6DT8	High- $\mu$ Dual Triode <sup>10</sup>	9DE	6.3	0.3	2.7	1.6	1.6	250	200*	—	—	10	10.9K	5500	60	—	—	
6DV4	Triode	12EA	6.3	0.135	3.7	0.25	1.8	75	100*	—	—	10.5	3.1K	11.5K	35	—	—	
6DW5	Beam Pwr. Amp.	9CK	6.3	1.2	14	9	0.5	200	-22.5	150	2	55	15K	5500	—	—	—	
6DZ4	Medium- $\mu$ Triode	7DK	6.3	0.225	2.2	1.3	1.8	80	-11	—	—	15	2.0K	6700	14	—	—	
6EA5	Sharp Cut-off Tet.	7EW	6.3	0.2	3.8	2.3	.06	250	-1	140	0.95	10	150K	8000	—	—	—	
6EA8	Triode	9AE	6.3	0.45	3	0.3	1.7	330	-12	—	—	18	5K	8500	40	—	—	
6EA8	Sharp Cut-off Pent.	9AE	6.3	0.45	5	2.6	0.02	330	-9	330	4	12	80K	6400	—	—	—	
6EB5	Dual Diode	8BT	6.3	0.3	—	—	—	—	—	—	—	—	—	—	—	—	—	
6EB8	High- $\mu$ Triode	9DX	6.3	0.75	2.4 11	.36 4.2	4.4 0.1	330 330	-5 -9	—	—	2 7	37K 25	2700 75K	100	—	—	
6EB8	Sharp Cut-off Pent.	9DX	6.3	0.75	11	4.2	0.1	330	-9	—	—	7	25	75K	12.5K	—	—	
6EH5	Power Pentode	7CV	6.3	1.2	17	9	0.65	135	0	117	14.5	42	11K	14.6K	—	3K	1.4	
6EH6	Triode	9JG	6.3	0.45	2.8	1.7	1.8	125	-1	—	—	13.5	—	7500	40	—	—	
6EH6	Pentagrid Conv.	9JG	6.3	0.45	4.8	2.4	0.02	125	-1	125	4	12	170K	6000	—	—	—	
6EHS	Tetrode	7FN	6.3	0.18	4.4	3.0	0.38	200	-1.2	0	0	10	8K	10.5K	80	—	—	
6ES5	Triode	7FP	6.3	0.20	3.2	3.2	0.5	200	-1	—	—	10	8K	9000	75	—	—	
6ES6	Dual Triode	9DE	6.3	0.365	3.4	1.7	1.9	130	-1.2	—	—	15	—	12.5K	34	—	—	
6EU7	Twin Triode	9LS	6.3	0.3	1.6	0.2	1.5	100	-1	—	—	0.5	80K	1250	100	—	—	
6EU8	Triode	9JF	6.3	0.45	5.0	2.6	0.02	150	—	—	—	18	5K	8500	40	—	—	
6EU8	Pentode	9JF	6.3	0.45	3.0	1.6	1.7	125	-1	125	4	12	80K	6400	—	—	—	
6EV5	Sharp Cut-off Tet.	7EW	6.3	0.2	4.5	2.9	0.035	250	-1	80	0.9	11.5	150K	8800	—	—	—	
6EZ8	Triple Triode	9KA	6.3	0.45	2.6	1.4 1.2	1.5	330	-4	—	—	4.2	13.6K	4200	57	—	—	
6FG5	Pentode	7GA	6.3	0.2	4.2	2.8	0.02	250	-0.2	250	.42	9	250K	9500	—	—	—	
6FG7	Triode	9GF	6.3	0.45	3.0	1.3	1.8	125	-1	—	—	13	5700	7500	43	—	—	
6FG7	Pentode	9GF	6.3	0.45	5.0	2.4	0.2	125	-1	125	4	11	180K	6000	—	—	—	
6FH5	Triode	7FP	6.3	0.2	3.2	3.2	0.6	135	-1	—	—	11	5600	9000	50	—	—	
6FM8	Duplex Diode	9KR	6.3	0.45	2.4 2.2	— —	— —	— —	— —	— —	— —	— —	— —	— —	— —	— —	— —	— —
6FM8	Triode	9KR	6.3	0.45	1.5	0.16	1.8	300	-3	—	—	1	58K	1200	70	—	—	
6FQ5A	Triode	7FP	6.3	0.18	4.8	4.0	0.4	135	-1.2	—	—	11.5	5500	11K	60	—	—	
6F55	V.h.f. Pent.	7GA	6.3	0.2	4.8	2.0	.03	275	-0.2	135	0.17	9	240K	10K	—	—	—	
6FV6	Sharp Cut-off Tetrode	7FQ	6.3	0.2	4.5	3	0.03	125	-1	80	1.5	10	100K	8000	—	—	—	
6FY8A	Triode	9FA	6.3	0.45	2.8	1.5	1.8	330	-1	—	—	14	5K	8000	40	—	—	
6FY8A	Pentode	9FA	6.3	0.45	5	2	0.02	330	-1	125	4	12	200K	6500	—	—	—	
6FW6	Medium- $\mu$ Twin Triode	9AJ	6.3	0.4	3.4	2.4	1.9	100	-1.2	—	—	15	2500	13K	33	—	—	
6FY5	Tetrode	7FN	6.3	0.2	4.75	3.3	0.50	135	-1	—	—	11	—	13K	70	—	—	
6GC5	Pwr. Pent.	9EU	6.3	1.2	18.0	7.0	0.9	110	-7.5	110	4	50	13K	8000	—	2K	2.1	
6GJ8	Triode	9AE	6.3	0.6	3.4	1.6	2.6	125	-1	—	—	13.5	5K	8500	40	—	—	
6GJ8	Pentode	9AE	6.3	0.6	8	2.4	0.36	125	-1	125	4.5	12	150K	7500	—	—	—	
6GK5	High- $\mu$ Triode	7FP	6.3	0.18	5	3.5	0.52	135	-1	—	—	11.5	5400	15K	78	—	—	
6GK6	Power Pentode	9BK	6.3	0.76	10	7.0	0.14	250	-7.3	250	5.5	48	38K	11.3K	—	5.2K	5.7	
6GM6	Pentode	7CM	6.3	0.4	10	2.4	0.036	125	—	125	3.4	14	200K	13K	—	—	—	
6GN8	High- $\mu$ Triode	9DX	6.3	0.75	2.4 11	0.36 4.2	4.4 0.1	250 200	-2 —	—	—	2 150	37K 5.5	2700 25	60K 11.5K	100	—	—
6GN8	Sharp Cut-off Pent.	9DX	6.3	0.75	11	4.2	0.1	200	—	150	5.5	25	60K	11.5K	—	—	—	
6GS6	Twin Pentode	9LW	6.3	0.30	6.0	3.2	—	100	-10	67.5	3.6	2.0	—	—	—	—	—	
6GV8	High- $\mu$ Triode	9LY	6.3	0.9	—	—	—	100	-0.8	—	—	5	7.6K	6500	50	—	—	
6GV8	Pentode	9LY	6.3	0.9	—	—	—	170	-15	170	2.7	41	25K	7500	—	—	—	
6GY8	Triple Triode	9MB	6.3	0.45	—	—	—	125	-1	—	—	4.5	14K	4500	63	—	—	
6GW5	V.h.f. Triode	7BK	6.3	0.19	5.5	4.0	0.6	135	-1	—	—	12.5	5.8K	15K	70	—	—	
6GZ5	Pwr. Amp. Pent.	7CV	6.3	0.38	8.5	3.8	0.24	250	270*	250	2.7	16	150K	8400	—	15K	1.1	
6HB6	Power Pentode	9PU	6.3	0.76	13	8.0	0.18	250	100*	250	6.2	40	24K	20K	—	—	—	
6HB7	Sharp Cut-off Pent.	9QA	6.3	0.45	5.0	3.4	0.010	125	-1	125	4	12	200K	6400	—	—	—	
6HB7	Medium- $\mu$ Triode	9QA	6.3	0.45	3.0	1.9	1.9	150	56*	—	—	18	5K	8500	40	—	—	
6HF8	High- $\mu$ Triode	9DX	6.3	0.78	2.8	2.6	3.5	200	-2	—	—	4	17.5K	4000	70	—	—	
6HF8	Sharp Cut-off Pent.	9DX	6.3	0.78	10	4.2	0.1	200	68*	125	7	25	75K	12.5K	—	—	—	
6HG5	Pwr. Amp. Pent.	7BZ	6.3	0.45	8.0	8.5	0.4	250	-12.5	250	4.5	47	52K	4100	—	5K	4.5	
6HK5	Triode	7GM	6.3	0.19	4.4	2.6	0.29	135	-1.0	—	—	12.5	5K	15K	75	—	—	
6HM5/ 6HA5	High- $\mu$ Triode	7GM	6.3	0.18	4.3	2.9	0.36	135	—	—	—	19	4K	20K	80	—	—	
6HQ5	Sharp Cut-off Triode	7GM	6.3	0.2	5.0	3.5	0.52	135	-1	—	—	11.5	5.4K	15K	78	—	—	
6HZ6	Sharp Cut-off Pent.	7BK	6.3	0.45	8.8	5.2	.006	150	0	75	2.8	8.8	500K	9500	—	—	—	
6HS8	High- $\mu$ Triode	9DX	6.3	1.125	3.8	0.4	5.0	200	-2	—	—	3.5	—	4K	70	—	—	
6HS8	Sharp Cut-off Pent.	9DX	6.3	1.125	12	5	0.1	250	100*	170	6	29	140K	12.6K	—	—	—	
6J4	Grounded-Grid Triode	7BQ	6.3	0.4	7.5	3.9	0.12	150	100*	—	—	15	4.5K	12K	55	—	—	
6JA1	Medium- $\mu$ Dual Triode	A <sub>1</sub> Amp. <sup>10</sup> Mixer	7BF	6.3	0.45	2.2	0.4	1.6	100	50*	—	—	8.5	7.1K	5300	38	—	—
6JA1	Dual Triode	A <sub>1</sub> Amp. <sup>10</sup> Mixer	7BF	6.3	0.45													



TABLE I—MINIATURE RECEIVING TUBES—Continued

Type	Name	Base	Fil. or Heater		Capacitances pf.			Plate Supply V.	Grid Bias	Screen Volts	Screen Ma.	Plate Ma.	Plate Res. Ohms	Transcon- ductance <sup>1</sup>	Amp. Factor <sup>1</sup>	Load Res. Ohms	Watts Output	
			V.	Amp.	C <sub>in</sub>	C <sub>out</sub>	C <sub>sp</sub>											
6JC8	Med.-μ Triode	9PA	6.3	0.45	2.8	.44	1.3	125	-1	—	—	12	6K	6500	40	—	—	
	Sharp Cut-off Pent.		4.8	0.9	0.038	125	-1	125	2.2	9	300K	5500	—	—	—	—		
6JK8	Dual V.h.f. Triode	9AJ	6.3	0.4	3.0	1.0	1.4	100	-1	—	—	5.3	8K	6800	55	—	—	
	—		5.0	4.0	0.6	135	-1.2	—	—	10	5.4K	13K	70	—	—			
6KD8	Sharp Cut-off Pent.	9AE	6.3	0.4	5.0	2.6	0.015	125	-1	110	3.5	9.5	200K	5000	40	—	—	
	Medium-μ Triode		1.5	2.8	1.8	125	-1	—	—	13.5	—	7500	40	—	—			
6KE8	Medium-μ Triode	9DC	6.3	0.4	2.4	2.0	1.3	125	68*	—	—	13	5.0K	8000	40	—	—	
	Sharp Cut-off Pent.		5.0	3.4	.015	125	33*	125	28	10	125K	12K	—	—	—			
6KR8	Sharp Cut-off Pent.	9DX	6.3	0.75	13	4.4	0.075	200	82*	100	3.0	19.5	60K	20K	—	—	—	
	Medium-μ Triode		4.2	3.0	2.6	125	68*	—	—	15	4400	10.4K	46	—	—			
6KZ8	Sharp Cut-off Pent.	9FZ	6.3	0.45	5.5	3.4	0.01	125	-1	125	4	12	200K	7500	—	—	—	
	Medium-μ Triode		3.2	1.8	1.6	125	-1	—	—	13.5	5400	8500	46	—	—			
6LJ8	Sharp Cut-off Pent.	9GF	6.3	0.4	5.5	3.4	0.015	125	33*	125	3.5	12	125K	13K	—	—	—	
	Medium-μ Triode		2.4	2.0	1.4	125	68*	—	—	13	5K	8000	40	—	—			
6SA4	Medium-μ Triode	9AC	6.3	0.6	4.2	0.9	2.6	250	-8	—	—	26	3.6K	4500	16	—	—	
	U.h.f. Triode		7DK	6.3	0.225	2.6	0.25	1.7	80	150*	—	—	18	1.86K	7000	13	—	—
6T8A	Triple Diode-High-μ Triode	9E	6.3	0.45	1.6	1	2.2	100	-1	—	—	0.8	54K	1300	70	—	—	
			250	-3	—	—	1	58K	1200	70	—	—						
6U8A	Medium-μ Triode	9AE	6.3	0.45	2.5	0.4	1.8	150	56*	—	—	18	5K	8500	40	—	—	
	Sharp Cut-off Pent.		5	2.6	0.01	250	68*	110	3.5	10	400K	5200	—	—	—			
6X8A	Medium-μ Triode	9AK	6.3	0.45	2.0	0.5	1.4	100	100*	—	—	8.5	6.9K	—	40	—	—	
	Sharp Cut-off Pent.		4.3	0.7	0.09	250	200*	150	1.6	7.7	750K	—	—	—	—			
12AB5	Beam Pwr. Amp. A <sub>1</sub> Amp. AB <sub>1</sub> Amp. <sup>3</sup>	9EU	12.6	0.2	8	8.5	0.7	250	-12.5	250	4.5	47.2	50K	4100	45 <sup>3</sup>	5K	4.5	
			250	-15	250	5	13	79.2	60K <sup>1</sup>	3750	70 <sup>3</sup>	10K <sup>3</sup>	10	—	—			
12AC6	Remote Cut-off Pent.	7BK	12.6	0.15	4.3	5	0.005	12.6	0	12.6	0.2	0.55	500K	730	—	—	—	
12AD6	Pentagrid Conv.	7CH	12.6	0.15	8	8	0.3	12.6	0	12.6	1.5	0.45	1 meg.	260	—	Grid No. 1 Res. 33K		
12AE6A	Dual Diode—Medium-μ Triode	7BT	12.6	0.15	1.8	1.1	2	12.6	0	—	—	0.75	15K	1000	15	—	—	
12AE7	Low-μ Dissimilar Double Triode	9A	12.6	0.45	4.7	0.75	3.9	16	—	—	—	1.9	31.5K	4000	13	—	—	
			4.2	0.85	3.4	16	—	—	7.5	985	6500	6.4	—	—				
12AF6	R.f. Pent.	7BK	12.6	0.15	5.5	4.8	0.006	12.6	0	12.6	0.35	0.75	300K	1150	—	—	—	
12AJ6	Dual Diode—High-μ Triode	7BT	12.6	0.15	2.2	0.8	2	12.6	0	—	—	—	0.75	45K	1200	55	—	—
			1.5	0.3	12	12.6	-0.9	—	—	0.25	27K	550	15	—	—			
12AL8	Medium-μ Triode Tetrode	9GS	12.6	0.45	8	1.1	0.7	12.6	-0.8	12.6**	50**	25	1K	8000	—	—	—	
			250	-12.5	250	4.5	7	47.2	50K	4100	45 <sup>3</sup>	5K	4.5					
12AQ5	Beam Pwr. Amp. A <sub>1</sub> Amp. AB <sub>1</sub> Amp. <sup>3</sup>	7BZ	12.6	0.225	8.3	8.2	0.35	250	-15	250	5	13	79.2	60K <sup>1</sup>	3750	70 <sup>3</sup>	10K <sup>3</sup>	10
			100	270*	—	—	3.7	15K	4000	60	—	—						
12AT7	High-μ Dual Triode <sup>10</sup>	9A	12.6	0.15	2.27	0.57	1.57	100	270*	—	—	3.7	15K	4000	60	—	—	
			6.3	0.3	2.28	0.44	1.54	250	200*	—	—	10	10.9K	5500	60	—	—	
12AU7A	Medium-μ Dual Triode <sup>10</sup>	9A	12.6	0.15	1.67	0.57	1.57	100	0	—	—	11.8	6.25K	3100	19.5	—	—	
			6.3	0.3	1.68	0.35 <sup>3</sup>	1.54	250	-8.5	—	—	10.5	7.7K	2200	17	—	—	
12AV7	Medium-μ Dual Triode <sup>10</sup>	9A	12.6	0.225	3.17	0.57	1.97	100	120*	—	—	9	6.1K	6100	37	—	—	
			6.3	0.45	3.18	0.4*	1.9*	150	56*	—	—	18	4.8K	8500	41	—	—	
12AW6	Sharp Cut-off Pent.	7CM	12.6	0.15	6.5	1.5	0.025	250	200*	150	2	7	800K	5000	42	—	—	
12AX7A	High-μ Dual Triode A <sub>1</sub> Amp. <sup>10</sup> Class B	9A	12.6	0.15	1.67	0.46 <sup>3</sup>	1.77	250	-2	—	—	1.2	62.5K	1600	100	—	—	
			6.3	0.3	1.68	0.34 <sup>3</sup>	1.7*	300	0	—	—	40 <sup>2</sup>	—	—	14 <sup>3</sup>	16K <sup>3</sup>	7.5	
12AY7	Medium-μ Dual Triode <sup>10</sup> A <sub>1</sub> Amp. Low-Level Amp.	9A	12.6	0.15	1.3	0.6	1.3	250	-4	—	—	3	—	175K	40	—	—	
			6.3	0.3	—	—	—	150	2700*	—	—	—	—	—	—	—	—	
12AZ7A	High-μ Dual Triode <sup>10</sup>	9A	12.6	0.225	3.17	0.57	1.97	100	270*	—	—	3.7	15K	4000	60	—	—	
			6.3	0.45	3.1*	0.4*	1.9*	250	200*	—	—	10	10.9K	5500	60	—	—	
12B4A	Low-μ Triode	9AG	12.6	0.3	5	1.5	4.8	150	-17.5	—	—	34	1.03K	6300	6.5	—	—	
			6.3	0.6	—	—	—	—	—	—	—	—	—	—	—	—		
12BH7A	Medium-μ Dual Triode <sup>10</sup>	9A	12.6	0.3	3.27	0.57	2.67	250	-10.5	—	—	11.5	5.3K	3100	16.5	—	—	
			6.3	0.6	3.28	0.4*	2.68	—	—	—	—	—	—	—	—	—		
12BL6	Sharp Cut-off Pent.	7BK	12.6	0.15	5.5	4.8	0.006	12.6	-0.65	12.6	0.0005	1.35	500K	1350	—	—	—	
12BR7A	Dual Diode—Medium-μ Triode	9CF	12.6	0.225	2.8	1	1.9	100	270*	—	—	3.7	15K	4000	60	—	—	
			6.3	0.45	—	—	—	250	200*	—	—	10	10.9K	5500	60	—	—	
12BV7	Sharp Cut-off Pent.	9BF	12.6	0.3	11	3	0.055	250	68*	150	6	25	90K	12K	1100	—	—	
			6.3	0.6	—	—	—	—	—	—	—	—	—	—	—	—	—	
12BX6	Pentode	9AQ	12.6	0.15	7.5	3.3	0.007	200	-2.5	200	2.6	10	550K	710 <sup>1</sup>	—	—	—	
12BY7A	Sharp Cut-off Pent.	9BF	12.6	0.3	11.1	3	0.055	250	68*	150	6	25	90K	12K	1200	—	—	
			6.3	0.6	—	—	—	—	—	—	—	—	—	—	—	—	—	
12BZ7	High-μ Dual Triode <sup>10</sup>	9A	12.6	0.3	6.57	0.77	2.57	250	-2	—	—	2.5	31.8K	320 <sup>1</sup>	100	—	—	
			6.3	0.6	6.58	0.55 <sup>3</sup>	2.58	—	—	—	—	—	—	—	—	—	—	
12CN5	Pentode	7CV	12.6	0.45	—	—	0.25	12.6	0	12.6	0.35	4.5	40K	380 <sup>1</sup>	—	—	—	
12CT8	Medium-μ Triode Sharp Cut-off Pent.	9DA	12.6	0.3	2.4	0.19	2.2	150	-6.5	—	—	9	8.2K	440 <sup>1</sup>	40	—	—	
			7.5	2.4	0.044	200	-8	125	3.4	15	150K	700 <sup>1</sup>	—	—	—			
12CX6	Sharp Cut-off Pent.	7BK	12.6	0.15	7.6	6.2	0.05	12.6	0	12.6	1.4	3	40K	310 <sup>1</sup>	—	—		
12DE8	Diode—Remote Cut-off Pent.	Fig. 81	12.6	0.2	5.5	5.7	0.006	12.6	-0.8	12.6	0.5	1.3	300K	150 <sup>1</sup>	—	—	—	
12DK7	Dual Diode—Tetrode	9HZ	12.6	0.5	—	—	—	12.6	0	12.6	1	6	4K	5000	—	3.5K	0.01	
12DL8	Dual Diode—Tetrode	9HR	12.6	0.55	12	1.3	—	12.6	-0.5	12.6**	75**	40	480	15K	7.2	—	—	
			6.3	0.26	1.6	0.39	1.7	100	-1.0	—	—	0.5	80K	125 <sup>1</sup>	100	—	—	
12DM7	Twin Triode	9A	12.6	0.3	10	3.8	0.1	330	—	180	5.6	26	53K	10.5K	—	—	—	
			6.3	0.6	—	—	—	—	—	—	—	—	—	—	—	—	—	
12DQ7	Beam Pwr. Pent.	9BF	12.6	0.3	10	3.8	0.1	330	—	180	5.6	26	53K	10.5K	—	—	—	
			6.3	0.6	—	—	—	—	—	—	—	—	—	—	—	—	—	
12DS7	Dual Diode Pwr. Tetrode	9JU	12.6	0.4	—	—	—	16	—	16	75	40	480	15K	7.2	800	—	
			150	-4.5	100	2.1	1.1	150K	—	—	—	—	—					
12DT6	Pentode	7EN	12.6	0.15	—	—	—	150										

Type	Name	Base	Fil. or Heater		Capacitances pf.			Plate Supply V.	Grid Bias	Screen Volts	Screen Ma.	Plate Ma.	Plate Res. Ohms.	Transcon- ductance <sup>11</sup>	Amp. Factor <sup>12</sup>	Load Res. Ohms	Watts Output
			V.	Amp.	C <sub>in</sub>	C <sub>out</sub>	C <sub>sp</sub>										
12DU7	Dual Diode Tetrode	9JX	12.6	0.275	Max. average diode current = 1.0 ma.												
	11				3.6	0.6	16	—	16	1.5	12	6K	6200	—	2.7K	.025	
12DV7	Dual Diode Triode	9JY	12.6	0.15	Max. average diode current = 1.0 ma.												
	1.3				0.38	1.6	16	—	—	—	0.4	19K	750	—	—	—	
12DV8	Dual Diode — Tetrode	9HR	12.6	0.375	9.0	1.0	12	12.6	18*	—	—	6.8 <sup>2</sup>	—	—	7.6	1250	.005
12DW7	Double Triode	9A	12.6	0.15	1.6	0.44	1.7	250	-2	—	—	1.2	62.5K	1600	100	—	—
					6.3	0.30	1.7	0.4	1.5	250	-8.5	—	—	10.5	7.7K	2200	17
12DW8	Diode	9JC	12.6	0.45	1.6 <sup>1</sup>	0.7	1.8	16	0	—	—	1.9 <sup>1</sup>	—	—	—	—	—
	4.4 <sup>4</sup>				0.7 <sup>4</sup>	3.2	7.5 <sup>4</sup>					—	—	6500	6.4	—	—
12DY8	Sharp Cut-off Triode Tetrode	9JD	12.6	0.35	2	2	1.5	16	0	—	—	1.2	10K	2000	20	—	—
	11				3	0.74	16	—	—	2	14	5K	6000	—	—	—	
12DZ6	Pwr. Amp. Pent.	7BK	12.6	0.175	12.5	8.5	0.25	12.6	—	12.6	2.2	4.5 <sup>2</sup>	25K	3800	—	—	—
12EA6	R.F. Pent.	7BK	12.6	0.175	11	4	0.04	12.6	-3.4	12.6	1.4	3.2 <sup>2</sup>	32K	3800	—	—	—
12EC8	Medium- $\mu$ Triode Pent.	9FA	12.6	0.225	2.6	0.4	1.7	16	-2.2	—	—	2.4	6K	4700	25	—	—
	4.6				2.6	0.02	16	-1.6	12.6	—	0.66	750K	2000	—	—	—	
12ED5 <sup>†</sup>	Pwr. Amp. Pent.	7CV	12.6	0.45	14	8.5	0.26	150	-4.5	150	11	36 <sup>2</sup>	14K	8500	—	—	1.5
12EG6	Dual Control Heptode	7CH	12.6	0.15	—	—	—	30	—	12.6	2.4	0.4	150K	800	—	—	—
12EK6	R.f. Pent.	7BK	12.6	0.2	10	5.5	0.032	12.6	-4.0	12.6	2	4.4	40K	4200	—	—	—
12EL6	Dual Diode — High- $\mu$ Triode	7FB	12.6	0.15	2.2	1	1.8	12.6	0	—	—	0.75	45K	1200	55	—	—
12EM6	Diode — Tetrode	9HV	12.6	0.5	—	—	—	12.6	0	12.6	1	6	4K	5000	—	—	—
12F8	Dual Diode — Remote Cut-off Pent.	9FH	12.6	0.15	4.5	3	0.06	12.6	0	12.6	0.38	1	333K	1000	—	—	—
12FK6	Dual Diode — Low- $\mu$ Triode	7BT	12.6	0.15	1.8	0.7	1.6	16	0	—	—	1.3	6.2K	1200	7.4	—	—
12FM6	Dual Diode — Med- $\mu$ Triode	7BT	12.6	0.15	2.7	1.7	1.7	30	0	—	—	1.8	5.6K	2400	13.5	—	—
12FQ8	Twin Double Plate Triode	9KT	12.6	0.15	1.7	0.27	0.9	250	-1.5	—	—	1.5	76K	1250	95	—	—
12FR8	Pentode Triode — Diode	9KU	12.6	0.32	8.5	5.5	0.15	12.6	-0.8	12.6	0.7	1.9	400K	2700	—	—	—
	2.6				2.0	1.7	12.6	-0.6	—	—	1.0	—	1200	10	—	—	
12FT6	Dual Diode — Triode	7BT	12.6	0.15	1.8	1.1	2.0	30	0	—	—	2	7.6K	1900	15	—	—
12FX5	Beam Pwr. Pent.	7CV	12.6	0.45	17	9	0.6	110	62*	115	12	35	—	—	—	3.0K	1.3
12FX8A	Triode Heptode	9KV	12.6	0.27	2.2	0.25	1.3	12.6	—	—	—	0.29	—	1400	10	—	—
	—				—	—	12.6	1.6	—	—	1.3	500K	—	—	—	—	
12GA6	Heptode	7CH	12.6	0.15	5.0	13	0.05	12.6	0	12.6	0.80	0.30	1 meg.	140	—	—	—
	12.6				0.15	—	—	—	90	0	—	10	—	—	3000	20	—
12H4	General Purpose Triode	7DW	12.6	0.3	2.4	0.9	3.4	250	-8	—	—	9	—	2600	20	—	—
					6.3	0.3	—	—	—	—	—	—	—	—	—	—	—
12J8	Dual Diode — Tetrode	9GC	12.6	0.325	10.5	4.4	0.7	12.6	0	12.6	1.5	12 <sup>2</sup>	6K	5500	—	2.7K	0.02
12K5	Tetrode (Pwr. Amp. Driver)	7EK	12.6	0.45	—	—	—	12.6	-2	12.6**	85**	8	800	7000	5.6	800	0.035
12R5	Beam Pwr. Pent.	7CV	12.6	0.6	13	9	0.55	110	-8.5	110	3.3	40	13K	7000	—	—	—
12U7	Dual Medium- $\mu$ Triode <sup>10</sup>	9A	12.6	0.15	1.6 <sup>1</sup>	0.4 <sup>1</sup>	1.5 <sup>1</sup>	12.6	0	—	—	1	12.5K	1600	20	—	—
18FWSA <sup>‡</sup>	Remote Cut-off Pent.	7CC	18	0.1	5.5	5	0.0035	150	—	100	4.4	11	250K	4400	—	—	—
18FX6A <sup>‡</sup>	Dual Control Heptode	7CH	18	0.1	—	—	—	150	—	—	—	2.3	400K	—	—	—	—
18FY6A <sup>‡</sup>	High- $\mu$ Triode — Diode	7BT	18	0.1	2.4	0.22	1.8	150	-1	—	—	0.6	77K	1300	100	—	—
25F5	Beam Pwr. Pent.	7CV	25	0.15	12	6	0.57	110	-7.5	110	3.7	36	16K	5800	—	2.5K	1.2
32E75	Beam Pwr. Pent.	7CV	32	0.1	12	6	0.6	150	-7.5	130	—	—	21.5K	5500	—	2.8K	1.2
34GD5	Beam Pwr. Pent.	7CV	34	0.1	12	6	0.6	110	-7.5	110	3	35	13K	5700	—	2.5K	1.4
35B5	Beam Pwr. Amp.	7BZ	35	0.15	11	6.5	0.4	110	-7.5	110	3.7	41 <sup>2</sup>	—	5800	40 <sup>3</sup>	2.5K	1.5
50B5	Beam Pwr. Amp.	7BZ	50	0.15	13	6.5	0.5	110	-7.5	110	4.8	50 <sup>2</sup>	14K	7500	49 <sup>3</sup>	2.5K	1.9
50FK5	Pwr. Pent.	7CV	50	0.1	17	9	0.65	110	62*	115	12	32	14K	12.8K	—	3K	1.2
1218A	U.h.f. Triode	7DK	6.3	0.225	2.9	0.25	1.7	200	100*	—	—	18	—	10.75K	55	—	—
5686	Beam Pwr. Pent.	9G	6.3	0.35	6.4	8.5	0.11	250	-12.5	250	3 <sup>2</sup>	27 <sup>2</sup>	45K	3100	—	9K	2.7
					12.6	0.45	4 <sup>1</sup>	0.6 <sup>1</sup>	4 <sup>1</sup>	120	-2	—	—	36	1.7K	11K	18.5
5722	Noise Generating Diode	5CB	6.3	1.5	—	2.2	—	200	—	—	—	35	—	—	—	—	—
5842/417A	High- $\mu$ Triode	9V	6.3	0.3	9.0	1.8	0.55	150	62*	—	—	26	1.8K	24K	43	—	—
5879	Sharp Cut-off Pent.	9AD	6.3	0.15	2.7	2.4	0.15	250	-3	100	0.4	1.8	2 meg.	1000	—	—	—
6386	Medium- $\mu$ Dual Triode <sup>10</sup>	8CJ	6.3	0.35	2	1.1	1.2	100	200*	—	—	9.6	4.25K	4000	17	—	—
6887	Dual Diode	6BT	6.3	0.2	Max. peak inverse plate voltage = 360 V. Max. d.c. plate current each diode = 10 ma.												
6973	Pwr. Pentode	9EU	6.3	0.45	6	6	0.4	440	-15	300	—	—	73K	4800	—	—	—
7189A	Pwr. Pentode	9CV	6.3	0.76	10.8	6.5	0.5	250	-7.3	250	5.5	48	40K	11.3K	—	—	—
7258	Sharp Cut-off	9DA	12.6	0.195	7	2.4	0.4	330	—	125	3.8	12	170K	7800	—	—	—
	2				0.26	1.5	330	-3	—	—	15	4.7K	4500	21	—	—	
7586	Medium- $\mu$ Triode	12AQ	6.3	0.135	4.2	1.6	2.2	75	100*	—	—	10.5	3000	11.5K	35	—	—
7587	Sharp Cut-off Tet.	12AS	6.3	0.15	6.5	1.4	0.01	125	68*	50	2.7	10	200K	10.5K	—	—	—
7895	High- $\mu$ Triode	12AQ	6.3	0.135	4.2	1.7	0.9	110	0	—	—	7	6800	9400	64	—	—
8056	Medium- $\mu$ Triode	12AQ	6.3	0.135	4.0	1.7	2.1	12	0	—	—	5.8	1.6K	8000	12.5	—	—
8058	High- $\mu$ Triode	12CT	6.3	0.135	6.0	0.046	1.3	110	47*	—	—	10	—	10K	—	—	—
9001	Sharp Cut-off Pent.	7BD	6.3	0.15	3.6	3	0.01	250	-3	100	0.7	2	1 meg.	1400	—	—	—
9002	U.h.f. Triode	7BS	6.3	0.15	1.2	1.1	1.4	250	-7	—	—	6.3	11.4K	2200	25	—	—
9003	Remote Cut-off Pent.	7BD	6.3	0.15	3.4	3	0.1	250	-3	100	2.7	6.7	700K	1800	—	—	—
9006	U.h.f. Diode	6BH	6.3	0.15	Max. a.c. voltage = 270. Max. d.c. output current = 5 ma.												

† Controlled heater warm-up characteristic.  
<sup>‡</sup> Oscillator gridleak or screen-dropping resistor ohms.  
<sup>§</sup> Cathode resistor ohms.  
<sup>\*\*</sup> Space-charge grid.

<sup>1</sup> Per Plate.  
<sup>2</sup> Maximum-signal current for full-power output.  
<sup>3</sup> Values are for two tubes in push-pull.  
<sup>4</sup> Unless otherwise noted.

<sup>5</sup> No signal plate ma.  
<sup>6</sup> Effective plate-to-plate.  
<sup>7</sup> Triode No. 1.  
<sup>8</sup> Triode No. 2.

<sup>9</sup> Oscillator grid current ma.  
<sup>10</sup> Values for each section.  
<sup>11</sup> Micromhos.  
<sup>12</sup> Through 33K.

TABLE II—METAL RECEIVING TUBES

Characteristics given in this table apply to all tubes having type numbers shown, including metal tubes, glass tubes with "G" suffix, and bantam tubes with "GT" suffix. For "G" and "GT" tubes not listed (not having metal counterparts), see Tables III, V, VI and VIII.

Type	Name	Base	Fil. or Heater		Capacitances pf.			Plate Supply V.	Grid Bias	Screen Volts	Screen Ma.	Plate Ma.	Plate Res. Ohms	Transcon- ductance <sup>12</sup>	Amp. Factor <sup>13</sup>	Load Res. Ohms	Watts Output	
			V.	Amp.	C <sub>in</sub>	C <sub>out</sub>	C <sub>sp</sub>											
6A8	Pentagrid Conv.	8A	6.3	0.3	—	—	—	250	-3	100	2.7	3.5	360K	550	—	—	—	
E <sub>bb</sub> (Osc.) 250 V. through 20K. Grid resistor (Osc.) 50K. I <sub>b1</sub> = 4 ma. I <sub>b2</sub> = 0.4 ma.																		
6AC7 1852	Sharp Cut-off Pent.	8N	6.3	0.45	11	5	0.15	300	160*	150	2.5	10	1 meg.	9000	—	—	—	
6AG7	Pwr. Amp. Pent.	8Y	6.3	0.65	13	7.5	0.06	300	-3	150	7.9	30/31	130K	11K	—	10K	3	
6B6	Dual-Diode — Pent.	8E	6.3	0.3	6	9	0.005	250	-3	125	2.3	10.	600K	1325	—	—	—	
6F6	Pwr. Amp. Pent.	7S	6.3	0.7	6.5	13	0.2	250	-20	20 <sup>10</sup>	—	31.34	2.6K	2600	6.8	4K	0.85	
								350	730*	132 <sup>11</sup>	—	50.60	—	—	—	—	10K <sup>7</sup>	9
								350	-38	123 <sup>11</sup>	—	48.92	—	—	—	—	6K <sup>7</sup>	13
								250	-16.5	250	6.11	34.36	80K	2500	—	7K	3.2	
								285	-20	285	7.13	38.40	78K	2500	—	7K	4.8	
375	-26	250	5.20	34.82	—	—	—	82 <sup>11</sup>	10K <sup>7</sup>	18.5								
375	340*	250	8.18	54.77	—	—	—	94 <sup>11</sup>	10K <sup>7</sup>	19								
6J5	Medium-μ Triode	6Q	6.3	0.3	3.4	3.6	3.4	250	-8	—	9	7.7K	2600	20	—	—		
6J7	Sharp Cut-off Pent.	7R	6.3	0.3	7	12	0.005	250	-3	100	0.5	2	1 meg.	1225	—	—		
Zero signal cathode current = 0.43 ma. 0.5 meg.																		
6K7	Variable-μ Pent.	7R	6.3	0.3	7	12	0.005	250	-3	125	2.6	10.5	600K	1650	990	—	—	
Osc. peak volts = 7																		
6K8	Triode — Hexode Conv.	8K	6.3	0.3	—	—	—	250	-3	100	6	2.5	600K	350	—	—		
I <sub>b1</sub> (Osc.) = 0.15 ma.																		
6L6-GB <sup>2</sup>	Beam Pwr. Amp.	7AC	6.3	0.9	11.5	9.5	0.9	250	-20	20 <sup>10</sup>	—	40.44	1.7K	4700	8	5K	1.4	
								250	167*	250	5.4/7.2	75.78	—	—	—	14 <sup>10</sup>	2.5K	6.5
								300	218*	200	3.4/6	51.55	—	—	—	12.7 <sup>10</sup>	4.5K	6.5
								250	-14	250	5/7.3	72.79	22.5K	6000	14 <sup>10</sup>	2.5K	6.5	
								350	-18	250	2.5/7	54.66	33K	5200	18 <sup>10</sup>	4.2K	10.8	
								250	125*	250	10.15	120.130	—	—	—	35.6 <sup>11</sup>	5K <sup>7</sup>	13.8
								270	125*	270	11/17	134.145	—	—	—	28.2 <sup>11</sup>	5K <sup>7</sup>	18.5
								250	-16	250	10/16	120.140	24.5 <sup>5</sup>	5500 <sup>5</sup>	32 <sup>11</sup>	5K <sup>7</sup>	14.5	
								270	-17.5	270	11/17	134.155	23.5 <sup>5</sup>	5700 <sup>5</sup>	35 <sup>11</sup>	5K <sup>7</sup>	17.5	
								360	270*	270	5/17	88.100	—	—	—	40.6 <sup>11</sup>	9K <sup>7</sup>	24.5
360	-22.5	270	5/11	88.140	—	—	—	45 <sup>11</sup>	3.8K <sup>7</sup>	18								
360	-22.5	270	5/15	88.132	—	—	—	45 <sup>11</sup>	6.6K <sup>7</sup>	26.5								
360	-18	225	3.5/11	78.142	—	—	—	52 <sup>11</sup>	6K <sup>7</sup>	31								
360	-22.5	270	5/16	88.205	—	—	—	72 <sup>11</sup>	3.8K <sup>7</sup>	47								
6L7	Pentagrid — Mixer Amp.	7T	6.3	0.3	—	—	—	250	-3	100	6.5	5.3	600K	1100	—	—		
Osc. Section in 88—108 Mc. Service.																		
6N7GT	Class-B Twin Triode	8B	6.3	0.8	—	—	—	300	0	—	—	35/70	1 meg.	350	—	8K <sup>7</sup>	10	
6Q7	Dual Diode — High-μ Triode	7V <sup>2</sup>	6.3	0.3	5	3.8	1.4	250	-5	—	—	1	58K	1200	70	—		
6R7	Dual Diode — Triode	7V <sup>2</sup>	6.3	0.3	4.8	3.8	2.4	250	-9	—	—	9.5	8.5K	1900	16	10K	0.28	
6SA7GT	Pentagrid Conv.	8R <sup>2</sup>	6.3	0.3	9.5	12	0.13	250	0 <sup>3</sup>	100	8	3.4	800K	—	—	—		
Grid No. 1 resistor 20K.																		
6SB7Y	Pentagrid Conv.	8R	6.3	0.3	9.6	9.2	0.13	250	-1	100	10.2	3.6	50K	900	—	—		
Osc. Section in 88—108 Mc. Service.																		
6SC7	High-μ Dual Triode <sup>5</sup>	8S	6.3	0.3	2	3	2	250	-2	—	—	2	53K	1325	70	—		
6SF5	High-μ Triode	6AB <sup>2</sup>	6.3	0.3	4	3.6	2.4	250	-2	—	—	0.9	66K	1500	100	—		
6SF7	Diode — Variable-μ Pent.	7AZ	6.3	0.3	5.5	6	0.004	250	-1	100	3.3	12.4	700K	2050	—	—		
6SG7	H.f. Amp. Pent.	8BK	6.3	0.3	8.5	7	0.003	250	-2.5	150	3.4	9.2	1 meg.	4000	—	—		
6SH7	H.f. Amp. Pent.	8BK	6.3	0.3	8.5	7	0.003	250	-1	150	4.1	10.8	900K	4900	—	—		
6SJ7 <sup>4</sup>	Sharp Cut-off Pent.	8N	6.3	0.3	6	7	0.005	250	-3	100	0.8	3	1 meg.	1650	—	—		
6SK7	Variable-μ Pent.	8N	6.3	0.3	6	7	0.003	250	-3	100	2.6	9.2	800K	2000	—	—		
6SQ7GT	Dual Diode — High-μ Triode	8Q	6.3	0.3	3.2	3	1.6	250	-2	—	—	0.9	91K	1100	100	—		
6SR7	Dual Diode — Triode	8Q	6.3	0.3	3.6	2.8	2.4	250	-9	—	—	9.5	8.5K	1900	16	—		
6V6GTA	Beam Pwr. Amp.	7AC	6.3	0.45	10	11	0.3	180	-8.5	180	3.4	29.30	50K	3700	8.5 <sup>10</sup>	5.5K	2	
								250	-12.5	250	4.5/7	45.47	50K	4100	12.5 <sup>10</sup>	5K	4.5	
								315	-13	225	2.2/6	34.35	80K	3750	13 <sup>10</sup>	8.5K	5.5	
								250	-15	250	5/13	70.79	60K	3750	30 <sup>11</sup>	10K <sup>7</sup>	10	
285	-19	285	4.13.5	70.92	70K	3600	38 <sup>11</sup>	8K <sup>7</sup>	14									
1620	Sharp Cut-off Pent.	7R	6.3	0.3	7	12	0.005	250	-3	100	0.5	2	1 meg.	1225	—	—		
5693	Sharp Cut-off Pent.	8N	6.3	0.3	5.3	6.2	0.005	250	-3	100	0.85	3	1 meg.	1650	—	—		

\* Cathode resistor-ohms.

<sup>1</sup> Screen tied to plate.

<sup>2</sup> No connection to Pin No. 1 for 6L6G, 6Q7G, 6RGT/G, 6S7G, 6SA7GT/G and 6SF5-GT.

<sup>3</sup> Grid bias = 2 volts if separate oscillator excitation is used.

<sup>4</sup> Also type 6SJ7Y.

<sup>5</sup> Values are for single tube or section.

<sup>6</sup> Values are for two tubes in push-pull.

<sup>7</sup> Plate-to-plate value.

<sup>8</sup> Osc. grid leak — Scrn. res.

<sup>9</sup> Values for two units.

<sup>10</sup> Peak a.f. grid voltage.

<sup>11</sup> Peak a.f. G-G voltage.

<sup>12</sup> Micromhos.

<sup>13</sup> Unless otherwise noted.

<sup>14</sup> G<sub>2</sub> voltage.

<sup>15</sup> Units connected in parallel.



TABLE III—6.3-VOLT GLASS TUBES WITH OCTAL BASES

(For "G" and "GT"-type tubes not listed here, see equivalent type in Tables II and VIII; characteristics and connections will be similar)

Type	Name	Plate Dissipation Watts	Base	Fil. or Heater		Capacitances pf.			Plate Supply V.	Grid Bias	Screen Volts	Screen H.A.	Plate M.A.	Plate Res. Ohms	Transcon-ductance*	Amp. Factor	Load Res. Ohms	Watts Output
				V.	Amp.	C <sub>in</sub>	C <sub>out</sub>	C <sub>sp</sub>										
6AL7GT	Electron-Ray Indicator	—	8CM	6.3	0.15	—	—	—	Outer edge of any of the three illuminated areas displaced 1/16 in. min. outward with +5 volts to its electrode. Similar inward disp. with -5 volts. No pattern with -6 volts grid.									
6AQ7GT	Dual Diode — High-μ Triode	—	8CK	6.3	0.3	2.8	3.2	3	250	-2	—	—	2.3	44K	1600	70	—	—
6AR6	Beam Pent.	—	6BQ	6.3	1.2	11	7	0.55	250	-22.5	250	5	77	21K	5400	—	—	—
6AR7GT	Dual Diode — Remote Pent.	—	7DE	6.3	0.3	5.5	7.5	0.003	250	-2	100	1.8	7	1.2 meg.	2500	—	—	—
6AS7GA	Low-μ Twin Triode — D.C. Amp. <sup>1</sup>	—	8BD	6.3	2.5	6.5	2.2	7.5	135	250*	—	—	125	0.28K	7000	2	—	—
6AU5GT	Beam Pwr. Amp. <sup>3</sup>	10	6CK	6.3	1.25	11.3	7	0.5	115	-20	175	6.8	60	6K	5600	—	—	—
6AV5GA	Beam Pwr. Amp. <sup>3</sup>	11	6CK	6.3	1.2	14	7	0.5	250	-22.5	150	2.1	55	20K	5500	—	—	—
6BG6GA	Beam Pwr. Amp. <sup>3</sup>	20	5BT	6.3	0.9	11	6	0.8	250	-15	250	4	75	25K	6000	—	—	—
6BL7GT	Medium-μ Dual Triode <sup>1</sup>	—	8BD	6.3	1.5	4.4	0.9	6	250	-9	—	—	40	2.15K	7000	15	—	—
6BQ6GTB	Beam Pwr. Amp. <sup>3</sup>	11	6AM	6.3	1.2	15	7	0.6	250	-22.5	150	2.1	57	14.5K	5900	—	—	—
6CU6	Dual Triode <sup>1</sup>	—	8BD	6.3	1.5	5	3.4	4.2	250	390*	—	—	42	1.3K	7600	10	—	—
6CX5GT	Beam Pwr. Amp. <sup>3</sup>	26	8GD	6.3	2.5	22	10	0.4	175	-30	175	6	90	5K	8800	—	—	—
6CD6GA	Beam Pwr. Amp. <sup>3</sup>	20	5BT	6.3	2.5	24	9.5	0.8	175	-30	175	5.5	75	7.2K	7700	—	—	—
6CK4	Low-μ Triode	—	8JB	6.3	1.25	8	1.8	6.5	550	-26	—	—	55	1.0K	6500	6.7	—	—
6CL5	Beam Pwr. Amp. <sup>3</sup>	25	8GD	6.3	2.5	20	11.5	0.7	175	-40	175	7	90	6K	6500	—	—	—
6CU6	Beam Pwr. Amp. <sup>3</sup>	11	6AM	6.3	1.2	15	7	0.55	250	-22.5	150	2.1	55	20K	5500	—	—	—
6DG6GT	Beam Pwr. Amp.	—	7S	6.3	1.2	—	—	—	200	180*	125	8.5	47	28K	9000	—	4K	3.8
6DN6	Beam Pwr. Pent. <sup>3</sup>	15	5BT	6.3	2.5	22	11.5	0.8	125	-18	125	6.3	70	4K	8000	—	—	—
6DN7	Dissimilar Dual Triode	—	8BD	6.3	0.9	2.2	0.7	4	350	-8	—	—	8	9K	2500	22	—	—
						4.6	1	5.5	550	-9.5	—	—	68	2K	7700	15	—	—
6DQ5	Beam Pwr. Amp. <sup>3</sup>	24	8JC	6.3	2.5	23	11	0.5	175	-25	125	5	110	5.5K	10.5K	—	—	—
6DQ6B	Beam Pwr. Amp. <sup>3</sup>	18	6AM	6.3	1.2	15	7	0.55	250	-22.5	150	2.4	75	20K	6600	—	—	—
6DZ7	Twin Pwr. Pent. <sup>1</sup>	13.2	8JP	6.3	1.52	11	5	0.6	300	120*	250	15	80	—	—	—	9K <sup>2</sup>	12
6E5	Electron Ray — Triode	—	6R	6.3	0.3	—	—	—	250	—	—	—	—	—	—	—	—	—
6EA7	Dissimilar — Dual Triode	—	8BD	6.3	1.05	2.2	0.6	4	350	-3	—	—	1.5	34K	1900	65	—	—
						6	1.3	8	550	-25	—	—	95	770	6500	5	—	—
6EF6	Beam Pwr. Amp. <sup>3</sup>	—	7S	6.3	0.9	11.5	9	0.8	250	-18	250	2	50	—	5000	—	—	—
6EX6	Beam Pwr. Amp. <sup>3</sup>	22	5BT	6.3	2.25	22	8.5	1.1	175	-30	175	3.3	67	8.5K	7700	—	—	—
6EY6	Beam Pwr. Pent.	—	7AC	6.3	0.68	8.5	7	0.7	350	-17.5	300	3	44	60K	4400	—	—	—
6EZ5	Beam Pwr. Pent.	—	7AC	6.3	0.8	9	7	0.6	350	-20	300	3.5	43	50K	4100	—	—	—
6FH6	Beam Pwr. Pent.	—	6AM	6.3	1.2	33	8	0.4	770	-22.5	220	1.7	75	12K	6000	—	—	—
6GW6	Beam Power Amp. <sup>3</sup>	17.5	6AM	6.3	1.2	17	7	0.5	250	-22.5	150	2.1	70	-15K	7100	—	—	—
6K6GT	Pwr. Amp. Pent.	—	7S	6.3	0.4	5.5	6	0.5	315	-21	250	4/9	25/28	110K	2100	—	9K	4.5
6S8GT	Triple-Diode — Triode	—	8CB	6.3	0.3	1.2	5	2	250	-2	—	—	—	91K	1100	100	—	—
6SD7GT	Semi-Remote Pent.	—	8N	6.3	0.3	9	7.5	0.0035	250	-2	125	3	9.5	700K	4250	—	—	—
6SL7GT	High-μ Dual Triode <sup>1</sup>	—	8BD	6.3	0.3	3.4	3.8	2.8	250	-2	—	—	2.3	44K	1600	70	—	—
6SN7GTB	Medium-μ Dual Triode <sup>1</sup>	—	8BD	6.3	0.6	3	1.2	4	250	-8	—	—	9	7.7K	2600	20	—	—
6W6GT	Beam Pwr. Amp.	—	7S	6.3	1.2	15	9	0.5	200	180*	125	2/8.5	46/47	28K	8000	—	4K	3.8
6Y6GA	Beam Pwr. Amp.	—	7S	6.3	1.25	15	1	0.7	200	-14	135	2.2/9	61/66	18.3K	7100	—	2.6K	6
16G5	High-μ Dual Triode	—	8B	6.3	0.6	—	—	—	300	0	—	—	6.6/54	—	—	—	12K <sup>2</sup>	10.4
6550	Power Pentode	35	7S	6.3	1.6	14	12	0.85	400	-16.5	225	18	105	27K	9000	—	3K	20
7027A	Beam Pwr. Amp.	—	8HY	6.3	0.9	10	7.5	1.5	450	-30	350	19.2	194	—	6000	—	6K <sup>2</sup>	50
7591	Beam Pwr. Amp.	19	8KQ	6.3	0.8	10	5	0.25	450	200*	400	22	94	—	—	—	9K <sup>2</sup>	28

\* Cathode resistor-ohms.  
<sup>1</sup> Per section.

<sup>2</sup> Plate-to-plate value.

<sup>3</sup> Horiz. Deflection Amp.

<sup>4</sup> Micromhos.

<sup>5</sup> Vert. Deflection Amp.

TABLE IV—6.3-VOLT LOCK-IN-BASE TUBES

For other lock-in-base types see Tables V, VI, and VII

Type	Name	Base	Fil. or Heater		Capacitances pf.			Plate Supply V.	Grid Bias	Screen Volts	Screen H.A.	Plate M.A.	Plate Res. Ohms	Transcon-ductance*	Amp. Factor	Load Res. Ohms	Watts Output	
			V.	Amp.	C <sub>in</sub>	C <sub>out</sub>	C <sub>sp</sub>											
7A8	Octode Conv.	8U	6.3	0.15	7.5	9	0.15	250	-3	100	3.2	3	50K	Anode grid 250 Volts max. <sup>1</sup>				
7AM7	Remote Cut-off Pent.	8V	6.3	0.15	7	6.5	0.005	250	250*	250	1.9	6.8	1 meg.	3300	—	—	—	
7AK7	Sharp Cut-off Pent.	8V	6.3	0.8	12	9.5	0.7	150	0	90	21	41	11.5K	5500	—	—	—	
7B7	Remote Cut-off Pent.	8V	6.3	0.15	5	6	0.007	250	-3	100	1.7	8.5	750K	1750	—	—	—	
7C7	Sharp Cut-off Pent.	8V	6.3	0.15	5.5	6.5	0.007	250	-3	100	0.5	2	2 meg.	1300	—	—	—	
7E7	Dual Diode — Pent.	8AE	6.3	0.3	4.6	5.5	0.005	250	330*	100	1.6	7.5	700K	1300	—	—	—	
7F8	Medium-μ Dual Triode <sup>2</sup>	8BF	6.3	0.3	2.8	1.4	1.2	250	500*	—	—	6	14.5K	3300	48	—	—	
7K7	Dual Diode — High-μ Triode	8BF	6.3	0.3	2.4	2	1.7	250	-2	—	—	—	2.3	44K	1600	70	—	—

\* Cathode resistor-ohms.

<sup>1</sup> Through 20K resistor.

<sup>2</sup> Each section.

<sup>3</sup> Micramhos.



**TABLE V—1.5-VOLT FILAMENT BATTERY TUBES**

Type	Name	Base	Fil. or Heater		Capacitances pf.			Plate Supply V.	Grid Bias	Screen Volts	Screen Ma.	Plate Ma.	Plate Res. Ohms	Transcon-ductance <sup>2</sup>	Amp. Factor	Load Res. Ohms	Watts Output
			V.	Amp.	C <sub>in</sub>	C <sub>out</sub>	C <sub>sp</sub>										
1A7GT	Pentagrid Conv.	7Z	1.4	0.05	7	10	0.5	90	0	45	0.7	0.6	600K	E <sub>ss</sub> Anode-grid	—	90	Volts.
1H5GT	Diode High- $\mu$ Triode	5Z	1.4	0.05	1.1	4.6	1	90	0	—	—	0.15	240K	275	65	—	—
1LN5	Sharp Cut-off Pent.	7AD	1.4	0.05	3	8	0.007	90	0	90	0.35	1.6	1.1 meg.	800	—	—	—
1N5GT	R.f. Pentode	5Y	1.4	0.05	3	10	0.007	90	0	90	0.3	1.2	1.5 meg.	750	—	—	—
3E6	Sharp Cut-off Pent.	7CJ	2.8 <sup>1</sup>	0.05	5.5	8	0.007	90	0	90	1.2	2.9	325K	1700	—	—	—

<sup>1</sup> Center-tap filament permits 1.4 volt operation.

<sup>2</sup> Micromhos.

**TABLE VI—SPECIAL RECEIVING TUBES**

Type	Name	Plate Dissi-pation Watts	Base	Fil. or Heater		Capacitances pf.			Plate Supply V.	Grid Bias	Screen Volts	Screen Ma.	Plate Ma.	Plate Res. Ohms	Transcon-ductance <sup>1</sup>	Amp. Factor	Load Res. Ohms	Watts Output
				V.	Amp.	C <sub>in</sub>	C <sub>out</sub>	C <sub>sp</sub>										
6AV11	Triple Triode	—	12BY	6.3	0.6	1.9	1.5	1.2	250	-8.5	—	—	10.5	7.7K	2200	17	—	—
	Dual Triode	—	12BF	6.3	0.6	—	—	—	250	-8	—	—	10	7.2K	2500	18	—	—
6B10	Dual Diode	—	12BQ	6.3	0.6	1.6	0.3	1.7	250	-2	—	—	1.2	62.5K	1600	100	—	—
6C10	Triple Triode	—	12BQ	6.3	0.45	2.2	0.5	1.5	125	-1	—	—	4.2	13.6K	4200	57	—	—
6D10	Triple Triode	—	12BQ	6.3	0.45	2.2	0.4	4.2	250	-11	—	—	5.5	8.75K	2000	17.5	—	—
6E7	Dissimilar Dual Triode	—	9HF	6.3	0.9	7.0	1.2	9.0	150	-17.5	—	—	45	800	7500	6	—	—
6F4	Acorn Triode	—	7BR	6.3	0.225	2	0.6	1.9	80	150*	—	—	13	2.9K	5800	17	—	—
6F7	Dissimilar Dual Triode	—	12BM	6.3	0.9	2.2	0.48	3.8	250	-8	—	—	8	9K	2500	22.5	—	—
	Dual Triode	—	12BM	6.3	0.9	4.0	0.54	5.0	250	-9.5	—	—	41	2K	7700	15.4	—	—
6GE5	Beam Pwr. Pent.	17.5	12BJ	6.3	1.2	16	7	0.34	250	-22.5	150	1.8	65	18K	7300	—	—	—
6GJ5	Beam Pwr. Pent.	17.5	9NM	6.3	1.2	15	6.5	0.26	250	-22.5	150	2.1	70	15K	7100	—	—	—
6GT5	Beam Pwr. Pent.	17.5	9NZ	6.3	1.2	15	6.5	0.26	250	-22.5	150	2.1	70	15K	7100	—	—	—
6HB5	Beam Pwr. Pent.	18	12BJ	6.3	1.5	22	9.0	0.4	130	-20	130	1.75	50	11K	9100	—	—	—
6HF5	Beam Pwr. Pent.	28	12FB	6.3	2.25	24	10	0.56	175	-25	125	4.5	125	5.6K	11.3K	—	—	—
6J11	Twin Pentode	—	12BW	6.3	0.8	11	2.8	0.04	125	96*	125	3.8	11	200K	13K	—	—	—
6JE6	Pentode	24	9QL	6.3	2.5	21	11	0.44	175	-25	125	5	115	5.5K	10.5K	—	—	—
						1.9	1.8	1.3	250	-8.5	—	—	10.5	7.7K	2200	17	—	—
6K11	Triple Triode	—	12BY	6.3	0.6	1.8	0.7	1.3	250	-2.0	—	—	1.2	62.5K	1600	100	—	—
						1.8	1.8	1.3	250	-2.0	—	—	1.2	62.5K	1600	100	—	—
6L4	Acorn Triode	—	7BR	6.3	0.225	1.8	0.5	1.6	80	150*	—	—	9.5	4.4K	6400	28	—	—
6M11	Twin Triode	—	12CA	6.3	0.77	3.4	0.8	1.8	125	120*	—	—	8	10K	8K	58	—	—
	Pentode	—	12CA	6.3	0.77	12	2.8	0.03	125	96*	125	3.4	11	200K	13K	—	—	—
6Q11	Triple Triode	—	12BY	6.3	0.6	1.9	1.7	1.8	150	0	—	—	22	7K	2500	18	—	—
						1.8	0.6	2.0	250	-2	—	—	1.2	62.5K	1600	100	—	—
						1.8	1.7	2.0	250	-2	—	—	1.2	62.5K	1600	100	—	—
7E5/1201	H.f. Triode	—	8BN	6.3	0.15	3.6	2.8	1.5	180	-3	—	—	5.5	12K	3000	36	—	—
954	Detector Amp. — Pentode (Acorn)	A <sub>1</sub> Amp. Detector	5BB	6.3	0.15	3.4	3	0.007	250	-3	100	0.7	2	1 meg.	1400	—	—	250K
						250	-6	100	—	—	—	—	—	—	—	—	—	—
955	Medium- $\mu$ Triode (Acorn)	—	5BC	6.3	0.15	1	0.6	1.4	250	-7	—	—	6.3	11.4K	2200	25	—	—
						90	-2.5	—	—	—	—	—	2.5	14.7K	1700	25	—	—
956	Remote Cut-off Pent. (Acorn)	A <sub>1</sub> Amp. Mixer	5BB	6.3	0.15	3.4	3	0.007	250	-3	100	2.7	6.7	700K	1800	—	—	—
						250	-10	100	—	—	—	—	—	—	—	—	—	—
958A	Medium- $\mu$ Triode (Acorn)	—	5BD	1.25	0.1	0.6	0.8	2.6	135	-7.5	—	—	3	10K	1200	12	—	—
959	Sharp Cut-off Pent. (Acorn)	—	5BE	1.25	0.05	1.8	2.5	0.015	135	-3	67.5	0.4	1.7	800K	600	—	—	—
6173	U.h.f. "Pencil" Diode	—	Fig. 34	6.3	0.135	Plate to K = 1.1			Peak inverse -375 Volts. Peak I <sub>p</sub> -50 Ma. Max. d.c. output -5.5 ma.									
7077	Ceramic U.h.f. Triode	—	—	6.3	0.24	1.9	0.01	1.0	250	-5	—	—	6.4	8.9K	9000	—	—	—
7360	Beam Deflection	—	9KS	6.3	0.35	—	—	—	For Practical Circuits See Chap. 11									
7695	Beam Pwr. Pent.	16	9PX	5.0	0.15	14	9	0.75	140	100*	140	14	100	—	—	—	1100	4.5
7888	Pwr. Pent.	19	9NZ	6.3	0.8	11	4.4	0.15	300	-10	300	15	75	29K	10.2K	—	3K	11

\* Cathode resistor-ohms

<sup>1</sup> Micromhos.

**TABLE VII—EQUIVALENT TUBES**

The equivalent tubes listed in this table are, in general, designed for industrial, military and other special-purpose applications. These tubes are generally not directly interchangeable because of mechanical and/or electrical differences involving basing, heater characteristics, maximum ratings, interelectrode capacitances, etc.

Type	Equivalent and Table	Base	E <sub>r</sub> <sup>1</sup>	I <sub>r</sub> <sup>2</sup>	Type	Equivalent and Table	Base	E <sub>r</sub> <sup>1</sup>	I <sub>r</sub> <sup>2</sup>		
1K3	1J3	X	3C	1.25	0.2	6A6	6N7	11	7B	6.3	0.8
1LH4	1H5GT	V	5AG	1.4	0.05	6A7	6A8	11	7C	6.3	0.3
3EA5	2EA5	I	7EW	2.9	0.45	6AE8	6K8	11	80U	6.3	0.3
3LF4 <sup>2</sup>	3Q5GT	VII	6BB	2.8	0.05	6AU7 <sup>1</sup>	12AU7A	I	9A	3.15	0.6
3V4 <sup>2</sup>	3Q4	I	6BX	2.8	0.05	6AX7 <sup>1</sup>	12AX7	I	9A	6.3	0.3
4D K6	3DK6	I	7CM	4.2	0.45	6C6	6J7	11	6F	6.3	0.3
5D J4	5U4GB	X	8KS	5.0	3.0	6CS8 <sup>1</sup>	6CR8	I	9FZ	6.3	0.45
5EA8	6EA8	I	9AE	4.7	0.6	6CU8	6AN8	I	9GM	6.3	0.45
5FV8	6FV8	I	9FA	4.7	0.6	6EW6	4EW6	I	7CM	6.3	0.4

TABLE VII—EQUIVALENT TUBES—Continued

Type	Equivalent and Table	Base	E <sup>1</sup>	I <sup>2</sup>	Type	Equivalent and Table	Base	E <sup>1</sup>	I <sup>2</sup>		
6SU/GTY	6SL7GT	III	8BD	6.3	0.3	14Q7	6SA7	II	8AL	12.6	0.15
6V6GT	6Y6GA	III	7S	6.3	1.25	19CL8A	6CL8A	I	9FX	18.9	0.15
7A4	6J5	II	5AC	6.3	0.3	25BQ6GA	6BQ6GTB	III	6AM	25	0.3
7A6	6H6	II	7AJ	6.3	0.15	25BQ6GT	6BQ6GTB	III	6AM	25	0.3
7A7	6SK7	II	8V	6.3	0.3	25BQ6GTB:	6BQ6GTB	III	6AM	25	0.3
7B4	6SF5	II	5AC	6.3	0.3	25C5	50C5	VIII	7CV	25	0.3
7B5	6K6GT	III	6AE	6.3	0.4	25C6GA	50C6GA	VIII	7S	25	0.3
7B5	6SQ7	II	8W	6.3	0.3	25CA5	6CA5	I	7CV	25	0.3
7B8	6A8	II	8X	6.3	0.3	25CD6G	6CD6GA	III	5BT	25	0.6
7C5	6V6	II	8AA	6.3	0.45	25CD6GA:	6CD6GA	III	5BT	25	0.6
7EY6:	6EY6	III	7AC	7.2	0.6	25CD6GB:	6CD6GA	III	5BT	25	0.6
7F7	6SL7GT	III	8AC	6.3	0.3	25CU6	6CU6	III	6AM	25	0.3
7H7	6SQ7	II	8V	6.3	0.3	25DN6:	6DN6	III	5BT	25	0.6
7H7	6SN7GT	III	8AC	6.3	0.6	25EC6:	25CD6GB	VIII	5BT	25	0.6
7Q7	6SA7	II	8AL	6.3	0.3	25EH5	6EH5	I	7CV	25	0.3
10E8B:	6EB8	I	9DX	10.5	0.45	25L6GT	12L6GT	VI	7S	25	0.3
12A8GT	6A8	II	8A	12.6	0.15	25SA7GT	6SA7GT	II	8AD	—	—
12AL5	6AL5	I	6BT	12.6	0.15	25W6GT	6W6GT	III	7S	25	0.3
12AT6	6AT6	I	7BT	12.6	0.15	35C5	35B5	I	7CV	35	0.15
12AU6	6AU6A	I	7BK	12.6	0.15	35L6GT	35B5	I	7S	35	0.15
12AV5GA:	6AV5GT	III	8CK	12.6	0.6	41	6K6GT	III	8B	6.3	0.4
12AV6	6AV6	I	7BT	12.6	0.15	42	6F6	II	8B	6.3	0.7
12B4	12B4A <sub>1</sub> <sup>3</sup>	I	9AG	12.6	0.3	50A5	12L6GT	VI	6AA	50	0.15
12BA6	6BA6	I	7BK	12.6	0.15	50BK5	6BK5	I	9BQ	50	0.15
12BA7	6BA7	I	8CT	12.6	0.15	50C5	50B5	I	7CV	50	0.15
12BD6	6BD6	I	7BK	12.6	0.15	50C6G	50C6GA	VI	7S	50	0.15
12BE6	6BE6	I	7CH	12.6	0.15	50L6GT	12L6GT	VI	7AC	50	0.15
12BF6	6BF6	I	7BT	12.6	0.15	75	6SQ7	II	8G	6.3	0.3
12BK5:	6BK5	I	9BQ	12.6	0.6	78	6K7	II	8F	6.3	0.3
12BK6	6BK6	I	7BT	12.6	0.15	1221	6J7	II	8F	6.3	0.3
12BN6	6BN6	I	7DE	12.6	0.15	1223	6J7	II	7R	6.3	0.3
12BQ6GA:	6BQ6GTB	III	6AM	12.6	0.6	1631	6L6GB	II	7AC	12.6	0.45
12BQ6GT:	6BQ6GTB	III	6AM	12.6	0.6	1632	12L6GT	VI	7S	12.6	0.6
12BQ6GTB:	6BQ6GTB	III	6AM	12.6	0.6	1634	65C7	II	8S	12.6	0.15
12BT6	6BT6	I	7BT	12.6	0.15	5591	6AK5	I	7BD	6.3	0.15
12BU6	6BU6	I	7BT	12.6	0.15	5854	6AK5	I	7BD	6.3	0.175
12BW4	6BW4	X	9DJ	12.6	0.45	5870	2C51	I	8CJ	6.3	0.35
12BY7	12BY7A <sub>1</sub> <sup>3</sup>	I	9BF	12.6	0.3	5879	6H6	I	7CX	6.3	0.15
12BZ6:	6BZ6	I	7CM	12.6	0.15	5891	6SL7GT	III	8BD	6.3	0.6
12C5:	50B5	I	7CV	12.6	0.6	5892	6SN7GT	III	8BD	6.3	0.6
12C8	6B8	II	8E	12.6	0.15	5725	6AS6	I	7CM	6.3	0.175
12CA5:	6CA5	I	7CV	12.6	0.6	5726	6AL5	I	6BT	6.3	0.3
12CM6	6CM6	I	9CK	12.6	0.225	5749	6BA6	I	7BK	6.3	0.3
12CR6	6CR6	I	7EA	12.6	0.15	5750	6BE6	I	7CH	6.3	0.3
12CS5:	6CS5	I	9CK	12.6	0.6	5751 <sup>1</sup>	12AX7	I	9A	12.6	0.175
12CS6	6CS6	I	7CH	12.6	0.15	5814A <sup>3</sup>	12SN7GT	VIII	9A	12.6	0.175
12CU5:	6CU5	I	7CV	12.6	0.6	5871	6V6GTA	II	7AC	6.3	0.9
12CU6	6CU6	III	6AM	12.6	0.6	5881	6L6GB	II	7AC	6.3	0.9
12DB5:	6DB5	I	9GR	12.6	0.6	5910	1U4	I	6AR	1.4	0.05
12DF7:	12AX7	I	9A	12.6	0.15	5915	6BY6	I	7CH	6.3	0.3
12DQ6A:	6DQ6B	III	6AM	12.6	0.6	5963 <sup>3</sup>	12AU7A	I	9A	12.6	0.15
12DT5	6DT5	I	9HN	12.6	0.6	5964	6J6A	I	7BF	6.3	0.45
12DT8	6DT8	I	9DE	12.6	0.15	5965 <sup>3</sup>	12AV7	I	9A	12.6	0.225
12DW5:	6DW5	I	9CK	12.6	0.6	6046	12L6GT	VI	7AC	25	0.3
12EF6:	6EF6	III	7S	12.6	0.45	6057 <sup>3</sup>	12AX7	I	9A	12.6	0.15
12G4	6J5	II	6BG	12.6	0.15	6058	6AL5	I	6BT	6.3	0.3
12GE5	6GE5	VII	12BJ	12.6	0.6	6059	6J7	II	9BC	6.3	0.15
12GW6	6GW6	III	6AM	12.6	0.6	6060 <sup>3</sup>	12AT7	I	9A	12.6	0.15
12H6	6H6	II	7Q	12.6	0.15	6061	6V6GTA	II	9AM	6.3	0.45
12J5GT	6J5	II	6Q	12.6	0.15	6064	6AM6	I	7DB	6.3	0.3
12J7GT	6J7	II	7R	12.6	0.15	6065	6BH6	I	7DB	6.3	0.2
12K7GT	6K7	II	7R	12.6	0.15	6066	6AT6	I	7BT	6.3	0.3
12K8	6K8	II	8K	12.6	0.15	6067 <sup>3</sup>	12AU7A	I	9A	12.6	0.15
12S8GT	6S8GT	III	8CB	12.6	0.15	6080	6AS7G	III	8BD	6.3	2.5
12SA7	6SA7	II	8R	12.6	0.15	6101	6J6A	I	7BF	6.3	0.45
12SG7	6SG7	II	8S	12.6	0.15	6132	6CH6	I	9BA	6.3	0.75
12SF5	6SF5	II	6AB	12.6	0.15	6136	6AU6A	I	7BK	6.3	0.3
12SF7	6SF7	II	7AZ	12.6	0.15	6186	6AG5	I	7BD	6.3	0.3
12SG7	6SG7	II	8BK	12.6	0.15	6201 <sup>3</sup>	12AT7	I	9A	12.6	0.15
12SH7	6SH7	II	8BK	12.6	0.15	6265	6BH6	I	7CM	6.3	0.175
12SJ7	6SJ7	II	8N	12.6	0.15	6350 <sup>3</sup>	12BH7A	I	9CZ	12.6	0.3
12SK7	6SK7	II	8M	12.6	0.15	6485	6AH6	I	7BK	6.3	0.45
12SL7GT	6SL7GT	III	8BD	12.6	0.15	6627	0B2	IX	5B0	—	—
12SN7GT	6SN7GTB	III	8BD	12.6	0.3	6660	6BA6	I	7CC	6.3	0.3
12SN7GTA	6SN7GTB	III	8BD	12.6	0.3	6661	6BH6	I	7CM	6.3	0.15
12SQ7	6SQ7	II	8Q	12.6	0.15	6662	6BJ6A	I	7CM	6.3	0.15
12SR7	6SR7	II	8Q	12.6	0.15	6663	6AL5	I	6BT	6.3	0.3
12W6GT:	6W6GT	III	7S	12.6	0.6	6664	6AB4	I	5CE	6.3	0.15
14A7	6SK7	II	8V	12.6	0.15	6669	6AQ5A	I	7BZ	6.3	0.45
14AF7	7AF7	IV	8AC	12.6	0.15	6676	6CB6A	I	7CM	6.3	0.3
14B6	6SQ7	II	8W	12.6	0.15	6677	6CL6	I	9BV	6.3	0.65
14F7	6SL7GT	III	8AC	12.6	0.15	6678	6UBA:	I	9AE	6.3	0.45
14N7	6SN7GTB	III	8AC	12.6	0.6	6679 <sup>3</sup>	12AT7	I	9A	12.6	0.15

TABLE VII—EQUIVALENT TUBES—Continued

Type	Equivalent and Table	Base	Er <sup>1</sup>	Ir <sup>2</sup>	Type	Equivalent and Table	Base	Er <sup>1</sup>	Ir <sup>2</sup>
668D <sup>3</sup>	12AU7A I	9A	12.6	0.15	7061	12AB5 I	9EU	13.5	0.210
6681 <sup>1</sup>	12AX7 I	9A	12.6	0.15	7137	6J4 I	7BQ	6.3	0.4
6629 <sup>1</sup>	5965 VIII	9A	12.6	0.225	7167	6CV5 I	7EW	13.5	0.09
6897	2C39 XI	—	6.3	1.05	7247	12AU7 I	9A	12.6	0.15
7000	6J7 II	7R	6.3	0.3	7400	6V6-GTA III	7AC	6.3	0.45
7025 <sup>1</sup>	12AX7 VII	9A	12.6	0.15	7543	6AU6 I	7BK	6.3	0.3
7054	12BY7 I	9BF	13.5	0.275	7581A	6L6GB II	7AC	6.3	0.9
7055	6AL5 I	6BT	13.5	0.155	7700	6J7 II	6F	6.3	0.3
7056	6CB6 I	7CM	13.5	0.150	ECC81 <sup>3</sup>	12AT7 I	9A	12.6	0.15
7057	6BZ7 I	9AJ	13.5	0.180	ECC82 <sup>3</sup>	12AU7A I	9A	12.6	0.15
7058	12AX7 I	9A	13.5	0.155	ECC83 <sup>3</sup>	12AX7 I	9A	12.6	0.15
7059	6U8 I	9AE	13.5	0.195	KT-68 <sup>4</sup>	6L6GB II	7AC	6.3	1.27
7060	6AU8 I	9DX	13.5	0.280	XDX	7AF7 IV	8AC	12.6	0.15

<sup>1</sup> Controlled heater warm-up characteristics.  
<sup>2</sup> Filament or heater voltage.  
<sup>3</sup> Filament or heater current.

<sup>4</sup> Heater center-tapped for operation at half voltage shown.  
<sup>5</sup> British version of 6L6.

TABLE VIII—CONTROL AND REGULATOR TUBES

Type	Name	Base	Cathode	Fil. or Heater		Peak Anode Voltage	Max. Anode Ma.	Minimum Supply Voltage	Operating Voltage	Operating Ma.	Grid Resistor	Tube Voltage Drop
				Volts	Amp.							
0A2	Voltage Regulator	5B0	Cold	—	—	—	—	185	150	5-30	—	—
9073	Voltage Regulator	4AJ	Cold	—	—	—	—	105	75	5-40	—	—
0A3A/VR75	Voltage Regulator	4V	Cold	—	—	—	—	With 105-120-volt a.c. anode supply, peak starter-anode a.c. voltage is 70 peak r.f. voltage 55. Peak d.c. ma = 100. Average d.c. ma = 25.				
0A4G	Gas Triode Starter-Anode Type	4V	Cold	—	—	—	—	Plate - 750 V., Screen - 90 V., Grid +3 V., Pulse - 85 V.				
1287	Gas Pentode	Fig. 19	Cold	—	—	—	—	—	—	—	—	—
0A5	Gas Pentode	Fig. 19	Cold	—	—	—	—	—	—	—	—	—
0B2	Voltage Regulator	5B0	Cold	—	—	—	—	133	108	5-30	—	—
9074	Voltage Regulator	4AJ	Cold	—	—	—	—	125	90	5-40	—	—
0B3/VR90	Voltage Regulator	5B0	Cold	—	—	—	—	105	75	5-30	—	—
0C2	Voltage Regulator	4AJ	Cold	—	—	—	—	135	105	5-40	—	—
0C3A/VR105	Voltage Regulator	4AJ	Cold	—	—	—	—	185	150	5-40	—	—
0D3A/VR150	Voltage Regulator	4AJ	Cold	—	—	—	—	—	—	—	—	—
2021	Grid-Controlled Rectifier Relay Tube	7BN	Htr.	6.3	0.6	650	500	—	650	100	0.1-10 <sup>4</sup>	8
						400	—	—	—	—	1.0 <sup>4</sup>	—
6D4	Control Tube	5AY	Htr.	—	—	—	—	Ep = 350; Grid volts = -50; Avg. Ma. = 25; Peak Ma. = 100; Voltage drop = 16.				
90C1	Voltage Regulator	5B0	Cold	—	—	—	—	125	90	1-40	—	—
884	Gas Triode Grid Type	8Q	Htr.	6.3	0.6	300	300	—	—	2	25000	—
						350	300	—	—	75	25000	—
967	Grid-Controlled Rectifier	3G	Fil.	2.5	5.0	2500	500	— <sup>5</sup>	—	—	—	10-24
1265	Voltage Regulator	4AJ	Cold	—	—	—	—	130	90	5-30	—	—
1266	Voltage Regulator	4AJ	Cold	—	—	—	—	—	70	5-40	—	—
1267	Relay Tube	4V	Cold	—	—	—	—	Characteristics same as 0A4G				
2050	Grid-Controlled Rectifier	9BA	Htr.	6.3	0.6	650	500	—	—	100	0.1-10 <sup>4</sup>	8
5851	Voltage Regulator	5B0	Cold	—	—	115	—	115	87	1.5-3.5	—	—
5862	Thyratron—Fuse	Fig. 79	Htr.	6.3	1.5	200 <sup>1</sup>	—	I <sub>k</sub> to fuse = 150 Amp., 60 cycle, half-wave 50 V. 100 ma. peak current; 25 ma. average.				
5896	Relay Service	7BN	Htr.	6.3	0.15	500 <sup>2</sup>	—	—	—	—	—	—
5727	Gas Thyratron	7BN	Htr.	6.3	0.6	650	—	—	—	—	—	—
5823	Relay or Trigger	4CK	Cold	—	—	—	—	Max. peak inv. volts = 200; Peak Ma. = 100; Avg. Ma. = 25.				
5962	Voltage Regulator	2AG	Cold	—	—	—	—	730	700	5/55 <sup>3</sup>	—	—
5998	Series Regulator	8BD	Htr.	6.3	2.4	250	125	—	110	100	350 <sup>4</sup>	—
6308	Voltage Regulator	8EX	Cold	—	—	—	—	3.5	115	87	—	—
6336A	Twin Triode Series-Regulator	8BD	Htr.	6.3	5.0	—	—	Ep = 400; Ip 400 ma.; Grid volts = -300				
6354	Voltage Regulator	Fig. 12	Cold	—	—	—	—	180	150	5-15	—	—
KY21	Grid-Controlled Rectifier	—	Fil.	2.5	10.0	—	—	—	3000	500	—	—
RK61	Radio-Controlled Relay	—	Fil.	1.4	0.05	45	1.5	30 <sup>1</sup>	—	0.5-1.5	3 <sup>4</sup>	30

<sup>1</sup> No base. Tinned wire leads.  
<sup>2</sup> At 1000 anode volts.

<sup>3</sup> Peak inverse voltage.  
<sup>4</sup> Megohms.

<sup>5</sup> Values in microamperes.  
<sup>6</sup> Cathode resistor-ohms.

TABLE IX—RECTIFIERS—RECEIVING AND TRANSMITTING  
 See Also Table VIII—Controls and Regulator Tubes

Type	Name	Base	Cathode	Fil. or Heater		Max. A.C. Voltage Per Plate	D.C. Output Current Ma.	Max. Inverse Peak Voltage	Peak Plate Current Ma.	Type
				Volts	Amp.					
0Z4-G	Full-Wave Rectifier	4R	Cold	—	—	300	75	1000	200	GAS
1G3-GT/1B3-GT	Half-Wave Rectifier	3C	Fil.	1.25	0.2	—	1.0	33000	30	HV
1K3/1J3	Half-Wave Rectifier	3C	Fil.	1.25	0.2	—	0.5	26000	50	HV
1V2	Half-Wave Rectifier	9U	Fil.	0.625	0.3	—	0.5	7500	10	HV
2B25	Half-Wave Rectifier	3T	Fil.	1.4	0.11	1000	1.5	—	9	HV
2X2-A	Half-Wave Rectifier	4AB	Htr.	2.5	1.75	4500	7.5	—	—	HV
2Y2	Half-Wave Rectifier	4AB	Fil.	2.5	1.75	4400	5.0	—	—	HV
2Z2/G84	Half-Wave Rectifier	4B	Fil.	2.5	1.5	350	50	—	—	HV
				5.0	3.0	—	60	20000	300	HV
3B24	Half-Wave Rectifier	Fig. 49	Fil.	2.5 <sup>3</sup>	3.0	—	30	20000	150	HV

TABLE IX—RECTIFIERS—RECEIVING AND TRANSMITTING—Continued

See Also Table VIII—Controls and Regulator Tubes

Type	Name	Base	Cathode	Fil. or Heater		Max. A.C. Voltage Per Plate	D.C. Output Current Ma.	Max. Inverse Peak Voltage	Peak Plate Current Ma.	Type
				Volts	Amp.					
3B28	Half-Wave Rectifier	4P	Fil.	2.5	5.0	—	250	10000	1000	GAS
5A74	Full-Wave Rectifier	5L	Htr.	5.0	2.25	550	800	1550	—	HV
5AU4	Full-Wave Rectifier	5T	Fil.	5.0	4.5	300 <sup>3</sup>	350 <sup>3</sup>	1400	1075	HV
						400 <sup>3</sup>	325 <sup>3</sup>			
						500 <sup>4</sup>	325 <sup>4</sup>			
5AW4	Full-Wave Rectifier	5T	Fil.	5.0	4.0	450 <sup>3</sup>	250 <sup>3</sup>	1550	750	HV
5BC3	Full-Wave Rectifier	9NT	Fil.	5.0	3.0	550 <sup>4</sup>	250 <sup>4</sup>	—	—	—
5R4GY	Full-Wave Rectifier	5T	Fil.	5.0	2.0	500	150	1700	1000	HV
5R4GYA						900 <sup>3</sup>	150 <sup>3</sup>	2800	650	HV
5U4G	Full-Wave Rectifier	5T	Fil.	5.0	3.0	950 <sup>4</sup>	175 <sup>4</sup>	—	—	HV
5U4GA	Full-Wave Rectifier	5T	Fil.	5.0	3.0	300 <sup>3</sup>	275 <sup>3</sup>	Same as Type 5Z3		HV
						450 <sup>3</sup>	250 <sup>3</sup>	1550	900	HV
						550 <sup>4</sup>	250 <sup>4</sup>			
5U4GB	Full-Wave Rectifier	5T	Fil.	5.0	3.0	300 <sup>3</sup>	300 <sup>3</sup>	1550	1000	HV
						450 <sup>3</sup>	275 <sup>3</sup>			
						550 <sup>4</sup>	275 <sup>4</sup>			
5V3	Full-Wave Rectifier	5T	Htr.	5.0	3.8	425 <sup>3</sup>	350	1400	1200	HV
5V4GA	Full-Wave Rectifier	5L	Htr.	5.0	2.0	500 <sup>4</sup>	—	—	—	HV
5X4G	Full-Wave Rectifier	5Q	Fil.	5.0	3.0	375 <sup>3</sup>	175	1400	525	HV
5Y3-G-GT	Full-Wave Rectifier	5T	Fil.	5.0	2.0	—	—	Same as Type 5Z3		HV
5Y4-G-GT	Full-Wave Rectifier	5Q	Fil.	5.0	2.0	—	—	Same as Type 80		HV
5Z3	Full-Wave Rectifier	4C	Fil.	5.0	3.0	500	250	1400	—	HV
5Z4	Full-Wave Rectifier	5L	Htr.	5.0	2.0	400	125	1100	—	HV
6AF3	Half-Wave Rectifier	9CB	Htr.	6.3	1.2	—	185	4500	750	HV
6AL3	Half-Wave Rectifier	9CB	Htr.	6.3	1.55	—	220	7500	550	HV
6AV4	Full-Wave Rectifier	5BS	Htr.	6.3	0.95	—	90	1250	250	HV
6AX5GT	Full-Wave Rectifier	6S	Htr.	6.3	1.2	450	125	1250	375	HV
6BW4	Full-Wave Rectifier	9DJ	Htr.	6.3	0.9	450	100	1275	350	HV
6BX4	Full-Wave Rectifier	5BS	Htr.	6.3	0.6	—	90	1350	270	HV
6BY5G	Full-Wave Rectifier	6CN	Htr.	6.3	1.6	375 <sup>3</sup>	175	1400	525	HV
6CA4	Full-Wave Rectifier	9M	Htr.	6.3	1.0	350 <sup>3</sup>	150	1000	450	HV
6DA4A	Half-Wave Diode	4CG	Htr.	6.3	1.2	—	155	4400	900	HV
6DE4	Half-Wave Rectifier	4CG	Fil.	6.3	1.6	—	175	5000	1100	HV
6U4GT	Half-Wave Rectifier	4CG	Htr.	6.3	1.2	—	138	1375	660	HV
6V4	Full-Wave Rectifier	9M	Htr.	6.3	0.6	350	90	—	—	HV
6X4/6063	Full-Wave Rectifier	7CF	Htr.	6.3	0.3	325 <sup>3</sup>	70	1250	210	HV
6X5GT		6S				450 <sup>4</sup>				
6Z3	Half-Wave Rectifier	4G	Fil.	6.3	0.3	350	50	—	—	HV
12DF5	Full-Wave Rectifier	9BS	Htr.	6.3	0.9	450	100	1275	350	HV
				12.6	0.45					
12X4	Full-Wave Rectifier	5BS	Htr.	12.6	0.3	650 <sup>3</sup>	70	1250	210	HV
						900 <sup>4</sup>	70	1250	210	
25Z5	Rectifier-Doubler	6E	Htr.	25	0.3	125	100	—	500	HV
35W4	Half-Wave Rectifier	5BQ	Htr.	35 <sup>1</sup>	0.15	125	60	330	600	HV
35Z4GT	Half-Wave Rectifier	5AA	Htr.	35	0.15	250	100	700	600	HV
35Z5G	Half-Wave Rectifier	6AD	Htr.	35 <sup>1</sup>	0.15	125	60	—	—	HV
36AM3	Half-Wave Rectifier	5BQ	Htr.	36	0.1	117	75	365	530	HV
50DC4	Half-Wave Rectifier	5BQ	Htr.	50	0.15	117	100	330	720	HV
50Y6GT	Full-Wave Rectifier	7Q	Htr.	50	0.15	125	85	—	—	HV
80	Full-Wave Rectifier	4C	Fil.	5.0	2.0	350 <sup>3</sup>	125	1400	375	HV
						500 <sup>4</sup>	125			
83	Full-Wave Rectifier	4C	Fil.	5.0	3.0	500	250	1400	800	MV
83-V	Full-Wave Rectifier	4AD	Htr.	5.0	2.0	400	200	1100	—	HV
117N7GT	Rectifier-Tetrode	8AV	Htr.	117	0.09	117	75	350	450	HV
117Z3	Half-Wave Rectifier	4CB	Htr.	117	0.04	117	90	300	—	HV
816	Half-Wave Rectifier	4P	Fil.	2.5	2.0	2200	125	7500	500	MV
836	Half-Wave Rectifier	4P	Htr.	2.5	5.0	—	—	5000	1000	HV
886-A-AX	Half-Wave Rectifier	4P	Fil.	2.5	5.0	3500	250	10000	1000	MV
886B	Half-Wave Rectifier	4P	Fil.	5.0	5.0	—	—	8500	1000	MV
886 Jr.	Half-Wave Rectifier	4B	Fil.	2.5	2.5	1250	250 <sup>2</sup>	—	—	MV
872A/872	Half-Wave Rectifier	4AT	Fil.	5.0	7.5	—	1250	10000	5000	MV

<sup>1</sup> Tapped for pilot lamps.  
<sup>2</sup> Per pair with choke input.

<sup>3</sup> Capacitor input.  
<sup>4</sup> Choke input.

<sup>5</sup> Using only one-half of filament.

TABLE X—TRIODE TRANSMITTING TUBES

Type	Maximum Ratings						Cathode		Capacitances			Base	Typical Operation							
	Plate Dissipation Watts	Plate Voltage	Plate Current Ma.	D.C. Grid Current Ma.	Freq. Mc Full Ratings	Amplification Factor	Volts	Amperes	C <sub>in</sub> pf.	C <sub>g</sub> pf.	C <sub>out</sub> pf.		Class of Service <sup>1</sup>	Plate Voltage	Grid Voltage	Plate Current Ma.	D.C. Grid Current Ma.	Approx. Driving Power Watts	P-to-P Load Ohms	Approx. Output Power Watts
95B-A	0.6	135	7	1.0	500	12	1.25	0.1	0.6	2.6	0.8	5B8	C-T-O	135	-20	7	1.0	0.035	—	0.6
6J6A1 <sup>2</sup>	1.5	300	30	16	250	32	6.3	0.45	2.2	1.6	0.4	7B8	C-T	150	-10	30	1.6	0.035	—	3.5



TABLE X — TRIODE TRANSMITTING TUBES — Continued

Type	Maximum Ratings						Cathode		Capacitances			Base	Typical Operation								
	Plate Dissipation Watts	Plate Voltage	Plate Current Ma.	D.C. Grid Current Ma.	Freq. Mc. Full Ratings	Amplification Factor	Volts	Amperes	C <sub>in</sub> pf.	C <sub>sp</sub> pf.	C <sub>out</sub> pf.		Class of Service	Plate Voltage	Grid Voltage	Plate Current Ma.	D.C. Grid Current Ma.	Approx. Driving Power Watts	P-to-P Load Ohms	Approx. Output Power Watts	
9002	1.6	250	8	2.0	250	25	6.3	0.15	1.2	1.4	1.1	7B5	C-T-O	180	-35	7	1.5	—	—	0.5	
955	1.6	180	8	2.0	250	25	6.3	0.15	1.0	1.4	0.6	5B6	C-T-O	180	-35	7	1.5	—	—	0.5	
HY114B	1.8	180	12	3.0	300	13	1.4	0.155	1.0	1.3	1.0	2T	C-T-O	180	-30	12	2.0	0.2	—	1.4 <sup>1</sup>	
													C-P	180	-35	12	2.5	0.3	—	1.4 <sup>2</sup>	
6F4	2.0	150	20	8.0	500	17	6.3	0.225	2.0	1.9	0.6	7B8	C-T-O	150	-15 550* 2000*	20	7.5	0.2	—	1.8	
12AU7A <sup>2</sup>	2.76 <sup>a</sup>	350	12 <sup>a</sup>	3.5 <sup>a</sup>	54	18	6.3	0.3	1.5	1.5	0.5	9A	C-T-O	350	-100	24	7	—	—	6.0	
6026	3.0	150	30	10	400	24	6.3	0.2	2.2	1.3	0.38	Fig. 16	C-T-O	135	1300*	20	9.5	—	—	1.25	
HY615 HY-E1148	3.5	300	20	4.0	300	20	6.3	0.175	1.4	1.6	1.2	Fig. 71	C-T-O	300	-35	20	2.0	0.4	—	4.0 <sup>1</sup>	
													C-P	300	-35	20	3.0	0.8	—	3.5 <sup>2</sup>	
6C4	5.0	350	25	8.0	54	18	6.3	0.15	1.8	1.6	1.3	6B6	C-T-O	300	-27	25	7.0	0.35	—	5.5	
2C36	5	1500 <sup>3</sup>	—	—	1200	25	6.3	0.4	1.4	2.4	0.36	Fig. 21	C-T-O <sup>12</sup>	1000 <sup>3</sup>	0	900 <sup>3</sup>	—	—	—	200 <sup>3</sup>	
2C37	5	350	—	—	3300	25	6.3	0.4	1.4	1.85	0.02	Fig. 21	C-T-O <sup>12</sup>	150	3000*	15	3.6	—	—	0.5	
5764	5	1500 <sup>3</sup>	11.5	—	3300	25	6.3	0.4	1.4	1.85	0.02	Fig. 21	C-T-O <sup>14</sup>	1000 <sup>3</sup>	0	1300 <sup>3</sup>	—	—	—	200 <sup>3</sup>	
5875	5	165	30	8	3000	20	6.3	0.135	2.3	1.3	0.09	Fig. 21	G-G-O	120	-8	25	4	—	—	0.05	
6N7GT <sup>2</sup>	5.5 <sup>a</sup>	350	30 <sup>a</sup>	5.0 <sup>a</sup>	10	35	6.3	0.8	—	—	—	8B	C-T-O <sup>11</sup>	350	-100	60	10	—	—	14.5	
2C40	6.5	500	25	—	500	36	6.3	0.75	2.1	1.3	0.05	Fig. 11	C-I-O	250	-5	20	0.3	—	—	0.075	
5893	8.0	400	40	13	1000	27	6.0	0.33	2.5	1.75	0.07	Fig. 21	C-T	350	-50	35	13	2.4	—	6.5	
													C-P	300	-45	30	12	2.0	—	6.5	
GL-6442	8.0	350	35	15	2500	47	6.3	0.9	5.0	2.3	0.03	—	C-T	350	-33	35	13	2.4	—	6.5	
													C-P	275	-50	35	15	—	—	—	
2C34/ RK34 <sup>2</sup>	10	300	80	20	250	13	6.3	0.8	3.4	2.4	0.5	Fig. 70	C-T-O	300	-36	80	20	1.8	—	16	
2C43	12	500	40	—	1250	48	6.3	0.9	2.9	1.7	0.05	Fig. 11	C-T-O	470	—	38 <sup>1</sup>	—	—	—	9 <sup>1</sup>	
6263	13	400	55	25	500	27	6.3	0.28	2.9	1.7	0.08	—	C-T	350	-58	40	15	3	—	10	
													C-P	320	-52	35	12	2.4	—	8	
6264	13	400	50	25	500	40	6.3	0.28	2.95	1.75	0.07	—	C-T	350	-45	40	15	3	—	8	
													C-P	450	-140	90	20	5.2	—	26	
HY75A	15	450	90	25	175	9.6	6.3	2.6	1.8	2.6	1.0	2T	C-T	400	-140	90	20	3.2	—	21	
													C-P	600	-150	65	15	4.0	—	25	
801-A/801	20	600	70	15	60	8.0	7.5	1.25	4.5	6.0	1.5	4D	C-T	500	-190	55	15	4.5	—	18	
													B <sup>7</sup>	600	-75	130	320 <sup>a</sup>	3.0 <sup>a</sup>	10K	45	
T20	20	750	85	25	60	20	7.5	1.75	4.9	5.1	0.7	3G	C-T	750	-85	85	18	3.6	—	44	
													C-P	750	-140	70	15	3.6	—	38	
TZ20	20	750	85	30	60	62	7.5	1.75	5.3	5.0	0.6	3G	C-T	750	-40	85	28	3.75	—	44	
													C-P	750	-100	70	23	4.8	—	38	
15E <sup>18</sup>	20	—	—	—	600	25	5.5	4.2	1.4	1.15	0.3	Fig. 51	C-T-O	2000	-130	63	18	4.0	—	100	
													1500	-95	67	13	2.2	—	75		
25T 3-25A3	25	2000	75	25	60	24	6.3	3.0	2.7	1.5	0.3	3G	C-T-O	1000	-70	72	9	1.3	—	47	
													2000	-80	16	80	270 <sup>a</sup>	0.7 <sup>a</sup>	55.5K	110	
3C28 <sup>18</sup> 3C34 <sup>18</sup> 3-25D3 24G	25	2000	75	25	100	23	6.3	3.0	2.1	1.8	0.1	Fig. 31	C-T-O	2000	-170	63	17	4.5	—	100	
					60									1500	-110	67	15	3.1	—	75	
3C24	25	2000	75	75 <sup>11</sup>	150	24	6.3	3.0	2.5	1.7	0.2	2D	C-T	1000	-80	72	15	2.6	—	47	
					2000									-85	16	80	290 <sup>a</sup>	1.1 <sup>a</sup>	55.5K	110	
HK24	25	2000	75	30	60	25	6.3	3.0	2.5	1.7	0.4	3G	C-T	2000	-140	56	18	4.0	—	90	
													C-P	1500	-145	50	25	5.5	—	60	
8025	30	1000	65	—	500	18	6.3	1.92	2.7	2.8	0.35	4AQ	G-M-A	1000	-135	50	4	3.5	—	20	
													C-P	800	-105	40	10.5	1.4	—	22	
HY31Z <sup>2</sup> HY1231Z <sup>2</sup>	30	500	150	30	60	45	6.3	3.5	5.0	5.5	1.9	Fig. 60	C-T	1000	-90	50	14	1.6	—	35	
													C-P	500	-45	150	25	2.5	—	56	
318A VT-131	30	450	80	12	500	6.5	2.0	3.65	1.2	1.6	0.8	—	C-T	400	—	80	12	—	—	7.5	
													C-P	400	—	80	12	—	—	6.5	
809	30	1000	125	—	60	50	6.3	2.5	5.7	6.7	0.9	3G	C-T	1000	-75	100	25	3.8	—	75	
													C-P	750	-60	100	32	4.3	—	55	
1623	30	1000	100	25	60	20	6.3	2.5	5.7	6.7	0.9	3G	B <sup>7</sup>	1000	-9	40	200	155 <sup>a</sup>	2.7 <sup>a</sup>	11.6K	145
													C-T-O	1000	-90	100	20	3.1	—	75	
T40	40	1500	150	40	60	25	7.5	2.5	4.5	4.8	0.8	3G	C-T-O	750	-125	100	20	4.0	—	55	
													B <sup>7</sup>	1000	-40	30	200	230 <sup>a</sup>	4.2 <sup>a</sup>	12K	145
TZ40	40	1500	150	45	60	62	7.5	2.5	4.8	5.0	0.8	3G	C-T-O	1500	-140	150	28	9.0	—	158	
													C-P	1250	-115	115	20	5.25	—	104	
3-50A4 35T 3-50D4 35TG	50	2000	150	50	100	39	5.0	4.0	4.1	1.8	0.3	3G	C-T	2000	-135	125	45	13	—	200	
													B <sup>7</sup>	2000	-40	4	167	255 <sup>a</sup>	4.0 <sup>a</sup>	27.5K	235
HK54	50	3000	150	30	100	27	5.0	5.0	1.9	1.9	0.2	2D	C-T	3000	-290	100	25	10	—	250	
													C-P	2500	-250	100	20	8.0	—	210	
													B <sup>7</sup>	2500	-85	20	150	360 <sup>a</sup>	5.0	40K	275

<sup>1</sup> See page V29 for Key to Class-of-Service abbreviations.

TABLE X — TRIODE TRANSMITTING TUBES — Continued

Type	Maximum Ratings					Cathode		Capacitances			Base	Typical Operation								
	Plate Dissipation Watts	Plate Voltage	Plate Current Ma.	D.C. Grid Current Ma.	Freq. Mc. Full Ratings	Amplification Factor	Volts	Amperes	C <sub>in</sub> pf.	C <sub>out</sub> pf.		C <sub>out</sub> pf.	Class of Service <sup>1</sup>	Plate Voltage	Grid Voltage	Plate Current Ma.	D.C. Grid Current Ma.	Approx. Driving Power Watts	P-to-P Load Ohms	Approx. Output Power Watts
T55	55	1500	150	40	60	20	7.5	3.0	5.0	3.9	1.2	3G	C-T	1500	-170	150	18	6.0	—	170
826	55	1000	140	40	250	31	7.5	4.0	3.0	2.9	1.1	7B0	C-P	1500	-195	125	15	5.0	—	145
													C-T-O	1000	-70	130	35	5.8	—	90
830B 930B	60	1000	150	30	15	25	10	2.0	5.0	11	1.8	3G	G-M-A	1000	-125	65	9.5	8.2	—	25
													C-T-O	1000	-110	140	30	7.0	—	90
811-A <sup>10</sup>	65	1500	175	50	60	160	6.3	4.0	5.9	5.6	0.7	3G	C-P	800	-150	95	20	5.0	—	50
													B <sup>7</sup>	1000	-35	20 280	270 <sup>9</sup>	6.0 <sup>9</sup>	7.6K	175
812-A	65	1500	175	35	60	29	6.3	4.0	5.4	5.5	0.77	3G	C-T	1500	-70	173	40	7.1	—	200
													C-P	1250	-115	140	35	7.6	—	130
5514	65	1500	175	60	145	7.5	3.0	7.8	7.9	1.0	4B0	B <sup>7</sup>	1500	-48	28 310	270 <sup>9</sup>	5.0	13.2K	340	
												C-T	1500	-106	175	60	12	—	200	
3-75A3 75TH	75	3000	225	40	40	20	5.0	6.25	2.7	2.3	0.3	2D	C-P	1250	-84	142	60	10	—	135
													B <sup>7</sup>	1500	-4.5	350 <sup>9</sup>	88 <sup>9</sup>	6.5 <sup>9</sup>	10.5K	400
3-75A2 75TL	75	3000	225	35	40	12	5.0	6.25	2.6	2.4	0.4	2D	C-T	2000	-200	150	32	10	—	225
													C-P	2000	-300	110	15	6	—	170
8005	85	1500	200	45	60	20	3.25	6.4	5.0	1.0	3G	B <sup>7</sup>	2000	-90	50 225	350 <sup>9</sup>	3 <sup>9</sup>	19.3K	300	
												C-T	2000	-300	150	21	8	—	225	
V-70-D	85	1750	200	45	30	—	7.5	3.25	4.5	4.5	1.7	3G	C-P	2000	-500	130	20	14	—	210
													B <sup>7</sup>	2000	-190	50 250	600 <sup>9</sup>	5 <sup>9</sup>	18K	350
3-100A4 100TH	100	3000	225	60	40	40	5.0	6.3	2.9	2.0	0.4	2D	C-T	1500	-130	200	32	7.5	—	220
													C-P	1250	-195	190	28	9.0	—	170
3-100A2 100TL	100	3000	225	50	40	14	5.0	6.3	2.3	2.0	0.4	2D	B <sup>7</sup>	1500	-70	40 310	310 <sup>9</sup>	4.0	10K	300
													C-T	1750	-100	170	19	3.9	—	225
VT127A	100	3000	—	—	150	15.5	5.0	10.4	2.7	2.3	0.35	Fig. 53	C-T	1500	-90	165	19	3.9	—	195
													C-P	1500	-90	165	19	3.7	—	185
211 311	100	1250	175	50	15	12	10	3.25	6.0	14.5	5.5	4E	C-T	1250	-72	127	16	2.6	—	122
													C-P	1250	-72	127	16	2.6	—	122
254	100	4000	225	60	—	25	5.0	7.5	2.5	2.7	0.4	2N	C-T	3000	-200	165	51	18	—	400
													C-P	3000	-65	40 215	335 <sup>9</sup>	5.0 <sup>9</sup>	31K	650
3C X100A5 <sup>15</sup>	100	1000	125 <sup>14</sup>	50	2500	100	6.0	1.05	7.0	2.15	0.035	—	G-M-A	3000	-400	165	30	20	—	400
													B <sup>7</sup>	3000	-185	40 215	640 <sup>9</sup>	6.0 <sup>9</sup>	30K	450
3X100A11 2C39	100	1000	60	40	500	100	6.3	1.1	6.5	1.9	0.035	—	C-T	2000	-340	210	67	25	—	315
													C-P	1500	-125	242	44	7.3	3K	200
GL2C39A <sup>15</sup> GL2C39B <sup>15</sup>	100	1000	125 <sup>14</sup>	50	500	100	6.3	1.0	6.5	1.9	0.035	—	C-T	1250	-225	150	18	7.0	—	130
													C-P	1000	-260	150	35	14	—	100
GL146	125	1500	200	60	15	75	10	3.25	7.2	9.2	3.9	Fig. 56	B <sup>7</sup>	1250	-100	20 320	410 <sup>9</sup>	8.0 <sup>9</sup>	9K	250
													C-T	3000	-245	165	40	18	—	400
GL152	125	1500	200	60	15	25	10	3.25	7.0	8.8	4.0	Fig. 56	C-P	2500	-360	168	40	23	—	335
													B <sup>7</sup>	2500	-80	40 240	460 <sup>9</sup>	25	25.2K	420
805	125	1500	210	70	30	40/60	10	3.25	8.5	6.5	10.5	3N	G-G-A	800	-20	80	30	6	—	27
													C-P	600	-15	75	40	6	—	18
AX9900/ 5866 <sup>13</sup>	135	2500	200	40	150	25	6.3	5.4	5.8	5.5	0.1	Fig. 3	C-T	2500	-200	200	40	16	—	390
													C-P	2000	-225	127	40	16	—	204
3-150A3 152TH	150	3000	450	85	40	20	5.0	12.5	5.7	4.8	0.4	4B0	B <sup>7</sup>	2500	-90	80 330	350 <sup>9</sup>	14 <sup>9</sup>	15.68K	560
													C-T	3000	-300	250	70	27	—	600
3-150A2 152TL	150	3000	450	75	40	12	5	12.5	4.5	4.4	0.7	4B0	C-P	2500	-125	40 340	390 <sup>9</sup>	16 <sup>9</sup>	17K	600
													B <sup>7</sup>	3000	-400	250	40	20	—	600
HF201A	150	2500	200	50	30	18	10-11	4.0	8.8	7.0	1.2	Fig. 15	C-T	3000	-260	65 335	675 <sup>9</sup>	3 <sup>9</sup>	20.4K	700
													C-P	2500	-300	200	18	8	—	380
572	150	2500	200	—	—	170	6.3	4.0	—	—	—	3G	B <sup>7</sup>	2500	-130	60 360	460 <sup>9</sup>	8 <sup>9</sup>	16K	600
													C-T	1650	-70	165	32	6	—	205
810	175	2500	300	75	30	36	10	4.5	8.7	4.8	12	2N	C-P	2000	-80	360	5	16.5K	530	
													C-T	2500	-180	300	60	19	—	575
													G-M-A	2250	-140	100	2.0	4	—	75
													B <sup>7</sup>	2250	-60	70 450	380 <sup>9</sup>	13 <sup>9</sup>	11.6K	725

<sup>1</sup> See page V29 for Key to Class-of-Service abbreviations.

TABLE X—TRIODE TRANSMITTING TUBES—Continued

Type	Maximum Ratings					Cathode		Capacitances			Base	Typical Operation								
	Plate Dissipation Watts	Plate Voltage	Plate Current Ma.	D.C. Grid Current Ma.	Freq. Mc. Full Ratings	Amplification Factor	Volts	Ampere	C <sub>in</sub> pf.	C <sub>gp</sub> pf.		C <sub>out</sub> pf.	Class of Service <sup>1</sup>	Plate Voltage	Grid Voltage	Plate Current Ma.	D.C. Grid Current Ma.	Approx. Driving Power Watts	P-to-P Load Ohms	Approx. Output Power Watts
800D	175	2500	300	45	30	16.5	10	4.5	5.0	6.4	3.3	2N	C-T-O	2500	-240	300	40	18	—	575
													C-P	2000	-370	250	37	20	—	380
													G-M-A	2250	-265	100	0	2.5	—	75
													B <sup>7</sup>	2250	-130	65 450	560 <sup>8</sup>	7.9 <sup>8</sup>	12K	725
T20D	200	2500	350	80	30	16	10	5.75	9.5	7.9	1.6	2N	C-T	2500	-280	350	54	25	—	685
													C-P	2000	-260	300	54	23	—	460
													C-T	3500	-270	228	30	15	—	600
592/1 <sup>15</sup> 3-200A3	200	3500	250	25 <sup>13</sup>	150	25	10	5.0	3.6	3.3	0.29	Fig. 28	C-P	2500	-300	200	35	19	—	375
													B <sup>7</sup>	2000	-50	120 500	520 <sup>8</sup>	20 <sup>8</sup>	8.5K	600
													C-T	3000	-400	250	28	16	—	600
4C34 HF300	200	3000	275	60	60	23	11-12	4.0	6.0	6.5	1.4	2N	C-P	2000	-300	250	36	17	—	385
													B <sup>7</sup>	3000	-115	60 360	450 <sup>8</sup>	13 <sup>8</sup>	20K	780
													C-T	3000	-400	250	28	20	—	600
													C-P	2000	-300	250	36	17	—	385
T-300	200	3000	300	—	—	23	11	6.0	7.0	7.0	1.4	—	B <sup>7</sup>	2500	-100	60 450	—	7.5 <sup>8</sup>	—	750
													C-T	3300	-600	300	40	34	—	780
													C-P	3000	-670	195	27	24	—	460
806	225	3300	300	50	30	12.6	5.0	10	6.1	4.2	1.1	2N	B <sup>7</sup>	3300	-240	80 475	930 <sup>8</sup>	35 <sup>8</sup>	16K	1120
													C-T-O	2000	-100	357	94	29	—	464
													C-P	3000	-350	335	45	29	—	750
3-250A4 250TH	250	4000	350	40 <sup>13</sup>	40	37	5.0	10.5	4.6	2.9	0.5	2N	C-P	2000	-150	333	90	32	—	335
													C-P	2500	-180	225	45	17	—	400
													C-P	3000	-200	200	38	14	—	435
													AB <sub>2</sub> <sup>7</sup>	1500	-40	220 700	460 <sup>8</sup>	46 <sup>8</sup>	4.2K	630
3-250A2 250TL	250	4000	350	35 <sup>13</sup>	40	14	5.0	10.5	3.7	3.0	0.7	2N	C-T-O	2000	-200	350	45	22	—	455
													C-T-O	3000	-350	335	45	29	—	750
													C-P	2000	-520	250	29	24	—	335
													C-P	2500	-520	225	20	16	—	400
5867 AX-9901	250	3000	400	80	100	25	5.0	14.1	7.7	5.9	0.18	Fig. 3	C-P	2500	-300	250	70	28	—	482
													B <sup>7</sup>	3000	-110	570 <sup>8</sup>	465 <sup>8</sup>	32	14.2K	1280
													C-T	3000	-250	363	69	27	—	840
													C-P	2500	-300	250	70	28	—	482
PL-6569 <sup>18</sup>	250	4000	300	120	30	45	5.0	14.5	7.6	3.7	0.1	Fig. 3	G-G-A	2500	-70	300	85	75 <sup>20</sup>	—	555
													G-G-A	3000	-95	300	110	85 <sup>20</sup>	—	710
													G-G-A	3500	-110	285	90	85 <sup>20</sup>	—	805
													G-G-A	4000	-120	250	50	70 <sup>20</sup>	—	820
3-300A3 304TH	300	3000	900	60 <sup>13</sup>	40	20	5.0	25	13.5	10.2	0.7	4BC	C-T-O	1500	-125	665	115	25	—	700
													C-T-O	2000	-200	600	125	39	—	900
													C-P	1500	-200	420	55	18	—	500
													C-P	2000	-300	440	60	26	—	680
3-300A2 304TL <sup>19</sup>	300	3000	900	50 <sup>13</sup>	40	12	5.0	25	12.1	8.6	0.8	4BC	C-P	2500	-350	400	60	29	—	800
													C-P	2500	-525	200	18	11	—	425
													C-P	2500	-550	400	50	36	—	830
													AB <sub>2</sub> <sup>7</sup>	1500	-118	270 572	236 <sup>8</sup>	0	2.54K	256
833A	350	3300	500	100	30	35	10	10	12.3	6.3	8.5	Fig. 41	C-T-O	1500	-118	1140 <sup>8</sup>	490 <sup>8</sup>	39 <sup>8</sup>	2.75K	1100
													C-T-O	2250	-125	445	85	23	—	780
													C-T-O	3000	-160	335	70	20	—	800
													C-P	2500	-300	335	75	30	—	635
3-400Z	400	3000	400	—	110	200	5	14.5	7.4	4.1	0.07	Fig. 3	G-G-B	3000	0	100 333	120	32	—	655
													G-G-B	4000	-110	350	92	105 <sup>20</sup>	—	1080
													G-G-B	2500	-70	350	95	85	—	660
PL-6580 <sup>18</sup>	400	4000 <sup>18</sup>	350	120	—	45	5.0	14.5	7.6	3.9	0.1	5BK	G-G-A	2500	-70	350	95	85	—	660
													G-G-B	3000	0	180 670	300	65	—	1360
													G-G-B	3000	0	100 750	400 <sup>8</sup>	20 <sup>8</sup>	9.5K	1650

\* Cathode resistor in ohms.  
<sup>1</sup> KEY TO CLASS-OF-SERVICE ABBREVIATIONS  
A<sub>1</sub> = Class-A<sub>1</sub> a.f. modulator.  
AB<sub>1</sub> = Class-AB<sub>1</sub> push-pull a.f. modulator.  
AB<sub>2</sub> = Class-AB<sub>2</sub> push-pull a.f. modulator.  
B = Class-B push-pull a.f. modulator.  
C-M = Frequency multiplier.  
C-P = Class-C plate-modulated telephone.  
C-T = Class-C telegraph.  
C-T-O = Class-C amplifier-osc.  
G-G-A = Grounded-grid class-C amp.  
G-G-B = Grounded-grid class-B amp. (Single Tone).  
G-G-O = Grounded-grid osc.

G-I-C = Grid-isolation circuit.  
G-M-A = Grid-modulated amp.  
<sup>2</sup> Twin triode. Values, except interelectrode capacitances, are for both sections in push-pull.  
<sup>3</sup> Output at 112 Mc.  
<sup>4</sup> Grid leak resistor in ohms.  
<sup>5</sup> Peak values.  
<sup>6</sup> Per section.  
<sup>7</sup> Values are for two tubes in push-pull.  
<sup>8</sup> Max. signal value.  
<sup>9</sup> Peak a.f. grid-to-grid volts.  
<sup>10</sup> Plate-pulsed 1000-Mc. osc.

<sup>11</sup> Class-B data in Table II.  
<sup>12</sup> 1000-Mc. c.w. osc.  
<sup>13</sup> Max. grid dissipation in watts.  
<sup>14</sup> Max. cathode current in ma.  
<sup>15</sup> Forced-air cooling required.  
<sup>16</sup> Plate-pulsed 3300-Mc. osc.  
<sup>17</sup> 1900-Mc. c.w. osc.  
<sup>18</sup> No Class-B data available.  
<sup>19</sup> Linear-amplifier tube-operation data for single sideband in Table II-1.  
<sup>20</sup> Includes bias loss, grid dissipation, and feed-through power.



TABLE XI—TETRODE AND PENTODE TRANSMITTING TUBES

Type	Maximum Ratings					Cathode		Capacitances			Base	Typical Operation												
	Plate Dissipation Watts	Plate Voltage	Screen Dissipation Watts	Screen Voltage	Freq. Mc. Full Ratings	Volts	Amps	C <sub>in</sub> pf.	C <sub>pp</sub> pf.	C <sub>out</sub> pf.		Class of Service <sup>14</sup>	Plate Voltage	Screen Voltage	Suppressor Voltage	Grid Voltage	Plate Current Ma.	Screen Current Ma.	Grid Current Ma.	Approx. Driving Power Watts	P-to-P Load Ohms	Approx. Output Power Watts		
8203	1.8	400	—	—	250	6.3	0.16	4.2	2.2	1.6	12AQ	C-P C-T	155	—	—	14/2700 <sup>1</sup>	21	—	5	0.4	—	—	1.55	
6939 <sup>1</sup>	7.5	275	3	200	500	6.3	0.75	6.6	0.15	1.55	Fig. 13	C-T	200	200	—	—	60	13	2	1.0	—	7.5		
						C-P	180					180	—	—	20	55	11.5	1.7	1.0	6				
2E30	10	250	2.5	250	160	6	0.65	10	0.5	4.5	7CQ	C-M	200	190	—	68K <sup>1</sup>	46	10	2.2	0.9	—	—		
												C-T	250	200	—	—	50	50	10	2.5	0.2	—		
7905	10	300	1.5	300	175	6.3	0.65	8.5	5.5	0.14	9PB	C-P	250	250	—	—	60	2.5	2.1	1.0	—	6.5		
												C-M	300	215	—	—	80	50	3.4	1.5	0.5	—		
837	12	500	8	300	20	12.6	0.7	16	0.2	10	6BM	C-T	500	200	40	—	70	80	15	4	0.4	—	28	
												C-P	400	140	40	—	40	45	20	5	0.3	—		
7551 7558	12	300	2	250	175	12.6	0.38	10	0.15	5.5	9LK	C-T	300	250	—	—	80	5.1	1.6	1.5	—	10		
						C-P	250					250	—	—	75	70	3.0	2.3	1.0	—				
5783 6417	13.5	350	2	250	50	6.3	0.75	9.5	0.3	4.5	9K	C-T	350	250	—	—	28.5	48.5	6.2	1.6	0.1	—	12	
						C-P	300					250	—	—	42.5	50	6	2.4	0.15	—				
2E24	13.5	600	2.5	200	125	6.3 <sup>1</sup>	0.65	8.5	0.11	6.5	7CL	C-M <sup>1</sup>	300	235	—	—	100	35	5	1	0.6	—	10	
						C-P	500					180	—	—	45	54	8	2.5	0.16	—				
2E28 <sup>1</sup> 6893	13.5	600	2.5	200	125	6.3	0.8	12.5	0.2	7	7CK	C-T	600	185	—	—	45	66	10	3	0.21	—	27	
						C-P	500					180	—	—	50	54	9	2.5	0.15	—				
6360 <sup>1</sup>	14	300	2	200	200	6.3	0.82	6.2	0.1	2.6	Fig. 13	AB <sub>2</sub> <sup>6</sup>	500	125	—	—	15	22/150	32 <sup>1</sup>	—	0.36 <sup>1</sup>	8K	54	
						C-T	300					200	—	—	45	100	3	3	0.2	—				
2E25	15	450	4	250	125	6	0.8	8.5	0.15	6.7	5BJ	C-P	200	100	—	—	15K <sup>1</sup>	86	3.1	3.3	0.2	—	9.8	
												C-M <sup>11</sup>	300	150	—	—	100	65	3.5	3.8	0.45	—		
832A <sup>1</sup>	15	750	5	250	200	6.3	1.6	8	0.07	3.8	7BP	AB <sub>2</sub> <sup>6</sup>	300	200	—	—	21.5	30/100	1/11.4	64 <sup>1</sup>	0.04	6.5K	17.5	
						C-T-O	450					250	—	—	45	75	15	3	0.4	—				
6252/ AX910 <sup>1</sup>	20	750	4	300	300	6.3	1.3	6.5	—	2.5	Fig. 7	C-P	400	200	—	—	45	60	12	3	0.4	—	16	
						AB <sub>2</sub> <sup>6</sup>	450					250	—	—	30	44/150	10/40	3	0.9 <sup>1</sup>	6K	40			
1614	25	450	3.5	300	80	6.3	0.9	10	0.4	12.5	7AC	C-T	750	200	—	—	65	48	15	2.8	0.19	—	26	
												C-P	600	200	—	—	65	36	16	2.6	0.16	—		
815 <sup>1</sup>	25	500	4	200	125	6.3	1.6	13.3	0.2	8.5	8BY	C-T	600	250	—	—	60	140	14	4	2.0	—	—	
						C-P	500					250	—	—	80	100	12	3	4.0	—				
1624	25	600	3.5	300	60	2.5	2	11	0.25	7.5	Fig. 66	B	500	250	—	—	26	25/73	0.7/16	52 <sup>1</sup>	—	20K	23.5	
												C-T	450	250	—	—	45	100	8	2	0.15	—		
4604 6146 <sup>1</sup> 6146A 8032	25	750	3	250	60	6.3	0.65	11	0.24	8.5	7CL	C-P	375	250	—	—	50	93	7	2	0.15	—	31	
						AB <sub>2</sub> <sup>6</sup>	530					340	—	—	36	60/160	20 <sup>1</sup>	—	—	7.2K	50			
8883	25	750	3	250	60	6.3	1.25	13	0.24	8.5	7CK	C-T-O	500	200	—	—	45	150	17	2.5	0.13	—	56	
						C-P	400					175	—	—	45	150	15	3	0.16	—				
6159	25	600	—	300	100	12.6	0.625	7	0.11	3.4	Fig. 76	AB <sub>2</sub> <sup>6</sup>	500	125	—	—	15	22/150	32 <sup>1</sup>	—	0.36 <sup>1</sup>	8K	54	
						C-T	600					300	—	—	60	90	10	5	0.43	—				
6524 <sup>1</sup> 6850	25	600	—	300	100	6.3	1.25	7	0.11	3.4	Fig. 76	C-P	500	200	—	—	61	100	7	2.5	0.2	—	40	
						AB <sub>2</sub> <sup>6</sup>	600					300	—	—	25	42/180	5/15	106 <sup>1</sup>	1.2 <sup>1</sup>	7.5K	72			
807 <sup>1</sup> 807W 5933	30	750	3.5	300	60	12.6	0.45	13	0.2	7	5AW	C-T	600	200	—	—	44	120	8	3.7	0.2	—	56	
												C-P	500	200	—	—	61	100	7	2.5	0.2	—		
1625 <sup>1</sup> 2E22	30	750	10	250	—	6.3	1.5	13	0.2	8	5J	AB <sub>2</sub> <sup>6</sup>	750	195	—	—	50	23/220	1/26	100 <sup>1</sup>	0	8K	120	
						C-T	750					250	—	—	45	100	6	3.5	0.22	—				
6146B/ 8298A	35	750	3	250	60	6.3	1.125	13	0.22	8.5	7CK	C-P	600	275	—	—	90	100	6.5	4	0.4	—	42.5	
						AB <sub>2</sub> <sup>6</sup>	750					300	—	—	32	60/240	5/10	92 <sup>1</sup>	0.2 <sup>1</sup>	6.95K	120			
AX- 9903 <sup>1</sup> 5894A	40	600	7	250	250	6.3	1.8	6.7	0.08	2.1	Fig. 7	B <sup>10</sup>	750	—	—	—	0	15/240	—	555 <sup>1</sup>	5.3 <sup>1</sup>	6.65K	120	
						C-T-O	750					250	22.5	—	60	100	16	6	0.55	—				
8298 <sup>1</sup> 3E29 <sup>1</sup>	40	750	7	240	200	6.3	2.25	14.5	0.12	7	7BP	C-T	750	200	—	—	77	160	10	2.7	0.3	—	85	
						C-P	600					175	—	—	92	140	9.5	3.4	0.5	—				
3D24	45	2000	10	400	125	6.3	3	6.5	0.2	2.4	Fig. 75	AB <sub>1</sub>	750	200	—	—	48	25/125	6.3	—	—	3.6K	61	
												C-T	600	250	—	—	80	200	26	2	0.2	—		
4D22	50	750	14	350	60	12.6	1.6	28	0.27	13	Fig. 26	C-T	2000	375	—	—	300	90	20	10	4.0	—	140	
						1500	375					—	—	300	90	22	10	4.0	—					
4D32	50	750	14	350	60	6.3	3.75	28	0.27	13	Fig. 27	C-P	750	300	—	—	100	240	26	12	1.5	—	105	
						600	—					—	—	100	215	30	10	1.25	—					
												AB <sub>2</sub> <sup>6</sup>	550	—	—	—	100	220	18	10	1.25	—	100	
													550	—	—	—	100	175	17	6	0.6	—	70	
													AB <sub>2</sub> <sup>6</sup>	600	250	—	—	25	100/365	26 <sup>1</sup>	70 <sup>1</sup>	0.45 <sup>1</sup>	3K	125

<sup>14</sup> See page V32 for Key to Class-of-Service abbreviations.



TABLE XI — TETRODE AND PENTODE TRANSMITTING TUBES — Continued

Type	Maximum Ratings					Cathode			Capacitances			Base	Typical Operation											
	Plate Dissipation Watts	Plate Voltage	Screen Dissipation Watts	Screen Voltage	Freq. Mc. Full Ratings	Volts	Amperes	C <sub>in</sub> pf.	C <sub>cp</sub> pf.	C <sub>out</sub> pf.	Class of Service <sup>1</sup>		Plate Voltage	Screen Voltage	Suppressor Voltage	Grid Voltage	Plate Current Ma.	Screen Current Ma.	Grid Current Ma.	Approx. Driving Power Watts	P-to-P Load Ohms	Approx. Output Power Watts		
8117 <sup>3</sup>	60	750	7	300	175	6.3 12.6	1.8 0.9	11.8	3.7	0.09	Fig. 7	AB <sub>1</sub>	600	250	—	-32.5	60	212	1.9	25	—	—	1410	76
814	65	1500	10	300	30	10	3.25	13.5	0.1	13.5	Fig. 64	C-T C-P	1500 1250	300 300	— —	-90 -150	150 145	24 10	1.5 3.2	— —	— —	160 130		
4-65A <sup>13</sup>	65	3000	10	600	150	6	3.5	8	0.08	2.1	Fig. 25	C-T-O C-P	1500 3000 1500 2500	250 250 250 250	— — — —	-85 -100 -125 -135	150 115 120 110	22 10 16 25	1.7 1.7 3.5 2.6	— — — —	— — — —	165 140 230 270		
785 <sup>4</sup>	68	1000	8	300	175	6.3 12.6	1.8 0.9	6.7	2.1	0.09	Fig. 7	C-T C-P	750 600	260 225	— —	-75 -75	240 200	12.7 7.8	5.5 3.5	3.5 —	— —	— —	123 85	
4E27/ 8001	75	4000	30	750	75	5	7.5	12	0.06	6.5	7BM	C-T C-P	2000 1800	500 400	60 60	-130 -130	135 135	11 8	1.7 1.7	— —	— —	— —	230 178	
HK257 HK257B	75	4000	25	750	75 <sup>14</sup>	5	7.5	13.8	0.04	6.7	7BM	C-T C-P	2000 1800	500 400	60 60	-200 -130	150 135	11 8	1.4 1.7	— —	— —	— —	230 178	
PL-177A <sup>13</sup>	75	2000	10	600	175	6	3.2	7.5	0.06	4.2	Fig. 14	C-T-C-P	2000 1000	400 400	0 0	-125 -105	150 150	12 16	5 5	0.8 0.7	— —	— —	220 100	
PL-6549	75	2000	10	600	175	6	3.2	7.5	0.09	3.4	Fig. 14	C-T C-P AB <sub>2</sub> <sup>8</sup>	2000 2000 2000	400 400 400	70 70 70	-125 -140 -85	150 125 30 225	12 15 0.1 10	5 4 180 <sup>8</sup>	0.8 0.7 0.05 <sup>7</sup>	— — —	— — 19K	270 200 325	
828	80	2000	23	750	30	10	3.25	13.5	0.05	14.5	5J	C-T C-P AB <sub>2</sub> <sup>6</sup>	1500 1250 2000	400 400 750	75 75 60	-100 -140 -120	180 160 50 270	28 28 2.6 240	12 12 0	2.2 2.7 0	— — 18.5K	— — 385		
7270 7271	80	1350	—	425	175	6.3 13.5	3.1 1.25	8	0.4	0.14	Fig. 84	C-T	850	400	—	-100	275	15	8	10	—	—	135	
8072	100	2200	8	400	500	13.5	1.3	16	0.13	0.011	Fig. 85	AB <sub>1</sub>	665	400	—	-119	220	15	6	10	—	—	85	
6816 <sup>9</sup> 6884	115	1000	4.5	300	400	6.3 26.5	2.1 0.52	14	0.085	0.015	Fig. 77	C-T-O C-P AB <sub>2</sub> <sup>6</sup> AB <sub>2</sub> <sup>8</sup>	900 700 850 850	300 250 300 300	— — -15 -15	30 170 80 200 80 335	1 10 0.25 46 <sup>8</sup>	10 3 0.3	3 — 0.3	— — 7K 3.96K	— — 80 140			
813 <sup>13</sup>	125	2500	20	800	30	10	5	16.3	0.25	14	5BA	C-T-O C-P AB <sub>2</sub> <sup>6</sup>	1250 1250 2000 2000	300 300 350 750	0 0 -175 -90	180 220 200 40 315	35 40 16 1.5 58	12 15 4.3	1.7 — 0.1 <sup>7</sup>	— — 16K	— — 455			
4-125A <sup>13</sup> 4D21 6155	125	3000	20	600	120	5	6.5	10.8	0.07	3.1	5BK	C-T-O C-P AB <sub>2</sub> <sup>6</sup> AB <sub>1</sub> <sup>6</sup> GG	2000 2500 2500 2500 2000	350 350 350 600 0	— — -43 -96	150 152 93 260 50 232	33 30 0.6 0.3 8.5	10 9 178 <sup>8</sup> 192 <sup>8</sup>	3.8 3.3 1.0 <sup>7</sup> 0	— — 22K 20.3K	— — 400 330			
4E27A/ 5-125B	125	4000	20	750	75	5	7.5	10.5	0.08	4.7	7BM	C-T	3000 1000	500 750	60 0	-200 -170	167 160	5 21	6 3	1.6 0.6	— —	— —	375 115	
803	125	2000	30	600	20	10	5	17.5	0.15	29	5J	C-T C-P	2000 1600	500 400	40 100	-90 -80	160 150	45 45	12 25	2 5	— —	— —	165 155	
7094	125	2000	20	400	60	6.3	3.2	9.0	0.5	1.8	Fig. 82	C-T C-P AB <sub>1</sub>	1500 1200 2000	400 400 400	— — -65	100 330 60 400	20 20 —	5 5	4 —	— —	— —	340 240 560		
4X150A 4X150G <sup>15</sup>	150 <sup>9</sup>	1250	12	400	500	6	2.6	15.5	0.03	4.5	Fig. 75	C-T-O C-P AB <sub>2</sub> <sup>6</sup>	1250 1000 1250	250 250 300	— — -44	200 200 475 <sup>7</sup>	20 0.65	10 100 <sup>8</sup>	3 5	0.8 —	— —	— —	195 140	
8121	150	2200	8	400	500	13.5	1.3	16	0.13	0.011	Fig. 85	C-T-O C-P AB <sub>2</sub> <sup>6</sup> AB <sub>2</sub> <sup>8</sup>	1000 2500 3000 2000	200 500 500 400	— — -150 -180	300 345 200	10 60 60	30 9	5 1.7	— —	— —	425 575 800		
4-250A <sup>13</sup> 5D22 6156	250 <sup>9</sup>	4000	35	600	110	5	14.5	12.7	0.12	4.5	5BK	C-T-O C-P AB <sub>2</sub> <sup>6</sup> AB <sub>2</sub> <sup>8</sup>	3000 2500 2000 2000	500 400 400 300	— — -200 -310	345 200 225	30 30	9 9	2.2 3.2	— —	— —	375 510		
4X250B	250 <sup>9</sup>	2000	12	400	175	6	2.1	18.5	0.04	4.7	Fig. 75	C-T-O C-P AB <sub>2</sub> <sup>6</sup>	2000 1500 2000	250 250 350	— — -50	250 200 500 <sup>7</sup>	25 30 <sup>7</sup>	27 100 <sup>8</sup>	2.8 2.1	— —	— —	625 250 650		
7034 <sup>9</sup> 4X150A 7035 <sup>13</sup> 4X150D	250	2000	12	300	150	6	2.6	16	0.03	4.4	Fig. 75	C-T-O C-P AB <sub>2</sub> <sup>6</sup> AB <sub>2</sub> <sup>8</sup>	2000 1600 2000 2000	250 250 300 300	— — -50 -50	250 200 100 500 100 470	24 0.36	5 106 <sup>8</sup>	3 0.2	— —	— —	230 630 580		
4C-X- 300A	300 <sup>9</sup>	2000	12	400	500	6	2.75	29.5	0.04	4.8	—	C-T AB <sub>1</sub> <sup>4</sup>	2000 1500	250 250	— —	-90 -100	200 200	25 25	2.8 2.1	— —	— —	410 250		
PL-175A <sup>13</sup>	400	4000	25	600	—	5	14.5	15.1	0.06	9.8	Fig. 86	C-T-C-P	4000 2500	600 600	0 0	-200 -180	350 350	29 40	6 7	3.4 1.6	— —	— —	960 600	
4-400A	400 <sup>9</sup>	4000	35	600	110	5	14.5	12.5	0.12	4.7	5BK	C-T-C-P GG	4000 2500	300 0	— —	-170 0	270 80 270 <sup>17</sup>	22.5 55 <sup>17</sup>	10 100 <sup>17</sup>	10 38 <sup>17</sup>	— —	— —	720 325	
8122	400	2200	8	400	500	13.5	1.3	16	0.13	0.011	Fig. 86	C-T-O	2000	200	—	-30	300	5	30	5	—	—	300	

<sup>14</sup> See page V32 for Key to Class-of-Service abbreviations.

TABLE XI—TETRODE AND PENTODE TRANSMITTING TUBES—Continued

Type	Maximum Ratings					Cathode		Capacitances			Base	Typical Operation											
	Plate Dissipation Watts	Plate Voltage	Screen Dissipation Watts	Screen Voltage	Freq. Mc. Full Ratings	Volts	Amperes	C <sub>in</sub> pf.	C <sub>sp</sub> pf.	C <sub>out</sub> pf.		Class of Service <sup>1,4</sup>	Plate Voltage	Screen Voltage	Suppressor Voltage	Grid Voltage	Plate Current Ma.	Screen Current Ma.	Grid Current Ma.	Approx. Driving Power Watts	P-to-P Load Ohms	Approx. Output Power Watts	
8166/ 4-1000A	1000	6000	75	1000	—	7.5	21	27.2	.24	7.6	—	C-T	3000	500	—	-150	700	146	38	11	—	1430	
												C-P	3000	500	—	-200	600	145	36	12	—	1390	
												AB <sub>2</sub>	4000	500	—	-60	300 1200	0.95	—	11	7K	3000	
												GG	3000	0	—	0	100 700 <sup>17</sup>	105 <sup>17</sup>	170 <sup>17</sup>	130 <sup>17</sup>	2.5K	1475	
4C X1000A	1000	3000	12	400	400	6	12.5	35	.005	12	—	AB <sub>1</sub>	2000	325	—	-55	500 2000	-4.60	—	—	2.8K	2160	
													2500	325	—	-55	500 2000	-4.60	—	—	3.1K	2920	
													3000	325	—	-55	500 1800	-4.60	—	—	3.85K	3360	
													2000	500	35	-175	850	42	10	1.9	—	1155	
PL-8295/ 172	1000	3000	30	600	—	6	8.2	38	.09	18	—	C-T	2500	500	35	-200	840	40	10	2.1	—	1440	
													3000	500	35	-200	820	42	10	2.1	—	1770	
													AB <sub>1</sub> <sup>13</sup>	2000	500	35	-110	200 800	12.43	110 <sup>8</sup>	—	2.65K	1040
														2500	500	35	-110	200 800	11.40	115 <sup>8</sup>	—	3.5K	1260
												3000	500	35	-115	220 800	11.39	115 <sup>8</sup>	—	4.6K	1590		

<sup>1</sup> Grid-resistor.  
<sup>2</sup> Doubler to 175 Mc.  
<sup>3</sup> Dual tube. Values for both sections, in push-pull. Interelectrode capacitances, however, are for each section.  
<sup>4</sup> Tripler to 175 Mc.  
<sup>5</sup> Filament limited to intermittent operation.  
<sup>6</sup> Values are for two tubes  
<sup>7</sup> Max. signal value.  
<sup>8</sup> Peak grid-to-grid volts.  
<sup>9</sup> Forced-air cooling required.  
<sup>10</sup> Two tubes triode connected, G<sub>2</sub> to G<sub>1</sub> through 20K Ω. Input to G<sub>2</sub>.  
<sup>11</sup> Tripler to 200 Mc.  
<sup>12</sup> Typical Operation at 175 Mc.  
<sup>13</sup> Linear-amplifier tube-operation data for single-sideband in Chap. 11.

<sup>14</sup> KEY TO CLASS-OF-SERVICE ABBREVIATIONS  
 AB<sub>1</sub> = Class-AB<sub>1</sub>  
 AB<sub>2</sub> = Class-AB<sub>2</sub>  
 B = Class-B push-pull a.f. modulator.  
 C-M = Frequency multiplier.  
 C-P = Class-C plate-modulated telephone.  
 C-T = Class-C telegraph.  
 C-T-O = Class-C amplifier-osc.  
 GG = Grounded-grid (grid and screen connected together).  
<sup>15</sup> No Class B data available.  
<sup>16</sup> HK257B 120 Mc. full rating.  
<sup>17</sup> Single tone.  
<sup>18</sup> ± 1.5 volts.

TABLE XII—ELECTROSTATIC CATHODE-RAY TUBES

Type <sup>6</sup>	Heater		Base	Anode No. 2 Voltage	Anode No. 1 Voltage <sup>1</sup>	Anode No. 3 Voltage	Cut-off Grid Voltage <sup>2</sup>	Deflection Avg. Volts DC/Inch	
	Volts	Amp.						D <sub>1</sub> D <sub>2</sub>	D <sub>3</sub> D <sub>4</sub>
1EP1-2-11	6.3	0.6	11V	1000	100/300	—	-14 -42	210/310	240/350
2BP1-11	6.3	0.6	12E	2000	300/560	—	-135	270	174
3AQPI	6.3	0.6	12E	2750	1100	—	-83 -193	73/99	26/35
3BP1A	6.3	0.6	14G	2000	575	—	-30 -90	200	148
3FP7A	6.3	0.6	14J	2000	575	4000	-30 -90	250	180
3GP1A-3GP4A	6.3	0.6	11N	1500	245/437	—	-25 -75	96/144	84/126
3JP1A-7A-11A	6.3	0.6	14J	2000	400/690	4000	-45 -75	180/220	133/163
3KP1-4-11	6.3	0.6	11M	2000	320/600	—	-0 -90	100/136	76/104
3RP1-4-3RP1A	6.3	0.6	12E	2000	330/620	—	-135	146/198	104/140
3SP1-4-7	6.3	0.6	12E	2000	330/620	—	-28 -135	146/198	104/140
3UP1	6.3	0.6	12F	2000	320/620	—	-126	240/310	232/296
3WP1-2-11	6.3	0.6	12T	2000	330/620	—	-60 -100	83/101	57/70
5ABP1-7-11	6.3	0.6	14J	2000	400/690	4000	-52 -87	26/34	18/24
5ADP1-7-11	6.3	0.6	14J	1500	300/515	3000	-34 -56	40/50	30.5/37.5
5AMP1	6.3	0.6	14U	2500	0/300	—	-34 -56	40/50	20/25
5AQPI	6.3	0.6	14G	2500	0/300	—	-34 -56	40/50	31.5/38.5
5ATP1-2-7-11	6.3	0.6	14V	6000	0/700	—	-34 -56	94/116	34/42
5BP1A	6.3	0.6	11N	2000	450	—	-20 -60	84	76
5BP7A	6.3	0.6	11N	2000	375/560	—	-20 -60	70/98	63/89
5CP1A	6.3	0.6	14J	2000	575	4000	-30 -90	92	78
5CP1B-2B-7B-11B	6.3	0.6	14J	2000	400/690	4000	-45 -75	83/101	70/86
5CP7A-11A-12	6.3	0.6	14J	2000	575	4000	-30 -90	92	74
5GP1	6.3	0.6	11A	2000	425	—	-24 -56	36	72
5HP1A	6.3	0.6	11N	2000	450	—	-20 -60	84	76
5JP1A-4A	6.3	0.6	11S	2000	333/630	4000	-45 -105	77/115	77/115
5LP1A-4A	6.3	0.6	11T	2000	376/633	4000	-30 -90	83/124	72/108
5MP1-4-5-11	2.5	2.1	7AN	1500	375	—	-15 -45	66	60
5NP1-4	6.3	0.6	11A	2000	450	—	-20 -60	84	76
5RP1A-4A	6.3	0.6	14P	2000	362/695	20000	-30 -90	140/210	131/197
5SP1-4	6.3	0.6	14K	2000	363/695	4000	-30 -90	74/110	62/94
5UP1-7-11	6.3	0.6	12E	2000	340/360	—	-90	56/77	46/62
5VP7	6.3	0.6	11N	2000	315/562	—	-20 -60	70/98	63/89
5XP1A-2A-11A	6.3	0.6	14P	2000	362/695	12000	-45 -75	130/159	42/52
902-A	6.3	0.6	8CD	600	150	—	-30 -90	139	117
908-A	2.5	2.1	7CE	1500	430	—	-25 -75	114	109
2002	6.3	0.6	Fig. 1	600	120	—	—	—	0.16 <sup>3</sup>
2005	2.5	0.6	Fig. 1 <sup>4</sup>	2000	1000	200	-35	0.5 <sup>5</sup>	0.56 <sup>5</sup>

<sup>1</sup> Boegey value for focus. Voltage should be adjustable about value shown.  
<sup>2</sup> Bias for visual extinction of undeflected spot. Voltage should be adjustable from 0 to the higher value shown.  
<sup>3</sup> Discontinued.  
<sup>4</sup> Cathode connected to Pin 7.  
<sup>5</sup> In mm./volt d.c.  
<sup>6</sup> Phosphor characteristics (see next column).

Designation      Color and persistence      Application  
 P1      Green medium      Oscilloscope.  
 P2      Blue-green medium      Special oscilloscopes and radar.  
 P4      White medium      Television.  
 P5      Blue very short      Photographic recording of high speed traces.  
 P7      Blue-white short      Radar indicators.  
 P11      Blue short      Oscilloscope.  
 P12      Orange long      Radar indicators.

TABLE XIII—TRANSISTORS

No.	Type	Maximum Ratings				Characteristics				Typical Operation Common Emitter Circuit				
		Diss. Mw.	Collector		Emitter	Noise Figure Db.	Input Res. Ohms <sup>1</sup>	Freq. Cutoff Mc.	Use	Collector		Power Gain Db.	Output Load R. Ohms	Power Output Mw.
			Ma.	Volts	Ma.					Ma.	Volts			
2N94	NPN	50	50	20	—	—	—	2.0	I.F.	0.5	6	24	100K	—
2N94A	NPN	50	50	20	—	15	—	5.0	I.F.-R.F.	0.5	6	30	100K	—
2N107	PNP	50	-10	-12	10	22	700	0.6	—	-1.0	-5	38	30K	—
2N109	PNP	50	-35	-12	35	—	750	—	Audio <sup>2</sup>	-35.0	-4.5	30	200	75
2N139	PNP	35	-15	-16	15	4.5	900	—	I.F.	-1.0	-9	30	30K	—
2N140	PNP	35	-15	-16	15	—	700	7.0	I.F.-R.F.	-0.4	-9	27	75K	—
2N169A	NPN	55	20	25	-20	—	500	5.0	I.F.-R.F.	1.0	5	27	15K	—
2N175	PNP	20	-2	-10	2	6	3570	—	Audio	-0.5	-4	43	—	—
2N217	PNP	50	-35	-12	35	—	750	—	Audio <sup>2</sup>	-35.0	-4.5	30	200	75
2N233	NPN	50	100	10	—	—	—	2.0	I.F.	—	—	21	—	—
2N247	PNP	35	-10	-35	10	8	—	30.0	R.F.	-1.0	-9	24	—	—
2N255	PNP	1500	-3000	-15	—	—	—	0.2	Audio <sup>2</sup>	-500.0	-6	27	—	5 <sup>3</sup>
2N256	PNP	1500	-3000	-30	—	—	—	0.2	Audio <sup>2</sup>	-500.0	-12	27	—	10 <sup>3</sup>
2N270	PNP	150	-75	-12	75	—	—	—	Audio <sup>2</sup>	—	-12	32	—	500
2N274	PNP	35	-10	-35	10	8	—	30.0	R.F.	-1.0	-9	45	—	—
2N278	PNP	—	-13000	-50	13000	—	—	0.004	Audio <sup>2</sup>	—	-12	24	—	—
2N301	PNP	7500	-1000	-20	1000	—	—	—	Audio <sup>2</sup>	—	-14.4	30	—	12 <sup>3</sup>
2N301A	PNP	7500	-1000	-30	1000	—	—	—	Audio <sup>2</sup>	—	-14.4	30	—	12 <sup>3</sup>
2N331	PNP	200	-200	-30	200	9	—	1.0	Audio	-1.0	-6	44	—	—
2N351	PNP	10000	-3000	-40	3000	—	—	—	Audio <sup>2</sup>	-3000	-40	—	—	—
2N370	PNP	80	-10	-20	10	—	1750	30.0	R.F.	-1.0	-12	125	—	—
2N371	PNP	80	-10	-20	10	—	—	30.0	R.F.	-1.0	-12	—	—	—
2N372	PNP	80	-10	-20	10	—	100	30.0	Mixer	-1.0	-12	17	11K	—
2N373	PNP	80	-10	-25	10	—	2200	30.0	I.F.	-1.0	-12	40	—	—
2N374	PNP	80	-10	-25	10	—	2600	30.0	Conv.	-1.0	-12	40	—	—
2N384	PNP	120	-10	-30	10	—	30	100.0	R.F.	-1.5	-12	15	—	—
2N404A	PNP	150	-150	-35	150	—	—	4.0	Switching	—	—	—	—	—
2N407	PNP	150	-70	-20	70	—	—	—	Audio <sup>2</sup>	-40	-9	33	800	160
2N411	PNP	80	-15	-13	15	—	700	10.0	I.F.-R.F.	-0.6	-9	32	—	—
2N414	PNP	150	-200	-20	200	6	30	8.0	Switching	—	—	—	—	—
2N441	PNP	—	-13000	-40	13000	—	—	0.005	Audio <sup>2</sup>	—	-12	23	—	—
2N442	PNP	—	-13000	-50	13000	—	—	0.005	Audio <sup>2</sup>	—	-12	23	—	—
2N544	PNP	80	-10	-18	10	—	2100	30.0	R.F.	-1.0	-12	30	—	—
2N586	PNP	250	-250	-25	250	—	—	—	On-off Control	—	—	—	—	—
2N588	PNP	80	-50	-18	50	—	—	200.0	R.F.	—	—	—	—	—
2N591	PNP	50	-20	-32	20	—	1000	0.7	Audio	-2.0	-12	41	10K	5
2N697	NPN	600	500	60	-500	—	—	30	1w. Pwr. Amp.	—	—	—	—	—
2N706A	NPN	300	—	-20	—	—	—	—	Switching	—	—	—	—	—
2N955	NPN	100	150	12	-100	—	—	100	50mw. Pwr. Amp.	—	—	—	—	—
2N1102	NPN	180	100	40	-100	—	500	—	Audio	—	—	—	—	—
2N1177	PNP	80	-10	-30	10	—	45	140	R.F. Amp.	-1.5	-12	14	3.8K	—
2N1178	PNP	80	-10	-30	10	—	—	140	H.F. Osc.	—	—	—	—	—
2N1180	PNP	80	-10	-30	10	—	325	100.0	F.M.-I.F.	-1.5	-12	20	24K	—
2N1225	PNP	120	-10	-30	10	—	30	100.0	R.F.	-1.5	-12	15	—	—
2N1302	NPN	150	-300	-25	300	—	—	3.0	Switching	—	—	—	—	—
2N1396	PNP	120	-10	-30	10	—	30	100.0	R.F.	-1.5	-12	15	—	—
2N1491	NPN	500	50	30	-50	—	—	10	1w. Pwr. Amp.	—	—	—	—	—
2N1492	NPN	500	50	60	-50	—	—	10	10 w. Pwr. Amp.	—	—	—	—	—
2N1493	NPN	500	50	100	-50	—	—	10	15w. Pwr. Amp.	—	—	—	—	—
2N1524	PNP	80	-10	-24	10	—	1550	33	I.F.	-1	-12	14	—	—
2N1526	PNP	80	-10	-24	10	—	2150	33	Conv.	-.65	-12	—	—	—
2N1632	PNP	80	-10	-34	10	—	1000	7	R.F. Amp.	1	-12	17	—	—
2N1637	PNP	80	-10	-34	10	—	1000	45.0	R.F. Amp.	-1.0	-11.2	25	—	—
2N1742	PNP	60	—	-15	—	—	—	1000.0	v.h.f. amp.	—	—	—	—	—
2N1743	PNP	60	—	-15	—	—	—	1000.0	v.h.f. mix.	—	—	—	—	—
2N1905	PNP	5000	-10000	-60	10000	—	—	—	Pwr. Osc.	—	—	—	—	—
2N2708	NPN	200	—	35	—	8.5	—	500	u.h.f.	—	—	—	—	—
2N2857	NPN	200	20	30	-20	4.5	—	1200	u.h.f.	—	8	19	—	30
2N2869	PNP	30000	-10000	-60	10	—	10	—	Audio <sup>2</sup>	640	14.4	30	10	12 <sup>3</sup>
CK722	PNP	180	-10	-22	10	25	800	—	—	-1.0	-6	39	20K	—

<sup>1</sup> Common emitter circuit

<sup>2</sup> Two transistors in Class B

<sup>3</sup> Power output watts

Code for identifying typical junction transistors. The leads are marked C-collector, B-base, E-emitter and S-interlead shield and metal case.

TABLE XIV—CRYSTAL DIODES<sup>1</sup>

Type	Use	Max. Inverse Volts	Max. Average Ma.	Min. Forward Ma. <sup>2</sup>	Max. Reverse $\mu$ -Amp.
1N21B <sup>4</sup>	Mixer		Avg. Freq. — 3060 Mc.		10.3 db. Overall Noise Figure
1N21C <sup>4</sup>	Mixer		Avg. Freq. — 3060 Mc.		8.3 db. Overall Noise Figure
1N23C <sup>4</sup>	Mixer		Avg. Freq. — 9375 Mc.		9.8 db. Overall Noise Figure
1N25 <sup>4</sup>	Mixer		Avg. Freq. — 1000 Mc.		10 db. Overall Noise Figure
1N34	General Purpose	60	50	5.0	800 $\mu$ — 50 V.
1N34A	General Purpose	75	50	5.0	500 $\mu$ — 50 V.
1N35	General Purpose	50	22.5	7.5	100 $\mu$ — 10 V.
1N38	General Purpose	100	50	3.0	625 $\mu$ — 100 V.
1N38A	General Purpose	100	50	4.0	500 $\mu$ — 100 V.
1N39A	General Purpose	225	40	4.0	600 $\mu$ — 200 V.
1N48	General Purpose	85	50	4.0	833 $\mu$ — 50 V.
1N52A	General Purpose	85	50	5.0	100 $\mu$ — 50 V.
1N54A	Hi-Back Resistance	75	50	5.0	100 $\mu$ — 50 V.
1N55A	General Purpose	170	50	4.0	500 $\mu$ — 150 V.
1N56A	Hi-Conduction	50	60	15.0	300 $\mu$ — 30 V.
1N58A	General Purpose	115	50	4.0	600 $\mu$ — 100 V.
1N60	Vid. Detector	25	50	5.0	40 $\mu$ — 20 V.
1N63	Hi-Back Resistance	125	50	4.0	50 $\mu$ — 50 V.
1N64	Vid. Detector	20	50	0.1	25 $\mu$ — 1.3 V.
1N65	General Purpose	85	50	2.5	200 $\mu$ — 50 V.
1N66A	General Purpose	60	50	5.0	800 $\mu$ — 50 V.
1N67	Hi-Back Resistance	80	35	4.0	50 $\mu$ — 50 V.
1N67A	Hi-Back Resistance	100	50	4.0	50 $\mu$ — 50 V.
1N68	Hi-Back Resistance	100	35	3.0	625 $\mu$ — 100 V.
1N68A	General Purpose	100	50	3.0	625 $\mu$ — 100 V.
1N69A	General Purpose	75	40	5.0	500 $\mu$ — 50 V.
1N70A	General Purpose	125	30	3.0	300 $\mu$ — 50 V.
1N77A	Photo Diode		50 V., 20 MW		
1N81	General Purpose	50	30	3.0	10 $\mu$ — 10 V.
1N82	Mixer		Max. Freq. — 1000 Mc.		16 db. Overall Noise Figure
1N82A	Mixer		Max. Freq. — 1000 Mc.		14 db. Overall Noise Figure
1N89	Restorer	80	30	3.5	100 $\mu$ — 50 V.
1N90	General Purpose	75	30	5.0	750 $\mu$ — 50 V.
1N91	Pwr. Rectifier	100	150	470 $\mu$ @ 0.5 V.	2700 $\mu$ — 100 V.
1N95	General Purpose	60	250	10.0	500 $\mu$ — 50 V.
1N96	General Purpose	60	250	20.0	500 $\mu$ — 50 V.
1N97	General Purpose	80	250	10.0	100 $\mu$ — 50 V.
1N98	Hi-Back Resistance	100	250	20.0	100 $\mu$ — 50 V.
1N126A	General Purpose	75	30	5.0	850 $\mu$ — 50 V.
1N127A	General Purpose	125	30	3.0	300 $\mu$ — 50 V.
1N151	General Purpose	100	500	1570 $\mu$ @ 0.7 V.	2400 $\mu$ — 100 V.
1N152	General Purpose	200	500	1570 $\mu$ @ 0.7 V.	1900 $\mu$ — 200 V.
1N153	General Purpose	300	500	1570 $\mu$ @ 0.7 V.	1200 $\mu$ — 300 V.
1N158	Pwr. Rectifier	380	500	—	—
1N191	Computer	90	30	5.0	25 $\mu$ — 10 V.
1N192	Computer	70	30	5.0	50 $\mu$ — 10 V.
1N198A	Hi-Temperature	100	30	4.0	250 $\mu$ — 50 V. (75°C)
1N278	Hi-Conduction	35	—	100.0	200 $\mu$ — 20 V.
1N283	Hi-Conduction	25	—	200.0	80 $\mu$ — 10 V.
1N294	Switching	70	60	5.0	800 $\mu$ — 50 V.
1N295	Vid. Detector	40	—	—	—
1N448	100-Volt Computer	120	—	25.0	100 $\mu$ — 100 V.
1N634	60-Volt Very Low Z	120	—	50.0	115 $\mu$ — 100 V.
1N636	General Purpose	75	—	2.5	20 $\mu$ — 20 V.
1N1763	Silicon Power Rectifier	400	500	—	—
1N1764	Silicon Power Rectifier	500	500	—	—
M150	Silicon Power Rectifier			Max. Rms. Input: 130 V., Peak Inverse: 360 V., D.C. Current: 150 Ma.	
M500	Silicon Power Rectifier			Max. Rms. Input: 130 V., Peak Inverse: 400 V., D.C. Current: 500 Ma.	

<sup>1</sup> A bar, plus sign, or color dot denote the cathode end of crystal diodes. Diode color code rings are grouped toward the cathode end.  
<sup>2</sup> At +1 Volts.  
<sup>3</sup> At +4 Volts.  
<sup>4</sup> Polarity is such that the base is the anode and the tip is the cathode, R-types have opposite polarity.

SILICON RECTIFIER TABLE

The types listed below are a small sampling of available rectifiers. They are rated at 750 ma. to a resistive or inductive load, 550 ma. to a capacitive load.  $V_{RMS}$  is halved with capacitive-input filter.

P.I.V.	$V_{RMS}$	Manufacturer				
		A	B	C	D	E
200	140	1N441B	1N538	1N3193	1N2485/20H	1N2069
400	280	1N443B	1N540	1N3194	1N2487/40H	1N2070
600	420	1N547	1N547	1N3195	1N2489/60H	1N2071
800	560			1N3196		

A — General Electric, 50° C.  
 B — International Rectifier, 50° C.  
 C — RCA, 75° C.  
 D — Sarkes-Tarjian, 100° C.  
 E — Sylvania.



# Index

A	PAGE		PAGE
"A" Battery	59	One-Element Rotary for 21 Mc.	390
"A"-Frame Mast	385	Rotary Beams	387
A-1 Operator Club	587	Supports	385-386
A.C.	16, 32-37	Dipole	362-365
A.C. Line Filters	555	Folded Dipole	381
A.G.C.	101	Ground-Plane	372
A.M. (see "Amplitude Modulation")	58	Half-Wave	362-365
ARRL Emblem Colors	584	Halo	489
ARRL Operating Organization	583-587	"Inverted V"	364
ATV	291	Long-Wire	365-366, 373
Abbreviations for C.W. Work	591	Mobile	484-491
Absorption Frequency Meters	517	Multiband	367-371
Absorption of Radio Waves	394	Off-Center Fed	368
Affiliation, Club	584	Quad	378-380
Air-Insulated Lines	346-347	Receiving	384
Alignment, Receiver	113-114	Resonating, Remote	488
"All-Band" Antennas	367-371	Restricted Space	367-372
Alternating Current	16, 32-37	Rhombic	374
Alternations	16	Switching	384
Aluminum Finishing	503	"Trap"	369
Amateur Bands	13-14	TVI	573
Amateur Radio Emergency Corps	580-583	V-Beam	373
Amateur Radio History	7-10	Vertical	371
Amateur Operator and Station Licenses	11	V.H.F.	452-453
Amateur Regulations	11-12	"Windom"	368
Amateur Television	291	160-Meter	372
Amateur's Code, The	6	Antinode	343
American Radio Relay League:		Appointments, Leadership	583
Headquarters	10-11	Appointments, Station	584
Hiram Percy Maxim Memorial Station	11, 585	Array	374, 453
Joining the League	587	Arrays in Combination	374-379, 458
Ampere	17	Assembling a Station	544-552
Amplification	61-67, 81	Atmospheric Bending	397, 399-400
Amplification Factor	62	Atoms	15-16
Amplification Factor, Current	82	Audio-Amplifier Classifications	65-67
Amplification Factor, Voltage	62-63	Audio-Circuit Rectification	554
Amplifier Adjustment	171, 312	Audio Converters	96
Amplifier, Cathode Follower	70-71	Audio Frequencies	17
Amplifier Classification	65-67	Audio Frequency Shift Keying	293
Amplifier, Grounded-Grid	70-71, 168-169	Audio Harmonics, Suppression of	239
Amplifier Keying	225	Audio Image	106
Amplifier, Linear	66-67, 277, 312	Audio Limiting	102
Amplifier, Speech	233	Audio Oscillators	312, 524
Amplifier (see basic classifications, e.g., "Receivers," "Transmitters," "Radio-telephony," and "V.H.F.")		Audio Power	261
Amplifiers, Class A, B, C	65-67, 277	Audio Range Restriction	243
Amplifiers, Resistance Coupled	234	Audio Squelch	111
Amplifiers, Transistors	83-84, 109	Auroral Reflection	399
Amplitude, Current	15-16	Autodyne Reception	86, 91
Amplitude Modulation	58, 257	Automatic Gain Control	101, 102
Angle of Radiation	359, 360, 362, 395	Automobile Storage Battery	493
Anode	59	Autotransformer	40
Antenna Construction	385, 454-463	Average-Current Value	17
Antenna Couplers	351-356, 450	Awards	584-586
Antenna Diameters vs. Length	361		
Antenna Gain	375, 376	<b>B</b>	
Antenna Input Impedance	380, 453	"B" Battery	59
Antenna Length	361, 379, 453, 454	Baud	229
Antenna Masts	385	BCI	553
Antenna Matching	380-384	B.F.O.	101
Antenna, Wire Breaking Load	508	BPL	587
Antennas:	359-392	Back Current	80
Beams	374-380	Back-E.M.F.	26, 31, 32
Bent	368, 373	Back Resistance	80
Construction	384-392	Back Scatter	396, 400
Plumber's Delight	388	Backwave	225
Compact 14 Mc. 3-Element Beam	389	Baffle Shields	54
		Balanced Circuit	54
		Balanced Modulator	273-274
		Balun	350, 383, 539-540

# INDEX

	PAGE		PAGE
Band-Changing Receivers	92-93	Capacitive Coupling	46, 158, 564
Band-Pass Coupling	48	Reactance	33, 45
Band-Pass Filters	50-51	Capacitor-Input Filter	322
Bands, Amateur	13-14	Capacitors:	
Bandspreading	92	Band-Setting	92
Bandwidth, Antenna	359	Bandspread	92
Bandwidth, I.F.	87	Buffer	495
Base, Transistor	81	Bypass	53, 170, 561
<i>Basic Radio Propagation Predictions</i>	397	Ceramic	507
Battery	16, 59-62, 493, 499	Color Code	507, 508
Battery, Service Life	499	Electrolytic	24
Bazooka	383	Filter	320, 322-326
Beam Antennas	374-380, 455	Fixed	24
Beam Element Lengths	377, 454	Grid Tank	169
Beam Tetrodes	70	Main-Tuning	92
Beat Frequencies	58	Neutralizing	160
Beat Note	86	Padding	93
Beat Oscillator	86, 100-101	Phasing	107
Bending, Tropospheric	397, 399-400	Plate Blocking	170
Bent Antennas	368, 373	Plate Spacing	169
Bias	63, 154-156	Plate Tank Voltage	169
Bias, Cathode	72	Ratings	152
Bias, Contact Potential	72	Semiconductor, Voltage-Variable	81, V34
Bias, Fixed	155	Trimmer	93
Bias, Operating	154-156	Variable	24-25
Bias, Protective	154-156	Carbon Microphone	232
Bias Stabilization	85	Carrier	58, 257
Bias Supplies	335-337	Carrier Suppression	273
"Birdies"	94, 114	Carriers, Semiconductor	79
Bleeder	321, 323	Cascade Amplifiers	66
Blocked-Grid Keying	116, 227	Cascode R.F. Amplifiers	402
Blocking Capacitor	53	Catcher	77
Booms, Rotary Beam	388	Cathode	59-60
Brass Pounders League	587	Cathode-Bias	72
Breakdown Voltage	23, 24, 25, 169	Cathode Bypass Capacitors	241, 242
Break-In	227, 298, 575	Cathode-Coupled Clipper	76
Bridge Rectifiers	318	Cathode, Directly Heated	60
Bridge-Type Standing-Wave Indicators	534-537	Cathode Follower	71
Bridge, Impedance	537	Cathode, Indirectly Heated	60
Broadband Antennas, V.H.F.	462	Cathode Injection	95
Broadcast Interference, Elimination of	553	Cathode Keying	225
Broadside Arrays	374	Cathode Modulation	267
Buffer Amplifier	144, 259	Cathode Modulation Performance Curves	267
Buffer Capacitors	495	Cathode-Ray Oscilloscopes	540
Buncher	77	Cathode-Ray Tubes	V32
Button, Microphone	232	Catwhisker	80
Bypass Capacitors	53	Cavity Resonators	57
Bypassing	53, 560	Cell	16
<b>C</b>		Center Loading, Mobile Antenna	486
"C" Battery	62	Center-Tap, Filament	71
C (Capacitance)	23	Center-Tap Full-Wave Rectifier	317
CCS	154	Center-Tap Keying	225
CHU	521	Ceramic Microphone	233
CL Computation	531	Channel Width	257
CR and L/R Time Constants	30-31	Characteristic Curves	61-62, 80, 82, 83
Cable Lacing	505	Characteristic, Impedance	341, 347, 348
Cable Stripping	505	Characteristics, Dynamic	62
Calibrator Crystal	519	Characteristics of Radio Waves	393-394
Capacitance and Capacitors	23-25	Charges, Electrical	15-16, 23
Capacitance:		Charging, Capacitor	23
Distributed	54	Chassis Layout	501-502
Feedback	69	Checking and Monitoring Transmissions	297-316
Formula	24	Chirp, Keying	148, 224
Grid Tank	157	Choke:	
Inductance and Frequency Charts	45	Coil	26
Interelectrode	68-79, 161	Filter	323-325
Measurement	531	Radio-Frequency	26, 53, 170
Parallel	25	Swinging	323
Plate Tank	150	Choke-Coupled Modulation	262
Series	25	Choke-Input Filter	323
Specific Inductive	23	Circuit Symbols	510
Tube Input	68-69	Circuit Tracking	93
Tube Output	69	Circuits, Balanced and Single-Ended	54
Capacitance-Resistance Time Constant	30-31	Clamp Tube Modulation	265
		Clamp Tubes	156

# INDEX

	PAGE		PAGE
Clapp Oscillator	146	Corrective Stub	453
Class A Amplifiers	65	Counterpoise	371
Class AB Amplifiers	67	Countries List, ARRL	589
Class B Amplifiers	66-67	Coupled Circuits	46-48
Class B Modulators	238	Couplers, Antenna	130, 351-356, 450
Class C Amplifiers	67	Construction	130, 353-356, 450
Clicks, Keying	224, 228	Coupling	29
Clipping Circuits	75-76	Coupling:	
Clipping-Filter Circuit	244	Amplifier-Output	149-153
Clipping, Speech	244	Antenna to Line	380
Club Affiliation	484	Antenna to Receiver	132
Coax-Coupled Matching Circuit	352-353	Band-Pass	48
Coaxial Antennas, V.H.F.	461	Capacitive	46, 158, 564
Coaxial-Line Circuits	55	Capacitor	64
Coaxial Line Data	347-349	Choke	64
Coaxial-Line Matching Section	380	Circuits	46, 64
Coaxial Plug Assembly Instructions	504	Close	29
Coaxial Transmission Lines	347-349	Coefficient of	29, 47-48, 533
Code (Continental) and Code Practice	12	Critical	47
Code Proficiency Award	586	Feedline	351
Code Transmission	224-231	Impedance	64
Code, Underwriters	548	Inductive	46, 150, 157
Coefficient of Coupling	29, 47, 533	Interstage	158-159
Coefficient, Temperature	19	Link	48, 150, 157
Coil (see "Inductance")		Loose	29
Coils, Dimensions of	28	Pi-Section	159
Coils, Winding	506	Resistance	64
Coils, Wire Sizes for Transmitting	170	Tight	29
Cold End of Coil	54, 505	To Flat Coaxial Lines	150
Collector	81	To Wave Guides and Cavity Resonators	57
Collinear Arrays	374, 454, 455, 460	Transformer	46, 64, 234
Color Codes, EIA	506, 507, 508	Transmitter to Line	351
Color Television	572	Tuned	151, 351
Colpitts Circuit	73, 147	Critical:	
Combination Arrays	375	Angle	395
Compact Antennas	367	Coupling	47
Compact 14-Mc. 3-Element Beam	369	Frequency	395
Complex Waves	17, 37	Inductance	323
Component Ratings and		Cross-Modulation	108, 554, 569
Installation	169-171, 323	Cross-Talk (Telephone)	559
Component Values	506-508	Crystal:	
Compression, Speech Amplifier	243	Diodes	79-80, V34
Concentric-Line Matching Section	380	Filters	106-107
Concentric Transmission Line	347	Microphones	232
Condenser (see Capacitor)	23	Oscillators	144, 145-146, 423
Conductance	19	Rectifiers	79-80
Conductance, Mutual	62	Resonator	51-52
Conductivity	16	Crystal Calibrator	519
Conductor Size, Antennas	362	Crystal-Controlled Converters	405-411, 416-422, 467-474
Conductors	16	Crystal-Controlled Oscillators	144, 145-146, 423
Cone Antennas, V.H.F.	463	Crystal Detector	79-80, 88
Constant, Time	30-31, 101	Crystal-Filter Phasing	106-107
Constants, LC	46	Crystal Filter, Tuning with	106
Constant-Voltage Transformers	339	Crystal, Germanium	79-80
Construction, Antenna	384-392	Crystal-Lattice Filter	276
Construction, Coupler	352	Crystals, Overtone	423
Construction Practices	500-510	Crystals, Piezoelectric	51
Construction Tools	500	Current:	
Contact-Potential Bias	72-73	Alternating	16, 32-37
Continental Code	12	Amplification Factor	82
Control Circuits, Station	545	Antenna	365
Control Grid	61	Direct	16
Controlled Carrier	265	Distribution, Antenna	365
Conversion Efficiency	94	Eddy	29
Conversion of Fractional and Multiple		Effective	17
Units	20	Electric	15-16
Converter Tube Operating Values	96	Gain	82
Converters, Audio	96	Lag and Lead	32-35
Converters, Frequency	94	Loop	343, 361
Converters, Teletype	293	Magnetizing	38
Converters, V.H.F.	405-411	Measurement	512-513
Converters, U.H.F.	416-422	Node	343, 361
Copper-Wire Table	509	Plate	60
Cores	27, 28-29, 37-40	Pulsating	16, 52
Corner Reflector Antenna, V.H.F.	460		

# INDEX

	PAGE		PAGE
Ratio, Decibel.....	41	DX Operating Code.....	578
Values.....	17	Dynamic:	
Curve Resonance.....	42, 44, 48, 88	Characteristics.....	62
Curves, Transistor Characteristic.....	82	Instability.....	74
Curves, Tube-Characteristic.....	61-62	Microphones.....	233
Cut-Off Frequency.....	82	Dynamometer Movement.....	515
Cut-Off, Plate-Current.....	61-62, 70	Dynamotors.....	494
C.W. Abbreviations.....	591	Dynatron-Type Oscillator.....	77
C.W. Procedure.....	574-576, 591		
C.W. Reception.....	112	<b>E</b>	
Cycle.....	16, 32	<i>E</i> (Voltage).....	17
Cyclic Variations in Ionosphere.....	396	<i>E</i> Layer.....	394
<b>D</b>		E.M.F., Back.....	26
D'Arsonval Movement.....	511	E.M.F., Induced.....	26
<i>D</i> Region.....	395	Eddy Current.....	29
D.C.....	16	Effective Current Value.....	17
D.C. Instruments.....	511-514	Efficiency.....	22-23
D.C. Measurements.....	511	Conversion.....	94
Decay, Voltage.....	30, 31	Power.....	22-23
Decibel.....	41	Transformer.....	38
Deflection Plates.....	540	Electric Current.....	15-16
Degeneration.....	67-68	Electrical Charge.....	15-16
Degree, Phase.....	32	Electrical Laws and Circuits.....	15-58
Delta Matching Transformer.....	363	Electrical Quantities, Symbols for.....	510
Demodulation.....	58	Electrical Safety Code, National.....	548
Density, Flux.....	15	Electrode.....	59
Design of Speech Amplifiers.....	236	Electrode Voltages, Sources.....	154
Detection.....	58, 86, 87-91	Electrolytic Capacitor.....	24
Detector Blocking and Pull-In.....	91	Electromagnetic:	
Detectors.....	87	Deflection.....	540
Deviation Ratio.....	269	Field.....	15
Diagrams, Schematic Symbols for.....	510	Waves.....	15, 393
Dielectric.....	23	Electromotive Force (E.M.F.).....	16
Dielectric Constants.....	23	Electron:	
Dielectric Puncture Voltage.....	23	Gun.....	540
Difference of Potential.....	15, 16	Lens.....	540
Differential Keying.....	227, 228	Transit Time.....	76
Diode Clippers.....	75	Electronic:	
Diode Detectors.....	88-89	Conduction.....	16, 79
Diodes.....	60	Speed Key.....	229
Diodes, Crystal.....	79-80, V34	Voltage Regulation.....	331
Diodes, Voltage-Variable Capacitor.....	81	Transmit-Receive Switch.....	231
Diodes, Zener.....	80-81	Electrons.....	15, 79
Dipole.....	361-365	Electrostatic:	
Dipole, Folded.....	363, 381	Deflection.....	540
Direct Current.....	16-17	Field.....	15
Direct Feed for Antennas.....	362	Element Spacing, Antenna.....	377, 378, 454, 457
Directive Antennas.....	373-380	Elements, Vacuum Tube.....	59
Directivity, Antenna.....	362, 363, 366	Emergency Communication.....	580-582
Director, Antenna.....	377	<i>Emergency Communications</i> .....	582, 592
Directors, ARRL.....	10	Emergency Coordinator.....	582, 583
Discharging, Capacitor.....	23	Emergency Points.....	582
Discriminator.....	117	Emergency Power Supply.....	494
Disk-Seal Tubes.....	76	Emission:	
Dissipation, Plate and Screen.....	156	Electron.....	59
Distortion, Audio.....	304	Secondary.....	69
Distortion, Harmonic.....	63-64	Thermionic.....	59
Distributed Capacitance and Inductance.....	54	Types of.....	14
Dividers, Voltage.....	329	Emitter, Transistor.....	81
Divisions, ARRL.....	10	End Effect.....	361
Doubler, Frequency.....	144	End-Fire Arrays.....	375
Double-Humped Resonance Curve.....	48	Energy.....	22-23
Double Sideband.....	273	Envelope Modulation.....	257
Double Sideband Phone.....	232-272	Equivalent Noise Resistance.....	86
Double Superheterodyne.....	94	Equivalent Series and Parallel Circuits (A.C.).....	36
Downward Modulation.....	258	Excitation.....	74, 156
Drift, Frequency.....	75, 148-149	Exciter Units (see "Transmitters").....	
Drift Transistor.....	82	Exciting Voltage.....	65
Drill Sizes (Table).....	501	Extended Double-Zepp Antenna.....	374
Driven-Element Directive Antennas.....	374		
Driver.....	66, 144, 241	<b>F</b>	
Drivers for Class B Modulators.....	240	F.M. (see "Frequency Modulation").....	
DXCC.....	585-586, 589	<i>F</i> Layer.....	395, 398-399
DX Century Club Award.....	585-586	Fading.....	396



# INDEX

	PAGE		PAGE
Farad	24	Frequency Standards	519
Fee, Licensing	11	Heterodyne Frequency Meters	520
Feedback	67, 109, 242	Interpolation-Type Frequency Meter	520
Feedback Percentage	243	Precise Measurements	520
Feed, Series and Parallel	53	WWV and WWVH Schedules	521
Feeder Length	348	Frequency and Phase Modulation	268-272
Feeders and Feed Systems	347-349	Narrow-Band Reactance-Modulator	
Feeding Dipole Antennas	362	Unit	271
Feeding Long-Wire Antennas	366	Deviation Ratio	269
Feeding Mobile Antennas	488	Discriminator	117
Feeding Rotary Beams	377	Index, Modulation	269
Fidelity	98, 232	Methods	271
Field Direction	15	On V.H.F.	424
Field, Electromagnetic	15	Principles	268
Field, Electrostatic	15	Reactance Modulator	271
Field Intensity	15	Reception	116
Field, Magnetostatic	15	Frequency Multiplication	166
Field Strength	359	Frequency Multipliers	123, 144, 166
Field-Strength Meter	491, 533	Frequency Response, Microphone	232
Filament	59-60	Frequency Shift Keying	293
Filament Center-Tap	71	Frequency Spectrum Nomenclature	18
Filament Hum	71	Frequency Spotting	545
Filament Isolation	165	Frequency Stability	259
Filament Supply	327	Frequency-Wavelength Conversion	18
Filament Voltage	154	Front End Overloading, TV	569
Filter Capacitors in Series	325	Front-to-Back Ratio	359
Filter Component Ratings	325	Full-Wave Bridge Rectifiers	318
Filter, Crystal	106	Full-Wave Center-Tap Rectifiers	317
Filter Resonance	325	Fundamental Frequency	17
Filters	50-51	Fusing	338, 548
Audio	239, 243, 244, 245		
Band-Pass	50-51	<b>G</b>	
Basic Sections	50	Gain, Directive Antennas	375, 377
Crystal-Lattice	276	Gain Control	110, 112, 236
Cut-Off Frequency	51	"Gamma" Match	378, 382, 458
Design Formulas	50	Ganged Tuning	93
High-Pass	50-51, 570	Gaseous Regulator Tubes	331, V25
Keying	224, 225	Gasoline-Engine-Driven Generators	498
Line	555	Gauges, Standard Metal	503
Lead	560	Generator	16
Low-Pass	50-51, 565	Generator Noise	465, 499
Mechanical	107	Germanium Crystal Diodes	79-80, V34
M-Derived	51	Glossary (see Foreword)	3
Pass-Band	51	Grid	61
Pi-Section	50-51	Bias	72, 156, 335, 238
Power-Supply	320	Capacitor	73, 169
R.F. Click	224	Current	61
Stop Band	51	Excitation	74, 156
Terminating Impedance	51	Impedance	157
Filtering, Audio	239, 243, 244, 245	Injection, Mixer	94
Filtering, Negative-Lead	325	Keying	226
Filtering, TVI	555, 559, 561, 565-567, 570	Leak	73, 156
Filter-Type S.S.B. Exciters	275	Resistor	64, 73
Finishing Aluminum	504	Suppressor	69
First Detector	93	Voltage	61
Fixed Bias	155	Grid-Cathode Capacitance	68-69
Fixed Capacitor	24	Grid-Dip Meters	522-525
Flat Lines	345	Grid-Input Impedance	157
Flux Density, Magnetic	15, 27, 28	Grid-Leak Detectors	91
Flux, Leakage	39	Grid Modulation	263-266
Flux Lines	15	Grid-Plate Capacitance	68-69
Fly-Back	541	Grid-Plate Crystal Oscillator	146
Focusing Electrode	540	Grid-Plate Transconductance	62
Folded Dipole	363, 381	Grid-Separation Circuit	70-71
Folded Dipole Nomogram	361, 382	Grid-Tank Capacitance	157
Force, Electromotive	16	Ground	54, 360, 373
Force, Lines of	15	Ground Effects	360
Form, Log	579	Ground-Plane Antenna	372
Form, Message	580	Ground Point, R.F.	75
Free-Space Pattern	360	Ground Potential	54
Frequency	16	Ground Waves	394
Frequency Bands, Amateur	13, 14	Grounded Antennas	373
Frequency Converters (Receiver)	94-96	Grounded-Base Circuit	83
Frequency Measurement:		Grounded-Collector Circuit	84
Absorption Frequency Meters	517		

# INDEX

	PAGE		PAGE
Grounded-Emitter Circuit	83	Input	70, 83, 156-157, 344
Grounded-Grid Amplifier	70-71, 163-165, 401-402	Matching	39, 49, 351, 453
Grounded-Grid Amplifier, Driving Power	164	Measurements	534, 539
Grounded-Grid Amplifier-Power Output	164	Modulating	261
Guys, Antenna	386	Output	70, 83
<b>H</b>			
Half-Lattice Crystal Filter	276	Parallel Circuits	36
Half-Wave Antenna	362-365	Ratio	39, 344
Half-Wave Antenna Lengths	362, 454	Resistive	44
Half-Wave Phasing Section	375	Series Circuits	36
Half-Wave Rectifiers	317	Surge	341
Halo Antenna	489	Transformation	45, 345
Halyards, Antenna	386	Transformer Quarter-Wave	380
Hang A.G.C. System	102	Transformer Ratio	39, 238
Harmonic	17	Transmission-Line	341, 347, 348
Amateur Bands/TV	548, 556, 566, 572	Impedance-Coupled Amplifiers	64
Antenna	367	Imperfect Ground	360
Distortion	63-64	Improving Receiver Performance	115
Generation	558	Impulse Noise	102
Reduction	424, 568, 569	Incident Power	342
Suppression	240, 568	Index, Modulation	269
Traps	559, 570	Indicating Wavemeters	518
Hartley Circuit	73, 147	Indicators, Signal-Strength	104-105
Hash Elimination	495	Indicators, Tuning	104-105
Headphones	104	Induced E.M.F.	26
Heater	59	Inductance	26-30
Heater Connections for 6-Volt and 6/12-Volt Tubes	496	Calculation	26, 27
Heater Voltage	154	Capacitance and Frequency Charts	45
Henry	26	Critical	323
Heterodyne Frequency Meters	520	Distributed	54
Heterodyne Reception	86	Leakage	39
Heterodyning	58	Measurement	531
Hi-Fi Interference	556	Mutual	29-30
High-C	45, 74	Parallel	29
High Frequencies	17-18	Plate Tank	169
High-Frequency Oscillator	96	Series	29
High-Frequency Receivers	86-136	Slug-Tuned	93
High-Frequency Transmitters	144-223	Small Coil	27, 28
High-Pass Filters	50-51, 570	Inductance-Resistance Time Constant	30-31
High-Q Circuit	43-44	Inductance in Series and Parallel	29
High-Vacuum Rectifiers	319, V25	Inductance Capacitance, Specific	23
High- $\mu$ Tubes	62	Inductive Coupling	46, 150, 157
Hiram Percy Maxim Memorial Station	12, 585	Inductive Neutralization	160
History of Amateur Radio	9-12	Inductive Reactance	33-34, 45
Hole Conduction	79	Inductor	26
Hole Cutting	502	Inductors, Dimensions of	28
Holes	79	Infinite-Impedance Detector	89-90
Horizontal Angle of Radiation	359	Input Choke	323
Horizontal Polarization of Radio Waves	393, 452, 489	Input Impedance	70, 83, 156-157, 344
Hum	71	Input, Plate Power	60, 154
Hysteresis	29	Instability, Receiver	87
<b>I</b>			
I (Current)	15-16	Instrument Calibration	517
ICAO Phonetics	577	Instantaneous Current Value	17
ICAS	154	Insulators	16
I.F.	98	Interelectrode Capacitances	68-69
ITV	566	Interference, Television and Broadcast	553-572
Ignition Interference	464	Intermediate Frequency	98
Image	94	Intermediate Frequency Amplifier	98, 404
Image, Audio-Frequency	106	Intermediate Frequency Amplifier, Transistor	100
Image Ratio	94	Intermediate Frequency Interference, TV	569
Image Response	554	Intermediate Frequency Transformers	99
Impedance	36, 37	Intermediate Frequency Transformer Color Code	507
Antenna	360, 362, 366	Intermittent Direct Current	16, 60
Bridge	539	International Amateur Prefixes	589
Characteristic	341, 347, 348	International Prefixes	590
Complex	37	International Morse Code	12
Grid Input	157	Interpolation-Type Frequency Meter	520
Grounded-Grid Amplifier Input	162	Interstage Coupling, Capacitive	158
Folded Dipole	381, 382	Interstage Coupling, Pi-Network	159
		Interstage Transformer	99
		Inverse-Distance Law of Propagation	393
		Inverse Peak Voltage, Rectifier	318
		Inversion, Temperature	400
		"Inverted V" Antenna	364

# INDEX

	PAGE		PAGE
Ionization.....	15, 394	Linear Amplifier Tube Operation, Grounded Cathode.....	278
Ionosphere.....	394-399	Linear Amplifier Tube Operation, Grounded Grid.....	279
Ionosphere Storms.....	396	Linear Amplifiers.....	66-67, 277, 312
Ionospheric Propagation.....	394-399	Linear Baluns.....	350
Ions.....	15, 394	Linear Sweep.....	541
Iron-Core Coils.....	27, 37	Linear Transformers.....	380
<b>J</b>			
Junction Diodes.....	80	Linearity.....	63, 259, 304, 312
Junction Transistors.....	82	Lines, Coaxial.....	347
<b>K</b>			
Keeping a Log.....	579	Lines, Matched.....	342
Key Chirps.....	148, 224	Lines of Force.....	15
Key Clicks.....	224, 228	Lines, Nonresonant and Resonant.....	345
Keyer Tubes.....	226	Lines, Parallel Conductor.....	346
Keyers, Vacuum-Tube.....	226	Lines, Transmission.....	341-358
Keying:		Lines, Unterminated.....	343
Amplifier.....	225	Link Coupling.....	48, 150, 157, 158
Audio Frequency Shift.....	293	Link Neutralization.....	160
Back Wave.....	225	Lissajous Figures.....	543
Break-In.....	227	Load, Antenna.....	380
Differential.....	227	Load Impedance.....	238
Frequency Shift.....	293	Load Isolation, V.F.O.....	147-148
Grid-Block.....	226	Load Resistor.....	22, 60, 62-63
Key-Click Reduction.....	224, 228	Loaded Circuit <i>Q</i> .....	44, 45
Methods.....	225-231	Loading-Coil Data.....	485
Monitoring.....	298	Local Oscillator.....	93
Oscillator.....	227	Log, Station.....	579
Speeds.....	229	Long-Wire Antennas.....	365-366
Testing.....	297	Long Wire Antenna Lengths.....	365
Keys, Speed.....	229	Long-Wire Directive Arrays.....	373
Keys, Electronic.....	229	Loops, Current and Voltage.....	361
Keys, Electronic, Speed Adjustment of.....	229	Losses, Hysteresis.....	29
Kilocycle.....	17	Losses in Transmission Lines.....	348
Kilowatt.....	22	Loudspeaker Coil Color Code.....	508
Kilowatt Hour.....	23	Loudspeakers.....	105
Kiloystrons.....	77	Low- <i>C</i> .....	46
<b>L</b>			
<i>L</i> (Inductance).....	26-30	Low-Frequencies.....	17-18
<i>LC</i> Computation.....	531	Low-Pass Filters.....	50-51, 570
<i>LC</i> Constants.....	46	Low- <i>Q</i> .....	44
<i>L/C</i> Ratios.....	45-46, 151-152, 264	Low- $\mu$ Tubes.....	62
<i>L</i> Network.....	49	<b>M</b>	
<i>L/R</i> Time Constant.....	30-31	M.U.F. (see "Maximum Usable Frequency").....	395, 398
Lacing Cable.....	505	Magnetic Storms.....	396, 399
Lag Circuits.....	225	Magnetizing Current.....	38
Lag, Current or Voltage.....	32-37	Magnetrons.....	77-78
Laminations.....	29	Majority Carriers.....	79
Laws Concerning Amateur Operations.....	11	Marker Frequencies.....	519
Laws, Electrical.....	15-58	Masts.....	385
Lazy-H Antenna.....	375	Matched Lines.....	342
Lead, Current or Voltage.....	32-37	Matching, Antenna.....	380-384
Lead-In, Antenna.....	387	Matching-Circuit Construction.....	352
Leakage Current.....	85	"Matchtone", The.....	298
Leakage Flux.....	39	Maximum Average Rectified Current.....	80
Leakage Inductance.....	39	Maximum Safe Inverse Voltage.....	80
Leakage Reactance.....	39	Maximum Usable Frequency.....	395, 398
Learning the Radiotelegraph Code.....	12	Measurements:	
Level, Microphone.....	232	Antenna.....	533
License Manual, <i>The Radio Amateur's</i> .....	11	Capacitance.....	531
Licenses, Amateur.....	11	Current.....	513, 528
Licensing Fee.....	11	Field Strength.....	491, 533
Light, Speed of.....	18	Frequency.....	517
"Lighthouse" Tubes.....	76, 402	Impedance.....	534, 539
Lightning Arrester.....	548	Inductance.....	531
Lightning Protection.....	548	Keying.....	228
Limiting Circuits.....	75-76, 117	Modulation.....	302
Limiters, Noise.....	103, 466	Phase.....	32
Limiting Resistor.....	329	Power.....	513, 531
Line Filters.....	555	Radio Frequency.....	528
Line, Open-Circuited.....	343	Resistance.....	514
Line Radiation.....	346	Standing-Wave Ratio.....	534
Line-Voltage Adjustment.....	338	Transmission Line.....	533-540
		Voltage.....	511, 516, 529
		Measuring Instruments.....	511

# INDEX

	PAGE		PAGE
Mechanical Filter	107	Plate Supply	260
Medium of Propagation	393	Power	258
Medium- $\mu$ Tubes	62	Screen-Grid Modulation	264
Megacycle	17	Suppressor-Grid Modulation	266
Megohm	20	Test Equipment	525, 542
Mercury-Vapor Rectifiers	319, V25	Velocity Modulation	76-77
Message Form	580	Wave Forms	258, 259, 301, 303-306, 308, 312
Message Handling	579-581	Modulator Tubes	235
Metal Gauges, Standard	503	Modulators (see "Radiotelephony")	238
Metal, Resistivity of	18	"Monimatch"	356
Meteor Trails	400	Monitoring Transmissions	297-316
Metering	166-167	Monitors	297-316, 543
Meter Accuracy	512	Motorboating	114
Meter Installation	166	Moving-Vane Instrument	511
Meter Multiplier	512	Mu ( $\mu$ )	62
Meter Switching	167	Mu, Variable	70
Meters, Volt-Ohm-Milliamperere	516	Multiband Antennas	367, 369
Mho	19, 62	Multiband Tank Circuits	153
Microampere	20	Multihop Transmission	395-396, 399
Microfarad and Micromicrofarad	24	Multimeters	151
Microhenry	27	Multipliers, Frequency	144, 166, 423
Micromho	19, 62	Multipliers, Voltage	330
Microphones	232	Multipliers, Voltmeter	512
Microvolt	20	Multirange Meters	516
Microwaves	76	Muting, Receiver	116
Miller Effect	68	Mutual Conductance	62
Millimeters	512	Mutual Inductance	29
Milliamperere	17, 20	<b>N</b>	
Millihenry	26	N-Type Material	79
Millivolt	20	N.F.M. Reception	116
Milliwatt	22	Narrow-Band Frequency Modulation	270
Minority Carriers	79	National Electrical Safety Code	548
Mixers	94-95, 403	National Traffic System	581
Mixers, Transistor	96	Natural Resonances	54
Mobile:		Negative Feedback	68, 242
Antennas	484-491	Negative-Lead Filtering	325
Mobile Modulators	483	Negative-Resistance Oscillators	77
Power Supplies	492, 497	Network Operation	580-581
Receivers:		Neutralization	153, 160-162, 401
Mobile Converter for 3.5-28 Mc	467	Neutralizing Capacitor	160
Crystal-Controlled Converters for 50 and 144 Mc	472	Neutral Wire	337
"Hybrid" Crystal-Controlled Converter	470	Nodes	343, 361
Transmitters:		Noise Figures	87
A 40-watt "Extended-Band" Mobile Transmitter	475	Noise Generators	526-528
A 65-watt Mobile Transmitter	479	Noise-Limiter Circuits	103, 466
25-watt Transistor Modulator	483	Noise, Receiver	86-87, 102
Signal Field-Strength Meter	491	Noise, Elimination, Mobile	464-466
Modes of Propagation	56	Noise Reduction	103, 466
Modulation, Heterodyning and Beats	58	Noise Silencer, I.F.	104
Modulation:		Noise Types	102
Amplitude Modulation	58, 257	Nomenclature, Frequency-Spectrum	17-18
Capability	260	Nonconductors	16
Cathode Modulation	267	Nonlinearity	63, 87, 260, 261
Characteristic	259	Nonradiating Loads	350
Characteristic Chart	260, 263, 267	Nonresonant Lines	345
Checking A.M. Phone Operation	302	Nonsynchronous Vibrators	494
Choke-Coupled Modulation	262	Nucleus	15
Clamp-Tube	265	<b>O</b>	
Controlled-Carrier Systems	265	Off-Center Fed Antenna	368
Driving Power	233, 240	Official Bulletin Station	584
Envelope	257	Official Experimental Station	584
Frequency Modulation	268	Official Observer	584
Grid Modulation	263	Official Phone Station	584
Impedance	239, 261	Official Relay Station	584
Index	269	Ohm	18
Linearity	259, 304	Ohm's Law	19-20, 22
Methods	260-268	Ohm's Law for A.C.	34, 36
Monitoring	308, 543	Ohmmeters	514
Narrow-Band Frequency	270	Old Timers Club	587
Percentage of	259	One-Element Rotary for 21 Mc	390
Phase Modulation	269	Open-Circuited Line	342
Plate Modulation	261	Open-Wire Line	346
		Operating an Amateur Radio Station	580, 581, 592



# INDEX

	PAGE		PAGE
Operating Angle, Amplifier.....	67	Phase Modulation (see also "Frequency and Phase Modulation").....	268
Operating a Station.....	574-587	Phase Modulation Reception.....	116
Operating Bias.....	154-156	Phase Relations, Amplifiers.....	63
Operating Conditions, R.F. Amplifier-Tube	153	Phase-Splitter Circuit.....	236
Operating Courtesy.....	572	Phased Antennas.....	374
Operating Point.....	63	Phasing-Type S.S.B. Exciters.....	274, 286
Operator License, Amateur.....	13	Phone Activities Manager.....	583
Oscillation.....	68, 73-75, 85	Phone Reception.....	112
Oscillations, Parasitic.....	161-162	Phonetic Alphabet.....	577
Oscillator Keying.....	227	Picofarad.....	24
Oscillators.....	73-75, 85	Pi Network.....	49
Audio.....	525	Pi Network Design.....	152
Beat-Frequency.....	101	Pi-Section Coupling.....	152, 159, 164
Crystal.....	144, 145-146, 423	Pi-Section Filters.....	49-50
Grid-Dip.....	522	Pi-Section Tank Circuit.....	49, 152, 164
Overtone.....	423	Pierce Oscillator.....	145-146
Transistor.....	85	Piezoelectric Crystals.....	51-52
V.F.O.....	144, 146-149	Piezoelectric Effect.....	51
Oscillators, Multipliers and Power		Piezoelectric Microphone.....	51
Amplifiers.....	144-223	Pilot-Lamp Data.....	508
Oscilloscope Patterns:..	258, 259, 301, 303-306, 308, 312	Plane-Reflector Antennas, V.H.F.....	462
Oscilloscopes.....	540	Plate-Cathode Capacitance.....	69
Output Capacitor, Filter.....	325	Plate-Current Shift.....	306
Output Limiting.....	243	Plate-Grid Capacitance.....	68-69
Output Power.....	65	Plate.....	59
Output Voltage, Power Supply.....	324	Blocking Capacitor.....	170
Overexcitation, Class B Amplifier.....	240	Current.....	60
Overloading, TV Receiver.....	569	Detectors.....	89
Overmodulation.....	259, 302, 308	Dissipation.....	154
Overmodulation Indicators.....	308	Efficiency.....	67
Overtone Oscillators.....	423	Modulation.....	261
Oxide-Coated Cathode.....	60	Resistance.....	61
		Resistor.....	64
<b>P</b>		Supply, Audio.....	240, 260
P (Power).....	22	Plate Tank Capacitance.....	150
P.E.P.....	280	Plate Tank Q.....	149-150
P-Type Material.....	79	Plate Tank Voltage.....	154
P.M. (see "Phase Modulation").....	268	Plate Transformer.....	326
Padding Capacitor.....	92	Plate Tuning, Power-Amplifier.....	167
Page Printer.....	292	Plates, Deflection.....	540
Parabolic Reflectors.....	463	"Plumber's Delight" Antenna.....	388
Parallel Amplifiers.....	65-66, 162	Point-Contact Diode.....	79-80
Parallel Antenna Tuning.....	351	Point-Contact Transistor.....	81
Parallel Capacitances.....	25	Polarization.....	359, 361, 452, 489
Parallel Circuits.....	20-22, 25, 29, 34, 36	Positive Feedback.....	68
Parallel-Conductor Line.....	346	Potential Difference.....	15, 16
Parallel-Conductor Line Measurements.....	539	Potential, Ground.....	54
Parallel Feed.....	53	Powder, Antistatic.....	465
Parallel Impedance.....	36, 44	Power.....	22-23
Parallel Inductances.....	29	Power Amplification.....	65-67
Parallel Reactances.....	34-35	Power Amplification Ratio.....	65
Parallel Resistances.....	20-21	Power Amplifier.....	65
Parallel Resonance.....	43-46	Power Connections and Control.....	548
Parastic Elements,		Power Efficiency.....	22, 23
Antenna Arrays with.....	375, 455	Power Factor.....	37
Parasitic Excitation.....	375	Power Gain, Antenna.....	359, 366
Parasitic Oscillations.....	160-161	Power, Incident.....	342
Patterns, Oscilloscope.....	258, 259, 301, 303-306, 308, 312	Power Input.....	60, 154
Patterns, Radiation.....	363, 366	Power, Instantaneous.....	258
Patterns, TVI.....	557-558	Power-Line Connections.....	337
Peak-Current Value.....	17	Power Measurement.....	22-23, 513, 531
Peak Envelope Power.....	280	Power Output.....	65
Peak-Voltage Rating (Rectifier).....	318	Power Ratio, Decibel.....	41
Pencil Tubes.....	402	Power, Reactive.....	35-36
Pentagrid Converters.....	95	Power, Reflected.....	342
Pentode Amplifiers.....	69-70	Power Sensitivity.....	65
Pentode Crystal Oscillators.....	146	Power-Supply Construction Data.....	327-337
Pentodes.....	69	Power Supplies:	
Percentage of Modulation.....	257, 305	Battery Service Life.....	499
Per Cent Ripple.....	322, 324	Bias Supplies.....	335-337
Permeability.....	27	Combination A.C.-Storage Battery	
Phase.....	32-33	Supplies.....	495
Phase Inversion.....	236	Construction.....	327
		Constructional (see Chapters Six and Twelve)	

# INDEX

	PAGE		PAGE
Dry Batteries	499	Radiation Characteristics	362
Dynamotors	494	Radiation from Transmitter	560
Emergency Power Supply	494	Radiation Patterns	363, 366
Filament Supply	326	Radiation Resistance	360, 362, 365
Heavy-Duty Regulated Power Supply	332	Radio Amateur Civil Emergency Service	380
Input Resistance	321	Radio Frequency	17-18
Load Resistance	321	Radio Frequency Choke	26, 53, 170
Mercury Batteries	499	Radio Frequency Circuits	41-52
Noise Elimination	499	Radiotelegraph Operating Procedure	574-576, 591
Output Capacity	260	Radiotelephone Operating Procedure	576-577
Output Voltage	322	Radiotelephony:	
Plate Supply	240, 260	Adjustments and Testing	302
Principles	317	Audio-Harmonic Suppression	239
Safety Precautions	340	Checking A.M. Transmitters	302
Selenium Rectifiers	318	Checking F.M. and P.M. Transmitters	310
Transformer Voltage	326	Constructional:	
Transistor	497	Class B Modulator	256
Typical	327-328	Low-Power Modulator (8 Watts)	246
Vibrator Supplies	495	Narrow-Band Reactance Modulator	271
Vibrators	494	Phasing-Type S.S.B. Exciters	274, 286
Preamplifier, Receiver	111	Speech Amplifier Circuit with	
Prediction Charts	397	Negative Feedback	242
Preferred Values, Component	506	Speech-Amplifier with Push-Pull	
Prefixes	589-591	Triodes	241
Primary Coil	37	25-watt Modulator using Push-Pull	
Probe, R.F.	530	6BQ6GTs	248
Procedure, C.W.	574-576, 591	50-watt AB <sub>1</sub> Modulator	250
Procedure, Voice	576-577	6146 Modulator and Speech Amplifier	253
Product Detector	90, 96	(120 Watts)	238
Propagation, Ionospheric	394-395, 396-397, 398-399	Driver Stages	302
Propagation Modes	56	Measurements	232
Propagation Phenomena	398-400	Microphones	257
Propagation Predictions	393, 521	Modulation	238
Propagation, Tropospheric	397, 399-400	Modulators and Drivers	297
Propagation, V.H.F.	397-400	Monitors	243
Protective Bias	154-156	Output Limiting	308
Public Relations, BCI-TV	553	Overmodulation Indicators	397
Public Service	581	Principles	110, 112
Pulleys, Antenna	387	Reception	235
Pulsating Current	52	Resistance-Coupled Speech-Amplifier	
Puncture Voltage	23, 24-25	Data	273
Push-Pull Amplifier	65-66, 163	Single-Sideband Transmission	233
Push-Pull Multiplier	166	Speech Amplifiers	243
Push-Push Multiplier	166	Volume Compression	291
<b>Q</b>			
Q	43, 47, 55, 149-150	Radioteletype	293
"Q-Fiver"	108	Radioteletype F.S.K. Converter	393-394
Q, Loaded Circuit	44-45	Radio Waves, Characteristics of	397-400
Q, Mobile Antenna	486	Radio Waves, Propagation of	587
Q Multiplier	107, 136	Rag Chewers Club	398
"Q"-Section Transformer	380	Range, V.H.F.	269
Q Signals	588	Ratio, Deviation	94
QST	10-11	Ratio, Image	39
Quad Antenna	378-380	Ratio, Impedance	83
Quad Antenna Length	379	Ratio, Short-Circuit Current Transfer	38
Quarter-Wave Transformer	380	Ratio, Turns	65
<b>R</b>			
R (Resistance)	18-22	Ratio, Power-Amplification	41
RACES	583	Ratio, Power Voltage, and Current	344, 535
RC Circuits	30-31	Ratio, Standing Wave	238
RC Time Constant	30-31	Ratio, Transformer	63
RCC Certificate	587	Ratio, Voltage-Amplification	45-46, 151-152, 264
R.F.	17	Reactance, Capacitive	33, 45
R.F. Probe	530	Reactance Charts	35, 45
R.M.S. Current Value	17	Reactance, Inductive	33-34
RST System	588	Reactance, Leakage	39
RTTY	291	Reactance Modulator	271
Radials	371	Reactance, Transmission-Line	341
Radiation, Transmission Line	346	Reactive Power	35-36
Radiation Angle	359, 360, 362	Readability Scale	588
		Receiver Alignment	113-115
		Receiver, Communications	86
		Receiver, Coupling to	132
		Receiver Muting	116
		Receiver Protection	116

# INDEX

	PAGE		PAGE
Receiver Servicing	113	Resonator, Cavity	57
Receivers, High-Frequency (See also "V.H.F.")	86-143	Response, Flat	48, 68, 68
Antennas for	384	Response, Frequency	48, 68, 232
Constructional:		Restricted-Space Antennas	367, 372
Antenna Coupler for Receiving	132	Restriction of Frequency Response	243
Crystal-Controlled Converter for 20, 15 and 10 Meters	129	Return Trace	541
HB-65 Five-Band Receiver	137	Rhombic Antenna	374
Regenerative Preselector for 7 to 30 Mc	133	"Ribbon" Microphone	233
Selective Converter for 80 and 40	127	Ripple Frequency and Voltage	321, 322, 324
"Selectoject"	131	RMS Voltage	17
Simple-X Super Mark II	118	Rochelle Salts Crystals	51, 232
Transistorized Q Multiplier	135	Rotary Antennas	375
2 X 4 + Superhet	122	Rotary Antennas, Feedlines for	377
Converters	94-96	Rotary-Beam Construction	387
Detectors	87-91	Route Manager	583
High-Frequency Oscillator	96	<b>S</b>	
Improving Performance of	115	S-Meters	104-105
Noise Reduction	102	S Scale	588
Radio-Frequency Amplifier	109	S.S.B. Exciters	275
Regenerative Detectors	90-91	S.W.R.	344, 535
Selectivity	86, 87, 106-107	Safety	340, 547
Sensitivity	86, 111-112	Safety Code, National Electric	548
Superheterodyne	93	Saturation	28
Superregenerative	404	Saturation Point	60
Tuning	92-93, 112-113	Sawtooth Sweep	541
Receiving Systems	86-143	Schematic Symbols	510
Reception, A.M. and C.W.	112	Screen Bypass Capacitor	73
Reception, N.F.M., F.M. and P.M.	116	Screen Circuits, Tuned	424
Rectification	60-61	Screen Dissipation	156
In Non-Linear Conductors	568	Screen Dropping Resistor	73
Rectified A.C.	60	Screen-Grid Keying	226
Rectifiers	317-320, V25, V34	Screen-Grid Modulation	264
Rectifiers, Mercury-Vapor	319, V25	Screen-Grid Neutralization	160
Rectifiers, Ratings	319	Screen-Grid Tube Protection	156
Rectifiers, Selenium	318	Screen-Grid Tubes	69-70
Rectifier-Type Voltmeter	515	Screen Voltage	156
Reflected Power	342	Screen-Voltage Supply	73
Reflection of Radio Waves	342, 398-400	Second Detector	93, 100-101
Reflection from Meteor Trails	400	Secondary Coil	37
Reflection, Ground	360, 394	Secondary Emission	69
Reflector, Antenna	377	Secondary Frequency Standard	519
Refraction of Radio Waves	394, 399, 400	Section Communications Manager	582, 583
Regeneration	67-68, 106, 112	Section Emergency Coordinator	582, 583
Regenerative Detectors	90-91	Section Nets	584
Regenerative I.F.	106	Selective Fading	396
Regulation, Voltage	320, 322, 331	Selectivity	42, 47-48, 86, 87
Regulations, Amateur	13-14	Selectivity, I.F.	106, 107, 108
Regulator, High Voltage	333	Selectivity Receiver	86, 87, 106-108
Regulator Tubes	331, V25	Selenium Rectifiers	318
Regulator, Voltage	331, V25	Self-Bias	155
Relays	447	Self-Controlled Oscillators	144, 146-149
Reperforator	292	Self-Inductance	26
Resistance	18-22	Self-Oscillation	69
Resistance, Back	80	Semiconductors	79-85
Resistance, Forward	80	Sending	575-576
Resistance-Bridge Standing-Wave Indicator	534	Sensitivity, Receiver	86, 111-112
Resistance-Capacitance Time Constant	30-31	Series Antenna Tuning	351
Resistance-Coupled Amplifier Data (Chart)	235	Series Capacitances	25
Resistance in Series and Parallel	20-22	Series Circuits	20-22, 25, 29, 34, 36
Resistive Impedance	44	Series Feed	53
Resistivity of Metals	18	Series Inductances	29
Resistor	19	Series-Parallel Resistances	20-22
Resistor Color Code	507	Series Reactances	34-35
Resistor Wattage	22	Series Resistances	20-21
Resonance	41-46	Series Resonance	41-43
Resonance Curve	42, 44, 48, 87	Series Voltage-Dropping Resistor	329
Resonance, Filter	325	Servicing Superhet Receivers	113
Resonance, Sharpness of	42, 379	Sharp Cut-Off Tubes	70
Resonant Circuits, Coupled	47	Sheet Metal Cutting and Bending	503
Resonant Frequency	42	Shielding	54, 560
Resonant-Line Circuits	55	Shields	54
Resonant Transmission Lines	345	Short-Circuiting	23
		Short Skip	399
		Shorting Stick	548

# INDEX

	PAGE		PAGE
Shot-Effect Noise	86	Station Control Circuits	562
Shot Noise	102	Station Log	579
Shunt Matching, Ground-Plane Antenna	371	Storage Battery, Automobile	494
Shunt, Meter	513	Straight Amplifier	144
Sideband Cutting	98	Stray Receiver Rectification	558
Sideband Interference	257	Stubs, Antenna-Matching	453
Sidebands	58, 257	Sunspot Cycle	396-399
Sidebands, F.M. and P.M.	269	Superheterodyne	93
Sideband Techniques	273	Superheterodyne, Alignment and Servicing	113-115
Side Frequencies	58, 257	Superhigh Frequencies (see Ultra High Frequencies and Very High Frequencies)	
Signal Envelope Shape	224	Superimposed A.C. on D.C.	52
Signal Generators	522	Superregeneration	404
Signal-to-Image Ratio	94	Suppressed Carrier	273
Signal Monitoring	297	Suppressor Grid	69
Signal-Strength Indicators	104-105	Suppressor-Grid Modulation	266
Signal-Strength Scale	588	Surface Barrier Transistor	82
Signal Voltage	62	Surface Wave	394
Silencer, Noise	104	Surge Impedance	341
Silicon Diodes	80, V34	Surplus Transmitters for Novices, Converting	220
Sine Wave	17, 32	Sweep Wave Forms	541
Single-Ended Circuits	54	Swinging Choke	323
Single Sideband (see also "Radiotelephony"):		Switch	19
Adjustment	311-312	Switch to Safety	340
Amplification	277	Switches, Power	547-548
Exciters	275	Switching, Antenna	384
Generators	274	Switching, Meter	167
Transmission	273	Symbols for Electrical Quantities	510
Two-Tone Test	312	Symbols, Schematic	510
Single-Signal Reception	106	Symbols, Transistors	82, V33
Skin Effect	19	Synchronous Vibrators	494
Skip Distance	395, 399		
Skip Zone	395	<b>T</b>	
Skirt Selectivity	87	"T"-Match to Antennas	378, 382
Sky Wave	394	"T"-Section Filters	50
Slug-Tuned Inductance	93	T.R. Switch	231
Smoothing Choke	323	Tank Circuit Capacitance	150, 152, 157
Solar Cycle	396, 399	Tank-Circuit Q	43, 151
Soldering	503, 505	Tank Circuits, Multiband	153
Space Charge	59	Tank Constants	151-152
Space Wave	394	Tap Sizes	501
Spark Plug Suppressors	465	Tape Printer	292
Specific Gravity	493	Telephone Interference	556
Specific Inductive Capacity	23	Teletype Code	293
Spectrum, Frequency	17, 18	Television Interference, Eliminating	553-572
Speech Amplifiers	233	Temperature Effects on Resistance	19
Speech-Amplifier Construction	237	Temperature Inversion	399
Speech Amplifier Design	236	Termination, Line	341
Speech Clipping and Filtering	244	Tertiary Winding	99
Speech Compression	243	Test Oscillators	522
Speech Equipment	232	Test Signals	575
Speed Key	229	Tetrode	69
Splatter	259	Tetrode Neutralization	160
Splatter-Suppression Filter	245	Tetrodes, Beam	70
Sporadic-E Layer Ionization	396-397, 399	Thermal-Agitation Noise	86
Sporadic-E Skip	399	Thermionic Emission	59
Spreading of Radio Waves	393	Thermocouple	528
Spurious Responses	94, 113, 402, 569	Thoriated-Tungsten Cathodes	60
Squegging	97	Tickler Coil	91
Squelch Circuits	111	Time Constant	30-31, 101
Stability, Amplifier	160-162	Time Signals	521
Stability, Frequency	259	Tone Control	243
Stability, Oscillator	74, 403	Tone Scale	588
Stabilization, Voltage	331	Tools	500-502
Stacked Arrays	374, 498	Top Loading, Mobile Antenna	486
Stagger-Tuning	48	Trace, Cathode-Ray	541
Standard Component Values	506	Tracing Noise	466
Standards, Frequency	513, 516	Tracking	93, 110
Standard Metal Gauges	503	Training Aids	584
Standing Waves	344	Transatlantics	8
Standing-Wave Ratio	344, 535	Transceiver, A Simple 432 Mc.	412
Starting Voltage (Regulator Tubes)	331, V25	Transconductance, Grid-Plate	62
Static Collectors	465		
Station Appointments	584		
Station Assembling	544-562		



# INDEX

	PAGE	PAGE	
Transformation, Impedance	45	Principles and Design	144-170
Transformer Color Code	507-508	Transverse-Electric and Magnetic Mode	56
Transformer Construction	40	"Trap" Antennas	369
Transformer Coupling	46, 64, 234	Trapezoidal Pattern	302, 303, 304
Transformer Current	38	Traveling-Wave Tube	78
Transformer, Delta-Matching	364	Trimmer Capacitor	93
Transformer Efficiency	38	Triodes	61-62
Transformer, Gamma	378, 382	Triode Amplifiers	163
Transformer Impedance	319	Triode Clippers	75-76
Transformer, Linear	380	Triode-Hexode Converter	95
Transformer Power Relationships	38	Tripler, Frequency	144
Transformer, "Q"-Section	380	Tri-Tet Oscillator	146
Transformer Ratio	238	Troposphere Propagation	397, 399-401
Transformer, T-Match	378, 382	Tropospheric Bending	397, 399-401
Transformerless Power Supplies	336	Tropospheric Waves	397
Transformers:	37-40	Trouble Shooting (Receivers)	113
Auto	40	Tube Elements	59
Constant-Voltage	339	Tube Keyer	226
Diode	99	Tube Noise	86
Filament	326	Tube Operating Conditions, R.F. Amplifier	153
I.F.	99	Tube Ratings, Transmitting	154
Permeability-Tuned	99	Tubes, Modulator	238
Plate	326	Tuned Circuits, Tapped	51
Triple-Tuned	99	Tuned Coupling	151, 353
Variable-Selectivity	99	Tuned Screen Circuits	424
Winding Resistance	321	Tuned-Grid Tuned-Plate Circuit	74
Transistors	81-85, V33	Tuned-Line Tank Circuit	56
Transistor Base Diagrams	V33	Tuned Transmission Lines	345
Transistor Current Transfer Ratio	83, 84	Tuners, Antenna,	
Transistor "Grid-Dip" Oscillator	522	Construction of	132, 352-356, 450
Transistor I.F. Amplifier	100	Tuning Indicators	104-105
Transistor Mixers	96	Tuning Rate	92
Transistor Power Supplies	497	Tuning R.F. Amplifiers	165
Transistor R.F. Amplifier	109	Tuning Receivers	92-93
Transistor Symbols	82, V33	Tuning Slug	93
Transit Time	76-77	Tunnel Diode	81
Transmission Lines	341	Turns Ratio	38
Transmission Lines as Circuit Elements	55-56	TVI	424, 553
Transmission-Line Attenuation	349	TV Receiver Deficiencies	569
Transmission-Line Construction	346	"Twin-Five" Array	460
Transmission-Line Coupling	150	Twin-Lead	347
Transmission-Line Data	347, 348, 349	Two-Tone Test	312
Transmission-Line Feed for Half-Wave			
Antennas	362	<b>U</b>	
Transmission Line Length	348	Ultra-High Frequencies:	
Transmission Line Losses	348-349	Cavity Resonators	57
Transmission Lines, Spacing	346, 347	Circuits	55-57
Transmission, Multihop	395-396, 399	Grid-Dip Meter	523
Transmit-Receive Switch	231	Klystrons	77
Transmitters: (see also "Very High		"Lighthouse" Tubes	76, 402
Frequencies", "Ultrahigh Frequencies"		Magnetrons	77-78
and "Mobile")		Pencil Tubes	402
Constructional:		Tank Circuits	55-57
A 75- to 120-Watt 6146B Transmitter	181	Transmission-Line Tanks	55-56
An Inexpensive 75-Watt Five-Band		Traveling-Wave Tubes	78
Transmitter	174	Tubes	76-78
Compact 3-400Z Grounded-Grid		Velocity Modulation	76-77
Amplifier	202	Waveguides	56-57
Converting Surplus Transmitters for		Unbalance in Transmission Lines	347
Novice Use	220	Underwriters' Code	548
High-Power Grounded-Grid Amplifier		Unsymmetrical Modulation	258
and Power Supply	214	Untuned Transmission Lines	345
Kilowatt Amplifier, One Band	210	Upward Modulation	258
Kilowatt 4-400A Amplifier	205	<b>V</b>	
Phased Single-Sideband Exciter	286	"V" Antennas	373
Self-Contained 450-Watt C.W.		V Signal	575
Transmitter	194	VAR	36
Single-Sideband Exciter	281	VOX	547
3-Band Transmitter for the Novice		VR Tube Break-In System	228
(30 Watts)	171	VR Tubes	331, V25
3-Band V.F.O.	178	Vacuum Tubes and Semiconductors	
90-Watt All-Purpose Amplifier	186	(Index to Tables)	V1
200-Watt Grounded-Grid 811		Vacuum Tube Input Capacitance	68
Linear Amplifier	190	Vacuum Tube Keyers	226
Metering	167		

# INDEX

	PAGE		PAGE
Vacuum Tube Plate Power Input, Plate Dissipation	154	Voltage Loop	343, 361
Vacuum Tube Principles	59-78	Voltage-Amplification Ratio	63
Vacuum Tube Voltmeter	516	Voltage Multiplier Circuits	330
Vacuum Tube Voltmeter R. F. Probe	530	Voltage Node	343, 361
Variable Capacitor	24	Voltage-Turns Ratio, Transformer	38
Variable-Frequency Oscillators	146-148, 178	Voltage Regulation	320, 322, 331
Variable- $\mu$ Tubes	70	Voltage-Regulator Interference	465
Velocity Factor	348	Voltage, Ripple	321, 322, 324
Velocity Microphone	233	Voltage Rise	43
Velocity-Modulated Tubes	77	Voltage-Stabilized Power Supplies	331
Velocity Modulation	76-77	Voltmeters	511, 516, 529
Velocity of Radio Waves	18, 393	Volume Compression	243
Vertical Angle of Radiation	359	<b>W</b>	
Vertical Antennas	372	W1AW	12, 585, 586
Vertical Antennas, Capacitance of	485	WAC Award	586
Vertical Polarization of Radio Waves	393, 452	WAS Award	585
Very High Frequencies (V.H.F.):		Watt	22
Antenna Arrays	454	Watt-Hour	23
Antenna Coupler	450	Watt-Second	23
Antenna Systems	452-463, 489	Wave Angle	359, 360, 362, 395
Propagation	398-400	Wave-Envelope Pattern	259, 297-312
Receivers	401-422	Wave Form	17
Construction:		Wave Front	393
Crystal-Controlled Converter for 432 Mc.	416	Wave, Ground	394
Crystal-Controlled Converter for 50 and 144 Mc. Mobile Use	472	Wave Guide Dimensions	56-57
Crystal-Controlled Converters for 50, 144 and 220 Mc.	405	Wave Guides	56
Crystal-Controlled Converter for 1296 Mc.	418	Wave Propagation	393-400
Superregenerative	404	Wave, Sine	17, 32
V.H.F. Receiver Design	401	Wave, Sky	394
Transceivers:		Wave Traps	570
432 Mc., A Simple	412	Wavelength	17-18
Transmitters	421-449	Wavelength-Frequency Conversion	18
Construction:		Wavelengths, Amateur	13, 14
Complete 50 Mc. through 432 Mc. Transmitter	425	Wavemeters	517
High-Power Transmitter for 50 and 144 Mc.	437	Waves, Complex	17, 37
50-Mc. Amplifier	440	Waves, Distorted	63
144-Mc. Driver-Amplifier	445	Waves, Electromagnetic	15
V.F.O. for 2 Meters	436	Wheel Static	465
Design	423-424	Wide-Band Antennas, V.H.F.	462
V.F.O.	146-148, 178	"Windom" Antenna	368
VVV Signals	574	Wire, Breaking Load for Antenna	508
Vibrator Power Supplies	494	Wire Table, Copper	509
Virtual Height	394	Wiring Diagrams, Symbols for	510
Voice-Controlled Break-In	547	Wiring, Station	548-549
Voice Equivalents to Code Procedure	576	Wiring, Transmitter	505
Voice Operating	576-577	Word Lists for Accurate Transmission	577
Volt	17	Working DX	577-578
Volt-Ampere-Reactive	36	Working Voltage, Capacitor	325
Volt-Ampere Rating	326	Workshop Practice	505-510
Voltage Amplification	62-63, 234	WWV and WWVH Schedules	521
Voltage Amplifier	65	<b>X</b>	
Voltage Breakdown	23, 24, 25	X (Reactance)	33
Voltage Decay	30, 31	<b>Y</b>	
Voltage Dividers	329	"Yagi" Antennas	453, 459
Voltage Distribution, Antenna	365	<b>Z</b>	
Voltage Drop	21, 329	Z (Impedance)	36
Voltage Gain	64, 234	Zener Diodes	80-81
		Zener Knee	80
		Zero Beat	91
		Zero-Bias Tubes	66



# *The Catalog Section*



In the following pages is a catalog file of products of certain principal manufacturers and distributors who serve the radio field: industrial, commercial, amateur. All firms whose advertising has been accepted for this section have met The American Radio Relay League's rigid standards for established integrity; their products and engineering methods have received the League's approval.



42nd EDITION 1965

# INDEX OF ADVERTISERS

CATALOG SECTION

## *The Radio Amateur's Handbook*

	Page		Page
Allied Radio Corp. ....	41	Instructograph Co. ....	32
American Radio Relay League, Inc. ....	27-30, 53, 60	International Crystal Mfg. Co., Inc. ....	18, 19
Aquaspace Development, Inc. ....	56	Johnson Co., E. F. ....	16, 17
Arrow Electronics, Inc. ....	49	Kahn Research Laboratories, Inc. ....	49
Automatic Telegraph Keyer Corp. ....	50	Lafayette Radio ....	39
Bird Electronic Corp. ....	20, 21	Lampkin Laboratories, Inc. ....	35
Burstein-Applebee Co. ....	43	Measurements Div. of McGraw-Edison ....	57
Carling Electric, Inc. ....	58, 59	Millen Mfg. Co., Inc., James ....	24
Cleveland Institute of Electronics ....	55	Miller Co., J. W. ....	47
Collins Radio Co. ....	11-14	Mosley Electronics, Inc. ....	23
Communication Products Co. ....	31	National Radio Institute ....	53
Communications Co., Inc. ....	45	Penta Laboratories, Inc. ....	34
Conar Instruments ....	52	Petersen Radio Co. ....	40
Datak Corporation ....	44	Shurite Meters ....	38
Editors & Engineers, Ltd. ....	48	Sprague Products Co. ....	42
Elmar Electronics ....	51	Technical Materiel Corp. ....	33
E-Z Way Products, Inc. ....	55	Telrex Laboratories ....	50
General Electric Co. ....	22	United Transformer Corp. ....	7
Gonset Division ....	37	Vesto Company, Inc. ....	46
Grantham School of Electronics ....	44	VHF Associates ....	43
Hallicrafters Co., The ....	3-6	Vibroplex Co., Inc. ....	36
Hammarlund Mfg. Co., Inc. ....	25	Wile, Eugene G. ....	54
Harrison Radio ....	15		
Harvey Radio Co. ....	26		
Heath Co., The ....	8, 9		
Hy-Gain Antenna Products Corp. ....	10		





**hallicrafters**

## 1965 AMATEUR EQUIPMENT

Hallicrafters is now in its fourth decade of service to the radio amateur, consistently offering that rare combination of inspired design, based upon sound engineering principles, with solid craftsmanship that has made the name a hallmark of quality. This tradition is fostered and protected by the most severe and uncompromising testing program in the industry. That is why we're proud of the equipment shown here, just as we are of the many, many other Hallicrafters products that are not shown. We know they are the very best.

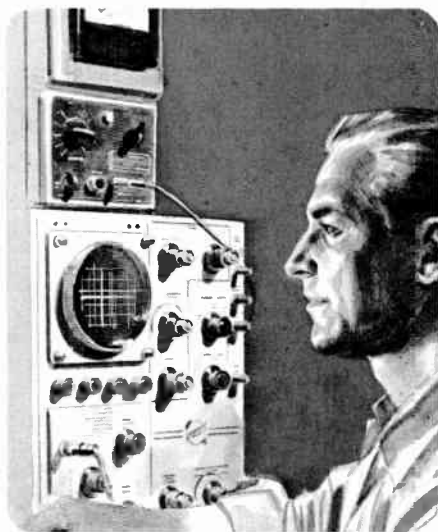

### SR-160 Transceiver

A compact, light-weight 80, 40, and 20 meter unit for either fixed or mobile SSB or CW operation. Equipped with Amplified Automatic Level Control for maximum talk power and Receiver Incremental Tuning for flexibility. Quartz crystal filtering is used and both carrier and unwanted sideband rejection is 50 db or better. Third and fifth order distortion is 30 db minimum. Provision built-in for 100 kc crystal calibrator. VOX accessory available. Power input, 150W SSB, 125W, CW. Cabinet is 13" wide, 6½" high, and 11" deep. Weight 13¼ lbs.

### SR-150 Transceiver

A rugged, high performance amateur band transceiver for fixed station or mobile use. Full coverage for 80, 40, 20 and 15 meters; 10M crystals furnished for operation on 28.5 to 29.0 mc. Other crystals may be added without adjustment, for full 10 meter coverage. Carrier and unwanted sideband suppression 50 db.; distortion products, 30 db. Power input, 150 W P.E.P., SSB; 125 W, CW. R.I.T. permits  $\pm 2$  kc adjustment of receiver frequency independent of transmitter for round-table, net, or CW operation. Amplified Automatic Level Control. Sensitivity less than  $1 \mu\text{v}$  for 20 db signal-to-noise ratio. Audio output, 2 W. Cabinet is 6½" high, 15" wide, and 13" deep; weight 17½ lbs.



*"Quality through Craftsmanship"*

*"Quality through Craftsmanship"*



**hallicrafters**

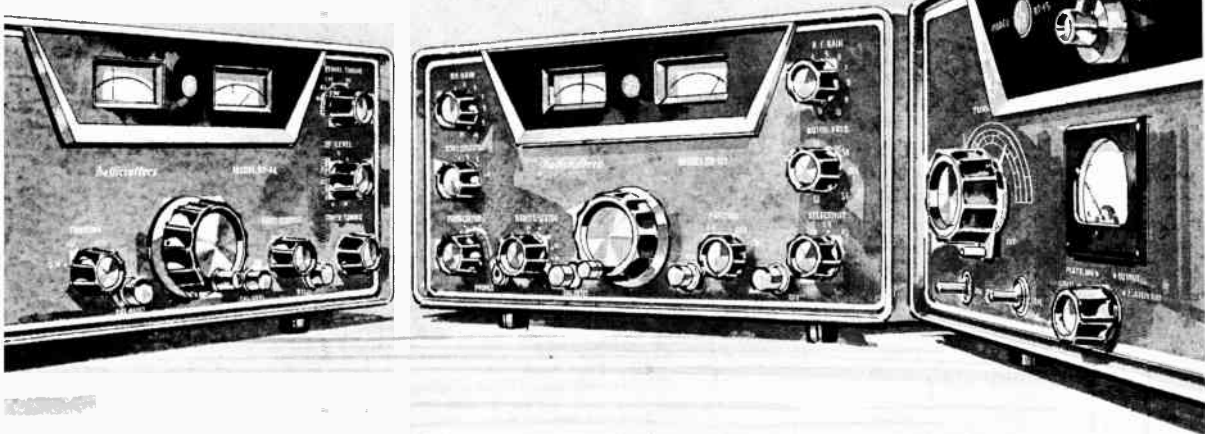

### **SX-117 Triple Conversion Receiver**

Highly stable, compact superheterodyne communication receiver. Constant rate, no-backlash tuning. Selectable sidebands. I.F. type noise limiter. T-notch for up to 50 db attenuation of unwanted heterodyne in I.F. pass band. Audio inverse feedback. Sensitivity of less than  $1.0 \mu\text{v}$  on AM, less than  $0.5 \mu\text{v}$  on SSB/CW. Selectivity variable in 3 steps; 0.5, 2.5, and 5.0 kc. Crystals provided for 3.5–4.0, 7.0–7.5, 14.0–14.5, 21.0–21.5, and 28.5–29 mc. Four additional crystal positions for 500 kc segments between 85 kc and 30 mc. For 85 kc to 3 mc coverage, must be used in conjunction with HA-10 Tuner (see Accessories page). Size; 15" wide,  $7\frac{1}{8}$ " high, 13" deep. Weight, 18 lbs.

### **HT-44 Transmitter**

Companion unit for the SX-117, which may be operated separately or as a transceiver

combination. AM, CW, upper and lower SSB operation, 80 through 10 meters. Full band coverage crystals for 28.0–28.5, 29.0–29.5, 29.5–30 mc optional extra. 200 watts DC input. Carrier suppression, 50 db; unwanted sideband, 30 db minimum. Third and fifth order distortion, 30 db minimum. Full VOX and push-to-talk. Cabinet is 15" wide,  $7\frac{1}{8}$ " high, and 13" deep. Weight, 16 lbs. Uses P-150 Power Supply and CA-44 Cable Assembly for transceiver interconnection with SX-117.

### **HT-45 Grounded Grid Linear Amplifier**

Covers 80-40-20-15-10 meter amateur bands. Styled to match HT-44 and SX-117. Complete metering—plate voltage, plate current, grid current, relative RF output. Runs full legal input when used with 3,000 volt plate supply (P-45 AC Power Supply available). Cabinet size 15" wide,  $7\frac{1}{8}$ " high, and 13" deep. Weight, 28 lbs.



## HT-40 Transmitter and SX-140 Receiver Kits

Made for each other! Coordinated design and performance give you an excellent station set-up with very modest investment. The HT-40 is a crystal-controlled 75 watt unit for 80 through 6 meters. Full band switching, and both AM and CW operation. Unit is fully metered and TVI filtered. The SX-140 offers complete coverage of all amateur bands 80 through 6 meters, with extremely high sensitivity and sharp selectivity. Unit has RF stage, S-meter, antenna trimmer, and crystal calibrator. Tuning ratio is 25:1. Cabinet is the same size as the HT-40; 13 $\frac{3}{8}$ " wide, 6 $\frac{5}{8}$ " high, and 8 $\frac{1}{8}$ " deep. Also available wired.



## SX-122 General Coverage Receiver

The SX-122 brings you a major advance in stability through additional temperature compensation of the HF oscillator circuits and use of crystal controlled second conversion oscillators. Covers standard broadcast band and three SW bands, 1720 kc to 34 mc, dual conversion on all bands. Band spread is calibrated for 80, 40, 20, 15, and 10 meter bands. Selectivity in three steps: 0.5, 2.5 and 5.0 kc at 6 db down. Audio output is 1.0 watts with 10% or less distortion. Amplified AVC, series noise limiter, separate AM and SSB/CW detectors, and antenna trimmer are built-in. A 100 kc crystal calibrator, HA-7, is available (see Accessories page). The unit is 18 $\frac{3}{4}$ " wide, 8" high, and 9 $\frac{3}{4}$ " deep. Weight, 29 lbs.

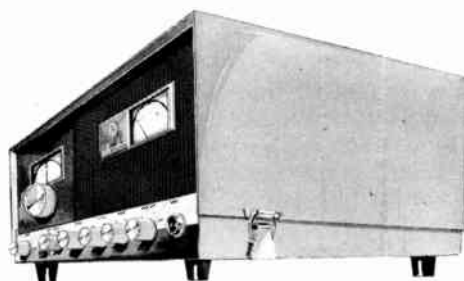

## SR-42 and SR-46 VHF Transceivers

Identical in appearance and performance, the SR-42 handles the 2 meter band, while the SR-46 takes over 6 meters. They provide complete coverage with double the usual bandspread, through use of dual tuning ranges. A neutralized nuvistor front end and eleven tuned circuits boost sensitivity while suppressing interference. These units are exceptionally free of TV and FM "birdies". Four transmitter crystal positions are provided (one high frequency crystal furnished), plus external VFO socket, all switch-selected from the front panel. Meter automatically switches from "S" units to RFO. Power input is 10-12 watts; built-in power supply is 115 VAC for fixed station operation, 12 VDC (vibrator, mounting strap and line cord, optional extra) for mobile use. The cabinet size is 5 $\frac{1}{2}$ " high, 12 $\frac{1}{8}$ " wide and 8 $\frac{1}{4}$ " deep. Weight 17 lbs.

## ACCESSORIES

### HA-1 T.O. Keyer

Meets all requirements of the CW perfectionist. Employs digital techniques to produce constant ratio of dot-to-space-to-dash throughout entire speed range. Transformer operated. Speeds from 10-65 WPM. Monitor or sidetone may be heard through built-in speaker.

### HA-5 Deluxe VFO

Heterodyne-type, 80-2 meters. Crystals for 80-10M furnished; 6 or 2M crystals available. 30:1 tuning ratio. Illuminated dial, built-in spotting switch.

### HA-7 100 kc Plug-in Crystal Calibrator for the SX-122.

### HA-8 "Splatter Guard"

Electronic modulation indicator, reduces splatter tendency due to excessive audio gain. Transformer operated, AC power. Complete with RF probe and connecting cable.

### HA-10 Low Frequency Tuner

For use with SX-117 triple-conversion receiver. Covers 85 kc to 3.0 mc. Terminal for ext. antenna. Coaxial cable with connector plugs into receiver LF input.

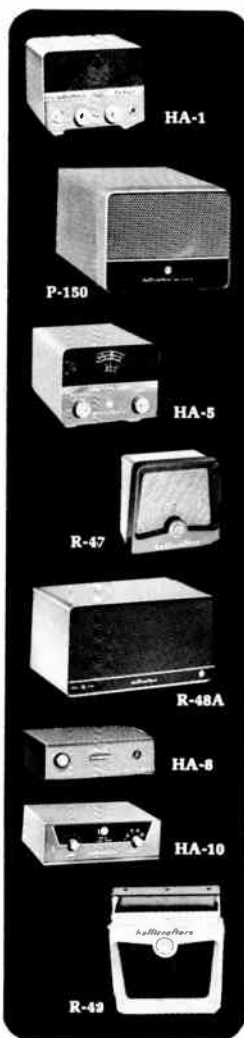

### P-150AC Power Supply

Use with SR-150, SR-160, and HT-44 at base. Styled to match SR-150. 5 silicon diode rectifiers, PM speaker.

### P-150 DC Mobile 12V. Power Supply for SR-150 and SR-160

### MR-150 Mobile mounting rack for SR-150

### MR-160 Mobile installation kit for SR-160

### CA-44 HT-44-SX-117 Transceive interconnecting cables.

### R-47 Speaker

For SX-110, SX-117, SX-122, SX-140 . . . For voice frequencies only . . . 3.2 ohm voice coil. Dimensions (WHD) 5 1/4" x 5 1/2" x 3 1/2".

### R-48A Speaker

Matching speaker for SX-62B, SX-110, SX-117, SX-122, SX-140 . . . 3.2 ohm voice coil. Switch selected full fidelity or voice response. Dimensions (WHD) 13 1/4" x 6 5/8" x 8 1/4".

### R-49 Mobile Speaker

Similar to R-48A, but for mobile service. Cone is moisture proof and swivel trunion bracket and four foot connection cable are provided.

## CHECK COUPON FOR FULL INFORMATION ON HALLICRAFTERS TEST INSTRUMENT KITS

For complete specifications on any item listed, just fill in this coupon and mail to Hallicrafters.

- |   |                                      |   |
|---|--------------------------------------|---|
| <input type="checkbox"/> SR-150               | <input type="checkbox"/> SX-122      | <input type="checkbox"/> P-150 AC       |
| <input type="checkbox"/> SR-160               | <input type="checkbox"/> SR-42/SR-46 | <input type="checkbox"/> P-150 DC       |
| <input type="checkbox"/> SX-117               | <input type="checkbox"/> HA-1        | <input type="checkbox"/> Mounting Racks |
| <input type="checkbox"/> HT-44                | <input type="checkbox"/> HA-5        | <input type="checkbox"/> CA-44          |
| <input type="checkbox"/> HT-45                | <input type="checkbox"/> HA-7        | <input type="checkbox"/> R-47           |
| <input type="checkbox"/> HT-40                | <input type="checkbox"/> HA-8        | <input type="checkbox"/> R-48A          |
| <input type="checkbox"/> SX-140               | <input type="checkbox"/> HA-10       | <input type="checkbox"/> R-49           |
| <input type="checkbox"/> Test Instrument Kits |                                      |   |

Name \_\_\_\_\_

Street \_\_\_\_\_

City \_\_\_\_\_ State \_\_\_\_\_ Zip \_\_\_\_\_

World Radio History

*"Quality through  
Craftsmanship"*



**hallicrafters**

Fifth & Kostner Aves., Chicago, Ill. 60624

Export: Hallicrafters International Div.





# FOR EVERY APPLICATION IMMEDIATELY AVAILABLE - FROM STOCK

Over 1,200 items to cover virtually every electronic application. . . 400 Hermetic items, proved to MIL-T-27B, eliminate costly test delays. . . Highest reliability in the field. . . Immediately available from your local distributor. Write for catalog.



## FILTERS



LOW PASS HIGH PASS BAND PASS 10 to 100,000 CYCLES.



TELEMETERING 400 to 70,000 CYCLES.



TELEGRAPH 425 to 3315 CYCLES.



VARIABLE STANDARD

## HIGH Q INDUCTORS



VARIABLE HERMETIC



DECADE INDUCTOR



LOW FREQ. TO 2500 HYS.



PERMALLOY DUST TROIDS HIGHEST Q, ACCURACY, STABILITY.

## TRANSISTOR AUDIO



DO-T

DI-T

SMALLEST SIZE

MINIATURE HERMETIC HIGHEST POWER

## COMPACT WIDE RANGE



OUNCER



PLUG-IN



ULTRA COMPACT

## HERMETIC POWER COMPONENTS

Military, Industrial



PLATE TO 6 KV CT



REACTORS TO 30ADC



FILAMENT 400 CYCLE

## PULSE



MINIATURE, WOUND CORE, .05 TO 25 uSec.

## HIGHEST FIDELITY



HERMALLOY



LINEAR STANDARD

BROADCAST AND HI-FI FAVORITES

## TRANSISTOR POWER



INVERTERS TO 550V .2A FROM BATTERY

TRANSISTOR SUPPLY TO 83V 9A

## LINE ADAPTORS



VOLTAGE ADJUSTORS STEPDOWN ISOLATION UNITS TO 2500 W.

## HERMETIC AUDIOS



FOR TUBE, TRANSISTOR, CHOPPER, AND MATCHING SERVICE .1 to 12 OZ.

## AMATEUR SERIES



COMPLETE LINE OF AUDIO & POWER FOR HAM, MARINE, ETC.

## MAGNETIC AMPLIFIERS



FOR SERVOMOTORS 2 TO 18 WATTS.

## COMMERCIAL GRADE



COMPLETE LINE OF AUDIO & POWER UNITS FOR COMMERCIAL EQUIPMENT.

## REPLACEMENT TYPES



AUDIO, POWER, FILAMENT AND REACTORS TO 5ADC

*And Special Units to Your Specifications*

## UNITED TRANSFORMER CORPORATION

150 Varick Street, New York 13, N. Y.

PACIFIC MFG. DIVISION: 3630 EASTHAM DRIVE, CULVER CITY, CALIF.  
EXPORT DIVISION: 13 EAST 40th STREET, NEW YORK 16, N. Y. CABLES "ARLAB"

# Start right

WITH HEATHKIT®

## LOW-COST GEAR FOR THE NOVICE "HAM"



### HEATHKIT HR-10 RECEIVER

- Covers amateur bands 80 through 10 meters • Tunes SSB, AM & CW signals • Prebuilt, pre-aligned tuning assembly • RF stage for extra sensitivity • Lattice-type crystal filter for high selectivity.

An ideal novice receiver! Easy to build with pre-assembled, aligned tuning unit; pre-cut, cabled wiring harness, and easy to follow instructions furnished! Versatile controls, large slide-rule dial, built-in "S" meter for easy tuning, built-in BFO for SSB & CW reception and a host of other high performance features designed into the HR-10 will delight any amateur radio fan! Features amateur band coverage only for maximum accuracy and stability. Provision for plug-in 100 kc crystal calibrator. A perfect style and performance mate to the DX-60A Phone & CW Transmitter!

Kit HR-10, 20 lbs. . . . \$8 dn., \$8 mo. . . . . \$79.95  
Kit HRA-10-1 Plug-in 100 kc crystal calibrator.

1 lb. . . . . \$8.95  
Export model available for 115/230 V. AC, 50-60 cps; write for prices.



### HEATHKIT DX-60A TRANSMITTER

- 90-Watts phone or CW on 80 through 10 meters • Neutralized 6146 final amplifier • Built-in low pass filter • Easy access to crystal sockets • Operates at reduced power for novice operation.

A tremendous value for the novice amateur! You'll be amazed at the superb signal quality, convenient operation and long-range capability of this transmitter on the amateur radio bands! Provides CW operation at the novice power limit and AM operation later as a general-class license holder. Clean, rugged construction, high quality components, and easy-to-follow instructions make assembly an easy, fun-filled task. Controlled-carrier modulator, and power supply are built-in. Single-knob bandswitching and Pi-network (coaxial) output provide for complete operating convenience. Panel meter monitors final grid or plate current for easy tuning. Less crystals.

Kit DX-60A, 24 lbs., \$8 dn., \$8 mo. . . . . \$79.95  
Export model available for 115/230 V. AC, 50-60 cps; write for prices.



## FREE! 108-PAGE HEATHKIT CATALOG!



Colorful! Contains the world's largest selection of electronic kits! See complete descriptions & specifications of Heathkit Amateur Radio equipment and accessories, as well as all Heathkit product lines . . . stereo/hi-fi, test & lab instruments, marine electronics, color TV, electronic organs, radios, CB & educational . . . over 250 kits! Learn how you can save up to 50% and more by building it yourself. Simply drop a card or note to *Heath Company, Benton Harbor, Michigan 49023.*



### HEATHKIT HG-10 VFO

This high quality Heathkit VFO requires only plug-in connection to the DX-60A transmitter to tune any frequency, any band from 80 through 10 meters! A tremendous savings over crystals for similar coverage! Beautifully designed throughout for years of top-notch performance & high stability.  
Kit HG-10, 12 lbs. . . .

\$4 dn., \$5 mo. . . . . \$34.95

# Stay right

## WITH HEATHKIT®

### DELUXE SINGLE SIDEBAND EQUIPMENT



#### SB-300 SSB RECEIVER

- Professional styling & features at 60% savings
- Covers 80 through 10 meters, crystals included
- Provision for VHF converters • Hermetically-sealed 2.1 kc crystal bandpass filter • Built-in 100 kc crystal calibrator • Smooth non-backlash vernier dial mechanism • Prebuilt, aligned Linear Master Oscillator (LMO), wiring harness and two heavy-duty circuit boards for fast, easy assembly • 100 cps stability.

Everything you could ask for in a professional receiver and more! Since its introduction, the SB-300 has received phenomenal acceptance by the amateur fraternity as one of the finest receivers of the decade! . . . a new dimension in quality, performance and dependability never before thought possible in a kit form instrument. Unique mechanical design with prebuilt LMO provides smooth, non-backlash tuning with 100 cps stability. Linear 1 kc dial calibrations and 100 kc per dial revolution provide bandspread equal to 10 feet per megacycle. Write for full specifications today!

Kit SB-300, less speaker,  
22 lbs., \$27 dn., \$22 mo. . . . . \$265.00



#### SB-400 SSB TRANSMITTER

- 180 watts PEP, SSB, 170 watts CW • All crystals included for 80 through 10 meter coverage • Built-in power supply • LMO frequency control • Automatic level control • Built-in antenna change-over relay • Crystal filter-type SSB generation • Operates SSB (upper or lower sideband) & CW • Complete transceive capability with SB-300 Receiver • Linear 1 kc dial calibration.

Following the same high standards set by the Heathkit SB-300 Receiver, the new SB-400 Transmitter offers a matching counterpart for complete transceive capability with a host of advanced design features to bring you professional performance and quality at tremendous savings! A prebuilt Linear Master Oscillator (LMO) and crystal SSB filter, two circuit boards and three wiring harnesses assure fast, easy assembly. Enjoy a new "high" in operating convenience and versatility with all the deluxe features you need for finest amateur radio communications . . . write for full specifications today!

Kit SB-400, 33 lbs., \$33 dn., as low as \$22 mo. . . . \$325.00  
Export model available for 115/230 V. AC, 50-60 cps;  
write for prices.

#### HEATHKIT SB-200 KILOWATT LINEAR AMPLIFIER!



- 1200 watts P.E.P. input SSB — 1000 watts CW • 80 thru 10 meter band coverage • Built-in SWR meter — antenna relay — solid-state power supply • Automatic Level Control (ALC) • Shielded, fan-cooled amplifier compartment • Pretuned cathode input circuit for maximum efficiency & low distortion • Circuit breaker power supply protection — no fuses • Designed for 120/240 volt operation.

**Easy-To-Build, Lightweight!** Simple assembly is assured with clean, open circuit layout and high quality, well-rated components. Employs two 572B/T-160L tubes in efficient grounded grid circuit. The modern low-profile styling and light 35 lb. weight make it an ideal desk-top linear!

Kit SB-200, 42 lbs., \$20 dn., \$17 mo. . . . . \$200.00



Whatever frequencies you plan to work...  
there's a **hy-gain** ANTENNA  
designed to give you maximum performance



Send for your **FREE COPY** of a Hy-Gain Full Line Catalog today. Verticals—Beams—Mobiles—for 80 through  $\frac{3}{4}$  Meters...every antenna completely described and illustrated.

**HY-GAIN ANTENNA PRODUCTS CORPORATION**  
8405 N.E. Highway 6—Lincoln, Nebraska

*The World's Largest Manufacturer of HF Communications Antennas*





## Collins 62S-1



**gives you full  
6 & 2 meter  
operation  
with only the  
flip  
of a switch**

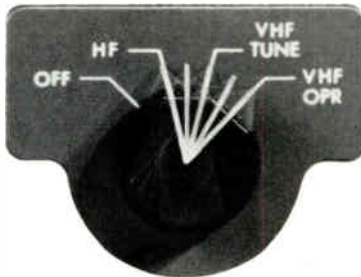

There's no cable change to make, either. The new Collins 62S-1 VHF Converter is a self-contained (using exciter's high voltage) unit and supplies a 3 to 5 db noise figure on receive . . . 160 watts PEP input on transmit.

You can use this new Collins converter to cover 49.6 to 54.2 mc and 143.6 to 148.8 mc (crystals for amateur bands provided). Crystal switching from the front panel tuning knob provides a choice of any one of twenty-three 200 kc bands in the 6 and 2 meter range.

The 62S-1 is system engineered for the S/Line/KWM-2 and requires no additional power supply when used with this equipment. It offers you excellent cross mod rejection from simple narrow banding of front end for 200 kc tuning range, and gives easy, accurate readout and 1 kc calibration on VHF. Here's something else. The Collins 62S-1 will convert most equipment operating in the 14.0 to 14.2 mc range.

The 62S-1 weighs 25 lbs. and measures 6½" H, 13" W, and 14¾" D.



## The Collins S/Line: System engineered to give you the cleanest signal on amateur bands

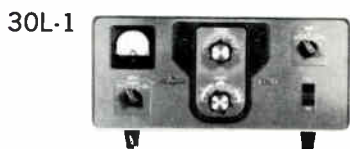
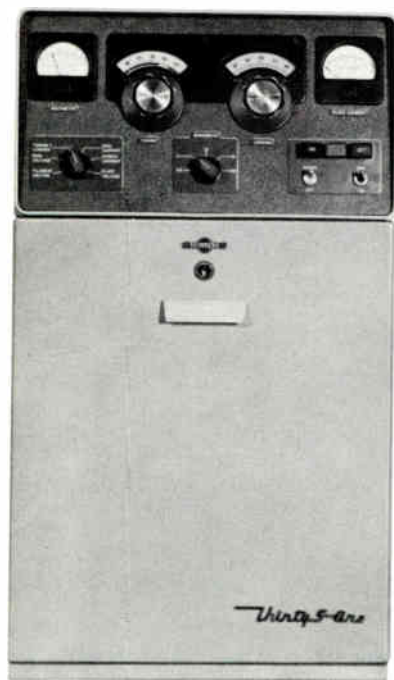

30S-1

Collins famous S/Line is engineered on the systems concept. Each piece of equipment in the line augments the other. When you interconnect a Collins S/Line receiver and transmitter, you can operate them as a transceiver. A frequency control switch provides for separation of transmit and receive operation. Systems engineering like this is the reason why more and more advanced radio operators look to Collins for the finest in SSB/CW performance. The modern look of Collins S/Line equipment is something else you'll like. It's finished in gray tones. It has smooth, clean lines and the front panels are of dark gray simulated leather. A handsome rig in your ham shack, den or family room. Ask your distributor about trade-in value of Collins S/Line equipment — you'll realize how little it costs to operate the finest.

### 32S-3 Transmitter

The 32S-3 is an SSB or CW transmitter with nominal output of 100 watts from 3.4 to 29.7 mc (except 5.0 to 6.5 mc). Choice of thirteen 200 kc bands covers all amateur bands except 10 meters, where one 200 kc band crystal is supplied with provision for two additional crystals.

The 32S-3 features Mechanical Filter sideband generation, permeability-tuned VFO, crystal-controlled HF oscillator, RF inverse feedback and automatic load control. The 32S-3 has grid block keying, spotting control, keying hardness control and sidetone level adjust.

The 32S-3 can operate transceive by using oscillator injection voltages supplied by the 75S-3B or any of the 75S-( ) series receivers.

### 312B-4 Speaker Console

The 312B-4 provides a unitized control for the S/Line or the KWM-2. It houses a speaker, RF directional wattmeter with 200- and 2000-watt scales, and switches for station control functions.

### 75S-3B Receiver

The 75S-3B provides SSB, CW and AM reception between 3.4 and 30 mc (except 5.0-6.5 mc) by selection of the appropriate HF heterodyning crystals. Crystals furnished cover HF amateur bands except the 10 meter band, where one crystal is supplied plus provision for two more.

Features incorporated in the 75S-3B include dual conversion with a crystal-controlled first heterodyning oscillator; *bandwidth filters selected by a front panel function switch*; band-pass first IF; stable permeability-tuned VFO; RF amplifier designed to minimize cross-modulation products; 2.1 kc Mechanical Filter; excellent AGC characteristics; both product and diode detector; rejection notch filter; manual and crystal-controlled BFO; and AGC time constant control. The advanced design of the 75S-3B includes the use of only 150 volts on vacuum tube plates, use of silicon diodes in lieu of conventional high vacuum rectifier; and the choice of two degrees of CW selectivity (with optional plug-in filters). Provision for obtaining power from a dc power supply.

With the new Collins 75S-3B, you can be assured of the finest amateur receiver available for reception of the CW, SSB or RTTY modes.

### 30S-1 and 30L-1 Linear Amplifiers

The 30S-1 is a completely self-contained, single

tube, grounded grid linear amplifier. Requiring 70 to 100 watts driving power (from the 32S-3 or KWM-2), it provides the full legal power input for SSB, CW or RTTY. The tube used is the Eimac 4CX1000A. The 30S-1 may be used on any frequency between 3.4 and 30 mc. A special comparator tuning circuit allows tune-up at low power to avoid exceeding the legal dc input of 1 kw. Push-button selection of linear amplifier or exciter output from the front panel. Antenna relay included. Conservatively rated.

The compact 30L-1 Linear (same size as the KWM-2) provides for 1 kw PEP input on SSB (500 watts average dc) and 1000 watts average on CW, and has a self-contained power supply. It is designed to be driven by Collins KWM-1, KWM-2 or 32S-3, as well as from most other 70-100 watt CW/SSB exciters. The unit also features RF inverse feedback; automatic load control; silicon rectifiers and a high/low power switch. Instant warm-up time. Automatic antenna switching from exciter to amplifier included.

### KWM-2 SSB Transceiver

This versatile transceiver serves both fixed station and mobile needs on any fourteen 200 kc bands between 3.4 and 30 mc (except 5.0 to 6.5 mc). Crystals are provided for all HF bands except 10 meters where one crystal is supplied with provision for two additional crystals.

It operates on 80 through 10 meters with 175 watts PEP input on SSB or 160 watts on CW.

Top features of the KWM-2 are filter-type SSB generation, Collins permeability-tuned oscillator, crystal-controlled HF double conversion oscillator, VOX and anti-trip circuits, automatic load control and RF inverse feedback.

### Extended Frequency Versions Of the S/Line

The 75S-3B is available in an extended frequency version, designated the 75S-3C. The receiver differs from the original in that an additional crystal board has been added beneath the chassis. In this board is placed the standard complement of ham band crystals normally supplied with the equipment. The upper board is available for the placement of whatever additional crystals may be desired up to a total of 14. A front panel switch is added to allow switching between the two crystal boards.

# Collins S/Line and KWM-2 Accessories



**302C-3 Directional Wattmeter** — Measures forward and reflected power on 200- and 2000-watt scales with accuracy and without calibrating adjustments. Coupler unit mounts separately from indicator-control box. Power loss and mismatch introduced by the instrument are negligible. Fixed or mobile applications.

**351E Table Mounts** — For mounting the S/Line and KWM-2 and accessories on planes, boats, etc. May be fastened to any flat surface. Front clamps attach to the feet of the units to hold them securely.

**351D-2 Mobile Mount** — Provides secure mounting for KWM-2 in most automobiles. Cantilever arms fold out of the way when the unit is removed. Mating plugs connect power, receive-transmit antenna, noise blanker antenna, speaker and antenna control as KWM-2 slides into place. Power Supply Cable included.

**DL-1 Dummy Load** — A 100-watt resistive load for all HF frequencies. Connects permanently in antenna coax line. Front panel or remote switch allows selection of "antenna" or "load." Provides easy comparison of antenna SWR and non-band interference tune-up. Will absorb 30L-1, 30S-1 outputs for short periods. Choice of Type N or RCA antenna connectors.

**312B-5 Speaker Console and External PTO** — Used with the KWM-2 in fixed station operation to provide separation of receive and transmit frequencies, speaker, directional wattmeter, plus switching for functional control of system. Styled to match KWM-2.

**136B-2 Noise Blanker** — An accessory for the KWM-2 for mobile operation. This noise blanker provides effective reduction of impulse-type noise — particularly ignition noise. Requires separate antenna resonant at 40 mc. Properly installed, this 136B-2 can be the difference between operating and not operating when around other cars.

**312B-3 Speaker** — Contains a 5" x 7" speaker and connecting cable. Styled to match receiver, transmitter.

**516F-2 AC Power Supply** — Operates from 115 v ac, 50-60 cps. Provides all voltage for the 32S-3 and KWM-2. Cabinet has provision for mounting a speaker styled to match the KWM-2.

**MP-1 Mobile Power Supply** — A transistorized inverter powered from a 12-v automobile, aircraft, or boat storage battery to the voltages required for operation of the KWM-1, KWM-2 or KWM-2A. Wiring cable is normally supplied with 351D-2.

**440E-1 Cable** — For use with MP-1 when the 351D-2 mount is not used. 22' long with plug to match KWM-2 on one end; provision for solder lugs on opposite end.

**PM-2 Portable Power Supply** — The new PM-2 is

compact, lightweight, and provides all voltages needed for the KWM-2. Connects easily and quickly to rear of KWM-2. Operates from either 115 v ac or 220 v ac at 50-400 cps to provide a completely portable SSB and CW station. Contains a small speaker. The PM-2 and KWM-2 may be carried in the CC-2 carrying case.

**MM-1 Mobile Microphone** — A dynamic microphone designed to fit comfortably in your hand. A 5' length of coiled cord and attached PJ-068 is supplied with the 22-ounce microphone. For use with the KWM-2 or the S/Line. Push-to-talk switch. Hanger bracket furnished. Brushed aluminum finish.

**MM-2 Boom Microphone** — A high-impedance reluctance microphone/single earphone combination for fixed or mobile operation. PTT not required; operates with VOX control. Sponge-padded headband clasps head firmly but lightly. Microphone boom and ear pipe adjustable for proper fit. Cord and attached plugs furnished.

**CC-2 Carrying Case** — Specially designed Samsonite Silhouette case for the KWM-2/PM-2 or 30L-1. Attractive molded Royalite interior protects equipment against rough handling. Two spare pockets.

**SM-1 Desk-Top Microphone** — A high-impedance, dynamic mike with styling and output level to match S/Line and KWM-2. Satin aluminum finish. Five-foot coiled cord and attached PJ-068 plug furnished.

**SM-2 Desk-Top Microphone** — A high-impedance, dynamic mike with styling and output level to match S/Line and KWM-2. Gray and chrome finish.

**351R-1 Rack Adapter** — Matching gray rack panel with hardware for mounting 75S, 32S, KWM-2 or 30L-1. Supporting shelf holds unit securely.

**351R-2 Rack Adapter** — Matching gray rack panels with hardware for rack mounting S/Line and KWM-2 accessories, 516F-2, 399C-1, 312B-4 and 312B-5. Supporting shelf holds unit securely.

**399B-4 Novice Adapter** — Plugs into 32S to provide four crystal-controlled channels for novice operation of 32S. Crystals not furnished.

**399B-5 Novice Adapter** — Plugs into KWM-2 to provide four crystal-controlled channels on transmit. Receiver remains PTO tuned. Crystals not furnished.

**Optional Filters** — Plug-in filters for the 75S-3B provide bandwidths of 200, 500, 800 and 1500 cps for CW applications; 2.1 kc for SSB; and 3.1, 4.0 or 6.6 kc for AM reception.

**For further information on the Collins S/Line and accessories, see your nearest authorized Collins distributor.**



At "Ham Headquarters, USA"®



## A HARRISON HAM SPECIALIST HELPS YOU SAVE WITH SAFETY

It's not hard to get the finest ham equipment for your needs...if money is no object. And there's no trick to saving dollars on equipment...if you're willing to take a chance on quality and performance. But, getting what's best for you while saving *safely* is something else again. And hams by the hundreds will tell you it's something you can *count on* when you choose your gear with the help of Harrison's staff of fully qualified ham specialists.

**An expert by your side...and ON your side...** a Harrison ham specialist with a wealth of radio know-how that can steer you away from costly mistakes. He's sure to have seen problems like yours many times before...and he's always delighted to show you how to solve them economically. You can rely upon his ability to help you and because *we're* so sure of it we guarantee 100% satisfaction with every piece of gear you buy from us!

**World's largest inventory** of new and used equipment is still further assurance that you'll find exactly what you want at Harrison.

**Highest trade-in allowance** for your present gear is waiting for you here, too. Our sales are the biggest in the field, so we work on a smaller margin per unit with substantial savings for you.

**Charge-card convenience and installment plans to fit you**—if you don't yet have a Harrison charge account, ask, phone or write for simple application form. Harrison tailors time payments to fit your budget—just ask for the deal you want.

Come in soon—browse and compare the *real* values. Discover the many reasons—as thousands of hams have done—why it pays to shop at "Ham Headquarters, U.S.A." Make us prove to you, as we've proved to hams since 1925, that Harrison can help you save with safety.

73 *Bil Harrison* W2AVA

# HARRISON

Mail orders carefully and promptly filled.

225 Greenwich Street • New York, N. Y. 10007 • (212) BA 7-7922  
(In Long Island: 139-20 Hillside Avenue, Jamaica RE 9-4101)

SPECIAL! Send \$1.00 to Dept. LM for new Harrison 43" x 33" Radio Operators' World Reference Map postpaid.

# Open the door with a



Excellent dollar value—solid performance—dozens of features—and an unmatched reputation for reliability—that's why, whether you're a novice or experienced amateur, it will pay you to investigate E. F. Johnson Company's complete line of Viking Amateur Radio Equipment!

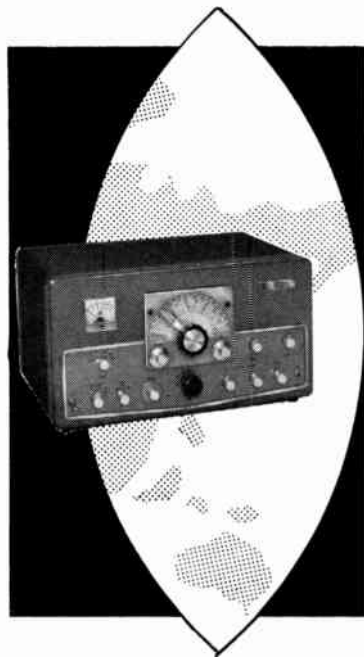

**"CHALLENGER"**—Ideal for fixed station or portable use. 70 watts phone input 80 through 6 meters—120 watts CW input 80 through 10 and 85 watts CW input on 6 meters. Crystal or external VFO control—TVI suppressed—wide range pi-network output. With tubes.

<b>Cat. No.</b>	<b>Net</b>
240-182-1 . Kit .....	\$124.75
240-182-2 . Wired .....	\$169.75



**"6N2"**—This compact VHF transmitter is rated at 150 watts CW and 100 watts phone. Bandswitching 6 and 2 meters—may be used with "Ranger II" or similar power supply/modulator combinations. Crystal control or external VFO with 8-9 mc output. With tubes, less crystals, key and microphone.

<b>Cat. No.</b>	<b>Net</b>
240-201-2 . Wired .....	\$194.50

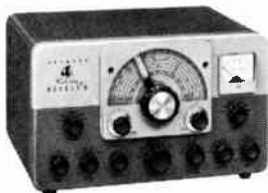

**"RANGER II"**—Now—a new version of the popular "Ranger" transmitter. 75 watts CW or 65 watts phone input. Also serves as an RF/audio exciter for high power equipment. Completely self-contained, instant bandswitching 160 through 6 meters! Operates by built-in VFO or crystal control. High gain audio—timed sequence keying—TVI suppressed. Pi-network load matching from 50 to 500 ohms. With tubes, less crystals, key and microphone.

<b>Cat. No.</b>	<b>Net</b>
240-162-1 . Kit .....	\$249.50
240-162-2 . Wired .....	\$359.50



**"6N2 THUNDERBOLT"**—1200 watts (twice average DC) input SSB and DSB, Class AB1; 1000 watts CW, Class C; and 700 watts input AM linear. Continuous bandswitched coverage on 6 and 2 meters. TVI suppressed. Drive requirements; approx. 5 watts Class AB1 linear, 6 watts Class C CW. With tubes and built-in power supply.

<b>Cat. No.</b>	<b>Net</b>
240-362-2 . Wired .....	\$549.50

**"VALIANT II"**—Bandswitching 160 through 10 meters—delivers 275 watts input CW or SSB (with auxiliary SSB exciter or Viking SSB adapter) and 200 watts AM! Low level audio clipping—differentially temperature compensated VFO provides stability necessary for SSB operation! High efficiency pi-network tank circuit—final tank coil silver-plated. TVI suppression; time sequence (grid block) keying; high gain push-to-talk audio built-in low pass audio filter; self-contained power supply; and single control mode switching. As exciter drives popular kilowatt level tubes and provides quality speech driver system for high power modulators. Provision for plug-in SSB operation with no internal modification. With tubes, less crystals.

<b>Cat. No.</b>	<b>Net</b>
240-105-1 . Kit .....	\$375.00
240-105-2 . Wired, tested.	\$495.00

## COMPACT, 10-METER TRANSCEIVER

10 watts input AM—instant selection of five pre-tuned frequencies in 29.4 to 29.7 mc. range, within 300 kc segment of the 10-meter band. 10 tubes (including rectifier)—built-in ANL, AVC, and "squelch". Transmitter designed with 7054 crystal oscillator coupled to a high gain 7061 final amplifier. Self-contained power supply. With tubes, microphone and crystals for 29,640 kc. Accommodates up to 4 additional crystal pairs.

<b>Cat. No. 242-202</b> . 115V and 6V .....	<b>Net \$139.75</b>
<b>Cat. No. 242-203</b> . 115 V and 12V .....	<b>Net \$139.75</b>



# to world-wide adventure Viking Transmitter!



**"SSB ADAPTER"**—Filter-type SSB generator—bandswitching 80 through 10 meters . . . more than 50 db sideband suppression . . . more than 45 db carrier suppression! When used with the Viking "Valiant" or "Valiant II" places 275 watts P.E.P. at your command. Two compact units and interconnecting cables . . . RF unit only 8" wide—power supply may be placed in any convenient location. Built-in multiplier requiring VFO input only—band-pass interstage couplers require no tuning—design and front panel make operating practically foolproof. Superb audio fidelity and balanced audio response; excellent sideband, spurious and carrier suppression. Other features: positive VOX and anti-trip circuits with built-in anti-trip matching transformer and adjustable VOX time delay. With remote power supply, tubes and crystal filter, less microphone.

**Cat. No.** **Net**  
240-305-2 . . . Wired, tested. \$269.50

**INVADER**—More exclusive features than any other transmitter/Exciter on the market today! Specially developed high frequency, symmetrical, multi-section band-pass crystal filter for more than 60 db sideband suppression—more than 55 db carrier suppression! Instant band-switching 80 through 10 meters—no extra crystals to buy—no realigning necessary. Delivers a solid 200 watts CW input; 200 watts P.E.P. SSB input; 90 watts input on AM! (25-30 watts output—upper sideband and carrier). Built-in VFO—exclusive RF controlled audio AGC and ALC (limiter type) provide greater average speech VOX and anti-trip circuits. Fully TVI suppressed. Self-contained heavy-duty power supply. With tubes and crystals.

**Cat. No.** **Net**  
240-302-2 . . . Wired, tested. \$619.50

**HIGH POWER CONVERSION**—Take the features and performance of your "Invader" . . . add the power and flexibility of unique "Hi-Power Conversion" system . . . and you're "on the air" with the "Invader 2000". Includes everything needed for conversion in one evening.

**Cat. No.** **Net**  
240-303-2 Wired, tested. \$619.50

**INVADER 2000**—All features of the "Invader", plus added power and flexibility of integral linear amplifier and remote controlled power supply. Rated a solid 2000 watts P.E.P. (twice average DC) SSB, 1000 watts CW, and 800 watts AM! (250 to 300 watts output—upper sideband and carrier.) Wide range output circuit (40 to 600 ohms adjustable). Final amplifier provides exceptionally uniform "Q". Heavy-duty multi-section power supply. With power supply, tubes and crystals.

**Cat. No.** **Net**  
240-304-2 Wired. . . . . \$1229.00

## FREE CATALOG—

E. F. Johnson Company also manufactures a complete line of station accessories and keys and practice sets. Write for your free catalog today!



## E. F. JOHNSON COMPANY

1102 Tenth Avenue S.W.

Waseca, Minnesota



# International Crystals...

*the first choice of the Radio Amateur*

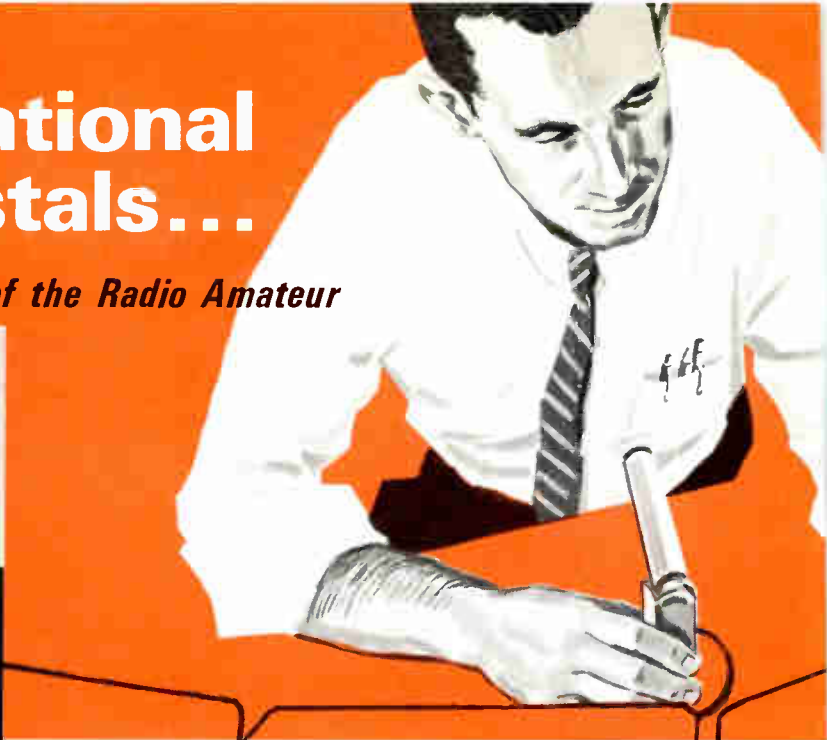
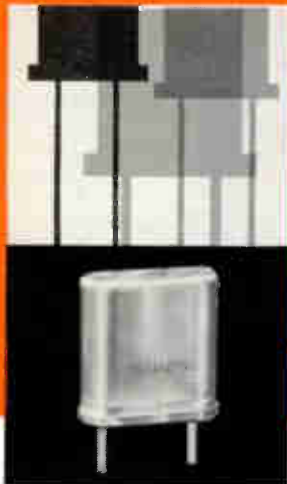

## NOW...DIRECT CRYSTAL CONTROL to 160 mc

- PORTABLE SIGNAL STANDARDS
- SIGNAL GENERATORS FOR RECEIVER ALIGNMENT
- BAND EDGE MARKERS

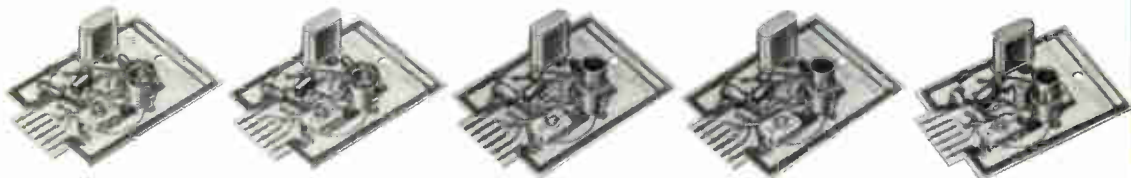

### HIGH FREQUENCY (20 mc - 160 mc)

Five transistor oscillators covering 20 mc-160 mc. Standard 77°F calibration tolerance  $\pm .0025\%$ . The frequency tolerance is  $\pm .0035\%$ . Oscillator output is .2 volts (min) across 51 ohms. Power requirement: 9 vdc @ 10 ma. max.

OSCILLATOR TYPE	OSCILLATOR RANGE	CRYSTAL TYPE	TEMPERATURE TOL. -40°F to 150°F	OSCILLATOR (LESS CRYSTAL) PRICE	CRYSTAL FREQUENCY	CRYSTAL PRICE
OT-24	20-40 mc	CY-7T	$\pm .0035\%$	\$ 9.10	20-60 mc	\$ 6.90
OT-46	40-60 mc	CY-7T	$\pm .0035\%$	9.10	60-100 mc	12.00
OT-61	60-100 mc	CY-7T	$\pm .0035\%$	15.00	101-140 mc	15.00
OT-140	100-140 mc	CY-7T	$\pm .0035\%$	15.00	141-160 mc	18.00
OT-160	125-160 mc	CY-7T	$\pm .0035\%$	15.00		



FOT-20



FOT-10

### AOC OSCILLATOR CASES

Small portable cases for use with the OT series of plug-in oscillators. Prices do not include oscillators.

(When oscillator and crystal are ordered with FOT-10 case a 77°F tolerance of  $\pm .001\%$  may be obtained at \$2.00 extra per oscillator/crystal unit. When oscillator/crystal units are ordered with FOT-20 case, a single unit can be supplied with temperature calibration over a range of 40°F to 120°F. Correction to  $\pm .0005\%$ . Add \$25.00 to the price of FOT-20 and oscillator/crystal unit.)



**FOT-20** For high accuracy calibration requirements. Includes battery and output jack, output meter circuit and battery check, as well as thermistor temperature measuring circuit.

**\$87.50**

**FOT-10** Basic case with battery and output jack for general wider tolerance applications.

**\$14.50**

**MT-1** Oscillator board mounting kit.

**\$4.95**

Order direct from International Crystal Mfg. Co.



## THE AMATEUR WHO SELECTS INTERNATIONAL CRYSTALS FOR HIS COMMUNICATION GEAR PROBABLY KNOWS THESE IMPORTANT FACTS:

- Every amateur crystal is manufactured by the same skilled craftsmen who make International commercial crystals.
  - International crystals are the product of a continuing research and development program.
  - International crystals are designed and manufactured to operate under all types of field conditions . . . fixed or mobile.
  - International crystals are used in all major makes of commercial two-way radio equipment.
  - International customers include broadcast stations, airlines, military services, Civil Air Patrol, taxicabs.
  - International crystals and electronic components are used in the United States missile and space research program.
  - All International crystals are guaranteed against defective materials and workmanship for an unlimited time when used in equipment for which they were specifically made.
- Whether you are an amateur building your first transmitter or an engineer with special crystal requirements, look to International for precision frequency control.

## with AOC PLUG-IN TRANSISTOR OSCILLATORS

- FREQUENCY MARKERS FOR OSCILLOSCOPES
- QUICK-CHANGE PLUG-IN OSCILLATORS
- ACCESSORY CASES

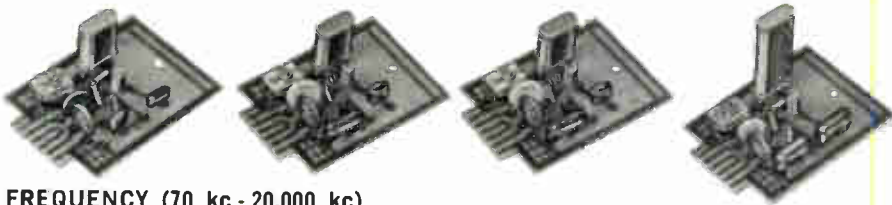

### LOW FREQUENCY (70 kc - 20,000 kc)

Four transistor oscillators covering 70 kc - 20,000 kc. Trimmer capacitor for zeroing crystal. When oscillator is ordered with crystal the standard will be  $\pm .0025\%$ . Oscillator output is 1 volt (min) across 470 ohms. Power requirement: 9 vdc @ 10 ma. max.

OSCILLATOR TYPE	OSCILLATOR RANGE	CRYSTAL TYPE	TEMPERATURE TOL. -40°F TO +150°F	OSCILLATOR (LESS CRYSTAL) PRICE	CRYSTAL FREQUENCY	CRYSTAL PRICE
OT-1	70-200 kc	CY-13T	$\pm .015\%$	\$7.00	70-99 kc	\$22.50
OT-2	200-5,000 kc	CY-6T	200-600kc $\pm .01\%$	7.00	100-200 kc	15.00
			600-5,000kc $\pm .0035\%$	7.00	200-499 kc	12.50
OT-3	2,000-12,000 kc	CY-6T	$\pm .0035\%$	7.00	500-849 kc	22.50
					850-999 kc	15.00
OT-4	10,000-20,000 kc	CY-6T	$\pm .0035\%$	7.00	1,000-1,499 kc	9.80
					1,500-2,999 kc	6.90
					3,000-10,999 kc	4.90
					11,000-20,000 kc	6.90

**KEEPING YOU ON FREQUENCY IS OUR BUSINESS**

Write for International's complete catalog of precision made crystals and quality electronic equipment.



**TERMALINE<sup>®</sup>** Are direct reading instruments for absorbing and measuring RF power in 50-ohm coaxial line systems through the frequency of 2 to 1000 mc. The load section of the TERMALINE Wattmeter serves as a dummy load. The indicating meter is calibrated to read RF power directly in watts with  $\pm 5\%$  of full scale accuracy. TERMALINE Wattmeters are available from milliwatts to kilowatts.



6154

67

Maximum Power	Calibrated Frequency Range	Power Scales Available	Connector	Model	U.S. Price
<b>50-OHM AIR-COOLED MODELS</b>					
2w	30-500mc	25, 50, 100, 250, 500, 1000 milliwatts, 2 watts	BNC/F	6254	\$ 85
60w	30-500mc*	Dual range: 0-15/0-60w	N/F	611	175
80w	30-500mc*	Dual range: 0-20/0-80w	N/F	612	175
80w	30-500mc*	Choice of two compatible scales (eg.: 1-5w, 5-25w, 2-20w)	N/F	61	220
150w	30-500mc*	Dual range: 0-30/0-150w	N/F	6150	225
150w	25-1000mc**	Four range: 0-5/0-15/0-50/0-150w	N/F	6154	265
500w	30-500mc*	Triple range: 0-25/0-100/0-500w	QC <sup>(1)</sup>	67	350
1000w	2-30mc	0-1000w	QC <sup>(1)</sup>	694	365
1200w	30-500mc	Triple range: 0-120/0-600/0-1200w	QC <sup>(1)</sup>	6835	485
<b>50-OHM WATER-COOLED MODELS</b>					
2500w	30-500mc*	Triple range: 0-100/0-500/0-2500w	QC <sup>(1)</sup>	67C	\$390
5000w	2-40mc	0-5000w	QC <sup>(2)</sup>	8245	535

\*Special calibration to 1000mc available at time of order.

\*\*25-500mc  $\pm 5\%$ , 500-1000mc  $\pm 10\%$  Accuracy



# BIRD QUALITY INSTRUMENTS FOR RF POWER MEASUREMENT

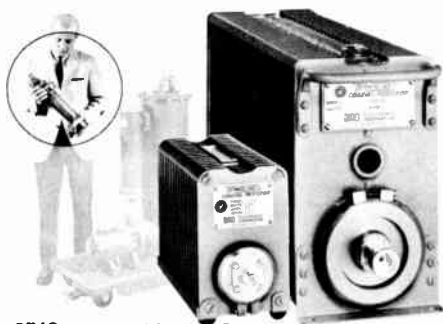

8740  
8750

502

8135

8890  
8329

**TERMALINE<sup>®</sup>** For accurate, non-radiating termination of 50-ohm RF coaxial transmission lines **LOAD RESISTORS** are designed for use in permanent installations, development testing and trouble shooting of transmitters, intermediate components, power tubes, and accessories.

**TENULINE<sup>®</sup>** In addition to terminating a 50-ohm system, deliver an output signal 30db or 40db below the input, for RFI measurements, for extending the range of low-power watt meters by a factor of  $10^3$  or  $10^4$ , etc.

<sup>(1)</sup> Female N normally supplied.

<sup>(2)</sup> Female LC normally supplied.

See other QC Connector choices in for right column.

Max. Power	Freq. Range	Max. SWR	Input Connector	Model	U.S. Price
<b>AIR COOLED</b>					
5w	0-4kmc	1.2	N/M or F	80	\$ 25
5w	0-4kmc	1.2	C, BNC, TNC, M or F	80	30
20w	0-2kmc	1.2	N/F	80A	30
50w	0-4kmc	1.2	QC <sup>(1)</sup>	8130	49
80w	0-4kmc	1.2	N/F	81B	65
150w	0-4kmc	1.2	QC <sup>(1)</sup>	8135	75
500w	0-2.5kmc	1.25	QC <sup>(1)</sup>	8201	165
1000w	0-1 kmc	1.1	QC <sup>(2)</sup>	8251	365
1000w	0-2.5kmc	1.25	QC <sup>(2)</sup>	8833	365
1000w	0-2kmc	1.25	1 1/8" EIA Flg.	8813	365
1200w	0-1 kmc	1.1	3/8" Unflg.	887**	365
1200w	0-2kmc	1.25	3/8" EIA Flg.	888	375
2500w					
5000w*	0-2kmc	1.25	QC <sup>(2)</sup>	8890	410
2500w					
5000w*	0-1 kmc	1.1	3/8" EIA Flg.	8891	425
2500w					
5000w*	0-1 kmc	1.1	1 1/8" EIA Flg.	8892	415
<b>WATER COOLED</b>					
2500w	0-2.5kmc	1.25	QC <sup>(2)</sup>	8230	\$180
5000w	0-2.5kmc	1.25	QC <sup>(2)</sup>	8246	450
7.5kw	0-500mc	1.3	3 1/8" Unflg.	8781	820
7.5kw	0-500mc	1.3	3 1/8" EIA Flg.	8783	975
15kw	0-500mc	1.1	3 1/8" EIA Flg.	8740	1850
25kw	0-500mc	1.1	3 1/8" EIA Flg.	8750	2350
25kw	0-500mc	1.3	3 1/8" Unflg.	502**	2150
25kw	0-500mc	1.3	3 1/8" EIA Flg.	5025	2300
50kw	0-500mc	1.3	6 1/8" Unflg.	890**	3300
50kw	0-500mc	1.3	6 1/8" EIA Flg.	8903	3600
<b>ATTENUATORS (AIR COOLED) 30db or 40db</b>					
500w	0-1 kmc	1.1	QC <sup>(1)</sup> in, <sup>(1)</sup> out	8325	\$400
2000w	0-1 kmc	1.1	QC <sup>(2)</sup> in, <sup>(1)</sup> out	8329	600
4000w*	0-1 kmc	1.1	QC <sup>(2)</sup> in, <sup>(1)</sup> out		

\*Continuous power rating with BA-88 Blower Accessory \$250. \*\*51.5 ohms.

**THRULINE®** Insertion instruments for measuring and monitoring incident and reflected power in coaxial transmission lines with  $\pm 5\%$  of full scale accuracy. Insertion VSWR is less than 1.05. Net power under any load condition is the difference between incident and reflected power readings, which also yield load VSWR from a nomograph.

ThruLine Model	Connectors	Plug-in Elements		U.S. Price
		Frequency (MC)	Power Ranges (Watts)	
43	QC(1)			\$ 95
Order one or more elements with your ThruLine Wattmeter to suit your frequency and power ranges.	2-30		50, 100, 250, 500, 1000, 2500, 5000	\$ 30 each
		25-60, 50-125	5, 10, 25, 50, 100, 250, 500, 1000, 2500	
	100-250, 200-500, 400-1000	5, 10, 25, 50, 100, 250, 500, 1000	\$ 50 each	
	60-80, 80-95, 95-125, 110-160, 150-250, 200-300, 275-450, 425-850, 800-950	1 Watt		
	60-80, 80-95, 95-150, 150-250, 200-300, 250-450, 400-850, 800-950	2.5 Watts		
950-1260, 1100-1800, 1700-2200	1, 2.5, 5, 10, 25	\$ 75 each		

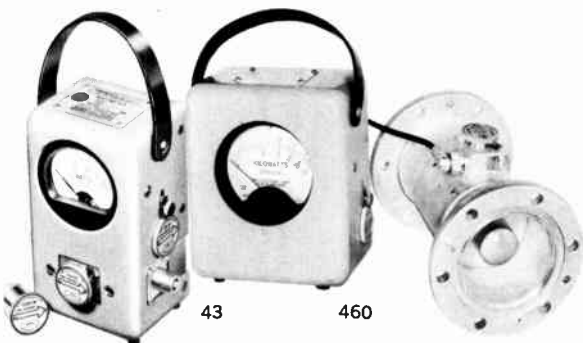

ThruLine Model	Connectors	Plug-in Elements		U.S. Price
		Frequency (MC)	Power Ranges (kilowatts)	
4712	1 1/2" EIA Flanged			\$206
		2-30	1, 2.5, 5, 10, 25	\$ 50 each
		25-60, 50-125	.25, .50, 1, 2.5, 5, 10, .1-1.25, .2-.5, .4-1 kmc	
		.1-1.25, .2-.5, .4-1 kmc	.25, .50, 1, 2.5, 5	
4717	1 1/2" EIA Flanged			\$206
1.1 VSWR, $\pm 10\%$ accuracy.		950-1260, 1100-1800, 1700-2200	.25, .5, 1, 2.5	\$ 75 each
460	3/8" EIA Flanged			\$235
480	3/4" Unflanged			\$161
		2-30	5, 10, 25, 50, 100	\$ 50 each
		25-60, 50-125, 100-250, 200-500, 400-1000	1, 2.5, 5, 10, 25	
4902	6 1/8" EIA Flanged			\$600
490	6 1/8" Unflanged			\$450
		2-30	25, 50, 100, 250	\$ 50 each
		25-60, 50-125	2.5, 5, 10, 25, 50	
		100-250, 200-500, 400-1000		
4910	9" EIA Flanged	Per Customer Specifications		
4310	QC(1)			\$149
Full scale peak power elements for pulsed systems $\pm 10\%$ accuracy.		2-30	.1, .25, .5, 1, 2.5, 5, 10	\$ 50 each
		25-60, 50-125, 100-250, 200-500, 400-1000, 950-1260	.05, .1, .25, .5, 1, 2.5, 5, 10	

**4310 THRULINE®** For pulsed RF systems such as air navigational aids, telemetry, radar, etc. from 0.1 microsecond pulse width.

**COAXIAL RF FILTERS** Custom engineered or field-proven designs. High rejection attenuation filters available with Low-pass cut-off from 30 to 2700 mc (nearly fifty designs at 400 mc), Hi-pass cut-off frequencies from 30 to 1000 mc, Band-pass as narrow as 5% of center frequency. Sizes from 3/4 cubic inches, with subminiature connectors, to 3 1/8" line.



## COAXSWITCH® COAXIAL SELECTOR SWITCHES



Employ a unique, rugged, and reliable design which assures positive contact, low insertion SWR, and negligible cross talk between channels. They are useful from dc to 10 kmc and may be panel mounted. Models listed are 50 ohms. 75 ohm versions available on special order.

Description	Model	U.S. Price	Description	Model	U.S. Price
Single-Circuit two-position	7422	\$49	Single-Circuit three-position	7441	\$ 50
Single-Circuit four-position	7431	51	Single-Circuit six-position	74	45
Single-Circuit eight-position	718	65	Single-Circuit ten-position	7181	100
Two-Circuit two-position	72-2	50	Two-Circuit reversing switch	72-R	55

**BIRD WATTCHER®** A panel mounted instrument for warning of system malfunction and for measuring power flow in both directions. Audible and visual alarms indicate system failures. Automatic shut-down occurs if fault is in transmission system or antenna. The WATTCHER combines two readout meters and is used with BIRD THRULINES.



**QC-TYPE (Quick Change) CONNECTORS** Adaptable to particular TERMINAL LINE, THRULINE, and TERMINAL units, these connectors may be changed in the field. Connector types available are: Female or male BNC, TNC, N, C, SC, HN, LC, UHF, LT, 7/8" and 1 1/8" EIA Flanged.

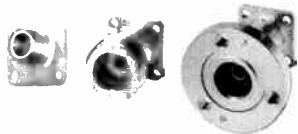

Prices subject to change without notice. F.O.B. Cleveland, Ohio

# BIRD ELECTRONIC CORPORATION

30303 AURORA RD. • CLEVELAND (SOLO) OHIO 44139  
Phone: 216-248-1200

TWX 216-248-6458 • TELEX 098-5298 • Cable BIRDELEC.

Western Representatives  
O. H. Brown, P.O. Box 128, Palo Alto, Cal. Phone: 415-321-8867  
Algood Asso., Inc., 3600 Wilshire Blvd., Los Angeles 5, Cal.  
Phone: 213-383-4443

# New General Electric Porta • Mobil

## FIRST 3 WAY 2 WAY RADIO

The all solid-state Porta • Mobil (no tubes) combines flexibility, compactness and quality never before found in an FM two-way radio. You get transmit power up to 18 watts in low band and 10 watts high band. In your vehicle it's a plug-in radio with mobile sensitivity and selectivity. On your desk it's a temporary base station for your headquarters. And on foot, it's a powerful portable with expanded range capabilities far greater than ever before achieved.

Using high reliability silicon transistors, Porta • Mobil will operate at 158°F (70°C)—a new record. Its transmit duty cycle capability far exceeds previous industry standards established for mobiles or portables. G.E.'s exclusive voltage regulation provides a new high in circuit stability—top performance over wide input voltage variation.

Porta • Mobil is available with a telephone handset, channel guard, selective calling, multi-frequency operation, an under-dash mounting bracket for your car and a leather field jacket. Snap-on dry battery or rechargeable nickel-cadmium power packs are optional. A 117 volt AC built-in charger is an exclusive feature of the nickel-cadmium pack.

Rugged, weatherproof and built to perform under the toughest operating conditions, Porta • Mobil is the first high-power all solid-state radio combination to meet your many portable, mobile and base station needs. For more information, call your General Electric Communications Consultant, listed in the Yellow Pages under "Radio Communications." Or write for Bulletin ECR-1162, Section 3165, Communication Products Dept., General Electric Company, Mountain View Road, Lynchburg, Va.

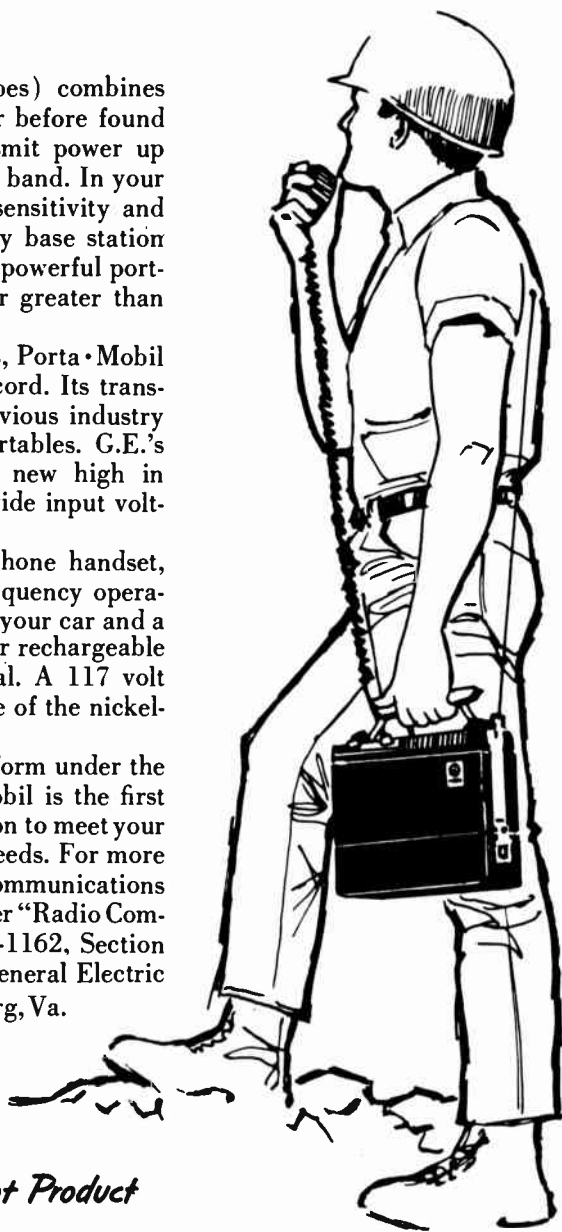

*Progress Is Our Most Important Product*

**GENERAL**  **ELECTRIC**



# What's New in Verticals ?

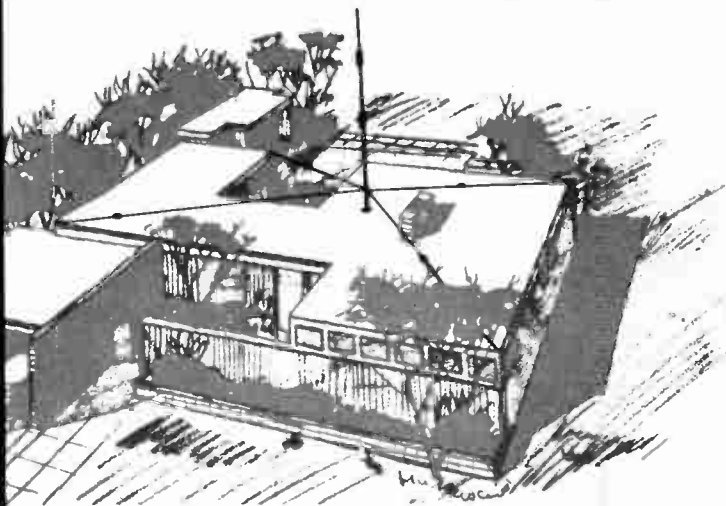
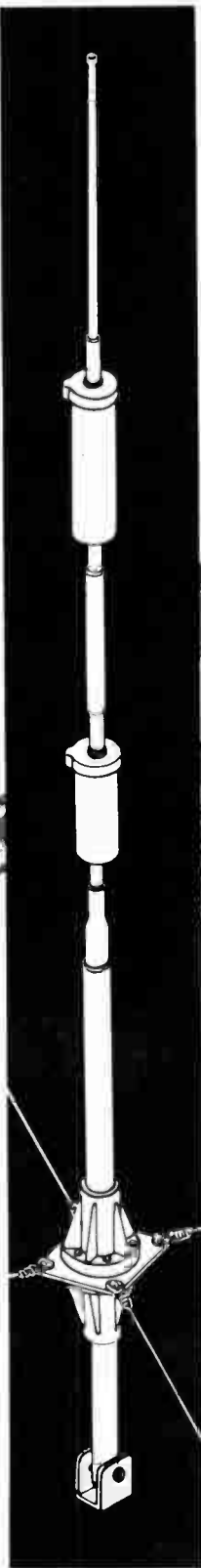

Setting the pace in 10, 15, 20 and 40 meters is Mosley's new RV-4 vertical antennas. These outstanding performance giving antennas can now be mounted on any roof as well as on the ground. They operate as a quarter wave vertical antenna on all four bands. The RV-4 features the Mosley slim line Trap-Master traps that have earned user acclaim through daily use in tens of thousands of installations throughout the world. These antennas have automatic band switching for 10 thru 40 meters. The RV-4 antennas are self-supporting and completely factory pre-tuned to maintain low SWR over entire range. The RV-4RK kit for roof mounting includes radial wire mast and hinged mounting. No radials required for ground mounting if a good ground connection can be provided within a few inches of the antenna base. Maximum power rating 750 watts on AM phone, 1000 watts CW and 2000 watts P. E. P. on SSB, input to final amplifier, Uses single 52 ohm coax line. Antenna height 20' 8-5/8" above insulator, with roof mount 25' 2-5/8" Weight of antenna 10 lbs., with roof mount 14½ lbs.

(In request of further information write for literature code # 8)

**Mosley Electronics, Inc.** 4610 N. Lindbergh Blvd.  
Bridgeton, Mo. 63044

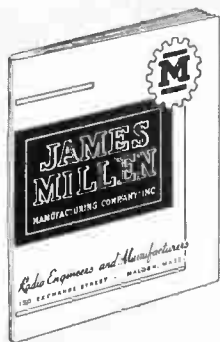
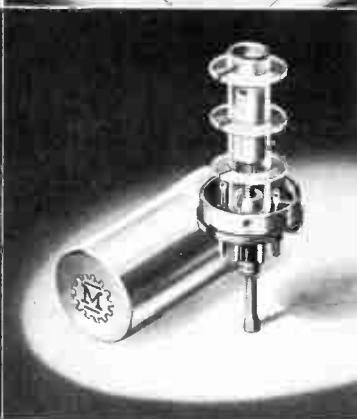
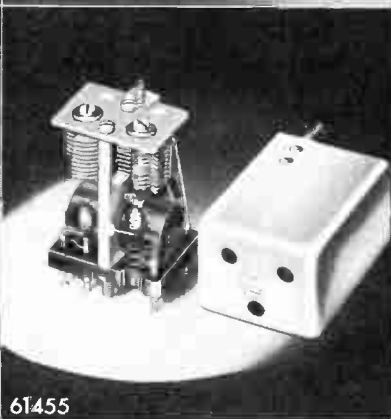
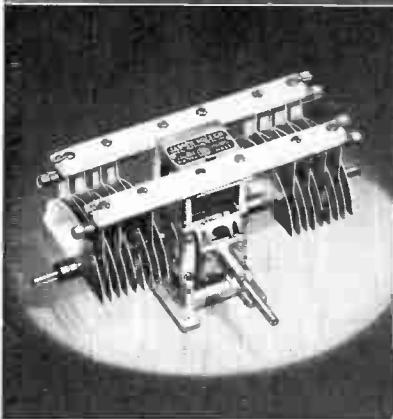
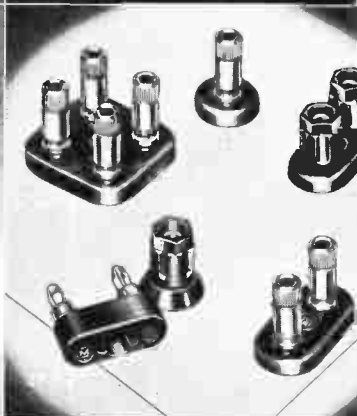
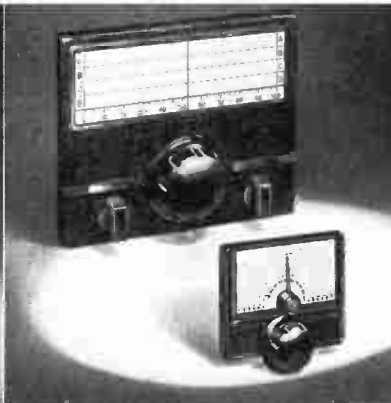
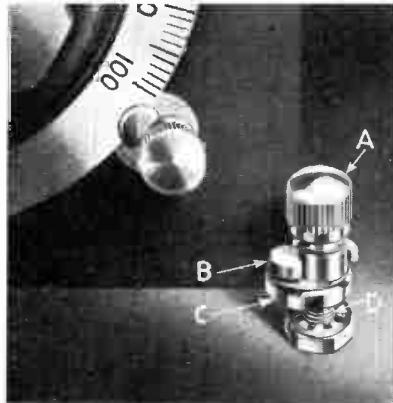

Herewith are illustrated just a few of the many exclusive Millen "Designed for Application" line of MODERN PARTS for MODERN CIRCUITS, which are fully listed and described in our general component parts catalog. A copy is available either through your distributor or direct from any of our district offices, or the factory.

**JAMES MILLEN**  
150 EXCHANGE ST.



**MFG. CO., INC.**  
MALDEN, MASSACHUSETTS



# vital link



**HQ-170A-VHF**

The SSB specialist with new extended coverage. From 160 to 2 meters inclusive. Retains all of the features of the HQ-170A — excellent electrical and mechanical stability, outstanding SSB performance PLUS separate nuvistor front-ends on both 6 and 2 meters for a 0.3 microvolt sensitivity at 10 db S/N ratio.

**\$419.00**

... the communications equipment between microphone and headphone. Hammarlund communications equipment has an enviable reputation for performance and reliability. Basic technical excellence combined with operating flexibility assure maximum "get through ability" under all conditions on every band. Check these latest additions to the famous Hammarlund line — their performance, reliability, versatility and operating ease are unexcelled!



**HQ-110A-VHF**

For the first time, complete amateur band coverage from 160 to 2 meters in a modestly priced communications receiver. No add-on converters. Superb sensitivity and signal-to-noise ratio due to separate nuvistor front ends on 6 & 2 meters. Expanded amateur bandspread. Separate detectors for CW/SSB & AM. Continuously variable selectivity. Unbeatable value!

**\$299.00**



**HQ-145A**

An outstanding value in general coverage communications receivers. Features separate detectors for SSB/CW & AM, dual conversion, complete coverage from 540 Kc to 30 Mc with calibrated amateur bandspread — 80 to 10 meters, variable crystal filter AND slot filter, and outstanding sensitivity.

**\$289.00**



**HX-50 and HX-50A**

The SSB transmitters acclaimed by amateurs the world over. The new HX-50A extends the operating flexibility and performance of the fabulous HX-50 by now adding ZBZ (Hammarlund's exclusive Zero-Beat-Zero) for hands-off-transmitter spotting, separate CW-VOX controls, and increased power — 200 watts P.E.P.

HX-50 **\$449.50** HX-50A **\$495.00**



## **HAMMARLUND MANUFACTURING COMPANY**

A GIANNINI SCIENTIFIC COMPANY

73-88 Hammarlund Drive • Mars Hill, North Carolina 28754

Export Department: 13 East 40th Street, New York, N. Y. 10016

# HARVEY



# AUTHORIZED DISTRIBUTORS



## **RCA Tubes and Harvey Service... For Double Dependability!**

HARVEY's line of RCA tubes is so complete, that HARVEY can fill virtually any requirement . . . right from stock . . . and deliver at almost a moment's notice.

This is particularly important to AM, FM, and TV Broadcasters, Industrial and Commercial users, Amateurs, and Service-Technicians, all of whom depend on tubes for sustained operation of important electronic equipment.

Write, Wire or Phone for  
**PROMPT HARVEY SERVICE**

Visit Harvey's New Ham Radio  
Center. The latest and best in  
ham gear is always on display.



103 West 43 St.  
New York, N.Y. 10036  
(212) JUdson 2-1500

**RADIO CO. INC.**

Visit our new subsidiary, **FEDERAL ELECTRONICS, INC.**, Vestal, N. Y., for all your industrial needs.



# ARRL PUBLICATIONS



**Storehouses  
of  
Information  
for:**

- **Novices**
- **Old Timers**
- **Students**
- **Engineers**

---

**Supplies  
for the  
Active Amateur**

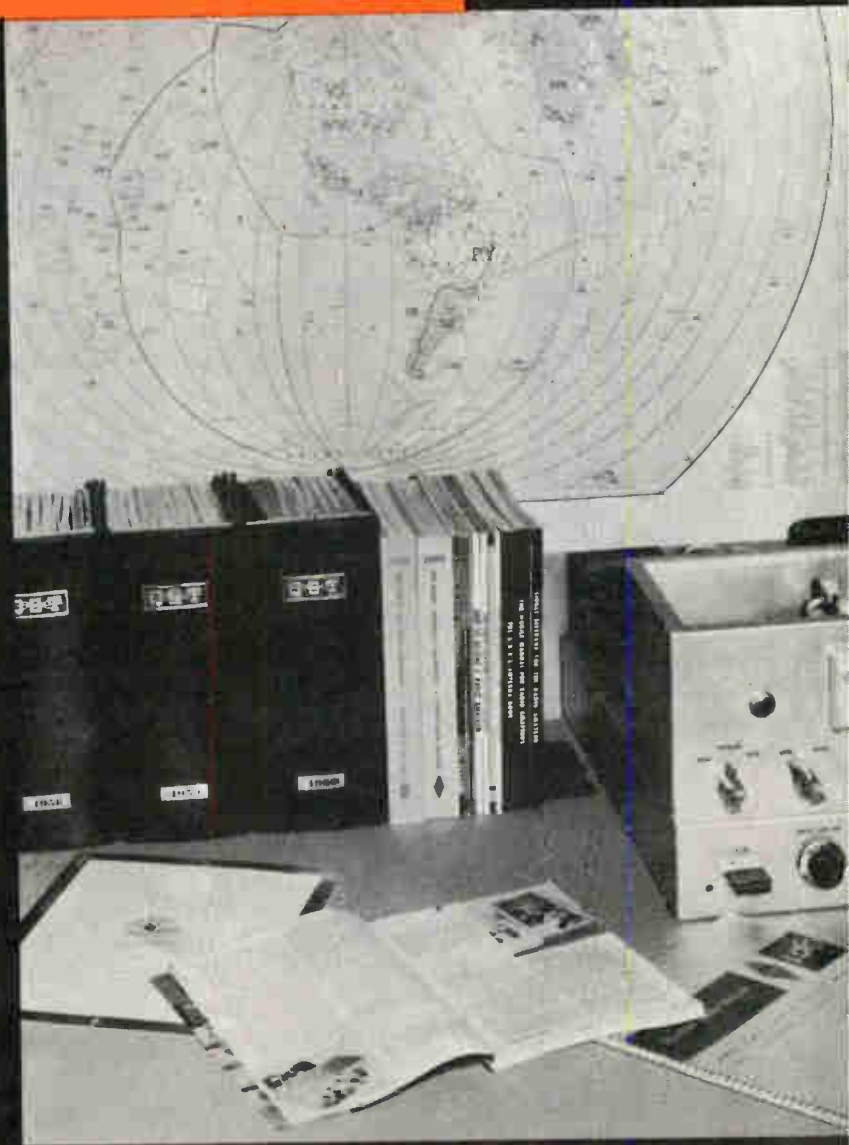

**THE AMERICAN RADIO RELAY LEAGUE • NEWINGTON 11, CONN.**

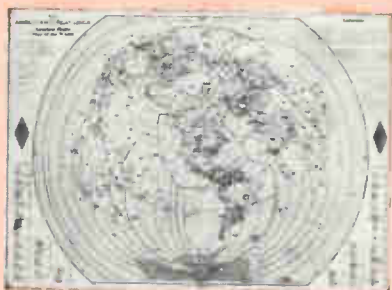
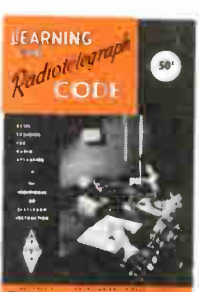
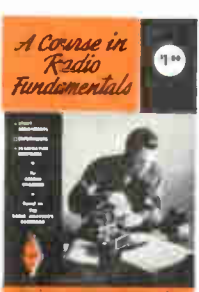
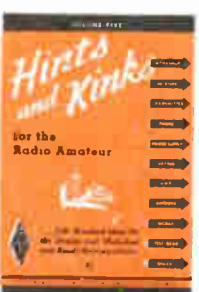
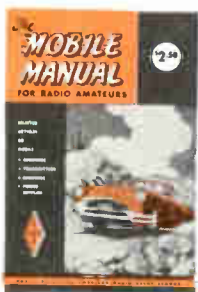
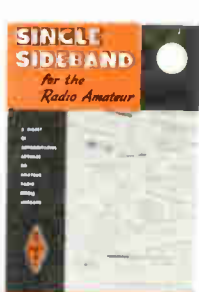
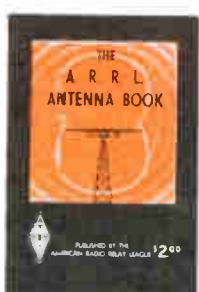
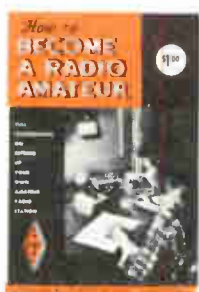
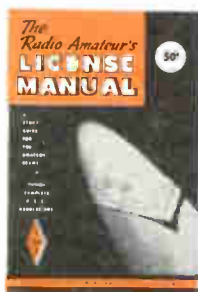
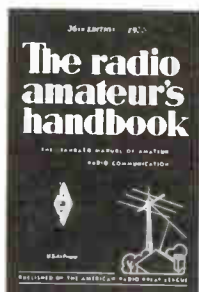

### ARRL WORLD MAP

Printed in eight colors on heavy map paper with 267 countries clearly outlined. Continental boundaries, time zones, amateur prefixes, plainly marked. Size: 30 x 40 inches. \$2.00.

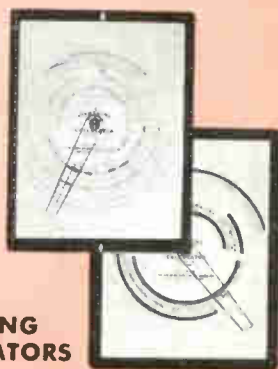

### LIGHTNING CALCULATORS

Quick and accurate answers with ARRL Lightning Calculators! Type A for problems involving frequency inductance, capacity. Type B for resistance, voltage, current and power. \$1.50 each.

- ★ **QST** Although primarily a ham magazine, QST is found on the desks of engineers, technicians and just about everyone in electronics. There is something for everyone in QST, from Novice to Old Timer. See next page for ARRL membership and QST subscription rates.
- ★ **THE RADIO AMATEUR'S HANDBOOK** Internationally recognized, universally consulted. Packed with information essential to the amateur and professional alike. Hundreds of photos, diagrams, charts and tables. \$4.00 U.S.A., \$4.50 U.S. Poss. and Canada, \$5.50 elsewhere; Clothbound Edition, \$6.50 in U.S.A. and Possessions and Canada, \$7.00 elsewhere.
- ★ **A COURSE IN RADIO FUNDAMENTALS** A complete course of study for use with the Radio Amateur's Handbook. Applicable to home study or class use. \$1 U.S.A. proper, \$1.25 elsewhere.
- ★ **UNDERSTANDING AMATEUR RADIO** Written for the beginner. Explains elementary principles in simple language. Tells how transmitters, receivers and antennas work, includes complete how-to-build-it information on low-cost stations up to 150 watts. \$2.00 U.S.A. proper, \$2.25 elsewhere.
- ★ **HOW TO BECOME A RADIO AMATEUR** Tells what amateur radio is and how to get started in this fascinating hobby. Emphasis is given to the needs of the Novice licensee, with three complete simple amateur stations featured. \$1.00.
- ★ **THE RADIO AMATEUR'S LICENSE MANUAL** Complete with typical questions and answers to all of the FCC amateur exams—Novice, Technician, General and Extra Class. Continually kept up to date. 50¢.
- ★ **LEARNING THE RADIOTELEGRAPH CODE** For those who find it difficult to master the code. Designed to help the beginner. Contains material for home study and classroom use. 50¢.
- ★ **THE ARRL ANTENNA BOOK** Profusely illustrated, the Antenna Book includes information on theory and operation of antennas for all amateur bands; simple doublets, multi-element arrays, rotaries, long wires, rhombics, mobile whips, etc. \$2.00 U.S.A. proper, \$2.25 elsewhere.
- ★ **SINGLE SIDEBAND FOR THE RADIO AMATEUR** A digest of the best SSB articles from QST. Includes discussions of theory and practical "how-to-build-it" descriptions of equipment. \$2.50 U.S.A. proper, \$2.75 elsewhere.
- ★ **THE MOBILE MANUAL FOR RADIO AMATEURS** It's a collection of articles on tried and tested equipment that have appeared in QST. A "must" for anyone interested in the installation, maintenance and operation of mobile stations. \$2.50 U.S.A. proper, \$3.00 elsewhere.
- ★ **HINTS AND KINKS** If you build equipment and operate an amateur radio station, you'll find this a mighty valuable book in your shack and workshop. More than 300 practical ideas. \$1 U.S.A. proper, \$1.25 elsewhere.



### QST BINDERS

No need to let your copies of QST rest in a disordered pile. A QST binder will keep them neat and orderly. Each holds a one-year file. \$3.00 (available in U.S. and Possessions only).



### SUPPLIES

Active amateurs need these supplies: ARRL Logbook, 50¢ U.S.A., 60¢ elsewhere. Minilog, 30¢ U.S.A., 35¢ elsewhere. Radiogram blanks, 35¢ per pad postpaid. Message delivery cards, 7¢ each stamped, 3¢ each unstamped. Members' stationery, 100 sheets \$1.50; 250 sheets \$3.00; 500 sheets \$4.50



*Application for Membership*



# AMERICAN RADIO RELAY LEAGUE

**Administrative Headquarters: Newington, Connecticut, U. S. A.**

..... 19.....

AMERICAN RADIO RELAY LEAGUE,  
Newington, Conn. 06111, U. S. A.

Being genuinely interested in Amateur Radio, I hereby apply for membership \* in the American Radio Relay League, and enclose \$5.00 (\$5.25 in Canada, \$6.00 elsewhere, U. S. funds) in payment of one year's dues, including a subscription to *QST* for the same period. Please begin my subscription with the ..... issue.

The call of my station is .....

The class of my operator's license is .....

I belong to the following radio societies .....

.....

Send my Certificate of Membership  or Membership Card   
(Indicate which) to the address below:

Name .....

.....

.....

**A bona fide interest in amateur radio is the only essential requirement, but full voting membership is granted only to licensed radio amateurs of the United States and Canada. Therefore, if you have a license, please be sure to indicate it above.**

\* Membership is available only to individuals. The yearly subscription price of *QST* to libraries, companies, laboratories and other organizations is \$6.00 per year in the United States and Possessions, \$6.50 in Canada and \$7.00 elsewhere.



# For Certified Performance!

— install industry-preferred  
**C-P COMPONENTS**

## Communication Systems Handbook

Catalog No. 664 features C-P antennas and related components. Includes comprehensive Technical Data Section.



## Rigid Coaxial Transmission Line Catalog

New Catalog RL1 includes 20 pages of product information and performance data on C-P rigid coaxial transmission line.



## Two-way Communication Systems

- BASE STATION ANTENNAS
- VEHICULAR ANTENNAS
- DUPLEXERS
- COAXIAL CABLE SYSTEMS
- ACCESSORIES

## Rigid Coaxial Transmission Line

- SUPPORTING HARDWARE
- GASSING ACCESSORIES
- AUTOMATIC DEHYDRATORS
- CONNECTORS & ACCESSORIES

**CONSULT C-P** — for recommendations on your specific requirements, or write for illustrated catalogs. Please address requests on your company letterhead.

*Communication Products Company*  
DIVISION OF  
**PHELPS DODGE ELECTRONIC PRODUCTS CORPORATION**



MARLBORO, NEW JERSEY  
Tel. (201) 462-1880  
LOS ANGELES, CALIFORNIA  
Tel. (213) 245-1143

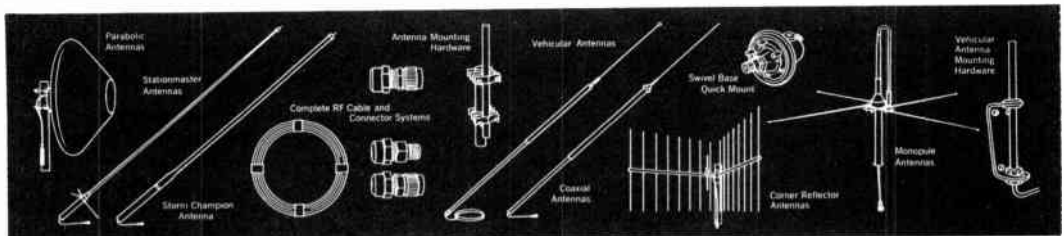

# Learn Code the EASY Way

*Beginners, Amateurs and Experts alike recommend the INSTRUCTOGRAPH, to learn code and increase speed.*

Learning the INSTRUCTOGRAPH way will give you a decided advantage in qualifying for Amateur or Commercial examinations, and to increase your words per minute to the standard of an expert. The Government uses a machine in giving examinations.

Motor with adjustable speed and spacing of characters on tapes permit a speed range of from 3 to 40 words per minute. A large variety of tapes are available — elementary, words, messages, plain language and coded groups. Also an "Airways" series for those interested in Aviation.

## MAY BE PURCHASED OR RENTED

The INSTRUCTOGRAPH is made in several models to suit your purse and all may be purchased on convenient monthly payments if desired. These machines may also be rented on very reasonable terms and if when renting you should decide to buy the equipment the first three months rental may be applied in full on the purchase price.

## ACQUIRING THE CODE

It is a well-known fact that practice and practice alone constitutes ninety per cent of the entire effort necessary to "Acquire the Code," or, in other words, learn telegraphy either wire or wireless. The Instructograph supplies this ninety per cent. It takes the place of an expert operator in teaching the student. It will send slowly at first, and gradually faster and faster, until one is just naturally copying the fastest sending without conscious effort.

## BOOK OF INSTRUCTIONS

Other than the practice afforded by the Instructograph, all that is required is well directed practice instruction, and that is just what the Instructograph's "Book of Instructions" does. It supplies the remaining ten per cent necessary to acquire the code. It directs one how to practice to the best advantage, and how to take advantage of the few "short cuts" known to experienced operators, that so materially assists in acquiring the code in the quickest possible time. Therefore, the Instructograph, the tapes, and the book of instructions is everything needed to acquire the code as well as it is possible to acquire it.

MACHINES FOR RENT OR SALE



## The Instructograph

ACCOMPLISHES THESE PURPOSES:

**FIRST:** *It teaches you to receive telegraph symbols, words and messages.*

**SECOND:** *It teaches you to send perfectly.*

**THIRD:** *It increases your speed of sending and receiving after you have learned the code.*

With the Instructograph it is not necessary to impose on your friends. It is always ready and waiting for you. You are also free from Q.R.M. experienced in listening through your receiver. This machine is just as valuable to the licensed amateur for increasing his speed as to the beginner who wishes to obtain his amateur license.

Postal Card *WILL BRING FULL PARTICULARS IMMEDIATELY*

# THE INSTRUCTOGRAPH CO.

4707 SHERIDAN ROAD  
4700 S. CRENSHAW BLVD.

CHICAGO 40, ILLINOIS  
LOS ANGELES 43, CALIFORNIA

**WORLD WIDE SUPPLIERS  
OF ELECTRONIC COMMUNICATION EQUIPMENT**

FOR **VLF • LF • MF • HF**

SSB • ISB • CW • MCW • AM • FSK • FAX  
FROM ACCESSORIES TO COMPLETE SYSTEMS



• **SOLID STATE** •

**SME/SMR**

A Solid State eight channel fixed tuned exciter and receiver featuring USB, LSB, AME, CW, MCW, AFSK, AFAX over the 1.6 to 32 mc range. Frequency stability 1 part in 10<sup>9</sup> per day (oven controlled crystals). Low operating power.

**BULLETIN  
2030/3010**



**STE/STR**

A Solid State "STRIP" exciter and receiver unit featuring LSB, USB, CW, AME, AFAX, AFSK over the 1.6 to 32 mc range utilizing 4 octave modules. Operating power 8 watts for each unit.

**BULLETIN  
2032/3014**



**TTR-10**

A Solid State SSB Transmitter/Receiver covering the 1.6 to 32 mc range with 100 watts PEP output. Oven crystal controlled. Remote control available. Simplex or duplex operation, wide variety of power supplies available.

**BULLETIN  
1004B**



**VLRC-1**

A Solid State very low frequency receiver providing CW, FSK and FAX modes continuously tuned from 10 to 40 kc. 7" Rack space, compact, lightweight. Can be synthesized to 1 part in 10<sup>9</sup> stability for 1 cycle incremental tuning.

**BULLETIN  
3017**



**VLRB-1**

A Solid State LF MF receiver covering AM, AME, CW, FSK, and FAX modes over the 30 to 600 kc range. 7" rack space, compact, lightweight. Ancillary devices for ISB and SSB reception available. Stability of 1 part in 10<sup>9</sup> per day with 10 cycle incremental tuning available.

**BULLETIN  
3015**



**VLFC-1**

A Solid State VLF Frequency Standard Comparison System. Utilizes VLF transmissions from 10 to 100 kc for communications and provides a means of correcting station frequency standards at a stability of 1 part in 10<sup>11</sup>. A fail safe battery supply is offered as an option.

**BULLETIN  
6003**

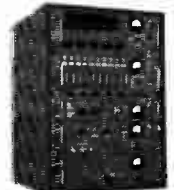

**LRRA-1**

A Solid State LF/MF Receiver providing CW, MCW, AM, AME, SSB, ISB, FAX and FSK reception from 30 to 600 KCS. Synthesized in 1 cycle steps from 30 to 100 kcs and 10 cycle steps from 100 kcs to 600 kcs. 1" NIXIE lights display frequency 1 part in 10<sup>9</sup> stability. Battery supply for emergency operation.

**BULLETIN  
3011**

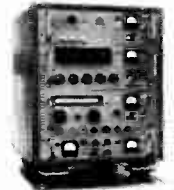

**CSS-3**

A Solid State Primary Frequency Standard providing highly stable outputs at 10 MC, 1 MC, 100 KC, 1 part in 10<sup>9</sup> stability. May be "phase locked" to higher stability standard.

**BULLETIN  
6005**



**GPR-92**

A completely new General Purpose Communications Receiver for CW, MCW, AM, AME, SSB, FSK, FAX. This receiver fulfills almost all of today's communication requirements from .54 to 32 mc. Special bandspread dials offer ease in tuning on ham bands, international broadcast bands with a third optional dial for general tuning purposes. High stability diversity reception available with the addition of the model TRX-1 (Bulletin 4006). 6 db noise figure. Better than 1 microvolt sensitivity.

**BULLETIN  
3006**

**THE TECHNICAL MATERIEL CORPORATION**  
MAMARONECK, NEW YORK

and Subsidiaries

OTTAWA, CANADA • ALEXANDRIA, VIRGINIA • GARLAND, TEXAS • OXNARD, CALIFORNIA  
SAN LUIS OBISPO, CALIFORNIA • LUZERN, SWITZERLAND • POMPANO BEACH, FLORIDA

World Radio History



Choose from these

# HIGH-EFFICIENCY PENTA TUBES

for your new rig or for replacement use

## BEAM PENTODES

Excellent linearity, low distortion, high efficiency in Class AB, SSB service.

Tube Type	Plate Diss., W.	Plate V., Max.	Plate I., Max.	Screen Volts, Max.
PL-175A	400	4000	350	800
PL-177WA	75	2000	175	600
*PL-8295/172	1000	3000	1000	600
*PL-8295A (ceramic)	1000	3000	1000	600
*PL-8432 (ceramic)	1000	3000	1000	600
PL-4E27A	125	4000	200	750

\* Special sockets, chimneys available

## GROUNDING-GRID TRIODES

High- $\mu$  power triodes designed especially for grounded-grid rf amplifier applications.

Tube Type	Plate Diss., W.	Plate V., Max.	Plate I., Max.	$\mu$
PL-6569	250	4000	300	45
PL-6580	400	4000	350	45

## POWER TETRODES

Popular power tubes, built for reliable performance, long life, high efficiency.

Tube Type	Plate Diss., W.	Plate V., Max.	Plate I., Max.	Screen Volts, Max.
°PL-6775	400	4000	350	800
PL-8165/4-65A	65	2000	150	600
PL-8166/4-1000A	1000	6000	700	1000
PL-8438/4-400A	400	4000	350	800
PL-4D21 (4-125A)	125	3000	225	600
†PL-4D21A	175	3000	225	600
PL-5D22 (4-250A)	250	4000	350	800

° Ruggedized version of PL-8438/4-400A

† Ruggedized version of 4D21 (4-125A)



PL-8295/172



PL-8432



PL-175A



PL-177WA



## THE PENTA LABORATORIES, INC.

A SUBSIDIARY OF RAYTHEON COMPANY

312 N. NOPAL STREET — SANTA BARBARA, CALIF. 93102



**EARN  
BIG MONEY**

# IN MOBILE-RADIO MAINTENANCE

Get into this rapidly growing field with 2nd Class Ticket and LAMPKIN MOBILE-SERVICE METERS



**LAMPKIN 105-B MICROMETER  
FREQUENCY METER**

**FREQUENCY RANGE** on local transmitters 0.1 to 175 MC - to 3000 MC by measuring in multiplier stages. **ACCURACY** conservatively guaranteed better than 0.0025%—actually 9 out of 10 results come within 0.001%. **CALIBRATION** table for each meter; charts show percentage off-frequency from FCC assignment. **DIAL** 4" diameter, 40 turns, totals 8000 divisions spread over 42 feet—resettable better than 5 parts per million. **CRYSTAL** thermometer on panel automatically indicates dial checkpoint. **SIGNAL GENERATOR**—a pinpoint CW source for mobile-receiver final alignment.



**LAMPKIN 205-A  
FM MODULATION METER**

**FREQUENCY RANGE** - Continuous 25 MC to 500 MC. No coils to change. Rough and vernier tuning controls. **PEAK FM** swing shows directly on indicating meter—calibrated 0-12.5 or 0-25.0 peak KC, positive or negative. No charts or tables. **ACCURATE**—within 10% at full scale. **FIELD STRENGTH METER** - Reads relative transmitter output. **PROTECTED**—Panel components recessed behind edges of the case. **PORTABLE** - Just a 2-finger load.

JUST THESE TWO METERS—WITH NO ADDITIONAL CRYSTALS OR FACTORY ADJUSTMENTS—WILL CHECK FREQUENCY AND FM MODULATION ON HUNDREDS OF TRANSMITTERS. LAMPKIN METERS ARE PREFERRED TEST EQUIPMENT—BY MUNICIPALITIES, 50 OUT OF 50 STATE GOVERNMENTS, BY MOST 2-WAY RADIO MANUFACTURERS, AND BY THOUSANDS OF INDEPENDENT MOBILE-SERVICE ENGINEERS.

NOW... THE PPM METER... AN ACCESSORY FOR THE TYPE 105-B... ACCURACY BETTER THAN 0.0001%. AMPEE FOR SPLIT-CHANNEL FREQUENCY CHECKS.

**FREE BOOKLET**—with facts and figures—send for "HOW TO MAKE MONEY IN MOBILE-RADIO MAINTENANCE".

**MAIL COUPON TODAY!**

**LAMPKIN LABORATORIES, INC.**  
BRADENTON, FLORIDA

Measurements Section  
Lampkin Laboratories, Inc.  
Bradenton, Florida

- At no obligation to me, please send
- "How To Make Money in Mobile-Radio Maintenance"
  - Technical data and prices on Lampkin Meters

Name \_\_\_\_\_

Address \_\_\_\_\_

City \_\_\_\_\_ Zone \_\_\_\_\_ State \_\_\_\_\_



# VIBROPLEX

THE PIONEER AND ALWAYS THE LEADER  
WORLD'S NO. 1 KEY SEMI-AUTOMATIC

Never tires the arm  
Never upsets the Nerves

New Super DeLuxe

## VIBROPLEX

Presentation

"PRESENTATION"

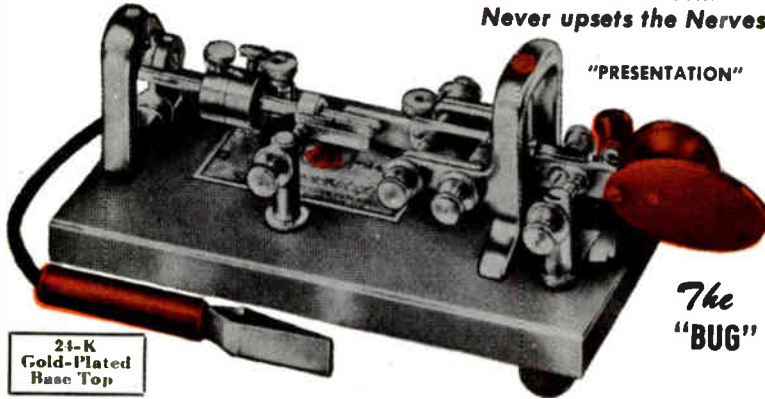

The  
"BUG"

The Super DeLuxe model's JEWEL MOVEMENT completely revolutionises sending. Makes it easy for every operator.

It has SUPER-SPEED CONTROL mainspring; you go from slowest to highest speed without changing weights.

Vibroplex has TOUCH CONTROL, adjustable to your individual desire.

Vibroplex has FIRM STANCE, a very important item. The rubber feet are so placed the key stays in position.

RICHLY DESIGNED — 24k gold-plated base top, polished chromium machine parts, red trim and jeweled movement. DeLuxe, only \$39.95.

### ALL LABOR TAKEN OUT OF SENDING

**SEND BETTER** — Vibroplex makes uniformly good signals at any speed. They are sharp and easy to read. You will like them.  
**SEND EASIER** — Vibroplex is a perfectly balanced key. You are relieved of all nervous and muscular tension.

**SEND FASTER** — Vibroplex gives you greater speed. More speed than you can ever use. But it's there if you need it.

**SEND LONGER** — Vibroplex keys last longer. Many keys are still in use after 30 or more years. Nothing to get out of order.

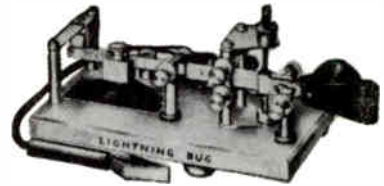

### Vibroplex Lightning Bug

Improved design with slotted weights that can't work loose. A bridged damper frame that protects key against damage. Instantly adjustable dot contact spring may be removed without disturbing speed weights. Precision machining, trouble proof and adjustable to any speed. Standard, with circuit closer, gray base and chrome top parts, priced at \$21.45. DeLuxe model, priced at \$25.95.\*

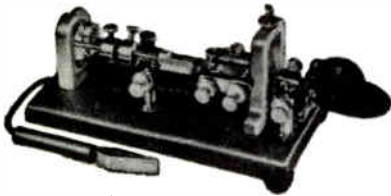

### Vibroplex Original

Acclaimed by thousands of the world's finest operators for ease of operation, clean signals and all around sending excellence. Precision machined, trouble-proof and efficient. A strong favorite of the elite. Standard, with circuit closer, grey base and chrome top parts, \$22.45; DeLuxe, with polished chromium base and top parts, red trim and jewel movement, \$26.95.\*

Replace your old-fashioned key with all its annoyances with an improved NEW VIBROPLEX. Enjoy sending as never before. Choose yours from those illustrated here.

### "VIBRO-KEYER"

Supplies the answer to many years of requests for Vibroplex parts for a keying mechanism to be used with ELECTRONIC TRANSMITTING UNITS. Features a beautiful base, size 3 1/4" by 4 3/4" and weighing 2 3/4 pounds. Red finger and thumb pieces, same large 3/4" contacts on main frame and trunion lever as used in Vibroplex. A real beauty, adjustable to suit your speed requirements. Standard model, priced at \$17.95; DeLuxe model, with Chrome Plated Base, priced at only \$22.45.

\*Cord and wedge, \$1.75 additional.

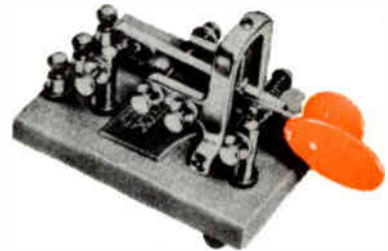

### Vibroplex Carrying Case

Keeps key like new. Black simulated morocco. Flexible leather handle. Protects key against dust, dirt and moisture, and insures safe-keeping when not in use. With lock and key, \$6.75.

Avoid imitations!  
The "BUG" Trade Mark  
Identifies the  
Genuine Vibroplex.  
Accept no substitute

### NEW SPECIAL ENLARGED Edition of PHILLIPS CODE, \$2.75 Postpaid

Also includes:  
Radio Code Signals  
International Morse  
American Morse  
Russian, Greek, Arabic  
Turkish and Japanese  
Morse Codes  
World Time Chart

United States Time Chart  
"Commercial" "Z" Code  
Aeronautical "Q" Code  
Miscellaneous Abbreviations. Used on international wire, submarine cable and radio telegraph circuits.

Get your copy today!



Prices subject to change without notice

Every Vibroplex key has 3/16 contacts and is available for left-hand operation, \$2.50 extra.



THE VIBROPLEX CO., Inc., 833 Broadway, New York 3, N. Y.

IF YOU SEND YOU SHOULD USE THE VIBROPLEX  
Buy World Radio history—easiest sending of your life

# POWERFUL



# BIG NEWS

## NEW!...2 METER-6 METER RF POWER AMPLIFIERS

More power in the VHF band!...and there is plenty of it in the new Gonset 2 and 6 Meter RF Power Amplifiers. Model 903A (2 meter) and Model 913A (6 meter) has a power input of 500 watt in all modes of operation. A 4X150A is used in the final, and the equipment is rated for CCAS\* service. Only 5 watts is required to drive the 903A and 913A to full rated output. Output impedance is 50 ohms nominal with an input impedance of 50 to 75 ohms. The all solid state power supply is self-contained within the amplifier chassis. All stages are metered and all controls are on the front panel for ease of operation. The new linear amplifiers may be used with any of the famous Gonset Communicator series, as well as being ideally compatible for the new Gonset Sidewinder series.

\*Continuous Commercial and Amateur Service.

Amateur Net Price \$299.00



## NEW!...GONSET SIDEWINDER 6 METER SSB-AM-CW TRANSCEIVER

The new Gonset Model 910A *Sidewinder* offers coverage of the entire 6 meter band in 1 mc segments. Like its mate—the Model 900A 2 meter *Sidewinder*—this ultra-compact transceiver features all-transistor receiver and power supply and partially transistorized transmitter (except mixer, driver, and final stages). Designed for mobile or fixed communications, the unit operates with separate AC (shown above) or DC power supplies.

...COMES IN

# POWERFUL LITTLE PACKAGES

from

# GONSET

### SIDEWINDER SPECIFICATIONS:

<b>TRANSMITTER:</b>	
Power Input:	20 watts PEP (SSB) 6 watts AM 20 Watts CW
Spurious Suppression:	-30 db
Carrier Suppression:	-50 db on SSB
Unwanted Sideband Suppression: VFO or Crystal Control	-40 db
<b>RECEIVER:</b>	
Frequency Stability:	Highly stable incremental tuning utilizes same VFO as transmitter
Sensitivity:	1/2 μv or better for 10 db S + N
Selectivity:	N Lattice crystal filter for both receiver and transmitter
Spurious Rejection:	-50 db or better
Image Rejection:	-50 db (both receiver and transmitter utilize double conversion)
<b>AMATEUR NET:</b>	\$399.50
AC Power Supply	\$ 67.75
DC Power Supply	\$ 79.50

**ANOTHER NEWSWORTHY NOTE:** the Gonset GSB-201 Linear Amplifier was recently increased from 1500 to 2000 watts PEP (SSB). For those who operate on 10 to 80 meters—the GSB-201 is a natural companion for any of today's excitors.

WOULD YOU LIKE TO BE PLACED ON OUR NEW PRODUCT MAILING LIST?

We'll send you complete information on the products above and keep you informed of new Gonset developments from time to time. Merely write Dept. RAH.

# ◀ GONSET, INC.

ALTEC LANSING CORPORATION

LFV A Subsidiary of Ling-Temco-Vought, Inc.

1515 SOUTH MANCHESTER AVENUE, ANAHEIM, CALIF.

© 1964 ALC



# Shurite®.. THE HAMS' NO.1 CHOICE



850 Series  
Shown  
Actual  
Size



Select the right meter from 258 catalog types. For instance, 0-1 DC Milliammeter at right has 1000 ohms internal resistance, model at left: 800 ohms with bridge type design to minimize effects of external magnetic forces.

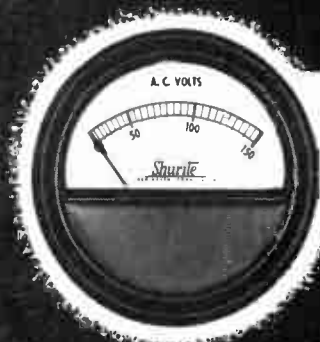

550 Series



350 Series  
0-40 db S meter illustrated

Shown approximately three quarter size

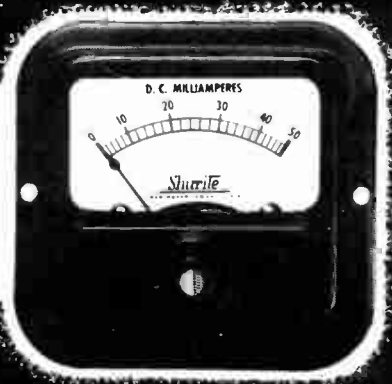

950 Series

**CLEAR-PLASTIC CASES:** Hams are enthusiastic about the modern, expensive-looking 850 series, and are pleased to find the meters cost only 15¢ more than equivalent metal cased meters. Equally good news is the longer, more visible scale arc... the removable front... the new high temperature case material... and the availability of zero adjusters on all AC or DC ranges.

**ATTRACTIVE METAL CASES:** For panel appearance or specialized service conditions, also consider the long-time metal favorites, the basic models 550 or 950 as illustrated. Although all have been modernized in appearance, each metal case continues to fit 2 1/2" mounting hole. Zero adjusters are included on some, and available on all DC ranges of these models.

**CHOICE OF MANY TYPES:** AC and DC Ammeters, AC and DC Milliammeters, AC and DC Voltmeters, new 0-500 DC Microammeters, DC Resistance Meters, VU, S, and new Field Strength Meters. AC meters are double-vane repulsion type with jeweled bearing. DC are polarized-vane solenoid type, moving magnet construction, or bridge-type design. Choice of sensitivity is available in popular DC Milliammeters as illustrated above. Ask for Catalog 94-E covering all types, and Bulletin VUS-63 with application notes on VU, S, and Field Strength Meters.

**EDGEWISE METERS:** The 350 series made with new high-tem-

perature plastic material provides an ideal way to dress up a panel. The clear jewel-like front is very rich looking, and gathers light for easy reading of the long scale. Yet it takes very little panel space and costs less than might be expected.

**DEPENDABLE PERFORMANCE:** Offering by far the best torque-to-weight ratio in its price range, Shurite provides a sturdy meter with fast responses and the ability to duplicate readings. Accuracy well within the standard 5%.

**REASONABLE PRICES:** Typical of the exceptional values are the meters illustrated, 0-50 DC Ma, \$2.40 in the 550 or 950 Series, \$2.55 in the 850 Series; 0-40 db S Meter in the 350 Series, \$3.45; 0-1 DC Ma, at right above, including zero adjuster, \$4.00 in the 550 or 950 Series, \$4.15 in the 850 Series; 0-1 DC Ma at left without zero adjuster, \$3.95; with zero adjuster, \$4.30. 0-150 AC Volts, \$4.05 in the 550 or 950 Series. Low costs are made possible by large quantity production.

**GUARANTEED:** For one year against defective workmanship and material. Will be repaired or replaced if sent postpaid to the factory with 50¢ handling charge.

**WIDELY AVAILABLE:** These American made meters are stocked by leading electronic parts distributors for prompt deliveries.



# NEW! LAFAYETTE



## 10-80 METER DUAL CONVERSION AMATEUR RECEIVER

MODEL HA-350

99-2524WX

# 189<sup>50</sup>

*Uses Mechanical Filter For Exceptional Selectivity—Offers 2KC Bandwidth!*

Lafayette's newest! A dual conversion superheterodyne communications receiver covering the 10 through 80 meter amateur bands and offering a high order of electrical and mechanical stability for superior AM, CW and SSB operation. Check some of the exceptional features!

- Sensitivity 1  $\mu$ V or Better
- 7 Band-Switching Positions—3.5, 7, 14, 21, 28, 28.5 and 29.1 MC, plus WWV on 15 MC
- Tuning Dial Covers 600 KC for Each Band
- 12 Tubes
- Crystal-controlled 1st Oscillator
- Transmitter-type VFO for 2nd Oscillator
- Preselector Tuning
- Crystal-controlled BFO (Dual frequencies)
- All Heterodyning crystals supplied
- Selectable upper and lower Sidebands
- Geared Tuning Mechanism
- 100 KC Calibrator Circuit (crystal optional extra)
- Separate Diode AM Detector and CW/SSB product Detector
- Coax Antenna Input
- 8 and 500 ohm outputs
- Imported



**LAFAYETTE 10-80 METER  
BAND TUNEABLE VERTICAL  
ANTENNA**

40-0104WX  
**14<sup>95</sup>**

- Single adjustment for tuning antenna
- Omni-directional—overall height 18 ft.
- Rugged, wind-resistant—Irridite-treated
- For Ground, Roof or Tower Installation
- 52 ohms impedance—1000 watts power rating

## FREE! LAFAYETTE RADIO ELECTRONICS LAFAYETTE LOCATIONS

1965 CATALOG NO. 650  
Over 500 Pages

Featuring Everything in Ham Gear and Electronics for Home • Industry • Laboratory

Mail the Coupon for Your FREE

1965 Lafayette Catalog.

### LAFAYETTE LOCATIONS

Our Newest Store  
NEW YORK, N.Y. (Midtown)  
71 W. 45th Street

BROOKLYN, N.Y., 2265 Bedford Ave.  
SYOSSET, L.I., N.Y., 111 Jericho Tpke.  
SCARSDALE, N.Y., 691 Central (Park) Ave.  
NEW YORK, N.Y., 190 Sixth Ave.  
JAMAICA, N.Y., 165-08 Liberty Ave.  
BRONX, N.Y., 542 E. Fordham Rd.  
NEWARK, N.J., 24 Central Ave.  
PLAINFIELD, N.J., 339 W. 2 St.  
PARAMUS, N.J., 182 Route 17  
BOSTON, MASS., 584 Commonwealth Ave.  
NATICK, MASS., 1400 Worcester St. (Rt. 9)

Lafayette Radio Electronics  
Dept. RAH-5, P.O. Box 10  
Syosset, L. I., N. Y. 11791

- Send me the Free 1965 Lafayette Catalog 650
- \$..... enclosed; send me #..... shipping charges collect.

Name.....  
Address.....  
City..... State..... Zip.....

# EVERY **PR** CRYSTAL is UNCONDITIONALLY GUARANTEED

*Unconditional Guarantee* is proof of the maker's absolute confidence in his product... and PR Crystals have been UNCONDITIONALLY GUARANTEED SINCE 1934. You're not taking the slightest chance when you put PRs in your rig, for you'll have the finest radio frequency control that money can buy! PR Crystals are made to PERFORM... under good conditions and bad. They have that extra measure of stability and dependability BUILT-IN, that guarantees years of outstanding performance. Get PRs today from your jobber.

## AMATEUR TYPES



Fundamental, PR Type Z-2  
Frequency Ranges in Kcs.: 1750 to 2000 (160M); 3,500 to 4,000 (80M); 7,000 to 7,425 (40M); 8,000 to 8,222 (2M); 8,334 to 9,000 (6M).  
Rugged. Low drift, fundamental oscillators. High activity and power output. Stands up under maximum crystal currents. Stable, long-lasting;  $\pm$  500 cycles. . . . \$2.95 Net  
(All Z-2 Crystals calibrated with a load of 32 mmfd.)

## AMATEUR TYPES



Third Overtone, PR Type Z-9A  
Hermetically sealed; calibrated 24,000 to 24,666 and 25,000 to 27,000 Kc.,  $\pm$  3 Kc.; .050" pins. . \$3.95 Net  
6 Meters, PR Type Z-9A  
Fifth overtone; for operating directly in 6-meter band; hermetically sealed; calibrated 50 to 54 Mc.,  $\pm$  15 Kc.; .050" pins. . . . \$4.95 Net



Type Z-1, MARS and CAP  
Official assigned frequencies in the range. Calibrated to .005%. 1600 to 10000 Kc. . . \$3.45 Net  
Type 2XP  
Suitable for converters, experimental etc. Same holder dimensions as Type Z-2. 1600 to 12000 Kc., (Fund.)  $\pm$  5 Kc. \$3.45 Net  
12001 to 25000 Kc. (3rd Overtone)  $\pm$  10 Kc. . . . \$4.45 Net

## PR-100 Transistorized Oscillator

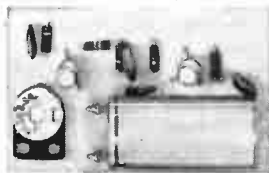

With PR-100 you can check harmonics at 100 Kc. intervals through 54 Mc. A precision oscillator, fully wired, ready to install. Includes a Z-6A Crystal. Power requirements: 12V DC @ 14 Ma. Oscillator output connects to receiver antenna, high side. Base is 1-7/8 x 2-13/16 inches. Negligible mounting space required. Weighs 2 ounces. . . . \$12.95 Net



Type Z-6A, Frequency Standard  
To determine band edge. To keep VFO and receiver properly calibrated. .050" pins. 100 Kc. . . . \$6.95 Net

ORDER FROM YOUR JOBBER

# PR Crystals

Since 1934

USE **PR** AND KNOW WHERE YOU ARE  
PETERSEN RADIO COMPANY, INC.  
COUNCIL BLUFFS, U.S.A.

COMMERCIAL CRYSTALS  
AVAILABLE FROM 100 KC.  
TO 70 MC.  
PRICES ON REQUEST.

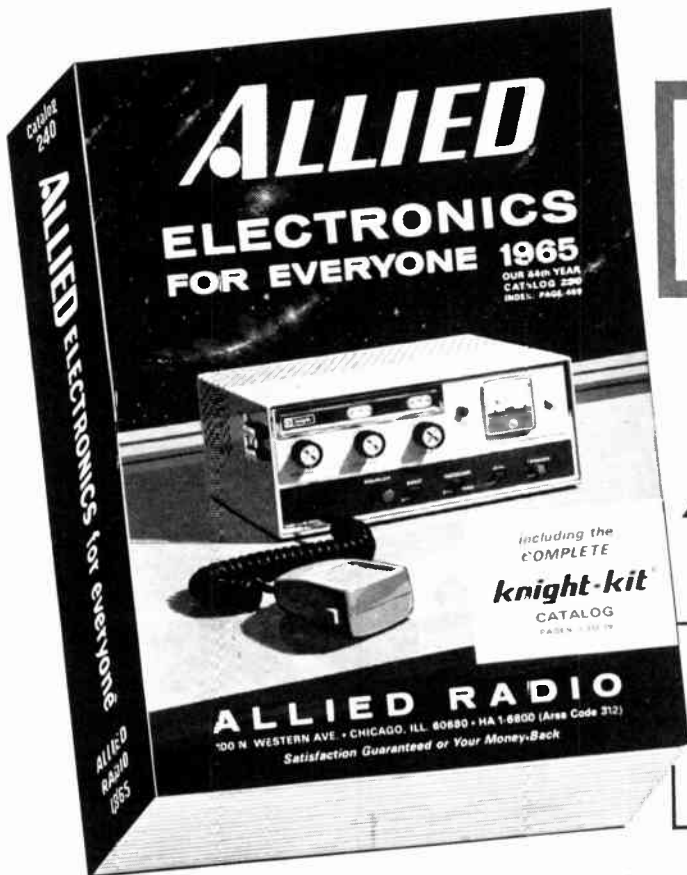

**FREE**

send today for  
your 490-page

**ALLIED**  
**1965 CATALOG**

world's most used  
electronics catalog

**BIGGEST SELECTION**  
**BIGGEST SAVINGS**

## EVERYTHING IN ELECTRONICS FOR THE AMATEUR

*get every Ham  
buying advantage*

### LARGEST SELECTION

ALLIED stocks the station gear you need—at lowest, money-saving prices. Get same day shipment from the world's largest stocks.

### HAM-TO-HAM HELP

Our staff of more than 60 licensed hams goes all-out to give you the personal help you want. Whether you write, call, or visit our Ham Shack, you'll like the friendly interest and attention you always get at ALLIED.

### EASY TERMS

Make full use of the convenient ALLIED Credit Fund Plan—have over 24 months to pay.

**ALLIED RADIO**

*erving the Amateur for 44 years*

- Ham Receivers, Transmitters, Transceivers
- World's Largest Stocks of Station Supplies
- Great Build-Your-Own Ham Knight-Kits®
- Citizens Band 2-Way Radio
- New Automotive Electronics
- Electron Tubes and Semiconductors
- Test Instruments and Meters
- Everything in Stereo Hi-Fi
- Tape Recorders and Tape
- Everything in Electronic Parts, Tools & Technical Books

**SEND FOR YOUR COPY TODAY**



ALLIED RADIO, Dept. 50-M  
100 N. Western Ave., Chicago, Ill. 60680

Send FREE 1965 ALLIED Catalog

Name \_\_\_\_\_  
PLEASE PRINT

Address \_\_\_\_\_

City \_\_\_\_\_ Zone \_\_\_\_\_ State \_\_\_\_\_

# With SPRAGUE CAPACITORS and RESISTORS you build Reliability into your equipment!

## CAN-TYPE ELECTROLYTICS



### Twist-Lok® Capacitors

Hermetically sealed in aluminum cases. Withstand high temperatures (85°C), high surge voltages, high ripple currents.



### Screwbase Capacitors

Aluminum cases. Will withstand high a-c ripple. Available with lugs or insulated wire leads. Common or separate negative terminals.



### High $\mu$ F Capacitors

Molded phenolic cases. Ratings to 10,000  $\mu$ F. Designed for low voltage (to 50V) filter circuits.

## TUBULAR ELECTROLYTICS



### Atom® Capacitors

Tiny, dependable single or multiple section units. Have low leakage, long shelf life. Metal case construction with outer Kraft tube.



### Litt-Lytic® Capacitors

Ultra-small, excellent for transistorized circuitry. All-welded construction—no pressure joints to cause "cpeps". Low leakage, extremely long shelf life.

## HYPASS® CAPACITORS



Exclusive 3-terminal feed-thru units which effectively by-pass vhf currents. Suppress TVI from transmitters, diathermy, line-conducted radiation, etc.

## PAPER-FILM TUBULARS



### Black Beauty® Capacitors

Dual dielectric (polyester film and paper) combines best features of both. Solid impregnant, nothing to leak or drip. Molded case. Withstand high temperatures, high humidity.



### Orange Drop® Capacitors

Dual dielectric (polyester film and paper), with solid impregnant. Double dipped in epoxy resin. Radial leads, ideal for printed wiring boards.

## OIL CAPACITORS



### Rectangular Oils

For transmitter power supplies and other high voltage applications. Hermetically sealed in rugged metal cases. Oil-impregnated, oil-filled. High insulation resistance.



### Screwbase Oils

Cylindrical screwbase can for easy single hole mounting. Oil-impregnated, oil filled. Small size, will fit tight spaces.

## SK-1 SUPPRESSIKIT®



Contains everything needed for effective mobile radio noise suppression of R-F interference up to 400 mc. For autos with 6 or 12 volt generators.

## CERAMIC CAPACITORS



### Cera-mite® Ceramics

Silvered flat-plate design for high by-pass efficiency, high self-resonant frequency. Tough moisture-proof coating. Available in general application, high-K, temperature stable, and temperature-compensating types.



### Buttonhead Ceramics

Flat-disc capacitor element sealed in top of hex head for easy screw-mounting. Low self-inductance, high self-resonant frequency. Available for by-pass or feed-thru applications.

## MICA CAPACITORS



### "Postage-stamp" Micas

Silvered ( $\pm 5\%$  cap. tol.) or standard ( $\pm 20\%$  cap. tol.). Carefully-selected, electrically graded raw mica assures maximum quality.



### Transmitting Micas

Voltage ratings to 2500 WVDC, 5000 V Test. R-F current tested before and after molding.

## WIREWOUND RESISTORS



### Koolohm® Resistors

Insulated shell power resistors wound with ceramic-insulated wire. Completely moisture-proof. Ratings to 120 watts in inductive and non-inductive types.



### Blue Jacket® Resistors

Vitreous enamel coating guards against humidity and failure from electrolysis. Ratings from 2 to 10 W.

For complete data on these and other Sprague components, get Catalog C-616 from your Sprague Distributor, or write to Sprague Products Company, 505 Marshall St., North Adams, Massachusetts.

**SPRAGUE®**  
THE MARK OF RELIABILITY



# 432 MC TRIPLER

MODELS	1432	2132
	144	216
\$ 54.95	to	to
net	432	432
	mc	mc



- SMALL SIZE 3 X 5 1/4 X 2 3/4 INCHES.
- NO POWER SUPPLY REQUIRED (varactor is self powered).
- COMPATIBLE WITH AM, FM & CW
- 20 WATTS INPUT PRODUCE 12 WATTS OUT (nominal)

## VHF ASSOCIATES

PO BOX 22135  
DENVER COLORADO 80222

**TUBES, PARTS ETC. AT LOWEST PRICES**

**EVERYTHING IN HI-FI AND STEREO**

**VALUES IN POWER & HAND TOOLS**

**100'S OF BIG PAGES CRAMMED WITH SAVINGS**

# FREE

## GIANT NEW 1965 CATALOG

THE OUTSTANDING

# MONEY SAVING

BUYING GUIDE FOR:

- Stereo & Hi-Fi Systems and Components
- Tape Recorders
- Electronic Parts, Tubes, Books
- Phonos & Records
- Ham Gear
- Test Instruments and Kits
- Cameras and Film
- Public Address
- Citizens Band
- Transistor & FM-AM Radios.

BURSTEIN-APPLEBEE CO.

Dept. 89, 1012 McGee St., Kansas City 6, Mo.

Rush me FREE 1965 B-A Catalog

Name .....

Address .....

City ..... State .....





# RADIO COMMUNICATIONS EQUIPMENT

VHF RECEIVERS  
REMOTE CONTROLS  
VHF ANTENNAS

- AIRPORT VEHICLES
- AIRLINE GROUND STATIONS
- CONTROL TOWERS



## COMCO THE LEADING MANUFACTURER OF RADIO EQUIPMENT FOR AIRPORT VEHICLES OFFERS A COMPLETE LINE FOR COMMERCIAL AND MILITARY APPLICATION



### MODEL 678 CONTROLLER

MOBILE, PORTABLE 118-150 MC  
6/12/24 VOLTS DC 10 WATTS OUTPUT

In production for past 12 years and recognized as standard of the Aviation Industry, this pioneer model now includes a new squelch and limiter circuit for noise free operation at the busiest airports.

### MODEL 678 GROUND STATION

MOBILE, PORTABLE 118-150 MC  
6/12 and/or 117 VOLTS AC

This popular 10 watt ground station is earning an excellent reputation for performance and low maintenance by many domestic airlines, ARINC, municipal airports, and government agencies, and for high quality unicom stations. Mobile transceiver features all-transistor power supply.

### MODEL 700 PORTACOM

MOBILE/PORTABLE/BASE 225-480 MC  
6/12/24 VDC OR 117 VAC 2 WATTS OUTPUT

Designed for military airport vehicles requiring communication with control tower and/or aircraft in vicinity of airport. Now being used by U.S.A.F., U.S.C.G., F.A.A., and other Government Agencies.

### MODEL 727 JETCOM

AM/FM MOBILE 118-150/25-470 MC  
6/12 OR 24 VOLTS DC  
3/20-40 WATTS OUTPUT

A combination AM/FM radio for commercial airport vehicles requiring communication with tower and a VHF-FM municipal or company frequency. Simultaneously monitors both frequencies with minimum battery drain.

For full details, write today!

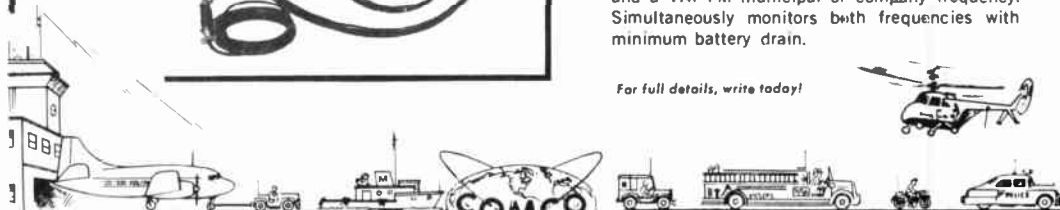

DESIGNERS AND MANUFACTURERS OF

RADIO COMMUNICATIONS EQUIPMENT

# COMMUNICATIONS COMPANY, Inc.

FOUNDED 1938

CORAL GABLES, MIAMI 34, FLORIDA

LIKE THE PYRAMIDS..

# VESTO

## SELF-SUPPORTING STEEL TOWERS LAST!

**LOW COST** Vesto Steel Towers are highest quality, low-cost, completely reliable!

**WIDE COMMERCIAL USE** Vesto Steel Towers are used as airport communication towers, railroad and harbor signal beacons, VHF-UHF communications, micro-wave transmission, municipal lighting and alerting systems, utilities and amateur applications.

**COMPACT—EASY TO TRANSPORT and SHIP** Vesto Steel Towers are banded into compact bundles making them easy to transport into difficult-to-reach sites, or to handle and ship.

**FAST, EASY ERECTION** Vesto Steel Towers require no special foundation, can be erected by one man! It's easy to build your own tower—and you save money, too!

**HURRICANE PROOF** Vesto Steel Towers have withstood hurricanes for many years—without a failure!

**SAFETY PLATFORM—QUALITY MATERIALS** Vesto Steel Towers feature an optional safety platform, with railing, near the top. Structural members are hot dip galvanized after cutting and punching.

**FAST DELIVERY—SMALL DOWN PAYMENT—EASY TERMS** Vesto Towers are available in a wide range of sizes to meet requirements of amateurs and commercial users. Note the low prices for these quality, lifetime all-steel towers!

22'	\$174	28'	\$219	33'	\$262	39'	\$312
44'	\$359	50'	\$416	55'	\$472	61'	\$539
77'	\$850	100'	\$1312				

Towers are shipped knocked down, F.O.B. Kansas City, Missouri, 4th Class freight. Prices are subject to change without notice.



"MAGE"  
MAGERS  
President  
WØOJ

Send check or money order  
... or ask for complete  
**FREE**  
INFORMATION  
and  
PHOTOGRAPHS!

# VESTO CO., INC.

20th and Clay  
North Kansas City, Missouri



# Symbol of Reliability

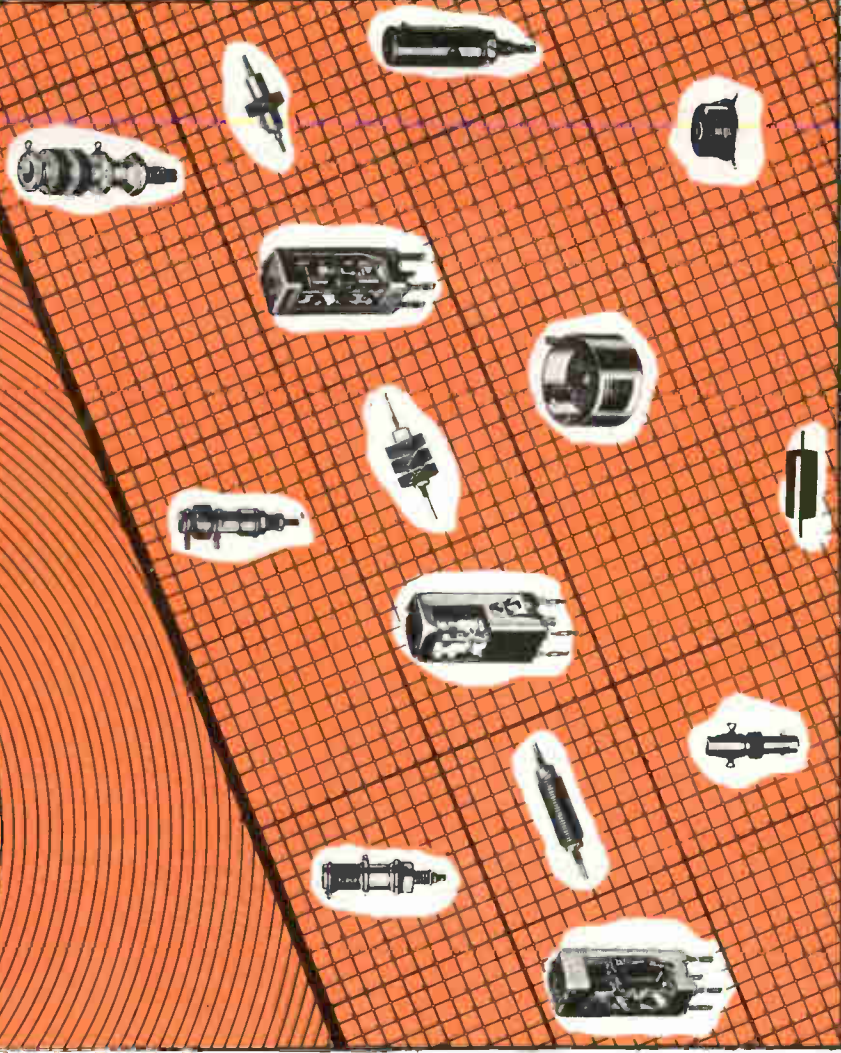

Manufacturers of the most complete line of Amateur, Industrial, Radio and Television R.F. Coils.

## J.W. Miller Co.

5917 South Main Street

Los Angeles 3, California

Available through your  
local distributor

# RADIO AND ELECTRONIC BOOKS FROM

EDITORS and ENGINEERS Ltd. New Augusta, Ind.

—comprehensive, up-to-the-minute data on designing and building equipment; surplus radio; preparation for operator's licenses; world electronic tubes.



## RADIO HANDBOOK—comprehensive theory, design, and construction data

The most valuable reference work for practical radiomen, radio technicians, and advanced amateurs. How to design, build, and operate standard types of radio transmitting and receiving equipment, from medium to ultra-high frequencies. Also hundreds of pages of basic theory and reference data; profusely indexed for easy finding, clearly illustrated, easy to read.

New information on simplified TVI-proofing, bandswitching, fixed-station and mobile transmitters, single-sideband exciters, complete station installations, and many new ideas for improved operation. Frequently revised and brought up to date in accordance with technical progress. Current edition has 800 pages, all editorial. Clothbound and gold stamped—the LARGEST "RADIO HANDBOOK" EVER PUBLISHED Book #166 . . . . . \$9.50 in U.S.A. (Elsewhere, \$10.50)

## TRANSISTOR RADIO HANDBOOK—Transistor Communications Equipment

by: Donald L. Stoner, W6TNS and Lester A. Earnshaw, ZL1AAX

Handbook covers a wide range of communication uses for both amateur radio and commercial applications. Simplified theory, plus practical construction projects including amplifiers, V.H.F. equipment, single sideband exciters and a complete S.S.B. transceiver. Book #044 . . . . . \$5.00 in U.S.A. (Elsewhere, \$5.50)

## SURPLUS RADIO CONVERSION MANUALS—3 volumes

**VOLUME I**/BC-221 Frequency Meter; BC-342 Receiver; BC-312 Receiver; BC-348 Receiver; BC-412 Radar Oscilloscope; BC-645 Transmitter/Receiver; BC-946 Receiver; SCR-274 (BC-453A Series) Revr.; SCR-274 (BC-457A Series) Xmitters; SCR-522 (BC-625, 624) Transmitter/Receiver; TBY Transceiver; PE-103A Dynamotor; BC-1068A/1161A Receiver; Electronics Surplus Index; Cross Index of A/N Vac. Tubes; Amateur Freq. Allocations; Television and FM Channels. Book #311

**VOLUME II**/BC-451 or ARC-5 Receivers; AN/APS-13 Transmitter/Rev.; BC-457 or ARC-5 Transmitters; ARC-5 V.H.F. Transmitter/Rev.; GO-9/TBW Transmitters; BC-357 Marker Receiver; BC-946B Receiver as Tuner; BC-375 Transmitter; Model LM Frequency Meter; TA-12B Bendix Transmitter; AN/ART-13 (Collins) Transmitter; Simplified Coil-Winding Charts; Selenium-Rectifier Power Units; AVT-112A Light Aircraft Xmitr.; AM-26/AIC to a Hi-Fi Ampl.; Surplus Beam Rotating Mechs.; ARB Revr. Diagram Only Book #322

**VOLUME III**/APN-1; APN-4; ARC-4; ARC-5; ART-13; BC-191; 312, 342, 348, 375, 442, 453, 455, 456-459, 603, 624, 636, 1066, 1253; CRY-5200 series; COL-43065; CRC-7; DM-34; DY-2; DY-8; FT-241A; LM Power Supply; MBF; MD-7/ARC-5; R-9/APN-4; R-28/ARC-5; RM-52-53; RT-19/ARC-4; RT-159; SCR-274N, 508, 522, 528, 538; T-15 to T-23/ARC-5; URC-4; WE-701-A. Schematics only: APA-10; APT-2; APT-5; ARR-2; ASB-5; BC-659; BC-1335A; CPR-46ACJ. Book #333 . . . . . \$3.00 per volume in U.S.A. (Elsewhere, \$3.50)

## THE SURPLUS HANDBOOK, VOLUME I (Receivers and Transceivers)

Schematic Diagrams and large photographs only on APN-1, APS-13; ARB; ARC-4; ARC-5 (L.F.); ARC-5 (V.H.F.); ARN-5; ARH-2; ASB-7; BC-222; 312, 314, 342, 344, 348, 603, 611, 624, 652, 654, 659, 669, 683, 728, 745, 764, 779, 794, 929, 1000; 1004, 1006, 1206, 1306, 1335; BC-ARR-231; CRC-7; DAK-3; GF-11; MARK II; MN-26; RAK-5; HAL-5; RAX-1; SCIT-522; Super Pro; TBY; TCS; Resistor and Capacitor Color Codes; Cross Index of A/N V.T. and Commercial Tubes. Book #510 . . . . . \$3.00 in U.S.A. (Elsewhere, \$3.50)

## RADIOTELEPHONE LICENSE MANUAL

One convenient volume helps you prepare for all USA commercial radiotelephone license exams. Gives the basis for a sound understanding of every pertinent subject.

Complete study-guide questions with clear, concise answers. Contains four sections: (1) Questions on Basic Law; (2) Basic Operating Practice; (3) Basic Radiotelephone; (4) Advanced Radiotelephone. Book #030 . . . . . \$5.75 in U.S.A. (Elsewhere, \$6.25)

## WORLD'S RADIO TUBES (Radio Tubes Vade Mecum)

Characteristics of all existing radio tubes made in all countries. The world's most comprehensive and authoritative tube book. All types classified numerically and alphabetically. To find a given tube is only a matter of seconds! Also complete section on base connections. Book #471 . . . . . \$8.00 in U.S.A. (Elsewhere, \$8.50)

## WORLD'S EQUIVALENT TUBES (Equivalent Tubes Vade Mecum)

All replacement tubes for a given type, both exact and near-equivalents (with points of difference detailed). From normal tubes to the most advanced comparisons. Also military tubes of 7 nations, with commercial equivalents. Over 43,900 comparisons! Book #493 . . . . . \$8.00 in U.S.A. (Elsewhere, \$8.50)

## WORLD'S TELEVISION TUBES (Television Tubes Vade Mecum)

Characteristics of all TV picture, cathode ray, and many special purpose tubes. Invaluable to technicians and all specialists in the electronic field. Book #482 . . . . . \$8.00 in U.S.A. (Elsewhere, \$8.50)



KAHN RESEARCH LABORATORIES, Inc.  
A TRUSTED NAME IN  
Commercial Communications and Broadcast Equipment

presents

THE FIRST IN A NEW LINE OF AMATEUR AM and SSB EQUIPMENT

# ECHOPLEX...

- is a unique audio processing device providing 7 db Signal-to-Noise gain and Minimum fading loss
- splits the voice wave into six frequency segments and differentially delays wave segments so as to reduce peaks and provide time diversity.
- units may be switched, remotely, from receiver to transmitter.



for full information write DEPT. QH

81 SOUTH BERGEN PLACE, FREEPORT, NEW YORK  
(516) FR 9-8800

AMECO

Accessories always available at **ARROW**

### AMECO 2 & 6 METER CW/PHONE XMTR WITH POWER SUPPLY



Model TX-62 complete 75 W. phone & CW transmitter has built-in power supply and modulator. Tunes easily by adjusting final plate and loading caps.

50-54 Mc. & 144-148 Mc, Xtal VFO, Meter reads final grid or cathode current or RF out. Built-in solid state power supply, fused, Mike/Key jack & xtal socket on front panel. Size: 11 1/2 x 9 1/2 — 6" high, shipping weight approx. 20 lbs. TX-62, wired and tested

\$149.95

### ALL BAND NUVISTOR PREAMP 6 THRU 160 METERS



MODEL PCL, Wired, \$24.95  
MODEL PCLP with built-in power-supply, wired, \$32.95

2 Nuvistors in cascode give noise figures of 1.5 to 3.4 db, depending on band. Weak signal performance, image and spurious rejection on all receivers are greatly improved. PCL's overall gain in excess of 20 db. Panel contains bandswitch, tuning capacitor and 3 position switch which puts unit into "OFF," "Standby" or "ON," and transfers antenna directly to receiver or through Preamp. Power required — 120 V. at 7 ma, and 6.3 V. at .27 A. — can be taken from receiver or Ameco PS-1 supply. Size: 3"x5"x3".

### NUVISTOR CONVERTERS FOR 50, 144 AND 220 MC. HIGH GAIN, LOW NOISE



Model CN

Has 3 Nuvistors (2 RF stages & mixer) and 6J6 osc. Available in any 1F output and do NOT become obsolete as their 1F is easily changed to match any receiver. Average gain — 45 db. Noise figure — 2.5 db. at 50 Mc., 3.0 db. at 144 Mc., 4.0 db. at 220 Mc. Power required 100-150V. at 30 ma., 6.3V. at .84A. See PS-1 Power Supply. Model CN-50W, CN-144W or CN-220W wired, (specify 1F.) \$49.95. Model CN-50K, CN-144K or CN-220K in kit form. (specify 1F.) \$34.95

CN-220K in kit form. (specify 1F.) \$34.95



CB-6

CB-6K — 6 meter kit, 6ES8-rf Amp., 6U8-mix./osc. .... \$19.95  
CB 6W — wired & tested ... \$27.50  
CB-2K — 2 meter kit, 6ES8 1st rf amp., 6U8 — 2nd rf amp/mix, 6J6 osc. .... \$23.95  
CB-2W — wired and tested, ... \$33.95  
Model PS-1 — Matching Power Supply — plugs directly into CB-6, CE-2 and CN units, PS-1K — Kit ... \$10.50  
PS-1W — Wired ..... \$11.50

**ARROW**

**ELECTRONICS INC.**

900 Broad Hollow Rd., Farmingdale, N. Y.  
516 — MYrtie 4-6822

65 Cortlandt St., N.Y. 7, N.Y. • 525 Jericho Tpke., Mineola, N.Y. • 225 Main St., Norwalk, Conn.  
212 — Digby 9-4730 516 — Pioneer 2-2290 203 — Victor 7-5899

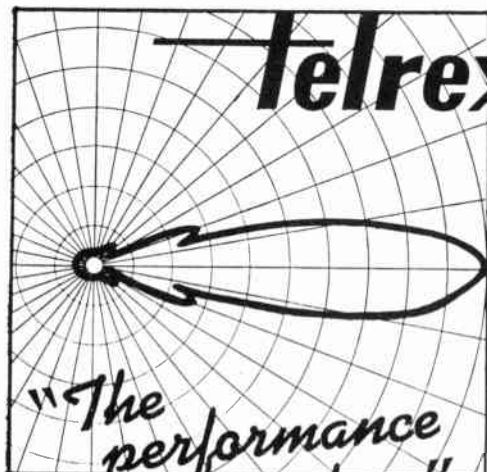

# “BEAMED-POWER” ANTENNAS and ANTENNA SYSTEMS

The Choice of the Discriminating  
Communication Engineer . . . the  
Man who Never Settles for Any-  
thing Less than THE-VERY-BEST!

You too—can enjoy world renowned TELREX performance and value! Send for PL65 condensed data and pricing catalog, describing the lowest priced antennas on the market, in relation to materials and performance! Expanded data sheets—including your favorite band, are also available.

with a *line*  
**MATERIAL DIFFERENCE  
—IN USE IN 135 LANDS!**

ANTENNAS COMMUNICATION SYSTEMS  
SINCE 1921 **telrex** LABORATORIES  
ASBURY PARK 40, NEW JERSEY, U.S.A.



*telrex* “BALUN” FED INVERTED “V” ANTENNA KITS  
SIMPLE-TO-INSTALL, HI-PERFORMANCE ANTENNA SYSTEMS:

2

\*Kit comprises, encapsulated, “Balun,” copperweld, insulators, plus installation and adjustment instructions for any Mono-band 80 thru 10 Meters. Also available 2, 3, 4, 5 Band Models.

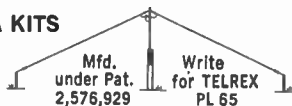

Mfd.  
under Pat.  
2,576,929

Write  
for TELREX  
PL 65

**TELREX LABORATORIES**  
ASBURY PARK, NEW JERSEY

## LEARN CODE THE MODERN ATKO WAY! NEW!

### ATKO MINI-KEYER MODEL 10A

A new compact dimension from ATKO, makers of the standard code training keyers now used by the Navy, Coast Guard, Air Force and other governmental agencies in their code training programs. The ATKO MINI-KEYER is actually a complete radio school, with the added advantages that it can be used to automatically key your transmitter, or monitor your sending.

#### FEATURES :

- Uses Wheatstone perforated tape. Standard the world over.
- Furnished with three reels of triple spaced tape. Additional, tapes, normal, double or triple spaced, available at nominal cost.
- Code speeds controlled by easily interchanged capstans. Capstan giving sending rate of 16 wpm, which is 5.3 wpm with triple spaced tape, comes with Keyer. This provides excellent means of practicing sending. With telegraph key connected, the 10A sends a perfectly formed character, pauses while you imitate what you have just heard.
- Has Volume and Broad Band frequency controls.
- Will key outside tone source or your transmitter.
- Equipped with built-in oscillator, speaker and Key jack for sending practice.
- Equipped with Phone jack. Will drive up to 25 pairs of head phones.



**Model 10A \$49.50**

- At 10 words per minute, tapes run for 1 hour.
- All solid state design. Needs no warm-up. Operates from 115 Volt 60 cycle AC power line. No batteries.
- Includes 11 page Instruction Manual.
- Other capstans available for 12, 14, 18, 20, 22, 25 and 30 wpm at \$2 each.

Model 10B identical to 10A except that it contains no tone source or speaker.

**Model 10B \$39.50**

**AUTOMATIC TELEGRAPH KEYER CORPORATION**  
275 Madison Ave., New York, New York 10016



# FIRST CHOICE

# ELMAR

FOREMOST WESTERN ELECTRONIC DISTRIBUTOR



- TUBES • SEMICONDUCTORS • COMPONENTS •
- ANTENNAS • TOWERS • ACCESSORIES •
- TRANSMITTERS • RECEIVERS • TRANSCEIVERS •
- EVERY MAKE AND MODEL •



ORDER BY PHONE • MAIL  
WIRE • OVER COUNTER

**ELMAR**  
ELECTRONICS

PHONE: (415) 834-3311 • WU-FAX • TWX (415) 891-9252  
140 ELEVENTH STREET, OAKLAND 7, CALIFORNIA.

*In 1965, ... also in Mountain View, Calif.*

# TWO NEW KITS FROM CONAR

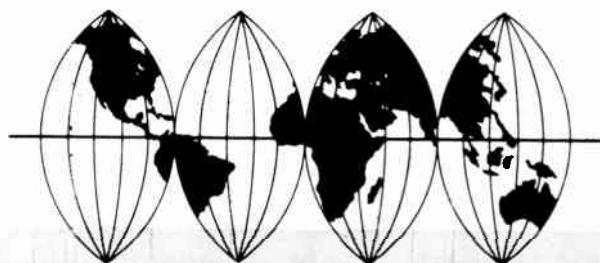

## 'ROUND THE WORLD RADIO FOR \$64.00



**MODEL 500**  
3 Band Novice Receiver

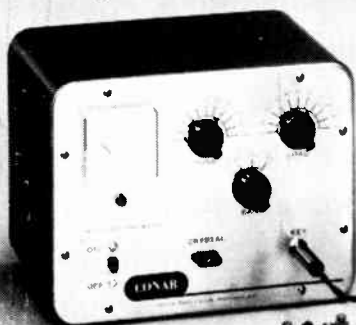

**MODEL 400**  
3 Band Novice Transmitter

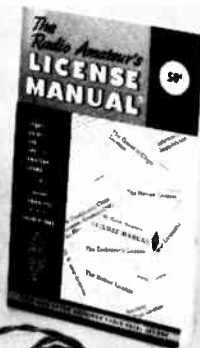

Designed with the novice ham radio enthusiast in mind. A complete, low cost, easy to build and easy to use amateur radio set-up that sends and receives signals around the world. Everything you'll need to begin a new, fascinating hobby is included . . . and you'll be on the air in one evening. Complete set-up includes transmitter, receiver, code key, assembly manuals, instruction manuals, ARRL Handbook and complete data about getting your Novice License. All this for just \$64.00. Use coupon below now. Cash or terms.

### THE MODEL 400 25-WATT TRANSMITTER

Inside this attractive 10" x 7½" x 6½" dark blue cabinet is a remarkable power house. Yet, it's so simple to build, so easy to tune, even an inexperienced kit builder can be on the air in one evening. Covers the popular Novice bands—80, 40 and 15 meters. 3" square panel meter for fast "tuning up". Special variable-impedance current-limiter assures pure signal on any band, protects your valuable crystals (crystals not included). Other features: Pi-network output; transformer power supply with dual silicon rectifier to produce ripple-free DC for plate power; bleeder resistor to regulate and discharge high-voltage capacitors when gear is turned off; co-ax output.

**KIT PRICE: \$32.50**  
(Stock #400UK)  
**Assembled: \$46.50**  
(Stock #400WT)

### THE MODEL 500 3 BAND RECEIVER

Identical in size and color to the Transmitter. Offers features of receivers priced much higher. Superhet circuit has TWO stages of i-f amplification to "dig down" for weak signals. Antenna trimmer lets you adjust front end for peak reception on each of three bands. Bands cover stretches over nearly full travel of large tuning dial. Separate, stable bfo for clear reception of CW and SSB signals. Variable i-f gain. Following the detector are two stages of audio amplification to drive either the built-in speaker or headphones. Transformer operated with semiconductor rectifier to supply power for various circuits. Receives AM, CW and SSB. So easy to build, so easy to use, so easy to own. Order today.

**KIT PRICE: \$37.50**  
(Stock #500UK)  
**Assembled: \$56.50**  
(Stock #500WT)

## CONAR

NO4C

Division of National Radio Institute  
3939 Wisconsin Ave.,  
Washington, D.C. 20016

- Please send me both new Conar Ham Radio Kits @ \$64.00 Complete
- Please send only Model 400 Transmitter Kit @ \$32.50 (Assembled \$46.50)
- Please send only Model 500 Receiver Kit @ \$37.50 (Assembled \$56.50)
- Tell me how I can buy this equipment on easy terms.

Name \_\_\_\_\_

Address \_\_\_\_\_

City \_\_\_\_\_ State \_\_\_\_\_ Zip Code \_\_\_\_\_



THE  
LEAGUE  
IS  
YOU!

Working together, the members of ARRL have for fifty years provided the base of support from which our great public-service hobby has grown and maintained the precious privileges that many amateurs now take for granted.

Through membership in the League and affiliated clubs, many people pool their knowledge, their skills, their energy, and a small part of their material resources to help one another. The result is top-notch training programs and publications, top-efficiency traffic nets, community communications programs—and an amateur radio service which is useful to our country and deserving of its privileges.

Newcomers gain from the experience of the old timers, and old timers gain from the enthusiasm of the beginners. The more we work together in the League, the greater will be our collective achievements—and our security.

Each and every radio amateur is vital to the League, and the League is vital to each and every radio amateur. Join now with over 100,000 League members so that we can all share more fully in these mutual benefits. League membership is only \$5 in the U.S., \$5.25 in Canada, and \$6.00 elsewhere.

If you are already a member, help strengthen your League by spreading this word to others!

THE AMERICAN RADIO  
RELAY LEAGUE, INC.  
Newington, Conn. 06111

# You get your "ticket" to greater income

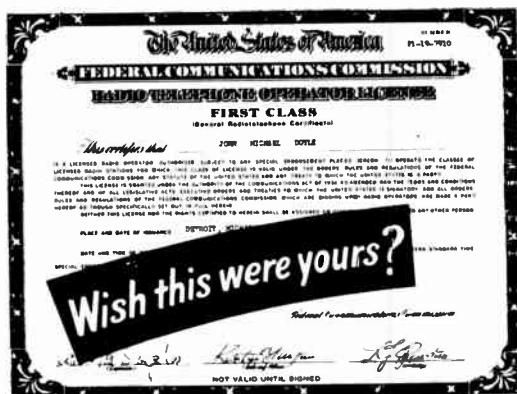

## or your money back

### THERE'S A WORLD OF OPPORTUNITY FOR THE MAN WITH AN FCC LICENSE

All it takes is a few spare hours a week and NRI's FCC License Course to open the way to increased opportunities in Communications. With an FCC License, you're ready to operate, service and install transmitting equipment used in aviation, broadcasting, marine, mobile and Citizens-Band communications.

What does it take? Men with absolutely no training or experience in Electronics complete the course in 10 months. A Technician or man with some background can easily cut that time in half. And because NRI has a greater enrollment than any other school of its type, training costs you less than comparable courses offered by other schools. Further, YOU MUST PASS your FCC exams or NRI refunds your tuition in full.

Get full details today about NRI FCC License Course plus 9 other home-study instruction plans offered by NRI, oldest and largest school of its kind. Mail coupon for free catalog. There's no obligation. No salesman will call. NATIONAL RADIO INSTITUTE, Washington, D.C.

### MAIL NOW for FREE CATALOG



NATIONAL RADIO INSTITUTE  
Electronics Division  
Washington, D. C. 20016

18-124

Please send me complete information on FCC License Training and other NRI courses, as checked below. (No salesman will call.)

- |  |   |
|--|---|
| <input type="checkbox"/> FCC License             | <input type="checkbox"/> Radio-TV Servicing         |
| <input type="checkbox"/> Complete Communications | <input type="checkbox"/> Industrial Electronics     |
| <input type="checkbox"/> Aviation Communications | <input type="checkbox"/> Electronics for Automation |
| <input type="checkbox"/> Marine Communications   | <input type="checkbox"/> Basic Electronics          |
| <input type="checkbox"/> Mobile Communications   | <input type="checkbox"/> Math for Electronics       |

Name \_\_\_\_\_ Age \_\_\_\_\_  
PLEASE PRINT

Address \_\_\_\_\_

City \_\_\_\_\_ State \_\_\_\_\_ Zip \_\_\_\_\_

ACCREDITED MEMBER NATIONAL HOME STUDY COUNCIL

# COMPLETE OUTFITTERS

FOR THE

- ▶ **HAM**
- ▶ **COMMUNICATIONS**
- ▶ **ELECTRONIC  
ENGINEERS**

---

**EUGENE G. WILE**

218-220 South 11th St. Philadelphia, Pa. 19107  
(215)-923-1343

*Distributors of*

Nationally Advertised Lines of  
RADIO, TELEVISION and ELECTRONIC Parts



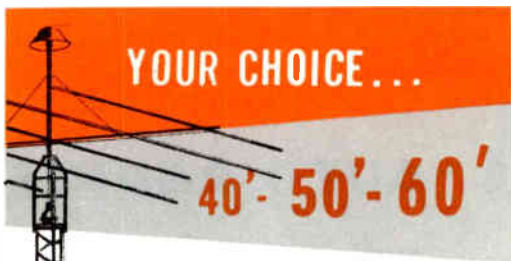

**& UP TO 75 FT. OF  
CRANK-UP TOWER!**

E-Z Way gives you a wide choice of towers that is a sure bet to fill any amateur requirement. E-Z Way towers are designed for the Ham. Complete antenna installation and maintenance of beam or rotor is provided through the *tilt over* feature that permits working at ground level.

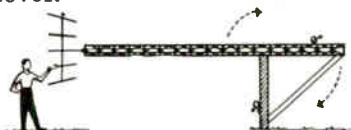

- TILTS OVER
- CRANKS UP & DOWN
- NO GUYS

All towers are aero-dynamically designed to lessen wind load and also to allow greater height and antenna load. Fabricated of high tensile steel, electric arc welded with diagonal bracing, hot dipped galvanize after fabrication assures dependability that has made E-Z WAY the *choice of Hams* the world over.

**MOTO-WINCH**

Add to hamming pleasure with the Moto-Winch. Positively the last word in convenience and protection to equipment. Operates from ham shack or from base of tower. Weather protected motor, worm gear drive, positive action Up or Down, will fit most E-Z Way towers.

Write Dept. HB for new 1965 catalog and price list.



Communications, mobile radio...

**A First Class  
FCC License**

**...or Your Money Back!**



Your key to future success in electronics is a First-Class FCC License. It will permit you to operate and maintain transmitting equipment used in aviation, broadcasting, marine, microwave, mobile communications, or Citizens-Band. Cleveland Institute home study is the ideal way to get your FCC License. Here's why:

Our training programs will quickly prepare you for a First-Class Commercial Radio Telephone License with a Radar Endorsement. Should you fail to pass the FCC examination after completing your course, you will get a *full refund* of all tuition payments. You get an FCC License . . . or your money back!

You owe it to yourself, your family, your future to get the complete details on our "proven effective" Cleveland Institute home study. Just send the coupon below TODAY. There's no obligation.

**Mail Coupon TODAY For FREE Catalog**

**Cleveland Institute of Electronics**  
1776 E. 17th St., Dept. RH  
Cleveland, Ohio 44114

Please send FREE Career Information prepared to help me get ahead in Electronics, without further obligation.

**CHECK AREA OF MOST INTEREST—**

<input type="checkbox"/> Electronics Technology	<input type="checkbox"/> First Class FCC License
<input type="checkbox"/> Industrial Electronics	<input type="checkbox"/> Electronic Communications
<input type="checkbox"/> Broadcast Engineering	<input type="checkbox"/> Advanced Engineering

Your present occupation \_\_\_\_\_

Name \_\_\_\_\_ (please print) Age \_\_\_\_\_

Address \_\_\_\_\_

City \_\_\_\_\_ State \_\_\_\_\_ Zip \_\_\_\_\_

Accredited Member National Home Study Council

# Crowne Converters

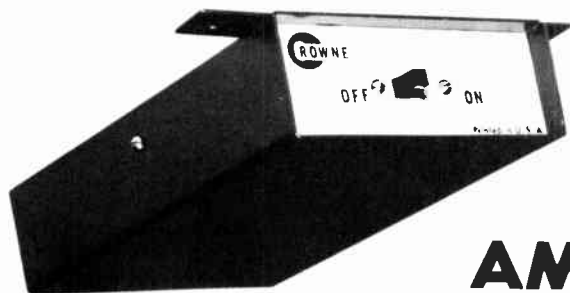

for

**AUTO RADIOS**

**AM or FM, to AM**

- Tune through **AUTO RADIO DIAL**
- Self-contained **Battery**, long life
- Inserts into Radio **Antenna Lead**

## MODELS:

**65M** covers entire **MARINE BAND** 2.10 to 2.75 mcs.

**65C** covers all **23 C.B. Channels** 26.9 to 27.3 mcs.

## Ham Bands:

<b>65C4</b>	<b>80 meters, Range</b>	<b>3.5 to 4.0 mcs.</b>
<b>65C7</b>	<b>40 meters, Range</b>	<b>7.0 to 7.3 mcs.</b>
<b>65C14</b>	<b>20 meters, Range</b>	<b>14.00 to 14.35 mcs.</b>
<b>65C21</b>	<b>15 meters, Range</b>	<b>21.00 to 21.45 mcs.</b>
<b>65C28*</b>	<b>10 meters, Range</b>	<b>28.50 to 29.50 mcs.</b>

\*A small frequency adjustment available on this model.

## SIZE;

**Face Plate: 3 ins. X 1 in.**

**Depth: 5 ins.**

**Mounting: 2 no. 6 self-tap screws.**

**OTHER PRODUCTS:**

**FM. AIRCRAFT & 150/160mcs.**

**AQUASPACE DEVELOPMENT INC.**  
**Box 586 canoga park, calif. U.S.A.**

**PHONE (213) 348-3410**

*Some franchised dealerships available*

# THE WORLD FAMOUS MODEL 59 MEGACYCLE METER



## FEATURES:

Measurements' MEGACYCLE METER is essentially the familiar "grid-dip" oscillator but one in which many unique features have been incorporated. The Model 59 consists of a compact oscillator connected by a flexible cord to its power supply/indicating unit. The instrument is a variable frequency oscillator, an absorption wave-meter, an oscillating detector, a tuned-circuit absorption detector. The engineer, technician, service man and amateur have found it a most versatile instrument in a multitude of applications.

## SPECIFICATIONS:

Frequency Range: 2.2 Mc to 420 Mc. with seven plug-in coils

Frequency Accuracy:  $\pm 2\%$

Output: CW or 120 cycle modulation. Provision for external modulation.

Power Source: 115 or 230 volts  $\pm 10\%$ , 50-60 cycles, 20 watts.

Weight: 8 pounds



0.1 Mc. to 940 Mc.

Price: \$168.00 f.a.b.  
Boonton, N. J.

## APPLICATIONS:

- For determining the resonant frequency of tuned circuits, antennas, transmission lines, or any resonant circuit.
- For measuring capacitance, inductance, Q, mutual inductance.
- For preliminary tracking and alignment of receivers.
- As an auxiliary signal generator; modulated or unmodulated.
- For antenna tuning and transmitter neutralizing.
- As a beat-frequency oscillator in conjunction with a fixed frequency oscillator for measuring video or wide-band amplifier bandwidths.

### TWO ADDITIONAL PLUG-IN HEADS AVAILABLE:

Model 59 L.F. Oscillator (100 Kc to 4.5 Mc) \$98.50  
Model 59 UHF Oscillator (420 Mc to 940 Mc) \$128.50

MANUFACTURERS OF:  
Standard Signal Generators  
FM Signal Generators  
Pulse Generators  
Square Wave Generators  
Crystal Calibrators  
Deviation Meters  
Frequency Meters  
Vacuum Tube Voltmeters  
R. F. Attenuators  
Special Test Instruments

# MEASUREMENTS

A MCGRAW-EDISON DIVISION  
BOONTON, NEW JERSEY



110 S-73 S.P.S.T.  
(Screw Terminals)  
111-16-73 S.P.S.T.  
(Wire Leads)



110-B 73 S.P.S.T.  
(Bottom lugs)  
110-73 S.P.S.T.  
(End lugs)



P27A S.P.S.T.  
(Momentary)

**SPECIFY**  
**Carling**

**FINEST QUALITY ■ BEST SERVICE ■ COSTS NO MORE**



TILA60-WH CL



LTILA54-WH  
(Imprinted, with snap-  
in bracket and split  
lens)



2FA53-73 S.P.-S.T.  
2FB53-73 S.P.-D.T.  
2FC53-73 S.P.-D.T.  
(Center Off)



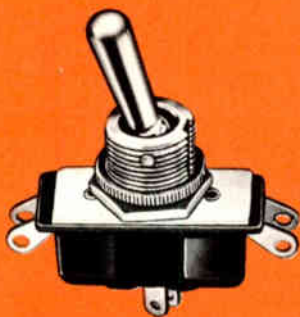

2BB62-73 S.P.D.T.  
2BK62-73 D.P.D.T.



2BL63-73 D.P.D.T.  
(Bottom lugs)



800-2 (ON-ON)  
800-3A (OFF-ON-ON)  
800-4A3 (ON-ON-OFF-ON)

# SWITCHES

Quality insulating material for the best arc tracking control.

Positive make and break action.

Precision handle operating forces.

Finer contact materials for dependable performance under varying loads.

Stronger return springs with minimum pressure.

A multitude of circuit arrangements available.

Easy to wire terminal arrangements and styles.

Exact lever to bushing seals.

Carling Quality Switches are available in the widest possible variety of styles and sizes and have extensive applications in the radio electronics field.

In addition to the popular distributor stocked items pictured here are thousands of variations and adaptations designed for our customers' specific needs. We are constantly engaged in the development of new products and welcome the opportunity to serve you.

Call or see your local distributor.

# Carling

## SWITCHES

WEST HARTFORD 10, CONNECTICUT

Switches shown approximately 3/4 actual size.



2GK250-73 D.P.-S.T.  
2GL250-73 D.P.-D.T.  
2GM250-73 D.P.-D.T.  
(Center Off)

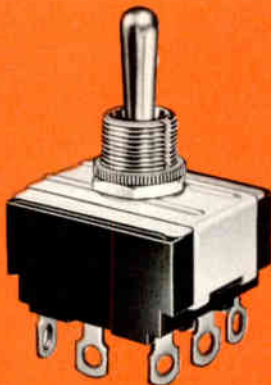

HK250-73 3P.-S.T.  
HL250-73 3P.-D.T.  
HM250-73 3P.-D.T.  
(Center Off)

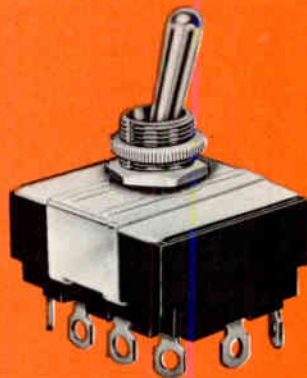

IK250-73 4P.-D.T.  
IL250-73 4P.-D.T.  
IM250-73 4P.-D.T.  
(Center Off)

## ***To Manufacturers and Distributors of Products Used in Short-Wave Radio Communication***

THE RADIO AMATEUR'S HANDBOOK is the standard reference on the technique of high-frequency radio communication. Now in its forty-second edition, it is used universally by radio engineers and technicians as well as by thousands of amateurs and experimenters. Year after year it has sold more widely, and now the Handbook has an annual distribution greater than any other technical handbook in any field of human activity. To manufacturers whose integrity is established and whose products meet the approval of the American Radio Relay League technical staff, and to distributors who sell these products, we offer use of space in the Handbook's Catalog Advertising Section. This section is the standard guide for amateur, commercial and government buyers of short-wave radio equipment. Particularly valuable as a medium through which complete data on products can be made easily available to the whole radio engineering and experimenting field, it offers an inexpensive method of producing and distributing a catalog impossible to attain by any other means. We solicit inquiries from qualified manufacturers and distributors.

**ADVERTISING DEPARTMENT . . .**

**American Radio Relay League**

**NEWINGTON, CONNECTICUT 06111**













