

AM/FM Broadcast Station Planning Guide

By Harry A. Etkin



FIRST EDITION

FIRST PRINTING—FEBRUARY 1970

SECOND PRINTING—JUNE 1976

Copyright © 1970 by TAB BOOKS

Printed in the United States
of America

Reproduction or publication of the content in any manner, without express permission of the publisher, is prohibited. No liability is assumed with respect to the use of the information herein.

International Standard Book No. 0-8306-0500-2

Library of Congress Card Number: 74-77381

Preface

A radio broadcasting station is a rather unique combination of several independent sub-systems, each interdependent on the proper operation of the others. From the microphone to the radiator or antenna, every major link must function as planned to achieve a technically successful broadcast operation. Therefore, unless strict attention is given to each phase during initial planning and construction of the facility, the end result will be something less than hoped for.

Since planning and operating a radio station requires considerable forethought, the guidelines established in this book will aid those contemplating a new facility or remodeling an existing station. All the basics have been included—from frequency search or channel allocation to planning and wiring studio and transmitter plant. To aid operation, separate chapters deal with preventive maintenance and proof-of-performance measurements—two vitally important considerations.

While this is not an absolute "how to" manual insofar as the actual details of construction are concerned, the basics are included in sufficient detail to enable those familiar with broadcasting, however remotely, to launch the venture and pursue it to completion. The only assumption is that you are "on speaking terms" with the most rudimentary fundamentals of the industry. So, whether you're an engineer, a manager, an announcer, or an "entrepreneur," you should be able to learn enough from the following chapters to enter the elite fraternity of broadcast operators.

The author extends his sincere appreciation and thanks to his friends at RCA. Acknowledgment should also be made of the useful information supplied by members of other companies such as Gates Radio Co. and Collins Radio Co. Some portions of this book have been excerpted from various issues of RCA "Broadcast News" with the permission of the editors, while others are based on some of the author's articles previously published in BM/E Magazine. Also, some of the material was taken from an editorial by James A. Lippke, entitled "Stop Air Pollution," which appeared in BM/E of October 1968.

Photographs used in this book appear through the courtesy of The American Broadcasting Co., Collins Radio Co., Gates Radio Co., General Electric Co., McMartin Industries, Inc., Radio Corporation of America and Group W Station KYW. I wish to thank, too, the broadcast stations which contributed material for this book:

American Broadcasting Co., ABC Network, New York, N.Y.

KOOL Radio, Phoenix, Arizona

KYW Radio, Philadelphia, Pennsylvania

WMJR-FM Stereo, Fort Lauderdale, Florida

and a special thanks to:

WPHC Radio, Waverly, Tennessee

KRAV-FM, Tulsa, Oklahoma

WRVA Radio AM/FM, Richmond, Virginia

WPAA-FM, Andover, Massachusetts

Finally, heartfelt acknowledgment is extended to the author's wife, Mollie, who has been a valuable assistant in the preparation of the manuscript by spending many hours in typing and editing.

Harry A. Etkin

Contents

1	PRE-PLANNING CONSIDERATIONS	7
	General Planning Considerations — Studio and Transmitter Site Selection — Studio and Control Room Requirements — Remote Studio Provisions — Recommended General Guidelines — Typical Floor Plans	
2	AM / FM FREQUENCY SEARCHES & CHANNEL ALLOCATIONS	11
	Standard Broadcast Stations (AM) — Frequencies Used for Standard Broadcast Stations — Predicting Interference — Frequency Verification — Primary Service Coverage and Interference — Groundwave Field Intensity Charts vs Distance — Ground Conductivity Variations — Skywave Interference — FM Broadcast Stations (FM) — Helpful Maps, Charts, and Graphs — New FCC Rules Proposals	
3	PREPARING ENGINEERING DATA: FORM 301	24
	Breaking Down the Application — Application Considerations — Cost Consideration — Preparing Section V-A — Section V-G, Antenna and Site Information — Selecting AM/FM Frequency — Section V-B: FM Antenna — Transmission Lines — Expected Coverage Information	
4	BASIC FLOOR PLANS	36
	Plan 1: Small Stations — Technical Facilities or “Plan 1” Stations — Plan 2 Stations—Medium Market and Community — Separate AM / FM Control Facilities — Some Unique Alternate Floor Plans	
5	PLANNING THE TRANSMITTER PLANT	52
	AM / FM Transmitter Equipment — Transmitter Performance Characteristics — Reliability — “Soundability” — Modulation Capability — Construction & Installation — Tower Consideration — Lightning Protection — Tuning House Construction Details — Proof-of-Performance Requirements	
6	AUDIO & POWER WIRING TECHNIQUES	61
	Control Room Wiring — Cable Ducts — Transmitter Installation	
7	TOWERS & AM ANTENNA SYSTEMS	70
	Tower Design — Tower Lighting — AM Antenna Designs — Tuning Unit — Directional Arrays — Common-Point Resistance — Initial Tuning — Phase and Current Ratios — Tower Layout — Installing the Ground System — AM Tower Feed and RF Sampling Systems — AM Phasor Branching Equipment — AM / FM Dummy Loads	
8	FM ANTENNAS	85
	ERP and Polarization — Horizontally—and Vertically—Polarized Antennas — Circularly—Polarized FM Antenna — Installing FM Antennas	
9	TRANSMITTER REMOTE CONTROL SYSTEMS	95
	System Requirements — Typical Equipment — STL Systems	
10	STUDIO & MONITORING EQUIPMENT	
	Audio System Equipment — Audio Control Consoles — Custom Audio Control Equipment for AM / FM Stations — Transcription Turntables — Monitor and Remote Equipment — Audio Signal Control Equipment — Monitoring Equipment	

11	PROGRAM AUTOMATION Cartridge Systems — Reel-to-Reel Systems — Tape Recorder Operation — Automatic Programming Systems — Typical Systems	112
12	MICROPHONES Impedance and Loading — Microphone Types — Mechanical Durability	124
13	AM / FM TRANSMITTERS Tubes vs Transistors — Transmitter Reliability and Economy — Remote Control Considerations — AM Transmitters — FM Power Expandable Transmitters — FM Exciters — Separate Solid-State Power Supplies	129
14	PREVENTIVE MAINTENANCE Maintenance Tools and Test Equipment — FCC Maintenance Performance Provisions and Logs — Maintenance Log Form and Contents — Maintenance Log Rules — Studio Maintenance — Transmitter Maintenance — Antenna Maintenance	136
15	AM / FM PROOF-OF-PERFORMANCE AM Measurements — FCC Rules — Proof-of-Performance Standards — Frequency Response Measurements — Harmonic Distortion Measurements — Carrier Shift Measurements — Carrier Hum and Extraneous Noise Measurements — Spurious Radiation and Harmonic Test — Conclusion of AM Proof of Performance Test — FM Procedures — Frequency Response Runs — Audio Frequency Harmonic Distortion — Output Noise Level (FM) — Output Noise Level (AM) — Stereo and SCA Applications — Proof-of-Performance Violations and Corrective Action Techniques — FM Proof-of-Performance Failures	144
16	PRESTIGE BROADCAST OPERATIONS ABC, New York — KOOL AM / FM, Phoenix, Arizona — WMJR-FM, Fort Lauderdale, Florida — KYW, Philadelphia, Pennsylvania — WPHC, Waverly, Tennessee — KRVA-FM, Tulsa, Oklahoma — WRVA AM/FM, Richmond, Virginia — WPAA / FM, Andover, Massachusetts — A Final Word	162
	APPENDIX	175
	INDEX	191

Pre-Planning Considerations

At its inception in the 1920's and early 1930's, radio broadcasting was small and specialized... as an industry and as a business. The total gross income of all the stations in the United States around 1931 was only 56 million dollars—about 4% of the present revenue.

On the technical side, the difference was almost as great. The "camera-shaped" condenser microphone was the big favorite in the studios. Audio equipment, or speech input equipment, as it is usually referred to, was large and clumsy and mostly battery-operated. Fig. 1-1 shows a typical 1920-1930 era audio speech input unit. In the right-hand rack are three preamplifier units, a volume indicator panel, and a program amplifier. In the left rack is a vacuum-tube rectifier plate

voltage supply, a meter panel, and a monitoring amplifier.

Transmitters were cumbersome by today's standards and contained many meters. Fig. 1-2 illustrates a 5-kilowatt broadcast transmitter which was popular in the 1920's. In addition to the main units shown, there were two large motor/generator units supplying DC for filaments and grid voltages, plus other auxiliary units such as a power-switching panel and a large water-cooling unit. Radiating towers were just coming into use and directional antennas were only a subject of conversation.

Of some 700 stations on the air about 1930, most were of composite manufacture. Many of them were really home-made in the most literal meaning of the word. This was not surprising because many, if not most, broadcasting stations which went on the air during the 20's did so by the grace, if not the inspiration, of some aspiring amateur. However, by 1931 quite a few stations were making money. As the cash registers started ringing, broadcasters stopped looking on their stations as hobbies or prestige operations and began running them like businesses.

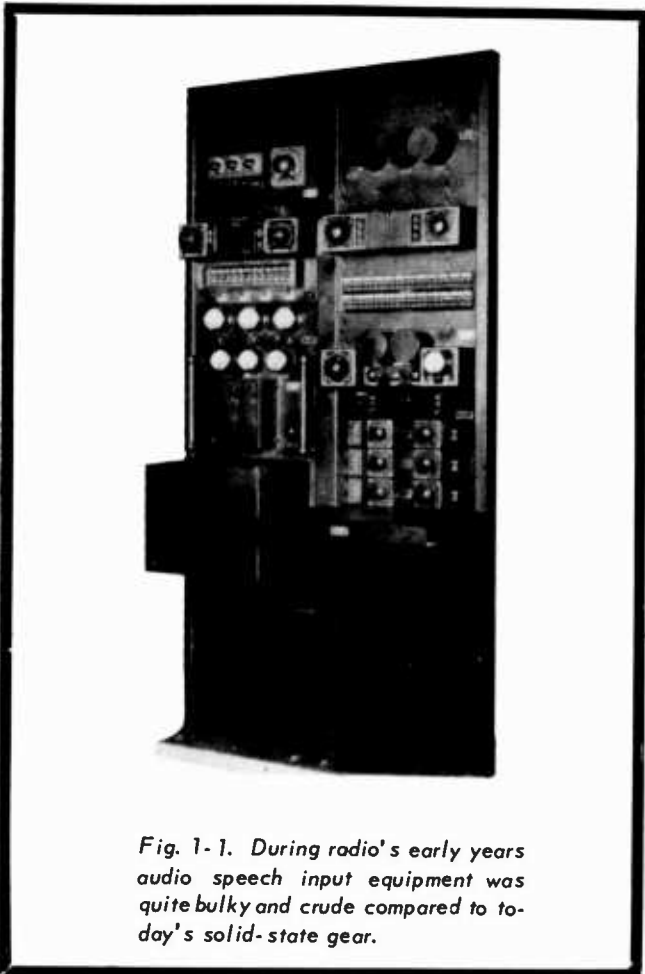

Fig. 1-1. During radio's early years audio speech input equipment was quite bulky and crude compared to today's solid-state gear.

GENERAL PLANNING CONSIDERATIONS

The broadcast engineer should carefully select equipment facilities to support the proposed programming and market coverage. The best approach is to begin with a basic layout or floor plan and then design the studio and transmitting facilities "on paper." Equipment groupings can be worked out ahead of time, thus enabling the planner to better relate the facilities to his operation and make appropriate cost decisions as required by the Federal Communications Commission.

STUDIO AND TRANSMITTER SITE SELECTION

AM or FM radio stations consist basically of a studio facility, control, administrative floor space, and a transmitting plant. The studio usually includes the equipment needed for program origination and the transmitting plant comprises

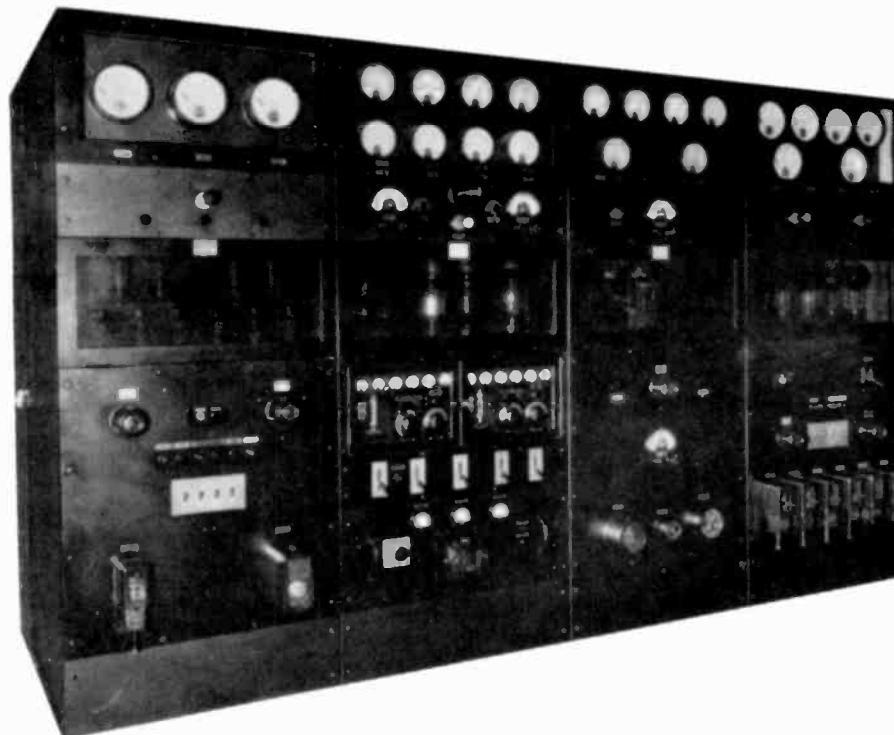

Fig. 1-2. This 5-kilowatt broadcast transmitter was "the equipment" at the time broadcasting was in its infancy.

COMMON STUDIO-
TRANSMITTER BUILDING



Fig. 1-3. In many stations, studio and transmitter facilities are combined within a common building.

the transmitter and antenna system. Studio and transmitter facilities may be located in one building or installed in different buildings separated by some distance and interconnected by telephone lines. The transmitter and antenna tower array should be at the same location and very near to each other.

Generally, the transmitter site is considered first by the FCC since it must be selected with due consideration to existing stations located in the same area. Modern radio concepts require maximum usage of space and personnel. Locating the transmitter and antenna system at the studio site minimizes the investment for land and equipment, lowers costs for heating and air conditioning, and reduces operating staff requirements. (See Fig. 1-3.)

The combined site also must meet the requirements of a good transmitter location, offering

sufficient space for the antenna towers needed to achieve the desired signal coverage. On the other hand, the studio should be conveniently accessible to station personnel. To avoid compromise in technical performance and operating efficiency, separate site locations are sometimes necessary. (Figs. 1-4 and 1-5) For example, it may be advisable to take advantage of a high mountain peak for the transmitter location and obtain a studio site that is closer to the city. A modern trend is to locate the studio in or near business centers, thus placing the studio on display to the public.

In some areas, zoning regulations prohibit erecting antenna towers on ideal studio-transmitter locations. When combined studio-transmitter layouts are not practical, it may be advantageous to operate the transmitter by remote control. Usually, the building containing the remote-controlled transmitter can be minimum in size, allowing

only space for the equipment, a small workshop area, lavatory, and a heating unit. Fig. 1-6 illustrates this type of setup.

STUDIO AND CONTROL ROOM REQUIREMENTS

In present-day radio stations, studios are receiving less consideration than in prior years because fewer live programs are being broadcast. However, sufficient thought should be given to studio planning, looking toward ultimate require-

ments. Neglect in planning of the studio imposes a handicap which could have been prevented with only a small additional expense and a little careful consideration at the time of construction. The plans presented in this book provide for normal expansion without undue expense.

Control rooms, large or small, are alike in many respects, differing mostly in the number and arrangement of microphones, turntables, tape recorders, and other programming equipment. Many stations locate the control console and an announce

Fig. 1-4. Separate studio and transmitter facilities, with attended transmitter operation, are used where downtown studio locations prohibit tower installation.

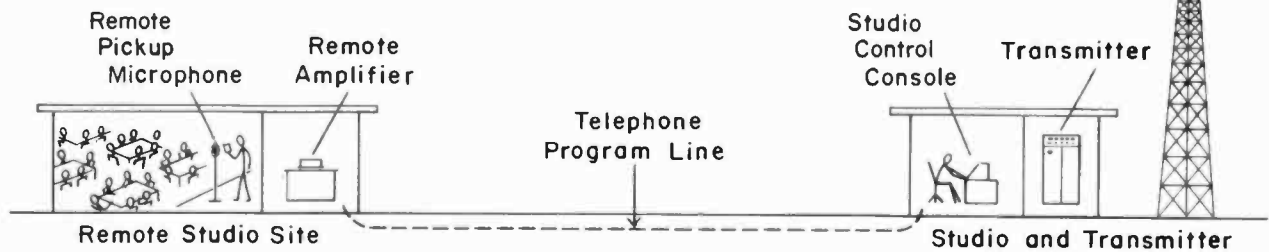
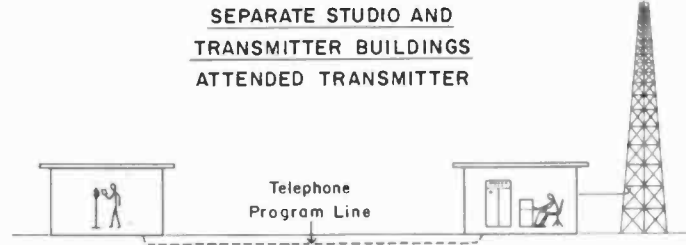
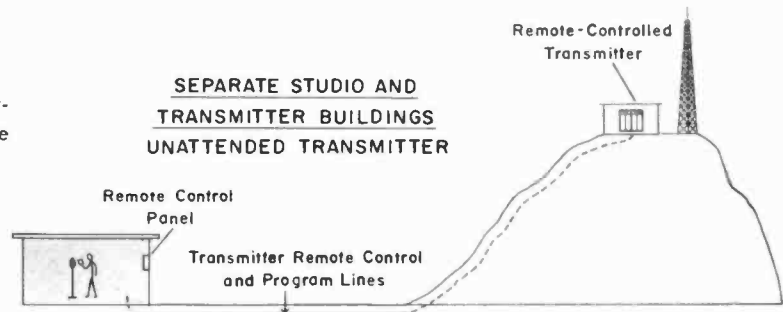

Fig. 1-5. Another variation in separate studio and transmitter facilities: Pickup and control equipment installed in public meeting places provides additional program sources.

Fig. 1-6. In separate studio-transmitter operations the transmitter can be operated by remote control.



microphone on a table in front of the studio viewing window. The turntables are normally installed on either one or both sides of the operator's position at the control console. Tape machines are located within easy reach, on the table or in a tape deck console beside the operator.

REMOTE STUDIO PROVISIONS

Facilities for picking up remote programs should be provided. Portable or mobile transmitting units are useful for on-the-spot coverage of events in and around the city or community. It is good practice for stations to provide for the operation of a remote amplifier at gathering points where prominent social, business, or political personalities can be interviewed. This includes places of business, sports arenas, or entertainment centers from where special variety or music programs may be broadcast. The remote amplifier used for this purpose should provide mixing and amplification of program signals prior to transmission over a telephone line or remote pickup to the studio control console.

RECOMMENDED GENERAL GUIDELINES

Every radio station, AM or FM, has some unique requirements that usually preclude the rigid application of a standard layout. There is a very definite feeling among experienced broadcasters that the lifetime cost of a product should be considered and not the initial buying price. For example, if two transmitters are being considered and Transmitter A requires 20 kw to operate under normal conditions and Transmitter B requires only 18 kw for the same power output, then the long-term buyer should purchase the transmitter requiring 18 kw even though its initial cost may be higher—providing it meets all FCC and station requirements, of course. The transmitter efficiency also should be considered, especially for FM broadcasting.

Another important area to consider is warranty. Is it five years for all parts, one year for non-moving parts, six months for moving parts, etc.? One area most often overlooked is the quality that

goes into a broadcast unit, which is closely related to the reputation of the manufacturer.

To illustrate the detail necessary in transmitter plant design, it is appropriate to mention cooling, which is not intended solely for personnel comfort. Adequate cooling is essential for efficient transmitter operation. When cooling ducts are installed, a method should be provided to keep the ducts at a negative pressure. It is also important that the transmitter building be kept clean. Normally, the life of a transmitter is most affected by these two factors which are covered later in more detail. They are brought up here to emphasize the thought and planning behind a well-designed station.

TYPICAL FLOOR PLANS

Later in this book you will find a number of functional plans to aid you in the creative planning of a modern, functional radio broadcasting facility, either AM or FM or both, with recommendations for using emphasis where it will do the most good. The plans section discusses and describes types of stations, ranging from those intended to operate within a small market to an arrangement suitable for a large, metropolitan operation. Your particular facility will most likely be a composite of several of these designs.

These plans do not necessarily represent existing stations, but they show typical layouts of studio equipment for efficient operation. With each floor plan discussed is a system diagram and a list of the suggested major equipment items used in the illustrated layout. Heating and air-conditioning equipment are not shown but should be selected in accordance with individual requirements.

It pays to utilize the services of an architect or contractor to turn your individual plans into reality. With modern building materials and techniques, any of the proposed stations can be built economically. Your personal preferences and the area in which you build will determine the exterior styling of your building, either an ornate colonial or a modern cement block structure. The plans shown are merely suggestions, since you are the best judge of your individual requirements.

CHAPTER 2

AM/FM Frequency Searches & Channel Allocations

One of the first steps—if not the first—is to determine the frequency or channel on which your station will operate. To go too far otherwise could result in disappointment, wasted effort and money. While many chief engineers and managers may be capable of conducting the required frequency allocation study, it is generally advisable to use the services of an engineering consultant, especially if the broadcast system is of a complex nature.

STANDARD BROADCAST STATIONS (AM)

The first or most important requirement in an AM frequency search, probably, is to find a channel which will not interfere with, or receive interference from, existing stations and stations proposed in pending applications.

AM broadcast stations operate on local, regional, or clear channels. Stations of 250 watts night-time and up to 1 kilowatt daytime generally serve small communities. Stations of 500 watts to 5 kilowatts cover larger population centers and surrounding regional areas. Stations of 10 to 50 kilowatts are intended for large-area coverage, particularly at night.

A good place to start a frequency search is to have the chief engineer and other appropriate station personnel become familiar with the FCC Rules and Regulations and applicable graphs in Paragraph 73.184, and the engineering charts listed in Paragraph 73.190, Part 73 of Volume III, March, 1968. The pertinent FCC Rules pertaining to this task are:

- 73.21 Classes of Standard Broadcast Channels and Stations
- 73.24 Broadcast Facilities
- 73.25 Clear Channels; Classes I and II Stations
- 73.26 Regional Channels; Classes III-A and III-B Stations
- 73.27 Local Channels; Class IV Stations
- 73.28 Assignment of Stations to Channels
- 73.29 Class IV Stations on Regional Channels
- 73.30 Station Location and Program Origination

- 73.37 Minimum Separation between Stations; Prohibited Overlap
- 73.182 Engineering Standards of Allocation
- 73.183 Groundwave Signals
- 73.185 Computation of Interfering Signals
- 73.187 Limitation on Daytime Radiation
- 73.188 Location of Transmitters

FREQUENCIES USED FOR STANDARD BROADCAST STATIONS

The frequency band from 535 to 1605 kHz is devoted to "standard broadcasting." It is generally divided into 107 channels of 10 kHz each. (For further reference and additional information see the FCC Rules.) The most logical way to investigate a specific frequency allocation is to check the FCC information and technical data. To be sure the desired frequency is available, other sources of information are the radio station channel allocation list published by the Cleveland Institute of Electronics, Cleveland, Ohio, and the U.S. Frequency list published by the Cooper-Trent Company, Arlington, Va.

The Cleveland Institute book refers to each broadcast frequency and provides information relative to the size of the radiation pattern. In the case of directional stations, the direction and radiated power in the various lobes is given in general values. In the U.S. Frequency List, the exact geographical location of each station (latitude and longitude), the antenna height, class of station, radiation at one mile, and other related data is illustrated.

PREDICTING INTERFERENCE

By using a suitable Department of Commerce map, the approximate location of the proposed station should be plotted. Then, using a copy of the Broadcasting Yearbook, the stations on each broadcast frequency within 120 miles of the proposed site should be listed. The required distance will usually vary with both frequency and ground conductivity. Generally, the separation should

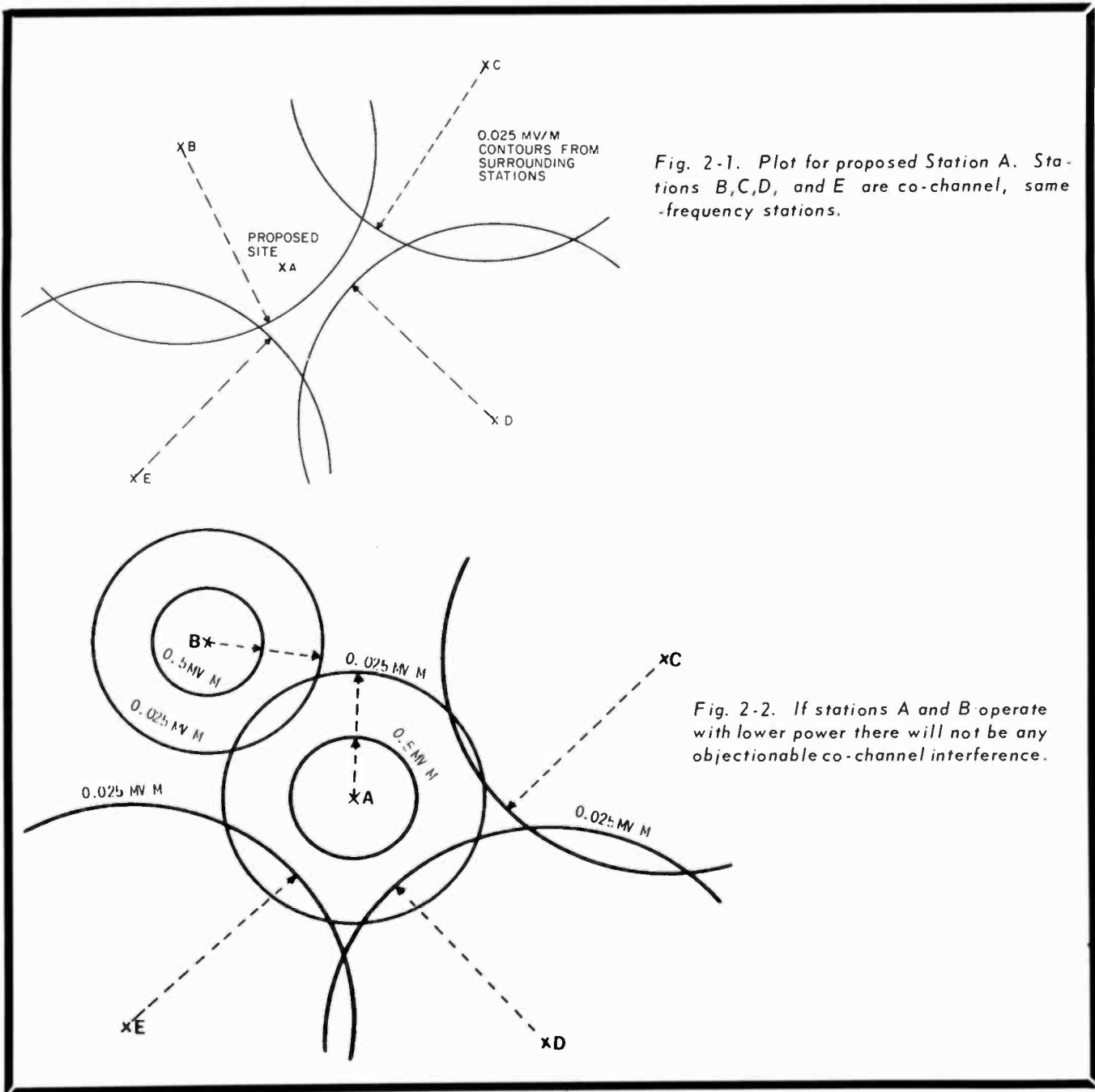

be increased as the frequency decreases and/or the conductivity increases. For each station listed in the desired area, compute the area covered by the 0.025 mv/m contour, which may be the objectional interference contour. Using the city where the existing stations are located, draw a semi-circle showing the coverage to scale in the direction of the existing radio stations and the probable interference pattern. (See Figs. 2-1 and 2-2.)

It can be seen from Fig. 2-1 that the 0.025 mv/m contours of Stations C, D, and E do not overlap Station A. Thus, the chosen frequency for Station A could be used, assuming that the contour of Station B did not cause any objectionable interference. These coverages are based on the condition that all the indicated stations have the same

ground conductivity paths to Station A. If the power of Station B is reduced, as shown in Fig. 2-2, so that its contour will not overlap the proposed station, Station A's 0.5 mv/m contour will not be subject to any interfering 0.025 mv/m contour and the co-channel frequency can be used for the proposed station.

The chief engineer, in particular, should make absolutely sure that there will be no overlap between the 0.5 mv/m contours of the proposed station and any station on a frequency within 10 kHz. Also, there must be no overlap between the 2 mv/m and 25 mv/m contours of the proposed station and any station on a frequency within 20 kHz, or between the 25 mv/m contours of the proposed station on a frequency within 30 kHz. Such over-

laps indicate that adjacent-channel interference is likely to result, and allocation for the proposed station will, therefore, be denied.

FREQUENCY VERIFICATION

In many cases the only available frequency has been applied for through a competing application. It is necessary to check on the current operating or granted stations and pending applications at the FCC Public Reference Room.

If the applicant wishes to use another frequency, the availability of that frequency must be verified. A check must be made of the applications granted to determine if any stations, other than those shown in the original reference material, are on the desired frequency. This search is required because the FCC is the only source which maintains an up-to-date file.

Since the FCC publishes a cut-off date for certain pending applications, it is an excellent idea to check the cut-off date of those applicants who want to use the same frequency. When the cut-off date has been reached, the general rule is that no further applications on that frequency in that particular area will be considered. When there is an available frequency in the desired market area, the broadcaster should submit an application as soon as possible before the cut-off date of the other pending applications.

PRIMARY SERVICE COVERAGE AND INTERFERENCE

The primary service area designates the area in which the groundwave is not subject to objectionable interference or objectionable fading. For clear-channel stations, other than Class IA, a minimum of 0.5 mv/m is required for suburban coverage. To achieve daytime service within a city or metropolitan area, at least 2 mv/m must cover the residential areas. In addition the city or metropolitan area must be completely covered by the 25 mv/m contour. It is important to prove that there is no primary service in the proposed broadcast signal area. If there is any interference which exceeds the 1.0 mv/m contour to the 0.5 mv/m contour, the grant will be denied.

When computing primary service coverage, you should get a list of all the stations in the area that could provide the service along with directional and non-directional antenna radiation pattern values for field intensity at one mile. Such computed radiation data should include the primary coverage of each station radiating in the direction of the proposed city. If some of these stations have directional antennas, then the actual measured conductivity values obtained during the

latest proof-of-performance must be used. Where there are no directional antennas, the conductivity values can be taken directly from the FCC conductivity map.

GROUNDWAVE FIELD INTENSITY CHARTS vs DISTANCE

In conducting a frequency search, it is assumed that the primary service area of a transmitter operating on a given frequency and power depends on the conductivity of the ground and the directivity of the antenna system. For computation purposes the graphs shown in Paragraph 73.184 of the FCC Rules illustrate the effect of soil conductivity on signal attenuation. Some 20 graphs are required to cover the broadcast band assignments. They show the groundwave field intensity curve plotted against distance for various conductivity values. (See Fig. 2-3.)

The reference 100 mv/m at 1 mile assumes that an antenna power and efficiency is such that the inverse distance field is 100 mv/m at 1 mile. (The conductivity of sea water is assumed to be 5,000 millimhos per meter.) Notice the upper group of curves (Fig. 2-3), which apply to the top miles-from-antenna scale. The topmost curve, 5,000 mmhos/m, intersects the 100 mv/m line at 1 mile. This line is transposed to the top of the lower set of curves where 10 mv/m occurs at 10 miles from the antenna. This means that the unattenuated wave is dependent only upon distance, and the field strength of the groundwave is inversely proportional to the square of the distance. Thus, if 10 mv/m exists at 10 miles, then 1 mv/m exists at 100 miles. The inverse-distance field of 100 mv/m divided by the distance in miles corresponds to the groundwave field intensity expected from an antenna with the same radiation efficiency and perfect ground conduction. To compute the value of the groundwave field intensity corresponding to a value of inverse-distance field other than 100 mv/m at 1 mile, simply multiply the field intensity as given on these FCC graphs by the desired value of inverse-distance field at 1 mile and divide by 100.

GROUND CONDUCTIVITY VARIATIONS

When different ground conductivity characteristics exist in the path of the radiated signal, the distance to a particular groundwave field-intensity contour is usually computed by using the equivalent distance method. When the wave passes from an area of one conductivity into an area of a second conductivity, the equivalent distance of the receiving point from the transmitter changes abruptly, but the field intensity does not change. From a point just inside the second area, the

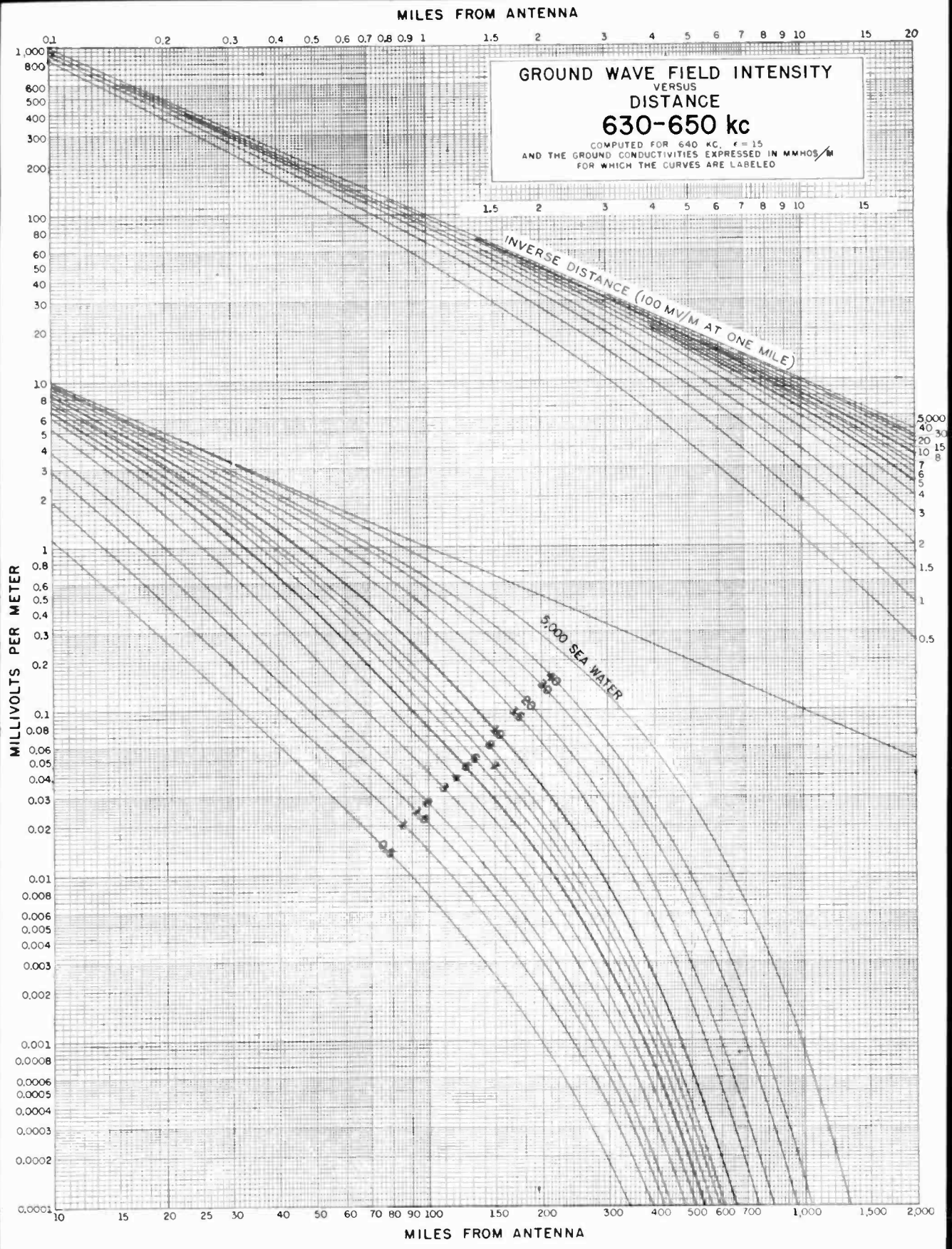

Fig. 2-3. Groundwave field intensity chart.

transmitter appears to be at a distance where (on the curve for a homogeneous ground of the second conductivity) the field intensity equals the value that occurred just across the boundary in the first area. Therefore, the equivalent distance from the receiving point to the transmitter may be either greater or less than the actual distance. An imaginary transmitter is considered to exist at the equivalent distance.

As you can see, considerable detail is involved in the use of the FCC propagation curves, even though the actual number of personnel involved in a frequency search and the location of a transmitter site is relatively small. However, an understanding of how to obtain and compute such data is very important to AM/FM broadcast station planners. The preceding information shows how to predict objectionable interference between groundwaves. When skywave interference is present, more complex computations are necessary.

SKYWAVE INTERFERENCE

The secondary service area is that which is served by the skywave and is not subject to objectionable interference. Normally, the skywave at AM frequencies is almost completely absorbed in the daytime; a secondary service area of any appreciable extent appears only at night. Fig. 2-4 shows how skywave attenuation varies during the sunset period.

Skywave (night-time) contour computations are usually more complicated. Therefore, many broadcast engineers leave such computations to consulting engineering personnel. After sunset it is most unusual for adjacent-channel interference to be troublesome over any distance. Night-time coverage is computed by using the same groundwave coverage charts, but interference contours are computed by using skywave curves. For signals from stations operating on clear channels, skywave interference is determined from Figs. 2-5 and 2-7. For signals from stations operating on regional and local channels, skywave interference is determined from Figs. 2-6 and 2-7.

Fig. 2-8 diagrams the phenomena of ionospheric reflection and the skywave effect thus produced. The distance between the transmitter and the distant point determines the critical reflection angle. Paragraph 73.185 of the FCC Rules, Computation of Interfering Signals, shows the method of calculating the skywave interference and how these curves are used.

Another important factor in skywave computation is that maximum expected operating value (MEOV) is always used in the determination to make sure that the worst-interference conditions are con-

sidered in the case of stations using directional antennas. In case of non-directional vertical antennas, the vertical distribution of relative fields for several heights is computed by using Fig. 2-9, assuming sinusoidal distribution of current along the antenna.

Fig. 2-9 reveals that although an antenna of 0.625 wavelength has a large low-angle lobe, a secondary lobe which decreases the effective face-free area exists at a higher angle. Fading will occur when the skywave meets the groundwave; the two signals tend to cancel because of phase reversal. The strength of the groundwave at a given distance is increased only a few decibels by increasing the height of the antenna from 0.125 to 0.5 wavelength, but the effective fade-free area is greatly increased due to the reduction in strength of high-angle radiation which produces an interfering skywave.

To determine that the proposed station will not cause objectionable interference with any co-channel station, and that the coverage pattern will comply with FCC requirements, the engineer must know the night limit resulting from the combined signals of all co-channel stations. An examination of the co-channel horizontal radiation patterns and engineering reports should be made to verify existing radiation data.

After the basic data is provided, the limits each would impose on the signal should be determined. Generally, the coverage limit is usually not the result of just one other station, but a number of stations adding their interfering signals on the proposed contours. The interfering limits are computed by the root sum square (RSS) method.

First, it is necessary to determine the highest limiting signal value produced at the proposed site. Then, the remaining signals, in order of decreasing magnitude, are tabulated. The mathematical effects of squaring, adding, and other calculations can produce some very complex situations. As noted in Paragraph 73.182 of the FCC Rules, it is possible that a new signal can cause the exclusion of a previously included signal, resulting in a new lower limit, even though the actual interference is greater.

Another difficult task in computing skywave (night-time) coverage is the necessity for computing data for many stations with the purpose of excluding many of them. It is also necessary to furnish proof—in the application—that a given limit value does not enter into the calculated figures.

Class IV station night-time coverage is normally calculated by following the instructions in Paragraph 73.182. It is based on the assumption of a 0.25 wavelength antenna height and 88 mv/m at one mile effective field for 250 watts power. Zones

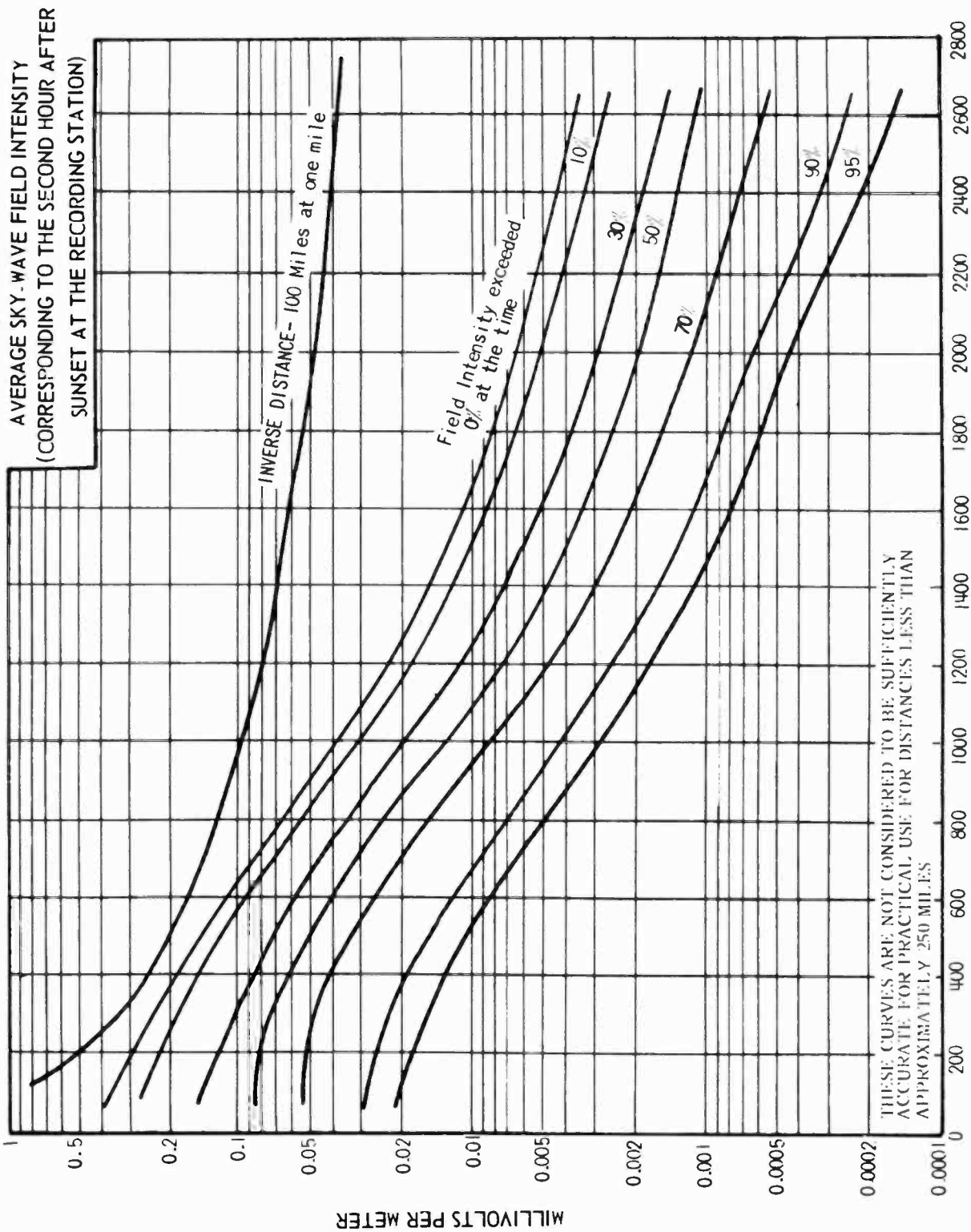

Fig. 2-4. Average skywave field intensity chart.

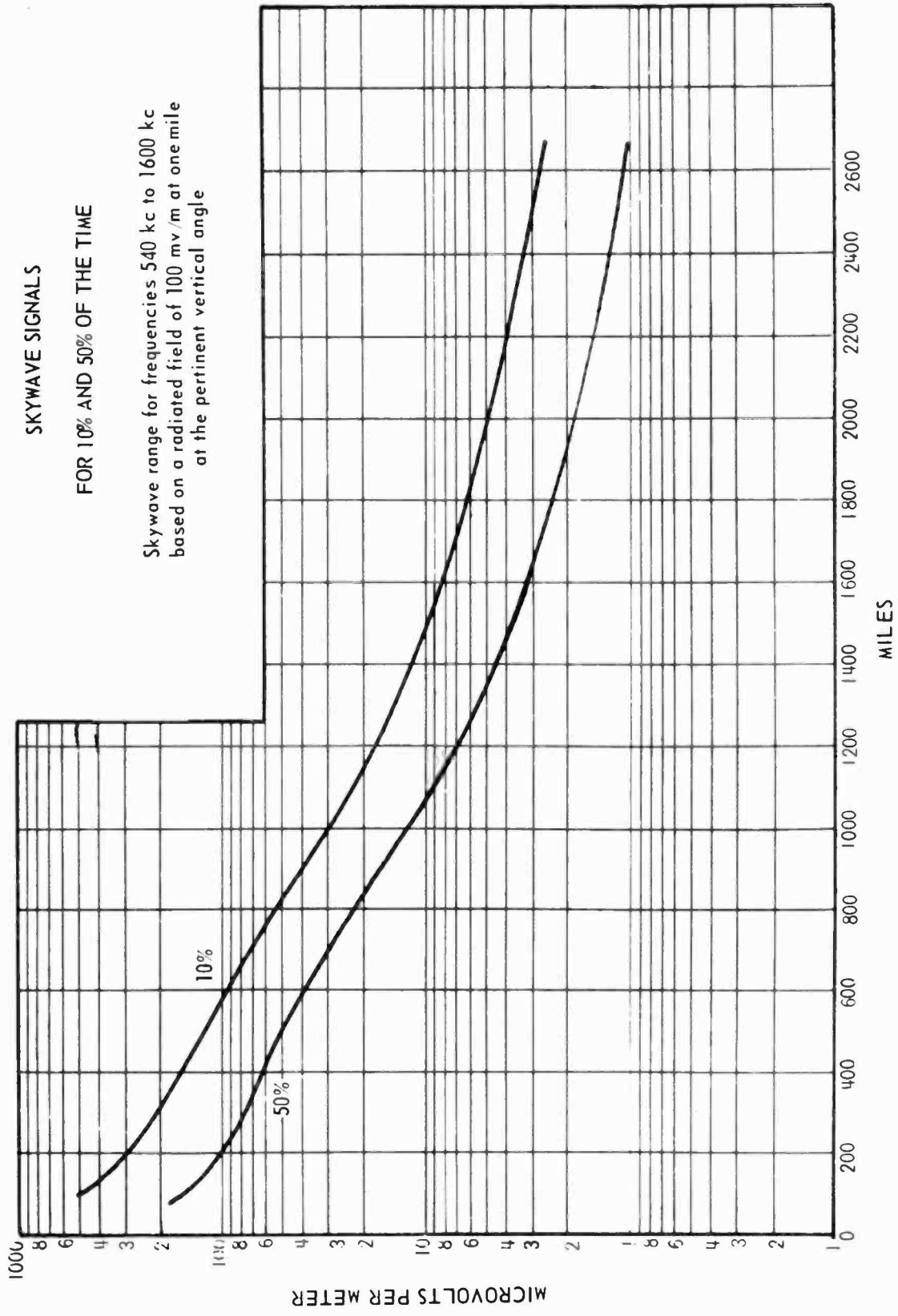

Fig. 2-5. Skywave signals for 10% and 50% of the time.

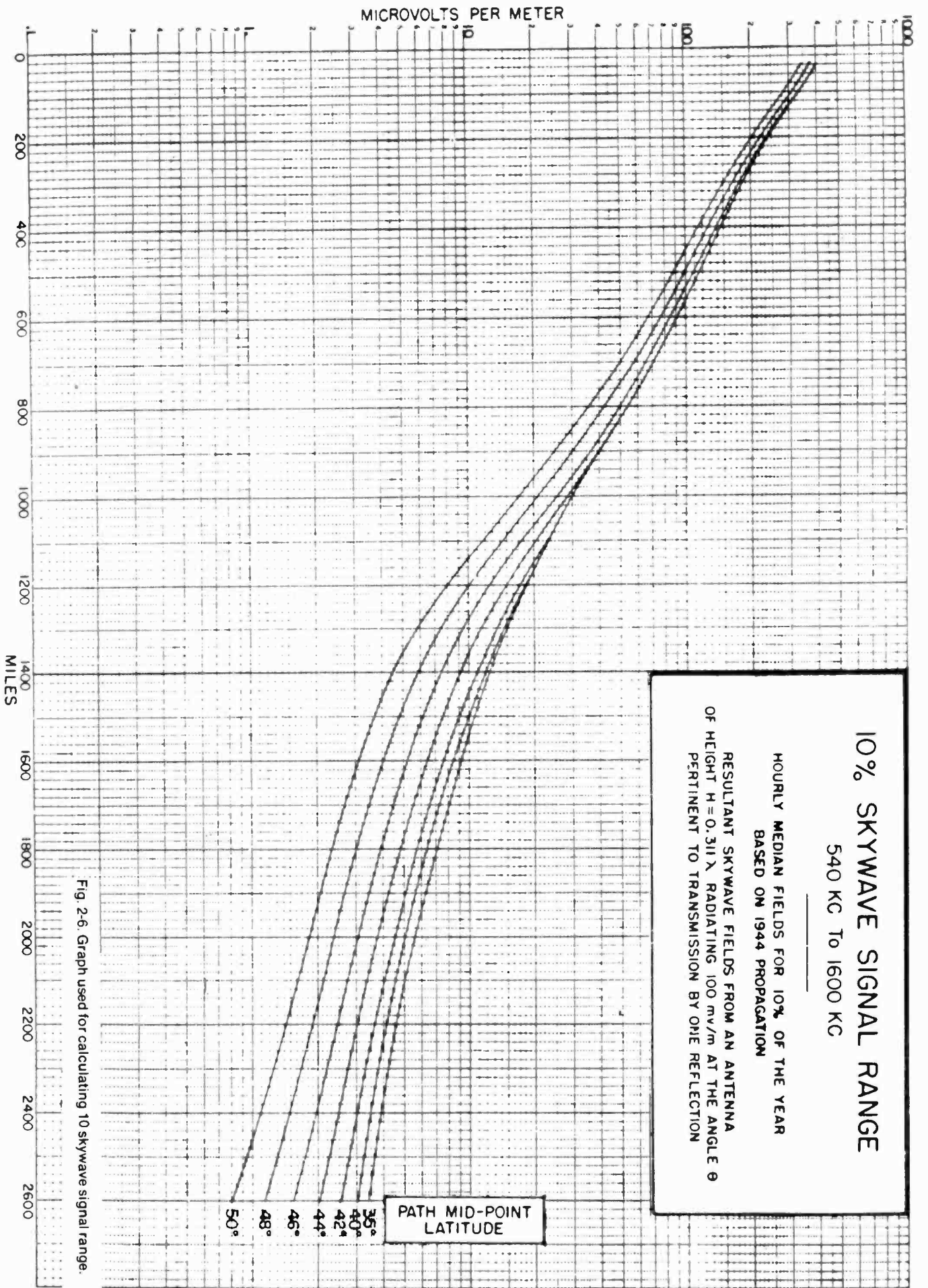

Fig. 2-6. Graph used for calculating 10 skywave signal range.

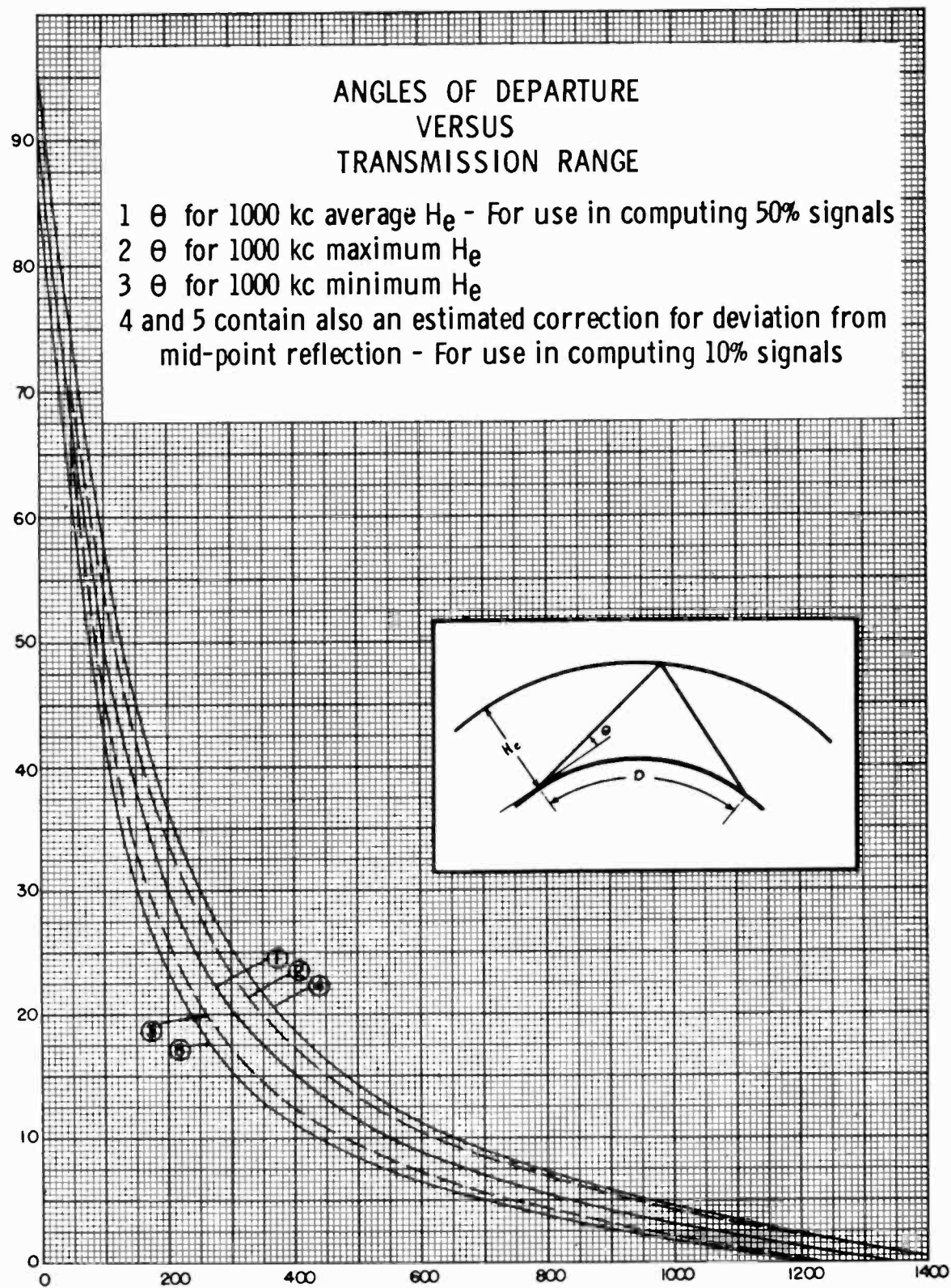

Fig. 2-7. Curves showing angles of departure versus transmission range.

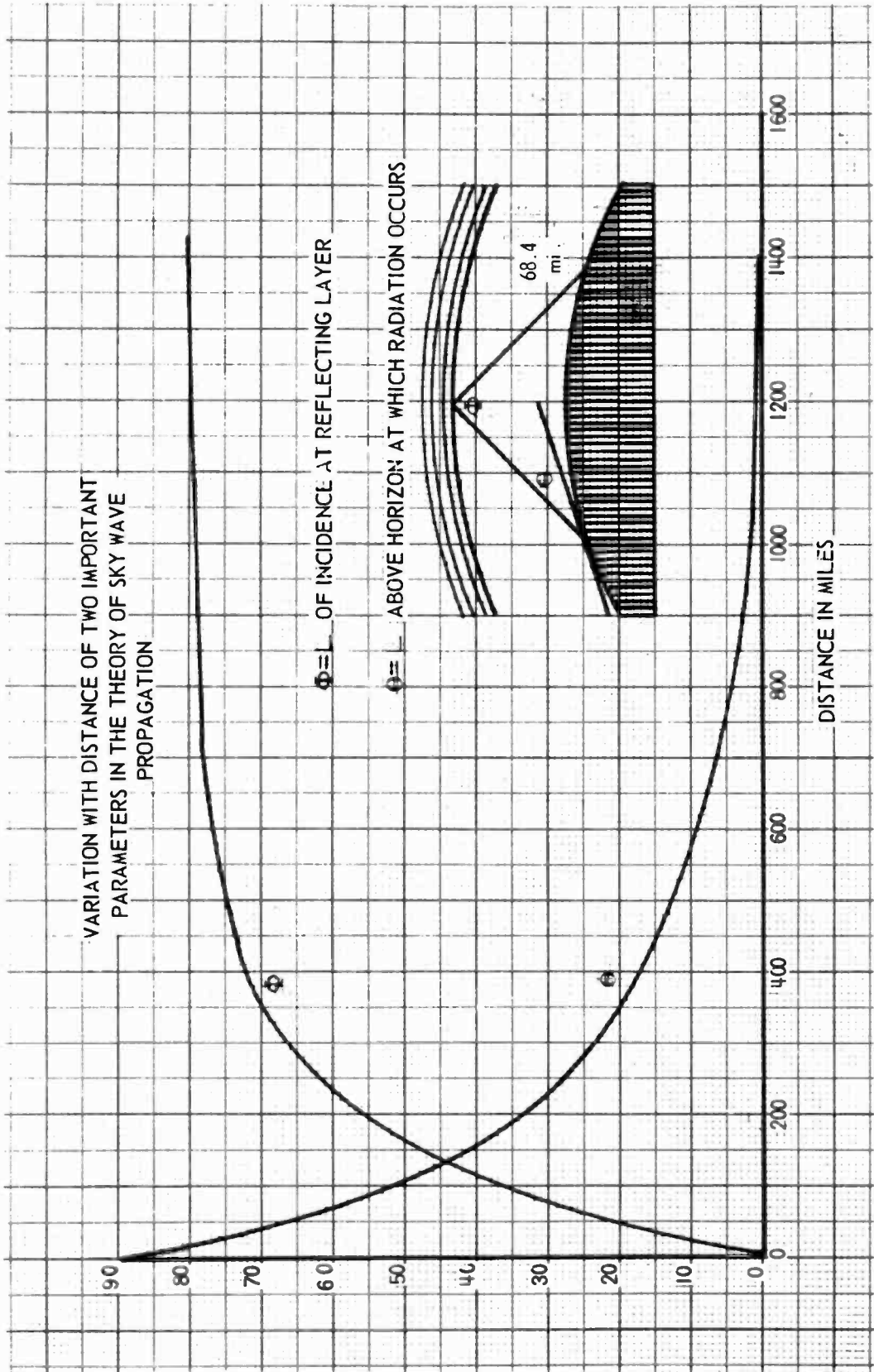

Fig. 2-8. Chart illustrating ionosphere reflections.

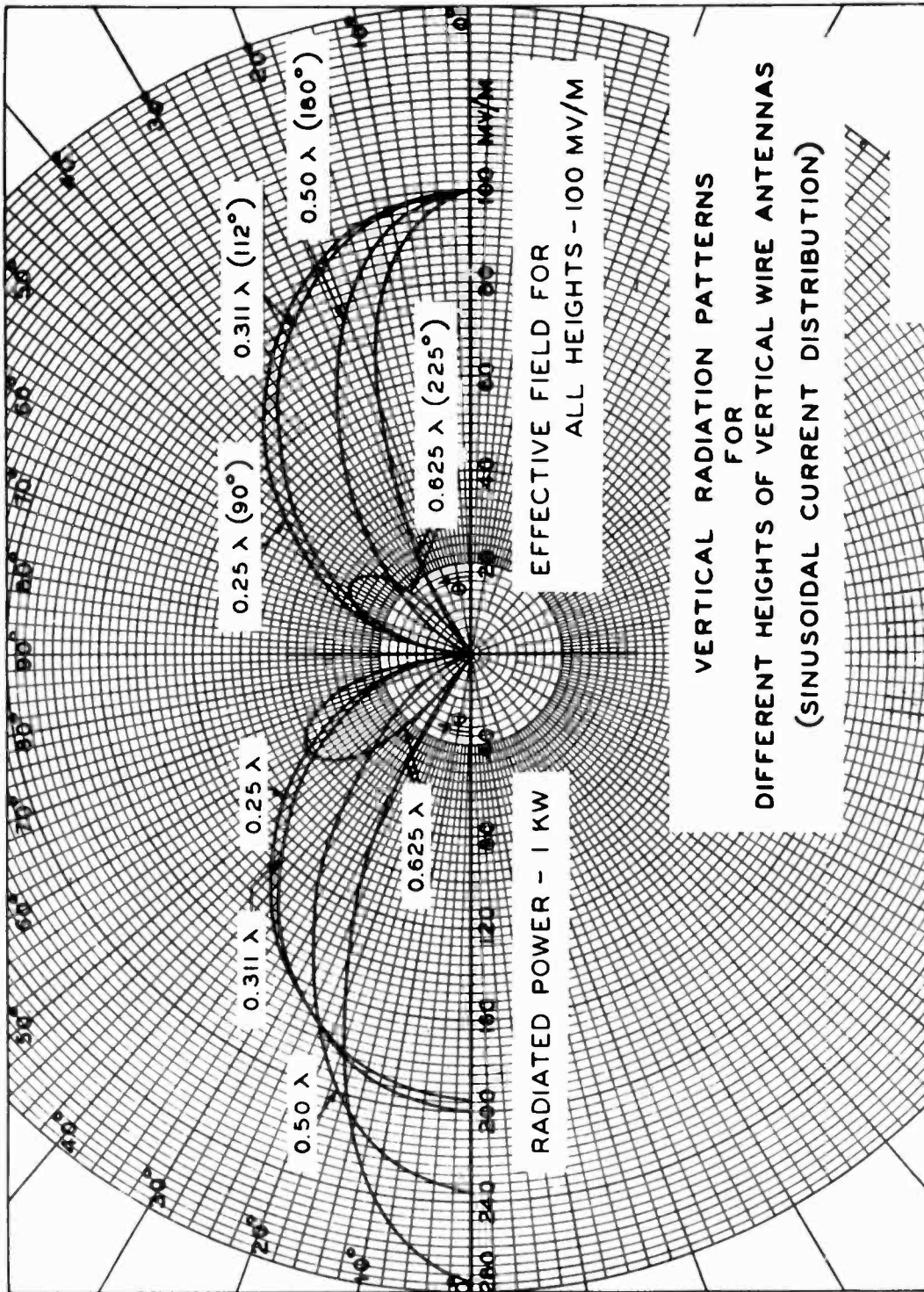

Fig. 2-9. Chart portraying vertical radiation patterns for different antenna heights.

defined by circles are drawn about the proposed site at distances indicated in the Rule. Each station in a given zone is considered to have an assigned field-intensity value. The effective interfering skywave signal is taken to be the RSS value of all signals originating within these zones and is considered to be the night-limit figure. Stations beyond 500 miles are not considered and stations achieving a radiation greater or less than 88 mv/m are adjusted by the square root of the ratio of the radiated power to 250 watts.

Class IV computations do not require as much research of the FCC files as night computations for a Class III station. Details for Class I and II stations are discussed in Paragraph 73.185 of the FCC Rules. Night-time coverage is not as easily computed as daytime coverage mainly because of the considerable amount of variable engineering data required for many other stations.

FM BROADCAST STATIONS (FM)

An FM station applicant must request an FM channel assigned to the community in which he proposes to operate, or a location within a 25-mile radius which has no FM channel assignment. Power, antenna height, and station separation are governed by the zone in which the station is to be located.

There are three classes of commercial FM stations: Class A stations operate with a power of from 100 watts to 3 kilowatts to cover a radius of about 15 miles; Class B stations may use 5 kilowatts to 50 kilowatts for 40-mile service, and Class C, 25 kilowatts to 100 kilowatts for a 65-mile range.

There is no point in repeating the necessary methods and procedures in obtaining the frequency-allocation search data for an FM broadcast station because they are substantially the same as for AM. In most cases, the information and instructions given in the FCC Rules are very straightforward and should be easily understood.

Consideration for FM stations are covered in the following FCC Rules and Regulations:

- 73.201 Numerical Designation of FM Broadcast Channels
- 73.202 Table of Assignment
- 73.203 Availability of Channels
- 73.204 International agreements and other restrictions on the use of channels.
- 73.205 Zones
- 73.206 Classes of commercial channels, and stations operating thereon.
- 73.207 Minimum mileage separations between co-channel and adjacent-channel station commercial channels.

- 73.208 Reference points and distance computations.
- 73.209 Protection from interference
- 73.210 Station location and program origination
- 73.211 Power and antenna height requirements
- 73.311 Field strength contours
- 73.312 Topographic data
- 73.313 Prediction of coverage
- 73.315 Transmitter location
- 73.333 Engineering charts

HELPFUL MAPS, CHARTS, AND GRAPHS

In the preparation of the necessary maps, charts, and graphs used in determining locations, heights, and elevations, helpful data may be obtained from:

U. S. Geological Survey Topography Quadrangle Sheets

U. S. Geological Survey
Department of the Interior
Washington, D. C. 20240
Sectional Aeronautical Charts
Department of Commerce
Washington, D. C. 20235

Map of the Density of Population & Number of People by Sections in the Area
Bureau of Census P-D and H-E
Superintendent of Documents
Government Printing Office
Washington, D. C. 20240

Geographic Contour Map with Contour Intervals of 20 to 50 feet (Map showing type, nature, and depth of the soil in the area with special reference to the condition of the moisture throughout the year.)

NEW FCC RULES PROPOSALS

At publication new, more restrictive rules governing acceptance of applications for new standard broadcast stations and for major changes in facilities of authorized stations have been proposed by the FCC. The Commission also proposes to regard both commercial FM and AM as part of a total aural service and to accept Class IV requests for power increases during the following year.

On July 17, 1968, the Commission amended its rules to bring a limited halt to the acceptance of AM applications pending rulemaking, noting a continuing proliferation of new AM stations, with a consequent depletion of remaining AM spectrum space and an increasing demand for new FM facilities.

In its effort to encourage development of FM broadcasting, the FCC pointed out that FM pro-

vides a fulltime service which daytime AM cannot provide, that FM has a generally greater range, and stations can be assigned without adding to interference on the channel, as nearly all night-time AM facilities do; FM is technically better than any AM service, freer from interference and with stereo and Subsidiary Communications Authorization capability; and FM assignment is more orderly and cheaper, both for the Commission and the applicants.

The Commission found several shortcomings in the present AM assignment process. It stated that most applications, pending and recently granted "are for new or increased daytime facilities, which do not provide night-time service to any of the areas they propose to serve, and preclude use of this and adjacent frequencies in the community and area by fulltime stations; that less than three percent of the applications pending before the "freeze" proposed to serve any appreciable white (unserved) area; that while a majority of the applications for new daytime-only stations are for communities now without a local AM outlet, less than half can be granted because of mutual exclusivity between applications; that many of these communities are small; that many of the applications for larger communities will require consideration as

to whether they are really applications for the community specified or for stations in fact primarily serving a larger nearby city; and that many AM applications are for communities with two or more existing stations.

The FCC believes proposed rule changes will provide a better complete aural radio service and will permit fuller use of available spectrum space. Evaluation of aural service development could take place after a few years of operation within the new guidelines, which also state that:

Existing FM service of 1mv/m or greater intensity, as well as AM service, would be taken into account in determining primary service.

Applicants for new facilities (but not for major changes) would have to show there is no FM channel available and unoccupied that could be used to serve the same "white" area.

Another change in existing rules permits Class IV stations to seek increases in power to the permissible maximum without regard to domestic interference caused or received, subject to the provisions of Section 316 of the Communications Act. The "freeze" on new Class IV applications will continue, pending rulemaking, even though the "freeze" on applications for power increases was lifted for one year, effective September 4, 1969.

CHAPTER 3

Preparing Engineering Data: Form 301

FCC Form 301 is an all-in-one application for authority to construct a new broadcast station or to make changes in an existing facility. The various sections include:

- I. General, Facilities Requested
- II. Legal Qualifications
- III. Financial Qualifications
- IV-A Statement of Program Service of Broadcast Applicant (AM-FM)
- V-A. Standard Broadcast Engineering Data
- V-B. FM Broadcast Engineering Data
- V-C. TV Broadcast Engineering Data
- V-G. Antenna and Site Information

Each section alone, although requesting a considerable amount of detailed information, is no more difficult to prepare than a Federal Income Tax form. Considered as a whole, however, a broadcaster may wonder if he has the tenacity to see an application through to its acceptance. Obviously, however, applications are continually being accepted and approved. The reason is that much of the data is prepared by experts—a procedure known to be sound and economical. However, it is also a sound policy for every broadcaster to know what is involved, if for no other reason than to realize he should seek qualified help.

BREAKING DOWN THE APPLICATION

Form 301 Sections II, III, and IV are used to determine an applicant's qualifications for operating a broadcast station. Thus, assuming the other sections (which deal with engineering aspects) are in order, the information these three sections contain weigh heavily in the Commission's judgment of an application.

Normally, the information requested in these sections is readily available to an applicant. And, although they should be completed with the aid of legal counsel, their preparation requires no undue expense. Section V, however, is another matter, especially if a new station is

being sought. Depending on the facilities requested, a great deal of time and expense may be involved in making tests, measurements, and calculations for the necessary supporting data. In fact, because of the complications involved in preparing this information, it is the rule, rather than the exception, to enlist the services of a consulting engineer. As an aid to managers and engineers, this section explains, in layman's language, what is required in filing such engineering data.

The most significant factor in assuring a successful filing of Form 301 is to supply all the specific data in complete detail. Thus, in planning a new station, or changes in an existing station, a broadcaster should be familiar with the engineering know-how required. Familiarity with the FCC Rules will aid in making the necessary decisions regarding site location, equipment requirements, and antenna location and construction. The engineering staff should, therefore, be acquainted with the following: Vol. 1, Jan. 1968: Part 1—Practice and Procedure Part 17—Construction, Marking, and Lighting of Antenna Structures; Vol. III, March, 1968: Part 73—Radio Broadcast Services; NAB Engineering Handbook 5th Edition, Section 2—Antennas, Towers and Wave Propagation.

Section V-A of the form applies to standard broadcast (AM) engineering data, and Section V-B to FM data. Section V-G specifically pertains to antenna and site information, although much of the engineering data required in the other applicable sections is directly related to the antenna system. Therefore, preparing data for Section V-A, for example, will provide most of the information for Section V-G.

Page 2 of Section V-A, Item 12, pertains to the allocation study. This is the tough part, relating to the normally-protected and interference-free contours proposed by the application. With today's crowded airwaves, it is becoming more and more difficult to find a location, frequency, and power that will fit the Commission's present allocation standards. Once this has been accomplish-

Broadcast Application		FEDERAL COMMUNICATIONS COMMISSION		Section V-A	
STANDARD BROADCAST ENGINEERING DATA		Name of applicant D. D. Foster, d/b/a Carolina Radio Broad- Casting Co.			
1. Indicate by check mark the purpose of this application. (The items of this Section that are applicable to, and must be answered for, each category are shown to the right of the category.)					
<input checked="" type="checkbox"/> Construct a new station <input type="checkbox"/> Change station location to a different city or town <input type="checkbox"/> Change power <input type="checkbox"/> Change transmitter location <input type="checkbox"/> Change frequency <input type="checkbox"/> Change from DA to Non-DA <input type="checkbox"/> Change from Non-DA to DA <input type="checkbox"/> Change in antenna system (including increase in height by addition of FM or TV antenna)		All items		<input type="checkbox"/> Install new Auxiliary Transmitter <input type="checkbox"/> Install new Alternate Main Transmitter <input type="checkbox"/> Change transmitter (non type accepted) <input type="checkbox"/> Change Main Studio Location to point outside city limits and not at transmitter site <input type="checkbox"/> Change Hours of Operation <input type="checkbox"/> Other (specify): _____	
				2 thru 7, and 10	
				2 thru 7	
				2 thru 7 (and appropriate other items)	
If this application is not for a new station, summarize briefly the nature of the changes proposed					
2. Facilities requested			10. Antenna system, including ground or counterpoise		
Frequency 1530 KC	Hours of operation LSR-LSS	Power in kilowatts Night Day 1(CH) D	Non-Directional Antenna: Day <input checked="" type="checkbox"/> Night <input type="checkbox"/>	Directional Antenna: Day only (DA-D) <input type="checkbox"/> Night only (DA-N) <input type="checkbox"/> Same constants and power day and night (DA-1) <input type="checkbox"/> Different constants or power day and night (DA-2) <input type="checkbox"/>	
3. Station location State South Carolina			(If a directional antenna is proposed submit complete engineering data. Show clearly whether directional operation is for day or night or both. If day and night patterns are different give full information on each pattern. This information is in addition to the information in Paragraph 10 and is submitted as Exhibit No. and signed by the engineer who designed the antenna system.)		
City or town Spartanburg					
4. Transmitter location State South Carolina					
County Spartanburg					
City or town Spartanburg			Type radiator Uniform		
Street Address (or other identification) .35 Mi North of Spartanburg city limits on State Hwy. #9			Cross-section guyed and base insulated		
5. Main studio location State Same as transmitter			Height in feet of complete radiator above base insulator, or above base if grounded. 250'		
County DNA			Overall height in feet above ground. (without obstruction lighting) 255		
City or town			Overall height in feet above ground. (With obstruction lighting) 1045		
6. Remote control point location State DNA			Overall height in feet above ground. (With obstruction lighting) 258		
City or town			Overall height in feet above ground. (With obstruction lighting) 1048		
Street Address (or other identification)			Excitation Series <input checked="" type="checkbox"/> Shunt <input type="checkbox"/>		
7. Transmitter Make RCA			Geographic coordinates to nearest second. For direction antenna give coordinates of center of array. For single vertical radiator give tower location.		
Type No. BTA-1R			North latitude 34° 58' 28"		
Rated Power 1 KW			West longitude 81° 56' 37"		
(If the above transmitter has not been accepted for licensing by the F.C.C., attach as Exhibit No. a complete showing of transmitter details. Showing should include schematic diagram and full details of frequency control. If changes are to be made in licensed transmitter include schematic diagram and give full details of change.)			If not fully described above, give further details and dimensions including any other antennas mounted on tower and associated isolation circuits as Exhibit No. (Height figures should not include obstruction lighting.)		
8. Modulation monitor Make General Radio			Submit as Exhibit No. E-1 a plat of the transmitter site showing boundary lines, and roads, railroads, or other obstructions; and also layout of the ground system or counterpoise. Show number and dimensions of ground radials or if a counterpoise is used, show height and dimensions.		
Type No. 1931-A			11. Attach as Exhibit No. E-2 a sufficient number of aerial photographs taken in clear weather at appropriate altitudes and angles to permit identification of all structures in the vicinity. The photographs must be marked so as to show compass directions, exact boundary lines of the proposed site, and locations of the proposed 1000 mv/m contour for both day and night operation. Photographs taken in eight different directions from an elevated position on the ground will be acceptable in lieu of the aerial photographs if the data referred to can be clearly shown.		
9. Frequency monitor Make General Radio					
Type No. 1181-A					

Fig. 3-1. Sample Page 1 of Form 301 Section V-A.

ed, however, preparing the data is a fairly straightforward engineering procedure.

APPLICATION CONSIDERATIONS

Applications lacking complete answers, or supplementary documents and engineering data, may be returned for additional information or corrections. While the application may be re-submitted, and no additional fee is required, approval for construction and operation will obviously be delayed, possibly resulting in unplanned financial loss. To minimize the possibility of such a delay, a cardinal rule is to become familiar with the instructions on the cover page of Form 301 and the applicable sections of Part 73 of the FCC Rules.

COST CONSIDERATIONS

One of the first points to consider about costs is whether the chief engineer or a consulting engineer should make the calculations and perform the tests to obtain the necessary data. While many chief engineers may be capable of preparing much of the data required, it is generally advisable to use the services of an engineering consultant, especially if the antenna system is complex (such as a directional array). Also, present-day regulations make it almost mandatory to enlist the aid of a consultant in making an allocations study and report for proposed facilities. In an operating station, engineering time is too valuable to perform the technical determinations. For a new station, however, it is most practical and economical for the chief engineer to work with a consulting engineer.

Engineering personnel assigned to the project should be advised of the necessity for keeping within the budget. Total cost for the engineering data will vary widely from station to station and area to area. As required tower heights and power outputs increase, costs will increase proportionately. Thus, the largest single cost generally involves preparation of antenna system data.

PREPARING SECTION V-A

Section V-A deals specifically with all the engineering data required for a standard broadcast station. The reproduction in Fig. 3-1 shows the information required for Page 1, and Exhibit E-1 is shown in Fig. 3-2. In connection with the information requested, Vol. III, Paragraph 73.33, Antenna Systems, states that an application for authority to install a broadcast antenna shall specify a definite site and include full details of the antenna design and expected performance.

All data necessary to show compliance with the terms and conditions of the construction permit must be filed with the license application. If the station is using a directional antenna, a proof of performance must also be filed. If a directional antenna is proposed, complete engineering data and measurements must be submitted.

Paragraph 73.150 specifies that engineering data for a directional antenna shall include a complete description of the proposed system showing:

1. Number of elements
2. Type of each element (guyed or self-supporting, uniform cross-section or tapered, base width, grounded or insulated, etc.)
3. Complete engineering details of top loading or sectionalizing, if any.
4. Height of vertical lead of each element in feet, (height above base insulator, or base if grounded).
5. Overall height of each element above ground.
6. Details including sketches of ground system for each element (length and number of radials, dimensions of ground screen, if used, and depth buried) and outline of property.
7. Ratio of fields from elements (identifying elements).

In addition, calculated horizontal (ground) plane field intensity patterns for each mode of operation must be plotted to the largest scale possible (approximately 7" by 10") on standard letter size point coordinate paper using only scale divisions and subdivisions having values of 1, 2, 2.5 or 5 times 10^{nth}. The data must include:

1. Inverse field intensity at 1 mile and effective field intensity (RMS).
2. Direction of true north at zero azimuth.
3. Direction and distance of each existing station with which interference may be involved. All directions should be determined by accurate calculation, or from a Lambert Conformal Conic Projection Map such as United States Coast and Geodetic Survey Map No. 3060 a, or map of equal accuracy. All distances should be determined by accurate calculation, or from a United States Albers Equal Area Projection Map,

Scale 1:2,500,000, or a map of equal accuracy.

4. Orientation of array with respect to true north and time phasing of fields from elements, specifying degrees leading (+) or lagging (-) and space phasing of elements in feed as well as in degrees.
5. The location of all the minima in the pattern.

In those instances where radiation at angles above the horizontal plane is a pertinent factor in station allocation, field intensity vs azimuth patterns must be calculated for every 5° of elevation through 60°. These patterns may be plotted along either polar or rectangular coordinates, but must be submitted one to a page. Minor lobe and null detail occurring between the 5° intervals need not be submitted.

Data used in computing field intensity patterns must also be submitted, along with the formula used for calculating the horizontal patterns, sample calculations, and formula derivations if other than standard. Any assumption made must be stated along with an explanation of its basis, including electrical height, current distribution and efficiency of each element and ground conductivity. Complete tabulation of final calculated data used in plotting patterns, including data for the determination of the RMS pattern value, is required.

Values of field intensity less than 10% of the effective field intensity of the pattern must be shown on an enlarged scale. If the values determined from actual measurements, particularly in sharp nulls, are different from the calculated values, maximum expected operating values (MEOV), as well as the calculated values, must be shown on both the full patterns and the enlarged sections. The requirements for field intensity measurements are elaborated in Paragraph 73.151, Field Intensity Measurements to establish Performance of Directional Antennas.

Appropriate information relating to the type of radiator, overall heights, top-loading or sectionalized antenna, and method of excitation is entered in the applicable blocks for Question 10 (see Fig. 3-1.) Special maps and charts may be used to tabulate the information and data required for the last portion of Item 10.

Ground level elevations may be obtained from the U.S.G.S. topographic quadrangle maps. Maps for specific areas may be obtained from U.S. Geological Survey, Department of the Interior, Washington, D.C. 20240. Maps of areas west of the Mississippi are available from U.S. Geological Survey, Denver 15, Colorado. Section aeronautical charts are available from United States Coast and Geodetic Survey, Department of Commerce, Washington, D.C. 20235.

Fig. 3-2. Typical exhibit showing the plot of a proposed antenna site.

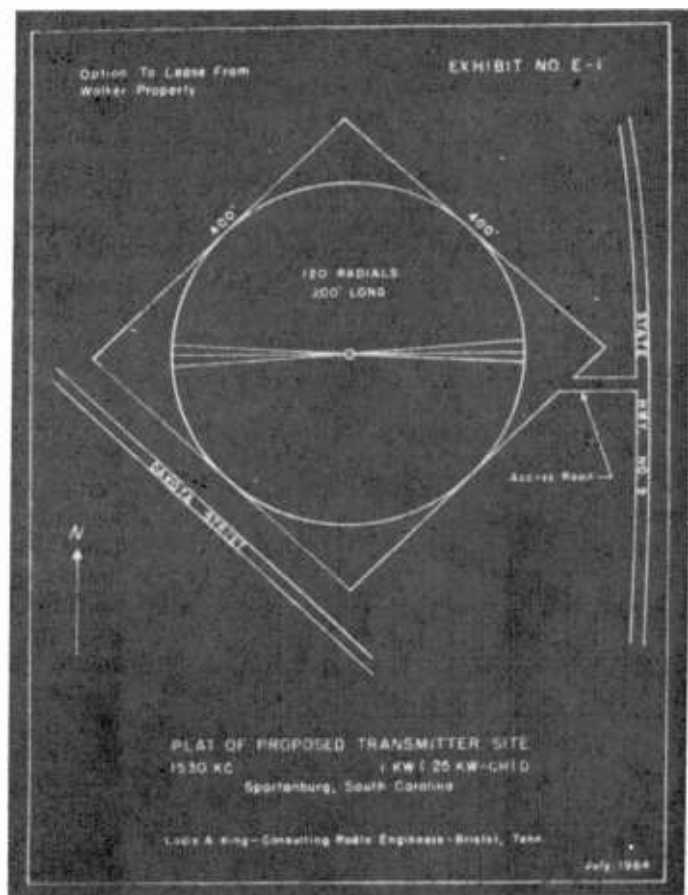

Some pertinent facts relating to standard broadcast antenna structures are:

1. All applicants for new, additional, or different broadcast facilities, and all licensees requesting authority to change the transmitter site of an existing station, shall specify a radiating system with an efficiency that complies with the requirements of good engineering practice for the class and power of the station.
2. No broadcast station licensee shall change the physical height of the transmitting antenna or supporting structure, or make any changes in the radiating system which will measurably alter the radiation pattern, except on application to and authority from the Commission.
3. The simultaneous use of a common antenna or antenna structure by more than one standard broadcast station, or by one or more standard broadcast stations and one or more broadcast stations of other class or service, may be authorized provided:
 - a. Verified engineering data is submitted to show that satisfactory operation of each station will be obtained without adversely affecting the operation of the other.
 - b. The minimum antenna height or field intensity for each station complies with Item 1 above.
4. Paragraphs 73.189 and 73.190 define the minimum antenna heights and field intensity requirements. Minimum physical heights of antennas permitted are shown in Fig. 3-3. Fig. 3-4 shows the requirements for effective field at one mile for one kilowatt.
5. Since the radiation pattern is computed on the basis of a perfectly conducting plane earth, a ground system of buried copper wires or ribbon must be installed in order to approach this condition as closely as possible. A properly installed and adequate ground system can contribute much to the efficiency and stability of a radiation pattern. The FCC minimum requirements consist of buried radial wires at least 1/4 wavelength long. They should be evenly spaced, and in no event should less than 90 radials be used (see Fig. 3-5).

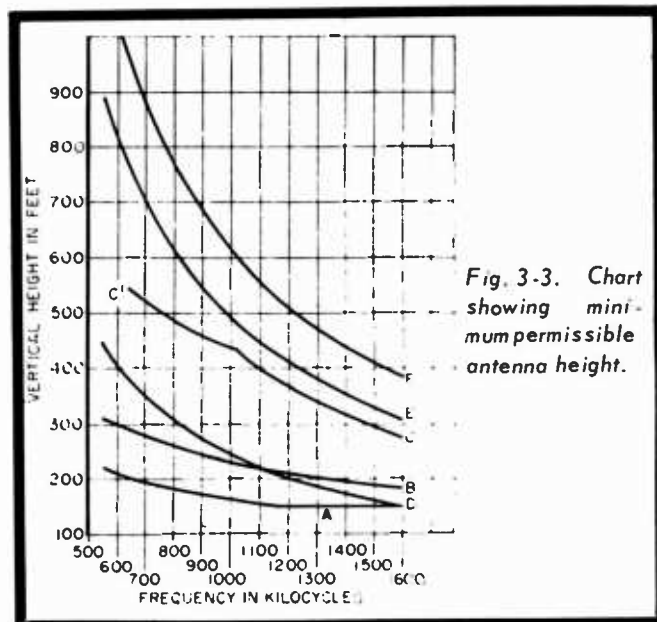

Fig. 3-3. Chart showing minimum permissible antenna height.

6. A station with an AM directional antenna system applying for remote control privileges must have an extremely stable antenna system and must also attest to its stability. The stability of directional AM antenna systems is important to successful remote control operation. In addition to the provision of an adequate ground system, attention should be given to bonding of the connecting elements, positioning of guy insulators, base insulators with sufficient leakage paths, and low-loss capacitors and inductors in the phasing and power-dividing networks.
7. The unattenuated inverse field strength at 1 mile is the field strength at 1 mile when the only attenuation is that of distance.
8. A sectionalized tower, in addition to the base insulator, has one or more insulators in the tower above the base. This type of tower is usually constructed for the purpose of obtaining greater AM broadcast coverage.

The engineering data required for Pages 2 and 3 of Section V-A is directly related to the information described in the following paragraphs:

1. Paragraph 73.37 Minimum Separation Between Stations; Prohibited Overlap.
2. Paragraph 73.182 Engineering Standards of Allocation.
3. Paragraph 73.183 Groundwave Signals.
4. Paragraph 73.184 Groundwave Field Intensity Charts.

5. Paragraph 73.185 Computation of Interfering Signal from a Directional Antenna.
6. Paragraph 73.186 Field Intensity Measurements in Allocation.
7. Paragraph 73.187 Limitation of Daytime Radiation.

SECTION V-G, ANTENNA AND SITE INFORMATION

This part of Form 301, as shown in Fig. 3-6, is for the specific use of the Regional Airspace

Subcommittee, which is concerned with obstructions to air navigation. Thus, even though most of the data requested duplicates engineering information called for in Section V-A, or B, it must not be entered by reference.

Antenna Site Considerations

An antenna located at a height above the service area, such as a mountain top, may have a pattern null falling in the vicinity of a heavily-populated section of the principal city. If a populated section lies within the area, the broadcaster should have the antenna manufacturer apply elec-

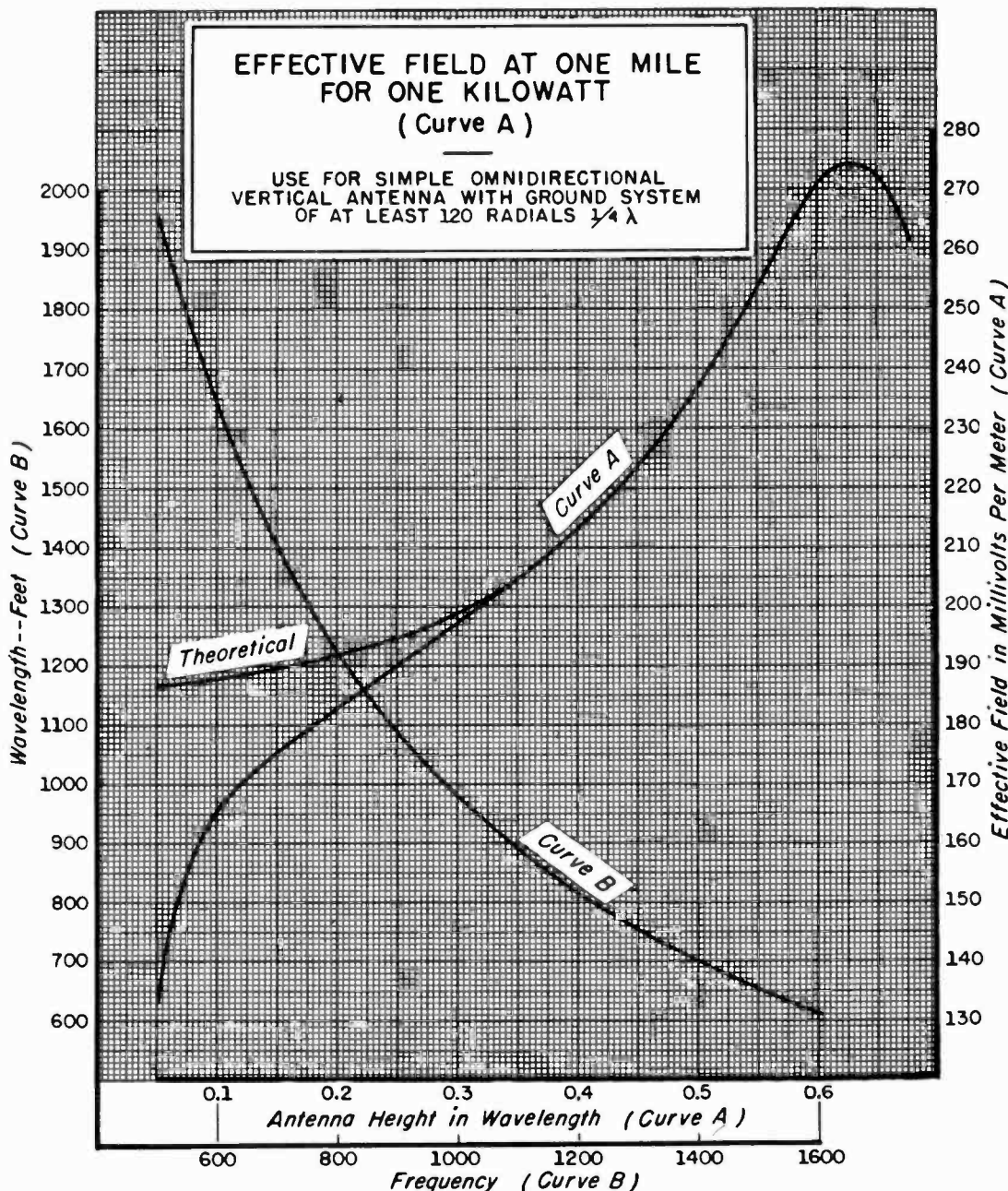

Fig. 3-4. Curve illustrating the requirements for the effective field at one mile.

trical beam tilt or null fill or a combination of both.

Polarization patterns, standing-wave ratio, and gain may be affected by side-mounting an antenna. A performance check should be made before deciding on a final location.

Topographical data may be obtained on roads which are along radials from the transmitter site by using a sensitive altimeter. The average elevation of each radial from 2 to 10 miles may be determined by averaging the mean values of mile or half-mile segments.

The height of the antenna radiation center above the average elevation of the radial is: Height of radiation center above sea level minus the 2- to 10-mile average radial elevation.

The free-space field intensity in mv/m at 1 mile is measured 1 mile from the antenna with 1-kw input in the half-wave dipole. At this 1-mile point, the field intensity for the half-wave dipole is equal to 137.6 mv/m. This measurement is made under conditions of free-space field intensity; i.e., the signal is free from reflections from earth or other objects.

Applicants who propose to operate an FM antenna in the immediate vicinity (200 ft. or less of another FM antenna, or TV antenna with frequencies adjacent to the FM band, must describe the effect the two systems will have upon each other. (FCC Rules, Par. 73.316: Antenna systems—Part e.)

If an FM antenna is to be mounted on a non-directional standard broadcast antenna tower, new resistance measurements must be made after the FM antenna is installed and tested. During the installation, and until the new resistance measurements are approved, the AM licensee should apply for authority (informal application) to use the indirect method of measuring power. The FM application will not be considered until the new resistance measurements are filed for the AM station. If the FM antenna is to be mounted on an element of an AM directional array, or on a tower in the vicinity of a directional array, a full engineering study of the effect on the performance of the AM array must be filed with the application. In some cases, the FCC may require readjustment and certain field intensity measurements of the AM system when the FM antenna is in operation.

SELECTING AM FM FREQUENCY

Available frequencies for FM broadcasting are listed in Paragraph 73.201—Numerical Designation of FM Broadcast Channels, Subpart B—FM Broadcast Stations (Vol. III of the Rules). The channel you request must be one assigned to your

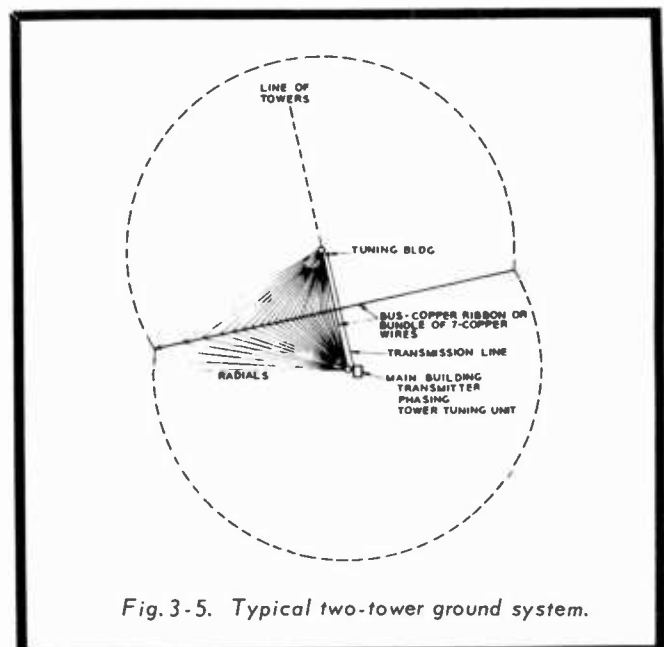

Fig. 3-5. Typical two-tower ground system.

Table I—Typical Horizontal FM Antenna Data

NO OF SECTIONS	G A I N		
	POWER KW	DB	FIELD
1	09	05	095
2	20	30	141
3	30	48	173
4	41	61	202
5	52	715	228
6	63	80	251
7	73	863	270
8	84	925	290
10	105	102	325
12	125	110	355
14	140	1165	383
16	166	1220	407
20	210	1322	459

community (Table of Assignments, Par. 73.202). If your community has no channel assigned, or is not within 25 miles of the assignment, or if there are stations already on the channels in your area, a petition must be filed with the FCC to change the Table of Assignments as required by Par. 73.203.

SECTION V-B: FM ANTENNA

If you plan to use a dual-polarized antenna, Tables I and II list data for horizontal and vertical polarization. Fig. 3-8 shows how data for dual polarization is entered on the form.

The mathematical expressions for antenna field gain and power gain are:

Field gain = field intensity in mv/m for multi-element antenna/137.6.

Power gain = (Antenna field gain). Ground level elevations may be obtained from the U.S. Geological Survey, Dept. of the Interior, Wash., D.C.

Broadcast Application		FEDERAL COMMUNICATIONS COMMISSION		Section V-G (Antenna)		
ANTENNA AND SITE INFORMATION (see instruction B, Section 1)		Name of applicant D. D. Foster, d/b/a Carolina Radio Broadcasting Co.				
Legal Counsel		Purpose of application (Check appropriate box)				
Address		a. New antenna construction <input checked="" type="checkbox"/>				
Consulting Engineer		b. Alteration of existing antenna structures <input type="checkbox"/>				
Louis A. King		c. Change in location <input type="checkbox"/>				
Address		2. Features of surrounding terrain				
510 Shelby St., Bristol, Tenn.		List any natural formations or existing man-made structures (hills, trees, water tanks, towers, etc.) which, in the opinion of the applicant, would tend to shield the antenna from aircraft and thereby minimize the aeronautical hazard of the antenna.				
Class of station		None				
Standard		Facilities requested				
		1530 Kc-1 KW(.25CH)D				
1. Location of antenna						
State		County		City or Town		
S. Carolina		Spartanburg		Spartanburg		
Exact antenna location (street address) (If outside city limits, give distance and direction from, and name of nearest town)						
.35 Mile North of Spartanburg City Limits on State Highway #9						
Geographic coordinates (to be determined to nearest second. For directional antenna give coordinates of center of array. For single vertical radiator give tower location.)						
North latitude		West longitude				
34° 58' 28"		81° 56' 37"				
3. Designation, distance, and bearing to center line of nearest established airway within 5 miles: None						
4. List all landing areas within 10 miles of antenna site. Give distance and direction to the nearest boundary of each landing area from the antenna site.						
		<u>Landing Area</u>		<u>Distance</u>		
(a)				<u>Direction</u>		
(b)		Spartanburg Municipal		3.2 Miles		
(c)				191°		
5. Description of antenna system (If directional, give spacing and orientation of towers).						
Single uniform cross-section, base insulated and guyed tower						
Type						
Description of tower(s)						
Self-supporting		Guyed <input checked="" type="checkbox"/>			Tubular (Pole)	
Tower (height figures should include obstruction lighting)		#1	#2	#3	#4	#5
Height of radiating elements		250'				
Overall height above ground		258'				
Overall height above mean sea level		1048'				
If a combination of Standard, FM, or TV operation is proposed on the same multi-element array (either existing or proposed) submit as Exhibit No. E9 a horizontal plan for the proposed antenna system, giving heights of the elements above ground and showing their orientation and spacing in feet. Clearly indicate if any towers are existing.						
Submit as Exhibit No. E9 a vertical plan sketch for the proposed total structure (including supporting building if any) giving heights above ground in feet for all significant features. Clearly indicate existing portions, noting painting and lighting.						
Is the proposed antenna system designed so that obstruction lights may be installed and maintained at the uppermost point(s)?						
Yes <input checked="" type="checkbox"/> No <input type="checkbox"/>						
6. Is the proposed site the same or immediately adjoining the transmitter-antenna site of other stations authorized by the Commission or specified in another application pending before the Commission? <input type="checkbox"/> Yes <input checked="" type="checkbox"/> No						
If the answer is "Yes", give: CALL LETTERS			FILE NUMBER			
I certify that I represent the applicant in the capacity indicated below and that I have examined the foregoing statement of technical information and that it is true to the best of my knowledge and belief.						
(date)		Signature				
		(check appropriate box below)				
		<input type="checkbox"/> Technical Director	<input type="checkbox"/> Chief Operator	<input type="checkbox"/> Registered Professional Engineer	<input type="checkbox"/> Consulting Engineer	

Fig. 3-6. Sample application, Section V-G, presenting antenna site information.

20240. West of the Mississippi: U.S.G.S., Denver 15, Colorado. Sectional aeronautical charts are available from the U.S. Coast and Geodetic Survey, Dept. of Commerce, Wash., D.C. 20235

Authorized power and antenna requirements are illustrated in Table III. No minimum antenna height above average terrain is specified. Heights exceeding those listed in Table III may be used if the ERP is reduced by the amount indicated by the appropriate curve in Fig. 3-9.

The height of the radiation center is the physical center of the radiating elements if uniform power distribution is used. If a split-feed or power divider system and non-uniform power distribution are employed, the height of the radiation center is not the same as the physical center (the manufacturer will furnish this data).

A directional antenna may not be used solely for the purpose of reducing minimum mileage separation requirements: it is permissible if it will improve service, or permit the use of a

particular site, and is designed for a noncircular radiation pattern. Directional antennas with a ratio of 15 db maximum to minimum radiation in the horizontal plane are not allowed.

Applications proposing the use of a directional antenna must be accompanied by:

1. A complete description of the proposed antenna system.
 - (a). A description of how directivity will be obtained.
 - (b). A means of determining the operational pattern and maintaining allowable tolerances, such as a rotatable reference antenna.
2. Horizontal and vertical plane radiation patterns showing the free space field strength in mv/m at 1 mile and ERP in dbk for each direction; a complete description of how the measurements were made, including the

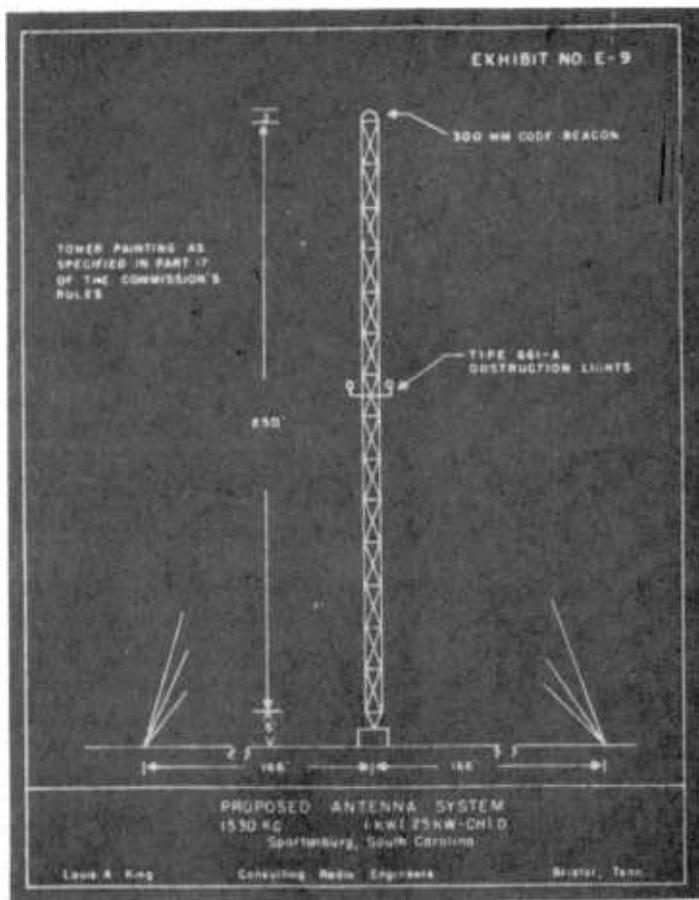

Fig. 3-7. A typical vertical antenna sketch requested in Section V-G.

Table II—Typical Vertical FM Antenna Data

NO. OF SECTIONS	G A I N		FIELD
	POWER KW	DB	
1	.95	22	.97
2	1.97	2.94	1.40
3	3.12	4.94	1.79
4	4.20	6.23	2.05
5	5.31	7.25	2.31
6	6.39	8.06	2.53
7	7.50	8.75	2.74
8	8.57	9.33	2.93
9	9.76	9.89	3.12
10	10.91	10.40	3.31
11	11.87	10.74	3.45
12	13.20	11.20	3.63
13	14.03	11.47	3.75
14	15.29	11.84	3.91
15	16.30	12.12	4.04
16	17.8	12.43	4.18

(b) Antenna data

Make Vert, Electronics	Type No. or designation 300 PMA-6E	No. of sections 6
Horiz: Gates	Antenna field gain Vert. 2.611	Antenna power gain Vert. 6.817
Effective free space intensity at one mile in mv/m for one kilowatt antenna input power Vert. 359.3	Horiz: 342.6	Horiz. 6.20
Is horizontal polarization proposed?	Yes <input checked="" type="checkbox"/> No <input type="checkbox"/>	
If "No", attach as Exhibit No. Eng complete engineering data on the Both horizontal & vertical proposed. antenna and the effective radiated power proposed.		
Is directional antenna proposed?	Yes <input type="checkbox"/> No <input checked="" type="checkbox"/>	
If "Yes", attach as Exhibit No. complete engineering data thereon.		

Fig. 3-8. Sample antenna data entries on Form 301.

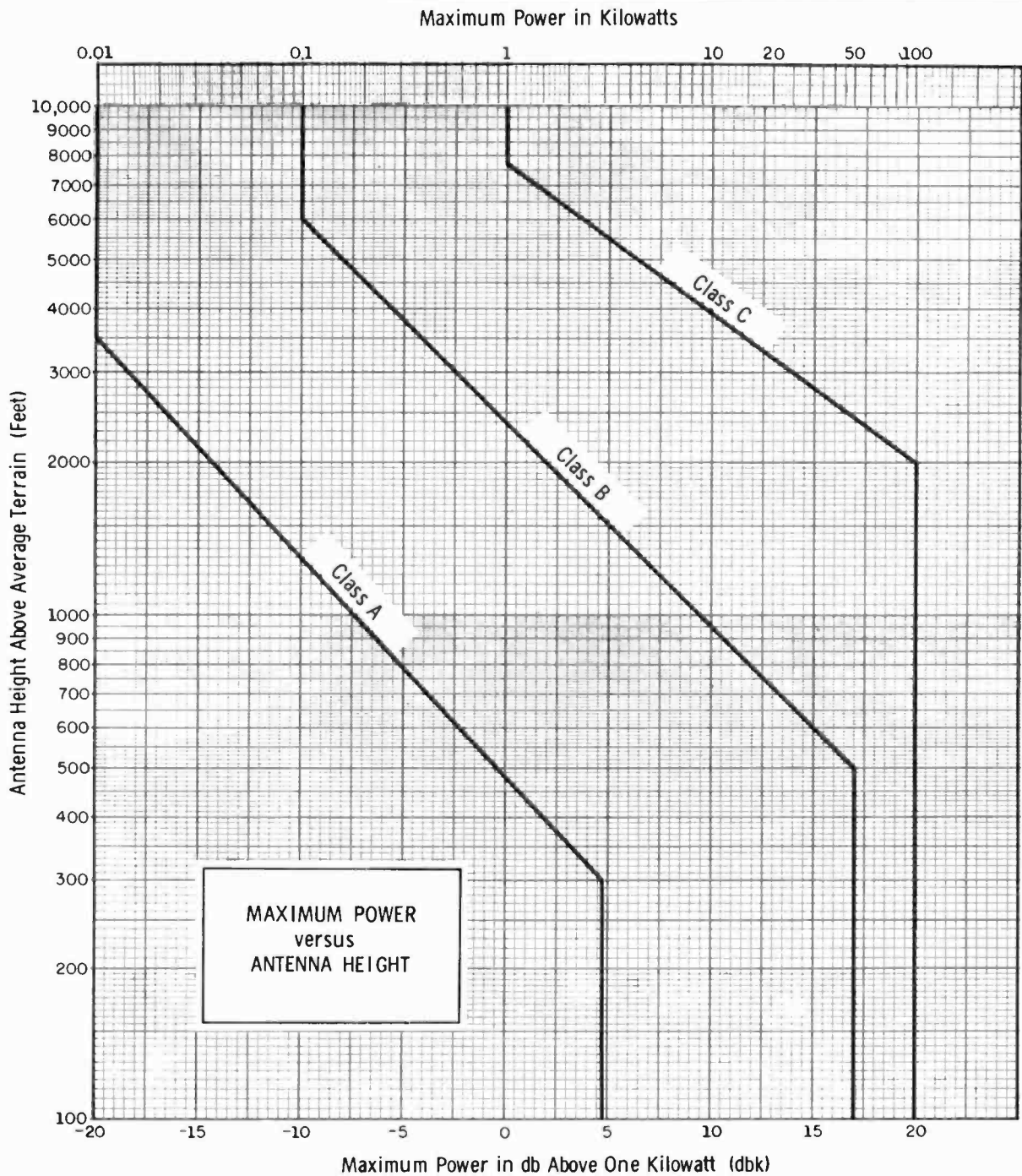

Maximum Power in db Above One Kilowatt (dbk)

Fig. 3-9. FM antenna height vs power chart.

Fig. 3-10. FM transmission line data as it should be entered on Form 301.

11. Transmission line proposed to supply power to the antenna from the transmitter		
Make Andrew	Dist. No. 452 562 A	Description Coaxial
Size (nominal transverse dimension) in inches 3-1/8	Length in feet 280	Rated efficiency in percent for this length 90.6
3-1/8	320	92.3 83.6
12. Proposed operation		
Transmitter power output in kilowatts 7.36	Power dissipation within transmission line in kilowatts 1.20	
Antenna input power in kilowatts Vert. 2.93 Horiz. 3.23	Effective radiated power in kilowatts (Must be same as shown in Para. 2) Vert. 20 Horiz. 20	

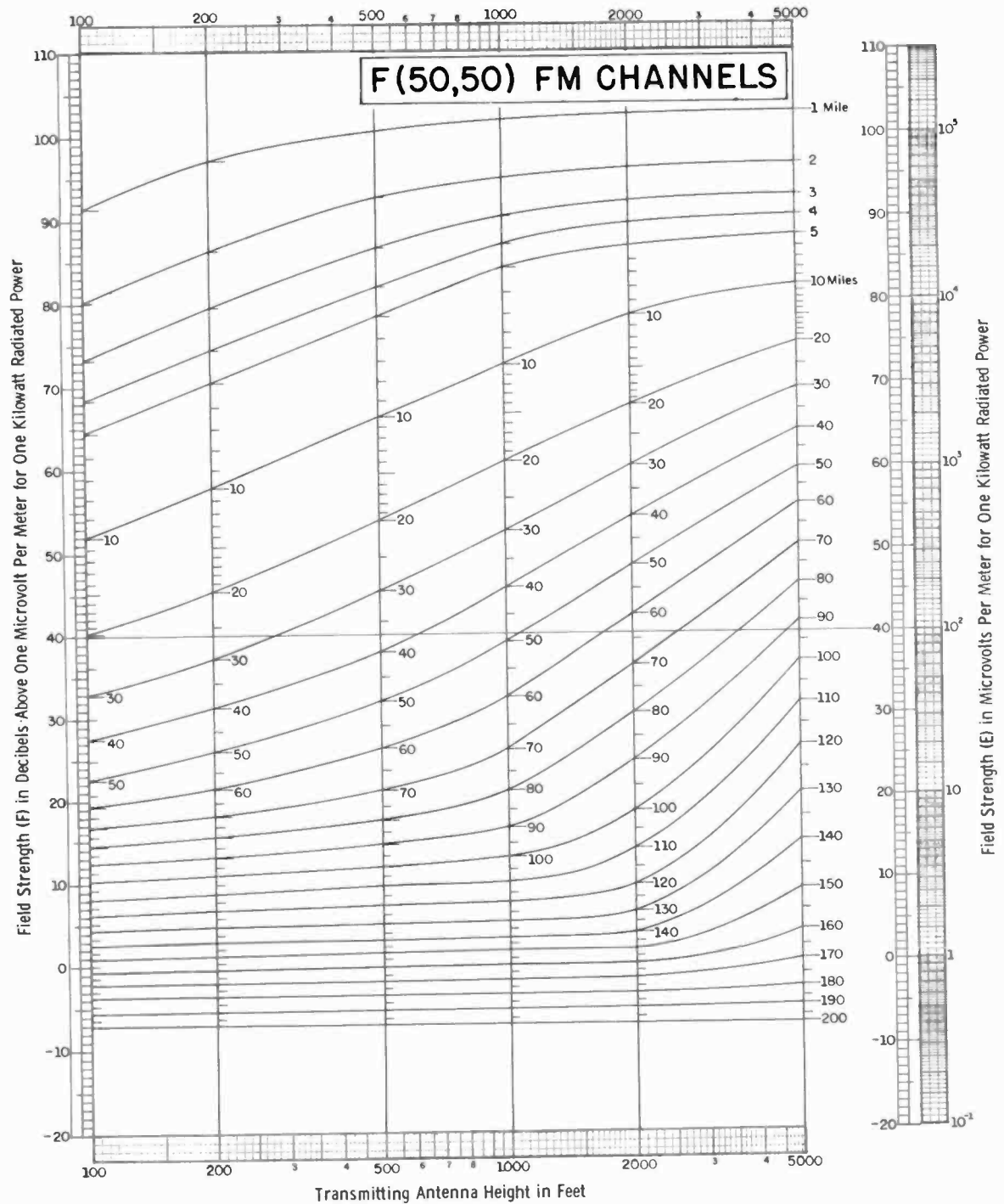

FM CHANNELS
 ESTIMATED FIELD STRENGTH EXCEEDED AT 50 PERCENT OF THE POTENTIAL
 RECEIVER LOCATIONS FOR AT LEAST 50 PERCENT OF THE TIME
 AT A RECEIVING ANTENNA HEIGHT OF 30 FEET

Fig. 3-11. The F(50, 50) field strength chart used to predict FM coverage.

Table III—Authorized Power and Antenna Requirements

CLASS	Minimum Effective Radiated Power	Antenna Height
CLASS A	100 watts (-10 dbk)	
CLASS B	5 kw (-7 dbk)	
CLASS C	25 kw (-14 dbk)	
CLASS	MAXIMUM POWER	MAXIMUM ANTENNA HEIGHT (feet above average terrain)
A	3 kw (48 dbk)	300
B	50 kw (170 dbk)	500
C	100 kw (200 dbk)	2000

Table IV—Operational Formulas

- ERP in KW = $\frac{\text{Transmitter power in KW} - \text{Transmission Line loss in KW} + \text{Antenna Power Gain in KW}}{\text{The transmission line loss includes the loss in harmonic filter and power divider when dual polarization is used}}$
- ERP in DBK = $\text{Transmitter Power in DBK} - \text{Transmission line loss in db} + \text{Antenna power gain in db}$
- Power in dbk = $10 \log_{10} \frac{\text{Power in KW}}{10}$
- Power in KW = $\text{Antilog}_{10} \frac{\text{Power in dbk}}{10}$

type equipment used and a tabulation of the measured data. If you compute directivity, methods used, formulae, sample calculations and tabulations of the data must accompany the application.

- Radiation characteristics above and below the horizontal plane illustrated by vertical patterns. Complete information and patterns for angles of $\pm 10^\circ$ from the horizontal plane, and the portion lying between $+10^\circ$ and the zenith of -10° and the nadir, to conclusively demonstrate the absence of undesirable lobes in these areas.
- The horizontal plane pattern must be plotted on polar coordinate paper with reference to true north. The vertical plane must be plotted on rectangular coordinate paper with reference to the horizontal plane.

TRANSMISSION LINES

Fig. 3-10 shows entries for the required information on the transmission line. These characteristics vary with frequency: size in inches, coaxial or waveguide, efficiency to produce the desired ERP and, of course, cost considerations. The total length in feet includes the horizontal run from the harmonic filter to the base of the antenna tower and the length up the tower to the antenna terminal point where the gain is rated. Power loss for this length may be determined from the manufacturer's specifications. (See Table IV.)

EXPECTED COVERAGE INFORMATION

Profile graphs of the terrain, from 2 to 10 miles for 8 or more radials from the transmitter location, must accompany the application. One or more radials must extend through the principal city. All radials should be plotted on a topographic map. Topographical maps for most areas are available at a nominal cost from U.S.G.S. If none is published for your area, use the information in Par. 73.312, subparagraph (a) FCC R&R.

The graph for each radial should be plotted by contour intervals of from 40 to 100 feet and, where the data permits, at least 50 points of elevation should be used for each radial. The graphs should indicate the topography accurately and should be plotted with the distances in miles as the abscissa, and the elevation in feet above the mean sea level as the ordinate. The elevations of the antenna radiation center and the source of the topographic data should be indicated on each graph.

The F(50, 50) field strength chart, Fig. 3-11, is used to predict field strength of the contours (Fig. 1 of Par. 73.33 may also be used). The chart is based on an effective power of 1KW radiated from a half-wave dipole in free space, which produces an attenuated field strength at 1 mile of 103 db above 1 $\mu\text{v/m}$ (137.6 mv/m).

The chart may be used for other powers; the sliding scale associated with the chart serves as the ordinate. Paragraph 73.313—Prediction of Coverage, explains its use.

If the terrain departs widely from the average elevation of the 2 to 10 mile sector, in one or more directions from the antenna site, the prediction method may indicate distances that are different from what may be expected in practice. For example, a mountain ridge may indicate the practical limit of service, while the prediction method indicates otherwise; the prediction method should be followed, accompanied by a supplemental exhibit concerning the contour distances as determined by a method based on actual conditions. The exhibit should describe the procedure employed and include sample calculations. Maps of predicted coverage should include both methods of prediction.

When measurements are required, these should include the area obtained by the regular method. In directions where the terrain is such that negative antenna heights or heights below 100 feet for the 2 to 10 mile sector are encountered, a supplemental showing of expected coverage must be included with a description of the method used in predicting the coverage. The Commission may require additional information about terrain and coverage in such cases.

CHAPTER 4

Basic Floor Plans

Market potential, available capital, and ownership goals are the criteria that usually determine the design of the physical plant—transmitter, facilities, etc. "Plan 1" layouts are designed for AM or FM station operators who want to start with a minimum investment. Included are all neces-

ary facilities and technical equipment to handle a complete program schedule such as announcements, disc and tape recordings, network programs, remotes, and live shows including news, interviews, and small orchestras or audience-participation shows.

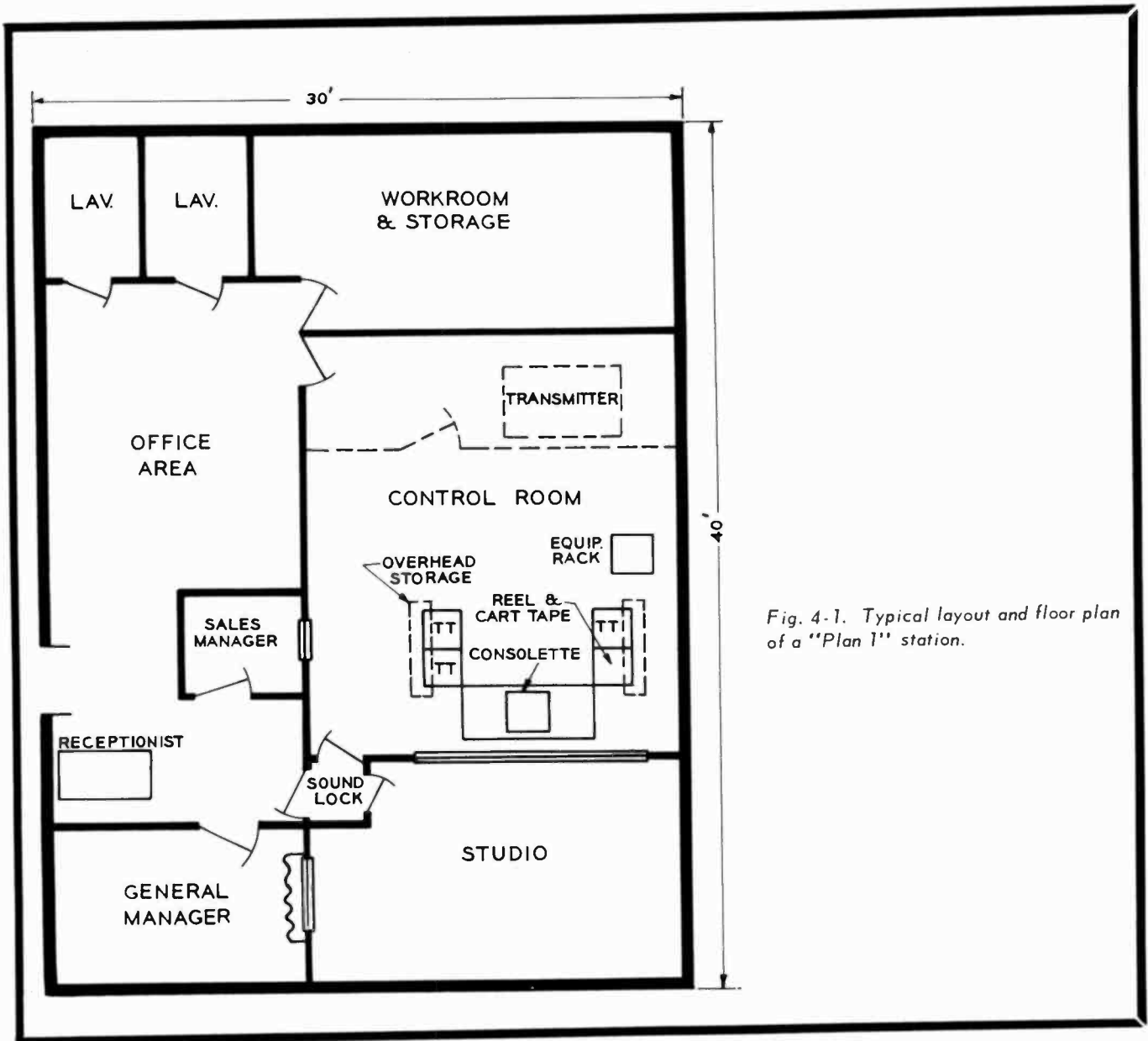

Fig. 4-1. Typical layout and floor plan of a "Plan 1" station.

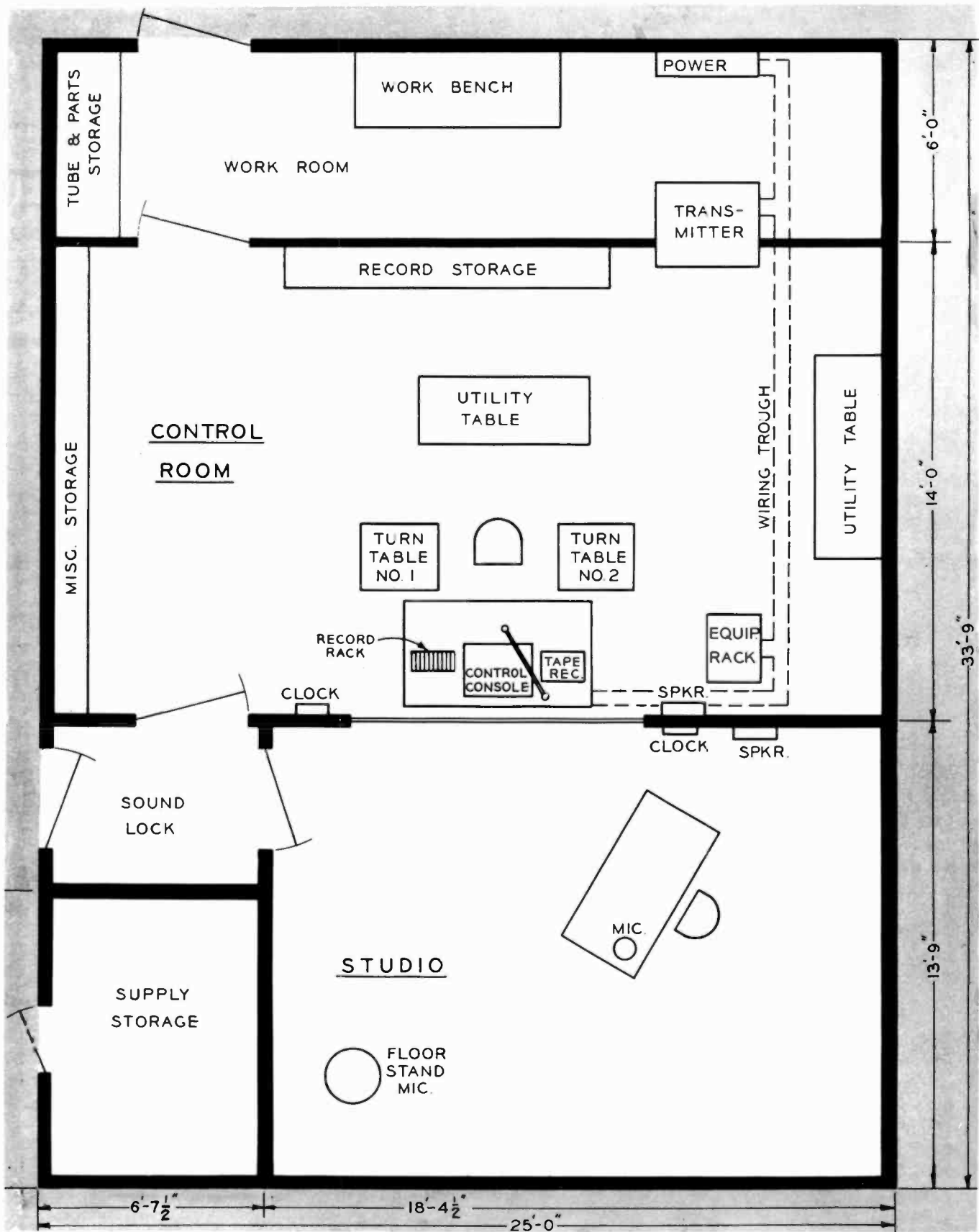

Fig. 4-2. Another desirable layout for "Plan 1."

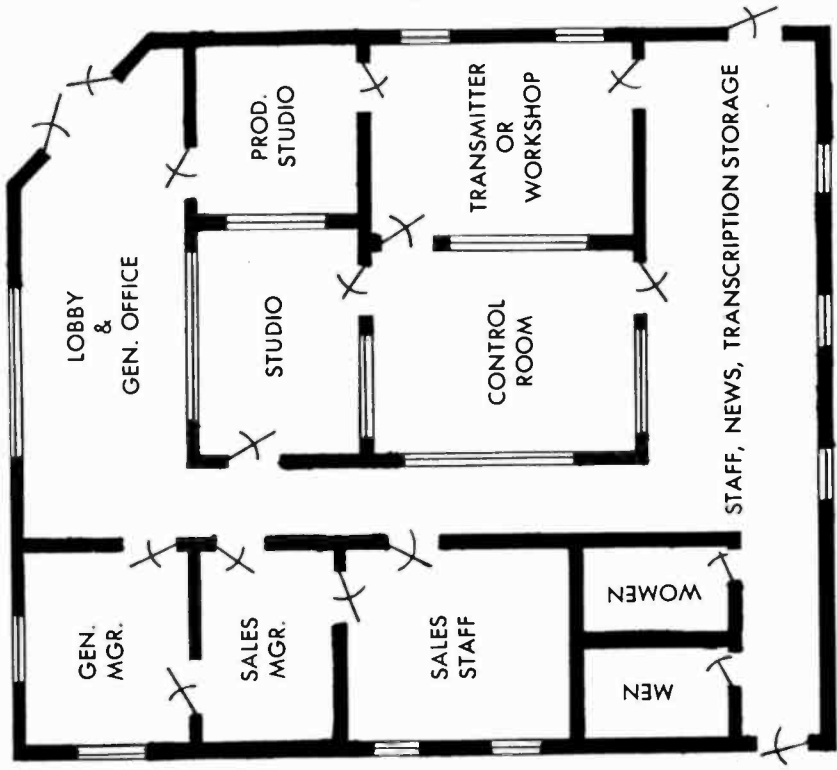

Fig. 4-3. "Plan 1" small-market, minimum-staff layout.

QUANTITY	MAJOR EQUIPMENT ITEM
4	Microphones
2	Two-Speed Turntables
1	Professional Tape Recorder
1	Audio Console
2	Multi-Cartridge Tape Playback Units
1	Cartridge Tape Record/Playback Unit
2	Cue Amplifiers
1	AGC/Limiter Amplifier
1	Cabinet Rack
1	Transmitter
1	Antenna System
1	Modulation Monitor
1	Frequency Monitor

Fig. 4-4. Major equipment list for "Plan 1" stations.

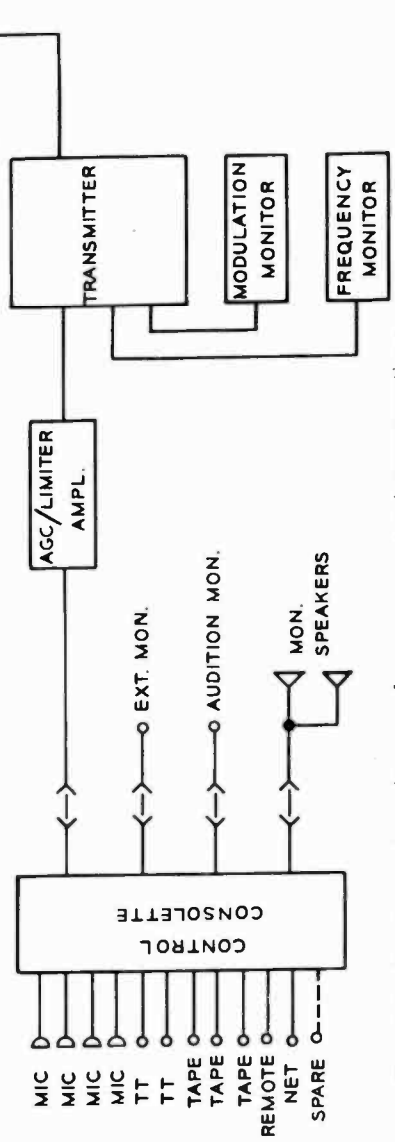
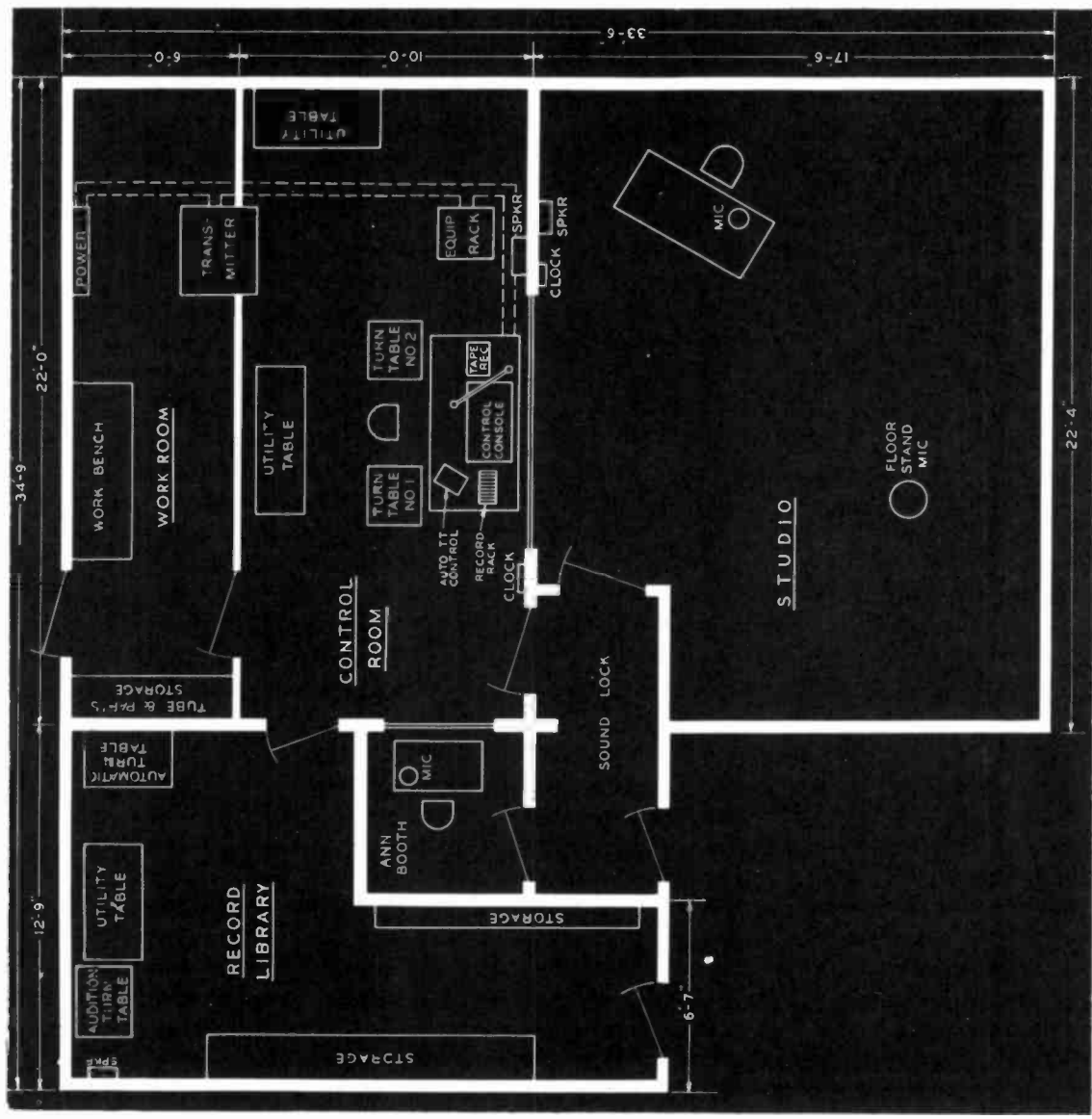

Fig. 4-5. Simplified block diagram of major equipment interconnections.



FREQUENCY MONITOR
MODULATION MONITOR
LIMITER AMPLIFIER
BLANK PANEL
JACK PANEL
BLANK PANEL
AGC AMP
BLANK PANEL
HOUSE MONITOR AMPLIFIER
BLANK PANEL
SWITCH & FUSE PANEL

Fig. 4-8. This "Plan 2" rack layout includes a house monitoring amplifier.

FREQUENCY MONITOR
MODULATION MONITOR
LIMITER AMPLIFIER
BLANK PANEL
JACK PANEL
BLANK PANEL
AGC AMP
BLANK PANEL
BLANK PANEL
BLANK PANEL
SWITCH & FUSE PANEL

Fig. 4-6. Complete rack layout for "Plan 1" equipment.

Fig. 4-7. Basic layout for a "Plan 2" facility.

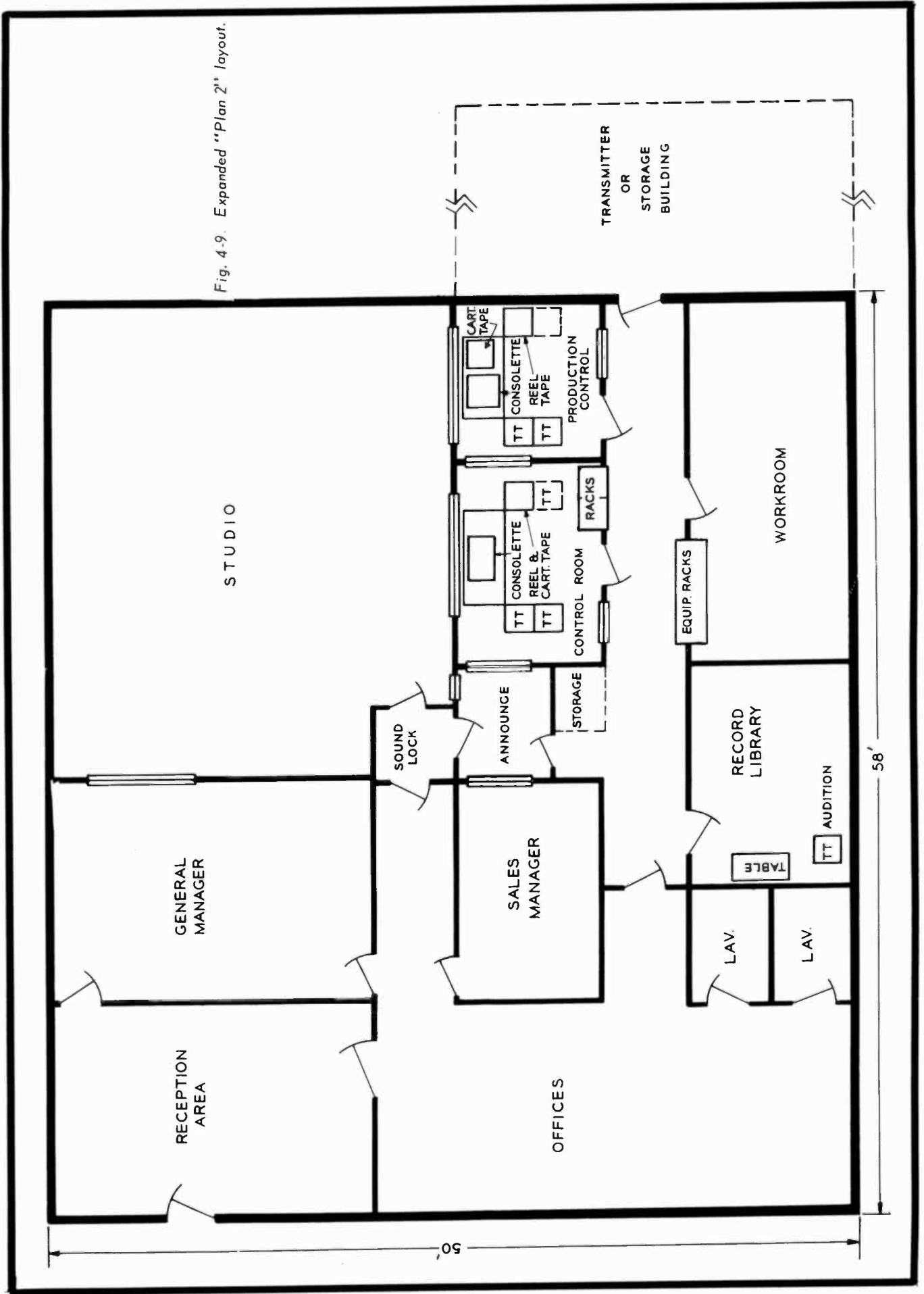

Fig. 4-9. Expanded "Plan 2" layout.

MAJOR EQUIPMENT

QUANTITY	ITEM
6	Microphones
5	Two-Speed Turntables
2	Professional Tape Recorders
2	Audio Consolettes
1	Multi-Cartridge Tape Playback Unit
2	Cartridge Tape Record/Playback Units
1	AGC/Limiter Amplifier
2	Cue Amplifiers
2	Monitor Amplifiers
5	Cabinet Racks
1	Transmitter
1	Antenna System
1	Modulation Monitor
1	Frequency Monitor

Fig. 4-10. Major equipment comple-
ment for a typical "Plan 2" station.

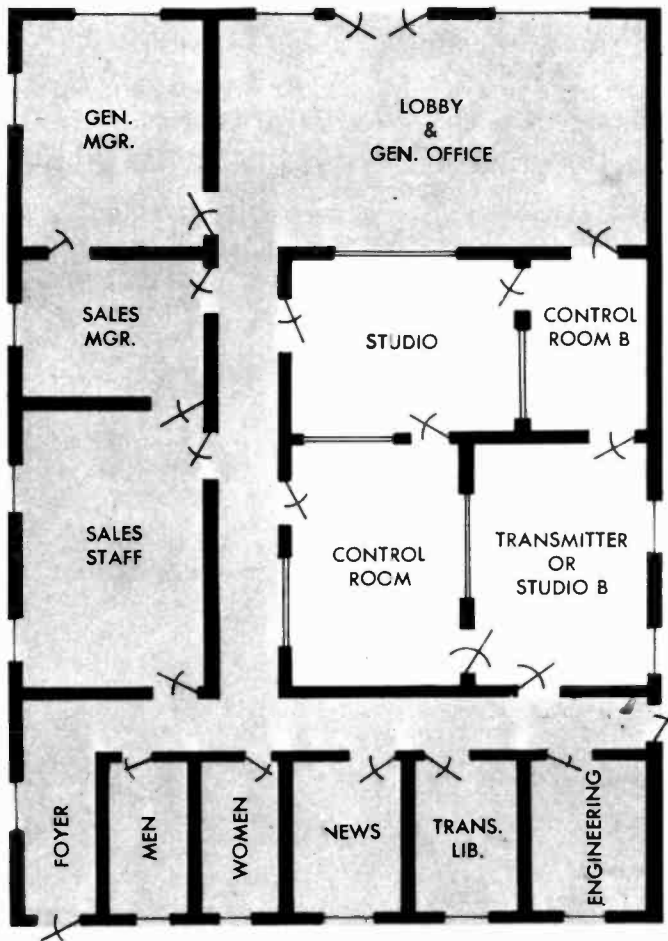

Fig. 4-12. A more desirable version of a "Plan 2" station layout.

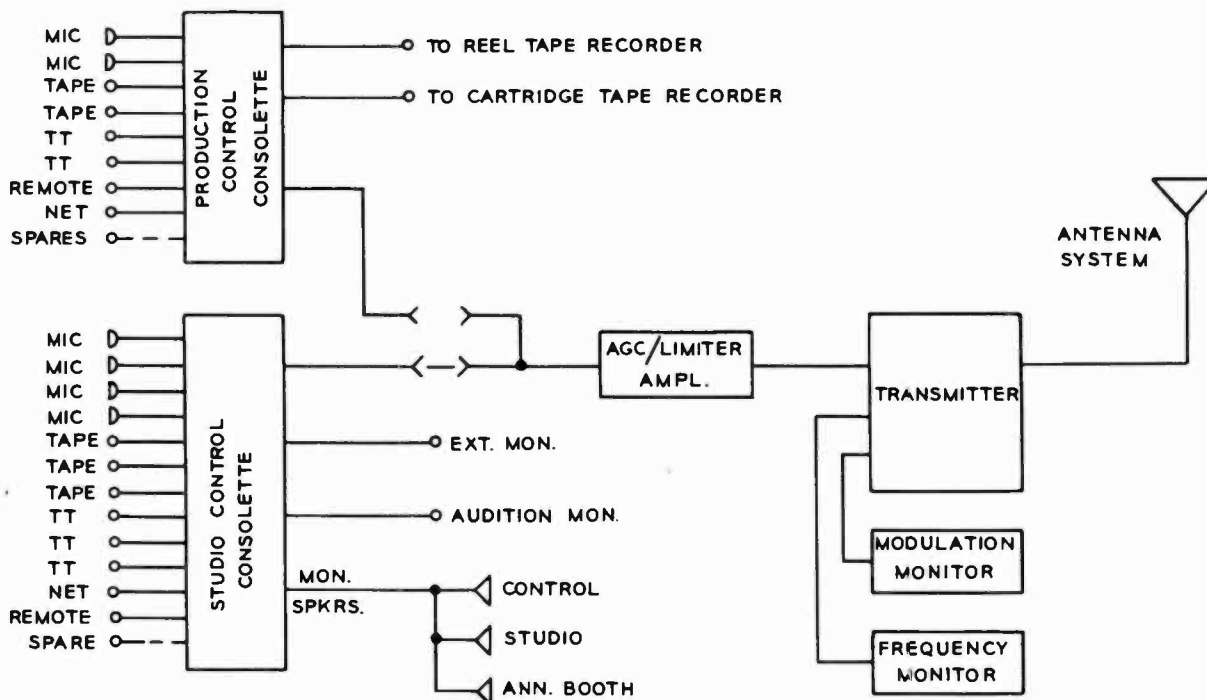

Fig. 4-11. "Plan 2" system block diagram showing how production control can also be patched into output line.

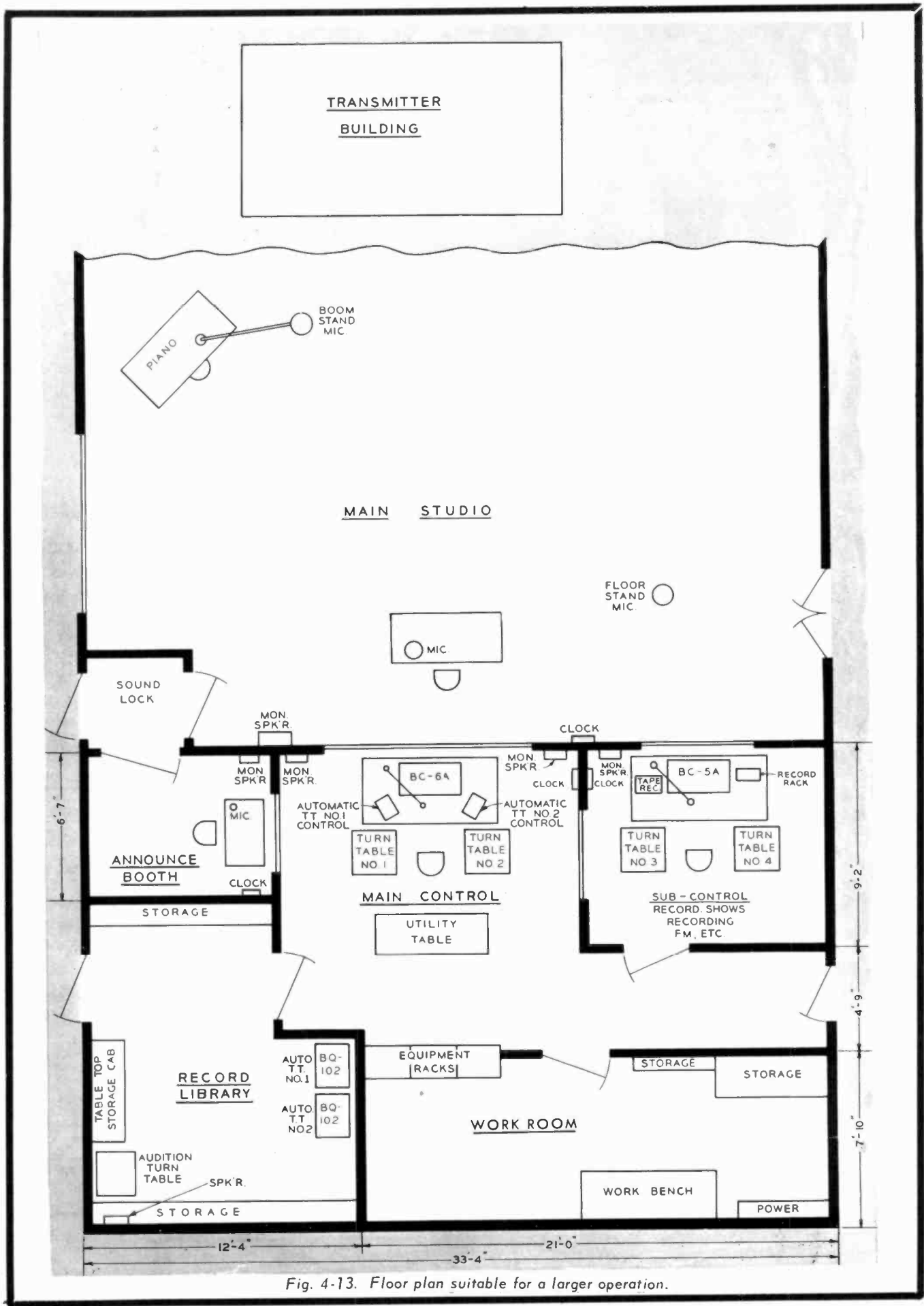

Fig. 4-13. Floor plan suitable for a larger operation.

PLAN 1: SMALL STATIONS

Notice in Fig. 4-1 that the floor plan is the keynote of simplicity. The layout occupies a small space, employs a minimum of equipment and is arranged to require a minimum of personnel. A single "combo" or combination announcer-operator works directly from the control room with turntables, tape recorders, control console, and overhead record rack all within easy reach. The control room and studio entrances from the office area share a common sound lock. A sound-proof wall partitions off the transmitter to minimize noise in the control room. The engineering workroom and storage facility is sometimes neglected in planning, but will prove its worth many times over.

A larger and more flexible layout, illustrated in Fig. 4-2, offers a combined transmitter and control room, small studio, engineering workroom and parts storage, supply storage, and a sound lock. The major equipment items required to

perform the programming operations are identified on the floor plan.

Within less than 1800 square feet the floor plan shown in Fig. 4-3 provides adequate space for a compact operation with a staff of six to thirteen persons. The spacious studio may be worked from either the main control room or the production studio. It also serves as a conference or client presentation room. Only one side of the layout is an outside wall and the normal live programming area is in the center of the building.

Since each member of a smaller staff necessarily has several responsibilities, partitioned general office space is omitted in favor of a large, 290-square-foot news, transcription, and general-use area at the rear of the building. The transmitter or workshop area is next to the control room with a window recommended (and required in combo operations) for a clear view of the transmitter meters.

TECHNICAL FACILITIES OR "PLAN 1" STATIONS

Fig. 4-4 itemizes the major equipment requirements and the system block diagram in Fig. 4-5 shows how the main equipment items are interconnected. The rack layout in Fig. 4-6 further details the location of the various equipments. Notice that the equipment rack is situated for convenient reading of the modulation-monitor and the frequency-monitor meters from the operating position. The transmitter to be selected for use in Plan 1 must, of course, be in accordance with the authorized operating power of the individual station.

The control console or consolette is the heart of the audio system. The ideal audio console should be designed for functional simplicity and smooth operation. This is enhanced by the proper location of important controls. Both from a system standpoint and from a physical standpoint, an outstanding "human engineering" feature is to have all controls easily accessible to the operator.

Turntables are next in importance. They usually are three-speed units—33 1/3, 45 and 78 RPM. Most types utilize a simplified speed changing mechanism driven by a hysteresis synchronous motor. The turntable should start very smoothly and quickly—attaining operating speed greater today than ever before. Recent advances in recording techniques have made new demands on reproducing equipment, also. Now, stereo broadcasting adds to these demands.

In the layout a tape recorder is located on the almost instantly—because today's program format places heavy reliance on transcribed music, commercials, and prepared programs. Thus, the importance of quality and performance is far

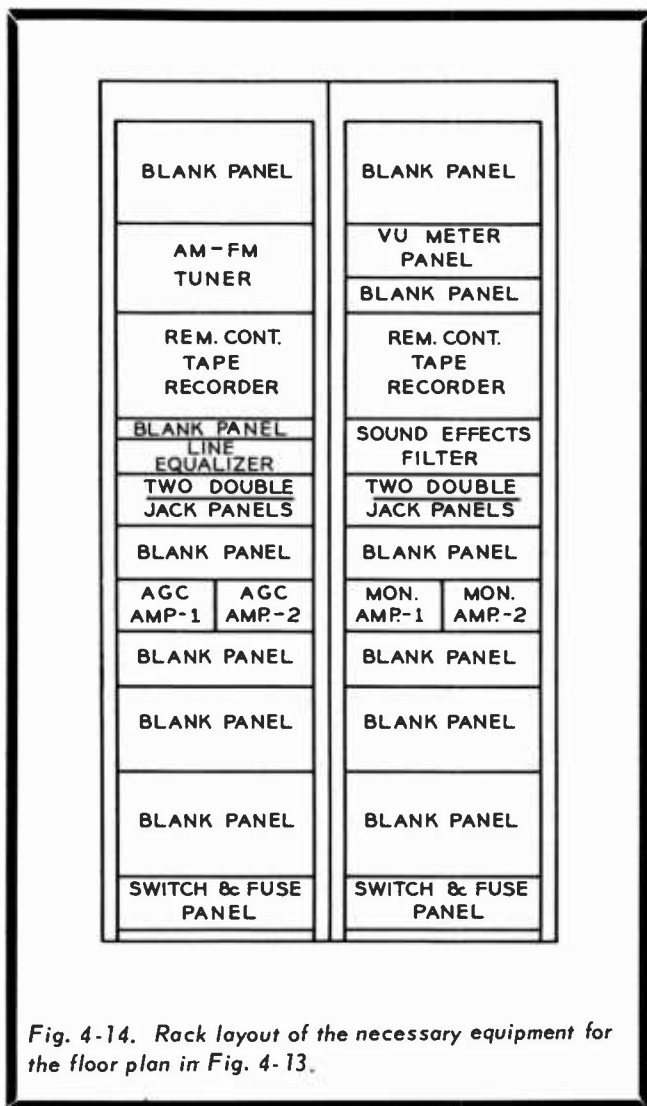

Fig. 4-14. Rack layout of the necessary equipment for the floor plan in Fig. 4-13.

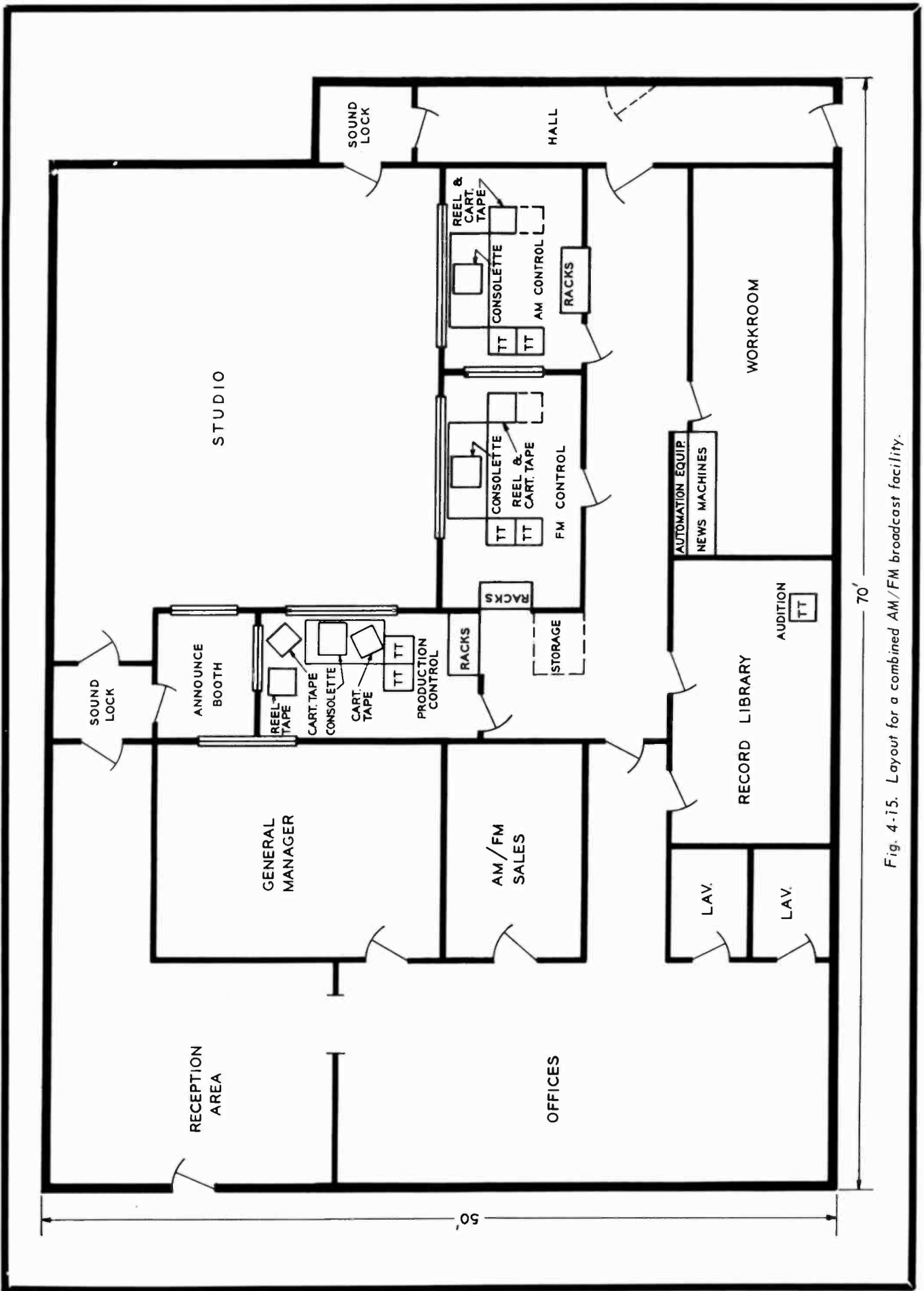

Fig. 4-15. Layout for a combined AM/FM broadcast facility.

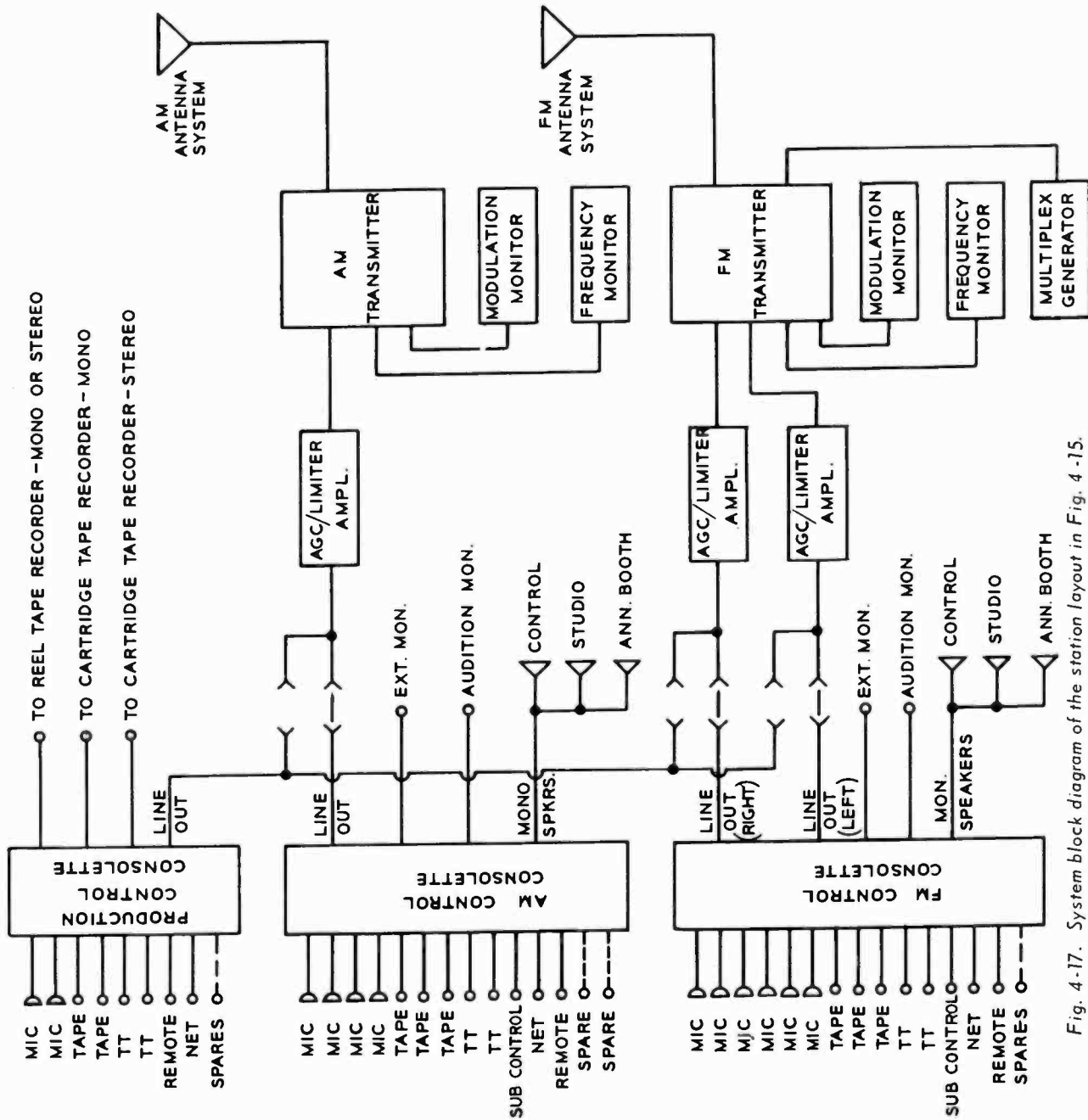

Fig. 4-17. System block diagram of the station layout in Fig. 4-15.

MAJOR EQUIPMENT

QUANTITY	ITEM
12	Microphones
7	Two-Speed Turntables
3	*Professional Tape Recorders
2	*Dual Channel Audio Consolettes
2	*Audio Consolettes
4	Cartridge Tape Record/Playback Units
2	*Multi-Cartridge Tape Playback Units
3	AGC/Limiter Amplifiers
4	Cue Amplifiers
6	Cabinet Racks
1	AM Transmitter
1	FM Transmitter
1	AM/FM Antenna System
2	Modulation Monitors
2	Frequency Monitors

*Stereo or monaural types

Fig. 4-16. Typical major equipment list for the Fig. 4-15 floor plan.

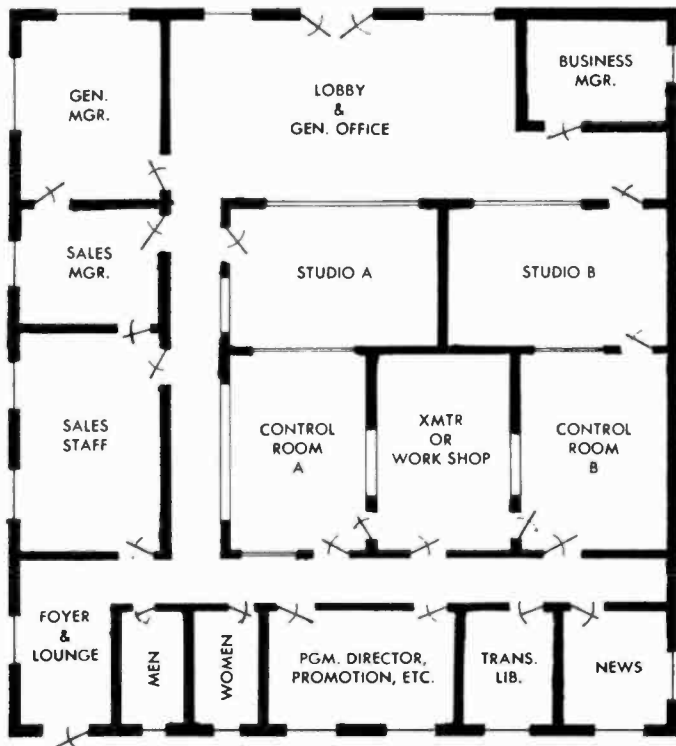

Fig. 4-18. A "Plan 3" layout arranged to suit AM/FM programming.

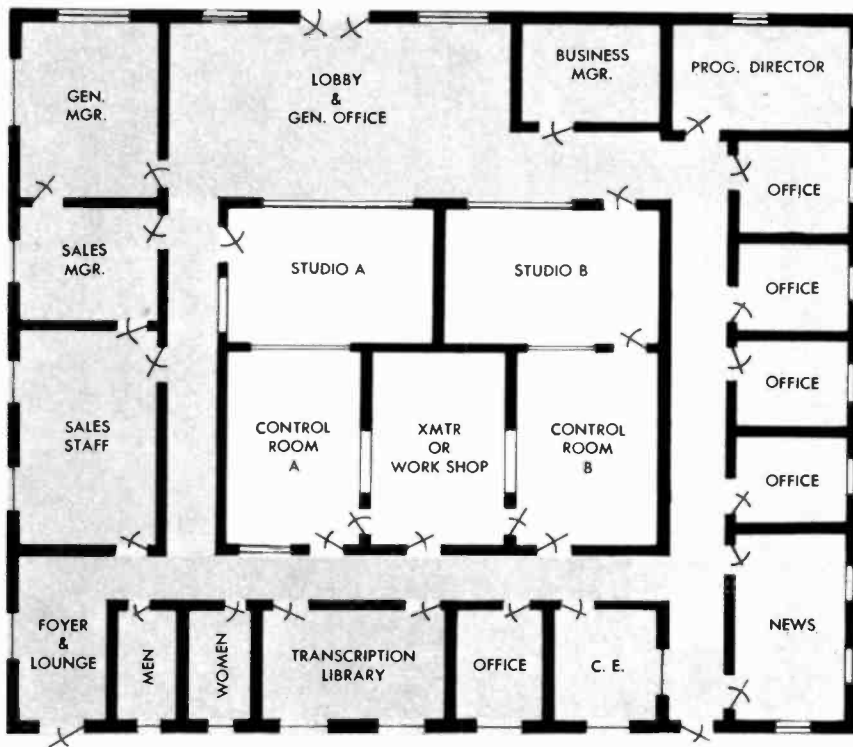

Fig. 4-19. A "Plan 3" metropolitan market layout.

table within easy reach of the operator. A dual-track, two-speed (3 3/4 and 7 1/2 IPS) unit, driven directly by a synchronous motor is used in this operation.

A program/AGC (automatic gain control) amplifier and a peak-limiting amplifier are normally located in the equipment rack. The functions of these two units are so related that they are the trusted guardians of the final audio signal. By preventing overmodulation due to consistently louder audio passages, these units provide better station coverage without distortion as a result of the higher average modulation level. A three decibel increase in overall average audio signal is equivalent to doubling the station's power. (More on this equipment later.) Other equipments, such as frequency and modulation monitors required by the FCC Rules and Regulations are also located in the equipment rack in Fig. 4-6.

PLAN 2 STATION—MEDIUM MARKET AND COMMUNITY

The "Plan 2" station layout illustrates several arrangements for a medium-market community-type radio station, either AM and/or FM.

While Plan 2 in Fig. 4-7 greatly expands the program facilities of Plan 1 layouts, the floor plans offer more than twice the space, featuring a larger studio, announce booth, production control room, and a record library. Programming can be expanded to include a substantial live studio program schedule. A major advantage of this plan is that with the announce booth serving as another point of origination it becomes practical to record announcements and other program material while on the air. Of course, by adding a small console, turntables, and tape equipment the announce booth becomes a production control room.

The floor plan in Fig. 4-7 is identical in many respects to those shown for Plan 1 stations, but it includes larger and additional facilities. An automatic turntable, an additional microphone, a monitor speaker, and associated items are included in this setup. A larger control console should be installed because of its greater flexibility.

There are provisions in the record library for auditioning records, building shows, filing, cataloging, and other operational functions that eliminate interruption of the station programming.

The automatic turntable in the record library is remotely controlled from the operator's desk. Any noise created during the record-change cycle will not get on the air when the control room announce microphone is open. The rack layout

for the floor plan shown in Fig. 4-7 is displayed in Fig. 4-8.

A more expanded floor plan is detailed in Fig. 4-9. It has a substantially larger studio—26 by 25 feet. The production control room is very convenient for recording news, spots, promotions, or music interludes for future broadcasts, or it can serve as an alternate operating position to air recorded programs. Fig. 4-10 and the system block diagram in Fig. 4-11 list the major equipment requirements. The modulation and frequency monitors and amplifiers are all rack mounted as shown in Fig. 4-8.

The floor plan in Fig. 4-12 represents, perhaps, the optimum system. As sales, promotion, and programming activities grow, office space requirements at first exceed the need for a substantially larger technical area. This floor plan offers approximately 2,500 square feet, providing more space for the general manager. Studio and control room space is 12% larger in anticipation of more equipment and activities in these areas.

SEPARATE AM/ FM CONTROL FACILITIES

The floor plan in Fig. 4-13 approaches the ultimate for the larger station. It is evident that a high degree of flexibility can be achieved, offering facilities for handling very extensive programming. Notice that the transmitter is located separate from the studio.

The size of the large studio is determined by the type of programs that are to be originated, whether choral groups, full orchestras, audience participation, or other forms of programming. A dual-channel control console is located in the main control room, each with its own monitoring amplifier. Included in this setup are two three-speed turntables, two automatic turntables, with miscellaneous amplifiers and accessory items.

The layout also includes a multi-purpose room which may be used instead of the main studio for regular programming auditions or recording, for disc jockey-type shows, or for separate programming such as FM or to another AM station. It also could double as a recording or production control room, announce booth, audition room, or as a facility for automatic program utilization.

When remodeling or building new plants along these or similar lines it is recommended that a dual-channel control console be installed. It should have at least 22 input channels, a split/fader system and as many VU meters as required for the desired capability. Such a console usually serves as master control, a "combo" or

operator-announcer's control board, a program source on one channel while running an audition or recording on the other. Fig. 4-14 shows the rack layout for the above floor plan.

The elaborate layout in Fig. 4-15 offers a combined AM/FM broadcast facility featuring individual AM and FM control rooms and a larger studio, production control room, library, and workshop areas. Notice the similar console, tape, and turntable facilities used in the AM and FM con-

trol rooms. The FM control room will usually be equipped for stereo operation. Although production control is primarily designed for recording, there is space to add a second control console and thus expand the operational capabilities of this room. The 25 by 28-foot studio should easily handle choral groups or a full orchestra and permit audience participation programs. The additional space in the workroom may be used to hold program automation equipment and news

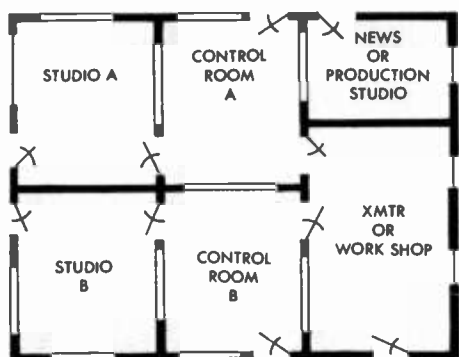

a.

"Spot News—Producer". Pressure on the two primary control room areas is reduced by providing this separate production studio for prerecording commercials, etc. It could serve double-duty as a live "News Flash" booth. Control rooms are re-oriented to maintain access to the transmitter or workshop area.

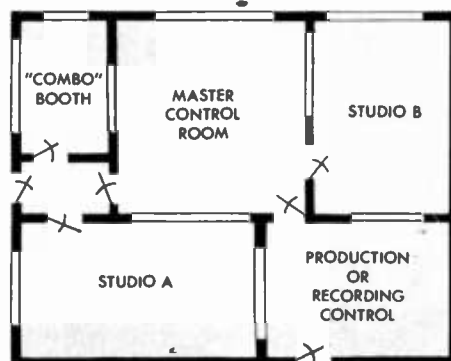

b.

"Metro-Combo". A proven design, where some program segments are worked with an announcer and Master Control engineer, while other periods can be "Combo" programming. Either studio is available to the Master Control equipment, or the Production Control Room which may operate, as in agency recording work, for long uninterrupted periods.

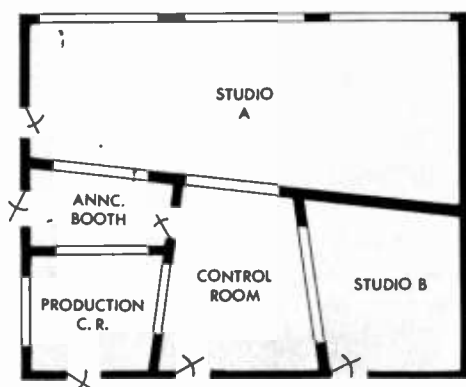

c.

"Local-Live". Radio in the traditional manner is possible, with the acoustically-correct studio "A" providing sufficient volume for a modest-size studio orchestra. Two studios and the announce-booth are operated from a central control room. A separate production facility is not overlooked.

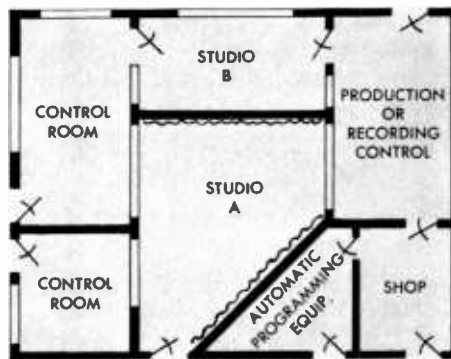

d.

"Automation or Live". Adequate control room and equipment space is emphasized. Three generous control rooms are combined with two central studios, for simultaneous local-live production and taping activities in other areas. The automatic programming equipment is logically located near the production studio and maintenance shop, rather than near live programming areas.

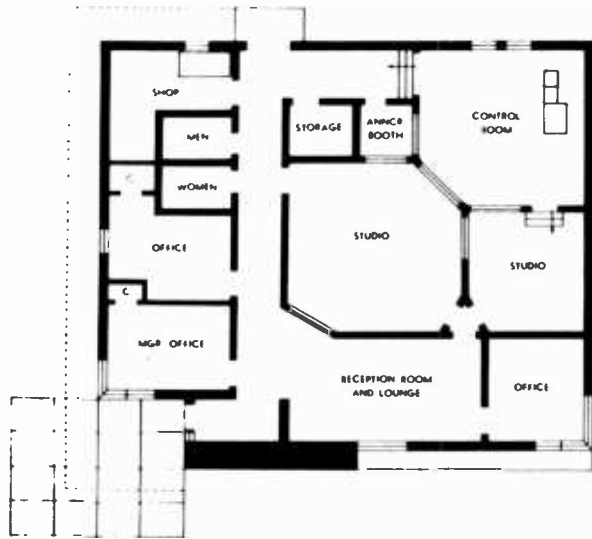

e.

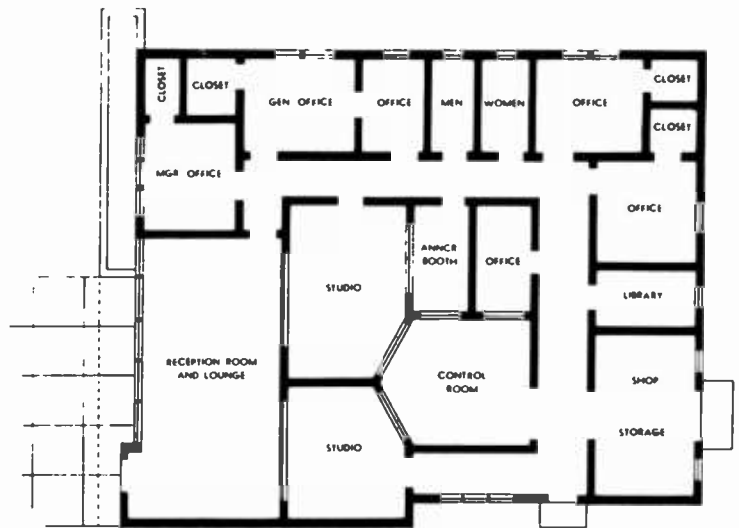

f.

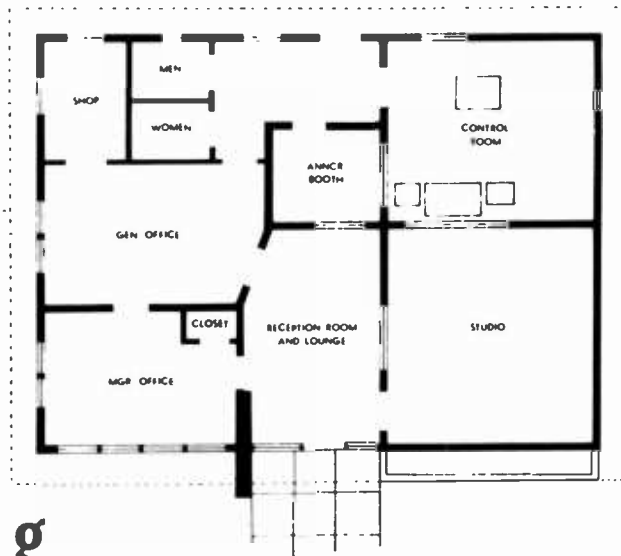

g.

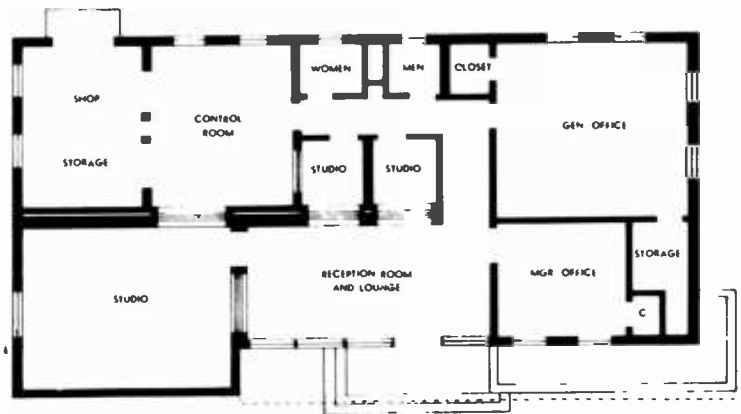

h.

Fig. 4-20. Floor plans offering a variety of layouts designed for specific needs.

machines. In this floor plan concept the building may be extended to house the transmitter and associated items or it may be used to accommodate additional storage space. (Transmitter equipment layouts are described later.)

The typical equipment list in Fig. 4-16 and system block diagram in Fig. 4-17 show the major units and their interconnection. The modulation and frequency monitors, including the amplifiers, are all rack mounted units.

An optimum floor plan, designed to meet the most demanding requirements of an AM/FM dual

control facility is shown in Fig. 4-18. Very few broadcasters require more space than is offered in this layout. The technical areas are shown expanded for two, full-size control rooms, each with a large associated studio and separated by the transmitter or workshop area. This floor plan is suggested for stations planning AM and FM programming. Additional office space is also allocated for a growing staff.

A creative metropolitan market full-staff floor plan appears in Fig. 4-19. This impressive studio complex covers 4,200 square feet. Of

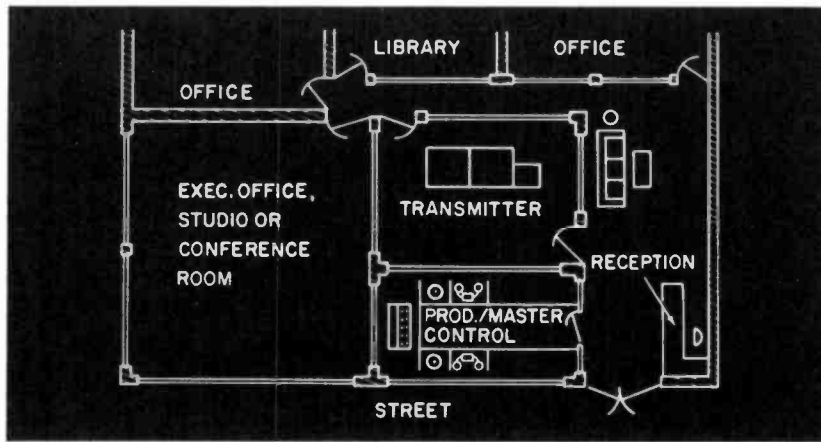

A

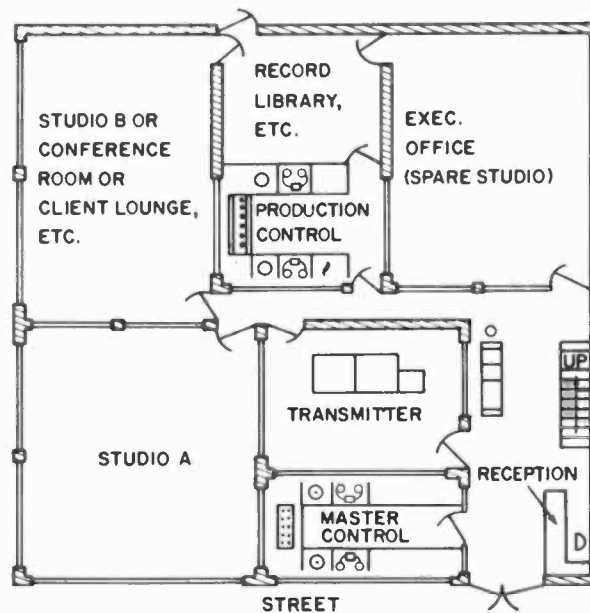

B

Fig. 4-21. Floor plan designed for operational flexibility (A) and a plan allowing for future expansion (B).

primary importance is the location of all control room and studio space in the center of the building, eliminating the problem of outside traffic noise in a metropolitan area. Operating personnel are assigned to the rear office areas, and the news room is strategically located near the control rooms and an outside exit.

SOME UNIQUE ALTERNATE FLOOR PLANS

The following plans are included to stimulate your thinking toward a flexible and efficient studio/control room layout most nearly suited to your programming concept. They are especially significant to a station planner since they por-

tray solutions to fundamentally different programming requirements. Fig. 4-20 offers an excellent example of comprehensive planning.

The floor plan in Fig. 4-21A follows the modern trend to place production facilities at the street side of the building. Large, double-pane picture windows allow passersby full visual contact with the facilities. The large room on the left, depending on the station's requirements, can serve as a studio, a conference room, or an executive office. Set up as either a conference room or an office, it could be quickly converted to a studio on a temporary or permanent basis.

The transmitter and associated gear is located in a sound-isolated room immediately to the rear

of the control room. Double-pane windows make the transmitter fully visible to the man on duty in the control room. The rooms to the rear of the corridor may be used for other offices, continuity, newsroom, record library, and other facilities.

The floor plan presented in Fig. 4-21B is a logical expansion of Fig. 4-21A. Notice there is additional studio space and another control room. Notice also that the two control rooms are nearly identical so that personnel don't have to adopt separate operating techniques in each location.

The additional studio and control room permits pre-recording of live programming at a convenient time prior to broadcast. For example, an all-night interview show (or parts of it) might be recorded during daylight hours when guest

personalities are available and while the regular day schedule is aired. The tape is aired at program time through the playback gear in the master control.

The location and size of the executive office to the right of production control permits its use as a spare studio, while studio B can serve primarily as a conference room or a client lounge. Obviously, this plan is designed for a large percentage of studio programming either live or pre-recorded.

The plans in this Chapter do not necessarily represent any existing station: they simply illustrate several ways in which equipment can be arranged in a variety of floor plans. With the cross-application of these plans practically all programming requirements can be met.

CHAPTER 5

Planning the Transmitter Plant

Land and building space required for the transmitter equipment is determined primarily by the power (and consequent size) of the transmitter, and whether or not it is to feed a directional array. If a directional array is to be used, phasing and branching equipments are required. Where a transmitter is located in the same building as the studio equipment, as is the case in many small market stations, still additional space is necessary. Fig. 5-1 is a layout of a typical combined operation housing the transmitter, phasing and branching equipment, and studio.

When a separate building or plant will house the transmitting equipment there are considerations other than the transmitter and antenna requirements, and one of them is whether it will be an attended or a remote-controlled operation. But since directional antenna systems are becoming more and more common, a building plan for attended transmitter operation

should be chosen because under present rules directional stations must have an operator on duty until the equipment is proven stable. A typical transmitter plant layout for such a system is shown in Fig. 5-2.

Notice in Fig. 5-2 that the phasing cabinet and equipment rack have been placed beside the transmitter. Also, there is a workbench, storage cabinet, a small desk or utility table, power panel, ventilating fan, and other optional items depending on type, location, and weather conditions. This type of transmitter building layout could go with any separate studio transmitter installation.

Another layout for a one-kilowatt AM directional system is shown in Fig. 5-3. This plan can also house up to a 10-KW FM transmitter. FM broadcasting does not require multi-tower arrays or phasing equipment, but provisions must be made in the transmitter building for an external power supply and an overhead harmonic filter.

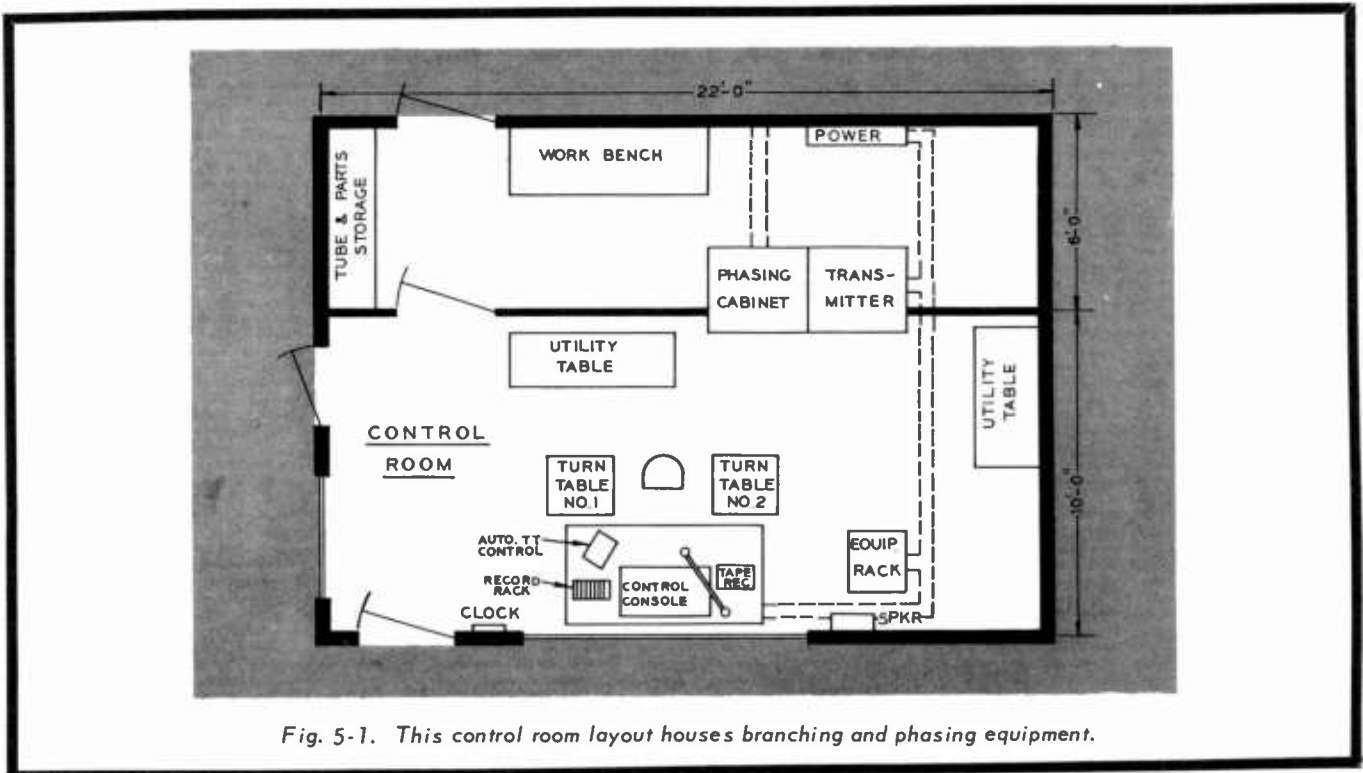

Fig. 5-1. This control room layout houses branching and phasing equipment.

The plan includes space for the transmitters, phasing cabinet, equipment rack, workspace, and lavatory facilities. Heating and air conditioning requirements will vary with the site location, of course. For higher transmitter powers the building is usually expanded in length and width to accommodate the larger equipment items.

Fig. 5-4 illustrates a typical cabinet rack layout showing the location of recommended transmitter input and monitoring equipment, and Fig. 5-5 is a block diagram showing how the normal input and monitoring equipment is interconnected. Notice the open jacks connected in parallel with the normalled-through jacks of the main

program circuits, providing convenient monitoring and measuring points. These points will be very helpful in isolating a case of trouble during routine maintenance or performance checks. In some stations if the line loss to the transmitter exceeds approximately 24 dbm a booster amplifier is recommended to raise the audio level for proper operation of the limiter amplifier. A monitor amplifier switch is included for convenience in selecting various points throughout the system. For normal operation two fixed pads are required, 20 and 40 db, respectively, at 600 ohms. The attenuation pads are important during certain performance measurements. The pads are optional and not operational in the

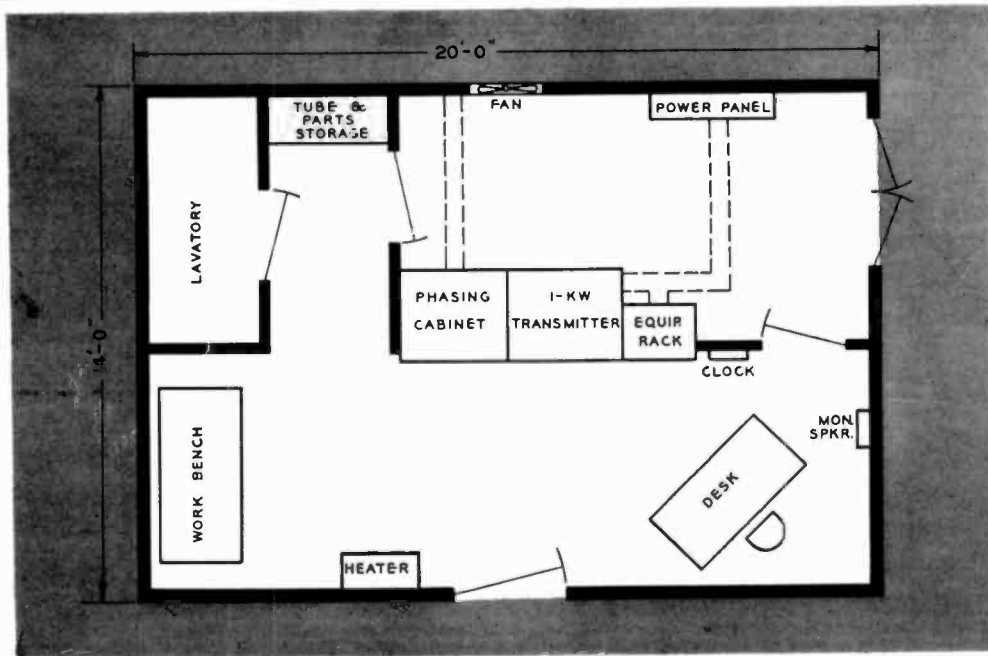

Fig. 5-2. Transmitter plant floor plan for a directional 1-KW attended operation.

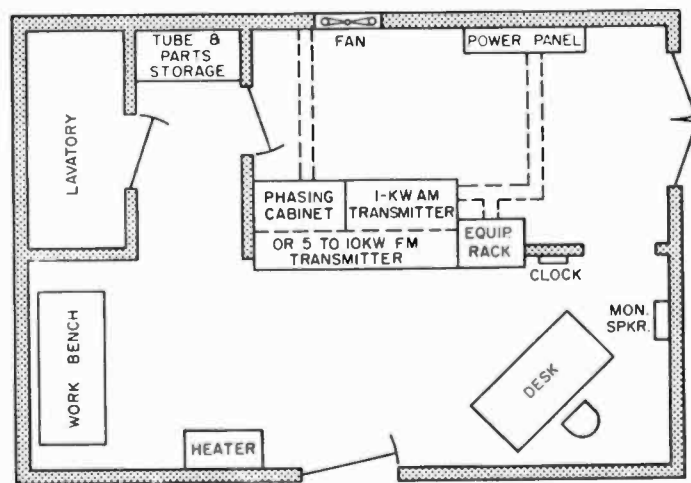

Fig. 5-3. Typical transmitter building layout for a one-kilowatt AM directional. Floor plan can also accommodate up to a 10-KW FM transmitter.

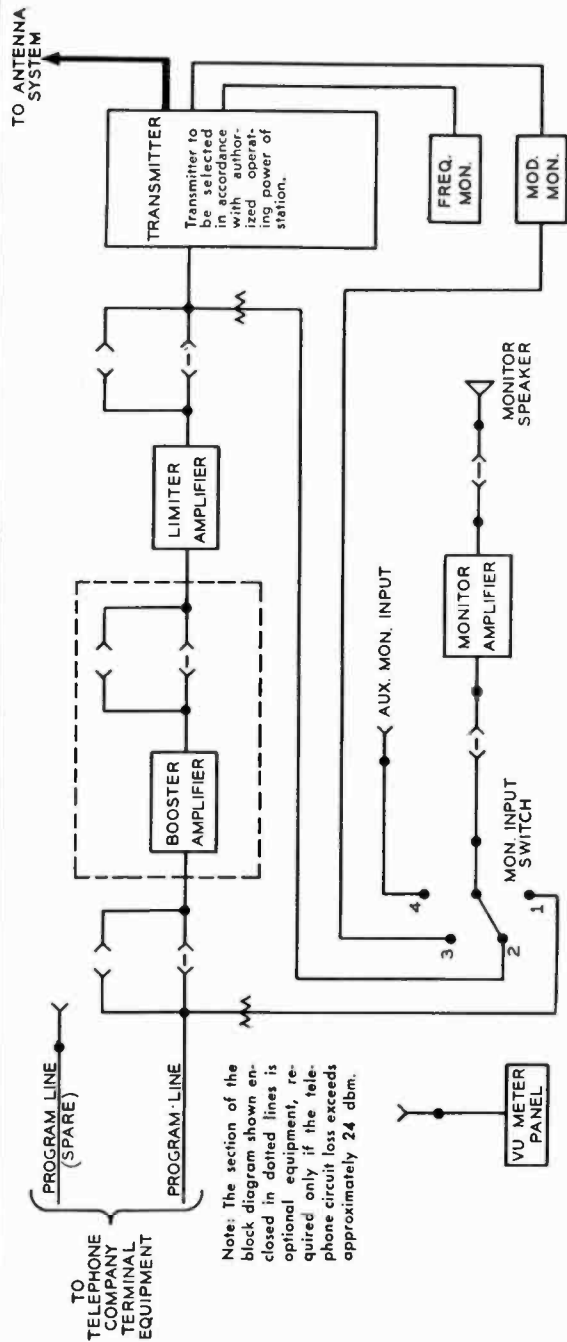
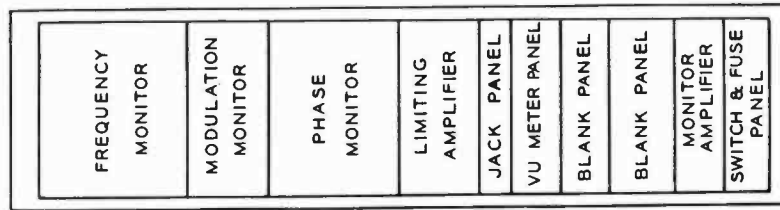

Fig. 5-5. Block diagram showing monitoring equipment interconnections (see Fig. 5-4).

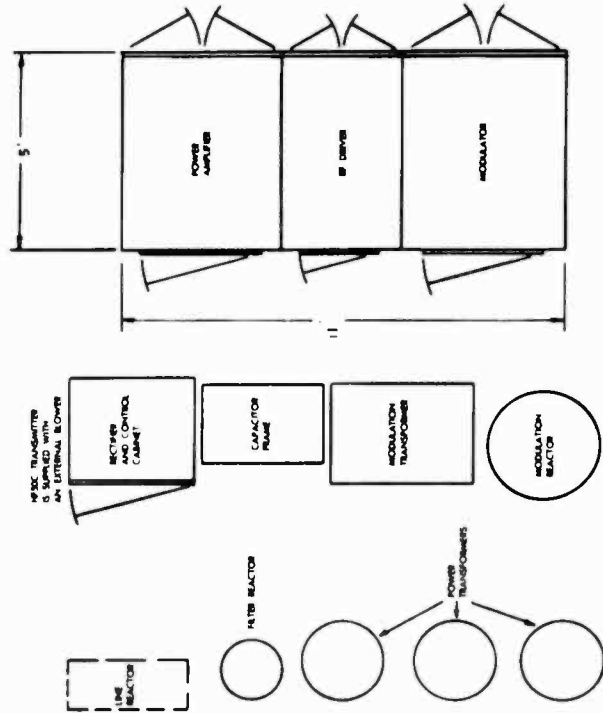

Fig. 5-6. Transmitter building floor plan for a 50-KW AM station.

Fig. 5-4. Layout of a typical transmitter monitoring equipment rack.

audio system. Floor plans of two transmitter plants housing a 50-KW AM transmitter are shown in Figs. 5-6 and 5-7.

AM/FM TRANSMITTER EQUIPMENT

Referring to the selected floor plan it should be obvious that the main factor determining the size of the transmitter to be used is the FCC-licensed operating power of the station. In the United States operating powers of 100 (in rare cases now), 250, 500 watts, 1, 5, 10, 20, 25, 40, and 50 KW are in common use. (Intermediate operating powers are sometimes authorized under special conditions.) An important rule to remember is that the purchase of a transmitter is a long-term investment. A station's success or failure in a highly competitive market may well depend upon choice of the transmitter.

The engineering departments of most transmitter manufacturers have certain philosophies and concepts that come to be known and identified with each product. Based on experience

each manufacturer follows certain design parameters such as specifications, features, size, styling, and other items. The manufacturer's success depends, more than anything else, upon the reliability and performance of the equipment when it is operated by the broadcaster.

TRANSMITTER PERFORMANCE CHARACTERISTICS

To assure performance that supplies the greatest benefits to the user, it is recommended that a prospective broadcaster check three major factors: reliability, "soundability," and modulation capability.

RELIABILITY

When speaking of reliability we refer both to the equipment and manufacturer. For a transmitter to provide day and night service without failure it must be of sound design. It should contain quality components that are conservatively rated and operated. The important achievement of a

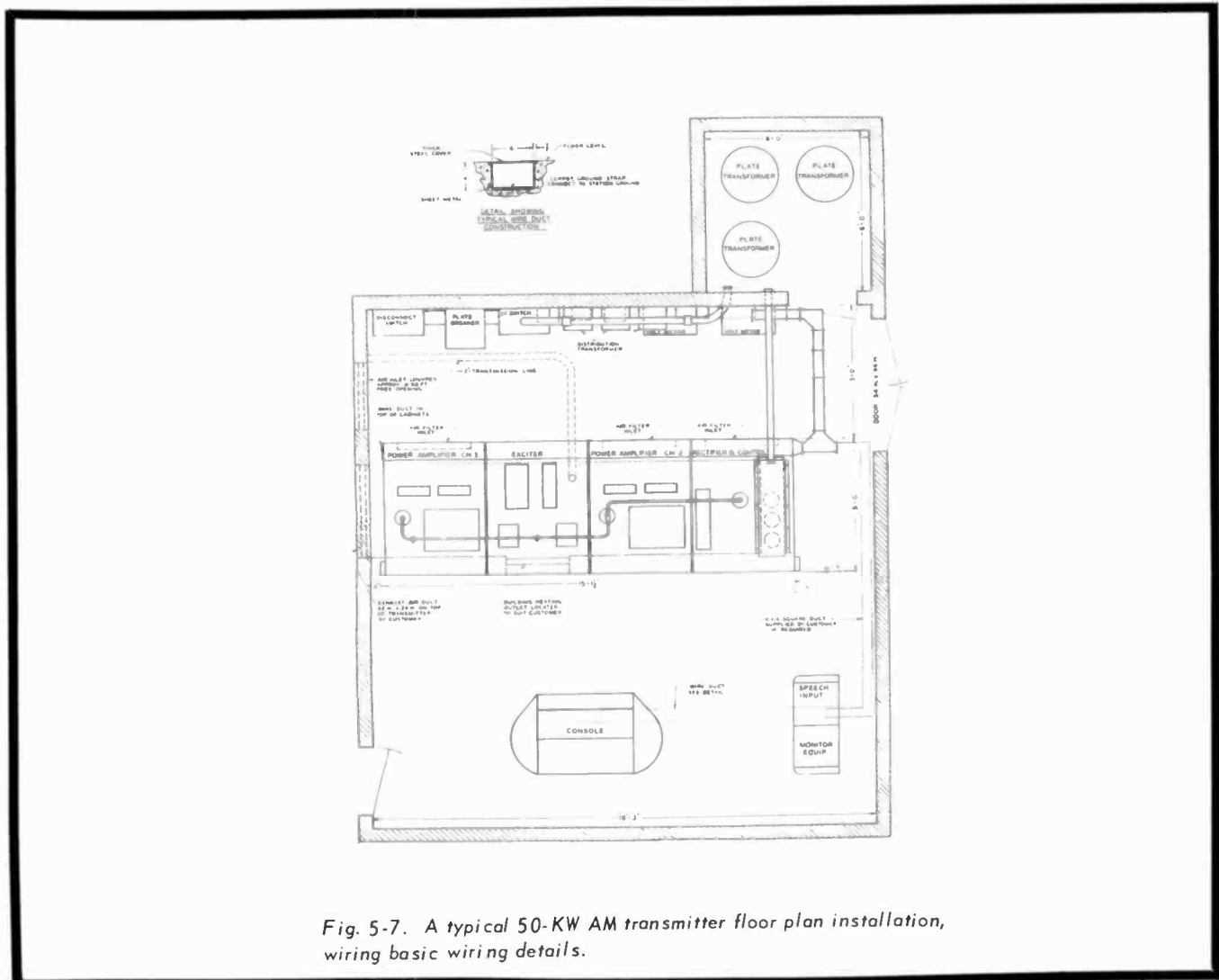

Fig. 5-7. A typical 50-KW AM transmitter floor plan installation, wiring basic wiring details.

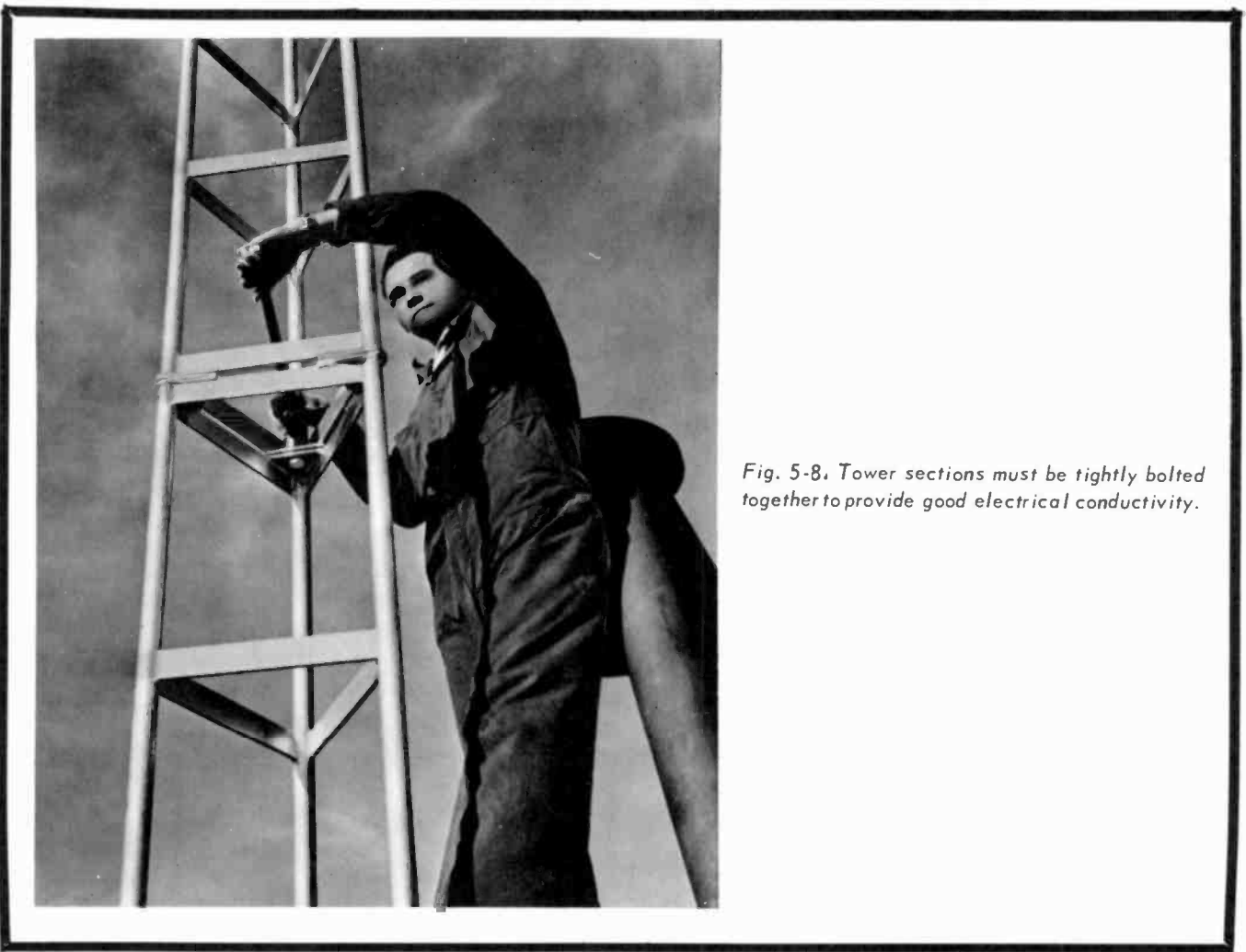

Fig. 5-8. Tower sections must be tightly bolted together to provide good electrical conductivity.

transmitter, of course, is to stay on the air. A true fact is that maximum reliability always costs less in the long run. The reliability of a particular make of transmitter can be verified by questioning a user.

“SOUNDABILITY”

The positive proof of performance is how good the transmitted signal sounds. Sound is the broadcasting product upon which he relies for income. So the best sound possible must be delivered to the listeners for a maximum listening audience. A universal rule is that the number of listeners has a definite relationship to the number of advertisers. A transmitter that will give the best sound is the one to buy and install. When a listener tunes in your station for the first time he will think his old set is brand new—and that is really an achievement!

MODULATION CAPABILITY

Regardless of the licensed transmitter power the broadcaster cannot exceed the authoriza-

tion, but he can make certain he is attaining maximum program coverage. It is a recognized fact that frequency, ground conductivity, terrain, and radiation pattern have a definite relationship to overall coverage. But the most important contribution is the ability to achieve and maintain a consistently high level of average modulation with minimum distortion, deterioration of signal, and good frequency response. With the use of AGC and limiting amplifiers, a very high average level of modulation can be maintained if the transmitter has the capability. Therefore, the modulation characteristics of a transmitter are a vital consideration—one of the major links in achieving maximum program coverage. Transmitter specifications are discussed further in Chapter 13.

CONSTRUCTION & INSTALLATION

Construction and installation of an AM/FM facility will usually vary with the station plan, finances available, local conditions, plus many other factors. Plans and equipment requirements should be reviewed with a broadcast sales repre-

sentative and a consultant. Make sure that the equipment list is complete and that a work schedule is provided to perform the following details: tower foundations, tower erection, tower lighting equipment, buildings, ground system, antenna resistance measurements, inside technical equipment installation, equipment tests, phasing equipment tuning, pattern measurements, proof-of-performance, and program tests. A delivery schedule should be worked out with the construction and installation con-

tractors and equipment supplier to assure construction, installation, and arrival of items when they are needed.

TOWER CONSIDERATIONS

Towers must be designed and installed to safely withstand the maximum wind velocities that may be encountered. If soil conditions are abnormal, or not known, test borings may be necessary as a worthwhile safety measure. The

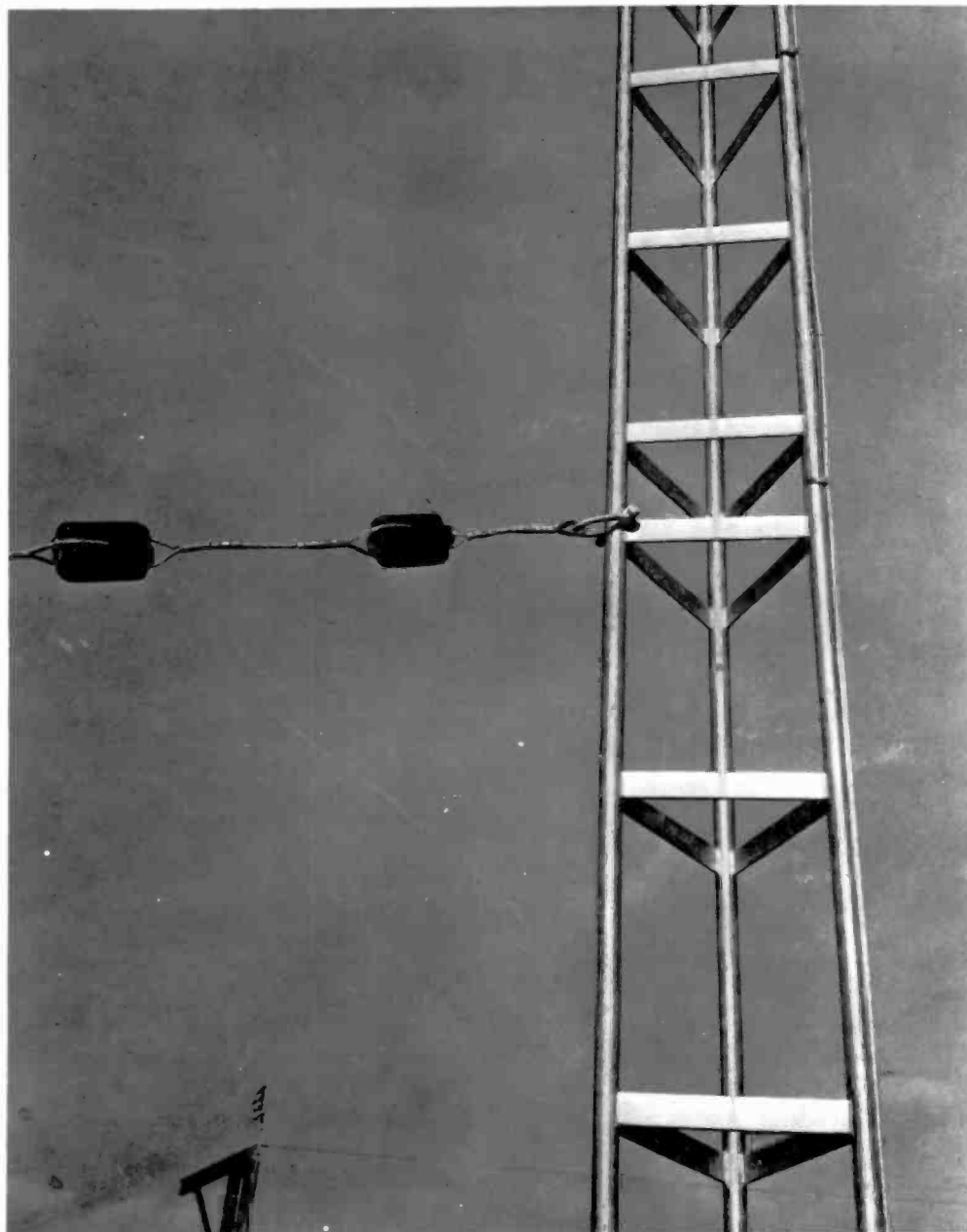

Fig. 5-9. Strain insulators in a typical guy wire attached to a tower.

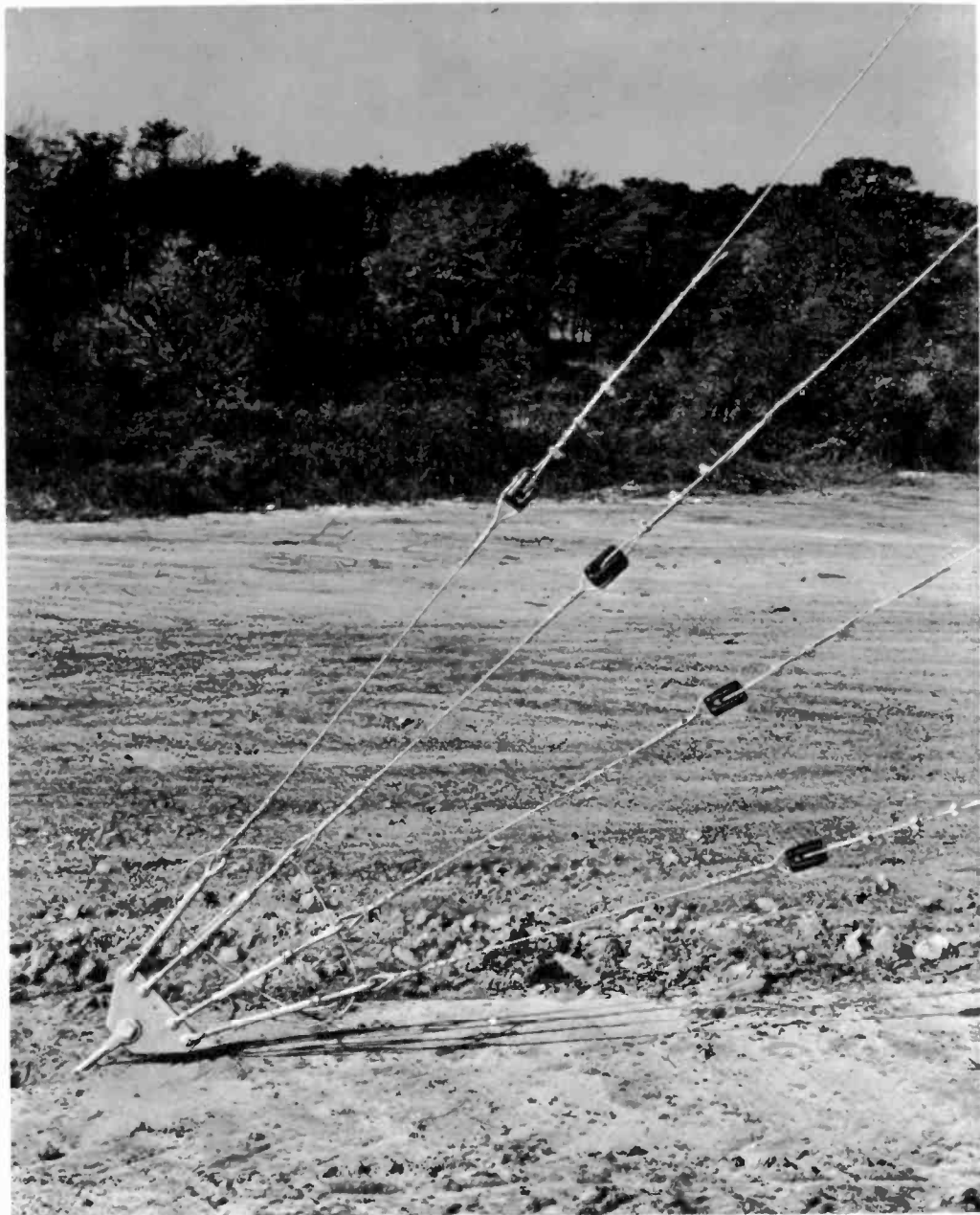

Fig. 5-10. Ground anchor point showing cable looped through turnbuckles to prevent turning.

Concrete for tower bases and guy anchors should be poured at least a week or ten days before any load is applied. If possible, more time than specified should be allowed for "curing."

Insofar as directional antenna systems are concerned, the towers should be as nearly identical as possible with respect to guy wire, height, azimuth location, positioning of guy insulators, etc. After the towers have been erected all joints should be weld-bonded or bolted tight to assure a continuous steel radiator (Fig. 5-8).

A positive electrical bond between tower sections will provide a stable conductivity path for

RF currents which will not be affected by oxidation or movement of the bolted tower joints. In some installations towers are painted prior to erection and in such cases care should be taken to assure that a good surface contact exists at all joints. Towers, of course, must be painted to conform with FCC/FAA regulations. All antenna installations should be inspected and checked for plumb and for proper guy tension in order to withstand design stress. Fig. 5-9 shows a guy wire and guy insulators attached to a tower leg. Fig. 5-10 illustrates one method of attaching the guy wires to a guy anchor.

LIGHTNING PROTECTION

Radiotowers are vulnerable to lightning. Therefore, it is very important to provide the necessary protection. Lightning rods should be provided at the top of each tower to protect the flasher beacon. Static drain choke coils, large-value static drain resistors, oil-filled insulators, or isolation stubs should be used to drain the static charges across the sectionalizing and base insulators. Ball gaps or horn gaps should be placed across the insulators also to drain off high surge currents. Fig. 5-11 shows a typical horn gap installation. It may also be necessary to install a larger than usual number of guy wire insulators in order to reduce the physical length of the guy wire sections. In some severe cases, the addition of static drain resistors across the

insulators may prove helpful in preventing damage to the guy wires resulting from continuous static discharge arcs.

To prevent lightning surges from entering the antenna tuning unit, heavy copper tubing formed into a one- or two-turn coil approximately 8 to 12 inches in diameter should be used as a connection from the antenna tuning unit to the tower. In some cases the tower lighting wires or the phase sampling line can be installed inside this tubing.

It is difficult to predict what a lightning strike will do, particularly if it is a direct hit on the tower. The stroke may jump to the transmission line side of the coupling network; hence, it is advisable to provide lightning protection gaps at the tower end of the transmission line.

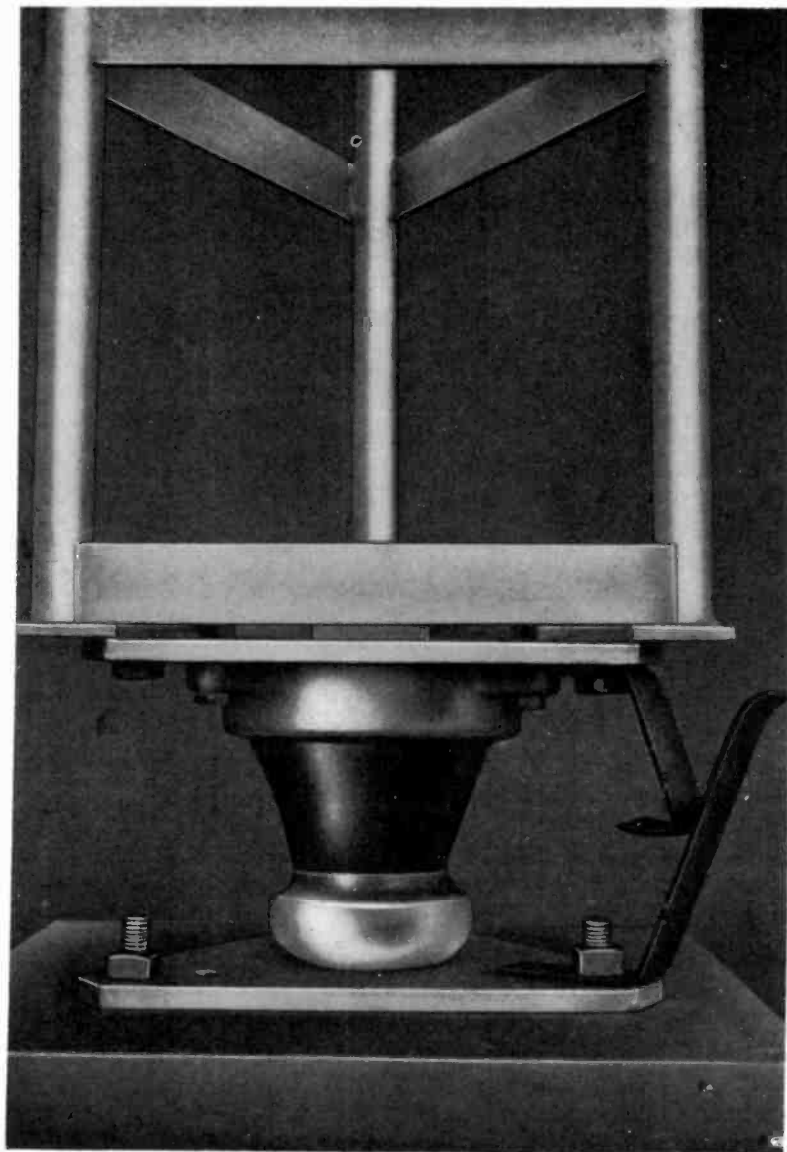

Fig. 5-11. A typical insulated tower base with horn gap across the insulator.

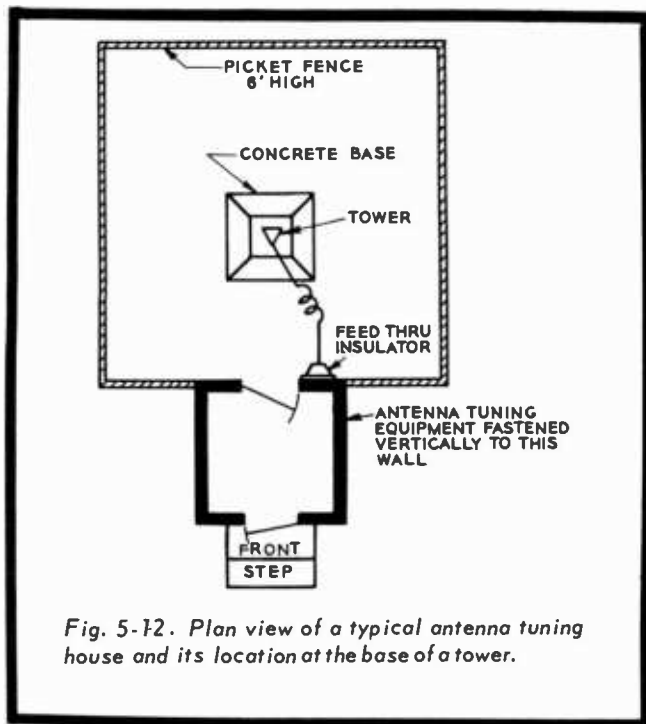

Fig. 5-12. Plan view of a typical antenna tuning house and its location at the base of a tower.

TUNING HOUSE CONSTRUCTION DETAILS

Fig. 5-12 is a layout of an antenna tuning house usually located at the base of the tower. Certain points should be borne in mind when constructing buildings at the antenna site. Tuning houses should be as entry-proof as possible. They should be provided with a feed-through insula-

tor and an opening in wall to provide for the transmission line, control wire for switching purposes, and a power line. A heavy copper ground strap serves as a bond between the tuning panel and the antenna ground system. A sound powered telephone or a two-way radio should be installed between the towers and transmitter building; a communications system is helpful during tower construction and future servicing and maintenance. Incidentally, on the subject of bonding—make sure that all ductwork, conduits, metal window frames, cabinets, and other metal items are bonded together and securely connected to the station's ground system. More details on antennas and towers will be found in Chapter 7.

PROOF-OF-PERFORMANCE REQUIREMENTS

Before a new or modified existing AM/FM broadcast station is authorized to go on the air it is necessary to submit to the FCC a "proof-of-performance" that the antenna system meets the requirements of the construction permit and good engineering practice. In addition, audio proof-of-performance measurements are required. These measurements are made from the microphone terminals at the studio to the antenna output including the effect of the program telephone lines. Detailed methods and procedures are included in Chapter 15.

CHAPTER 6

Audio & Power Wiring Techniques

Contrary to the belief of the uninitiated, broadcast station audio wiring isn't extremely complicated—unless it is made that way by carelessness and a lack of planning. In fact, most wiring is simply interconnecting cables between equipment as illustrated in Figs. 6-1, 6-2, and 6-3. The illustrations depict, in simplified form, the setup necessary for mixing and blending of voice and music from a studio, switching between studios, disc and tape recording, remote and network lines, and wire transmission to the transmitter, and associated equipment.

The setup in Fig. 6-1 could be used in planning a control center for a "Plan 1" small-market minimum staff station or a "Plan 2" medium-market normally staffed broadcast facility (see Chapter 4).

Fig. 6-2 illustrates a setup which could be utilized with a "Plan 3" separate AM/FM control or dual-control room operation or a metropolitan station. As you can see in Fig. 6-2, the subcontrol facilities are practically identical to the equipment in the main control room. Fig. 6-3 displays a portion of the subcontrol unit. The transmitter can be at the studio or located at a separate site.

Fig. 6-4 is a block diagram of a solid-state installation suitable for a "Plan 1" or a "Plan 2" operation and it could be modified with additional units for "Plan 3" stations. This transistorized setup is designed to provide a flexible and efficient means for controlling a variety of functions, including recording applications, switching, and mixing inputs from microphones, turntables, tape machines, remote and network lines, as well as other audio sources. In addition, facilities are provided for auditioning, cueing, and monitoring. The input and output impedances of each unit in this installation make it possible to use it with other tube or transistorized broadcast equipment. All amplifiers and power supplies are solid-state and individual attenuators and master attenuators are DC-controlled by photocell lamp assemblies. Thus, all high-level and low-level inputs are isolated from the front panel attenuator controls.

CONTROL ROOM WIRING

The operations center, or control room, may be quite complex in the number of circuits and control functions. However, modern centers are planned and installed to provide a foolproof switching system with flexibility. In many cases the simple type of control room, containing only a control console without auxiliary amplifiers and patch jack panels, is the most difficult type to return to the air on short notice in case of trouble because of its limitations.

On the other hand, in more flexible installations all inputs can be switched to the monitor or spare amplifier which feeds the regular program line. Also, with all equipment terminated at patch panels, it is a simple matter to eliminate or substitute one unit for another, or to bypass a unit completely. Fig. 6-5 shows a typical layout, with corresponding jack-panel designations, suitable for "Plan 1" or "Plan 2" stations. Fig. 6-6 is a jack-panel layout designed for a "Plan 3" station installation.

Planning a useful and flexible jack panel layout requires thorough planning and forethought. It should be obvious that such flexibility offers numerous operational functions. Console inputs (mics, turntables, etc.) can be patched to other mixers or to other equipment, for example. Also, with the jack panel setup, it is a simple matter to locate a defective unit (by interrupting normalled jacks) and then "patch around" it, thus providing an alternate path by patch cords. Typical patch panels (usually rack mounted) should terminate all major equipment inputs and outputs and those convenient for proof-of-performance measurements so as to minimize operational errors.

CABLE DUCTS

The careful planning and layout of cable trenches and ducts is essential to economical installations and efficient operation. Once the initial planning is complete, it is time to plan trench runs—pro-

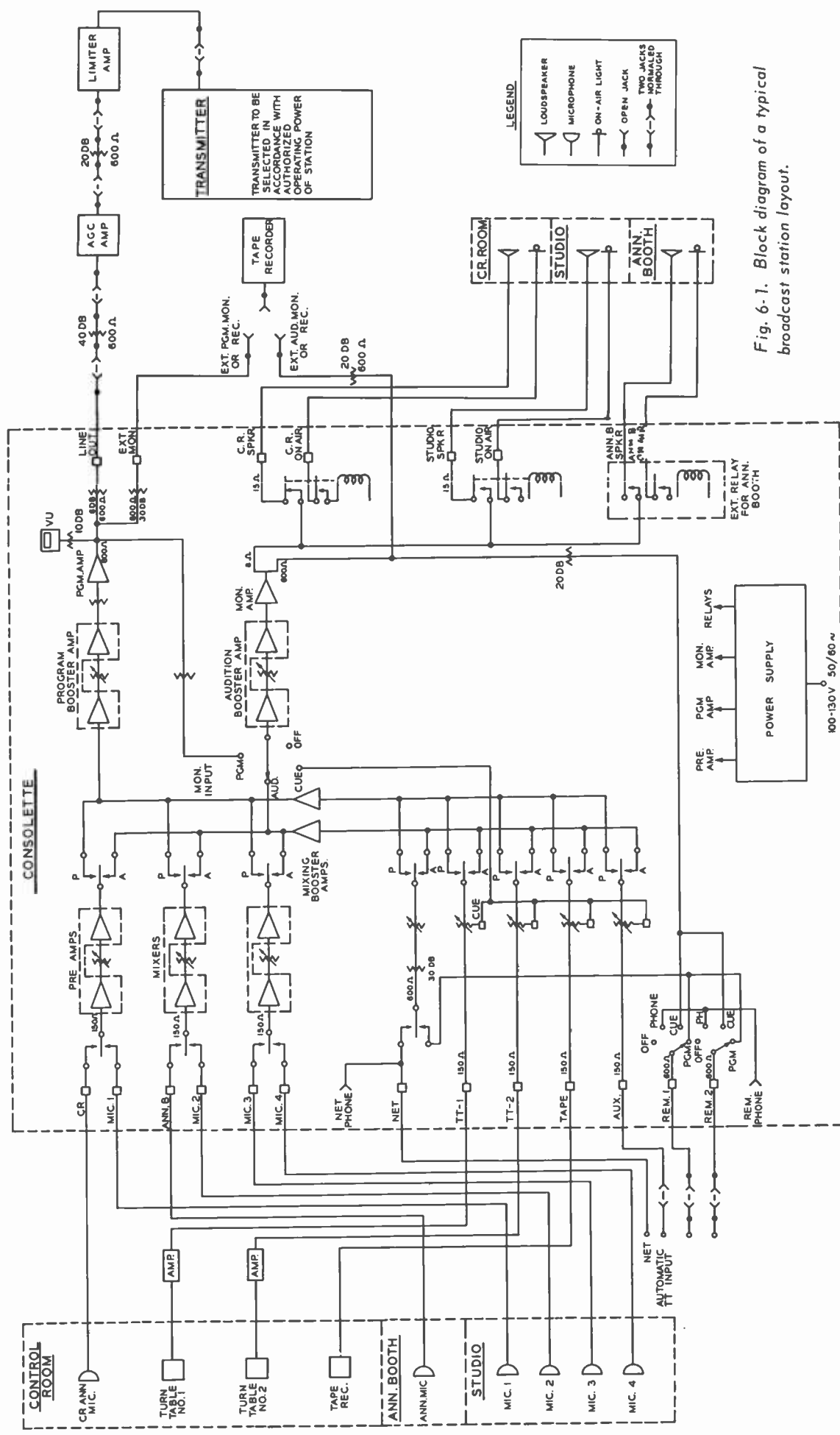

Fig. 6-1. Block diagram of a typical broadcast station layout.

viding, of course, for some measure of future expansion.

FCC Rules relative to transmitter and studio construction, wiring, and shielding is discussed in Section 73.40, Transmitter, Design, Construction, and Safety of Life Requirements For AM Facilities, and 73.317, Transmitters and Associated Equipment For FM Broadcast Stations.

The transmitter should be located so that it is visible to the operating personnel at all times. In some installations the transmitter, rack equipment, and the associated items are visible from the control console position.

All audio wiring, AC, and RF cabling should be labeled and logged as to their origin and termination as the installation progresses. Written data regarding cable runs, etc., may save a lot of headaches later and avoid wasted hours tracing cables. In FM stereo operation the left and right audio channels must be identified and polarities observed. An FM stereo studio and transmitter layout is shown in Fig. 6-7. High-, low-, and medium-level audio circuits should be carefully isolated.

Some planners prefer to run the wiring trenches, ducts, and conduits either beneath or under the floor, above the ceiling, or a combination of both. As a typical example, the primary AC power cable to the transmitter should be run through a 3-inch conduit buried beneath the floor and terminate in a trench beneath the transmitter. A 3/4-inch conduit imbedded in the floor between the control room and studio will allow for further expansion. Also, a 3/4-inch conduit should be run from the trench at the console to the control room ceiling and wiring installed to feed audio to monitors, cue speakers, intercoms, and on-the-air lights. Additional trenching to hold cabling between the transmitter, console, automation systems, and many other associated equipments will eliminate the need for exposed wiring, which is not good from an appearance or technical standpoint. Normally, the transmitter and automation equipment are installed over the wiring trench so that AC, audio, and control wiring and cables are readily accessible to the equipments.

In some installations, it is feasible to mount on the studio walls a wiring trough of the type used by electrical contractors to tie together major switch installations and power panels. These ducts or channels usually come in short sections about 36 inches long with elbows, ends, and reducers. Such troughs are large enough for cabling and for terminals mounted inside the duct entrance in each room. All high- and medium-level cabling for monitors, intercom, and all inter-equipment audio wiring should run directly from one room to the next with a tap brought up to the terminal

connector. Out of the duct at each piece of equipment install a cable or conduit containing the required wiring pairs—and spares—for the equipment interconnections.

Layout and wiring procedures in the studio, control room, and transmitter are vital to the ultimate quality of the installation, which has a direct bearing on the quality of performance. A careless installation will result in poor performance regardless of equipment quality. In many cases the advice of an engineering consultant is a necessity during planning, installation, layout, and wiring of the station. We make no attempt to fix hard and fast rules, but offer only suggested procedures and practices, based on experience, as a guide.

TRANSMITTER INSTALLATION

Basic steps in AM/FM transmitter installation consist of planning the equipment layout and making provisions for transmitter room power and light, transmission line runs, and connections to the equipment. The units then should be wired as specified in the instructions. Space for items such as auxiliary input equipment or line dehydrating units should not be overlooked in the planning.

The room in which the transmitter is located should be well ventilated and provided with an abundant supply of clean, dry air. Transmitter room layout can be prepared from floor plan figures which give the overall dimensions of the equipment. A minimum clearance for the opening of the doors is required at the front of the transmitter, and a similar space should be provided at the rear for access to transmitter components and circuits. If the wiring is to be placed in floor ducts, they should be laid out so that the cables can leave the duct and enter the holes provided in the bottom of the transmitter. As a word of precaution, all applicable local wiring codes should be followed. On points where conflict is evident, the local code should be followed.

At the same time the transmitter is set up and wired, consideration is due other important items to be placed within the broadcast system—the frequency and modulation monitors and the phase monitor if a directional antenna system is used. This group of equipment would also logically include the limiter amplifier, jack panel, house monitor amplifier, and switch/fuse panel. Sound wiring practices must be observed. The transmitter and all other station equipment should be connected to the station ground with a copper strap or heavy copper bus wire.

All personnel concerned with the layout and installation should refer to the equipment instruction books for specific details. It is an established

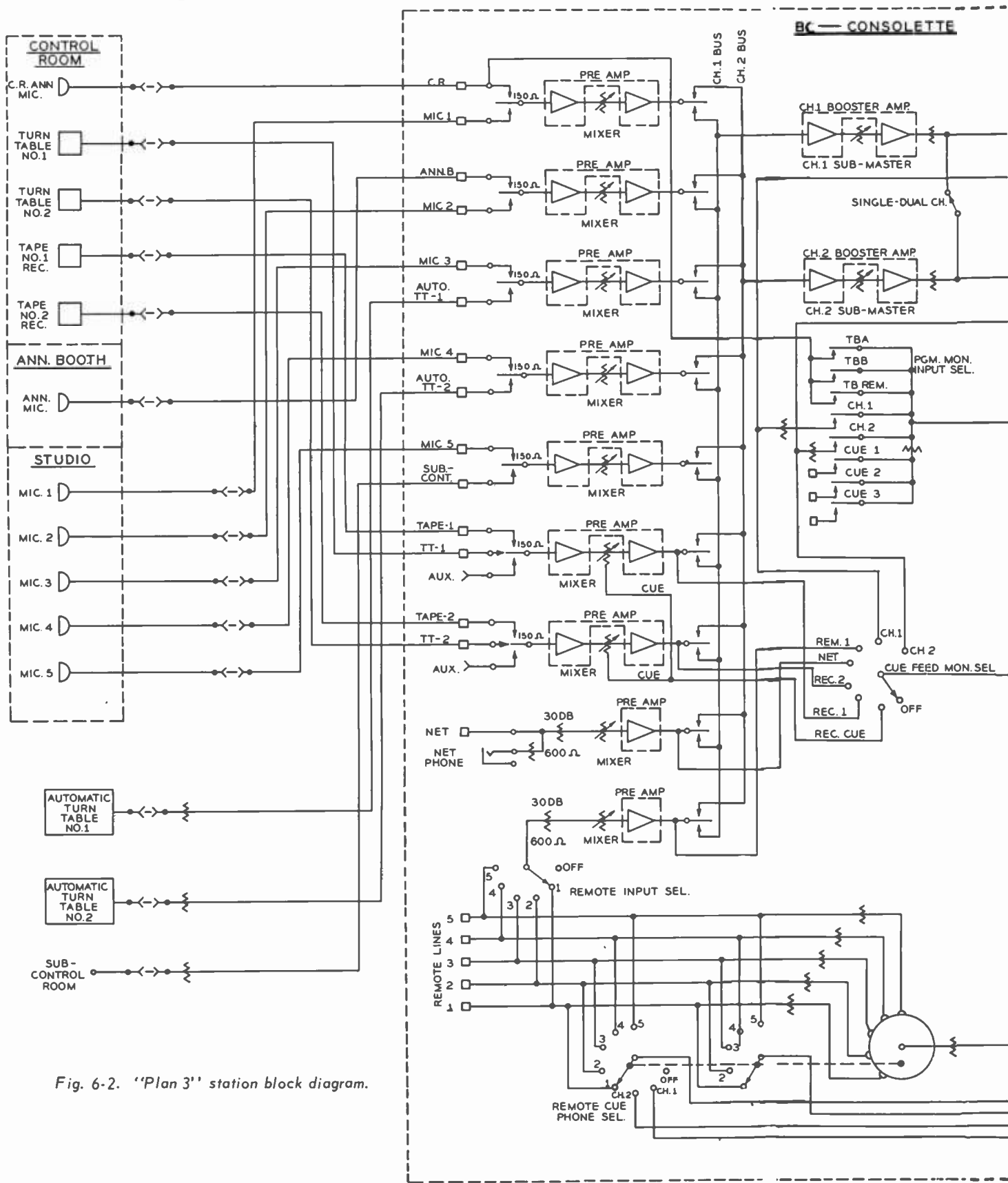
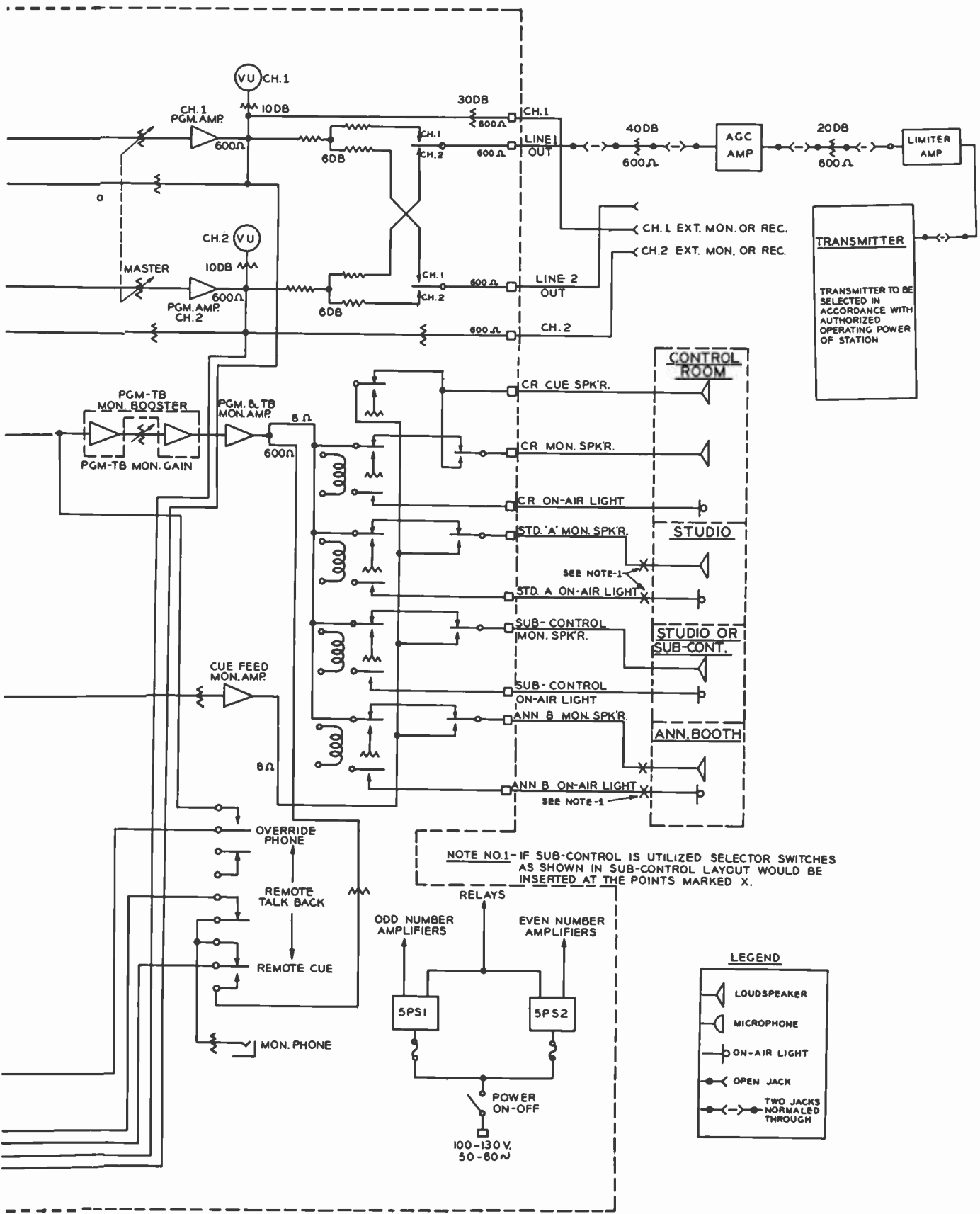

Fig. 6-2. "Plan 3" station block diagram.



NOTE NO.1-IF SUB-CONTROL IS UTILIZED SELECTOR SWITCHES AS SHOWN IN SUB-CONTROL LAYOUT WOULD BE INSERTED AT THE POINTS MARKED X.

LEGEND

- LOUDSPEAKER
- MICROPHONE
- ON-AIR LIGHT
- OPEN JACK
- TWO JACKS NORMALED THROUGH

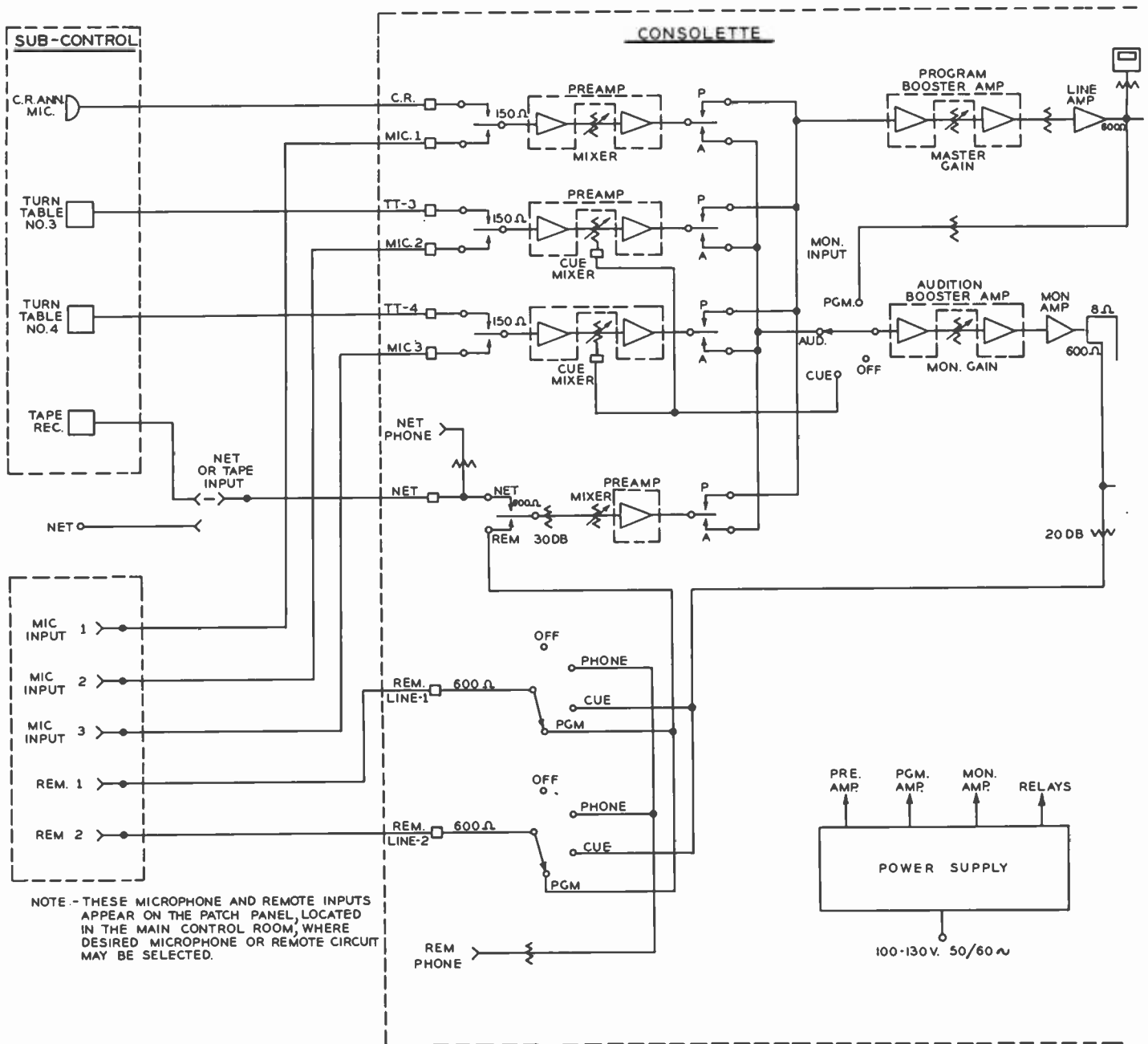

Fig. 6-3. Block diagram of a "Plan 3" sub-control unit.

CONNECTION POINTS A, B, C & D SHOWN CONNECTED FOR SINGLE CHAN OPERATION USING CHAN 2 AMP AS A MONITOR. CONNECTIONS SHOWN DOTTED APPLY TO TWO CHAN OPERATION.

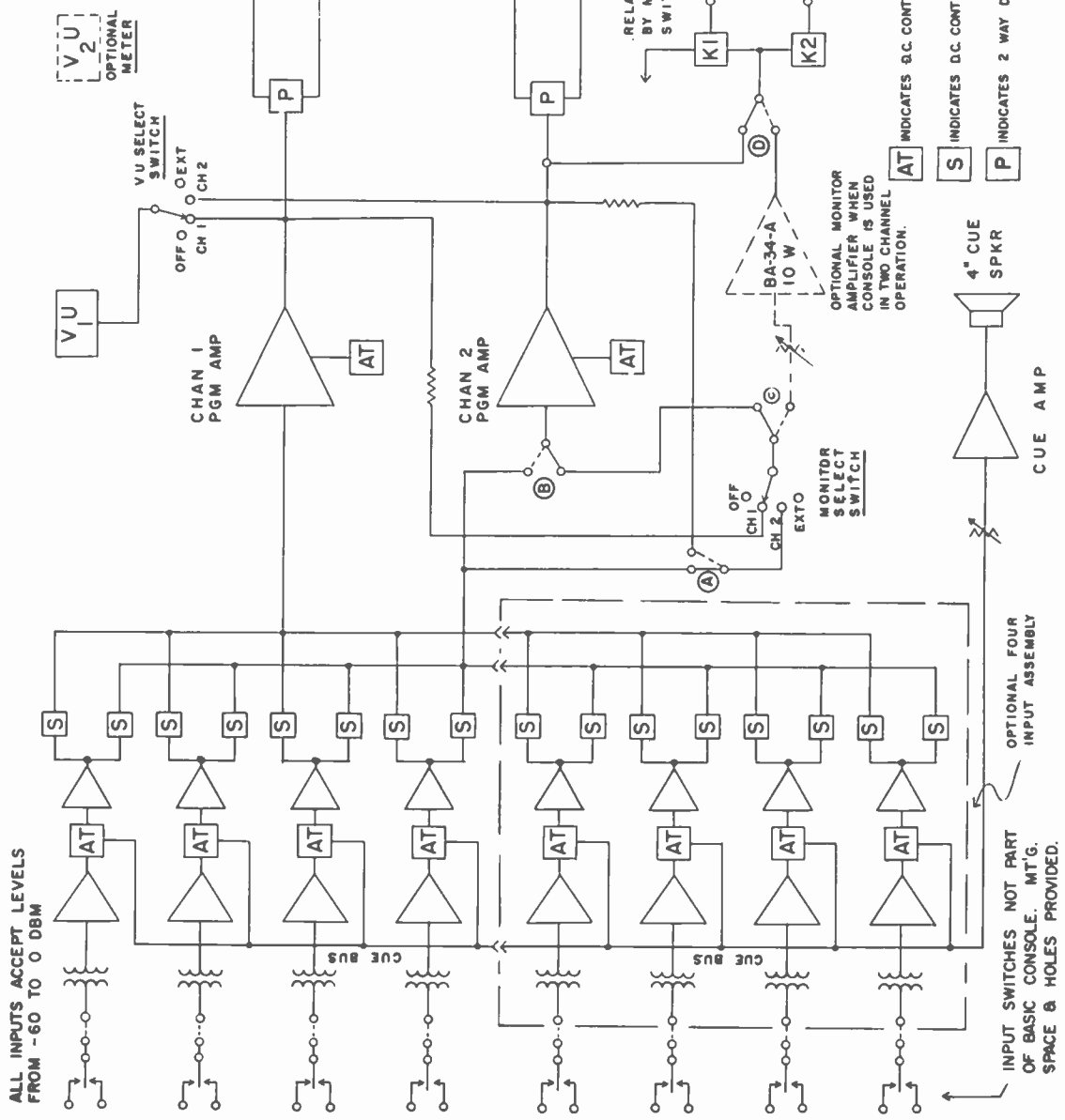

Fig. 6-4. Block diagram of a broadcast station layout using solid-state equipment.

NET	AUTO TT	REM 1	REM 2	REM 3	EXT PGM OUT	EXT AUD OUT	CONSOLE OUT	40 DB PAD OUT	AGC AMP OUT	20 DB PAD OUT	LIMITER AMP OUT
NET IN	AUTO TT IN	REM 1 IN	REM 2 IN	REM 4	TAPE REC IN	SPARE	40 DB PAD IN	AGC AMP IN	20 DB PAD IN	LIMITER AMP IN	XMITTER IN

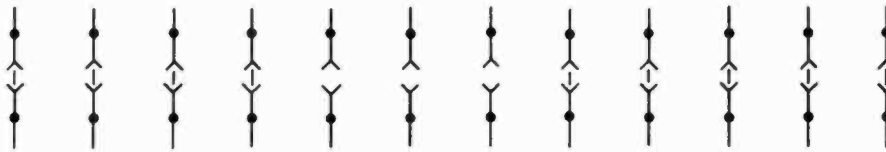

Fig. 6-5. Typical jack panel terminations for "Plan 1 or 2" broadcast stations.

LEGEND OPEN JACK NORMALED THROUGH

REM LINE 1	REM LINE 2	REM LINE 3	REM LINE 4	REM LINE 5	NET LINE	LINE EQ-ZR 1-IN	LINE EQ-ZR 2-IN	CONSOLE LINE-1 OUT	40DB PAD OUT	AGC AMP OUT	20DB PAD OUT
REM INPUT 1	REM INPUT 2	REM INPUT 3	REM INPUT 4	REM INPUT 5	NET IN	LINE EQ-ZR 1-OUT	LINE EQ-ZR 2-OUT	40 DB PAD IN	AGC AMP IN	20 DB PAD IN	LINE TO XMTR
SPARE	AM FM TUNER OUT	HOUSE MON 1-OUT	SPARE	SPARE	SPARE	SPARE	SPARE	HOUSE MON 2-OUT	SPARE	EXT MON 1	CONSOLE LINE-2 OUT
SPARE	HOUSE MON 1-IN	HOUSE MON CKT	SPARE	CUE 1-IN	CUE 2-IN	CUE 3-IN	HOUSE MON 2-IN	HOUSE MON CKT	SPARE	EXT MON 2	SPARE LINE TO XMTR

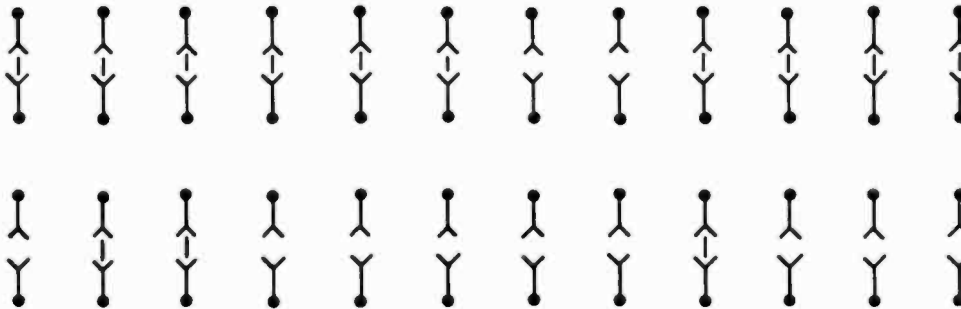
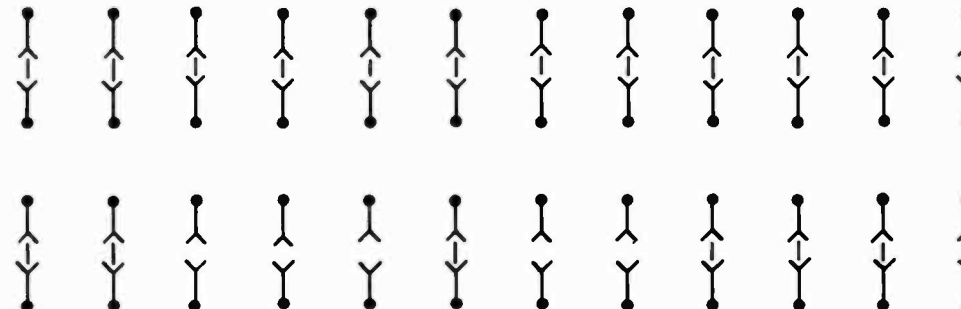

Fig. 6-6. Jack panel connections for a "Plan 3" broadcast station.

C.R. MIC	ANN. B MIC	MIC 1	MIC 2	MIC 3	MIC 4	MIC 5	TT 1	TT 2	TAPE 1 OUT	TAPE 2 OUT	SUB CONT OUT 1
PRE AMP 1-A	PRE AMP 2-A	PRE AMP 1-B	PRE AMP 2-B	PRE AMP 3-A	PRE AMP 4-A	PRE AMP 5-A	PRE AMP 6-B	PRE AMP 7-B	PRE AMP 6-A	PRE AMP 7-A	PRE AMP 5-B
AUTO TT 1	AUTO TT 2	SPARE	SUB CONT PRE-AMP 1-B	SUB CONT PRE-AMP 3-B	TAPE 3 OUT	SUB CONT REM-1 IN	SUB CONT MON OUT	SUB CONT CONSOLE OUT	40DB PAD OUT	AGC AMP OUT	20DB PAD OUT
PRE AMP 3-B	PRE AMP 4-B	SPARE	SUB CONT PRE-AMP 2-B	NET LINE	SUB CONT NET IN	SUB CONT REM-2 IN	SUB CONT AUD OUT	40DB PAD IN	AGC AMP IN	20DB PAD IN	TAPE 3 IN



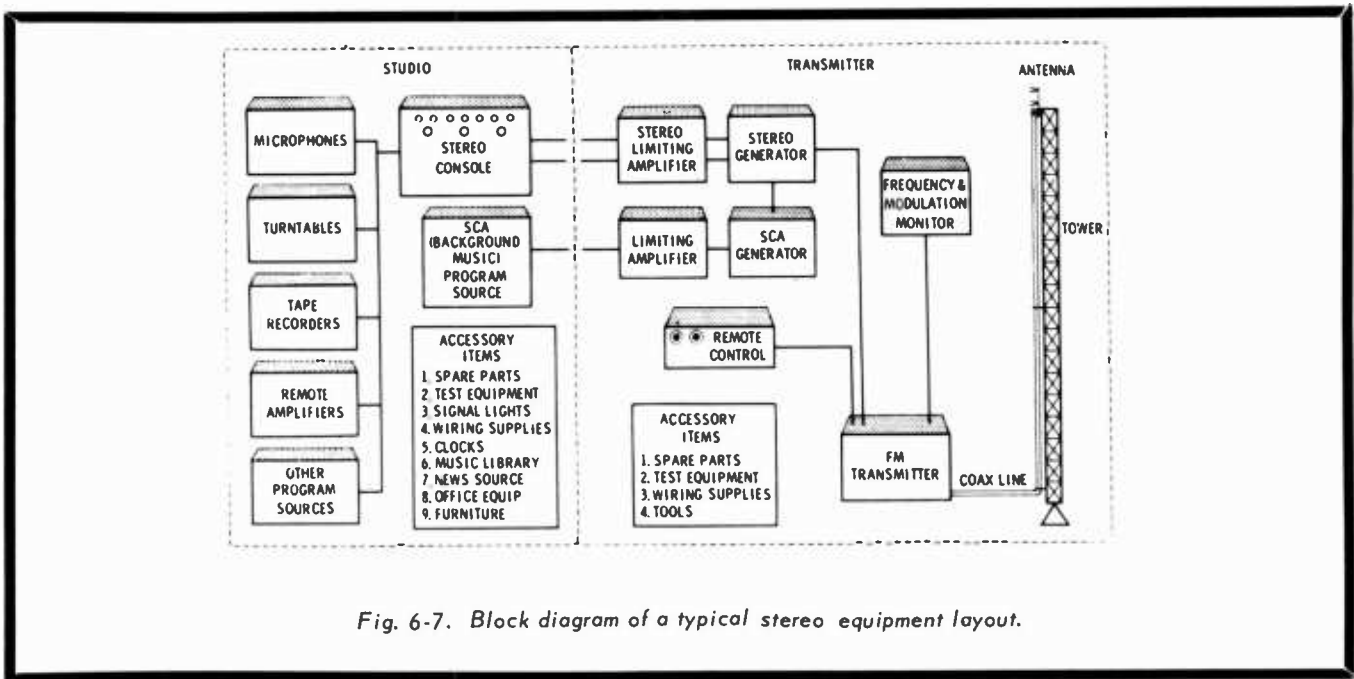

Fig. 6-7. Block diagram of a typical stereo equipment layout.

fact that regardless of how many broadcast stations one has installed, experience reveals that 95% of the delays in achieving equipment performance results from failure to comply with the specific instructions supplied with the equipment. Also, make sure that any recommendations sugg-

ested by addendas in the manual are observed. Addendas usually are very important because they reflect changes resulting from field experience with the equipment. After the complete layout and wiring task has been completed, make a check to be sure that all instructions have been followed.

CHAPTER 7

Towers & AM Antenna Systems

One of the most important "links in the broadcast chain" is the tower. It is the radiating element of an AM broadcast station system and for FM stations it serves as the antenna support. Towers are divided into two types: self-supporting and guyed. Either type may be used in a grounded or insulated version. See Figs. 7-1 and 7-2.

TOWER DESIGN

AM antenna systems usually consist of a tower insulated from its base and fed in series. Grounded towers may be used as AM radiators if shunt feeding is used. The schematics in Figs. 7-3 and 7.4 illustrate a series-fed and a shunt-fed tower. (More later in this Chapter.)

If space is at a premium, a self-supporting tower may be necessary. They require no guys, and as a general rule the distance between the self-supporting tower legs is normally considered as $1/8$ the height of the tower structure. However, insulated guyed towers are the most popular and commonly used because they are less expensive and generally of a smaller uniform cross section, making a very efficient and satisfactory RF radiator for AM installations. With a guyed tower it is necessary to insulate the guy wires from the tower and it is also necessary to insert several insulators in each guy wire to break the electrical continuity. The insulators also "detune" the guy wires, preventing possible resonance at broadcast frequencies which would, in turn, affect the radiation pattern.

When the type of tower has been selected, thorough consideration should be given to the wind and ice load specifications with due reference to wind velocities and weather conditions typical in the chosen area. See the "Wind Velocity and Pressure" and "Estimated Ground Conductivity" maps in the Appendix. The detailed information is very important during tower design and installation. Building codes and zoning ordinances should be carefully investigated. As stated before, if the soil con-

dition of the tower site is unknown, test borings should be made. Soil samples may then be analyzed and foundations designed accordingly.

TOWER LIGHTING

A prospective broadcaster should become familiar with certain points listed in Part 17: Construction, Marking, and Lighting of Antenna Structures, Volume I, FCC Rules and Regulations. Lighting equipment must conform to FCC/CAA regulations as specified on the construction permit. All AC lines can be buried or mounted on the poles carrying the transmission lines. It is suggested, though, that lighting and RF lines be isolated.

Further isolation of the RF and AC power lines is required when feeding AC to the tower lights. This can be accomplished with either a lighting filter choke, shown in Fig. 7-5, or either an Austin lighting transformer or a Hughey & Phillips isolation transformer, as shown in Fig. 7-6. Either device provides a means of supplying energy to the tower lighting circuits and at the same time prevents any appreciable loss of RF energy supplied to the tower by the transmitter. Depending on height, towers must be lighted at the top with a "flashing" beacon and at several intermediary points. See Fig. 7-7 for a typical beacon installation.

Many AM radio stations employ a single-tower array, radiating an omnidirectional signal. Fig. 7-8 illustrates this type of installation. Where you see two or more towers employed, it is to limit the radiation in the direction of other stations occupying the same or adjacent frequency allocations. In fact, many newer stations—even "daytimers"—must install directional antenna systems because of band "crowding."

Figs. 7-9 and 7-10 show the layout and antenna structures of a typical two-tower directional antenna system. Notice the small buildings shown at the towers to house the antenna tuning units, isolation coils, lighting chokes, and beacon flashers. Phasing and branching equipment and the phase monitor are located in the transmitter building with the transmitter.

The radiation pattern is determined by the number and location of the towers, the phase relationship of the RF signal fed to each tower, and the power division among towers. Power distribution and phasing is achieved by appropriate equipment normally located in the trans-

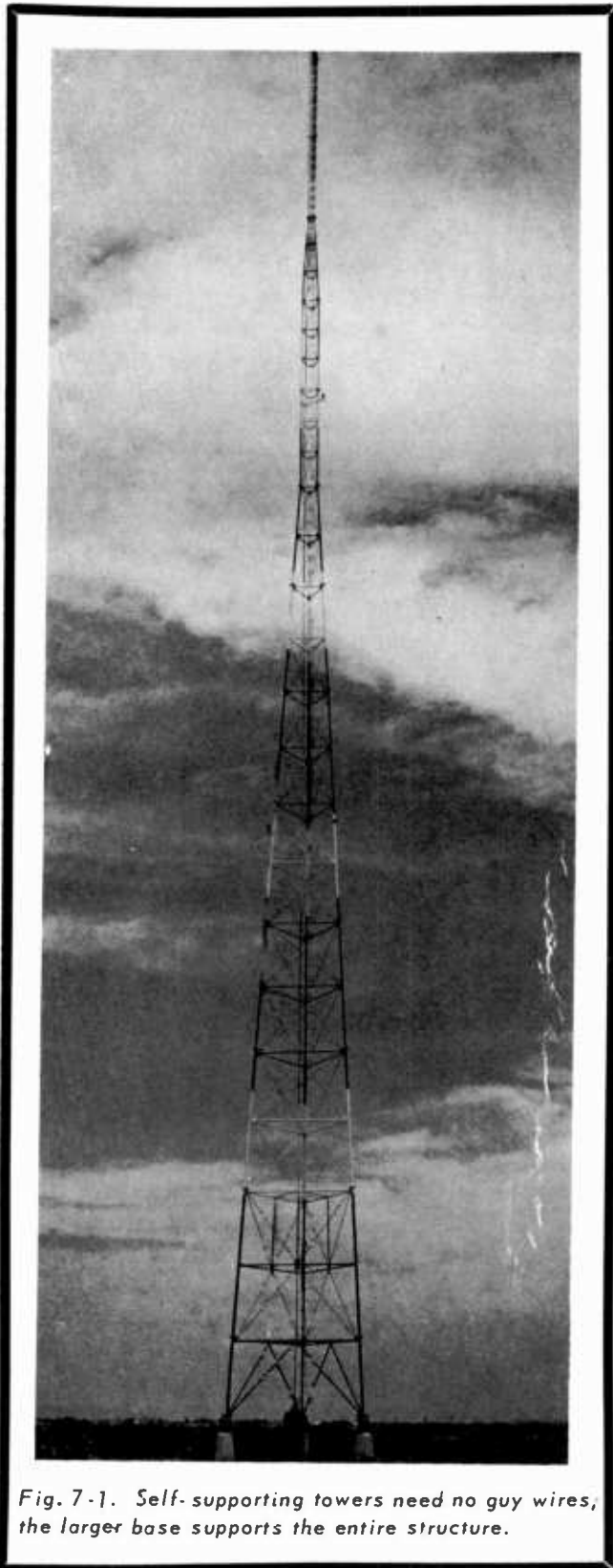

Fig. 7-1. Self-supporting towers need no guy wires; the larger base supports the entire structure.

mitter building as shown in Fig. 7-9. Phasing and branching equipments also can be installed on open panels in the transmitter building or in a small weatherproof building near the center of the antenna array.

An AM phasing system is designed to maintain the required radiation pattern over a long period of time without failure and adjustment. As with most other broadcast equipment, phasing equipment design and cost varies with the unit's built-in quality and complexity. A simple unit employs a single coil with power take-offs for the various towers in the array. A high-quality phasor unit has a separate coil for each tower and is easier to set up since there is less interaction between adjustments. See Fig. 7-11.

Specially designed phasing equipment (covered later in this Chapter) definitely adds a substantial cost factor to the tower system. If the filing data submitted in the FCC application is to be used for cost estimating purposes it should be accompanied by design information prepared by the consultant so that the supplier is aware of the unusual conditions that must be satisfied in the phasing equipment design. The following submitted data should state:

1. Acceptable type and length of transmission line.
2. Preferred type of phasor with components specified.
3. Remote control or front panel control requirements.
4. Recommended metering requirements.
5. Type of phasor mounting such as cabinet or open construction.
6. Antenna tuning units installed in weatherproof housing or open construction.
7. Monitoring details.
8. Tower lighting isolation requirements.

AM ANTENNA DESIGN

In planning the design parameters of AM non-directional and directional antenna systems, the following important FCC Rules and Regulations are applicable:

- 73.45 Radiating systems
- 73.54 Operating power; direct measurements
- 73.57 Operating power; maintenance of

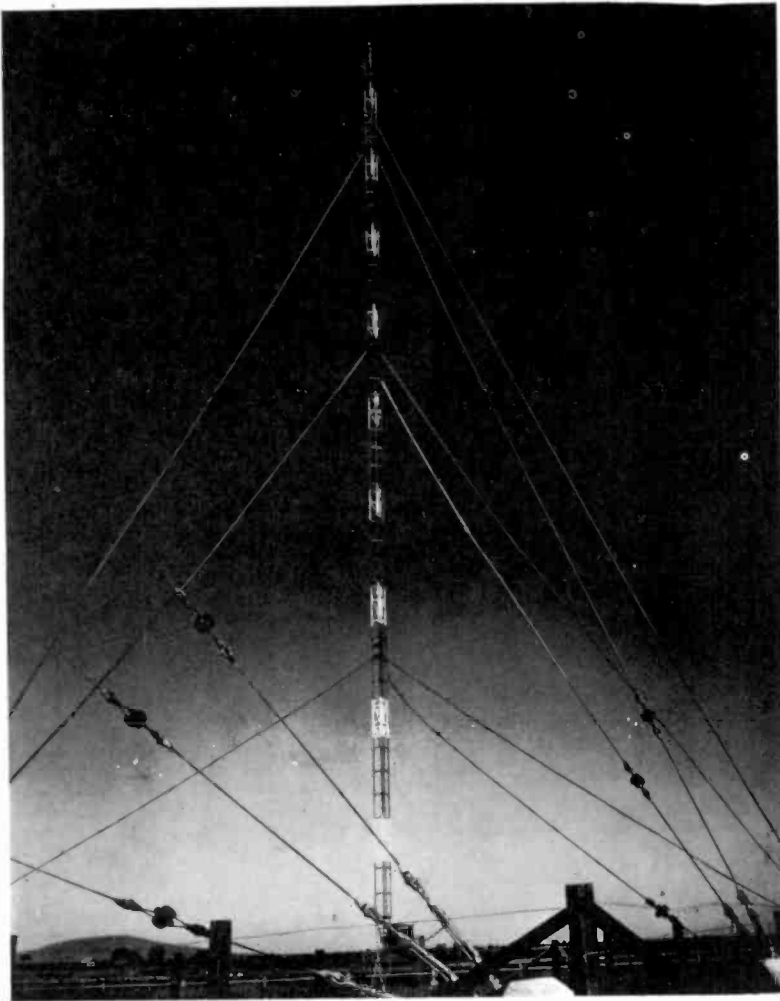

Fig. 7-2. This insulated guyed tower has a uniform cross section. Observe the insulators used to break the continuity of the guy wires.

Fig. 7-3. This is a schematic representation of a series-fed tower. Notice the impedance-matching network (antenna tuner) between the transmitter and the tower.

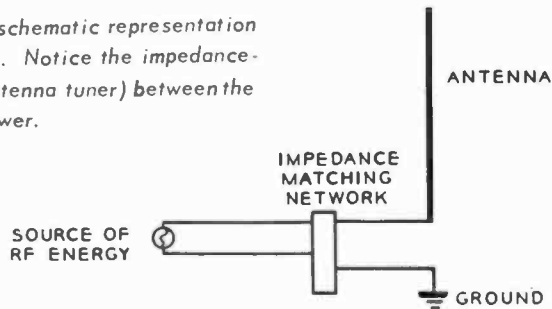

Fig. 7-4. A shunt-fed tower is represented here. Observe the feed point. The section of the tower between the feed point and ground offers an impedance at the operating frequency of the station.

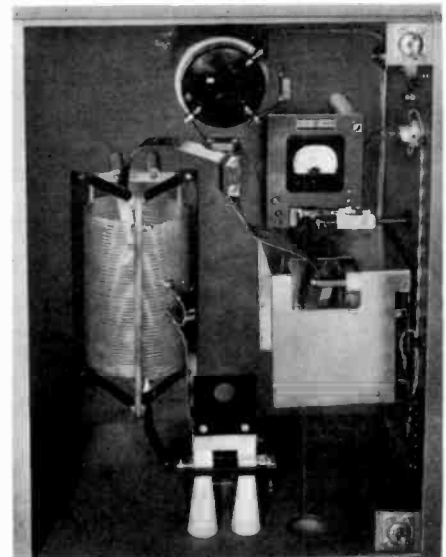
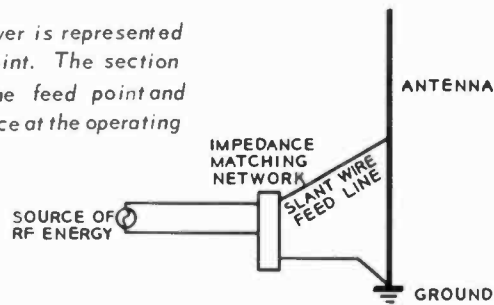

Fig. 7-5. A typical antenna tuning unit. The lighting choke is at the top of the cabinet.

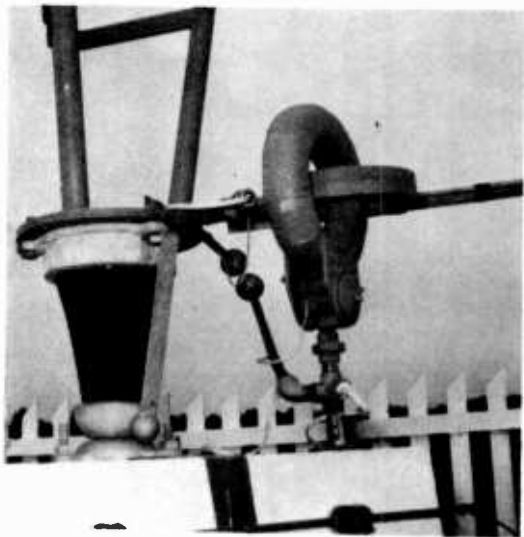

Fig. 7-6. Typical installation of a lighting transformer to isolate the AC circuit from RF.

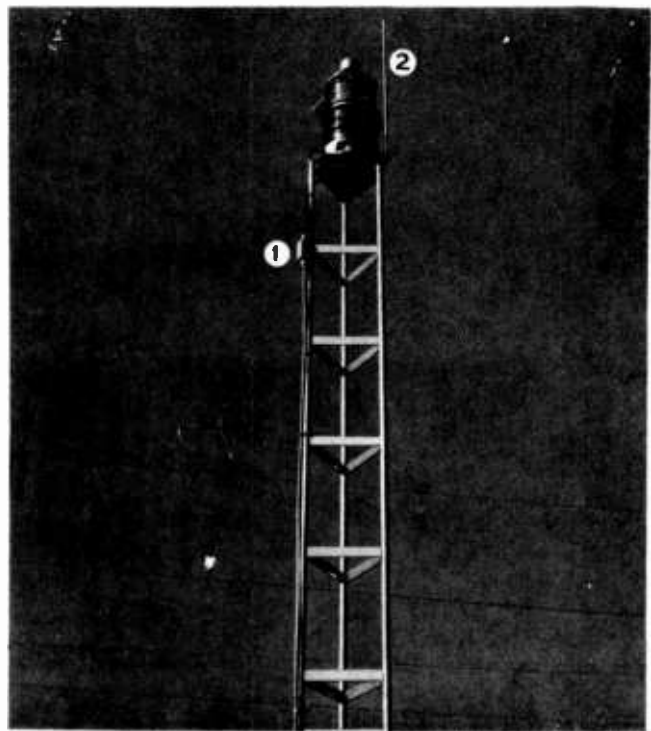

Fig. 7-7. A typical beacon installation. Notice the location of the junction box (1) and the lightning rod protector (2).

- 73.184 Groundwave intensity chart
- 73.186 Field intensity measurements in allocation; establishment of effective field at one mile.
- 73.187 Minimum antenna heights or field intensity requirements.
- 73.190 Engineering charts.

TUNING UNIT

The circuit of a single AM antenna tuning unit, shown in Fig. 7-12, usually consists of a single T-section low-pass filter. The two series inductors allow independent adjustment of their respective terminating impedances—L1 for the transmission line and L2 for the antenna circuit. The capacitive shunt leg, common to both branches, is given a fixed value determined by the operating frequency. Another antenna tuning unit schematic is shown in Fig. 7-13.

The antenna tuning unit (coupling network) serves two primary functions. One is to match impedances and the other is to tune the antenna to the exact resonant frequency of the station. In the tuning unit illustrated in Fig. 7-12, antenna tuning is achieved by adjusting L2 to series resonate with the capacitive reactance of the antenna. If the reactive component is inductive, it is considered to be absorbed into inductance L2. L1 is adjusted to match the resistance of the

transmission line to the resistance component in the antenna circuit. Resistance and reactance values of various tower heights, whether self-supporting or guyed, must be accurately determined by an RF bridge or other method.

There are normally two methods of tuning a standard (AM) broadcast antenna: the RF bridge and the substitution method. The antenna tuning circuits shown in Figs. 7-12 and 7-13 form a low-pass filter network with excellent harmonic attenuation. The reactance values may cause a phase shift between zero and a cut-off of 180° , but in standard practice a value of 90° is chosen.

When an antenna is properly tuned the reactive component is cancelled, leaving only the resistive component. Therefore, the power input equals the square of the RF current times the antenna resistance in which the current is measured. The antenna resistance is determined during the original installation and is part of the data filed with the FCC.

Whichever tuning method is used, a final check of antenna match conditions should be made before applying full power to the antenna. The measuring equipment should be removed and low-range thermal milliammeters placed at each end of the ungrounded transmission line conductor. Generally, when sufficient power is applied from a low-power stage of the transmitter and the tuning adjustments are correct, the meter readings

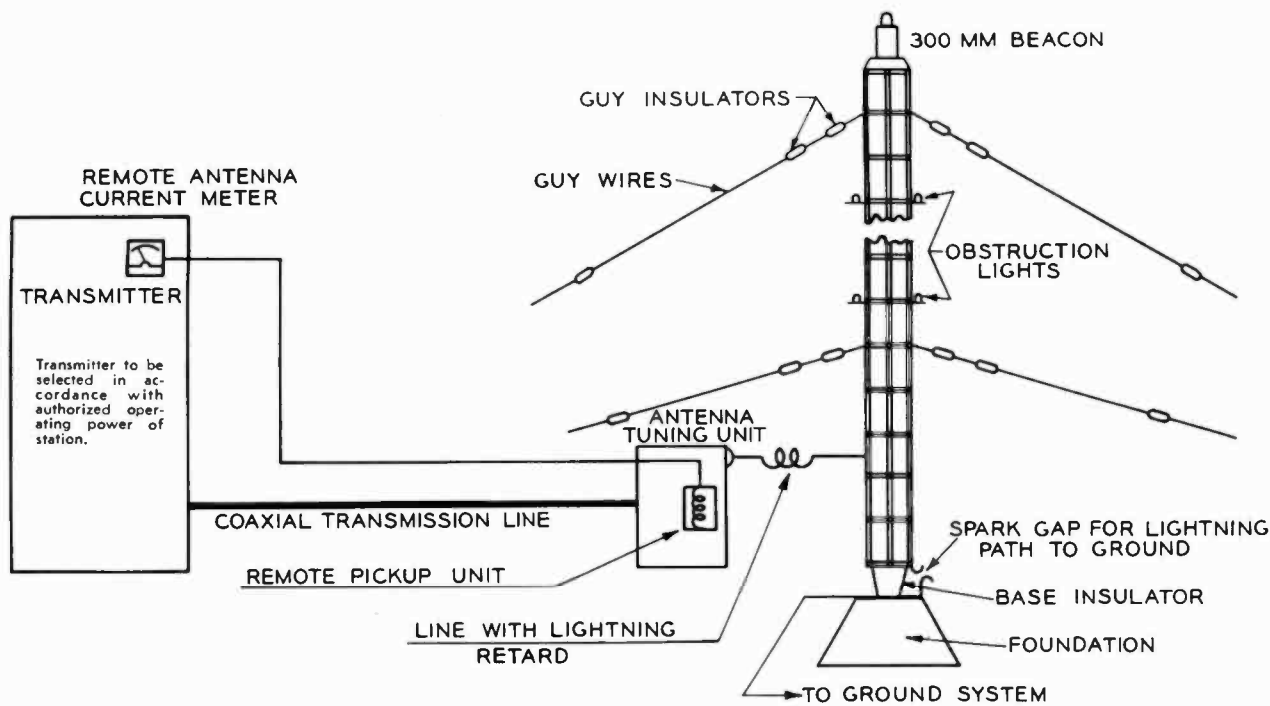

Fig. 7-8. A typical single-tower AM system. The remote antenna current is measured at the transmitter. Observe the position of the tower lights.

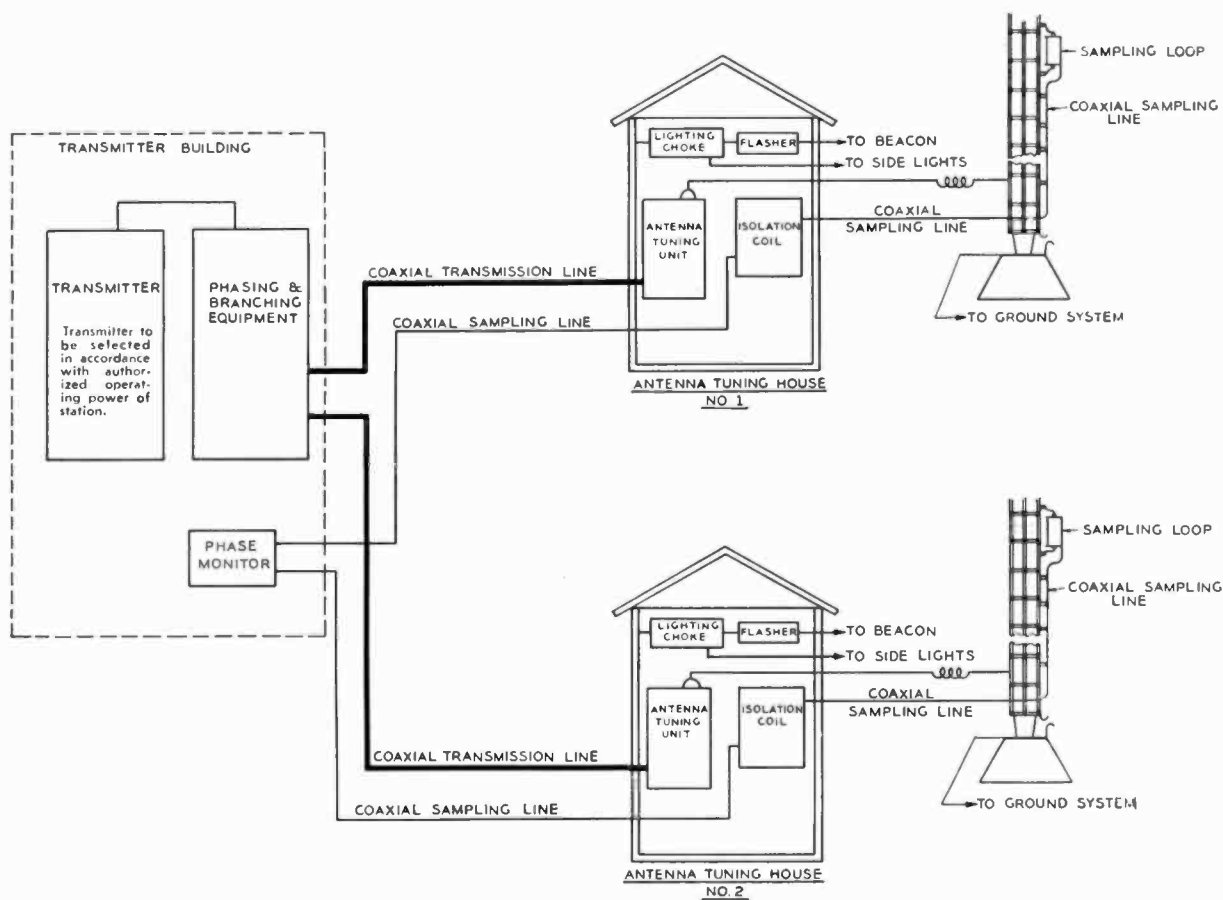

Fig. 7-9. Layout of a typical two-tower directional AM system showing the position of the phasing and branching equipments.

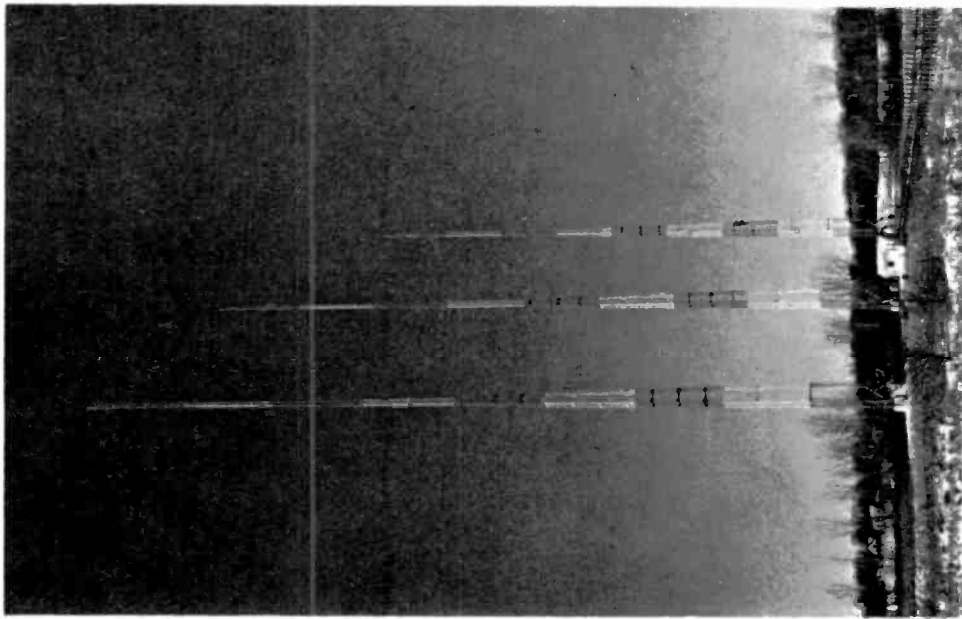

Fig. 7-10. A typical three-tower directional antenna array using self-supporting towers.



Fig. 7-11. Phasing equipment such as this is required for a directional antenna system.

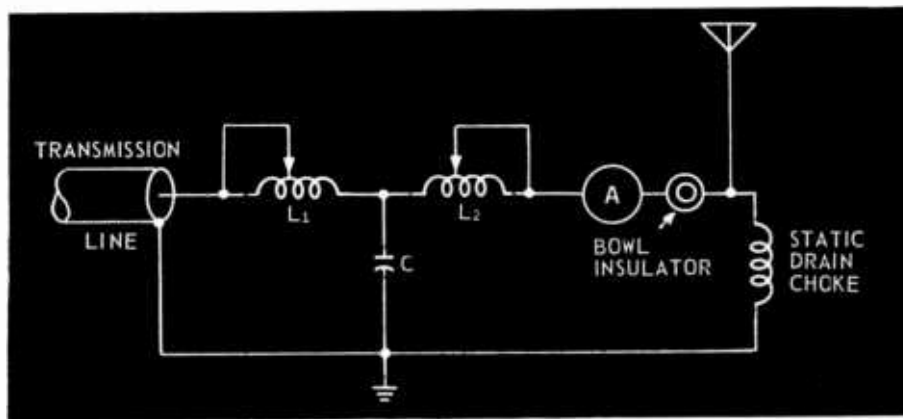

Fig. 7-12. Schematic of a single-tower basic antenna tuning unit.

should agree within 15%, showing a proper feeding match between the line and tower networks.

DIRECTIONAL ARRAYS

Directional arrays vary from two towers to as many as six. The radiation pattern must adequately cover the intended service areas from the "legal" transmitter location and at the same time provide the required protection to other stations. Refer again to Fig. 7-9. In most directional antenna systems, the transmission line will first be connected to a phasing and branching cabinet and a coaxial line will go out to each terminating unit in the multiple tower array. It now becomes necessary not only to determine each tower's resistance and adjust the matching networks, but to make the proper adjustments on the phasing and branching equipment. These adjustments are a part of "tuning up" the directional and usually should be attempted only by highly qualified personnel or a licensed consulting engineer, because it is a specialized field requiring considerable training, the use of complex mathematics, experience, and an extensive knowledge of directional systems.

A sampling loop on each tower is connected by a coaxial line, through an isolation coil, back to the phase monitor located in the transmitter building. The sampling loop picks up some of the radiated RF energy from each tower and feeds it back to the phase monitor so that the relationship between the towers can be determined.

COMMON-POINT RESISTANCE

The "common-point resistance" (at the phasor input or transmitter output) should be adjusted and measured as a part of the initial directional antenna tuneup. The impedance is measured at several frequencies above and below the operating frequency and the data calculated. The re-

sistance should then be determined according to FCC Rule 73.54 (c). The common-point is considered as the power source for a directional antenna since it is common to all the towers and is the point at which total power to the system is measured. The common-point is usually in the phasor cabinet and a network is used to match the transmitter output impedance to the phasing and branching equipment. The use of the network allows the common-point resistance to be maintained at a value which will result in a specific ammeter reading. See Fig. 7-14.

FCC Rule 73.57 (a) states that the power should not be allowed to exceed limits of 10% below or 5% above the licensed value. This value is controlled by adjusting the transmitter power output according to FCC Rule 73.54 (e). Additional power can be fed into directional antenna phasing equipment to compensate for phasing network and line losses.

INITIAL TUNING

The initial adjustment of a directional antenna system begins with setting the reactances of the antenna-tuning and power-dividing components to the computed values and supplying power to the antenna system. Usually, the phase and field-ratio indications will be different from those desired. To compensate, adjustable tuning components are varied until the phase and field-ratio indications correspond closely to the computed values.

The ideal directional pattern provides service to the desired city A, while protecting adjacent-channel stations located in cities B and C, as shown in Fig. 7-15. As displayed in this sketch, both the size and shape of the directional pattern are important factors. With constant ratios between transmitter power and tower current, the phase relationships between towers will determine the pattern shape by cancellation in certain

directions (cross minima measurements). Pattern shape variations can be achieved when the parameters are all constant except the phase in one of the towers. Generally, the current ratio in the various towers of the system will also determine pattern shape by affecting the depth of the nulls. As the current ratio approaches unity the null becomes deeper; at either side of unity the null is filled.

A directional antenna pattern is drawn on a polar graph showing the amount of radiation in each direction in terms of the unattenuated field intensity in millivolts per meter (mv/m) at one mile. The major lobe (the cardioid pattern in the direction of the arrow) is directed toward the city service area. Fig. 7-16 shows a typical computed pattern.

In the usual installation one of the main factors is the individual antenna ammeters which indicate the current being fed to each tower. The readings are essential in computing antenna current ratios. Antenna ammeters are almost always

equipped with a shorting switch that usually removes the meter from the circuit. It should be out of the circuit when not in use because it can easily be damaged or destroyed by an overload, lightning, or a static discharge.

PHASE AND CURRENT RATIOS

As stated previously, a significant parameter of a directional antenna is the phase relationship of the various towers making up the system. The phase monitor at the transmitter indicates the phase angle in degrees of the RF current fed to each tower. Fig. 7-17 shows a solid-state phase monitor which is unaffected by modulation when presenting phase-angle readings on a continuous 0 to 180° scale panel meter. Loop current appears on a single meter as a percentage of the reference tower current. This unit can be used in systems with up to nine towers. Automatic day-night switching of reference levels can be incorporated if desired. The pro-

Fig. 7-13. Simplified schematic diagram of a single-tower tuning unit.

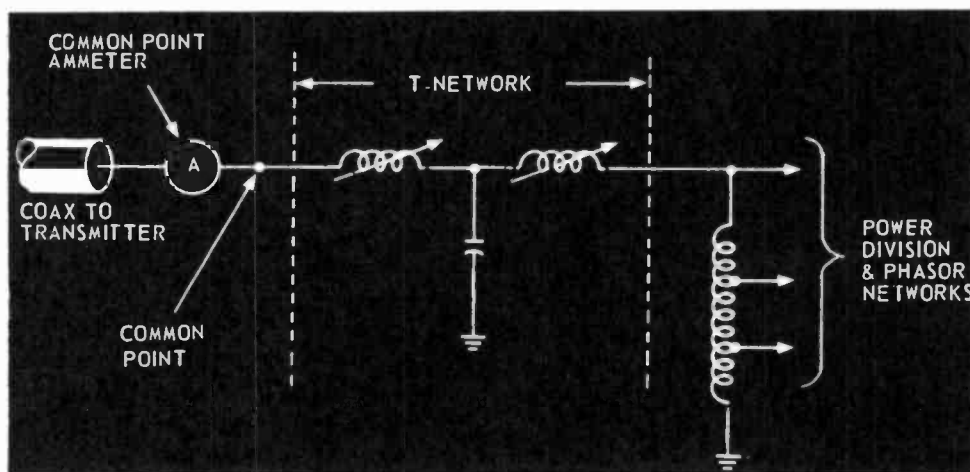
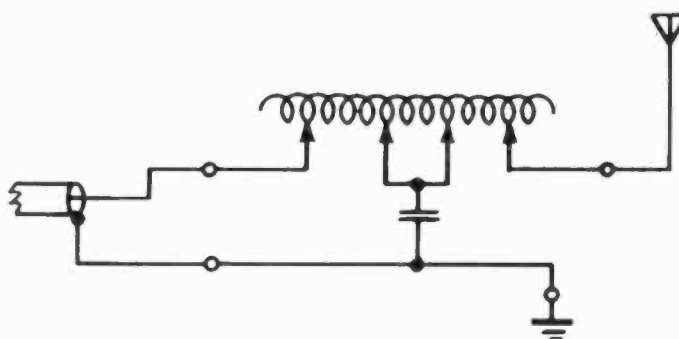

Fig. 7-14. Common-point circuit schematic showing location of the ammeter.

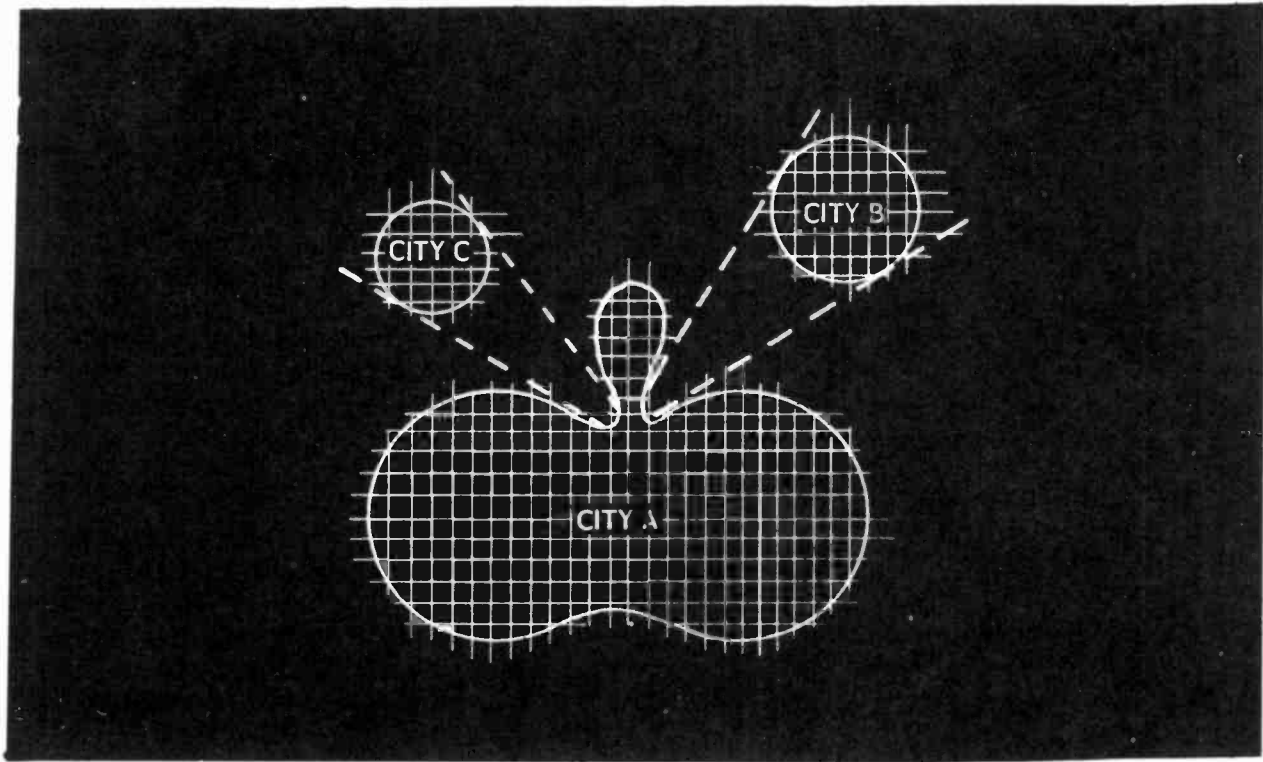

Fig. 7-15. Directional antenna pattern sketch showing protection for stations in Cities B and C.

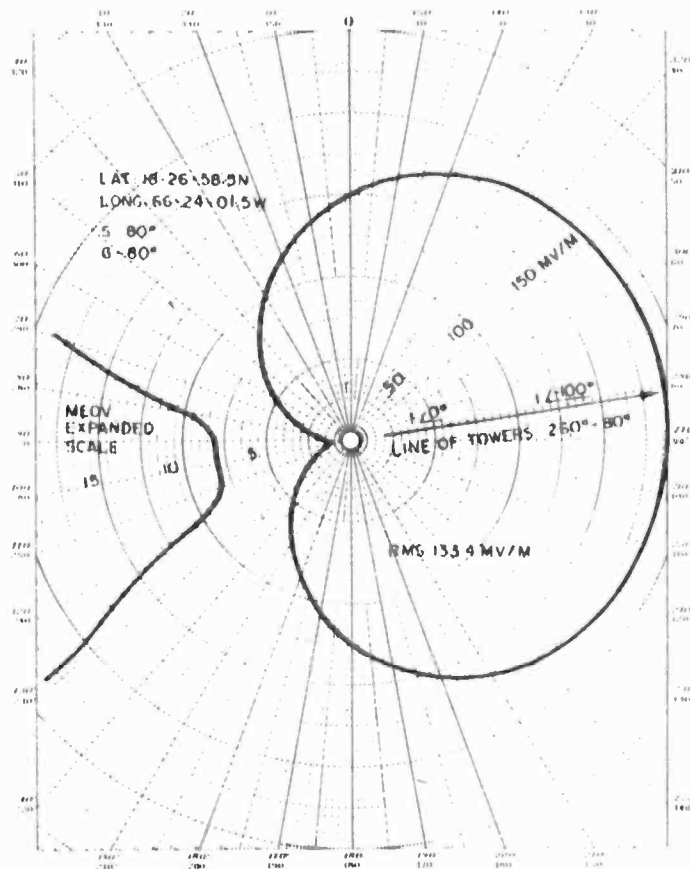

Fig. 7-16. Typical computed directional pattern.

portional linear DC voltage which provides phase angle and loop current indications to operate a chart recorder and digital voltmeter can be fed over lines to a remote meter panel.

In designing a directional antenna the engineer computes the current ratios and phase relationships which will achieve the desired radiation pattern. These are the values shown in the station license, the actual values that are specified as the operating specifications in the station license and which must be read on the phase monitor in order to maintain the directional antenna pattern. FCC rules require that the ratios of base currents and sampling loop currents be maintained within 5% of the values specified in the license, as stated previously. There is no tolerance for phase relationship specified in the FCC Rules, although a deviation beyond four degrees is considered excessive. In some instances, critical directional antenna systems require operation within tolerances closer than four degrees in order to provide the required protection.

In maintaining a directional antenna phase relationship, it is a standard procedure to specify one tower as a reference tower. The phase of the currents in the other towers is measured in relation to the reference tower. Normally, the reference tower is considered to be at zero degrees. As seen in Fig. 7-18 Number 1 is the reference and the phase of towers 2, 3, and 4 are shown compared to Tower 1. In this case the assigned phase angle readings LAG (-) the 0° phase angle reading of reference Tower No. 1. Thus, the readings are: -23° for Tower No. 2 with a 2:1 phase relationship with respect to Tower No. 1, -47° for Tower No. 3 and a phase relationship of 3:1, and -125° for Tower No. 4 showing a phase relationship of 4:1.

Likewise, the current ratio of a directional antenna system usually is the ratio of the current in a given tower in the array to the current in

the reference tower. Therefore, if one tower has four amperes and another 8 amperes, the ratio is obtained by dividing 4 by 8, resulting in 0.5. The FCC Rules do not require the operator to maintain the directional antenna base currents at any specific values. But section 73.57 (b) specifies that the antenna current ratios be held within 5% of that specified by the terms of the license. Normally, the station license will specify a ratio of 1.00 to the reference tower.

After the pattern is properly adjusted and confirmed by the proof-of-performance, monitor points are established in each direction specified by terms of the construction permit and license. The field strength is measured at each monitor point at regular intervals to provide an indication of any variation in the radiated field. Most engineers try to locate monitor points that are readily accessible and located in areas where new construction is not planned or underway. Usually, public parks, school playgrounds, golf courses, cemeteries, and similar areas are satisfactory monitor point locations.

Obviously, monitor points are determined by the station's protection and coverage requirements and must be selected to provide a point free of re-radiation or other undesirable effects. A field intensity meter is used to measure the signal strength in millivolts per meter and a record is kept of all measurements showing the data, time, monitor point number, and field strength.

TOWER LAYOUT

The submission of a well prepared specification for phasor design assures a transmission system that will not only conform with FCC Rules and Regulations but one that will perform in a stable manner, will be easy to adjust, and require only a minimum of maintenance.

Spacing and orientation of the towers is an extremely important factor. A reference azimuth

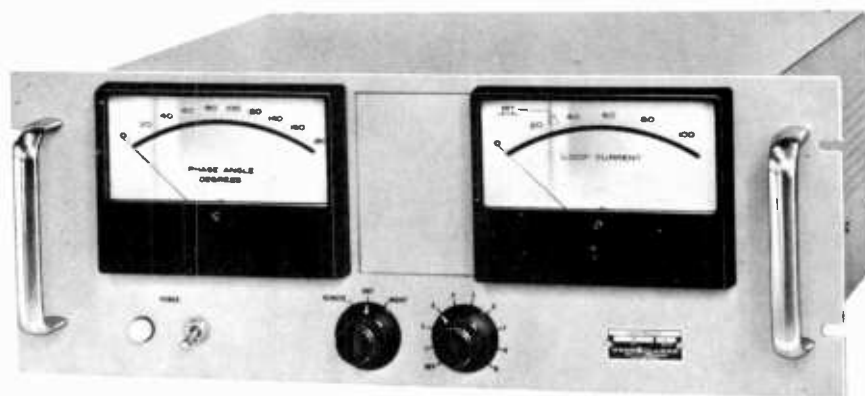

Fig. 7-17. This new solid state phase monitor is designed for multi-tower directional AM system.

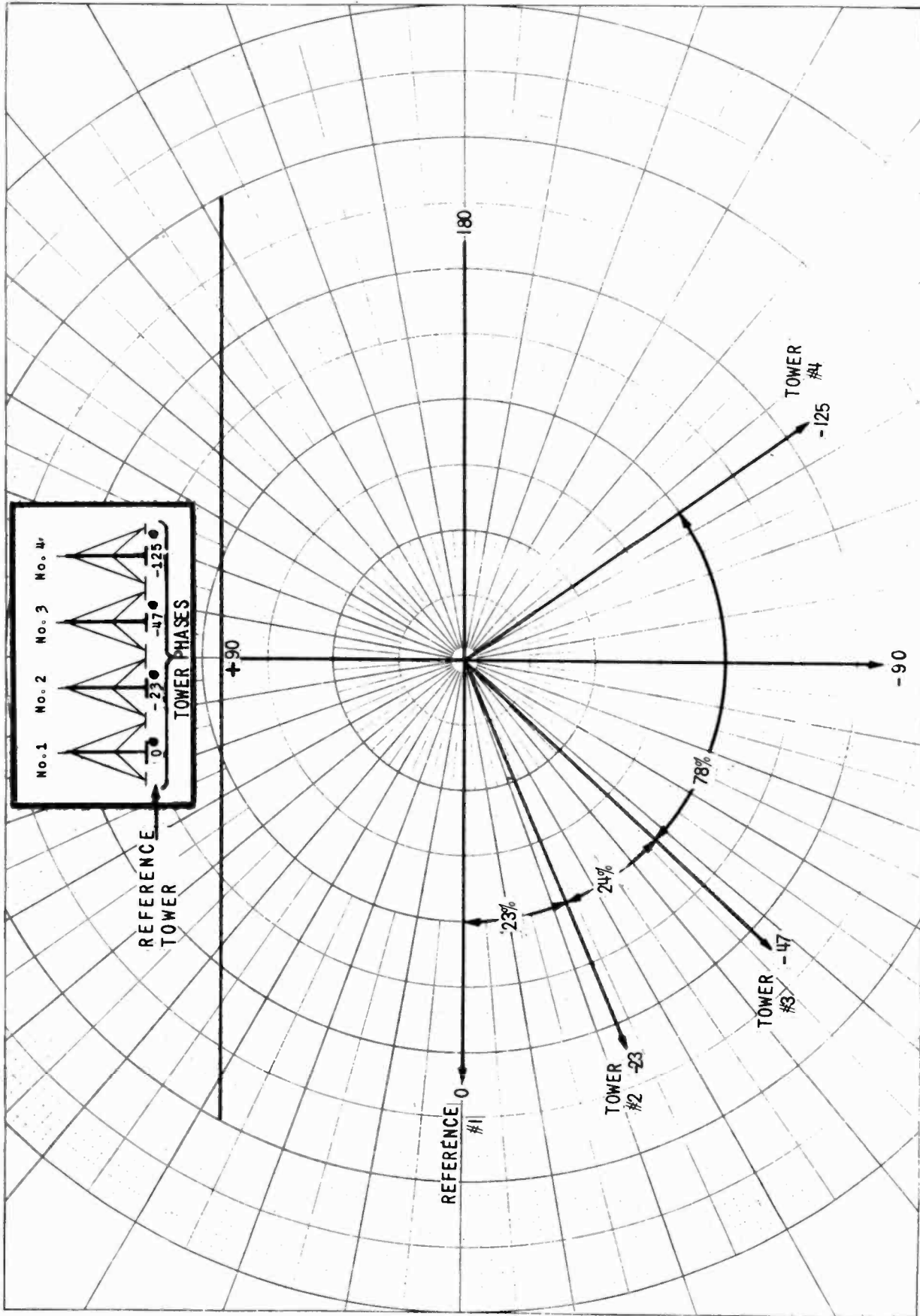

Fig. 7-18. Typical phase-angle vector diagram of a four-tower in-line directional antenna array.

at true north should be determined and the bearing of the line of towers should be plotted with a high degree of accuracy from this reference point. It is important that this bearing be determined accurately and independently from other sources. An error in the true tower alignment may make it impossible to achieve the required directional pattern.

Due to the complexity of the computations, and in order to provide an accurate layout of the antenna towers and satisfy the terms of the speci-

fications, the broadcaster should obtain the services of a registered civil engineer or surveyor. All the computations and measurements, duly attested, should be supplied to the consultant.

INSTALLING THE GROUND SYSTEM

Closely associated with the tower is the antenna ground system installed at the base of each tower, an extremely important part of the overall antenna system. It is utilized in an attempt to

Fig. 7-19. Sketch of a typical single-tower ground system.

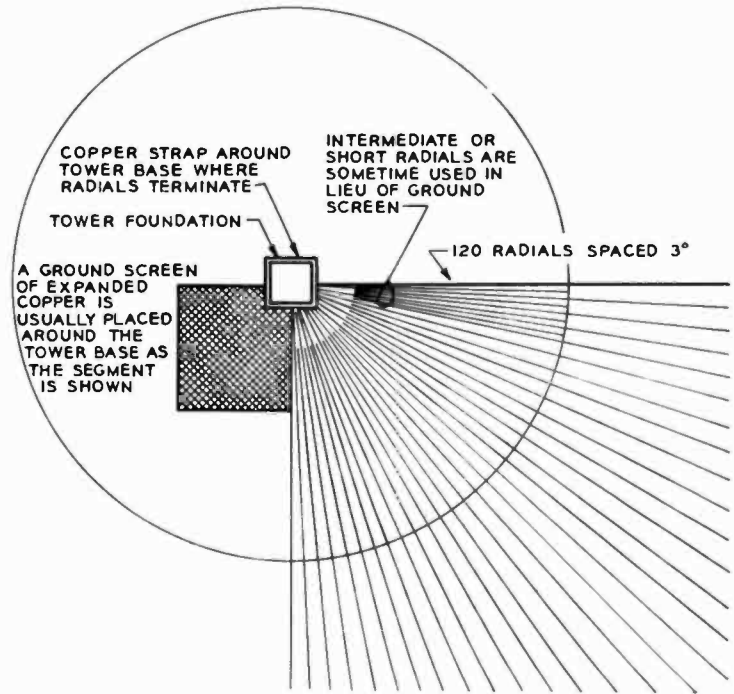
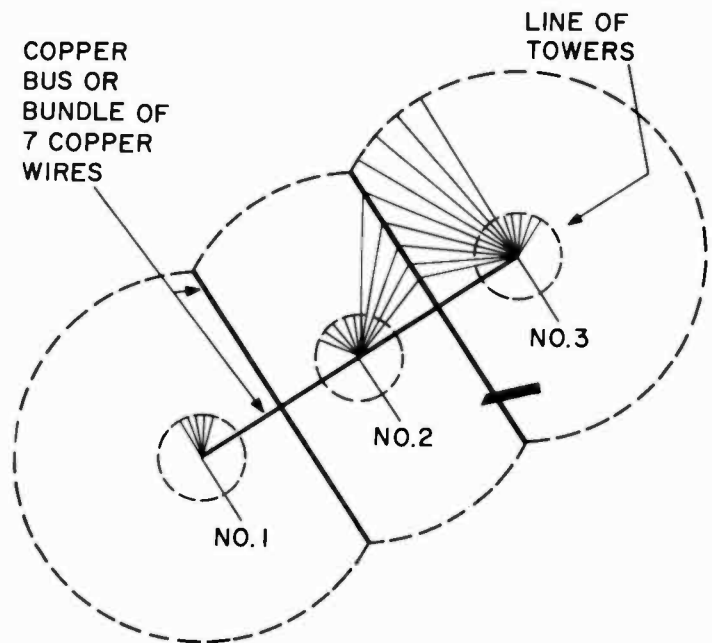

Fig. 7-20. Ground system diagram for a three-tower directional array showing, in part, ground radials which should be bonded in the main copper busses.



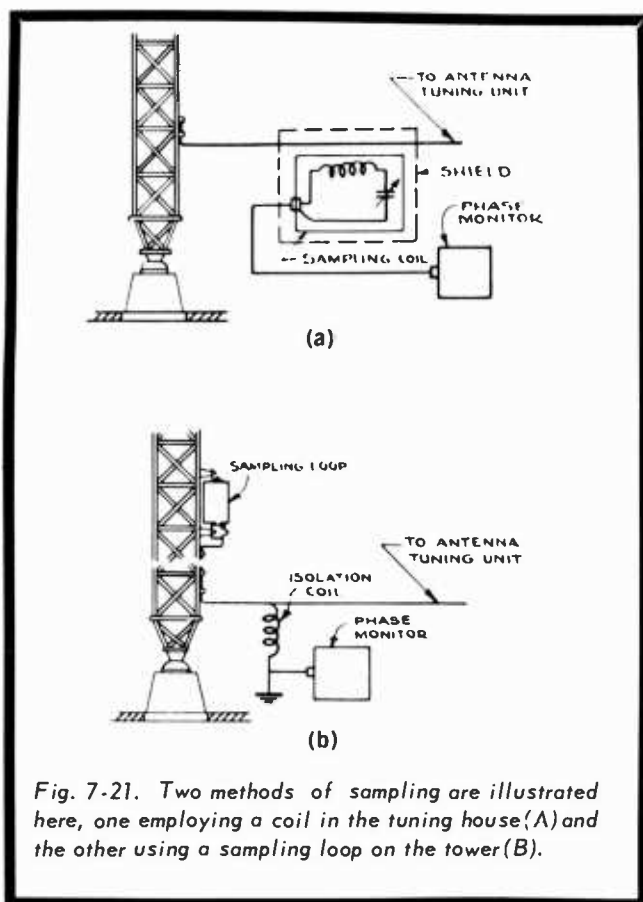

Fig. 7-21. Two methods of sampling are illustrated here, one employing a coil in the tuning house (A) and the other using a sampling loop on the tower (B).

achieve nearly perfect conductivity at the earth's plane in the area around the tower. This is where the improvement is most effective when related to the radiated signal. (An estimated ground conductivity map is included in the appendix section.)

The ground system usually consists of at least 120 radials of No. 10 soft copper wire, as long or longer than the height of the associated tower. The radials are laid in furrows spaced three degrees apart around the entire tower base. Then, a ground screen or mat made of expanded copper is located completely around the tower base, usually covering an area of approximately 24 by 24 feet. Typical ground system drawings are shown in Figs. 7-19 and 7-20. The entire system is bonded together by silver soldering, brazing, or welding around the base of the tower.

In some installations the mat can be replaced by increasing the number of radials. Also, short radials about 50 feet long are placed between the full length radials to replace the mat or ground screen in some installations. All the radials should be bonded to a copper strap or to a bundle of seven copper wires placed around the tower base. In a typical installation it is also usual to have a copper ground strap on each face of the tower support pier, criss-crossing under the tower insulator. The same type of strap or a bundle of wires is required to tie

tower bases together as shown in Fig. 7-20. When towers are spaced so that the radials do not meet, the radials that could intersect should be extended to a point where they overlap and be bonded in the same way.

The actual length and number of radials and the size and shape of the ground system will depend upon various conditions and should be computed by the engineering consultant. The transmitter building, located close to the tower or within the circumference of the ground system, should be surrounded by a copper bus or strap at the foundation. All radials that approach the building should be bonded to the copper bus or strap. A chart listing tower height in feet for each 10-kHz increment in the AM broadcast band appears in the Appendix.

AM TOWER FEED AND RF SAMPLING SYSTEMS

The two most commonly adopted methods of feeding tower radiators are the series-fed system shown in Fig. 7-3 and the shunt-fed system diagrammed in Fig. 7-4. A 52- or 72-ohm air or solid dielectric coaxial transmission line and line-terminating unit is utilized in both systems. As shown in the diagrams, the series-fed system requires a tower base insulator and in the shunt system the tower is directly grounded and RF energy is fed to the tower by a copper conductor connected to a point located well up the tower. In the shunt-fed system the section of the tower between the feedpoint and the ground serves as an element of sufficient impedance; this in combination with the impedance-matching network effects the satisfactory transfer of power from the transmission line to the tower.

The transmission line feeding the line or antenna tuning unit can be buried, supported on wood or metal posts, or enclosed in a wood trough for protection against damage. The trough should measure at least four by eight inches, have a removable top, and be mounted not more than 36 inches above ground.

A good practice is to lay rigid air dielectric coax as straight as possible. Bends, sags, or bumps should be avoided since the flanged seals will have a tendency to leak if there is a bending strain set up in the coax. One end of the transmission line should be anchored and the other end should be left free to move as the line expands and contracts. In some installations where portions of the line run near to the ground system, the outer conductor should be bonded to the ground system every 20 feet, usually to the heavy copper strap running between the towers. For normal operation, dry air can be flushed through the line and kept at the recom-

mended pressure. All joints, plugs, and end seals should be tested for leaks after installation by an approved test procedure.

Coaxial lines of either the semi-rigid or flexible type may be employed for a sampling system. Sampling loops (or sampling coils) pick up some of the radiated energy from the tower and feed it to a phase monitor so that the phase relationship between towers can be measured.

In one method of sampling, a coil is installed in the tuning house at the base of the tower and this becomes a part of the tower tuning unit (see Fig. 7-21A). The other method of sampling requires a shielded or an unshielded loop mounted on the tower (Fig. 7-21B). When sampling loops are tower mounted, isolation coils are necessary to bring the sampling lines across the base insulator. The "cold" end of the isolation coil should be bonded to the ground system.

Flexible coaxial line is generally used for the sampling line. They usually can be either buried in the ground or put in the same trough that supports the transmission line. The characteristic impedance of the sampling line must match the monitor input.

AM PHASOR BRANCHING EQUIPMENT

Ideal phasor and branching equipment is custom built to provide precise coverage patterns to

fully meet the requirements of the construction permit. From the initial plan to the finished product, the manufacturer bases his design on requirements of the consultant. Be sure of what you are buying so that you need not be faced with having to replace inadequate components or to make costly design modifications in the field to relieve difficult adjustment. Such precaution will avoid expensive readjustment and a re-proof of pattern later on. Some phasors should not be used in big arrays with four or five towers because of the interaction of controls. Although it may be more expensive, a phasor suited for your needs will result in less interaction, take less time to set up, and in the end offer a savings.

Reliable switching facilities are indispensable for changing from day to night patterns, or from nondirectional to directional patterns. Pattern switching is accomplished with remotely - controlled, positive-latching relays which select the required power divider and phasing network and also change the values of the inductive arms of the line-terminating units. On the pattern-switching relays it is a good idea to have contacts which control indicating lights to monitor relay operation.

In planning transmitting facilities, you should take into consideration future needs for a stand-by transmitter so that the required transfer

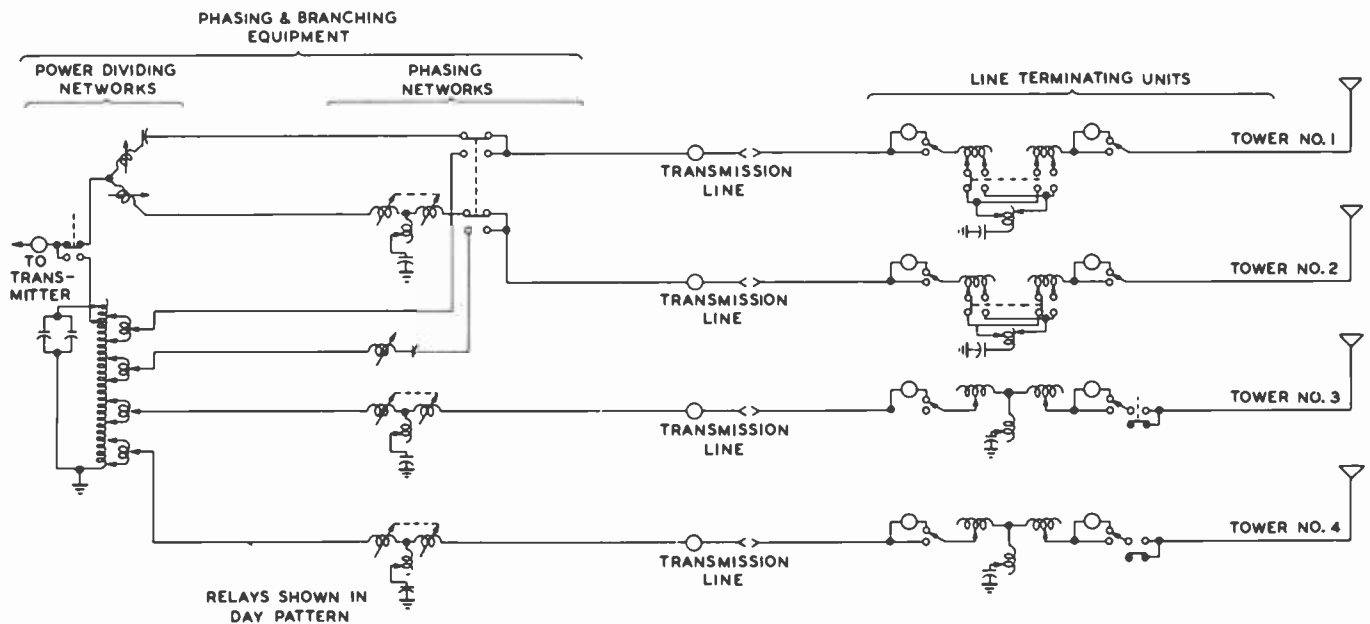

Fig. 7-22. Schematic diagram of a typical phasing unit.

switches and relays between the transmitter and antenna system may be installed. Fig. 7-22 shows the circuit of a typical antenna phasing unit.

AM/FM DUMMY LOADS

A relatively non-inductive resistance, called a dummy load, is an essential component in all AM/FM transmitting installations. Dummy loads are available in different power-handling capacities, air-cooled or water-cooled, to fit indi-

vidual requirements and at the impedance specified. A dummy load provides the means for adjustment and maintenance of the transmitter without feeding the antenna during prohibited hours.

An AM dummy load should be selected to handle the modulated peak power. Most dummy loads are wirewound types, and although designed to be non-inductive they do have some inductance. Therefore, an adjustable compensating network is required to cancel out the inductance.

CHAPTER 8

FM Antennas

Selection of an FM antenna array is especially important because it provides a means of reducing null effect, improving fringe area reception, and fill-in of shadow areas. In addition, stereo and SCA service should benefit both in quality and coverage. Of course, a logical decision on transmitter power and antenna type can be made only after the station's effective radiated power and antenna radiation pattern is established. Another factor to be taken into consideration is the polarization of the radiated signal.

ERP AND POLARIZATION

Effective radiated power as authorized by the FCC Rules and Regulations is based on a measurement of the horizontally-polarized signal. Many broadcasters choose an antenna system which also radiates a vertically-polarized signal. This enables an FM station to transmit a supplemental signal to achieve elliptical or circular polarization. It may be used in combina-

tion with any type of horizontally-polarized FM antenna and is designed to improve and maximize monaural, stereo, and SCA multiplex operation. Better reception efficiency is realized on car radios, portables with whip antennas, and home receivers with built-in or line-cord antennas. Figs. 8-1 and 8-2 indicate the difference in reception realized when a horizontally- and a dual-polarized FM transmitting antenna is used.

FCC regulations permit simultaneous FM radiation in both horizontal and vertical planes. For example, a station authorized for operation at 50 KW ERP horizontal can legally radiate a full 50 KW in the vertical plane. This can be achieved by intermixing vertically- and horizontally-polarized antennas, by adding vertically-polarized antennas to an existing system, or by installing a circularly-polarized antenna. The best method will be dictated by the requirement of either additional transmitter power or higher antenna gain to match the original ERP obtained from a horizontally-polarized array.

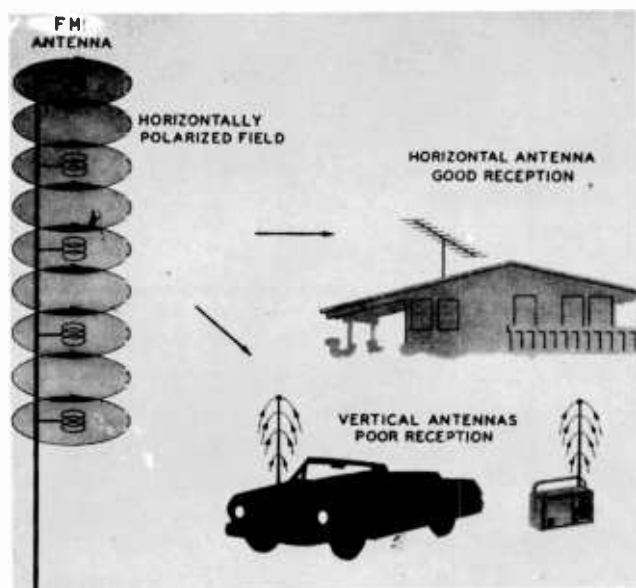

Fig. 8-1. Horizontally-polarized transmission provides good reception for homes but tends to serve autos and portables poorly.

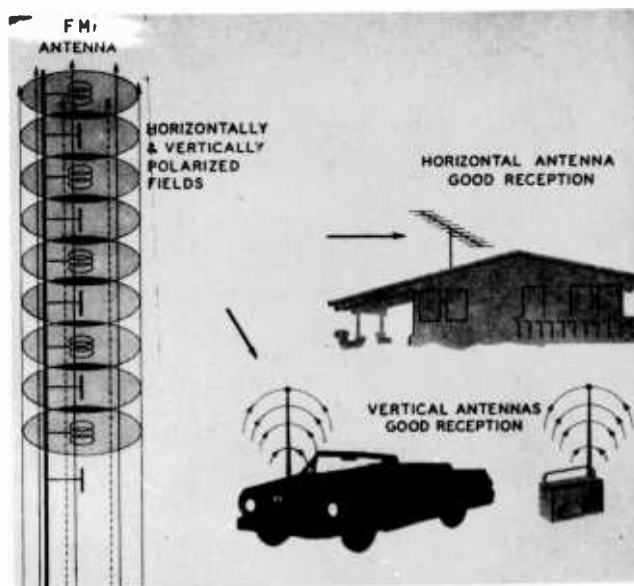

Fig. 8-2. Dual polarized transmission provides excellent reception for all types of receivers.



Fig. 8-3. Radiating element of a ring-type horizontally-polarized FM antenna.

Fig. 8-3 illustrates a horizontally-polarized FM antenna. Fig. 8-4 shows a vertically-polarized FM antenna and radiating element. Fig. 8-5 shows an interlaced horizontally- and vertically-polarized antenna which is tower-mounted.

HORIZONTALLY-AND VERTICALLY-POLARIZED ANTENNAS

Both horizontally- and vertically-polarized FM signals can be achieved by:

(1) Mounting both the horizontally- and vertically-polarized antennas on a new or existing

tower and using a power divider at the base of the antenna or at the transmitter building to split the feed to both antennas.

(2) By using a circularly-polarized antenna; most manufacturers offer three types of antennas: a horizontally-polarized antenna up to 5 KW per section, and the circularly-polarized antenna rated at 10 KW per section.

Combined horizontally- and vertically-polarized antennas are usually more expensive than

circularly-polarized antennas. But separate antennas may be of special advantage to those who already have horizontally-polarized antennas and can readily add vertical radiation. The dual antennas should have the same gain to enable the FM station to transmit a circularly-polarized signal. The H and V elements can be mounted in almost any position on the tower, but preferably they should be mounted at the same height in arrays as shown in Fig. 8-5.

Antennas of equal gain fed in quadrature will achieve elliptical or circular polarization. It is now the consensus of opinion that circular polarization is generally considered superior to that produced by a combination of horizontally- and vertically-polarized radiating elements. Also, dual antenna arrays have the disadvantage of additional weight and higher wind and ice loading than that of a circularly-polarized antenna array.



Fig. 8-4. Radiating element of a typical vertically-polarized FM antenna.

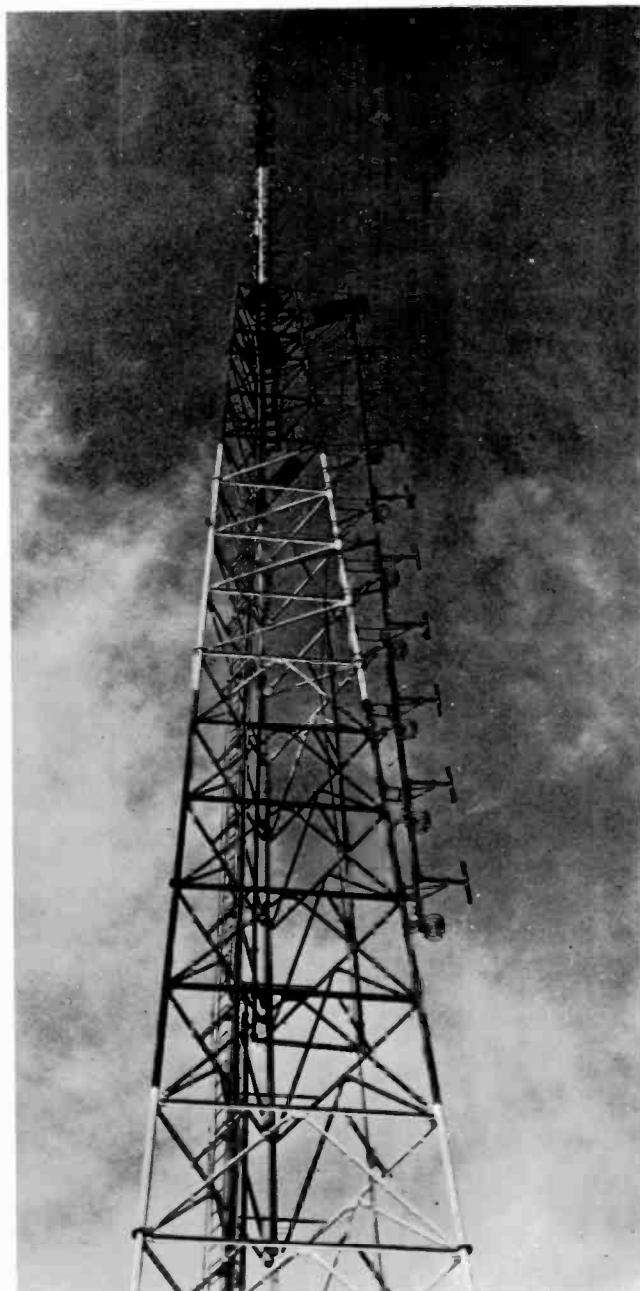

Fig. 8-5. Dual polarized antenna radiators side-mounted on an existing TV tower as an interlaced system.

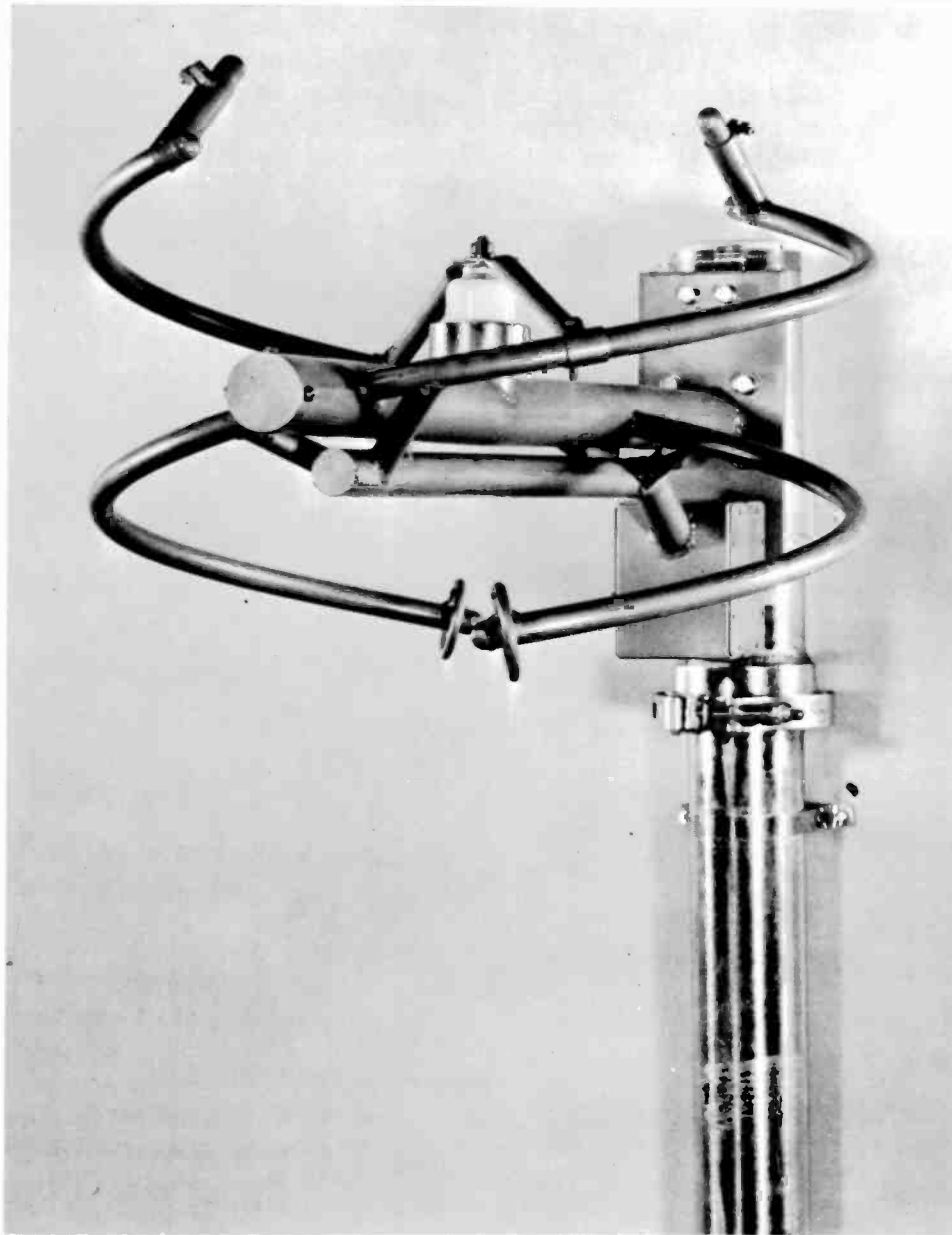

Fig. 8-6. A circularly-polarized antenna replaces horizontal and vertical elements. One antenna does the work of two.

CIRCULARLY-POLARIZED FM ANTENNA

A primary advantage of a circularly-polarized antenna is the reduction in the number of bays required. Previously, individual elements, horizontal and vertical, and in most cases a power divider, had to be installed to attain dual polarization. Now, only a single circularly-polarized FM antenna is required to achieve at least comparable results.

A circular antenna radiates with a low standing-wave ratio over a bandwidth of 200 kHz, ideal conditions for the transmission of today's complex FM monaural, stereo, and SCA multiplex signals. There are numerous circularly-polarized antennas designed for the ultimate trans-

mission of an FM signal. Figs. 8-6 and 8-7 illustrate two types.

A station's effective radiated power is still determined by the signal radiated in the horizontal plane. This is multiplied by the power fed to the antenna (power input). Antenna data can be determined from Fig. 8-8.

Circularly-polarized antennas provide equal horizontal and vertical power gains from 0.46 for a single section to 8.9 for 16 stacked sections. As indicated, any number of elements from one to sixteen may be utilized, thus providing the maximum flexibility in the selection of power gain for a particular installation. No external combiner is required since power division is

accomplished within the antenna. Maximum power rating per bay is 10 KW and arrays will handle power inputs as high as 40 KW. Special antennas with null fill and beam tilt are available. De-icers or radomes are recommended for climates that experience icing conditions.

When using circular polarization instead of horizontal polarization, transmitter power can be doubled without exceeding the licensed horizontal effective radiated power. This is because the additional power radiated is in other planes of polarization. Conversely, for a given transmitter power the number of antenna bays can be doubled for the same reason. This can be seen by comparing the systems. Transmitter power and antenna gain requirements are computed as follows:

$$\text{ERP} = P \times G \times \text{Eff}$$

Where:

P	=	Transmitter output power
G	=	Antenna power gain
Eff	=	Transmission line Efficiency

Performing a simple determination, you can assume that the circularly-polarized antenna has a gain of approximately 0.5 per section, and the horizontal and vertical radiator has a gain of approximately 1.0 per section. Therefore, for a typical installation the combined H and V antenna or the circular antenna should be calculated at one half gain per section since power fed to each antenna system is equally divided between the horizontally- and vertically-polarized modes. This method can be used in determining the transmitter and antenna combination required to achieve a given ERP. In filling out FCC Form 301 the consultant or the station's chief engineer will use the exact antenna gain figures and in case of a combined antenna array the required power splitting or division ratio is to be indicated. Fig. 8-9 compares combined H and V and circularly-polarized antenna systems.

Some typical interesting facts pertaining to circularly-polarized antenna arrays:

1. Antennas of one to seven or up to ten bays are normally end fed; arrays of 10 bays and over are center fed, with even numbers of bays or at a point 1/2 bay below center with odd number of bays. See Fig. 8-10.
2. To obtain the field gain, take the square root of the power gain.
3. To obtain the effective free space field intensity at one mile in mv/m for one kilowatt antenna input power, multiply field gain by 138.



Fig. 8-7. A typical version of a circularly-polarized radiating element.

INSTALLING FM ANTENNAS

FM antenna design is flexible and permits easy installation or mounting on the side of an existing tower or pole-mounting on top of towers or buildings. Side-mounting is more popular for FM broadcasting because it can be added to an existing AM or TV tower and it does not affect the electrical height of the radiator. When the effective height of an AM radiator is changed it can upset a phased array. This will require FCC and FAA approval for the increased height and re-tuning of the system to compensate for the additional height.

The supporting AM or TV tower structure normally has some effect on the radiating pattern of the FM antenna. Usually, the smaller the structure the less effect. Side-mounting an FM an-

NO OF BAYS	POWER GAIN		DB GAIN		APPROX LENGTH @ 98 MC (ft)	WEIGHT LBS.	POWER RATING KW
	HOR	VERT	HOR	VERT.			
1	0.46	0.46	-3.37	-3.37	0	41	10
2	1.0	1.0	0	0	10	110	20
3	1.5	1.5	1.76	1.76	20	179	30
4	2.1	2.1	3.22	3.22	30	248	40
5	2.7	2.7	4.31	4.31	40	317	40
6	3.2	3.2	5.25	5.25	50	386	40
7	3.8	3.8	5.80	5.80	60	455	40
8	4.3	4.3	6.34	6.34	70	524	40
9	4.9	4.9	6.87	6.87	80	593	40
10	5.5	5.5	7.40	7.40	90	662	40
11	6.0	6.0	7.80	7.80	100	731	40
12	6.6	6.6	8.20	8.20	110	800	40
14	7.8	7.8	8.92	8.92	130	937	40
16	8.9	8.9	9.49	9.49	150	1074	40

Fig. 8-8. Chart listing typical characteristics of circularly-polarized FM antennas.

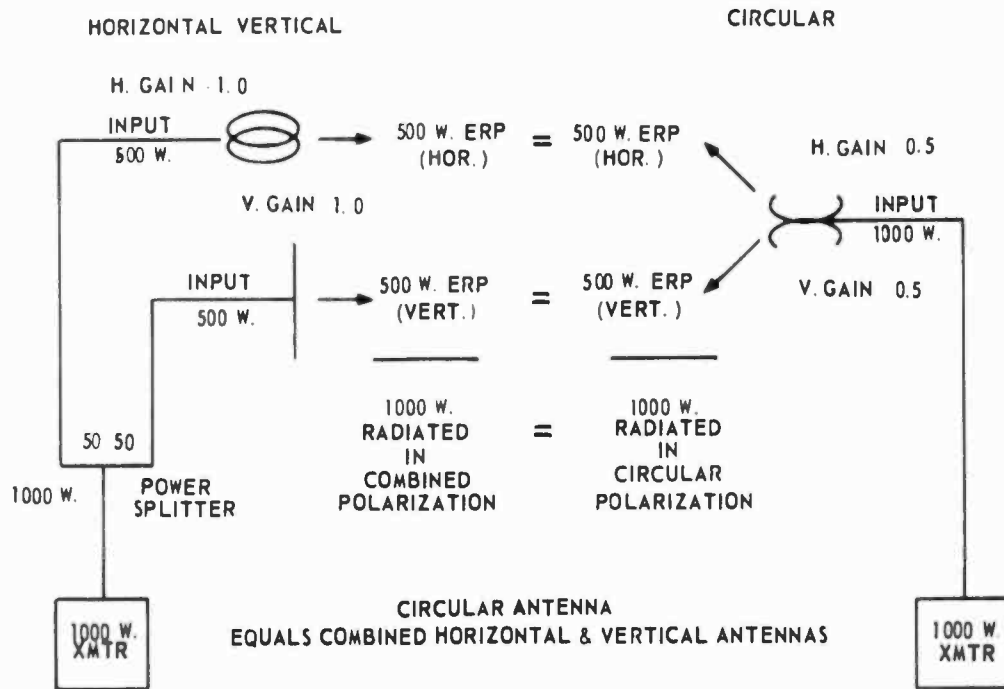

Fig. 8-9. Comparison of feed systems and the effective radiated power of a circularly-polarized antenna with combined horizontally and vertically polarized antennas. No power splitter is required for the circularly polarized antenna.

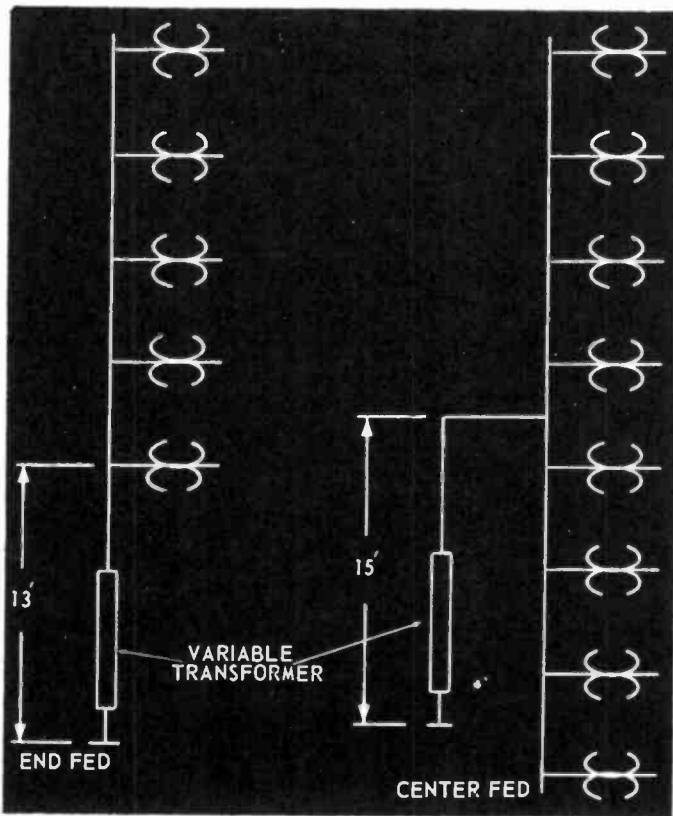

Fig. 8-10. Simplified diagram showing feed line input locations for end-fed and center-fed antennas.

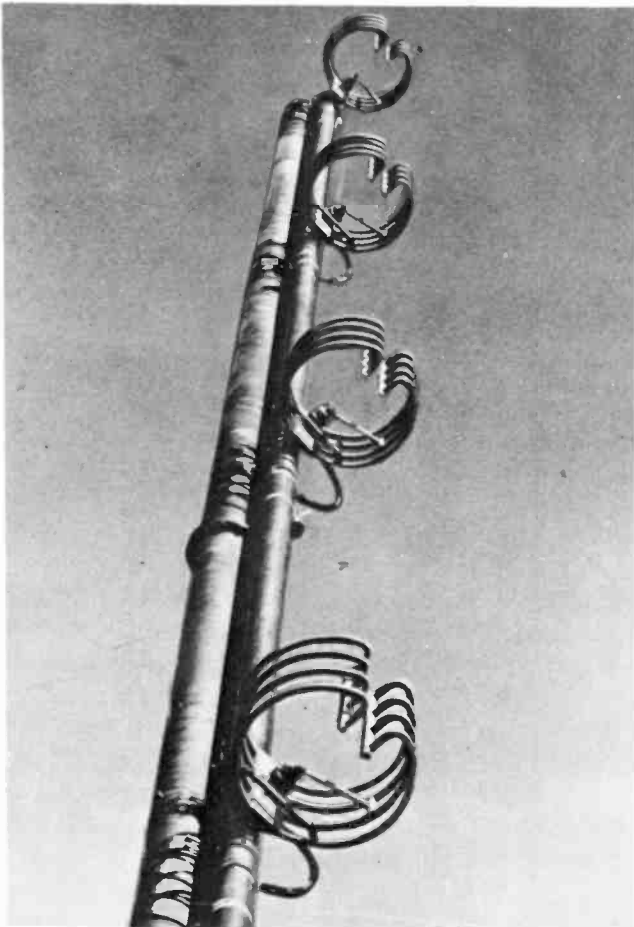

Fig. 8-11. A four-bay horizontally-polarized FM antenna array.

tenna on a self-supported tapered tower (see Fig. 8-5) introduces an effect that may distort the elevation pattern as well as the azimuthal pattern. As there are more vertical components in the structure than horizontal, it is logical that there will be a considerably greater amount of azimuthal radiation pattern effect of a vertically-polarized wave than with a horizontally-polarized wave.

With a top-mounted antenna a minimum effect of 1 db is achieved for azimuthal horizontally-polarized radiation. This effect is greater but acceptable for antennas side-mounted on a tower

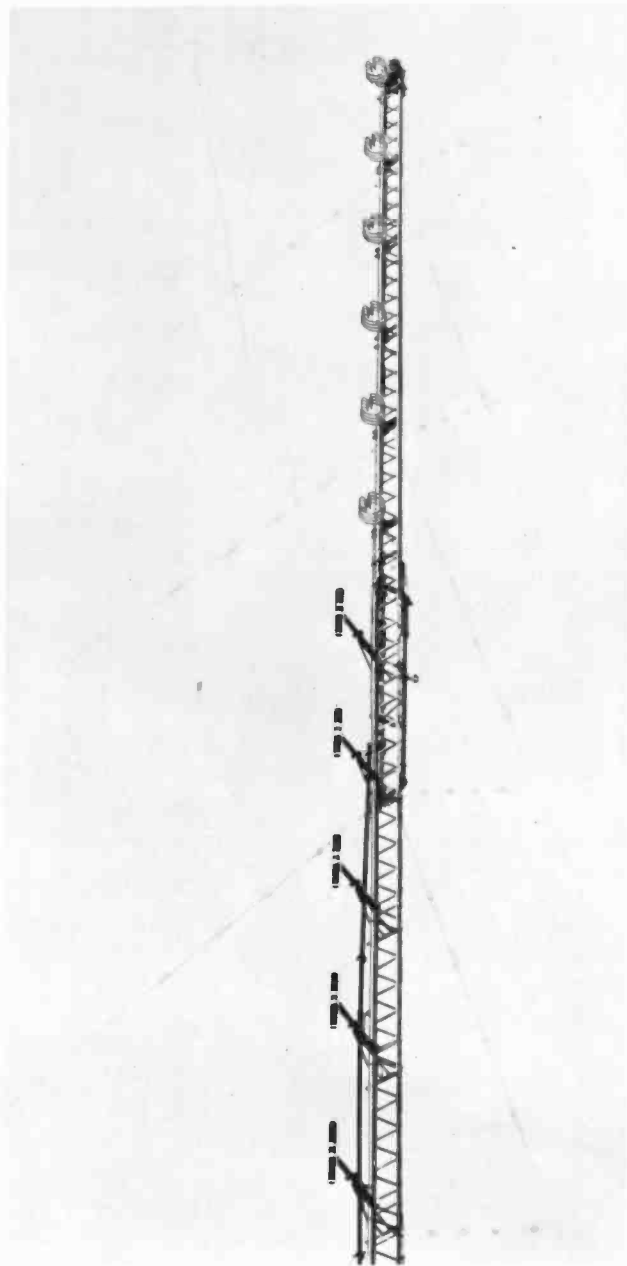

Fig. 8-12. H and V radiator elements side-mounted on a tower.

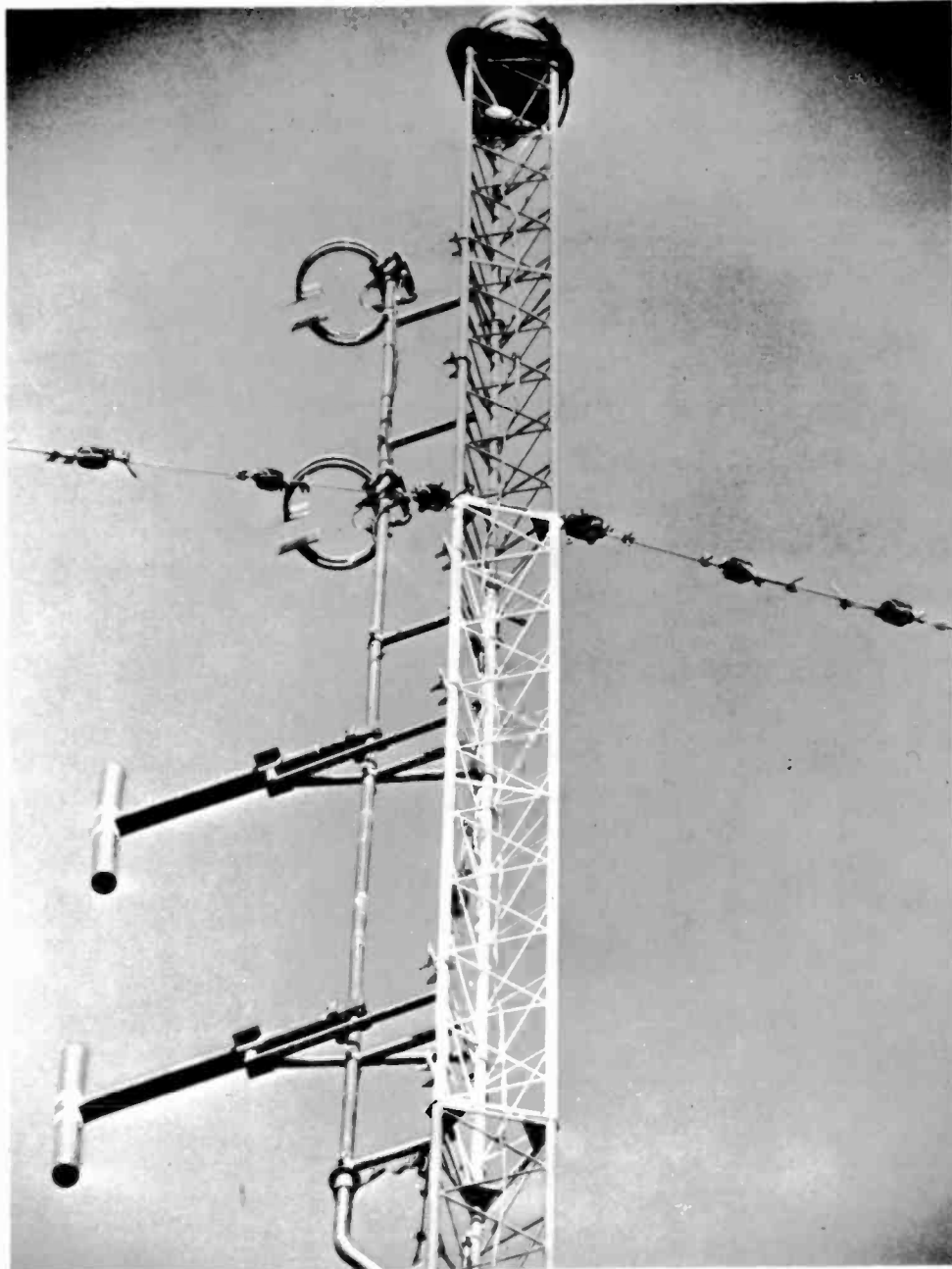

Fig. 8-13. A typical dual-polarized FM antenna array.

of 18 to 24 inches cross section and increases rapidly for larger cross sections. The size and number of cross members in a tower, transmission lines, and lighting wires, all have an effect on any type of FM antenna. As a general statement, FM coverage in the area is best in the direction the antenna array is facing away from the tower. Figs. 8-5, 8-11, 8-12, 8-13, and 8-14 show some typical FM antenna installations.

Transmission lines can be exactly tailored to the application. The antennas can be fed with rigid coaxial copper lines of either 1 5/8-inch or 3 1/8-inch outer diameter, depending upon power levels used, or with heliax air or foam

dielectric semi-flexible line. For FM applications 1 5/8-inch rigid copper transmission lines can handle up to 10 KW (25 KW AM) and 3 1/8-inch cable of the same type will handle up to 40 KW (94 KW AM). Heliac low-loss cable is available in numerous sizes and in either air or foam dielectric types having peak power ratings ranging from 2 to 820 KW. (For low-power AM applications RG cable provides an inexpensive installation. Fig. 8-15 illustrates various types of transmission lines.

Semi-flexible foam dielectric Heliac is lighter and provides maximum resistance to crushing, kinking, and denting, and it requires no pressurizing. Feedlines to the FM antennas should be

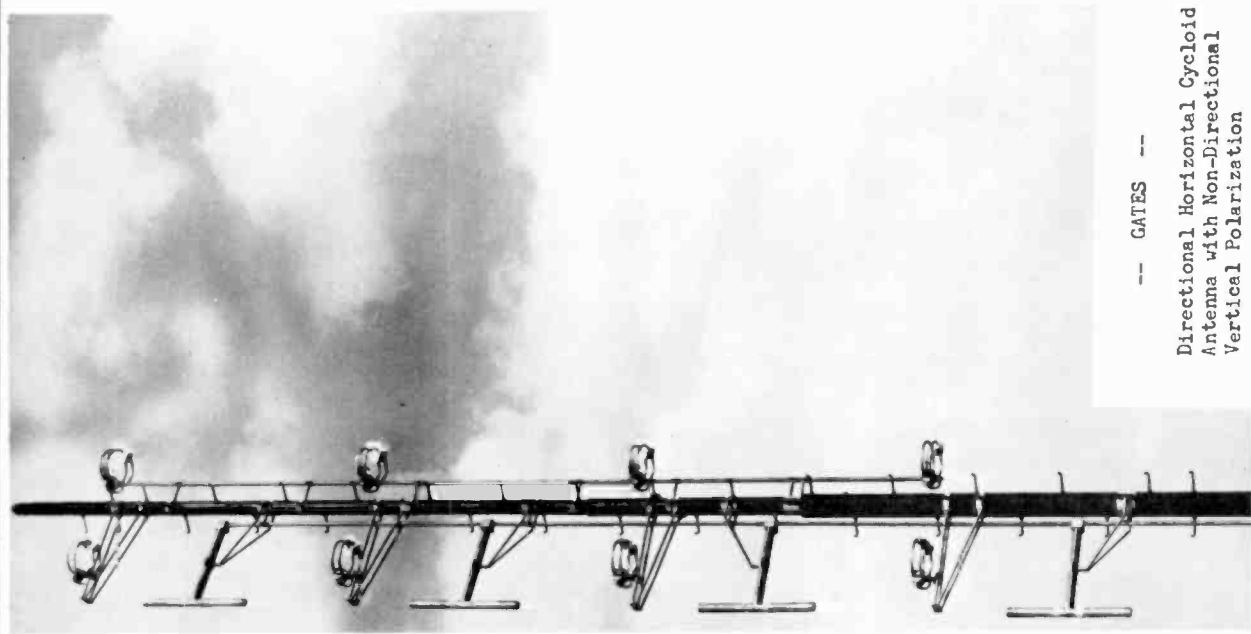

-- GATES --
 Directional Horizontal Cycloid
 Antenna with Non-Directional
 Vertical Polarization

Fig. 8-14. Directional horizontal antenno with non-directional vertical antenno.



Fig. 8-15. Types of transmission line: Rigid 3 1/8-inch copper (a), rigid 1 5/8-inch copper (b), flexible RG cable (c) and flexible Heliac cable (d).

pressurized, however. If foam dielectric cable is used up to this point, a small copper line will have to be run up the tower to pressurize the feedlines and combining harness.

Attenuation and VSWR requirements should be considered when selecting the size and type of transmission line for a given application. In cases where long transmission lines are used, it is proper to select larger and more efficient

lines than indicated by the power considerations. For normal operation FM antennas can be adjusted to VSWRs of 1.1:1 or 1.18:1, depending on whether single- or dual-polarized antennas are employed. In AM applications, VSWRs of 1.5:1 to 2.0:1 are not unusual. An item to consider in AM operation is that the peak power output of an AM transmitter is four times the carrier level.

CHAPTER 9

Transmitter Remote Control Systems

It is becoming almost standard practice in many cases to operate the transmitter remotely from the studio control room. Remote control units are normally interconnected by telephone lines or microwave links. This makes possible an unattended transmitter and eliminates human environmental requirements in a remote transmitter building. A remote control system saves space, and transmitter personnel can be relocated to perform duties in the studio or other areas.

SYSTEM REQUIREMENTS

The method of achieving remote control is not specified by the FCC as long as the system provides the following control and metering functions:

1. Filaments off and on.
2. Transmitter off automatically if the control system fails in any way.
3. Transmitter final plate supply off and on.
4. Meter the final output tube plate current and plate voltage.
5. Meter the antenna current.

6. Monitor the frequency and modulation level.
7. Monitor proper operation of the tower beacon and obstruction lights.

Many installations may require other desirable control functions, with one or two control functions made available in the system for emergencies or for future assignment. A block diagram of a typical remote control system is shown in Fig. 9-1.

For remote control operation the transmitter must have the necessary relays, motor-driven controls, and meter shunts. Existing transmitters without them can be modified to include the necessary equipment.

TYPICAL EQUIPMENT

High reliability and stability should be a major consideration in remote control equipment, because a minor fault resulting in a power shut-down may cause considerable loss of air time. Remote control systems are available for simple or the most complex unattended operations, providing the numerous metering functions, switching, or control operations. The simplified

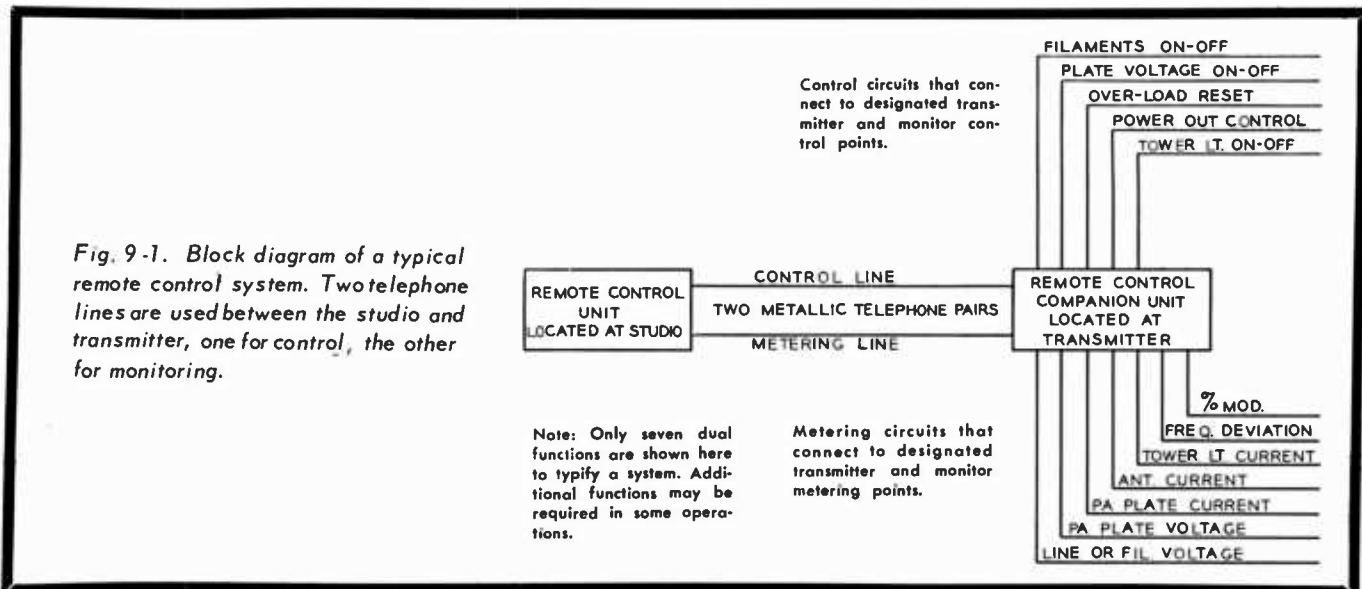

Fig. 9-1. Block diagram of a typical remote control system. Two telephone lines are used between the studio and transmitter, one for control, the other for monitoring.



Studio Unit



Transmitter Unit

Fig. 9-2. Studio and transmitter remote control units.

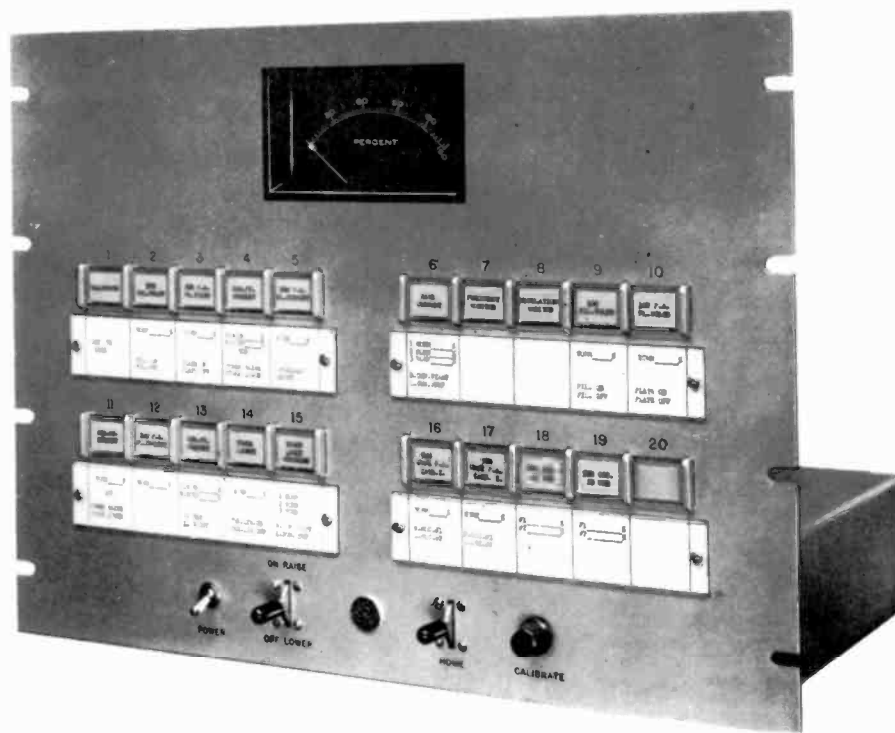

Fig. 9-3. Remote control system control panel.

block diagram in Fig. 9-1 shows the master unit at the studio and the slave unit at the transmitter. Figs. 9-2 and 9-3 show some typical remote control equipments.

The above equipment requires only two metallic telephone pairs. Control orders are sent to the transmitter via one pair of telephone lines. A second pair permits very positive results over

lines up to 60 miles in length or 5000 ohms loop resistance for returning metering information to the studio.

In the DC system, control and metering signals are fed between the units. A 60-Hz tone is used as a fail-safe feature that removes the transmitter from the air should any fault exist or loss of power develop in the control circuits. Tone

operation added to the remote control system permits operation on a single voice-grade telephone line or microwave link.

Accessories may be added to perform virtually any remote control operation such as switching in an emergency power plant, measurement of antenna base currents in multi-tower arrays, tower light metering, switching of standby transmitter, antenna pattern switching, and many other functions. A tone alarm system may be utilized to detect a building over-temperature condition, smoke, burglary, or any condition that could be electrically detected and sensed. Fig. 9-4 lists the functions of a complex remote control system.

Automatic logging equipment is now available to record all operating parameters as required by the FCC Rules and Regulations. The units can perform 5, 10, and 20 functions, either for local or remote control operation. The single point strip chart recorders log as many as five operating parameters which are selected sequentially by a stepping switch. Each function is recorded within a two-second period on inkless pressure-sensitive chart paper.

STL SYSTEMS

Studio-to-transmitter links (STL) are sometimes employed instead of wire facilities to relay transmitter control functions. An STL remote control installation affords considerable flexibility; it can reach into areas where wire circuit services are not available, and it can facilitate expansion of remote control capabilities without increasing the cost of the transmission medium. AM/FM broadcasters are

eligible for licenses in the STL service as designated in Part 74 Subpart E-Aural Broadcast STL and Intercity Relay Stations, Volume III, dated March, 1968.

STL remote control frequencies are allocated in the 942-952 MHz band, and Section 74.531 (c) authorizes operational communications including cues, orders, and other communications directly related to the operation of the broadcast station, as well as special signals used for telemetry or the control of apparatus used in conjunction with broadcasting operations.

For some time, now, many FM broadcasters have been using a subcarrier on the main FM carrier to relay metering data to the studio, where it is picked up with a receiver and fed to monitoring equipment. And for AM broadcasters, effective Dec. 8, 1969, the FCC rules allow meter readings and other telemetry signals to be relayed from transmitter to studio via amplitude modulation of low-frequency tones on the AM carrier. Prior to the above date, such practice was denied AM stations.

If the AM/FM broadcast station planner is extremely conscious of antenna height above the average terrain, it would normally be advantageous to seek an elevated or distant location for the transmitter and antenna array. Frequently, such a location will be in an inaccessible area where telephone lines have not been installed. Therefore, to a broadcaster planning a new station or modernization of an existing station, microwave becomes extremely important.

A typical FM remote control system utilizing a 950-MHz studio-to-transmitter link is shown in Fig. 9-5. The studio is 11 miles by air from the transmitter site which is situated at an elevated location.

Fig. 9-5 shows the makeup of the twin-channel signals. Main-channel audio is transmitted from the studio to the transmitter on approximately 945 MHz while the second audio channel (stereo) is transmitted on 951 MHz. Multiplexed on the 945-MHz channel is an unmodulated 26-kHz subcarrier, and an unmodulated 67-kHz subcarrier is multiplexed on the 951-MHz channel. Before reaching the main transmitter carrier, the 26-kHz subcarrier is modulated with the second audio channel while the 67-kHz subcarrier is modulated with metering data for relay back to the studio via the station's radiated signal, as just mentioned. A stereo receiver at the studio feeds frequency and modulation monitors and the metering data on the 67-kHz subcarrier is fed into direct-readout circuitry.

This system also provides the studio operator with an intricate remote control function channel

Dial	Control	Metering
1	AM Transmitter On-Off	Filament Line
2	AM Plate On-Off	Plate Volts
3	AM Output Raise-Lower	Common Point Current
4	Overload Reset	Plate Current
5	AM Day-Night	Common Point Current
6		Base Current 1
7		Base Current 2
8		Base Current 3
9		AM Frequency Deviation
10		AM % Modulation
11	Spare	
12	Spare	
13	FM Transmitter On-Off	Filament Line
14	FM Plate On-Off	Plate Volts
15	FM Output Raise-Lower	Reflectometer
16	FM Overload Reset	Plate Current
17		FM Frequency Deviation
18		
19	Tower Lights On-Off	Lighting Current
20	Home	Calibrate

Fig. 9-4. List of control and metering functions offered by a complex system.

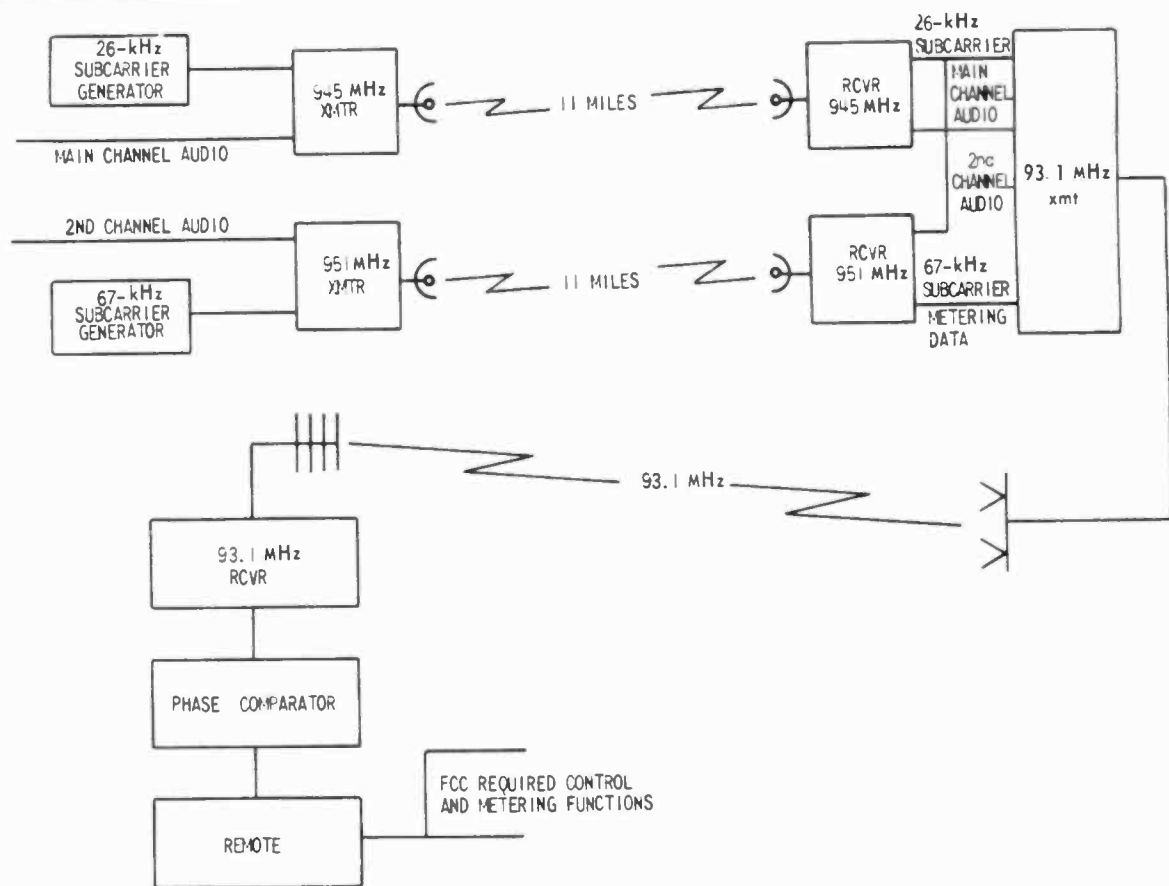

Fig. 9-5. Block diagram of a typical FM remote control system using an STL.



Fig. 9-6. Block diagram showing other STL remote control functions.

to raise and lower voltages and adjust the transmitter and turn it on and off at will. It also incorporates a "fail-safe" system which removes the carrier from the air if the control system itself fails.

Although the FCC Maintenance Rules require that a first class radiotelephone operator inspect and log the transmitter meter readings five days each week, the need for constant supervision is eliminated by remote metering and control functions. Usually, AM/FM remote

control STL requirements are such that any broadcast engineer can install the equipment, connect the antennas, transmission lines, and transmitter-receiver units and put it in operation.

Also available to the station planner are other STL units offering four or five circuits where required from the transmitter site to the remote control point. As shown in Fig. 9-6, these include:

1. A control channel
2. A telemetering channel

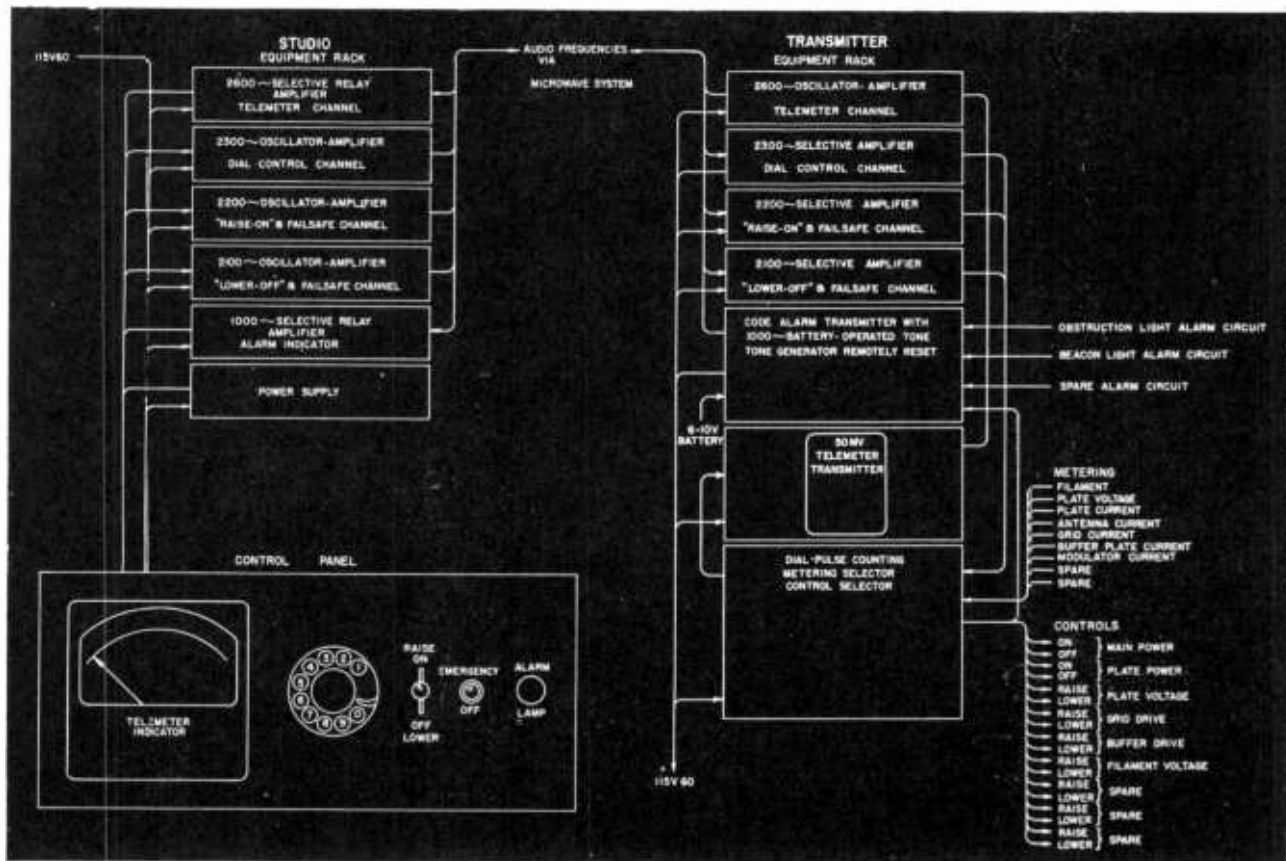

Fig. 9-7. A block diagram of an STL remote control and telemetering system.

3. An order wire
4. A program circuit
5. A second program circuit (stereo)

These equipments represent a new concept in the design of broadcast transmitter remote control systems.

The STL remote control system is simple, versatile, and reliable and usually features pushbutton and telephone dial mechanism selection of 42 control and 21 telemetering metering

channels. Complete remote control systems are available from many broadcast equipment manufacturers. A block diagram of a commercial system is shown in Fig. 9-7. Usually in each case existing conditions determine economic feasibility. But immediately obvious is the saving in telephone line costs (if lines are available), plus the fact that an STL system is less susceptible to outages caused by violent acts of nature which can cause the destruction of leased lines.

CHAPTER 10

Studio & Monitoring Equipment

While the technical equipment required for an AM or FM radio facility is usually determined basically by station size, power, layout, and programming, it should be remembered that operating flexibility depends on the equipment selected.

AUDIO SYSTEM EQUIPMENT

It is a well-known fact that no two broadcast stations have the same operating requirements. The selection and arrangement of microphones, turntables, tape systems, control consoles, amplifiers, and other operational equipment will certainly differ for each installation. So, many broadcasters choose to have their control equipment exactly tailored to the station's requirements.

AUDIO CONTROL CONSOLES

The most important reason for the addition of or the replacement of a control console is the need for more inputs, better performance, and ease of operation. A new console may be needed because of the addition of a new studio facility, additional microphones, or when FM stereo facilities are added to the broadcast station. As the number of remote programs increases, the telephone input requirements to the console increase, also. Many stations settle for a small audio console in order to increase the flexibility of facilities in the production control room to produce commercials and station promotion recordings.

The audio system console should be constructed of the highest quality components. Components should be selected for their long life and dependability. Consoles that provide quality performance with versatility and adaptability use telephone-type switches for their superiority over wafer switches and step attenuators rather than carbon types. Manufacturers presently offer broadcast consoles containing photoconductive cells and lamps in sealed enclosures that per-

form switching and control attenuation of the audio signal.

Many consoles are fully transistorized using the most advanced state-of-the-art circuitry. Plug-in modular design provides complete accessibility with interchangeability of modules and sub-assemblies and quick convenient servicing. Due to the shortage of competent technical maintenance personnel, reliable equipment operation is that much more vital to a successful broadcast system. Figs. 10-1 through 10-5 picture audio control consoles suitable for a variety of applications.

The console in Fig. 10-1 is a fully transistorized compact stereo console offering mixing and switching functions. It features pushbutton selections of high-level sources, relay switching, and built-in intercom. Operation can be remoted and the plug-in modules are interchangeable. The unit will normally provide audio amplification, switching control, and monitoring facilities for the operation of a small AM/FM broadcast station.

The single-channel studio console shown in Fig. 10-2 (upper left) is a completely self-contained, high-fidelity audio system for three-channel mixing, switching, and monitoring. This console features dependable solid-state plug-in amplifiers, low-impedance mixing circuits, and built-in cue/intercom amplifier.

The dual-channel audio console is a completely self-contained unit providing both stereo or monaural mixing, switching, and monitoring facilities, plus dependable plug-in transistorized amplifiers and a built-in cue intercom amplifier. There are ten mixer positions consisting of five low-level, three high-level and two line-level. Dual mixer controls are used in all stereo positions. Provisions are included for the installation of AGC meters so the gain reduction of an external AGC amplifier may be observed while controlling program gain. Plug-in modules for both consoles are also shown in Fig. 10-2.

The speech input console shown in Fig. 10-3 features a new concept in switching technique—

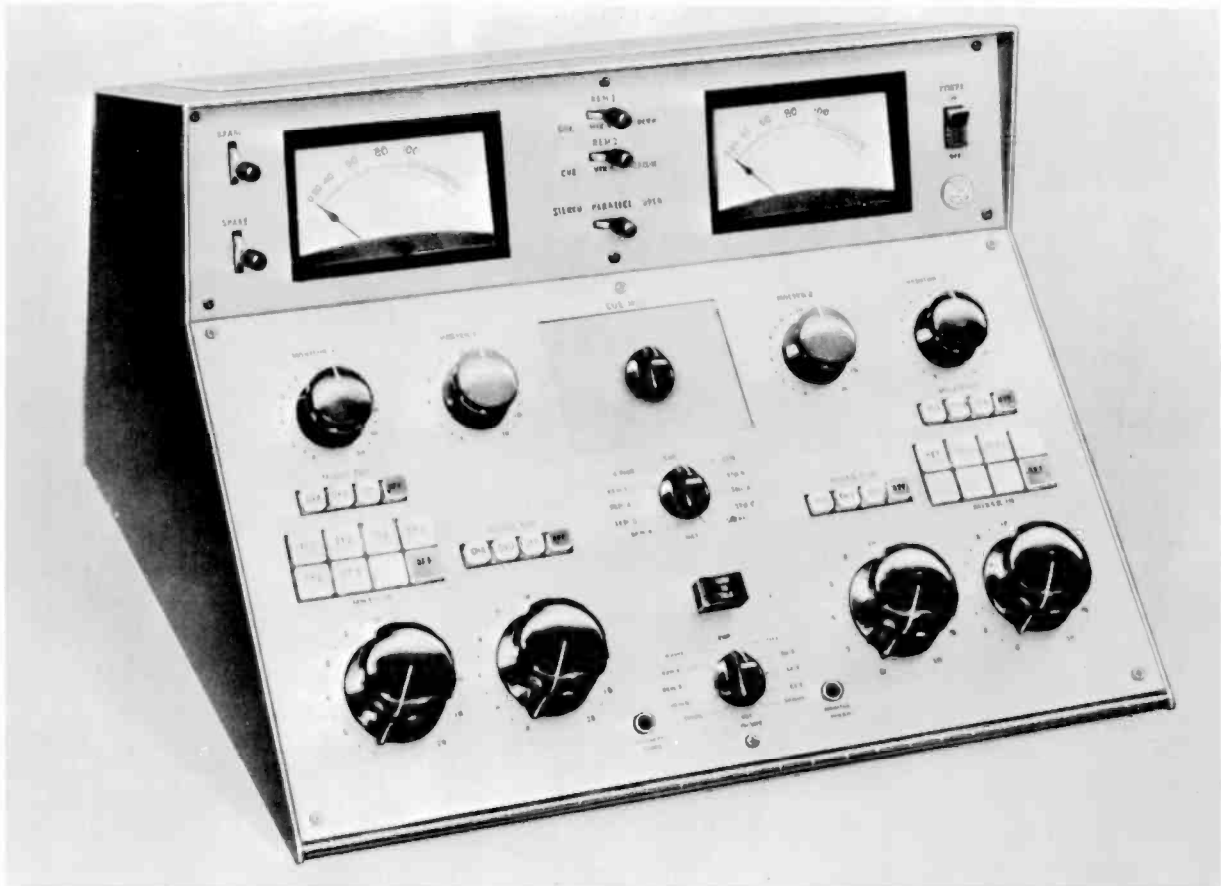

Fig. 10-1. A compact solid-state audio mixer console.

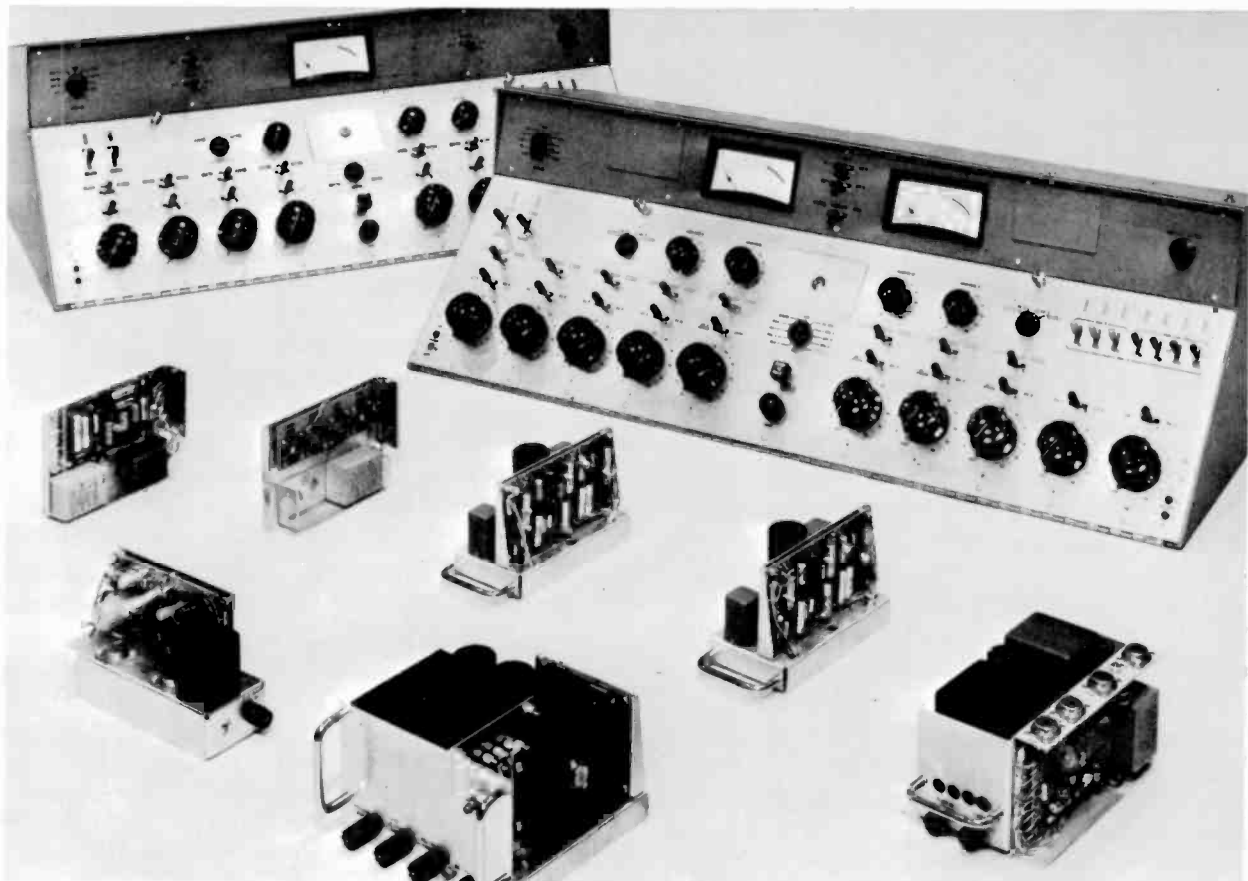

Fig. 10-2. Single and dual channel audio consoles.

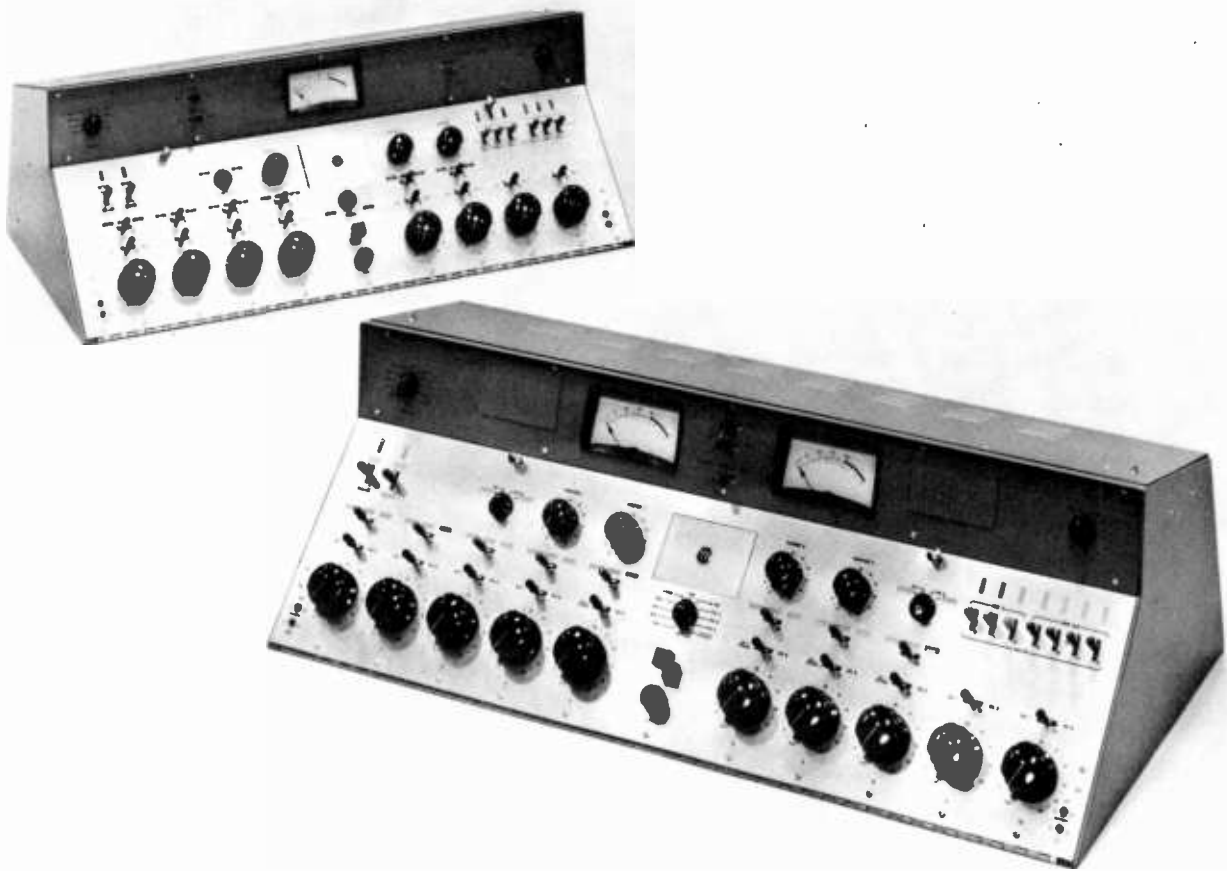

Fig. 10-3. Stereo speech input console.

a photo-conductive cell and a lamp in a sealed enclosure. The panel control varies the intensity of the lamp on the photocell which in turn controls the audio level. A similar device for program level control is also used. Although the unit was designed primarily for stereo, it can also be used for monaural. In fact, it can provide a monaural output simultaneously on both program channels from a single input, or can handle completely separate monaural signals from inputs through two program outputs.

The solid-state amplifiers and control elements in the console shown in Fig. 10-4 are mounted on plug-in cards that fit in two card boxes, one for each program channel. The card box provides space and receptacles for six high- or low-level preamplifiers, one program amplifier, one monitor amplifier, and one switch matrix for remote line input switching (Fig. 10-5).

Another type of console shown in Fig. 10-6 offers maximum operational flexibility plus all the benefits of transistorized design. This monaural console is designed for either single- or dual-channel applications in studio and mas-

ter control audio systems. Notice that the console has eight input channels and eight mixers. Another model has four input channels and four mixers. Instead of knobs the attenuators are slide-operated.

Both models include two mixer buses, two program/monitor amplifiers, and a built-in cue facility. All input amplifiers function at either low-levels (microphone) or medium-levels (tape line, phone, etc.). All amplifiers are mounted on plug-in boards for simple conversion or servicing.

These consoles may be operated in either single- or dual-channel modes and the design is such that mixer attenuation is accomplished by a balanced bridge circuit which includes a light-dependent resistor and a controlling lamp. The lamps are controlled by vertical step-type control units located on the hinged front panel.

CUSTOM AUDIO CONTROL EQUIPMENT FOR AM/FM STATIONS

Some control rooms are quite complex in the

number of circuits and control functions required. Therefore, such stations incorporate custom audio control equipment designed and installed to achieve an easily operated setup that allows nearly foolproof switching along with functional flexibility. Leading equipment manufacturers, in addition to offering a comprehensive line of standard studio control equipment, specialize in designing and building complete custom speech input systems to meet the individual needs of stations and networks.

Since no two AM/FM broadcast stations have exactly the same operating requirements, equipment needs range from special equipment for small and medium size stations to more complex systems for the largest installation. In planning new installations, or modifying existing facilities, this custom-built equipment service is available to every AM/FM broadcast station. For those who insist on designing the system themselves, the equipment manufacturer usually will provide specifically built units to meet the station specifications for the equipment needed. Fig. 10-7 illustrates one type of modern custom audio control console.

Fig. 10-8 is a view of a modern control position designed for operating ease. The center features built-in turntables, dual-channel stereo console, and cartridge tape equipment.

The custom master control console in Fig. 10-9, designed for a large radio network, features solid-state circuitry, sound-effects controls, sub-mixers, equalizers, echo effect, monitor controls, and unitized construction for troubleshooting accessibility. The left side of the console contains effects filters and space for another mixer module. In the center is the echo control, submaster equalizers, and Vu meters. The desk portion contains mixing faders and sub-master controls. To the right, the console has monitor and sound reinforcement controls and mixer modules; below are four monitor selector knobs. Further to the right is the patching unit.

TRANSCRIPTION TURNTABLES

The most important "audio" characteristics of the turntable, pickup, and associated preamplifier are wow, flutter, hum, rumble, and frequency response. Due to the recent advances in

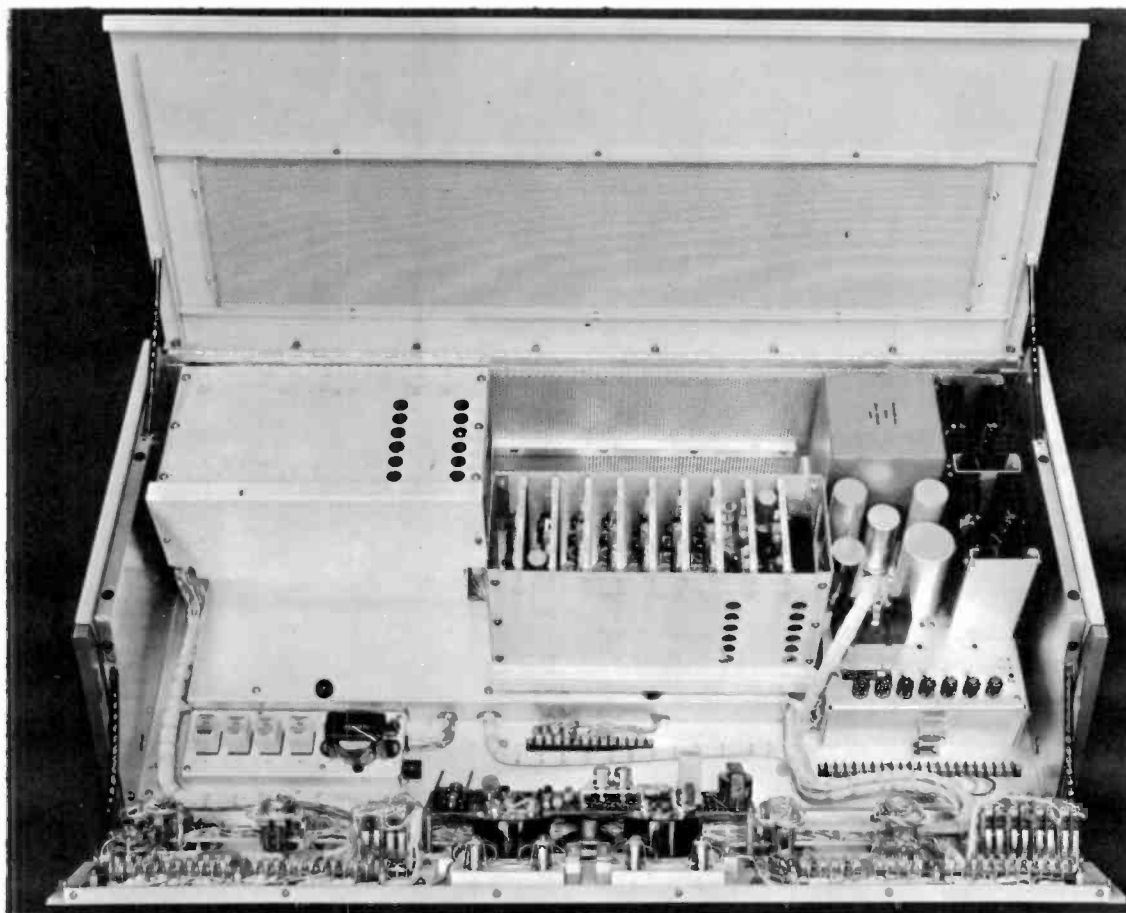

Fig. 10-4. Card box used to mount the plug-in cards.

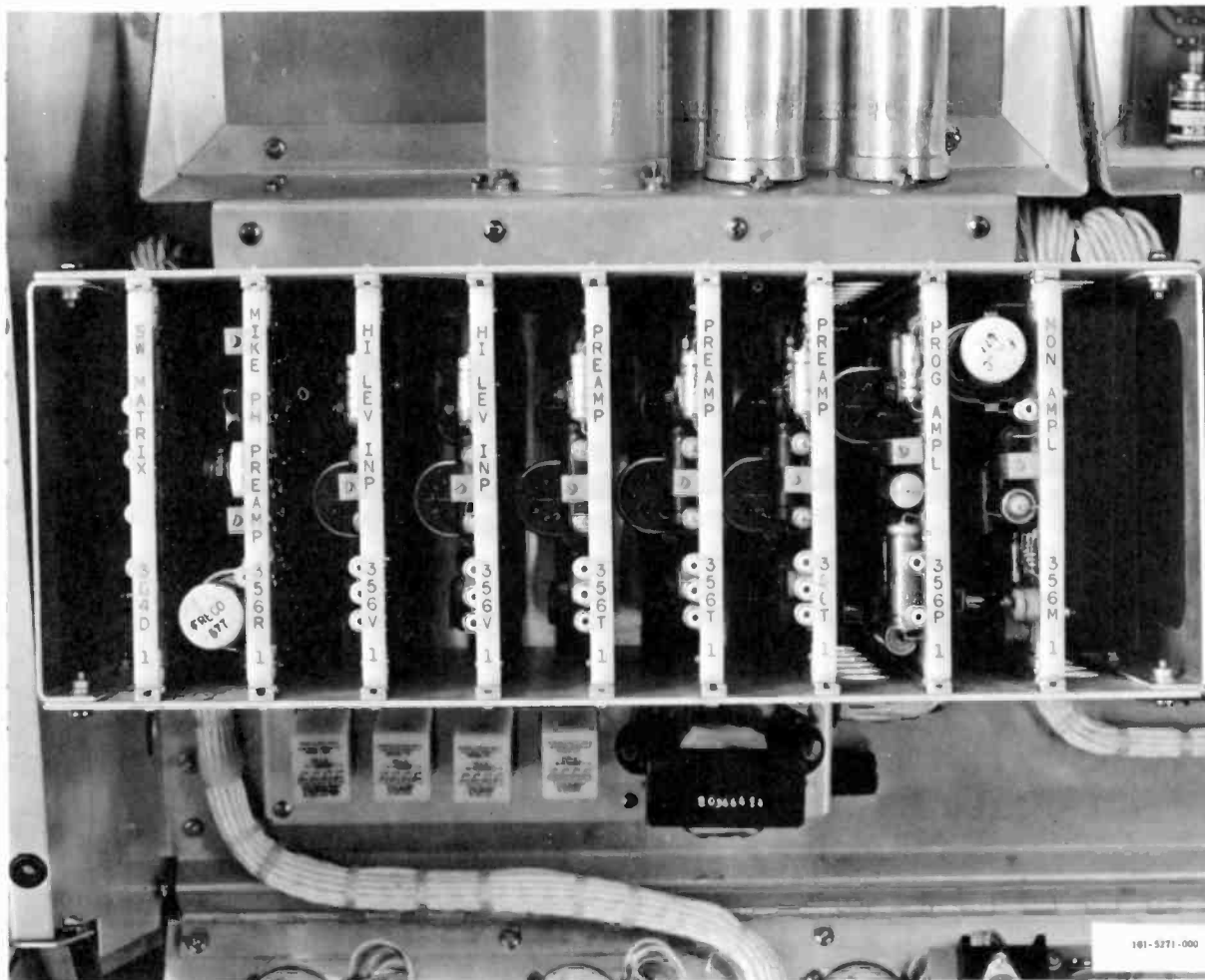

Fig. 10-5. A close view of the plug-in cards installed in a card box.

recording techniques and stereo broadcasting, vertical rumble must now be as negligible as lateral rumble. "Rumble" is actually an industry-coined word used to define all unwanted noises in transcription equipment that, if existing above a certain level, will be transmitted through the pickup cartridge in the form of objectionable noises. The turntable shown in Fig. 10-10 is a compact precision unit for 33 1/3 and 45 RPM. It is smooth in operation with low rumble and rapid start. The unit has provisions for two tone arms and pickup preamplifier.

MONITOR AND REMOTE EQUIPMENT

The speaker pictured in Fig. 10-11 is ideal for studio or control room monitoring and other broadcast applications. Frequency response is 25 to 16,000 Hz; it offers wide-angle distribution and low distortion. Speakers such as this can be

installed in an in-line formation in a cabinet for various output ratings.

The four-channel portable remote amplifier illustrated in Fig. 10-12 is a lightweight unit with a transistorized amplifier; it has a self-contained battery power supply or will operate from the AC line. It affords amplification and control facilities for broadcast programs remote from the studio, amplifying low-level signals to a point suitable for transmission over a telephone line to the station studio. Complete cueing and monitoring facilities are useful features in remote equipment.

AUDIO SIGNAL CONTROL EQUIPMENT

Audio signal processing equipment is a vital link in a broadcast installation. Such equipment is designed to automatically control audio peak and average levels fed to an AM or FM trans-

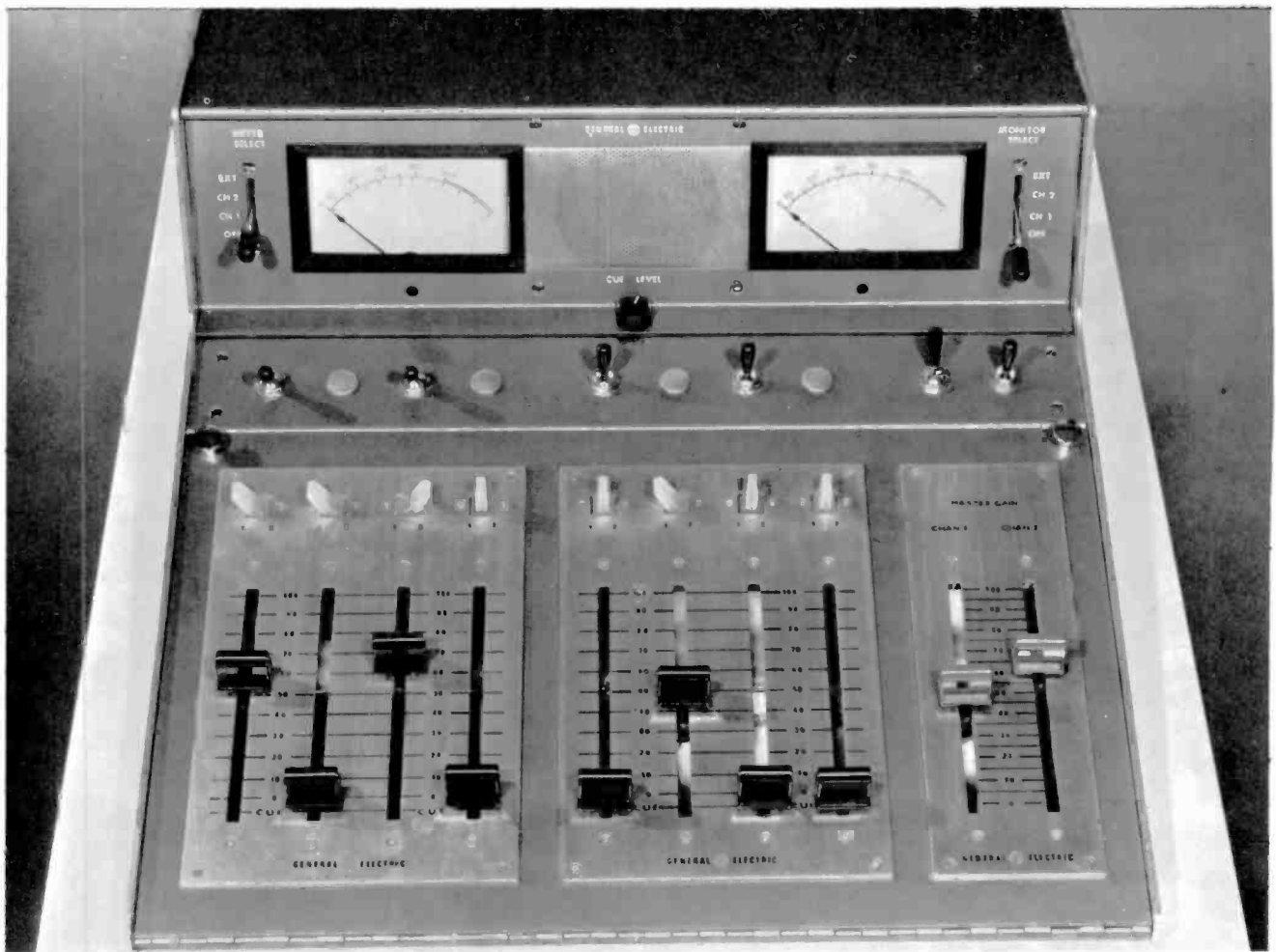

Fig. 10-6. A solid-state monaural audio control console.

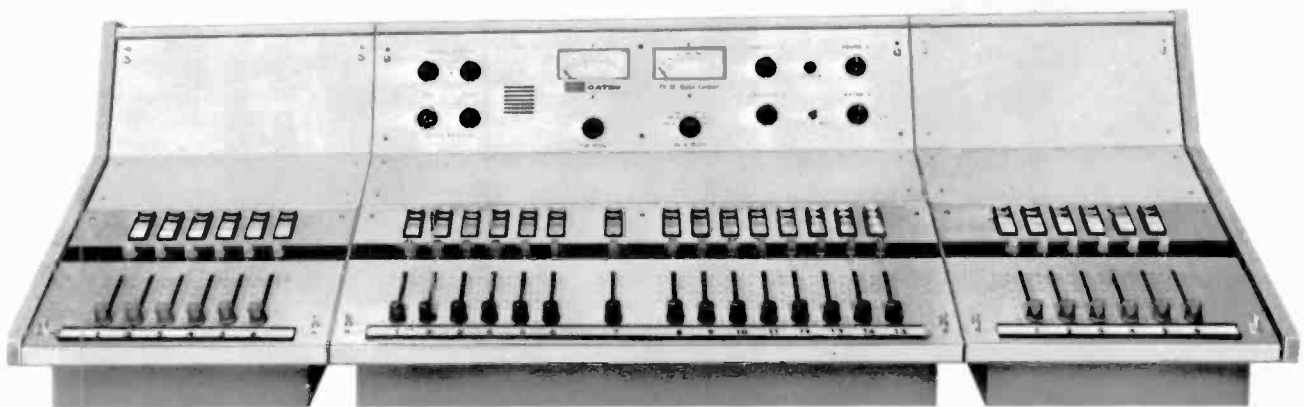

Fig. 10-7. Custom-built master console with numerous individual mixers.

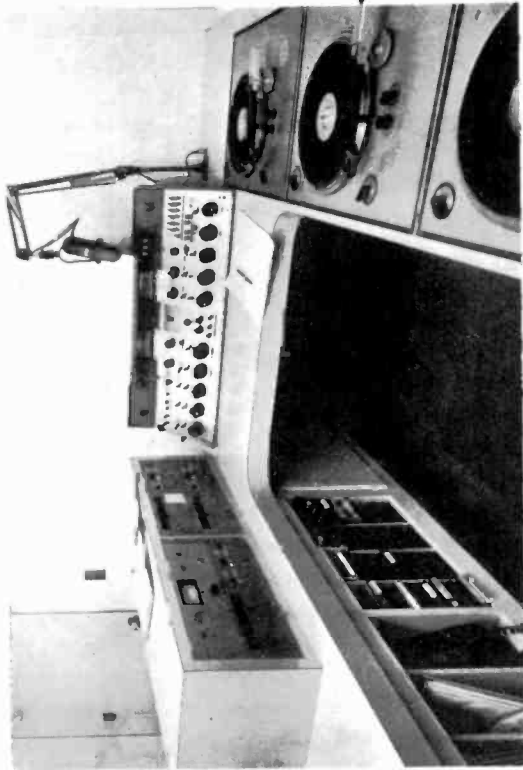

Fig. 10-8. A custom designed operating center.

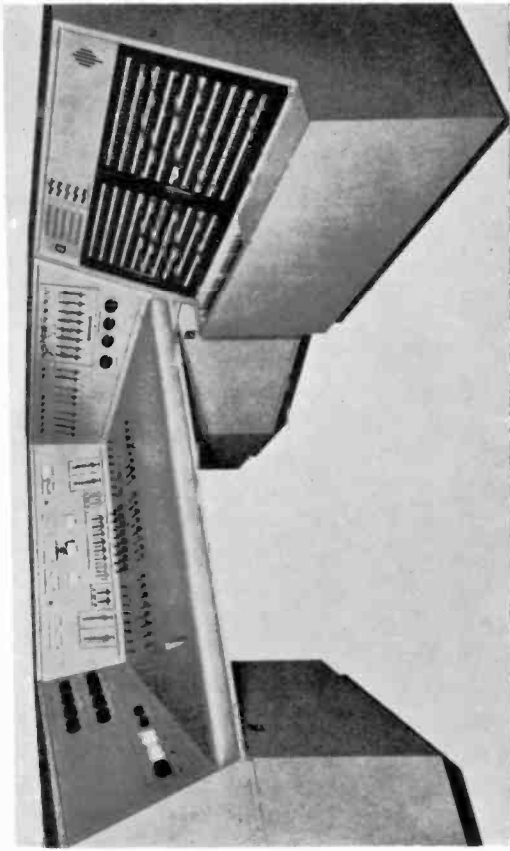

Fig. 10-9. Custom-built master control facility.

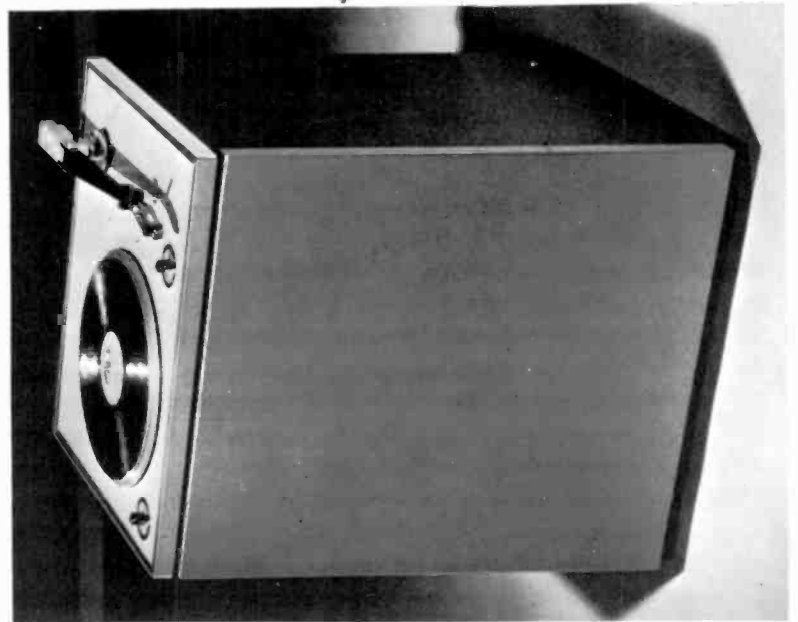

Fig. 10-10. A dual-speed transcription turntable.

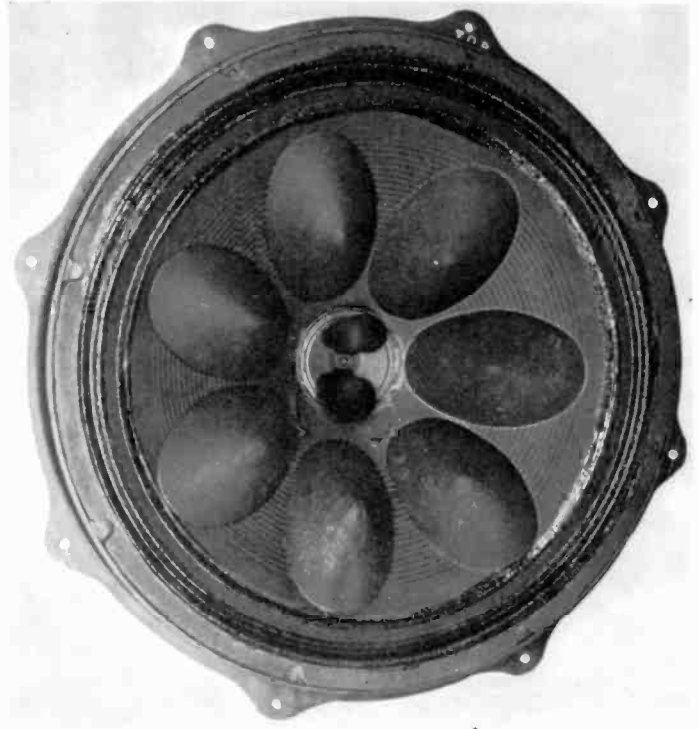

Fig. 10-11. Duo-cone speaker ideal for control room or studio monitoring.

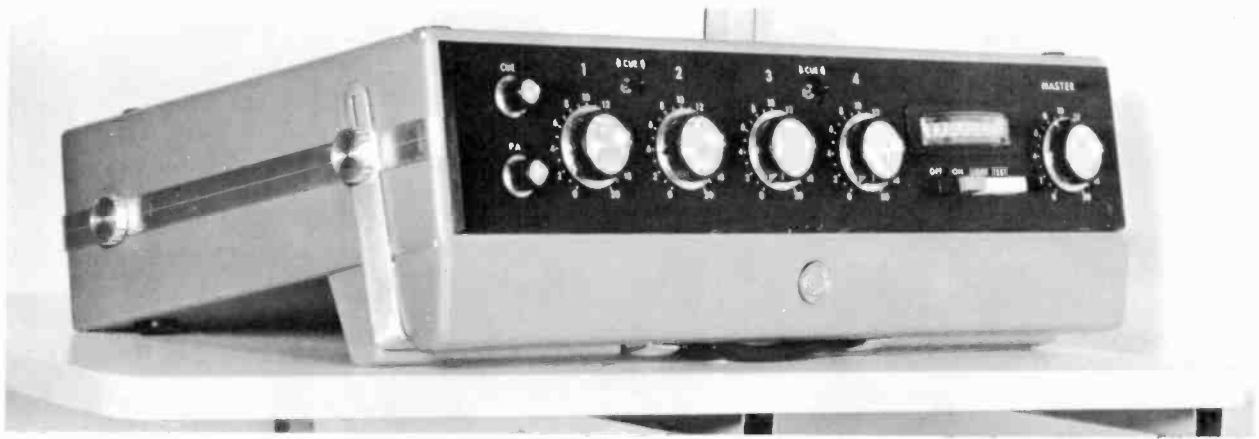

Fig. 10-12. A four-channel solid-state remote amplifier.



Fig. 10-13. Program amplifier shown with AGC and limiter units in a rack-mounting shelf.



Fig. 10-14. A peak clipper amplifier.



Fig. 10-15. Dual peak-limiting amplifier designed for stereo or dual monaural operation.



Fig. 10-16. A dual-channel FM program level control unit for stereo and monaural service.

mitter. The purpose of such equipment is to prevent overmodulation, interchannel interference, or damage to the transmitter.

In some installations automatic gain control (AGC) amplifiers with slower "attack" and "recovery" times are used to maintain a constant average audio level from the console. However, the old "standby" peak limiter with its faster attack time is normally used at the input of the transmitter because of its ability to limit the

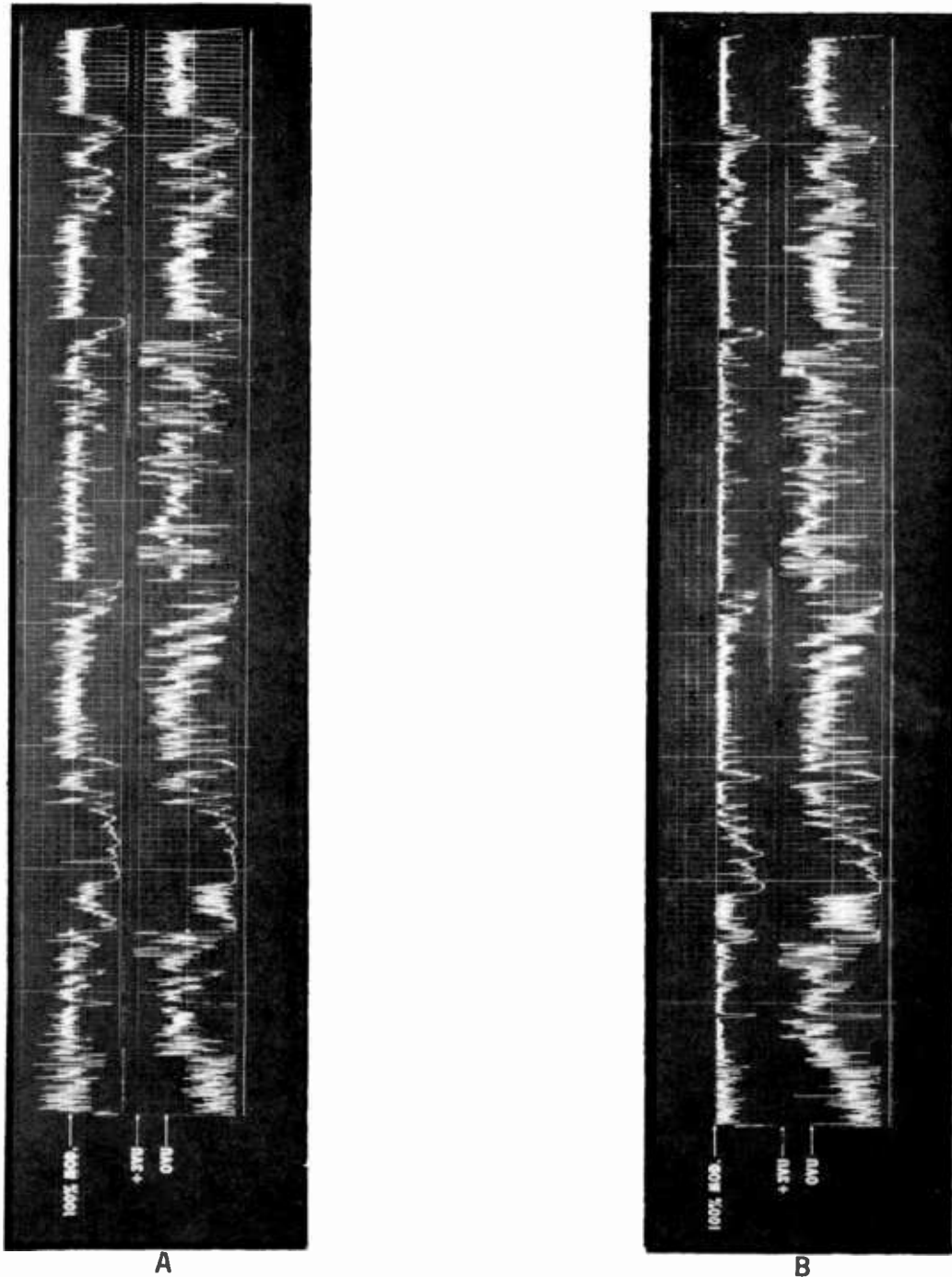

Fig. 10-17. Graphic chart of AGC amplifier output over the input signal (A). A strip recording made at the output of an automatic audio program level control equipment.(B)

amplitude of rapid transient peaks.

In FM broadcasting, the higher audio frequencies are given special treatment by a 75 microsecond pre-emphasis network normally installed at the FM transmitter input. The result is a high-frequency boost that tends to cause overmodulation, which can be prevented by a high-frequency "roll-off" or by peak clipping equip-

ment used after pre-emphasis, or by a combination of both.

Several types of equipment have been developed in an attempt to cope with the FM overmodulation problem. It is necessary to reduce the peaks without affecting the average level. One equipment type resorts to "rolling-off" the high-frequency response by some amount that depends

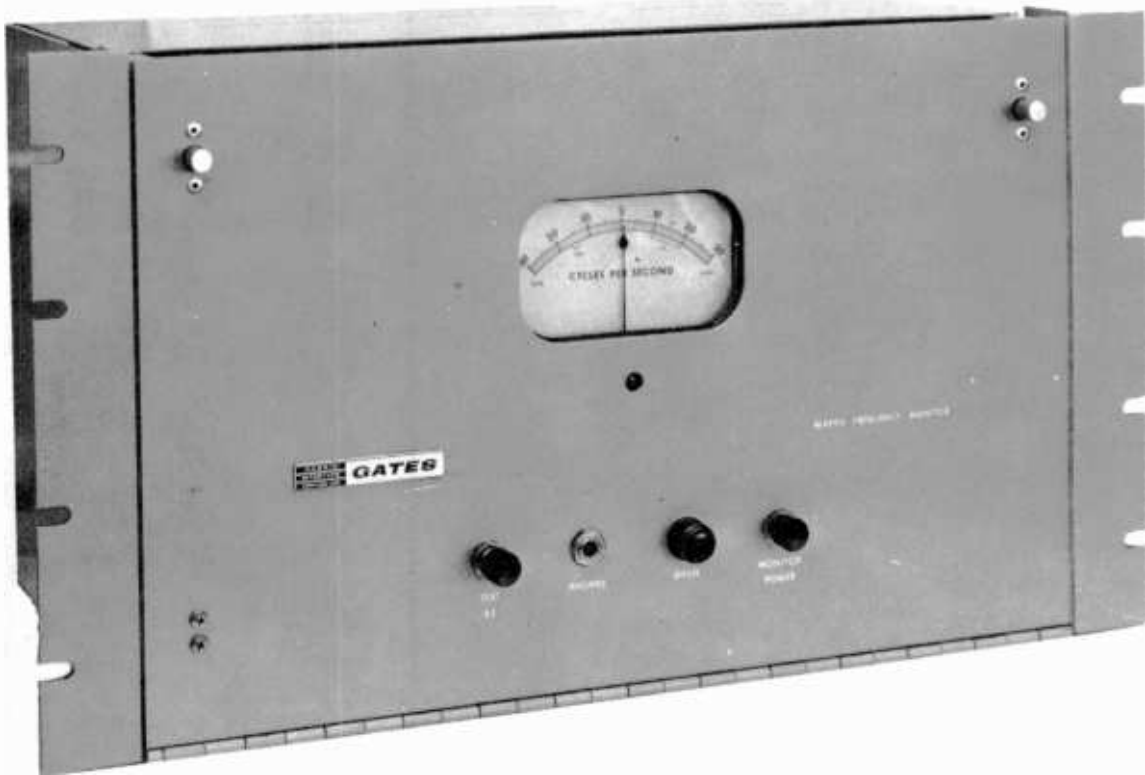

Fig. 10-18. AM frequency monitor.

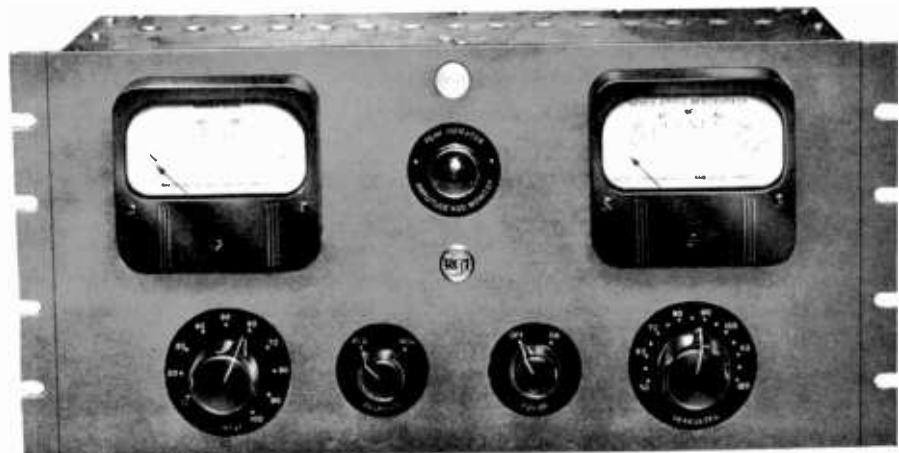

Fig. 10-19. AM modulation monitor.

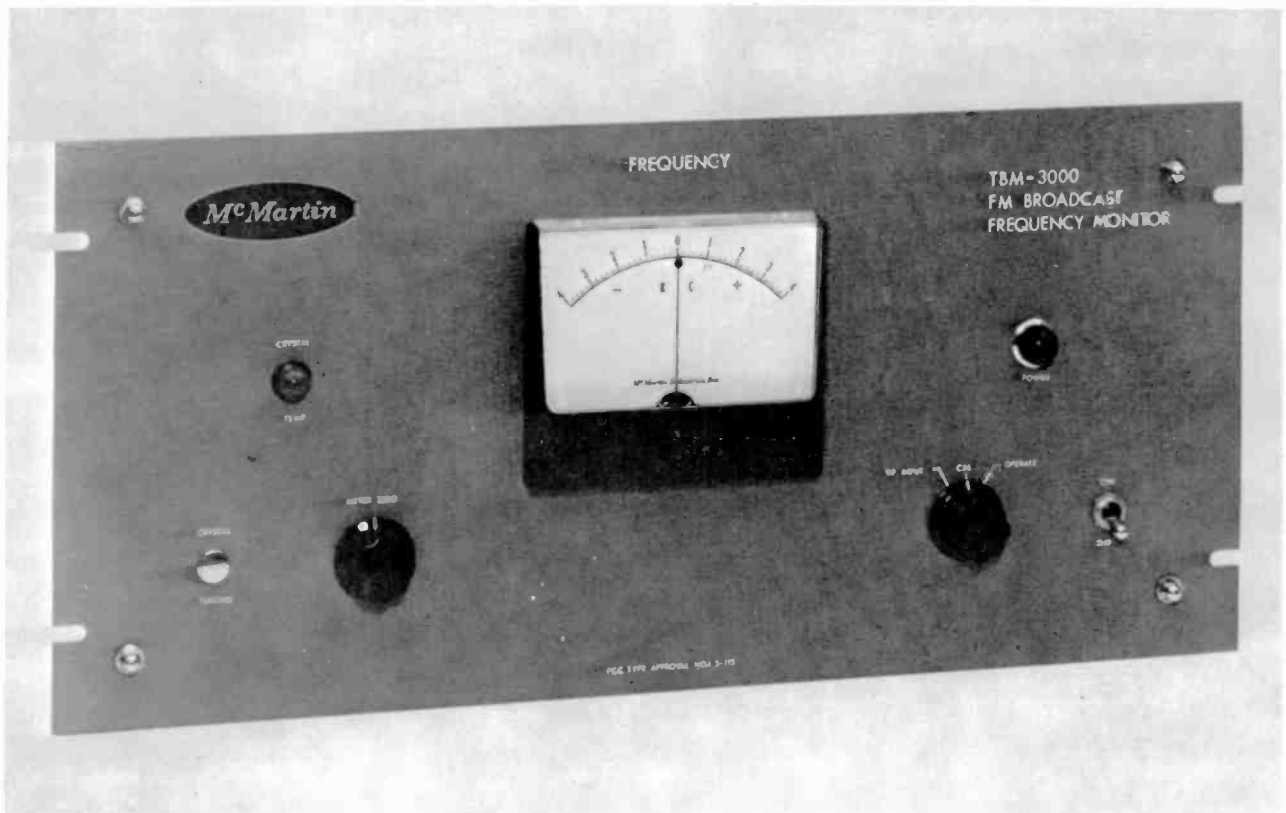

Fig. 10- 20. FM frequency monitor.



Fig. 10- 21. FM modulation monitor.



Fig. 10-22. FM/SCA modulation monitor.

on the signal level and the other uses peak clipping after pre-emphasis. Therefore, it is extremely important to select the proper signal processing equipment to provide absolute protection against overmodulation but at the same time without reducing signal gain and with no audible degradation of the signal. Figs. 10-13, 10-14, 10-15, and 10-16 show various automatic audio program level control units.

The strip recording reproduced in Fig. 10-17A shows the audio signal output from an AGC amplifier. Although the AGC chart exhibits an extremely uniform average signal level, the signal definitely exceeds 100% modulation. Fig. 10-17B shows graphically the performance of automatic audio program level control equipment when a normal program signal is properly under control. Notice the better controlled peaks and higher average signal levels achieved by the addition of signal control equipment. Automatic gain peak level control equipment specifically prevents transmitter overmodulation and maintains

a higher and more uniform audio level with the least distortion. For broadcast stations which must maintain a uniform program level from various sources, including a control console, the necessity of such equipment is apparent.

MONITORING EQUIPMENT

High quality monitoring equipment is an important adjunct of AM/FM station facilities. Such equipment is necessary to maintain broadcast operations and assure compliance with FCC standards. The input and monitoring equipment for the AM/FM station usually consists of FCC type-approved frequency and modulation monitors. Figs. 10-18 and 10-19 are photographs of an AM frequency monitor and modulation monitor. Fig. 10-20 shows an FM frequency monitor and Fig. 10-21 an FM modulation monitor. Fig. 10-22 is a photograph of an FM modulation-SCA multiplex monitor.

Program Automation

Magnetic tape and tape cartridges contribute considerably to modern AM/FM broadcast techniques, and the nature of the tape medium lends itself readily to automation in varying degrees. The practice of assembling various program categories on magnetic tape provides extra flexibility in scheduling, simplifies program operations, and reduces the cost of program production. Numerous tape formats are available in mono or stereo, cartridge and reel-to-reel, two-track and four-track stereo, manual and automatic equipment.

CARTRIDGE SYSTEMS

Cartridge tape systems offer instant playback of recordings without cueing and threading. Using a continuous-loop cartridge, the program material is recorded with a "stop" tone immediately preceding it. After playback on the air, the material (announcement, promo, etc.) is re-cued, ready for repeat play, by the "stop" tone.

Tape cartridges provide precise timing of program segments and offer the broadcaster the most

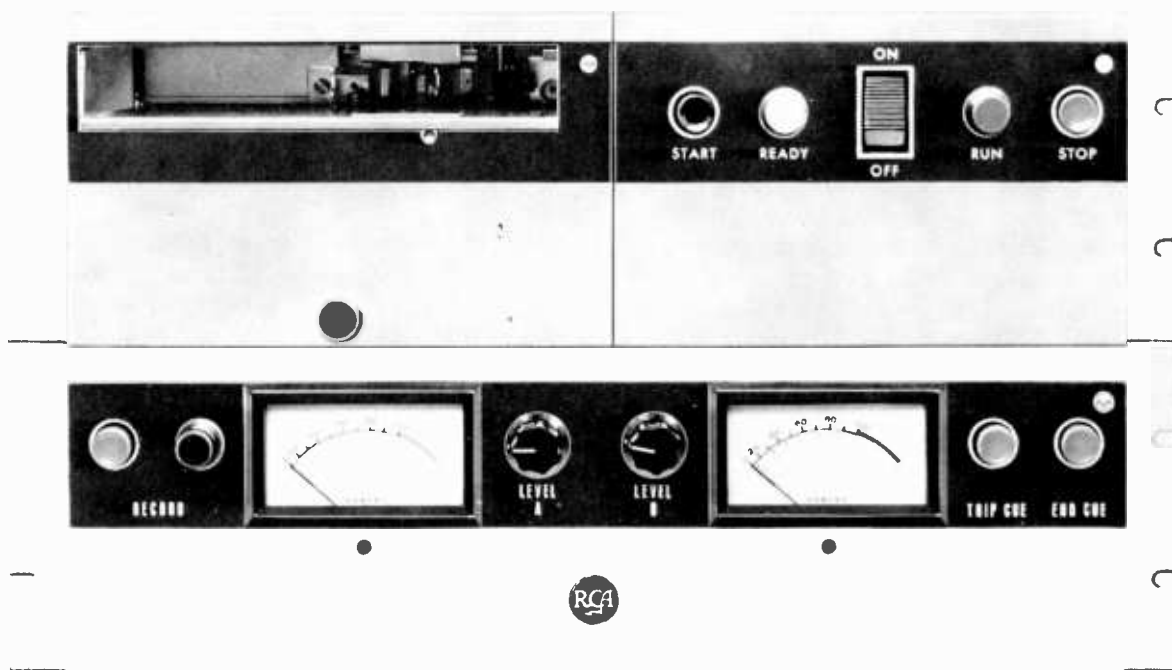

Fig. 11-1. A typical, modern cartridge tape system.

convenient storage medium and the quickest and easiest access to selected segments of program material. Also, "cue" tones, recorded before

and/or after program segments to activate associated equipment make the equipment readily adaptable for automatic or semi-automatic operation.

Multi-cartridge tape systems, designed especially for heavy traffic stations, relieve operating personnel by automatically handling a series of program segments through start/stop and audio switching in rapid succession. At least two hours of recorded material can be programmed with one multi-cartridge unit, an advantage which can be applied with as many other units as desired. Cartridge tape systems can be remotely controlled, too. Figs. 11-1, 11-2, and 11-3 illustrate basic cartridge tape systems.

The cartridge tape units shown in Figs. 11-1 and 11-2 feature solid-state construction and are designed for monaural or stereo cartridge record and playback operation. Each offers three cue-tone frequencies, plug-in circuit boards, and a pull-out tape transport. Fig. 11-3 shows a compact monaural or stereo unit which plays all NAB standard-size cartridges. The unit can be con-

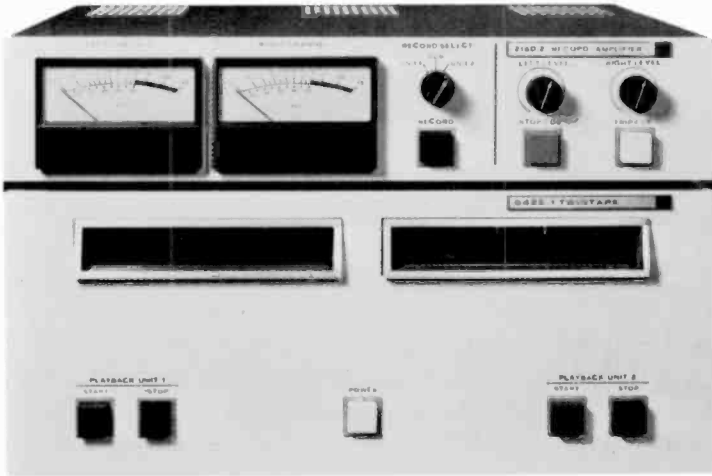

Fig. 11-2. Another solid-state cartridge tape system.

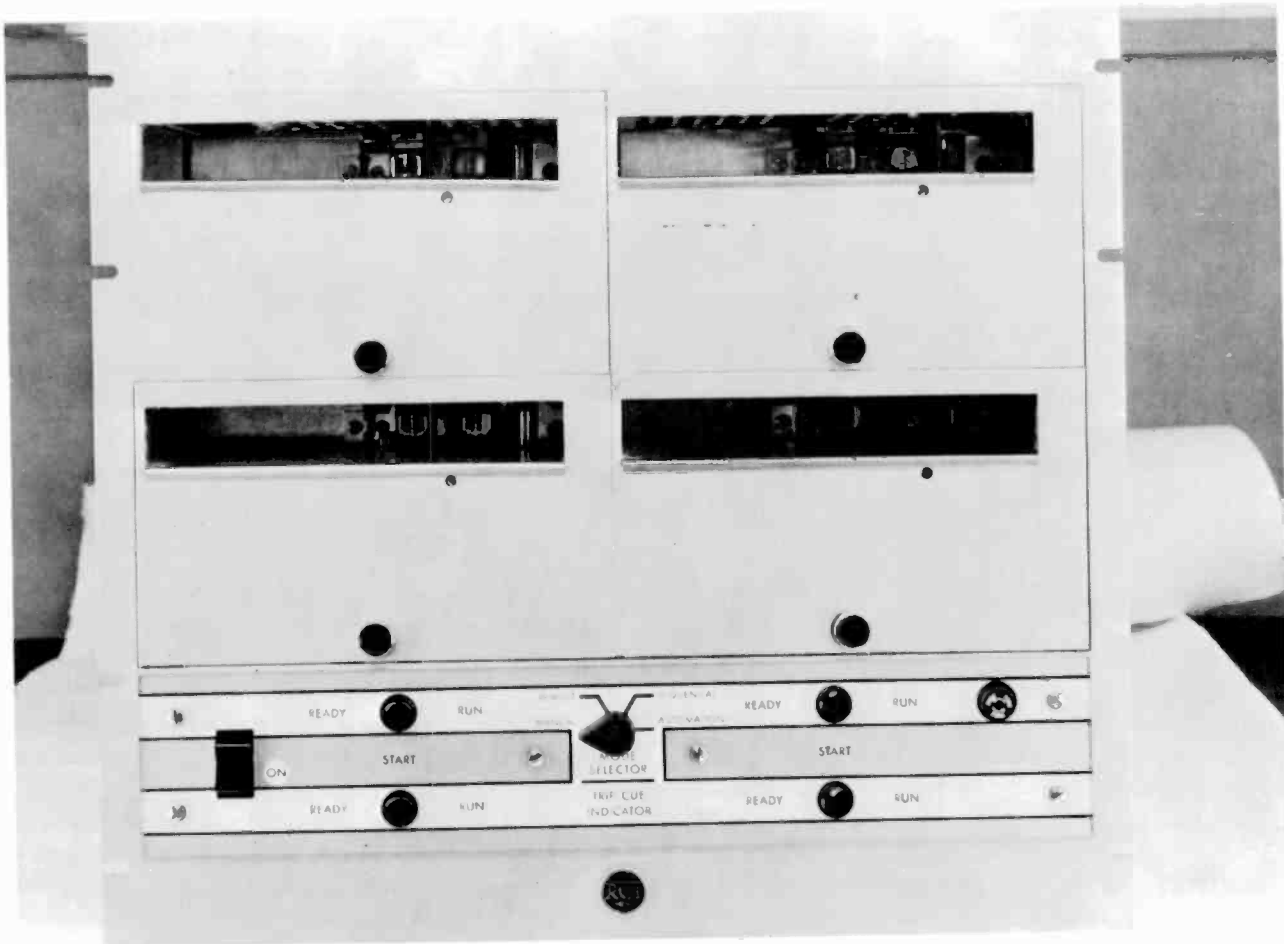

Fig. 11-3. A compact multicartridge tape system used in many semi-automated control rooms.

nected in multiples to produce a system of 8, 12, 16, or more automatic cartridge playback functions.

REEL-TO-REEL SYSTEMS

Reel-to-reel audio tape recorders provide several unique advantages, chiefly the ease with which editing may be accomplished, and multi-speed operation. Reel-to-reel machines operate at various speeds so that the program material can be tailored to the station's program needs. With some systems hours of programming may be recorded on a single reel; another feature is that some reel-to-reel units can be used as portable recorders for interviews and news events. Manually-operated and self-cueing equipments are available for broadcast use. Typical reel-to-reel audio tape recorders are shown in Figs. 11-4 and 11-5.

The unit shown in Fig. 11-4 is a professional solid-state recorder for monaural or stereo operations. It accommodates a wide range of record input levels and high playback output levels. The recorder is available in dual speeds, either 7 1/2 and 15 or 3 3/4 and 7 1/2 ips. It also contains a plug-in record equalizer and variable tape speed cueing. The recorder can be mounted in a rack, console, or portable carrying case.

The record/playback machine in Fig. 11-5 is available in either stereo or monaural models. It also has variable tape speed cueing, plus the fact it can record NAB cue tones on a tape for automatic operation. Other features include plug-in circuit modules and facilities for remote control operation. The unit can be used in automatic systems teamed with cartridge tapes. With relay switching, it can automatically program multi-event sequences from several different tape systems with a minimum of attention from station personnel. A monaural reel-to-reel record/playback unit is pictured in Fig. 11-6 and a mono/stereo playback deck appears in Fig. 11-7.

TAPE RECORDER OPERATION

Much of the overall performance capability of conventional magnetic recorders depends on the operation of the heads. Usually, the erase head is the least critical, requiring only that it make good contact with the tape and pass the symmetrical waveshape of the erase voltage. The erase head is normally mounted separately from the record head and the playback monitor head and precedes these heads in the path of tape travel. Some less expensive units have one head for recording and reproducing. The combined record/playback head does not allow direct off-the-tape

monitoring while recording and it prohibits optimum adjustment for both record and playback functions. With separate heads the gap spacing of each can be adjusted for optimum performance.

Recording and reproducing heads should be adjusted for the recommended critical azimuth alignment and the reproducing head gap width adjusted for the best possible high-frequency response. It is very important that all the heads make good contact with the tape, or a considerable loss of high-frequency response will be noticed. It is also conducive to good operating practice that tape heads and the entire mechanism are cleaned and serviced regularly.

During normal operation the recording head is "biased" to improve overall operation. Usually, it is a standard practice to use an AC bias at a frequency sufficiently beyond the range of hearing. With bias the tape is in an unmagnetized condition when no audio is applied. A bias value that is too low may result in high distortion and a low signal-to-noise ratio, while excessive bias will cause a loss of high-frequency response.

It is a general practice to erase out-dated program material from the tape so that it can be re-used. Both DC and AC erasing methods are acceptable, but the AC method is almost always used. Usually, a common high-frequency oscillator provides the current for both the erase and bias functions. Some equipments have metering provisions to adjust the proper erase and bias current. Generally, the erase current should be properly adjusted before adjusting bias, since erase current adjustments will affect the bias.

The recording amplifier is normally used to drive the recording head. This amplifier usually contains the bias and erase oscillator which drives the recording and erase heads. The playback amplifier raises the signal to a level suitable for feeding the program console or other speech input equipment.

AUTOMATIC PROGRAMMING SYSTEMS

The most common AM/FM broadcast application of "automation" is the recording of network or local programs for delayed broadcast. Another popular use of an automatic program facility is to record one track of a stereo tape with program announcements and the other track with control tones which are used to initiate automatic functions. During playback, frequency-selective relays—triggered by the control tones—will switch from a reel-to-reel playback, to a cartridge reproducer, to an automatic record changer, etc., to complete a predetermined sequence of program elements. Another tone will allow the controlling tape unit to cue to the beginning of the next an-

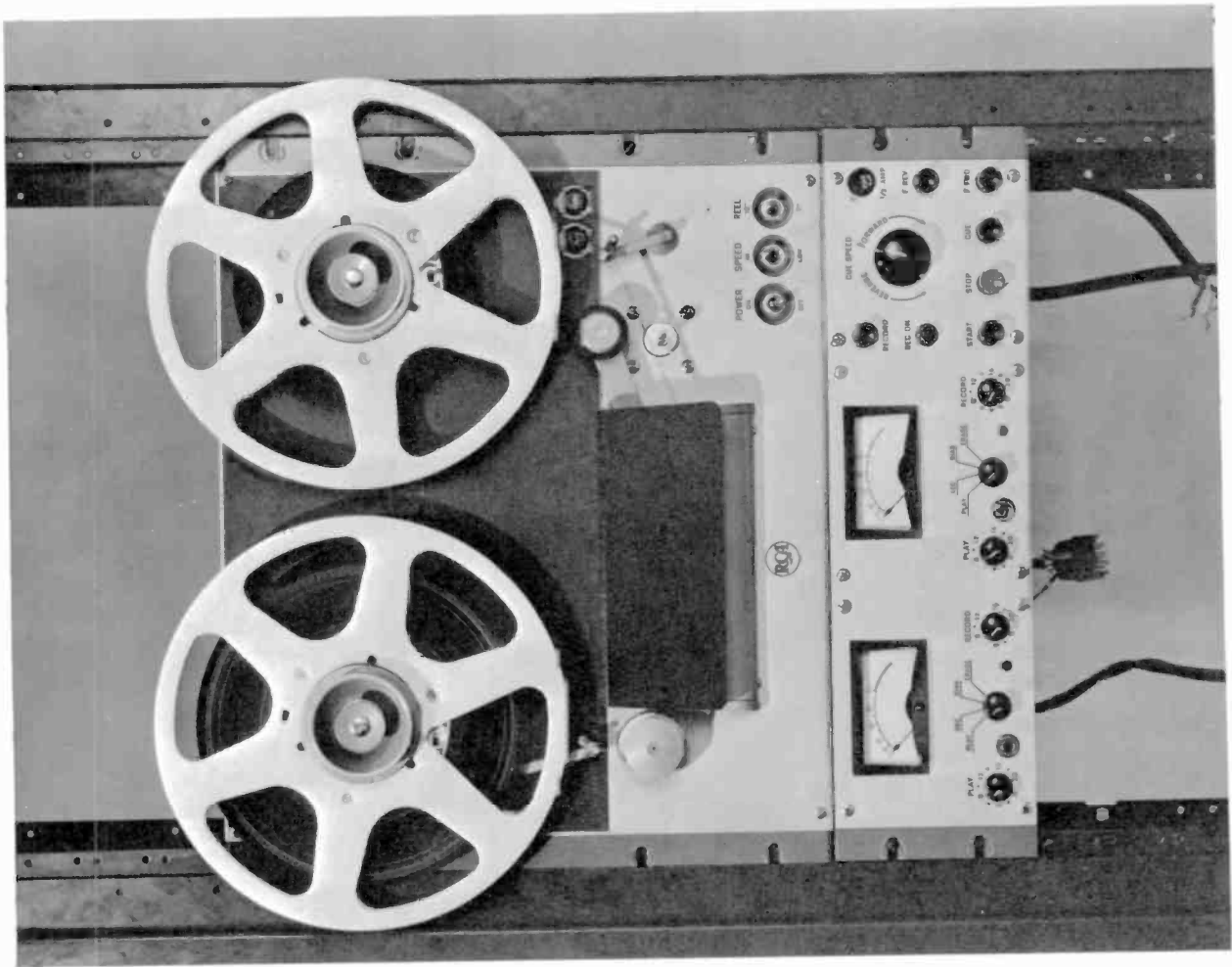

Fig. 11-4. A basic reel-to-reel audio tape recorder installed in a rack.

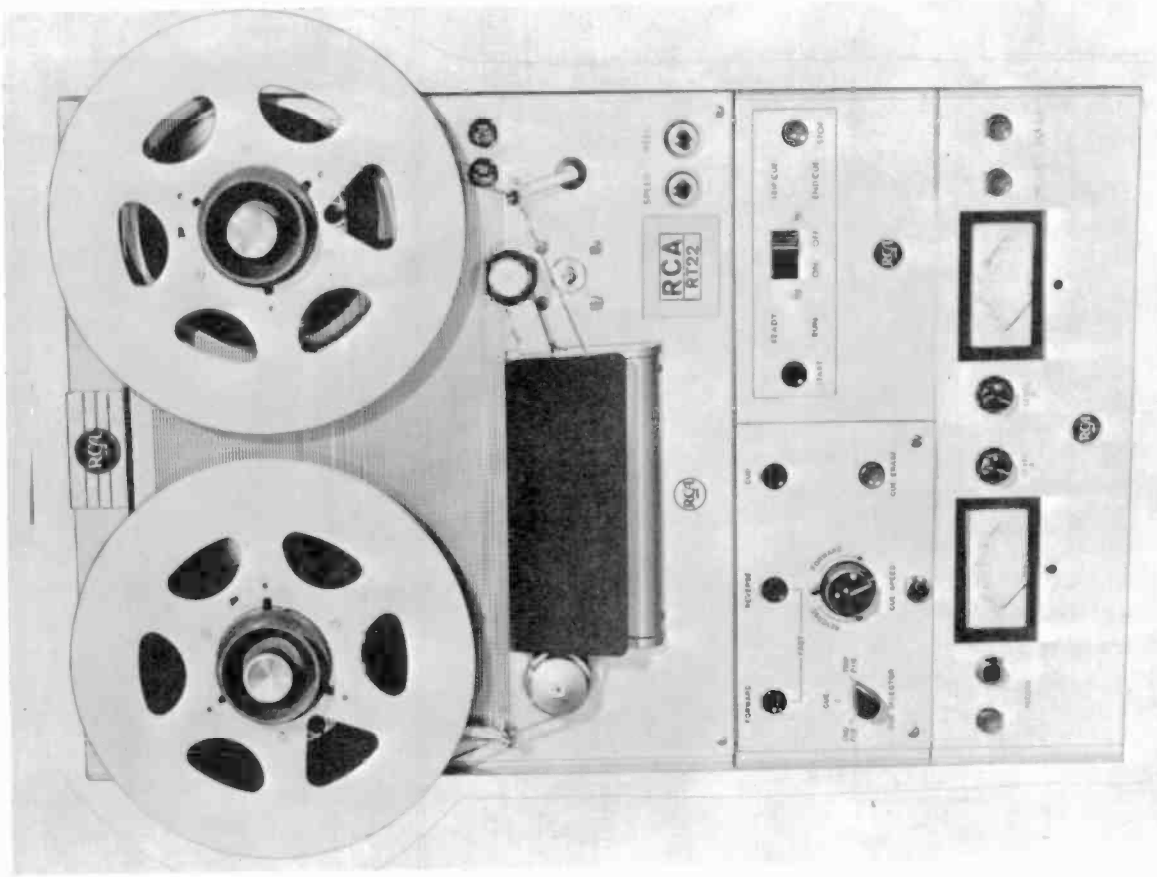

Fig. 11-5. This automated tape recorder features variable speed cueing and may be operated by remote control.



Fig. 11-6. Reel-to-reel tape record/playback unit.

nouncement and then produce an automatic command to start playback again.

All recorder-reproducer units contain many precision components that require periodic maintenance and adjustment. Brake tension adjustments should be checked with the methods and equipments prescribed in the instruction and installation manuals to achieve optimum performance.

For the best operating results it is desirable that the automation system be maintained as recommended in the instruction book, considering the following factors:

- Lubrication
- Cleaning
- Head demagnetization
- Take-up and holdback tensions
- Brake tensions
- Capstan idler pressure
- Playback level adjust
- Erase current
- Bias current
- Signal-to-noise measurements
- Azimuth alignment of the heads

- Playback response
- Record response

Installation

A necessary consideration in any system is that the equipment be connected to the station ground. In studio installations where no transmitter is located nearby, ordinary rack grounding procedures are sufficient. In transmitter locations, or where the system is to be located in a relatively intense RF field, it is desirable that the racks be securely bonded upon installation and bonded to a low-impedance ground such as copper ribbon. The best procedure is to use the same general grounding procedures which have been used in other portions of the program audio input installation. Generally, a two-inch copper ribbon should be adequate in most installations. However, some high-power AM/FM station locations may be more critical.

It is absolutely essential that no strain be placed upon racks as they are bolted together. Such strain will cause physical distortion of the racks and can create numerous subtle-type problems later on. Since most program automation systems

now use solid-state components and relays, cooling requirements are kept to a minimum. However, it is important that clean air be supplied to the system. Most components can be affected adversely by air-borne dust and dirt. A supply of clean, cool air will assure the maximum life and highest component reliability.

Basic Components

A program automation system for modern AM/FM broadcasting usually consists of several of the following units installed in individual racks tied together to form one complete unit:

1. Record/playback reel-to-reel tape decks programmed in any sequence desired.

2. A programmer which executes the program schedule.
3. Tone-filtering and generating equipment for recording cue tones on music tapes.
4. Cartridge record/playback unit for recording and playback of spots, news, weather, and IDs.
5. Cartridge playback units.
6. Recording amplifiers for record/playback tape units.
7. Audio control unit with VU meters.



Fig. 11-7. Reel-to-reel mono or stereo tape playback unit.

8. Monitor amplifier and cue selector to monitor the automation system output and to cue sources in the automation system.
9. AGC line amplifier in the transmitter feed line.
10. A timer, working in conjunction with the programmer, enables the selection of a number of time corrections to be made and also controls length of program segments.
11. Silence sensor alarm which monitors the audio output of the system and automatically selects the next programmed event in case of source failure.
12. Fade - start unit to automatically fade the selection on the air to start a program event required at an exact time.
13. Logging decoder designed to decode pulsed signals from cartridge tape units and transform them to digital information for the logging printer.
14. Audio switcher which provides all audio, control, and logging switching functions for operating the automation system.
15. External audio adapter, providing inputs for two external audio sources such as network and studio.
16. Logging printer which provides a printed record of programming by indicating the time of broadcast and the code number of the tape cartridge.

The heart of the automation system is the programmer or program control unit, sometimes referred to as the "brain." All that has to be accomplished is to determine the program schedule and set it up on the programmer which, in turn, automatically executes it. The great flexibility comes from the fact that the programmer can schedule numerous events in sequence, plus additional insertions at specified times. Reel-to-reel tapes are used in some systems for sequential events such as music, and tape cartridges are used to insert IDs, spots, news, weather, musical intros, back announcements, and specially featured musical numbers at pre-selected times. Because insertions are made automatically on time cues, there is no reason to worry about the length of broadcast material. The program control unit controls the airing of many program input audio sources and events. Additional sources

and events can be added to the system, plus remote and network sources, when desired.

One of the advantages of program automation is the reduction of hour-to-hour labor and the addition of many time-saving functions. Some of the features are:

- Exact-time programming allows automatic switching to network for news or for live remote pickups.
- Provision for automatic fading when exact-time events are scheduled. Normally, unused events in a prior program segment are automatically skipped, assuring program time accuracy without precise timing of material. Generally, four fades can be made each hour.
- Provides at least five audio sources plus the addition of network and remote.
- Capable of programming as many as 1,000 events without repetition and allowing up to 16 hours of programming with over 60 events each hour.
- Separate recording facilities enable the production of future programs, spots, and IDs without affecting system operation.
- Reel-to-reel tape machines with 14-inch reels normally provide over three hours of music.
- The system with automatic program logging, including a digital printer unit, provides exact visual verification of what cartridge was broadcast and the time it was broadcast. When the transmitter output fails the printer will automatically print red entries on the logging tapes.
- The logging printer verification tape attached to the previously prepared program schedule satisfies all FCC logging requirements.
- Digital readouts if used in the system will indicate the present position in the program schedule. Readout on the programmer shows the next event to be broadcast and the switcher readout shows the event being broadcast.
- Format can be changed simply by changing the sequence tape cartridge or by the insertion of another cartridge pre-recorded with the desired schedule.
- Specific events can be skipped during a program without interfering with the balance of the broadcast.

CLASS		Broadcast Schedule and Log		Signature	
1B	Special (Special Announcement)	Scheduled Time	Program and Sponsor	Type	Signature
300P24876	1B Special (Special Announcement)	3:00 PM	NEWS (5 Minutes) (FIRST NATIONAL BANK)	CNL	<i>John Doe</i>
305P74824	1B Non-Commercial Announcement		PEPSI-COLA (Min)	CA	
306P10049	1B Commercial Announcement	3:06	JOHN DOE SHOW	CER	
308P46814	1B Commercial Announcement		S & H GREEN STAMPS (Min)	CA	
312P64734	1B Commercial Announcement		FORD MOTORS (Min)	CA	
315P38444	1B Commercial Announcement		NEJMKDE HOSIERY (Min) Station ID	CA	
316P00011	1B Commercial Announcement	3:16	NEWS REMOTE (Min)	ID	
316P01004	1B Commercial Announcement		FALSTAFF BREWING (Min)	SNL	
318P96434	1B Commercial Announcement		IGA FOOD STORES (Min)	CA	
321P42434	1B Commercial Announcement		HILLS BROS. COFFEE (Min) Station ID	CA	
325P58914	1B Commercial Announcement	3:30	LOCAL NEWS (3 Minutes) (CITIES SERVICE)	ID	
330P00011	1B Commercial Announcement		MONTGOMERY WARD	CNL	
330P64505	1B Commercial Announcement	3:34	JOHN DOE SHOW	CA	
333P92844	1B Commercial Announcement		SUNBEAM BREAD (Min)	CER	
334P10049	1B Commercial Announcement		L & M CIGARETTE (Min)	CA	
337P46984	1B Commercial Announcement		SEVEN-UP (Min) Station ID	CA	
340P21134	1B Commercial Announcement	3:46	WEATHER REPORT (Min)	ID	
345P82184	1B Commercial Announcement		VOLKSWAGON (Min)	SNL	
346P00011	1B Commercial Announcement		Red Cross (Min)	CA	
346P02004	1B Commercial Announcement		CARSON-PIRIF-SCOTT (Min) Station ID	NCA	
348P71334	1B Commercial Announcement			CA	
351P03004	1B Commercial Announcement			CA	
355P55674	1B Commercial Announcement			CA	
400P00011	1B Commercial Announcement			ID	

Fig. 11-8. A typical automated system broadcast schedule and log.

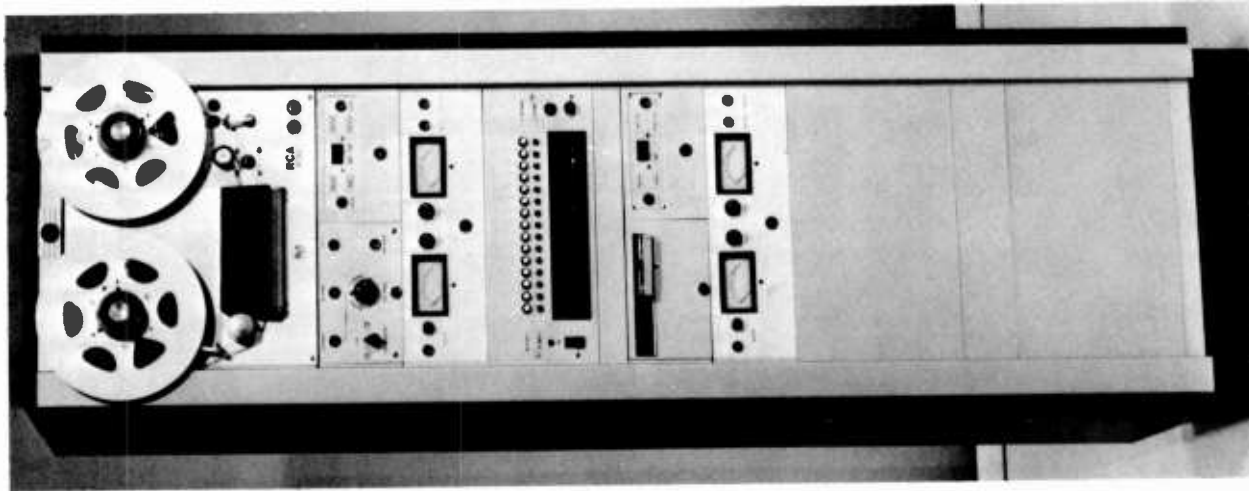

Fig. 11-9. This automatic audio system uses a stereo reel-to-reel recorder, (top) an automatic tape programmer, and a cartridge tape system.

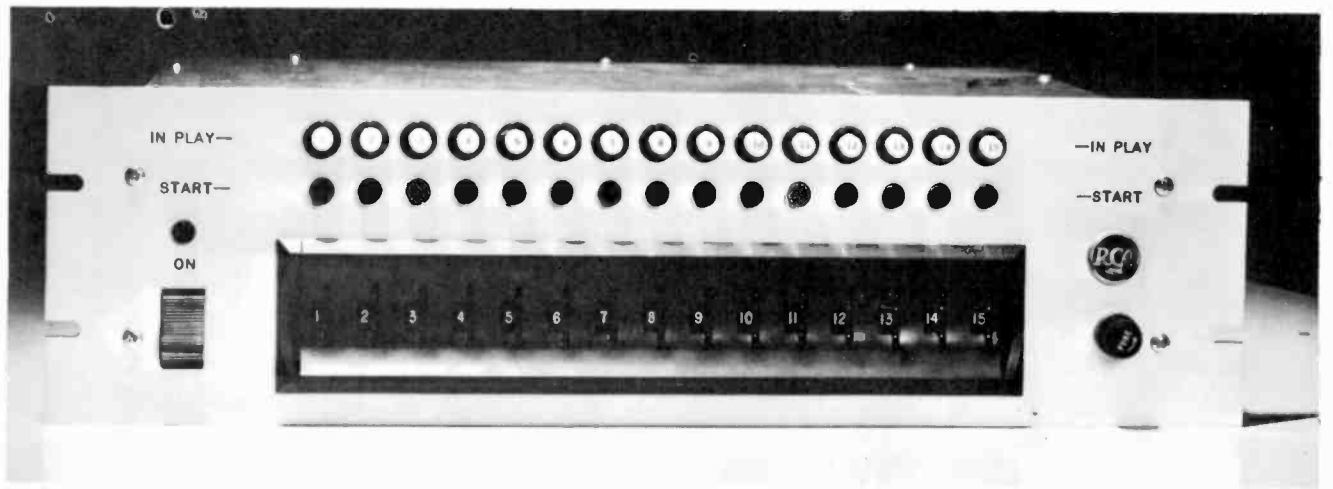

Fig. 11-10. Another automatic programmer.

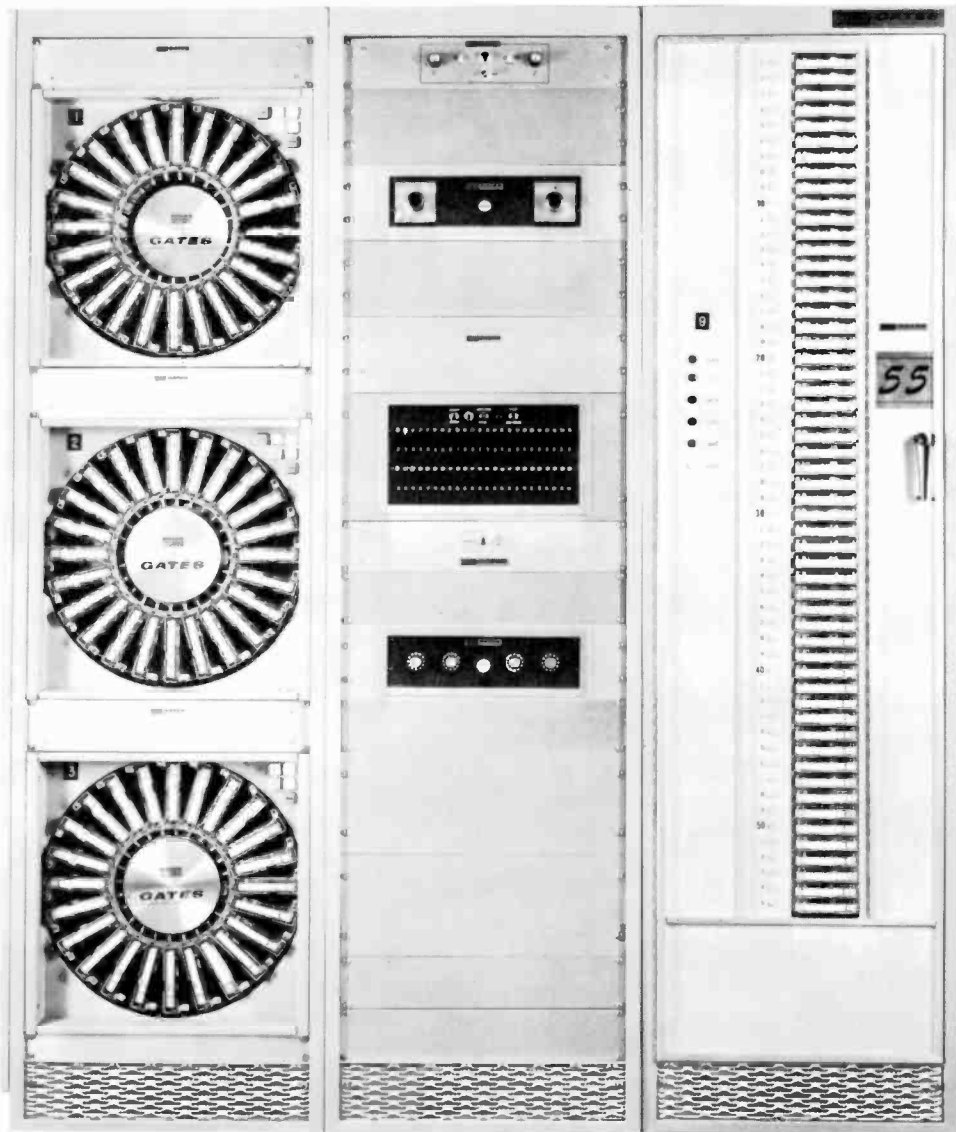

Fig. 11-11. The WVMI automation system, using tape cartridges exclusively.

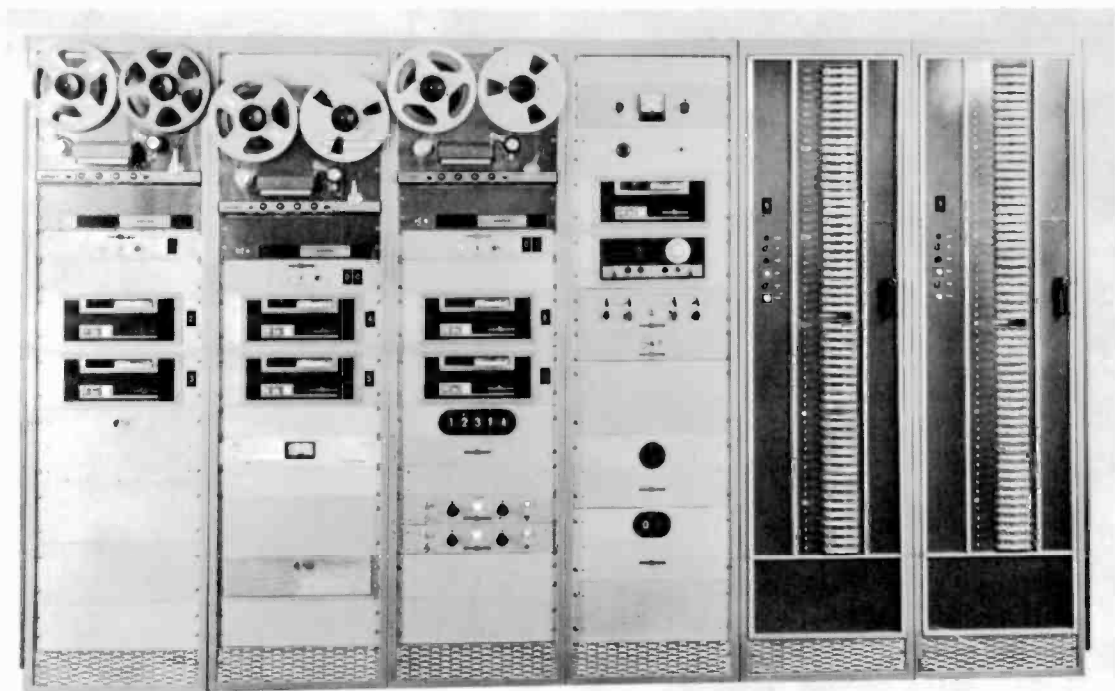

Fig. 11-12. WRKO's system employs reel-to-reel and cartridge tapes.

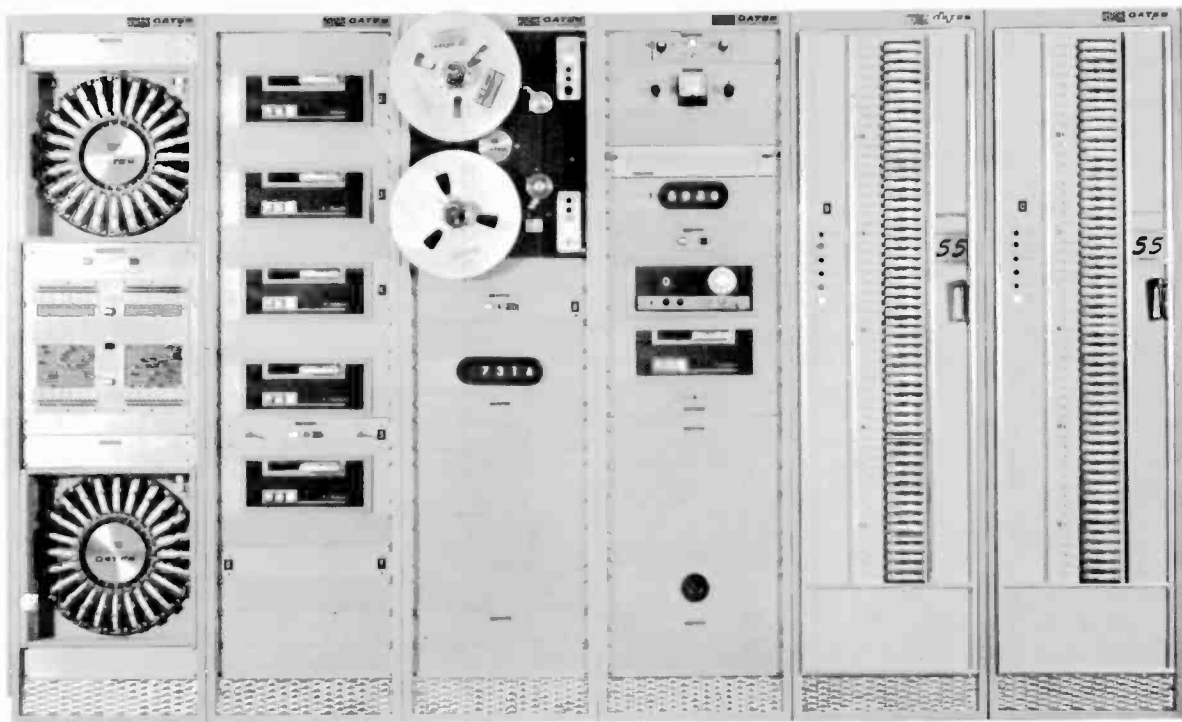

Fig. 11-13. The WOMA automation system.

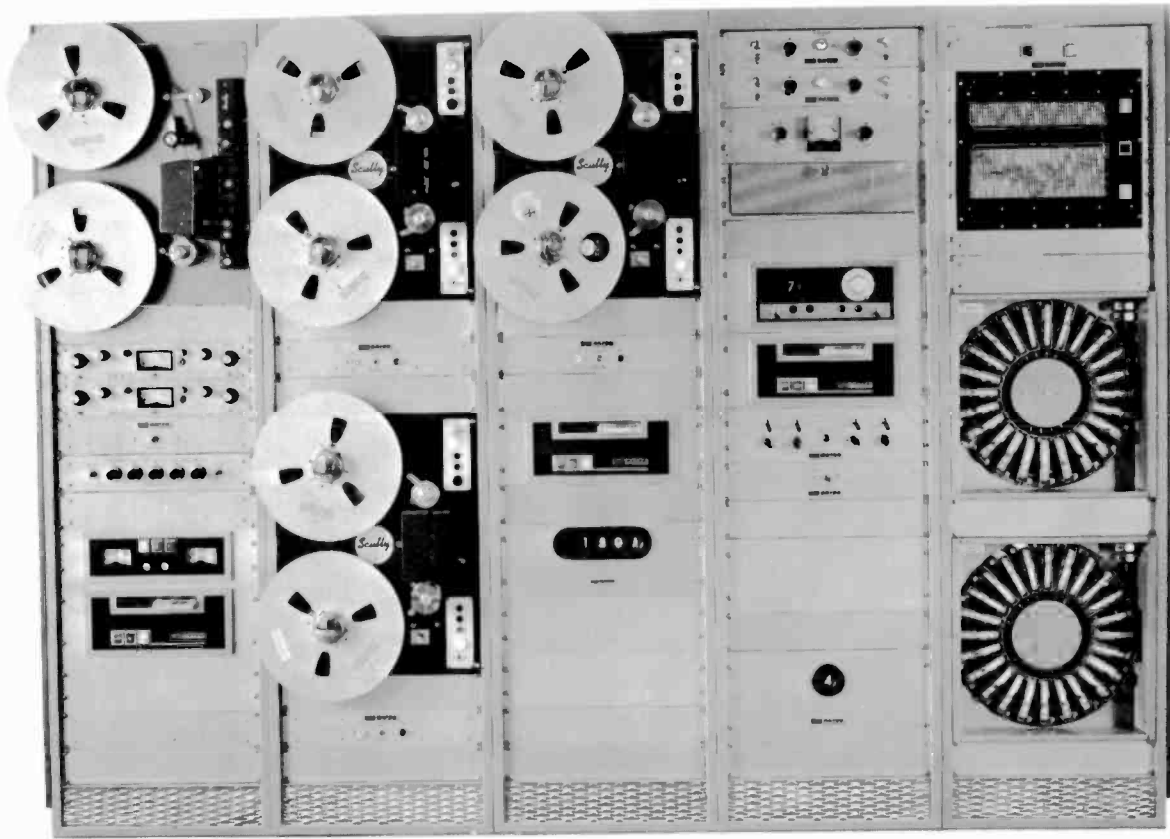

Fig. 11-14. KRSP-FM is programmed by this system.

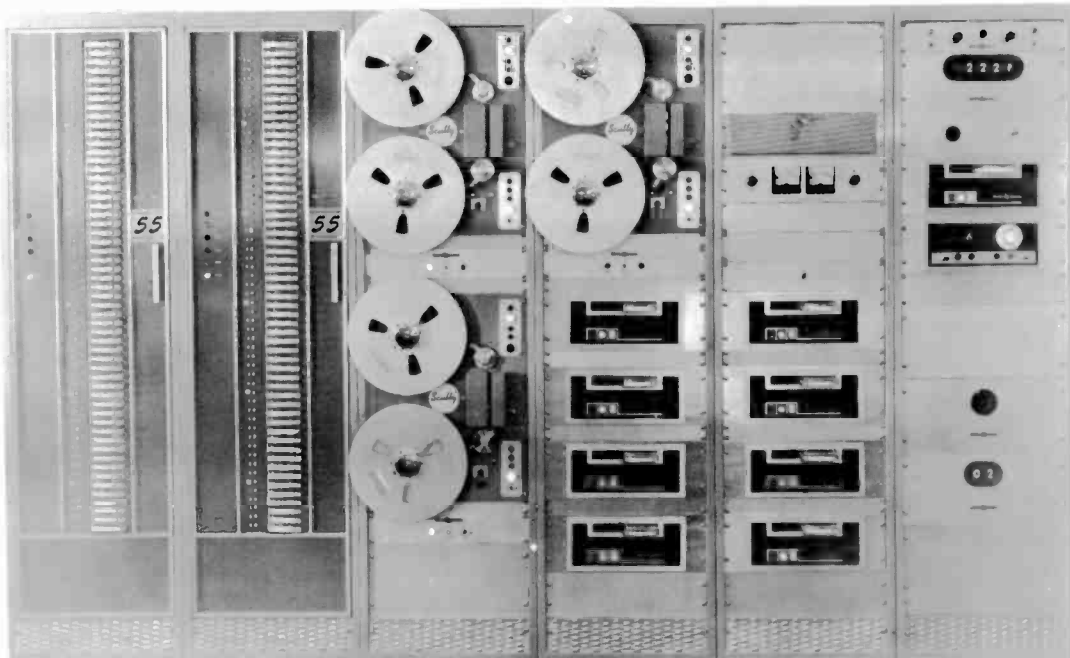

Fig. 11-15. KPOL programming is by this automation equipment.

● Broadcast equipment manufacturers offer stereo or monaural units for any type station, FM, AM, AM / FM, or FM stereo. Any of the automation systems can be expanded to provide the equipment which will generate exactly the "sound" wanted.

The program achievement efficiency of an automation system makes true automation a reality. Its value is further enhanced by using an automatic tape control program logging system which automatically prints all logging information as it is being broadcast. Fig. 11-8 is a reproduction of an automated station program schedule and the printed log verification produced by the automatic program logging system. These forms, usually signed by the operator, meet all FCC logging requirements.

TYPICAL SYSTEMS

The unit presented in Fig. 11-9 can be used with both monaural and stereo systems. It is designed to select several audio sources and sequence them in any preset pattern as consecutive events. It achieves advantageous operation for stations requiring separate AM and FM programming. The operator who may be handling both programs can preset the system to sequence the FM events during times when live broadcasts or program changes

must be made on AM broadcasts. An automatic audio tape programmer unit is shown in Fig. 10.

Other automatic audio programming systems shown in the following illustrations are designed to operate continuously and unattended for 24 hours or more, in mono or stereo modes. An individual music format is achieved and placed under management control for a consistent sound by separating the music into categories, along with any special features, and placing this material on separate tape transports for programming in any combination. Each segment of the program can be changed so that the music sound is automatically varied to suit the time of the day. Program material can be prepared locally, or material from a network or commercial music libraries can be utilized in any combination desired.

The program automation systems illustrated in Figs. 11-11 to 11-15 are in actual operation in varying size markets. Fig. 11-11, WVMI's system, uses cartridge tapes exclusively. WRKO's automation system (Fig. 11-12) features both reel-to-reel and cartridge tapes. The automatic programmers in Figs. 11-13 through 11-15 employ varying ratios of reel-to-reel and cartridge tape functions. Fig. 11-13 pictures WOMA's system; Fig. 11-14, KRSP-FM; and Fig. 11-15, the system in operation at KPOL.

CHAPTER 12

Microphones

In dealing with any mechanical or electrical component, there is usually an "ideal" which the designer must use as a performance criterion. For most purposes, an "ideal" microphone should have an output voltage independent of frequency and uniform response in any pickup direction. In this ideal case, the microphone should deliver to the audio amplifier a signal whose frequency, phase, and amplitude parameters are exactly the same as the original acoustical energy. In practice, though, each different type of microphone exhibits a different response pattern, representing the actual pickup characteristics, for varying positions of the sound sources about the microphone.

Since "the ideal" is not realistically attainable, the limitations of existing microphone types must be accepted. Therefore, special attention should be given to the selection of type and quality based on the environment in which they will be used. In many cases the microphones selected do not complement the quality of other station equipment; consequently, overall station performance is usually impaired. Unless microphone quality closely matches the characteristics of other equipment, "live" pickups will be decidedly inferior.

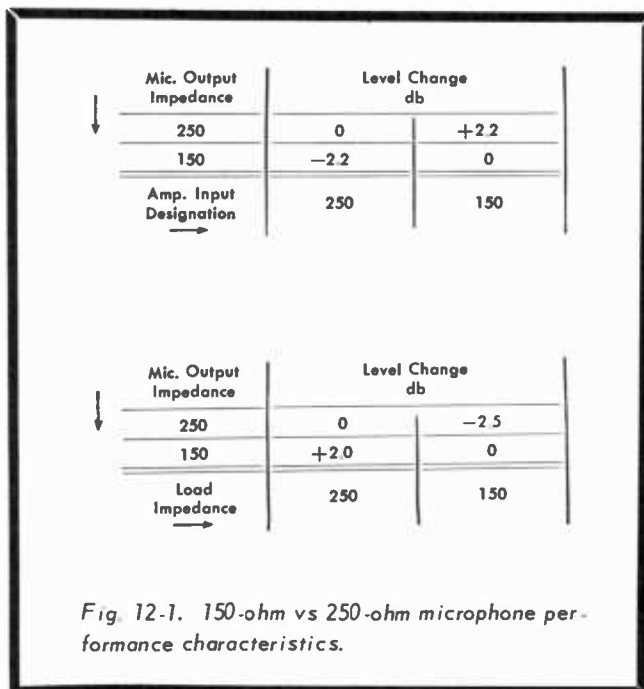

Fig. 12-2. A polydirectional microphone.

mance is usually impaired. Unless microphone quality closely matches the characteristics of other equipment, "live" pickups will be decidedly inferior.

There is considerable overlap in applications of various microphone types but each does possess certain attributes which make it particularly well suited to some specific application. The main features are smooth frequency response over the audio range, low distortion, high output levels, and well shielded, shock-mounted output transformers to prevent hum and noise

pickup. Response limitations should always be considered when microphones are used for broadcast applications.

IMPEDANCE AND LOADING

Fig. 12-1 illustrates the considerations of microphone resistance loading. When a microphone is connected to an unloaded input transformer, impedance matching is not a consideration. The effect of connecting a microphone with an output impedance of 150 ohms to a microphone amplifier designed for a 250-ohm source and vice versa will usually be of small consequence. The effect on the level is tabulated in Fig. 12-1A.

However, there will be some change in the overall frequency response characteristic of the system below 100 and above 5000 Hz. The magnitude will depend on the connection and the design of both the microphone and the amplifier input transformer. Variations in response with

quality microphone amplifiers in most cases will not exceed ± 2 db.

When microphones are connected to a resistance load the changes in level appearing in Fig. 12-1B will result when the output is referred to a matched condition.

MICROPHONE TYPES

The polydirectional microphone shown in Fig. 12-2 is a high fidelity, ribbon type which easily adjusts to a variety of directional patterns such as unidirectional, bidirectional, or nondirectional. It is ideal for AM/FM use since it has a frequency range of 30 to 20,000 Hz. It contains a three-position switch for selecting the best voice operating characteristics. Typical directional patterns and frequency response curves for this type of microphone are displayed in Fig. 12-3.

The uniaxial microphone is a dependable, high quality ribbon instrument with unidirectional

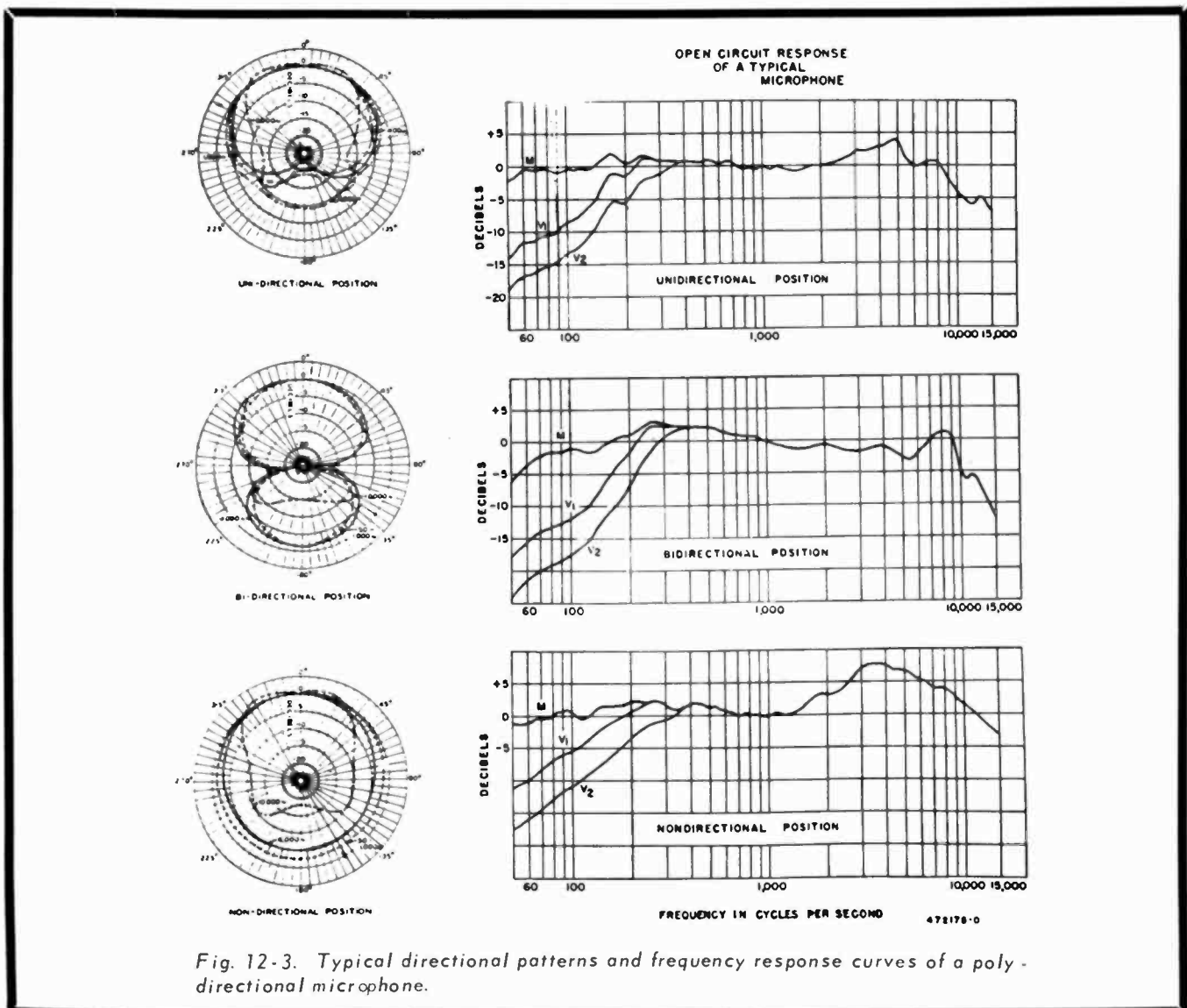



Fig. 12-4. A uniaxial microphone.



Fig. 12-5. A pressure-type microphone.

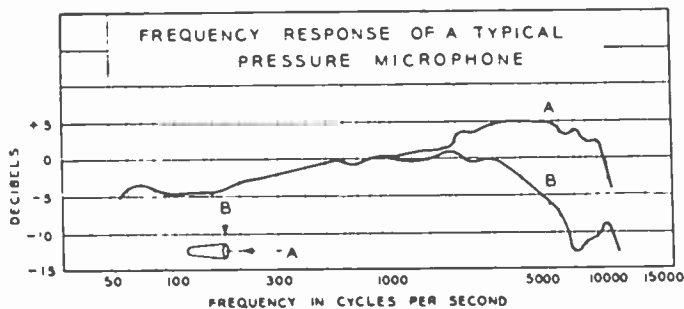

Fig. 12-6. Typical pressure microphone response curve.

characteristics. The uniaxial frequency response is essentially uniform from 30 to 20,000 Hz. Its response and frequency range, combined with the cardioid directional characteristic, makes this type microphone ideal for both speech and music pickup. It is especially suited for use in high-noise areas, ideal for boom operation in general studio applications, and as a desk-mounted control room microphone. Fig. 12-4 shows this type of microphone mounted on a boom structure.

The pressure microphone shown in Fig. 12-5 is particularly well suited for remote pickups. The response and frequency range curve illustrated in Fig. 12-6 indicates that this type of

microphone is suitable for both music and speech. Rugged and insensitive to mechanical vibration, the microphone is ideal for outdoor use where constant handling by the announcer is necessary, or for programs where the performer must work close to the microphone.

The velocity microphone is bidirectional and is rather rugged. It is especially suited for high-fidelity music pickups, general program and announce, conference pickup, and programs where microphones may be positioned to reduce audience noise. Fig. 12-7 represents a typical velocity microphone and Fig. 12-8 the directional characteristics.

The miniature and subminiature microphone is



Fig. 12-7. A typical velocity microphone.

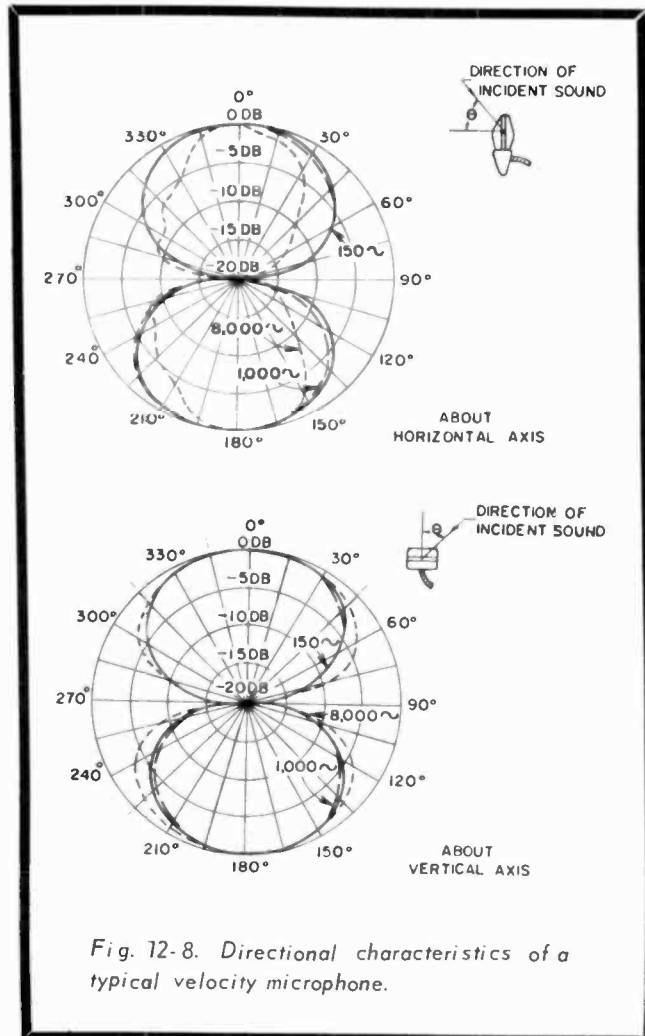

Fig. 12-8. Directional characteristics of a typical velocity microphone.

usually a lightweight, easily concealed lavalier dynamic with excellent speech balance for studio and public address. The frequency response and directional characteristics are engineered to complement human speech so that the microphone offers excellent balance when the performer is talking "off mike." It is inconspicuously worn around the neck, clipped to the clothing, or hand held as shown in Fig. 12-9. The instrument has a frequency response of 60 to 18,000 Hz and a directional characteristic in the nondirectional mode.

At one time many broadcasters had to use four separate microphones on a show, but now they can back off with a directional microphone and pick up all four people. It obviously simplifies things when you can reduce the number of microphones required.

MECHANICAL DURABILITY

The ability to withstand shock is a major problem in routine microphone usage. In general, today's broadcasters are not requiring the high quality microphone performance demanded in the past. Dynamic microphones inherently are somewhat more prone to abuse, but they are also inherently inferior in pickup quality. Most broadcasters are willing to put up with this difference, however, at least in some applications. The ribbon microphone, because of its design, can be subjected to somewhat more abuse. How-



Fig. 12-9. A lavalier dynamic microphone.

ever, if the ribbon microphone is stationary, mounted on a boom or desk stand, there is every reason to believe it is of superior quality and will last every bit as long as the dynamic microphone. Velocity microphones are also not dependent on a lot of seals which eventually dry out and cause performance to change. Thus, the ribbon microphone is definitely more stable than a dynamic one. Another big problem with microphone operation is performer mishandling.

Microphone manufacturers are currently concerned with improving shock susceptibility, re-

liability, and discrimination patterns of microphones. Microphones with cardioid patterns are being improved and some manufacturers reportedly are on the verge of introducing several new types.

Wireless microphones are still in the future according to some manufacturers. Current models used in broadcasting have proven unreliable in many cases. The main problem is that many users have been plagued by interference and had to give up using them. Major manufacturers are working on the problem, though.

CHAPTER 13

AM/FM Transmitters

Since transmitter selection is of the utmost importance, let us establish a foundation that will

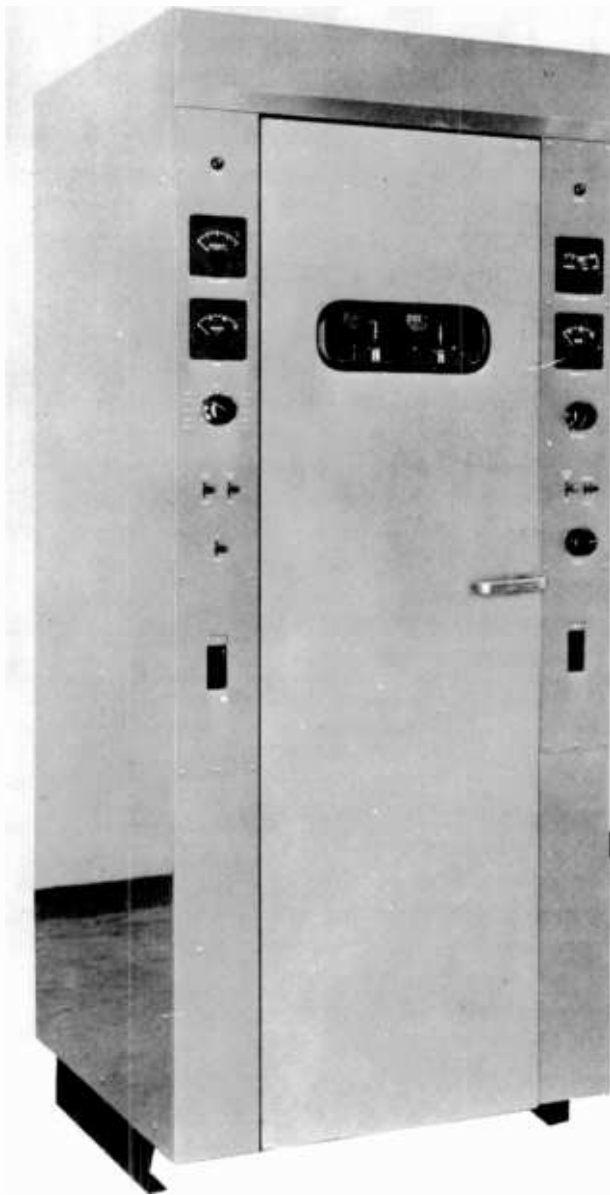

Fig. 13-1. A 1000 / 250 -watt AM broadcast transmitter.

aid in relating equipment features and characteristics to the situation at hand.

A transmitter capable of high levels of modulation over a wide frequency range with low distortion will provide a signal which "stands out" in any market. Obviously, transmitters should employ the highest quality components operated at conservative levels. The result is better quality sound and longer component life. Unusually, frequent tube replacement is avoided by using the types best suited to the application and by operating tubes well within their specification ratings. Where tubes are operated too near the limits, early failure is almost inevitable. Special attention should be given to all details affecting the proper cooling of the tubes, too. The importance of using conservatively designed and operated components in a broadcast transmitter cannot be over-emphasized, particularly for a station that wishes to maintain the highest reliability with a minimum loss of air time.

True, some equipment manufacturers offer compact, lightweight AM transmitters. Low weight, often associated with low cost, may not be economical in the long run. Reduction of weight is laudable if it can be achieved without sacrificing reliability. In AM transmitters, weight is directly related to the type of transformers and reactors used. It is extremely difficult to achieve satisfactory high fidelity audio response and component reliability with so-called lightweight transformers. In fact, if transformers and reactors are reduced in size as the principal means of reducing weight, it is advisable to study and compare basic designs. A failure of one transformer could wipe out most of the savings realized in purchasing a "lightweight."

TUBES vs TRANSISTORS

Good design calls for transistors wherever adequate engineering and packaging considera-

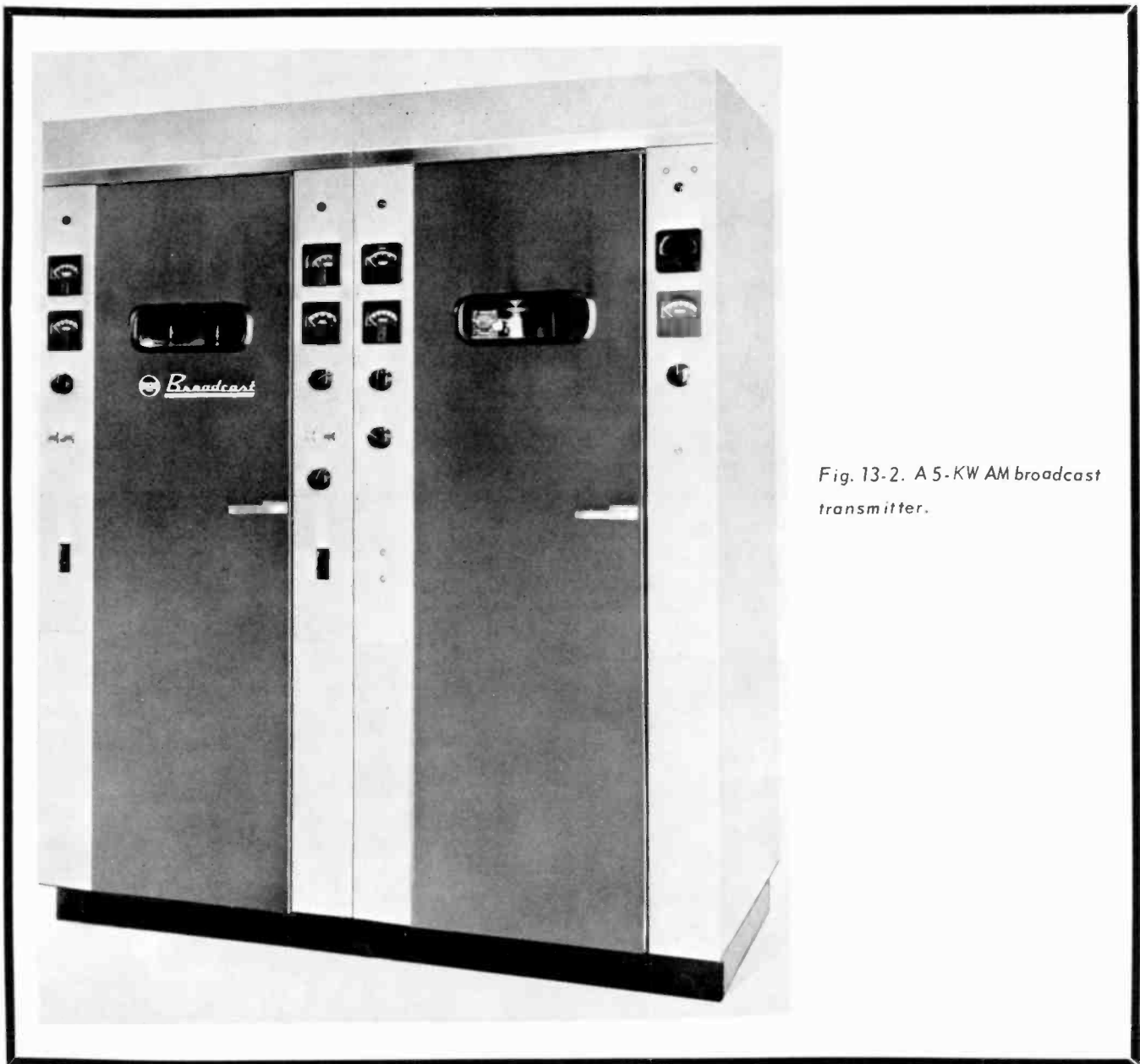

Fig. 13-2. A 5-KW AM broadcast transmitter.

tions indicate their use will be beneficial. In some transmitters, transistors and tubes are being placed in a way that presents certain disadvantages. For example, it is a well known fact that transistors do not work well when they are located in high RF fields. Also, many times very expensive tubes are needed to overcome the low power outputs common with transistors. Usually, the cost of one such tube may exceed that of several common types in another transmitter. In one transistorized transmitter containing the required special high-power PA, the tube and transistor complement costs more than twice the complete set of tubes in a conventional tube-type transmitter of the same power output. Due to the low drive power obtained from transistors, the PA in some transistorized transmitters must be capable of producing the required

output with a comparatively low input—which almost doubles the average power consumption of the transmitter! Additionally, when RF feedback is employed in such transmitters, there are problems with antenna load changes. The complex circuitry of transistorized transmitters requires a high level of technical competence of the station engineering staff. Therefore, it is wise to make a careful comparison of transmitter circuitry, considering cost, complexity, and reliability.

TRANSMITTER RELIABILITY AND ECONOMY

It is difficult to estimate the economies of transmitter reliability without having previous experience with a given design. Loss of broadcast time because of equipment failure can be very ex-

pensive. Some interesting points are: how much money will be lost in advertising time? How much will be spent on replacement parts? Will equipment problems cause the transmitter to be operated at reduced power for long periods of time? What about overtime pay to the staff? What will these problems cost in terms of listening audience, prestige, income, and profits? Station operating costs are difficult to measure, but they can be strongly related to equipment reliability. The difference between an economical and costly transmitter design can be quite misleading if reliability is ignored solely in favor of initial cost considerations. That is why it is most prudent to carefully weigh all aspects of transmitter design, construction, performance, and operating features.

REMOTE CONTROL CONSIDERATIONS

The question often arises as to whether or not it is possible to "automate" the transmitter in an

existing or new station. Automatic or remote operation is becoming more widespread because many existing "automatically-operated" stations are reporting months of unattended transmitter operation without the need for a single adjustment at the transmitter site. To prevent time-consuming and expensive modifications, the transmitter—when purchased—should include provisions for remote control as standard equipment.

Components such as relays, motor-driven controls, wiring, meter shunts, multipliers, and everything required should be a part of a new transmitter and not have to be added as a modification. Remote control can be achieved with DC voltages sent over telephone lines or tone signals which permit operation on a single voice-grade telephone line or microwave link.

AM TRANSMITTERS

AM transmitters of various power output ratings are shown in Figs. 13-1, 13-2, 13-3 and 13-4.

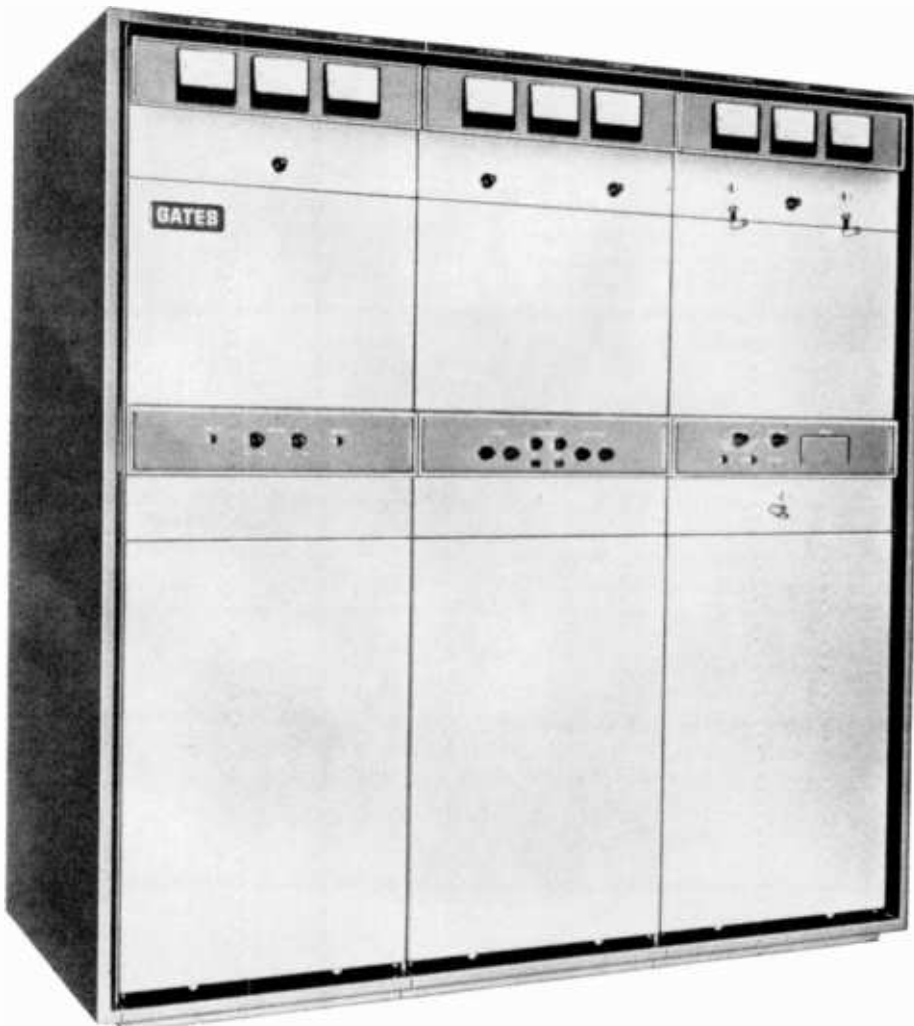

Fig. 13-3. A 10,000-watt AM transmitter.



Fig. 13-4. A 50-KW AM transmitter.

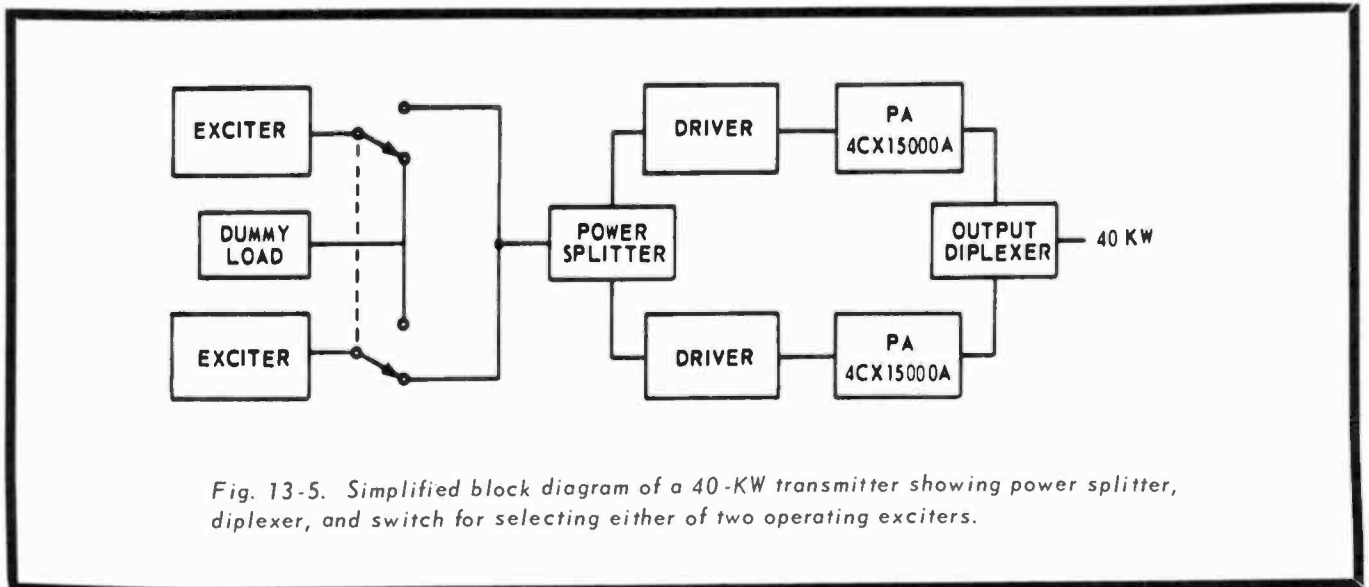

Fig. 13-5. Simplified block diagram of a 40-KW transmitter showing power splitter, diplexer, and switch for selecting either of two operating exciters.

A typical 1,000/250-watt AM transmitter is shown in Fig. 13-1. It incorporates a power reduction facility for "day-night" operation, a built-in power cutback system. The transmitter power can be reduced to either 500 or 250 watts by local or remote control.

Modern trends in AM radio broadcasting demand increased power and remote control requirements, together with all-around economy and dependability. Highly perfected radio frequency circuits and audio frequency circuits with large, high quality transformers and reactors provide

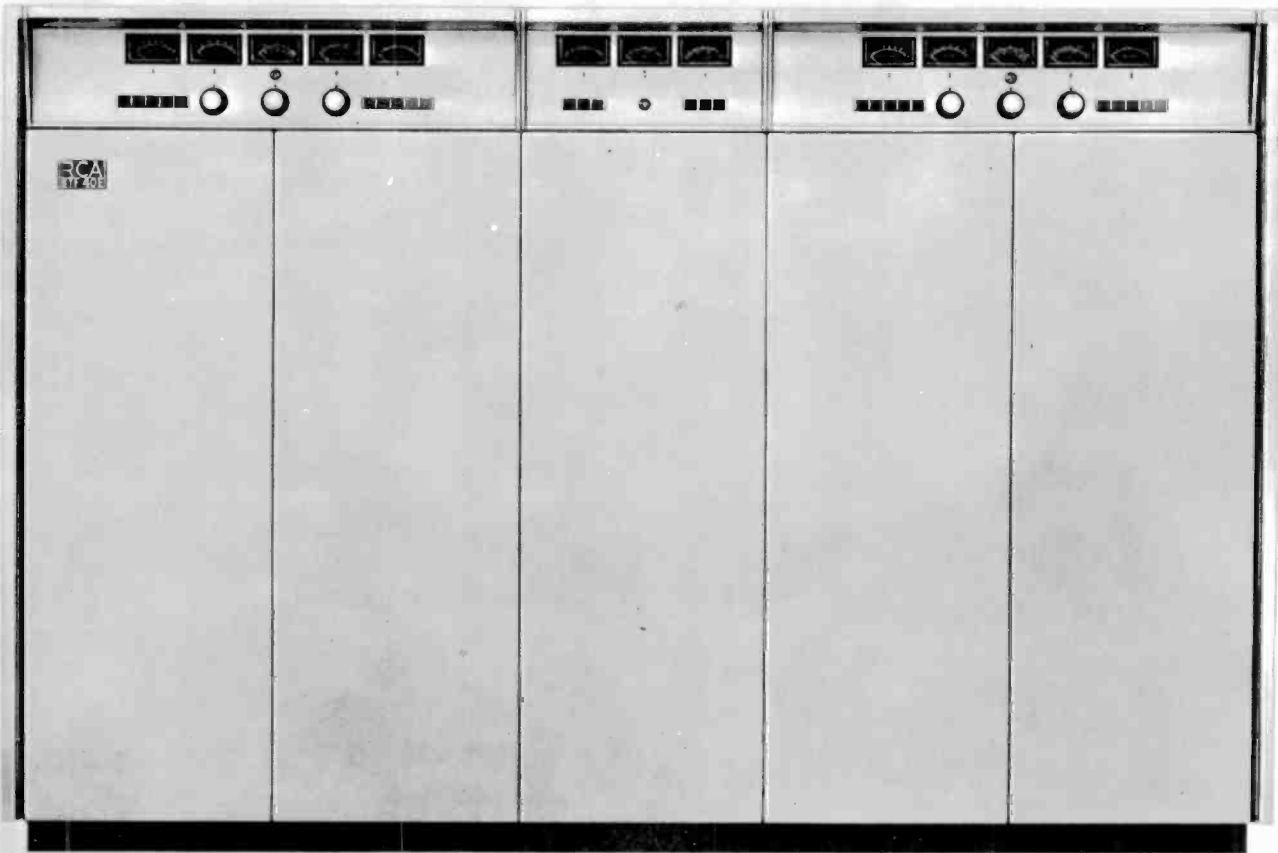

Fig. 13-6. A 40-KW FM transmitter.

for outstanding modulation and unusually high fidelity sound. The AM transmitters shown in Fig. 13-2, 13-3, and 13-4 are 5, 10, and 50-KW AM transmitters, respectively.

FM POWER EXANDABLE TRANSMITTERS

An important factor in transmitter design, especially for FM broadcast, is power expandability. For example, savings result if a 5-KW transmitter is expandable to 10 or 20 KW, and a 20-KW transmitter is expandable to 40 KW, rather than replacing the original transmitter. In some cases the design is such that the power can be doubled simply by substituting higher power electrical components with no increase in floor space.

Parallel-Operated Transmitter

Becoming quite popular are FM transmitting plants featuring duplication of parallel-operated transmitters. See Fig. 13-5. Normally, an

installation begins with a transmitter that can be diplexed with another identical transmitter to provide a power increase, plus the added reliability of two operating transmitters. It is like having a standby transmitter, warm and ready for instantaneous switchover if trouble develops in the main transmitter. Should either amplifier fail, the other continues to operate unaffected, supplying reduced power to the antenna. A relay system permits switching to the "hot" standby exciter if the main exciter fails. Since the power supplies and controls are separate and duplicated, the individual circuits of either transmitter may be shut down and repaired while the other is in operation.

Fig. 13-6 presents a 40-KW FM transmitter using the combined outputs of two 20-KW units; combining equipment is housed in the center cabinet. As discussed earlier, the 5-KW FM transmitter as a basic unit can be expanded into a 10- or 20-KW transmitter simply by substituting the driver and power amplifier tubes, power supply, and some electrical components

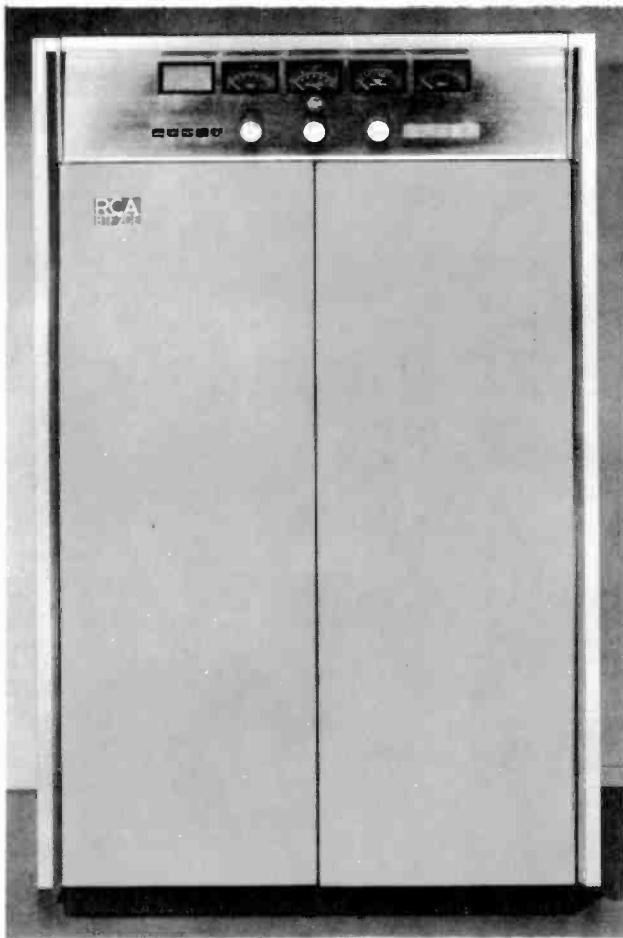

Fig. 13-7. A "power-expandable" 20-KW FM transmitter.

with higher power types. A transmitter which can be power expanded is shown in Fig. 13-7.

FM EXCITERS

The modern FM exciter should adequately attenuate harmonics and other spurious signals and produce a clean drive signal for trouble-free operation of subsequent stages of the transmitter.

An FM exciter should not be deficient in instrumentation. Some manufacturers today have a tendency to place the FM exciter in a very small space with a minimum of visual monitoring facilities. As a result, the operator must expend unnecessary time and effort to determine the operating status of the equipment. The best exciter incorporates basic instrumentation such as metering circuits and visual indicators, making it easy to see at a glance whether the unit is inoperative. Fig. 13-8 presents a view of a typical FM exciter.

SEPARATE SOLID-STATE POWER SUPPLIES

A trend in design that makes transmitters easier and less expensive to install is the two-unit construction concept in which the high-voltage trans-

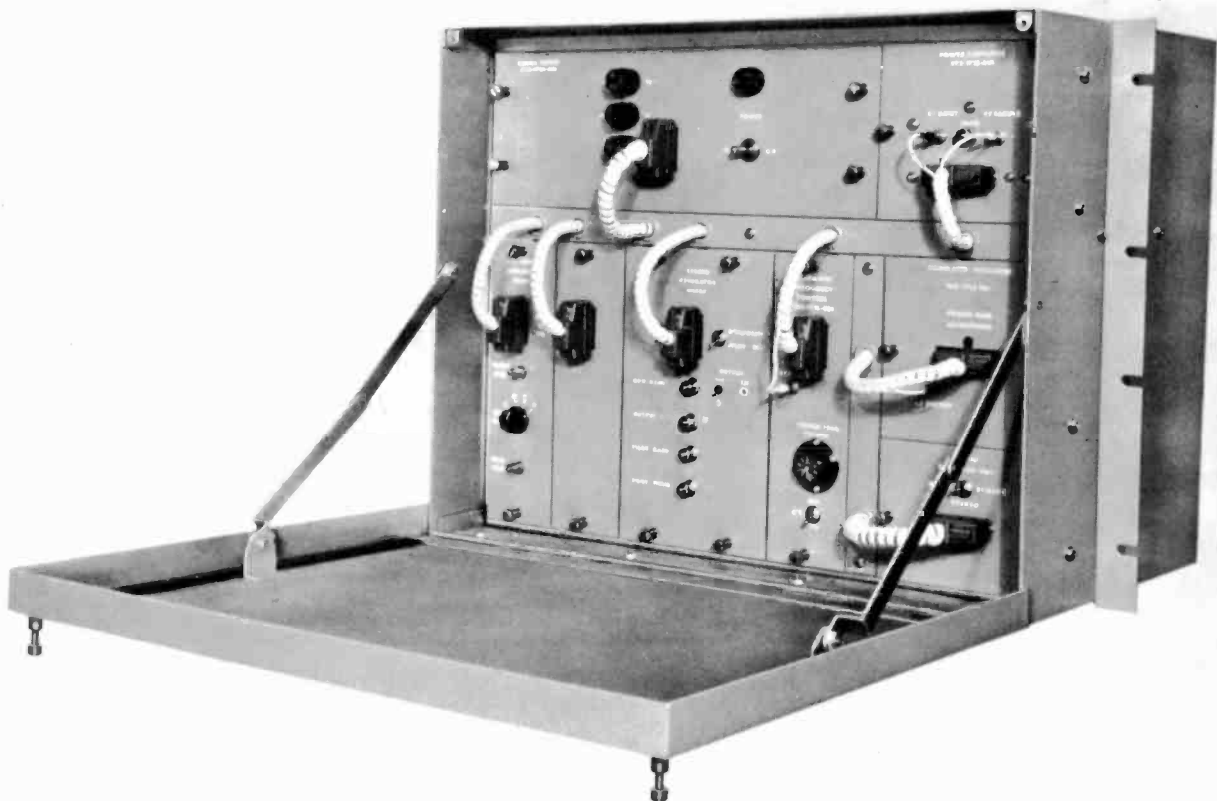

Fig. 13-8. A typical solid-state FM exciter.

former and its rectifier are contained in a separate interlocked enclosure. The power supply enclosure may be installed in the basement or in other seldom-used areas of the transmitter building. Locating the power supply near the commercial power entrance does much to re-

duce wiring expense during installation. It also simplifies power increases when expanding the power outputs of the transmitter. The advantages with respect to flexibility, space utilization, and convenience in maintenance afforded by a separate high-voltage enclosure are manifold.

Preventive Maintenance

Broadcast equipment should give reasonably trouble-free performance year after year, but it all depends on how well "preventive maintenance" is executed. Manufacturers' instruction books usually contain detailed maintenance information and procedures applicable to each unit, but each station engineer should take the time to analyze the equipment and prepare various maintenance operations on check lists, cards, or sheets to be sure that each maintenance operation is performed and completed regularly.

In general, preventive maintenance consists of the following procedures: inspect, clean, tighten, lubricate, tube check, "spot-proof," and FCC "station proof." The latter involves measurement of overall performance from studio microphone input to the transmitter output and is described in Chapter 15.

All equipment, particularly tubes, insulators, and other high-voltage components, must be kept free of dust and oily deposits. Dust is the number one enemy. By preventing proper heat dissipation, by changing electrical values of components, causing arcing, and by preventing proper electrical contact in relays and switches, dust accumulation can (and usually does) result in pre-mature failure. Dust filters on equipment, though effective, do not prevent all dust from reaching components. Any improvement in dust elimination will certainly contribute to improved equipment reliability.

Routine visual inspection should be made. All connections involving screw-type terminals should be periodically checked for tightness. Look for any components that are changing color, shape, or any other sign of deterioration. Periodically test high-voltage contactors. Check all moving and rotating items for proper function and lubrication. Keep switches and relay contacts clean. More operational failures are caused by dirty switch and relay contacts than result from actual equipment failure. Door interlocks should be checked frequently for proper alignment and condition of contacts. Safety grounding switches, if used, should be checked in the same manner.

Low-current circuits sometimes use small fuses. It is good maintenance practice to change them once a year.

MAINTENANCE TOOLS AND TEST EQUIPMENT

A well-equipped broadcast station should have an adequate set of hand tools, for use in making repairs and maintaining the equipment, plus the required test equipment such as an audio oscillator, distortion and noise meter, transmission measuring set or a set of calibrated attenuation pads, volt-ohmmeter, VTVM, cathode ray oscilloscope, tube tester, transistor tester, and field intensity meter. A suggested list is shown in Fig. 14-1. Also, a supply of replacement tubes is mandatory, and it is recommended that an adequate stock of spare parts be maintained.

FCC MAINTENANCE PERFORMANCE PROVISIONS AND LOGS

The FCC Rules indicate that each AM/FM broadcast station must keep a maintenance log. No specific log form is prescribed although they

HAND TOOLS

Heavy-duty, dual-heat 200/275 soldering gun
5 lb. spool rosin-core solder
Extra-long chain-nose pliers
Short-nose needle-point pliers
Thin-nose pliers
Needle-point diagonal pliers for stripping and cutting
1/4-inch electric drill
Hexnut driver set (seven wrenches)
Dual-purpose screwdriver kit
Set of round blade 2-, 4- and 6-inch screwdrivers
Tank-type vacuum cleaner
Standard speedex wire stripper
Scotch No. 33 electrical tape

TEST AND MEASURING EQUIPMENT

Audio oscillator
Noise and distortion meter
Transmission measuring set or a set of calibrated attenuation pads
Volt-ohmmeter or VTVM
Tube tester
Field intensity meter

Fig. 14-1. A list of hand tools and test equipment which are necessary for a well equipped broadcast station.

do specify the content that it must include. It is required that certain inspections be made at designated intervals and that notations be made concerning these inspections, listing the maintenance performed.

The general requirements relating to logs are discussed in Volume III, FCC Rules and Regulations, dated March 1968. These Rules, found in Paragraph 73.111 for AM stations and Paragraph 73.281 for FM stations, are very similar in both cases.

Each station shall maintain a maintenance log as designated, and each log shall be kept by the station employee or employees (or contract operator) competent to do so, an individual having actual knowledge of the facts required. This person shall sign the log when starting duty and again when going off duty.

Each maintenance log shall be kept in an orderly and legible manner so that all the data entered is readily available and understandable. Key letters or abbreviations may be used if their proper meaning or explanation is shown on the log. Each sheet must be numbered and dated, time entries shall be either in local, standard or daylight saving time, and times must be so indicated. No portion of a log may be erased, obliterated, or willfully destroyed, and all logs must be retained for at least two years, or longer if specifically requested by the FCC. Any necessary corrections may be made only by the personnel originating the entry who shall strike out the erroneous portion, initial the correction made, and indicate the date of correction.

MAINTENANCE LOG FORM AND CONTENTS

An ideal maintenance log form should contain the following information:

Title of form: Maintenance Log

Station call letters and city of license

Date: Should include both the day of the week and day of the month; example, "Friday, February 7, 1969." In some cases the beginning and ending date of the entire week should be listed and individual entries must be dated also.

Page Number: Numbers should be inserted as the logs are completed and filed.

Time Zone: Indicate the station location's time zone, such as EST or EDST.

Operator On/Off Signature: A standard requirement for all logs.

Abbreviation Code: Any convenient code is permissible but an explanation must be given. Thus; Ant, antenna; Ep, plate voltage; Ip, plate current; Freq, frequency; etc. As noted in the illustrated logs, some stations do not use abbreviations but spell out every word instead.

MAINTENANCE LOG RULES

The details describing maintenance log rules are listed in the FCC Rules; Paragraph 73.114 for AM and Paragraph 73.284 for FM.

1. Tower Base Current Ammeter(s) (AM only)—A weekly reading and an entry must be made.

2. Remote Antenna Ammeter(s) (AM only)—A weekly reading and entry must be made of each meter before it is recalibrated to the actual tower base ammeter (s).

3. Remote Antenna Ammeter(s) (AM only)—A weekly reading and entry should be made of the same ammeter(s) after each has been calibrated against the tower base ammeter(s).

4. Auxiliary Transmitter (AM, FM)—73.63 (AM) and 73.255 (FM) require that an auxiliary transmitter be tested at intervals of at least once a week, unless the auxiliary transmitter has been used upon failure of the main transmitter. The maintenance log should normally contain a weekly entry of the time and the result of the test. Generally, an AM transmitter should be tested only between midnight and 9 AM local time, and an FM transmitter must be tested between midnight and 6 AM local time.

5. Frequency Checks and Measurements (AM, FM)—This entry must show periodic frequency checks and measurements by some means other than the frequency monitor. If the measurement is made by anyone other than station personnel, it is advisable to specify the name of the company, the measured deviation shown, and the time the measurement was computed. Also, the station frequency monitor reading at that time should be recorded, along with a note indicating what adjustments were necessary to bring the station monitor in agreement with the independently measured frequency.

6. Calibration of Automatic Recording (Logging) Devices (AM, FM)—73.113 (b) (3) (AM), 73.283 (b) (3) (FM)—All stations may utilize automatic devices to record entries in the operating log. The automatic devices must be cali-

brated once each week and a notation of fulfillment made in the maintenance log.

7. Defective Instruments—An entry of the data and time of removal from and restoration to service of any of the following equipment in the event it becomes defective:

- Modulation monitor (AM, FM)
- Frequency monitor (AM, FM)
- Final stage plate voltmeter (AM, FM)
- Final stage plate ammeter (AM, FM)
- Base current ammeter(s) (AM)
- Common-point ammeter (AM)
- Transmission line RF voltage, current or power meter (FM)

Many broadcast stations also show an entry of the date of occurrence and the locations of the FCC district office to which failure notification was submitted as required by the FCC Rules.

8. Tower Light Inspections and Failures (AM, FM)—Tower light inspection must be logged as required by the FCC Rules. Paragraph 17.49 states that there must be a record of the daily inspection of the tower lights and associated control equipment required by Paragraph 17.47. Section 17.47 also states that once every three months a complete inspection should be made of all automatic or mechanical control devices, indicators, and alarm systems associated with the tower lighting to insure that such apparatus is functioning properly. Paragraphs 17.48 and 17.49 also cover tower light failures. Entries should be made indicating the nature of such failure, the date and time the failure was observed or noted and the date, time, and nature of required adjustments, repairs, or replacements. Identification and location must be shown of the Flight service station of the Federal Aviation Administration which was notified of the lighting failure. This should also include the date and time of such notification, as well as the date and time notice was given to the Flight Service Station when the required illumination was resumed.

9. Experimental Operation (AM, FM)—Entries made so as to describe fully any experimental operation or testing covered in 73.10 (AM) and 73.262 (FM). These entries must fully describe the details of experimental operation such as date, time, purpose, result, whether carrier was modulated or not modulated, time(s) of station identification, power and mode of operation.

10. Provisions of daily inspection (AM, FM)—73.93 (e) AM and 73.265 (e) FM require that

a complete inspection of all transmitting equipment shall be made by an operator holding a valid radio-telephone first-class operator license at least once each day, five days a week, with an interval of less than 12 hours between successive inspections. The operator must sign a statement that this inspection has been made, noting in detail the tests, adjustments, and repairs which were performed in order to insure operation in accordance with FCC Rules and the station's current instrument of authorization. The statement shall also specify the amount of time, exclusive of travel time to and from the transmitter, that was devoted to such inspection duties. If complete repair could not be effected, the statement shall set forth in detail the items of equipment concerned, the manner and degree in which they are defective, and the reasons for failure to make satisfactory repairs.

Some stations will list the items to be inspected such as tower, transmitter, console, limiter, AGC amplifier, frequency monitor, and other station operating equipments, so that the condition of each unit may be noted individually.

The maintenance log must be kept only by a first-class licensed operator. The inspecting operator should sign and date the maintenance log at the conclusion of each inspection. It is a good idea to provide a space for the operator's signature, preceded by a statement: "I certify that I hold a currently valid radio-telephone first class operator license and that I have this date made the above required inspection." The operator's license number can also be inserted.

11. Other entries (AM, FM)—Any other entries should be made as required by the current instrument of station authorization. An entry should show whether the station is operating on A CP, equipment test, program test, license authorized by telegram, letter, or postcard. Information and data should include the authorized frequency, power, DA or NDA patterns, ERP, antenna power gains, line and transmitter efficiency, and the type of transmitter in use where more than one is licensed. Many stations also include the transmitter oscillator plate, buffer plate, and grid drive meter readings. Another entry shows a list of tube replacements by type, number, serial number, position or stage, and elapsed-time meter reading.

In some cases the calibration of the remote control equipment and failure, plus removal from and restoration to service of the phase monitor unit, may be required by station license. Regular daily inspection regarding the condition of some of the following equipments could also be entered in the log: Antenna tuning unit, antenna

phasing equipment, condition of PA and modular tubes, fuses, relays, transmission line gas leakage, material parts stock, frequency monitor crystal oven temperature, transcription equipment, EBS receivers, building ventilating fans, air-conditioning and heating equipment, fire extinguishers, burglar alarm systems, and general conditions inside and outside the buildings. It is of prime importance to record the periodic checks of audio input and output levels, distortion, noise, and transmitter phase shift.

Usually, stations with DA patterns must take monitor point readings with a field meter, and these readings could be entered in the maintenance log. Several maintenance logs are displayed in Figs. 14-2, 14-3. No log is perfect; what is suitable for one station may not be desirable for another. Careful design and possible changes can be considered.

STUDIO MAINTENANCE

A procedure should be developed by the station engineer which covers the inspection, checking, repair, and testing of all the commonly employed studio units from the microphone to the line output terminals. Following are some of the studio units on which maintenance operations must be performed:

1. Microphones of all types
2. Turntables
3. Stylus, pickup head, and preamplifier
4. Jack and patchcords
5. Keys and switches
6. Attenuators
7. Amplifiers (tubes and transistors)
8. Reel and cartridge tape recorders
9. Remote transmitter control equipment
10. Field and remote equipment
11. Radio intercommunication units
12. Stereo system equipments

TRANSMITTER MAINTENANCE

An adequate routine maintenance system should be set up for the transmitter. Various maintenance operations are usually listed on cards or sheets with spaces provided for the maintenance engineer to initial and date each operation as it is completed. Following are some of the most important maintenance operations:

1. Cleaning
2. Air filter care
3. Breakers, switches, contactors, and relays
4. Rotating equipment
5. Power tubes, operational and spare

6. Rectifier tubes and silicon rectifiers
7. All other tubes
8. Performance tests

A regular schedule of performance tests should be included in the maintenance schedule. This is done each month at many broadcast stations but less frequently at others. The following measurements should be included:

1. Carrier noise level (AM, FM)
2. Distortion (AM, FM)
3. Audio response (AM, FM)
4. Carrier shift at 400 Hz with 100% modulation (AM)

A typical maintenance schedule should usually contain the following:

Daily

1. Check and compare all meter readings at start up. Adjust filament voltages if necessary. Correct any conditions revealed by abnormal readings.
2. Check the PA filament voltages periodically.
3. Make general visual inspections after shutdown.
4. If overloads have occurred, examine the components involved and repair or replace as necessary.

Weekly

1. Clean internal parts of the transmitter; use a clean soft cloth on insulators and a vacuum cleaner or hand blower to remove dust and dirt.
2. Test all door interlocks and grounding switches.
3. Check PA and output RF circuits for evidence of heating at connector or junction points.
4. Make an overall check of distortion and noise levels.

Monthly

1. Check the spare crystal in the operating crystal socket.
2. Check the condition of relay contacts; service if necessary.
3. Check tube socket voltages. Compare with previous readings.

WEEKLY REPORT OF D.A. MEASUREMENTS

1350 Kcs.

Radio Station WHWH Princeton, N. J.

Day Pattern						Date Made _____
Heading	230	250	270	25	55	
Place	swim club	woosa-monsa Rd.	woods-ville Rd.	hollow Rd.	starkey residence	
Time	_____	_____	_____	_____	_____	
Reading	_____	_____	_____	_____	_____	
Maximum	10.6	5.6	8.0	25.0	4.0	
Weather	_____			Temperature	_____	
				Engineer	_____	

Nite Pattern						Date Made _____
Heading	48	13	335	308	262	222
Place	Mt. View Rd.	Prov line Rd.	St. Mich-aels Sch.	Van Dyke Rd.	Golf Course	King George Rd.
Time	_____	_____	_____	_____	_____	_____
Reading	_____	_____	_____	_____	_____	_____
Maximum	6.7	8.5	16.0	9.6	13.7	11.8
Weather	_____			Temperature	_____	
				Engineer	_____	

REMARKS

Fig. 14-3. Maintenance log for recording DA antenna monitor point readings.

4. Inspect the air filter. Clean if necessary, using a vacuum cleaner or brush.

Quarterly

Lubricate tuning drive mechanism gears and bearings. Use Petrolatum or equivalent.

Semi - Annually

1. Inspect relay contacts and replace where required
2. Test spare tubes.
3. Tighten all connections in transmitter.

ANTENNA MAINTENANCE

In the maintenance of an antenna system, as in the maintenance of other broadcast equipment, one rule is important: Keep the system clean. Antenna components should be wiped and cleaned each week. Tuning houses should be kept rodent and reptile free. Vegetation should be kept down in the vicinity of each tower base. Cut vegetation should be raked away from the tower base and burned. Chemicals can be used to inhibit the growth of vegetation.

Pressure in the transmission and sampling lines should be maintained at 10 to 15 pounds, using dry air or dry gas to prevent the entry of moisture. If a leak develops, it should be located and repaired promptly. Periodic checks should be made of the pressure gauges so as to be certain that no gauge has become stuck and is giving false indications. Make sure that all insulators are kept free of paint.

An important part of the antenna maintenance procedure is to make a weekly visual inspection of all elements of the antenna system. Broken insulators or other damaged components should be replaced at once. Lightning gaps should be checked and re-spaced with the proper feeler gauge. All connections in the antenna tuning equipment should be inspected and re-tightened at quarterly intervals. At yearly intervals, and also after every violent windstorm, a plumb check of the tower is advisable. At the same time, check all tower bolts and nuts for tightness and look for bent tower members. This should include a visual inspection of the guy wires and insulators for any signs of damage or deterioration.

The maintenance report should contain a complete list and schedules of the daily maintenance work to be done and where necessary complete instructions covering the methods and equipment to be used. A suggested maintenance schedule

would normally contain the following information:

Daily

1. Check all capacitors and equipment in the tuning and coupling house for overheating immediately after sign-off.
2. Check the spacing and clean the antenna and transmission line horn gaps.
3. Check and clean all antenna lead-in insulators.
4. Check and clean all transmission line end seals.
5. Clean the contacts and check the alignment of the antenna relay.
6. Clean the contacts and check the alignment of the antenna ammeter switch.
7. Check and tighten all inductor and capacitor connections.
8. Clean all meters.
9. Read and record all transmission line gas pressures.

Weekly

1. Clean and check all connections at remote meters, the phase monitor, and meter panels.
2. Check all phase monitor tubes and transmission line protective circuits.
3. Check the nondirectional or directional antenna drive point impedance.
4. Compare readings of all antenna and remote antenna meters. Make proper adjustments.
5. Make a complete set of field strength readings at the indicated monitor points (directional antenna).

One important aid in maintaining a directional antenna system is to provide an additional maintenance report listing:

1. A complete description of the individual components, consisting of coils, capacitors, resistors, and relays.

2. All the meters used in the operation of the array, by location and function.

3. Monitoring points.

4. Wiring diagram of the complete antenna array.

The logical reasons as to why preventive maintenance schedules should be followed are to:

... combat the detrimental effects of dirt, dust, moisture, water, and weather on the equipment.

... keep the equipment in condition to insure uninterrupted operation for the longest period of time.

... maintain the equipment so that it always operates at maximum efficiency.

... prolong the useful life of the equipment.

CHAPTER 15

AM/FM Proof-of-Performance

Each broadcast licensee must make equipment performance measurements at yearly intervals as required by the FCC. Technical personnel responsible for making such measurements should become familiar with the procedures, standards, and accepted techniques and practices. AM and FM measurements differ in frequency response, audio frequency, harmonic content, carrier hum, noise and spurious radiations.

AM MEASUREMENTS

The paramount reason for making performance measurements is to provide an accurate check of studio audio facilities. By such measurements the performance characteristics of the entire equipment chain, from the microphone input terminals to antenna, can be checked. On this basis it affords a means of locating and applying corrective action to defective equipment. In fact, a regular proof testing schedule is the starting point in a program of preventive maintenance, since it permits a comparison of present performance with performance recorded previously. Each microphone preamplifier, including program amplifiers and turntable preamplifiers,

should be tested so that the entire audio chain is maintained at peak performance.

The station engineer usually is qualified to make a complete FCC proof-of-performance test, although some broadcasters employ a consulting engineering firm or use the services of an equipment manufacturing company. The choice depends on management recommendations and cost estimates. Many stations consider it an economical justification to purchase and have available all the test equipment necessary to perform a complete proof. This is desirable because it permits station personnel to investigate problem areas and maintain close observation of equipment performance on a continuing basis. The usual practice when difficulties arise or when less than optimum performance is revealed is to locate the source of the deficiency and then correct the situation.

Modern broadcast stations should transmit an adequate audio frequency range so that the performance will be equal to or better than FCC limits in all respects. Needless to say, before attempting proof measurements, technical personnel should understand the characteristics and operation of all test instruments. Always be sure to follow the manufacturer's instructions to

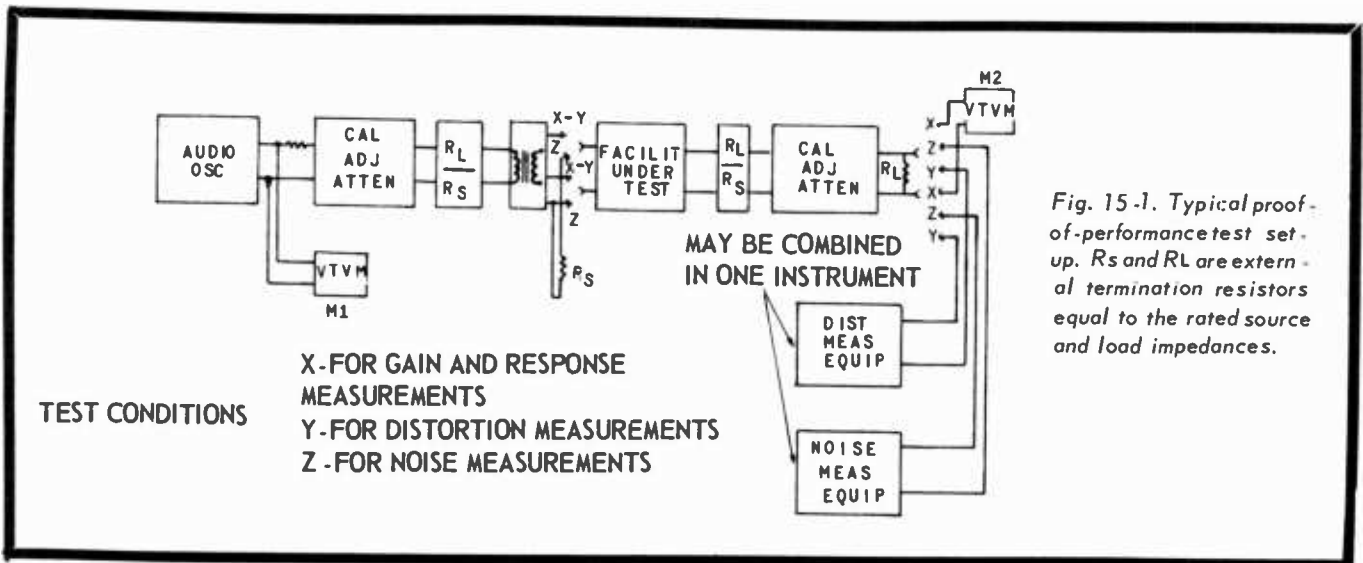

Fig. 15-1. Typical proof-of-performance test setup. R_s and R_L are external termination resistors equal to the rated source and load impedances.

bring the equipment within the necessary specifications.

A typical proof-of-performance measuring system is shown in Fig. 15-1. A block diagram of a typical proof-of-performance setup, from microphone input to transmitting antenna, is shown in Fig. 15-2. Input and output circuits include any isolating coils, fixed matching networks, and output load resistance, as well as a provision for ground or lack of grounds at the input and output terminals of the facility under test.

FCC RULES

Paragraph 73.47 states that each standard broadcast station licensee shall make equipment performance measurements at yearly intervals. One such set shall be made during the 4-month period preceding the date on which a license renewal application is filed.

Section 73.47 (a)(1) was amended, effective July 5, 1969, to correct an inconsistency. Subparagraph (1) requires that audio frequency response be measured over the range of 30-7500 Hz, whereas the lowest frequency at which audio frequency harmonic content is to be measured, according to subparagraph (2) is 50 Hz. Subparagraph (1) is amended to specify a range of 50-7500 Hz.

1. Data and curves showing overall audio frequency response from 50 to 7500 Hz for approximately 25, 50, 85, and 100 (if obtainable) percent modulation. A family of curves should be plotted (one for each modulation percentage with db readings above and below a reference frequency (abscissa).

2. Data and curves showing audio frequency harmonic content for 25, 50, 85, and 100% modulation for fundamental frequencies of 50, 100, 400, 1000, 5000, and 7500 Hz (either arithmetical or root sum square values up to the tenth harmonic or 16,000 Hz). Plot a family of curves (one for each percentage) with the percentage of distortion as the ordinate and the audio frequency as the abscissa.

3. Data showing the percentage of carrier shift for 25, 50, 85, and 100% modulation with a 400-Hz tone.

4. Carrier hum and extraneous noise generated with the equipment and measured as the level below 100% modulation throughout the audio spectrum or by bands.

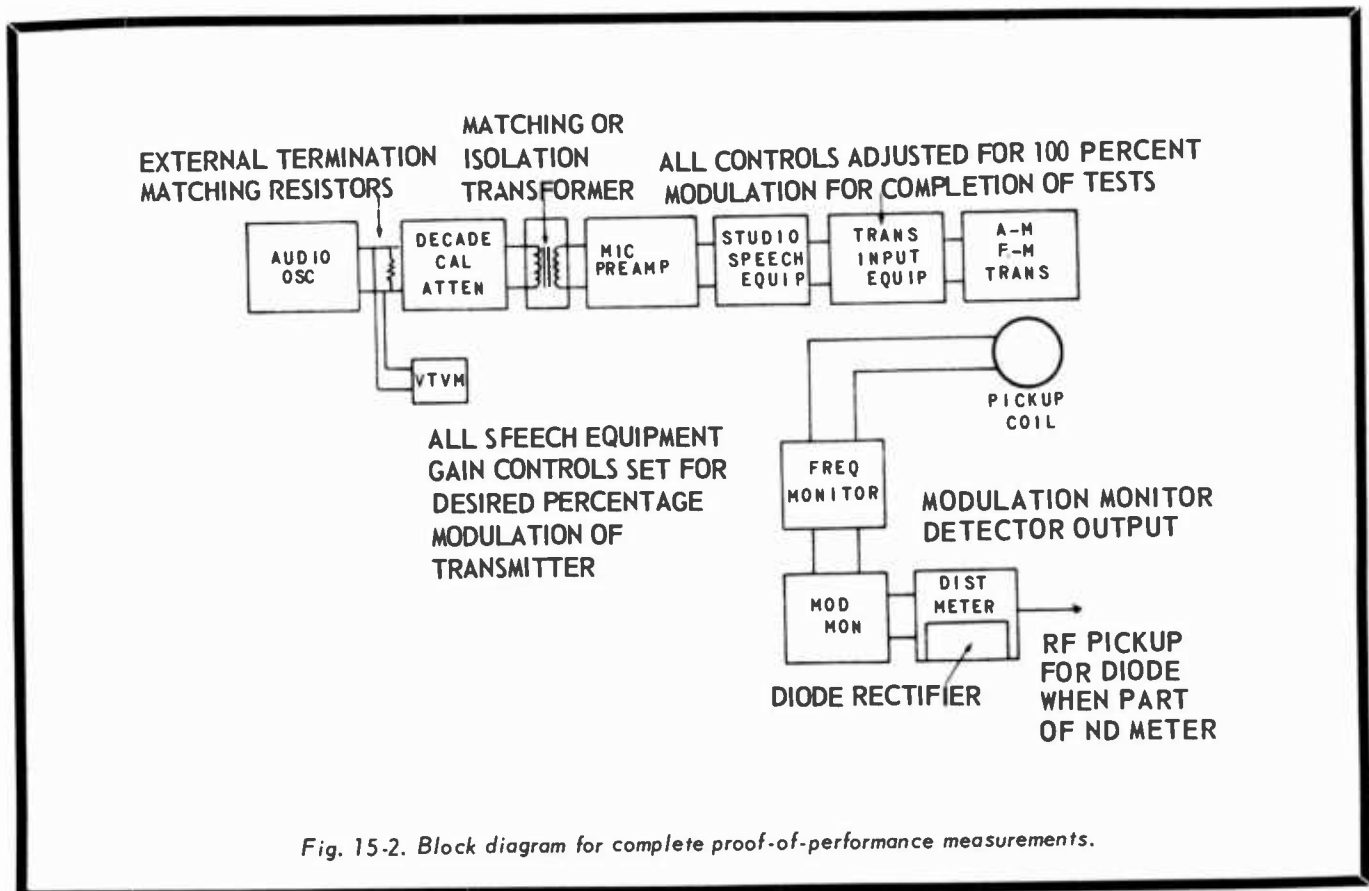

Fig. 15-2. Block diagram for complete proof-of-performance measurements.

5. Measurements or evidence showing that spurious radiations, including RF harmonics, are suppressed or are not present to a degree capable of causing objectionable interference to other radio services. Field intensity measurements are preferred, but observations made with a communications type receiver may be accepted. However, in cases involving interference or controversy, the Commission may require actual measurements. Measurements shall be made with the equipment adjusted for normal program operation and shall include all circuits between main studio amplifier input and antenna output, including equalizer or correction circuits normally employed, but without compression if such an amplifier is employed.

6. The required data and a description of the instruments and procedures used—and signed by the engineer making the measurements—shall be kept on file at the transmitter and retained for a period of two years; on request it shall be made available during that time to any duly authorized FCC representative. Additional information may be found in Paragraphs 73.39 to 73.45 and Paragraphs 73.51 to 73.68.

PROOF-OF-PERFORMANCE STANDARDS

Overall proof-of-performance measurements cover the entire audio facility from the microphone preamplifier input terminals to the transmitter input terminals, excluding STL equipment which may be either wire line or radio. Pre-emphasis is not included in the audio system.

Input Signal: 2.45 mv RMS in series with 150 ohms.

Output Signal: For facilities feeding telephone lines the level is -18 dbm; for a direct transmitter feed the standard output level is -12 dbm.

Frequency response: Audio frequency response characteristics are expressed in db relative to 1000 Hz within the specified frequency range; frequency response is measured between two limits: The upper limits must be uniform from 50 to 15,000 Hz and the lower limit must be uniform from 100 to 7500 Hz within 2 db at the upper limit.

Harmonic distortion: Harmonic distortion is the RMS value of the harmonic signal content within 50 to 30,000 Hz, and at fundamental frequencies it shall not exceed 1.75% RMS from 50 to 100 Hz; 1.0% RMS from 100 to 7500 Hz; and

1.5% RMS from 7500 to 15,000 Hz. The limits for fundamental frequencies from 7500 to 15,000 Hz can be based on subjective listening.

Signal-to-noise ratio: The ratio, expressed in db, between the sine-wave signal power required for standard output and the noise power measured with zero applied signal is known as the signal-to-noise ratio. Measurements must be made at the rated load impedance of the equipment under test. The noise level shall be down at least 65 db at frequencies between 50 to 15,000 Hz. Measurements are to be made at standard input and output signal levels.

Test Equipment

Audio Oscillator: Output frequency should range from 10 to 15,000 Hz, and possibly up to 100,000 Hz, at 600- and 5000-ohm impedance outputs. Waveform distortion should be less than 0.2% and frequency calibration should be accurate within 2%.

Level Indicator: May be a VOM, VTVM, or a counter-type device.

Attenuator or Pad: Must have an attenuation range from at least 50 to 80 db. A gain-and-measuring set, consisting of VU meter and associated attenuation circuits with the proper input and output impedance, may be used.

Isolation and Matching Transformer: Used to match impedances and isolate test equipment from systems under test.

Distortion and Noise Meter: Must be capable of distortion measurements from 0.3 to 30% and distortion levels as low as 0.1%. Noise measurement range should reach 80 db below the reference calibration, or at the 0 dbm level it should have a frequency range of 20 to 200,000 Hz. Should have 600- and 100,000-ohm inputs.

Diode and Pickup Coil: Usually consists of an RF pickup coil, a length of coaxial cable and germanium crystal, and RF filtering circuits.

Field Intensity Meter: Used to measure RF field strength.

Communications Receiver: Frequency range should include at least the 15th harmonic of the carrier frequency.

Oscilloscope: Used to analyze audio system output waveform displays.

Many manufacturers offer a complete package containing all necessary equipment for proof tests. Satisfactory instruments may be obtained from used equipment dealers, but equipment quality should never be sacrificed for economy if suitable and meaningful measurements are to be made.

FREQUENCY RESPONSE MEASUREMENTS

FCC Rules require a flat frequency response characteristic (± 2 db) from 100 to 5000 Hz. Measurements should be made at 25, 50, 85 and 100% (or the highest attainable) modulation from 50 to 7500 Hz, as stated previously.

1. Be sure that any AGC amplifier is bypassed and that limiter amplifier compression has been disabled.

2. Set the audio oscillator to 1000 Hz.

3. Adjust the oscillator gain control until the VTVM indicates zero dbm. (See Figs. 15-1 and 15-2).

4. Set the calibrated attenuator to approximately 50 db.

5. Adjust the generator gain control to obtain approximately 15 dbm on the VTVM.

6. Connect the audio signal generator to a microphone input circuit.

7. Set the attenuator so that the modulation monitor indicates 25% modulation while maintaining a reading of 15 dbm on the VTVM. Keep readjusting the attenuator and gain control until the modulation monitor reads 25% and the VTVM reads 15 dbm.

8. Record the attenuator setting on Form No. AFP-1 (Fig. 15-3). Notice that the attenuator response data reading for 25% modulation at 1000 Hz is recorded along the entire top row. Copy the same figure in Row 2 under the 1000 Hz heading.

9. Tune the oscillator to 50 Hz.

10. Readjust the attenuator and gain control (if necessary) to again obtain 25% modulation. Make sure the VTVM is still reading 15 dbm as in Step 8.

11. Record the new attenuator setting in Row 2 under 30 Hz on Form No. AFP-1 (Fig. 15-3).

12. Fill in Row 3 by subtracting the readings in Row 2 from those in Row 1 and enter the difference in Row 3. This entry represents the response variation.

13. The entire procedure, Steps 10 to 12, is repeated for 100, 400, 5000, and 7500 Hz.

14. The entire procedure is also repeated at the higher percentages of modulation 50, 85, and 100%; if 100% modulation is not attainable, use the highest percentage obtainable.

15. Plot the response readings for each percentage of modulation on the graph sheet in Row 3, Form No. AFP-2 (Fig. 15-4).

If the response variation between 100 and 5000 Hz is greater than 2 db, relative to 1000 Hz, the audio system is deficient and in violation of FCC

25% MODULATION

CPS	30	50	100	400	1000	5000	7500
(1)							
(2)							
(3)							

50% MODULATION

CPS	30	50	100	400	1000	5000	7500
(1)							
(2)							
(3)							

85% MODULATION

CPS	30	50	100	400	1000	5000	7500
(1)							
(2)							
(3)							

100% (or %) MODULATION

CPS	30	50	100	400	1000	5000	7500
(1)							
(2)							
(3)							

Fig. 15-3. Form AFP-1: Overall audio frequency response data.

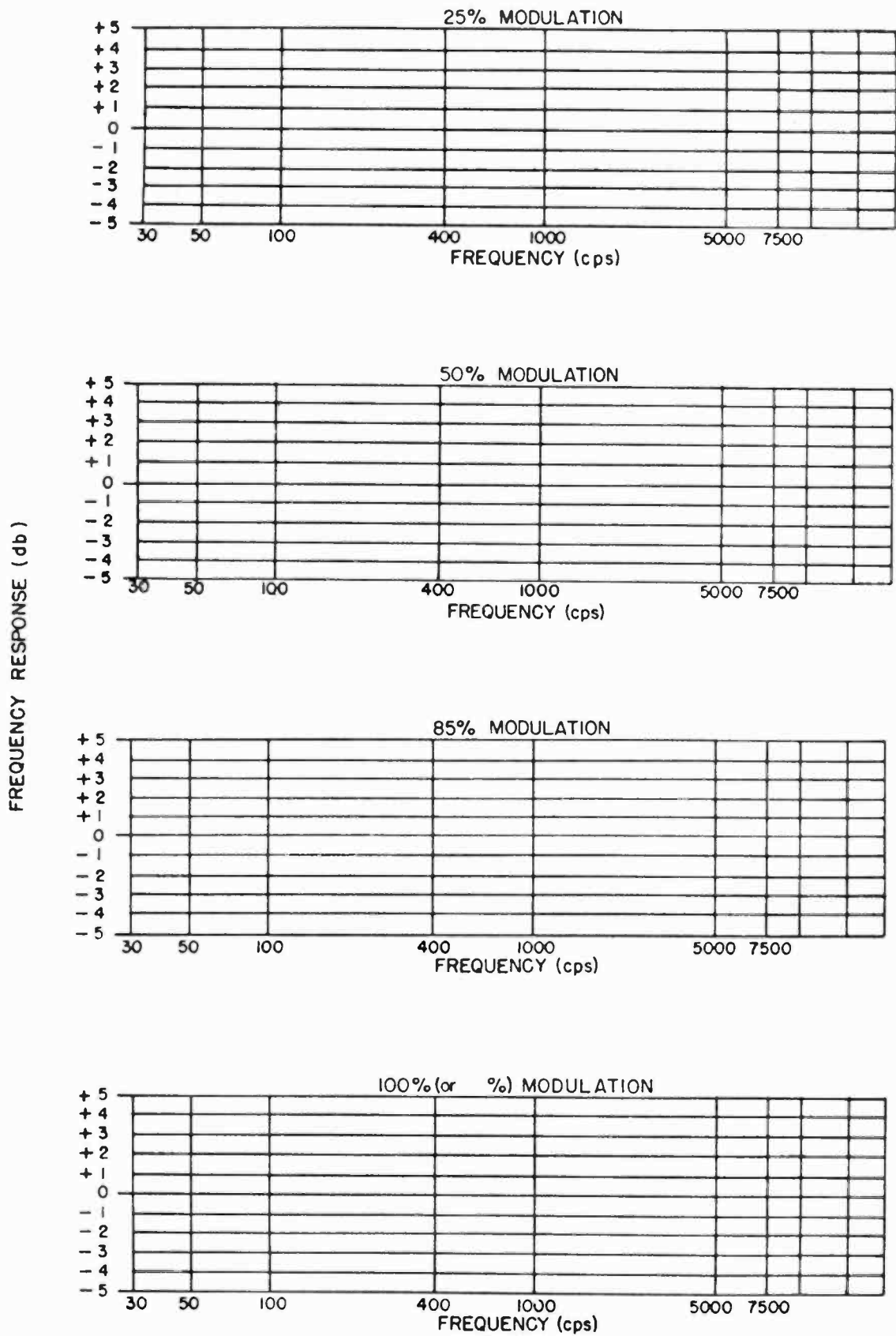

Fig. 15-4. Form AFP-2: Overall audio frequency response curves.

HARMONIC DISTORTION

CPS	30	50	100	400	1000	5000	7500
25							
50							
85							
100							

% DISTORTION

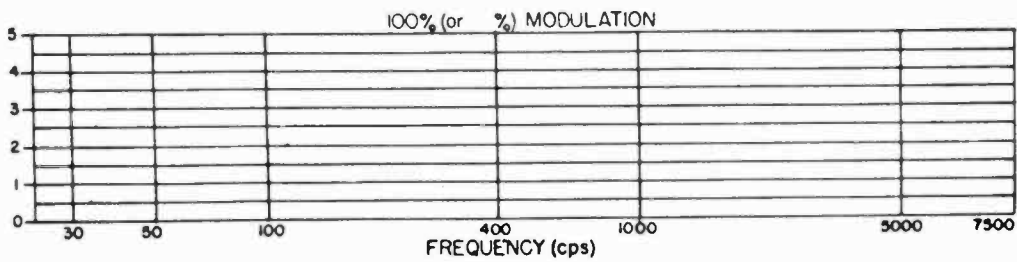
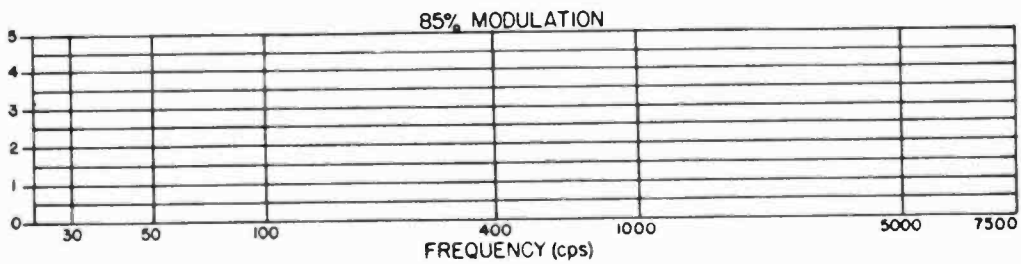
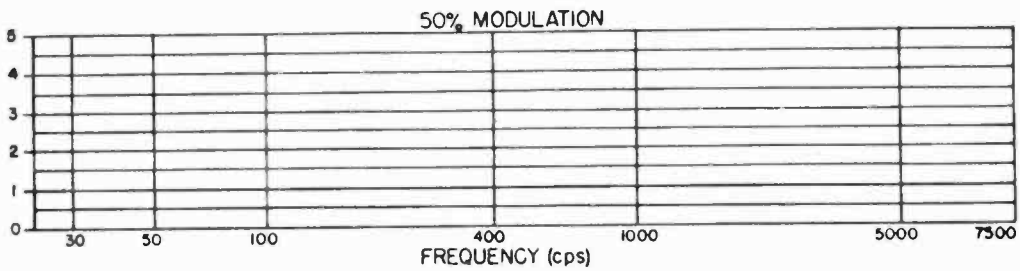
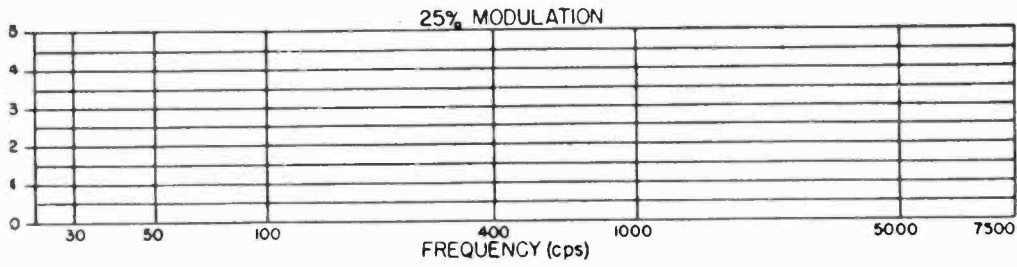

Fig. 15-5. Form AFP-3: Audio frequency harmonic content data and curves.

standards. Proper remedial steps should be taken to correct obvious deficiencies in equipment or in measurement procedures. (See the last half of this Chapter.)

HARMONIC DISTORTION MEASUREMENTS

The distortion and noise meter must be capable of measuring throughout the harmonic spectrum. Harmonic distortion must not exceed 5% up to 84% modulation, or 7.5% at modulation percentages greater than 84%.

1. After program levels are set for normal operation, repeat Steps 1 to 7 under Frequency Response Measurements.

2. Connect the distortion and noise meter to the transmitter output (see Figs. 15-1 and 15-2). Be sure the meter is in the distortion position. If the meter doesn't have a built-in RF rectifier unit, a separate detector must be used. Usually, the modulation monitor contains an RF rectifier which can be used for this measurement.

3. Read the noise-and distortion meter instruction manual thoroughly to determine the method of measuring harmonic content. Then adjust controls to obtain the harmonic content for the 1000-Hz reference frequency and record in the space on Form No. AFP-3 (Fig. 15-5).

4. Repeat Steps 7 through 10 under Frequency Response Tests and Step 3 of this section for 30, 50, 100, 400, 5000, and 7500 Hz.

5. Continue to perform Steps 4 through 10 under Frequency Response Tests and Steps 3 and 4 for 50, 85, and 100% modulation levels.

6. Record data and plot curves on the graph on Form No. AFP-3 (Fig. 15-5).

Excessive harmonic distortion greater than 5% up to 84% modulation or exceeding 7.5% for modulation levels from 85 to 95% is in violation of FCC standards. Corrective action must be taken and the measurements repeated.

CARRIER SHIFT MEASUREMENTS

Carrier shift is a change in the average value of the modulated RF carrier compared to the average value of the unmodulated carrier. A carrier shift upward is called a positive carrier shift and a shift downward is called a negative carrier shift. Excessive carrier shift results in unwanted harmonics and additional sideband frequencies with resultant interference on adjacent frequencies. The maximum carrier shift

at any of the specific modulation percentages must be less than 5% in either the positive or negative direction.

1. Set up all the equipment for normal program operation.

2. Bypass the AGC or limiting amplifier.

3. Connect the audio signal generator or oscillator as illustrated in Figs. 15-1 and 15-2.

4. Set the oscillator frequency to 400 Hz.

5. Adjust the oscillator gain control for minimum output.

6. Set the attenuator to 40 or 50 db.

7. Connect to the input of a microphone pre-amplifier.

8. Connect a high-impedance DC voltmeter to either the output of the detector or the detector in the noise and distortion meter and adjust the control until maximum DC voltage is obtained.

9. Read and record the DC voltmeter reading (without modulation) in Row 1 or Form No. AFP-4 (Fig. 15-6).

10. Increase the gain of the audio generator and adjust the attenuator until the modulation monitor reads 25% modulation.

11. Record the DC voltage in Row 2 on Form No. AFP-4 (Fig. 15-6).

12. With the 25% modulation, the DC voltmeter reading will drop. This is recorded under the first reading in Row 2.

13. The difference between the two readings is recorded in Row 3.

14. The ratio of the number in Row 3 to the corresponding number in Row 1 multiplied by 100 is recorded in Row 4.

15. Repeat Steps 10 through 14 at 50%, 85% and 100% modulation.

If the carrier shift exceeds 5% at any level of modulation, it is in violation of the FCC standards. Action should be taken to correct the deficiencies and the measurements repeated.

CARRIER SHIFT DATA (at 400 cps)

% MOD.	25	50	85	100
(1)				
(2)				
(3)				
(4)				

COMBINED NOISE AND HUM READING

DB	%

Fig. 15-6. Form AFP-4: Carrier shift and combined noise and hum data.

- ON A GENERAL COVERAGE COMMUNICATIONS TYPE RECEIVER SLOWLY SCAN THE RADIO SPECTRUM FROM 540 KC TO 30 MC. FOR ANY INDICATION OF SPURIOUS EMISSIONS (OTHER THAN HARMONIC RADIATION) AND RECORD RESULTS BELOW.

FREQUENCY	DESCRIPTION AND INTENSITY OF EMISSION

- USING THE SAME RECEIVER, MAKE OBSERVATIONS ON HARMONICALLY RELATED FREQUENCIES UP TO AND INCLUDING THE 15TH HARMONIC, NOTING IN THE BOX BELOW THE S METER OR AUDIBLE RESULTS FOR EACH HARMONIC.

HARMONIC	S-METER READING OR AUDIBILITY RATING
2nd	
3rd	
4th	
5th	
6th	
7th	
8th	
9th	
10th	
11th	
12th	
13th	
14th	
15th	

Fig. 15-7. Form AFP-4A: Results of spurious radiation and harmonic tests.

CARRIER HUM AND EXTRANEOUS NOISE MEASUREMENTS

Hum and noise must be at least 45 db below the 100% modulation signal level between 150 and 5000 Hz, and down 40 db outside this range.

1. Adjust and set up all the equipment as indicated in Steps 1, 2, and 3 under Carrier Shift Tests.
2. Adjust the audio oscillator to a reference frequency of 400 Hz.
3. Adjust the gain control to 15 db.
4. Set the attenuator to approximately 40 db.
5. Connect to a microphone preamplifier input and adjust the attenuator until the modulation monitor indicates 100% modulation.
6. Connect the noise and distortion meter to the transmitter output and adjust the sensitivity controls to obtain a full-scale reading with the output meter set for maximum reading.
7. After the reference level has been set, remove or disconnect the audio oscillator and terminate the preamplifier input with a resistor equal to its input impedance.
8. Leave all the gain settings as originally set; be sure no other faders are open.
9. Place the noise and distortion meter in the "noise" position.
10. Increase the sensitivity until a reading of the noise level on the unmodulated carrier is obtained. Record the reading in Form No. AFP-4 (Fig. 15-6).
11. The combined hum and noise reading is calculated by dividing the reading in Step 11 by the reading obtained in Step 6, and then multiplying by 100.
12. Convert the hum and noise ratio to db values and record on Form No. AFP-4 (Fig. 15-6).

If the hum and noise level is less than 45 db below 100% modulation between 150 and 5000 Hz, or less than 40 db outside this range, it is in violation of the FCC standards. Corrective action should be taken and the measurements should be repeated.

SPURIOUS RADIATION AND HARMONIC TESTS

This form of interference must be kept to a minimum and should be suppressed. It must never be of sufficient amplitude to cause undue interference to other radio services. Form No. AFP-4A (Fig. 15-7), which is self-explanatory, should be used to record the resultant data. All equipment should be adjusted for normal program operation. In cases involving controversy, the Commission may want actual field intensity measurements.

CONCLUSION OF AM PROOF OF PERFORMANCE TESTS

Past experience has shown that a few precautions taken during equipment setup will increase the accuracy of proof measurements. If the setup procedure is followed carelessly, inaccuracies are inevitable. In fact, carelessness at any point in the measurements may cause normally operating equipment to appear defective.

Proof-of-performance measurements are to be made with the equipment adjusted for normal program operation. All circuits between the main studio microphone input terminals and the antenna output, including telephone lines, pre-emphasis networks, equalizers, and limiter (without compression), must be measured simultaneously. Duplicate measurements are not required where the station operates with a DA-2 or DA-N pattern.

Before attempting to make the measurements, determine the input and output impedances of the audio system. There should be no question as to whether load impedances are balanced or unbalanced. Do not operate into impedance mismatches. To prevent stray fields, currents, and ground loops, use short power cords and reverse the plug for the best residual reading. Use short and shielded instrument leads, and bypass if necessary with capacitors or RF chokes. Bond all instruments to the station ground bus; leads should be kept as short as possible. Overloaded input circuits will cause excessive distortion, misleading noise measurements, and usually poor frequency response.

FM PROCEDURES

FM station licensees are required to make periodic proof-of-performance measurements, just as is required of AM stations. While the

same basic techniques are used in both cases, FM performance requirements are more stringent; therefore, greater care must be exercised and a different philosophy must be adopted when making measurements. FM broadcast station licenses are issued and renewed for the same periods as AM licenses; the only exception is that additional proof measurements are required and must be filed with the application to cover the construction and installation of FM broadcast stations.

Required Transmitter Performance

The construction, installation, operation, and performance of the FM transmitting system shall be in accordance with Paragraph 73.317. FM licensees shall make the following equipment performance measurements at least at yearly intervals, and one such set of measurements shall be made during the 4-month period preceding the date of filing application for license renewal.

1. Audio frequency response must be essentially flat from 50 to 15,000 Hz at approximately 25, 50, and 100% modulation. Measurements shall be made on at least the following audio frequencies: 50, 100, 400, 1000, 5000, 10,000 and 15,000 Hz. Frequency response measurements normally should be made without de-emphasis; however, standard 75- μ s de-emphasis may be employed in the measuring equipment or system, provided the accuracy of the de-emphasis circuit is sufficient to insure that the measured response is within the prescribed limits.

2. On the fundamental frequencies of 50, 100, 400, 1000, and 5000 Hz, the combined audio frequency harmonic distortion of the entire system must be measured at 25, 50 and 100% modulation. Audio frequency harmonics, at 100% modulation, normally shall include harmonics to 30,000 Hz on the 10,000- and 15,000-Hz measurements. The distortion measurements shall be made employing 75- μ s de-emphasis in the test equipment.

3. The output noise level (frequency modulation) in the band of 50 to 15000 Hz must be measured in db below the audio frequency level representing a frequency swing of 75 kHz. The noise measurements shall be made employing 75- μ s de-emphasis in the measuring equipment or system.

4. The output noise level (amplitude modulation) in the band of 50 to 15,000 Hz must be measured in db below the level representing 100% amplitude modulation. The noise measurements shall be made employing 75- μ s de-emphasis in the measuring equipment or system. All measurements shall be made with the equipment adjusted for normal program operation and shall include all circuits between the main studio microphone terminals and the antenna output, including telephone lines, pre-emphasis circuits, and any equalizers employed (except microphones), and without compression if a compression amplifier exists in the installation.

The above data, with a description of instruments and procedure signed by the engineer making the measurements, shall be kept on file at the transmitter and retained for a period of two years, and it shall be made available during the time upon request to any duly authorized representative of the FCC.

Additional requirements specify that some automatic means shall be provided in the transmitter to maintain the assigned center frequency with the allowable tolerance (\pm 2000 Hz). The transmitter shall be equipped with suitable indicating instruments to determine operating power, as well as other necessary instruments to facilitate proper adjustment, operation, and maintenance of the equipment. Adequate provision shall be made for varying the transmitter output power to compensate for excessive variations in line voltage or for other factors affecting output power. The ratings and specifications of all component parts must be adequate to avoid overheating at the rated maximum power output.

Means should be provided to operate approved frequency and modulation monitors continuously, and if a limiting or compression amplifier is employed, precaution should be maintained in its connection in the circuit due to the use of pre-emphasis in the transmitting system. Any emission appearing on a frequency removed from the carrier frequency by between 120 and 240 kHz inclusive shall be attenuated at least 25 db below the level of the unmodulated carrier. Compliance with this specification will be deemed to show that the occupied bandwidth is 240 kHz or less. On a frequency removed from the carrier by more than 240 kHz, and up to and including 600 kHz, any emission shall be attenuated at least 35 db below the level of the unmodulated carrier. Any emission appearing on a frequency removed from the carrier by more than 600 kHz shall be attenuated at least $43 + 10 \log_{10}$ (power in W) db below the level of the unmodulated carrier, or 80 db, whichever is the lesser attenuation.

25% MODULATION

CPS	50	100	400	1000	5000	10000	15000
(1)							
(2)							
(3)							

50% MODULATION

CPS	50	100	400	1000	5000	10000	15000
(1)							
(2)							
(3)							

100% MODULATION

CPS	50	100	400	1000	5000	10000	15000
(1)							
(2)							
(3)							

—% MODULATION

CPS	50	100	400	1000	5000	10000	15000
(1)							
(2)							
(3)							

Fig. 15-8. Form AFP-5: FM overall audio frequency response data.

FREQUENCY RESPONSE RUNS

1. Use the same techniques and procedures outlined for AM stations. Tabulate the results using audio frequencies of 50, 100, 400, 1000, 5000, 10,000 and 15,000 Hz at modulation percentages of 25, 50, and 100. The frequency response measurements should be made without de-emphasis, but standard 75- μ s de-emphasis may be used in the measuring equipment.

2. Record the data in the proper rows on Form No. AFP-5, shown in Fig. 15-8.

3. Plot the data curve on Form No. AFP-6. (See Fig. 15-9).

4. The figures from Form No. AFP-6 are then plotted on the standard 75- μ s pre-emphasis curve. Notice limits for this curve, indicated in Paragraph A2 of FM Electrical Performance Standards. (See Fig. 15-2).

AUDIO FREQUENCY HARMONIC DISTORTION

1. Audio frequency harmonic distortion is measured in the same manner as described for AM, except distortion must be measured on the fundamental frequencies of 50, 100, 400, 1000 and 5000 Hz at 25, 50, and 100% modulation. In addition, at 100% modulation, distortion on frequencies of 10,000 and 15,000 Hz must also be measured. The measurements must include harmonics to 30,000 Hz. Standard 75- μ s de-emphasis may be used in the measuring equipment.

2. Record the data in the proper rows on Form No. AFP-7 shown in Fig. 15-10.

3. Plot the curves on Form No. AFP-7.

4. The maximum allowable distortion is as follows: 3.5% from 50-100 Hz, 2.5% from 100-7500 Hz and 3.0% from 7500-15,000 Hz. If distortion exceeds any of these limits the system is operating in violation of FCC standards; therefore, corrective action should be taken and the measurements should be repeated.

OUTPUT NOISE LEVEL (FM)

1. The output noise level on the frequency-modulated carrier is measured the same way as described for AM. This includes any noise in the entire system that would result in frequency modulation of the carrier. FM noise is measured in db below the level corresponding to 100% modulation, which is a frequency swing of ± 75 kHz. The measurement must be made using a 75- μ s de-emphasis and the indicating instrument must have ballistic characteristics similar to those of a standard VU meter.

2. Record the data in proper spaces on Form No. AFP-8. (See Fig. 15-11).

3. If the output noise level exceeds 60 db down from the audio level representing a frequency swing of ± 75 kHz the system is in violation of the FCC standards. Corrective action should be taken and the measurements repeated.

OUTPUT NOISE LEVEL (AM)

1. Connect a 600-ohm wirewound resistor across the microphone preamplifier input terminals.

2. In measuring the noise level which is amplitude modulating the carrier, determine the audio voltage corresponding to 100% modulation.

FREQUENCY RESPONSE (db)

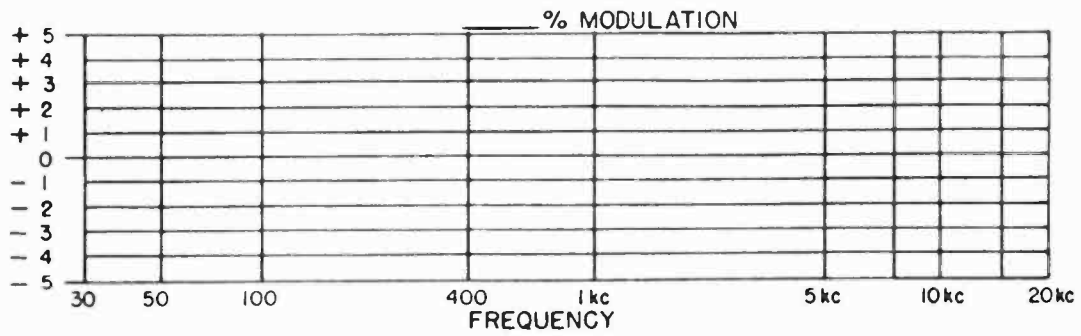
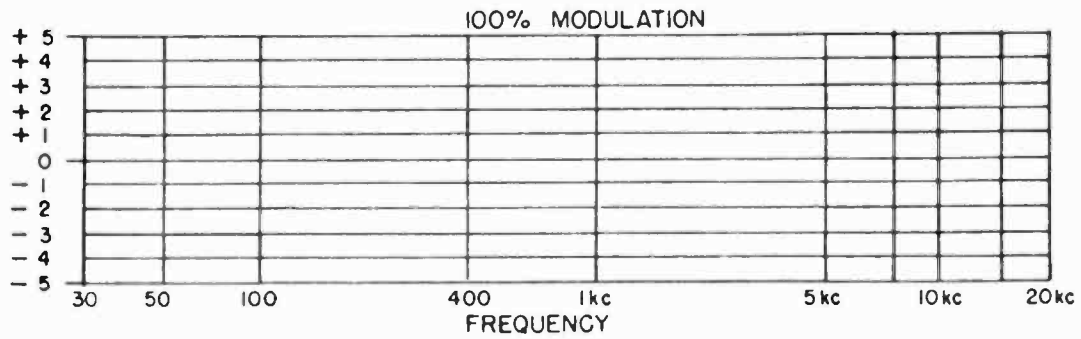
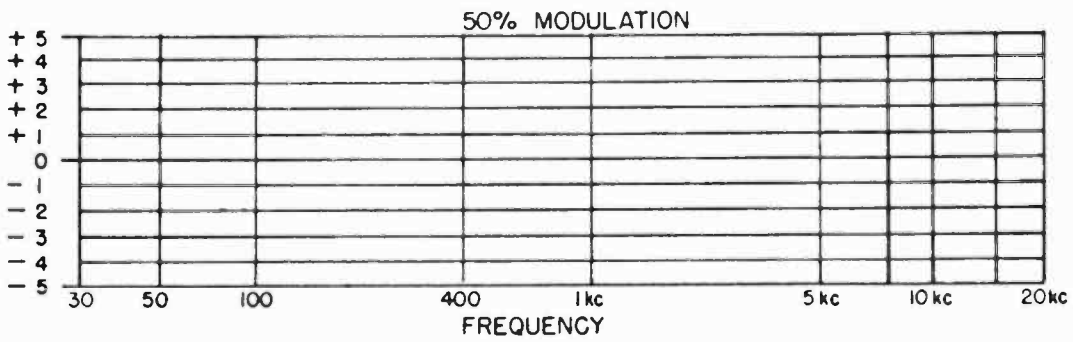
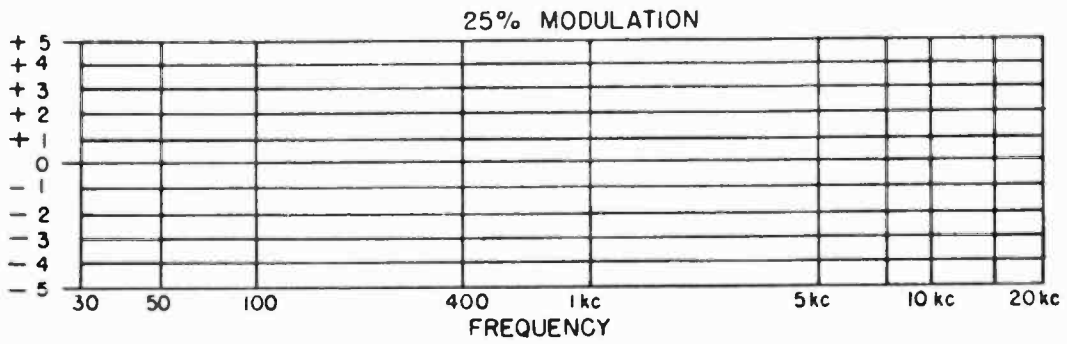

Fig. 15-9. Form AFP-6: FM overall audio frequency response curves.

HARMONIC DISTORTION

	CPS	50	100	400	1000	5000	10000	15000
% MOD	25							
	50							
	100							

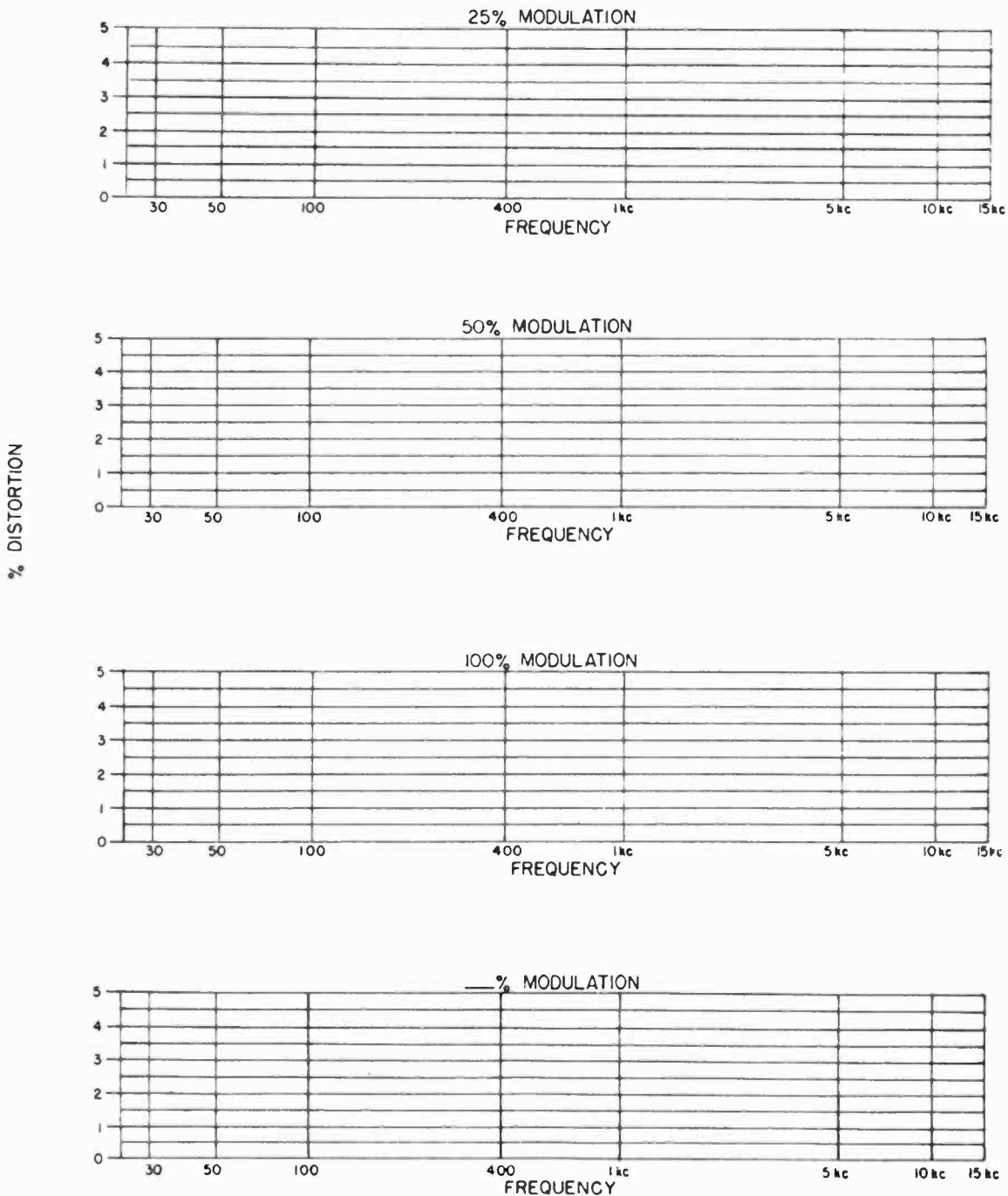

Fig. 15-10. Form AFP-7: FM audio frequency harmonic content data and curves.

This value is equal to the DC voltage across the meter determining the power level in the monitor.

3. Determine the audio voltage at the identical point for the same carrier level by using the noise and distortion meter with standard 75- μ s de-emphasis and VU meter.

4. To calculate the percentage of amplitude modulation, divide the audio voltage by the carrier level voltage, then multiply by 100. Convert this figure into db down from 100% modulation and record this data in the proper spaces on Form No. AFP-8. (Fig. 15-11).

5. If the output noise level is less than 50 db below the audio level representing 100% modulation, the system violates FCC standards. Corrective action should be taken and the measurements repeated.

STEREO AND SCA APPLICATIONS

Paragraph 73.322 of the FCC Rules and Regulations is the significant paragraph related to stereophonic operations. Paragraph 73.319 of the FCC Rules and Regulations lists requirements of subsidiary communication authority operations. After proper adjustment of the subcarrier, the SCA, and the stereophonic subcarrier in accordance with Section 73.319 and 73.322 of the FCC Rules and Regulations, proof procedures are substantially the same as for main carrier FM tests.

PROOF-OF-PERFORMANCE VIOLATIONS AND CORRECTIVE ACTION TECHNIQUES

Broadcast air and "ear" pollution is an unhappy

fact. Bad signals leave transmitting towers with such regularity that distorted AM and fuzzy FM stereo are often the rule rather than the exception. A clean signal is a quality signal. It must have minimum distortion and low noise. The ultimate goal is to supply a high fidelity audio signal to the listener. The FCC has set certain minimum standards. Part of the problem is that too many chief engineers have been willing to let these minimums become their station's maximum.

In the past, biggest offenders have been AM broadcasters. Fortunately, competitive pressures from FM broadcasters have been forcing many AM stations to clean up their signals. But FM in itself is not the entire answer either. Many FM stations are also guilty of abominable quality. A favorite station may sound good on a tiny portable, but pipe it in through the high fidelity equipment with those big speakers and the signal sounds horrible.

Improvement must come from within the industry. Stations do have appropriate test equipment and techniques at their disposal. For some of them, especially the low-budget FM stations, cost may be a crucial problem. For some, engineering experience may be lacking. This latter problem can again be boiled down to a question of finances.

Money is not the ultimate answer either. New developments in instrumentation technology, largely spurred by the FCC's modified monitoring requirements, make it possible for technically unsophisticated station personnel to do complex checks as routinely as they prepare the station log.

OUTPUT NOISE LEVEL (Frequency modulation)			
VM READING AT 100% MODULATION	NOISE VOLTAGE	% NOISE: $\frac{\text{COLUMN 2}}{\text{COLUMN 1}} \times 100$	DB DOWN

OUTPUT NOISE LEVEL (Amplitude modulation)			
VM READING AT 100% MODULATION	NOISE VOLTAGE	% NOISE: $\frac{\text{COLUMN 2}}{\text{COLUMN 1}} \times 100$	DB DOWN

Fig. 15-11. Form AFP-8: FM output noise level test results.

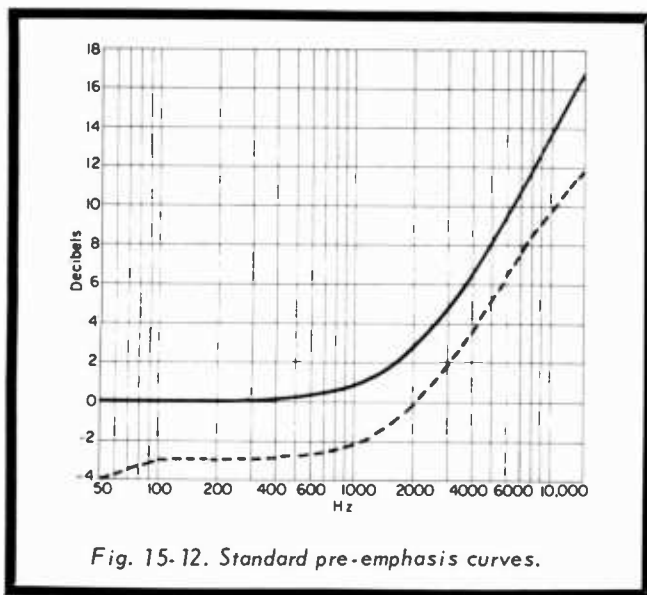

Fig. 15-12. Standard pre-emphasis curves.

A station that earns a reputation for having the cleanest signal in its market can garner a larger share of the advertising dollar. Clean signals benefit everyone. It would be a wonderful idea to set a station goal of improving critical proof-of-performance measurements by 10%. You may be surprised at the results.

The basic idea behind proof-of-performance measurements is the assurance that the entire system is operating within the FCC requirements. These tests are a record of the performance as it exists at the time of measurement. There is no guarantee that a tube or any other component in the system will not fail, resulting in different performance characteristics. However, when the system fails to meet the performance specifications the proper remedial steps should be taken to correct the deficiencies.

Audio Frequency Response

When the AM/FM system fails to meet the FCC audio frequency response specifications, the first step is to determine whether the trouble is located at the studio, the transmitter, or in the line or STL system. If the transmitter is at a separate location from the studio, the signal from the audio oscillator should be fed directly into the line. If the trouble is still present, run a frequency response check on the line or STL itself to isolate the fault and determine if the problem is cumulative. If the deficiency is at the studio audio frequency response measurement.

Amplifier frequency response can be modified by defective coupling, filtering, bypass capacitors, transformer loading resistors, input and output transformers, negative feedback circuits, and equalization networks.

Before any steps are taken, the matter of re-

placement components must be investigated thoroughly. Become familiar with the circuit in question, as well as the practical design theory of the amplifiers and associated networks.

Audio Frequency Harmonic Distortion

An important goal of any modern AM/FM broadcast installation is to maintain the proper distortion levels necessary for the required dynamic range. If normal adjustments and maintenance are performed there should be little difficulty in meeting the FCC specifications with respect to harmonic distortion.

Excessive harmonic distortion can be caused by tubes, low regulated power supply voltages, or by over-driving any amplifier or system. The source of distortion should be narrowed down to the transmitter, line or STL, or studio. If excessive noise is present the distortion measurement is apt to be high because of the high noise level.

With the exception of the lower level stages, the majority of the audio stages from the console to the modulators are operated as linear amplifiers. Perhaps the most important characteristic of a linear amplifier is its distortion level. Since the primary cause of distortion is nonlinearity, it is necessary to control as much as possible any unbalance introduced by tubes.

Special attention must be given to the push-pull nonlinearity caused by tube differences. Such effects become more noticeable in the high-level stages because of the large plate current excursions under signal conditions. Actually, all high-level amplifier stages exhibit some degree of nonlinearity and hence will produce some degree of distortion. Because of this limitation it is important that individual tubes do not add to the nonlinearity. The degree of distortion can be minimized by matching push-pull tubes as closely as possible.

A Class A output stage in a console will exhibit some characteristic curvature, but it will not approach the Class AB1 audio driver in the transmitter. Class B and AB2 modulators will introduce more distortion because they must be operated with their grids going positive for a portion of the operating cycle to develop sufficient audio power to accomplish their purpose.

Distortion, or nonlinearity, can be minimized by adjusting the dynamic balance of the modulator tubes. If each modulator has its own plate current meter the static currents can be adjusted by the individual bias controls to the desired value. In dynamic operation the meters should both swing in unison and reach the same values of peak current at maximum program modulation levels.

As distortion trouble will almost always be in the modulator, the prevention of any slight amount of distortion in the modulator is more important than anywhere else in the broadcast system. Unbalanced modulator tubes can cause much difficulty in making proof tests. Therefore, as a starting point towards minimizing modulator distortion, the instruction manual should be consulted for the recommended tube current and procedure for balancing the stage.

In adjusting the stage according to the specifications, it is a good idea to rotate tubes prior to the adjustment procedure. After selecting the tubes which cause the least amount of distortion when adjusted according to the manual, slight readjustments in the bias controls can be made to see if the level cannot be reduced even further. Apply a 1000-Hz signal and modulate the transmitter at 100%. Vary the bias controls a small portion at a time to see if a slight decrease in distortion is noted on the noise-distortion analyzer. Increase or decrease the bias adjustment to achieve minimum distortion. If the tubes are well matched and the high-voltage supply well regulated there will be a big improvement in performance. In any event, care must be taken in attempting to reduce distortion by varying the bias. In some instances the plate current may be increased to an abnormal value while attention is focused on the distortion meter.

Although the static currents are adjusted for minimum distortion at 1000 Hz with 100% modulation, in some cases this will result in undue distortion at 50 Hz. If this is the case the tubes should be readjusted for minimum distortion at 50 Hz. Then check 1000 and 7500 Hz to see that readings remain in the proper range at the higher frequencies.

After balancing the transmitter modulator tubes, the test equipment may indicate that the total distortion still exceeds the specification limits. At this time the other amplifiers in the audio chain should be checked.

Normally, objectionable distortion will occur only in the higher level stages of the chain due to tube mismatch. The console output stages, line and program amplifiers, and limiter should be checked. The console output amplifiers, which in most cases operate with a signal-balancing resistor shared by push-pull tubes, should be balanced with a volt-ohmmeter. The balancing control should be adjusted so that there is equal resistance to both tubes and the results of this adjustment verified by a distortion measurement.

Following this procedure the line-program amplifier and limiter should be checked if necessary. It is usually a good idea to check the balance in all push-pull stages, although the output stages

are the most likely source of mismatch distortion.

If excessive distortion is still present in the console and other amplifiers, it might be caused by a faulty circuit component anywhere in the chain. It is advisable to measure all DC plate, screen, grid, and cathode voltages and compare them to the voltage charts shown in the maintenance section of the instruction manual. If any discrepancies are located, inspect the circuit wiring for shorts, bad solder joints, and defective socket terminals. The DC voltage measurements should detect the location of a defective resistor, an open, shorted or leaky capacitor, and an open or shorted transformer winding. Substitution of the defective components should be accomplished and the audio frequency harmonic distortion measurement should be repeated.

Carrier Shift

Excessive carrier shift will cause severe distortion and in an extreme condition will produce unwanted harmonics and additional sideband frequencies with consequent interference on adjacent carriers. This type of deficiency may be the result of overmodulation, improper grid bias, poor grid bias supply regulation, poor plate supply regulation, defective power supply filters, faulty neutralization, and improper RF excitation.

The FCC requires the use of continuously operating monitors in broadcast stations. Some instruments have two meters, one which reads the average carrier level, and the other reads the percentage of modulation. The carrier level meter will also indicate carrier shift. This term refers to the change in average carrier amplitude as modulation is changed from 0 to 100%. Most modulation monitors are also provided with an overmodulation lamp which flashes when the modulated signal exceeds the operating value. Excessive values of carrier shift are normally corrected by re-establishing the proper operating procedures.

Carrier Hum and Extraneous Noise

One of the major factors contributing to frequent failures in proof-of-performance tests is noise and hum. In fact, the presense of noise and hum could be the cause of a distortion violation. Preamplifier input tubes are the most common cause of noise. If an oscilloscope is available, connect it to the noise-distortion meter analyzer terminals and determine if the noise is caused by a hum component or thermal and random noise created in the components. Many am-

plifiers or preamplifier power supplies employ hum adjusting controls which should be set while checking noise. "Hash" often appears where audio equipment is located close to the transmitter. Stray RF energy is rectified within audio stages and added to the program material. Also, hum and extraneous noise signals picked up from fluorescent lighting and similar lighting equipment will also be displayed.

Usually, the total noise component will consist of 60- and 120-Hz hum, plus pulses from detected RF, neon, and fluorescent wavefronts. These pulses will have a sporadic waveform, spaced at regular intervals across the noise spectrum. Hum is displayed by continuous waviness, and excessive component noise is indicated by intermittent pops occurring throughout the trace.

Before searching for a noisy component or item, an attempt should be made to see whether or not the infiltrating hash is the major problem. As a precaution, all fluorescent and neon lighting and tape recorders should be turned off and the scope trace and distortion meter should be observed. To prove the situation, the next step is to check the transmitter. This is accomplished by feeding the oscillator directly to the transmitter input and a noise measurement made separately. In some transmitters mercury vapor rectifier tubes can cause considerable hash. If the noise level improves considerably at any point in the above steps the transmitter may be regarded as satisfactory.

With the oscillator feeding the console input, connect the distortion meter to the output of the limiting amplifier and measure noise at this point. The transmitter percentage of modulation is normally set at 100% with a 400-Hz input and a regular noise test is conducted. If excessive noise is evident at the limiter output, cut off the transmitter; if the meter reading drops appreciably, the system prior to the transmitter should be investigated.

If the noise level remains excessive with the transmitter off, the next step is to determine whether external hum is being induced into the system, or if the high-level noise is distributed among several amplifiers or localized to one unit.

To determine if hum is getting into the control console, the input wiring should be shorted at the terminals inside the console and the noise meter checked for any significant decrease in reading. Perform the same test by shorting the input terminals of the limiter and check the meter reading. If shorting the console input terminals achieves a noticeable drop in the meter reading, there is a deficiency in the console input wiring. If the noise level is reduced after shorting the limiter input terminals, then the trouble has been

isolated to the console. If no significant change is shown with the limiter terminals shorted, the trouble is attributed to the limiter. Remember, the analyzer is still connected at the limiter output terminals.

Other factors responsible for excessive noise are defective tubes and transistors in the low-level amplifier stages. By replacing the suspected tubes and transistorized plug-in amplifiers these possibilities will be revealed or cleared. High noise levels can be introduced by defective plate and screen grid resistors, as well as electrolytic bypass and filter capacitors. Such problems are usually accompanied by some degree of popping or surging on the noise meter, although in many cases it will be indicated as a smooth noise display.

Generally speaking, such component noise can be detected and isolated to a particular stage by using a shielded probe connected to the vertical input terminals of an oscilloscope. With this setup, no signal should be fed to the amplifier under test and the input terminals should be shorted. By probing from the output stages back down through each preceding stage, plate by plate, and transistor by transistor, the noise can be isolated. When the noise disappears or becomes minimal on the scope, the trouble is usually found in the stage prior to this point. After determining the defective stage, the faulty components (plate, screen, grid resistors and capacitors) should be replaced by substituting an equivalent item. Bypass capacitors are usually checked for noise by unsoldering one lead and observing the waveform to see if the noise disappears.

Another unit which may create a noise problem is the power supply. To check for noise, the leads feeding the amplifiers should be disconnected and in many cases a load resistor substituted. The supply should be placed in operation to examine the output voltage for noise with the scope. Separate supply sections, or a separate supply, can be treated in the same manner. The series dropping resistors can be disconnected at the power supply and a scope check made at the terminals.

When the main power supply is declared free of noise, it would be advisable to investigate the decoupling networks located in the amplifiers—the series isolating voltage-dropping resistors and the associated bypass capacitors installed between the power supply and the amplifier stages. When a suspected capacitor is removed it may result in a change in gain or develop some form of oscillation. Noisy dropping resistors are best isolated by actual substitution. When probing decoupling networks the scope should be con-

nected to the plate of the tube which the network feeds.

The power supply could also be a source of excessive hum. As the filtering efficiency decreases, as the capacitors begin to age, the ripple component in the DC output begins to increase. It usually is an excellent idea to use the distortion analyzer to measure the ripple of the supply. Hum will also be caused by defective tubes and plug-in electrolytic capacitors if contact resistance develops. Hum induced by wiring coupling can be reduced by re-positioning low-level console input wiring, especially in relation to AC wiring to turntables and tape recorders.

Similar techniques can be used to check the transmitter driver circuits. Generally, the high-level stages will not contain the noise levels found in the earlier amplifiers in the chain. Except for defective noisy tubes and microphonic noise caused by the vibrating blower motors, it is good practice not to tamper around the transmitter unless the excess noise has been definitely isolated to the transmitter.

Noise can be created by high-resistance contacts at tube sockets, plug-in capacitor contact resistance, dirty or worn-out attenuator contacts and blades, and poor solder and loose connections. When the carrier hum and extraneous noise violations have been corrected, this portion of the proof measurement should be repeated.

Spurious Radiations and RF Harmonics

It is important that 99% or more of the radiated power lies within the bandwidth permitted for each class of service. Spurious radiation and

Another type of spurious radiation are the excessive sidebands generated as the result of over-modulation. In some transmitters where the output frequency is obtained from a mixer and multipliers, the unwanted mixer products and subharmonics must be sufficiently attenuated and not radiated.

Spurious output frequencies can be attenuated by filters, stubs, or other devices in the transmission line between the transmitter and antenna. It is also important that direct spurious radiation from cabinets be kept to a minimum. Complete shielding, in addition to the application of grounding strips to all cracks, is frequently necessary. A gap between panels of only a few thousandths of an inch can provide a slot antenna. In particular cases involving controversy the FCC may require actual field intensity measurements. Form AFT-4A is used to record the required measurements and is self-explanatory.

FM PROOF-OF-PERFORMANCE FAILURES

Since FM proof-of-performance measurements are practically the same as those described for AM, with the exception that performance requirements are broadened and more stringent, the same techniques and methods can be used to trace failures which occur in the FM broadcasting system during audio frequency response runs, audio frequency harmonic distortion, output noise level (FM and AM) measurements.

RF harmonics can seriously interfere with other broadcasting services. The most common type of spurious radiation occurs on frequencies which are multiples or harmonics of the desired station frequency.

CHAPTER 16

Prestige Broadcast Operations

The following AM/FM broadcast operations have been selected meticulously on the basis of the planning and versatility that went into their construction. Ranging in size from a network headquarters to an educational facility, these stations used the best approach through a systems layout plan incorporating the required programming and transmitting facilities. In not a single case were there any compromises insofar as technical equipment is concerned because they are interested in getting complete coverage and a high fidelity signal. The approach is paying off.

ABC, New York

Housed on the 5th floor at 1926 Broadway, the ABC network's multi-faceted operation encompasses studios, control rooms, and news facilities, all located at advantageous points for outstanding operational performance. The floor plans shown in Figs. 16-1 and 16-2 depict the ABC facilities used to service four different network operations.

Standardizing Operations

From a technical viewpoint, one of the greatest problems with the previous facility was the lack of standardization among the various studios located in the former ABC operations facility. Almost no two units were alike. Some were 20-year-old vacuum tube units, others were of more recent vintage, and a few were solid-state. Several different manufacturers were represented among the maze. This made operation instructions difficult; each board operated differently, maintenance was difficult since there was so little equipment and component interchangeability.

The new facility offers many advantages, principally that in the new location, as shown in the floor plans, all operations are now grouped on one floor and are completely compatible with the new programming concept.

Operating Features

The basic unit in all but two of the areas is a solid-state modularized control console, modified to meet ABC's special requirements. Control consoles are shown in Fig. 16-3, Power supplies, amplifiers, input switches, and other console functions are quickly removable for service. A spare module can be plugged in to replace a defective unit for on-the-spot servicing. This holds down-time to a minimum. Cartridge and reel tape machines are terminated in easily removed plugs designed for rapid equipment interchange when needed. For maximum flexibility and minimum crosstalk, all audio input switching is done by low-voltage DC control circuits.

A closer look at the studio console shown in Fig. 16-4 reveals a matrix of 50 possible inputs arranged in ten rows of five. The selector is a push-button matrix with a letter designation (A through E) over each of the vertical rows, and there are ten numbered pushbuttons opposite the ten horizontal rows. When a selection is made, the appropriate designation lights up on the readout panel. The readouts, connected by low-voltage DC to the stepping-relay bank, eliminate patch-cords. All this is accomplished in a panel space of only 4 x 8 inches. ABC engineers are enthusiastic about this unit, believed to be the first of its kind in broadcasting.

Another innovation is the automatic output routing system which can feed out on any of four program routes. Studios 5T and 6T have overseas control units from which newsmen can hold two-way conversations with foreign correspondents on the overseas lines. All tape machines and cartridge recorders are remotored to the console in their studio. A built-in safety feature eliminates the possibility of tape being rewound on the air; tape equipment will not supply any output to the console unless they are in play position.

All clocks at the 1926 Broadway studios are linked to a master clock which is locked to WWV. The

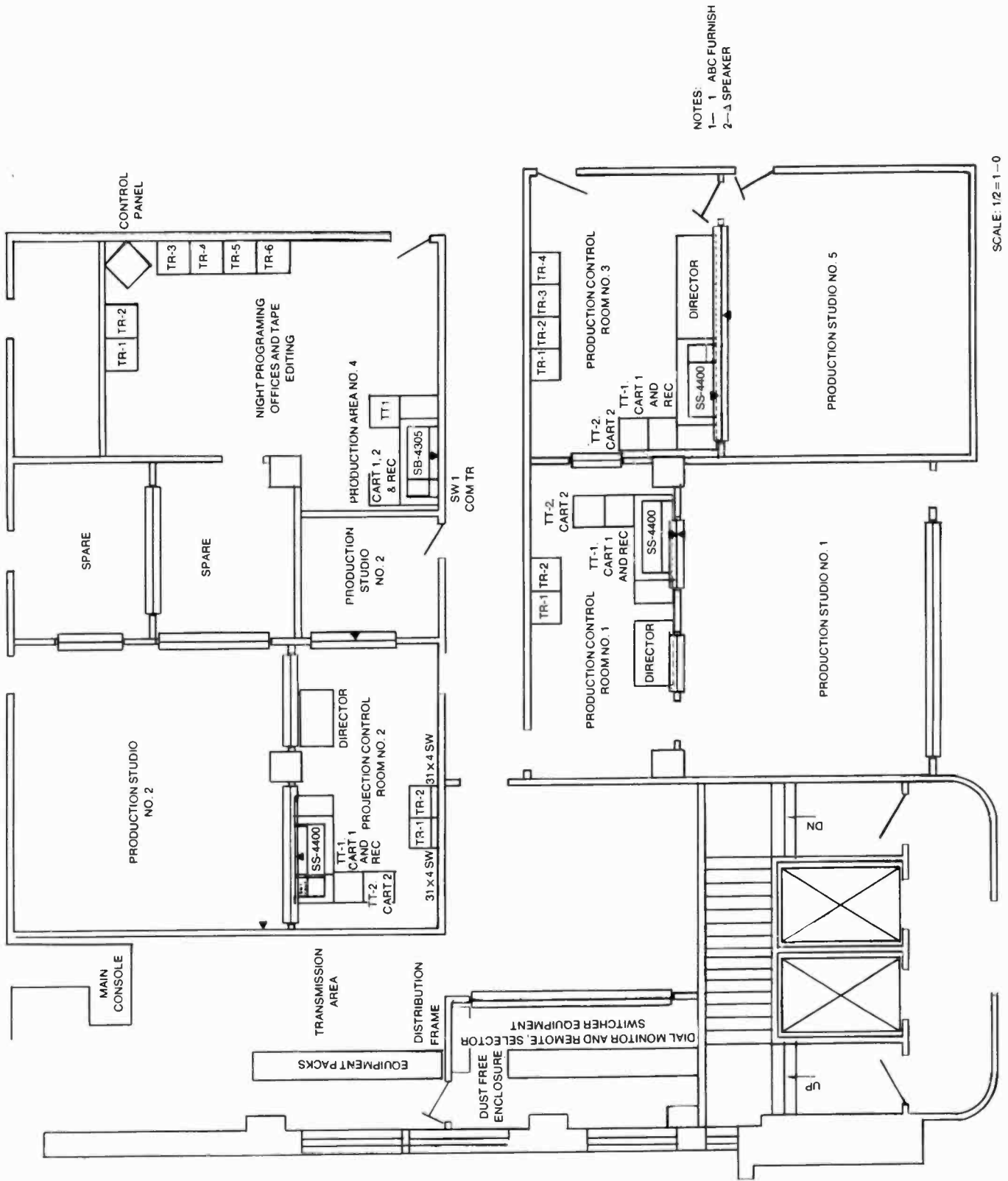

Fig. 16-1. Studios 1 to 4, ABC network.

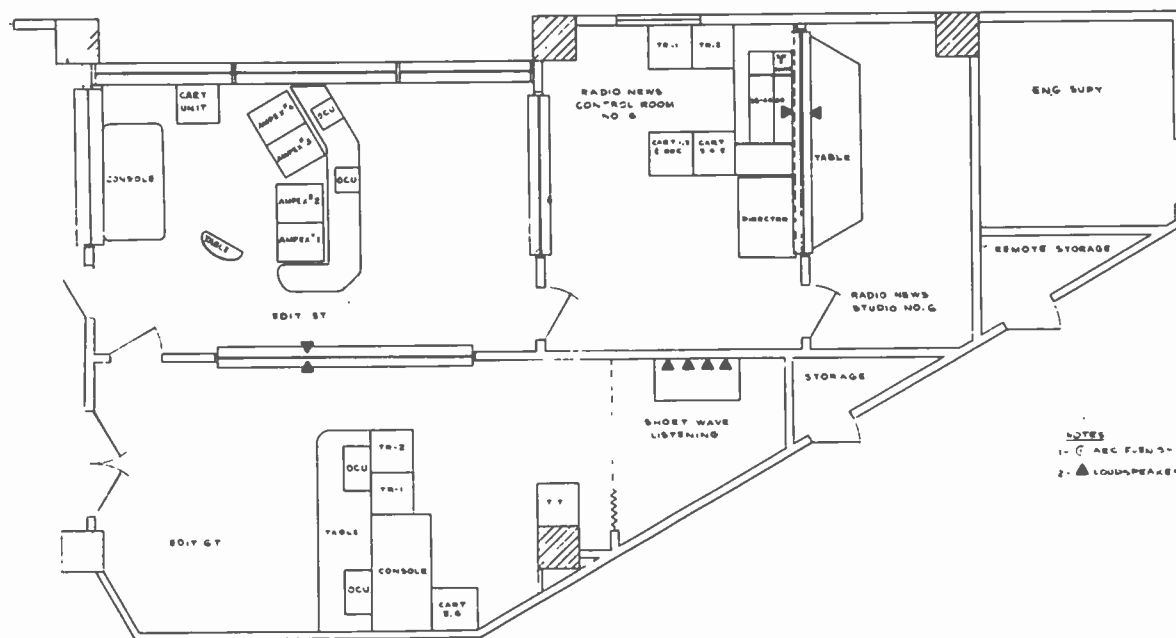
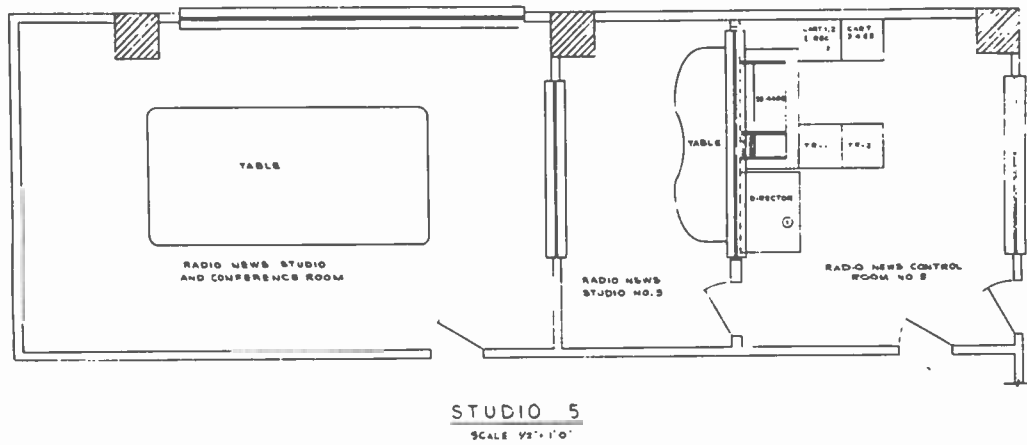

Fig. 16-2. ABC Network Studios, 5, 6, 5T, and 6T.

new ABC radio plant was conceived and designed around the objectives of standardization and reliability to handle modern network radio.

KOOL AM/FM, PHOENIX, ARIZONA

The foremost thought in building the KOOL studio facilities was how to build an attractive, dignified, modern, and practical station. They used transistorized studio equipment throughout for its modern and attractive design and low heat dissipation. Any equipment that was retained from the old facility was fully transistorized by the engineering staff.

Floor Plan and Building Features

The floor plan shown in Fig. 16-5 is simple yet serves very well. Master control, from which the daily operation originates, is a room 10 by 16 feet. A custom-built console desk and equipment housing leaves ample space for record storage and work space. A view of the master control is presented in Fig. 16-6. Production control (Fig. 16-7) is separated by a hallway from master control and is the same size.

One studio serves the entire operation. It is located next to production control, since 90% of its use is associated with production and taping. Full

visibility is afforded also from master control. The news room is adjacent to master control, thus providing quick access and close visual and physical communication.

Master and Production Control Equipment

Master control is equipped with three turntables, a reel-to-reel tape deck, two cartridge tape machines, and the control console. Notice cartridge storage bins above the cartridge tape machines (Fig. 16-6). The equipment layout was designed for ease of operation, hence the "U" shaped console.

Production control is arranged very much like master control, except there are two reel-to-reel tape machines and one tape cartridge system equipped with recording facilities (Fig. 16-7).

Operating Features

In the control rooms there are no equipment racks, not a single rack in the entire studio

plant. By using 100% transistorized equipment they were able to eliminate all racks. All operating equipment is mounted within custom-built control cabinets.

After operating in the new control rooms for a number of months, no problems of any consequence have arisen. The operators are exceptionally happy with the simplicity and ease of the operation. Due to the identical design of master control and production control, operators are able to step from one control room to the other without changing operating habits. Should anything go wrong in master control all the operator needs to do is step across the hallway, throw a key and program from production control.

WMJR-FM, FORT LAUDERDALE, FLORIDA

This station is designed to operate efficiently in commercial production, traffic, and presentation. It broadcasts a successful program format of good music, news, weather, and sports around the

Fig. 16-3. ABC's transmission control console.



Fig. 16-4. Another ABC studio console.



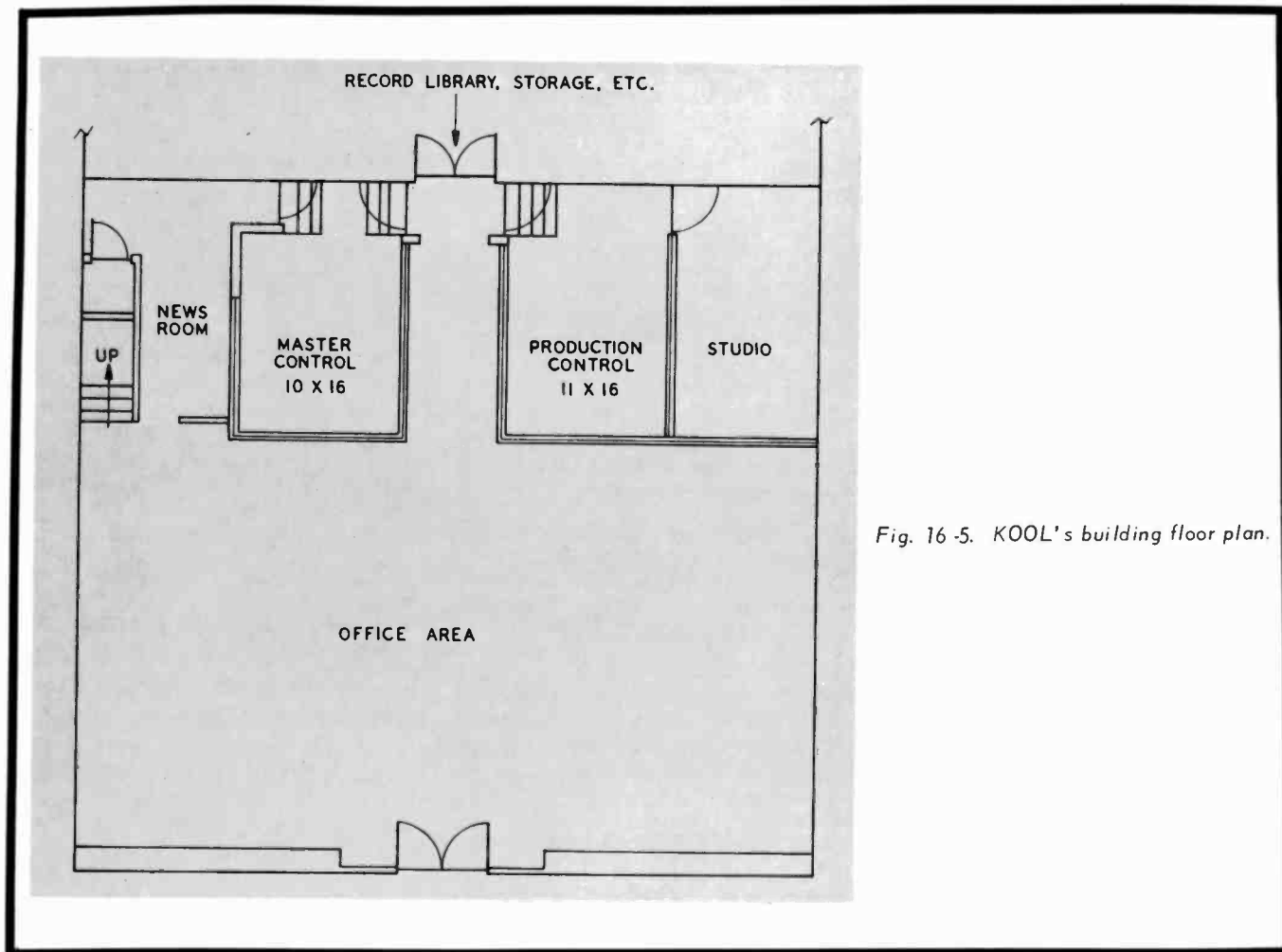

Fig. 16-5. KOOL's building floor plan.

clock. As shown in the floor plan illustrated in Fig. 16-8, one part is devoted to offices, the other side to programming and production. In the latter category are: main control room, news department, record library, and production room.

The transmitter is located at the top of the building in a room under the roof. Directly above, atop the building, is the tower. A 10-KW FM transmitter is employed with FM stereo equipment and a 6-bay antenna is side-mounted on the tower.

Control Room

Control room equipment includes the stereo control console, two turntables, three cartridge tape recorders, two stereo reel-to-reel tape machines, two microphones for stereo announcements, remote extension meters for the FM multiplex monitor and a transmitter remote control system.

From this control room the greater part of the programming is put on the air. Most of the music is on tape, advertising spots are on cartridge tape, and announcements are made live. Tape is employed for music to achieve stability of programming as well as highest quality sound. Use of tape permits pre-programming to a fixed for-

mat rather than a variety of individual formats which results when records are used.

Included in this setup is a special master remote switching panel. This incorporates pushbuttons and indicator lights for start and stop of:

1. Eight reel-to-reel tape machines
2. Six cartridge tape machines
3. Four transcription turntables

The console in the control room is hooked up with the console in the production room so that either can be used for on-the-air operation. See Fig. 16-9.

Production Room

Production control, as viewed in Fig. 16-10, resembles the main control room in equipment complement and layout. Beside the console there are dual microphones for stereo pickup, stereo reel-to-reel cartridge tape equipment, and a disc turntable. Although the room is designed primarily for program production, on-air operation is occasionally delegated to this console.

The production room is used to productapes for

announcements, sign on, and spots. All material is on stereo tape and some of the spots with musical background are staff produced.

Operational Features

Mounted at the base of the control consoles are custom designed switching panels which permit the operators to start and stop turntables and tape equipment directly from the panel without moving away to operate these equipments locally. The station has provided two centers of operation that give unusual flexibility and assurance that any temporary problems in either area can be bypassed.

The transmitter is remotely operated from the main control room by the station's own remote system. It is designed to read directly the output power, the actual plate voltage, and the plate current percentage.

KYW, PHILADELPHIA, PENNSYLVANIA

"All-news" KYW production control, studio, and news facilities are pictured in Figs. 16-12 through 16-17. You'll notice a departure from the previous facilities as necessitated by the all-news format, particularly in the number of record and playback facilities.

WPHC, WAVERLY, TENNESSEE

Waverly, Tennessee is the county seat of Humphreys County and is located approximately 65 miles west of Nashville. Operating at 1060 kHz, WPHC's 1000 watts serves the area with all local programming for almost 20,000 radio homes in the Tennessee Valley.

As presented in Fig. 16-18, the master control is equipped with a control console at the center of the "U" with two turntables to the left. Four cartridge tape racks flank the console with two



Fig. 16-6. KOOL's master control room.

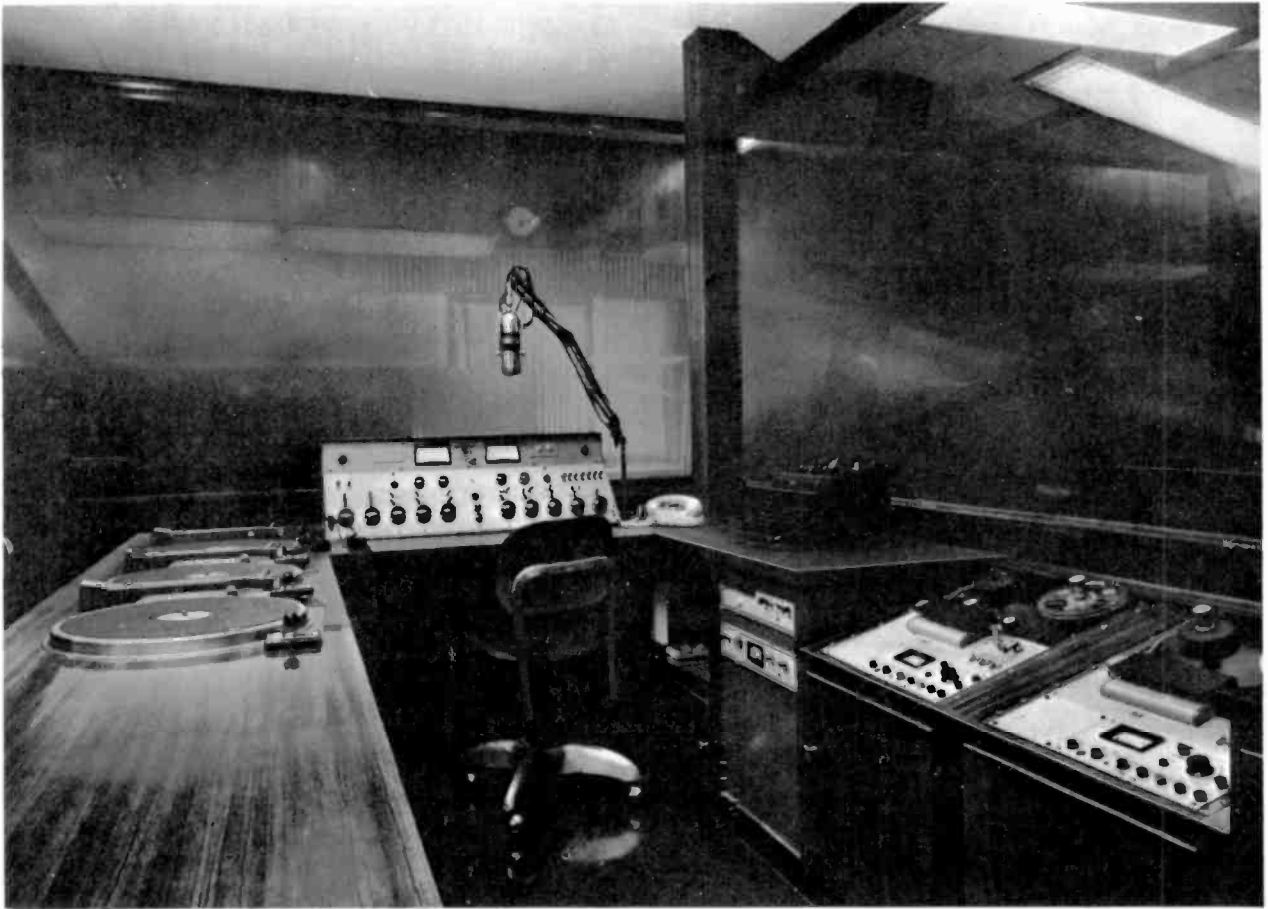

Fig. 16-7. Production control room is a virtual carbon copy of KOOL's master control.

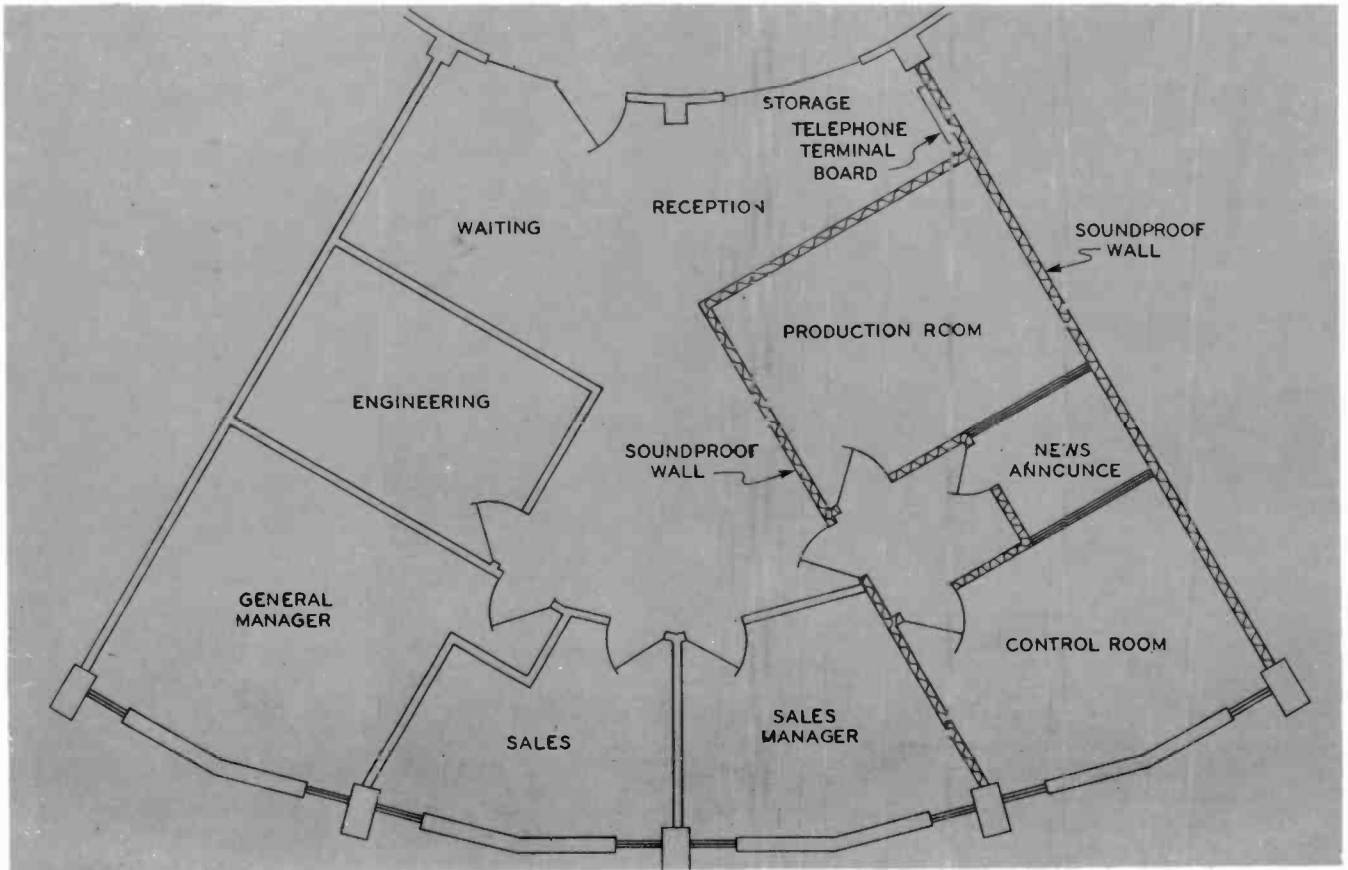

Fig. 16-8. Floor plan of the WMJR-FM facilities.



Fig. 16-9. WMJR-FM main control room.

on the left and two on the right. A tape bin and a record cabinet finish out the "U." A mike is used for live pickup in the control room. WPHC's 1000-watt transmitter is located in a separate room so that the front of the transmitter is visible to the master control operator through a glass-windowed door.

Additional recording equipment in the studio augments the gear in master control. As a result, WPHC is equipped for virtually any programming assignment. WPHC's floor plan clearly shows the compact arrangement that works so well. Notice the proximity of the antenna tower to the rear of the transmitter room.

KRAV-FM, TULSA, OKLAHOMA

Serving the Tulsa countryside with 20 KW effective radiated power, KRAV programs in stereo from downtown Tulsa, Oklahoma. A top-rated station, it is a success as a result of its con-

sistently high quality sound as well as program content.

Fig. 16-19 shows the KRAV floor plan. Occupying only 600 square feet, this plan makes efficient use of layout to provide plenty of creative elbow room for the talent.

WRVA AM/ FM, RICHMOND, VIRGINIA

As illustrated in Fig. 16-20 the WRVA transmitter building contains a 50-KW AM and a 20-KW FM transmitter. Both transmitters are cooled by internal blowers, mounted on the concrete floor inside each unit. Warm air is transmitted through sheet metal ducts to the outside of the building. Thermostatically controlled louvers allow the transfer of some of the heat to the working areas on the main floor of the transmitter building.

A 200-KW Cummins diesel generator in an adjacent building is on standby duty. Sufficient power can be derived from the standby unit to

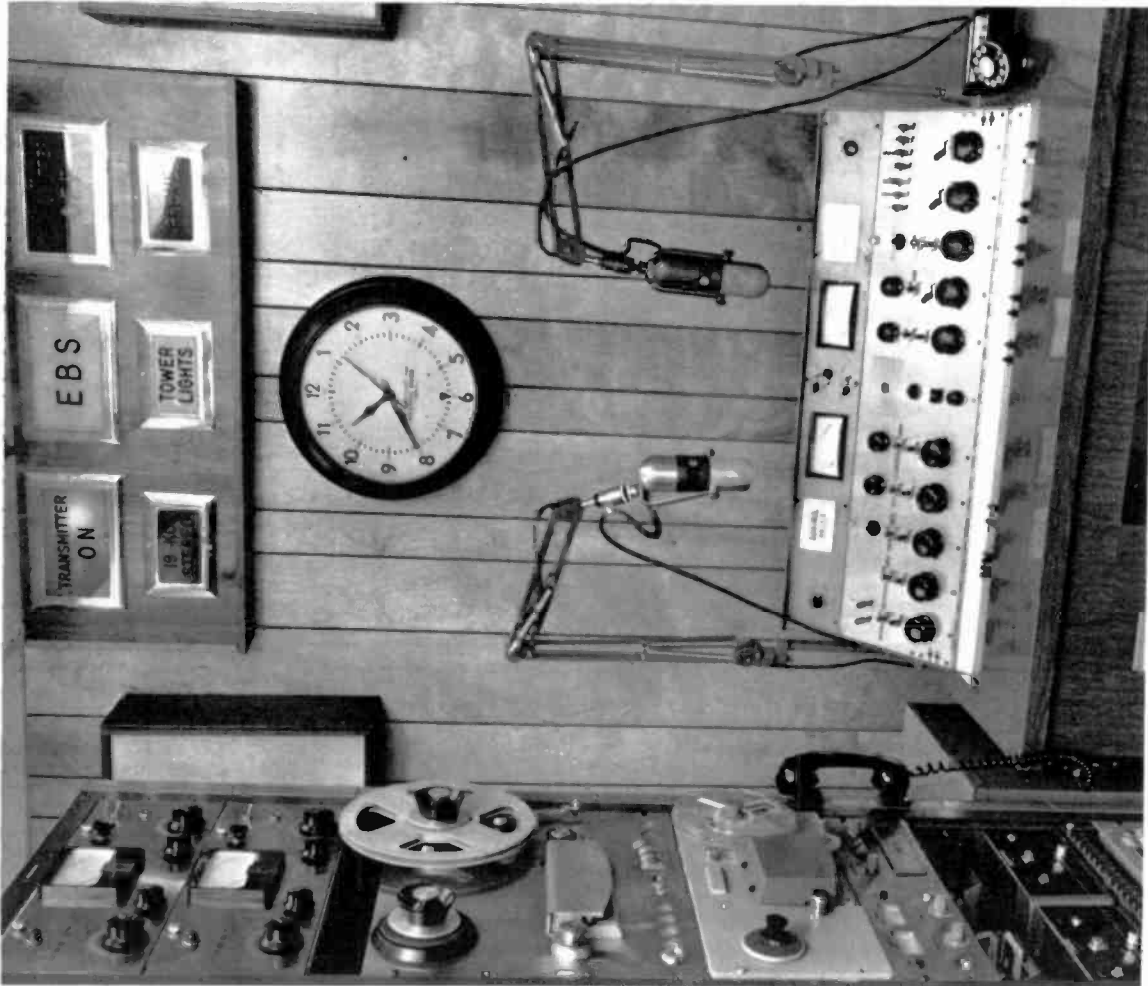

Fig. 16-10. WMJR-FM production control room.



Fig. 16-11. KYW's production control utilizes a transistorized stereo cartridge



Fig. 16-12. A view of KYW's production control room.

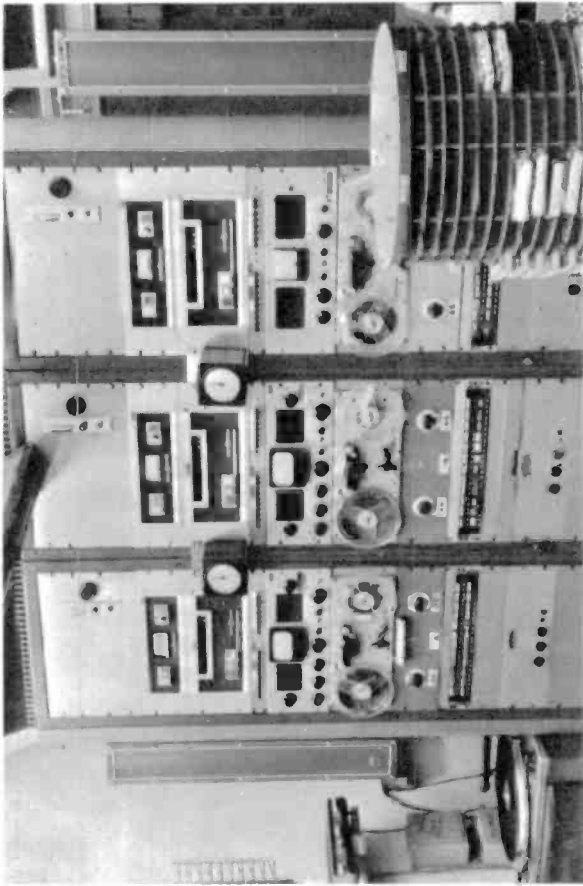

Fig. 16-14. KYW's recording facilities are rather extensive, a requirement of the all-news format.

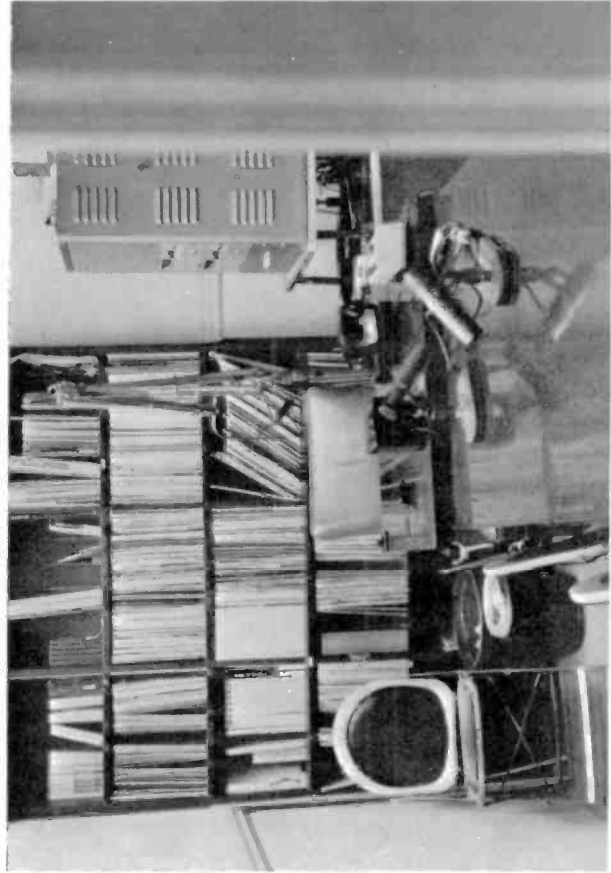

Fig. 16-13. KYW production studio.



Fig. 16-15. Washington line recording racks in KYW's news gathering facilities.

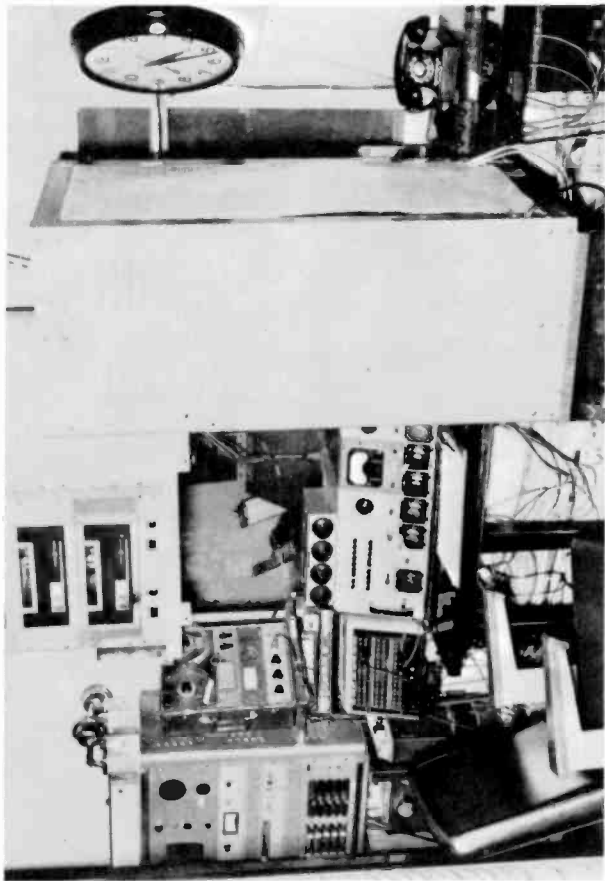

Fig. 16-16. KYW news control room "A"

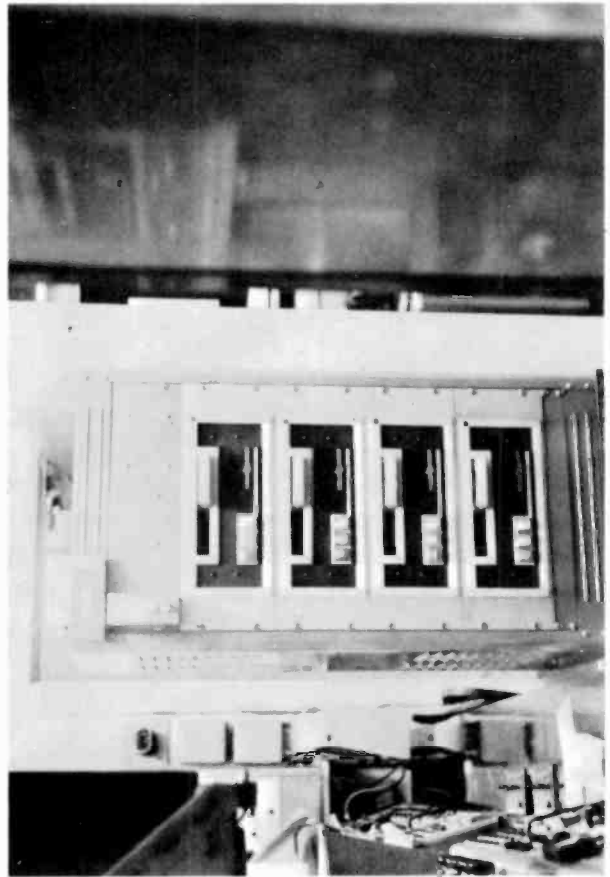

Fig. 16-17. KYW news control room "B"

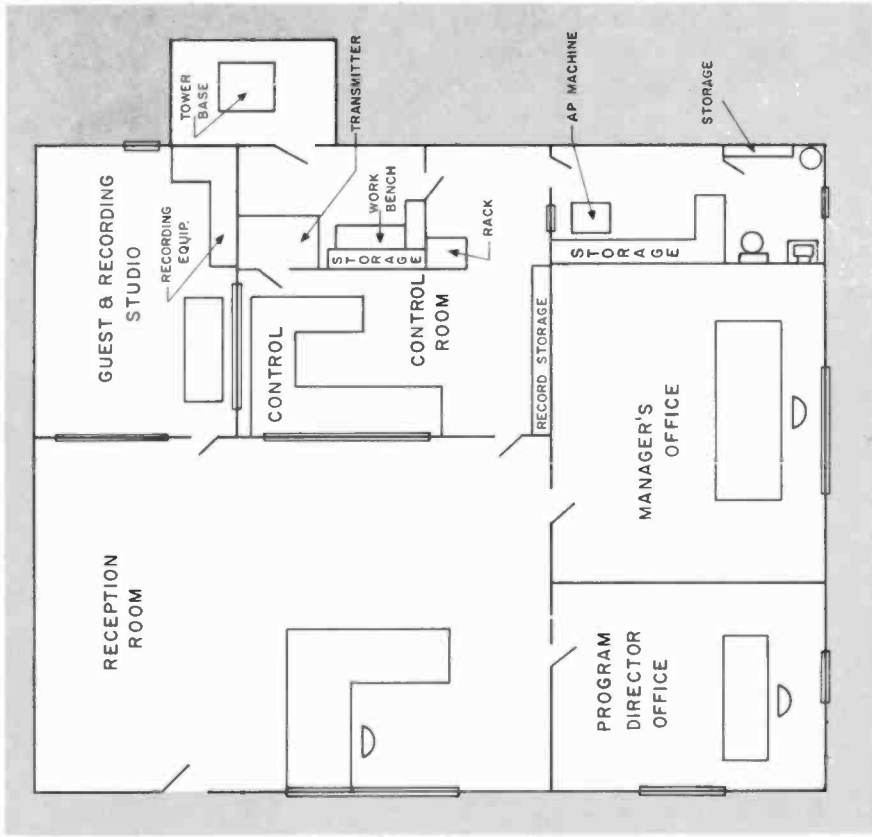

Fig. 16-18. Floor plan for WPHC's plant.

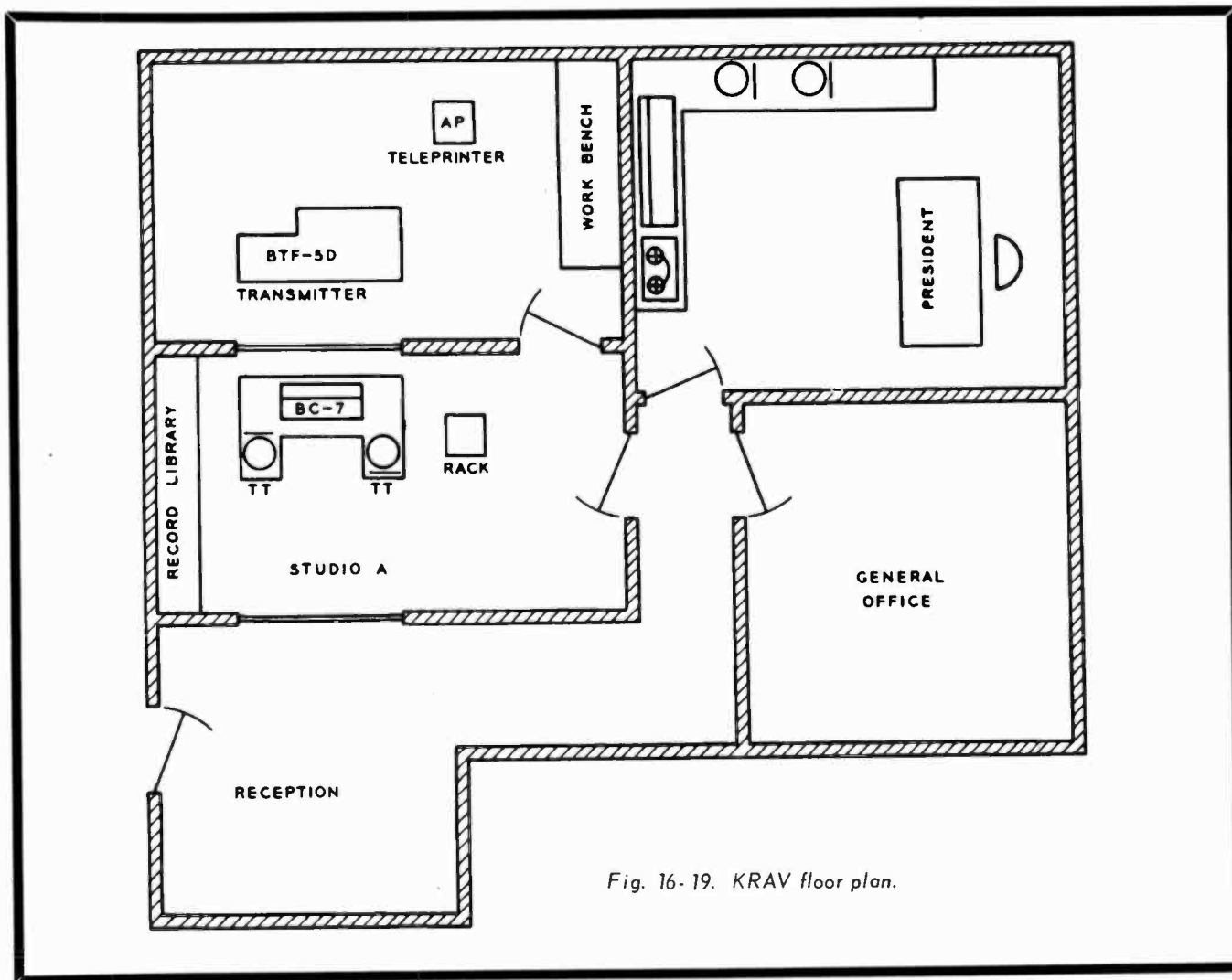

Fig. 16-19. KRAV floor plan.

operate both transmitters at full power, plus all auxiliary building services. The generator is entirely automatic in operation, thus reducing or eliminating any loss of air time in the event of commercial power failure.

To date, excellent FM reception reports have been received in excess of 100 miles out. The FM transmitter is located in the same room with the speech input equipment for all three transmitters. If, in the future, multiplex or stereo operation should be desired, the required sub-carrier generators can be added to the FM transmitter.

The FM antenna pattern is nondirectional and the AM antenna is directional in order to bring into its intensive coverage the bulk of Virginia's population.

WPAA/ FM, ANDOVER, MASSACHUSETTS

Radio Station WPAA-FM is located on the campus of Phillips Academy, Andover, Massachusetts. It is a non-commercial, educational station operating on 91.7 MHz with 10 watts output power.

The facilities occupy 600 square feet and consist of control and news room, live studio, and alcove. Fig. 16-21 shows the floor plan. Full visibility is afforded to all sections of the broadcasting operation. The control room provides adequate space for the custom-built master control console desk with storage space, two turntables, tape recorders, teletype, equipment racks, work table, record storage, and extra seating to encourage student participation programs

There are remote-control elements on the console to operate two professional tape recorders. Telephone connections are provided directly to the console for possible broadcast of major off-campus events. The WPAA-FM transmitter is located in a rooftop penthouse and the antenna is a single section broadcast FM antenna mounted on a guyed tower.

A FINAL WORD

The foregoing material has been presented with the hope and intention of alerting the broadcast

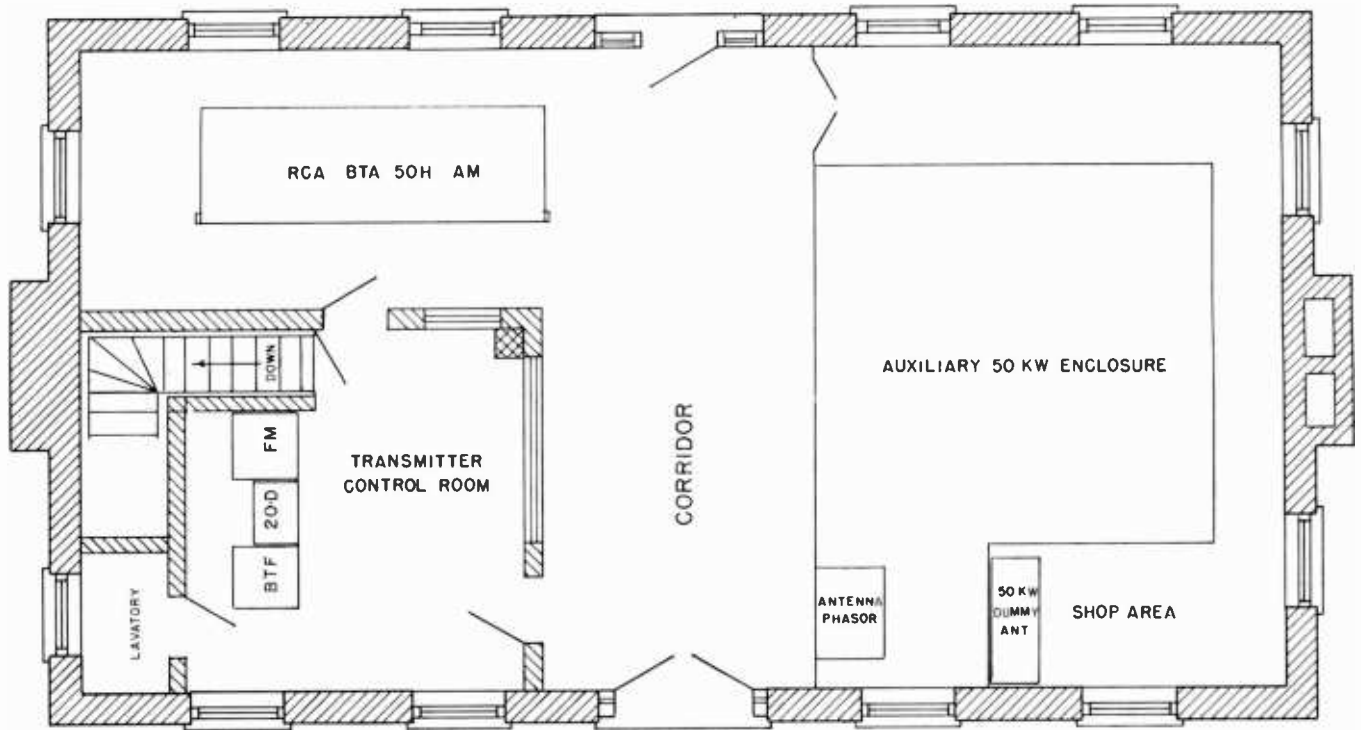

Fig. 16-20. WRVA radio transmitter building floor plan.

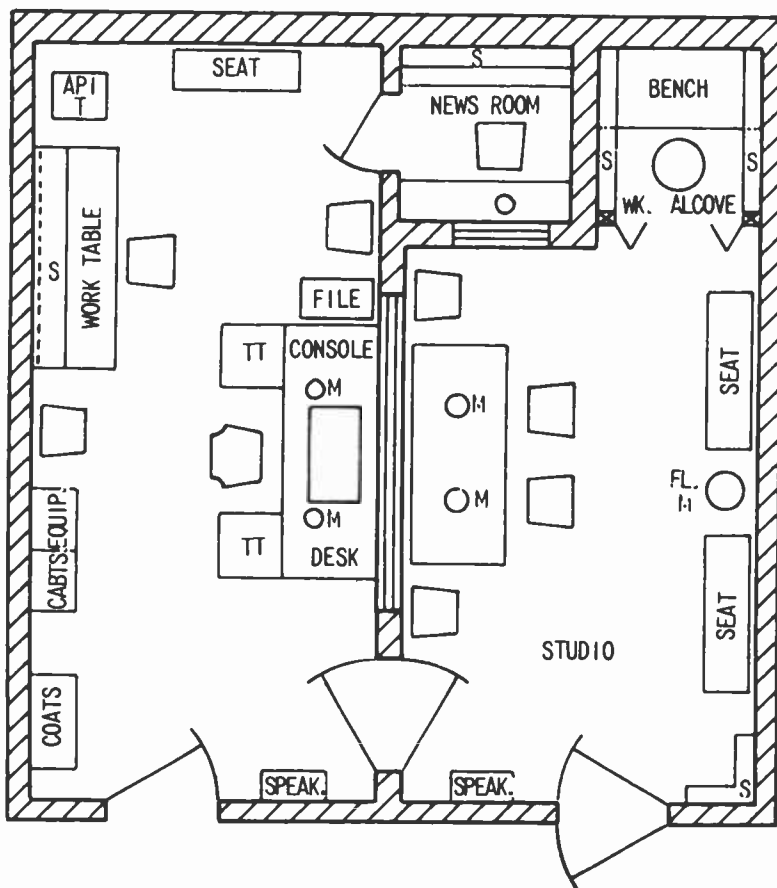

Fig. 16-21. Floor plan of the WPAA-FM radio facilities.

station planner to certain techniques which, if followed, will provide him with an AM/FM broadcast system as efficient and reliable as present procedures will allow. While this book should not

be taken as the final word in specific areas, since each broadcast installation is unique, it will, hopefully, guide you along the path to a successful operation.

APPENDIX

CHARTS	PAGE NO.
Footage Table for Broadcast Tower Heights.....	176
Tower Lighting.....	177
Tower Wind Loading.....	178
Wind Velocity and Pressure Map.....	179
Relation Between Antenna Current and Modulation	180
Field Intensity vs. Radiator Height	180
Distance in Miles From an FM Transmitter to Its 54 dbu (0.5 mv/m) Contour for Various Heights and Powers	181
Distance in Miles From an Fm Transmitter to Its 60 dbu (1mv/m) Contour for Various Heights and Powers.....	181
Distance in Miles From an FM Transmitter to Its 80 dbu (10mv/m) Contour for Various Heights and Powers.....	182
Conversion Table for Units of Length.....	182
Attenuator Network.....	183
Estimated Ground Conductivity Map.....	183
Power Rating-Rigid Transmission Lines.....	184
Attenuation - Rigid Transmission Lines.....	185
Power Rating-Heliac/Air Dielectric Cables.....	186
Attenuation-Heliac/ Air Dielectric Cables	187
Attenuation-Heliac/ Foam Dielectric Cables.....	188
Power Rating-Heliac/ Foam Dielectric Cables.....	189
Forward VS Reflected Power.....	190

Footage Table for Broadcast Tower Heights

550 KHZ TO 1070 KHZ					1080 KHZ TO 1600 KHZ				
KHZ	METERS	1 WAVE	1/2 WAVE	1/4 WAVE	KHZ	METERS	1 WAVE	1/2 WAVE	1/4 WAVE
550	545	1787.6	893.8	446.8	1080	277.8	911.1	455.5	227.7
560	536	1758.0	879.0	439.5	1090	275.2	902.6	451.3	225.6
570	526	1725.3	862.6	431.3					
580	517	1695.7	847.8	423.9	1100	272.7	894.4	447.2	223.6
590	509	1669.5	834.7	417.3	1110	270.3	886.5	443.2	221.6
					1120	267.9	879.0	439.5	219.7
600	500	1640.0	820.0	410.0	1130	265.5	870.8	435.4	217.7
610	492	1612.7	806.3	403.1	1140	263.2	862.6	431.3	215.6
620	484	1587.5	799.7	396.8	1150	260.9	855.7	427.8	213.9
630	476	1561.2	780.6	390.3	1160	258.6	847.8	423.9	211.9
640	469	1546.3	773.1	386.5	1170	256.4	840.9	420.4	210.2
650	462	1515.3	757.6	378.8	1180	254.2	834.7	417.3	208.6
660	455	1492.4	746.2	373.1	1190	252.1	826.8	413.4	206.7
670	448	1469.4	734.7	367.3					
680	441	1446.4	723.2	361.1	1200	250.0	820.0	410.0	205.0
690	435	1426.8	713.4	356.2	1210	247.9	813.1	406.5	203.2
					1220	245.9	806.3	403.1	201.5
700	429	1407.1	703.5	351.2	1230	243.9	799.1	399.5	199.7
710	423	1387.4	693.7	346.8	1240	241.9	793.7	396.8	198.4
720	417	1367.7	683.8	341.9	1250	240.0	787.2	393.6	196.8
730	411	1348.0	674.0	337.0	1260	238.1	780.9	390.4	195.2
740	405	1328.4	664.2	332.1	1270	236.2	774.7	387.3	193.6
750	400	1312.0	656.0	328.0	1280	234.4	768.8	384.4	192.2
760	395	1295.6	647.8	323.4	1290	232.6	762.9	381.4	190.7
770	390	1279.2	639.6	319.8					
780	385	1262.8	631.4	315.7	1300	230.8	757.0	378.5	189.2
790	380	1246.4	623.2	311.6	1310	229.0	751.1	375.5	187.7
					1320	227.3	746.2	373.1	186.5
800	375	1230.0	615.0	307.5	1330	225.6	739.9	369.9	184.9
810	370	1213.6	606.8	303.4	1340	223.9	734.7	367.3	183.6
820	366	1200.4	600.2	300.1	1350	222.2	728.8	364.4	182.2
830	361	1184.0	592.0	296.0	1360	220.6	723.2	361.1	180.5
840	357	1170.9	585.4	292.7	1370	219.0	718.3	359.1	179.5
850	353	1157.8	578.9	289.4	1380	217.4	713.4	356.2	178.1
860	349	1144.7	572.3	286.1	1390	215.8	707.8	353.1	176.5
870	345	1131.6	565.8	282.9					
880	341	1118.4	559.2	279.6	1400	214.3	703.5	351.2	175.6
890	337	1105.3	552.6	276.3	1410	212.8	696.9	348.4	174.2
					1420	211.3	693.7	346.8	173.4
900	333	1092.2	546.1	273.0	1430	209.8	688.1	344.0	172.0
910	330	1082.4	541.2	270.6	1440	208.3	683.8	341.9	170.9
920	326	1069.2	534.6	267.3	1450	206.9	678.6	339.3	169.6
930	323	1059.4	529.7	264.8	1460	205.5	674.0	337.0	168.5
940	319	1046.3	523.1	261.5	1470	204.1	669.4	334.7	167.3
950	316	1036.4	518.2	259.1	1480	202.7	664.2	332.1	166.5
960	313	1026.6	513.3	256.6	1490	201.3	660.2	330.1	165.0
970	309	1013.5	506.7	253.3					
980	306	1003.6	501.8	250.9	1500	200.0	656.0	328.0	164.0
990	303	993.8	496.9	248.4	1510	198.7	651.7	325.8	162.9
					1520	197.4	647.8	323.4	161.7
1000	300	984.0	492.0	246.0	1530	196.1	643.2	321.6	160.8
1010	297	974.1	487.5	243.7	1540	194.8	639.6	319.8	159.9
1020	294.1	964.6	482.3	241.1	1550	193.5	634.6	317.3	158.6
1030	291.3	955.3	477.6	238.8	1560	192.3	631.4	315.7	157.8
1040	288.5	946.2	473.1	236.5	1570	191.1	626.8	313.4	156.7
1050	285.7	937.1	468.5	234.2	1580	189.9	623.2	311.6	155.8
1060	283.0	928.2	464.1	232.0	1590	188.7	618.9	309.4	154.7
1070	280.4	919.7	459.8	229.9	1600	187.5	615.0	307.5	153.7

Tower Lighting

This chart illustrates the requirements for the standard lighting of antenna towers and supporting structures in accordance with "Indicated paragraphs of FCC Form 715 and FCC Rules Part 17", and "FAA Standards for Marking and Lighting Obstructions to Air Navigation, Sept. 1962".

Aeronautical study by the FCC and FAA may determine that other than standard lighting is required for a specific tower installation. The FCC Construction Permit will specify the required lighting for each installation and should be carefully checked for this information.

Antenna structures over 1500 feet up to and including 2100 feet in height above the ground shall be lighted in accordance with FCC Sections 17.34 through 17.37.

OVERALL HEIGHT 1351 TO 1500 FT. FCC ¶ No's. 3.10, 19, 21, FAA SPEC. "A-10". Standard lighting requires 3 Beacons, 15 Obstruction Lights (20 for square tower), and Beacon Flasher. Photo-Electric Control is required.

OVERALL HEIGHT 1201 TO 1350 FT. FCC ¶ No's. 3.9, 18, 21, FAA SPEC. "A-9". Standard lighting requires 4 Beacons, 15 Obstruction Lights (20 for square tower), and Beacon Flasher. Photo-Electric Control is required.

OVERALL HEIGHT 1051 TO 1200 FT. FCC ¶ No's. 3.8, 17, 21, FAA SPEC. "A-8". Standard lighting requires 4 Beacons, 12 Obstruction Lights (16 for square tower), and Beacon Flasher. Photo-Electric Control is required.

OVERALL HEIGHT 901 TO 1050 FT. FCC ¶ No's. 3.7, 16, 21, FAA SPEC. "A-7". Standard lighting requires 3 Beacons, 9 Obstruction Lights (12 for square tower), and Beacon Flasher. Photo-Electric Control is required.

OVERALL HEIGHT 751 TO 900 FT. FCC ¶ No's. 3.6, 15, 21, FAA SPEC. "A-6". Standard lighting requires 3 Beacons, 9 Obstruction Lights (12 for square tower), and Beacon Flasher. Photo-Electric Control is required.

OVERALL HEIGHT 601 TO 750 FT. FCC ¶ No's. 3.5, 14, 21, FAA SPEC. "A-5". Standard lighting requires 2 Beacons, 6 Obstruction Lights (8 for square tower), and Beacon Flasher. Photo-Electric Control is required.

OVERALL HEIGHT 451 TO 600 FT. FCC ¶ No's. 3.4, 13, 21, FAA SPEC. "A-4". Standard lighting requires 2 Beacons, 6 Obstruction Lights (8 for square tower), and Beacon Flasher. Photo-Electric Control is required.

OVERALL HEIGHT 301 TO 450 FT. FCC ¶ No's. 3.12, 21, FAA SPEC. "A-3". Standard lighting requires 1 Beacon, 4 Obstruction Lights, and Beacon Flasher. Photo-Electric Control is required.

OVERALL HEIGHT 151 TO 300 FT. FCC ¶ No's. 3.11, 21, FAA SPEC. "A-2". Standard lighting requires 1 Beacon, 2 Obstruction Lights, and Beacon Flasher. Photo-Electric Control is required.

Overall Height 21 to 150 Ft. FAA Spec. "A-1". Standard lighting requires 1 Double Obstruction Light.

FCC AND FAA SPECIFICATIONS

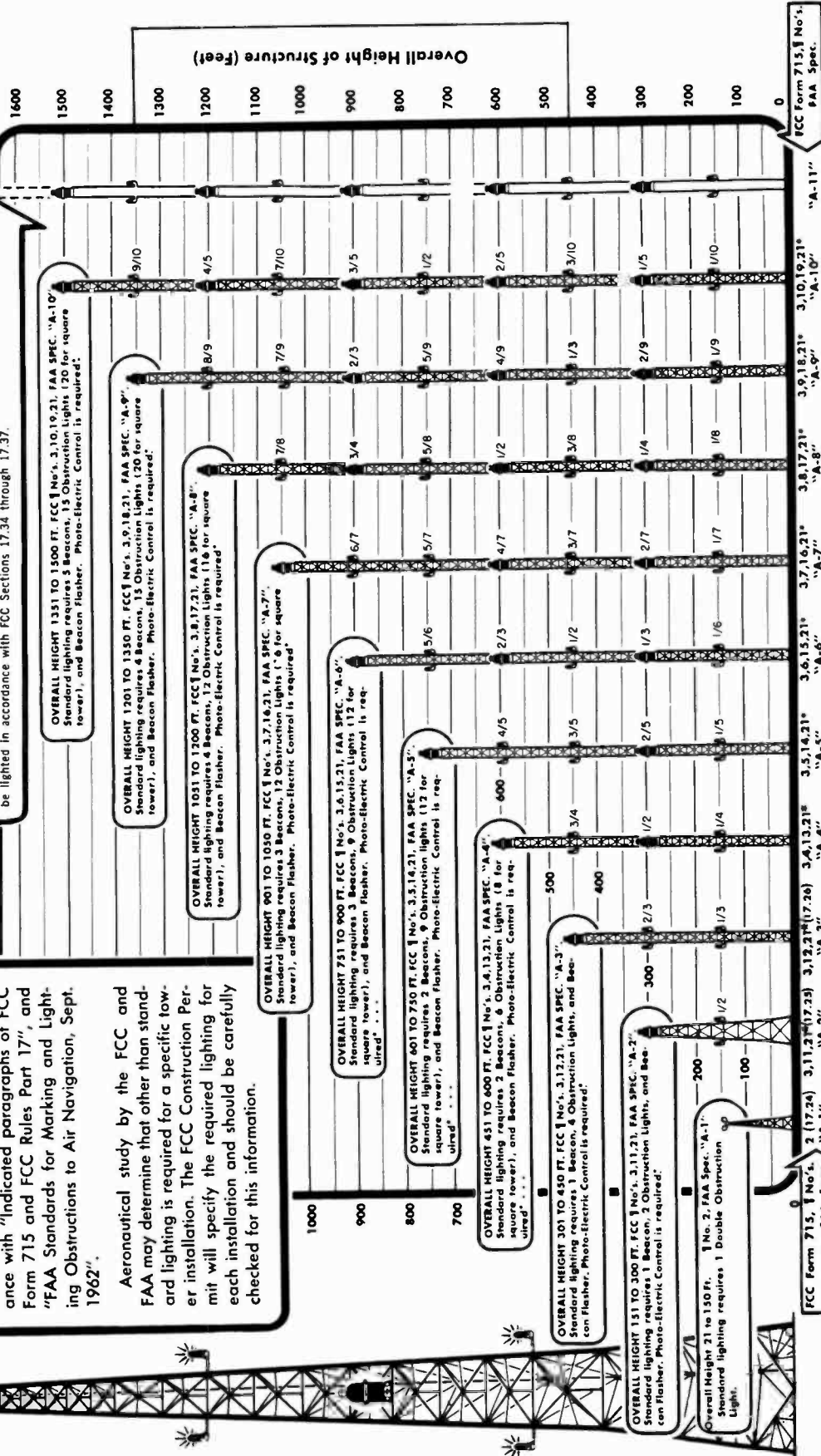

DAILY INSPECTION

FCC § 17.47 requires that the licensee: (1) shall make an observation of the tower lighting at least once each 24 hours, either visually or by observing an automatic test indicator or alternatively (2) shall provide an automatic alarm system.
 ● FCC Form 715 Paragraph 21 states, "All lights shall burn continuously or shall be controlled by a light sensitive device..."

LAMP SOCKET VOLTAGES

FCC § 17.54 and FAA "Standards for Marking and Lighting Obstructions to Air Navigation, Sept. 1962" specify that the lamp socket voltage correspond to or be within 3% of the rated voltage of the lamp used.

CABLE SUPPORTS

The National Electric Code specifies that conductors in vertical runs shall not be supported by terminals... and the cable supports shall be provided in each vertical run, and at intervals not greater than 100 ft.

TOWER WIND LOADING

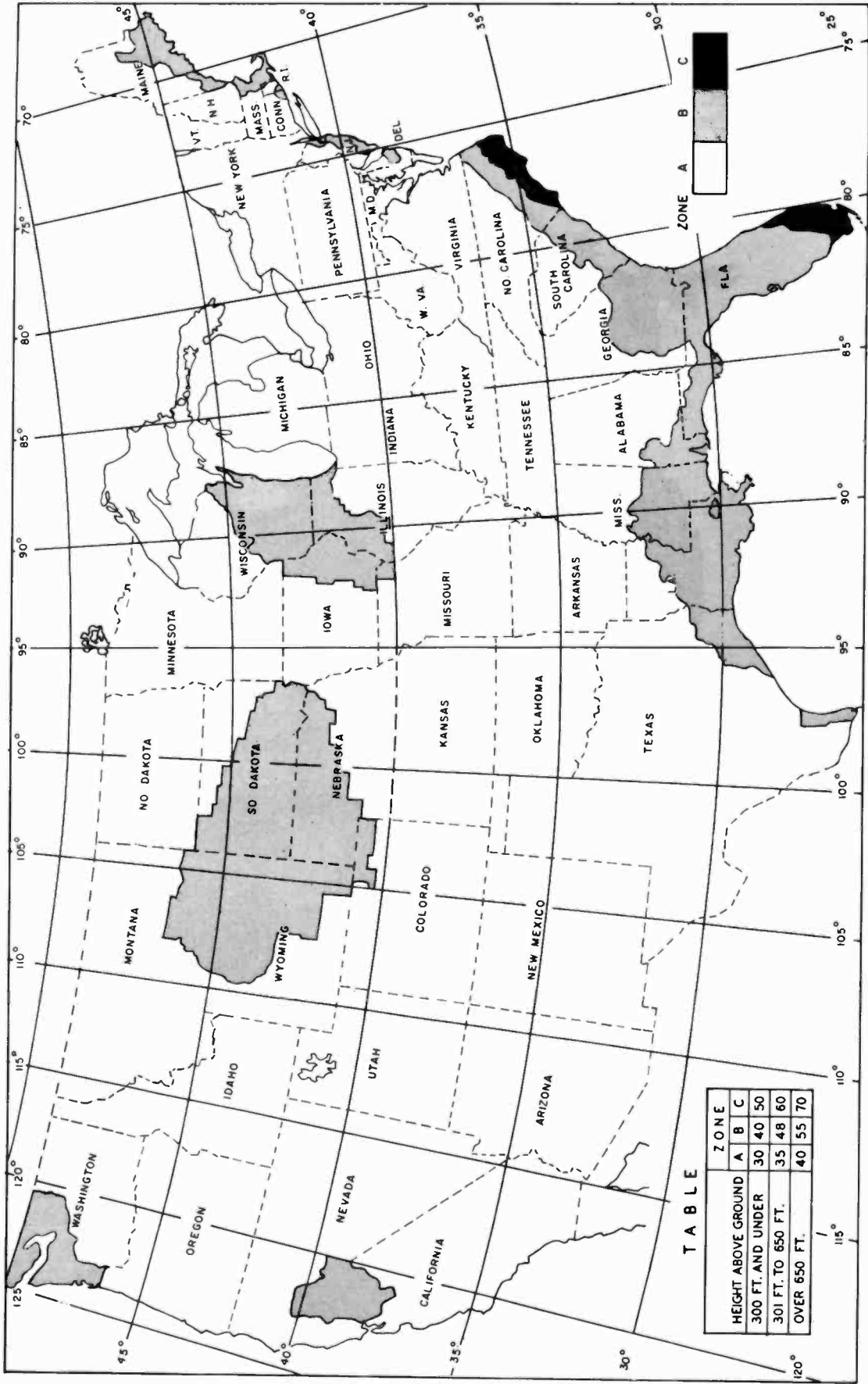

The above map and table, extracted from EIA Standard RS-222, gives minimum windload design pressures in pounds per square foot on flat surfaces with no ice for the zones indicated. This map, as well as the table, must be interpreted in view of local knowledge and applicable building codes. See Table 1 of RS-222 for zone boundaries listed by state and county.

WIND VELOCITY AND PRESSURE MAP

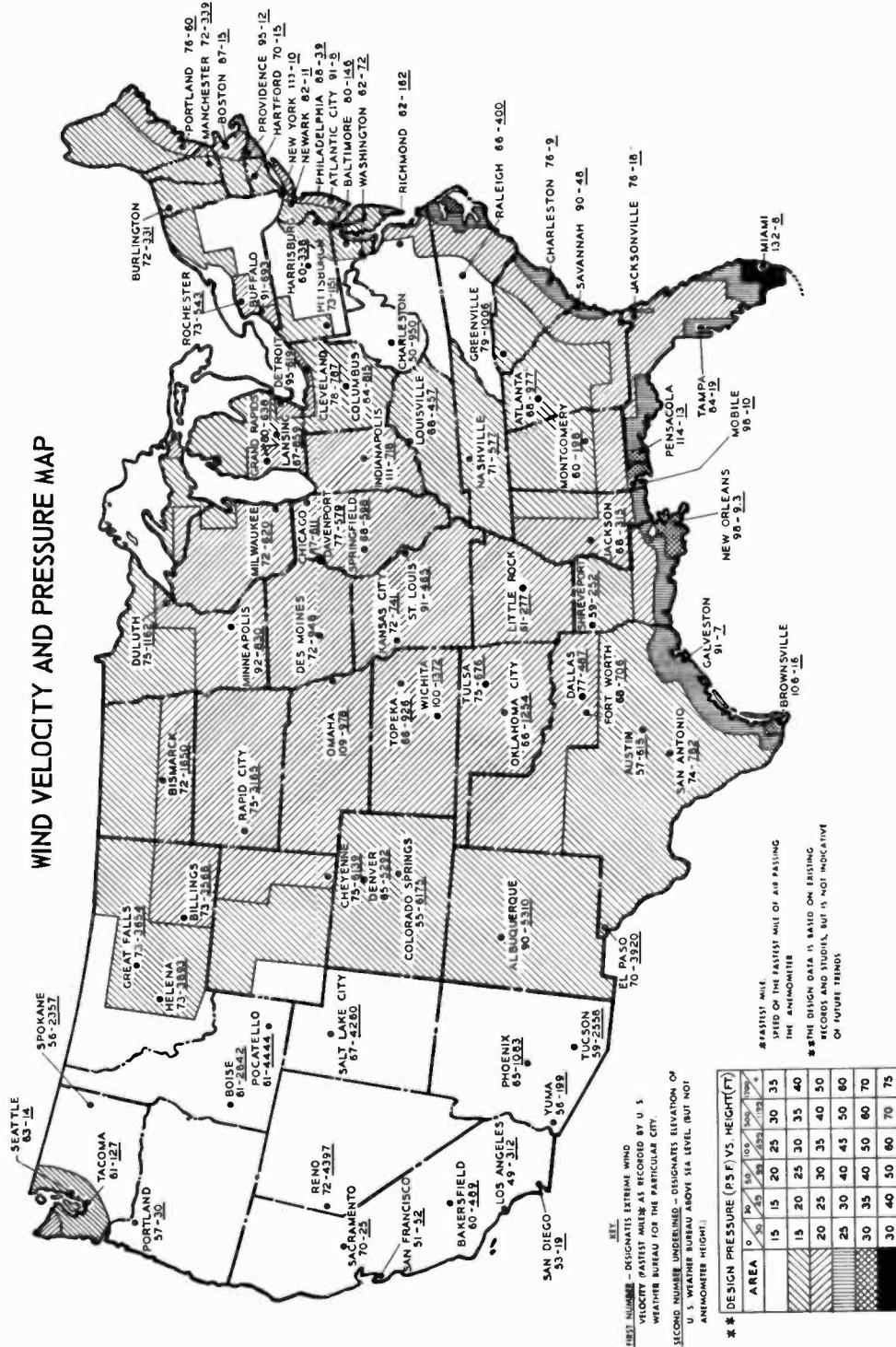

Published records of the U. S. Weather Bureau are given as "maximum" (5 minute average velocity) or "extreme" (the speed of the fastest mile of air passing the anemometer). The selection of design loads should be based on "extreme" velocity. If no data is available on "extreme", the published "maximum" figures should be increased by approximately 20%.

The plotted areas shown on the map are derived from careful studies made by authorities in this field and the information is based on monthly and yearly average velocities, frequency of occurrence, probability of extremes, topographical conditions, etc.

Installations on mountain tops and areas subject to heavy icing conditions should be given special consideration. Building codes and zoning ordinances should also be carefully investigated.

Relation Between Antenna Current and Modulation

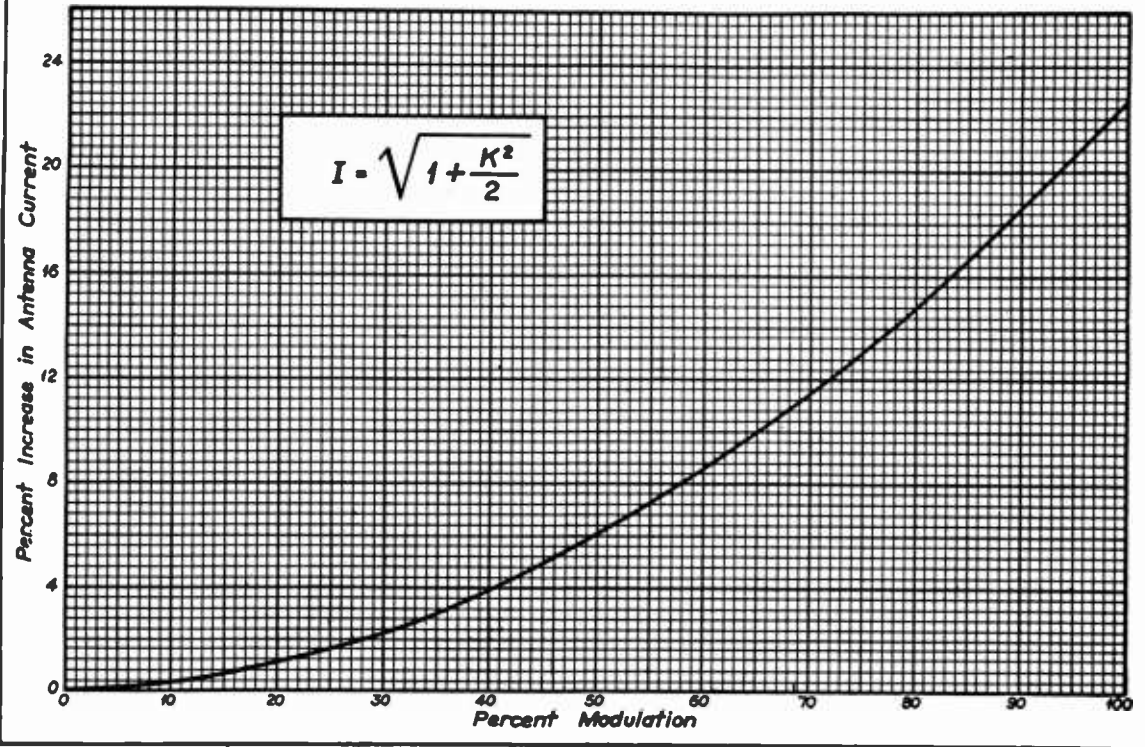

FIELD INTENSITY VS. RADIATOR HEIGHT FOR SEVERAL LENGTHS OF GROUND WIRES.

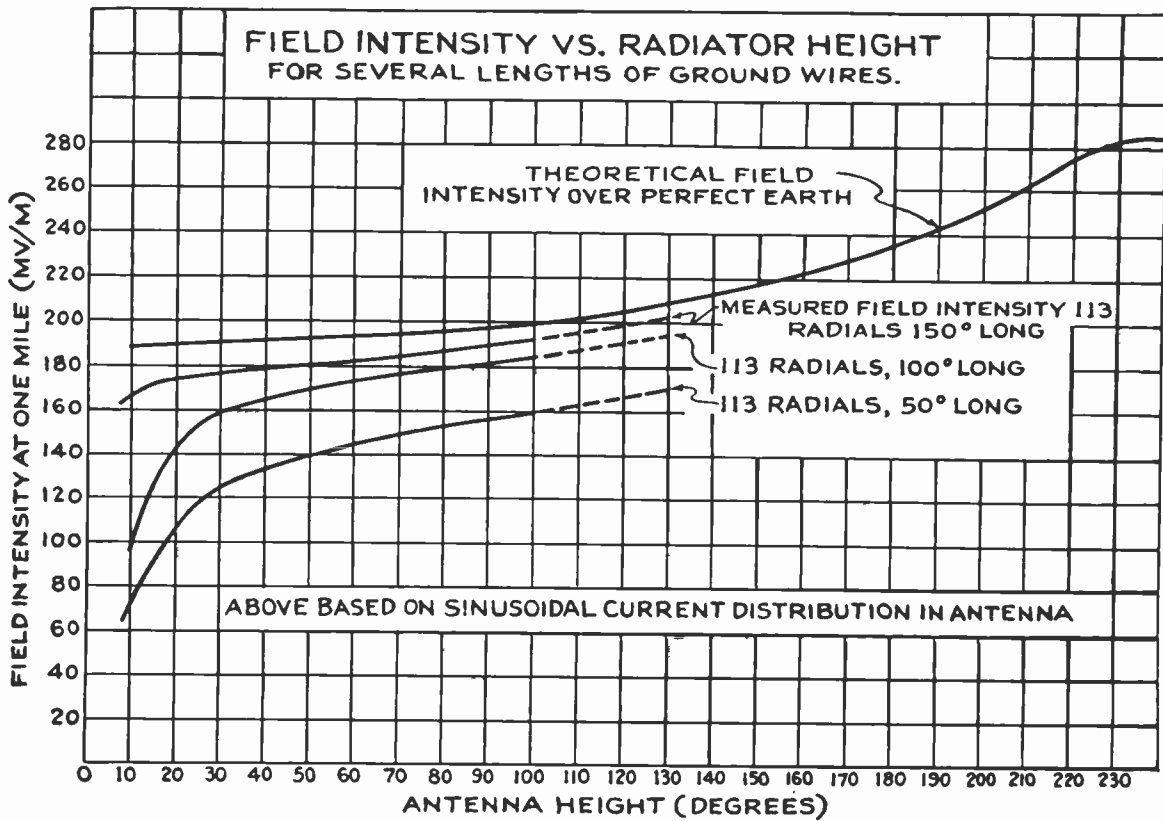

EFFECT OF GROUND WIRES ON FIELD STRENGTH

**Distance in Miles From an FM Transmitter to
Its 54 dbu (0.5 mv/m) Contour for Various Heights and Powers**

AHAAT IN FT	POWER IN DBK																				
	-20	-18	-16	-14	-12	-10	-8	-6	-4	-2	0	2	4	6	8	10	12	14	16	18	20
3400	20	23	26.5	30	34	38	42	47.5	51.5	55	60	65	69.5	73	78	82	87	91.5	95	100	113.5
3200	19	22	25	29	32.5	37	40.5	45	50	53.5	58.5	63	67	71	75	80	85	90	93	97	100.5
3000	18.5	21.5	24.5	28	31.5	35	40	43	48	52	56.5	60.5	65	69.5	73	77.5	82	86.5	91.5	95	98.5
2800	18	20.5	23	27	30	33.5	38	42	45.5	50	54.5	58.5	63	67	71	75	80	84	89	93	96
2600	17.5	20	22	25.5	29	32	36	40	44.5	48.5	52	56	60	65	69	73	77	81.5	85.5	90	94
2400	17	19	21.5	24.5	28	31	35	38.5	42	46	50.5	54.5	58.5	62	67	70.5	75	78.7	83	88	92
2200	16	18.2	20	23	26.5	29	32.5	36.5	40	44.5	48	52	55.5	60	65	68	72	76.5	80	85	90
2000	15	17.4	19	22	25	28	31	35	38	42	45.5	50	53	57	61.5	65	69.5	73.7	78	82	86
1900	15	17	18.5	21.5	24.5	27	30	33.5	37.5	40.5	45	48.5	52	55.5	60	64	68	72	76	80	85
1800	14	16	18	20.5	23	26.5	29	32.5	36	40	43	47.5	51	55	58.5	62.5	66	70	75	79	83
1700	13.5	15.5	17.5	20	22.5	25	28	31.5	35	38	42	45.5	50	53	57	60.5	65	69	71.5	77	81
1600	13	15	17	19	21.5	24.5	27	30	33	36.5	40.5	44	48	52	55.5	60	63	67	71	75	80
1500	12.5	14.6	16.5	18.5	21	23.5	26.5	28.5	32	35.5	39.5	43	46.5	50	54.5	58	61.5	65	69.5	73	78
1400	12	14	16	18	20	22	25	28	30.5	34.5	38	41.5	45	48.5	52.5	56	60	63	67	71.5	75
1300	11.5	13.4	15.5	17	19	21.5	23.5	27	30	32.5	36	40	43	47	50.5	55	58	61.5	65	70	73.5
1200	11	13	14.5	16.5	18.5	20.5	23	25.5	28	31	35	38	41.7	45	48.5	52.5	56	60	63	67	71.5
1100	10	12	13.5	15.5	17.5	19.5	21.5	24.5	26.5	30	33	36.5	40	43	47	50.5	54.5	58	61.5	65	70
1000	9.1	11.5	13	15	17	18.5	20.5	23	25.5	28	31.2	34.5	38	41	45	48	52	56	58.5	63	68
900	8.7	10.5	12	14	16	18	19.5	21.5	24.5	27	29.6	32.5	35.5	38.5	42.5	46	50	54	57	60.5	65
800	8.2	9.2	11.5	13	15	16.5	18	20	22	25	28	30.5	33.5	37	40	43	47.5	52	55	58.5	63.5
700	7.7	8.7	10.5	12	13.5	15.5	17	18.5	21	23	26	28.5	32	35	38	41	45	49	53	56.5	63
600	7.2	8	9	11	12	14	15.5	17.5	19	21.5	24	26.5	29.7	32	35	38	42	45.5	50	55	60
500	6.5	7.3	8.2	9	11	12.5	14	16	17.5	19	22	24	27	29	32.5	35.5	38.5	43	47	52	57
400	5.8	6.6	7.3	8.3	8.5	11	12.5	14	16	17.5	19	22	24.5	27	29.5	32	35.5	40	43.5	49.5	55
300	5	5.7	6.5	7.2	8	8.7	10.5	12	13.5	15	17	18.5	21	23.5	26.5	28.5	32	35.5	40	45.4	52
200	4	4.6	5.2	5.7	6.5	7.3	8.2	9	11	12	13.7	15.5	17.5	19	22	24.5	28	31.5	35	42	48
100	2.8	3.2	3.7	4.1	4.6	5.2	5.8	6.6	7.4	8.2	9	10.7	12.5	14	16	18.2	21.5	25	30	35.5	45

**Distance in Miles From an FM Transmitter to
Its 60 dbu (1 mv/m) Contour for Various Heights and Powers**

AHAAT IN FT	POWER IN DBK																				
	-20	-18	-16	-14	-12	-10	-8	-6	-4	-2	0	2	4	6	8	10	12	14	16	18	20
3400	11	13	15	17.5	20	22.5	27	30	34	37	40.5	45	49	52	57	60	64	65	65	65	65
3200	11	12.2	14.5	16.5	19.5	22	25	28.5	32	35	39	42.5	47	50.5	55	59	62	64	65	65	65
3000	10.5	12	14	16	19	21.5	24.5	28	31	34	38	41	45	49.5	53	57	60	64	65	65	65
2800	10	11.8	13.5	15.7	18	20.5	24	26.5	30	33	36	40	44	48	51	55	59	62	64	65	65
2600	9.7	11.5	13	15	17	20	22.5	25.5	29	32	35	39	42	46	49.5	53	58	60	63	64	65
2400	9.4	11	12.8	14	16	19	21.5	24.5	28	30.5	34	37	40	44	47.5	51	55	59	61	64	65
2200	9.2	10.8	12	13.5	15.5	18	20.5	23.5	26	29	32	35	39	42	45.5	49	52	56.5	59.5	62	65
2000	9	10.2	11.7	13.1	15	17	20	22	25	28	30	33.5	37	40	44	46.5	50.5	54	57.5	60.5	64
1900	8.7	10	11.2	12.7	14.5	16.5	19	21.5	24.5	27	29.5	33	35.5	39	43.5	45.5	49.5	52.5	55.5	59.5	62
1800	8.5	9.7	11	12.6	14	16	18	20.5	23.5	26.5	29	31.5	35	38.5	43	44.5	48.5	51.5	55	59	61
1700	8.3	9.2	10.5	11.6	13.8	15.5	17.3	20	22.5	25	28	30	33	37	40	43	46.5	50	53	57.5	60
1600	8.1	9	10.3	11.5	13.2	15	17.1	19.2	21.5	24	26.5	29.5	32.5	35.5	39	42	45	49	51.5	55	58
1500	8	9	10	11.4	13	14.9	16.9	18.6	21	23	26	28.5	31.5	35	38	40.5	44	47	50.1	54	57
1400	7.5	8.6	9.7	11.2	12.5	14	16.2	18	20	22	25	27.5	30	33	36	40	43	46	48.5	52	55
1300	7.3	8.2	9.3	10.5	12	13.8	15.5	17.5	19	21.5	24	26.5	29	32.5	35	38	41.5	45	47.5	51	54
1200	7	7.8	9	10	11.5	13	15	17	18	21	23	25.5	28	31	34	37.5	40	44	46	49	52
1100	6.8	7.6	8.5	9.5	11	12.5	14.5	16	17.1	20	22	24.5	26.5	29.5	32	35	38	41	44.5	47	50
1000	6.4	7.2	8	9	10.2	12	14	15.6	17	19	21	23	25.5	28	31	34	36.5	40	43	45.5	49
900	6.2	6.8	7.8	8.8	9.7	11.2	13	14.5	16.4	18	20	21	24.5	26	29	32	35	38	40.5	44	47
800	5.8	6.6	7.3	8.2	9.2	10.3	12	13.5	15.2	17	18.5	20.5	23	25	27.5	30	33	36	39	41.5	45
700	5.4	6.2	7	7.8	8.6	9.7	10.5	13	14	16	17	19.2	21	24	26	28.5	31	33	36	39	42
600	5	5.7	6.5	7.1	8	9	9.8	11.8	12.3	14.5	16	18	19.7	21.5	24	26	29	32	35	36.5	40
500	4.6	5	5.8	6.6	7.3	8.2	9	10	12	13.2	14.5	16.1	17.9	20	22	24.5	27	29.5	31.5	35	37
450	4.2	4.8	5.5	6.2	7.0	7.8	8.6	9.6	10.5	12.5	14.0	15.2	17.0	19.0	20.5	23.0	25.4	28	30	33	36
400	4	4.6	5.1	5.9	6.6	7.4	8.2	9	10	11.8	12.5	14.5	16	17.8	19.8	21.5	24.5	26.5	29	31.5	35
350	3.8	4.2	4.8	5.3	6.1	7.0	7.8	8.6	9.5	10.3	11.0	14.0	15	16.8	18.5	20.2	23	25	27.5	30	33
300	3.6	4	4.5	5	5.7	6.3	7.2	8	8.8	10	10.5	12.6	14	15.6	17	19	21	23	25.5	28	30
250	3.2	3.7	4.0	4.6	5.1	5.9	6.7	7.3	8.0	8.9	9.9	10.6	12.5	14.0	15.8	17.8	19	21.5	24	26	28
200	2.9	3.3	3.7	4.1	4.7	5.1	5.9	6.6	7.4	8.1	9	10	11.3	12.5	14	15.5	17.5	19.5	21.5	24	26
150	2.5	2.8	3.2	3.6	4.0	4.5	5.0	5.7	6.4	7.1	7.9	8.8	9.7	10.8	12	14.0	15.2	17.0	19	21	24
100	2	2.3	2.7	2.9	3.2	3.8	4.1	4.7	5.2	5.9	6.5	7.4	8.3	9	10	11.3	12.9	14.5	16.2	18.1	20

Distance in Miles From an FM Transmitter to Its 80-dbu (10 mv/m) Contour for Various Heights and Powers

AHAAT IN FT	POWER IN DBK																				
	-20	-18	-16	-14	-12	-10	-8	-6	-4	-2	0	2	4	6	8	10	12	14	16	18	20
3400	1.3	1.8	2.1	2.6	3.2	4.0	4.8	6.0	7.3	9	12.5	15	18	20	23	26.5	30	34	38	42	46.5
3200	1.3	1.8	2.1	2.6	3.2	4.0	4.8	6.0	7.3	8.8	12	15	17	19	22	25	29	32.5	36.5	40.5	45
3000	1.3	1.8	2.1	2.6	3.2	4.0	4.8	6.0	7.1	8.5	11.5	14.5	17	18.5	21.5	24.5	28	31.5	35	40	43
2800	1.3	1.8	2.1	2.5	3.2	4.0	4.8	5.9	7.1	8.4	11.3	14	16	18	20	23	26.5	30	34	38	41.5
2600	1.3	1.8	2.1	2.5	3.2	4.0	4.7	5.8	7.0	8.1	11	13	15.5	17.5	19.6	22	25.5	29	32	35.5	40
2400	1.3	1.8	2.1	2.5	3.2	3.9	4.7	5.7	7.0	8.1	10.5	12.5	15	17	19	21.5	24.5	27.5	30.5	35	38.5
2200	1.3	1.8	2.1	2.5	3.2	3.8	4.7	5.6	6.8	8	10	12	14.5	16.5	18	20	23	26.5	29.5	32.5	36.5
2000	1.3	1.8	2.0	2.5	3.1	3.8	4.6	5.4	6.7	7.8	9	11.5	13.5	15	17.5	19.5	21.5	25	28	31	35
1900	1.3	1.8	2.0	2.5	3.0	3.7	4.6	5.3	6.6	7.7	9	11	13	14.8	17	19	21	24.5	27	30	34
1800	1.3	1.8	2.0	2.5	3.0	3.7	4.5	5.3	6.3	7.6	8.7	10.5	12.5	14.5	16.5	18.5	20.5	23	26	29	32.5
1700	1.3	1.8	2.0	2.4	2.9	3.6	4.4	5.2	6.1	7.3	8.4	10	12	14	15.5	18	20	22	25	28	31
1600	1.2	1.7	2.0	2.3	2.9	3.6	4.3	5.1	6	7.0	8.1	9.2	11.8	13.5	15	17.5	19	21.5	24.5	27	30
1500	1.2	1.7	2.0	2.3	2.8	3.6	4.2	5.0	5.9	7.0	8.0	9.0	11	13	14.5	17	18.5	20.5	23	26	29
1400	1.2	1.7	1.9	2.3	2.8	3.5	4.2	5.0	5.7	6.7	7.7	8.7	10.5	12	14	16	18	20	22	25	28
1300	1.2	1.7	1.9	2.2	2.7	3.4	4.1	4.8	5.6	6.4	7.4	8.3	10	11.5	13	15	17	19	21.5	24	26.5
1200	1.2	1.7	1.8	2.2	2.7	3.3	4.0	4.7	5.4	6.2	7.1	8	9.2	11	12.5	14.5	16.5	18	20.5	23	25.5
1100	1.2	1.7	1.8	2.2	2.7	3.2	3.9	4.6	5.2	6	6.8	7.8	8.7	10.2	11.5	14	15.5	17.5	19.5	22	24.5
1000	1.2	1.6	1.8	2.2	2.6	3.1	3.8	4.4	5	5.8	6.4	7.2	8.2	9.2	11	13	15	17	18.5	20.5	23
900	1.2	1.6	1.7	2.1	2.6	3	3.7	4.2	4.8	5.6	6.2	7.0	7.8	8.8	10.5	12	14	16	18	19	22
800	1.2	1.5	1.7	2.1	2.5	2.9	3.4	3.9	4.6	5.1	6.0	6.7	7.4	8.3	9.3	11.5	13	15	16.5	18	20
700	1.2	1.5	1.7	2.0	2.4	2.8	3.2	3.7	4.2	4.8	5.5	6.3	7.0	7.8	8.8	10	12	13.5	15.5	17	18.5
600	1.2	1.4	1.7	1.9	2.3	2.7	3.0	3.4	3.8	4.5	5.0	5.8	6.5	7.2	8	9.0	10.5	12.5	14	15.5	17.5
500	1.1	1.4	1.6	1.8	2.1	2.5	2.8	3.2	3.6	4	4.6	5.2	6	6.7	7.5	8.2	9.2	11	12.5	14.5	15.5
400	1.0	1.3	1.5	1.7	2.0	2.2	2.6	2.8	3.2	3.7	4.1	4.7	5.2	6.0	6.7	7.5	8.2	9.1	11	12.5	14.5
300	0.9	1.2	1.3	1.5	1.8	1.9	2.2	2.6	2.8	3.2	3.6	4	4.5	5.0	5.8	6.2	7.2	7.8	8.9	10.5	12
200	0.8	1.0	1.2	1.3	1.5	1.7	1.8	2	2.3	2.6	3.0	3.3	3.8	4.2	4.7	5.2	6.0	6.7	7.5	8.2	9.0
100	0.5	0.6	0.8	0.9	1.0	1.2	1.3	1.5	1.7	1.9	2.0	2.3	2.7	3.0	3.3	3.7	4.2	4.7	5.2	6.0	6.8

Conversion Table for Units of Length

MULTIPLY NUMBER OF BY TO OBTAIN NUMBER OF	ANGSTROMS MICRONS MILS INCHES FEET MILES MILLIMETERS CENTIMETERS KILOMETERS									
	ANGSTROMS	1	10 ⁴	2.540 × 10 ⁵	2.540 × 10 ⁶	3.048 × 10 ⁷	1.609 × 10 ¹³	10 ⁷	10 ⁸	10 ¹³
MICRONS	10 ⁻⁴	1	2.540 × 10	2.540 × 10 ⁴	3.048 × 10 ⁵	1.609 × 10 ⁹	10 ³	10 ⁴	10 ⁹	
MILS	3.937 × 10 ⁻⁴	3.937 × 10 ⁻²	1	10 ³	1.2 × 10 ⁴	6.336 × 10 ⁷	3.937 × 10	3.937 × 10 ²	3.937 × 10 ⁷	
INCHES	3.937 × 10 ⁻⁷	3.937 × 10 ⁻⁵	10 ⁻³	1	12	6.336 × 10 ⁴	3.937 × 10 ⁻²	3.937 × 10 ⁻¹	3.937 × 10 ⁴	
FEET	3.281 × 10 ⁻¹⁰	3.281 × 10 ⁻⁴	8.333 × 10 ⁻⁵	8.333 × 10 ⁻²	1	5.280 × 10 ³	3.281 × 10 ⁻³	3.281 × 10 ⁻²	3.281 × 10 ³	
MILES	6.214 × 10 ⁻¹⁴	6.214 × 10 ⁻¹⁰	1.578 × 10 ⁻⁸	1.578 × 10 ⁻⁵	1.894 × 10 ⁻⁴	1	6.214 × 10 ⁻⁷	6.214 × 10 ⁻⁴	6.214 × 10 ⁻¹	
MILLIMETERS	10 ⁻⁷	10 ⁻³	2.540 × 10 ⁻²	2.540 × 10	3.048 × 10 ²	1.609 × 10 ⁴	1	10	10 ⁴	
CENTIMETERS	10 ⁻⁸	10 ⁻⁴	2.540 × 10 ⁻³	2.540	3.048 × 10	1.609 × 10 ⁵	0.1	1	10 ⁵	
KILOMETERS	10 ⁻¹³	10 ⁻⁹	2.540 × 10 ⁻⁸	2.540 × 10 ⁻⁵	3.048 × 10 ⁻⁴	1.609	10 ⁻⁴	10 ⁻⁵	1	

Attenuator Network



DB LOSS	R ₁	R ₂	DB LOSS	R ₁	R ₂	DB LOSS	R ₁	R ₂	DB LOSS	R ₁	R ₂
0.5	17.2	10464	16	435.8	195.1	0.5	8.6	10464	16	217.9	195.1
1	34.5	5208	17	451.5	172.9	1	17.25	5208	17	225.7	172.9
2	68.8	2582	18	465.8	152.5	2	34.4	2582	18	232.9	152.5
3	102.7	1703	19	479.0	136.4	3	51.3	1703	19	239.5	136.4
4	135.8	1249	20	490.4	121.2	4	67.9	1249	20	245.2	121.2
5	168.1	987.6	22	511.7	95.9	5	84.1	987.6	22	255.9	95.9
6	199.3	803.4	24	528.8	76.0	6	99.7	803.4	24	264.4	76.0
7	229.7	685.2	26	542.7	60.3	7	114.8	685.2	26	271.4	60.3
8	258.4	567.6	28	541.1	47.8	8	129.2	567.6	28	277.0	47.8
9	285.8	487.2	30	563.0	38.0	9	142.9	487.2	30	281.6	38.0
10	312.0	421.6	32	570.6	30.2	10	156.0	421.6	32	285.3	30.2
11	336.1	367.4	34	576.5	24.0	11	168.1	367.4	34	288.3	24.0
12	359.1	321.7	36	581.1	19.0	12	179.5	321.7	36	290.6	19.0
13	380.5	282.8	38	585.1	15.1	13	190.3	282.8	38	292.5	15.1
14	400.4	249.4	40	588.1	12.0	14	200.2	249.4	40	294.1	12.0
15	418.8	220.4				15	209.4	220.4			

Estimated Ground Conductivity

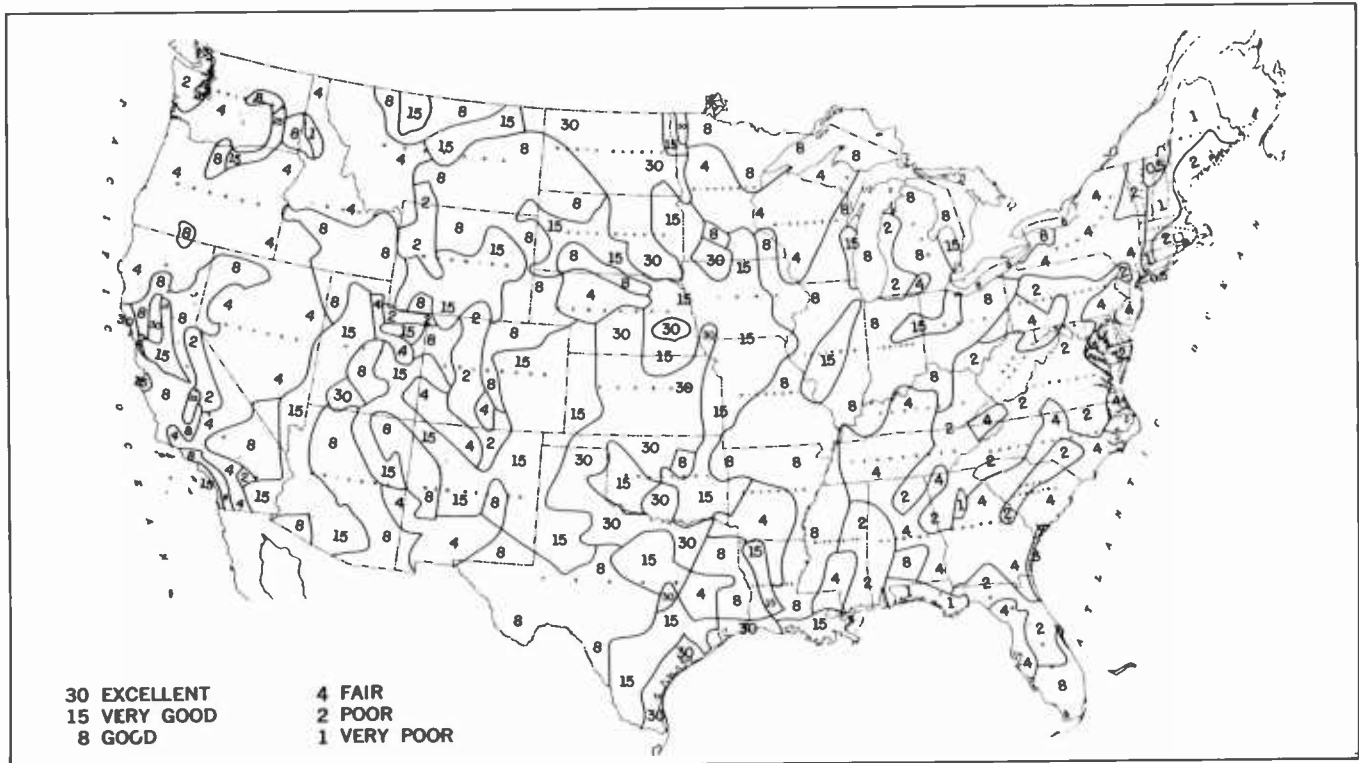

Power Rating — Rigid Transmission Lines

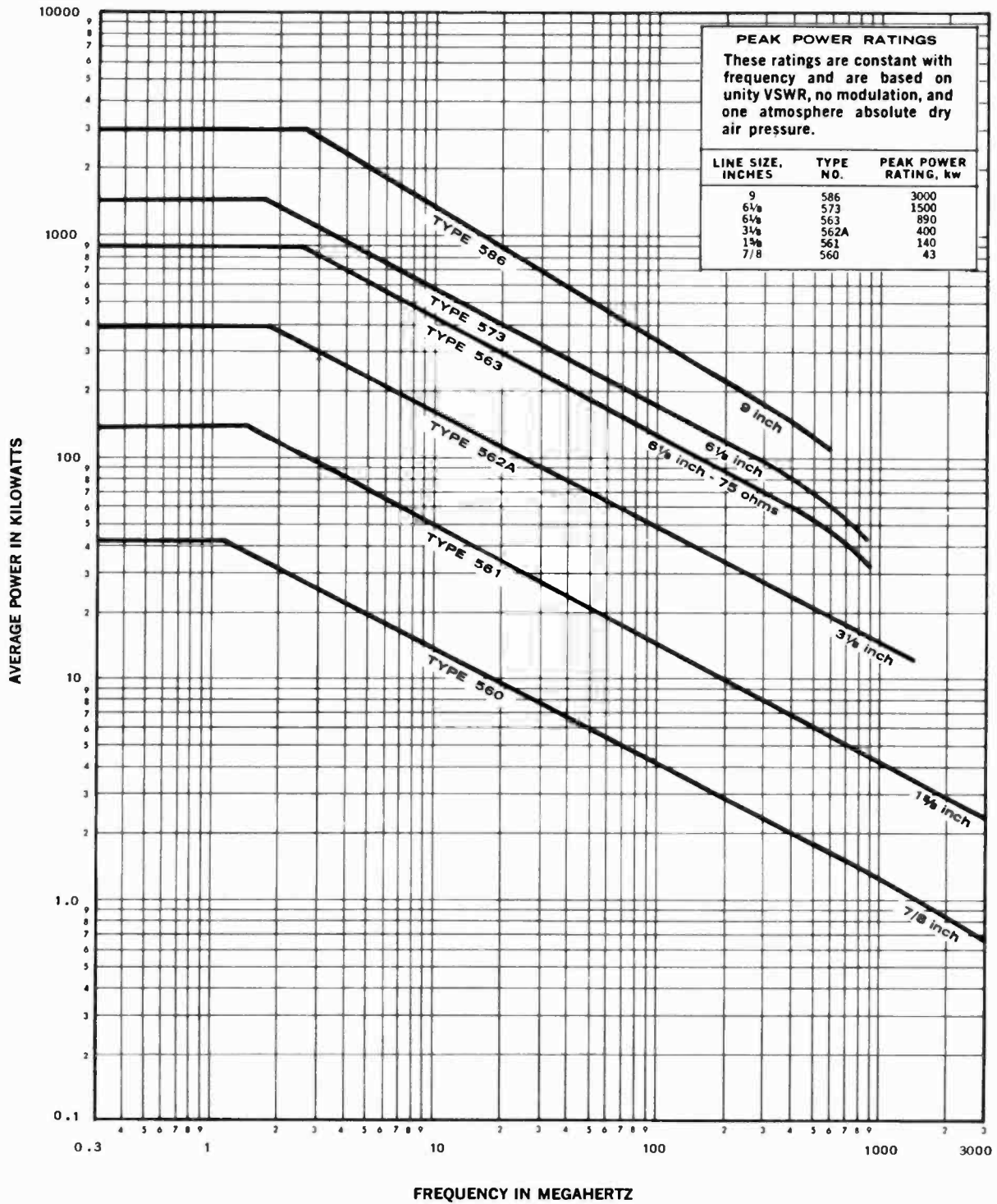

The average power ratings shown above are based on unity VSWR and a maximum inner conductor temperature of 216°F at an ambient temperature of 104°F.

Attenuation — Rigid Transmission Lines

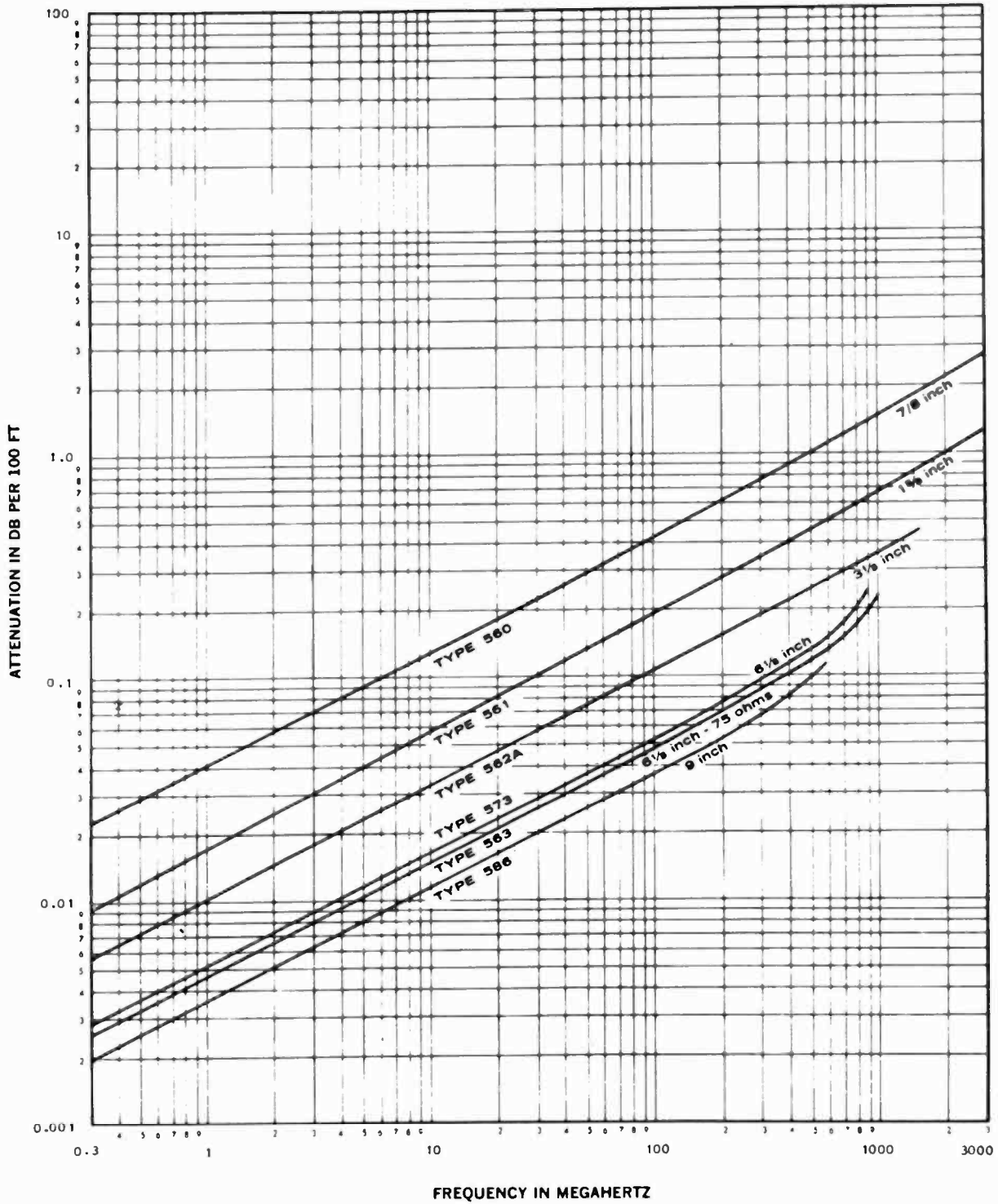

The attenuation curves above are based on unity VSWR.

Power Rating — Helix/Air Dielectric Cables

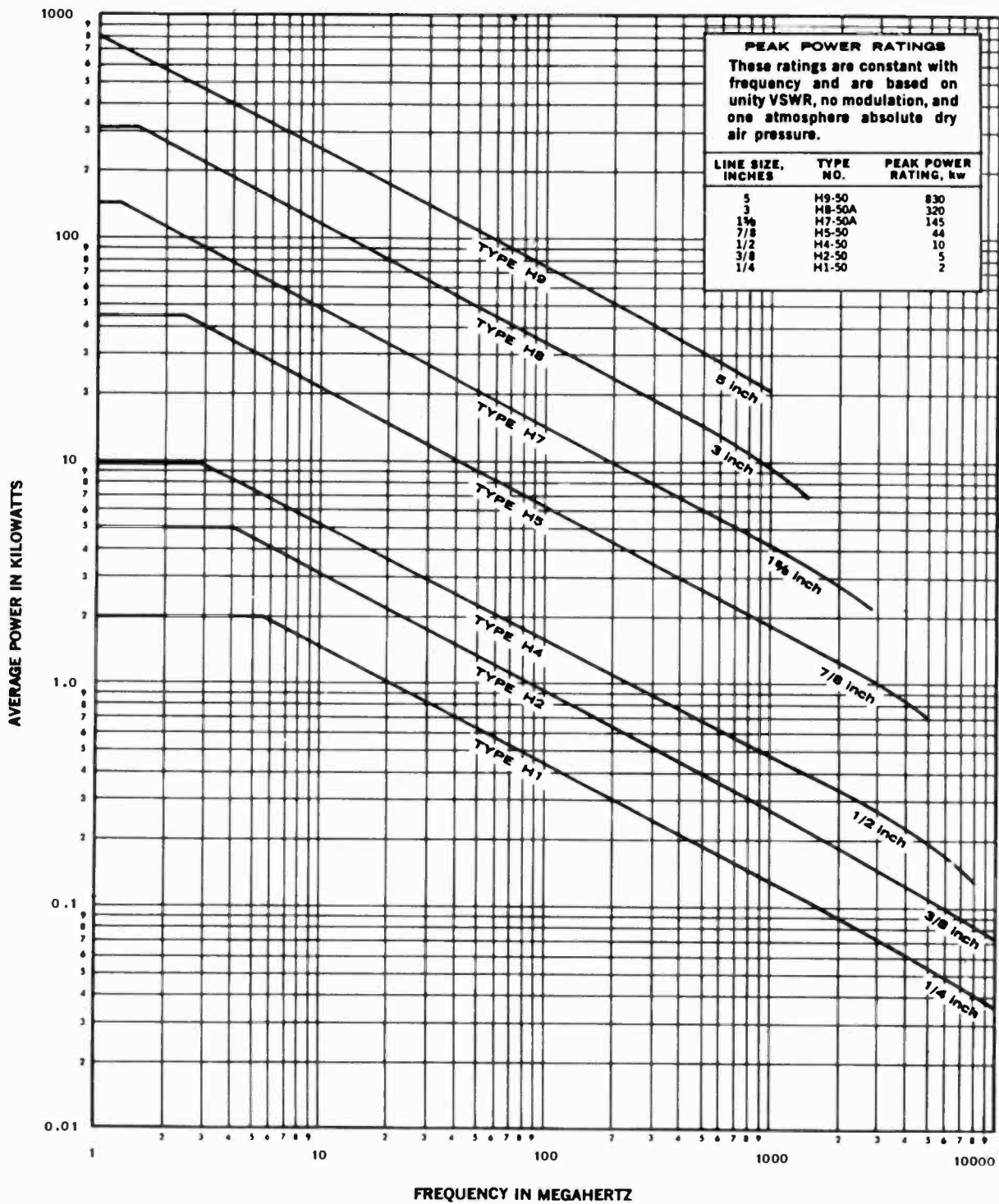

The average power ratings shown above are for 50-ohm copper Helix and are based on unity VSWR and a maximum inner conductor temperature of 212°F at an ambient temperature of 104°F. For 75-ohm copper cables the values shown should be reduced 30%. For 50-ohm aluminum (outer conductor) cables the values should be reduced 10%. For Teflon insulated cables, average power ratings should be increased by 35%.

Attenuation — Heliax/Air Dielectric Cables

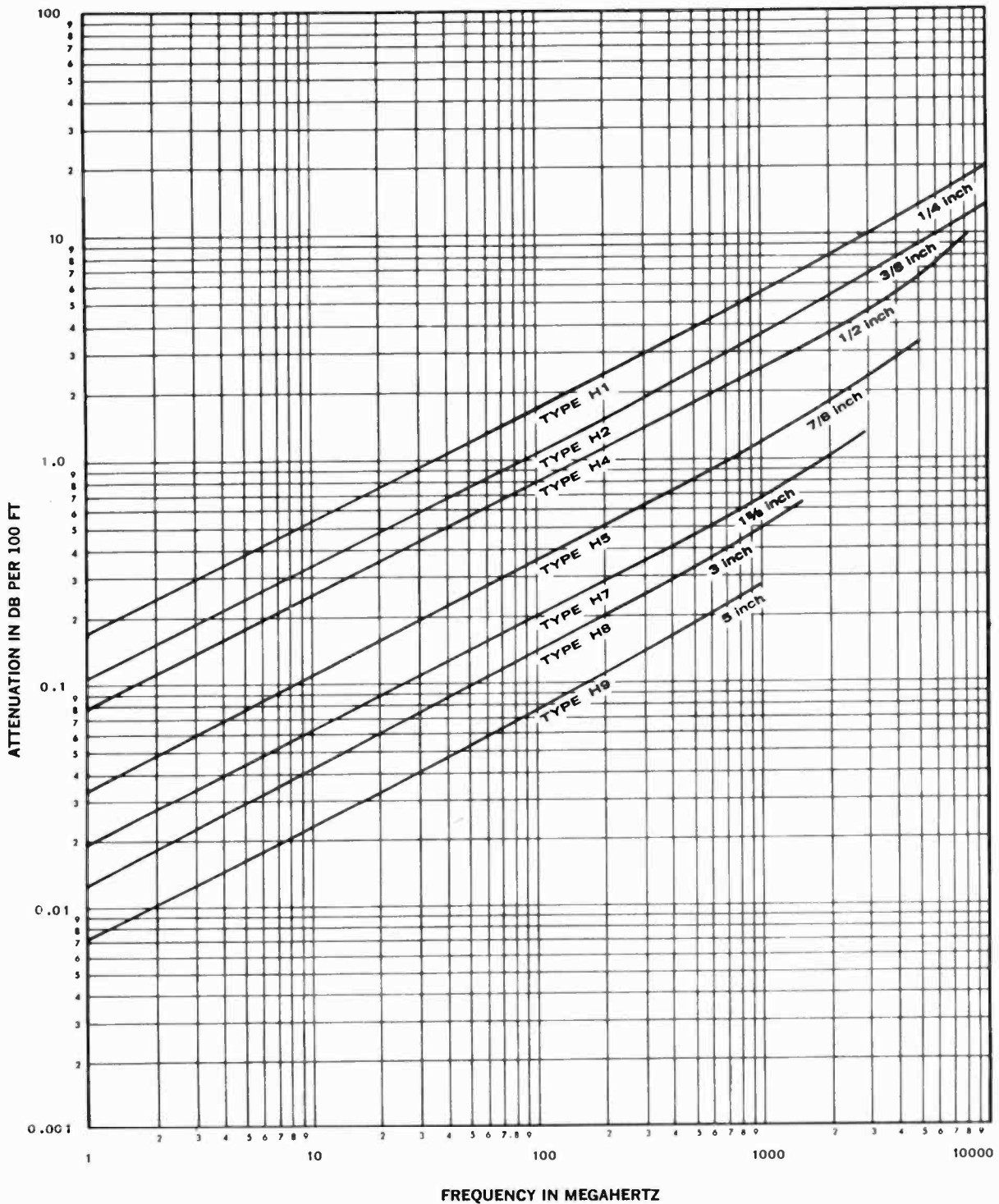

The attenuation curves above are for 50-ohm copper Heliax at unity VSWR. For 75-ohm copper cables the values shown should be reduced 5%. For 50-ohm aluminum (outer conductor) cables the values should be increased 12%.

Attenuation — Helix/Foam Dielectric Cables

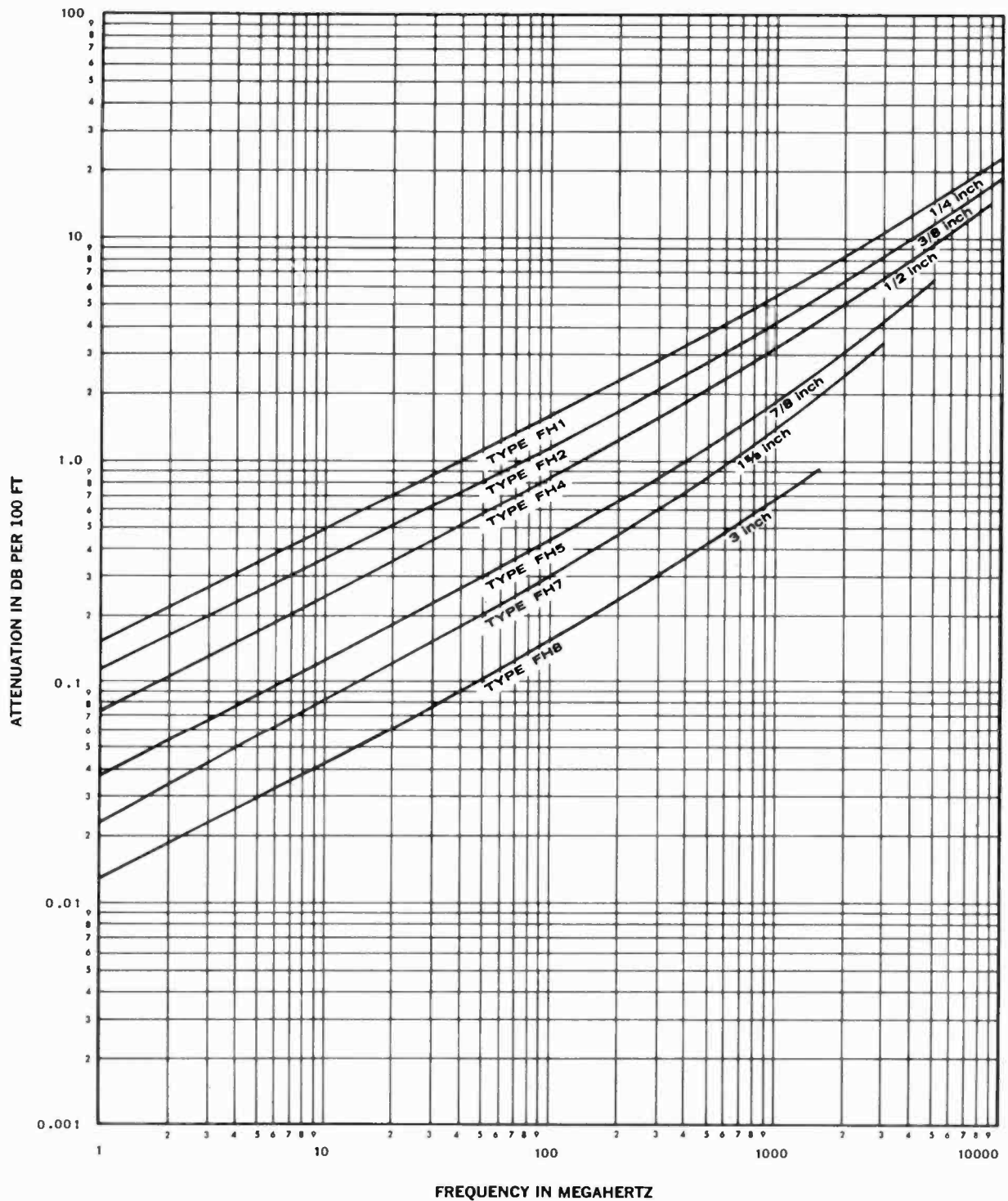

The attenuation curves above are for 50-ohm copper Helix at unity VSWR. For 75 ohm copper cables the values shown should be reduced 5%. For 50-ohm aluminum (outer conductor) cables the values should be increased 12%.

Forward VS Reflected Power

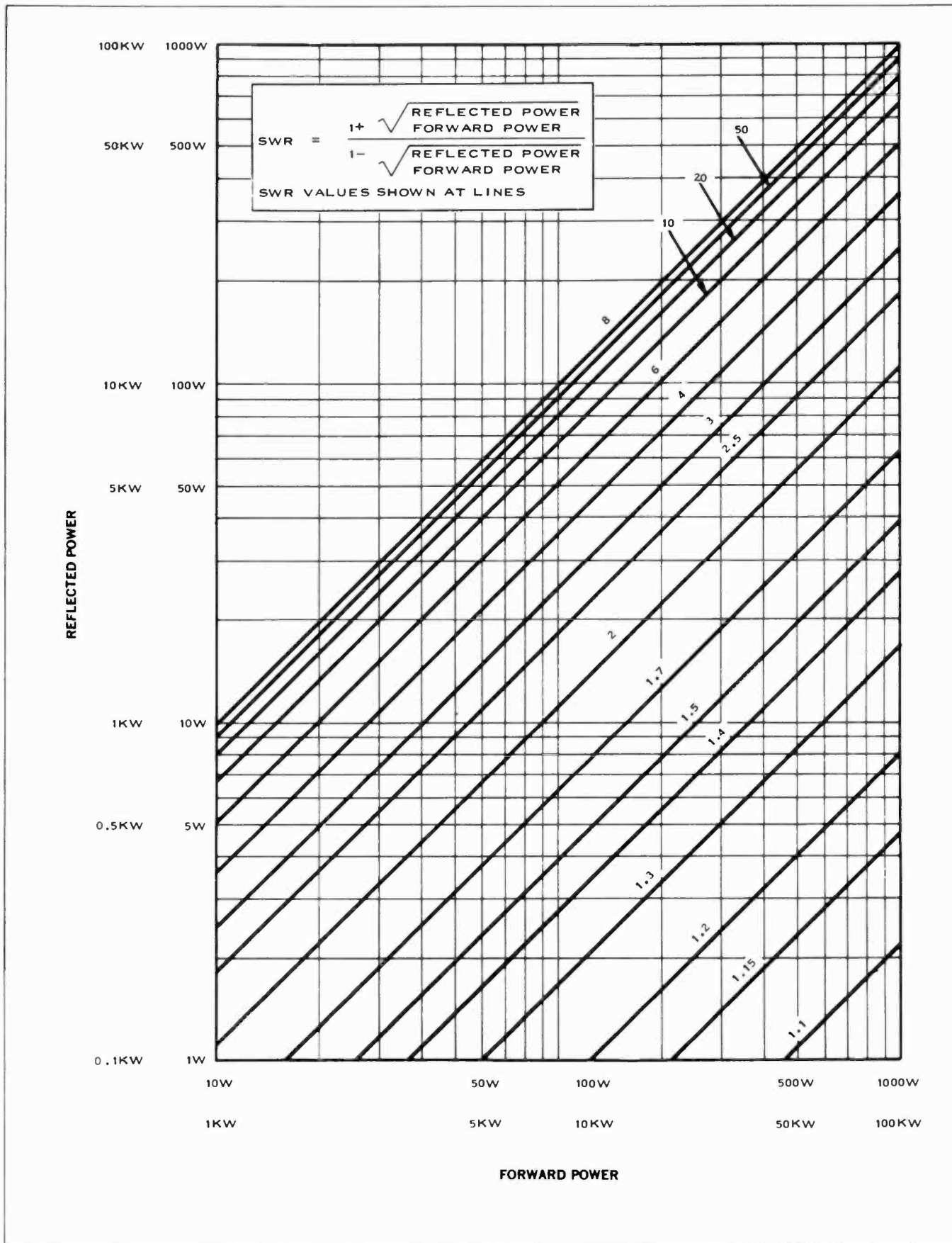

Power Rating — Helix/Foam Dielectric Cables

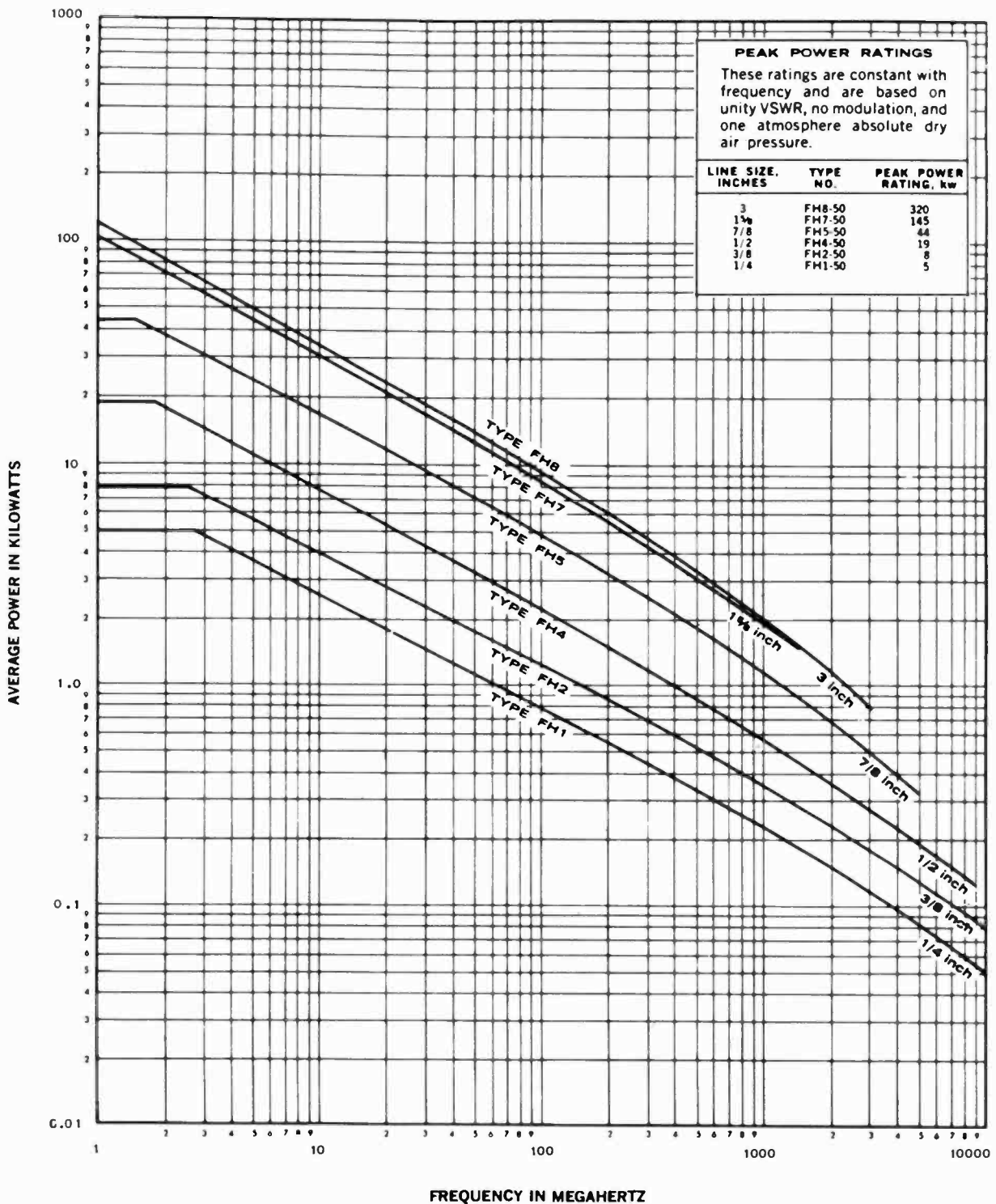

The average power ratings shown above are for 50-ohm copper Helix and are based on unity VSWR and a maximum inner conductor temperature of 175°F at an ambient temperature of 104°F. For 75-ohm copper cables the values shown should be reduced 30%. For 50-ohm aluminum (outer conductor) cables the values should be reduced 10%.

Index

- A**
- ABC, New York, 162
 - AC bias, tape recorder, 163
 - AC wiring, 63
 - Adjacent channel interference, 15
 - AGC amplifier, 47, 108
 - Alarms, remote control, 97
 - Alignment, tape heads,
 - Allocation study, Form, 301
 - AM/FM control facilities, 47
 - AM frequency search, 11
 - Ammeter, antenna, 77
 - AM monitors, 111
 - AM output noise level measurement, 161
 - AM phasor, 83
 - AM proof measurements, 159
 - AM towers, 70
 - AM transmission line, 92
 - AM transmitters, 131
 - Antenna ammeters, 77
 - Antenna gain circular polarization, 89
 - Antenna height, AM, 28
 - Antenna height, FM, 31, 97
 - Antenna maintenance, 142
 - Antenna radiation center, 30
 - Antenna site, 29
 - Antenna system, AM, 26
 - Antenna tuning house, 60
 - Application, station, 26
 - Attended transmitter operation, 52
 - Attenuation, transmission line, 94
 - Attenuator, 146
 - Audio equipment, 100
 - Audio frequency response trouble, 153
 - Audio oscillator, 158
 - Audio wiring, 61
 - Automatic gain control amplifiers, 108
 - Automatic program level control, 111
 - Automatic program logging, 123
 - Automatic transmitter, 131
 - Automatic transmitter log, 123
 - Automatic transmitter logging, 97
 - Automatic tunable, 47
 - Automation, program, 112
 - Auxiliary transmitter, 137
- B**
- Balance, modulators, 79
 - Ball gaps, 59
 - Bandwidth, FM, 157
 - Base current ammeter, 137
 - Base, tower, 58
 - Beacon, 70
 - Bias, tape recorder, 114
 - Bidirectional microphone, 125
 - Bond, tower, 58
 - Bond, tuning house, 60
 - Boom microphones, 128
 - Branching equipment, antenna system, 83
- C**
- Cable ducts, 61
 - Carrier hum, 152
 - Carrier hum measurement, 152
 - Carrier shift, 150, 159
 - Carrier shift measurements, 150
 - Carrier shift trouble, 150
 - Cartridge tape systems, 112
 - Channel assignments, FM, 30
 - Charts, 22
 - Circular polarization, 88
 - Class A stages, 158
 - Class ABI stages, 158
 - Class B stages, 158
 - Classes, FM stations, 22
 - Class IV night-time coverage, 15
 - Cleaning equipment, 136
 - Clear-channel stations, 13
 - Co-channel interference, 15
 - Combined operation, 52
 - Combined site, 8
 - Common-point resistance, 76
 - Communications receiver, 146
 - Conductivity, soil, 13
 - Conduits, 63
 - Conference pickup microphone, 126
 - Console, audio, 100
 - Console, control, 43
 - Console input wiring, 160
 - Console, modular, 108
 - Construction, transmitter plant, 56
 - Consulting engineer, 26
 - Continuous-loop cartridge, 112
 - Control console, 160
 - Control console, audio, 100
 - Control room, 9
 - Control room equipment, 100
 - Control room: monitor speaker, 104
 - Control room: wiring, 61
 - Controls, transmitter remote control, 95
 - Cooling, transmitter, 10
 - Coupling network, AM antenna, 73
 - Coverage, 35, 56
 - Coverage, directional antenna, 77
 - Cueing, tape, 113
 - Cue tones, tape cartridges, 113
 - Current ratios, AM directional antenna, 79
 - Custom audio control equipment, 102
 - Cut-off date, 13
- D**
- Daily inspection, 139
 - Daily transmitter maintenance, 139
 - Daily transmitter plant maintenance, 138
 - Day-night switching, 77, 83
 - Daytime service, 13
 - DC remote control, 96
 - De-emphasis, 154
 - Deck-mounted microphone, 128
 - Directional AM arrays, 76
 - Directional antenna, FM, 31
 - Directional microphones, 125
 - Distortion, FM, 154
 - Distortion measurements, FM, 158
 - Distortion meter, 146
 - Distortion trouble, 159
 - Dual-channel console, 47, 100
 - Dual-polarized antenna, 30
 - Ducts, cable, 63
 - Dummy load, 84
 - Dust, equipment, 136
 - Dynamic microphones, 127
- E**
- Effective radiated power, 31
 - Elliptical polarization, 87
 - Engineering data, Form 301, 24
 - Equipment rack, 43
 - Equipment warranty, 10
 - Erase head, tape recorder, 114
 - Erasing, tape, 114
 - ERP, 31
 - Exciter, FM, 134
 - Existing allocations, 11
 - Experimental operation, 138
 - Extraneous noise measurement, 152
 - Extraneous noise trouble, 152
- F**
- Facilities, 7
 - Fading, 15
 - Fail-safe, remote control, 96
 - FCC Form 301, 24
 - Field gain, circular antennas, 89
 - Field intensity, AM, 27
 - Field intensity meter, 146
 - Field strength chart, F(50, 50), 35
 - FM antenna, 30
 - FM antenna installation, 89
 - FM channel assignments, 30
 - FM channels, 22
 - FM frequency selection, 30
 - FM monitors, 111
 - FM output noise level measurement, 158
 - FM proof-of-performance measurements, 153
 - FM transmission line, 92
 - FM transmitters, 133
 - Free-space field intensity, 30
 - Frequency monitor checks, 153
 - Frequency monitor, 63, 111
 - Frequency monitor, FM, 157
 - Frequency response, FM, 153
 - Frequency response measurements, 147
 - FM, 151
 - Frequency response, microphone, 126
 - Frequency response trouble, 153
 - Frequency response variation, 147
 - Frequency search, AM, 11
 - Frequency tolerance, FM transmitter, 153
 - Frequency verification, 13
- G**
- Gain, circularly-polarized antenna, 88
 - Graphs, 22
 - Ground conductivity, 13
 - loops, 152
 - screen, 82
 - system, AM antenna, 38
 - system, AM directional arrays, 81
 - Groundwave, 13
 - field intensity, 13
 - Guy anchors, 58
 - Guyed towers, 70
- Guy wire insulators, 58**
- Guy wires, 58, 70**
- H**
- Hand tools, 136
 - Harmonic content, 146
 - Harmonic distortion, 154
 - Harmonic distortion, FM, 154
 - Harmonic distortion measurements, 150
 - FM, 158
 - Harmonic distortion trouble, 154
 - Harmonics, FM, 134
 - Harmonic trouble, 154
 - Haah, 160
 - Heads, tape recorder, 114
 - High-level audio wiring, 63
 - Horizontally-polarized antenna, 85
 - Horizontal plane radiation, 31
 - Horn gaps, 59
 - Hum measurement, 152
- I**
- Ice load, tower, 70
 - Impedance, AM antenna, 73
 - Impedance, microphone, 125
 - Impedance, proof-of-performance measurements, 152
 - Initial tuning, AM directional antenna, 76
 - Insulated guyed towers, 70
 - Insulator, guy wire, 70
 - Interconnecting wiring, 61
 - Interference, 11, 15, 152
 - Interlaced horizontal and vertical antenna, 87
 - Inverse field strength, 28
 - Ionospheric reflection, 15
 - Isolation stubs, 59
 - tower RF/AC, 70
 - transformer, 146
- J**
- Jack panels, 61
- K**
- KOOL facilities, 164
 - KRAV facilities, 169
 - KYW, facilities, 167
- L**
- Lavallier microphone, 127
 - Lightning filter choke, 70
 - Lightning —
 - gaps, 59
 - rods, 59
 - tower, 70
 - Limit amplifier, 53
 - Limit, audio level, 108
 - Limiting amplifier, 47
 - Loading, microphone, 125
 - Logging —
 - automatic program, 118
 - transmitter, automatic, 97
 - Log, maintenance, 137
 - Loudspeaker, monitor, 104
- M**
- Maintenance log, 137
 - Maps, 22
 - Matching transformer, 146
 - Maximum expected operating values, 15, 27
 - Medium-market floor plan, 47
 - MEOV, 15, 27
 - Metering functions, remote control, 95
 - Metropolitan-market floor plan, 50
 - Microphones, 125
 - Miniature microphone, 126
 - Modular console, 108
 - Modulation monitor, 63
 - Modulation monitor, FM, 157
 - Modulation monitors, 111
 - Modulation, transmitter, 56
 - Modulator balance, 79
 - Monitoring equipment installation, 63
 - Monitoring, transmitter, 53
 - Monitor point field readings, 79
 - Monitor points, AM directional antenna, 79
 - Monitors, 111
 - Monitors, FM, 157
 - Monitor, speaker, 104
 - Monthly transmitter maintenance, 139
 - Monthly transmitter plant maintenance, 139
 - Multi-cartridge tape systems, 113
- N**
- Negative carrier shift, 150
- Night-time coverage, 15**
- Noise level, AM, 157
 - Noise level, FM, 154
 - Noise level measurement, AM, FM, 159
 - Noise measurement, 152
 - Noise meter, 146
- O**
- Oil-filled insulators, 59
 - Oscilloscope, 146
 - Outdoor microphone, 126
 - Output noise level —
 - AM, 154
 - FM, 154
 - Output noise level measurement —
 - AM, 159
 - FM, 159
 - Overall frequency response, 146
 - Overlap, 12
 - Overmodulation, 109
- P**
- Pad attenuator, 146
 - Painting, tower, 58
 - Parallel-operated transmitters, 133
 - Patch panels, 61
 - Pattern, AM antenna, 27
 - Peak clipping, 109
 - Peak limiter, 108
 - Performance tests, 139
 - Phase angle, AM directional antenna, 77
 - Phasing equipment, 71
 - Photocell level control, 102
 - Pickup coil, 146
 - "Plan 1" floor plan, 36
 - "Plan 2" floor plan, 47
 - Playback head, tape recorder, 114
 - Polarity, stereo, 63
 - Polarization, FM antenna, 85
 - Polydirectional microphone, 124
 - Positive carrier shift, 150
 - Power classifications, 11
 - Power divider, 88
 - Power reduction transmitter, 132
 - Power supply transmitter, 133
 - Power wiring, 63
 - Predicting interference, 11
 - Pre-emphasis, FM, 109
 - Pressure microphone, 126
 - Preventive maintenance, 136
 - Primary service area, 13
 - Program automation, 112
 - Program control unit, 118
 - Program level control, 111
 - Program logging, automatic, 123
 - Programmer, automatic, 118
 - Proof-of-performance —
 - antenna system, 60
 - standards, 152
 - Propagation curves, 15
- Q**
- Qualifications, applicant, 24
 - Quality, microphone, 124
 - Quarterly transmitter plant maintenance, 139
- R**
- Radial, ground system, 82
 - Radiation center, antenna, 30
 - Radiation center, FM antenna, 31
 - Radiation patterns, 11, 71
 - Record/playback head, 114
 - Record/playback tape recorder, 114
 - Reel-to-reel tape systems, 114
 - Reference tower, AM directional array, 79
 - Reliability transmitter, 130
 - Remote amplifier, 104
 - Remote and metering control functions, 95
 - Remote antenna ammeter, 137
 - Remote control, cartridge tape systems, 113
 - Remote control, directional antenna, 28
 - Remote control, reel-to-reel tape recorders, 114
 - Remote control transmitter, 131
 - Remote pickup microphone, 126
 - Remote studio, 10
 - Resistance, AM antenna, 73
 - Response, microphone, 126
 - Response, FM, 153
 - Response measurements, 147
 - Response measurements, FM, 157
 - Response variation, 147
 - RF sampling tower current, 83

RF wiring, 63
Ribbon microphone, 125
Rumble, turntable, 104

S

Sampling loop, 76
Sampling, tower current, 83
SCA multiplex monitor, 111
SCA proof-of-performance measurements, 85
Secondary service area, 15
Sectionalized tower, 28
Self-supporting towers, 70
Semi-annual transmitter plant maintenance, 142
Series-fed towers, 82
Service area, 13
Shunt-fed tower, 82
Signal levels, proof-of-performance, 146
Signal-to-noise ratio, 157
Single-channel console, 100
Single-tower array, 70
Site, transmitter, 7
Skywave, 15
Slide attenuators, 102
Small-station floor plan, 43
Soil conductivity, 13
Solid-state consoles, 100
Solid-state transmitter power supply, 134
Sound lock, 43
Sources of existing allocations, 11
Spare tubes and parts, 136
Speaker, monitor, 104
Speech-input consoles, 100
"Spot-proofs", 136

Spurious radiation, 152
Standard broadcast channels, 11
Standard broadcast engineering data, Form 301, 27
Static drain chokes, 59
Static drain resistors, 59
Station inspection, 137
Stereo consoles, 102
Stereo proof-of-performance measurements, 102
Stereo wiring, 63
STLs, 97
Stray currents, 152
Stray fields, 152
Studio maintenance, 139
Studio monitor speaker, 104
Studio, preventive maintenance schedule, 137
Studios, 9
Studio-to-transmitter link, 97
Switching control room, 61

T

Table of Assignments, FM, 30
Tape cartridges, 112
Tape recorder, 43
Tape recorder bias, 114
Tape recorder maintenance, 116
Test equipment, 136
Tools, maintenance, 136
Tower base current ammeters, 137
Tower —
 design, 57
 layout, AM directional arrays, 79
 lighting, 70
 light inspection, 138

 maintenance, 143
 site, 70
 specifications, 70
 towers, 70
Transcription turntables, 103
Transistors, transmitter, 130
Transmission line, 35, 92
Transmission line pressure, 82
Transmission line tower, 82
Transmitter buildings, 52
Transmitter components, 129
Transmitter features, 55
Transmitter input equipment, 53
Transmitter logging, automatic, 97
Transmitter maintenance, 139
Transmitter plant, preventive maintenance schedule, 133
Transmitter site, 7
Transmitter wiring, 63
Tube checks, 136
Tubes, transmitter, 129
Tuning, AM directional arrays, 76
Tuning house, 60
Tuning unit, antenna, 73
Turntables, 43, 103
Two-tower array, 70

U

Unbalanced modulators, 152
Uniaxial microphone, 126
U. S. Coast and Geodetic Survey maps, 26
U. S. Geological Survey maps, 27

V

Velocity microphone, 127

Vertical distribution, 15
Vertically-polarized antenna, 86
Vertical plane radiation, 31
Visual inspection, equipment, 136

W

Warranty, equipment, 10
Weekly antenna system maintenance, 137
Weekly transmitter maintenance, 139
Weekly transmitter plant maintenance, 137
Wind load, tower, 70
Wiring conduits, 63
Wiring trenches, 63
WMJR-FM facilities, 165
WPAJ-FM, 173
WPHC facilities, 167
WRVA facilities, 169

