

# WESTERN Music and Radio Trades JOURNAL

## • TROJAN • RADIOS •

Pentode

Hi-Mu

EIGHT  
TUBES



SUPER  
GIANT

Trojan, a pioneer in the Western radio manufacturing world. As a result of many thousands dollars spent to perfect the new Pentode and Hi-Mu chassis, Trojan brings to you a finished article at a startling price in this new demanding merchandise. Pentode and Hi-Mu will do to the radio trade exactly what the screen grid did two years ago. It is the new stimulant to the radio business. You cannot afford to have a store without this Trojan super-giant with 8 tubes. While slightly larger than the Junior, it is still in the midget class. Its size is 11 inches by 14½ inches by 17 inches high. A beautiful piece of cabinetry, well marked in fine grain walnut. A beautiful set that will fit in with the most artistic room or the most carefully designed office or place of business. It is to your advantage to, at least, hear this new sensational product of the West, manufactured by Trojan.

• 69<sup>50</sup> •

**SHIELDING:** Entire chassis including coils and radio frequency screen grid and Hi Mu tubes completely shielded to avoid interstage coupling.

**POWER SUPPLY:** Operated from any 105-120 volt, 50 or 60 cycle, with specially designed transformer, capable of withstanding considerable overload.

**R. F. COILS:** Our own make, especially built and designed for use in our circuit.

**CONTROL:** Single illuminated dial, tapered volume control, combined with on and off switch, and an especially designed tone control.

**PARTS USED:** All of the very best material, especially designed and selected for use in our own particular set.

Also hear a sample of the new Trojan "Baby" five tube dynamic \$49.50 radio—it will amaze you!

*Dealers and distributors write, wire, or phone for exceptional discount!*

### TROJAN FACTORIES, LTD.

5862 South Hoover Street

Los Angeles, California

APRIL, 1931

# Ken·Rad

## Fine Radio Tubes



### *What Kind of Economy is This?*

**M**ILLIONS of dollars are spent each year by set manufacturers for engineering and development work alone—to give you dealers and distributors better radio performance to sell.

But the finest instrument possible to build can be no better than the tubes that are used. Fine tubes can make a cheap set do more than the finest set with cheap tubes.

Why, then, should you or any set manufacturer supply any but the finest tubes available? . . . This certainly is

the last place that anyone should attempt to economize—because cheap tubes always prove to be false economy.

You can get cheaper tubes than Ken-Rads—but you can't get finer tubes. You practice sensible economy when you supply Ken-Rad Fine Radio Tubes as equipment in every set you sell. And you make more money, because the better performance of Ken-Rads will get and hold more customers for you . . . May we have the opportunity of presenting definite proof? Just write us!

**THE KEN-RAD CORPORATION, Incorporated, OWENSBORO, KY.**

*Licensed Radio Tubes and Incandescent Lamps*



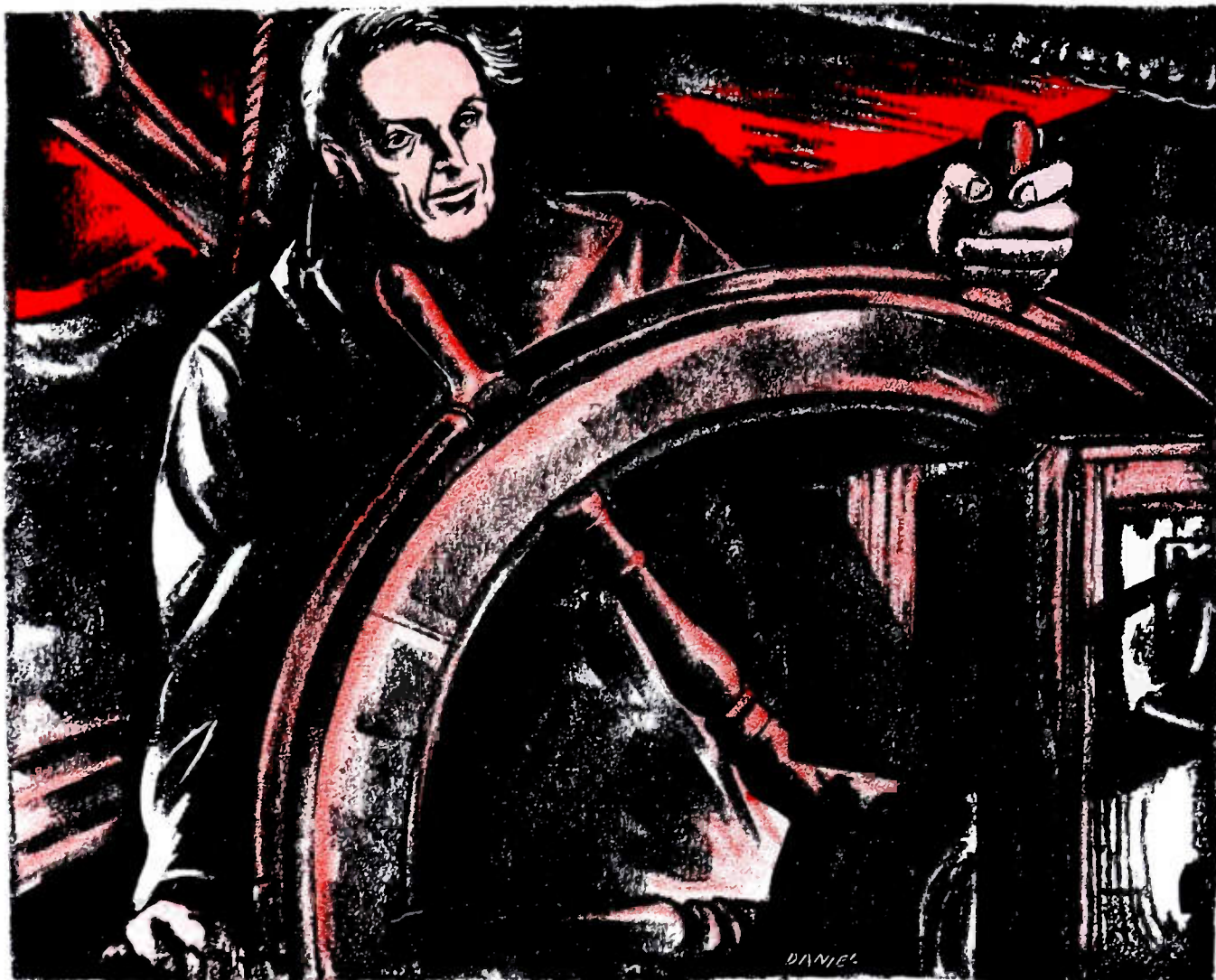

# A straight course... straight ahead!

Radio dealers know now that the one sure way to profits lies in the sale of merchandise that is built to sound standards of quality and is backed by a name of long-established reputation. Brilliant stars may flash across the sky... but they burn out while the steady, unflick-

ering light of old, standard names grows from year to year as a dependable guide to the safe and sure pathway to profits and success.

*Brunswick Radio Corporation*  
 MANUFACTURERS OF RADIO, PANATROPE AND  
 THE WORLD-FAMOUS BRUNSWICK RECORDS  
 NEW YORK — CHICAGO — TORONTO  
 Subsidiary of WARNER BROS. PICTURES, Inc.

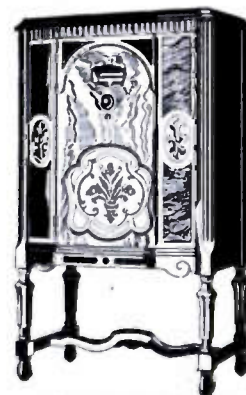

**BRUNSWICK LOWBOY  
 MODEL 15**  
 Armored chassis with 4 screen-grid tubes and two 45's in parallel. Uni-Selector and Illuminated Horizontal Tuning Scale. Tone Control. Cabinet of seasoned and selected butternut with carved front panels. **\$13950**  
 Other models \$170 up (less tubes)

# BRUNSWICK RADIO

Entered as Second Class Matter, January 24, 1928, at the Postoffice at Los Angeles, California, under Act of March 3, 1879. \$2.00 a year. Western Music & Radio Trades Journal, Vol. XII, No. 4. Published monthly at 1220 Maple Avenue, Los Angeles, California.



New  
Profits

The 10 Features  
listed below  
make  
**MAYFLOWER**  
Electric Refrigerators the Hot-  
test selling line  
on the market  
this year.

We Offer You In . . .

# MAYFLOWER

## Electric Refrigerators

A Complete Line That Gives Every Advantage You Can Want for  
Today's Market

If you have seriously considered adding refrigeration to your business, you have become conversant with the selling points that should make a refrigerator attractive to the public.

You will recognize these selling features as important. Mayflower Refrigerators have them all:

1. Colonial Period, beautiful in design, giving an aristocratic impression. Specially designed Colonial type hardware, satin chromium finish.
2. One-piece, gleaming white porcelain lined interior, no cracks or seams.
3. Porcelain cooling unit; sanitary in appearance, only found in the most expensive boxes. Freezes ice cubes in 90 minutes. Large ice trays.
4. Temperature control for faster freezing—positive in action.
5. Ribbon type wire shelves—small bottles will not easily tip over.
6. "Remova-shelf"—a patented feature found only in Mayflower Refrigerators—makes more room for full size bottles.
7. An amazingly quiet compressor—costing less to operate.
8. No troublesome installation—just plug into the light socket.
9. Fully guaranteed and backed by manufacturer's ten years' experience in electric refrigeration.
10. Lower priced than any refrigerator incorporating these features.

A margin of profit that will make Mayflower Refrigerators an asset to you.

### KIERULFF & RAVENSCROFT, Inc.

LOS ANGELES  
137-139 West 17th St.

SAN FRANCISCO  
121-131 Ninth St.



# ECHOPHONE STABILITY

**ECHOPHONES**  
**ECHOES OF THE WORLD**

THE PUBLIC has purchased more Echophones than any other midget.

Today more Echophones are being built and sold than any other midget.. there must be a reason.

*Distributed by*

**ROGERS & GOETZ, Ltd.**

21 Laskie Street  
SAN FRANCISCO  
Phone Market 3124

7626 Santa Monica Blvd.  
HOLLYWOOD  
Phone GRanite 1194-1195



# IT'S ROOTS that COUNT

AS the mania for purely price selling checks itself because of its own weakness, the true situation in radio becomes more and more apparent. Under the surface there remains the great, unshaken foundation of quality buyers who form the bulwark of American industry. They are the sound customers who don't *want* distressed merchandise, who don't *buy* it, and who enable the strong manufacturers in any industry to sell their products through good times and bad.

Sparton has kept an even keel by continuing to cater to this solid market. Sparton dealers have survived the storm by tying in with this sane policy. Both are anticipating a flying start as conditions in radio right themselves, and there are still openings for dealers with the same sound outlook.

THE SPARKS-WITHINGTON COMPANY  
JACKSON, MICH., U. S. A.  
(Established 1900)

*Pioneers of Electric Radio without batteries of any kind*

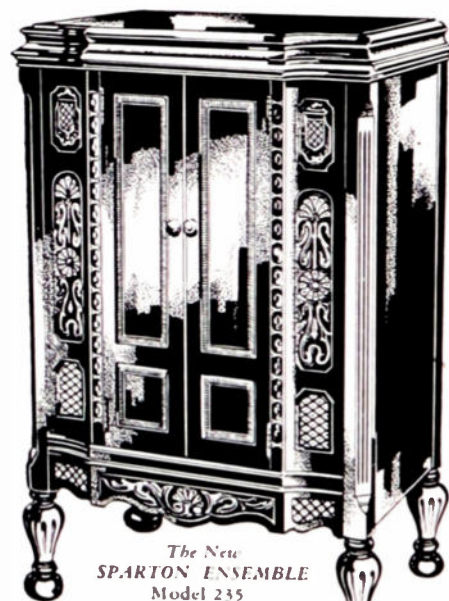

The New  
SPARTON ENSEMBLE  
Model 235

A 12-record, fully automatic, combination radio-phonograph, Sparton-built throughout, for . . . . \$280 less tubes

Only SPARTON has the MUSICAL BEAUTY of  
**SPARTON RADIO**

*Western and Canadian prices slightly higher*

*"Radio's Richest Voice"*

(110)

# WESTERN MUSIC and RADIO TRADES JOURNAL

"Published in the West for the West"

## CONTENTS

Editorial of the Month (Mort Stuart) - - -	9
Midgets—What's Being Done With Them? (Fred Christian and Clarence Mansfield) -	10
Work As Hard As Your Iceman (Leo White) - - - - -	12
He Buys 'Em All and Sells 'Em All! - - -	14
Wise and Otherwise (Shirley Walker) - - -	15
Big Ideas That Click - - - - -	16
April Record Hits - - - - -	17
Western Viewpoint - - - - -	18
News of the Western Trade - - - - -	20
Under the Gavel - - - - -	22
Looking Ahead with Ken Ormiston - - -	24
People Who Do Things - - - - -	26
The Lowdown on the New Tubes (K. G. Ormiston) - - - - -	28
In Answer To Your Question - - - - -	31
Doings in the Industry - - - - -	34
Interesting Westerners—William MacDonald	40
New Merchandise from the Factory - - -	44

Be sure to get the June issue of Western Music and Radio Trades Journal. It will be the big annual Show number, containing pictures and descriptions of all the brand-new radio products to be displayed at the Radio Show in Chicago, with interesting features and news.

The Show this year promises to be one of the most interesting and important in the history of the industry and the new models displayed by manufacturers will all be pictorially represented in the big June issue.

THE EDITOR

APRIL, 1931



## BYAM PUBLISHING COMPANY

*Publishers of the Radio Dealers' Blue Book*

WALLACE M. BYAM

MARION E. BYAM

1220 MAPLE AVE., LOS ANGELES, CALIFORNIA Phone WEStmore 1972

New York: C. A. Larson, 254 W. 31st St.

Editorial Offices Maintained in San Francisco, Portland, Seattle, Salt Lake, Denver.



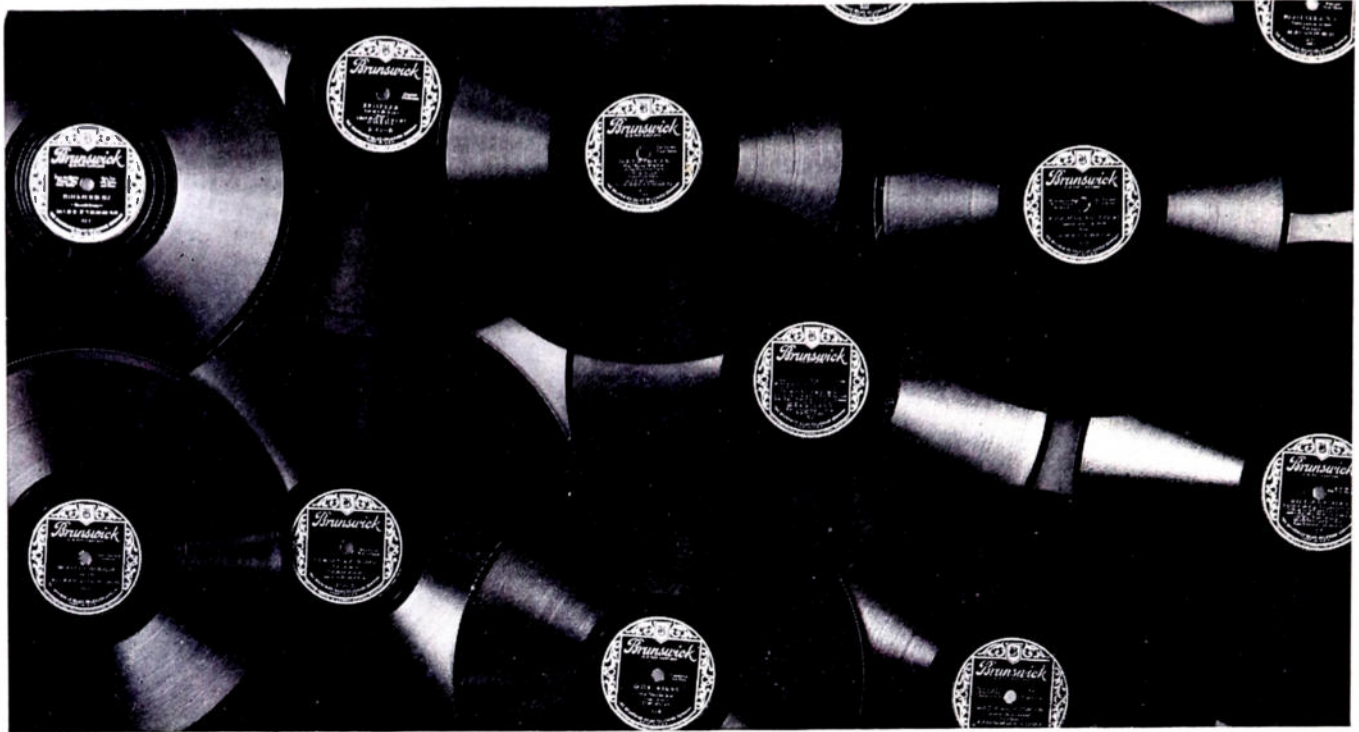

# YOU CAN ALWAYS DEPEND ON BRUNSWICK FOR RECORD HITS THAT SELL

- |   |   |
|---|---|
| <p><b>6055</b> WOULD YOU LIKE TO TAKE A WALK . . . . . Fox Trot<br/>         (Sump'n Good'll Come from That)<br/>         From the Musical Comedy "Sweet and Low"<br/>         HAL KEMP AND HIS ORCHESTRA—With Vocal Trio<br/>         BY SPECIAL PERMISSION . . . . . Fox Trot<br/>         (Of the Copyright Owners, I Love You)<br/>         From Musical Comedy "The Gang's All Here"<br/>         HAL KEMP AND HIS ORCHESTRA—With Vocal Chorus</p> <p><b>6052</b> JUST A GIGOLO<br/>         WHEN YOUR LOVER HAS GONE<br/>         Comedion with Orchestra, HARRY RICHMAN</p> <p><b>6051</b> YOU'RE THE ONE I CARE FOR OVERNIGHT<br/>         Comedienne with Orchestro, BELLE BAKER</p> <p><b>6048</b> WALKIN' MY BABY BACK HOME . . . . . Fox Trot<br/>         FALLING IN LOVE AGAIN . . . . . Waltz<br/>         From UFA Production "The Blue Angel"<br/>         NICK LUCAS AND HIS CROONING TROUBADOURS<br/>         Vocal Refrain by NICK LUCAS</p> <p><b>6045</b> YOU DIDN'T HAVE TO TELL ME . . . . . Fox Trot<br/>         (I Knew it all the Time)<br/>         WHEN YOU WERE THE BLOSSOM OF BUTTERCUP LANE<br/>         AND I WAS YOUR LITTLE BOY BLUE . . . . . Fox Trot<br/>         NICK LUCAS AND HIS CROONING TROUBADOURS<br/>         Vocal Refrain by NICK LUCAS</p> <p><b>6041</b> MY IDEAL . . . . . Fox Trot<br/>         From Paramount Prod. "Playboy of Paris"<br/>         I'M SO AFRAID OF YOU . . . . . Fox Trot<br/>         ISHAM JONES' ORCHESTRA—With Vocal Chorus</p> <p><b>6031</b> CHIMES OF SPRING . . . . . Waltz<br/>         (Spring Beautiful Spring)<br/>         TWO HEARTS IN WALTZ TIME . . . . . Waltz<br/>         From German Screen Operetta "Two Hearts in Waltz Time"<br/>         BOB HARING AND HIS ORCHESTRA—With Vocal Chorus</p> | <p><b>6035</b> THE PEANUT VENDOR . . . . . Fox Trot<br/>         SWEET ROSITA . . . . . Fox Trot<br/>         RED NICHOLS AND HIS FIVE PENNIES—With Vocal Chorus</p> <p><b>6029</b> "YOU SAID IT" . . . . . Fox Trot<br/>         From Musical Comedy "You Said It"<br/>         SWEET AND HOT . . . . . Fox Trot<br/>         From Musical Comedy "You Said It"<br/>         LORING "RED" NICHOLS &amp; ORCHESTRA<br/>         Vocal Chorus by the Composer, Harold Arlen</p> <p><b>6034</b> TO MAKE A LONG STORY SHORT—(I Love You) . . . . . Fox Trot<br/>         I SURRENDER, DEAR . . . . . Fox Trot<br/>         EARL BURTNETT AND HIS LOS ANGELES<br/>         BILTMORE HOTEL ORCHESTRA</p> <p><b>6036</b> I'VE GOT FIVE DOLLARS . . . . . Fox Trot<br/>         From Musical Com. "America's Sweetheart"<br/>         WE'LL BE THE SAME . . . . . Fox Trot<br/>         From Musical Com. "America's Sweetheart"<br/>         EMIL COLEMAN AND ORCHESTRA—With Vocal Chorus</p> <p><b>6038</b> ROCKIN' IN RHYTHM . . . . . Fox Trot<br/>         TWELFTH STREET RAG . . . . . Fox Trot<br/>         THE JUNGLE BAND</p> |
|---|---|

*Brunswick Radio Corporation*  
 MANUFACTURERS OF RADIO, PANATROPE AND  
 THE WORLD-FAMOUS BRUNSWICK RECORDS  
 NEW YORK—CHICAGO—TORONTO  
 SUBSIDIARY OF WARNER BROS. PICTURES, Inc.

# Brunswick Records



# YES

---



## We have no Profits!

**Y**ES! We have no profits!" is the latest song hit being sung with such great gusto by the radio dealers, going very nicely to the music of that famous song a few years ago concerning bananas. And today we have everything else but profits.

At least in some small way we have come to our senses, concerning this little word, "Volume," that everyone seemed to think was the panacea for all the ills of the radio industry. Now we are beginning to see it in its true light.

It has given most of the radio dealers that very contagious disease known as "Volumeitis," which infected the manufacturers, distributors, retailers, chain store managers and individual salesmen, until it has developed into a real epidemic that we are all familiar with at the present time.

Those who expect to stay in this most highly-developed business of selling radios will find in the very near future that all that glitters is by no means gold. They will find that to maintain their so-called prestige, that their bank account holdings with what surplus some may have, will be hard to locate with a microscope by the fall of this year if the present acavities are continued.

### "The Bigger They Are . . ."

There is an old saying that is just as appropriate today as in the past, and that is "The bigger they are, the harder they fall," and it is more truth than poetry.

There were many who could at least see beyond their noses, and realized from the start that such practices could only lead to one conclusion—business suicide. But rather than die of the causes of someone else's folly, they decided to join the band-wagon, and are now singing the same tune as fortissimo as the others, "Yes, we have no profits!"

A great number of our successful dealers, who are supposed to have finally "arrived," after years of merchandising experience, offer the finest circuit known—the superheterodyne, the greatest development in tubes—Pentode, Variable Mu, Multi Mu, and any old kind

### EDITORIAL OF THE MONTH

• By **MORT STUART**, manager of the radio department of the Los Angeles Furniture Company, and President of Radio and Music Trades Association of Southern California.

of Mu, with marvelous selectivity, sensitivity, distance and volume; in fact, all that anyone can ever expect or need in the present or future radio—at the astounding low price of \$69.50! Beautiful hand-carved cabinets, and SO easy to buy, at only \$1.00 down and 25 cents a week. Or better than that, *no* money down! Old razors, pocket knives, chalk, or the children's marbles are accepted as down payment, and the set is delivered. Somebody deserves great honor and distinction with medals for this outstanding achievement.

### Let's Get Together

The association offers today the open door to those who would care to come in and meet, put their feet under the table of friendship, and have a respect for the other man who wants to merchandise his products without the necessity of having an advantage before he begins. Where all build for the future and refuse to entertain any plan that will tend to tear down what confidence there may be left in the public's mind in its appreciation of one of the greatest gifts to mankind—the Radio.

Let's get together as honest-to-God he-men and attempt to pull this great industry back out of the mire by a unified effort in the right direction towards stabilization.

If all will make the resolution today to let Profits be the guide in the future, and the yardstick to measure merchandising policies, many evils upsetting the industry will pass out of the radio picture forever.

# MIDGETS — What's Be

"They're now in a class of quality merchandise all by themselves . . . with a great, profitable field.. of their own—"



Says—

## FRED W. CHRISTIAN

Manager, Electric  
Lighting Supply  
Company.

**M**IDGETS have turned out to be a gold mine. About a year and a half ago, when a few progressive Los Angeles radio men, feeling the need of a radio set that could be sold at a popular price, developed the first midget, they little knew the significance of what they were starting.

For the first year it was strictly a local proposition, the large Eastern manufacturers not deigning to fall in line. But recently, after the possibilities of the midget have been proven, they have followed suit and are building their own mantel models.

There is plenty of money to be made from midgets, and the dealer who neglects them is missing a great opportunity. There will always be a huge class of people who cannot afford high and even average priced radios, constituting an exceedingly great customer trade for the radio dealer, because the midget is priced to fit their pocket books.

### Radio For The Masses

Just as Henry Ford took the automobile out of the novelty-luxury stage and put the world on wheels, midget manufacturers have made radio possible for the masses, and given the greatest entertainment factor on earth a great shove forward.

This great class of people to whom the midget made Radio possible would have gone without a set otherwise. Now they can find a set within their means that combines quality and performance. Many who live in small apartments or rooms would have no place for a large set, even if they could afford one.

Then too, there is a great market for the midget among people who already own large sets. Formerly it

was the practice among these people to have speakers in various rooms of the home, wired to a central receiver. Now they may have an individual radio in any room, where they are able to select programs of their choice. They buy midget sets as a second set because of its compactness, to take along on beach and mountain trips.

The comparative low price of the midget encourages cash payments in full, that might have been poor-pay accounts if handled on a credit basis on an expensive set. Even with generous terms, the percentage of cash sales is high.

Its portability makes home demonstrations easy, when necessary, for the salesman can take the set to and from the customer's home in his own car with little trouble. Delivery of the small set is also simple and inexpensive.

Last year the sale of midgets was little short of astounding. Nearly 1,200,000 of them were sold, constituting about a third of our total unit sales. And the forecast for this year is even more encouraging for the midget.

Modern midgets have developed by leaps and bounds until most of them are fine, high quality instruments.

*(Continued on Page 41)*

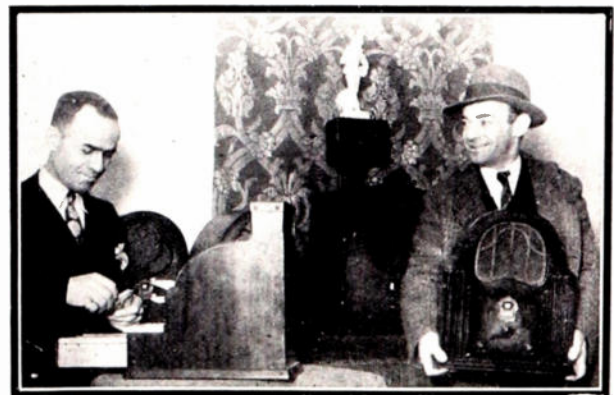

The midget fits the purses of a huge percentage of the public, and is a gold mine for the dealer.



# ing Done With Them?

"We're saturating the market with them and neglecting the higher-priced field... where our biggest profits are—"



Says—

**CLARENCE MANSFIELD**

Manager,  
Radio Department,  
Platt Music Co.

**T**HIERE has been much discussion and much prognostication as to the future of the higher-priced unit, and probably one man's guess is as good as another's.

But in the light of recent events, there appears to be some ray of hope for the sale, in satisfactory quantities, of higher-priced merchandise in the not far-distant future.

The low-priced radio came just as the depression started, and it will always be a most definite question as to how much the industry was benefited by the introduction of this type of merchandise. Certainly, coming at such a time, it did create many buyers who might otherwise not have purchased any kind of a radio just then, thus giving the dealer some volume

at a time when it was sorely needed. But on the other hand, it is doubtful if very many dealers were able to show a profit on this sort of business, that wouldn't have been far greater had they sold higher priced units.

**More Net Profit**

The dealer can sell one customer a higher-priced radio, and still have as much volume as if he had sold midgets to two or three customers—and most important of all, will have more net profit, only one delivery, only one service obligation, and only one account to handle, instead of two or three. In selling midgets, we have two or three times the delivery expense for the same volume, and two or three times the bookkeeping, service, and collection expense. Furthermore, by selling midgets, we will saturate our market more quickly—and that's something to think about.

The radio volume and retail profits in 1930 in the West were far less than in 1929, and yet probably there were many thousand more units sold last year than in 1929. There is enough food for thought in this to keep the average radio dealer from going hungry for something to worry about for some time.

A great percentage of small sets went into homes that should have had a much better radio—and they were not used as second radios, either, except in a pitifully small number of cases.

If all the thousands of midget radios that have been sold in the past year and a half had been purchased either as second-hand radios, or to people who actually could afford nothing higher priced, then we could well consider the midget a welcome member of our

*(Continued on Page 10)*



Too many salesmen are trying to sell midgets to customers who can afford higher-priced sets.

# WORK! As H And You Will Sell

By LEO WHITE

Sales Manager, Refrigeration Division,

Thompson and Holmes, Ltd.

**E**LECTRIC refrigeration affords the radio dealer a real opportunity to make sales and to make a profit, but his motto must be "*work, work, and more work.*"

He has a large customer list already because of his radio sales. Eighty-five per cent of these customers are potential buyers of electric refrigerators. If he has played the game; if he has given adequate service and built up the good-will necessary to maintain good business, he has a tremendous potential list of refrigerator customers.

## Idea Must Be Sold

But these customers must be "sold" the value of electrical refrigeration. The same methods apply to refrigerator selling as apply to radio selling. Foremost of these is that one which pertains to house-to-house selling.

Public interest has been aroused, yet the average housewife has not yet been convinced—sold—the idea of the necessity of this form of refrigeration as compared with other types, particularly that of the icebox. That is the situation which confronts every radio dealer who enters this field.

The above statement must be modified to the extent that only will electrical refrigeration supplant other methods if the public is "sold" upon the value and necessity of this form of refrigeration.

## A Virgin Sales Field

On the other hand, only about 14 per cent of the wired homes of the United States are equipped with electrical refrigerators. There is the story in a nut shell. The radio dealer who takes on electrical refrigeration is entering a virgin sales field.

Only 15 per cent of our American families take ice or use any sort of refrigeration. Only one family in seven takes ice the year around. Oh, boy! what an opportunity for a clean-up!

Practically all electrical refrigerators sold to date have been sold to families having an annual income in excess of \$5,000 a year. Practically none of the families living on annual incomes of \$3,000 a year and less have purchased mechanical refrigerators. Yet government statistics show that the number of families in the latter category far exceed those in the preceding one.

But wherein lies the weakness of the radio dealer in merchandising electric refrigerators? In the failure to recognize that electric refrigeration must be "sold"—that the potential customer does not walk into the dealer's store and ask for an electric refrigerator.

Again for a comparison. Radio, in its inception, had no competition. If you owned or purchased a piano you had to learn to play it. This involved additional expense. The same was true of any musical instrument. Homes were equipped with phonographs but the owner had to purchase records to enjoy this form of amusement.

Immediately it received public acceptance. Every radio dealer knows that. Nothing could compete with Radio. It was new and complete within itself and furthermore, it supplied a certain "want" in the American home.

## Other Devices "Satisfactory"

But refrigeration? How different. The housewife for years has had her icebox, or the so-called "cooler." Each of these devices "apparently" satisfied the wants and necessities of the moment.



She has been satisfied because she either never learned or was not convinced that either of these devices was insufficient to maintain the standards of food preservation in accordance with modern medical and health standards.



# ard As Your Iceman— Electric Refrigerators

For the average radio dealer, when considering electrical refrigeration, competitive lines of merchandise assume tremendous proportions. This is and should be only secondary. Your greatest competitor will not be another dealer carrying a competitive electric refrigerator but—the *ice man*—good stories regarding the ice man not to the contrary.

The average temperature in the average icebox over a twenty-four hour period is between 60 and 70 degrees Fahrenheit. The temperature is constantly fluctuating due to the constant melting of the ice. As the foods must be kept below 50 degrees Fahrenheit to insure perfect safety it will be readily seen that the ordinary ice box does not meet the requirements.

## Calls for Hard Work

Again it must be reiterated that the public has not yet been "sold" on this fact.

Therefore, we must revert to the statement made in the early portion of this article that no more lucrative field offers itself to the radio dealer for additional profits than that of the electric refrigeration, providing the radio dealer enters upon this new field in an energetic manner and is willing to work as he has never worked before.

Compared with the ice box, the electric refrigerator price seems high to the housewife. When, however, food preservation, absence of waste and savings in ice bills are shown her, she can easily be sold. But they must be concretely presented.

## Salesmen—Know Your Stuff!

A direct house-to-house campaign is necessary. Salesmen must be employed who "know" electric refrigeration. Often times the radio salesman can be used as an electric refrigeration salesman, but he must know his "stuff." At least one salesman should be employed who is experienced in the selling of electric refrigerators.

The radio dealer must remember that he is not selling furniture or pleasure or amusement, but that he is selling a utility. And whenever a utility is sold its virtue must be demonstrated—strange as it may seem.

And what better virtue can be offered than that of food preservation—that of maintaining life of adults and particularly children!

Most people assume that milk is safe to drink if it does not smell or taste sour. If they knew that milk, which seems to be sweet, kept for twenty-four hours at a temperature above 50 degrees (and that is the temperature of the average ice box) is not only injurious to adults but is often fatal to infants and children, they will be glad to get rid of a faulty icebox and buy an electric refrigerator which will maintain a temperature considerably under the 50 degree mark.

## Dealer Must Advertise

Advertising, naturally, must be used. National advertising can do only one thing, that is, create public interest in the merchandise itself. The dealer's advertising tells where the particular merchandise may be purchased and upon what terms. Therefore it is up to the dealer to do his own advertising in local mediums.

Direct mail advertising has its proportionate value. Store location and window displays all add to the picture, but above all, the dealer must consider the matter of direct canvass.

At this point it is but fair to point out that the dealer must give his salesman a fair opportunity. Remember that when you embark into the field of electrical refrigeration you are entering upon a pioneering job. Immediate sales will be the exception. It will be a matter of education of your buyers. Therefore, do not expect the impossible of your salesman to begin with, nor be disappointed yourself if you do not make an immediate sale. Statistics show that it is a matter of thirty to sixty days from the time

that the first contact is made before the ordinary sale of an electric refrigerator is made.

## Sales Are Permanent

But when the sale is made it is a permanent one. Witness the attitude of the finance companies. They look upon refrigeration paper as the finest in the financing field. The average finance company in financing electric refrigeration paper will return to the dealer 100 per cent of the unpaid balance of the contract. Compare that with radio paper and you have the answer.

Reverts in electrical refrigeration are the exception. You are dealing with an entirely different type of purchaser. In electrical refrigeration you are dealing with the home owner; one of substantial means. You are merchandising a utility and not a luxury.



If the dealer and his salesman get out and work as they never worked before, they'll get refrigerator business.

# He Buys 'Em All and Sells 'Em All

**M**AURICE CALDERON'S business for the year 1929 amounted to a quarter of a million dollars. More than 80 per cent of this was from the sale of Spanish phonograph records alone. The other 20 per cent was from miscellaneous merchandise—phonographs, instruments, a few radios, and sheet music.

Calderon has the largest retail stock of records of any individual dealer in the world. He has as many as 150,000 records, all Spanish, in his stock room the greater part of the year, and his total sales during his 15 years of business can be estimated in several millions of records sold.

More than 80 per cent of his business is mail order. He prints his own complete record catalogue, costing 22 cents to print, with a circulation of 25,000. Two or three times a year revised supplements are published.

## Customer Always Right

How does he do it? He modestly credits his success to hard work, and lots of it. But his greatest secret is the fact that he religiously follows the principle that the "Customer Is Always Right." He goes to more trouble and expense to correct an error, or make good an un-

satisfactory or broken record, than he does to gain a new customer.

"The Mexican people, who constitute practically all of my customers," Calderon explained, "are very suspicious by nature. To do business with them one must be absolutely fair and honest. Once you get their confidence, they are life-long friends and steady customers. They are a very musical people, and can always be counted on for a large amount of repeat sales."

## Consistent Advertiser

Calderon is a consistent and enthusiastic advertiser. His advertisements appear regularly in twenty newspapers throughout the United States. He advertises daily over several broadcast stations. And during dull seasons or depression, instead of cutting down on his advertising, he increases it, believing that then it is even more necessary to keep his name alive.

At present, twelve salesmen are employed in his store. They are all trained to be exceedingly courteous and are never allowed to argue with a customer. They are paid generous salaries, and receive bonuses each year. Several of them have been with Calderon for from four to ten years.

The success of Calderon is even

more significant when the facts of his early business career are considered. Fifteen years ago he came to the United States from Mexico after the revolution. He had 10,000 pesos in his pocket, which at that time was about \$800 in United States currency.

By the time he had chosen his location for a music shop he had only \$400 left, and was unable to obtain a loan from the Bank of Italy. In this connection, it is interesting to note that he was recently made a member of the branch advisory council of this same bank.

## Minded Own Business

The location he chose happened to be directly across the street from two established competitors, but Calderon minded his own business and went right ahead. The competitors have long since faded out of the picture.

Very often Calderon receives mail orders which have been enclosed by the sender in envelopes that the store had sent out as long as ten years ago. His prestige is so strong among these people that they carry his catalogues and order blanks around as part of their household goods, and seldom lose contact with him. Many of them even hold the opinion that the records he sells are of far better quality than the same records sold by other dealers.

## Keeps Full Stock

In his record stock are thousands of records that have been long discontinued by the manufacturer. There are very few orders that he can't fill, unless they are for records so old that they have been sold out. He buys every Mexican record that comes out, and even imports many from Europe and Mexico. In one year he bought \$118,000 worth of merchandise from one American company alone.

He admits that he has worked hard. In the whole 15 years he has had only one vacation, which was a year ago. He took two weeks off and went to the mountains for a pleasure trip.



In this store, located in the old Spanish section of Los Angeles, Calderon has the largest stock of Spanish records in the world, does a whale of a big mail-order business, and employs 12 salesmen to take care of his over-the-counter trade.





# WISE and OTHERWISE



By **SHIRLEY WALKER**  
Associate Editor

**A**CCORDING to a compilation made by the Alexander Hamilton Institute from the annual reports of 94 companies, merchants' profits in 1930 decreased 36 per cent from 1929. In 1930 these companies reported a total net profit of \$136,904,000 (after taxes were deducted) compared with \$213,648,000 the year before. Twelve reported deficits; twelve reported greater profits than in 1929, while seventy reported smaller profits. The average of nine wholesale companies showed a decline of 109 per cent. Four mail order companies operating chain stores showed a decrease in profits of 75 per cent.

\* \* \*

Take the old yardstick off the hook and lay it against your enterprise, whatever it is; the old stick is ruled off into six words: "The purpose of business is profits."

\* \* \*

Amos Parrish says: "The one thing everybody has in common is *want*. Any effort to sell something is measured by its ability to fill wants—whether new or old wants for new or old things."

\* \* \*

### Deciding for the Customer

More people would buy goods if they did not have to make a decision. If the dealer could decide the question for them, he would not only sell them, but actually do them a favor. The labor of deciding anything is painful to the human mind. There is a decided trend in this country by the business interests to do the people's thinking for them. The investment trust, the life insurance trust, the living trust—are all offers by experts to do the other fellow's thinking and deciding for him.

The strongest sales argument possible is: "We will not accept your money until you have used our empty ump for thirty days and proved your own judgment sound." That saves the prospect all chance of error in judgment; it obviates the trouble of getting his money back after he has paid; it removes fear and timidity that accompany signing on the dotted line; and it saves all trouble of thinking. In short, it will make *sales*.

\* \* \*

Here is a new idea for a live retailer. In New Orleans somebody has set up a "Time Bureau." On inquiry the correct time is given—also the information that the Blank Store is having a marvelous sale of underwear. The "Time Bureau" receives 1,000 calls

daily and operates 24 hours a day with three operators.

\* \* \*

The latest coup in the cigarette merchandising war was made by Old Gold. Thousands of beauty shops are receiving samples of Old Gold cigarettes (velour package of 50) with the suggestion that they be placed in the reception rooms for the convenience of customers.

\* \* \*

The magazine "Time" says that one thousand New York taxicabs are soon to be equipped with a device to flash a quick changing series of 22 flood-lighted advertising cards before the passenger.

\* \* \*

Seventy-five per cent of the radio sets are in daily use—66 per cent are in use every night. There is an average of 3.1 listeners per set. These are some of the findings in the Radio Survey made by Crosley, Inc., for the Association of National Advertisers. Crosley so far has interviewed 50,000 people. Incidentally, this job got them the 1930 Bok Advertising Award on Research.

\* \* \*

### Home Talkie Campaign

Talking Motion Pictures in twenty million homes throughout the United States is the goal behind the campaign started by the manufacturers of sound apparatus. Shortly available will be projectors manufactured by Bell & Howell, Hollywood Film Enterprises, Pathe, Q R S, DeVry, Sentry Safety Control Corp., Sprague Specialties Co., Victor Animatograph Corp., and Visionola Manufacturing Co.

Film companies specializing in the home field include Burton Holmes, Columbia Pictures Corp., Hollywood Film Enterprises, Pathe, Show-At-Home (Universal), and U. F. A. Films (educational). The home talkie machines use records exclusively for the sound, 16 inches in diameter and turning at a speed of thirty-three and one-third revolutions a minute, as compared to the usual phonograph speed of seventy-eight. Sound on 16-millimeter film, another method of synchronization, has not yet proved feasible.

\* \* \*

A professor of Northwestern University tells his class in Contemporary Thought that woman's fashions invariably decree long skirts just before a period of depression, and short skirts just before a period of prosperity. Interesting if true.

# BIG IDEAS . . .

## that click!

### Displaying Radios With Meals

The radio department of a large department store recently made use of the cafe maintained by the store to display radio sets. A new model was placed in a glass display case near the front of the cafe, in plain view of most of the patrons. Flowers, drapes and knick-knacks were used to decorate the sets. Various models were substituted regularly to provide variety.

### Offering Ringside Seats

Business Reply Cards, left at homes where the doorbell is unanswered, are supplied the salesmen of the Potomac Electric Appliance Company.

The card bears the catch-line "Will you accept these choice seats?" And below: "The front row—where all the action takes place—that's where your seats will be for every important event. Modern radio reception brings you all the outstanding sport events; music of the concert and theatre stage; broadcasts of important happenings the world over. We want you to know the thrill of hearing it all from front row seats right in your own home. Merely fill in and mail this card and we will send 'your seats.'" Occupying almost half of the message side of the card is an illustration of a group of theatre seats.

### Set—Station—Theater Tie-up

A radio firm made arrangements with the manager of a theatre in Salt Lake City to tie-up with a broadcast program over KDYL. The station was given a half hour for a special act, which was amplified through one of the radio company's receivers placed on the stage. A lobby display, window and newspaper tie-up with the dealer and distributor added to the interest.

### Fooling the Joy-Rider

Dealers in a Western association have cooperated in handling "joy riders" and "poor pay" accounts, by having blank forms printed upon which each dealer-member keeps a record of his customers and their financial habits.

The form is a pink slip, which has blanks for the customer's name, address, occupation, amount of payment due, etc. In one corner, under the heading "How Pays" are listed ten items, with blank spaces for check marks. The items are: "30-60 days, 30-90 days; takes up to six months; pays irregularly on account; account closed; account placed for collection; have charged off amount; issues 'hot' checks; repossessed; just opened, not cleared.

These slips are filled out by the dealers and filed with the association, where all the members have access to them for reference.



### Period Model? Sure!

The accompanying picture is of an Eighteenth Century English period design grand in an Open Pore Wax Finish, in mahogany. The piano was originally a straight Knabe style "64" and was made into a period model by Milbeck, a craftsman of Southern California.

Gene Redewill, of the Redewill Music Company, Phoenix, conceived the idea that keeping a customer waiting several months for an authentic period designed piano, or one to match up some certain decorative scheme was a needless wait in this day and age. The results of the experiment are evident in the picture.

So in the future if a piano man has a piano that "just suits" the buyer in all musical requirements except the case, he may have it made into any imaginable model in a couple of weeks' time. Sketches may be had and a wide variety of finished details submitted that will lose no time in securing the piano on short notice and with satisfaction to the customer besides a guarantee that there will be no other instruments like it in event the buyer wants something exclusive.

The dealer may also avail himself of the opportunity of having his checked varnished instruments and otherwise casual damaged pianos made over into periods—thus saving an occasional loss on the usual shop re-finished instruments.

This particular Knabe was designed to order for one of Redewill's customers in the Country Club district in Phoenix.

### Phone "R-A-D-I-O"

A San Diego dealer, through arrangement with the telephone company, managed to obtain for his store the phone number "Randolph 2346." When dialed on a dial phone, the number spells "R-A-D-I-O," with the letters all in correct order.

This dealer cashed in on his good luck, and uses the phone number wherever possible in his advertising, cards, and circulars.

### Tubes and Taxis

A dealer made arrangements with a taxi company in his city to place a sign in each cab stating that his brand of tubes would be delivered to any address in the city for the price of the tubes plus the taxi fare.



# APRIL RECORD HITS

## Brunswick

6090—"Out of Nowhere." *Bing Crosby*. This is Bing's first record made for Brunswick. Accompanied by Gus Arnheim, he sings this sweet tune in his best ballad manner. Much of the number is not intended for dancing, although part of it is in a soft, easy-going fox trot rhythm.  
"If You Should Ever Need Me." *Crosby*. A sentimental ballad, with violin obligato and soft instrumental accompaniment.

6073—"Got the Bench—Got the Park" (But I Haven't Got You). *Noble Sissle*. A straight arrangement of this catchy fox trot, with tenor vocal refrain accompanied by piano and clarinet. One of the sax men takes a difficult hot chorus.  
"Loveless Love." *Sissle*. A very simple number, almost like "Silver Threads Among the Gold" set to snappy fox trot rhythm. Lots of good hot instrumental parts, especially trumpet and clarinet.

6063—"Under a Roof in Parce." *Brunswick Hour Orchestra*. A pretty waltz, with violins predominant. Harmonious and plain arrangement.  
"By the River Saint Marie." A beautiful love-song, different from the usual run of tunes. Tenor vocal refrain, with chimes, church bells, and violins much in evidence. A fox trot.

519—"Prairie Skies." *Beverly Hill Billies*... "Zeke" opens the number with a fancy accordion introduction, and the boys gather around and jine in on the singin' parts. A waltz.  
"She Sleeps Beneath the Daisies." *Hill Billies*. One of their favorite pieces. A sleepy, sad lament about a dead sweetheart, sung with an abundance of vocal harmony.

6070—"Were You Sincere?" *Loring "Red" Nichols*. Nichols plays this popular fox trot in a sweet style of arrangement, with violin and tenor vocal chorus.  
"Teardrops and Kisses." *Nichols*.

6069—"I Have to Laugh" (When I Think How I Danced With Tears in My Eyes Over You). *Ben Bernie*. There is some good sweet instrumental work in this tune, and the vocal chorus is careless, and easy-going, in the tropical modern style. Sax and violin do clever work with rhythm background.  
"You're Just a Lover." *Bernie*. The best part of this number is the varied and complicated instrumental arrangements a la Bernie.

6038—"When I Take My Sugar to Tea." *Boswell Sisters*. With the Dorsey brothers furnishing rhythm and hot accompaniment, the girls really put this number over. The orchestra cuts loose at intervals and renders a variety of scorching interludes.  
"Wha'd Ya Do To Me?" *Boswell Sisters*. A galaxy of unusual rhythm effects and vocal parts. Combines slow lowdown and snappy fox trot tempo.

## Columbia

2428D—"Egyptian Ella." *Ted Lewis and his Band*. In his best style, Ted relates vocally the adventures of Ella, the 220-pound miss who knocked 'em dead with her dancing in Egypt. There is lots of Lewis monologue in this fast-moving fox trot.  
"I'm Crazy About My Baby." This is a hot, swinging fox trot, with a negro blues song chorus, sung in listless, darty fashion with piano accompaniment.

2417D—"Walkin' My Baby Back Home." *Lee Morse*. The words of this number have been changed to the feminine standpoint. Morse puts all of her personality and much feeling into the number, and uses many new vocal tricks. As usual, she accompanies herself on the guitar.  
"I've Got Five Dollars." *Lee Morse*. A novelty number, from "America's Sweetheart." A sudden switch from slow, swinging rhythm to fast fox trot is a surprise. Morse is quite sophisticated in her execution of this amusing number.

2423D—"Oh Donna Clara." *Guy Lombardo*. A number imported from England, from the show "Wonder Bar." It is a Spanish tango, with plenty of castanets and sound effects. Slow and lazy, with deep bass effects, it is a good dance tune. Tenor song chorus with one-string guitar obligato.  
"Elizabeth." *Lombardo*. Here is a simple melody, with good instrumental rhythm and xylophone parts. A male trio sings vocal choruses.

2409D—"Please Don't Talk About Me When I'm Gone." *Ethel Waters*. The first part of this record is a sweet ballad, in which Waters does some good sentimental singing. Then she switches to her characteristic hard-boiled monologue and parody. *Ben Selvin* accompanies.  
"When Your Lover Has Gone." *Waters*. She puts a lot of personality plus in this number. The chorus is hummed to very nice sustained harmony by the band, with muted trumpet.

2427D—"Got the Bench—Got the Park." (But I Haven't Got You). *Fred Rich*. Irving Berlin wrote this wistful ballad. The vocal refrain is sung by a whispering tenor, with beautiful sustained harmony and rhythm behind him. There is an unusual double-piano chorus.  
"I'm the Last One Left on the Corner." *Rich*. One of those "Old Gang of Mine" fox trots, played in a sentimental, soothing manner by Fred and the boys. It is a lonesome ballad, very simple and sweet.

24221—"Mama Inez." *Enrique Madriquer's Havana Casino Orchestra*. A Rumba, played by one of the introducers of the Cuban fox trot to America. The sound effects are genuine and interesting, and the record is full of variety.  
"African Lament." Another Rumba, with very pronounced Cuban fox trot rhythm and effects.

## Okeh

41486—"Just a Gigolo." *Louis Armstrong*. This popular negro entertainer puts his own inimitable interpretation on this number. The first part is quite sentimental, with Louis accompanied by soft guitar. Then he suddenly breaks into lowdown, and from then on out it is all hot arrangement.

"Shine." *Armstrong*. An old standby dressed all up by Louis, so that the old tune is hardly recognizable. Louis puts all he has in it, and winds it all up with his famous high trumpet solo, with drum.

41484—"Two Hearts." *Harry Reser*. From the German picture "Two Hearts" this waltz is typically German. Violins and stringed instruments predominate, with tuba and accordion used liberally. Tenor vocal chorus. "Please Don't Talk About Me When I'm Gone." *Fred Rich*.

## Victor

22635—"Please Don't Talk About Me When I'm Gone." *Gene Austin*. In his usual high soft tenor, Gene sings and takes a novelty vocal chorus in this fox trot number. He is accompanied by piano, stringed bass, and guitar.

"When Your Lover Has Gone." *Austin*. A sad, lonesome number, full of deep harmony. Orchestra furnishes accompaniment.

22631—"You Didn't Have to Tell Me." *The Troubadors*. A slow, rolling fox trot played in sweet arrangement. There are some excellent sax parts and a tenor refrain by Paul Small, with piano accompaniment.  
"With All My Heart." *Troubadors*.

22637—"Walkin' My Baby Back Home." *Ted Weems*. This is a lively fox trot, with clever instrumental arrangements and individual breaks. Parker Gibbs sings the vocal choruses.  
"I Lost My Gal Again." *Weems*. The words are clever, and a nice dance tune is set to the clean-cut, snappy Weems rhythm.

22638—"Falling In Love Again." *Johnny Hamp*. From the Paramount picture "The Blue Angel." A slow, dreamy waltz arranged in plain, smooth style. The vocal refrain is sung by Carl Graub.

"Two Hearts." *Hamp*. A German waltz, from the Tobis picture "Two Hearts in Waltz Time."

22642—"Hello Beautiful!" *Wayne King*. Varied arrangements of a lively fox trot. An instrumental feature of the number is a hot violin chorus. Vocal trio get together on vocal parts.  
"One Little Rain Drop"

23037—"The Candy Man." *Don Jose's Havana Orchestra*. Consisting mostly of singing in Spanish, this Cuban Rumba is the real article. Voice and trumpet produce echo effects, backed by usual rumba rhythm.  
"Rumba Negro." *Bennie Moten*. The number starts out in rumba rhythm and all that goes with it, but changes suddenly into a hot stomp, which is carried out to the end. There is a hot guitar chorus and lots of instrumental solo parts.

# THE WESTERN

## The Next Convention

**T**HE ANNUAL CONVENTION OF THE Music and Radio Trades Association has been postponed until 1932. Radio manufacturers did not wish to have American products sent into Canada because the present prices are so much lower than the same products sell for in Canada. They appealed to Canadian customs officials with the result that the arrangement that the Convention officials had made for the Hoover Hotel to be made the port of entry were ended.

It will, as a result, be impossible to hold a trade show in Vancouver, as the usual custom duties prohibit. Kelly and his Canadian officers association believe that a Convention and trade show would be but partially successful with time as they are at present.

Los Angeles, San Francisco, and Seattle were asked to hold the Convention, and the associations in these cities, the Radio and Music Trades, Music and Radio Trades Association of Northern California, the Pacific Radio Trades Association of San Francisco, and the Radio Trades Association of Seattle, to sponsor the Convention and show on such short notice.

Still there is considerable feeling for a Convention alone in Vancouver, but it is postponed until 1932. President Kelly has done his best, and it is only through powers beyond his control that his plans were thwarted. He is receiving the sympathies of prominent music and radio leaders throughout the West.

\* \* \*

## Television Around the Corner?

**T**HREE LARGEST JOBBERS IN THE WEST state that radio dealers will be selling television apparatus to satisfied listeners, and making money on the sale before Christmas of this year.

The general consensus of opinion is that television is not that close at hand, however, although it is a known fact that it is not far in the offing.

A number of Eastern stations are broadcasting television daily. It is estimated that there are between 3000 and 4000 television sets in use in and around New York. The Columbia Broadcasting System, and the stations connected with it are making definite plans for television, and some of these stations already have a portion of the apparatus installed.

It is stated on what is considered good authority that a television station will go on the air in San Francisco about the middle of June. Several interests are seriously considering the construction of a television transmitter in Los Angeles.

The newspapers consider television as hot news. Any kind of television story is worth a top column, black-face heading. The newspapers usually know what the public is interested in. When television comes it means that the radio industry will have the biggest boom in its history. Those who profess to know, predict that the boom will come next year unless it is forced across this year.

Television at present has its limitations. It is broadcasted through motion picture film, and most television apparatus will not pick up anything more than eight feet away and requires very brilliant illumination. As yet, it is not possible to broadcast such events as baseball and football games.

\* \* \*

## On To Chicago!

**I**F RADIO MEN OF THE WEST ARE TO SEE new models and new products of radio this year, they will have to journey to Chicago to see them. No trade shows will be held in the West. A number of Western jobbers are planning to have trade shows of their own, and Los Angeles will have a Consumer's Show on the second.

What Chicago will show in the way of new merchandise has not yet been disclosed, but it is generally believed that there will be one or two television sets on exhibition, a number of talking movies for the home, a great number of new models using Pentode, and Hi-Mu tubes, and possibly one or two sets with entirely new circuits patterned along each line.

\* \* \*

## Stopping High Trade Ins

**R**ADIO DEALERS HAVE BEEN THE GOAT long enough and some manufacturers' policy of advertising high trade-ins rather than cut prices. A number of radio trade associations in the West have taken definite action against such practices: It is undoubtedly the greatest evil in the industry today.

Here is an instance: a radio dealer advertised a \$50.00 trade-in on a certain model. A customer traded in his old set, bought a new model, and didn't like it. Came back in three weeks and wanted to trade the new model for another make that did not have a high trade-in connected with its sale. Dealer refused. The customer stated, "I have a credit slip here in your store for my old radio. What kind of a store are you if you won't honor it?"

The result was that the dealer had to honor the credit slip on another radio that had no trade-in allowance attached—with a resultant loss of \$50.00. The customer admitted that the old set was not worth \$50.00, but it was the dealers own proposition, and the customer accepted it at its face value.

\* \* \*

## Price On The Bounce

**O**VER the West come reports that sales of larger merchandise range from \$130.00 to \$155.00. The cheaper consoles are not moving so fast. The cheaper midgets have practically gone off the market, and the only midgets that are selling at all are the higher priced ones. That is good news for all radio dealers.

Moreover, dump stock sales are not so successful. Dump stock operators are curtailing their efforts. The reason is that the public is not buying cheap merchandise. Why, nobody knows, unless there is a change in



# VIEWPOINT . . . .

the trend of the times for the better. Mr. and Mrs. Radio Buyer are loosening up their purse strings. They are spending the money they have been hoarding for months past in fear of hard times ahead.

Now, that there is a spirit of optimism in the air, they are out to buy good merchandise and to pay a fair price for it. Price was the big feature a year ago; Quality is the big feature today.

\* \* \*

## Radio News in Newspapers

**T**HE AMERICAN NEWSPAPERS PUBLISHERS' Association in annual convention in New York passed a resolution stating, "Whereof, with few exceptions, radio programs as published in newspapers relate solely to advertising in one form or another, therefore be it resolved, that such programs, if published, should be handled as paid advertising."

The reason for such action is that newspaper advertising lineage dropped down considerably last year, while the advertising appropriation of broadcast sponsors showed a remarkable increase. The newspaper publishers believe they are cutting into the advertising revenue of the newspapers. Now the question is, will newspapers stop publishing radio broadcast news unless the stations pay advertising rates for it? Most stations cannot afford such expense. Moreover, newspapers will not accept such a policy in spite of the resolution passed by the American Newspapers Publishers' Association.

Radio programs are certainly news, and they constitute news that newspapers subscribers want to read. Radio news is just as vital and just as necessary as theatrical news, as motion picture news, and as sporting news. Moreover, the radio industry has contributed very generously toward the come of the newspapers. Radio manufacturers, jobbers, and retailers have used and are still using large advertising space in the daily newspapers, and certainly deserve the newspapers support.

Certainly there is no place for discussion between the radio stations and the newspapers. There is a great need for both. Wise advertisers will not use either to the exclusion of the other. Broadcasting is chiefly valuable in building good will and trade-name acceptance for a product. Newspaper advertising is absolutely essential in getting definite action, in closing the sale.

Newspaper publishers who know their game will cooperate more closely with broadcasting stations; will feature radio news, and will have the station assist them in getting broadcast sponsors to advertise their radio programs in the newspapers. There is no reason why a radio page carrying so much news, should not be as interesting, and should not carry as much advertising revenue as a theatrical page. What must come in the future, the quicker it is done the better for the newspapers, radio stations, industry, and the public at large. There is something for radio trade associations in the West to think about.

## Cheaper Tubes—More Replacements

**T**HE FACT THAT THIS DRASTIC REDUCTION in list price presents a remarkable opportunity for replacement sales is obvious. The purpose of the price reduction was for the purpose of stimulating buying. Many dealers right now can show that their tube sales constitute fully a third of their gross business.

In the past, figures show that the replacement market has been grossly neglected. In 1930 twenty-eight million tubes were used in new sets. In the same year, only 24,000,000 tubes were sold for replacements. Obviously, the tube department has been shoved into the back room. But with the advent of the highly developed testing equipment, new sales plans, and great activity on the part of the tube manufacturer, 1931 has all the earmarks of being a big tube year.

On the basis of the tube business done last year, and the developments which have come about this year, including this new drop in list prices, it is estimated that tube replacement sales for 1931 should be twice those of 1930. Roughly, this means that there should be about 48,000,000 tubes sold for replacement this year. There were approximately 15,000,000 sets in use in the country as of January 1, 1931. That is only three tubes per set that must be sold this year. Following is a comparison of old and new prices in some of the types of tubes:

Type 224 from \$3.30 to \$2.00; type 227 from \$2.20 to \$1.25; type 245 from 02.00 to \$1.40; type 280 from \$1.90 to \$1.40; type 281 from \$7.25 to \$5.00; type 250 from \$11.00 to \$6.00; type 210 from \$9.00 to \$7.00; type 235 from \$3.50 to 2.20; and type 247 from \$3.00 to \$1.90.

This substantial reduction removes the greatest objection of the consumer to purchasing a complete set of new tubes, instead of replacing tubes singly and waiting until they are actually useless. It is estimated that the average life of a tube is 1000 hours, and the average number of tubes per set, eight. Every tube replaced in the past has cost the customer around \$1.50 for service call, plus the cost of the tube. Now, the whole eight tubes can be replaced at once for around \$12.00—about half the former cost when replaced one at a time.

The dealer's average profit per tube is about sixty-seven cents, and volume and turnover prospects are exceedingly high. He can successfully compete with the "jingo" bugaboo and chain stores not in the radio business. Instead of haggling with the customer over the disadvantages of getting the limit out of a tube, he can now offer him a whole new set very reasonably.

\* \* \*

**A. G. FARGUIHARSON**, SECRETARY OF the Radio and Music Trades Association of Southern California sent questionnaires to all the dealer members asking their opinion on the advertising of high trade-ins. Over 80 per cent replied that they would like to see the high trade-in evil eliminated.

# News of the

## Western Centralab Office

Central Radio Laboratories of Milwaukee, Wis., (have recently established a West Coast branch office at 2149 East Sacramento Avenue, Los Angeles. The branch office is under the supervision of William B. Winslow. Centralab also have announced a complete line of new fixed resistors to their line of volume controls, tone controls and potentiometers.

## Sherman, Clay Close Fresno Store

Concentrating their business in their bay district stores, Sherman, Clay and Company have announced their retirement from the Fresno field, and the closing of their store at Fulton and Merced Streets.

F. R. Sherman, vice-president of the company, stated that they would endeavor to service the Fresno trade through the parent stores in San Francisco and Oakland. The Fresno store was established 25 years ago. E. R. Armstrong, who was manager of the store for 21 years, before going to the Portland and Sacramento branches, is assisting George T. Bacon, present manager, to close out the branch.

## Offer Instruction Course

Glendale branch, Platt Music Company, at 301 North Brand, Glendale, Calif., will open a Platt School of Music in keeping with the policy of giving local residents the same conveniences as afforded by the main store, Los Angeles. Courses will be taught by the "fun" method.

## Mayflower in Colonial Design

Kierulff and Ravenscroft, Inc., 121 Ninth Street, San Francisco, recently appointed distributors of the Mayflower refrigerator, report a ready acceptance of the new models.

The new Mayflower has been patterned in colonial period design, intended to have a strong appeal to housewives, E. G. Arnold, manager, said. The manufacturers chose the colonial period design for its general and permanent charm and beauty, combining with it mechanical and structural improvements for convenience and service.

## Taufenbach Has Open House

Celebrating his appointment as Southern California distributor for Clarion radios, Les Taufenbach, presi-

dent of Western Radio, Inc., 1135 S. Wall Street, Los Angeles, recently held an open house for several days.

The new Clarion superheterodyne models, manufactured by the Transformer Corporation of America, Chicago, were displayed for the inspection of visiting dealers. Among the new Clarion developments are Pentode and Variable-Mu tubes.

In addition, Taufenbach also presented his first complete showing of the Capehart Automatic Combination line, manufactured by the Capehart Corporation, Fort Wayne, Ind. The new Acrometer Visible Tube Tester, for which Western Radio is Southern California distributor, was also presented to the dealers.

## Woman Dealer Enlarges Business

One of the youngest business women on the peninsula, Miss Margaret Lial, in the two years she has been in business, has made a success of her music shop in Carmel, Calif. She has now opened a branch store in Monterey, at 490 Alvarado St., in the same building with Sherman Clay & Company. The Monterey shop stocks violins, radios, phonographs, records, and sheet music.

## • Lasher Organizes Company •

Phillip Lasher has established the Phillip Lasher Company, Ltd., Western Distributor for Q.R.S. DeVry, at 300 Seventh Street, with offices at San Francisco. Lasher was formerly Western manager for DeVry.

G. Todd Taylor is vice-president of the new company, and Phillip Meisenzahl has been made Southern California representative, with offices at 123 South Kilkea Drive, Los Angeles. Q.R.S. DeVry Company, Chicago,

are manufacturers of a complete line of 16mm. home movie equipment, ranging from inexpensive, amateur items to standard professional models. Among their products is a new sound-on-film portable unit for home talkies, educational work and amusement. Phillip Lasher Company, Ltd., are also distributors for other photographic specialties.



G. TODD TAYLOR



PHIL H. LASHER



PHILLIP MEISENZAHL



# Western Trade



New Pacific Coast headquarters of W. H. Cooke, Sylvania factory representative, at 3440-46 South Hill Street, Los Angeles. Cooke was formerly located in the Laughlin Bldg., Long Beach, Calif.

### Ford Takes Over G-M Line

The Walter F. Ford Company at 15 East First South, Salt Lake City, has taken over the retailing of General Motors radios in Salt Lake City. Ford has also taken over the retail office of Frigidaire, which was formerly known as the Frigidaire Service Company and operated by the Electric Light and Refrigeration Company, wholesalers for this line. The new firm carries his name. Ford takes over the General Motors store supply of radios, which has now closed down. The sales force selling Frigidaire has been retained and also sells the G-M radio line.

Dial Radio Shops, Inc., San Francisco, have leased another store in the Hotel Whitcomb corner at 1209 Market St.

### Dishman Leases New Location

W. D. Dishman, of the Dishman Radio Shop, 1205 Fulton St., Fresno, Calif., has leased a new corner location at 1463 Fulton. The new store has been renovated and has added a radio and musical instrument repair department. Musical instruments have recently been added to the stock of radios and electric refrigerators handled. Dishman has been in the musical merchandising business in Fresno for the past 18 years.

### Form Accordion Bands

Knight-Campbell Music Company, Denver, Colo., has recently inaugurated the idea of organizing accordion bands. All of the organization and band work is handled by C. O. Bohon and Jimmy Hoar. At present about 400 students have joined, and all have purchased comparatively expensive instruments.

Columbia Radio Company, Portland, Ore., has undergone extensive repairs and installation of new radio repair equipment. The store, formerly known as the Radio Tube Service, was recently purchased by Mart Hooks.

### Adds Fishing Dept.

The Caladyne Radio Company, 2806 Mission St., San Francisco, has added a fishing supply department, according to John Maguire, owner.

### Doner Takes New Quarters

The Donor Piano Company, Inc., formerly located at 1621 Third Ave., Seattle, Wash., has moved to new quarters at 1901 Third Ave., according to C. E. Doner, manager. In addition to the regular lines handled by the company in the past, the new Brambach Grand piano has been added. H. A. Ruthben is sales manager of the new store.

### Woman Sells Pianos

Mrs. H. O. Purucker has joined the ranks of Medford, Ore. business women by accepting the dealer's contract for the sale of Baldwin pianos, which she carries in stock at the Electric Wiring Company, 30 South Grape St.

### Platt Passes Dividend

Directors of Platt Music Company, Los Angeles, have omitted the regular quarterly dividend of 43¼ cents a share on the no-par capital stock.

Benjamin F. Platt, president, said that at such times as the present, desirable opportunities for expansion are available, and directors who have under consideration such steps deemed it advisable to conserve the cash resources of the company.

### Add Wholesale Radio Dept.

Merry Company, Ltd., 18th and Portero Sts., San Francisco, are contemplating adding a wholesale radio department to their present business, according to company officials. The Merry company is well-known for its "Gold Seal" storage batteries, and is also distributor for bicycles, toy novelties and other accessories. The company has been established for more than thirty years.

### Form Refrigeration Bureau

At a meeting of electric refrigerator distributors, held in San Francisco recently, an "Electric Refrigeration Bureau of Northern California" was formed. It was decided that this bureau should be composed of one representative from every refrigerator distributor in Northern California.

The following officers were elected to serve the balance of the year: O. R. Doerr, Pacific Gas & Electric Co., president; and F. M. Rowles, General Electric, Treasurer.

The matters which it was decided should be immediately taken up, were the organization of local bureaus in Northern California, a collection of funds to be contributed by individual distributors, co-operation with the P. G. & E. advertising department, arrangement for distribution of advertising material prepared by the N.E.L.A. for dealers' use, and an arrangement for collection of data pertaining sales and the reporting of same to New York bureau headquarters.

A. C. Joy, chairman of the advertising committee, recommended the expenditure of a \$30,000 newspaper advertising fund in a spring drive to run until about June 30.

A uniform offer to consumers was suggested, providing terms of \$10 down, and the balance in 24 months. These, and other matters could not be definitely decided at the meeting, and were referred to the executive committee.

An announcement was made recently by Gerhard Fisher, radio research engineer of Radio Laboratories, Lt., 9033 Venice Blvd., Los Angeles, that the company would soon be in production of short wave receivers and radio marine compasses.



Charles L. Lawson, general sales manager of General Motors Radio Corporation, visited the West this month and conferred with G-M officials on the Pacific Coast. Left to right: L. C. Warner, regional manager; E. F. Rybolt, Los Angeles zone manager, and Lawson (seated).



# UNDER THE GAVEL

## — Association News —

### Current Given New Position

Paul E. Current has been appointed radio interference investigator for the Pacific Radio Trades Association in the East Bay territory. Current has had extensive experience in the electrical and radio field, having been master electrician at the naval base at Coco Sola, Panama, for two years.

For two years he was chief electrician at the naval high-power radio station, NPL, and served one year as instructor in the naval electrical school. A pioneer in the radio field, Current was operator of the first radio successfully operated between submarines. Through his activities with the Certified Servicemen he was made chairman of the East Bay Certified Servicemen. In his present position he succeeds Paul Rowe, who is handling the San Francisco territory.

### R.M.T.A. Complain Report

In March, according to an analysis of complaints compiled by George R. Walters of the Interference Department of the Radio & Music Trades Association for Los Angeles and vicinity, a total of 363 complaints were investigated.

Listeners reported 198 of the complaints, Walters found, while dealers reported 84 and the utilities 81. Causes of interference were, in order of number of complaints, power lines, street cars, equipment and medical.

Twenty-eight questionnaires reported steady interference, 74 reported intermittent, and 32 desired distance.

### Klamath Falls Dealers Unite

Dealers in Klamath Falls, Ore., have organized, and have joined the Oregon Radio Trades Association.

The immediate problem under discussion is interference. Preliminary plans for a Radio Listeners' League to assist in the finding and removal of interferences have been made at local round-table meetings.

"In my ten years of travel as factory representative I have found no town with the amount of interference that Klamath has," stated Randall Bargelt, temporary chairman. "We are isolated from all large stations and their programs are difficult for us to receive."

Plans to alter the city ordinance to make it effective were discussed, and co-operation with the city electrical inspector was achieved.

### Broadcasters Make Survey

In a survey recently made by San Francisco broadcast stations to determine the amount of listener attention in the Bay district, it was found that 89 per cent of homes having telephones were also equipped with radio sets.

Nearly 7,000 persons were called on the phone and asked what station they were listening to. The survey revealed

that 18.4 per cent of the listeners used their sets between the hours of 7:00 a.m. and 12:30 p.m., 37 per cent between 12:30 p.m. and 6:00 p.m., and 64.28 per cent between 6:00 p.m. and 10:00 p.m. Between eight and nine in the evening, an average of 73.32 per cent of the listeners tuned in.

### Convention Resume Published

The executive offices of the N.F.R.A. and the R.W.A. have just completed the publishing of a comprehensive booklet covering the reports of the various committees, addresses and convention proceedings, as given at the Fifth Annual Convention in Indianapolis.

The resume covers completely the addresses of the presidents, J. Newcomb Blackman of the National Federation of Radio Association, and Harry Alter of the Radio Wholesalers Association. Within the resume are also the reports of the executive offices by H. G. Erstro, executive vice-president, and the addresses given by Bond P. Geddes, executive vice-president of the Radio Manufacturers Association, on the "Manufacturers' Viewpoint for 1931." The "Value of Local Wholesalers' Clubs," by Hollis Vaughan of Boston; "Cooperative Credit Control," by Howard J. Shartle of Cleveland; "Dealer Cooperative Advertising," by R. H. Bechtel of Cleveland, as well as "Cleaning Up False and Misleading Advertisements," by H. E. Richardson of Chicago, are presented in complete detail.

The problems of the retailers are also discussed very completely and the paper presented on "Cost of Accounting Systems" by R. H. Lemley of Chicago; "Radio Retailers' Insurance," by Mr. Blewitt of Chicago; "Financing Time Payment Sales," by Mr. Lee of Chicago; "Service Men's Problems," by Marcus Hinson of Winnetka, Ill., and "Merchandising," by Julian E. Sampson of St. Louis, Mo. Copies of the booklet are available by writing to the executive offices at Chicago, Ill.

### Report Shows P.R.T.A. Active

A total of 3,648 interference complaints were investigated by the interference branch of the Pacific Radio Trades Association, according to a recent report. Expense involved in the carrying out of the investigations amounted to \$9,600, or \$2.65 per complaint.

Minor defects in the receivers themselves were responsible for 360 of the complaints, while defective aerials and grounds caused trouble in 233 cases. The utilities caused 1,844 of the complaints.

The Pacific Gas & Electric Company, Great Western Power Company, Key System, Ltd., Southern Pacific Company, Market Street Railway Company and the Sacramento Short Line subscribed to a total of \$6,780, while the balance of \$2,720 was paid by the association.

### New Officers Begin Work

The Mountain States Music and Radio Trades Association recently held its first real reorganization luncheon since the installation of new officers. The new president, C. M. McDonald, presided and introduced R. E. Folland, who is the new secretary of the association. He succeeds Harold W. Jennings, who resigned to become secretary of the Utah Manufacturers Association.

Folland is also secretary of the Electrical League of Utah, which is closely allied with radio, and he assumes the secretaryship of the radio trades as well.

A fair representation of radio and music men, both wholesalers and retailers, were present. The matter of membership was taken up as a real problem. The committee on membership, consisting of R. L. Parry, Fred Albers and Jack Lee, was appointed to see delinquent members and some who had resigned. It was thought that the heavy dues previously of \$15 quarterly were responsible for lack of interest.

Upon motion an amendment was made to the by-laws changing membership dues to \$2.00 annually. A letter was also to be sent to delinquent members stating that if they paid for six months in advance their back delinquent dues would be cancelled. It was thought this plan was much better than dropping delinquents.

The following committees were formed: Interference, W. M. Scott, chairman, J. G. McCollom, H. T. Plumb; entertainment and speakers, J. M. Perliqitz, chairman, P. G. Lasky and Earl Glade; publicity, Harry O'Loughlin, chairman, Carl Brown and Harold H. Jensen. The matter of continuing spending money from the association for radio interference was taken up and Chairman Plumb of this committee said he did not think this would be necessary.

The close association of the Electrical League with radio made it possible, Folland said, for radio and music men to participate in the forthcoming Electrical League convention, April 30 and May 1, with invitations extended to all meetings and special events. The invitation was accepted with closer harmony a future possibility between these two trades.

The new officers of the Mountain States Music and Radio Trades Association for 1931 are: C. M. McDonald, president; J. C. Dwyer, vice-president; R. W. Folland, secretary; V. P. Felt, treasurer. The board of governors includes McDonald, Dwyer, Felt, W. O. Smith and Wayne G. Stillman.

### Suggests City Cooperation

Enforcement of the ordinance regulating the use of electrical equipment that interferes with radio reception has been urged on Mayor Baker of Portland by J. H. Hallock, president of the Oregon Radio Trades Association, who suggested that the city join with the association in eliminating interference.

Mayor Baker recommended to the council that the matter be referred to Commissioner Clyde for investigation. Hallock, in his letter, pointed out that the city ordinance relating to this matter had never been fully enforced, and that "Our association feels sure that the effective enforcement of this ordinance would be a real boon to thousands of city listeners." He suggested that the city contribute \$100 a month and the association \$50 to employ a man to investigate interference.



**30** For many weeks prior to the actual appearance of the Majestic Refrigerator, this company assured Distributors, Dealers and the Public that its new product would be, above all else, a piece of Highest Quality Merchandise.

**AMAZING  
FEATURES**

- Every promise made was amply fulfilled . . . as has been proved by the performance of many thousands of these refrigerators in the homes of delighted and completely satisfied owners.

- It becomes more apparent each week that a Majestic Refrigerator Franchise is one of the most valuable that a Dealer can hold. Our Distributors are rapidly closing such agreements assuring dealers the handsome profits of the greatest year in electrical refrigeration history.

GRIGSBY-GRUNOW COMPANY, CHICAGO, ILLINOIS

*Majestic*

**ELECTRIC REFRIGERATOR**





Cartoon by Kem

**O**F LATE Western radio manufacturers have been in a turmoil over the necessity of adopting new tubes—pentodes and multi-mu. Coming close on the heels of the radical change from r.f. to superhet, the new tubes seem to have some of the boys a bit dizzy. It would appear that the only thing to do is to empty all of the bag of tricks into the chassis right now, so that nobody can go one better for some time. Give them a superhet with bi-mu, variable-mu or multi-mu tubes, plus a couple of pentodes and then enjoy a little peace of mind. That is, until some upstart puts in "free wheeling" and then the fun will start all over again.

**T**HE next "sensation" will probably be the sets employing the Stenode Radio-principle. Dame Rumor hath it that one of the big national manufacturers has already secured license from the new Stenode Corporation. A certain Dr. Robinson of Merry England is responsible for the new idea. It consists mainly of inserting a quartz crystal in the input circuit of the second detector in a more or less conventional superheterodyne. The crystal is ground to the intermediate frequency, and is so arranged in the circuit that nothing gets by to the detector except the intermediate frequency, plus and minus a paltry 50 cycles or so.

How hard we have labored for years in an effort to preserve a 10 kilocycle band of frequencies through the RF channel of the receiver! And now the good doctor builds a set with such terrific selectivity that he considers one-hundredth of that band-width still quite broad! Recently in New York, a demonstration of the Stenode Radiostat was most convincing. A set was tuned to WJZ on 750 kilocycles. Two oscillators, modulated by phonograph pick-ups, had their outputs fed into the Stenode receiver at 755 and 745 kilocycles respectively. The level of input signal was higher from the oscillators than from WJZ. Yet the set played WJZ with good tone quality and not a trace of the two oscillator signals 5 Kc. removed.

According to standard practice, this degree of selectivity would only result

in miserable tone quality, but the many prominent radio "big-shots" who witnessed the tests report that the tone quality was on a par with that obtained from our most modern high grade American sets-

**T**HIS thing called "Television" also seems to be receiving an undue amount of publicity in the press lately. It has had these little flares for several years now, but the "just around the corner" predictions do not seem to materialize.

In our opinion, the only system which holds real promise is that of Philo Farnsworth of San Francisco. His system employs no scanning disc or other moving mechanical parts. Scanning is accomplished by means of a cathode ray, which is deflected by a moving magnetic field. Farnsworth recently obtained a license from the Federal Radio Commission to erect an experimental transmitting station on the Coast. Heretofore there has been no reliable television west of Chicago, and hence no encouragement for Western experimenters.

The television licenses issued by the Commission provide for experimental work only, and absolutely no commercialism. This has retarded the advance of the art, since only the manufacturers of television equipment could hope to derive a profit from broadcasting. Those who operate broadcast stations as a business naturally have not been interested under the present licensing arrangements.

**I** THINK that the merchandisers of radio are making a sad mistake when they ceaselessly shout to high heaven of the number of tubes and gadgets with which their sets are equipped, the kind of cabinet it is housed in, the size of the speaker and what-not. Apparently they are under the delusion that they are selling a mass of complicated and highly technical apparatus or a handsome piece of furniture.

Possibly this sort of appeal is all well and good when the public is already sold on radio and it is simply a matter of deciding which one. But right now, the trouble is that the public has gone slightly sour on radio. And you can't make 'em want it because it has Pentodes or looks like a clock, when they simply don't want it at all. It is high time to re-

# LOOKING AHEAD

with K. G. ORMISTON

sell them on radio itself. After all, the customer doesn't really invest his money in so much bakelite, tin, glass, copper, iron and wood. What he buys is the radio enjoyment that only the broadcasters can give him.

We need to advertise the program, the special international broadcasts, the big features—the things that will make Mr. Public want to own a radio or a better one. Could a theatre prosper by endlessly calling attention to its comfortable seats, its wide aisles, its fresh cool air, the size of the stage, etc., with never a mention of the show on the stage? Let's devote a little thought and time to making 'em want to see our show, and then they'll buy the means which we have to offer. After all, it's the greatest show on earth!

**T**HE Federal Radio Commission is not going to mess around with poorly equipped broadcast stations much longer. Hereafter, they've got to modulate the old carrier at least 75 per cent and stick within 50 cycles plus or minus of the assigned frequency. And that takes modern equipment and operators who know what it is all about. There will soon be a lot of haywire composite transmitters for sale with no market for them, while RCA-Victor and Western Electric will sell some new crystal controlled, 100 per cent modulated jobs.

All of which will be a great boon to the radio industry as a whole. The industry is at the mercy of the broadcasters, and when they do a poor job everybody suffers. Every dealer, jobber, manufacturer, and set owner should be grateful to the Commission for the things which they have accomplished, and particularly to Commissioner Harold A. Lafount of the Fifth Zone

**A**LL branches of the radio industry have been organized in Southern California under the various divisions of the parent body, the Radio and Music Trades Association, except the servicemen and technicians. And now this group has finally organized under the guidance of the Educational Committee of the Association. It is called the "Servicemen's and Technicians' Auxiliary," and Mr. Thomas is acting as temporary chairman.





# GENERAL MOTORS RADIOS

*maintain*  
their outstanding value

There are few sales points in radio today so effective with prospective buyers as this . . . Anyone can purchase a General Motors Radio with the assurance that his investment is *protected*.

Not only is every technical feature completely modern, but the distinctive Period console cabinets can be regarded as permanent furniture. Any future chassis or speaker will be designed to permit installation in the console cabinets purchased previous to such development.

Outstanding value in nine models ranging from \$74.60 to \$270 including tubes. Write or wire for information about the profit advantages of a General Motors Radio franchise.

GENERAL MOTORS RADIO CORPORATION, DAYTON, OHIO

# PEOPLE WHO DO THINGS

*R. J. McNeely*, general sales manager of Gillfillan Brothers, Inc., Los Angeles, has just returned from an extended trip throughout the northern Pacific Coast territory. He visited all Gillfillan dealers, and worked with the salesmen in boosting sales.

McNeely visited the San Francisco branch, 1315 Howard Ave., in charge of Ray Cook; the Portland branch under the supervision of A. S. Cobb, and the Seattle branch, managed by E. J. Parsons. He covered all cities in between these points, discussing with dealers the general developments in the industry, the new tubes, and new Gillfillan plans.

*W. H. Hutter*, formerly chief engineer of the Webster Electric Company, Racine, Wis., has been appointed chief electrical engineer for the Capelhart Corporation, Fort Wayne, Ind., manufacturers of record-changers and automatic phonograph combinations. For the past 25 years, Hutter has specialized in audio and acoustics, gaining much of his experience while connected with the American Telephone and Telegraph Company.

*Fred J. Marco*, prominent Chicago consulting engineer, is now in the employ of *W. Bert Knight*, factory representative, 1646 West Adams Street, Los Angeles. Knight obtained Marco's services to assist in the technical application of his factory products to the requirements of the Western trade, and to advise on engineering problems.

*Russ Hines*, formerly with Bert Knight, factory representative, is now in business for himself, as manufacturer's representative for the following companies: Cornell Electric Company, Long Island City, N. Y.; Premier Electric Company, Chicago; and Reliance Die and Stamping Works, Chicago. His offices are located at 1709 West Eighth Street, Los Angeles.

*Arthur A. Trostler*, has joined F. A. D. Andrea, Inc., Long Island City, N. Y., manufacturers of Fada radios, as special sales representative. Trostler is well-known throughout the industry, having been sales manager for Brunswick Radio Corporation for the past two years. Prior to this position, he was vice-president in charge of sales for Freed-Eisemann Radio Corporation.

He has been identified with the talking machine industry for many years, and was president of the National Association of Talking Machine Jobbers. His present activities include the territory from coast to coast.

Sales activities of the *Sylvania Products Company*, Emporium, Pa., are now under the direction of *E. H. McCarthy*, recently appointed general sales manager. Prior to his connections with Sylvania, McCarthy was vice-president of Symphonic Sales Corporation, and held executive positions in the Grigsby-Grunow organization for several years.



**E. T. CUNNINGHAM**

*Elmer T. Cunningham* has been appointed president of the RCA Radiotron Company, Inc., Harrison, N. J., it has been announced by David Sarnoff, chairman of the board of RCA. At 42, he is one of the youngest men to hold such an important executive office in the industry.

The E. T. Cunningham, Inc., radio tube organization, of which he is the founder, is likewise a wholly-owned subsidiary of the Radio Corporation of America. Sixteen years ago Cunningham started in the tube business in San Francisco, and operated there until 1926, when the offices were moved to New York.

His new headquarters as president of the RCA Radiotron Company, are in Harrison, N. J.

*J. A. Walsh* has taken over the factory representation for *American Bosch* in the Pacific Northwest and Intermountain districts. Walsh has been identified with both radio and automotive trades in the Northwest for many years. His recent affiliation has been with General Motors as sales representative. He is now contacting Washington dealers, and will then make a tour of his new territory, comprising the states of Oregon, Washington, Idaho, Utah and Montana, with headquarters at Portland.

*T. Frank Carr* is now with the Howard D. Thomas Company, 2513 South La Salle Ave., Los Angeles. The Howard company is Pacific Coast selling agent for Perryman Electric Company, and also sole selling agent for Austin Radio Manufacturing Corporation, 1015 West Vernon Ave., Los Angeles.

*M. J. Melton*, formerly associated with the Foster Auto Supply Co., of Denver, is acting as manager of the Bechtold Music Company, retail radio and music dealer which is located in the heart of the business district, one of the oldest and best known music stores in Colorado.

*Charleston Dow* has taken over the reins as head of the reorganized Fitzgerald Music Company, Los Angeles. His former position was general manager of the company, where he started years ago as truck-driver. In taking the new office, Dow stated that the same methods formerly employed will continue to be the policy of the new management, with the addition of several new policies and enlarged advertising and merchandising plans.

*V. D. Landon* has been appointed to head the development work on Majestic receivers, according to an announcement by H. E. Kranz, vice-president in charge of engineering, of Grigsby-Grunow Company, Chicago.

*George K. Brown* has been made district radio manager for *American Bosch* in California, Nevada, and Arizona. Brown succeeds A. J. Carlson, who recently became radio sales manager for Waterhouse, Lester, Scovel Company, Bosch distributors in Northern California. Prior to joining American Bosch, Brown was assistant sales manager of the Coast branch of the Sonora Phonograph Company, and previous to that with Columbia Phonograph Company, Inc., for eleven years as assistant branch manager of the Seattle and Los Angeles branches.

*E. F. Morford* has been placed in charge of the Radio Sales Department of Stewart-Warner Corporation, Chicago, effective April 20th.

Mr. Morford has been associated with the Stewart-Warner Corporation for a period of twenty years, acting the last three as the Stewart-Warner Radio Distributor in Cleveland, Ohio, and brings to his new position an enviable record of achievement.

*Ted Holman*, who has been employed by the B. F. Schlesinger Company, Oakland, Calif., has resigned his position there to become manager of the radio department of the Wurlitzer Company, San Francisco.

*Arthur Nachbauer*, pioneer San Francisco radio dealer, has moved from 1051 Bush Street to 688 Geary Street. Nachbauer has opened a beautiful new store at his new location, where he handles RCA, Victor, Philco and Austin radios.

*E. J. Jordan* has been appointed western manager for Gulbrandsen, with headquarters at the Martin Music Company, Los Angeles.

*Dan Packard*, former president of the Colorado Radio Trades Association, and for the last year a General Motors Radio representative in the Rocky Mountain territory, now has charge of city sales for General Motors Radio Company in Chicago.

*Howard D. Thomas*, Pacific Coast manager for Peryman Electric Company of North Bergen, N. J., and sole selling agent for Austin radios, has been visiting in his San Francisco office.

*the new*  
**PENTODE**  
*Commercial Chassis*

16½ Inches

Long

•

Strong

•

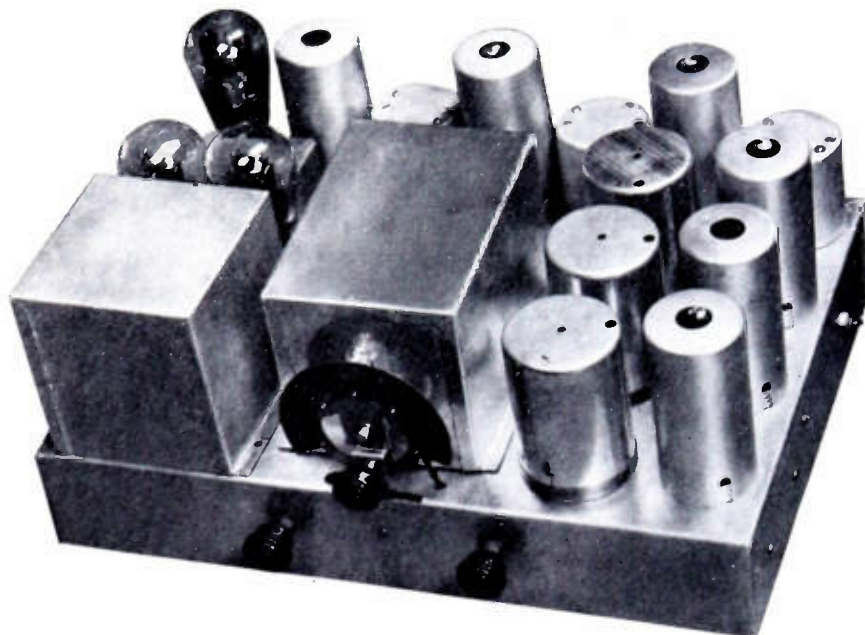

12½ Inches

Wide

•

Massive

•

*A Custom built Chassis incorporating QUALITY, PERFORMANCE and EYE APPEAL together with LOW PRICE!*

The Larger Radio Merchandisers are rapidly realizing the additional profit in merchandising their own brand of radio. The individualism of exclusively designed cabinets is building confidence in the general following of these companies. The California Radio Mfg. Co. has completed a chassis well worth investigation . . . at least! With all the latest developments scientifically matched into one unit, this new MULTI-MU — PENTODE — SUPER HETERODYNE chassis has brought back the higher grade merchandise (steadily increasing in demand).

It is not a midget . . . it is designed especially for the console . . . the larger and more thorough radio . . . built for those who can afford a higher type of radio and can appreciate what EYE APPEAL means to their sales . . . THE PRICE . . . interesting enough to start merchandising this new idea . . . custom-built chassis for your exclusively designed cabinet! The California Radio Manufacturing Company wants you, as a progressive Key Account, to hear the performance of its new radio sensation. . . . Just wire, phone or write . . . Action will gain exclusive territory rights!

**THE SUPER-HETERODYNE PENTODE CHASSIS**

*A double-strength console chassis having either 9 or 10 tubes, using two '24's, two '27's, two PENTODES, one '80 and two MULTI-MU tubes. The pentodes are used in push-pull amplification. Eleven tuned circuits with three intermediates, band-pass tuning throughout, fully shielded, 10 kilocycle selectivity, local-distance switch. The chassis is built with 18 gauge steel, insuring stability and strength. A choice of Magnavox or Utah speakers! Built for simple installation, fully balanced and sealed at the factory.*

R. C. A. LICENSED

**CALIFORNIA RADIO MFG. CO.**

1682 West 35th Place

Los Angeles, California

Telephone REpublic 4151



# The LOWDOWN ON Pentode and

By K. G. ORMISTON

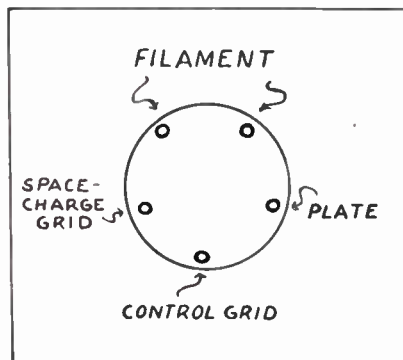

Pentode terminal layout, looking at bottom of base.

**R**ADIO has rightly been called a young man's business. It moves so fast that the conservative old-timers get lost in the shuffle. The young fellows with plenty of stamina and some degree of foresight manage to keep abreast of the tide, but just "unlax" for a bit and watch the parade go by! Radical changes take place almost overnight. The manufacturer gets into production on what appears to be the last word in modern engineering, and phooey! Tomorrow somebody upsets the apple-cart with an advertising campaign on a new wrinkle, perhaps marcelled plates on tuning condensers. The present agitation seems to be over multi-mu and pentode tubes.

Some time last year, two engineers, named Snow and Ballentine, presented a paper before the Institute of Radio Engineers in New York, describing a new type of screen grid tube intended to replace the 224 type. It has since been produced with various modifications by many of the tube companies and is in use in many sets. Unfortunately, the tube manufacturers have not standardized on the tube, either in name, type number or characteristics. It is called "Multi-mu," "Bi-mu," "Variable-mu" and "Super-control." Type numbers are either '35 or '51.

"Mu" is the Greek symbol which is used to denote amplification factor. Amplification factor is the ratio between *changes* in plate and grid voltages. It may be defined as the ratio between the plate voltage change necessary to produce a cer-

tain plate current change and the grid voltage change necessary to produce that same plate current change.

For example, if the mu of a tube is 3, adding say 30 volts to the plate voltage will increase the plate current a certain value, and adding 10 volts (negative) to the grid will bring the plate current back to its original value. 30/10 is 3. The amplification factor in the ordinary tube is a fairly fixed value, being determined largely by the mechanical construction of the tube and not by the conditions under which the tube operates. In the "Variable-mu" tube, however, this factor is not a fixed value, but automatically varies with the value of the input signal voltage.

#### Purpose of 51 Type

Its purpose is to overcome certain disadvantages of the conventional '24 type. The 224, possessing a very high amplification factor, overloads with a small grid swing. Hence, with a small input signal, and R.F. grids strongly negative with the corresponding drop in plate current, the received carrier is apt to become modulated with an undesired signal, producing cross-talk. Volume control is also a problem, since it is difficult to sufficiently reduce the input signal from a powerful local without upsetting the tube voltage values to the point distortion is apparent. A system of dual volume control is often necessary. An arrangement whereby an antenna shunt operate simultaneously with an RF grid bias regulator, or similar method.

In the new tube, the amplification factor varies with the input signal. High values of negative grid potential may be applied before the plate current is dragged down to zero and this Pi-Ge characteristic is practically straight. A powerful local signal may sock the grid 30 volts negative, whereas a weak distant station may operate at

one volt negative or even less. The characteristic curve is long and straight, and the incoming signal picks its own spot to work on. We're talking theoretically, of course.

It follows that if this is true, the matter of volume control is simplified, dual methods no longer being necessary. Cross-talk is reduced, and the ratio of signal to noise is improved because of the elimination of RF losses out in front in selector stages and antenna shunt volume controls.

The new tubes do these things to a degree only. They do not completely eliminate cross-talk, do not make the volume control as easy and simple as is desired, do not make it wholly possible to eliminate the pre-selectors and other means of preventing cross-modulation, do not totally eliminate the carrier hum due to AC modulation of the carrier in the RF stages.

However, they do these things to a great degree, and that makes it worthwhile. This new tube with the fantastic array of names, boils down to a refined and improved '24. It is less sensitive than the '24, but the other advantages outweigh this consideration.

RCA and Cunningham agree on their '35 type with the following characteristics which are announced as tentative. Fil. voltage 2.5 v. Fil. current 1.75 amps. Plate voltage 180. Screen grid 75 volts. Grid voltage —1.5 volts. Plate current 9 mils. Screen current 1/2 plate current. Plate resistance 200,000 ohms. Mutual conductance 1100 ohms.

The '51 type announced by Arc-turas and Triad differs from the '35 type in that the screen grid voltage is 90 volts, grid voltage —3, plate current 5.5 mils, screen current less than 2 mils. Plate resistance 300,000 ohms, and mutual conductance 1000 ohms.

The set must be especially de-

# THE NEW TUBES

## Variable-Mu

signed for multi-mu tubes. Simply inserting the new tubes in a set designed for '24 tubes will result in a loss in sensitivity and no advantage from the multi-mu tubes. The new tube differs from the '24 mechanically only in the construction of the control grid.

### The Pentode

Almost simultaneously with the advent of the multi-mu tubes, the power pentode is introduced. It is intended to replace the '45 power tube. The '45 is a tube of high power output but small gain. The pentode combines high power output with high amplification.

It is a screen grid tube wherein three grids are employed in addition to the filament and plate electrodes. One is the control grid; one is the space-charge grid, connected to the fifth prong on the base. The third is located between the plate and the space-charge grid and is connected to the center of the filament. Its purpose is to eliminate the detrimental effects of secondary emission.

Secondary emission, or the discharge of electrons from the plate due to the bombardment from the filament, has prevented the use of

an ordinary type of screen-grid tube as a power amplifier. Lowering of the plate voltage below that of the screen-grid due to a heavy signal resulted in distortion. In the pentode, the plate voltage may drop far below the screen voltage without distortion, due to the additional grid connected to the filament center. This "cathode grid" picks up most of the electrons of the secondary emission and prevents them from reaching the screen.

The pentode will deliver a strong undistorted output with a weak input signal, this being the ideal condition in an output amplifier. A single pentode will operate out of a power detector, resistance-coupled thereto, with sufficient volume for small-set performance.

However, such an arrangement will not equal the performance of a pair of '45's, push-pull, transformer coupled. Pentodes in push-pull, transformer coupled, comprise a very satisfactory arrangement.

In the usual three element power tubes, it is customary to work the tube into a load resistance equal to twice the plate resistance of the tube. This is not the case with the pentode.

The latter has a plate resistance

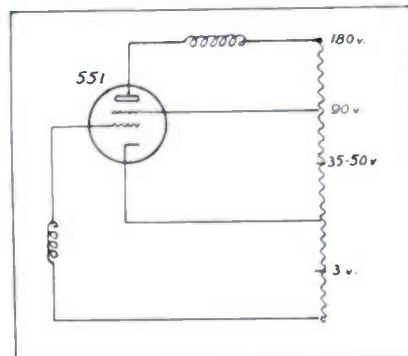

Method of applying control grid bias type on '51 tube.

of 38,000 ohms, but the optimum load resistance is in the neighborhood of 7000 ohms. And unless the tube works into such a load there will be present a considerable amount of harmonic distortion.

Loud-speaker manufacturers have therefore been forced to produce new models wherein the transformer mounted on the speaker has suitable characteristics for pentode feed. It is far from satisfactory to use an ordinary output transformer (designed for '45 tube operation) with pentodes.

The characteristics of the pentodes, usually designated as type '47, are as follows: Filament voltage 2.5 v., Fil. current 1.5 amps., Plate voltage 250., Screen voltage 250., Grid voltage -16.5 v., Plate current 32 mils., Screen current, 7.5 mils., and Plate resistance 38,000 ohms. Mutual conductance 25000 micromhos. Power output 2.5 watts.

Hum becomes a problem in designing a receiver for the use of a pair of pentodes in push-pull. In the case of a single pentode, resistance coupled to the detector, the phase difference of the ripple coming through from the detector is 180 degrees from the ripple in the pentode circuits, hence they will automatically balance out with a little care.

In the case of the push-pull arrangement, however, the hum must be eliminated by other means. Since the addition of another filter section is economically out of the question, a cancellation method must be used.

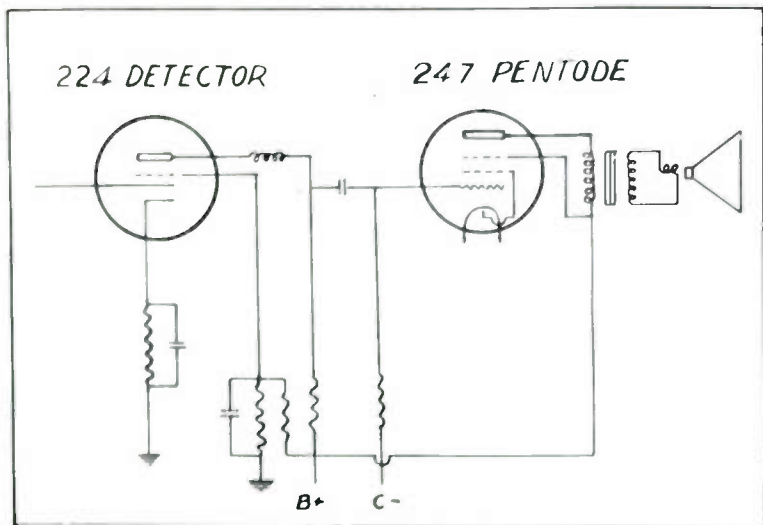

Using single pentode resistance-coupled to '24 detector.

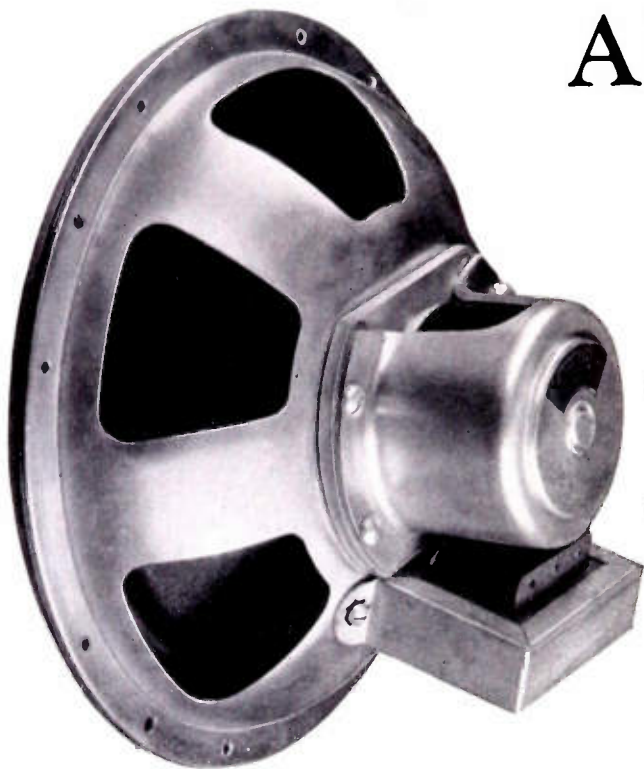

# Always Planning the FUTURE



## LANSING

**T**HIS NEW model embodies all the speaker improvements that have been devised and developed in radio laboratories during the past year. At the same time improved methods of production have been incorporated in its construction to such an extent that the price is actually lower than on preceding models. The first Electro-Dynamic equipped midgets contained Lansing speakers and Lansing has steadily maintained its pre-eminence in this highly specialized field. Today, as always, the manufacturers of quality midgets are equipping their receivers with Lansing speakers. Service, Cooperation, and ability to keep pace with an ever-changing industry, have all been prominent factors in Lansing popularity.

*Extreme outside diameter of speaker illustrated is eight inches; extreme depth  $4\frac{1}{4}$  inches.*

LANSING MANUFACTURING CO.

Los Angeles, California

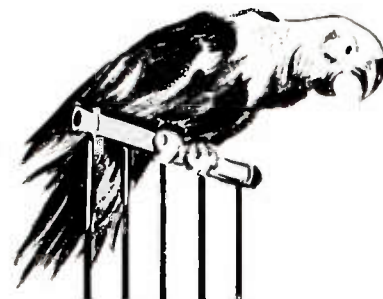



# In Answer To Your Question . . .

*Q.—H. L., Los Angeles, asks: "What is a good method for testing electrolytic condensers, both for leakage and capacity?"*

**A.**—Electrolytic condensers cannot be tested for capacity by the methods usually employed with condensers which operate on alternating current.

We cannot apply A. C. or even use the charge-discharge method, because of the fact that the electrolytic has definite polarity and because of the leakage which is always present.

The best method is to maintain a high DC voltage across the terminals of the condenser under test, and then superimpose an AC current through the condenser. The capacity may then be computed from the AC values. In this way, we can put AC current through the condenser without actually causing a reversal in polarity of the applied voltage.

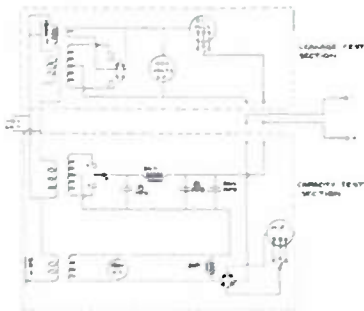

Figure 1.

In the diagram, Figure 1, which is reproduced from the Elkon service booklet, the lower portion indicates the layout for making this capacity test. The condenser to be tested for capacity is connected to the terminals at the right, with polarity as indicated.

It will be noted that a conventional power pack provides a source of DC, exceedingly well filtered. In shunt with one of the chokes of the pack is the secondary of the transformer in the lower left corner of the diagram. Raw AC is thus superimposed upon the DC. A rheostat in the primary circuit provides for always maintaining the AC voltage below that of the DC. The DC voltage may be 150 volts and the AC 70 volts, for example. A meter (DC type fed through a dry-disc rectifier) reads AC milli-

amperes, and an AC voltmeter is provided and connected as shown. From the readings of these two meters, the capacity may be computed from the following formula:

$$C = \frac{I \times 10^6}{E \times 2 \pi f}$$

where I is the AC current, E is the AC voltage, and f is the frequency of the AC supply. By means of this formula, the AC milliammeter may be calibrated to read directly in micro-farads.

The upper portion of the diagram indicates the arrangement of test equipment to measure the leakage in electrolytic condensers. Here 450 volts raw AC is applied to the condenser under test, and the leakage is indicated by the milliammeter. The value of leakage current varies with the different makes of condensers.

In the Elkon type for example, the manufacturer specifies a leakage of .1 milliamperes per micro-farad at 450 volts. However, this decreases with use, and after 100 hours of operation should be practically a negligible value. A high value of leakage current may be indicated after the condenser has been idle for some time. In this case the condenser should be aged for 10 minutes.

*Q.—R. T., Fresno. "How can I make a direct-reading ohmmeter for quickly measuring the resistance values of resistors used in radio receivers?"*

**A.**—The equipment required consists of a milliammeter with 0-1 range, a precision resistor of known value, and a battery. Connect as shown in the diagram, Figure 2. A 22½ volt battery and a 22,500 ohm resistor (R) will be satisfactory, or any other values of voltage and resistance which will result in a current flow of 1 milliamperes when the points XX are shorted together.

Using the values suggested, it is obvious from Ohm's Law that with no resistance in the circuit at XX, the milliammeter will indicate full scale deflection or 1 mil.

Now insert the resistance to be measured at XX. The reading of the meter will drop because of the reduced current in the circuit. The scale of the meter may be calibrated to read directly the value of the re-

sistance inserted in the circuit at XX. Simply add any value of resistance to 22,500 and divide the total into 22.5, and the result will be the corresponding reading of the milliammeter. Then mark the resistance value at this point on the scale.

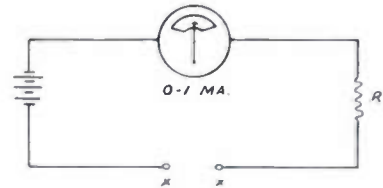

Figure 2.

For example, take 50,000 ohms. Adding this to the 22,500 already in the circuit we have 72,500 ohms. Dividing this into 22.5 (the voltage) we get .31 milliamperes. At this point on the scale, mark 50,000 ohms.

Continue this process until the scale is sufficiently calibrated to suit your purpose. It is obvious that a resistance of 22,500 ohms will register at .5 milliamperes, etc.

## UNIVERSAL MICROPHONES



—There Are None Better!

**"HANDI-MIKE"**  
The Most Efficient General Utility Microphone Known



List \$10 Complete

The truly perfected single button hand microphone. Two models, "Regular" and "Special Home Recording." Scientifically damped diaphragm, gold plated button, toggle switch, 15-foot cord. Finished bronze or gunmetal. Dealers, write for our "direct deal." Get our complete catalog.

Microphones \$5 to \$350. Also cables, plugs, transformers, mountings, stands, etc. Expert microphone repairs.

UNIVERSAL MICROPHONE CO.  
1163 Hyde Park Blvd.  
INGLEWOOD CALIFORNIA

# Why SET-TESTED

**Give you . . . . .  
Quicker sales  
More profits  
Greater satisfaction**

**T**HERE is one thing every set-owner wants to know about the tubes he buys: "Do they give perfect results in my particular set?"

There is one way to answer that question to his complete satisfaction: *Tell him that Sylvania Tubes have been tried out in a set exactly like the one he owns.*

That is what SET-TESTED means—to you and to your customers. That is why sales are quick, profits bigger, and complaints fewer. You know, and the people who buy

from you know, that Sylvania Tubes have been actually tested in every one of the fine radios listed at the right—that they have passed strict tests for tone, distance, volume and selectivity.

Write at once for the Sylvania Certified Test Chart. Dealers everywhere are using it side by side with their stock of Sylvania Tubes. Note for yourself how quickly tube sales increase—how much less time you need to spend with each one of your customers.

SYLVANIA PRODUCTS CO., EMPORIUM, PA.

SYLVANIA RADIO TUBES

SYLVANIA INCANDESCENT LAMPS



# Sylv

•  
Licensed under RCA Patents  
•



# TUBES

SILVER MARSHALL

SIMPLEX

AUDIOLA

GENERAL ELECTRIC

SONORA

APEX

GENERAL MOTORS

SPARTON

ATWATER KENT

GRAYBAR

STEINITE

BOSCH

GREBE

STERLING

BRUNSWICK

GULBRANSEN

STEWART WARNER

CLARION

HOWARD

STROMBERG CARLSON

COLONIAL

KENNEDY

VICTOR

STAR-RAIDER

LYRIC

WESTINGHOUSE

CROSLY

MAJESTIC

ZENITH

EDISON

PHILCO

FADA

RADIOLA

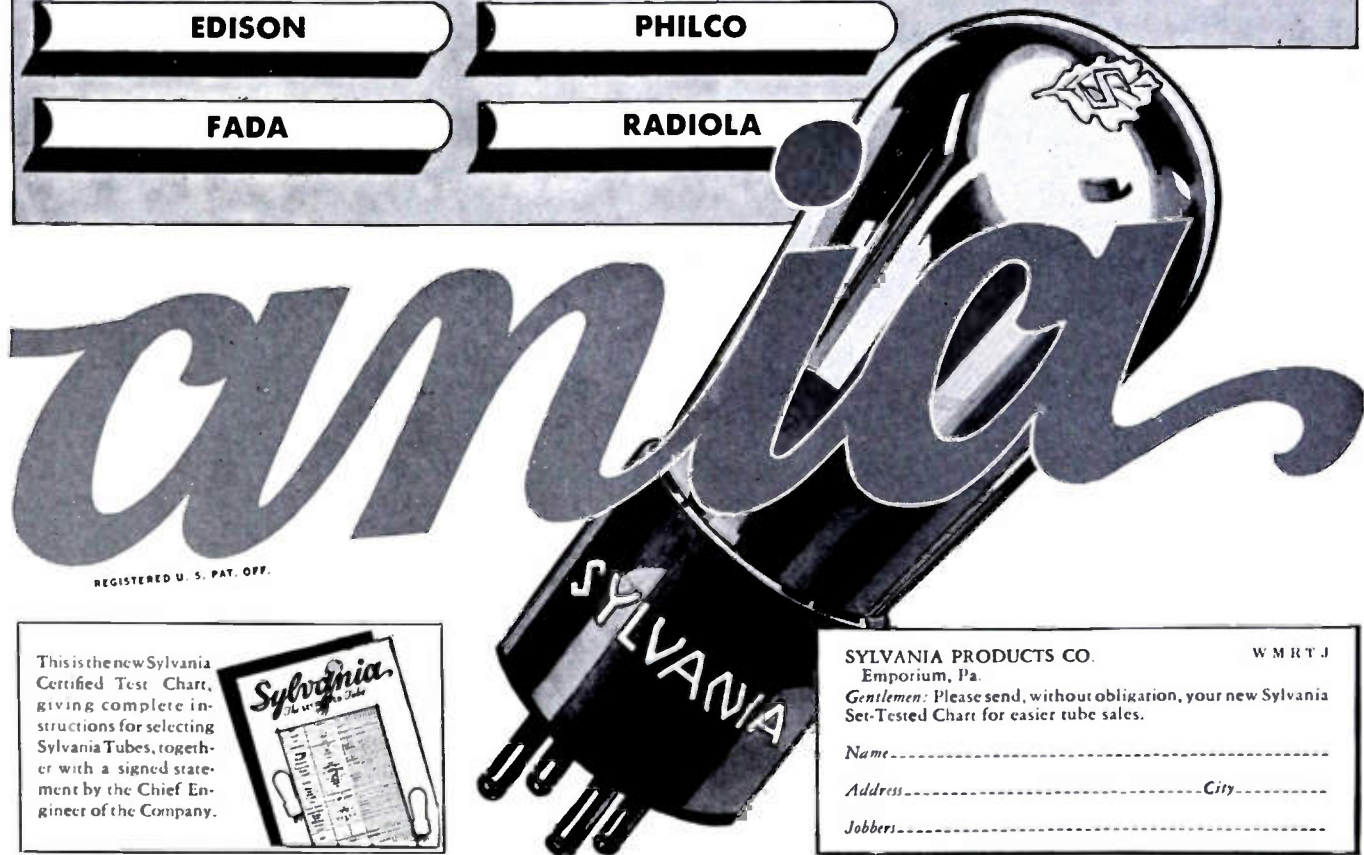

REGISTERED U. S. PAT. OFF.

This is the new Sylvania Certified Test Chart, giving complete instructions for selecting Sylvania Tubes, together with a signed statement by the Chief Engineer of the Company.



SYLVANIA PRODUCTS CO.  
Emporium, Pa.

WMRTJ

Gentlemen: Please send, without obligation, your new Sylvania Set-Tested Chart for easier tube sales.

Name.....

Address..... City.....

Jobbers.....

# DOINGS IN THE INDUSTRY

## Sherman, Clay Becomes Wholesaler

Plans for retirement of Sherman, Clay & Company from the retail business in Portland, Ore., and opening as a wholesale concern, have been announced by P. T. Clay, manager of operations for the firm in the Northwest.

"We will continue operation of the present retail store at West Park and Alder Streets until all arrangements have been made for dealerships in the city and throughout the state," Clay said. "The change has been contemplated for some time and we believe this is the logical time to put it into effect.

Portland will cover the Northwest section as the wholesale center Clay announced. Negotiations for wholesale headquarters space are being made.

## Wilson Returns From Hawaii

Clyde Wilson, Western representative of C. Bruno and Son, Inc., New York, has just returned from a business trip to Honolulu. He reports that all of his company's musical instruments are going over except the brass, and finds that the Hawaiians prefer stringed instruments entirely, especially the guitar. Wilson brought the following trade news items back with him:

The Hawaiian Sales, Ltd., managed by Ryan Dung, are the largest Columbia dealers in the islands. They handle a complete line of Columbia phonographs, records and radios.

Phil Kellerman, a former Boulder, Colo., dealer, is now general manager of the Thayer Piano Company in Honolulu, also handling Victor radios.

Philco is handled by the Market Music Company, Honolulu.

Billy Male is Columbia representative in Honolulu, and the success of his company in that territory is due largely to his efforts.

The Bruno Company is now in its ninety-eighth year, having been established in 1834. Much of its activities are foreign, with Australia leading in amount of business done.

## RCA Reports To Stockholders

In the annual report to the stockholders of RCA, the gross income of the corporation and its wholly-owned subsidiaries, was \$137,037,596 for the year 1930. The net income for the year was \$5,526,293, comparing with a net income of \$15,892,562 in 1929.

The report announced that, while television had been demonstrated on a laboratory basis, further development must precede its sale to the public and that RCA would not attempt to market such equipment this year.

Gross earnings of the Westinghouse Electric and Manufacturing Company for the year 1930 were \$180,283,579, as compared to \$216,364,588 in 1929. Gross income from all sources amounted to \$11,886,205, as against \$27,062,611 for the previous year. Net earnings per share were \$4.45.

## A.K. Distributors Meet

Eighty-four Atwater Kent distributors from all sections of the country assembled in Philadelphia recently, for a sales conference and convention. The outstanding high-light of the two-day conference was the announcement by A. Atwater Kent of the new Golden Voiced Compact with the Pentode tube, to sell, complete with tubes, for \$72.50.



Golden Voiced Compact

## Survey Shows Tube Market

Based on interviews with 31,000 listeners, a report issued by the Radio Committee of the Association of National Advertisers shows that the potential radio audience numbers 27,000,000, and a tube replacement market of 63,000,000 tubes exists.

Figures show an average of three listeners per set. The average length of the listening period was found to be three hours per day, or 1100 hours a year for every set. The number of sets in use was estimated at 9,000,000, and the final tube figure was reached by allowing a replacement of one set of tubes, an average of seven to a set, a year.

## Columbia Litigation Settled

In line with the extensive plans for future developments in the field of sound reproduction, Columbia Phonograph Company, Inc., 1819 Broadway, New York City, has announced the settlement of the litigation over the use of the name "Columbia."

Although complete details of the contemplated expansion have not as yet matured sufficiently to make possible further announcements at this time, W. C. Fuhri, general sales manager stated, it is understood that the successful termination of this legal dispute with another radio manufacturer is the first step in an extensive program.

Under the terms of the settlement, effective in the near future, Columbia Phonograph Company, Inc., retains exclusive use of the name "Columbia" for radio, phonographs, records, and pictorial and sound reproducing apparatus.

## Inca Moves Eastern Office

The Woolworth Building, 233 Broadway, New York City, is the new Eastern address of the Inca Manufacturing Division of the National Electric Products Corporation. The new office, which includes both sales and service organizations, is under the direct charge of Paul Stouffer. The main plant and general offices are located at Fort Wayne, Ind., where a complete line of magnet wire and coils for the radio and electrical industries is manufactured.

The former Eastern office was located in Newark, N. J. The warehouse for the Eastern stock, and a coil-winding department, continue to be operated, under the supervision of the Woolworth office.

## Rola Factory Moves East

Rola Company, manufacturers of Rola speakers, has announced the removal of its factory and executive offices to new and larger quarters at 2530-2570 Superior Avenue, Cleveland. The company was formerly located at Oakland, Calif.

## Noel Company Moves

The R. J. Noel Company, Triad tube distributor, has moved into new and larger quarters at 704 Larkin Street, San Francisco. George Noel is district manager.

## Pilot Reorganizes

A complete reorganization of the engineering department of the Pilot Radio & Tube Corporation, Lawrence, Mass., has been announced. Wayne W. Cowan replaces John Geloso as chief engineer. Kenneth Harkness is supervising receiver design. R. F. Shea, formerly with Bosch and Atwater Kent, is in charge of test and development. The facilities of the department have been greatly enlarged. One complete floor has been set aside for laboratories, and several thousand dollars of new equipment has been added.

## Subscribe G.-G. Bond Issue

Three million dollars of the five million dollars six per cent bond issue of the Grigsby-Grunow Company, recently approved by stockholders, has been subscribed for by creditors of the Majestic Household Utilities Corporation now consolidated with Grigsby-Grunow, and by distributors and stockholders of the parent corporation, according to Don M. Compton, vice-president.

## Vierheller Moves Shop

Vierheller's Radio Shop, 1237 Fulton Street, Fresno, Calif., will be moved to new and larger quarters at 1321 Fulton Street, Charles E. Vierheller, proprietor, stated. The move is being made to increase the facilities of his shop, which handles radios, equipment and electric refrigerators. Vierheller has been in business at Fresno for 16 years.



*This strong trend toward*  
**COMBINATIONS**

---

*is one more good reason for pushing*  
**COLUMBIA RECORDS**

More and more people are realizing there's no substitute for getting just the musical selection you want right when you want it. That's why combination radio-phonographs are now bigger-selling favorites than ever before. Indicating that a healthy boom in *record* sales is under way.

Columbia Records are the most profitable disc line

you can back. Recordings that catch the heart and purse of *every* possible customer. Classics, latest dance hits, popular ballads, race and foreign favorites—all performed by the finest *exclusive* recording artists obtainable, and on Columbia's perfect, silent-surface discs.

Here are some examples of recent Columbia successes—sellers every one! Stock them now and see!

### DANCE

Record No. 2408-D, 10-inch, 75c

At Last I'm Happy (Incidental Singing by Ted Lewis).  
 Truly I Love You—Fox-Trots—Ted Lewis and His Band.

Record No. 2297-D, 10-inch, 75c

Body and Soul (from "Three's A Crowd").  
 Something to Remember You By (from "Three's A Crowd") — Fox-Trots — Paul Whiteman and His Orchestra.

Record No. 2401-D, 10-inch, 75c

By the River Sainte Marie.  
 Running Between the Rain-Drops—Fox-Trots—Guy Lombardo and His Royal Canadians.

Record No. 2400-D, 10-inch, 75c

Love For Sale (from "The New Yorkers").  
 99 Out of a Hundred Wanna Be Loved—Fox-Trots—Ben Selvin and His Orchestra.

Record No. 2406-D, 10-inch, 75c

We Can Live On Love.  
 I Hate Myself (For Falling in Love with You)—Fox-Trots—Smith Ballew and His Orchestra.

Record No. 2403-D, 10-inch, 75c

I Surrender, Dear.  
 Sing Song Girl (Little Yella Cinderella)—Fox-Trots—Mickie Alpert and His Orchestra.

### VOCAL

Record No. 2398-D, 10-inch, 75c

Love Is Like That (What Can You Do?).  
 You're The One I Care For—Ruth Etting.

Record No. 2374-D, 10-inch, 75c

Shine On, Harvest Moon (with the Rondoliers).  
 If You're Happy, I'll Be Glad—Art Gillham (The Whispering Pianist).

Record No. 2388-D, 10-inch, 75c

Blue Again.  
 I'm One of God's Children (Who Hasn't Got Wings) (from "Ballyhoo")—Lee Morse and Her Blue Grass Boys.

Record No. 2419-D, 10-inch, 75c

Jesus Christ Is Risen Today—Cathedral Male Choir.  
 The Strife Is O'er.

## New Distributor Appointments

*Electric Corporation*, 281 Couch Street, Portland, Ore., has been appointed Lyric distributor for the Portland territory, according to an announcement by Eugene R. Farny, president of the All American Mohawk Corporation, manufacturers of Lyric radios. With the addition of this new firm, this makes a total of four of the Electric Corporation branches distributing Lyric radios on the Pacific Coast.

*Economy Auto Supply Company*, 809 Bannock Street, Boise, Idaho, now distribute Bosch radios, operating under the Pacific Coast branch of the United American Bosch Corporation, Springfield, Mass.

*Harper-Meggee, Inc.*, have been appointed exclusive distributors of R.C.A. Radiolas, Victor instruments and records in Washington, Idaho, Oregon, and Montana, according to C. M. Anderson, Spokane manager.

The present dealer set-up is maintained and the two lines are merchandised separately. Harper-Meggee include service and parts for both lines, Anderson said.

*Philco Radio Distributors, Inc.*, have taken over the distributing activities of the Portland branch of the Philadelphia Storage Battery Company, it has been announced by Harry Boyd Brown, of the Philadelphia home office.

"For a long time," said Brown, "we have felt that Philco radio business could be handled more satisfactorily as an independent organization than as a factory branch, so this change has been made. It is in line with changes we have made all over the United States."

The new company is headed by R. W. Neighbors, president, and H. D. Hansen, vice-president. In the wholesale division L. V. Hewitt and John J. Gerber continue to represent Philco. In addition to the new company, Philco maintains two factory branch managers in Portland, under the direction of Sam W. Phelps.

*Home Appliance Sales Company* at Sugarhouse, Salt Lake City, has been appointed by the Western Supply Company, distributors for the new Mayflower electric refrigerator and Crosley radio, to handle the first named exclusively in Salt Lake City.

Paul W. Bialkowsky, division representative for Crosley Radio Corporation with headquarters at Cincinnati, is in Salt Lake consulting with H. W. Eskuche, manager of Western Supply, relative to the new Super-Crosleys which are being shown.

*S. C. James* has been made distributor for the Salt Lake district for the De Forest Radio Company, and at present is conducting his business at 204 West First North, Salt Lake City, but is looking for a down-town location.

*Seattle Hardware Company*, Seattle, Wash., has been appointed territorial distributor for U. S. Apex radios, manufactured by the U. S. Radio and Television Company, Marion, Ind. J. H. Hopwood, Northwest Apex representative, has moved to Seattle, where he has made his headquarters.

*Brunswick Distributing Company* of Oregon has taken over distribution for Oregon and several southern Washington counties from the Stubbs Electric Company. New showrooms and office space have been leased at 509 Davis St., Portland, Ore. C. H. Wilks has been recently appointed district manager of the Brunswick Distributing Company in Oregon.

*Ernest Ingold, Inc.*, Northern California Atwater Kent distributor, is now distributing the Cinderella Clothes Washer and Dry Cleaner, a "midget" washing machine, weighing 19 pounds, vacuum action, retailing for \$37.50.

## New Western Dealers

*Wedel Company, Inc.*, with headquarters in Seattle and doing both domestic and foreign business, has established a new store in Portland, Ore., at 443 Washington Street. A. H. Willoughby, pioneer Portland radio man, is the new manager. Catering principally to dealers, the new store has a large stock of the various makes of kits, replacement parts, tubes and accessories. Specialties for the amateur radio station operator and tubes for television experimenters are also handled.

*F. H. Williamson* has opened the *Philco Sales and Service* at 813 West Lombard Street, Portsmouth, Ore.

*Corson's Music Shop* has been established at 829 Wall Street, Bend, Ore. C. J. Corson, of Hood River, is in charge of the store, and handles a complete line of musical instruments and radios. Corson has maintained a store in Hood River for the past seven years.

*Sherman, Clay and Company* have added another new store at 2006 Broadway, Oakland, Calif. The company now has three stores in San Francisco, three in Oakland, and others in Santa Rosa, Palo Alto, San Jose, Bakersfield, Modesto, Stockton, Sacramento, Vallejo and Burlingame. In Oregon stores are located at Portland, Salem, Eugene and Corvallis, and in Washington at Seattle, Everett, Tacoma, Chehalis, Aberdeen, Longview and Spokane. There is one store in Reno, Nev., and one in Lewiston, Idaho.

*The Coast Radio Stores*, with head offices at 455 Eleventh Street, Oakland, Calif., have increased their stores to five, according to L. D. Starke, owner.

*F. H. Williamson* has established a radio store at 813 West Lombard Street, Portland, Ore.

*Fred M. Kiser* is the owner of a new store in Phoenix at 303 North First St. Waltham midgets are handled, in addition to other lines. Kiser maintains a modern service department.

*Tung-Sol Lamp Works, Ltd.*, Pacific Coast Division, 1816 South Flower Street, Los Angeles, has taken over the distribution of Tung-Sol condensers for the Pacific Coast. The Tung-Sol Condensers, Inc., is a division of the Tung-Sol Lamp Works, Ltd., Newark, N. J. L. P. Schwamb is manager of the Pacific Coast division of Tung Sol Lamp Works.

*H. R. Curtiss Company*, 895 O'Farrell St., San Francisco, has included the Servel electric refrigerator to the general lines handled.

*Northern Automobile Company* of Bozeman, Mont., has been given the franchise for handling General Motor automobile sets.

*H. W. Kuettl*, Bremerton, Wash., has added the Servel electric refrigerator to his musical, sports and radio lines.

*Hopper-Kelly*, Seattle radio firm, has opened a branch store in Columbia, Wash., at 4922 Rainier Avenue. The store is managed by I. R. Bowron and Charles H. Willitt. Edison, Atwater Kent and Victor radios are handled, and a repair and parts department is maintained.

*Radio and Electric Shop* has been established in Yreka, Calif., by the Mount Shasta Electric Company. It is managed by M. F. Smith, formerly of Klamath Falls, Ore., who has had several years experience in selling and servicing radios.

*Burnett's Melody Shoppe* has been opened at 66 East San Fernando St., San Jose, Calif. E. W. Burnett is owner and manager. The store keeps a stock of music and accessories, and also gives musical instruction.

*T. K. Bellamy*, factory representative for the Kimball Piano Company, has opened a retail store at Fourth and Alder Streets, Walla Walla, Wash. The interior of the store, formerly occupied by a dry goods company, has been entirely redecorated. Kimball pianos are handled.

*Bob Milner*, well-known Idaho dealer, has established a modern radio store in Jerome, Ida., where he is distributing Majestics in Jerome, Lincoln and Gooding counties. Milner was formerly with the Sampson Music Company of Buhl, Mont.

*Russ Fisher*, for several years manager of the Don C. Preston music store, Bakersfield, Calif., now has a store of his own, where he handles Majestic radios and refrigerators. Don Clark, former head of the Preston service department is in charge of the service.

*Marius Music House*, Lakeview, Ore., recently established, handles radios and accessories, and maintains a service department. W. R. Olesen is in charge of the new store, which is owned by Charles B. House.



● an advertisement of  
Western Music & Radio Trades Journal

*when it's springtime  
in the rockies-its*

# • SHOW TIME •

*in the West!*

## WATCH

### Western Music and Radio Trades Journal

# JUNE NUMBER

A Glorified Showing of Radio Products Will Blaze Forth With New Ideas and Startling Announcements

*"Tell Your Competitor"*

#### *Interference Problems Are Now Solved!*

• • •

George R. Walters, Interference Engineer and Chief of the Engineer Department of the Radio and Music Trades Association of Southern California has enlarged upon, and greatly added to the series of articles recently published by him in Western Music and Radio Trades Journal, and has written a book on Interference problems and their solutions, which is unquestionably the most authoritative volume ever published.

Chapter heading: antennas, transposition aerials, shielded lead-ins, inside aerials, apartment house installations, the use of chokes and condensors, diagram, wiring sketches, specific instructions, and an ideal interference ordinance.

• • •

*This booklet properly  
used will put an end to 90%  
of your interference prob-  
lems.*

**\$1.00**  
The Copy

#### *And for Dealers Who Appreciate Fan News!*

RADIO DOINGS, "The New Movie Magazine of the Air" is the fastest selling radio magazine in the United States today. The entire first issue was completely sold out in eight days.

The new Doings dramatizes radio stars just as movie stars are featured in movie magazines. It is crammed with facts, data, human interest, and pictures of the radio stars behind the microphone. Your wife will want it, your children will want it, your customers will want it. If you want to sell them we can give you a wholesale rate.

Subscribe to Western Music and Radio Trades Journal and RADIO DOINGS on our special combination offer of \$3.00 a year for both magazines.

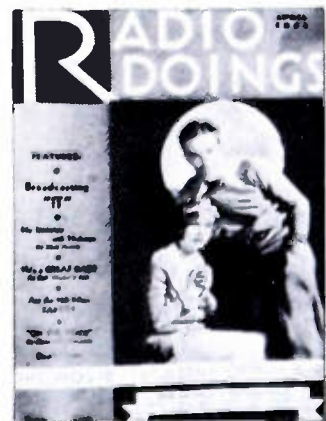

**\$3.00**  
Both



One of the greatest innovations since radio itself, this NEW IMPROVED WELLSTON GOLD TEST AERIAL eliminates both outside and inside aerials. It follows closely upon the success attained by the original WELLSTON GOLD TEST AERIAL which at present is giving satisfactory service to thousands of radio owners throughout the world. Absolutely non-directional and non-corrosive, the NEW IMPROVED WELLSTON GOLD TEST AERIAL brings in distant stations with crystal clear tone quality and greater volume—gives selectivity without distortion and helps to eliminate overlapping of stations, noise and electrical interference. It does away with all lightning hazards and because it does not connect into a light socket, all AC hum and line noise are eliminated.

### EASY TO INSTALL

It is a simple matter to install the WELLSTON GOLD TEST AERIAL—even a child can do it in a few minutes time. No extra tools are needed. Place it anywhere—inside or on the back of the radio cabinet. Once installed no further attention is required.

### IT WILL NEVER WEAR OUT

Made of emerald green genuine solid Condensite, with binding posts to match, this NEW AND IMPROVED WELLSTON GOLD TEST AERIAL is of the filtered type endorsed by radio engineers and will last a lifetime. Although small enough to fit the palm of your hand, it has a capacity equivalent to 54 ft. of best grade aerial wire strung 50 ft. high in the air.

Price \$2.50 (Retail)

**Bushnell & Raynor**

212 9th St., Oakland, Calif.

Western Representatives

**Wellston Radio Corp.**

Manufacturers

Dept. 119 St. Louis, Mo.

## Famous Broadcasters who Sell Your Radios

●  
**RAYMOND PAGE**

Musical Director, KHJ



**M**AKE out your check book and write a check for one thousand thanks and mail it to Raymond Page, musical director for KHJ, the Don Lee Station broadcasting on 900 meters!

He sells radios to the old folks, the young folks, the intellectual people and the common people . . . it makes no difference, he sells them all, for he is the king of versatility.

### Wham! He's off!

At the flash of a green light in the studio, a program begins. For fifteen minutes the KHJ staff orchestra and singers under the direction of Raymond Page present a program of popular tunes. There is a minute intermission, and the same orchestra and singers are heard in a radio version of "The Rogue Song." The dramatic cast will have been conscripted from the staff announcers, the singers and members of the Production Department. The next fifteen minutes, for contrast, is a program of Wagner, Tschaiakowsky and Gounod with the next fifteen minutes devoted to a miniature of the opera, Faust, or perhaps, a rendition of the Ravel Bolero. Another intermission, and again the orchestra is on the air. This time it is an arrangement of dance music.

### Change of temperature

Quite a sight, a revelation, to watch musicians, who have been concert masters and first-chair men with the world's great Symphony Orchestras, "getting hot," and not under the collar, as they give their highly educated fingers and souls to the demands of modern dance rhythms, of jazz. Another minute's pause, and the string section and vocalists are sending out to a million listeners a seductive array of ballads, new and old, of gems from the classics, perhaps, a theme song, operatic arias, folk dances

and, undoubtedly, a well-remembered melody from a Victor Herbert operetta.

In other words, if he doesn't "get" you one minute, he will the next. There are undoubtedly two main objects Mr. Page attempts to obtain. First, to get to as many listeners as possible during the period of his program for the benefit of his station and the sponsoring advertiser. Second, at the same time give to these listeners a program jammed full of rich, clean, wholesome entertainment with a background of musical renditions that nearly touches the works of the New York Philharmonic Symphonic Orchestra directed by the mighty Toscanini for symphony, and for jazz and popular dance rhythms he puts his foot on the front step of Paul Whiteman, Guy Lombardo and other dynamic orchestras.

### . . . and it's a pleasure

As Mr. Page will say:

"Many times we have made extensive surveys among thousands of radio fans asking their favorite class of music. The results showed that all classes were "neck and neck." So we attempt to please all of them, by giving them everything. Yes, sometimes, it may seem puzzling to get such a wide arrangement of music in so short a time, but with the artists I have been very fortunate to acquire, the work has turned out to be a pleasure."

It is indeed a lucky radio salesman or dealer who will demonstrate his radio in his prospects home and be fortunate enough to tune right in on one of Raymond Page's programs. If the radio is being demonstrated for the purpose of honest music he will dish it out to your prospect faster than they can take it. It is wise for the radio dealer to know his "air" to make it a point to make his demonstrations at the time of programs that come up to the high standard as those of Mr. Page.



# PRICED for TODAY'S Market

yet—

*No Refrigerator could be made better*

## SYNCHRONIZED **HOLBROOK** ELECTRIC REFRIGERATOR

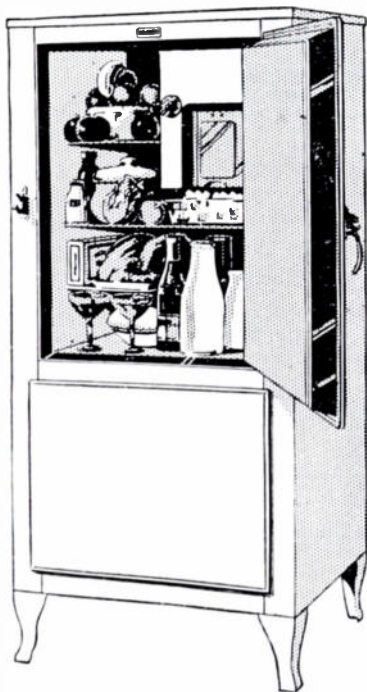

●  
*3" Insulation*

*7.7 sq. ft. Shelf Area*

●  
*54 Ice Cubes*

●  
*Starting at*

# \$159<sup>50</sup>

●  
*Without Legs*

### Easy Payment Floor Plan if Required



A Product of Holbrook, Merrill & Stetson  
82 Years on the Pacific Coast



---

IS BETTER—COSTS LESS and IS MADE IN LOS ANGELES

---

*For Full Information—Communicate with*

## PACIFIC WHOLESALE, LTD.

*Southern California Distributors*

*Walter M. Fagan*

President

# Interesting Westerners



**O**VER a period of six years William MacDonald, of Chula Vista, Calif., has logged 1225 broadcast stations, situated in 65 countries of the world! This bare statement is apt to arouse the skepticism of the average fan who has perhaps two or three hundred stations to his credit. But one has only to meet MacDonald and spend an evening examining his voluminous files of verifications to be convinced.

Mac attributes a large percentage of his remarkable results to the fact that Chula Vista is a highly favorable location for DX reception. There is no doubt that it is a most unusual spot, and yet the most casual observer is impressed with the fact that besides this

advantage and that of having the highest type of equipment for DX work, the real secret lies in the extreme patience and perseverance of the operator.

An invalid for years, MacDonald turned his attention to radio and found in it a hobby of gripping interest and physical and mental relaxation. His doctors attribute his returned health to this keen interest in radio. DX is his business, his chief interest in life. To add new stations to his already staggering log is the ambition that puts zest into living.

Mac's equipment is not unusual, in that many other DX fans possess identical sets. It is a Magnaformer 9 tube superbet, operated with batteries and loop.

He is possessed of an admirable modesty that discourages the publicizing of his accomplishments. He has devoted years of his time and considerable money in acquiring his huge log, for no other return than the satisfaction in accomplishment.

Among the long list of world-wide stations which he has heard and received positive confirmation from, are such prizes as 7UX, a 20 watt station at Launceston, Tasmania; and 3TF, Akuzeri, Iceland. The list of 1225 stations in 65 countries reads like a world atlas. And in every case there is a complete file of the correspondence, including the post office registration card for MacDonald's letter to the station dated but a few hours after the reception, the reply from the station, and in many cases newspaper clippings from the foreign countries reporting the unusual reception.

Some of his other notable receptions have been from the following stations: CKX, Brandon, Manitoba; KZRM, Manila, P. I.; Stamboul, Turkey; Budapest, Hungary; Oslo, Norway; Rome, Italy; Manchester, England; Kiel, Germany; Barcelona, Spain; Sao Paulo, Brazil; Montevideo, Uruguay; Santiago, Chile; Caracas, Venezuela; Vienna, Austria; Glasgow, Scotland; Helsingborg, Sweden; Amsterdam, Holland; Khar-toum, Egypt; Vera Cruz, Mexico; Kaunas, Lithuania, and Bombay, India.

## MIDGETS—by Mansfield

*(Continued from Page 11)*

family. But anyone who believes that such a thing was true with even a sizable percentage of the number sold probably also still believes in Santa Claus.

So it is easy to see that the midget, while it may have been a benefactor to the industry, has also been a potential volume and profit robber. If a dealer is to make a profit in the future, it will be through his ability to get a volume at a profit, by applying 100 per cent salesmanship to the higher-priced unit first.

Not that there isn't a place for the midget in the radio industry, for there is. It is the same one occupied by the portable phonograph. It should be used to sell the "two radio" idea, or as a second radio for use in a mountain or beach home. It should not be given the place in the living room of the home that can afford a higher type of set, except temporarily.

A shopper recently went the rounds of several stores, and remarked on the type of radio salesmanship encountered. In four out of five stores visited, the salesman immediately took the shopper over and began to give a high-powered talk on a \$59.50 radio, without even trying to find out if he could afford a more expensive one.

Think of it—intelligent, capable radio salesmen, concentrating their efforts on the sale of \$59.50 radio sets, when right under their noses they had good values at two or three times the price, the sale of which would give them more volume and more profits.

If the radio business were a repeat order business, like groceries, or clothing, then we might not be so greatly criticized for selling so many low-priced units. But when we consider that the average radio owner buys a radio only once in three or four years, then we can realize how stupid we are not to concentrate our attention on the high-priced unit first.

## There is a High-Price Field

Is there a present field in higher priced units? That is, units selling for around \$150? You bet your life there is, and that business will begin to increase only as fast as salesmen begin to try to sell them.

The average salesman is afraid to even try to sell a higher-priced radio. He just says to himself: "What's the use? The customer probably won't buy anything but a low-priced set anyway, so why waste my time trying to sell something better?" It is no wonder that so many dealers have taken the attitude that there isn't any more high-priced business.



## MIDGETS—by Christian

(Continued from Page 10)

The midget manufacturers have taught the big fellows a few things about manufacturing. No sooner does a new tube, speaker or circuit come out than we find the midgets snapping it up. Now they are equipped with dynamic speakers, pentodes and superhet circuits and all of the features that go to make a good radio.

Midget manufacturers are now bending all of their efforts towards Quality and Performance. The modern midget cannot be classed as "cheap merchandise." Rising list prices have made it possible for the manufacturer to accomplish things that were practically impossible under the old rock bottom prices.

They are making attractive cabinets, with finer finish and decoration. They have struck a size that will comfortably contain the larger chassis and additional tubes, without detracting from its compactness and portability. In short, the midget has become a fine little instrument, and a piece of merchandise that the customer can be proud of and completely satisfied with.

Furthermore, under the new prices, there is a good substantial profit in midgets for the dealer. With more than a third of the total sales those of midgets, this is a field that must be exploited thoroughly.

The midget has no quarrel to pick with the expensive set. It is in a class by itself, and can be merchandised as such. The sales field for the midget is so expansive that the two need not overlap. There is plenty of room for both, and plenty of money to be made in each.

With a year and a half of phenomenal progress behind it, the midget is only beginning. With fair prices, quality and performance, good margin of profit and a wide demand and sales field, the midget is on the way to big business.

# KIMBALL PIANO



Kimball  
Chippendale  
Grand

### FRANCHISE

EMBRACES — The most salable line in the industry. The only

financing plan under which the dealer secures his full margin of profit.

Co-operative Sales Helps  
offered by our two  
West Coast Representatives:

T. V. Anderson  
519 Cooper Bldg.  
Los Angeles,  
and  
250 Chronicle Bldg.  
San Francisco  
Rep. Southwest

F. W. Grosser  
521 Knott St., Portland  
Rep. for Oregon, Wash.,  
Idaho and Northwest

### W. W. KIMBALL COMPANY

Established 1857

306 S. Wabash Ave., Kimball Bldg.

Chicago

## Echophone Dealers Meet

About 60 Southern California Echophone dealers gathered at the Rosslyn Hotel, Los Angeles, on April 24 for a get-together meeting, sponsored by the Echophone Manufacturing Company, whose factory was recently moved from Hollywood to Waukegan, Ill. Rogers and Goetz, Echophone distributors, were hosts at the luncheon, and conducted the meeting.

The guest of honor and principal speaker was A. U. Magnan, originator of the Echophone radio, and present general manager of the company, who is in Los Angeles for a business visit.

In his talk Magnan spoke of the history of Echophone, and outlined its

progress and policies. Recent developments in the set design were discussed and an informal financial report of the company was made.

"Echophone is now nationally advertised and distributed," said Magnan. Our cash policies and day to day buying have appealed to the trade throughout the country, because it is evident that Echophone is safe from over-production and dumping." Magnan announced that in a short time Echophone would establish an assembly plant in Toronto, Canada.

The meeting was closed with a half-hour of open discussion among the dealers.

set and tubes should be examined and tested, periodically, and the same care given as to any delicate instrument that is subject to normal wear and deterioration.

### Take New Quarters

William J. Shafering, owner of the La Jolla Radio Shop, La Jolla, Calif., has moved to larger space on Girard Avenue from the old location on Fay Avenue. Elmer and Roscoe Lampugh are associated with Shafering in the sales and service departments. The shop handles radios, Serevel electric refrigerators, and electrical equipment.

### Tubes Durable, Though Delicate

Seldom, if ever, are tubes damaged as a result of leaving the set turned on over a long period of time, report tube engineers of a prominent tube company. In view of the complexity and delicacy of this unit as compared to other devices which make up a radio set's construction, this is an interesting fact.

This group of experts have also found that of all electrical appliances and instruments in the home, the radio tubes get the greatest amount of use on the average. For these reasons, they point out, it is a great mistake to merely plug in the radio, and forget all about it. The

### Common Window Faults

An analysis made by five leading window trimmers disclosed the following common faults in window displays:

1. Glare—caused by improper placing of lights, or reflecting background.
2. Goods displayed in window are "buried" in the store. Salespeople not informed of changes in window displays.
3. Displays are confusing and crowded, and lack coordination.
4. Slovenly window-trimming. Dirty windows, faded or torn trimming, and crooked displays.
5. Dingy displays. Poor lighting, unattractive merchandise, or poor choice in color harmony.
6. Displays not in harmony with store's interior arrangements. The interior of the store should be as attractive as the window, and dressed up to match.
7. Freaky, or too elaborate displays.
8. Over emphatic windows. Too prominent price cards, boastful screaming of values, make customer wonder "What's wrong with that stuff?"

Lew A. McEachran, well-known in the Northwest and Nevada, has been appointed district manager for the Howard D. Thomas Company in Northern California and Nevada. The Thomas company is sole agent for the national distribution of the Austin superheterodyne.

Wholesale Radio Supply, 269 Seventh St., San Francisco, has added a line of electrical appliances and accessories to the regular stock, according to Aaron Rapaport, owner.



*DeVry No. 57  
Retail Value \$57.50*

## VACATION TIME

IS  
MOVIE MAKING TIME  
AND  
MONEY MAKING TIME  
FOR  
DEALERS WITH THE  
DeVRY LINE

### DeVRY MOTION PICTURE EQUIPMENT

Everybody goes on a vacation.

Everybody wants to see themselves in the movies.

Everybody will take a DeVry movie camera at \$57.50.

Everybody knows that the live Radio dealers will cash in during the dull radio months if they handle the popular priced DeVry line of motion picture equipment.

*Call, Wire, or Write*

## PHIL LASHER, Ltd.

*Exclusive Distributors QRS DeVry Products*

300—7th Street

San Francisco, California

Hemlock 0954

*Southern California Representative*

PHIL MEISENZAHN

123 S. Kilkea Drive

Los Angeles, California

Phone WYoming 3780



There is **NO BUSINESS DEPRESSION** for Dealers handling the



# Paramount

## 10 TUBE

### Super-Heterodyne

With the **Marvelous**  
**PENTODE TUBES IN PUSH-PULL**

**\$69<sup>50</sup>**  
List

Complete with *Arcturus* tubes

This radio is the final achievement developed from our radio laboratories. It was designed and engineered with but one purpose in mind; to create a radio that would outperform other radios for some time to come. The results were truly amazing. A radio that would play stations some 1500 miles distant, in the evenings by merely placing your finger on the antenna post. Over 100 stations tuned in within a single evening. Such results and selectivity are truly amazing and that such a radio could be manufactured to sell at \$69.50 would have been impossible last year. As you will note, we are using the marvelous new Pentode power tubes in Push-Pull—which help to attain the marvelous results and tone in this radio.

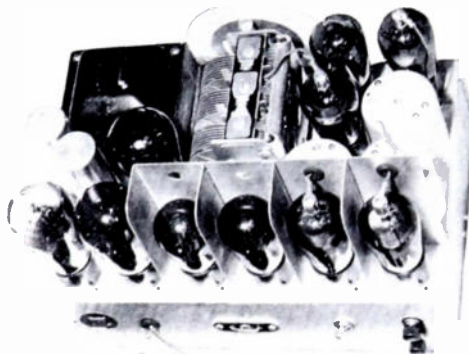

— FEATURES —

- 10 Tuned Circuits.
- Band-Pass Filter.
- Pre-Selector.
- 4-Gang Condenser.
- Pentode Matched Dynamic Speaker.
- Tone Control—Full Range.
- Electrolytic Self-Healing Condensers.
- All Steel Chassis.
- Laced Cable Wiring.
- Screen-Grid.
- Local-Distance Switch.
- Shielded, etc.

**TO LARGE QUANTITY BUYERS**

Our proposition is attractive. If desired chassis will be built to your own specifications and may be marketed under your own trade name.

**PARAMOUNT**  
**( PEE-WEE )**

SMALLEST RADIO MADE  
SELLS ON SIGHT

**\$17<sup>95</sup> NET**  
TO DEALERS

Using the new PENTODE TUBE. Only a 4 tube set, but its performance will surprise you. All big features — Screen-Grid — Dynamic Speaker — Tone Control — Illuminated Dial, etc.

We also manufacture a 6 tube Super Heterodyne Midget at \$49.50 List, using Pentode Tube, regular discount.



Size  
11½ in. High—8½ in. Wide

PROFITS, MR. DEALER—Our discounts are large, allowing you a liberal margin of profit on which to advertise. Write us at once for quotations. Beautiful console models at small additional cost.

Members of  
Los Angeles  
Chamber of Commerce

**Los Angeles Radio Mfg. Co.**  
1810 West Seventh Street      Los Angeles, Calif.

Manufacturers of Quality  
Radios Since  
1925.

**Gillfillan Superhet**

Model 110 is an attractive lowboy, manufactured by Gillfillan Brothers, Inc., 1815 Venice Blvd., Los Angeles. An eight tube superheterodyne chassis is used, employing four 224, one 227, two 245 in push-pull, and one 280. It is a large, full size chassis, and includes tone-control, local distance switch and volume control. A new type intermediate coil is included, which is bank wound with Litz wire. The AC lead from set to plug is fully shielded with metal, eliminating radiation. The cabinet is made of solid 13/16 panel, with sand blast decorations and antique finish. Height, 38 inches, width 25 inches, and depth 14 inches. Gillfillan Brothers supply chassis, speaker and tubes as special items, without cabinet for \$106.50. List price of Model 110, \$127.50, complete.



Jewell Pattern 213

**Jewell Tube Sellers**

Two new models of full-vision tube merchandisers are manufactured by the Jewell Electrical Instrument Company, 1642-U Walnut Street, Chicago. Pattern 213 has a big indicating meter, complete for accurate tube testing. Includes pre-heater and short-checker, rotary filament voltage switch and means for testing pentodes. Pattern 219 includes the advantages of 213, in addition to a counter-type tester.

**Clarostat Volume Control**

A graphite element unit, recently announced by the Clarostat Manufacturing Company, Inc., 285 North Sixth Street, Brooklyn, N. Y. Designed to eliminate volume control troubles, caused by erosion of the metal contact on ordinary types. This new unit employs a new positive rolling contact. Clarostat Graphite Element Volume Controls are available either as rheostats or as potentiometers, either tapered or without taper, with or without 110-volt switch, with insulated or grounded shafts and in all resistance values from 1000 ohms up to and including one megohm.

**Arvin Electric Heater**

Small, compact and attractive, the Arvin Fan-Forced electric heater both heats and circulates the air in the room. The unit consists of a heating element, a fan and an induction motor. Air is forced by the motor over the hot wires, and the fan circulates it over the room. The cabinet is 15 inches high, 10 inches deep and 11 inches wide at the base. It weighs 10½ pounds net, and 12 pounds packed. Operates on 110 to 125 volts, 25 to 60 cycles AC, and is also available in DC. Designed in Morocco finish in dawn grey, mahogany brown, Nile green and old rose. List price, complete with 7½-foot rayon gold cord, \$12.75. (\$15.00 for DC type). Manufactured by Noblitt-Sparks Industries, Inc., Indianapolis.

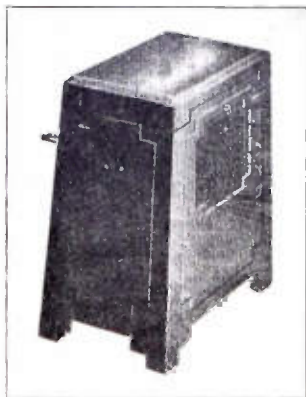

Arvin Heater

**Wurlitzer Refrigerator**

Added to the products of Wurlitzer is the new "Mohawk" electric refrigerator, manufactured by the All-American Mohawk Corporation, Tonawanda, N. Y. Model 5 is a popular-priced model with five cubic feet. Other models are 10, 15, and two de luxe models, 20 and 25. It has two units, one for freezing and one for cooling. The Chill-Rator has eight speeds for freezing, start and stop switch, automatic temperature control, porcelain on steel finish inside, and lacquer on steel outside. De luxe models have other features in addition.

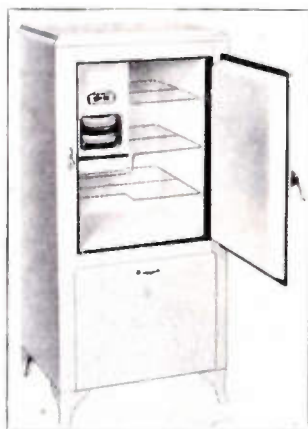

Mohawk Electric

**New Philco Batteries**

Philco has added three dry-cell batteries to the list of its products. The batteries are a 4½-volt C battery, a 45-volt standard B battery, and a 45-volt extra heavy-duty B battery. The introduction of the Philco Transitone automobile set was responsible for the production of these batteries, officials of the Philadelphia Storage Battery Company have announced.

**Radiola Model**

This RCA Radiola employs a seven-tube, four-circuit, screen-grid r.f. chassis. It employs four Radiotrons—one 224, two 245, and one 280. The walnut veneer cabinet is 38 inches high, 20½ inches wide, and 13 inches deep. Equipped with the new compound-volume control. Has illuminated dial, RCA dynamic speaker, and tone control. Price, complete with Radiotrons, \$91.50.

**RCA Victor Superette**

For the first time, RCA and Victor have combined the two trademarks on a new set, the "RCA Victor Superette." It is an eight-tube superheterodyne, housed in a miniature cabinet, employing two super-control tubes in the first r.f. stage and in the intermediate frequency amplifier. It also uses one 224, one 227 oscillator, one 227 power, two 245, and one 280. An eight inch electro-dynamic speaker is used. Manufactured by the RCA Victor Company, Camden, N. J.

**G-M Antenna Coupler**

Interference is eliminated and a multiple radio receiver installation on one antenna accomplished through a new antenna coupler by General Motors Radio, Dayton, Ohio. This coupler also makes it possible to use long lead-ins without loss of signal strength, sensitivity or selectivity. Tests have shown that 20 sets can be operated on one antenna with this coupler, making it adaptable for apartment house installation. When used with a single set the coupler is installed in the speaker compartment. If two or more sets are used an additional or master coupler is connected into the lead-in wires, using one master coupler to every ten sets.

# New Mel From the



Sparton Model 32

**Sparton Battery Set**

A Sparton battery-operated set, Model 32, has been developed for use in rural communities and other localities. Sparton has housed the set in an attractive console cabinet similar to AC models. Reduction of current consumption to very low levels is one of the features of the new set. Six dry cells are sufficient for two months of ordinary usage, or if a storage battery is used, only one cell need be connected. List price, \$95.00, less tubes. Manufactured by Sparks-Withington Company, Jackson, Mich.

**Magnavox "Symphonic"**

A new type of speaker, called the "140 Symphonic," has been developed by the Magnavox Company, Ltd., Chicago. The speaker is designed to eliminate slurring, distortion and overaccenting of band instruments' tones, human voice, or orchestra. It is compact, easily mounted and accessible.

**Golden Voiced Compact**

This new model is a midget receiver manufactured by the Atwater Kent Manufacturing Company, Philadelphia. It employs the new Pentode tube, three 224, one 227, and a 280. The Pentode is a five-element power amplifier, which, when used as audio output, can handle as much power as two 245 and one 227. The superheterodyne chassis is housed in a cabinet of Gothic cathedral design, 9 inches high, 15½ inches wide, and 9½ inches deep. List price \$72.50, complete.

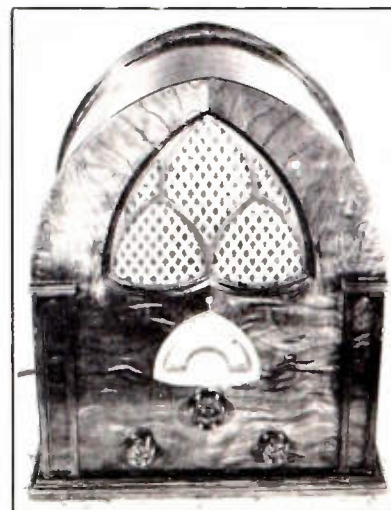

Atwater Kent Compact



# Handise Factory

### Gulbransen Receivers

Three new models have been added to the line of the Gulbransen Company, 3232 West Chicago Ave., Chicago. The chassis is t.r.f., with four 224 screen grids, one 245, and one 280 tubes. Licensed under RCA, Haveline and Meissner patents. Model 163 is a low cabinet, flat top for use as smoking stand or end table. Controls are mounted on top. Height 23 1/2 inches, width 14 inches, and depth 20 inches. List price, \$64, less tubes. Model 63 is a console 40 inches high, 24 1/2 inches wide and 14 1/2 inches deep. List price \$70, less tubes. Model 263 is a midget 18 inches high, 16 1/2 inches wide and 10 1/4 inches deep. List price \$51.50, less tubes.

### Lyric Models With Pentode

The latest Lyric models, P4 and P9, employ the new Pentode tube in their chassis. The Pentode gives increased audio amplification, with the result that on full output volume the detector operates at lower output voltage and does not overload. In the Lyric chassis, six tubes are employed; four are screen grid, one is a Pentode, and one a 280 type. The P4 mantle model lists at \$69.50, complete with tubes, the P8 consolette at \$89.50 complete, and the P9 console at \$99.50, complete. Manufactured by the All American Mohawk Corporation, Tonawanda, N. Y.



Jackson Bell

### Jackson Bell Super

The new Model 69, a midget superheterodyne, fourth and latest model manufactured by Jackson Bell Company, Los Angeles, contains eight tubes. Three 224, two 227, two 245, and one 280. Uses electrolytic filter condensers and Magnavox dynamic speaker. An illuminated vernier dial is calibrated in kilocycles. Jackson Bell have developed an exclusive tone control which is employed. Has 10 kilocycle sensitivity. The cabinet is of matched walnut, with recessed panel of burl walnut. List price, \$69.50 complete.

### New CeCo 247

A space charge grid and a suppressor have been added to this tube, between the space charge grid and the plate. The suppressor grid is connected directly to the center of the filament. This new pentode employs an oxide-coated filament designed for AC operation.

### Arcturus Pentode

Type PX, a new Pentode developed by the Arcturus Radio Tube Company, Newark, N. J., delivers an output of 2.5 watts, with 11.7 volts input, allowing maximum output from detector. It has an amplification factor of 95, and is designed to be four times as sensitive as the 245 type.

### Capehart Models

The new model 10-12C record changing mechanism handles 10 records, either 10 or 12 inch, plays encores, and repeats the last record until re-stacked or switch is thrown. The chassis is equipped with reject device and record unloading lever, volume control and master switch. List price, chassis only, \$90.00.

### Jackson Bell Supers

Equipped with both Pentode and Variable mu tubes, the new Jackson Bell is offered in three superhet models. The chassis includes two Pentode, two 51 variable-mu, one 24, two 27, and one 80, Magnavox speaker, vernier illuminated kilocycle dial and tone control. Employs a local-distance switch, electrolytic filter condenser and push-pull power output. List price for high-boy model, \$89.50, complete, and for low-boy \$82.50 complete. Midget model list price, \$69.50. Jackson Bell Company, Los Angeles.

### New Noellen Models

The Noellen Clock Model is a custom built, six tube screen grid set. The chassis includes tone control, phonograph attachment, Magnavox speaker, volume control and switch combined. List price, \$59.50, complete. The Noellen automobile or motor boat model has five tubes. Unit box is 10 inches long, six inches wide and six inches high, with compact control unit for dash. List price, \$75.00, including tubes and batteries. Noellen Radio Corporation, Ltd., 3926 South Vermont Ave., Los Angeles.



Radiette Model 90

### Radiette Super

A nine-tube midget superheterodyne is being manufactured by Keller-Fuller Manufacturing Company, Ltd., 1573 West Jefferson Boulevard, Los Angeles. The new set, Model 90, has Litz wire coils, four-gang ball-bearing condenser, antenna pre-selector, local distance switch and gear-driven vernier dial. The chassis also includes kilocycle markings, dial light, tone control, phonograph connection, and is completely shielded. A Tandem Detector improves tone quality and allows greater volume without overloading. The cabinet is 19 inches high, 14 inches wide, and 19 inches deep. Shipping weight, 35 pounds. List price \$79.50. Also available in a console at \$89.50.

### Cardinal Super Combination

Model 71, a combination radio-phonograph manufactured by the Cardinal Radio Manufacturing Company, 2812 South Main Street, Los Angeles, is a midget combination using a nine-tube superheterodyne chassis. Equipped with two variable-mu tubes, one 224, two 227, two 245 and one 280, the new set is very compact. It is 19 1/2 inches high, 17 inches wide, and 11 inches deep. The cabinet is walnut, with full-vision dial, tone control, and long distance switch mounted on panel. List price, \$105.50 complete.

### Four Clarion Models

Transformer Corporation of America, Chicago, Ill., have developed four new models. Model 80 is a seven-tube midget listing at \$67.50 complete; Model 81 in a seven-tube console at \$84.50; Model 90 is an eight-tube midget at \$79.50; and Model 91, an eight-tube console at \$99.50. In the chassis are employed a Pentode tube, full-vision dial, static reducer automatic volume control, and variable-mu tubes.

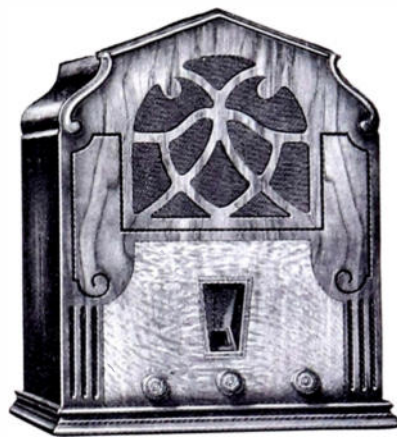

Sentinel 108

### Sentinel Superhet Midget

Double-action volume control, with tuned antenna and coupled type pre-selector, are calculated to reduce cross-talk tendencies to a minimum in the new Sentinel 108 superhet midget. The chassis is of extra heavy gauge steel, cadmium plated, and employs seven tubes. Four 224, screen grid, one 227 heater, one 245 power, and one 280 rectifier. Height of walnut cabinet, 18 1/2 inches, depth 11 1/4 inches, and width 14 inches. Shipping weight, 38 pounds. List price, \$57.50. Manufactured by Radio Division, United Air Cleaner Corp., 9705 Cottage Grove Ave., Chicago.

### American Mike Models

Four new models are being produced by the American Microphone Company, 251 West Fifty-eighth Street, Los Angeles. Model SD is a two button microphone, with frequency range from 30 to 6500 cycles. It is made in three sensitivities: A—very sensitive; B—medium sensitive; and C—dampened. List price, \$50.

American Baby Mike is a single button type, with on-off switch, and 25 feet of cord. Uses a positive back upon which the diaphragm works. List price \$7.50. Model SI is a single button mike, built for use where only the voice is needed. Hand made throughout, and will handle frequencies from 70 to 3000 cycles. The button is 100 ohm resistance. List price \$12.50.

American FG Handy Case is a convenient carrying case for use on remote control, public address trucks, where service is rough. List prices, \$8.00 for small ring size, and \$12.00 for large ring.



Luxeau Water Purifier

### "Lux-eau"

A simple little machine which softens and filters water from the faucet is being manufactured by the Dow-Harriman Pump and Machinery Company, 325 Fifth Street, San Francisco. The machine is small, bottle shaped and fits over the end of the faucet. It is capable of filtering, softening and purifying water at the rate of a gallon a minute. List price \$10.00 with 35 per cent discount prepaid to dealers.

# Music and Radio

## Headquarters at

# SAN FRANCISCO'S

(New Half Million Dollar Hostelry)



# HOTEL ROOSEVELT

## JONES at EDDY

Every Room with Bath and Shower

Single	\$2.00 & \$2.50
Double	\$3.00 & \$3.50

SUITES AND SPECIAL ACCOMMODATIONS FOR FAMILIES

Convenient to Theatres and Shops  
Radio Connections in Rooms  
Spacious Lobby and Mezzanine

Garage Under Same Roof

Indorsed by the

# NATIONAL AUTOMOBILE ASSOCIATION

Write for Illustrated Folder

Management of RENE A. VAYSSIE

### STATEMENT OF THE OWNERSHIP, MANAGEMENT, CIRCULATION, ETC., REQUIRED BY THE ACT OF CONGRESS OF AUGUST 24, 1912

Of Western Music & Radio Trades Journal, published monthly at Los Angeles, Calif., for April 1, 1931.  
State of California,  
County of Los Angeles

ss. Before me, a notary public in and for the State and county aforesaid, personally appeared Wallace M. Byam, who, having been duly sworn according to law, deposes and says that he is the (state whether editor, publisher, business manager, or owner) business manager of the (insert title of publication) Western Music and Radio Trades Journal and that the following is, to the best of his knowledge and belief, a true statement of the ownership, management (and if a daily paper, the circulation), etc., of the aforesaid publication for the date shown in the above caption, required by the Act of August 24, 1912, embodied in section 411, Postal Laws and Regulations, printed on the reverse of this form, to wit:

- That the names and addresses of the publisher, editor, managing editor, and business managers are:  
Publisher: Marion E. Byam, Los Angeles, Calif.  
Editor: Wallace M. Byam, Los Angeles, Calif.  
Managing Editor: Donald McDowell, Los Angeles, Calif.  
Business Managers: Wallace M. Byam, Los Angeles, Calif.
- That the owner is: (If owned by a corporation, its name and address must be stated and also immediately thereunder the names and addresses of stockholders owning or holding one per cent or more of total amount of stock. If not owned by a corporation, the names and addresses of the individual owners must be given. If owned by a firm, company, or other unincorporated concern, its name and address, as well as those of each individual member, must be given.) Marion E. Byam, Los Angeles, Calif.
- That the known bondholders, mortgagees, and other security holders owning or holding 1 per cent or more of total amount of bonds, mortgages, or other securities are: (If there are none, so state). None.
- That the two paragraphs next above, giving the names of the owners, stockholders, and security holders, if any, contain not only the list of stockholders and security holders as they appear upon the books of the company but also, in cases where the stockholder or security holder appears upon the books of the company as trustee or in any other fiduciary relation, the name of the person or corporation for whom such trustee is acting, is given; also that the said two paragraphs contain statements embracing affiant's full knowledge and belief as to the circumstances and conditions under which stockholders and security holders who do not appear upon the books of the company as trustees, hold stock and securities in a capacity other than that of a bona fide owner; and this affiant has no reason to believe that any other person, association, or corporation has any interest direct or indirect in the said stock, bonds, or other securities than as so stated by him.
- That the average number of copies of each issue of this publication sold or distributed, through the mails or otherwise, to paid subscribers during the six months preceding the date shown above is \_\_\_\_\_ (This information is required from daily publications only.)  
(Signed) WALLACE M. BYAM, Business Manager.  
Sworn to and subscribed before me this 11th day of April, 1931.  
(Seal) (Signed) ROYAL S. CAHN,  
(My commission expires April 12, 1933)

# HOTEL HARRISON

## CHICAGO'S NEWEST DOWNTOWN HOTEL

RUNNING ICE WATER IN EVERY ROOM  
**\$2.50 AND \$3.00**  
WITH BATH  
NO HIGHER

**RADIO IN EVERY ROOM**

NO PARKING WORRIES  
DIRECT ENTRANCE FROM HOTEL TO GARAGE

HARRISON STREET JUST OFF MICHIGAN BOULEVARD

# CHICAGO



# DISTINCTION

Everything in prehistoric Peru belonged to the Inca; the copper and gold mines were worked exclusively for their benefit. According to tradition the Incas governed wisely, and never made war without just cause. They were of a high order of intelligence and had that capacity for leadership which resulted in a most efficiently organized government.



Distinction in coils? Yes . . . distinction in appearance . . . distinction in performance . . . distinctions of utmost importance to the finished set or radio unit.

Inca coils have a practical side, too. Your engineers will recognize their superiority from an electrical standpoint; your plant manager will find them better to handle and assemble.

The patented field coil for dynamic speakers, audio coils, choke coils, radio frequency coils and power coils . . . all have outstanding features which distinguish them from the ordinary.

We would welcome the opportunity to furnish samples wound to your specifications.

# INCA

**MANUFACTURING DIVISION**

*Symbolic of the best in copper wire products.*

*Central Office and Factory:  
Fort Wayne, Indiana.*

*Eastern Office: 233 Broadway,  
New York, N. Y.*

of NATIONAL ELECTRIC  
PRODUCTS CORPORATION

1547 Venice Blvd., Los Angeles

# The New Gilfillan Super-Heterodyne Will Help You Build Business At a Profit



MODEL 110 LOW BOY  
*8-Tube Super-Heterodyne*



**E**NCASED in a strikingly artistic cabinet, the sensational new Gilfillan 8-tube Super-Heterodyne Radio puts the dealer in a position to attract new business and to do so at a real profit.

As might be expected of a Gilfillan product, it is outstanding in its performance. It is extremely selective — unusually sensitive. The set has wonderful tone. It is easy to tune, unusually smooth and quiet in operation. All these points are important and attractive to the layman.

And here's a further rich source of business—You can sell the new Model 110 Chassis (without cabinet) at an attractive figure. Thus you open up an entirely new market of buyers who have invested considerable money in fine cabinets, which they don't care to throw away. They can now bring their radio sets up to date—can enjoy the latest and best in radio entertainment at the lowest possible cost.

Write or wire us today for our proposition on this sensational new model. Then you can see for yourself what it offers you as a business-builder and profit-maker.

**Gilfillan Bros. Inc.,**

1815 Venice Blvd., Los Angeles

San Francisco    Portland    Seattle  
1315 Howard St.    A. S. Cobb    100 Elliott Ave. W

Care Rudie Wilhelm  
Warehouse Co.  
Eighth and Everett Sts.