

# ELECTRONIC INDUSTRIES

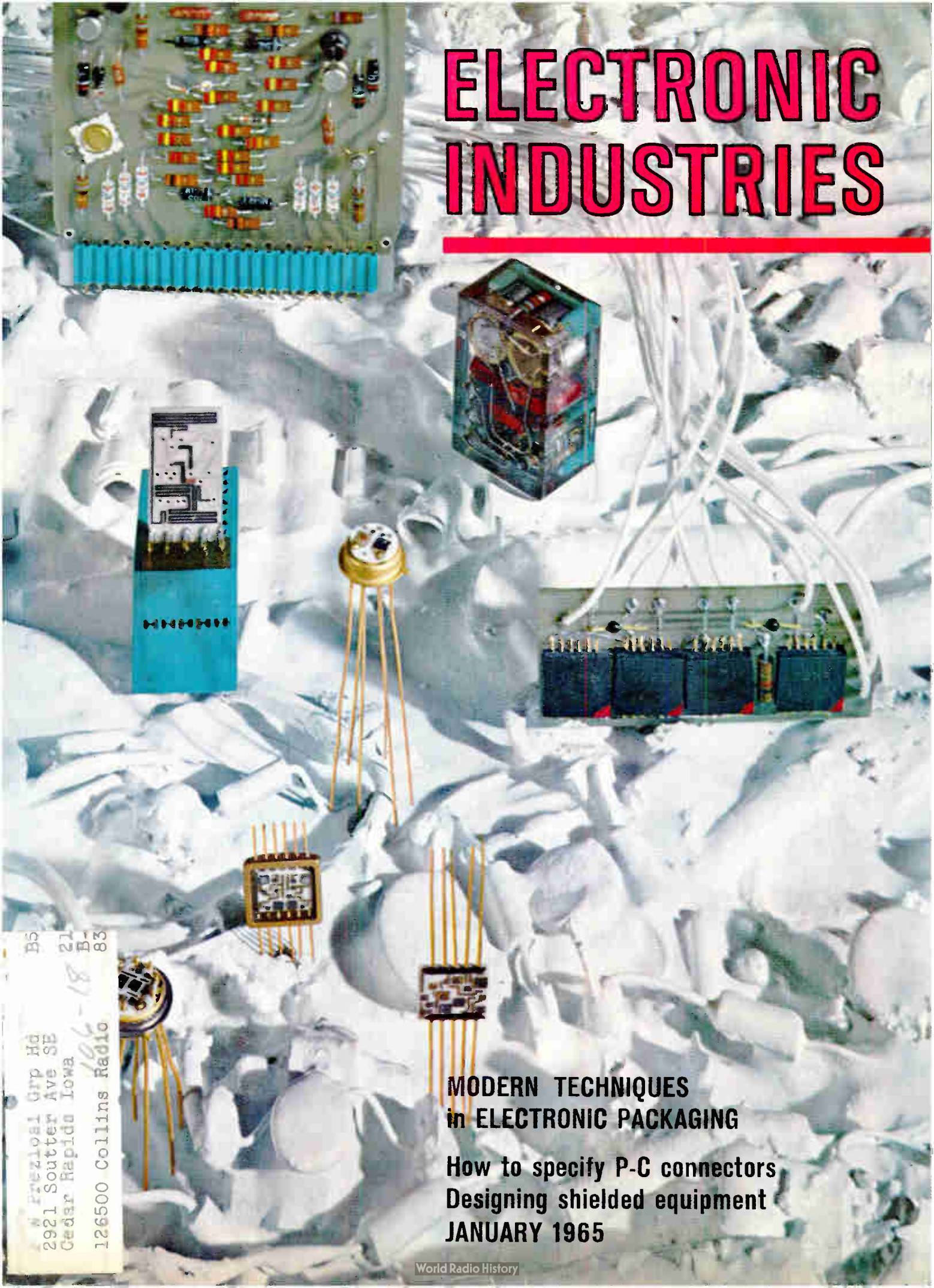

B6  
21  
83  
N. Frezioso Grp Hd  
2921 Soutter Ave SE  
Cedar Rapids Iowa  
106-18  
126500 Collins Radio

**MODERN TECHNIQUES  
in ELECTRONIC PACKAGING**

**How to specify P-C connectors  
Designing shielded equipment  
JANUARY 1965**





# "SPECIAL" (CUSTOM BUILT) FILTERS

## TO YOUR SPECIFICATIONS

### ILLUSTRATED ARE TYPICAL SPECIAL FILTERS

RANGE OF FREQUENCIES ON SPECIAL UNITS  
IS FROM 0.1 CYCLE TO 400 MC.

Over thirty years of experience in the design and production of special filters have resulted in UTC being a first source for difficult units. Present designs both military and commercial incorporate a wide variety of core structures, winding methods, and capacitors to provide maximum performance, stability, and reliability. Fully experienced, top engineering talent backed by complete environmental testing and life testing facilities assure the highest standard in the industry. Full analysis and evaluation of materials are conducted in UTC's Material and Chemical Laboratories. Rigid quality control measures coordinated with exhaustive statistical findings and latest production procedures results in the industry's highest degree of reliability.

### MILITARY AND COMMERCIAL TYPES FOR EVERY PHASE OF THE ELECTRONICS ART

- POWER TRANSFORMERS • AUDIO TRANSFORMERS
- INDUCTORS • PULSE TRANSFORMERS
- ELECTRIC WAVE FILTERS • LUMPED CONSTANT DELAY LINES
- HIGH Q COILS • MAGNETIC AMPLIFIERS • SATURABLE REACTORS • REFERENCE UNITS

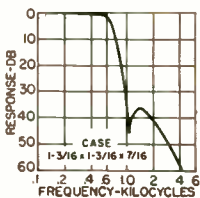
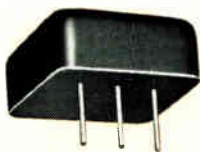

560 — Telemetering low pass filter. Available from 400 to 70 KC.  $\pm 7.5\%$  bandwidth flat to 1 db. Attenuation greater than 35 db beyond the 2nd harmonic of  $\pm 7.5\%$  frequency. Impedance 47K ohms. MIL-F-18327B. Wt. 0.8 oz.

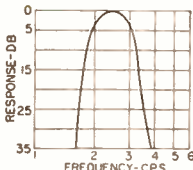

Low frequency band pass filter. Designed for 2.5 cps center frequency. At 2 to 3 cps within 3 db. At 1.5 cps and lower, and 4 cps and higher, greater than 30 db. Source and Load 10K ohms. Size: 4 x 4-11/16 x 6". MA MIL case, MIL-F-18327B.

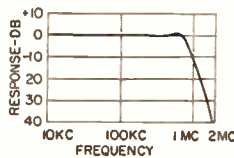
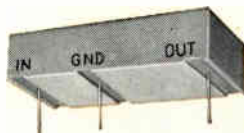

High frequency low pass filter. Zero to 700 KC within 1 db. 1.95 mc to 10 mc 40 db minimum. Source and Load 1000 ohms. Molded flat construction for printed circuit applications. Size: 1 x 2 x 1/2"; Wt: 1 oz. MIL-F-18327B.

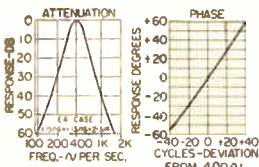

Band pass 400 cycle Gaussian filter. Linear phase response in pass band. Attenuation 380 cps to 420 cps within 0.5 db. 2nd harmonic down 25 db. 3rd harmonic down 45 db. Source and load 5K ohms. MIL-F-18327B Wt., 0.9 lbs.

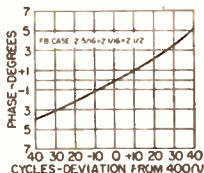

Minimum phase shift 400 cycle band pass filter. Within  $\pm 1.5$  db 370 to 430 cycles, greater than 45 db beyond 1100 cycles. 1K ohms to 100K ohms. MIL-F-18327B; 1 lb.

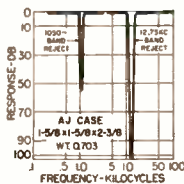

Band reject filters (two shown). The 1050 KC filter has 50 db attenuation and is only 3 db at 950 and 1150 cycles. The 12.75 KC filter has more than 100 db attenuation and is only 3 db at 10.8 and 15 KC. Source and load 600 ohms, both are MIL-F-18327B.

Write for catalog of over  
1,200 UTC HIGH RELIABILITY  
STOCK ITEMS  
IMMEDIATELY AVAILABLE  
from your local distributor.



## UNITED TRANSFORMER CORP.

150 VARICK STREET, NEW YORK 13, N. Y.

PACIFIC MFG. DIVISION: 3630 EASTHAM DRIVE, CULVER CITY, CALIF.  
EXPORT DIVISION: 13 EAST 40th STREET, NEW YORK 16, N. Y. CABLE: "ARLAB"

Circle 1 on Inquiry Card  
World Radio History

## SOUND GROWTH FOR 1965!

OUR FORECAST FOR THE INDUSTRY (page 26) shows that 1965 will be another record year. Growth will be sound though not as spectacular as some recent years.

A record \$16 billion sales of goods and services was set in the year just closed despite many problems, and significant shifts in government requirements. For many companies, 1964 was their best year in both sales and profits. Others faced severe problems. There were more mergers and failures than in any previous year.

The most important change in the marketplace is the abundance of technical skills and capabilities. This means strong competition in every area—government, commercial and consumer products. There are still those in our industry who think that technical competence alone guarantees success. The buyer's market is here and products and capabilities must be sold aggressively.

Knowledge of the marketplace and understanding modern selling methods are two areas where electronic manufacturers have much to learn. Too many in our industry do not understand how to locate their markets and how modern mass communications can increase sales and lower selling costs.

The most successful manufacturers are those whose advertisements appear in the pages of **ELECTRONIC INDUSTRIES** and other publications serving the field. They have learned that mass communication to the people who can buy or specify their products is the most efficient method of selling.

Personal selling will always be important, yet it is by far the most expensive way to communicate. The average cost of a personal sales call is more than \$31.00. Advertising in magazines like **ELECTRONIC INDUSTRIES**, can tell a company's product story to thousands of potential buyers for less than the cost of a letter.

As our industry matures it is natural for the well managed companies to become stronger. The less efficient must improve to avoid merger or failure.

The growth of the industrial market for electronic equipment and the gain in both consumer and replacement markets will continue through 1965. Bright spots in the industrial market are in computing, data processing and industrial control equipment which will show important gains in 1965. Other areas will show modest gains. The consumer electronic market will grow moderately with color television setting the pace.

We can expect higher expenditures for electronic research and development, both government and privately sponsored, reaching an all-time high of \$4.15 billion in 1965.

Total government electronic expenditures for 1965 will be slightly ahead of 1964. NASA will take up some of the slack from the Department of Defense where procurements are leveling off and may decline in years ahead.

The challenge for the electronic industries in 1965 is to take full advantage of the booming state of the national economy. As generic industries, electronic manufacturers should benefit in all areas.

The gross national product will move up from \$624 billion in 1964 to \$660 billion in 1965. An eight million car year is forecast and new housing starts will reach 1,600,000 units in 1965. Capital expenditures will establish an all time high of \$48 billion which will be at least 9% ahead of 1964.

With all signs GO in the national economy the electronic industries should find 1965 a year of sound growth. Improved sales and profits await those who are ready to make an all out effort to solve marketing problems and keep costs down.

*Shelby McMillion*

# New from Sprague!

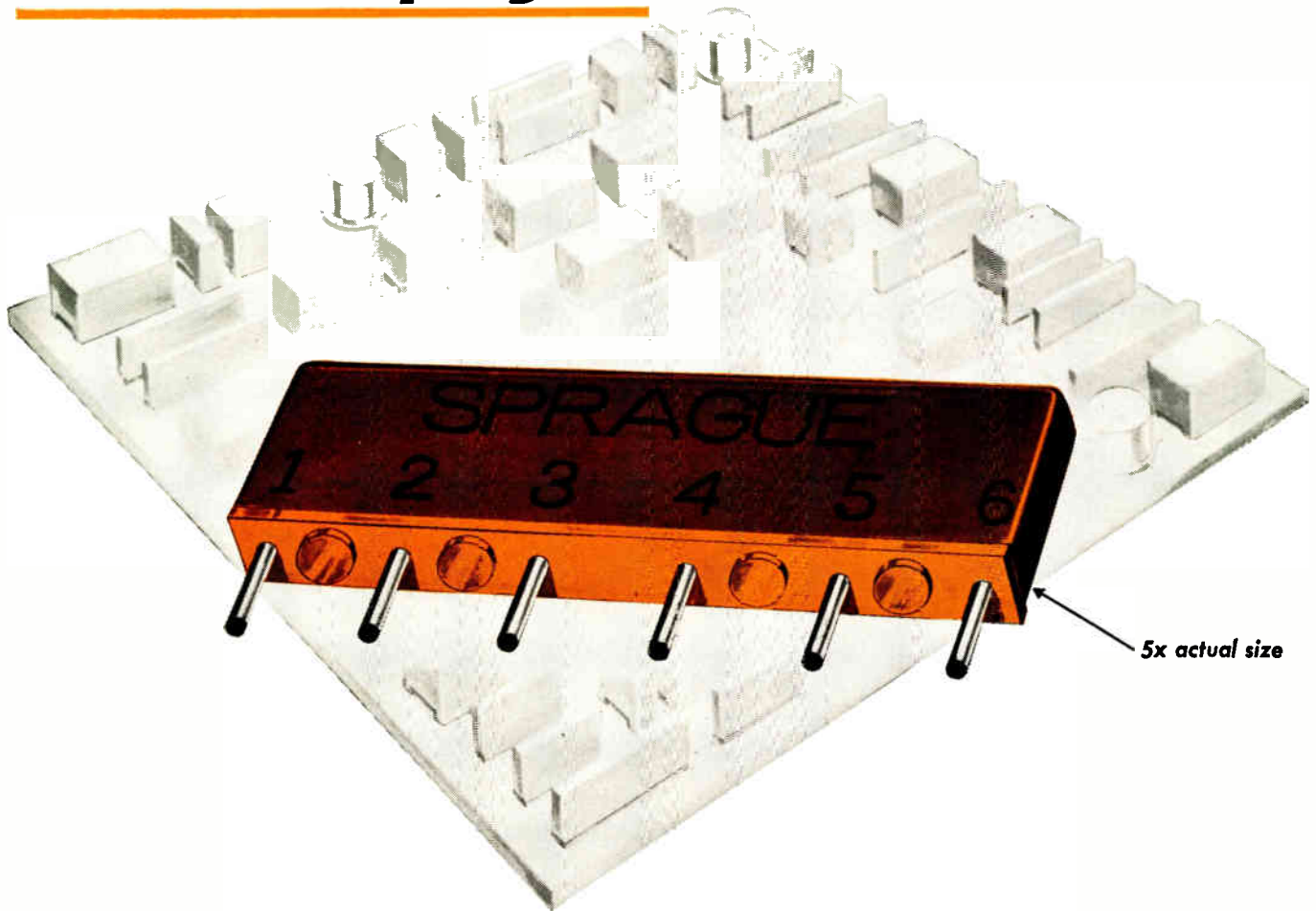

## METANET<sup>®</sup> TRUE METAL-FILM NETWORKS PRECISION RESISTOR

# Save Space, Time, and Money

- High packaging density—4 to 8 times that of individual components.
- Fewer components to stock, handle, inspect, install. Entire module can be hand-inserted faster than one axial-lead component.
- Permit substantial savings over equipment assembled with individual components.
- Epoxy terminal board keeps pin terminals free of resin coating, unlike conventional dipped components, and provides uniform lead spacing.
- Stand-off bosses permit efficient flux removal after soldering. Also prevent dirt and moisture traps around leads.
- Extremely stable and reliable. Meet performance requirements of MIL-R-10509E Resistance tolerances to  $\pm 1\%$ .
- Ceramic capacitors can be incorporated for further savings and size advantages over individual components



For complete information write to  
Integrated Circuit Application Engineering Dept.,  
Sprague Electric Company, 233 Marshall St.,  
North Adams, Massachusetts 01248

### SPRAGUE COMPONENTS

RESISTORS  
CAPACITORS  
TRANSISTORS  
INTEGRATED CIRCUITS  
THIN-FILM MICROCIRCUITS

PULSE TRANSFORMERS  
INTERFERENCE FILTERS  
PULSE-FORMING NETWORKS  
TOROIDAL INDUCTORS  
ELECTRIC WAVE FILTERS

CERAMIC-BASE PRINTED NETWORKS  
PACKAGED COMPONENT ASSEMBLIES  
BOBBIN and TAPE WOUND MAGNETIC CORES  
SILICON RECTIFIER GATE CONTROLS  
FUNCTIONAL DIGITAL CIRCUITS



'Sprague' and '®' are registered trademarks of the Sprague Electric Co.



Editorial: Sound Growth for 1965 ..... 1

## STATE-OF-THE-ART FEATURES:

1965 Review and Forecast for the Electronic Industries .....	26
The 1965 Electromagnetic Spectrum Chart .....	33
Guide to Connector Specifications: Part 1—P-C Connectors .....	48
Manufacturers of Printed-Circuit Connectors .....	56

## DESIGN/DEVELOPMENT:

Materials for Packaging Microelectronic Devices .....	D. Nixen	66
Comparing the Backplane Wiring Techniques .....	R. Noschese	76
Designing the RFI-Shielded Package .....	A. Albin	80
Selecting Epoxies for High-Z Circuits .....	M. E. Lyles	85

## MEASUREMENT/TEST:

A Microwave Beamfield Plotter .....	H. Klapper	104
-------------------------------------	------------	-----

## PROFESSIONAL GUIDELINES:

New Market Looms in Electronic Toys .....	E. T. Ebersol	124
---	---------------	-----

## WHAT'S NEW

Silicon Slicer .....	61	New Welder Handles Tape Cable .....	84
Fast Printout for Film Documents .....	61	Integrated Thin-Film Network, Soon ..	85
Random Access Device Uses Air Floated Tape .....	62	New Computer Series Features Inte- grated Circuits .....	112
Front and Back P-C Layouts on Single Sheet .....	79	Aid to Blind .....	118

## DEPARTMENTS

Highlights .....	4	New Tech Data .....	90
Radarscope .....	8	Books .....	101
Coming Events .....	15	Measurement News .....	103
Washington Trends .....	20	International News .....	121
Snapshots of the Electronic Industry .....	22	Employment News .....	123
Circuit-Wise .....	75	New Products .....	128

### COVER

Cover Designer Mike Louridas poured plaster of paris over an old hand-wired TV receiver to achieve this wintry background. The units shown are (from the bottom): Microcircuits — General Instrument Co.; Small circuit board — Hughes Aircraft Co., with connectors by Elco; Cordwood module-fabricated for Lockheed Aircraft by WEMS Inc.; and the Printed Circuit Connector on the upper P-C board by Elco Corp.

\*STATE-OF-THE-ART: up-to-the-moment capability in each area of electronic technology





1965 Spectrum Chart

**THE 1965 ELECTROMAGNETIC SPECTRUM CHART! 33**

Our exclusive Electromagnetic Spectrum Chart has been brought up-to-date to include the latest U. S. frequency allocations. The types and classes of services using these frequencies are clearly shown in this handy 4-page, multi-color wall chart. Remove your chart now, lest you forget!

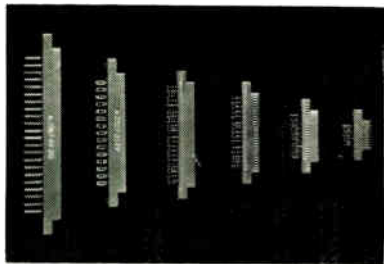

Printed Circuit Connectors

**1965 REVIEW AND FORECAST FOR THE ELECTRONIC INDUSTRIES 26**

A brief review of previous year's sales of electronic products in various segments of the total electronic market, both domestic and abroad. Tables and graphs illustrate years just past, the current market, and predictions and forecasts for the market through 1966.

**SPECIFYING PRINTED-CIRCUIT CONNECTORS 48**

This is the first in a series of Electronic Industries Special Reports on Connectors. In this part, key technical specifications are discussed in detail and directions on how to specify p-c connectors are given. A handy directory of p-c connector suppliers is included.

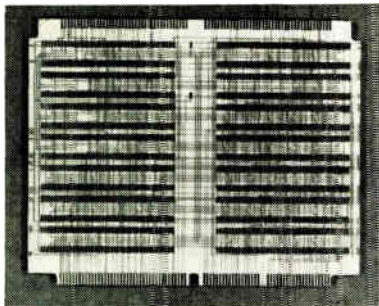

Packaging Materials

**MATERIALS FOR PACKAGING MICROELECTRONIC DEVICES 66**

The design of microelectronic circuits has reached a point where the choice of packaging materials is a key consideration. It is a matter of cost vs. performance. Some of the materials available differ widely in cost, and it becomes important to know precisely what their electrical characteristics are.

**DESIGNING THE RFI-SHIELDED PACKAGE 80**

In designing an RFI-shielded electronic package, what material should be used? Should shielding and filters be installed? How should the seams, joints, etc., be designed? These and other pertinent questions are answered here.

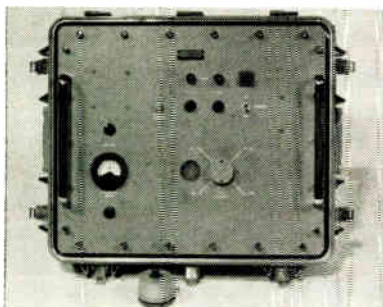

RFI-Shielded Package

**SELECTING EPOXIES FOR HIGH-Z CIRCUITS 85**

Circuit designers must consider electrical and chemical resistance, electrical polarization, nuclear radiation and thermal effects when picking an encapsulant for high impedance circuits. The wrong selection can affect impedance, create hot spots, break wires and cause undue stress.

Epoxyes for High-Z Circuits

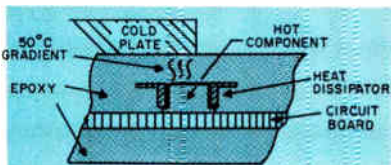

**NEW MARKET LOOMS IN ELECTRONIC TOYS 124**

In the wake of the shrinking government market for electronic industries, a number of consumer and industrial fields are rising in importance that may help build the electronic market for the future. Among them are toys. Births are increasing and kids are getting smarter.

• A REPRINT of ANY ARTICLE in this issue is available from ELECTRONIC INDUSTRIES Reader Service Department, 56th & Chestnut Streets, Philadelphia, Pa. 19139



**Now from Sprague!**

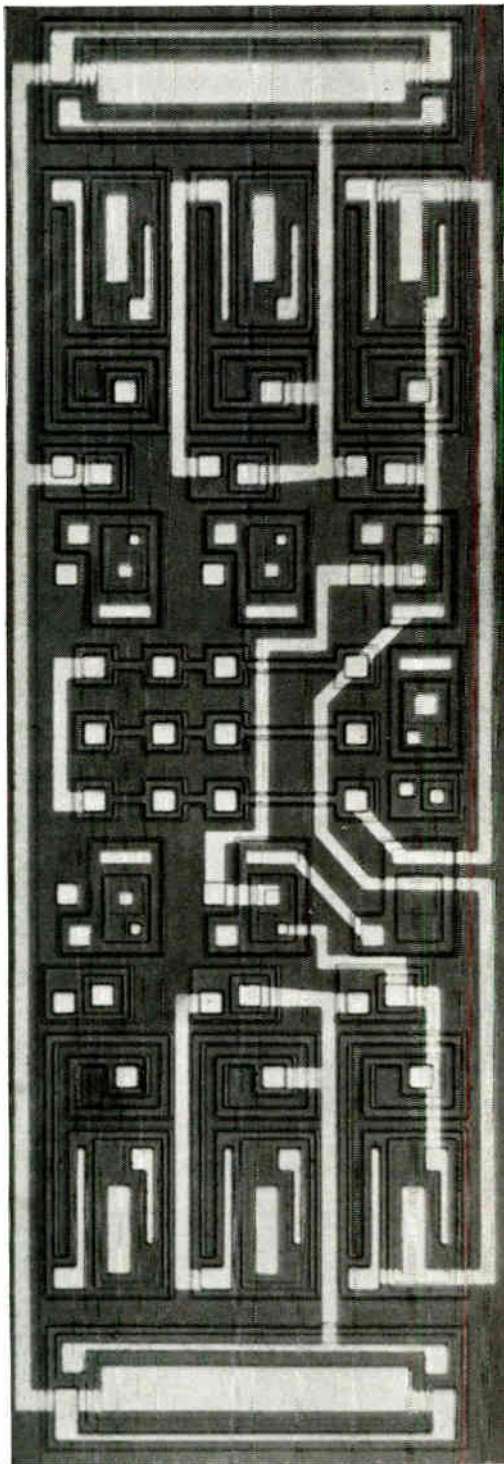

# UNICIRCUIT<sup>®</sup>

## INTEGRATED CIRCUITS

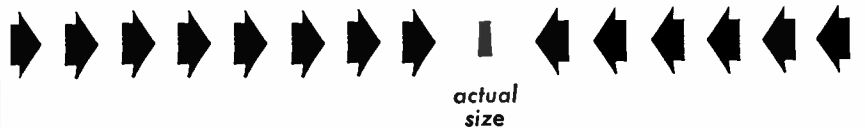

This is a master-matrix UNICIRCUIT, interconnected to meet the requirements of a military systems manufacturer for an RS flip-flop. The photograph at the left, enlarged 38 diameters (1444 times area), speaks for itself as to the technical capability of the Sprague Electric Company to produce complex silicon monolithic integrated circuits.

If you would like to discuss your integrated circuit needs with an old-line established electronic components manufacturer who has a proven reputation for reliability, please write or telephone Mr. Albert B. Dall, Marketing Manager, Semiconductor Division, Sprague Electric Company, Concord, New Hampshire.

area code 603 Tel. 224-1961

### SPRAGUE COMPONENTS

INTEGRATED CIRCUITS  
THIN-FILM MICROCIRCUITS  
CAPACITORS  
TRANSISTORS  
RESISTORS

PULSE TRANSFORMERS  
INTERFERENCE FILTERS  
PULSE-FORMING NETWORKS  
TOROIDAL INDUCTORS  
ELECTRIC WAVE FILTERS

CERAMIC-BASE PRINTED NETWORKS  
PACKAGED COMPONENT ASSEMBLIES  
BOBBIN and TAPE WOUND MAGNETIC CORES  
SILICON RECTIFIER GATE CONTROLS  
FUNCTIONAL DIGITAL CIRCUITS

**SPRAGUE<sup>®</sup>**  
THE MARK OF RELIABILITY

'Sprague' and '®' are registered trademarks of the Sprague Electric Co.

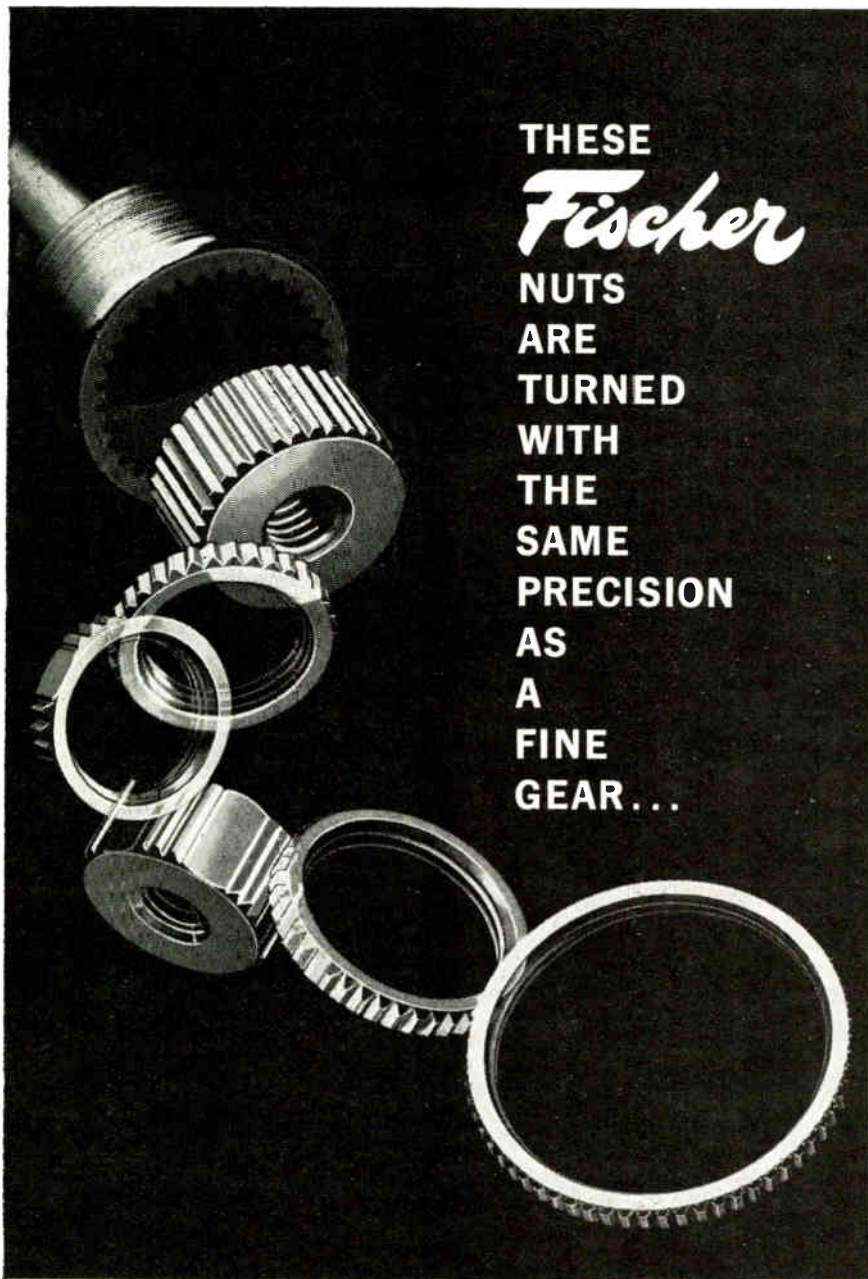

THESE  
**Fischer**  
 NUTS  
 ARE  
 TURNED  
 WITH  
 THE  
 SAME  
 PRECISION  
 AS  
 A  
 FINE  
 GEAR...

B2006-FS

## ... AND HERE'S WHY!

They're made for fast positive wrenching in confined or recessed spaces where ordinary hex nuts would be impractical. Precision teeth fit snugly into mating wrenches for manual or automatic assembly operations . . . nuts locate accurately and seat fast without damage to either mounting surfaces or teeth. And as for protective coatings . . . solid teeth will not flake . . . surfaces remain intact permanently! Of course, some jobs do not need this much precision, but when you have one that does, let Fischer work out the fine points. And remember . . .

*there's no premium for precision at*

**Fischer** SPECIAL MANUFACTURING CO.  
 496 MORGAN STREET • CINCINNATI, OHIO 45206

**ELECTRONIC  
 INDUSTRIES**



SHELBY A. McMILLION,  
 Publisher

BERNARD F. OSBAHR,  
 Editor

CREIGHTON M. MARCOTT  
 Executive Editor

JOHN E. HICKEY, Jr.  
 Managing Editor

SMEDLEY B. RUTH  
 SIDNEY FELDMAN  
 Associate Editors

JOHN J. HUNTER  
 ROBERT J. BRAMLETT  
 Assistant Editors

DR. ALBERT F. MURRAY  
 Consulting Editor

ELMER KETTERER, Art Director

ANNE AXE, Editorial Assistant

ANN LAVENDER, Research Assistant

MAE MOYER, Reader Service

IDA GOOD, Editorial Secy.

### EDITORS-AT-LARGE

#### Eastern Region

ELMER T. EBERSOL,  
 100 East 42nd St.  
 New York 17, N. Y.  
 (Area Code 212) OXford 7-3400

#### Western Region

J. PHILIP GEDDES,  
 198 S. Alvarado St.  
 Los Angeles 57, Calif.  
 (Area Code 213) DUNkirk 7-1271

#### Defense/Space

CHARLES R. WILHIDE,  
 Pentagon News Room  
 The Pentagon  
 Washington, D. C.

### WASHINGTON NEWS BUREAU

1093 National Press Bldg.  
 (Area Code 202) 393-3474  
 TWX—202 965-0675

GEORGE BAKER, Mgr.  
 NEIL R. REGEIMBAL

### BUSINESS DEPARTMENT

ELMER DALTON  
 Advertising Promotion  
 & Circulation Manager

EDWARD G. SHAUD, Jr.  
 Marketing Manager

ARA H. ELOIAN  
 Production Manager

See Advertisers Index on page 141 for  
 Regional Sales Managers.

Chilton Company—G. C. BUZBY, President.  
 Executive Vice Presidents: R. E. McKenna,  
 G. T. Hook. Vice Presidents: P. M. Fahr-  
 dorf, L. V. Rowlands, M. E. Cox, E. B.  
 Terhune, Jr., R. W. Case, Jr., J. H. Kofron.  
 Treasurer: Stanley Appleby. Secretary: J. A.  
 Montgomery. Other Directors: C. A. S.  
 Heinle, G. E. Cameron, T. C. Campbell,  
 H. W. Barclay, W. A. Phair; Assistant  
 Treasurer: J. Miades; Assistant Secretary:  
 I. C. Holloway.

JOHN H. KOFRON  
 Chilton Research Director

ELECTRONIC INDUSTRIES, January, 1965.  
 Vol. 24, No. 1. A monthly publication of  
 Chilton Company, Executive, Editorial &  
 Advertising offices at Chestnut & 56th Sts.,  
 Phila., Pa. 19139. (Area Code 215) SHer-  
 wood 8-2000. Controlled circulation postage  
 paid at Philadelphia, Pa. \$1 a copy; Refer-  
 ence Issue (June), \$5.00 a copy. Sub-  
 scription rates U. S. and U. S. Posses-  
 sions: 1 yr. \$10.00; 2 yrs. \$18.00. Canada  
 1 year, \$12.00; 2 yrs. \$20.00. All other  
 countries 1 yr. \$18.00; 2 yrs. \$30.00.  
 Copyright 1964 by Chilton Company. Title  
 Reg. U. S. Pat. Off. Reproduction or re-  
 printing prohibited except by written au-  
 thorization.



**new**  
**nine ways to "skin a cat"**  
**in meter applications**



**IMPROVED TAUT BAND**—  
 Rect. 2½", 3½", 4½" . . . DC  
 microammeters stocked



**CONTACTLESS RELAYS**—4½"  
 rect. stocked . . . also contact  
 type



**PANCAKE**—0.5" x 1.81" x 1.28"  
 horiz. or vert. stacking . . .  
 special order



**BEHIND PANEL MOUNTING**—  
 4½" on special order



**1% METERS**—Series 1150 . . .  
 mirror scale DC microammeters  
stocked



**COMPENSATED WATTMETERS**  
 —Round 2½", 3½", and rect.  
 2½", 3½", 4½" in stock

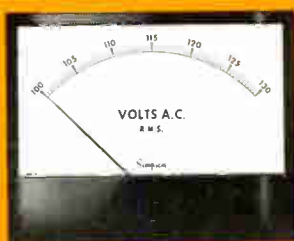

**SEGMENTAL VOLTMETERS**—  
 Round and rect.; 2½" to 4" x  
 6" in 3 stock types



**ELAPSED TIME**—Round and  
 rectangular 3½" size stocked

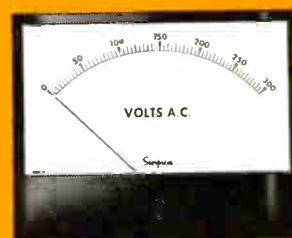

**RUGGED SEAL**—3½", 4½",  
 4" x 6", 57 Models stocked

**Simpson**  
 INSTRUMENTS THAT STAY ACCURATE



SEE YOUR ELECTRONIC DISTRIBUTOR FOR STOCK ITEMS

Write for Complete Stock Catalog which Lists 1370 Sizes, Types, and Ranges  
 Representatives in Principal Cities . . . See Telephone Yellow Pages

**SIMPSON ELECTRIC COMPANY**  
 5213 W. Kinzie Street, Chicago, Illinois 60644  
 Phone: (312) EStebrook 9-1121

**California:** Simpson Instruments, Inc., P.O. Box 488, 1130 Simpson Way,  
 Escondido, Calif. • Phone: (714) SH 5-8202

**In Canada:** Bach-Simpson Ltd., London, Ontario

**In India:** Ruttonsha-Simpson Private Ltd., International House,  
 Bombay-Agra Road, Vikbrali, Bombay

Analyzing current developments and trends affecting the State-of-the-Art of technologies throughout the electronic industries



#### ELECTRON EMISSION MICROSCOPE

Image of molybdenum sample is shown on fluorescent screen of thermionic electron emission microscope developed by Electro-Optical Systems, Inc., Pasadena. With temperatures and vacuums higher than any similar unit, it will allow studies of refractory metal grain growth and recrystallization phenomena as these processes occur.

**STEREOPHONIC SOUND FOR TV** is a subject being looked into by the FCC. They want to find out if stereophonic sound will contribute any worthwhile improvement to TV. The FCC will welcome comments from industry—particularly any data obtained from tests. They would like to know the effect of stereophonic sound on the quality of picture and sound reception for both monophonic and stereophonic TV receivers. Also, they would like to know the costs and complexities involved.

**THIN-FILM MICROCIRCUITS** on a continuous production line are being made by Corning Glass with non-vacuum techniques. The first step is making the thin-film capacitors on a glazed alumina substrate material. The entire substrate is then covered with tin oxide and fused. The oxide is masked and patterned by the Photo-Resist method. Copper interconnecting runs are then plated on the tin oxide. After the resistors are tailored, the plate is sawed into circuits. Active devices can be added at this time if desired. This type of production has a potential of tens of thousands of completed microcircuits per day.

**INFRARED TECHNIQUES** make possible a clean, low temperature method of soldering. And, there is no contact between the heat source and the metal to be soldered. Advantages of this new method were reported recently by Bernard J. Costello of Western Electric Co., Princeton, N. J., at a meeting of the ASME. IR heating makes it possible to solder at the lowest possible temperature for a given solder. Joints soldered with IR energy have been made consistently at less than 430°F. This represents a differential of about 125° when compared to a hot iron commonly used for printed circuit repair.

**EMPHASIS ON RELIABILITY** of parts, equipment, and systems will continue to grow, and methods of assuring reliability will change to meet new problems. The changes will be due to limited systems. In the past failure conclusions were drawn from failure rates. With limited systems, statistical methods are inadequate for extrapolation because they depend upon failures which may not exist. Or the failures may be so small in number that sound conclusions cannot be drawn. The November "Batelle Technical Review" discusses these and other reliability problems.

**HARD MAGNETIC FILMS** are receiving attention by IBM researchers. Work is being conducted toward using iron, cobalt and nickel for fast, high capacity data storage mediums. Factors that influence switching speed and data capacity of thin films are being looked into. Both vacuum and chemical deposition are used in the research.

**RED PICTURE TUBE PHOSPHORS** have been receiving a lot of attention lately. The latest announcement is from Westinghouse. They have developed a red phosphor that is composed chiefly of two rare earths, yttrium and europium. These metallic elements are said to give 100% brighter reds than standard reds used previously. The green and blue brightness had to be limited in the past so that they did not outweigh the red.

**OPTICAL COUPLING** for microcircuits has been the object of increased research. The possibility of using rays of light instead of leads has some exciting aspects. The use of a light source would provide wide-band signal coupling while giving increased circuit isolation. Elimination of wires should simplify manufacturing, improve reliability and reduce costs. Two types of infrared diodes are being tried, the gallium arsenide diode and a single crystal compound of cadmium and tellurium. Both Texas Instruments Incorporated and Autonetics have reported doing experimental work toward using optical coupling.



**CHEMICAL VAPOR DEPOSITION (CVD)**, now considered the basis of a billion-dollar industry, was the subject of papers presented at a symposium held by Battelle Memorial Institute. The promise and the research challenge of CVD as an industrial process was explored in depth. The process is characterized by deposition of solid materials from gaseous compounds. CVD makes it possible to grow single crystals and to produce pigments, coatings and semifinished shapes of refractory metals, pyrolytic carbon, carbides, oxides, and other heat-resistant materials at temperatures well below their melting points. To date, emphasis has been on production of electronic-grade bulk products, but future chemically vapor-deposited products may be manufactured as complete integrated systems.

**POLARIZATION DIVERSITY RECEPTION** can be used to reduce high frequency fading. It has been used experimentally with results comparable or superior to those of space diversity. But, it has not been generally applied to operational circuits. This is probably due to two reasons: the basic phenomena have not been adequately understood, and suitable broadband antennas have not been available. In this receiving system a single antenna of the polarization diversity type is used. It operates on the principle that the horizontal and vertical components of the received wave usually do not fade at the same time. Granger Associates have a report, Technical Bulletin No. 4, that describes the results of research and field tests with this method.

### LASER MEASURES CURRENT

A gallium arsenide laser has been adapted to high voltage transmission line current monitoring system. The "Traser" was developed by Allis-Chalmers. Laser produces infrared output from current at its terminals. Light is transmitted through fiber optics to a photo sensitive element and converted to signal for metering.

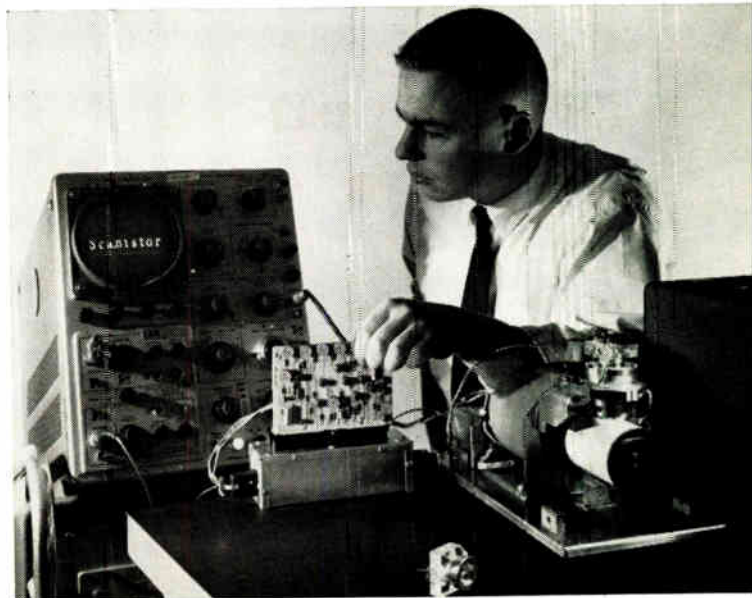
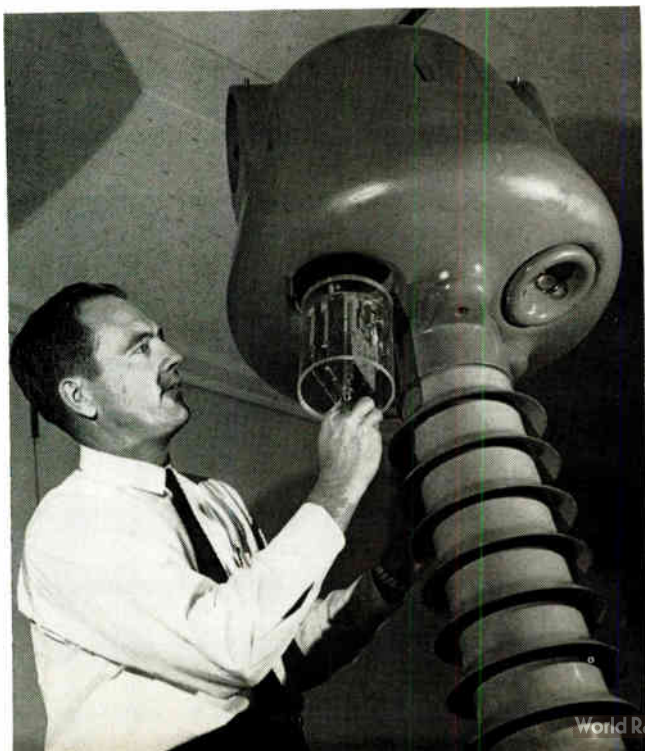

### SOLID STATE SCANNING DEVICE

An experimental solid state optical device, the Scanistor, was developed by IBM. A card with the word "Scanistor" on it has been placed on a rotating drum. A light source and lens above the drum focuses the image onto the device. Output of the device and its associated circuitry is shown on the oscilloscope.

**EXTREME SHORT WAVELENGTH** sensitivity has been found in silicon p-n junctions. This discovery may lead to a totally new generation of solid state devices for space measurements according to Stephen Kaye, co-discoverer of the phenomenon at Electro-Optical Systems, Inc., Pasadena, Calif. One of the highly sensitive devices has already been produced in quantity by EOS for the detection of ultraviolet radiation in extreme space environments. Sensitivity of the new detector ranges from about 4,000 Å down to 300 Å.

**IMAGE INTENSIFIERS** are being added to photographic telescopes to triple observable brightness of stars. The tube will enable a 60-inch reflector telescope to photograph faint star images or objects now only obtainable with 180-in instruments. Carnegie Institution is purchasing 20 tubes from RCA for allocation to observatories throughout the world.

**BETTER ISOLATION** of elements within integrated circuits is one way to increase reliability. An approach North American Aviation's Autonetics Division has taken to improve isolation is the deposition of a dielectric on a single crystal semiconductor. Design freedom is a major advantage since the substrate does not need to be connected to the circuit. This freedom also allows fabrication of novel devices and subsystems using present integrated circuit manufacturing methods. Typical devices made are full-wave diode rectifiers and diode matrices for selective switching.

(MORE RADARSCOPE on Page 11)



# HOW DO YOU DESIGN PEACE OF MIND?

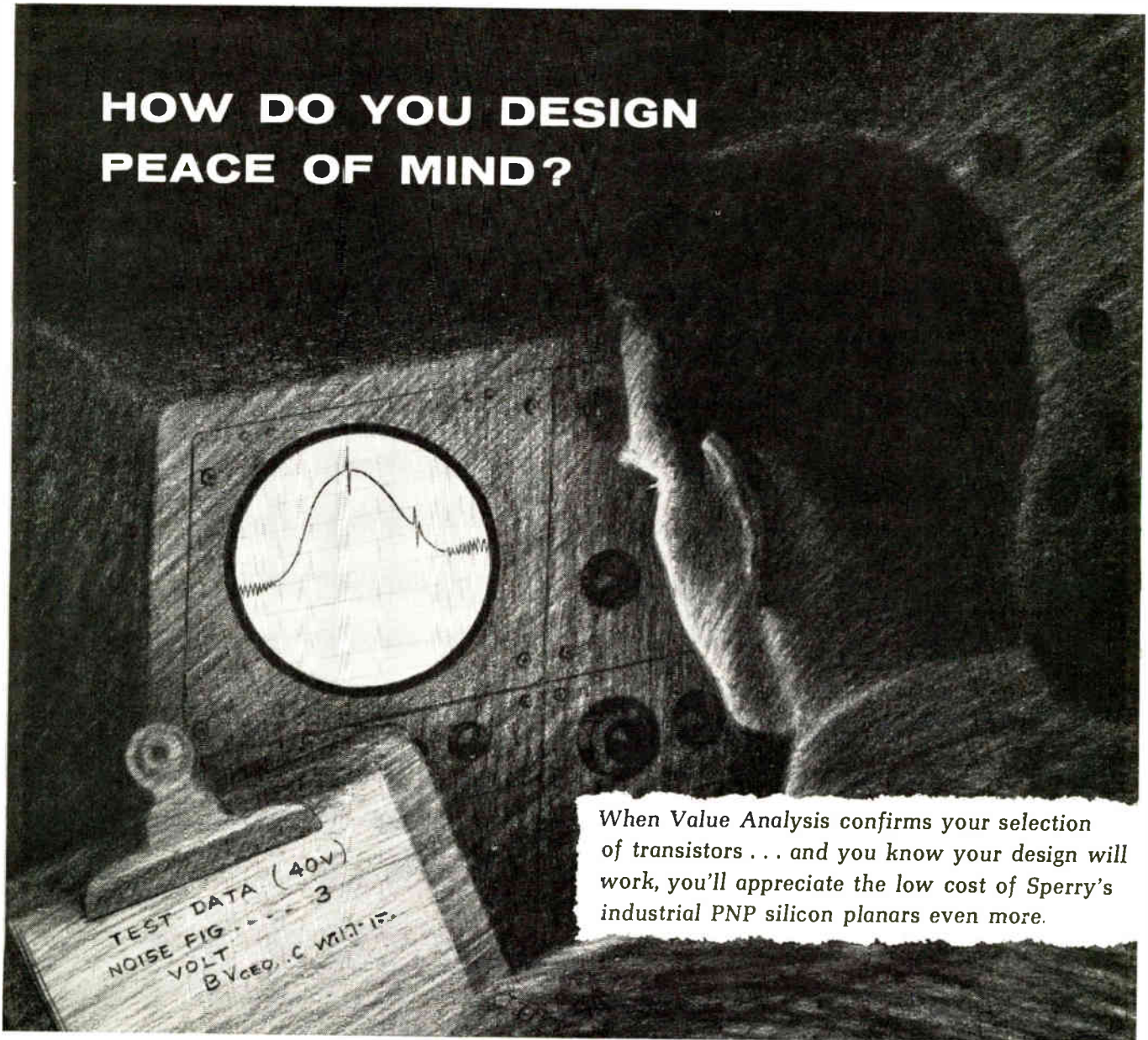

When Value Analysis confirms your selection of transistors . . . and you know your design will work, you'll appreciate the low cost of Sperry's industrial PNP silicon planars even more.

**EVALUATE  
SPERRY**



Send for Sales Representative    Check 7 Reader Service Card



Specification Sheets    Check 8 Reader Service Card

**Low cost PNP Planar Transistors, Sperry's industrial types, provide quality . . . and a heads-up method of reducing cost.** You get the proven reliability of the planar process in a hermetically sealed TO-46 package. Which of these features will provide your peace of mind . . . low noise figure for minimum error signal detection; a typical gain bandwidth in the 50 mc range to provide design ease in broad band amplifiers;  $BV_{CEO}$  of 40 V and 60 V compatible with commonly used industrial power sources. Circuit designers and systems designers in many industries are turning to Sperry's industrial transistors to preserve their own economy. Makes sense. Here are our new types: 2N3579 . . . 2N3580 . . . 2N3581 . . . 2N3582.

Try a little peace of mind for yourself . . . write for the technical data on Sperry's industrial types . . . now.  **SPERRY SEMICONDUCTOR, Norwalk, Connecticut 06852.**

**SPERRY**  
SEMICONDUCTOR  
DIVISION OF  
SPERRY RAND  
CORPORATION



# RADARSCOPE

**CONVEYOR BELT** that has a memory has been perfected by Goodyear. Ferromagnetic material is imbedded between plies of a conveyor belt. When magnetized, the material becomes the memory section. It accepts coded destination information and retains it until the package, which is over the coded area, arrives at its destination. The memory belt is used in a belt coding system developed by Maitrol Products Div. of Magnetics, Inc. The system will have use where conveyor belting is used to sort and dispatch packaged items.

**AN ANALOG COMPUTER** which shows exactly how much space an article or other printed matter will take up when set in type has been announced by Caps Equipment, Ltd., London, England. The computer will supply an answer in seconds. If the space available is fixed, the computer can be used to decide what measure, leading, or type size or style should be used to make the item fit exactly. If, on the other hand, the item is already in type and has to be changed for a different space, the computer will show what changes are needed.

**AUTOMATIC DRAFTING** is the latest entry in cutting down drafting time for making schematics. A record-like disc containing 168 transparent symbols, lines letters, and numbers is the key to Keuffel & Esser Co. "Photo-Draft" system. Disc is inserted into a photographic unit having photosensitive drafting paper. Disc revolves and is positioned by a coded, 8-channel paper tape. Light passes through selected symbols and exposes film. Rate is about 200 per minute. Control tape can be punched by a trained typist. Film then can be used in conventional process for making copies.

## doing a space-age job with stone-age tools

?

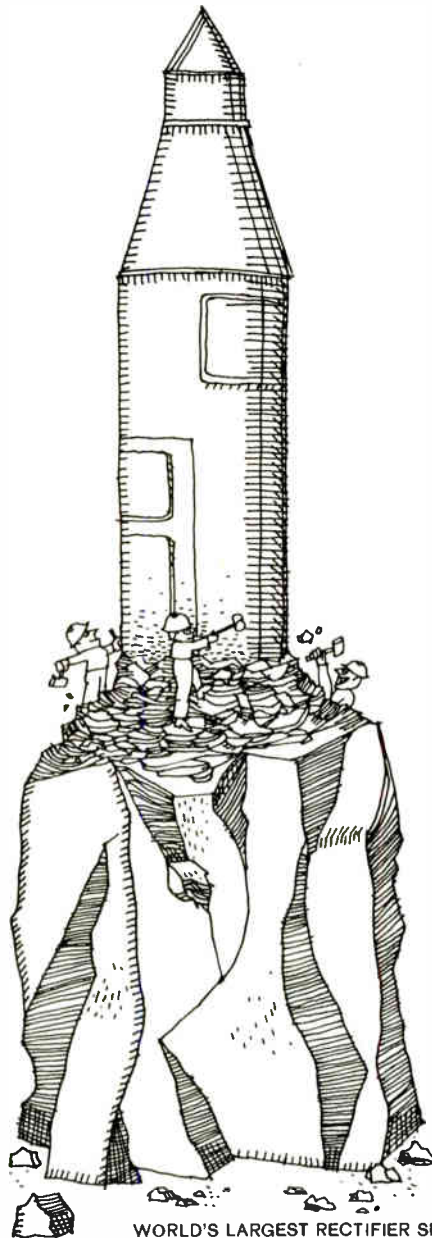

WORLD'S LARGEST RECTIFIER SPECIALISTS

## IR<sup>®</sup> INTERNATIONAL RECTIFIER

INTERNATIONAL RECTIFIER CORP., EL SEGUNDO, CALIF., PHONE OR 8-6281 • CABLE RECTUSA  
 • REGIONAL OFFICES IN NEW YORK CITY, CH 4-0748 • FORT LEE, N. J., WI 7-3311 • SYRACUSE, N. Y., HE 7-8495  
 • CAMBRIDGE, MASS., UN 4-6520 • ARDMORE, PA., MI 9-3667, GR 3-3932 • SILVER SPRING, MD., JU 9-3305 • MIAMI, FLA., 445-5201 • CHICAGO, ILL., OR 6-4090 • CLEVELAND, OHIO, 734-4100 • DAYTON, OHIO 223-7691 • HUNTINGTON WOODS, MICH., LI 8-1144 • ST. LOUIS, MO. TE 8-6633 • MINNEAPOLIS, MINN., 920-1200 • RICHARDSON, TEX., AD 1-2504 • LOS ANGELES, CALIF. 750-0550 • IN CANADA: TORONTO, ONT., PL 9-7581 • MONTREAL, QUE., 861-0562

EUROPEAN GENERAL SALES OFFICE: 38 AVENUE DES ARTS, BRUSSELS 4, BELGIUM • TELEPHONE: 111774

*Of course you aren't. That's what our applications engineers call "exaggeration for effect."*

But chances are that a session with one of them would uncover some more efficient, less costly ways of doing things. More specifically, they're experts at modernizing equipment designs by the incorporation of silicon rectifier stacks.

We never cease to be amazed at some of the problems our customers throw at us. And they continue to marvel at the simple, effective solutions we have to offer.

Want some examples?

**I**n the West a refiner of rare metals required a dependable control system for the d-c power supply to his arc furnaces. Constant temperatures are a must in such operations, and line surges are intolerable. Our line of single- and 3-phase hybrid controlled rectifier stacks contain just the unit needed.

**A**nother firm, supplying equipment for the fabrication of delicate, high-precision space-age components, needed a constant-current, constant-voltage power source for welding exotic metals. Slight variations in either parameter cause burn-outs and disintegration of expensive work pieces. An IR designed SCR assembly enabled this manufacturer to eliminate this bothersome problem. Our design can deliver as low as 14 watts or as high as 1400 watts.

**M**anufacturers of heavy industrial d-c motors are plagued with the problem of absorbing regenerative power when the motor is driven overspeed. At such times these motors act as d-c generators, and damage to armature circuits can result. We've developed a special stack assembly which switches a dynamic braking resistor into the armature circuit and protects expensive windings.

Why are so many people turning to IR silicon rectifiers for solutions to their problems?

For several reasons:

Advanced technologies and production methods developed at IR have tumbled the price of SCR's and rectifier stacks. Advantages inherent in these ultra-modern devices make it feasible—economically, almost necessary—to replace out-dated mechanical rectifiers, selenium rectifiers and ignitrons.

For all practical purposes, the ceiling on available currents and voltages has been removed.

And IR's conscientious applications engineers are willing to take the time and are anxious to help you find better ways of doing more things with SCR's. Contact your local **International Rectifier** sales office or write to 233 Kansas Street, El Segundo, California, for an **IR Custom Application Form**. On it you can spell out the particular requirements for your individual problem.

# What makes us think we can enter the highly competitive counter field?



## A GREAT COUNTER, OF COURSE!

Here's good news for users of electronic counters — a new line of competitively-priced counters with the finest quality available at any price. The 2 mc and 300 kc models launching the line (50 mc coming soon) prove the point beautifully by providing traditional NLS quality at lower cost.

*And that's why we have the audacity to enter the crowded counter field.*

You've got to look at an NLS counter to see what we mean by NLS quality. You'll find no production short cuts. Virtually all circuits are mounted on plug-in boards (only exceptions are some power supply components, front panel switches, a few resistors) . . . boards themselves are beautifully constructed on epoxy fiberglass . . . all-transistor design with 25 w. dissipation eliminates any need for a fan. Both the 2 mc and 300 kc models measure frequency, frequency ratio, period and multiple period average as well as totalize.

Features? They're loaded with them. Input sensitivity of 0.1 volt . . . input impedance of 1 meg and 60 pf . . . selectable ranges of 1/10/100 v . . . digital output in decimal or BCD . . . stability of 5 parts in  $10^7$ /month . . . wide range for both  $f_1$  and  $f_2$  in frequency ratio (2 cps to 300 kc in 300 kc model and 2 cps to 1.2 mc in 2 mc model). All amplifiers, all decades, and all gates are self-checking.

All this plus unsurpassed service to protect your instrument investment — from NLS engineering/service centers throughout the country.

**SEE AN NLS COUNTER IN ACTION.** No obligation . . . no pressure. The instruments will do our talking for us.

NLS 2810 (2 mc) complete: \$1,240

Other Series 2800 counters are available with 300 kc range, or with less accuracy and fewer features — at lower prices, of course.



*Originator of the Digital Voltmeter*

**non-linear systems, inc.**

DEL MAR, CALIFORNIA

Phone: (714) 755-1134



**Name the frequency—  
FXR has the meter!**



## **Meters from 1.0 to 220 Gc —most of them, in stock!**

You name it! Any frequency from 1 to 220 Gc—Microlab/FXR (and *only* Microlab/FXR) can supply you with the Frequency Meter you need, coax or waveguide. (Which is what you would expect from the company with the widest line of microwave products in the industry!)

And what can you expect from an FXR Frequency Meter? First, you'll get a direct-reading unit (except in the millimeter band; we haven't worked that out yet). You'll get a precision, spring-loaded drive mechanism that eliminates backlash. And model for model, you'll get accuracy *equal to or better than* any unit in the industry!

Prices are the real surprise! From \$165 to \$650. All lower than "equivalent" competitive models—as much as \$35 to \$120 lower!

For complete specs on all 17 models, along with a copy of the full FXR catalog, circle the Reader Service Card. Or write to us at Dept. EI-16.



# **MICROLAB/FXR**

Livingston, New Jersey 07039 Phones: (201) 992-7700; (212) 721-9000

# high-speed

**Tektronix Oscilloscope  
with general-purpose  
convenience**

## Type 585A / 82 unit features

- **Dual-Trace Operation** with 4 operating modes and independent controls for each channel—for individual attenuation, positioning, inversion, and ac or dc coupling as desired.
- **Passband typically DC-TO-85 MC** (3-db down) at 100 mv/cm (12-db down at 150 Mc), and typically DC-TO-80 MC (3-db down) at 10 mv/cm.
- **Calibrated Sensitivity in 9 steps** from 100 mv/cm to 50 v/cm, and in 10X Amplifier Mode, from 10 mv/cm to 5 v/cm, variable between steps.
- **Internal and External Triggering** to 150 Mc.
- **Sweep Range from 10 nsec/cm to 2 sec/cm.**
- **Single-Sweep Photography** at 10 nsec/cm.
- **Calibrated Sweep Delay** from 2 microseconds to 10 seconds.

■ **Bright, High-Resolution Display** with small spot size.

■ **Conventional Passive Probes** for convenience.

**plus**

■ **Compatibility with 17 Letter-Series Plug-Ins** to permit differential, multi-trace, sampling, other laboratory applications—when used with Type 81 adapter.

Type 585A Oscilloscope . . . . . \$1725  
 Type RM585A Oscilloscope . . . . . \$1825  
 Type 581A Oscilloscope . . . . . \$1425  
 No sweep-delay capabilities, but other features similar to Type 585A.

Type 82 Dual-Trace Unit . . . . . \$ 650  
 Type 86 Single-Trace Unit . . . . . \$ 350  
 Type 81 Plug-In Adapter . . . . . \$ 135

Allows insertion of 17 Tektronix letter-series plug-ins. Band-width (up to 30 Mc) and Sensitivity depend upon plug-in used.

U.S. Sales Prices, f.o.b. Beaverton, Oregon

**For a demonstration, call your Tektronix Field Engineer.**

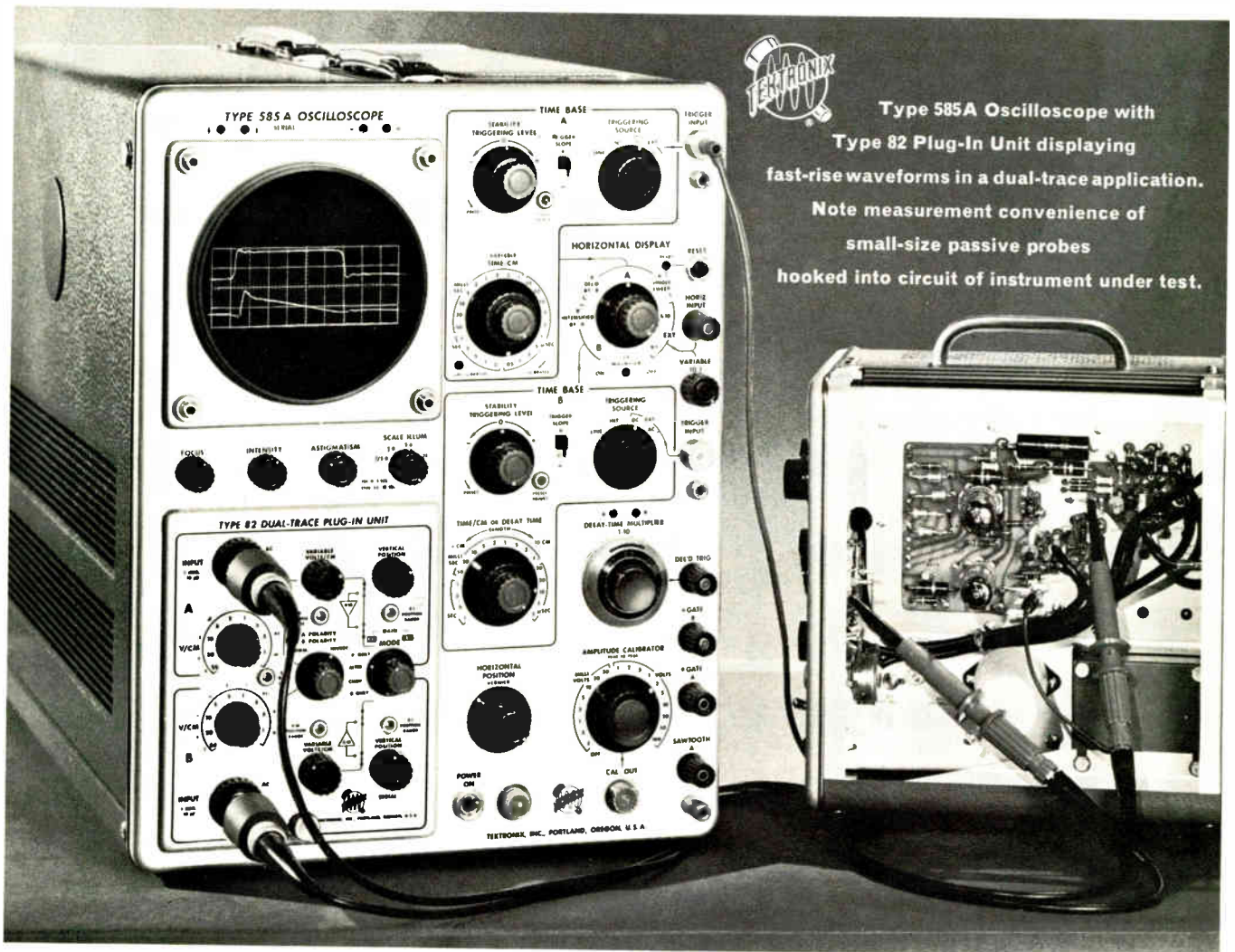

Type 585A Oscilloscope with Type 82 Plug-In Unit displaying fast-rise waveforms in a dual-trace application. Note measurement convenience of small-size passive probes hooked into circuit of instrument under test.

**Tektronix, Inc.**

P.O. BOX 500 • BEAVERTON, OREGON 97005 • Phone: (Area Code 503) 644-0161 • Telex: 036-691  
 TWX: 503-291-6805 • Cable: TEKTRONIX • OVERSEAS DISTRIBUTORS IN OVER 30 COUNTRIES  
 TEKTRONIX FIELD OFFICES in principal cities in United States. Consult Telephone Directory

Tektronix Australia Pty., Ltd., Melbourne; Sydney • Tektronix Canada Ltd., Montreal; Toronto

Tektronix International A.G., Zug, Switzerland • Tektronix Ltd., Guernsey, C. I. • Tektronix U. K. Ltd., Harpenden, Herts



# COMING EVENTS

## January

- Jan. 12-14: 11th Annual Symp. on Reliability & Quality Control, IEEE, ASQC; Fontainebleu Hotel, Miami Beach, Fla.  
 Jan. 18-21: Int'l Symp. on Solar Radiation Simulation, ASTM, IES; International Hotel, Los Angeles, Calif.  
 Jan. 31-Feb. 5: IEEE Winter Power Meeting, IEEE; Statler-Hilton Hotel, New York, N. Y.

## February

- Feb. 2-4: 20th SPI Reinforced Plastics Div. Conf., SPI; Edgewater Beach Hotel, Chicago, Ill.  
 Feb. 3-5: 6th Winter Conv. on Military Electronics, IEEE; Ambassador Hotel, Los Angeles, Calif.  
 Feb. 15-17: 5th Electrical/Electronic Trade Show, ERC, ERA; Denver Auditorium Arena, Denver, Colo.  
 Feb. 17-19: Int'l Solid State Circuits Conf., IEEE, Univ. of Pa.; Phila., Penna.

## March

- Mar. 1-5: 21st Annual Tech. Conf. (ANTEC) Society of Plastics Engineers, SPE; Statler-Hilton, Boston, Mass.  
 Mar. 21-24: 19th Annual Broadcast Eng. Conf., NAB; Sheraton-Park and Shoreham Hotels, Washington, D. C.  
 Mar. 22-25: IEEE Int'l Conv., IEEE; Coliseum & N. Y. Hilton Hotel, New York, N. Y.

## '65 Highlights

- IEEE Int'l Conv., Mar. 22-25; Coliseum, New York Hilton, New York, N. Y.  
 WESCON, Western Electronic Show & Conv., Aug. 24-27, IEEE WEMA; Cow Palace, San Francisco, Calif.  
 NEREM, Northeast Research & Eng. Mtg., Nov. 3-5, IEEE; Boston, Mass.

- Mar. 31-Apr. 2: 7th Annual Electron Beam Symp., Alloyd Corp.; Penna. State Univ., University Park, Penna.  
 Mar. 31-Apr. 4: National Electronics Week, EISC; N. Y. Hilton & Americana Hotels, New York, N. Y.

## April

- Apr. 5-6: Rubber & Plastics Industries Conf., RPI; Sheraton-Mayflower Hotel, Akron, Ohio.  
 Apr. 6-8: Railroad Conference, IEEE, ASME; Penn-Sheraton Hotel, Pittsburgh, Penna.  
 Apr. 13-15: Nat'l Telemetry Conf., IEEE, AIAA-ISA; Shamrock Hilton Hotel, Houston, Tex.  
 Apr. 14-15: Electronics & Instrumentation Conf. & Exhibit, IEEE & ISA; Cincinnati Garden, Cincinnati, Ohio.

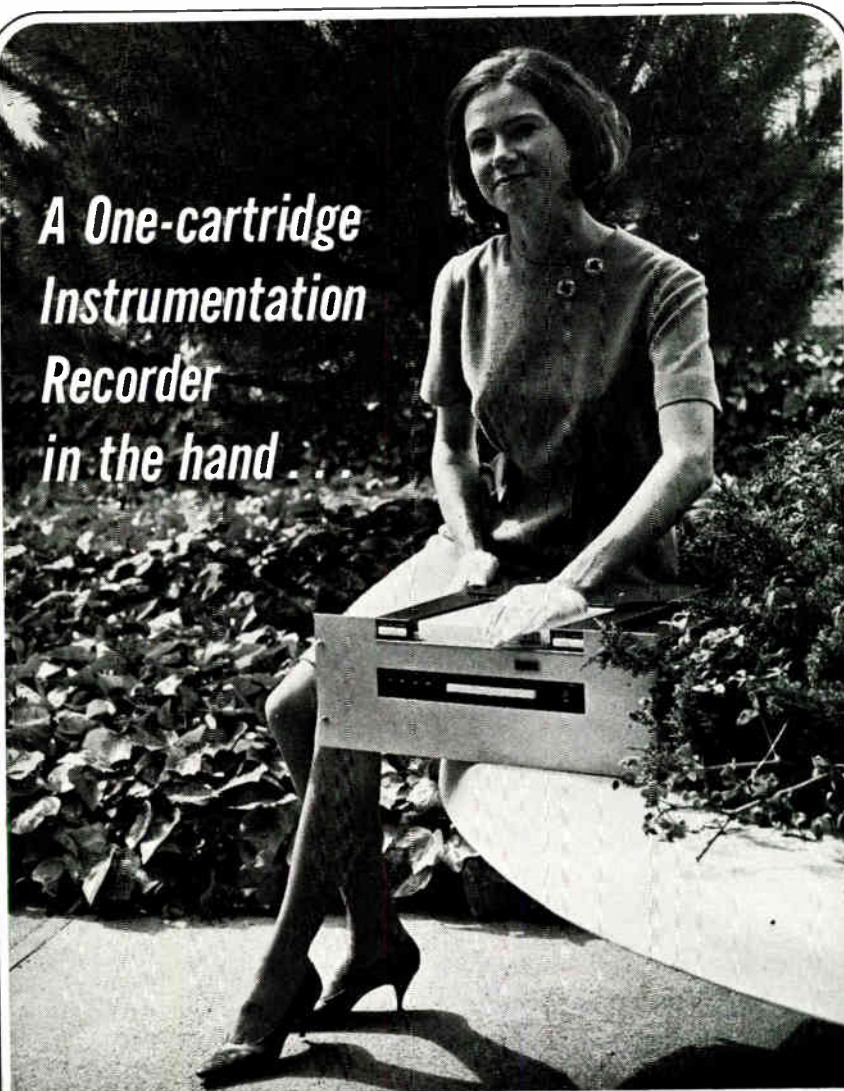

*A One-cartridge  
Instrumentation  
Recorder  
in the hand*

...is worth up to four straight hours of data logging in the bush—on a geological survey. In a laboratory—on a biomedical research project. Anywhere! The remarkable new KRS DATA-STACT™ MD-2 fits any need for a portable recorder with big tape capacity. This trim 20-pounder covers a range of DC to 100 kc, handles up to four channels, and gives you bigger performance features in a smaller package than any other portable tape recorder available today.

1200 FEET OF CONTINUOUS-LOOP TAPE! The handy size MD-2 recorder uses one KRS STACTape™ Cartridge—the precision magnetic tape cartridge that holds up to 1200 feet of ¼" tape in an endless-loop roll, and incorporates unique reversing and fast-forward features. Models are available in all standard tape speeds from 15½ to 30 ips.

WOW? FLUTTER? Extremely low, even at low tape speeds. Classically simple design eliminates all mechanical adjustments—you concentrate on your work, not the machine. Complete with solid-state standard instrumentation electronics (FM or Direct), MD-2 recorders sell in the price range of \$850 to \$2500.

™ Trademarks of KRS Electronics

For complete data on the new KRS DATA-STACT MD-2 Cartridge Instrumentation Recorder, send for Instrumentation Division Bulletin MD-2.



KRS Electronics, 2370 Charleston, Mountain View, California

4 5 6 8 9 7 2 3  
 7 5 9 3 8 2 1 6  
 2 4 8 6 7 5 1 3

*Beckman 1453  
 \$1,320\**

1 3 6 6 6 6 6 4  
 1 3 6 6 6 6 6 4  
 1 3 6 6 6 6 6 4  
 1 3 6 6 6 6 6 4  
 1 3 6 6 6 6 6 4

*Hewlett-Packard 562AR  
 \$1,715*

9 9 9 9 9 9 9 9  
 8 8 8 8 8 8 8 8  
 7 7 7 7 7 7 7 7  
 6 6 6 6 6 6 6 6  
 5 5 5 5 5 5 5 5  
 4 4 4 4 4 4 4 4  
 3 3 3 3 3 3 3 3  
 2 2 2 2 2 2 2 2  
 1 1 1 1 1 1 1 1  
 0 0 0 0 0 0 0 0

*CMC 410 Printer  
 \$1,480*

# Just one darn second!

\*Plus extras to make model comparable.

Actual size facsimile tapes show results of 1-second printing time.

Tear a piece of tape off all three big-name digital instrumentation printers. Compare speed and readability. One obviously prints at least twice as fast. Obviously one can be read without getting ink on your nose. One reason is, our new CMC 410 Printer is not just another rebuilt adding machine. Another reason: our logic conversion is all electronic. 35-millisecond data-gathering doesn't stall your source. The CMC 410 is quiet, compact (only half-rack size) solid-state, versatile, and all that. Our basic unit spews out 8-digit columns at 10 lines per sec. Column width expands to 12 digits. This new CMC 410 Printer is another step in our demiacal plan to unseat some of the other big names in this business. Wait 'til you see what's next! Incidentally, we still have some of our glorious Crusading Engineer medals lying about. We'd sure be happy to send you this status symbol along with the specs for the new CMC 410 Printer. Just write and ask. If you already have a medal, pin this one on your secretary... or are you man enough?



12976 Bradley • San Fernando, California • Phone (213) 367-2161 • TWX 213-764-5993

COMPUTER MEASUREMENTS COMPANY IS A LEADING DESIGNER AND MANUFACTURER OF ELECTRONIC INSTRUMENTATION TO COUNT, MEASURE, AND CONTROL.



University surveys indicate:

# STARTING SALARIES OF ENGINEERS ARE DECEPTIVELY HIGH

By James M. Jenks



TWO SEPARATE STUDIES of the salaries made by college graduates appear to contradict the commonly held belief that engineers today make out better financially than their classmates who major in non-technical subjects.

Both surveys were conducted by large universities. The first polled graduate engineers; the second, company executives. And both resulted in identical findings! That is, the average engineer today — despite a deceptively high starting salary—climbs fast but not far.

The need for technically trained men in recent years has exceeded the supply to such an extent that companies have been forced to bid for their services—to actually set-up “recruiting” offices on college campuses all over the country. Thus, starting salaries have gone up and up. But the income ceiling for these technically-trained men is lower than that for managerial personnel.

*Despite the substantial head start engineers have, the differential in money earned over a ten-year period averages out at \$7,000 more for the management man.*

And from the tenth year on, the administrator’s salary obviously outstrips that of the engineer by a wider and wider margin.

This, of course, is not to say that engineering students would be wise to shift to the study of business administration—or that working engineers face a bleak future. Quite to the contrary, the continuing growth of technology means that men with technical backgrounds are as ideally qualified for the highest rewards industry has

to offer—if they also have a knowledge of the underlying principles of business.

FREE...“FORGING AHEAD IN BUSINESS”

If you want to avoid the thorny barriers to success — if you’re ambitious, determined to move up fast — send today for the Institute’s 32-page descriptive booklet, “Forging Ahead in Business.”

It explains what a man must know today to make \$15,000 or more a year . . . what he must do to accumulate this knowledge. It tells why men of equal ability fare so differently in the race for better jobs and bigger salaries. It analyzes the causes of failure . . . the reasons for success. And it outlines an executive-training program which is so complete and so scientific that each day subscribers are brought a little closer to a mastery of business procedures.

There’s no charge for “Forging Ahead in Business.” And no obligation . . . other than the obligation to read it thoughtfully, and decide for yourself whether the training it describes is meant for you. To obtain your complimentary copy, simply fill out and return the coupon. It will be mailed to you promptly.

**ALEXANDER HAMILTON INSTITUTE**

235 East 42nd Street, New York 17, New York

ALEXANDER HAMILTON INSTITUTE

Dept. 593, 235 East 42nd Street  
New York 17, New York

In Canada: 57 Bloor St., W., Toronto, Ontario

Please mail me, without cost or obligation, your 32-page book,  
“Forging Ahead in Business.”

Name.....

Firm Name.....

Business Address.....

Position.....

Home Address.....

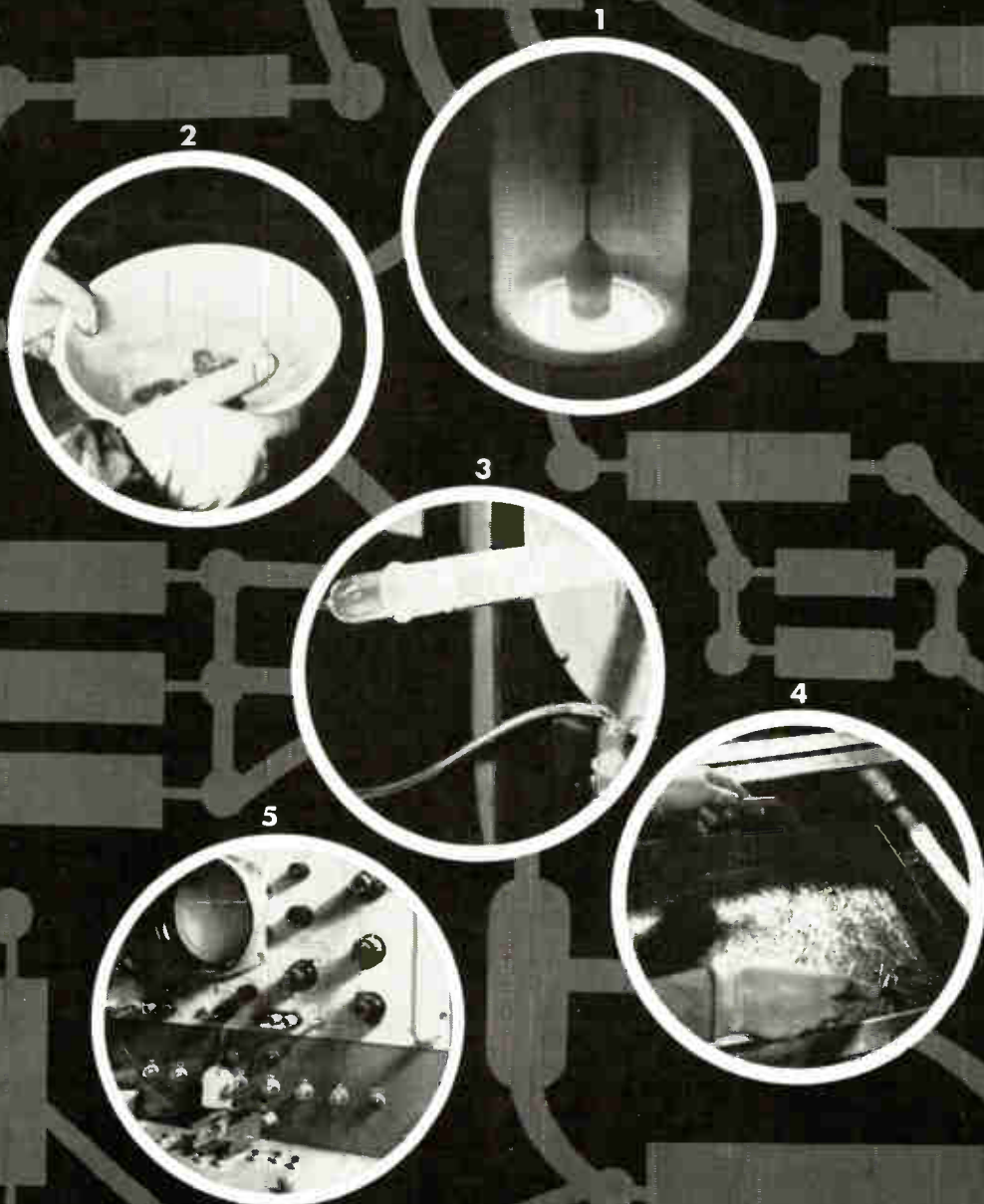

**What's our line? Electronic Chemicals.** Only Mallinckrodt makes such a complete line . . . just for the electronics industry. Look what's in it: Czochralski crystals **1** up to 1¼ inches in diameter. TransistAR® Etchants **2** including the first Ammonium Fluoride offered in convenient solution form. Dip, paint-on and diffusion dopants **3** . . . quality found nowhere else. Solvents with unusually low particulate levels . . . such as Trichloroethylene TransistAR **4**, the industry's standard cleaning solvent. For higher device yields, be sure of the purity and compatibility of your chemicals. Rely on the technical competence of Mallinckrodt . . . a company that knows electronics, as well as electronic chemicals. It'll pay off. **5** You can check it.

Mallinckrodt Chemical Works  Electronic Chemicals

St. Louis • New York • Los Angeles

Circle 14 on Inquiry Card

World Radio History



## New IBM Component Insertion Machine automatically assembles circuit cards at high speed – cuts unit costs, eliminates faulty assembly

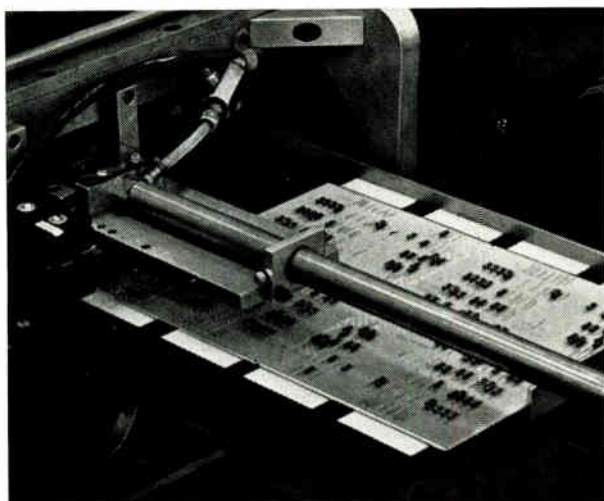

Circuit boards go in one end, perfectly assembled circuit packages come out the other.

We originally designed this machine to solve one of our own problems. Existing production equipment simply could not keep up with our need for

the proper components.

The ME 501 then automatically hopper-feeds printed

fast and reliable circuit board assembly.

The IBM Component Insertion Machine ME 501 not only solved that problem: it has saved us thousands of dollars a year by reducing unit assembly costs. Maybe it can do the same for you.

Because it's numerically controlled, the ME 501 can select components from 24 magazines in any random sequence. You decide the sequence you want to use then load the magazines with

circuit boards. It selects, positions, inserts and clinches up to 24 different ¼-watt resistors in printed circuit cards – at speeds up to 4500 components an hour. All automatically.

The IBM Component Insertion Machine features automatic self-checking. If a component cannot be inserted for any reason (faulty boards or faulty leads), the machine automatically repeats the attempt. If it fails a second time, it will stop and signal the operator. Once the operator corrects the problem, the ME 501 resumes automatic, self-checking operation.

Call us for more information or write: IBM Industrial Products Division, 1000 Westchester Avenue, White Plains, New York 10604.

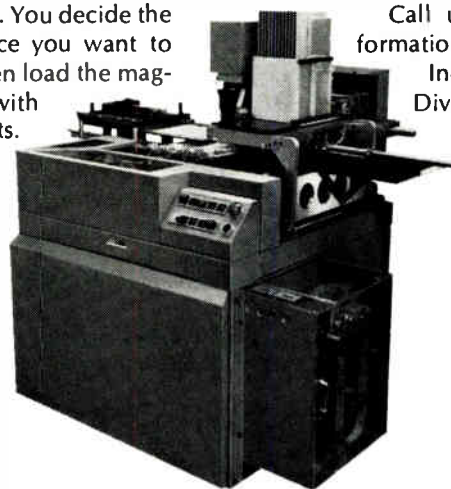

**NEW LOOK AT PATENTS**—Congress will have the final say in settling patent questions. But, the lead for action on a patent system review will come from the White House. A presidential commission will review the system and recommend legislation. The commission will concentrate on patent backlogs, filing problems, and also industry's rights.

**FCC MAY BYPASS CONGRESS**—One FCC officer, Robert E. Lee, thinks the Commission should ignore congressional limits imposed on FCC and should take over new areas without approval from Congress. He says he is now "willing to take the giant step of assuming jurisdiction of all community antenna television (CATV) systems." He urges fellow commissioners to join him. Supreme Court may be asked to rule on constitutionality.

**MORE STAR STUDIES ASKED**—Scientists participating in a NASA panel urged a 10-year, \$225 million expansion of ground telescope activity. They contend the U. S. leans too heavily on orbiting observatories and not enough on ground facilities. They recommend \$97 million for radar telescopes, \$68 million for optical telescopes, \$20 million for instruments, and \$40 million for operating costs. They suggest two more 300-foot radio telescopes of the kind at Green Bank, W. Va.

**GERMAN ELECTRONIC GROWTH**—U. S. Government electronics experts say that West German electronic firms will expand industrial and military production sharply in coming years and will become more competitive in the world market. There will be emphasis on commercial and military production, based on labor shortage, increased competition and government demands. There will be some growth in consumer electronics and component production. Despite this, however, experts also say that U. S. firms should be able to increase sales in West Germany.

**MORE TRADE WITH REDS?**—There's talk in Congress about relaxing bans on trade with Russia. The feeling is that restrictions on most space, nuclear, and electronic equipment are no longer important—Reds have technical know-how to duplicate most previous government secrets anyway. Shipment of such so-called strategic equipment has been and still is barred on the ground that it would enhance Red war-making capability. Through expanded export, U. S. firms can widen production and employment at home.

**NAVY 'SPECIAL PROJECT'**—The Navy has moved deep submergence systems into the special projects office—originator of the Polaris. A five-year program is under way to come up with complete program systems for working under water. Included will be much more sophisticated sensors, especially those for searching the ocean floor. Some \$61 million is needed for two-ocean operational capability of two search units.

**HARDWARE TREND TO REVERSE**—Air Force emphasis in the next decade may shift from missiles back to manned aircraft. As reasons, military experts cite the growing number of combat and support jobs for which the airplane is ideally suited. Missiles don't have such flexibility. Experts also report we are on the threshold of a revolution in aircraft technology—new systems will enhance aircraft capability.

**ACDA TURNABOUT**—U. S. Arms Control and Disarmament Agency signed a research contract with TRW Space Technology Labs to determine how ICBM's can be made and deployed more quickly. Paradox? ACDA wants to make sure no country that breaks a treaty limiting ICBM production could gain a military advantage.

**TESTING OF SOLAR CELLS**—Four solar cell panels will be tested by the Air Force in mid-1965 to learn which performs best in space. The four types: Gallium arsenide; cadmium sulfide thin-film; webbed silicon dendrite, and a V-ridge concentrating panel using conventional silicon cells. Panels were produced by Westinghouse, Boeing, RCA, and Harshaw Chemical.

**CONVERSION, CONVERSION**—A majority of government agencies are digging deep to help segments of industry switch to other products and markets. There seems to be more confusion, thus far, than actual help. The feeling in many circles is that a central point of information on the help/switch status would be welcomed by everyone, including some government people.

**ENGINEERING DATA RETRIEVAL**—Defense Supply Agency says pilot test of its engineering data retrieval system is working well and will probably become a full scale program by late next summer. Microfilm files are now at 25 defense contractor locations engaged in R&D. DSA hopes to reduce duplication in design, testing, documentation, search time, data management costs, and costs of entry of new items into the supply system.





# STEVENS *Certified* THERMOSTATS for electronic and aerospace applications

- If smaller size, lighter weight, utmost reliability and realistic costs are part of your product cosmos, take a long, hard look at Stevens *Certified* Thermostats.
- Because Stevens makes the broadest line of bimetal thermostats in the industry, you can get all the special features to fit your special requirements exactly right from a *proven*, standard production-line Stemco thermostat, or from a minor modification thereof. This also gets your product off the ground faster . . . by cutting lead time, slashing engineering and development costs.
- And we back Stemco Thermostats by Applications Engineering Service that's right out of this world. A card or call will bring our representative on the double.

**STEVENS** *manufacturing company, inc.*

P. O. Box 1007 • Mansfield, Ohio



## THERMOSTATS



### **Type MX Hermetic**

Snap-acting to open on temperature rise only. Copper housing responds more readily than steel types. Standard tolerances  $\pm 3^\circ\text{F}$  with 2 to  $6^\circ\text{F}$  differentials; 1 to  $4^\circ\text{F}$  differentials on special order. Temperature  $10^\circ$  to  $260^\circ\text{F}$ . Various terminals and mounting brackets. See Bulletin 6100.



### **Type AX Hermetic**

Similar to Type MX but to close on temperature rise. Wide selection of terminals and mounting provisions, highly responsive non-ferrous metal housing. 2 to  $6^\circ\text{F}$  differential. Bulletin 3200.



### **Type C Hermetic**

Field-adjustable, positive-acting. Electrically independent bimetal strip type for operation from  $-10^\circ$  to  $300^\circ\text{F}$ . Nickel-silver case with or without plating, depending on specifications. Turret terminals or wire leads. For ratings, etc., Bulletin 5000.



### **Type A Hermetic**

Electrically independent bimetal disc and high-response brass case for quick, snap-action control from  $-10^\circ$  to  $300^\circ\text{F}$ . Various non-ferrous metal enclosures, wide variety of terminal arrangements and mounting provisions, including brackets. Bulletin 3000.

\*Above Stemco Thermostats are designed and manufactured to meet most requirements of applicable MIL specifications.

# ELECTRONIC SNAPSHOTS

The Changing  
STATE-OF-THE-ART  
in the electronic industries

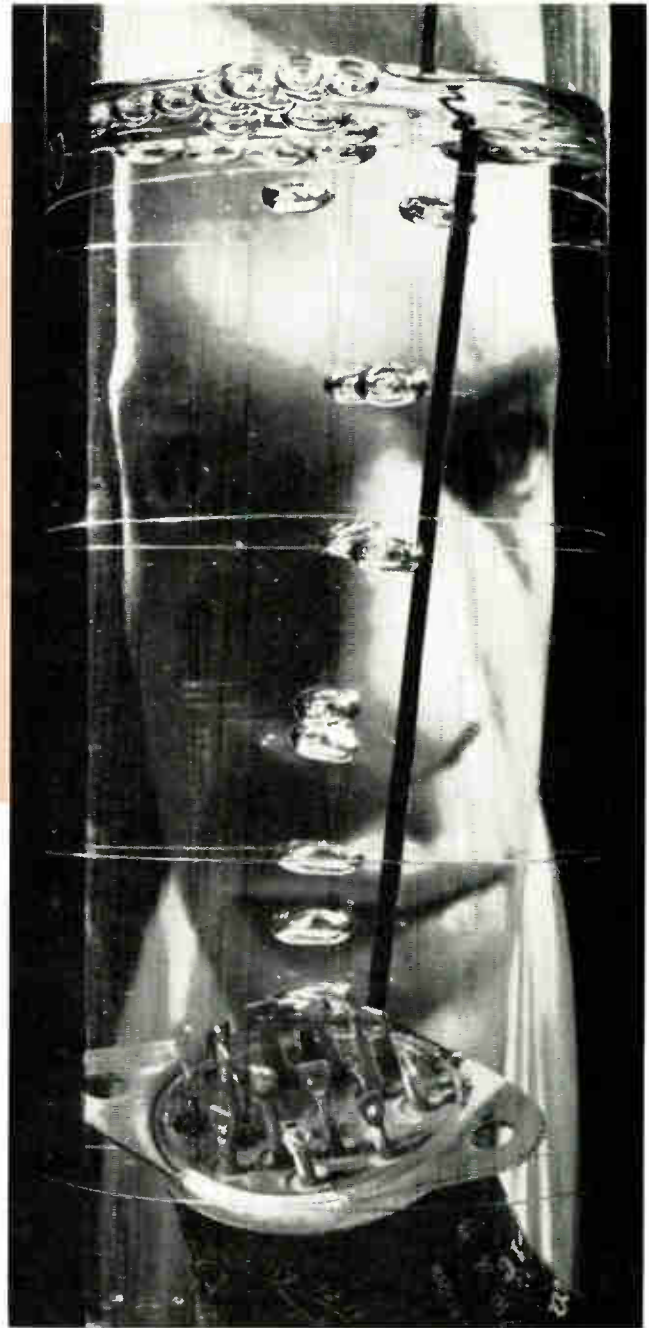

## ▲ TEST FOR LEAKAGE

Technician peers into column of water and watches electronic part sink in a shower of bubbles during tests at Astronautics Division of General Dynamics, Corp. Tests show whether parts are sealed according to military specs. after several hours of helium pressure.



## ▲ MICROWAVE DARKROOM

New design in anechoic chamber developed by B. F. Goodrich Co. Tapered chamber is now in use at Bunker-Ramo Corp. The largest of its type, it operates from 100MC to 100GC.

## MICROFILM UP-DATER ►

New system by General Precision allows micro film to be up-dated without film processing. The system (PARD—for Precision Annotated Retrieval Display) stores 500,000 data items on 5,000 EAM-Cards. PARD produces cards in six seconds and zoom magnifies them.





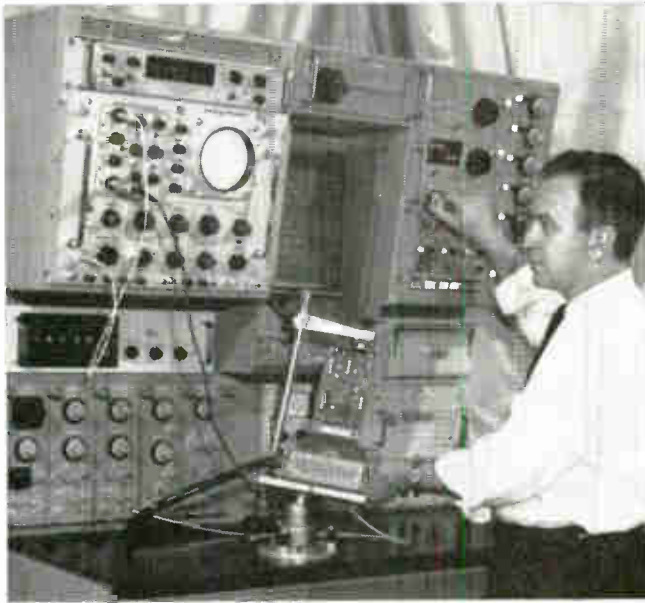

▲ **MODULE ANALYZER FOR RADAR**

Norden engineer Leo McCue tests module of APQ-92 search radar on Norden's module analyzer test console. The MATC will be installed on the USS Independence, first to deploy the Grumman A-6A Intruder. Grumman Aircraft Engineering Corp. has ordered six more consoles.



◀ **HAYSTACK RADAR**

Precision antenna of Haystack radio/radar research facility. The 120-foot dish will be used by M.I.T. and the Air Force for communications and radar experiments.



▲ **SPACECRAFT SOLAR ARRAY TEST**

World War II 40 mm anti-aircraft mechanism converted to peace-time science use as a sun tracker for Pioneer spacecraft by TRW Space Technology Labs. Tracker keeps Pioneer inside "gun barrel" exposed to sun rays.

◀ **MICROWAVE TOWER**

Microwave antenna on Western Union building in New York City, one of 267 stations on firm's new 7,500-mile transcontinental microwave system. The system is capable of handling all digital and analog signals.

# Introducing Photo-Draft

## New automated system that produces detailed schematics 10 times faster than a draftsman



Now, free your professional designer or skilled technical draftsman from routine production drafting with this revolutionary system. With Photo-Draft, the average stenographer with very little training can start with an engineer's rough sketch and "type" reproducible schematics by photo-mechanical means in a tenth of the time it now takes. The result? A significant gain in overall man-hour efficiency!

There are savings on paper costs, too. You use A-size (8½" x 11"), not C-size (17" x 22") drafting

paper. Furthermore, quantity diagrams can be reproduced inexpensively on office-type printing machines on standard offset stock.

And Photo-Draft is flexible. It will grow with you. Today, it fits the scope of your needs like a glove. Tomorrow, it can meet your expanding needs just as efficiently.

For complete specifications and application information on this major advance, see your K&E dealer. Or contact Keuffel & Esser Co., Hoboken, New Jersey.

**KEUFFEL & ESSER CO.**





# OHMITE

Exclusive adjustable extension shafts  
Unique heat-sink quick-change brushes

Exclusive,  
smallest size  
transformer



Model VT1 (1.0 and 1.2 amp)

New  
intermediate  
size transformer



Model VT3 (2.6 and 3.0 amp)

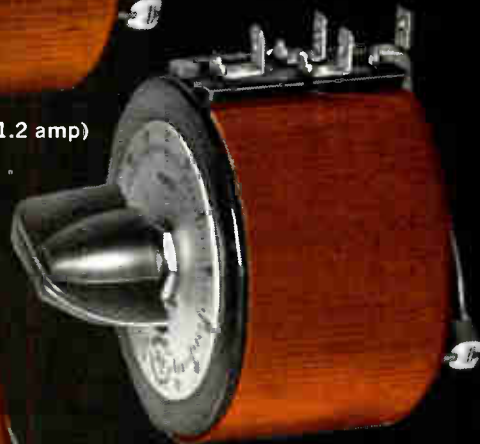

Model VT02 (1.75 and 2.0 amp)

## it's triplets!



SHOWN 2/3 SIZE

## New low-power variable transformers

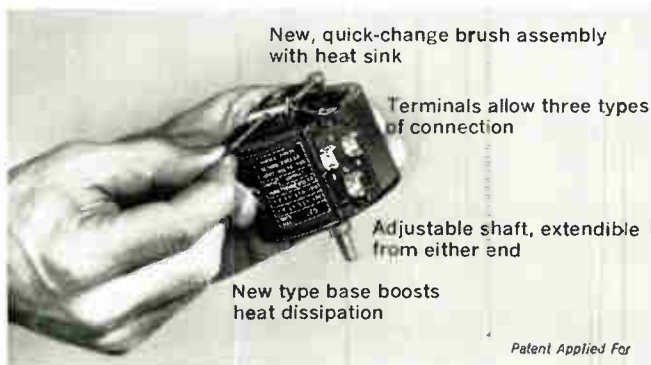

New, quick-change brush assembly with heat sink

Terminals allow three types of connection

Adjustable shaft, extendible from either end

New type base boosts heat dissipation

Patent Applied For

■ There are lots of exciting things about this new series of Ohmite v.t.<sup>®</sup> transformers. They give you six closely spaced ratings down to one ampere . . . plus quickly replaceable brushes that can't work loose or get out of alignment . . . plus insulated metal bases that boost heat dissipation . . . plus terminals you can connect to by soldering, 1/4" push-on connectors, or No. 2 screws and nuts . . . plus adjustable shaft, extendible from either end. Input is 120 volts. Variations include fixed and portable enclosures, ganged assemblies, and motor-driven arrangements. *WRITE FOR BULLETIN.*



# OHMITE

MANUFACTURING COMPANY  
3662 Howard Street, Skokie, Illinois 60076  
Phone: (312) ORchard 5-2600

RHEOSTATS • POWER RESISTORS • PRECISION RESISTORS • VARIABLE TRANSFORMERS • TANTALUM CAPACITORS • TAP SWITCHES • RELAYS • R.F. CHOKES • SEMICONDUCTOR DIODES

# 1965 REVIEW and FORECAST for the ELECTRONIC INDUSTRIES

By **ROBERT J. BRAMLETT**  
Assistant Editor  
and **EDWARD G. SHAUD, Jr.**  
Marketing Manager  
ELECTRONIC INDUSTRIES

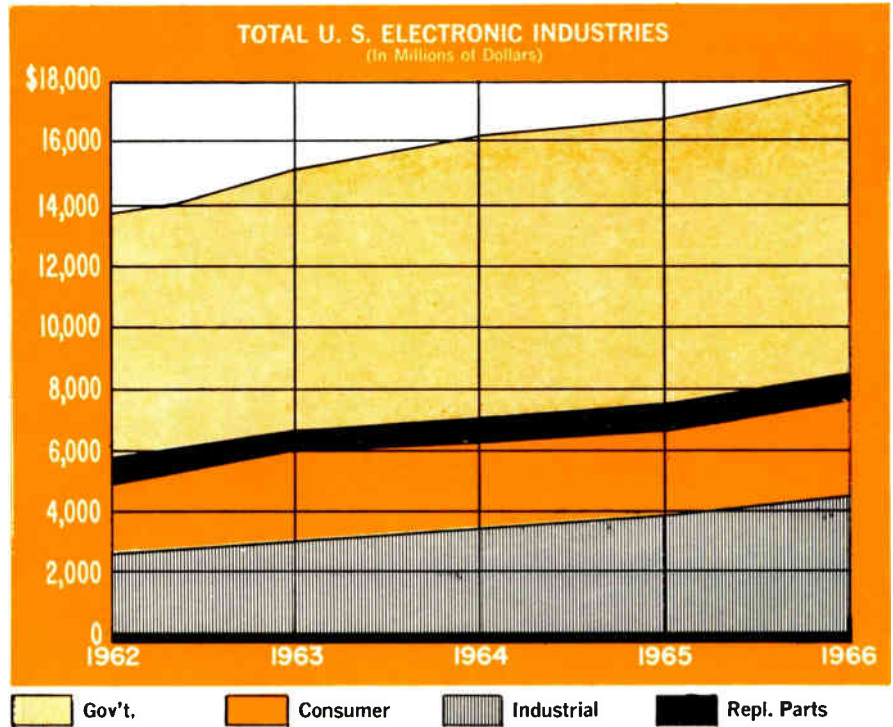

**ELECTRONIC INDUSTRIES**  
(In Millions of Dollars)

	1962	1963	1964	1965	1966
<b>TOTAL</b>	\$13,817	\$15,125	\$16,136	\$17,022	\$17,905
Government	8,080	8,940	9,366	9,615	9,820
Industrial	2,710	3,060	3,430	3,877	4,350
Consumer	2,407	2,535	2,720	2,880	3,050
Replacement Components	620	590	620	650	685

THE U. S. ELECTRONIC INDUSTRIES have again rung up a record level of total sales—though the growth rate was not quite as spectacular as in recent years.

Estimated sales of \$16,136,000,000 for electronic products sold in 1964 put the total about a billion-dollars ahead of 1963's \$15,125,000,000.

The industry reached this 16-billion-dollar level in spite of moderately severe cuts in defense contracts, and the failure of more than 118 electronic firms—a new high.

While nearly all major segments of the electronic industries showed gains, there was a marked difference in their growth rates.

For 1965, sales of electronic products within U. S. industry are expected to increase by 13%, and consumer sales may increase as much as 5.9%. Although still the biggest customer for electronic goods, the U. S. Government is expected to buy enough to account for a sales increase of only 2.6% for 1965.

The electronic industries are emerging from a period of rapid growth. The defense budget increased by about 40% in the past decade; NASA has come on the scene at a \$5-billion-plus spender, of which \$1.3 billion was spent on electronic products and systems in 1964.

Looking toward the second half of the 1960s, the electronic industries foresee yearly sales increases. The growth rate, however, is expected to diminish slightly, though no minimum or plateau is expected in the foreseeable future.

The prediction for total sales for the electronic industries in 1965 is a level of slightly higher than \$17 billion, another record in dollar sales volume. For 1966 the forecast is for nearly \$18 billion—not quite as high a percentage increase, but still another sales record.

As the growth of the defense market slows, industry experts look for ways to fill the gap. Consumer products,

industrial controls, automation, and expanded foreign markets are receiving increased attention.

Annual sales of U. S. electronic products now account for about 2.6% of the U. S. gross national product, which in 1964 is estimated at \$624 billion.

## International Markets

The U. S. now produces about 60% of the total world output of electronic products. The Common Market nations, or European Economic Community (EEC), comprise the next largest single producing area. Japan ranks third, as an individual nation.

Of the estimated total of \$865 million in exports of U. S. electronic products in 1963 (the latest figure available), Canada received the largest share, nearly \$112 million. The United Kingdom imported more than \$47 million; France received U. S. exports valued at \$67 million; and West Germany took some \$87 million. Exports to the EEC totalled nearly \$195 million.

## ESTIMATED WORLD ELECTRONIC OUTPUT

(In Millions of Dollars)

	1962	1963	1964	1965	1966
<b>TOTAL</b>	\$22,000	\$24,300	\$26,300	\$28,400	\$30,300
United States	13,800	15,100	16,100	17,000	17,900
Japan	1,600	1,900	2,500	3,000	3,400
Britain	1,500	1,600	1,700	1,800	1,900
<b>European Economic Community</b>	3,800	4,300	4,500	5,000	5,400
Canada and other nations	1,300	1,400	1,500	1,600	1,700



## ELECTRONIC R & D FUNDS

Dispersal for 1964-'65  
(E. I. Estimate by %)

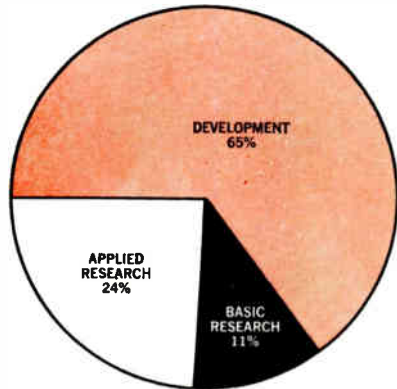

**DEVELOPMENT** — design and production of new products.

**APPLIED RESEARCH** — for product development and design.

**BASIC RESEARCH** — pure science and theory.

**SOURCES OF FUNDS FOR ALL R & D**  
(In Millions of Dollars)

	1962	1963	1964	1965	1966
<b>TOTAL</b>	\$16,000	\$18,000	\$20,000	\$22,000	\$24,000
Federal	11,040	12,420	13,800	15,180	16,560
Industry	4,480	5,040	5,600	6,160	6,720
Non-Profit	480	540	600	660	720

## ELECTRONIC RESEARCH & DEVELOPMENT EXPENDITURES

(In Millions of Dollars)

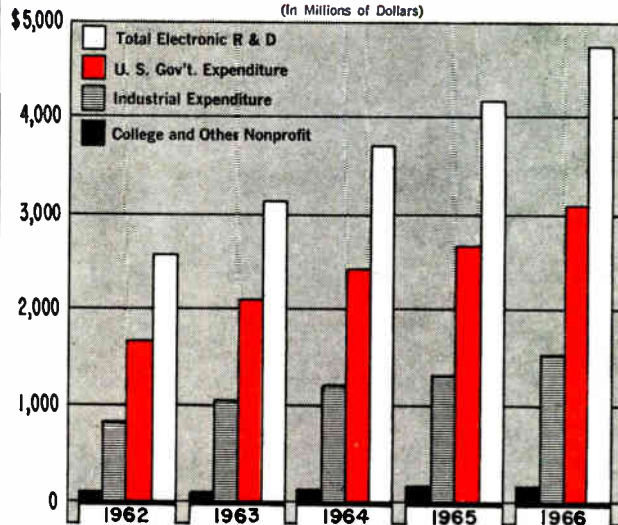

**SOURCES OF FUNDS FOR ELECTRONIC R & D**  
(In Millions of Dollars)

	1962	1963	1964	1965	1966
<b>TOTAL</b>	\$2,618	\$3,226	\$3,690	\$4,150	\$4,770
Federal	1,700	2,100	2,400	2,700	3,100
Industry	838	1,030	1,180	1,325	1,527
Non-Profit	80	96	110	125	143

Biggest exporter to the U. S. has been, and still is, Japan which shipped nearly \$162 million of its electronic goods into this country in 1963. The 1964 total is expected to be nearly 5% more. Canada is a distant second with slightly more than \$53 million. The EEC exported \$43 million in electronic goods to the U. S. in 1963 and the United Kingdom \$36 million. If U. S. trade barriers are relaxed, imports could rise substantially in the next few years.

Although total dollar sales volume is much less than that of the U. S., the aggregate rate of growth in electronic output in all other countries taken together appears to be nearly 15%. Current rate of growth of U. S. sales in electronic goods is about 5.5%. By far the fastest grower in electronic output, so far, is Japan. Dollar volume of Japan's electronic output in 1964 could reach \$2.5 billion.

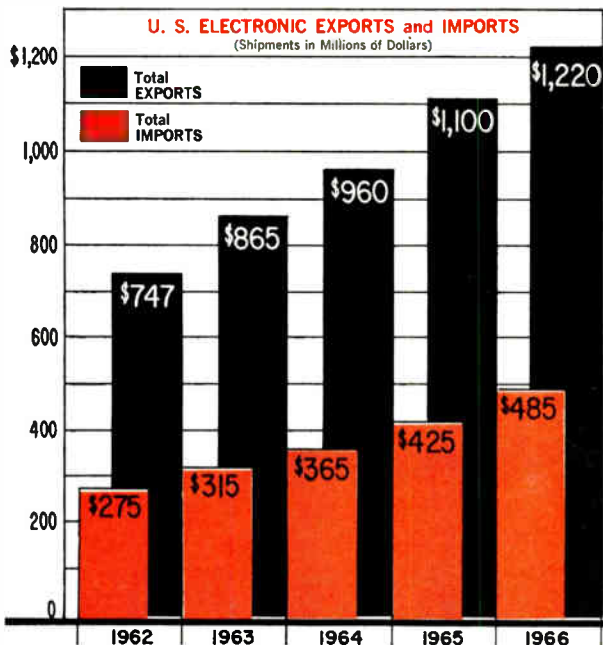

## Research and Development

Expenditures for research and development, including basic research, are at a high level, and should continue to increase during the next few years. Detailed figures on R&D expenditures are somewhat elusive. Current estimates put the total for electronic R&D in 1964 at about \$3.7 billion. This includes funds from government, industrial, and private non-profit sources. The government, alone, spent \$2.4 billion.

Total expenditures in 1964 for all R&D in all scientific disciplines are currently estimated at \$20 billion. By 1966, total expenditures for R&D may approach \$24 billion. The U. S. government share of the 1964 total is about \$13.8 billion.

Average current dispersal of funds for electronic research and development are estimated as follows: for development (design and production of new products)—65%; for applied research (product development and design)—24%; for basic research (pure science and theory)—11%.

## Government

Defense electronic procurement has begun to level off, and it is not likely that NASA space funds will completely offset the lag—though they will help. Nearly \$2 billion has been trimmed from DOD's 1965 fiscal year budget. Between now and 1970, procurement of some items is likely to decline from 3% to 5% yearly. The government is well-stocked with missiles, rockets, and airplanes, and auxiliary systems; much of it is almost brand new. Unless U. S. industry develops star-

**ELECTRONIC INDUSTRIES SALES AS PERCENTAGE OF GROSS NATIONAL PRODUCT**  
(In Billions of Dollars)

	1962	1963	1964	1965	1966
<b>GNP</b>	\$556	\$584	\$624	\$661	\$694
<b>ELECTRONIC</b>	13.8	15.1	16.1	17.0	17.9
<b>Percent</b>	2.49%	2.59%	2.59%	2.57%	2.58%

**REVIEW  
AND  
FORECAST  
(Continued)**

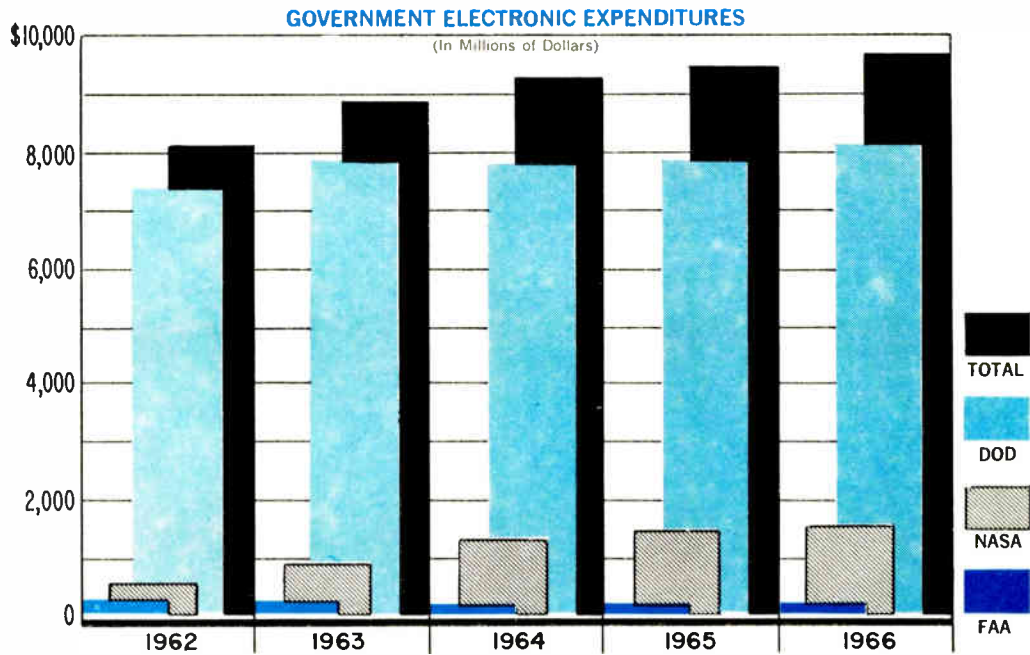

ting innovations, DOD and other Federal agencies are unlikely to do much more shopping for awhile.

The electronic content of annual total DOD budget, however, should remain comfortably in the 16% to 17% level for a few years.

DOD remains the single biggest customer for electronic hardware and components. DOD's money bought about \$7.9 billion in electronic goods and services in 1964. The expected for 1965 is about \$8 billion. NASA on the other hand is expected to buy about \$1.5 billion in electronic products for space in 1965, against an estimated \$1.3 billion in 1964. The FAA, though small in comparison, could develop into an attractive market for some specialty firms.

As in recent years, a large part of the total government money spent in 1964 went for tracking, control, telemetry, and general EDP systems used for aircraft, missiles, and rockets. Largest single portion was for RDT&E (research, development, test and evaluation), which is included in overall government R&D expenditures.

For separate and detached electronics equipment and communications gear (not manufactured into missiles, aircraft, or ships) DOD paid more than \$1 billion in 1964, and may increase this by more than 25% in 1965.

All in all, the Government will probably buy slightly more electronic gear each year, but no great increases are anticipated.

**Consumer**

Consumer buying accounted for \$2.7 billion in 1964, compared with \$2.5 billion in 1963—more than a 7% rise.

Sales of television receivers showed substantial growth from 1963 to 1964. Estimated sales for 1964, including all types, were \$1.2 billion. Fastest growth rate in consumer electronic products belongs to color television.

A sales level of slightly more than \$3 billion is predicted for 1966; consumer sales should keep pace with an expected increase in disposable personal income. Pacing the consumer electronic market will be sales in color television which are expected to show total sales increases of more than \$200 million by 1966.

Additional sales of about \$50 million by 1966 should result from marketing such items as electronic organs, electronic ovens, toys, and consumer communications equipment.

Faster and newer developments in industrial and consumer electronics are expected to eventually fill the market gap left by declining government procurement.

**GOVERNMENT ELECTRONIC EXPENDITURES**  
(In Millions of Dollars)

	1962	1963	1964	1965	1966
<b>TOTAL</b>	\$8,080	\$8,940	\$9,366	\$9,615	\$9,820
<b>DOD</b>	7,360	7,834	7,931	7,980	8,025
<b>NASA</b>	560	956	1,310	1,500	1,650
<b>FAA</b>	160	150	125	135	145

**DEPARTMENT OF DEFENSE  
ELECTRONIC EXPENDITURES**  
(In Millions of Dollars)

	1964	1965	1966
<b>TOTAL</b>	\$7,931	\$7,980	\$8,025
<b>Procurement</b>	4,410	4,400	4,380
Aircraft	1,350	1,300	1,250
Missiles	1,402	1,250	1,050
Ships	498	475	465
Ordnance, Vehicles, etc.	97	95	95
<b>Electronics &amp; Communications</b>	1,041	1,260	1,500
Other	22	20	20
<b>Operation &amp; Maintenance</b>	1,388	1,410	1,425
<b>R. D. T. &amp; E.</b>	2,007	2,050	2,100
<b>Military Construction</b>	55	50	50
<b>Other</b>	71	70	70

**Industrial**

Some sources predict that the future growth of the electronic industries depends upon the industrial and consumer markets. This surely seems so when we observe that both segments experienced outstanding rises from 1963 to 1964. Industrial electronic sales accounted for more than a 12% rise from \$3.06 billion in 1963 to more than an estimated \$3.4 billion in 1964.

In contrast, there was a rise of more than 10% in government procurement in 1963 over 1962; and only a 5% increase in 1964 over 1963.

Largest part of electronic hardware purchased by industry was in computing and data processing equipment, at \$1.38 billion for 1964. The next largest part was communications equipment used by industry and common carrier firms. Total sales for such hardware in 1964 are estimated at about \$1.06 billion.



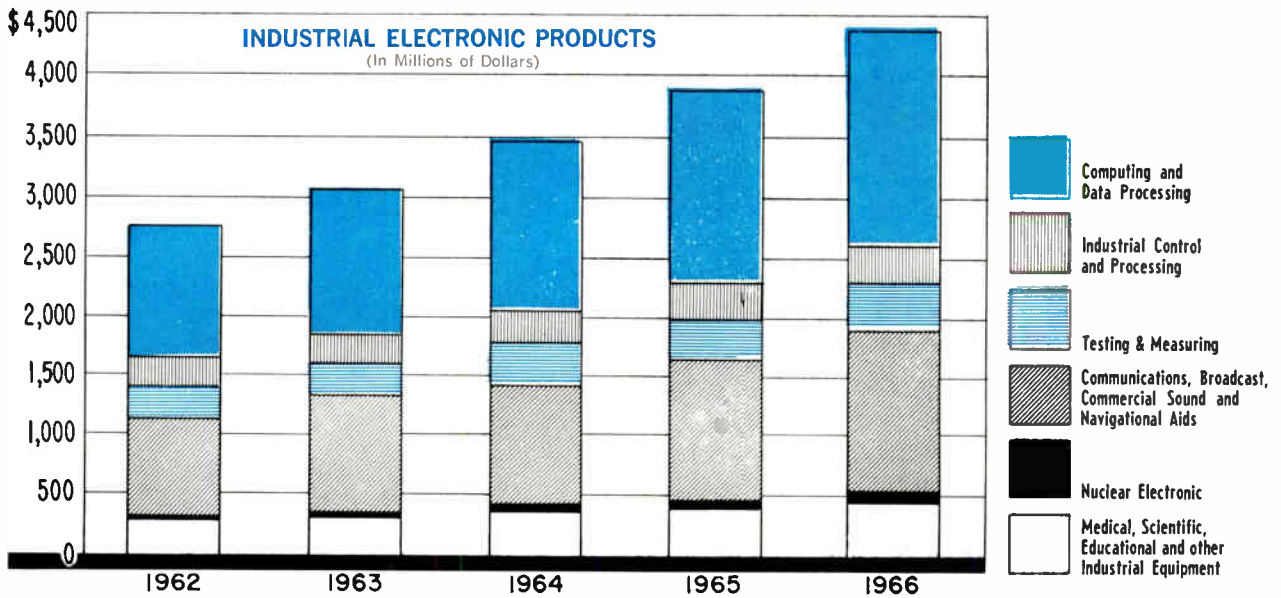

**INDUSTRIAL ELECTRONIC MARKET**  
(In Millions of Dollars)

	1962	1963	1964	1965	1966
<b>TOTAL</b>	<b>\$2,710</b>	<b>\$3,060</b>	<b>\$3,430</b>	<b>\$3,877</b>	<b>\$4,350</b>
Computing & Data Processing	1,065	1,240	1,375	1,600	1,800
Industrial Control & Processing	215	244	270	310	360
Test & Measuring	260	280	300	330	365
Communications, Broadcast, Commercial Sound & Navigation Aids	860	935	1,065	1,170	1,310
Nuclear Electronic	44	47	55	57	60
Medical, Scientific, Educational & Other Industrial Equip.	266	314	365	410	455

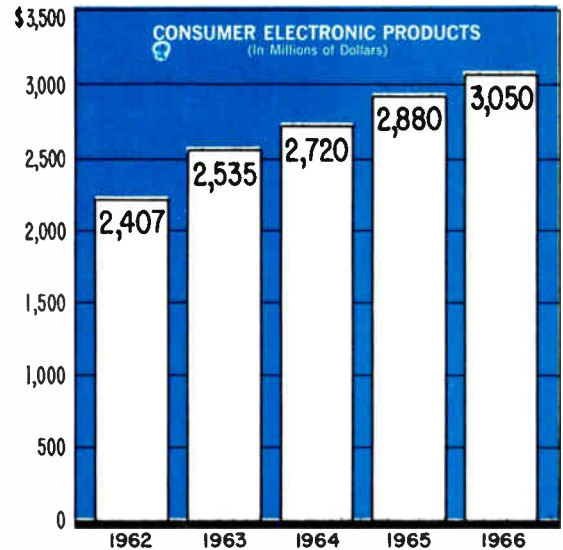
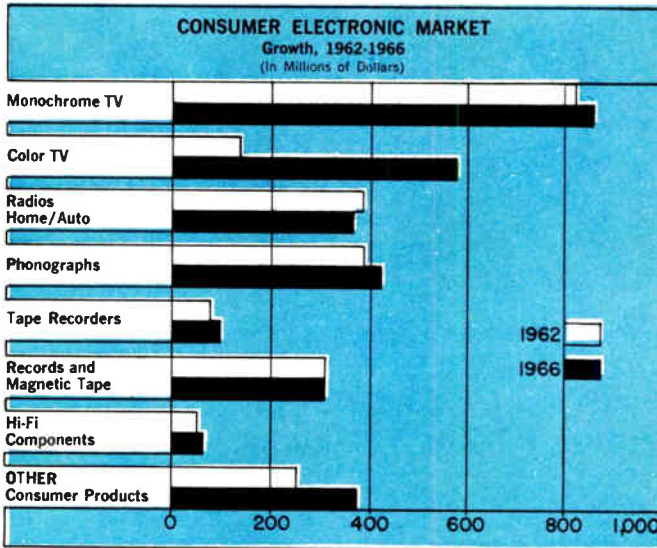

**CONSUMER ELECTRONIC MARKET**  
(In Millions of Dollars)

	1962	1963	1964	1965	1966
<b>TOTAL</b>	<b>\$2,407</b>	<b>\$2,535</b>	<b>\$2,720</b>	<b>\$2,880</b>	<b>\$3,050</b>
Television	953	1,030	1,200	1,315	1,440
Monochrome	822	833	850	855	860
Color	131	197	350	460	580
Radio	386	383	365	360	360
Home	205	177	155	150	150
Auto	181	206	210	210	210
Phonographs	385	417	405	410	415
Tape Recorders	75	80	85	90	95
Records & Magnetic Tape	310	286	290	300	310
High Fidelity Components	48	48	50	55	55
Other Consumer Products*	250	291	325	350	375

\* Includes electronic organs, pleasure boating equipment, home training kits, electronic ovens, toys, etc.

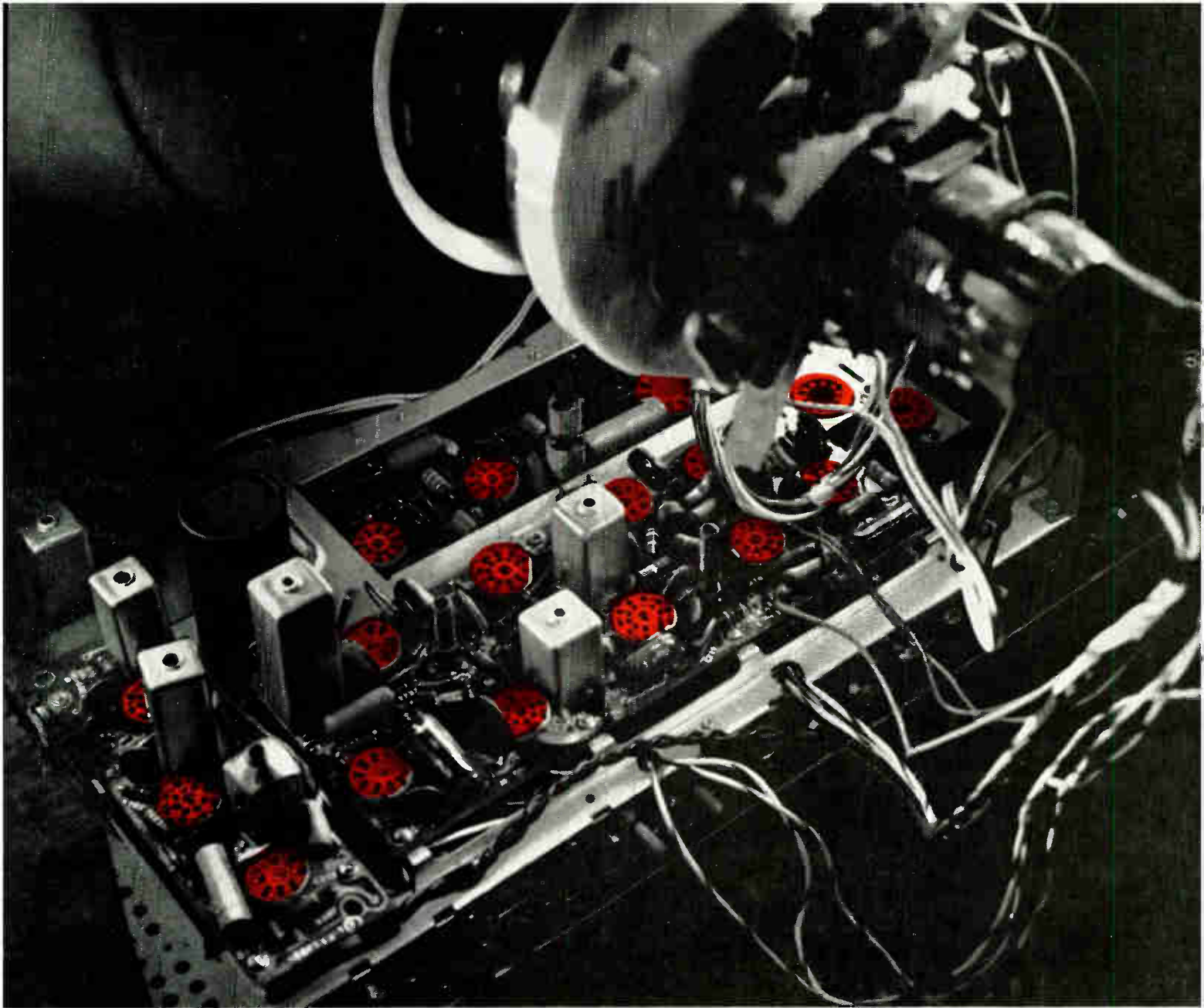

## For the best possible color-TV picture **THESE SOCKETS NEED COLOR-TV RECEIVING TUBES BY RCA**

In today's growing and highly-competitive color-TV market, your company's reputation rides on the performance of the color sets you manufacture.

That's why it's so important that you specify dependable RCA COLOR-TV RECEIVING TUBES for every socket.

### **What's so special about RCA COLOR-TV RECEIVING TUBES?**

As pioneer of today's compatible color TV, RCA has accumulated knowledge of color-TV circuitry that is unmatched in the industry. This knowledge has enabled us to select and develop the group of receiving tubes that best meet the exacting requirements of today's high-fidelity color TV.

The tubes have been field-proven in thousands of color-TV sets across the nation.

Samples of each week's production of RCA COLOR-TV RECEIVING TUBES are given exhaustive tests, under actual field conditions, in our Tube Reliability Laboratory. The performance of these sample tubes must meet rigid quality standards before their respective production lots are released to the warehouses.

**This group of RCA tubes offers color-TV manufacturers the best combination of price, performance and reliability on the market today.**

**RCA ELECTRONIC COMPONENTS AND DEVICES, HARRISON, N. J.**

**RCA DISTRICT OFFICES**—EAST: 32 Green St., Newark, N. J. 07102, (201) 485-3900 • MID-ATLANTIC: 605 Mar tan Pike, Haddonfield, N. J. 08034, (609) 428-4802 • MID-CENTRAL: 2511 East 46th St., Building Q2, Atkinson Square, Indianapolis, Ind. 46205, (317) 546-4001 • CENTRAL: 1154 Merchandise Mart Plaza, Chicago, Ill. 60654, (312) 527-2900 • WEST: 6363 Sunset Blvd., Hollywood, Calif. 90028, (213) 461-9171



**The Most Trusted Name in Electronics**



# REVIEW AND FORECAST (Continued)

## FACTORY SALES OF SELECTED ELECTRONIC COMPONENTS

(In thousands of dollars)

	1963	1964	1965		1963	1964	1965
<b>RECEIVING TUBES</b>	\$280,000	\$264,000	\$240,000	<b>CAPACITORS</b>	\$343,000	\$353,000	\$364,000
Subminiature	15,000	13,000	12,000	Paper dielectric	54,000	56,000	58,000
Miniature	197,000	187,000	170,000	Film dielectric	28,000	29,000	30,000
Standard Glass (G & CT)	58,000	55,000	50,000	Metallized paper, film and dual dielectric	36,000	37,000	38,000
Other (metal, ceramic, lock-in, etc.)	10,000	9,000	8,000	Electrolytic	123,000	126,000	130,000
				Aluminum	65,000	66,000	68,000
				Tantalum	58,000	60,000	62,000
<b>RESISTORS</b>	\$333,000	\$344,000	\$353,000	Mica, glass and vitreous enamel dielectric, fixed	33,000	34,000	35,000
Fixed, composition	70,000	72,000	74,000	Ceramic dielectric, fixed	42,000	43,000	44,000
Fixed, deposited carbon and borocarbon	24,000	25,000	25,000	Variable	27,000	28,000	29,000
Fixed, metal film	32,000	33,000	34,000				
Fixed, wire wound	50,000	52,000	53,000	<b>CONNECTORS</b>	\$258,000	\$266,000	\$274,000
Variable, non-wire wound	60,000	62,000	64,000	Coaxial	31,000	32,000	33,000
Variable, wire wound	74,000	76,000	79,000	Cylindrical	94,000	97,000	100,000
Attenuators, voltmeters, multipliers, etc.	5,000	5,000	5,000	Multiple contact (rack and panel)	61,000	63,000	65,000
Other (including varistors and thermistors)	18,000	19,000	19,000	Fusion sealed (except coaxial)	8,000	8,000	8,000
				Printed circuit	34,000	35,000	36,000
				Miscellaneous (Special purpose connectors)	30,000	31,000	32,000
<b>SEMICONDUCTOR DEVICES</b>	\$586,000	\$610,000	\$628,000	<b>QUARTZ CRYSTALS</b>	\$ 43,000	\$ 47,000	\$ 50,000
Diodes and rectifiers	197,000	213,000	224,000	Hermetically sealed, glass or metal case	42,000	46,000	49,000
Germanium	40,000	38,000	35,000	Clip mounted-plated	20,000	21,000	23,000
Silicon	138,000	155,000	168,000	Pressure and wire mounted	22,000	25,000	26,000
Selenium and copper oxide	19,000	20,000	21,000	Other (including unsealed, plastic case)	1,000	1,000	1,000
Special and light sensitive semiconductor devices	85,000	87,000	90,000				
Voltage regulator diodes	30,000	30,000	31,000	<b>POWER AND SPECIAL PURPOSE TUBES</b>	\$301,000	\$295,000	\$290,000
Voltage reference diodes	8,000	8,000	8,000	High vacuum tubes	74,000	71,000	69,000
Multi-layer devices (controlled rectifiers, PNP diodes, and related devices)	20,000	21,000	22,000	Gas and vapor tubes	23,000	22,000	21,000
Microwave diodes (mixers and detectors)	7,000	7,000	8,000	Klystrons	50,000	48,000	46,000
Variable capacitance diodes (including parametric diodes, harmonic generators, etc.)	3,000	4,000	4,000	Magnetrons	36,000	35,000	34,000
Tunnel diodes	2,000	2,000	2,000	Forward and backward wave tubes	52,000	51,000	49,000
Light sensitive semiconductor devices	15,000	15,000	15,000	Light sensing tubes	21,000	22,000	23,000
Transistors	304,000	310,000	314,000	Light emitting, storage and display tubes	27,000	27,000	28,000
Germanium	165,000	160,000	145,000	Other	18,000	19,000	20,000
Silicon	139,000	150,000	169,000				
<b>TV PICTURE TUBES</b>	\$276,000	\$285,000	\$296,000	<b>RELAYS (For Elec. Appl.)</b>	\$195,000	\$201,000	\$208,000
				Clapper rotary, plunger or solenoid (except telephone types)	94,000	97,000	100,000
				Telephone types	23,000	24,000	25,000
				Crystal can types	22,000	22,000	23,000
				Stepping switches	12,000	12,000	13,000
				Thermal	4,000	4,000	4,000
				Other (including coaxial, mercury wetted and motor driven relays)	40,000	42,000	43,000
<b>TRANSFORMERS AND REACTORS</b>							
(By Grades MIL-T-27A)	\$204,000	\$210,000	\$216,000				
Other than toroidal	175,000	180,000	185,000				
Toroidal	29,000	30,000	31,000				

### SOURCES OF STATISTICAL DATA

Battelle Memorial Institute  
 Dept. of Commerce, BDSA, Electronics Div.  
 Department of Labor  
 Economic Index & Surveys, Inc.  
 Lionel D. Edie & Co.  
 Electronic Industries Association  
 ELECTRONIC INDUSTRIES Marketing Department  
 Industry Survey/Standard and Poors  
 National Aeronautics and Space Administration  
 National Science Foundation  
 Sprague Electric Co.  
 Sylvania Electric Products Inc.

For further information on marketing statistics or any other phase of ELECTRONIC INDUSTRIES Marketing Assistance Program (M-A-P) contact:

Edward G. Shaud, Jr.  
 Marketing Manager  
 ELECTRONIC INDUSTRIES  
 Chestnut & 56th Streets  
 Philadelphia, Pennsylvania 19139  
 Area Code 215, SHERWOOD 8-2000

## REVIEW AND FORECAST (Concluded)

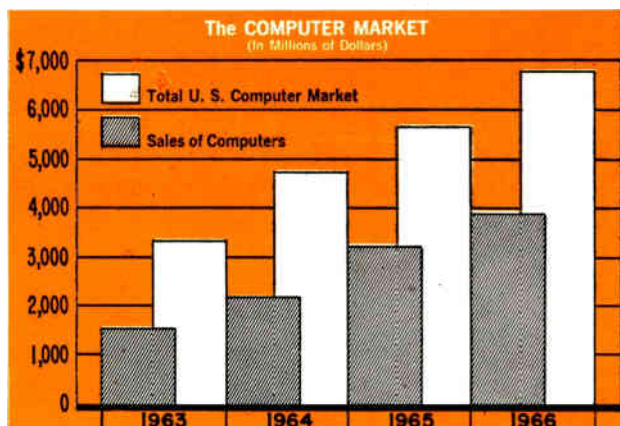

**INTEGRATED CIRCUIT PACKAGES**  
(In Millions of Dollars)

	1962	1963	1964	1965	1966
<b>TOTAL</b>	\$110	\$155	\$197	\$252	\$329
Filters	34	44	51	59	68
RCL Modules	12	14	17	20	23
Functional Assemblies	49	75	91	110	133
Microelectronic Circuits	15	22	38	63	105
Thin-Film Semiconductor	5	6	12	22	42
	10	16	26	41	63

## Computers

Sales of computing and data processing equipment accounted for \$1.5 billion in 1963 and are estimated at \$2.2 billion for 1964. At year's end there was an estimated 16,000 EDP units and systems in service.

The complete EDP market for 1964—including hardware, software, peripheral equipment and service—is estimated at about \$4.5 billion. Projections through 1966 suggest \$3.9 billion for computing equipment, and a grand total of \$6.8 billion for the entire computer market. The bulk of computing equipment is sold to American business and industry.

Many large U. S. manufacturers are planning to establish plants in West Europe to produce computer equipment right at the market. Since 1960, according to recent estimates, about 20 plants have been established in Europe. The European computer market is about one-fourth the size of the U. S. market, it is reported. If U. S. firms had sales of about \$2.2 billion in 1964, then the European market could be about \$500 million currently.

## Integrated Circuits

Integrated circuits have enjoyed an outstanding growth rate in sales, which promises to be more spectacular when projected to 1966 and beyond. Major application for the circuits is in computers and EDP systems. Total sales for integrated circuit packages in 1964 are estimated at \$197 million, which may more than double by 1970. Microelectronic circuits and functional assemblies show the greatest promise for growth in coming years.

Total sales for microelectronic circuits in 1966 are forecast at more than \$100 million. Of this total some 40% may be spent for thin-film circuits, while semiconductor circuits may account for 60%. Functional assemblies, however, should lead the group by 1966 with total sales estimated at \$133 million.

**United States, by Geographic Division—  
1964 Electronic Industries**

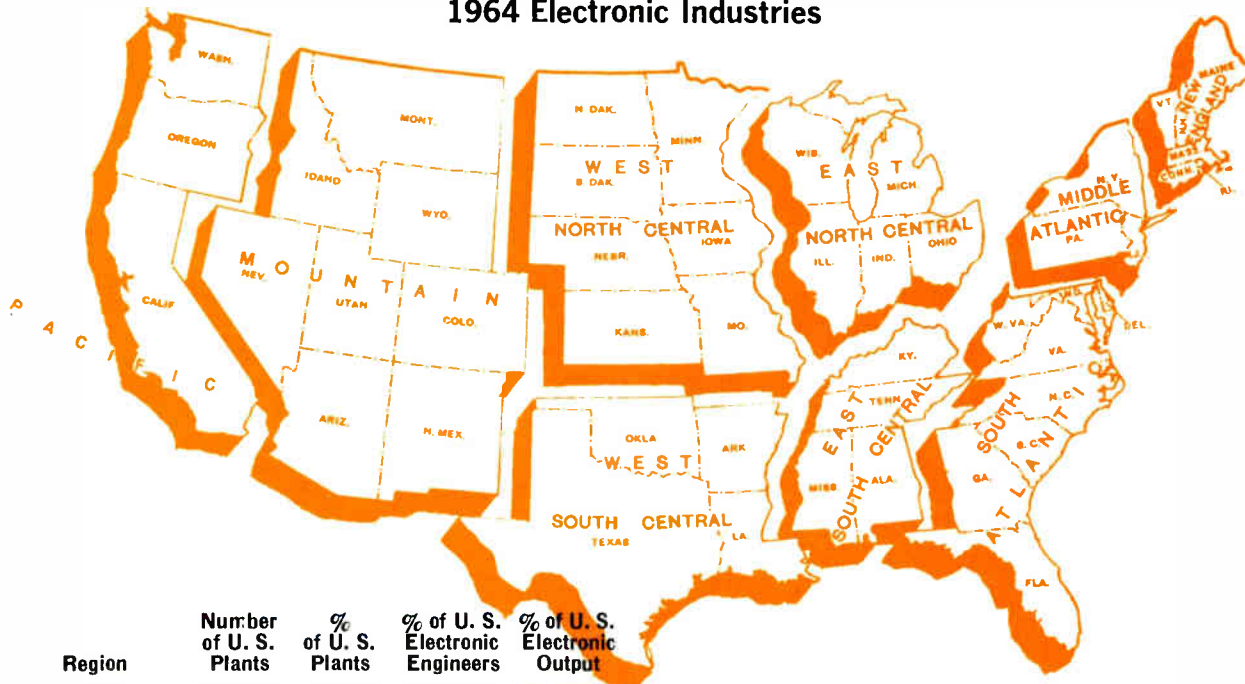

Region	Number of U. S. Plants	% of U. S. Plants	% of U. S. Electronic Engineers	% of U. S. Electronic Output
New England	875	14.64	10.70	10.60
Middle Atlantic	1,949	32.57	24.20	36.50
South Atlantic	307	5.13	10.10	5.30
East North Central	1,220	20.38	14.43	23.00
East South Central	56	.93	.41	.50
West North Central	189	3.16	4.99	2.60
West South Central	100	1.67	5.12	2.30
Mountain	109	1.82	2.62	2.50
Pacific	1,179	19.70	27.43	16.70
<b>TOTAL</b>	<b>5,984</b>	<b>100.00%</b>	<b>100.00%</b>	<b>100.00%</b>

• A REPRINT of ANY ARTICLE in this issue is available from ELECTRONIC INDUSTRIES Reader Service Department.



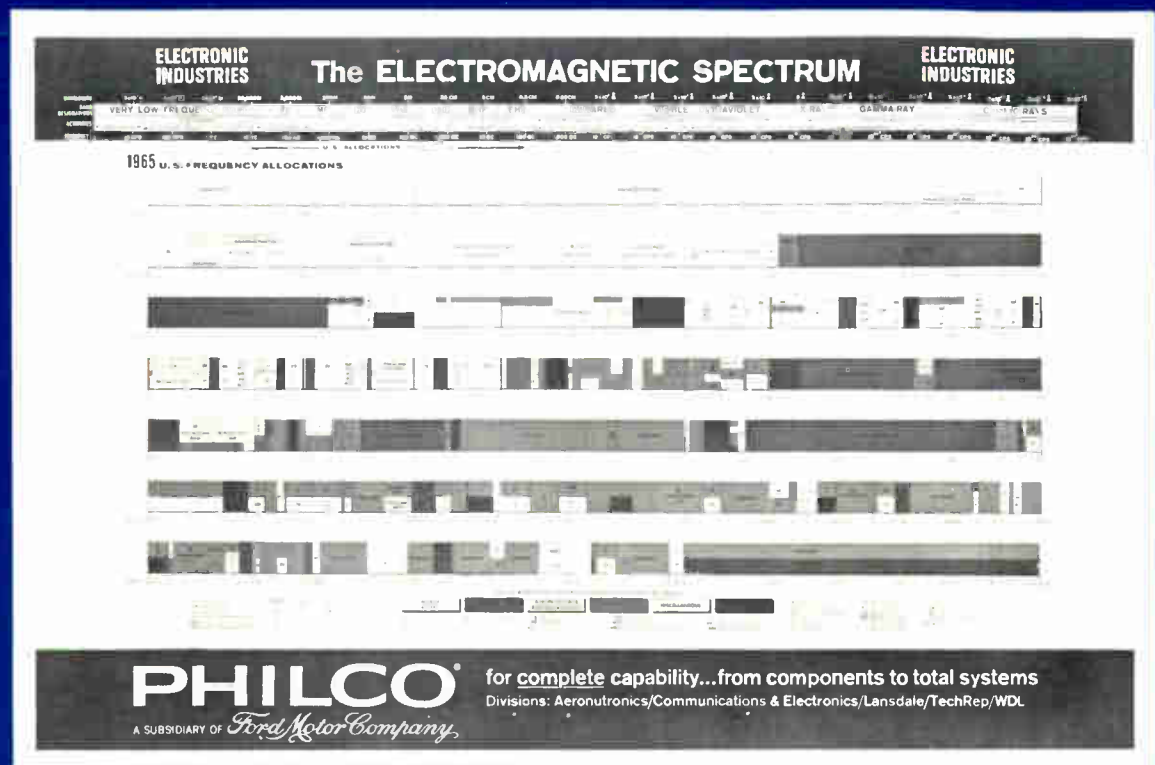

This foldout contains  
your newly revised  
wall-size  
Electromagnetic  
Spectrum Chart,  
presented by Philco

Inside. Your new  
wall-size  
Electromagnetic  
Spectrum...revised  
for 1965...all new  
FCC allocations...  
presented by Philco

**PHILCO**<sup>®</sup>  
A SUBSIDIARY OF *Ford Motor Company*







# Before you hang up your chart... consider the full spectrum of Philco capability

## Aeronutronic Division

Re-entry Systems  
Weapons Systems  
Reconnaissance-Intelligence  
Systems  
Anti-Weapon Systems

## Communications & Electronics Division

Communications Systems  
Information Systems  
Industrial Electronics  
Bio-Medical Electronics  
Underwater Systems

## Lansdale Division

Microelectronics  
Voltage Variable  
Capacitors  
Microwave Components  
Electro-Optical  
and Infrared Detectors  
Solid-State Power Sources  
and Tunnel Diode Amplifiers

## Research Laboratories

Physics  
Fluid Mechanics  
Chemistry  
Electromechanics  
Materials  
Biosciences  
Electronics  
Mathematics

## TechRep Division

Maintenance and Operation  
Site Engineering and  
Installation  
Education  
A and E services  
Documentation  
Training and Training Aids

## Western Development Laboratories

Space Communications  
Space Support Systems  
Space Vehicles

**PHILCO**<sup>®</sup>  
A SUBSIDIARY OF *Ford Motor Company*

Specialists in individual disciplines...for components and services.  
Organized on a task-force basis...for total systems capability.



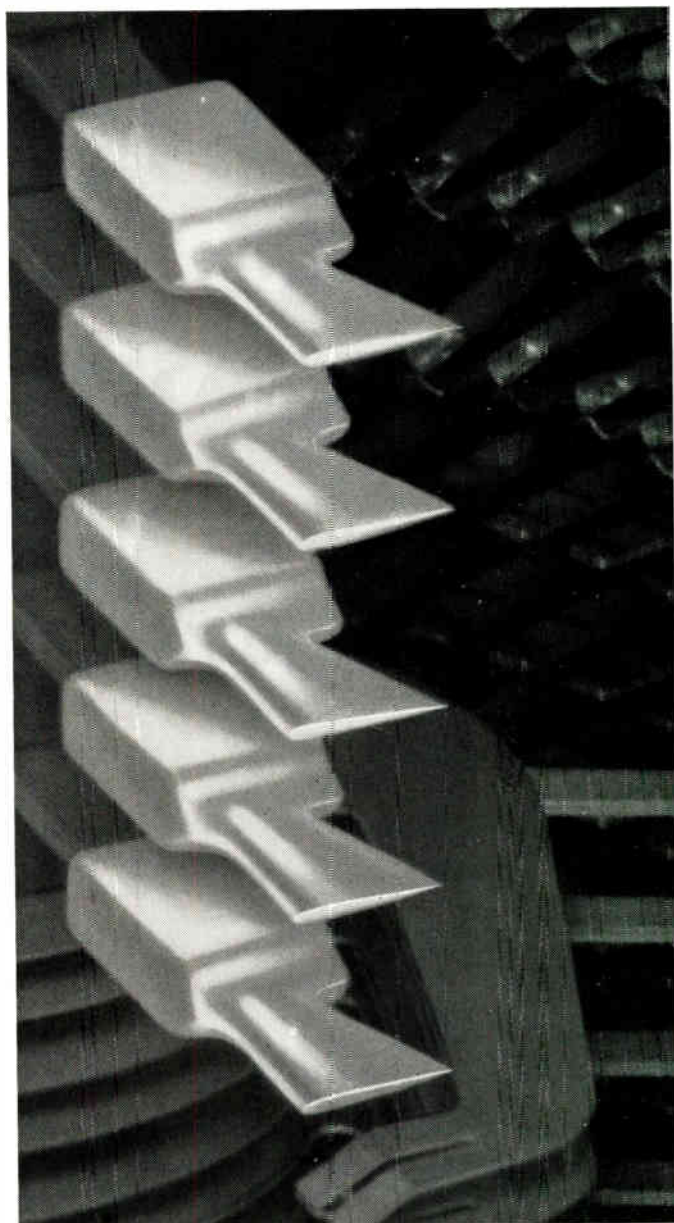
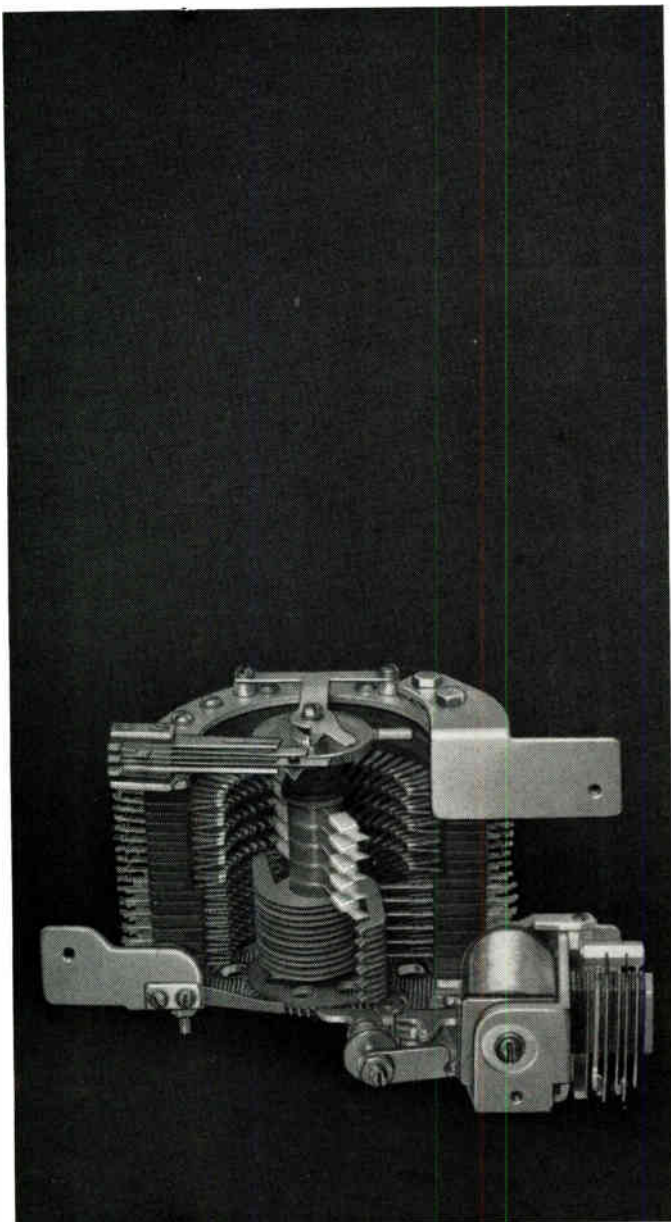

## so, what's new?

This is AE's new Type 45NC Rotary Stepping Switch. Each bank is made up of two standard levels tensioned together so that each set of bank contacts forms a closed circuit. The wiper assembly, tipped with a molded Delrin insulator, opens the contacts one at a time as it rotates. Normally open and normally closed banks may be specified on the same switch. ■ Contacts are gold-plated phosphor

## normally closed contacts, that's what

bronze, providing contact resistances of only 10 to 20 milliohms measured at 6 volts, 100 milliamperes. ■ The 45NC is ideal for self-interrupted hunting or testing circuits. In either case, no auxiliary relays are needed to initiate operation. For full information, ask for our "Product News: 45NC." Write Director, Control Equipment Sales, Automatic Electric, Northlake, Illinois.

# ***AUTOMATIC ELECTRIC***

Subsidiary of

***GENERAL TELEPHONE & ELECTRONICS***



# If your scopes are more than three years old, you have **T.O.\*** and it's costing you money.



\*Technological Obsolescence

**FAIRCHILD SERIES 765 SCOPES ARE T.O.-RESISTANT. YOUR INVESTMENT IN ONE MAIN FRAME IS INSURED AGAINST T.O. THROUGH THE VERSATILITY OF 22 PLUG-INS—AND MORE ARE ON THE WAY.**

If you're doing advanced work with aging oscilloscopes, you are probably taking longer than you should to make less precise measurements than you need.

The Fairchild Solid State Series 765 main frame has unmatched value and add-on versatility. With it you keep abreast of the state-of-the-art with a minimum of capital investment. Buy one main frame at \$595, then add the plug-ins you need—for example, multi-trace displays, 100mc high gain amplifiers, raster displays, spectrum analyzers—as you need them. All the signal circuitry is in the plug-in; none is in the main frame.

22 plug-ins are now available for Series 765 main frames. Equally important, Fairchild research is continually developing new ones to keep even the first 765 up to date. So, instead of buying costly special purpose scopes, you merely add appropriate plug-ins as your instrumentation needs change.

Two examples of Fairchild versatility are shown on the next page. If you need these (or other) capabilities and your present scopes don't have them, T.O. is costing you money. It's both good engineering and good management to call in your Fairchild Field Engineer for a demonstration. Fairchild Scientific Instrument Dept., 750 Bloomfield Ave., Clifton, N.J.

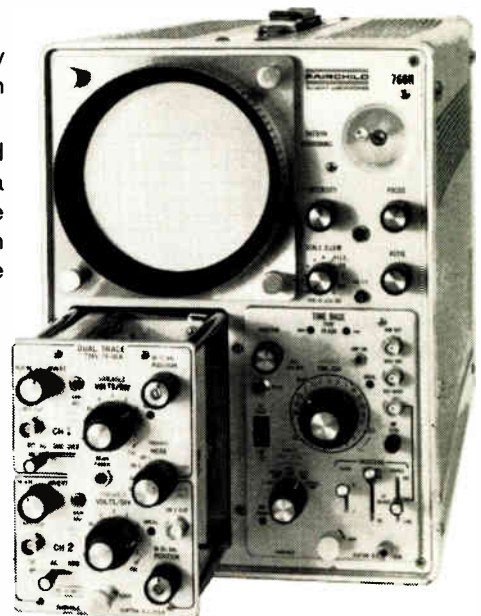



# How Fairchild Scopes help curb **T.O.**

## With three new plug-ins, Series 765 doubles as spectrum analyzer

For just \$820 any Fairchild Series 765 oscilloscope becomes an accurate spectrum analyzer. Three new plug-ins are available to cover a frequency range from 10cps to 500kc. When used with the type 777 dual beam scope, two analyzer plug-ins provide two simultaneous spectrum displays on the same CRT.

PLUG-INS	TYPE 74-91	TYPE 74-92	TYPE 74-93
Center Freq. Range	10cps to 20kc	35cps to 100kc	150cps to 500kc
Dispersion (sweep width) continuously variable	100cps to 6kc	500cps to 30kc	2.5kc to 150kc
Resolution Bandwidth (continuously variable)	10cps to 100cps	35cps to 250cps	150cps to 2kc
Sensitivity	40 $\mu$ v/cm	40 $\mu$ v/cm	40 $\mu$ v/cm

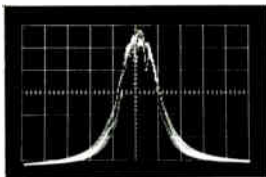

80kc carrier modulated at 35cps; maximum analyzer resolution.

## New dual trace plug-in offers 100mc bandwidth, 10mv/cm sensitivity

Owners of Series 765 scopes who find a need for bandwidth beyond the range of any existing direct reading scope do not have to buy a costly sampling scope. A Type 79-02A 100mc dual-trace plug-in for \$1,200 provides the widest available bandwidth in conventional instruments. As a single trace amplifier, the 79-02A offers sensitivity of 1mv/cm with bandwidth greater than 50mc. Rise-time is 3.5ns. in dual trace 100mc operation.

Ask for complete data on these new Fairchild plug-ins

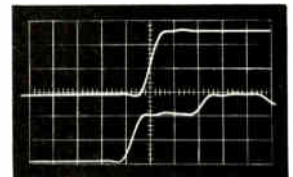
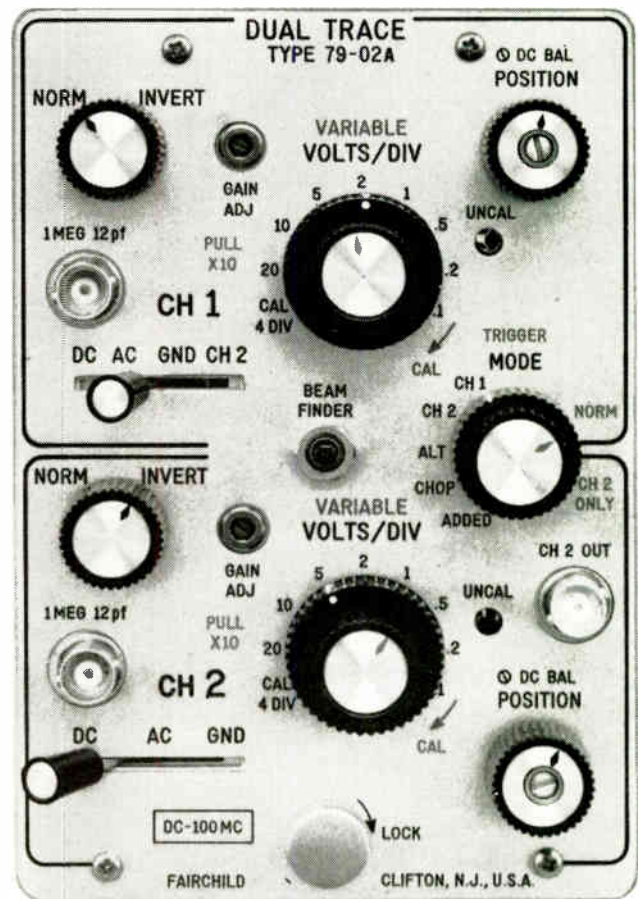

5nsec/div sweep rate. Lower trace shows reflection of piece of unterminated 50 ohm cable.

\*Technological Obsolescence



**FAIRCHILD**

DU MONT LABORATORIES  
SCIENTIFIC INSTRUMENT DEPARTMENT

# Only New JFD Modutrim ceramic variable capacitors give you...

Modutrim Model #	Capacitance Ranges (PF)
MT 100	5 to 15
MT 120	2 to 20
MT 130	3 to 30
MT 140	4 to 40
MT 150	5 to 50
MT-100 at 500 wvdc. All others at 50 wvdc.	
<b>widest <math>\Delta C</math></b>	

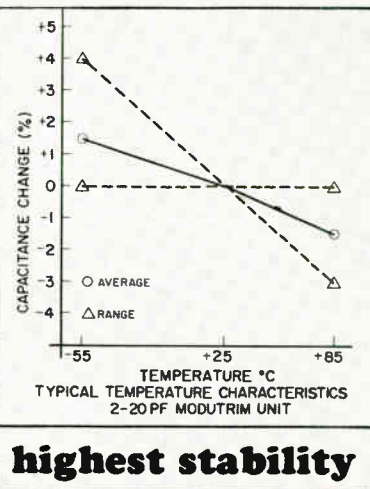
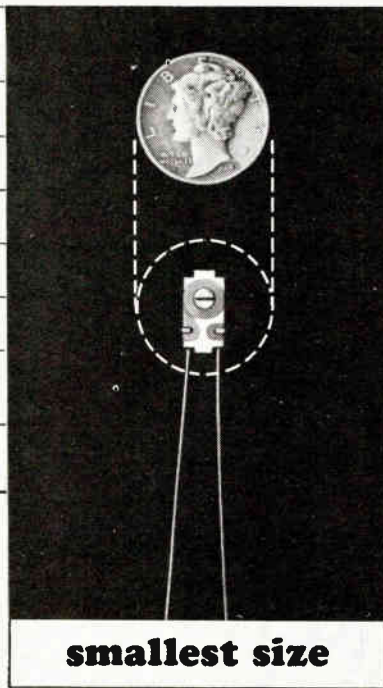

• If you are designing micromodule or hybrid circuits, this new MT Series of Modutrim micro-miniature ceramic variable capacitors offers **three** exclusive features.

(1) Note that  $\Delta C$  is extended to as high as 5-50 pf. (2) **Highest stability** results from the use of both a special ceramic material (developed in JFD's own Glass and Ceramic Laboratories) and a unique monolithic rotor. (3) These Modutrim units are the **smallest** available. Standard unit size is only 0.208 in. x 0.401 in. x 0.120 in. thick.\*

Other Modutrim Advantages:

1. Capacitance adjustment is approximately linear for 180 degree rotation.
2. Temperature coefficient of capacitance is  $-250$

$\pm 250$  ppm/ $^{\circ}C$ , exact values depending on the capacitance range. (Exception: Model MT150, temperature coefficient  $-700 \pm 250$  ppm/ $^{\circ}C$ )

3. Capacitance drift is 0.75% of maximum capacitance for temperature cycling, from  $-55$  to  $+85^{\circ}C$ .

4. Guaranteed minimum Q of 500 at 1MC. (Exception: Model MT 150 has minimum Q of 300 at 1MC)

5. Adjust torque is 1 to 5 in. ounces.

6. Dielectric strength test: 1000 volts for 500 volt rating; and 100 volts for 50 volt rating.

7. Modutrim units meet or exceed all requirements of Military Specification MIL-C-81A.

\*(Units as small as 0.208 x 0.280 x 0.120 in. thk. can be furnished upon special order. Other configurations are also available.)

WRITE FOR BULLETIN MT-64

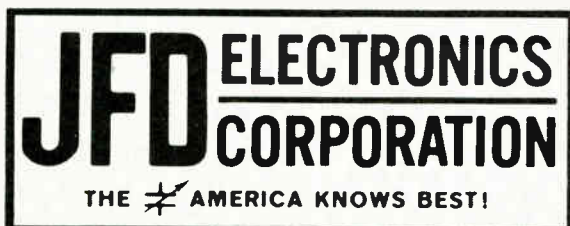

Components Division

JFD ELECTRONICS CORPORATION, 15th Ave. at 62nd St., Brooklyn, N. Y. 11219  
 JFD NORTHEASTERN, Ruth Drive, P. O. Box 228, Marlboro, Mass. 07152  
 JFD NEW YORK-NORTHERN, Damiano Pl., P. O. Box 96, New Hartford, N. Y. 13503  
 JFD MID-ATLANTIC, 313 E. Broad St., Palmyra, N. J. 08065  
 JFD MID-ATLANTIC-MARYLAND, P. O. Box 7676, Baltimore, Maryland 21207  
 JFD MIDWESTERN, 6330 W. Hermione St., Chicago, Illinois 60646  
 JFD MIDWESTERN-OHIO, P. O. Box 8086, Cincinnati, Ohio 45208  
 JFD WESTERN, 9 Morlan Place, Arcadia, California 91006  
 JFD CANADA LTD., 51 McCormack Street, Toronto, Ontario, Canada  
 JFD ISRAEL LTD., Industrial Area B, Bldg. 23, Azur, Israel  
 DUCON CONDENSER PTY., LTD., Christina Road, Villawood, N.S.W., Australia  
 LCC STEAFIX, 128 Rue de Paris, Boite Postale 51, Montreuil-sous-Bois, Seine, France  
 MURATA MANUFACTURING CO., LTD., Nagaoka Otokuni, Kyoto, Japan  
 STANDARD TELEPHONE & CABLES LTD., Footscray, Sidcup, Kent, England

Variable Trimmer Piston Capacitors ■ Metalized Inductors ■ LC Tuners ■ Ceramic Fixed and Variable Capacitors ■ Fixed and Variable Distributed and Lumped Constant Delay Lines

Circle 21 on Inquiry Card

World Radio History



# 400V 1.0A 2.5A SILICON TRANSISTORS

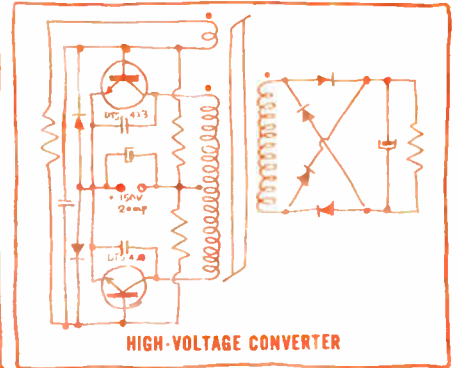
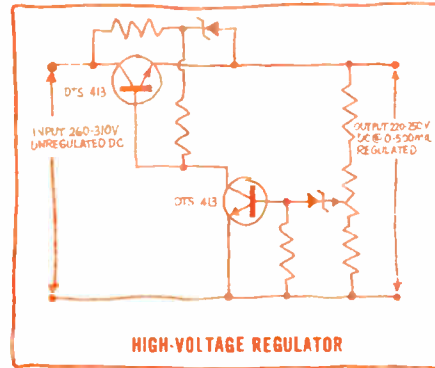
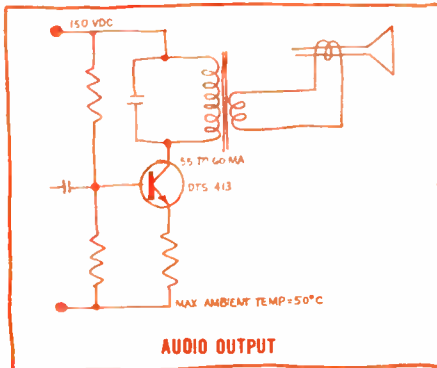
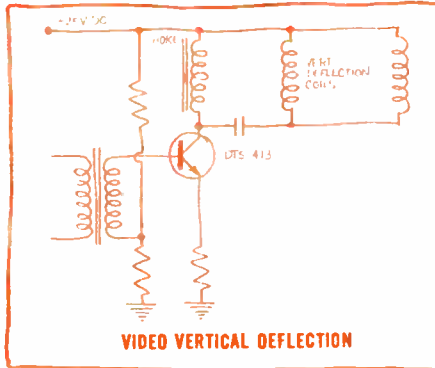
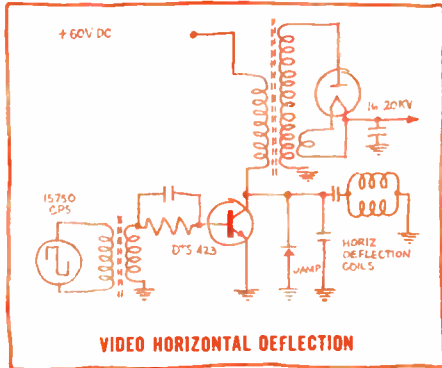

## INEXPENSIVE

From Delco Radio, today, come two new silicon power transistors that transcend the known limits of semiconductor cost and capability. **V<sub>CEO</sub> 400V at less than three cents a volt—even in sample quantities!** ■ The DTS-413 and DTS-423 open the door to a host of new ideas, new circuits, new products and product improvements. ■ As an example, practical—and immediate—applications are both vertical and horizontal TV outputs. Large-screen all-transistor TV is, for the first time, technically and economically practical. ■ Delco's achievement also permits a reduction in current, reduction in size of other components, and a hike in efficiency in circuits where high energy output is needed. ■ High punch-through voltage, high frequency response, and low saturation resistance are provided by the silicon element itself, which is fabricated by our unique triple sequential diffusion process. ■ Complete freedom from "purple plague" and exceptional resistance to thermal and mechanical shock are a result of ultrasonic bonding of aluminum to aluminum base and emitter contacts. ■ Contact us right now for data sheets and prices. Be one of the first to take advantage of these Delco Radio high-voltage silicon power transistors.

		DTS-413	DTS-423				DTS-413	DTS-423
Collector diode voltage (V <sub>ceo</sub> )		400V	400V	Base current (I <sub>b</sub> )			0.5A	1A
Emitter diode voltage (V <sub>ee</sub> )		5V	5V	Maximum operating junction temp.			150°C	150°C
Collector to emitter voltage (V <sub>ceo</sub> )		400V	400V	Minimum operating junction temp.			-65°C	-65°C
Collector current (I <sub>c</sub> )		1.0A	2.5A	Maximum storage temperature			200°C	200°C
SYMBOL	PARAMETER	TYPE	CONDITIONS	MIN.	TYPICAL	MAX.	UNITS	
h <sub>rc</sub>	Current gain	DTS-413 DTS-413 DTS-423 DTS-423	I <sub>c</sub> = 0.5A, V <sub>ce</sub> = 5V I <sub>c</sub> = 1.0A, V <sub>ce</sub> = 5V I <sub>c</sub> = 1.0A, V <sub>ce</sub> = 5V I <sub>c</sub> = 2.5A, V <sub>ce</sub> = 5V	20 15 30 10		80 90		
V <sub>ce(Sus.)</sub>	Sustaining voltage	DTS-413, 423	I <sub>c</sub> = 50ma, I <sub>b</sub> = 2ma	325			Volts	
V <sub>ce(Sat.)</sub>	Collector to emitter saturation voltage	DTS-413 DTS-423	I <sub>c</sub> = 0.5A, I <sub>b</sub> = .05A I <sub>c</sub> = 1.0A, I <sub>b</sub> = .10A		0.3 0.3	0.8 0.8	Volts Volts	

**FIELD SALES OFFICES**  
**UNION NEW JERSEY\***  
 Box 1018 Chestnut  
 Station  
 (201) 687-3770  
**DETROIT, MICHIGAN**  
 57 Harper Avenue  
 (313) 873-6560  
**PALO ALTO, CALIFORNIA**  
 201 Town & Country  
 Village  
 (415) 326-0365

**SANTA MONICA, CALIFORNIA**  
 726 Santa Monica Blvd.  
 (213) 870-8807  
**SYRACUSE, NEW YORK**  
 1054 James Street  
 (315) 472-2668

**CHICAGO, ILLINOIS\***  
 5151 N. Harlem Ave.  
 (312) 775-5411  
 General Sales Office: 700  
 E. Firmin, Kokomo, Ind.,  
 (317) 452-8211—Ext. 500  
 \*Office includes field lab and  
 resident engineer for applica-  
 tions assistance.

**DELCO RADIO**  
 DIVISION OF GENERAL MOTORS, KOKOMO, INDIANA

# KLEIN PLIERS *Speed up electronic wiring*

When the crystal set was a seven-day wonder, Klein long nose pliers were used to adjust the cat's whisker. Through the era of B and C battery sets, Klein kept pace by providing pliers specially adapted for electronic wiring.

Today, more than 100 different styles and sizes of Klein pliers are available to provide the exact tools needed for any job. Klein engineers have developed a special plier for wiring printed circuits; a high hardness

plier for cutting nickel ribbon wire; a transverse end cutting plier for cutting closely in confined spaces; extremely small pliers for wiring midget assemblies—and many others.

Klein has also developed special pliers to do special jobs requested by electronic manufacturers.

For better work done more quickly and at lower cost, be sure the pliers you use are exactly suited to the job . . . made by Klein, of course, "Since 1857."

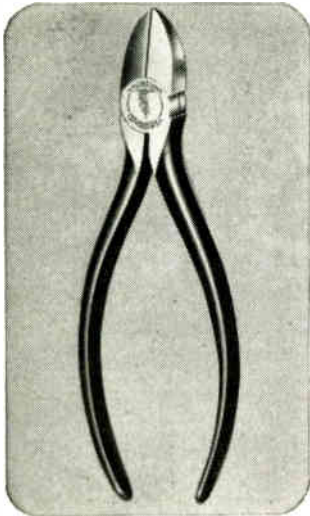

202-5C Oblique Cutting Plier with narrow nose. Available with coil spring. 5½-, and 6-in. sizes.

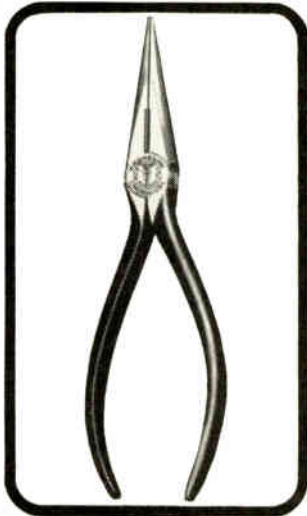

203-5C Long Nose Side Cutting Plier. Available in 5½-, 6½- and 7-in. sizes. Supplied with coil spring.

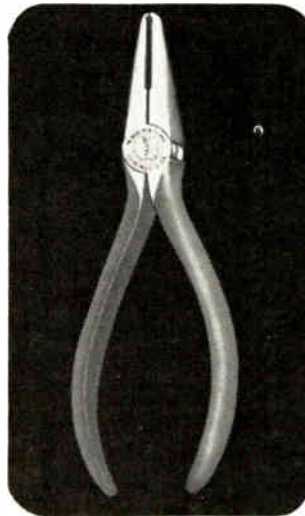

204-6C Transverse End Cutting Plier, 6-in. long. Supplied with coil spring to hold jaws open.

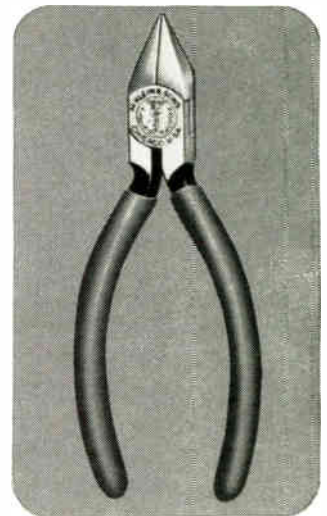

D209-5C Lightweight, Pointed Nose, Flush Cutting Plier. Supplied with coil spring to hold jaws open.

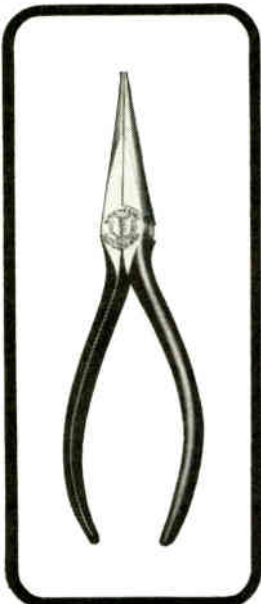

301-5C Long Nose Plier. Available in 5½-, 6½- and 7-in. lengths. Coil spring.

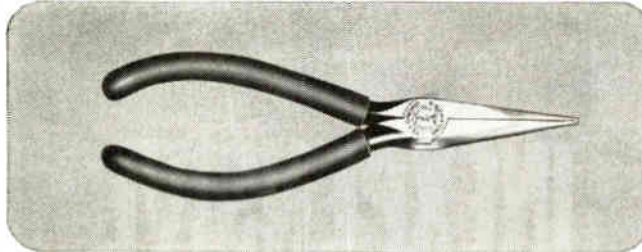

D307-5½C Slim Long Nose Plier for reaching into confined spaces. Yellow plastisol handles. Supplied with coil spring to hold jaws open.



D310-6C Slim Long Nose Plier. Handles are yellow plastisol covered. Supplied with coil spring to keep jaws open.



314-8 8-in. Long Nose Plier. Jaws have knurl.



Mathias **KLEIN** & Sons  
 Established 1857 Chicago, Ill., U.S.A.  
 INCORPORATED  
 7200 McCORMICK ROAD, CHICAGO 45, ILL.

See Your Distributor  
 Foreign Distributor: ITT Export Corporation, New York





# Belden has it...

Every electronic and electrical wire you need—from the finest drawn magnet wire to the most complex multi-conductor cables.

There is a Belden wire or cable in every insulation and shielding to meet your application and design needs. Here is just part of this complete line. Available from stock. Ask your Belden electronics distributor for complete line information or write for catalog. Request also a copy of A Buyers' Guide to Specifying Electrical Wire and Cable.























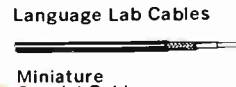







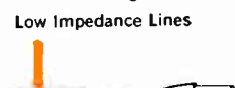



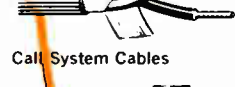

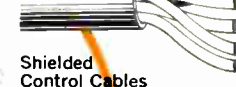



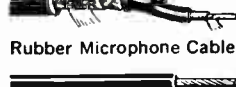

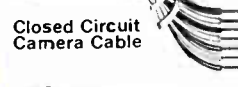
### 3 REASONS WHY Belden is the most specified line

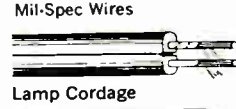
1. **Basic Manufacturer**—Belden draws its own wire—compounds its own insulations for complete quality control.
2. **Research and Testing**—All Belden wire and cable are laboratory tested to guarantee insulation and conductor efficiency. Lab test data available.
3. **Design and Engineering Service**—Belden has a completely staffed design and engineering department to help customers meet unusual wire application or design requirements.

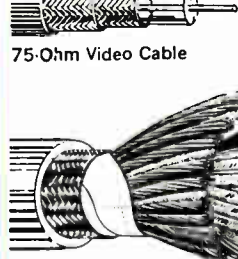
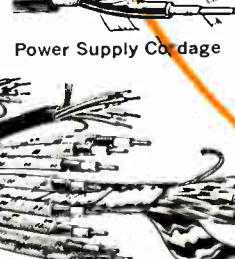
Better Built... Better Buy...

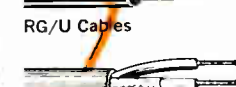

**BELDEN MANUFACTURING COMPANY • P.O. Box 5070-A • Chicago, Illinois 60680**

 Cathode Ray Tube Lead	 Miniaturized Cables	 Magnet Wire	 Automation Cable	 Miniature Microphone Cables
 Shielded Power Supply Cables—Rubber or Vinyl	 Grid Wires	 60 KV D.C. High Voltage Cable	 Language Lab Cables	 Control Cables
 Plastic Microphone Cables	 Multi-Conductor Cables	 TV Distribution Cables	 Miniature Coaxial Cables	 Unshielded Audio Cables
 Shielded Interconnecting Cables	 Low Impedance Lines	 Multiple Pair Individually Shielded RF Cables	 RG/U Transmission Line Cables	 Shielded Control Cables
 Strain Gauge Cables	 Call System Cables	 Test Prod Wires	 3-Conductor Power Cords	 Rubber Microphone Cables
 Broadcast Audio Cables	 PA System Cables	 2 & 3 Conductor Extension Cords	 Hook-Up Wires	 Coiled Test Prod Wire
 Closed Circuit Camera Cable	 Sound & Alarm System Cables	 Mil-Spec Wires	 Duplex Wires	 RG/U Cables
 75-Ohm Video Cable	 Power Supply Cordage	 Lamp Cordage	 Multiple Pair Cables	 Shielded Cables
 Color, Studio, Camera Cables	 Industrial Audio & Sound Wires	 Teflon* Hook-Up Wires	 Coiled Cords	 Miniature Audio Cables
		 Multiple Pair Individually Shielded Audio and Data Cables	 Shielding & Bonding Cable	 Special Sound Cables

\*DuPont Trademark

8-1-4

# 1965 Connector Specifications Guide

## Part I: Printed Circuit Connectors

**ELECTRONIC  
INDUSTRIES**

STATE-OF-THE-ART

**FEATURE**

This is the first in a series of Electronic Industries Special Reports on Connectors. In this part, key technical specifications are discussed in detail and directions on how to specify p-c connectors are given. A handy directory of p-c connector suppliers is included.

### When Specifying Connectors Do Not Overlook any Of These Requirements:

- OPERATING TEMPERATURES
- MAXIMUM CURRENT
- MAXIMUM VOLTAGE
- WEIGHT RESTRICTIONS
- SIZE RESTRICTIONS
- TERMINATION TECHNIQUES
- NUMBER OF CONTACTS
- CONTACT RESISTANCE
- DRY CIRCUIT RESISTANCE
- FREQUENCY OF MATING & UNMATING
- VIBRATION REQUIREMENTS
- SHOCK REQUIREMENTS
- INTERCONTACT CAPACITANCE
- HUMIDITY CONDITIONS
- BAROMETRIC PRESSURE

There are more. List all of the above, AND THEN get engineering assistance from a connector manufacturer!

First of A Series of Reports  
Industry's Most Complete

### ELECTRONIC CONNECTOR SURVEY

Watch Future Issues For:

**PART 2: COAXIAL AND SHIELDED  
CABLE CONNECTORS**

**PART 3: MULTI-PIN CONNECTORS  
(Shell and Rack & Panel Types)**

**PART 4: PLUGS, JACKS,  
CORDS AND TERMINALS**

IF YOU'RE IN THE MARKET for printed circuit connectors, there are about 75 manufacturers with as many and maybe more connector designs for you to choose from.

Some of these manufacturers once may have made a connector that just fits your application. But, if you're not that lucky, you can have him make you one that does. That is the extent of standardization in this industry.

As costly to the user as this may be, unfortunately, it has been the procurement pattern for some time. ELECTRONIC INDUSTRIES has discussed this problem at length.<sup>1</sup>

Most manufacturers would prefer to sell off-the-shelf items to save the customer the high cost and time required for the tooling of custom designs. But more often than not, the connector is the last item considered in equipment design. Industry engineers and manufacturers both agree that the vendor should be consulted as early in the design stage as possible for any help that the vendor may be able to give, or at least so that the design engineer is made aware of what is available. Attacking this problem from another angle, a few manufacturers are offering molded headers which act as the framework design for pluggable, cordwood modules. Thus, in effect, the circuit is designed around the connector.

### Choosing a Connector Design

A connector should be considered an extension of the wires it connects, and while it cannot improve the performance of any circuit, it should always equal the reliability of the conductor itself.

There are tendencies with connector customers to under-specify: that is, expect connectors to perform in environments or functions for which they were not intended. There are others who "over indulge" in quality by specifying, for example, Mil standards or other requirements unnecessary to



their use. Both these extremes always prove more costly.

It's most economical, of course, to design the p-c circuit to use an existing connector style. This may not be desirable or even possible in some cases. But, if large quantities are involved, the tooling costs may be spread out so that the unit price of even a custom designed connector may not be excessive after all.

### Supply Complete Information

Manufacturers say that the basic problem which confronts both buyer and seller is the lack of information as to what the customer *needs*. This prompted a few suppliers to devise questionnaires detailing the description and use of the proposed design to guide customer engineers in specifying connector needs.

In addition to obvious factors of size, number of contacts, current/voltage capacity and environmental specs, one questionnaire also notes contact arrangement (square or offset pattern), contact finishes, insulator material and the wiring methods to be used, such as printed circuit, solder, crimp, wire, wrap, weld or other.<sup>2</sup>

### Connector Size

Connectors for p-c use are commonly referred to as miniature, subminiature, microminiature and ultraminiature; although there are presently no standards by which to measure these classifications.

Some manufacturers classify their connectors according to contact size; others classify theirs according to center-to-center contact spacing, which they claim is more the limiting factor in connector miniaturization.

Connectors are generally available with contact spacings down to 0.025 in. Theoretically, this gives several hundred contacts per square inch, although the highest contact densities given in available product literature are only slightly higher than 100/in.<sup>2</sup> Of course, insertion and withdrawal forces multiply tremendously with high contact densities. Commonly used spacings are 0.050, 0.075, 0.100, 0.156, 0.175, 0.200 and 0.250 in.

Current and voltage capacity are other limiting factors in connector contact size and spacing. Hence, connector size reduction and voltage capacity may become a problem for minute contact spacings, particularly at high altitudes.

### Frequency of Mating and Unmating

A point often overlooked by the buyer, yet essential to reliable connector selection, is whether the connector will be engaged and disengaged often, never, or only for purposes of test and maintenance. If it is to undergo a thousand or more insertions and withdrawals, contacts must be plated with materials that will provide the desired wearability with-

TRIAC line (National Connector Corp.) of double sided board connectors offers 0.050 in. or 0.156 in. contact centers and triple action spring contacts for 1/32 or 1/16 in. boards and in 20, 30, 36, 40, 44, 60 and 80 contact models.

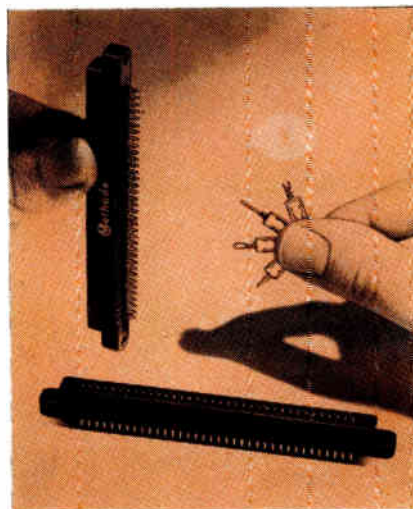
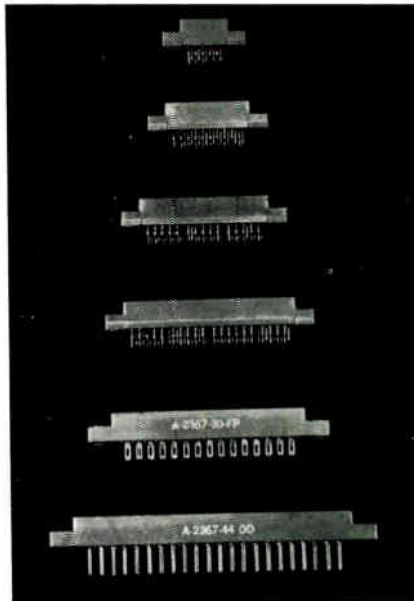

Single side card receptacle made by Methode Electronics, Inc., provides 36 contacts on 0.100 in. centers. The 3 1/2 in. long connector is designed to accommodate four styles of terminals.

Combined connector and guide (Elco Corp.) prevents p-c board misalignment and excessive tilting, and provides additional support and rigidity while in use.

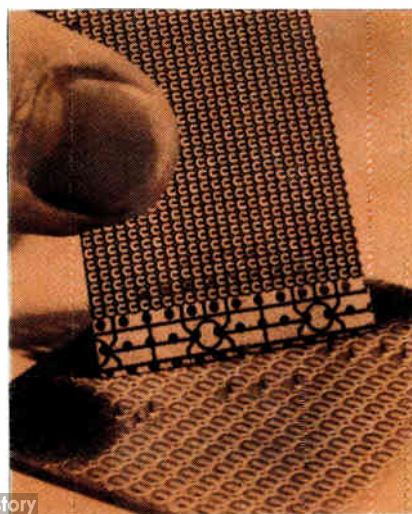
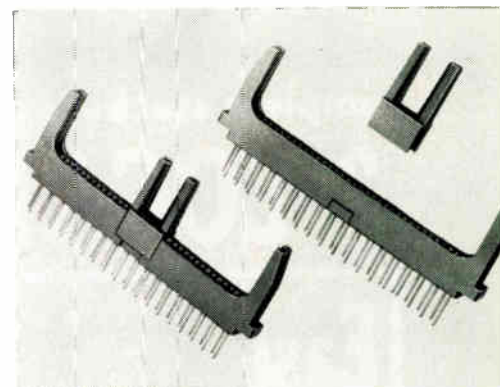

Intercon grid with weldable tabs on 0.050 in. centers to permit high density packaging of integrated circuit flat packs. (Amphenol).

# ARCO IS ON THE MOVE

## serving the entire country

### with **DEUTSCH**

#### CONNECTORS

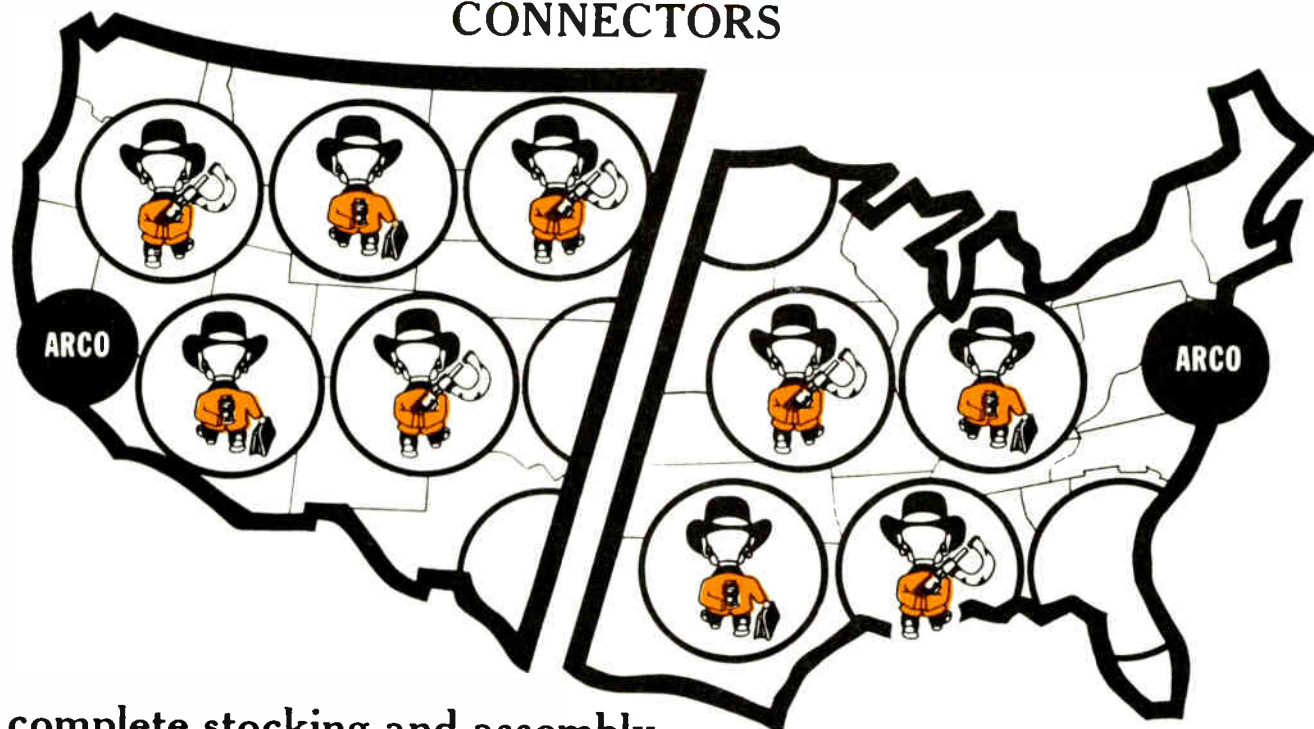

complete stocking and assembly

## 2•LOCATIONS

OVER 2,000,000 COMPONENTS IN STOCK  
FOR IMMEDIATE ASSEMBLY AT FACTORY  
PRICES!

### East

ARCO ELECTRONICS, INC. □ Community Drive, Great Neck, N.Y. 11022 □  
516 HU 7-0500 □ TWX 516-466-0235

### West

ARCO PACIFIC, INC. □ 2707 East Foothill Blvd., Pasadena, California 91107  
□ 213-684-1510 □ TWX 910-588-3293

ELMenco CAPACITORS  
ALLIED CONTROL RELAYS  
EDISON RELAYS-THERMOSTATS

# ARCO

electronics inc.

DEUTSCH CONNECTORS  
U. S. SEMCOR PRODUCTS

□ DRESSER-HST TRANSFORMERS □ ARCO CAPACITORS

Community Drive, Great Neck, New York 11022 □ 516 HU 7-0500 □ TWX 516-466-0235 □ ARCO PACIFIC, INC. □ 2707 East Foothill Blvd., Pasadena, California 91107 □ 213-684-1510 □ TWX 910-588-3293 □ ARCO ELECTRONICS, INC. □ 2523 Farrington Street, Dallas, Texas 75207 □ 214-631-0270 □ TWX 214-631-5910



Arco Electronics, Inc.

A LORAL SUBSIDIARY



## "CAGE" PRINTED CIRCUIT JACKS (CAMBION)

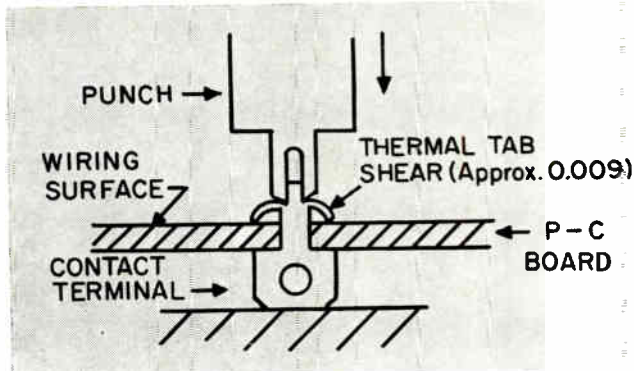

The above diagram shows the principle of staking a contact to a printed-circuit laminate. (Information courtesy of Elco Corp.).

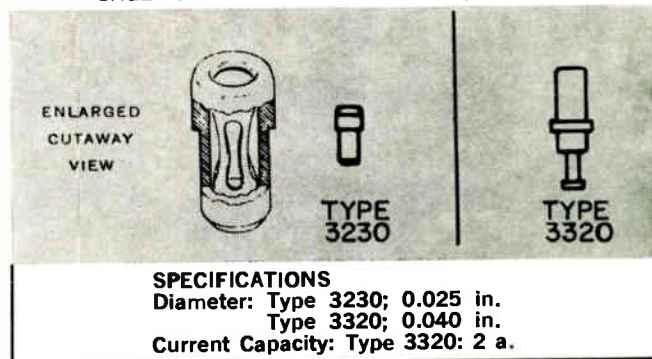

Contact designs employing multiple mating areas are shown in the diagram at the right and in those on the following page.

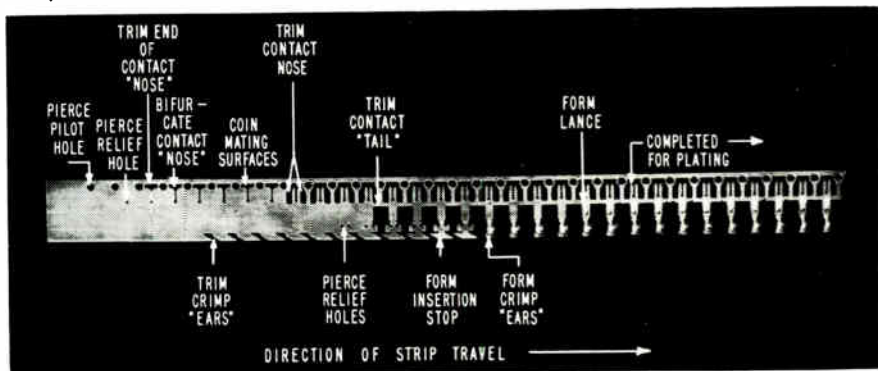

Progression strip above shows Varilock (Elco Corp.) contact stamping and forming. In producing the contact, a 0.026 phosphor bronze strip advances in short strokes through the die which accomplishes the functions identified above for each group of 22 contacts. After forming, the contact strip is plated with 10 to 20 micro inches gold over 30 to 150 micro inches of nickel.

out sacrificing conductivity. Insertion and withdrawal force, and consequent wear, are functions of contact pressure, but both are also influenced by the type of plating used. Silver provides the lowest contact resistance, partly because of its inherent low resistance and partly because of the galling effect due to the wiping action between the soft mating surfaces of the silver. Galling actually increases contact area (with some consequent lowering of resistance) but it also causes higher insertion and withdrawal forces than exhibited by other precious metals. For example, gold plating of only 20 or 30 micro-inches over the silver minimizes galling and reduces the withdrawal force considerably. Further reductions in withdrawal force (with a corresponding increase in contact resistance) are effected by plating one or both contacts with nickel under gold or under rhodium.

Silver or nickel plating is needed on most contact materials to prevent diffusion of the base metal with the relatively porous gold plate, and eventual contact contamination.

### Contact Resistance Considerations

In most p-c multi-pin connector uses, where r-f is seldom carried, it matters little whether the contact resistance is 0.002 or 0.003 ohms, for example, unless of course the circuit includes a number of series connectors. What is more important than very low contact resistance is the stability of the parameter after a number of insertions and withdrawals, and on throughout the life of the equipment.

Contact resistance is also governed by the contacting area and the pressure between the mating surfaces. Two surfaces held tightly together will actually touch each other at three places. This applies to pin and socket configurations as well as to flat contacts. Thus, contact will not be made over the entire area; although, of course, the larger the mating surfaces the larger the contacting areas and the lower the resistance. It also follows that the more independent mating surfaces

used, the more redundancy and the larger the aggregate contacting area.

The latter principle is responsible for the success of bifurcated cantilever contacts, hermaphroditic tuning fork type contacts and cage type pin and socket connectors. AMP, Inc., uses a helical spring to obtain several independent mating surfaces in their high density packaging connector. Elco's Varicon contacts, which are a variation of the tuning fork, provide four "coined" mating surfaces electrically in parallel and contacting under a force of about 15 ounces. Coining of the surfaces is a smoothing and hardening process achieved by pressure. Cambridge Thermionic Corp.'s new cage type jack is said to provide uniform contact resistance with 1,000 to 8,000 insertions and only slightly increased resistance with 30,000.

### Connector Reliability

The greatest areas of improvement in connector reliability have been in termination methods and contact nose design.

Automation, now widely used in producing terminals and assembling connectors, has increased the uniformity of contacts and terminals. It has also increased the ease of handling them in assembly work. Contacts are now supplied by several manufacturers in endless strips or reels of up to 100 or more contacts stamped out with a common inter-connecting bus. At assembly, each contact is locked into a corresponding hole in the connector. As a result, connections between the terminal and the bus, always a po-

### ▼ HERMAPHRODITIC VARICON CONTACT (ELCO CORP.)

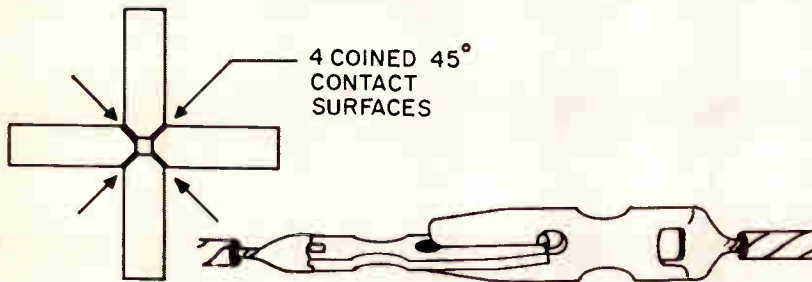

#### TYPICAL CONTACT CHARACTERISTICS

	MICROMINIATURE	ULTRAMINIATURE
Current Rating:	7 a.	3.5 a.
Contact Resistance:	0.005 ohm	0.0035 ohm
Withdrawal Force:	8 oz.	6 oz.
Contact center-to-center Spacing:	0.075 in.	0.050 in.

### CRIMP, SNAP-IN PIN AND SOCKET CONTACT (AMP, INC.)

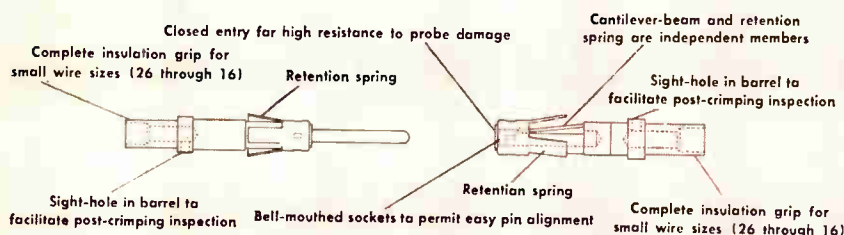

### LEAF TYPE, DUAL- AND SINGLE-CONTACT P-C BOARD CONTACTORS (AMP, INC.)

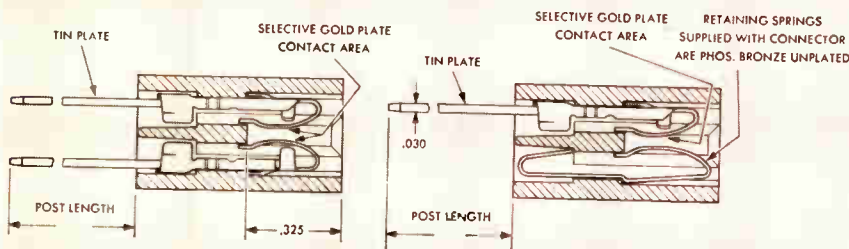

### HELICAL SPRING CONTACT (AMP, INC.)

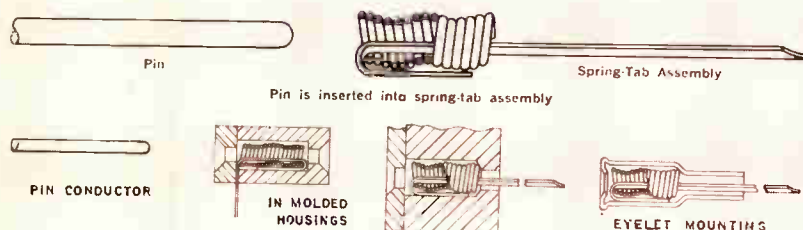

#### TYPICAL SPECIFICATIONS

Pin Diameters: 0.016; 0.020; 0.030; 0.040  
 Contact Spacings, Center-to-Center: 0.045 to 0.145  
 Operation: Inserting pin tends to straighten spring making firm contact.

tential source of trouble, are eliminated.

Another new development is the use of annealed dual-metal contacts. These contacts have "soft tails" that have longer life and are better adapted to particular wire terminating methods, and "hard noses" to resist damage and maintain contact pressure over long periods of time.

Of particular interest is a development which permits welding of connectors to flat cable conductors without need for stripping insulation from the cable. This removes a problem previously associated with the use of flat cable, or tape cable as it is also called. The welder electrode first melts through the insulation then performs a resistance type weld.

Other advances are in methods for securing p-c connections. Bendix is using a tinned, bifurcated terminal in place of plated-through holes. The terminal, which is slotted to accept components for soldering, is specially fused to the board. Components can be soldered and unsoldered without dislodging the post and with only a minimum of heat being transmitted to the component or the board. AMP, Inc., offers a similar connector which they call a "Circuitip."

### Staking

Staking is a simple mechanical process by which a compression joint is formed between a contact and the wiring on a p-c board. Contacts are staked to p-c laminates by applying pressure with a knife-like tool which shaves a small amount of metal from the contact termination and presses it tightly against the circuitry of the board. As many as 60 contacts may be staked at one time using motor-driven dies, and little skill is needed. The staked joint has higher resistance than the crimp. But staked joints are usually dip soldered which overcomes this and provides a connection which is excellent both mechanically and electrically.

### References

- (1) "Connectors and Terminations," ELECTRONIC INDUSTRIES, April, 1963.
- (2) "Circuit Interconnections," ELECTRONIC INDUSTRIES, May, 1964.



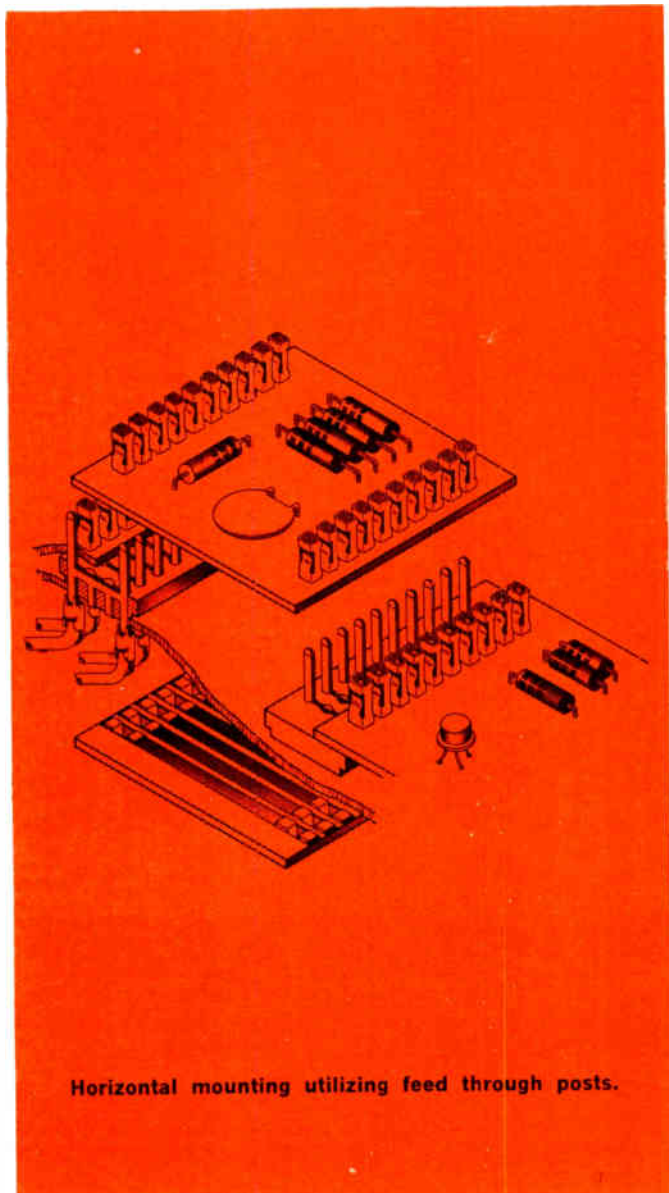

Horizontal mounting utilizing feed through posts.

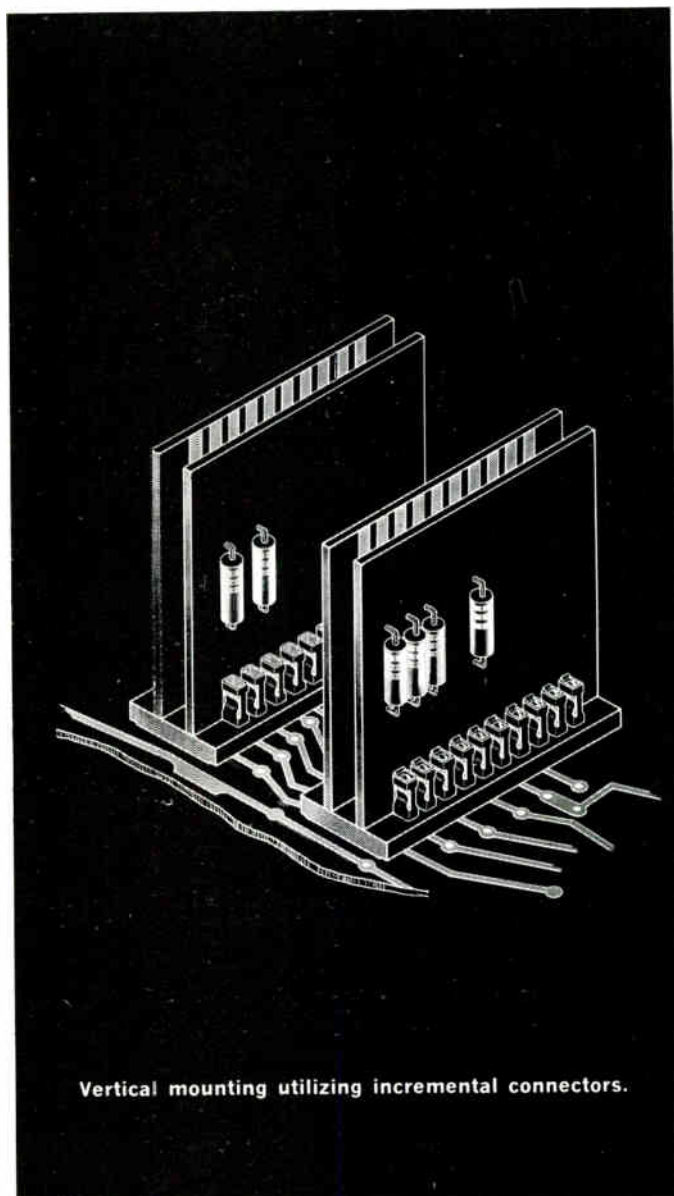

Vertical mounting utilizing incremental connectors.

## Flexibility across the board

Here's a two-piece connector that offers unlimited design potential in printed circuit and modular applications. Plan the layout any way you want—horizontal, vertical, end-to-end. The AMPMODU\* Interconnection System not only gives you *reliable* interconnections, but its sound contact design and adaptability to automated assembly techniques reduce installed costs in the bargain.

Male contacts are available as incremental connectors or as feed-through posts to accept TERMI-POINT\* clip applications and other automated wire terminations. Female contacts come in strip form for automatic staking to printed circuit boards. They are designed to overcome mating misalignments, can be mounted with center-to-center densities up to .100 inch.

Reliability is increased by the contact design which features redundant cantilever beams with built-in anti-overstress protection. In addition, modular circuits can be conveniently job-lot assembled on a true production line basis . . . no need to solder or test until they're all assembled.

Before you start working on that new design, check these features:

- Lowest per line cost
- Compatible with TERMI-POINT Terminals and tools
- Automatic staking of contacts to board
- Reliability—simple spring contact and built-in anti-overstress
- Versatility—for boards  $\frac{1}{32}$ ,  $\frac{1}{16}$ ,  $\frac{3}{32}$ -inch thick
- Flexibility—contacts mounted vertically or horizontally

Why not design it with the AMPMODU Interconnection System and get all these benefits at the lowest installed cost? Write today for complete details.

\*Trademark of AMP INCORPORATED



A-MP\* products and engineering assistance are available through subsidiary companies in: Australia • Canada • England • France • Holland • Italy • Japan • Mexico • West Germany

# PRODUCTS FOR EVALUATION

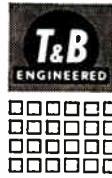

## CONNECTION SYSTEMS AND CABLING TECHNIQUES

Product samples available on letterhead request.

### NEW SELF-TYING **TY-RAP™** CABLE TIE

IT ALMOST TIES ITSELF — INSTALLED COST CUT UP TO 60%.

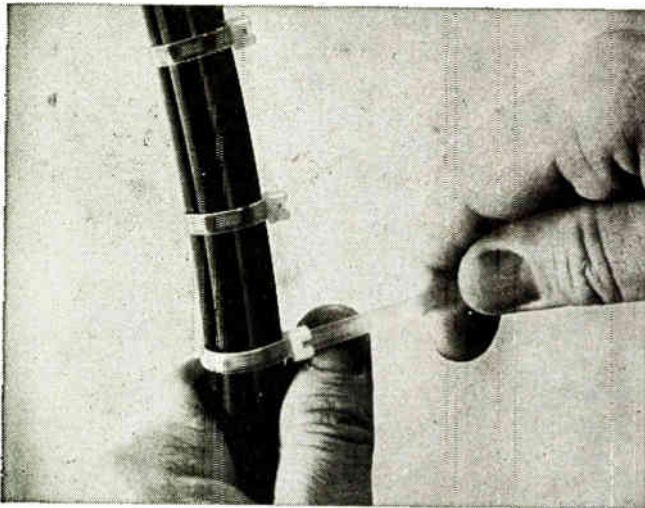

Now harnessing fabrication is easier, neater, and quicker with new TY-RAP cable ties. Training time reduced 75% — 46 sizes of clamps can be eliminated from inventory. Substantial improvement of appearance of wiring in equipment are some of the advantages over string or tape ties. Meets MIL-S-23190 (WEP) and other applicable MIL specs.

The nylon TY-RAP cable tie bundles anything from 3/16" to 4" diameter. The complete line of TY-RAP products includes color-coded ties, clamps, mounting brackets and identification plates. Hand and air power tools are available for high-speed production.

Write for illustrated brochure T-35 and self-tying TY-RAP sample.



Circle 30 on Inquiry Card

### FLEXIBLE HIGH-DENSITY WIRING SYSTEM

NEW STA-KON® SERIES '53' SOLID TAPER PIN SYSTEM

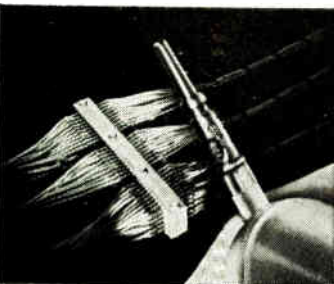

The STA-KON TAPER PIN SYSTEM gives you a flexible building block principle using standard components which permits customized high-density connections.

The STA-KON TAPER PIN SYSTEM is designed to offer you improved reliability at lower installed costs. The system utilizes two components: a solid taper pin which affords longer life for a self-wiping, self-locking connection, a solderless dual crimp makes the wire and solid pin an integral unit with high pull-out strength; and a molded diallyl phthalate block which has

negligible moisture absorption for a warp-free life. Molded barriers on the block provide an excellent creepage path.

The STA-KON Series "53" accommodates a wire range from #26 to #14 AWG. Blocks available are 10, 20, 30 single and common receptacles. Fewer tools are required.

Write for technical bulletin T30-256.



Circle 31 on Inquiry Card

### SOLDERLESS COAXIAL GROUNDING CONNECTORS & R. F. ADAPTERS

NEW COMPRESSION TECHNIQUE REDUCES NOISE

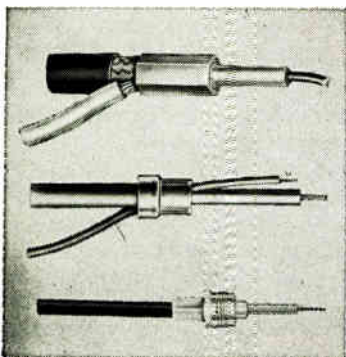

A permanent hex-compression method for reliable grounding termination and insulation of shielded and coaxial cable at lower installed costs. Provides a noise-free, solderless, secure connection without damage to insulation or measurable change in impedance. Mechanically, the bond is stronger than the braid.

T & B has designed a line of R. F. Adapters which are pre-matched to fit widely used coaxial cables to specified R. F. Connectors. They provide a complete, secure, threaded joint in addition to the advantages of the hex-compression. These adapters lower inventory and tool requirements which make

them particularly attractive to users of coaxial cable.

A wide selection of sizes in several connector styles are available for the complete range of shielded cable. Standard and special types for every need — non-insulated, flared, self-insulated, half-length and special high temperature, to 500°F, inner and outer sleeves. T & B flag type for special applications is also available. Hand and power tools are available.

Write for complete technical information.

Circle 32 on Inquiry Card

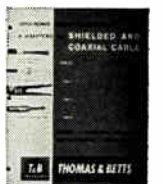

The Thomas & Betts Co., Incorporated • Elizabeth 1, New Jersey  
In Canada, Thomas & Betts Ltd • Montreal



# THOMAS & BETTS





**CONNECTO-BLOK™ WIRING SYSTEM**  
NEW BLOCK AVAILABLE FOR SNAP-ON TERMINALS OR WIRE WRAP

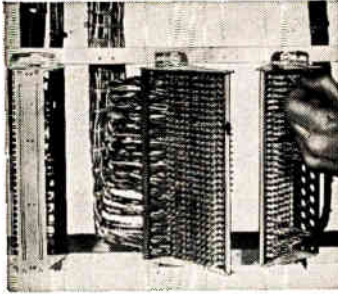

The Connecto-Blok is a flexible wiring system for audio, video, control, and high-density circuits. This terminal block saves on board assembly, rewiring costs and space. The Connecto-Blok provides greater reliability than a soldered terminal board plus the flexibility of a multi-pin type connector in one compact device.

Matching .110 terminals accommodate No. 24 — No. 18 AWG stranded wire. Flash-over — up to 4200 volts, pin-to-pin. Mounting arrangement accommodates a heavy

concentration of plug-in connections — 4800 or more — in rack space height of only 10½". Savings in wiring costs of 20% have been reported — 40% savings have been recorded through the use of high-speed strip terminal attaching machines.

Write for technical bulletin T-21-225A.



Circle 33 on Inquiry Card

**STA-KON® SOLDERLESS TERMINALS AND CONNECTORS**  
NEW WT-145A HAND TOOL — THE ONLY TOOL THAT CONFORMS TO MIL SPECS. AND INSTALLS INSULATED TERMINALS, SPLICES AND END CAPS ON NO. 26 — NO. 10 WIRE.

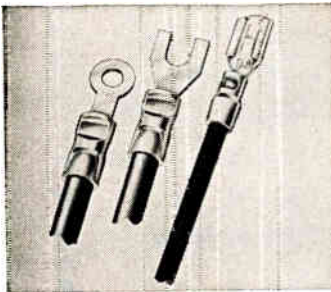

An extensive line of insulated and non-insulated tin-plated copper terminals, disconnects, end caps, wire joints and special terminals. Available with Teflon®, Nylon® and PVC insulation. Wire range from #26 to 250 mcm. Stud sizes #0 to ¼". High-temperature (2000°F.) terminals are also available. Meet MIL-T-7928 and are UL and CSA listed where applicable.

The STA-KON WT-145A is the only tool that conforms to military specifications for installing insulated (TYPE II) Class I

terminals, per MIL-T-7928, MS-25036-1A. It replaces 3 tools. It is the smallest, lightest, most economical and easiest-to-squeeze tool. Weighs only 24 ozs. and can be held easily with one hand.

Write for complete technical information.



Circle 34 on Inquiry Card

**MIL TYPE SPLICES AND MULTI-SPLICES**  
NEW TECHNIQUE SAVES SPACE . . . ELIMINATES TERMINAL STRIPS

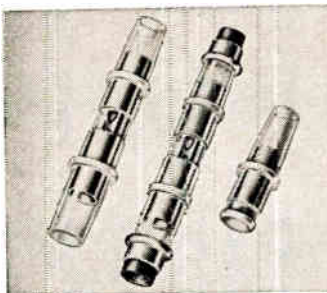

This line meets MIL-T-7928. It has found wide acceptance in the electronic and aerospace industries. Permits splicing of multi-conductors anywhere in the wire bundle. It is a compact, self-contained junction, completely insulated, provides extended flex protection. Inspection window gives reliability check. These connectors operate over a wide temperature range. The insulation material is nylon (Zytel®). When compared to other methods the multi-splice system offers weight and space savings, reduced

installation costs, less noise interference and elimination of moisture and fungus traps. The line accommodates wire sizes from No. 10 to No. 26. All sizes can be installed with only one tool — WT-145A. SEE STA-KON solderless terminals for tool features.

Write for complete technical information.



Circle 35 on Inquiry Card

**NEW IRRADIATED HEAT SHRINKABLE INSULATORS**  
QUICK, CLEAN, MOISTURE-TIGHT INSULATION IN SECONDS.

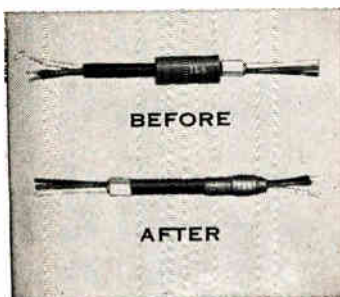

T&B'S color-coded heat-shrinkable insulators are made or irradiated polyolefin tube which shrinks at 275°F. and immediately conforms to the shape of the product being insulated. Ideal for insulating terminals, taper pins, splices, connectors and components. The calibrated shrinking of the insulator provides a tight fit and gives excellent strain relief at flex points.

The tubing is available in lengths from ½" to 3¾" and from .125" to .625" dia.

(shrink ID .063 to .312). Dielectric strength of 1000 volts/mil., and a tensile strength of 3000 psi.

A special low-cost heat gun is available which supplies fast heat evenly distributed in seconds.

Write today for complete technical information.



Circle 36 on Inquiry Card

The Thomas & Betts Co., Incorporated • Elizabeth 1, New Jersey  
In Canada, Thomas & Betts Ltd • Montreal



**THOMAS & BETTS**



# New Dav Pak

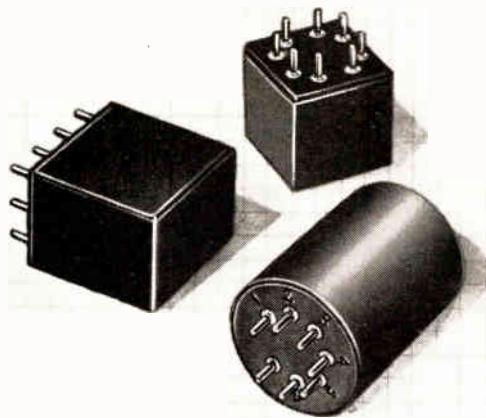

## resistance networks cut assembly time and inventory —end resistor matching problems!

Brand new from Daven—Dav Pak precision wire wound resistance network packages in standard sizes down to .590" square.

First advantage: seven standard sizes mean faster delivery and lower initial cost on most applications. Other advantages: these pre-packaged resistor modules cut assembly time, inventory time, inspection time. And completely eliminates resistor matching problems!

Daven has utilized its long experience in producing thousands of different types of precision wire wound networks to come up with this money-saving, reliability-adding idea.

All Dav Pak modules exceed the requirements of MIL-R-93. Resistance tolerances are as low as  $\pm .005\%$ . Resistance ratio match as low as  $\pm .002\%$ .

And the seven standards are available with a variety of pin placements to fit your specific requirements.

The Dav Pak is designed for analog computer circuits, voltage dividers, summing networks, RC networks, etc., and can also be supplied with other components to form network circuits. Daven's Engineering Department is at your service for specific applications. Write today for details.

**DAVEN**   
MANCHESTER, NEW HAMPSHIRE  
(603) 625-9746 • TWX 603 623-4938 • Cable: Daven Manchester N H



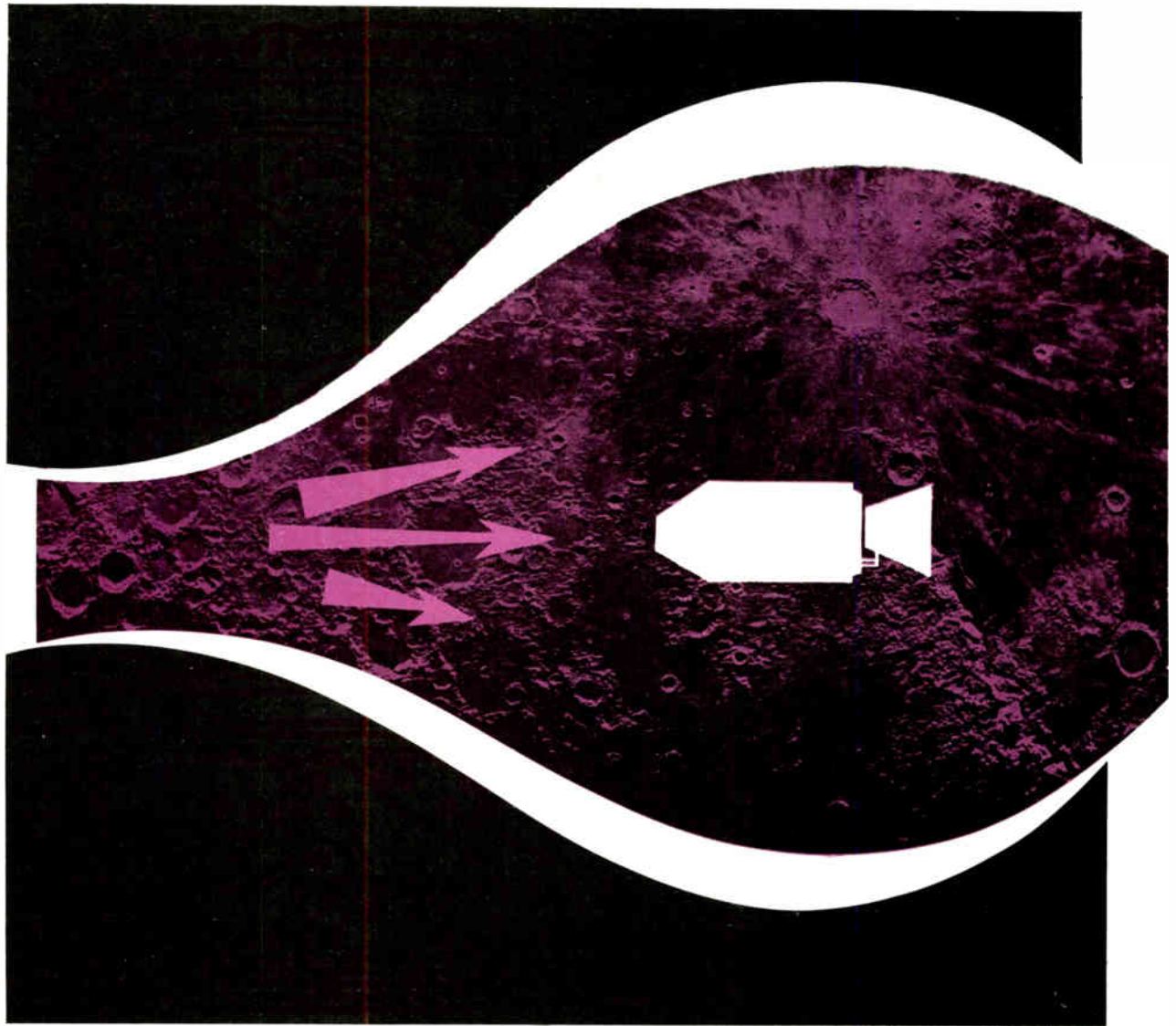

**Catching data in a  
mach 15 windstorm,  
with an accuracy of  
better than 0.75 microvolts**

... that was the problem. Astrodata's solution was a data acquisition system under complete computer control. Performance indicates end-to-end uncertainty for the over-all system, using 2.5 mv full-scale signals, is less than 0.75  $\mu$ v, or 0.025% of full scale (3 sigma). Correct us if we're wrong, but to our knowledge, this is the most accurate low-level data system ever built. The general-purpose, on-line, digital computer controls the rate at which data from a number of wind-tunnel sites is acquired, selecting data from 240 input channels. Operators at each remote wind-tunnel site, in one case up to 500 ft. from the central system, have a comprehensive control and readout console. They may request

any of several data acquisition runs. The computer honors the request, in accordance with a pre-arranged site priority, loads the appropriate program from a master tape, then organizes the central system as required to execute the requested program.

Perhaps you don't have a hypersonic wind tunnel to control, but you do have other problems in the data acquisition and processing, telemetry, or range timing instrumentation fields where Astrodata's vast experience in dynamic information handling and hybrid computer techniques can help you. *Write for your free copy of our 20-page brochure, "Astrodata's Systems Experience."*



**ASTRODATA**

P.O. Box 3003 ■ 240 E. Palais Road, Anaheim, California ■ 92803

**PROTECTS AGAINST** • Bent Pointers • Burned-Out Resistors  
 • Damaged Pivots • Overheated Springs • Burned-Out Meter  
 • Changes in Accuracy Due to Overheating



**Model 630-PLK**

# BURNOUT PROOF V-O-M

**\$79.50**

Suggested  
U.S.A. User Net

## USES UNLIMITED

School Classrooms • Field Engineers • Application Engineers  
 • Electrical, Radio, TV, and Appliance Servicemen • Electrical  
 Contractors • Factory Maintenance Men • Industrial Elec-  
 tronic Maintenance Technicians • Home Owners, Hobbyists

## FACTS MAKE FEATURES:

- 1** Comprehensive overload protection.
- 2** One selector switch minimizes chance of incorrect settings
- 3** Polarity reversing switch

Additional protection is provided by Model 630-PLK's new transistorized relay circuit. Transistorized overload sensing device does not load circuit under test, eliminating the possibility of damaging circuit components. A special meter shorting feature on "off" position offers high damping when moving tester. The exclusive patented Bar Ring Movement provides self-shielding and is not affected by stray magnetic fields. Wider spread scales, and unbreakable clear plastic window assure maximum readability. Diode network across meter protects against instantaneous transient voltage.

**TRIPLETT ELECTRICAL INSTRUMENT COMPANY, BLUFFTON, OHIO**

## RANGES

DC Volts:	0-2.5-10-50-250-1,000-5,000 at 20,000 ohms/volt. 0-0.25 at 100 microamperes.
AC Volts:	0-3-10-50-250-1,000-5,000 at 5,000 ohms/volt.
Decibels:	-20 to +11, +21, +35, +49, +61, +75; "0" DB at 1 MW on 600 ohm line.
DC Microamperes:	0-100 at 250 Mv.
DC Milliamperes:	0-10-100-1,000 at 250 Mv.
DC Amperes:	0-10 at 250 Mv.
Ohms:	0-1,000-10,000 (4.4-44 at center scale).
Megohms:	0-1-100 (4,400-440,000 at center scale).

Output Volts (AC): 0-3-10-50-250-1,000 at 5,000 ohms/volt; jack with condenser in series with AC ranges.

## CARRYING CASE

Model 639-OS black leather carrying case, built-in stand. Flaps open to permit use of tester in the case. Suggested U.S.A. User Net. ....\$12.10

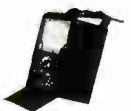

**THE WORLD'S MOST COMPLETE LINE OF V-O-M'S. AVAILABLE FROM YOUR TRIPLETT DISTRIBUTOR'S STOCK**



## SILICON SLICER

SILICON FUNCTIONS BEST IN INTEGRATED CIRCUITS when cut into the thinnest possible wafers.

Diamond-impregnated blades have achieved a thinness of 200 microns in slicing these silicon wafers at Fairchild Semiconductor, Mountain View, Calif. The slicing operation is done with a circular phosphor-bronze saw blade, 8 mils thick, which has an internal cutting edge containing 325-mesh natural diamond grit. The blade is held rigid in a tension clamp, which is mounted horizontally on a spindle driven at 3800 rpm.

The vertically-held bar of silicon, 1 1/8 in. in diameter, is then advanced into the diamond blade to cut a wafer, drawn back, lowered automatically by a calibrator the distance of 200 microns, and fed into the blade again. The operation produces 40 wafers/hour. Fairchild estimates the productive life of the internal-diameter diamond blades, which are made by Navan Products, El Segundo, Calif., at 1500 wafers before the need for replacement.

**The blade used to saw silicon into wafers 200 microns thin is made of phosphor-bronze and contains 325-mesh natural diamond grit sintered into its internal-diameter cutting edge.**

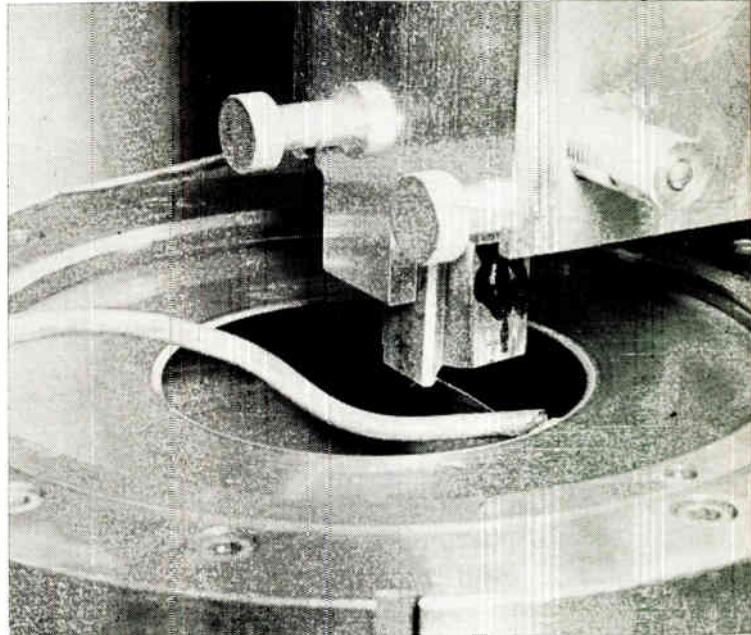

## Fast Printout For Film Documents

Using the Xerox process, coupled with optical magnifiers and automatic paper handling equipment, it is now possible to reproduce a document of up to 96 pages, filed on microfilm, in a matter of minutes in full size.

So far, only one experimental model of the printer has been made. But, now that the process is proven, it is expected that Xerox will produce the automatic printers in volume.

The medium for storage and ready reference of documents is a transparent sheet film format called microfiche. Each microfiche contains rows of miniaturized images of pages of information in frames arranged in sequence. As many as 96 separate pages of a document can be put on one 5 x 8 in. sheet. The Xerox unit automatically enlarges and copies each page. It then collates the pages into a single report. It turns out 10 pages a minute and can be set to repeat the scanning of the microfiche file card any number of times up to a maximum of 15. Thus, one could get up to 15 complete copies of a given report automatically. The machine will copy photographs as well as line drawings, printed and written material, in any color. Reproduction is black on white.

Although the first machine was designed for use by several U. S. Government agencies for distribution of scientific reports, it has interesting possibilities for other purposes. For instance, a weekday issue of

most daily newspapers could be placed on a single microfiche; and with the printer could be available to any student in a class within a matter of minutes.

**Experimental equipment enlarges and copies microfiche images of an entire 96-page document on ordinary paper in 10 min.**

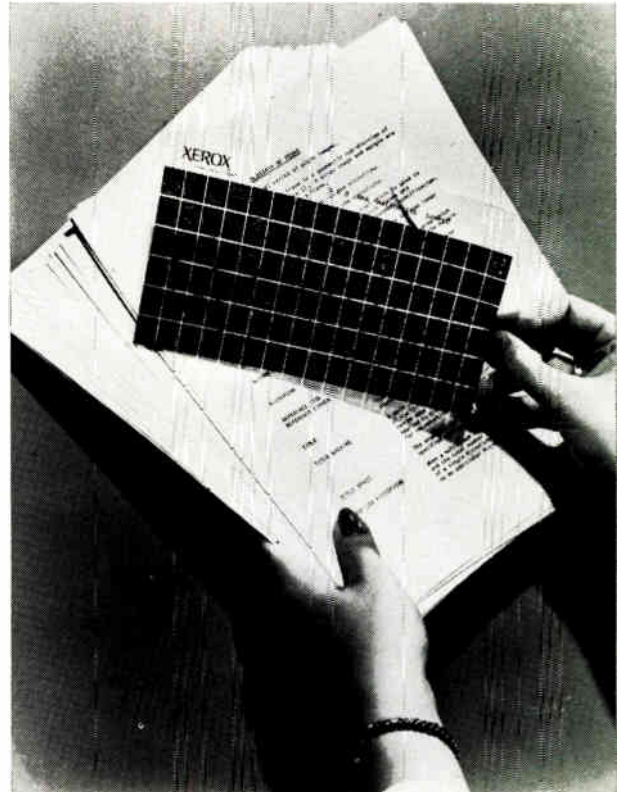

## Carrier Device Uses Air Floated Tape

A UNIQUE TAPE CARTRIDGE loaded random access storage device (RAM), Fig. 1, having a storage capacity in excess of 50 million bits of information, has just been developed by Potter Instrument Company, Inc. It is reported to be 50% faster in all modes of operation than any presently used system for random access storage. Heart of the device is a new drive system, several years under development, which permits the use of high density magnetic tape loops in random access memory applications for the first time. The tape loops are assembled in a new "Tape Pack" cartridge.

Another "first" by Potter in its RAM Model TLM-4505 is the first cartridge loaded random access memory system to provide an immediate check-read-after write capability. It is not necessary for the recording medium to make an additional full revolution to check read, as required in other memories.

Exceptionally long machine and cartridge life is achieved by using air-floated techniques for the tape loops. The recording medium never makes contact with any solid material while in operation. The flexible tape storage medium flies over the head. The loops are driven by a serrated plastic capstan with contact made to the back of the tape only during start up and stop. During operation, there is a thin air film between capstan and tape. Accurate head positioning is achieved by linear movement of a head post common to the 16 tape loops in each tape cartridge, and is actuated by a simple mechanical linkage.

Each Tape Pack cartridge holds over 50 million bits of information. Working through a computer, any one of these records can be retrieved in less than 1/10 sec for use in such applications as tabulations, check printout, and inventory listings.

In contrast to magnetic disks used in other memories, a flexible substrate (the tape base) is used. This eliminates the need for critical mechanical adjustments and results in a lower-cost package and one less susceptible to damage. There is no danger

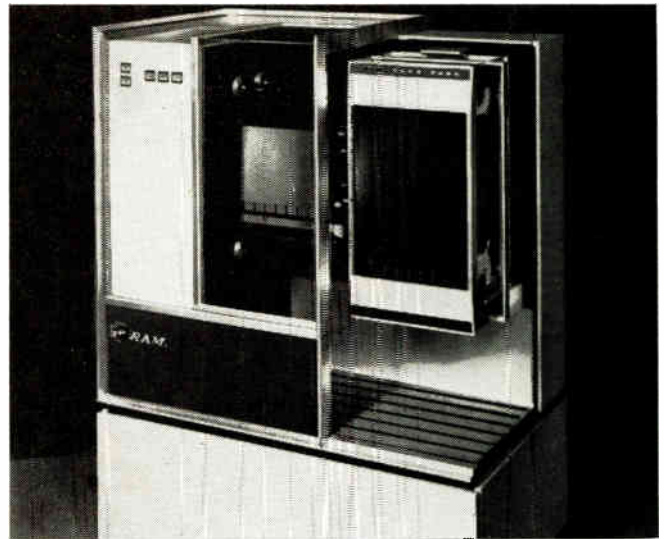

Fig. 1: Potter RAM, Model TLM-4505 cartridge loading random access memory system.

of data loss due to rough handling. Information is recorded serially, in a multiplicity of tracks on each tape loop, and information may be written or read at random by transmitting address information to the machine.

The loops of high quality digital magnetic recording tape in the cartridge each have an associated drive unit on the machine. Fig. 2a shows the position of the tape loop which clears the drive assembly and the head as the cartridge is loaded, with the capstan stationary. When the tape loops are positioned, vacuum is applied to the buffer chamber above the capstan, deflecting the tape so that its backing surface makes a non-slipping contact with the surface of the capstan, which is now rotating. The tape loop is now in the driving condition as shown in Fig. 2b.

Of special importance is the fact that the tape flies over the write-read head, maintaining a precise and stable gap between the oxide recording surface and the head profile.

The fixed air bearings which control the tape loop, at top and bottom, are shown in Fig. 2c. These fixed elements conduct air under pressure to the bearing surfaces which forms a supporting film. Thus the tape loop is entirely supported on an air cushion while it is in motion.

Fig. 2: Drive System Schematic,

Left—Position of Tape Loop as Cartridge is Loaded,

Center—Tape Loop in Driving Condition,

Right—The Tape Loop is Entirely Supported on An Air Cushion while in Motion.

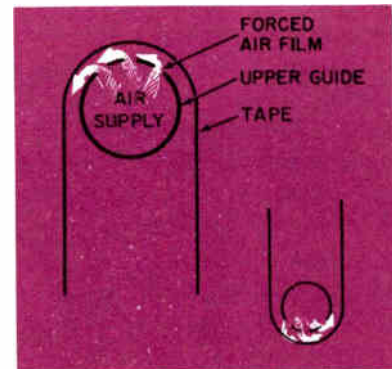
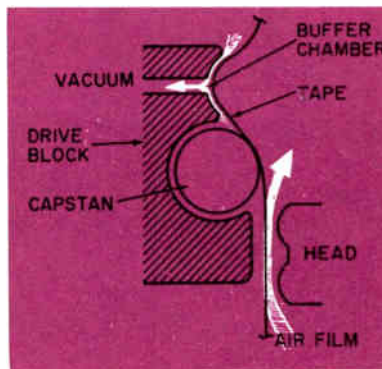
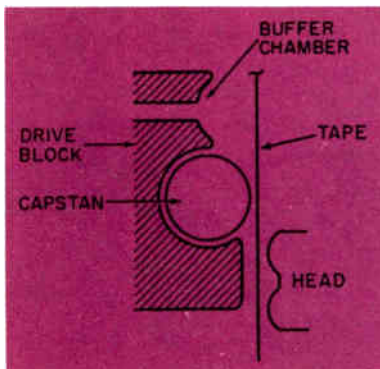



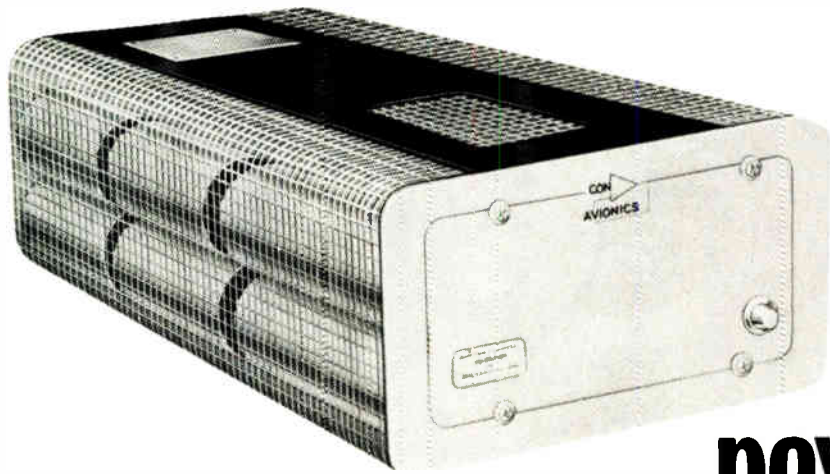

**the price  
of systems  
power supplies**

**Just Dropped \$100**

## (Con Avionics Has Another New Line)

When we cut \$100 from the going market price for systems power supplies, we kept all the features you need most.

For example, Con Avionics' new line carries an unconditional five year guarantee. It has a Mean Time Between Failure of 35,000 hours, calculated according to Mil Handbook 217. We use silicon transistors exclusively, so the units operate to 75°C. They are designed and manufactured to meet specifications under the worst possible combination of operating conditions.

The secret to maintaining all this quality at a low price lies in designing a systems power supply right from the start. Most modules used in high power systems applications are just modified lab units.

But when you design a supply just for systems use you worry about things like panel space. So Con Avionics new HS supplies are available in rack and half-rack size. You can pack 12 volts at 20 amps into 5¼" of panel height and 8" of width.

And in a system supply you design-in optimum air flow, for both vented and forced air cabinets. Our units are self-cooled, too.

Before you buy another power supply for a systems application, remember that the price is now \$100 lower than it used to be. Call, write, wire or TWX Mr. Gerry Albers at Con Avionics for all the details.

### PARTIAL SPECIFICATIONS

**Input:** 105-125 VAC, 47-63 cps  
**Regulation:** (Line and load combined)  $\pm 0.05\%$   
**Ripple:** 1 mv RMS max.  
**Response time:** 25 microseconds  
**Temperature Coefficient:** 0.015%/°C or  
 18 mv/°C., whichever is higher  
**Temperature:** 75°C max.

The entire voltage range between 5.5 vdc and 51.0 vdc is covered in twenty-six models. Currents range from 8.0 amps to 46.0 amps. Wattages from 104.5 to 816.

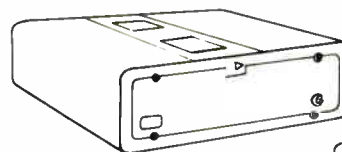

FULL RACK SIZE

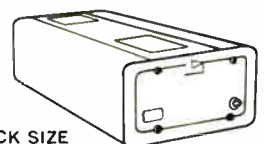

HALF RACK SIZE

**CONSOLIDATED AVIONICS CORPORATION** | 800 Shames Drive, Westbury, New York  
 (516) ED 4-8400 TWX: (516) 333-1097



For complete details and visit with engineering representative, circle number 41.  
 For product data and general information, circle number 60.

# LICON

## SNAPS IN PLACE!

### TYPE 01 ONE-LITE

The new "Square Bezel" Type 01 LPB has an integral plastic housing that "snaps-in" from panel front without hardware or bushing. Offered in one and two pole, momentary and alternate (push-push) action. Switches rated at 10 Amps.

- Integral lite and switch.
- Selection of lens cap colors.
- 3/8" or 1/4" lens cap, square or round.

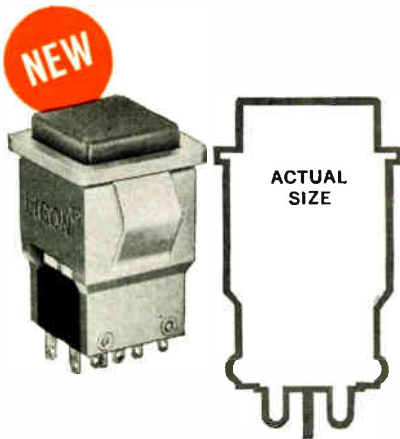

## SNAP OR CLAMP!

### TYPE 04 FOUR-LITE

Completely re-designed Type 04 LPB has a four-sided square bezel for dressy panel appearance. Available in no-hardware "snap-in" or two-screw "clamp-on" mountings, both applied front-of-panel. A snap-on switch module is also offered. Switches rated at 10 Amps.

- Four bulb illumination.
- Selection of panel and screen colors.
- Easy lamp servicing.



## REALLY SMALL!

### TYPE 18 DOUBLE-BREAK SUB-SUBMINIATURE

All the reliability and performance of the famous Licon® Type 16 has been packed into this new sub-subminiature switch. It offers a big switch rating and a 20 million cycle life in a package. Size: .500" x .350" x .200"!

#### ELECTRICAL RATING

125/250 VAC: 10 Amps

30 VDC: Form X or Y 10 Amps Res.

5 Amps Ind.

Form Z

10 Amps Res.

3 Amps Ind.



Send for new Licon full-line catalog and distributor list. Contains complete Licon switch specifications, details, dimensions.





# INTRODUCES SIX NEW SWITCHES

## DOUBLE-POLE MIDGET!

### TYPE 26 DOUBLE-POLE, DOUBLE-BREAK SUBMINIATURE

A new-to-the-industry switch that packs double-pole performance in an absolute minimum of space; has the durability and versatility of quality switches twice its size. Simultaneous break eliminates complicated multipole actuator mechanisms. Size: .25<sup>32</sup>" x .761" x .250"!

**ELECTRICAL RATING**  
125/250 VAC: 10 Amps  
30 VDC: Form XX or YY 15 Amps Res.  
Form ZZ 10 Amps Ind.

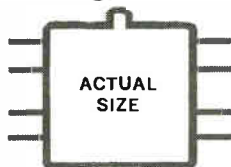

## VERSATILITY PLUS!

### TYPE 19 SINGLE-BREAK CRICKET<sup>T.M.</sup> SUBMINIATURE

The new Type 19 Cricket<sup>T.M.</sup> subminiature switch provides a long-life 5 million cycle snap-action switch enclosed in an accurately molded plastic case. Wide choice of terminals and actuators. Size: .780" x .360" x .250".

**ELECTRICAL RATING**  
125/250 VAC: 5 Amps  
28 VDC: 4 Amps Res.  
2.5 Amps Ind.



## MORE RELIABLE!

### TYPE 23 SINGLE-BREAK HI-CAPACITY

A competitive switch that brings Licon's well-known 20 million cycle reliability to the field for the first time. Available in a wide selection of terminals, actuators and circuitries. Size: 1.344" x .625" x .410".

**ELECTRICAL RATING**  
125/250 VAC: 10 Amps  
30 VDC: 10 Amps Res.  
6 Amps Ind.  
6 Amps Motor

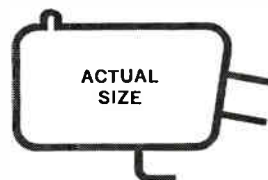

Six different switches—all new—are now added to the Licon line of precision switches and controls. They include two completely re-designed lighted push button switches; two new-to-the-industry double-break switches with exclusive Licon® butterfly<sup>T.M.</sup> action, and two new competitive single-break switches. Get the cataloged facts on the complete Licon line—and see for yourself. Request sample/demonstration on your letterhead.

**it LICON**  
DIVISION ILLINOIS TOOL WORKS INC.  
6615 WEST IRVING PARK ROAD — CHICAGO, ILLINOIS 60634

IN CANADA: CANADA ILLINOIS TOOLS, LTD. • 67 SCARSDALE ROAD • DON MILLS, ONTARIO, CANADA

By **DAVID NIXEN**

Sr. Technical Specialist,  
Autonetics,  
A Div. of North American Aviation Inc.  
Anaheim, Calif.

# Materials for

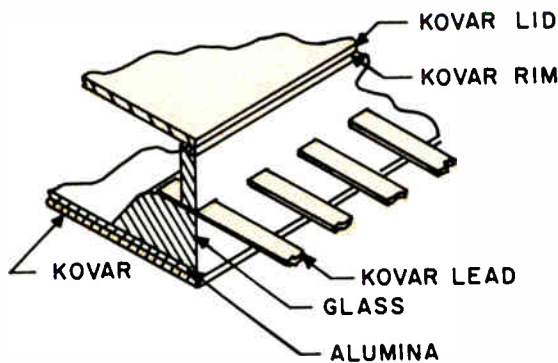

Fig. 1: A typical glass sealed case that is available for microelectronic devices. This is a common type of seal used in today's packages.

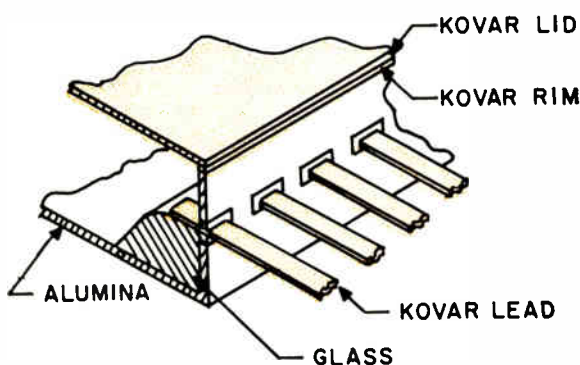

Fig. 2: This typical ceramic body case uses a glass seal. The materials used are listed in Tables 1 and 2. Usually a hard glass is used as seal.

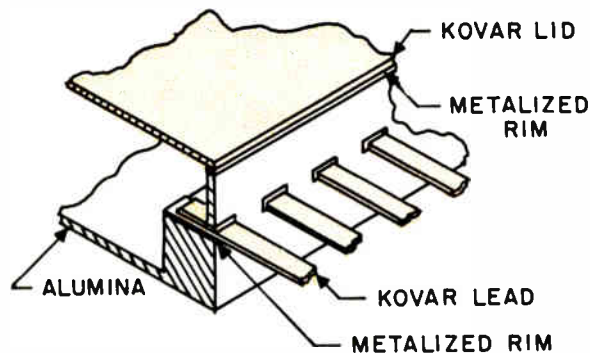

Fig. 3: Typical ceramic body case uses a metallized seal. These metallizations are complicated and require very careful mixing and materials selection.

KNOW-HOW ACHIEVED FROM MINUTEMAN II—the Air Force's first production system using microelectronic circuitry—will have a profound bearing on future systems. Experience gained in materials, design, and packaging of integrated circuits is being used by device and circuit manufacturers on a number of programs. The fallout will be more widespread as programs progress.

Our objective is to aid this fall out by outlining the major approaches to packaging, while considering some aspects including joining materials, processes and economics.

\* \* \*

## Package Materials

In the area of semiconductors, the package is no longer considered only a box in which to put a part for safe handling. The package is now a part of the device which can protect or destroy it. The package has to offer physical and chemical protection, as well as affect the electrical characteristics of the device. Under the heading of hermeticity, the mechanical and chemical protection of the package contributes to the unit's electrical behavior.

The basic parts of the package are: body, lead material, and seal material. In some instances the body and the seal material are the same (a molded glass package).

## The Body

The body of the package is glass, ceramic, metal, or any combination of them. The glass package is usually a hard glass (Table 1), and it seals to both the ceramic and the metal. The molded glass package is low cost and seals directly to the lead material, giving a good, reliable seal. The hard glasses are usually thermal shock resistant and have a coefficient of thermal expansion range of  $45-55 \times 10^{-7}$  in/in/°C.

There are some manufacturers who use a soft glass. These fall into the thermal expansion range of  $85-95 \times 10^{-7}$  in/in/°C and do not afford the thermal shock resistance of hard glass. The lead material used will vary from hard to soft glass. Where hard glass will seal to kovar, soft material will seal to platinum, dumet, or #52 alloy. The choice of glass body material is sometimes determined by the proc-



The design of microelectronic circuits has reached a point where the choice of packaging materials is a key consideration. It is a matter of cost vs. performance. Some of the materials available differ widely in cost, and it becomes important to know precisely what their electrical characteristics are.

# Packaging Microelectronic Devices

essing of the leads, e.g., welding or soldering to a multi-layer board.

Where a ceramic is used, a different set of variables exist. The ceramic must be capable of being either metallized, or have glass sealed to it, and form a hermetic joint. Some common ceramics are listed in Table 2. The body is a fired alumina-silica system which has excellent chemical, thermal and mechanical shock resistance. The ceramic, however, does require an intermediate material between the lead and itself to form a hermetic seal. A hard glass, which is compatible with the ceramic and the lead, is chosen for a glass seal.

A typical glass sealed case available is shown in Fig. 1; a typical ceramic body case (with glass seal) is shown in Fig. 2, and a typical ceramic body case (with metallized seal) is seen in Fig. 3.

If glass is not chosen, a form of metallization is used—the ceramic is metallized, a braze material is chosen and the lead brazed onto the metallized area. A high temperature process is used so that further processing will not affect the hermetic seal. The most common type of metallization used here is a molybdenum-manganese composition. Metallizations are complicated. Here is a partial list of the materials that go into one typical composition:

Molybdenum powder, manganese powder, iron powder, silicic acid, calcium oxide, nitrocellulose lacquer, acetone, methyl ethyl ketone, and cellosolve.

The materials are carefully mixed, and the organics are fired off. The surface is molybdenum. Below is a manganese layer, which has combined with the ceramic to form a thin Spinel type layer. Following this metallization, a nickel or copper plating, and a gold plating are applied.

These platings are sintered in, and the unit is ready for brazing. The braze material is usually in the 600-900°C range. Composition elements include: indium, copper, silver, zinc, gold and nickel. The choice of elements and their percentages determine braze melting points.

Thermal conductivity is of prime importance to body materials. Ceramic suppliers are working on a suitable beryllia body for package purposes. Beryllia would offer an extremely good dielectric with metallization and sealing characteristics, and a coefficient of thermal conductivity higher than many metals.

## Lead Material

The lead material must be compatible with the sealing material. If the sealing is glass or pyroceram, there must be an expansion match or high stress risers may be induced and a fractured seal result.

**ELECTRONIC  
INDUSTRIES**  
STATE-OF-THE-ART  
FEATURE

**Table 1**  
General Properties of Glass

	1723 Alumino- silicate	7040 Boro- silicate	7050 Boro- silicate	7052 Boro- silicate	7056 Boro- silicate
<b>Corrosion Resistance</b>					
Weathering	1	3	3	2	2
Water	1	3	3	2	2
Acid	3	4	4	4	4
<b>Thermal Expansion</b> (10 <sup>-7</sup> in./in./ °C)					
0-300 °C	46	48	46	46	51
Room temp setting point	54	54	51	53	57
<b>Upper Working Temps</b> (Mechanical Considerations Only)					
<b>Annealed</b>					
Normal Service °C	200	200	200	200	200
Extreme Limit °C	650	430	440	420	460
<b>Tempered</b>					
Normal Service °C	400	—	235	210	—
Extreme Limit °C	450	—	235	210	—
<b>Viscosity Data</b>					
Strain Point °C	670	450	460	435	470
Annealing Point °C	710	490	500	480	510
Softening Point °C	910	700	705	710	720
Working Point °C	1175	1080	1025	1115	1045

Courtesy Corning Glass Works, Corning, N. Y.

**Table 3**  
Common Lead Materials

	Kovar (54% Fe, 29% Ni, 17% Co)	Platinum	(Platinum Substitute) "Dumet" alloy. (43% Ni-Fe alloy Sheathed with copper)	42% Ni, 52% Fe, 6% Cr alloy
<b>Max. Operating Temp. °C</b>				
<b>Melting Point</b>	ca. 1450	1750	—	—
<b>In Vacuum</b>	ca. 1000	1600	400	700
<b>In Air</b>	ca. 600	1400	150	—
<b><math>\alpha \times 10^6</math> (20° to 350° C)</b>		9.25	ca. 7.1 ca. 9.0	8.9
<b>Ultimate Strength</b> (tons/sq. in.)	38-40	8-9	30-34	30-32
<b>Yield Stress</b> (tons/sq. in.)	25	ca. 2	20-23	16-18
<b>Elongation</b> (% on 100 mm.)	32	30-40	25	25
<b>Spec. Elect. Resistance</b> (ohm/cm.)	44	10.6	5.7	94
<b>Thermal Conductivity</b> (cals/sq. cm/cm <sup>1</sup> °C/sec.)	0.04	0.166	—	—

**MICROELECTRONIC PACKAGING**

(Continued)

The most common material used for hard glass sealing is kovar. Table 3 lists kovar along with a few other common lead materials. Although kovar seals well, it does require careful preparation.

Preparing kovar involves a degassing of the metal in a controlled atmosphere furnace (about 1100°C). Since kovar is a Ni-Fe-Co composition, it tends to oxidize easily, and care is needed not to over-oxidize the parts. The metal parts are then sealed to a match-

ing glass using a controlled atmosphere furnace. The oxide is cleaned from the lead's unsealed section by "kovar-dip and kovar-bright" solutions (essentially chromic and nitric acid compositions), and the leads are ready for platings.

In the case of a soft glass seal, the common lead material is dumet, which has a nickel-iron core and copper sheath. An oxide is required (as in the case of kovar) and is applied as a borate. The borate acts as the interface between the dumet and the glass. As in the case of any matched seal, the glass must be in the same thermal expansion range. In this instance both the glass and the dumet are about  $90 \times 10^{-7}$  in/in/°C. After completing the seal, the borate on the unsealed part of the lead is stripped so that plating or tinning can be applied.

Some other materials used or leads are platinum, #52 alloy, silver, and 1010 steel. These are used for various types of seals and require different processing steps.

**Sealing Material**

Sealing material is the material between the body and the lead which affords a hermetic joint. This may be a dielectric or a conductor, depending upon whether the body is a conductor or not. The most common used is the hard glass. The glasses listed in Table 1 also apply here.

Another dielectric used is the pyroceram family. It has strength and the advantage of being a low firing material. Where a glass seal requires a firing temperature of about 1000°C, pyroceram needs only 425°C for maturity. In the complete package, all three components (body, lead, sealing material) must be compatible. There must be a matching of thermal

**Table 2**  
Electronic Grade Ceramics

Property	Unit	6096 Alu- mina	4462 Alu- mina	Felds- pathic Porce- lain	13889 Steatite
<b>True Specific Gravity</b>		3.61	3.88	2.51	2.86
<b>Weight</b>	lbs/cu in.	0.124	0.127	0.086	0.097
<b>Pore Volume</b>	percent	4.7	3.3	5.4	6.5
<b>Linear Coef. of Thermal Expansion x 10<sup>6</sup></b>	52°-100° C	5.33	3.60	4.13	5.47
	25°-400° C	6.85	6.11	5.43	6.58
	25°-700° C	7.42	7.29	6.01	7.28
<b>Coef. of Thermal Conductivity</b>	c.g.s.	0.0144	0.0180	0.0047	0.0057
<b>Softening Temp</b>	°F	3580	3500	2830	2530
	°C	1971	1927	1554	1388
<b>Tensile Strength</b>	lbs/sq in.	13,230	15,510	3310	7500
<b>Compressive Strength</b>	lbs/sq in.	144,400	187,100	70,700	74,700
<b>Flexural Strength</b>	lbs/sq in.	29,200	36,070	10,970	17,080
<b>TE Value</b>	°F	1380	1470	660	1170
	°C	749	799	349	632

Courtesy Frenchtown Porcelain Co., Frenchtown, N. J.



expansions, there must not be any detrimental effect of one component on another, and there must be a compatibility in further assembly operations. In the forming of the glass seal to kovar, the processing should not induce stresses which cause cracks later. Proper firing cycles should be used to produce acceptable strain in the seal.

Fixture material and design in the sealing process can be very important. A carbon body is used so molten glass does not adhere to it. This carbon must be dense and oxidation resistant. If it is prone to oxidation it tends to powder easily and carbon particles are picked up in the surface of the molten glass. When this happens, "shorts" are likely to occur between two leads and the device fails. Although the dense carbon body does cost more than some of the other carbon-graphite bodies, the life of the jig is increased. It is also possible to design the fixture so that the most common wear points occur in areas which allow re-machining and therefore, re-use of the carbon block. This can often reduce the overall cost of fixtures.

Where a conductive material is used as the sealing agent, the body itself is the dielectric, thus insulating all leads from each other. The body is a metallized ceramic. The lead is inserted in the metallized area, and a braze preform inserted.

Since cost has always been considered in a design, the three cases in Figs. 1, 2 and 3 should also be evaluated on this basis. The least expensive is the glass sealed case (Fig. 1). Its parts are easily made and the final yield is good. Vendors of glass seals, through automation, have reduced the cost, and will reduce it further as production increases. The ceramic body case with glass seal (Fig. 2) is only slightly higher in price. The additional cost is due to fabrication. Many seal manufacturers make both glass seal cases. The ceramic body case with metallized seals (Fig. 3) is by far the most costly. Current prices are three to four times that of glass seal cases. Advantages of the metallized ceramic case is the greater seal strength and the higher degree of hermetic reliability.

The ultimate choice is a question of cost vs. performance.

The final packaging processing is the installation, the multi-layer board (MLB). The device may be applied by soldering or welding irons, lasers, electron beams, etc. The two methods now in use are soldering and resistance welding. Boards are either glass/epoxy with copper pads, or ceramic with metallized pads. The solder method can be used on all types of pads, while the use of resistance welding depends on pad material, plating type and thickness, and board composition. Soldering has a long history of reliability. But, automation to cut assembly costs has introduced resistance welding.

Resistance welding, either by adjacent electrodes or by parallel gap, is a fast, automated means of

**Table 4**  
**Heat Conductivity of Materials**

Giving the quantity of heat in calories which is transmitted per second through a body one centimeter thick across an area of one square centimeter when the temperature difference is one degree Centigrade.

	Minus 160° C	18° C	100° C	200° C	300° C
Copper, Pure	1.097	0.918	1.043	0.969	0.931
Silver, Pure	0.998	0.974	0.992		
Gold	0.700	0.700	0.703		
Aluminum	0.514	0.504	0.492	0.550	0.640
Tungsten		0.350			
Molybdenum	0.278	0.346			
Porcelain BeO 787 (Dense Ceramic)		0.323			
Tin	0.192	0.155	0.145		
Palladium		0.1683	0.182		
Platinum		0.1664	0.1733		
Nickel	0.129	0.142	0.138		0.126
Aluminum Oxide		0.040			
Steatite Ceramic		0.006			
Kovar		0.0395			
Glass		0.0025			
Mica		0.0018			

Courtesy Frenchtown Porcelain Co., Frenchtown, N. J.

joining a flat lead to an MLB pad. The advantages of welding are: flux free operation, no added weight, "operator-free" performance, high speed process, automated process and dynamically controlled sensing pulse. Some welding units have a feedback system which sends out a pulse to the work piece, "reads" the thickness of the work piece, and sets the power needed before making the weld. In this way, smaller pads or thinner leads do not cause blown welds which destroy the board.

Resistance welding has been used to join integrated circuit (IC) packages to one set of pads six times. An IC is welded to the pads and then removed, etc., until six units had been used. All six showed good joints.

Work is continuing on the use of laser and electron beam for this type of joining. These methods will ultimately achieve greater reliability and a higher degree of automation.

### Joining Materials

The area of packaging cannot be discussed without considering joining. It is sometimes hard to determine where the package ends and joining begins.

There are two general categories of joining materials—interconnection bonding wire and die-to-case bonding material—although some unusual deviations may be added.

### Interconnection Bonding Wire

The first method developed was thermo-compression bonding. It is a very fine and delicate operation. The lead material is gold (99.999% pure) and has a diameter from 0.0005 to 0.002 inches. Very delicate  
(Continued on page 72)



## HIGH-SPEED SWITCH FOR MODERN TELEPHONE SYSTEMS

"Ferreed" switches are key elements in the talking paths for telephone conversations in the Bell System's new electronic central office. In setting up connections through the office, the appropriate ferreeds are closed under the direction of the system's central control unit.

As indicated in the drawing (top right), ferreed switches include glass-enclosed contacts operated by external magnets. Contacts close when central control causes short current pulses to energize the external magnets. A contact remains closed, without expenditure of additional power, until another pulse opens it.

The name for the ferreed switch was coined from "ferrite," the material used in the external magnet when this device was first described by Bell Telephone Laboratories in 1960, and "reed," referring to the magnetic members inside the glass enclosure.

In its most recent form as developed at Bell Laboratories, Remendur is used in place of ferrite. Remendur, also a Bell Laboratories development, is a cobalt-iron-vanadium alloy with square hysteresis loop and values of coercive force intermediate between those of soft magnetic materials and permanent magnets. The device achieves fast contact closure (about a half millisecond) with even faster control pulses—characteristics that are compatible with the high-speed, versatile performance of modern telephone communication systems.

**Bell Telephone Laboratories**  
Research and Development Unit of the Bell System

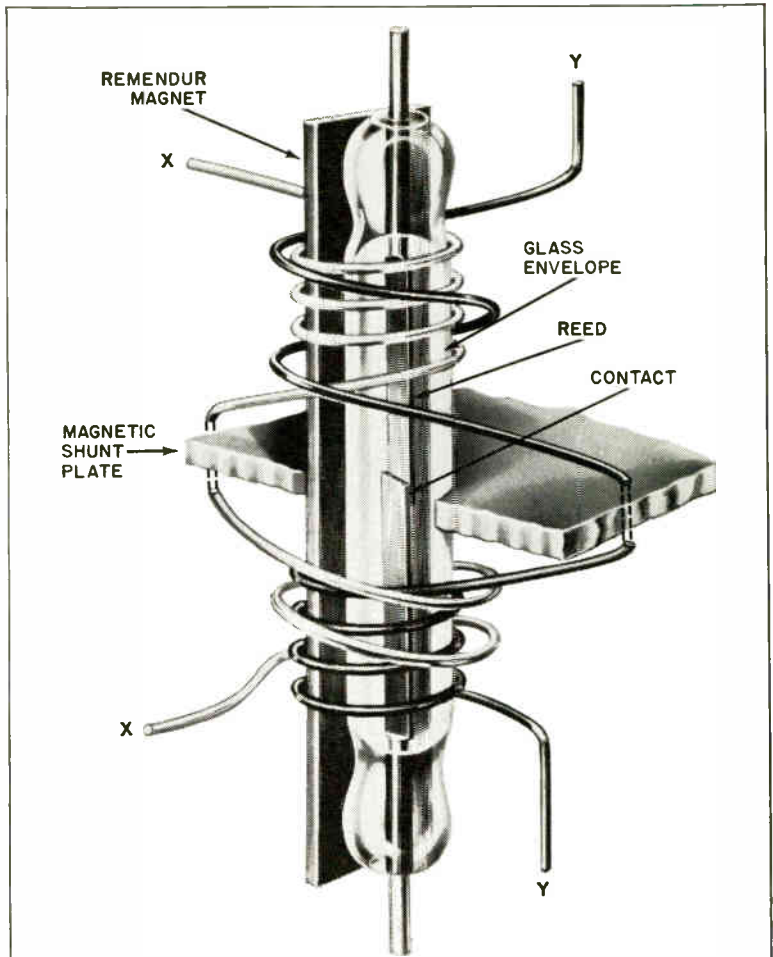

Concept of the ferreed in simplified form. Windings around magnet and glass-enclosed reeds are arranged in such a way that the contact is opened or closed in response to pulses of current on the x and y leads. For the closed state shown here, simultaneous pulses on both x and y leads effectively cause the Remendur to become one magnet. The two reeds are now magnetically attracted and the contact is closed. To open the contact, a pulse is applied to either the x or the y winding. This pulse effectively divides the Remendur into two magnets at the magnetic shunt plate. The ends of the Remendur then are both north (or both south) poles, and the contact is opened.

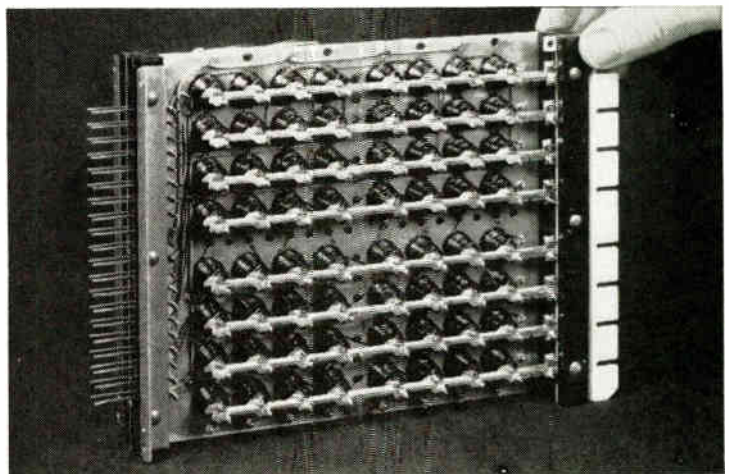

Typical array of 64 ferreed elements used as network crosspoints in electronic switching systems. Coincident current pulses on x and y leads (see drawing) permit operation of one ferreed crosspoint but not others in the same horizontal row and vertical column. Unit was carefully designed, in cooperation with the Western Electric Co., for efficiency of manufacture and economy.



# NEED TECHNICAL INFORMATION ON METALLIZED CERAMICS?

## AVAILABLE FROM AMERICAN LAVA UNDER ONE RESPONSIBILITY:

### 15 METALLIZABLE CERAMICS

6 Steatites 1 Forsterite 1 Zircon  
2 Beryllias 5 Aluminas

### 4 METALLIZING PROCESSES

Refractory Metal Powder Silver  
Active Metal Platinum-Gold

Since all ceramics and metallizing processes are not interchangeable, our engineers will suggest combinations likely to meet your requirements.

**PLUS PLATING, including:**  
Copper, tin, silver, nickel,  
cadmium, gold.

**SOLDERS AND BRAZES, including:**  
60% tin-40% lead; 95% lead-5% silver;  
95% lead-5% indium;  
97½% lead-2½% silver;  
60% silver-30% copper-10% tin;  
72% silver-28% copper;  
Electronic Grade-copper;  
Electronic Grade-Silver

**METALS FOR ATTACHMENT, including:**  
Nickel-Cobalt-Iron alloys,  
molybdenum, nickel, copper,  
stainless steel-300 series.



*If you need facts about metallized ceramics, we suggest that you request*

## **ALSIMAG<sup>®</sup>** BULLETIN No. 632

It has 20 pages on high and low temperature metallizing, high and low temperature hermetic seals, ceramics and metals commonly used in metal-ceramic assemblies, property charts, graphs comparing thermal expansions of these ceramics and metals, suggestions on patterns, and on design and installation.

If you will submit your problem in detail, our engineering staff will help you find the best combinations for your requirements. Prototypes can be supplied at reasonable cost.

**American Lava Corporation**

**3M**  
COMPANY

A SUBSIDIARY OF

PHONE 265-3411 (Area 615), CHATTANOOGA, TENN. 37405

For service, contact American Lava representatives in Offices of Minnesota Mining and Manufacturing Co. in these cities (see your local telephone directory): Birmingham, Michigan • Boston: Needham Heights, Mass. • Chicago: Bedford Park, Illinois • Cleveland, Ohio • Laurens, S. C. • Los Angeles, Calif. • Minneapolis, Minn. • Metropolitan New York: Ridgefield, N. J. • Up-State New York: Phelps New York • Philadelphia, Pennsylvania • Richardson, Texas • South San Francisco, California • All export except Canada: Minnesota Mining and Manufacturing Co., International Division, 99 Park Ave., New York, N. Y.

63rd  
YEAR  
OF  
CERAMIC  
LEADERSHIP

Circle 37 on Inquiry Card  
World Radio History

## MICROELECTRONIC PACKAGING (Continued)

treatment of the wire is required. Dropping a closed spool on the floor, storage over an abnormally long period of time, and kinking, all require re-processing.

One of the major problems encountered with the gold wire is the formation of  $AuAl_2$  (purple plague). This is a very brittle material which cracks easily under minimum shock and causes an open circuit. Gold and aluminum, which form  $AuAl_2$  in the presence of silicon, may cause purple plague. Industry has concentrated on removal of one of the variables. An approach has been to eliminate the gold wire. Aluminum wire was first tried, but it was too soft for thermo-compression bonding. As a result, it sagged and would draw into thin areas and finally sever. When 1% silicon is added to the aluminum, its wire hardens so that it becomes workable. This material is being used with ultrasonic bonding. The advantage of ultrasonic over thermo-compression bonding is the elimination of heating the device.

Figs. 4 and 5 show the general characteristics of thermo-compression and ultrasonic bonding. Both processes require clean room conditions. Current production rates for bonds of this type approach one a second. This involves magazine loading and feeding, special handling aids, and special jigs and fixtures.

Another method of thermo-compression bonding becoming popular is diffusion. Current is passed through a split electrode which acts as a high resistance heater. The end of this electrode wire passes through the capillary at the end of the electrode. The main advantage is that heat is applied only from the top. This is a vital factor in the problem of device degradation.

Other means of interconnection introduce various materials. All have extremely high purity. One method used in the field is the insertion of copper balls on device pads. These balls are then coated with a solder material, and the device is placed face down on a mirror imaged substrate which connects to the external circuitry. Heat causes the solder to flow, making contact with the metallized substrate. The solder plated copper balls are used both for electrical interconnection and mechanical retention.

Another method is the use of a silver pad on the interconnection points of a die. Small drops of solder are applied to the pads, and in the manner described above, the device is placed face down on a registered substrate and heated, causing the interconnections.

Platings are also being used as an interconnection medium. Aluminum, in the form of platings and vacuum depositions, is being applied to the lead protruding through the case wall. The lead is positioned over the pad material and ultrasonically bonded. Platings and vacuum depositions are becoming more important in interconnection work.

### Die-to-Case Bonding

This bonding area can be divided into the conductive and non-conductive materials. The conductive materials are in the gold alloy family: gold-tin (80-20), gold-silicon (94-6), gold-germanium (99-12), and gold.

	Composition	Melting Point
Gold-Tin	80-20	280°C
Gold-Germanium	88-12	356°C
Gold-Silicon	94-6	370°C
Gold	—	1063°C

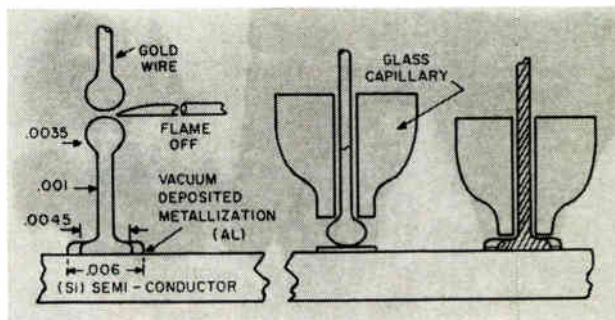

Fig. 4: Thermo-compression bonding has been widely used for connections on microelectronic devices by manufacturers.

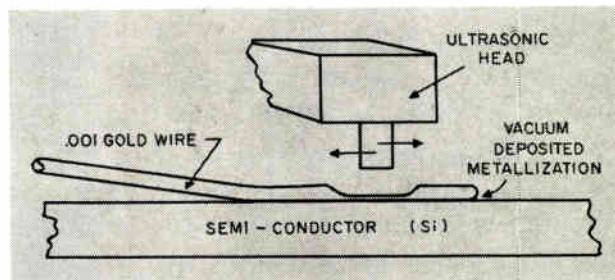

Fig. 5: Ultrasonic bonding of microelectronic devices to leads has the advantage of not creating any heat.

The alloys are all of eutectic composition. For these alloys to be used as a braze the substrate must be metallic or metallized. It is also preferable that the substrate present a gold face to the braze material.

If gold-silicon, gold-germanium, or gold is used as the braze material, it can be doped to give the device another characteristic. Dopants vary in types and amounts, but typical ones are 0.5% antimony and 0.5% allium. This depends on whether N or P characteristics are desired. In the use of these braze materials, it is important to prevent oxidation. To do this, a protective gas envelope is used. Generally, the envelope is a forming gas (85% hydrogen-15% nitrogen). There is a belief that the hydrogen is detrimental to the device (electrical characteristics are affected) and plain nitrogen is used. The gas is filtered and dry.

Although gold-tin has the lowest in melting point, its fragility prevents wide acceptance. When molten and alloyed, gold-tin forms a very brittle joint. Any vibration or mechanical shock tends to create a weak area in the braze.

The non-conductive materials used for adhering the die to the substrate can be categorized as the "glass" family. The most popular is a member of



Let me explain why  
Allen-Bradley's one grade resistor policy  
is of utmost importance to you

■ Over the last quarter century, Allen-Bradley's hot molded composition resistors in all ratings have established their reputation for being of uniformly consistent quality—not even approached by any other molded resistor on the market. Neither years of service, nor years of only shelf life will affect this uniformity within the rating under which the units were originally purchased.

Allen-Bradley feels that it has a responsibility to its multitude of customers all over the world, that when they order Allen-Bradley resistors they have the confidence—based on years of experience—that the quality and dependable performance will be the same as before! No wide deviations in characteristics—even in isolated resistors—can cause questionable performance in your equipment. Catastrophic failures are an impossibility with A-B hot molded resistors.

Perhaps Allen-Bradley, as the manufacturer, doesn't deserve credit for such uniformity because it results from automatic machinery which completely eliminates the human element. Variations are not tolerated by this machinery.

Besides, if Allen-Bradley had succumbed to the price argument and had placed on the market a lower quality resistor, how would you be able to tell them apart—without having this cost you extra money? How about the wrong resistor accidentally getting into the wrong place? This

could only be discovered on final test—and correcting such careless mistakes is expensive. Do you really save money when you buy an inferior make of resistor???

Leading electronic manufacturers have found it really pays to standardize on Allen-Bradley quality resistors—you will, too. For complete specifications, please write for Technical Bulletin 5050: Allen-Bradley Co., 222 West Greenfield Ave., Milwaukee, Wisconsin 53204. In Canada: Allen-Bradley Canada Ltd., Galt, Ontario.



HOT MOLDED FIXED RESISTORS available in all standard EIA and MIL-R-11 resistance values and tolerances, plus values above and below standard limits. Shown actual size.



**ALLEN-BRADLEY**  
QUALITY ELECTRONIC COMPONENTS

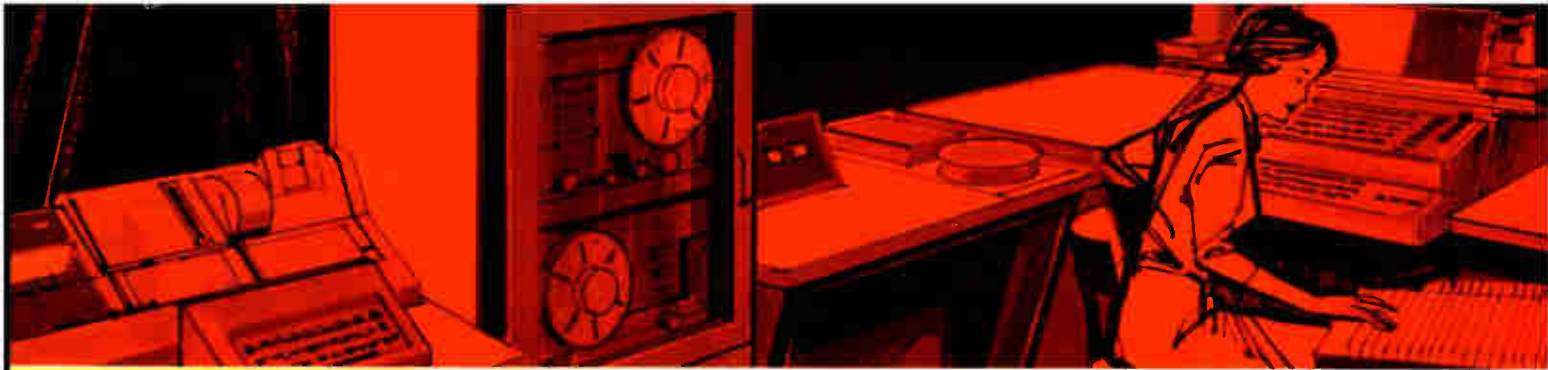

## Allen-Bradley hot molded resistors contribute to **NCR 390** business computer's dependable performance

■ To insure the dependable operation of their NCR 390 business computer, National Cash Register engineers selected Allen-Bradley fixed and variable resistors. The reliability of Allen-Bradley fixed resistors is determined by the hot molding process by which they are made. This process—pioneered, perfected, and used *only* by Allen-Bradley—produces such complete uniformity from resistor to resistor—and from one year to the next—that long term performance can be accurately predicted.

Allen-Bradley Type J variable resistors are also made by this hot molding process which “fixes” the resistor, terminals, faceplate, mounting bushing, and insulation material into an integral assembly. The solid resistance track assures smooth, quiet control—the objectionable discrete steps of wire-wound units are done away with. And on accelerated tests, the Type J exceeds 100,000 complete operations with less than 10% resistance change.

Identify your product as “quality.” Take advantage of the fact that Allen-Bradley hot molded resistors are produced only in one “quality”—and sold only at one price level. Allen-Bradley’s reputation for producing the highest quality of fixed and variable composition resistors is the result of our customers’ long years of experience with these resistors. Incidentally, during the 25 to 30 years that these resistors have been “on the market,” there has not occurred a single case of catastrophic failure. With such reputation for top quality so firmly established, Allen-Bradley could not afford to play around with a “second quality”—for no better reason than to conform with the cut price ideas of a certain type of buyer.

For more details on all A-B quality electronic components, please write for Publication 6024: Allen-Bradley Co., 222 W. Greenfield Ave., Milwaukee, Wis. 53204. In Canada: Allen-Bradley Canada Ltd., Galt, Ontario.

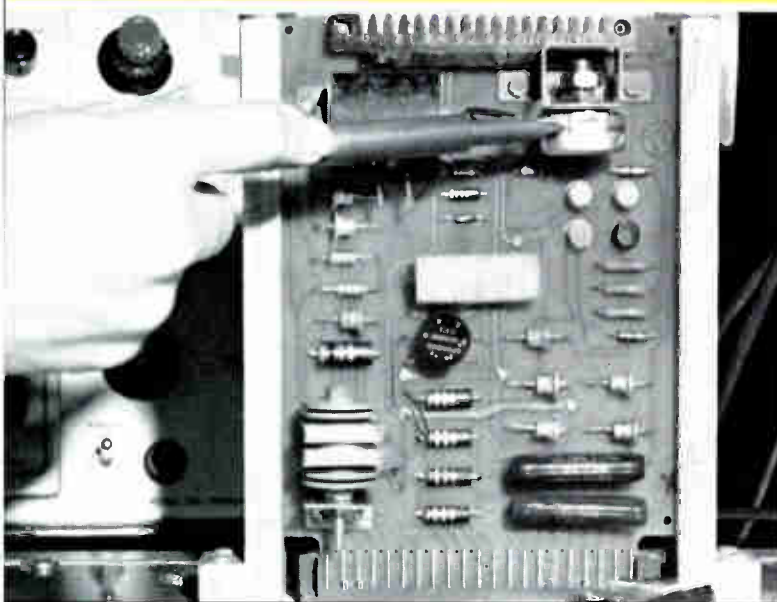

Circuit board for National Cash Register Company NCR 390 computer showing use of Allen-Bradley Type J hot molded variable resistor and several A-B hot molded fixed resistors.



HOT MOLDED FIXED RESISTORS available in all standard EIA and MIL-R-11 resistance values and tolerances, plus values above and below standard limits.



**TYPE J CONTROLS** are rated 2.25 watts at 70°C and are available in single, dual, and triple units with standard tapers and standard total resistance values up to 5 megohms. Special tapers and special, as well as higher, total resistance values are available.

# ALLEN-BRADLEY

QUALITY ELECTRONIC COMPONENTS



the pyroceram family, which fires to a crystalline state. The time and temperature used to mature the pyroceram must be compatible with that of the substrate and die, care must be exercised in the firing. Pyroceram has good mechanical strength and a comparatively low working point (in the 425°C range). It also has the unusual characteristic of progressively going higher in working point (in increments of 30°C) each time it is worked. Since semiconductor work involves chemical processing at various stages, it is mandatory that careful thought be given to the sequence of operations.

One aspect of the bonding which is becoming more important is thermal conductivity. With the greater power demands being imposed on semiconductors, it is more and more critical to dissipate the generated heat. Table 4 lists a series of commonly used materials and their thermal conductivity. Where size and weight are factors (such as in the integrated circuit) a massive heat dissipator cannot be used. Therefore, wherever possible full use is made of the basic structure materials. Since heat originates in the die, the first means of heat transfer is in the bond material between the die and substrate. The gold wires bonded to the pads can be disregarded, since their contribution to thermal dissipation is so low as to be negligible. Table 4 shows that the thermal conductivity of glass is far lower than that of the gold family. The bonding material, therefore, becomes a large factor in the thermal dissipation.

Since thermal dissipation needs are increasing, many manufacturers have gone to die bonding by conductive braze. This involves a redesign of parts and process and results in a more costly operation. But, it is necessary. Glass is applied to the alumina substrate by putting a small drop of frit bearing vehicle (amyl acetate, butyl carbitol, nitrocellulose, etc.) on the substrate, placing the Si die on it and passing it through a furnace. To bond the die with the braze material, the alumina must be metallized before being assembled into the package, and it must be nickel and gold plated. The cost of the materials and labor is higher. A higher degree of dissipation results since the heavy glass interface between die and case has been eliminated. A very fine glassy phase in the form of a Spinel type layer exists in the metallization itself, but in a very narrow band. The result is a greatly improved thermal system.

### Conclusion

In the past fifteen years, science and industry have created components and systems so highly sophisticated that they bear only slight resemblance to earlier products.

Pacing this rapid advancement has been the need for higher systems reliability and maintainability, lower costs, lighter weights, smaller sizes, and lower power requirements. Microelectronics has made this possible. Packaging, it may be said, has made it practical.

# CIRCUIT-WISE

## Pulse Stretcher with NOR Gate

A NOR gate with an output pulse of some predetermined minimum duration was needed. Conventional circuitry has employed an additional NOR gate used with a triggered monostable multivibrator. A pulse-stretching circuit combined with a conventional NOR gate solved the problem.

Fig. 1 shows a pulse-stretcher circuit added to a conventional NOR gate circuit. With all the inputs at ground potential, the output is positive, current flows through  $C_1$  and  $R_1$  into the base of  $Q_2$  turning it on. Current flows into the base of  $Q_2$  until  $C_1$  is charged (about 3 times the  $R_1 C_1$  time constant). If the inputs become positive while  $Q_2$  is still conducting,  $Q_1$  will not be affected since its base is being held at ground potential by  $Q_2$ .

When  $Q_2$  stops conducting, the inputs regain control of the output. A diode in series with  $R_1$  provides  $C_1$  with a discharge path to ground. Fig. 2 depicts a binary counter using this pulse stretcher-NOR gate for reset. The binary counter must be reset to zero when a certain preselected count has been reached. The NOR gate detects the preselected state and produces a pulse that the pulse stretcher maintains for a period long enough to reset all counter stages.

The circuit works equally well with pnp transistors, all polarities being reversed. It has been used successfully in a square-root computer and with digital oscillators.

For further information contact: Technology Utilization Officer, Goddard Space Flight Center, Greenbelt, Maryland. 20771, Reference: B64-10150.

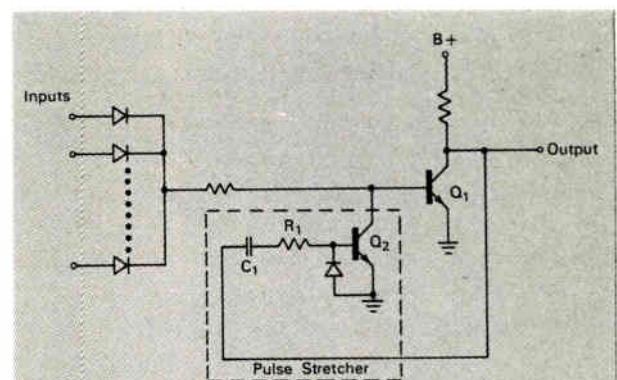
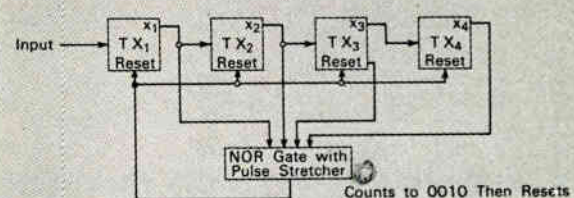

FIGURE 1



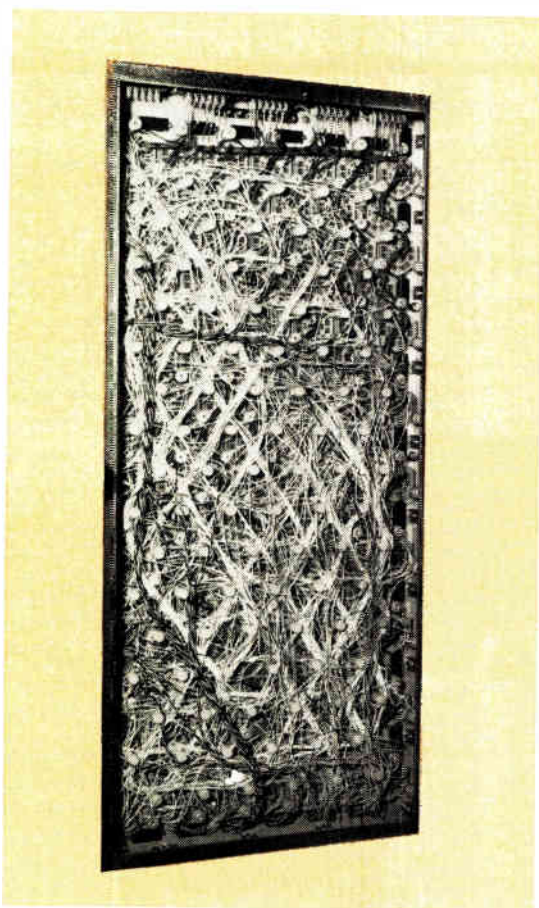

Fig. 1: Backplane wiring for a large console.

THE PENALTY FOR CHOOSING AN INADEQUATE wiring system is paid in terms of increased costs in assembly, maintenance and repair. So, a little extra time in the planning is well-spent.

To select the most efficient backplane system, we should follow three steps:

(1) Establish the important needs and parameters of the equipment being designed (i.e., low cost, easy maintenance, high density, etc.).

(2) Review each of the backplane wiring methods available by determining their advantages and limitations.

(3) Select the method which satisfies the largest number of important needs.

We will explore each of these steps in this article.

\* \* \*

Before going into the details of Step #1, we must clarify the term "backplane" so that there is no question as to the area we will cover.

The backplane referred to in this article is the surface or plane of an electronic package where interconnections are made between components or modules: This could be the chassis in a small electronic package or it could refer to the jumper wires at the back of printed circuit (P.C.) connectors, which serve to interconnect component boards.

A backplane varies in size from about 4 in.<sup>2</sup> when used as the interconnection means for a microelectronic package, Fig. 2; to 4 ft.<sup>2</sup> when used in a large electronic console, Fig. 1.

# Comparing The Backplane Wiring Techniques

A confusing array of backplane wiring methods exist. This has made it difficult for the engineer to choose the best wiring system for a given application. The information here will serve as a guide to the most efficient backplane system.

By **ROCCO NOSCHESI**

Burdny Corp.  
Norwalk, Conn.

We will cover the complete backplane field here. It is our aim to bring all the factors pertaining to backplane wiring into focus so that they can be readily compared. We have confined the uses and backplane wiring methods to their basic descriptions so that the overall backplane picture would be available for analysis.

## Establish Requirements

To establish requirements use Step 1 and Table 3.

There are many parameters which affect the choice of the best backplane wiring method. In our review, we have selected the seven which we feel are the most important; they are: high reliability, weight, size (density), environment resistance, cost, maintainability, and versatility.

For any given use, it is necessary to determine the sequence of importance for the seven parameters mentioned above. This will provide emphasis to the important needs when the choice of backplane method is made.

To include as many uses as possible, we have selected four major categories. Each one is different from the others in that it has a different listing of important parameters. The four categories (Table 3) are:

- (1) Missiles and satellites.
- (2) Aircraft (and some portable equipment).
- (3) Ground based military equipment.
- (4) Commercial uses.



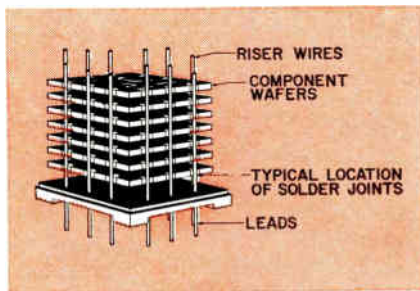
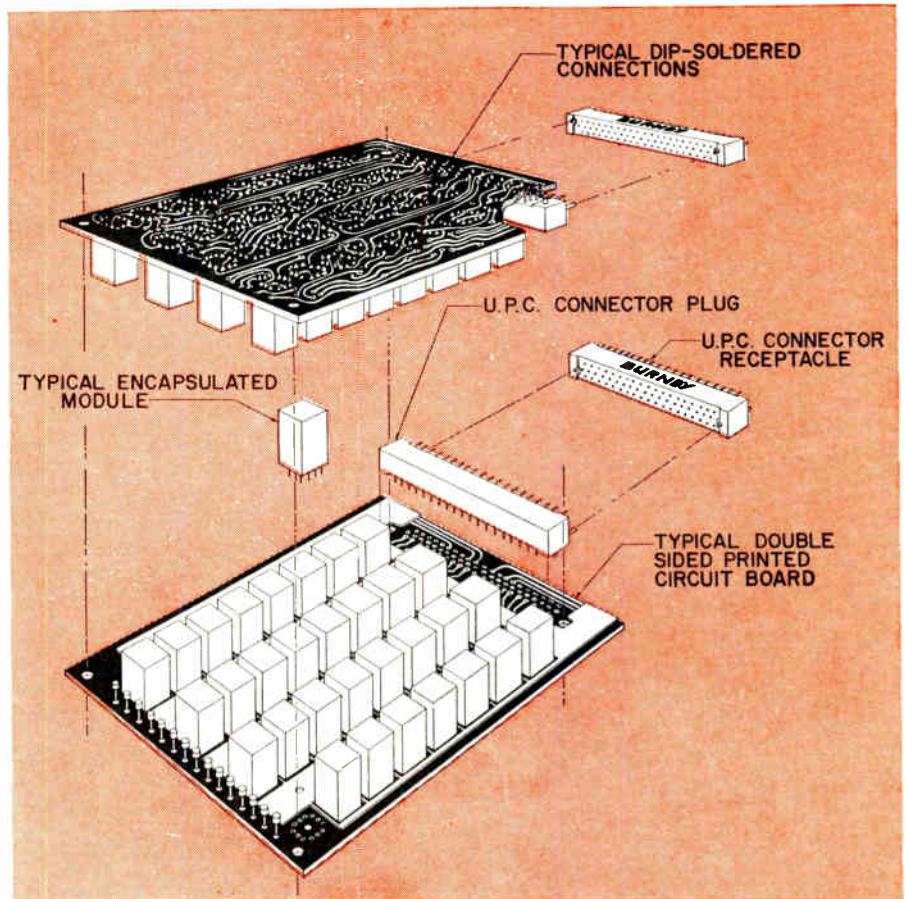

Fig. 2: Diagram at right shows backplane wiring when used as the interconnection means for a microelectronic package. Above diagram shows an enlarged view of construction of encapsulated module.



For *missile and satellite uses*, reliability, weight, and size are paramount, with environment and cost of lesser importance. Maintainability and versatility are last, mainly because of the unique "one-shot" aspect of the uses in this category.

Reliability in missiles and satellites is of major importance because of the complexity and number of components in typical systems. Weight and size are important because of the high cost of fuel that would be needed to launch unnecessary weight.

In *aircraft uses* (and some portable systems), reliability and weight are also of major importance. Maintainability becomes important because of the need to easily service aircraft. Environmental resistance and size follow in sequence, with cost and versatility of least importance.

In *military ground equipment*, reliability retains an important position. But, maintainability is more important because operation of military equipment relies upon easy and rapid repair. Environment and cost follow in the order of importance. Versatility, weight and size are of lesser importance in this category.

*Commercial uses* require that cost and maintainability are at the top of the order because of the highly competitive aspect in this field. Reliability and versatility come next with size, weight and environment at the end of the list of importance.

With the order of importance assigned to the

parameters in each of the four major categories, we can now proceed to Step 2.

### Review of Techniques

To review backplane wiring methods we will use Step 2 and Table 2.

Table 2 is a comprehensive description of each of the backplane approaches that will be discussed. The methods are:

- (1) Solder cup or tab (hand soldered).
- (2) Crimp (snap-in).
- (3) Solderless wrap (automatic).
- (4) Welded ribbon.
- (5) Printed circuit (solder dip).

The table is arranged so that each backplane method is rated in each of the seven parameters used in Step 1.

The comparative rating system we have chosen is: 4 = very good, 3 = good, 2 = fair, and 1 = poor.

We know that there is no single rating system that could be assigned to backplane methods that would be realistic for all electronic packagers. The differences that exist between each manufacturer makes this impossible. Such differences as equipment, labor rates and operational procedures affect the relative merit of each backplane method.

To include as many packagers as possible, we have based our ratings upon experience gained in the connector field and by contact with many diversified uses.

Table 1

## BACKPLANE TERMINATION COMPARATOR CHART

APPLICATION	PARAMETER	Multiplier	SOLDER Cup or Tab		CRIMP (Snap-In)		SOLDERLESS WRAP		WELD		PRINTED CIRCUIT	
			Rating	Score	Rating	Score	Rating	Score	Rating	Score	Rating	Score
MISSILES and SATELLITES	Reliability	7	1	7	4	28	3	21	3	21	4	28
	Weight	6	1	6	1	6	3	18	4	24	4	24
	Size	5	3	15	2	10	1	5	4	20	3	15
	Environment	4	2	8	4	16	3	12	3	12	3	12
	Cost	3	1	3	3	9	4	12	2	6	3	9
	Maintainability	2	2	4	4	8	3	6	1	2	1	2
	Versatility	1	4	4	4	4	3	3	3	3	1	1
<b>TOTAL SCORE</b>				47		81		77		88		91
AIRCRAFT (And Some Portable Equip.)	Reliability	7	1	7	4	28	3	21	3	21	4	28
	Weight	6	1	6	1	6	3	18	4	24	4	24
	Maintainability	5	2	10	4	20	3	15	1	5	1	5
	Environment	4	2	8	4	16	3	12	3	12	3	12
	Size	3	3	9	2	6	1	3	4	12	3	9
	Cost	2	1	2	3	6	4	8	2	4	3	6
	Versatility	1	4	4	4	4	3	3	3	3	1	1
<b>TOTAL SCORE</b>				46		86		80		81		85
MILITARY Ground Equipment	Maintainability	7	2	14	4	28	3	21	1	7	1	7
	Reliability	6	1	6	4	24	3	18	3	18	4	24
	Environment	5	2	10	4	20	3	15	3	15	3	15
	Cost	4	1	4	3	12	4	16	2	8	3	12
	Versatility	3	4	12	4	12	3	9	3	9	1	3
	Weight	2	1	2	1	2	3	6	4	8	4	8
	Size	1	3	3	2	2	1	1	4	4	3	3
<b>TOTAL SCORE</b>				51		100		86		69		72
COMMERCIAL	Cost	7	1	7	3	21	4	28	2	14	3	21
	Reliability	6	1	6	4	24	3	18	3	18	4	24
	Maintainability	5	2	10	4	20	3	15	1	5	1	5
	Versatility	4	4	16	4	16	3	12	3	12	1	4
	Size	3	3	9	2	6	1	3	4	12	3	9
	Weight	2	1	2	1	2	3	6	4	8	4	8
	Environment	1	2	2	4	4	3	3	3	3	3	3
<b>TOTAL SCORE</b>				52		93		85		72		74

## BACKPLANE WIRING (Continued)

## Selecting the Technique

To select the appropriate backplane method use Step 3 and Table 1.

In Step 1, we assigned an "order of importance" to the parameters of each major use.

In Step 2, we established a rating of the backplane methods for each of the parameters.

For Step 3, the ratings of all backplane methods will be compared so that their relative merits in each use can be evaluated.

To add proper emphasis to the important parameters in each category, we have selected an arbitrary multiplying factor. The multiplier is used to increase a rating for an important parameter, and reduce the effect of a rating for a parameter of lesser importance.

As shown in Table 1, the most important parameter in each category has the multiplier of "7." The next important parameter has a multiplier of "6," the next "5," etc.

If a different "weighing" system is needed for a specific use, the multipliers should be changed.

Results shown in Table 1 show that the attributes of most backplane methods make them more desirable for one use than the other.

*Hand soldered terminations* yielded a low score for all uses. This can be attributed to the inconsistencies associated with hand soldering. Hand soldering may have a place in packaging, but as this study shows, it does not belong on the backplane.

*Crimped terminations* showed as "best" for military ground equipment and commercial systems. They also had relatively good scores for the categories of missiles and satellites as well as for aircraft.

*Solderless wrap* had a score which showed it to be fairly good for aircraft, military and commercial uses.

*Welded terminations* scored high for missiles and aircraft but low for military ground uses and commercial uses.

*Printed circuit board* also showed high for missiles and aircraft and low for military ground and commercial systems.

The results presented in this review should be considered as a guide. A more realistic selection of a backplane method for any specific use can only be made by using the three steps that have been outlined and adjusting the various ratings to satisfy the particular circumstance.



**Table 2**

**BACKPLANE TERMINATION RATING**

TERMINATION TYPE	Reliability	Weight	Size	Cost	Environment	Maintainability	Versatility
Solder Cup or Tab (HAND SOLDERED)	1	1	3	1	2	2	4
Crimp (Snap-In)	4	1	2	3	4	4	4
Solderless Wrap	3	3	1	4	3	3	3
Welded Ribbon	3	4	4	2	3	1	3
Printed Circuit (SOLDER DIP)	4	4	3	3	3	1	1

CODE—4. Very good. 3. Good. 2. Fair. 1. Poor.

If this plan is used, the best and most efficient backplane wiring system will be achieved.

**Acknowledgement**

Grateful acknowledgement is made to R.C.A., Camden, N. J. and I.T.&T. Federal Laboratories, Nutley, N. J., for the use of concepts shown in Figs. 1 and 2.

**Table 3**

**APPLICATIONS AND PARAMETERS**

<b>Missiles and Satellites</b> 1. Reliability 2. Weight 3. Size 4. Environment 5. Cost 6. Maintainability 7. Versatility	<b>Aircraft (and some portable equip.)</b> 1. Reliability 2. Weight 3. Maintainability 4. Environment 5. Size 6. Cost 7. Versatility
<b>Commercial</b> 1. Cost 2. Reliability 3. Maintainability 4. Versatility 5. Size 6. Weight 7. Environment	<b>Military Ground Equipment</b> 1. Maintainability 2. Reliability 3. Environment 4. Cost 5. Versatility 6. Weight 7. Size

• A REPRINT of ANY ARTICLE in this issue is available from ELECTRONIC INDUSTRIES Reader Service Department.

# WHAT'S NEW

## Front and Back P-C Layouts on Single Sheet

PERSONNEL CONCERNED WITH ASSEMBLY AND TESTING of printed circuit boards find it useful and time-saving to be able to see both the front and back of a p-c board at the same time. One way to make this possible is to use overlay images of the two circuits on one sheet. NASA has announced a double-exposure method for doing this. In this method (see illustration), the front and back circuits are reproduced as images of different intensity on a single sheet. A normal diazo process is used for development of the foil on which the overlays are imaged. Other photographic processes can also be used.

Drawings can be on clear plastic, or they can consist of diazo transparencies, photographic film positives, or drawings on tracing paper. Drawings of components, notes, and instructions may be included on the front layout or on the mat side of the foil prior to exposure.

On the finished print, the darker front-circuit layout can easily be distinguished from the lighter back-circuit layout.

This method should have widespread use in the preparation of illustrations as teaching aids and guides for construction and maintenance of complex devices.

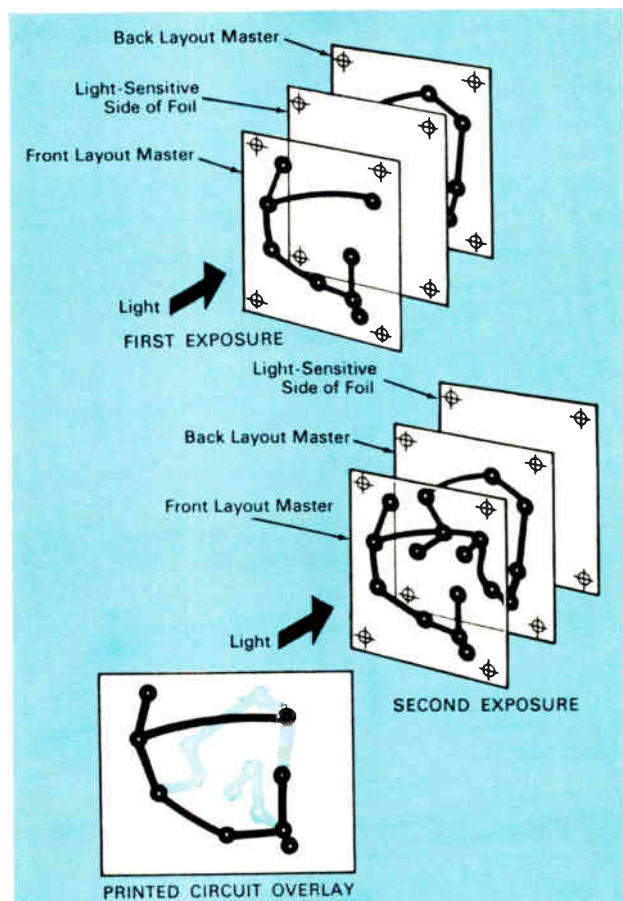

When designing an RFI shielded electronic package, certain questions must be answered. What material should be used? Should shielding and filters be installed? How should the seams, joints, etc., be designed? These and other pertinent questions are answered here.

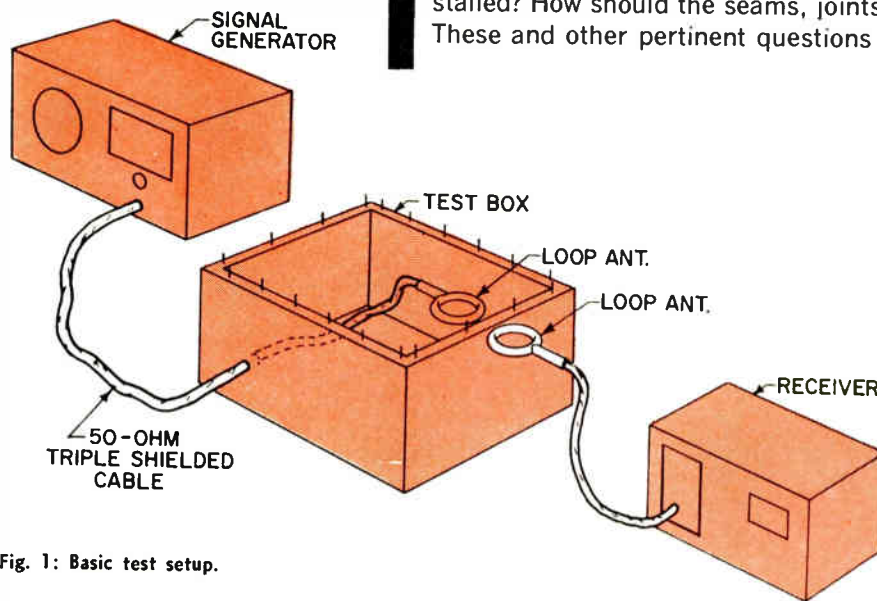

Fig. 1: Basic test setup.

# Designing the RFI Shielded Package

THERE ARE THREE BASIC PROBLEMS to be considered in designing the shielded electronic package. The material to be used and its thickness should be determined. The seams, joints, meter openings, and other apertures should be designed so as to reduce leakage. And, shielding and filters should be installed to block interference on interconnecting cables.

In this article we will show the design approach which was used to achieve shielding in a representative package.

\* \* \*

Designing shielded equipment is not hard if the basic means by which interference enters or leaves the equipment is understood. (Consider interference to be any undesired radiation which exceeds certain specified levels.) Shielding will confine the interference and prevent escape of r-f energy from the enclosure. Shielding may also reduce the influence of external fields.

A perfect shield is not possible. What factors permit interference to escape from an enclosure? Power lines are an important source of interference because of the direct connection to internal devices. Control leads also are often connected to interference sources. Holes for component mounting, and joints in the equipment case, also provide a means of escape for an interference signal. Attenuation of the signal through the material of the case itself may sometimes be less than through these alternate paths.

A test set used for calibrating camera photo sensors is shown in Fig. 2. While relatively simple in terms of interference generating features, it illustrates the basic design principles.

In the initial design review we considered interference sources to be the mercury-vapor lamp used for the internal light source and the lamp start switch used for its ignition. The power on-off switch was not considered a problem, because of infrequent use.

What are possible sources of leakage from the equipment? The design drawings showed a panel on which parts would be mounted, and an outer dust cover. The case had to be moisture resistant and interference-free. The panel face contained many possible sources of leakage. Some of these were the light source aperture, calibration meter, cable and connector, fuses, switches, and pilot lamp. We shall now consider the methods used to reduce leakage.

## Metal Selection

Shielding may be obtained by using highly conductive metals such as copper, aluminum or magnesium.

By **ARNOLD L. ALBIN**,  
 Manager, RFI Compatibility Section of  
 Fairchild Space and Defense Systems,  
 300 Robbins Lane,  
 Syosset, L.I., N.Y.





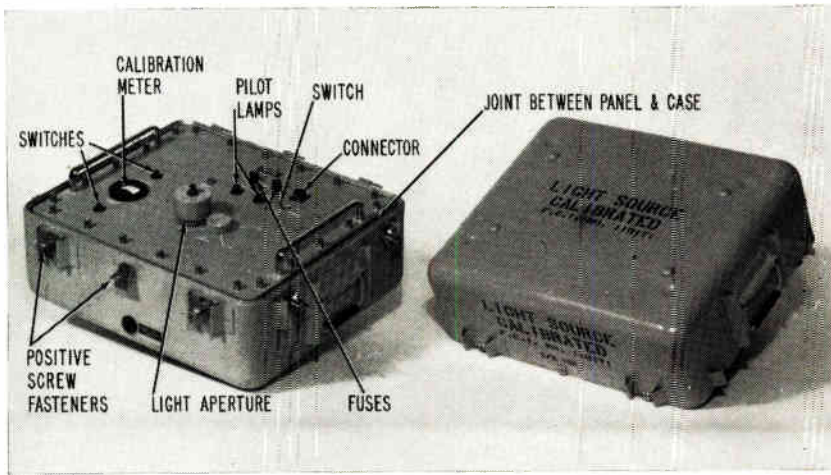
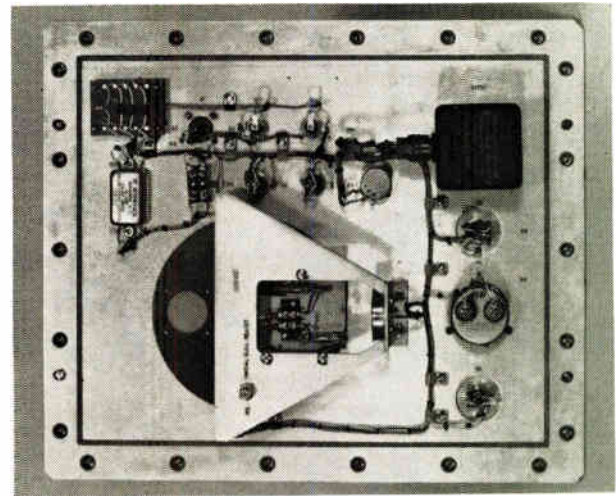

Fig. 2: Panel and outer dust cover of this test set are used to illustrate basic design principles. Some possible sources of RFI leakage from the equipment are the light source aperture, meter, cable and connector, fuses, switches, and pilot lamp.

Fig. 3: Rear view (below) of the panel and the electrical wiring. The knitted monel gasket in the groove (around the periphery) provides moisture resistance and assures electrical contact between the housing and the panel.



While ferrous materials offer good shielding to magnetic fields and are often used for isolating motors and tachometers, they are not efficient where weight is also important. Thus, because this equipment was designed for portable use and minimum cost, aluminum alloy was chosen as the basic material. A shielding efficiency of 40 db, which has an attenuation of 100-to-1, was desired. The shielding efficiency provided by the wall of the structure (which was chosen to be 3/32 in. thick for structural reasons) gave an attenuation of over 100 db. In many uses, it may be assumed that materials having adequate structural rigidity will also be thick enough to provide shielding efficiency.

### Seams and Joints

The next consideration is leakage reduction from seams and openings. Because the enclosures have seams, and servicing and ventilation will require other openings, provision must be made in construction for continuous shielding. The first thought is to use as few joints as possible. For example, it may be feasible to use a drawn can in making small cases. When a joint is needed, a clean metal-to-metal contact is important. Where possible, such seams should be welded, brazed, or soldered. The housing seam design uses continuous welding. There are no points of leakage except where the housing mates with the panel. Fig. 4 shows a detail of the seam design. The case has a raised lip around the periphery. This is to assure good electrical contact with a shielding gasket installed in the panel.

Fig. 3 shows a rear view of the panel and the electrical wiring. This panel is about 5/16 in. thick to permit machining a groove around its periphery. A knitted monel gasket with rubber core is inserted in this groove. This gasket provides moisture resistance and assures electrical contact between housing and panel. Note that the raised lip of the housing penetrates into the gasket. Closely spaced screw fasteners are needed around the outside to assure enough joint pressure.

Two key gasket properties are its resilience and electrical conductivity. Some needed design factors include provision of the minimum gasket thickness which will allow for the expected joint unevenness, correct joint width, compatibility of the gasket material with the mating surfaces from the viewpoint of corrosion, and electrical conductivity.

Gaskets are always used in compression. They are held in place by friction, soldering, mechanical means or even glue. If a glue or epoxy is used, it should be applied at intervals so that electrical continuity is not impaired.

Another approach is the use of spring contact fingers. These can provide good reduction of r-f leakage at much lower joint pressures. But, the fingers are fragile, and are more often used in hinged doors, where a wiping contact is desired.

Fig. 6 shows gaskets used in other applications. One type is used underneath connector bodies to assure that there is no leakage between connector and panel. O-rings are used under meter faces and for electrical shafts which penetrate the equipment case.

### Openings

Shielding effectiveness for an enclosure is reduced as the number and size of holes increases. Thus,

## SHIELDED PACKAGE (Continued)

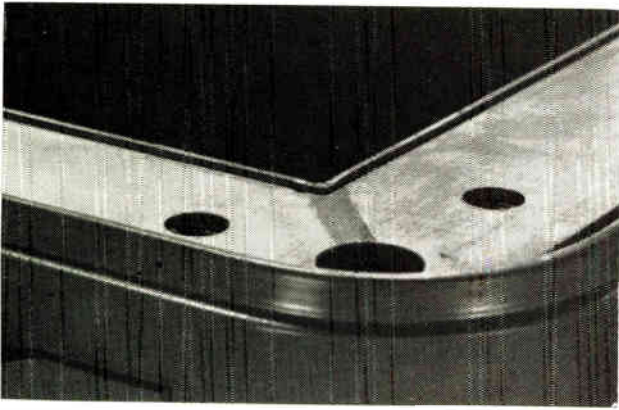

Fig. 4: Detail of the seam design is shown in the above photo. The case has a raised lip around the periphery which is used to assure good electrical contact with a shielding gasket installed in the panel.

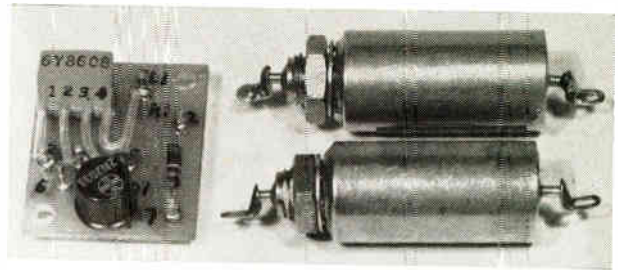

Fig. 5: The photograph above shows a transistorized driver circuit which was developed for specialized applications. The equivalent filters which it replaces are also shown here.

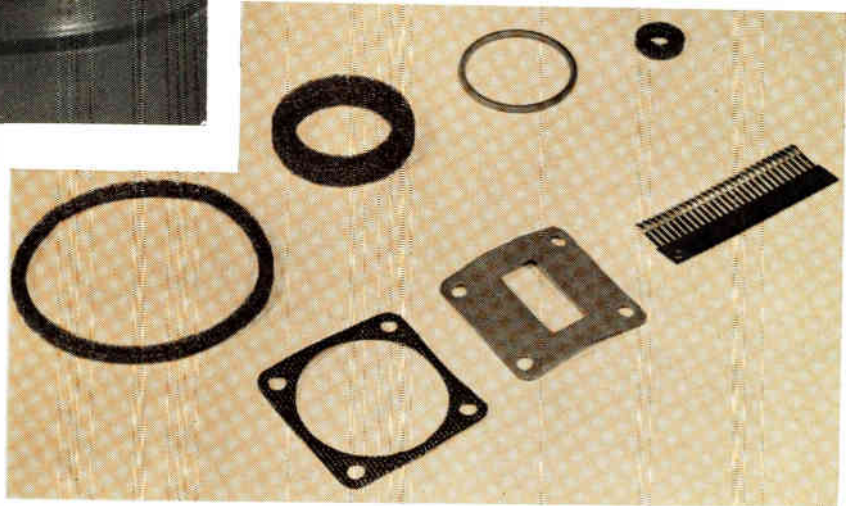

Fig. 6: Various gaskets (right) used for RFI leakage prevention are shown here.

such openings should be kept to a minimum and their diameter kept as small as feasible. The largest openings on this panel are the meter face and the light source aperture. Here, a shielded meter was used. Since the meter is contained in an hermetically sealed housing, it acts as a shielded enclosure; and, with proper filtering of the connecting leads, it will not permit the escape of energy. Further, the meter face is sprayed with an electrically conductive finish which also provides shielding.

A similar method is used to shield radiation from the light source. A coated glass plate is used to shield this opening. A key provision is a silver ring on the periphery. This ring makes contact to the conducting coating and to the panel. The glass cover must be installed with enough pressure to maintain shielding continuity.

Other openings, such as fuse receptacles and pilot lamps, could be covered with spring loaded caps or screening material. But, in this use, enough reduction was obtained by filtering the leads.

Although not used in this equipment, openings are often needed for ventilation. Materials commonly used include metal screening, perforated metal sheet, and a specialized ducting. The ducting provides high shielding efficiency and low air resistance.

This material is similar in construction to an automobile radiator. Factors to be considered are the dimensions of the opening, thickness and bonding of the walls, depth, and the method of fastening. Such structures are available.

### Filters and Cable Shielding

The calibrated light source contained two problem areas, as described above. One was the light emitting element and its power supply. Another was the associated control switch. Tests held under standard conditions showed leakage from the power cable and from the pilot lamp and lamp-start switch. Because of the simplicity, the approach taken was to shield the associated leads and filter the points at which the interference was leaving the enclosure. The power cable was acting as an antenna and permitting the radiation of energy contained within the shielded case. A simple filter was designed and installed in the power input lines. Fig. 7 shows the two section filter designed for this purpose.

For maximum efficiency, the filter must be installed in the correct manner. What are the exact needs? First, the filter must be installed in a metal-to-metal contact on the ground plane. In this case, the leads should be isolated to avoid contaminating filtered lines. The figure shows the space maintained between the leads from the input connector and power switch. Note also the use of shielded wiring at input and output leads. The shields should be terminated within an inch of the filter lugs to keep a high degree of shielding effectiveness.

Other filter uses are shown in Fig. 8. The meter terminals were bypassed with filter capacitors. These capacitors are of the ceramic type, which have low inductance and are effective at r-f. Use of paper or



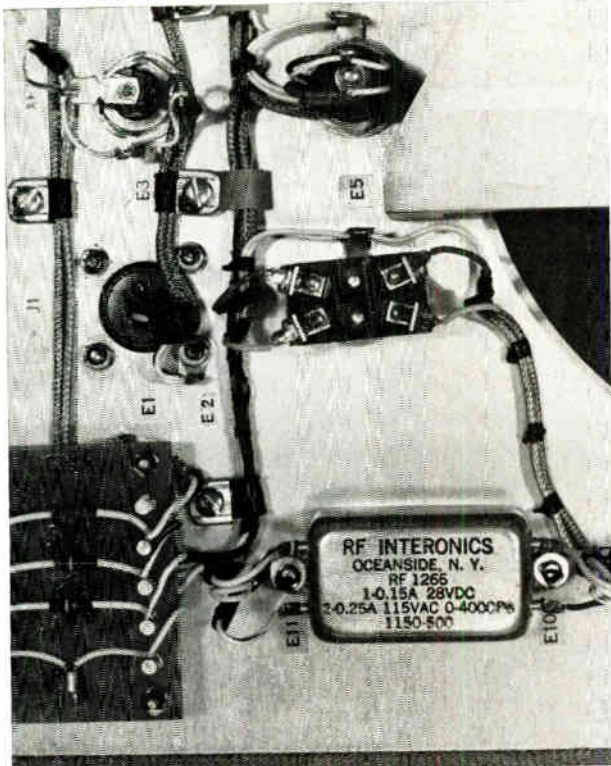

Fig. 7: Simple filter designed to prevent RFI leakage.

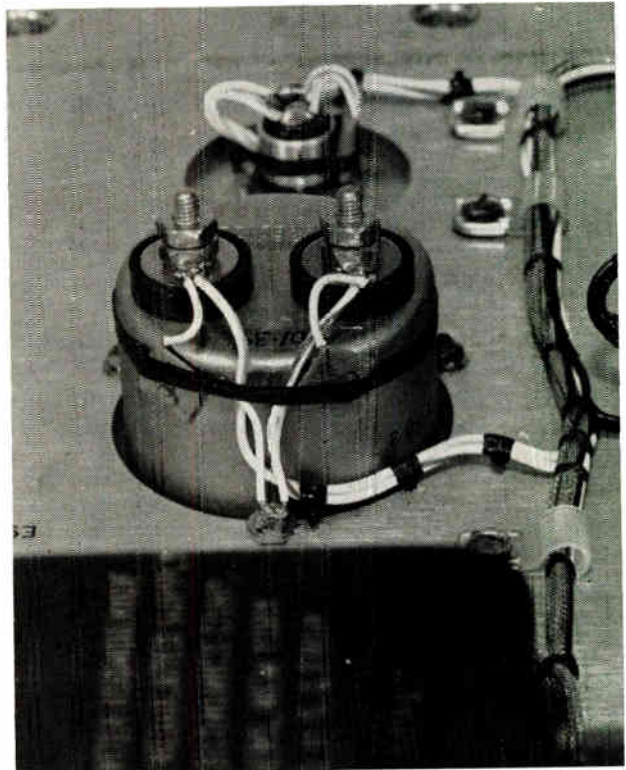

Fig. 8: Meter terminals bypassed with filter capacitors.

plastic capacitors should be avoided unless they are of special interference-reducing design. The relatively small amount of filtering was enough, in this use, to reduce levels of conducted interference on the power lines and leakage from the switches and lamps.

Sometimes the use of normal filters may be prohibitive because of the space and weight needs. We have developed for specialized uses, such as switching solenoids and other inductive loads, a transistorized driver circuit. This circuit is shown in Fig. 5, along with the equivalent filters which it replaces. There is a tradeoff between the mechanical and electrical designs which must be considered when space is at a premium.

### Conductive Finishes

Throughout this article, emphasis has been placed on the need for clean metal-to-metal contact to assure

electrical continuity. Equipment mating surfaces must be free of normal organic and inorganic finishes such as paint, primer, and anodizing. To provide electrical conductivity and a measure of corrosion protection, proprietary chromate conversion finishes are available for aluminum and magnesium. But, not all such finishes are suitable, and the needs for electrical conductivity should be specified. Other means used for corrosion protection are plating with a noble metal such as gold or silver.

Fig. 9: Typical shielding attenuation.

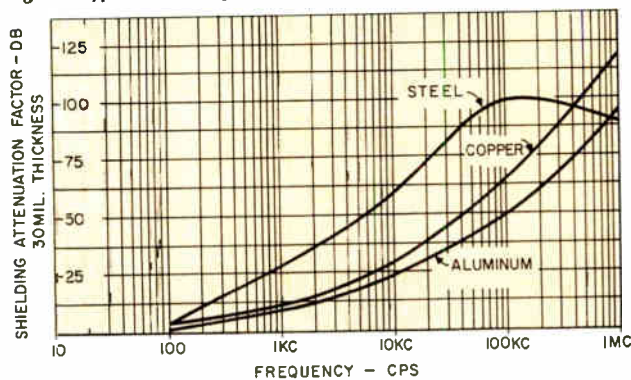

### Test Methods

Where the equipment is available, it is a rather simple task to measure the shielding effectiveness of an enclosure. Fig. 1 shows the basic test setup. A signal source and a receiver are needed. This signal is injected into the case, and the level of radiated energy measured with the receiver. This method permits probing a case for points of leakage and provides measurements of the shielding efficiency.

### References

- (1) Vasaka, C. S., "Problems in Shielding Electronic Equipment," *Proceedings of the First Conference on Radio Interference Reduction*, Armour Research Foundation, 1954, pp. 86-103.
- (2) Albin, A. L., "Designing Noise-free Enclosure Openings," *Electronics*, Aug. 29, 1958, p. 46.
- (3) Albin, A. L., "Optimum Shielding of Equipment Enclosures," *Electronic Design*, Feb. 3, 1960, pp. 48-49.
- (4) Albin, A. L., "Applying Shielding Cables to Reduce Interference," *Electronic Design*, Jan. 4, 1962, pp. 48-49.
- (5) Albin, A. L., "Shielding Efficiency of Electrically Conductive Protective Coatings for Magnesium and Aluminum Surfaces," *Symposium Digest*, 5th National Symposium on Radio Frequency Interference (IEEE), June 4-5, 1963.
- (6) Deuber, G., "Development of RFI Shielding Urged at Circuit Design Stage," *Electronic News*, May 18, 1964.

## NEW WELDER HANDLES TAPE CABLE

BEFORE FLAT FLEXIBLE CABLE can be competitive with conventional wiring, a cheaper method must be devised for terminating the cable to the connector. The methods of terminating the cable that have been tried have had drawbacks ranging from high cost to poor reliability.

Welding has been looked to as possibly the best method. The connection can be stronger than the parent metals and it has no interface to add resistance. The welded joint is small and the reliability is very good. With welding no strain relief is needed.

A welded termination functions as a fused continuation of the conductor. More than one weld can be applied to each connection if required. The welded joint is smaller than other electrical connections, needing scarcely more room than the end of the conductor.

To achieve a good welded joint for this cable, ELCO Corp. has developed a projection welding process for terminating the cable to connector terminals without removing the insulation. Termiweld™ is a relatively simple projection welding process that can be done by a production line employee.

This welder consists of a power supply, precision welding head, and a temperature control unit. Set-

Enlargement shows a weld made with the tape cable welder.

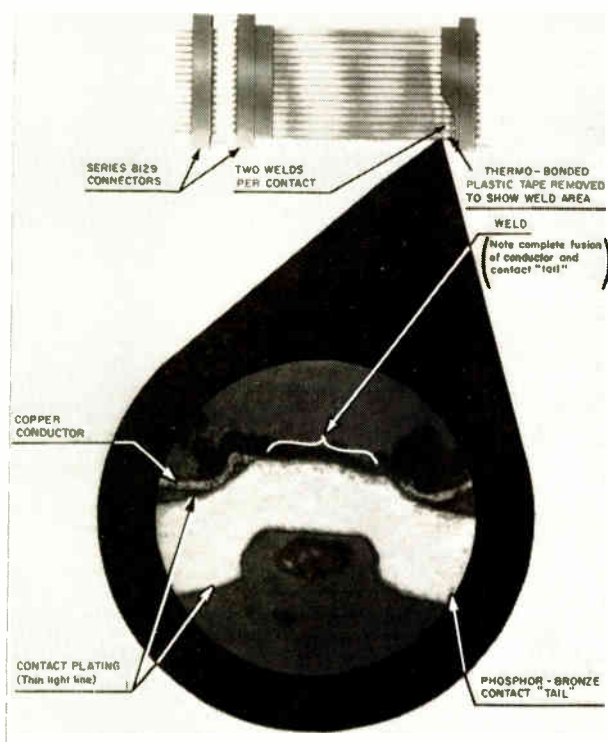

This tape cable welder was developed by ELCO, with the assistance of WEMS.

ting up the welder for a weld schedule involves selecting a thermostatically controlled temperature for each electrode, pre-setting the required pre-heat timer selecting the power supply output, and pre-setting the electrode pressure.

The weld is done by positioning the connector and cable on a platform between electrodes. Depressing a foot pedal brings the electrodes together with pre-set pressure. After the pre-heat time, which melts the insulation, a built-in time triggers the power supply. This completes the weld.

To provide smooth and accurate linear travel of the upper electrode, the welding head is equipped with a full-compliance, self-adjusting, ball-bearing raceway. This, coupled with a minimum amount of moving mass and simple foot-pedal operation, provides practically effortless operation. This keeps operator fatigue to a minimum.

The welder repetition rate is 125 welds per minute at 0.5 watt-sec. and 60 per minute at 200 watt-sec. The discharge time is 4 msec. Storage voltage is 15 to 408 vdc, adjustable. Welder's discharge time is 4 msec. Electrode force is adjustable from 0.5 to 50 pounds.

Some advantages of the Termiweld Techniques are:

1. Eliminates pre-stripping of conductors.
2. Capable of terminating through a broad range of insulations.
3. It will terminate composite layers of dissimilar insulator materials of different thicknesses.
4. Can terminate seven or more multilayer cables simultaneously.
5. Uses a minimum number of weld schedules of short time duration.
6. Requires little operator skill.
7. Rapid set-ups and simple fixture requirements.

This information was supplied by Mr. Sidney V. Worth, Chief Engineer, ELCO Corp., Willow Grove, Pa. 19090.



Circuit designers must consider electrical and chemical resistance, electrical polarization, nuclear radiation and thermal effects when picking an encapsulant for high impedance circuits. The wrong selection can affect impedance, create hot spots, break wires and cause undue stress.

## Selecting Epoxies for High-Z Circuits

By **MARVIN E. LYLES** Sr. Research Asst., Physiological Measurements Grp., Beckman Instruments, Inc., 2500 Harbor Blvd., Fullerton, Calif.

WITH THE ADVENT OF HIGH IMPEDANCE, low noise semiconductor devices and the need for high impedance circuits, the task of selecting the proper epoxy resin for encapsulation becomes more difficult. Many times an engineer will have a well-designed circuit and will want to improve the reliability and protect it against shock, vibration, and moisture by encapsulating it. Generally, no matter how much work went into the design of the circuit, the encapsulating resin is chosen as if it were a roulette game. The choice of an improper encapsulating resin may be worse than no encapsulant at all. Our purpose is to acquaint the design engineer with the most important properties of epoxy resin encapsulation.

\* \* \*

When the circuit design engineer is dealing with high impedance circuits, he may consider the electrical resistance of the epoxy system to be the most important parameter. We shall see that this is only part of the overall picture. The electrical resistance of epoxy systems is a volume resistivity and is measured in ohm centimeters. It may run from  $10^5$  ohm centimeters to  $10^{18}$  ohm centimeters or higher. As one might expect, the resistance drops very rapidly as the temperature is raised.

The electrical resistance is a good indication of the amount of impurities present in the system, as well as the completeness of the cure. Also, there seems to be a relationship between electrical resistance and chemical resistance. The higher the electrical resistance, the more chemically inert epoxy systems seem to be. For example, if two samples of the same epoxy system are cured under different curing cycles, the one having the highest electrical resistance will also have the highest chemical resistance.

Significant factors in obtaining a high electrical resistance are the type of curing agent used, the type of filler, and the amount of active impurities in the system. The most important is the curing agent. The room temperature cured epoxy systems have a lower resistance than do the high temperature cured.

The ratio of curing agent to resin is very critical in room temperature cures. A weight error factor

of 1% may contaminate the epoxy system with unbonded molecules of hardener or resin and reduce the electrical resistance to an unusable level or may not harden at all. In some high temperature cures, a weight error factor as high as 40% can be tolerated. This is because of the intermediate reaction molecular structure stability.

Although the chemical resistance of the unmodified epoxy system is always higher with a high temperature cure, it is affected by the completeness of the cure. The chemical resistance is greatly affected by impurities, and dilutants or solvents such as acetone in the epoxy system. The room temperature epoxy systems tend to be less resistant to chemicals than the high temperature cured. There are two categories of curing agents—acid and alkaline. Alkaline cured epoxy systems are less resistant to acids, whereas the acid cured are less resistant to alkalis.

The type and quantity of filler may also greatly affect the chemical resistance of the system. For instance, an epoxy system containing an inert filler, such as silica, is more chemically resistant than a system containing a relatively active filler, such as calcium carbonate.

### Electrical Polarization

Electrical polarization is closely related to the chemical and electrical resistance of the epoxy system. It is caused by the diffusion of ions and polar molecules through the crystal lattice under an applied electrical field. The electrical polarization may be represented by a large capacitor in series with the volume resistivity. If the circuit to be encapsulated involves low level dc voltage along with resistances approaching the volume resistivity, the electrical polarization effect may be a problem.

This polarization effect can be kept low by an epoxy system that contains an inert filler, a minimum amount of impurities, and a curing agent and curing cycle that will insure a complete cure. This electrical polarization takes place at dc or very low frequencies and is not to be confused with the dielectric constant or the dissipation factor of the epoxy system.

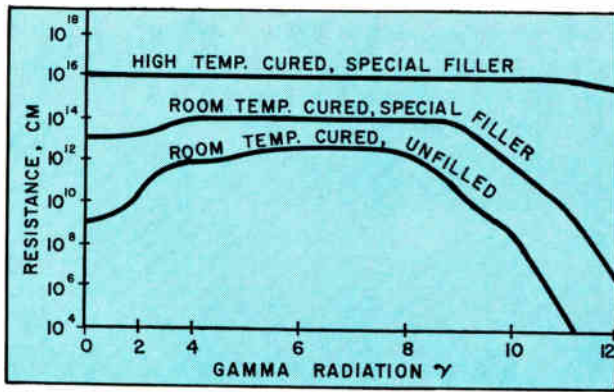

Fig. 1: The effects of radiation on volume resistivity.

## ENCAPSULATION (Continued)

The dielectric constant increases and the dissipation factor decreases with the higher temperature cures. It is possible to obtain an epoxy system which has low loss at 100 mc and a dielectric constant as high as 600 v/mil.

### Nuclear Radiation

The nuclear radiation resistance of epoxy systems is also varied greatly by the curing agent used, completeness of cure, the amount of impurities, and by the type of filler used in the system. For instance, an epoxy system filler containing a compound of high atomic number elements, such as barium sulfate, will resist nuclear radiation better than will fillers with lower atomic numbers, such as calcium carbonate.

Some epoxy systems have withstood  $10^{12}$  roentgens with a very small amount of deterioration. Exposure of room temperature cured epoxies to small amounts of nuclear radiation for a short time enhances the physical properties (Fig. 1). This effect is attributed to the increased energy within the crystal lattice promoting molecular movement. This increased molecular movement makes possible the combination of uncombined resin and hardener trapped in small pockets of the crystal lattice. However, if the amount of radiation or the length of exposure is increased, the increased energy will rupture the chemical bonds between resin and hardener. This type of deterioration is observed whenever the radiation wavelength

Fig. 2: Cut-away view of a package shows a hot component and a  $50^{\circ}\text{C}$  gradient across the epoxy encapsulating material.

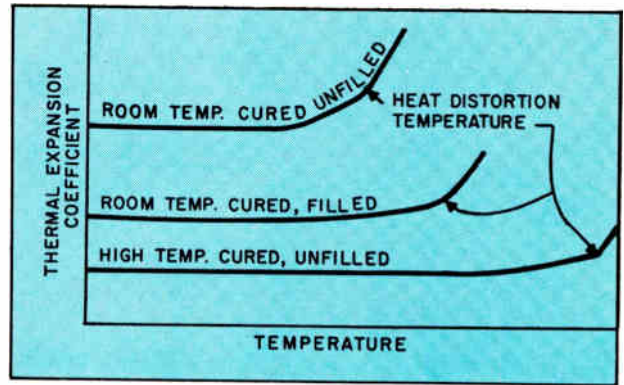
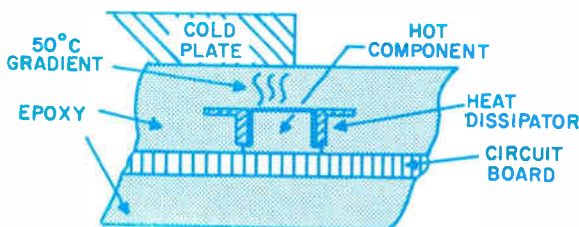

Fig. 3: Thermal expansion at the heat distortion temperature.

approaches the distance between molecules in the crystal lattice.

### Thermal Effects

The engineer who wishes to cool a hot package will certainly be interested in thermal conductivity. Epoxy resin systems cannot compete with the thermal conductivity of common metals. Some metal-filled epoxies can approach the thermal conductivity of some common solid metals. But, these cannot be used for encapsulating circuits because of their low volume resistivity and low chemical resistance. There are some very expensive filler systems, such as boron nitride compounds, which impart high electrical resistance and approach the thermal conductivity of some common metals.

The thermal expansion coefficient of epoxy resin systems should nearly match that of the largest encapsulated body. It is necessary to maintain a nearly even temperature gradient across the epoxy package because of the thermal expansion of the epoxy system. If isolated hot spots exist, the thermal expansion can create internal pressures of  $2000\text{ lb/in}^2$  on the epoxy, as well as on the encapsulated components. For instance, if an encapsulated component operates with a  $50^{\circ}\text{C}$  thermal gradient in the package, the thermal expansion could exert enough pressure to fracture the crystalline structure of the epoxy. Also the epoxy could pull away from the component raising the thermal resistance of the interface and eventually causing the component to fail.

In cases like this, it would be very wise to use a metal heat dissipator so that the temperature gradient would be lower at the epoxy interface. (Fig. 2.) The thermal expansion coefficient and the thermal conductivity are both very dependent on the quantity and type of filler used in the system. The type of curing agent used also affects these parameters, but is small when compared with the effect of the filler. Higher thermal conductivity and lower thermal expansion coefficients are achieved with the higher temperature acid cured systems.

Generally, the room temperature alkaline cured



systems have a low heat distortion temperature.<sup>1</sup> The thermal expansion coefficient radically increases when the heat distortion temperature is approached. (Fig. 3.)

### Stress

Stress in epoxy systems is an area which is generally disregarded except at the point of crystalline fracture. Stress generated by shrinkage or thermal expansion as the epoxy system is curing can exert internal pressures up to 2000 lb/in<sup>2</sup>. These pressures can cause broken wires, loose solder joints, or any number of mechanical failures. Stress on wires or terminals leading outside the package can promote water absorption through microscopic cracks in the epoxy.

When stress is generated upon the crystal lattice, it forces mechanical movement of the molecular structure. This mechanical movement causes some of the molecules to disassociate from the chain, thus developing a potential. However, the molecular dis-

association naturally lowers the resistivity and promotes electrical polarization in the localized area. The stress potential voltage equivalent circuit can be represented by a battery in series with the volume resistivity of the epoxy. In practical units, this voltage can be as high as 50 mv with an output resistance of 10<sup>10</sup> ohms in an epoxy system with a volume resistivity of 10<sup>14</sup> ohm centimeters. Epoxy systems under extreme stress may generate several volts with a resistance of 10<sup>10</sup> ohms or lower. Stress in the epoxy system can be kept to a minimum by carefully selecting the proper thermal conductivity and thermal expansion coefficient.

The old adage "an ounce of prevention is worth a pound of cure" is very applicable to epoxy resin encapsulating systems. By taking a little time to do some research into the physical properties of epoxy systems and their effect on circuits or components, a lot of valuable engineering and production time may be saved.

TABLE 1

Properties of Some Good Encapsulating Epoxy Resin Systems

Physical Properties	Units	EpoxyLite 810	Furane 233	Stycast* 2982	Stycast* 2651
Pot Life	Hours	0.75	0.5	3000	.....
Curing Temperature	°C	130	28	180	25
Thermal Coefficient of Expansion	10 <sup>-6</sup> in/in/°C	42	.....	.4	22
Thermal Conductivity	10 <sup>-4</sup> Cal/Sec/cm <sup>2</sup> /°C/cm	3.5	.....	10	.....
Linear Shrinkage	in/in/°C	0.02	.....	.....	0.002
Moisture Absorption	25°C for 24 hr.	0.1%	0.09%	0.1%	0.1%
Chemical Resistance	Outstanding to Acids Good to Caustics	.....	.....	.....	.....
Heat Distortion	°C	<200°	.....	.....	150
Volume Resistivity	Ω-cm	10 <sup>16</sup>	10 <sup>14</sup>	10 <sup>14</sup>	10 <sup>15</sup>

\*Emerson & Cuming, Inc.

### References

1. ASTM D648-56, Heat Distortion Procedure.
2. Lee, Henry and Neville, Kris, "Epoxy Resins, Their Applications and Technology," McGraw-Hill, 1957.
3. Harder, Charles, "Electronic Packaging with Resins," McGraw-Hill, 1961.
4. Flory, Paul J., "Principles of Polymer Chemistry," Cornell University Press, New York, 1953.

• A REPRINT of ANY ARTICLE in this issue is available from ELECTRONIC INDUSTRIES Reader Service Department.

## INTEGRATED THIN-FILM NETWORK, SOON

A COMPLETELY INTEGRATED THIN-FILM NETWORK is feasible. This is the prediction of scientists at North American Aviation's Autonetics Div., who have produced a thin-film active microelectronic device.

The scientists have developed an insulated-gate field-effect transistor by growing single crystal silicon films on a sapphire insulating base. It is believed to be the first time an active component has been produced using single-crystal thin-film deposition techniques, and makes possible production of circuits where active and passive elements are integrated into a single substrate.

At present active elements are produced separately and soldered to thin-film passive circuits. This complex fabrication technique prohibits complete circuit microminiaturization, limits performance, and increases cost.

Autonetics is now working on thin-film integrated

circuits using the transistor in combination with thin-film evaporated resistors. Such circuits will offer low cost, low radiation sensitivity, high frequency, high yield advantages over conventional silicon integrated or hybrid thin-film circuits, due to processing simplicity and superior electrical isolation between devices.

Using silicon thin-film on a sapphire base makes possible fully integrated circuits with excellent electrical isolation between individual elements. The majority carrier nature of the transistor and the use of thin-film resistors will give integrated circuits higher radiation resistance than more conventional bipolar transistors and diffused resistor circuits.

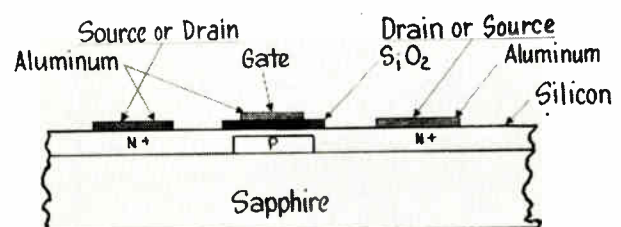

# Why did Engineers from over 600 Companies answer this Ad?

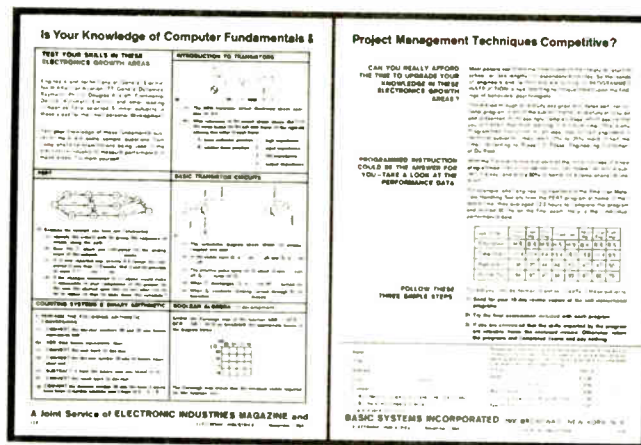

They decided to keep their skills competitive by teaching themselves PERT, Transistors and Transistor Circuits, Binary Arithmetic, and Applied Electricity. They did it with these Programmed Instruction\* courses and then they started to write us . . .

## Compare your answer with theirs...

"I have recently received your programmed instruction course. The method which you employ is excellent, I cannot see how anyone could help learning the subject matter."

"... I believe it is the best instructional method I have encountered ..."

"... it seemed to motivate me to learn ..."

"... I consider this an ideal instructional form ..."

"... feeling of accomplishment throughout the course ..."

"I feel I really learned."

\*The "teaching machine" technology.

A Joint Service of **ELECTRONIC INDUSTRIES MAGAZINE** and



# Test your Knowledge

of these fundamental subjects. Here are some sample questions from comprehensive examinations being used in the electronics industry to measure performance in 2 of these 5 areas.

Try them yourself . . .

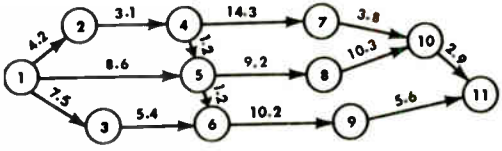
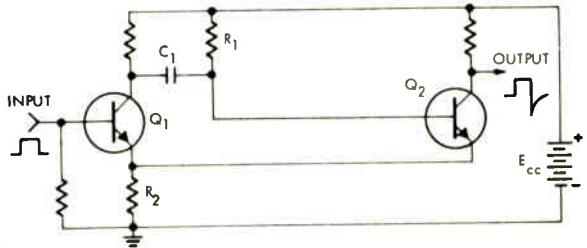
PERT	BASIC TRANSISTOR CIRCUITS
 <p>12. Examine the network you have just constructed.</p> <p>(a) Identify the critical path by giving the sequence of events along the path: _____</p> <p>(b) Give the <math>T_E</math> which you calculated for the ending event of the network _____ weeks</p> <p>(c) It is now reported that activity 6-9 cannot be completed in less than 11.8 weeks. Will it still be possible to meet <math>T_L</math>? <input type="checkbox"/> yes <input type="checkbox"/> no</p> <p>(d) If the changes mentioned in (c) above would make it impossible to plan completion of the project by the time the allotted span has run out, what can he do to replan so that he does meet the schedule?</p>	 <p>27.</p> <p>(a) The schematic diagram above shows an emitter-coupled one-shot _____</p> <p>(b) In the stable state <math>Q_1</math> is <input type="checkbox"/> on <input type="checkbox"/> off and <math>Q_2</math> is <input type="checkbox"/> on <input type="checkbox"/> off.</p> <p>(c) The positive pulse turns on <math>Q_1</math>, which in turn: <input type="checkbox"/> cuts off <math>Q_2</math> <input type="checkbox"/> turns on <math>Q_2</math>.</p> <p>(d) When <math>C_1</math> discharges, <math>Q_2</math> is: <input type="checkbox"/> cut off <input type="checkbox"/> turned on.</p> <p>(e) When <math>Q_2</math> conducts, drawing current through <math>R_2</math>, <math>Q_1</math> becomes _____ biased.</p>

To rate your own performance and skill needs in these 5 subjects:

- 1) Send for your 10-day review copies of all 5 self-instructional programs.
- 2) Try the final examination included with each program.
- 3) Only if you are convinced that the skills imparted by the program are valuable to you should you keep the programs. Otherwise, return them with completed exams and pay nothing.

Name \_\_\_\_\_  
 Title \_\_\_\_\_  
 Address \_\_\_\_\_  
 City \_\_\_\_\_ State \_\_\_\_\_  
 Company \_\_\_\_\_

- My check or company purchase order is enclosed.  
 Bill me or my company directly.

Clip and send this coupon to:

Please send me the programs designated below. At the end of 10 days, I'll either send the indicated price, plus a few cents for packing and postage, or return the program and my completed final examination and owe nothing.

TITLE	PRICE	
PERT	\$12.50	<input type="checkbox"/>
Introduction to Transistors	9.50	<input type="checkbox"/>
Basic Transistor Circuits	9.50	<input type="checkbox"/>
Counting Systems and Binary Arithmetic	7.50	<input type="checkbox"/>
Applied Electricity	12.50	<input type="checkbox"/>

**BASIC SYSTEMS INCORPORATED** 880 THIRD AVENUE/NEW YORK, N.Y.

"... STATE-OF-THE-ART information on Components and Equipment."

## Power Transistors Brochure

The latest developments in power transistors, reliability data, device selection and replacement cross reference charts are included in brochure T4258. Transistor selection charts include performance parameters, and case descriptions, for both power and mw transistors, with special replacement charts for hard-to-find devices. Extensive cross reference charts cover entire device lines. Motorola Semiconductor Products Inc., Box 955, Phoenix, Ariz.

Circle 146 on Inquiry Card

## Connectors Wall Chart

This 12 x 25 in. wall chart will be especially useful for designers, quality control, and production personnel. It illustrates each shell size available with each alternate key position. It also shows each of the various insert configurations in every key position. The units described are qualified to Mil-C-26500B. The Pyle-National Co., 1334 N. Kostner Ave., Chicago, Ill.

Circle 147 on Inquiry Card

## SCR Handbook

This handbook on silicon controlled rectifiers covers general descriptions of the construction, operation, and applications of SCRs. Included are sections on definition of terms, ratings, and characteristics. Complete electrical specs. and typical circuit applications are provided. Request Catalog No. 64SCR9. Sarkes Tarzian Inc., Semiconductor Div., 415 N. College Ave., Bloomington, Ind.

Circle 148 on Inquiry Card

## Truth Tables

This catalog contains 4 pages of truth tables, grouped by switch types, for binary codes. Chicago Dynamic Industries, Inc., Precision Products Div., 1725 Diversity Blvd., Chicago, Ill.

Circle 149 on Inquiry Card

## Control-Problem Solutions

This illustrated brochure describes engineered solutions to control problems through the design, layout, and manufacturing of custom-switch control panels. Licon Div., Illinois Tool Works, Inc., 6615 W. Irving Park Rd., Chicago, Ill.

Circle 150 on Inquiry Card

## Bus-Bar Brochure

This brochure gives complete information on a line of bar products and manufacturing capabilities. Units include solder, quick connect, spare or ring lug, screw and wire wrap termination types. A section entitled, "Considerations in the Design of a Multi-Conductor Bus Bar" lists features and advantages that bus bars offer. Methode Mfg. Corp., 1700 Hicks Rd., Rolling Meadows, Ill.

Circle 151 on Inquiry Card

## Instruments Catalog

This short-form catalog describes a line of strip-chart recorders, transistor diode test system, a switching-time measurement instrument, etc. Also included is a line of high-performance pulse generators, A-D converters, and multiplexers. Texas Instruments Incorporated, Industrial Products Group, P. O. Box 66027, Houston, Tex.

Circle 152 on Inquiry Card

## Potentiometers Catalog

This 59-page catalog presents photos, characteristic curves and operating specs. for a line of conductive plastic potentiometers. In addition, a 4-page list of potentiometer terms and definitions is included. Markite Corp., 155 Waverly Place, New York, N. Y.

Circle 153 on Inquiry Card

## Connector Catalog

Catalog DPZ-2B describes a series of rack/panel plugs. Receptacles are available in 3 lengths of right angle contacts (0.055 in. dia.) to fit printed circuit boards of 1/16, 1/8, or 1/4 in. thickness. ITT Cannon Electric Inc., 3208 Humboldt St., Los Angeles, Calif.

Circle 154 on Inquiry Card

## Instruments Catalog

An SWR nomograph is included in this 56-page catalog of coax load resistors and attenuators, absorption wattmeters, directional wattmeters, coax switches and r-f filters. It is a comprehensive reference of r-f measurement instrumentation from 25mw to 250kw in the freq. range of 2 to 2200mc. Bird Electronic Corp., 30303 Aurora Rd., Cleveland (Solon), Ohio.

Circle 155 on Inquiry Card

## Power Supplies Monograph

This monograph discusses problems that are solved with isolated power supplies. The approach is biased towards a practical, simple solution of design problems rather than a rigorous, theoretical one. EpSCO Inc., 411 Providence Hwy., Westwood, Mass.

Circle 156 on Inquiry Card

## Capacitors Bulletin

Bulletin 2312, 12 pages, describes a complete line of Type MHW welded seal button mica capacitors. They are available in 9 different styles to comply with various mounting configurations. The bulletin provides engineering data, test data, and dimension drawings. Curves and graphs are used wherever possible. A military section gives a complete cross-reference index. Sangamo Electric Co., Box 359, Springfield, Ill.

Circle 157 on Inquiry Card

## Digital System Modules

This 250-page catalog describes a complete line of 500kc, 5 and 10mc digital system modules and accessories. It includes an 85-page summary of Boolean algebra, basic logic circuits, and standard circuit configurations, as well as specific loading rules, signal definitions, and wiring hints for the system engineer with limited digital circuit experience. Over 200 different circuits described. Digital Equipment Corp., Maynard, Mass.

Circle 158 on Inquiry Card

## Tube Chart

The new edition of GE's receiving tube interchangeability chart (ETR-1749B) covers 369 American and foreign types. Shirt-pocket-sized chart lists U.S.-made replacements for 243 foreign types and direct replacements for 126 older American types. General Electric Co., Electronic Components Div., Schenectady, N. Y.

Circle 159 on Inquiry Card

## Potentiometer Catalog

A 44-page catalog describing precision potentiometers, trimmers and dials is now available. The 1964-65 catalog contains photographs, drawings and detailed specs. on the complete line of potentiometer products. In addition to data on wire-wound single-turn and multi-turn models, standard cermet and conductive plastic precision potentiometers are included for the first time. Helipot Div. of Beckman Instruments, Inc., 2500 Harbor Blvd., Fullerton, Calif.

Circle 160 on Inquiry Card

## Resistor Handbook

This colorful 16-page handbook describes the manufacturing and quality control of the fixed carbon resistor. It tells how resistors are made and the materials and methods used. The handbook should prove of particular interest to electronics engineers. Requests should be made on company letterheads to Speer Resistor Div., Speer Carbon Co., Bradford, Pa.

## Program Generator Catalog

Catalog 5mc DPG-1 features specs. and applications for a 5mc solid-state, variable freq., multi-channel pulse train generator. Used where series/parallel pulse patterns are needed, the instrument provides programmed pulsing for a wide range of uses. These include evaluation of magnetic-core and thin-film device parameters, development of computer circuits and logic, high-speed clock or word generation, magnetic-tape system checkout and subsystem control for automated systems. Computer Control Co., Inc., Old Connecticut Path, Framingham, Mass.

Circle 161 on Inquiry Card





## THIS SENSITIVE RELAY REPLACES COSTLY TRANSISTORS

You can operate this inexpensive relay using low cost, low power transistors. As little as 20 milliwatts of power per movable arm will effect switching. This combination—relays and solid state devices—often results in substantial savings when our ML is used in place of costly power transistors. The ML is especially suited for battery powered equipment.

You can specify up to 18 springs (9 per stack) for multi-pole switching. Single lot prices for standard ML relays range from only \$6.05 (DPDT) to \$8.60 (6PDT). Ask your P&B representative or write us for complete engineering data.

STANDARD P&B RELAYS ARE AVAILABLE AT LEADING ELECTRONIC PARTS DISTRIBUTORS



### POTTER & BRUMFIELD

Division of American Machine & Foundry Company, Princeton, Indiana  
In Canada: Potter & Brumfield, Division of AMF Canada Ltd., Guelph, Ont.

Circle 42 on Inquiry Card

WorldRadioHistory

#### ML SERIES SPECIFICATION HIGHLIGHTS

##### Pull-In:

Current: 20 mw min. @ 25°C.  
Voltage: 75% or less of nom. DC voltage @ 25°C.

##### Contacts:

3 amps @ 115VAC, 60 cycles resistive at nominal power. Other ratings available with additional coil power.

##### Power:

20 milliwatts per movable min., 3 watts max. @ 25°C.

##### Voltage:

To 110V DC.

##### Resistance:

33,000 ohms max.

##### Dimensions:

1<sup>3</sup>/<sub>32</sub> x 2<sup>5</sup>/<sub>32</sub> x 1<sup>7</sup>/<sub>16</sub> (6 Form C).

# Still home-brewing SERVO AMPLIFIERS?

**BULOVA**—*the leader—can make 'em faster, better, and at less cost!*

Developing your own electronic components to meet servo system requirements is a waste of time, money, and engineers! Bulova's group of engineering specialists probably have already tackled a problem similar to yours, and can quickly provide you with unexcelled servo products at surprisingly low cost.

## Bulova provides you:

- Many engineering man-years of experience developing electronic servo products to solve problems like yours.
- Full line of products—off-the-shelf, or custom designed to your requirements.
- Quick action—prototypes when you need them.
- Production units to your schedule.

*No matter what your problem in servo amplifiers or frequency control, you'll get quick, usable answers from Bulova Electronics, the company with the widest line. Call or write to us at Dept. EI-12.*

## SPECIFY BULOVA SERVO PRODUCTS

Bulova offers a full line of electronic products for the servo system, featuring:

- Solid-state servo amplifiers, resolver amplifiers, modulators and demodulators, quadrature rejection filters, buffer and pre-amplifiers, and solid-state relays.
- DC torquer amplifiers and general-purpose power amplifiers also available.
- Standard and miniature units (down to 3.5 watts in ¼ cubic inch!)
- Voltage gains up to 5000; higher, on request!
- Power up to 16 watts standard; higher, on request!
- MIL-E-5272 environmental specs met; NASA-200 as required.
- Maximum output per unit volume and weight.

## NEW TECH DATA

### Crystal-Controlled Oscillator

Data is available on a product line of crystal-controlled oscillators using integral circuits. Within the range of 640kc to 2Mc, the oscillator is available in a package of less than 2 cu. in. with a freq. tolerance of  $\pm 0.015\%$  from  $-55^{\circ}\text{C}$  to  $+85^{\circ}\text{C}$ . General Microelectronics Inc., 2920 San Ysidro Way, Santa Clara, Calif.

Circle 162 on Inquiry Card

### Plastics Brochure

Fifteen plastics and resins are described in a new 20-page brochure. Properties of the plastics and resins are shown in 11 tables, with examples of plastic parts presented in 29 photographs. Plastics Div., Allied Chemical Corp., Box 365, Morristown, N. J.

Circle 163 on Inquiry Card

### Tubing Brochure

This brochure contains data on Tungsten-26% Rhenium Seamless Tubing. It is available in sizes to 0.050 in. dia., and in continuous lengths to 45 in. Featured is thermal expansion, thermal conductivity and vapor pressure data. Hoskins Mfg. Co., 4445 Lawton, Detroit 8, Mich.

Circle 164 on Inquiry Card

### Power Meter

This data sheet describes the 686 Power Meter. Uses and features as well as detailed specs. are given. These include power ranges, accuracies, operating impedances, dimensions, auxiliary equipment, etc. PRD Electronics, Inc., sub. of Harris-Intertype Corp., 202 Tillary St., Brooklyn, N. Y.

Circle 165 on Inquiry Card

### Computer Brochure

A brochure describing the AMBILOG 200 Stored Program Signal Processor is available. The unit is neither an analog nor a digital computer, but exploits fully the best of both. Information includes a description and diagram of the system organization. Adage Inc., 292 Main St., Cambridge 42, Mass.

Circle 166 on Inquiry Card

### Gearmotor Selection Guide

Bulletin A-2430 is a useful guide for choosing the proper dc gearmotor to fit the application. It gives information on how to match the motor to the geartrain. Globe Industries, Inc., 1784 Stanley Ave., Dayton, Ohio.

Circle 167 on Inquiry Card

### Cabinet

Data is available on a sq. corner/shadow-box front cabinet which gives 19 x 24 in. wide panel space and is 30 $\frac{3}{8}$  in. deep. It encompasses a modular concept with effective functional design. Stantron Div. of Wyco Metal Products, N. Hollywood, Calif.

Circle 168 on Inquiry Card

**BULOVA** / **ELECTRONICS DIVISION**  
WATCH COMPANY, INC. 61-20 WOODSIDE AVE., WOODSIDE 77, N.Y., 212 NE 9-5700



# NEW TECH DATA

## Connector Chart

This r-f connector chart lists approx. 300 different connector numbers, classifies them as to their mechanical configurations, relates 8 different manufacturer's designations, and gives the general ratings and electrical characteristics for the group. Star-Tronics, Georgetown, Mass.

Circle 169 on Inquiry Card

## Filters Bulletin

Physical size and effective suppression represent critical problems to the designer using EMI/RFI filters. These problems are solved with the 2JX100 series of Tantoroid filters. The units use solid tantalum feed-thru capacitors in combination with toroidal inductors. This new series offers a high level of insertion loss of freqs. down to 14kc. Complete technical details are given in Engineering Bulletin No. 8110. Sprague Electric Co., 233 Marshall St., No. Adams, Mass.

Circle 170 on Inquiry Card

## Aluminum Coatings

Data is available on System 126, a new coating system consisting of 0.003 in. pure metallized aluminum with vinyl treatment. It provides long lasting protection of iron and steel surfaces against atmospheric corrosion. Metco Inc., Westbury, N. Y.

Circle 171 on Inquiry Card

## Stripping Tool

Bulletin N-213 describes a new concept in thermal wire stripping. The new tool, "Swing-Grip" moves the wire over a heated element for a speedier, high quality strip. Specs. cover tooling for proper wire sizes. Ideal Industries, Inc., 5180 Becker Place, Sycamore, Ill.

Circle 172 on Inquiry Card

## Filters Bulletin

Bulletin 2610A describes a standard line of cylindrical r-f interference filters. Current and voltage ratings range from 0.5a 100 vdc to 50a 250 vac. Insertion loss characteristics are all specified at full rated load. RF Interonics, Inc., 15 Neil Court, Oceanside, L. I., N. Y.

Circle 173 on Inquiry Card

## Power Resistors

Bulletin 109 describes a wide line of power resistors with a temp. coefficient of resistance and high stability. The units have precision tolerances. Units are available to 1kw. Ohmite Mfg. Co., 3630 Howard St., Skokie, Ill.

Circle 174 on Inquiry Card

## Electrical Tapes

"Reference Data for Design Engineers," a revised brochure, contains an electrical tape property chart including Mil spec. references on 37 varieties of "Scotch" brand electrical tapes. Copies may be obtained by writing Dept. D4-701, 3M Co., 2501 Hudson Rd., St. Paul, Minn.

Circle 175 on Inquiry Card



Mark II Series 400

## BORN 8 YEARS OLD! A new 2PDT relay with established dry-circuit reliability

Electro-Tec's wedge-action design\* has been proving itself in 6PDT operations for 8 years. It's established a confidence level of 90%, based on a failure rate of .01% per 10,000 operations. (Tops in the industry.) Now we've put wedge-action to work in a subminiature. Each precious-metal contact combines a long contact wipe area with a 60-gram contact force. Results? Low, low contact resistance, stable within 15 milliohms over 100,000 operations. Extreme shock, vibration, and acceleration immunity. Performance far beyond all MIL-R-5757/8 requirements. (Test data available on request.) Competitively priced, with in-house testing to your high-rel specs.

\* U. S. Patent No. 2,866,046 and others pending.

### CHARACTERISTIC PERFORMANCE DATA

Contact Rating: Low-level to 2 amps @ 28 VDC  
Operate and Release Time: 10 ms max. @ 26.5 VDC and 25°C  
Contact Bounce: 300 microseconds max. even at low-level loads  
Shock: 100G — 11 ± 1 ms  
Vibration: 35G up to 5000 cps



# Electro-Tec Corp.

SLIP RINGS • RELAYS • SWITCHES  
P. O. BOX 667 • ORMOND BEACH, FLA.  
(Area Code 305) 677-1771 • TWX 305-677-5115  
Manufacturing facilities: Ormond Beach, Fla. — Blacksburg, Va.

**VISUAL  
INDICATING**

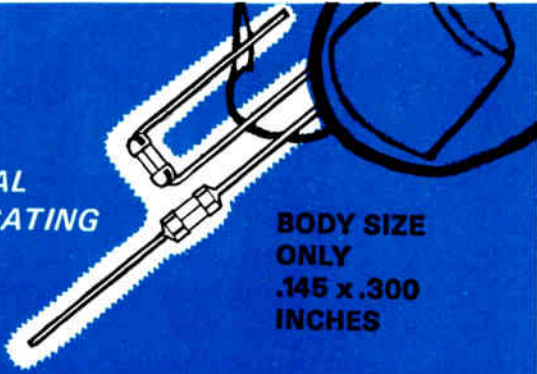

**BODY SIZE  
ONLY  
.145 x .300  
INCHES**

## BUSS Sub-Miniature PIGTAIL TRON FUSES

For use on miniaturized devices,— or on gigantic multi-circuit electronic devices.

Glass tube construction permits visual inspection of element.

Smallest fuses available with wide ampere range. Twenty-three ampere sizes from 1/00 thru 15 amps.

Hermetically sealed for potting without danger of sealing material affecting operation. Extreme high resistance to shock or vibration. Operate without exterior venting.

# BUSS

Write for BUSS  
Bulletin SFB

BUSSMANN MFG. DIVISION, McGraw-Edison Co., St. Louis, Mo. 63107

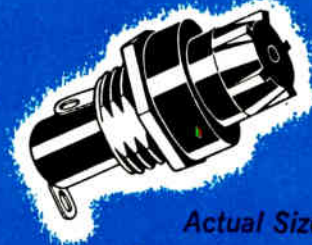

**Actual Size**  
Only 1-5/8 inches long...  
Extends just 29/32 inch  
behind front of panel

## BUSS Space Saver Panel Mounted Fuseholder

- Fuseholder takes  $\frac{1}{4} \times 1\frac{1}{4}$  inch fuses. Converts to  $\frac{9}{32} \times 1\frac{1}{4}$  inch fuses simply by changing screw type knob. Holder is rated at 30 ampere for any voltage up to 250.

- Also available in military type which meets all requirements of MIL-F-19207A.

# BUSS

Write for BUSS  
Bulletin SFH-10

BUSSMANN MFG. DIV., McGraw-Edison Co., ST. LOUIS, MO. 63107

# BUSS: 1914-1964, Fifty years of Pioneering....

## NEW TECHNICAL DATA

### Power Module

Data is available on compact power modules designed for 60 cycle power. At 120w. output power, this V12/HA12 series provides any required voltage from 5vdc to 3650v. Forty watt modules in this group can supply output voltages to 10,400vdc. Abbott Transistor Laboratories, Inc., 3055 Buckingham Rd., Los Angeles, Calif.

Circle 176 on Inquiry Card

### Hardware Catalog

Catalog Q64, 20pp, shows specs. and ordering information for a complete line of steel Mil-specs., chassis slides, cable retractors, aluminum chassis handles, relay rack panels, and mounting hardware. The catalog is fully illustrated. Zero-Pak Products, 1121 Chestnut St., Burbank, Calif.

Circle 178 on Inquiry Card

### Spectrum Analyzer

This brochure describes the "signal finder" spectrum analyzers. These instruments use an array of magnetostrictive rod filters, which are sampled by a high-speed commutator. These signal finders detect weak signals buried in noise backgrounds. The analyzers use 0.6 cps bandwidth filters. Spectran Electronics Corp., 146 Main St., Maynard, Mass.

Circle 180 on Inquiry Card

### Circuit Design Aid

This applications note describes the SOAR method of specifying the exact transistor to use in switching or dc applications. The design engineer will find the design principle fills the gap between the data sheet and the breadboard. By applying the principle to a high-current switching circuit, the designer can quickly determine the correct power transistor to use. The Bendix Corp., Bendix Semiconductor Div., Holmdel, N. J.

Circle 177 on Inquiry Card

### Wirewound Resistors

This 16-page catalog describes a line of precision wirewound resistors. It contains a list, comprehensive descriptions, and illustrations of various types. A discussion of resistors and resistance technology with accompanying diagrams, wattage rating curves, and a chart showing temp. coefficients of resistance of commercial alloys used in resistors are also included. General Resistance, Inc., 430 Southern Blvd., New York, N. Y.

Circle 179 on Inquiry Card

### Timing Relays

Publication LC-15 covers a complete line of industrial-rated timing relays. Pneumatic, synchronous and electronic timers are features. Operation, operating specs., design features and options are detailed for each classification. A section outlining major considerations for proper timing relay selection is also included. Cutler-Hammer Inc., 436 N. 12th St., Milwaukee, Wisc.

Circle 181 on Inquiry Card



## Contact Solutions

This 20-page illustrated booklet is entitled, "Contact Headaches—Why Have Them?" It describes typical contact problems and their solutions. It lists service applications cross-indexed to contact material compositions. Write for Bulletin TB-511, Gibson Electric Co., Box 598, Delmont, Pa.

Circle 182 on Inquiry Card

## Capabilities Brochure

Capabilities in design and manufacture of micro-miniature wire parts, special springs, parts for semiconductor industry, micro-miniature connectors, etc. are described in this brochure. It is fully illustrated and contains specs. Haydu Corp., 998 Kenyon Ave., Plainfield, N. J.

Circle 183 on Inquiry Card

## Molding Compound

Molding Compound Grade G-85 is a new member of the Halon® TFE (tetrafluoroethylene) family of plastics. This granular fluorocarbon resin is available in 2 particle size of 300 microns. Type G-85-6 is recommended for extrusion of rod, tubing and profiles. Halon G-85-3 is recommended for extrusion of rod, tubing and profiles. Halon G-85-3 is well-suited for the molding of billets, slabs and other heavy shapes. More data available from Plastics Div., Allied Chemical Corp., Box 365, Morristown, N. J.

Circle 184 on Inquiry Card

## Transistors

These silicon planar power transistors are used for high-current, high-gain military applications. The 20a. units, designated 2N3597, 2N3598 and 2N3599, are rated to dissipate 100w. at 100°C case temp. They are packaged in the TO-63. Further information may be obtained from Honeywell Semiconductor Products Div., 1177 Blue Heron Blvd., Riviera Beach, Fla.

Circle 185 on Inquiry Card

## Gold Stripper

This gold stripper removes 0.0001 in. of gold in 5 min. without etching or pitting base metals. It may be used on printed circuits, semiconductors, connectors, and other electronic components. Hope Chemical Corp., Pawtucket, R. I.

Circle 186 on Inquiry Card

## Cooling Primer

This pocket-size handbook, "Forced Air Cooling Primer," is for the electronic engineer who must design a forced air cooling system. It provides a basic design outline and check lists of factors that should be considered. It will aid in determining the quantity of air required for cooling, and gives directions on how to calculate the pressure drops through densely packaged electronic equipment. The Henry G. Dietz Co., Inc., 14-26 28th Ave., Long Island City, N. Y.

Circle 187 on Inquiry Card

## Subminiature Relay

A comprehensive data sheet on the series 400, Mark II 2PDT subminiature electromagnetic relay is available. Enclosed in a hermetically sealed case, it is designed for low level to 2a. operation. Literature shows standard electrical characteristics. Relay Div., Electro-Tec Corp., Ormond Beach, Fla.

Circle 188 on Inquiry Card

## DC Amplifiers

Data is available on 3 new amplifiers designed for data and systems. The Models 884-101, 885-135 and 885-235 are all solid-state and contain their own internal power supply. Chopper stabilization without mechanical choppers is achieved by using field-effect transistors. Common mode rejection is 160db at dc and 120db to 60cps. Astrodata Inc., 250 E. Palais Rd., Anaheim, Calif.

Circle 189 on Inquiry Card

## Communication Terminal

The Model 2400 send/receive terminal permits transmission of data on any type of communication line at selectable speeds up to 2400 bauds. The unit provides alphanumeric edge interpretation simultaneously, and in line with the coded data. This feature eliminates, in most cases, the need for a separate printout. More data available from Omnitronics, Inc., 511 N. Broad St., Phila., Pa.

Circle 190 on Inquiry Card

# ...New Developments in Electrical Protection

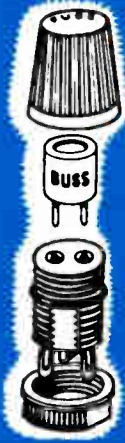

**GMW FUSE  
and HWA  
FUSEHOLDER**

**FUSE SIZE  
ONLY .270 x .250  
INCHES**

**BUSS  
VISUAL  
INDICATING**

**Sub-Miniature  
FUSE-HOLDER COMBINATION**

For space-tight applications. Fuse has window for inspection of element. Fuse may be used with or without holder.

Fuse held tight in holder by beryllium copper contacts assuring low resistance.

Holder can be used with or without knob. Knob makes holder water-proof from front of panel.

Military type fuse FM01 meets all requirements of MIL-F-23419. Military type holder FHN42W meets all military requirements of MIL-F-19207A.

**BUSS** Write for BUSS Bulletin SFB

BUSSMANN MFG. DIVISION, McGraw-Hill Co., St. Louis, Mo. 63107

Circle 45 on Inquiry Card



**FUSETRON**  
dual-element Fuses  
time-delay type

"Slow blowing" fuses that prevent needless outages by not opening on motor starting currents or other harmless overloads—yet provide safe protection against short-circuits or dangerous overloads.

**BUSS** Write for BUSS Bulletin SFB

BUSSMANN MFG. DIVISION, McGraw-Hill Co., St. Louis, Mo. 63107

Circle 45 on Inquiry Card

pick  
a  
signal

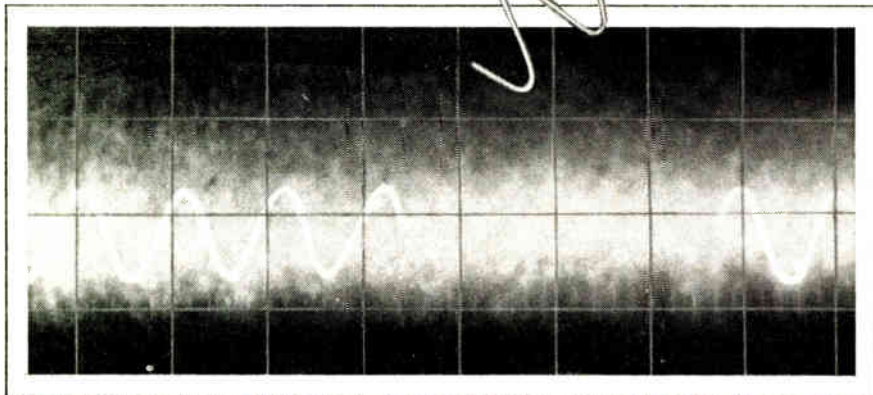

out of a 38 db noise background  
and reproduce it clean at 1v rms.  
with INTERSTATE'S AUTOMATIC  
SIGNAL TRACKING FILTER

■ Automatic Bandpass Filter ■ AM and FM Demodulator ■ Automatic Doppler Signal Tracker ■ Variable Bandpass: 2.5 to 100 cps ■ Wide Frequency Range ■ Solid State ■ Third Order Filter ■ Reliable.

This all solid state variable bandpass filter picks a signal out of -38db signal: noise. Its center frequency locks to the frequency of the signal to be tracked, then tracks it anywhere through a 100 cps to 120 kc spectrum. Output is a clean replica of the tracked signal. Send for brochure.



ELECTRONICS CORPORATION

A SUBSIDIARY OF INTERSTATE ENGINEERING CORPORATION

707 East Vermont Avenue, Anaheim, California

Telephone: (714) 772-2222, TWX (714) 776-0280

Worldwide Representatives

## NEW TECH DATA

### Switch Bulletin

This switch selector aids the user in selecting the proper magnetic reed switch by load requirements, size and configuration, and specific electrical and operating characteristics. Facilities are also discussed. Hamlin, Inc., Lake & Grove Sts., Lake Mills, Wisc.

Circle 191 on Inquiry Card

### Rotary Converters

Data is available on dc to ac rotary converters which can be mounted easily in any position. AC output is 35w., 115v single phase, and dc input can be any standard dc low voltage as specified. Other ac voltages are also available and ratings range up to 5000kw. Kato Engineering Co., Mankato, Minn.

Circle 192 on Inquiry Card

### Soldering Equipment

Soldering equipment, which handles the smallest subminiature job or the large soldering and brazing project, is described in Bulletin 7. The 2-color presentation offers specs. and applications. Ideal Industries, Inc., 5180 Becker Place, Sycamore, Ill.

Circle 193 on Inquiry Card

### Instrument Catalog

Catalog M-65, 100 pages, covers a complete line of field and laboratory electric and electronic measuring instruments and related products. Included are useful formulas and graphs, and pertinent technical reference material pertaining to the use of these instruments. A section describing facilities and capabilities is also given. The Singer Co., Metrics Div., 915 Pembroke St., Bridgeport, Conn.

Circle 194 on Inquiry Card

### D-to-A Calibrator

Data Sheet No. 9 describes the Model 6206 DAC calibrator. The unit powers, displays, and calibrates up to 50 digital-to-analog converters. It features dynamic display of any of 50 channels in real time, and permits calibration with any bit combination between zero and full scale. Telemetrics, Inc., 2830 S. Fairview St., Santa Ana, Calif.

Circle 195 on Inquiry Card

### Delay Line Brochures

This brochure describes how high speed miniaturized computer circuitry has made obsolescent many conventional serial memory devices, and led to their replacement by digital ultrasonic delay lines. Also included are special digital definitions and measurements, digital vs. conventional delay lines, and glass vs. quartz as the delay medium. LFE Electronics, div. of Laboratory for Electronics, Inc., 985 Commonwealth, Boston, Mass.

Circle 196 on Inquiry Card



## NEW TECH DATA

### DC Amplifier

With Model 3300, 12 amplifiers fit into a standard 19-in. rack adapter module  $3\frac{1}{2}$  in. high. It has continuous gain from 10 to 1000 with a 0 position; freq. response is  $\pm 1$ db dc to 20kc. Input impedance is 100 megohms min. Bulletin available from California Instruments Corp., 3511 Midway Dr., San Diego, Calif.

Circle 197 on Inquiry Card

### Cable Grip

This 1659-20 grip deforms the cable slightly under load assuring max. pulling power with no slippage in any weather. Neither insulation nor conductor is damaged by deformation. Complete data available from Mathias Klein & Sons, Inc., 7200 McCormick Rd., Chicago 45, Ill.

Circle 198 on Inquiry Card

### Selecting DC Motors

Bulletin A-10 describes performance characteristics of dc permanent magnet and wound field motors, and includes useful application data on selection and basic engineering considerations. Bulletin is a useful guide for designers. Globe Industries, Inc., 1784 Stanley Ave., Dayton, Ohio.

Circle 199 on Inquiry Card

### Brazing & Soldering Manual

This 40-page, 3-part manual describes principles and techniques for brazing and soldering ferrous and nonferrous metals. Charts and illustrations are distributed throughout. All-State Welding Alloys Co., Inc., White Plains, N. Y.

Circle 200 on Inquiry Card

### Ceramic Seals

Data is available on glass-bonded ceramic seals which provide an economical solution to high-voltage problems. The seals offer at peak voltage above 10kv. Electrical Industries, Murray Hill, N. J.

Circle 201 on Inquiry Card

### Aluminum Connector

Data is available on an aluminum alloy connector which is mechanically safe and hermetically sealed. It will operate continuously at 350°F, and stands current surges up to 750°F at intermittent periods with no loss of insulation or seal. Available from 1 through 55 pins. Thermacon Div. of Avdel, Inc., 210 So. Victory Blvd., Burbank, Calif.

Circle 202 on Inquiry Card

### Connector Pins

This data sheet details complete specs. of 68 sizes of standard connector pins. The specs. cover pins with sq. cut ends, also tapered and flared. The sheet includes enlarged drawings and gives parts numbers and 8 dimensions for each pin. Auto-Swage Products, Inc., 25 Brook St., Shelton, Conn.

Circle 203 on Inquiry Card

# new, economical WIREWOUND VERNIER CONTROL



Series  
VA-AW

15/16" dia. 5 Watt  
Wirewound Variable Resistor

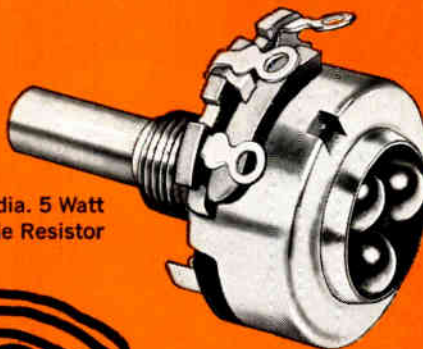

**8 $\frac{3}{4}$  turns: 1 turn**

## priced under \$1.50 ea. in lots of 300

### SUBSTANTIAL SAVINGS

Replaces more expensive multi-turn semi-precision wirewound potentiometers.

For fine tuning commercial and industrial uses which are difficult or impossible to adjust with a conventional single turn control.

### ELECTRICAL SPECIFICATIONS

Resistance Range: 1 through 25,000 ohms.

Voltage Rating Bushing to Terminals: High pot test, 1,000 VAC.  
Operating Max. 500VDC.

Power Rating: 5 watts @ 25°C, 4 watts @ 55°C, derated to no load @ 105°C.

Tapers Available: Standard—linear. Special—non-linear, such as 15% modified log.

Request Catalog 2150 for complete technical data.



Founded 1896

## CTS OF ASHEVILLE, INC.

SKYLAND, N.C.

Subsidiary of CTS CORPORATION, Elkhart, Indiana

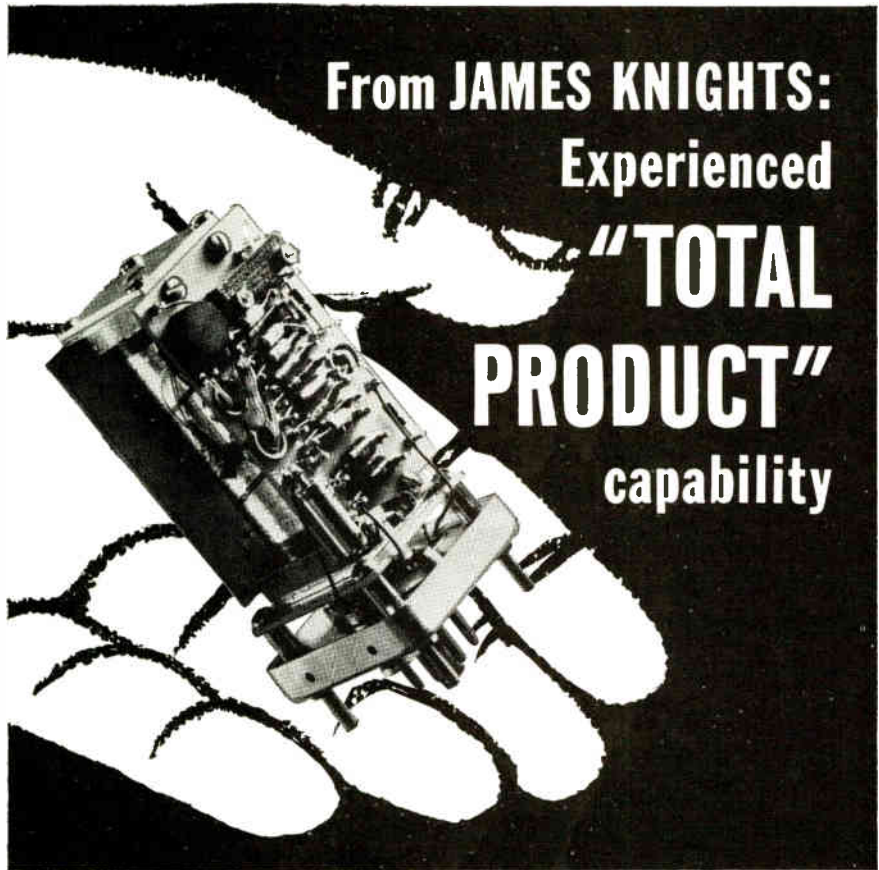

From JAMES KNIGHTS:  
Experienced  
"TOTAL  
PRODUCT"  
capability

Expect *more* of THE JAMES KNIGHTS COMPANY than simply complete crystal-controlled filter and oscillator packages, designed to work compatibly with today's newest components and circuitry. Expect *more* of THE JAMES KNIGHTS COMPANY than acknowledged specialty in frequency management problems.

Expect—and receive—all the advantages inherent in experienced "Total Product" capability.

Here's why: As one of the nation's largest crystal suppliers, who pioneered complete crystal controlled oscillators, filters and discriminators as plug-in functional units, we have remained directly acquainted with the end-use performance in the manufacture of today's crystal units, plus bringing into focus the requirements of tomorrow's improved designs—unattainable under the old concept of supplying crystal units only.

At THE JAMES KNIGHTS COMPANY, we have brought together the engineering skills and equipment required for the development and broad-scope testing of our frequency management products. Thus equipped to expose *our* products to tests of exceeding environmental severity, we are prepared to assume maximum responsibility for the frequency management aspects of *your* products.

May we work with you? On complete crystal-controlled packages? On crystals for your filter or oscillator designs?

*Interested in crystals for filter and oscillator design? Write for design studies brochure on your company letterhead.*

**THE  
JAMES  
KNIGHTS  
COMPANY**   
Sandwich, Illinois

## NEW TECH DATA

### Control Catalog

Catalog No. 251, 16 pages, Master Stock Catalog describes relays and control components. The catalog lists characteristics and distributor quantity net prices for relays and control modules, mercury-wetted contact relays, stepping switches, telephone-type relays and military-type relays. C. P. Clare & Co., 3101 Pratt Blvd., Chicago, Ill.

Circle 204 on Inquiry Card

### Coaxial Cable

Bulletin 202B gives the parameters for a coaxial cable designed for cryogenic applications. The MicroCoax meets specific design requirements which call for cables that are non-magnetic, able to withstand high pressures/vacuum, and have low thermal conductivity. MicroDelay Div., Uniform Tubes, Inc., Collegeville, Pa.

Circle 205 on Inquiry Card

### FM Receivers

This report discussed techniques for extending the threshold of FM receivers used primarily in tropospheric scatter communications systems. The practical use of such techniques have frequently provided the margin of reliability required to establish workable communications systems. Radio Engineering Laboratories, 29-01 Borden Ave., Long Island City, N. Y.

Circle 206 on Inquiry Card

### Solid-State Switching

This bulletin explains how to provide high-speed, high-current switching with solid-state devices in memory testing circuits. The theory of prefiring is discussed briefly, and waveforms are shown for direct firing and prefiring of silicon-controlled rectifier switches. Digital Equipment Corp., 146 Main St., Maynard, Mass.

Circle 207 on Inquiry Card

### Decommutation System

Model 670-3 accepts FM, PAM, and PDM signals, and produces parallel digital words accompanied by an ID code for output to computers and tape recorders. FM input includes PM/FM, PAM/FM, and PDM/FM or any IRIG subcarrier channels. FM input freq. includes IRIG channels 12 through 18 and A through E. More data available from Telemetry Inc., 2830 S. Fairview St., Santa Ana, Calif.

Circle 208 on Inquiry Card

### Integrated Circuits

Data is available on an integrated circuit line. It features custom circuit configurations comprising active and passive elements. The new series, called "Mesa-Logic," is available in a variety of form factors including TO-5, TO-18 and standard flat package. MicroSemiconductor Corp., 11250 Playa Court, Culver City, Calif.

Circle 209 on Inquiry Card



# NEW TECH DATA

## Instrumentation Recorder

This spec. sheet contains a general description and specs. for the FR-900 wideband instrumentation recorder. It is designed for use in radar recording communications monitoring, pre-detection recording and other advanced techniques. Ampex Corp., Mail Stop 6-1, 401 Broadway, Redwood City, Calif.

Circle 210 on Inquiry Card

## Laser Products

A new group of advanced laser products is detailed in this literature. Features include a broadband resonant reflector for use in laser cavities, and a novel solid-state Q-switch material. Several laser systems featuring high reliability and built with modular power components are also described. Lear Siegler, Inc., Laser Systems Center, 2320 Washenaw Ave., Ann Arbor, Mich.

Circle 211 on Inquiry Card

## Silicones Digest

Publication CDS-509, 16 pages, contains a discussion of silicone adhesive/sealants, new rubbers for the space engineering, and electrical insulation. General Electrical Co., Waterford, N. Y.

Circle 212 on Inquiry Card

## Instruments Catalog

This 12-page catalog lists specs. for a complete line of instruments and accessories. The line consists of recording spectrophotometers; recording spectropolarimeters; respiration pattern analyzers, vibrating reed electrometers; mass spectrometers, and other analytical instruments. Applied Physics Corp., 2724 S. Peck Rd., Monrovia, Calif.

Circle 213 on Inquiry Card

## Relay and Switch Bulletin

Bulletin C-1053-A lists more than 200 kinds of relays, stepping switches, and accessories available. They include EIN (plug-in) relays with or without power contacts, rotary stepping switches with gold levels for low-level circuits, ERM (magnetic latch) relays, Class E relays equipped with taper-tab terminals for easy adaptation to EIN, Correeds and many more. Automatic Electric, Northlake, Ill.

Circle 214 on Inquiry Card

## Multi-Layer Materials

Specs. are available which cover the raw materials used in the manufacture of high density multi-layer circuitry. The set is comprised of NELCO ML-1 and NELCO ML-2. The ML-1 spec. covers the B-staged epoxy-glass prepreg that is used as the adhesive-insulation layer in the multi-layer package. The ML-2 spec. covers properties of the thin copper-clad epoxy-glass laminates. New England Laminates Co., Inc., 481 Canal St., Stamford, Conn.

Circle 215 on Inquiry Card



You are looking at the control panel of *this* world's most accurate AC meter calibrator. If you now calibrate, maintain or inspect AC electrical instruments in quantity we'll be happy to invest \$50. of our own money to demonstrate exactly how and why this equipment can save you its purchase price within a year. And if speed is not your problem but high accuracy is, there's nothing like trying it inside your own four walls to separate performance fact from fancy claims. We welcome comparison; at RFL, instrument calibration is a science . . . not an art. Call us soon.



**Radio Frequency  
Laboratories, Inc.**

EST. 1922  
**BOONTON, NEW JERSEY, U.S.A.**

Tel: 201-334-3100 TWX: 201-334-0930

Cable: RADAIRCO, NJ

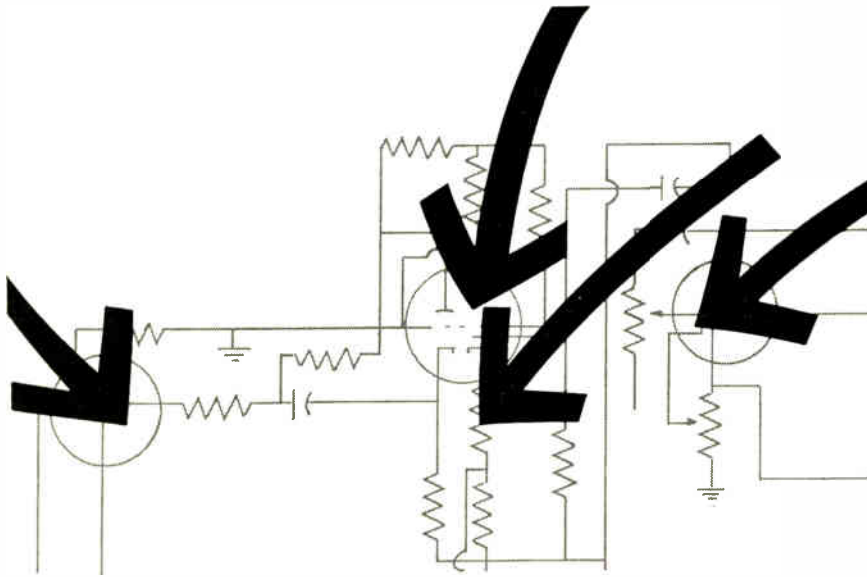

## how to avoid the high cost of beefing-up circuits to protect components...

### START YOUR DESIGNS WITH SOLA CV CONSTANT VOLTAGE TRANSFORMERS

- CV's eliminate over-designing of circuits to withstand voltage variations.
- CV's protect components from damaging transients and voltage surges.
- CV's react in 0.02 seconds to voltage variations.
- CV's have no moving parts, last much longer, require no maintenance.
- CV's add to equipment reliability, permit scheduled — not emergency — component replacement.
- CV's current-limiting feature withstands outright load shorts.

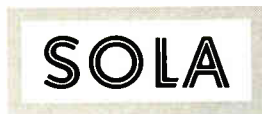

Division of Basic  
Products Corporation  
**SOLA ELECTRIC CO.**  
1717 Busse Rd., Elk Grove, Ill., HEmpstead 9-2800  
IN CANADA: SOLA BASIC PRODUCTS, LTD.,  
377 Evans Avenue, Toronto 18, Ontario



### Industry's voltage regulation headquarters

Here's how I'd like to use the Sola CV transformer; send me the facts covering this application.

.....  
 .....  
 NAME .....

TITLE .....

COMPANY .....

ADDRESS .....

CITY ..... STATE ..... ZIP .....

### Temperature Test Systems

This brochure describes systems for the temp. testing and processing of semiconductors, microcircuits and other components. The brochure also details capabilities for the custom design of systems for special component testing and processing applications. The Scionics Corp., 8900 Winnetka Ave., Northridge, Calif.  
**Circle 216 on Inquiry Card**

### VHF-UHF Transistor

Data is available on a silicon npn epitaxial planar transistor developed for use as a general-purpose r-f amplifier. It operates at freqs. to 450mc. The transistor, RCA 2N3478, has low noise figure at high freqs., low leakage current, and a high gain-bandwidth product. Commercial Engineering, RCA Electronic Components and Devices, Harrison, N. J.  
**Circle 217 on Inquiry Card**

### Disk Files

This illustrated data sheet describes Models 80 and 800 random access disk files. It includes descriptions and specs. Each kit contains 6 disks and has a total storage capacity of 24 million bits. Analex Corp., 150 Causeway St., Boston, Mass.

**Circle 218 on Inquiry Card**

### Display Indicators

This data describes the Series 250 indicators. The 2-lamp units are varied leg-end-plate types. They are said to give the panel layout engineer wide flexibility. Korry Mfg. Co., 223 8th Ave. N., Seattle, Wash.

**Circle 219 on Inquiry Card**

### Wiring Tester

Data is available on a high-speed series of Space™ automatic wiring checkout systems. Test time for a typical 1000-point wiring assembly is approx. 5 min. Tests performed when making comparisons of system speed include continuity, hipot, and leakage resistance measurements. Brooks Research Inc., East Rochester, N. Y.

**Circle 220 on Inquiry Card**

### Coppermetals Index

The 11th edition of its "Coppermetals Specifications Index" contains an extensive updating of ASTM, SAE, AMS, Federal and Military specs. SAW specs. listed in the index are now based upon the Copper Development Assoc. designation system. Copies of the booklet are available by writing for Publication B-34. Anaconda American Brass Co., Waterbury, Conn.

**Circle 221 on Inquiry Card**



# BOOKS

## Electronic Digital Integrating Computers—Digital Differential Analyzers

By F. V. Mayorov. Edited by Dr. Yaohan Chu. Published 1964 by American Elsevier Publishing Co., Inc., 52 Vanderbilt Ave., N.Y. 17, N.Y. Price \$15.00. 382 pages.

Principles, organization, uses, circuits, memories, and input-output devices of electronic digital differential analyzers are presented in this book. The book also describes both serial and parallel machines as well as both binary and decimal types.

The material contained in the book has been drawn mostly from the U.S. and Russia. A supplementary bibliography is provided for those who wish to pursue this subject further.

## Physics of Magnetism

By Soshin Chikazumi. Published 1964 by John Wiley & Sons, Inc., Publishers, 605 Third Ave., New York, N.Y. 10016. Price \$15.75. 554 pages.

Covering recent investigations in detail, this book describes concepts of ferro-, ferri-, and antiferro-magnetism, domain structure, magnetization processes, magnetic annealing and various other topics of magnetism. Emphasis is placed on explanation of physical concepts.

Up-to-date topics such as magnetic thin films, helical spin configurations, neutron diffraction, Mossbauer effect, etc., are covered.

## Standard Operating Procedures

Edward A. Altshuler. Order from Every Businessman's Library, 9255 Sunset Blvd., Los Angeles, Calif. 90069. Price \$5.00. 132 pages.

This book is based upon material for the Traveling College of Knowledge which the author conducts for the National Electronic Distributors Association (NEDA) in conjunction with the Electronic Industries Show Corp. It is a collection of organization outlines radiating from the "10 centers of business activity." Of these, six internal areas discussed in this book are: (1) General, including various indexes, definitions, policy/procedure preparation; (2) Organization, involving owners, managers and employees; (3) Personnel; (4) Marketing; (5) Operations; and (6) Finance.

Engineers interested in pursuing supervisory, sales or other management careers can benefit from studying this book.

## Books Received

### Linear Network Theory

By K. F. Sander. Published 1964 by The MacMillan Co., 60 Fifth Ave., New York 11, N.Y. Price \$3.75. 164 pages, paperback.

### Elementary Theory of Electric & Magnetic Fields

By Warren B. Cheston. Published 1964 by John Wiley & Sons, Inc., 605 Third Ave., New York, N. Y. 10016. Price \$9.75. 393 pages.

## IN YOUR OPINION, HOW WELL DOES THIS CHECK LIST FOR SELECTING READOUTS STACK UP?

**A READOUT MUST BE READABLE.** No ifs or buts about it. Legible presentation of the message is a readout's only mission.

**IT MUST PROVIDE DISPLAY VERSATILITY.** You should be able to select the message medium best suited to your needs: letters, numbers, words, colors, symbols, or a combination of any of these.

**WIDE VIEWING ANGLES.** The operator can't be chained to his post. A good readout should be readable from fairly wide angles to permit freedom of movement.

**PROPER BRIGHTNESS/CONTRAST RATIO.** The two should work together to assure crisp, legible display under varying ambient light conditions, without eye fatigue.

**DISPLAY CHARACTERS MUST BE FAIL-SAFE.** A readout using shared character segments can give a wrong reading if one of the segments fails. It's much safer when the readout indicates trouble by showing no message at all.

**VARIETY OF CHARACTER SIZES.** Why marry your designs to one or two sizes? The readout you select should provide the height character you require, from 1/16" to 3 3/8"

\_\_\_\_\_  
(You add one)

\_\_\_\_\_  
(One more)

If this seems like a reasonable list of reasons to specify just about any readout, you'll be interested in an equally reasonable list of reasons to specify IEE readouts.

## HERE ARE AT LEAST TEN GOOD REASONS TO SPECIFY IEE REAR-PROJECTION READOUTS. TAKE YOUR PICK.

### GOOD REASON 1: SINGLE-PLANE PRESENTATION

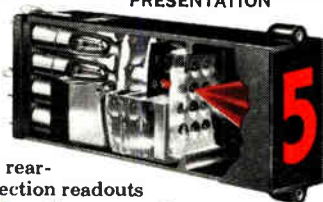

IEE rear-projection readouts

display the required messages, one at a time, on a non-glare viewing screen. Only the message that's "on" is visible for visual crispness and easy readability.

### GOOD REASON 2: INFINITE DISPLAY VERSATILITY



You name it, we'll display it. Because IEE readouts are miniature projectors using lights, lenses, film, and a screen, they can display literally anything that can be put on film. And, each readout has 12 message positions which may be used singly or in any combination to display letters, words, numbers, colors, symbols.

### GOOD REASON 3: MOST READABLE CHARACTERS

Since we can put anything on film, our readouts may be ordered with any style char-

acters, Mil Spec or otherwise, you specify. Human factors studies have shown that **FUTURA MEDIUM** and **ALTERNATE GOTHIC #3** are the character styles providing the optimal stroke/width/height ratio for good legibility.

### GOOD REASON 4: BALANCED RATIO OF BRIGHTNESS TO CONTRAST

It's not enough to display bright characters! Excessive brightness in itself leads to eye strain. On the other hand, a character of comfortable brightness displayed against a dark, glare-free screen is actually more readable than a glaring filament against an illuminated background.

### GOOD REASON 5: WIDE-ANGLE READABILITY

The combination of single-plane projection, flat viewing screen, proper ratio of brightness to contrast and big, bold characters offers wide-angle readability and longer viewing distances.



### GOOD REASON 6: CLARITY IN HIGH AMBIENT LIGHT

IEE readouts remain readable in brightly lighted surroundings, with no filters, screens, or shades required. Equally important, our readouts may be dimmed in dark areas for greater eye comfort.



### GOOD REASON 7: FAIL-SAFE CHARACTERS

False indications are impossible with IEE readouts. Failure of a single lamp is detected in an instant, and just as rapidly replaced without tools of any kind. The commercial or MS lamps used provide up to 30,000 hours of operation per lamp; the rest of the readout has no moving parts, hence, offers unlimited unit life.

### GOOD REASON 8: EASY TO OPERATE

IEE readouts are available with voltage requirements from 6 to 28 volts, depending on lamps specified. Operate from straight decimal input or driver/decoders with low current levels are available to accept conventional binary codes. Additional internal translation is not required.

### GOOD REASON 9: SELECTION OF MAXIMUM CHARACTER HEIGHTS



IEE readouts come in four sizes to supply maximum character heights of 3/8", 1", 2", and 3 3/8". The smallest readout has an effective viewing distance of up to 30 feet; the largest can be read from 100 feet away!

**GOOD REASON 10:** We are one of the largest readout manufacturers. That's because our rear-projection readouts do their job better than any other readouts. All of our customers feel the same way. Let us demonstrate our readouts for you—you just might feel the same as our customers do.

CIRCLE OUR READER SERVICE NUMBER OR WRITE DIRECTLY TO US. WE'LL SEND YOU ILLUSTRATED LITERATURE, AND IF YOU PERMIT, WE'LL ARRANGE A PRODUCT DEMONSTRATION AT YOUR CONVENIENCE.

## INDUSTRIAL ELECTRONIC ENGINEERS, INC.

7720 Lemona Avenue, Van Nuys, California  
Phone: (213) 787-0311 • TWX (213) 781-8115  
Representatives in Principal Cities

## Signed

Each drum of Genesolv® D Electronic-Grade Solvent carries the signature of the quality control inspector. The analysis of the drum's contents is right on top. Genesolv D is 99.99% pure...has less than 1 ppm undissolved and dissolved residue.

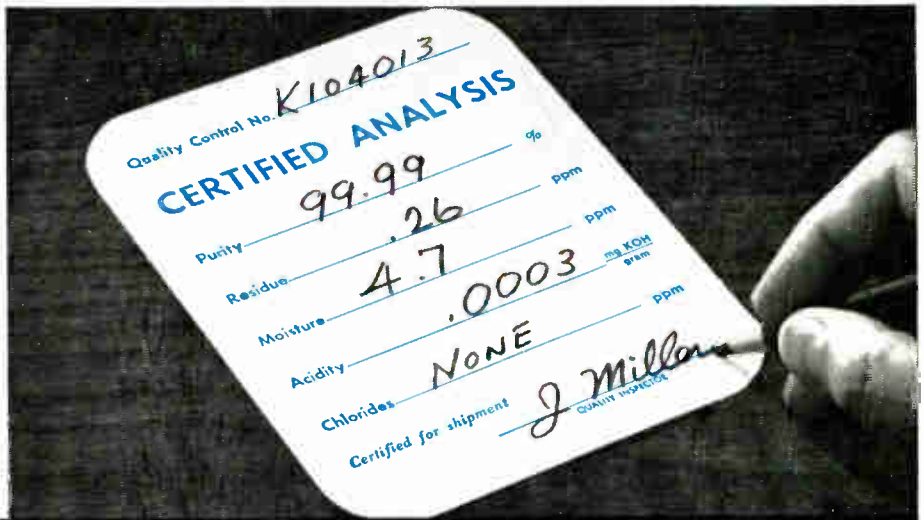

## Sealed

The drums are filled under clean room conditions to insure purity. 55-gallon plastic-lined drums of Genesolv D have snap-on protector-covers that further assure an ultra-clean solvent.



## Delivered Ultra-Clean

Genesolv D arrives at your door certified ultra-clean. It offers you selectivity, low toxicity, nonflammability, low surface tension (increased wettability, with minimum dragout), and quick drying.



Got a precision cleaning problem? We'll be glad to help. Write or phone your nearest General Chemical office.



**GENERAL CHEMICAL DIVISION**

P.O. Box 353, Morristown, N.J.



## CHECKING ELECTRONIC COMPONENTS

**Detecting Hidden Flaws.** By coupling the output of a Thermograph infrared detector to a cathode-ray oscilloscope, it is possible to speed the analysis of electronic components for hidden flaws. The oscilloscope's horizontal deflection is synchronized with the Thermograph's horizontal scanning system, and the temperature-variation signal is applied to the vertical deflection system of the oscilloscope. The camera of the Thermograph scans the component in a single line, thus requiring only a few seconds to develop the required information. The accompanying illustration is a typical thermal trace—in this instance on a 10w wirewound resistor.

This development at Barnes Engineering Company is an improvement over the conventional method of taking thermograms. In the old method, 180 sweeps were required across the component to produce a complete photograph that was then analyzed by observing various shades of gray which represented the temperature differentials.

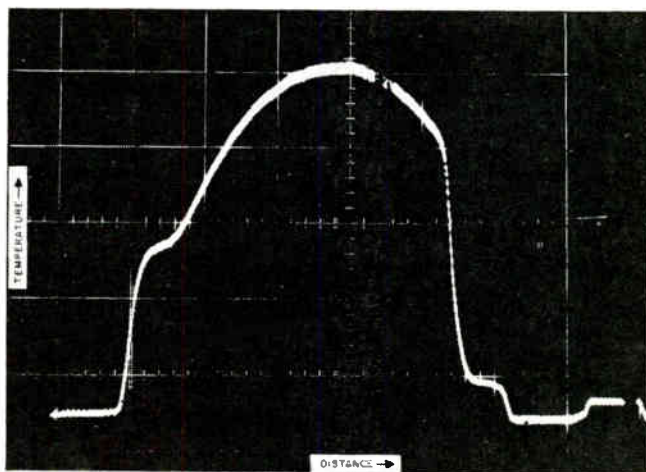

Thermogram of electrically perfect 10w wirewound resistor. Note rapid temperature drop at the right and poor thermal contact between right terminal cap and resistor body. Uneven heating could lead to early failure.

## TEMPORARY TEST EQUIPMENT

**Instruments On Lease.** The sophistication of electronic test instrumentation, coupled with its increased cost, has focused attention in the direction of renting or leasing electronic instruments. Leasing makes sense when the need for a particular costly instrument may be temporary—lasting only as long as a particular contract is in force or a particular design is being developed.

A recent entry in the lease business is The Singer Company's Metrics Division. Singer makes it possible for potential users to acquire instruments on a "short term lease" with purchase option or on a standard "equipment lease"

basis. Singer also has a time payment plan for purchase of instruments, something rather unique in this field.

Singer is by no means the first to enter the rental field. Typical of the potential in this type of marketing for test instruments is the large program carried on by the General Electric Company. General Electric has available a 30-page "Instrument Rentals" catalog listing about 300 different test instruments available for rental, manufactured by a number of companies in addition to General Electric. The business is handled through GE's Schenectady Instrumentation Service. ELECTRONIC INDUSTRIES will report rental and leasing arrangements more fully in an early issue.

## CALL FOR PAPERS

El's State-Of-The-Art Reference Issue

on

## ELECTRONIC INSTRUMENTATION

ELECTRONIC INDUSTRIES will pay \$100.00, in addition to regular space rates, for each article selected. Publication will be in June, 1965. Abstract (100 words) required Feb. 15, approved manuscript Apr. 1. We are looking for up-to-the-minute articles of real usefulness to practicing electronic engineers. Acceptable are how-to-do-it measurement articles, articles on techniques of measurement or test, discussions of established and projected measurement standards, and articles on related topics.

Article length should preferably be between 2500 and 3000 words and include suitable sketches, line drawings and photographs for illustration.

If you have an idea for an article, contact:

Measurement & Test Editor  
ELECTRONIC INDUSTRIES  
100 E. 42nd Street  
New York, N. Y. 10017  
Phone OXford 7-3400

**Electronic System Weighs Aircraft.** By applying electronic principles it is possible with portable equipment to determine the weight of an airplane to a quarter percent, and pinpoint its center of gravity to within a half inch. The system, developed by Baldwin-Lima-Hamilton Corporation and operating at McGuire Air Force Base, N. J., includes five weighing platforms, plus instrumentation consisting of a computer and planner console. The computer determines payload weight and placement for up to 15 compartments in a cargo plane, and indicates the weight that can be loaded in each compartment. It holds load records in a memory and prints a final record to show loading and centroid, gross weight and center of gravity.

The International Bureau of Weights and Measure has added a new facility on the outskirts of Paris for radiation measurements. The new laboratory will promote the use and control of ionizing radiations for medical, industrial and scientific purposes on a world-wide scale. It will also provide international intercomparisons for radiation measurement standards, including those for X-rays, gamma rays, radio-nuclides, and neutrons. Andre Alfisy, an outstanding French physicist, is in charge and heads up a staff of ten scientists at the new laboratory.

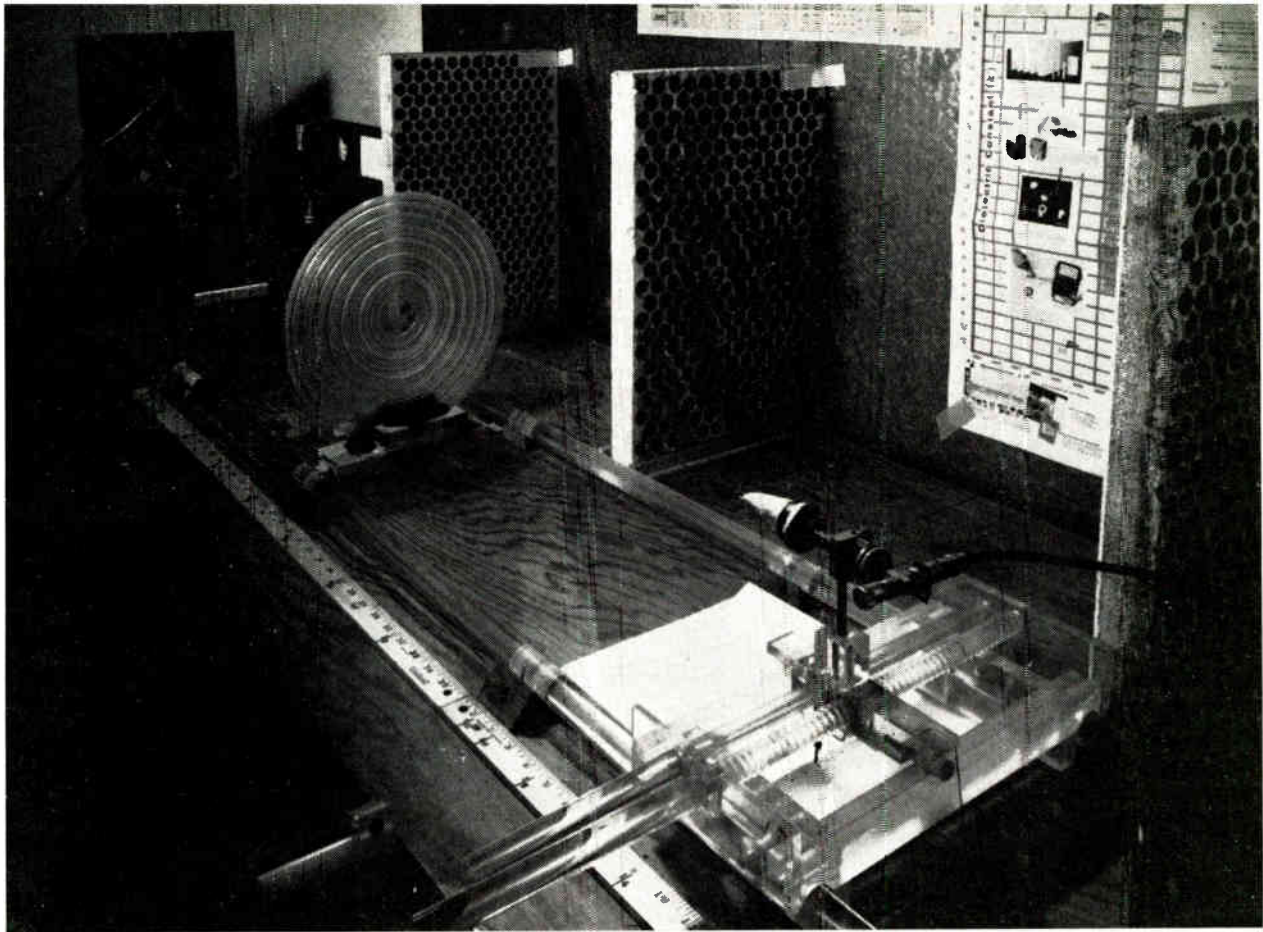

Fig. 1: Microwave Beam Field Plotter

# A Microwave Beamfield Plotter

THE NEED FOR A QUICK, ACCURATE METHOD to determine field patterns occurs often in microwave plasma diagnostics. Radiator elements used to probe plasmas must conform to definite parameters, and their performance must also be checked by accurate methods. Long runs of waveguide, with accompanying attenuation losses, are often necessary to avoid the effects of magnetic fields on detecting and generating devices. But, a focused-beam system (with lens and reflector elements) could possibly provide a more efficient system for transmitting microwaves. Characteristics of beam-forming elements, lenses, reflectors, radiators, etc., can be found rapidly and accurately with the apparatus described here.

\* \* \*

The method was developed to plot the field intensity contours of waves focused by microwave dielectric lenses. Many readings were needed covering a field depth of up to 6 ft. The plots of Fig. 1 show the system's versatility. Plot A, recorded at 35 gc, shows the beam formed by a dual frequency Fresnel Zone plate. The 3 db contours, up to a range of 4 ft, are shown. Plot B, taken at 67 gc, shows two significant contours to a range of 1 ft. Plot C is a pattern of field intensity readings from a horn at 35 gc.

## Applications

Measurement of field intensity is fundamental to the design and use of microwave instrumentation in plasma research. As the frequencies of interest go higher, the concept of beam transmission becomes more attractive. Development of focused lens systems with elements of lenses, radiators, reflectors, etc., calls for a method of analysis and testing of their design.

Purpose of the beam plotter is basically one of microwave field sampling. Then, with a microwave pattern of known characteristics, a plasma is investigated. The physical features of the plasma are found on the basis of the effect it has on the microwave beam. The sample plot shown in Fig. 1C is for a horn, while plots A and B are for a beam-focusing dielectric element. But, the plotting procedure is the same for intensity contours in both cases. The source at the desired frequency is modulated by a 1.0 kc square wave.

To begin a plot, a zero reference point is established by the use of a calibrated attenuator. For example, in plotting Fig. 1C, the waveguide stub with the horn radiator removed was taken as zero db with 30 db of attenuation inserted by the calibrated attenuator. The amount of attenuation must be



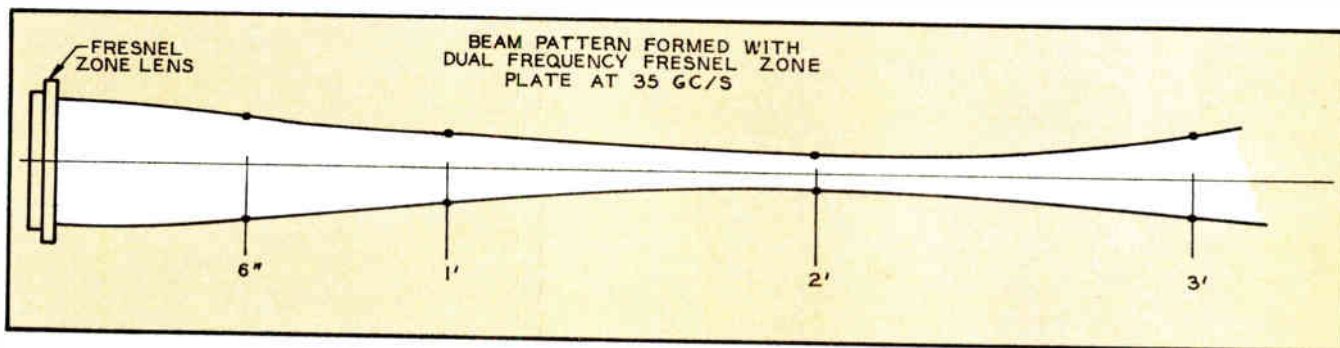
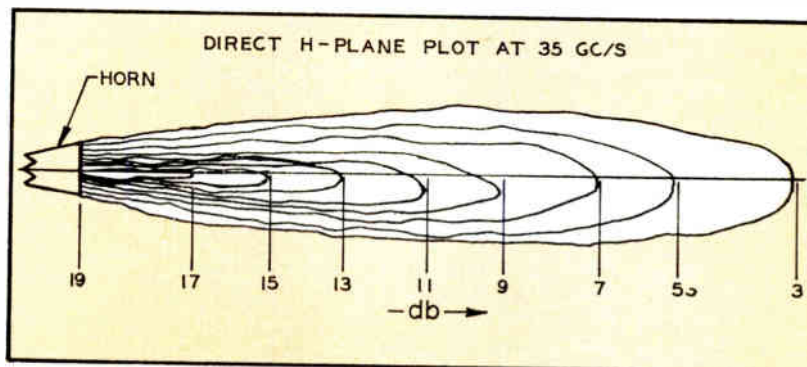
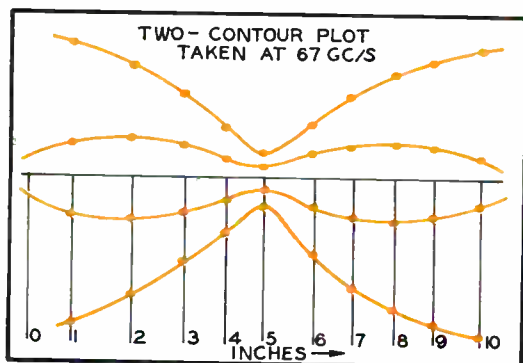

Fig. 2: Beam patterns using Microwave Beam Field Plotter



This useful technique for examining dielectric lenses, horn and slot radiators allows plotting field configurations difficult by normal methods.

By **HARRIS KLAPPER**

Electronic Engineering Dept.,  
Lawrence Radiation Laboratory,  
University of California

chosen to allow for the number of contour steps desired. Withdrawal of 3 db steps on the attenuator, as the field is explored by the probe, will produce contours of constant intensity. That is, a constant output will be indicated on the power meter for a given contour at each point plotted. Curves are then drawn through the series points produced, for constant power readings. If phase contours are desired, a waveguide connection may be provided "up stream" from the radiator. This is done so that a mixer device may be installed through an attenuator and flexible waveguide section between the probe and the detector. A given phase relationship will produce a constant output from the detector. Points of higher output indicate an in-phase condition, and lower output an out-of-phase condition. A contour of similar phase difference could be followed out in a similar fashion to an intensity plot. Attenuation should be adjusted for field strength as the probe is moved in relation to the radiator. But, care must be taken to insure that the waveguide and other components do not produce reflection interference.

### Construction

As a primary consideration, metal was excluded in the construction of the plotter. This was to reduce

the possibility of errors due to reflections. Lucite was chosen because it has sufficient strength, good workability, and low reflectivity. Metal has been kept to a minimum, and no appreciable effects have been observed due to the essential metal parts used.

If readings are taken in a screen room, absorbent panels, as shown in Fig. 2, must be placed along the length of the carriage rails to suppress reflections from the walls next to the system. To provide the solid base needed for smooth operation, three 5 ft benches were placed end-to-end for the system described here. The bench surfaces were covered with  $\frac{3}{4}$  in. plywood composed of two  $7\frac{1}{2}$  ft lengths joined in the center of the middle bench. The plywood surface was sanded smooth and level before installation of the lucite rails.

The system consists of a carriage assembly which rides on a parallel pair of 1 in. lucite rods  $9\frac{1}{2}$  ft long. A space of 3 ft was left at one end of the bench for setting up the microwave generating equipment. An 8 mm set-up that includes a klystron oscillator panel, an isolator, calibrated attenuator and horn radiator, is shown in Fig. 2. The main carriage runs the length of the rails on nylon rollers. Grooves cut along the top of the main carriage allow a smaller transverse probe carrier, also on nylon rollers. The

# NEED SOPHISTICATED COMPONENTS SUCH AS THESE?



**THIS?**  
*Most circuit designers do.*

**OR THIS?**  
*Integrated circuit packages are critical in use by just about any standard.*

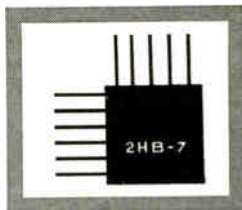

**AND HOW  
ABOUT**

**THIS TWO TERMINAL  
DEVICE**—*a small but critically important Resistor?*

After perusing the following details, more circuit designers and component-reliability engineers than ever before will realize that SAGE SILICOHM® miniature power resistors stand out above all others in providing:

- ① smallest size vs wattage rating
- ② fully welded construction using precision wire elements
- ③ Sage IMPERVOHM® silicone encapsulation, designed for 1000 volt body insulation and operating temperature extremes  $-65^{\circ}\text{C}$  to  $350^{\circ}\text{C}$
- ④ close tolerance, 1%, .5%, .25%, .1%, .05%
- ⑤ close TC,  $\pm 20$  ppm/ $^{\circ}\text{C}$
- ⑥ Copper leads standard, weldable nickel or Dumet when specified



- ⑦ non-inductive windings when specified
- ⑧ low values to  $.05\Omega$ , specials even lower
- ⑨ millions of unit-hours reliability documentation under Polaris and Improved Minuteman programs

*Request Catalog R-62 for more details.*



# SAGE

**SAGE ELECTRONICS CORP.**  
Country Club Road • East Rochester, N. Y.



## BEAMFIELD PLOTTER (Concluded)

probe is held in a block drilled to take a waveguide mount, Fig. 3. The probe carrier is driven by a threaded lucite rod, or "lead screw" of  $\frac{1}{2}$  in. dia. and a lead of four turns to the inch. The lead screw is rotated through an epoxy thread case in the top carrier to provide a transverse movement.

The marker consists of a triangular rod with slightly concave sides which runs through a hole drilled parallel to the lead screw. The headed nylon rod, which holds the stylus, fits in a hole drilled vertically through the top carrier. This stylus holder cuts a chord through the circular plan of the hole. The stylus is held under tension by a lucite spring in a manner which causes the head to press down on the edge of the triangular rod. A triangular block is pivoted and spring-loaded in a position which allows another edge of the triangular rod to be held against the spring tension. The marking stylus is inserted in the nylon rod in such a manner that when the triangular rod is rotated clockwise, the stylus is lifted and then dropped under the spring tension. This causes the stylus to make a point on the graph, Fig. 3. As the motion is continued the stylus is lifted, while simultaneously a pivoted block is depressed until the edge moves over the end of the block. The block then rises, and the rod is trapped between the stylus head and the edge of the block.

This is the "ready" position. The clockwise movement provides for both triggering and cocking. The design of the marker allows full freedom of movement for the transverse carrier.

Fig. 3: Close-up view of plotting mechanism

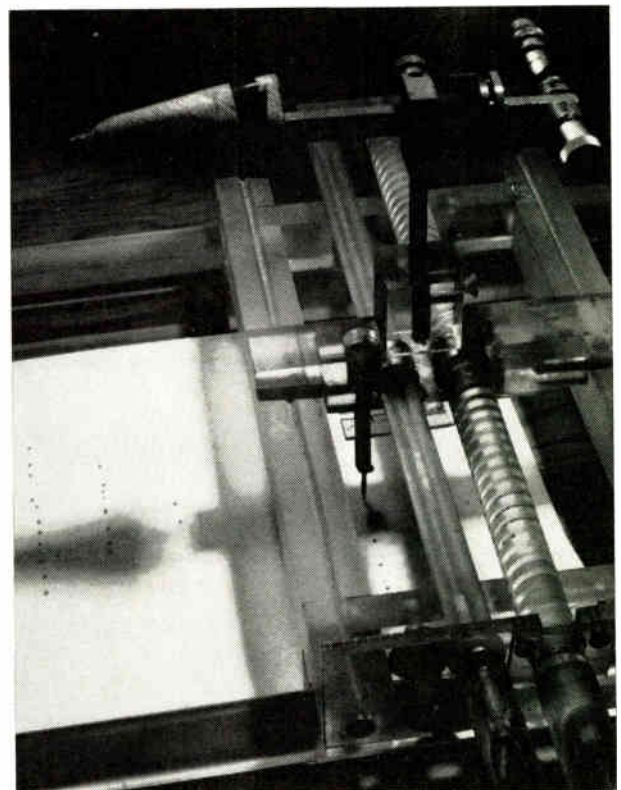



ELECTRO INSTRUMENTS ANNOUNCES

NEW LINE

OF DIGITAL CAPACITANCE METERS



PROVIDING RAPID, PRECISE MEASUREMENTS  
WITHOUT TEDIOUS MANUAL ADJUSTMENTS

By Dr. Walter East  
President, Electro Instruments, Inc

It is always a satisfying experience to introduce a product which is an improvement over anything in its field. But it is doubly satisfying when the improvements inherent in the product are such that they may open up whole new areas and fields of usage for it. That may well be the case with our new line of Digital Capacitance Meters.

Their primary users will continue to be those industries and firms which have a need to measure capacitance to

highly precise degrees. As electrical engineers are well aware, this has heretofore required the services of a technically competent operator, and the measuring process itself could not be accomplished with any degree of accuracy in less than minutes of time.

#### Offer Production Savings

Our new capacitance meters, by completely eliminating the need for manual adjustment, make capacitance measuring a job which can now be handled by relatively unskilled personnel. Also, they cut the time element involved to less than a second. On both counts, therefore, these new capacitance meters offer such firms as manu-

facturers of electronic components, and manufacturers who utilize such components, valuable production savings.

#### Other Possible Uses

But I can visualize a practical use for these new meters on research and manufacturing jobs where capacitance meters are not now normally employed. Automatically monitoring thicknesses, molecular structure, insulating properties of such solids as paper, plastics, fabrics—and many forms of liquid and gaseous matter.

Let one of our field sales engineers acquaint you with the advantages of our new digital capacitance meters today. Or call or write me directly.



**Electro Instruments, Inc.**

8611 Balboa Avenue San Diego, California 92112

ELECTRO INTERNATIONAL, INC., ANNAPOLIS, MD. • TRANSFORMER ENGINEERS, SAN GABRIEL, CALIF.

# This is Siemens

---

Serving the entire field of electronics and nucleonics, the Siemens Group is one of the world's most diversified electrical engineering organizations.

The particular strength of the Siemens Group is in its all-round capabilities—both in the overall handling of large-scale technical projects, from planning to final delivery, and also in the quantity production of electrical components and electronics devices. Distribution companies and agencies in 80 countries, backed by Siemens factories and hundreds of depots maintained in all parts of the world, guarantee customers a maximum of service. In cooperation with their central offices, they provide or arrange for every conceivable form of service that may be required in connection with electrical installations.

---

Siemens & Halske AG  
Telephone and Switching Division

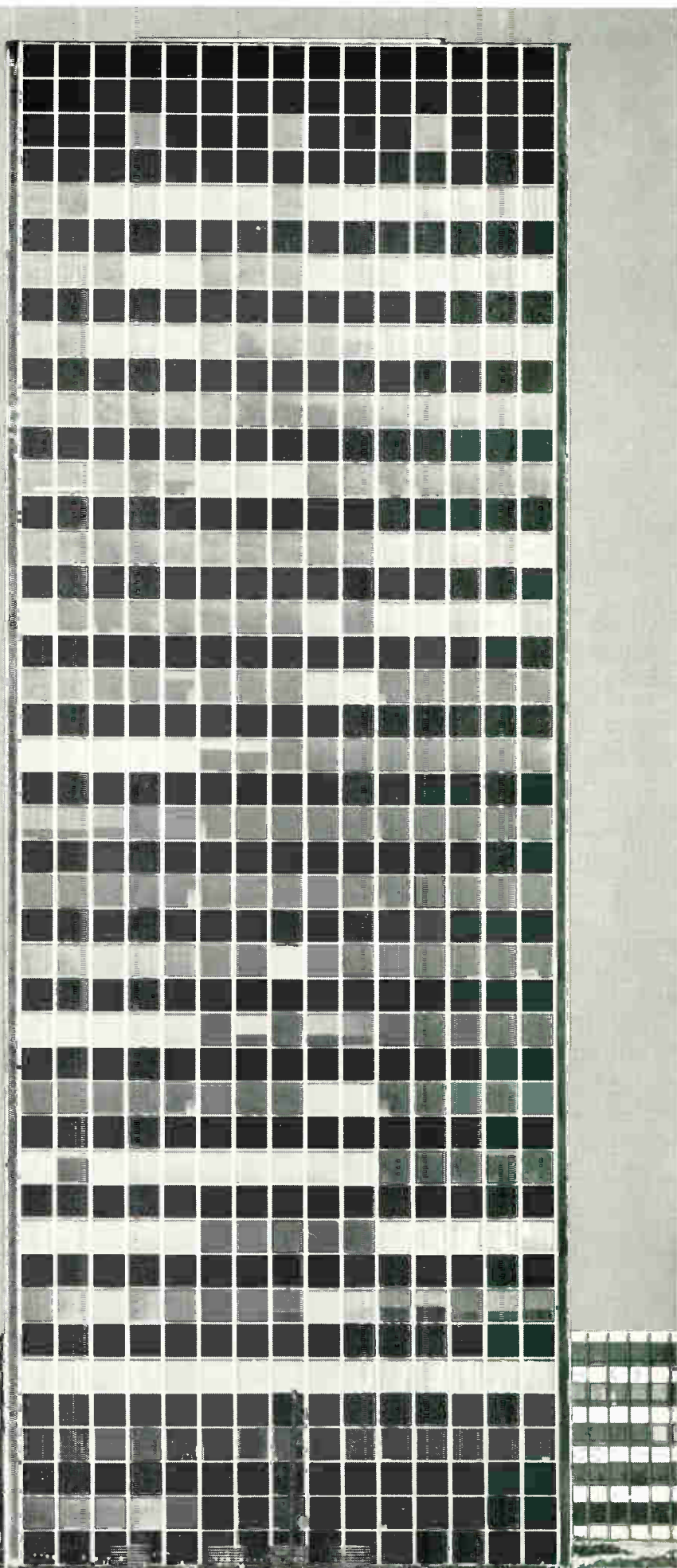
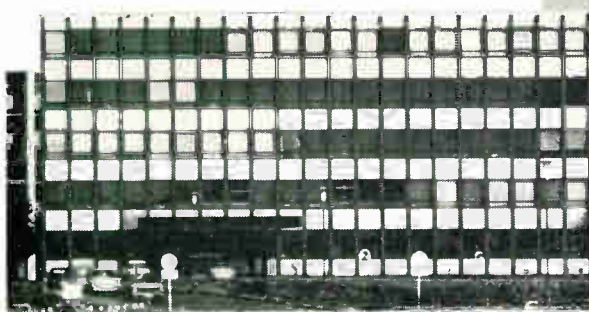



# Siemens Tubes

## Special Quality Tubes

with frame grid and special interface-free cathode, high mutual conductance to anode current ratio, especially designed for use in critical industrial and military applications where reliability and long life are of primary importance.

Description		EC 8010 8556 UHF Triode	ECC 8100 Twin Triode	E 88 CC 6922 Twin Triode	E 288 CC 8223 Twin Triode	
Characteristics	Anode supply voltage	200	100	100	100	V
	Anode current	25	25	15	30	mA
	Mutual conductance	28	20 <sup>1</sup>	12.5	20	mA/V
Maximum ratings	Anode voltage	200	250	220	250	V
	Anode dissipation	4.5	2.5	1.5	3.0	W
	Cathode current	35	40	20	40	mA

<sup>1</sup> System II only; for System I (with internal neutrode screen) 16 mA/V

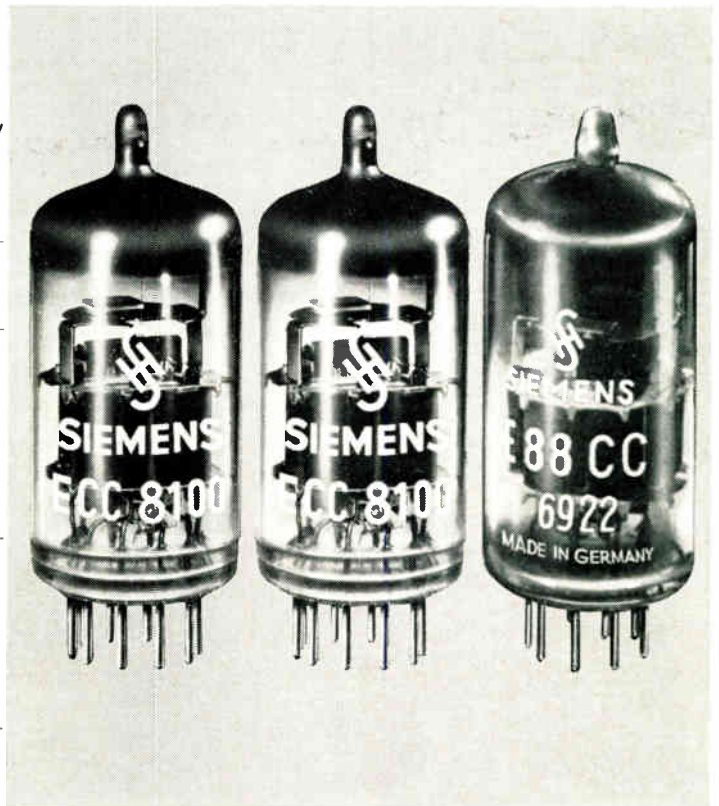

## SIEMENS AMERICA INCORPORATED

350 Fifth Avenue, New York, N.Y. 10001

A Corporation of THE SIEMENS GROUP IN GERMANY  
Berlin • Munich • Erlangen

In Canada:

SIEMENS HALSKE SIEMENS SCHUCKERT (CANADA) LTD.  
407 McGill Street, Montreal 1, P.Q.

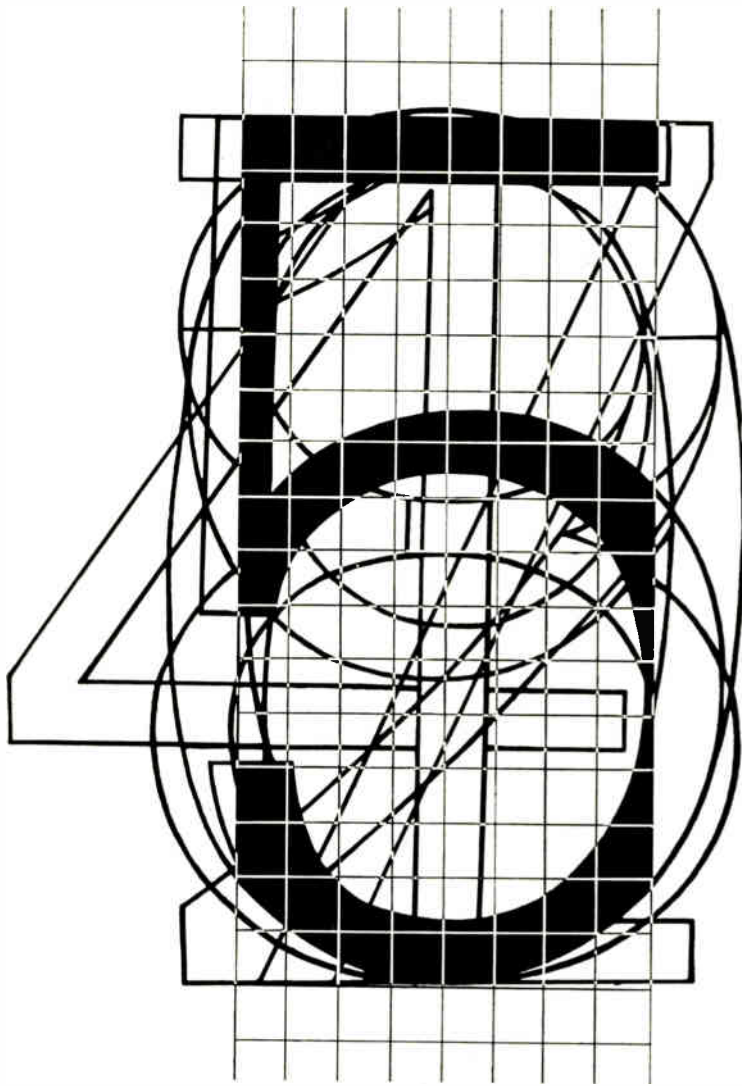

### **What tells the machine, "I am a 5"?**

Designing recognition logic is a key to developing systems for recognizing handwriting, multifont printing, or magnetic-ink characters. Engineers face the questions: What minimum information must the scanner sense from a character, and what measurements are necessary to ensure accurate recognition?

There are a number of aspects of character recognition you might work on: computer simulation of new recognition logic, investigation of the probability of accurate recognition for different styles of writing or printing, or development of new methods of scanning the characters.

The field of character recognition and associated areas such as document handling could be of great potential for you at IBM. Write to Manager of Employment, Dept. 557-A, IBM Corporate Headquarters, Armonk, New York 10504.

An Equal Opportunity Employer

# **IBM®**

ELECTRONIC INDUSTRIES • January 1965



FIRST CLASS  
PERMIT NO. 36  
PHILA., PA.

BUSINESS REPLY MAIL  
No Postage Stamp Necessary If Mailed in U.S.A.

POSTAGE WILL BE PAID BY

ELECTRONIC INDUSTRIES

P. O. Box 9801

Philadelphia, Pa. 19140



FIRST CLASS  
PERMIT NO. 36  
PHILA., PA.

BUSINESS REPLY MAIL  
NO POSTAGE STAMP NECESSARY IF MAILED IN UNITED STATES

POSTAGE WILL BE PAID BY

ELECTRONIC INDUSTRIES

Chilton Company

Chestnut & 56th Sts.

Philadelphia, Pa. 19139



Att: Circulation Dept.

# FREE!

## Use this card for:

- Catalogs, Bulletins, Literature
- New Tech Data for Engineers
- Information about new Products

NAME

COMPANY

ADDRESS

CITY, STATE & ZIP

TITLE

DEPT.  
MAIL STOP

Please send me the items I have circled.

	1	2	3	4	5	6	7	8	9	10	11	12	13	14	15	16	17	18	19	20
	21	22	23	24	25	26	27	28	29	30	31	32	33	34	35	36	37	38	39	40
	41	42	43	44	45	46	47	48	49	50	51	52	53	54	55	56	57	58	59	60
	61	62	63	64	65	66	67	68	69	70	71	72	73	74	75	76	77	78	79	80
	81	82	83	84	85	86	87	88	89	90	91	92	93	94	95	96	97	98	99	100
	101	102	103	104	105	106	107	108	109	110	111	112	113	114	115	116	117	118	119	120
	121	122	123	124	125	126	127	128	129	130	131	132	133	134	135	136	137	138	139	140
	141	142	143	144	145	146	147	148	149	150	151	152	153	154	155	156	157	158	159	160
	161	162	163	164	165	166	167	168	169	170	171	172	173	174	175	176	177	178	179	180
	181	182	183	184	185	186	187	188	189	190	191	192	193	194	195	196	197	198	199	200
	201	202	203	204	205	206	207	208	209	210	211	212	213	214	215	216	217	218	219	220
	221	222	223	224	225	226	227	228	229	230	231	232	233	234	235	236	237	238	239	240
	241	242	243	244	245	246	247	248	249	250	251	252	253	254	255	256	257	258	259	260
	261	262	263	264	265	266	267	268	269	270	271	272	273	274	275	276	277	278	279	280
	281	282	283	284	285	286	287	288	289	290	291	292	293	294	295	296	297	298	299	300
	301	302	303	304	305	306	307	308	309	310	311	312	313	314	315	316	317	318	319	320
	321	322	323	324	325	326	327	328	329	330	331	332	333	334	335	336	337	338	339	340
	341	342	343	344	345	346	347	348	349	350	351	352	353	354	355	356	357	358	359	360
	361	362	363	364	365	366	367	368	369	370	371	372	373	374	375	376	377	378	379	380
	381	382	383	384	385	386	387	388	389	390	391	392	393	394	395	396	397	398	399	400

1-A EI-229 JANUARY 1965

### SPECIAL PRIORITY REQUEST

Postcard valid 8 weeks only

For immediate need or a call by a sales representative, write number (s) in box (do not circle above)

Item No.	Item No.	Item No.	Item No.	Item No.

## Change of Address

**NEW**

Company \_\_\_\_\_

Mail Stop/or \_\_\_\_\_

Dept., Div. \_\_\_\_\_

Street \_\_\_\_\_

City \_\_\_\_\_ State \_\_\_\_\_ Zip \_\_\_\_\_

**OLD**

PASTE WRAPPER IMPRINT OR WRITE COMPLETE OLD ADDRESS

# ELECTRONIC INDUSTRIES

Source  
Date

Co. Code

File No.

Function  
Industry

Title  
Unit

1. Do you wish to continue receiving ELECTRONIC INDUSTRIES? Yes \_\_\_\_\_ No \_\_\_\_\_

Signature \_\_\_\_\_ Title \_\_\_\_\_

2. Check ONE box for your PRIME FUNCTION

Corporate Management	Engineering Management	Manufacturing Management	DESIGN ENGINEERING				Research & Development Engineering	Application	Evaluation	Mechanical	Quality Control	Production	Reliability	Standard	Test	Value	Purchasing	Sales	Co. Copies & Libraries	All Others
			Circuits	Components	Equipment	Systems														
A	B	C	D	E	F	G	H	J	K	M	N	P	R	S	T	V	W	X	Y	Z

3. Check ONE box for your plant's PRIME nature of business

#### MANUFACTURING INDUSTRIES

- (01) Computers, Data Processing & Peripheral Equipment Mfr.
- (02) Communication Systems & Equipment Mfr.
- (03) Consumer Electronic Equipment Mfr.
- (04) Industrial Control Systems & Equipment Mfr.
- (05) Navigation & Guidance System Mfr.
- (06) Test Measurement & Instrumentation Mfr.
- (07) Aircraft, Ground Support, Missile, Space Vehicle & Undersea Access & Equipment Mfr, not covered in other product classifications
- (08) Component Mfr.
- (09) Sub-System Assembly Mfr. (Modules, Assembled Circuits)

- (10) Materials & Hardware Mfr.
- (11) Industrial Co. Using or Incorporating Any Electronic Equipment In Their Manufacturing, Research or Development Activities. (Other than Electronic Co.)

#### NON MANUFACTURING INDUSTRIES

- (12) Commercial Users of Electronic Equipment
- (13) Independent Research, Test & Design Laboratories & Consultants (Not Part of a Manufacturing Company)
- (14) Government Agencies & Military Agencies
- (15) Distributors, Mfr. Representatives
- (16) Education & Libraries
- Other (explain) \_\_\_\_\_

4. This Address is (check most applicable)

Mfg. Plant (\*)  Mfr's R&D Lab. (&)  Other (explain) \_\_\_\_\_

If address shown is your home, where is your company located? City \_\_\_\_\_ State \_\_\_\_\_



# FREE!

## Use this card for:

- Catalogs, Bulletins, Literature
- New Tech Data for Engineers
- Information about new Products

NAME ..... TITLE .....

COMPANY ..... DEPT. .... MAIL STOP .....

ADDRESS .....

CITY, STATE & ZIP .....

Please send me the items I have circled.

													1-B	EI-229	JANUARY 1965				
1	2	3	4	5	6	7	8	9	10	11	12	13	14	15	16	17	18	19	20
21	22	23	24	25	26	27	28	29	30	31	32	33	34	35	36	37	38	39	40
41	42	43	44	45	46	47	48	49	50	51	52	53	54	55	56	57	58	59	60
61	62	63	64	65	66	67	68	69	70	71	72	73	74	75	76	77	78	79	80
81	82	83	84	85	86	87	88	89	90	91	92	93	94	95	96	97	98	99	100
101	102	103	104	105	106	107	108	109	110	111	112	113	114	115	116	117	118	119	120
121	122	123	124	125	126	127	128	129	130	131	132	133	134	135	136	137	138	139	140
141	142	143	144	145	146	147	148	149	150	151	152	153	154	155	156	157	158	159	160
161	162	163	164	165	166	167	168	169	170	171	172	173	174	175	176	177	178	179	180
181	182	183	184	185	186	187	188	189	190	191	192	193	194	195	196	197	198	199	200
201	202	203	204	205	206	207	208	209	210	211	212	213	214	215	216	217	218	219	220
221	222	223	224	225	226	227	228	229	230	231	232	233	234	235	236	237	238	239	240
241	242	243	244	245	246	247	248	249	250	251	252	253	254	255	256	257	258	259	260
261	262	263	264	265	266	267	268	269	270	271	272	273	274	275	276	277	278	279	280
281	282	283	284	285	286	287	288	289	290	291	292	293	294	295	296	297	298	299	300
301	302	303	304	305	306	307	308	309	310	311	312	313	314	315	316	317	318	319	320
321	322	323	324	325	326	327	328	329	330	331	332	333	334	335	336	337	338	339	340
341	342	343	344	345	346	347	348	349	350	351	352	353	354	355	356	357	358	359	360
361	362	363	364	365	366	367	368	369	370	371	372	373	374	375	376	377	378	379	380
381	382	383	384	385	386	387	388	389	390	391	392	393	394	395	396	397	398	399	400

### SPECIAL PRIORITY REQUEST

For immediate need or a call by a sales representative, write number (s) in box (do not circle above)

Item No.	Item No.	Item No.	Item No.	Item No.

Postcard valid 8 weeks only

## ELECTRONIC INDUSTRIES

Company \_\_\_\_\_

Mail Stop/or Dept., Div. \_\_\_\_\_

Name \_\_\_\_\_

Company Address \_\_\_\_\_

City \_\_\_\_\_ State \_\_\_\_\_ Zip \_\_\_\_\_

Source Date	_____
Co. Code	_____
File No.	_____
Function Industry	_____
Title Unit	_____

1. I wish to receive ELECTRONIC INDUSTRIES

Signature \_\_\_\_\_

Title \_\_\_\_\_

2. Check—ONE—box for your PRIME FUNCTION

Corporate Management	Engineering Management	Manufacturing Management	Research & Development	Application	Evaluation	Mechanical	Quality Control	Production	Reliability	Standard	Test	Value	Purchasing	Sales	Co. Copies & Libraries	All Others	
A	B	C	D	E	F	G	H	I	J	K	L	M	N	O	P	Q	R

WorldRadio History

3. Check—ONE—box for your plant's PRIME nature of business

- MANUFACTURING INDUSTRIES**
- (01) Computers, Data Processing & Peripheral Equipment Mfr.
  - (02) Communication Systems & Equipment Mfr.
  - (03) Consumer Electronic Equipment Mfr.
  - (04) Industrial Control Systems & Equipment Mfr.
  - (05) Navigation & Guidance System Mfr.
  - (06) Test Measurement & Instrumentation Mfr.
  - (07) Aircraft, Ground Support, Missile, Space Vehicle & Undersea Access & Equipment Mfr. not covered in other product classifications
  - (08) Component Mfr.
  - (09) Sub-System Assembly Mfr. (Modules, Assembled Circuits)
- NON MANUFACTURING INDUSTRIES**
- (10) Materials & Hardware Mfr.
  - (11) Industrial Co. Using or Incorporating Any Electronic Equipment in Their Manufacturing, Research or Development Activities. (Other than Electronic Co.)
  - (12) Commercial Users of Electronic Equipment
  - (13) Independent Research, Test & Design Laboratories & Consultants (Not Part of a Manufacturing Company)
  - (14) Government Agencies & Military Agencies
  - (15) Distributors, Mfr. Representatives
  - (16) Education & Libraries
  - Other (explain) \_\_\_\_\_

4. This Address is (check most applicable)

- Mfg. Plant (\*)
  - Mir's R&D Lab. (&)
  - Other (explain) \_\_\_\_\_
- If address shown is your home where is your company located? City \_\_\_\_\_ State \_\_\_\_\_

FIRST CLASS  
PERMIT NO. 36  
PHILA., PA.

BUSINESS REPLY MAIL  
No Postage Stamp Necessary If Mailed in U.S.A.

POSTAGE WILL BE PAID BY

ELECTRONIC INDUSTRIES

P. O. Box 9801

Philadelphia, Pa. 19140



FIRST CLASS  
PERMIT NO. 36  
PHILA., PA.

BUSINESS REPLY MAIL  
NO POSTAGE STAMP NECESSARY IF MAILED IN UNITED STATES

POSTAGE WILL BE PAID BY

ELECTRONIC INDUSTRIES

Chilton Company

Chestnut & 56th Sts.

Philadelphia, Pa. 19139



Att: Circulation Dept.



















Bourns offers you 17 proven, off-the-shelf answers to MIL-STD-202A, Method 106 (cycling)—the most stringent humidity spec in the book. More than just “moisture-resistant” or “humidity-defying,” these units are humidity-proof. No coatings or potting compounds are required.

The reliability of Bourns potentiometers is a matter of record in virtually every space and defense program. Don't MIL-SPECulate—SPECify Bourns!

UNITS READY FOR IMMEDIATE DELIVERY.  
WRITE FOR DETAILS!

# BOURNS® Potentiometers

 <b>TRIMPOT® MODEL 3000</b> Micro-miniature, high-temperature, wirewound; 50Ω to 20K; 0.5W at 70°C; Max. oper. temp. 175°C.	 <b>TRIMPOT MODEL 3051</b> High-temperature, RESISTON carbon element; 20K to 1 Meg.; 0.25W at 50°C; Max. oper. temp., 150°C.	 <b>BOURNS MODEL 3281</b> Square, micro-miniature RESISTON carbon element; 20K to 1 Meg.; 0.5W at 50°C; Max. oper. temp., 150°C.
 <b>TRIMPOT MODEL 3001</b> High-temperature, RESISTON carbon element; 20K to 1 Meg.; 0.20W at 70°C; Max. oper. temp., 150°C.	 <b>BOURNS® MODEL 3250</b> Square, high-temperature, wirewound; 10Ω to 50K; 1.0W at 70°C; Max. oper. temp., 175°C.	 <b>BOURNS MODEL 3300</b> Single-turn, wirewound, micro-miniature; 10Ω to 20K; 0.5W at 70°C; Max. oper. temp., 175°C.
 <b>TRIMPOT MODEL 3010</b> High-temperature, wirewound; 10Ω to 100K; 1.0W at 70°C; Max. oper. temp., 175°C.	 <b>BOURNS MODEL 3251</b> Square, high-temperature, RESISTON carbon element; 20K to 1 Meg.; 0.50W at 50°C; Max. oper. temp., 150°C.	 <b>BOURNS MODEL 3301</b> Single-turn, RESISTON carbon element, micro-miniature; 10K to 1 Meg.; 0.25W at 70°C; Max. oper. temp., 150°C.
 <b>TRIMPOT MODEL 3011</b> High-temperature, RESISTON carbon element; 20K to 1 Meg.; 0.25W at 50°C; Max. oper. temp., 150°C.	 <b>BOURNS MODEL 3280</b> Square, micro-miniature, wirewound; 10Ω to 50K; 1.0W at 70°C; Max. oper. temp., 175°C.	 <b>TRIMPOT MODEL 220</b> Sub-miniature, high-temperature, wirewound; 10Ω to 30K; 1.0W at 70°C; Max. oper. temp., 175°C.
 <b>TRIMPOT MODEL 224</b> High-temperature, wirewound; 10Ω to 100K; 1.0W at 70°C; Max. oper. temp., 175°C.	 <b>TRIMPOT MODEL 3052</b> High-temperature, PALIRIUM element; 20K to 1 Meg.; 1.0W at 70°C; Max. oper. temp. 175°C.	 <b>TRIMPOT MODEL 3020</b> High-power, high-temperature, wirewound; 5.0W at 25°C; Max. oper. temp., 200°C.
 <b>TRIMPOT MODEL 3012</b> High-temperature, PALIRIUM® element; 20K to 1 Meg.; 1.0W at 70°C; Max. oper. temp. 175°C.	<b>ALL UNITS SHOWN ½ ACTUAL SIZE</b>	

Your Widest Choice of Answers to Problems in

# HUMIDITY

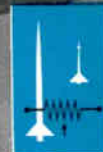

**BOURNS**

BOURNS, INC., TRIMPOT DIVISION  
1260 COLUMBIA AVE., RIVERSIDE, CALIF.  
PHONE 684-1700 • TWX: 714-682 9582  
CABLE: BOURNSINC.

MANUFACTURER: TRIMPOT® & PRECISION POTENTIOMETERS, RELAYS; TRANSDUCERS FOR PRESSURE, POSITION, ACCELERATION. PLANTS: RIVERSIDE, CALIFORNIA; AMES, IOWA; TORONTO, CANADA

**Miniature  
to Midget**

**Many  
Switching  
Combinations**

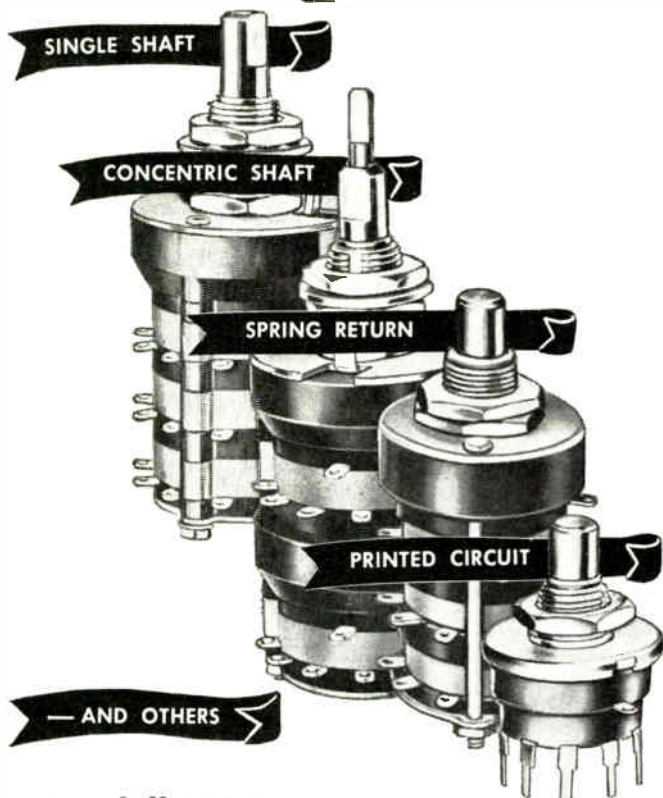

## Grayhill Miniature Rotary Tap Switches

Grayhill Switches are designed to provide maximum performance—inspected and tested to exacting quality control standards—ruggedly constructed to provide over 100,000 cycles of operation. They are suitable for military and commercial applications. What is your switching problem?

### TYPICAL SPECIFICATIONS

- Contact Resistance .010 ohms typical
- 100,000 cycle life
- Make or Break 1 Amp. 115 VAC, Resistive
- 1 to 6 Poles Per Deck
- 2 to 12 Positions Per Pole
- 1 to 12 Decks • Explosion Proof

Grayhill offers a full line of Rotary Tap Switches, Push Button Switches, Test Clips, Binding Posts, and other miniature electrical and electronic components.

Ask for Current Catalog



543 Hillgrove Avenue  
La Grange, Illinois 60526  
Area Code 312, Phone 354-1040



"PIONEERS IN MINIATURIZATION"

Circle 55 on Inquiry Card

## WHAT'S NEW

### NEW COMPUTER SERIES FEATURES INTEGRATED CIRCUITS

A NEW FAMILY of third generation computer systems using integrated circuits has been announced by RCA. The series is called Spectra 70, a name which connotes a series of advanced systems embracing the spectrum of data processing uses. And, it does this within a single family of compatible equipment that looks ahead to the needs of users well into the 1970's.

Principal building blocks for the two largest computers in the series are fully integrated circuits. This high-volume use of integrated circuitry should have quite an impact on the industry as a whole. The decision to make computers in quantity with fully integrated circuits was the result of logic circuitry research begun years ago in RCA Laboratories.

Initially, the Spectra 70 family includes four com-  
(Continued on page 114)

Integrated circuit package is dwarfed by a conventional printed circuit package which it has replaced in the design of the Spectra 70 computers. Integrated circuits for these computers are made by Fairchild Semiconductor, Westinghouse and RCA.

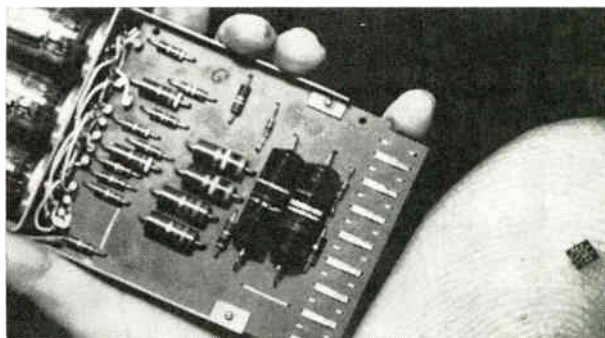

Lilliputian integrated circuit used in the new RCA computer systems can pass through the eye of a needle.

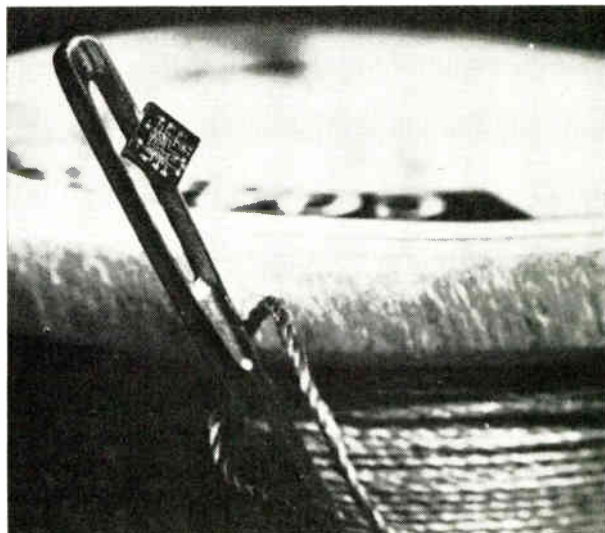



cut customizing costs

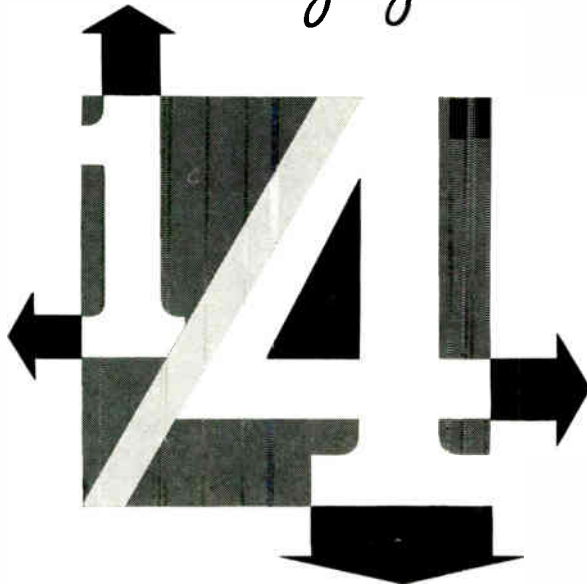

- Manufacturing tolerances held to  $\pm .015"$ .
- Choice of standard and special finishes.
- Options in doors, trims, and grilles.
- Human Engineering principles rigidly adhered to in all component design.
- Unified single source for planning, designing, fabricating, and finishing.

now... enclosures in  
quarter inch increments  
...any dimension

New design concept by Systems Enclosures, Inc. brings costs of custom enclosures down. Any specific equipment housing and installation requirement can be met with the versatility in configuration and multiplicity of sizes -- available in one-quarter inch increments in all dimensions. SEI quality enclosures can be individualized with a variety of styling detail and finish selections. It's a new, economical approach that assures more efficiency, maximum density, servicing simplicity in custom enclosures and complete packaging systems.

*Let an SEI engineer show you how to cut customizing costs in quality enclosures.*

**SYSTEMS ENCLOSURES, INC.**

A SUBSIDIARY OF ANETSBERGER BROTHERS, INC.  
200 North Anets Drive, Northbrook, Illinois  
1125 Shulman Avenue, Santa Clara, California

Circle 56 on Inquiry Card

## More Relay — 25 Amps!



You get more relay with the new Series WH. It features a new holding coil and contact for momentary contact switching which lets you build "inching" or "jogging" capability into machinery.

Like other Series W relays, this new version is:

- COMPACT:** Measures only  $1\frac{1}{2}"$  x  $1\frac{1}{2}"$  x  $1\frac{7}{8}"$ . Weighs only 10 oz. More compact than most 10 amp relays.
- RELIABLE:** More than 10,000,000 cycle life.
- RATED HIGH:** Up to 25 amps, 240V, a-c or 28V, d-c
- EASY TO INSTALL:** Spade, solder or pigtail terminals available.
- VERSATILE:** Eight different contact circuits.

Write today for further information.



**HART MANUFACTURING CO**  
306 BARTHOLOMEW AVENUE  
HARTFORD 1, CONNECTICUT  
Telephone: Area Code 203. 525-3491  
A SUBSIDIARY OF OAK MANUFACTURING CO.

Circle 57 on Inquiry Card

ELECTRONIC INDUSTRIES • January 1965

## SERVO-CHART RECORDERS DON'T HAVE TO BE COSTLY!

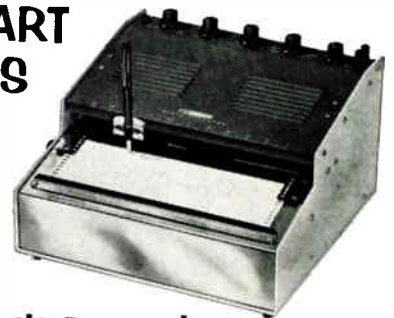

### This Heath-Built Recorder Costs Just \$199!

Completely Factory Assembled & Tested!

Ready to use. True potentiometric input. Five adjustable ranges: 10, 25, 50, 100 & 250 mv plus plug-in 5-pin connectors for special ranges. Rapid chart advance; pen lift; paper tear-off guide; optional motor speeds; 10" chart; 1 sec. response. For full details on the famous Malmstadt-Enke Lab Series *Free*, simply tear out coupon and mail.

Assembled EUW-20A, Recorder, 20 lbs. . . . . \$199.00

**HEATH Built**

**HEATH COMPANY, Dept. 53-1** Benton Harbor, Mich. 49023

Please send Free Folder on Malmstadt-Enke Lab Series and Free 1965 Heathkit Catalog.

Name \_\_\_\_\_  
(Please Print)

Address \_\_\_\_\_

City \_\_\_\_\_ State \_\_\_\_\_ Zip \_\_\_\_\_

EK-169R

Circle 58 on Inquiry Card



**More  
Connections  
Per  
Dollar  
With  
Methode**

# CIRCUIT BOARD EDGE CONNECTORS

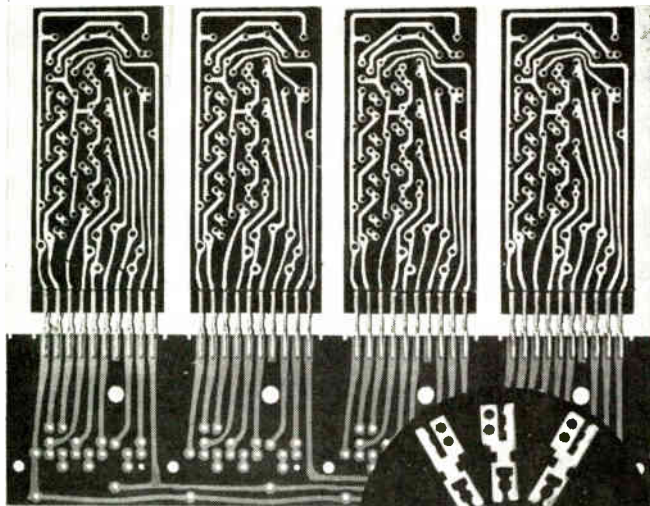

Methode's #652 series edge connectors provide an economical and reliable medium for inter-connecting multiples of circuit cards.

Standard material is phosphor bronze with solder plated finish. Available are standard female contacts and also polarizing lugs which can engage with a slot in the plug-in board. The terminals have supplemental holes for hand wiring taps or attaching test probes.

The termination end of the contact bites into the copper pad on the mother circuit card providing excellent mechanical contact, which can be supplemented by soldering if desired. Mounting press is available for use with contacts.

**Methode Manufacturing Corp.**  
1700 Hicks Road • Rolling Meadows, Illinois

Circle 59 on Inquiry Card

## NEW COMPUTER SERIES (continued)

patible general purpose computers and over 40 interchangeable peripheral devices. These can speak many machine languages and communicate with the majority of other systems on the market today. The absence of this capability today is a source of duplication, delay, and waste for both manufacturer and user.

These computers will accommodate programs written for the company's 301, 3301, and 501 computers, as well as for non-RCA systems.

According to RCA, the Spectra 70 series has the ability to meet all principal system and application needs of science and industry. These "multilingual" computers will be able to live harmoniously with many of their contemporaries.

Price range starts at \$800 a month for the smallest of the new series and extends up to \$22,500 a month for the largest.

A unit has been developed that converts a general-purpose oscilloscope into a sampling oscilloscope. The Model S-30 Sampler, by Electro Desing Inc., San Diego, Calif., allows inputs to be sampled by an electronic switch with an equivalent closed time of less than 350 psec. Sweep speeds are from 10 nsec. to 5  $\mu$ sec. per sweep.

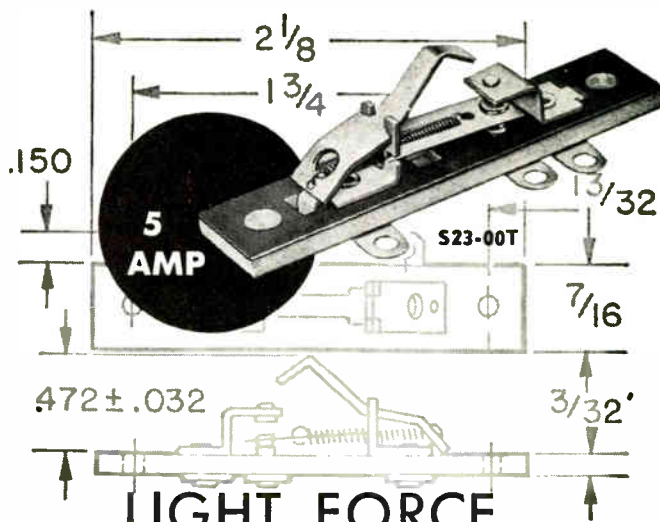

### LIGHT FORCE SNAP-ACTION SWITCH

- Coil spring construction for long mechanical life
- Many actuator variations available
- UL rating 5 amp 125v a-c

... the complete snap-action switch line

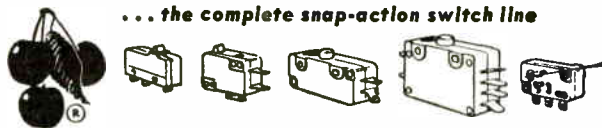

**Cherry Electrical Products Corporation**

P. O. Box 437-21, Highland Park, Ill.

IN CANADA: BARRY ELECTRIC LTD., REXDALE, ONTARIO

Circle 61 on Inquiry Card

ELECTRONIC INDUSTRIES • January 1965



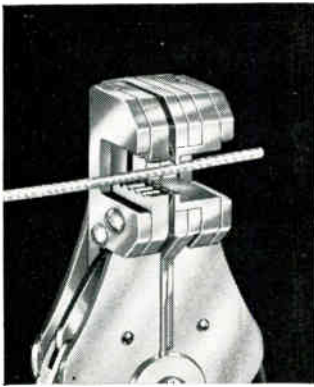

1. Place wire in proper collet-blade hole.

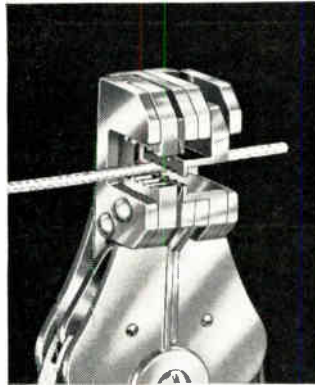

2. Squeeze. Slug gripper moves down to impinge on slug with only slight penetration.

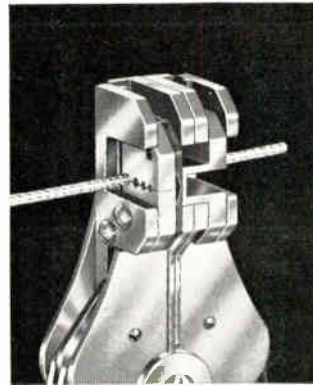

3. Keep squeezing. Simultaneously, collet-blade severs insulation without contacting conductor.

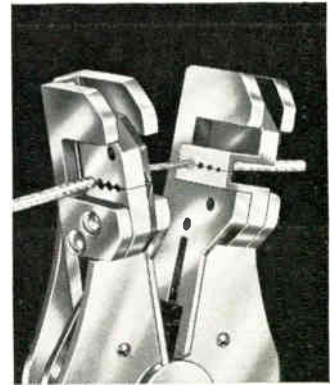

4. End of squeeze. As jaws open, moving gripper removes slug. Stationary collet-blade retains stripped lead. No blade scrapes along conductor.

## NEW WAY TO STRIP WIRE

MIL 5086-II 600v aircraft electrical wire (or any other wire having comparable finished diameter) can now be stripped consistently with no nicks, no scrapes, no ragged ends, no damage to either conductor or insulation. Ideal has added to its line of the industry's finest precision strippers... the new DUAL-BLADE STRIPMASTER®.

New in concept, smoothly precise, this new hand tool advances the state-of-the-art in mechanical wire stripping to match the quality assurance and reliability standards in present critical programs of wire stripping and terminating.

This new design has a sharp, close-tolerance



stationary blade to cut the insulation without leaving any ragged strands. Then the slug is slipped off the conductor by the moving gripper without scraping or burnishing the strands. One quick squeeze neatly strips fiberglass insulation from number 10, 12, 14, 16, 18, 20 or 22 wire. Two models available, each with replaceable blades and grippers. Write for performance specifications.

**IDEAL INDUSTRIES, INC.**

5127-A Becker Place, Sycamore, Illinois

Circle 62 on Inquiry Card

## PRECISION Molded Bobbins

Save  
You  
Money!

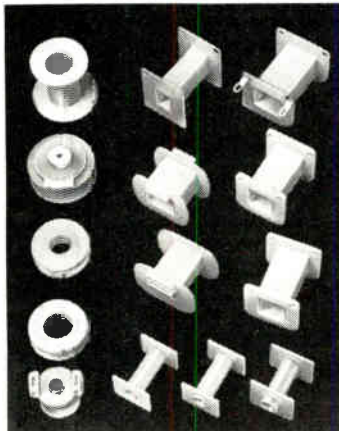

Precision molded bobbins can be furnished at low unit cost in any size or shape. This economy is achieved by a specially designed, fully automatic, single-cavity mold process that holds down costs on both relatively small production runs as well as in larger quantities. This process also permits increased flexibility in production and fast delivery.

Bobbins can be molded from a variety of materials including nylon, polystyrene, polycarbonate, and other thermoplastics to provide the highest electrical, mechanical, and corrosion-resistant properties.

Send or phone specs. for quote.  
Request bulletin and arbor list.



**PRECISION PAPER TUBE CO.**

1049 SOUTH NOEL AVE., WHEELING, ILL. (Chicago Suburb)

Telephone: (Area Code 312) 537-4250

OTHER PLANTS IN HARTFORD, CONN., CLEVELAND, O.

Circle 63 on Inquiry Card

ELECTRONIC INDUSTRIES • January 1965

**P** GRIEVE-HENDRY  
PORTABLE  
ELECTRIC  
OVENS...  
Standard Models  
For Every  
Special Need!



Model CR-225  
10 cu. ft. capacity — 30" wide x 25"  
deep x 24" high. Removable shelves  
and drip pan..... \$132.50  
f.o.b. Chicago

Portable. Costs less than 5¢ per hour to operate. Fan driven forced air circulation. Uniform temperature throughout. Plugs into any 110V wall outlet —no special wiring required.

Quick Quotations  
—Prompt Delivery  
—Reasonable Prices—on Ovens  
made to your specifications.

Can be used in a group or bank. Use them on the production line —save handling—hauling.

Other standard models with temperature ranges to 1000°F. available. Write for literature.

Specialists in Heat Process Equipment



**GRIEVE-HENDRY CO.**

1335 North Elston Avenue, Chicago, Illinois 60622

Circle 64 on Inquiry Card



Computer programmer at General Motors Research Laboratories takes role of automotive designer to test out new GM DAC-1 system. The large and complex computer system features a graphic console and image processor. Console monitors and controls computer progress on a design problem. At any design stage, designer may request a permanent photo copy of a new drawing using the image processor.

**HANOVER FAIR EXPANDS ELECTRONIC SHOW SPACE**

Additional exhibit space will be available for electronic firms at the 1965 Hanover Fair in Hanover, West Germany, set for April 24 to May 2.

According to a report from Fair officials, lively interest has been shown in the past by firms from various other nations, including the U. S. as well as West Germany. A new special hall has been built that provides an additional 75,000 square feet for electronic exhibits.

Some 500 manufacturers of electronic equipment are expected to take part in the Fair, among them about 150 firms appearing for the first time. According to the latest figures, the Fair will host a total of some 6,000 manufacturers representing a sizable cross section of world industry. Exhibit space will cover about 6,500,000 square feet. In addition to electronic exhibits, the Fair will include exhibits on electrical engineering, mechanical engineering, iron and steel, fine mechanics and optics, chemicals and plastics, tools, office equipment, china, ceramics, glassware, watches and clocks, metalware and cutlery.

The foreign exhibitors at the Fair will consist mainly of firms from France, Great Britain, Italy, Japan, Scandinavia, Switzerland, and the U. S.

# RMC DISCAPS

HIGH STABILITY, TYPE JE

are Practically Immune to Severe Temperature Change

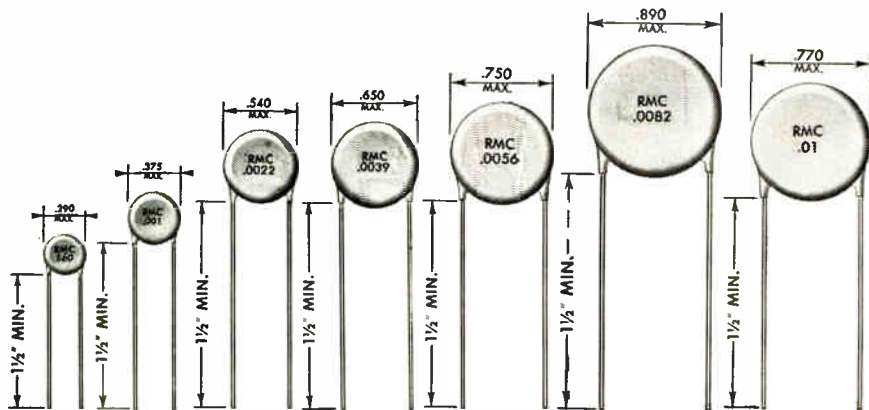

150	330	680	.0012					
180	390	820	.0015	.0027	.0047	.0068	.01*	
220	470	.001	.0018	.0039	.0056	.0082		
270	560		.0022					

\*Dual Disc construction—long leads only. Disc sizes under 1/2" diameter have lead spacing of .250". Disc 1/2" diameter and over have .375" spacing.

**Specifications**

CAPACITANCE: Within tolerance @ 1KC and 25°C.

CAPACITANCE TOLERANCES: +10%, +20% or +80 - 20%

WORKING VOLTAGE: 500 VDC

POWER FACTOR: 2.0% @ 1KC

INSULATION RESISTANCE: Greater than 7500 Megohms @ 500 VDC

TEMPERATURE COEFFICIENT: Z5E, Y5E

FLASH TEST: 1250 VDC for one second

LIFE TEST: Per EIA RS-198 Class II

POWER FACTOR AFTER HUMIDITY: 3.0% @ 1KC

INSULATION RESISTANCE AFTER HUMIDITY: Greater than 1000 Megohms @ 500 VDC

BODY INSULATION: Durez phenolic -- vacuum wax impregnated

LEAD STYLES AVAILABLE: Long lead - #22 tinned copper -, fin-lock, kinked lead plug-in and pin type plug-in

RMC Type JE Discaps exhibit only  $\pm 4.7\%$  capacitance change over the extended  $-30^{\circ}$  to  $+85^{\circ}\text{C}$  temperature range. These capacitors are especially suited for use in mobile communication and like equipment. Typical usage in R-C response shaping networks and feedback loops, in addition to conventional applications, is indicated.

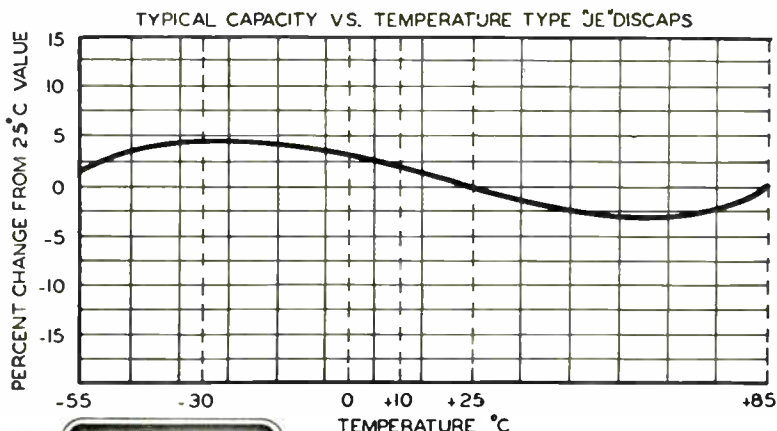

DISCAP CERAMIC CAPACITORS

**RADIO MATERIALS COMPANY**  
 A DIVISION OF P. R. MALLORY & CO., INC.  
 GENERAL OFFICE: 4242 W. Bryn Mawr Ave., Chicago 46, Ill.  
 Two RMC Plants Devoted Exclusively to Ceramic Capacitors  
 FACTORIES AT CHICAGO, ILL. AND ATTICA, IND.



An electrical-output storage tube, molded by imagination, has converted slow-scan pictures from space to flickerless, earthbound television pictures.

Same tube, other imaginations, have seen the possibilities of a Loran-C integrator, three-dimensional X-ray, sonar and radar-to-television scan conversion, computer output display, and satellite detection in a star background.

Possible applications to frequency conversion, automatic correlation, expanding or contracting time scales, stopping high speed motion, and others as yet undreamed, await your own particular insights.

Oh, yes — the honeycomb. Because of experience, special knowhow and talent, there are some tasks best left to others. Our niche is designing and building single-gun, dual-gun and multitube systems to fit your applications, just as we have designed and built the systems above. Write or call.



**image** instruments, inc.

2300 Washington St.  
Newton, Mass. 02162  
617-969-8440

**Video  
Storage,  
Imagination  
and  
Honeycombs**



Circle 66 on Inquiry Card

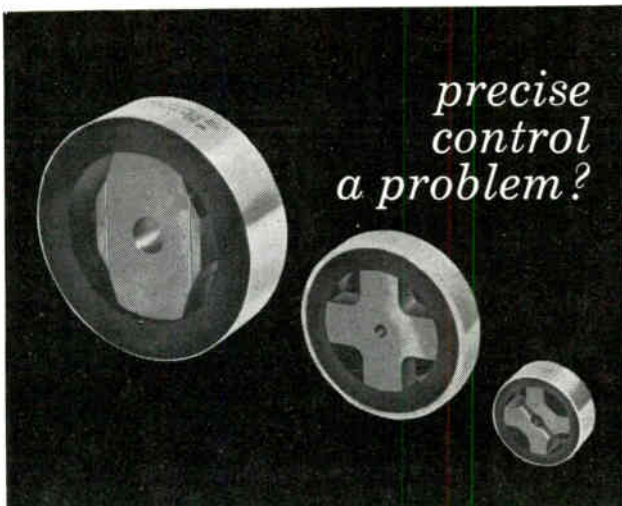

*precise  
control  
a problem?*

It won't be if you use an Aeroflex "brushless" DC torque motor. The only torquer designed for limited angular excursion. Successfully used on:

- Mid-course motor for Mariner and Ranger
- Satellites
- Horizon sensors for Saturn V
- Throttle control for automated trains
- Aero-space stabilized platforms
- Antenna and tracking mount drives

*For free specification charts on torquer performance, write to Dept. RB-98.*



**AEROFLEX LABORATORIES**  
INCORPORATED  
South Service Road, Plainview, L. I., New York  
(516) MYrtle 4-6700

Circle 68 on Inquiry Card

ELECTRONIC INDUSTRIES • January 1965

**INSTANT**

Instant drafting with symbols and drawing details preprinted on tri-acetate sheets ready for use. Your own engineering details can be applied in seconds, rather than drawn in hours.

The STANPAT formula gives permanent adhesion without ghosting. Crisp, clean reproduction everytime on all types of tracing media. Excellent for microfilm reproduction.

Write today and find out how STANPAT can save you hours of routine drafting time. Literature and samples on request, or enclose your symbols for quote.



*faithfully serving  
the engineer for  
over two decades*

**STANPAT PRODUCTS, INC.**

Whitestone 57, N.Y., Dept. C1  
Telephone: 212-359-1693



Circle 69 on Inquiry Card

**NEW**  
**from Motorola**  
**... the industry's**  
**most stable**  
**plug-in oscillator**



- Aging Less Than  $2 \times 10^{-9}$  per day
- Temperature  $5 \times 10^{-8}$  from  $-55^{\circ}$  to  $+71^{\circ}\text{C}$
- Frequency Adjust Voltage or Manual
- Low Cost—\$345.00

The new 1 mc plug-in oscillator is only  $2'' \times 2'' \times 4\frac{1}{4}''$  and is ideal for use in frequency and time applications such as digital frequency counters, phase-locked receivers, synthesizers, SSB systems, missile guidance and satellite tracking systems, and navigation and communications equipment. Model S1072A at 1 mc—other frequencies on request. Write Dept. AEI 51



**UNEXCELLED STABILITY**  
**... FOR MILITARY**  
**APPLICATIONS**

**SLN6039 SERIES**  
**OSCILLATOR**

- Stability Better Than  $1 \times 10^{-9}$  per day
- Fast Warm-Up within  $5 \times 10^{-9}$  after 1 hour
- 100 KC to 5.0 MC Models
- 3 MC Model SLN6039D \$565.00

This high stability oscillator with its fully proportional oven control and precision glass-enclosed crystal meets MIL specifications for both airborne and ground equipment.



Motorola Communications & Electronics Inc.  
 4501 Augusta Blvd., Chicago, Illinois 60651

Circle 70 on Inquiry Card

# WHAT'S NEW

## AID TO BLIND

A PHOTO-ELECTRIC SENSOR which shows promise as an aid to the blind has resulted from Air Force communications research. The battery-powered device, about the size of a two-cell flashlight, will enhance the mobility of the blind. Carried in a subject's hand, it vibrates and warns of obstacles in his path and terrain changes, such as curbs, steps, and slopes.

The sightless person holds the handle of the device with the photo-electric sensor pointed forward. Changes in light values caused by obstacles or terrain are detected by the sensor. At the front of the device is a variable iris in which the aperture can be set according to light conditions. Environmental information is fed to a photo resistor which changes value with the amount of light hitting it. This, in turn, is applied to an oscillator which changes frequency with light values. The man feels these pulse changes as vibrations on the inside of his hand. Frequency changes energize the tactile (sense of touch) nerves, transmitting the signals to the brain. Pulses to the subject's hand vary from 4 to 400/second, depending on the values sensed from the environment.

The environmental sensor was built by Santa Rita Technology, Menlo Park, Calif., under contract with the Communications Branch, Electronic Warfare Div., Air Force Avionics Laboratory, Wright-Patterson AFB, Ohio.

The photo-electric sensor produces signals that warns of obstacles such as terrain changes, curbs, steps, etc.

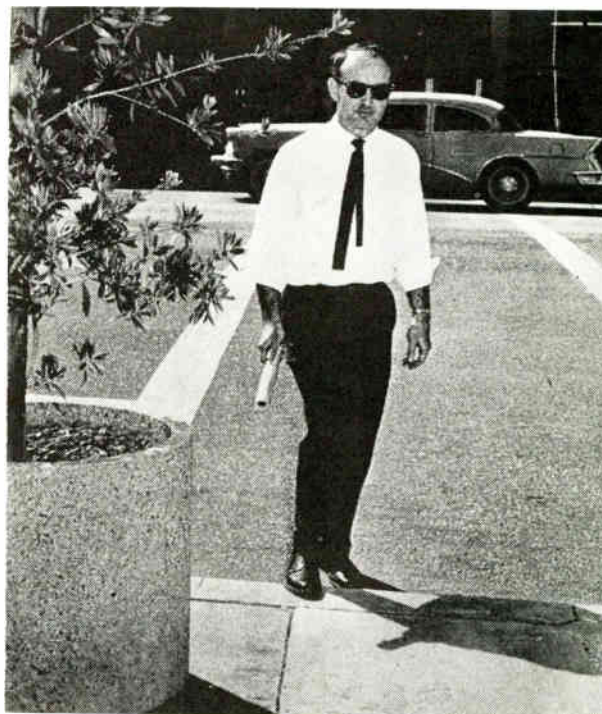



# PRICE

**SERIES 8129 ELCO VARICON\* Sub-Miniature Connectors**  
for Printed Circuit, Cable, Rack-and-Panel Applications

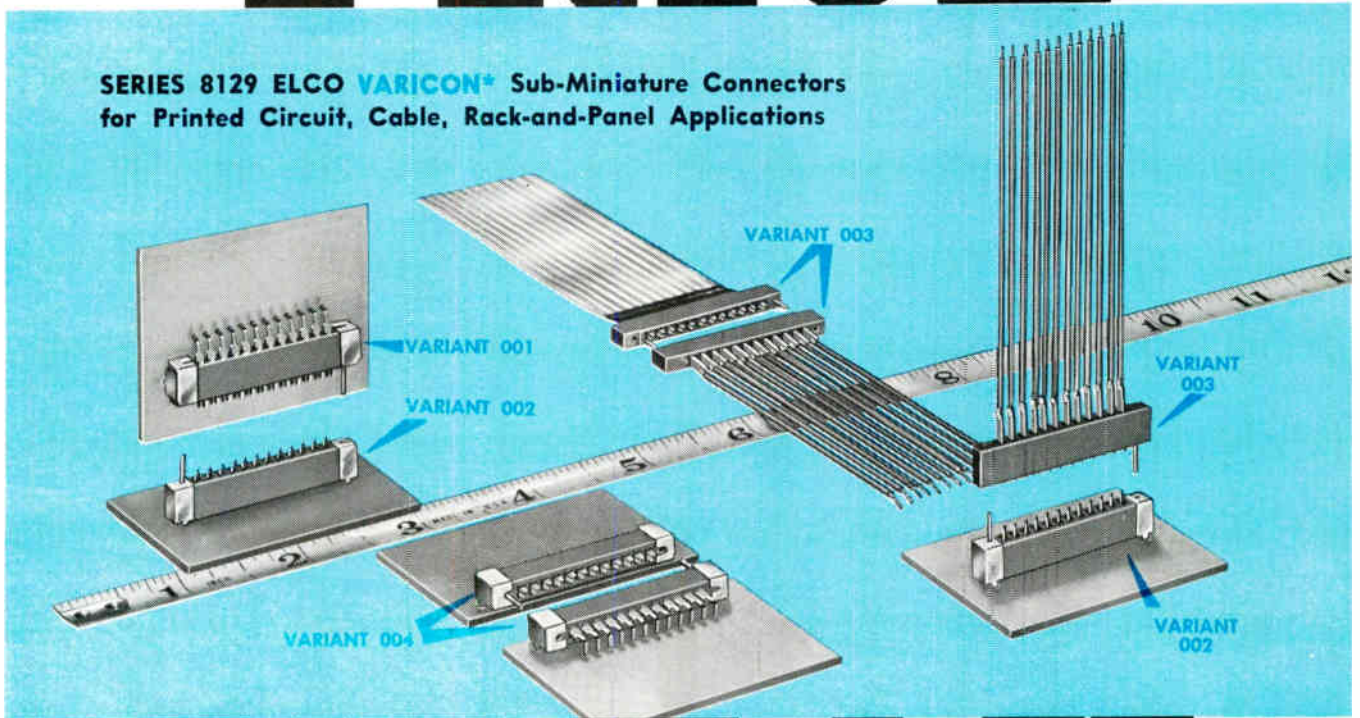

\*TRADE-MARK  
†PAT. PENDING

# BREAK

Another dimension, lower prices, has just been added to the parameters which would have previously dictated your instant selection of Series 8129 sub-miniature connectors—the most versatile, multi-feature, high-density connectors of their type on the market. Now, due to the great demand and the volume production economies effected, you no longer have any reason to specify other connectors of lesser characteristics. Series 8129 is now also available in 4 sizes: 6, 9, 12 and 15 contacts; each with its own custom molded, glass filled, flame resistant, diallyl phthalate insulator. Contacts, in a single row at .100" spacing, and at 45° to center line, are the world's most reliability-proven ELCO VARICON\* fork-nose contacts; with a choice of 20 tail-end terminations. Available for 1/16" through 1/8" cards, as well as for cable, and rack-and-panel applications—hermaphroditic guide-pin and socket arrangement, two basic types of

mounting brackets, and polarization feature are a few of the numerous additional advantages. Four of the many variants are illustrated above. These include 003, depicting Series 8129's applicability to our revolutionary, award-winning TERMIWELD\*† technique. This eliminates for all time the necessity of stripping the insulation when welding flexible flat cable conductors to contact terminations. For new lower prices, engineering assistance and technical Bulletin 8129, please write, wire, phone or TWX us at once. ELCO Corporation, Willow Grove, Pa. 19090; 215-659-7000; TWX 510-665-5573. ELCO Pacific, W. Los Angeles, Cal. 90064. ELCO Midwest, Chicago, Ill. 60645. Also Representatives, Licensees and Joint Ventures Throughout the World.



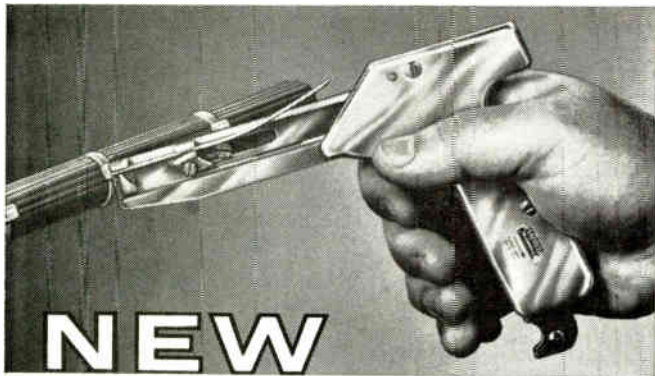

**NEW**

## Panduit® TENSION-CONTROLLED CABLING TOOL

Simply insert Panduit STA-STRAP® cable tie and squeeze trigger. Improves quality, reduces labor.

FROM THE MANUFACTURERS OF  
PANDUCT® PLASTIC WIRING DUCT



# PANDUIT

17301 Ridgeland Avenue, Tinley Park, Illinois 60477 • Phone: 312 532-1800

Circle 72 on Inquiry Card

## NEW! VERSATILE! Model 410-DVP Weld Head Makes All Kinds of Welds!

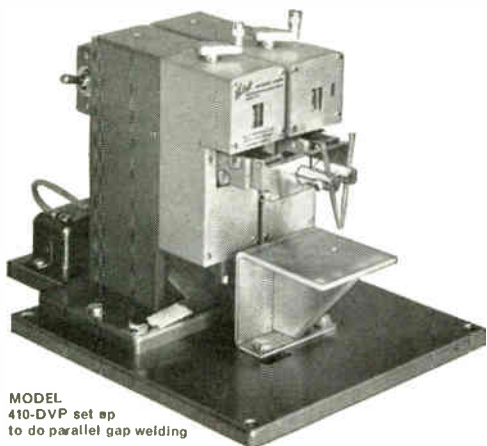

MODEL 410-DVP set up to do parallel gap welding

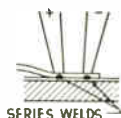

SERIES WELDS



PARALLEL GAP WELD

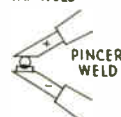

PINCER WELD



OPPOSED ELECTRODE WELD



STEP SERIES WELD

This all-purpose laboratory weld head will do 3 kinds of one-sided welding plus vertical opposed-electrode welding and vertical pincer welding! Bonds ribbon or wire from .0003" up to .050" diameter. Force range 3 oz. to 20 lbs. Compact, sturdy, easy to set up. Use with either DC or AC power supplies. Send for details.

### FREE WELD SAMPLE SERVICE!

We'll help you with your welding problems. Send sample materials to Weltek Sales Mgr.

**Weltek Precision Welders**  
by **WELLS ELECTRONICS, INC.**  
1701 S. Main Street, South Bend, Indiana, U.S.A.  
Circle 73 on Inquiry Card

**ELECTRONIC INDUSTRIES**

**MARKETING ASSISTANCE PROGRAM**

## CENSUS OF ELECTRONIC MANUFACTURERS NOW AVAILABLE!

AN IMPORTANT MARKETING TOOL  
ESSENTIAL TO EFFECTIVE MARKETING MANAGEMENT

Data on 6,000 electronic plant locations is now available through ELECTRONIC INDUSTRIES Census of Electronic Manufacturers. All of the Census data has recently been updated and includes—

- Company Name & Address
- Employment by Size Group
- Number of Electronic Engineers & Production Workers
- Plant Function
- Percent of Plant Sales to the Military, Industrial and Consumer Markets
- All Products Manufactured

This information is available in whole or part in IBM punchcard or printout form.

For further information contact your ELECTRONIC INDUSTRIES Regional Manager listed on page 141 or Edward G. Shaud, Jr., Marketing Manager, ELECTRONIC INDUSTRIES, Chestnut & 56th Streets, Philadelphia, Pennsylvania 19139.

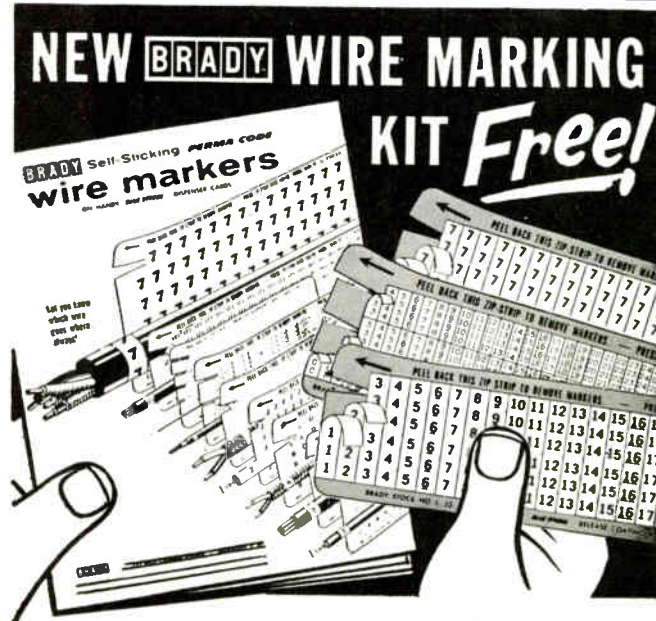

## NEW BRADY WIRE MARKING KIT Free!

Big, 16-page, illustrated catalog lists 4700 stock Brady Wire Markers . . . Tech Data, Industrial and Mil specs, types, sizes, prices . . . plus time-saving automatic application methods. Over 200 individual self-sticking markers included for testing. Order your free kit now for complete data on Brady's low-cost, flexible wire marking system.

W. H. **BRADY** CO., 749 W. Glendale Ave. • Milwaukee, Wis. 53209

EST. 1914

Manufacturers of Quality Pressure-Sensitive Industrial Tape Products, Self-Banding Nameplates, Automatic Machines for Dispensing Labels, Nameplates, Masks and Tape



Circle 74 on Inquiry Card

ELECTRONIC INDUSTRIES • January 1965



## INTERNATIONAL NEWS

London—Standard Telephones and Cables Ltd., subsidiary of IT&T Corp., disclosed a new STC Data Systems Division to expand interests in advanced on-line real-time computer-based systems.

London—Against a background of fierce competition among industrial nations, the 1965 London International Engineering Exhibition will be held at Olympia and Earls Court, April 21 to 30, 1965. Among features will be the latest in electronic industrial methods.

Santiago—British United Airways Vickers aircraft, on a new flight route to South America, are equipped with Marconi Sixty Series radio equipment to provide navigation and communications for the 8,000-mile flight to Chile and other points.

Paris—Transatlantic communications via Relay satellite made another mark when the heartbeat of an unborn child was transmitted from Mt. Sinai Hospital in Milwaukee to a hospital in Paris, as part of a program by Marquette University to assess problems in rapid transmission of biomedical data.

Stockholm—Some 43 U.S. electronic companies took part in the recent U.S. Exhibition at the Stockholm Technical Fair. Displayed were computers, test instruments, optical instruments, oscillators and communications equipment.

The Hague—A World Body for the radio and television profession, called the International Broadcasters Society, has been formed with headquarters in Bussum, The Netherlands. The new group lists members from 50 nations, and many firms have already donated technical aid and equipment.

Tokyo—A ten year contract to allow Toshiba (Tokyo Shibaura Electric Co., Ltd.), one of Japan's largest electrical firms, to produce GE's series 200, 400, and 412 computers, has been approved by the Japanese Government. Toshiba will also improve its own Tosbac series.

Hong Kong—Fairchild semiconductor, making transistors for Hong Kong's consumer market, has broadened production to the industrial market. Lower assembly costs in Hong Kong allowed Fairchild to introduce a new line of low cost, silicon planar and planar epitaxial transistors.

## RFI-SHIELDED ENCLOSURES

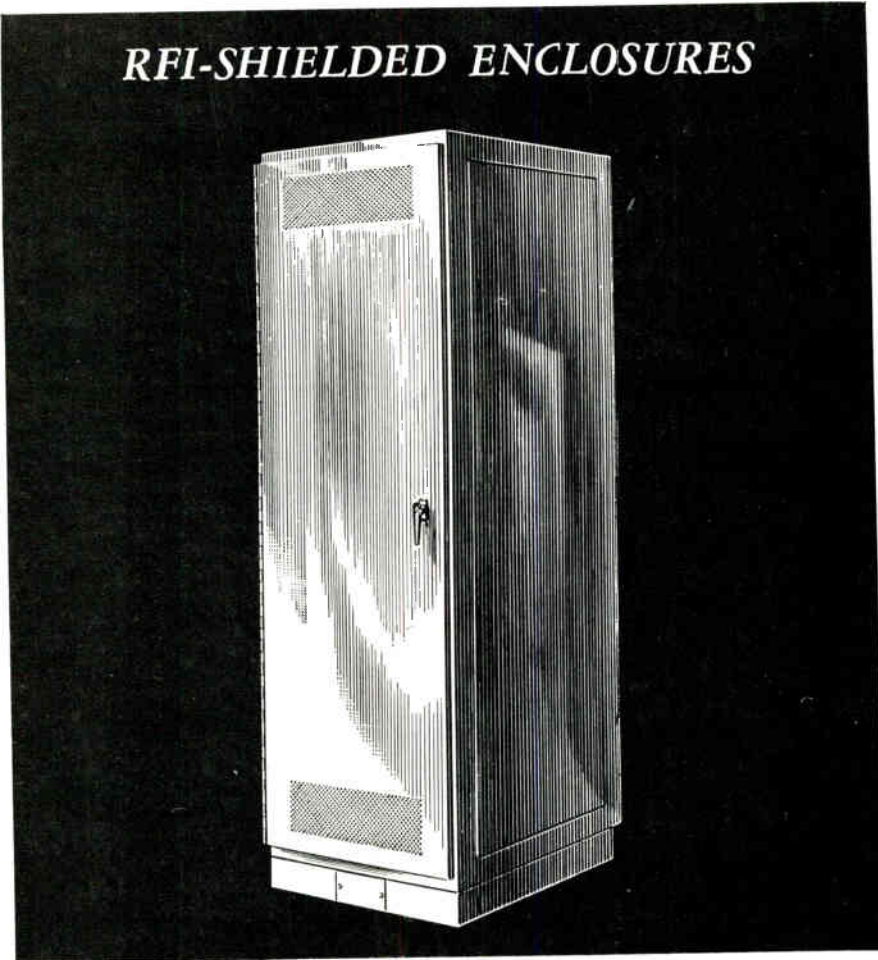

The enclosure shown above is only one of hundreds of AMCO RFI Shielded Modular Electronic Instrument enclosures presently in use in both government and commercial programs.

Amco is the first to develop a truly MODULAR RFI-Shielded Enclosure System conforming to EIA Hole & Panel Mounting Standards. Enclosures can be sealed individually, as combined groups or in combinations of both... essential for systems inter-wiring.

**EFFECTIVE ATTENUATION CHARACTERISTICS** in both electro-magnetic and electric fields:

.15 mc to 1000 mc—100 db to 45 db attenuation

These enclosures feature field-replaceable RFI gasketing and are available in vertical, slope-front and low silhouette frames for both 19" and 24" wide mounting panels, in vented or non-vented styles.

Write for complete specifications, or contact the Amco factory trained representative in principal cities of the U.S. & Canada.

*TOTAL COVERAGE* of your enclosure requirements through selection of Amco Custom, Semi-Custom, Aluminum and RFI Modular Instrument Enclosure Systems.



**AMCO ENGINEERING CO.**

7333 West Ainslie Street, Chicago 31, Illinois

No. 4 of A Series of U.S.C. Connectors At Work

## RCA 3301 REALCOM COMPUTER RELIES ON

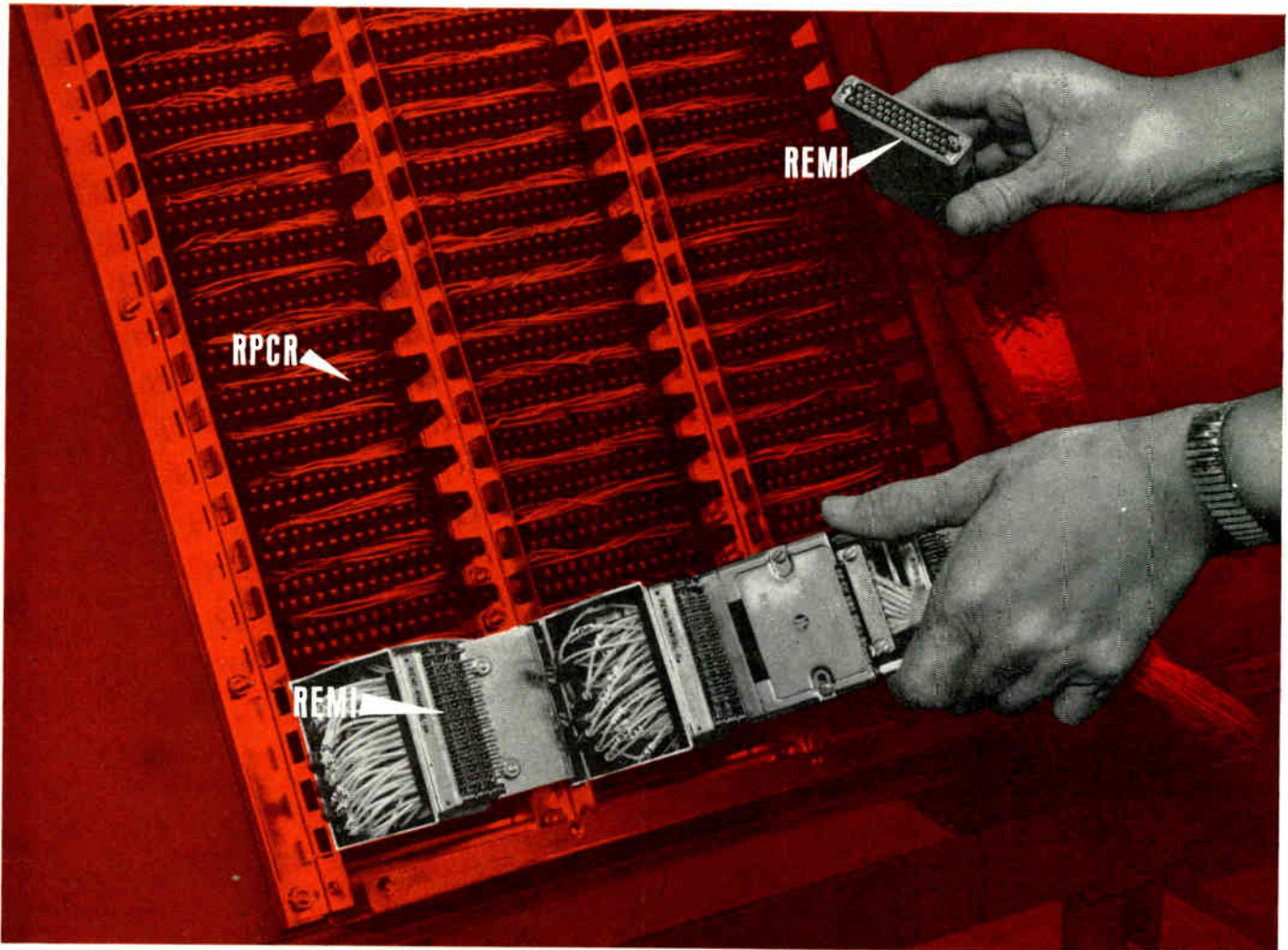

## U. S. C. **REMI**® and **RPCR** CONNECTORS

■ The RCA 3301 Realcom derives its name from the real-time and communications capabilities which it adds to conventional data processing. It brings users functional modularity—a new computer concept which enhances function, as well as capacity and speed. RCA called on U. S. C. REMI sleeve-fitted, closed-entry, crimp type contact plug and receptacle connectors and U. S. C. RPCR printed circuit receptacles for its 3301 Processor and Control Module. REMI male and female spring phosphor bronze contacts snap into same special heat-treated beryllium copper sleeves at 7 lbs. max.—do not ride in bare plastic. Permanently assembled sleeves in strong plastic body mean outstanding retention repeatability. High-reliability U. S. C. RPCRs, in tough polycarbonate plastic body, use with (1/8" or 1/10") special heat-treated beryllium contacts and take wide tolerance (1/16" nominal) printed boards.

■ REMI® connectors are available in 7, 14, 18, 20, 21, 26, 34, 41, 42, 50, 75, 104, 123, 150, 225 contacts; meet applicable MIL-C 8384B provisions. Wire sizes A. W. G. #14 to #30 and MIL-W-16878A #16 to #32. Crimping by MIL-T-22520A (WEP) Class I or II tools.

■ RPCR's are available in 26 contact (13 on a row) and 52 contact (26 on a row) sizes with either wire wrap, solder eyelet or half eyelet terminations. Plating both series as desired. WRITE NOW FOR DETAILS ON BOTH SERIES.



U.S.C. REMI Connectors    U.S.C. RPCR Connectors



### U. S. COMPONENTS, INC.

1320 ZEREGA AVENUE • BRONX, N. Y. 10462  
or use TWX: 212-824-6990; TEL: 212-TA 4-1600  
TELEX: 01-2411; or Cable: COMPONENTS NYK.





Reporting late developments affecting the employment picture in the Electronic Industries

### **NIGHT SCHOOL EXPENSES DEDUCTIBLE, COURT RULES**

Technicians who take night school courses without specific recommendation of employer may still deduct fees, tuition and expenses for income tax purposes, according to a U. S. Tax Court ruling.

An engineer aide at one firm took night courses relating to his job. Later, his supervisors suggested a leave of absence for full time day college and a B.S. He got his degree, then later left the firm for another job.

On his tax return, the new engineer claimed deductions for the two years of night school but not for the day college. The Internal Revenue Commissioner denied the deduction, contending that the night school courses were taken to qualify for a better job rather than to maintain or improve skills required in employment as specified in the Tax Code.

The court, however, ruled that qualification for a degree had nothing to do with deductibility of night-school expenses, which were taken mostly "to maintain or improve skills required by the technician in his then present job."

### **SCIENTIST/ENGINEER DEMAND DROPS DURING SEPTEMBER**

The uptrend in demand for engineers and scientists that occurred in August has proved to be short lived. Demand dropped again in September, marking the first time in the five-year history of the Engineer/Scientist Demand Index that September has not shown a gain.

The Index, maintained by Deutsch & Shea, of New York, registered 78.2 for September, down 7.3 from August. Demand had taken a rather strong upturn during August. The Index had reached 85.5, the highest figure recorded in 1964 (so far). It was the first time in the year that the Index had risen above the 70s.

This August gain had not been equaled since January 1963, and it may still be followed by more active demand for professional people in the coming months, providing the September drop does not continue.

### **COMPUTER SYSTEM FOR INSTRUCTION**



Employees at IBM's Thomas J. Watson Research Center shown taking experimental courses via computer assisted instruction. A teacher's instruction, questions and guidance can be stored and presented to student through typewriter consoles. Replies are put on typewriter and analyzed by computer. Course material can be tailored to needs.

### **EDUCATIONAL OPPORTUNITIES GO BEGGING, SAYS NSPE**

Engineering employees in many firms are not taking advantage of built-in educational opportunities, according to a report by the National Society of Professional Engineers.

Among engineers surveyed 85% of non-supervisory engineers and 90% of supervisory engineers indicated that their companies do provide opportunities for engineers to attend university courses.

A majority of both groups, however,

estimated that fewer than one-third of the engineers in their firms took advantage of training opportunities offered. Only 22% of non-supervisory and 4% of supervisory engineers indicated that they were working toward a higher degree. Among those who said "no," 20% non-supervisory and 3% supervisory said they are planning to take such study.

Companies seemed to be about even between those requiring that courses be relevant to employment and those which do not. About one third said courses were all subsidized, yet 17% of non-supervisory and 14% supervisory engineers reported their companies pay nothing.

### **DEMAND FOR '64 GRADUATES STILL HIGH, SAYS EJC**

Despite concern that demand for engineers is declining, a total of 88% of the 1964 engineering graduates either had accepted jobs or were otherwise committed by mid-June, according to a recent survey by the Engineers Joint Council. A survey in 1961 showed 91.8% committed.

Of some 14,143 engineering graduates surveyed, 54.3% had accepted job offers. Slightly better than 17% reported they would attend graduate school, with 4.5% indicating they had accepted employment but also had planned graduate study.

### **STARTING SALARIES TOP 60% GROWTH SINCE 1954**

Average starting salary for Illinois Institute of Technology engineering graduates has increased more than 60% in the last 10 years and more than 600% in the last 25, reports Earl C. Kubicek, director of placement and alumni relations for the Chicago institute.

Starting salaries for electrical engineers average \$609.00 a month.

# New Market Looms In Electronic Toys

In the wake of the shrinking government market for electronic industries, a number of consumer and industrial fields are rising in importance that may help build the electronic market for the future. Among them are toys. Births are increasing and kids are getting smarter.

ONE OF THE FASTEST GROWING INDUSTRIES in the world today is toys, according to leading toy designers. Within the last decade, annual toy sales have jumped from \$1 billion to nearly \$2 billion at the retail level.

The toy population is defined as children under 15 years of age. Statistics recently released by the Bureau of Census reveal that by 1975 the toy consuming population will increase 24% and by 1980 will be one-third larger than today, reaching about 82 million.

Surprising as it may seem, the biggest problem facing toy manufacturers is the lack of good, sound toy ideas which can be marketed. Many of the larger toy companies employ new product and development departments to create innovations for mass appeal. The toy consumer's ability to burn up ideas faster than they can be introduced requires that these companies also seek out independent toy inventors and designers.

## One Year Life

The normal life span of a toy is one year, with those toys that last three years being considered excellent; and, if a toy should reach the age of seven years, it is considered a staple item. There are very few staple toys on the market today. There are several professional organizations that solicit outside toy ideas. No person or organization has a monopoly on toy ideas, and just about every mother or father

Transistorized listening device, that works on same principle as missile-tracking antennas, is good example of electronic toy trend.



is a potential toy inventor. Successful toy ideas have been presented to one leading toy designer by flight engineers, doctors, housewives, clerks, and even a fruit peddler.

Much like other industries, toys and toy production have experienced revolutionary changes since the end of World War II. The introduction of plastics has enabled toy makers to mass produce products and provide detailing never before thought of. The mechanical features of toys were replaced by battery-operated mechanisms which provide a youngster with more realistic play value. Children are becoming more sophisticated in the selection of toys, requiring toy companies to be more exact in their standards and specifications.

## A New Electronic Frontier

We are on the threshold of an electronic era in toy creation. Several companies have already introduced toys which work on electronic principles, such as an infra-red shoot-

ing range which utilizes a photo electric eye, and a solar hobby kit which is energized by the sun. A large influx of new electronic-type toys is expected in the next few years, motivated a great deal by our accomplishments in space and missile development. Many of the leading children's shows on TV now have a segment devoted to space adventures, which helps to introduce children into thinking about space toys. As children become better able to associate with space and science these toys will become more meaningful. Kitchen utensils and appliances used by the housewife continue to be big sellers because of this association.

## Getting Into the Business

Almost everyone at one time or another fancies himself a toy inventor, and may have tried, unsuccessfully, to sell their ideas to a toy company. One leading designer, Ned Strongin, of Ned Strongin As-

By **ELMER T. EBERSOL**

Editor-at-Large  
ELECTRONIC INDUSTRIES



sociates, Brooklyn, N. Y., says: "In my many years as a toy inventor-designer, I have learned that the most critical test of an idea's worth is the first impression. Many sound, honestly good ideas are lost because the idea was shown to a subordinate who didn't have the insight or experience to judge the merits of an idea.

"Before an idea is ready for presentation, our staff must predetermine the cost of molds and materials, have suggested packaging ideas available, and be able to estimate the retail price. The prototype must blend attractive coloring, size, and engineering ease. This is the area that requires the most research and time. It is also the biggest service we can offer a toy inventor, because we make an idea marketable."

Many manufacturers will not deal with the unknown inventor because they know that large amounts of capital are required to introduce a new toy. They try to minimize their chances of having a toy turn out to be a "dud" by dealing with toy inventors who have a long list of successful toy items.

### The Do's and Don't's

Following is a general "Do" and "Don't" list developed by various designers for toy inventors. It is de-

Just like a grown-up walkie-talkie, the toy below has a multi-transistor press talk circuit. Set is effective up to 100 feet.

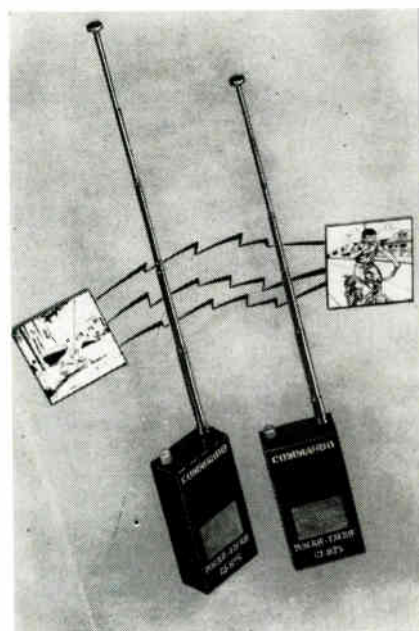

Portable, transistorized megaphone transmits audio, blinker and Morse code. Average range is 100 yards. Has selector switch and volume control.



signed to guide inventors into the right thought channels and to prevent them from making unnecessary and sometimes costly mistakes.

DO keep in mind that a product must appeal to children in the under 15 age group to be considered a toy.

DO keep the retail cost low. Seventy-five per cent of all toys sold cost under \$5, with \$10 and under considered optimum.

DO concentrate on toys that actually make a child play. Interest-retention is the most important element in a toy.

DO think like a child—analyze his likes and dislikes.

DO have a working model of your toy idea available. It should be as simple as possible; because, in most cases, the models are changed for presentation purposes.

DO put your ideas into action *TODAY*. Ideas in the head don't put royalties in your pocket. They must be acted upon.

DON'T give up your job to become a toy inventor. Look for a company that can utilize your services or work with design firms.

DON'T try to invent a game. Most games are variations of other games already on the market and are usually developed within the company.

DON'T make a toy complicated. Remember, fun is the basic function

of a toy. This doesn't mean it can't be challenging, but it cannot induce frustration.

DON'T invent toys that might be toxic or have a shock hazard. Remember the primary users of these products are children.

DON'T be afraid to be different. No one can forecast the success or failure of a toy. Who could have predicted the success of the Hoola Hoop?

DON'T give up the thought of toy invention because your first attempts failed. Successful inventors earn \$5,000-\$10,000 royalties on a single item and can conceivably earn ten times this amount.

Most toy designers and producers agree that inventors should NOT patent a toy simply because they are fearful that someone might steal their idea. The high mortality rate (with most toys only lasting one year) enables the inventor to get adequate protection by using a disclosure form which most toy companies and toy design firms have available. The design firm will get a patent if it is deemed advisable.

### Begin Now

At the present time, designers are working on toys for 1966. Research, patent searches, material selection, model making, and marketing evalu-  
(Continued on following page)

**ELECTRONIC INDUSTRIES EDITORS** have been investigating various avenues of diversification for the electronic industry in the face of cutbacks in defense spending for electronic products.

One industry that offers potential for fertile electronic ideas is the toy industry. The accompanying article outlines possibilities for exploration by electronic designers. Special thanks are due Mr. Ned Strongin of Ned Strongin Associates, 128 32nd Street, Brooklyn, N. Y., a leading toy designer, for many helpful suggestions in this interesting field.

## TOYS—AN OPPORTUNITY (Concluded)

ation are time consuming and require that an inventor submit his ideas as early as possible. These ideas are usually presented to a toy company about one year ahead of actual production, and working models are shown at the Toy Fair in New York City in March of each year.

Every inventor should send for a

Designer Ned Strongin shows what designers can do. Toy at left resulted from prototype at right which had little appeal to a child.



submission form before sending any ideas to a design house. The submission and disclosure form protects the inventor and the design firm. The terms of payment and royalties are outlined in an agreement form.

Some of the things that toy designers would like to see at present are:

- Games that are three-dimensional and utilize some electronic principle.
- An influx of toy ideas for girls;

toys which retail for \$2-\$3 and have continuous play value, such as miniature household appliances that work.

- Outdoor activity toys that retail for \$1-\$3.
- New improvements in model road racing. This segment of the toy field will reach \$50 million in sales in the next few years.
- New approaches in chemistry, and the scientific-type toys.

## ITT ENGINEER PREDICTS ALL-DIGITAL OCEAN CABLE

A case for an all-digital transatlantic cable system within the next decade has been made by William S. Litchman, an engineer with ITT Communications Systems, Inc.

Mr. Litchman believes that such a system would help fill the rapidly growing transoceanic data transmission needs. It would be compatible with the present complex of atlantic telephone cables. The system could also be adapted for use with communications satellites.

Existing cables and vacuum-tube-repeater technology would be used in the system for sending multilevel digital data at rates beyond 1.5 megabits per second. Many different data streams could be accepted and combined for sending together at six different rates up to a maximum 32 kilobits. Some streams could be synchronous, other asynchronous.

Voice would be transmitted over the cable using a vocoder scheme that squeezes each voice channel into a digital 8-kilobit output including signaling and synchronizing.

## HAND SOUND LASER



IBM's new pistol-shaped laser sound projector can send voice and other signals great distances. The 12-oz. projector contains all equipment, except batteries, for generating laser beams and modulating them with audio information. Works at room temperatures.

## PLATING PROCESS MAY CUT GOLD COST, BROADEN USES

Two gold-plating processes that can reduce gold costs in electroplates and also allow use of gold for the first time in scores of industrial and consumer products, have been disclosed by the Sel-Rex Corp.

The processes reported by Sel-Rex, reduce the gold needed for certain uses to as little as 30% of former amounts.

## NEW ONE-PACKAGE SYSTEM TELEMETERS AND CONTROLS

General Electric Company has introduced a new solid-state digital telemetering and supervisory control system.

Called GE/TAC (General Electric Telemetering and Control), the new system integrates telemetering and control in one package. It can provide remote control, remote alarm or status indication, remote data collection and digital telemetering, or a combination of all these functions, engineers report. The system is designed for use by utilities, oil and gas pipelines, or wherever there is a need for remote control and/or remote data collection, according to data supplied by the company.

GE/TAC is available with both high and low transmission speeds to satisfy both large and small data collection and remote control markets. High speed GE/TAC will operate between 600 and 2500cps, while its low speed counterpart will send at 15 to 45cps.

A GE/TAC system can handle up to 1,000 remote functions from a single master station.



# This Is Not the First 1<sup>13</sup>/<sub>16</sub>" 10-Turn Precision Potentiometer. Just the Best.

Bourns Model 3400 is the rugged result of a fresh design approach. In punishing side-by-side environmental tests, it performed dependably long after competitive units had sagged, sogged or snapped under the strain. In rotation-life tests, it displayed a longer useful life than any other unit. In vibration and shock tests, it kept operating after fragile terminations had put competitive units out of commission.

This sturdy newcomer has a molded, all-plastic case for superior humidity performance... sliding contacts to eliminate fragile pigtails... an extra-thick slider block for high stability... a shaft supported at both ends... a husky dual-collector pickoff. And it has the exclusive, virtually indestructible SILVERWELD® termination that replaces vulnerable single-wire terminations to overcome the chief cause of potentiometer failure.

Model 3400 undergoes 100% in-process and final inspections,

and is subjected to the famous Bourns Reliability Assurance Program. In reliability and performance, it is a premium potentiometer. One of its best features is that there is no premium in price.

Write today for complete technical data.

Model 3400, 1<sup>13</sup>/<sub>16</sub>" Diameter, Bushing Mount

LINEARITY:	±0.15%, STANDARD
Resistances:	100Ω to 1 Meg., standard
Temp. Coeff.:	20ppm wire over entire resistance range
Power rating:	5.0W at 40°C
Humidity:	Steady state
Operating temp. range:	-65 to +105°C
Resolution:	0.005 to 0.045%
Body length:	1.75" (12% shorter than competitive units!)



ONE-HALF ACTUAL SIZE



**BOURNS**

BOURNS, INC., TRIMPOT DIVISION  
1200 COLUMBIA AVE., RIVERSIDE, CALIF.  
PHONE 684-1700 · TWX: 714-682 9582  
CABLE: BOURNSINC.

MANUFACTURER: TRIMPOT® & PRECISION POTENTIOMETERS, RELAYS; TRANSDUCERS FOR PRESSURE, POSITION, ACCELERATION. PLANTS: RIVERSIDE, CALIFORNIA; AMES, IOWA; TORONTO, CANADA

"... advancing the STATE-OF-THE-ART in Components & Equipment.

## RESISTOR LINE

Rated at 1/20, 1/10, 1/8, 1/4 and 1/2w., all at 125°C.

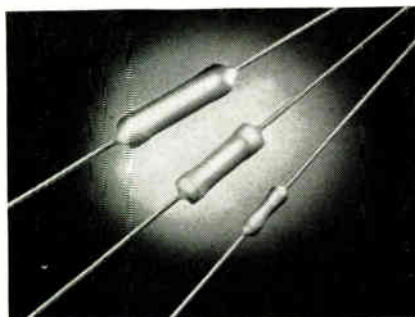

This line of conformally coated resistors achieve a failure rate of no more than 0.0004%/1000 hrs. The CHM line is suited to low temp. operation, and is available in 5 sizes with a combined resistance range from 30.1Ω to 1 megohm. The resistance tolerance of the 1/20w. unit is 1%, while for the others it is 0.25, 0.5 and 1%. Characteristic C temp. coefficient range is ±50 PPM/°C. Electra Mfg. Co., Independence, Kans.

Circle 120 on Inquiry Card

## PRECISION POTENTIOMETER

Std. resistance values: 1K, 10K, and 100KΩ; resolution: 0.028 to 0.010%.

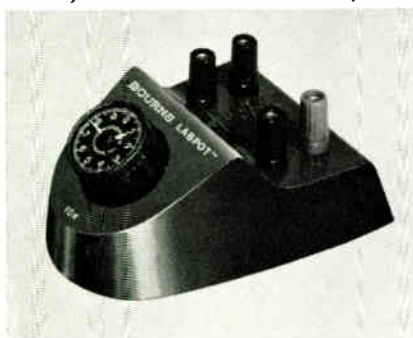

Model 3660 Labpot is a dial-readout precision potentiometer unit designed for laboratory uses. It allows rapid setting of precise voltages, or reading of the required voltages to achieve null in a bridge-circuit application. It may be used for the introduction of known resistance values in a circuit. The unit features dial accuracy (including linearity) of 0.10% (10K and 100K); 0.15% (1K); repeatability of dial reading: ±0.05% voltage ratio; operating temp. range: -65 to +125°C; and power rating: 2.5w. at room temp. Bourns, Inc., 1200 Columbia Ave., Riverside, Calif.

Circle 121 on Inquiry Card

## DC POWER SUPPLY

Adjustable with 0.05% resolution from 0-3kv at continuous currents of 0-20ma.

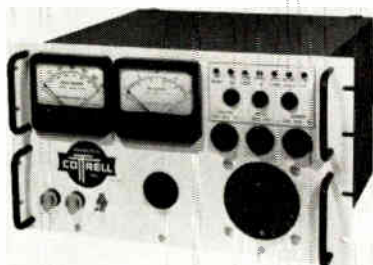

The PSA 3-200 is an adjustable 3kv, 600w. rack-mount power supply for tube, semiconductor test, and R&D applications. The unit has 1.8% ripple, 20% load regulation, and reversible polarity. Current limiting and fast response overload circuits permit surge on operation, sparking, and short-circuiting without damage to equipment. Research-Cottrell, Inc., Electronics Div., P. O. Box 750, Bound Brook, N. J.

Circle 122 on Inquiry Card

## CABLE ASSEMBLIES

New soldering method eliminates braid movement, minimizing self-generated noise.

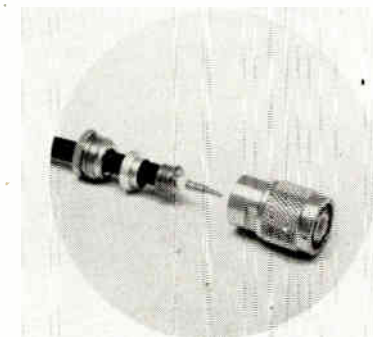

These flexible or semi-rigid r-f cable assemblies feature a proprietary method of saturate soldering, rather than clamping a cable braid to the connector. Two-hundred pound pull strength provides endurance of extreme shock and vibration environments. The new soldering method reduces r-f leakage. The cables are r-f matched to customer's freq. band and are 100% tested for vswr and insertion loss. The standard version operates from dc to 8gc, while the high freq. version extends the upper range to 12gc. Quantatron, div. of Teledyne, Inc., 12964 Panama St., Los Angeles, Calif.

Circle 123 on Inquiry Card

## MAGNETIC DEMODULATOR

Has no moving parts or contacts; provides high reliability and unlimited life.

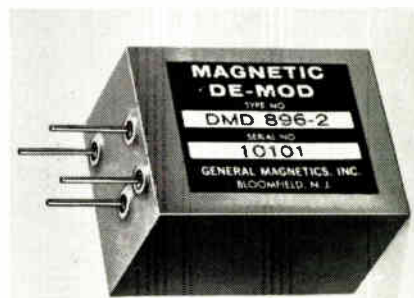

The G/M Magnetic Demodulator is a solid-state circuit for converting phase-reversing ac signal voltages into phase detected polarity-reversing dc voltages. The amplitude and polarity of the dc output are directly proportional to the phase and amplitude of the ac signal. Output to ±10vdc in present units; unit operation freqs.: 60 cps to 10kc. General Magnetics Inc., 135 Bloomfield Ave., Bloomfield, N. J.

Circle 124 on Inquiry Card

## PRECISION ATTENUATORS

Provide freq.-insensitive millimeter attenuation measurements.

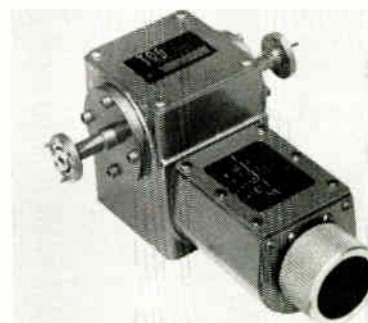

The Series 510 permits the accurate measurement of isolation, coupling, insertion loss and gain. Other applications include calibration of radiation pattern recorders and bolometer amplifiers, and the setting of signal source power levels. They are designed in 6 waveguide sizes for laboratory operation over the 26.5 to 140gc range. Variable attenuation is accomplished rotating a resistive vane mounted in a section of circular waveguide. Attenuation is insensitive to freq., and depends solely on the angle of rotation. TRG Inc., 400 Border St., E. Boston 28, Mass.

Circle 125 on Inquiry Card



## NEW PRODUCTS

### PUSHBUTTON INDICATORS

*Snap-apart design permits a variety of switch actions, holding coils, lens, colors.*

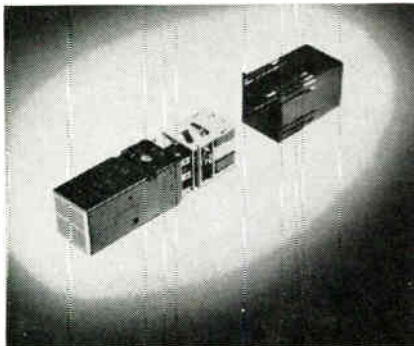

R2900 Series illuminated switch-indicators occupy a panel area of 0.781 sq. in., including mounting bracket. They provide legend space for 4 rows of 8 characters in a max. of 4 colors. According to the company, the series offers up to a 75% reduction in weight from other comparable switch-indicators, and mounts in any panel thickness up to  $\frac{3}{8}$  in. without tools. The indicators are relampable from the front and can be mounted in rows, columns and matrices. Radar Relay, div. of Teledyne, Inc., 1631 10th St., Santa Monica, Calif.

Circle 126 on Inquiry Card

### CAPACITANCE BRIDGE

*Measures from 0.0002pf to 110,000pf with 0.1% accuracy.*



Model 74D measures conductance from 0.001 micromhos to 1000 micromhos and shunt resistance from 1000 $\Omega$  to 1000 megohms. It may be operated in either the 3 terminal (direct) mode in which measurements are essentially independent of capacitance to ground, permitting precise remote measurements, or in the conventional 2 terminal (grounded) mode. The capacitance bridge is completely self-contained, including 100kc test oscillator and detector, dc bias supply, and all required power supplies. Boonton Electronics Corp., Parsippany, N. J.

Circle 127 on Inquiry Card

# VICTOREEN DIODES

## for regulation and reference

## from 350 TO 30,000 VOLTS



GV1A Series, shown actual size, above, weighs 0.8 gm.



### RELIABLE

Victoreen Corotron diodes enhance circuit reliability because they are free from catastrophic failure caused by nominal surges or transients . . . are immune to space radiation, even radiation greater than disaster levels. They are also unaffected by ambient light variations, have a very low TC, and withstand extremes of shock and vibration.



### MICROMINIATURE

Victoreen Corotron diodes are compact, lightweight. Corotrons enable designers to use, at high voltages, the same simple circuitry used with Zeners at low voltages. A *single* Corotron diode can be used as a reference, shunt regulator, DC coupling element, or portion of a divider up to 30kV.



### LOW POWER CONSUMPTION

Victoreen Corotron diodes minimize power drain, can operate from solar cells and other low power sources. Excellent temperature characteristics, particularly at low currents. GV1A Series is available in any desired nominal voltage from 350 to 2000 volts; other sizes available for higher voltages and currents.



## VICTOREEN

THE VICTOREEN INSTRUMENT COMPANY  
5806 Hough Ave. • Cleveland 3, Ohio, U. S. A.

now  
available:

high-  
power  
Trygon  
half  
racks!

Up to 300 watts — precision regulated power — constant voltage — constant current — remote sensing — remote programming! Models for every application, from \$149. For the lab: self-cased; for systems: single or dual in 5¼" panel. Write today for complete specs. Dept. EI-28.



**TRYGON**<sup>®</sup>  
**POWER SUPPLIES**  
Roosevelt, L. I., N. Y. (516) FReeport 8-2800

Circle 79 on Inquiry Card

## NEW PRODUCTS

### DIGITAL VOLTMETER

Uses integrated circuits. Has readout resolution of 10 $\mu$ v or 1 $\Omega$ ; accuracy is  $\pm 0.01$

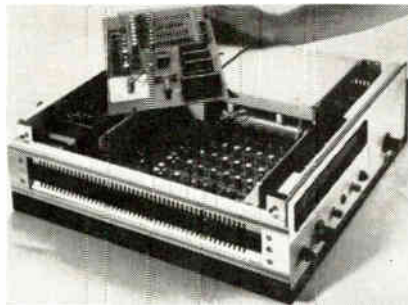

Model 7100 uses a completely new integrating technique which eliminates critical circuits. It gives true-integral performance without degradation from high-peak noise or cross-over effects. The instrument is actually a digital volt-ohm-ratiometer. It offers 4-digit readout with fifth-digit over-range. The basic instrument makes voltage measurements up to 1kv, and resistance measurements to 15 megohms. Ratio measurements are from 0.0001 to 1.5 without accessory plug-ins. Fairchild Semiconductor, 545 Whisman Rd., Mountain View, Calif.

Circle 128 on Inquiry Card

### MINIATURIZED RESISTORS

Accuracies to  $\pm 0.002\%$  absolute, 0.001% ratio. Temp. coef. to 1ppm/ $^{\circ}$ C absolute.

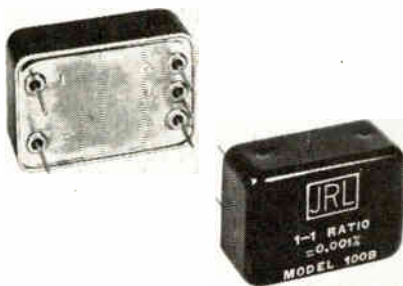

These miniature resistors are for PC uses. A 5-terminal can, with dimensions of 1-9/64 x 5-7/64 x ½ in. high, mounts either one 4-terminal or two 2-terminal resistors. Fifth terminal is case, which may thereby be grounded, guarded, or floated. Hermetically-sealed oil-bath construction provides: electrostatic shielding and closely matched environment for resistor pairs; lowest thermal resistance to internally generated heat; and highest decoupling of external destabilizing influences such as environmental contamination and soldering irons. Julie Research Laboratories, Inc., 211 W. 61st St., New York, N. Y.

Circle 129 on Inquiry Card

Physicists and Electrical Engineers  
for research into

### NEW COMPONENT PART CONCEPTS

Unusual opportunities now exist in the field of component development and performance analysis, due to a conceptual approach developed by our Research and Development Laboratories. These positions demand the ability to perform laboratory evaluation on existing components and prepare a critical analysis of their performance. Where the state of the art is a limiting factor, new approaches must be proposed and development work initiated to provide the required component performance.

In the process of developing new approaches to the solution of component problems, papers must be prepared which will be used as the basis for proposals.

Well equipped laboratories are provided in which the applicant can employ the latest techniques in development and instrumentation to assist in the exploitation of his ideas.

Qualifications should include at least a BS degree from an accredited university in Physics or Electrical Engineering. In addition, the applicant must be able to demonstrate 5 to 10 years of progressive creative experience through issued patents or publications in technical journals.

Please airmail your resume to:

**MR. ROBERT A. MARTIN**  
Head of Employment  
Hughes Aerospace Divisions  
11940 W. Jefferson Blvd.  
Culver City 12, California

Creating a new world with electronics

**HUGHES**

HUGHES AIRCRAFT COMPANY  
AEROSPACE DIVISIONS

An equal opportunity employer.

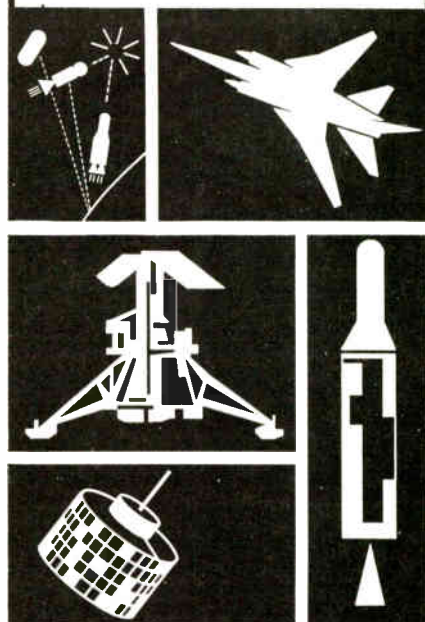



## NEW PRODUCTS

### READOUT CONTROL SWITCH

*Combines the features of a push-button switch and a visual control.*

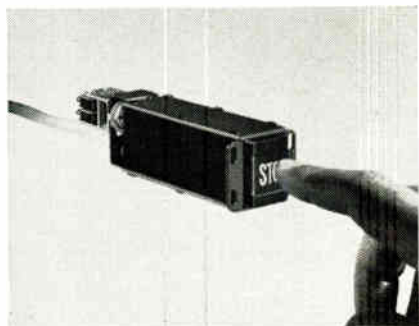

The Shelly ROS Readout Switch features 12 message positions which may be displayed individually or in combination by depressing the front viewing screen of the readout. It provides 1-plane presentation in that all words, numbers and colors appear on the surface of the readout screen. Rated lamp life is 5000 to 100,000 hrs. depending upon voltage and current used and brightness and life requirements. Cal-Glo Co., 111 Eucalyptus Dr., El Segundo, Calif.

Circle 130 on Inquiry Card

### STEPPER MOTOR

*New concept in motor design offers 360° rotation/pulse.*

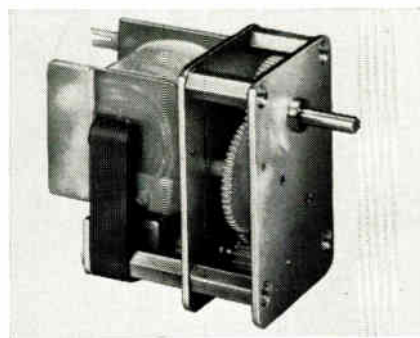

For each power impulse, the HSI 35 Series rotor revolves a full 360°—180° on the leading edge and 180° on the trailing edge of the pulse. This 2-wire stepper motor requires no logic circuitry. It operates from SPST switching, such as relay contacts, transistors, SCRs, etc. Total power consumed is low, since the coil is energized for only the duration of each pulse. Positive detenting is provided magnetically even when the coil is de-energized. The 360° rotation/pulse enables almost any desired step angle to be obtained through the proper choice of spur gear reductions. Haydon Switch & Instrument, Inc., 1500 Meriden Rd., Waterbury, Conn.

Circle 131 on Inquiry Card

# new!

A free guide book to the profit potential available in Florida's electronics industry.

Write for your free copy today! Full, factual and detailed information about your future as a Florida industrialist. A partial list of subjects covered: the fantastic "Space-Age Market"; the solid growth of the industry in Florida; the markets for electronic components... instrumentation... and general manufacturing; the welcome climate that offers a tax structure so favorable, you'll want to investigate; the unlimited R&D facilities available to you; the ease of recruitment of engineers and technicians, and the solid growth environment Florida offers you.

*But write today! Investigate Florida—the growth state!* Discover what a Florida plant can mean to you and your company's profit picture! Write today for your free copy of "OPPORTUNITIES IN ELECTRONICS."

## INDUSTRIAL Florida

# opportunities in electronics

Florida Development  
Commission, Dept. 4435C  
Tallahassee, Florida 32304

Please send me free copy of  
"OPPORTUNITIES  
IN ELECTRONICS"

NAME.....

FIRM NAME.....

ADDRESS.....

CITY.....STATE.....ZIP.....

# SCHAUER

## Heavy Duty 1/2 Watt

# ZENERS

— are the highest quality, lowest priced in the industry!

Check the data below and compare Schauer Zeners with the units you are now using for quality and price. These 10-watt silicon junctions in a 1/2-watt package feature very low dynamic impedance and very high surge capacity—25-watt-ms surge from 1.0 to 10 ms.

### TYPICAL CHARACTERISTICS

V <sub>Z</sub> @ 25°C.	I <sub>Z</sub> @ 20 ma	I <sub>Z</sub> @ 100 ma	TC %/°C.	1.99 price 10% Tol.
2.4 V.	14 ohms	3.2 ohms	-.054	81c
2.7	16	3.7	-.055	81c
3.0	17	3.9	-.055	64c
3.3	17	3.9	-.054	64c
3.6	18	4.1	-.050	64c
3.9	17	3.9	-.045	64c
4.3	17	3.9	-.037	64c
4.7	12	2.8	-.029	64c
5.1	10	2.3	-.019	64c
5.6	6.0	1.4	-.009	64c
6.2	2.0	0.5	+.018	64c
6.8	1.5	0.4	+.035	64c
7.5	1.5	0.4	+.044	64c
8.2	2.0	0.5	+.049	64c
9.1	4.0	0.9	+.053	81c
10.0	6.0	1.4	+.055	81c

In addition to the communications industry, a wide range of products incorporate Schauer semiconductors in their circuitry. Shown below is the circuit for an inexpensive automobile tachometer.

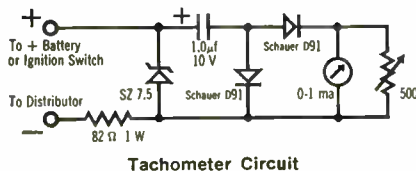

Contact your local distributor or write direct for prices and Catalog No. 621.

Semiconductor Division  
**SCHAUER MANUFACTURING CORP.**  
 4518 Alpine Avenue  
 Cincinnati, Ohio 45242

Circle 81 on Inquiry Card

## NEW PRODUCTS

### CURRENT INTEGRATOR

Features an electrochemical mercury coulometer and resistive readout.

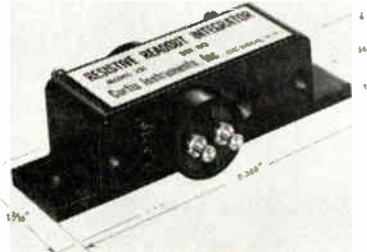

The Model 251 integrator provides a resistive output proportional to the integral of any dc input current from -5 to +5ma. Accuracy is 0.5%. Output resistance nominally varies from 2K to 150KΩ and is proportional to the current-time integral. Operating temp. range is from -20°C to +125°C. It may be used as a time integrating controller or cycle timer with the output used as an endpoint detector. Another application is the replacement for electromechanical nulling devices in analog applications. Curtis Instruments, Inc., 351 Lexington Ave., Mt. Kisco, N. Y.

Circle 132 on Inquiry Card

### PHOTOCELL LAMP

Cells can be operated as variable resistors by changing lamp voltage.

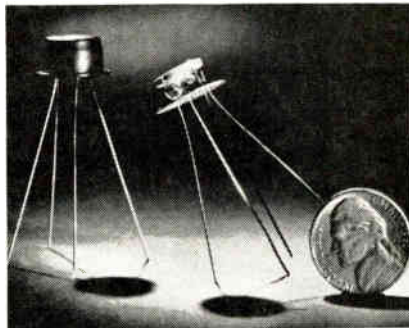

Complete electrical isolation of remote control potentiometry is one circuit application for this special kind of photocell. These cells have their own light sources sealed inside metal cases adjacent to the photosensitive surfaces. Varying the lamp voltage raises or lowers the lamp brilliance and thus controls the resistance of the photoconductive cell. In this manner they can be used as variable resistors. Photocell-lamp (PC-L) combinations can eliminate the need for motor-driven potentiometers or long, shielded in-circuit remote control cables. General Electric Co., Tube Dept., Schenectady, N. Y.

Circle 133 on Inquiry Card

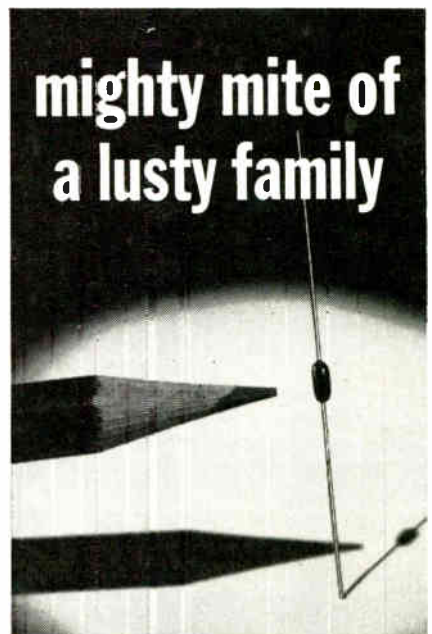

## New 1/20 watt METOHM

conformal coated metal film resistor designed to exceed MIL-R-10509E Specs.

Engineered for sub-miniature circuitry, this sturdy little resistor has a rugged end cap construction consisting of gold plated end caps and butt welded nickel leads for maximum strength and low contact resistance. And a hard, high temperature solvent resistant coating for ideal moisture protection and dielectric strength.

Here's how the entire METOHM family rates:

Metohm Type	WLC50	WLC55	WLC60	WLC65	WLC70
Rated Watts @ 125°C	1/20	1/10	1/8	1/4	1/2
@ 70°C	1/10	1/5	1/4	1/2	1
Resistance (Ohms) Min.	30.4	20	20	20	20
Max.	100K	301K	500K	1.3Meg.	1.5Meg.
Dimensions					
Max. L	.180	.280	.330	.540	.630
Max. D	.065	.098	.100	.160	.175

Ward Leonard also supplies Vitrohm power resistors and S-coat (silicone coated) precision-power resistors. All Ward Leonard resistors are available at your local A-I-Distributor. Ward Leonard Electric Co., Metal Film Division, 94 South Street, Mount Vernon, New York.



WARD LEONARD METAL FILM DIVISION

Circle 82 on Inquiry Card

ELECTRONIC INDUSTRIES • January 1965



## NEW PRODUCTS

### PRECISION YOKE

Encapsulated unit has deflection angle to 70° for 7/8 in. to 1 in. neck dia. CRTs.

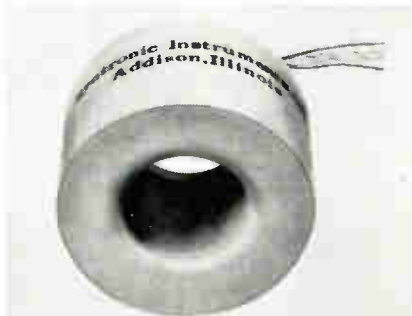

The Type Y65 comes in either a push-pull or single-ended configurations. It is designed for a wide variety of small neck tube uses, such as flood gun storage tubes, small compact displays and data displays. It can be furnished in a wide range of impedances for both transistor drivers and vacuum-tube circuits. Electrically balanced windings provide equal deflection sensitivities. Perpendicularity and colinearity are within 0.5°, overall length 1 5/8 in., O.D. 2 1/4 in. and weight 7 oz. Synchronic Instruments, Inc., 100 Industrial Rd., Addison, Ill.

Circle 228 on Inquiry Card

### TEMPERATURE SENSOR

Sensor can detect variations of less than 1000th of a degree.

The solid-state Ultra-Sensor M-2100 is a combined resistance thermometer and amplifier. It will cause output to snap on and off when it senses less than 1000th of a degree variation. It has an adjustable sensitivity from 2v./°C up to 6000v./°C. Under normal laboratory use, drifts of less than 0.05°C/month are guaranteed. Carter-Princeton, 178 Alexander St., Princeton, N. J.

Circle 229 on Inquiry Card

### COMPOSITE INSULATION

Used as slot liner, phase and center stick insulation in 155°C Class motors.

Isoplex G/P/D is a composite flexible electrical insulation with permanently bonded layers. It is composed of a layer of glass cloth and a layer of polyester-wrap glass-filter cloth, both polyester treated, with a layer of polyester film between. It can be used for barrier and ground insulation in 130° and 155°C Class dry-type transformers. Other uses are for applications requiring a tough, though moderately flexible heat and oil resistant electrical insulation. Natvar Corp., 211 Randolph Ave., Woodbridge, N. J.

Circle 230 on Inquiry Card

# ALL ROADS LEAD TO

# Resistotrip



The new *RESISTOTRIP* provides the control engineer with a low cost, all solid state trip amplifier. Simply connect a thermistor, photoresistor, or potentiometer type sensing element and create a highly accurate ON-OFF controller of 60 CPS power. Truly new roads are opened for the sensing of temperature, light level, position and pressure.

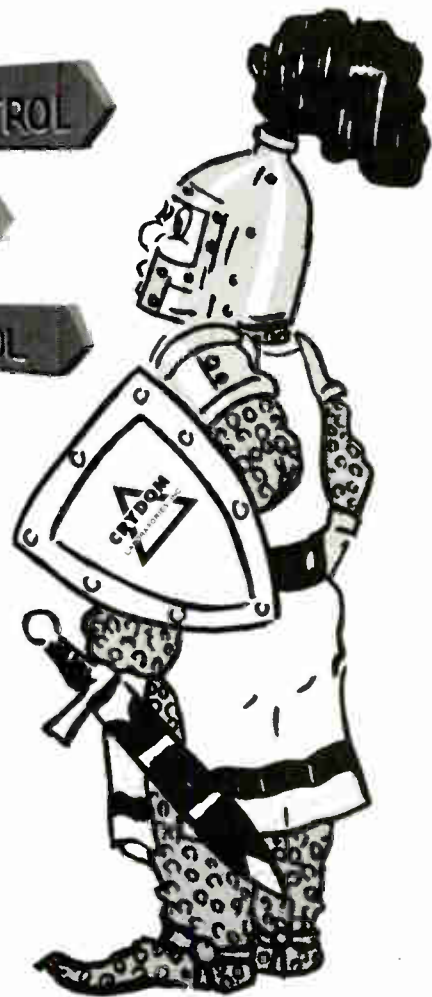

### RESISTOTRIP OFFERS:

1% Accuracy  
500 to 50,000 ohms Trip Limits  
1 amp., 115 or 230 VAC Output  
Infinite Contact Life  
Small Size (3.12" x 3.60" x 2.0")  
and **PRICES UNDER \$40.00.**

## CRYDOM LABORATORIES, INC.

3115 WEST WARNER AVENUE • SANTA ANA, CALIFORNIA  
Area Code 714 • 540-1390

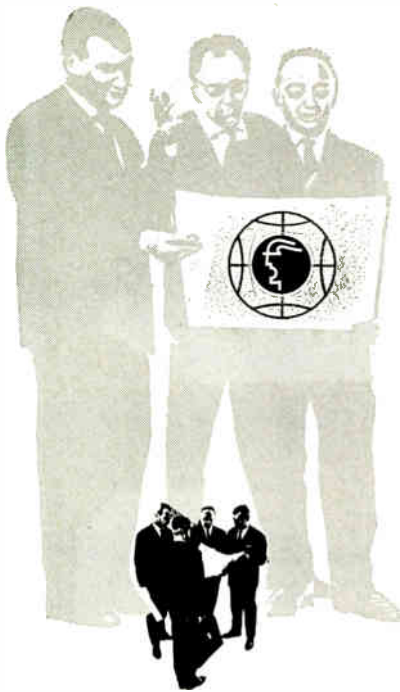

American businessmen are now making plans to visit the

## Hanover Fair

Market Place for World Trade

April 24-May 2  
Hanover, Germany

Exhibits arranged strictly according to product category

More than 1,350 manufacturers will present latest products in the groups, electronic instruments and components, electrical engineering.

Can we help you with your arrangements?  
Call 212-JU 2-7788 or write:

**GERMAN AMERICAN  
CHAMBER OF COMMERCE**  
New York: 666 Fifth Avenue  
Chicago: 77 East Monroe St.

Circle 84 on Inquiry Card

## NEW PRODUCTS

### PARAMETRIC AMPLIFIER

Signal freq. is 7.5-8.05gc with gain of 15db nominal. Offers 1.0db noise figure at 77°C.



The X-14 parametric amplifier is a new coolable X-band design. Of non-degenerate design, the unit offers ultra-low noise amplification with great sensitivity at liquid nitrogen temp. Designed for 48 hr. operation on a single charge of liquid nitrogen, it is supplied with a highly stable klystron power supply; a parametric amplifier in a  $\pm 45^\circ$  tiltable Dewar; and a remote monitor with bias power supply. It has an instantaneous bandwidth of 20Mc to 1.0db points. The unit is primarily for radio astronomy, space communications, or advanced radar applications. Microwave Physics Corp., 420 Kirby St., Garland, Tex.

Circle 231 on Inquiry Card

### TOGGLE SWITCH

Rated for a minimum of 10,000 operations @ 120vac or 28vdc.

The type T4203 subminiature, SPDT 2-position toggle switch is for military and commercial instrumentation. The switch measures 11/32-in. dia. x 27/32-in. overall including an 11/32-in. bat handle. The unit mounts in a 1/4-in. hole. It is rated at 10,000 operations under 1a. resistive loads, 1/2a. inductive loads, or 1/4a. lamp loads. Control Switch Div., Controls Co. of America, 1420 Delmar Dr., Folcroft, Pa.

Circle 232 on Inquiry Card

### SUBCARRIER DISCRIMINATOR

Accepts subcarrier levels 10mv to 10v. without adjustment; output variable  $\pm 0.5$ .

Model GSD-5 is the principal component for a high-channel capacity FM data processing systems. The GSD-5 can be remotely computer programmed or manually controlled. It covers the full range of a subcarrier freq. to 200kc. Active 5-pole Gaussian Filters make possible great adjacent channel rejection and high dynamic linearity. Adjacent channel signals 20db over prime signals produce noise more than 60db down from full BW output signal. AM rejection is such that a 20db step change in the center freq. signal produces less than 1% full BW output noise. Data-Control Systems, Inc., Danbury, Conn.

Circle 233 on Inquiry Card

# FURANE PLASTICS

## Has NEW Developments In TRANSFER MOLDING

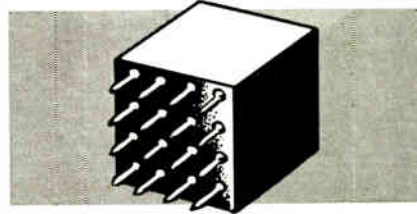

## EPOXY Molding Compounds

1. WELDED MODULES  
Low Pressure  
Soft Flow
2. TRANSFORMERS  
Shock Resistance  
Non-Burning
3. CAPACITORS  
Moisture Resistance  
Mass Production

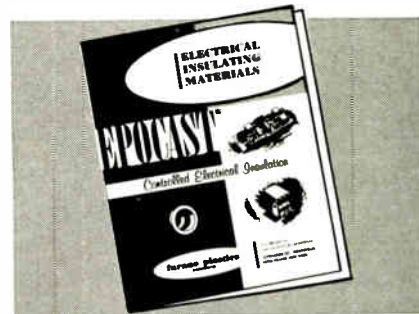

WRITE FOR FREE  
ELECTRICAL INSULATING  
MATERIALS BULLETIN EP 63-14

LOOK TO FURANE FOR LEADERSHIP  
IN PROFITWISE IDEAS

**furane plastics**  
INCORPORATED

WEST COAST:  
4516 Brazil St., Los Angeles 39, Calif.  
CH 5-1151  
EAST COAST:  
42 Chasner St., Hempstead, L.I., N.Y.  
IV 3-6246

Circle 85 on Inquiry Card

ELECTRONIC INDUSTRIES • January 1965



# PRECISION WIREWOUND RESISTOR HI-RELIABILITY

## BEGINS HERE

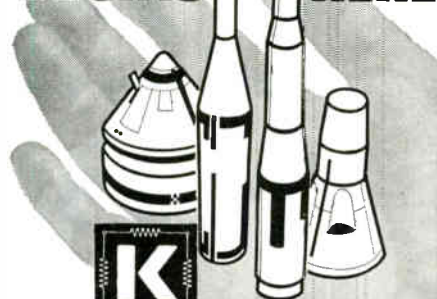

... IN THE  
**EXPERIENCED HANDS OF  
KELVIN RESEARCH ENGINEERS**

Kelvin is the prime or sole source for precision wirewound resistors on many of the nation's most important high reliability missile and space programs. As the reliability requirements grow more exacting and stringent with each new system, Kelvin engineers are meeting the challenge through a proper balance of advanced research, quality control and reliability engineering. Kelvin resistor superiority in high reliability specifications is indicated in the following typical test data:



"HRL" Resistor Test Results\*

TEST	38101/12A	"HRL" SERIES	
	Maximum	Average	Maximum
Short Time Overload	±.05%	.0012%	.0080%
Temperature Cycling	±.1 %	.0014	.0100
Moisture Resistance	±.1 %	.0072	.0192
Dielectric Strength	±.05%	.0010	.0013
Terminal Strength	±.05%	.0001	.0004
Failure Rate	±.2 %	.0150	.0240
Shock	±.05%	.0008	.0010
Vibration	±.05%	.0007	.0020

\*Kelvin's "HRL" Series Resistors were designed to achieve a failure rate of .005%/1000 hours at a 90% confidence level. All data is based on life tests conducted at full rated power at 125°C for a minimum of 1500 hours. No "acceleration factors" are used.

Write for Bulletin "HR-04" for complete data on Kelvin's "HRL" Series High Reliability Resistors.



Representatives in principal cities

# KELVIN

5919 Noble Ave., Van Nuys, Calif.  
Phone: (213) 782-6662

Circle 86 on Inquiry Card

## NEW PRODUCTS

### D.C. STEPPER

*Handles complex switching, counting, totalizing, and selecting operations.*



This dc stepper is a permanent magnet stator device. It delivers its predetermined stepping motion to the desired load through a preselected gear train. It requires no special input sequencing or phase shifting for its operation. The 20/step/revolution device can be used for positioning a specified load by using an appropriate control wafer. Kollsman Motor Corp., Dublin, Pa.

Circle 134 on Inquiry Card

### MICROWAVE POWER SOURCE

*Features extremely low spurious FM and AM modulation.*

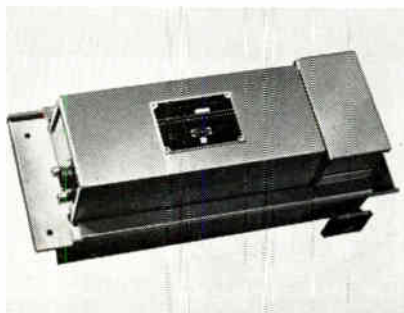

The Model R-501 has a min. output of 150mw over a 3.5% freq. range in the band from 5.1 to 5.9gc. The 601 delivers at least 75mw over a 2.5% freq. range between 10.225 and 10.525gc. The R-501 (C-band) and the R-601 (X-band) can be used as local oscillators and parametric amplifier pumps where very high signal-to-noise ratios are required. Model R-601 provides FM short term stability of better than 1.5 cycles RMS max. from 1kc to 100kc from the carrier. Short term AM stability is 105db min. below the carrier, and 110db min below the carrier from 10kc to 100kc from the carrier. Model R-501 is comparable. Raytheon Co., Microwave and Power Tube Div., Waltham, Mass.

Circle 135 on Inquiry Card

# PROVEN



... Low Capacitance  
(as low as .02pf)  
Insures Signal Integrity

## Series 267 Reed Relay

- Contact Rating: 10W Resistive
- Coil Rating: 200 MW
- Coil Voltages: 6, 12, 24 or 48 VDC
- Operating Time: 1.0 MS, Maximum
- 100% Tested
- "Cradled Reed" Design
- Contacts:
  - 1 to 4 Pole - Form A
  - 1 & 2 Pole - Form B
  - 1 Pole - Form C

### TEST REPORT

describing the capacitance measurements of Wheelock Series 267 Glass Reed Relay now available.



*Wheelock*  
273 Branchport Ave.  
Long Branch, N. J.  
201-222-6880

Circle 87 on Inquiry Card

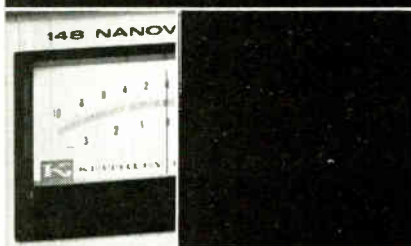
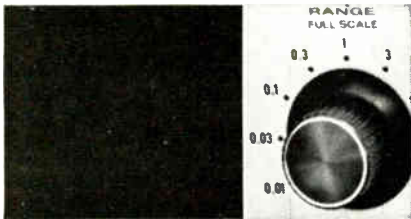

## MEASURE A NAVOVOLT!

The new Keithley 148 Nanovoltmeter provides the most dc voltage sensitivity, highest stability and lowest noise of any commercially available voltmeter. The 148 has 1% accuracy at the output terminals, input impedance of 1000 ohms on the  $10^{-6}$  volt range rising to 1 megohm on the  $10^{-3}$  volt range, front panel zero suppression and amplifier gains up to  $10^4$ .

Applications include measuring outputs of thermocouples; measuring super conductivity in the  $10^{-6}$  ohm range; conducting Hall Effect studies and use as a null detector.

- 10 nanovolts ( $10^{-6}$ v) full scale sensitivity
- 10 nanovolts per 24 hours stability
- 1 nanovolt noise, peak-to-peak
- 3000:1 line frequency rejection
- line or rechargeable batteries
- \$1275

Send for New 148 Engineering Note

### other microvoltmeters

- Model 149 0.1  $\mu$ v sensitivity \$895
- Model 150A 1  $\mu$ v sensitivity \$750
- Model 151 100  $\mu$ v sensitivity \$420



**KEITHLEY  
INSTRUMENTS**

12415 Euclid Avenue • Cleveland 6, Ohio

Circle 88 on Inquiry Card

## NEW PRODUCTS

### PRINTED-CIRCUIT CONNECTOR

*Provides the high density potential necessary for micro-electronic circuits.*

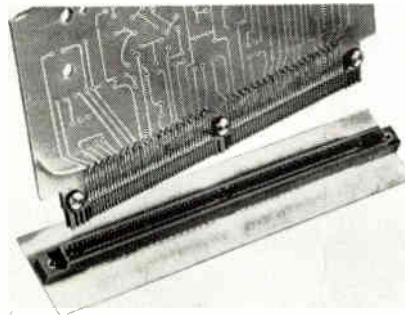

This subminiature board-to-board connector uses unique contacts on true 0.050 in. centers. The AMP-MECA™ connector offers several advanced mechanical/electrical features: low insertion force of 3 to 4 oz./contact; 4 pt. contact redundancy with wiping action provides max. conductivity. The new connector can be supplied in 160 to-the-row contact standard or 156 contact split versions, which can be used to mate with 2 mother boards. AMP Inc., Harrisburg, Pa.

Circle 136 on Inquiry Card

### PHOTON-COUPLED AMPLIFIER

*Transfers signals from one circuit to another without electrical contact.*

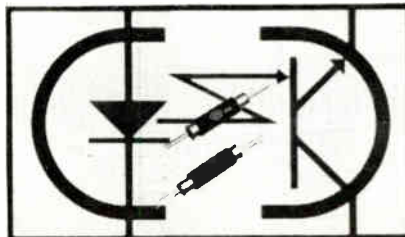

The Model 4302 solid-state amplifier provides a new concept in practical functional electronic building blocks. This 4-terminal signal isolator has no mutual input-output electrode. The optical coupling is done by driving a GaAs injection luminescent diode, and channeling the photon radiation generated to a high-gain silicon phototransistor. A fiber optic light-pipe is used for a high transmission efficiency from the photoemitter to the photodetector. The device can be used as a general circuit isolator, for remote sampling of current waveforms, to replace transformers or relays, and to eliminate ground loops in electronic systems. It can provide dc coupling with  $\mu$ sec. response over potentials of up to 10kv. H P Associates, an affiliate of Hewlett-Packard Co., 620 Page Mill Rd., Palo Alto, Calif.

Circle 137 on Inquiry Card



*New! Low-cost*

*Instrumentation Head tooled for high volume... fast prototype delivery!*

**Deposited quartz gaps down to 50-millionths. Gap is extra-hard with precision edges — eliminates smear!**

Multiple channels for less—with Nortronics new, compact "BQQ" heads. Designed for digital, instrumentation, analog and audio recording or reproduction, "BQQ" heads are readily available in production quantities — will fit existing 4-track systems. Types include Record only and Record/Reproduce heads in no-mount, base-mount, rear-mount and side-mount styles.

### TYPICAL APPLICATIONS

Used for instrumentation recording including carrier modulated types such as: AM, FM or Pulse; as straight Digital and Analog recording. Ideal for Audio Duplication, Background Music and 4-Channel "in-line" Stereo. In multiple staggered channel use, the "BQQ" accommodates 14 channels on 1" tape and 7 channels on 1/2" tape.

For complete information on Nortronics heads, write for our Form #7177



8149 10th Ave. No., Minneapolis, Minn 55427

Circle 89 on Inquiry Card

ELECTRONIC INDUSTRIES • January 1965



## NEW PRODUCTS

### PLUG-IN RELAY

*New switch design eliminates all contact terminal solder connections.*

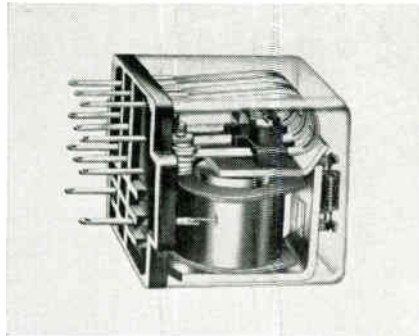

The series 1200 is a compact general-purpose plug-in relay with contact combinations up to 3PDT. The new relay with the Uni-Guard switch design eliminates all contact terminal solder connections. By using the terminal panel as the male plug, the relay eliminates the radio-type plug. Operates on ac or dc coil voltages, and contact rating is 10a. @ 115vac resistive. Guardian Electric Mfg. Co., 1550 W. Carroll Ave., Chicago, Ill. Circle 138 on Inquiry Card

### SPEED SERVO RECORDER

*Features 1/8 sec. second full-scale response and adjustable zero, adjustable span.*

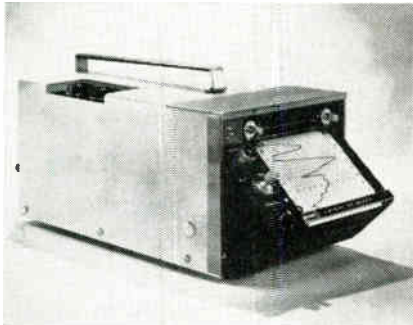

The Speed Servo AZAS Recorder measures any calibrated span from 1 to 100mv full scale without changing range cards or internal connections. Even higher levels of span and zero adjustment can be obtained with optional voltage dividers. Other features are zero displacement of  $\pm 100$ mv, simple controls for rapid selection of span and zero,  $100K\Omega$  source impedance, high impedance input circuitry, and a shuttle servo motor with no drive cords or gears. The circuitry is completely integrated into the basic recorder feedback circuit. It maintains a potentiometric input though its entire 1 to 100mv span is changed. Esterline Angus Instrument Co., Inc., P. O. Box 24000, Indianapolis, Ind.

Circle 139 on Inquiry Card

**MAGNETICALLY SHIELD YOUR COMPONENT IN SECONDS**

Versatile Netic and Co-Netic Foils cut to any size or outline with ordinary scissors—wrap easily

High attenuation to weight ratio possibilities; can dramatically enhance component performance. The shields stop degradation from unpredictable magnetic fields. When grounded, they also shield electrostatically. Co-Netic and Netic shielding foils are not significantly affected by dropping, vibration or shock, and do not require periodic annealing. Foils are available in thicknesses from .002" in rolls 4", 15", and 19-3/8" wide. Extensively used in experimental evaluation and production line operations for military, commercial and industrial applications

**MAGNETIC SHIELD DIVISION**  
Perfection Mica Company  
1322 N. ELSTON AVENUE, CHICAGO 22, ILLINOIS  
ORIGINATORS OF PERMANENTLY EFFECTIVE NETIC CO-NETIC MAGNETIC SHIELDING

Circle 90 on Inquiry Card

**Measures 0 —  $\pm 1,100$  V dc;**  
**0 — 350 V ac ( $\frac{20 \text{ Hz}}{1000 \text{ MHz}}$ ); 0 — 5,000  $M\Omega$**

### Ballantine DC/AC Voltmeter/Ohmmeter

Ballantine's Model 345 DC/AC Voltmeter/Ohmmeter is a multi-purpose instrument for use in the laboratory and on the production line.

It features a single, 5-inch, mirror-backed logarithmic scale and decade switching for both ac/dc volts and ohms measurements . . . and assures you of unrivaled ease, speed, accuracy and resolution in making these measurements. Its logarithmic scale, for example, permits an accuracy specification of 1% of indication for dc; 2% of indication for ac; and 3% of indication for ohms.

Since there are no wrong scales to read, errors in reading are reduced greatly. Because of the instrument's decade switching, you can make more measurements without the need for range switching.

The Model 345's accuracy is maintained for power line voltage changes of  $\pm 20\%$ , so necessary for use on the production line. Because its built-in ac and dc reference standards enable you to check its accuracy in a few seconds, there's no need of removing it from service.

Write for full details

Model 345 Price: \$350



— Since 1932 —

**BALLANTINE LABORATORIES INC.**  
Boonton, New Jersey

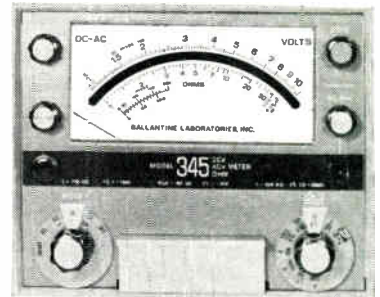



# AMPERITE

## Thermostatic DELAY RELAYS

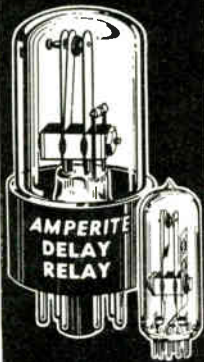

**Delays:**  
**2 to 180 seconds**

Actuated by a heater, they operate on A.C., D.C., or Pulsating Current . . . Being hermetically sealed, they are not affected by altitude, moisture, or climate changes . . . SPST only—normally open or normally closed . . . Compensated for ambient temperature changes from  $-55^{\circ}$  to  $+80^{\circ}$  C. . . Heaters consume approximately 2 W. and may be operated continuously . . . The units are rugged, explosion-proof, long-lived, and—inexpensive!

PROBLEM? Send for Bulletin No. TR-81

TYPES: Standard Radio Octal, and 9-Pin Miniature.  
List Price, \$4.00

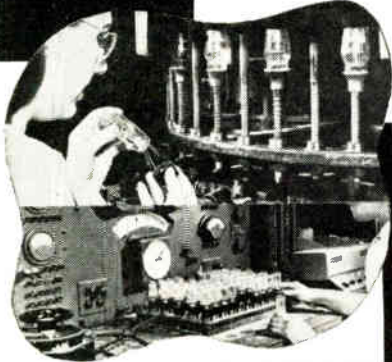

Individual inspection and double-checking assures top quality of Amperite products.

## AMPERITE BALLAST REGULATORS

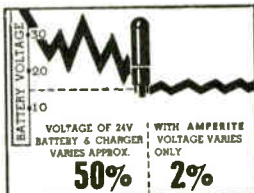

Hermetically sealed, they are not affected by changes in altitude, ambient temperature ( $-50^{\circ}$  to  $+70^{\circ}$  C.), or humidity . . . Rugged, light, compact, most inexpensive.

List Price, \$3.00

Write for 4-page Technical Bulletin No. AB-51

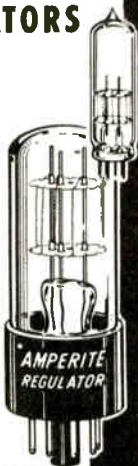

## AMPERITE

600 PALISADE AVE., UNION CITY, N.J.  
Telephone: 201 UNION 4-9503  
In Canada: Atlas Radio Corp., Ltd.,  
50 Wingold Ave., Toronto 10

Circle 92 on Inquiry Card

## NEW PRODUCTS

### CALIBRATION SYSTEM

Absolute calibration of accelerometers at freqs. up to 50kc.

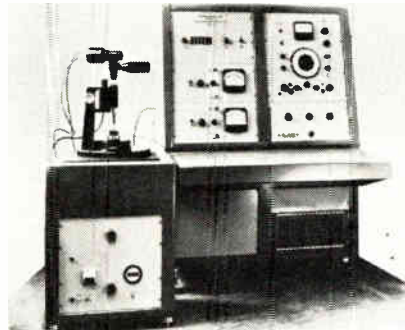

Ease of operation, including setup time of under 5 min., makes the new calibration system, Model KA-2826, ideal for laboratory or production use. Waveform distortion is less than 2% to 20kc, 5% to 50kc. The new system is composed of an interferometer, piezo-electric vibrator and a driver. The interferometer has a useful freq. range of 500 cps to 50kc and can measure absolute displacements from  $4 \times 10^{-6}$  in. to  $45 \times 10^{-6}$  in. Gulton Industries, 212 Durham Ave., Metuchen, N. J.

Circle 140 on Inquiry Card

### DIRECT FREQUENCY COUNTER

Measures from 0 to 6.4cc without heterodyning, prescaling, or transfer oscillators.



Model 950 visually displays the true count within msec. on polarized Nixie® readout with display storage. Complex operations and calculations are avoided. Connecting the unknown input freq. and adjusting trigger level are the only actions required for measurement. As a result, operator fatigue and error are reduced. It features 7 digit accuracy, 1 part in  $10^7/24$  hrs. Freq. range 0—110mc, 100—900mc, and 800—6400mc. Three operating ranges cover the 0—6.4cc band, with extended freq. to 18.4cc available. Eldorado Electronics, 601 Chalmar Rd., Concord, Calif.

Circle 141 on Inquiry Card

## SPECIAL TOOLS FOR SPECIAL PROBLEMS

Odd as they look, these are actual production tools. They were manufactured by Xcelite to increase efficiency on special assembly work where conventional hand tools proved inadequate.

Chances are that "special function" tools can speed your production. Supply prints (model if available) of part on which tool will be used. Prototype designed and tool'd for your approval. Any quantity . . . to meet your production schedule. Contact factory direct.

Complete information in new "Custom-made Tool" Brochure No. 660. Request on your letterhead.

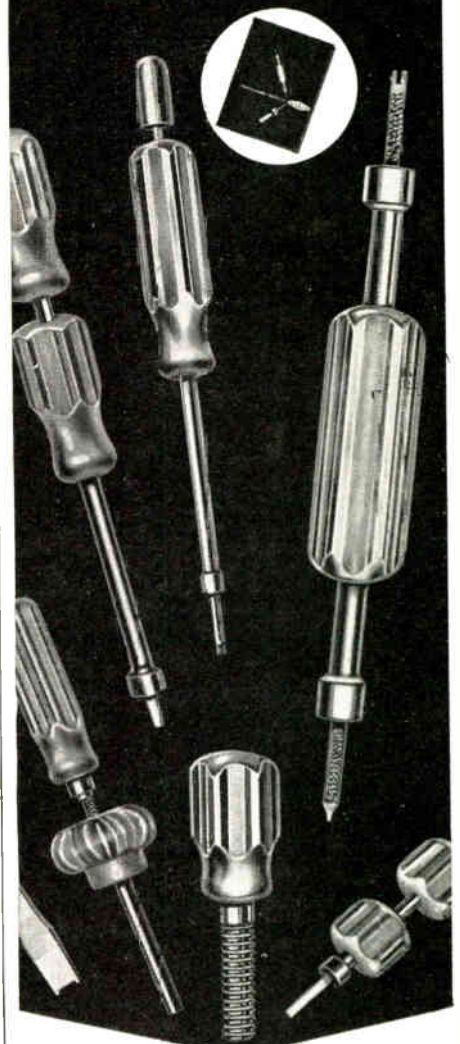

## XCELITE

## INDUSTRIAL HAND TOOLS

XCELITE, INC. • 28 BANK ST., ORCHARD PARK, N. Y.

Circle 93 on Inquiry Card

ELECTRONIC INDUSTRIES • January 1965



# NEW PRODUCTS

## ROTARY SELECTOR SWITCH

Contact resistance is 0.004Ω (initial); dielectric strength, 1Kv.

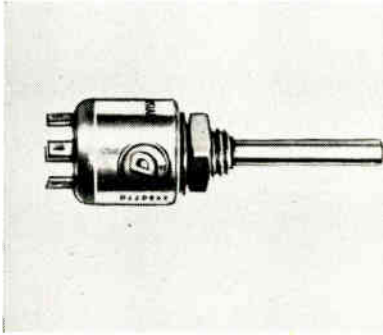

The subminiature Series K measures ½-in. in dia. and ⅝ in. behind the panel; is completely enclosed; and features gold-plated contacts and wiper. It is tested for a min. of 500kc. It withstands 50G deceleration; has a vibration resistance of 10–20,000 cps with a force of 15G; and will continuously carry 3a. max. Operating temp. range is –65°C to +125°C. Switches are available in various contact arrangements, both shorting and non-shorting types. Daven Div., McGraw-Edison Co., Livingston, N. J.  
Circle 142 on Inquiry Card

## VOLTMETER/OHMMETER

Reading accuracy is 1% for dc, 2% for ac, and 3% for ohms.



Model 345dc/ac voltmeter/ohmmeter has a single 5 in. logarithmic scale for dc and ac volts, and a single 5 in. logarithmic ohms scale. Each is individually calibrated to provide higher accuracy and resolution than any similar instrument. Features: dc volts to ±1100; ac volts to 350, 20 cps to 100mc, lowering to 35v. at 1gc. Resistance is to 5000 megohms. The instrument has built-in stabilized reference voltages for calibration checks on all functions. It is stabilized for operation on power line voltages of ±20% of nominal 115/230v. Ballantine Laboratories, Inc., Boonton, N. J.

Circle 143 on Inquiry Card

# WHICH DEFLECTION YOKE FOR YOUR DISPLAY ?

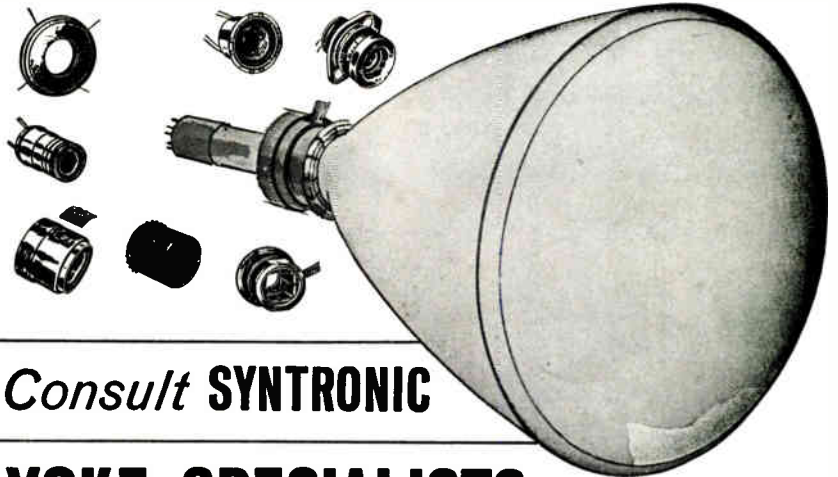

Consult **SYNTRONIC**

## YOKE SPECIALISTS

Syntronic's team of experts knows more about yoke design, engineering and quality control than anyone else. A solid 10-year record of leadership—acknowledged throughout the industry. Benefit from it.

*syntronic* INSTRUMENTS, INC.  
100 Industrial Road, Addison, Illinois  
Phone: Kingswood 3-6444

Circle 94 on Inquiry Card

Specifically  
Engineered  
for RF  
Components!



A-27 Superfine  
**Q-max**  
EXTREMELY LOW-LOSS  
RF LACQUER

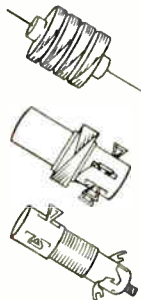

Q-MAX impregnating and coating composition penetrates deeply, seals out moisture, provides a surface finish. Q-MAX imparts rigidity and promotes stability of the electrical constants of high frequency circuits. Effect on the "Q" of RF windings is negligible.

Write for catalog today.

**Q-max Corporation**

MARLBORO, NEW JERSEY

Telephone: 462-3636 (Area Code 201)

Circle 95 on Inquiry Card



**LOOK TO RCI for**  
AC and BRUSHLESS DC  
**ROTATING COMPONENTS**



**CENTRIFUGAL BLOWERS**



**AXIAL FANS**



**BLOWER CABINETS**



**GEAR MOTORS**



**SERVO MOTORS**



**MOTORS**  
• SYNCHRONOUS  
• INDUCTION  
• NEW POLARIZED SYNCHRONOUS  
• NEW BRUSHLESS DC

Write for **NEW 1964 CATALOG**

**ROTATING COMPONENTS, INC.**  
1560 FIFTH AVENUE, BAY SHORE, N. Y.

Circle 96 on Inquiry Card

ANOTHER



STATE-OF-THE-ART  
CAPABILITY

SOLID STATE

# PHASE SHIFTERS

Here's a typical example

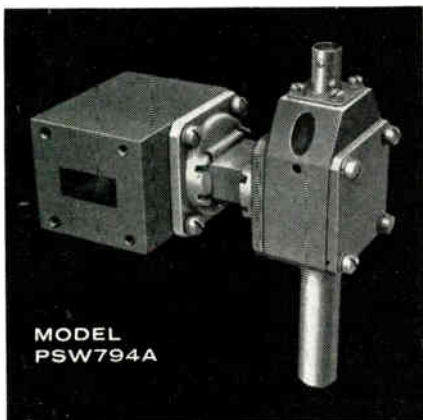

MODEL  
PSW794A

The new AEL Model PSW794A Phase Shifter represents a major state-of-the-art development in this field.

**Check these features . . .**

- Solid state, 180°, X-Band.
- Typically one nanosecond speed of phase shift change over X-Band.
- No hysteresis effect in phase shift.
- Low VSWR—maximum of 1.3:1.
- 1.5 db typical insertion loss through entire phase shift range.
- Less than 0.1 Watt drive power required.
- Dynamic phase shift range exceeds 180°.

Let AEL provide you with the custom Phase Shifter to meet your exact requirements. Send us your specifications . . . we will reply with our quote.



**American Electronic  
Laboratories, Inc.**

P.O. BOX 552, LANSDALE, PENNA.  
(215) 822-2929

Circle 97 on Inquiry Card

## NEW PRODUCTS

### ELECTRICAL THERMOMETER

Uses one probe for temp. readings in the range of  $-25^{\circ}\text{C}$  to  $+280^{\circ}\text{C}$ .



Model 380 is a compact, lightweight, fully self-powered, direct reading electrical thermometer. It has 2 ranges: a LO range of  $-25^{\circ}\text{C}$  to  $+130^{\circ}\text{C}$  and a HI range of  $+120^{\circ}\text{C}$  to  $+280^{\circ}\text{C}$ . The probe consists of an 0.065 in. dia. single crystal thermo-element having a small mass and mounted at the end of a 1/16 in. dia. Pyrex tube. This miniature design permits high accuracy surface temp. measurements of electro-components and circuit assemblies. Radio Frequency Laboratories, Inc., Boonton, N. J.

Circle 144 on Inquiry Card

### RECEPTACLE

For use with microelectronic integrated circuits packaged in TO-5 cans.

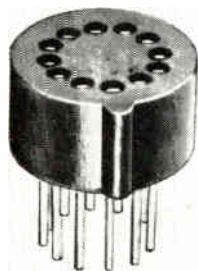

This receptacle provides a triple function in its use with microelectronic integrated circuit chips packaged in modified TO-5 cans. It serves as a breadboard component, carrier at the device manufacturer's plant, and hermaphrodite capable of accepting itself for use as a socket in test equipment. It features: probe-proof sockets; contact spacings that will accept devices to Mil-M-23700 (6, 8, 10, and 12 leads); accepts 0.017  $\pm$  0.002  $-$  0.001 leads (pins), visual polarization; and less than 2pf capacitance pin to pin (12 lead receptacle). The Bendix Corp., Scintilla Div., Sidney, N. Y.

Circle 145 on Inquiry Card

### SIDE-LOOKING RADAR SYSTEMS ANALYSTS

New programs at HUGHES are generating opportunities for Systems Analysts experienced in high-resolution data gathering, data transfer and data processing systems. Openings exist for Systems Engineers, Mathematicians and Physicists qualified in synthetic array radars, optical, and other data collection systems (IR, Electro-Optical, SIGINT and others). Assignments include:

**Senior Systems Scientist** with 20 years' electronic systems experience—at least 10 years relevant to side-looking radar systems. Applicants will be considered for important program management responsibilities. M. S. or Ph. D. degree required.

**Senior Systems Analysts** with 10 years' electronic systems experience—at least 5 years relevant to high-resolution systems pre-design and evaluation. Applicants will be considered for assignments in concept formulation; single and multi-sensor applications; data transmission, processing and interpretation; systems integration and performance evaluation. M. S. or Ph. D. required.

**Systems Analysts** with 5 years' experience in: detection of signals in noise, optimum filter theory, non-linear signal processing, information theory, MTI and doppler systems analysis. B. S. or M. S. required.

Please airmail your resume to:

**MR. ROBERT A. MARTIN**  
Head of Employment  
Hughes Aerospace Divisions  
11940 W. Jefferson Blvd.  
Culver City 11, California

Creating a new world with electronics

**HUGHES**

HUGHES AIRCRAFT COMPANY  
AEROSPACE DIVISIONS

U. S. CITIZENSHIP REQUIRED  
An equal opportunity employer.

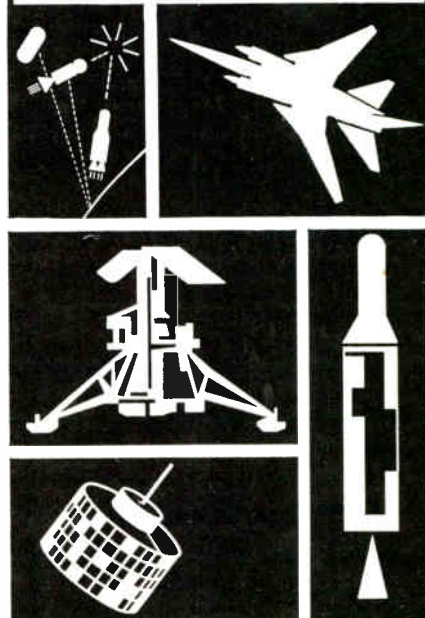



This index is published as a convenience.  
No liability is assumed for errors or omissions.

<b>A</b>	
Aeroflex Laboratories, Inc. ....	117
Alden Products Company .....	142
Alexander Hamilton Institute .....	17
Allen-Bradley Co. ....	Insert fol. p. 72
Allied Chemical Corporation, General Chemical Division .....	102
Amco Engineering Company .....	121
American Electronic Laboratories, Inc. ....	140
American Machine & Foundry Co., Potter & Brumfield Division .....	91
AMP, Incorporated .....	53
Amperite .....	138
Anetsberger Bros., Inc. Systems Enclosures .....	113
Arco Electronics, Inc. ....	50
Astrodata, Inc. ....	59
Automatic Electric .....	41
<b>B</b>	
Ballantine Laboratories, Inc. ....	137
Basic Systems, Inc. ....	88, 89
Belden Mfg. Co. ....	47
Bell Telephone Laboratories .....	70
Bourns, Inc. ....	111, 127
Brady Co., W. H. ....	120
Bulova Electronics .....	92
Bussmann Mfg. Division McGraw-Edison Co. ....	94, 95
<b>C</b>	
Cherry Electrical Products Corp .....	114
CMC-Computer Measurements Company .....	16
Consolidated Avionics Corp. ....	63
Crydon Laboratories, Inc. ....	133
CTS Corporation, Asheville Division .....	97
<b>D</b>	
Dale Electronics, Inc. ....	Inside Back Cover
Daven .....	58
Delco Radio .....	45
<b>E</b>	
Elco Corporation .....	119
Electro Instruments, Inc. ....	106A
Electro-Tec Corp. ....	93
<b>F</b>	
Fairchild Dumont Laboratories, Instrument Div. ....	42, 43
Fischer Special Mfg. Co. ....	6
Florida Development Commission .....	131
FXR Division of Microlab/FXR .....	13
Furane Plastics, Inc. ....	134
<b>G</b>	
German American Chamber of Commerce .....	134
Grayhill, Inc. ....	112
Grieve-Hendry Co. ....	115
<b>H</b>	
Hart Manufacturing Co. ....	113
Heath Company .....	113
Hughes Aircraft Company, Aerospace Division .....	130, 140
<b>I</b>	
IBM Corporation Industrial Products Division .....	19
Recruitment Division .....	106D
Ideal Industries, Inc. ....	115
Image Instruments, Inc. ....	117
Industrial Electronic Engineers, Inc. ....	101
Institute of Electrical and Electronic Engineers, Incorporated, The .....	142

International Rectifier Corp. ....	11
Interstate Electronics Corp .....	96
<b>J</b>	
James Knights Company, The .....	98
JFD Electronics Corp. ....	44
<b>K</b>	
Keithley Instruments .....	136
Kelvin .....	135
Keuffel & Esser Co. ....	24
Klein & Sons, Mathias .....	46
KRS Electronics .....	15
<b>L</b>	
Licon Division Illinois Tool Works, Inc. ....	64, 65
Lindgren & Associates, Inc., Erik .....	142
<b>M</b>	
Mallinckrodt Chemical Works .....	18
Methode Mfg. Corp. ....	114
Microlab/FXR FXR Division .....	13
Minnesota Mining & Mfg. Co., American Lava Corporation .....	71
Motorola, Inc. Communications & Electronics Division .....	118
<b>N</b>	
Non-Linear Systems, Inc. ....	12
Nortronics Company, Inc., The .....	136
<b>O</b>	
Ohmite Manufacturing Company .....	25
<b>P</b>	
Panduit .....	120
Perfection Mica Company Magnetic Shield Division .....	137
Phico Corporation .....	Insert fol. p. 32
Potter & Brumfield, Division of American Machine & Foundry .....	91
Precision Paper Tube Co. ....	115
<b>Q</b>	
Q-Max Corporation .....	139
<b>R</b>	
Radio Corporation of America Electronic Components & Devices .....	30
Semiconductor Division .....	Back Cover
Radio Frequency Laboratories, Inc. ....	99
Radio Materials Company .....	116
Rotating Components, Inc. ....	139
<b>S</b>	
Sage Electronics Corp. ....	106
Schauer Mfg. Corp. ....	132
Siemens America Incorporated .....	106B, 106C
Simpson Electric Company .....	7
Sola Electric Co. ....	100
Sperry Rand Corporation Sperry Semiconductor .....	10
Sprague Electric Company Circuit Division .....	2
Semiconductor Division .....	5
Stanpat Products, Inc. ....	117
Stevens Manufacturing Company, Inc. ....	21
Syntronic Instruments, Inc. ....	139
<b>T</b>	
Tektronix Inc. ....	14
Thomas & Betts Co., Inc. ....	54, 55
Triplet Electrical Instrument Company .....	60
Trygon .....	130

<b>U</b>	
U. S. Components, Inc. ....	122
United Transformer Corp .....	Inside Front Cover
<b>V</b>	
Victoreen Instrument Co. ....	129
<b>W</b>	
Ward Leonard Co. ....	132
Wells, Electronics, Inc. ....	120
Wheelock Signals, Inc. ....	135
<b>X</b>	
Xcelite, Inc. ....	138



## REGIONAL SALES MANAGERS

Philadelphia 19139—56th & Chestnut Sts.  
(Area Code 215) Sherwood 8-2000  
**JOSEPH DRUCKER**  
**ROBERT Q. HINCKLE, Jr.**

New York (17)—100 East 42nd St.  
(Area Code 212) OXford 7-3400  
**GERRY PELISSIER**  
**HUGH ROBINSON**

Boston (10), Mass.—10 High St.  
(Area Code 617) Liberty 2-4460  
**ROBERT G. SMITH**

Chicago (11)—540 N. Michigan Ave.  
(Area Code 312) 467-9660  
**JOHN W. BERNHARDT**  
**PHILIP T. CLARK**

Cleveland (15)—601 Rockwell Ave.  
(Area Code 216) Superior 1-2860  
**ROBERT COBURN**

Los Angeles (57)—198 S. Alvarado St.  
(Area Code 213) DUUnkirk 7-1271  
**GEORGE F. KELLEY**  
**BURT UNOERWOOD**

San Francisco (3)—1355 Market St.  
(Area Code 415) 861-7107  
**ODN MAY**

Atlanta (9)—1776 Peachtree St. N.W.  
(Area Code 404) 875-1255  
**JOHN W. SANGSTON**

Dallas (6)—Meadows Bldg.  
Expressway at Milton  
(Area Code 214) EMerson 3-6426  
**HAROLD E. MOTT**

## EUROPEAN SALES OFFICES

London, S. W. (1)—67/68 Jermyn St.  
St. James  
**MAX F. HOLSINGER**

United International Industrial Press  
Eitelstrasse 32  
4 Dusseldorf—Rath, Germany  
**MAX F. HOLSINGER**

## FAR EAST SALES OFFICE

Tokio Marunouchi, Japan  
C. P. O. Box #1572, Room 814  
Tel.: 211-3506-3509  
Togin Bldg.  
**CLARENCE T. SAKAGUCHI**

# ALDEN

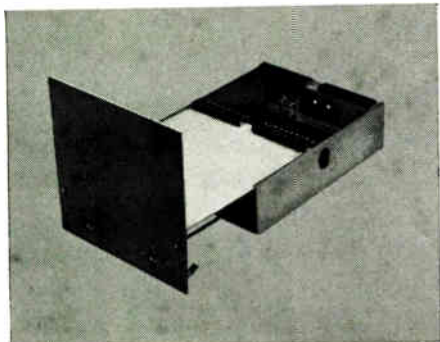

## modular SLIDE-IN CHASSIS

... makes it possible to design, construct and service your industrial electronics equipment in 1/2 the time.

- Available off-the-shelf in 2", 4", 8" and 17" widths; two front panel heights: 7" and 8 3/4".
- 48-hour delivery — chassis and front panel — punched, plated, silk screened and painted — to your specs ... ready for snap-in circuitry.
- Inputs/outputs/interchassis connections organized for straight line point-of-check at the Alden Back Connectors.
- Detachable front panel for controls and monitors.
- Designed for snap-in circuit planes, produced as logical sub-assemblies.
- 1/2 Turn of Serve-a-Unit Lock handle disconnects or locks chassis in: carrying case as portable gear, roll-in console or standard rack with adapter.
- Rugged steel construction, cadmium plated and baked enamel finish.



Let us quote on complete circuitry packaging to your specs.

A unique product from Alden's broad line of components to mount, house, fasten, connect and monitor your electronic/electrical circuitry.



WRITE FOR 24-PAGE  
QUICK ORDER GUIDE

# ALDEN

PRODUCTS COMPANY  
1123 N. Main Street, Brockton, Massachusetts  
Circle 99 on Inquiry Card

## NEW PRODUCTS

### MEMORY MODULE

Stores a block of data up to 20 characters long, with 8 bits/character.

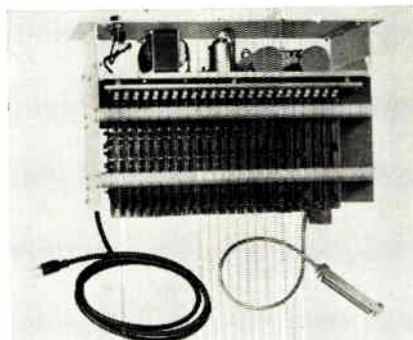

The Block Reader Memory Module is basically a flip-flop memory into which individual characters are distributed under control of a built-in counter and appropriate gating. Data can be accepted by the memory at speeds up to 50 $\mu$ sec./character. Fundamentally, the BRMM is designed to operate with perforated tape reader as an input device. The block reader can be stopped on a predetermined code in the tape, permitting variable block lengths. Digitronics Corp., Albertson, N. Y.

Circle 234 on Inquiry Card

### TIME-DELAY RELAY

Reset time under 1/5 sec., repeat accuracy more than 1.5% of full scale.

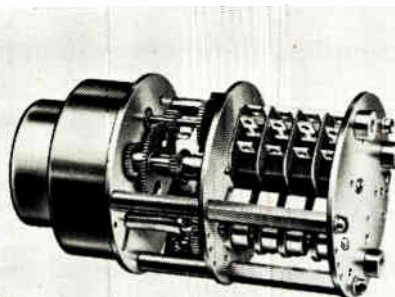

This time-delay relay is designed for general timing uses requiring an instantaneous reset type of action. Designated as Series 21, it is a combination of a standard Circle B motor, a solenoid-operated differential-type clutch and enclosed snap-action switches. The motor, which drives the switch-operated mechanism through the differential clutch system, is available with either direct or reverse clutching. Over 1 million cycles may be expected. Bristol Motors, div. of Vocaline Co. of America, Old Saybrook, Conn.

Circle 235 on Inquiry Card

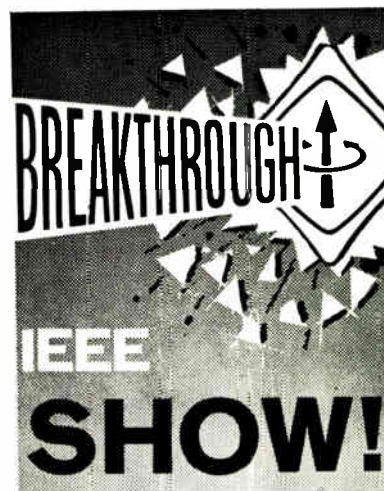

March 22-26, 1965

ELECTRICAL-ELECTRONICS

Exhibit hours (4 days):

Monday & Thursday, 9:45 a.m.—9 p.m.

Tuesday & Wednesday, 9:45 a.m.—6 p.m.

Technical sessions (5 days)

HILTON & COLISEUM

10 a.m.—5 p.m.



NEW YORK COLISEUM  
and the N. Y. HILTON

Buses every few minutes  
Members \$2.00; Non-Members \$5.00

Circle 100 on Inquiry Card



Lindgren D.E.I. enclosures give 20-40 db more from 60 cycles to 10,000 megacycles.

This is a fact proven by independent testing firms and attested to by industrial and governmental users of the Lindgren Double Electrically Isolated enclosures.

Erik A. Lindgren also produces the new Single Steel Shielded rooms. For information write:

Erik A. Lindgren & Associates, Inc.  
4515 North Ravenswood Avenue  
Chicago, Illinois 60640

Circle 101 on Inquiry Card





**RELIABILITY**  
TOTAL CAPABILITY IN  
PRECISION RESISTANCE

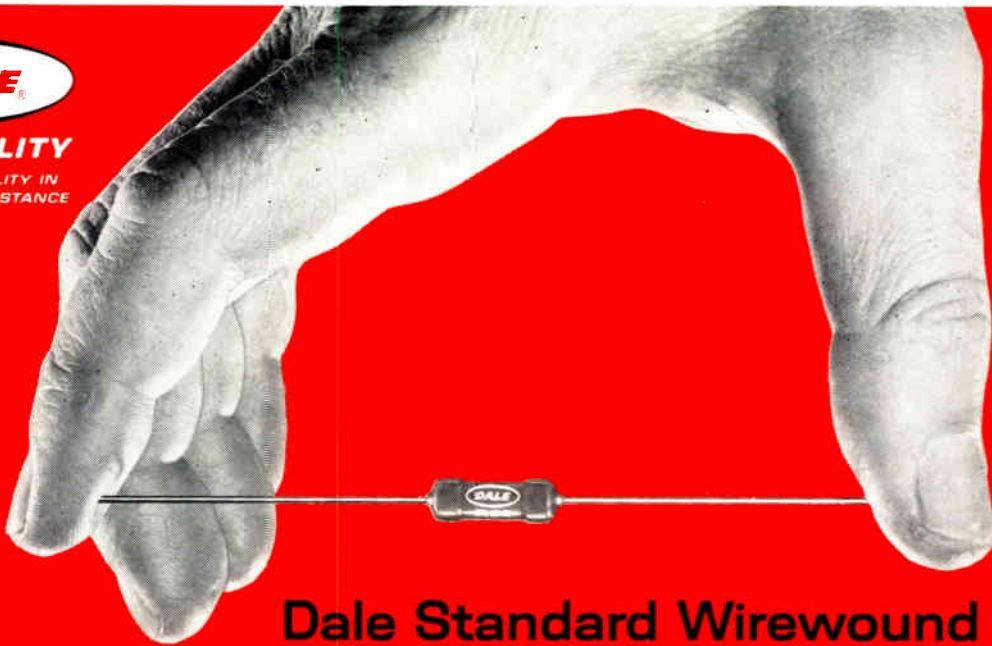

Dale Standard Wirewound  
Power Resistors Prove  
**99.994% RELIABLE**  
in 32,000,000  
Unit Hours of Testing!

RS Type Precision Wirewound Resistors are a part of the DALE High-Rel Development Program.

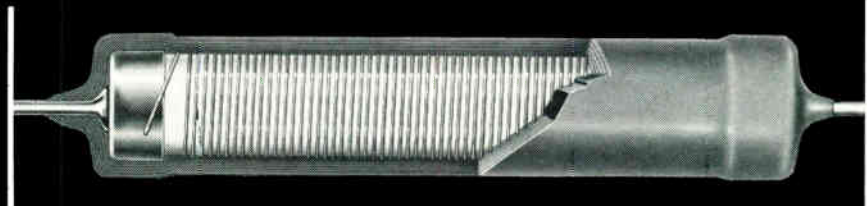

You simply can't match the reliability and versatility which Dale makes available in its RS Precision Power Wirewounds. *RS reliability*—yours at no extra cost—is solidly documented in continuing tests patterned after Dale's famous Minuteman High Reliability Development Program. Write for test report. *RS versatility* is so broad that more than 400 special variations have been made from our basic silicone-coated, all-welded construction. Standard or special— you simply can't buy more confidence at competitive prices.

WRITE FOR ■ RS Reliability Study  
■ Catalog A

**LATEST RS RELIABILITY REPORT**

**Unit Test Hours:** 32,000,000 • **Reliability:** 99.994%  
**Stability:** Units will not shift more than initial tolerance after 1,000 hours load life.  
**Test Conditions:** 60% confidence level, 100% rated power, 25 C ambient 1% Δ R failure point.

**RS SPECIFICATIONS**

- **Applicable Mil. Spec:** MIL-R-26C & MIL-R-23379 (a new Spec. designed especially for precision power resistors)
- **Wattage Sizes:** ¼, ½, 1, 2, 2.5, 3, 5, 7, 10
- **Tolerances:** 0.05%, 0.1%, 0.25%, 1%, 3%
- **Operating Temperature Range:** -55 C to 350 C
- **Resistance Range:** .1 ohm to 273K ohms
- **Load Life Stability:** 1% max. Δ R after 1000 hours at full rated power
- **Moisture Resistance:** .5% max. Δ R after MIL-R-26C moisture test
- **Dielectric Strength:** 500 volts, RS-¼ through RS-1B; 1000 volts RS-2 through RS-10
- **Thermal Shock:** .5% max. Δ R after MIL-R-26C thermal shock test
- **Insulation Resistance:** 100 megohms minimum
- **Temperature Coefficient:** 20 ppm (high values); 30 ppm (intermediate values); 50 ppm (low values). Specific T.C. chart available on request.



**DALE ELECTRONICS, INC.**

1304 28th Avenue, Columbus, Nebraska

Also Sold by Dale Electronics Canada, Ltd., Toronto, Ontario, Canada



Circle 98 on Inquiry Card

# 400V $V_{CER(sus)}$

# 5A $I_C(peak)$

# 10 Mc $f_T(min)$

For the first time  
at Economy Prices

2N3583

$V_{CER(sus)}$  min 250 V

2N3584

$V_{CER(sus)}$  min = 300 V

2N3585

$V_{CER(sus)}$  min = 400 V

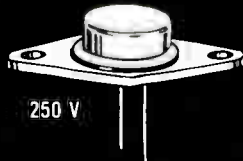

40255

$V_{CEO(sus)}$  min = 350 V

$I_C$  max = 1 amp

$\theta_{j-c}$  = 15° C/W

40256

$V_{CEO(sus)}$  min = 250 V

$I_C$  max = 1 amp

$\theta_{j-c}$  = 15° C/W

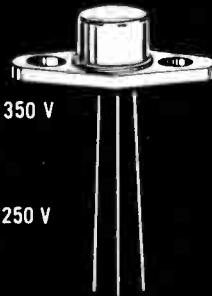

2N3439

$V_{CEO(sus)}$  min = 350 V

$I_C$  max = 1 amp

$\theta_{j-c}$  = 30° C/W

2N3440

$V_{CEO(sus)}$  min = 250 V

$I_C$  max = 1 amp

$\theta_{j-c}$  = 30° C/W



## RCA ADDS THREE NEW "SMALL TO-3" (TO-66) HIGH-CURRENT TRANSISTORS TO THE LOW-COST, HIGH-VOLTAGE SILICON LINE

Here's high-voltage, high-current, high-frequency, silicon power with big performance built-in and high cost built-out. New RCA mass-production assembly techniques, new triple-diffused mesa process, and RCA's "small TO-3" (TO-66) diamond package put these three new transistors in a price class that's right for:

- High Voltage Inverters and Switching Regulators
- Line-Operated or High-Voltage Amplifiers
- Operational Amplifiers
- Electrostatic or Magnetic Deflection Circuits

Check RCA-2N3583, 2N3584, and 2N3585 for every socket, for every new design that requires big, high voltage performance and real economy. These three new types are conservatively rated for long-term field reliability.

		2N3583	2N3584	2N3585
$h_{FE}$	@ $I_C = 100$ ma, $V_{CE} = 10$ V	40 min	40 min	40 min
	@ $I_C = 1$ amp, $V_{CE} = 10$ V	10 min	25-100	25-100
$h_{fe}$ @ 5 Mc	@ $I_C = 200$ ma, $V_{CE} = 10$ V	2 min	2 min	2 min
$I_{S_b}$	@ $V_{CE} = 100$ V	250 ma min	250 ma min	250 ma min
$V_{CEO(sus)}$	@ $I_C = 200$ ma	175 V min	250 V min	300 V min
$V_{CE(sat)}$	@ $I_B = 125$ ma, $I_C = 1$ A		0.75 V max	0.75 V max
$I_C$		5 amp peak 2 A continuous	5 amp peak 2 A continuous	5 amp peak 2 A continuous

For price and delivery information, check your RCA Representative, or your RCA Distributor. And ask him about RCA's high voltage, small signal, TO-5 types 2N3435, 2N3550, and flange TO-5 types 40255 and 40256. For technical data, write: RCA Commercial Engineering, Section JJ1, Harrison, N.J.

Also Available Through Your RCA Distributor  
RCA ELECTRONIC COMPONENTS AND DEVICES, HARRISON, N.J.



The Most Trusted Name in Electronics

Circle 102 on Inquiry Card