

# ELECTRONIC INDUSTRIES

---

**OCTOBER 1962**

**Power supplies... definitions to design  
Designing integrated circuit resistors  
Nuclear blast effects on components**

STABILITY IS INHERENT IN

**DALE**

**RHM RESISTORS**

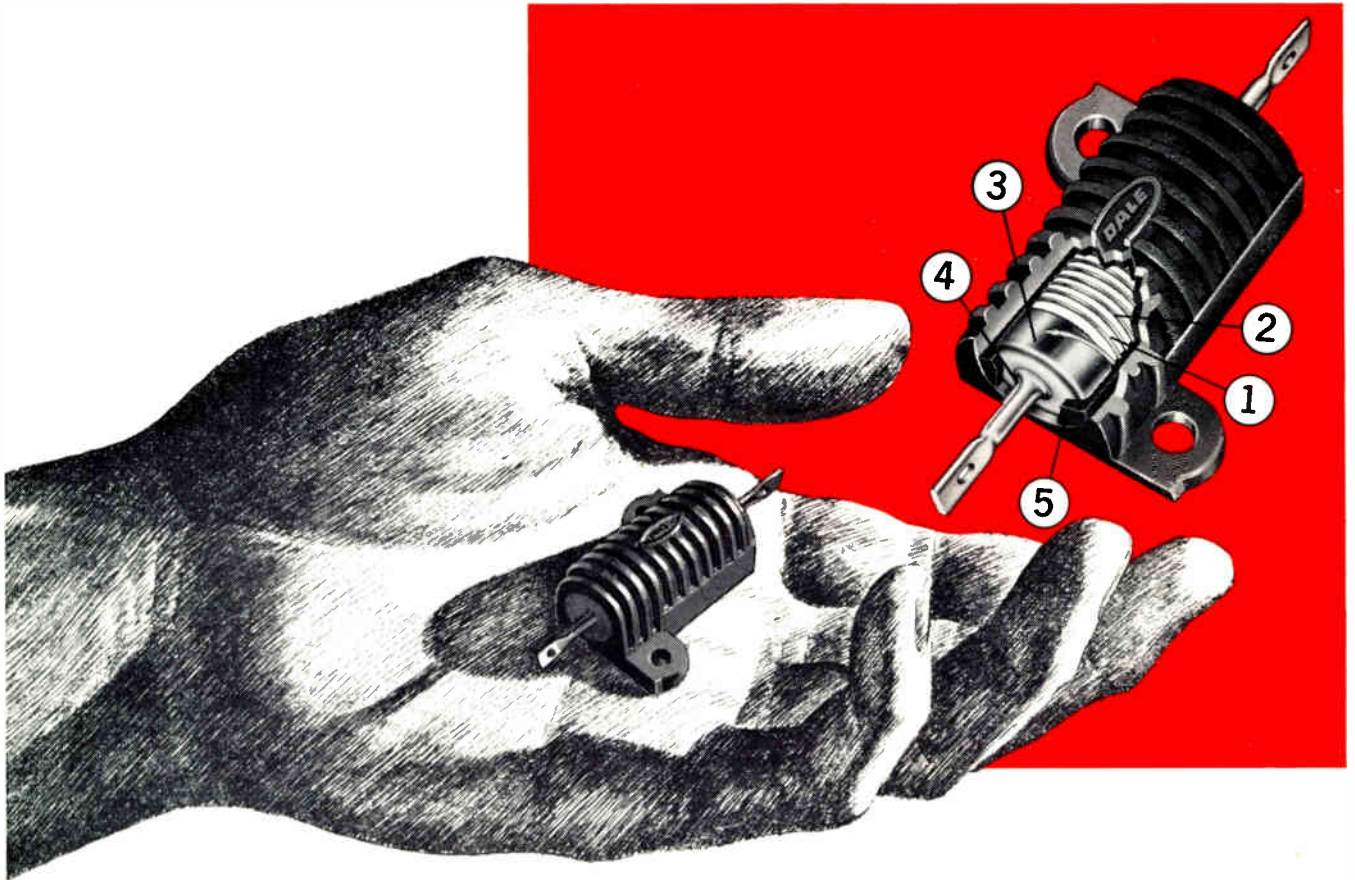

Designed for primary application of high power requirements, coupled with precision tolerance. Mounts on chassis for maximum heat dissipation. Operates under severe environmental conditions.

### SPECIFICATIONS

- Three physical sizes rated at 10, 25, 40 watts.
- Exceed requirements of MIL-R-18546C.
- Resistance range from 0.1 ohm to 60K ohms, depending on type and tolerance.
- Tolerances 0.5%, 1%, 3%.
- Temperature coefficient 20 P.P.M./degree C.
- Operating temperature range -55 degrees C to 275 degrees C.

Write for Dale Resistor Catalog A

### HERE'S HOW DALE "BUILDS IN" RELIABILITY

- **CORES** are centerless ground, high purity ceramic, untouched by hand or foreign materials. Wire lays firmly and uniformly, eliminating local hot spots.
- **RESISTANCE WIRE** is procured to rigid specifications (analysis of each melt required). Untouched by hand or foreign materials. Tension accurately controlled; pitch limited to 200% minimum.
- **END CAPS** are made from non-corrosive stainless steel for good weldability and ideal mechanical properties.
- **COMPLETE WELDED CONSTRUCTION** from terminal to terminal. Welds tested on sample basis to destruction.
- Dale uses an **EXCLUSIVE MOLDING PROCESS** (patent applied for) that makes possible the use of superior, high temperature, high density insulation materials. The material completely surrounds the resistor and adheres to the housing so tightly that it cannot be removed mechanically. The fact that it is a continuous material insures maximum heat dissipation. Better centering of the resistor eliminates possibility of high voltage breakdown. Dale RHM is the most mechanically sound resistor made.

**MOMENTARY OVERLOAD:** Will take 5x **RATED** wattage, even though maximum working voltages are greatly exceeded. This exceeds Mil. Spec. requirements.

**COMPLETE TESTING PROGRAM:** Resistance check: 100% final and 100% during processing; 100% Hipot test; complete military specification environmental test on sampling basis.

## DALE ELECTRONICS, INC.

1304 28th Avenue, Columbus, Nebraska

A subsidiary of THE LIONEL CORPORATION

Also Made and Sold by Dale Electronics Canada, Ltd., Toronto, Ontario, Canada

**DALE**

SEE OUR SPECIFICATIONS IN  
**VSMF**  
THE MICROFILM CATALOG FILE

Circle 98 on Inquiry Card

SHELBY A. McMILLION,  
Publisher  
BERNARD F. OSBAHR,  
Editor

# ELECTRONIC INDUSTRIES

EPITAXIAL planar integrated circuits, as items of practical hardware are experiencing a steady growth. We believe this to be especially significant because the increased use of these items will cause some radical changes in engineering design concepts. Fifteen months ago only one or two manufacturers offered these as an off-the-shelf line. Today more than a dozen manufacturers have announced production availability of such circuits. Also, at the recent WES-CON, it was interesting to note the relatively large numbers of exhibitors displaying integrated electronic components, although, of course, not all of these employ epitaxial planar techniques in their construction.

Presently most all characterizations of available epitaxial planar circuits appear to pertain to digital circuitry. On the basis of unit costs and application, the computer area undoubtedly offers the most immediate profitable prospects. Here integrated circuits can offer significantly reduced interconnection and reliability problems along with lower power consumption. Ultimately we can expect to grow circuits that will have a wide variety of application in consumer electronic equipment as well.

There are also differences of opinion as to the most effective way in which to manufacture and distribute such circuits. Some believe that standardized packaged circuits offer the best means for mass production techniques and that these in turn will provide for lowest unit costs. Others feel that circuit requirements should be specified by the customer and that manufacture should be on a custom basis. Undoubtedly both approaches will continue to be used in the foreseeable future, but as our manufacturing know-how advances in this area, it is very probable that the custom

THE GOVERNMENT this year will spend some \$12.5 billion on research and development. This represents about 65% of all the R&D being carried out across the country.

It would seem to be a natural concern of everyone in industry — and particularly the electronic industry — just how much of this R&D is to find its way into new commercial and industrial products. The future development of the U. S. economy may well depend on it.

In the past, we have pointed out that there was no orderly program for releasing the results of government-sponsored R&D, and that one was sorely needed. It is heartening, then, to read this month that NASA is establishing an Industrial Applications Advisory Committee whose specific responsibility will be to assist NASA "to transfer new scientific and technological knowledge from NASA's R&D program to industry."

Among the specific objectives of the Committee will be: to recommend methods for identifying innovations having a high potential for industrial applications; to assist in developing procedures for the most effective transfer of technology from NASA R&D programs to the industrial community.

## INTEGRATED CIRCUITS GROW

design approach will also become very feasible economically.

The availability of integrated circuits as practical hardware has brought us to the beginning of another transitional era. Over the last decade new equipments accentuated solid state (transistor and diode) designs as contrasted to earlier vacuum tube design. Now we shall be transferring from the solid state device designs into the use of integrated circuits. Initially many of these designs will be hybrid in character, but again, as manufacturing know-how develops, integrated circuitry will become more and more encompassing.

To us, editorially, this represents a whole new avenue of activity, on which we shall be reporting regularly. Our first article in this new series appeared in the September issue on page 100 and was entitled "Packaging and Interconnecting Integrated Networks." The second article entitled, "Designing Integrated Circuit Resistors," appears in this issue. We have also arranged for more than a dozen other manuscripts in this field in order to provide you with the most up-to-date engineering design concepts and data. Because we believe that this series will have significant future reference value, we take this means to call your especial attention to it.

## FEEDBACK RESEARCH & DEVELOPMENT!

This marks the first time, to our knowledge, that a government agency has set up a program to disseminate results of its R&D to industry.

During this same month, there is the announcement that the Air Force is establishing a permanent Research and Technology Div., headquartered at Bolling AFB, Washington, D. C. Its job will be to provide centralized planning and direction of applied research and advanced technology programs.

There is an impressive list of responsibilities that the new agency will have, but nowhere among them is this function of seeing to the conversion of its R&D findings to civilian applications. Nor do the other agencies of DOD seem concerned over this problem. Isn't it certainly time that they were!





## MONTHLY NEWS ROUND-UP

Radarscope: What's ahead for the Electronic Industries	4
As We Go To Press	7
Electronic Shorts	9
Coming Events	13
TOTALS: Late Marketing Statistics	21
Electronic Industries News Briefs	23
Snapshots . . . of the Electronics Industries	26
International News	32
Next Month in Electronic Industries	87
EDITORIAL: Integrated Circuits Grow and Feedback R & D	1
DESIGNING DIFFUSED INTEGRATED CIRCUIT RESISTORS H. Dicken	88
SEMICONDUCTOR PULSE AMPLIFIER USES . . . AVALANCHE SWITCHING J. J. Naborowski	92
NUCLEAR BLAST EFFECTS ON COMPONENTS & EQUIPMENT L. L. Kaplan & R. G. Saelens	94
TRANSIENTS IN RELAY DIELECTRICS K. B. Austin	102
COAXIAL SWITCHING WITH MERCURY CONTACTS G. J. Falkenbach & A. J. Koda	106
POSSIBILITIES OF FIELD-EFFECT DEVICES E. G. Fonda	112
WHAT'S NEW	116
POWER SUPPLIES . . . DEFINITIONS TO DESIGN	121
■ UNDERSTANDING POWER SUPPLY TERMINOLOGY K. Kupferberg	122
■ SPECIFYING DC ELECTRONIC POWER SUPPLIES . . . D. W. Tanner	128
■ UNDERSTANDING POWER SUPPLY VOLTAGE REGULATORS H. Weitzel	138
■ ENGINEER'S NOTEBOOK #64—POWER SUPPLY REGULATOR NOTES L. C. Oakley	145
■ USING CONSTANT CURRENT POWER SUPPLIES J. Baugher	148
■ VOLTAGE DROP NOMOGRAPH	152
ELECTRONIC OPERATIONS	193
SATELLITES NEED . . . VERSATILE PCM TELEMETRY SYSTEMS S. A. Mixsell	194
PROFESSIONAL OPPORTUNITIES	209
TECHNICAL SESSIONS HIGHLIGHT NEREM '62 SHOW	211
<b>NEW PRODUCTS &amp; TECH DATA</b>	
Power Supply New Tech Data	154
New Tech Data for Engineers	160
New Products	180
<b>DEPARTMENTS</b>	
Tele-Tips	36
Letters	44
Books	58
Personals	82
Systems-Wise	193
Systems & Circuits	204
Industry News	215
News of Mfrs. Representatives	220

SHELBY A. McMILLION, Publisher

BERNARD F. OSBAHR, Editor

CREIGHTON M. MARCOTT  
Executive Editor

RICHARD G. STRANIX  
Features Editor

SMEDLEY B. RUTH  
LOUIS S. GOMOLAK  
CHARLES WEBB  
Assistant Editors

DR. ALBERT F. MURRAY  
Contributing Editor

ROLAND C. DAVIES  
Washington News

JOHN E. HICKEY, Jr.  
Managing Editor

ELMER KETTERER  
Art Director

IDA M. GOOD  
Editorial Secretary

ANNE N. AXE  
Editorial Asst.

MAE E. MOYER  
Readers' Service

### EDITORIAL CORRESPONDENTS

Los Angeles—198 S. Alvarado St.  
(Area Code 213) Dunkirk 7-1271  
J. PHILIP GEDDES, Mgr.

Washington—1093 National Press Bldg.  
GEORGE BAKER, Mgr.  
NEIL R. REGEIMBAL  
DAVID R. HEINLY

### BUSINESS DEPARTMENT

ELMER DALTON  
Advertising Promotion  
& Circulation Manager

DONALD J. MORAN  
Marketing Manager

GORDON HERNDON  
Production Manager

See Advertisers Index for Regional Sales Managers.

Chilton Company—G. C. BUZBY, President  
Executive Vice Presidents: R. E. McKenna,  
G. T. Hook. Vice Presidents: P. M. Fahr-  
endorf, L. V. Rowlands, M. E. Cox, E. B.  
Terhune, Jr., R. W. Case, Jr., J. H. Kofron.  
Treasurer: Stanley Appleby. Secretary: J. A.  
Montgomery. Other Directors: F. P. Tighe,  
C. A. S. Heinle, G. E. Cameron, T. C.  
Campbell, Assistant Secretary: I. C. Hollo-  
way.

JOHN H. KOFRON  
Chilton Research Director

ELECTRONIC INDUSTRIES, October, 1962.  
Vol. 21, No. 10. A monthly publica-  
tion of Chilton Company, Executive, Editor-  
ial & Advertising offices at Chestnut & 56th  
Sts., Phila. 39, Pa. Controlled circulation  
postage paid at Philadelphia, Pa. \$1 a  
copy; Directory issue (June), \$5.00 a copy.  
Subscription rates U. S. and U. S. Posses-  
sions: 1 yr. \$10.00; 2 yrs. \$18.00. Canada  
1 year, \$12.00; 2 yrs. \$20.00. All other  
countries 1 yr., \$18.00; 2 yrs. \$30.00.  
Copyright 1962 by Chilton Company. Title  
Reg. U. S. Pat. Off. Reproduction or re-  
printing prohibited except by written author-  
ization.





# HIGHLIGHTS

of this issue

---

## Designing Diffused Integrated Circuit Resistors page 88

Certain problems arise when both passive and active circuit elements are constructed in a solid crystal of semiconductor material. A method is shown here for obtaining resistors by diffusing a thin layer of p- or n-type impurity into a substrate of the opposite type material.

---

## Avalanche Switching page 92

Avalanche switching is important because of its fast switching speed and its ability to deliver high current pulses to low impedance loads. Here are the details on two switching circuits frequently used.

---

## Nuclear Blast Effects on Components & Equipment page 94

Requirements for radiation hardening are reviewed in relation to military requirements. Problems connected with the evaluation of parts during and after irradiation are discussed. A review of the state of the art for nuclear resistance parts is covered.

---

## Transients in Relay Dielectrics page 102

The unexpected failure in testing a relay's dielectric is usually due to a transient. But what causes the transient? Can we avoid it and still fulfill the specifications? Here are the answers to both questions.

---

## Coaxial Switching With Mercury Contacts page 106

Coaxial switching devices are not new . . . but here's a novel one which uses mercury-wetted contacts that operate magnetically. The relays for both 50-ohm and 75-ohm coaxial lines offer a highly reliable means for remote switching of high-frequency circuits.

---

## Possibilities of Field-Effect Devices page 112

The potentialities of this voltage-controlled semiconductor device may be staggering to the industry. It could replace the bulk of today's tube transistor circuits; it will solve low-noise, high input impedance problems.

---

## Power Supplies . . . Definitions to Design page 121

The articles in this section consist of: Understanding Power Supply Terminology; Specifying DC Electronic Power Supplies; Understanding Power Supply Voltage Regulators; Engineer's Notebook #64—Power Supply Regulator Notes; Using Constant Current Power Supplies; Voltage Drop Nomograph.

---

## Versatile PCM Telemetry Systems page 194

The system in NASA's Orbiting Astronomical Observatory accepts digital and analog information in many different programmable modes. By using the latest modular packaging methods total weight is held to less than 35 pounds. And its probability of proper operation for a full year in orbit is 98%.

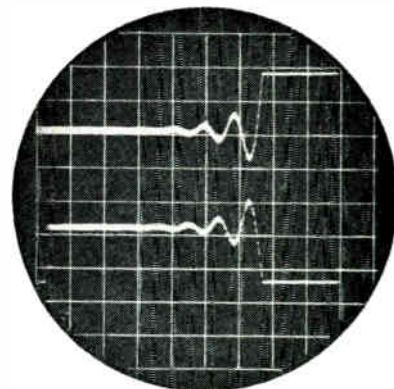

Power Supplies

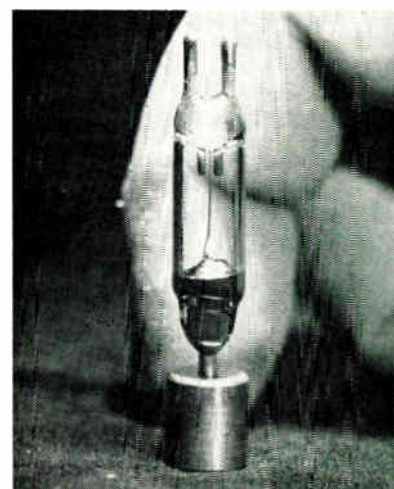

Coaxial Switching

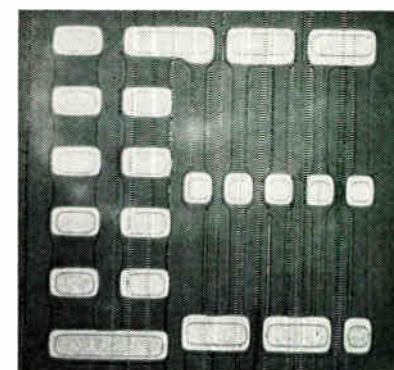

Integrated Circuit Resistors  
PCM Telemetry Systems

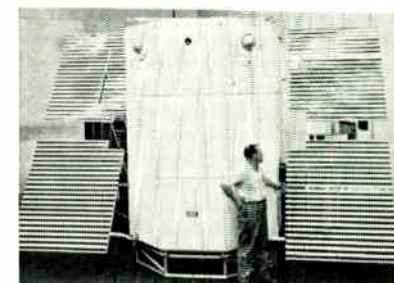

# RADARSCOPE

Analyzing current developments and trends throughout the electronic industries that will shape tomorrow's research, manufacturing and operation

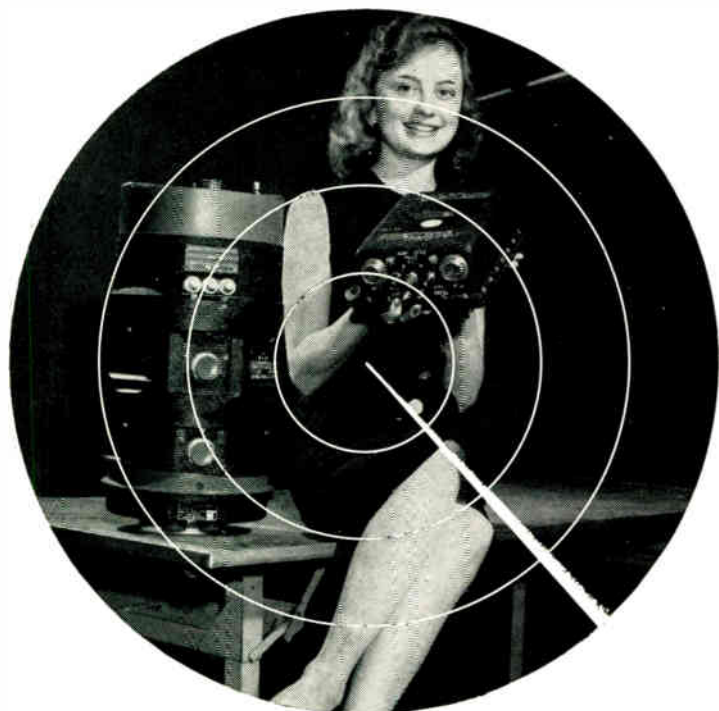

## MARINER II GUIDANCE

The first leg of Mariner II's journey to fly-by Venus was controlled by a lightweight, transistorized radio transponder similar to this equipment held by Judy Brandis, employee of GE's Defense Systems Dept. The 12-lb. decoder held here is one of three components of the airborne portion of GE's radio-command guidance system.

**THE NUMBER OF SCIENTISTS AND ENGINEERS** employed in all industries now totals 850,000, says the National Science Foundation and the Bureau of Labor Statistics. Some 80% are engineers. Comparing salaries for the year 1960, scientists earned a median salary of \$9,000 while engineers, according to the Engineering Manpower Commission, earned a median salary of \$9,600.

**THE NATIONAL SOCIETY OF PROFESSIONAL ENGINEERS** has taken issue with a union official's characterization of engineering as an "apprenticeable trade." The statement was made by R. M. Stephens, pres. of the American Federation of Technical Engineers, AFL-CIO before a Congressional committee. NSPE said such a statement can "discourage young people from engineering careers to the detriment of the defense and security of the Nation."

**IMPROVEMENTS IN AIR TRAFFIC CONTROL** recommended by the FAA's System Design Team include: increased reliance on radar for separation and control; development of altitude transponder equipment to automatically provide height information to ground controllers; stepped up use of computers to assist FAA controllers; and gradually stepped up reliance on the Air Traffic Control Radar Beacon System (ATCRBS) rather than primary radar return from "target" aircraft.

**AT ABSOLUTE ZERO** aluminum retains and even improves upon its desirable characteristics. Battelle Memorial Institute scientists report that in the characteristics of tensile strength, notch toughness, and ductility aluminum either improves, or retains its properties, as the temperature approaches  $-460^{\circ}\text{F}$ .

**EDUCATIONAL TV** within the next decade will need more than three times the 309 channels already allocated to ETV, according to Anthony J. Cellebreeze, Secretary of Health, Education and Welfare. The estimate is based on information gathered from colleges and universities, school systems and active educational TV stations.

## SHIELD FOR RELAY SATELLITE

At Douglas Aircraft Co.'s Missile and Space Systems Div., Santa Monica, Calif., a test model of Project Relay active repeater communications satellite is used to check compatibility of spacecraft and third stage of Delta launch vehicle with fiberglass shrouds. The two 10½-ft. high shrouds protect satellite during flight into outer space.

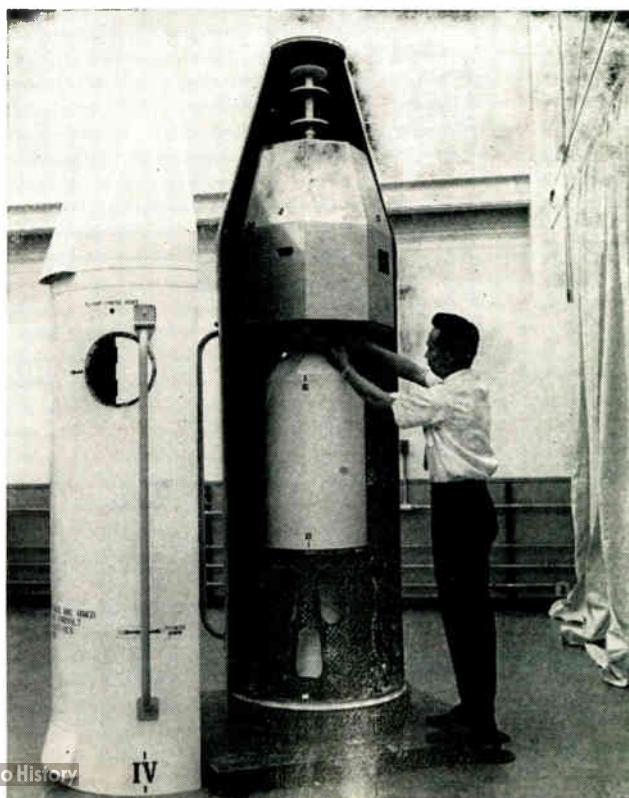



**NEW RADAR ANTENNA SYSTEM** developed at the Univ. of Tenn. is reportedly the world's first rigid 360° scanning antenna. Antenna is made up of 25 different elements through which seven different voltages can be driven. By varying the voltages, the radiated beam can be pointed in any direction.

**EXTREMELY FINE WIRE**, as thin as 0.00012 in. in diameter, can be made through a new technique developed by Glass Developments Ltd., London, England. A piece of glass tubing containing a length of copper wire is passed through a r-f induction heating coil. The molten metal is drawn to an even finer diameter than the glass surrounding it. And the glass coating eliminates need for separate insulation.

**LASER-PUMPED MASER** developed by Hughes Aircraft Co. fills the gap in the electromagnetic spectrum between 50 KMC and 50,000 KMC. The experimental device uses intense red light from a synthetic ruby laser to generate radiation at lower frequencies in a second ruby. This development has broken fundamental limitations to invading the broad 8 or 10 octave gap between microwaves and the infra-red.

**TELSTAR AND THE COMMUNICATIONS SATELLITE** bill have focussed attention on the capabilities of AT&T in this field. At the same time, they have stirred up a number of anti-trust minded Senators who have long been suspicious of AT&T's position of power. Last month, Sen. Estes Kefauver recommended to the Senate Appropriations Committee that \$3,000,000 be set aside "to enable the FCC to conduct an investigation of the telephone industry." The FCC has voiced the opinion that the investigation would be "beneficial."

**SHIPMENTS OF COMPONENTS** in the first quarter 1962 were 4% above the previous quarter's level, and about 18% higher than the first-quarter level last year. Largest gains were in transformers (18%), receiving tubes (12%), and semiconductor devices (8%). Factory shipments of transistors were up only 1.4% from the fourth quarter 1961 total because of falling prices. The average unit price of germanium transistors dropped from \$1.02 to \$0.93, and silicon transistor unit prices from \$5.64 to \$5.29 from the fourth quarter of 1961 to the first quarter of 1962.

**AN IMMEDIATE CENSUS OF ENGINEERS** and scientists was called for by Sen. Howard W. Cannon. He asserted that the scientific manpower shortage was "courting national disaster," and that competition between government and industry for scientific talent was jeopardizing the defense program. Companies are stockpiling engineers, he said, hoping for future government contracts. This thwarts the free movement of engineers into jobs where they are most needed.

**TELEVISION REVENUES ROSE** last year. Totals for the year were \$1,318.3 million, an increase of \$49.7 million over 1960. The three networks and their 15 owned and operated stations reported revenues of \$675.3 million, or 51.2% of the industry total. Almost 80% of the VHF stations, but only about 40% of the UHF stations, reported profitable operations.

**SUPERCONDUCTIVITY** has a new explanation, provided by a British scientist, Dr. Eric Mendoza. As he sees it, normal electrical resistance is produced when the electrons of an electric current are knocked out of their paths by metallic atoms. In superconductors, the electrons can pass these atoms without being deflected. The reason for this, says Dr. Mendoza, is that the electrons move in pairs. Under the conditions near absolute zero, the vibrations of the metallic atoms are slowed down to such an extent that they are unable to break the pairs.

#### **HIGH-POWER LASER TRIGGER**

Raytheon scientist Howard B. Glenn demonstrates new optical device which triggers laser ruby to produce single 20-nanosecond super-power pulses from commercial laboratory laser (disassembled on table). Pulse amplitude is more than 10 times that of conventionally triggered laser of comparable size and power supply. Pulse power is approximately 1,000,000 watts. Pulses with a  $2 \times 10^{-8}$  rise time have been produced. The device, says Raytheon, will make possible a highly accurate optical radar.

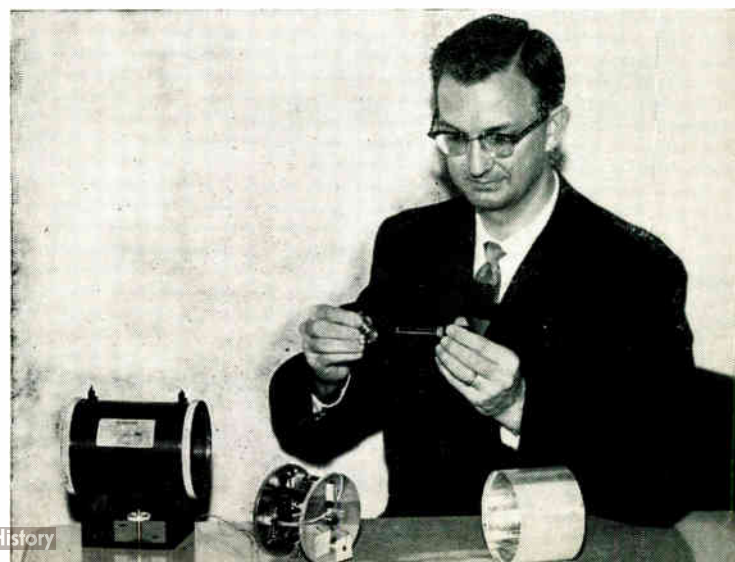



**New from Sprague!**

2 x  $\mu$ F

## Get nearly twice the capacitance of older designs in Sprague's new high-gain etched-foil TANTALEX<sup>®</sup> Capacitors

**IMPROVE FILTERING EFFICIENCY WITH NO SACRIFICE IN RELIABILITY, SIZE, OR WEIGHT!**

**H**IGH CAPACITANCE Tubular Tantalex Capacitors with almost double the capacitance of standard etched-foil tantalum capacitors have been developed by the Sprague Electric Company to meet the needs of design engineers.

A new etching technique, the result of an intensive research program, gives considerably higher effective surface area to the capacitor electrodes *without sacrifice in reliability or in any of the electrical parameters* by which foil tantalum capacitors are usually judged.

Unlike other "high capacitance" foil tantalums, Sprague Tantalex Capacitors continue to maintain their rigid standards for shelf and service life under severe environmental conditions. Certain performance characteristics have actually been tightened. For example, allowable leakage current has now been halved, making the use of these capacitors possible in many new applications.

Etched-foil Tantalex Capacitors are available in two operating temperature ranges—polarized Type 112D and non-polarized Type 113D for  $-55\text{ C}$  to  $+85\text{ C}$  operation, as well as polarized Type 122D and non-polarized Type 123D for  $-55\text{ C}$  to  $+125\text{ C}$  operation.

The Foil-type Tantalex Capacitor Line also includes conventional low-gain etched-foil and plain-foil capacitors in both polarized and non-polarized construction, providing a foil tantalum capacitor for every application.



*For complete technical data on 85 C capacitors, request Engineering Bulletin 3601B. For the full story on capacitors for 125 C operation, write for Engineering Bulletin 3602B. Address Technical Literature Section, Sprague Electric Company, 233 Marshall Street, North Adams, Massachusetts.*

### SPRAGUE COMPONENTS

CAPACITORS  
TRANSISTORS  
MAGNETIC COMPONENTS  
RESISTORS  
MICRO CIRCUITS

INTERFERENCE FILTERS  
PULSE TRANSFORMERS  
PIEZOELECTRIC CERAMICS  
PULSE-FORMING NETWORKS  
TOROIDAL INDUCTORS

HIGH TEMPERATURE MAGNET WIRE  
CERAMIC-BASE PRINTED NETWORKS  
PACKAGED COMPONENT ASSEMBLIES  
FUNCTIONAL DIGITAL CIRCUITS  
ELECTRIC WAVE FILTERS



'Sprague' and '®' are registered trademarks of the Sprague Electric Co.

# AS WE GO TO PRESS

## ALTIMETER



Sperry Gyroscope Co. engineer tests accuracy of low-level altimeter the company is developing for the Air Force. System's transmitter hangs on a piece of sheet metal. Instrument will allow planes to maneuver safely at altitudes previously impractical because of limited measuring capabilities. Altimeter can even measure a plane's altitude as it sits on the runway.

## PENCIL-BEAM RADAR UNDER DEVELOPMENT

A pencil-beam radar to trace and analyze "signatures" of various test targets during reentry is under development by Raytheon Co. at Bedford, Mass.

The six-story high radar is scheduled for installation in 1963 at White Sands Missile Range, N. M. Work is being performed under a USAF contract.

Called RAMPART, the radar derives its name from its role: Radar Advanced Measurements Program for Analysis of Reentry Techniques. It will join other equipment to make up a reentry measurements complex at White Sands.

At the same time RAMPART is tracing the path of payloads plummeting through test areas at reentry speeds, it will obtain measurements making up their identifying radar "signatures." Its tracking and data processing units will take about 100 of these measurements per second.

The radar's 60 ft. dish antenna and its peak power of 24 million watts will give it the capability, if needed, to track basketball-sized objects more than 1000 miles out in space.

## DU PONT MOVES INTO INSTRUMENTS MARKET

Du Pont Co. is invading the analytical instruments field, which has an estimated total industry market of \$25 million a year. The company is offering for sale a process control instrument it developed to monitor processes in its own plants.

Called the Du Pont 400 Series Photometric Analyzer, the electronic-optical instruments range in price from \$2,200 to \$4,500, depending on its use. The instruments are being manufactured by an outside contractor, but sales are being handled through a newly formed Instrument Products division.

At least three additional instruments, currently in use at several Du Pont plants, will be introduced in the future. Du Pont plans to "phase into" manufacturing the instruments itself, but no schedule has been established, a spokesman said.

## CIRCUIT STANDARDS DIVISION ENLARGED

Three new sections have been created in the Circuit Standards Div. at the Boulder Labs. of the Nat'l Bureau of Standards, U. S. Dept. of Comm. The new sections were formed from units of the Electronic Calibration Center. Each of the new sections will continue to develop, maintain, and improve calibration services, instrumentation, and measurement techniques for their appropriate region.

## "WILLIAM TELL"

TV coverage of flight line action at USAF "Project William Tell" at Nellis AFB is supplemented by portable camera and transmitter. Dage "Tele-Tran" TV system allows coverage up to 1/2-mi. from central control area without cable. Camera weighs only four lbs. and transmitter 12 lbs.



## REMOTE OPERATION

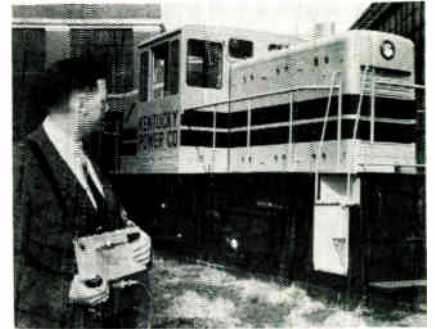

This 80-ton GE diesel-electric locomotive, delivered recently to Ky. Power Co., features fail-safe remote-control radio operation as well as standard "in-cab" operation by an engineer. Button in operator's hand must be depressed to activate carrier signal, providing cutoff in case of operator failure.

## CAPACITORS TO USE HERMETIC SEAL

The U. S. Signal Corps has awarded G. E. a contract to develop the first tantalum foil capacitor employing a true hermetic seal. Sealing by means of tantalum-to-glass bonding techniques will be achieved on 10 experimental models to be developed within eight months and 50 final models, with test data, to be readied 10 months later.

The capacitors will use etched tantalum foil construction and will be enclosed in a single tubular metallic case. They will have axial leads and glass-to-metal and/or ceramic-to-metal seals.

*More News on Page 9*

**CUT CONTROL PANEL COSTS  
AND SAVE SPACE WITH  
COMBINED SIGNAL & SWITCH**

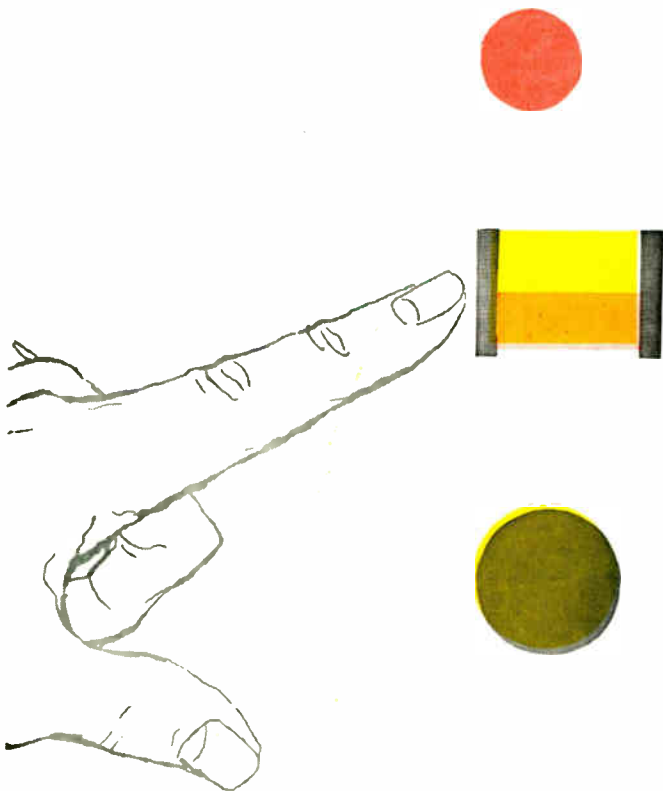

The most modern control panel designs combine indicator lights and pushbutton switches wherever possible. This cuts costs by reducing the number of components, and speeds assembly. Overall panel size can often be reduced as much as 75%. And these "human-engineered" controls sell better because operation is obviously simplified. Here are just three of the many lighted pushbuttons available from Control Switch Division...

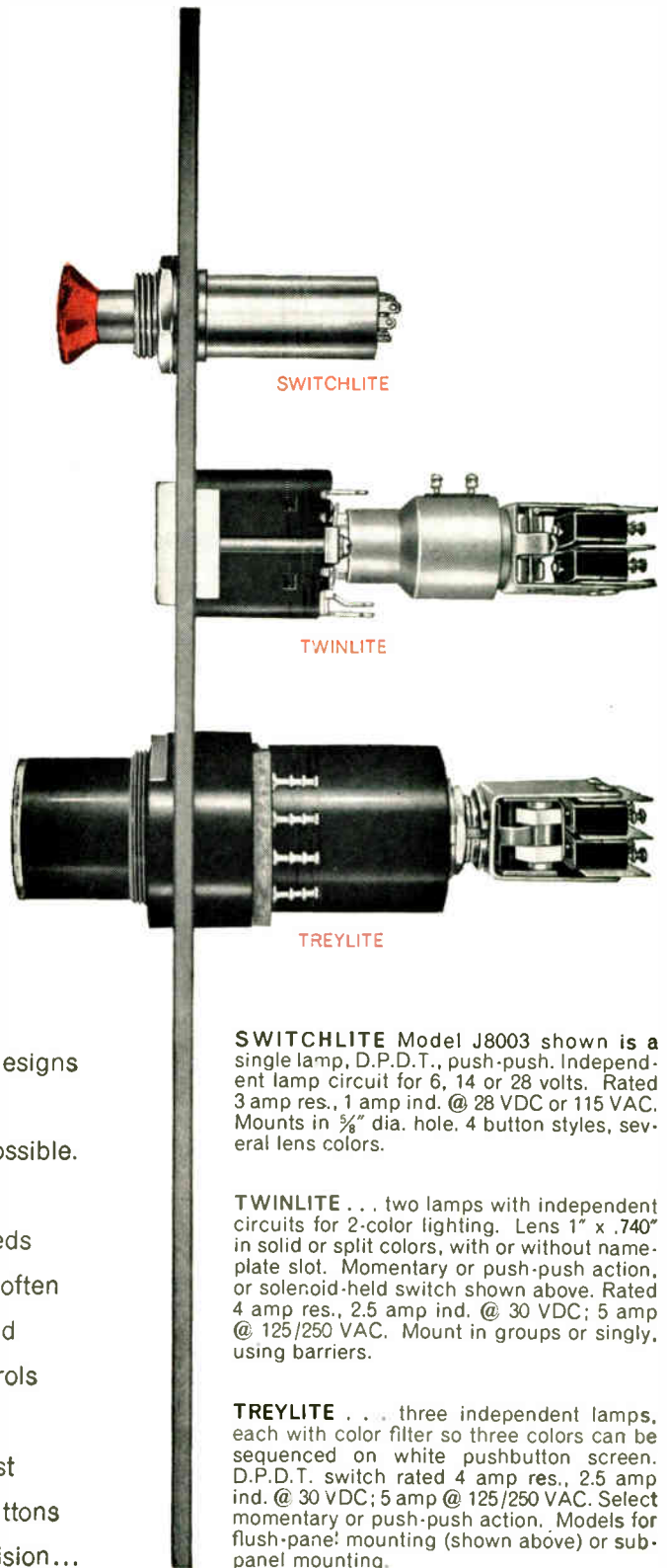

**SWITCHLITE** Model J8003 shown is a single lamp, D.P.D.T., push-push. Independent lamp circuit for 6, 14 or 28 volts. Rated 3 amp res., 1 amp ind. @ 28 VDC or 115 VAC. Mounts in  $\frac{5}{8}$ " dia. hole. 4 button styles, several lens colors.

**TWINLITE** . . . two lamps with independent circuits for 2-color lighting. Lens 1" x .740" in solid or split colors, with or without nameplate slot. Momentary or push-push action, or solenoid-held switch shown above. Rated 4 amp res., 2.5 amp ind. @ 30 VDC; 5 amp @ 125/250 VAC. Mount in groups or singly, using barriers.

**TREYLITE** . . . three independent lamps, each with color filter so three colors can be sequenced on white pushbutton screen. D.P.D.T. switch rated 4 amp res., 2.5 amp ind. @ 30 VDC; 5 amp @ 125/250 VAC. Select momentary or push-push action. Models for flush-pane! mounting (shown above) or sub-panel mounting.

**CONTROLS COMPANY OF AMERICA**  
**CONTROL SWITCH DIVISION**

1420 Delmar Drive • Falcroft, Pennsylvania • Telephone LUdlaw 6-7500 • TWX 215-534-0241

Write for **FREE CATALOG**  
on **LIGHTED SWITCHES.**

Manufacturers of a full line of switches, controls and indicators for all military and commercial applications. All standard units stocked for immediate delivery by leading parts Distributors.



## AS WE GO TO PRESS

### ARMY SCIENTISTS ANALYZE THUNDERSTORMS

Project BATON, a Dept. of Defense research project supported by the Advanced Research Project Agency, has been established to study atmospheric processes and modification. As a part of this program, the Dept. of the Army and its contractor, Meteorology Research, Inc., of Pasadena, Calif., are jointly conducting experiments in the central Ariz. area.

Analysis of data from this experiment is expected to expand man's understanding of storm physics, and to provide new knowledge useful for forecasting, fire prevention, and, possibly, for artificially shaping the weather some day.

The experiment is concerned with the study of the evolution of isolated thunderstorms, and the relationship between their physical development and lightning formation. The experiments will not affect the area's weather pattern.

The scientists select "guinea pig" storms and sprinkle them with chemicals and dry ice to create minor structural changes. The effects are thoroughly analyzed from the ground and from the air with time-lapse motion picture cameras, stereo still cameras, storm cameras, storm radar, lightning detectors, and airborne heat sensors.

### TEST CENTER

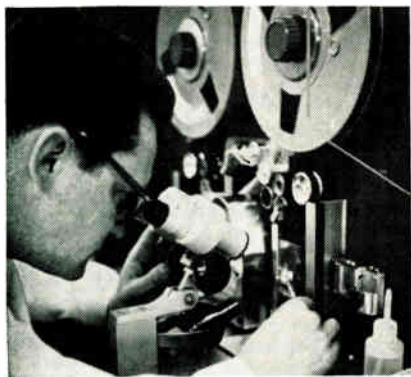

Inspector at new IBM magnetic tape testing center at Poughkeepsie, N. Y., uses scalpel to remove minute speck from magnetic tape. If a defect cannot be removed, entire reel of tape is rejected as small imperfections in the tape can prevent accurate processing of information by computers.

*(Continued on page 10)*

## ELECTRONIC SHORTS

■ NASA has contracted Measurement Systems, Inc. of South Norwalk, Conn. to design and build an optical system which will track a missile automatically and read out its angular position in space with an accuracy of 5 seconds of arc. System is called a Prototype Real Time Optical Tracker. It will include a tracking telescope, precision mount, video displays and digital data handling equipment.

■ Calif. Inst. of Technology's Jet Propulsion Lab has contracted Electro-Optical Systems, Inc. of Pasadena to build prototype flight model fuel cells for spacecraft power systems. EOS will build three multicell electrically regenerative hydrogen-oxygen fuel cell assemblies under the contract. They will operate in the 25 to 34 volt range and will have a capacity of 30 to 40 amp hours. They must also meet environmental specifications for Mariner flight equipment.

■ U. S. Navy aircraft carriers will be equipped with closed circuit TV equipment from Ampex Corp., under a new safety program. Equipment will cover all landings from several angles and display the progress of each landing so that carrier personnel can "talk the pilot down" with greater precision than ever before. TV tape and audio recordings of each landing will be rerun for evaluation and pinpointing of inaccuracies.

■ A six-month feasibility study to determine a system of extreme accuracy in pin pointing the position of a rocket booster during early launch stages for purposes of trajectory, thrust and stability determination, has been made by Electro-Optical Systems, Inc., Pasadena, Calif., for NASA. As a result of this study EOS engineers feel that a Laser beacon optical tracking system can perform this function more accurately than can r-f devices, or inertial guidance systems. They have proposed a system which would use a 20 joule ruby Laser with a frequency of 6943 Angstroms.

■ A contract to design and make remote handling systems for the NERVA (Nuclear Engine for Rocket Vehicle Application) program has been awarded to American Machine & Foundry Co., by Aerojet-General Corp. Remote handling of the NERVA engine will be required whenever the radioactivity level of the engine or any of its components precludes direct contact by personnel. This will include assembly of the engine when radioactive components are re-used, removal of the radioactive engine from the test stand, reactor core replacement in a tested engine, and teardown and inspection of a tested engine.

■ A trainable machine that learns from experience how to perform human-like tasks has been demonstrated by Stanford Univ. electronic scientists. Called "Madaline 1" by its developers, the machine balanced a cardboard broom and read letters of the alphabet. And a "simulated" Madaline system typed out numbers dictated by its scientist "boss." Madaline is trained by letting the machine "see," "hear," or "feel" their instructions by means of photo cells, a microphone, or manually-operated buttons and knobs.

■ USAF has awarded Lear Siegler, Inc., Long Island City, N. Y., a \$2.2 million contract for production of meteorological radar sets for the Air Force's worldwide modernized weather system. The radar units are designed to measure and display the horizontal and vertical cross section of weather phenomenon such as storms, fronts and precipitation. They consist of a C band (5000 MC) magnetron and modulator, paraboloid antenna and associated feed systems.

■ A contract to develop and fabricate a complete instrumentation system for a study of bottom currents and sediment movement across the Continental Shelf, which borders the Pacific Northwest, has been awarded Oceanic Instruments, Inc., Houghton, Wash. Contract was received from the Univ. of Wash. The instrument package will include an underwater TV camera, current meters, sediment collectors, an underwater platform, a shipboard power supply control, the platform and shipboard control chassis.

# AS WE GO TO PRESS

## NUCLEAR REACTOR

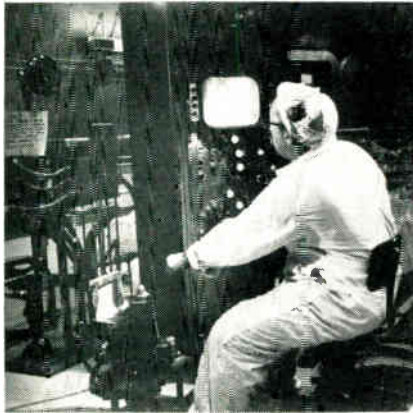

Technician at Consolidated Edison Co. of New York's new nuclear power plant uses televised pictures from cameras in 25 ft. of water to guide him in the operation of remotely-controlled handling equipment. Closed circuit TV system, built by RCA, monitors loading of 120 fuel elements into reactor core where they will remain during an operating cycle of two years.

## ARMY ORDERS BROADCASTING SYSTEM

Army Signal Corps has contracted for a powerful broadcasting system designed to be airlifted by helicopter. Gates Radio Co., Quincy, Ill., will build the first system.

One of the transmitters will be a 50 kw standard broadcast unit. The other is a 50 kw short wave transmitter. The system is housed in 21 packaged units and will include telescoping antenna towers, fully equipped studios with tape recorders, turntables and teletypes for news wires, diesel-powered electrical generators, and a sensitive receiving station.

## SENSOR STEERS SOLAR ENERGY CONVERSION UNIT

A "sun seeker" that permits unattended operation of solar energy conversion power units has been developed by Goodyear Aircraft Corp. under contract to the Army.

The sensor operates on control signals provided by solar cells mounted on three sides of the device. When the direction of sunlight changes from the apex of the triangle, the sensor feeds an electrical impulse to a drive motor that rotates the panel back into a position facing the sun.

Electrical power derived from the solar cell panel may be stored in a battery which can then supply power to the panel drive motor in addition to the primary load (radio transmitter, beacon, etc.), even during night hours.

## USA TESTING MOSAIC MAP SYSTEM

An automatic system for the construction of mosaic maps from aerial photographs is currently being tested by the U. S. Army Engineer Geodesy, Intelligence and Mapping R & D Agency (GIMRADA), Fort Belvoir, Va.

The system, which uses an automated autofocusing rectifier and an automated variable magnification positioning printer, is designed to meet the demand for rapid and accurate map positions. Photomosaics normally are made by a cut and paste process, which is time consuming but which still saves time over the laborious drafting of a topographic map.

Each of the two units in the system is equipped with an individual electronic control console capable of conversion to punched tape operation.

## BETATRON

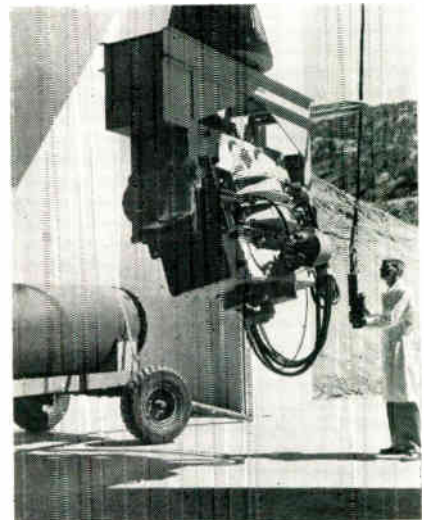

Non-destructive test technician aims Lockheed Propulsion Company's 25-million electron volt X-ray machine at solid propellant rocket motor at the firm's Potrero facility near Beaumont, Calif. The new test equipment, capable of inspecting 156-inch diameter solid rocket motor segments or 20-inches of steel, can detect in seconds flaws which might otherwise go unnoticed.

## FAA ANNOUNCES NEW DIVISIONS

New organizations for Frequency Management and Applications Engineering have been established in the Systems R & D Service of the Federal Aviation Agency.

The Frequency Management Div. will be responsible for establishing the FAA needs in the radio frequency spectrum and obtaining radio frequency channels for FAA use from the Office of the Director, Telecommunications Management, which makes frequency assignments to U. S. Govt. agencies. It will also be responsible for assuring that the agency is complying with conditions of the assignments.

This division was formerly under the FAA Aviation Facilities Service, which has been split into a Systems Maintenance Service and an Installation and Material Service.

The newly formed Applications Engineering Div. will be responsible for final engineering design, development of prototypes, and specification for production of all equipment systems used by the agency for air traffic control and navigation. The organizational change is designed to speed up improvements in air traffic control and navigation systems.

## SERVICE STATION

Maintenance stations such as this would remain in space permanently to maintain and refuel atomic-powered space craft. The self-propelled repair shop for radio-active equipment is shown with another space vehicle docked for maintenance (r). Personnel quarters are in the center and station's propulsion system is at left.

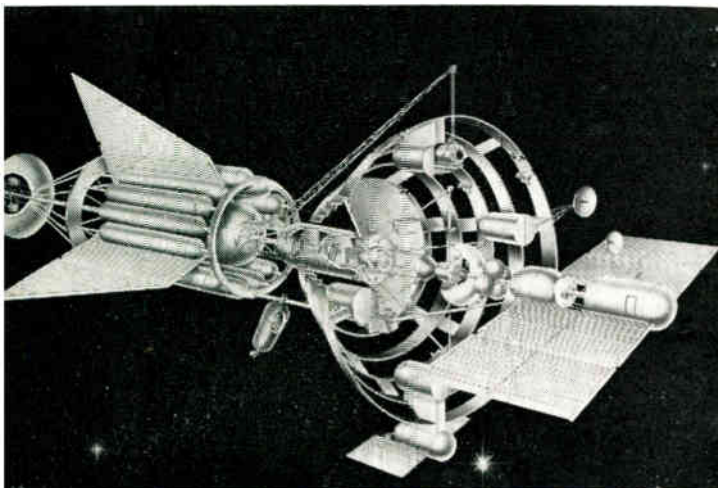

*More News on Page 23*



# our stock answer is

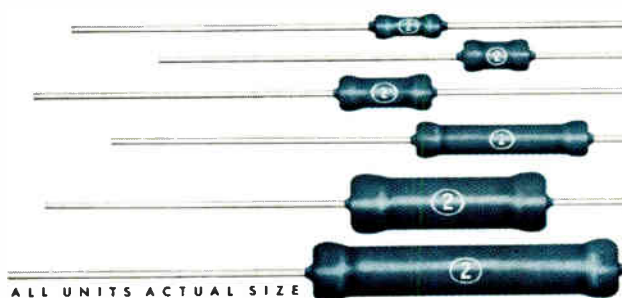

# YES!

## ALL AXIAL LEAD BLUE JACKET RESISTORS

*in 1, 2, 3, 5, 7 and 10-watt power ratings are carried in factory stock for immediate delivery. Place your order now with your nearest Sprague District Office or Sales Representative.*

*Key Sprague Industrial Distributors carry most popular ratings in local stocks.*

### S P R A G U E   S A L E S   O F F I C E S

Ariz. Phoenix, Sprague Electric Co., 3550 N. Central Ave., 279-5435  
 Cal. Los Angeles, Sprague Electric Co., 12870 Panama St., UP 0-7531 or EX 8-2791  
 San Francisco, W. J. Purdy of Calif., 312 7th St., UN 3-3300  
 Colo. Denver, R. G. Bowen Co., Inc., 721 S. Broadway, RA 2-4641  
 D.C. Washington, Sprague Electric Co., 2321 Wisconsin Ave., N.W., 338-7911  
 Fla. Clearwater, Sprague Electric Co., 1152 Cleveland St., 446-3119  
 Ill. Chicago, Sprague Electric Co., 5942 W. Montrose Ave., MU 5-6400  
 Mass. North Adams, Sprague Electric Co., Marshall St., 664-4411  
 Newton, Sprague Electric Co., 313 Washington St., WO 9-7640  
 Mich. Detroit, ABM Sales Co., 10116 Puritan Ave., UN 2-1300  
 Minn. Minneapolis, H. M. Richardson & Co., Inc., 9 E. 22nd St., FE 6-4078

Mo. St. Louis, Sprague Electric Co., 3910 Lindell Blvd., JE 5-7239  
 N. J. Camden, Sprague Electric Co., 545 Cooper St., WO 6-1776  
 N. M. Albuquerque, Bowen & Carlberg Co., 2228A San Mateo Blvd., N.E., AM 5-1579  
 N. Y. New York, Sprague Electric Co., 50 E. 41st St., OR 9-1195  
 Great Neck, William Rutt, Inc., 123 Middle Neck Rd., HU 2-8160  
 N. C. Winston-Salem, Sprague Electric Co., 928 Burke St., 722-5151  
 Ohio Chagrin Falls, Sprague Electric Co., 24 N. Main St., CH 7-6488  
 Dayton, Sprague Electric Co., 224 Leo St., BA 3-9187  
 Tex. Dallas, Sprague Electric Co., 3603 Lemmon Ave., La 1-9971  
 Utah Salt Lake City, R. G. Bowen Co., Inc., 463 E. 3rd St., S., EM 3-4528  
 Wash. Seattle, Sprague Electric Co., 4601 Aurora Ave., ME 2-7761

*For application engineering assistance write:  
 Resistor Division, Sprague Electric Co., Nashua, New Hampshire.*

### SPRAGUE COMPONENTS

RESISTORS	INTERFERENCE FILTERS	HIGH TEMPERATURE MAGNET WIRE
CAPACITORS	PULSE TRANSFORMERS	CERAMIC-BASE PRINTED NETWORKS
MAGNETIC COMPONENTS	PIEZOELECTRIC CERAMICS	PACKAGED COMPONENT ASSEMBLIES
TRANSISTORS	PULSE-FORMING NETWORKS	FUNCTIONAL DIGITAL CIRCUITS
MICRO CIRCUITS	TOROIDAL INDUCTORS	ELECTRIC WAVE FILTERS



'Sprague' and '®' are registered trademarks of the Sprague Electric Co.



# THIS 10MC SHIFT REGISTER

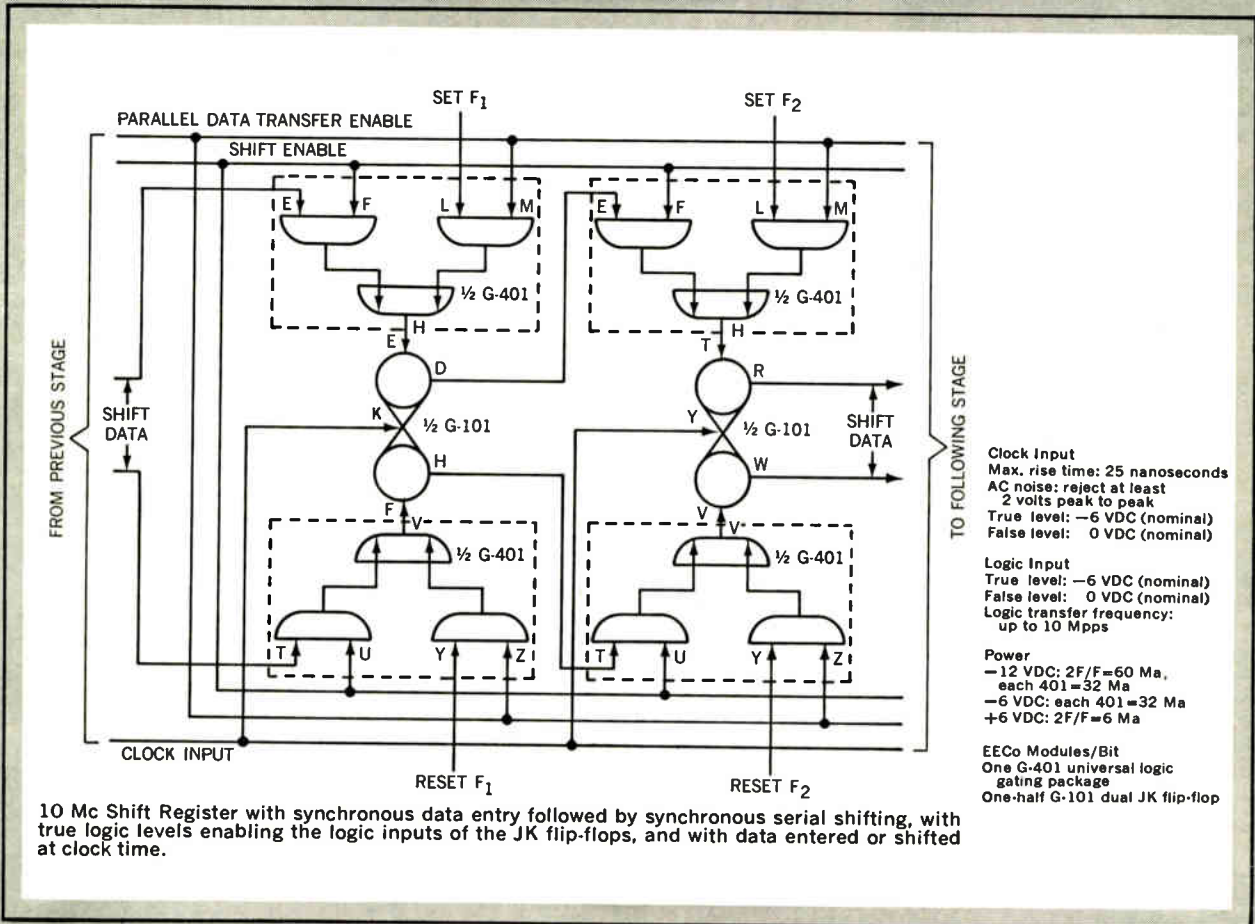

**Clock Input**  
 Max. rise time: 25 nanoseconds  
 AC noise: reject at least 2 volts peak to peak  
 True level: -6 VDC (nominal)  
 False level: 0 VDC (nominal)

**Logic Input**  
 True level: -6 VDC (nominal)  
 False level: 0 VDC (nominal)  
 Logic transfer frequency: up to 10 Mpps

**Power**  
 -12 VDC: 2F/F=60 Ma, each 401=32 Ma  
 -6 VDC: each 401=32 Ma  
 +6 VDC: 2F/F=6 Ma

**ECo Modules/Bit**  
 One G-401 universal logic gating package  
 One-half G-101 dual JK flip-flop

## COSTS LESS THAN \$68/BIT

Yet, it utilizes the most reliable circuits you can buy today—ECo G-Series extended-service digital-circuit modules. Every ECo module is guaranteed reliable and will be repaired or replaced under conditions defined in the company's written warranty. In addition, every module is a catalog item, available from stock. You can select from the 10 Mpps, 500 Kpps, and 25 Kpps basic frequency groups. No matter what your choice, three major benefits will always be yours—reliability, economy, availability.

This is just one of the many practical applications of this versatile new series. Perhaps another will be of direct interest to you. Write, wire, or phone today for complete details; ask for the new G-Series catalog or a call from one of our experienced staff of applications engineers.

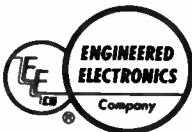
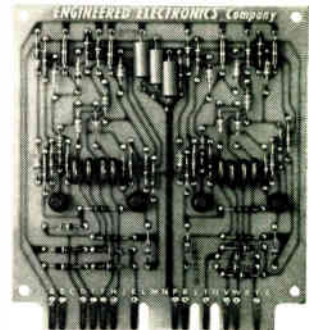

**ENGINEERED ELECTRONICS Company**  
 1441 East Chestnut Avenue, Santa Ana, California  
 Telephone: 547-5651 Cable Address: ENGELEX

See these new circuits in Booth 311 at the National Electronics Conference in Chicago.

# COMING EVENTS

...in the electronic industry

## OCTOBER

- Oct. 14-17: Conf. on Electrical Insulation, Nat'l. Academy of Science, Nat'l. Rsrch. Council; Hershey Hotel, Hershey, Pa.
- Oct. 15-16: NAB Fall Reg. Conf.; Dinkler-Plaza Hotel, Atlanta, Ga.
- Oct. 15-17: 18th Annual Conv., Magnesium Assoc.; Biltmore Hotel, Los Angeles, Calif.
- Oct. 15-18: Int'l. Symp. on Space Phenomena & Measurement; IRE (PGNS), AEC, NASA; Statler-Hilton Hotel, Detroit, Mich.
- Oct. 15-19: 1962 Audio Eng. Soc. Fall Conv.; Barbizon-Plaza Hotel, New York, N. Y.
- Oct. 15-19: 17th Int'l. Instrument-Automation Conf. & Exh., ISA Annual Mtg.; New York Coliseum, New York, N. Y.
- Oct. 15-20: Pacific Coast Reg. Mtg., ACS; Olympia Hotel, Seattle, Wash.
- Oct. 16-19: South Central Reg. Conf. & Exh., NACE; Granada Hotel, San Antonio, Tex.
- Oct. 18-19: AIEE Reg. Conf.; Lafayette Hotel, Buffalo, N. Y.
- Oct. 18-19: 6th Annual Display, AES; Conference Bldg., Balboa Park, San Diego, Calif.
- Oct. 18-19: NAB Fall Reg. Conf.; Biltmore Hotel, New York, N. Y.
- Oct. 19: 3rd New York Conf. on Electronic Reliability, IRE (PGRQC, PGPEP, PGCP); Stevens Inst. Tech., Stevens Ctr., Hoboken, N. J.
- Oct. 21-26: Semiannual Fall Conv. & Equip. Exh., SMPTE; Drake Hotel, Chicago, Ill.
- Oct. 22-23: NAB Fall Reg. Conf.; Edge-water Beach Hotel, Chicago, Ill.
- Oct. 22-24: 9th Annual East Coast Conf. on Aerospace & Navigational Electronics, IRE (PGANE); Emerson Hotel, Baltimore, Md.
- Oct. 24-25: 1962 Computer Applications Symp., ARF; Morrison Hotel, Chicago, Ill.
- Oct. 24-26: Annual Mtg., Soc. for Experimental Stress Analysis; Schroeder Hotel, Milwaukee, Wisc.
- Oct. 24-26: Electrical Insulating Materials Mtg., AST&M; Statler-Hilton Hotel, Boston, Mass.
- Oct. 25-26: NAB Fall Reg. Conf.; Statler-Hilton Hotel, Washington, D. C.
- Oct. 25-27: 1962 Electron Devices Mtg., IRE (PGED); Sheraton-Park Hotel, Washington, D. C.
- Oct. 26-27: Midwest Quality Control Conf., ASQC; Statler-Hilton Hotel, Denver, Colo.
- Oct. 29: "Space Science Down to Earth," 4th Annual Western Tech. Conf., AIEE Committees on Domestic Appliances and Domestic & Com-

- mercial Applications; Biltmore Hotel, Los Angeles, Calif.
- Oct. 29-31: 15th Annual Int'l. Systems Mtg., Systems & Procedures Assoc.; Statler-Hilton, Sheraton-Plaza Hotels, Boston, Mass.
- Oct. 29-31: Mtg., Soc. of Rheology; Johns Hopkins Univ., Baltimore, Md.
- Oct. 29-31: Symp., "Dynamics of Manned Lifting Planetary Entry," AFOSR; Philadelphia, Pa.
- Oct. 29-Nov. 2: World Metal Show & 44th Nat'l. Metal Cong., ASM; Coliseum, New York, N. Y.
- Oct. 30-31: Nat'l. Spaceborne Computer Eng. Conf., IRE (PGEC); Disneyland Hotel, Anaheim, Calif.
- Oct. 30-Nov. 1: 8th Tri-Service Conf. on Electromagnetic Compatibility, ARF; Ill. Inst. Tech., Chicago, Ill.

## NOVEMBER

- Nov. 1-2: 6th Nat'l. Conf. on Product Eng. & Production, IRE (PGPEP); Jack Tar Hotel, San Francisco, Calif.

### '63 Highlights

- IRE Int'l. Conv., Mar. 25-28: Coliseum and Waldorf-Astoria Hotel, New York, N. Y.
- WESCON, Western Electronic Show & Conf., Aug. 20-23, IRE, WEMA; Cow Palace, San Francisco, Calif.
- NEC, Nat'l. Electronics Conf., Oct. 28-30, IRE, AIEE, McCormick Place, Chicago, Ill.
- NEREM, Northeast Research & Eng. Mtg., Nov. 4-6, IRE; Boston, Mass.
- Nov. 1-2: Chemtronics Conf., ASQC; Statler-Hilton Hotel, New York, N. Y.
- Nov. 1-2: Annual Instrumentation Conf., La. Polytech. Inst.; Ruston, La.
- Nov. 1-2: AIEE Reg. Conf.; Deauville Hotel, Miami Beach, Fla.
- Nov. 1-3: Fall Mtg., Nat'l. Soc. Prof. Engrs.; Hotel Westward Ho, Phoenix, Ariz.
- Nov. 1-3: AIEE Reg. Cong.; Shoreham Hotel, Washington, D. C.
- Nov. 4-7: 15th Annual Conf. on Eng. in Medicine & Biology, IRE, AIEE, ISA; Conrad-Hilton Hotel, Chicago, Ill.
- Nov. 5-7: 1962 Northeast Electronics Res. & Eng. Mtg., IRE; Commonwealth Armory & Somerset Hotel, Boston, Mass.
- Nov. 5-9: Fall Mtg., AIME, MS; Chicago, Ill.
- Nov. 7-10: Fall Mtg., Acoustical Soc. of America; Olympia Hotel, Seattle, Wash.
- Nov. 8-9: NAB Fall Reg. Conf., Sheraton-Dallas Hotel, Dallas, Tex.
- Nov. 8-9: Nat'l. Mtg., Operations Rsrch.

- Soc. of America; Sheraton Hotel, Philadelphia, Pa.
- Nov. 8-9: Regional Tech. Conf., SPE; Hotel Essex House, Newark, N. J.
- Nov. 10-25: World Economic Progress Assembly & Exp., Ctr. for Int'l. Economic Growth; McCormick Pl., Chicago, Ill.
- Nov. 12-13: NAB Fall Reg. Conf.; Muehlbach Hotel, Kansas City, Mo.
- Nov. 12-15: 8th Annual Magnetism & Magnetic Materials Conf. & Exh., AIEE, AIP; Penn-Sheraton Hotel, Pittsburgh, Pa.
- Nov. 12-18: Annual Mtg. & Astronautical Exp., ARS; Pan Pacific Audit., Los Angeles, Calif.
- Nov. 15-16: NAB Fall Reg. Conf.; Brown Palace Hotel, Denver, Colo.
- Nov. 19-20: 1962 Mid-American Electronics Conf., Kansas City Section, IRE; Continental Hotel, Kansas City, Mo.
- Nov. 19-20: NAB Fall Reg. Conf.; Sheraton-Portland Hotel, Portland, Ore.
- Nov. 23-24: Thanksgiving Mtg. of the APS; Cleveland, Ohio.
- Nov. 25-30: Annual Winter Mtg., ASME; Statler Hilton Hotel, New York, N. Y.
- Nov. 26-28: Machine Tools Conf., AIEE; Statler-Hilton Hotel, Detroit, Mich.
- Nov. 26-28: AIF Conf.; Sheraton-Park Hotel, Washington, D. C.
- Nov. 26-29: ANS Winter Mtg.; Shoreham Hotel, Washington, D. C.
- Nov. 27-29: AtomFair-62, ANS, AIF; Shoreham Exh. Hall, Washington, D. C.
- Nov. 27-29: EIA Mtg.; Jack Tar Hotel, San Francisco, Calif.
- Nov. 28-30: 1962 Ultrasonics Symp., IRE (PGUE); Columbia Univ., New York, N. Y.
- Nov. 28-30: Human Factors Soc. Annual Mtg.; Barbizon-Plaza Hotel, New York, N. Y.

## DECEMBER

- Dec. 2-6: Annual Mtg., AICHe; Conrad Hilton Hotel, Chicago, Ill.
- Dec. 4-6: Fall Joint Computer Conf., IRE (PGEC), AIEE, ACM, Simulation Councils, Inc.; Sheraton Hotel, Philadelphia, Pa.
- Dec. 6-7: 13th Nat'l. Tech. Conf., IRE (PGVC); Disneyland Hotel, Los Angeles, Calif.
- Dec. 26-29: Winter APS Mtg.; Stanford, Calif.
- Dec. 26-31: Space Physics Conf., ARS; Phila., Pa.

## 1963

## JANUARY

- Jan. 8-10: "Millimeter & Submillimeter (Continued on page 15)



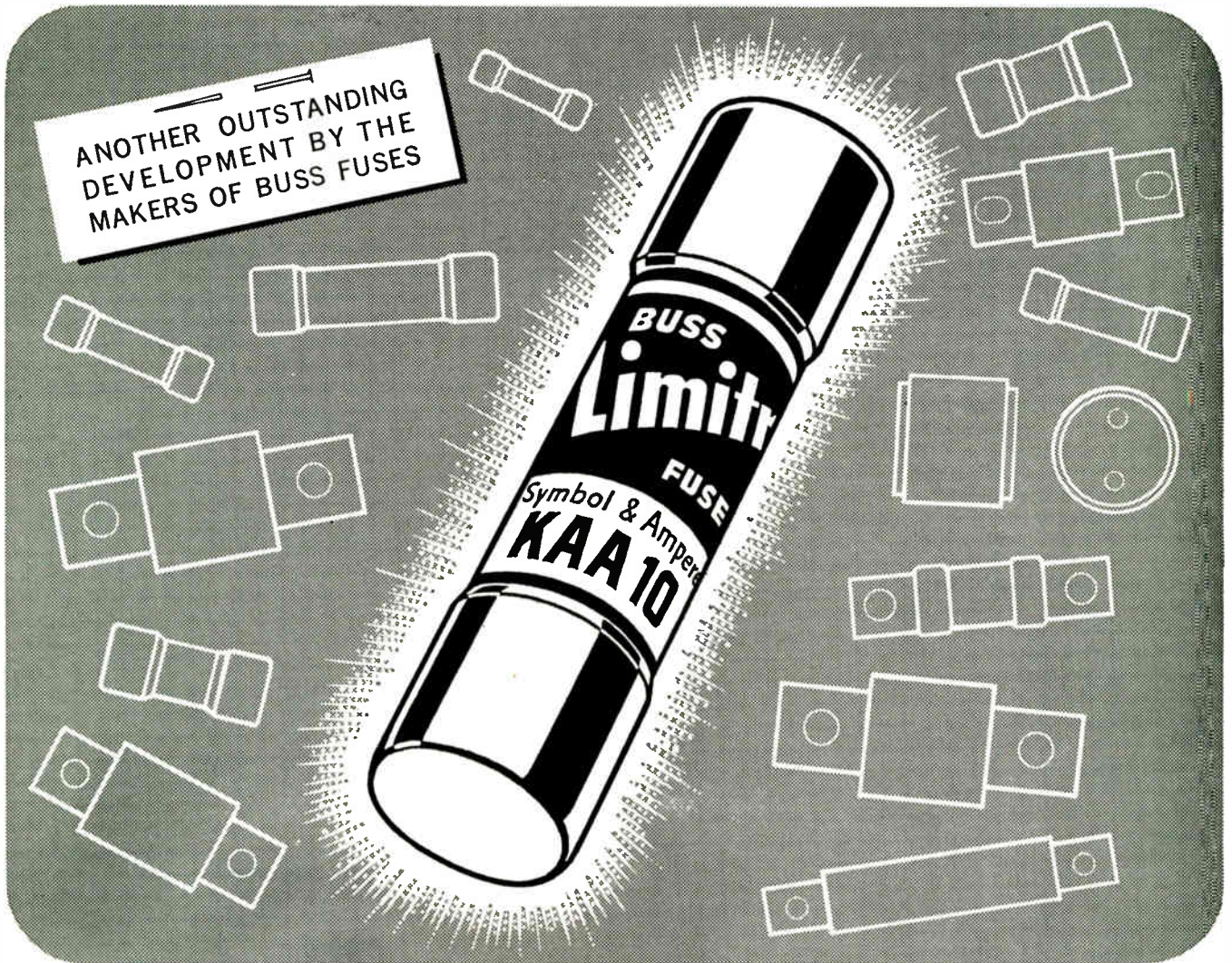

**For Protection of  
Semi-Conductor Rectifiers—  
BUSS designed special LIMITRON Fuses**

BUSS Limitron fuses are especially designed for the protection of semi-conductor rectifiers. They provide extremely fast opening on overload and fault currents, with a high degree of restriction of the let-thru current.

If each diode is protected by the proper size BUSS Limitron fuse, the fuse will open very quickly when the current drawn exceeds the rating of the diode.

Thus when a short-circuit occurs in a diode the fuse opens and takes that diode out of the circuit. This protects other good diodes in the rectifier which might otherwise be damaged.

For time-current characteristic charts ask for *BUSS Limitron fuse bulletin HLS*.

**If your protection problem is unusual . . .**

. . . let the BUSS fuse engineers work with you and save you engineering time. If possible, they will suggest a fuse already available in local wholesalers' stocks so your products can easily be serviced wherever sold.

**BUSS: one source for every electrical protection need**

You can save time and trouble by relying on BUSS as your one source for fuses of unquestioned high quality. There is a complete line of BUSS fuses in sizes from 1/500 amperes up . . . plus a companion line of fuse clips, blocks, and holders.

**BUSS**

BUSSMANN MFG. DIVISION  
MAKERS OF THE COMPLETE LINE OF FUSES OF UNQUESTIONED HIGH QUALITY  
McGraw-Edison Co. • St. Louis 7, Mo.



# COMING EVENTS

- Conf.," IRE; Cherry Plaza Hotel, Orlando, Fla.
- Jan. 21-24: Annual Mtg., American Mathematical Soc., Mathematical Assoc. of America; Univ. of Calif., Berkeley, Calif.
- Jan. 21-24: 9th Nat'l. Symp. on Reliability & Quality Control, IRE (PG-RQC), AIEE, ASQC, EIA; Sheraton-Palace Hotel, San Francisco, Calif.
- Jan. 22-25: ERA Annual Conf.; Mark Hopkins Hotel, San Francisco, Calif.
- Jan. 23-26: Mtg., APS & AAPT; Statler-Hilton Hotel, New York, N. Y.
- Jan. 28-Feb. 1: 1963 AIEE Winter Gen'l. Mtg. & Electrical Eng. Exp.; Hotel Statler-Hilton & Coliseum, New York, N. Y.
- Jan. 30-Feb. 1: 4th Nat'l. Winter Conv. on Military Electronics, IRE (PG-MIL), Dept. of Defense; Ambassador Hotel, Los Angeles, Calif.

## "CALL FOR PAPERS"

1963 *Electronic Components Conf.*, May 7-9, 1963, Washington, D. C. Sponsored by AIEE, EIA, IRE, with ASQC participating. Papers to cover new developments in components, including processing techniques, evaluation and materials. A 500-word summary should be submitted by Nov. 1, 1962. Forward to: Chief, Bureau of Ships; Department of the Navy; Washington 25, D. C.; Att'n. Code 681A2C (E. J. Kaputa).

## ENGINEERING EDUCATION

Short courses of interest to engineers.

### Government Contracting

A series of quality control and procurement education meetings for small businessmen is being held throughout the Southeast by the *Orlando (Fla.) Division of the Martin Co.* Lectures scheduled in the near future will be in Miami, Oct. 19, 1962, and Birmingham, Nov. 15, 1962. In succeeding months Jacksonville, Pensacola-Mobile, Baton Rouge-New Orleans, Charlotte (N. C.) Knoxville, Columbia-Florence (S. C.) and Jackson (Miss.) will be visited. Experts from the Orlando Div. will brief businessmen on government and Martin quality control and procurement requirements. For more information, contact E. J. Cottrell, Public Relations Director, Orlando Div., the Martin Co., P. O. Box 5837, Orlando, Fla.

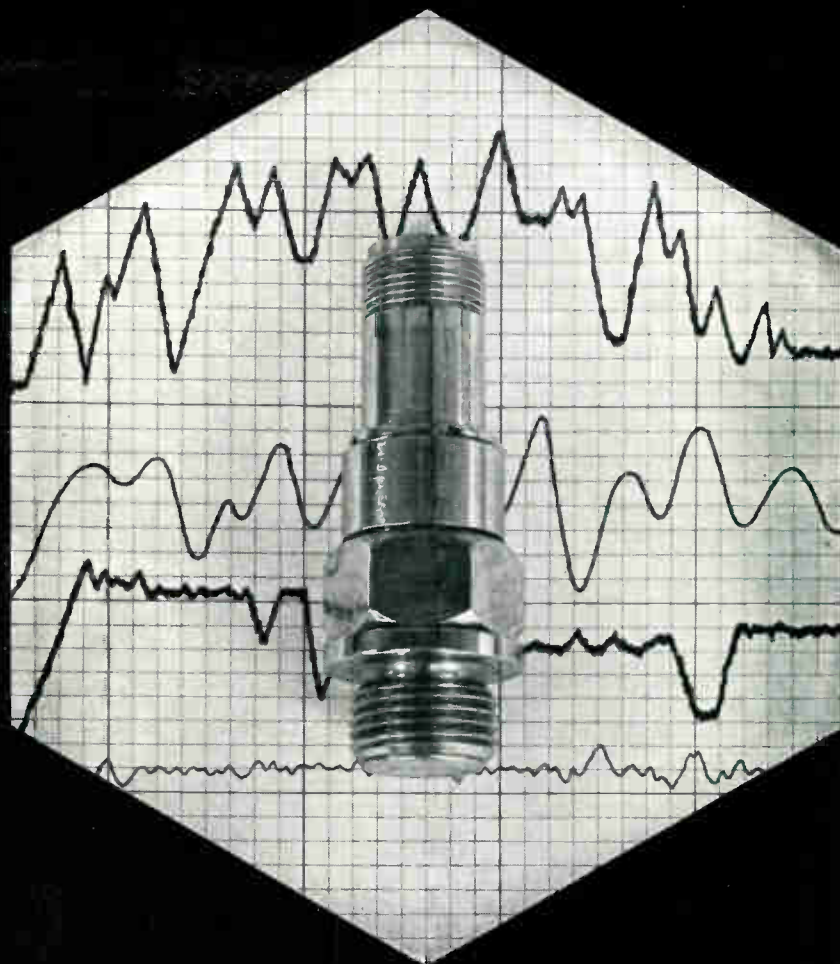

## HIGH FIDELITY PRESSURE TRANSDUCER

ATL Norwood pressure transducers "follow the music." The output stays in tune with the input whether the pressure is at zero or fluctuating up to 20,000 cycles per second. The secret is the small mass and minute deflection of the sensitive element—precision-wound 2-axis strain gauges bonded to a strain tube, opposing a specially formed flush diaphragm of stainless steel.

Neither tempo nor temperature fluctuations affect the sustained high accuracy and repeatability (better than 0.1%) of ATL Norwood pressure transducers, even under the conditions encountered in rocket combustion chambers, "hot-shot" tunnels, and explosive detonation tests. Their performance is virtually unaffected by extremes of shock, vibration, and acceleration—they'll take 100 g in any direction with only a 1% change in output. Linearity is better than 0.5%, and resolution is limited only by the readout equipment.

ATL Norwood pressure transducers are available in models for operation from 25 to 60,000 psi, for temperatures to 5,000°F, in a variety of configurations—standard, air-cooled, and water-cooled. Complete technical data sheet information is available.

ADVANCED TECHNOLOGY LABORATORIES

A DIVISION OF



**AMERICAN-Standard**

369 WHISMAN ROAD, MOUNTAIN VIEW 51, CALIFORNIA

American-Standard and Standard  
are trademarks of American Radiator  
& Standard Sanitary Corporation

Circle 7 on Inquiry Card →

# Analab ANNOUNCES

## a dual-trace STORAGE OSCILLOSCOPE and all-electronic x-y recorder

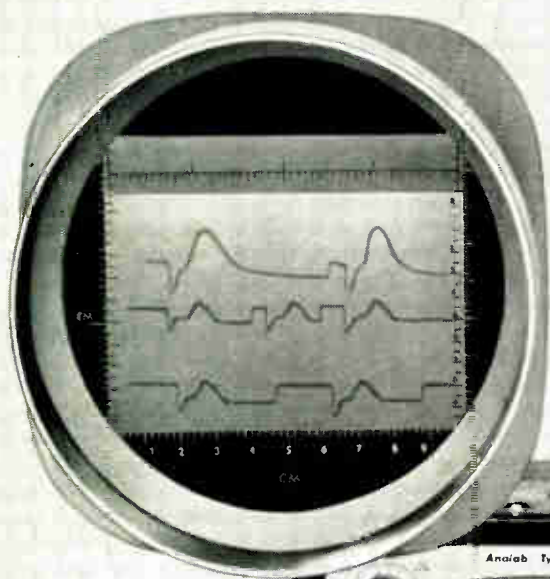

Typical solid-state ↑  
power-supply turn-  
off transient..

Illustration shows  
Type 1220 main  
frame with Type 700  
plug-in.

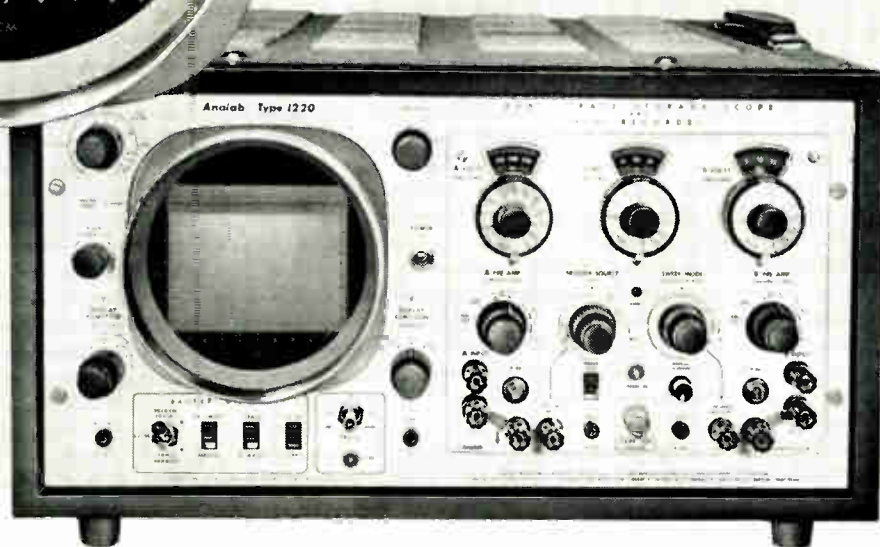

## A major advance in precision oscilloscopes

From ANALAB, makers of specialized 'scopes and plug-ins of better than  $\pm 2\%$  system accuracy for the most demanding aerospace, medical, and industrial applications, comes this remarkable new instrument which offers up to 20 minutes' recording time with the convenience of indefinite image retention or fast erase. The Type 1220 Storage Scope features an exclusive "preview" target which permits "scratch-pad" observations of signals before recording. Type 1220 allows 1, 5, and 10-track automatic or manual programming.

Save measurement time, achieve greater accuracy, eliminate ink and paper with the Type 1220 Scope and a choice of plug-ins. Call, write, or wire for a demonstration in your laboratory.

### TYPICAL APPLICATIONS

- Editing magnetic tape
- Plotting antenna patterns
- Plotting Smith charts
- Alignment of crystal filters
- Shock and vibration testing
- Readout for sampling scopes
- Observation of power-supply transients
- Readout integration of repetitive signals through very high noise levels
- Plotting hysteresis effects not achievable with mechanical x-y recorders

# Analab

INSTRUMENT CORPORATION

Cedar Grove, N.J.

A subsidiary of THE JERROLD CORPORATION\*





*Allen-Bradley Hot Molded Resistors prove their complete reliability in the brilliant success of Telstar*



ALLEN-BRADLEY HOT MOLDED RESISTORS ARE AVAILABLE IN ALL STANDARD EIA RESISTANCE VALUES AND TOLERANCES

Allen-Bradley Co., 222 W. Greenfield Ave., Milwaukee 4, Wis. • In Canada: Allen-Bradley Canada Ltd., Galt, Ontario

**ALLEN-BRADLEY**  
QUALITY ELECTRONIC COMPONENTS

■ In their latest engineering achievement, the Telstar satellite, Bell Telephone Laboratories took a bold new design approach that emphasized the use of high reliability components with virtually total elimination of redundancy. All apparatus packages for Telstar were built "in-house" by Bell Labs, and they were carefully designed and tested for long life. Thus, the use of A-B Type CB ( $\frac{1}{4}$  watt) and Type EB ( $\frac{1}{2}$  watt) hot molded resistors for this important project *clearly* acknowledges their ability to meet the most severe operating conditions.

Allen-Bradley resistors are made by a unique hot molding process—developed and used exclusively by A-B—which assures such uniform and stable characteristics that their performance is accurately predictable in service . . . and they are completely free from catastrophic failures.

You can obtain this same outstanding performance *only* when you insist on A-B fixed resistors. For full details on the complete line of A-B *quality* electronic components, please write for Publication 6024, today.

The satellite Telstar was designed and built by American Telephone & Telegraph Co.'s Bell Telephone Laboratories, and AT&T paid for the cost of launching by NASA.



**A. HOT MOLDED RESISTORS**

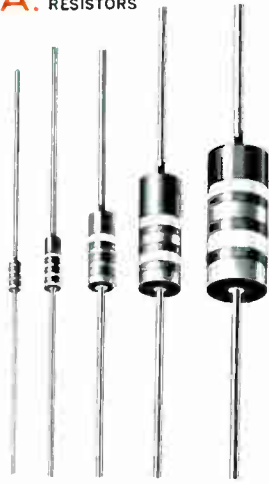

**C. PRECISION METAL GRID RESISTORS**



**E. HOT MOLDED POTENTIOMETERS TYPE J AND TYPE K**



**G. FERRITES AND CERAMIC MAGNETS**



**H. FEED-THRU AND STAND OFF CAPACITORS**



**B. HERMETICALLY SEALED RESISTORS**

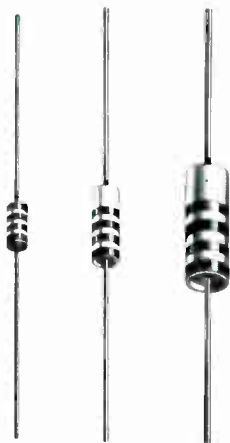

**D. ADJUSTABLE FIXED RESISTORS**

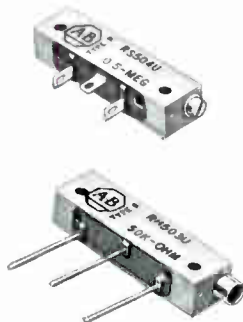

**F. HOT MOLDED POTENTIOMETERS TYPE G AND TYPE L**

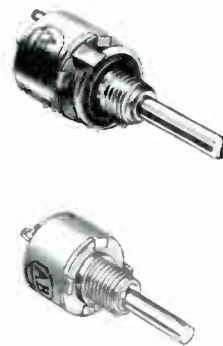

**I. HIGH FREQUENCY LOW-PASS FILTERS**

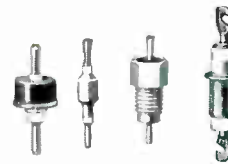

**J. HIGH TEMPERATURE CAPACITORS**

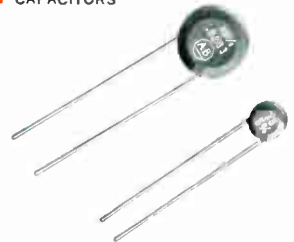

They're all A-B quality... your assurance of utmost reliability and peak performance

**A. EXCLUSIVE HOT MOLDED RESISTORS** are conservatively rated. Stable and uniform characteristics assure superior performance. No known instance of catastrophic failure. Rated 1/10, 1/4, 1/2, 1, and 2 watts at 70°C. Values to 22 meg. Tol: ±5, 10, and 20%.

**B. HOT MOLDED SOLID RESISTORS**, hermetically sealed in ceramic tubes, remain stable. Rated 1/8, 1/3, and 1 watt. Res. to 22 meg.

**C. PRECISION RESISTORS**—Metal Grid Construction. Non-inductive. Tol: ±0.1, 0.25, 0.5, and 1.0%. TC=±25 PPM/°C. Rated 1/4, 1/2, and 1 watt at 100°C.

**D. ADJUSTABLE FIXED RESISTORS.** Resistance element and terminals hot molded into integral

unit with insulated mounting base. Stepless adjustment. Non-inductive. Remains fixed in "set" position. Watertight. Rated 1/4 watt at 70°C. Values to 2.5 meg. Tol: ±10 and 20%

**E. TYPE J POTENTIOMETERS.** Solid, hot molded resistance element. Smooth, quiet control which improves with long life. Compact. Rated 2.25 watts at 70°C. Values to 5 meg.

**TYPE K POTENTIOMETERS.** Same as the above but rated 1 watt at 125°C; 2 watts at 100°C; and 3 watts at 70°C.

**F. TYPE G POTENTIOMETERS** are miniature controls with solid molded resistance element. Only 1/2" diam. Smooth control—also improves with age. Rated 1/2 watt at 70°C. Values to 5 meg.

**TYPE L POTENTIOMETERS** are similar to Type G but rated 1/2 watt at 100°C. Can be used up to 150°C with reduced "load."

**G. FERRITES** in a wide range of "items," such as flared rings, quarter rounds, U cores, E cores, cup cores, toroids, etc., can be supplied for a very large variety of applications. Consistently uniform magnetic characteristics. Contact us for complete information on A-B ceramic permanent magnets having a high energy-to-weight ratio.

**H. FEED-THRU AND STAND-OFF CAPACITORS.** Discoidal design eliminates all parallel resonance effects at 1000 Mcps and less. Standard values 470 mmf ±20% and 1000 mmf GMV. Special

values from 6.8 mmf to 1500 mmf. Rated to 500 v DC max.

**I. HIGH FREQUENCY LOW-PASS FILTERS** for eliminating undesired radiation in the range from 100 to 8000 Mcps. Effective filtering actually increases with frequency over a wide band. Attenuation to 75 db and more. Ratings to 500 v, and to 5 amp DC or low frequency AC current.

**J. HIGH TEMPERATURE CAPACITORS.** Ceramic disc type—encapsulated in ceramic case—for use where reliability and superior performance are important. For continuous operation at 500 v in 150°C ambient. Values from 2.2 to 3300 mmf. Tol: ±5, 10, and 20%.

10-62-E

**ALLEN-BRADLEY**

**QUALITY ELECTRONIC COMPONENTS**

Allen-Bradley Co., 277 W. Greenfield Avenue, Milwaukee 4, Wisconsin • In Canada: Allen-Bradley Canada Ltd., Galt, Ontario

**BIPCO<sup>®</sup> LOGIC** is the new approach to microelectronics

**BIPCO<sup>®</sup> LOGIC** is low cost and reliable

**BIPCO<sup>®</sup> LOGIC** solves the interconnection problem

**BIPCO<sup>®</sup> LOGIC** yields highest component density

**BIPCO<sup>®</sup> LOGIC** permits circuit design flexibility

**BIPCO<sup>®</sup> LOGIC** yields multi-component uniformity

**BIPCO<sup>®</sup> LOGIC** is applicable to any circuit

**BIPCO<sup>®</sup> LOGIC** is available now



*Typical 96 diode BIPCO Module.  
(Measures 7/16" x 1 1/8" x 1 3/16")*

BIPCO Logic represents an entirely new approach to microelectronics. Batches of identical components are "Built-In-Place" at one time in patterns determined by the logical function to be performed. Individual component handling is eliminated, interconnections are simplified, and electrical uniformity is achieved. For the first time, the cost barrier inherent in other approaches has been eliminated so that reliability and low cost can be obtained.

Functional diode logic is now available in individual BIPCO Modules or in printed circuit packages including: Decimal Counters, Binary and Alpha-Numeric Decoders, Encoders, and Distributors. BIPCO Transistor, Resistor, and Capacitor Modules will be available soon.

← Circle 10 on Inquiry Card

Circle 11 on Inquiry Card

*Write for complete technical information  
on the growing BIPCO Module line.*

ANOTHER ELECTRONIC CONTRIBUTION BY  
**Burroughs Corporation**  
Ⓟ  
 ELECTRONIC COMPONENTS DIVISION  
 PLAINFIELD, NEW JERSEY



at 30 mc, 2.5 db n.f.  
at 1 Gc, 8.5 db n.f.

... at every frequency, PHILCO delivers lowest noise,  
highest gain, per transistor dollar

From industry's only functionally-tested FM radio transistor complement, to industry's only proved-in-use 2 Gc communications transistor, Philco offers lowest noise AND highest gain per transistor dollar. And there are Philco transistors, uniformity-assured by MADT<sup>®</sup> automation, for every segment of the usable frequency spectrum.

Complementing the devices, industry's most comprehensive and most experienced communications transistor applications group stands ready to assist you in your specific applications.

You probably will find an unusually comprehensive answer to *your* requirement in one of the many published Philco Application Notes. Write Dept. EI 1062 or call Philco applications people direct at (Area Code 215) UL 5-9531.

*\*Micro Alloy Diffused-base Transistor*

*All Philco Communications  
Transistors are available  
today from your  
Philco Industrial  
Semiconductor Distributor*

**PHILCO**<sup>®</sup>

A SUBSIDIARY OF *Ford Motor Company*

LANSDALE DIVISION, LANSDALE, PA.

World Radio History





# MARKETING

Facts and Figures Round-Up

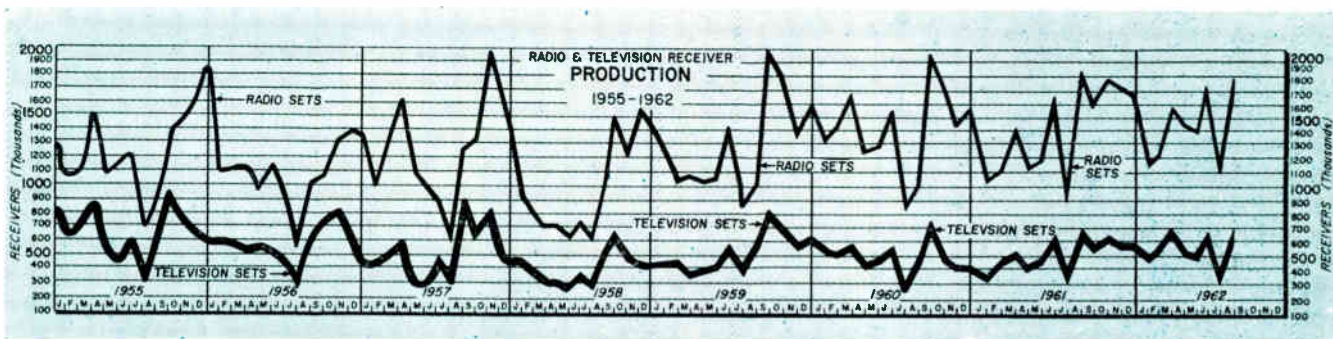

## GOVERNMENT ELECTRONIC CONTRACT AWARDS

This list classifies and gives the value of electronic equipment selected from contracts awarded by government agencies in August, 1962.

Actuators	116,358
Amplifiers	735,035
Analyzers	284,449
Antennas	1,518,855
Attenuators	28,713
Batteries	702,973
Cable Assembly	160,487
Cable, coaxial	135,374
Cable, telephone	204,386
Calibrators	398,380
Communication equipment	2,555,266
Computers	199,830
Controls	210,062
Detectors	36,406
Digital data transmission system	174,400

Distance measuring equipment	47,000
Dummy load	26,087
Echo sounders, portable	166,669
Filters	79,378
Gyros	187,708
Indicators	111,557
Intercommunication equipment	121,922
Interrogator set	717,498
Loudspeaker	118,376
Measuring systems	300,918
Meters	146,445
Microphones	310,849
Multiplex equipment	32,488
Navigation equipment	3,443,663
Oscillator	33,501
Oscilloscope	464,379
Power system, fuel cell	120,204
Radar	343,965
Radio sets	6,674,738
Receivers	307,917
Recorder	164,452

Recorder/Reproducer	345,512
Recording system	193,500
Relay armatures	112,931
Resistors	181,391
Semiconductors	464,588
Signal generators	303,430
Switchboard	27,834
Switches	279,062
Synchros	242,460
Telemetering equipment	27,953
Telephone equipment	189,886
Test equipment	179,036
Test sets	470,079
Timers	46,665
Transceivers	35,748
Transducers	270,285
Transmitters	54,322
Tubes, electron	2,914,274
Tubes, magnetron	1,513,400
Tubes, traveling wave	195,765
Ultrasonic equipment	29,930
Wire & Cable	181,433
X-Ray equipment	52,844

## QUANTITY of PRODUCTION of SELECTED COMMUNICATION EQUIPMENT: 2nd QUARTER 1962 and 1961

Product	Unit of Measure	Production (Quantity)	
		1962	1961*
Telephone sets	Sets	2,428,520	2,046,872
Dial central office equipment	Lines	907,437	970,651
Manual central office equipment	Positions	444	518
Manual PBX equipment	Positions	1,689	2,369
Dial PBX equipment	Lines	213,783	211,561

\* Revised.

## VALUE of SHIPMENTS of TOTAL COMMUNICATION EQUIPMENT: 2nd QUARTER 1962 and 1961

Type of Equipment	Value of Shipments (\$1,000)					
	1962			1961*		
	Total	Domestic	Export	Total	Domestic	Export
<b>TOTAL</b>	<b>676,560</b>	<b>669,312</b>	<b>7,248</b>	<b>549,519</b>	<b>544,040</b>	<b>5,479</b>
Total communication equipment—produced or assembled <sup>1</sup>	676,560	508,656	7,248	549,519	426,819	5,479
Supply items—purchased for resale <sup>2</sup>						

\* Revised.

<sup>1</sup> Includes telephone sets, dial central office equipment, manual central office and PBX equipment, dial PBX equipment, ringing machines, cable terminals, carrier equipment, repeater equipment, nonamplified intercommunications equipment, telegraph office equipment, communication cords, communication protectors, metal telephone booths, and supply items produced by companies which manufacture communication equipment.

<sup>2</sup> Includes such items as cable, wire, linemen's tools, batteries, etc.

Source: Bureau of the Census and the Communications Industries Div., Business and Defense Services Admin.



**NEW**

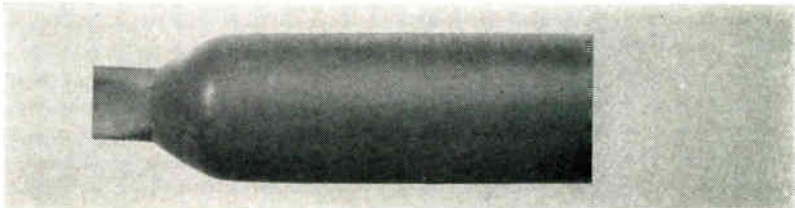
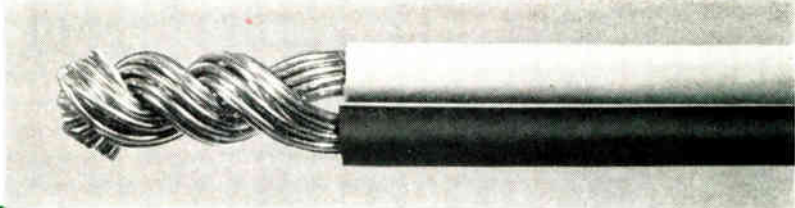

S L I P   O N

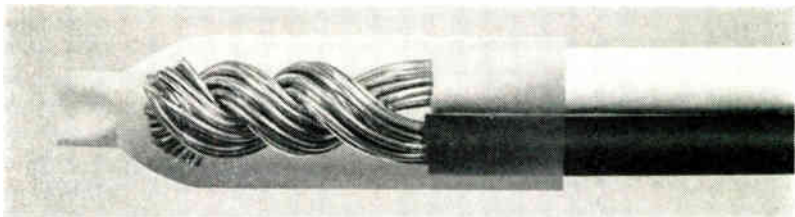

H E A T



*heat-shrinkable ....*  
**THERMOFIT CAPS**

- **SPACE SAVING**
- **VIBRATION PROOF**
- **INEXPENSIVE**
- **EASY TO APPLY**

PART NO.	MAX. RECOVERED I.D.	MIN. EXPANDED I.D.	NOMINAL WALL THICKNESS	NOMINAL LENGTH	COLOR
TC 4001 CRN	.025"	.063"	.016"	.750"	WHITE
TC 4003 CRN	.050"	.125"	.020"	1.000"	RED
TC 4005 CRN	.100"	.250"	.025"	1.000"	SLATE
TC 4007 CRN	.200"	.500"	.030"	1.250"	BLACK



**RAYCLAD TUBES**  
 INCORPORATED

AN ALLIANCE OF  
 RAYCHEM  
 CORPORATION

# NEWS BRIEFS

Capsule summaries of important happenings in affairs of equipment and component manufacturers

## EAST

**SILICON TRANSISTOR CORP.**, Corle Place, N. Y., has purchased all the stock of **SECOA ELECTRONICS CORP.**, Westbury, N. Y. Secoa will continue to operate as an autonomous subsidiary of STC.

**BULOVA WATCH CO., INC., INDUSTRIAL & MILITARY PRODUCTS DIV.**, Jackson Heights, N. Y., has been awarded a \$279,000 contract for mechanical fuses for the warhead of the Bullpup air-to-ground missile by the Navy's Bureau of Weapons.

**TUNG-SOL ELECTRIC INC.**, Newark, N. J., has announced plans to add 25,000 sq. ft. of space at its electron tube plant at Weatherly, Pa. The additional space is for a facility for the production of subminiature electronic tubes, now based at the company's plant in Washington, N. J.

**ANTENNA SYSTEMS INC., ELECTRONIC SYSTEMS DIV.**, Maitland, Fla., has received a contract from **SELENIA SPA**, Rome, Italy, for \$481,464 for a number of tracking antennas and control systems.

**MELPAR, INC.**, Falls Church, Va., has been awarded a follow-on production contract in excess of \$24 million for high reliability circuit boards for the Minuteman ICBM by Autanetics, div. of North American Aviation, Inc., Downey, Calif.

**AVCO EVERETT RESEARCH LABORATORY**, div. of **AVCO CORP.**, Everett, Mass., has received 3 contracts totaling \$1,767,961. One contract, \$752,500, from the USAF Ballistic Systems Div. is for continuance of the laboratory's ballistic missile re-entry research program. The second contract, \$682,832, from the U. S. Army Ordnance Missile Command is for the study of wake measurements as a means of discriminating between missiles and decays for the Army's NIKE ZEUS system. The last contract, \$332,629, is from the USAF Office of Scientific Research for continuation of basic plasma propulsion research.

**ANTENNA & RADOME RESEARCH ASSOCIATES**, Westbury, L. I., N. Y., has announced the purchase of the assets of **CONSOLIDATED MICRO-WAVE CORP.**, Brooklyn, N. Y. Consolidated will operate as a separate division of ARRA, Inc.

**GENERAL PRECISION, INC., GENERAL PRECISION AEROSPACE, KEARFOTT DIV.**, Little Falls, N. J., has received a contract in excess of \$1 million from the USAF Missile Development Center, Holloman AF Base, New Mexico, for the development, fabrication and installation of a celestial-inertial test complex.

**DALCO MFG. CO., INC.**, Philadelphia, Pa., is expanding its **K&F ELECTRONICS CO. DIV.** by moving it into a new 95,000 sq. ft. plant.

**DYNAMICS RESEARCH CORP.**, Stoneham, Mass., has recently acquired the **JOHN F. KLARMANN LABORATORY**, Waltham, Mass. Klarmann will operate the division of Dynamics Research.

**WALTER KIDDE & CO., INC.**, Belleville, N. J., has acquired **DOUGLAS RANDALL, INC.**, Westbury, R. I. Douglas will operate as a wholly-owned subsidiary of Walter Kidde & Co.

**GENERAL ELECTRIC'S LIGHT MILITARY ELECTRONICS DEPT.**, has announced the opening of a \$150,000, 1400 sq. ft., microelectronics manufacturing facility in Utica, N. Y. Production capacity is said to be 1000 thin-film circuits a month.

**RADIO CORP. OF AMERICA, ELECTRON TUBE DIV.**, Harrison, N. J., has received a \$1,279,133.04 order for 107,780 electron tubes (type 4X150A, power tetrode) placed against a requirements-type contract awarded by the Defense Electronics Supply Center, Dayton, Ohio. The contract, awarded for five types of electron tubes, covers a one year period.

**SYLVANIA ELECTRIC PRODUCTS INC., subs. of GENERAL TELEPHONE & ELECTRONICS CORP.**, has announced plans to build a 100,000 sq. ft. multimillion dollar plant for manufacturing electron tubes at Brookville, Pa. The new facility will replace the present 3 plants Sylvania already has in Brookville and is expected to be in production late in 1963.

**AMICON CORP.**, Cambridge, Mass., a new research and development firm in the applied chemistry field, is working in surface, colloid, and polymer chemistry to produce special coatings, pigments, adhesives, and plastic composites.

**TAYLOR FIBRE CO.**, Norristown, Pa., has changed its name to **TAYLOR CORP.**, with a new address: Valley Forge, Pa.

## MID-WEST

**MOTOROLA INC., COMMUNICATIONS DIV.**, Chicago, Ill., has been awarded a \$170,000 contract by the Washington State Purchasing Div. for 4 two-way radio equipment. Equipment includes 35 base stations, 249 mobile units, 3 aircraft radio units and 5 portable radiophones.

**AVCO CORP.'S ELECTRONICS AND ORDNANCE DIV.**, Cincinnati, Ohio, has received contracts totaling \$7,604,751 from the U. S. Army Signal Corps for spare parts and accessories for the AN/VRC-12 combat area communications system.

**THE BENDIX CORP., PIONEER-CENTRAL DIV.**, Davenport, Ia., has been awarded a \$287,000 order for the design, development and manufacture of electronic tankage instrumentation for the X-20 (Dyna-Soar) space glider by the **BOEING CO.**, Seattle, Wash.

**BURROUGHS CORP.**, Detroit, Mich., has announced the acquisition of the **STRAND ENGINEERING CO.**, Ann Arbor, Mich. from **DATRONICS ENGINEERS, INC.** Strand will become a Michigan Unit of Burroughs Laboratories.

**CENTRALAB, ELECTRONICS DIV. of GLOBE-UNION INC.**, Milwaukee, Wisc., has announced two major plant expansions underway. A \$350,000, 41,000 sq. ft. plant addition to the Fort Dodge plant will double that facility's capacity. An increase of 50% over current facilities is underway at Centralab Canada Ltd., Ajax, Ont., Canada.

## WEST

**BECKMAN INSTRUMENTS, INC.**, Fullerton, Calif., has changed the name of its **MILITARY PROJECTS GROUP to SPACE ENGINEERING GROUP.** The Space Engineering Group is part of the Scientific and Process Instruments Div. of Beckman.

**NEELY ENTERPRISES**, Na. Hollywood, Calif., and **HEWLETT-PACKARD CO.**, Palo Alto, Calif., have announced affiliation through an exchange of stock. The agreement is subject to approval

by the respective Boards of Directors and completion of necessary legal procedures.

**GENERAL DYNAMICS/CONVAIR**, San Diego, Calif., has been awarded a \$159,000 contract by the USAF Missile Test Center, Polk AFB, Fla., to develop a directional airborne antenna receiving system that will track missile nose cones reentering the atmosphere.

**HOFFMAN ELECTRONICS CORP.**, Los Angeles, Calif., has received 3 Navy production contracts totaling \$7 million. \$3.7 million from the Naval Aviation Supply Office, for building radio test sets for TACAN; \$2.8 million from the Bureau of Naval Weapons for the production of SSQ-23A Sonobuoys; and \$500,000 from the Bureau of Ships for radio transmitters and associated equipment.

**GENERAL DYNAMICS/ASTRONAUTICS**, San Diego, Calif., has been awarded a contract to design, develop and construct a prototype lunar transponder for the Air Force Cambridge Research Laboratories, Bedford, Mass.

**THE DEUTSCH CO., ELECTRICAL COMPONENTS DIV.**, Los Angeles, Calif., has acquired the electrical **CONNECTOR PRODUCTS SECTION of CONSOLIDATED ELECTRODYNAMICS CORP.**, subs. of **BELL and HOWELL**, Los Angeles, Calif.

**CALIFORNIA COMPUTER PRODUCTS, INC.**, Downey, Calif., has announced leasing an additional facility in Anaheim, Calif. The company will relocate its corporate headquarters, research, engineering, test and certain manufacturing and fabrication activities to a 40,000 sq. ft. building at 305 Muller Ave., Anaheim, Calif.

**ROTATING ELECTRONIC SYSTEMS CO. (RESCO)**, Van Nuys, Calif., has become a subsidiary of **THE LAU BLOWER CO.**, Dayton, Ohio.

**TELECOMPUTING CORP., POWER SOURCES DIV.**, Denver, Colo., has added a new temperature- and humidity-controlled plant for the manufacture of silver-zinc batteries to its present facilities in Denver. The new plant provides an additional 10,000 sq. ft. of environment-controlled floor space.

**AUTONETICS, a DIV. of NORTH AMERICAN AVIATION, INC.**, Downey, Calif., has received contracts totaling \$41 million from the Navy for Ship's Inertial Navigation Systems (SINS) to be installed on 10 new Lafayette-class Polaris submarines.

**PERKIN ELECTRONICS CORP.**, El Segundo, Calif., has received contracts totaling over \$100,000 for dc power supplies from the Atomic Energy Commission.

**U. S. INDUSTRIES, INC., ENGINEERED PRODUCTS DIV.** is the new name of **WESTERN DESIGN & ELECTRONICS, a DIV. of U. S. INDUSTRIES, INC.**, Goleta, Calif.

**MILITARY ELECTRONICS DIV., MOTOROLA INC.**, Scottsdale, Ariz., has been awarded a \$914,000 contract by the U. S. Navy Bureau of Weapons for the fabrication, test and delivery of a quantity of Type AN/APN-132 airborne radar transponders.

**RAYTHEON CO.'S MARINE PRODUCT OPERATION**, So. San Francisco, Calif., has received a \$167,000 contract for 35 Fathometer depth sounders, that automatically record soundings, from the U. S. Coast & Geodetic Survey. The DE-723 depth sounders will be used for precision underwater survey work and chart-making.



Sylvania—first with the Sarong and Bikini cathodes—now announces a new development that significantly increases the reliability of Sylvania tubes. "Life-Boost Cathode" is the name...the secret is an ultra-pure, uniform alloy made possible by Sylvania's leadership in powder metal technology. Contrasted to conventional melted alloys, the Life-Boost powder-metal alloy is so pure and uniform, with performance so predictable, that it eliminates any need for the usual "melt approval." Alloy uniformity inhibits the formation of leakage paths, which extends tube life. It also means

better-controlled electron emission and regulated barium release throughout life—tube performance stays within specifications. Further, the new cathodes have 25% greater mechanical strength, which significantly reduces equipment failure in the field.

**Precise control of alloy composition** is the key. The basic pure nickel powder plus carefully controlled powdered reducing agents are thoroughly blended and immediately rolled into thin-gauge strip. Because no critical temperatures are involved, no impurities are introduced from crucibles and con-

## New Life-Boost Cathode gives increased life, stability and

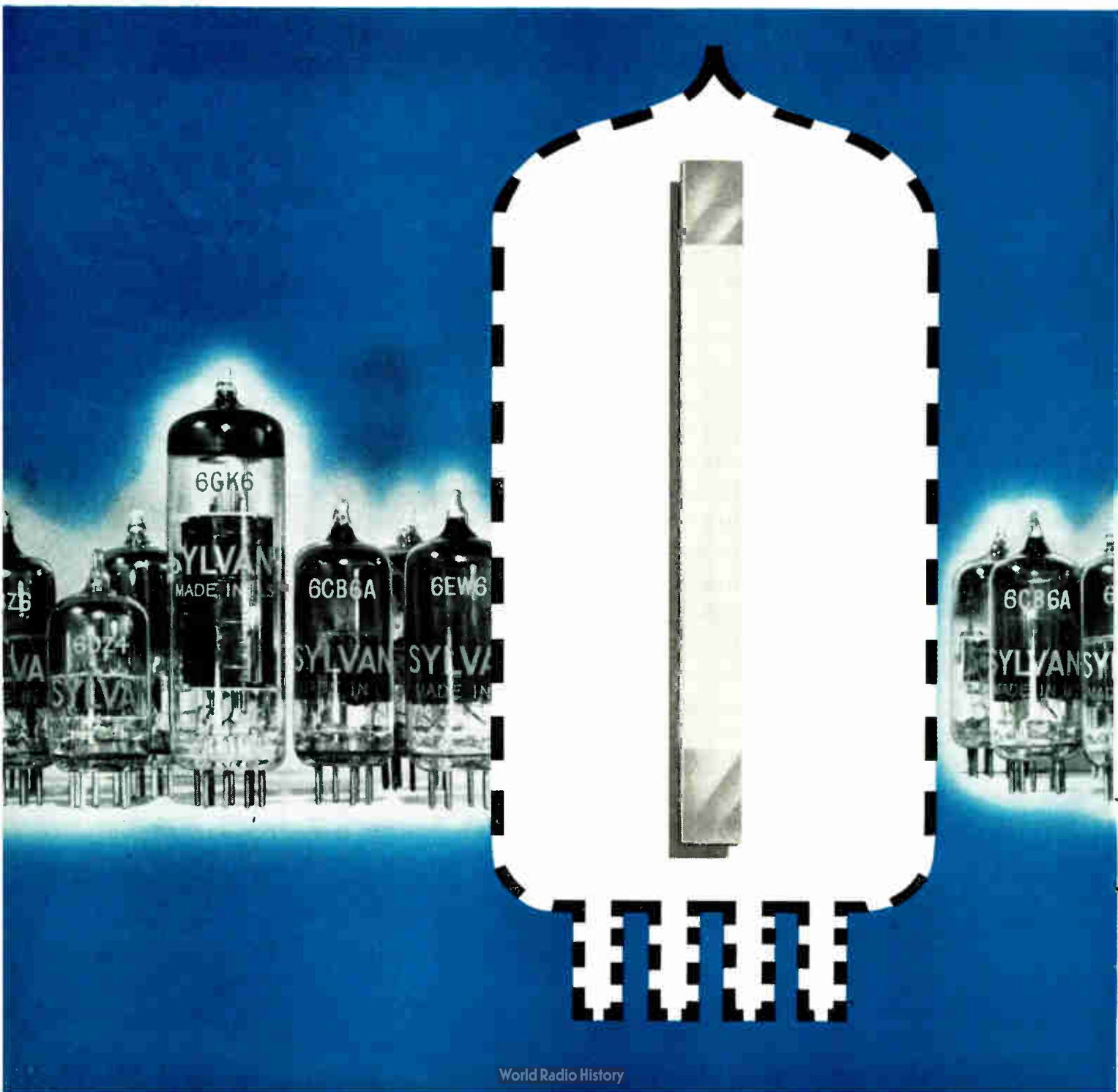

ainers, forging hammers or hot-rolling equipment. And the powder process permits previously impossible or hard-to-attain combinations of wanted properties, such as electrical passivity and mechanical strength at high temperature.

A planned conversion of Sylvania tubes to the Life-Boost Cathode is under way. For information on types available now, contact your Sylvania Sales Engineer, or write: Electronic Tubes Division, Sylvania Electric Products Inc., 1100 Main Street, Buffalo 9, New York.

# Sylvania Tubes uniformity



## Here's evidence of what the Life-Boost\* Cathode can do

... in 6DZ4 UHF oscillator:

**No failures, greatly improved stability**

Test: 40 tubes operated at 130 VAC for 1500 hours in 40 TV sets (4 models, 3 manufacturers represented).

Failures: None resulting in set failure. (Statistical estimate: 1% per 1000 hours at 130 V, or about 0.3% per 1000 hours at 117 V.) Failure rate for same tube made with conventionally prepared cathode material: 13.1%.

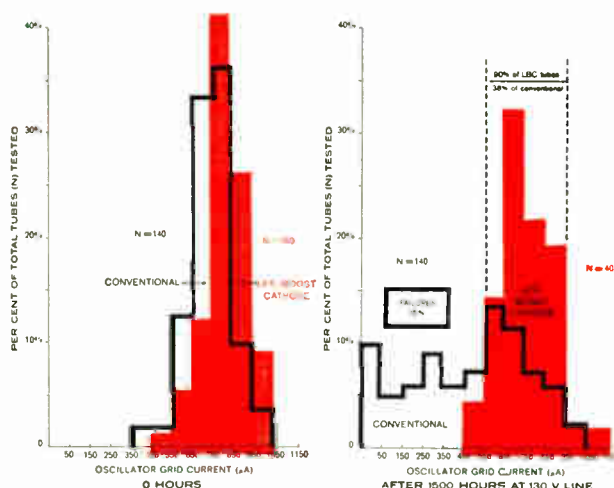

**Oscillator Grid Current:** After 1500 hours at 130 V, 90% of Life-Boost Cathode tubes had grid current between 550 and 950  $\mu$ A (see right-hand chart). Only about 38% of the tubes with conventional cathodes remained within these limits after period of test.

... in 6GK6, used for critical vertical output:  
**TV set manufacturer reports improved stability**

Test: More than 1000 hours at 135 VAC line.

Results: No leakage problems, no slump in characteristics; tube can be used in vertical socket as well as other sockets of customer's TV set line.

Sylvania tests show significantly reduced sublimation (formation of leakage paths), and improved plate current stability under accelerated life test and heater cycling conditions with over-voltages applied.

... in RF pentodes:

**Reduced grid emission, no insulation breakdown**

RF pentodes BZ6, CB6, EW6 and others, when subjected to life testing, showed reduced grid emission levels after conversion to the Life-Boost Cathode. Insulation levels during and at the completion of life showed little or no change—an indication of improved stability—and end-point failures due to breakdown were virtually nonexistent.

CIRCLE 12 ON READER SERVICE CARD

\*Trademark

# SYLVANIA

SUBSIDIARY OF

GENERAL TELEPHONE & ELECTRONICS





# SNAPSHOTS... OF THE ELECTRONIC INDUSTRIES

## LASER BURST

Photomicrograph shows cross section of a hole generated in mild steel by a six-joule laser burst during experiments performed at Hughes Aircraft Co. by scientists studying the laser's effects and applications in metallurgical processes. Etchant is 5% nital. Magnification is 100.

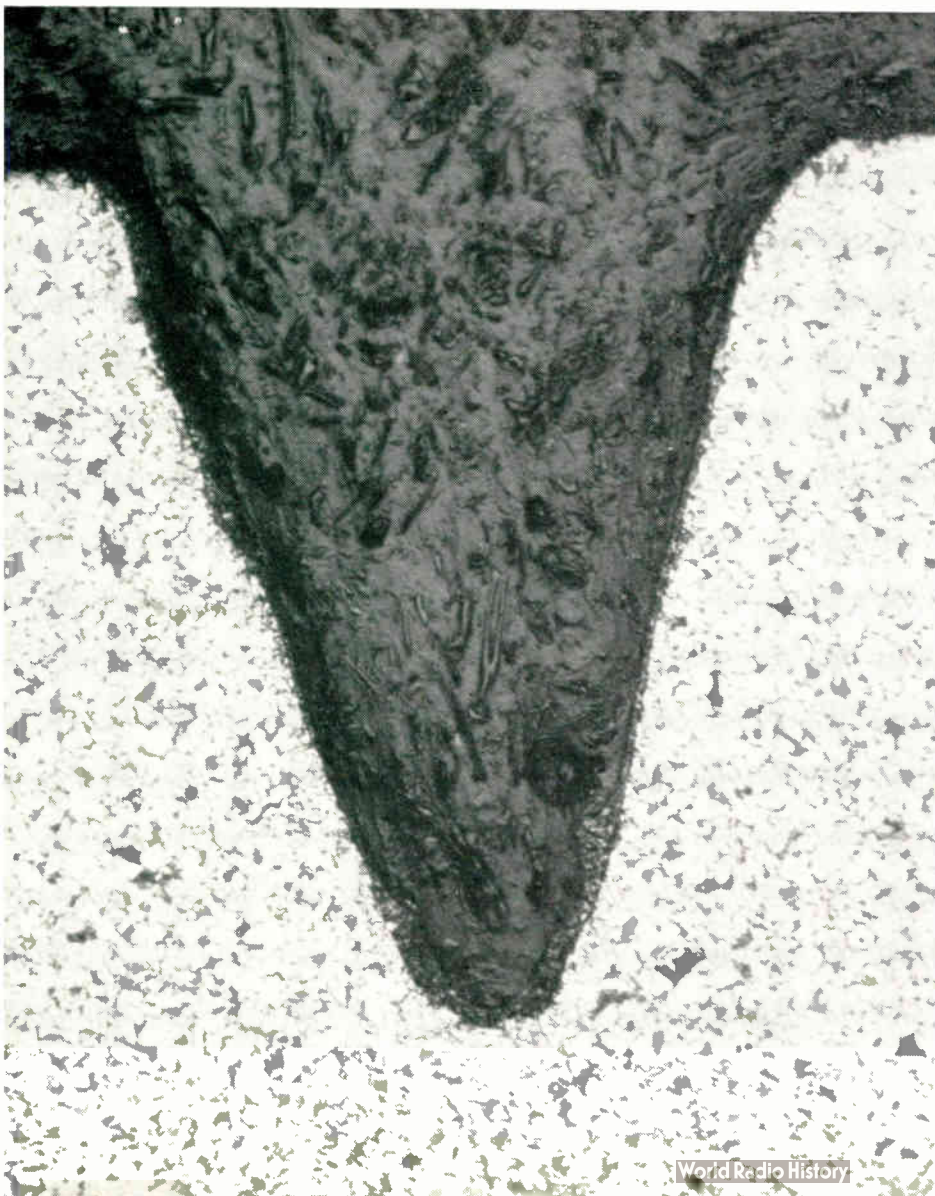

## TALLEST STRUCTURE

This 1,749 ft. TV tower at Columbus, Ga., is now the world's tallest structure. Bethlehem Steel Co. supplied over half of the steel for the 215-ton structure. Stainless, Inc., of North Wales, Pa., designed and built the tower which serves over 25,434 square miles.

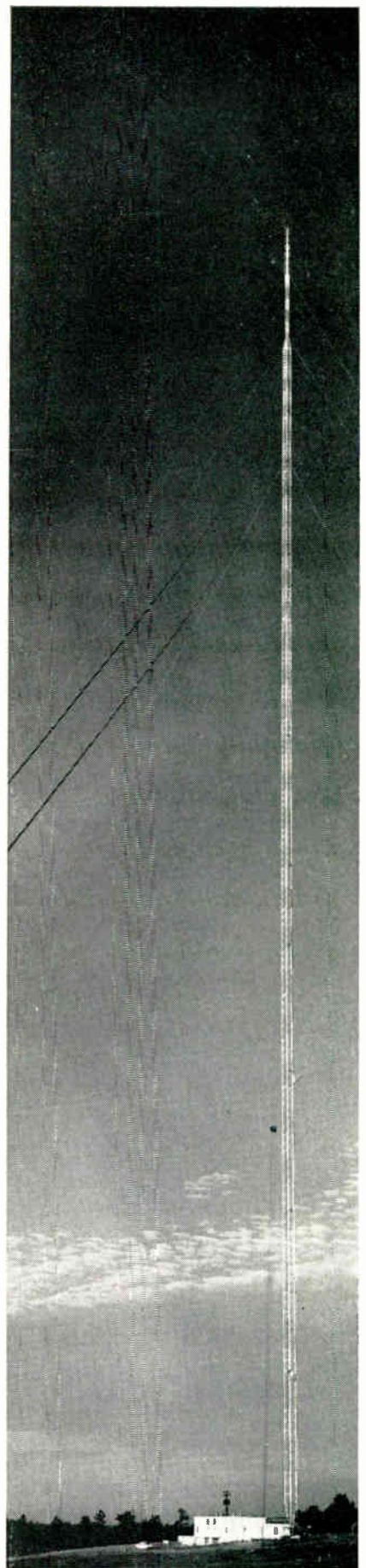

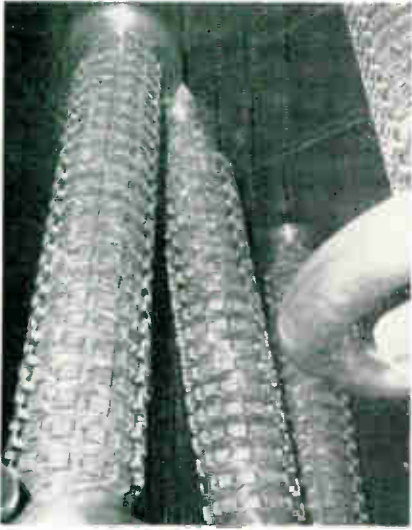

### HV RECTIFIER STACKS

Rectifier stack assembly made by G.E. Co., Transformer Department, Holyoke, Mass., is rated at 150 kv, 4 amps and 80 kv, 6.8 amps. Each of the diodes is rated 600 v. and has been put in series for 150,000 v.

### FLYING SAUCER

Thin film seven-resistor ladder network for use as an analog-to-digital or digital-to-analog converter in instrumentation and multiplex systems. Network was recently introduced by Philco Corporation's Lansdale Div.



### "TIRED"

Face of a Goodyear Aircraft Corp. inspector assumes a distorted appearance as he studies, through a magnifying glass, slip rings to be used in rotating radar antenna.

### CRANIAL VIBRATIONS

Head mounted microphone assembly picks up and amplifies high intelligibility speech direct from the cranial vibrations of the user. Microphone assembly is part of a communications system devised by Dyna Magnetic Devices, Inc., of Hicksville, N. Y.

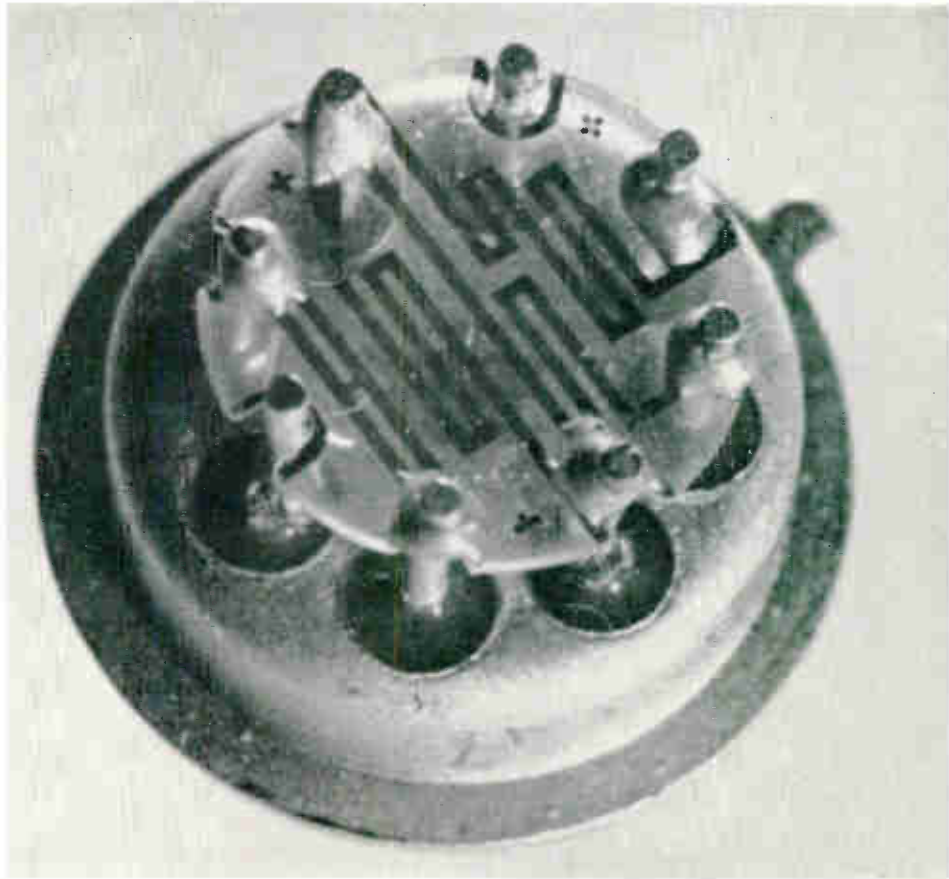



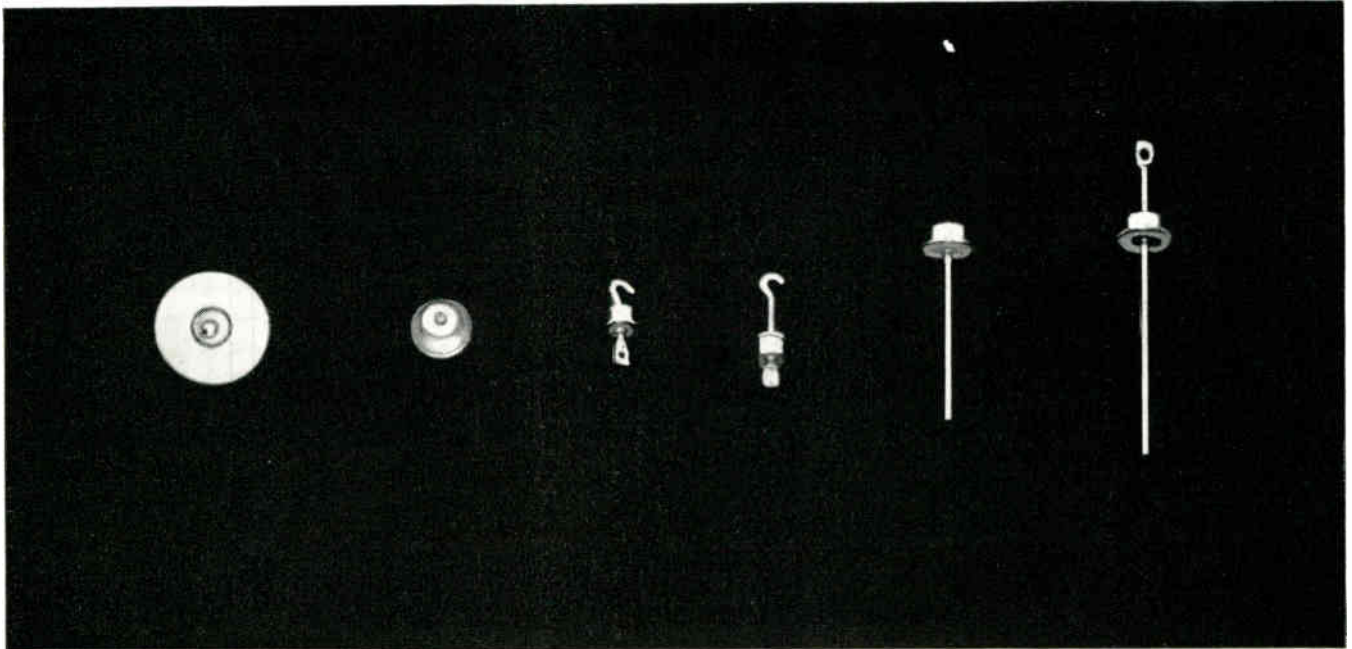

**How can you be sure our Cerameterm<sup>®</sup> terminals will withstand heat up to 1700° F, resist shock and tensile forces up to 250 pounds, and will stand up under the severest vibration? Test one at our expense.**

Electron Tube Products  
Red Bank Division  
The Bendix Corporation  
Eatontown, New Jersey

Gentlemen: Please send me a sample of your new CERAMETERM header/transistor base or feed-thru terminal. I understand this request for Ceramic Seals places me under no obligation.

NAME \_\_\_\_\_

TITLE \_\_\_\_\_

COMPANY \_\_\_\_\_

ADDRESS \_\_\_\_\_

CITY \_\_\_\_\_ ZONE \_\_\_\_\_ STATE \_\_\_\_\_

**Send for a free sample.**

FOR ADDITIONAL INFORMATION, WRITE US IN EATONTOWN, NEW JERSEY

**Red Bank Division**



## SPRING-DRIVEN

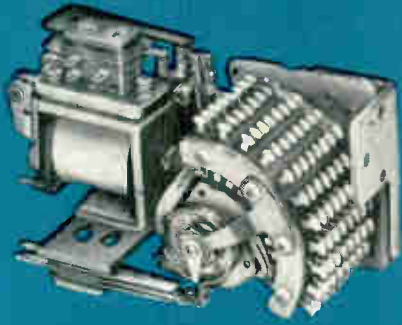

**TYPE 210**

Up to twelve 10-point levels  
or four 33-point levels

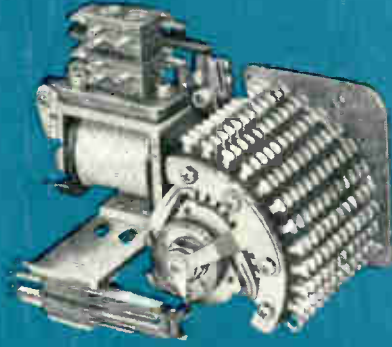

**TYPE 211**

Up to twelve 11-point levels  
or four 33-point levels

## CAM-OPERATED



**TYPE 200**

Up to eight cams with 30, 32  
or 36 tooth ratchets



**TYPE 20**

Up to sixteen 20-point levels  
or twelve 40-point levels



**TYPE 26**

Up to sixteen 26-point levels  
or twelve 52-point levels

## DIRECT-DRIVE



Up to five 10-point levels

# Let Clare put the exactly right stepping switch in your design

Designers who count on CLARE stepping switches as components for complex counting, totalizing and sequence-control equipment know that from the wide CLARE line they can select the exact switch their application requires. If necessary, CLARE engineering will provide special switch designs.

CLARE stepping switches are available as spring-driven, cam-operated or direct-drive switches with capacities from 10 to 52 points. All may be hermetically sealed in nitrogen or oil, or provided with dust covers.

All CLARE stepping switches are well known for their long life, high capacity and minimum maintenance through millions of precise stepping operations. For complete information write for Catalog 202.



**C. P. CLARE & CO., 3101 Pratt Blvd.,  
Chicago 45, Illinois. In Canada:  
C. P. Clare Canada Ltd., 840 Caledonia Road,  
Toronto 19, Ont. Cable address: CLARELAY.**



### DAP\* INSULATION STANDARD ON SPRING-DRIVEN SWITCHES

FOR—

- High insulation resistance
- Good arc resistance
- Stable insulation resistance
- Strength and stability
- Low moisture absorption

\*diallyl phthalate



**C. P. CLARE & CO.**

*Relays and related  
control components*





The Oak Approach

Pronto  
-type

## service on prototype switches

*Go ahead and draw!* Just send us your sketch and we'll do the rest. OAK has initiated the fastest delivery cycle in the industry for prototype rotary switches — normally, your switch is completed within *three* days after receipt of your drawings.

That's pretty fast on *your* draw. It's speed made possible by a completely equipped and integrated department devoted to prototype orders *only*. These

special jobs are immediately separated and hand tended through all production stages. Four daily "switch runs" to O'Hare International Airport make sure you get your switch on time.

Layout sheets are available at no cost to help in diagramming your switch. For information on prototype service, products and production scheduling, contact us or your nearest OAK representative.

### OAK MANUFACTURING CO.

CRYSTAL LAKE, ILLINOIS • Telephone: Area Code 815; 459-5000; TWX: 815-459-5628

Plants in Crystal Lake, Illinois • Elkhorn, Wisconsin

**Subsidiaries:** OAK ELECTRONICS CORPORATION      DELTA-f, INC.      McCOY ELECTRONICS CO.  
Culver City, Calif.      Geneva, Ill.      Mt. Holly Springs, Pa.

ROTARY AND PUSHBUTTON SWITCHES • TELEVISION TUNERS • VIBRATORS • APPLIANCE  
AND VENDING CONTROLS • ROTARY SOLENOIDS • CHOPPERS • CONTROL ASSEMBLIES

Circle 17 on Inquiry Card

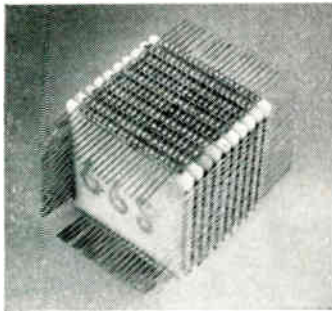

Micro assemblies of 0.030-inch thick aluminum wafers with riser wire interconnections welded by a new Hamilton Standard electron beam technique.

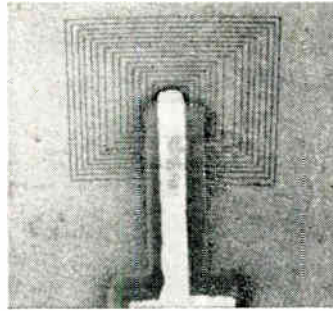

Thin film inductor, consisting of titanium film on an aluminum oxide wafer, scribed by high-power density Hamilton-Zeiss cutting equipment.

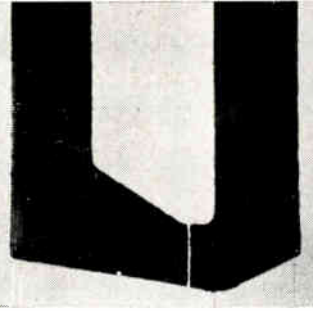

Ferrite memory core, 0.005-inch thick, with slots cut by electron beam. Slot widths: 0.0005- to 0.001-inch.

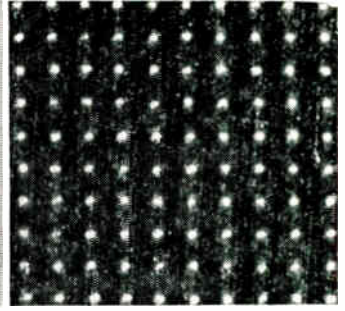

Grid screen of .003-inch diameter holes on .010-inch centers drilled in .020-inch stainless steel sheet.

# NOW — THE FIRST COMPLETE MICROMINIATURE PRODUCTION TOOL

## The new Hamilton-Zeiss Electron Beam CW-1 Cuts, Welds, Drills, Scribes

The new Model CW-1 Electron Beam Cutter-Welder is the most advanced machine yet developed for work in microminiaturization. With CW-1 equipment, you can fabricate complete microminiature assemblies, cut, scribe and drill thin film and solid state components. You can also weld necessary leads without distorting the workpiece. And the vacuum chamber provides a contamination-free environment with a bonus in "free" vacuum for hermetic encapsulation operations. Almost all metallic elements and many nonmetallies including aluminum oxide, quartz, and ceramics, can be processed by the CW-1.

The new CW-1 can cut and drill shapes of practically unlimited geometries for fabrication of micro-storage devices. All materials that are chemically and metallurgically compatible may be welded without distortion or contamination, and heat-affected zone is for all practical purposes eliminated. For the first time, you can fabricate thin film resistors and capacitors to extreme accuracies by "in-process" monitoring and corrective feed-back, thus eliminating high reject rates and selective assembly techniques.

Heart of the CW-1 is a highly developed electron gun and electron optical system providing a focused spot diameter of .0005" or less. The system operates at a maximum accelerating voltage of 150 KV and provides currents to 15 Ma during pulsed operation

providing nearly 10,000 megawatts per square inch at the workpiece. Such extremely high power densities permit the cutting of any material known today.

### UNIQUE FEATURES OF THE MODEL CW-1

- *A Zoom Type Binocular Optical Viewing System* (14X to 40X) provides stereo-effect microscopic examination of the workpiece at all times permitting precise positioning and eliminating the need for removal of the workpiece for inspection. Fabrication and inspection can be combined in one operation.
- *A Precision Beam Deflection System* permits programming of the beam (workpiece stationary) over the workpiece in any pre-selected pattern using electronic programming\* and simple external control knob adjustments.
- *A Precision Work Table* with all backlash eliminated provides positioning accuracies to .0002".
- *Polished Stainless Steel* is utilized on the inside of the work chamber and on all apparatus exposed to the work chamber, thus providing an extremely clean workpiece environment free from corrosion, outgassing and extraneous contamination.
- *Tape Controlled Programming.\** Operation of the CW-1 can be fully automated. Beam deflection and table position can be programmed on tape using conventional industrial numerical controls.

\*With optional equipment at extra cost.

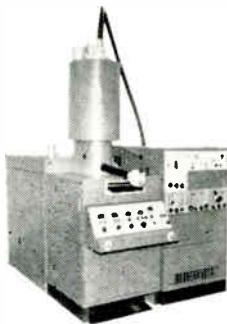

For complete information on the Model CW-1, contact: Sales Manager, Electron Beam Machines, Hamilton Standard, Windsor Locks, Conn.

**Hamilton Standard** DIVISION OF UNITED AIRCRAFT CORPORATION



# INTERNATIONAL NEWS

## Common Market Plans Single Patent System

The six Common Market countries are moving rapidly toward a single patent system—which should be of major concern to Americans dealing with international patent laws.

This was the gist of a statement made recently by U. S. Commissioner of Patents David L. Ladd to the Patent, Trademark and Copyright Section, American Bar Association in San Francisco.

Ladd said the proposed patent system should concern U. S. inventors and industries because it will leave them unable to secure common patents for these countries. He suggested the U. S. work toward having a single patent system with them.

U. S. inventors and industries take out more patents each year in these countries than those of any nation outside the Common Market. At present, an American national, like one of any Common Market country, must take out patents in each nation if he wants to protect his product in them.

Under the common system, which was drafted in June, a complete patent law and system would be set up for the countries (West Germany, France, Italy, Belgium, Luxemburg and the Netherlands). There would be a single office to issue common patents. The nations, however, could still issue individual patents.

Ladd said if a U. S. applicant could not get a common patent, he could still  
*(Continued on page 34)*

## EUROPE

London — A closed-circuit EMI TV camera is being used in archaeological excavations at Wilsford Shaft near Stonehenge. Located at the bottom of the shaft, it facilitates visual contact between under and above-ground operators.

Stockholm — Sweden has successfully launched, on an American Nike-Cajun rocket, the first probe in a joint US-Swedish program to explore noctilucent clouds.

London—A 30 ft. dia. experimental dish reflector designed to operate at wavelengths down to 3 cm. has been produced by Marconi. With a measured surface accuracy of better than 0.02 in. standard deviation, it may be used in satellite tracking.

Brussels—Fansteel Metallurgical Corp., No. Chicago, Ill., and Soci t  Generale Metallurgique de Hoboken, of Belgium, have agreed to form a joint company. The new company will be called Refractory Metals Fansteel—Hoboken. It will be 50% owned by each company.

Rome — Marconi Italiana, Italian subsidiary of Guglielmo Marconi's original British Company, is again headed by a member of the Marconi family. The Marchese Giulio Marconi, son of the founder, recently became Marconi Italiana President. He has worked for the company for 28 years.

Berlin—AEG, GE and Hochtief will begin construction of a full-size nuclear power station at Gunzburg on the Danube in West Germany with a gross output capacity of 250,000 kw.

## PRODUCTION TEAM



Members of a production team of engineers and plant managers, jointly sponsored by India and the U. S., watch hand assembly of components made for special purpose tubes at Amperex Electronic Corp., Hicksville, L. I., N. Y. The Indian group visited Amperex as part of 7-week world study tour.

## ASIA

Karachi—Central Treaty Organization nations are building a 3,060-mile microwave telecommunications network along the Southern Soviet Russian border. It will extend from here to Ankara. Fifteen engineers from Pakistan, Iran and Turkey are in the U. S. getting technical advice.

Tokyo—A joint venture in semiconductor development, manufacturing and marketing by Komatsu Mfg. Co. here and Hoffman Electronics Corp. has been approved by the Japanese government.

Tokyo—About 59% of Japan's space research expenditure has come from private industry. Over 30% of this private contribution came from electrical manufacturers. Japan has been engaged in space research since 1952.

Tokyo—Export sales of Japanese-made industrial communications equipment climbed sharply in the first half of 1962. They reached a total of \$11,800,000, compared to \$675,000 in the first half of 1961.

## AUSTRALIA

Canberra—Raytheon Co. has introduced high-speed electronic ovens in Australia. It is expected that these will accelerate the country's acceptance of "convenience foods," such as frozen, pre-cooked and pre-portioned.

## NORTH AMERICA

Mexico City—Reliance Electric & Engineering Co., Cleveland, O., has acquired a financial interest in Reliance de Mexico, S.A. The Mexican company manufactures industrial electric motors to Reliance product designs. It  
*(Continued on page 34)*

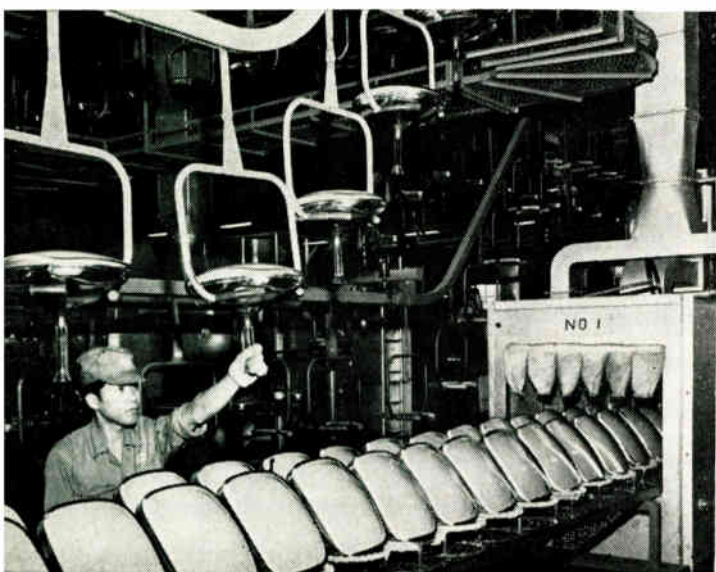

## DRYING MACHINE

TV picture tubes are dried by machine as final processing step at Tokyo Shibaura Electric Co.'s Himeji Works. The plant makes 100,000 picture tubes a month, also vacuum tubes & fluorescent lamps.

From Fairchild

# PLANAR\* TRANSISTORS

## ELECTRICALLY ISOLATED

## FROM PACKAGE

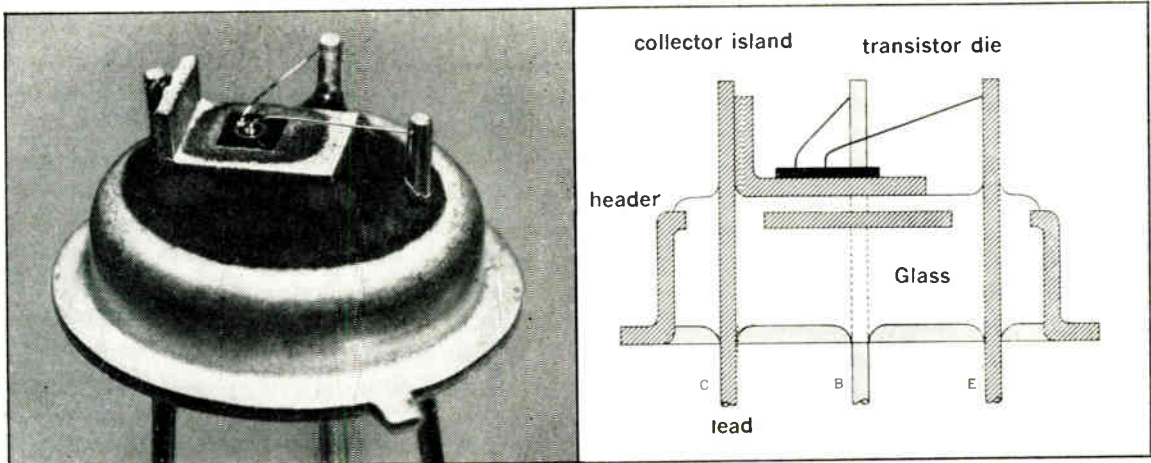

Enlarged photo of header with can off. 7 times actual size.

Cross-section of header and isolated transistor.

Gold-plated Kovar island is electrically welded to collector lead and fused onto glass insulator completely isolating transistor from can.

Fairchild now offers Planar transistors with collectors electrically isolated from their TO-5 packages. The entire transistor die is isolated; it is bonded to a gold-plated Kovar "collector island" which is fused onto a layer of glass, providing positive insulation from the rest of the package. All three leads are glass-insulated as they pass through the header platform. This isolation means you may now design using Planar transistors which are independent of their conductive packages in the circuit. Electrically isolated transistors eliminate the cost of special design and/or assembly necessary for transistor insulation. This type of construction also offers excellent resistance to thermal shock, mechanical shock and vibration. Mounting of the silicon transistor die and attachment of leadwires inside are accomplished by standard Fairchild bonding operations.

2N1893 }  
2N911 } These types offered in TO-5 Isolated  
2N910 } Collector packages

2N1893 Type - SP8400      2N910 Type - SP8401  
2N911 Type - SP8402

Data sheets available on all items.

**FAIRCHILD**  
**SEMICONDUCTOR**  
545 WHISMAN ROAD MOUNTAIN VIEW, CALIF. • YORKSHIRE 8 8161 • TWX: MN VW CAL 853  
A DIVISION OF FAIRCHILD CAMERA AND INSTRUMENT CORPORATION

\*Planar: A patented Fairchild process



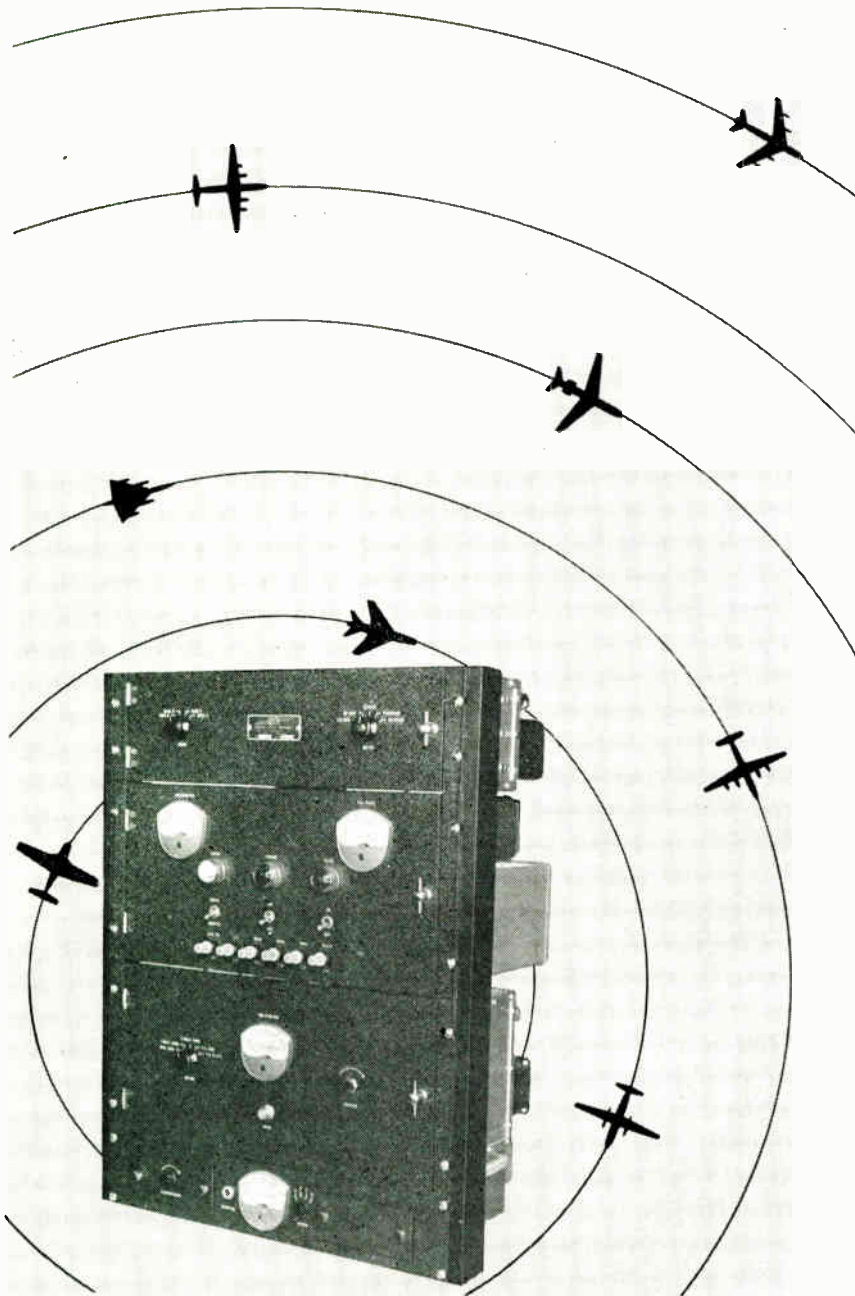

# VERSATILE

## UNIVERSAL TRANSMITTER FOR COMMUNICATING WITH AIRCRAFT

ERCO'S Type 637-T UHF Transmitter is ideal for any ground-to-air application in the 225 to 400 mc band. FCC-type accepted, this versatile, dependable transmitter incorporates all of ERCO'S long experience and engineering creativity in the aircraft and marine communications field. ■ Type 637-T is a fixed-frequency, crystal-controlled unit of modular construction. All R.F. elements are self contained; solid state modular is in drawer-type units. Write for full details. ■ Attention Manufacturers' Representatives: Several choice territories available.



*Pioneers in Quality Radio Communication Equipment*

**ERCO RADIO LABORATORIES, INC. • GARDEN CITY, N.Y.**

## INTERNATIONAL NEWS

*(Continued from page 32)*

was the first company to produce explosion-proof motors for the Mexican petroleum and chemical industry.

Toronto — Citizen band two-way radios were used to guide the "Hutari safari" through the streets of Toronto. Raytheon sets led John Wayne, Pat Wayne and Elsa Martinelli around mobs of movie fans to keep the parade on schedule.

Ottawa—Renwell Electronics Corp., South Hadley Falls, Mass., has acquired Tresco Ltd., Montreal, Canada, numerical machine tool control manufacturer, for an undisclosed amount of cash and stock.

New York—Seven grants have been made by the International Copper Research Association for studies to expand the uses of copper. Grants have been made to universities and private laboratories in Italy, Sweden, Belgium, England and the U. S.

Washington, D. C.—Latest reports on the markets for U. S. telecommunications equipment in individual foreign countries may be obtained by writing the U. S. Dept. of Commerce, Washington 25, D. C.

### AFRICA

Cairo—The United Arab Republic Broadcasting & TV Service has ordered five Mark IV TV cameras and associated equipment from Marconi's of England.

### Common Market

*(Continued from page 32)*

get individual ones in each country, but this would be an additional effort for him. The nations, also, would be depriving themselves of an advantage: issuing just one patent and thereby avoiding duplication.

Under the treaty, courts of the country where an alleged infringement occurs would be used for legal action. These courts, however, would not decide questions of patent validity. Such questions would be decided by a multinational tribunal. The treaty would govern on any specific point it covers.

The Commissioner said the U. S. Patent Office, Dept. of Commerce and State Dept. are watching the situation closely. He solicited views from members of the patent bar and others on the attitude the U. S. is to adopt.

predictable performance over wide ambient temperatures...



# it's thermoproof!



## solid state PORCELAIN CAPACITORS

- \* low loss
  - \* low noise
  - \* greater stability
- \* wide temperature range
  - \* impervious to humidity

-55°C to +125°C operation  
0.5 mmf to 6800 mmf  
50 to 500 vdc  
Conforms to MIL-C-11272B

© Vitramon, Inc. 1962

The monolithic, solid state construction of "VY" Capacitors give them a stability over a wide range of temperatures that is unique among components. When cycled between -55°C and 125°C, "VY" Capacitors exhibit essentially no capacitance drift (less than .05%) with no resultant physical damage or electrical change.

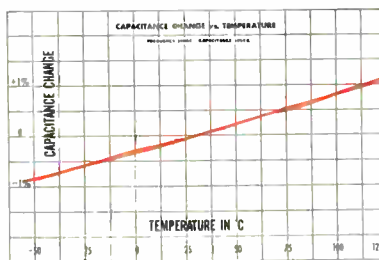

*And performance is predictable!* All "VY" Capacitors will retrace the curve, illustrated, within 5 ppm — an important factor in multi-stage circuits where capacitance must change in an identical manner in all stages, or where precise compensation is needed.

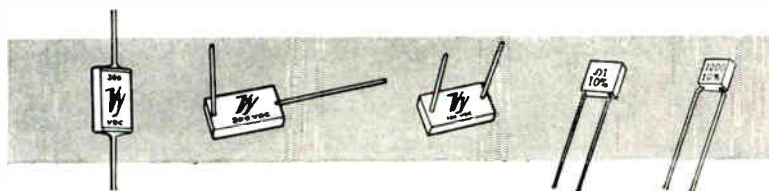

**Vitramon**<sup>®</sup>  
INCORPORATED

Box 544 • Bridgeport 1, Connecticut



Another Methode Advance...

## Closed Entry Socket Contacts



## In New, Improved NAS 714-715 Series Receptacles and Plugs

*NOTE: for special requirements, we can and do make custom variations of these connector types.*

Methode's product improvement doctrine is ample evidenced with the introduction of these high reliability pin and socket connectors which are substantially superior to card edge connectors. They are available with 7, 11, 15, 19 or 23 contacts and are specifically designed to meet all the requirements of NAS-713 specification. Also available with 35 contacts in standard 23 size shell.

### **The significant features:**

- closed entry, removable socket contacts for solder or crimp termination in NAS-714 type receptacle
- crimp type socket terminations meet MIL-C-26636 requirements
- closed entry sockets use heat treated Berylco pressure spring for maximum reliability and performance
- optional split type phosphor bronze socket contacts

with competitive pricing and Methode's ultra-high service make these connectors the ones to specify!

**Write for informative literature.**



ROLLING MEADOWS, ILLINOIS



HARWOOD HEIGHTS, ILLINOIS



**Methode Electronics, Inc.** 7447 W. Wilson Ave. • Chicago 31, Ill.

Telephone: UNDERhill 7-9600

## TELE-TIPS

**GI'S EARS** are protected from the high intensity noise of gunfire through a new electronic device developed by the U. S. Army Medical Research Lab. Just before the gun fires, the device generates a pulse that damps the gunner's earphones.

**MINIATURE TV SET**, about the size of a flashlight, is called "Electrocular." It mounts on the person's head, projecting its image on a small, semi-transparent mirror in front of the right eye. A wide range of applications are foreseen, for pilots, in remotely controlled industrial applications and in surgical operations.

**TELSTAR** was used by the United States and United Kingdom to synchronize their clocks. Time signals were sent simultaneously through Telstar from Andover and Goonhilly. The time of arrival of the pulse from the other station was compared with the transmission pulse. It was then possible to determine both the time of transmission of the signal and the difference in the time of the clocks at the two transmitting stations. The accuracy of the measurement was 10 microseconds.

**FIRST ISOTOPE-POWERED** automatic weather station began transmitting observations just one year ago from the Canadian Northwest Territory. Team of scientists visited the station for the first time since its installation and reported it in excellent condition.

**TRAFFIC IN ELECTRONIC PARTS**, trans-shipping them to Iron Curtain countries, is a continuing problem to the Dept. of Commerce. Importers and exporters have been notified that certain items are not to be passed on, but the practice continues nevertheless, probably because it is so lucrative. Hardly a month goes by that some European or Far East trader does not lose his U. S. export privileges. This month, four European traders, in West Germany and Sweden, are blacklisted for passing on X-ray tubes to Communist China.

**PROJECT ECHO**, the 100 ft. diameter plastic balloon that first demonstrated the feasibility of relay satellites, celebrated its second birthday last month. In the two years she orbited the Earth 9,000 times, travelling

*(Continued on page 40)*

## RESEARCH STATION CONSTRUCTION HALTED

Work on the 600 ft. radio telescope under construction by the U. S. Navy at Sugar Grove, W. Va., has been halted on instruction of the Secretary of Defense.

The Secretary's action followed a study of the potential usefulness of the telescope. It was determined that the need originally established in 1954 for classified research in ionospheric physics, space communications, navigation and radio astronomy has been reduced by major advances in science and technology not foreseen at that time.

Because of this decrease in potential usefulness and the increase in costs, the stop order was issued. The project is currently being carried on at the rate of about \$1 million a month.

## RESEARCH CONTRACTS AWARDED TO MARTIN

Three government agencies have awarded Martin Co.'s Research Inst. for advanced Study (RIAS) contracts for basic research in non-linear mathematics—an area relating to problems in space flight, long range communications and automation.

Contracting agencies are the Air Force Office of Scientific Research, NASA, and the Office of Naval Research.

Research in non-linear mathematics is expected to provide a better understanding of the fundamental mathematics of control and stability.

## NEW TYPE OF RIGID REPEATER DISPLAYED

A new type of rigid submarine repeater was recently demonstrated at the Clark, N. J. plant of Western Electric Co.

The repeater, a form of amplifier, was designed by Bell Labs to provide two-way simultaneous transmission of 128 conversations over a single cable. The undersea systems now in use can handle 48 conversations over two separate cables—one for each direction of transmission.

The twin-cable systems use flexible repeaters, compatible with the armored cable used in those systems. The rigid repeaters, however, are for use with a new kind of "armorless" cable.

The entire unit must function perfectly for a minimum of 20 years on the ocean's floor.

# The First of its Kind!

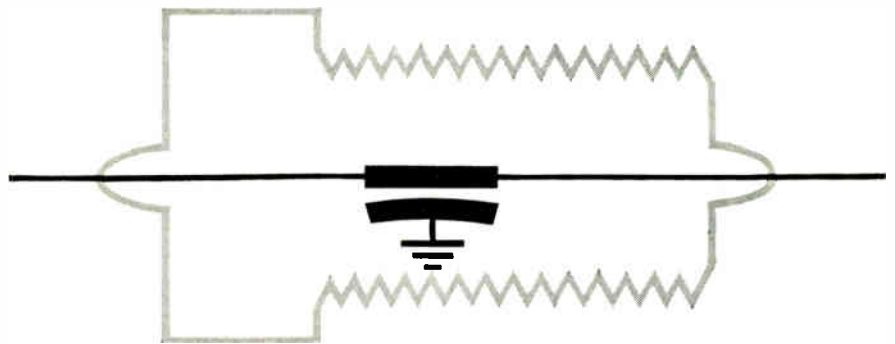

## A Solid Tantalum 5-Ampere Feed-thru Capacitor for RFI Suppression

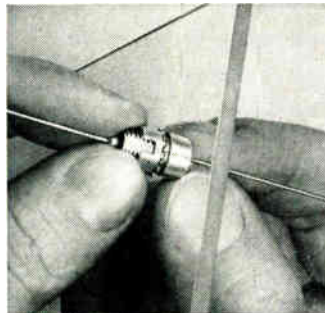

*Sprague Type 180D Tantalex Capacitor on transparent panel to illustrate feed-thru mounting.*

- Sprague's Type 180D Tantalex® Capacitor is another result of extensive pioneer work in the field of solid-electrolyte tantalum capacitors.
- Three-terminal unit—line current is carried through tantalum section from lead to lead, case is ground terminal.
- Negligible self-inductance, minimum length of internal path for RFI—large values of capacitance in small physical size account for unusually effective elimination of spurious and unwanted signals.
- Completely new case design assures firm metallic contact with mounting surface over a closed path, completely encircling the feed-thru conductor.
- Threaded body and spanner nut of same outside diameter as collar of the case permit close mounting and maximum stacking capacity.
- Corrosion-resistant metal case, hermetically-sealed with glass-to-metal solder seal terminals for maximum protection against severe environmental conditions.
- All units carry 5 amperes thru-current. Capacitance ratings range from 60  $\mu\text{F}$  at 6 volts to 6.8  $\mu\text{F}$  at 35 volts d-c.

*For complete technical data, write for Engineering Bulletin 3525A to Technical Literature Section, Sprague Electric Company, 233 Marshall St., North Adams, Mass.*





### "M" AND "S" MINIATURES

Slightly larger than the "U" and "UB" Types, still excellent for use in compact equipment. Soldered plate construction, heavily anchored stator supports. DC-200 treated steatite insulators. Plates are nickel-plated brass. Available in Single Section, Butterfly and Differential types with straight, locking and screwdriver shafts. "S" also available in Dual type.

**TYPE "M"**—Requires only  $\frac{5}{8}$ " x  $\frac{3}{4}$ " panel area. Peak voltage rating: 1250 volts on .017" spaced units; 850 volts on 160-130, spaced .013"; mounting bushing,  $\frac{1}{4}$ "-32.

**TYPE "S"**—Slightly larger than Type "M". Peak voltage rating: 850 volts—plate spacing .013", other spacings available on special order. Mounting studs tapped 4-40 on  $17/32$ " centers.

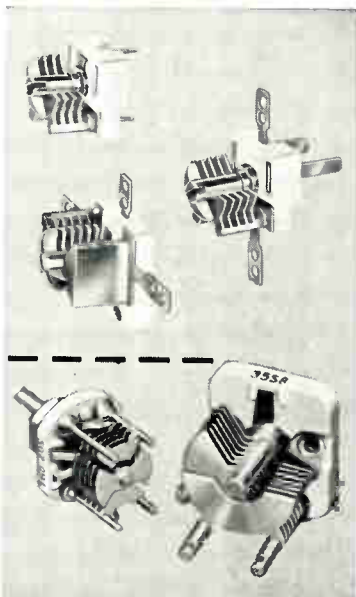

### SUB MINIATURE "U" AND "UB" TYPES

These tiny, sub-miniatures require less than 0.2 or 0.3 square inch mounting area, depending on type. Unique, precision machined design from one piece of solid brass delivers outstanding reliability, with exceptionally uniform delta C and voltage characteristics.

All metal parts silver-plated—ceramic is steatite Grade L-4 or better. Virtually impervious to shock and vibration damage—provides freedom from moisture entrapment found in trimmer capacitors of enclosed or solid dielectric type. Voltage breakdown ratings to 1,300 volts DC. Extra heavy rotor end plate is slotted for screwdriver adjustment. Choice of 3 fast, easy mounting types: "LocTab", Printed Circuit or 2-Hole.



**E. F. JOHNSON COMPANY**

3002 TENTH AVENUE S.W. • WASECA, MINNESOTA

- Outstanding reliability—exceptional mechanical stability!
- High "Q"—greater than 1500 at 1 mc!
- High torque-to-mass ratio—2 to 7 inch ounces!
- Low temperature coefficient—approx. 35 PPM/°C positive!

# "U," "UB" AIR VARIABLES

*Available in Butterfly, Differential,  
Dual and Single Section Types*

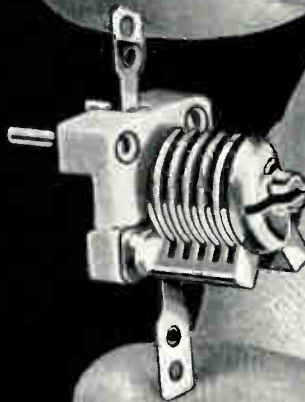

**DETAILED COMPONENTS CATALOG AVAILABLE**—Write today on company letterhead

● CAPACITORS ● TUBE SOCKETS ● CONNECTORS ● PILOT LIGHTS ● INSULATORS ● KNOBS AND DIALS ● INDUCTORS ● HARDWARE

# a New Concept

## PRECISION CAPACITANCE BRIDGE

with lever balancing controls, digital readout, automatic decimal point location and unit indication greatly simplifies balancing.



**RANGE, 10  $\mu$ pf to 1 $\mu$ f**

**DIRECT READING  
ACCURACY,  $\pm 0.01\%$**

**RESOLUTION, 1 ppm**

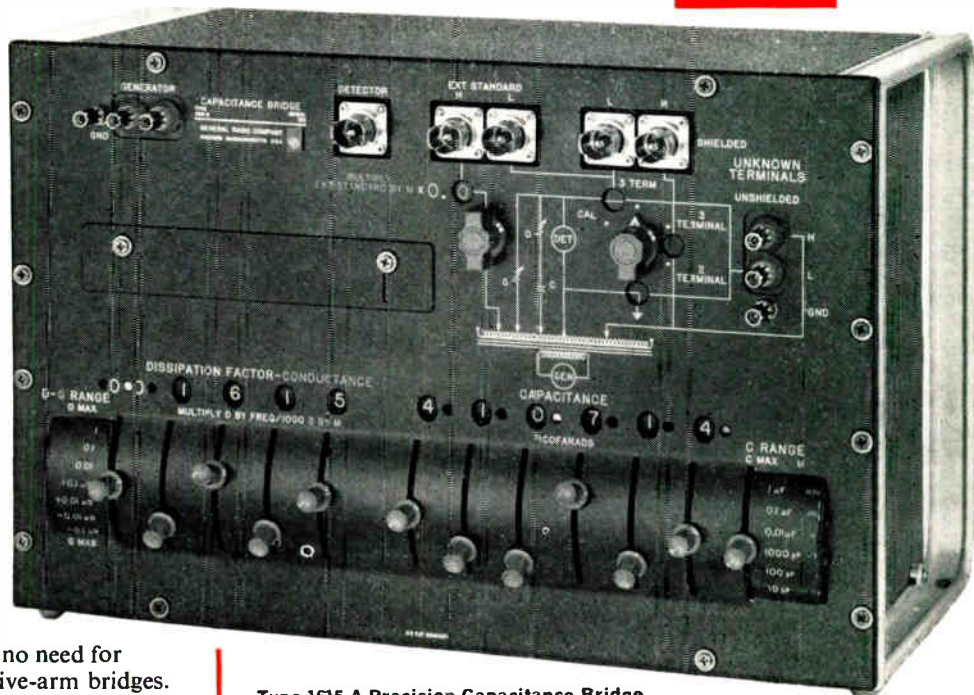

- ★ A transformer ratio-arm capacitance bridge having the capability of one-step 3-terminal capacitance measurement — no need for secondary balances as required by resistive-arm bridges.
- ★ Measures 3-terminal and grounded or ungrounded 2-terminal capacitors. A ground capacitance of 1  $\mu$ f produces an error of only 0.01% in the measurement of a 1000-pf capacitor.
- ★ Highly stable and accurate internal capacitance standards . . . all standards are made from Invar alloy, and the six largest are hermetically sealed in dry nitrogen, resulting in a stability of better than 5 ppm/ $^{\circ}$ C.
- ★ All internal standards can be quickly checked against each other for consistency. Only a single external standard is required to establish the absolute calibration of the entire set.
- ★ Fast one-step intercomparisons of 3-terminal capacitors differing in value by 10,000 to 1 can easily be made.
- ★ When loss of unknown capacitor is less than that of standard, indication is given directly in terms of G.
- ★ Bridge circuit on panel automatically indicates proper bridge connections for each measuring situation.

### Type 1615-A Precision Capacitance Bridge

**Capacitance Range (6 ranges):**  $10^{-17}$  to  $10^{-6}$  farads (10  $\mu$ pf to 1 $\mu$ f), direct reading; 6-figure resolution, smallest division  $10^{-17}$  farads. Ranges can be extended by use of external standards.

**Dissipation-Factor Range (3 ranges):** 0.000001 to 1 at 1 kc, direct reading. Directly proportional to frequency at other frequencies.

**Conductance Range (2+ ranges; 2- ranges):**  $10^{-8}$   $\mu$ mho to 100  $\mu$ mho; independent of frequency; 4-figure resolution, smallest division  $10^{-8}$   $\mu$ mho.

**Accuracy: Capacitance,**  $\pm 0.01\%$ ; direct reading, with internal standards; at high frequencies, error is  $0.002\% C_{\mu f} \left(\frac{f}{1000}\right)^2$   
**Capacitance,** approximately 1 ppm when comparing against external standards.

**Dissipation factor,**  $\pm (0.1\% + 7 \text{ ppm})$  of measured value.

**Conductance,**  $\pm 1\% + 0.0001 \mu\text{mho}$ .

**Frequency Range:** Approximately 100 cycles to 10 kc.

**Temperature Coefficients of Internal Standards:** About 5 ppm/ $^{\circ}$ C.

**Maximum Voltage:** 20 volts at 1 kc. Proportional to frequency.

**Price:** \$1475

### Complete Capacitance Measuring Assembly.

**Type 1620-A** . . . includes the Type 1615-A Bridge; Type 1232-A Tuned Amplifier and Null Detector, a low-noise high-gain instrument with a 20-c to 20-kc range and a full scale sensitivity of 1  $\mu$ v; and the new Type 1311-A Bridge Oscillator, with 11 fixed frequencies from 50c to 10 kc. Price for the complete assembly is \$2080.

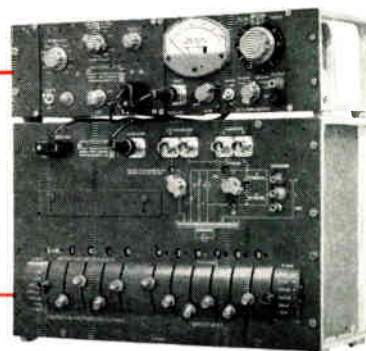

Write for Complete Information

## GENERAL RADIO COMPANY

WEST CONCORD, MASSACHUSETTS

NEW YORK, Worth 4-2722  
District Office in Ridgfield, N. J.  
Whitney 3-3140

CHICAGO  
Oak Park  
Village 8-9400

PHILADELPHIA  
Abington  
Hancock 4-7419

WASHINGTON, D. C.  
Silver Spring  
Juniper 5-1088

SYRACUSE  
Syracuse  
GLenview 4-9323

SAN FRANCISCO  
Los Altos  
Whitecliff 8-8233

LOS ANGELES  
Los Angeles  
Hollywood 9-6201

ORLANDO, FLA.  
Orlando  
Garden 5-4671

IN CANADA  
Toronto  
CHerry 6-2171

Circle 29 on Inquiry Card



# Reliability Through Design Simplicity



Actual size

## *Sensitive Micro-Miniature Relay/Style 6B*

### General Characteristics

- Contact Combination:**  
2 Form C
- Contact Rating:**  
2 amp resistive 26.5 VDC  
1 amp inductive 26.5 VDC  
Low level switching
- Operating Characteristics:**  
40 milliwatts sensitivity  
30,000 ohms max. coil resistance
- Ambient Temperature:**  
-65°C to +125°C
- Vibration:**  
10-55 cps at .120" DA  
55-2000 cps at 20 G
- Shock:**  
50 G operational
- Acceleration:**  
100 G operational
- Terminals:**  
Leads; solder; printed circuit  
and spade types.

*For Additional Information, contact:*

## PRICE ELECTRIC CORPORATION

323 Church Street • Frederick, Maryland  
Area Code 301: 663-5141 • TWX: Fred 565-U

Circle 30 on Inquiry Card

## TELE-TIPS

(Continued from page 36)

277,257,677.67 miles. Her initial orbit was an apogee of 1,049 statute miles and perigee of 945 miles. Right now the orbit is 1,175 miles apogee and 704 miles perigee. The difference is explained by the pressure of solar radiation.

**SUN PROBE** is being planned by NASA with three study contracts being awarded to Ball Bros. Research Corp., Republic Aviation and Space Technology Labs. One Orbiting Solar Observatory—the OSO 1—is now in orbit. The projected studies will help our understanding of solar-earth relationships and perhaps allow us to develop better methods of predicting solar flares.

**CITIZENS BAND LICENSES** now total over 305,000. Nearly 100,000 stations were licensed during the year ended June 30, 1962. An estimated 90% of these stations are in the Class D (AM radiotelephony on 22 frequencies in the 26.96-27.23 MC band) category.

**SMALL BUSINESS ADMINISTRATION** has prepared a booklet to guide small manufacturers in the essential functions of administrative management — planning, organizing, staffing, directing and controlling. The booklet, "Management Aids for Small Manufacturers—Annual Number 8," is available from the U. S. Government Printing Office for 35¢. Topics include: export assistance, copyrights, providing capital for your firm, steps in incorporating, selecting a lawyer and using deferred compensation in small business.

**ELECTRONIC EQUIPMENT** sold to the public, particularly novelty items, are often very badly misrepresented and the Federal Trade Commission is waging a continuing battle against them. Latest to be slapped down is a Midwest manufacturer peddling "New Magic Walkie Talkie" which he promises will have a range of ½-mi. for any home radio receiver located in buildings, and up to 10 mi. when transmitting from one car to another. The FTC says the device actually has a range of 50 ft. in urban areas and no more than 75 ft. in other areas. The FTC adds that the manufacturer fails to mention that the "device, when an extended wire antenna is used, requires an FCC station license."

# NEW TEKTRONIX DUAL-BEAM OSCILLOSCOPE with Sweep Delay and Plug-in Versatility

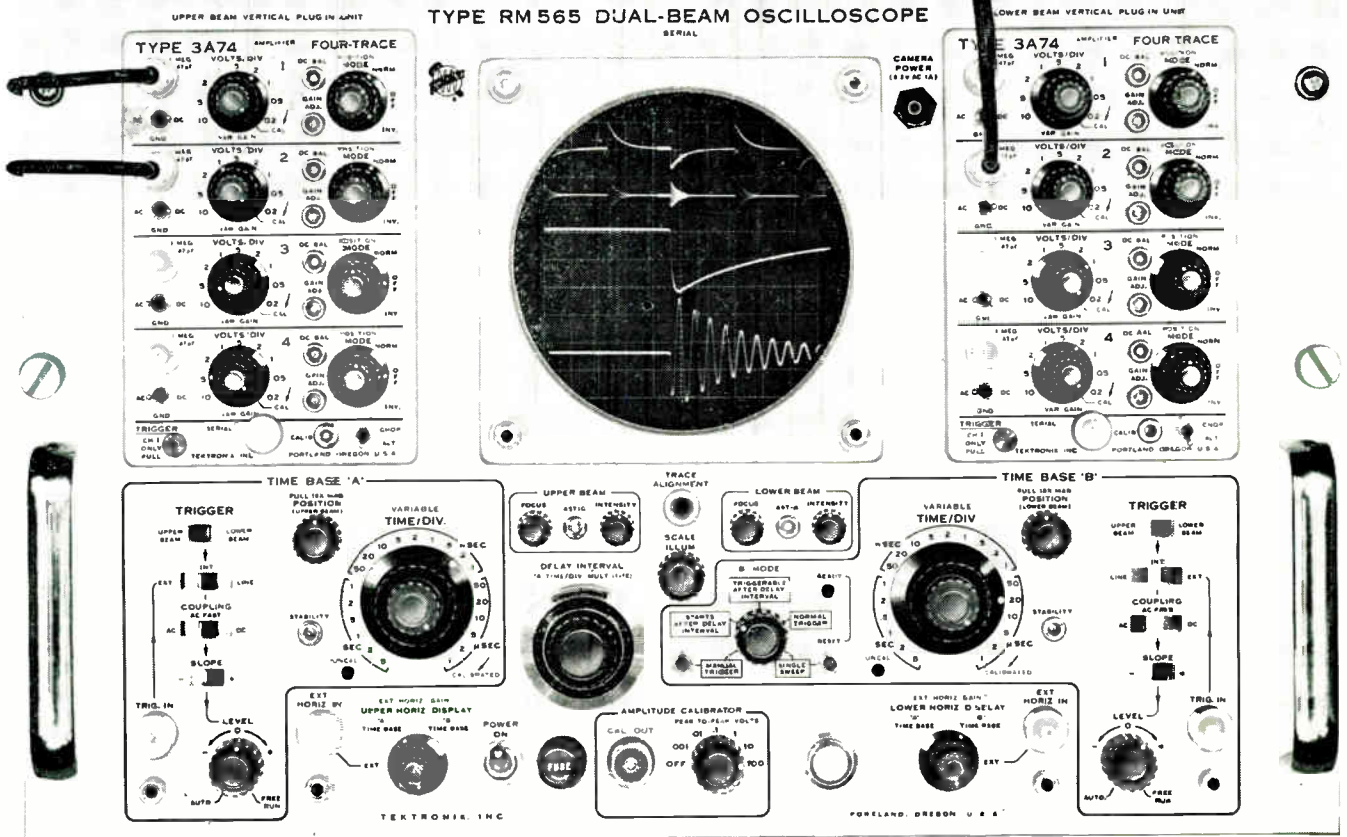

The waveform display represents four time-related functions—two trace-intensified by use of delayed sweep and two expanded presentations of these intensified portions.

Four additional traces are available from this oscilloscope/plug-in combination.

Sweep-delay characteristics include delay interval range of 1  $\mu$ sec to 50 sec, calibrated and continuously adjustable—with 0.5% incremental accuracy and wide-range, jitter-free magnification.

- 2 Completely Independent Beams
- 2 Identical Independent Sweep Systems
- 2 Vertical Amplifier Compartments
- Delayed-Sweep Operation
- Single-Sweep Operation
- Rear-Panel Output Connectors
- Rack-Mount or Cabinet Model

### PLUG-IN UNITS

AMPLIFIER UNITS TYPE	PASSBAND (3-db down)	SENSITIVITY	PRICE
2A60	dc-1 Mc.	50 mv/cm-50 v/cm 4 decade steps with variable control	\$105
2A63-Differential (50:1 rejection ratio)	dc-300 kc.	1 mv/cm-20 v/cm 1-2-5 sequence with variable control	\$150
3A1-Dual Trace (Identical Channels)	dc-10 Mc. (each channel) 6-cm linear scan.	10 mv/cm-10 v/cm 1-2-5 sequence with variable control.	\$410
3A72-Dual Trace (Identical Channels)	dc-650 kc. (each channel)	10 mv/cm-20 v/cm 1-2-5 sequence with variable control.	\$250
3A74-Four Trace (Identical Channels)	dc-2 Mc. (each channel)	20 mv/cm-10 v/cm 1-2-5 sequence with variable control.	\$550
3A75-Wide Band	dc-4 Mc.	50 mv/cm-20 v/cm 1-2-5 sequence with variable control.	\$175

Rack-Mount Model, illustrated.

(Mounts on tilt-lock, slide-out tracks to standard 19" rack.)

Dimensions—12 $\frac{1}{4}$ " high by 19" wide by 22" deep.

Weight—67 pounds.

Type RM565 Oscilloscope (without plug-ins) . . . . . \$1500

Cabinet Model

Dimensions—13 $\frac{1}{2}$ " high by 17" wide by 23 $\frac{3}{8}$ " deep.

Weight—62 pounds.

Type 565 Oscilloscope (without plug-ins) . . . . . \$1400

U.S. Sales Prices f.o.b. Beaverton, Oregon

**For more information on either model of this versatile new dual-beam oscilloscope, please call your Tektronix Field Engineer.**

**Tektronix, Inc.** P. O. BOX 500 • BEAVERTON, OREGON / Mitchell 4-0161 • TWX-503-291-6805 • Cable: TEKTRONIX

**TEKTRONIX FIELD OFFICES** are located in principal cities throughout the United States. Please consult your Telephone Directory.

**TEKTRONIX CANADA LTD:** Montreal, Quebec • Toronto (416) 291-0011 • Ontario

**TEKTRONIX OVERSEAS DISTRIBUTORS:** Kentron Hawaii Ltd., Honolulu, Hawaii • and other distributors in twenty seven overseas countries by qualified engineering organizations. European countries and the countries of Lebanon, Syria, and Algeria, please contact TEKTRONIX INTERNATIONAL A.G., Terrassenweg 1A, Zug, Switzerland, for the name of your local overseas distributor. Other Overseas areas, please write or cable directly to Tektronix, Inc., International Marketing Department, P. O. Box 500, Beaverton, Oregon, U.S.A. Cab5a: TEKTRONIX.

**SEE THE LATEST TEKTRONIX INSTRUMENTS AT NEC**



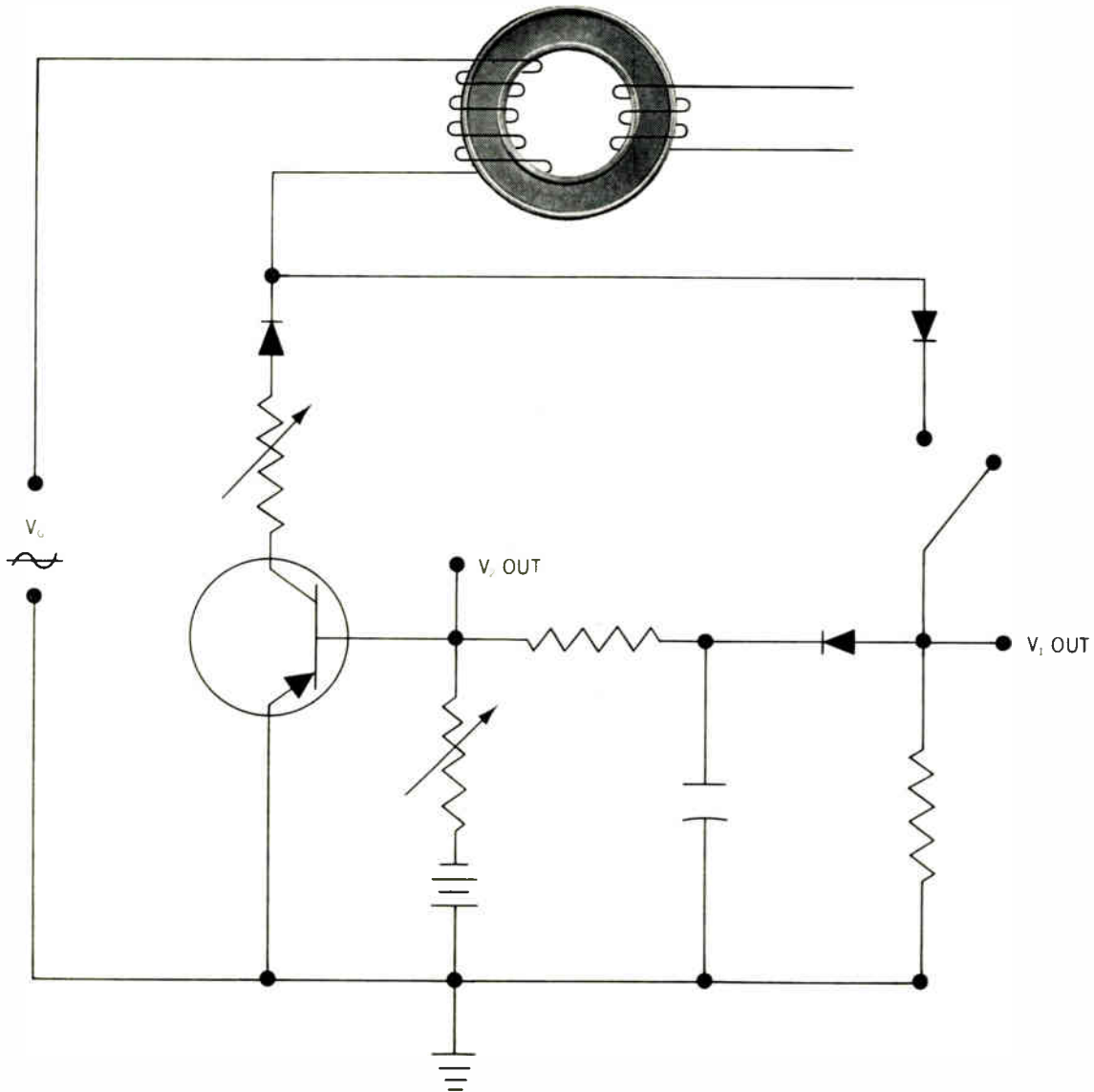

## HOW TO GET 2 MINUTES TIME DELAY WITH 1% ACCURACY

HERE'S AN ADVANCED DESIGN that uses alternate positive and negative volt-second signals to pulse an Orthonol® core to produce time delays up to 2 minutes with 1% accuracy. Key to extreme accuracy in this bi-directional trigger technique: the nearly ideal rectangular loop characteristics of Magnetics Inc.'s Orthonol® that permit switching sharply from the unsaturated to the saturated state.

What makes the circuit superior to mechanical devices, commonly used r-c circuits or magnetic core circuits of the past? Just this. Trigger pulses can come from any constant frequency source. The circuit is symmetrical; hence, compensating for effects of variations in temperature, voltage and frequency.

And because the circuit features solid state devices, high reliability is assured.

Useful for electronic counters and timers where accuracy and reliability are paramount, the circuit can also be applied to converting low level analog signals to frequency signals. By using the storage capacity (volt-second capacity) of the Orthonol® core, high sensitivity for any desired frequency range can be achieved.

For specific information about this circuit and the Magnetics Inc. cores that make it possible, write to *Magnetics Inc., Dept. O-5, Butler, Pa.*

**MAGNETICS inc.**  
®

# RAYTHEON 1N3728 CUTS DIODE COSTS IN HALF

New high reliability 1N3728 (formerly Rheem RD250) is direct replacement for more than 250 general purpose and high voltage silicon diodes.

Now you can reduce qualification and specification expenses, lower inventory costs, and obtain higher reliability with the Raytheon/Rheem 1N3728 *Universal* silicon diode. It is priced at less than one-half the average of manufacturer's published prices for the diodes it replaces, and meets or exceeds all tests and specifications for these units.

The 1N3728 features very high voltage with very low leakage. Reverse leakage is specified at nine points, forward current at ten. Replacement of

standard 100 and 200 volt diodes with the low cost 550-volt 1N3728 greatly increases the safety margin of the reverse characteristic, substantially reducing the major point of diode failure. Dependable performance is assured by more than two years of testing and field use.

For complete data of the 1N3728, please contact the Raytheon Field Office nearest you, or write Semiconductor Division, 900 Chelmsford Street, Lowell, Massachusetts.

MAXIMUM RATINGS @ 25°C		1N3728	UNIT
Peak rectified current	$i_F$	650	mA
Average rectified current	$I_0$	200	mA
Surge current (1 sec.)	$i_F$ (surge)	1000	mA
Pulse current (2 $\mu$ sec. 1% duty cycle)	$i_F$ (pulse)	2000	mA
Power dissipation (derate 1.4 mw/°C)	$P_t$	250	mW
Operating temperature	$T_A$	-65 to +200	°C
Storage temperature	$T_{stg}$	-65 to +200	°C

SPECIFICATIONS	MIN.	TYP.	MAX.	UNIT
Forward Voltage @ 1 mAdc	.61	.64	.68	V
@ 10 mAdc	.72	.75	.80	V
@ 100 mAdc	.84	.87	.98	V
@ 200 mAdc	.88	.92	1.09	V
@ 400 mAdc	.92	.98	1.20	V
Reverse Current @ 20 Vdc				$\mu$ Adc
@ 25°C		.0005	.005	$\mu$ Adc
@ 100°C		.050	.100	$\mu$ Adc
@ 150°C	1.00		2.0	$\mu$ Adc
Reverse Current @ 175 Vdc				$\mu$ Adc
@ 25°C		.010	.025	$\mu$ Adc
@ 100°C		.150	.500	$\mu$ Adc
@ 150°C	2.0		5.0	$\mu$ Adc
Reverse Current @ 400 Vdc				$\mu$ Adc
@ 25°C		.085	.100	$\mu$ Adc
@ 100°C		.500	1.0C	$\mu$ Adc
@ 150°C	4.0		10.0	$\mu$ Adc
Saturation Voltage -65°C to +200°C @ 100 $\mu$ A	500	—	—	Vdc
Saturation Voltage @ 25°C @ 100 $\mu$ A	550	650	—	Vdc

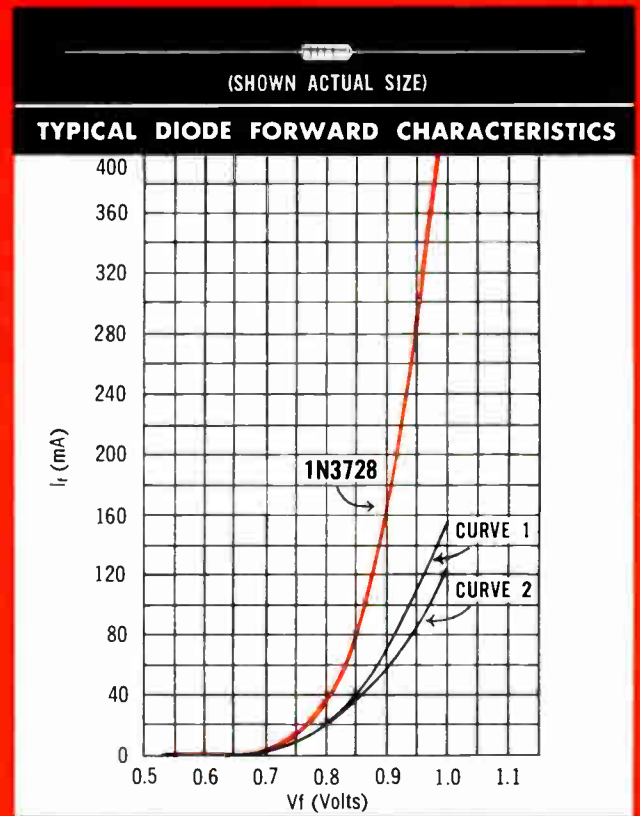

### TYPES REPLACED BY 1N3728

Some of the currently-used types replaced by the 1N3728/RD250 are such general purpose, high voltage silicon diodes as:

Type	Curve	Type	Curve	Type	Curve	Type	Curve
1N456	2	1N461	2	1N482	1	1N485	1
1N456A	1	1N461A	1	1N482A	1	1N485A	1
1N457	2	1N462	2	1N482B	1	1N485B	1
1N457A	1	1N462A	1	1N483	1	1N486	1
1N458	2	1N463	2	1N483A	1	1N486A	1
1N458A	1	1N463A	1	1N483B	1	1N487	1
1N459	2	1N464	2	1N484	1	1N487A	1
1N459A	1	1N464A	1	1N484A	1	1N488	1
				1N484B	1	1N488A	1

SEMICONDUCTOR DIVISION

LOWELL MASSACHUSETTS

RAYTHEON

Circle 11 on Inquiry Card

World Radio History



Ideal "NERVE-CENTER HOUSINGS" for production line automation equipment...



# EMCOR ENCLOSURES

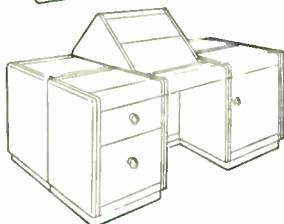
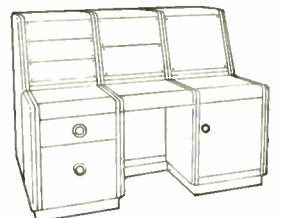
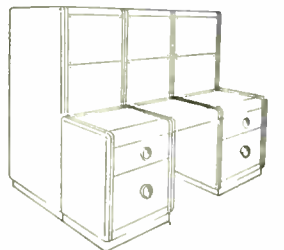

Ideal "NERVE-CENTER HOUSINGS" for production line automation equipment takes in a mighty big area. EMCOR Enclosures provide unmatched flexibility in covering this area. *Costly Custom Enclosure Design Time* is eliminated with the hundreds of standard enclosure widths, depths and heights available in the EMCOR Modular Enclosure System. From this wide variety of enclosure styles, an engineer can find an ideal enclosure to meet his electrical, electronic or electro mechanical equipment housing requirements. In addition, EMCOR Enclosures provide rugged construction, increased load carrying capacity and functional flexibility which is so essential in meeting production line automation demands. Advanced design and "human engineering" brings all controls within easy sight and reach of the operator. Request full details today.



EMCOR—The Original Modular Enclosure System By  
**INGERSOLL PRODUCTS**  
 Division of Borg-Warner Corporation  
 1000 W. 120th St. • Dept. 1245 • Chicago 43, Ill.

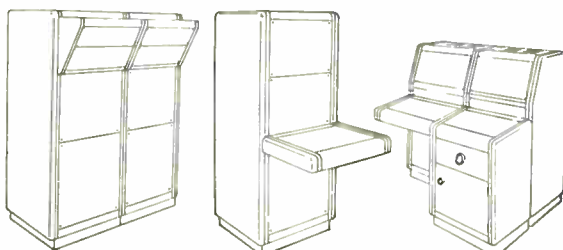

WRITE FOR  
 DESIGN  
 MANUAL  
 107

VISIT US AT THE NEC SHOW, OCTOBER 8-10—BOOTH 1003

## LETTERS

to the Editor

### Technician Shortage

Editor, ELECTRONIC INDUSTRIES:

I was interested to see the note on page 4 of the July 1962 issue of ELECTRONIC INDUSTRIES concerning the technician shortage.

Several of my colleagues and I have introduced a bill, The Technical Education Act of 1962, in Congress in order to help increase the supply of two-year, college level semi-professional technicians.

I am taking the liberty of sending you some information concerning this legislation which may be of interest to you and your readers.

John Brademas

Member of Congress

Congress of the United States

House of Representatives

Washington, D. C.

Aim of the bill is given as: "The best way of meeting the Nation's rising requirements for semiprofessional technicians is to expand existing or create new 2-year technical institutes at the college level, whether operated as independent institutions or by universities and community colleges, and that Federal funds are necessary to stimulate the development of these institutes. We believe it is important that professional societies should have a role in approving the programs of such institutes."

### "RFI Shielding—"

Editor, ELECTRONIC INDUSTRIES:

Much of the comment (Letters To The Editor, August 1962) about the shielded enclosure article by Mr. Durnovo in the January 1962 issue of ELECTRONIC INDUSTRIES seems to spring from the failure to recognize it as a general article cutting across specific areas in RFI control. Thus, there were many exceptions put forth to attempt to prove that a generality is not necessarily a truth. I'd like to take exception to some of those exceptions.

1. In the first place, there is no such thing as a standard solution to an RFI problem—be it shielding or filtering. Solution of an RFI problem is properly the function of RFI engineering consultation followed by the recommendation of equipment to meet economic, practical, and technical requirements.

2. Mr. Schreiber seems intent on changing the meaning of the word  
*(Continued on Page 48)*

# Here Is The New Bourns 10-Turn, 1/2" Precision Potentiometer

The Bourns precision potentiometer line now includes this brilliant newcomer featuring small size and independent linearity of  $\pm 0.25\%$  standard.

With customary care and attention to detail, Bourns has built into the Model 3700 all of the qualities that typify the rest of the line. Military reliability is ensured by 100% inspection for conformance to guaranteed characteristics as well as by participation in Bourns' rigorous Reliability Assurance Program. In addition, every unit incorporates the virtually indestructible Silverweld® termination which replaces delicate single-wire terminations.

Model 3700 exceeds steady-state requirements for resistance to humidity and, as an optional feature, meets the stringent

demands of MIL-STD-202B, Method 106 (Cycling Humidity). Available from stock today in quantity; write for descriptive literature.

Standard Resistance Range	500 to 100K ohms
Special Resistance Range	100 to 250K ohms
Resolution	0.06 to 0.02%
Linearity (Independent)	$\pm 0.25\%$

Power Ratings:	
70°C (158°F) Ambient	1.0 watt
125°C (257°F) Ambient	0 watts
Operating Temp. Range	-65 to 125°C

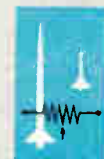
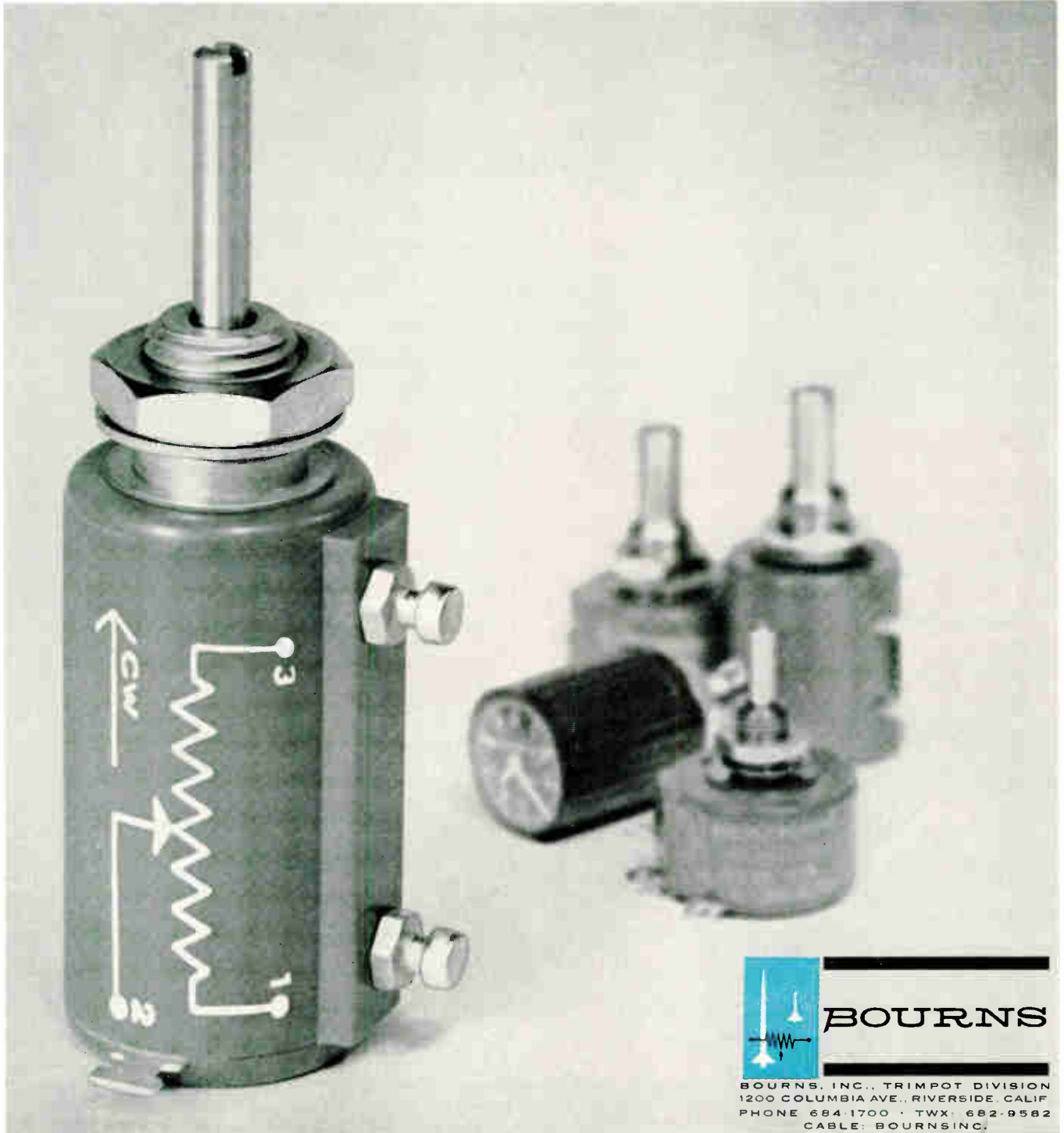

**BOURNS**

BOURNS, INC., TRIMPOT DIVISION  
1200 COLUMBIA AVE., RIVERSIDE, CALIF.  
PHONE 684-1700 • TWX: 682-9582  
CABLE: BOURNSINC.



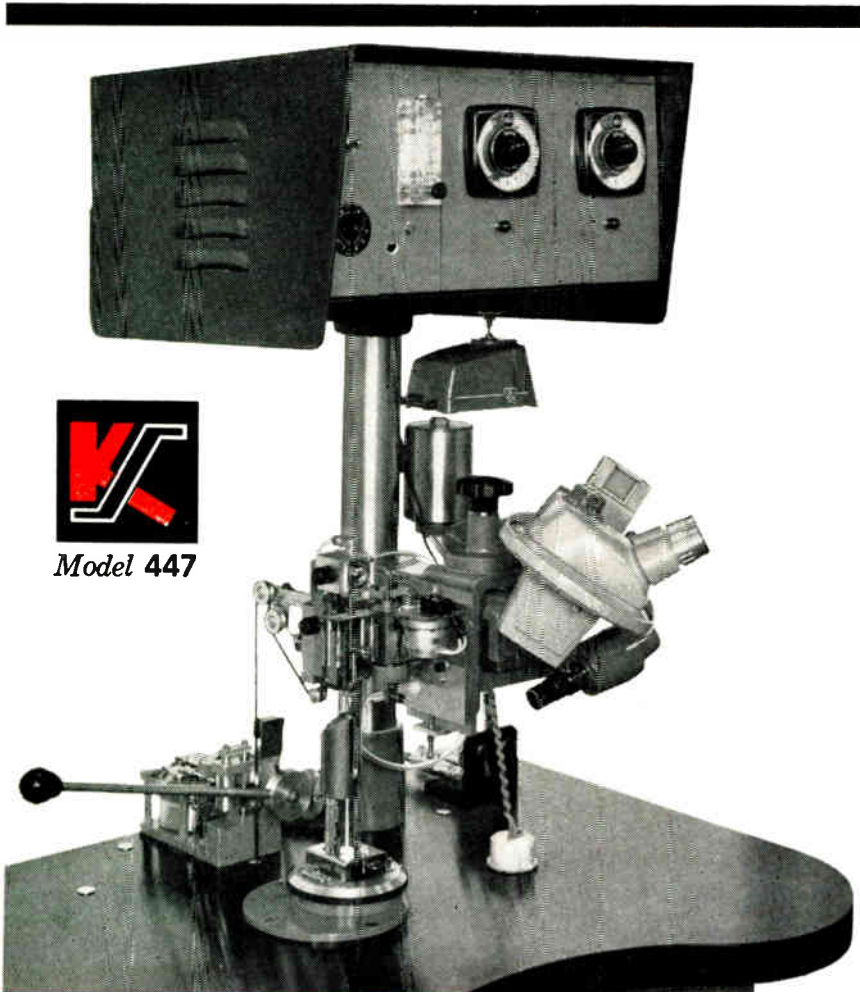



Model 447

**NAIL HEAD BONDER**

Bonds wire to the dice 

Bonds wire to the post . . . . . 

Stitch bonds from one device to another 

Terminates wire in a pigtail 

- HIGHER CAPACITY** Users report up to 30% higher hourly output over fastest competitive machine.
- IMPROVED YIELDS** Accurately controllable and reproducible machine functions give 10-30% higher yields.
- EASIER-TO-USE** New operators produce good units in first hour; reach peak performance in a few days.

Write today for complete information

**OTHER IMPORTANT K & S PRODUCTS**  
 Micropositioners • probing & test instruments • scribes • pellet, wafer & chip bonders • alloy junction transistor assembly machines • thermocompression & nail head bonders • microcircuitry assembly units • a full line of special tools & accessories.

**KULICKE and SOFFA**  
 MANUFACTURING COMPANY

*Designers, Builders and Suppliers of Research and Production Equipment*  
 135 COMMERCE DRIVE, INDUSTRIAL PARK, FT. WASHINGTON, PA.  
 215-646-5800



**NEW METHOD OF MEASURING TEMPERATURES ABOVE 5,000° F.**

A new method of measuring temperatures above 5,000° F. has been reported by Dr. W. H. Giedt, Research Scientist of the Advanced Technology Labs., Mountain View, Calif. The method will simplify readings of heat generated in rockets, arc-heated plasmas and advanced types of propulsion systems.

Dr. Giedt proposes to immerse two thermal elements (thermocouples, thermistors, etc.) having identical dimensions but unequal thermal capacities in high temperature streams for a short time, and record temperatures. His initial concern pertains to selecting the proper ratio of the heat capacities of the sensors, geometry of the sensors and also the type of sensors to be used.

One of the methods tested involved the use of two cylindrical thermocouples of the same material and size, but differing in construction (one solid and the other hollow), to obtain a difference in heat capacities. These sensors were exposed to an oxygen-acetylene flame, and the first results were within 5% agreement of standard measuring techniques.

**NASA BEGINS STUDIES**

NASA has begun studies to determine whether an unmanned lunar logistics system will be needed to support manned landings on the moon. Studies will be by both NASA field centers and industry.

Two separate studies will be made by industry—one of a spacecraft bus which could carry the support payload to the moon, and the other of a variety of payloads which could be soft-landed near the Apollo landing site, both before and after Apollo manned missions.

**OTS SHIFTED**

Secretary of Commerce Luther H. Hodges has announced the transfer of the Office of Technical Services from the Business and Defense Services Admin. to the Office of the Asst. Secy. for Science and Technology.

The Office of Technical Services (OTS) is the Federal Govt.'s center for collection and distribution of U. S. Govt. research information, translations of foreign technical literature, and other scientific data of use to American science and industry.

# WHY BUY SIX SWEEPERS to cover 1 to 26.5 Gc?

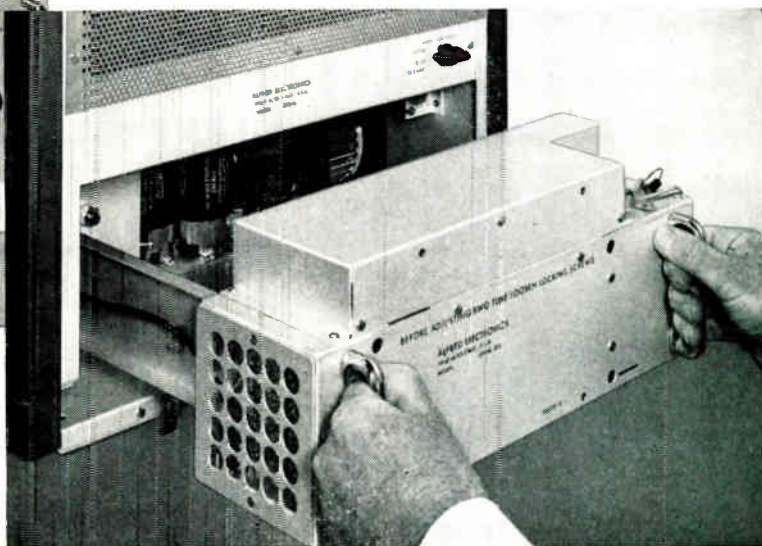
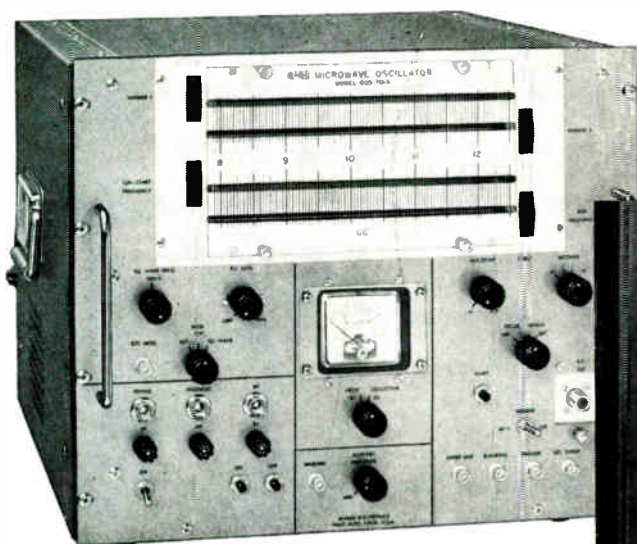

Plug-in Generator Head slides simply and quickly into Alfred's Model 605 General Frequency Oscillator.

**ALFRED 605 saves time, plug-in heads save money.** Buy one Model 605 and only the plug-in Generator Heads you need now. Extend frequency range with additional Heads when your requirements change. The 605 with six plug-ins provides electronically swept or single frequency coverage from 1 to 26.5 Gc. Sweep rate adjustable from 100 cps to 0.01 cps permits either oscilloscope or recorder display of broadband microwave component characteristics.

Your Model 605 is never obsolete; greater coverage is possible with new Heads as they become available. Special frequency requirements are covered with intermediate range Heads (some are listed below).

**Heads Easily Installed** — Heads are pre-calibrated — no adjustment needed — and can be changed in 3 minutes. Any Head can be used with any Model 605.

**Replaces Signal Generators** — As single frequency signal sources ALFRED Microwave Oscillators are as stable as mechanically tuned signal generators.

**Field Proven Performance** — Over 2 years in production and over 200 units in service.

## SPECIFICATIONS

**SWEEP WIDTH** Continuously adjustable from 0 to any part of the entire frequency range with direct calibrated dial.

**SELECTOR** Recurrent Sweep, Single Sweep, CW, and External.

**CONTROL** Single Sweep triggered by panel button, external positive going 20 v signal or internal line frequency signal.

**TIME** 100 to 0.01 second.

**EXTERNAL SWEEP** 200 v gives full sweep. DC to approx. 10 Kc response.

**FREQUENCY MARKERS** Two markers continuously adjustable over entire frequency range.

**INTERNAL AM** Square wave, 800 to 1200 cps.

**EXTERNAL AM** 25 v for 100% control. DC to 1 Mc response.

**PRICE** Model 605: \$1,750 fob factory.

# ALFRED ELECTRONICS

3176 Porter Drive • Palo Alto, California • Phone: DAVenport 6-6496

GENERATOR HEADS FOR MODEL 605		A Generator Head consists of voltage tuned backward wave oscillator and focusing magnet arranged for convenient insertion into Model 605. When installed the Heads will perform to following specifications:									
Generator Head Model Number	GA102	GA103	GA204	GA408	GB6012	GB7013	GB7013A	GB10015	GB12018	GC15022	GC18026
Frequency Range Gc	1 to 2	1.4 to 2.5	2 to 4	4 to 8	6.5 to 11.5	8 to 12.4	8.2 to 12.4	10 to 15.5	12.4 to 18	15 to 22	18 to 26.5
Power Output—minimum mw	10	10	10	10	10	10	10	10	10	5	3
Residual FM percent peak	0.003	0.003	0.0025	0.002	0.002	0.0015	0.0015	0.001	0.001	0.001	0.001
Drift % of max. freq./hr.	±0.025	±0.02	±0.02	±0.01	±0.01	±0.01	±0.01	±0.01	±0.01	±0.01	±0.01
Price of Generator Heads	\$1690	\$1790	\$1690	\$1590	\$1590	\$1590	\$1650	\$1940	\$1990	\$2650	\$2950



*hp  
oscillators  
stay on  
frequency*



⊕ 204B

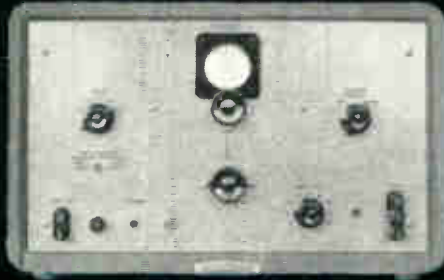

⊕ 202A



⊕ 201C

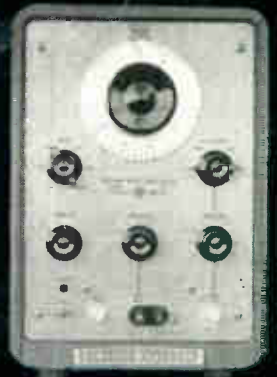

⊕ 211A

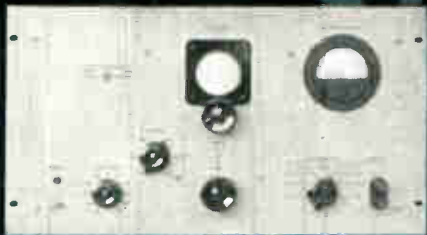

⊕ 650A



⊕ 205AG



⊕ 200AB



⊕ 206A



⊕ 200CD



⊕ 202C



# Accurate Test Signals 0.008 cps to 10MC

The resistance-capacity oscillator, pioneered and developed by Hewlett-Packard, provides simple operation with high stability and wide frequency range. Just select the signal you want on easy-to-read controls, and you get a dependable output without tedious resetting

or adjustment. These oscillators give you low distortion, excellent frequency response and extreme amplitude stability. These instruments can make your test work easier, faster, successful, economical.

## HEWLETT PACKARD COMPANY

1501 Page Mill Road, Palo Alto, California, Area Code 415, DA 6-7000  
Sales and service representatives in all principal areas; Europe,  
Hewlett-Packard S.A., 54-54bis Route des Acacias, Geneva; Canada,  
Hewlett-Packard (Canada) Ltd., 8270 Mayrand Street, Montreal



Model	Frequency Range	Description, Features	Output	Price
200AB Audio Oscillator	20 cps to 40 KC, 4 ranges	Ideal for amplifier testing, modulating signal generators, testing transmitter modulator response.	1 watt (24.5 v/600 ohms)	\$165.00*
200CD Wide Range Oscillator	5 cps to 600 KC, 5 ranges	Subsonic to radio frequencies, useful for testing servo and vibration systems, medical and geophysical equipment, audio amplifiers, video frequency circuits. Easy reading.	160 mw (10 v/600 ohms)	\$195.00*
201C Audio Oscillator	20 cps to 20 KC, 3 ranges	High power, designed for testing amplifiers, speakers, crossover nets. $\pm 1$ db frequency response, entire range.	3 watts (42.5 v/600 ohms)	\$250.00*
202A Function Generator	0.008 to 1,200 cps, 5 ranges	Source of continually variable, transient-free sine, square, triangular waves for electrically simulating mechanical, physical, medical phenomena. $\pm 1\%$ stability.	28 mw (30 v/4,000 ohms)	\$550.00**
211A Square Wave Generator	1 cps to 1 MC, 1 range	Useful for audio, video testing. 0.02 $\mu$ sec rise time. Full amplitude variation available on each of two outputs.	7 v p-p/75 ohms 55 v p-p/600 ohms	\$350.00
202C Low Frequency Oscillator	1 cps to 100 KC, 5 ranges	Ideal for subsonic, audio, ultrasonic applications such as vibration, electro-cardiograph, electro-encephalograph. Low distortion and hum. Recovery time less than 0.5% above 5 cps.	160 mw (10 v/600 ohms)	\$300.00*
204B Portable Oscillator	5 cps to 500 KC, 5 ranges	Solid state, portable, battery or optional ac operation. Output fully floating, will drive balanced and unbalanced loads referenced above or below ground. Highly stable. Distortion less than 1%.	10 mw (2.5 v/600 ohms)	\$275.00***
205AG Audio Signal Generator	25 cps to 20 KC, 3 ranges	A single instrument for making high power audio tests, gain and frequency response measurements. Two VMs measure input and output of device under test.	5 watts adjustable/50, 200, 600, 5,000 ohms	\$600.00**
206A Low Distortion Audio Signal Generator	20 cps to 20 KC, 3 ranges	Distortion less than 0.1%. Ideal for testing FM broadcasting units, high fidelity audio systems. Metered output, variable in 0.1 db steps.	+15 dbm/50, 150, 200 ohms	\$900.00**
650A Test Oscillator	10 cps to 10 MC, 6 ranges	Ideal for measurements in audio, supersonic, video, rf ranges. Metered output flat within 1 db. Distortion less than 1%, 20 cps - 100 KC; less than 2%, 100 KC-1 MC; approx. 5% at 10 MC.	15 mw (3 v/600 ohms)	\$550.00**

\*Cabinet models; rack-mount models \$5.00 additional. \*\*Cabinet models; rack-mount models \$15.00 less. \*\*\*AC operation optional, \$25.00 extra. Data subject to change without notice. Prices F.O.B. factory.

7966



# KEARFOTT

## LOW COST-LOGIC CIRCUITS IN TO-5 CASES

The all welded construction of Kearfott's MicroFunction Circuits, in Standard TO-5 cases, permits 16:1 volumetric reduction of conventional digital circuit design.

Through the use of pre-tested, close tolerance components, high density circuits of unlimited flexibility handling high power can be supplied quickly, at low cost, to match any system requirement.

Kearfott's Germanium or Silicon Transistors may be specified; dependent on temperature requirements. Also available are dual matched pairs within a TO-5 case. A number of available circuits can be provided in TO-18 cases on special order.

DEVICE	SYMBOL	GERMANIUM	SILICON
INVERTER		11 INVG	11 INVS
NOR		TO 5 21 NRLG	TO 5 21 NRLS FAN IN FAN OUT
EMITTER FOLLOWER (BUFFER)		TO 5 21 EFG	TO 5 21 EFS
OR		TO 5 21 ORG	TO 5 21 ORS
AND		TO 5 TO 18 41 DLG	TO 5 TO 18 41 DLS
FLIP FLOP		2 TO 5 INVERTED 2 TO 5 PIGGY BACK 22 FFG	2 TO 5 INVERTED 2 TO 5 PIGGY BACK 22 FFS
MATCHED PAIRS (TO 5)		TO 5 TO 18 22 MPG	TO 5 TO 18 22 MPS
DARLINGTON		TO 5 TO 18 21 DARG	TO 5 TO 18 21 DARS
DELAY		2 TO 5 INVERTED 2 TO 5 PIGGY BACK 21 DELG	2 TO 5 INVERTED 2 TO 5 PIGGY BACK 21 DELS

For complete data write Kearfott Semiconductor Corp., West Newton, Massachusetts.



# GENERAL PRECISION

## LETTERS

to the Editor

"attenuation" as it has always been applied in radiation theory. According to Van Nostrand Scientific Encyclopedia, "attenuation" is a term used to express the reduction in flux density, or power per unit area, with distance from the source—the reduction being due to absorption or scattering. Therefore, "attenuation" is actually a reduction in the strength of an electromagnetic field rather than a property of a material used to inhibit a field.

3. Mr. Lindgren's remark about inside bolting being "only a sales gimmick" is a hard one to understand. How else may you gain access for re-tightening (to maintain shield integrity) in cases where one or more walls of a shielded enclosure fits flush to a building wall? How else would you be able to retighten bolts on shielded buildings which have an integral exterior weather walls?

These are only a few of the exceptions I noted while reading the letters. I could list others but I believe it is fruitless to wage controversy over product features when RFI design considerations actually dictate the selection of a specific product.

Finally, I believe that ELECTRONIC INDUSTRIES was fully justified in presenting the article. Essentially a tutorial presentation, it is a step in the right direction because, even though shielding concepts are in a rapid state of evolution, the basic principles of shielding are still not widely understood.

C. C. Borden  
Vice President

Ace Engineering & Machine Co.  
Tomilson Rd.  
Huntingdon Valley, Pa.

### What Price Reliability?

Editor, ELECTRONIC INDUSTRIES:

A copy of a report which appeared in your Sept. 1961 issue of ELECTRONIC INDUSTRIES entitled "What Price Reliability" by John E. Hickey, Jr. was brought to my attention. The contents of this report presented the general scope of the problems in Reliability and some approaches to them. This material can be utilized very effectively.

(Continued on page 54)

# SANGAMO

## RESIN-DIPPED SILVERED-MICA

# CAPACITORS

*Incorporating Nearly Forty Years Experience in the Design & Manufacture of Mica Capacitors*

New Sangamo Type D dipped-mica capacitors are designed for applications requiring high stability, high reliability and low-loss characteristics.

Multiple coatings of the thermosetting resins provide excellent environmental protection and thermal shock characteristics. The case resists the high temperatures of soldering without damage.

Standard Type D dipped-mica capacitors are available in 4 case sizes corresponding to sizes CM05, CM06, CM07 and CM08 of Mil-C-5B and in voltage ratings of 300 and 500 wvdc. Units can be supplied with C, D, E or F characteristics for operation over a temperature range of  $-55^{\circ}\text{C}$  to  $+125^{\circ}\text{C}$ . Special units are available with voltage ratings up to 3000 wvdc and a temperature range to  $+150^{\circ}\text{C}$ .

STANDARD RATING		
STYLE	VOLTAGE	CAPACITANCE RANGE PF
D-15	500	1- 400
	300	1- 820
D-19	500	5- 5,100
	300	5- 6,200
D-30	500	470-22,000
	300	470-30,000
D-42	500	3,300-51,000
	300	3,300-68,000

Write for complete information.



**SANGAMO ELECTRIC COMPANY**  
SPRINGFIELD, ILLINOIS

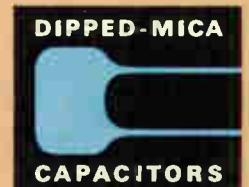

SANGAMO  
SANGAMO  
SANGAMO  
SANGAMO  
SANGAMO  
SANGAMO  
SANGAMO  
SANGAMO  
SANGAMO



NEW FROM  
**SANGAMO**

SANGAMO  
SANGAMO  
SANGAMO  
SANGAMO  
SANGAMO  
SANGAMO  
SANGAMO  
SANGAMO  
SANGAMO  
SANGAMO  
SANGAMO  
SANGAMO  
SANGAMO  
SANGAMO  
SANGAMO  
SANGAMO  
SANGAMO

# **TOUGHER** **TANTALUM** **CAPACITORS**

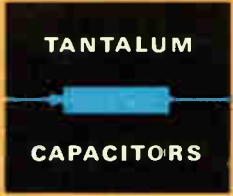

These solid electrolyte capacitors, Sangamo Type 595, represent a distinct achievement in tantalum capacitors. They utilize Sangamo's exclusive "Innerseal" construction with the terminals mechanically secured to the tubular container and precisely positioned without regard to the capacitor element. The seal is produced with a minimum of solder and flux, and with minimum thermal and mechanical stress on the glass insulator. There is absolutely no reliance on solder for mechanical strength. That's why these *tougher* units give peak performance under the most drastic shock and vibration conditions.

Sangamo tantalum capacitors comply with all the electrical and mechanical requirements of Mil-C-26655A.

Basically, these tantalum capacitors provide the highest capacitance per-cubic-inch in an extremely small and strong, hermetically sealed package.

Sangamo Type 595 capacitors are designed for filter, by-pass, coupling, blocking, and low voltage applications in telemetering devices, airborne systems, computers, missiles, and transistor circuits. They have low dissipation factor, low dc leakage, and excellent shelf life. They are available in capacitance values of 0.22 to 330 mfd, and in voltages from 6 to 35 WVDC. They're suitable for operation at full-rated voltages over a temperature range of  $-80^{\circ}\text{C}$  to  $+65^{\circ}\text{C}$  and, when properly derated, will operate up to  $+125^{\circ}\text{C}$ . Complete information is yours for the asking.



**SANGAMO ELECTRIC COMPANY**  
SPRINGFIELD, ILLINOIS

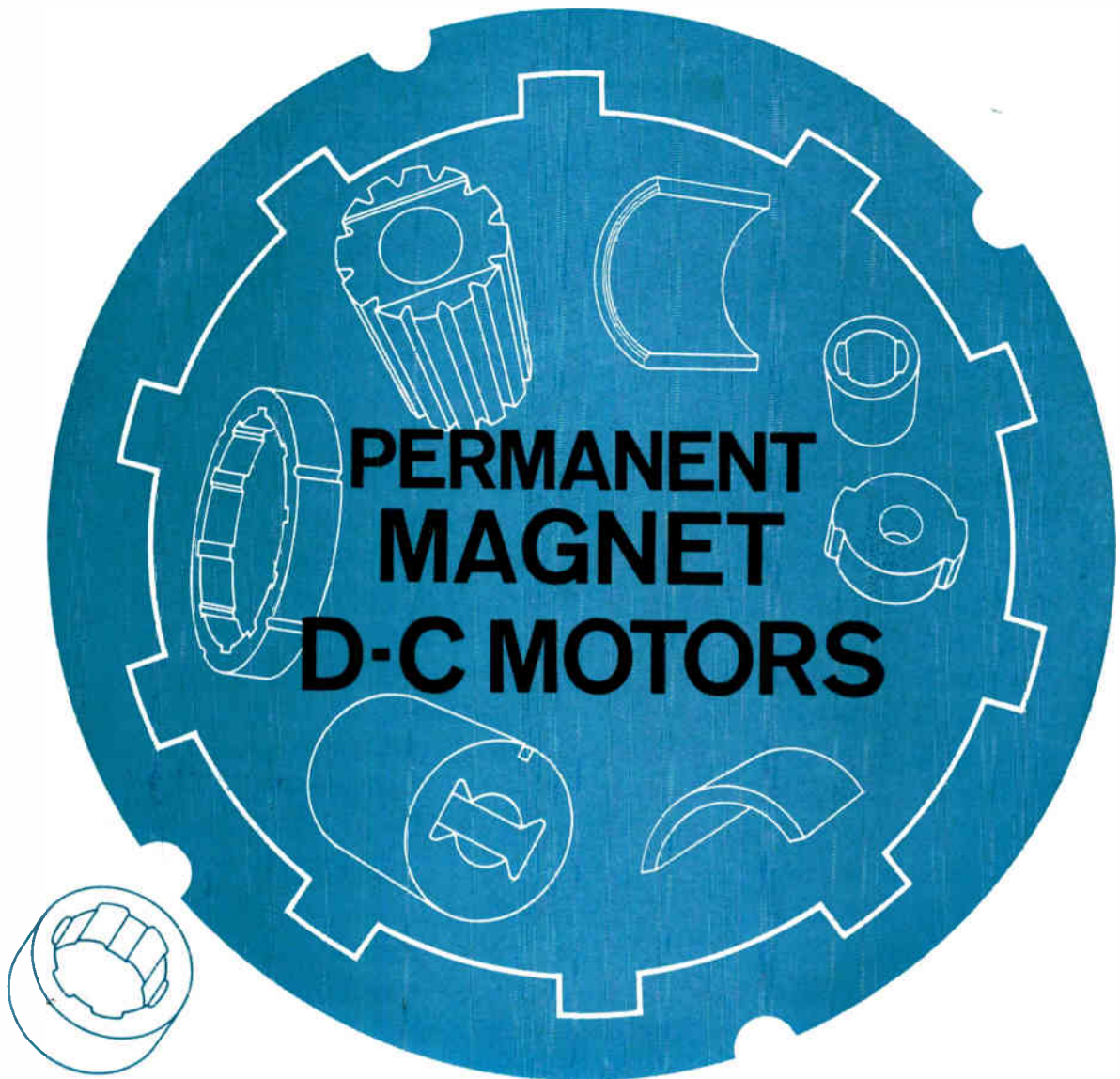

**... up to 20% efficiency increase**

Continental Electric Co., in producing Permanent Magnet D-C motors to replace wound field types, used Crucible magnets specifically designed for their applications. Some of the advantages proved by Continental's tests are:

1. Increased efficiency.
2. Smaller size and lighter weight for given power rating.
3. Reduced inrush starting current—because of starting with full magnetic field flux.
4. Lower temperature rise or greater output for given sizes.
5. Fewer parts.
6. Better humidity resistance.
7. Lower manufacturing costs.

COMPARISON DATA					
TYPICAL CONTINENTAL P-M MOTORS VS. COMPARABLE WOUND FIELD TYPES					
			% REDUCTION FROM EQUIVALENT WOUND FIELD MOTOR		% EFF. INCREASE FOR P-M TYPES
BODY DIAM.	H.P.	R.P.M.	LENGTH	WEIGHT	
2 1/4"	1/30	6,000	12	15	8
2 3/4"	1/10	8,000	15	16	15
3"	1/4	7,200	16	20	20

Use the services of Crucible's experienced magnet engineers for your own design and development projects. For more information write to Dept. EI3, Box 88, Pittsburgh 30, Pa.



**CRUCIBLE**

**STEEL COMPANY OF AMERICA**



MAGNET DIVISION, P.O. BOX 32, HARRISON, N. J.

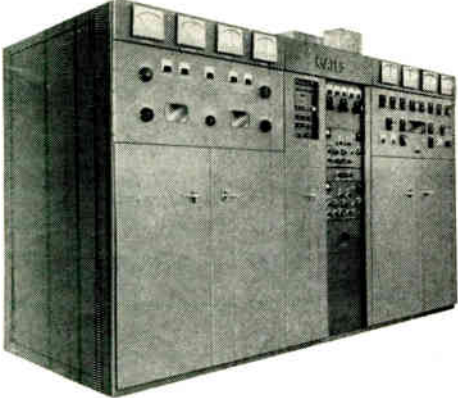

# GATES RADIO COMPANY BUILDS 50 KW TRANSMITTER FOR VOICE OF AMERICA





**UCSXHF 450**  
40 kv  
60 AMPS

**UCSF 500**  
15 kv  
45 AMPS

**MMHC 450**  
55 kv  
125 AMPS

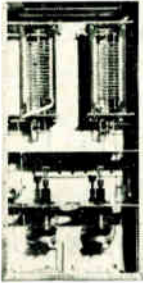
**A.** **B.**

A. Output network of Gates HF-50C using Jennings UCSF 500 vacuum variable capacitors. B. Power amplifiers with Jennings UCSXHF 450 capacitors in the plate tuning circuit. Jennings capacitors are also used for grid loading, neutralizing, and plate by-pass.

## RELIABILITY AND REDUCED SIZE GAINED BY USING JENNINGS VACUUM CAPACITORS

These new 50 kw high frequency transmitters built by Gates Radio Company are the first available to meet rigid USIA specifications that harmonic and spurious radiation be attenuated at least 80 db. The transmitters only occupy 5x11x6½ feet and are tunable through front panel controls over the entire range of 3.9 to 30 mc.

Jennings vacuum capacitors are the logical choice where compactness is desired because the high strength vacuum dielectric allows them to be made much smaller which results in the added effectiveness of lower inductive losses.

Jennings vacuum capacitors are more reliable because the sealed plates never become contaminated. They possess an extremely wide capacity change ratio that makes possible a wide frequency range. Further, vacuum capacitors have a very low dielectric loss and are self sealing after moderate overloads.

Jennings 350 types of fixed and variable vacuum capacitors permits selection of the right capacitor to meet your circuit requirements.

Write today for more detailed information about our complete line of vacuum fixed and variable capacitors.

RELIABILITY MEANS VACUUM / VACUUM MEANS *Jennings*®

JENNINGS RADIO MFG. CORP., 970 McLAUGHLIN AVE., SAN JOSE 8, CALIF., PHONE CYpress 2-4025

## LETTERS

to the Editor

(Continued from page 50)

tively in a Reliability Indoctrination session that I have planned for the near future.

I would appreciate receiving a copy of this report. I would also like to be put on your individual distribution list for future issues of your publication.

James Leggio

Reliability Coordinator

Defense Products Division

Fairchild Camera and Instrument Corporation

300 Robbins Lane

Syosset, Long Island, New York

### Coming Events Calendar

Editor, ELECTRONIC INDUSTRIES:

Please send me the latest 1962 issue of ELECTRONIC INDUSTRIES' "Coming Electronic Events Calendar." We have found this a great source of interest and an invaluable aid in the preparation of our weekly Calendar of Events.

Frank Lindauer

Laboratory Information Services International Business Mach. Corp.

Data System Div.

Development Laboratories

P. O. Box 390, Poughkeepsie, N. Y.

"Thanks! —"

Editor, ELECTRONIC INDUSTRIES:

Enclosed is the complimentary renewal form for ELECTRONIC INDUSTRIES. This seems to be a propitious time for me to write to you about your fine periodical. For many years I have been familiar with your publication, but in the past few years since I have been associated with CREI, I have appreciated it more and more. I understand from my associates that one copy has always been open on the Chief Editor's desk, that another copy was nearby for research, and still other copies available for the student library each month. I want to thank you for the "extra" copy that has been made available for my own personal use.

Henry I. Metz

Vice President in Charge of Engineering

The Capitol Radio Engineering Institute

3224 Sixteenth Street, Northwest Washington 10, D. C.

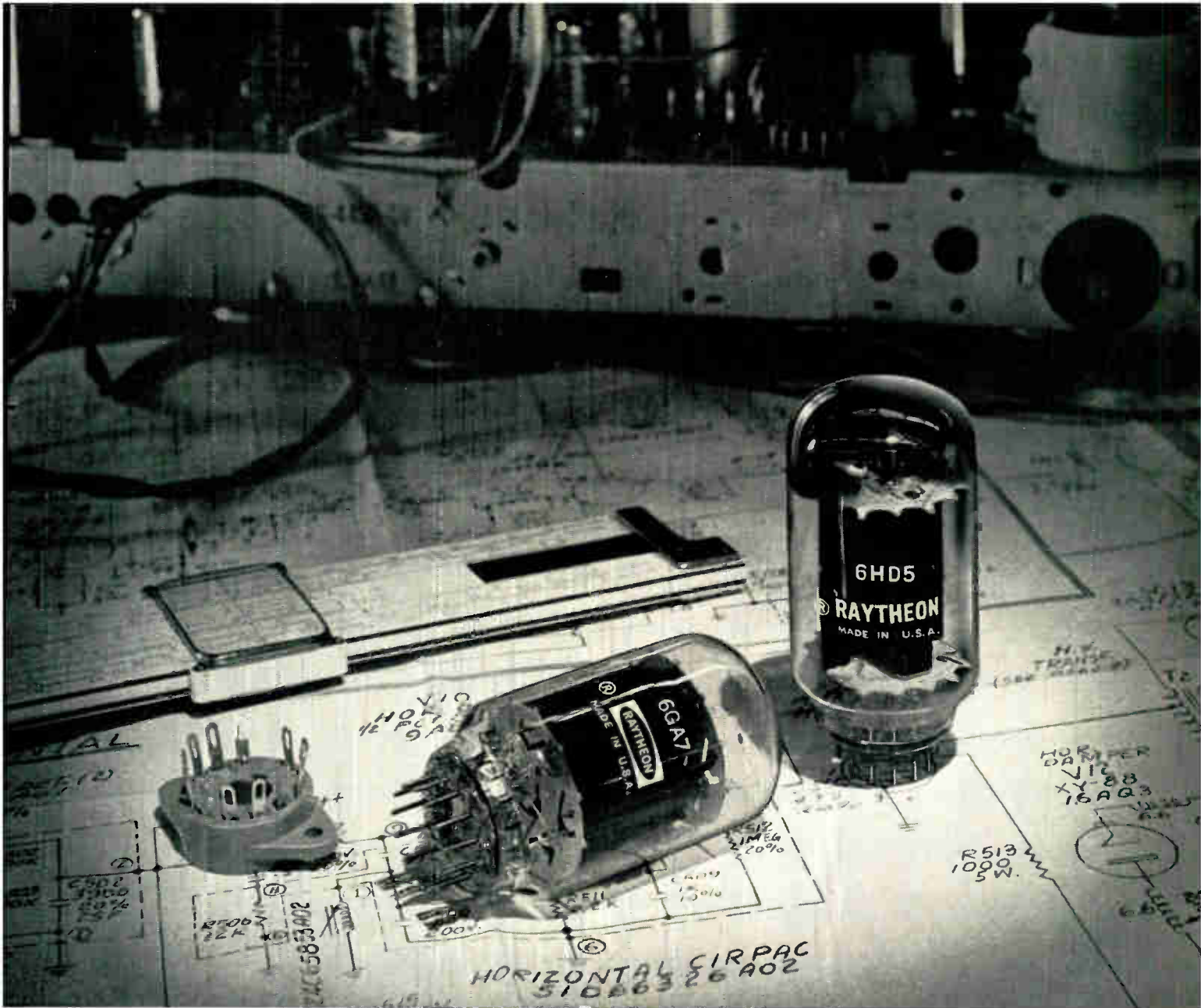

## Star Performers from Raytheon Increase Design Performance, Lower Tube Costs

Raytheon now offers TV set designers two new exceptionally high quality tubes designed to outperform other types at lower cost. The 6HD5 and 6GA7 are 12-pin integral all-glass base types with exclusive Raytheon design and production features.

The Raytheon 6HD5 (heavy duty) designed for TV sets using 130 volts B+ or higher will provide 114° sweep on 19" picture tubes operating at 18 KV on the anode, and it achieves a level of performance in low B+ circuits unattainable with any other tube. In addition, the 6HD5 is rated for and is capable of providing full sweep for color TV sets. It is available also with 450 and 600 ma. heater ratings.

The Raytheon 6GA7 is ideal for use in portable sets where savings in volume and cost are important requirements. Operating as a horizontal amplifier and damping rectifier, the 6GA7 delivers performance

equivalent to separate 6DQ6B and 6AX4A tubes with a savings of 16%. The 6GA7 is available also with 450 and 600 ma. heater ratings.

The 6HD5 and 6GA7 are representative of Raytheon's broad line of high quality entertainment receiving tubes for radio, TV, and high fidelity designs. For engineering assistance on your specific application as well as technical data on these tube types, please contact: Raytheon Company, Receiving Tube Operation, Industrial Components Division, 55 Chapel Street, Newton 58, Massachusetts. For small order and prototype requirements see your local franchised Raytheon Distributor.

Circle 53 on Inquiry Card





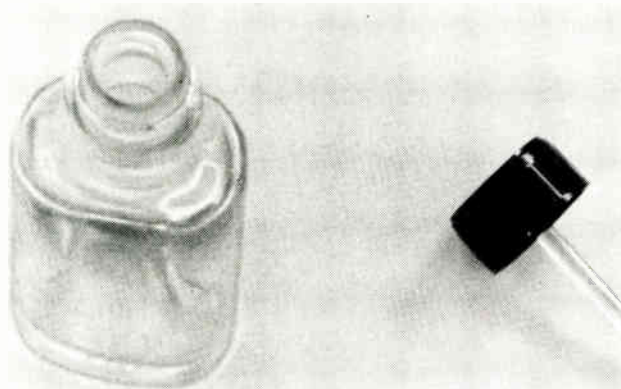

forget eradicators...

just erase,  
re-draw

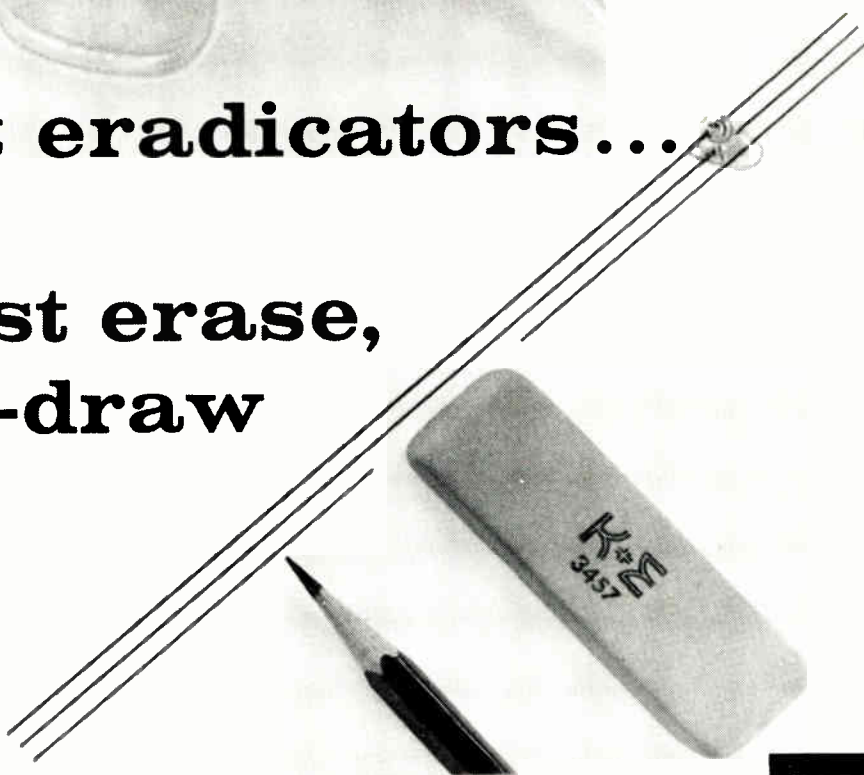

# ON PHOTACT<sup>®</sup> BY K&E

the photographic film with  
a reserve drafting surface

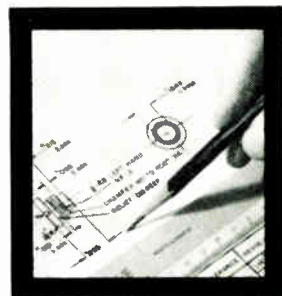

Forget eradicators? Forget those slow, messy, hard to confine little bottles and droppers?

Yes . . . forget them for good. With K&E PHOTACT polyester films, erase photographic image lines as easily as pencil. You can re-draw . . . erase again . . . over and over again. The reason is K&E's *exclusive* drafting surface beneath the photographic emulsion. It's a special tough undercoating with a tooth of its own.

Ordinary photographic films on a polyester base give you a drafting tooth in the emulsion only. Try removing image lines with an eraser and you rub right through to the glossy base, which will not take ink or pencil. Their advice — use eradicators. K&E's advice — use PHOTACT and a moistened

eraser. Save yourself a lot of time and aggravation.

**Clean, Sharp Reproductions, Too.** With the wide exposure latitude of PHOTACT films, the first exposure almost always is the right one. Blacks are solid,—no drop-out or fill-in.

**Use paper developers.** Prints are developed in regular paper developer, not in costly, short-lived litho solutions.

**Free PHOTACT Selection Guide . . .** helps you choose the PHOTACT materials best for your purposes, including PHOTACT polyester films — Contact for same-size exposure; Direct Positive for same-size positives from transparent originals; Projection for prints from microfilm negatives. Write for your free copy — crammed with time-and money-saving tips, or see your local K&E dealer.

3454

**K+E KEUFFEL & ESSER CO.**

NEW YORK • HOBOKEN, N. J. • PHILADELPHIA • DETROIT • CHICAGO • MILWAUKEE • ST. LOUIS  
DALLAS • DENVER • SAN FRANCISCO • LOS ANGELES • SEATTLE • ANCHORAGE • TORONTO • MONTREAL

First as a matter of record...SCOTCH® BRAND Instrumentation Tapes

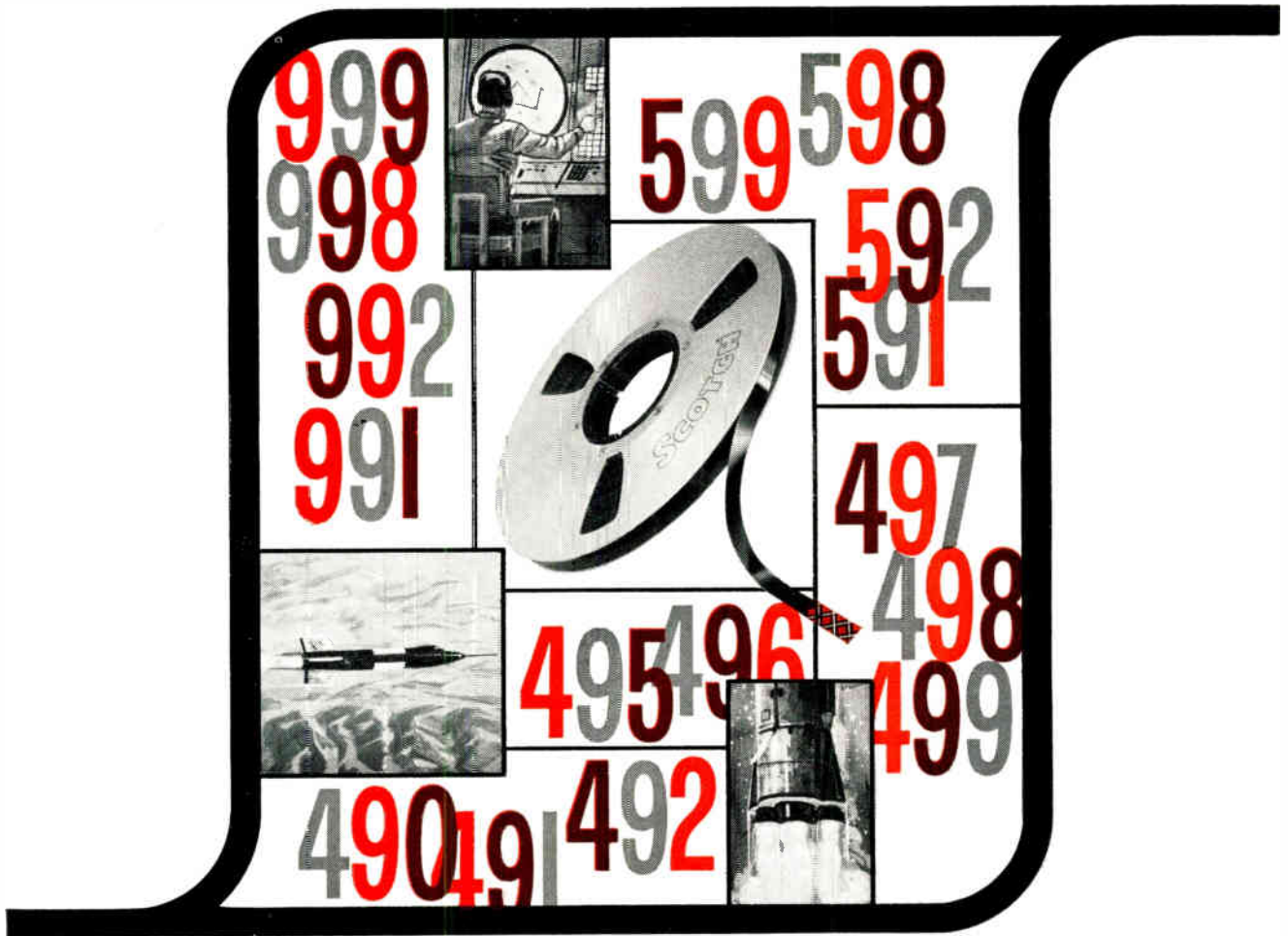

## World's widest tape selection offers heavy-duty constructions for every instrumentation need!

Today's stepped up pace for data recording calls for magnetic instrumentation tapes that stay cool despite ever-increasing transport speeds, greater tensions, high heat build-up at recording heads. And the "SCOTCH" BRAND Instrumentation Tape line, with a tape for every instrumentation requirement, now includes 16 heavy-duty constructions that conquer difficult operating environments.

"SCOTCH" Heavy Duty Instrumentation Tapes are made with a special high-potency oxide and binder formulation that minimizes rub-off, withstands temperatures from -40°F to as high as 250°F! Field tests prove these tapes last a minimum of 15 times longer than ordinary tapes—capture signal with certainty despite high pressures and speeds.

The oxide coating affords nearly 1000 times greater conductivity than conventional tapes—drains off dust-attracting static charges to assure a clean tape pass every time! And exclusive Silicone lubrication protects against head wear, extends tape life! These three

series of heavy duty tapes are available in a variety of widths and lengths . . .

"400" series tapes feature exceptionally long wear, excellent high and low frequency resolution. 8 constructions—.18 and .43 mil oxide coatings on .65, 1, 1.5 mil polyester backings; .56 mil coatings on 1 and 1.5 mil backings.

"500" series tapes combine long wear, outstanding smoothness, assure sharp resolution for broad band, other high-frequency requirements. 4 constructions—1 or 1.5 mil polyester backings; .18 or .43 mil oxide coatings.

"900" series tapes provide ultra-smooth recording surfaces for critical short wave length requirements. Especially recommended for predetection recording systems. 4 constructions—1 or 1.5 mil polyester backings; .18 or .43 mil oxide coatings.

Whatever your tape requirements—standard, high output, high resolution, sandwich or heavy duty—there's a right "SCOTCH" Instrumentation Tape. Consult the nearby 3M representative. Or write Magnetic Products Division, Dept. MBR-102, 3M Company, St. Paul 19, Minnesota.

"SCOTCH" AND THE PLAID DESIGN ARE REGISTERED TRADEMARKS OF MINNESOTA MINING & MANUFACTURING CO., ST. PAUL 19, MINN. EXPORT: 99 PARK AVE., NEW YORK, CANADA: LONDON, ONTARIO ©1962 3M CO.



Magnetic Products Division **3M** COMPANY



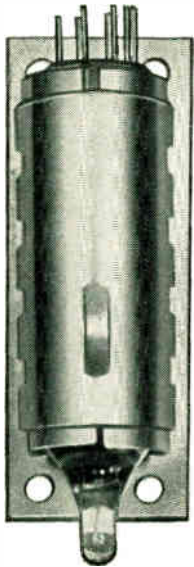
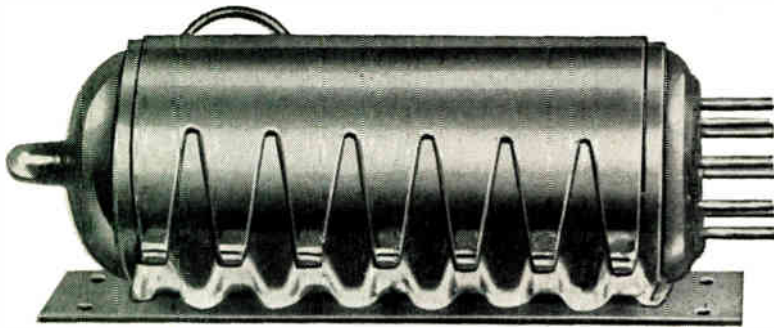

**VERSATILE  
TUBE  
RETAINERS  
FOR OPTIMUM  
THERMAL  
DESIGN!**

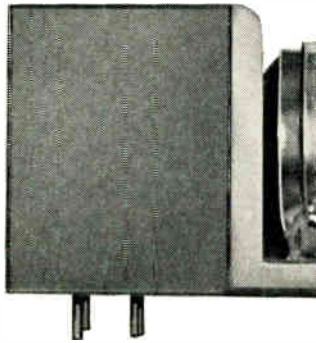

Patented.

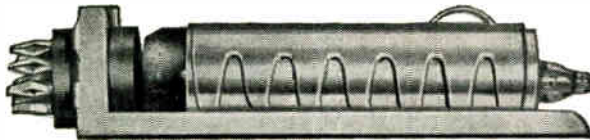

**IERC Horizontal Hardmount Series for all Miniature and Subminiature tubes give you Maximum Control and Isolation of tube-generated heat!**

Separate hot tubes from associated components — thermally link tubes to a heat sink or cold plate with IERC horizontal mounting tube shields for the most efficient removal of tube-generated heat!

Compatibility with a wide variety of design and mounting techniques plus complete availability for all miniature and subminiature tube sizes provides you with new, versatile and effective answers for improved thermal design. Efficient tube cooling and vibration protection gained with the Hardmount Series extends tube life and reliability — cuts costs!

**IERC**  **D I V I S I O N**



**HORIZONTAL SERIES** — part of the complete line of more than 1,400 sizes and types of IERC Heat-dissipating Electron Tube Shields in Military, Industrial and Commercial Use.

**INTERNATIONAL ELECTRONIC RESEARCH CORPORATION**  
135 West Magnolia Boulevard, Burbank, California • Victoria 9-2481  
Foreign Manufacturers: Europelec, Paris, France. Garrard Mfg. & Eng. Co., Ltd., Swindon, England

## BOOKS

### The Encyclopedia of Electronics

Edited by Charles Susskind. Published 1962 by Reinhold Publishing Corp., 430 Park Ave., New York 22, N.Y. 974 pages. Price \$22.50.

This reference contains over 500 articles on all phases of electronics. It covers the basic principles and physical effects underlying electronic science: materials, components, systems, and their specific applications. It includes entries on industrial applications and manufacturing processes as well as the latest analytical techniques being employed in electronics.

The contents reflect the most recent discoveries of basic technological significance. In addition, there are numerous entries on subjects in which electronics overlaps astrophysics, mathematics, chemistry, geophysics, and physics. There are articles on the economics of the electronics industry, patents, electronic music, and on the historical background of electronics, as well as two dozen short biographies of the engineers and scientists who made the most important contributions to the progress of electronics.

### Network Analysis and Synthesis

By Louis Weinberg. Published 1962 by McGraw-Hill Book Co., Inc., 330 West 42nd St., New York 36, N.Y. 692 pages. Price \$19.50.

Some of the most modern techniques for solving network problems—matrix theory, function theory, and linear graphs, are introduced. In so doing, the author discusses the excellent work of the past (going back to Kirchhoff) and couples it with results that are now appearing in the scientific journals.

Fundamental concepts are first presented clearly and then utilized in a variety of the subsequent chapters, where the concepts are integrated in a discussion of significant problems.

### Physics for Students of Science & Engineering, Part II, 2nd Edition

By David Halliday & Robert Resnick. Published 1962 by John Wiley & Sons, Inc., 440 Park Ave. South, New York 16, N.Y. 1167 pages. Price \$6.50.

The current intimate connection between engineering practice and scientific research calls for a revision of the traditional course in general physics. This book sets the tone and leads the way for such a revision. To achieve their goals, the authors stress the fundamental principles, at a mathematical level that assumes a concurrent calculus course.

Part I of the book dealt with mechanics, wave motion, and heat. Part II is concerned with electromagnetism, optics, and quantum physics.

(Continued on page 64)

# SOUND SOLUTION

□ Greater power. Higher gain. Lower noise. Lower leakage current. Fewer stages of amplification. Silicon reliability. Physical ruggedness. Extremely small packaging . . . Beltone Hearing Aid Company's transistor specifications for their new miniature Companion Hearing Aid were the highest and most complex ever demanded by their industry. Transitron research, working closely with Beltone engineers, perfected the first glass-packaged nano-transistor that met or exceeded every rigid specification. And Transitron produced it in volume at economical prices.

□ The major packaging breakthrough achieved on the Beltone program now permits Transitron to encapsulate any variety of its comprehensive line of quality small signal silicon transistors in a rugged, uniform glass nano-package. The smallest units of their type yet available, Transitron's "nano-transistors" feature excellent environmental protection, greater durability of leads in mounting, and an enduring resistance to the high vibration and shock levels of modern missile and space technology.

*Beltone*  
needed a  
remarkable  
silicon  
transistor...

Transitron  
research  
created it.

□ Transitron's engineering staff invites your inquiry regarding further details of its nano-transistor packaging capabilities.

□ Today, wherever there's electronics — in medicine, industry, defense, business, space exploration — there's Transitron, continuing to lead the way toward greater miniaturization and increased product reliability and versatility.

**Transitron**   
electronic corporation  
wakefield, melrose, boston, mass.

SALES OFFICES IN PRINCIPAL CITIES THROUGHOUT  
THE U.S.A. AND EUROPE. CABLE ADDRESS: TRELCO



# Embed, pot, encapsulate

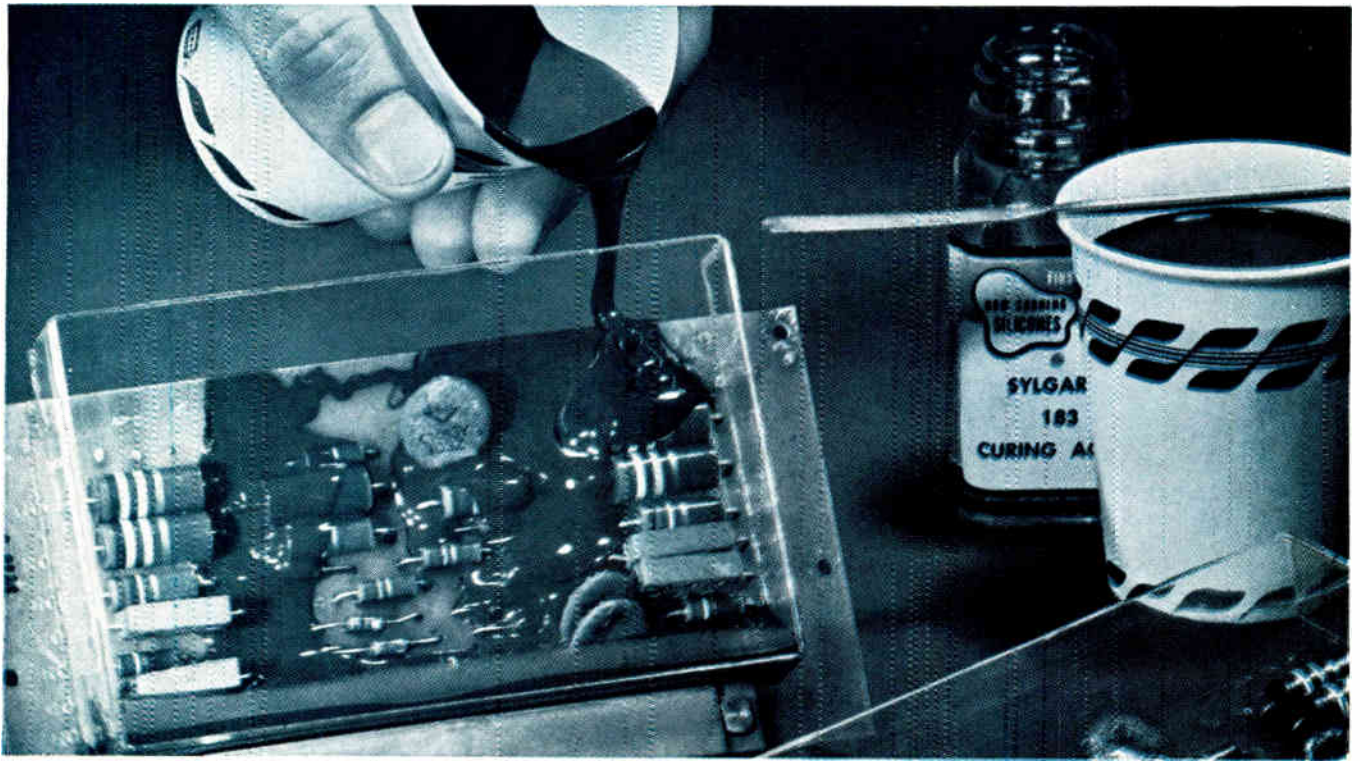

## Cut encapsulating costs with tough, flexible, easy-to-use Sylgard® 183

This new, opaque, solventless silicone resin protects intricate components against heat, moisture, shock, vibration, ozone, voltage stress and thermal cycling. Combining toughness with flexibility, Sylgard 183 offers long pot life, deep section cure, and requires no post cure.

**Fast, easy to use.** Supplied as a low viscosity black fluid, Sylgard 183 flows freely and smoothly into place after blending with a curing agent. When heat is applied, the material sets up without exotherm to form a tough-but-flexible dielectric material. Recommended curing schedule: four hours at 65 C (150 F); can be varied from 15 minutes at 150 C (300 F) to 24 hours at 40 C (100 F). Sylgard 183 cures in sections of unlimited thickness even when completely sealed; is usable at temperatures from -65 to 250 C (-85 to 500 F) immediately after curing.

Repair of sealed components is simple: sections of the resin are cut out, repairs made, new Sylgard 183 poured in place. The new resin bonds tightly to the original embedment. Sylgard 183 is compatible with a wide range of materials including metals, plastics, glass, asbestos, natural and synthetic fibers, and ceramics.

**Physically, dielectrically tough.** When cured, Sylgard 183 retains its properties over a wide range of temperature, frequency and humidity;

is effective from -65 to 250 C; shows no significant change in physical or electrical properties after 1,000 hours of continuous aging at 250 C; has tensile strength in the range of 300 to 1,000 psi.

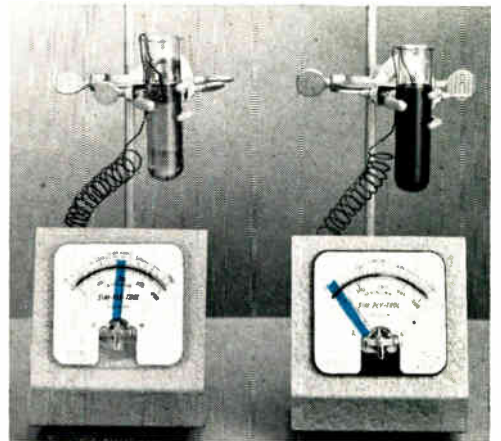

Test shows absence of exothermic heat. Sylgard 183 (right) holds room temperature throughout cure; organic material (left) generates temperatures of more than 400 F.

CIRCLE 21 ON READER-SERVICE CARD

Dow Corning is your best source for a broad line of silicone fluids, gels, elastomers and rigid forms for potting, filling, embedding and encapsulating.



# Dow Corning

# - with these silicones

## See-through embedding

Supplied as an almost colorless liquid, Sylgard 182 solventless silicone resin pours easily in place; forms a tough transparent mass that provides maximum protection and complete visual inspection of components. Sylgard 182 features a cure schedule similar to that of Sylgard 183; offers equal curability in thick sections, and in confined spaces; has good dielectric properties and moisture resistance. Long service life from  $-65$  to  $200$  C.

Elongation is in the range of 100%; tensile strength from 800 to 1,000 psi. Repair of embedded parts follows same procedure as for Sylgard 183.

CIRCLE 22 ON READER-SERVICE CARD

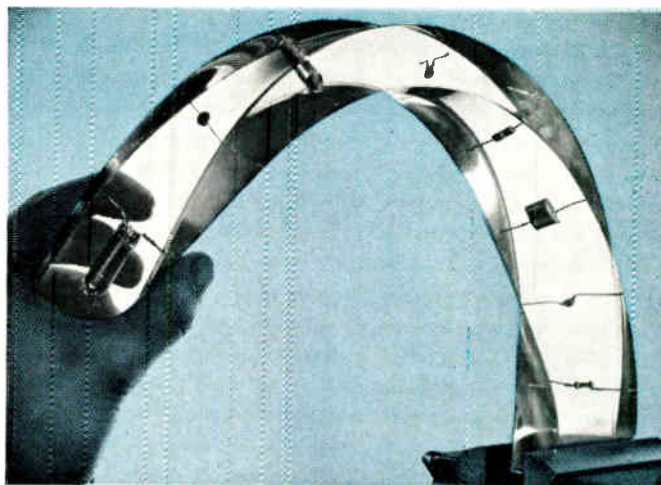

## Resilient encapsulating

Silastic® RTV silicone rubber cures without heat to form a tough, rubbery dielectric mass. Available in several colors and grades, it is easily applied by caulking gun or by pouring. Though higher in viscosity than Sylgard 183, it flows smoothly around delicate components without stress or pressure; forms a solid rubber jacket that protects from  $-55$  C to about  $250$  C ( $-67$  F to about  $132$  F); resists weathering, moisture, ozone, corona, shock and vibration. Repair of encapsulated circuits or components is easy, using a procedure similar to that detailed for Sylgard 183.

CIRCLE 23 ON READER-SERVICE CARD

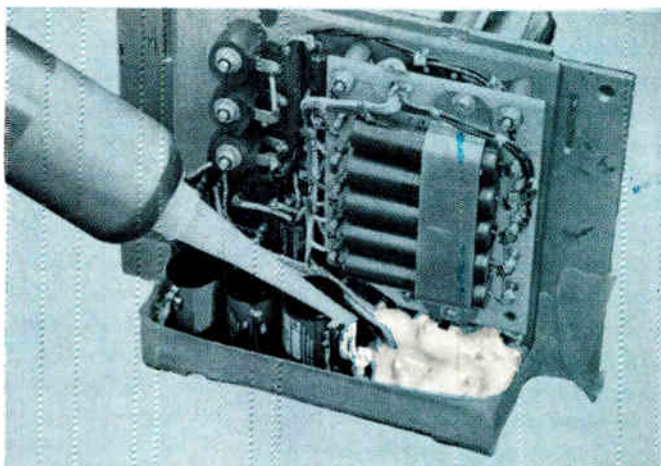

## Self-healing protection

This clear potting compound pours easily into assemblies; fills all voids; exerts negligible stress on components; cures to a jelly-like, transparent, resilient mass without exotherm. Curing time can be varied from 30 minutes to 48 hours; curing temperatures from  $40$  to  $150$  C. Potted parts can be quickly checked, either visually or by instrument probe. When probe is removed, Dielectric Gel reseals itself with no alteration of properties. Fully cured, it is self-healing from  $-60$  to  $200$  C (usable to  $-100$  C) has exceptionally stable dielectric properties; resists moisture; will not revert to fluid. Repair procedure is similar to that previously described.

CIRCLE 24 ON READER-SERVICE CARD

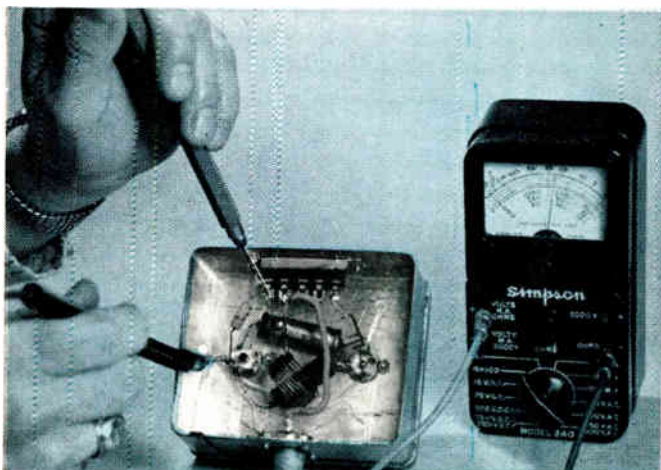

For detailed data on these silicones, contact Dow Corning Corporation, Dept. 3610, Midland, Michigan.





**DOUBLED PERFORMANCE** Bandwidth and speed have both been doubled in Mincom's Series G-100 Recorder/Reproducer. This superb all-purpose system now has a Direct response of 300 cycles to 600 kc at 120 ips. At 60 ips FM response is dc to 20 kc (extended), dc to 10 kc (standard). With fourteen interchangeable analog or FM tracks in one standard rack, the G-100 is now even better equipped for its job of static or dynamic testing — with Mincom's reliable simplicity. Plug-in card system record/reproduce modules and Mincom's exclusive DC tape transport reduce maintenance down time to a minimum. Write today for details and complete specifications.

**Mincom Division** **3M**  
COMPANY  
Los Angeles 25, California • Washington 4, D.C.

75% smaller  
than the smallest  
(by volume)

new size Y Ohmite  
tantalum slug capacitor



Size Y  
Actual Size



Size U  
MIL Size T1



Size F  
MIL Size T2



Size G  
MIL Size T3

ACTUAL  
SIZES

NOW  
**5**

CHOICES IN  
OHMITE  
TANTALUM SLUG  
CAPACITORS

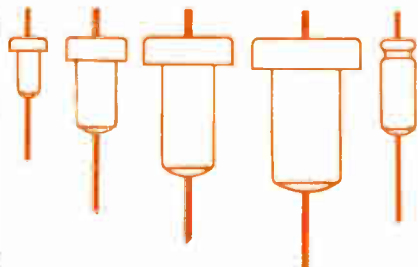

■ Size Y is the tiniest hat-shaped capacitor ever developed. Its case measures only  $\frac{19}{64}$ " long with a flange diameter of  $\frac{13}{64}$ " and body diameter of  $\frac{1}{8}$ ". Yet this miniature unit offers characteristics equal to any of the larger sizes. Size Y meets all requirements of MIL-C-3965B.

Eleven stock values from 0.91 to 15 mfd (125 volts DC max.) are available for fast delivery. Tolerances of  $\pm 10\%$  (K) and  $\pm 20\%$  (M) are offered in all values. Operating temperature range is  $-55^{\circ}$  to  $+85^{\circ}\text{C}$ .

WRITE FOR BULLETIN 159



**OHMITE**

MANUFACTURING COMPANY  
3662 Howard Street, Skokie, Illinois

RHEOSTATS • POWER RESISTORS • PRECISION RESISTORS • VARIABLE TRANSFORMERS  
TANTALUM CAPACITORS • TAP SWITCHES • RELAYS • R.F. CHOKES • GERMANIUM DIODES





**RESILIENCY  
THAT  
STAYS  
AND  
STAYS  
AND  
STAYS  
AND  
STAYS  
AND  
STAYS...**

CHR Silicone Sponge Rubber sheet is low in compression set and keeps its resiliency because: ■ It is flexible from minus 100 degrees to plus 500 degrees. ■ It is immune to aging. ■ It is non-absorbing. ■ It is a uniform closed cell structure. ■ For gasketing, vibration dampening and pressure applications, where you want *a material that can take it and keep taking it*, use CHR Silicone

Sponge Rubber. ■ Stocked by distributors across the country in thicknesses from  $\frac{1}{16}$  to  $\frac{1}{2}$  inch in  $\frac{1}{15}$  increments. Check Thomas Register for your local CHR distributor.



**CONNECTICUT HARD RUBBER CO., NEW HAVEN, CONN.**

## BOOKS

### Permanent Magnets and Their Applications

By R. J. Parker & R. J. Studders. Published 1962 by John Wiley & Sons, Inc., 440 Park Ave. South, New York 16, N. Y. 406 pages. Price \$16.00.

Treated in detail are the often encountered problems of magnetization, demagnetization stability, and measurements. Special attention has been given to the estimation of leakage, the determination of magnet volume and configuration, and the comparison and selection of materials. The authors have carefully described the properties of commercially useful permanent magnetic materials.

### Nonlinear & Parametric Phenomena in Radio Engineering

By A. A. Kharkevich. Published 1952 by John F. Rider Publisher, Inc., 116 West 14th St., New York 11, N. Y. 208 pages. Price \$6.50.

This monograph discusses the theory of nonlinear systems and applies it directly to typical electronic problems. Translated from a Russian text published earlier, it is written at the senior or graduate engineer level. Topics covered include discussions of the theory of operation of oscillation in oscillators, development of limit cycles, parametric action, and related subjects.

### Advanced Pure Mathematics

By J. D. Hodson. Published 1961 by St. Martin's Press, 175 Fifth Ave., New York 10, N. Y. 470 pages. Price \$10.00.

Much of the work in the text is based on calculus, but other ideas are introduced when and where they are required. Hence such topics as reduction formulae, hyperbolic functions, elementary convergence and divergence of series, polar coordinates, partial differentiation, differential equations, Leibnitz' Theorem and the operator  $D$ , are well covered. Several applications of calculus to statics and dynamics are considered. In geometry the conic sections are dealt with both analytically and from the viewpoint of pure geometry, including work on coaxial systems, inversion and reciprocation.

### Basic Technical Writing

By Herman M. Weisman. Published 1962 by Charles E. Merrill Books, Inc., 1300 Alum Creek Drive Columbus 16 Ohio. 512 pages. Price \$7.95.

Book is designed to assist scientists, engineers and technologists in developing skills in communications and reporting by providing a firm foundation in semantics, the communication process and the scientific method. Readers will benefit from practical illustrations of the process of clear thinking, enabling them to communicate effectively in all areas of engineering, science and high-level management.

(Continued on page 68)

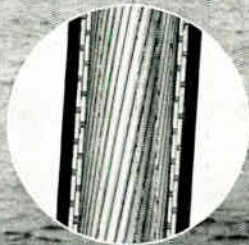

## TIMES HELICOPTER-DROP CABLE ASSEMBLY

### vital link in Navy's newest ASW system

A unique Times cable assembly is the mechanical and electrical lifeline of the Bendix sonar detection system in the Sikorsky HSS-2 subhunter—one of the Navy's new ASW helicopters. Meeting demands for extreme reliability, Times manufactures this assembly to withstand the stress of being reeled and dereeled at high speeds. The cable, which directly supports the transducer, is rugged, extremely flexible and designed for indefinite use in seawater.

To insure the cable's perfect electrical performance, Times maintains the tightest quality control requirements on all components and processes from start to

finish. This is the same exacting control which Times programs for all its cables and assemblies.

Other special-purpose Times cables are used in a variety of applications which require top reliability engineering—buoyant, and non-hosing coaxial cables for submarines, cables for electronic computers, GSE, and special cable assemblies for missiles and aircraft.

Times' years of cable experience can be applied to your system problems at any stage—from concept through production. Make Times your *first* choice when you have a cable or cable assembly problem. For information, wire or write Times' Sales Manager.

Dept. 1002

\*A DuPont Trademark



## TIMES WIRE AND CABLE

Division of The International Silver Company  
Wallingford, Connecticut

TRANSMISSION SYSTEM DESIGN AND ENGINEERING • STANDARD & SPECIAL PURPOSE COAXIAL CABLE • MULTICONDUCTOR CABLE • COMPLETE CABLE ASSEMBLIES • TEFLON\* HOOK-UP WIRE



PROJECT  
"BREAKTHROUGH"

# 100-VOLT AEROTAN<sup>®</sup> SOLID TANTALUM CAPACITORS

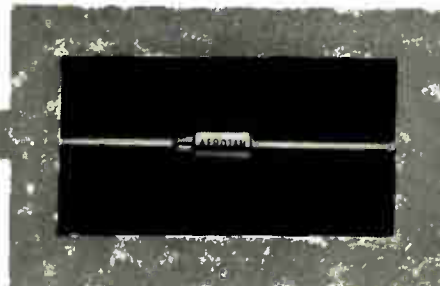

A new series of high-voltage solid tantalum capacitors has been developed by Aerovox engineers through the application of new technologies and advanced research facilities at the New Bedford Division.

These low-leakage, 100-volt AEROTAN capacitors are especially suited for such demanding applications as space vehicles and military equipment where the design practice is to derate to lower voltages in order to achieve *higher reliability*. They are also ideally suited for computer use where it is necessary that noise and current spikes be eliminated . . . as well as in airborne and ground support equipment.

Call our nearest sales office today, or write for specifications and availability information.



**AEROVOX CORPORATION**  
NEW BEDFORD DIVISION      NEW BEDFORD, MASS.

*Technical Leadership - Manufacturing Excellence*

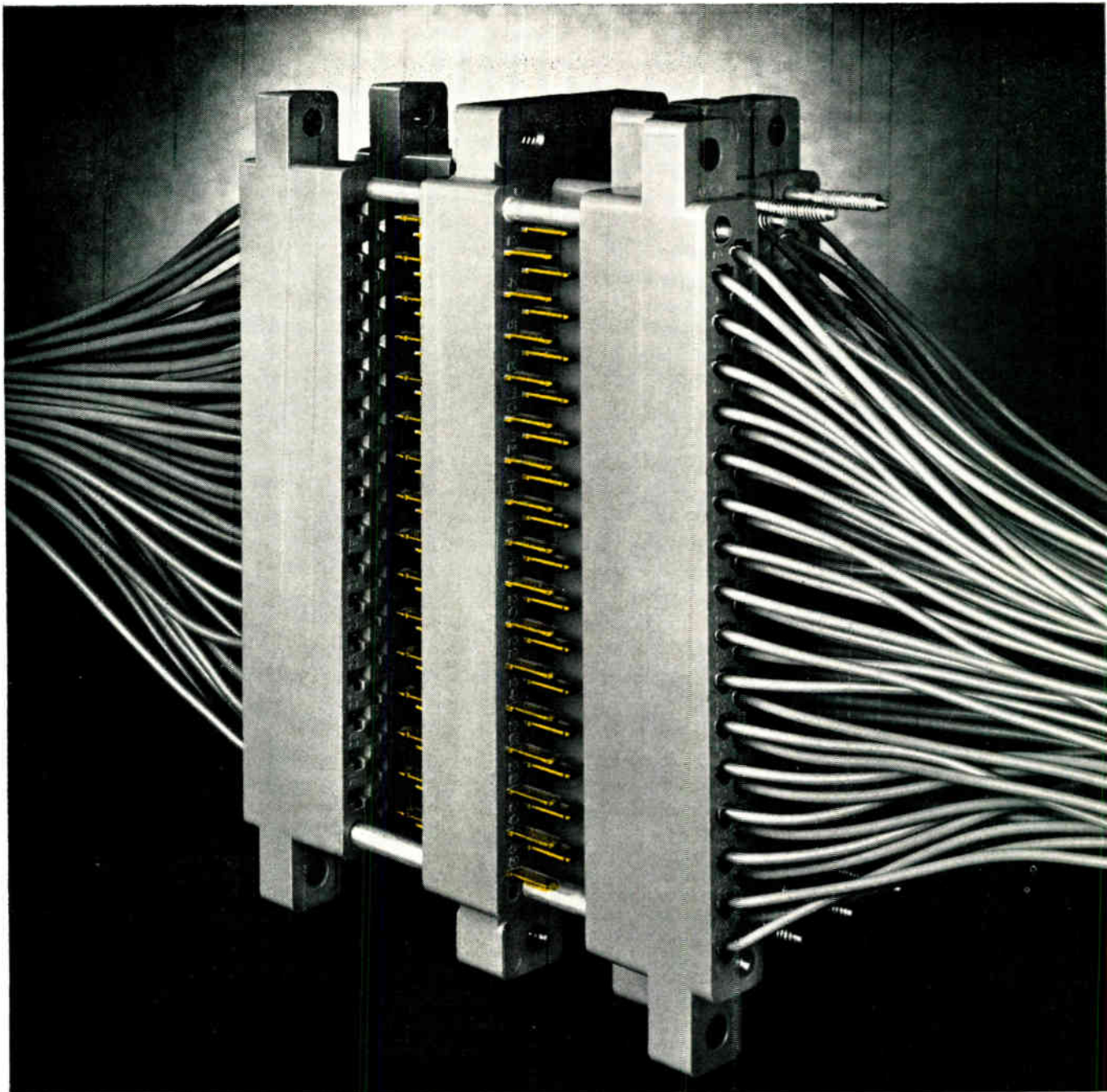

## Propensity for density!

192 connections in a cubic area approximately 3.375" — that's the AMP-BLADE\* Multi-Circuit Feed-Thru Connector. This high density potential, combined with feed-thru versatility, permits wide variations in both intra- and inter-rack connections, and makes possible complete modularization in all rack wiring installations.

Feed-thru block consists of 128 male tabs on one side commoned in with 64 male tabs on the other side. Choice of either 2 to 1 or 4 to 2 circuit combinations. 32 position female housings accept all standard AMP-BLADE receptacle contacts. Receptacle housings are not preloaded, meaning you pay for only those contacts necessary.

Receptacle contacts are crimp, snap-in type. Available in strip form for high-speed applications with A-MP\* automachine tooling. This patented, compression-crimp method of contact application provides rates of 3,000 uniform terminations per hour.

\*Trademark of AMP INCORPORATED

Standard AMP Contact Plating: .000030" gold over .000030" nickel.

Package all your rack wiring with this high-density connector. Get feed-thru variability. Get consistently high AMP quality. Specify AMP-BLADE Multi-Circuit Feed-Thru Connectors. Wherever your need... whatever your need, AMP puts an end to every circuit problem.

Complete information available on request.



AMP products and engineering assistance are available through subsidiary companies in: Australia • Canada • England • France • Holland • Italy • Japan • Mexico • West Germany



# BOOKS

## Custom House Guide (100th year)

Published 1962 by Custom House Guide, Box 7, Bowling Green Sta., Custom House, New York 4, N. Y. Price \$30.00 plus postage (including 12 monthly issues of the Bulletin).

In conjunction with the Bulletin, subscribers will have available the new GATT (General Agreements on Tariff and Trade) rates of duty applicable to thousands of commodities, effective July 1. It appears in simplified form, arranged numerically by tariff paragraphs.

In addition, the Guide features the latest U. S. Import Duties Reporting Numbers (U.S.I.D.). This section contains revisions of information previously erroneously reported by official sources.

Of particular interest to shippers conducting business through the various Ports of the U. S. and its territories, as well as of Canada and the Philippines, are the Guide's Port Sections. Alphabetically arranged, each port is treated independently and features Port charges, descriptions and geographical limits; various firms servicing shippers; all forms of transportation; customs personnel, Consular offices; etc.

## Books Received

### Psychological Principles in System Development

By Robert M. Gagne and Others. Published 1962 by Holt, Rinehart and Winston, Inc., 383 Madison Ave., New York 17, N. Y. 260 pages. Price \$9.00.

### Techniques of Television Production, 2nd Ed.

By Rudy Bretz. Published 1962 by McGraw-Hill Book Co., Inc., 330 West 42nd St., New York 36, N. Y. 517 pages. Price \$10.75.

### The BEAMA Directory, 1961-1962

Published by The British Electrical & Allied Manufacturers' Association (Inc.), 36 and 38 Kingsway, London, W.C. 2, England. Distributed by Pergamon Press, Ltd., Oxford, England. 496 pages. Price \$10.00.

### Handbook on RFI, 4 Volumes

Published 1962 by Frederick Research Corp., 2601 University Blvd., West, Wheaton, Md. Price \$80.00 per set.

### Basic Principles and Applications of Relays

By Harvey Pallack. Published 1962 by John F. Rider Publisher, Inc., 116 W. 14th St., New York 11, N. Y. Paperback, 112 pages. Price \$2.90.

### Electrochemical Measuring Instruments

By John R. Collins. Published 1962 by John F. Rider Publisher, Inc., 116 W. 14th St., New York 11, N. Y. Paperback, 128 pages. Price \$3.25.

### How to Build Electronic Equipment

By J. R. Johnson. Published 1962 by John F. Rider Publisher, Inc., 116 W. 14th St., New York 11, N. Y. Hardcover, 288 pages. Price \$6.95.

(Continued on page 76)

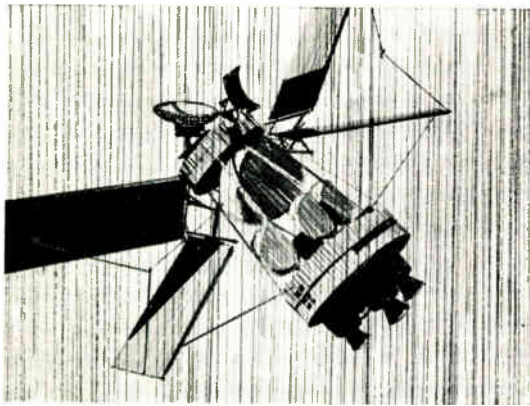

## GERTSCH WWV AND VLF STANDARDS RECEIVERS



RHF-1 High-Frequency Standards Receiver

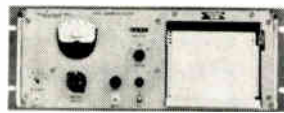

PCR-1 Phase Comparison Receiver

— provide rapid calibration checks on frequency and time standards . . . frequency comparisons against carrier-stabilized frequency transmissions — with high accuracy.

**High-Frequency Standards Receiver** — an all transistorized superheterodyne receiver designed for reception of WWV and other high-frequency standard transmissions. Ideal in precision time measurements, reception of standard audio frequencies, pulse code modulation, and radio propagation notices transmitted at these frequencies. Local frequency standards comparisons accurate to 1 part in  $10^7$ . Operates from either a 115/230-volt power line, or a 12-volt battery. Send for Bulletin RHF-1.

**Phase Comparison Receiver** — used with local frequency standards accurate to 1 part in  $10^7$  or better. Instrument utilizes the propagation stability of low-frequency waves, allowing comparisons to an accuracy of 5 parts in  $10^{10}$  to be made in one hour. Higher accuracies, proportionately longer. This all solid-state unit also includes a built-in, servo-driven, strip-chart recorder. Front-panel frequency selection permits rapid switching of up to 4 frequencies within the range of 10 to 100 KC. Send for Bulletin PCR-1.

# — Gertsch —

GERTSCH PRODUCTS, INC.

3211 S. La Cienega Blvd., Los Angeles 16, Calif. • UPTON 0-2761 • VERMONT 9-2201

# BENDIX NOW OFFERS . . . the Pygmy SE electrical connector

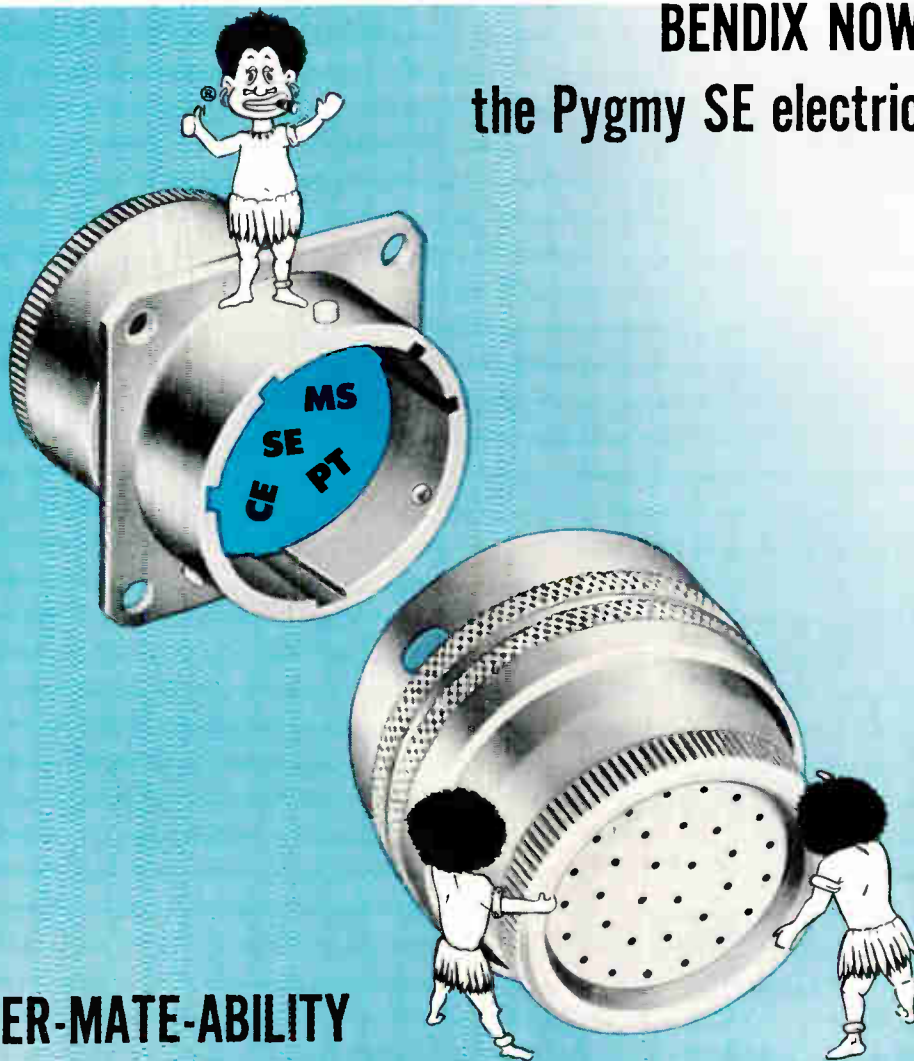

## INTER-MATE-ABILITY PLUS MILITARY STANDARD CRIMP CONTACT GEOMETRY

There's a new addition to the growing Pygmy family—the SE series of Pygmy® Electrical Connectors. This new series gives complete inter-mate-ability with several million PT and SP solder type, CE crimp type and MIL-C-26482 connectors.

The combination of proven Bendix Pygmy materials and designs with MIL-C-26636 contact geometry and MS3190 wire well area eliminates wiring diagram changes and costs, retains solder option, and provides contacts compatible with standardized application tooling. Want more facts? Write us today. The Bendix Corporation, Scintilla Division, Sidney, New York.

Canadian affiliate: Aviation Electric, Ltd., 200 Laurentien Blvd., Montreal 9, Quebec.  
Export Sales & Service: Bendix International, 205 E. 42nd Street, New York 17, N. Y.

Send for your free campaign button and a copy of the Pygmy SE connector folder.



For Convenience, Efficiency and Economy, Join the Bendix Campaign in Support of Evolutionary Connector Specifications

- Inter-mate-ability . . . with millions of Pygmy connectors now in the field.
- Military Specifications . . . BUWEPS and Signal Corps
- Termination Option . . . crimp or solder, depending on the application.
- Shell Finish Option . . . cadmium or alumilite.
- Wire Sealing Option . . . grommet or potting seal.
- Strain Relief Option . . . in both basic series.
- All Shell Styles . . . widest possible user choice.
- Full Range of Shell Sizes . . . 10 thru 24.
- Multiple Insert Patterns . . . 20 tooled—continually expanding.
- User Engineered . . . evolved from 6 years of Pygmy field experience.

BENDIX CONNECTORS—BENDIX CABLES: DESIGNED TOGETHER TO WORK BEST TOGETHER

**Scintilla Division**





# the magnificent trifle

news about solders, fluxes, preforms  
special alloys, lead and tin products

alpha

alpha metals, inc. 56 Water Street, Jersey City, New Jersey • Henderson 4-6778  
Los Angeles, Calif. • Alpha Alloy Corp. (Div.) Chicago, Ill. • Alpha Metals, Inc. (U. K.) Ltd., London, Eng.

## NEW SPECIFICATIONS FOR ALPHA CONTINUOUS CONDUCTIVE COATED METALS (CCC)\*

Research developments at Alpha Metals have expanded the specification range for Continuous Conductive Coated strip. ALPHA CCC\* strip consists of a preselected base metal to which a thin coating of a specific alloy has been permanently bonded. This strip is used for stamping parts that serve as a base to support the germanium wafer in transistors as well as for use in a variety of applications where a solder-coated part acting as its own preform can be used.

The alloy can be applied as a full coating on one or both sides, or as a precision located stripe on one side. The manufacturing process produces a true alloy bond at the interface of the two metals, assuring a low resistance junction and excellent ohmic contact.

■ ALPHA CCC strips with tempers ranging from dead soft to full hard can be supplied. Note: Coating process does not change temper; makes possible the punching of drawn parts. A variety of base materials, including nickel, Kovar, Rodar, Therlo, palladium, copper, brass, iron, silver and other special alloys can be supplied as base metals for a long list of tin, lead and indium pure and alloyed coatings.

Complete information available in Catalog 107-B. Write or call for your free copy today.

\*patent applied for

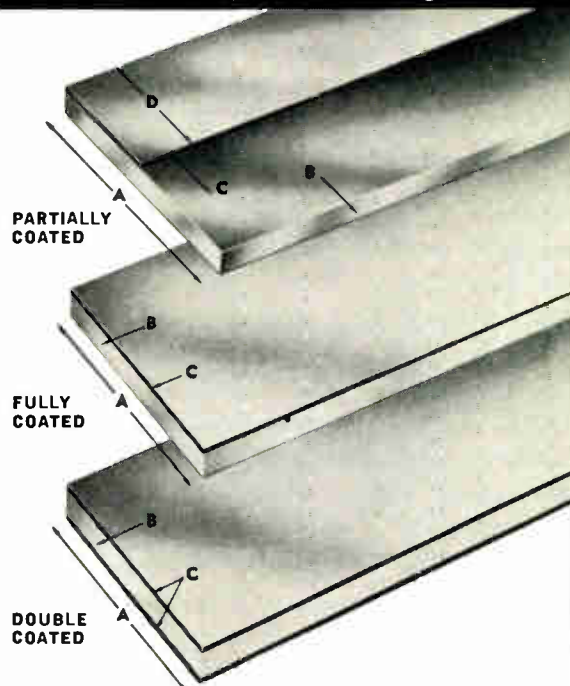

PARTIALLY COATED

	MINIMUM	MAXIMUM
A WIDTH OF STRIP	.187"	1.500"
B THICKNESS OF BASE METAL	.003"	.020"
C COATING THICKNESS	.0005"	.005"
D WIDTH OF PARTIAL COATING	.137"	1.45"

FULLY COATED

	MINIMUM	MAXIMUM
A WIDTH OF STRIP	.020"	1.500"
B THICKNESS OF BASE METAL	.002"	.040"
C COATING THICKNESS	.0005"	.007" (.020" on Ag or Cu Base)

DOUBLE COATED

	MINIMUM	MAXIMUM
A WIDTH OF STRIP	.020"	1.000"
B THICKNESS OF BASE METAL	.002"	.020"
C COATING THICKNESS	.0002"- .0007"* (.0015" on Ag or Cu Base)	.001" (.020" on Ag or Cu Base)

\*Specific thickness varies with alloy



Shielded Power Supply Cables—Rubber



Plastic Microphone Cables



Shielded Interconnecting Cables



Duplex Connector Extension Cords



Low Impedance Lines



Cathode Ray Tube Lead



Miniaturized Cables

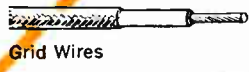

Grid Wires



Unpaired Intercom Cables

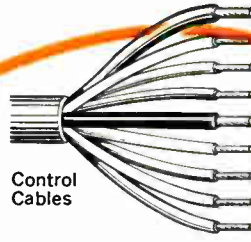

Control Cables



Audio Cables

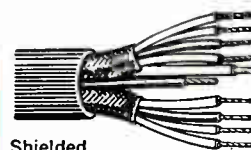

Shielded Control Cables



Coiled Test Prod Wire



RC/U Cables



Control Cables



Miniature Audio Cables



2-Conductor Power Cords



Miniature Microphone Cables



Magnet Wire



Automation Cable

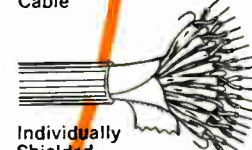

Individually Shielded Intercom Cables



RG/U Transmission Line Cables



3-Conductor Power Cords



Rubber Microphone Cables

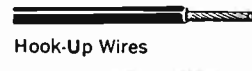

Hook-Up Wires



Duplex Primary Wires



Multiple Pair Cables



Strain Gauge Cables



Broadcast Audio Cables



TV Eye Camera Cable

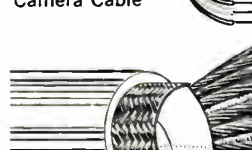

Color, Studio, Closed Circuit Camera Cables



75-Ohm Video Cable



Portable Cordage



Call System Cables



PA System Cables



Sound & Alarm System Cables

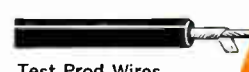

Test Prod Wires



2 & 3 Conductor Extension Cords



Mil-Spec Wires

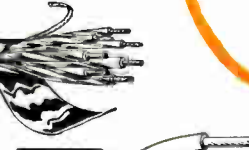

Industrial Intercom Wires



Lamp Cordage



Teflon\* Wires \*Du Pont trademark



2-Conductor Power Cords



Miniature Microphone Cables



Shielding & Bonding Cable



Special Sound Cables

# Mr. Design Engineer... BELDEN Has It

Every electronic and electrical wire you need—from the finest drawn magnet wire to the most complex multi-conductor cable.

There is a Belden wire or cable in every insulation and shielding to meet your design and application requirements. Here is just part of this complete line. Available from stock.



One Wire Source for Everything Electronic and Electrical

- electronic wire • magnet wire • lead wire • power supply cords
- cord sets • portable cordage

8-4-1



# new

*precision resolver developments by*

FOR GUIDANCE • STABILIZATION • COMPUTER APPLICATIONS

*Reeves*

#### 10-SECOND ACCURACY PANCAKE RESOLVER

Integral bearings permit direct mounting to gimbal structures of stable platforms. Beryllium housings provide highly stable operation in environments with extreme temperature variations.



#### 20-SECOND ACCURACY SIZE 23 RESOLVERS

Double-ended design simplifies their incorporation into data transmission systems.



#### HIGH IMPEDANCE PANCAKE RESOLVERS

Tuned impedance of 80,000 ohms makes these units ideally suited for use as control receivers. Rotor and stator assemblies may be independently attached to their mounting members. Standard units have an accuracy of 3 minutes of arc. One-minute accuracy can be supplied on special order.



#### 0.005% FUNCTIONAL ACCURACY PANCAKE RESOLVER

100% compensated Resolver with integral Class III precision rotor gear. The ideal unit for high accuracy computer chains.

#### 0.01% FUNCTIONAL ACCURACY SIZE 23 RESOLVER

100% compensated winding. Extreme accuracy in a standard resolver case size.

For complete information, write for Technical Data File 310

Qualified engineers seeking rewarding opportunities in these advanced fields are invited to get in touch with us.



**REEVES INSTRUMENT CORPORATION**

*A Subsidiary of Dynamics Corporation of America, Roosevelt Field, Garden City, New York*

*Reeves*

7RV61

# New IEE MINIATURE READOUT



Series 220000 miniature readout can be installed individually or in a 230000 assembly.

## Series 220000 Specifications—Single Unit

### CHARACTER SIZE

1/8" to 3/4" maximum

### INPUT

Straight decimal system

### VIEWING ANGLE

160° both vertical and horizontal, standard screen  
175° both vertical and horizontal, V-1 screen

### SINGLE UNIT SIZE

1 1/16" W x 1 1/16" H x 4 1/2" D

Also available for sub-panel mounting with common screen. Single unit prices start at \$47.50 in 1-9 quantities.

New IEE Series 230000 front plug-in readout assemblies permit quick, easy lamp replacement, allow permanent wiring, and eliminate the need for flexible cabling.

Available in both single units and assemblies, these rear projection readouts give you 12 displays (one for each lamp) that can consist of words, numbers, colors, or symbols either singly or in combination.

## Only IEE One-Plane Readouts Give You So Much *Versatility*



Up to 12 single or multiple-word messages can be obtained by using one lamp for each message.



Mode designations can be added by using one of the 12 lamps for each mode number and one lamp for each message.



Color emphasis can be added to indicate condition by using one of the 12 lamps for each color and one lamp for each message.

Polarity can be obtained by using one lamp each for plus and minus, and the remaining 10 lamps for 0 through 9 numerals.



Now you can design your own readout message display. Write on your company letterhead for FREE Readout-Message Designer's Kit.



**INDUSTRIAL  
ELECTRONIC  
ENGINEERS, INC.**

5528 Vineland Avenue • North Hollywood, Calif. • Phone: TR 7-1144





TIPS (Technical Information and Product Service)

## 4 MORE "ACCENT ON VALUE"

Circle 63 on Inquiry Card

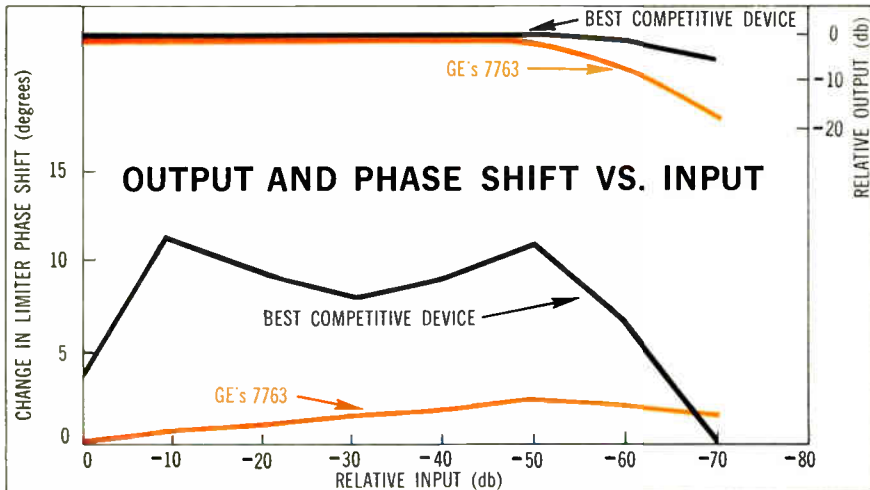

### G.E. introduces new zero-degree phase shift amplifier-limiter tube

The 7763 sheet-beam tube is the only active device available today to achieve 0° phase shift in IF amplifier-limiter applications. Unlike other active limiting devices, the 7763 does not limit as the direct result of a change in impedance and is thus able to achieve true phase-fidelity. The 7763 provides superior phase limiting performance up to 100 megacycles.

The graphs above, and the chart at right, show a comparison of a limiting amplifier using 7763's versus one using today's best competitive device. The limiter using competitive devices was designed with specific emphasis on phase stability.

SPECIFICATIONS— LIMITING AMPLIFIER	G-E's 7763	Best Competing Device
Band width (Megacycles)— Centered on 30 megs. . . . .	4	4
Number of limiting stages. . .	4	3
Number of tubes per stage . .	1	3
Power consumption (watts) . .	26	67
Maximum dynamic range per stage (db) . . . . .	20	5

7763 applications include: (a) radar IF-amplifier limiting where it will allow signal amplification from microvolts to volts with no phase shift and the same output pulse polarity; (b) mixers and modulators where the 7763's low interelectrode capacitances are ideal for signal interaction and suppression; and (c) high-frequency adder circuits.

Circle 64 on Inquiry Card

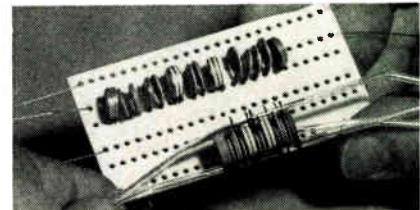

### TIMM high-temperature, microminiature circuit elements now available

TIMM (Thermionic Integrated Micro Module) circuits represent the only known high-temperature (580°C.), radiation-resistant microminiature system available today. Ceramic and titanium components tolerate 10,000 times the steady-state radiation of circuits employing solid-state devices. TIMM component densities as high as 250,000 parts per cubic foot are possible.

Individual components are now available for breadboard experimentation, characteristics evaluation, and overall familiarization with TIMM microminiaturization techniques.

**Resistors**—1,000 ohms to 100,000 ohms rated at ½ watt (at 580°C.)

**Capacitors**—20 pf to 200 pf units to 300 vdc (at 580°C.)

**Diodes**

50 volts max. p.i.v.  
2mA DC plate current... (at 580°C.)  
2.3 v self-bias

**Triodes**—As a switch (at 580°C.)

off:  $E_b = 10_v$ ,  $E_g = 0_v$ ,  $I_b = 100 \mu a$  max.

on:  $E_b = 7.5_v$ ,  $E_g = +2.5_v$ ,  $I_b = 2.0 \text{ mA}$ ,  
 $I_g = 200 \mu a$

To help you value-analyze TIMM circuit elements at high temperatures, General Electric has prepared a TIMM accessory kit consisting of:

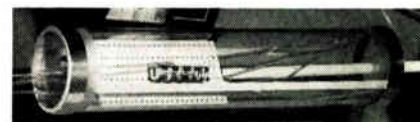

One mounted 1½"-dia. x 8"-long oven, two circuit mounting boards, quartz insulating sleeves, four circuit spacers, connecting wire and ribbon, asbestos tape, thermocouple (Cr-Al), end plugs, thermal insulating sheet.

Write for price and availability information today.

# PRODUCT DEVELOPMENTS FROM G.E.

Circle 65 on Inquiry Card

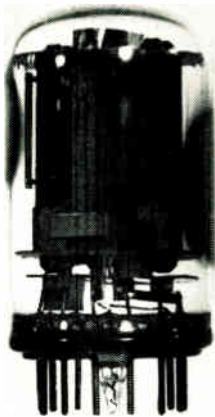

## Higher power output from new 8156 for RF power amplifier applications

Designed for use in aircraft and mobile two-way radio equipment, G.E.'s new 8156 compactron can replace any of four other tube types: 6360, 5686, 7551, or 2E26. Specific features of the new compactron include low lead inductance due to multiple leads, low-output capacitance (5.0 pf) and reduced seated height—over 1¼" lower than the 2E26, and 15/16" lower than the 6360.

A comparison of the 8156's output power and efficiency to those of the four tubes listed above shows:

1. Better power output for the 8156 (20 watts versus 15 watts for the 6360; 16 watts for the 2E26; 12 watts for the 7551; and 7 watts for the 5686) when operating at 175 megacycles.
2. Improved efficiency for the 8156 (60% versus 50% maximum for the best of the other four tubes) at 175 megacycles.

As an added benefit, the 8156 offers least cost per watt output.

Circle 66 on Inquiry Card

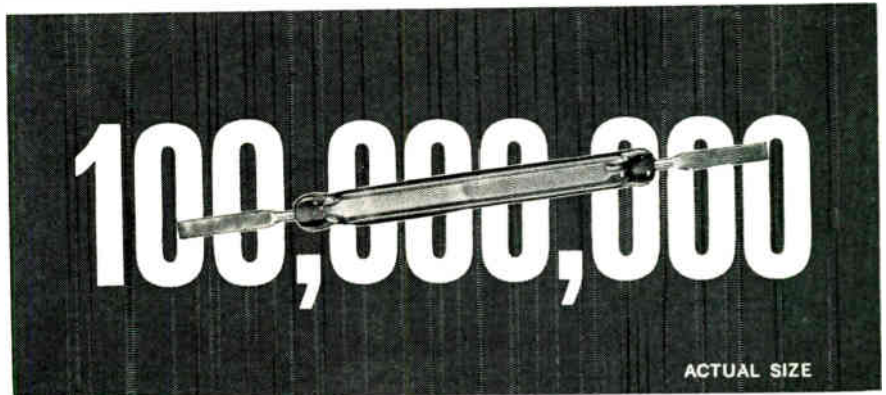

## Now from G.E.... new dry reed switch has life expectancy up to 100,000,000 cycles

The 2DR15, General Electric's first entry into the dry reed switch field, offers such value-analyzed benefits as:

**Long Life**—Simplified design and construction, plus external magnetic actuation, can result in a life expectancy in the order of 100,000,000 cycles, when operated within ratings.

**Trouble-Free Operation**—Contact contamination is eliminated by hermetically sealing the reeds in an atmosphere of inert gas. High-purity gold is used as the contact material.

**Versatility**—The 2DR15 can carry loads ranging from 15 volt-amperes down to microamperes. Ideal for transistor-drive applications. Mounts in any position.

**Design Flexibility**—Individual reed switches do not limit the designer to a few "standard" switching modules.

**Low Cost**—The 2DR15 is priced lower than most other relays or switching devices.

*Progress Is Our Most Important Product*

**GENERAL  ELECTRIC**

*Please send me more value-analysis information about:*

- 7763 Amplifier-Limiter Tube
- TIMM Circuit Elements
- 8156 Compactron
- G-E Dry Reed Switches

G-E Receiving Tube Department  
 Technical Information and Product Service  
 (TIPS)  
 Box 1769-B, Owensboro, Kentucky

Name.....

Title.....

Company.....

Address.....

City..... Zone..... State.....



## DESIGN SIMPLICITY

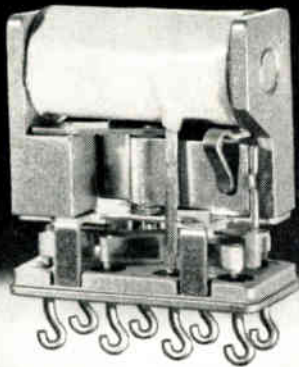

shown twice size with case removed

## MICRO-MINIATURE ROTARY RELAYS\*

40 MW | 100 MW | 250 MW

ONE SIZE — 3 DIFFERENT SENSITIVITIES

Catalog Number	Coil Resistance ±10% @ 25°C	Maximum Pull-In Current	Minimum Drop-Out Current	Nominal Operating Value	Coil Sensitivity
	Ohms	MA.	MA.	Volts	Milliwatts
2R25A420-B	625	19	1.9	26.5	250
2R10A440-B	1500	8.2	.82	26.5	100
2R04A460-B	4000	3.2	.32	26.5	40

Weight: 18 ± 1 Gram  
Ambient Temperature: -65°C to +125°C  
Contacts: 2PDT (2 Form C) 2A @ 30 VDC

Vibration: 30 G to 2,000 CPS  
Shock: 100 G  
Dielectric Strength: 1,000 VAC

\*CVE type

*Couch*

**ORDNANCE, INC.**

A subsidiary of S. H. Couch Company, Inc.

3 ARLINGTON STREET, NORTH QUINCY 71, MASS. Tel-Boston CYPRESS 8-4147

## BOOKS

### FM Multiplexing for Stereo

By Leonard Feldman. Published 1962 by Howard W. Sams & Co., Inc., 2201 East 46th St., Indianapolis 6, Ind. 160 pages. Price \$2.50.

### Single-Sideband Communications Handbook

By Harry D. Hootan. Published 1962 by Howard W. Sams & Co., Inc., 2201 East 46th St., Indianapolis 6, Ind. 320 pages. Price \$6.95.

### Subminiature Electron Tube Life Factors

By M. W. Edwards, D. E. Lammers and J. A. Zaelner. Published 1961 by Engineering Publishers, P.O. Box 2, Elizabeth, N. J. 173 pages. Price \$10.00.

### Electronic Drafting 1962

By K. Karl Kuller. Published 1962 by the McGraw-Hill Book Co., Inc., 320 West 42nd St., New York 36, N. Y. 286 pages. Price \$8.00.

### Redundancy Techniques for Computing Systems

Edited by Richard H. Wilcox and William C. Mann. Published 1962 by Spartan Books, 6411 Chillum Place, N.W., Washington 12, D. C. 403 pages. Book is based upon Symposium on Redundancy Techniques for Computing Systems, which was held Feb. 6 and 7, 1962.

### Photo and Thermoelectric Effects in Semiconductors

By J. Tauc. Published 1962 by Pergamon Press, Ltd., Headington Hill Hall, Oxford, England. 248 pages. Price \$10.00.

### Basic Electronics Series: Vol. 4, Transistor Circuits

By Thomas M. Adams. Published 1962 by Howard W. Sams & Co., Inc., 2201 East 46th St., Indianapolis 6, Ind. 136 pages. Price \$2.95.

### 1952 Radio Registry: No. 1, Industrial Radio Systems

Published 1962 by Radio Magazines, Inc., P.O. Box 629, Mineola, N. Y. 313 pages, paperbound. Price \$7.00.

### 1962 Radio Registry: No. 2, Transportation Radio Systems

Published 1962 by Radio Magazines, Inc., P.O. Box 629, Mineola, N. Y. 110 pages, paperbound. Price \$5.00.

### abc's of Synchros & Servos

By Alan Andrews. Published 1962 by Howard W. Sams & Co., Inc., 2201 East 46th St., Indianapolis 6, Ind. 96 pages, paperback. Price \$1.95.

### How to Read Schematic Diagrams

By Donald E. Herrington. Published 1962 by Howard W. Sams & Co., Inc., 2201 East 46th St., Indianapolis 6, Ind. 128 pages, paperbound. Price \$1.50.

### Modern Infrared Technology

By Barran Kemp. Published 1962 by Howard W. Sams & Co., Inc., 2201 East 46th St., Indianapolis 6, Ind. 255 pages, paperbound. Price \$4.95.

### How to Make Money in Growth Stocks

By Victor J. Melane. Published 1962 by Growth Investment Services of the Nuclear Energy Research Bureau, Inc., 68 William St., New York 5, N. Y. 94 pages, paperbound. Price \$2.00.

### NARM Relay Testing Procedures, Issue A

Prepared by NARM Technical Committee II consisting of six subcommittees. Work is an extension of the original Progress Report published in 1959. Copies are available from Mr. Alex White, Executive Director, National Assoc. of Relay Manufacturers, P.O. Box 1, Bellrose 26, L. I., N. Y. 86 pages paperbound. Price \$1.00.

# BMEWS ... eyes of the free world

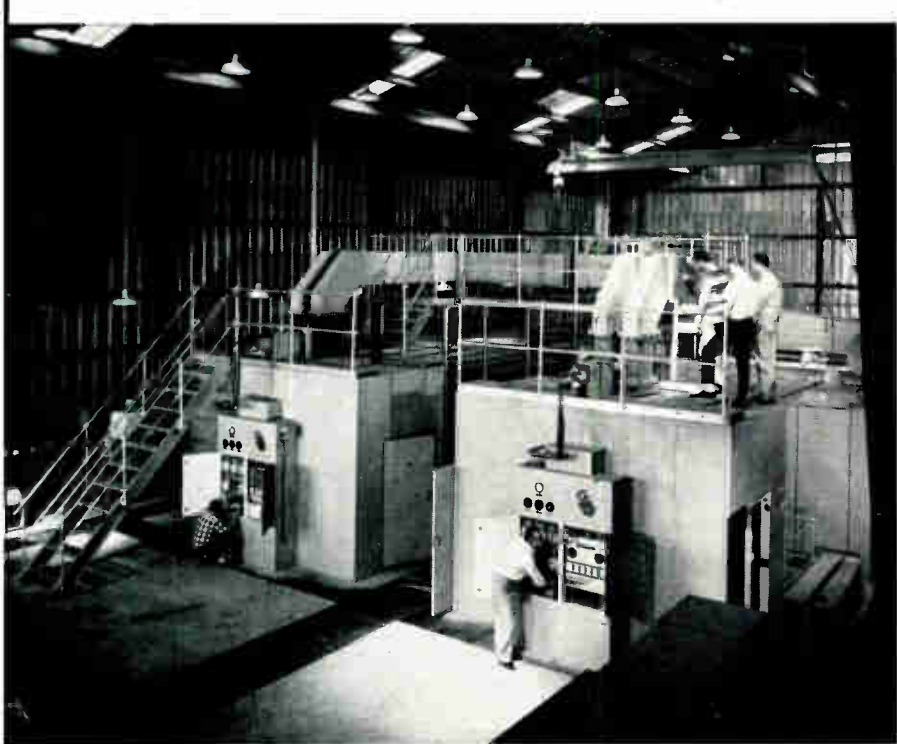

BMEWS ... the Ballistic Missile Early Warning System is the free world's first warning of enemy ICBM attack.

Powerful radars with an accurate range of thousands of miles can detect incoming ICBMs minutes after launching. The transmitters for this defense system are being built by Continental Electronics ... specialists in super power transmitting equipment.

Provided under sub-contract to General Electric and R.C.A., these transmitters from Continental Electronics are another contribution to our country's defense.

## Continental Electronics

MANUFACTURING COMPANY • MAILING ADDRESS: BOX 17040 • DALLAS 17, TEXAS  
4212 S. BUCKNER BLVD. • EV 1-7161 • LTV SUBSIDIARY OF LING-TEMCO-VOUGHT, INC.  
*Designers and Builders of the World's Most Powerful Radio Transmitters*



ENGINEERS ... FOR STIMULATING WORK ON THE ELECTRONICS FRONTIERS OF TOMORROW WITH A DYNAMIC, CREATIVE ORGANIZATION, SEND RESUME TO DIR. OF PERSONNEL

Circle 68 on Inquiry Card



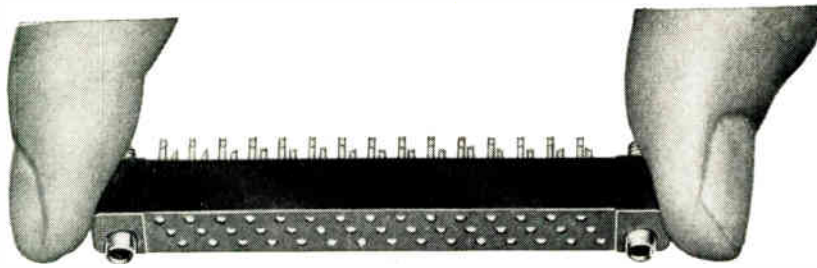

## This PC Connector gives you 45 Contacts in 2<sup>7</sup>/<sub>8</sub>" .050" center-to-center printed circuit board

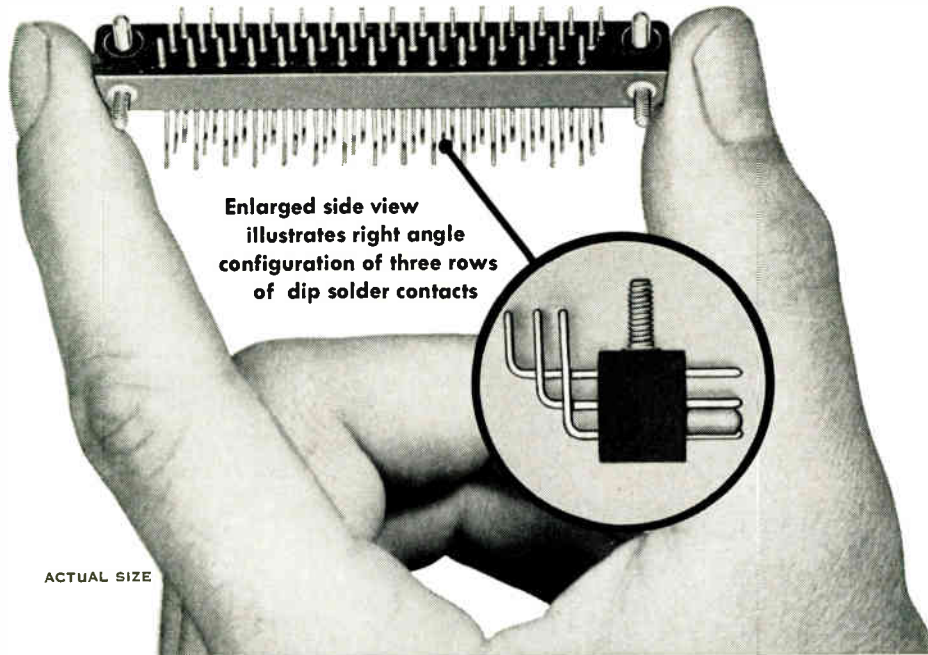

Enlarged side view  
illustrates right angle  
configuration of three rows  
of dip solder contacts

ACTUAL SIZE

Continental's Series 600-1-45 Sub-Miniature PC Connectors have been designed specifically for critical, high density printed circuitry in airborne and other severe environments where built-in design reliability is of utmost importance. Three-row, staggered contact arrangement provides 45 terminations for #22 wire in only 2<sup>7</sup>/<sub>8</sub>" by 0.36" area. Right angle pins dip solder directly to PC board, with threaded studs assuring mechanical security. Other reliability features include polarized guide pins and guide sockets, phosphor bronze pins and sockets with gold plate over silver plate, and moldings of glass reinforced Diallyl Phthalate per MIL-M-19833, type GDI-30F for low moisture absorption,

high impact strength, flame resistance and high dielectric properties. At Continental, new PC connector designs are constantly under development. Our Engineering Department will be pleased to assist you in solving special connector problems. Simply tell us your requirements.

### DESIGNER'S DATA FILE

If you're designing for right angle printed circuit applications you'll want to have Continental's Catalog RTA 362, compiled to help you select and specify the type best suited to your needs. For a free copy, write to: Continental Connector Corporation, 34-63 56th Street, Woodside 77, New York, or call TW 9-4422.



MICRO-MINIATURE • SUB-MINIATURE • MINIATURE • PRINTED CIRCUIT • RIGHT ANGLE PIN & SOCKET • CENTER SCREWLOCK

# CONTINENTAL CONNECTORS

CONTINENTAL CONNECTOR CORPORATION • WOODSIDE 77, NEW YORK

now...

# 30 MILLION test hours on TI hermetic film resistors

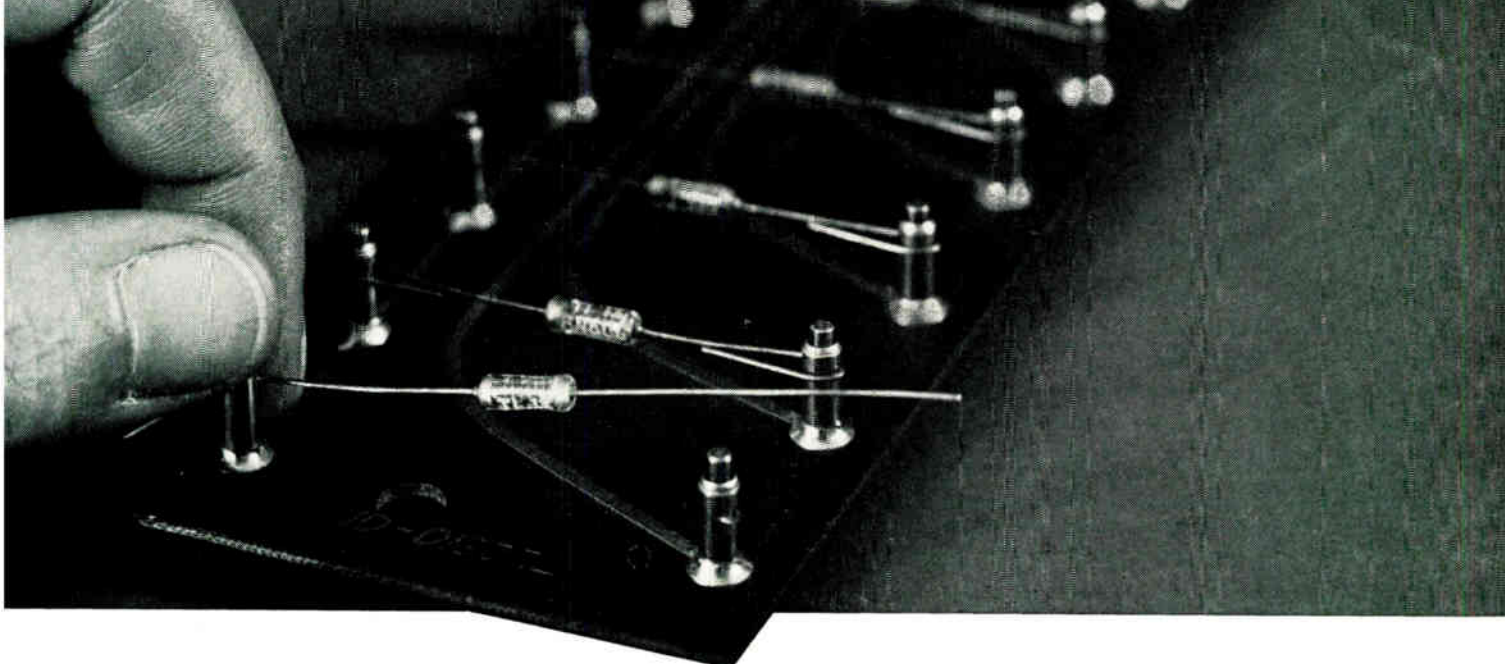

## RESULTS: No Catastrophic Failures—Excellent Stability

More than 30 million unit hours of extended load life have been run on Texas Instruments CG series hard-glass, hermetic resistors. Not a single catastrophic failure has occurred during these tests, for a remarkably low failure rate of 0.003% per thousand hours (60% confidence level). In addition to this impressive evidence of built-in resistor reliability, TI has accumulated a "library" of test data on resistor stability.

**Test Conditions:** Over the past two years, more than 60 standard production lots of CG1/4 and CG1/8 resistors have been subjected to long-term load life tests, up to 10,000 hours per lot. These tests include: five ambient temperatures — from 25° C to 175° C; seven wattage levels — 0, 1/64, 1/32, 1/16, 1/8, 1/4, 1/2 w; three maximum voltages — 250, 300, 350 v; and 35 ohmic values — 24.9 ohms to 1 megohm.

**Stability Proof:** The graph at right shows one test, typical of the series. Notice the

exceptional stability indicated by the drift curve, even under conditions of maximum power and maximum continuous working voltage.

You may be surprised to learn how economically you can buy TI hermetic resistors which provide all of the superior performance indicated by the test data. Ask your Texas Instruments sales engineer for more detailed information. Or write for the appropriate resistor life test data, stating your specific application requirements.

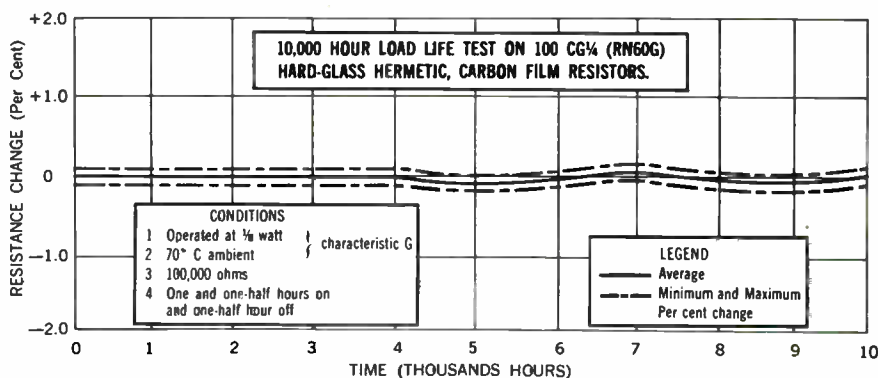

Circle 80 on Inquiry Card

MEETS OR EXCEEDS MIL-R-10509D, CHARACTERISTICS B, D, & G

SEMICONDUCTOR-COMPONENTS  
DIVISION

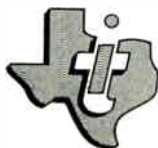

**TEXAS INSTRUMENTS**  
INCORPORATED  
13500 N. CENTRAL EXPRESSWAY  
P. O. BOX 5012 • DALLAS 22, TEXAS



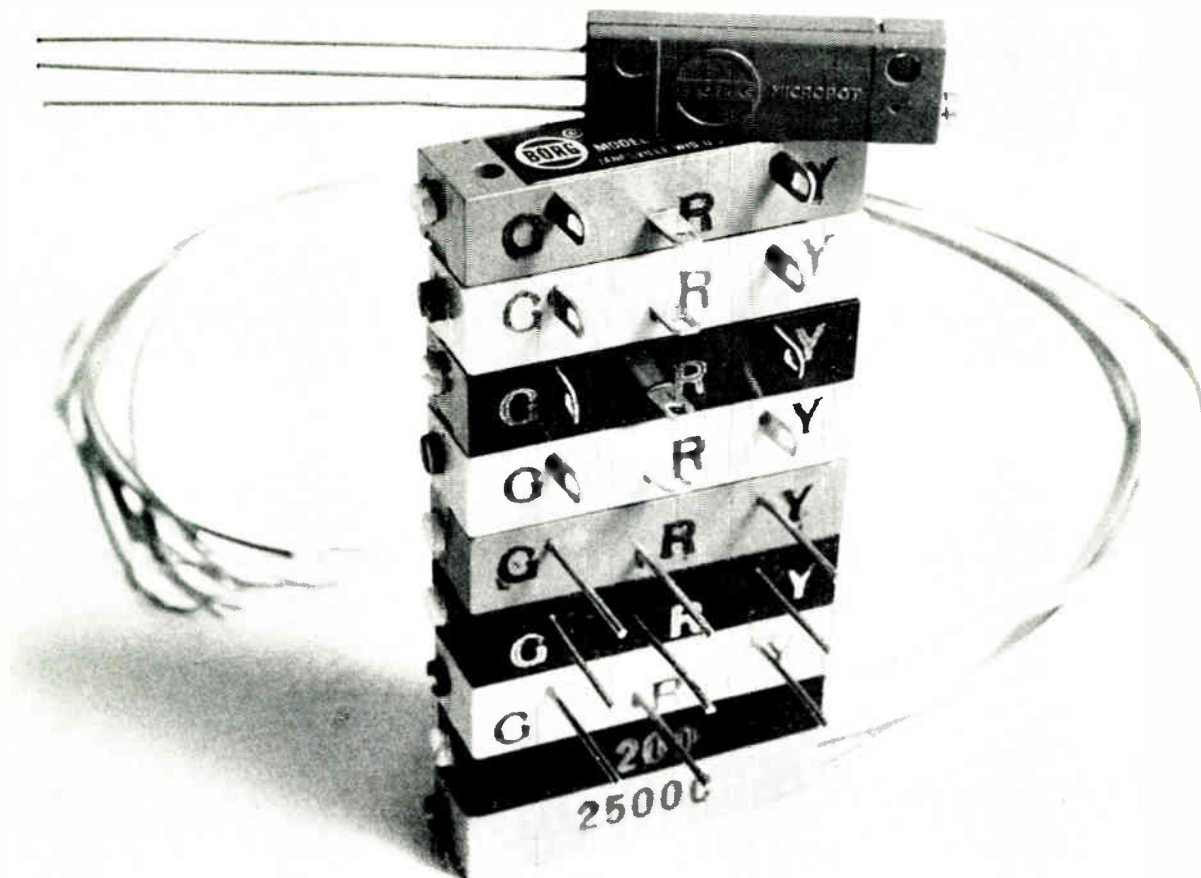

## The complete Borg Trimmer line starts at the top

Everything must start someplace. The complete Borg line of Trimming Micropot® potentiometers can be said to start with its latest addition, the subminiature (1" x 3/16" x 5/16") 2700 series. This new Micropot is not only tiny, but a high-temperature, humidity-proof model as well.

However, if a quarter of an inch isn't important to your application, there are six other Borg Trimmer series from which to choose:

- 2800—High temperature, humidity proof, wirewound.
- 990—High temperature, wirewound.
- 992—General purpose, wirewound.
- 993—General purpose, carbon.
- 994—General purpose, humidity proof, wirewound.
- 995—General purpose, humidity proof, carbon.

Here are some of the advantages of-

- fered by Borg Trimmers: 1. Single-piece, welded terminations. 2. Low-mass contacts. 3. 100% noise test. 4. 100% contact resistance check. 5. 100% ratcheting test. 6. Resistances from ten ohms to one meg.

Selecting the right Borg Trimmer can be a lot easier if you'll call your nearby Borg technical representative or Amphenol-Borg Industrial Distributor. Or, if you prefer, write directly to R. K. Johnson, Sales Manager:

Circle 70 on Inquiry Card



### BORG EQUIPMENT DIVISION

Amphenol-Borg Electronics Corporation,  
Janesville, Wisconsin.

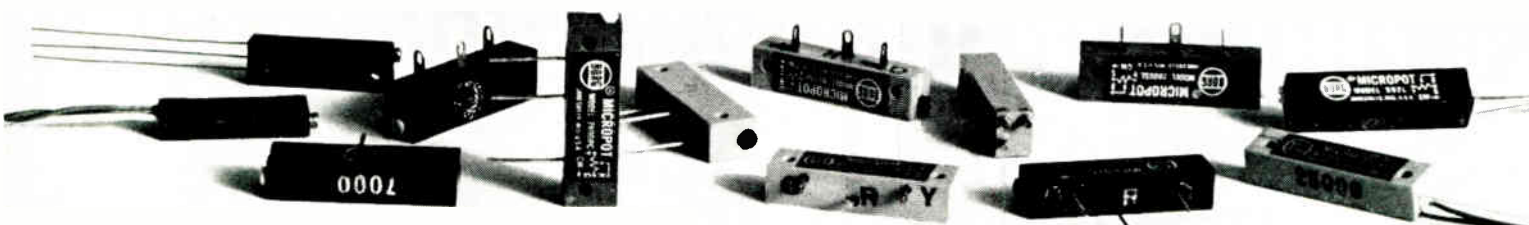

# New Sylvania *epitaxial* Ge Mesas combine both!

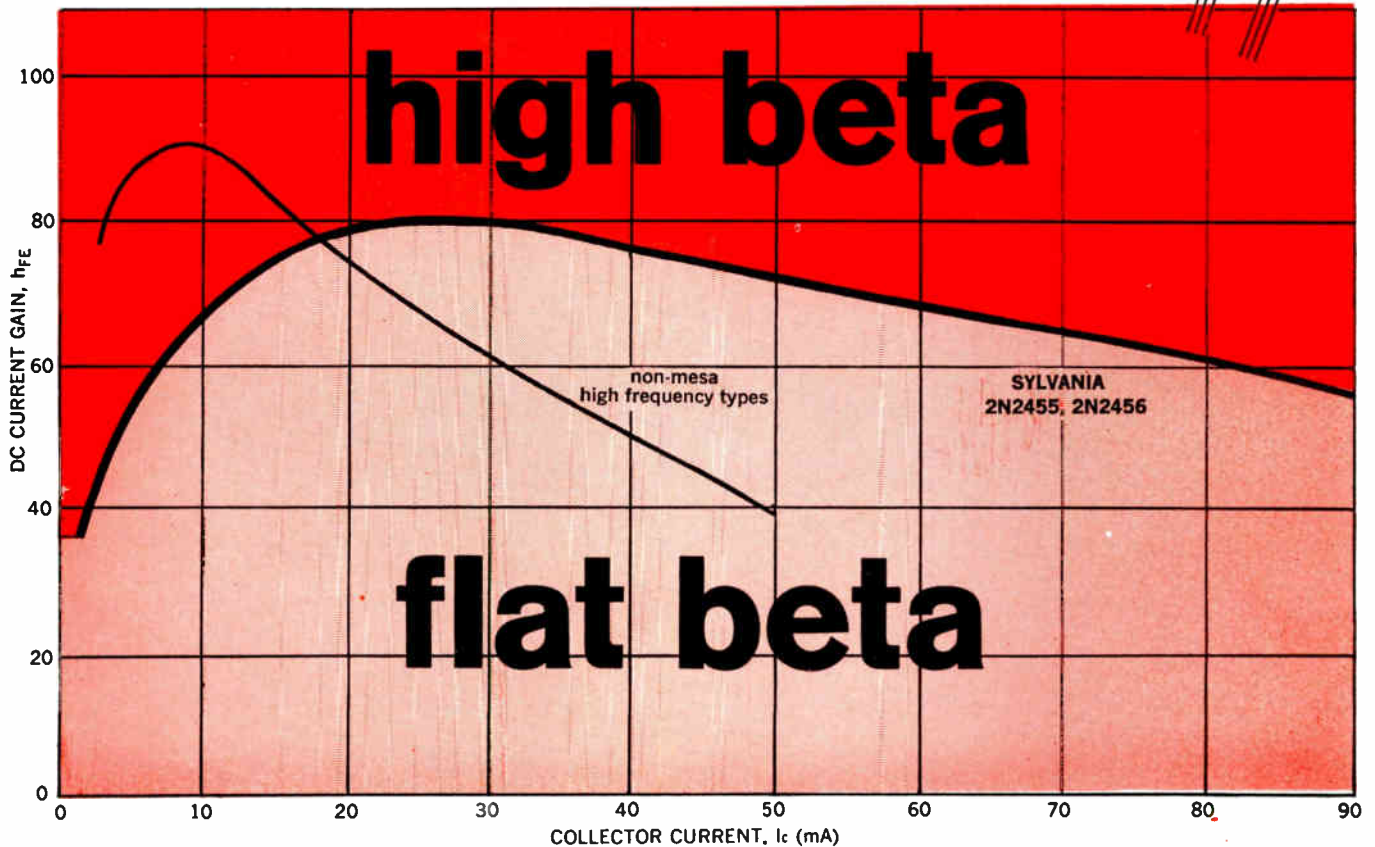
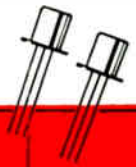

...offer superior GBW (2N2456 typically **1200MC**)

New 2N2455, 2N2456 provide high beta at low current and exhibit virtually linear beta over a *wide current range*. In this respect, as well as in GBW product, they far surpass performance of popular high-frequency types.

Packaged in TO-18, the 2N2455 and 2N2456 offer optimum performance in both PNP switching and amplifier applications. Both combine the well-known reliability and dissipation capabilities of the mesa structure with the reduced storage time, low saturation voltage and extraordinary uniformity inherent in Sylvania epitaxial process.

The full range coverage of Sylvania high beta types—at low current (2N2455, 2N2456)—at medium current (2N960 series)—and at high current (2N705, 2N781) offers wide design flexibility at optimum current levels. Your Sylvania Sales Engineer or Sylvania Franchised Semiconductor Distributor can give you full details. Ask him. Or, write for tech data to Semiconductor Division, Sylvania Electric Products Inc., Woburn, Massachusetts.

#### ABSOLUTE MAXIMUM RATINGS AT 25°C

Collector To Base Voltage, $V_{CB}$	.....	-15 volts
Collector To Emitter Voltage, $V_{CES}$	.....	-15 volts
Collector Current, $I_C$	.....	200 ma
Storage Temperature, $T_{stg}$	.....	-65°C to +100°C
Junction Temperature, $T_J$	.....	-65°C to +100°C
Power Dissipation, $P_J$	.....	150 mw

#### ELECTRICAL CHARACTERISTICS AT 25°C

	Min.	Typ.	Max.	Unit
Current Gain, $h_{FE}$	20	52	100	—
$I_C = 2.0$ ma, $V_{CE} = -20$ V				
Current Gain, $h_{FE}$	40	76	—	—
$I_C = 30$ ma, $V_{CE} = -40$ V				
Gain Bandwidth Product, $f_T$				
$I_C = 10$ ma, $V_{CE} = -6.0$ V	2N2455	600	820	— mc
	2N2456	1000	1200	— mc
Output Capacitance, $C_{ob}$				
$I_E = 0$ , $V_{CB} = -6$ V, $f = 1$ mc	2N2455	—	—	3.5 pf
	2N2456	—	—	3.0 pf
Input Capacitance, $C_{ie}$				
$I_C = 0$ , $V_{EB} = -1.0$ V, $f = 1.0$ mc				
Rise Time, $t_r$	2N2455	—	11	30 nsec
	2N2456	—	8.0	15 nsec
Off Time, $t_{off}$	2N2455	—	45	65 nsec
	2N2456	—	37	65 nsec
Storage Charge Factor, $K_s$			30	60 nsec

# SYLVANIA

SUBSIDIARY OF

GENERAL TELEPHONE & ELECTRONICS





# NEW, RECTANGULAR KELVIN Wire-Wound RESISTORS

*for reliability  
in printed circuit  
high-density packaging*

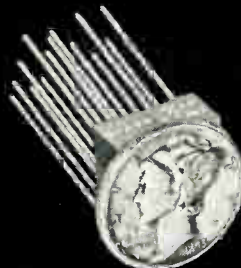
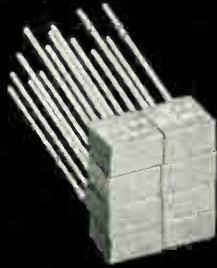
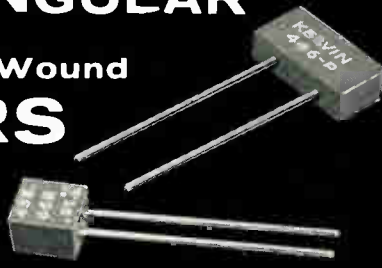

RECTANGULAR RESISTORS ..... SAVE MORE SPACE!!

Rectangular and flat in configuration, the new Kelvin Series "E" precision wire-wound resistors offer a circuit designer the ideal solution for high density packaging.

The new, flat configuration permits "stacking" one on top of another or laying resistors side-by-side for minimum space requirements, especially in printed circuit applications. All units are wound with a single length of wire (no splices permitted) using Kelvin developed "relaxed" winding techniques. This method, by allowing a winding tension of only 1½ to 3 grams, minimizes resistance drift with age and "opens" or "shorts" resulting from over-stressed wire. Units are further stabilized by artificial aging and temperature cycling prior to final inspection. Vacuum encapsulation eliminates voids.

## GENERAL SPECIFICATIONS

**\*WATTAGE RATINGS:** based upon maximum ambient temperature of 125°C, derated 5%/°C above 125°C.

**WINDINGS:** card type

**TEMPERATURE COEFFICIENT:** ±20 ppm/°C; (as low as ±2 ppm/°C — limited temperature range). Resistance wire having low thermal E.M.F. to copper is used exclusively.

**TEMPERATURE RANGE:** -65°C to +125°C.

**STANDARD TOLERANCES:** 1%, 0.5%, 0.1%, .05%, .025%, .02%, .01%.

**CONNECTIONS:** welded.

**ENCAPSULATING MATERIAL:** high temp. epoxide resin.

KELVIN TYPE	COMMERCIAL WATTAGE*	MAXIMUM OHMS	MINIMUM OHMS	SIZE	MAXIMUM VOLTS	LEAD SPACING	LEAD DIA.
446-P	.200	2 Meg.	1	½" x ¼" x ½"	100	.250	#20
447-P	.125	1 Meg.	1	⅜" x ¼" x ¼"	100	.125	#20

Our experienced engineers will answer your high-density packaging application inquiries promptly.

Send specifications or requirements to:

Representatives in principal cities



**KELVIN ELECTRIC COMPANY**

5907 Noble Ave., Van Nuys, Calif., TRiangle 3-3430  
New York: Yonkers, 916 McLean Ave., BEverly 7-2500

## PERSONALS

**Seymour Levine**—appointed Applications Engineer, Silicon Transistor Corp., Carle Place, N. Y.

**Dr. Franklin E. Lowance**—named Chief Scientist, Military Products Div., Hoffman Electronics Corp., Los Angeles, Calif.



Dr. F. E. Lowance



T. E. Lunak

**Thomas E. Lunak**—appointed Manager, Ceramic Engineering, at Centralab, The Electronics Div. of Globe-Union, Inc., Milwaukee, Wis.

**C. Bruce Fritz**—named an Account Executive Microwave Consultant in the East by Motorola Communications and Electronics, Inc., Chicago, Ill.

**Dr. J. M. Hirshon**—named Associate Director, Active Component Development, International Resistance Co., Philadelphia, Pa.

**Morris G. Watson**—appointed Manager, Communications Dept., Melpar, Inc., Falls Church, Va., a subsidiary of Westinghouse Air Brake Co.

**Ben Barr**—named Supervisor, Filter Engineering Section, Sprague Electric Co., North Adams, Mass.

**Dr. Bruce B. Barrow**—appointed Senior Engineering Specialist, Applied Research Laboratory, Sylvania Electric Systems, Waltham, Mass., a division of Sylvania Electric Products, Inc.

**Dr. Peter M. Kelly**—appointed Associate Director of Philco Scientific Laboratory, Blue Bell, Pa.

**Harry A. Keit**—appointed Director of the Systems Design Div., International Electric Corp., Paramus, N. J., a subsidiary of International Telephone and Telegraph.

**John F. Moore**—appointed Consulting Scientist for Lockheed Electronics Co., Plainfield, N. J., a division of Lockheed Aircraft Corp.

(Continued on page 84)

# Special Pliers for the Highly Specialized Electronics Field

When the early transmission lines were strung in this country a century ago, it was Klein Pliers in the hands of linemen that helped do the job.

Klein has kept pace with the development of the electrical field, meeting each new challenge with tools specially designed to do the wiring job better . . . more economically.

Shown here are a few of the many highly specialized Klein Pliers carried in stock to meet the needs of electrical and electronics manufacturers.

You will find your assemblies go together more smoothly and wiring is done more rapidly when the right Klein Plier is used.

**SEE US AT THE  
NEREM MEETING  
BOOTH 1813**

**SEE YOUR DISTRIBUTOR**



**Mathias KLEIN & Sons**  
Established 1857 Chicago, Ill., U.S.A.

INCORPORATED  
7200 McCORMICK ROAD, CHICAGO 45, ILL.

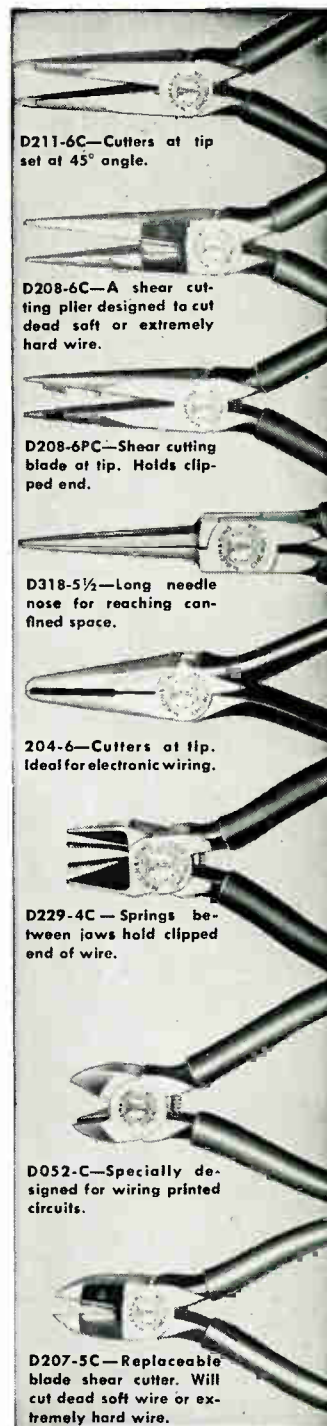

D211-6C—Cutters at tip set at 45° angle.

D208-6C—A shear cutting plier designed to cut dead soft or extremely hard wire.

D208-6PC—Shear cutting blade at tip. Holds clipped end.

D318-5½—Long needle nose for reaching confined space.

204-6—Cutters at tip. Ideal for electronic wiring.

D229-4C—Springs between jaws hold clipped end of wire.

D052-C—Specially designed for wiring printed circuits.

D207-5C—Replaceable blade shear cutter. Will cut dead soft wire or extremely hard wire.

Mathias Klein & Sons, Inc. 7200 McCormick Road, Chicago 45, Ill.  
Please send me the Klein Plier Catalog and information.

Name \_\_\_\_\_  
Title \_\_\_\_\_  
Company \_\_\_\_\_  
Address \_\_\_\_\_  
City \_\_\_\_\_ State \_\_\_\_\_



# Resistance Values up to 100,000,000 Megohms



■ Model RX-1 Hi-Meg Resistor

*Victoreen Hi-Meg Resistors —  
Standard of the Industry  
for Over 18 Years*

*Available tolerances*

1% 2% 5% 10%

■ For longer life, Victoreen Hi-Meg Resistors are in a class by themselves, especially for all high-impedance, low-current applications. Hi-Meg Resistors have a carbon-coated glass rod element with silver-banded ends for best electrical contact . . . are vacuum sealed in a glass envelope treated with special silicone varnish that minimizes moisture effects. Always specify Victoreen Hi-Meg Resistors for the ultimate in long-term stability.



WORLD'S FIRST NUCLEAR COMPANY

THE VICTOREEN INSTRUMENT COMPANY  
5806 HOUGH AVENUE • CLEVELAND 3, OHIO

Represented internationally by:  
Terminal Radio International, Ltd.  
3 West 61st Street • New York 23, New York  
Victoreen European Office: The Hague

A-4136A

## PERSONALS

**Bernard Rider**—appointed Director of Research and Development for the Maryland Div., Litton Systems, Inc., College Park, Md.

**Henry Mutz**—appointed Chief Engineer of Film Capacitors, Inc., New York, N. Y.



H. Mutz



C. H. Reynolds

**Carl H. Reynolds** — named Systems Planning and Development Manager, Data Systems Div., International Business Machines Corp., Poughkeepsie, N. Y.

**Charles E. Sporck**—named Operations Manager of Fairchild Semiconductor Corp., Mountain View, Calif.

**Albert W. Brandmaier**—named System Products Manager, Systems Div., Beckman Instruments, Inc., Fullerton, Calif.

**John Donovan**—named Quality Control Manager, MicroSemiconductor Corp., Culver City, Calif.

**Mois Gerson** — appointed Manager, Manufacturing Dept., United Aero-Space Div., Pasadena, Calif., a division of United ElectroDynamics, Inc.

**Richard J. Bazard** — appointed Engineering Manager, Donner Div., Systron-Donner Corp., Concord, Calif.

**Deloy G. Monroe**—appointed Director of Engineering and **Barry C. Passman** —appointed Chief Engineer for Sparton Electronics, division of Sparton Corp., Jackson, Mich.

**David W. Pendleton**—named Manager of American Machine & Foundry Co.'s new Instrument Div., Alexandria, Va.

**Ken Clayton**—named Sales Engineer for the Instrument Div., Victoreen Instrument Co., Cleveland, Ohio, to cover the Midwest.

**Massino M. Petrei**—appointed to the Special Projects Group, Taylor Fibre Co., Norristown, Pa.

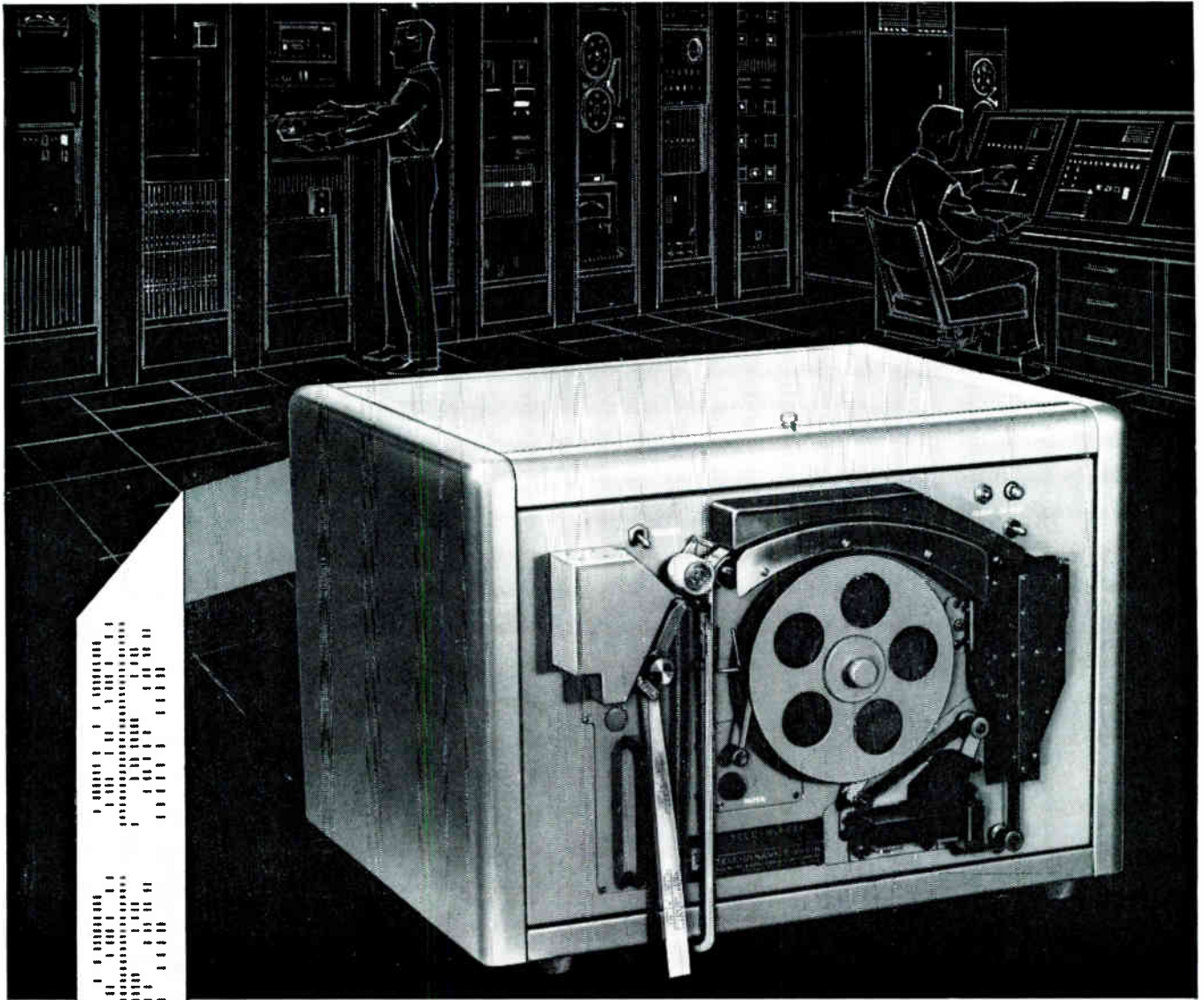

## ***New high-speed paper tape recorder/reader Tele-Dynamics' Tele-Buffer***

This new paper tape recording and reading slack-loop data buffer is designed for high speed communications and other systems characterized by high-rate bursts of data. Tele-Buffer employs an electrostatic charge deposition technique to record coded information as permanent visible dots on the tape . . . without mechanical punching or chemical processing.

The 5903A Tele-Buffer combines a 300 character per second, 5 bit recorder and a 10 character per second, 5 bit reader. The output of the 5903A is suitable for direct entry into a teletype machine operating at 100 characters per minute. The capacity of the slack-

loop data buffer is limited only by the length of the tape supply.

The recorder and reader can also be procured separately. Recording rates as high as 600 characters per second at up to 8 bits per character are available. Reader rates and format can be varied as required.

Tele-Buffer has a wide variety of applications. It can be used wherever high speed paper tape recording and slower speed playback are required. Typical applications include message speed buffering, message routing, computer output recording and digital data communications systems. Write today for complete details.

# **TELE-DYNAMICS** DIVISION

## **AMERICAN BOSCH ARMA CORPORATION**

5000 Parkside Avenue, Philadelphia 31, Pa.

Tele-Buffer is a trademark

8906



this is  
the Brush  
Mark II . . .  
anyone  
can  
plug  
it in  
put it  
in writing  
anywhere



There is no direct writing recorder on the market that approaches the compact Mark II in sheer usefulness. It is a completely integrated engineering tool that can be operated by anyone . . . in the shop or in the field . . . for countless research or design requirements. Every function necessary for uniform, crisp, easily reproduced readouts is "built-in". The Mark II gives you two analog channels plus two event markers; 4 chart speeds; DC to 100 cps response with 40 mm amplitude; 10 mv/mm sensitivity; high input impedance. Ink or electric writing models. Immediate shipment from stock.

**brush** INSTRUMENTS  
DIVISION OF  
37TH AND PERKINS **CLEVITE** CLEVELAND 14, OHIO  
CORPORATION

World Radio History

# NEXT MONTH

in ELECTRONIC INDUSTRIES

## ■ MOBILE TRACKING ANTENNAS

With Telstar already in operation and Relay soon to be placed in orbit, the tempo of activity in the low-cost satellite communications field has quickened. One of the

prime requirements of a compact, remote ground station is a mobile tracking antenna. This article gives the details on the design of such antennas.

## ■ CRYSTALS FOR THE LASER DEVICES

A laser beam passing through an ammonium dihydrogen phosphate crystal (ADP) which has a varying field applied, is modulated linearly with the applied field. It is this linear electro-optical effect in ADP which makes it a

key component in converting the passive laser beam into an active modulated light beam of practical application. Graphs, charts, and pictures should provide the engineer with critical design specifications.

## ■ WIDE PULSE WIDTH MODULATOR

With the advent of sophisticated microwave tubes such as the klystron, traveling wave tube, and carcinotron, there has been a noticeable change in modulators and power supplies necessary to power these tubes. This

article concerns itself with the approach and method of building a test modulator to power TWT's requiring pulses corresponding to specifications imposed upon equipment powering cw tubes.

## ■ HIGH SPEED SWITCHING

Here's a tutorial article on the state-of-the-art of high speed switching. Starting with the basic theory—impedance mismatch, gating, commutation—it progresses

logically to the latest applications of broad-band devices. It should prove to be a valuable reference to all those interested in the field.

## ■ SUMMARY OF MICROWAVE ELECTRON DEVICES

Completely revised and updated is this listing of technical specifications for approximately 2000 commercially available microwave power generating or amplifying devices in the region above 500 MC. Devices covered will include:

Magnetrons, klystrons, TR tubes, traveling wave tubes, backward wave tubes, parametric amplifiers, coaxial tubes, and planar tubes.

---

## COMING SOON

## ■ MICROELECTRONICS . . . WHERE WE ARE; WHERE WE ARE GOING

The staff of ELECTRONIC INDUSTRIES is preparing a comprehensive special report on microelectronics for early publication. There will be a brief review of the

paths followed to get us where we are, a thorough discussion of the activity taking place today, and some reliable predictions on where we are going . . . and when!

---

## WATCH FOR THESE COMING ISSUES:

**\*JANUARY**

Statistical and  
Annual Industry Review

**\*MARCH**

Annual IRE Issue

**\*JUNE**

Annual All-Reference Issue



# DESIGNING DIFFUSED INTEGRATED CIRCUIT RESISTORS

Certain problems arise when both passive and active circuit elements are constructed in a solid crystal of semiconductor material.

A method is shown here for obtaining resistors by diffusing a thin layer of p- or n- type impurity into a substrate of the opposite type material.

IN INTEGRATED CIRCUITS, when the active and passive circuit elements are constructed in a solid crystal of semiconductor material, conventional methods of obtaining circuit resistance are not always possible or practical.

One method of obtaining a compatible resistor is by diffusion. The resistor is obtained by diffusing a thin layer of p- or n-type impurity into a substrate of the opposite type material. The resistance of this layer will depend on the concentration profile of the impurity in the diffused material, the depth of diffusion, and the length-to-width ratio of the diffused area. For uniformly doped bulk semiconductor material, the end-to-end resistance  $R$  is given by

$$R = \frac{\rho l}{t w}$$

where

- $\rho$  = the resistivity of the material (ohm-cm)
- $l$  = length of the material (cm)
- $w$  = width of material (cm)
- $t$  = thickness of material (cm).

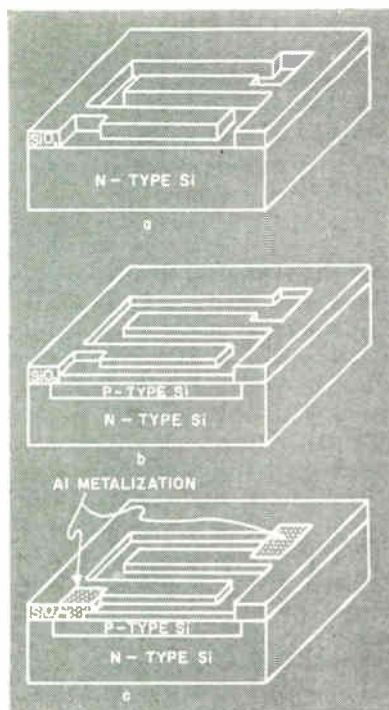

Fig. 1: Construction of a typical unit.

With diffused resistors used in integrated circuits, the diffusion depth is extremely small and is relatively constant. The resistance value of the diffused area can be stated in terms of the sheet resistance ( $R_s$ ) of the material, measured in ohms/sq, and the  $l/w$  ratio of the diffused area as:

$$R = \left( \frac{\rho}{t} \right) \frac{l}{w} = (R_s) \frac{l}{w}$$

When silicon is used, we can take advantage of the protective coating of silicon dioxide ( $\text{SiO}_2$ ) which may be grown on the surface of the crystal. This dioxide coating acts as both a mask against impurity diffusion and as an insulating and passivating coating for the junctions. Fig. 1 illustrates the construction of a typical unit. As shown in Fig. 1a, an area, the length and width of which partially determines the value of the resistor, is etched through the silicon dioxide. The unit is then placed in a furnace for a boron diffusion to form a p-type layer, several microns deep, as shown in Fig. 1b. The silicon

By HOWARD DICKEN

Semiconductor Products Div.,  
Motorola, Inc.,  
Phoenix, Ariz.

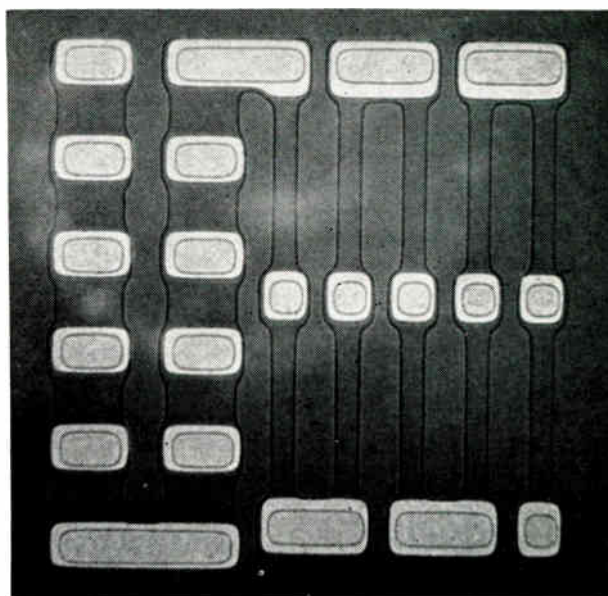

Fig. 2: Diffused resistors used to test purposes. Typical values from  $10\Omega$  to  $100\text{K}\Omega$ .

dioxide forms again during the diffusion and is then etched again to form holes for the ohmic contact areas as shown in Fig. 1c. Aluminum or gold is deposited into the holes to form the ohmic contact to the p-type layer. Wire leads may be bonded to the metalized areas by standard techniques. Fig. 2 is a photograph of a group of diffused resistors used for test purposes. Typical values of resistance obtained by this method may range from 10 ohms to 100K ohms. Tolerances may be controlled to  $\pm 10\%$  in the diffusion process. When two or more resistors are diffused into the same substrate, the resistance values will vary slightly, even for identical pattern configurations, due to the properties of the substrate. Normally, however, these variations can be held to within  $\pm 3\%$ .

### Equivalent Circuit

The equivalent circuit of a diffused resistor is shown in Fig. 3. A diode and the distributed capacitance of the p-n junction is available when a contact is made to the substrate material. Some of the values of these parameters which are indicated in Fig. 3 are as follows:

$$\begin{aligned} BV_f &\approx 0.5 \text{ volt} \\ BV_r &\approx 50 \text{ volts} \\ I_{co} &\approx 10 \text{ nanoamps} \end{aligned}$$

where

- $BV_f$  = forward voltage drop across the junction
- $BV_r$  = reverse breakdown voltage of junction
- $I_{co}$  = leakage current of junction

The value and variation of the capacitance will be discussed later. These parasitics must be taken into account, as shown later, when the substrate becomes part of an integrated circuit.

The following parameters are usually considered, in addition to the above values, to describe a diffused resistor: (1) frequency effects, (2) parasitic capacitance, (3) temperature coefficients, and (4) maximum ratings.

Fig. 5 illustrates, in terms of "h" parameters, some of the characteristics of a diffused 5K ohm resistor as a function of frequency. These results were obtained with the substrate as the common ground and with the resistor terminals as the input and output. The plot of

$$h_{21} = i_2/i_1$$

where

- $i_1$  = input current
- $i_2$  = output current

illustrates the transfer characteristics while the plot of

$$h_{11} = v_1/i_1$$

where

- $v_1$  = input voltage

illustrates the actual values of resistance as a func-

tion of frequency. As shown, these measurements indicate useful resistor action up to nearly 10 mc. However, by isolating the substrate, the parasitic capacitance effect is reduced and the frequency range is extended.

For resistors of this type, the distributed junction capacitance is a function of both the impurity concentration of the substrate and the voltage across the p-n junction. As an example, a diffused resistor of 100 ohms per square, diffused 3 microns deep into 0.5 ohm-cm silicon, will have approximately 0.13 pf/mil<sup>2</sup> at 1 v. reverse bias. The value of this capacitance also closely follows the theoretical form for a reverse biased graded junction of

$$C' = KV^{-1/3}$$

where

$$K = 18 \times 10^{-12}$$

Thus the effective junction capacitance may be governed by a reverse bias voltage placed on the resistor substrate.

The temperature coefficient is another variable which should be considered in the application of these devices to integrated circuits. One of the most critical parameters affecting the value of the temperature coefficient is the surface impurity concentration of the diffused area. The total resistance  $R$  of the units is determined primarily by  $\rho$  as given by

$$R = \frac{\rho \text{ area}}{A}$$

Fig. 3. Equivalent circuit for a diffused resistor.

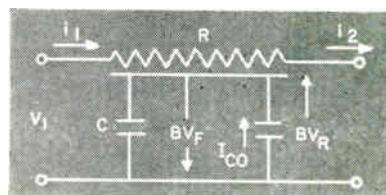
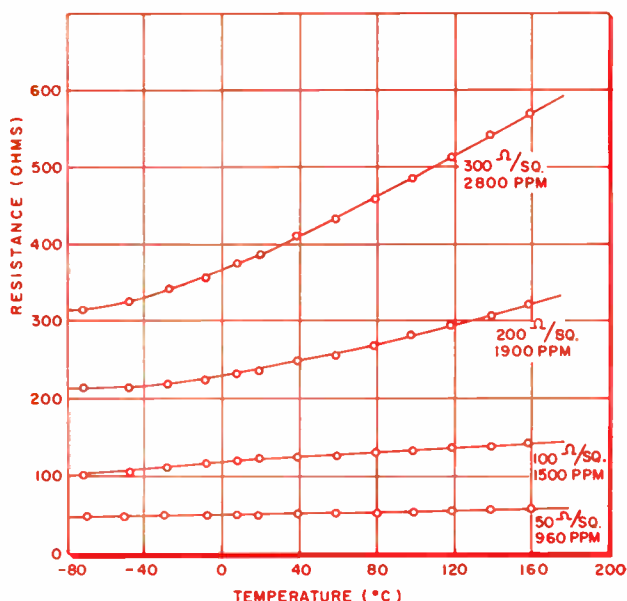

Fig. 4: Various resistor values plotted as a function of temperature.





## INTEGRATED RESISTORS (Continued)

where

$l$  = the length of the diffused area

area  $A$  = the width times depth of the junction

$\rho_{ave}$  = an average value of the resistivity in the diffused area.

From semiconductor theory, in a highly concentrated p-type layer,  $\rho$  is given by

$$\rho = \frac{1}{q \mu_p p}$$

where

$q$  = the electron charge

$p$  = the hole concentration

$\mu_p$  = the hole mobility.

Thus, in the normal temperature range,  $\mu_p$  is the primary temperature dependent parameter in the determination of  $R$ . Gartner<sup>1</sup> shows how the temperature variation of hole mobility is a function of the impurity concentration, becoming less temperature dependent with the higher concentrations. The mobility normally decreases with temperature, thus giving a positive temperature coefficient for the total resistance of the unit. However, for high impurity concentrations ( $10^{19}$  to  $10^{20}$  atoms per cc) of both n- or p-type, the mobility remains relatively constant over the normal temperature range.

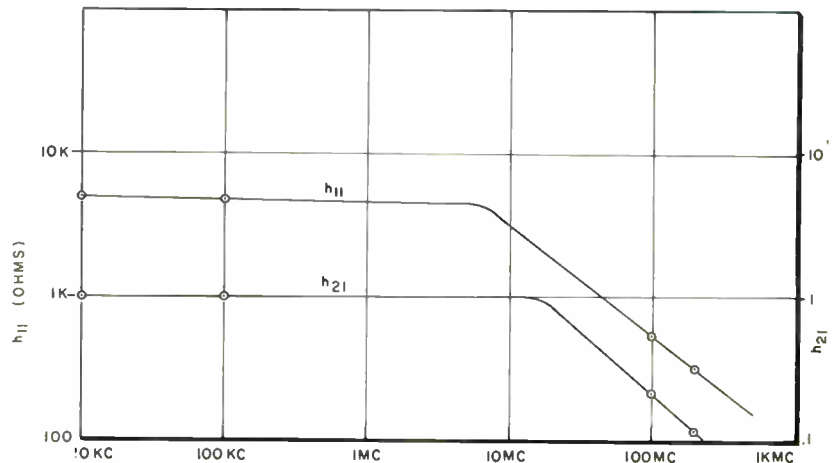

Fig. 5: Characteristics of diffused 5K resistor as a function of frequency.

This effect is shown in Fig. 4 where various resistor values are plotted as a function of temperature. The top curve illustrates the effect of a low value of impurity concentration (approximately  $10^{18}$  atoms per cc), while the lower curves show the effect of higher concentrations. At 100 ohms per square, diffused approximately 3 microns deep, the temperature coefficient is approximately 1500 parts per million per degree Centigrade. Thus the temperature coefficient of the diffused resistor may be controlled to a great extent by the initial surface impurity concentration of the diffused area.

There are some inherent low frequency limitations in the application of these devices, mainly power dissipation and maximum voltage ratings. The amount of power dissipation in the resistor is limited primarily by the heating effects on the material of the diffused layer. Excessive heating will result in a non-

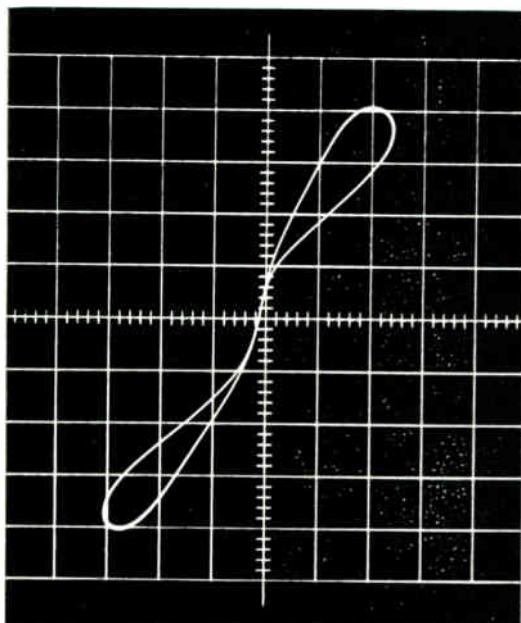

Fig. 6 (l): The V-I characteristics at high power levels. (20 ma/div.—vert., 10 v./div.—horiz.)

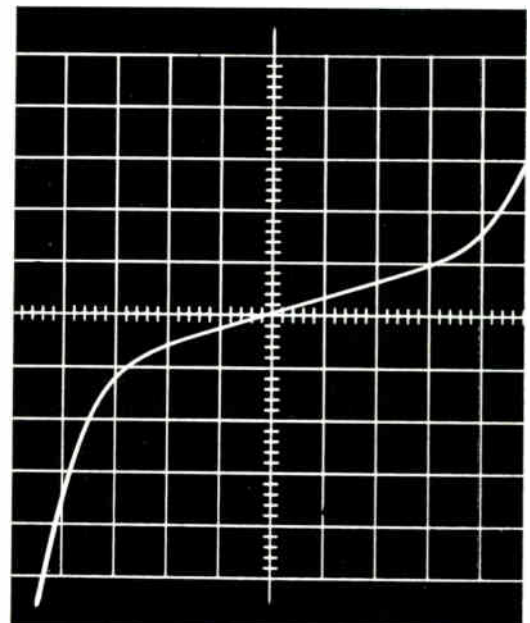

Fig. 7 (r): Reverse voltage breakdown is normally in the range of 30-80 v., depending on the impurity concentration of substrate material.

linear current voltage relationship. Measurements indicate that the maximum power dissipation, for units mounted in a standard TO18 can, is on the order of 3 mw per square mil of diffused area.

### V-I Characteristics

Fig. 6 illustrates the V-I characteristics at high power levels. The maximum voltage drop across the unit is limited by the reverse voltage breakdown of the p-n junction in the substrate. This value is normally in the range of 30-80 volts, as shown in Fig. 7, depending only upon the impurity concentration of substrate material. Because of the small cross-section of the diffused area, there is also a limitation on the maximum current due to current limiting effects. However, this effect is usually hidden by the heating action at high currents.

Typical applications of these devices usually fall into two general categories: applications such as load and bias resistors or applications involving the use of the substrate connection, such as R-C filters and "speed-up" resistors in logic circuits.

When used as a single independent element, these devices may be connected as any standard resistor, within the rated values. However, when included in fully integrated circuits in conjunction with other elements, the proper bias voltage must be maintained between the resistance element and the substrate material.

As shown in the example in Fig. 8, a p-type diffusion may be used for the emitter resistor directly on the n-type collector region. In this example, the substrate potential is always greater than the potential of any portion of the resistance element, and thus the p-n junction remains reverse biased. In the example of Fig. 9, the p-type diffusion is always at a higher potential than the remainder of the circuit, and thus the resistor substrate must be electrically isolated from the remaining circuit elements. In this example, the isolation is accomplished by n- and p-type regions forming back-to-back diodes between the circuit elements.

### Other Applications

In other applications, the inherent parasitic junction capacitance of the device may be used to an advantage. In some applications, such as the coupling resistor of a flip-flop circuit, a small speed-up capacitor is usually placed in parallel with the resistor. By connecting the isolated substrate to one terminal of the diffused area, part of the junction capacitance will appear across the resistor. Hurley<sup>2</sup> has shown that for a resistor with a distributed capacitance, approximately 1/2.7 of the total junction capacitance

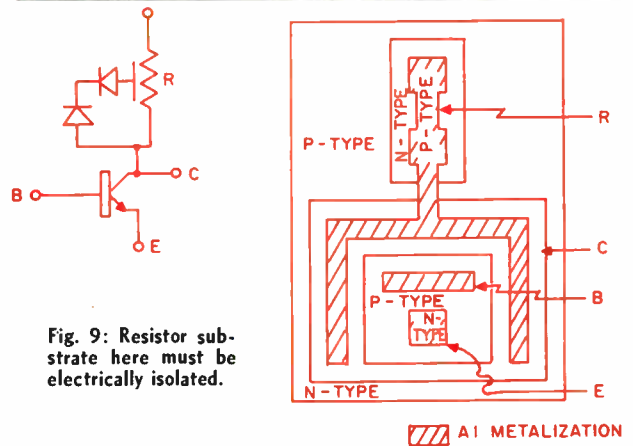
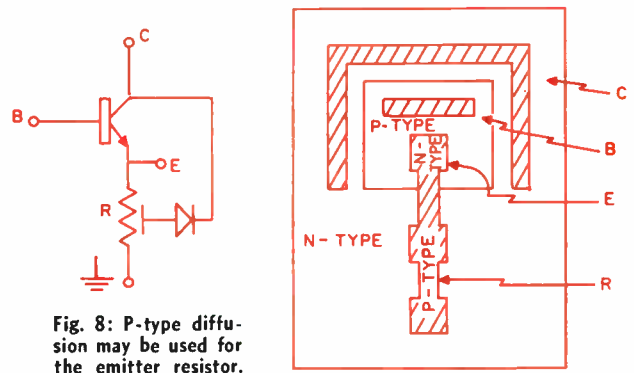

will appear in parallel when connected in this manner. Thus for some applications, a diffused resistor is capable of performing a dual function. Fig. 10 illustrates an actual application of diffused resistors in an integrated circuit.

### Acknowledgments

1. Gartner, W. W., *Transistors*. Princeton, New Jersey: D. Van Nostrand Company, Inc., 1960.
2. Hurley, R. B., "Approximations to Distributed Speed-Up Capacitance," *Electronic Equipment Engineering*, December, 1961.
3. Much of this work was done under Air Force Contract #AF33-(616)8276 on Compatible Techniques for Integrated Circuits.

Fig. 10: Application in an integrated circuit.

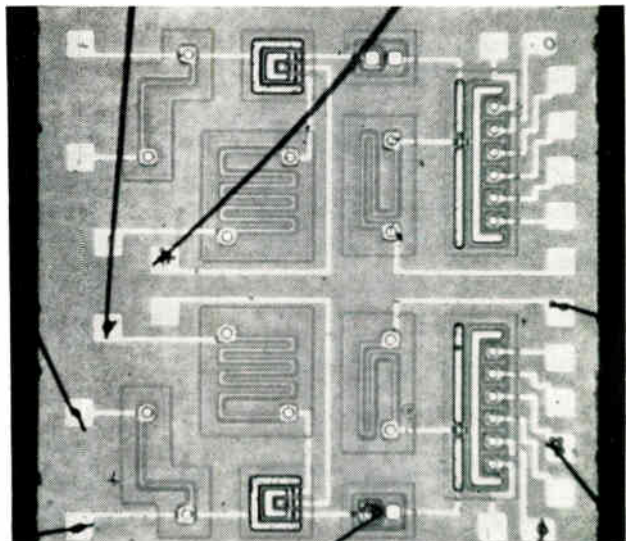



# AVALANCHE SWITCHING

Avalanche switching is important because of its fast switching speed and its ability to deliver high current pulses to low impedance loads. Here are the details on two switching circuits frequently used.

AVALANCHE SWITCHING CIRCUITS are important because of the fast switching speed and high pulsed current that can be delivered to low impedance loads. In the circuits used, the transistor is switched from a low current to the avalanche mode at a high current level. In the avalanche mode, the transistor continues to conduct until the current drops to a low value. This value is called the extinction current.

Triple diffused metallized silicon mesa transistors are ideal for avalanche uses because they have punch through voltages that are higher than the avalanche voltage rating. They can also withstand high pulsed power and they have a long thermal time constant.

## Basic Circuits

Two basic circuits are: Fig. 1a, a free running circuit that requires no external signal; and, Fig. 1b, a pulse amplifier circuit. The latter requires a pulse on the base to turn on the transistor.

The output of these circuits is also shown in Fig. 1. If taken between points 2 and 1, the output wave-

form will be a fast rising negative pulse; between points 3 and 1, it will be a linear ramp with a fast fall time.

An idealized collector characteristic, Fig. 2, shows two negative resistance regions. These negative resistances cause the oscillations of the free running circuit. The transistor must operate in at least one of these regions for continued circuit operation.

## Free Running Circuit

In the free running circuit, the collector current exceeds the current  $I_1$ , Fig. 2, and enters the negative resistance region; the capacitor charges to a voltage equal to  $BV_{CER}$ ; and, the transistor enters the negative resistance region conducting a large current like  $I_2$ . The large current is supplied by the capacitor discharge; and, it is limited by the resistor  $R_0$ .

When the transistor conducts this large current,

MR. NABOROWSKI was a Fellow Engineer with Astroelectronics Dept., Westinghouse Electric Corp., Newbury Park, Calif., when this article was prepared.

Fig. 1: The pulse amplifier, one of the two basic circuits used in avalanche switching, needs a pulse on the base to turn on the transistor. The output of each circuit is also shown.

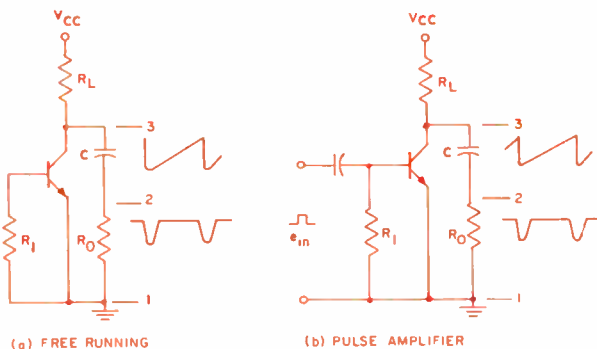

By **JOHN J. NABOROWSKI**

Sr. Project Engineer  
Aero/Weapons Division  
Raytheon Company  
P. O. Box 949  
Oxnard, Calif.

the emitter to collector voltage drops to  $V_1$ , Fig. 2. As the capacitor continues to discharge, the current decreases until the extinction current is reached. Then the transistor stops conducting. The capacitor starts to charge again and the cycle is repeated.

### Pulse Amplifier Circuit

In the pulse amplifier circuit, the collector current is limited to a value below the current  $I_1$ , Fig. 3; and, the transistor cannot enter the negative resistance region. A base current  $i_b = x$  is introduced and operation shifts to the  $i_b = x$  curve which permits the transistor to avalanche. The capacitor starts to discharge and the base pulse disappears; but, the transistor continues to conduct until the current reaches the extinction current. Then it stops conducting. The capacitor recharges and the cycle is repeated.

The input and output waveforms of the pulse amplifier circuit are shown in Fig. 4. The sawtooth voltage has some distortion between  $t_1$  and  $t_2$ . This is caused by the transistor conducting and the collector voltage remaining at the voltage  $V_1$  during capacitor discharge. The output voltage  $V_{RO}$  is a result of the capacitor discharge current. When the transistor turns off, the output voltage reverses because the capacitor charging current passes through this resistor.

A more linear sawtooth is possible if a constant current source is used in place of  $V_{CC}$ . A constant current source also permits use of a lower supply voltage.

In the pulse amplifier circuit, proper choice of  $R_L$  and  $C$  can compensate for variations in the  $BV_{CER}$  voltage. Pulse repetition rate is determined by the application; or, it can be specified as the first step in the design. After repetition rate determination,  $R_L$  and  $C$  are chosen so that the collector to emitter voltage never exceeds  $V_2$ , Fig. 3. The minimum  $BV_{CER}$  voltage can then be chosen as a value larger than  $V_2$ . It does not have to be the same for every transistor in the circuit.

### Applications

Many uses can be found for these basic avalanche circuits. The free running circuit is limited because small variations in the values of  $I_1$  and  $BV_{CER}$  in a transistor will cause the repetition rate to change. The pulse amplifier circuit can be made independent of  $I_1$  and  $BV_{CER}$  and the repetition rate determined by a synchronizing pulse. Many other circuits can be developed to use the fast rise time associated with avalanche switching.

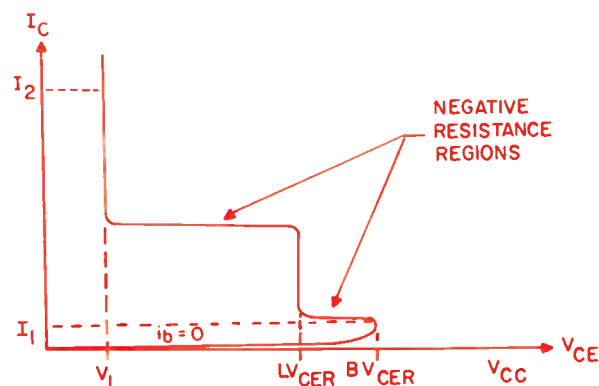

Fig. 2: The idealized collector has two negative resistance regions which cause the free running circuit to oscillate.

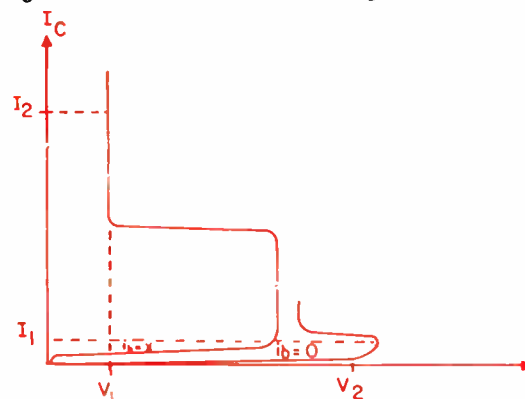
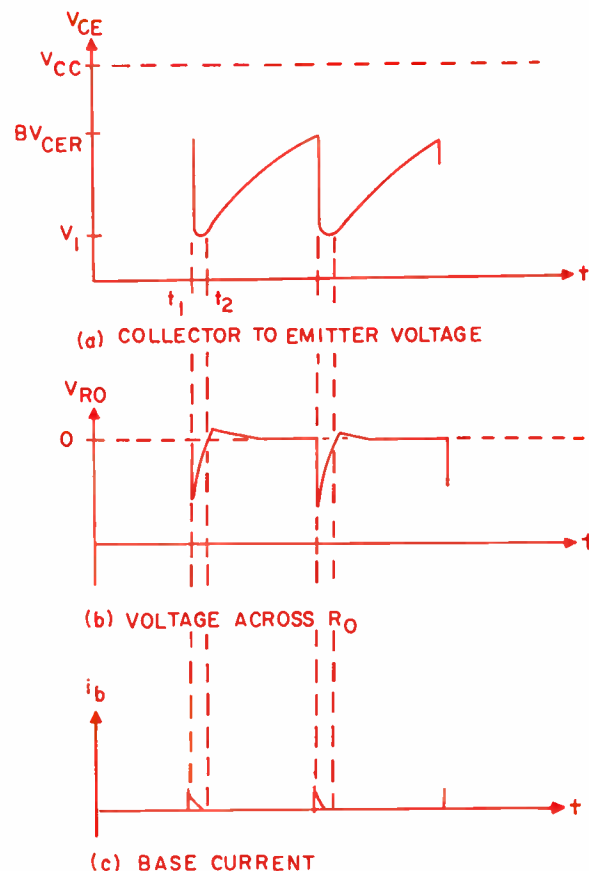

Fig. 3: The collector characteristic with the base current.

Fig. 4 (below): Input & output waveforms of pulse amplifier.





Requirements for radiation hardening are reviewed in relation to military requirements.

Problems connected with the evaluation of parts during and after irradiation are discussed.

A review of the state of the art for nuclear resistance parts is covered.

# NUCLEAR BLAST EFFECTS ON COMPONENTS & EQUIPMENT

## **No. 4 in EI's Series on Nuclear Radiation**

MILITARY ELECTRONICS EQUIPMENTS must operate reliably, accurately, and dependably in nuclear environments. The design and development of electronic equipment, the performance of which under field use will not be affected deleteriously by nuclear radiation, must be based upon the results of thorough investigations of the vulnerability and reliability of the electron devices used in equipment, when subjected to nuclear radiation.

A program for the improvement of electronic components for the nuclear environment is now being pursued by the Signal Corps. It was found that statistical data for use in equipment applications were severely lacking in many areas. In fact, experimental data on the behavior of electron tubes in complete circuits were also found to be very limited. Acquisition of these data in depth is now being planned.

### **Effects of Radiation on Parts**

Let us now examine each of the classes of electronic piece parts, determine the state of the art and the areas which need further investigation.

### **Electron Tubes**

In general, electron tubes exhibit radiation tolerances superior to those of other piece parts. Information on the behavior of tubes in a steady-state radiation environment is abundant. Effects such as discoloration of glass, fractures of glass, and failure of glass-to-metal seals are major factors in tube malfunctions in a steady-state radiation environment. Investigations have shown that soft glasses and high-temperature hard glasses, such as alumina-silicate glasses free of boron, are more radiation resistant than hard glasses<sup>1</sup> containing boron (Nonex and Pyrex). The use of metal-ceramic seals and the elimination of glasses containing boron have shown the possibility of raising the nuclear radiation tolerance levels up to  $10^{17}$ - $10^{18}$  n/cm<sup>2</sup>.

Part of this information was gained during the Aircraft Nuclear Propulsion (ANP) program. Certain types of electron tubes, after exposure to a steady-state nuclear reactor environment, consistently had fractures in the glass or gas leaks after long-term irradiation. Correlation between these effects and the different types of tubes was not initially apparent to the groups performing these ex-

Fig. 1: Typical transient response of electron tube during 60 microsec. radiation pulse.

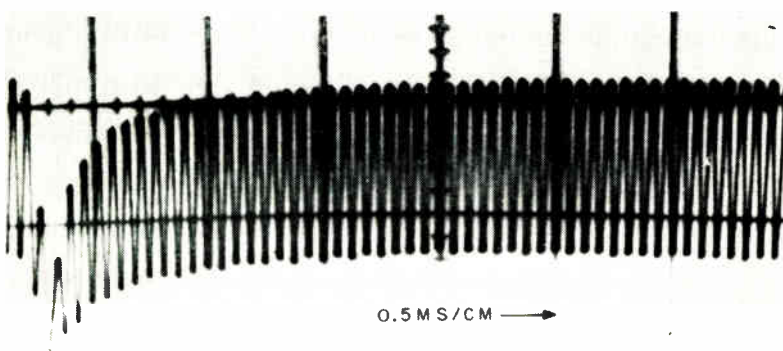

By **LOUIS L. KAPLAN**  
and **RICHARD G. SAELENS**  
U. S. Army Signal R. & D. Lab.  
Fort Monmouth, N. J.

periments. However, to those familiar with electron tube design and fabrication, it was quite evident that the glass fractures and gassing were occurring in certain types of glass envelopes. This failure could be attributed to the type of glass rather than the type of tube. Hard glasses containing boron were causing the glass fractures and gassing. Neutron interaction with atomic boron caused glass fractures. Initially, only small leaks at the metal-to-glass interfaces occurred, which resulted in leakage into the tube. However, as the damage became more severe, failure of the glass ensued. A similar method of analysis, it is believed, will lead to the final solution of the pulsed nuclear radiation damage problem. However, each of these investigations requires much time, numerous manhours, and the availability of proper exposure facilities.

In contrast to the permanent damage observed in electron tubes at steady-state reactors, only transient changes have been recorded during pulse-type exposures. A typical transient perturbation in an electron tube exposed in a pulse environment is shown in Fig. 1. The trace represents the transient change in the ac gain.

The information on pulse radiation effects on tubes has been limited to a few types and for a very small sample size of each type. Statistical information is

Fig. 3: Photo of typical changes in transistor parameters during radiation pulse.

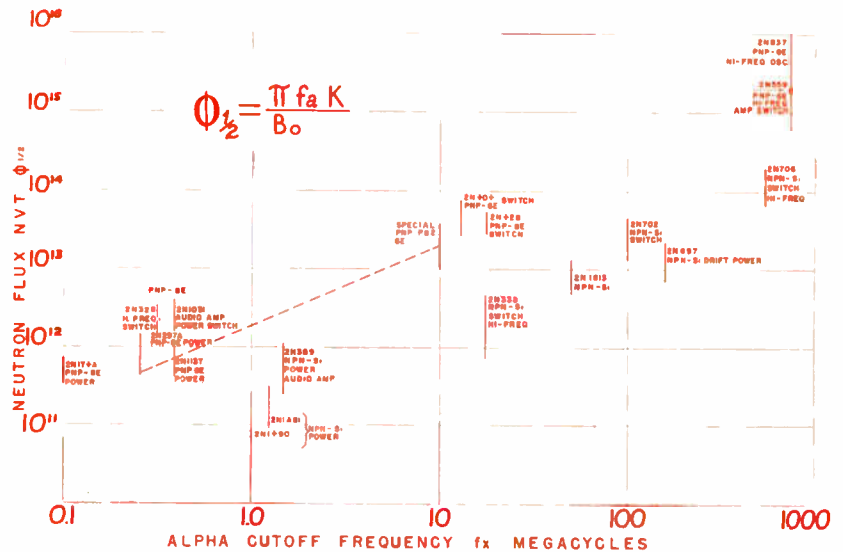
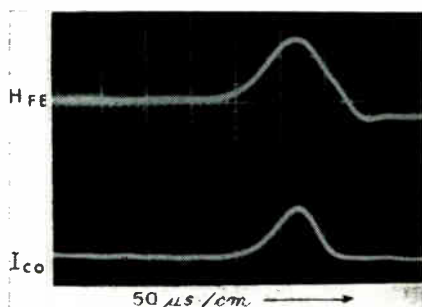
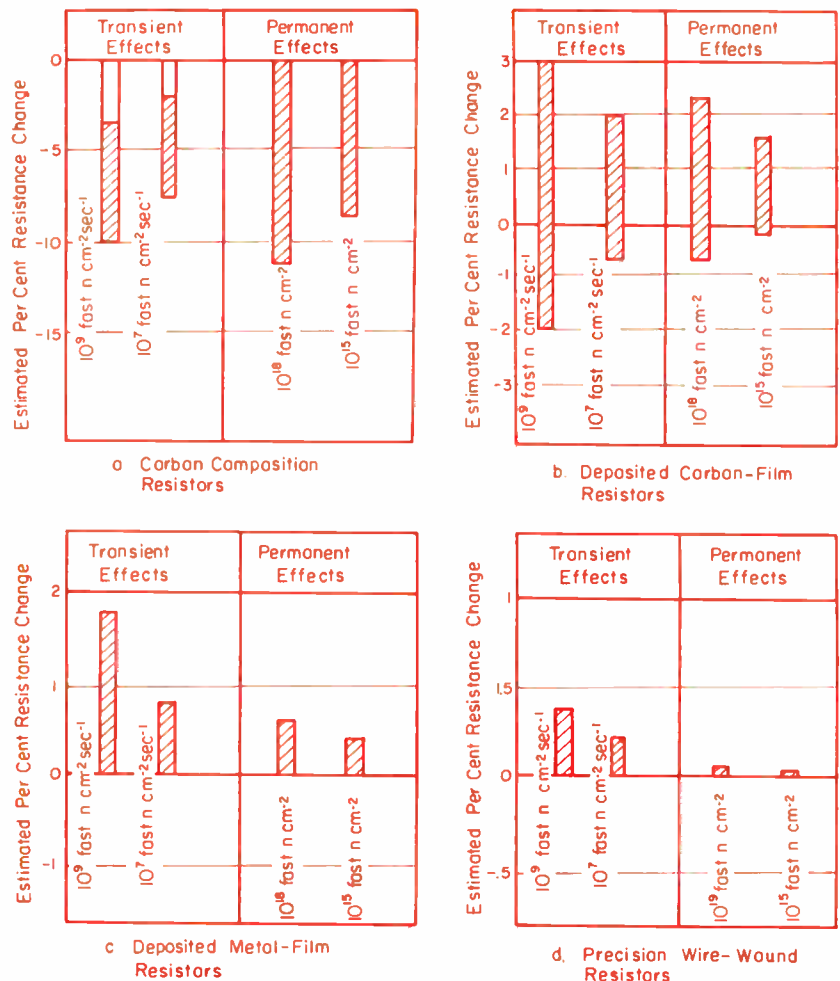

Fig. 2 (above): Shown is the radiation dosage at which a pertinent parameter of a solid state device will fall to one half value.

Fig. 4 (below): Graphs show the estimated effects of nuclear radiation on various resistors.





## RADIATION EFFECTS (Continued)

---

lacking on many types of tubes, including microwave devices of all types, power tubes, ferrite devices, etc. Programs have been initiated by the USASRDL to investigate the magnitude of the problems associated with these special groups of devices. Specifically, studies are being conducted on the effects of nuclear radiation on a voltage-tunable magnetron.<sup>2</sup> This study is directed at one specific device. Later other types, which are representative of this category of devices, will be evaluated in radiation environments, and efforts for improvement started. A program is also underway to find the effects of pulse nuclear radiation on a ferrite duplexer.<sup>3</sup>

Several programs are also in progress to find the basic mechanisms which produce transient radiation effects in tubes. Before radiation-resistant devices are developed, it will be necessary to fully understand the basic interaction between nuclear radiation and the electron tube materials, and electron tube operation. A program is now underway to ascertain the quantity and type of gases evolved in tubes during a pulse nuclear radiation.<sup>4</sup> Another comprehensive program has been started to investigate such phenomena as radiation-induced conductivity in tube insulating material, secondary electron emission from tube material, and correlation studies between effects, radiation rate, and spectrum.<sup>5</sup>

---

## Semiconductor Devices

Permanent radiation damage in semiconductors is blamed on defects caused by fast neutron interaction in the crystalline lattice structure. Impurity atoms are formed, vacancies and interstitials thus created change the electronic equilibrium in transistor operation. The degree of permanent change is proportional to the total integrated fast neutron dose, and varies with materials and construction. Transient effects in transistor operation are caused by the interaction of gamma radiation with orbital electrons, and ionization resulting from atoms which are displaced by fast neutrons. Because of the large mobility of these electron-hole pairs, effects exist only as long as the source of ionization or radiation is present. Thus, a transistor exposed to a pulse of mixed radiation will exhibit both a transient and permanent change after exposure. The permanent change may anneal-out in seconds, minutes, or days.

In some complex military electronic systems a change in device parameter, lasting in the order of seconds, cannot be tolerated. Also, when the transient and permanent changes in transistors are coupled with the transient changes in resistors, capacitors, insulators, etc., serious difficulties can arise.

In general, it can be stated that h-f germanium devices are many times more superior in radiation resistance than low-frequency or power silicon devices. A chart depicting this range in devices is shown in Fig. 2. This chart represents the radiation dosage at which a pertinent parameter will fall to one-half its original value. As can be seen, a spread exists through 3-4 orders of magnitude.

Some typical results of transient effects in semiconductor devices are shown in Fig. 3. The top trace is the change in forward current transfer ratio  $H_{FE}$ , while the lower trace is the transient change in leakage current  $I_{CO}$ . Note the permanent change in  $H_{FE}$ . This particular device is a h-f germanium switching type. The results are part of the data obtained during a recent Signal Corps experiment at a pulsed reactor, where about 500 solid state devices (20 types) were exposed to the pulsed nuclear environment. This experiment was done to ascertain the radiation damage vulnerability of some of the most recently developed solid state devices. In addition, the relatively large number of each type of device will provide a basis for statistical analysis. With this type of information, it will be possible to plot curves showing data on variations and confidence limits of each type of device. The equipment designer can then use this information for the selection of components which must operate in a radiation

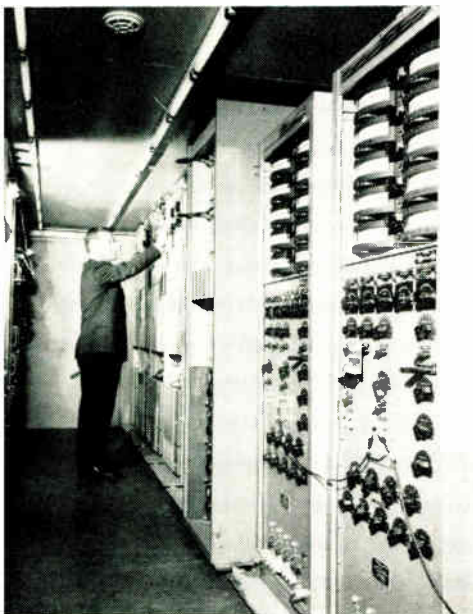

Fig. 5: Interior of a radiation effects mobile laboratory used by Signal Corps at Ft. Monmouth.

environment and compensate for the perturbation.

Additional theoretical studies are being conducted to define the basic mechanisms which produce transient effects in transistor operation.<sup>6</sup> Early device improvement studies have resulted in prototype models which have radiation resistance to orders of magnitude higher than the same devices of previous design.<sup>7</sup>

More research is needed on some of the new materials being used in semiconductor construction. Concomitant with the new materials, newly developed devices must be evaluated in a pulse radiation environment. At present, much of the available information is unreliable due to errors attributed to the manner of data acquisition. Many times the spread of data is so wide that the data cannot be used by the equipment designers. Experiments to be conducted in the future should be designed using statistical methods, proper sample sizes, techniques, etc., including dosimetry.

### Resistors

Present information on the effects of steady-state nuclear radiation on resistors shows that the ranking of tolerance is as follows: wire wound, metal film, carbon film, and carbon composition. The threshold for damage for carbon composition is  $10^{13}$  n/cm<sup>2</sup>, while wire wound resistors can withstand exposures up to  $10^{19}$  n/cm<sup>2</sup>. Early data on the effects of transient nuclear radiation on resistors showed that the major problem was due to shunt leakage paths across the resistor caused by air ionization. This has since been shown to be only one of the contributing factors. Experiments are being performed to learn the significance of variables such as physical size of resistor, ohmage value, applied voltage, and manufacturing processes.

A brief summary of the data which exist on resistors in a radiation environment is shown in Fig. 4.<sup>8</sup> When using this chart, it must be realized that the definition of failure in these cases is somewhat arbitrary. Many conditions and factors influence the judgment of whether a resistor has exceeded its critical parameter tolerance. The chart does not represent any single experiment or manufacturer's type of resistor.

More research is needed to determine the significance of cable effects on resistors during experiments. During some experiments, the same effect is observed with or without the resistor at the end of the cable. Statistical data are lacking on variations in resistor effects in relation to the manufacturer. More experimental data are needed on thin film re-

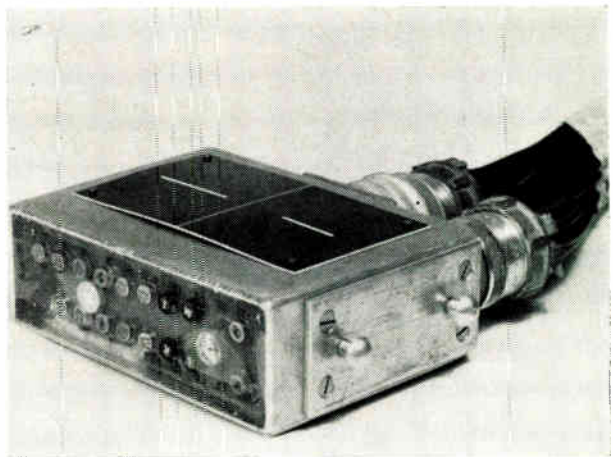

Fig. 6: Typical test head for transient radiation effects studies.

sistors. Standardization and improvement of measuring techniques are also needed.

### Capacitors

A brief summary of the effects of nuclear radiation on capacitors and their tolerance is given as follows:

*Ceramic Dielectric Capacitors:* Ceramic capacitors exposed to a total integrated neutron dose of  $1.3 \times 10^{18}$  n/cm<sup>2</sup> and  $2.5 \times 10^{10}$  ergs g<sup>-1</sup> (C) showed increases in capacitance of between 3.7 and 18.8% of their initial value. Upon removal from the radiation field, the capacitance generally returned to within its original tolerance value. Ceramic-type capacitors exposed to pulse nuclear radiation levels of  $10^{17}$  fast n/cm<sup>2</sup>.sec and  $10^9$  ergs g<sup>-1</sup> (C) sec<sup>-1</sup> showed negligible transient effects during the radiation pulse. Permanent changes varied between -3.2 and +8.7%.

*Glass Dielectric Capacitors:* Glass and vitreous enamel capacitors exposed to an integrated neutron dose of  $2.5 \times 10^{17}$  fast n/cm<sup>2</sup> and  $6.1 \times 10^{10}$  ergs g<sup>-1</sup> (C) showed changes in capacitance of +2% or less, and decreases in insulation resistance of 2 to 3 orders of magnitude during irradiation. Pulse radiation experiments (Godiva reactor) on glass capacitors have shown little or no effect on their electrical characteristics.

*Mica Dielectric Capacitors:* Mica capacitors exposed to an integrated fast neutron dose of approximately  $10^{14}$  n/cm<sup>2</sup> and  $5.7 \times 10^8$  ergs g<sup>-1</sup> (C) showed only small changes during irradiation. However, these changes remained after removal from the radiation field. Pulse nuclear radiation (Godiva reactor) has shown little effect on mica capacitors.

*Paper & Oil-Impregnated Paper Dielectric Capacitors:* Paper and oil-impregnated paper capaci-

## RADIATION EFFECTS (Continued)

tors have shown significant changes at integrated neutron doses of about  $10^{18}$  n/cm<sup>2</sup> and  $2.5 \times 10^{10}$  ergs g<sup>-1</sup> (C) gamma radiation. In almost all cases, the electrical characteristics of this type capacitor were beyond tolerance levels. In general, these capacitors are more sensitive to radiation than the inorganic types by factors of from 100 to 1000.

**Plastic Dielectric Capacitors:** Inorganic dielectric type capacitors are superior to the plastic dielectric type by a factor of 10. The capacitance of a plastic dielectric capacitor increased about 14% after exposure to  $7.2 \times 10^{18}$  n/cm<sup>2</sup> and  $6.1 \times 10^{10}$  ergs g<sup>-1</sup> (C) gamma units. No permanent changes were observed.

**Electrolytic Capacitors:** Changes in capacitance have varied between -9.7% and +25% for tantalum capacitors, and -6.0% and +65% for aluminum-type capacitors. The neutron and gamma dose ranged between  $3.4 \times 10^{12}$  n/cm<sup>2</sup> ( $5.7 \times 10^8$  ergs g<sup>-1</sup> (C)) and  $2.5 \times 10^{18}$  n/cm<sup>2</sup> ( $4.4 \times 10^{10}$  ergs g<sup>-1</sup> (C)). Changes have been observed in tantalum capacitors in a pulse radiation environment. However, it was considered that these changes were attributable to other causes.

### Quartz Crystals

Effects observed early in the program on quartz frequency control crystals were later attributed to shunt leakage paths. More recently, transient effects were observed in the CR-18, CR-52, and CR-56 military-type crystals at the Godiva II reactor and the Linac. These effects were evidenced by phase changes ranging between 10° and 90°, lasting up to at least 5000 μs. Experiments conducted at steady-state reactors indicate that aluminum-plated crystals are less susceptible to radiation damage than gold and silver-plated crystals. Damage levels vary between  $10^{14}$  n/cm<sup>2</sup> to  $10^{18}$  n/cm<sup>2</sup>. Manufacturing processes appear to be an important factor in the degree of effect.

More research is being performed to learn the effects of short pulses of neutron and gamma radiation on quartz crystals.<sup>10</sup> Experimentation is needed to provide statistical information from which theories as to the mechanism of the radiation damage can be formulated.

### Magnetic Materials<sup>11</sup>

Ferrite cores exposed to a neutron dose of  $1.6 \times 10^{17}$  n/cm<sup>2</sup> at a steady-state reactor showed no per-

manent change. Experiments were conducted at the Sandia Pulse Reactor to detect changes in magnetic cores during radiation pulses. The integrated neutron dose during these exposures was about  $2 \times 10^{12}$  n/cm<sup>2</sup> E > 2.5 Mev. Mg-Mn ferrite (wide temperature range) memory cores, Cr-Mn-Ni-Zn ferrite and 4-79 Permalloy-type switching cores showed no variations due to irradiation. Transient effects were not observed in 4-79 Mo-type Permalloy tape (logic application). However, post-test voltage measurements showed a 30% decrease. Permanent damage measurements, performed several days later, indicated the 4-79 Permalloy tape had returned to its original state. The post-test voltage decrease may have been caused by a drive current change. Mg-Mn ferrite memory devices have shown some changes during radiation pulse. Post-irradiation measurements indicated no permanent changes.

More experimentation is needed to clarify discrepancies observed for certain types of devices.

The foregoing review of the damage in electronic piece parts exposed to nuclear radiation, pulsed or steady-state, has been very limited for various reasons, including scarcity of reliable information. In fact, one class of problem has been completely omitted, and that is activation of piece part materials. It is obvious that nuclear activation of materials in piece parts could cause problems over and above either interrupted operation or actual failure. For instance, the creation of a long-lived isotope could prevent the repair of these electronics for long periods of time. A case in point is the use of kovar

Fig. 7: A magnesium oxide radiation detector for testing use.

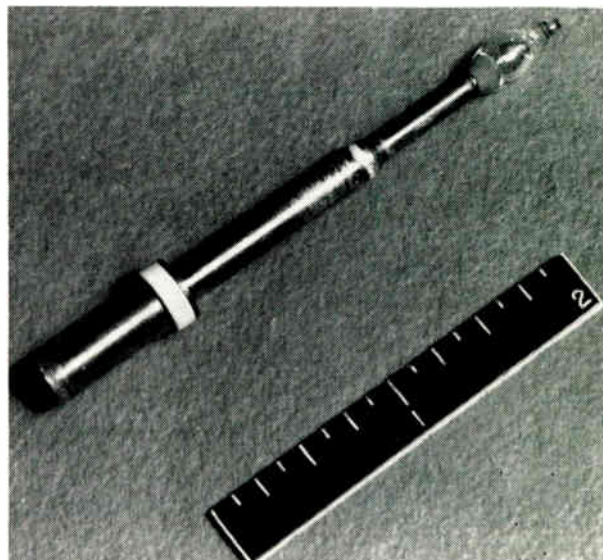



in tubes. This alloy contains cobalt which, when activated, produces the cobalt-60 isotope—a very hot material with a long half life. Problems of this type are being studied in a Signal Corps contract with Stevens Institute of Technology.<sup>12</sup>

At present, the Radiation Effects Information Center (REIC) at Battelle Memorial Institute, Columbus, Ohio, has been designated by the Department of Defense (DOD) as the information collation agency for work covering pulsed radiation effects on electronics. This group has published a number of general reports on the effects of nuclear radiation. In the future, REIC plans to issue a handbook on nuclear effects information for electronic equipment designers. This book will be a working tool. It will be modified in time to include more information as it becomes available.

### Problems Connected With Evaluation

The main problem to an investigator evaluating nuclear effects on piece parts is the scarcity of valid information. This scarcity is due to a severe lack of exposure facilities in the past. Also, the geographical location of most of the existing pulse radiation facilities, and the inherent hazards of the radiation environment, create many difficulties which are not found in similar environmental laboratory-type experiments. A brief review and description of the pulse radiation facilities which are being used are given below.

*Sandia Pulse Reactor Facility (SPRF):* The SPRF, located at the Sandia Corp., Albuquerque, N. M., is a reactor similar to the Godiva II which was used for radiation effects experiments at the Los Alamos Scientific Lab. In fact, the SPRF reactor is identical to the Godiva II except that increased reactivity is available, and additional safety factors have been added.

*TRIGA—Mark F (General Atomic):* Several TRIGA reactors are in operation in addition to the TRIGA facility at General Atomic, Torre Pines, Calif. These reactors are located at Diamond Ordnance Fuze Lab., Washington, D. C.; Armed Forces Radiobiology Research Institute, Bethesda, Md.; and Norair Div. of Northrop, Hawthorne, Calif. The TRIGA reactor produces high integrated neutron doses. However, because of its millisecond pulse width, it is not useful for all electronic piece parts and equipment.

*KEWB Reactor (Atomics International (AI) Div. of North American Aviation):* The KEWB reactor is located at Conoga Park, Calif., and was developed by AI. The KEWB pulse width is in the millisecond

Fig. 8:

### Radiation Levels Outlined in MIL Standard 446A

ENVIRONMENTAL CHARACTERISTICS	GRP. IV	GRP. VI	GRP. VIII
<b>Nuclear Radiation (Reactor)</b>			
<b>Neutron Flux Level (Fast, E &gt; 10 Kev.)</b>			
Intensity, n/cm <sup>2</sup> -Sec	NA	10 <sup>10</sup>	10 <sup>10</sup>
Time, Hours	NA	1,000	1,000
<b>Gamma Flux Level</b>			
Intensity, R/hr	NA	5x10 <sup>5</sup>	5x10 <sup>5</sup>
Time, Hours	NA	1,000	1,000
<b>Thermal Neutrons</b>		****	****
<b>Nuclear Radiation (Pulse)</b>			
<b>Neutrons (Fast, E &gt; 10 Kev.)</b>			
Total Dose, n/cm <sup>2</sup>	10 <sup>13</sup>	10 <sup>13</sup>	NA
Duration, Half Amplitude, Sec.	5x10 <sup>-6</sup> to 5x10 <sup>-2</sup>	5x10 <sup>-6</sup> to 5x10 <sup>-2</sup>	NA
<b>Gamma</b>			
Peak Intensity, R/Sec.	10 <sup>8</sup>	10 <sup>8</sup>	NA
Duration, Half Amplitude, Sec.	<10 <sup>-5</sup>	<10 <sup>-5</sup>	NA

\*\*\*\* Thermal Neutrons are not listed as a requirement but, since all neutron fluxes have some thermal component, this component should be measured and reported with all tests. In no case should the total thermal neutron dose exceed the fast neutron dose by more than a factor of ten.

region and, therefore, the integrated neutron doses are high. However, the use of the KEWB is not feasible for short pulse width type effects experiments.

*White Sands Missile Range Godiva II Reactor:* This reactor is to be constructed at the WSMR, and will be a type similar to the Sandia reactor. The reactor will be used for specific types of missile electronics evaluation programs.

*Linear Accelerators:* Several Linacs are available for short pulse width type radiation effects experiments. These Linacs are located at Rensselaer Polytechnic Institute, Troy, N. Y. (45 Mev); Hughes Aircraft, Fullerton, Calif. (10 Mev); General Atomic, Torre Pines, Calif. (45 Mev); and WSMR (10 Mev).

The large use factor planned for the various facilities, and their location in the western part of the U. S., has led to consideration of more facilities, mainly for advanced Godiva-type reactors. These would be capable of producing neutron outputs one to two orders of magnitude above those of conventional Godiva-type reactors, and at shorter pulse widths. These include:

*Army Pulse Reactor—Aberdeen (ARPA):* This

## RADIATION EFFECTS (Continued)

---

facility, proposed to be located at Aberdeen Proving Ground, Aberdeen, Maryland, would be mainly for use by the Army Ordnance Corps, Army Chemical Corps, and the Signal Corps, as well as by electronic component manufacturers located within a 200-mile radius of Aberdeen Proving Ground.

*Proposed New York State Pulsed Reactor:* The State of New York, in cooperation with a number of manufacturing groups in that State, are now studying the possibilities for use of a pulsed reactor of the beyond-Godiva type. A consultant engineering firm has been employed to complete the study and make recommendations for a facility, which will be partially financed by the State of New York.

*General Electric Company Reactor:* The General Electric Co. has been studying the possibility of constructing a beyond-Godiva pulsed reactor for use in their radiation effects program, and for general use by other electronic equipment contractors. No definite decision has been reached to date as to the location of such a facility.

### Radiation Effects Mobile Lab (REML)

From the description and location of the presently available facilities, the varied exposure requirements, and the long delay expected in obtaining the planned reactors, it becomes evident that the piece parts electronic monitoring equipment associated with this program must be made completely mobile. Also, the equipment must be shock-mounted to withstand transportation environments for multi-thousand mile trips. The equipment must also be completely reliable, since limitations in on-site pre-experimental time virtually preclude the possibility of trouble shooting equipment malfunctions at the site. An example of the type of fully equipped vehicle which is being used in radiation effects experiments by the Signal Corps is shown in Fig. 5. This particular trailer, referred to as the Radiation Effects Mobile Laboratory, is one of the most complex instrumentation vehicles now in use. With the instrumentation in the REML, it is possible to monitor 90 channels of dynamic information at one time. This instrumentation system is needed because of the large

number of devices which are exposed during each experiment. The number of devices is predicated on the minimum sampling of devices which will provide statistically valid information.

To determine the effects of nuclear radiation on a single component, such as an electron tube or transistor, etc., all associated circuitry must be completely shielded from the radiation field. The intense radiation fields from a pulse reactor necessitate that extreme precautions be taken to preclude effects on monitoring equipment and associated circuitry. Transient effects noted during some early field experiments at pulsed nuclear reactors were later found to be attributable to the effects of an air capacitor oscillator, which was part of the instrumentation equipment. Extreme care must be taken to eliminate all extraneous phenomena, such as cable effects and air ionization, which cause shunt leakage, etc. The latter effect can be reduced by potting the test chassis with paraffin or other solid dielectrics, as shown in Fig. 6, or by immersing the sample in oil.

Dosimetry is also an area in which deficiencies exist. The radiation levels to which a device is exposed must be known before any correlation or analysis is possible. Many times it is impossible to determine the dose or dose rate at the exposure sample and, therefore, only mean values are available necessitating extrapolation which adds more errors. Dosimetry is rapidly advancing, and devices such as the Magnesium Oxide Radiation Detector (MgO-RAD), developed by one of the authors (R. G. Saelens), and shown in Fig. 7, as well as the SEMI-RAD, developed by Dr. S. Kronenberg and Mr. H. Murphy of USASRD, are helping to alleviate some of these problems.

Difficulties have also arisen in correlating transient changes in electron device operation to the type of incident radiation, i.e., neutron and gamma. The size of many detectors precludes measurement of radiation levels at the same position as the exposure sample and, therefore, one must extrapolate to find the exact dose level to which the part has been exposed.

It should be mentioned that gamma as well as neutron radiation effects must be considered. The cause of transient radiation effects on many components has been attributed to gamma radiation. Accurate and dependable data about damage caused by gamma radiation on piece parts are scarce. However, work is now being stressed on materials effects, and further tests on piece parts are planned. In general, it can be said that the damage threshold for piece parts ranges from  $10^4$  to  $10^8$  R/sec.

---

A REPRINT OF THIS ARTICLE CAN BE OBTAINED  
by writing on company letterhead to  
The Editor  
ELECTRONIC INDUSTRIES  
Chestnut & 56th Sts., Phila. 39, Pa.

---

## Reliability of Electronic Systems

The Signal Corps Laboratory is approaching the nuclear environment problem in a manner similar to that used in solving the high shock and vibration problems of the early fifties. After much effort, it was learned that the best approach to high shock and vibration environment reliability was to first learn the capability of the individual piece parts. Later this information on parts was extrapolated into an equipment or black box capability. At this time, new problems pertaining to the equipment itself appeared. For example, resonances occurred in the main structural members of the equipment itself, which caused large g levels to be transmitted to the piece parts, resulting in early failure. Since no structure could be made absolutely resonance-free and serve the other purposes for which it was intended, compromises were necessary. On the one side, attempts were initiated to reduce the occurrence and intensity of the resonance, and on the other hand to harden the piece parts to the enhanced environment. The success of this approach has been documented, and it is now in general use.

## Standardization

To insure a successful program for the development of radiation-resistant electronic components, a standard must be established by which all electronic parts and systems can be measured. Since the electronic piece part is the basic building block in systems reliability, if criteria are established for the piece parts, then the equipment designer must carry through under the same standard. DOD is aware of this need, and a preliminary standard has been prepared for the guidance of military electronic designers. This document, known as MIL-STD 446, was prepared in April 1959, and revised in November 1960 as MIL-STD 446A. It is under the cognizance of the Armed Forces Supply Support Center, Washington 25, D. C.

The express purpose of this document is to establish uniform environmental design requirements for use in planning of R&D programs, and to provide a guide for use in the preparation of military specifications and standards involving electronic parts, tubes, and solid state devices. This standard has been approved by DOD, and is mandatory for use in R&D. Fig. 8 shows the nuclear environmental requirements as indicated in the MIL-STD 446A. Categories shown are defined in the document as follows:

Group IV covers that group of electronic parts, tubes, and solid state devices for use in electronic

equipment of high performance aircraft and surface-to-air and air-to-air missiles.

Group VI covers that group of electronic parts, tubes, and solid state devices for use in electronic equipment of nuclear powered aircraft and ballistic missiles.

Group VIII covers that group of electronic parts, tubes, and solid state devices for use in electronic equipment of nuclear powered weapons.

Standardized paragraphs cover the measurement of the nuclear environment, and the criteria of failure are also included in MIL-STD 446A.

## Conclusion

It is apparent from the foregoing that a large and growing effort has been mounted by DOD to harden, for certain specialized applications, electronic systems for the nuclear environment. The program has now reached a point which shows much progress and excellent planning toward achieving the end goals. The expanding work now requires the inclusion of many other commercial electronic development and research organizations. Without a doubt, most of those which have not been involved in this problem to date will be exposed to it shortly. Unless preparations are made now, these companies will find themselves badly handicapped in responding to the growing DOD nuclear environment requirements.

## References

1. Development and Evaluation of Electron Tube Glasses Resistant to Radiation Damage, Contract DA 36-039 sc-78312, Chatham Electronics
2. A Study of Radiation Effects on Microwave Devices, Contract DA 36-039 sc-87253, General Electric Company
3. Study of Radiation Effects on Microwave Ferrite Duplexers, Contract DA 36-039 sc-89113, Sperry Microwave Electronics
4. Radiation Induced Gas Effects on Electron Tube Materials, Contract DA 36-039 sc-89121, RCA, Lancaster, Pa.
5. Basic Radiation Effects Mechanisms Study on Electron Tubes, Contract DA 36-039 sc-90735, General Electric Company
6. Evaluation of Radiation Effects Data on Semiconductor Devices, Contract DA 36-039 sc-87306, Edgerton Germeshausen & Grier
7. Nuclear Radiation Resistant Power Transistor, Contract DA 36-039 sc-78307, Philco Corporation
8. REIC Report #18, Effects of Nuclear Radiation on Electronic Components, 1 June 1961
9. REIC Report #15, The Effect of Nuclear Radiation on Capacitors, 15 February 1961
10. Evaluation of the Effects of Pulse Nuclear Radiation on Quartz Crystal Units, Contract DA 36-039 sc-85322, Admiral Corporation
11. Study of Effect of High Intensity Pulsed Nuclear Radiation on Electronic Parts and Materials (Score), Report No. 4 on Contract DA 36-039 sc-85395, IBM
12. A Survey on the Effects of Nuclear Radiation on Electron Tube Materials, Contract DA 36-039 sc-87382, Stevens Institute of Technology

## Bibliography

- REIC Report #20, The Effect of Nuclear Radiation on Resistors and Resistor Material, 15 January 1960
- REIC Report #22, Radiation Effects State of the Art 1960-1961, 30 June 1961
- REIC Report #10, The Effect of Nuclear Radiation on Semiconductor Devices, 15 July 1961
- REIC Report #14, The Effect of Nuclear Radiation on Electron Tubes and Tube Materials, 15 February 1961



# TRANSIENTS IN RELAY DIELECTRICS

The unexpected failure  
in testing a relay's dielectric  
is usually due to a transient.  
But what causes the transient?  
Can we avoid it  
and still fulfill the specifications?  
Here are the answers to both questions.

IN RELAY DIELECTRIC TESTING, failures may be grouped as: ordinary or common; intermittent or borderline; and, unexpected or unexplainable.

Common types, e.g., those due to insufficient clearance, faulty or misplaced insulation, burrs or sharp points, foreign or loose particles, are readily apparent. If the dielectric test is repeated, these types continue to show breakdown unless the cause has been burnt away or dislodged.

Borderline types are those

where the dielectric strength is barely sufficient to withstand the high voltage specified. Therefore, failure may occur intermittently with slight variations in the voltage supply. Or, it may be due to small shifts in the relative position of some of the relay parts when the relay is handled or operated. Repeating the test may, or may not, show a failure, but breakdown usually will recur if the voltage is increased slightly, or if left "on" a number of seconds.

Unexpected failures are those

where breakdown occurs without any apparent reason, even though the air-gap or insulation in question is more than adequate for the test voltage applied. Failures may recur at random upon repeating the test, providing, of course, that the initial failure was only momentary. A visible or audible spark-over sometimes occurs which is too short to actuate the usual hi-pot breakdown indicator; but, it does register as a flash, or click, on a corona indicator.

Study of the causes of these unexpected failure types revealed a few obscure cases due to hidden metal particles or insulation damage. Some cases were due to excessive voltage impressed on the relay by severe line voltage transients.

However, most cases were traceable to high transient-voltage peaks originating within the high-potential test sets or associated high-voltage switching units. Our object is not only to call attention to the possible presence of these transients in the output of most ac high-potential test equipment in use today, but to point out their deleterious effects

## OSCILLOGRAM DATA

All oscillograms show secondary voltage only.  
Secondary voltage is 1,000 volts rms (500 volts/div.)  
All include 2 megohm oscilloscope multiplier load.

Fig.	Test Set	Condition	Degrees	Transient Volts	Peak Volts	Remarks
1	B	Pri. Break	163	3,400	2,600	
		Pri. Make	270	600	2,000	
2	B	Pri. Break	180	3,600	Est. 3,600	
		Pri. Make	270	600	2,000	
3	B	Pri. Break	193	3,200	Est. 3,900	
		Pri. Make	270	550	1,950	
4	B	Normal Secondary Volt.			1,414	
		Pri. Make	256	650	1,900	
6	B	Pri. Make	178	100	Est. 4,900	Includes Powerstat Pri. Current near zero Pri. Current near max.
		Pri. Break	283	6,100		
7	B	Pri. Break	21	1,050	1,450	
		Pri. Make	73	500	1,800	
8	B	Pri. Make	15	200	200	Pri. Current near zero
		Pri. Break	73	2,350	1,150	
9	A	Sec. Break	100	0	1,500	44 pf load Expansion of Fig. 9
		Sec. Make	287	200		
10	A	Sec. Make	287	200	1,500	
		Sec. Break	102	0		
11	B	Sec. Make	277	200	1,600	Oscilloscope load only 200 pf load
		Sec. Break	86	650	2,050	
12	B	Sec. Break	286	0	2,050	Expansion of Fig. 12
		Sec. Make	86	650		
13	B	Sec. Break	110	0	Est. 3,350	Values from Fig. 15 Portion of Fig. 14 Expansion of Fig. 15
		Sec. Make	280	1,950		
14	C	Sec. Break	110	0	3,350	
		Sec. Make	280	1,950		
15	C	Sec. Make	280	1,950	3,350	
		Sec. Break	280	1,950		

By **KIRBY B. AUSTIN**

Director of Research  
Allied Control Co., Inc.  
New York, N. Y.

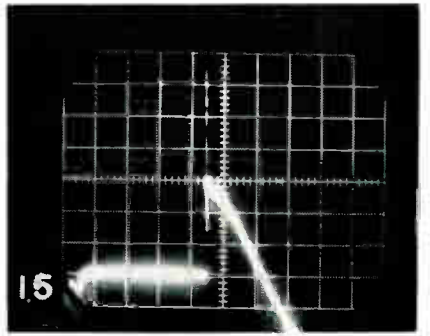
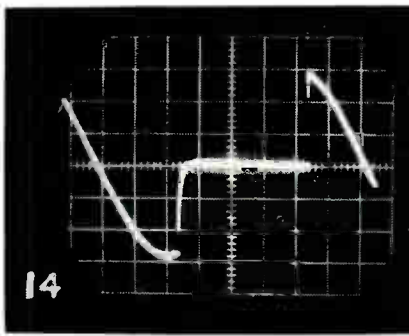
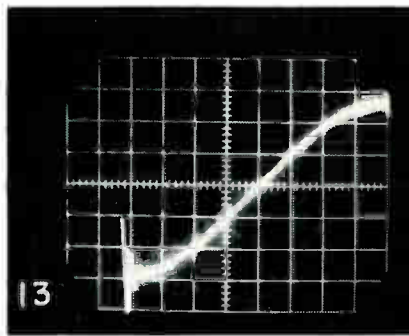
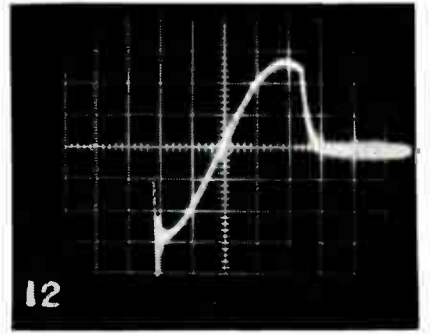
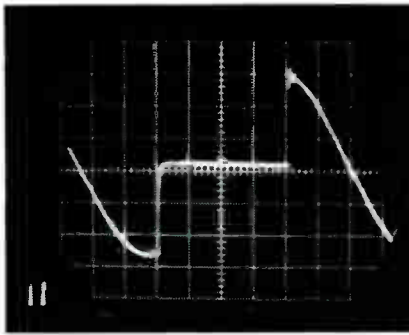
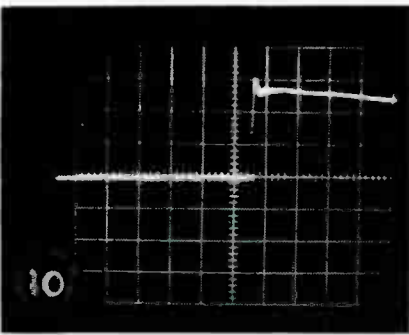
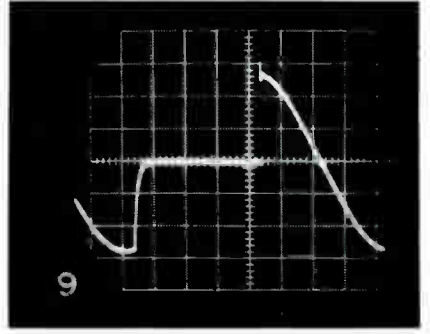
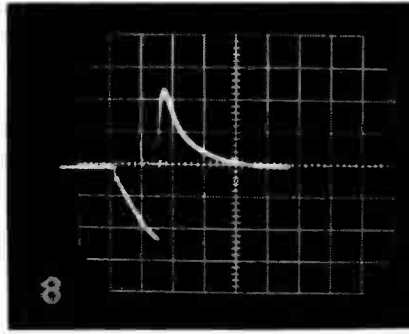
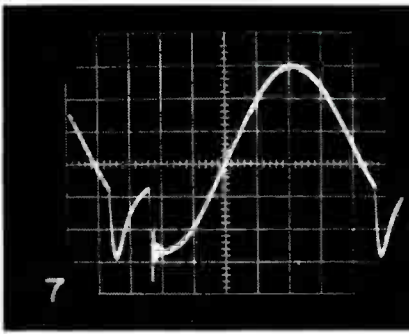
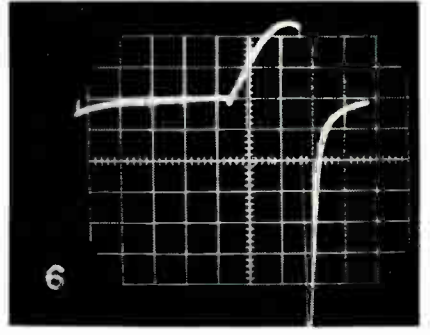
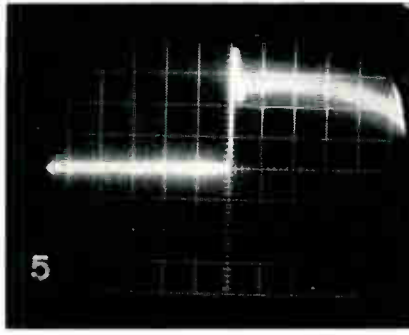
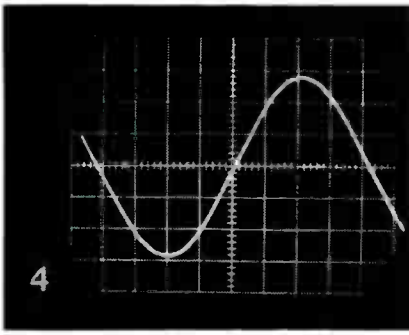
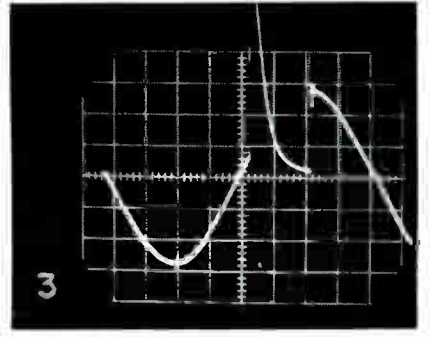
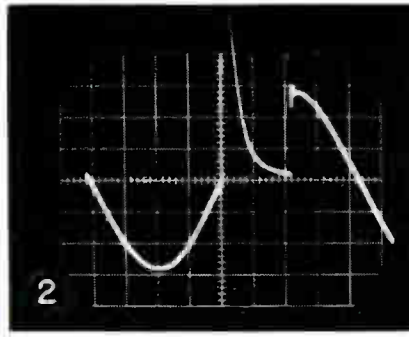
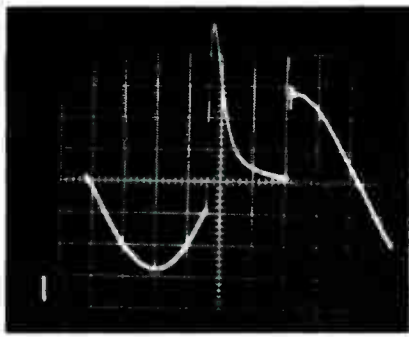

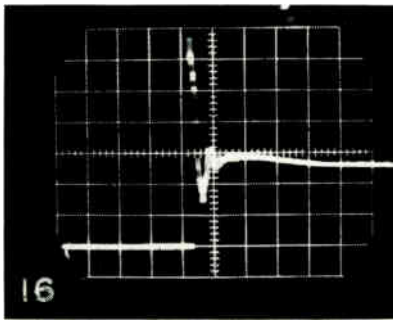

## RELAY DIELECTRICS (Continued)

on the reliable performance of relay contacts and insulation. Some suggestions on minimizing or preventing these switching transients also will be given.

### Specifications

Paragraph 3.4. Method 301, MIL-STD-202B on Dielectric Withstanding Voltage specifies: "The test voltage shall be raised from zero to the specified value as uniformly as possible at a rate of approx. 500 volts (rms or dc) per second unless otherwise specified." The gradual voltage increase prevents generation of the "make" type of transient encountered in abruptly closing either the primary or secondary circuits of the high-potential test transformer. However, the same paragraph permits the test voltage to be applied instantaneously at the option of the manufacturer, during inplant acceptance testing, even though paragraph 3.1 cautions that care should be taken that the test voltage is free of recurring transients or high peaks.

Paragraph 3.5 specifies: "The test voltage shall be maintained at the specified value for a period of 60 seconds for qualification testing. For inplant acceptance testing, when specified, reduced time with a possible correlated higher test voltage may be used.

Upon completion of the test, the test voltage shall be gradually reduced to avoid voltage surges." Here again, the same paragraph permits the test voltage to be removed instantaneously during inplant acceptance testing at the option of the manufacturer. In my opinion, this is a very dangerous option to be permitted without specific restriction. Shutting off the test voltage abruptly by opening the secondary circuit poses no transient problem since the relay under test and its wiring are a capacitive load. But, if the voltage is removed by interrupting the primary circuit, a severe transient will be produced unless the primary current is very small at that instant. Thus, the relay under test, having passed its dielectric test, may have its contact surfaces damaged by arc-over or its insulation overstressed if not actually broken down without actuating the breakdown indicator on the high-potential test set.

### Test Set Survey

In a survey of high-potential test sets, none have been found so far in which specific design features were included to minimize or prevent switching transients; nor were any suggestions to this effect given in their instruction books. Relatively large differences in the magnitude of switching transients under similar conditions in various high-potential test sets are attributed to circuit differences. These are mainly in methods of varying the primary voltage and in types of breakdown indicators. For example, Hi-Pot

Test Set "A" shows only a 200-volt "make" transient, Fig. 9, with a 44-pf wiring capacity load; whereas, Hi-Pot Test Set "C", Fig. 15, produced a 1950-volt transient with the same load. The breakdown indicator circuit in Test Set "A" has a series resistance of several hundred thousand ohms which limits the charging current to the capacitive load and quickly damps the transient oscillation. The series resistance in the secondary circuit of Test Set "C" is only a few hundred ohms. Test Set "B" had no series resistance at all in the secondary circuit yet generated only a 650-volt transient, Fig. 12, with a 200-pf load. Since the frequency of its transient oscillation with only a 44-pf load would still be much lower than that of the Test Set "C" transient, it appears that the transformer in Test Set "B" has a much higher leakage inductance; possibly, to obtain poorer regulation for limiting breakdown currents.

When ac high potential test sets are switched "on" and "off" in the primary circuit of their step-up transformers, current transients occur both on "making" and on "breaking" the circuit unless the current happens to be passing through zero at the instant. Fig. 4, shows the normal secondary voltage wave-shape which is applied to the relay under test. Figs. 1 through 8, excluding Fig. 4, show the secondary voltage peaks arising from the primary current transients and which also are impressed on the relay under test with potentially disastrous results.

The tabulation of data taken from the oscillograms shows peaks of up to 2,000 volts on primary "make" and well over 4,000 volts on primary "break" for this one design of high-poten-

A REPRINT OF THIS ARTICLE  
CAN BE OBTAINED BY WRITING  
on company letterhead to  
The Editor  
ELECTRONIC INDUSTRIES  
Chestnut & 56th Sts., Phila. 39, Pa.



tial test set. Other designs may show higher or lower peaks depending on their primary circuit characteristics. The magnitude of the "make" transient depends mainly on the resistance in the primary circuit, the primary inductance, and the current value at the point of closure in the cycle. The effective primary inductance at the instant of closure depends on the direction and amount of residual magnetism left in the core of the transformer from the previous energization.

The magnitude of the more severe primary "break" transient depends on the primary inductance, the current value at the point of opening in the cycle, and the speed of break of the circuit interrupting means. Both types are also affected by core loss, distributed winding capacity, leakage inductance, and the nature of the load on the secondary of the transformer.

### Transient Oscillations

Figs. 9 through 16 show the transient oscillations encountered when the output of the energized high-potential test set is switched to a capacitive load such as a relay with its test socket and associated wiring. The maximum transient for a given load occurs when the circuit is closed at the instant when the voltage is at the maximum point in the cycle. The transient oscillation frequency is largely determined by the load capacity and the transformer leakage inductance.

Another type of transient may be encountered when relays are used to connect the high voltage from the energized test set to the relay test socket; or, in a semi-automatic or automatic switching unit, to change the connections to the relay test socket terminals. The surge voltage peaks

from the relay coil or coils are transferred by the capacity coupling of the wiring directly to the relay test socket and have been observed as high as 4,000 volts. To measure these peaks, the relay under test must be removed from the test socket so that it does not act as a voltage-limiting spark-gap, and the voltage multiplier for the oscilloscope should have a resistance of at least 10 megohms.

Needless to say, the voltage peaks of this magnitude occurring just during switching of connections will ruin, or seriously reduce, the reliability of a relay whether the normal test voltage is applied or not. Transients of this type may be minimized by adding suitable suppression across each relay coil, whether ac or dc operated, and by separating and shielding all coil wiring from the wiring to the contacts.

The best solution to the switching transient problem is to avoid the switching and use the procedure given in ASTM Standard D-149 or in Method 301, MIL-STD-202B. That is to apply the test voltage by starting from zero and increasing the voltage at a constant rate and reducing it to zero in the same manner. No switching is permissible during the cycle from the time the voltage

starts to increase until it has returned to zero. Power line surges can be reduced by inserting a silicon-carbide varistor limiter (Globar or Thyrite type) between the power line and the high-potential test set. The limiter, however, will not reduce transients caused by abrupt dips or accidental removal of the power line voltage.

If the test voltage must be applied instantaneously to save time, the next best solution to the transient problem is to use a control similar to a synchronous welding control, which will close and open the primary circuit directly or through bounce-free relays at a zero current point of the cycle. In case secondary switching is desired, the control would be designed to operate a high voltage relay to close the circuit at a zero voltage point and open the circuit at a zero current point of the cycle.

Attention to the reduction or elimination of the transient voltages encountered in the dielectric testing of relays will not only reduce the number of unexpected failures and the number of borderline and common failures originally triggered by transients, but will contribute to the overall reliability of relays.

★ ★ ★

---

### Wise Ol' Owl Teams With Computer

The steady gaze of an owl is an important factor in studies on the nervous system at MIT. The owl's pupillary system is under careful scrutiny of a General Electric computer for a clearer understanding of human nerve and brain disorders.



Coaxial switching devices are not new...  
 but here's a novel one  
 which uses mercury-wetted contacts  
 that operate magnetically.  
 The relays for both 50-ohm  
 and 75-ohm coaxial lines  
 offer a highly reliable means  
 for remote switching  
 of high-frequency circuits.

# COAXIAL SWITCHING WITH MERCURY CONTACTS

MERCURY CONTACT RELAYS have been extensively developed for telephone switching.<sup>1, 2</sup> The mercury switch, heart of the telephone relay, is adaptable to fast-action switching in coaxial transmission lines.<sup>2, 3</sup> The mercury-wetted contact switch used in our coaxial devices in this article is adapted from that of Brown and Pollard.<sup>2</sup>

The switch, Figs. 1 and 2, is magnetically operated and gives single-pole double-throw (SPDT) action. The fixed contacts are small platinum-alloy balls on nickel-iron pole pieces sealed in the glass envelope at the upper end. The common contact is an armature reed, also a nickel-iron alloy. The reed has many fine grooves: and, it is treated such that it is readily wetted by mercury which is fed to the fixed contacts by capillary action.

The armature reed is welded to a tubular stem sealed in the glass envelope at the lower end. A reservoir of mercury, and hydrogen gas under many atmospheres' pressure, are introduced via the stem into the switch after evacuation and baking out. The stem is then welded closed. The surfaces of the pole pieces (except the platinum-alloy contacts) are oxidized to prevent wetting by mercury. A ceramic

spacer prevents mercury collection between the pole pieces.

These switches offer several excellent properties such as long life, high speed, excellent sensitivity, and uniform, low contact resistance without bounce.

The rf properties of the mercury-wetted contact switch were studied initially using the switch as the center conductor in a three-terminal 50-ohm coaxial device. In general, this structure showed reasonable impedance and insertion-loss characteristics up to nearly 1000 mc, but the crosstalk isolation was low. The crosstalk versus frequency characteristics closely approximated the transfer function of a simple high-pass RC filter. The curve had a slope of 6 db/octave below the critical frequency, which was about 6,800 mc with a 50-ohm termination on the unconnected output (crosstalk) terminal.

## SPDT Coaxial Relay

To obtain adequate, > 40 db, crosstalk isolation in a coaxial relay, the critical frequency must be about 100 times the highest operating frequency. Crosstalk coupling occurs principally through the internal switch capacitance. Thus, to raise the critical frequency, the terminating impedance at the unconnected output (crosstalk) terminal must be lowered. This terminal is usually grounded.

A coaxial relay with a single SPDT switch cannot simultaneously make connection to one output terminal and ground the other. Two SPDT switches are

Fig. 1: This mercury-wetted contact switch is magnetically operated; it provides single pole double throw (SPDT) action.

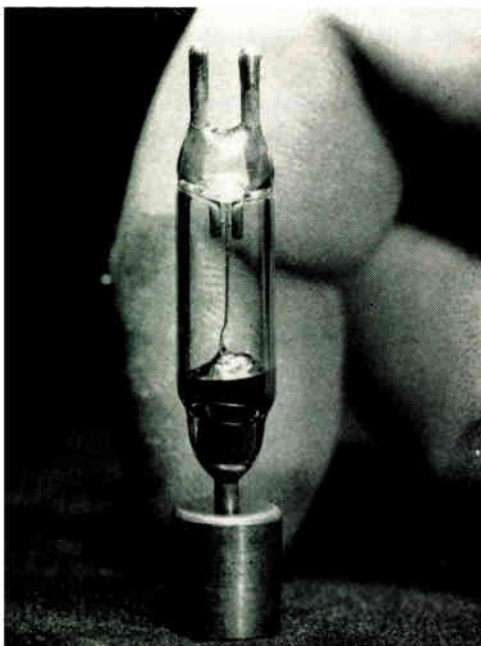

G. J. Falkenbach



A. J. Koda



By **GEORGE J. FALKENBACH**

Staff Member  
 Battelle Memorial Institute  
 Columbus, Ohio

and **ARTHUR J. KODA**

Project Engineer  
 C. P. Clare & Company  
 Chicago, Illinois

required to do this, Fig. 3. In Fig. 3a, one switch transfers, the other grounds. In Fig. 3b, each switch alternatively transfers or grounds.

A SPDT coaxial relay as in Fig. 3b has a shorter grounding path length and better isolation between the output terminals than the relay in Fig. 3a. One of the former is shown partially disassembled in Fig. 4. The upper connector is the input terminal, and the lower connectors are the output terminals.

This SPDT relay showed crosstalk isolations of 61 db at 70 mc and 40 db at 500 mc. The relay initially had an input VSWR in a 50-ohm line which was less than 1.10 below 400 mc and which increased gradually to 1.35 at 1000 mc. Analysis of the input impedance versus frequency showed the switch-stem region to be responsible for much of the mismatch. To correct this difficulty, the line impedance in the switch-stem region was reduced. Two schemes were used: for one of the switches, the stem was wrapped with solid copper wire to build up its diameter; for the other, a slotted sleeve was installed over the stem. Both schemes are visible in Fig. 4. With these matching techniques the resulting VSWR did not exceed 1.05 below 500 mc. Mismatch contributed by the connectors was measured and found to be negligible below 1000 mc. Insertion loss was less than 0.2 db (including reflection loss) below about 700 mc. Data to 1000 mc for this SPDT coaxial relay are shown in Fig. 5.

A typical operating coil for the relay consisted of 8160 turns of A.W.G. No. 36 enamel wire wound on a 1¼-inch-long bobbin of over-all dimensions about 1½ by 2 inches. Two biasing magnets, one for each switch, were used with the coil. The magnets were recessed in the relay body at locations close to the pole-piece ends of each switch. With a coil voltage of 48 vdc to operate the relay, switching occurred in 2 msec; switching power under these conditions was 1.4 watts. Nominal release time was 1 msec.

### SPST Coaxial Relay

One mercury-wetted contact switch can provide single-pole single-throw (SPST) coaxial relay operation. A choice of internal terminations for the output terminal of such a relay is also possible. The output terminal can be short circuited, terminated in the line impedance, or open circuited. The latter two terminations provide nearly the same crosstalk isolation, whereas the former gives greatest isolation. Line-terminated and short-circuit terminated SPST coaxial relays are shown in Fig. 6. These devices are shown disassembled in Fig. 7.

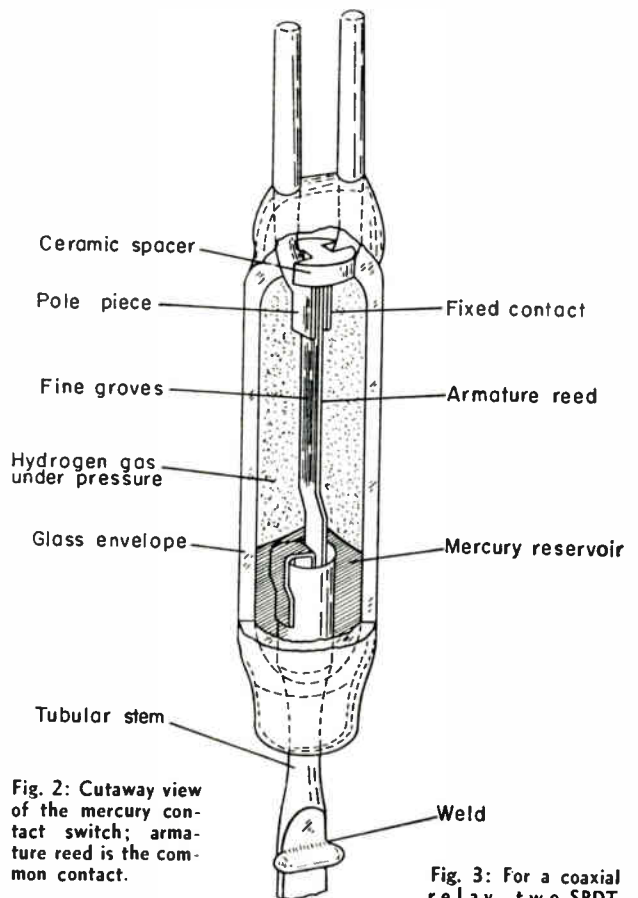

Fig. 2: Cutaway view of the mercury contact switch; armature reed is the common contact.

Fig. 3: For a coaxial relay, two SPDT switches are needed to connect one to the output and ground the other.

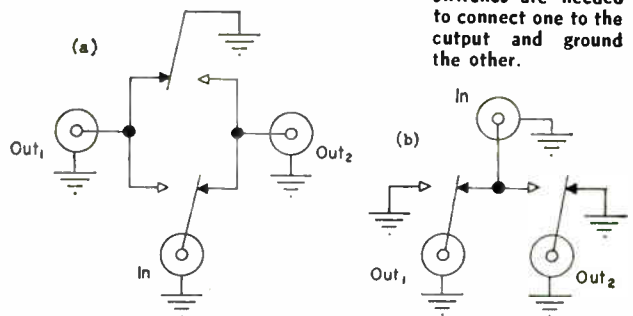
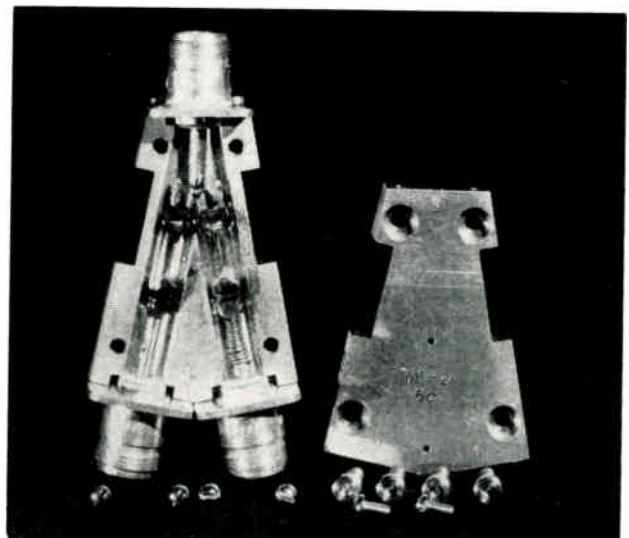

Fig. 4: A coaxial relay with the arrangement of Fig. 3b.





## MERCURY CONTACTS (Continued)

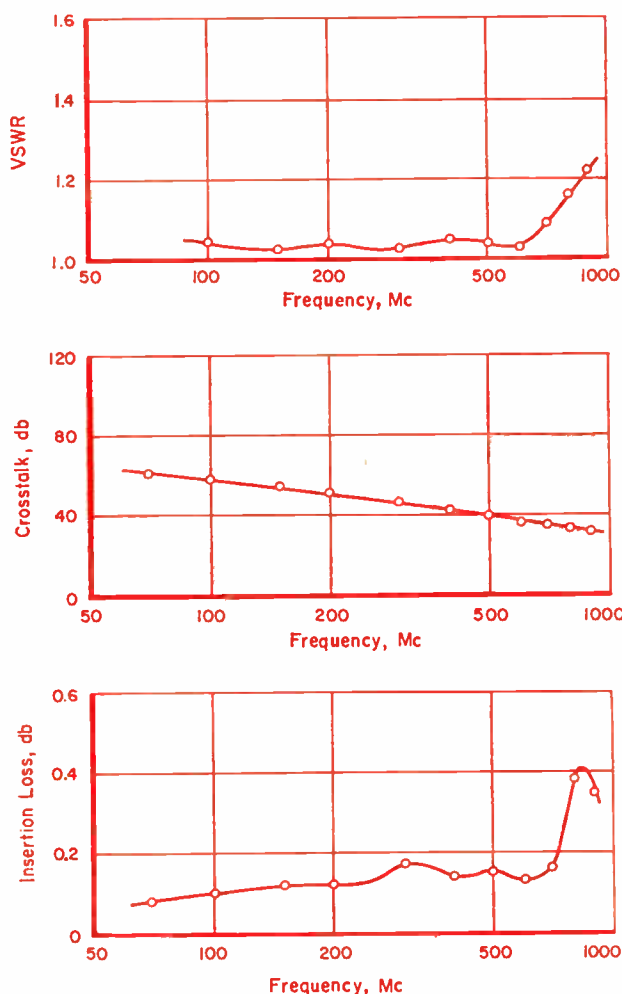

Fig. 5 (left): Characteristics of the 50-ohm SPDT coaxial relay shown in Fig. 4. Mismatch contributed by the connectors was measured and found to be negligible below 1000 MC.

The input VSWR, crosstalk, and insertion loss for the 50-ohm line-terminated SPST relay are shown after matching in Fig. 8. Input VSWR is less than 1.10 below 500 mc. Crosstalk isolation is 37 db at 70 mc and 20 db at 600 mc.

A molded composition resistor is used in the line-terminated relay. VSWR at the output connector was measured for several different resistors. In general, best over-all match to a 50-ohm line resulted with a 1-watt resistor of about 55 ohms dc resistance. Lower-valued resistors gave a better match at 100 mc, whereas higher values were better above 500 mc. It was not difficult to obtain a maximum VSWR at the output connector of less than 1.3 below 500 mc.

In the 50-ohm short-circuit terminated SPST relay, a stud that grounds one pole piece replaces the resistor. Only crosstalk isolation was determined for this relay since its input VSWR and insertion loss will be similar to the line-terminated relay. At 70 mc, crosstalk isolation was more than 30 db greater than for the line-terminated relay.

**Table 1**

Measured Attenuation Loss in Nickel-Iron and Copper and Permeability of Nickel-Iron

Freq. MC	Atten. in Ni-Fe, db/in.	Atten. in Cu, db/in.	Effective Permeability for Ni-Fe(a)
100	0.10	—(b)	3700
200	0.11	—(b)	2100
400	0.06	—(b)	300
700	0.05	0.006	110
1000	0.10	0.008	60

(a) Assuming resistivity constant at  $48 \times 10^{-6}$  ohm-cm.

(b) Could not be accurately determined because of connector losses.

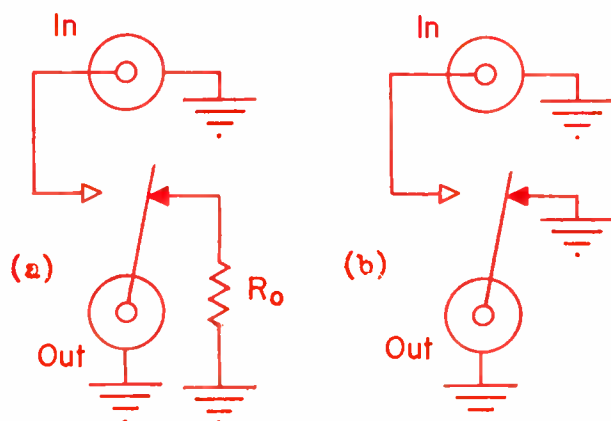

### Coaxial Combinations

The SPDT relay in tandem with the line-terminated SPST relay resulted in an assembly with excellent crosstalk characteristics below 400 mc. Crosstalk was about 100 db at 70 mc and 60 db at 400 mc. Data for the combination are shown in Fig. 9. The dip in cross talk isolation to 35 db just below 500 mc was from a resonance caused by the electrical spacing between the switch in the SPDT relay and the one in the SPST relay. In effect, the spacing enhances the coupling of the small energy which appears at the grounded side of the SPDT relay. One way to reduce the effect of this resonance, and to extend the upper frequency limit, is to incorporate the features of both the SPDT and SPST relays into a single combined device with a minimum spacing between the switches. However, this detracts from the versatility of separate devices.

Fig. 6 (left): The two types of single pole single throw (SPST) relays; they are line-terminated and short-circuit terminated.

Greater crosstalk isolation was obtained by using the short-circuit terminated SPST relay in place of the line-terminated one. Crosstalk isolation exceeded 80 db below 400 Mc in this 50-ohm combination, Fig. 10. Input VSWR and insertion loss were not measured for this combination, but these can be expected to be nearly the same as shown in Fig. 9.

### 75-Ohm Devices

The basic SPDT and SPST designs were used to make devices for 75-ohm coaxial line. Besides the connector change, the 75-ohm devices required considerably more effort to obtain satisfactory input impedance characteristics. These devices are shown disassembled in Fig. 11.

Data for the matched 75-ohm SPDT relay and the line-terminated SPST relay are shown in Figs. 12 and 13, respectively; data for their combination in Fig. 14. In general, the characteristics were quite similar to those of the 50-ohm devices. In particular, input VSWR's were somewhat higher and crosstalk isolations were a few db poorer for the 75-ohm devices.

### Measurement Methods

Device characteristics, both for 50-ohm and 75-ohm uses, were obtained by measuring with 50-ohm equipment. For the 75-ohm devices, the measured impedance was referred to 75-ohm normalization by commonly known graphical and analytical methods. The Hudson<sup>6</sup> chart offered the most expedient means, although the Smith<sup>7</sup> chart was also useful. Two coaxial slotted lines were required to cover the frequency range. The lower frequency measurements were made on a precision dielectric-filled line useful to as low as 50 Mc.

Insertion loss measurement needed particular attention. By definition, the insertion loss of a device is the ratio of power delivered by a generator to a load in the absence of the device to the power delivered with the device inserted.<sup>8</sup> Insertion loss thus includes reflection loss *and* dissipation loss. Dissipation loss is sometimes referred to as insertion attenuation to distinguish it from insertion loss.

Insertion loss was measured by two different methods. When the loss was larger than about 0.2 db, it was measured directly with a known square-law detector (bolometer) and calibrated amplifier (standing-wave indicator). When the loss was less than about 0.2 db, it was determined indirectly by measuring the power-reflection ratio with a short-circuit termination.<sup>9</sup> Insertion loss for the 75-ohm devices is thus approximate since it includes reflection-loss con-

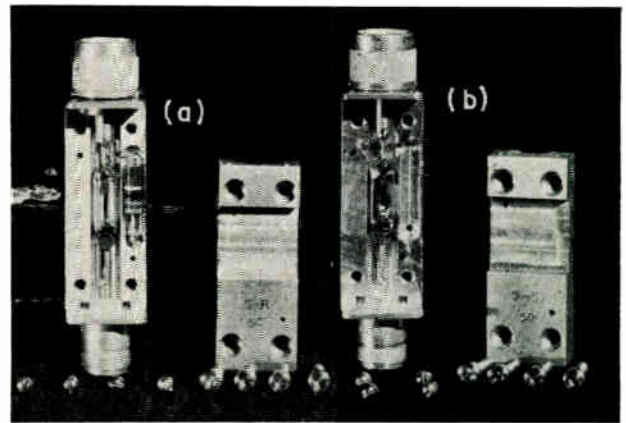
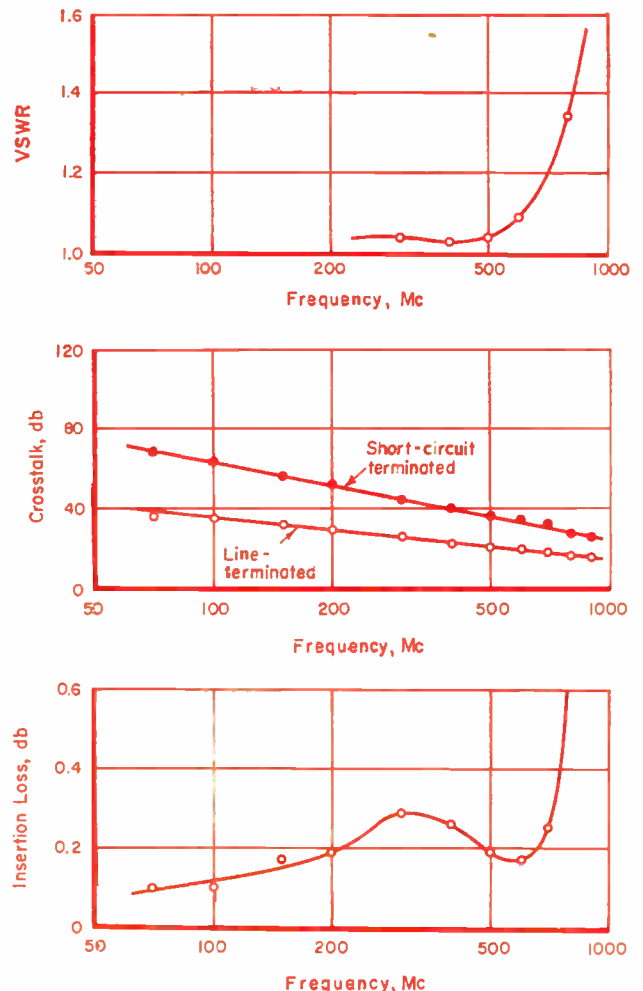

Fig. 7: Disassembled views of the two types of SPST switches shown in Fig. 6; (a) line-terminated, (b) short-circuited.

A REPRINT OF THIS ARTICLE CAN BE OBTAINED  
by writing on company letterhead to  
The Editor  
ELECTRONIC INDUSTRIES  
Chestnut & 56th Sts., Phila. 39, Pa.

Fig. 8: The characteristics of the 50-ohm SPST coaxial relay after matching. Input VSWR is less than 1.10 below 500 Mc.



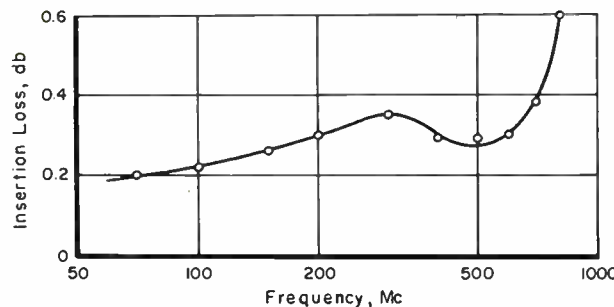
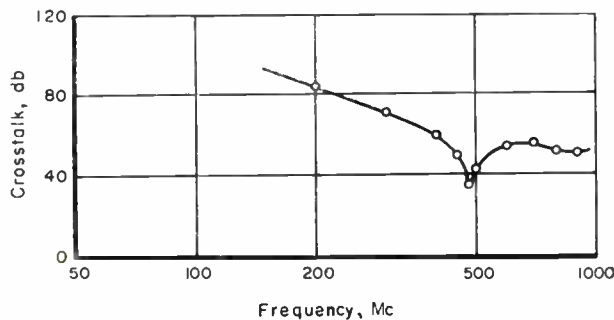
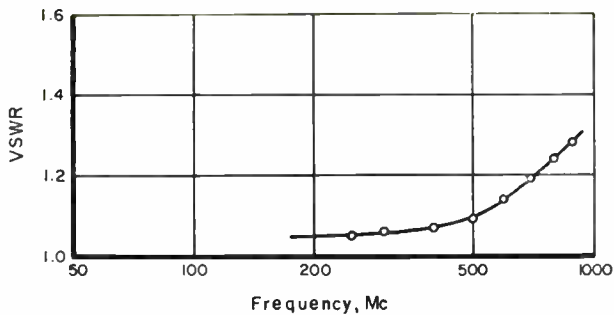

Fig. 9 (above): 50-ohm SPDT with line-terminated SPST relay.

Fig. 10 (below): Crosstalk isolation of the 50-ohm SPDT relay with short-circuit terminated single pole single throw relay.

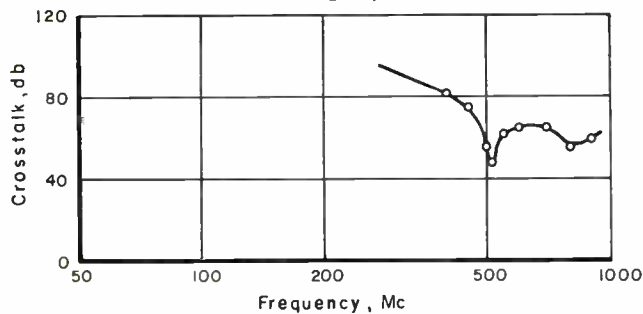
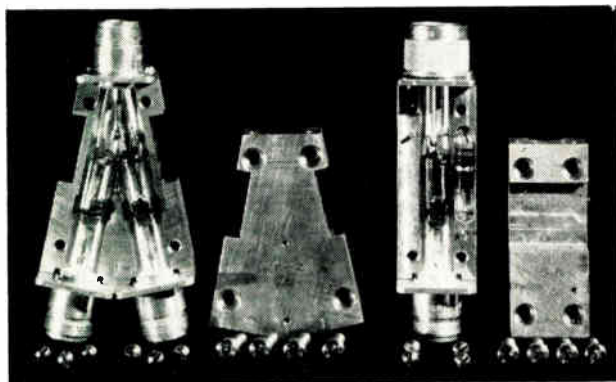

Fig. 11 (below): Typical 75-ohm SPDT and SPST coaxial relays.



## MERCURY CONTACTS (Continued)

tributions because of the 75-to-50 ohm impedance changes. Crosstalk was measured by the rf substitution method.

In determining crosstalk characteristics of the 75-ohm devices with 50-ohm equipment, no special precautions were necessary since the crosstalk exceeded 10 db. In actual practice, errors less than about 0.5 db resulted from the 75-to-50 ohm impedance changes. Such an error is insignificant when crosstalk isolations are high.

## Conclusions

The relays described for both 50-ohm and 75-ohm coaxial lines offer highly reliable means for remote switching of high-frequency circuits. The heart of these devices, the mercury-wetted contact switch,

Fig. 12: Characteristics of 75-ohm SPDT Coaxial relays.

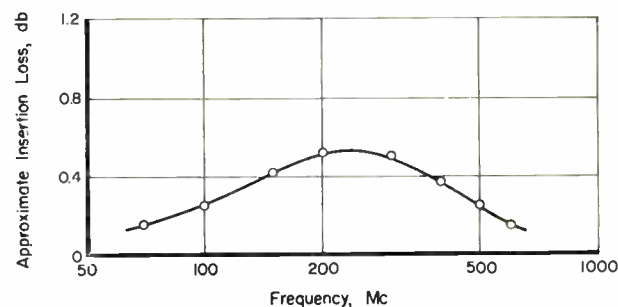
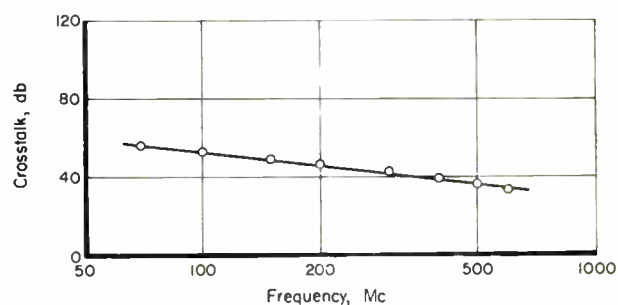
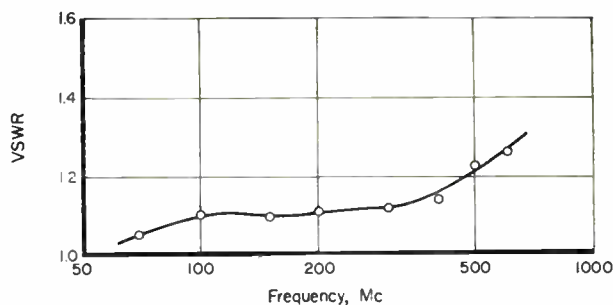



affords outstanding features such as long life, high speed, excellent sensitivity, and freedom from contact bounce and wear.

The SPDT coaxial relay described can be used alone for applications below 500 mc where a minimum crosstalk isolation of 40 db is required. Input VSWR does not exceed 1.05, and insertion loss is less than 0.2 db in a 50-ohm line. The characteristics of the 75-ohm SPDT relay are nearly as good.

The SPDT relay can be used in combination with one of two SPST relays to provide additional crosstalk isolation at frequencies below 500 mc. Typically, crosstalk isolations of about 100 db at 100 mc are possible with the addition of the line-terminated SPST relay, and of greater than 120 db with the short-circuit-terminated SPST relay.

The SPDT relay in tandem with an SPST relay has one disadvantage which affects the upper frequency limit. A unified device with the features of both would minimize this effect.

## Acknowledgment

The authors are indebted to Mr. C. P. Clare of C. P. Clare & Co. for the keen interest displayed in these devices and to Messrs. R. T. Compton, Jr., and W. E. Rife of Battelle for their able assistance.

## References

- 1 Brown, J. T. L. and Pollard, C. E. "Mercury Contact Relays," *Elect. Engng.*, vol. 66, pp. 1106-1109; Nov., 1947.
- 2 Brown, J. T. L. and Pollard, C. E., "Balanced Polar Mercury Contact Relay," *Bell Syst. Tech. J.*, vol. 32, pp. 1393-1411; Nov., 1953.
- 3 Slonczewski, T., "Precise Measurement of Repeater Transmission," *Elect. Engng.*, vol. 73, pp. 346-348; Apr., 1954.
- 4 This particular switch is manufactured by C. P. Clare & Co. under patent license agreement with Western Electric Co.
- 5 An independent similar design was recently described by D. Leed and O. Kummer, "A Loss and Phase Set For Measuring Transistor Parameters and Two-Port Networks Between 5 and 250 Mc," *Bell Syst. Tech. J.*, vol. 40, pp. 841-884; May, 1961. Fig. 6 on p. 860 shows the BTL design.
- 6 Hudson, A. C. "A Logarithmic Transmission Line" *IRE Trans. on Microwave Theory and Techniques*, vol. MTT-7, pp. 277-281; Apr., 1959.
- 7 Smith, P. H., "An Improved Transmission Line Calculator," *Electronics*, vol. 17, pp. 130-133, 318, 325; Jan., 1944.
- 8 Ginzton, E. L., *Microwave Measurements*, McGraw-Hill Book Co., Inc., New York, New York, p. 462; 1957.
- 9 Montgomery, C. G., *Technique of Microwave Measurements*, McGraw-Hill Book Co., Inc., New York, N. Y., pp. 816-821; 1947.

Fig. 13: Data for the line terminated 75-ohm SPST relays.

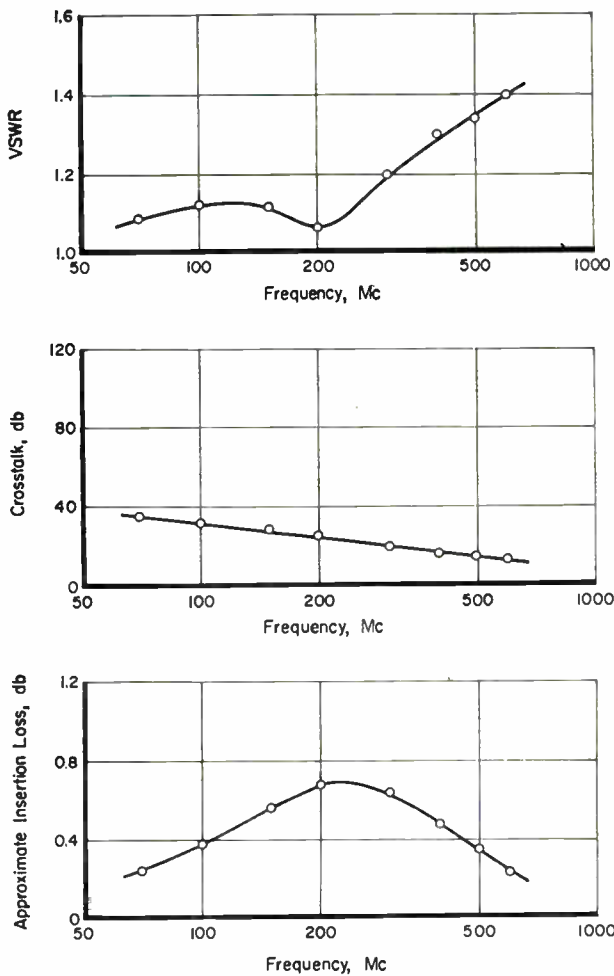
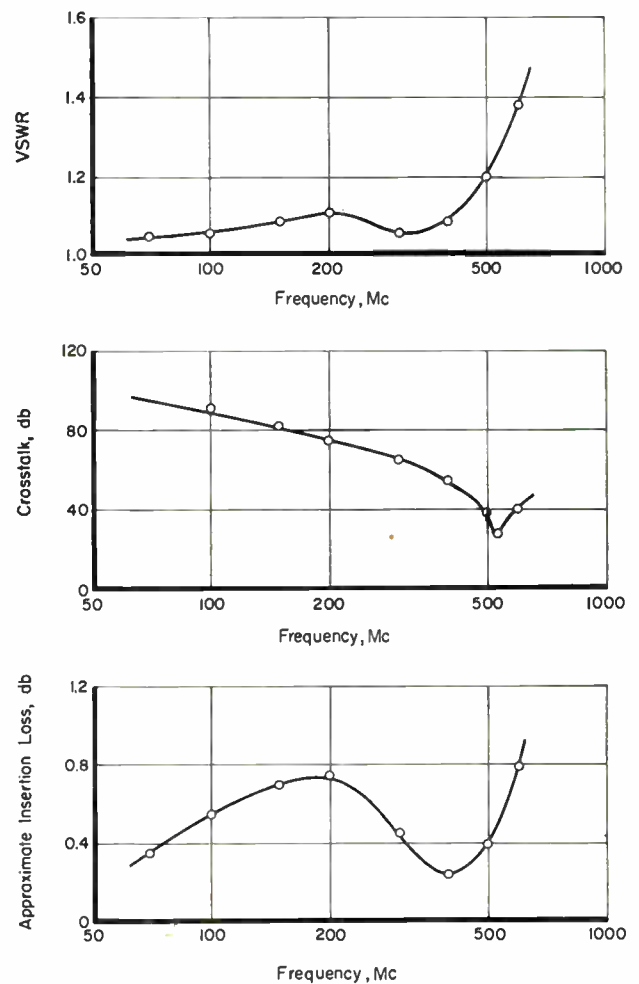

Fig. 14: 75-ohm SPDT relay with line terminated SPST relay.



The potentialities of this voltage-controlled semiconductor device may be staggering to the industry. It could replace the bulk of today's tube/transistor circuits; it will solve low-noise, high input impedance problems.

## POSSIBILITIES OF FIELD-EFFECT DEVICES

THE SOLID-STATE VOLTAGE AMPLIFIER in Fig. 1 is different from the usual transistor medium-gain amplifier. This circuit combines high input impedance and low S/N characteristics; they easily exceed 30 megohms and 0.5 db noise figures using a minimum of components. This reverses the standard high-gain/low-input impedance and high-output impedance use normally encountered in transistor amplifier designs (unless transformers or feedback are used).

Silicon Field-Effect transistors are used. They are voltage-controlled. This device may represent a major breakthrough in the field of voltage-controlled transistorized circuitry.

### Evolution

Primarily, the field-effect principle evolves the resistance of a doped bar, Si or Ge. This can be controlled by increasing or decreasing its conductive cross-sectional area by exerting a controlled field-effect (pinching) on the electron flow through the N-type bar.

Actually, the basic principle isn't entirely new; it was discussed in 1928 by Lilienfeld (U.S. Patent 1900018) and Shockley,<sup>1</sup> among others in 1951. But only recently have companies been able to produce workable units in volume production.

Field-effect transistors can best be described as fundamentally low noise devices, because they do not pass any working current or develop leakage paths across the gate junctions. Furthermore, units do not depend upon minority carrier conduction for amplifying action; the field-effect action occurs completely within the bulk of the bar material; consequently, it doesn't depend upon surface interaction for operation.

These units are the electrical equivalent of pentode tubes and are able to withstand the same en-

vironments as available units; besides, they offer additional circuit advantages.

Hardware for a typical two-stage amplifier was breadboarded to evaluate the working characteristics of several types. Absolute maximum ratings for the Crystallonics C650 series disclose that these units provide 250 mw power dissipation at a maximum shut-off voltage ( $V_{gso}$ ) of -40 volts.

### Circuit Operation

The circuit in Fig. 1 operates the same as one using tubes. One obvious advantage is that no filament power is necessary. Current self-biasing is secured using series cathode resistors in both stages to reduce anode current variations with temperature and provide interchangeability of different units. For the components shown, dc quiescent current drain was 4.6 ma, with a signal input of 100 microvolts producing an average voltage output of 200 microvolts. The 3 db down points were  $F_1 = 8$  cps and  $F_2$  flat to approximately 70 kc.

The first stage input grid resistor is not necessary. It was omitted to arrive at an accurate measurement of input impedance. This was done by feeding a small ac signal to the input; measuring the voltage output of amplifier; then, switching, in series, several different resistors to the input. This was continued until the voltage output dropped to one half of its original value. In this circuit, for all five C650 specimens checked, the input impedance was above 30 megohms measured at 1 kc.

---

**By E. G. FONDA**

Research Specialist  
Lockheed Missile & Space Dept.  
Sunnyvale, California  
or 1690 Nilda Avenue  
Mountain View, Calif.

For noise considerations, optimum circuit applications require lowest possible operating dc voltages and conditions to minimize leakage paths.

However, a compromise is necessary to achieve gain requirements. These switching units indicate noise figures below 2-5 db at 2 ma using 100 cps BW are feasible. Other static parameters, measured at 25°C, show saturation resistance below 4.5 K ohms, input capacitance values from 9 to 14 pf.

### Characteristic Curves

Typical curves of anode current ( $I_A$ ) vs. anode voltage ( $V_A$ ) for different grid voltages are shown in Fig. 2. The top-most curve represents grid bias ( $V_{GC}$ ) equal to zero potential applied; then, progressively displaced in 1 volt steps. Fig. 2b is the same unit under evaluation but with  $V_{GC}$  equal to 2 volts per step.

These scope pictures compare favorably with the plotted static output curves, Fig. 3, using the test set-up shown. Note the dashed line is the same shape as the  $V_G$  equal zero but is rotated 180°. This curve approximates the locus of pinch-off region where further increase in anode potential merely pinches off further increase in anode current.

The area between zero and pinch-off defines the voltage-variable resistance region. After curves flatten, the device's output resistance approaches that of pentode tubes. Output curves for the C650 units are identical with presentations displayed by a thermionic pentode tube.

These field-effect output characteristic curves were obtained with a Tektronix 575 curve tracer using a series load of 500 ohms. Using this method, one must place the anode pin into the collector socket terminal, grid into the base, and cathode pin into the emitter socket terminal. Note that collector supply potential applied is set for NPN, and base

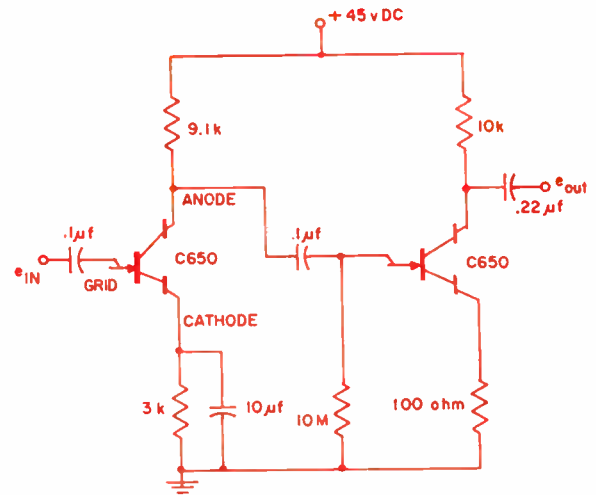

Fig. 1: Preamplifier design using field-effect transistors.

supply for PNP settings on the tracer. Shunting the high-input impedance of the device with a 1 K ohm resistor assures that 1 ma steps of base current is approximately equal to 1 volt steps on the grid.

### Applications

It is conceivable that field-effect devices will be 6-8 times more resistant to change from radiation exposure than conventional transistors; because, the transistor parameters proven<sup>2</sup> most significantly altered by irradiation are the decrease in beta and increase in collector diode reverse leakage current ( $I_{co}$ ). These prime parameters are not apparent in field-effect operation.

Possible application areas for these devices include input stages of audio/dc amplifiers, analog multipliers, voltage-controlled resistance circuits, AGC circuitry, and switching applications.

(Continued on following page)

Fig. 2: Anode characteristic curves of field-effect transistors closely resemble those of pentode tubes. At left (a)

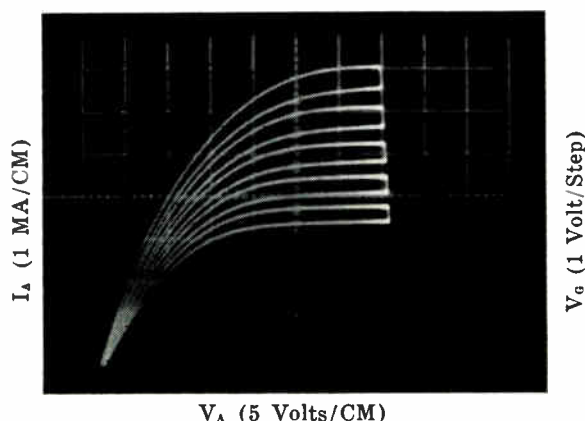

the grid bias is progressively displaced in 1 volt steps; at right (b) same unit but grid bias displaced in 2 volt steps.

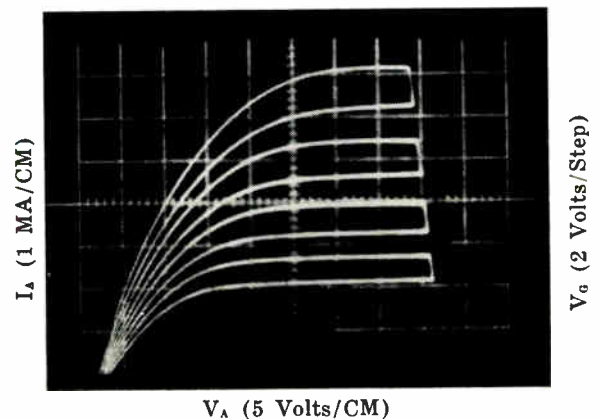



## FIELD-EFFECT DEVICES (Continued)

Fig. 3: The plotted characteristic curves for the test set-up shown compare favorably with the scope pictures that were shown in Fig. 2.

### Acknowledgment

The author wishes to express thanks to a co-worker, Roger Semple, for his assistance in this investigation.

### References

1. Shockley, W., "A Unipolar Field-Transistor," *Proc. IRE*, Nov. 1951.
2. Behrens, W. V., and Shaull, J. M., "Effects of Short Duration Neutron Radiation on Semiconductor Devices," *Proc. IRE*, March 1958.

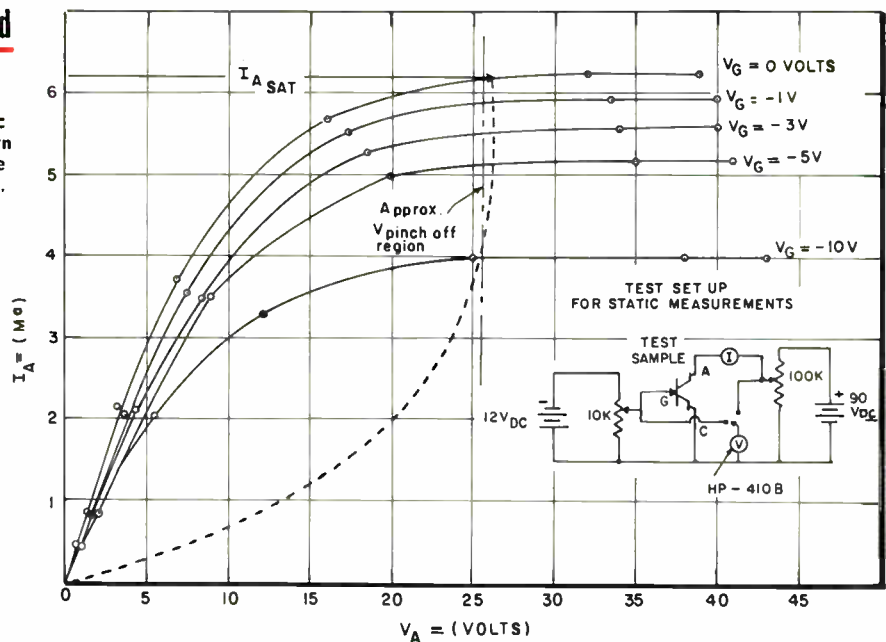

## "BALLOONS" INSULATE CABLE

A METHOD IMPORTED FROM FRANCE makes communications cable that looks like linked miniature balloons. Superior Cable Corp., Hickory, N. C., and Simplex Wire & Cable Co., Cambridge, Mass., are exclusive licensees for manufacturing and marketing the product in this country.

The "balloon" design, as it is known throughout Europe, makes possible improved transmission combined with exceptional mechanical strength and anticipated economy over existing coaxial and telephonic types now available to U. S. cable users.

Widespread use is expected for carrying all kinds of information electronically, whether words, pictures or symbols.

Balloon cable, say its licensees, will also be ideal for connecting up individual apartments with building rooftop antennas, and a similar use is predicted for new and modernized office buildings so that individual offices and tenants can plug into centralized computers and other data transmission equipment.

Air is the most nearly perfect insulator; it has a dielectric constant of 1.0. Dielectric loss in transmission is the product of two elements—capacitance and power factor.

Different methods of approaching a true, air-dielectric insulation have been used in the United States to improve signal quality in transmission by cable. Solid insulation around the conductor has a dielectric constant on the order of 2.4; foam plastic insulation brings this figure down to about 1.4, but the chemical and physical properties of foam do not permit the attainment of consistency along each unit of length in a cable. Another method is to spiral a plastic strand, either solid or foam, around the conductor. Still another, use spaced "buttons" or discs through the center of which the conductor may pass, and around whose perimeter the plastic insulator may rest at a prescribed distance from the conductor.

But spiral, button or disc separators do not provide a moisture barrier, and, quality control to achieve a uniform product is difficult.

The patented French method of producing an air dielectric cable uses a method whereby the insulating plastic tube is crimped tightly to the centered conductor at regular intervals. The crimping may be done so that a water-tight or gas-tight barrier is formed between each little insulating balloon of captive air.

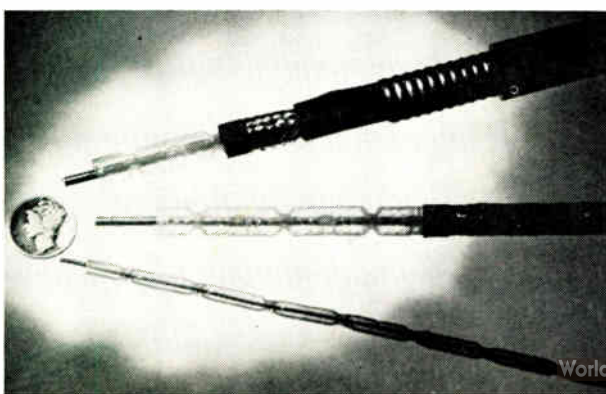

Crimping of the insulating plastic tube at regular intervals is plainly visible in the photo at left. Introduced during WESCON, EI's Editor, Bernie Osbahr, center, poses with M. A. Williams, VP-Marketing, Simplex, left, and J. L. Robb, President, Superior.





**Cinch**  
ELECTRONIC  
COMPONENTS

CONNECTORS, ENGINEERED FOR SPECIFIC RELIABILITY REQUIREMENTS

# NEW! JONES BARRIER BLOCKS\*

## with Wrap Post terminals

### CONNECT 4 TIMES FASTER EVEN IN TIGHT PLACES!

New Jones Barrier Blocks with new wrap post terminals on one side permit faster connections—four times faster than standard screw terminals! There are three terminal angles—parallel to, at a 45° angle, and perpendicular to the mounting surface. You choose the angle that is exactly right for your packaging. One is sure to be easily accessible for connection—even in tight spaces created by increasingly compact, complex package design.

#### All Jones Barrier Blocks Prevent Direct Shorts . . . Minimize Creeping and Arcing

Jones terminals are isolated by barriers. Result: a long leakage path. Creeping and arcing are minimized. Direct shorts from frayed wires are prevented!

For more information contact your local Cinch representative, your Cinch-Jones Distributor, or write our Chicago headquarters.

\*A new addition to the famous Jones 140 Series Barrier Terminal Blocks.

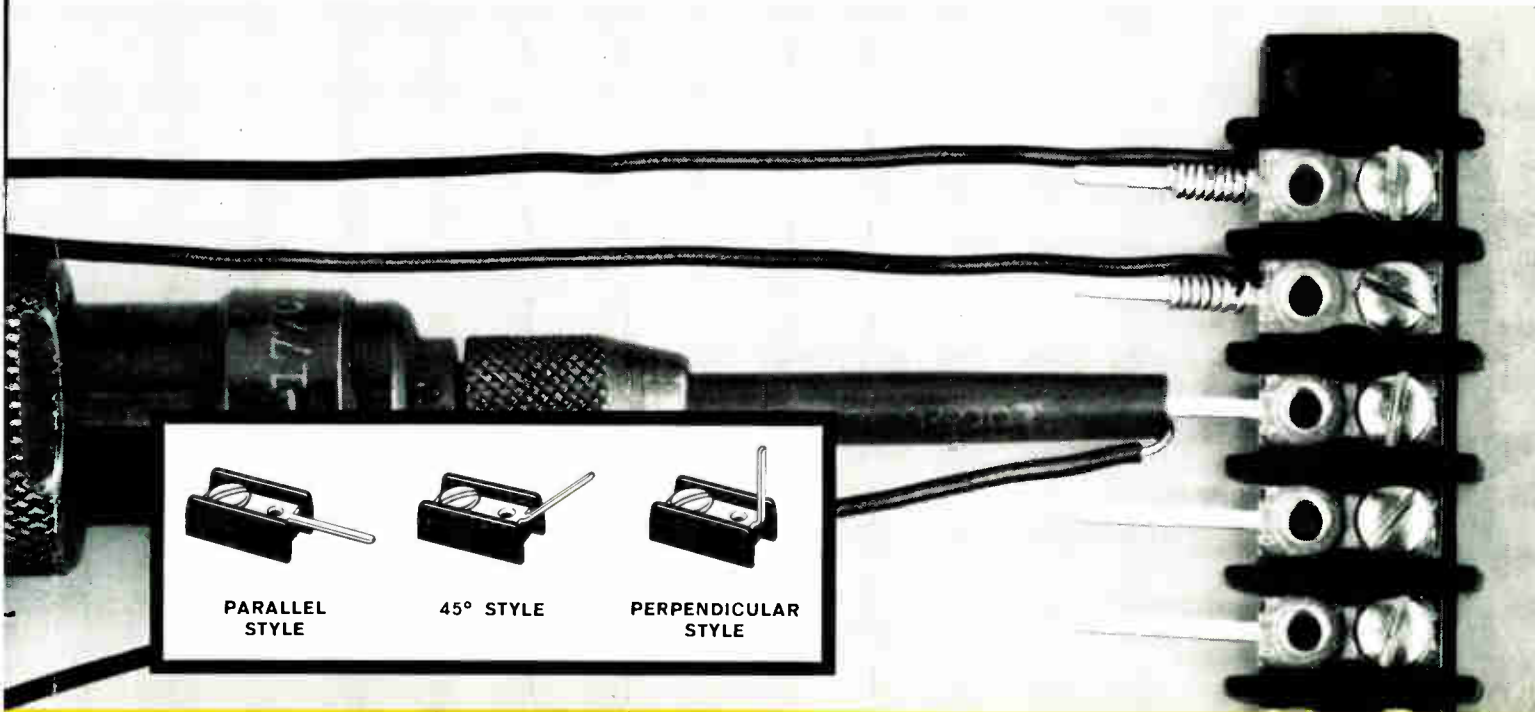

## CINCH MANUFACTURING COMPANY

1026 South Homan Avenue, Chicago 24, Illinois  
Plants located in Chicago, Illinois; Shelbyville, Indiana;  
City of Industry, California; and St. Louis, Missouri.

**DOT** A DIVISION OF UNITED-CARR FASTENER CORPORATION, BOSTON, MASSACHUSETTS

# WHAT'S NEW

## Satellite Ground Stations

### Compact . . . from BTL

A SINGLE TWO VOICE CHANNEL via Telstar can be accomplished with equipment which is simple and relatively inexpensive compared with the ground station at Andover, Maine.

While the capabilities of such a small station do not compare to that installation, it could provide basic service where communication needs are limited. The Andover station can provide one television channel or 600 voice channels.

The control equipment for the simplified ground station is housed in a trailer. Although an available 18-foot "dish" antenna has been used in demonstrations, the same job could be performed with a 10-foot "dish" of appropriate design. This compares with the 68-foot opening of the giant horn antenna at Andover.

The compact ground station is nearly self-sufficient. The only outside help needed is orbital information for the initial positioning of the antenna. This information can be predicted weeks or months in advance. Once the antenna picks up the satellite's beacon signal, tracking is automatic.

Studies made more than a year ago convinced engineers that small and simple ground stations could make use of an orbiting, low-level satellite, such as Telstar, for limited communications.

On July 27, 1962, with a working Telstar satellite orbiting the earth, BTL engineers decided to conduct

A compact ground station used to demonstrate single two-way communications via Telstar with inexpensive equipment.

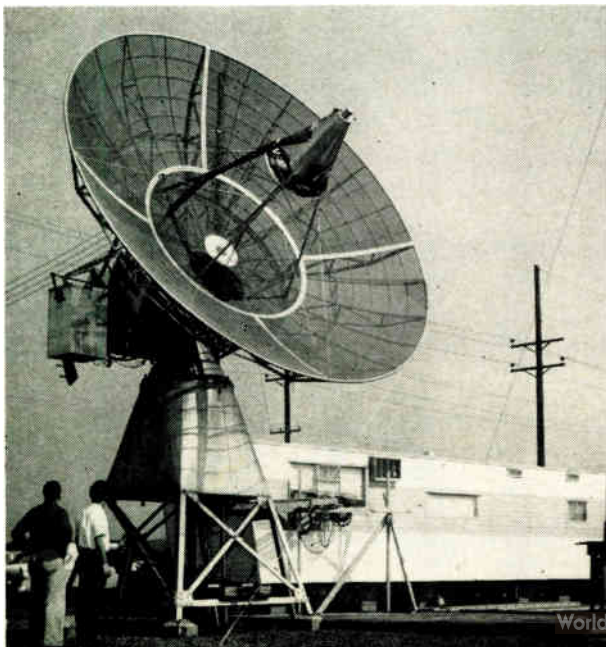

an experiment to demonstrate that such a satellite communications system was feasible.

In 2½ weeks they assembled existing communications equipment and built a comparatively inexpensive sending and receiving station at Holmdel, N. J.

A modified Bell System TH microwave transmitter was used in the experiment. Output from this equipment was further amplified to 850 watts (at 6 KMC) by an air-cooled klystron tube. The transmitter carrier frequency was 6384.58 MC. It was modulated over a radio frequency bandwidth of 60 KC. Width of the transmitted beam was 0.8°. Receiving frequencies for the experiment were 4165 MC or 4175 MC.

A low-noise 4 KMC receiving system was used. To obtain the high receiver sensitivity required, two very low noise parametric amplifiers, one cooled to 77°K, the other at room temperature were used in tandem.

The amplifier's heart is a hermetically-sealed gallium arsenide diode that has very low intrinsic noise. An FM demodulator with negative feedback reduces noise still further.

In tracking Telstar, the antenna was controlled by a simplified version of the automatic tracking method used with the large horn antenna.

As Telstar passed through the predetermined region, the antenna picked up its 4080 MC precision tracking beacon. The autotrack system then "locked on" and positioned the antenna to follow the satellite to within a small fraction of the antenna beam width. When the antenna tracks just a slight bit off the center of the satellite signal, the 4080 MC energy is propagated in a different manner through the waveguide leading from the "dish." This change in mode of propagation was used as an error signal to correct the pointing of the antenna. The antenna has a beam width of 1.2° when receiving the microwave signals from Telstar.

### Mobile . . . from ITT

PLANS FOR THE FIRST SATELLITE communication experiment linking North and South America call for connecting ITT's space station, Nutley, N. J., with mobile ground equipment to be set up by ITT on the outskirts of Rio de Janeiro, Brazil. NASA will employ the 4820-mile Pan American communication bridge in its soon-to-be-launched Project Relay satellite.

(Continued on page 118)





COMPONENTS ENGINEERED FOR SPECIFIC RELIABILITY REQUIREMENTS

## Now! Through Cinch Creative Engineering **SPECIAL CONNECTORS AND SOCKETS WITHOUT EXPENSIVE TOOLING COSTS!**

### Are you paying more than you should?

Special connectors are "one-shot" jobs to most manufacturers. Naturally, tooling costs—which you pay for—are expensive. But they need not be!

At Cinch, special and standard connector problems are everyday matters. You see, only Cinch Engineers can draw upon a treasure of thousands of successful connector designs to solve **your** problem. That is why only Cinch, with over 30 years of specialized connector experience, can give you the fastest, most reliable solution to your special connector problem, without expensive tooling costs!

For more information, contact your local Cinch representative or write to our Chicago headquarters.

### TELEPHONE COMMUNICATIONS EQUIPMENT COMPANY\* SAVES THOUSANDS ON SPECIAL SOCKET!

This company had searched for a special "space cheater" transistor socket for a high density layout. It seemed that no known socket would do. Estimated costs for a newly designed socket were high.

Cinch Creative Engineers had the answer! An existing

\*Company names will be provided on request

Cinch socket, expertly modified with new mold core pins, fit exactly into the tight space. All design requirements were met, including reliability.

The cost? Just 25% of what a newly designed socket would have cost . . . a savings of thousands on tooling alone!

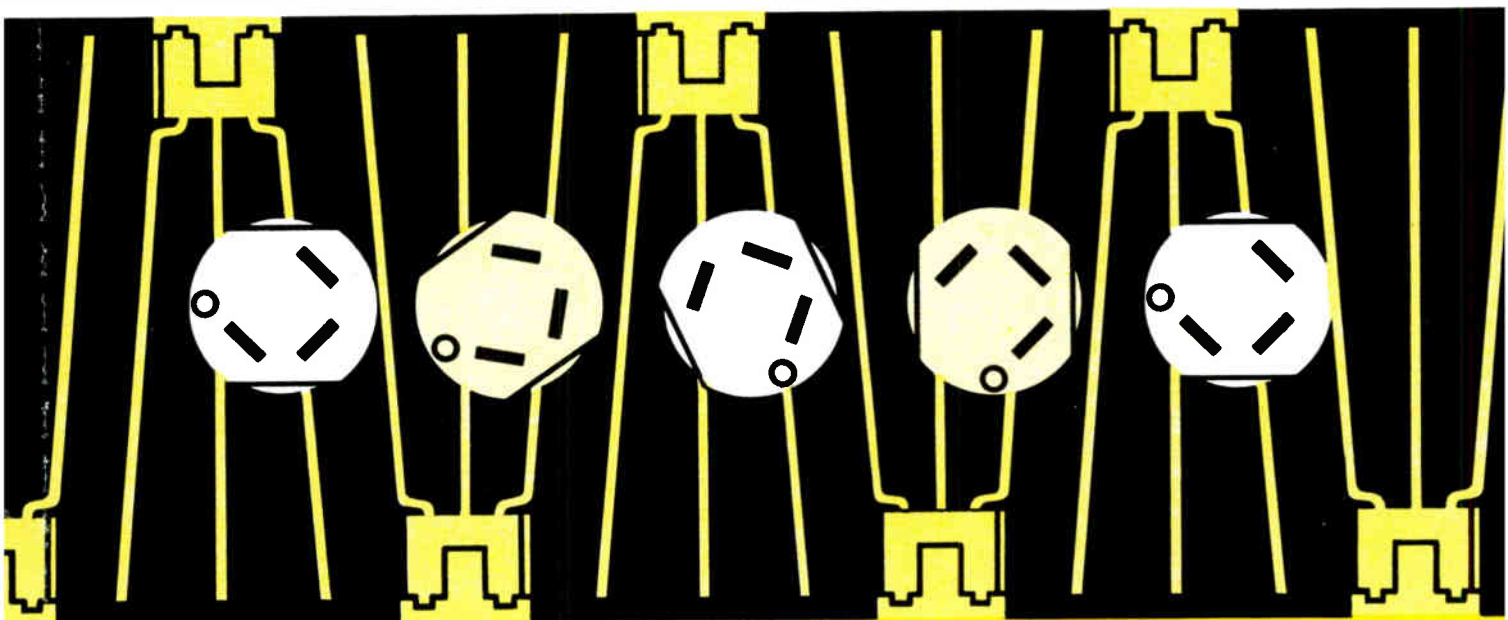

### CINCH MANUFACTURING COMPANY

1026 South Homan Avenue, Chicago 24, Illinois

Plants located in Chicago, Illinois; Shelbyville, Indiana;  
City of Industry, California; and St. Louis, Missouri.



A DIVISION OF UNITED-CARR FASTENER CORPORATION, BOSTON, MASSACHUSETTS

Circle 82 on Inquiry Card

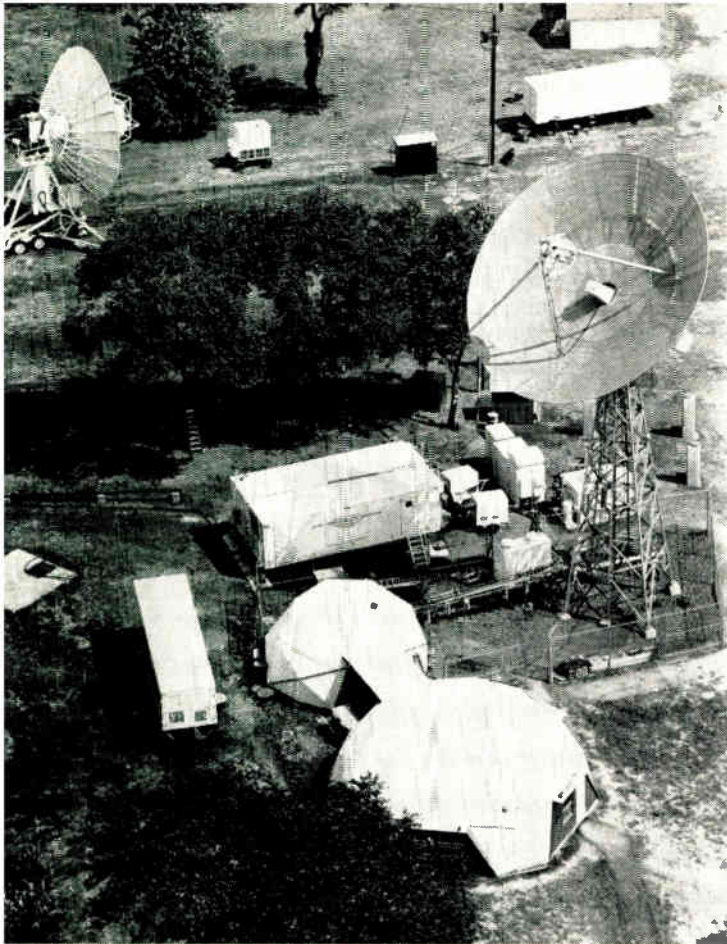

The equipment shown was developed by ITT Federal Labs and will take part in intercontinental communication tests via NASA's Relay experimental satellite. At the top of picture is a transportable antenna and control van for use in Brazil.

## Mobile (Concluded)

The transmissions to and from South America will be significant because they will show the feasibility of high-quality, long distance communications to any nation in the world.

The transportable equipment which makes the Brazilian participation possible is a completely self-contained space communications ground terminal which provides telephone, teleprinter and high-speed data transmission capabilities. The equipment may be modified later to include television transmissions.

The mobile station travels in a van and 3 trailers which can be shipped by sea, air, rail, or road. Included in this packaging is a 30-foot "dish" antenna which can be dismantled into pie-shaped sections, and the antenna support tower which resembles an old-time locomotive when readied for shipment. In practice runs, four men have assembled the terminal in as little as 16 hours.

The Rio station, to be operated by Companhia Radio Internacional do Brasil (Radional) by authority of the Brazilian Administration in cooperation with NASA, has a capacity for 12 simultaneous two-way telephone conversations. The station can handle 12 simultaneous teleprinter or high-speed data

circuits per voice channel, or 144 total circuits for these purposes when voice is not being transmitted.

The transportable space communications terminal is characterized by a 10 kw transmitter, the 30-foot antenna reflector, and a system noise temperature of  $420^{\circ}\text{K}$ . The operating frequencies match those of the respective satellites for which the terminal may be used.

The antenna is oriented by an elevation-over-azimuth tracking mount. The 30-foot aperture is illuminated by the microwave feeds in a Cassegrain reflector arrangement which places the apparent focus of the antenna system at the vertex of the parabolic reflector. The feed location provides minimum length waveguide runs to the power amplifiers and receiver front-end components. The antenna, which can track at  $6^{\circ}/\text{sec}$ . in winds up to 35 miles per hour, has a surface accuracy which will permit operation of between 1000-10,000 mc. Pointing accuracy is at least one milliradian.

The station's 10 kw transmitter system is partially housed in the electronics van and partially in the antenna-mounted package.

A completely solid-state exciter modulator is employed in the transmission system. The master oscillator has a frequency stability of better than one part in  $10^6$ . The exciter covers the required frequency range by simply selecting the proper crystal for the master oscillator and retuning the frequency multiplier stages.

Each power amplifier employs a 4-cavity, 10 kw klystron operating nominally at 1725 and 6390 mc, both of which can be remotely tuned from the radio equipment van.

The beam power supply is capable of supplying 19 kv at 2.2 amps which satisfy the beam requirement of all current 10 kw klystrons.

Heat exchanger unit—the heat exchanger is a self-contained, enclosed unit, capable of dissipating 35 kw of heat continuously with cooling temperatures as high as  $120^{\circ}\text{F}$ .

Terminal equipment includes a console which controls antenna-mounted components and the antenna. The voice terminal equipment includes a 12-channel frequency division multiplex unit. Teletype terminal equipment is also provided. Modulation is applied to the transmitter by applying the baseband signal to a 70 mc modulator. This signal is fed to the exciter where mixing takes place and the modulated output is amplified in the power amplifier.

The high-voltage power supply for the power amplifiers is an all solid-state unit employing static inverters which reduce size and weight.

Moving air is easy . . . controlling it takes an expert

---



---

A mixture of nitrogen, oxygen, argon, carbon dioxide, helium, krypton, neon and xenon can be controlled in a musical instrument to bring enjoyment to millions. These same gases, commonly known as air, can also be piped through a high frequency whistle to summon an errant dog. In either case the air must be controlled to be effective. In our capacity as air moving specialists we have brought many complex problems to heel and won the applause of our customers. Write for Brochure 102 to the Torrington Manufacturing Company, Torrington, Conn.



**TORRINGTON**



# BELL LABORATORIES' NEW CONNECTOR STREAMLINES CABLE SPLICING

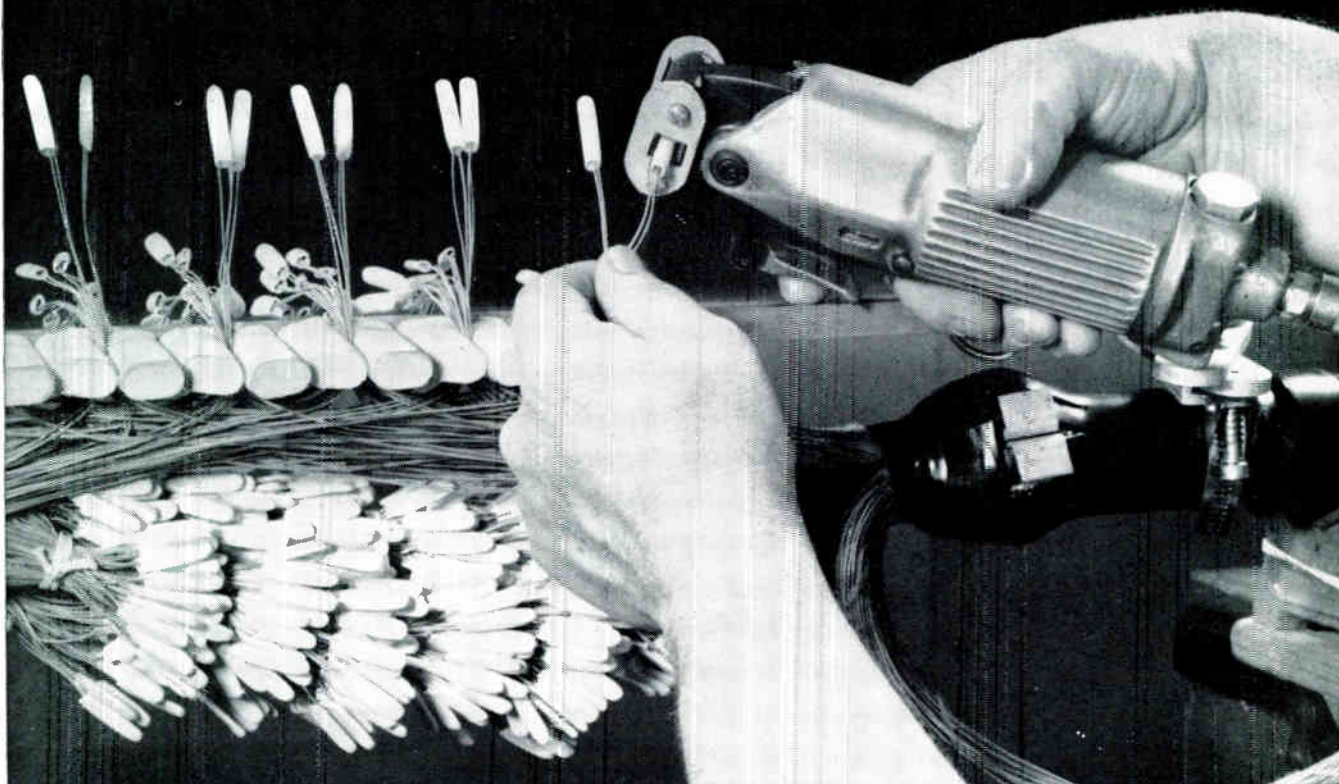

Telephone craftsman uses special pneumatic tool to flatten connector onto insulated wires. Metal tangs pierce insulation and produce a splice that is equivalent to a soldered joint.

Along the cable routes of the Bell System, wires are spliced at a rate of 250,000,000 a year. Conventionally, connections are made by "skinning" the insulation, twisting the bare wires together, and slipping on an insulating sleeve. Now, with a new connector initiated at Bell Telephone Laboratories, (diagram at lower right) splices can be made faster, yet are even more reliable.

The craftsman slips the two wire ends—with insulation intact—into the connector, then flattens the connector with a pneumatic tool. Springy phosphor bronze tangs inside the connector bite through the insulation to contact the copper wire. The stable, low-resistance splice established is maintained for many years, even under conditions of high humidity, corrosive atmospheres and vibration.

Ultrasensitive measuring techniques devised by our engineers demonstrate that the new connector provides the equivalent of a soldered connection,

even with voltages as low as 25 millionths of a volt.

Working with our manufacturing partners at Western Electric, our engineers developed this connector into a design capable of being mass-produced at low cost. It is being introduced in the Bell System.

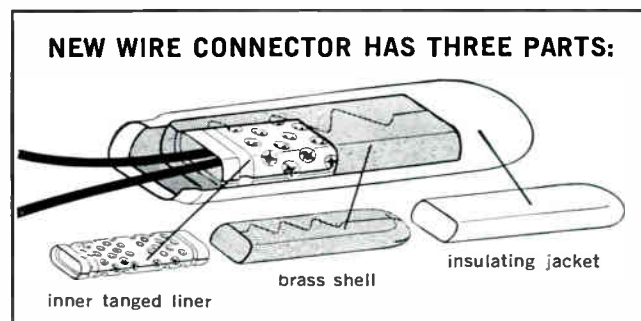

## BELL TELEPHONE LABORATORIES

World center of communications research and development

# ELECTRONIC INDUSTRIES

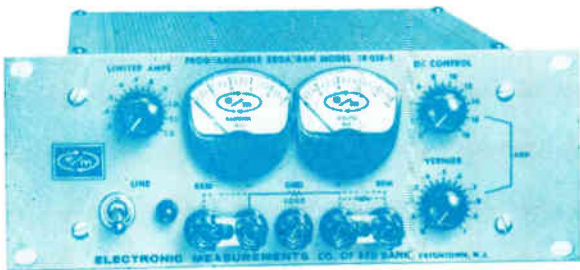

■ What do you know about power supplies? Do you consider them at the beginning of a project, or leave them till the design is frozen? Are you using the correct terminology? For your application, do you have the correct supply? In our travels, talking with users and manufacturers, we found much to be desired on both sides of the fence.

The following articles, by authorities in the field, will give you the information necessary to correctly specify and buy power supplies: what terminology to use; a definitive analysis of regulator circuits; and a comprehensive study of constant current types.

■ AN E. I. SPECIAL REPORT

## POWER SUPPLIES...

### DEFINITIONS TO DESIGN

Understanding Power Supply Terminology ■

Specifying DC Electronic Power Supplies ■

Understanding Power Supply Voltage Regulators ■

Using Constant Current Power Supplies ■

Power Supply Regulator Notes ■

Power Supply Voltage Drop Nomograph ■

# UNDERSTANDING POWER SUPPLY TERMINOLOGY

Confusion exists in understanding the terms used to specify and describe power supplies. Some of the terms are even being misused. The descriptions given here should eliminate this problem.

**AMBIENT OPERATING TEMPERATURE (range):** The range of environmental temperatures in which a power supply can be safely operated. For units with forced air cooling, the temperature is measured at the air intake.

**COMPARISON BRIDGE:** A type of voltage comparison circuit whose configuration and principle of operation resemble a four-arm electrical bridge (Fig. 1). The elements are so arranged that, assuming a balance exists in the circuit, a zero error signal is derived. Any tendency for the output voltage to change in relation to the reference voltage creates a corresponding error sig-

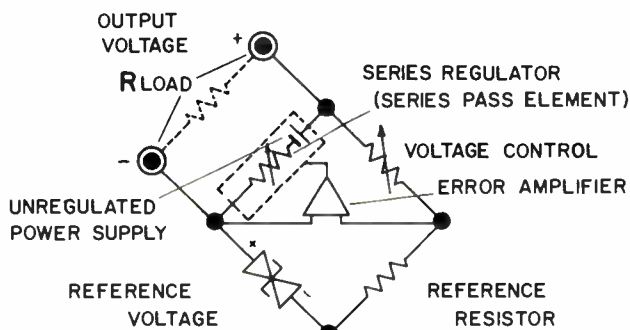
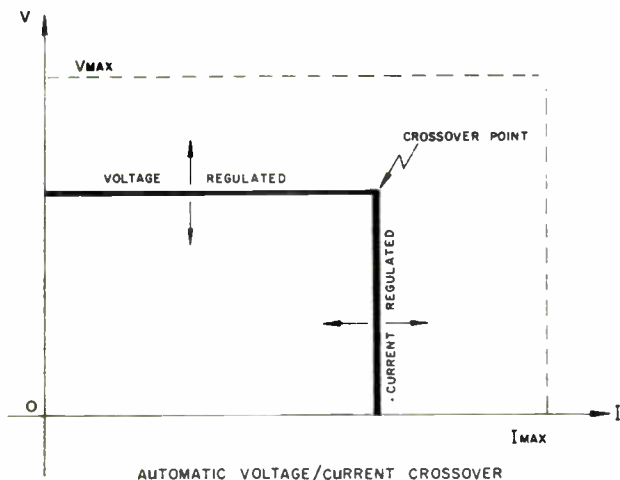

Fig. 1: Comparison Bridge for constant voltage operation.

nal, which, by means of negative feedback is used to correct the output in the direction toward restoring bridge balance.

Fig. 2: Automatic supply can change method of regulation.



This comparison bridge is capable of achieving better than 0.01% regulation and stability.

**COMPLEMENTARY TRACKING:** A system of interconnection of two regulated supplies in which one (the master) operates to control the other (the slave). The slave supply voltage is made equal (or proportional) to the master supply voltage and of opposite polarity with respect to a common point.

**COMPLIANCE VOLTAGE (range):** The output voltage range of a dc power supply operating in constant current mode. Compliance voltage is the voltage range required to sustain a given value of constant current throughout a range of load resistances.

**CONSTANT CURRENT POWER SUPPLY:** A Power Supply that is capable of maintaining a preset current through a variable load resistance. This is achieved by automatically varying the load voltage in order to maintain the ratio,  $V_{load}/R_{load}$  constant.

**CONSTANT VOLTAGE POWER SUPPLY:** A Power Supply that is capable of maintaining a preset voltage across a variable load resistance. This is achieved by automatically varying the output current in order to maintain the product of load current times load resistance constant. (Fig. 1).

**CONTROL RATIO:** The required change in control resistance to produce a one volt change in the output voltage. The control ratio is expressed in ohms per volt.

**COOLING:** In power supplies, the cooling of regulator elements refers to the method used for removing heat generated in the regulating process. Methods include radiation, convection, and conduction or combinations thereof.

**COOLING, CONVECTION:** A method of heat transfer which uses the natural upward motion of air warmed by the heat dissipators.

**COOLING, LATERAL FORCED AIR:** An efficient method of heat transfer by means of side to side circulation which employs blower movement of air through, or across the heat dissipators.

**CROSSOVER, VOLTAGE/CURRENT (automatic):** The characteristic of a power supply that automatically

By **KEN KUPFERBERG**

Director of Engineering  
Kepco, Inc.  
131-38 Sanford Ave.  
Flushing 52, N. Y.



changes the method of regulation from constant voltage to constant current (or vice versa) as dictated by varying load conditions. (Fig. 2). The constant voltage and constant current levels can be independently adjusted within the specified voltage and current limits of the power supply. The intersection of the constant voltage and constant current lines is called the crossover point (V,I) and may be located anywhere within the volt-ampere range of the power supply.

**CURRENT LIMITING (automatic):** An overload protection mechanism which limits the maximum output current to a preset value, and automatically restores the output when the overload is removed. (See short circuit protection, Fig. 3.)

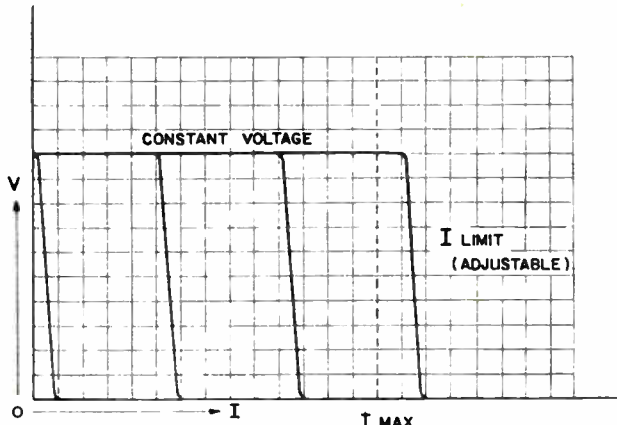

Fig. 3: Plot of typical current limiting curves.

**CURRENT SENSING RESISTOR:** A resistor of low value placed in series with the load to develop a voltage proportional to the output current. A current regulated dc power supply regulates the current in the load by regulating the voltage across this sensing resistor.

**DRIFT:** See Stability.

**ERROR SIGNAL:** The error signal is the output of the

Fig. 4: Comparison of the meanings of several different ways of writing load regulation specification.

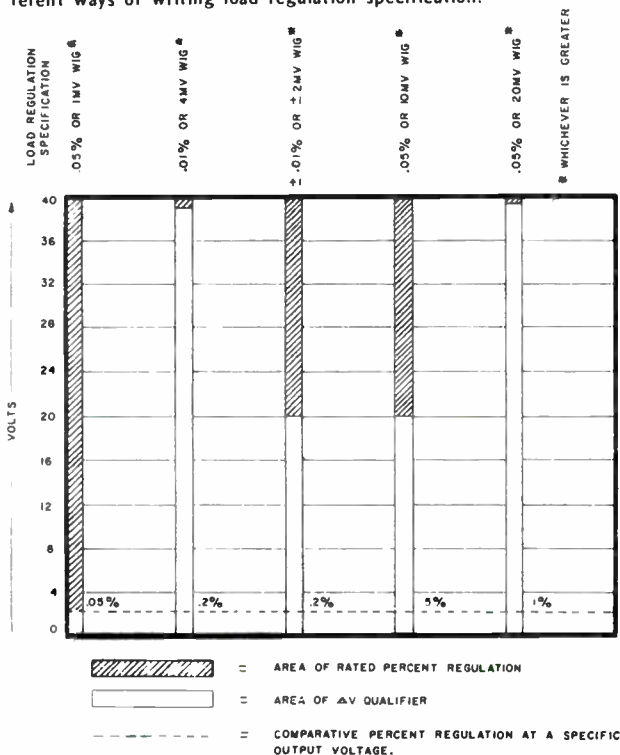

comparison bridge. It is amplified to drive the series Pass Elements.

**LINE REGULATION:** The maximum amount that the output voltage or current will change as the result of a specified change in line voltage, usually for a step change between 105-125 volts, unless otherwise specified. (Regulation is given either as a percentage of the output voltage or current, or as an absolute change,  $\Delta V$  or  $\Delta I$ .)

**LOAD REGULATION:** The maximum amount that the output voltage or current will change as the result of a specified change in output load, generally from no-load to full-load unless otherwise specified. (Regulation is given either as a percentage of the output voltage or current or as an absolute change,  $\Delta V$  or  $\Delta I$ .) (Fig. 4.)

**OUTPUT IMPEDANCE:** The effective dynamic output impedance of a power supply is derived from the ratio of the measured peak-to-peak change in output voltage to a measured peak-to-peak change in alternating load current. Output impedance is usually specified throughout the frequency range dc—100 kc.

**OVERSHOOT:** A transient rise beyond regulated output limits, occurring when the ac power input is turned on or off, and for line or load step changes. (Fig. 5.)

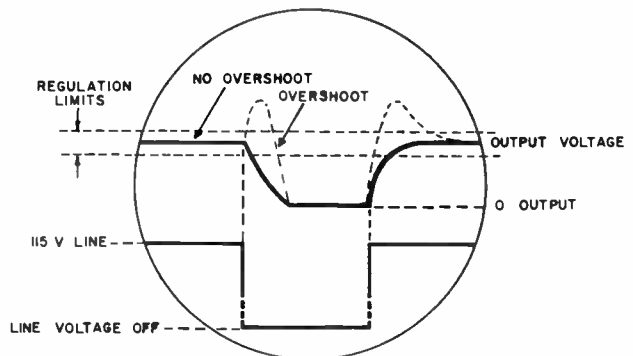

Fig. 5: Scope view of turn off-turn on effects on supply.

**OVER-TEMPERATURE PROTECTION:** A thermal relay circuit which turns off the power automatically should an over-temperature condition occur.

**PARALLEL OPERATION:** The output of two or more power supplies connected together so that their individual output currents are added and flow in a common load. In feedback controlled supplies, the control input to the pass elements of all of the supplies are connected in parallel, to be driven by a common error signal from one master control unit.

**PASS ELEMENT:** An automatic variable resistance device, either a vacuum tube or power transistor, in series with the source of dc power. The pass element is driven by the amplified error signal to increase its resistance when the output needs to be lowered or to decrease its resistance when the output must be raised. (See series regulator.)

Fig. 6a: Scope view shows the effects of a step load change.

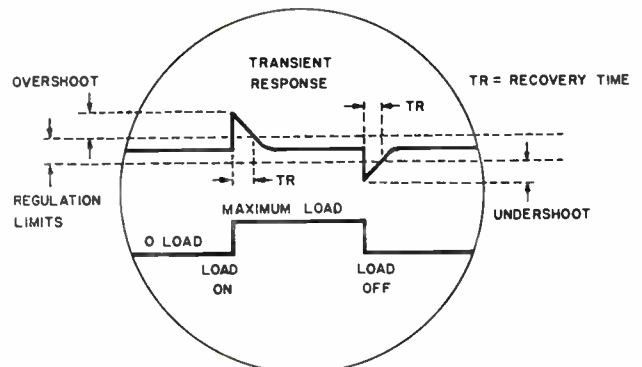

## POWER SUPPLY TERMINOLOGY (Continued)

**POWER SUPPLY (AC to DC):** Generally, a device consisting of transformer, rectifier and filter for converting available ac mains to a prescribed dc voltage or current.

**PROGRAMMING:** The control of any power supply function, such as output voltage or current, by means of an external or remotely located variable control element. Control elements may be variable resistances, conductances, or variable voltage or current sources.

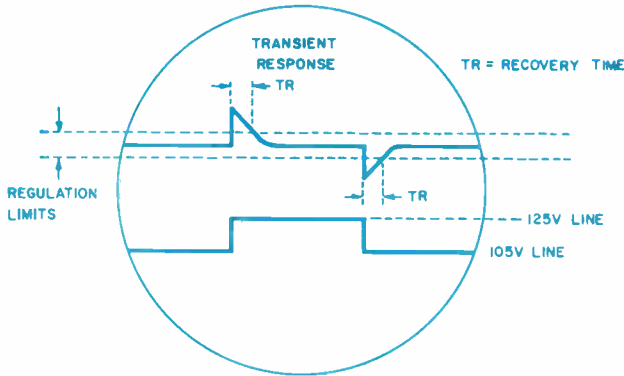

Fig. 6b: Scope view shows the effects of a step line change.

**RECOVERY TIME:** Specifies the time needed for the output voltage or current to return to a value within the regulation specification after a step load or line change. Recovery time, rather than response time, is the more meaningful and therefore preferred way of specifying power supply performance, since it relates to the regulation specification. (Fig. 6a & 6b.)

**REGULATED POWER SUPPLY:** A power supply which maintains a constant output voltage (or current) for changes in the line voltage, its output load, ambient temperature and time.

**REGULATION, OVERALL:** The maximum amount that the output will change as a result of the specified change in line voltage, output load, temperature, and time. (See line regulation, load regulation, stability, and temperature coefficient.)

**REMOTE ERROR SENSING:** A means by which the regulator circuit senses the voltage directly at the load. This connection is used to compensate for voltage drops in the connecting wires.

**RESPONSE TIME (Time Constant):** Specifies the time required for the voltage or current excursion to be reduced to 37% of its peak value after a step load or line change.

**RIPPLE:** Stated either in peak-to-peak or in rms value, "ripple" specifies the maximum ac component that appears in a dc output. Unless specified separately, ripple includes unclassified noise.

Fig. 7: Plot shows instantaneous step line voltage changes.

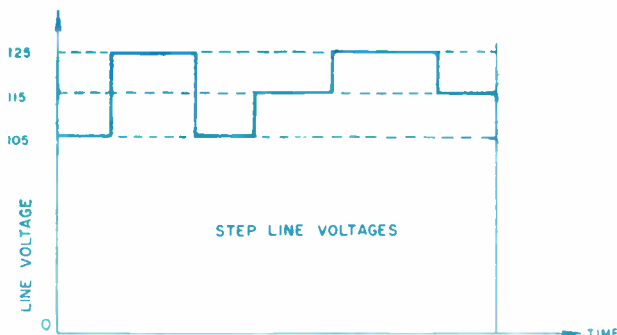

**SERIES OPERATION:** The output of two or more power supplies connected together to obtain a total output voltage equal to the sum of their individual voltages. Load current is equal and common through each supply. The extent of series connection is limited by the maximum specified potential rating between any output terminal and ground.

**SERIES REGULATOR:** A device placed in series with a source of power that is capable of controlling the voltage or current output by automatically varying its series resistance. (See Pass Element.)

**SHORT CIRCUIT PROTECTION (Automatic):** Any automatic current limiting system which enables a power supply to continue operating at a limited current, and without damage, into any output overload including short circuits. The output voltage is restored to normal when the overload is removed, as distinguished from a fuse or circuit-breaker system which opens at overload and must be closed to restore power. (See current limiting, Fig. 3.)

**SHUNT REGULATOR:** A device placed across the output, which controls the current through a series dropping resistance to maintain a constant voltage or current output.

**SLAVED TRACKING:** A system of interconnection of two or more regulated supplies in which one (the master) operates to control the others (the slaves). The output voltages of the slave units may be equal or proportional to the output voltage of the master unit. (The slaved output voltages track the master output voltage in a constant ratio.) (See Complementary Tracking.)

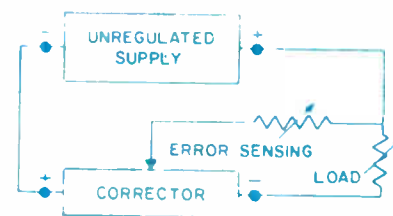
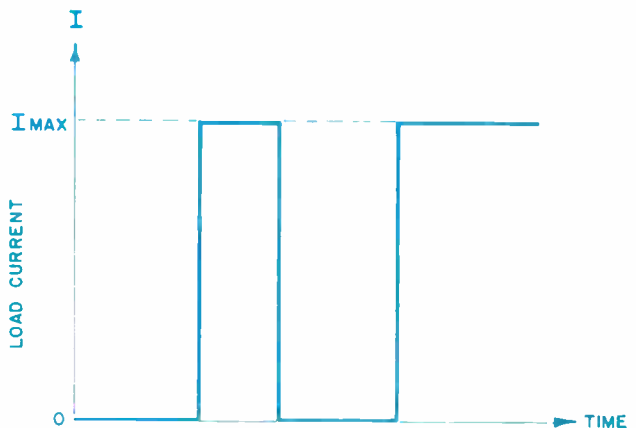

Fig. 8: Plot of instantaneous change in load current.

Fig. 9a: Circuit used to sense output voltage changes.

**STABILITY:** The change in output voltage or current as a function of time, at constant line voltage, load and ambient temperature (sometimes referred to as drift).

**STEP LINE VOLTAGE CHANGE:** An instantaneous change in line voltage (e.g. 105-125 vac); for measuring line regulation and transient response. (Fig. 7.)

**STEP LOAD CHANGE:** An instantaneous change in load current (e.g. 0 to full load); for measuring the load regulation and transient response. (Fig. 8.)

**STORAGE TEMPERATURE:** The range of environmental temperatures in which a power supply can be safely stored (e.g.  $-20^{\circ}\text{C}$  to  $+85^{\circ}\text{C}$ ).

**TEMPERATURE COEFFICIENT:** The % change in the output voltage or current as a result of a  $1^{\circ}\text{C}$  change in the ambient operating temperature (% per  $^{\circ}\text{C}$ ).

(Continued on page 146)

# ➔ Here are some **COOL** customers for critical hot spots

## Model 094567 SINGLE STAGE STUD MOUNTED COOLER

Cooling Capacity:  
 —33°C with no load  
 —30°C with 10 mw load  
 Heat Sink Capacity: 0.5 watt  
 Input Power: 5 amps at 0.1 VDC

## Model 094492 SINGLE STAGE COOLER

Cooling Capacity:  
 —33°C with no load  
 —25°C with 200 mw load  
 Heat Sink Capacity: 3 watts  
 Input Power: 3.5 amps at 0.85 VDC

## Model 094446 SINGLE STAGE COOLER

Cooling Capacity:  
 —33°C with no load  
 —31°C with 50 mw load  
 Heat Sink Capacity: 3 watts  
 Input Power: 7 amps at 0.4 VDC

## Model 094447 TWO-STAGE CASCADE COOLER

Cooling Capacity:  
 —53°C with no load  
 —50°C with 20 mw load  
 Heat Sink Capacity: 4 watts  
 Input Power: 3 amps at 1.2 VDC

## Model 094520 THREE-STAGE CASCADE COOLER

Cooling Capacity:  
 —75°C with no load  
 —65°C with 15 mw load  
 Heat Sink Capacity: 1 watt  
 Input Power: 6 amps at 0.17 VDC

Models illustrated are actual size. All ratings taken in vacuum with heat sink temperatures 27°C.

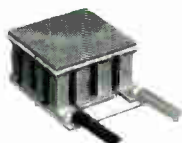

## PESCO THERMOELECTRIC COOLERS

**GIVE HIGH DELTA-T WITH LOW  
CURRENT INPUT IN A COMPACT  
MINIATURIZED PACKAGE**

PESCO thermoelectric coolers are entirely electronic in operation . . . can be used wherever spot cooling will increase sensitivity in devices such as infrared detectors, semiconductors, electronic components, and specialized instrumentation. PESCO'S unique capability to cascade elements in miniaturized packages that will withstand rugged usage make these units extremely suitable for applications where space is limited. Many other designs with greater pumping capabilities can be supplied.

*Discuss your cooling requirements with thermoelectric specialists at . . .*



### PESCO PRODUCTS DIVISION BORG-WARNER CORPORATION

24700 North Miles Road Bedford, Ohio

Export Sales:  
 Borg-Warner International Corporation  
 36 South Wabash Avenue, Chicago 3, Ill.

© 1962 Borg-Warner Corporation



## Model 094438 FOUR-STAGE CASCADE COOLER

Cooling Capacity:  
 —87°C with no load  
 —78°C with 15 mw load  
 Heat Sink Capacity: 12 watts  
 Input Power: 20 amps at 0.6 VDC  
 Can be provided complete with heat sink, blower, motor, and heat exchanger.

10740-PC



# Now from LAMBDA new LE SERIES Transistorized Regulate

DESIGNED  
TO PERFORM  
TO MILITARY  
ENVIRONMENT  
SPECIFICATIONS

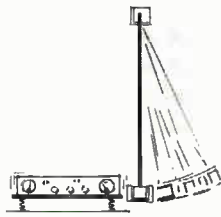

SHOCK



VIBRATION

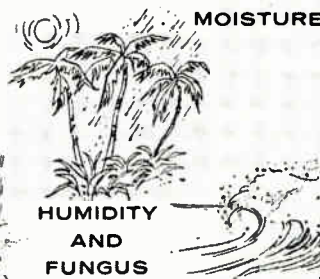

HUMIDITY  
AND  
FUNGUS

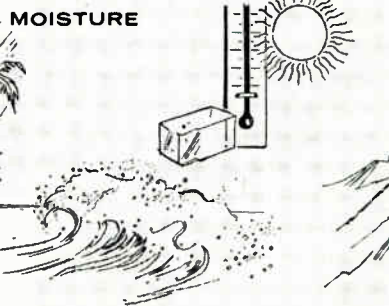

TEMPERATURE

SALT SPRAY

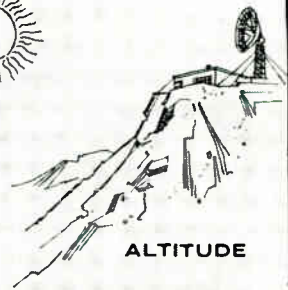

ALTITUDE



**nvironment-engineered...**

**...at mass-production prices**

LE 101-FM  
LE 105-FM  
LE 109-FM

LE 102-FM

LE 103-FM

LE 104-FM

PATENTS  
PENDING

for:

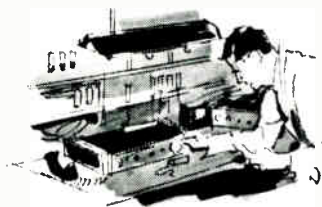

LABORATORY

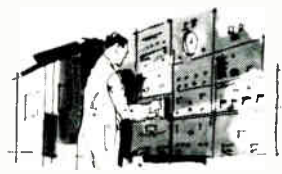

INDUSTRIAL

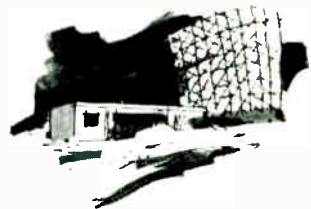

MILITARY  
APPLICATIONS



**LAMBDA ELECTRONICS CORP.**

515 BROAD HOLLOW ROAD • HUNTINGTON, L.I., NEW YORK • 516 MYRTLE 4-4200

Western Regional Office: 230 North Lake Avenue, Pasadena, California • Phone: Code 213, MUrray 1-2544

New England Regional Office: 275 Boston Post Road, Marlboro, Massachusetts • Phone: Code 617, HUNtley 5-7122

Middle Atlantic District Office: 515 Broad Hollow Road, Huntington, L. I., New York • Phone: Code 516, MYrtle 4-4200

Southeastern Region: W. A. Brown & Associates, Inc., Engineering Representative

Orlando, Fla. • Fort Lauderdale, Fla. • Huntsville, Ala. • Alexandria, Va. • Winston-Salem, N. C.

# Power Supplies

## CONVECTION COOLED

No blowers or filters; maintenance free.

## CONSTANT VOLTAGE CONSTANT CURRENT

by automatic switchover.

**6 MODELS  
AVAILABLE**

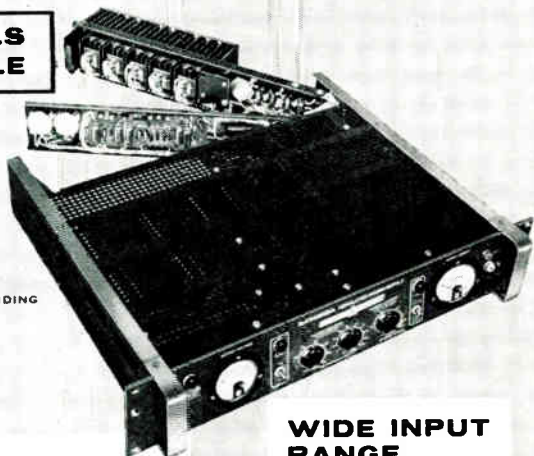

PATENTS PENDING

## COMPLETELY PROTECTED

against—short circuit and electrical overload; input line voltage transients; excessive ambient temperatures. No voltage spikes due to "turn-on, turn-off" or power failure.

## WIDE INPUT RANGE

Wide input voltage and frequency range—105-135 VAC, 45-66 CPS and 320-480 CPS in two bands selected by switch.

## REMOTELY PROGRAMMABLE AND CONTINUOUSLY VARIABLE

Voltage continuously variable over entire range. Programmable over voltage and current range.

## OTHER FEATURES

- Adjustable automatic current limiting.
- 0°C to +50°C ambient.
- Grey ripple finish.
- Ruggedized voltmeters and ammeters per MIL-M-10304B on metered models.



## 5-YEAR GUARANTEE

**covers all Lambda Power Supplies  
including LE Series models**

Every Lambda power supply sold since 1953 has been backed by Lambda's 5-year guarantee, which covers workmanship and materials (except for tubes and fuses).

**WRITE  
FOR COMPLETE  
CATALOG**

## LE SERIES CONDENSED TENTATIVE DATA

### DC OUTPUT (VOLTAGE REGULATED FOR LINE AND LOAD)<sup>(1)</sup>

Model	Voltage Range	Current Range	Price <sup>(2)</sup>
LE101	0-36 VDC	0- 5 Amp	\$420
LE102	0-36 VDC	0-10 Amp	525
LE103	0-36 VDC	0-15 Amp	595
LE104	0-36 VDC	0-25 Amp	775
LE105	0-18 VDC	0- 8 Amp	425
LE109	0- 9 VDC	0-10 Amp	430

<sup>(1)</sup>Current rating applies over entire voltage range.

<sup>(2)</sup>Prices are for nonmetered models. For models with ruggedized MIL meters add suffix "M" to model number and add \$40 to the non-metered price. For metered models and front panel control add suffix "FM" and add \$50 to the nonmetered price.

### REGULATED VOLTAGE:

Regulation (line) . . . . . Less than .05 per cent or 8 millivolts (whichever is greater). For input variations from 105-135 VAC.

Regulation (load) . . . . . Less than .05 per cent or 8 millivolts (whichever is greater). For load variations from 0 to full load.

Transient Response (line) . . . . . Output voltage is constant within regulation specifications for any 15 volt line voltage change within 105-135 VAC.

(load) . . . . . Output voltage is constant within 25 MV for load change from 0 to full load or full load to 0 within 50 microseconds of application.

Remote Programming . . . . . 50 ohms/volt constant over entire voltage range.

Ripple and Noise . . . . . Less than 0.5 millivolt rms either positive or negative terminal grounded.

Temperature Coefficient. . . . . Less than 0.015%/°C.

### DC OUTPUT (CURRENT REGULATED FOR LINE AND LOAD)<sup>(3)</sup>

Current range 10% to 100% rated load for entire voltage range. Full specifications upon request.

AC INPUT . . . . . 105-135 VAC; 45-66 CPS and 320-480 CPS in two bands selected by switch.

### OPERATING AMBIENT TEMPERATURE AND DUTY CYCLE. . . . .

Continuous duty at full load 0°C to +50°C (122°F) ambient.

### OVERLOAD PROTECTION:

Thermal . . . . . Thermostat, reset by power switch, thermal overload indicator light front panel.

### Electrical:

#### External Overload

Protection . . . . . Adjustable, automatic electronic current limiting circuit limits the output current to the preset value upon external overloads, including direct short, thereby providing protection for load as well as power supply. Current limiting settable from 10% to 110% of load.

METERS: . . . . . Ruggedized voltmeter and ammeter to Mil-M-10304B specifications on metered models.

### CONTROLS:

DC Output Controls . . . . . Coarse and fine voltage adjust and current adjust on front panel for models with suffix "FM", all other models same controls are mounted in rear.

### PHYSICAL DATA:

Mounting . . . . . Standard 19" rack mounting.

Size . . . . . LE101, LE105, LE109 3 1/2" H x 19" W x 16" D  
LE102, 5 1/4" H x 19" W x 16" D  
LE103, 7" H x 19" W x 16 1/2" D  
LE104, 10 1/2" H x 19" W x 16 1/2" D

Circle 85 on Inquiry Card

# SPECIFYING DC ELECTRONIC POWER SUPPLIES

To properly order a power supply you must know how to specify the pertinent characteristics. Even if a standard catalog item is purchased, it is important to know how to interpret the published specifications. Here we discuss the various specifications and explain their meanings.

WHEN SPECIFYING A POWER SUPPLY it is important not to ask for characteristics that are not really needed. Over-specifying often results in increased size and cost.

A specification check list is included in Table 1 as a ready reference. The glossary ahead of this article should be referred to for definition of terms used here.

## Output Power

The first information to specify when ordering a dc electronic power supply is output voltage and current. Is the voltage fixed or adjustable? If voltage is fixed, the tolerance or setting accuracy must be given. This is particularly true for unregulated or magnetic-type line-regulated supplies where no inexpensive means of adjustment is available. Normal tolerances, principally the turns ratio tolerance of transformers, will result in variations of several per cent around nominal value. Ambient temperature change and thermal drift will also cause appreciable variations. The tolerance around the fixed value must be specified at some condition of

input voltage and frequency, load current, ambient temperature, and length of time after turning unit on.

If voltage is adjustable, the adjustment range in volts or in a percentage of either side of nominal should be given. If adjustment can be in steps rather than continuous, it should be stated. If output is continuously adjustable, what is the setting accuracy or resolution?

It should be emphasized that specifying output voltage adjustment down to zero volts, if it is not necessary, can be expensive. Adjustment range should be kept as small as possible in high performance supplies using passing tubes or transistors to keep wattage dissipation down.

Current is easier to specify than voltage if the maximum value of current needed is known. Often the total load is not known when the power supplies are ordered. This cannot be helped because if the equipment designer waits until he is sure of the total load, he leaves little time for the supplier to design and build the power supply. The answer is, of course, to ask initially for more current than needed. It is

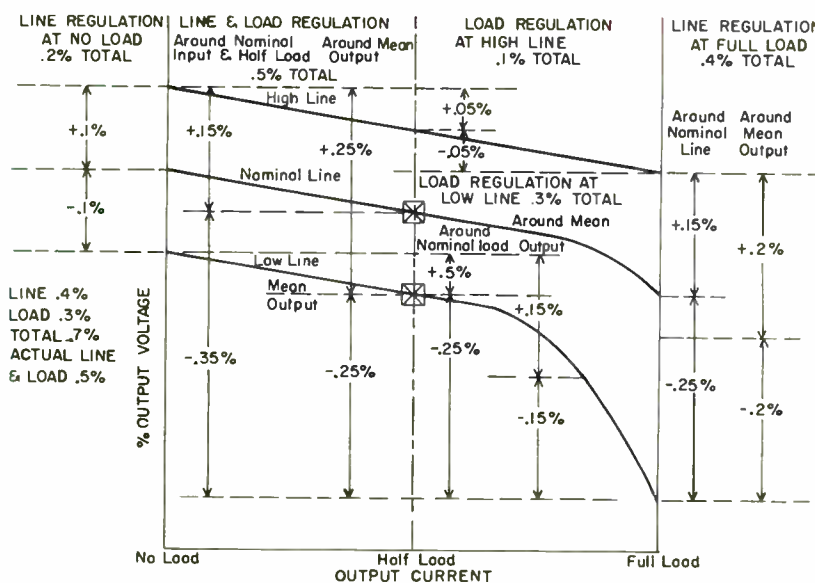

Fig. 1: Shown are the curves of output voltage vs. load current for high, nominal, and low line voltage of a power supply set at the high end of its built-in adjustment range.

By D. W. TANNER

Raytheon Company  
Sorensen Products  
South Norwalk, Conn.





Photograph shows a typical power supply

easier to redesign the supply for less current, for cost reduction purposes, after the maximum value is finally established than it is to find ways of increasing current in an existing design.

Minimum current at which the supply will be expected to operate should also be stated. If this current is appreciable, built-in bleeder current in the power supply can be lowered, reducing cost and size of power supply. If there is a chance that part or all of the minimum load may be accidentally removed, this fact should be clearly specified. This condition might result in a higher-than-normal voltage which would cause damage.

Unless load current is continuous, duty cycle and repetition rate of the load current should be stated. Specify conditions where the load goes on and off in some periodic cycle. For example, a unit which has to carry full load for only 5 minutes in every hour and no load the other 55 minutes would be less expensive than one which has to carry full load continuously.

Constant current supplies are sometimes needed. These supplies are required to hold the load current constant rather than the voltage. In such cases, the range of load resistance variations must be defined (e.g., from 10 to 50 ohms). It is also necessary to specify the range of the desired current (e.g., adjustable output current from 1 to 5a.).

Sometimes, the required range of the voltage delivered to the variable impedance load is specified, rather than load impedance range.

### Input Power

Three important input power requirements which must be specified are input voltage, phase, and fre-

quency. The frequency is determined by what is available where the equipment is to be used. If there is a choice, selection of higher frequencies, such as 400 cps instead of 60, will reduce power supply size and weight. Whether frequency is fixed, as on commercial power lines, or variable, as in most 400 cycle military applications, must be specified. In some cases, operation at two fixed frequencies such as 50 and 60 cps may be requested.

Three-phase power is more efficient for ripple reduction and rectification, but it requires the use of more rectifiers and transformer windings. It is seldom economical to specify 3  $\phi$  below 1 kw of output power. From 1 to 5 kw, the most economical phase depends on individual needs. Above 5 kw, single phase is seldom used. When there are a number of power supplies, many of which should be single phase on an individual basis, but the total power involved is large, 3  $\phi$  power is recommended. Individual supplies can be 1  $\phi$  and a specification for unbalance in input current between phases provided. Large 1  $\phi$  loads in other parts of the total system can be compensated for by unbalancing power supply loads. Unbalance in total system load will result in phase unbalance in input voltage. This condition causes increased ripple in dc output. If 3  $\phi$  rectification is being used, phase unbalance, if more than 1%, should be stated.

Single-phase units with input currents less than 30 amps are usually designed for 115 v. input. Above 30 a. input, 208 or 230 vac. is usually the nominal input value.

Three-phase units are rated at 120/208 vac. unless input current needs are high; then 240/416 vac. can

# now you can draw on a full line of Sola d-c power supplies from stock

Choose from many "ready made" models: a complete line of regulated Sola d-c supplies, stocked for *immediate delivery!* Sure sources of precisely regulated voltage for operating critical circuitry. Check these four comprehensive categories —

CVDC (lower left) — "Brute force" supplies: offer good regulation for line-voltage fluctuations, particularly with fixed loads. Wherever loads are electromechanical or can tolerate small voltage variations, CVDC assures desired regulation at *very modest cost*. Available in both *fixed* and *adjustable output* modes. Outputs from 5 to 400 v, 1 to 15 amps.

CVDR (upper right) — "Medium category" saturable-reactor supplies: compensate for input voltage fluctuations, and for changes in output voltage arising from load variations. Ideal for low-voltage power working into varying static loads. Outputs from 6 to 24 v, 2.5 to 8 amps.

CVQ (upper left) — Much finer regulation than either CVDC or CVDR. A transistorized shunt-regulation power supply used to

advantage wherever loading fluctuates rapidly and voltage must be held within tight limits. Outputs from 5 to 18 v, 6 to 22 amps.

QSA (lower right) — New adjustable-voltage, transistorized supply. Ideal for bench and laboratory, or one-of-a-kind custom-built systems. Change output by just turning the dial. Guarantees coarse or vernier line and load regulation, with a minimum of components, no electron tubes. Nine models, offering variable voltages from 0 to 60 v; ratings from 1 to 10 amps.

Sola also supplies *custom* units to fit special requirements, in a wide range of ratings. See your nearest Sola distributor or write us direct for a copy of our new "D-C Bulletin No. 750."



DIVISION OF BASIC PRODUCTS CORPORATION

SOLA ELECTRIC CO., 1711 Busse Road,  
k Grove Village, Illinois, HEMPSTEAD 9-2800  
IN CANADA, SOLA BASIC PRODUCTS LTD.,  
377 Evans Avenue, Toronto 18, Ontario



S-1-63

## POWER SUPPLIES (Continued)

be specified. The variations around the nominal input must also be given since this is related to regulation accuracy. If the input voltage range is specified too wide, it may greatly increase the costs of the power supply.

The other input characteristics, such as current, efficiency, and power factor, are determined by the output power and the performance specifications. Often they cannot be closely specified early in design. It should be noted, however, that the power factor of magnetic-amplifier regulated supplies is poor, sometimes as low as 50% lagging. Power-factor correction can be used, but because of the non-sinusoidal waveshapes of the current, correction to 100% is not possible. Power factor correction is a system problem, not a power supply problem, particularly if the system load is much larger than the power supply load. For example, increasing the power factor from 55 to 75% on a power supply might only raise the system power factor from 70 to 71%.

### Regulation

Regulation is usually expressed as plus or minus a certain percentage or voltage. For example, a line

regulation value of  $\pm 0.2\%$  means there is a 0.4% variation between the highest and lowest output voltage as input voltage is varied. This is called total variation or bandwidth and is equal to twice the plus-and-minus value. It does not mean that with the output voltage set at a given value (with the input at some unknown value), the output will not vary more than 0.2% in either direction when the input varies. Also, if the input voltage varies, for example, from 105 to 125, one cannot set the input at 115 v. and expect the output variation to be  $\pm 0.2\%$  as line voltage goes up or down. Most of the variation can occur in one direction. This is the nature of many regulating devices. At full load, the tendency is for most of the change to occur from nominal to low line and at light load, from nominal to high line. The  $\pm 0.2\%$  applies around the mean output voltage.

It is sometimes desirable to specify line regulation with load held fixed and load regulation with line held fixed. In other cases, regulations for both line and load changes together is desirable. Methods of specifying which type is called for are vague. The statement "line or load" appears to apply to the first case and "line and load" to the last, but in many cases purchasers specifying "line or load" think they are getting "line and load." It is best to clearly state which is desired, "line and load combined" or "line or load separately."

Fig. 1 shows curves of output voltage vs. load current for high, nominal and low line voltage for a power supply set at the high end of its adjustment range. At full load the load regulation around nominal line is  $+0.15\%$  and  $-0.25\%$  or a total of 0.4%. The  $\pm 0.2\%$  develops around a mean output value which occurs at some input voltage below nominal. Load regulation at low line is only  $+0.05\%$  from half to no load, but is  $-0.25\%$  from half to full load. Total load regulation of 0.3% is equally divided around the load point that represents about 85% of full load.

Line and load total regulation is the difference between the highest output voltage which usually occurs at high-line no-load, and the lowest output which usually occurs at low-line full-load. In this case, the total variation is 0.5% or  $\pm 0.25\%$  about the mean value.

Note that adding the line regulation of  $\pm 0.2\%$  to the load regulation of  $\pm 0.15\%$  gives a total of  $\pm 0.35\%$  although the line and load regulation combined is only  $\pm 0.25\%$ . The reason for this is that the low output voltage value at low line and full load contributes a major part of both line regulation and load regulation.

Fig. 2: Graphs show the transient or surge response characteristic with sudden load changes for 3 cases of damping.

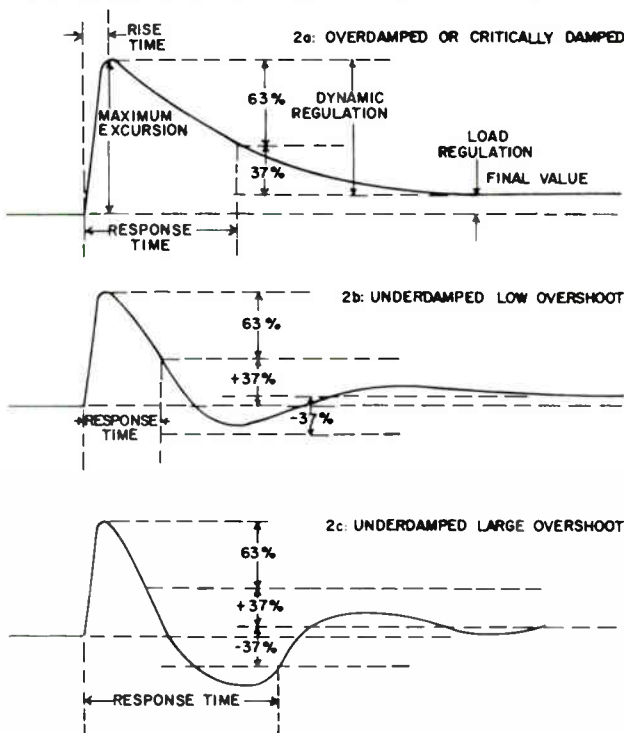



*New!*

"BUILDING BLOCKS" FOR

# INCREASED POWER

AT MINIMUM COST

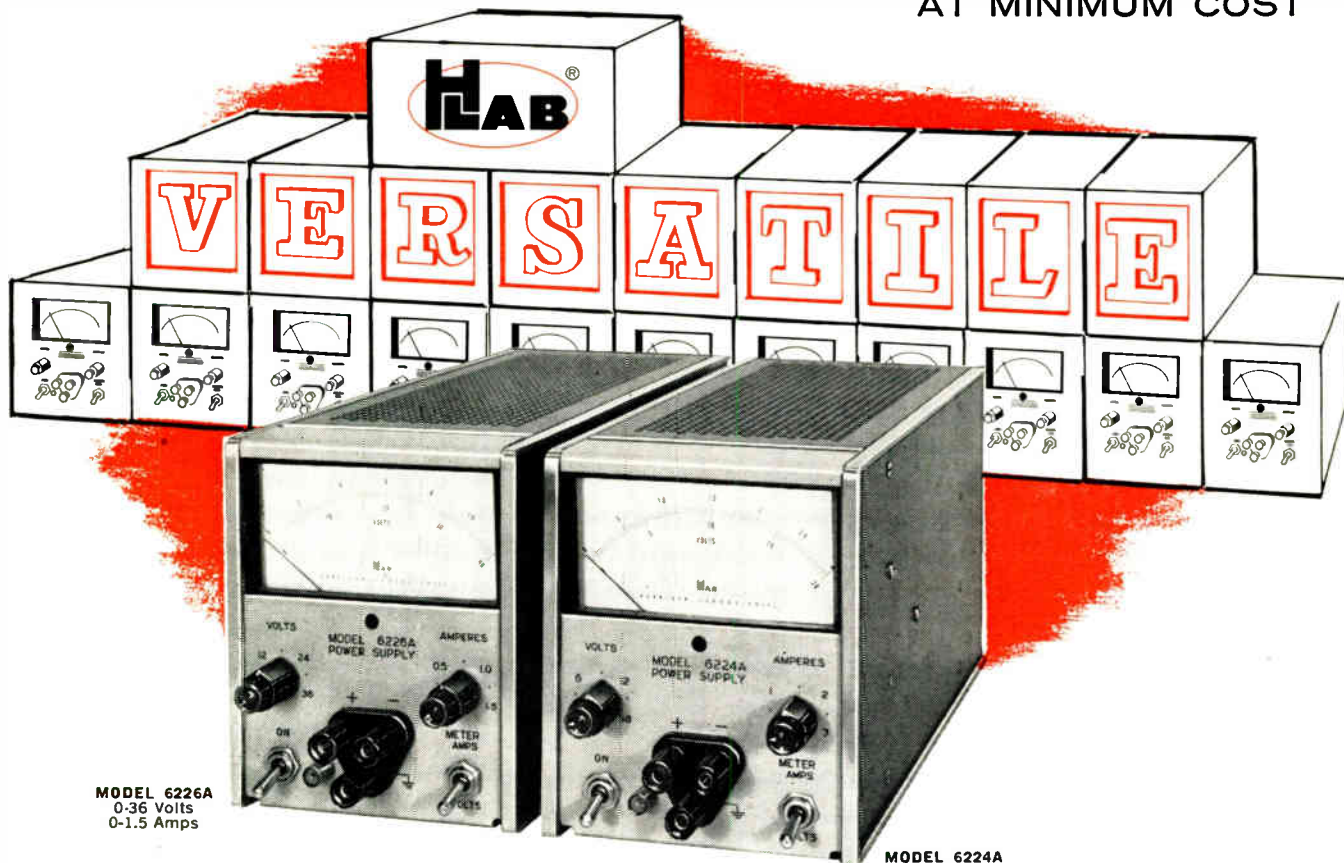

MODEL 6226A  
0-36 Volts  
0-1.5 Amps

MODEL 6224A  
0-18 Volts  
0-3 Amps

REGULATED D. C.

# POWER SUPPLIES

*Constant Voltage — Constant Current*

Series them! Parallel them! Program them! • Remote sensing! Bench or Rack Mounted!

Harrison Laboratories now offers you a truly advanced concept for meeting your present power supply needs — and providing for the inevitable increased requirements of the future.

The new H-Lab models 6224A and 6226A are already in

big demand to serve as "building blocks" for increased power as needed. The new add-on feature of these supplies will pay for themselves over and over again. End discarding of power supplies forever. Build with H-Lab.

Price: \$295.00 each.

H-Lab Models 6224A and 6226A are compact DC power supplies suitable for either bench use or relay rack operation. These power supplies were designed to satisfy the need for a reliable general purpose source of power for engineers working with transistor circuitry.

**SPECIFICATIONS**

		MODEL 6224A 0-18 volts 0-3 amperes	MODEL 6226A 0-36 volts 0-1.5 amperes
LOAD REGULATION	Constant Voltage	0.1% or 2 mv	0.01% or 2 mv
	Constant Current	0.05% or 600 $\mu$ a	0.05% or 300 $\mu$ a
LINE REGULATION	Constant Voltage	0.2% or 1 mv	0.02% or 1 mv
	Constant Current	0.03% or 250 $\mu$ a	0.03% or 250 $\mu$ a
RIPPLE	Constant Voltage	500 Microvolts rms	500 Microvolts rms
	Constant Current	200 Microvolts rms	200 Microvolts rms

- Constant Voltage and Constant Current Operation with automatic crossover.
- Auto-Series and Auto-Parallel Operation.
- One-knob Continuous Output Voltage and Current Control no range switching.
- No overshoot on Turn-on or Turn-off.
- Short Circuit Proof in Constant Voltage Operation.
- Open Circuit Proof in Constant Current Operation.
- Linear Remote Programming in both Constant Voltage and Constant Current.
- Remote Sensing.
- Adjustable Current Limit in Constant Voltage Operation.
- Adjustable Voltage Limit in Constant Current Operation.
- New large easy-to-read meter scale.



For detailed specifications, contact your nearest H-LAB Rep. or write factory. Write for long form catalog.

**HARRISON LABORATORIES**

A DIVISION OF  
HEWLETT-PACKARD 

45 INDUSTRIAL ROAD • BERKELEY HEIGHTS, NEW JERSEY  
464-1234 • Area Code 201 • TWX—201-464-2117

## POWER SUPPLIES (Continued)

So far, we have discussed "static" regulation. This means the output voltage changes measured only after sufficient time has elapsed to permit the transient changes to come to rest. Regulation specifications are always based on static regulation, unless dynamic regulation is specifically called out. Dynamic regulation is always a larger percentage than static regulation, since the instantaneous excursions of the output voltage under line or load transients are included. Dynamic regulation is discussed further under "Transient Response" below.

It is sometimes desirable to specify regulation to

remain within a certain range, regardless of what causes the change. The first step is to combine line, frequency, and load regulation. The next step is to state that the instantaneous voltage must stay within a certain plus or minus percentage. This adds peak ripple and maximum excursion (or dynamic regulation) to line and load. If we add stability changes (i.e., time drift or temperative drift) to the dynamic regulation, we obtain the maximum figure on "total regulation."

### Ripple

Ripple may be expressed either as RMS or "peak to peak," or in some cases as "peak." "Peak to peak" specifications are useful when spikes in output voltage may cause trouble. It should not, however, be

**Table 1**  
**SPECIFICATION CHECK LIST**

1. *Output Voltage:*
  - a. Fixed
  - b. Adjustable
  - c. Adjustment Range
  - d. Continuous or Tapped Adjustment
  - e. Resolution or Tolerance (on Fixed Supplies)
2. *Output Current:*
  - a. Maximum
  - b. Minimum
  - c. Duty Cycle
3. *Input Voltage:*
  - a. Frequency
  - b. Single Phase
  - c. Three Phase
  - d. Voltage Variation
  - e. Frequency Variation
  - f. Phase Voltage Balance
4. *Input Power:*
  - a. Current
  - b. Efficiency
  - c. Power Factor
  - d. Phase Current Balance
5. *Regulation: (Static)*
  - a. Line
  - b. Load
  - c. Line and Load Combined
  - d. Plus and Minus or Band Width (Specify which)
  - e. Total regulation including one or more of following; ripple, dynamic regulation, ambient temperature, stability. (Define carefully)
6. *Ripple:*
  - a. RMS
  - b. Peak to Peak
  - c. Percent
  - d. Absolute Value
7. *Transient Response:*
  - a. Dynamic Regulation or Maximum Excursion
  - b. Response Time
  - c. Recovery Time
  - d. Output Impedance. (specify frequency range)
8. *Ambient Temperature:*
  - a. Maximum
  - b. Minimum
  - c. Temperature Coefficient or output variation permitted
9. *Stability:*
  - a. Initial Warm-up
  - b. Short Time
  - c. Long Time
10. *Environmental Conditions:*
  - a. Humidity
  - b. Altitude
  - c. Shock
  - d. Vibration
  - e. MIL Specification
11. *Meters:*
  - a. Voltmeter
  - b. Ammeter
  - c. Other
  - d. Size
  - e. Accuracy
12. *Switches:*
  - a. Input
  - b. Output
13. *Protective Devices:*
  - a. Fuses
  - b. Thermal or Magnetic Circuit Breakers
  - c. Current-Limiting or Over-Voltage Requirements
14. *Pilot Lights:*
  - a. AC On
  - b. Other
15. *Terminals:*
  - a. Line Cord
  - b. Binding Posts
  - c. Terminal Strips
16. *Mechanical Construction:*
  - a. Bench Mounted
  - b. Rack Mounted
  - c. Built into Equipment
17. *Cooling:*
  - a. Convection
  - b. Forced Air
  - c. Cooling Air Supplied

# TRANSISTORIZED POWER SUPPLIES

With exclusive automatic overvoltage protection.

## MERCURY SERIES SYSTEM SUPPLIES

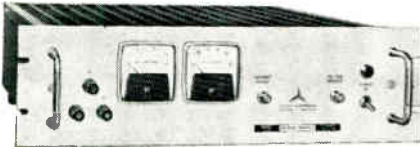

DYNAMIC REGULATION: 0.01% or 3 mv†  
 RIPPLE: 1 mv RMS max  
 RESPONSE TIME: Better than 50 μsec

- Automatic Overvoltage Protection
- Automatic Adjustable Short Circuit Protection
- Turn-on/Turn-off Transient Elimination

Model	Volts	Amps	Panel Ht.	Price*	Model	Volts	Amps	Panel Ht.	Price*
MS6-30AF	4-8	0-30	5¼"	\$585	MS36-15A	0-36	0-15	5¼"	\$595
MS12-30AF	11-13	0-30	5¼"	\$600	MS36-20A	0-36	0-20	5¼"	\$645
MS15-10	0-15	0-10	3½"	\$450	MS60-2.5	0-60	0-2.5	3½"	\$430
MS15-20A	0-15	0-20	5¼"	\$510	MS60-5A	0-60	0-5	5¼"	\$525
MS18-30AF	17-19	0-30	5¼"	\$615	MS60-10A	0-60	0-10	5¼"	\$650
MS36-2.5	0-36	0-2.5	3½"	\$355	MS160-1	0-160	0-1	3½"	\$470
MS36-5	0-36	0-5	3½"	\$385	MS160-2A	0-160	0-2	5¼"	\$595
MS36-10A	0-36	0-10	5¼"	\$495	MS160-3A	0-160	0-3	5¼"	\$645

\*Meters and overvoltage protection optional extra.

†(Models with Suffix A or AF) • 0.05% or 15mv (All other models)

Also available as Mercury instrument series with complete range remote programming.

## CENTURY SERIES

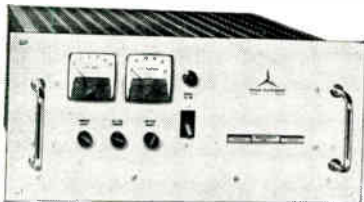

DYNAMIC REGULATION: 0.03% or 10 mv  
 RIPPLE: 1mv RMS max  
 RESPONSE TIME: Better than 100 μsec

- Constant Voltage/Constant Current
- Automatic Overvoltage Protection
- Automatic Adjustable Short Circuit Protection
- Complete Range Remote Programming
- Turn-on/Turn-off Transient Elimination

Model	Volts	Amps	Panel Ht.	Price*
C15-50	0-15	0-50	8¾"	\$1250
C15-80	0-15	0-80	8¾"	1925
C36-30	0-36	0-30	8¾"	1120
C36-50	0-36	0-50	8¾"	1690
C60-15	0-60	0-15	8¾"	1120
C60-25	0-60	0-25	8¾"	1395
†C160-8	0-160	0-8	8¾"	1250
†C160-16	0-160	0-16	10½"	1945

\*Includes ammeter, voltmeter, complete range remote programming, variable current limiting and constant current operation. †Constant current not included in these models. Overvoltage protection optional.

## TRYPACK SERIES MODULAR SUPPLIES



DYNAMIC REGULATION: 0.05%  
 RIPPLE: 0.5 mv RMS max.  
 RESPONSE TIME: Better than 50 μsec.

- Adjustable Overcurrent Protection
- Complete Range Remote Programming
- Turn-on/Turn-off Transient Elimination
- Modular Construction

- Four Trypacks mount in standard rack with 7" panel
- Rack adapters available with complete controls and output connections.

Model	Volts	Amps	Price
P20-2	0-20	0-2	\$184
P32-1.5	0-32	0-1.5	\$184
P50-750	0-50	0-0.75	\$184

## TRYLAB SERIES



DYNAMIC REGULATION: 0.05% or 15mv  
 RIPPLE: Less than 0.5mv  
 RESPONSE TIME: Better than 50 μsec

- Adjustable Overcurrent Protection
- Complete Range Remote Programming
- Turn-on/Turn-off Transient Elimination
- Constant Voltage/Constant Current

Model	Volts	Amps	Price
T20-2	0-20	0-2	\$199.50
T50-750	0-50	0-¾	199.50
*T50-2	0-50	0-2	249.50

\*Constant voltage only. Optional extra: This is a bench supply unit; Rack Panel Adapters extra.

Also available as modular supplies in the "Trypack" series. Four units occupy 7" rack space.

## "300" SERIES



DYNAMIC REGULATION: 0.02%  
 RIPPLE: 3mv RMS max; 1 mv on \* units  
 RESPONSE TIME: Better than 100 μsec

- Complete Solid State Design
- Lower Heat Dissipation
- Solid State Reliability
- Minimum Panel Height

Model	Volts	Amps	Panel Ht.	Price†	Model	Volts	Amps	Panel Ht.	Price†
S300-200	110-325	0.2	3½"	\$395	*S100-3F	95-105	3	5¼"	\$675
S300-400	110-325	0.4	3½"	450	*S100-4F	95-105	4	5¼"	795
S300-800	110-325	0.8	3½"	495	*S150-1F	145-155	1	5¼"	485
S300-1500	110-325	1.5	5¼"	685	*S150-2F	145-155	2	5¼"	575
*S100-1F	95-105	1	5¼"	470	*S150-3F	145-155	3	5¼"	775
*S100-2F	95-105	2	5¼"	525	S300-1F	295-305	1	5¼"	540
					S300-2F	295-305	2	5¼"	645

†Includes Meters



**TRYGON ELECTRONICS, INC.**  
 111 Pleasant Avenue, Roosevelt, L.I., N.Y. FReport 8-2800



## POWER SUPPLIES (Continued)

assumed that (neglecting spikes) the "peak to peak" value is 2.82 times the RMS value. Unbalance in input voltage or controlling elements, particularly in 3 $\phi$  supplies, may cause ripple to be present at frequencies other than the basic ripple frequency. The resulting waveshapes will have a "peak to peak" voltage 4 to 5 times the RMS voltage. "Peak" specifications are generally unsatisfactory in that positive and negative "peaks" are rarely alike.

Transient voltage "spikes" often appear on the output due to commutation in the rectifiers. Such spikes are generally of very short deviation (a few microseconds) and hence contribute little to an RMS reading. If the power supply must be "spike-free," this should be stated.

### Transient Response

Transient response is the most difficult of the performance requirements to specify. With regulated supplies capable of performing up to several kc, it is usually expressed as output impedance (to sinusoidal load changes). Standard test is based on a 10% peak to peak variation super-imposed on 90% static load. Results are also affected by the amplitude of load current change, and the operating point at which tests are taken. There is also some doubt as to the practical value of the results, since sinusoidal load changes are not often encountered in practice. Output impedance specifications for square wave pulse loads would be of more practical value, since this type of loading is often found.

The best way to specify transient response is to define what happens when a step change of line or load is suddenly applied. This is known as the transient or surge response characteristic and consists of the amplitude of the voltage excursion and the time that it takes for the voltage to recover.

Fig. 2a shows what happens when a sudden load change is made with "over-damped" or "critically damped" conditions. Fig. 2b and c shows what happens when "under-damped" conditions occur for two amplitudes of over-shoot.

It is obvious that the maximum excursion is the difference between the peak voltage obtained and the initial value. The total rise time, or the initial rate of rise, can also be given if it is deemed necessary.

When step change or square wave impedance measurements are made, the rise and fall times should be stated. Short rise times will increase the excursion.

Dynamic regulation is another method of specifying maximum excursion. This is not well understood unless stated whether this is the difference between maximum excursion and steady state regulation, or whether it is another term for maximum excursion.

Response time and recovery time are often confused. Response time refers to the time for 63% recovery (see Fig. 2). Recovery time refers to the time at which voltage has returned to the regulation band. In the highly oscillatory condition of Fig. 2c, recovery time would be the time in which voltage finally stays inside regulation band.

Response to pulse loads must also be considered. Pulse amplitude, pulse repetition rate and, for other than square wave pulses, the on and off time must be given. If the pulse rate is slow and the on and off times are several times longer than response time, pulse may be treated in the same manner as a step change.

If the pulse rate is fast and the on time is much shorter than the rise time, then ripple will be induced in the output voltage at the same frequency as pulse. The specification should define the peak to peak value of this ripple. The output impedance, in this case, is determined by capacitance across the output. If the pulse rate is intermediate in speed, peculiar-looking output voltage transients may result, depending on what part of response cycle the pulse goes on and off.

With pulse loads, the average value of the pulse determines the basic size of the lower supply. However, pulse amplitude (etc.), may need more output capacitors or other special design considerations.

### Stability and Drift

Aside from changes in the line, load and frequency, output voltage will also change because of two other factors—temperature and time. Characteristics of various circuit elements vary with temperature, changing the output voltage of the unit. Output voltage of voltage reference elements, such as zener diodes, also change with temperature. In unregulated supplies, the resistance of transformer and choke windings changes. Compensation circuits may be added to reduce these effects.

Temperature stability should be expressed as a change in output voltage (or percentage change) for

---

A REPRINT OF THIS ARTICLE CAN BE OBTAINED  
by writing on company letterhead to  
The Editor  
ELECTRONIC INDUSTRIES  
Chestnut & 56th Sts., Phila. 39, Pa.

---

# An important development in A-C POWER SUPPLIES ...from Behlman-Invar

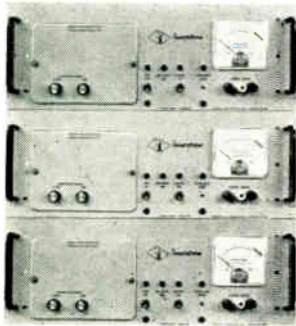

Three Model 351A units stacked for 1000 VA, three-phase operation.

A new family of modular a-c power supplies so compact and so versatile that they revolutionize present concepts in power supply design. Amazingly, they occupy as little as one-third the space of existing units—a significant breakthrough to fill your power supply requirements. With these new Behlman-Invar a-c supplies, up to 2250 VA can be obtained in units less than 27 inches high!

■ Three models are now available: Model 161A Invertron®, 160 VA, 1 $\phi$ ; Model 351A Invertron®, 350 VA, 1 $\phi$ ; Model 751A Invertron®, 750 VA, 1 $\phi$ . (Model 1501A, a 1500 VA unit, will soon be announced.)

These units utilize Behlman-Invar's new series of plug-in oscillators, which are available in fixed or variable frequencies from 45 cps to 5 kc in 1, 2, or 3 phase. (See table.)

Two or three units can be stacked, using rear interconnecting terminals, to provide two- and three-phase outputs. For example, two Model 161A's can be stacked to provide 325 VA, two-phase or three Model 751A's can be stacked to provide 2250 VA, three-phase.

## MODEL 161A INVERTRON®

This power supply provides 160VA single-phase power in a total panel height of only 5¼ inches. Two units stacked provide 325VA two-phase power in a total panel height of 10½ inches. 500VA three-phase power output is obtainable by stacking three units with a total height of only 15¼ inches.



350VA single-phase power is provided in a supply only 7 inches high. Two units stacked provide 700VA two-phase power in at total panel height of 14 inches. 1000VA three-phase output is obtained utilizing three units stacked, with a total height of only 21 inches.

## MODEL 351A INVERTRON®

## MODEL 751A INVERTRON®

This unit supplies 750VA single-phase power in a panel height of 8¾ inches. Two units stacked provide 1500VA two-phase power output and are only 17¼ inches high. 2250VA three-phase output is obtainable by stacking three units, with a total panel height of 26¼ inches.



PLUG-IN OSCILLATORS		
TYPE	FREQUENCY RANGE	FREQUENCY ACCURACY
External Signal Drive	45–5000	
*Fixed Oscillators	Any single freq. 45–5000 cps	.1% .01% .001%
*Continuously Variable Oscillator	1 Band 300–500 cps	.5%
*Continuously Variable Oscillator	4 Bands 45–150 cps 150–500 cps 450–1500 cps 1500–5000 cps	2%

\*These oscillators are available in 1, 2, or 3 phase versions.

CONDENSED SPECIFICATIONS				
SPECIFICATIONS	MODEL 161A	MODEL 351A	MODEL 751A	
Output Power	1 $\phi$ 2 $\phi$ 3 $\phi$	160VA $\pm$ 0.7 PF load 325VA (two units) 500VA (three units)	350VA $\pm$ 0.7 PF load 700VA (two units) 1000VA (three units)	750VA $\pm$ 0.7 PF load 1500VA (two units) 2250VA (three units)
Output Volts	0-130V: Full Power: 100-130V 0-130V—Line to Neutral in 2 $\phi$ and 3 $\phi$			
Basic Amplifier Response	45 cps to 5 kc			
Distortion	1% Maximum over frequency range at full power; 0.5% maximum mid band	0.9% Maximum over entire frequency range at full power; 0.4% maximum mid band		
Regulation Vs Line	$\pm$ 0.5% for $\pm$ 5% line at full power; $\pm$ 1% for $\pm$ 10% line at ¼ power	$\pm$ 0.5% for $\pm$ 10% line at full power		
Recovery Time	Zero (maximum load transient does not exceed regulation band)			
Power Requirements	117VAC, 60 cps	117VAC, 47-62 cps	230VAC, 47-62 cps	
Dimensions	1 $\phi$ 2 $\phi$ 3 $\phi$	5¼" high x 16" deep 10¼" high (two units) 15¼" high (three units)	7" high x 20" deep 14" high (two units) 21" high (three units)	8¾" high x 20" deep 17¼" high (two units) 26¼" high (three units)



For additional technical information write to:

## BEHLMAN-INVAR ELECTRONICS CORP.

1723 Cloverfield Blvd., Santa Monica, Calif. • UPTon 0-9346 • EXbrook 3-9611 • TWX SMON 7098

Behlman-Invar representatives are: T. Louis Snitzer Company— Los Angeles, La Jolla and Sunnyvale, California • Cain and Company— Albuquerque; Great Neck, N. Y.; Boston; Orlando, Fla.; Philadelphia; Chicago; Dallas; Washington, D. C. • Trans-World Trade (Los Angeles)— International

## POWER SUPPLIES (Concluded)

a given change in ambient temperature. It can also be expressed as a temperature coefficient in volts per degree. Temperature coefficient is a somewhat restrictive specification. It implies that the rate of change must never exceed this coefficient; if the actual characteristic is non-linear, this will result in an overall change less than desired, which may be costly. It is industry practice to interpret the voltage coefficient as the average value over the stated temperature range.

Temperature range over which temperature stability specification holds should, if possible, be made narrower than the full operating temperature range. For example, electronic ground equipment designed to operate over a wide range of temperatures from arctic to tropical zones will never be subjected to the full temperature range in any one period of operation.

Change of output voltage with respect to time is divided into several periods, the first of which is not really a drift. Initial warm-up time, caused principally by tube filaments, results in an output not even approaching final value for a short time. If no tubes are present, initial delays are short, being mostly due capacitor-charging time.

After the initial warm-up, a thermal drift occurs due to the changing temperature of the components. This is related to ambient temperature change and may last on large units for many hours. Since a large part of the change occurs fairly rapidly, it is advantageous to allow a warm-up period of 5 to 60 minutes before calling on power supply to meet drift specifications.

After the thermal warm-up period is completed, further drift occurs because of aging of components, causing permanent changes of their characteristics. This is also, to some extent, still a thermal effect since aging of some components, such as selenium rectifiers, is at least partially caused by high temperatures. There are also random variations in components. Two types of drift specifications are commonly used: "short-time drift" and "long-time drift." Short-time drift specifies permissible output variation (%) over a time period of from one to 60 minutes. Long term drift specifies drift over a time period of from 8 to 24 hours (in some cases several hundreds of hours).

### Protective Devices

Commonly, fuses or circuit-breakers are used to protect both power supply and the load from dam-

age. Both input lines and output can be protected individually.

Sometimes, special forms of protective circuitry are needed. Current limiting of the output is used to protect the supply and the load without the necessity for resetting after overloads. Generally, this is more expensive than simple fuses or breakers. Current-limiting can be either of the fixed type or adjustable. Fixed limiting is pre-set at 110 or 125% of full load current. Adjustable limiting can be set to limit the output unit over any specified range limiting 10% to 110% of full load.

Over-voltage protection is specified when the load is particularly sensitive to voltage surges. Nominal loads will be sufficiently protected by fuses or breakers. However, sensitive loads, especially semiconductors, may be damaged. Over-voltage devices can be either relays or special circuitry. Most of these devices shut-down the supply until reset (since over-voltage generally represents a failure in the supply).

Electronic devices (over-voltage or current limiting) can be designed to provide essentially instantaneous action.

Over-temperature protective devices are often specified to protect supplies using semiconductors. These thermal devices detect over-temperatures and shut-down the supply to prevent permanent damage. Fan-cooled supplies generally need such devices to detect fan failure or air-filter clogging.

### Physical Considerations

Environmental factors should be an early design consideration and included in the power supply specifications. Usually environmental conditions other than ambient temperature are not too important, except for the military. These can best be specified by calling for the military specification for a particular test, such as humidity, vibration, altitude, shock, etc.

Special features such as meters, switches, connectors, etc., should be stated. If known initially, the designer can specify the type of mounting, method of cooling, location of controls and meters, types and thickness of materials, finishes, etc. Life, reliability, size, shape and weight of a power supply are often important too.

However, many of these factors cannot be known with any degree of accuracy until all the electrical power output and performance demands are met. A check list of most of the physical and electrical specifications are given in Table 1.

★ ★ ★



# UNDERSTANDING POWER SUPPLY VOLTAGE REGULATORS

The purchaser of a dc voltage regulated power supply is usually confused by the seemingly large variety of regulators available. Actually this is not as bad as it seems—there are only six general types used. The basic information given here on how these six operate should clear-up the confusion.

THE SYSTEMS ENGINEER OR BUYER of regulated dc power supplies has a large variety of regulators from which to choose. To the user of a regulated supply, this variety of regulators may offer confusion. In reality, only a few basic regulators are used in regulated dc power supplies. The object here is to look at the various types of regulators and look into what they do and why they are used.

In all regulated dc power supplies, a transformer, rectifiers and filters are used. The transformer is used to convert the ac line voltage to the desired

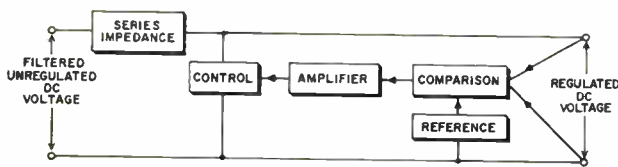

Fig. 1: The functional elements of a shunt regulator.

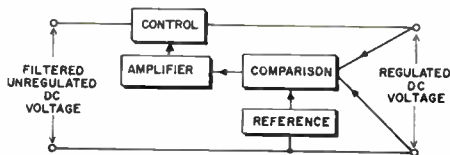

Fig. 2: The functional elements of a series regulator.

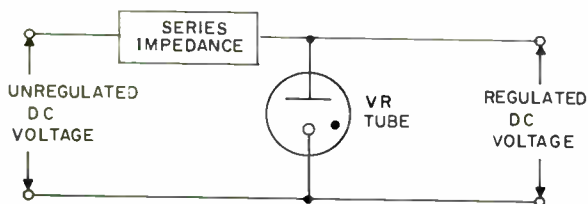

Fig. 3: Shown is a simple VR tube regulator circuit.

level of voltage; the rectifiers convert the ac voltage to dc; and the filters reduce the amount of ripple. However, a conventional transformer, rectifiers, or filter components provide no regulation to variations in input line voltage, load impedance changes, or temperature variations. Components and circuitry must be added to the above to provide regulated dc voltage.

There are six basic types of regulators used in dc voltage regulated supplies. These are:

1. Vacuum Tubes
2. Zener Diodes
3. Transistors
4. Ferroresonant Transformers
5. Magnetic Amplifiers
6. Silicon Controlled Rectifiers (SCRs)

To understand the usage of the 6 types of regulators, let us first look at the two ways these regulators may be used. All regulators are used either in shunt or series. Shunt regulators have the regulating or controlling element (transistor, zener, vacuum tube, etc.) placed in shunt with the load impedance. This type is generally preferred where the load impedance is relatively constant. The series regulator places the controlling element in series with the load impedance. In contrast to shunt regulators, series regulators are preferred to supply constant voltage to a varying load impedance.

Whether the regulated power supply has a shunt or series regulating circuit, the basic regulator used will include elements to do one or more of 4 basic functions: comparison, reference, amplification and controlling.

Fig. 1 shows, in block diagram form, these 4 functions for a shunt regulator while Fig. 2 shows the same 4 functions in a series regulator.

## Vacuum Tubes

The vacuum tube regulated power supply usually contains a voltage regulator (VR) tube. The VR tube is a gas filled tube in which the degree of ionization of the gas depends upon the amount of the



By **HAROLD WEITZEL**

Section Head  
Electronic Systems Sect.  
Sola Electric Co.  
Elk Grove Village, Ill.

voltage applied. Greater ionization of the gas results in a lower internal impedance and more current flow through the tube. Over the operating range of the VR tube, the product of the current through the tube and the internal impedance of the tube is a constant. Fig. 3 shows a VR tube in its simplest form as a shunt regulating element. Fig. 4 shows the VR tube in use with triode amplifiers. This is a series regulated power supply circuit, where the VR tube is used as a reference element.

The circuit of Fig. 3 uses a series impedance to allow more or less voltage drop as the VR tube conducts more or less current. When the VR tube is used this way, the voltage regulation is limited to about 3%. Output power and nominal voltage tolerance are also limited in the use of the circuit of Fig. 3. Better regulation accuracy (limited only by the closed loop gain) and more power handling capabilities can be had by using triode amplifiers to perform the functions of comparison, amplifying and controlling, while the VR tube is used as the reference element only.

### Zener Diodes

The zener diode, or avalanche diode as it is sometimes called, is a solid-state semiconductor. It not only has the characteristics of a rectifying junction, but also has a unique reverse characteristic. It is the reverse breakdown characteristic that make zener diodes most useful as a regulating or reference element. Fig. 5 shows a typical current-voltage characteristic of a zener diode.

The operation of a zener diode in a regulating circuit is very similar to that described for a VR tube. In the circuit of Fig. 6, more voltage across the zener diode in its reverse polarity direction will cause a greater current to flow through the zener in a reverse direction. As in any shunt regulator, a series impedance is used to drop the voltage.

Zener diodes, as controlling elements, have the same basic disadvantages as VR tubes. Nominal tolerance of available zener diodes ranges from  $\pm 1\%$  to  $\pm 20\%$ . However, the low tolerance zeners are quite expensive. Since the zener diode is a silicon junction device, it also has a temperature coefficient which must be considered as part of the total regulation accuracy when it is used as a controller, as in the circuit of Fig. 6. However, when the zener is used as a referencing element (Fig. 7) the proper voltage zener can be chosen to give a nearly zero temp. coefficient. The zener diode in Fig. 7 clamps the base of one transistor of a differential amplifier. Here a very low power, low voltage zener may be

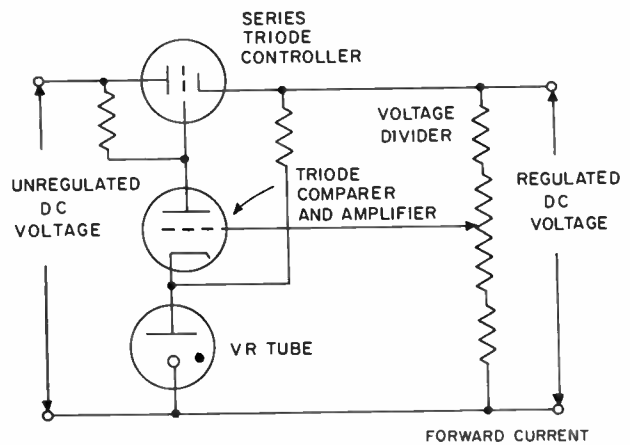

Fig. 4: VR tube as a reference element with a triode amplifier and controller.

Fig. 5: Typical current-voltage characteristic of zener diodes.

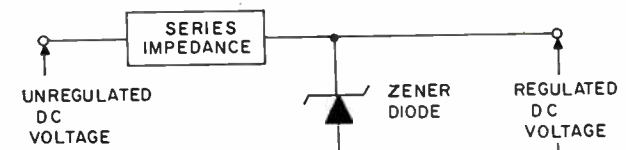
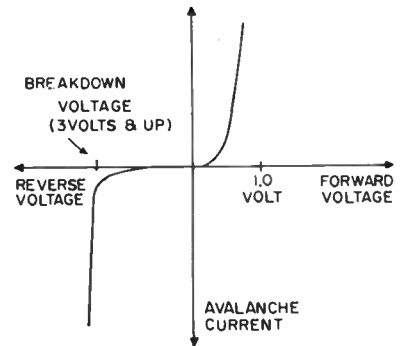

Fig. 6: Drawing shows a basic zener diode voltage regulator.

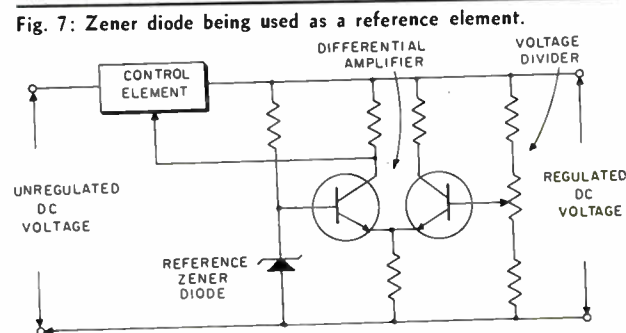

Fig. 7: Zener diode being used as a reference element.

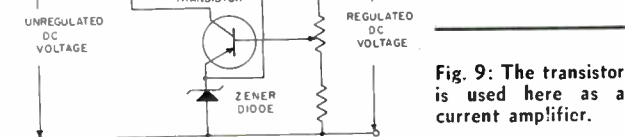

Fig. 8: A transistor being used as a comparison element.

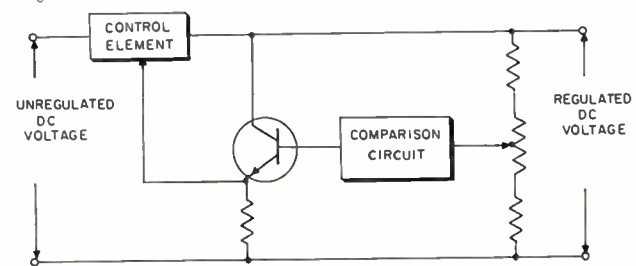

Fig. 9: The transistor is used here as a current amplifier.

## REGULATORS (Continued)

used to control larger powers and greater voltages through the use of transistors. The small size, dependability, light weight, and ruggedness of the zener diode makes it a very useful element for regulated dc power supplies.

### Transistors

As zener diodes have been the semiconductor equivalent to VR tubes, so have transistors been the semiconductor equivalent to triode vacuum tubes. The basic operation and use of transistors and triodes are very similar. A vacuum tube, in its basic form, is a variable impedance controlled by a grid voltage. Likewise, a transistor is a variable impedance between collector and emitter (path of load current flow) controlled by a signal current between base and emitter. Because of this similarity to tubes, transistors are used in comparing, amplifying and controlling functions.

The transistor, due to its electrical performance and small size, is one of the most versatile regulating elements available today as a regulator for dc power supplies. By using transistors as a shunt or series regulator, almost any needed regulation performance can be met. Since regulator accuracy is dependent upon loop gain, an increase in loop gain of 20 to 100 (depending upon Beta of the transistor) is possible with the addition of one transistor. Typical regulation of transistorized power supplies range down to 0.05% for combined wide input line and load variations.

The circuit of Fig. 8 shows a transistor used as a comparison element. A zener diode is used as a reference element, against which the transistor compares a portion of the output voltage. Voltage differences between the output voltage and zener reference voltage are amplified and transmitted as control signals to the controlling element. Temperature stability can be provided for in the circuit of Fig. 8. However, if wide range temperature stability is desired, the comparison circuit in Fig. 7 is used. In the circuit of Fig. 7, the symmetrical arrangement

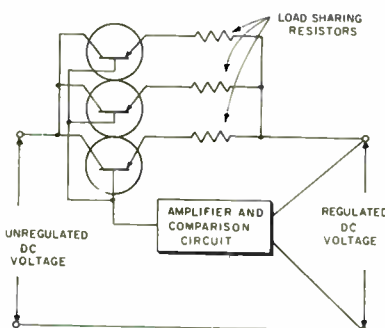

Fig. 10: Parallel transistors used in a series regulator.

Fig. 11 (1.): Parallel transistors in a shunt regulator.

of the transistors in the differential amplifier tends to make it self-compensating for temperature changes.

Between the comparison and controlling functions, transistors are used to amplify the error signal from the comparison circuit to obtain a larger signal for controlling the main control transistors. Since current amplification is generally needed, emitter-follower circuits, such as shown in Fig. 9 are used. Here the transistor is used as a current amplifier.

Transistors used as controlling elements act as variable impedances in series with the output. If the control transistor is used as a series regulator, all of the load current must flow through the transistor. Since very large power transistors are presently not available, currents above a few amps dictate the use of paralleled transistors. The circuit of Fig. 10 shows paralleled transistors used in a series regulator. There is virtually no limit to the number of transistors that can be paralleled, as long as sufficient control current is available. Fig. 11 shows transistors used as a shunt regulator. Here the transistors must carry full load current only if the load current drops to zero. If the load current does not go to zero, the shunt transistors need to carry only a portion of the load current. If the load on the regulator is constant, a shunt transistor regulator is much more efficient and needs fewer control transistors than a series regulator.

Since transistors can operate in  $\mu\text{sec.}$ , rapidly changing loads or line transients have little effect on the regulated load voltage. Although the response time depends upon the gain of the regulator, response times down to 1  $\mu\text{sec.}$  are possible. Because these regulators do not permit large voltage changes for rapidly changing load currents, they have many applications, such as in digital computers and data processing equipment.

Transistors do have disadvantages. They can not take overload currents or over-voltage for longer than a few milliseconds. Consequently, when they are used in a regulated power supply, precautions and circuitry must be employed to prevent transistor damage. Regulated supplies above 100 volts generally do not use transistors, due to their excessive cost and auxiliary circuit protection. While, under

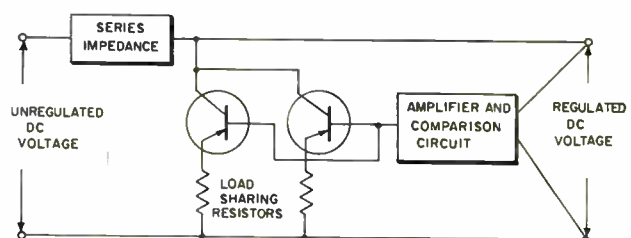



only

# ELECTRONIC MEASUREMENTS

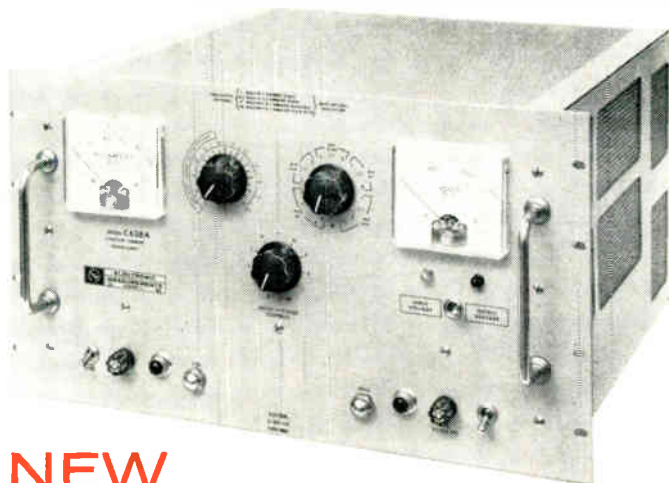

**NEW**

## CONSTANT-CURRENT POWER SUPPLIES

*offer all these exclusive features:\**

- 1 Constant-current from less than 0.5 microampere up to 3 A.
- 2 Models to 1500 V DC compliance.
- 3 Voltage-limiting control to limit compliance.
- 4 Remotely programmable.
- 5 Modulation input . . . power supply can also be used as general purpose or operational amplifier.

Electronic Measurements Constant-Current Power Supplies were designed specifically for constant-current output. In this respect, they offer advantages in the field of semiconductor work that can't be matched by conversions of constant-voltage (voltage-regulated) power supplies . . .

Ask for Specification Sheet 3072C for all the facts.

**\*BRIEF SPECIFICATIONS**

MODEL	CURRENT RANGE		†VOLTAGE COMPLIANCE AT	
	MIN.	MAX.	MIN. I	MAX. I
C612A	1 $\mu$ a	100 ma.	260 V	100 V
C631A	1 $\mu$ a	100 ma.	420 V	300 V
*C638A	0.5 $\mu$ a	100 ma.	2100 V	1500 V
C624A	2.2 $\mu$ a	220 ma.	260 V	100 V
C632A	2.2 $\mu$ a	220 ma.	420 V	300 V
*C636A	2.2 $\mu$ a	220 ma.	735 V	600 V
C629A	2.2 $\mu$ a	300 ma.	205 V	150 V
C633A	2.2 $\mu$ a	300 ma.	420 V	300 V
C620A	5 $\mu$ a	500 ma.	110 V	50 V
C621A	5 $\mu$ a	500 ma.	160 V	100 V
C613A	10 $\mu$ a	1 AMP	115 V	50 V
C614A	10 $\mu$ a	1 AMP	170 V	100 V
*C628A	10 $\mu$ a	1 AMP	215 V	150 V
*C630A	10 $\mu$ a	1 AMP	280 V	200 V
*C625A	22 $\mu$ a	2 AMP	150 V	75 V
*C626A	22 $\mu$ a	2 AMP	190 V	100 V
*C615A	22 $\mu$ a	3 AMP	125 V	50 V
*C618A	22 $\mu$ a	3 AMP	170 V	100 V

\* Voltage limiting control standard. Optional on all other models.

† For current vs. voltage compliance curves, request Specification Sheet 3072C.



**ELECTRONIC**  
**MEASUREMENTS**  
 COMPANY, INCORPORATED  
 EATONTOWN • NEW JERSEY

## REGULATORS (Continued)

normal operating conditions, it may operate at a voltage many times below the load voltage, the transistor under some conditions, such as a short circuited load, must support the full load voltage. Likewise, under normal conditions, the current through the transistor may be only a fraction of short circuit current. Schemes have been devised to limit the current under over-load conditions. Fast acting circuit breakers, or additional transistorized circuits that bias the control transistor off, have been used. The shunt regulator has a distinct advantage under over-current conditions, since all the controlling elements are in shunt with the shorted load. Likewise, the shunt regulator has an advantage in over-voltage protection. In a series regulator the load voltage is always lower than the input voltage. Failure of a series control transistor may result in over-voltage at the load. Failure of a shunt control transistor does not result in over-voltage at the load.

Although an all-transistor regulator gives the best overall regulation, response, lowest output impedance, smallest size, and weight of any regulator, nevertheless, the most economical and practical design of a regulated power supply often is to use a transistor regulator along with other types of regulators. Many "hybrid" regulators have been built combining magnetic amplifiers, silicon controlled rectifiers, and ferroresonant transformers with a transistor regulator.

### Ferroresonant Transformers

Of all the types of regulators used today, ferroresonant transformers are probably the most unique. The ferroresonant transformer (also known as a static-magnetic or constant voltage transformer) combines the ruggedness, reliability, and transform-

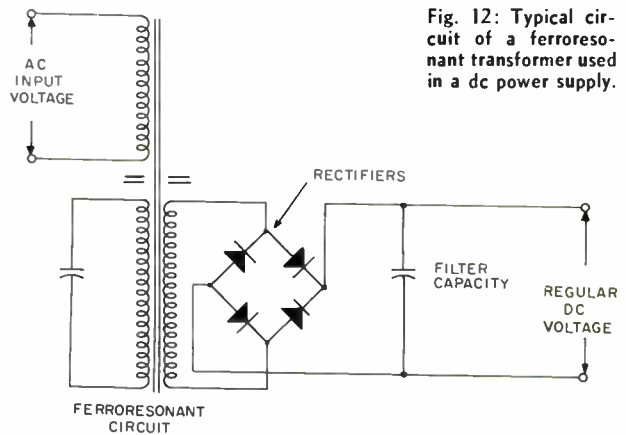

Fig. 12: Typical circuit of a ferroresonant transformer used in a dc power supply.

ing capabilities of a conventional transformer with regulating capabilities. While it is not a closed loop regulator, its regulating capabilities have been widely accepted as a fine "brute force" type. Fig. 12 shows a ferroresonant transformer used as a dc voltage regulator.

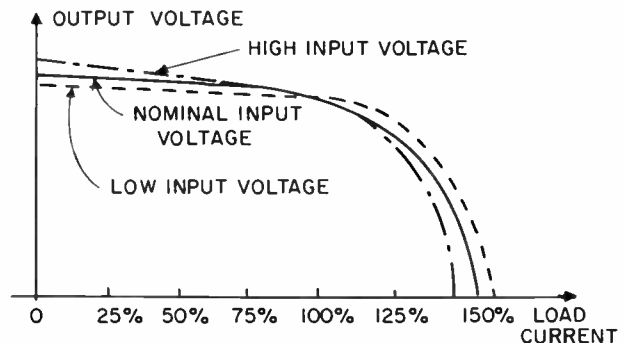

Fig. 13: Typical E-I curves for a ferroresonant transformer.

Although, the ferroresonant transformer is basically a line regulator, nevertheless, it does exhibit some load regulating qualities in its magnetic circuitry. This makes it a better load regulator than a conventional transformer. Typical ferroresonant transformers will regulate a  $\pm 10\%$  input line voltage variation to a  $\pm 1\%$  output voltage variation. Depending upon the voltage and current rating and the type of filtering employed, load regulation as good

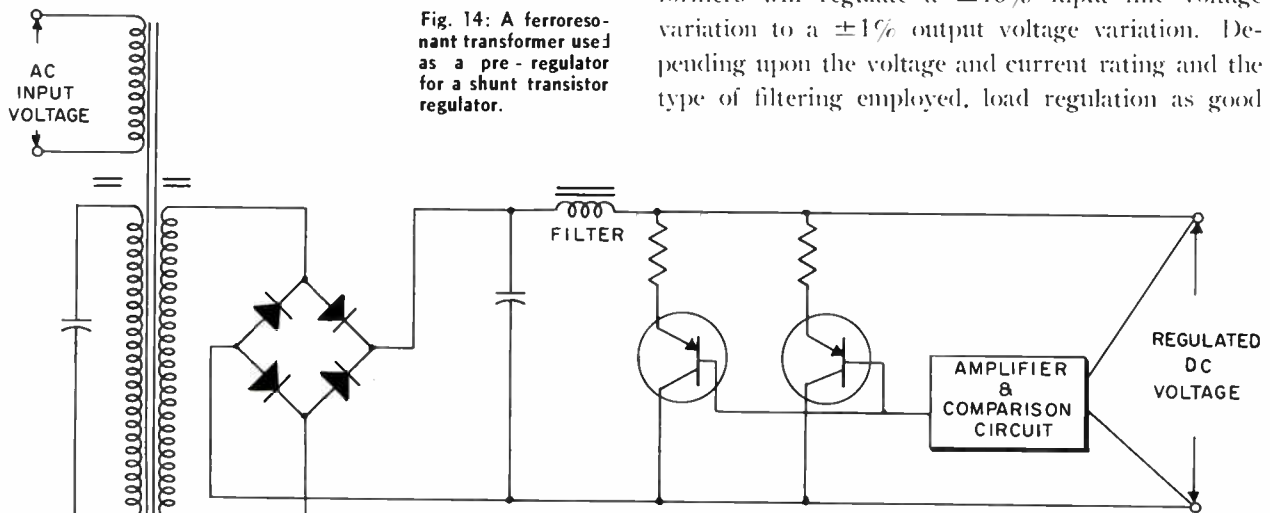

Fig. 14: A ferroresonant transformer used as a pre-regulator for a shunt transistor regulator.

as 2% can be expected for 50% load current variations.

A ferroresonant transformer uses the principle of saturation to produce regulation. A capacitor, connected across a winding on the transformer, causes capacitive currents to flow through the winding. This current saturates the transformer iron under the secondary winding. Since this portion of the transformer is saturated, changes in input voltage will not be directly transformed to the transformer secondary, but rather will be attenuated. Hence, the secondary voltage will remain relatively constant over a wide range of input voltage variation.

Ferroresonant transformers offer excellent short circuit and over-voltage protection. Since the transformer iron under the secondary winding is saturated, higher input voltages will only cause a slight increase in the output voltage. When greater than rated load current is drawn from the ferroresonant transformer, the flux produced by the load current will oppose and cancel the flux produced by the ferroresonant circuit. This results in its acting as a high reactance transformer, and the secondary voltage will drop to zero. Fig. 13 shows a typical load regulation curve of a ferroresonant transformer. The complete collapse of the secondary voltage will occur at 150 to 200% of rated load current. Due to the collapsing of the secondary voltage with increased load current, current limiting is inherent.

Since a ferroresonant circuit is used, ferroresonant transformers are frequency sensitive. Changes in input frequency result in output voltage changes. Typical designs exhibit a 1.5 to 2% change in output voltage for a 1% input frequency variation. Although the response time is relatively slow (may be 2 to 5 cycles of the supply frequency), regulated dc supplies, using ferroresonant transformers, are still widely used in pulse load applications. This is practical as long as a fairly large amount of filter capacitor is used for ripple reduction and energy storage.

Since the ferroresonant transformer is a good line regulator, it is often found used as a preregulator for other regulating elements. The ferroresonant transformer has been used widely as a preregulator for transistorized "final" regulators. In this combination a conventional transformer is replaced with a regulating transformer which not only regulates the line voltage fluctuations and reduces the total number of controlling transistors needed, but also gives the transistor regulator its short circuit and over voltage characteristics. This is especially true for transistors used in a shunt regulating circuit. For a series transistor regulator, additional protective cir-

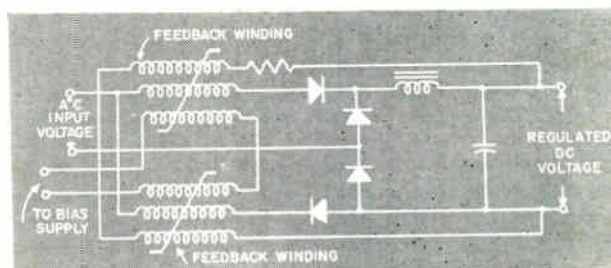

Fig. 15: A magnetic amplifier as a simple dc supply regulator.

cuits are needed. Fig. 14 shows a ferroresonant transformer used as a transformer, preregulator, over current and over voltage protector for a transistor regulator.

### Magnetic Amplifiers

Magnetic amplifiers, being composed mainly of copper and iron, exhibit the same ruggedness and reliability as a transformer. Because of their construction, magnetic amplifiers, as regulators, lend themselves to large current dc supplies. Magnetic amplifiers, like transformers, are excellent for sustained overloads without damage.

The simplest form of a magnetic amplifier is a saturable reactor. However, most applications as regulators in dc power supplies will use a self-saturating magnetic amplifier due to the greater gain obtainable from this type of circuit.

A self-saturating magnetic amplifier has two cores with their associated power and control windings on each. Fig. 15 shows a magnetic amplifier in a bridge circuit arrangement. The rectifiers in series with each power winding allow current to flow only one way through the winding. This causes saturation or minimum impedance of the cores, and maximum load voltage results. If a current flows through a control winding in a direction to oppose the dc in the power windings, the cores will be unsaturated during a portion of the cycle and a greater voltage will appear across the cores, and less across the load. Using this principle of operation, a bias current is used to set the operating or steady state voltage. A feedback current is then used to increase or decrease the output voltage around the operating voltage.

The magnetic amplifier, in this form, serves as a controlling element, and also as an amplifying and comparing element. Separate control windings on the magnetic amplifier give circuit isolation for comparing the output voltage to the reference or bias voltage. However, when the magnetic amplifier is used to compare, amplify and control, degradation of performance results. Since gain (regulation accuracy) can only be had at a sacrifice of response time,



## REGULATORS (Concluded)

and since high control impedance can only be had at a sacrifice of response, magnetic amplifiers are generally used in multiple stages or in conjunction with a transistor or other regulating element for better regulation.

Magnetic amplifiers alone can regulate input line and load fluctuations to 1%. With the combination magnetic amplifier and transistor regulator, 0.5% regulation or better can be expected. The magnetic amplifier is a relatively slow acting device, requiring about 5 to 20 cycles to respond (depending on the loop gain and regulation accuracy).

### Silicon Controlled Rectifiers

Silicon controlled rectifiers (SCR), like magnetic amplifiers, are time modulating devices. This means that the ability to control the amount of a voltage, using SCRs or magnetic amplifiers, lies in the fact that for a portion of a half-cycle (as predetermined by the bias current in a magnetic amplifier or as determined by the timing of the gate pulse for an SCR) the device is not delivering power to its load. Consequently, the SCR exhibits many of the characteristics of a magnetic amplifier. Silicon controlled rectifiers are similarly slow in response. Minimum theoretical response (as for magnetic amplifiers) is  $\frac{1}{2}$  cycle of the supply frequency. However, the practical design, due to closed loop gain and stabilization, will have response times 10 to 20 times the theoretical minimum response time.

SCRs, as regulators, are very compact and rugged devices. Although over voltage and over current failures are more likely with SCRs than with magnetic devices, they are, however, better than tran-

sistors. Since SCRs are available in high voltage and current ratings, they are widely used in regulated supplies where the current and/or voltage needs have made the parallel or series operation of transistors uneconomical.

The SCR is not only an amplifier, but will conduct current in one direction only, thereby also serving as a rectifier in dc circuits. SCRs require a gate signal (approximately 10 to 75 ma. depending upon unit size) to "fire" or cause the rectifier to conduct. Once the rectifier has started to conduct, the voltage across the rectifier must be reduced to zero in order to turn it off. After the rectifier has been turned off, another pulse of current to the gate is needed to cause the rectifier to conduct. Because of this type of action, the control circuitry becomes the most involved part of an SCR regulator.

Fig. 16 shows a typical SCR in a regulated power supply. In this circuit, a unijunction transistor is used in a relaxation oscillator circuit to provide synchronous pulses which gate the SCR. A transistor controls the charging current for the capacitor in the relaxation oscillator. It does this by comparing the reference voltage to a voltage proportional to the output voltage. Deviations in the output voltage from the reference voltage cause the SCR to conduct sooner or later in the cycle. This results in a larger or smaller output voltage.

Regulators using SCRs as the regulating element can result in very accurately regulated dc voltage supplies. Accuracies of  $\pm 0.5\%$  are not uncommon. However, due to their cost, present usage of SCRs are in high voltage and/or high current supplies.

### Conclusion

Although there are 6 basic regulators used to provide regulated dc voltage, any of the six can be used to complement the others in a regulated supply. As a result, the possible combinations are only limited by the ingenuity of the designer. Since many combinations can give equal regulation accuracy, the second-order effects become important.

Response time, remote sensing, variable voltage, current limiting, over voltage protection, reliability, ruggedness, size and weight, are factors that determine the use of one regulator or another.

Fig. 16: Typical regulated dc power supply using silicon controlled rectifiers.

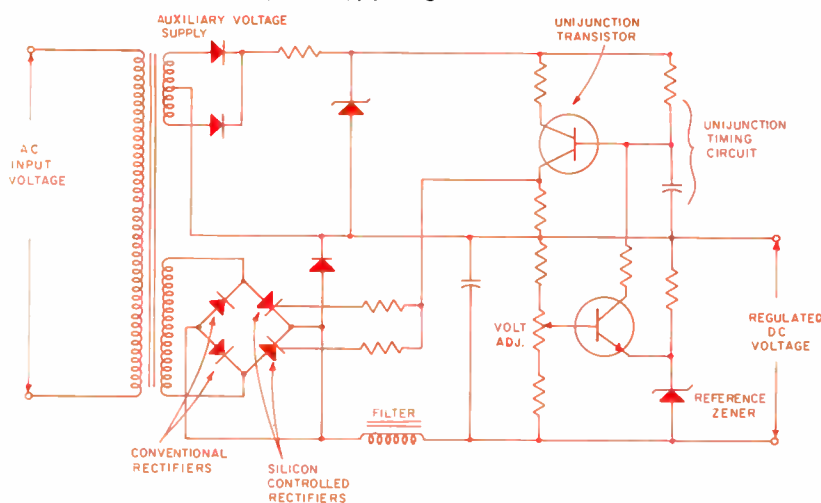

## #64 POWER SUPPLY REGULATOR NOTES

HERE, IN BRIEF FORM, are some notes about types of regulation employed in today's power supplies. While the first type listed is unregulated, it is included to give some idea of what can be expected when no regulation is used.

1. **Unregulated:** Comments are based on medium voltage supplies (approx. 28 volts) and on using silicon rectifiers. Capacitive input filtering is considered on the basis of 1000 microfarads per ampere of load.

Input	Rectification	Filtering	Approx. Load Regulation
1 $\phi$	Full Wave	Cap. Input	35%
1 $\phi$	Full Wave	Choke Input	25% (with a 10% preload)
3 $\phi$	Half Wave	Cap. Input	20%
3 $\phi$	Half Wave	Choke Input	17% (with a 10% preload)
3 $\phi$	Full Wave	Cap. Input	10% (with a 10% preload)
3 $\phi$	Full Wave	Choke Input	10% (with a 10% preload)

These figures are based on 60 cps input. At 400 cps input, everything is about the same except that less capacitance and less inductance is needed for the same degree of filtering. Supplies designed for use from 400 cps sources, of course, can be made considerably smaller than their 60 cps counterparts.

Line Regulation of Unregulated power supplies is always directly proportional to input line changes; i.e., if the line voltage changes 10%, the output dc voltage will change 10%. For unfiltered supplies, the load regulation is about 5%. The load regulation figures improve for higher dc voltage outputs and becomes worse for lower voltages. There is no significant change with output current.

2. **Line Regulated:** This type of supply uses a saturable type of line voltage regulator—there is no further attempt at regulation. Line Regulation is usually about 1%—Load Regulation is slightly better than the figures under Unregulated supplies. This method is frequency sensitive and a tolerance of about  $\pm 2-3$  cycles is normally required on the input voltage.

3. **Magnetic Amp Regulated, Single Stop:** This type is not often used, but is capable of providing  $\pm 3\%$  combined line and load regulation. Response time can be made as fast as 200 msec. with 60 cps input. Ripple is normally 1% rms with 60 cps input, but can easily be made better, especially with 400 cps input.

4. **Magnetic Amp Regulated, 2 or 3 Stage:** This type can provide regulation between  $\frac{1}{4}\%$  and 1%. Ripple is the same as with single stage magnetic amp units. Response can be made as fast as 100 msec. with 60 cps input.

5. **Transistor Driven Magnetic Amp:** This type is not as reliable as the pure magnetic amp types, but is easier and less costly to build than 2 stage magnetic amps. Ripple is the same, and response can be made as fast as 50 msec. Regulation ranges between  $\frac{1}{4}\%$  and 1%.

6. **Transistor—Series Regulator:** This type has been given the most publicity in recent years. It has the following advantages:

- Fast response — In the microsecond range.
- Close regulation — Such as 0.01%.
- Low ripple — 1 millivolt for example.

It also has some disadvantages:

- Large size for high power compared with magnetic-amp. Series Transistor regulation is a power absorbing method, magnetic-amp is a "wattless" method of controlling output.
- Lower reliability than the magnetic-amp, even when carefully designed.

By **LAWRENCE C. OAKLEY**

President  
Mid-Eastern Electronics, Inc.  
32 Commerce St.  
Springfield, N. J.

## REGULATOR NOTES (Concluded)

**7. Magnetic-Amp Preregulation Followed By Series Transistors:** This method combines some of the advantages of both—the magnetic-amp keeps dissipation down and permits a smaller collector to emitter voltage in the series pass transistors. The series regulator permits a 50  $\mu$ sec response to limited load steps. If properly designed, this type can be made so that failure of any component will not cause an undue output voltage rise. The combination is not as reliable as a pure magnetic-amp supply, however.

**8. Transistor or Magnetic-Amp Driven SCR:** This is also a relatively lossless method of controlling output. Reliability, however, is not proven, you have to extremely be careful not to exceed the published ratings of the SCR's. Care must also be taken to design units so that radiated and conducted noise is reduced. Switching transients in this type of supply are difficult to minimize. Characteristics are fairly similar to magnetic-amp types. The only advantage to be gained by this approach is the reduction of size and weight.

**9. SCR Preregulation Followed By Series Tran-**

**sistors:** Pretty much the same characteristics as the Magnetic-Amp/Transistor combination in No. 7, but somewhat lower reliability.

**10. Switching At High Frequency:** If the 60 cps input is rectified and filtered and then chopped at about 2 kc, size and weight can be reduced. Subsequent regulation can be accomplished by any of the methods listed. This method is sometimes used to save space, since the size of magnetic and filtering components can be smaller when the frequency is high. It cannot be, of course, as reliable, due to the increased number of components.

**11. Switching Transistors:** Similar to the SCR types, resulting in similar characteristics. This approach is generally only used for a small number of low voltage, medium power applications.

**12. Vacuum Tube:** Vacuum tube supplies can provide close regulation, fast response and low ripple similar to Transistor types. They have the added advantage of being less costly, especially for high voltage units. Reliability is limited and maintenance is greater of course. Another disadvantage is the large size for high power and the great amount of heat generated.

## TERMINOLOGY (Concluded)

**VOLTAGE CORRECTOR:** An active source of regulated power placed in series with an unregulated supply to sense changes in the output voltage (or current); and to correct for these changes by automatically varying its own output in the opposite direction, thereby maintaining the total output voltage (or current) constant. (Fig. 9a & 9b.)

**VOLTAGE REFERENCE:** A separate, highly regulated voltage source used as a standard to which the output of the power supply is continuously referred.

**WARM-UP TIME:** The time (after power turn on) required for the output voltage, or current to reach an equilibrium value within the stability specification.

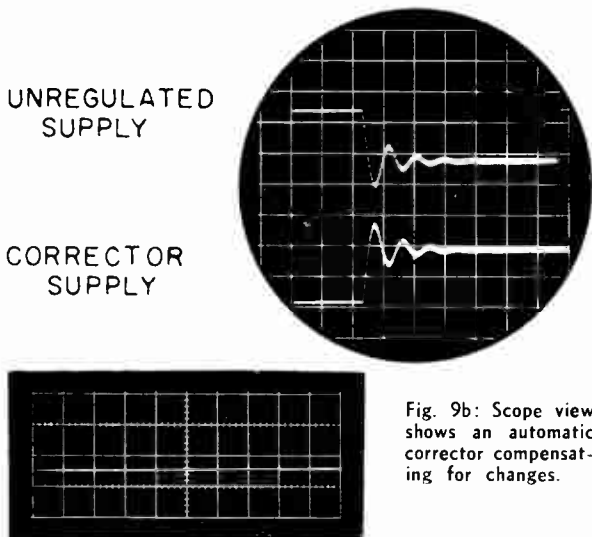

Fig. 9b: Scope view shows an automatic corrector compensating for changes.

## ACKNOWLEDGEMENTS

We wish to thank the following companies for their gracious aid in providing us with technical assistance and information, through personal interview and literature.

Anders Electronics, Inc., Cambridge, Mass.  
California Magnetic Control Corp., N. Hollywood, Calif.  
Christie Electric Corp., Los Angeles, Calif.  
Cohu Electronics, Inc., Kin Tel Div., San Diego, Calif.  
Elasco, Inc., Roxbury, Mass.  
Electric Regulator Corp., Norwalk, Conn.  
Electronic Measurements Co., Inc., Eatontown, N. J.  
Electronic Research Associates, Inc., Cedar Grove, N. J.  
Electro-Seal Corp., Des Plaines, Ill.  
Gates Electronic Co., New York, N. Y.  
Harrison Laboratories, Berkley Heights, N. J.  
Kepco, Inc., Flushing, N. Y.  
Keithley Instruments, Inc., Cleveland, Ohio  
Lambda Electronics Corp., Huntington, L. I., N. Y.  
Line Electronics Corp., Saxonville, Mass.  
Microdot Inc., S. Pasadena, Calif.  
Mid-Eastern Electronics, Inc., Springfield, N. J.  
NJE Corp., Kenilworth, N. J.  
North Hill Electronics, Inc., Glen Cove, N. Y.  
Pek Labs, Inc., Palo Alto, Calif.  
Perkin Electronics Corp., El Segundo, Calif.  
Plug-In Instruments, Inc., Nashville, Tenn.  
Power Devices, Inc., Northridge, Calif.  
Quan-Tech Laboratories, Inc., Boonton, N. J.  
Richardson-Allen, College Point, N. Y.  
Sola Electric Co., Elk Grove, Ill.  
Sorenson & Co., S. Norwalk, Conn.  
Texas Instruments Incorporated, Dallas, Tex.

A REPRINT OF THIS ARTICLE CAN BE OBTAINED  
by writing on company letterhead to  
The Editor  
ELECTRONIC INDUSTRIES  
Chestnut & 56th Sts., Phila. 39, Pa.



Accent  
on  
**VALUE**



GENERAL ELECTRIC INDUCTROL<sup>®</sup> REGULATOR'S

## Automatic voltage control accuracy of $\pm 1\%$ keeps Frescan on target

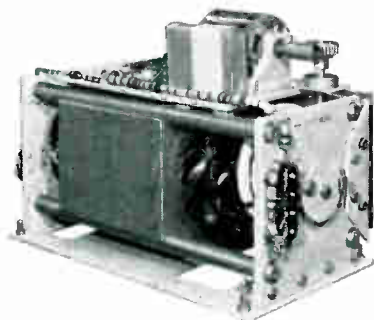

G-E INDUCTROL REGULATOR

- Automatic voltage control accuracy of  $\pm 1\%$
- Smooth, stepless voltage control
- Drift-free controls
- 100% overload capacity up to 1 hr.
- 98 to over 99% efficiency
- Load power-factor, frequency, and temperature compensated
- No harmful waveform distortion
- Rugged, compact design

*Frescan* is the first seaborne electronic scanning radar capable of pinpointing simultaneously three essential target dimensions—range, bearing and altitude. Developed by Hughes Aircraft Company for the U.S. Navy, the *Frescan* system requires automatic voltage control accuracy of  $\pm 1\%$  to stay on target. That's why General Electric Inductrol regulators are used in the plant for component testing and aboard ship as part of the *Frescan* system itself.

In the plant, Inductrol regulators eliminate the need for constant monitoring of fluctuating load and manual adjustment of equipment. Aboard ship, they provide the steady voltage required for radar accuracy and save

space over alternative voltage-control methods. Inductrol regulators' high-quality construction withstands shocks and vibrations normally encountered on board ship.

Radar is just one of the many Inductrol regulator applications. Others include communications equipment, computers, rectifiers, and laboratory apparatus. In fact, if your company uses or manufactures electric or electronic equipment, you can benefit from the precise voltage control offered by G-E Inductrol regulators.

For more information, see your G-E Sales Engineer, or write for Bulletins GEA-7690 and GEC-1450C to General Electric Company, Section 457-12, Schenectady 5, N. Y.

*Progress Is Our Most Important Product*

**GENERAL  ELECTRIC**

Circle 91 on Inquiry Card  
World Radio History

Constant current power supplies can be a very useful engineering tool. However, we find that they are not being used as extensively as expected through lack of understanding. We overcome this with a brief description about the supplies and describe many applications that will stimulate even more uses.

# USING CONSTANT CURRENT POWER SUPPLIES

TRADITIONALLY, CIRCUITS AND EQUIPMENT have been powered by low output impedance, or constant voltage, power sources. The reason for this is that all of the available power sources were, basically, low impedance devices. For example, batteries, most mechanical generating devices, and the ac line voltage all have low output impedance. With new equipment, such as that developed by Electronic Measurements Co., the high output impedance source became available at a reasonable cost.

This article will supply some answers to the following questions: What is a constant current, high output impedance power supply? How does it differ from the constant voltage, low output impedance power supply? What is the general design philosophy used to obtain high output impedance, and thus a constant current power supply? What are some uses of constant current power supplies?

## Defining a Constant Current Supply

For an explanation of what a constant current power supply is, refer to Fig. 1. Fig. 1 shows two typical equivalent circuits of a power supply. The ideal voltage source,  $V$ , ideal, has zero output impedance, and the ideal current source,  $I$ , ideal, has zero output admittance. The ideal voltage source is capable of supplying an infinite current, and the ideal current source is capable of supplying an infinite voltage. The output impedance and admittance in the equivalent circuits define the action of the actual power supply.

A practical power supply is constant current or voltage in degree only. If the output resistance is made very low, it is said to be a good constant voltage power supply. If the output admittance is made very low, it is said to be a very good constant current power supply. However, there is a large region between these two extremes where a power supply is neither a good constant voltage power supply nor a good constant current power supply. It is only with the extreme, where the output admittance is very low, that this article will be concerned.

## Constant Current Supply Design

One method of designing a constant current power supply is to simulate Fig. 1. This is done by putting a very large resistance in series with a constant voltage power supply. The series resistance is much larger than the maximum load resistance. This can be a very adequate constant current supply for small load resistance. However, for larger values of load resistance, this method becomes unusable. Under these circumstances the voltage output of the power supply and the wattage of the series resistor would become extremely high.

A better approach is to design this power supply for low output admittance. To do this, the current must be measured and compared to a known quantity. It is corrected when any perturbations occur. Unfortunately, the state of the art is not as far advanced in the ease and accuracy of measuring current as it is in measuring voltage. The easiest way is to run the load current through a resistor and look at the voltage drop across that resistor. This voltage drop can be compared to a known voltage, and perturbations in the voltage drop used to actuate the regulator amplifier.

Figs. 2 and 3 show two methods of comparing the voltage drop to a known voltage. Each of these two methods contain certain advantages. The big disadvantage of the method in Fig. 2 is the need for a reference voltage that is floating. Floating voltages always present problems. For example, it is difficult to get low ripple. Any time a voltage can be tied to the common line, the ripple problem greatly

---

By **JOHN BAUGHER**

Ass't Chief Engineer  
Electronic Measurements Co., Inc.  
Eatontown, N. J.

diminishes. The method suggested in Fig. 3 was selected by EMC. It is only necessary to amplify the error signal from the detector and use it to control a series element, tube or transistor between the load and the unregulated power source.

### Uses for Constant Current

What can a constant current power supply do that a constant voltage supply cannot? The answer is nothing. The important thing is that a constant current supply is able to do some things more easily. A general rule of thumb would be that any operation where it is necessary to accurately control the output current, a constant current power supply is desirable. This immediately brings to mind such items as magnetic fields, gas plasmas, certain semiconductor applications, etc.

### Magnetic Field Applications

Constant current power supplies are well suited for magnetic applications. Where it is desired to set and maintain a magnetic field, a constant current supply is useful. Magnetic flux density is a function of the number of turns of wire, and the current in each turn. If a constant voltage supply were to be used, the magnetic field would become a function of the temperature of the magnet wire. As the wire changed temperature, the resistance would vary. Hence the current would vary, as would the magnetic field. However, if a constant current were used, it would change its voltage as the resistance changed and would keep the current constant. Hence, the magnetic field would be unaffected by the variations in magnet wire temperature.

An additional degree of sophistication that EMC constant current power supplies offer is the capability of being modulated. By sensing the magnetic field, supplying the information to a comparator, and using the comparator to modulate the constant current power supply, a closed loop control system can be devised.

An example would be a device that would maintain a constant overall magnetic field when several magnetic fields are involved, some of which can vary (see Fig. 4).

In Fig. 4, lever arm A is of magnetic material. It is pivoted at one end and held at the other with a spring. The tension of the spring determines the position of the arm, and thus the strength of the magnetic field. Also attached to the arm is a linear potentiometer. The potentiometer is connected to a comparator. The comparator measures the resistance of the potentiometer and thus the position of the lever arm. Any perturbation in the location of the

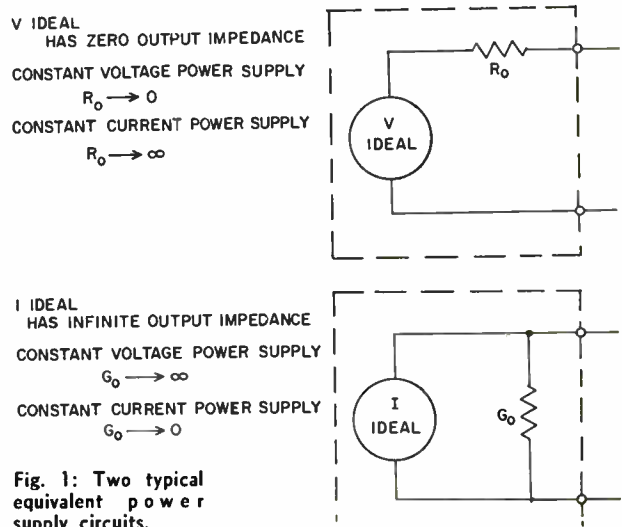

Fig. 1: Two typical equivalent power supply circuits.

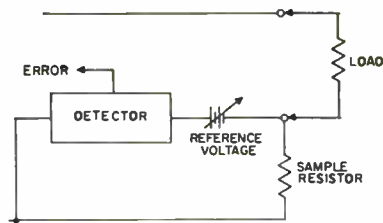

Fig. 2: A method of comparing the voltage drop to a known voltage. Here the reference is floating.

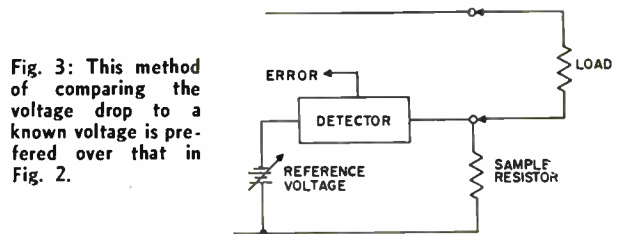
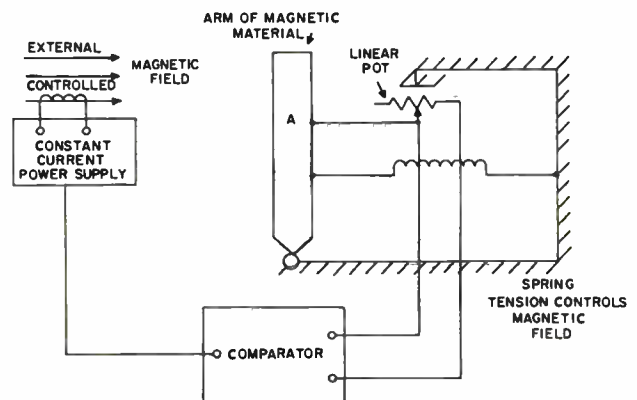

Fig. 3: This method of comparing the voltage drop to a known voltage is preferred over that in Fig. 2.

Fig. 4: A constant current supply can maintain a constant overall magnetic field when several fields are involved.



A REPRINT OF THIS ARTICLE CAN BE OBTAINED by writing on company letterhead to The Editor ELECTRONIC INDUSTRIES Chestnut & 56th Sts., Phila. 39, Pa.



## CONSTANT CURRENT (Continued)

arm is transmitted to the comparator through the potentiometer, and a corrective voltage is fed to the modulation input of the constant current power supply. Thus, as other magnetic fields vary, the system will keep the overall magnetic field constant.

Another use of the constant current power supply in controlling a magnetic field would be the precessing of a gyro. Gyros can be precessed in several ways. One way would be to precess it by means of a magnetic field. The constant current power supply, with modulation, can be used to control the magnetic field, and using a circuit similar to Fig. 4, the rate of precessing can be adjusted and controlled.

Relays are another area of constant current application. Many relays are gross types of devices, requiring little sophistication in the power supplies used to operate and test them.

However, in the field of finely balanced relays where the coil current has to be closely controlled, the constant current power supply is recommended. For example, where the latch current and the release current must be known to an accurate degree, the constant current power supply can be used with ease and accuracy. Where the constant voltage supply would have required an ammeter, the calibrated constant current power supply needs no external meters to determine the latching and releasing current.

Fig. 5 shows a typical relay test device. A programming potentiometer is driven by a reversible motor. The current in the relay under test is recorded. The motor is set into operation and the current begins to increase. Soon the relay under test closes, causing the motor to reverse. The current begins to decrease. When the releasing current is reached, the test relay opens and the motor once again reverses, causing the current to again increase. This oscillation will continue, with the current being continually recorded for as many cycles as is desired.

### Gaseous Devices

The area of gaseous discharge devices is also one where the constant current power supply is of great value. Most such devices, VR tubes are examples, require a firing potential higher than the running potential. Constant voltage power supplies can be used, but are sometimes cumbersome, and require more equipment than does a constant current power supply.

For example, if a gas device is to be operated at a fixed current, it is only necessary to set the cur-

rent supply to that current. The output voltage will rise to the voltage needed to fire the tube, then fall back to the operating voltage. This suggests an interesting method of testing and sorting regulator and reference tubes.

The task in this case could be to sort a batch of reference tubes, according to operating voltage at a given current. Fig. 6 shows a very simple method of doing this. The constant current is set to operate at the required current. A tube is placed in the test position. The current supply is turned on and the tube is fired. The operating voltage is read from the volt meter. The tube is classified according to its voltage. This test can be extended to much more complicated tests. For example, if a life run is needed to find how the voltage changes with time, the current can be left running, and voltage readings can be taken from time to time. By cycling the temperature, the temperature coefficient can be found.

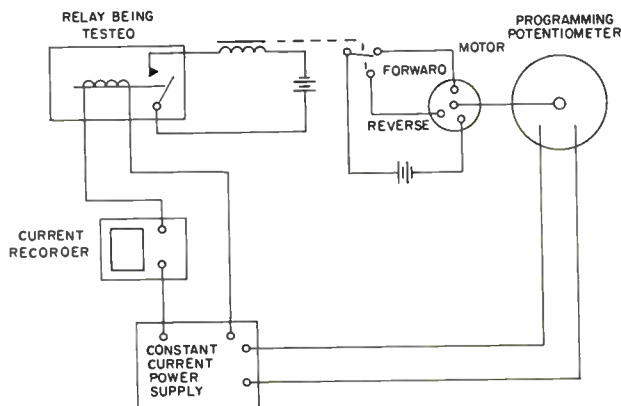

Fig. 5: A typical relay test device using constant current.

Another extension is a test to determine ac impedance. The modulation features of some constant current power supplies makes this test very simple. Using an identical setup as in Fig. 6, except the volt meter is an ac meter, the current supply is modulated with a known signal. The output current will have a known amount of modulation about its dc base. The ac impedance is the quotient of the ac voltage across the reference tube and the modulation current.

### Semiconductor Devices

Perhaps the area where the constant current power supplies find their greatest use is in the testing of semiconductor devices. A test that is difficult to perform with a constant voltage power supply is determining PIV (peak inverse voltage). Usually a junction is specified by giving a maximum leakage

current at a particular voltage; that voltage being the PIV. If a voltage supply is used, it is necessary to have an ammeter, or some method of measuring the current, a volt meter to measure the voltage across the junction, and a resistor in series with the junction and the voltage supply. The resistor is needed because there will be faulty junctions, and we must protect them, as well as the power supply.

With a constant current power supply it is easy to make and to automate the test. It is necessary only to have a volt meter across the junction. The constant current supply is set to the maximum leakage current. The junction is placed across the supply and the voltage drop is measured. By observing the voltage, the junction can be classified according to PIV. For example, look at Fig. 7. Assume that the junctions are to be classified at 50 volt *intervals*. The diode is placed in the circuit. The constant current power supply is turned on. The volt meter rises to 75 volts. The diode would then be classified with a PIV of 50 volts. This can be completely automated, and the junctions sorted automatically.

A similar test, the forward voltage drop, is also easily done with a constant current power supply. The same circuit can be used, except that the diode is placed in the forward direction. The only difference is in the numbers. Usually PIV's are large numbers, and leakage currents are small numbers, while forward voltage drops are small numbers, and forward currents are large numbers.

### Reference Diode

Another test that is a relative to the ones discussed is checking the operating voltage of a reference diode. The technique is exactly the same as that used in checking the operating potential of a VR tube. Similar information is required in both cases. The only differences are in the numbers. Reference diodes are available in many more voltage and current ranges than the VR tubes. AC impedance is determined in a manner similar to VR tubes.

An extension of the tests that can be performed on semiconductor junctions are those needed to test transistors. Many of the specifications for transistors require a constant current base drive and/or a constant current collector source. Hence, a constant current power supply is the one to use. Transistor testing is a subject that involves a large amount of other equipment and techniques, and will not be discussed here.

### Miscellaneous Applications

The list of possible applications could continue for pages. However, only a few more will be listed

here. A good use for a constant current power supply is in the generating and maintaining of a very accurate and stable voltage source. Most solid state types of references prefer to be driven from a current source. If a reference diode is powered from a constant current power supply that has been well regulated and stabilized, the voltage across the diode will remain very accurate and stable.

Another use that a constant current power supply can be put to is in the field of plating. Inasmuch as the plating is mechanically a process of placing charged ions of metal on the surface of another piece of metal, it is natural to want to control the number of these charged ions. The constant current power supply does just that. The number of molecules that have actually been deposited can be accurately determined by measuring the time that the constant current power supply has been in operation. In the case of the depositing of precious metals, the amount of metal deposited is very important. If a constant current power supply is used, it is necessary only to have a timer with the power supply, and the amount of deposited metal can be accurately computed.

Capacitor forming has long been troublesome. It is necessary to run a current at a low value through the capacitor. As the film is formed, the voltage increases. It is usually desired to keep the current constant while the voltage rises. Soon the voltage reaches a value that is supposed to be held. A constant current power supply will do the job. With a voltage limiter set to a maximum voltage, the current will remain constant as the voltage rises, until the maximum voltage is reached. At that time the voltage begins holding, and the current diminishes.

Fig. 6 (top): A simple method of sorting reference tubes.  
Fig. 7 (bot.): PIV of semiconductor diodes can be checked.

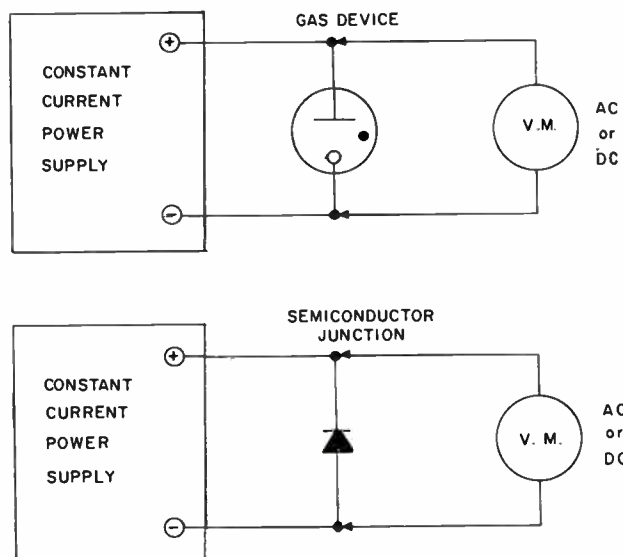

## CONSTANT CURRENT (Concluded)

Thus there is little danger in the process, and it is unnecessary to watch and control it manually all of the time.

The charging of special batteries offers a problem also. The current is supposed to be kept at a certain rate, and diminish as the voltage of the battery is reached. The same technique as used in capacitor forming can be used here. The voltage limiter with the constant current power supply is the

item that makes the process possible without constant watching.

These are only a few of the many possible applications. The fertile imagination of engineers can probably dream up many more. It is necessary to determine what has to be accomplished, and then decide how a constant current power supply can be used. The next thing is to decide how a constant voltage power supply can be used. Compare the two methods, and choose the one that looks the most promising.

### NOMOGRAPH OF VOLTAGE DROP ACROSS LOAD SUPPLY LEADS (as a function of wire size and load current)

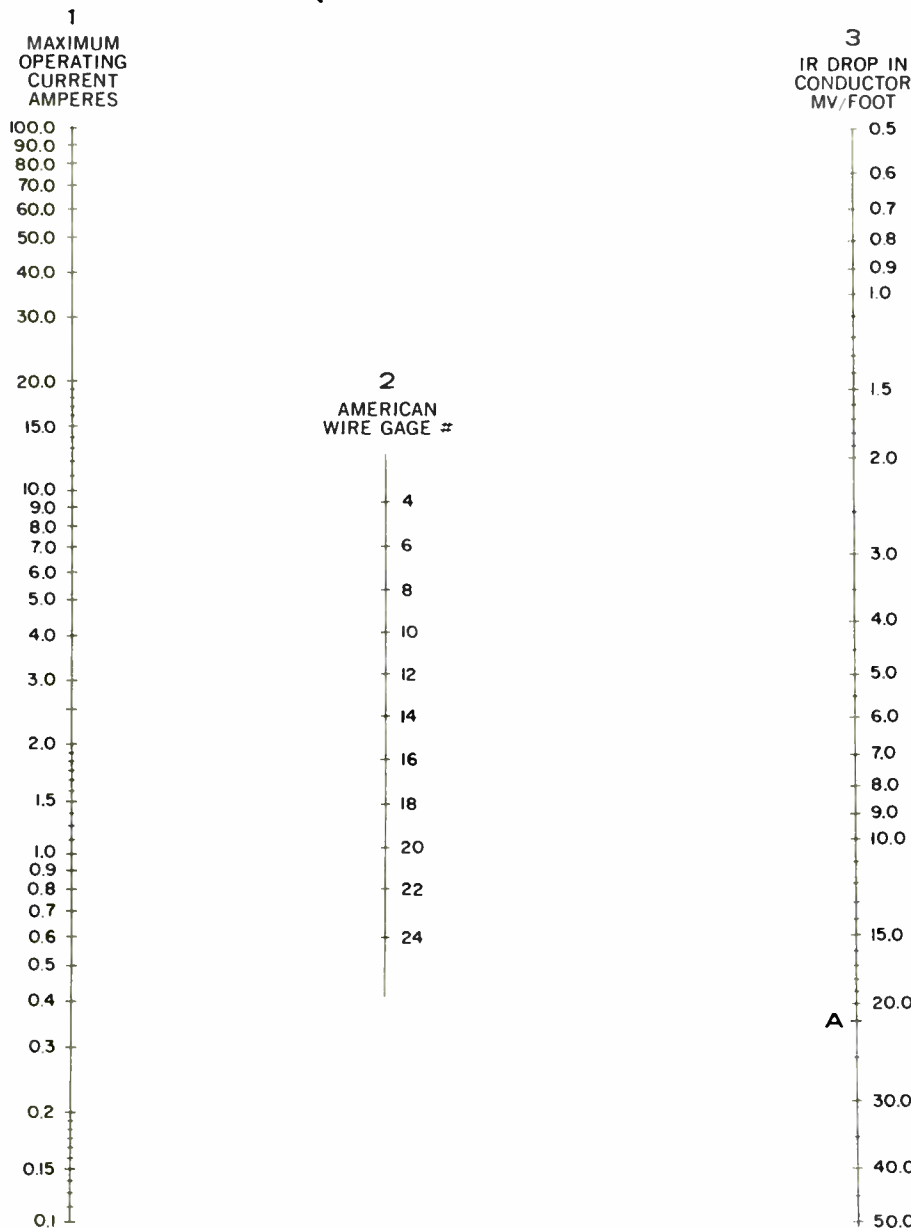

This nomograph  
can be used  
to find:

**A.**

**Maximum current carrying capacity recommended for any standard wire size.**

- 1) With straight edge connect wire size (scale 2) to point "A" (on scale 3).
- 2) Read  $I_{max}$  on scale 1.

**B.**

**Voltage drop in millivolts per foot for known wire size & operating current.**

- 1) With straight edge connect known current (scale 1) & wire size (scale 2).
- 2) Read voltage drop on scale 3.

**C.**

**Wire size required for known operating current & known maximum tolerable voltage drop across supply leads.**

- 1) Determine max. tolerable drop in millivolts per foot of lead (sum of positive & negative leads).
- 2) Connect value on scale 3 as determined in step (1) to known current on scale 1.
- 3) Read wire size on scale 2.

**NOTE:** A voltage regulated Power Supply controls the voltage across its output terminals. Hence the wire conductors used to connect the load must be considered as part of the load. At high load currents the voltage drop across the supply leads may appreciably degrade regulation at the load. (Nomograph courtesy of Kepco, Inc.)



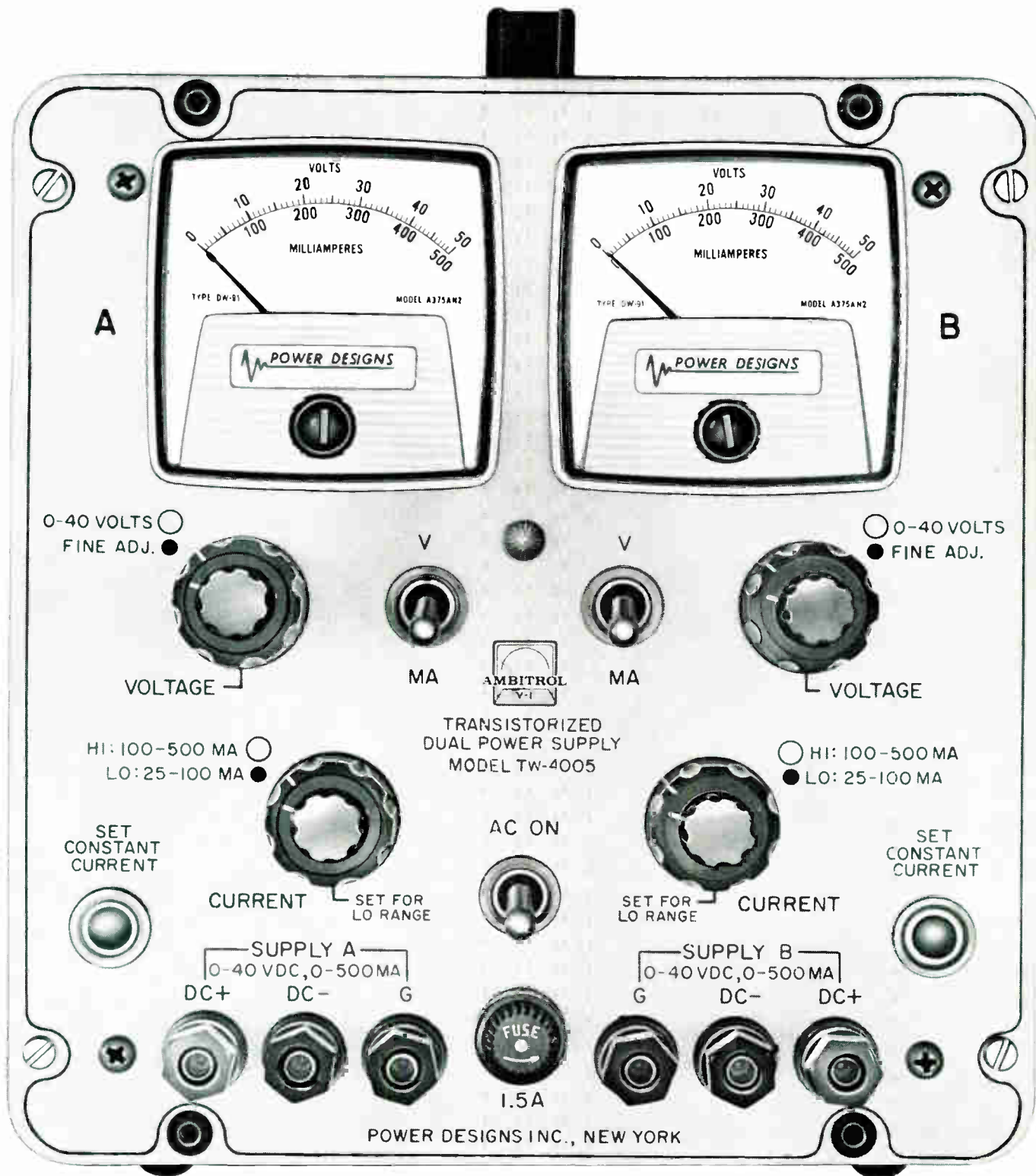

# TWIN POWER

INDEPENDENT · SERIES · PARALLEL

by



**POWER DESIGNS INC.**

1700 Shames Dr., Westbury, L. I., N.Y.

516 EDgewood 3-6200 • TWX: 516 333-5698

## NEW TECH DATA

### POWER SUPPLIES AND COMPONENTS

#### Power Supply

Model M-401, Universal Point Source Power Supply will operate 3 difference point source lamps. The supply features low current ripple, reliable starting and constant power regulation. Pek Labs, Inc., 4024 Transport St., Palo Alto, Calif.

Circle 180 on Inquiry Card

#### Power Supplies

Tech. data is available on 'Environment-Engineered' supplies featuring 0 to 36vdc at 5, 8, 10, 15, and 25a, which are completely protected — adjustable automatic current limiting, continuously variable and remotely programmable. Lambda Electronics Corp., 515 Broad Hollow Rd., Huntington, L. I., N. Y.

Circle 181 on Inquiry Card

#### Power Supplies

This 31-page, 2-colors, contains comprehensive specs, photos, and descriptions on Sorensen's line of: regulated dc, high-voltage dc, and miniature transistorized dc supplies, and line voltage regulators, voltage-regulating transformers, freq. changers, high-voltage ac and dc testers and miniature transistorized inverters and converters. The 1962 Power Supply Catalog is available from Sorensen, unit of Raytheon Co., Richards Ave., S. Norwalk, Conn.

Circle 182 on Inquiry Card

#### Power Rectifiers

Tech. data is available on the 1N1581 to 1N1587 silicon power rectifiers which have output currents to 3adc at 150°C and are available in voltages from 50-600v. The Bendix Corp., Semiconductor Div., Holmdel, N. J.

Circle 183 on Inquiry Card

#### Power Supplies

"Long Form 1962 Catalog on Regulated Power Supplies" is available from Harrison Laboratories, 45 Industrial Rd., Berkeley Heights, N. J. Included is a fold-out chart on 35 models including vacuum tube and semiconductor types with outputs from 0 to 500v and 800v and currents from 0 to 75a. Also featured are high efficiency, Auto-Series and Auto-Parallel operation variable current limit types.

Circle 184 on Inquiry Card

#### Power Supplies

Data on a line of transistorized power supplies with line and load regulation and stability (in 24 hours) at 1% is offered by Power Devices, Inc., 8710 Darby Ave., Northridge, Calif.

Circle 185 on Inquiry Card

#### DC Power Supplies

This 39-page catalog, 2-colors, No. B-621, includes comprehensive information on a variety of power supplies. The transistorized versions feature 0.5, 0.1 and 1% accuracies; the vacuum tube group features 0.1% accuracies; magnetic group features 0.5 and  $\pm 1\%$  accuracies; and the solid state group features  $\pm 1\%$  accuracies. Other information covered includes data on programmable current and voltage regulated power supplies; nomograph of voltage drop vs. wire size and supply current; selection and application of power supplies; and a glossary of power supply terms. Kepco Inc., 131-38 Sanford Ave., Flushing 52, N. Y.

Circle 186 on Inquiry Card

#### Power Supplies

This 30-page, 2-color catalog contains 2 tabbed lead sections, one on transistorized power supplies and one on instruments. Power supplies cover system component, laboratory, bench, high current and programmable power supplies, as well as RMS line voltage regulators. Instrument section covers certified resistance standards, meter calibrators, ultra high resistance bridges and megatimeters. Mid-Eastern Electronics, Springfield, N. J.

Circle 187 on Inquiry Card

#### Power Supplies

Tech. data is available on constant current Current Governors (8 models in a range of 0.1 $\mu$ a to 30adc, with output voltage ranging from 0 to 250v and line and load regulation from 0.002 to 0.1%). Uses include diode aging and life test, diode pIV tests and transistor avalanche testing. North Hills Electronics, Inc., Alexander Place, Glen Cove, N. Y.

Circle 188 on Inquiry Card

#### Power Supplies

Data is offered on the Electro-Pac 'A' line of standby ac power supplies. Six models are offered, giving power outputs from 0.5 to 7.5kva, 60cps, continuous duty. Bulletin 6271 available from Electro-Seal Corp., 938 North Ave., Des Plaines, Ill.

Circle 189 on Inquiry Card

#### Power Supply Catalog

This catalog illustrates Perkin's entire line of dc power supplies. Listings include silicon controlled rectifiers-transistor series regulated TVCR and TVR dc power supplies; MTR magnetic transistor series regulator dc types; MRST line of magnetic amplifier transistor preamplifier type regulated units; and transistorized ac line voltage regulators for laboratory use. Perkin Electronics Corp., 345 Kansas St., El Segundo, Calif.

Circle 190 on Inquiry Card



A  
SARATOGA  
THOROUGHbred

### 10 WATT ZENER VOLTAGE REGULATOR

**Reliability** — assured by 100% load testing, burn-in and curve trace. All units meet the requirements of MIL-S-19500C.

**Availability** — from stock in the IN2973-IN3015 series. (INI808-INI815 and INI351-INI375 series also available from stock).

**Zener Voltages** — from 9.1 to 200 Volts. (5%, 10%, 20% tolerances).

**Military Types (Sig. C)**—IN2974B through IN3007B (20 Volts through 110 volts) per MIL-S-19500C/124 (Sig. C).

For additional information on Saratoga's complete line of voltage regulators, write:



### Saratoga Semiconductor

A Division of Espy Mfg. & Electronics Corp.  
Saratoga Springs, N. Y. • Telephone 4100

Circle 93 on Inquiry Card

## DC Power Supplies

Spec. sheet 2020A describes the Series PV design group of Regatran Semiconductor DC Power Supplies. They use SCR input circuitry, are 100% programmable from 0 to rated max. of 32, 36 or 60v at currents up to 30a. They can be ganged for slaved series or parallel operation. Electronic Measurements Co., Inc., Eatontown, N. J.

Circle 191 on Inquiry Card

## Power Supply Design

"Application Report — DC Regulated Power Supply Design," 27-pages, uses a block-diagram approach to present regulator-design techniques. The characteristics and limitations of the functional elements used in the regulator circuit are explained. Regulator performance is discussed along with some simple test circuits used to measure performance parameters. Texas Instruments Incorporated, P. O. Box 5012, Dallas 22, Tex.

Circle 192 on Inquiry Card

## Power Supplies

This catalog describes the Power Plus line of Silicon Power Supplies. Bulletin No. 701 covers 14 different typical installations, highlighting such features as Non-aging 'Surg-Cap' silicon diode rectification and fail-safe regenerative controls. Richardson - Allen, College Point, N. Y.

Circle 193 on Inquiry Card

## Voltage Regulators

Tech. data is available on the REG-OHM Voltage Regulators. These low-cost units feature stringent dc voltage regulation specifications, ac or dc current regulation capabilities and can be used in ac-dc supplies. Electric Regulator Corp., Pearl St., Norwalk, Conn.

Circle 194 on Inquiry Card

## High-Voltage Equipment

Bulletin GED 4203 contains information on General Electric's high voltage specialty transformer section. Also included with this capabilities brochure, is a Technical Summary of Power Supply Components, including rectifier transformers, filament transformers, filter inductors; a Technical Summary on Transformer Information, including high frequency transformers and power supply transformer components; and a Technical Summary on High Frequency Transformers, which includes pulse transformers, charging inductors, and modulation transformers and inductors. These technical summaries are 17, 15, and 15 pages respectively, and include characteristic curves, schematics, drawings, and specification guides. General Electric Co., High-Voltage Specialty Transformer Section, Holyoke, Mass.



# NEW MYLAR TUBULAR SELENIUM RECTIFIERS . . .

the only new rectifier development in the industry for over a decade that is electrically and mechanically superior to the conventional selenium cartridges.

BRADLEY, the originator of the insulated base Silicon stud rectifier — REDTOPS — achieves another first in design and production. The company's new and revolutionary production technique recently introduced makes the Mylar tubular the lowest cost in the industry — less than \$0.17 per 1000 volts PRV in quantities of 1000 for units of 5kv and up, at 5 ma average dc.

BRADLEY now offers you the most comprehensive line of silicon, selenium, and copper oxide rectifiers and assemblies in the industry. Complete information on selenium and silicon rectifiers available on request.

FOR POWER SUPPLY SPECIALISTS



Your source for . . .  
MIL approved USAF  
1N1199-1N1206 — 12  
amp stud series.

MIL approved REDTOP  
Sig C 1N2153 — 6  
amp 600v.

Availability of REDTOPS from stock . . .  
EAST COAST . . . from Milgray Electronics.  
WEST COAST . . . from Flight Electronics and Wesco Electronics in L.A., and Pacific Wholesale in San Francisco.

FREE Plastics card (2 1/4" x 3 3/8") containing multipliers necessary for obtaining PRV of a single rectifier in 6 circuit configuration under various load conditions from either the a-c RMS input or d-c average volt output.

**BRADLEY SEMICONDUCTOR CORP.**

275 WELTON STREET • NEW HAVEN 11, CONNECTICUT

Rectifier Specialists Since 1939



## NEW TECH DATA

### POWER SUPPLIES and COMPONENTS

#### Power Supplies

A new catalog containing tech. data on standard rack and bench type dc power supplies is available from Anders Electronics, Inc., 640 Memorial Dr., Cambridge 39, Mass. Included are transistorized regulated, unregulated, and instrument type units.

Circle 195 on Inquiry Card

#### Oil-Paper Capacitors

"Large Drawn-Rectangular Case Oil-Paper Capacitors" includes information on Types 170P Mineral-Oil, Type 171P Chlorinol® P, and Type 172P Vitamin Q® impregnated capacitors. Engineering Bulletin No. 2140 includes dimension tables, outline drawings, comprehensive specifications with ratings, and performance characteristics, curves, explanations and descriptions. Sprague Electric Co., Marshall St., No. Adams, Mass.

Circle 196 on Inquiry Card

#### Rectifier PRV Card

A handy plastic pocket card to obtain the Peak Reverse Voltage rating for rectifiers used in doubler, half-wave, full wave-center tap, 1PH, full wave bridge, 3-phase half wave and 3-phase full wave circuits, is offered by Bradley Semiconductor Corp., 275 Welton St., New Haven 11, Conn.

Circle 197 on Inquiry Card

#### Power Transistors

Tech. data is available on 5a and 15a germanium power transistors. These transistors are designed for high-power switching, control and amplifier applications. Bulletin TB 231-2 and 231-3 provide complete data. Clevite Transistor, Waltham 54, Mass.

Circle 198 on Inquiry Card

#### Power Supply

The Model 6VT6C High Voltage Supply features 0.001% regulation (combined line and load) and 0.001% hum & ripple at 50kv and 0.5ma. Output voltage may be continuously varied from 0 to 50kv and resetability is indicated at 0.1% of range. California Magnetic Control Corp., 11922 Valerio St., N. Hollywood, Calif.

Circle 199 on Inquiry Card

#### Zener Diodes

This semiconductor catalog shows a complete listing of glass cased 400mw Zener diodes from USN 1N962B through 1N992B, metal cased 1w Zeners from USN 1N3020B through 1N3051B, and 1a silicon rectifiers from USN 1N3189 through 1N3191 in hermetically sealed welded cases. Also included are Zener reference diodes, regulators, and single and double anode diodes. Complete electrical and mechanical specs. are included. American Semiconductor Corp., 3940 N. Kilpatrick Ave., Chicago 41, Ill.

Circle 200 on Inquiry Card

# CHRISTIE ANNOUNCES

## 100-200-250-400-600 AMP.

# "TRANSIENT FREE"

## D-C POWER SUPPLIES

Dynamic  
Regulation  
± 0.5 volt

Recovery  
Time  
50 Microsec.

Output  
Impedance  
1 Milliohm

Ripple  
1 Millivolt

Some 200 other Power Supply and Battery Charger  
Models in the range of 15 to 1500 amp. Write for catalog.

**CHRISTIE**

**CHRISTIE ELECTRIC CORP.**

Over 30 Years D-C Power Supplies • Battery Chargers

3402T West 67th Street, Los Angeles 43, California

Circle 95 on Inquiry Card

## ONLY PERKIN GIVES YOU THIS CHOICE IN 30A DC POWER SUPPLIES



MODEL TVCR040-30

#### TRUE DYNAMIC REGULATION OF BOTH VOLTAGE AND CURRENT

DC OUTPUT: 0-40v, 30a. STATIC REGULATION: (Line) E ± 0.01% or ± 2mv, I ± 0.02% or ± 3ma; (Load) E ± 0.02% or ± 4mv, I ± 0.05% or ± 7.5ma; DYNAMIC REGULATION: Line ± 50mv for inst. ± 10V line change, Load ± 0.5v for FL change, RIPPLE RMS: E 2mv, I 5ma. RESPONSE: 50μ sec. \$1295.



MODEL TVR040-30

#### VOLTAGE REGULATION WITH ADJUSTABLE CURRENT LIMITING

DC OUTPUT: 0-40v, 0-30a. STATIC REG: Line ± 0.01%, Load ± 0.02%. DYNAMIC REG: Line ± 50mv for inst. ± 10v line changes, Load ± 0.5v for FL change. RIPPLE RMS: 2.0 mv. RESPONSE: 50μ sec. CURRENT LIMITING REGULATION ACCURACY: ± 0.1% or ± 30ma. \$1120.

Only Perkin gives you these two big choices in 30a DC power supplies:

1. A supply that has true voltage regulation *and* current limiting with automatic voltage programming.
2. A supply that has *both* voltage *and* current regulation with automatic voltage *and* current programming.

Both these all-solid state units are transient-free. Both feature current limiting adjustable from 0 amps upwards, series *and* parallel operation, remote sensing, and immunity to short circuits. Off-the-shelf delivery, prepaid in U.S.

Write for complete technical information.

**PERKIN**  
electronics

345 Kansas St., El Segundo, Calif., Spring 2-2171

Circle 96 on Inquiry Card

# FOR PRODUCTION ECONOMY

## CONSIDER TUNG-SOL PRESS-FIT SILICON RECTIFIER ASSEMBLIES

For applications requiring 3 amps to 75 amps, Tung-Sol production techniques can deliver attractively economical, production-ready rectifier assemblies employing press-fit diodes. Availability of rectifiers in both polarities makes it possible to mount more than one diode on a single heat sink, resulting in assemblies that are the lightest weight available for any given power capacity. They lend themselves to compact designs, as the shortest dimension can be mounted in any of three planes. Minimal operating temperatures in the 1-15 amp range, plus surge ratings to 400 amps and PRV ratings to 600V assure maximum circuit protection.

Tung-Sol press-fit diodes have proved highly reliable in a wide variety of applications. They are hermetically sealed, with welded cases and ceramic-to-metal seals. All have protective finishes to withstand moisture and the corrosive conditions present in normal industrial environments.

For more information about Tung-Sol rectifier assemblies, or press-fit diodes for use with your own heat sinks, contact the Tung-Sol regional office nearest you, or write for Bulletin CT-17, Tung-Sol Electric Inc., Newark 4, New Jersey. TWX: NK193.

### TYPICAL CONFIGURATIONS

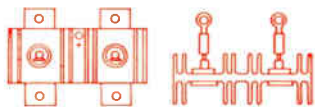

SINGLE PHASE CENTER TAP

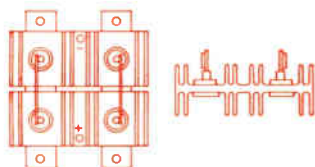

SINGLE PHASE BRIDGE

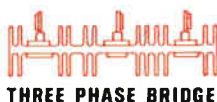
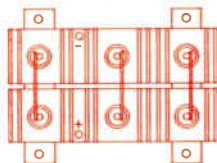

THREE PHASE BRIDGE

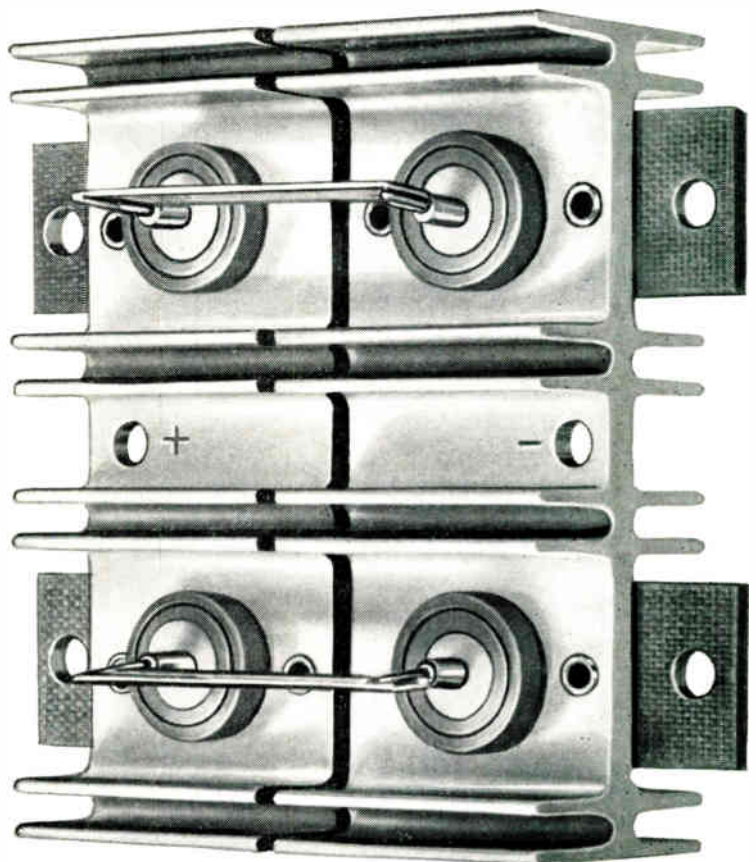

Sales Offices: Atlanta, Ga.; Columbus, Ohio; Culver City, Calif.; Dallas, Tex.; Denver, Colo.; Detroit, Mich.; Melrose Park, Ill.; Newark, N. J.; Seattle, Wash. CANADA: Montreal, Que.; Abbey Electronics, Toronto, Ont.; Prairie Pacific Distributors, Ltd., Edmonton, Alta.

 **TUNG-SOL<sup>®</sup>**

Meet 90% of Your  
D-C Power Needs  
With a Single Unit . . .

**AT A SINGLE UNIT COST!**



## ANDERS NEW OMNI-POWER 40W

### 4 RANGES

0-8V — 0-4A

0-16V — 0-2.5A

0-32V — 0-1.3A

0-50V — 0-9A

**IN 1 UNIT**

**0.05% REGULATION  
1.0 MV RIPPLE**

- BENCH AND RACK MOUNTING
- REMOTE PROGRAMMING
- CONSTANT VOLTAGE
- CONSTANT CURRENT
- SERIES AND PARALLEL OPERATION
- INPUT — 105-125V, 55-65 CPS, 1 PHASE

WRITE FOR COMPLETE  
SPECIFICATIONS AND  
PRICE



A Subsidiary of  
*AirTechnology Corp.*

**ANDERS ELECTRONICS, INC.**

640 MEMORIAL DRIVE, CAMBRIDGE, MASS.

**UNiversity 4-6800**

Circle 99 on Inquiry Card

## NEW TECH DATA

### POWER SUPPLIES AND COMPONENTS

#### Power Supply

Keithley Model 242 delivers 300 to 3,500v at 25ma with 0.1% accuracy and 0.005% line and load regulation. Keithley Instruments, Inc., 12415 Euclid Ave., Cleveland 6, Ohio.

Circle 201 on Inquiry Card

#### Power Supplies

A short-form catalog on modular constructed power supplies featuring a regulation of 0.1% max, 0.05% typical and 0.01% on request, is available from Elasco Inc., 5 Prescott St., Roxbury 19, Mass.

Circle 202 on Inquiry Card

#### Frequency Changers

Electronic Research Associates, Inc., Cedar Grove, N. J., is offering a 5-page Technical Bulletin #39-762-5, covering their MOPA line of Transpac Static Frequency Changers, giving power conversion for 60cps to 400cps or 400cps to 60cps with power ratings up to 500va.

Circle 203 on Inquiry Card

#### Miniature Rectifiers

Tech. data is available on 1/2 silicon rectifiers measuring 0.412 x 0.110 in., which are designed to withstand dip-solder range temps. as high as 300°C. Curves, specs. and dimensional drawings included. Diodes, Inc., 7303 Canoga Ave., Canoga Park, Calif.

Circle 204 on Inquiry Card

#### AC-DC Voltage Calibrator

Model 7065 is a low-cost portable voltage source for use in ac or dc calibration. This unit, with a certificate traceable to NBS, has an accuracy of 0.15% dc reading and 0.2% ac reading. Tensor Electric Development Co., Inc., 1873 Eastern Pkwy., Brooklyn, N. Y.

Circle 205 on Inquiry Card

#### Power Supply

Tech. information is available on the GX 30-5, which delivers 26, 28, and 30vdc from appropriate taps at 5a. Gates Electronic Co., 2243 White Plains Rd., New York, N. Y.

Circle 206 on Inquiry Card

#### Static Inverter

This solid state inverter supplies up to 5kw of ac power from a wide range of dc battery source. Adjustable output freq. ranges from 380 to 2000 cps. Microdot Inc., 220 Pasadena Ave., S. Pasadena, Calif.

Circle 207 on Inquiry Card

#### Power Supplies

Modular, Plug-in, and Rack type power supplies are described in Bulletin 50000, available from Plug-In Instruments, Inc., 1416 Lebanon Rd., Nashville 10, Tenn. Included are packaging hardware, Analog and Digital Plug-in Circuits, power supplies, and instrumentation and control equipment.

Circle 208 on Inquiry Card

#### Converter Transformer

This 4-page, 2-color bulletin on dc to dc and dc to ac converter transformers for three basic types of push-pull converter circuits is available from Polyphase Instrument Co., E. Fourth St., Bridgeport, Pa. Bulletin 101T.

Circle 209 on Inquiry Card

#### Constant Current Source

Tech. information is available on the Model MF11-A constant current source which performs to  $\pm 0.5\%$  absolute accuracy without external voltage limiting devices. The unit is particularly suitable for diode and rectifier forwarding testing. Line Electronics Corp., 9 & 11 Elm St., Saxonville, Mass.

Circle 210 on Inquiry Card

#### Power Supplies

The Kin Tel Absolute DC Power Supplies are essentially high-powered standard cells. Load regulation is  $\pm 0.01\%$ , line regulation is  $\pm 0.002\%$  or 0.5mv, response time is 0.2msec. and output hum and noise is less than 0.5mv. Kintel Div., Cohu Electronics, Inc., 5725 Kearny Villa Rd., San Diego 12, Calif.

Circle 211 on Inquiry Card

#### Static Control Panel

Type 34B28-7 Control Panel is a transistorized static unit designed for use in aircraft brushless ac generator systems. This panel is capable of continuous operation of  $-55^\circ$  to  $+125^\circ\text{C}$  from sea level to 65,000 ft. The Bendix Corp., Red Bank Div., Eatontown, N. J.

Circle 212 on Inquiry Card

#### Corona Effects

The 24-page bulletin includes drawing and data on: Effects of Corona on Performance of Electrical Equipment; Corona Detection and Measurements; and Selection of Corona Test Equipment. Graphs, block diagrams, and photographs included. James G. Biddle Co., 1316 Arch St., Philadelphia 7, Pa.

Circle 213 on Inquiry Card





# How to stop voltage transients and diode failures

Any circuit that is switched can generate high voltage spikes of harmful amplitude to semiconductor devices. Sarkes Tarzian voltage transient suppressors (Klipvolts) offer an economical, efficient solution.

One recurrent problem that suppressors solve is encountered when switching is at the primary of a transformer. Magnetizing currents are interrupted, causing a voltage spike many times the steady state value of secondary voltage. The result is failure of voltage sensitive devices in the circuit.

Transient voltage spikes of very short time duration often

escape detection by instruments of normal sensitivity. Spikes occurring in control circuits where oscillation or "ringing" can occur are also hard to find. These transients can often be the reason for circuit problems that seem to have no obvious cause.

Standard Tarzian suppressors can handle discharge currents as high as 430 amperes (43,000 ampere load current in a three-phase circuit). Special types can be custom-designed for any practical rating. The diagrams shown here represent actual applications in which Klipvolt suppressors have been used. Your circuit is probably well within their wide range of application.

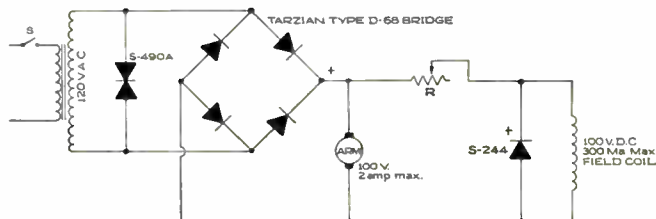

## Transient Voltages in Motor Speed Control Rectifier (Fig. 1)

**Problem:** D-68 bridge rectifier assembly with 400V diodes is used to supply DC to controlled speed DC motor. Switching is accomplished at primary of an isolation transformer. Random switching causes intermittent rectifier failures. Tests show transients to 600V without suppression.

**Solution:** Use S-490A non-polarized Klipvolt across transformer secondary. Use S-244 Klipvolt across the motor field coil to limit transient spikes to less than 150V.

**Result:** Rectifier failure eliminated.

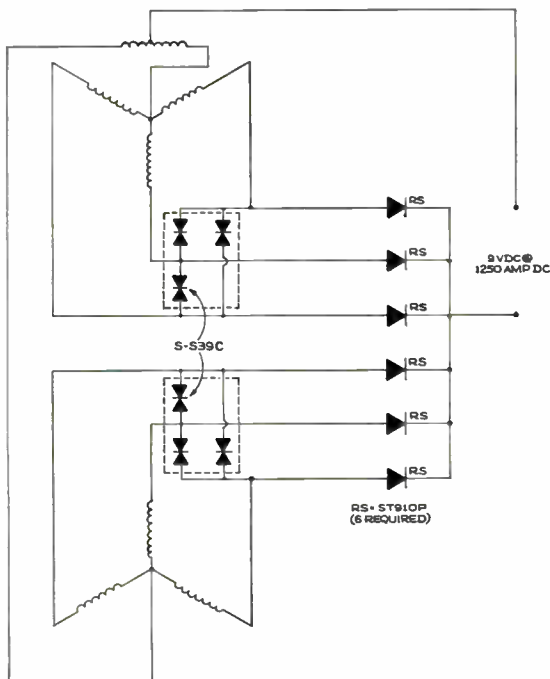

## Voltage Transients in Electroplater (Fig. 2)

**Problem:** Three-phase center tap and six-phase star connections causing transient voltages several times the steady state peak value at the secondary...in excess of 200V.

**Solution:** Connect an S-539C suppressor across the secondary to reduce transients to below 100V. Use 100 PIV rated diodes instead of 300 PIV ratings.

**Result:** Substantial cost saving on heavy current diodes.

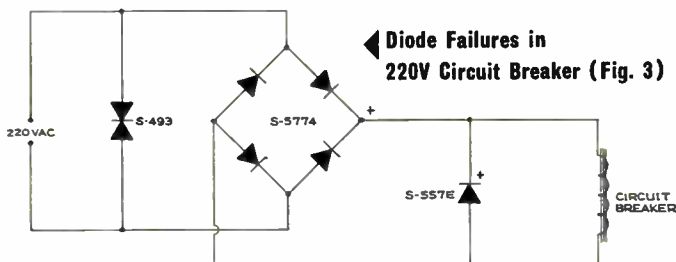

## Diode Failures in 220V Circuit Breaker (Fig. 3)

**Problem:** Failures reported even though all operating parameters are well within the rating of S-5774 rectifier assembly. Laboratory investigation discloses voltage spikes in excess of 3000V, peak to peak, above steady state value...an oscillatory transient set up by the inductance and inter-turn capacity of the circuit breaker.

**Solution:** Use S557E Klipvolt suppressor to dampen the superimposed peak to 35V above steady state values. Place type S-493 Klipvolt across line to protect against random input transient voltages.

**Result:** "Mystery" failures eliminated.

## TYPICAL TARZIAN KLIPVOLT SUPPRESSORS

POLARIZED				NON-POLARIZED			
Type	Max DC Volts	Max PIV	Peak Dischg. Amperes	Type	Max RMS Volts	Max PIV	Peak Dischg. Amperes
S-550	27	45	5.5	<b>Single Phase</b>			
S-550L	27	45	430	S-487	35	50	2.5
S-554	135	225	5.5	S-490A	140	200	4.5
S-554L	135	225	430	S-492L	210	300	180
S-556	189	315	5.5	S-493	400	280	2.5
S-556L	189	315	430	<b>Three Phase</b>			
S-557E	216	360	65	S-539C	50	35	13.5
				S-544L	210	300	180



## SARKES TARZIAN, Inc.

World's Leading Manufacturers of TV and FM Tuners • Closed Circuit TV Systems • Broadcast Equipment • Air Trimmers • FM Radios • Magnetic Recording Tape • Semiconductor Devices

SEMICONDUCTOR DIVISION • BLOOMINGTON, INDIANA

Canadian Licensee: Marsland Engineering Limited • 350 Weber Street North, Waterloo, Ontario

## Weldable Strain Gage

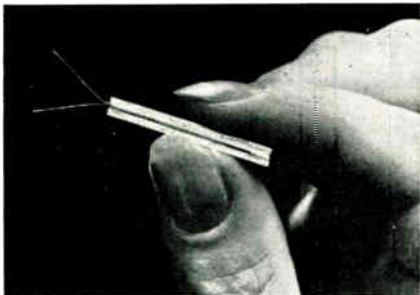

Precise, rugged gage is capable of continuous operation at 750°F and dynamic test to 1500°F. These gages employ one-piece etched wire filaments in swaged stainless steel tubes, and are suitable for use from cryogenic to elevated temperatures. They are also available with inherent temperature compensation (no dummy gages required). Easy installation through the use of stored-energy welding equipment eliminates complicated bonding and curing processes. Also available in integral lead strain gage versions.

Circle 101 on Inquiry Card

## Force Measuring Transducers



These rugged, ring-configuration load cells measure both tension and compression loads at high temperatures over a full scale range of 100 to 500,000 lbs. They can withstand considerable overload without destroying calibration and have been successfully used in radiation environments. Sensing is performed by resistance-type, high temperature welded strain gages in bridge configuration within a ring. Total all-cause error is within  $\pm 1\%$  over a temperature range of  $-300^\circ\text{F}$  to  $+750^\circ\text{F}$ . Units can be provided sealed.

### MICRODOT INC.



220 Pasadena Ave.  
South Pasadena, Calif.

Circle 102 on Inquiry Card

## NEW TECH DATA

### Space Craft Evaluation

"Physical Simulation Engineering," 31-pages, illustrated, describes the facilities of General Electric's Valley Forge Space Technology Center for evaluating attitude control systems in space craft. General Electric Co., Valley Forge Space Technology Center, P. O. Box 8555, Philadelphia 1, Pa.

Circle 214 on Inquiry Card

### Cam Layout Scale

Commercial Cam & Machine Co., 400 N. Ashland Ave., Chicago 22, Ill. is offering a plastic 'Cam Layout Scale' for laying-out 4 different cam motions as explained in the instructions on the scale.

Circle 215 on Inquiry Card

### Infrared Terminology

This 2-page "Glossary of Infrared Detector Terminology" defines the most common terms encountered in working with infrared detectors and bolometers, as well as infrared system and sub-system design. Included are formulae from which basic parameters are derived. Servo Corp. of America, 111 New South Rd., Hicksville, L. I., N. Y.

Circle 216 on Inquiry Card

### Thin-Film Microcircuits

Advantages and the construction of thin-film microcircuits are described in a 4-page bulletin available from Halex, Inc., P. O. Box 546, El Segundo, Calif. Illustrations of current production applications are included.

Circle 217 on Inquiry Card

### Silicone Encapsulant

Tech. information is available on Dow Corning 304 which is a silicon molding compound designed specifically for encapsulating diodes and transistors. Dow Corning Corp., Midland, Mich.

Circle 218 on Inquiry Card

### Servo Components Catalog

This catalog, 116 pages is divided into 4 sections: Instrument Servomotors (1 through 20w output), Power Servomotors (25 through 750w output), Resolvers and Phase Shifters, and Servo Amplifiers. Accessory components, such as tachometers, gear reductions, modulators and power supplies, are also included. Comprehensive specifications are included. Diehl Mfg. Co., Somerville, N. J.

Circle 219 on Inquiry Card

### Hall Generators

A complete line of HALLEFEX solid state voltage generators is described in tech. data available from Helipot Div. of Beckman Instruments, Inc., 2500 Harbor Blvd., Fullerton, Calif. The publication contains details on miniature thin-film Hall effect voltage generators with indium antimonide and indium arsenide elements.

Circle 220 on Inquiry Card

### Recreation

A new edition of very interesting and enjoyable "Problematical Recreations" is available from Problematical Recreations, Litton Industries, 336 No. Foothill Rd., Beverly Hills, Calif.

Circle 221 on Inquiry Card

### TV Tower

An "action" brochure is available on the tallest (1749-ft.) television tower now standing. Information covers designs and descriptions of this tower which supports a 245 ft. antenna assembly weighing 10 tons. Stainless, Inc., North Wales, Pa.

Circle 222 on Inquiry Card

### Radiated Magnetic Tape

"The Effects of Nuclear Radiation on Magnetic Tape" includes data on neutron damage, beta and gamma dosage, dosage effects on magnetic properties and dosage effects on physical properties. Magnetic Products Div., Minnesota Mining and Manufacturing Co., 2501 Hudson Rd., St. Paul 19 Minn.

Circle 223 on Inquiry Card

### Mercury Batteries

"Mallory Product Guide," 27 pages, 2 colors, contains information on mercury batteries, mercury voltage reference batteries, buzzers, ceramic and tantalum capacitors, diodes, jacks and plugs, microelectronics, potentiometers, silicon rectifiers, resistance welding electrodes, sensing and switching devices, and interval timers. P. R. Mallory & Co., Indianapolis, Ind.

Circle 224 on Inquiry Card

### Protective Spray

Information is available from Quelcor, Inc., 670 W. Washington St., Norristown, Pa., on its aerosol vinyl spray, a moisture, salt spray and chemical splash protective coating.

Circle 225 on Inquiry Card

### Component Lead Table

"Impulse Bonding Data" is a reference table listing typical physical, mechanical and chemical properties of 39 common lead materials. Illustrated are some factors in determining proper heat balance relationships in impulse welding. Write under company letterhead to Weldamatic Div., Unitek Corp., 952 Royal Oaks Dr., Monrovia, Calif.

Circle 226 on Inquiry Card

### Wing Nuts

This 8-page, 3-color catalog illustrates and describes standard and special low cost versions of stamped and pressed wing nuts. Charts and diagrams show wing spread, wing height, wing base, stock thickness, thread sizes suitable for manufacture in both steel and brass, and weights/1000 pieces. Central Screw Co., 3501 S. Shields Ave., Chicago 9, Ill.

Circle 227 on Inquiry Card

**TRW  
Electronics**



# NEW HIGH TEMPERATURE HIGH VOLTAGE SILICON RECTIFIERS

- INCREASED CURRENT HANDLING CAPABILITIES
- OPERATION TO 200°C ■ IMPROVED REVERSE LEAKAGE

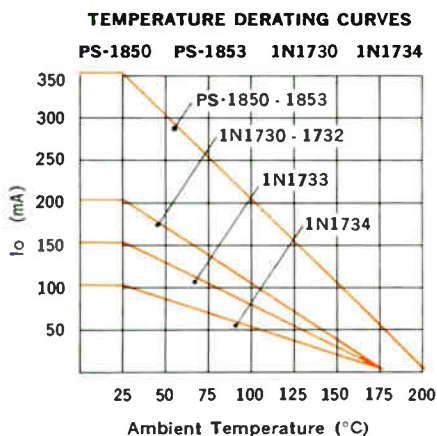

As demonstrated by the derating curve, the new PS-1850 high-voltage, high-current silicon rectifier series offers outstanding performance characteristics over a wide range of temperature and environmental conditions.

Direct replacements to the popular 1N1730-1N1734 series, the PS-1850-PS-1853 series exhibits increased current handling capabilities of 350 mA at 25°C and are substantially smaller in size. At 175°C, these new devices handle 50 mA.

Featuring no voltage derating to 200°C, and an operating and storage temperature range of -65° to +200°C, these all-welded units provide reverse leakage and forward voltage drop characteristics which are greatly improved over previously available types.

TRW Electronics rectifiers are packaged in a non-metallic case providing a dielectric strength of 400 volts/mil, and a resistivity greater than 10<sup>14</sup> ohm-cm. Mounting of these light-weight rectifiers is greatly simplified due to the electrically "cold" case. These new devices exceed the most stringent military environmental tests including shock, vibration, and moisture resistance (MIL-S-19500).

The PS-1850 high-voltage, high-current series is immediately available through leading electronic distributors coast to coast.



Circle 144 on Inquiry Card

PSI Type Number	MAXIMUM RATINGS										
	Peak and Continuous Inverse Voltage -62°C to +200°C (Vdc)	RMS Input Voltage (Vrms)	dc Reverse current at Rated PIV (μA)		dc Reverse current at 90% of PIV at 25°C (μA)	Average Rectified Current (I <sub>a</sub> ) (mA)			Forward Voltage at 400 mAdc (Vdc)	Dimensions (inches)	
			25°C	150°C		25°C	100°C	175°C		L	D
PS-1850	2000	1400	1.0	12	0.1	350	200	50	3	.500	.375
PS-1851	4000	2800	1.0	12	0.1	350	200	50	6	.900	.375
PS-1852	5000	3500	1.0	12	0.1	350	200	50	8	1.000	.500
PS-1853	6000	4200	1.0	12	0.1	350	200	50	9	1.300	.375



**TRW Electronics**

**Pacific Semiconductors, Inc.**

© SUBSIDIARIES OF THOMPSON RAMO WOOLDRIDGE INC.

Aerospace Center, 650 N. Sepulveda Blvd., El Segundo, Calif. Phone: EA 2-6500. SP 2-3321, TWX: 213-322-6936

World Radio History





WX118

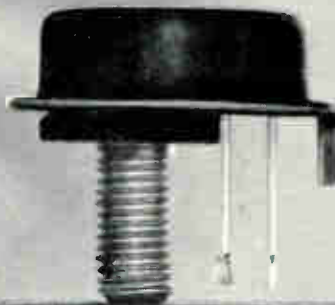

2N1015-2N1016



2N1809

# Look to Westinghouse for Silicon Power Transistors with lowest saturation resistance

**LSR<sup>\*</sup> = .037** Lowest saturation resistance ratings in the industry enable design engineers to obtain three-fold increases in power-handling capability. Now—with these higher performance specifications you can replace germanium units and gain the silicon power transistor advantages of reduced heat sink size . . . higher allowable ambient . . . improved control range . . . and upgraded reliability in almost all circuits.

	I <sub>c</sub>	V <sub>CE</sub>	Typical R <sub>CE (SAT)</sub>
2N1809-2N2109 series	30 A	50-200V	.037
2N1015-2N1016 series	7.5 A	30-200V	.25
WX118 series	10 A	50-150V	.22

\*Lowest Saturation Resistance

**2N1809-2N2109 series. New 30-amp "Rock-Top" transistors . . . world's most powerful!** With 30-amp, 200-volt, 250-watt ratings these newest Westinghouse series 2N1809 and 2N2109 transistors are designed to meet the most exacting high power applications. Germanium-level saturation resistance (.037 ohms), and freedom from secondary breakdown mean highest efficiency and operating reliability.

**WX118 series. World's highest gain power transistors provide current gain of 400 at 10 amps!** New Westinghouse Type WX118 high-gain silicon transistors simplify circuitry, increase reliability, reduce cost of assembly. They're ideal for application in high power, high efficiency regulators, inverters and switching circuits. Saturation resistance is only 0.22 ohms.

**2N1015-2N1016 series. Highest reliability from production-proved 150 watt designs.** Get maximum circuit reliability at no extra cost by specifying the Westinghouse 2N1015-2N1016 series. These popular transistors have

been field-proven in thousands of operating equipments. They can replace lower rated transistors (2N1489-2N1490, 2N1069-2N1070, 2N389 and others), and give you up to twice-the-power derating margin. In addition to the exclusive rating characteristics of these transistors, you get greater assurance of performance reliability from:

- **True voltage ratings.** Westinghouse transistors can be operated continuously at their full published ratings into highly inductive loads. True Voltage Ratings are verified by 100% Power Testing.
- **100% Power Testing.** Each Westinghouse transistor is 100% Power Tested before leaving the plant. Tests are conducted over the full operating range—under all conditions of base bias and collector current at maximum rated dissipation.

For more information or technical assistance, see your nearest Westinghouse representative or write: Westinghouse Electric Corporation, Semiconductor Department, Youngwood, Penna. You can be sure . . . if it's Westinghouse. SC-1054

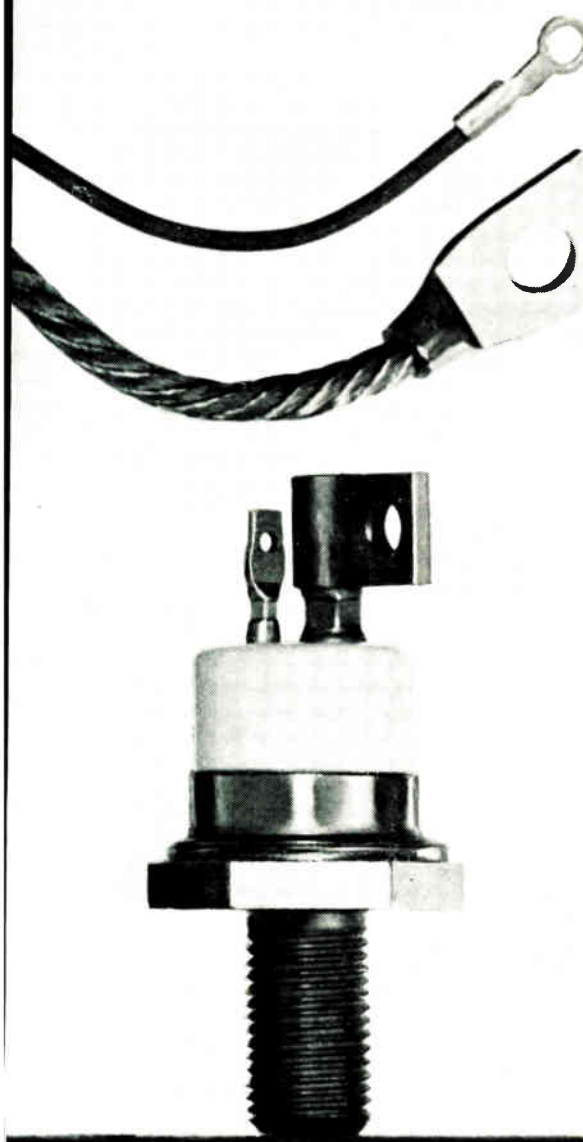

2N2109

## FDR IMMEDIATE "OFF-THE-SHELF" DELIVERY, ORDER FROM THESE WESTINGHOUSE DISTRIBUTORS:

### EASTERN

ACK SEMICONDUCTORS, INC. Birmingham, Ala./FA 2-0588  
 CAMERADID Pittsburgh, Pa./EX 1-4000  
 CRAMER ELECTRONICS, INC. Newton, Mass./WD 9-7700  
 Hamden, Conn./AT 8-3581  
 Newport, R. I./VI 7-8547  
 EASTERN SEMICONDUCTOR SALES, INC. Syracuse, N.Y./GR 8-0903  
 ELECTRONIC WHOLESALERS, INC. Melbourne, Fla./PA 3-1441  
 GENERAL RADIO SUPPLY CO., INC. Camden, N. J./WO 4-8560  
 GENESEE RADIO & PARTS CO. Buffalo, N.Y./TR 3-9661  
 KANN-ELLERT ELECTRONICS, INC. Baltimore, Md./TU 9-4242  
 MILGRAY ELECTRONICS New York, N.Y./YU 9-1600

RADIO & ELECTRONIC PARTS CO. Cleveland, Ohio/UT 1-6060  
 SCHWEBER ELECTRONICS Mineola, N.Y./PI 6-5220  
 Silver Spring, Md./JU 5-7023

### MIDWESTERN

E.C.I. SEMICONDUCTORS, INC. Kansas City, Mo./WE 1-0829  
 ELECTRONIC COMPONENTS FOR INDUSTRY CO. St. Louis, Mo./MI 7-5505  
 HALL-MARK ELECTRONICS CORP. Dallas, Texas/TA 4-1648  
 INTER-STATE RADIO & SUPPLY CO. Denver, Colo./TA 5-8257  
 LENERT CO. Houston, Texas/CA 4-2663  
 MIDLAND SPECIALTY CO. El Paso, Texas/KE 3-9555  
 Phoenix, Ariz./AL 8-8254  
 Albuquerque, N. M./CH 7-0236

RADIO DISTRIBUTING CO. Indianapolis, Ind./ME 7-5571  
 SEMICONDUCTOR SPECIALISTS, INC. Chicago, Ill./NA 2-8860  
 UNITED RADID, INC. Cincinnati, Ohio/MA 1-6530

### WESTERN

ALMAC ELECTRONICS CORP. Seattle, Wash./PA 3-7310  
 DENNY-HAMILTON ELECTRONICS San Diego, Calif./AC 4-3451  
 ELMAR ELECTRONICS Oakland, Calif./TE 4-3311  
 HAMILTON ELECTRO SALES Los Angeles, Calif./BR 2-9154  
 Palo Alto, Calif./DA 1-7541  
 Phoenix, Ariz./272-2601  
 NEWARK ELECTRONICS CO. Inglewood, Calif./OR 4-8440

### CANADA

CANADIAN WESTINGHOUSE CO., LTD. Hamilton, Ontario/JA 8-8811

Circle 104 on Inquiry Card

# Westinghouse



**MOST OF  
THE BEST  
TOROIDS  
ARE WOUND  
ON  
BOESCH  
MACHINES**

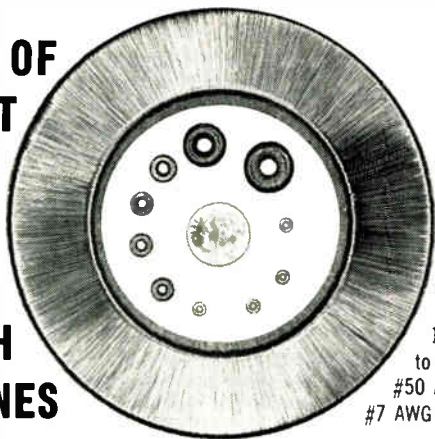

From  
1/32" I. D.  
to 14" O. D.  
#50 AWG to  
#7 AWG wire

**BECAUSE 1.** BOESCH MACHINES ARE RUGGED PRODUCTION WORKHORSES . . . providing continuous high production outputs with a minimum of downtime.

**2.** BOESCH MACHINES ARE EXTREMELY FLEXIBLE . . . each machine is designed to accommodate a wide range of product requirements and operating conditions.

**3.** BOESCH OFFERS THE LATEST AND MOST COMPLETE LINE OF TOROIDAL COIL WINDING EQUIPMENT AVAILABLE.

**4.** BOESCH MAINTAINS A COMPLETE WINDING LABORATORY SERVICE TO HELP CUSTOMERS EXPERIMENT WITH NEW CORES AND DEVELOP EFFICIENT METHODS.

Write For Complete Information

**BOESCH MANUFACTURING DIVISION**

WALTHAM PRECISION INSTRUMENT COMPANY, INC.

OANBURY, CONNECTICUT / Telephone: Pioneer 3-3886 / Teletype: OANB 468

Circle 105 on Inquiry Card



## NEW TECH DATA

### Transistor Replacement

A radio transistor replacement guide is available from General Electric Co., 3800 N. Milwaukee Ave., Chicago, Ill. This 17 x 22 in. wall chart (ETR-3345) cross-references GE's 8 basic "universal" replacement transistors with 1,128 types of commonly used transistors.

Circle 228 on Inquiry Card

### Thermistors

This 16-page booklet on Negative Temp. Coefficient Resistors (Thermistors) is available from Ferroxcube Corp. of America, Saugerties, N. Y. Applications of NTC's are discussed in detail, along with fact for determining requirements for selecting the right type and value. Diagrams and graphs are included.

Circle 229 on Inquiry Card

### Identification Tapes

Dymo vinyl embossing tapes are available in rolls 12 ft. x 1/2 in., with pressure-sensitive adhesive backs. All standard roll plastic tapes of high gloss finish for resistance to dirt, moisture, most acids, oil and grease. A variety of different colors are available. Information also includes photographs and specifications on tape writer units and accessories. Dymo Industries, Inc., Berkeley, Calif.

Circle 230 on Inquiry Card

### CCTV Systems

This 28-page catalog gives details of the basic Fairbanks Morse/EMI closed circuit television system including specs, monitors, lenses and optional accessories. Applications chart covers 76 uses. Fairbanks, Morse & Co., Electronics Div., 100 Electra Lane, Yonkers, N. Y.

Circle 231 on Inquiry Card

### Vibration Control

"Index to Lord Library on Vibration Control" lists 23 authoritative technical articles on vibration control. Bulletin No. D-103 is a guide to recently published material now on file in the library. Lord Mfg. Co., Erie, Pa.

Circle 232 on Inquiry Card

### Styrene Sheet Calculator

White high impact styrene sheet in all commonly used gauges to 0.250 in. is described in a brochure available from Baum Chemical Corp., 625 Nash St., El Segundo, Calif. An Impact Styrene Sheet Calculator is also offered.

Circle 233 on Inquiry Card

### Optical Shaft Encoders

Tech. data is available on 3C Dicotron Optical Shaft Encoders, which use the technique of placing more slits on more densely packed encoder tracks to increase the light factor. Computer Control Co., Inc., Old Connecticut Path, Framingham, Conn.

Circle 234 on Inquiry Card

## A NEW TERMINAL BLOCK

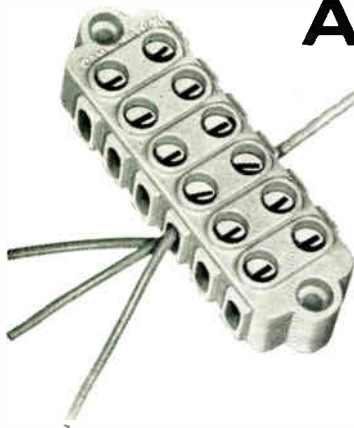

**NO LUGS      NO SOLDER  
NO SCREWS  
NO LOOSE PARTS  
NO SPECIAL TOOLS  
NO BREAKAGE  
NO PROBLEMS**

**JUST BETTER CONNECTIONS  
MECHANICALLY and ELECTRICALLY**

Shock, vibration, current carrying capacity, dielectric properties of Camblock terminal blocks are superior. Cam action reduces wiring time and saves you money.

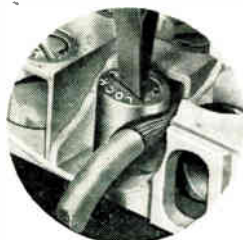

**CAMBLOCK**  
DIVISION



WALTHAM PRECISION INSTRUMENT  
COMPANY, INC.

221 CRESCENT STREET, WALTHAM 54, MASS.  
Tel: TWInbrook 3-4000 TWX: WALTH 1183-X

Circle 106 on Inquiry Card





## WHAT DOES THE LITTLE WHITE DISC DO?

### THIS IS WHAT IT IS AND WHAT IT DOES:

It's high density alumina ceramic—now available as a standard item on all Hughes "Golden Line" stud-mounted power rectifiers.

It provides maximum leakage of 1  $\mu\text{A}$  at 2,000  $V_{\text{DC}}$  at sea level!

It can be operated at 1,200  $V_{\text{RMS}}$  at 70,000 feet.

It provides over 40% more thermal conductivity than mica washers.

It eliminates the need to buy reverse polarity units.

It ends costly inventory confusion and assembly mistakes.

It eliminates the tedious, time-consuming assembly of teflon and mica washers, and connecting lugs.

Ask for the new Hughes HF series (1 to 30 amps) "Golden Line" silicon power rectifiers *with a typical recovery time of 0.08  $\mu\text{sec}$ .*

Insulated bases are available on DO-4 and DO-5 packages.

For more details—and your copy of the new Hughes 6-page rectifier brochure (C-22)—call your nearest Hughes representative; or write Hughes Semiconductor Division, Marketing Department, Newport Beach, California. For export, write Hughes International, Culver City, California.



Creating a new world with Electronics

**HUGHES**

HUGHES AIRCRAFT COMPANY  
SEMICONDUCTOR DIVISION

DIODES • TRANSISTORS • RECTIFIERS • PACKAGED ASSEMBLIES • CRYSTAL FILTERS



## It stands alone

You can't buy HYDRAZINE-ACTIVATED FLUX\* or Core Solder under any other brand name. Fairmount is the sole producer.

Hydrazine-Activated Flux and Core Solder offers an exclusive combination of advantages:

- High wetting properties for good "bite."
- Non-corrosive connections.
- Residues removed by heating or water rinse.
- No change on aging.

These performance characteristics were confirmed in a recent evaluation of leading fluxes used in the fields of printed wiring and etched circuitry.

No one flux is best for all purposes. TEST HYDRAZINE FLUX AND CORE SOLDER FOR YOURSELF. The liquid permits pre-fluxing, is useful for soft-soldering a wide range of copper and copper-based alloys. The core solder flows at an ideal rate, leaves a minimum of soldering residues. Write for samples of either, or technical literature.

\*U.S. Patent No. 2,612,459 and others

Available only from Fairmount and its sales agents.

**Fairmount**  
CHEMICAL CO., INC.  
136 Liberty St., N. Y. 6, N. Y.

Circle 108 on Inquiry Card



thin wall

## Silicone Rubber Sleeving

Space-saving thin wall construction and precision ID dimensions make Varglas Silicone Rubber Sleevings the best answer for miniaturization. Highly flexible with dielectric strength up to 8,000 volts, Varglas resists deterioration, cracking, crazing, and "cut through" in temperature from minus 70° to plus 400° F. Meets government specification MIL-I-18057A.

A complete range of sizes from .010" to 3" ID, in brilliant, non-fading colors for instant coding identification. Comes in coils, spools or 36" lengths for off-the-shelf delivery. Of course, Vargflex engineers are always ready to work with you at any time to develop the special sleevings and tubings you need for your applications. No obligation or charge for this cooperation.

- Write for free folder containing test samples

**Vargflex**

"Never satisfied until you are"

VARFLEX SALES CO., INC. • 308 N. Jay St., Rome, N. Y.

Circle 110 on Inquiry Card

# FREE SAMPLES!

## PLASTIC CLAMPS

TEST 'EM AT OUR EXPENSE - SEE WHY THERE ARE MILLIONS IN USE!

Available in . . .

- Nylon • Saran
- Ethyl Cellulose
- Polypropylene

1/8" to 3" in 61 Stock Sizes

MAIL IT TODAY!

SEND SAMPLES OF PLASTIC CLAMPS

NAME \_\_\_\_\_

FIRM \_\_\_\_\_

STREET \_\_\_\_\_

CITY \_\_\_\_\_ STATE \_\_\_\_\_



FOR GROUP WIRE

FOR SINGLE WIRE

FOR FLAT TWIN LEAD-IN



**HOLUB INDUSTRIES, Inc.**

448 Elm St., Sycamore, Ill.

Circle 109 on Inquiry Card

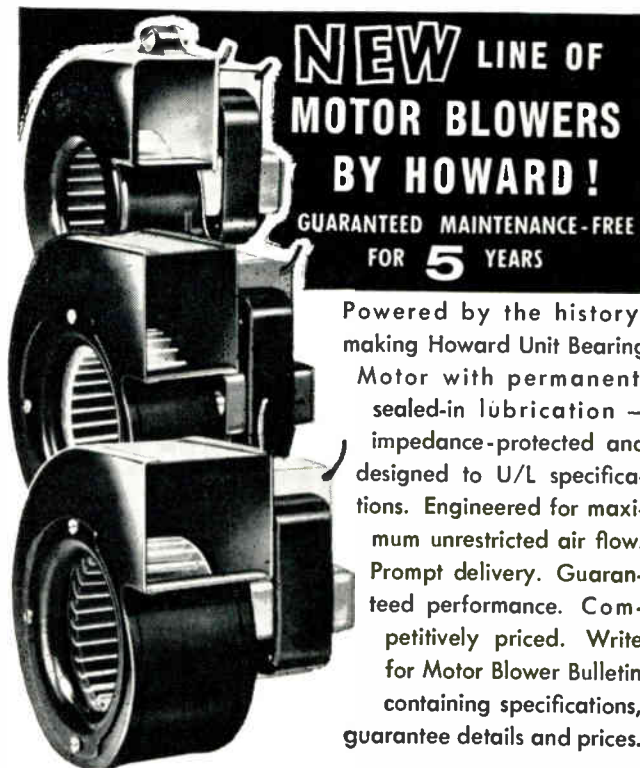

## NEW LINE OF MOTOR BLOWERS BY HOWARD!

GUARANTEED MAINTENANCE-FREE FOR 5 YEARS

Powered by the history-making Howard Unit Bearing Motor with permanent, sealed-in lubrication — impedance-protected and designed to U/L specifications. Engineered for maximum unrestricted air flow. Prompt delivery. Guaranteed performance. Competitively priced. Write for Motor Blower Bulletin containing specifications, guarantee details and prices.

POWERED BY

**HOWARD**

**HOWARD INDUSTRIES, INC.**  
1730 STATE ST., RACINE, WISCONSIN

Divisions:

Electric Motor Corp., Cyclohm Motor Corp., Racine Electric Prods., Loyd Scruggs Co.

Circle 111 on Inquiry Card



## NEW TECH DATA

### Load Cell Terminology

The Industrial Instrument Load Cell Committee of the Scientific Apparatus Makers Assoc (SAMA) is offering recommended terminology definitions for use by manufacturers and users to clarify the meaning of load cell specifications. SAMA Industrial Instrument Section, 20 N. Wacker Drive, Room 2018, Chicago 6, Ill.

Circle 235 on Inquiry Card

### Transistor Transformers

This 40-page catalog of transformers and related components for military and commercial use is offered by Stancor Electronics, Inc., 3501 W. Addison St., Chicago 18, Ill. Catalog CS-102, 2 colors, lists detailed electrical and physical specs., including performance curves where applicable, on almost 900 transformers for military and commercial applications. New types (56) for transistor and rectifier circuits are included.

Circle 236 on Inquiry Card

### Seal Sketchbook

"Engineer's Sketchbook" describes Parker Sel Company's Gask-O-Seal. Besides giving a factual discussion of the product with comprehensive engineering data and details, this book also contains some very illuminating and monotony-breaking doodles. This 16-page book is available from Parker Seal Co., 10567 Jefferson Blvd., Culver City, Calif.

Circle 237 on Inquiry Card

### Resistor Noise Screening

"Current Noise Level: New Reliability-Screening Technique for Corning Metal-oxide Film Resistors" includes data on the relationship between current noise and electrical performance in metal-oxide film resistors. The 4 charts show correlations of current noise with temp. coefficient and life performance for precision and general purpose type resistors. Corning Glass Works, Corning Electronic Components, Raleigh, N. C.

Circle 238 on Inquiry Card

### Insulation Testing

"The Testing Challenge" gives details of methods whereby non-destructive dc insulation leakage current measurements and dc breakdown tests eliminate the need for ac breakdown tests which often damage the device under test. Associated Research, Inc., 3777 W. Belmont Ave., Chicago 18, Ill.

Circle 239 on Inquiry Card

### Wire and Cable Selector

This 4-page bulletin describes the selection of proper high temp. wire or cable for electronic circuitry. The chart covers both primary and jacket insulation of Teflon® insulated single and multi-conducted cables, coaxial cables, airframe wire, hookup wire, silicone rubber fixture wire, magnet wire, and 1000°F MGT wire. American Super-Temperature Wires, Inc., W. Canal St., Sinooski, Vt.

Circle 240 on Inquiry Card

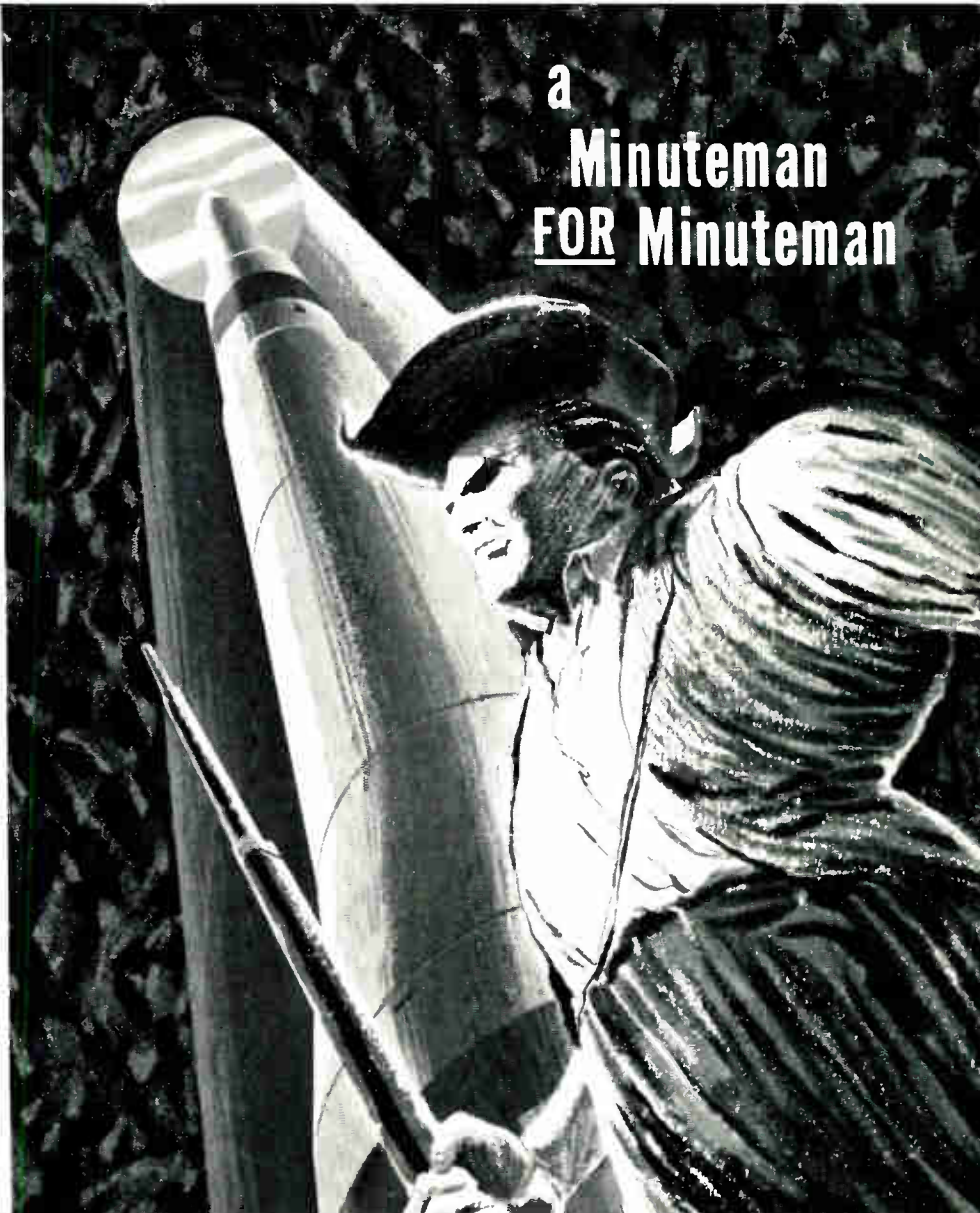

## a Minuteman FOR Minuteman

Guarding the Air Force's Minuteman against accidental or deliberate firing by unauthorized persons. This will be one of the functions of an improved ground electronics command and control system being developed by SES—Central and her sister SES facilities. This recently acquired prime contract, awarded by the Air Force Ballistic Systems Division, will provide continuous control of the unmanned missile sites, will monitor the operational readiness of the missiles, and if needed, transmit firing orders and target information.

*CONTRIBUTORS URGENTLY NEEDED to man this and other recently-acquired command and control systems projects in the aerospace, surface and sub-surface communications/navigation fields. Candidates should have BSEE or equivalent with backgrounds in one or more of the following: solid state design, digital communications and/or wideband techniques. We are located ten miles northeast of Buffalo in the picturesque suburban village of Williamsville.*

**SYLVANIA ELECTRONIC SYSTEMS**  
Government Systems Management  
for **GENERAL TELEPHONE & ELECTRONICS**



*Please send resume in confidence to  
Robert E. Artman*

**SYLVANIA ELECTRONIC SYSTEMS—CENTRAL**  
1179 Wehrle Drive Williamsville, N. Y.

**An Equal Opportunity Employer**





**SAVE  
MONEY  
WITH  
AUTOMATIC  
TESTING\***

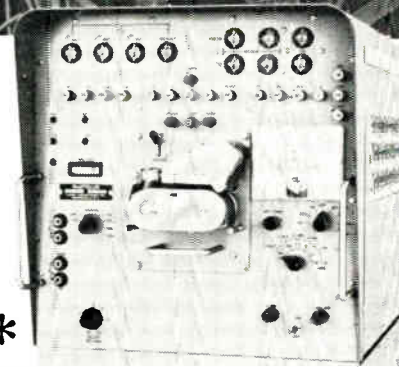

Model LA 303

**\*More than one test per second with unskilled labor saves over 50% of cost!**

Lavoie's Robotester provides rapid and reliable automatic checkout of components, assemblies and systems. Fully programmable by punched tape, the Robotester eliminates human error and releases highly specialized technicians for other critical tasks.

Unsurpassed versatility through pre-programmed tape insures adaptability throughout the production line.

**Tests:**

Resistances  
Insulation resistances  
AC and DC volts  
Capacitive and  
inductive reactance  
Complex impedance

**Features:**

Low cost  
Small physical size  
Better service and reliability  
Easy to program  
Go-No-Go testing  
Permanent printed test record  
Self-checking and fail safe

Let us show you how Robotester can serve you.

*Lavoie Laboratories, Inc.*

MORGANVILLE, NEW JERSEY • LOWell 6-2600 • TWX MWN-1250

Since 1939, one of America's leading manufacturers and designers of: Oscilloscopes, Spectrum Analyzers, Frequency Standards, Frequency Comparators, Pulse Generators, Digital Counters, Automatic Test Equipment.

## NEW TECH DATA

### Filter Applications

"Filter Applications Review" briefly summarizes electric wave filter applications in circuits and systems. The information is a review of recent and past literature and field applications. Write under company letterhead to TT Electronics, Inc., P. O. Box 180, Culver City, Calif.

Circle 241 on Inquiry Card

### Toroidal Cores

The subminiature G63 Series, Genalex Toroidal Core is described in tech. data available from Comolly & Co., Inc., P.O. Box 295, Menlo Park, Calif. The core has an O.D. of 0.310 in., an I.D. of 0.156 in. and a thickness of 0.125 in.

Circle 242 on Inquiry Card

### Ion Exchange Hints

Practical considerations in the design, operation and maintenance of industrial ion exchange installations used for the deionization of water are discussed in tech data available in 'Aaher-Hi-Lites' available from Rohm & Haas Co., Resins Dept., Philadelphia 5, Pa.

Circle 243 on Inquiry Card

### Fasteners

An up-to-date edition of an 8-page catalog describing die cast zinc alloy and molded nylon fasteners is available from Gries Reproducer Corp., 400 Beechwood Ave., New Rochelle, N. Y. Catalog No. 2002-D contains information on wing nuts, round head thumb nuts, thumb screws, and wing screws. Extensive line of molded nylon fasteners are also shown, including machine screws, headless set screws, screw insulators, bushings, and washers.

Circle 244 on Inquiry Card

### RF Instruments

Catalog SK, 60 pages, describes in detail slotted lines, tunable probes, tapered and compensated reducers, adapters, instrument loads, adjustable matching networks, automatic impedance plotters, automatic SWR and transfer characteristic meter, r-f bridges, hybrids, attenuators, coaxial switches, power dividers, and dipoles. Photographs, drawings, prices, and ordering information are included. Alford Mfg. Co., 299 Atlantic Ave., Boston 10, Mass.

Circle 245 on Inquiry Card

### Control Devices

"An Introduction to Solions" is available from Texas Research and Electronic Corp., 6612 Denton Drive, Dallas, Tex. Solions is the name given to a family of electronic devices which function by controlling and monitoring a reversible electrochemical reaction. The 12-page brochure covers electrochemical principle of the solion redox system and describes the characterization of solion tetodes and solion 2-terminal devices. Applications notes and circuit design techniques are included.

Circle 246 on Inquiry Card

*Don't fritter away your funds!*

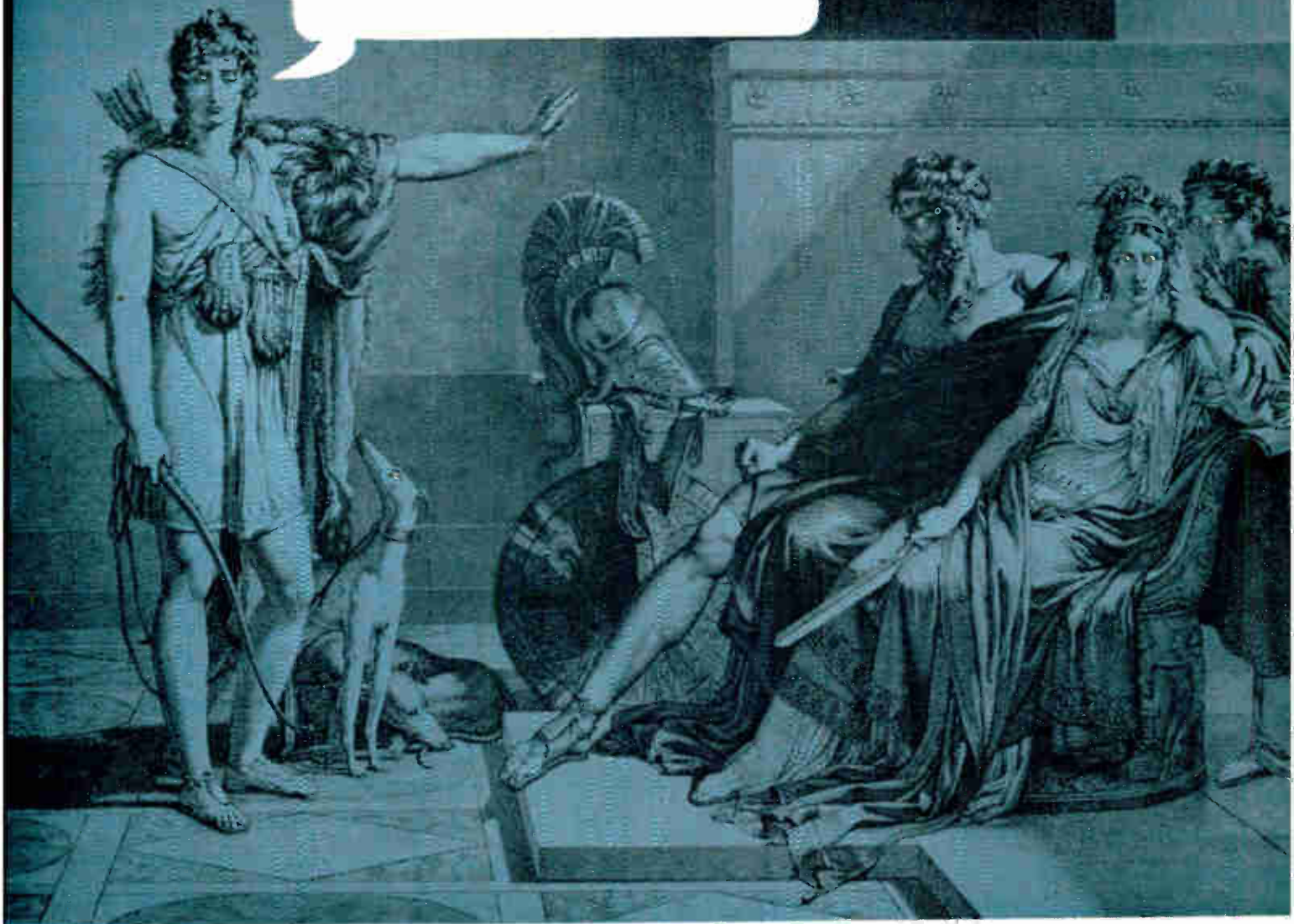

## There's 4% of the electronic market you don't want...

Conversely, there's 96% you *do* want and can reach — the 6100 plants delivered by Electronic Industries that comprise 96% of the market. ■ Without buying multiple book coverage for the unprofitable 4%, regular advertisers in Electronic Industries can concentrate their coverage where it pays off. ■ *Editorial Vigor Wins Readership.* Editorial is tailored specifically, exactly to the needs of all the important influences that specify — research, design, development, management. ■ *Exclusive Marketing Assistance Program* gives all information necessary to perform the most effective marketing... helps advertisers determine potentials... measure product acceptance... rate competitors or buyer attitudes. ■ *Market Coverage.* Circulation is now at an all-time high of over 61,000 — the largest group of engineering decision-makers in the electronic OEM. ■ Call in your local representative for the full story on Electronic Industries — its market, its monolithic coverage, its readership.



# ELECTRONIC INDUSTRIES

*The Source of Useful Theory and Applied Engineering*

A Chilton Publication

Chestnut and 56th Streets • Philadelphia 39, Pa.

World Radio History



# Now! Borg Micropot<sup>®</sup> Trimmers

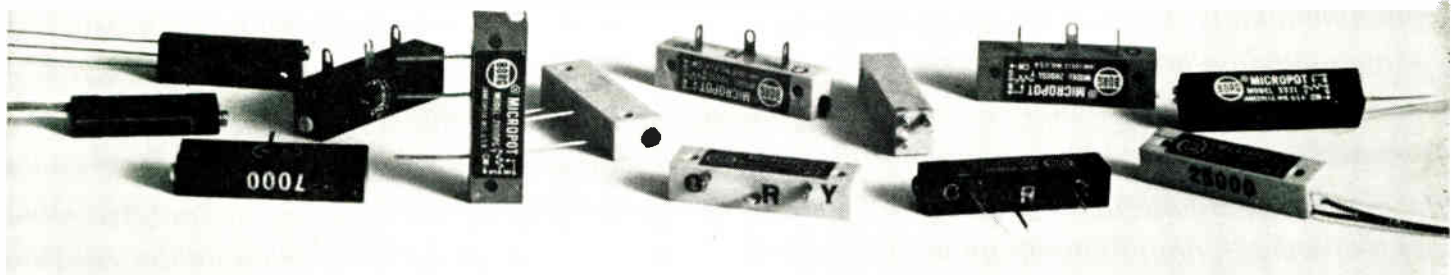
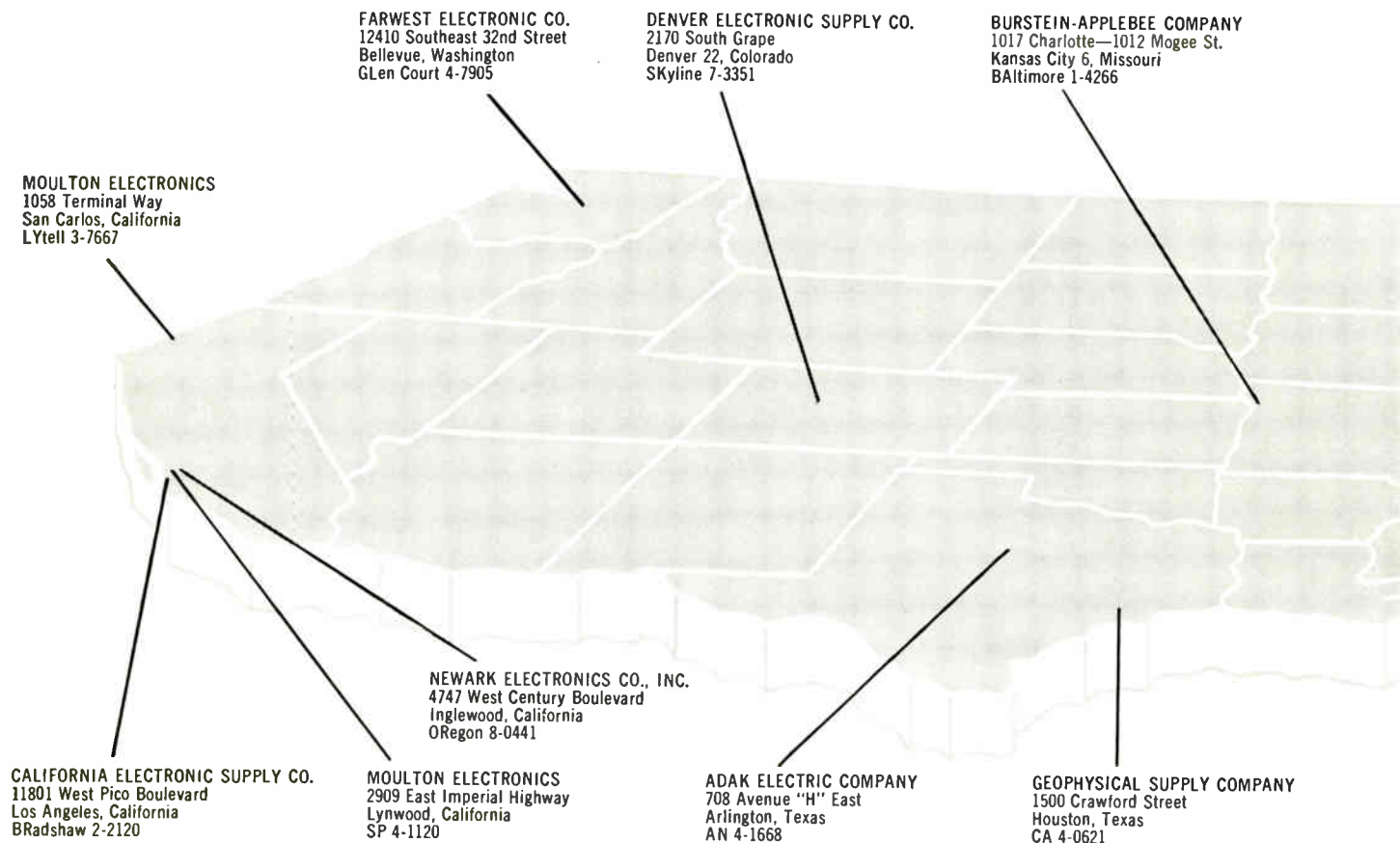



# are available everywhere!

**NORTHWEST ELECTRONICS CORP.**  
336 Hoover Street Northeast  
Minneapolis, Minnesota  
FEderal 8-7551

**RADIO PARTS COMPANY, INC.**  
1314 North 7th Street  
Milwaukee 5, Wisconsin  
BRoadway 6-4160

**NEWARK ELECTRONICS CORPORATION**  
223 West Madison Street  
Chicago 6, Illinois  
STate 2-2944

**GRAHAM ELECTRONICS' SUPPLY, INC.**  
122 South Senate Avenue  
Indianapolis 25, Indiana  
MEIrose 4-8486

**SREPCO, INC.**  
314 Leo Street  
Dayton 4, Ohio  
224-3871

**RADIO & ELECTRONICS PARTS CORPORATION**  
3235 Prospect Avenue  
Cleveland, Ohio  
UT 1-6060

**GENESEE RADIO & PARTS COMPANY**  
2550 Delaware Avenue  
Buffalo 16, New York  
TR 3-9661

**CRAMER ELECTRONICS, INC**  
320 Needham Street  
Newton 64, Massachusetts  
WOODward 9-7700

**PROGRESS ELECTRONICS COMPANY**  
107 Franklin Street  
New York 13, New York  
CANal 6-5611

**ADELPHI ELECTRONICS**  
Jericho Turnpike  
Westbury, Long Island, New York  
EDgewood 3-7000

**FEDERATED PURCHASER, INC.**  
1021 U. S. Route 22  
Mountainside, New Jersey  
ADams 2-8200

**KANN-ELLERT ELECTRONICS, INC.**  
2050 Rockrose Avenue  
Baltimore 1, Maryland  
TU 9-4242

**ALPHA ELECTRONIC SERVICES**  
5817 Roosevelt Avenue  
Pennsauken, New Jersey  
NOrmandy 2-1310

**MG, ELECTRONICS & EQUIPMENT CO., INC.**  
203 South 18th Street  
Birmingham 3, Alabama  
FAirfax 2-6449

**ELECTRA DISTRIBUTING COMPANY**  
1914 West End Avenue  
Nashville 4, Tennessee  
ALpine 5-8444

## (Well, almost everywhere)

You won't find a Borg Trimmer AID (Amphenol Industrial Distributor) in Broken Bow, Nebraska. But *starting now*, the metropolitan electronic centers like New York, Los Angeles, Boston, Seattle, Dayton, and Chicago *do* have well-stocked Borg Trimmer AIDs.

How well-stocked?  
Completely.

No matter which of the AIDs (shown on the map) you call—you can expect to find these Borg Trimmers ready and waiting to fill *your* trimmer requirements:  
2700—Microminiature, high temperature, humidity-proof, wirewound  
2800—High temperature, humidity-proof, wirewound

990—High temperature, wirewound  
992—General purpose, wirewound  
993—General purpose, carbon  
994—General purpose, humidity-proof, wirewound  
995—General purpose, humidity-proof, carbon

Need trimmers?

Call your nearest Borg Trimmer AID.

He's the man who sells trimmers with these Borg quality features: 1. 100% noise, continuity and ratcheting tested. 2. Can be gang mounted. 3. Dust proof. 4. Higher *standard* power ratings (1 watt, wirewound; ½ watt, carbon). 5. Welded internal terminations.



**Distributor Division / Amphenol-Borg Electronics Corporation**

# NEW TECH DATA

## Relay Catalog

Ohmite's complete line of made-to-order and stock relays are described in a 28-page, 2-color catalog. Types included are molded-panel, pile-up telephone, aircraft, plate-circuit, small contactors, general purpose and special purpose type relays. A handy "Selection Guide" is included to pre-select a relay on the basis of ratings, size, type of mounting or enclosure. Catalog 700 is available from Ohmite Mfg. Co., 3698 Howard St., Skokie, Ill.

Circle 247 on Inquiry Card

## Servo Valves

Series 242 and 247 Servovalves are described in Specification Sheets 242 and 247. The units are electro-hydraulic control valves primarily for driving hydraulic actuators or motors in closed loop servo systems. American Measurement and Control, Inc., N.W. Industrial Park, Burlington, Mass.

Circle 248 on Inquiry Card

## Dielectric Capacitors

Bulletin GEC-1745, 32 pages, gives ratings, catalog numbers, bracket and case dimensions, and specs. for standard commercial and Mil-C-25 lines of fixed paper-dielectric electronic capacitors. General Electric Co., Schenectady 5, N. Y.

Circle 249 on Inquiry Card

## Servo Control

An 8-page brochure on servo packages containing rotating components is available from Daystrom, Inc., Transicoil Div., Worcester, Pa. The package shows Transicoil's capabilities in servo packaging techniques. "Cases in Servo Control" is divided into 4 sections: analog to digital/digital to analog conversion; guidance and control systems; speed controls and integrated assemblies; and navigational equipment.

Circle 250 on Inquiry Card

## Computer Diodes

Tech. information is available on high-reliability planar epitaxial line of computer diodes. The units have a high ratio of forward conductance to 0 bias capacitance. The MA-4441 to 4445 have a 2pf max. capacitance limit. Microwave Associates, Inc., Burlington, Mass.

Circle 251 on Inquiry Card

## Vacuum Valves

Catalog Sheet C-25 describes details and features of Mikros motor-driven valves for use in 2 in. vacuum systems. Specs. and pricing are included. Mikros, Inc., 7634 S.E. Capitol Highway, Portland 19, Ore.

Circle 252 on Inquiry Card

## Foil Capacitors

Data Log No. MHA-107, 4 pages, contains information on plastic encased Mylar and Foil Capacitors with a complete selection chart for 188 capacities and voltages in a choice of 7 diameters and 9 lengths. Chart is available from Hopkins Engineering Co., 12900 Foothill Blvd., San Fernando, Calif.

Circle 253 on Inquiry Card

## Audio Oscillator

Tech. data is available on the Model 101 Audio Oscillator Module. Features include 6 standard freqs. immediately available from stock; 3 wave forms offered; modified square, saw tooth, and sine wave; and all operate on 12vdc regulated Henry Francis Parks Laboratory, P. O. Box 1665, Lake City Station, Seattle 55, Wash.

Circle 254 on Inquiry Card

## PC Laminated Plastic

Tech. data is available on F1-75 (NEMA Grade FR-4) glass-epoxy grade, flame retardant laminated plastics. Features include high electrical and machine properties for flame-resistant printed circuitry uses. Formica Corp., 4614 Spring Grove Ave., Cincinnati 32, Ohio.

Circle 255 on Inquiry Card

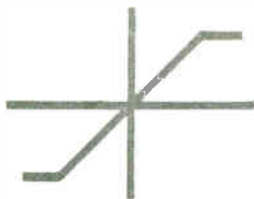

# Put **STABILITY** into your F-M System

## Test Midland's Type AB-1 Discriminator in your New Equipment and Check the Results

- Better Component Density
- Better Discriminator Stability
- Better Performance Reliability
- Less Component Population
- Less Production Steps
- Less Manufacturing Costs

The Type AB-1 is a single-component discriminator, solder-sealed in a 1 1/8 x 1 1/8 x 3/4 H metal case with a center frequency adjustment screw, bottom-center, for F<sub>0</sub> peaking after final equipment assembly. The Type AB-1 provides for a center frequency adjustment of ±4KC and features a voltage output essentially linear from F<sub>0</sub> to ±15KC with less than 3% harmonic distortion. For complete technical information, write to Midland Manufacturing Company requesting literature.

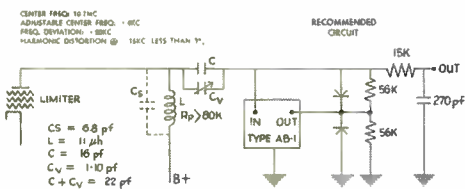

MANUFACTURING COMPANY  
3155 FIBERGLAS ROAD • KANSAS CITY 15, KANSAS

world's largest producer of quartz crystals / division of Pacific Industries, Inc.

# NEW FLEXIBLE PERMANENT SEALANT



- seal metal joints, sheet work
- seal leaks
- insulate wiring and terminals
- use as adhesive for pre-fabricated silicone rubber

For a thousand jobs, just squeeze it on and it's on to stay! No pre-mixing or priming. RTV-102 silicone rubber adheres to almost anything — glass, metal, plastics, tile, wood, silicone rubber. Sets in minutes, cures in a few hours, forms a resilient rubber that never dries out, cakes or cracks. Resists moisture, grease, weathering, many chemicals, and temperatures from  $-75^{\circ}\text{F}$  to  $500^{\circ}\text{F}$ .

RTV-102 won't sag on vertical surfaces, can be smoothed over large areas, "gives" with vibration and flexing. For free evaluation sample plus technical data, write on your letterhead describing your application to Section 001070, Silicone Products Department, General Electric Company, Waterford, N.Y.

**GENERAL ELECTRIC**

Circle 115 on Inquiry Card

## NEW TECH DATA

### Shaft Position Encoder

Bulletin 302 describes the lightweight Datex CG-735 V-Scan Shaft Position Encoder, which is designed for rugged, high-reliability military and airborne uses. The unit provides 8,192 counts in binary code to an accuracy of  $\pm 1$  count. Datex Corp., 1307 S. Myrtle Ave., Monrovia, Calif.

Circle 256 on Inquiry Card

### Cooling Equipment

This catalog describes McLean's line of packaged Mil-Spec blowers. Included are rack-mounted, recessed, single and dual centrifugal, panel-mount blowers, panel-mount fans and a variety of related equipment and accessories. A table of the principal military specs. covering equipment and material for blowers and fans are included. McLean Engineering Labs., P. O. Box 228, Princeton, N. J.

Circle 257 on Inquiry Card

### Terminal Blocks

This 24-page catalog contains information on miniature and standard size terminal blocks. Catalog describes the Burndy Minilok® (a high density miniature modular terminal block), the Coaxial Minilok® (a modular miniature coax double tier, horizontal feed-through block), the Modulok® (for application where AN wire size 12-22 is used), Coax Modulok® (for standard cable), and the Crablok® (a terminal block for application where high strength and temp. resistance are required). Bulletin MMC available from Burndy Corp., Norwalk, Conn.

Circle 258 on Inquiry Card

### Block Readers

This brochure describes automatic program control using the block concept; specifications for 11 block readers for punched tape programming; typical applications; and accessory equipment including automatic tape spoolers, tape preparation center, and a program simulator. The block reader brochure is available from Electronic Engineering Co. of California, Box 58, Santa Ana, Calif.

Circle 259 on Inquiry Card

### Slide Switch

A series of low-cost miniature slide switches are described in a 4-page brochure available from Oak Mfg. Co., Crystal Lake, Ill. Features, models, ratings, operating characteristics, dimensions, tolerances, and options are included.

Circle 260 on Inquiry Card

### Injection Molding

A 20-page comprehensive guide entitled, "Injection Molding of Shell Polypropylene" SC-62-81 is available from Shell Chemical Co., Plastics & Resins Div., 50 W. 50th St., New York 20, N. Y. Subjects covered include polypropylene grade, part design, mold design, molding procedures and conditions, coloring and suggested remedies for molding problems.

Circle 261 on Inquiry Card

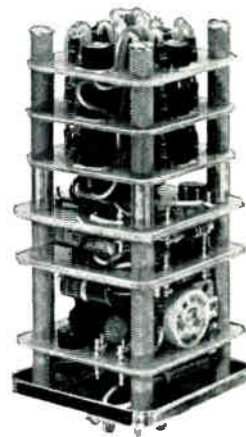

## BULOVA CRYSTAL- CONTROLLED PULSE GENERATOR

Capable of a wide variety of pulse widths, rise times, and pulse repetition rates, the Bulova Model SYS 12 is a precision crystal-controlled pulse generator. A temperature-controlled high precision crystal oscillator driving a blocking oscillator as the pulse forming circuit is incorporated.

Hermetically sealed, the Model SYS 12 is available in various mounting configurations. Specifications are: Pulse Repetition Rate: 20CPS to 1MCS. Output: Pulse Output. Pulse Widths: .05  $\mu\text{sec}$ . to 10  $\mu\text{sec}$ . Rise Time: 10:1 Ratio of Pulse Widths to Rise Time. Output Voltage: 1 to 6 Volts. Load Impedance: 1000 Ohms. Crystal Oscillator Driver Stability: 1PP10<sup>6</sup> /24 Hours. Oscillator Power: 28 Volts DC at 75MA. Oven Power: 115 Volts; 15 Watts. Operating Temperature Range:  $-40^{\circ}\text{C}$  to  $+70^{\circ}\text{C}$ . Size: 4" x 4" x 2".

Bulova offers sophisticated engineering assistance with high precision, crystal-controlled oscillators and time standards. When key factors of systems are low cost, subminiature size, and optimum reliability (prototype or production) — call on or write Department 2703, Bulova Electronics, Woodside 77, New York.



INDUSTRIAL/DEFENSE GROUP

**BULOVA**  
ELECTRONICS DIVISION

Circle 116 on Inquiry Card



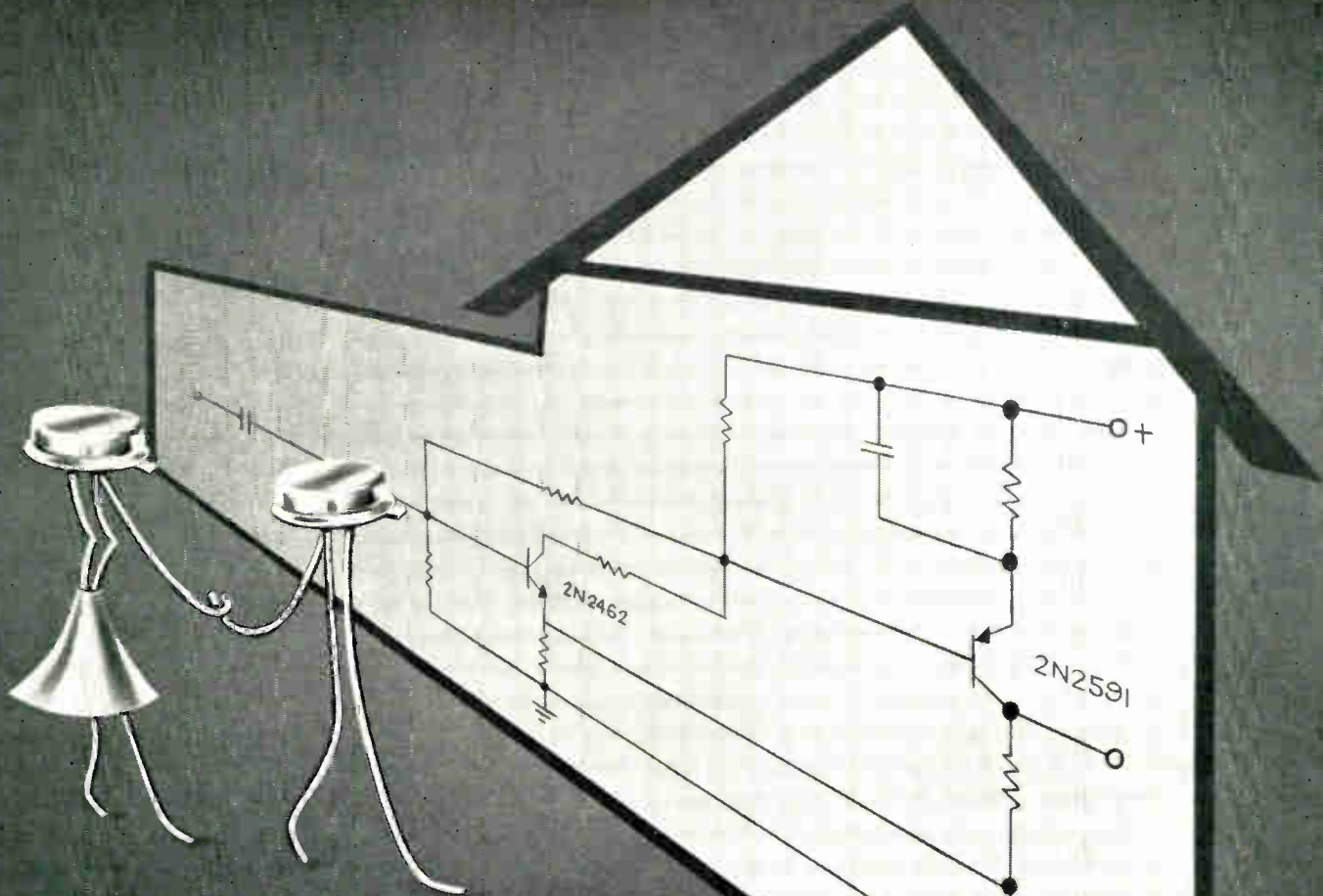

# GOING STEADY

COMPLEMENTARY AMPLIFIER CIRCUITS

## NEW PNP SILICON PLANAR TRANSISTORS COMPLEMENTARY WITH NPN SILICON PLANARS — BOTH IN TO-46 CASE STYLE

The SPERRY 2N2590 through 2N2593 series of PNP silicon planar transistors are complementary with SPERRY NPN silicon planar types 2N2459 through 2N2462. They are designed for high-frequency, high-voltage linear amplifier, oscillator and nonsaturating switching circuits. Four restricted beta ranges, two-point control of  $h$  parameters and typical  $f_T$  of 100 mc insures superior performance in small signal applications, replacing grown junction, mesa, and other planar transistor types.

Write for complete technical specifications.

Listed below are the original version NPN silicon transistors with their Sperry NPN planar counterparts and their Sperry PNP complementary planar types:

Original version NPN Types in TO-18 case	Sperry improved NPN types in TO-46 case	Sperry PNP complementary types in TO-46 case
2N929 2N930	2N2523 2N2524	2N2604 2N2605
2N738 2N739 2N740	2N2517 2N2518 2N2519	2N2598 2N2599 2N2600
2N734 2N735 2N736A	2N2514 2N2515 2N2516	2N2595 2N2596 2N2597
2N758A 2N759A 2N760A	2N2520 2N2521 2N2522	2N2601 2N2602 2N2603

# SPERRY

## SEMICONDUCTOR

DIVISION OF  
SPERRY RAND CORPORATION  
NORWALK, CONNECTICUT

Circle 117 on Inquiry Card

SEMICONDUCTOR INTEGRATED NETWORKS (SEMI-NETS\*),  
ALLOY SILICON TRANSISTORS AND DIODES

SALES OFFICES: CHICAGO, ILLINOIS; LOS ANGELES, CALIFORNIA; OAKLAND, NEW JERSEY;  
MEDFORD, MASSACHUSETTS; SYKESVILLE, MARYLAND; BETHPAGE, L. I., NEW YORK

SEMICONDUCTOR OPPORTUNITIES  
AVAILABLE TO QUALIFIED ENGINEERS

\*Trade Mark, Sperry Rand Corporation

WorldRadioHistory

## AUTHORIZED DISTRIBUTORS

# SPERRY

**SEMICONDUCTOR  
DIVISION OF  
SPERRY RAND CORPORATION**

### EAST

Avnet Electronics Corporation  
70 State Street  
Westbury, Long Island, New York  
Telephone: EDgewood 3-5800  
TWX: WESTBURY NY 2617

45 Winn Street  
Burlington, Massachusetts  
Telephone: BRowning 2-3060

Milgray Electronics, Inc.  
160 Varick Street  
New York 13, New York  
Telephone: YUkon 9-1600

1023 Vine Street  
Philadelphia, Pennsylvania  
Telephone: WALnut 3-2210  
Camden — 966-7750

5133 Lawrence Place  
Hyattsville, Maryland  
Telephone: UNion 4-6330

### WEST

Avnet Corporation  
5877 Rodeo Road  
Los Angeles 16, California  
Telephone: UPton 0-6141

Avnet Electronics Corporation  
of Northern California  
1262 North Lawrence Station Road  
Sunnyvale, California  
Telephone: REgent 6-0300

Avnet Electronics Corporation  
of The Pacific Northwest  
11240 Main Street  
Bellevue, Washington  
Telephone: GLencourt 4-4911

Avnet Electronics Corporation  
of Arizona  
3138 East McDowell Road  
Phoenix 8, Arizona  
Telephone: 273-1261

Avnet Electronics Corporation  
of Utah  
816 South Main Street  
Salt Lake City 1, Utah  
Telephone: DAVIS 8-0245

Radio Products Sales, Inc.  
1501 South Hill Street  
Los Angeles 15, California  
Telephone: RIchmond 8-1271  
TWX: LA 06

Pacific Wholesale Company  
1850 Mission Street  
San Francisco, California  
Telephone: UNderhill 1-3743

### MID-WEST

Avnet Electronics Corporation  
10130 West Pacific Avenue  
Franklin Park, Illinois  
Telephone: GLadstone 5-8160  
TWX: FRANKLIN PK 2187

## NEW TECH DATA

### Thumbwheel Switch

Information is available, giving full electrical and mechanical specs. on modular thumbwheel type switches. The Series SM-412 are thumbwheel rotary switches with numerical readout of switch position. Standard switches are 3-pole, 11 positions/module or 2-pole, 12 positions/module. North Atlantic Industries, Inc., Terminal Drive, Plainview, N. Y.

Circle 262 on Inquiry Card

### Transistor Can Relay

Tech. data is available in a low cost relay, rated as  $\frac{1}{2}$ a at 32vdc and housed in a 0.200 x 0.400 x 0.600 n. can. The CBR-500 is designed for commercial ground switching and control applications. Babcock Relays, Div. of Babcock Electronics Corp., 1645 Babcock Ave., Costa Mesa, Calif.

Circle 263 on Inquiry Card

### Measuring Apparatus

Angstrom Precision Inc., 1136 N. La Brea Ave., Hollywood 38, Calif. is offering tech. data on the Angstrom Bridge, which is a deviation principle, 4 terminal extended range device, covering from 1.0 to  $10^9\Omega$  with accuracies of 0.01% and precision of 0.0005% self contained. Bulletin #102.

Circle 264 on Inquiry Card

### Electrochemical Testing

A tech. paper discussing procedures and techniques for making precise electrochemical measurements using the Cary Model 31 Vibrating Reed Electrometer is available from Applied Physics Corp., 2724 S. Peck Rd., Monrovia, Calif. Report 31-1, 32 pages, is complete with diagrams, charts and bibliography on measurement-circuit design theory, current requirements, sensitivity, and stability.

Circle 265 on Inquiry Card

### Telemetry Antennas

This 16-page catalog gives detailed data on TACO's complete line of telemetry antennas and systems. Covered are: multimode telemetry and command types; special purpose antennas; steerable parabolic; cross-polarized yagis, and manually positionable parabolic antenna systems. Technical Appliance Corp., Sherburne, N. Y.

Circle 266 on Inquiry Card

### Fasteners

This 2-page, full-colored booklet lists, illustrates and classifies 25,000 different sizes, styles and types of stainless steel, aluminum, brass, bronze and Monel fasteners. More than 450 different AN and MS fasteners are classified, and the full range of sizes is shown. Items include machine, thread cutting, type U-drive and thread cutting screws, elevator bolts, nuts and washers, SEMS and SEL-SKREWS. Albany Products Co., Inc., 351 Connecticut Ave., So. Norwalk, Conn.

Circle 267 on Inquiry Card



**DECITRAK®**

*All New*

## SHAFT ENCODER

For INDICATION and  
DATA LOGGING

**DECIMAL OUTPUT** Generates 10 wire/digit code directly. No expensive translation from binary, BCD or Gray.

**LOWER COST** Less than half the price of conventional encoders.

**ON-THE-FLY OUTPUT** Instantaneous, continuous output to lampbanks or printers.

**5 TIMES LONGER LIFE** Absence of brush logic ensures 5-10 times longer life.

**DIRECT LAMPBANK OR PRINTER ACTUATION** Simply connect. Converters not required.

Write today for complete technical and application brochures.

*Theta*

INSTRUMENT CORPORATION

520 Victor Street • Saddle Brook, N. J.  
Area Code 201 HUBbard 7-3508

Circle 118 on Inquiry Card



# TRANSISTOR INVERTER TRANSFORMERS

For 12/14 or 24/28 Volt Battery



PIONEERS IN  
MINIATURIZATION

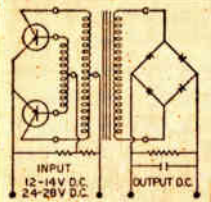
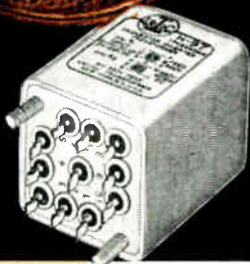

Hermetically  
Sealed to  
MIL-T-27A  
Grade 4

**IMMEDIATE DELIVERY**  
From Stock

**HIGH RELIABILITY** and **EFFICIENCY** in small size are achieved through the use of layer insulation, in sharp contrast to the random wound coil so often encountered in this field. Advanced coupling technique, between windings, has reduced the spikes that often endanger the driving transistors. A frequency of approximately 1000 cycles was chosen for optimum results. Input voltages of 12/14 V or 24/28 V can be used. With 6/7 V input instead of 12/14 V, output is halved, current rating remains the same.

Type No.	DC output, when used in circuit shown	MIL Case
H-97	250V- 60MA	AH
H-98	375V-100MA	AJ
H-99	425V-175MA	FA
H-100	550V-200MA	GB

## UNITED TRANSFORMER CORPORATION

150 Varick Street, New York 13, N.Y.

PACIFIC MFG. DIVISION

3630 Eastham Drive, Culver City, Calif.

EXPORT DIVISION

13 East 40th Street, New York 16, N. Y.

**WRITE FOR LATEST CATALOG**

Circle 119 on Inquiry Card

## NEW TECH DATA

### Crystal Products

This 2-color, short-form catalog describes electrical specs., response characteristics and typical uses (over the center freq. range from 50kc to 100mc) of crystal filters, discriminators, oscillators, measurement equipment and freq. control units. The crystal products catalog is available from Systems, Inc., 2400 Diversified Way, Orlando, Fla.

Circle 268 on Inquiry Card

### Hi-Alumina Ceramic

Tech. data is available on 4 high alumina formulations including information on polished, glazed and metalized alumina for custom item purposes. Photographs, comprehensive specifications and applications information is included. Electro-Ceramics, Inc., 2645 S. 2nd West, Salt Lake City 15, Utah.

Circle 269 on Inquiry Card

### Pulse Equipment

"Pulse Equipment Bulletin," 6 pages, illustrates and describes pulse, sweep, and time-delay generators, pulse amplifiers and variable delay lines. General Radio Co., W. Concord, Mass.

Circle 270 on Inquiry Card

### Military Diodes

Catalog AM-100 describes a line of military type Gold Bonded Germanium diodes available from National Transistor, 500 Broadway, Lawrence, Mass. Specs. are given for 7 diodes including JAN-1N128, 1N198, 1N270, 1N276, and 1N277.

Circle 271 on Inquiry Card

### Program Timer

Model PT-96 consists of a stable freq. oscillator, a freq. divider section, a gating section and 6 decade counters. The PT-96 is basically a master decade counting device, capable of generating selective timed outputs with a range from 0 to 10,000 sec. with time spacing of 10msec. Electronic Products Corp., 4642 Belair Rd., Baltimore 6, Md.

Circle 272 on Inquiry Card

### Connector Bulletin

This 16-page, 3-color bulletin, C262, gives complete details on Superior's entire line of electrical connectors. Included are 5-way binding posts, Supercon electrical connectors and Dub-L-Dual electrical connectors. Also included are photographs, dimensional drawings and descriptions. The Superior Electric Co., Bristol, Conn.

Circle 273 on Inquiry Card

### Accelerometer

Tech. data is available on the self-generating, high capacity accelerometer, Model 5D41, designed for direct measurement of vibration by vacuum tube voltmeter without the use of a pre-amplifier. Form #95018 is available from Clevite Electronic Components, 232 Forbes Rd., Bedford, Ohio.

Circle 274 on Inquiry Card

# "MATCHED" NUTDRIVER SET

hollow shaft . . . color coded  
. . . every tool in its place

- 7 popular sizes 1/4" thru 1/2"
- hollow shafts for extra clearance
- precision fit, case-hardened sockets
- high carbon steel: chrome or nickel plated
- color coded, shockproof plastic handles (UL)
- heavy gauge, non-tip stand with handle wells
- large, readable, size indexes



No. 147  
bench set

OTHER SETS, TOO: solid-shaft, hollow-shaft, or mixed . . . bench and wall rack models

**PLUS FULL RANGE OF SEPARATE  
NUTDRIVERS:** 3/32" thru 3/4" - regular, stubby, extra-long, midget (pocket clip)

available through leading electronic  
and industrial distributors

XCELITE, INC. • ORCHARD PARK, N. Y.  
Canada: Charles W. Pointon, Ltd., Toronto, Ont.

# XCELITE HAND TOOLS

QUALITY SCREWDRIVERS, NUTDRIVERS, PLIERS,  
WRENCHES, SERVICE KITS, and SPECIAL PURPOSE TOOLS  
Circle 120 on Inquiry Card



## NEW TECH DATA

### PC Kits

Tech. information is available on Kepro Lab Kits which provide all printed circuit board development needs from laboratory experiments to short production runs. The Kits supply 3 sq. ft. of single and double-clad materials plus photolayout materials and chemicals, solutions and tools necessary to produce prototype and short production runs. Keil Engineering Products, Inc., 6833 Manchester Ave., St. Louis 10, Mo.

Circle 275 on Inquiry Card

### RFI Shielding Gaskets

Information is available on die-compressed, formed knitted wire gaskets for tight shielding against Radio Frequency Interference. Data Sheet RF-103 includes a general description, suggested uses and limitations plus RFI control rating, forms available and specs. Technical Wire Products, Inc., 129 Dermody St., Cranford, N. J. Also offered is a design catalog.

Circle 276 on Inquiry Card

### Lubrication Problems

This pamphlet contains information on lubricant, friction and wear testing. Ten different test machines designed to determine lubricant effectiveness are described along with applicable test procedures and specs. Bulletin 135 is available from The Alpha-Molykote Corp., 65 Harvard Ave., Stamford, Conn.

Circle 277 on Inquiry Card

### Ultra-Violet Sources

Specs. and characteristics of 25 "Spectrolite" long and short wave ultra-violet lamps for lab. and industrial use are included in an 8-page catalog available from Black Light Eastern Div., Spectronics Corp., 24 Kinkel St., Westbury, L. I., N. Y. Bulletin 1462 gives emission and transmission characteristics of listed U-V light sources and filters.

Circle 278 on Inquiry Card

### Miniature Blower Catalog

Standard miniature blowers, available in 4 sizes—1½, 2, 2½, and 3 are described in a detailed bulletin available from Indiana General Corp., Electro-Mechanical Div., 517 W. Walnut St., Oglesby, Ill. Bulletin 401 contains information on both ac and dc motor designs with electrical connections which can be made to meet Mil standards.

Circle 279 on Inquiry Card

### PNPN Switches

Applications Note 200.23 "PNPN Switches with Gate Turn-Off Control (Using the ZJ-224 Gate Turn-Off Switch)" 8 pages, is available from General Electric Co., Rectifier Components Dept. W. Genesee St., Auburn, N. Y. The ZJ-224 is a 3-terminal pnnp silicon power-switching device able to handle currents up to 2a and block voltages up to 400v.

Circle 280 on Inquiry Card

# TWINS

*Honeywell AC Iron Vane meters, available in a wide selection of case styles, are counterparts to the popular Honeywell DC line. Whether you prefer conventional round or square meter cases or the distinctive Honeywell Medalist series, you can enhance the appearance of your equipment and instrument panels by using matching case styles for both AC and DC meter requirements.*

■ *Honeywell's AC Iron Vane meters deliver top performance at moderate cost. Scale linearity equals or exceeds that of any comparable meters and for applications where space is at a premium, the shallow depth of Honeywell AC Iron Vane meter cases is a distinct advantage. For a catalog write to: Honeywell Precision Meter Division, Manchester, New Hampshire.*

MM3 (3½") Case style illustrated. Note high readability of extended scale.

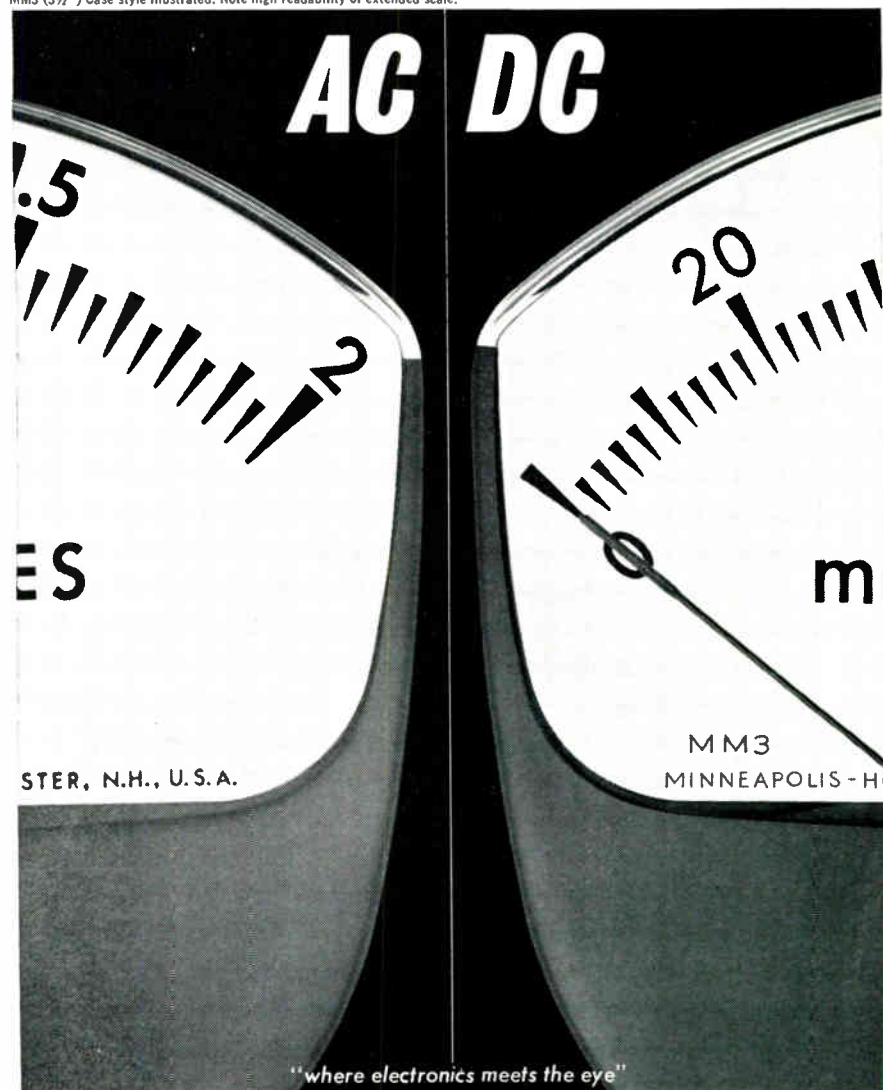

## Honeywell



Precision Meters

# 1

Silicon wafer is fabricated with a matrix of 1100 transistors and 4000 resistors . . .

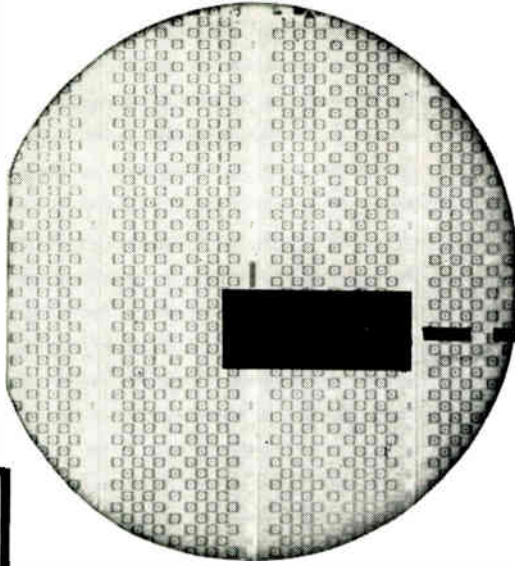

# 2

. . . which can be interconnected to produce a large variety of circuits as shown in this greatly enlarged section . . .

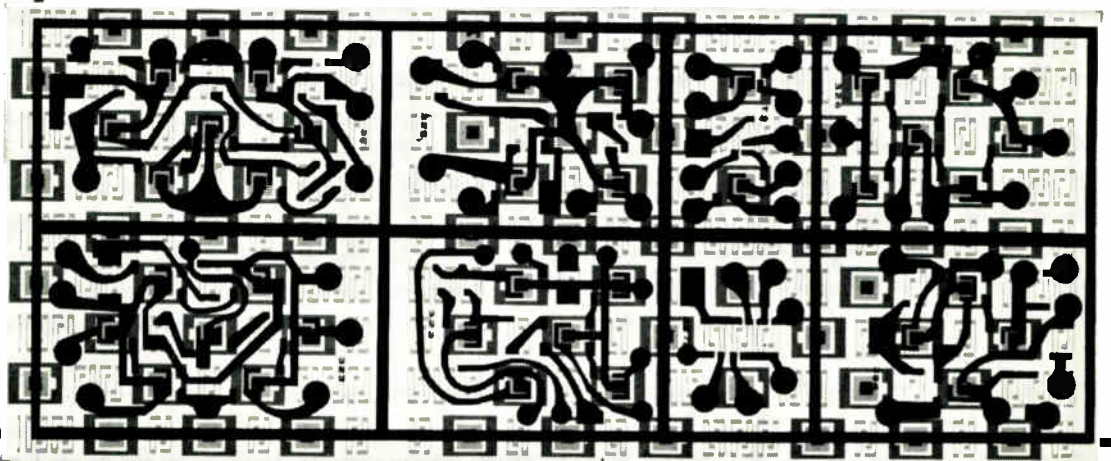

# 3

. . . such as these presently available ECLO circuits that feature 1) high fan-in and fan-out 2) high speed to power ratio 3) freedom from current hogging 4) low component count.

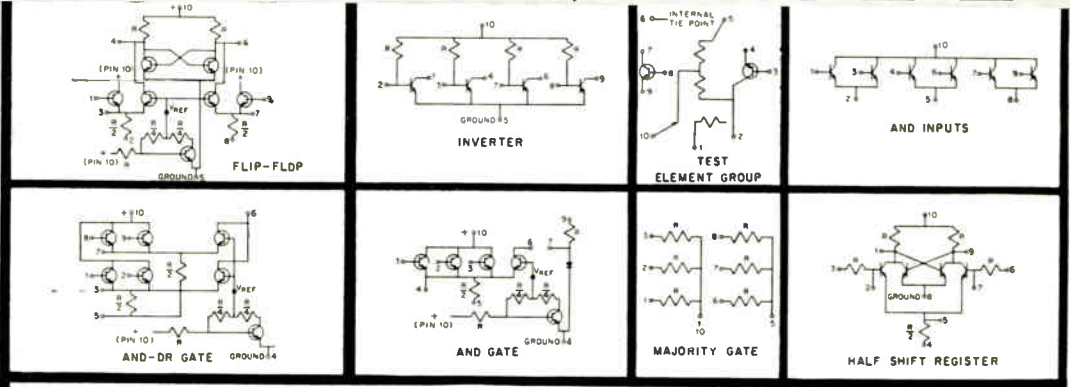

We will be pleased to send you complete data on how you can use M1 Matrix circuits in your computer applications, plus data on the now-available ECLO functional components. Please contact your General Electric Semiconductor District Sales Manager, or write Section 13J140 Semiconductor Products Department, General Electric Company, Electronics Park, Syracuse, New York.



# FUNCTIONAL COMPONENTS FROM GENERAL ELECTRIC

**Planar Epitaxial Passivated M1 Matrix results in more flexible, reliable and efficient logic circuits. A variety of emitter-coupled logic operators are available now, with M1 Matrix circuits of your own design soon to follow.**

The M1 Matrix is the practical answer to your use of miniature functional components. This is how it works:

On a silicon wafer approximately one inch in diameter are diffused 1100 transistors and 4000 resistors. Interconnections then are formed between these elements to produce over 100 different circuits. These circuits are cut and separately mounted in TO-5 headers with up to ten leads. The simplicity of the General Electric M1 Matrix results in these advantages:

- 1** A tremendous variety of circuits can be obtained from a wafer. Presently available are several emitter-coupled logic operators (ECLO's) for your immediate evaluation and use. ECLO circuits feature 2 mc speed at an average of 10 mw of power, per operator, about one-sixth the power needed by direct-coupled transistor logic.
- 2** Lead time to produce new circuits or circuits to your own design will be inherently short.
- 3** Areas of the wafer can be reserved as "test elements" to determine performance characteristics and reliability of all the circuits on the wafer. All circuits will be numbered so as to maintain historical record.
- 4** The Planar Epitaxial Passivated diffusion process is used for its high performance, high reliability characteristics. Transistor specifications are similar to the high speed 2N914 type, with exceptionally low saturation resistance.

GENERAL  ELECTRIC



# LOW-LEVEL DC PREAMPLIFIERS

## IMPROVE RELIABILITY

A new series of low-level ACROSTAT DC Preamplifiers, epoxy potted, self-contained, operate from 115 V  $\pm$  10% AC, 2 watts. Model 104 amplifies signals of 1 micro-microwatt with a power gain of 330,000 in a single stage from thermocouples, strain gages, Hall devices, and other low-level DC sources. Input, output and AC supply are isolated and floating. Null stability is better than 10 microvolts over moderate environments, and 50 microvolts over severe environments.



Price only \$139.00 each, 1-5 units; quantity discounts; immediate delivery. Request Technical Bulletin No. 10.



**acromag**<sup>®</sup>  
INCORPORATED

15360 TELEGRAPH RD.

DETROIT 39, MICH.

Teletype:

DE 970

Phone: 538-4242, Area Code 313

Circle 123 on Inquiry Card

## MAGNECRAFT Class 22 Telephone Type RELAY



2 1/4 x 1 1/4  
x 1 1/2 (DPDT)

Class 22 Relay with twin contacts for reliable switching of extremely low voltage and low current.

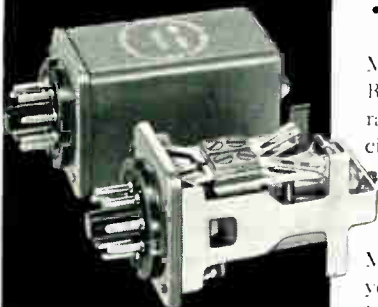

Class 22—the Relay you can RELY on with plug-in mounting and removable dust cover.

**275**

High Reliability Relays in stock for same day service. Send for Stock Relay Catalog.

## The RELAY YOU can RELY on

- For wide adaptability AC or DC operation.
- To meet low wattage sensitive requirements.
- For multiple switching functions with minimum power input.
- For extremely low voltage, low current switching.
- For heavy duty power switching.
- To meet applicable military specifications.
- For stable contact adjustment thru long life.
- To make friends and get you out of trouble!

MAGNECRAFT Class 22 Telephone Type High Reliability Relays are available with a complete range of contacts; solder type, taper tab and printed circuit terminals or plug-in mounting; open, with removable dust cover and hermetically sealed. You name it — MAGNECRAFT can furnish it

Magnecraft Engineers like to help adapt relays to your requirements. Whether you are in trouble or just want reliable magnetic switching tell us your requirements or send for 36 page Catalog and Relay Hand Book.

**MAGNECRAFT ELECTRIC CO**

5577 North Lynch Chicago 30

Phone (area Code 312) 282-5500

Representatives in principal cities.

# NEW PRODUCTS

## RECTIFIERS

Units withstand 200a surge current with 100% PIV.



The 1N3491 series of "press-fit" rectifiers include hermetic sealing and extensive thermal cycling to ensure stability of parameters in temp. environments between  $-65^{\circ}$  and  $+175^{\circ}$ C. Average dc current capability of the series is 18a; riv ranges are from 50 to 400v. Max. junction temps. are  $200^{\circ}$ C with max. peak forward drop of 1.3v @ 60a. The knurled base of the units is designed to be "press-fit" mounted in a heat sink or chassis base. Delco Radio Div., General Motors Corp., Kokomo, Ind.

Circle 281 on Inquiry Card

## UHF RECEIVER

Type CEI 702 Receiver features AM, FM and CW reception.



Designed for critical reconnaissance work, this UHF receiver contains such features as: wide frequency coverage of 235 to 1000Mc; low noise of max. of 10db in Band A and 12 db in Band B; a small size of 3 1/2 in. panel height by 19 in. rack; low oscillator radiation; and 3 i-f bandwidths of 50, 300kc and 2Mc. The instrument uses solid state plug-in audio and video circuits and contains a carrier operated relay. Communication Electronics, Inc., 4900 Hampden Lane, Bethesda 14, Md.

Circle 282 on Inquiry Card

# NEW PRODUCTS

## FLAT-DIPPED CAPACITORS

Mylar® film capacitor is dipped to improve moisture-resistance.

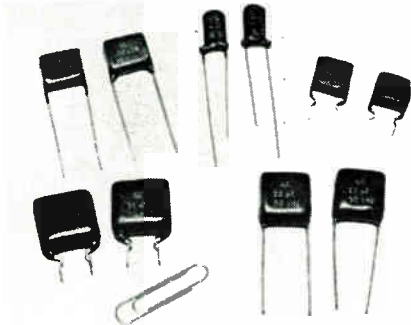

Lectrofilm® -B capacitor range from 0.01 to 1.0  $\mu\text{f}$  at 100vdc and 0.01 to 0.15  $\mu\text{f}$  at 600vdc with tolerances of  $\pm 20$ , 10 and 5%. Voltages range from 50 through 600vdc at 85°C. Advantages of the dipped package include small size, resistance to vibration and shock, extended foil construction and high insulation resistance. The flattened-roll construction permits higher component densities without sacrifice of component performance. Capacitor Dept., General Electric Co., Hudson Falls, N. Y.

Circle 283 on Inquiry Card

## MULTIPLEX SWITCH

High speed, solid state unit for digital and logic circuitry.

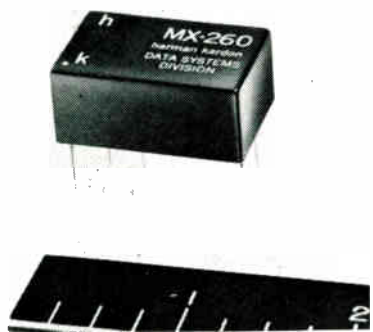

The MX-260 Multiplex Switch is completely encapsulated and offers switching speeds from dc to 10kc with operating temp. range of  $-30^{\circ}$  to  $+71^{\circ}\text{C}$ . The miniature package is 0.5 cu. in., capable of being stacked to any desired number of channels. The MX-260 is designed for such applications as digital meters, low level switching, high speed scanning, stable amplifier choppers or dc amplifier choppers, analog computers and multiplexers. Harman-Kardon, Inc., 520 Main St., Westbury, L. I., N. Y.

Circle 284 on Inquiry Card

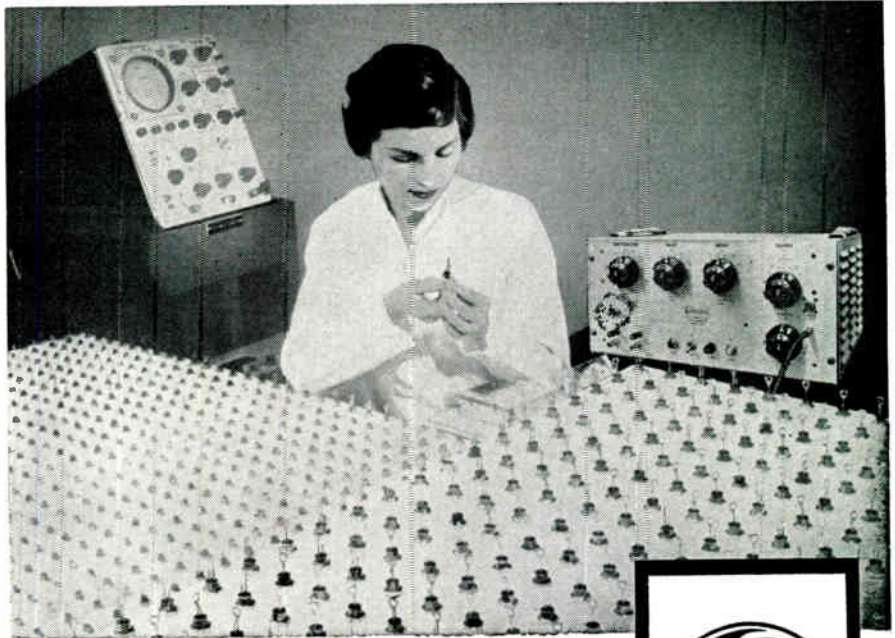

"A Rutherford pulse generator is being used to test silicon rectifiers at the Clyde, N.Y., facilities of the G. E. Semiconductor Products Department."

# Rutherford PULSE GENERATORS for TESTING Semiconductors

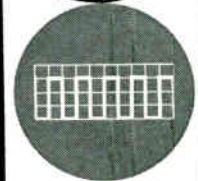

MODEL  
**B-7B**

The Rutherford B-7B Pulse Generators are engineered to meet today's rigid standards of testing, research and development.

If your requirements are for high performance and wide versatility at low cost ... specify the Rutherford Model B-7B.



## SPECIFICATIONS

Rack mountable ... single unit construction ... variable time rise control ... 50 volts into 50 ohms at 30% duty factor ... rep. rate to 2 mc ... widths .05  $\mu\text{s}$  to 10,000  $\mu\text{s}$  ... delays to 10,000  $\mu\text{s}$ .

Low budget price: \$720.00 F.O.B. Culver City, California

For complete information, write to Dept. E11062.

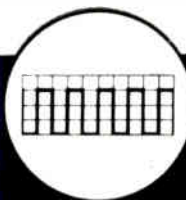

# Rutherford ELECTRONICS CO.

P. O. Box 472 • Culver City, California • TWK-CVR-CY-4133

pulse generators / pulse systems / accurate time delay generators



- **SCAN CONVERSION**
- **FLICKERLESS DISPLAY STORE**
- **VIDEO STORAGE**

**RECORDING STORAGE TUBE SYSTEMS**

Single-gun, dual-gun, multi-tube systems to convert scan for radar, sonar, television, and to perform analog processing, data analysis, contract or expand time scale, auto correlation.

- **SLOWED TELEVISION TRANSMISSION**

by telephone line or other narrow-band systems.

- **IMAGE ENGINEERING**

OPTICAL CHART READERS, FLYING SPOT SCANNERS, LOW-LIGHT-LEVEL CAMERAS, and IMAGE RECTIFICATION. Automatic inspection and recognition of size, shape, color, and texture.



Write or call for complete information:



**INSTRUMENTS, Inc.**

2300 Washington Street  
Newton 62, Massachusetts  
617 WOODWARD 9-8440

Circle 126 on Inquiry Card

**NEW PRODUCTS**

**MINIATURE TRANSFORMER**

Designed for space pulse and broad-band audio circuitry.

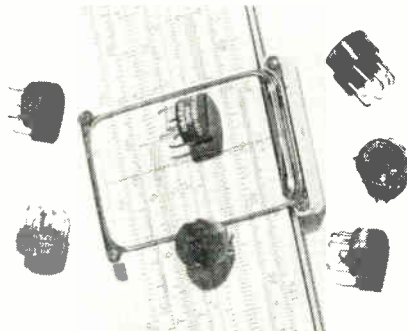

"Millimag," a microminiature coupling transformer, is for use in spacecraft and hard vacuum environments. It can be substituted for existing transformers with a considerable reduction in weight and volume. The transformer is designed with close tolerance terminals for printed circuit board use and has electroplated nickel terminals for soldering or welding. It has a volume of 0.038 cu. in. Hughes Aircraft Co., P. O. B. 90426, Airport Sta., Los Angeles 9, Calif.

Circle 285 on Inquiry Card

**HIGH STRENGTH ADHESIVE**

General purpose compound bonds metal, glass, wood, plastics and rubber.



The adhesive, designated EC-2126, provides high strength bonds; has high resistance to aromatic fuels, oils and weathering; good heat resistance and high flexibility. It meets the requirements of Mil-A-5092A, Type III. The adhesive can be applied by brush or roll coating methods to both bonding surfaces. After air drying 1 to 3 min., only hand pressure is required to join the parts. Minnesota Mining and Mfg. Co., 900 Bush Ave., St. Paul 6, Minn.

Circle 286 on Inquiry Card

**CURTISS-WRIGHT ELECTRONICS...**

*adding a new dimension to the capability of man*

**B-58 BOMB NAV SIMULATOR.** Designated AN/ASQ-T2, uses hemispherical recorders to trace "flight." Precise position is determined by celestial navigation using six stars and the sun together with position verification from a stand-mass radar system. The Curtiss-Wright simulator provides stored radar data for four million sq. miles of area with sufficient resolution to detect landmarks as small as 200 feet.

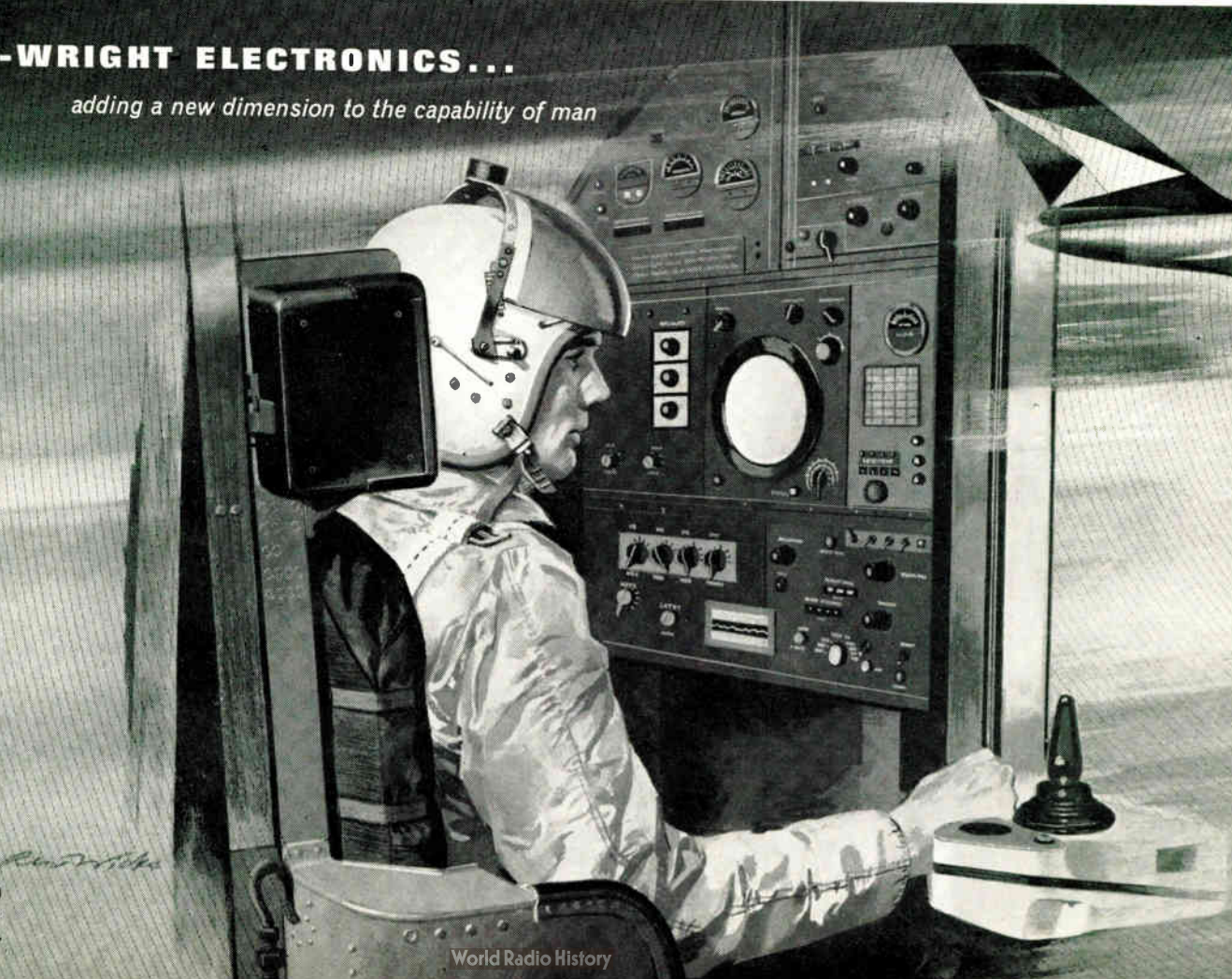



## SCHMITT TRIGGER

Digital block solid state circuit is for aerospace environments.



Model DBST1071 consists of a high speed Schmitt Trigger and associated diode clamped buffer amplifier. The input is capacitor, coupled to provide dc isolation and min. loading. The output pulse duty cycle is adjustable by means of a potentiometer. Applications include: squaring and proper shaping of pulses; level standardization; pulse code generation; and ac level detection. It measures 0.75 x 1.00 x 2.00 in. Solid State Electronics Corp., 15321 Rayen St., Sepulveda, Calif.

Circle 287 on Inquiry Card

## TINY BATTERIES

Solid-electrolyte types for low continuous-duty power uses.

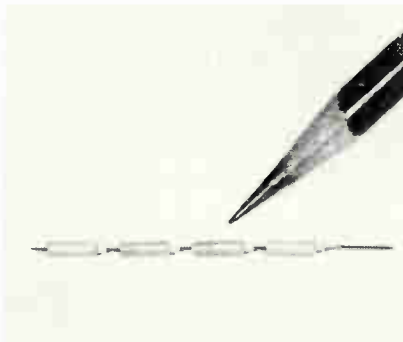

These batteries are particularly useful for charging and maintaining the charge on low-leakage film capacitors. These batteries are not intended for applications where continuous current requirements exceed 10  $\mu$ a. However, battery life times up to 20 years are anticipated where low current applications are involved. Recovery of open circuit voltage after severe current drain is essentially instantaneous. Sprague Electric Co., 233 Marshall St., North Adams, Mass.

Circle 288 on Inquiry Card

## LOOKING FOR COILS?

Turn to section 1800



You'll find the catalog data of these manufacturers:

ACDC Electronics • Arnold Magnetics • Automatic Coil • Barker & Williamson • Caddell-Burns Mfg. • Cleveland Electronics • Components Corp. • Constantine Engineering Labs. • Delevan Electronics • Delta Coils • Forbes and Wagner • Freed Transformer • Hisonic • J. W. Miller Co. • Relcoil Products • Speer Carbon • Stanwyck Winding • Syntronic Instr. • Torotel • Torotron Corp. • Torwico Electr. • Universal Mfg. • Universal Toroid Coil Winding • Vanguard Electr. • Vari-L Co. • Wabash Magnetics • Wilco.

eem ELECTRONIC ENGINEERS MASTER  
60 Madison Avenue • Hempstead, N. Y.

Circle 128 on Inquiry Card

Circle Number 805 Professional Profile, page 210



## PROJECT IN POINT:

**This B-58 navigator thinks he's on target at 53,000 feet!**

Simulation reflects the ultimate in the application of science and technology. It is the electronic bridge from research to reality. At Curtiss-Wright, electronic simulation systems orient men and machines to missions for many military and industrial programs.

*Project in Point:* Today at Carswell and Bunker Hill Air Force Bases, B-58 navigators are being trained by the most sophisticated BOMB NAV simulators in existence. They were designed and manufactured by Curtiss-Wright under contract to General Dynamics/Convair.

The skills in systems and products developed by this and other programs are now being applied to the USAF

C-141, the Lockheed turbopfan freighter. Curtiss-Wright will produce fully digital simulators for flight crew training—a major step forward in this field.

These advanced activities have created immediate opportunities at Curtiss-Wright Electronics Division for solid state circuit designers, digital computer programmers and others experienced in the application of real-time digital computation to the most challenging problems in simulation.

For complete information, please write Mr. Gene E. Kelly, Manager of Professional Placement, Electronics Division. An equal opportunity employer.



ELECTRONICS DIVISION  
**CURTISS-WRIGHT CORPORATION**

World Radio History  
35 MARKET STREET, EAST PATERSON, N. J.

These two PRD instruments offer you the widest choice of microwave power measurements, and both are direct-reading, highly portable units. The PRD 668 Peak Power Meter is the newest of the line, measuring peak power levels up to 300 mw, from 2.6 to 18.0 kmc. with appropriate PRD bolometer mounts. It also measures average power from 0 to 2 mw. The PRD 650-C Microwave Power Meter is a self-balanc-

ing bridge type instrument measuring up to 100 mw instantaneously. With appropriate PRD bolometers, it will measure CW and pulse power from 0.5 to 40 kmc. The meter reads in mw and db. Send for data!

PRD Electronics, Inc.  
202 Tillary Street, Brooklyn 1, New York

A subsidiary of Harris-InterType Corporation



# PRD Electronics, Inc.

Brooklyn, New York • Los Angeles and Redwood City, Calif. • Haddonfield, N. J.

## TWO WAYS TO MEASURE MICROWAVE POWER!



# CENTRALAB

## THE LARGEST MANUFACTURER

ULTRA MINIATURE 1/10 WATT  
CARBON COMPOSITION POTENTIOMETERS  
AVAILABLE WITH SPST SWITCHES!

When you need ultra-miniature high reliability potentiometers, for military or commercial use, think first of Centralab. These three units, for example, are available in a variety of mounting styles, and may be had with or without SPST switches. They can be supplied in values from 500 ohms to 10 megohms, in a wide range of tapers. For extreme environmental conditions, any of them can be potted—and all are available in high torque versions.



**MODEL 1**  
Diameter .625"  
Depth .371"



**MODEL 6**  
Diameter .502"  
Depth .155"



**MODEL 8**  
Diameter .286"  
Depth .110"

## OF THE SMALLEST POTENTIOMETERS

for high reliability military  
and commercial applications

For detailed technical literature describing these units, write Centralab, The Electronics Division of Globe-Union Inc., 900 E. Keefe Avenue, Milwaukee 1, Wisconsin, leader in ultra-miniature potentiometers.

Your Centralab Industrial Distributor stocks the Model 1 and the Model 6, in quantity, for immediate delivery at factory prices. Ask him about the B16 series (Model 1) or the SM series (Model 6).



THE ELECTRONICS DIVISION OF GLOBE-UNION INC.  
900 EAST KEEFE AVE. • MILWAUKEE 1, WISCONSIN  
In Canada: Centralab Canada Ltd., Box 400, Ajax, Ontario



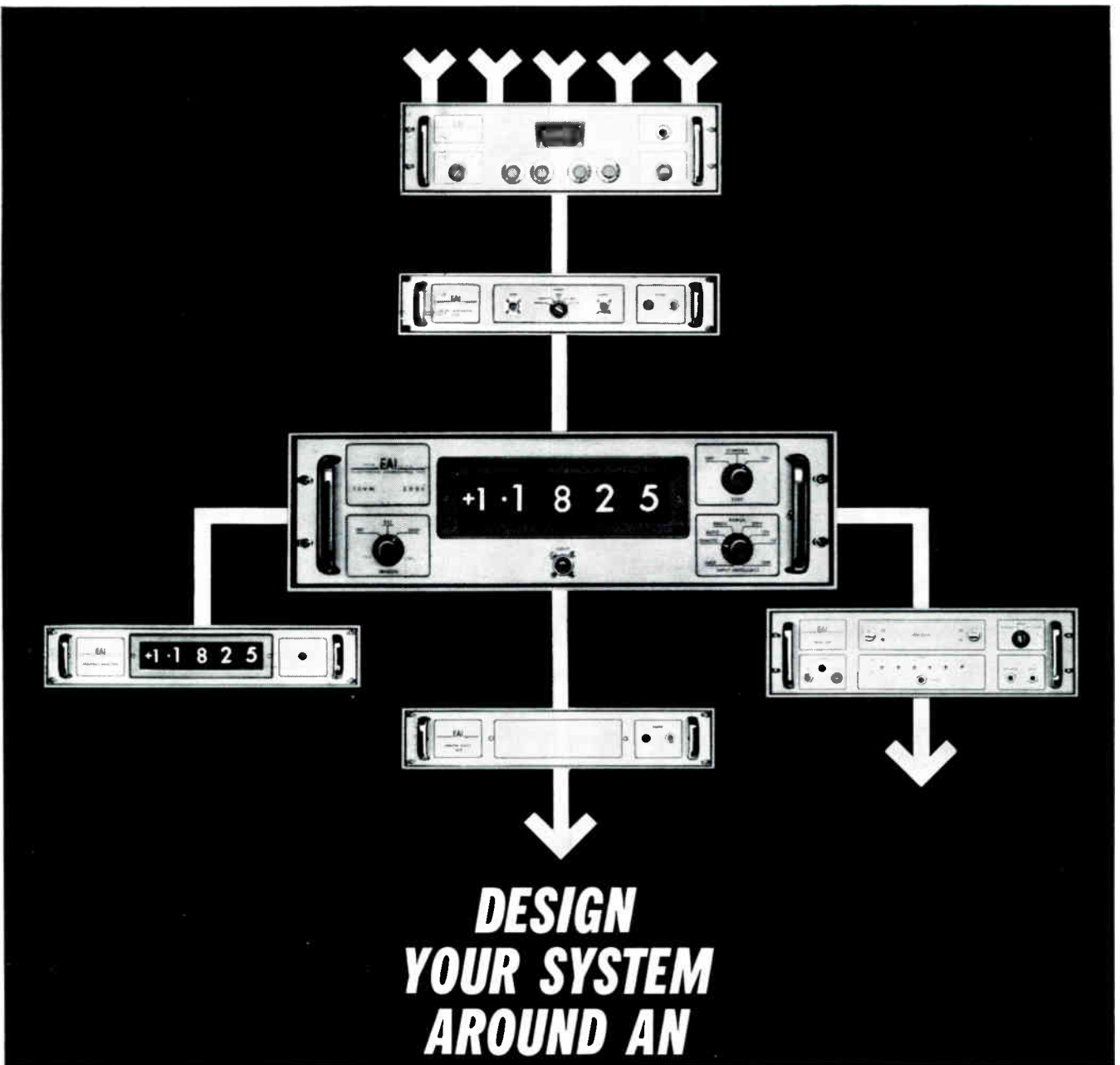

New instrumentation system capabilities are available to systems designers and laboratory engineers in EAI's fully transistorized digital voltmeters and system accessories. Solid-state reliability, six-month guaranteed stability, high speed and complete system provisions make EAI Series 5000 and 5001 DVM's ideal for the most critical applications. □ EAI Series 5000 and 5001 Digital Voltmeters are completely solid-state with 0.01% plus 1 digit absolute accuracy, six months stability, 10 milliseconds maximum reading time, buffer storage with BCD and decimal outputs and full-time input impedance to 1000 megohms. □ Series 5500 AC-DC Converter is a completely solid-state operational amplifier type providing 0.05% accuracy with 150 milliseconds maximum settling time. □ Series 5700 Input Scanner utilizes highly reliable cross-bar switching for scanning up to 30 points per second. **EAI output devices include:** □ Series 5600 Remote Visual Readout □ Series 5610 Printer Control for compatibility with parallel printer □ Series 5010 Serializor for compatibility with serial recorder □ Series 5620 High Speed Printer for recording up to 220 lines per minute □ Complete information on EAI Series 5000 and 5001 transistorized digital voltmeters and system accessories are available in Bulletin IC 6077. Write for your copy today.

# EAI

ELECTRONIC ASSOCIATES, INC. Long Branch, New Jersey

See this product demonstrated at our booth No. 827 at the National Electronics Conference in Chicago, October 8-10

for solid state applications

silicon  
rectifier

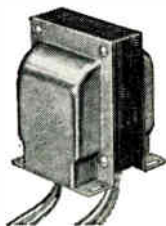

power  
transformers

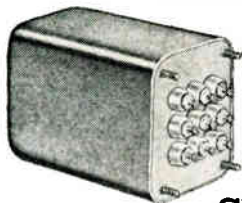

from  
**STANCOR**

**IMMEDIATE DELIVERY  
INDUSTRIAL QUANTITIES  
FACTORY PRICES**

Through your local **asid\***  
(\*Authorized Stancor  
Industrial Distributor)

Stancor Electronics, Inc., offers you a wide choice of silicon rectifier power transformers for use with semi-conductor circuitry. Depending on the circuits and rectifiers used, you can choose transformers with D.C. outputs ranging from 23V, 3950 ma to 1040V, 75 ma.

These units are available for commercial applications, or hermetically sealed in Military Standard cases to meet the requirements of MIL-T-27A.

Ask your **asid\*** or write us for a copy of the Chicago-Stancor Industrial Catalog, listing these and hundreds of other transformers, chokes and filters for industry.

## STANCOR SERVES THE OEM

For your special or volume requirements, Stancor can design and produce transformers to your exact specifications. The Stancor engineering department has the experience and facilities to handle your most complex needs with an economical approach. We would like an opportunity to quote your next transformer requirement.

**STANCOR  
ELECTRONICS, INC.**

3516 West Addison Street  
Chicago 18, Illinois

Circle 131 on Inquiry Card

## NEW PRODUCTS

### ZENER DIODES

*Insulated base units bolt directly to heat dissipating surfaces.*

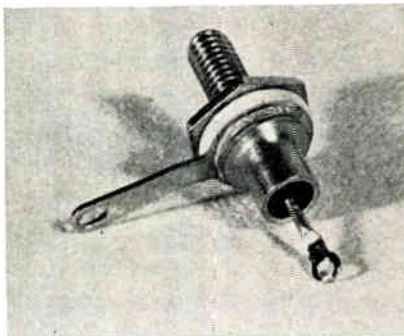

The diodes are high-power, voltage-regulating devices, that eliminate the usual mica or plastic insulating washers. A 0.050 in.-thick ceramic insulating disc withstands potentials in excess of 1000v, and has high thermal conductivity. Base provides 30% more contact area than usual with lower thermal resistance, while remaining in the outlines of the JEDEC DO-10 package. ITT Components Div., International Telephone and Telegraph Corp., Clifton, N. J.

Circle 289 on Inquiry Card

### PORTABLE TRANSCEIVER

*Features complete freedom for both of the operator's hands.*



Designed to provide wearer with instant two-way radio communications, the Shoulder-Talk unit weighs approx. 3 oz. and rests on the shoulder where it functions as speaker and microphone. The communicator itself's shoulder-strap worn and weighs 10 oz. Communication is possible with other wearers of the shoulder-talk unit as well as with fixed office stations. The equipment is fully transistorized and includes push-to-talk feature. Marco Electronic Products, Inc., Ft. of Jones St., Fisherman's Wharf, San Francisco 11, Calif.

Circle 290 on Inquiry Card

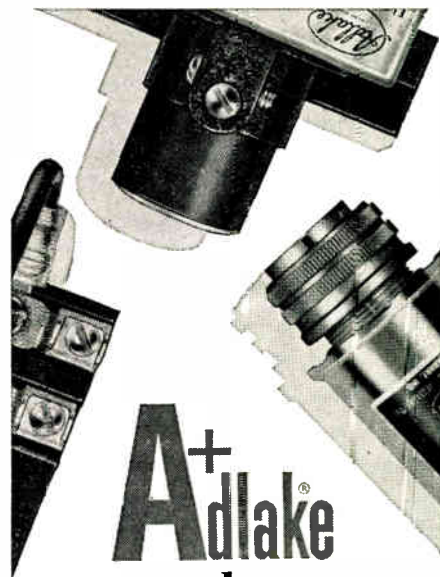

**A<sup>+</sup>  
Adlake**

**makes  
more kinds of  
mercury relays  
than anybody\***



A recent addition to the Adlake line: the polarized bi-stable mercury wetted contact relay, pictured above, which delivers speeds up to 100 operations per second. Others include: time delay; load (contacts open or closed); wetted contact (including epoxy encapsulated and sensitive non-bridging). For full information call your Adlake representative or Adlake direct. \*Send for an Adlake catalog today!



**THE ADAMS &  
WESTLAKE COMPANY**  
Elkhart, Indiana

Dept. M-8810, Relay Division  
Dial Area 219 Congress 4-1141  
Circle 132 on Inquiry Card

# SYNCRO SLITTERS

HI-SPEED SLITTING OF FOIL,  
FABRIC, PLASTICS & PAPER

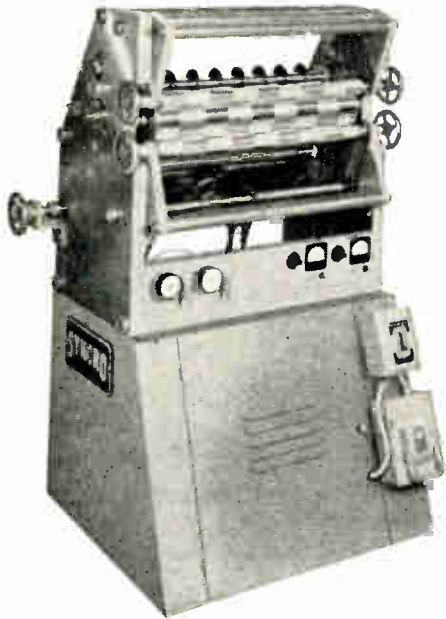

Particularly suited to dead soft strip conductors, these machines are also adaptable to film, fabric, plastic, and paper. Will handle etched, formed, anodized and coated foils without damage. No edge curling or wrinkling; no interleaving, no trimming needed.

Speeds 100-600 fpm, thickness capacity .00025" to .010". Takes rolls up to 26" wide and 15" diameter. Will slit widths down to 1/8", in smooth even cuts with scissor-type knives.

Send for catalog. Various designs available.

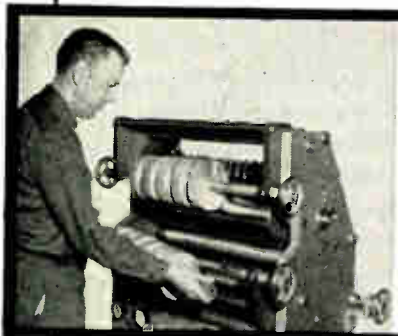

### FAST SET UPS

A complete change in total width and slit width takes only 20 minutes. Single load and unload takes only a few minutes. May be operated by unskilled personnel.

SYNCRO  
CORPORATION  
HICKSVILLE, OHIO

Circle 133 on Inquiry Card

## A SERIES OF MODERN KNOBS FOR TODAY'S INSTRUMENTS

From 3/4" to 2" diameter to conform with latest instrument designs. FREE, on request, complete catalog with wide selection of standard plastic parts on NO TOOLING COST basis.



HARRY DAVIES MOLDING COMPANY  
1428 N. Wells St. • Chicago 10, Illinois

Write  
for  
samples.

Circle 134 on Inquiry Card



## Molded Nylon SCREWS and NUTS

- FASTEN and INSULATE WITHOUT BUSHINGS
- CORROSION RESISTANT
- NON-MAGNETIC
- HIGH DIELECTRIC STRENGTH

Round, flat, and fillister head screws . . . slotted headless set screws. Hex and slotted cap nuts. Thread sizes 2-56 to 1/4-20.

DELIVERED  
FROM  
STOCK

Write for free samples to fit your production

Weckesser COMPANY, Inc.

5711 Northwest Highway • Chicago 46, Illinois

Circle 135 on Inquiry Card



## DOUBLE-FACED RADAR-MIRROR BOTH FORMS AND DIRECTS PENCIL OR FAN TYPE BEAMS

Engineers at General Dynamics/Electronics, San Diego, Calif., are using the mirror reflection principle to form and direct radar beams. Using the flat side a pencil-beam is possible. Using the curved side produces a fan type beam. Advantages are said to include: unlimited power capability; elimination of electrical joint problems; beam shape versatility; and simple design and beam steering.

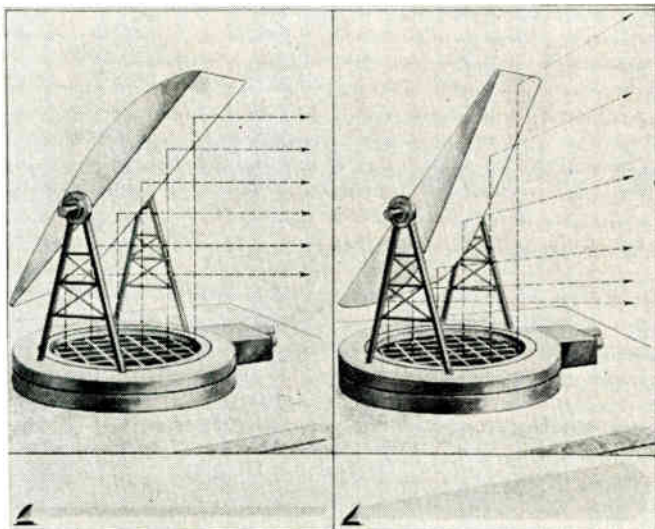

■ The NAB has endorsed the FCC's proposal for automatic logging devices to record technical operations of radio and TV stations. NAB, however, did object to part of the proposal requiring that a first-class operator check the automatic devices daily.

■ A high-speed computer was used for scoring at the recent Sixth World Championship Parachute Meet. The computer scoring center, using a Programmed Data Processor-1, was provided by Digital Equipment Corp., Maynard, Mass. In some of the events, the scores of individuals and teams were known before the jumper 'hit the deck'.

■ The U. S. Air Force has awarded a \$679,000 contract to Electronic Associates, Inc., Long Branch, N. J. for a large-scale analog computer system to be used in the X-20 (Dyna-Soar) space program. Using 3 PACE 231R computers, the system will be used for pre-flight studies of missions and in the training of pilots for the manned vehicle.

■ The Navy plans to put operational Transit Satellites into polar orbit from Point Mugu, Calif., late this year or early in 1963. Circling the earth 600 miles up, at intervals of 90°, the satellites will enable, for instance, Polaris submarines to make a pinpoint position fix once every four hours.

■ Massachusetts Institute of Technology is having a Honeywell Electronic Data Processing 1800 computer installed in connection with studies for Project Apollo. The

# ELECTRONIC OPERATIONS

## SYSTEMS WISE

Honeywell 1800 will be used to design the circuitry of the guidance computer in the Apollo capsule; check-out machine logic; and simulate full operation.

■ The U. S. District Court, District of Idaho, has stepped into the continuing battle between TV stations and Community Antenna Television systems (CATV). The court ruled that a broadcaster has a contractual exclusive right to the first run of network and film programs; and can enjoin CATV systems from duplicating these programs in the same community in which the broadcaster operates his station. Needless to say, the NAB was 'gratified'.

■ The U. S. Weather Bureau will soon have in operation a microwave relay and closed circuit TV system to send radar weather photos to N. Y. International, LaGuardia and Newark Airports. Pilots about to take-off will be able to see what the weather is for a radius of 280 miles. They view actual radar echoes, decide the best route to fly, and once in the air use their airborne radar to continue watching.

■ With the recent successful test of closed-circuit educational TV at Plainedge, L. I., N. Y., the FCC has proposed a new class of service to promote educational TV using channels in the 1990 to 2110 or 2500 to 2690MC band. The cost of such a system is estimated at 1/5 to 1/3 of the cost of a moderately powered TV station doing the same job (1-channel serving 25 schools in a single community). Signals could only be received on special receivers.

## SYNCOM II STATIONARY SATELLITE ALLOWS CONTINUOUS 24-HOUR TV AND VOICE HOOKUP

Advanced communication satellites are now being designed by Hughes Aircraft Co., Culver City, Calif., under a multi-million dollar contract from NASA. Designed to orbit at 22,300 miles altitude, they will 'view' 1/3 of the Earth's surface at all times. Able to provide 1200 phone calls or a combination such as 600 telephone conversations and 2 TV programs simultaneously, they will require cheap, fixed antennas on the ground, allowing the smaller nations to participate.

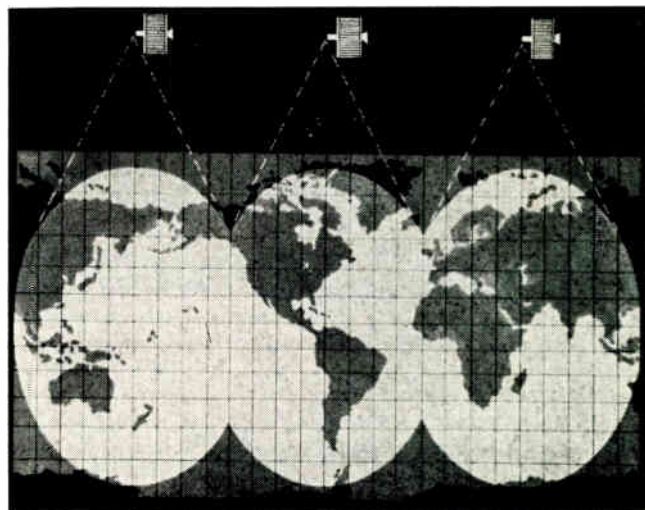

Satellites Need...

## VERSATILE PCM TELEMETRY SYSTEMS

The system in NASA's Orbiting Astronomical Observatory accepts digital and analog information in many different programmable modes. By using the latest packaging methods total weight is held to less than 35 pounds. And its probability of proper operation for a full year in orbit is 98%.

TWO MAIN SYSTEMS comprise the Orbiting Astronomical Observatory (OAO): the spacecraft itself and the experimental equipment supplied to NASA by leading astronomers. Basically, there are two lightweight, low-power Pulse Code Modulation (PCM) telemetry systems required to monitor the systems: the Spacecraft Data Handling Equipment (SDHE) and the Experimenters Data Handling Equipment (EDHE).

### Abbreviations

**NASA** National Aeronautics & Space Administration  
**OAO** Orbiting Astronomical Observatory  
**PCM** Pulse Code Modulation  
**EDHE** Experimenters Data Handling Equipment  
**SDHE** Spacecraft Data Handling Equipment

The EDHE accepts all experimental data, converts it to PCM format and channels the data to the proper transmitter, at the desired rate, for transmission to the ground. SDHE accepts all spacecraft operational data for transmission. OAO data is recorded on the ground by tape for later analysis by the experimenter and spacecraft operator.

### SDHE and EDHE Features

A primary feature of the two systems is their ability to act in response to a variety of commands. Besides experiment commands, ground control of

astronomical equipment, the OAO can be sent many spacecraft commands. These can slew, point, and re-stabilize the observatory as well as turn on and off many spacecraft components. Four receivers assure receipt of commands.

Commands can be delayed or given in real-time. Delayed commands—those to be executed after some predetermined elapsed time—are stored in the command storage unit until the proper time. The system clock provides an accurate time reference for determining when stored commands are to be executed. Real-time commands are executed immediately.

Information is relayed by both narrow- and wide-band PCM telemetry links. The narrow-band link, capable of handling digital information at the rate of 1000 bits per second, operates at 136.20 mc. A 400.550 mc wide-band link transmits analog data at frequencies up to 62 kc and digital data at rates up



By **STEPHEN A. MIXSELL**

Project Engineer—OAO  
Data Systems Division  
Radiation Incorporated  
Melbourne, Florida

to 50,000 bits per second with a bandwidth of 300 c approx. A tracking beacon operating at 136.440 mc is also provided.

A data storage unit with over 200,000 bit capacity is provided in the satellite for PCM telemetered information derived when the OAO is beyond line-of-sight of the ground station. Data can be retained on board until an appropriate time for transmission to the ground, a period of about 9 minutes per orbit. This complex data includes both spacecraft performance and up-to-date information concerning the OAO's two experiments.

### OAO Experiments

Two prime experiments will be carried in the satellite. One will map the entire celestial sphere in ultraviolet down to a wavelength of 1100 Angstroms. The other is directed toward determination of the stellar energy distribution in the spectral region from 3000 to 800 Angstroms; and, at the measurement of emission line intensities of diffuse nebulae in the same region.

In the first, Smithsonian Astrophysical Observatory's 8-inch telescopes will be coupled with a video tube to map ultraviolet radiation over the entire sky. Hydrogen is a thousand times more prevalent in the universe than any other element; and, it shows

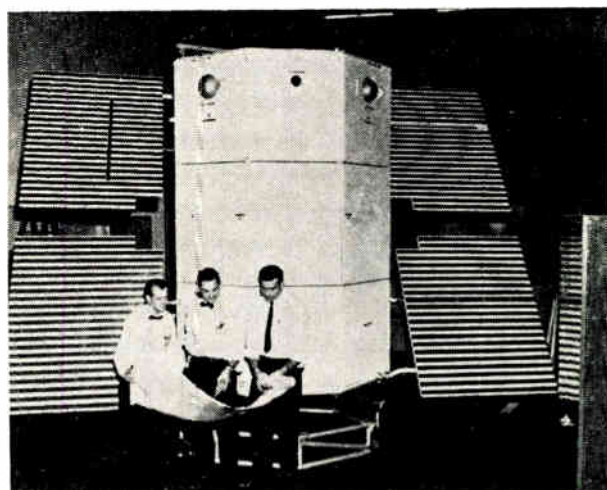

Engineers review details of the OAO which stands behind them.

its presence most strongly in the ultraviolet. By investigating this region, we hope to learn more about how stars are born, because new stars probably have strong ultraviolet emissions.

The second, conducted by the Univ. of Wisconsin, is expected to lead to information on star temperatures and structures and their life histories.

Three further OAO flights are in the planning stages. *(Continued on following page)*

Fig. 1. The equipment which will be aboard the OAO satellite uses three-dimensional welded modules in logical function blocks.

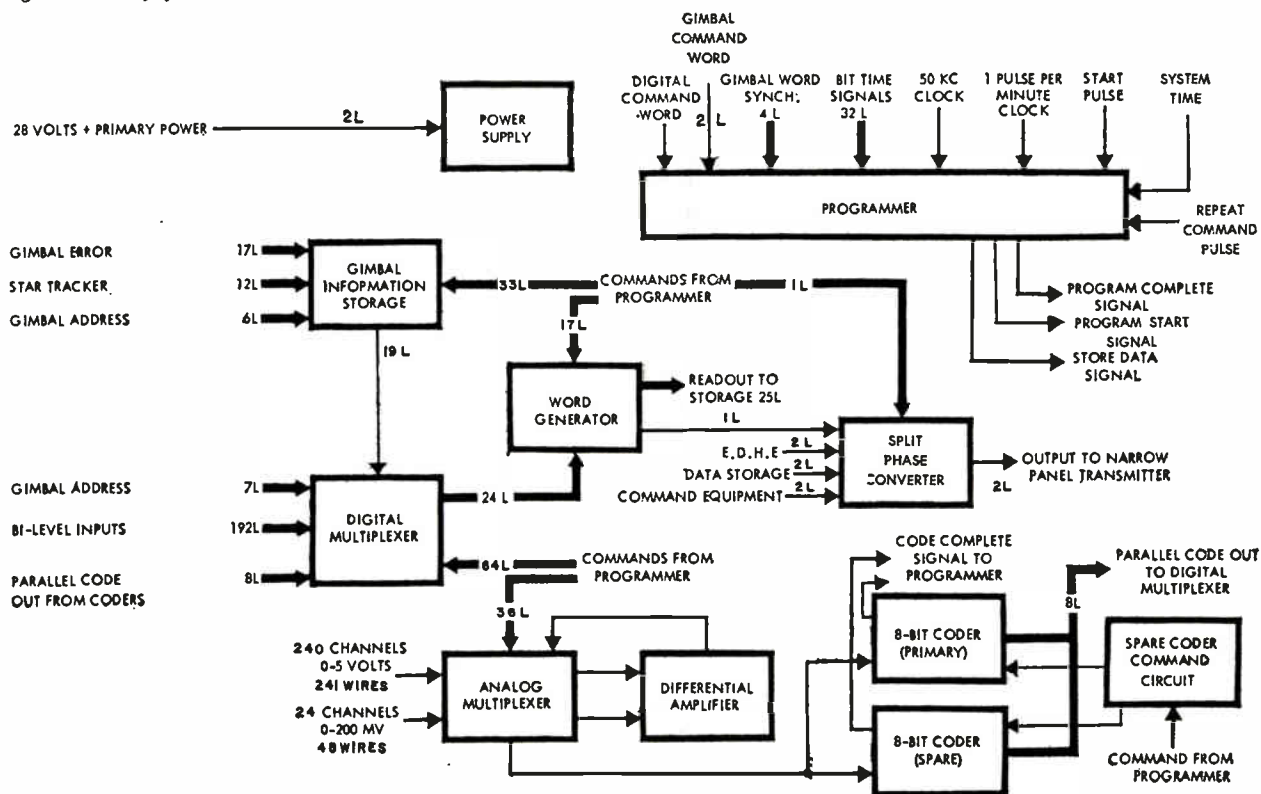



## OA0 TELEMETRY (Concluded)

### Reliability for One Year Orbit

OA0's overall reliability for one full year is specified as 70%. The high reliability of the spacecraft itself, however, coupled with an extremely tight development schedule, precludes sufficient system testing to prove statistically 70% reliability of OA0. To overcome this problem a reliability apportionment approach has been taken. To achieve the overall reliability objective, the 70% overall reliability is apportioned among the various subsystems and components. This is done on the basis of relative complexity and importance to the successful operation of the spacecraft as indicated by a failure effect analysis. The telemetry has been designed for very high reliability. The estimated performance probability within specification for one year's time in orbit is 98% for digital channels, 90% for EDHE analog channels, and 82% for SDHE analog channels.

The systems will incorporate advanced modular packaging techniques which will bring total weight for both systems to less than 35 pounds; SDHE 20 pounds, EDHE 15 pounds. Construction methods will include three-dimensional welded modules in logical function blocks similar to those used in the PCM telemetry system for NASA's Nimbus weather satellite, Fig. 1.

### Power Requirements

The OA0's power supply includes a fixed array of silicon solar cells used with rechargeable nickel-cadmium storage cells. An average usable power of approximately 270 watts can be derived from the array at the end of one year under the most unfavorable of normal spacecraft orientations.

Both systems will operate from 28 volts, dc primary power, with the SDHE requiring only 2 watts of power and the EDHE requiring only 1 watt. This low power requirement is necessary because of the use of solar cells as the prime source aboard OA0. Some of the experimental units in the satellite require concentrated power for short periods; therefore, PCM power supplies must be kept to a minimum.

### Processing Capabilities

The SDHE has the capability of processing the following input data channels:

- 240 High Level Analog (0 to 5 volts)
- 24 Differential Analog Inputs (0 to 200 millivolts)
- 192 Digital Bi-Level Channels
- 27 Digital channels which contain serial, parallel, and series-parallel combinations of digital data

The EDHE has the capability of processing the following input channels:

- 200 Digital Bi-Level Channels
- 30 High Level Analog Channels (0 to 5 volts)
- 3 Digital Information Channels containing serial, parallel, and series-parallel combinations of digital data

A redundant component approach is being used in the design of all digital circuitry to achieve the required reliability. Every digital circuit has redundant components, allowing for many component failures without losing circuit performance.

In the coder alone, 98% reliability will be achieved through component redundancy as well as circuit redundancy. This is the highest of any existing satellite. In pursuing this method, we developed redundant circuits, including redundant monostables and bistables, as well as crystal oscillators. In the Nimbus satellite, with its shorter life, only the components with lower reliability are duplicated.

### System Testing

Two prototypes of each telemetry system will be made and tested. The first SDHE prototype will be Flight Proof Tested to prove the equipment's ability to survive the launch vibration and to operate satisfactorily in space environment conditions. The second SDHE will be tested in OA0 Spacecraft under simulated environmental conditions.

Two test facilities at Grumman Aircraft Engineering Corp., Bethpage, N. Y., will play important roles in the qualification and acceptance test programs. One is the high vacuum chamber measuring 19 ft. diameter and 26 ft. high. The other, a large air bearing simulator, will be used for precision stabilization and control tests. Other major OA0 test programs include a vibration test on the 30,000 pound shaker and an extended performance demonstration. Grumman is prime contractor and systems manager of the OA0 project.

After delivery of the two EDHE prototypes to Grumman, the first will be used for integration testing and the second will undergo environmental testing in the OA0 Spacecraft. Both units will be tested at levels 1.5 times the predicted load.

---

A REPRINT OF THIS ARTICLE CAN BE OBTAINED  
by writing on company letterhead to  
The Editor  
ELECTRONIC INDUSTRIES  
Chestnut & 56th Sts., Phila. 39, Pa.

---

## NEW PRODUCTS

### TUNNEL-DIODE DEVICES

Oscillator and mixer for airborne receivers and phased array systems.



Model SS111, a tunnel-diode oscillator, can supply a min. power output of 6.0mw at 1.6cc. The device uses the negative resistance of tunnel diode to excite a microwave resonant circuit. The unit measures 2½ in. in dia., ¾ in. in height and weighs only 5 oz. Model SS504, a tunnel-diode down-converter (mixer), operates at a carrier freq. of 1250cc with an output i-f freq. of 30mc. The device has a 5.5db max. noise figure and gain of -2 to -3db. Radio Corp. of America, Electron Tube Div., Harrison, N. J.

Circle 297 on Inquiry Card

### FM SIGNAL GENERATOR

For use from 400-550mc with 6-digit readout.



Model 412 is capable of precision operation in command receiver checkouts, bandwidth tests, discriminator and sensitivity measurements, and receiver alignment. It also has the ability to furnish freq. search, by single knob freq. control, pushbutton function selection, and 6-digit illuminated readout. Accuracy of display is within 0.0003%. Measures 13 x 19 x 18 in.; weighs, 135 lbs. Input power requirements are 105-126v at 60cps. Microdot Inc., 220 Pasadena Ave., S. Pasadena, Calif.

Circle 298 on Inquiry Card

make **Keystone** your key source for

## SPECIAL CONFIGURATION THERMISTORS AND ASSEMBLIES

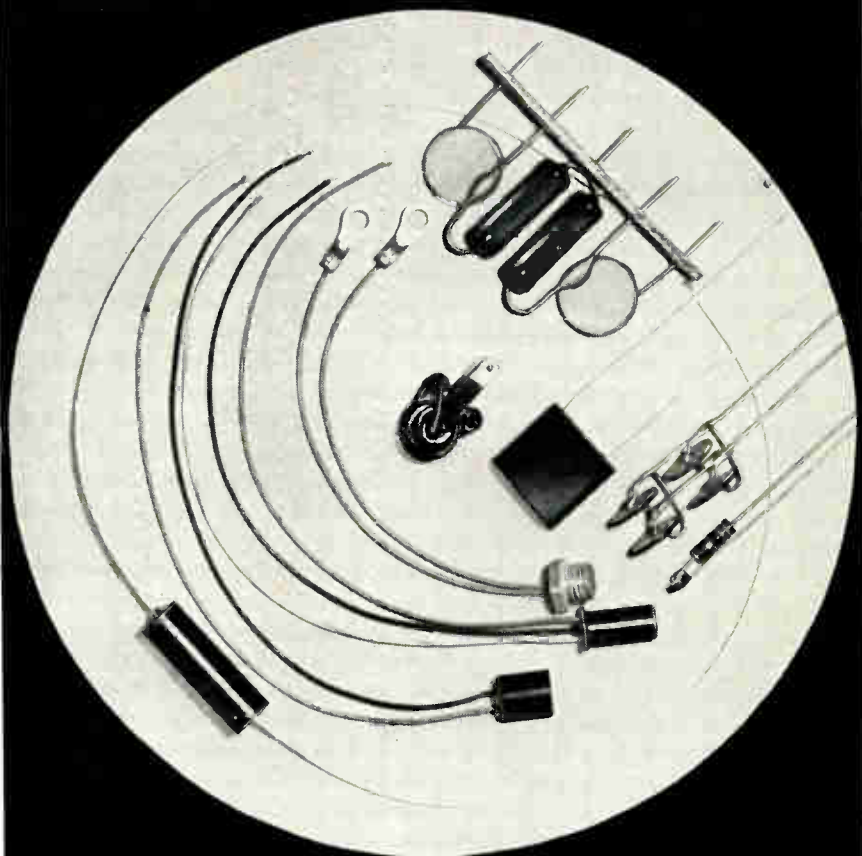

### these complete units

- SHORTEN ASSEMBLY TIME
- CUT YOUR ASSEMBLY COSTS
- ELIMINATE ASSEMBLED REJECTS

Keystone "specials" include threaded headers, phenolic and epoxy headers, plate-mounted units for heat sinks, specially wired assemblies, and electronic packages—which include fixed resistors and thermistors suitably mounted and wired. • You get high quality in Keystone volume production—plus close assembly tolerance, good appearance, environmental protection. Write us!

**Keystone**  
CARBON COMPANY  
ST. MARYS, PA.

**THERMISTOR DIVISION**

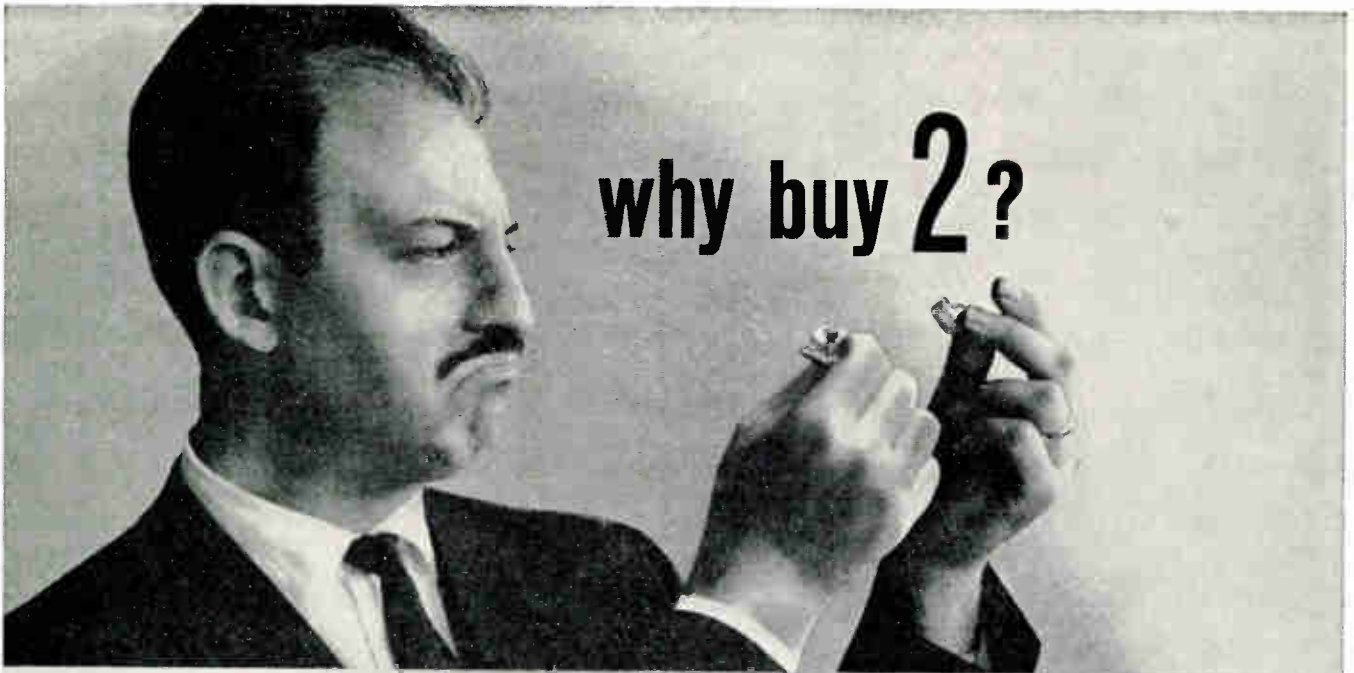

why buy 2?



when 1 will do!

**Why buy two (a trimmer capacitor and inductor) when one JFD LC TUNER SEALCAP® will do?**

If high reliability, stability and ruggedness are a must and if space, costs and weight are putting the squeeze on your critical circuit designs, look into the versatile JFD LC Tuner. Its unique combination of capacitive and inductive characteristics in one rugged, compact assembly cost cuts down bulk, cost and weight problems to size...ups reliability, frequency, stability and performance capability.

To these outstanding features the LC Tuner Sealcap series add the advantages of the exclusive "Sealcap" construction. Since they lock out moisture and atmospheric effects they are ideal for seaborne, airborne and space applications.

When your circuits call for standard or special panel or printed circuit types, other JFD LC Tuners can be designed to meet and beat your specs. Your JFD sales engineer or sales representative will be pleased to tell you more. Contact him or your nearest JFD franchised distributor, or write direct for LC Tuner Catalog T172.

Model	Self-Resonating Freq. Range, Mc.		Nominal Q of Inductor Over Tuning Range	Nominal Inductance $\mu$ h	
	Min.	Max.		Min.	Max.
LCS363	400	725	170-200	0248	.0277

U.S. PATENT NO. 3,932,093 CANADIAN PATENT NO. 604,810

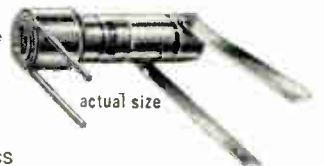

AT WORK IN THE NEW FRONTIERS OF ELECTRONICS

**JFD ELECTRONICS CORPORATION**

Components Division • 6101 16th Avenue, Brooklyn, New York • Phone DEwey 1-1000 • TWX-NY25040 • Cable-JEFDEE NY

JFD WESTERN  
P. O. Box 3416, Van Nuys, Calif.  
Phone: EMpire 4-4131

JFD NORTHEASTERN  
Ruth Drive, P. O. Box 228, Marlboro, Mass.  
Phone: RUntley 5-7311

JFD MIDWESTERN  
P. O. Box 588, Skokie, Illinois  
Phone: 675-1740

JFD CANADA  
51 McCormack Street, Toronto, Ontario, Canada  
Phone: ROGers 9-1129

VARIABLE TRIMMER PISTON CAPACITORS • FIXED METALIZED INDUCTORS • LC TUNERS • DIPLEXERS  
FIXED AND VARIABLE DISTRIBUTED AND LUMPED CONSTANT DELAY LINES • PULSE FORMING NETWORKS

**JFD**

See What's New From JFD In Booth 823 At The NEC



# CLARE

## Crystal Can Relays offer *PROVED* reliability plus design flexibility

■ CLARE Crystal Can Relays, available with either latching or non-latching circuitry, offer the designer a constantly higher norm of *proved* reliability.

The CLARE Quality Assurance Program tests these relays to provide check of a broad cross section of the materials, the processes and the individual skills which contribute to their fabrication. Sample lots are selected, tested in general accordance with MIL-R-5757D (par.4.6.1.4., Group B), then tested to failure, to discover the cause of final breakdown... and take steps toward increasing reliability.

*Information on how these tests are performed is available on request.*

Type F and Type LF (both one-coil and two-coil) relays in one-sized enclosure.

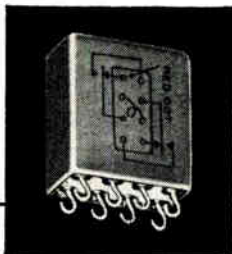

### LATCHING OR NON-LATCHING CIRCUITS

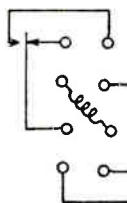

Type F (non-latching)

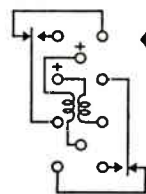

Type LF2000 (two-coil latching) Additional coil termination configurations on request.

Type LF-1000 (one-coil latching)

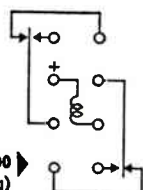

For complete information send for Catalog 203 and Bulletin CPC-12. Address: C. P. Clare & Co., 3101 Pratt Blvd., Chicago 45, Illinois. Cable Address: CLARELAY. In Canada: C. P. Clare Canada, Ltd., 840 Caledonia Road, Toronto 19, Ontario. In Europe: Europelec, les Clayes-sous-Bois (S.-et-O.), France.



**C. P. CLARE & CO.**

*Relays and related*

*control components*

Circle 137 on Inquiry Card

# "IRON OXIDES for ferrites?"

# "Yes- MAPICO!"

"Why Mapico above all others? First, these pure synthetic iron oxides are unmatched for uniformity . . . and subjected to the most precise production controls."

"Then there's range—a Mapico iron oxide raw material for every end use area from magnetic tape to, well, broadcast receiver antennae."

"That's right. They're made in three typically different particle shapes, each available in several ranges of particle size. Selection of the right iron oxide gives controlled electronic characteristics and shrinkage."

"And Mapico offers a useful, up-to-date chart on these many oxides with detailed data by particle shapes and properties."

"Write for it today."

## MAPICO IRON OXIDES UNIT COLUMBIAN CARBON COMPANY

380 Madison Avenue, New York 17, N. Y.  
Branch offices and agents in principal cities



**COLUMBIAN CARBON COMPANY**  
380 Madison Avenue, New York 17, N. Y.  
Please send me the new, up-to-date chart on  
MAPICO IRON OXIDES FOR FERRITES.

Name .....

Position .....

Firm .....

Address .....

City.....Zone.....State.....

Circle 138 on Inquiry Card

## EISLER

Makes the largest assortment of Precision Press Type Resistance Spot—Wire Butt—Seam—Tweezer—Gun and Flash Welders. We also carry in stock Welding Tips, Holders and other Welding Accessories.

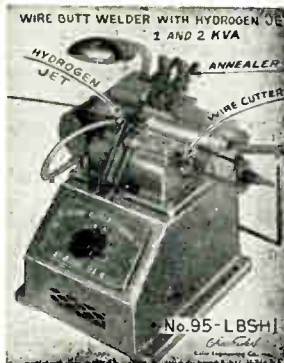
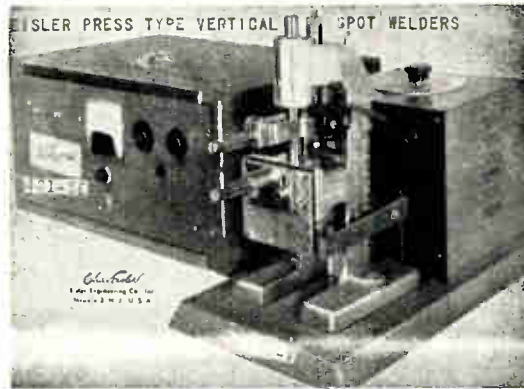

**EISLER ENGINEERING CO., INC.** 770 So. 13th St., NEWARK 3, N. J.

Circle 139 on Inquiry Card

## NEW PRODUCTS

### EPOXY-PIGMENTING KIT

*A kit of color pastes in small quantities for pigmenting epoxy resin.*



Containing 12 different colors in 2-oz. jars, the color-paste kit provides the small-volume user with an economical means for color-coding or branding epoxy coatings or castings. The color pastes have been specifically selected for electrical-electronic applications, and offer minimum alteration of the electrical and physical characteristics of the epoxy. The pastes are free-flowing and pourable, and mix readily with simple stirring. Valley Products, P. O. Box 271, Oakland, N. J.

Circle 291 on Inquiry Card

### HIGH-SPEED TRANSISTOR

*Silicon device has pulse propagation time to 3nsec.*

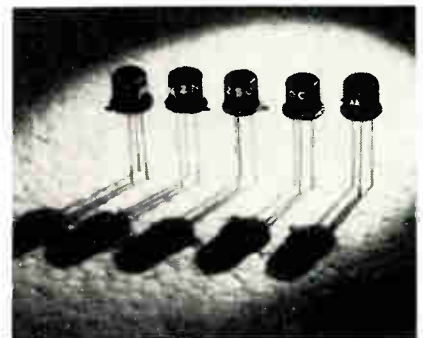

Type 2N2501, silicon epitaxial planar transistor features a low pulse propagation time resulting from its very low capacitance, low storage time characteristics, and high gain-band-width product. Housed in a T0-18 package, it is for low-level logic switching in the 100 $\mu$ a to 100ma region. Saturation voltage is specified at 10, 50, and 100ma. The transistor is rated for 360mw dissipation at 25°C amb. and has a 200°C max. junction temp. Motorola Semiconductor Products, Inc., 5005 E. McDowell Rd., Phoenix, Ariz.

Circle 292 on Inquiry Card

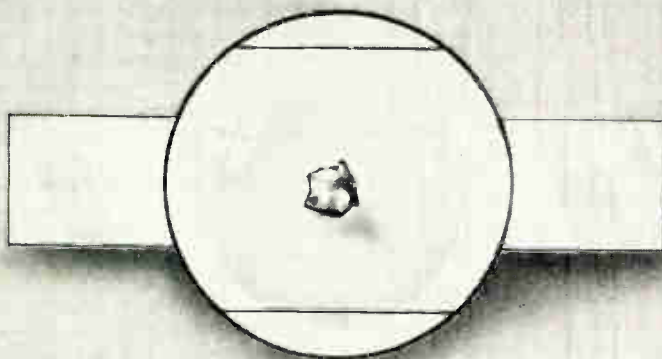

## How Clean Is "Clean"

This microscopic chip would undoubtedly cause a malfunction in a gyro mechanism or a computer relay. The same chip might be of little or no importance on a missile structure or an electronic chassis.

Such products require different degrees of cleanliness and this is where NU shines. We specialize in ultrasonic cleaning equipment and systems tailored to the product end use or subsequent processing requirements. Write for brochure detailing NU Cleaning Equipment Products and Services. Our technical personnel will be glad to discuss ultrasonic equipment, applications and operating techniques without cost to you.

**nu NATIONAL ULTRASONIC CORP.**  
Foot of James Street, Somerville, N. J. • Phone: Area Code 201 722-5200

**ULTRASONIC CLEANING AND PROCESSING EQUIPMENT**

Circle 140 on Inquiry Card



# Vlchek Plastic Boxes for every need

Vlchek Model P-824  
24 compartment, clear plastic box  
one of largest compartmented boxes ever molded

\*If you require plastic boxes for packaging or storing your electronic products, see Vlchek.

Vlchek, pioneer plastics manufacturer, stocks boxes in 30 standard sizes . . . ready for immediate shipment. These are available in 1,000 compartment arrangements . . . crystal clear, tinted transparent, or solid colors. Complete imprinting service.

Or, if you need a special box of any type or shape, Vlchek will design and custom-manufacture it. Write us today. Our representative will call promptly.

A-6470A

\*good for fishing tackle, too!



Vlchek Plastics Co.  
Middlefield, Ohio

Circle 141 on Inquiry Card

## What could YOU do with this Sensitive Abrasive?



**Without significantly changing dimensions of the workpiece, CRATEX® deburrs, smooths, cleans and polishes easy and hard-to-reach surfaces.**

The unusual performance of Cratex results from its cushioned chemical rubber base. It is slightly compressible; shaped in a variety of forms, including Wheels, Points, Blocks, Sticks and Cones. First quality Silicon Carbide abrasive particles are evenly distributed throughout the base and each Cratex shape is available in 4 grit textures: (C) coarse; (M) medium; (F) fine; (XF) extra fine.

Typical Cratex applications include:

- |   |  |
|---|--|
| precision finishing without loss of tolerances, | relieving stress concentration,        |
| cleaning out and finishing intricate designs,   | radiusing, removing surface blemishes. |

**You can count on CRATEX® to do the same dependable job, time after time.**

A comprehensive Cratex catalog and price list is available on request, without charge. Product and performance data provided may suggest how Cratex will benefit you in terms of time-saving cost reduction and quality improvement.

**CRATEX®** MANUFACTURING COMPANY, INC.  
1600 ROLLINS ROAD BURLINGAME, CALIF.

Cratex is sold through leading industrial distributors.

Circle 142 on Inquiry Card



## TRANSISTOR SOCKETS

for  
TO's 5, 9, 11, 12, 16, 18,  
25, 28, 29, 31, 39 and 46

One piece contacts — extend all the way through socket. Molded thermosetting plastic per MIL-M-14. Terminal numbers are molded into bottom of socket — top face keyed for alignment with transistors.

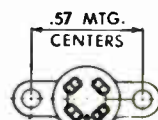

### No. 22-11

screw mount style for 3/8" hole. 4 terminals standard. 3 terminals on special order.

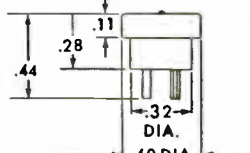
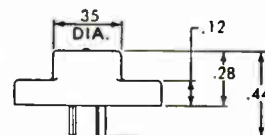

### No. 22-16

Solder direct to printed circuit, or fits "D" hole. 3 or 4 terminals. Also available in colors.

.20 DIA. CIRCLE OF CENTERS



### No. 22-101

allows transistor leads to extend all the way through socket.



NO. 22-101 for TO's 18, 28 and 46

Write for complete specifications.  
Your current Grayhill Engineering Catalog will be sent on request.



"N. Gineer"



Area Code 312, Phone 354-1040  
543 Hillgrove Avenue  
La Grange, Illinois



PIONEERS IN MINIATURIZATION

Circle 143 on Inquiry Card



## Switch to the Best

- 24,000 volt peak flashover at 60 cps
- 100 ampere current carrying capacity
- Current carrying members heavily silver plated
- Low loss silicone impregnated steatite shaft and stators

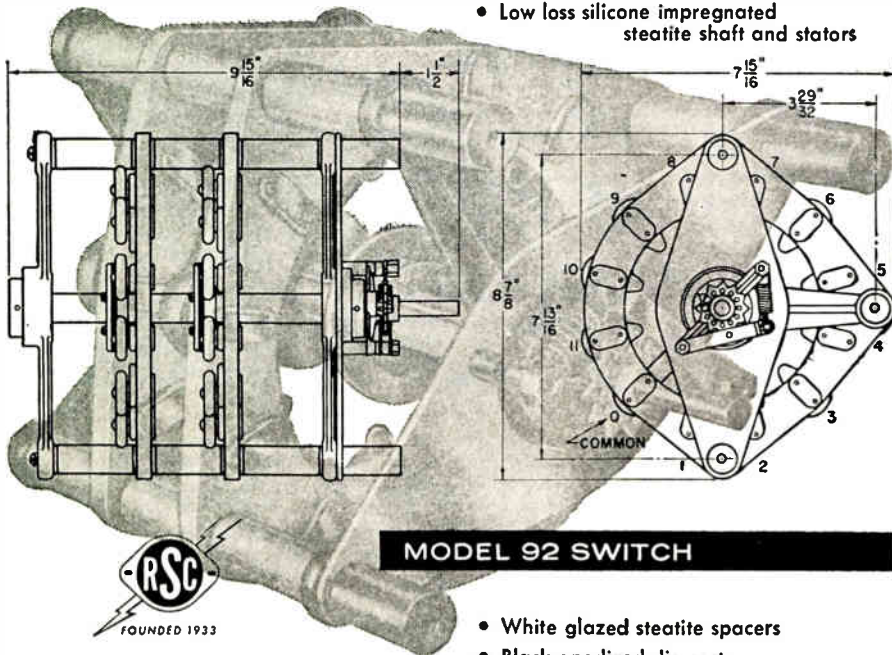

**MODEL 92 SWITCH**



**RADIO SWITCH CORPORATION**

MARLBORO, NEW JERSEY  
Telephone: HOpkins 2-6100

Circle 145 on Inquiry Card

- White glazed steatite spacers
- Black anodized die cast aluminum support brackets
- Ball bearings
- Each contact and rotor equipped with a corona shield
- Forged copper stator contacts

## NEW PRODUCTS

### SUBMINIATURE SWITCH

*Precision snap-action switch features max. actuating force of 2 oz.*

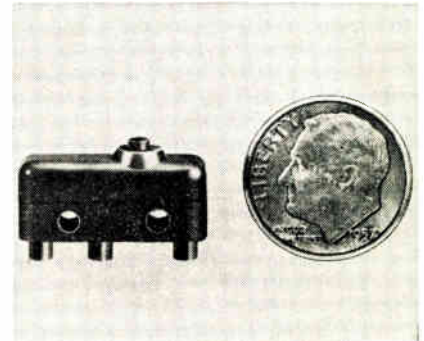

The Model 760 sub-miniature switch using a single piece mechanism, has an operating point which is guaranteed to remain constant, assuring high repeatability. Precision characteristics, such as low differential travel and low differential force, low resistance, long life and no dead break can also be incorporated into the switch, according to the requirements of the application. Mounting dimension holes are standard. U. S. Switch Corp., 7 Jefry Lane, Hicksville, L. I., N. Y.

Circle 293 on Inquiry Card

for size ...  
stability ...  
service

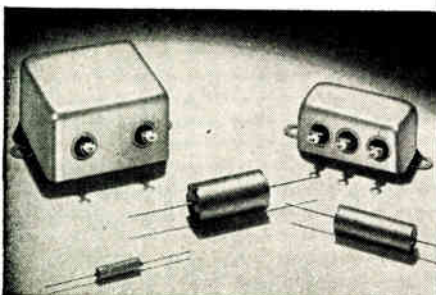

**Exceed MIL Requirements!**

Available in two case styles:  
bathtub (TYPE AB) Metal  
clad miniature (tubular —  
TYPE AM)

**Plastic Capacitors, INC.**

2620 N. Clybourn • Chicago 14, Illinois  
DI 8-3735

## the New METALLIZED MYLAR\* CAPACITORS

by



On the job, Metallized Mylar\* really delivers with such outstanding characteristics as: self healing; elimination of weak dielectric areas; great reliability; excellent economy. Temperature range for operating and storage — 90°C + 125°C; capacitance tolerances are 1%, 2%, 5%, 10% and 20%; with low dielectric absorption and high resistance. Write today for complete information including literature with curves, all listings, technical information and illustrations.

\*Dupont Polyester Film.

"Custom  Engineered at  
Production Prices!"

### CAPACITOR TESTER

*Tests paper, mylar and electrolytic capacitors for leakage.*



Model E-2 indicates capacitor leakages ranging from 1000 megs to 5000 megs. "Cappy" features a "current" leakage test for large capacitance and high working voltage electrolytics. This dynamic test will indicate leakage ranging from 0.3ma to 10ma. In addition the unit can be used to perform a quick and accurate check for silicon and selenium rectifiers, motor capacitors, r-f high voltage, and insulation leakage of cable and appliances. Watsco Inc., 1800 W. 4th Ave., Hialeah, Fla.

Circle 294 on Inquiry Card

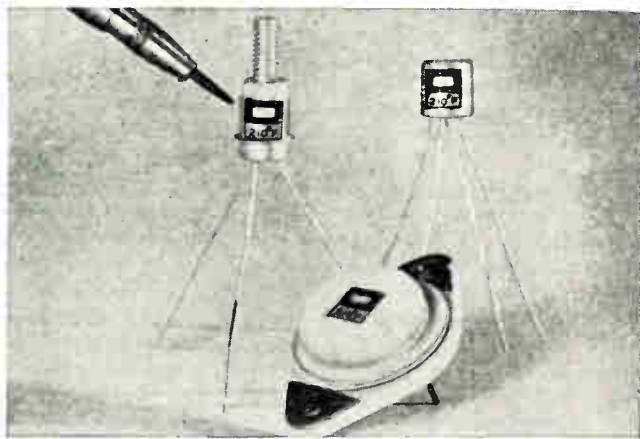

## TEMP-PLATE<sup>®</sup>

### DETECTS ELECTRONIC OVERHEATING

Overheating of transistors, diodes, resistors and transformers is detected by Temp-Plate in a positive, direct manner. Simple, easy to use, irreversible, Temp-Plate is the little plastic tab that sticks to the component, turns black when the temperature reaches any desired value between 100° and 1100°F. Impervious to ambient atmosphere and production line handling, Temp-Plate is accurate to  $\pm 1\%$ , provides for absolute indication of heat damage. Write now for free sample.

TEMP-PLATE/Pyrodyne, Inc.

11876 Wilshire Boulevard

Los Angeles 25, California

Openings available for qualified missile-space systems fluid components designer

Circle 147 on Inquiry Card



# NOW ANYONE CAN STRIP WIRE ALL DAY WITHOUT NICKING!

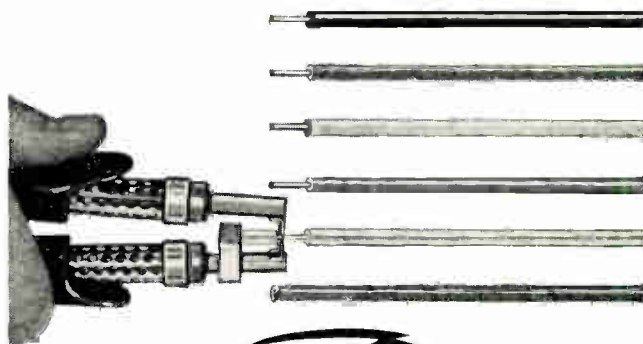

New **IDEAL**

## THERMO-STRIP<sup>™</sup> WIRE STRIPPER FOR PLASTIC INSULATION

### The Precision Stripper That Can't Harm Wire

Make precision stripping routine — for missile components, aircraft, computers, instruments — any equipment where wire damage can't be tolerated. New Ideal Thermo-Strip melts through insulation — no cutting, no tearing — prevents all nicking and breaking. Won't disturb strands of even finest wire. Works on all thermo-plastic insulation, including Teflon. Infinitely variable heat control prolongs element life, cuts fumes, lets you pick the exact temperature for the job. Can operate continuously — with no warm-up wait. Safe, fast, easy to use — Thermo-Strip is a precision wire stripper, not a converted soldering gun.

JUST PLUG IT IN . . .  
Comes complete with 50-watt transformer and your choice of tools:



**Pincer** — for high-speed production stripping. Just grip wire, and pull off insulation slug with heating elements.

**Single Element** — for probing into miniature or crowded assemblies. Just put wire end in electrode V-notch.

Selection of elements.

TRY IT IN YOUR SHOP! IDEAL INDUSTRIES, Inc.  
5127-J Becker Place, Sycamore, Illinois

Please arrange a trial for me  Send data only

Name \_\_\_\_\_

Company \_\_\_\_\_

Address \_\_\_\_\_

City \_\_\_\_\_ Zone \_\_\_\_\_ State \_\_\_\_\_

Sold Through America's Leading Distributors. IN CANADA: IRVING SMITH, Ltd., Montreal

Circle 149 on Inquiry Card

## ...ON TO VICTORY

for Sophisticated, Ultra-Reliable

### MODULAR | POWER | SUPPLIES

✓ MILITARY APPROVED PROPRIETARY POWER SUPPLIES

✓ MINIATURE HIGH VOLTAGE POWER SOURCES  
Up To 25,000 Volts DC

✓ HIGHLY REGULATED INVERTERS

✓ TRANSISTORIZED POWER SUPPLIES, REGULATORS  
AC To DC, DC To DC, DC To AC (In Stock)  
Operate Without Fans, Blowers Or Heat Sinks

Comprehensive Technical Literature On Request



- RESEARCH
- DEVELOPMENT
- MANUFACTURE

**VICTORY ELECTRONICS, INC.**

©1962

145 MICHAEL DRIVE  
SYOSSET, L. I., N. Y.  
WAlnut 1-6400

Reps—Choice Territories Available—Call, Wire, Write

Circle 148 on Inquiry Card



# Another Gibson Quality Component INTERMETALLIC WAFERS

**ASSURE MAXIMUM EFFICIENCY...LONG LIFE FOR SILICON RECTIFIERS, DIODES AND OTHER ELECTRONIC DEVICES**

Gibson intermetallic heat sink wafers are the result of extensive research and product development to solve the problems of adequately sandwiching the high purity silicon rectifier disc used in the semi-conductor field. Gibson wafers match the desired coefficient of expansion of the silicon disc in every case. Their heat absorption and emission meet optimum requirements for the atomic excitation of the semiconductor. Gibson's years of experience in precision manufacturing of pressed and sintered refractory metal parts permits conformation to the tight tolerances required for attaching the wafer to the silicon disc and to the pedestal of the encapsulating hardware. Heat Sink Wafers are available in discs and rectangles in a range of metal and bimetal structure to meet most silicon semiconductor needs.

## PLUS VALUES

1. Gibsotronic Heat Sink Wafers are more readily attached to the rectifying element and bases by electroplating with either one or a combination of copper, nickel or gold. On tungsten-silver powder metal discs, Gibson can supply the wafer encapsulated with a controlled thickness of silver.

2. Gibson can provide prewetting of one or both surfaces with appropriate solders.

3. Gibson can provide practically any surface finish from ground to highly lapped surface.

For complete specifications, information and ordering procedure, write for Technical Information Bulletin 700-A to:

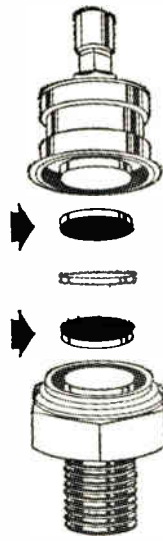

## SYSTEMS & CIRCUITS

**"ELECTRONICS" DEFINED** by Canadian EIA. Here is what they said: "Electronics is that branch of science and technology which deals with the study, application and control of the phenomena of conduction of electricity in a vacuum, in gases, in liquids, in semiconductors and super conducting materials." This definition was given by EIA at recent tariff hearings in Ottawa.

**MICROMODULE** program received a financial vote of confidence recently when the US Army Signal Corps disclosed that it anticipates committing \$8-million for equipment and systems in fiscal year 1963. That's double the 1962 funding. Even more is considered for 1962. Up to 1962, \$18-million had already been invested in the program. But, the Army is investing in this form of discrete component circuitry only because it is the most advanced of the microelectronic techniques which can now supply hardware. In a personal interview, the head of the Army's new Electronics Command, Maj. Gen. Stuart S. Hoff, told **ELECTRONIC INDUSTRIES** that the other microelectronic techniques—thin film, integrated network, and epitaxial planar methods—were being enthusiastically pursued by the military as the next goal. Further, that this goal offered the answer of the real automated production line, or factory, for electronic circuits, if not equipment and systems.

**QUALITY CONTROL** does not always require new or exotic production methods. Giannini Controls Corp. found that to be true when an old standby—induction heating proved to be the best answer to the problem of hermetically sealing their oil-filled accelerometers. The seal had to be positive—and quickly performed. Hand soldering & furnace brazing were tried and found to be only partially successful—the processes were slow and costly. Making a serious effort to do something about the problem, the firm tried soldering irons, normal torches, resistance sealing, and threaded screw fittings—all with low yield results. Then induction heating was explored. Not only did the TOCCO 15-kw, 10,000 cycle induction heating machine do the job but it reduced the rejects to practically nil—and upped production from 4 to 30 units an hour. TOCCO is a division of Ohio Crankshaft Co., 4620 East 71st St., Cleveland, Ohio.

**GIBSON ELECTRIC SALES CORP.**

BOX 598 DELMONT (PITTSBURGH DISTRICT), PA.

Representatives in Principal Cities  
of the United States and Canada

**Gibsiloy**  
ELECTRICAL CONTACTS  
Since 1933

Circle 150 on Inquiry Card

# WANT TO CUT COSTS?

USE **BRADY** Card/Mounted  
Self-Sticking **NAMEPLATES**

**Permanent  
Fast-to-Apply**

105R  
Brady Tape No. B-330, MADE IN U.S.A.

Brady self-bonding 5 mil aluminum foil Nameplates cost far less to buy. BIG savings in application time—no heat, solvents, fasteners, or tools needed. Any wording, trademark, illustration. Mounted on handy Dispenser Cards—easy to inventory . . . protect plates from damage and loss.

Write today for free samples.

**W. H. BRADY CO.**, 749 W. Glendale Ave., Milwaukee 9, Wis.  
EST. 1914

Manufacturers of Quality Pressure-Sensitive Industrial Tape Products, Self-Bonding Nameplates, Automatic Machines for Dispensing Labels, Nameplates, Masks and Tape.

Circle 151 on Inquiry Card



**MICROWAVE COMPONENT** factory sales reached \$27.7 million in the first quarter of this year according to EIA. This figure is exclusive of billings for R & D. Estimates for three categories of components are as follows: \$25.4 million for non-ferrite components; \$1.4 million for ferrite parts; and \$890,000 for semiconductor and solid state duplexer assemblies.

**POWER PRODUCTION** by direct conversion from light and heat energy will become the fourth great area of business for the electronics industries within the next few decades according to Dr. Elmer W. Engstrom, President of RCA.

Dr. Engstrom compares the potential importance of new electronic power-producing techniques with that of the advances and growth of radio, TV and solid state electronics. He said that the "seed of a power revolution" is contained in current research progress toward silent mobile generators using solar cells, chemical fuel cells, and thermoelectric and thermionic devices to convert light and heat directly to electrical energy.

**COMPUTER METHODS** of fallout prediction are to be improved through a research contract awarded to Technical Operations, Inc., by the Office of Civil Defense.

The program is expected to provide more accurate information about the behavior of particles in the radioactive cloud which follows a nuclear blast—especially as it affects local-area fallout. This information will be incorporated in a computer simulation of fallout to provide a more accurate and rapid assessment of fallout damage for civil defense planning, and more effective mobilization of CD units in the event of a nuclear attack.

**PRACTICALLY ALL COMPUTING SYSTEMS** in Russia still rely on vacuum tubes instead of transistors according to J. Presper Eckert, vice-president, Univac division of Sperry Rand Corp., New York. Mr. Eckert told the Northwest Computing Assoc. Conf. in Seattle, Wash., that Russia is at least three years behind the U. S. in the area of electronic computers.

He said that there are between 600 and 800 computers in Russia compared to 10,000 in the U. S., but almost half of the computers in the U. S. are capable of large, complex tasks, while most of the Soviet computers can only deal with more restricted and generally simpler problems.

He also noted that their tape and printing devices would be considered obsolete by U. S. standards.

**AN ANALOG COMPUTER** for calculating the amount of xenon produced as a by-product of nuclear fission is being developed by the Minneapolis-Honeywell Regulator Co. It has been ordered by North American Aviation for installation as part of the safety system of an experimental sodium reactor at Santa Susana, Calif.

Xenon is a gas that is poisonous only to nuclear reactions. It absorbs neutrons that bombard reactor fuel elements, slowing the fission process. Until dissipated, it affects reactor startup following a shutdown, necessitating delays of as much as several days.

The computer will calculate the value of neutron absorption on core reactivity through the solution of differential equations and indicate this on a meter. Xenon is generally calculated by slide rule, a time-consuming job which is subject to error.

**U. S. EXHIBITION** at the International Trade Fair in Zagreb, Yugoslavia, last month used as a theme, "The Constructive Use of Leisure Time." Among the exhibits: self-assembly hi fi and radio kits, and electronic teaching methods.

## WHO BUILT THE TIROS STRUCTURES?

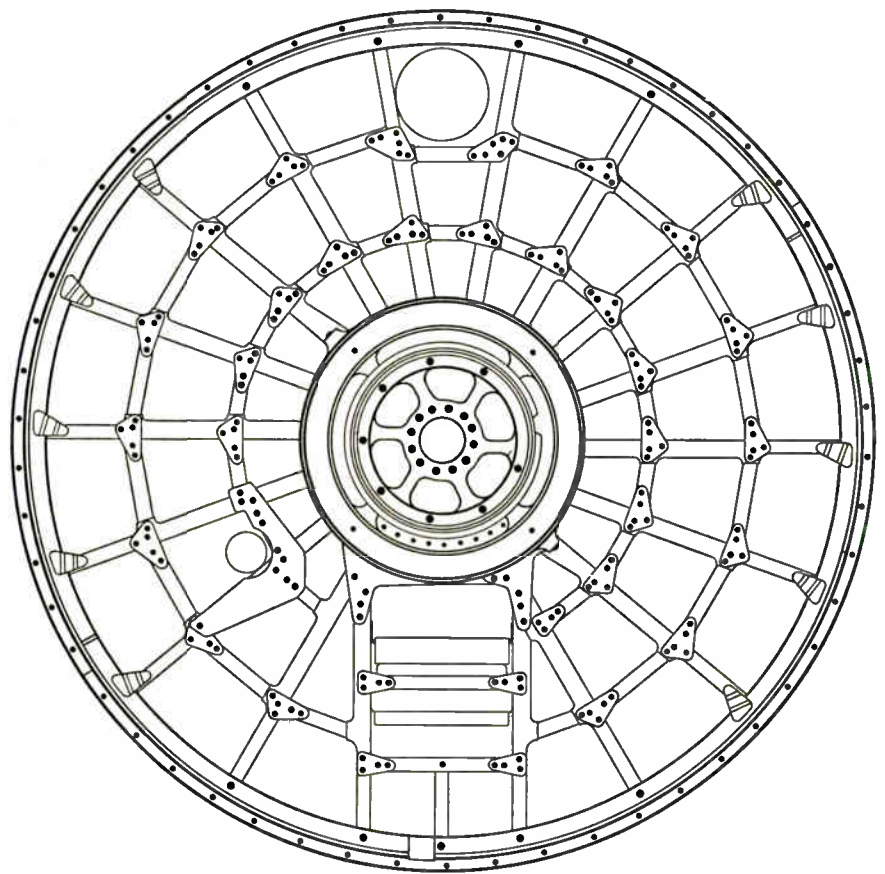

RCA developed the NASA weather satellite . . . Lavelle built the complex 18-sided structure to carry its active components. Lavelle specializes in the precision fabrication of sheet metal structures for missiles and space vehicles, aircraft and ground support equipment. Major contractors know it. Write for brochure detailing Lavelle quality controlled services: Engineering Production Planning / Sheet Metal Forming / Welding / Machining / Metal Finishing.

*Lavelle*

**LAVELLE AIRCRAFT CORPORATION • NEWTOWN, BUCKS COUNTY, PA.**  
*Between Philadelphia, Pa., and Trenton, N. J.*

# PRECISION CAPACITORS—

TOLERANCES TO 0.1%

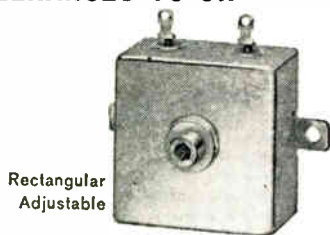

Rectangular Adjustable

EAI precision capacitors—fixed or adjustable—are available in tolerances of  $\pm 0.1\%$  or better and with stability closer than  $\pm .01\%$  over operating temperature range. These unusually high standards result from EAI's specialized manufacturing know-how which includes the ability to measure capacity to accuracies of .005% and dielectric absorption to any circuit requirements.



Rectangular Fixed

## TYPICAL SPECIFICATIONS: PS521—Polystyrene Dielectric

Capacitance Range: .001 mfd to 10 mfd.  
Tolerance:  $\pm 5\%$  is standard,  $\pm 2\%$ ,  $\pm 1\%$ , and  $\pm 0.1\%$  on request.  
Stability: Better than .01%.  
Dielectric Absorption: Less than .01%.  
Construction: Non-inductive.  
Temperature Range:  $-55^{\circ}\text{C}$ . to  $+85^{\circ}\text{C}$ .  
Insulation Resistance:  $10^{12}$  ohm/mfd, minimum.  
Capacitance Change: 110 ppm/ $^{\circ}\text{C}$   
 $\pm 10$  ppm/ $^{\circ}\text{C}$ ;  $\pm 5$  ppm/ $^{\circ}\text{C}$ , upon special request.



Tubular Fixed

## M521—Mylar Dielectric

Capacitance Range: .001 mfd to 10 mfd.  
Tolerance:  $\pm 5\%$  is standard,  $\pm 10\%$ ,  $\pm 1\%$ ,  $\pm 0.5\%$  or closer on request.  
Construction: Non-inductive. Sealed under inert gas.  
Temperature Range:  $-60^{\circ}\text{C}$  to  $+150^{\circ}\text{C}$ .  
Insulation Resistance:  $10^{11}$  ohm/mfd, minimum.

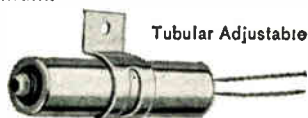

Tubular Adjustable

EAI production facilities can provide capacitors of virtually any tolerance or stability in temperature ranges in excess of  $200^{\circ}\text{C}$ . Write describing your requirements. Additional data is available by writing to Components Department.

# EAI

ELECTRONIC ASSOCIATES, INC.  
Long Branch, New Jersey

Circle 153 on Inquiry Card

## NEW RADAR SYSTEM BEGINS OPERATIONS

Operation of a new missile and space research radar system has begun at the U. S. Naval Research Laboratory's Chesapeake Bay Annex, located near Washington, D. C. The system features a fully steerable paraboloidal-reflector ("dish") antenna 150 ft. in diameter.

The radars to be used initially are housed in an equipment shelter located on the rotating antenna turntable. Op-

erating frequencies are approximately 140 and 435 mc. Pulse power is 500 kw. Radars of higher power and higher frequency, up to the limit of 1400 mc at which the antenna will operate effectively, may be added later.

The system will be used for studies of the radar detection properties of missiles, satellites, and other targets of military interest and for fundamental studies in the field of pure science.

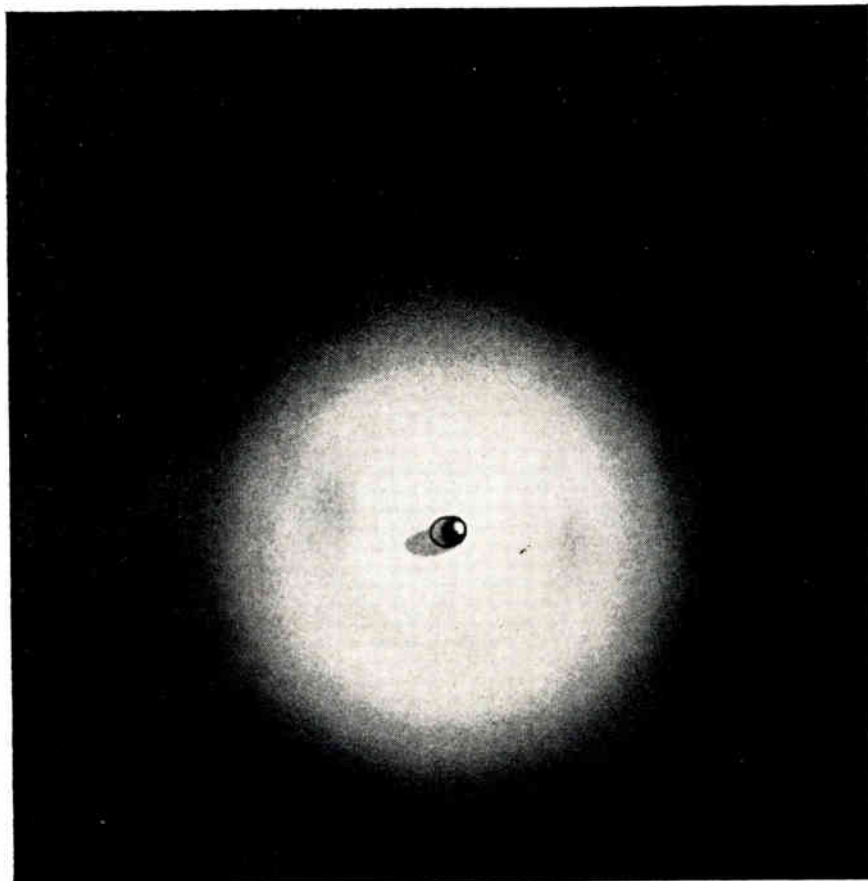

## This can be too much solder!

Even this small amount can be in excess of what constitutes a well-soldered connection. An excess build-up of solder serves no purpose. In fact, it's wasteful and tends to weaken a soldered connection.

The answer? Kester "Solderforms," solder prefabricated to fit your components or parts exactly. With "Solderforms," you automatically get the correct volume and placement of solder. Every connection is identical. There are no

costly rejects. "Solderforms" are available in both Flux-Core or Solid Types, and all alloys in the soft solder range.

Solder and soldering fluxes are Kester's only business. Have been for 68 years. That's why no one knows solder like Kester. Write for this free booklet, "Solder: its fundamentals and usage." You'll find it a valuable reference. Send for your copy today!



# KESTER SOLDER

KESTER SOLDER COMPANY

4210 Wrightwood Avenue, Chicago 39, Ill. • Newark 5, N. J. • Anaheim, Calif.  
Brantford, Ontario, Canada • Over 63 years manufacturing quality solders, fluxes

Circle 154 on Inquiry Card



measures  
.002 microvolts!



## KEITHLEY MILLI-MICROVOLT METER

The Keithley Model 149 is the most sensitive electronic voltmeter available today, having a signal-to-noise ratio that approaches the theoretical limit. Recommended for use with thermocouples or thermopiles, the Model 149 is also ideal in cryogenics investigations and Hall Effect studies.

Zero suppression up to 100 times full scale adds versatility for the user. Line-operated, the Model 149 can accommodate either a floating or ground-referenced input. Output is 5 v or 5 ma on all ranges. Brief specifications:

- **range:** 0.1 microvolt to 100 millivolts in 13 overlapping 1x and 3x steps.
- **noise:** less than  $6 \times 10^{-10}$  v rms with shorted input.
- **input impedance:** 10K ohms on 0.1  $\mu$ v range rising to 10 megohms on 100  $\mu$ v scale.
- **stability:** within 0.01  $\mu$ v per hour.
- **speed of response:** to 90% fs in .5 seconds on most ranges.
- **accuracy:** 2% fs on all ranges.
- **price:** \$895.00

### Other MICROVOLT METERS:

Model 150A 1  $\mu$ v sensitivity \$750.00  
Model 151 100  $\mu$ v sensitivity \$420.00

full details in latest catalog...



**KEITHLEY  
INSTRUMENTS**

12415 EUCLID AVENUE  
CLEVELAND 6, OHIO

Circle 155 on Inquiry Card

## NEW PRODUCTS

### DC AMPLIFIER

For use with thermocouples, strain gauges and low level sources.

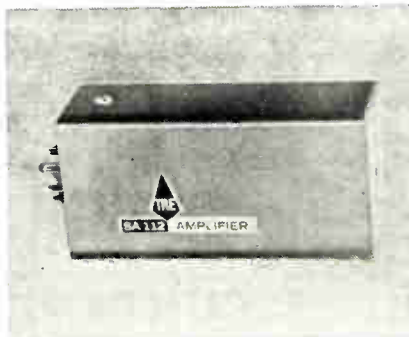

The SA 112 Galvanometer-Recorder Amplifier has noise and drift comparable to chopper stabilized amplifiers for use with low level, low impedance sources. These signals can be recorded at 1mv F.S. on galvanometer recorders. Using solion tetrodes, the SA 112 requires only 60 mw (can be used on battery power), does not require a well regulated supply and does not use a chopper. Texas Research and Electronic Corp., 6612 Denton Dr., Dallas, Tex.

Circle 295 on Inquiry Card

### POWER TRANSISTOR

This 7.5a silicon power transistor line features a  $V_{CE}$  of 250v.

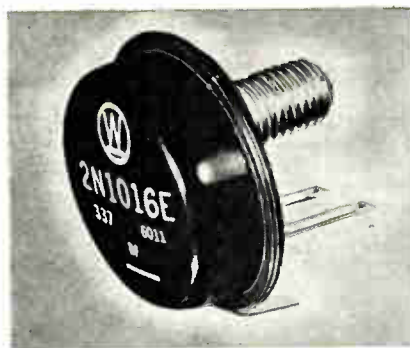

JEDEC registered as the 2N1015E and 2N1016E, these npn devices feature a 150w continuous power dissipation rating, a thermal impedance of less than  $0.7^{\circ}C/w$ , and typical saturation resistance of  $0.12\Omega$ . The true voltage rating of the devices allows operation at rated collector-emitter voltage under any base-emitter biasing condition. Additional feature is hard solder construction and hermetically weld-sealed case. Westinghouse Semiconductor Div., Youngwood, Pa.

Circle 296 on Inquiry Card

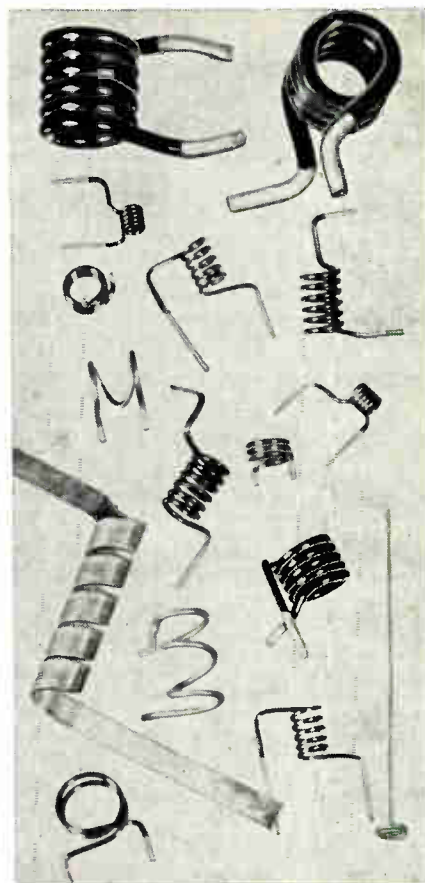

**High production  
AIR WOUND  
CUSTOM COILS  
at "stock" prices!**

Stop paying "custom" prices for special application air wound coils. ROWLEY can produce air wound RF or choke coils of your design within 10 days, at "stock" prices! . . . magnet-wire coils with ends stripped and tinned, ready for assembly, in the following range: .010 to .187 inch diameter wire — 50 turns maximum. Send us your specifications for quotation . . . no obligation, of course.



**ROWLEY  
SPRING  
COMPANY, INC.**

BRISTOL, CONNECTICUT

Circle 156 on Inquiry Card



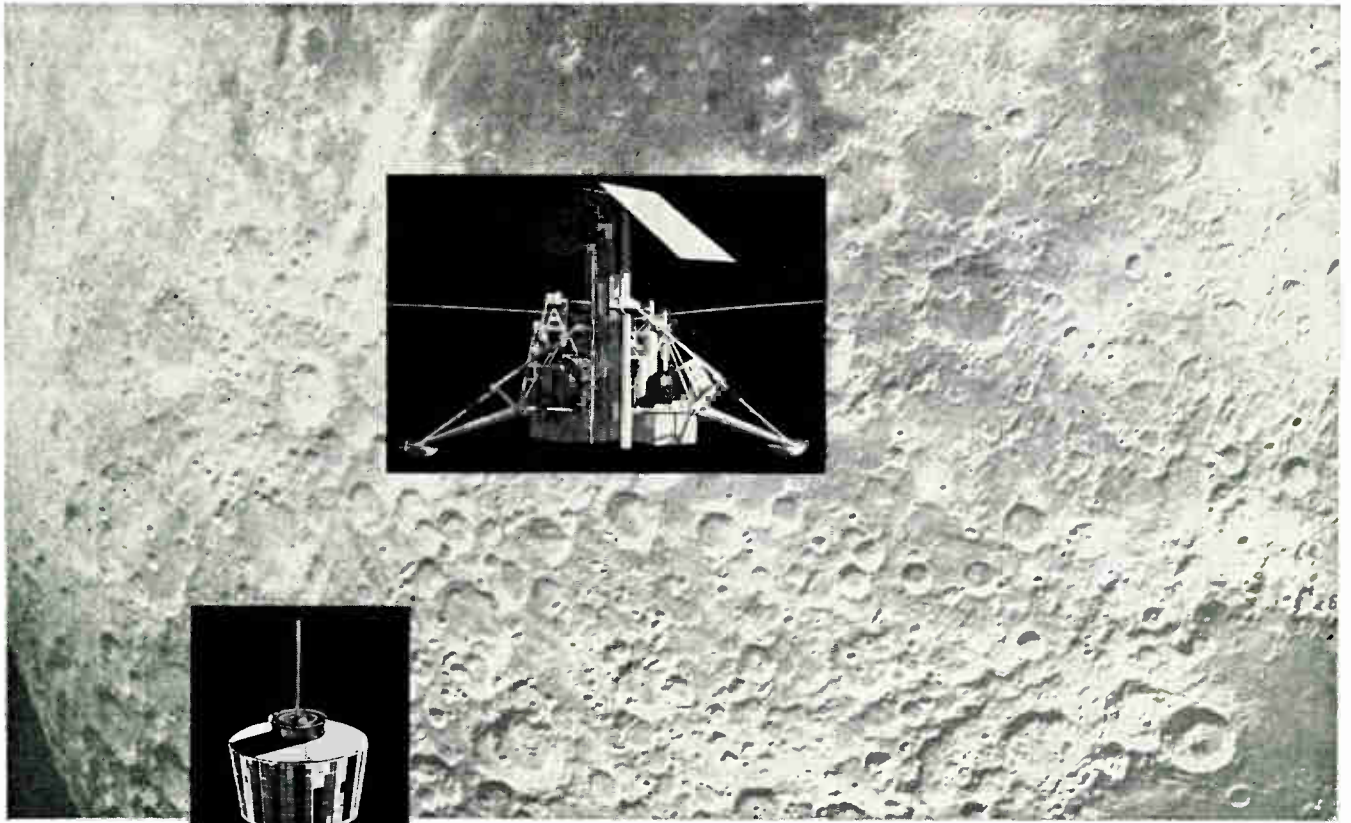

# systems analysts:

Quantify the complex on important projects at Hughes!

SURVEYOR (soft lunar landing spacecraft), SYNCOM (synchronous communications satellites), VATE (automatic test equipment), anti-ballistic missile defense systems (boost-intercept, mid-course, terminal)—these are a few of the many important and complex projects under design, development and study at Hughes.

Because of these projects and others important to the nation's defense, preparedness and space effort, Hughes offers more opportunities to Systems Analysts than ever before.

Involved with these positions are the consideration of many basic problems such

as: the proper mix of manned vs. unmanned satellites; the requirements of manned space flight; IR systems requirements for high speed strike reconnaissance systems or unmanned satellites; analysis of weapon systems from conception through development, test and customer use; and many others.

**Inquire today.** If you are a graduate engineer or physicist from an accredited university, a U. S. citizen, and believe that you can contribute to and benefit from the important projects at Hughes, contact us today. Airmail your resume to:

**Mr. Robert A. Martin,  
Head of Employment  
Hughes Aerospace Divisions  
11940 W. Jefferson Blvd.,  
Culver City 70, California**

We promise you a reply within one week.

An equal opportunity employer.

Creating a new world with ELECTRONICS

**HUGHES**

HUGHES AIRCRAFT COMPANY  
AEROSPACE DIVISIONS

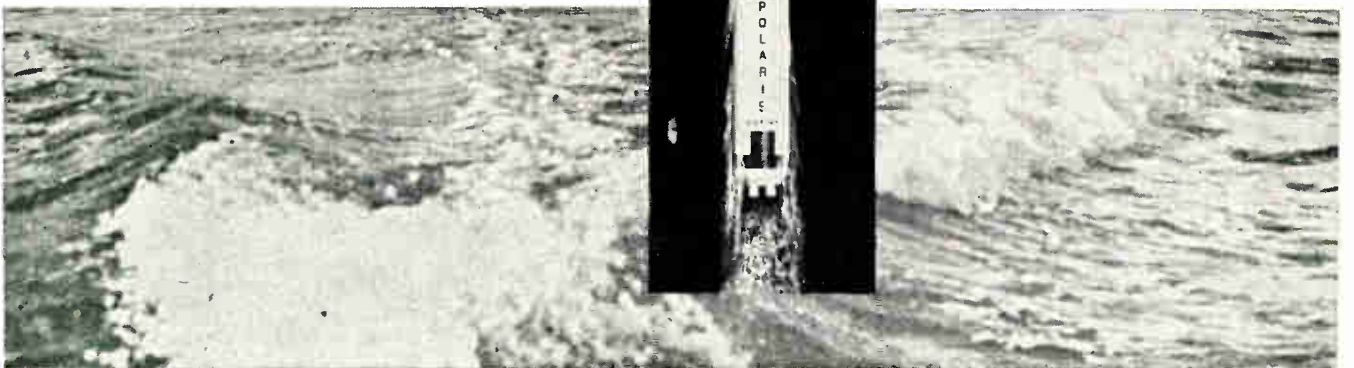

# PROFESSIONAL OPPORTUNITIES

Reporting late developments affecting the employment picture in the Electronic Industries

Design Engineers  
Development Engineers  
Administrative Engineers  
Engineering Writers  
Physicists  
Mathematicians  
Electronic Instructors  
Field Engineers  
Production Engineers

## ENGINEER EMPLOYMENT INCREASED 64% IN 10 YEARS

The number of men working as professional engineers in the U. S. rose 64% between 1950 and 1960. Increases in research and development, defense spending and technical changes in industry were responsible.

This was revealed recently in Manpower Report No. 1, published by the Office of Manpower, Automation and Training, U. S. Dept. of Labor.

The report also stated the number of men employed in the engineering profession went from 520,000 in 1950 to 854,000 in 1960. All states reported increases in male engineering forces. Only the District of Columbia showed a drop.

By contrast the male employment rate only went up one ninth as fast. The total employment rate increased but one fourth as fast.

A geographical shift occurred in defense contracts with the Western states getting 33% of such contracts in 1961, compared with 19% in 1950. This was laid to the change of the country's defense needs from traditional weapons to missiles and related weapons.

California employs more men in the engineering field than any other state. New York, the second state, and California account for about 25% of male engineering jobs in the country.

## GRAD SCHOOL POPULAR AT NCE

Two surveys taken at Newark College of Engineering showed that between 54 and 62% of NCE's 261 graduates last June planned to enter graduate school this fall.

NCE's Placement Office and members of Tau Beta Pi, national engineering scholarship society, carried out the surveys.

**FOR MORE INFORMATION . . . on opportunities described in this section fill out the convenient resume form, page 210.**

## ASEE President States Two Major Problems Confront the Nation's Engineering Schools

The President of the American Society for Engineering Education has declared that the nation's engineering schools must solve two serious problems. These, he said, are (1) declining engineering enrollments and (2) increased student attrition.

Dr. Robert W. Van Houten, also President of Newark College of Engineering, made the statement. He told delegates at the recent ASEE meeting at the Air Force Academy that no one really knows why engineering enrollments, both in numbers and percentages of college applications, have steadily declined.

## 42 NSF GRANTS WILL AID TEACHING RESEARCH

The National Science Foundation has awarded 42 grants, totaling \$587,455, to aid institutions in developing science, engineering and mathematics teaching equipment.

Colleges, universities and research institutes in 22 states and the District of Columbia received the grants.

Grantees are expected to provide information on equipment they devise, through reports, professional journal articles and presentations at professional meetings. They are to allow commercial suppliers to negotiate for possible production and marketing.

## PRACTICAL TRAINING

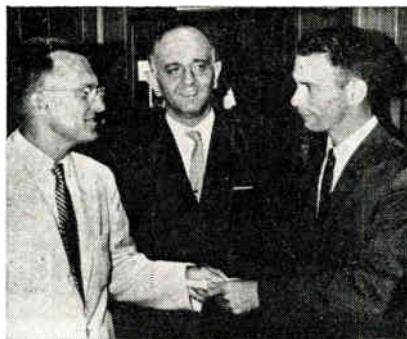

C. D. Close, Pres. and Board Chairman, CompuDyne Corp., Hatboro, Pa., presents \$1,000 check to Prof. T. W. Moore, Drexel Inst. of Technology, who just completed training course there. George Gumas, VP for R&D, looks on. Course was one of those sponsored by foundation of which CompuDyne is member to enable educators to strengthen instrumentation courses through experience.

"The basic challenge facing engineering education," Van Houten said, "is to answer the question of how to bring the supply of engineering graduates more closely in line with the demand.

"I'm advised that a reasonable estimate of the needs of the country for engineering graduates for the next several years will be 80,000 per year, whereas the most optimistic prediction of the annual number of engineering graduates for the same year will be 40,000."

Van Houten named as a corollary problem the trend toward more student attrition. He said if this continues less than 40% of those who enter as freshmen will receive their degrees four years later. He said this could be true by 1965.

"In my opinion," the educator declared, "it is a national disgrace when about half of the students who enter the engineering colleges . . . never graduate."

He announced that the Engineering College Administrative Council, made up of deans of engineering, has appointed a committee headed by Dean LeRoy A. Brothers, of Drexel Institute of Technology, to look into the problem.

Other activities in progress under Society auspices, Van Houten said, include a major new evaluation of the engineering curriculum and exploration of methods for greater cooperation between ASEE and government agencies.

# ELECTRONIC INDUSTRIES

# Professional Profile

The ELECTRONIC INDUSTRIES Job Resume Form for Electronic Engineers

Name \_\_\_\_\_ Tel. No. \_\_\_\_\_

Street Address \_\_\_\_\_ Zone \_\_\_\_\_

City \_\_\_\_\_ State \_\_\_\_\_

Single  Married  Citizen  Non-Citizen Date of Birth \_\_\_\_\_

Will Relocate  Yes  No. If Yes  Another City  Another State

Salary Desired to Change Jobs in present area \_\_\_\_\_

Salary Desired to Change Jobs and relocate in another area \_\_\_\_\_

Professional Memberships \_\_\_\_\_

College or University	Major	Degree	Dates

## RECENT WORK EXPERIENCE

Company	Div. or Dept.	Title	Dates

## SIGNIFICANT EXPERIENCE AND OBJECTIVES

State any facts about yourself that will help a prospective employer evaluate your experience and job interests. Include significant achievements, published papers, and career goals.

Mail to: ELECTRONIC INDUSTRIES—Professional Profile—56th & Chestnut Sts.—Philadelphia 39, Pa.  
 This resume is confidential. A copy will be sent only to those Companies whose number you circle below.  
 800    801    802    803    804    805    806    807    808    809    810



# TECHNICAL SESSIONS HIGHLIGHT NEREM '62 SHOW

The 16th Northeast Electronics Research and Engineering Meeting will explore a variety of technical fields in detail in its technical papers program and exhibits. Here are some ideas on what is in store for the 20,000 engineers and scientists who will attend

THE TECHNICAL PROGRAM of NEREM '62, to be held Nov. 5-7 in Boston at the Somerset Hotel and Commonwealth Armory, promises to explore in depth a variety of topics. About 20,000 scientists and engineers are expected to attend.

The 25-session papers program will include over 100 works by some 150 authors on 18 topics. Sessions will include three, four or five papers on a subject. Five subjects will be explored in two meetings and one in three sessions.

More than \$10 million worth of the latest electronic equipment will be displayed at the Armory, site of the exhibits. Over 440 booths will make up the display.

NEREM '62 sponsors are the Boston, Connecticut and Western Massachusetts sections of the IRE. These three sections make up IRE Region I.

## Keynote Address

Other highlights include a keynote address, "The Shape of Things to Come," by Ernst Weber, President of Brooklyn Polytechnic Institute, and a banquet talk, "Communications Across Ocean Expanses," by Julius P. Molnar, Executive Vice President, Bell Telephone Laboratories, Inc.

John F. Collins, Mayor of Boston, will address the NEREM '62 Banquet, which will be held Tuesday, Nov. 6, at 7 p.m. at the Somerset. A social hour will precede the banquet.

The week of Nov. 4-11 has been proclaimed "Electronics Week" in Massachusetts by Governor John A. Volpe in recognition of the many scientists and engineers who will attend the conference and the growth of Massachusetts as a national electronics center.

*(Continued on page 213)*

The Commonwealth Armory, Boston, site of the NEREM exhibits.

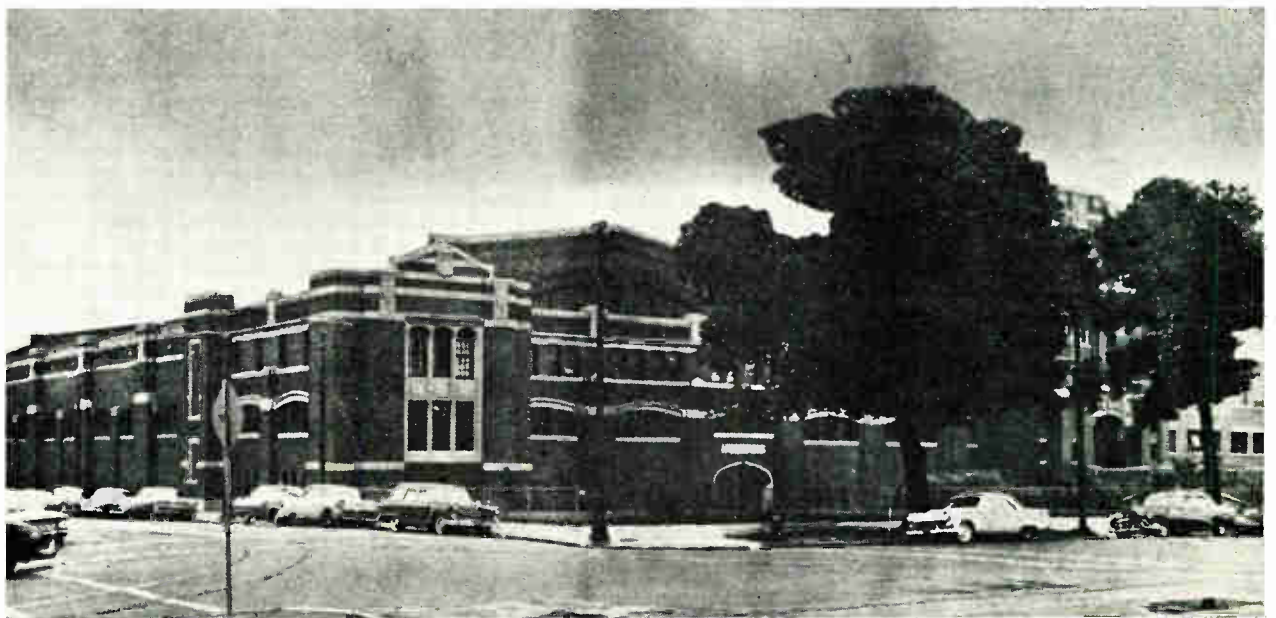

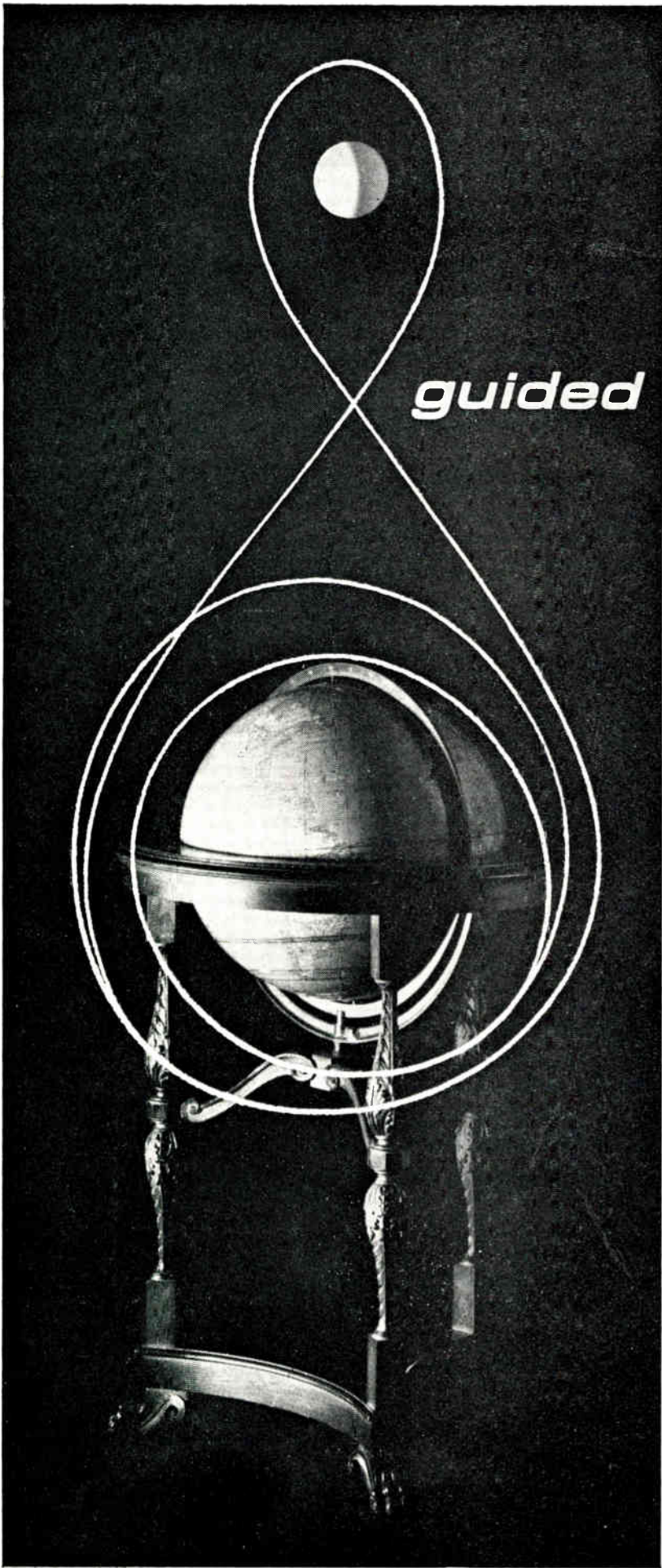

*guided tour by*

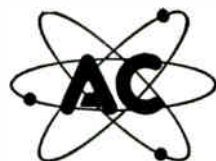

AC Spark Plug, The Electronics Division of General Motors, is now starting work on the most exciting project in our nation's space program: development and production of portions of the critically important navigational-guidance system for NASA's manned APOLLO flight to the moon. This new assignment is another significant step in the progress being made by AC's highly skilled, highly respected staff of creative engineers and scientists.

We urge you to inquire about the opportunities and advantages of being associated with our new APOLLO program and the other navigational projects now underway at AC. If you have experience in any one of the following specialties, and a BS, MS or PhD in Electrical Engineering, Mechanical Engineering, Physics or Mathematics, send your résumé to H. A. Raasch, Director of Scientific and Professional Employment, AC Spark Plug Division, Dept. 5753, Milwaukee 1, Wisconsin. You will receive a prompt reply.

**MILWAUKEE** ■ Systems Design Engrs. ■ Field Service Engrs. ■ Mechanical Design Engrs. ■ Product Support Engrs. ■ Ground Support Equipment Engrs. ■ Field Maintenance Engrs. ■ Systems Test & Evaluation Engrs. ■ Design Review Engrs. ■ Reliability Program Engrs. ■ Technical Writers and Editors ■ Supplier Contact Engrs. ■ Computer Analysts/Programmers

**LOS ANGELES RESEARCH AND DEVELOPMENT LABORATORY** (Airborne Digital Computers & Advanced Inertial Guidance Systems) Electronic System Mechanization ■ Circuit Design Engr. ■ Re-entry Simulation ■ Aerodynamicist ■ Advanced Guidance System Analysis ■ Programmer

**BOSTON RESEARCH AND DEVELOPMENT LABORATORY** (Advanced Inertial Guidance Systems & Components for Future Aircraft, Ballistic Missiles & Space Vehicles) Circuit & Logic Design (Digital Computers) ■ Electronic Circuit Engrs. ■ Systems Engrs. & Mathematicians ■ Physicists ■ Instrument Engrs. ■ Electromagnetic Engrs.

**AC SPARK PLUG  THE ELECTRONICS DIVISION OF GENERAL MOTORS**

MILWAUKEE • LOS ANGELES • BOSTON • FLINT  
*An Equal Opportunity Employer*

Achiever Inertial Guidance for the TITAN II, THOR and MACE / Bombing Navigation Systems Integrator for the B-52 (C&D) / Polaris Gyros and Accelerometers / ALRI



The technical sessions include: "Antennas and Propagation," "Audio and Acoustics," "Highlights of Army Communications and Electronics R & D," "Microwave Solid State," "Radio Astronomy," "Electronics in Outer Space," "Bio-medical Electronics," and "New Advances in Specification of Component Reliability."

Some other session titles: "Quantum Electronics," "Computers," "Information Processing and Retrieval" (a panel discussion), "Transistor Symposium," "General Communications and Radio Signal Technology," "Information Technology," "Waveguides and Transmission Lines," "Microwave Plasma Interaction," "Thin-film Amplifiers," and "Position Fixing on Earth and in Space."

The papers are authored by leading government and civilian scientists and engineers from across the nation. Technical authorities from as far away as California will be there to present their papers.

### NEREM Record

Illustrated digests of the talks will be published in a 200-page book, Volume IV of the NEREM Record.

IRE members attending will receive a copy of this book at no additional charge. Cost to non-members attending will be \$2. Post-conference copies, at \$7.50 per book, may be obtained from: the Boston Section, IRE, 313 Washington St., Newton 58, Mass.

### Masers-Lasers

Many uses are being projected for *Masers/Lasers* in the near future. As our understanding of these devices increases, so will the applications. These devices are looked to as a means for increasing the useable electro-magnetic spectrum. Right now masers/lasers are about the hottest subject in the microwave field. Many companies are pouring dollars into research and development of these devices. Several companies now have units available for purchase.

Two papers being delivered at Session 14 will describe some late developments in gas masers. The first paper by R. A. Paananen, Raytheon Co., is titled "A Resonant Gas Maser Amplifier." It gives information about the optical gain of a gas maser when driven by another gas maser. Included in this talk will be some special properties of gas masers. The second paper, by A. D. White and J. D. Rigden, Bell Telephone Labs., is titled "Continuous Gas Maser Operation in the Visible." Here the authors will describe the continuous operation of a gas maser in the visible light region. The maser line is at 6328 Å and the active medium is a helium-neon plasma. Total power output from each end is about 1.7 mw.

Among the more exciting applications of lasers is the field of space navigation and astronomy. An interesting paper will be presented by G. Fiocco, Re-

NEREM 62 Conference officials are seated (l. to r.): I. Goldstein, Program Chairman; H. G. Rudenberg, Gen'l. Conf. Chairman; and J. E. Shepherd, Vice Chairman. Standing (l. to r.): L. Winner, Nat'l. Relations Advisor; A. O. McCoubrey, Program Vice Chairman; G. J. Rath, Treas.; J. Kadet, Arrangements Chairman; J. D. Rooney, Publicity Chairman; M. J. Arkin, Ass't. Treas.; E. E. Witschi, Jr., Bus. Mgr.; S. K. Gibson, Exhibits Mgr.; and K. C. Black, Gen'l. Mgr.





Large production gives you low prices!  
— that's why...

Over 100 O.E.M.s  
have standardized  
on

# AMPERITE

## Thermostatic DELAY RELAYS

2 to 180 Seconds



Actuated by a heater, they operate on A.C., D.C., or Pulsating Current.

Hermetically sealed. Not affected by altitude, moisture, or climate changes. SPST only—normally open or closed.

Compensated for ambient temperature changes from  $-55^{\circ}$  to  $+80^{\circ}$  C. Heaters consume approximately 2 W. and may be operated continuously. The units are rugged, explosion-proof, long-lived, and—inexpensive!

TYPES: Standard Radio Octal, and 9-Pin Miniature . . . List Price, \$4.00.

Also — Amperite Differential Relays: Used for automatic overload, under-voltage or under-current protection.

PROBLEM? Send for Bulletin No. TR-81

## BALLAST REGULATORS

Amperite Regulators are designed to keep the current in a circuit automatically regulated at a definite value (for example, 0.5 amp.) . . . For currents of 60 ma. to 5 amps. Operate on A.C., D.C., or Pulsating Current.

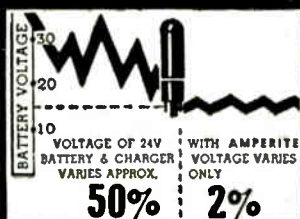

Hermetically sealed, they are not affected by changes in altitude, ambient temperature ( $-50^{\circ}$  to  $+70^{\circ}$  C.), or humidity . . . Rugged, light, compact, most inexpensive . . . . . List Price, \$3.00.

Write for 4-page Technical Bulletin No. AB-51

# AMPERITE

561 Broadway, New York-12, N. Y. . . . CAnal 6-1446

In Canada: Atlas Radio Corp., Ltd., 50 Wingold Ave., Toronto 10

search Laboratory of Electronics, M.I.T., titled, "Some Applications of Optical Radar to Astronomy and Geophysics." The paper will describe equipment designed and built at MIT. Features of the optical maser radar will be described, including the narrow beam width, and its unusual attenuation characteristics. In many situations, the laser beam follows an  $R^{-2}$  law of attenuation with distance instead of the usual  $R^{-4}$ . It also provides relatively high spectral purity allowing for substantial filtering against background illumination.

The high level of interest in plasma research is evident here at NEREM in the two separate sessions that will be devoted to the subject. In the paper, "New Microwave Applications for Plasmas," which will be presented by G. S. Kino of Stanford Univ., experiments will be described that have been carried out at Stanford and elsewhere on a number of new plasma microwave devices. Among the examples to be discussed will be efficient harmonic generators, beam plasma amplifiers and large dynamic range detectors.

Ever since its inception, NEREM has been noted for its excellent sessions on Bio-Medical Electronics. This year, one of the outstanding papers of the session will be presented by J. B. Reswick of the Case Institute in Cleveland, Ohio. Mr. Reswick's presentation is not that of a technological "breakthrough" but rather a recapitulation of some of the finer, and more recent, examples of engineers, medical doctors, and others in the biomedical field working together as a team. Title of his paper is "Case Studies of Successful Collaboration Between Biomedical Scientists and Engineers."

Our satellite program has scheduled three comsats (communications satellites) for test within the next six months. TELSTAR is already up. RELAY is timed for a November launch. SYNCOM goes up the first of next year.

Two papers at NEREM deal with these subjects. I. A. Getting's "Tracking and Control of Near Space Satellites," (ME 6.1) will discuss the variety of types of satellites in development and the present methods for tracking and controlling them. Present techniques and their worthiness, as applied to future military space systems, will be reviewed, and developments needed to handle predicted requirements will be discussed.

The second paper is S. W. Herwald's "Electronic Reliability in Space," (ME 6.4) which takes up the long mission times, and the challenges to reliability they represent. New techniques in design and test, as well as advances in solid-state circuitry (the tools for the job) will be discussed and appraised.

## INDUSTRY NEWS

**Richard Hodgson**—named President, Fairchild Camera & Instrument Corp., Syosset, L. I., N. Y.

**W. C. Holmes**—named President, Fabtron Co., Redwood City, Calif.

**Roy P. Jackson**—named Vice President and Assistant General Manager of Space Laboratories, Northrop, Corp., Hawthorne, Calif.

**C. Harry Knowles**—appointed General Manager of the new Molecular Electronics Div., Westinghouse Electric Corp., Pittsburgh, Pa.

**Walter W. Vannoy**—elected Vice President, Mechanical Div., American Avionics, Inc., Los Angeles, Calif.

**Edwin J. Bradley**—named Marketing Manager, Diodes, Inc., Canoga Park, Calif.



E. J. Bradley



W. W. Wood, Jr.

**William W. Wood, Jr.**—appointed President, GPE Controls, Inc., Chicago, Ill., a General Precision subsidiary.

**Jay D. Wethe**—named Assistant Marketing Director, Autonetics Div., North American Aviation, Inc., Downey, Calif.

**Curtis B. Hoffman**—elected Vice President, Marketing and Product Development, and **Dr. S. J. Begun**—elected Vice President, Overseas Development, Clevite Corp., Cleveland, Ohio.

**Robert L. Grove**—appointed Vice President, Operations, for Vitramon, Inc., Bridgeport, Conn.

**Seymour Cuker**—named to the new position of Vice President, Research, Astronautic Research, Inc., Nashua, N. H.

**Earl D. Hilburn**—elected Vice President of Curtiss-Wright Corp. and appointed General Manager of its Electronics Div., E. Paterson, N. J.

**Hal Salzmen**—appointed Vice President, Marketing, National Resistance Corp., Pearl River, N. Y.

(Continued on page 216)

ENGINEERS • SCIENTISTS

**CAN YOU CARRY  
A PROJECT FROM  
CONCEPTUAL REALIZATION  
TO LABORATORY  
DEVELOPMENT IN ONE  
OF THESE AREAS:**

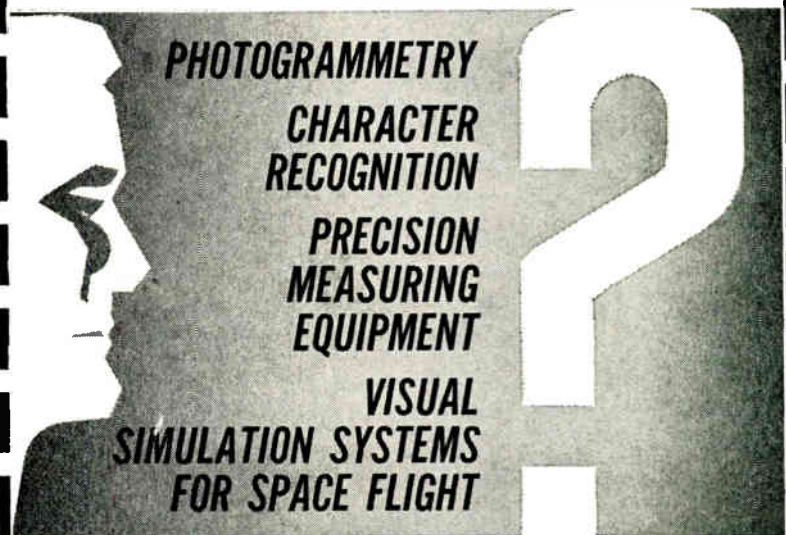

If your answer is "yes" we sincerely believe that Link Division/General Precision, Inc. can offer you an unusual opportunity to employ your full professional talents on meaningful, long-term programs. The Engineers and scientists we are seeking to fill a number of select openings will have the ability to depart from off-the-shelf concepts and the competence and confidence to work in previously unexplored areas.

To arrange a convenient interview, direct your inquiries in confidence to:

Mr. J. T. Gibbons

POSITIONS ARE AVAILABLE TO INDIVIDUALS WITH PREVIOUS EXPERIENCE IN:

- Optical Systems
- Photogrammetry
- Interferometry
- Circuit Development
- TV Systems
- Digital Systems
- Servo Systems Analysis
- Analog/Digital Systems
- Mechanical Systems

**LINK DIVISION  
GENERAL  
PRECISION  
BINGHAMTON, NEW YORK**

An Equal Opportunity Employer



**CRITICAL PHASE  
IN THE EVOLUTION OF AN OLD SCIENCE  
... WAR**

As the art of war evolves, the time available for command decision shrinks and the consequences of decision become greater. Modern warfare places a whole new set of technical requirements on military systems at every level . . . from weapons and sensors to the highest levels of command.

MITRE's prime assignment is to meet the challenge of these problems . . . the challenge of command and control. We are looking for talented systems men to help us.

As a systems man at MITRE, you might perform feasibility studies on new techniques in system design; or process intelligence data with large scale computers; or work on space hardware analysis. These are just a few of many work areas at MITRE. All have a direct bearing on this country's defense.

MITRE is located in pleasant, suburban Boston. Rewards are competitive. Requirements, B.S., M.S., or Ph.D. in these disciplines — electronics, physics, and mathematics.

Write in confidence to Vice President — Technical Operations, The MITRE Corporation, Box 208, Dept. MK40, Bedford, Mass.

THE  
**MITRE**  
CORPORATION  
An Equal Opportunity Employer



MITRE is an independent, nonprofit corporation working with — not in competition with — industry. Formed under the sponsorship of the Massachusetts Institute of Technology, MITRE serves as Technical Advisor to the Air Force Electronics System Division, and is chartered to work for such other Government agencies as the Federal Aviation Agency.

## INDUSTRY NEWS

**Robert W. Dabbs**—appointed Assistant Sales Manager, Houston Instrument Corp., Houston, Tex.

**John Sheldon**—appointed Sales Manager, Hi-Q Div., Aerovox Corp., Myrtle Beach, S. C.

**A. Randall Walthers**—named Marketing Manager, Frontier Div., International Resistance Co., Cleveland, Ohio.

**Alan Schwartz**—appointed Vice President, Mansol Ceramics Co., Belleville, N. J.

**Austin B. Speed**—named Sales Director, Subcontracts and Services Dept., Republic Aviation Corp., Farmingdale, L. I., N. Y.

**Justin J. McCarthy**—appointed Eastern Regional Sales Manager, Electron Tube Div., Sylvania Electric Products, Inc., New York, N. Y.



J. J. McCarthy



J. L. Coddington

**John L. Coddington**—named Assistant Marketing Manager, Radar and Systems, for the Electronics and Ordnance Div., Avco Corp., Cincinnati, Ohio.

**Herbert W. Pollack**—named General Manager, Industrial Products Div., Polarad Electronics Corp., Long Island City, N. Y.

**John H. Ihrig**—named Vice President, Marketing, Tempel Steel Co., Chicago, Ill.

**Marvin B. Lorig**—named Vice President, New Products Div., Shure Bros., Inc., Evanston, Ill.

**G. Nels Johnson**—appointed Instrumentation Products Sales Manager, Mincom Div., Minnesota Mining & Manufacturing Co., Los Angeles, Calif.

**Donald W. Cook**—elected Vice President and General Manager, Transducer Div., Consolidated Electrodynamics Corp., Pasadena, Calif.

**Edward F. Lazar**—named Marketing Manager, Electronic Tube Div., Sperry Rand, Great Neck, L. I., N. Y.

*(Continued on page 218)*





## RESEARCH ENGINEERING

### PROFESSIONAL PERSONNEL

If your potential is not being recognized, consider the excellent growth atmosphere at NCR:

- Extensive Company backed R & D
- New facilities: 40% expansion in building for R & D (complete—1963)
- Advanced programs encompassing major sciences integrated for practical results
- Excellent employee benefits
- An aggressive management group
- Professional advancement encouraged through Company sponsored programs

We have openings at this time as listed below. All are for our Dayton, Ohio, R & D Center:

### SENIOR CIRCUIT DESIGNER:

Familiar with solid-state circuitry; creative; desire to work at advanced development stage.\*

### THIN FILM:

Materials research; device development.\*

### DATA REDUCTION ENGINEERS/MATHEMATICIANS:

Large systems background required; project leader experience; (military).

### CHEMISTS—RESEARCH:

Project leader capability; desire background and interest in physical chemistry; polymers.

### TEST EQUIPMENT DESIGN ENGINEERS: BS OR MSEE

### MECHANICAL DESIGN ENGINEERS:

Small mechanism experience desired.

### ADVANCED DEVELOPMENT

### PLANNING SPECIALISTS\*

### OPERATIONS RESEARCH\*

### INTEGRATED ELECTRONICS\*

\*These positions are not limited to any special level. Ph.D. background is preferred for many, and some areas of responsibility involve Management or Technical Director qualifications.

Send your personal letter to: T. F. Wade, Technical Placement  
The National Cash Register Company, Dayton 9, Ohio  
An equal opportunity employer

Circle Number 804, Professional Profile page 210

## AT WM. A. FORCE

# ENGRAVING IS OUR BUSINESS

Since 1875, whenever engraved parts are specified, the call goes out for the Force representative. Force manufactures engraved components to your particular requirements, such as numbering units, wheels, type, etc.—from the most complex assembly in elec-

tronic scanning to a single part. For many firms, engraved components by Force specialists has meant increased production rates, fewer rejects, all reflected in savings. Force products are turned out by the latest, automatic high-speed machines.



### DATING AND NUMBERING UNITS

Furnished as complete assemblies and designed for many uses, such as certifiers, endorsers, postage devices, metering machines, etc.



### WHEELS

Precision engraved, ready for assembly with gears and ratchets. Mounting holes and internal broaching included as specified.

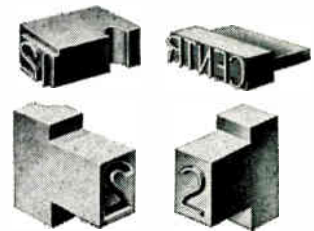

### ENGRAVED TYPE

Any variety to meet any specification. Expertly machined and supplied with holder and attachments as required.

Tell us your needs and we will be happy to send you further information.

WM. A. **FORCE** & CO., Inc.  
216 Nichols Ave.  
Brooklyn 8, N. Y.



TIME-SAVING  
GUIDE FOR...  
**SPECIFYING  
DEFLECTION  
YOKES**



Helps speed your project. Eliminates confusion in choosing the right yoke.

Engineers have saved countless hours, many dollars and numerous headaches by using this simple Guide Sheet For Specifying Deflection Yokes.

Offered as a public service to engineers by SYNTRONIC INSTRUMENTS, INC., YOKE SPECIALISTS, the only firm devoted primarily to deflection yoke manufacture; therefore preeminently qualified to help you specify the correct yoke for your application. Complete line for every military and special purpose—in production quantities or custom designed to your specific requirement.

Phone our nearest rep. today for your Time-Saving Guide Sheet.

**Boston-New Eng.:** Stan Pierce, Inc.  
Phone: NORwood 7-3164

**New York Area:** Bressler Associates  
Phone: N.Y. OXford 5-0255

**Philadelphia Area:** Massey Associates  
Phone: MOhawk 4-4200

**Wash.-Balt. Area:** Massey Associates  
Phone: APpleton 7-1023

**Indianapolis:** Joe Murphy  
Phone: VICTor 6-0359

**Los Angeles:** Ash M. Wood Co.  
Phone: CUMberland 3-1201

No Obligation. We are glad to help you.

***syntronic***  
**INSTRUMENTS, INC.**

100 Industrial Road, Addison, Illinois  
Phone: KINGSwood 3-6444

Circle 158 on Inquiry Card

**INDUSTRY NEWS**

Carlton E. Chase—appointed District Sales Manager, Receiving Tube Dept., General Electric Co., Owensboro, Ky. Also J. Ray Topper—named Manager of the department's Sales Planning Sub-section. GE's Silicone Products Dept., Waterford, N. Y., announces the following appointments: Lysander T. Ashlock — named Sales Representative; Donald V. Brown—named Electrical Market Development Manager; Davidson Clark—named Fluid Market Development Manager; and Donald W. Marshall—appointed Sales Representative.

John L. Herre—named Vice President, Government Relations, Radio Receptor Div., General Instrument Corp., Hicksville, N. Y.

Peter J. Vann—appointed Manager, Houston Sales Office, AC Electronics Div., General Motors Corp., Milwaukee, Wis.

James P. Andersen — elected Vice President - Components and Alan L. Friedman — elected Vice President - Systems, Dynamics Research Corp., Stoneham, Mass.

**How To Get Things Done  
Better And Faster**

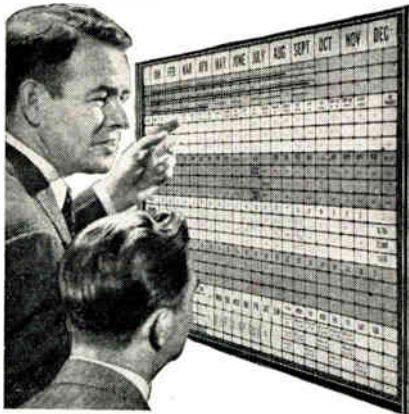

**BOARDMASTER VISUAL CONTROL**

- ☆ Gives Graphic Picture—Saves Time, Saves Money, Prevents Errors
- ☆ Simple to operate—Type or Write on Cards, Snap in Grooves
- ☆ Ideal for Production, Traffic, Inventory Scheduling, Sales, Etc.
- ☆ Made of Metal. Compact and Attractive. Over 750,000 in Use.

Full price **\$49<sup>50</sup>** with cards

**FREE** 24-PAGE BOOKLET NO. Z-30  
Without Obligation

Write for Your Copy Today  
**GRAPHIC SYSTEMS**  
Yanceyville, North Carolina  
Circle 159 on Inquiry Card



Got a  
**CLEAN ROOM  
Clothing Problem?**  
Consult a specialist . . . your  
local LINEN SUPPLY SERVICE!

On a rental basis, he'll provide you with the exact quantity and type of lint-free garments you require. And you won't have to worry about special laundry problems, maintenance, inventory . . . anything! He does it all!

Look in the Yellow Pages under "Linen Supply" or write for information.

**Linen Supply**

ASSOCIATION OF AMERICA

22 W. Monroe St., Chicago 3, Ill.

Circle 150 on Inquiry Card

ELECTRONIC INDUSTRIES • October 1962



# INDUSTRY NEWS

Vernon A. Kamin — appointed Vice President, Marketing, Centralab, The Electronics Div. of Globe-Union, Inc., Milwaukee, Wis.

Charles A. Sereno—named Vice President, Marketing, GPL Div., General Precision, Inc., Tarrytown, N. Y.

Dr. Fred P. Baughman—elected Vice President, Research and Development, Taylor Corp., Valley Forge, Pa.

Cecil Dotson—named Director of the new Semiconductor/Components Div., Texas Instruments Incorporated, Dallas, Tex.

J. Howard Teeter—named Group Vice President, Hoffman Electronics Corp., Los Angeles, Calif. Teeter will be in charge of the Military Products Div. and the Hoffman Science Center.



J. H. Teeter

W. I. George

William I. George — appointed Marketing Manager, Precision Parts and Contact Materials Dept., Metals & Controls, Inc., Attleboro, Mass., division of Texas Instruments, Incorporated.

Freeman E. Hazlett—named Western Region Computer Sales Manager, Packard-Bell Computer Corp., Los Angeles, Calif.

Edson Ryder—appointed Engineering Sales Manager, Celco, Constantine Engineering Laboratories, Mahwah, N. J.

Alan J. Waters — appointed Product Sales Manager, Computer Components, Ferroxcube Corp. of America, Saugerties, N. Y.

Dawson L. Newton—appointed Marketing Manager, Franklin Systems, Inc., West Palm Beach, Fla.

S. Dean Wanless—elected a Vice President, Philco Corp., Philadelphia, Pa., and appointed General Manager of its Computer Div.

# OREC OZONATORS

for your *OXIDATION* process

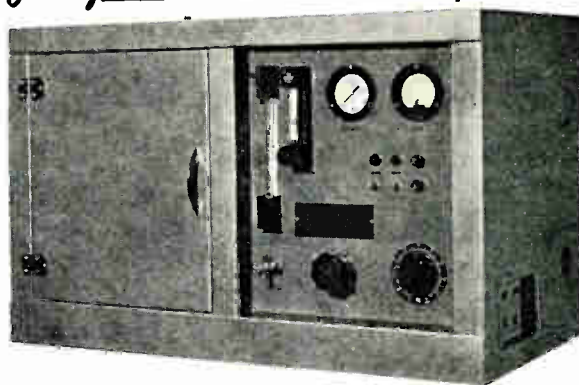

MODEL 03C6 OZONATOR

*Have you given ozone a crack at it?*

Ozone is more efficient and economical than other oxidants in many oxidation processes, often uniquely so, or providing improved oxidation at far lower temperatures.

OREC O3C Series Ozonators are the highest output and most technically advanced ozonators available for both laboratory and medium production process applications. They include ozone monitoring instrumentation and are ready for operation upon receipt by the customer.

Write for brochure 114 and free Ozone Handbook.

Ozone Research & Equipment Corporation

3840 North 40th Ave. — Phoenix, Arizona

Circle 161 on Inquiry Card



## MIL-SPEC MOLDED CHOKES

MOLDED COILS CONFORM TO MIL-C-15305 B

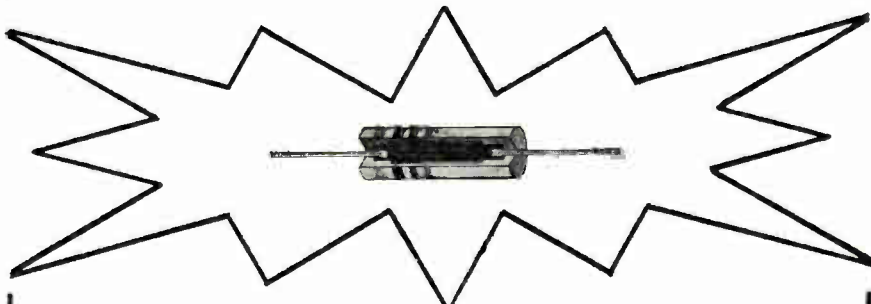

### MILLER SERIES 9360

(MS 91189)

Mold Size: 0.281 ± .031 diameter; 0.937 ± .062 length.

Leads: AWG #21 TCW; 1.500 ± .125 length.

Power Rating: 1/2 Watt Max. at 90° C.

PART NO.	L uh	Q MIN.	TEST FREQ. (Mc)	Fo (Mc) ±10%	Rdc. MAX.	Ma. MAX.	CORE MTL.
9360-01	1.1 ± 20%	60	10.0	200	.09	2800	PHENOLIC
9360-02	2.2 ± 20%	65	10.0	165	.20	1800	PHENOLIC
9360-03	3.3 ± 10%	50	6.0	130	.32	1500	PHENOLIC
9360-04	4.7 ± 10%	45	5.0	100	.60	1100	PHENOLIC
9360-05	6.8 ± 10%	40	4.0	90	1.10	800	PHENOLIC
9360-06	10.0 ± 10%	40	3.5	70	1.80	600	PHENOLIC
9360-07	15.0 ± 10%	40	3.0	55	3.00	500	PHENOLIC
9360-08	22.0 ± 10%	30	2.5	27	.30	1500	IRON
9360-09	33.0 ± 10%	45	2.0	21	.60	1100	IRON
9360-10	47.0 ± 10%	70	1.5	16	1.20	700	IRON
9360-11	82.0 ± 10%	85	1.2	14	2.20	600	IRON
9360-12	100.0 ± 10%	85	1.0	14	2.80	500	IRON
9360-13	120.0 ± 10%	85	1.0	13	4.00	400	IRON

For a Complete Listing of MILLER PRODUCTS ask for a copy of our Latest General Catalog on your Company Letterhead.

**J. W. MILLER COMPANY • 5917 So. Main St., Los Angeles 3, Calif.**



# MUCON

makes

# MU CAPS

SUB-MINIATURE

**MOLDED BOX  
CAPACITORS**  
with AXIAL LEADS

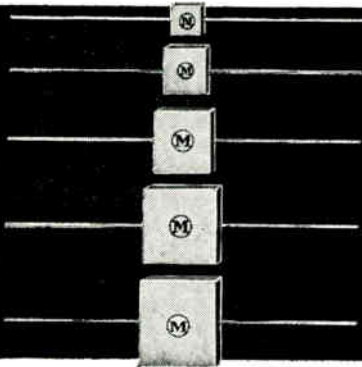

and

# MU CAPS

SUB-MINIATURE

**MOLDED BOX  
CAPACITORS**  
with RADIAL LEADS

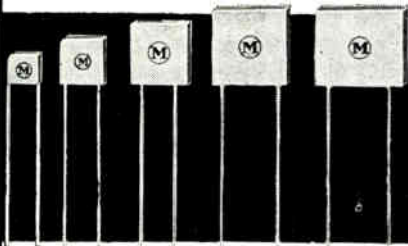

**Both in 5 BOX SIZES**

Capacitance Values from 10mmf to .056Mf

Voltage ratings 200 WVDC & 500 WVDC

Write for Bulletin M-2 which describes MU-CAPS axial lead box capacitors and Bulletin M-1 which describes MU-CAPS radial lead box capacitors as well as Mucon's entire line of sub-miniature ceramic capacitors made with any one of 13 ceramic bodies. Tailored capacitors to fit your special space and electrical requirements are readily produced in any quantity.

# MUCON CORPORATION

9 ST. FRANCIS ST., NEWARK 5, N. J.

201 Mitchell 2-1476-7-8

Circle 163 on Inquiry Card

## NEWS OF MFRS. REPRESENTATIVES

R. H. Muenzer Co., Pacifica, Calif.—named Northern California and Northern Nevada representative by Computer Logic Corp., Los Angeles, Calif., manufacturer of digital instruments.

Martin P. Andrews, Inc., Fayetteville, N. Y.—appointed representative by Rotron Manufacturing Co., Inc., Woodstock, N. Y., to cover all of New York except Westchester and Rockland Counties, Long Island and New York City. Rotron manufactures precision fans and blowers.

Bonn Associates, Inc., Metuchen, N. J.—named representative for the Philadelphia, Pa., and New York areas by Systems Div., Beckman Instruments, Inc., Fullerton, Calif. The division makes precision systems products, including amplifiers, analog-digital converters, digital logic boards, multiplexers, and buffer memories.

R. L. Moubrey & Associates, Dayton, Ohio—appointed sales representative by Fairchild Controls Corp., Hicksville, N. Y., to cover Ohio, Western Pennsylvania and Kentucky. Fairchild Controls manufactures transducers, potentiometers, accelerometers, rate gyros and subsystems.

Barnhill Associates, Salt Lake City, Utah—named representative to cover Utah, Colorado and New Mexico by Dorsett Electronics, Inc., Norman, Okla., manufacturer of telemetering transmitters and receivers, power supply equipment and associated components.

Functional Communications Co., Chicago, Ill.—named representative for RCA-engineered sound systems in Cook County, Ill., Northern Indiana and Southern Michigan.

W. R. Hays Co., Dallas, Tex.—named representative to cover Texas and Oklahoma by Clevite Electronic Components, Div. of Clevite Corp., Cleveland, Ohio. Clevite manufactures piezoelectric ceramics, ceramic filters, self-generating accelerometers and brush headphones.

Bartlett Associates, Inc., Washington, D. C.—named representative for Kin Tel Div., Cohu Electronics, Inc., San Diego, Calif., to cover Maryland, Delaware, Northern Virginia and West Virginia. Kin Tel Div. manufactures DC amplifiers and digital instrumentation and closed-circuit TV systems.

# Celco DEFLECTION

**HIGH**  
Efficiency

**MAXIMUM**  
Resolution

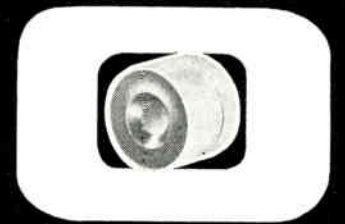

**MINIMUM**  
Distortion

**LOW**  
Residual

**FASTEST**  
Spot Recovery

**WIDE**  
**RANGE**  
Inductances

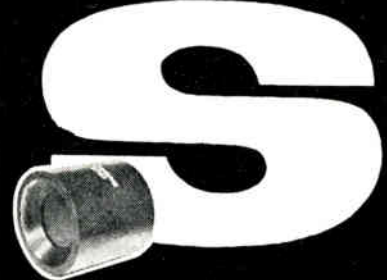

Celco Precision Deflection Yokes are now available for neck diameters from 1/2" to 5" for all types of military and commercial CRT displays. For technical assistance or Celco's latest catalog, call or write:

# Celco

**CONSTANTINE ENGINEERING  
LABORATORIES COMPANY**

Mahwah, N. J.  
Area Code: 201  
DAvis 7-1123  
Ed Ryder

Miami, Fla.  
Area Code: 305  
PLaza 1-1132  
Walt Faust

Upland, Cal.  
Area Code: 714  
YUkon 2-0215  
Bob Reese

Circle 164 on Inquiry Card

# ELECTRONIC INDUSTRIES Advertisers - October 1962

This index is published as a convenience. No liability is assumed for errors or omissions.

<b>A</b>		<b>H</b>		Sylvania Electric Products, Inc.	
AC Spark Plug, The Electronics Division of General Motors	212	Hamilton Standard		Electronic Systems	167
Acromag Incorporated	180	Division of United Aircraft Corp.	31	Electronic Tube Division	24, 25
Adams & Westlake Company, The	191	Harrison Laboratories Inc.	132	Semiconductor Division	81
Aerovox Corporation	66	Hewlett Packard Company	Inside Back Cover, 48, 49	Syncro Corporation	192
Alfred Electronics	47	Holub Industries, Inc.	166	Syntronic Instruments, Inc.	218
Allen-Bradley Co., The	Insert following page 16	Honeywell Precision Meter Division	177		
Alpha Metals, Inc.	70	Howard Industries, Inc.	166	<b>T</b>	
American Bosch Arms Corporation		Hughes Aircraft Company		Texas Instruments Incorporated	
Tele-Dynamics Division	85	Aerospace Division	208	Semiconductor-Components Division	79
American Electronic Laboratories, Inc.	222	Semiconductor Division	165	Tektronix, Inc.	41
Advanced Technology Laboratories				Theta Instrument Corporation	175
Division of American-Standard	15	<b>I</b>		Times Wire and Cable	
AMP Incorporated	67	Ideal Industries, Inc.	203	Division of International Silver Co.	65
Amperite	214	Image Instruments, Inc.	182	Torrington Mfg. Co.	Insert following pg. 118
Amphenol-Borg Electronics Corporation		Industrial Electronic Engineers, Inc.	73	Transitron Electronic Corporation	59
Distributor Division	170, 171	International Electronic Research Corp.	58	Trygon Electronics, Inc.	134
Borg Equipment Division	80			Tung-Sol Electric, Inc.	157
Analab Instrument Corporation	16	<b>J</b>			
Anders Electronics, Inc.		Jennings Radio Mfg. Corp.	54	<b>U</b>	
A Subsidiary of Air Technology Corp.	158	JFD Electronics Corporation	198	United Transformer Corporation	176
		Johnson Company, E. F.	38		
<b>B</b>		<b>K</b>		<b>V</b>	
Behlman-Invar Electronics Corp.	136	Kearfott		Variflex Sales Co., Inc.	166
Belden Co.	71	Division of General Precision Inc.	50	Victoreen Instrument Co.	84
Bell Telephone Laboratories	120	Keithley Instruments	207	Victory Electronics, Inc.	203
Bendix Corporation, The		Kelvin Electric Company	82	Vitramon Incorporated	35
Red Bank Division	28	Kester Solder Company	206	Vichek Plastics Co.	201
Scintilla Division	69	Keuffel & Esser Co.	156		
Boesch Manufacturing Division		Keystone Carbon Company	197	<b>W</b>	
Waltham Precision Instrument Co., Inc.	164	Klein & Sons, Mathias	83	Weckesser Company, Inc.	192
Borg-Warner Corporation		Kulicke and Soffa Mfg. Co.	46	Westinghouse Semiconductor Division	162, 163
Pesco Products Division	125				
Ingersoll Products	44	<b>L</b>		<b>X</b>	
Bourns Inc.	45	Lambda Electronics Corp.	126, 127	Xcelite, Inc.	176
Bradley Semiconductor Corp.	155	Lavelle Aircraft Corporation	152		
Brady Co., W. H.	204	Lavoie Laboratories, Inc.	168		
Brush Instruments Div. of Cleveite Corp.		Linen Supply Co.	218		
Insert following pg.	85	Link Division of General Precision Inc.	215		
Bulova Electronics Division	173				
Burroughs Corporation	19	<b>M</b>			
Bussmann Mfg. Division McGraw Edison	14	Magnecraft Electric Co.	180		
		Magnetics Inc.	42		
<b>C</b>		Method Electronics, Inc.	36		
Camblock Division		Microdot Inc.	160		
Waltham Precision Instrument Co., Inc.	164	Midland Mfg. Co.	172		
Constantine Engineering Laboratories Co.	220	Minnesota Mining & Manufacturing Co.			
Centralab Electronics Division		Magnetic Products Division	57		
of Globe-Union Inc.	Insert following page 188	Mincom Division	62		
Christie Electric Corp.	156	Miller Company, J. W.	219		
Cinch Manufacturing Company		Mitre Corporation	216		
Division of United-Carr Fastener Corp.	115, 170	Mucon Corporation	220		
Clare & Co., C. P.	29, 199				
Columbian Carbon Company	199	<b>N</b>			
Connecticut Hard Rubber Company	64	National Cash Register Co.	217		
Continental Connector Corporation	78	National Ultrasonic Corp.	200		
Continental Electronics Manufacturing Co.	77				
Controls Company of America		<b>O</b>			
Control Switch Division	8	Oak Manufacturing Co.	30		
Couch Ordnance, Inc.	76	Ohmite Mfg. Co.	63		
Cratex Manufacturing Company, Inc.	201	Ozone Research & Equipment Corp.	219		
Crucible Steel Company of America					
Magnet Division	53	<b>P</b>			
Curtiss-Wright Electronics	182, 183	Pacific Semiconductors, Inc.	161		
		Subsidiary of Thompson Ramo Wooldridge			
<b>D</b>		Perkins Electronics	156		
Dale Electronics, Inc.	98	Philco Lansdale Division	20		
Davies Molding Company, Harry	192	Plastic Capacitors, Inc.	202		
Dow Corning Corporation	60, 61	Power Designs, Inc.	153		
		PRD Electronics Inc.	184		
<b>E</b>		Price Electric Corporation	40		
EICO Electronic Instrument Co., Inc.	222	Pyrodyne Inc.	203		
Eisler Engineering Co., Inc.	200				
Electronic Associates, Inc.	190, 206	<b>R</b>			
Electronic Engineers Master	183	Radio Corporation of America	Back Cover		
Electronic Industries	169	Radio Switch Corporation	202		
Electronic Measurements Company, Inc.	141	Rayclad Tubes Inc.	22		
Engineered Electronics Company	12	Raytheon Company			
Erco Radio Laboratories, Inc.	34	Industrial Components Division	55		
		Semiconductor Division	43		
<b>F</b>		Reeves Instrument Corporation	72		
Fairchild Semiconductor	33	Rowley Spring Company, Inc.	207		
Fairmount Chemical Co., Inc.	166	Rutherford Electronics Co.	181		
Force & Co., Inc., Wm. A.	217				
		<b>S</b>			
<b>G</b>		Sangamo Electric Company	Insert following pg. 50		
General Electric Company		Saratoga Semiconductor			
Receiving Tube Department	74, 75	Division of Espey Mfg.	154		
Semiconductor Products Department	178, 179	Sarkes Tarzian, Inc.	159		
Silicone Products Department	173	Sola Electric Co.			
Voltage Regulator Department	147	Division of Basic Products Corp.	130		
General Radio Company	39	Sperry Semiconductor Division	174, 175		
Gertsch Products, Inc.	68	Sprague Electric Company	6, 11, 37		
Gibson Electric Sales Corp.	204	Stancor Electronics, Inc.	191		
Graphic Systems	218				
Grayhill, Inc.	201				

## ELECTRONIC INDUSTRIES REGIONAL SALES MANAGERS

Philadelphia (39)—56th & Chestnut Sts.  
(Area Code 215) SHERWOOD 8-2000  
JOSEPH DRUCKER  
HERMANN W. BOZARTH  
(Classified Advertising)

New York 17—100 East 42nd St.  
(Area Code 212) OXFORD 7-3400  
GERRY PELLISSIER  
HUGH ROBINSON

W. Hartford, Conn.—62 LaSalle Rd.  
(Area Code 203) 236-4237  
AL KAISER

Boston (10) Mass.—10 High St.  
(Area Code 617) LIBERTY 2-4460  
JOHN PICKERING, Jr.

Chicago (1)—360 N. Michigan Ave.  
(Area Code 312) RANDOLPH 6-2166  
GEORGE H. FELT

Cleveland (15)—930 Keith Bldg.  
(Area Code 216) SUPERIOR 1-2860  
ROBERT COBURN

Los Angeles (57)—198 S. Alvarado St.  
(Area Code 213) DUNKIRK 7-1271  
GEORGE F. KELLEY  
BURT UNDERWOOD

San Francisco (3)—1355 Market St.  
(Area Code 415) 861-7107  
DON MAY

Atlanta (9)—1776 Peachtree St., N.W.  
(Area Code 404) 875-1255  
JOHN W. SANGSTON

Dallas (6)—Meadows Bldg.,  
Expressway at Milton  
(Area Code 214) EMERSON 3-6426  
HAROLD E. MOTT

## EUROPEAN SALES OFFICES

London, S.W. (1)—67/68 Jermyn St.  
St. James  
MAX F. HOLLSINGER

Dusseldorf—Huttenstrasse 17  
Am Ernst-Reuter-Platz  
MAX F. HOLLSINGER



# EXTREMELY BROADBAND

## 2 → 16 Gc

MODEL T-601

## 10 → 20 Gc

MODEL T-602



# TWT POWER AMPLIFIERS



with 1 watt output guaranteed over most of range

### FEATURES:

- Periodic permanent magnet focusing on all tubes
- Ruggedly built for long service
- Continuously variable gain controls
- CW, pulsed or AM modulated operation

### PRICES:

Model T-601 . . . 2-16 Gc  
\$3,990.

Model T-602 . . . 10-20 Gc  
\$4,950.

ALSO AVAILABLE FROM AEL . . . A COMPLETE LINE OF OTHER LOW AND MEDIUM POWER MICROWAVE POWER AMPLIFIERS.

Write for more information



**American Electronic Laboratories, Inc.**

RICHARDSON ROAD, COLMAR, PENNSYLVANIA  
Just north of Philadelphia

Circle 165 on Inquiry Card

## DIGITAL SYSTEM "AUTOMATES" READINGS

An electronic instrumentation system that will "automate" the readings from spark chamber films obtained during nuclear research is being designed by Datex Corp., Monrovia, Calif. It is for use by the Univ. of Washington. A spark chamber is a device which makes visible the tracks of subatomic particles.

The spark chamber has the advantage of very high time resolution and a very short dead time. This allows photographing of trajectories of a great many highly-selected particles in a relatively short time. A typical experiment using spark chambers may involve 250,000 to 1 million photographs.

Pertinent information on these tracks must be extracted from this immense number of photographs. The system will permit researchers to scan the photographs and measure the parameters of the tracks and automatically record the information to a high accuracy. The digitizing system also produces an output in a form directly usable by a computer.

## ELECTROSENSITIVE PRINTER ORDERED

Lawrence Radiation Laboratory, Univ. of Calif., has awarded Radiation-Orlando, Orlando, Fla., a contract for the design, fabrication and installation of a super-speed alpha-numeric printer.

The printer will have an instantaneous output rate of 600,000 words/min., operating at 500 alpha-numeric lines/sec. with 120 characters/line. Input rate will be 60,000 characters/sec. It will also have two lower input data rates of 41.7 kc and 15 kc with instantaneous printing rates of 347 and 125 lines/sec. respectively.

Recording medium for the printer is a dry, electro-sensitive paper. Letters and numbers are produced by controlling a flow of electrons through dry chemical compounds which react either chemically or physically to cause a rapid and permanent color change in the compounds. The printer will be able to accept any of five types of electro-sensitive paper.

## MARKETING NEWSLETTER

Industrial marketing men will be interested in a new monthly newsletter, "Mainly Marketing," published by Schoonmaker Associates, P. O. Box 35, Larchmont, N. Y. Typical topics covered are "Selling To The Electronics Industry," "Factory Force or Manufacturers' Reps?," "Company Image, Fortune Telling or Reconnaissance?." The annual subscription fee is \$10. A free sample copy is available upon the receipt of a stamped self-addressed envelope.

## EQUIPMENT, MATERIALS, PARTS & COMPONENTS

## THE ORIGINAL Safe Brulin Solvent Degreaser



Classified by Underwriters' Laboratories as to Fire Hazard Only

**BRULIN & COMPANY, INC.**  
2939 Columbia Avenue • Indianapolis 7, Indiana  
West Coast: P. O. Box 4641, Bayshore Sta., Oakland 23, Calif.

## EMPLOYMENT OPPORTUNITIES

### ELECTRONICS OR RADIO ENGINEER

Rapidly growing Manufacturing Company, employing 160, located near Philadelphia requires individual with minimum of 3 years experience in microwave design and measurements to head research and development in the application of coaxial cable to high frequency equipment; B.S. in physics or E.E. minimum requirement, Masters desirable. Send resume and salary requirements to  
Box 43972, c/o ELECTRONIC INDUSTRIES  
Chestnut & 56th Sts. Philadelphia 39, Pa.  
An equal opportunity employer.

**EICO®**  
**PUTS THE BEST IN CREATIVE ELECTRONICS INTO YOUR HANDS**

Send for **FREE** Catalog

28 pages of professional electronic equipment in kit and wired form — for Lab . . . Line . . . Home

EICO, 3300 N. Blvd., L.I.C., N. Y. E.I.N. 10  
 Send free 32-page catalog & dealer's name.  
 Send new 36-page Guidebook to Hi-Fi for which I enclose 25¢ for postage & handling.

Name \_\_\_\_\_  
 Address \_\_\_\_\_  
 City \_\_\_\_\_ Zone \_\_\_\_\_ State \_\_\_\_\_

**EICO®** 3300 N. Blvd., L.I.C. 1, N. Y.  
 Export Dept., Roburn Agencies  
 431 Greenwich St., N. Y. 13, N. Y.

Circle 166 on Inquiry Card



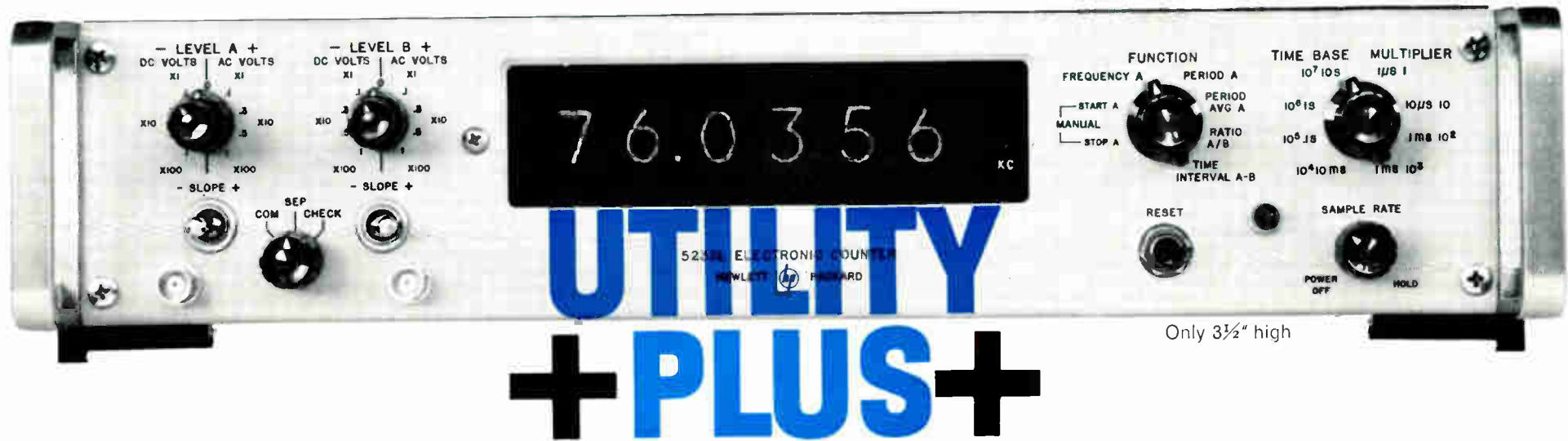

## **COUNT** the features on the new hp 5233L 2.0 MC Universal Counter

1. Measures frequency, 0 to 2.0 MC dc coupled, 10 cps to 2.0 MC ac coupled
2. Measures time interval, 10  $\mu$ sec to 10<sup>6</sup> sec
3. Measures period, 0 to 100 KC
4. Measures period average to 10<sup>7</sup> periods
5. Measures ratio, multiples of ratio
6. Refined A and B trigger level controls for precise positioning of trigger points
7. Six digit resolution, rectangular close-spaced Nixies
8. Input impedance of 1 megohm, sensitivity of 0.1 v rms
9. Time base stability  $\pm$  2 parts in 10<sup>7</sup> per month
10. High sampling rates (0.2 to 5 sec, variable), independent of gate time
11. Display storage, continuous display
12. Automatic measurement unit, decimal display
13. BCD code output for systems, digital recorders
14. Self check in all function and multiplier positions
15. Operates  $-20^{\circ}$  to  $+65^{\circ}$  C
16. Small, compact, 3 $\frac{1}{2}$ " high, 16 $\frac{3}{4}$ " wide, 11 $\frac{1}{2}$ " deep, only 19 lbs
17. Solid state construction, low power consumption, high reliability
18. Plug-in module construction for easy maintenance
19. Costs only \$1,850.00 complete

Contact your Hewlett-Packard representative today for a demonstration of this versatile counter! Data subject to change without notice. Price f.o.b. factory.

**HEWLETT  
PACKARD  
COMPANY**

1501 Page Mill Road, Palo Alto, California, Area Code 415, DA 6-7000. Sales and service representatives in all principal areas; Europe, Hewlett-Packard S. A., 54-54bis Route des Acacias, Geneva; Canada, Hewlett-Packard (Canada) Ltd., 8270 Mayrand Street, Montreal



8063

Circle 1 on Inquiry Card

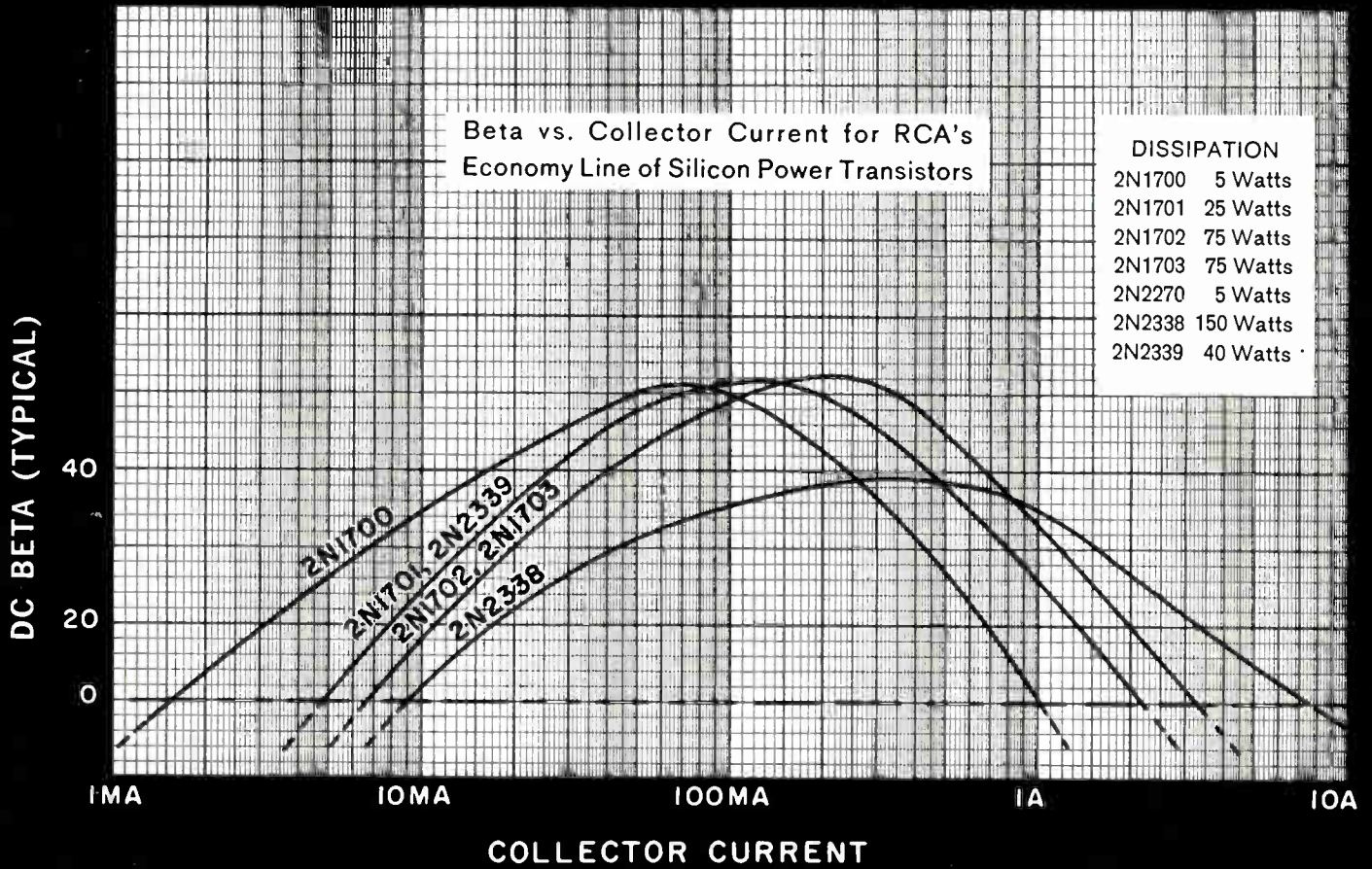

# RCA EXPANDS ECONOMY SILICON LINE FOR LOW COST DESIGN FLEXIBILITY UP TO 150 WATTS

Now, RCA adds 3 new types, 2N2338, 2N2339, 2N2270 to its line-up of low-cost silicon transistors at prices starting as low as comparable Germanium Power Types.

Here's RCA's answer to today's value and performance requirements for industrial and military applications... a broad new economy line of silicon transistors. This low-cost, high performance line now includes three new types, 2N2338 and 2N2339, high and medium power types, respectively, and the 2N2270, RCA's new economy version of the "Universal" triple-diffused planar silicon transistor type 2N2102. With these additions, RCA's economy silicon line now offers:

- High dissipation... up to 150 watts
- Top performance at high temperatures... up to 200°C
- Wide-range beta control... up to 10 amps

These low-cost silicon types are immediately available to bring you new economy and greater design freedom for industrial and military circuits demanding the reliability and performance of silicon transistors.

AVAILABLE THROUGH YOUR RCA DISTRIBUTOR



**THE MOST TRUSTED NAME IN ELECTRONICS**

Circle 42 on Inquiry Card



For new low prices call your RCA representative today. For FREE Technical Bulletin on RCA's Economy Silicon Line, write RCA Semiconductor and Materials Division, Commercial Engineering, Section 1J10, Somerville, N. J.



**FIELD OFFICES...**  
 EAST: Newark, N. J., 744 Broad St., HU 5-3900 • (Camden-Philadelphia Area) Eriton, N. J., 605 Marlton Pike, HA 8-4802 • Syracuse, N. Y., 731 James St., Rm. 402, GR 4-5591 • Baltimore, Md., EN 9-1850 • NORTHEAST: Needham Heights 94, Mass., 64 "A" St., HI 4-7200 • SOUTHEAST: Orlando, Fla., 1520 Edgewater Dr., Suite #1, GA 4-4768 • EAST CENTRAL: Detroit 2, Mich., 714 New Center Bldg., TR 5-5600 • CENTRAL: Chicago, Ill., Suite 1154, Merchandise Mart Plaza, WH 4-2900 • Indianapolis 5, Ind., 2132 East 52nd St., CL 1-1405 • Minneapolis 16, Minn., 5805 Excelsior Blvd., WE 9-0676 • Denver 11, Colorado, Continental Terrace Bldg., Suite 301, 2785 N. Speer Blvd., 477-1688 • WEST: Los Angeles 22, Calif., 6801 E. Washington Blvd., RA 3-8361 • (San Francisco Area) Burlingame, Calif., 1838 El Camino Real, OX 7-1620 • Seattle 4, Wash., 2250 First Ave. S., MA 2-8816 • SOUTHWEST: Dallas 7, Texas, 7905 Carpenter Freeway, ME 1-9720 • GOV'T: Dayton, Ohio, 224 N. Wilkinson St., BA 6-2366 • Washington, D. C., 1725 "K" St., N.W., FE 7-8500 • RCA INTERNATIONAL DIV., 30 Rockefeller Plaza, N. Y. 20, N. Y. Cable Address: RADIOINTER, N. Y.