

ELECTRONIC INDUSTRIES

A CHILTON PUBLICATION



THE CHALLENGE OF SPACE!

What We Have —

and

What We Need!

April
1960

How Coriolis Works 70

In this Issue:

- RFI in Satellite Communications Systems 92
- BMEWS Guards Against Sneak Attack 98

from top to bottom

RMC DISCAPS[®]

are stable

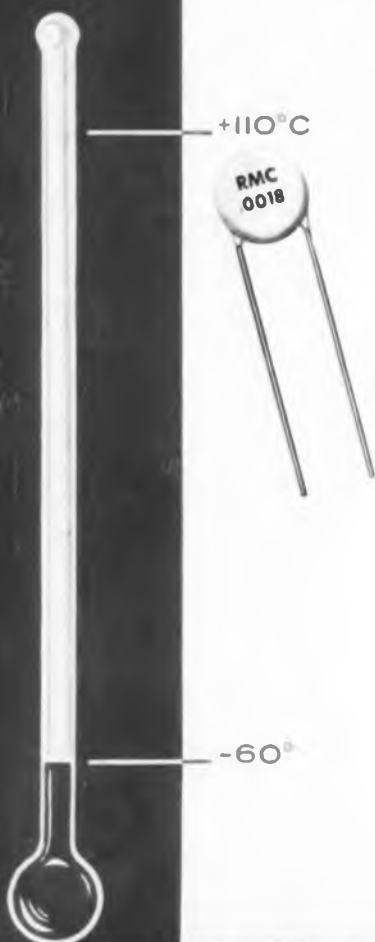

RMC Type JL DISCAPS should be specified for applications requiring a capacitor that exhibits a minimum of capacity change over an extended temperature range. As temperature varies from -60° to $+110^{\circ}\text{C}$, Type JL DISCAPS show a capacity change of only $\pm 7.5\%$ of capacity at 25°C . With a standard working voltage of 1000 V.D.C., Type JL DISCAPS are the ideal cost saving replacement for paper or general purpose mica capacitors.

SPECIFICATIONS

POWER FACTOR 1.5% Max. @ 1 KC (initial)

POWER FACTOR 2.5% Max. @ 1 KC (after humidity)

WORKING VOLTAGE 1000 V.D.C.

TEST VOLTAGE (FLASH) 2000 V.D.C.

LEADS No. 22 tinned copper (.026 dia.)

INSULATION Durez phenolic — vacuum waxed

INITIAL LEAKAGE RESISTANCE: Guaranteed higher than 7500 megohms

AFTER HUMIDITY LEAKAGE RESISTANCE: Guaranteed higher than 1000 megohms

CAPACITY TOLERANCE $\pm 10\% \pm 20\%$ at 25°C

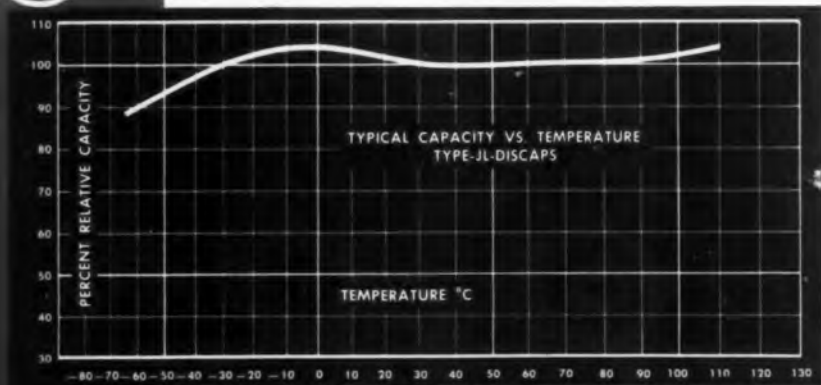

DISCAP
CERAMIC
CAPACITORS



RADIO MATERIALS COMPANY
A DIVISION OF P. S. MALLORY & CO., INC.
GENERAL OFFICE: 3323 N. California Ave., Chicago 18, Ill.
The RMC Plants Devoted Exclusively to Ceramic Capacitors
FACTORIES AT CHICAGO, ILL. AND ATTICA, IND.

Circle 1 on Inquiry Card

ELECTRONIC INDUSTRIES

ROBERT E. McKENNA, Publisher

• BERNARD F. OSBAHR, Editor

Electronic Military Procurement—1960

THE Electronic Industries Association is to be congratulated for its sponsorship of the first Defense Market Planning Seminar. This event, attended by more than 400 representatives of government agencies and electronic firms, was held concurrently with the Association's annual spring conference in Washington in mid-March. It was an all-day and evening affair, where representatives from the various military branches presented their views during the morning session and selected industry representatives responded during the afternoon. Witnessing an open airing of military procurement problems and military defense problems between the two groups most responsible was very heartening.

Press time and available space will not permit us to present a comprehensive report of all views presented. In our next issue we will carry an editorial feature summarizing the important points in all of the papers. At this writing our aim is to provide "awareness" information for our readers.

The military services recognize the impact that their procurement practices have on the Electronic industries. They estimate that in today's total electronic market of some \$10.13 billion, 58½% is in military business, 17% industrial, 15.7% consumer and 9½% in replacement parts. In 1950, 4% of all defense expenditures was for electronic equipment while last year this total rose to 14%. In the next ten years a further increase to 20% can be expected.

It is also generally recognized that the government's present method of allocating funds on a fiscal year basis causes a great many procurement problems. Congress should avoid peaks and valleys and a piecemeal approach in authorizations and appropriations for defense spending to introduce

an element of "stability" into national security.

The rapid advances in the electronic arts will tend to limit the actual purchase of electronic hardware. In today's technology the actual hardware can be obsolete before production is finished. Thus we can expect more R&D efforts in the future. The National Science Foundation reports that total funds for all R&D are now about \$12 billion, up some \$7 billion from 1953. In 1957 electronic R&D totaled about 1/5. By 1970 this should become about 1/3.

We must also all recognize that today's threat to national security is not only military but political and economic as well. Changes in either of these areas can effect military defense planning and procurement. Inflation is a major problem. For example in the last two years the average yield on government bonds has gone from 3.1% to 4.3% and interest on national debt has gone from \$7 billion to \$9.4 billion for 1960. Rising prices for new hardware, higher operational and maintenance costs, and a balance of payments deficit (\$3.4 billion for calendar 1958) tend to dilute the government's purchasing power.

Points from industry's side of the picture include: Recognition that the present military markets are fluctuating markets. Early stabilization is highly desirable because engineering talent, R&D facilities, and highly technical production facilities are not as flexible or as available as they may be in other industry segments.

The shift to missiles has resulted in some serious industry dislocations. Airframe manufacture, which heretofore was prime, has become secondary to electronic and propulsion considerations. Many of the well known airframe producers have had to diversify and this in

turn affects the electronic industries as well as many others.

Present procurement situations also tend to favor larger organizations with more diverse technical talents. This is reflected in the great amount of merger and acquisition activity that we have noted throughout the industry in recent years.

With R&D becoming the more active area of military interest, the profit structure on such contracts should be modified to be more in keeping with that on production type contracts.

Industry also would like to overcome the solidly entrenched government idea that military services are never "sold" anything, rather—they "buy" systems that they know they want. Industry also desires to propose new systems and new R&D studies to government because with their talent and facilities they believe that they are in a better position to do this.

We drew two conclusions from this seminar. Each of them requires some extensive overhaul in existing government practices. First, in this critical electronic area, effort should be made to attract a hard career-minded core of top flight engineers into government service. They should not be hamstrung with endless civil service regulations but should be permitted to operate in an industry-like atmosphere and they should be paid at industry scales. Such a group functioning as a "continuing" liaison with industry would inject high stability and performance factors. Secondly, the scientific areas of military security should be greatly modified. Perhaps a facility could be created which would let the military keep classified what must be classified, but which would release information in the purely scientific areas. Our military electronic editorial staff study starts on page 101 of this issue.

ROBERT E. McKENNA, Publisher
BERNARD F. OSBAHR, Editor

CREIGHTON M. MARCOTT
Managing Editor
RICHARD G. STRANIX
JOHN E. HICKEY, Jr.
Associate Editors
CHRISTOPHER CELBINT
Assistant Editor
DR. ALBERT F. MURRAY
Contributing Editor
ROLAND C. DAVIES
Washington News
MARIE T. McBRIDE
Directory Editor
ELMER JETTERER
Art Editor
CHARLES F. DREYER
Cover Designer
IDA M. GOOD
Editorial Secretary
MAE E. MOYER
Readers' Service

EDITORIAL CORRESPONDENTS

Washington—1073 National Press Bldg.
GEORGE BAKER
NEIL R. REGEIMBAL
RALPH W. CROSSBY

BUSINESS DEPARTMENT

ELMER DALTON
Circulation Manager
DONALD J. MORAN
Marketing Manager
GORDON HERNDON
Production Manager
ARA H. ELOIAN
Production Assistant

REGIONAL SALES MANAGERS

Philadelphia (39)—64th & Chestnut Sts.
5Harwood 8-2800
JOSEPH DRUCKER
New York (17)—100 East 42nd St.
OXford 7-3400
GERALD B. PELISSIER
Metropolitan N. Y.
MENARD DOSWELL III
New England
Chicago (1)—246 N. Michigan Ave.
RAndolph 6-2166
GEORGE H. FELT
Cleveland (15)—720 Keith Bldg.
SUperior 1-2868
SHELBY A. McMILLION
Los Angeles (57)—158 S. Alvarado St.
DUinkirk 7-4337
B. WESLEY OLSON
San Francisco (3)—1265 Market St.
UNderhill 1-9737
DON MAY
Atlanta (3)—911 William-Oliver Bldg.
JACKson 3-6791
JOHN W. SANGSTON
Dallas (6)—Meadows Bldg., Expressway
at Millton
EMerson 8-4761
MAROLD E. MOTI
London, WI—4 Old Burlington St.
D. A. Goodell Ltd.
A. B. RACE
GErard 8617/8/9

G. C. BUZEY, President

Vice Presidents: P. M. Fahrendorf,
Leonard V. Rowlands, George T.
Heck, Robert E. McClanna; Treasurer,
William H. Veltor; Directors: Maurice
E. Cox, Frank P. Tisha, Everil B. Ter-
hune, Jr., Russell W. Case, Jr.,
Charles A. S. Heine, John H. Kofron.
Washington Member of the Editorial
Board, Paul Weston.

Comptroller, Stanley Appleby.

ELECTRONIC INDUSTRIES, March, 1960, Vol.
19, No. 3. A monthly publication of Chilton Com-
pany, Executive, Editorial & Advertising offices
at Chestnut & 64th Sts., Phila. 39, Pa. Accepted
as controlled circulation publication at Phila.,
Pa. \$1.00 copy; Directory issue (June), \$5.00 a
copy. Subscription rates U. S. and U. S. Posses-
sions: 1 yr. \$10.00; 2 yrs. \$18.00 Canada 1 year,
\$12.00; 2 yrs. \$20.00. All other countries 1 yr.
\$18.00; 2 yrs. \$30.00. Copyright 1960 by Chilton
Company, Title Reg. U. S. Pat. Off. Reproduc-
tion by reprinting prohibited except by written
authorization.

ELECTRONIC INDUSTRIES

Vol. 19, No. 4

April, 1960

MONTHLY NEWS ROUND-UP

Raderscope: What's Ahead for the Electronic Industries	4
As We Go To Press	7
TOTALS: Late Marketing Statistics	19
Snapshots . . . of the Electronic Industries	24
Coming Events	12
Electronic Industries' News Briefs	14
International News	32
Electronic Shorts	8
Washington News Letter	174
Next Month in Electronic Industries	69

Editorial:	1
When Watching Missiles Remember . . . How Coriolis Works Richard H. Pervin	70
RC Filter Networks in Missile Control R. Hookway and R. H. Mayer	73
Applying Microwaves to Space Problems H. M. Hart	78
Thermistors—The Key to . . . Bio—Medical Measuring in Space C. T. Paludan	83
What's New	86
Selecting and Using Bonded Wire Strain Gages N. C. Parrish	88
RFI in Satellite Communications Systems O. M. Salati	92
"BMEWS" Guards Against Sneak Attack	98
The Challenge of Space . . . What We Have and What We Need! C. M. Marcott	101
Electronic Operations	169
New System Design for . . . Detecting Interference to Missiles H. Kilberg	170
Pioneer V . . . U.S. Solar Satellite #2	182
International Electronic Sources	189
Professional Opportunities	225
Engineering for Space—Opportunity & Challenge . . . E. B. Gilroy	229

NEW PRODUCTS & TECH DATA

New Products	149
New Tech Data for Engineers	124

DEPARTMENTS

Personals	62	Industry News	234
Tele-Tips	30	News of Mfrs. Representatives . . .	238
Books	40	Cues for Broadcasters	176
Letters	52	Systems-Wise	169



Highlights

of this issue

Bio-Medical Measuring in Space

page 83

Before man orbits, his physiological behavior in space must be known. Since their reactions approach human, primates have been tested. One problem was measuring their breathing rate during ballistic flight. This article presents a successful solution—using thermistors.

RC Filter Networks in Missile Control

page 73

When a gimballed rocket engine is deflected to control the flight path, the motion of the engine causes local deflections in the rocket structure. The automatic pilot gyros "see" these unwanted structural deflections as well as changes in the rocket attitude. An RC filter in the control system is a practical corrective measure. Several illustrations from the Vanguard rocket booster are described here.

RFI in Satellite Communications Systems

page 92

A review of proposed space communications is given followed by an analysis of the interference aspects of each part of the system. The influence of man-made and celestial radiators on system performance is shown, and a prediction is made of the improvements to be expected by appropriate design of each item of the communications link.

Detecting Interference to Missiles

page 170

Unfortunately RFI detection equipment has not kept pace with the latest missiles equipment. The missile equipment has been more sensitive than the detection equipment. A new system has been designed which should overcome this problem. This system boasts flexibility and sensitivity, and provides for recording and storing information.

How Coriolis Works

page 70

Is that missile really veering: How can the earth's rotation affect our vision: Should we believe "only half of what we see"? This article assists in getting an intuitive grasp on the Coriolis Effects.

Applying Microwaves to Space Problems

page 78

Many problems associated with the use of powerful microwaves in space are described. Solutions and approximate costs are discussed. A helicopter space platform powered by microwave signals is proposed.

Engineering for Space—Opportunity and Challenge

page 229

The development of ballistic and space vehicles present many challenges to the engineering team. The electronic engineer is and will continue to be an integral part of that team. He is needed in systems engineering, equipment and circuit engineering, and in component engineering. Each presents special problems and each has special opportunities for the growth of the professional electronic engineer today.

The Challenge of Space . . .

What We Have and What We Need?

page 101

In the "change of thinking" necessary for successfully meeting the problems of space travel, research and development must assume a new role as a commodity on its own. Pieces of hardware will be exceedingly complex and costly and the result of thousands of hours of engineering time. Reliability factors will achieve new orders of magnitude through sophisticated applications of redundancy.



Superpower Microwaves

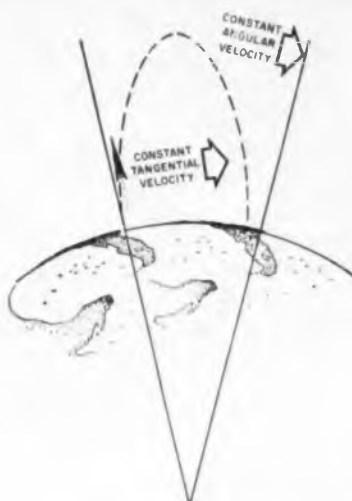

How Coriolis Works

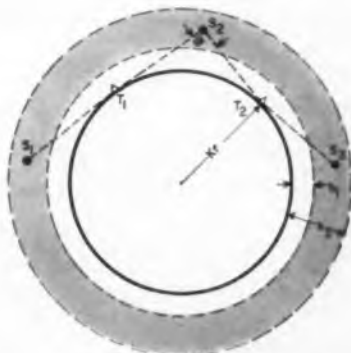

RFI in Satellite Systems

Bio-Medical Measuring in Space



RADARSCOPE



RESEARCH COMPUTER PROGRAMMED

Atlantic Research Corp. initiates the first program on its new computer built by Burroughs. Computer cost about \$750,000. The first program is a flight trajectory calculation for one of ARC's sounding rockets. Computer is at Alexandria, Va.

CHECKING OUT AIRLINERS EQUIPMENT in the course of short layovers is becoming increasingly important in the field of instrumentation. As speeds of the airliners are increased, and traveling times compressed, the ground checkout time becomes extremely expensive. Look for a strong push in this direction, with equipment that will completely check out an airliner's instrumentation in much reduced time.

EMPLOYMENT. The aircraft and parts industries showed a decline of about 50,000 workers during 1959.

SIMPLIFIED COMPUTER LANGUAGE has been developed by Socony Mobil Oil Co. which greatly cuts training period necessary for engineers to work directly with computers. Called PROLAN (processed language) it is like basic English or Esperanto. However, it uses the specialized vocabulary of refinery engineers. With PROLAN the engineer can describe to a computer in his own engineering language a new processing setup for a new refinery. The new language enables the engineer to work with the computer after only a few days training.

DATA PROCESSING AND DISPLAY is taking a new and highly sophisticated turn. The most pressing demand is being visualized as the coordination of integrated, significant facts immediately at a business manager or military commander's disposal. The continuous flow of multitudinous facts and data must be sorted out into the significant information for decision-making. The decision-making aspect is the key.

DURING 1959 the Federal Aviation Agency commissioned a new navigational aid or air traffic management facility at a rate of one a day, for a total of 365 during the year. These included 72 approach-like systems, 11 new air port traffic control towers, 18 long range radars, 9 precision approach radars and 2 airport surveillance radars.

SILICON P-N LAYERS are made directly from the vapor-phase growth of single crystal production in a new method developed by scientists of Merck Research Laboratories, Advanced Electronic Materials Section. In this new procedure alternate P-N single crystal layers are deposited from the vapor-phase. Close control can be exercised over resistivity, thickness and other parameters of junctions. The new technique may find use in the field of solid circuits or "molecular electronics."

TRANSISTOR MANUFACTURING

Over 1,800 transistors/hr. are produced by the new automated transistor assembly system developed by IBM. The system, first automatic method for making NPN alloy junction transistors, has now successfully completed 1 month of operation.



MINIMUM WAGE RATES for the Electronic Component Parts Industry will be discussed by the U. S. Dept. of Labor on March 29th. Under the Walsh-Healey public contracts act, Secretary of Labor is authorized to issue industry minimum wage determinations, on the basis of the minimum wages he finds to be prevailing. The act applies to employees working in Government supply contracts in excess of \$10,000.

IMPROVED RADAR performance, equivalent to a 50% increase in range or 125% increase in area covered, is claimed by Zenith Radio Corp. as a result of their new electron-beam parametric amplifier tube and a special method called synchronous pumping. The new equipment was tested on an L-Band radar at Rome ADC. Among the important potential applications: the new long range radar system being installed at Air Traffic Control Centers by the FAA and surveillance radars to control traffic around busy airports.

ATTEMPTS WILL BE MADE to clarify the patent rights on inventions made by private firms under Government contracts. A new bill being offered in Washington calls for a review of the entire problem, with an eye to laying down ground rules for future agreements between the contractor and Government. The Dept. of Justice is concerned with concentration of economic power in the large firms conducting the bulk of the Government's R&D business.

TV LICENSEES hoarding permits for unbuilt UHF TV stations are being handed "build or else" orders by the Federal Communications Commission. Some of the permits date back to 1952 and 1953. With the present disenchantment over the higher frequencies it is unlikely that many will want to build, but the permits do have an attractive side. If TV decides to shift to UHF, the permits will become very valuable.

THE STEREO QUESTION is left hanging in air, after the disbandment of the National Stereophonic Radio Committee. In the final report to the Federal Communications Commission, President D. R. Hall of the Electronic Industries Assoc. pointed out that the reports come to no conclusions, nor do they offer any recommendation. In one of the reports on systems specifications, the Chairman points out that it "represents nothing more than a firm foundation for the choice of a system for a stereophonic broadcast on FM." EIA had requested, but the FCC declined, to set up a Government sponsored committee to conclude the work of NSRC, and to provide legal clearance for the participation of two major companies which had declined to join NSRC.

LOW-COST TV STATION has been designed by the Electron Corp., subsidiary of Ling-Altec Electronics Inc., complete with an advisory service to help buyers obtain construction permits. Key to the low cost construction, says the company, is the simplicity of the camera circuits, exclusive with the firm. Equipment packages are available costing as low as \$30,000. With the package the company also makes available a programming service which includes films for operating at least 4 hours a day, 30 days a month. Chief sales prospects for the package are small radio station operators and educational institutions.

NEW INFRA-RED SYSTEM, called the Phothermionic Image Converter, and developed by Westinghouse Research Laboratories changes the IR radiation emitted by an object into a visual picture on a TV screen. The speed with which it responds to infra-red is roughly equal to that of the human eye to visible light. The system uses IR radiation of relatively long wave lengths, and this radiation is emitted by comparatively cool objects such as the human body. The key component of the new system is a unique IR detector, or retina, a 3-layer sandwich only a few millionth of an inch thick with a center layer of aluminum oxide only 1×10^{-6} in. thick.

BMEWS SCANNER

High Speed Scanning switch for the Air Force's BMEWS Surveillance radar subsystem is shown being installed. The 16-ft. high, 21-ft. diameter unit houses a unique high-speed rotary switch which distributes the power generated by the transmitters to the feedhorns. GE's Heavy Military Electronics Dept. is the developer under a sub-contract with RCA. See story on page 78.



new transistors from Sprague*



SUPER HIGH-SPEED SWITCHING TRANSISTORS TYPE 2N501

	Typical	Maximum	Units
Rise Time (t_r)	9	18	μsec
Storage Time (t_s)	9	12	μsec
Fall Time (t_f)	7	10	μsec

In circuit with current gain of 10 and voltage turnoff.

Also available as special type 2N501A for
100° C. maximum storage and
junction temperatures.

This table tells the story. Sprague Type 2N501 germanium micro-alloy diffused-base transistors are the fastest mass-produced transistors available anywhere! They are unexcelled for high-speed computer applications. The ultra-low rise, storage, and fall time cannot be matched by any other transistor.

Ultra-precise process control in manufacture results in superb and consistent high quality. The basic electrochemical process of fabrication takes the guesswork out of transistor manufacturing. The result is outstanding uniformity of product.

Because of the electrochemical process, Sprague is able to fabricate a graded-base transistor with no intrinsic base region. The Type 2N501 can thus maintain its super high-speed switching characteristics right down to its saturation voltage, providing all the advantages of direct-coupled circuitry with no impairment of switching speeds.

Type 2N501 Transistors are available from Sprague now at extremely reasonable prices. They are transistors you can use today! You need not delay your development work for the future when you design high-speed switching circuits with Type 2N501 Micro-Alloy Diffused-Base Transistors.

Write for complete engineering data sheet to the Technical Literature Section, Sprague Electric Company, 233 Marshall Street, North Adams, Massachusetts.

* Sprague micro-alloy, micro-alloy diffused-base, and surface barrier transistors are fully licensed under Philco patents. All Sprague and Philco transistors having the same type numbers are manufactured to the same specifications and are fully interchangeable.

SPRAGUE COMPONENTS:

TRANSISTORS • CAPACITORS • RESISTORS
MAGNETIC COMPONENTS • INTERFERENCE FILTERS
PULSE NETWORKS • HIGH TEMPERATURE MAGNET
WIRE • CERAMIC-BASE PRINTED NETWORKS
PACKAGED COMPONENT ASSEMBLIES



As We Go To Press...

PERSHING MISSILE READY



The Army's Pershing missile is being made ready for its first firing. The missile is a surface-to-surface bird.

Radar Tracks Missiles 2,000 Miles Away

Giant new dual-purpose tracking radars will be featured at the recently announced third, or British site of the Ballistic Missile Early Warning System. The newly-developed tracking radars, being built by Goodyear Aircraft Corp., can both detect an enemy ballistic missile over 2,000 miles away, and, once the target has been detected, "lock on" to the missile to predict its speed, direction and impact point.

The third BMEWS site will be at Flyingdale Moor, Yorkshire, between London and Edinburgh.

Tiny Mikes Record Space Hits

The 142-lb. Explorer VI satellite is carrying 2 tiny microphones as a part of a micrometeorite detection experiment. The instruments measure the number of times the "paddle wheel" satellite is struck by tiny particles in space.

The microphones are located opposite each other, firmly mounted in the center of 6-in. by 12-in. strips of the satellite's 1/16th of an in. aluminum skin. The hits are transmitted as electrical pulses to the earth. Size of the particles are determined between certain known limits from the magnitude of the pulses generated.

New Space-Tracking Method Announced

A new method for tracking satellites, space capsules or other objects in outer space has been announced by ACF Electronics Div. of ACF Industries, Inc.

The new system, known as celestial moving-target indicator, detects a moving luminous source (man-made or otherwise) in the sky by charting its movement in relation to relative stationary star sources.

The technique is applicable to satellites traveling in orbits about the earth and to missiles carrying flash bombs for tracking purposes, as well as rockets during their boost phase. A telescope is used to image a sky field onto a beam intensifier whose output stage is a P-7 phosphor screen. Fixed objects in outer space fluoresce blue and phosphoresce yellow on the screen at the same time, while moving objects phosphoresce yellow. Blue-yellow light of fixed objects is separated and used to develop independent electrical signals. The signal from the yellow light then will contain the information about the position of the fixed and moving sources while the signal from the blue light will contain essentially only the information about the fixed sources. The difference between the blue and yellow yields a signal that describes the position only of the moving source or sources.

The light output of the P-7 phosphor screen is viewed with a 2-color TV orthicon, which gives separate signals for the blue and yellow images. The separated signal then is amplified, combined with the star reference material and displayed on the cathode-ray receiver.

Republic Licenses Electronic Line

A product line of electronic check-out equipment for industrial, marine and military applications will be manufactured, sold and serviced by Pearce-Simpson, Inc. Republic Aviation Corp. made this announcement after completion of licensing arrangements with the company.

TEST VEHICLE DROPPED



A General Electric technician displays the space radiation measurement vehicle dropped 7 miles into the ocean. Vehicle is called nuclear emulsion recovery vehicle (NERV). Drop was made to test vehicle's recovery system and its survival capabilities.

ARS Celebrates 30th Anniversary

The American Rocket Society, the largest professional society in the world devoted solely to the advancement of the field of astronautics and related sciences, now numbers over 15,000 members.

In accordance with the Society's purpose to promote the field of astronautics, it has in its 30-year history been a leader in the effort to obtain for this country a superior space program.

ARS is comprised of and dedicated to astronautical scientists and engineers, carries out its objectives principally through the dissemination of information in its two publications, "Astronautics" and "ARS Journal," and through its technical meetings, numbering over 400 per year on both local and national level.

Though most recognition has been given to the Society in the post Sputnik era, it was organized on April 4, 1930, by a group of 11 men and one woman, primarily science fiction writers, for the purpose of promoting interest in space flight. Of the original dozen only one man, Dr. G. Edward Pendray, is still a member of the Society, but the organization spawned by this group has continued to grow.

The founders originally named the group the American Interplanetary Society but changed its name to the present one in 1934.

ELECTRONIC SHORTS

▶ A trainer, designed to help Japanese naval officers perfect themselves in techniques of anti-submarine warfare tactics before they go to sea was shipped to the Japanese Staff College at Kodaira by Daystrom, Inc. Known as the Action Speed Tactical Trainer, the unit was developed by Daystrom in collaboration with the U. S. Naval Training Devices Center as a project in the latter's "Tools for More Effective Training" program.

▶ Safety and efficiency of the New York City subway operation have been enhanced by a railway detector car that uses ultrasonics to uncover rail defects. The car and equipment are owned and operated by Sperry Products Co., Danbury, Conn., a division of Howe Sound Co. The self-propelled car will work over the subway's 723.4 miles of rails at 15 to 20 miles an hour, a speed which makes it possible to test without disrupting the regular movement of trains.

▶ First on-the-site industrial demonstration of a high-speed digital data communications system was successfully completed recently when Collins Radio Co.'s Western Division, Burbank, Calif., transmitted more than 500,000 punched cards at the rate of 100 per minute over a telephone line for the Chrysler Corp. The Chrysler card transmission circuit linked the automaker's general offices in Highland Park, Mich. with the Dodge main plant in Hamtramck, Mich.

▶ A 75% increase in the number of engineers will be required during the next ten years to meet the growing demands of American industry, Harry R. Wege, Vice President and General Manager, RCA Missile and Surface Radar, recently told a conference of the Engineering Society of Southern New Jersey.

▶ Minneapolis-Honeywell Regulator Co. has embarked on an extensive new program to expand its activities in the field of electronic medicine. Mr. Paul B. Wishart, President, said the company had assigned specialists to a newly formed medical instrumentation group that would take over work already under way in three Honeywell divisions. More important, the firm will institute "entirely new development programs" in cooperation with medical authorities. "The tremendous possibilities that electronics offer in advancing medical science are only now beginning to be fully appreciated and explored in a major way," Wishart said.

▶ The Electronic Industries Association has submitted to the Labor Department its proposed definition of the Electronic Equipment industry and urged that it be used in the upcoming survey preliminary in a Walsh-Healey wage determination for the industry. The EIA proposal defines the industry in terms of classes of products it manufactures, and limits the categories to those that are specifically electronic.

▶ A contract for the design and manufacture of a 60 ft. parabolic antenna "dish" for use in a radar system capable of tracking and identifying ICBM's thousands of miles away has been awarded the Fairchild Aircraft and Missiles Div. by the Raytheon Co., prime contractor. Raytheon's Missile Systems Div is developing the radar system for the Advanced Research Projects Agency. The antenna dish is part of a \$15 million radar unit called the "Pincushion."

▶ The FAA will start procurement of the distance measuring portion of the VOR/DME navigation system, designed in accordance with the standards recommended by a special meeting of the International Civil Aviation Organization (ICAO) early this year. VOR, the international standard since 1949, provides direction-of-flight information to the pilot while DME shows the distance to a selected ground station.

▶ A General Electric leader in the space industry advocates that this country should have more politicians with scientific backgrounds for "political and technological decisions are increasingly intermingled today." Hilliard W. Paige, General Manager of GE's Missile and Space Vehicle Dept., points out that it is virtually impossible to find an American high in government who has a scientific background. In Russia 70% of the cabinet come from a background of technology or science.

As We Go To Press (cont.)

Bounce Signals Off Moon for Radio Net

Radio transmitters located in Washington, D. C., and in Hawaii will furnish radio signals powerful enough to bounce off the moon and return to a receiving set at the other end of the triangular circuit. The "L" Band, 100 kw transmitters are being supplied by Continental Electronics Manufacturing Co., Dallas, Texas, a subsidiary of Ling-Altec Electronics, Inc. BuShips is sponsoring the net.

Expected to be operational by early this year, the system lessens the possibility of jamming. Both transmitters and receivers have motor driven positioning antennas which track the moon. Five to seven hours service per day is possible (when the moon is visible to both sides).

DO-IT-YOURSELF PROJECT



Rice Institute designed and built their own computer. The work is being financed by the Atomic Energy Commission and Shell Development Co. Shown is a view of the barrier-grid tube memory with the arithmetic unit shown in the background.

Engineering Seminars

The Pennsylvania State University, University Park, Penna., has announced plans for ten 1960 Summer Engineering Seminars. Included are seminars on "Electrical Contacts," "Underwater Missile Engineering," "R & D Management Development," and "Technical Report Writing."

Inquiries should be directed to: Engineering Seminars, Conference Center, The Pennsylvania State University, University Park, Penna.

For greater computer design flexibility

high current
silicon switching diodes in a
subminiature package



100 mA Min. @ 1V Forward Current...0.3 μ sec recovery...4 μ f at -2V...now HUGHES can offer you these diode characteristics with no sacrifice in package size. Result: greater design flexibility for computer applications! With these characteristics, these diodes will cover practically every major computer switching requirement.

An added feature: the ability of these diodes to handle high current with a fast recovery time makes it possible to use them in many general purpose applications, as well as computers. With their hermetically sealed glass envelopes, these HUGHES[®] diodes have been engineered for extreme reliability under adverse environmental conditions.

TYPICAL SPECIFICATIONS:

Type	Min. Es (@ 100 μ A)	Min. Forw. Current @ 25°C (@ +1.0V)	Max. Reverse Current (μ A) @ 25°C	Reverse Recovery Resist. (R) (ohms)	Max. Rec. Time (μ sec)
1N937	100	150	0.1 @ -75V 15 @ -100°C	400 K	0.5*
1N938	150	150	0.1 @ -175V 15 @ -175V	400 K	0.5*
1N939	200	150	0.1 @ -175V 15 @ -175V	400 K	0.5*
1N940	50	150	0.1 @ -40V 15 @ -40V	400 K	0.3*
1N941	150	150	0.1 @ -120V 15 @ -120V	400 K	0.3*
1N944	100	200	0.1 @ -80V 15 @ -80V	400 K	0.5*
Improved Standards					
1N943A	200	100	.025 @ -10V 5 @ -10V	200 K	0.3†
1N962A	100	100	1.0 @ -10V 20 @ -10V	100 K	0.5†
1N963A	100	100	0.1 @ -75V 15 @ -75V	200 K	0.3†

*Measured in JAN test circuit and switched from 30mA forward current to -35V.
†Measured in JAN test circuit and switched from 5mA forward current to -40V.
Typical capacitance: C₋₁₀ = 2.2 μ f C_{-1.5} = 4.4 μ f C₋₀ = 9.0 μ f
Operating temperature range: -65°C + 150°C Storage temp. range: -65°C + 200°C

For additional information concerning these unique HUGHES diodes call or write the Hughes sales office or distributor nearest you. Or write Hughes, Semiconductor Division, Marketing Department, Newport Beach, California. For export write: Hughes International, Culver City, California.

Creating a new world with ELECTRONICS

HUGHES

©1960 HUGHES AIRCRAFT COMPANY
SEMICONDUCTOR DIVISION



Full Photographic Detail for Ground Mapping with Hughes TONOTRON Storage Tubes

The Hughes TONOTRON[®] tube presents a complete spectrum of grey shades. **Result:** high-fidelity picture reproduction. The illustration above shows an unretouched photograph of a typical radar display as viewed on a Type 7033 TONOTRON storage tube.

Additional outstanding characteristics of the TONOTRON tube are: high brightness (in excess of 1500 foot-lamberts with full half-tone range), and controllable persistence. The family of TONOTRON tubes is ideally suited for ground mapping, weather radar displays, slow-scan TV, "B" scan radar, oscillography, armament control radar, optical projection systems and miniature radar indicators.

In addition to the Type 7033 TONOTRON tube, Hughes also offers you 21 other storage tubes (including MEMOTRON[™] tubes and TYPOTRON[®] tubes) ranging in size from 3 inches to 21 inches—the world's most complete line of storage tubes!

For complete technical data and application information, write or wire: HUGHES, Vacuum Tube Products Division, 2020 Short Street, Oceanside, California.

For export information, write: Hughes International, Culver City, California.



Creating a new world with ELECTRONICS

HUGHES

VACUUM TUBE PRODUCTS DIVISION

TRADEMARK OF HUGHES AIRCRAFT COMPANY

For more precise
measurement
of transients

Hughes MEMO-SCOPE® Oscilloscope



The new Hughes MEMO-SCOPE Oscilloscope offers you higher performance, greater dependability and easier operation in all of your transient measurements. Maximum accuracy is assured by new advanced circuitry, new panel layout, new mechanical design and many other added features.

The MEMO-SCOPE Oscilloscope eliminates expensive "hit-or-miss" methods of measuring non-recurring transients. It stores nonrepetitive events for an indefinite period—hours, or days—keeping them available for thorough study until intentionally erased.

For full information on how the MEMO-SCOPE Oscilloscope can help solve your measurement problems, write today to: Hughes, Industrial Systems Division, International Airport Station, Los Angeles 45, California.

For export information,
please write: Hughes International,
Culver City, California.



Hughes MEMO-SCOPE Oscilloscope: The Hughes MEMO-SCOPE Oscilloscope is one of the most versatile measuring and recording devices available to science and industry today. It is a dual service instrument—for storage or conventional oscilloscopy. Features: *simplified panel layout and carefully designed trigger circuit* for ease of operation; *built-in single sweep ("one-shot") trigger circuit* to avoid cluttered display; *advanced mechanical design* for better cooling and easier maintenance.

New Storage Tube Burn-Out Protection! A circuit designed to protect the delicate storage mesh surface is now incorporated in the Hughes MEMO-SCOPE Oscilloscope. This circuit renders it virtually impossible to burn the storage tube unintentionally as a result of improper operation of the intensity control on the instrument. The intensity control is automatically adjusted by the new protective circuit in the event the operator suddenly switches from the fastest sweep rate to the slowest without decreasing the intensity (an action which formerly might burn the tube), or in the event of similar operational errors.



Hughes Scope Cart: Especially designed for the MEMO-SCOPE Oscilloscope, an all-aluminum scope cart facilitates movement of the instrument to different locations for varied applications. Features: *mounting provisions* for two spare amplifiers, *6' retractable power cord* for convenience in connecting equipment, *ample drawer space, accessibility* from both sides, *pull-out writing board, full-swivel casters* for ease of movement from one area to another.



Hughes Multitracer Unit: Designed to operate in conjunction with the MEMO-SCOPE Oscilloscope, the portable Hughes Multitracer enables you to store and compare up to 20 stepped-down traces in one display. The stored sweeps appear at equal, preselected intervals forming a raster type of display. The all-electronic Multitracer is a combined attenuator, gate amplifier and storage counter designed to be placed between the signal source and the regular MEMO-SCOPE Oscilloscope input.

Creating a new world with ELECTRONICS



©1960 HUGHES AIRCRAFT COMPANY
INDUSTRIAL SYSTEMS DIVISION

Coming Events in the electronic industry

A listing of meetings, conferences, shows, etc., occurring during the period April-May that are of special interest to electronic engineers

Apr. 3-7: Annual Conv., NAB; Conrad Hilton Hotel, Chicago, Ill.
 Apr. 3-8: 6th Nuclear Congress, EJC, IRE (PGNS) (28 Sponsors); N. Y. Coliseum, New York City.
 Apr. 4-6: Southwest District Meeting, AIEE; Shamrock - Hilton Hotel, Houston, Tex.
 Apr. 5: Automatic Recording Spectropolarimeter, Soc. for Applied Spectroscopy; Stevens Institute, Hoboken, N. J.
 Apr. 5-9: Electrical Engineers' Exhibition, Electrical Engineers (ASEEO) Exhibition Ltd. (Brit); Museum House, London, England.
 Apr. 6-8: National Meeting "Hyper-Environments—Space Frontier," Institute of Environmental Sciences; Biltmore Hotel, Los Angeles, Calif.
 Apr. 11-13: Conf. on Electrical Engineering in Space Technology, AIEE, IRE, ARS; Baker Hotel, Dallas, Tex.
 Apr. 11-13: Spring Assembly Meeting, Radio Technical Commission for Marine Services; Washington, D. C.
 Apr. 12-13: 11th Annual Spring Tech. Conf. on Electronic Data Processing, IRE (Cinn. Section), ARS; Hotel Alms, Cincinnati, Ohio.
 Apr. 12-14: 32nd Annual Meeting (Exhibits), Petroleum Industry Electrical Assoc., Petroleum Electrical Supply Assoc.; Municipal Auditorium, Kansas City, Mo.
 Apr. 12-27: 38th Annual Milan Trade Fair, Milan, Italy.
 Apr. 13-14: ASME-AIEE Railroad Conf., ASME, AIEE; Penn-Sheraton Hotel, Pittsburgh, Pa.
 Apr. 18-19: Conf. on Automatic Techniques, AIEE, ASME, IRE (PGIE); Sheraton Cleveland Hotel, Cleveland, Ohio.
 Apr. 19: Joint Dinner Meeting, Assoc. of Electronic Parts & Equipment Manufacturers; Chicago, Ill.
 Apr. 19-21: Int'l Symp. on Active Networks and Feedback Systems, Microwave Research Institute of the Polytechnic Institute of Brooklyn, IRE, AFOSR, U.S. Army (Signal Corps), ONR; Engineering Societies Bldg., 33 W. 39th St., New York, N. Y.
 Apr. 20: 16th Annual Quality Control Conf., Rochester Soc. for Quality Control; University of Rochester, Rochester, N. Y.
 Apr. 20-22: S. W. IRE Regional Conf. and Electronics Show (SWIRCO), also: Nat'l Medical Electronics Conf., IRE (Region 6); Shamrock Hilton Hotel, Houston, Tex.

Apr. 20-22: 3rd Conf. on Biological Waste Treatment, Manhattan College, New York, N. Y.
 Apr. 20-22: Nat'l Symp. on Manned Space Stations, IAS, NASA, Rand Corp.; Ambassador Hotel, Los Angeles, Calif.
 Apr. 21-22: Management Conf., ASME, SAM; Statler-Hilton Hotel, New York, N. Y.
 Apr. 21-22: Seminar — Dimensional Metrology, ASTE; Detroit, Mich.
 Apr. 21-22: 7th Annual Conv., Soc. of Technical Writers and Editors; Drake Hotel, Chicago, Ill.
 Apr. 25-27: MPI 16th Annual Meeting, Metal Powder Assoc.; Drake Hotel, Chicago, Ill.
 Apr. 25-28: Meeting, The American Physical Soc.; Washington, D. C.
 Apr. 25-29: Metals Engineering Meeting, ASME; Hotel Biltmore, Los Angeles, Calif.
 Apr. 25-29: Annual Meeting & Welding Exposition, American Welding Soc.; Hotel Biltmore and Great Western Exhibit Center, Los Angeles, Calif.
 Apr. 27-29: Great Lakes District Meeting, AIEE; Milwaukee, Wis.
 Apr. 28-29: Seminar, Aids in Design Room Management, University of Illinois; Urbana, Ill.
 May 1-4: 52nd Annual Conv., Nat'l Assoc. of Electrical Distributors; Dallas Memorial Auditorium, Dallas, Tex.
 May 1-5: Conf. on Electric Insulation, Electronics, Electrothermics and Metallurgy; The Electrochemical Soc., LaSalle Hotel, Chicago, Ill.
 May 1-7: 87th Semi-Annual Conv. and Equipment Exhibit, Soc. of Motion Picture and TV Engineers; Ambassador Hotel, Los Angeles, Calif.
 May 2-3: Electrical Safety Instrumentation Symp., ISA; Wilmington, Del.
 May 2-3: Company Member Conf., American Standards Assoc.; Sheraton Hotel, Phila., Pa.
 May 2-4: 12th Annual Nat'l Aeronautical Electronics Conf. and Exhibit (NAECON), IRE-Dayton Section, Institute of Aeronautical Sciences; Biltmore and Miami-Pick Hotels, Dayton, Ohio.
 May 2-5: 6th Nat'l Flight Test Symp., ISA; San Diego, Calif.
 May 2-5: URSI-IRE Spring Meeting, URSE, IRE; Sheraton Park Hotel and Nat'l Bureau of Standards, Washington, D. C.
 May 3-5: Western Joint Computer Conf. (Exhibits), IRE, AIEE, ACM;

Jack Tar Hotel, San Francisco, Calif.
 May 3-5: 8th Nat'l Conf. on Electromagnetic Relays, Nat'l Assoc. of Relay Manufacturers and Oklahoma State Univ.; Oklahoma State University, Stillwater, Okla.
 May 9-11: PGMAT Nat'l Symp., IRE (PGMTT); Hotel Coronado, Coronado (San Diego), Calif.
 May 9-12: 3rd Nat'l Power Instrumentation Symp., ISA; Civic Auditorium, San Francisco, Calif.
 May 9-12: Instrument Automation Conf. and Exhibit, ISA; Civic Auditorium and Brooks Hall, San Francisco, Calif.
 May 10-12: Electronic Components Conf., IRE, AIEE, EIA, WEMA; Hotel Washington, Washington, D. C.
 May 23-25: 7th Regional Tech. Conf. & Trade Show, Region 7, IRE; Olympic Hotel, Seattle, Wash.
 May 23-26: Design Engineering Conf. & Show, ASME; Coliseum and Statler-Hilton Hotel, New York, N. Y.

SOME HIGHLIGHTS OF 1960

Aug. 23-26: WESCON, IRE, WCEMA; Ambassador Hotel & Memorial Sports Arena, Los Angeles, Calif.
 Oct. 10-12: National Electronics Conference, AIEE, IRE, Ill. Inst. of Tech., EIA, SMPTE; Hotel Sherman, Chicago, Ill. Arthur H. Streich, National Electronics Conf., 184 E. Randolph St., Chicago, Ill.
 Nov. 14-16: Mid-America Electronic Convention (MAECON), IRE, Kansas City, Mo.
 Nov. 15-17: Northeast Res. & Eng. Meeting (NEREM), IRE, Boston, Mass.
 Dec. 11-14: Eastern Joint Computer Conf., IRE, AIEE, ACM; Hotel New Yorker, New York, N. Y.

Abbreviations

ACM: Assoc. for Computing Machinery
 AFOSR: Air Force Office of Scientific Research
 AIEE: American Institute of Electrical Engineers
 AIME: American Institute of Metallurgical Engineers
 ARS: American Rocket Society
 ASME: American Society for Mechanical Engineers
 ASTE: American Society of Tool Engineers
 EIA: Electronic Industries Association
 EJC: Engineers Joint Council
 IAS: Institute of Aeronautical Sciences
 ISA: Instrument Society of America
 IRE: Institute of Radio Engineers
 NAB: National Association of Broadcasters
 NASA: National Aeronautics and Space Agency
 ONR: Office of Naval Research

SOMETHING NEW IN A SUITCASE

... Complete transistorized EECO Digital System Breadboard

Designers who want to go places fast systemswise can be sure of getting there on time with an EECO suitcase. It's packed with a complete and integrated breadboarding system designed around mutually compatible EECO T-Series Germanium circuit modules, N-Series transistorized decades, and R-Series Minisig® sensitive indicators.

Standard 19" amateur-notched panels have the necessary permanent wiring to accommodate any standard EECO Germanium circuit module, and all other circuit interconnections are made by patch cords or plugs, with unique, prepunched circuit cards to guide you. No soldering is required, and experimental arrangements of T-Series circuits can be quickly patched up, changed, or taken down without waste of time or materials.

CIRCUIT CARDS

A unique feature of the EECO T-Series breadboarding system is the use of plastic circuit cards, which are imprinted with circuit symbols, showing input and output connections, power connections, part number, application notes, etc. These cards fit on the panel below sockets for the plug-in units, and expose the proper pattern of banana jacks that are permanently wired to pins on the sockets.

EECO T-Series breadboard equipment is available in both suitcase and rack mounted types. Breadboard Kits of any degree of complexity can be built up in stages, according to the specific panels and number of circuits incorporated. Compatible interconnections between racks or suitcases further enable the designer to expand the equipment into a complete systems development console. Compatible solid-state, convection-cooled power supplies are also available in two different models: ZA-720 is a dual 12-volt, 5-amp supply; ZA-721 is a 12-volt, 1 amp plug-in power supply.

Analysis of the operation of a digital system can be made with a minimum of test instrumentation.

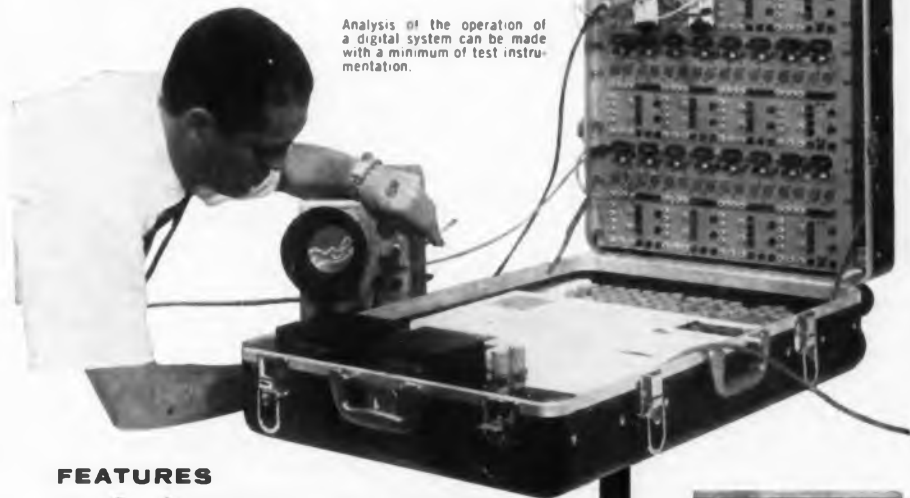

EECO T-Series Breadboard Suitcase is a standard "3-suitcase" that can be locked and stored when not in use, to prevent tampering and "circuit snatching."



Bottom half of breadboard suitcase is compactly laid out to store all necessary T-Series circuit modules, circuit cards, patch cords, and compatible power supplies.

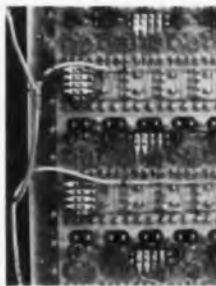

Panels are mounted on piano hinge to permit easy access to permanent wiring and power cabling.

FEATURES

- Permits rapid formulation of digital electrical systems.
- System may be operated slowly to permit inspection of its mode of operation, or over-speed to indicate system derating.
- Operation may be analyzed with a minimum of test equipment.
- Provides a means for rapidly building and testing alternate ways of formulating a system.
- Minimizes wiring errors and the inclusion of defective parts.
- Circuit cards provide a means for rapidly visualizing the system, and facilitate drawing a circuit diagram.
- Circuit cards enable the designer to determine the elements involved, as well as the cost of the system.

A request, on your company letterhead, will bring detailed information on the flexibility of the EECO T-Series Breadboarding equipment, and a demonstration if desired.

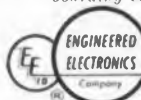

ENGINEERED ELECTRONICS COMPANY

1441 East Chestnut Avenue • Santa Ana, California

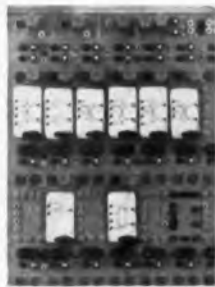

Circuit cards are selected according to the system it is desired to breadboard and placed on the panel in alignment with the jack pattern. Corresponding T-Series circuit modules are plugged in above each card.

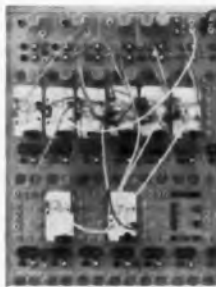

Circuit interconnections are made by patching through holes in the circuit cards. Resulting pattern of symbol cards and patch cords shows a schematic and bill of materials for the system, once it is checked out.

Electronic Industries' News Briefs

Capsule summaries of important happenings in affairs of equipment and component manufacturers

EAST

ASSOCIATED TESTING LABORATORIES, INC., has opened a large environmental testing facility for missiles in Orlando, Fla.

IRRADIATED INSULATIONS, INC., is the name of a new company formed by Carlisle Corp. and Radiation Applications, Inc., an affiliate of Schenley Industries, Inc. The new firm will utilize the production, engineering and marketing experience in high-temperature wire and cable of Carlisle's subsidiary, Tenso-lite Insulated Wire Co., Inc. The new company will produce insulated wire for special requirements in the electronics, aviation and missile fields.

ACP ELECTRONICS, div. of ACF Industries, Inc., has received a \$1.1 million contract for conversion of an electronic flight and tactics simulator. The contract was awarded by the Naval Training Device Center, Port Washington, N. Y.

SYLVANIA ELECTRIC PRODUCTS, INC., will build a new electron tube research and development center at Emporium, Pa.

BURROUGHS CORP. received a new contract for \$7,980,000 in the SAGE program of continental air defense. The bulk of the contract is applicable to Burroughs' Military Field Service Div., headquartered in Radnor, a Philadelphia suburb.

RADIO CORP. OF AMERICA will build a new industrial computer systems facility in Natick Industrial Center, 15 miles west of Boston. It will contain 10,000 sq. ft. of floor area, with provision for tripling its size.

THE MARTIN CO., Orlando, Fla., has received an \$82,599,690 contract from the Dept. of the Army for continued research and development of the Pershing weapon system. This contract, added to several other contract modifications, brings the total amount allocated by the Army to the Pershing program for fiscal 1960 to \$118,057,000.

GENERAL TRANSISTOR CORP., Jamaica, N. Y., will spend nearly \$2 million in 1960 as part of an expansion program.

ATLAS ENGINEERING CO., INC., Roxbury, Mass., has started construction of a 15,000 sq. ft. ultra modern, electronics plant in Natick, Mass., Industrial Center for their controls subsidiary.

ATLANTIC RESEARCH CORP. of Alexandria, Va., has added a "Space Vehicles Group" to the staff. The group was formerly with the Aerolab Development Co., Inc.

INTERNATIONAL RESISTANCE CO. is increasing the area of its general offices and main plant at Philadelphia by some 11%.

NEMS-CLARKE CO., a div. of Vitro Corp., has received orders covering all the radio-frequency portion of the ground-based telemetry equipment for the 17 tracking stations to be installed for reception of information from Project Mercury, the man-in-space project. Contract is for about \$500,000.

POLYTECHNIC INSTITUTE OF BROOKLYN will establish a graduate engineering school in Farmingdale, L. I. The educational facility, with attendant research laboratories, will be erected at a cost of \$1.2 million on 25 acres of land donated to them by Republic Aviation Corp.

SERVO CORP. OF AMERICA has been awarded an \$819,475 contract by the Dept. of Commerce Weather Bureau for additional radiotheodolites.

WESTON INSTRUMENTS, div. of Daystrom, Inc., has received a half-million dollar contract for VHF omni-range electronic equipment from the Federal Aviation Agency.

RAYTHEON CO., under a \$6.5 million contract from the Air Force's Rome Air Development Center, will develop the world's largest modulator and ultra-high powered microwave tubes.

NATIONAL CO., INC., of Malden and Melrose, Mass., has acquired Servo-Dynamics Corp. of Somersworth, N. H.

ARK ELECTRONIC CORP. is the new name for Ark Engineering Co. of Philadelphia, Pa.

MAGNETIC AMPLIFIERS, INC., New York City, a producer of equipment utilizing solid state devices, has agreed to merge into the Siegler Corp. of Los Angeles.

ELECTRONIC COMMUNICATIONS, INC., has received a \$9.5 million subcontract for ALRI electronic equipment from Burroughs Corp.

AMERICAN BOSCH ARMA CORP. has signed an agreement to purchase Tele-Dynamics, Inc., of Philadelphia, a subsidiary of Raymond Rosen & Co., Inc.

LIECO, INC., has just recently consolidated its operations in their new 20,000 sq. ft. plant at Syosset Industrial Park on Long Island.

HIGH VOLTAGE ENGINEERING CORP. announced immediate plans for 50% expansion of their rolling Massachusetts plant. The move will increase the present plant area from 120,000 sq. ft. to 180,000 sq. ft.

MID-WEST

P. R. MALLORY & CO., INC., has acquired a 17-acre tract in Lexington, N. C., and will build a 60,000 sq. ft. plant. It will be occupied by the Mallory Battery Co.

VICTOREEN INSTRUMENT CO., Cleveland, Ohio, has acquired all of the outstanding capital stock of John E. Fast & Co. The Fast Co. develops and manufactures capacitors.

ADC, INC., is the name of a new firm which has acquired all the stock of Audio Development Co. and of Donlen Mfg., Inc. The two subsidiaries will continue operating under their present names.

DOW CORNING CORP. has reduced prices of all its Silastic LS (fluorosilicone rubber) stocks by approximately 25%.

INDIANA GENERAL CORP. is the new name for the consolidation of Indiana Steel Products Co. and General Ceramics Co.

HOWELL ELECTRIC MOTORS CO. has acquired the flat-type motor line of the Diehl Mfg. Co., electrical div. of the Singer Mfg. Co. Howell plans to produce the newly-acquired line at its Leland Ohio Electric Div. plant in Dayton, Ohio.

BARIUM AND CHEMICALS, INC., of Willoughby, Ohio, announced the start of an expansion program by the purchase of a 165,000 sq. ft. plant at Steubenville, Ohio.

WEST

BENDIX AVIATION CORP. has acquired an 80-acre site in the San Fernando Valley for a new "electronics center." A 650,000 sq. ft. facility for the development of military and industrial electronic systems will eventually be constructed on the site by Bendix.

PACKARD BELL ELECTRONICS' new Defense and Industrial Group has received a \$11 million contract from the Dept. of the Navy, Bureau of Naval Weapons. The contract calls for the production of the ASQ-17B integrated electronic central consisting of communication, navigation and identification equipment for use in high-altitude, high-speed operational military aircraft.

ZERO MFG. CO., has broken ground on a new 33,600 sq. ft. building to increase production facilities on the company's new Modular Re-usable Shipping/Storage Container System. The new plant will be located in Burbank, Calif.

LEACH CORP. has acquired Electrospace Laboratories, Inc., of Pasadena, Calif. Electrospace specializes in the development of sub-miniature solid-state command receivers for missiles and other space vehicles.

TELECOMPUTING CORP. of Los Angeles has received a \$2,084,222 contract from the Dept. of the Army to provide research and developmental data reduction services at Holloman Air Force Base on the White Sands Missile Range.

MOTOROLA, INC., Phoenix, Ariz., plans to substantially expand its semiconductor plant in Phoenix.

SYNTHANE CORP., Oaks, Pa., has established new fabricating and warehouse facilities to speed and improve service to West Coast customers at Glendale, Calif.

SERVOMECHANISMS, INC., Hawthorne, Calif., has received a follow-on production order from the Douglas Aircraft Co., in the amount of \$892,173 for the production of True Airspeed Computers.

AUDIO DEVICES, INC., has sold its silicon rectifier division in Santa Ana, Calif., to the Lark Corp. of Dallas, Tex.

LITTON INDUSTRIES, INC., has acquired the Electronic Systems Div. of General Controls Co.

AMERICAN ELECTRONICS, INC., Los Angeles, Calif., has received contracts totaling approximately \$2,750,000. The \$2 million contract, for ground support generator spare parts on the Air Force F-106A, was awarded by Convair. The other contract, \$725,000, is for mobile air conditioners for the Air Force B-58 manned bomber program, awarded also by Convair.

ELECTRONIC ENGINEERING CO. of California, has purchased the Anaheim Electronics Co., Inc., 1016 Raymond Way, Anaheim. Anaheim's main product is an electronic program control device.

PACIFIC AUTOMATION PRODUCTS, INC., was awarded a contract by RCA to perform emplacement of ground support electronic equipment at 3 Atlas Missile Launch Control Centers and in the Squadron Maintenance Area located at Offutt Air Force Base in the vicinity of Omaha, Neb.

Whether Congress would go along with giving the President this authority, however, is not certain.

MAJOR MERGER IN SWITCH INDUSTRY

Controls Company of America Merges Hetherington Div. With Electrosnap Corp. to form New Control Switch Division.

One of the precision switch industry's most complete product lines has come into existence with the announcement by Louis Putze, President of Controls Company of America, Schiller Park, Ill., that its subsidiary Hetherington, Inc., has been merged with Electrosnap Corporation, Chicago. The Electrosnap organization was recently merged with Controls Company of America.

"This merger is important to switch users", Mr. Putze stated, "because it combines two major manufacturers of panel switches, indicator lights and limit switches for military and industrial applications into a single source of supply.

"Now, customers need deal with just one sales engineer instead of two. Three plant locations—Folcroft, Pa., Chicago, Ill. and El Segundo, Calif.—will provide regional engineering and manufacturing facilities to speed up delivery and service.

"The combination of military and industrial experience will enable the new Division to expand its activities in areas such as human factors, sub-sub-miniaturization, image displays and controls for special environments.

"Local sales offices with factory-trained personnel have been set up to provide on-the-spot application engineering. An expanded nation-wide distributor organization will assure our customers of immediate delivery from local sources," Mr. Putze said.

Changes in Stockholdings

ELECTROSAP
HETHERINGTON

**CONTROL
SWITCH** **CC**
DIVISION
CONTROLS COMPANY OF AMERICA
4218 W. Lake Street • Chicago 24, Illinois
Telephone: Van Buren 6-3100 • TWX No. CG-1400

ELECTRONIC INDUSTRIES • April 1960

Circle 7 on Inquiry Card

NEW RECTIFIERS FROM

Free from thermal fatigue: All G-E medium and high-current silicon rectifiers—including the new 6 and 12-amp. devices described at right—are completely free of soft solder joints, which often fail as a result of thermal fatigue. They can be worked right up to maximum current and temperature ratings, even on highly cyclical loads.

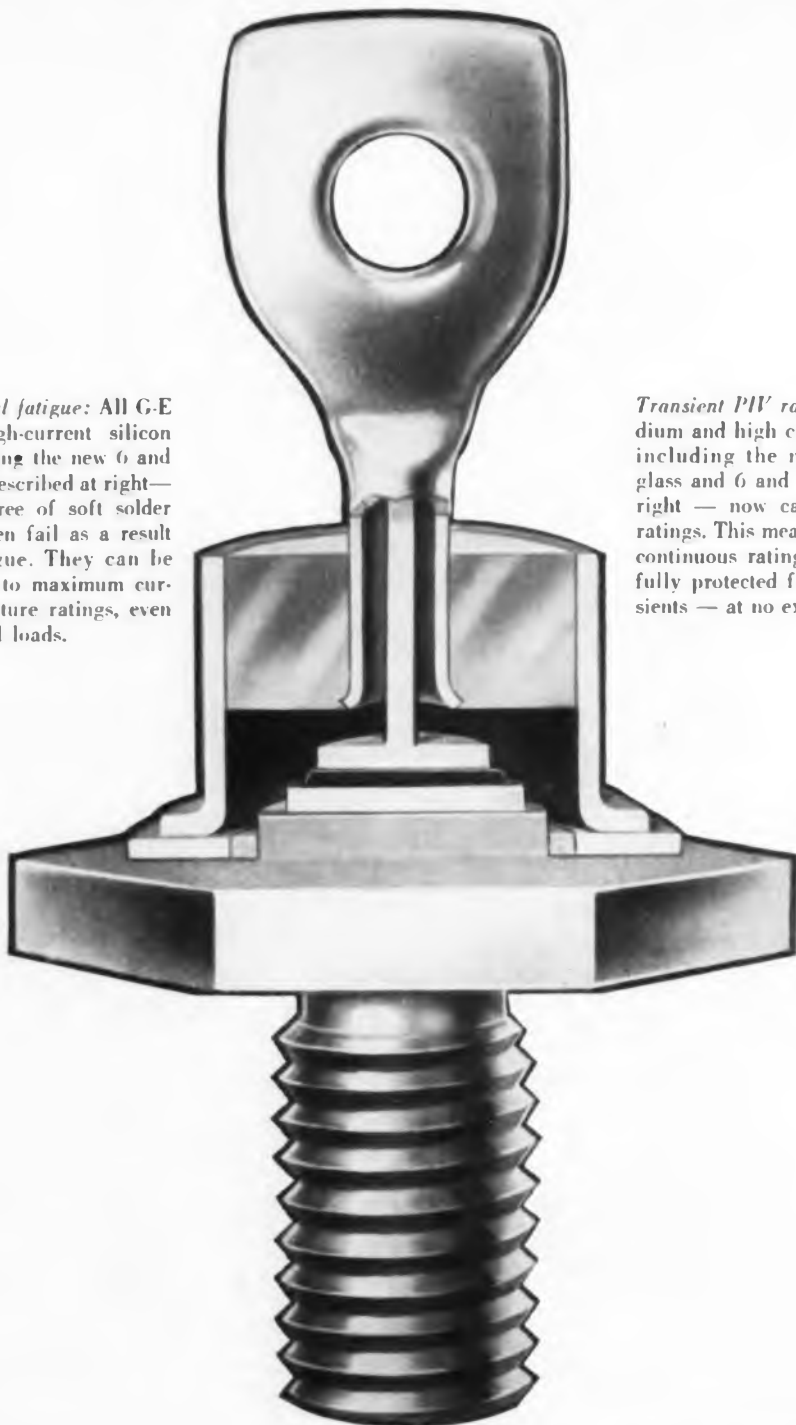

Transient PIV ratings. All G-E medium and high current rectifiers — including the new subminiature glass and 6 and 12-amp. devices at right — now carry *transient* PIV ratings. This means you can buy the continuous rating you need and be fully protected for occasional transients — at no extra cost!

GENERAL ELECTRIC

New Silicon Subminiature Glass Rectifier



Designed for maximum thermal conductance over a wide temperature range. Suitable for MIL-E-1/1143. Extremely low leakage currents. Ideal for magnetic amplifier, blocking and other low-leakage applications.

JEDEC or GE Type Number	Repetitive PIV	Transient PIV	Max. I _{oc} at T°C	Max. Lkge Cur.	Max. Full Load Voltage Drop (Full cycle Av.)	Max. Oper. Temp.
				(Full cycle Av.)		
1N645	225	275	@ 150°C	@ 100°C	@ 75°C	175°
1N646	300	360	150 ma	15 µa	IV	175°
1N647	400	480	150 ma	15 µa	IV	175°
1N648	500	600	150 ma	20 µa	IV	175°
1N649	600	720	150 ma	25 µa	IV	175°
1N677	100	20	400 ma	@ 150°C 2 ma	IV	175°

1N676-1N679, 1N681-1N687 and 1N689 also available in this package.

New Silicon Insulated Stud Mounted Junction Rectifier

Designed for applications requiring fins or direct chassis mounting. Stud electrically insulated from rectifying junction. High forward currents permitted at case temperatures up to 150°C (up to 165°C with derating). Reverse current at maximum junction temperature extremely low, making these devices ideal for low-leakage applications.



JEDEC or GE Type Number	PIV	Max. I _{oc} at T°C	Max. Peak 1 cycle Surge	Max. Lkge Cur.	Max. Full Load Voltage Drop (Full Cycle Av.)	Max. Oper. Temp.
				(Full Cycle Av.)		
1N2851	500	@ 50°C Case 1.5 Amps	15 Amps	@ 150°C .3 ma	@ 150°C .65V	150°
1N2852	600	1.5 Amps	15 Amps	.3 ma	.65V	150°
1N2847	100	@ 75°C Case 1.5 Amps	15 Amps	.4 ma	.65V	165°
1N2848	200	1.5 Amps	15 Amps	.3 ma	.65V	165°
1N2849	300	1.5 Amps	15 Amps	.3 ma	.65V	165°
1N2850	400	1.5 Amps	15 Amps	.3 ma	.65V	165°

New Silicon Medium Current 6 and 12-amp. Junction Rectifiers



With these new devices, General Electric now offers the widest selection of rectifiers in the medium current range. Designed for all rectifier applications from 2 to 15 amperes. Extremely low forward voltage drop and thermal impedance combined with high junction temperature rating permit high current operation with minimum space requirements. May be mounted directly to chassis or fin or electrically insulated from heat sink by using mica washer kit provided with each unit.

JEDEC or GE Type Number	Repetitive PIV	Transient PIV	Max. I _{oc}	Max. Peak 1 Cycle Surge	Max. Lkge Cur.	Max. Full Load Voltage Drop (Full Cycle Av.)	Max. Oper. Temp. °C
			@ 145°C Stud Single Phase		(Full cycle Av. @ Full Load)		
1N1341A	50	100	6A	150A	@ 150°C Stud 3 ma	@ 150°C Stud .64V	200°
1N1342A	100	200	6A	150A	2.5 ma	.64V	200°
1N1343A	150	300	6A	150A	2.25 ma	.64V	200°
1N1344A	200	350	6A	150A	2.0 ma	.64V	200°
1N1345A	300	450	6A	150A	1.75 ma	.64V	200°
1N1346A	400	600	6A	150A	1.5 ma	.64V	200°
1N1347A	500	700	6A	150A	1.25 ma	.64V	200°
1N1348A	600	800	6A	150A	1.0 ma	.64V	200°
1N1199A	50	100	12A	240A	3 ma	.55V	200°
1N1200A	100	200	12A	240A	2.5 ma	.55V	200°
1N1201A	150	300	12A	240A	2.25 ma	.55V	200°
1N1202A	200	350	12A	240A	2.0 ma	.55V	200°
1N1203A	300	450	12A	240A	1.75 ma	.55V	200°
1N1204A	400	600	12A	240A	1.5 ma	.55V	200°
1N1205A	500	700	12A	240A	1.25 ma	.55V	200°
1N1206A	600	800	12A	240A	1.0 ma	.55V	200°

For more information, see your General Electric Sales Representative, or write Semiconductor Products Dept., Electronics Park, Syracuse, N. Y. In Canada: Canadian General Electric Co., 189 Dufferin St., Toronto, Ont. Export: International General Electric Co., 150 E. 42 St., N. Y. C. See your authorized General Electric Distributor for fast service, factory-low prices.

GENERAL ELECTRIC

PHILCO ... FOR HIGH SPEED SILICON SWITCHES

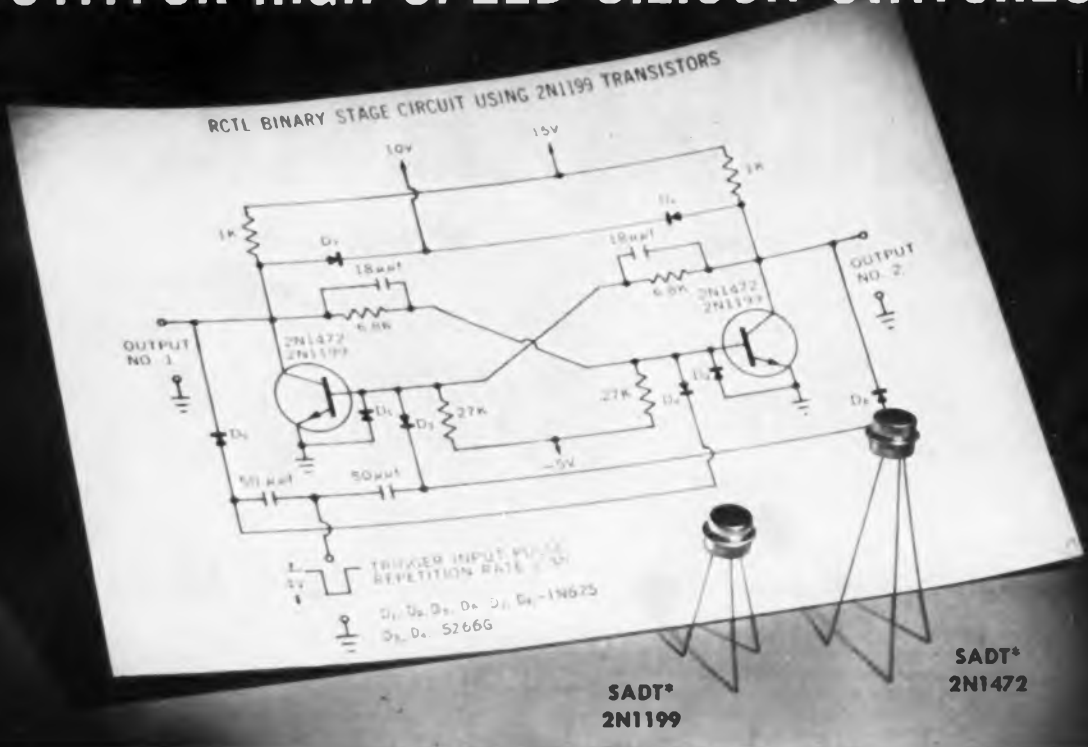

PHILCO HIGH FREQUENCY NPN SILICON TRANSISTORS OFFER EXCEPTIONALLY LOW SATURATION VOLTAGE

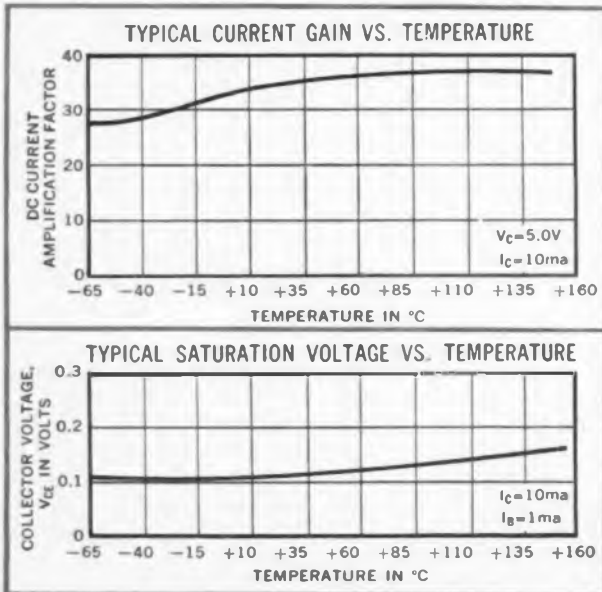

The high frequency response, together with the very low saturation voltage of these silicon Surface Alloy Diffused-base Transistors (typically 0.125 V), permits practical design of 5 mc pulse circuits, using conventional saturated switching configurations. With non-saturating techniques, pulse rates as high as 30 mc are obtainable. The typical switching circuit shown above will operate satisfactorily at trigger pulse rates up to 15 mc. When triggered with a 4-volt pulse at a 10 mc rate, the rise time will be typically less than 24 μ sec over a temperature range of $-60^\circ C$ to $+130^\circ C$. The typical fall time will be less than 36 μ sec over the same temperature range.

Both of these transistors have demonstrated consistently more stable characteristics over a wide temperature range than any other silicon transistors available. Both meet the environmental and life test requirements of MIL-S-19500B.

NEW, MORE COMPLETE DATA SHEETS

The new data sheets on these transistors, for the first time, provide the designer with complete information upon which he may predict switching speeds in any circuit. They also contain the full military environmental and life test specifications, in accordance with MIL-S-19500B. Copies are available on request. Write Dept. EI-460.

*Reg. U.S. Pat. Off.

Available in quantities 1-999 from your local
Philco Industrial Semiconductor Distributor.

PHILCO

LANSDALE DIVISION • LANSDALE, PENNSYLVANIA

Circle 9 on Inquiry Card



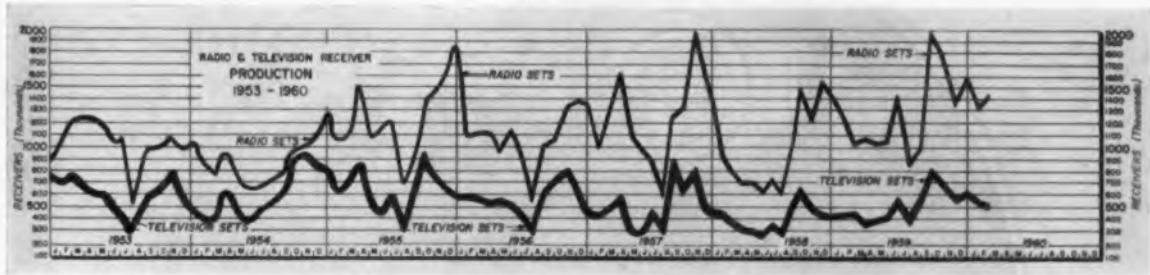

**GOVERNMENT ELECTRONIC
CONTRACT AWARDS**

This list classifies and gives the value of electronic equipment selected from contracts awarded by government agencies in February, 1960.

Ammeters	30,428
Amplifiers	37,614
Amplifiers, r-f	75,230
Amplifiers, servo	304,473
Antennas	713,570
Batteries, dry	1,165,791
Cable, electronic	32,400
Cable, r-f	37,789
Cable, telephone	308,802
Circuit breakers	41,726
Coders, transponder	924,858
Computers, air data	1,343,880
Controls, radar	3,161,108
Converters, analog to digital	79,213
Countermeasures sets	289,987

Counters, pulse	39,465
Crystal units	27,082
Data converters, range height	166,320
Decoders, satellite	56,424
Diodes, semiconductor	42,240
Equipment, communications	66,493
Filters, dc power	54,215
Generators, signal	44,425
Generators, thermoelectric	87,720
Governors, electronic	54,120
Handset-headsets	28,263
Indicators, radio navigation	45,530
Indicators, telemetering	30,515
Intercom systems	591,061
Inverters	294,588
Measuring sets, sound	35,446
Measuring sets, transmission	162,033
Memory systems, magnetic core	27,736
Meters, frequency	35,335
Meters, radiac	35,210
Monitors, r-f	119,873

Movements, sonar meters	177,188
Networks, impedance	27,056
Oscillators, subcarrier	53,646
Oscillographs	93,374
Oscilloscopes	126,276
Pedestals, antenna	36,507
Radiac sets	187,270
Radiation sets, solar	35,060
Radio sets	2,383,805
Receivers, radio	658,882
Recorders, potentiometer	43,270
Recorder/reproducers, magnetic tape	97,903
Relays	68,247
Relay, armature	87,710
Resistors, variable	372,390
Semiconductor devices	210,600
Servos	72,413
Standards, frequency	26,399
Switches	168,949
Switches, pressure	101,202
Switches, toggle	117,019
Systems, microwave	26,075
Tape, magnetic	272,000
Telephone sets	122,591
Terminal blocks	32,823
Test sets, radar	27,910
Towers, radar	178,781
Tracking equipment, satellite	29,160
Transformers, audio	26,081
Transformers, i-f	26,860
Transistors, silicon	36,294
Transmitters, synchro	48,511
Tubes, cathode ray	39,800
Tubes, electron	1,567,957
Tubes, klystron	29,625
Tubes, thyratron	68,928

PHONOGRAPH SALES*

	Factory Sales (Units)		Retail Sales (Units)	
	Monaural	Stereophonic	Monaural	Stereophonic
January	184,147	177,336	231,429	159,214
February	164,873	188,750	171,127	156,477
March	119,075	168,117	139,577	140,075
April	47,153	125,111	94,228	118,197
May	33,356	89,827	70,228	82,765
June	44,976	152,900	86,979	100,982
July	44,591	158,668	82,742	124,978
August	65,179	277,545	98,132	198,926
September	102,399	377,785	132,688	257,857
October	139,579	456,471	152,248	343,428
November	187,879	455,582	183,774	468,048
December	154,574	407,744	229,989	592,772
1959 Totals	1,267,781	3,035,838	1,653,137	2,744,720
1958 Totals	2,565,139	892,509	Not compiled	Not compiled

*Figures shown for complete packages only; no components are included.

TUBES FACTORY SALES

	TV Picture Tubes		Receiving Tubes	
	Units	\$ Value	Units	\$ Value
January	784,906	\$15,209,896	31,150,000	\$28,808,000
February	738,336	14,084,922	33,155,000	28,630,000
March	717,144	13,804,012	39,841,000	35,286,000
April	696,503	13,275,123	29,800,000	26,047,000
May	667,080	12,745,714	30,612,000	25,904,000
June	766,566	15,136,612	37,421,000	33,099,000
July	750,352	14,648,444	38,394,000	29,788,000
August	823,098	15,493,908	35,435,000	28,974,000
September	913,697	18,068,647	41,989,000	34,810,000
October	1,007,211	19,306,788	42,680,000	35,527,000
November	840,866	16,058,816	37,211,000	31,600,000
December	816,787	15,941,040	37,248,000	32,401,000
1959 Totals	9,522,546	\$183,771,922	432,936,000	\$368,872,000
1958 Totals	8,252,480	\$163,482,674	397,386,000	\$341,929,000

—Electronic Industries Association

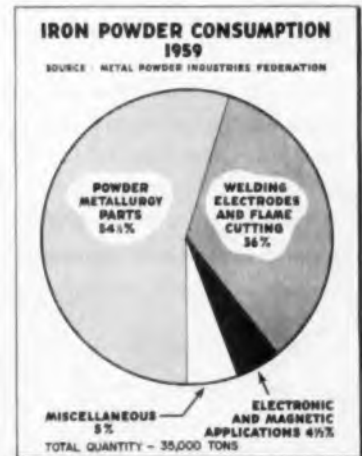



The one cathode alloy you can use for every application

Superior introduced X-3012* just last year. It was the first all-purpose cathode alloy ever developed. Since then, users have put it into all sorts of tubes, for all sorts of service. And the results have proven Superior's laboratory findings.

X-3012 can be used where you want either a passive alloy or an active alloy. It combines both high emission capacity and long life. In addition, sublimation and interface impedance are reduced practically to zero. The alloy has twice the hot strength of ordinary nickel

*U.S. Patent No. 2,833,647 (Superior Tube Co.)

alloys. It can take high current and over-voltage abuse. And the cathode coating adheres well.

Superior developed X-3012 in its electronic laboratories. The precise combination of nickel, tungsten and zirconium is carefully selected from a wide range of different heats to insure the most effective proportions. Available in Lockseam†/Lapseam, seamless/WELDRAWN® cathodes and disc cathodes; also tubular parts for all types of electron tubes. Write for detailed report. Superior Tube Company, 2502 Germantown Ave., Norristown, Pa.

†Manufactured under U.S. patents

Superior Tube
The big name in small tubing
NORRISTOWN, PA.

Johnson & Hoffman Mfg. Corp., Mineola, N.Y.—an affiliated company making precision metal stampings and deep-drawn parts.

VAP-AIR cooling effect detector

Senses the actual cooling effectiveness of the air being delivered over electronic components . . . regardless of volume, density or temperature delivered.

A unique and proven device — lightweight, positive, accurate . . . under all conditions.

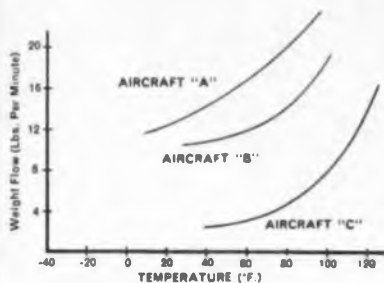

COOLING EFFECT DETECTOR SCHEDULES

Area of adequate cooling lies above each curve. Area of deficient cooling lies below and to right of each curve. Since the Cooling Effect Detector is adjustable, it can be matched to each curve.

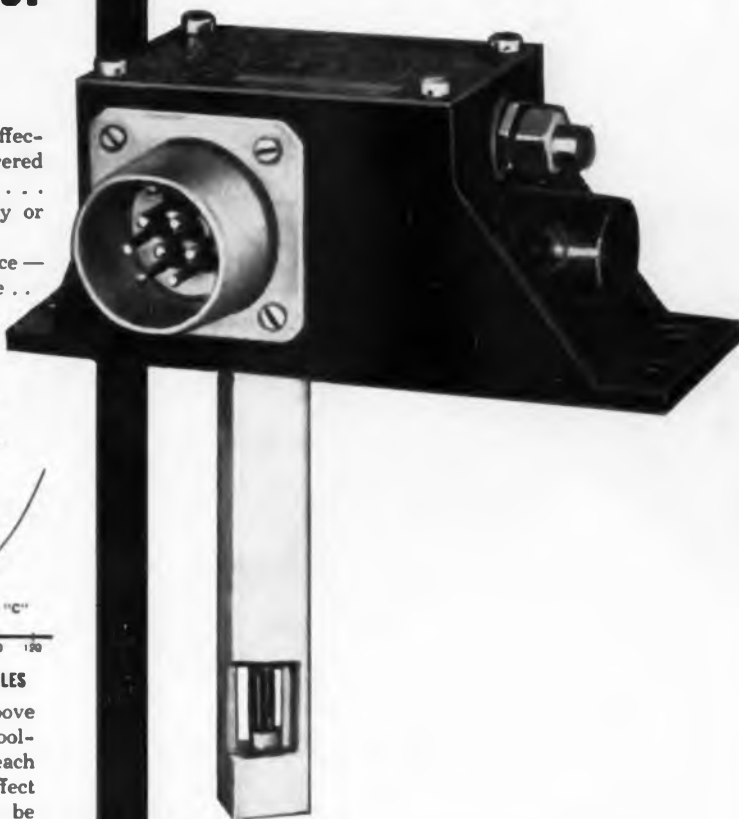

VAP-AIR — SPECIALISTS IN AIRCRAFT TEMPERATURE CONTROLS FOR NEARLY 20 YEARS

Entire systems and a complete line of sensors, electronic controls and precise voltage regulation, electropneumatic and electromechanical valves, advanced in-line valves and regulators, electric power controllers and heat exchange equipment — for aircraft, missiles and ground support.



for complete technical information
and applications write:

VAP-AIR AERONAUTICAL PRODUCTS DIVISION
VAPOR HEATING CORPORATION, DEPT. 61-D
80 East Jackson Blvd., Chicago 4, Illinois

NEW YORK • ST. PAUL • DENVER • WASHINGTON • PHILADELPHIA • ATLANTA
SAN FRANCISCO • HOUSTON • RICHMOND • LOS ANGELES • ST. LOUIS

Please send me complete information on the VAP-Air
Adjustable Cooling Effect Detector.

NAME _____

FIRM _____

ADDRESS _____

CITY, ZONE, STATE _____



THOR
 MACE
 TITAN
 HAWK
 ATLAS
 SNARK
 NIKE B
 BOMARC
 NIKE ZEUS
 SPARROW I
 SPARROW II
 SPARROW III
 NIKE HERCULES
 SIDEWINDER
 REGULUS II
 VANGUARD
 REDSTONE
 JUPITER C
 PERSHING
 BULL PUP
 MERCURY
 POLARIS
 CORVUS
 FALCON

N.D. Adds New Dimensions To High Speed Gyro Rotor Bearings!

At speeds up to 24,000 RPM precision rotor bearings in inertial guidance and navigational systems are highly critical components. Early research and development in design and manufacturing at New Departure is solving the problem and thus winning vital roles for N.D. integral rotor bearings in missile projects. For example, "B" Series bearings with separable inner ring developed by N.D. are helping set performance records in such inertial guidance systems as the Achiever.

New Departure is also supplying high-precision rotor bearings for the inertial guidance system in Polaris.

These bearings, through advanced manufacturing techniques, exacting inspections and controlled environmental tests, backed by 50 years of laboratory testing experience, give precision and uniformity far above the most precise industry standards. They promise new performance and reliability for the submarine-launched IRBM.

You can look to improved performance and reliability when you include an N.D. Miniature/Instrument Bearing Specialist in early design level discussions. Call or write Department L.S., New Departure Division, General Motors Corporation, Bristol, Connecticut.

NEW DEPARTURE
 MINIATURE & INSTRUMENT BALL BEARINGS
proved reliability you can build around

It was inevitable

DIFFUSED SILICON DIODES FROM FAIRCHILD

THE FIRST — An ultra-fast computer diode:

Four millimicrosecond maximum reverse recovery time of this new FD 100 overcomes the diode-caused speed limitations in computer circuits. Capacitance is only $2\mu\text{f}$ at zero volts bias.

THE REASON — A need and the technology

to serve it: Fairchild's diffused silicon transistors have achieved heretofore unattainable performance. Application of these transistors has in turn created the need for silicon diodes of similarly outstanding performance.

THE FOLLOW UP — A broad line of high reliability diodes: This Fairchild FD 100 diode is being followed by others providing industry-leading standards in reliability and uniformity — backed by a continuing accumulation of statistical data on a large scale.

4300 REDWOOD HIGHWAY • SAN RAFAEL, CALIFORNIA • GLENWOOD 6-1130 • TWX SRF 26

New York Area: Pioneer 1-4770 • Syracuse: Granite 2-3391 • Philadelphia Area: Turner 6-6623
Washington, D.C.: National 8-7770 • Chicago: Browning 9-5680 • Los Angeles: Oleander 5-6058

TENTATIVE SPECIFICATIONS — FAIRCHILD FD 100
25°C Except As Noted

Symbol	Characteristic	Min.	Max.	Conditions
BV	Breakdown Voltage	40 volts		@ $I_R = 100 \mu\text{A}$
I_R	Reverse Current		.100 μA	@ $V_R = 30\text{v}$, 25°C
V_F	Forward Voltage Drop	1 v		@ $I_F = 10 \text{mA}$
C	Capacitance		2 μf	@ $V_R = 0\text{v}$
t_{rr}	Reverse Recovery Time To $I_r = 1 \text{mA}$		4 μs	@ $I_F = I_r = 10 \text{mA}$
	Maximum Power Dissipation		200 mw.	
	Temp. Range Operating	-65°C to 175°C		
	Storage	-65°C to 200°C		

For full specifications, write Dept. J-4





DEFINITION PLUS

A jeep traveling at 55mph, left arrow, is caught on this radar. Walking people are at the right arrow. Extremely short pulses, 0.02 microsecond, reduce recovery time donut to minimum. K-band system uses Amperex 7093 magnetron as a fixed frequency pulsed oscillator.

Snapshots of the Electronic Industries



TW SOLID-STATE AMPLIFIER

Using the negative resistance of tunnel diodes in combination with non-reciprocal ferrite attenuation, Bell Labs' traveling wave solid-state amplifier gets a high amplification ratio without self-oscillation.

"SHISH-KEBAB"

Nuvistor electron tubes are lowered into an exhaust and sealing machine as RCA starts commercial production on this industrial triode.



**"EENIE, MEENIE,
MINIE, MO"**

Miniaturized alumina ceramic parts, easily metalized, undergo 100% inspection at Diamonite Mfg Co.'s new facilities at Shreve, Ohio.





MILLION DOLLARS A POUND

Bead thermistors, 0.01 in. diameter, mounted on 0.001 in. wire, measure temperature on inner and outer surfaces of Polaris and Atlas missiles. The Manufacturers, Gulton Industries, Metuchen, N. J., value a pound of the completed transducers at \$1-million.



SNOW DRIFT?

Not drifting snow, but a giant vinyl-covered nylon balloon! This 200 ft. by 80 ft. hyperbolic paraboloid is 40 ft. high. It will permit installation of ITT sorting equipment at the new automatic Post Office in Providence, R. I., before the walls are erected.



GROUND SUPPORT

Ground receiving equipment for CBS Lab's high speed, high acuity photo reconnaissance system. Photoscan uses special image enhancement techniques which sharpen the transmitted image as it is reconstituted in the ground equipment.



CORE TESTER

A constant-current flux-reset core tester for production testing of magnetic amplifier cores has been installed at the Westinghouse Electric Corp.'s specialty transformer department in Greenville, Pa.

MERCURY ANTENNAS

All ground based telemetry, communications, and command control antennas for NASA Project Mercury will be supplied by Canoga Div., Underwood Corp., Van Nuys, Calif.

SMOG-FREE HORSELESS CARRIAGE

First sun-powered auto uses 10,000 silicon solar cells. International Rectifiers Corp., El Segundo, Calif., says that the large, detachable panel can be mass produced for \$2,000 to \$3,000.



OFF THE SHELF DELIVERY

FROM STOCK
delivered
in 24 hours

TRANSFORMERS



TRANSISTOR DRIVER

Designed specifically for transistor, servo and audio



Frequency response 0.20K
Size AF mil. thru 1/4" AH Hermetically sealed in MIL-T-27A

EPOXY MOLDED
ON SPECIAL ORDER
Part Number

Part Number	Application	Pri. Imp.	Sec. Imp.	Unbal. Ma.	Level Watts
M8002*	Coll. to P.P. Emit.	560	400 C.T.	18	15
M8003*	Coll. to P.P. Emit.	625	100 C.T.	20	1.5
M8004	Coll. to P.P. Emit.	5,400	600 C.T.	15	.075
M8005	Coll. to P.P. Emit.	7,000	320 C.T.	7	.040
M8006	Coll. to P.P. Emit.	10,000	6,500 C.T.	.75	.005

*B-Filar wound to minimize switching transients

SILICON RECTIFIER Power Supply



Circuitry Primary 105/115/125 Volts**
Hermetic sealed to MIL-T-27A
See Catalog for additional information.

Part Number	Secondary A.C. Volts	R.M.S. Amperes	Rectifier Circuit C.T.**	F.W.** Bridge
M8018*	18.5 C.T.	1	7V.	14V.
M8019*	18.5 C.T.	3	7	14
M8020*	35 C.T.	3	14.5	29
M8021*	70 C.T.	1	30	60
M8022*	18.5 C.T.	3	7	14
M8023*	35 C.T.	3	14.5	29
M8024*	70 C.T.	1	30	60

**380-1600 Cy.
*50-60 Cy.

**DC output volts stated are for resistive or inductive loads. Capacitor input may be used if RMS AMPS is not exceeded.

ULTRA MINIATURE TRANSISTOR



Open frame (F)* Wt. .08 oz. size 7/16" x 7/16" x 11/32"
Molded (M)* Wt. .14 oz. size 1/2" x 1/2" dia.
Nylon Bobbin, Nickel Alloy Core.

Part Number	Application	Primary Impedance (Ω, C.)	Secondary Impedance
UM 21*	Input	100,000	1,000
UM 22*	Driver	20,000	1,000
UM 23*	Driver	20,000	1,200 C.T.
UM 24*	Output	1,000	50
UM 25*	Output	400	50
UM 26*	Output	400	11
UM 27*	Output	400 C.T.	11
UM 28*	Choke	10 Hy. (0 dc) 8 Hy. (5 ma) 650	

*Add either F or M to designate construction. See catalog

VERI-MINIATURE TRANSISTOR



Open (F)* Wt. 16 oz. size 7/16" x 7/16" x 1/2"
Frame (FB)* Wt. 2 oz. 15/32" x 7/16" x 17/32"
Molded (M)* Wt. 1/4 oz. 1/8" x 1/16" x 1/2" high
4 color coded leads, resin impregnated

Part Number	Application	Primary Impedance (ΩC)	Secondary Impedance (ΩC)
VM 3*	Interstage	25,000	600 (1 ma)
VM 4*	Input or Interstage	200,000	1200 (.72 ma)
VM 5*	Interstage	50,000	690 (1.0 ma)
VM 6*	Interstage	100,000	1200 C.T. (.72 ma)
VM 7*	Output	500 (3.5 ma)	3.4
VM 9*	Output	1250 (2.0 ma)	50
VM 10*	Interstage	2,500 (1.5 ma)	2500 C.T.
VM 11*	Choke	20 Hy. (0 ma) 12 Hy. (.5 ma)	
VM 12*	Interstage	20,000 (.75 ma)	1000
VM 13*	Interstage	20,000 (.72 ma)	1000 C.T.

*Add either F, or M, or FB to part number to designate construction. See catalog

DC-DC CONVERTER

All Items Designed for 13.6V. Except 8034 which is for 28V Input.



TYPICAL DC DC CONVERTER CIRCUIT

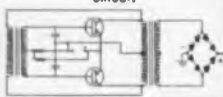

Part Number	Total V.A. Output	F. W. Bridge Volts	D.C. Output Ma.	C.T. Full Wave Ma.
M8034	125	500	250	420
M8035	125	500	250	420
M8036	40	450	90	155

LOW LEVEL CHOPPER



Efficiently transfers 30 to 500 cps. Transducer or Thermocouple signals to instrument amplifiers. Signal level range from .5V. to .5 volts. Resin impregnated to minimize mechanical vibration noise signal. Low hum pick up assured by 3 mu metal and 2 copper shields.

Part Number	Turns Ratio		Ind. of Full Pri. @ 5V	Imped. of Full Pri. @ 5V
	To Full Sec.	To Full Sec.		
M8025	1.77	1.154	17.5	6,600
M8026	1.32	1.64	60 Hy.	22,500

Part Number	D.C. Resistance		Mag. Shield	Hght.	Dia.	Wt.
	Full Pri.	Sec.				
M8025	365	4140	90 DB	129/32	1 3/16	4.5
M8026	455	3500	90 DB	129/32	1 3/16	4.5

MOTIONLESS GENERATOR

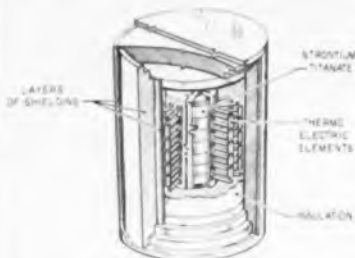

Cut away view shows the arrangement in a 5 watt generator designed by The Martin Co. It has no moving parts and is capable of powering a weather station for at least two years. Strontium-90 generates the heat through spontaneous decay.

Revolving Globe May Help Astronauts Return

A little revolving globe-type replica of the world may help our first astronaut return safely to earth. The new device—called an Earth Path Indicator—will permit the astronaut to "see" where he is over the earth at all times. This information would be necessary for a landing if contact with tracking stations was lost.

The globe is inside of a shoe-box sized container. It is viewed through a window on the instrument panel in the same manner as the earth below would be viewed through a window.

The device was developed by Minneapolis - Honeywell Regulator Co. for Project Mercury.

New Recorder To Aid Traffic Control

A new electronic system that records as many as 20 separate radio or telephone communications simultaneously on 1-in. magnetic tape has been developed by Minneapolis-Honeywell Regulator Co.

The transistorized system, known as the MultiTrak Voice Monitor, is designed primarily to help solve complex communications and traffic problems by providing highly reliable recording of all verbal data received and transmitted at central control facilities. The system can also be used for police, fire, Coast Guard, and other public service communications, traffic dispatching, and for recording telephone switchboard calls. Should an emergency occur, recording communications will prove invaluable to determine the nature and cause.



Write TODAY for catalog and price list of the complete MICROTRAN line company, inc.
145 E. MINEOLA AVE., VALLEY STREAM, N. Y.

COMPACT

Hi-Q PLATE ASSEMBLIES



Epoxy Clad For Still Greater Moisture Resistance and Superior Mechanical Strength

Now... all the economical and space-saving advantages of several components combined into one compact assembly are yours in Hi-Q Plate Assemblies with still another advantage... specially formulated epoxy conformal coating to provide superior moisture resistance and greater mechanical strength along with uniform appearance. All this is available to you at prices completely competitive with more conventional units.

Hi-Q Plate Assemblies will meet or surpass the requirements of MIL-C-11015A for capacitors and MIL-R-11C for resistors. Depending upon the circuit, Plate Assemblies are available in the following sizes: 1" x 3/4", or split to form two plates 1" x 3/8", 1/2" x 3/4", or 3 plates 1/4" x 1" and finally four plates 1/4" x 3/4" (exclusive of coating). Available with wire leads or tab leads for automatic insertion into printed-wiring boards.

NEW—HI-Q MICRO-CIRCUITS ONLY 1/2" x 1/2" x 1" CONTAINS 85 COMPONENTS!

The unit illustrated here is a complete adder circuit for ballistic missile computers. Made up of 7 ceramic plate circuits and measuring only 1/2" x 1/2" x 1, it represents a reduction of 50 times the volume of the smallest packages made with conventional parts. Some 85 components (resistors, capacitors and transistors) are contained in the package composed of commercially available components and designed to sell for a price comparable to the same unit assembled from conventional parts. If you would like to explore the use of such packages in your equipment write to...



Hi-Q
DIVISION

AEROVOX CORPORATION

OLEAN, NEW YORK

AT MANSON . . . STATE-OF-THE-ART TECHNOLOGY IS A CONTINUAL ACHIEVEMENT!



MODEL N317 Crystal Frequency Synthesizer

A prime example is the MODEL N317 CRYSTAL FREQUENCY SYNTHESIZER . . . known to the military as the 0-464 Oscillator . . . which generates over 66,000 discrete sinusoidal frequencies — each stable to 1×10^{-9} per day!

Replacing bank upon bank of precision crystal oscillators, the N317 Synthesizer reduces packaging space to *less than 1.1 cubic feet*. Exact, infallible selection — and *re-selection* — of any of its frequencies is made in a matter of seconds.

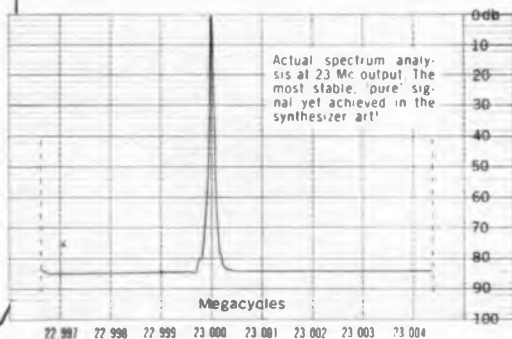

- **ZERO ERROR READABILITY AND RESETTABILITY**
- **OUTPUT FREQUENCY RANGE:** 2 Mc to 34 Mc in four bands
- **TUNING INCREMENTS:**
 - 125 cps from 2-4 Mc
 - 250 cps from 4-8 Mc
 - 500 cps from 8-16 Mc
 - 1000 cps from 16-34 Mc
- **FREQUENCY STABILITY:** 1 part in 10^9 per day, with higher stability available using external reference
- **SPURIOUS SIGNALS DOWN 80 db**, except harmonics of the output
- **100 MILLIWATTS MINIMUM OUTPUT** across 50 ohms
- **NEW DISCRIMINATOR*** gives automatic and equal pull-in and hold-in without moving parts
- **ALL ELECTRONIC SYSTEM** eliminates mechanical servos
- **COMPACT SIZE:** 17 $\frac{3}{4}$ " W x 5 $\frac{1}{4}$ " H x 20" D, for rack or bench use
- **SIMPLIFIED CIRCUITRY AND MIL CONSTRUCTION** permit rapid, easy maintenance

*Pat. No. 2,871,349

Manson's advanced technology also results in a unique line of highly stable, *low-cost* oscillators and related components, typically represented here:



MODEL RD-140A
1 Mc High Stability Oscillator
\$395.00



MODEL RD-170
1000 Mc Reference Generator
\$950.00

MODEL RD-134
Ultra-Accurate
Crystal Oven
\$100.00



MANSON LABORATORIES, INC.

376 FAIRFIELD AVENUE
STAMFORD, CONNECTICUT
DAVIS 5-1391



Other oscillator packages and frequencies available . . . PHONE OR WRITE FOR DETAIL SPECIFICATION SHEETS

Here are some of the **NEW**

**LITTLE
DIAMOND**



ELECTRONIC PLIERS

Precision pliers especially designed for easy convenient use in the hard exacting service of manufacturers of electronic instruments.

Diamalloy pliers stay snug in the joints, true on the points, and sharp on cutting edges in continuous service under which lesser quality brands soon wear out and have to be replaced.

These new electronic items are added to the line of quality pliers and wrenches so long manufactured under the famous Diamond and Diamalloy trade marks:



Sold only through regular trade channels. Ask your electrical supplies wholesaler or write the manufacturer for a Diamond Tool catalog.

"There is nothing finer than a DIAMOND"



DIAMOND TOOL *and Horseshoe Co.*
BULUTH · MINNESOTA Established 1908 · TORONTO · ONTARIO

Circle 16 on Inquiry Card



Fights all



FANSTEEL HP Type Tantalum Capacitors

For High Temperature (125°C) Applications

Reliability and unexcelled stability over the -55° to $+125^{\circ}$ C ambient temperature range plus the ability to withstand severe vibration and impact shock . . .

Add to these advantages Fansteel's patented seal (No. 2,744,217)—the best method of sealing a tantalum electrolytic capacitor—provides absolutely leak-proof throughout the unit's temperature range

Back this up with the knowledge that HP's benefit from the longest experience in the business of tantalum and tantalum capacitors . . .

That's why Fansteel HP's go far beyond expected service under conditions of severe heat, shock and vibration. Use them yourself, prove them yourself. Ask for complete technical data in Bulletin 6.111-2.

FANSTEEL

RELIABILITY

FANSTEEL METALLURGICAL CORPORATION North Chicago, Ill., U.S.A.

Tele-Tips

COMPUTERS have introduced the theory of "gaming" into many vital research efforts in government and industry. At the U. S. Army Logistics Management Center, Ft. Lee, Va. three games have been set up utilizing an IBM 650 and another using an IBM RAMAC 305. The games demand that the "players" make executive decisions which are weighted by mathematical formulas to score the participants on the effectiveness of judgements they would be called on to make in actual management positions.

THE ELECTRONIC INDUSTRY has done a poor job of selling itself to its employees, says Admiral's Carl E. Lantz. Manufacturers should try harder to convince their own personnel of the advantages of owning the products they are selling and building. "Every employee can and should be a salesman for his company," Lantz points out. "His enthusiasm and pride of ownership can help convince outsiders of the quality of the product with which he is associated.

RADIO WAVES have been used to measure the depth of polar ice caps by the U. S. Army Signal Research and Dev. Lab. Depth is determined by measuring the time required for transmitted signals to pass through the ice, reflect off the hidden ground beneath and return to the receiving antenna. The waves travel at approximately 93,000 mph through polar ice. At some points in the Antarctic the ice is 2 mi. thick.

THE SPACE MAN may end up cranking or pedaling his way through space, says Franklin Institute's Ezra S. Krendel, head of their engineering psychology branch. "Man-generated-power" may be necessary, he says, in order to conserve batteries, and to provide an emergency source if other power fails. Data on the human's ability to maintain sustained pedalling effort is found in details on

Tele-Tips

early efforts to make a flying bicycle, a propeller driven aircraft powered by the flyer's feet. And Leonardo da Vinci sketched a similar device, called an "ornithopter," some 450 years ago.

STANDARDS are getting increased attention, and one of the first steps is to coordinate standards between countries. In one of the most recent steps, a wisp of platinum wire in a gold-plated mount was carried from Tokyo to NBS's Boulder Labs. The platinum thread, 30 times thinner than a human hair, is the heart of a Japanese bolometer mount, measuring microwave power. NBS found that the agreement between the Japanese and U. S. microwave power standards are better than 1%—exceptional precision.

INTENSIFIER PICKUP TUBE was used by the Air Force to increase the sensitivity of night photography equipment. An improvement of 14 times was achieved, and potential improvements of 20 times are expected with the new 2-stage intensifiers.

SPACE SATELLITES may soon be able to change their color for protection. A method devised by scientists at Space Technology Labs in Los Angeles would use a heat sensitive coating for satellite skins to control the internal temperatures while the vehicle is whirling through space. The coating would change the color, and control the heat absorption and radiation qualities of the satellite.

GUIDED MISSILES may soon be "beam riding" to any point in the world on errands of mercy. R. P. Haviland, engineer for GE's Missile and Space Vehicle Dept., raised the possibility that improved guidance systems will enable a re-entry Vehicle to "ride in" on any radio beacon and land at predetermined points. One of the uses could be delivery of hospital supplies to stricken areas.

The Latest in RELIABLE Silicon Power Rectifiers

The
NEW
Fansteel
70
AMP.

1N SERIES TYPE 8B

1N 1388
1N 1367
1N 1398
1N 1399
1N 1400
1N 1401
1N 1482
1N 1483

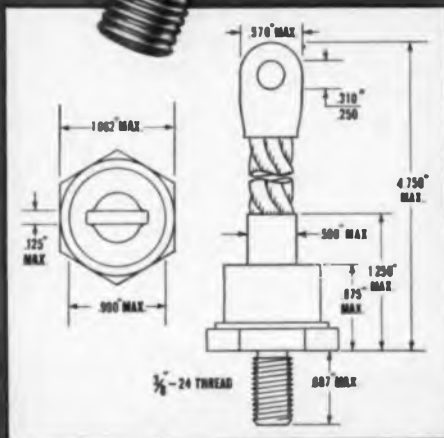

Full 70 amp. load in half-wave circuits up to 200 amps in bridge.
Operating temperature 100 to 150°C case temperature. Peak reverse
voltage 50 to 800 V. Storage from -50°C to +175°C.

Also available to most Military specifications, see our 1130B (military)

Write for complete data.

FANSTEEL

RELIABILITY

FANSTEEL METALLURGICAL CORPORATION North Chicago, Ill., U.S.A.

EUROPE**New International Award**

Rome—Permindex, the World Trade Center in Rome, is sponsoring an annual award in memory of Guglielmo Marconi, the world famous radio pioneer. The award will be made to the individual making the greatest contribution to the development of Marconi's discoveries. Recipients will be chosen by a committee of important international personalities, a member of the Marconi family, and representatives of Permindex. The award will be a gold medal, patterned after a Marconi memorial to be erected in Rome.

Form Swiss Subsidiary

Eitel-McCullough, Inc., San Carlos, Calif., has formed a new subsidiary in Geneva. The corporation, Eitel-McCullough, S. A., will serve as a marketing function for Eimac in Europe. Eimac foreign sales were approximately \$2.5 million in 1959 (double the 1958 figure).

Warren Hoffman, Export Mgr. of Eimac will become Managing Administrator and Chairman of the Board of the new Company. Other members of the board are Eric Homburger and Leopold Cramer, both of Switzerland.

Form German Subsidiary

Collins Radio Co., Dallas, Texas, has formed a new German subsidiary to manufacture, sell, and service Collins airborne equipment. The new Company is Collins Radio Company

GmbH, at (In Gruendung) Flughafen Rhein/main, Frankfurt aM Germany. New Manager is William Dunn; Floyd Gleason will be in charge of technical activities.

PUERTO RICO**Bi-Lingual TV**

San Juan—A Puerto Rican TV station (WKAQ-TV) is planning a series of TV shows for the Spanish markets in cities such as New York, Detroit, Los Angeles, Chicago, and Miami. The bi-lingual programs, 39 half-hour shows, will be taped in Puerto Rico using Puerto Rican talent. A new Ampex VTR installation will be used to tape the shows.

Ask OK for New Cables

RCA Communications, Inc. has applied for authority from the FCC to operate telegraph channels in the new U. S.—Puerto Rico coaxial telephone cable. The channels would be used to supplement existing radio communication facilities between the mainland and Puerto Rico. The "increasing demand for such service as telex and private leased channels, and an increasing volume of message telegraph traffic" were cited as reasons for wanting the OK.

T. H. Mitchell, President of RCA Communications said that it, "in no way reflects a diminution of interest in radio. The company is devoting major efforts and resources to the continued expansion of RCA's global radio network."

CANADA**Acquire Canadian Company**

Textron, Inc. New York has acquired the Terry Machinery Co., Ltd., Montreal, Canada. The Canadian firm makes pumps, generators, and electronic systems. They also perform special contract work for the Canadian Government. Subsidiaries are in British Columbia, Alberta, Ontario, Quebec, New Brunswick and Nova Scotia. W. H. Terry will continue as President of Terry Machinery Co.

**Sign Technical
Collaboration Agreement**

Malcolm M. Hubbard (right), President of Hermes Electronics Co., Cambridge, Mass., and A. W. H. Cole, Marconi's Wireless Telegraph Co., England, sign agreement for general technical collaboration in the field of point to point communications.

UNITED KINGDOM**Hungary Buys British TV**

Hayes, Middlesex—E. M. I. Electronics, Ltd. has received an order from Elektroimpex, Budapest, for one of the company's Outside Broadcast Units. The Hungarian Broadcasting Authority will use the unit for televising outdoor events.

The vehicle will be equipped with four E.M.I. Image Orthicon Cameras and a zoom lens. The cameras can be fitted with either 3 inch or 4½ inch Image Orthicon pick-up tubes. Four video outputs and four sound outputs from the vehicle make it possible to distribute signals independently to four monitors when the vehicle is used as a control room for a TV studio.

**International Conference
On Medical Electronics**

London—The Institution of Electrical Engineers (Brit.) and the International Federation for Medical Electronics are organizing the Third In-

(Continued on Page 38)

**Transmitter for
Radio Tokyo**

Radio Tokyo's Shiba Transmission Station is using this new 50 kw TV transmitter built by Tokyo Shibaura Electric Co. It can broadcast color and black and white. Unit uses three 25 kw pentodes giving it a 12.5 kw audio and a 50 kw video output.

Reliability in volume...



CLEVITE
TRANSISTOR
WALTHAM, MASSACHUSETTS



**FAST
SWITCHING**
plus
HIGH CONDUCTANCE
in
**SILICON JUNCTION
DIODES**

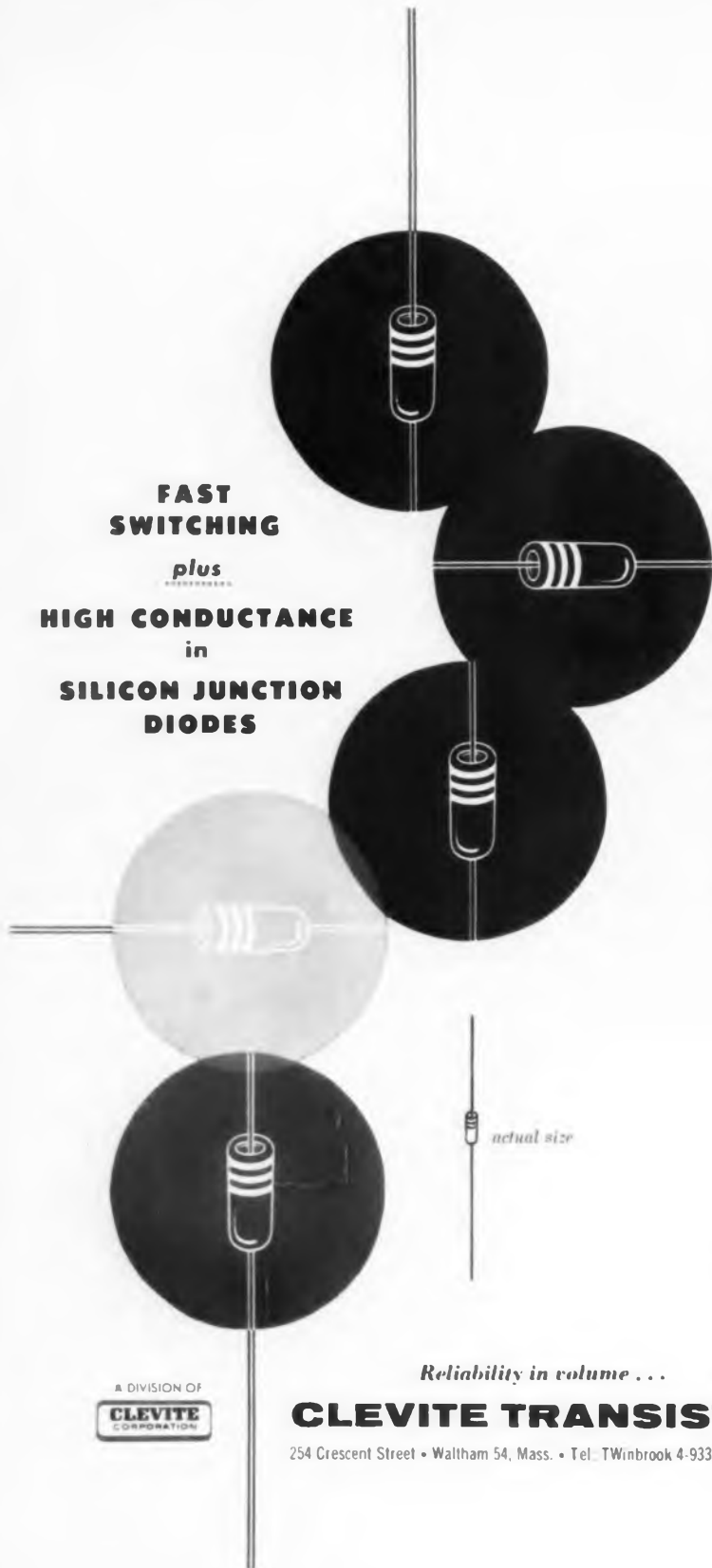

A DIVISION OF
CLEVITE
CORPORATION

Reliability in volume . . .

CLEVITE TRANSISTOR

254 Crescent Street • Waltham 54, Mass. • Tel. TWinbrook 4-9330

SWITCHING TYPES

New circuit possibilities for low impedance, high current applications are opened up by Clevite's switching diodes. Type CSD-2542, for example, switches from 30 ma to $-35v$. in 0.5 microseconds in a modified IBM Y circuit and has a forward conductance of 100 ma minimum at 1 volt.

Combining high reverse voltage, high forward conductance, fast switching and high temperature operation, these diodes approach the ideal multi-purpose device sought by designers.

GENERAL PURPOSE TYPES

Optimum rectification efficiency rather than rate of switching has been built into these silicon diodes. They feature very high forward conductance and low reverse current. These diodes find their principal use in various instrumentation applications where the accuracy or reproducibility of performance of the circuit requires a diode of negligible reverse current. In this line of general purpose types Clevite has available, in addition to the JAN types listed below, commercial diodes of the 1N482 series.

**MILITARY TYPES
JAN**

1N457	MIL-E-1/1026
1N458	MIL-E-1/1027
1N459	MIL-E-1/1028

Signal Corps

1N662	MIL-E-1/1139
1N663	MIL-E-1/1140
1N658	MIL-E-1/1160
1N643	MIL-E-1/1171

All these diodes are available for immediate delivery. Write now for Bulletins B217A-1, B217A-2 and B217-4.

Phone for data and prices.



TUNING FORK CONTROLLED PRECISION FREQUENCY PACKAGES

FROM 1.0 TO 4,000 CPS.

Overall accuracies from $\pm 0.05\%$ to $\pm 0.01\%$ over -55°C to $+85^{\circ}\text{C}$ range, and to $\pm 0.001\%$ from zero $^{\circ}\text{C}$ to $+75^{\circ}\text{C}$, without use of ovens.

Silicon and germanium transistorized. Sinewave, squarewave and pulse outputs. 18, 20, 24, and 28 volt DC inputs.

Conservatively designed reliable units, potted in silicone rubber and hermetically sealed, for operation under MIL environmental conditions.

PHONE EDgewood 3-1700, or TWX WBRY 5103, or write:



PHILAMON LABORATORIES INC.

90 HOPPER STREET, WESTBURY, LONG ISLAND, N.Y.

unique contact



with 4 outstanding features

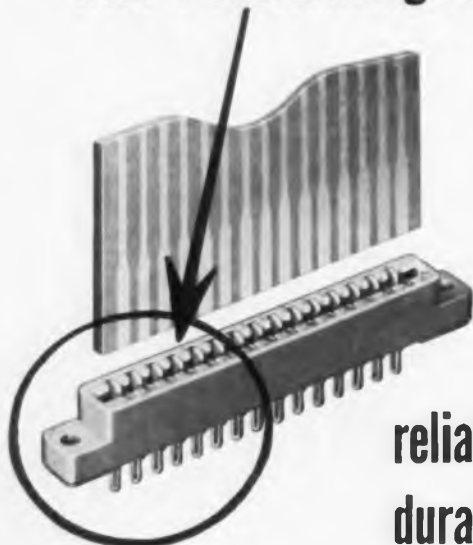

reliable,
durable

PRIN-CIR connectors

AMPHENOL Princir receptacles have been used in high-reliability applications ever since their introduction a few years ago. Princir popularity in rough jobs is based upon a unique contact design with these outstanding features:

1. **CONTACT CAN'T BE OVERSTRESSED**—Even after repeated insertions Princir contacts form-fit any .055"-.073" board. Warped boards or boards varying in thickness are effectively accommodated. Wiping action is excellent.
2. **CONTACT CAN'T BE SET**—The long spring base of the tough phosphor bronze contacts prevents setting.
3. **LOW MILLIVOLT DROP**—After 1000 insertions and withdrawals in reliability-durability testing the millivolt drop is negligible. Only after 5000 cycles is it appreciably affected.
4. **HARD GOLD-OVER-ALBALOY PLATING**—Assures low electrical contact resistance, prevents tarnishing.

Princir receptacles are available with from six to twenty two contacts; there are five contact tail types. A complete family of mating Princir plugs and adapters are also available.

AMPHENOL

CONNECTOR DIVISION

CHICAGO 50, ILLINOIS

Amphenol-Borg Electronics Corporation

Circle 22 on Inquiry Card

International News

(Continued from Page 32)

International Conference on Medical Electronics. The conference will be held at Olympia, London, July 21 to 27, 1960. For information: Secretary, The Institution of Electrical Engineers, Savoy Place, London, W.C. 2.

Included in the subjects to be covered will be applications to space research, aids for the totally deaf, automatic control of artificial limbs and of heart action, and techniques involving the use of pills containing miniature radio transmitters.

Build Irish Gyros in U. S.



Giannini Controls Corp., New York, will build gyroscopes used in this launcher for the Seacat anti-aircraft missile under license from Short Brothers & Harland, Ltd., Belfast, Ireland. Short will give tech assistance for 2 years.

Stereoscopic CCTV

Hayes, Middlesex — A stereoscopic closed-circuit TV has been developed by E.M.I. Electronics, Ltd. It is designed for nuclear plants and other establishments where dangerous materials must be manipulated remotely.

Two camera channels are mounted side-by-side and relay pictures onto two monitors. The pictures from these are superimposed with mirrors and polarized glass to form a single image. When viewed with polarized glasses a realistic three-dimensional picture results.

JAPAN

Portable Neutron Generator

Tokyo—Work has started on a portable neutron generator by Tokyo Shibaura Electric Company (TOSHIBA) of Japan. The generator, which is not dependent on the use of a reactor, is expected to open atomic research possibilities to universities and industrial corporations that cannot make use of existing atomic research facilities. The generator should be completed by October, 1960.

Circle 23 on Inquiry Card →

The **CARE** that produces **QUALITY** in **THERMISTORS**



Besides the technology and manufacturing resources you'd expect of Keystone, there's a great deal of individual patience and care bound up in each thermistor we make. Our Thermistor Division is staffed by people who appreciate the importance of precision workmanship—and many of them have been with us since we made our first negative temperature coefficient resistance unit over 20 years ago. ● Along with our complete laboratory, engineering and manufacturing facilities, our "people who care" have made Keystone the key name in thermistors today.

How do you benefit by all this? It's simple. Whether the thermistor you need is as large as your thumb or as small as a gnat's eye, it will perform as specified . . . on earth, in space, or below the seas . . . if made by the people at Keystone. ● We'd be more than pleased to hear from you about your possible application for thermistors. Chances are we can help. Write us.



K *eystone*

CARBON COMPANY
Thermistor Division
ST. MARYS, PA.

THE IDEA THAT GREW FOR 100 YEARS



At Bell Laboratories, M. Uenohara (left) adjusts his reactance amplifier, assisted by A. E. Bakanowski, who helped develop first suitable diode. Extremely low "noise" is achieved when certain diodes are cooled in liquid nitrogen.

First practical diode for amplifier, shown here held by tweezers, was jointly developed by A. E. Bakanowski and A. Uhlir.



How basic scientific ideas develop in the light of expanding knowledge is strikingly illustrated by the development of Bell Laboratories' new "parametric" or "reactance" amplifier.

Over 100 years ago, scientists experimenting with vibrating strings observed that vibrations could be amplified by giving them a push at strategic moments, using properly synchronized tuning forks. This is done in much the same way a child on a swing "pumps" in new energy by shifting his center of gravity in step with his motion.

At the turn of the century, scientists theorized that *electrical* vibrations, too, could be amplified by synchronously varying the *reactance* of an inductor or capacitor. Later amplifiers were made to work on this principle but none at microwave frequencies.

Then came the middle 50's. Bell Telephone Laboratories scientists, by applying their new transistor technology, developed semiconductor diodes of greatly improved capabilities. They determined theoretically *how* the electrical capacitance of these new diodes could be utilized to amplify at *microwave* frequencies. They created a new microwave amplifier with far less "noise" than conventional amplifiers.

The new reactance amplifier has a busy future in the battle with "noise." At present, it is being developed for applications in tropospheric transmission and radar. But it has many other possible applications, as well. It can be used, for instance, in the reception of signals reflected from satellites. It is still another example of the continuing efforts to improve your Bell System communications.



BELL TELEPHONE LABORATORIES

WORLD CENTER OF COMMUNICATIONS RESEARCH AND DEVELOPMENT

CANNON



WEATHERPROOF



PLUGS...



AVAILABLE NOW FOR ANY MOISTURE ENVIRONMENT

Wherever water threatens an electrical connection, you can be sure of positive dry contact by choosing from Cannon's many types of weatherproof plugs. For rocket engine test stands... ground support equipment... buried or exposed cables... underwater research equipment... or any wet weather condition... Cannon has the right plug for you.

- Moistureproof types maintain sealed characteristics at high altitudes and over a wide temperature range.
- Weatherproof types repel water under severe mud, ice, and water conditions.
- Watertight types may be used underground and in swamps, lakes, and rivers... may be submerged in water up to 550 feet without leaking.

Cannon's weatherproof plugs are another of many reasons why you should always consult the first name in plugs... why you should always consult Cannon for all your plug requirements. For information on Cannon weatherproof plugs, or any Cannon product, write to:

CANNON

PLUGS

CANNON ELECTRIC COMPANY, 3208 Humboldt St., Los Angeles 31, Calif.

ELECTRONIC INDUSTRIES • April 1960

Circle 24 on Inquiry Card

39

NEW VENTURI DESIGN SOLENOID VALVE FEATURES 1" SIZE, 255 P.S.I. RATING, DIRECT ACTING, YET WEIGHS ONLY 1¾ LBS.

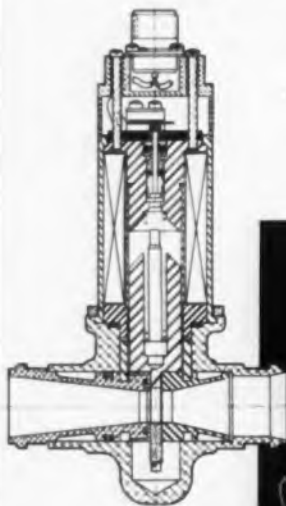

**Valcor
V-20000-04
Shut-Off Model
For Air,
Gases, Fuels,
Just 5½" High**

KENILWORTH, N. J.—An entirely new direct acting venturi-type valve, in a 1" line size, yet weighing only 1¾ lbs., has been announced by Valcor Engineering Corp.

The valve combines an efficient venturi plus Valcor's patented, optically flat floating seal principle to insure a straight-through flow path without obstructions. The pressure recovery characteristics of the venturi allow the reduction of the inside diameter of the fluid line to a relatively small throat; this permits the use of a minimum weight, direct acting solenoid. The self-lapping, floating seal disc, with its self-cleaning action withstands normal contaminants and foreign matter. The combination of the efficient venturi, the floating disc, and the direct acting design produces maximum reliability.

Only high temperature insulating materials are used: teflon, silicone and glass. The coils are unaffected by mechanical and thermal shock, and maintain dielectric strength under salt spray, temperatures to 500 F and other adverse environmental conditions. Both valve and solenoid are rated from zero to 255 psi, over an ambient temperature range of -65 F to +250 F, with fluid temperatures between -30 F and +350 F—and up to 550 F for a maximum of 10 minutes.

Ports are constructed in accordance with military standard fittings AND 10058-16. The valve is easily adaptable to any type of fitting.

Further information, including technical literature on the new Model V-20000-04 venturi-type solenoid valve, is available from **VALCOR ENGINEERING CORP., Kenilworth, New Jersey.**

Books

Cybernetics and Management

By Stafford Beer. Published 1960 by John Wiley & Sons, Inc., 440 Fourth Ave., New York 16, 214 pages. Price \$4.50.

This book is an account of the new science of cybernetics and is the first to be written with management specially in mind. It presents the basic principles of the subject, introduces important ideas, and explains the main terms without a mass of mathematics and scientific detail.

Cybernetics is the scientific study of the nature of control, not in the narrow sense of command in the giving of orders, but in the subtle sense of self-regulation and adaptability.

Over the past 15 years scientists have discovered ways of describing large and complicated systems which exhibit self-regulation and adaptive behavior, and of discussing their structures and control mechanisms. They have found with excitement that there are hitherto unsuspected principles which seem to underlie them all; this is the unity which makes cybernetics a science in its own right, whether it is talking about control in biology, or economics, or computers, or industry.

Management might be called the profession of control. For this reason it will find in cybernetics a scientific tool for understanding and organizing systems and machines to set beside its own arts in the handling of men and situations.

Materials and Techniques for Electron Tubes

By Walter H. Kohl. Published 1960 by Reinhold Publishing Corp., 430 Park Ave., New York 22, 638 pages. Price \$16.50.

The principal subjects here are the composition, properties, and behavior of the materials used in electron tubes and the techniques for assembling these materials. The book completely revises the author's previous "Materials Technology for Electron Tubes," long known as a standard work on the subject in English. The new text is written and organized on the basis of replies to questionnaires sent to a select list of users of the previous book.

The book covers all the material components of electron tubes and the methods of uniting them, such as joining of metals by brazing, glass-to-metal sealing, and ceramic-to-metal sealing. Chapters dealing with specific materials contain extensive tabulations of physical characteristics, chemical reactions with various reagents, and processes used in application.

(Continued on page 44)

AMP taper technique points the way to greater reliability



Magnetic Amplifiers, Inc. of New York carefully manufactures its Static Inverters with a step-by-step quality control and testing program to build in the reliability required for aircraft and missile applications.

It found that AMP Taper Technique simplified this procedure. A high speed AMP Automachine pre-terminates circuit leads with crimp-type, pre-insulated solid Taper Pins. Components are then easily tested in the modular stage before final assembly. Crimping eliminates difficult soldering operations and the danger of burning wound components while Taper Technique permits checking and trouble shooting without destroying the main cable. After final assembly, when the Pins are inserted into the Blocks, this Technique provides rugged vibration resistance and operational reliability.

AMP solderless Taper Pins are made in formed and solid types, with or without pre-insulation and mate with a wide range of one or two piece stackable Taper Blocks. You'll find that AMP Taper Technique is ideal for your quality control or circuit density problems too.



Magnetic Amplifiers' 250VA Static Inverter Model SIS-425041

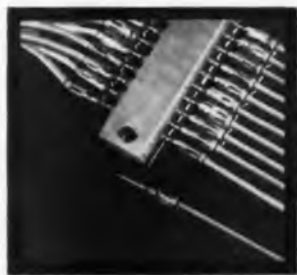

AMP Pre-Insulated Taper Pins and stackable Taper Blocks

Write for our new Taper Technique brochure.

AMP INCORPORATED

GENERAL OFFICES: HARRISBURG, PENNSYLVANIA

AMP products and engineering assistance are available through subsidiary companies in: Australia • Canada • England • France • Holland • Italy • Japan • West Germany



*when you can't
afford power failure*



WRITE FOR
DATA SHEET
BED-A132

Borg sub-fractional horsepower motors mean reliable power for your precision instruments and equipment. All Borg motors are totally enclosed, using precision machined die-cast alloys for end bells and gear-train housings. Borg motors are reversible, capacitor-type motors rated for operation on 110 and 220 volts, 50 or 60 cycles. Available in synchronous or induction types, two or four pole, with or without gear trains, from 1/750 to 1/2000 horsepower. Capacitors are optional. Contact your nearest Borg distributor or technical representative, or write us for full information.

BORG EQUIPMENT DIVISION

Amphenol-Borg Electronics Corporation
Janesville, Wisconsin

Micropot Potentiometers • Turns-Counting Microdials • Sub-Fractional Horsepower Motors • Frequency and Time Standards



1200°—Yet No Catastrophic Failure With New Electra Precision Carbon Film Resistor

Check at right the histograms showing test results on the new Electra Precision Carbon Film Resistor. See for yourself the remarkable ability of this resistor to withstand extreme conditions of heat and humidity, also its exceptional load life. Primary credit for these outstanding characteristics goes to Electra's exclusive new Type R-5 coating, developed in our laboratory after a long period of scientific study and experimentation. But performance alone is not the whole story. Check, too, the sizes; truly, this resistor opens up a whole host of new possibilities in your design and engineering work.

Electra Part No.	MIL Style	Wattage			MIL Resistance Range	Manufactured Resistance Range	Max. Rated Voltage	Length A	Dia. B
		70°C	125°C	175°C					
CF 1/4	RN60B	1/4	1/4	1/4	10 Ω 1 Meg	10 Ω 1 Meg	250	.375 +1/32 -1/32	.125 +0.040 -0.10
CF 1/4	RN65B	1/4	1/4	1/4	10 Ω 2 Meg	10 Ω 2 Meg	300	.625 +1/32 -1/32	.1875 +1/32 -1/32
CF 1/2	RN70B	1/2	1	1/2	10 Ω 2.5 Meg	10 Ω 5 Meg	350	.750 +1/32 -1/32	.250 +1/32 -1/32

Lead length C, 1 1/2 for all, ±1/8. Dia. leads, ⌀22 for CF 1/4 and CF 1/4, ⌀20 for CF 1/2.

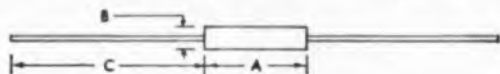

WRITE FOR NEW BROCHURE—Just off the press...new brochure describing Electra's complete line of precision carbon film resistors. Electra also manufactures a complete line of precision metal film resistors and ceramic disc and plate capacitors.

Electra

MANUFACTURING COMPANY

4051 Broadway

Kansas City, Missouri

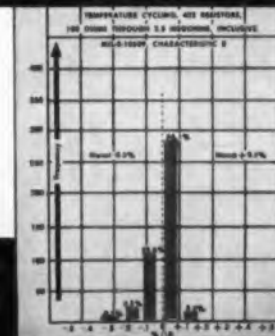
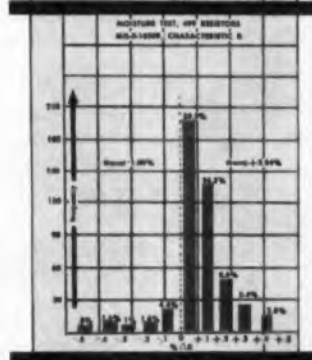
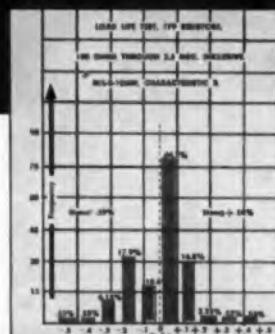

CLEVELITE*

PHENOLIC TUBING



...has the Electrical and Physical Qualities in the size... in the shape...

YOUR DESIGN REQUIRES!

- | ELECTRICAL
features: | PHYSICAL
features: |
|---|--|
| <ul style="list-style-type: none"> ● High Heat Resistance over 250° F. continuous ● Non-tracking and Insulation Resistance ● Dielectric Strength up to 250 v.p.m. ● Low dielectric loss factor ● Low moisture absorption | <ul style="list-style-type: none"> ● Unaffected by Oils and Solvents ● Mechanically and structurally strong ● Easily punched, sawed and machined ● Diameters from .090" to 8.000"; wall thicknesses from .0075" to .250" |

Molded nylon coil forms are also available in 8/32 and 1/4-28 core sizes.

Write for latest CLEVELITE brochure and samples.
CLEVELITE will make your product BETTER and at LOWER cost!

*Reg. U. S. Pat. Off.

PLANTS & SALES OFFICES:

THE CLEVELAND CONTAINER CO.

6201 BARBERTON AVE. • CLEVELAND 2, OHIO

ABRASIVE DIVISION of CLEVELAND, OHIO

SALES OFFICES:
 CLEVELAND
 CANADA, LTD
 TORONTO &
 PRESCOTT, ONT.
 NEW YORK
 WASHINGTON
 MONTREAL

REPRESENTATIVES:
 NEW ENGLAND: R. S. PETTIGREW & COMPANY
 10 N. MAIN ST., W. HARTFORD, CONN.
 NEW YORK: THE MURRAY COMPANY, 604
 CENTRAL AVE., E. ORANGE, N. J.
 PHILADELPHIA: MIDLANTIC SALES COMPANY,
 5 E. ATHENS AVE., ARLMORE, PA.
 CHICAGO: McFARLANE SALES COMPANY
 5950 W. DIVISION ST., CHICAGO
 WEST COAST: COCHRANE-BARRON CO., 844
 S. MARIPOSA AVE., LOS ANGELES
 CANADA: PAISLEY PRODUCTS OF CANADA,
 LTD., BOX 159 - STATION "H", TORONTO

Books

(Continued from page 40)

Industrial Packaging

By Walter F. Friedman and Jerome J. Kipnees.
 Published 1960 by John Wiley & Sons, Inc.,
 440 Fourth Ave., New York 16. 536 pages. Price
 \$11.50.

The significance of the industrial packaging function in the total business picture may be recognized from the important proportion of the total product and distribution expenditure which packaging costs frequently consume. The staggering damage claims paid by transportation agencies also testify to an often neglected customer service function in assuring, through proper protection, the complete serviceable and useable conditions of the product.

This book establishes those criteria controls which are indispensable for the formulation and execution of sound packaging policy. Offering a thorough and up-to-date survey of packaging materials, methods, and equipment, the work will prove an invaluable aid to all those facing the problem of adequate product protection and minimum container, labor, and transportation cost.

The authors include an economic analysis of the field, and organize and define basic principles applicable to all package-using industries. Many new and original concepts and analyses are presented, and valuable new techniques and methods are emphasized.

Telemetering Systems

By P. A. Borden and W. J. Mayo-Wells. Pub-
 lished 1959 by Reinhold Publishing Corp., 430
 Park Ave., New York 22. 249 pages. Price \$8.50.

Here are the full details on the practical aspects and possibilities of both stationary and mobile telemetering. The latter phase, now so important in rocketry is entirely new to this treatment which grew out of Borden's earlier successful book, "Principles and Methods of Telemetering," written before mobile telemetering was a developed science.

The authors stressed the similarity between the two methods in order to point out their increasing mutual dependencies in regard to practice and techniques. This new book will be highly useful in explaining this valuable type of instrumentation for various industrial, research and military activities.

Structure and Properties of Thin Films

Edited by C. A. Neugebauer, J. B. Newkirk, and
 D. A. Vermilyea. Published 1959 by John Wiley
 & Sons, Inc., 440 Fourth Ave., New York 16.
 561 pages.

The first English-language report on the structure and properties of thin films, this book presents the complete proceedings of an international conference on thin films held at Bolton

(Continued on page 48)

NEW ... FROM INDUSTRY'S BROADEST RECTIFIER LINE

SILICON CARBIDE RECTIFIERS

FEATURES

- IMPROVED RELIABILITY AT ELEVATED TEMPERATURES
- HIGHER TEMPERATURE PERFORMANCE TO 500°C
- EXCELLENT RADIATION RESISTANCE

Silicon carbide rectifiers are now available for production requirements. Their inherent higher temperature capabilities (to 500°C) provide greater reliability in existing circuitry subject to high ambient temperatures. Resistance to radiation is up to 100 times greater than previously available in any semiconductor rectifiers.



Type	SPECIFICATIONS @ 500°C			RATINGS @ 500°C	
	Peak Inverse Voltage (volts)	Maximum Inverse Current I_R (mA)	Maximum Forward Voltage @ Specified Current (volts @ mA)	Maximum Average Forward Current I_F (mA)	Maximum Peak Inverse Voltage (volts)
TCS10	100	500	8 @ 100	100	100
TCS5	50	500	4 @ 100	100	50

Type	SPECIFICATIONS @ 75°C		
	Peak Inverse Voltage (volts)	Maximum Inverse Current I_R (mA)	Maximum Forward Voltage @ Specified Current (volts @ mA)
TCS10	100	10	12 @ 100
TCS5	50	10	8 @ 100

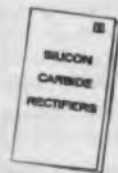

Write for Bulletin PB-70

Transitron

electronic corporation • wakefield, massachusetts



Leadership in Semiconductors

SEE YOUR LOCAL AUTHORIZED TRANSITRON DISTRIBUTOR FOR QUALITY FROM 1969



CERAMIC SPEAKER MAGNETS

INDOX V Can Cut . . .

- **Magnet Costs 20%**
- **Speaker Weight 25%**
- **Speaker Length 46%**

*Performance Proven in Hundreds of Thousands of
High-Fidelity Loud-speakers*

A leading high-fidelity loud-speaker manufacturer realized the above savings when his Alnico speakers were redesigned to use INDOX V. Here is why he changed . . . and why you, too, may achieve substantial savings by changing to INDOX V.

INDOX V loud-speaker magnets are guaranteed to have a minimum energy product of 3.25 million BHmax. Made of highly oriented barium ferrite material, their energy level is comparable on an equivalent weight basis to that of Indiana's Hyflux ALNICO V — the most powerful magnet material available.

Now with INDOX V, designers and manufacturers can look forward to:

- Speaker assemblies that are less than half as deep
- Fewer magnet parts, simpler assemblies
- Less over-all weight, lower shipping costs

Yet the advantages of comparable Alnico magnets are retained:

- Highest sound level possible
- Best transient response, assuring a full range of tones and overtones
- Truest possible reproduction of sound



Indiana offers a wide range of INDOX V high-fidelity loud-speaker magnets . . . in both standard and special sizes.

Investigate the possibility of improving *your* loud-speaker designs with INDOX V. Indiana's *experienced* design engineers are available to help you solve your speaker design problems — at no cost or obligation to you. Write for Bulletin 18N-4 today for more detailed information.

INDIANA STEEL PRODUCTS
Division of Indiana General Corporation
Valparaiso, Indiana

In Canada: The Indiana Steel Products Company of Canada Limited,
Kitchener, Ontario

**INDIANA
PERMANENT
MAGNETS**



Another Tinnerman Original...

Cost-cutting Tubular **SPEED CLIP**[®] takes positive "bite" to hold assemblies tight!

In seconds, you can front-mount trim, name plates, grilles, knobs, insulation, with Tubular SPEED CLIPS. And at interesting savings in assembly time and costs!

Snap these quality spring-steel fasteners into holes in metal, plastic or wood. Then press the mounting studs, nails or rivets into the clips to complete the attachments... anywhere along your assembly line.

As the SPEED CLIP is inserted, spring fingers compress, then expand behind the panel to lock tight. The rolled-in end permits easy entrance, but bites hard into the stud to prevent back-off or vibration-loosening.

Tubular SPEED CLIPS are available for a full range of stud sizes and panel thicknesses. Permanent lock or removable types.

Check your Sweet's Product Design File (Section 8/Ti) for data on Tubular SPEED CLIPS and

other SPEED NUT brand fasteners. Then call your Tinnerman representative for samples and additional information. If he isn't listed under "Fasteners" in your Yellow Pages, write to:

TINNERMAN PRODUCTS, INC.
Dept. 12 • P. O. Box 6688 • Cleveland 1, Ohio



CANADA: Dominion Fasteners Ltd., Hamilton, Ontario. GREAT BRITAIN: Simmonds Aerocessories Ltd., Treforest, Wales. FRANCE: Simmonds S. A., 3 rue Salomon de Rothschild, Suresnes (Seine). GERMANY: Mecano-Bondy GmbH, Heidelberg.



5,348 ways to save time and trouble in getting relays

Chances are mighty good that Struthers-Dunn can help you avoid lost time, confusion and headaches in locating the one specific relay type best suited for your job. And, by "best suited" we mean electrically, mechanically, size-wise, weight-wise, mounting-wise and price-wise!

With 5,348 Dunco relay types and adaptations from which to choose and with many of them available from stock, Struthers-Dunn relay specialists can match your requirements to a T—whatever the type and whether the call be for one relay, or for thousands. Struthers-Dunn, Inc., Pitman, N. J.

Member, National Association of Relay Manufacturers

STRUTHERS-DUNN

Relay headquarters since 1923

Sales Engineering Offices in: Atlanta • Boston • Buffalo • Charlotte • Chicago • Cincinnati • Cleveland • Dallas • Dayton • Detroit • Kansas City • Los Angeles • Montreal • New Orleans • New York • Pittsburgh • St. Louis • San Francisco • Seattle • Toronto

Books

(Continued from page 44)

Landing on Lake George, N. Y., September 1959.

Review papers, contributed by recognized experts in their specialized fields, discuss problems which have been recently solved and those that still await solution. Topics include the preparation, growth and structure of thin films, and the mechanical, electrical, optical, and magnetic properties of thin films. In addition, a review of processes occurring at the metal surface is given, since a large fraction of thin film atoms resides on or near the surface.

Current research papers presented at the conference describe some of the more fundamental problems of physics and chemistry involved in the special nature of thin films. The problem of ferromagnetism in very small specimens, the nature of chemisorption, and the effect of small dimensions on various properties receive prime attention.

A complete transcript of the conference discussion is included.

Books Received

The Source Book in Mathematics

By D. E. Smith. Vol. I: 701 pages, paper back, price \$1.85. Vol. II: 701 pages, paper back, price \$1.85.

Functions of a Complex Variable

By James Pierpont. 583 pages, paper back. Price \$2.45.

A course in Mathematical Analysis

By Edouard Goursat. Vol. I: 548 pages, paper back, price \$2.25. Vol. II, Part I: 259 pages, paper back, price \$1.65. Vol. II, Part 2: 300 pages, paper back, price \$1.65.

The Theory of Functions of Real Variables

By James Pierpont. Vol. I: 560 pages, paper back, price \$2.45. Vol. II: 645 pages, paper back, price \$2.45. Published 1959 by Dover Publications, Inc., 180 Varick St., New York 14.

Servo Engineers Handbook

Published 1959 by Daystrom Transcoil, Div. of Daystrom Inc., Worcester, Montgomery County, Pa. 128 pages, paper bound. Price \$3.00.

Value Engineering—1959

Published 1959 by Engineering Publishers, P. O. Box 2, Elizabeth, N. J. 165 pages. Price \$6.00.

Space Communications Handbook

Published 1959 by Philco Corp., G & I Div., Western Development Labs., 3875 Fabian Way, Palo Alto, Calif. 55 pages, paper bound.

Airborne HF SSB/AM System, ARINC Characteristic No. 533.

Published 1960 by the Airlines Electronic Engineering Committee of the Airlines Communications Administrative Council, associated with Aeronautical Radio, Inc., 1700 K Street NW, Wash. 6, D. C. 92 pages, paper bound.

Swift, sure DISTORTION READINGS



-hp- 330B/C/D Distortion Analyzer



Measure distortions as low as 0.1%
Measure noise on voltages as small as 100 μ v
High sensitivity, high stability
Wide band 20 db gain amplifier
Oscilloscope terminals; built-in VTVM

-hp- 330B Distortion Analyzer is a basic instrument universally used to measure total audio distortion, voltage level, power output, gain, total AM carrier distortion, noise and hum level and audio signal frequencies.

Model 330B consists of a frequency selective amplifier, a regulated power supply and a VTVM. The amplifier operates with a resistance-tuned circuit to provide almost infinite attenuation of the fundamental while passing harmonic frequencies at normal gain. Negative feedback minimizes distortion and insures uniform response and stability. The VTVM is used to set the load and measure the value of harmonic voltages, thus providing a direct reading of total distortion. The VTVM may also be used separately.

For FM broadcasters, -hp- 330C is offered. Similar to 330B, this instrument has a meter with VU ballistic characteristics meeting F.C.C. requirements and a VTVM frequency range of 10 cps to 60 KC.

For FM-AM broadcasters, -hp- 330D is available. This instrument is similar to -hp- 330C except for addition of an AM detector covering 500 KC to 60 MC.

Details from your -hp- representative, or write direct

HEWLETT-PACKARD COMPANY

48198 PAGE MILL ROAD • PALO ALTO, CALIFORNIA, U.S.A.

CABLE "HEWPACK" • DAVENPORT 5-4451

Field Engineers in all Principal Areas

SPECIFICATIONS

Distortion Measurement: 20 cps to 20 KC.

Dial Calibration Accuracy: $\pm 2\%$ full range.

Elimination Characteristics: Reduces fundamental frequency more than 99.9%.

Accuracy: $\pm 3\%$ full scale at distortion levels of 0.5%.

Sensitivity: Distortion levels of 0.3% are measured full scale. Accurate readings on 0.1% levels.

Input Impedance: 200,000 ohms, 40 μ f shunt.

Required Input: 1 v RMS.

Voltmeter: Nine 10 db ranges, 0.03 to 300 v. Full scale sensitivity all ranges.

Noise Measurement: 300 μ v full scale. Coverage 10 cps to 20 KC.

Oscilloscope Terminals: 75 db max. gain from AF input to terminals.

Price: -hp- 330B, \$410.00 (cabinet), -hp- 330C, \$440.00 (cabinet), -hp- 330D, \$500.00 (cabinet), (Rack models \$15.00 less).

Data subject to change without notice.
 Prices f.o.b. factory.



now has a 200 KC 'scope for \$435! Seen it?

Important facts to know about laminated plastics

New Guide Developed by Taylor

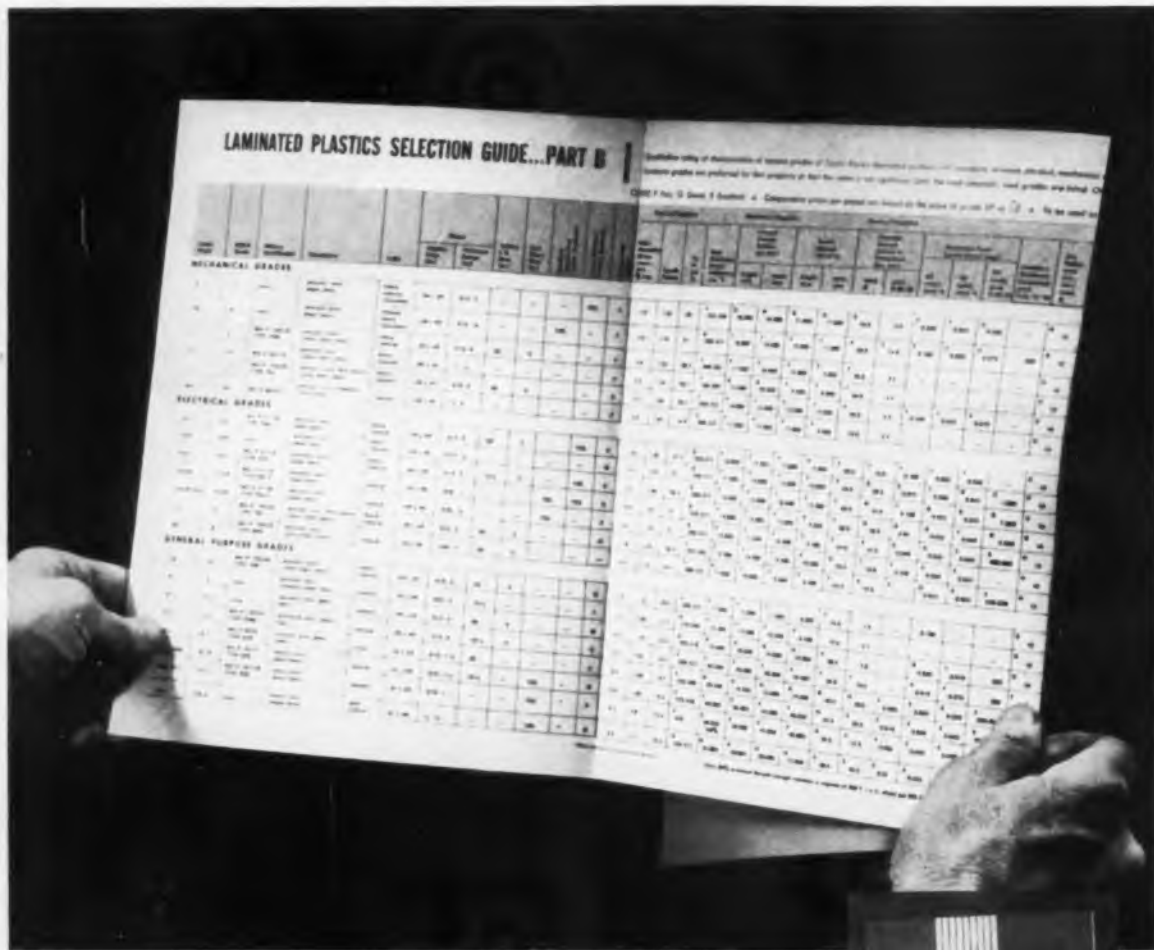

If you have specialized in metals and are considering industrial laminated plastics as a material for certain components in your design for the first time, this newly devised Taylor Selection Guide will help you evaluate the different grades available. The simplified properties chart lists the various grades now produced and clearly indicates the properties in which they excel. An accompanying booklet gives helpful hints on the selection of laminated plastics for your specific application. Write for your copy of this handy Taylor Laminated Plastics Selection Guide today. Use it to make

tentative selections of the laminated plastics that most nearly fit your requirements. Then consult us on the design and application of laminated plastics and parts fabricated from them before making a final decision. Our application engineers will be glad to discuss them with you. Write Taylor Fibre Co., Norristown 53, Pa.

Simplifies Laminate Selection

Suggested applications of different grades of Taylor Laminated Plastics



For the fabrication of springs, silent gears, pinions, cams and bearings: Taylor Grade C—a phenolic resin, cotton fabric base, mechanical grade and Taylor Grade L, a phenolic resin, fine weave cotton fabric base grade.

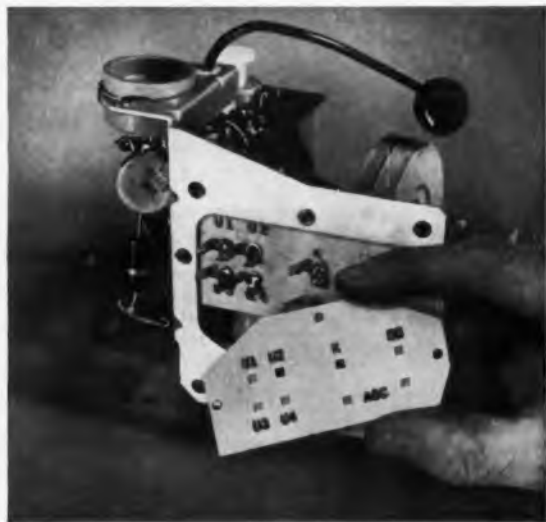

For high-temperature electrical applications and high-frequency radio equipment: Taylor Grade GSC—a silicone resin, glass fabric base, high-heat-resistant electro-mechanical grade.

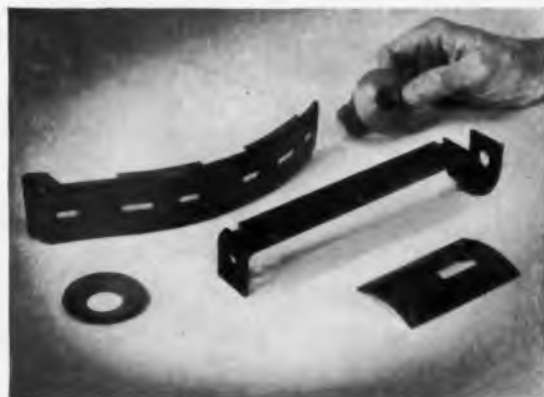

For forming into intricate shapes, compound curves, and deep draws: Taylor Grade C-7—a phenolic resin, cotton fabric base, postforming grade. Also Taylor XX-7—a phenolic resin, paper-base postforming grade.



For applications requiring high-strength retention at elevated temperatures: Taylor Grade GEC—an epoxy resin, glass-fabric base grade.

Taylor

LAMINATED PLASTICS VULCANIZED FIBRE

CABLE-*bility*!



OVER 70 APPROVALS to MIL-C-17B

AMPHENOL Cable & Wire Division leads the entire industry in qualification approvals of RG-/U coaxial cables to MIL-C-17B. Now, this is not important unless you're an engineer on a demanding project or a purchasing agent up against multiple-sources trouble. Single-source is a real advantage if you are. From AMPHENOL Cable & Wire Division you may count on fast delivery from stock of approved MIL-C-17B USAF and Navy specification cables. In addition, many cables manufactured to JAN-C-17A are also available from stock. Over 140 RG-/U cables are available in all.

Behind this wide availability stands unrivalled engineering talent to provide assistance in problem areas where presently available cables are not the answer. In standards or in specials, AMPHENOL Cable & Wire *Cable-bility* can help you!

A new edition of the authoritative AMPHENOL cable catalog is now being prepared. May we add your name to our distribution list?



CABLE & WIRE DIVISION
S. HARLEM AVE. at 63rd ST., CHICAGO 38
AMPHENOL-BORG ELECTRONICS CORPORATION

Letters

to the Editor

"Case for DC Restoration"

Editor, ELECTRONIC INDUSTRIES:

Congratulations on the publication of R. J. Nissen's article on "The Case for DC Restoration" which appeared in your January 1960 issue.

We have been advocating the return to the use of DC restoration for many years, without much success.

We would like to have about 20 reprints to send to our engineering representatives in the field in the hope of renewing interest in this worthy undertaking.

If you will inform me of the cost of the 20 reprints, a purchase order will be prepared.

N. R. Olding,
Operations Engineer
Canadian Broadcasting Corporation
P. O. Box 10, Snowdon, Montreal, P.Q.

"Human Factors"

Editor, ELECTRONIC INDUSTRIES:

My compliments to you and your staff, and especially to Mr. Christopher Celent, for your excellent special editorial staff report in the February 1960 issue of ELECTRONIC INDUSTRIES, "Human Factors" — Newest Engineering Discipline.

This constitutes the most complete coverage of human engineering activities that I have yet seen. To my knowledge, only two significant activities in engineering psychology were neglected in your report: (1) those of the Laboratory of Aviation Psychology, Ohio State University, and (2) those of the Vehicle Dynamics Department, Cornell Aeronautical Laboratories. Your readers might be interested in knowing, also, that Dr. Paul M. Fitts (who first headed the engineering psychology work at the Aeromedical Laboratory, Wright Air Development Center, and later directed the work at the Laboratory of Aviation Psychology, Ohio State University, but is now located at the University of Michigan) generally offers a "short course" in engineering psychology during the summer.

Earl A. Alluisi, Ph.D.
Assistant Professor
Emory University, Atlanta 22, Ga.

Editor, ELECTRONIC INDUSTRIES:

I was very pleased to note your excellent special staff report on HUMAN FACTORS in the February issue of ELECTRONIC INDUSTRIES. It assembles ideas from a wide enough variety of applications to catch the attention of many people.

I should very much appreciate it if you could send us 2 reprints of the report, one for the Human En-
(Continued on page 56)

TAPCO ELECTRONIC COMPONENTS

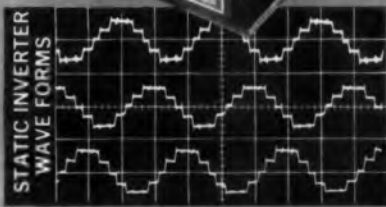
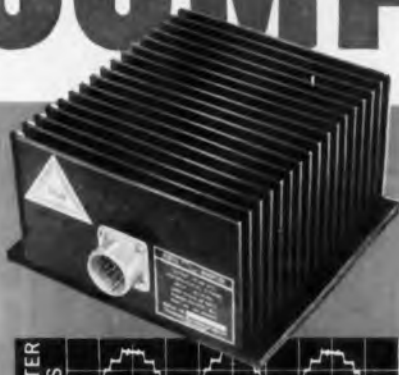

UNFILTERED

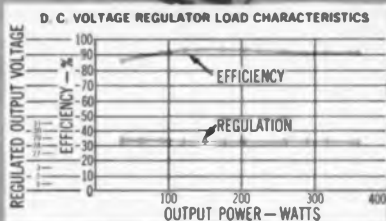

STATIC INVERTER—The Tapco inverter employs special logic and power circuitry which generates the three-phase output shown in the photograph at left. This technique of "synchronous switching"* provides an output which is essentially devoid of 3rd and 5th harmonics and their multiples as well as all even harmonics. Although the resultant wave form can be used unfiltered in many applications, a total harmonic distortion of less than 5% can be obtained with a filter that is appreciably smaller and lighter than would be required to filter a square wave. Special controlled rectifier output circuitry provides both efficient voltage regulation and short circuit protection. Switched mode operation throughout insures maximum efficiency as well as minimum size and weight.

*Patent applied for

PERFORMANCE DATA—**Input Voltage d.c.**: 18-31 vdc. **Output Voltage 3-phase**: 115 vac $\pm 1\%$, WYE or DELTA connected. **Output Power**: 500 VA. **Power Factor**: Unrestricted. **Output Frequency**: 400 cps $\pm 0.02\%$ standard $\pm 0.0001\%$ where required. **Distortion**: Less than 5%. **Maximum ambient at full load**: 125°C. **Wave Form**: Sine wave. **Short Circuit Protection**: Limits to 300% rated current. **Efficiency Full Load**: 85%. **ENVIRONMENTAL DATA** **Vibration**: 10g through 3000 cps. **Shock**: 40g. **Acceleration**: 12g for 5 minutes. **Temperature**: -55°C to +125°C. **PHYSICAL DATA**—Envelope Dimensions Including Fins: 4.5" x 9" x 10". **Weight**: 25 lb.

VOLTAGE REGULATOR—This regulator utilizes a pair of silicon controlled rectifiers in a full-wave, buck-boost configuration. By means of a fast response magnetic amplifier, this circuit simultaneously provides efficient voltage regulation, transient elimination, and short circuit protection. A stable internal d.c. reference in conjunction with the magnetic amplifier provides the necessary control to maintain an output voltage constant to within $\pm 0.7\%$. Efficiency of over 90% is obtained with d.c. input voltage variations as high as 22 to 30 vdc.

PERFORMANCE DATA—**Voltage Regulation** (Under worst combination of load, environment, input power): $\pm 0.7\%$. **Input Voltage d.c.**: 22-30 vdc. **Output Voltage d.c.**: 28.3 $\pm 0.7\%$. **Input Voltage a.c.**: 115v $\pm 5\%$, 2000 cps $\pm 1\%$. **Output Power**: 350 watts. **Output Ripple**: 15 mv peak to peak. **Efficiency Full Load**: 90%. **Transient Protection**: Will absorb up to 46 volts peak at the d.c. input terminals. **Short Circuit Protection**: Current limited to 300% rated current. **Output Impedance**: .02 ohms d.c., 2 ohms 10 cps to 40 kc. **ENVIRONMENTAL DATA**—**Vibration**: 10g through 3000 cps. **Shock**: 40g. **Acceleration**: 12g for 5 minutes. **Temperature**: -65°F to +165°F. **PHYSICAL DATA**—**Size**: 3" x 4" x 6". **Weight**: 5.3 lbs.



TAPCO GROUP
Thompson Ramo Wooldridge Inc.

CLEVELAND 17, OHIO

DESIGNERS AND MANUFACTURERS FOR THE AIRCRAFT, MISSILE,
ORDNANCE, ELECTRONIC AND NUCLEAR INDUSTRIES

TAPCO GROUP, Dept. EI-488
Thompson Ramo Wooldridge Inc.
Cleveland 17, Ohio

Please send me a Product Data Folder on:

Static Inverter Voltage Regulator

Name _____

Title _____

Company _____

Address _____

CORES CAN BE SMALLER AND LIGHTER, ASSURE LOWER LOSSES, REQUIRE LESS COPPER IF MADE OF ARMCO THIN ELECTRICAL STEELS

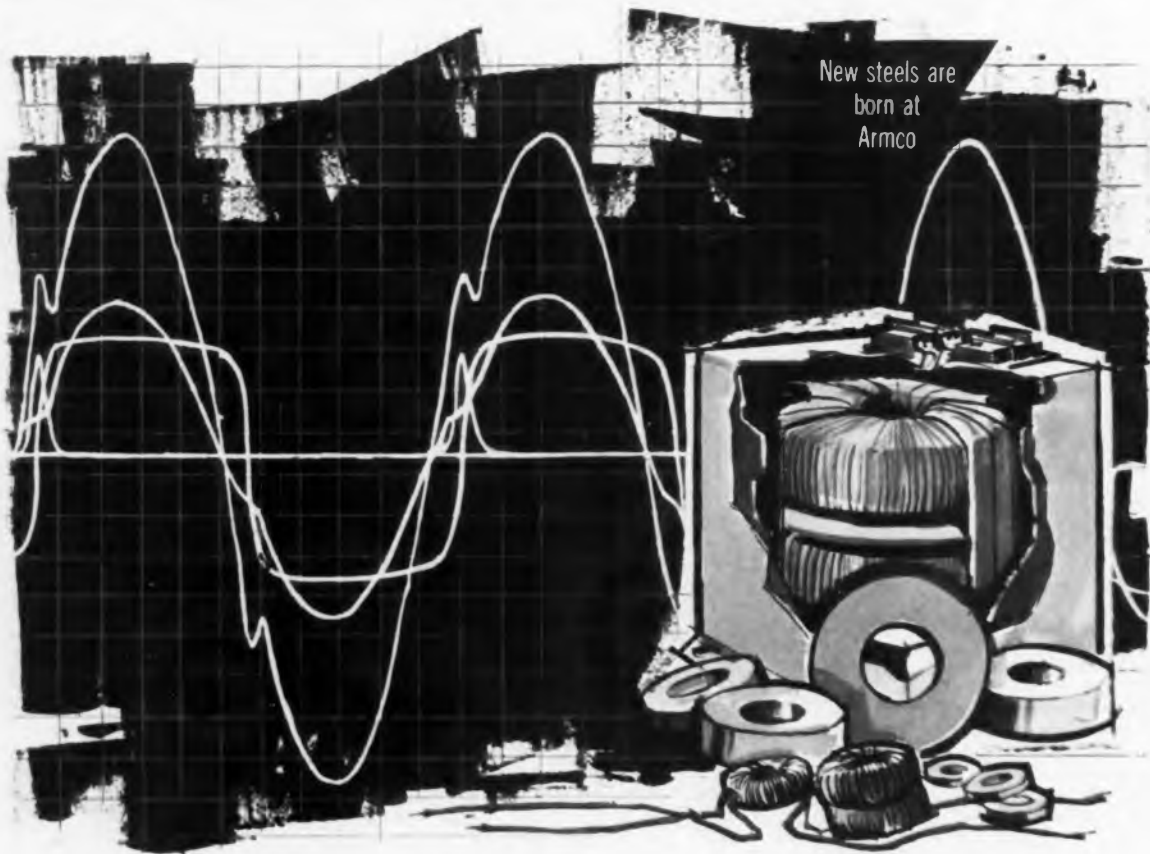

Exceptional magnetic properties and extensive design data offer opportunities to improve performance and cut cost of magnetic and electronic units for 400 to 2000 cps and higher frequency service.

Armco Thin Electrical Steels offer you these advantages because they have a unique combination of magnetic and physical properties assured by precise processing and control:

- Exceptionally high permeability
- Low hysteresis loss
- High lamination factor
- Minimum interlaminar loss
- Properties fully developed at the mill

Available in three different grades, Armco Thin Electrical

Steels enable you to select the material most precisely suited to your requirements.

Armco TRAN-COR T— A non-oriented grade, available in 7 and 5 mil thicknesses.

Armco ORIENTED T— Best permeability, in rolling direction, 4, 2, and 1 mil thicknesses.

Armco ORIENTED TS— Super-oriented with exceptionally high permeability, 4 mil thickness.

Use the properties of Armco Thin Electrical Steels to improve performance and reduce both the size and cost of your products. Extensive design data is available to help you utilize their advantages most effectively. Just write Armco Steel Corporation, 1410 Curtis Street, Middletown, Ohio, for complete information.

ARMCO STEEL



Armco Division • Sheffield Division • The National Supply Company • Armco Drainage & Metal Products, Inc. • The Armco International Corporation • Union Wire Rope Corporation

The Newest from
MINCOM
 the **CM-100**
 records & reproduces **6 SPEEDS**

1 mc - 120 ips - 12 min.
 500 kc - 60 ips - 24 min.
 250 kc - 30 ips - 48 min.
 125 kc - 15 ips - 96 min.
 100 kc - 12 ips - 120 min.
 62.5 kc - 7.5 ips - 192 min.

7 TRACKS ON
 1/2" TAPE

Greater bandwidth at a given speed—in six words that's the story of Mincom's newest system, the Mincom Model CM-100 Magnetic Tape Instrumentation Recorder/Reproducer. There's more, too: one-rack compactness, no belt changes, dynamic braking, complete compatibility, modular construction. For versatile and reliable performance in any instrumentation application, the CM-100 stands alone. Interested? Write today for brochure.



... WHERE RESEARCH IS THE KEY TO TOMORROW

MINCOM DIVISION **M**INNESOTA **M**INING AND **M**ANUFACTURING COMPANY

2049 SOUTH BARRINGTON AVENUE • LOS ANGELES 25, CALIFORNIA

Not a worry in the world...



THIS IS ONE SNAP-IN CONTACT THAT WON'T PULL OUT!

...the Deutsch snap-in contact, of course—guaranteed to withstand 25 pounds pull. In Deutsch DS miniature connectors, each pin and socket is locked in place by an exclusive, patented spring mechanism.

WHAT'S MORE... Deutsch-designed tools whip the problem of fast, reliable crimping (hand or automatic)—insertion and removal.

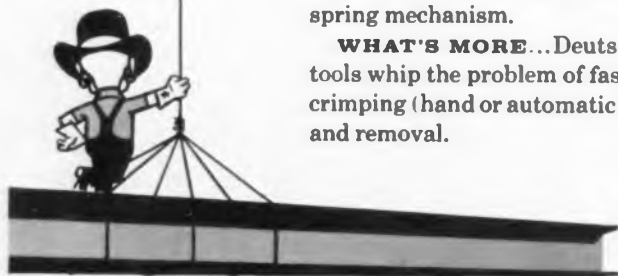

And...just glance at these specs:

- Deutsch-designed crimp, stronger than the wire itself (AN #18 wire and smaller)
- 7 shell sizes, with alternate clocking and insert arrangements
- exclusive Deutsch ball-lock coupling
- superior interfacial seal
- silicone inserts; no shrinkage, bonding or reversion
- temperature range -67° to in excess of 300° F
- seal before electrical contact
- interchangeable with existing Deutsch DM (MS) miniatures and hermetics
- meet all applicable requirements of MIL-C-26482

So why worry? For details on completely reliable snap-in type connectors, contact your local Deutsch representative or write for data file A-4.

The Deutsch Company
ELECTRONIC COMPONENTS DIVISION
Municipal Airport • Banning, California



Letters

to the Editor

gineering Branch office and one for Mr. Coburn's Man-Machine Section office. We think it would be very useful as reference reading for visitors to our offices.

C. M. Harsh, Head
Human Engineering Branch
U. S. Navy Electronics Laboratory
San Diego 52, California

Editor, ELECTRONIC INDUSTRIES:

My attention has been recently directed to your article, "Human Factors"—Newest Engineering Discipline, which appeared in the February 1960 issue of *ELECTRONIC INDUSTRIES*. Your article is one of the most complete and comprehensive outlines of current human factors areas being covered by industry, military organizations, and consulting firms. I would like to offer my heartiest congratulations for your participation in gathering this information and in the preparation of the article per se.

Dr. V. A. Sklodowski, Director
Human Factors Engineering Group
Avco Corporation
Crosley Division
Cincinnati 25, Ohio

Editor, ELECTRONIC INDUSTRIES:

Your special staff report, "Human Factors in Engineering Design," appearing in the current issue of *Electronic Industries* has provided the basis for extensive discussions within our engineering department. The two copies of the article we have available are becoming dog-eared with use—may we have three (3) re-prints?

We would like to congratulate you on the breadth of coverage given the field of human factors and upon the understanding of the role of human engineering exhibited in your coverage of this relatively new and controversial discipline.

Wesley E. Woodson, Head
Human Factors Engineering Group
Convair
P. O. Box 1950
Mail Zone 6-141
San Diego 12, California

"Frequency Chart"

Editor, ELECTRONIC INDUSTRIES:

Thanks sincerely and very much for the new multi-color frequency chart that your staff has prepared. This is a service of primary importance to the industry and I congratulate you on the achievement.

Dorman D. Israel
Exec. Vice-Pres.
Emerson Radio and Phonograph Corporation
14th and Coles Sts.
Jersey City 2, N. J.

© 1960 THE DEUTSCH COMPANY

BOURNS TRIMPOT® WITH BUILT-IN TEMPERATURE STABILITY

Stable settings under extreme temperature conditions is an outstanding feature of the Trimpot® potentiometer. This thermal stability is built-in through all phases of design and production—

MATCHED COEFFICIENTS OF THERMAL EXPANSION

Resistance wire and mandrels have matched coefficients of thermal expansion to reduce the "strain gage effect." Linear expansion rates for the mandrel and wire match so closely that the temperature coefficient value for the entire wirewound element approximates that of the wire itself.

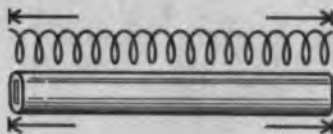

THERMALLY STABLE CERAMIC MANDRELS

Bourns takes advantage of high thermal stability of ceramic materials for element mandrels. Today, all Bourns Trimpot potentiometers provide the improved performance and reliability afforded by ceramic materials.



EXCLUSIVE SILVERWELD® TERMINATION

Silverweld is an actual metal-to-metal fusion of element wire and external terminal. In doing away with mechanical or soft-solder joints, Bourns eliminates potential hot spots thus extending the potentiometer's temperature range. The fusion of the Silverweld terminal to many turns of wire on the resistance element avoids the problem of single wire termination. Silverweld is virtually indestructible under thermal stresses.

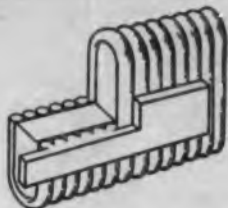

EXCLUSIVE TENSION CONTROL EQUIPMENT

Bourns has developed specialized winding equipment that provides constant and precise control of wire tension during winding operations. "Necking" of the wire or resistance-altering stresses never occur. Instead the wire remains uniform—well able to withstand temperature variations with no appreciable change in resistance.

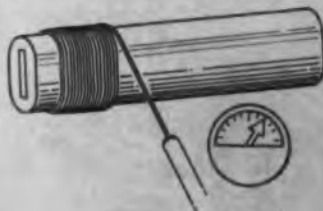

Specify Trimpot—the original leadscrew-actuated potentiometer with reliability on which you can depend. 20 basic models—4 terminal types—3 mounting styles.



Write for new Trimpot summary brochure and list of stocking distributors.

Exclusive manufacturers of Trimpot®, Trimit® and E-Z-Trim®. Pioneers in transducers for position, pressure and acceleration.

**ENGINEERED
COMPONENTS**
for the Electronic
Industry



Garlock electronic components are skillfully engineered for high temperature, high voltage, high frequency service.

**WHERE RELIABILITY
IS CRITICAL**

1. Chemelec® Stand-Off and Feed-Thru Insulators are easy to install, resistant to heat and breakage, and—above all—reliable under severest conditions . . . ideal for critical electronic circuits such as missile guidance, fire control, tracking, radar systems. Teflon**—due to its excellent dielectric, mechanical and thermal properties—is used as the insulator body. And, Chemelec Compression-Mounted Stand-Off and Feed Thru Insulators are designed for easy installation. You simply press them into pre-drilled holes; they become self-fastening, requiring no additional hardware or adjustment. Available in compression-mounted, metal-base, miniature and sub-miniature types . . . standard R.M.A. colors, a wide range of sizes and terminal designs.

2. Chemelec Sub-miniature Tube and Transistor Sockets have body insulating material of Teflon; contact material of brass, silver-plated and gold flashed. Capacitance pin to pin .6 MMF—pin to $\frac{1}{16}$ " Chassis .7MMF. Chassis retention 50 lbs min. in $\frac{1}{16}$ " panel. Contact retention 4 oz. per pin.

3. Chemelec Connectors are Teflon-insulated for outstanding high frequency service. Once installed, they require no further adjustment or hardware. .040, .050, .064 pin size, female also in .080 size.

4. Plastic Stock Shapes and Intricate Parts, inserts, thin sections, threaded parts to precision tolerances are available. Excellent facilities and experience in compression and injection molding, extruding, machining of Teflon, Nylon, Delrin**, Kel-F† or other industrial plastics.

Garlock facilities and personnel are at your disposal for design and development of new electronic products.

G A R L O C K
ELECTRONIC PRODUCTS

Garlock maintains complete electrical, chemical, and physical laboratories staffed by top-flight research and development engineers.

Find out more about what Garlock offers. Contact the Garlock Electronic Products representative near you. Call him, or write for Catalog AD-169, Garlock Electronic Products, The Garlock Packing Company, Camden 1, New Jersey.

*Registered Trademark **DuPont Trademark
†Trademark, Minnesota Mining & Manufacturing

FROM
 VARIAN:
 A LINE
 OF RUGGED,
 PM FOCUSED
 BACKWARD WAVE OSCILLATORS

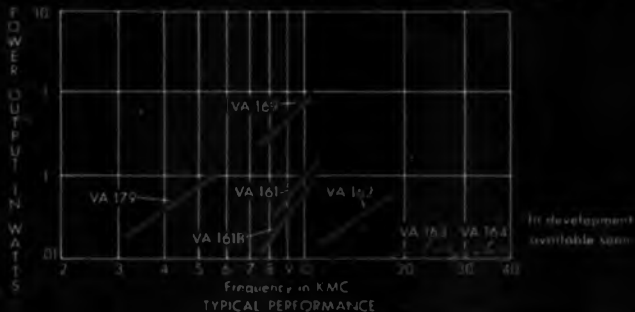

Varian now offers a line of permanent magnet focused backward wave oscillators in frequency ranges to cover a wide variety of circuit application requirements. All models feature small size low voltage operation, long life expectancy and rugged construction. These tubes are available either from stock or on short delivery schedules. The metal and ceramic construction offers the most reliable tube at the lowest cost and assures dependability in severe environments. Typical applications for Varian BWO's are: signal generators, electronic countermeasures and systems requiring frequency agility.

Varian is the world's largest manufacturer of klystrons. Our new catalog illustrates and describes our complete line...write for your free copy. Address Tube Division.



VARIAN associates
 PALO ALTO, CALIFORNIA

Electronics, Tube, Tube, and Switching Tubes, Magnetrons, High Vacuum Equipment, Linear Accelerators, Microwave System Components, and a wide variety of electronic equipment. MAGNETOMETERS, STALDS, POWER AMPLIFIERS, GRAPHIC RECORDERS, RESEARCH AND DEVELOPMENT EQUIPMENT.



What do **you**
know about the
VICTOREEN
COROTRON*?

Only the name—Corotron—is new. Victoreen has been the leading manufacturer of Corona Type Voltage Regulator Tubes for over 9 years. During that period reliability-conscious electronic designers have successfully applied them to high-voltage circuits for voltage regulation. Chances are there's a tube to solve your voltage regulation problem, too. Contact our Applications Engineering Department for full details.

A-505A

*Victoreen's name for Corona
Type Voltage Regulator Tubes



Victoreen

5806 Hough Avenue • Cleveland 3, Ohio
Export Department, 240 West 17th St., New York 17, N. Y.

Letters

to the Editor

"Outlooks and Reviews"

Editor, ELECTRONIC INDUSTRIES:

I know you will be interested to learn that the tremendous pulling-power of ELECTRONIC INDUSTRIES has just been demonstrated again. The announcement in your editorial in the February 1960 issue brought such a flood of requests for the Electronic Industries Outlook for 1960 and Review of 1959 that we found it necessary to develop a form letter to cope with them. So many requests came in that we ran out of copies, and are now referring inquirers to the Superintendent of Documents for the "U. S. Industrial Outlook for 1960."

We were certainly pleased with the nice comments on the usefulness of our reports on the electronic industries.

(Signed) Donald S. Parris
Director
Electronic Industries

U. S. Department of Commerce
Business and Defense Services
Administration
Washington 25, D. C.

Wall Street Has Data Processing Center

The first full range Electronic Data Processing Center designed to serve all types of firms in New York's financial business community was opened at 45 Wall St. by the Radio Corp. of America. This new center cost \$4½ million. The center's operation, says RCA, can cut the present paper work of brokerage firms in half. The average cost of using the Center will range from 50¢ to \$1.50 per trade in most cases—a saving of up to 50%.

The Wall St. Center is equipped with two RCA 501 electronic data processing systems. The systems are completely transistorized. The center will be staffed by 90 RCA specialists — systems planners, programmers, operators and maintenance experts—and will operate around the clock, processing a day's business for any firm for delivery the following morning.

At the outset, clients are expected to hand-deliver records of transactions and other punch-card form. Ultimately, data will be transmitted by wire from the client to the center and reproduced on perforated tape.

Solid State Reliability

IN A 10 mc Counter



The CMC 700 Series is the only major breakthrough in counting, timing and frequency measuring equipment in the past 10 years. Here is the first successful application of transistors to high frequency counting and timing. Transistors perform all the functions in CMC's 700 series that required 63 tubes in old style counting equipment. These are the most reliable counters ever made.

TRUE DIGITAL LOGIC CIRCUITRY

By answering an obvious need for a completely new, up-to-date approach to counting and timing instrumentation, CMC has produced solid state instruments with greatly simplified circuitry, using logic "and" and "or" gates.

LIGHT AND SMALL, LOWER POWER DRAIN

Each 700 series instrument weighs only 27 pounds, measures 7 inches high, 17 inches wide, and 14 inches deep. Power consumption is a meager 46 watts, 1/10 the amount for vacuum tube models.

DO ALL THESE JOBS

Measure frequency from dc to 10 mc, time interval from 0.1 μ sec, ratio 1 cps to 1 mc and unlimited multiple period selection. Frequency converters available for higher frequencies. The counter also generates time interval marker pulses from 1 μ sec to 1 second. Data can be presented on standard decades or inline Nixie tubes. The 700 series will operate digital recording equipment, punches, inline readouts, and other data handling gear.

These Features, Too—Decade count-down time base — frequency divider circuits never need adjustment. Accuracy, ± 1 count \pm oscillator stability. Sensitivity, 0.25 v rms; input impedance, 25 k ohms/volt.

And The Price—Higher than vacuum tube models. But you can save the difference on down time in the first year. Model 727A Universal Counter-Timer, \$3,500; Model 707A Frequency-Period Meter, \$2,700; Model 757A Time Interval Meter, \$2,500. Rack mount optional at no extra cost. All prices f.o.b. Sylmar, California.

More Information Available — Your nearby CMC engineering representative will be happy to arrange a demonstration and provide you with complete technical information. Or you may write Department 44.



**Computer
Measurements Co.**

A Division of Pacific Industries

12970 Bradley Avenue, Sylmar, California
Phone: EMpire 7-2161

Measures 1 mv to 1000 v
from
15 cps to 6 mc

**BALLANTINE
WIDE-BAND
SENSITIVE
VOLTMETER**

Model 314

**gives
you
these
advantages:**



Price: \$300.

- Same accuracy and precision at ALL points on a logarithmic voltage scale and a uniform DB scale: 3% to 3 mc; 5% above.
- Only ONE voltage scale to read with decade range switching.
- Probe with self-holding connector tip enables measurements to be made directly at any point of circuit.
- High input impedance of 11 megohms shunted by 8 pf insures minimum loading of circuit.
- Can be used as 60 DB video pre-amplifier.

For 8 years this has been a widely-used instrument in the laboratory and for quality control

Write for brochure giving many more details



— Since 1932 —
BALLANTINE LABORATORIES INC.

Boonton, New Jersey

CHECK WITH BALLANTINE FIRST FOR LABORATORY AC VACUUM TUBE VOLTMETERS, REGARDLESS OF YOUR REQUIREMENTS FOR AMPLITUDE, FREQUENCY, OR WAVEFORM. WE HAVE A LARGE LINE, WITH ADDITIONS EACH YEAR. ALSO AC DC AND DC AC INVERTERS, CALIBRATORS, CALIBRATED WIDE BAND AF AMPLIFIER, DIRECT READING CAPACITANCE METER, OTHER ACCESSORIES

Personals

Dr. Joseph Neustein has joined the staff of Electro-Optical Systems, Inc., Pasadena, Calif., as Head of the Advanced Power Systems Dept. of the Energy Research Div.

Dr. Leo Esaki, discoverer of the Esaki diode, has joined IBM as a Resident Consultant. He will work with the IBM Semiconductor Research Dept. at Poughkeepsie.

James R. Fisher is now Product Specialist on piezoelectric ceramic materials for the Sprague Electric Co., North Adams, Mass.



J. Fisher



G. Walsh

George W. Walsh has received a Special Act Award for his work in the design, development and testing of a fuze for the BOMARC missile from the Diamond Ordnance Fuze Labs.

J. P. Field has been promoted to Staff Assistant to the General Manager and R. R. Wendt promoted to Manager of Quality and Reliability at Bendix Products Div., Mishawaka, Ind.

Col. Robert F. Sladek, USAF, Ret., has joined Page Communications Engineers, Inc., Washington, as Assistant Director of Engineering for Administration.

Dr. Philip G. Lichtenstein, Electronic Scientist, has joined the staff of the U. S. Naval Radiological Defense Laboratory in San Francisco, working with the Technical Engineering Branch.

Hazeltine Research Corp. has announced the appointment of William F. Bailey, Richard J. Farber and Donald Richman as Associate Directors of Research.

Irving K. Cohen has joined the Technical Staff of Ramo-Wooldridge, a division of Thompson Ramo Wooldridge Inc. as a member of the Intellectronics Labs.

John P. Jasionis has been named Technical Operations Manager of the Research Laboratory for the Electron Tube Div. of Litton Industries, San Carlos, Calif.

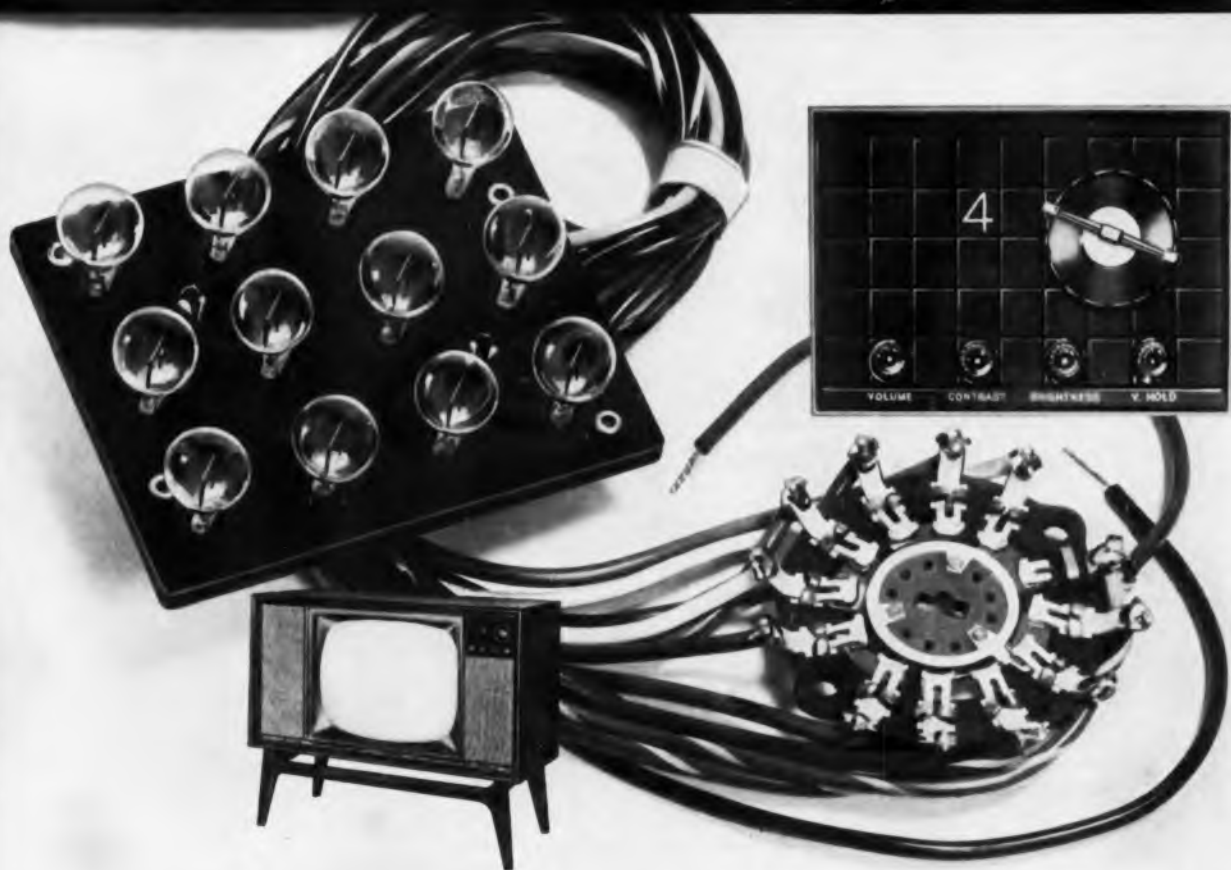

Tung-Sol lamps give long life light-up to *Packard Bell* TV "Computer Control"

By adapting computer readout techniques, Packard-Bell has come up with an exclusive TV tuning device that makes channel selection an exciting, space-age treat. Featured on all new Packard-Bell TV sets, "Computer Control" flashes each TV channel number into its proper position on the computer panel as you dial.

Tung-Sol lamps supply the readout illumination so that clear, bright figures are displayed with across-the-room visibility! Packard-Bell engineers selected the Tung-Sol #12 Baseless Lamp for its outstanding reliability and long life. Such full-life dependability results from Tung-Sol's unparalleled manufacturing processes and unexcelled quality standards.

Whatever your lamp requirements for instrument panels or any other low

voltage application, there's a Tung-Sol miniature lamp ready to provide the exact service you need. Initial equipment manufacturers have long depended on Tung-Sol not only to supply both 'stock' and 'special' lamps of superior quality, but also to meet the strictest delivery schedules.

In view of the apparent similarity between many lamp types, it is recommended that you consult Tung-Sol before freezing your design. Our lamp experts will help you select the precise unit for your application. Tung-Sol Electric Inc., Newark 4, New Jersey. TWX: NK 193.

Technical assistance is available through the following sales offices: Atlanta, Ga.; Columbus, Ohio; Culver City, Calif.; Dallas, Texas; Denver, Colo.; Detroit, Mich.; Irvington, N. J.; Melrose Park, Ill.; Newark, N. J.; Philadelphia, Pa.; Seattle, Wash. Canada: Montreal, P. Q.



TUNG-SOL®

Circle 47 on Inquiry Card

Monadnock Mills expands its line of HARD-ANODIZED INSULATOR WAFERS for semi-conductors to include STUD MOUNTED DIODE WAFERS

Five diameters for stud sizes 8-32, 10-32 and $\frac{1}{4}$ -28 are now in stock... additional sizes will be available shortly.

Diode wafer part no. 294833 for 8-32 stud
Diode wafer part no. 294835 for 10-32 stud
Diode wafer part no. 294836 for 10-32 stud
Diode wafer part no. 294837 for $\frac{1}{4}$ -28 stud
Diode wafer part no. 294838 for $\frac{1}{4}$ -28 stud

Wafers designed for use with semi-conductors of other configurations are also available.

In common with Monadnock Mills power transistor wafers, these aluminum diode wafers feature thermal conductivity 400% greater than conventional mica wafers of comparable thicknesses and dielectric properties equal to the best insulating materials. The thin, hard-anodized aluminum wafer insulates semi-conductor from chassis and dissipates the substantial heat generated at rated capacities. Unlike mica that is fragile and difficult to handle, the hard-anodized wafer is extremely durable with high abrasion and corrosion resistance. Wafer is installed between semi-conductor and chassis, heat sink or other surface on which the semi-conductor is mounted. Write for bulletins.

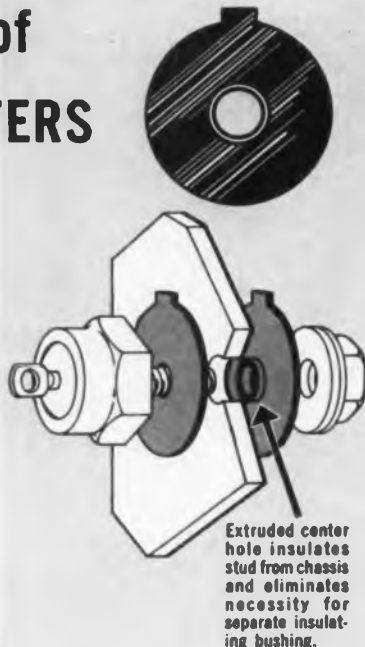

Power transistor wafer part no. 294665



Power transistor wafer part no. 294666

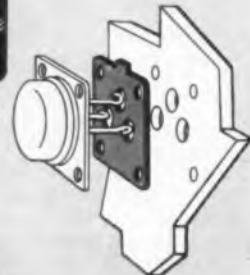

Power transistor wafer part no. 294457

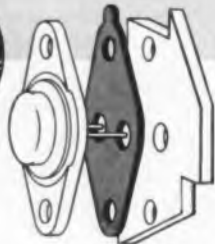

MONADNOCK MILLS
SAN LEANDRO, CALIFORNIA

SUBSIDIARY OF
UNITED-CARR FASTENER CORP., BOSTON, MASS.

OFFICES: ATLANTA, BOSTON, CHICAGO, CLEVELAND, DALLAS, DETROIT, LOS ANGELES, NEW YORK, PHILADELPHIA, SYRACUSE

Experience—the added alloy in A-L Electrical Steels

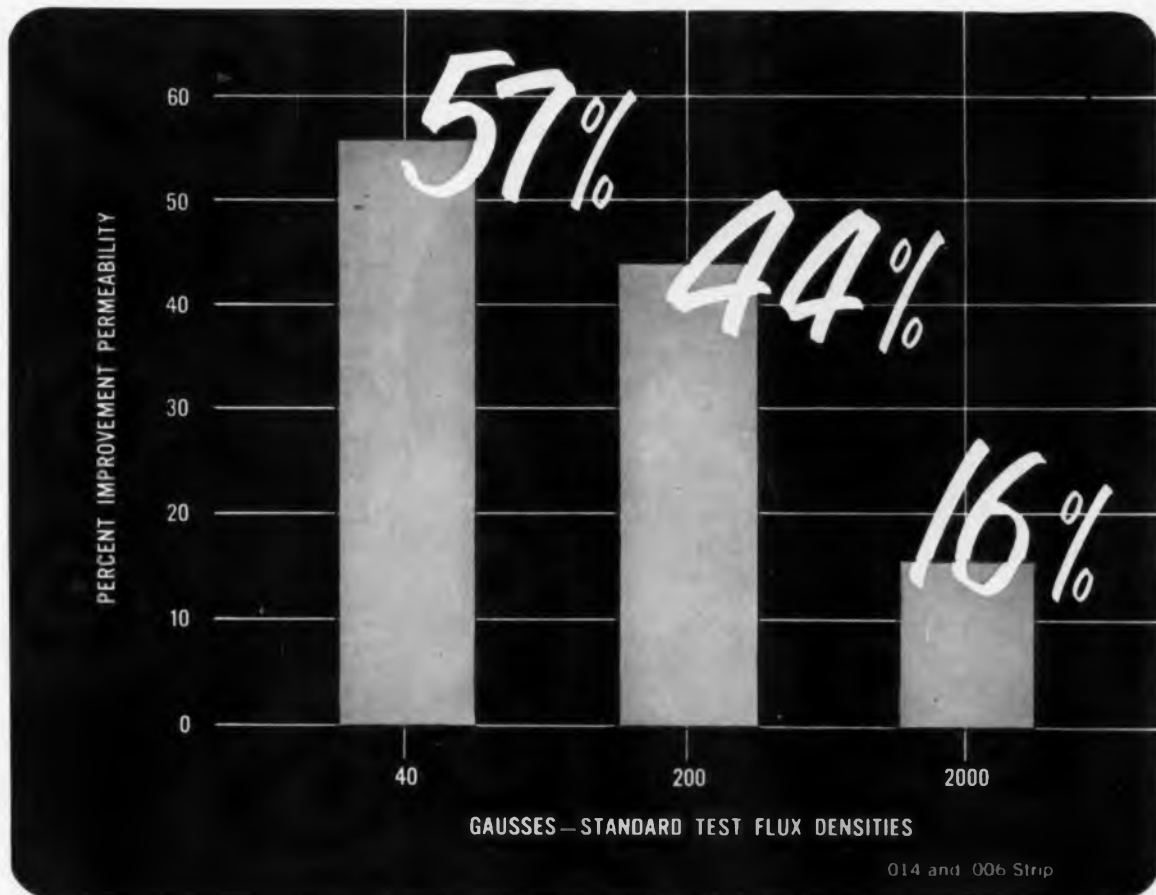

Greater permeability for Allegheny Ludlum's AL-4750...and it's *guaranteed*

promises more consistency, higher predictability for magnetic cores

AL-4750 nickel-iron strip now has higher *guaranteed* permeability values than ever before. For example, at 40 induction gaussses AL-4750 now has 57% higher permeability than in the past, using the standard flux density test.

This greater permeability means better consistency and predictability for magnetic core users . . . and allows careful, high performance design.

This improvement in AL-4750 is the result of Allegheny Ludlum's continuing research on electrical alloys and

nickel-bearing steels. Moly Permalloy has been similarly improved in permeability. A-L constantly researches silicon steels, including A-L's well-known grain-oriented silicon, Silectron, and other magnetic alloys.

Complete facilities for the fabrication and heat treatment of laminations are available at Allegheny Ludlum. And A-L's technical know-how guarantees you close gage tolerance, uniformity of gage throughout the coil and minimum spread of gage across the coil-width.

If you have a problem on electrical steels, laminations or magnetic material, call A-L for prompt technical assistance. Write for blue sheet EM-16 for complete data on AL-4750. *Allegheny Ludlum Steel Corporation, Oliver Building, Pittsburgh 22, Pa. Address Dept. EI-28.*

7481

ALLEGHENY LUDLUM
STEELMAKERS TO THE ELECTRICAL INDUSTRY

Export distribution, Electrical Materials: AIRCO INTERNATIONAL INC., NYC 17
Export distribution, Laminations: AD. AURIEMA, NYC 4



What makes this transmitter possible?



**100 KW
BANDSWITCHING
TRANSMITTER
ELIMINATES
TUNED
INDUCTANCES**

4. Vacuum capacitors in the output tuned circuit.

1. Exposed circuitry of transmitter.

2. Type MLC 1000 mmfd. vacuum capacitors for plate blocking. Band switching is accomplished with Type R1 vacuum switches.

3. Type VMMHC vacuum capacitors in the plate tank circuit. Switching from each output tank to a common lead is done with Type RC10 vacuum coaxial relays.

This 100 kw transmitter is used to test and establish ratings on Jennings high voltage vacuum components. The testing program may require rapid frequency changes to 2, 4, 8, 16 and 32 mc. Each band is tuned by motor driven vacuum capacitors. Single dial panel switching between bands is accomplished with vacuum relays.

Fixed inductances were desired in the tank circuit in order to avoid problems of maintenance and resetability associated with transmitters that use tap switches and sliding contacts. This was made possible by taking advantage of the low minimum capacitances, small size, and low inductance of vacuum variable capacitors. This circuitry would be particularly useful in any rf transmitter design demanding daily repetitive frequency changes.

Space reduction and efficiency were further improved by using Jennings vacuum relays with their high voltage and current carrying capabilities. The sealed contacts are clean and remain clean because they are free of all oxides and contaminants. In addition vacuum relays never need maintenance.

Write for our new vacuum component catalog summary. It may suggest the answer to some of your present high voltage problems

RELIABILITY MEANS VACUUM

VACUUM MEANS

Jennings

JENNINGS RADIO MANUFACTURING CORPORATION • 970 McLAUGHLIN AVE. P. O. BOX 1278 • SAN JOSE 8, CALIF.

Personals

Alan F. Culbertson is now Director of Engineering at Lenkurt Electric Co., Inc., San Carlos, Calif.

Homer A. Ray, Jr., has been selected for the newly created position of Engineering Assistant at Rixon Electronics Inc.

Airborne Instruments Laboratory (AIL), Deer Park, N. Y., has appointed Dr. E. G. Fubini and Dr. G. C. Comstock as Vice Presidents. They were formerly co-directors of AIL's Research and Engineering Div.

Two promotions in its engineering personnel at Cuba, N. Y., have been announced by Acme Electric. Clair Wentworth is now Chief Engineer of the Transformer section, and Dale Burdick is Chief Engineer of Power Assembly section.

Promotion of Dr. Joseph Hull to Director of the Research Laboratory of the Litton Industries Electron Tube Div. has been announced.

Dr. Robert T. Watson, has been appointed Associate Director of the Components and instrumentation Lab. of International Telephone and Telegraph Corp.

Frank A. Comerci has joined Audio Devices, Inc., as Sr. Project Engineer at the Stamford, Conn. lab.

Anthony Del Duca has been appointed Chief Engineer at Metrolog Corp., a div. of Air Logistics Corp.

Carlo V. Bocciarelli is now Associate Director of Philco Corp.'s Research Div. in charge of the Basic Science and Technology Dept.

Two design development engineers have joined the National Cash Register Co.'s Electronics Div., Hawthorne, Calif. They are Earl Q. Bowers and Richard J. Dempsey.

Dr. Raymond H. Warner, Jr., has been named Chief Engineer, Diode Development for the Semiconductor Div., Motorola, Inc., Phoenix, Ariz.

Dr. Robert C. Langford has been appointed Director of Engineering of the Newark Operations of Weston Instruments Div., Daystrom, Inc.

Six Project and Sr. Level Engineers have been added by the Systems Engineering Div. of Adler Electronics, Inc., New Rochelle, N. Y. They include Martin Heller, Project Engineer; George Gould, Norton Hight, Abraham Rubenstein and Bernard Schechtman, Sr. Engineers; and Jack Titen, Administrative Engineer.

this is
the Brush
Mark II...
anyone
can
plug
it in
put it
in writing
anywhere

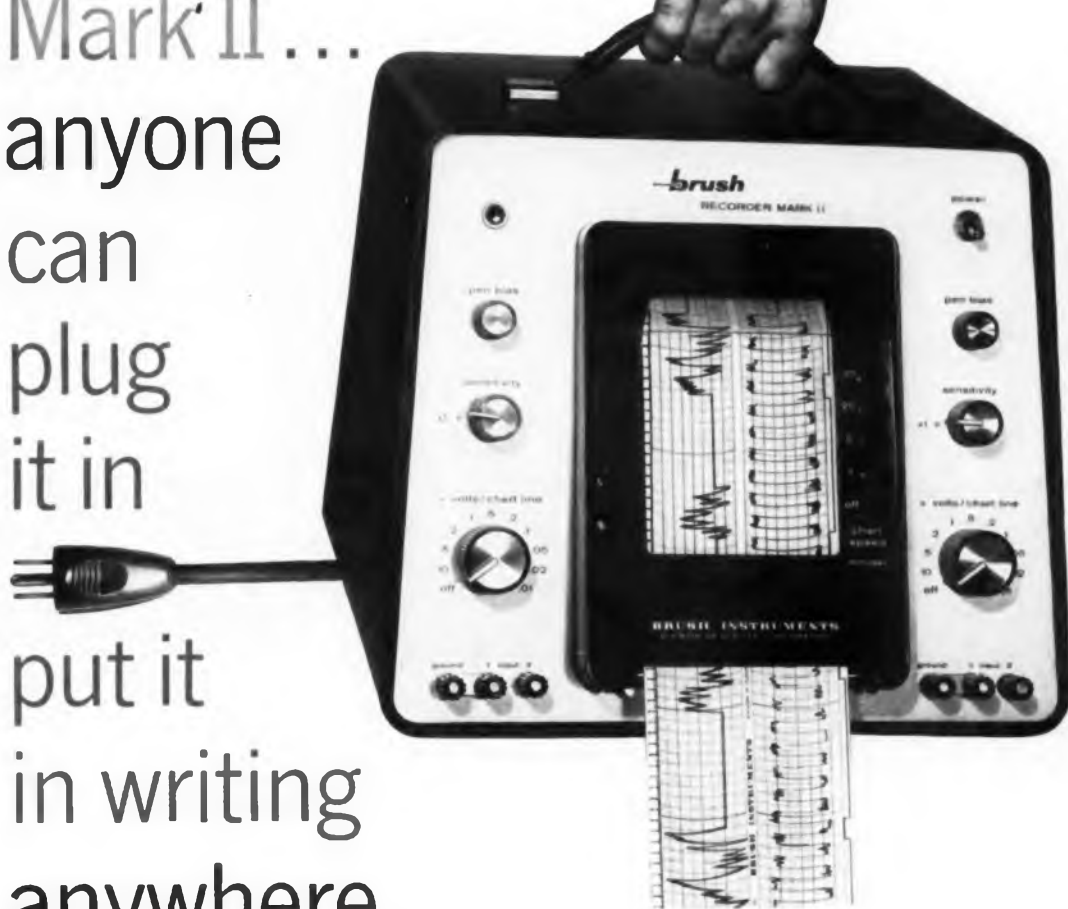

There is no direct writing recorder on the market that approaches the compact Mark II in sheer usefulness. It is a completely integrated engineering tool that can be operated by anyone . . . in the shop or in the field . . . for countless research or design requirements. Every function necessary for uniform, crisp, easily reproduced readouts is "built-in". The Mark II gives you two analog channels plus two event markers; 4 chart speeds; DC to 100 cps response with 40 mm amplitude; 10 mv/mm sensitivity; high input impedance. Immediate shipment from stock. Call, write or wire for complete details.

brush INSTRUMENTS

DIVISION OF
37TH AND PERKINS **CLEVITE** CORPORATION CLEVELAND 14, OHIO

for direct writing
 recording
 systems
 no one is
 as qualified
 as Brush

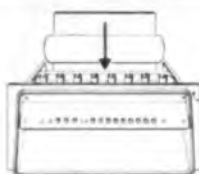

Chart paper loads from top



Trace contrast control

Simple pushbutton speed selection



Why? Simply because Brush recording systems such as this 6-8 channel unit incorporate all of the known refinements in the art of recording by direct writing. No comparable system in existence today is as compact . . . as simplified . . . as reliable . . . as versatile. Note slide-mounted oscillograph and interchangeable "plug-in" signal conditioners that provide four vital functions in addition to amplification: high input impedance, zero suppression, attenuation and calibration.

Instantaneous rectilinear presentation gives clear, uniform and reproducible traces for precise readout of telemetry, computer, ground control and other data gathering operations. Further, this functionally designed system has a "pull-out" horizontal writing table for convenient annotation and reading . . . without turning off the recorder! Check these and many other advanced features for yourself and you'll see why *no one* is as qualified as Brush. Call, write or wire for complete details.

brush INSTRUMENTS

DIVISION OF

37TH AND PERKINS

CLEVITE
CORPORATION

CLEVELAND 14, OHIO

Next month

● DESIGN for a DOUBLE COIL RELAY WITH ONE WORKING GAP

Rectangular shaped miniature relays dictate a two-coil design if sufficient ampere-turns are to be available. This design gives a two coil relay with a single working gap and the entire mechanical operation is close to the relay mounting surface for resistance to shock and vibration.

● HEAT SINKS for POWER TRANSISTORS

Heat transfer problems of semiconductor power devices differ from those encountered in vacuum tube techniques. Presented here is a simple method which enables the busy engineer to quickly determine the best heat transmission path.

● WIDE BAND AFC SYSTEM for KU BAND APPLICATION

This paper describes the wide band afc used in the Radar Target Simulator which is to be incorporated into an automatic tactical ground support equipment for the MD-7 fire control system. In order to keep operator skill at a minimum the target simulator must be completely automatic, acquiring the radar pulse frequency, locking on and sending a return target with proper con-scan modulation.

● ENCAPSULATING WITH ALKYD

A fabricating process for the encapsulation of small and intricate electrical and electronic devices which completely encases these parts within a protective shell of thermosetting material. Process features great speed and precision.

● APPLICATION of SOLID TANTALUM CAPACITORS to TIMING CIRCUITS

The application of solid tantalum capacitors to timing circuits is of increasing importance due to reliability and size reduction, particularly where long delays are required. Variations of timing with temperature and voltage can be of concern in this application, and a circuit designer will want to specify these capacitors which held timing variations within prescribed limits.

● ULTRASONIC WELDING

Ultrasonic welding is a mechanical process whereby solids are joined together through the action of high frequency vibrations. In order to be effective these vibrations must be transverse at the interface between the materials to be joined. Perpendicular vibrations of the same power level as the transverse ones will not produce welding effects. Above the threshold welds are obtained which appear to improve in strength for an increase in the sound energy.

Plus all our other regular departments

Our regular editorial departments are designed to provide readers with an up-to-the-minute summary of world wide important electronic events. Don't miss Radarscope, As We Go To Press, Elec-

tronic Shorts, Coming Events, El Totals, Snapshots of the Electronic Industries, El International, News Briefs, Tele-Tips, Books, Rep News, International Electronic Sources, Personals, Industry News, etc.

Watch for these coming issues

* JUNE ● 18th Annual (Verified Directory & All-Reference Issue

* AUGUST

Annual WESCON Issue

* NOVEMBER

Annual Microwave Issue

* JANUARY

Statistical Issue

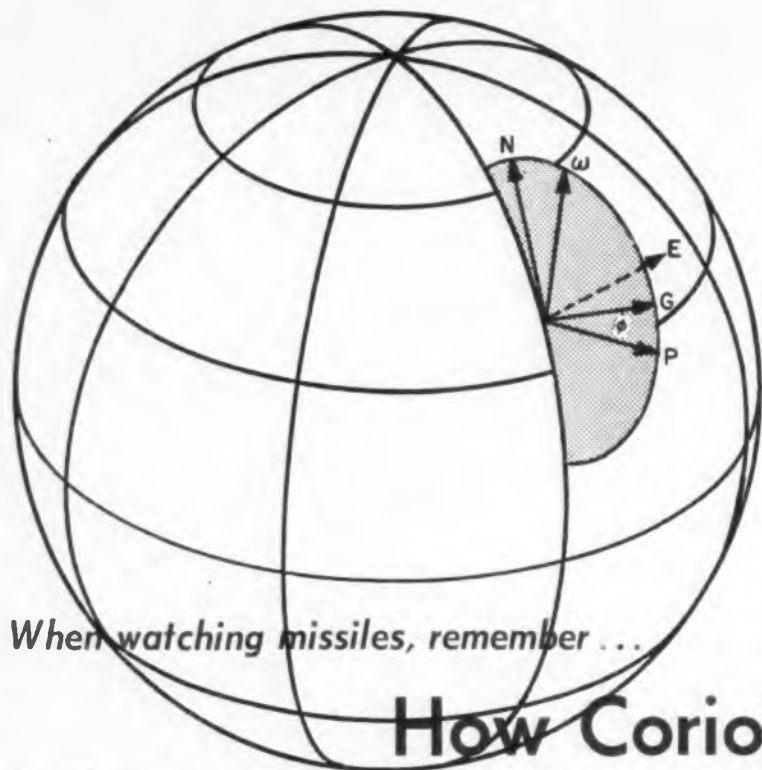

When watching missiles, remember ...

How Coriolis Works

Fig. 1: Basic assumptions for an earth-referenced coordinate system.

*Is that missile really veering?
How can the earth's rotation affect our vision?
Should we believe "only half of what we see"?
This article assists in getting an intuitive grasp
on an interesting subject—Coriolis.*

TO the earth-bound observer, whenever a body has a velocity it travels not in a straight line, but veers off to one side under the influence of an apparent force called Coriolis. Firing a missile from the rotating earth does, in fact, physically resemble playing catch on a merry-go-round. This is simply the result of transforming from a space coordinate system to the rotating earth system. The engineer working with high velocity vehicles and inertial navigation systems is interested in the various manifestations of this force.

Newtonian Motion

Newton's second law of motion holds true only when referenced to inertial space. The earth is a different coordinate system. Goldstein¹ shows the development of the coordinate transformation from Newtonian forces (referenced to inertial space) to earth-observed forces (referenced to a rotating spheroid). The vector equation for the coordinate transformation is:

$$A_e = A - 2\omega \times v - \omega \times (\omega \times r) \quad (1)$$

where A_e is the effective acceleration as seen by the observer on earth, A is the actual acceleration referenced to inertial space, ω is the earth's angular velocity (about 7.29×10^{-5} radians per second), v is the velocity of the vehicle with respect to earth, and r is the earth's radius vector.

Centrifugal Acceleration

The last term

$$-\omega \times (\omega \times r)$$

is the term for centrifugal acceleration. The algebraic sum of earth's centrifugal acceleration and mass is commonly felt as gravity.² Assuming a homogeneous spheroidal earth, gravity theoretically varies, at sea level, only with latitude.

The Coriolis Term

The Coriolis term

$$-2\omega \times v$$

will be expanded here, and physical effects described.

By RICHARD H. PARVIN

Supervisor, System Evaluation
 Minneapolis-Honeywell Regulator Co.
 Aeronautical Div., Inertial Guidance Center
 St. Petersburg, Florida

In the earth coordinate system, Fig. 1, the origin is any given point on the surface of the earth, ω is parallel to the polar axis, E is eastward, and P is perpendicular to ω and E . N and G are perpendicular to E . P and G are positive away from the earth. The angle ϕ is latitude, positive in the northern hemisphere and negative in the southern.

Converting the Coriolis term from vector notation to trigonometric terms and expanding, we have:

$$|-2\omega \times V_n| = -2\omega V_n \sin \phi = |A_e| \quad (2)$$

$$|-2\omega \times V_e| = -2\omega V_e = |A_p| = |A_g - jA_n| =$$

$$|A_p \cos \phi - jA_p \sin \phi| \quad (3)$$

$$|-2\omega \times V_g| = -2\omega V_g \sin(90 - \phi) =$$

$$-2\omega V_g \cos \phi = |A_e| \quad (4)$$

where V_n , V_e , V_g , A_n , A_e , A_g are velocities and accelerations along the N , E , and G vectors, Fig. 1, and are positive in the direction shown. When ω is in radians per second and V is in feet per second, A will be in feet per second per second.

In the description below, Northern Hemisphere effects will be assumed.

Fig. 2: Apparent eastward acceleration due to north velocity.

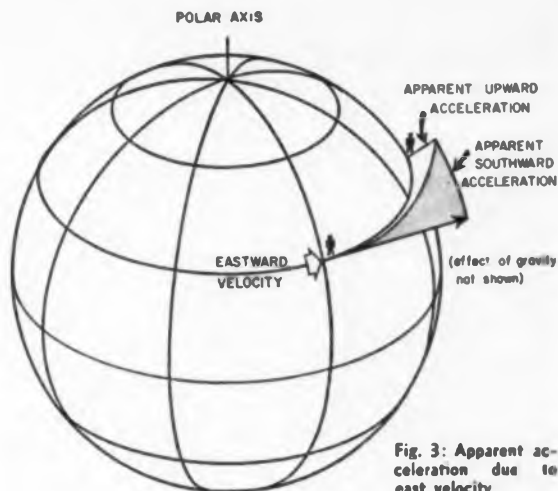
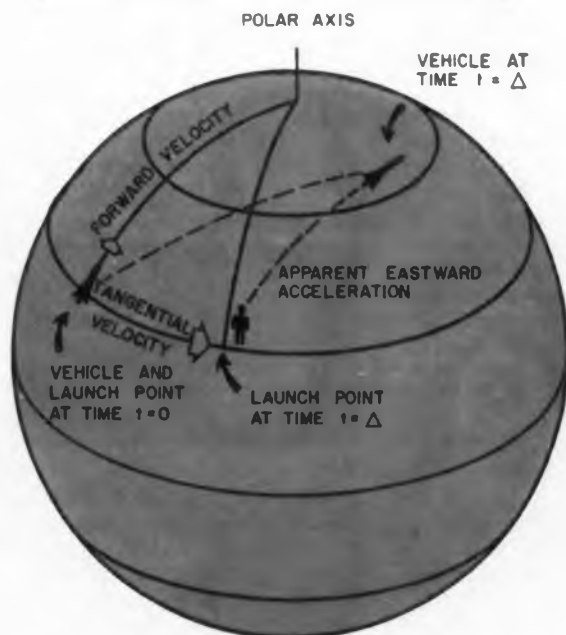

Fig. 3: Apparent acceleration due to east velocity.

Effect of North Velocity

Considering each of these three equations individually, we see, by Eq. (2) that a vehicle having a north velocity, appears to the earthbound observer to be accelerated also to the east. This apparent eastward acceleration is a result of the tangential velocity of the earth's surface. It is highest (1040 mph) at the equator and reduces to zero at the poles.

A vehicle moving northward would tend to maintain the tangential velocity of its origin. If no external force is applied to constrain the tangential velocity to that of the earth's surface at higher and higher latitudes, it would veer off to the east, Fig. 2.

Effect of Eastward Velocity

Eq. (3) shows that a vehicle having an eastward velocity is accelerated outward along vector P , perpendicular to the earth's polar axis. This acceleration can be resolved into components along the gravity vector G , and south. Fig. 3 shows how a projectile fired to the east moves outward and to the south to the earthbound observer, although its path in inertial space is affected only by the force due to gravity.

Effect of Vertical Velocity

When a vehicle is fired straight up, it tends to maintain the tangential velocity it had on the surface of the earth. As it moves farther out from the earth's axis, it would have to increase its eastward velocity if it were to stay over the launch point, Fig. 4. If no eastward force is provided, the vertically-fired vehicle will move westward.

It is sometimes thought that the vertically-fired vehicle would have an upward velocity for part of its flight and a downward velocity for the remainder of the flight and, therefore, the Coriolis effects would cancel out. However, this is not the case. During the upward flight there is Coriolis acceleration proportional to vertical velocity, Eq. 4. During this time the acceleration is being integrated into a westward velocity until the vehicle reaches its apex at which point the westward velocity is at its maximum. The reverse

Coriolis Effect (Continued)

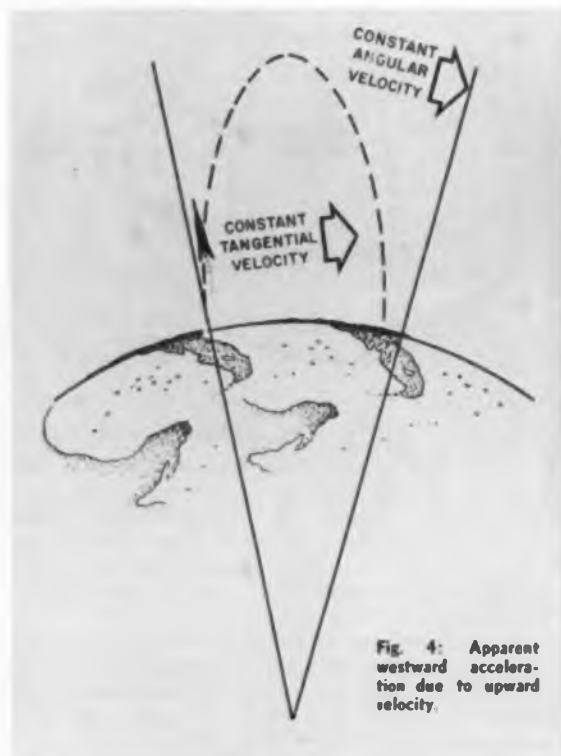

Coriolis acceleration during the vehicle's descent then reduces the westward velocity to zero. The effect is a westward distance traveled on the surface of the earth.

Summary of Effects

In the Northern Hemisphere, a vehicle moving to the north has an eastward acceleration; a vehicle moving to the east has an upward and southward acceleration; and a vehicle moving upward has a westward acceleration.

Numerical Example

The magnitude of these accelerations can best be realized by substituting numerical values for this acceleration. Assuming a vehicle with a velocity of 1000 ft/sec (680 mph) to the east, we have:

$$\begin{aligned} |A| &= -2\omega V_e = 2(7.29)(10^{-5}) \text{ rad/sec} \times 1000 \text{ ft/sec} \\ &= 0.1458 \text{ ft/sec}^2 \\ &= 4.52(10^{-3})g \end{aligned} \quad (5)$$

The direction of this acceleration will be perpendicular to the polar axis and so will have upward and southward components, depending on the latitude in accordance with Eq. 3.

Masses react to forces in accordance with Newton's laws evolved for inertial space. However, to the observer, or navigation system, referenced to the rotating earth, Coriolis accelerations appear whenever a vehicle has a velocity.

References

1. Goldstein, H., *Classical Mechanics*, p. 135; Addison-Wesley, Cambridge, 1953.
2. Mitchell, Hugh C., *Definitions of Terms Used in Geodetic and Other Surveys*, SPL PUB. 242, p. 35; US Coast and Geodetic Survey, Washington, 1948.

Power Resistors

RESISTANCE wound ceramic cores potted in vitreous enamel in a ceramic cavity are now available from Superior Resistor and Electronics Corp., Box 274, Frankfort, Indiana. These units, selling at the price of tubular vitreous enameled axial-lead resistors, give high dielectric strength in a completely moisture proof enclosure with high thermal and mechanical shock resistance.

The 5 watt sizes have been run at 15 watts continuously, with intermittent thermal shocks in water. No damage to the unit resulted. Additionally, the stamping on the side is vitreous enamel and will not rub off or burn off. It will be legible till the equipment is scrapped.

The small, high power resistors have special alloy end caps attached to the ceramic core. Lead wires and resistance wires are attached by spotwelding. All parts have thermal expansion characteristics matched. Low resistance units feature coreless construction with axial leads welded directly to the element. Resistance range of cored construction is 0.05 to 0.09 ohms $\pm 10\%$, 0.1 ohm to 5 ohm $\pm 5\%$. Resistance range of cored construction is 5 thru 25,000 ohms $\pm 3\%$. Wattage ratings are 5, 7, 10 and 25 watts.

The firm also supplies non-inductive resistors. For the first time bringing the cost of these resistors into the same price field as regular fixed resistors. These resistors are

made possible by a unique cord winding machine that winds oxidized wire in parallel and in opposite directions onto fiberglass cord, continuously. The advantages

These power resistors are completely immersed in vitreous-enamel in a ceramic boat for maximum heat dissipation. Non-inductive and 3% units are also available.



of the small diameter cord and the Ayrton-Perry type winding give a unit with inductances of less than 1% of a conventionally wound resistor. Tolerance: $\pm 10\%$, standard; 5%, on special order. Resistance range: 5 to 2500 ohms.

STRUCTURAL feedback in a large rocket is a potentially disastrous situation, but the conditions which produce it often do not come to light until the design has been established and a dynamic analysis is made. Under the circumstances, the most practical corrective measure is the addition of an RC filter in the control system. Several varieties of such filters are described in this article with illustrations taken from the Vanguard rocket booster.

The structural feedback phenomenon can occur when the gimballed rocket engine is deflected to control the flight path. The motion of the engine causes local deflections in the rocket structure, and the automatic pilot gyros "see" these unwanted structural deflections as well as changes in the rocket attitude. Under certain conditions this structural feedback loop can become self-exciting and can cause the control system to saturate or the structure to fail, or both.

In a typical rocket control system (Fig. 1), the input differential is provided by the gyroscopic reference which sends signals to the control system amplifiers. The resulting actuator motion deflects the engine which, in turn, closes the loop to the gyro through the missile dynamics. In addition, the structural deflection resulting from actuator motion is also fed back to the gyro as indicated in the box labelled structural characteristics. The unwanted signals arising from the structural feedback can be attenuated by inserting filters in the control system. Design of such filters becomes critical when the frequencies of the control loop coincide with the resonant frequency of the structure. To remove the structural signals without degrading the control system performance, the filter must have an ex-

When a gimballed rocket engine is deflected to control the flight path, the motion of the engine causes local deflections in the rocket structure. The automatic pilot gyros "see" these unwanted structural deflections as well as changes in the rocket attitude. An RC filter in the control system is a practical corrective measure. Several illustrations from the Vanguard rocket booster are described.

RC Filter Networks

In Missile Control

By **RALPH HOOKWAY**
and **ROBERT H. MAYER**

Space Flight Div.
The Martin Co.
Baltimore, Md.

remely sharp rejection notch and introduce as little phase lag as possible into the control loop.

If the problem can be isolated

early enough in the design history of the rocket, changes can be made in the structural configuration to separate the structural resonant frequencies from the control frequencies. Such parameters as the length and diameter of the rocket, the inertial characteristics of the

Fig. 1: Structural feedback in rocket control system. Motion of the actuator deflects rocket motor resulting in change of flight attitude θ_s ; but actuator motion is reacted by rocket structure and produces input, $\Delta\theta_s$, to the flight control system.

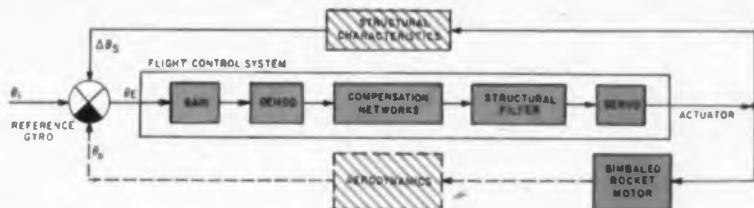

A REPRINT
of this article can be obtained by
writing on company letterhead to
The Editor
ELECTRONIC INDUSTRIES
Chestnut & 56th Sts., Phila. 39, Pa.

Filter Networks

(Continued)

rocket motor, and the magnitude of the motor thrust are known quite early in the design cycle. Other significant parameters, however, such as the mode shape of the oscillating rocket and location of the gyros relative to structural nodes, are not well known until much later. As a result, much of the rocket design is frozen by the time dynamic analysis can begin. If a structural feedback problem is indicated, the most expeditious solution is to place appropriate filters in the control system. Even at this stage the solution of the problem and the establishment of the filter requirements is difficult. The Vanguard problem involved differential equations of the 22nd order.

RC filters seem to be the most practical, with the bridged tee and parallel tee filters being common examples. Cascaded RC lead-lag networks also offer limited possi-

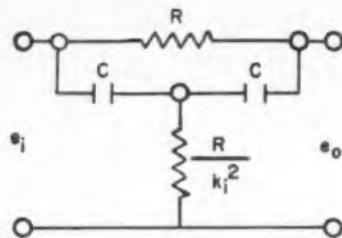

Fig. 2: Bridged tee filter circuit

bilities. The most appropriate filter worked out for the Vanguard system is a two-stage RLC configuration. Design data for these four filter types follow.

Bridged Tee

The bridged tee circuit (Fig. 2) often used as a stabilization network in feedback control systems, has been examined for application in rocket control systems to damp structural feedback. The circuit is a special case of the general transfer function:

$$\frac{e_o}{e_i} = \frac{1 + ja \frac{d}{1-d^2}}{1 + jb \frac{d}{1-d^2}}$$

where $a =$ | constants
 $b =$ |

$$d = \frac{\omega}{\omega_o} \quad (1)$$

The characteristics of the general transfer function for several values of a and b are shown in Figs. 3, 4, and 5.

For the bridged tee, a and b are defined as follows:

$$a = \frac{2}{k_1} \quad \text{and} \quad b = \frac{2 + k_1^2}{k_1}$$

and the transfer function becomes:

$$\frac{e_o}{e_i} = \frac{1 + j \frac{2}{k_1} \frac{d}{1-d^2}}{1 + j \frac{2 + k_1^2}{k_1} \times \frac{d}{1-d^2}} \quad (2)$$

Obviously then, for every value of a there is a corresponding value of b . The dotted curves in Figs. 3, 4 and 5 represent the characteris-

Fig. 3: Bridged tee performance characteristics

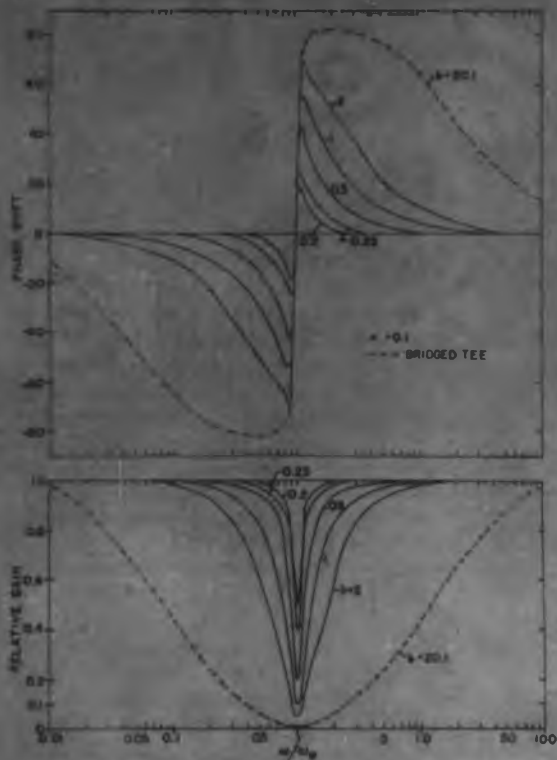
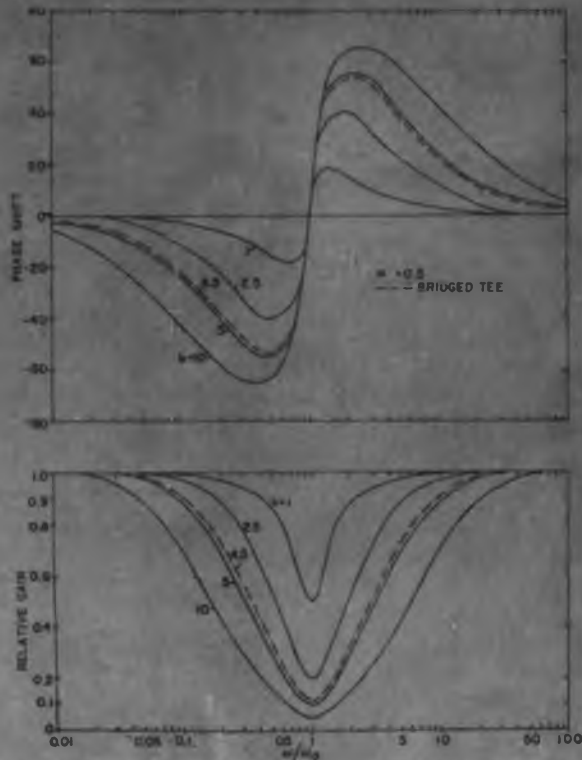

Fig. 4: Bridged tee performance characteristics



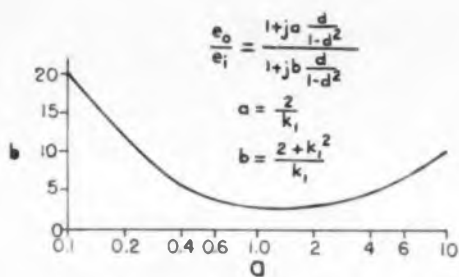

Fig. 6: Bridged tee filter constants

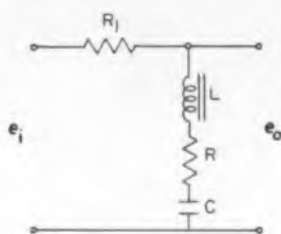

Fig. 7: Simple RLC filter circuit

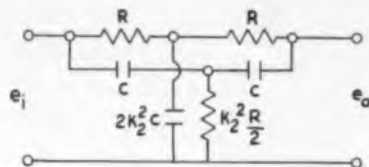

Fig. 8: Parallel tee filter circuit

tics of the bridged tee for the selected values of a . To adequately compensate some control systems, values of a and b may be required which are not realizable with the bridged tee. The relationship between a and b is shown in Fig. 6. The curves of Figs. 3, 4, 5 and 6 provide a rapid means for determining whether or not the stability requirements of a given system can be met with a bridged tee. In Vanguard, for instance, the system characteristics indicate that the best overall performance with this circuit would be obtained if $a = 0.6$ and $b = 2.0$. Fig. 6 shows, how-

ever, that the bridged tee is not applicable in this particular case, since for $a = 0.6$, $b = 3.93$.

When this situation arises, the circuit of Fig. 7 may be useful. This circuit is described by the same general transfer function given in Eq (1); for this circuit

$$a = Q, b = Q \frac{R + R1}{R} \text{ and } Q = \frac{R}{\omega L}$$

For the Vanguard system, where $a = 0.6$ and $b = 2.0$ were desired, the circuit looked particularly attractive since $a = Q = 0.6$ is a circuit Q which can be obtained readily with practical circuit

values. For values of Q which require unrealistic component values, the equation can be mechanized using operational amplifiers or amplifiers with regenerative amplifiers in the feedback loop.

To summarize, it is evident that circuits which represent Eq (1), produce relatively broad band rejection notches and large phase shifts. These characteristics may be adequate in rocket control systems where the rocket structure is inherently well damped. However, for rockets which possess the high Q (very lightly damped) characteristics of the Vanguard, mechaniz-

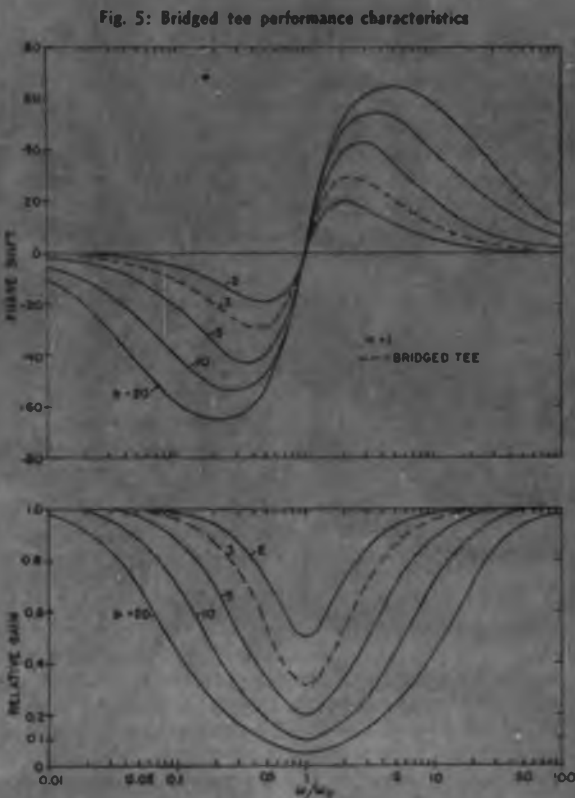

Fig. 5: Bridged tee performance characteristics

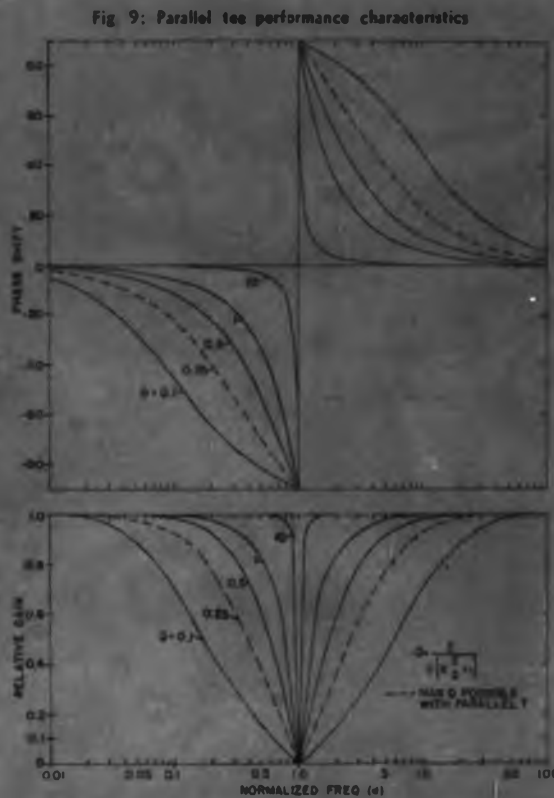

Fig. 9: Parallel tee performance characteristics

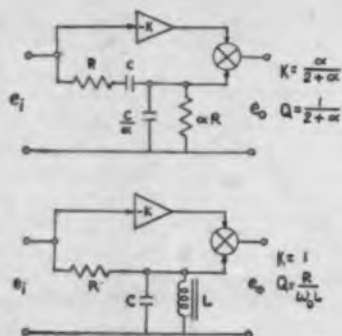

Fig. 10: Extensions of parallel tees by means of operational amplifiers.

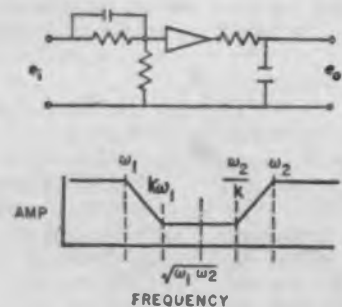

Fig. 11: Cascaded lead lag filter. (a) Circuit diagram. (b) Performance characteristics change.

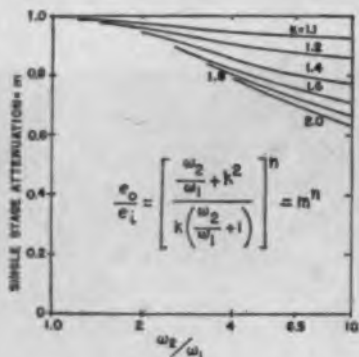

Fig. 12: Cascaded lead lag filter—single stage attenuation.

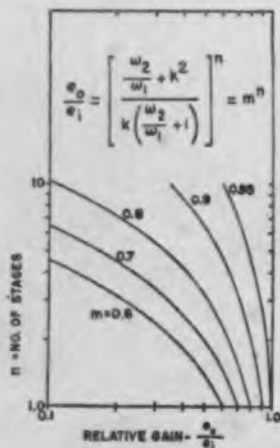

Fig. 13: Cascaded lead lag filter—overall performance.

Filter Networks (Continued)

ing this equation is not an adequate solution for damping structural feedback.

Parallel Tee

Another filter which is frequently employed in the stabilization of closed loop control systems is the parallel tee shown in Fig. 8. This circuit has the transfer function:

$$\frac{e_o}{e_i} = \frac{1}{1 + j2 \times \frac{k_2^2 + 1}{k_2} \times \frac{d}{1 - d^2}} \quad (3)$$

and is a special case of the general equation:

$$\frac{e_o}{e_i} = \frac{1}{1 + j \frac{1}{Q} \times \frac{d}{1 - d^2}} \quad (4)$$

The frequency response of this transfer function for various values of Q is given by Fig. 9. From Eq. (4) and (5) it is evident that the Q of the parallel tee is given by:

$$Q = \frac{k_2}{2(k_2^2 + 1)} \quad (5)$$

and is thus limited to a maximum value of 0.25.

It is typical of the parallel tee to have a narrower notch with higher phase shift than is produced by comparable bridged tees. In many control systems this phase shift is excessive, particularly in view of the relatively broad band rejection characteristics of the circuit. For this reason, just as in the case of the bridged tee, the parallel tee can only be of use in those applications where the Q of the structural response is low and the Q required in the compensating network does not exceed 0.25.

The general Eq (4) may also be mechanized by a number of schemes employing operational amplifiers. Two possibilities are shown in Fig. 10. The advantage of these circuits is that Q 's higher than 0.25 can be realized if required by the overall characteristics of the control system in question.

Cascaded Lead-Lag

In some control systems the necessary compensation may be obtained by cascading sections of conventional lead networks with sections of lag circuits as shown in Fig. 11. For a first approximation it is assumed that the stages are isolated from each other. The circuit can then be represented by the transfer function:

$$\frac{e_o}{e_i} = \left[\frac{1 + \frac{s}{k\omega_1}}{1 + \frac{s}{\omega_1}} \right]^n \left[\frac{1 + \frac{s}{\omega_2}}{1 + \frac{s}{\omega_2}} \right]^n \quad (6)$$

where the quantity in the first bracket is the lag circuit and the second quantity is the lead circuit and n is the number of stages. The frequencies in this expression are shown in the Bode plot of Fig. 11. To determine attenuation at the center frequency, its

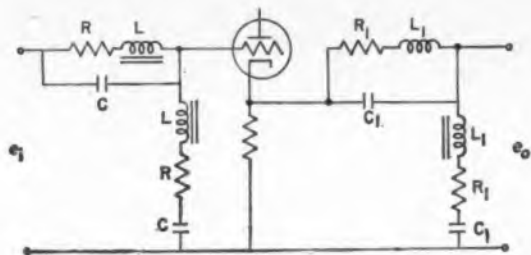
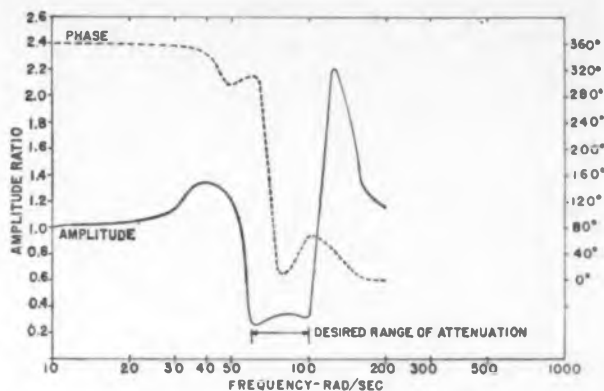

Fig. 14 (above): Vanguard RLC filter

Fig. 15 (right): Performance of filter used in Vanguard



value, $\sqrt{\frac{\omega_2}{\omega_1}}$ is substituted for s in Eq (6) and the expression of Eq (7) results.

$$\frac{e_o}{e_i} = \left[\frac{\frac{\omega_2}{\omega_1} + k^2}{k \left(\frac{\omega_2}{\omega_1} + 1 \right)} \right]^n \quad (7)$$

Design curves based on this relation are given in Figs. 12 and 13. To determine the possible applicability of cascaded lead-lag circuits, the rejection range required is determined from the stability analysis and thus $\frac{\omega_2}{\omega_1}$ and k are determined. Using these values, m is determined from Fig. 12. The stability analysis will also indicate the amount of attenuation required. With this value and the value of m as determined above, the number of stages n can be deter-

$$\begin{aligned} \frac{e_o}{e_i} &= \frac{1}{(1-d^2) - 1 + j \frac{d}{Q}} \\ &\times \frac{1}{(1-d_1^2) - 1 + j \frac{d_1}{Q_1}} \end{aligned} \quad (8)$$

where:

$$\begin{aligned} d &= \frac{\omega}{\omega_o} & Q &= \omega_o \frac{L}{R} \\ d_1 &= \frac{\omega}{\omega_{o_1}} & Q_1 &= \omega_{o_1} \frac{L_1}{R_1} \end{aligned}$$

The attenuation of each stage at null is given by:

$$\left(\frac{e_o}{e_i} \right)_n = \frac{1}{1 + Q^2 - jQ} \quad (9)$$

Thus a circuit Q of 5 will give an attenuation of approximately 26 per stage. Two stages can be cascaded in order to broaden the rejection notch. Fig. 15 shows the performance of the filter as used in Vanguard.

REFERENCE PAGES

The pages in this section are perforated for easy removal and retention as valuable reference material. SOMETHING NEW HAS BEEN ADDED

An extra-wide margin is now provided so as to permit them to be punched with a standard three-hole-punch without obliterating any of the text. They can then be filed in standard three-hole notebooks or folders

mined. A study of Figs. 12 and 13 shows that the application of this particular type of filter is limited to those cases where a relatively wide frequency range (greater than 3 to 4) must be rejected; sharp cutoff characteristics are not required ($k = 1.6$ or more); and where gain can be greater than about 0.4. For conditions outside of these boundaries an impractically large number of stages would be required, and excessively large phase shifts result. In the case of Vanguard, for example, a gain of 0.1 at 4 rad/sec was desired for which $n = 10$ giving a total of 20 stages and an 80° phase lag at 2 rad/sec.

Two-Stage RLC

A two-stage RLC filter, shown in Fig. 14, turned out to be the most appropriate configuration for use in the Vanguard control system. The circuit is easily mechanized and has no static loss other than that due to the cathode follower buffer stage. The transfer function for this filter is:

ELECTROLUMINESCENT DEVICES

Max Krawitz, assistant chief engineer and Irving Greenberg, product manager of Sylvania's Picture Tube Operations, look over electroluminescent panels. This new light source is now in production. The devices are designed for use in electronic display systems for many applications.



Many of the problems associated with the use of powerful microwaves in space are described. Possible solutions and approximate costs are discussed. A helicopter space platform powered by microwave signals is proposed.

By **HAROLD M. HART**

Manager, Surface Radar & Navigation Operations
Equipment Div., Raytheon Co.
Wayland, Mass.

Applying Microwaves to Space Problems

IT is almost commonplace today to think of space travel to the moon and even to our near planetary neighbors. Some are so bold as to consider space probes to the far reaches of the solar system or even out of the solar system toward the nearest star. These journeys will be undertaken for only one justifiable reason, and that is scientific curiosity. In turn, curiosity is satisfied by information and information is obtained by communication.



H. M. Hart

As a somewhat intermediate subject between earth-bound living and space living, the ability to produce large amounts of power at microwaves permits the consideration of powering airborne vehicles from the ground so that long endurance high altitude platforms can be realized. Such platforms could be of great importance. They would allow broad band reliable global communications of various kinds and provide an observation platform out of the weather producing part of the atmosphere. Such a platform could be a stable optical beacon providing navigation aid to astronauts, as well as aeronauts. It might form the support for a radar and optical observation post which would be useful 24 hours a day.

Numbers are ordinarily used to tie down imagination. I would like to present some numbers which I hope will stimulate your imagination. They are the

result of calculations which have been carried out by several different groups at Raytheon who have been interested in the problems of space communication and radio transmission of power.

Factors Affecting Power

Looking first at space communications, Fig. 1 shows the factors affecting the power received at a remote station. Other factors being constant the received power is proportional to the reciprocal of the square of the wavelength. Now at wavelengths much longer than 150 centimeters ionosphere effects will be harmful, and at wavelengths less than 3 centimeters weather effects will be prohibitive. One is therefore led to a choice of a wavelength of a few centimeters for a communication link from a ground based station to space. The shorter the wavelength the smaller the antenna for a given power transfer. Throughout this discussion it will be assumed that a wavelength of 10 centimeters would be used as being most free of weather effects and as being in a region where galactic noise corresponds to a temperature of less than 10° K.

Fig. 2 shows the minimum power required for a signal to noise ratio of 20 db at 1 KC bandwidth assuming unity noise figure at a noise temperature of 30° K. 30° K is chosen rather than 10° K to allow for operation with the antenna pointed close to the horizon. With the figure for minimum power received we are now in a position to calculate the power re-

$$P_R = \frac{P_T (A_T)^2 A_R A_R}{\lambda^2 R^2}$$

P_T = Transmitted power
 A_T = Area of transmitting antenna
 A_R = Area of receiving antenna
 λ = Wavelength

Other parameters constant:

$$P_R \propto \frac{1}{\lambda^2}$$

λ	P_R
3 cm	0 db
10 cm	- 10 db
150 cm	- 33 db

Fig. 1: The factors affecting power received at a remote station are given.

quired for various communication paths, Fig. 3. In making these computations we have assumed a wavelength of 10 centimeters, a transmitting antenna of 50 meters diameter, a receiving antenna of 5 meters diameter, a signal to noise ratio of 20 db, a noise figure of 30 db at 30°K, and the various channel bandwidths shown. One notices immediately that for voice bandwidths only moderate amounts of power are required for our near neighbors. If we look, however, to the future when our colony on Mars or Venus will want to watch the Army-Navy football game (or will it be the Air Force-Army game) powers of the order of 40 kw, to Venus and 90 kw, to Mars will be required. To Pluto, super power will be required for bandwidths above 100 kc and to our nearest star, Proxima Centauri, 200,000 of Mr. Brown's super-power tubes* working in parallel would be required to achieve a 1 kc bandwidth under the condition stated.

Antenna Sizes

Now, you might very well question the assumed antenna sizes which have a great deal to do with the power. You have probably also noticed the bandwidths hold good only for one-way transmission, that is, from earth to remote station. This is because we didn't feel qualified to judge the capability of space ships or space colonies to build antennas or to unfurl antennas. We decided that we would have to leave that particular conjecture for the future and only say that we will accept information at a slower rate from space than we will be able to send it. The size of the transmitting antenna, however, is a sort of practical choice which considers that in the absence of electronic scanning (which would probably be just as complicated) the transmitting antenna must be mechanically pointed at the receiver. Inasmuch as a 50 meter diameter antenna would have a beamwidth of only 8 minutes of arc, the mechanical control is a serious problem.

There is of course a trade-off between antenna size and power for a given bandwidth and Fig. 4 is informative in demonstrating how this works. In this Figure we have assumed a bandwidth communication channel of 100 kc, except for the case to Proxima

* Editor's Note: The author makes reference to super-power tubes. These are Amplatron tubes which would have average power capabilities of 200 kw. Their development possibilities were described in a paper by William C. Brown titled "The Generation of Super Power at Microwave Frequencies" delivered at NIREM on November 19th, 1959.

$$P_{min} = KTB (NF) S/N$$

$KTB = 4 \times 10^{-15}$ w./kc at 30° K
 $NF = 0$ db at 30° K
 $S/N = 20$ -db signal-to-noise ratios reqd.
 $P_{min} = 4 \times 10^{-17}$ w./kc

Fig. 2: Minimum power for S/N of 20 db at 1 kc bandwidth.

Centauri, in which a bandwidth of one cps has been assumed. One cps does not correspond to a very high information rate, but on the other hand at any currently anticipated velocities there will be plenty of time, probably years, to get the messages across. One can get philosophical at this point in discussing the control function, but I am sure it is not pertinent here. What is pertinent is that with 500 super power tubes* in parallel, using a 150 meter diameter antenna, communication can be sent to a 5 meter diameter antenna close to the nearest star.

Cost Figures

A check on the cost figures shown for the various size antenna is provided by the 584 Fire Control antennas which were produced in great quantities during the war for about the figures shown for 30 db gain, and another check is provided by the Millstone Hill antenna which lies somewhere closely above the 50 db gain antenna and was built, we understand, for about \$1 million. Also, our experience at Raytheon has been that antenna cost is directly proportional to area which in turn is directly proportional to gain. The interesting point about this chart is that it shows that a lower cost communication system can be built using super power. If one were restricted to 4 kw. of power, for example, and communicating with Venus, a 50 db antenna costing one million dollars would be required. Whereas, with super power at 40 kw. the job can be done with a 40 db antenna at a total cost of \$140,000. For communication to Pluto, if we were restricted to 23 kw. of power then a \$100 million system would be required. By paralleling 11 super power tubes to produce 2.3 megawatts and using a 50 db antenna one could build the same communication system for \$3.3 million. If anyone had told me we could communicate with Proxima Centauri for \$200 million before these figures were prepared I wouldn't have believed him but by paralleling 500

Fig. 3: Calculated power requirements for various signal paths.

	Channel Bandwidth in Kilocycles				
	1	10	100	1000	10,000
E - Moon	9 μ w	90 μ w	900 μ w	9 mw	90 mw
E - Venus	4 w	40 w	400 w	4 kw	40 kw
E - Mars	9 w	90 w	900 w	9 kw	90 kw
E - Pluto	2.3 kw	23 kw	230 kw	2.3 megw	23 megw
E - Proxima Centauri	10 ¹¹ w	10 ¹² w	10 ¹³ w	10 ¹⁴ w	10 ¹⁵ w

Wavelength: 10 cm
Diameter - Transmitting Antenna: 50 m
Diameter - Receiving Antenna: 5 m
S/N: 20 db
NF: 0 db at 30° K
 P_{min} : 4 x 10⁻¹⁷ w./kc

Microwaves in Space

(Continued)

Fig. 6: Graph illustrates passive satellites for an earth-to-earth communications system via microwave

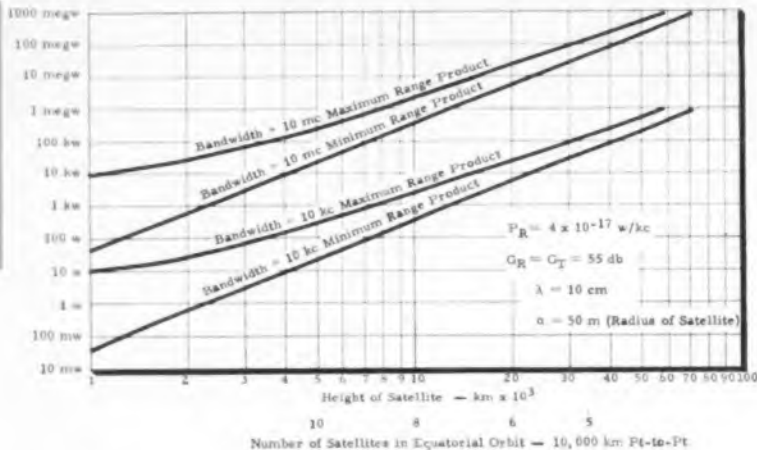

super-power tubes the job can be done with a \$100 million antenna.

Fig. 5 shows the trade-off for the case of an Earth to Mars channel as a function of bandwidth. Here again we notice how strongly a free choice of power level can influence cost. For instance, using 900 kw. of power or 5 super-power tubes, satisfactory TV link could be provided to Mars for a cost of about

two million. With ten 10 kw. tubes the same link would cost over \$10 million.

Turning now to the situation closer to home, what about communication from point to point on earth by way of a passive reflecting satellite. Sadly, for our industry, such a system is much discussed nowadays, it not being considered that sufficiently reliable transponders are available. Fig. 6 shows the power requirements using 100 meter reflecting satellites at various heights to provide continuous service between two points as far distant at the equator as 10,000 kilometers. The powers shown on the ordinate are required for the bandwidths of 10 kc and 10 mc. as shown. Since the path length from point to satellite to point is not constant, two curves are drawn to show the maximum and minimum power required. Evidently about 10 to 20 db margin is required to take care of this effect. It is clear that for TV bandwidths and heights involving a reasonable number of satellites (which is to say heights above 500 kilometers) super-powers of the order of 200 kw. will be required. In making this calculation antennas 30 meters in diameter having gain of 55 db were assumed. Here again there is probably a trade-off situation which could be optimized and the availability of super-power will make designing to a price very much easier.

In Terms of Horsepower

Thus far we have been talking about super-power as power in the region of 200 kw. If instead we speak in terms of horsepower, each one of Mr. Brown's tubes will deliver 280 horsepower which is enough to really get things moving even in this day of super-powered automobiles. Of course, as has been implied in the statements which I have made previously amplifier tubes, being amplifiers, can be driven in phase from a common source. They are quite suitable for parallel operation and there is no technical reason why powers of almost any desired magnitude can not be produced. With hundreds of horsepower available at microwaves, where focussing antennas are feasible, leads to the exciting prospect that radio transmission of power may be a feasible thing to do. As Mr. Brown pointed out, microwave power can be produced for only about three times the cost of primary power. While this is still too expensive to replace wires for

COST VS GAIN AND POWER
EARTH INSTALLATION

WAVELENGTH = 10 CM - $G_R = 40$ db

ANTENNA GAIN	BANDWIDTH = 10 kc					PROXIMA CENTAURI Bandwidth 1 cps
	MOON	VENUS	MARS	PLUTO		
10 db \$19 K	\$1 K 50 w \$19 K	\$400 K 400 kw \$410 K	\$400 K 900 kw \$410 K	\$2.10 M 210 megw \$2.10 M		\$1,000,000 M 1,000,000 megw \$1,000,000 M
20 db \$700 K	\$1 K 100 w \$700 K	\$4 K 40 kw \$40 K	\$90 K 90 kw \$90 K	\$2.1 M 21 megw \$2.1 M		\$100,000 M 100,000 megw \$100,000 M
30 db \$1 M	\$1 K 30 w \$1 M	\$4 K 4 kw \$1 M	\$9 K 9 kw \$1 M	\$2.1 M 2.1 megw \$3.3 M		\$10,000 M 10,000 megw \$10,000 M
40 db \$10 M	\$1 K 9 w \$10 M	\$1 K 1 kw \$10 M	\$1 K 1 kw \$10 M	\$2.10 K 210 kw \$10.2 M		\$1,000 M 1,000 megw \$1,010 M
50 db \$100 M	\$1 K 3 w \$100 M	\$1 K 300 w \$100 M	\$1 K 300 w \$100 M	\$2.1 K 21 kw \$2.1 K		\$100 M 100 megw \$200 M
60 db \$1,000 M	\$1 K 1 w \$1,000 M	\$1 K 1 kw \$1,000 M	\$1 K 1 kw \$1,000 M	\$2.1 K 2.1 kw \$1,000 M		\$10 M 10 megw \$1,010 M

Fig. 4: Table illustrates trade-off between antenna size and power along with estimated costs.

Fig. 5: Table shows how power level affects costs.

COST VS GAIN AND BANDWIDTH
EARTH INSTALLATION

EARTH TO MARS

WAVELENGTH = 10 CM - $G_R = 40$ db

GAIN	BANDWIDTH				
	1 kc	10 kc	100 kc	1 mc	10 mc
30 db \$10 M	\$9 K 9 kw \$19 K	\$90 K 90 kw \$100 K	\$900 K 900 kw \$910 K	\$9 M 9 megw \$9 M	\$90 M 90 megw \$90 M
40 db \$100 K	\$1 K 900 w \$101 K	\$9 K 9 kw \$109 K	\$90 K 90 kw \$190 K	\$900 K 900 kw \$1.9 M	\$9 M 9 megw \$9.1 M
50 db \$1 M	\$1 K 90 w \$1 M	\$1 K 900 w \$1 M	\$9 K 9 kw \$1 M	\$90 K 90 kw \$1.1 M	\$900 K 900 kw \$1.9 M
60 db \$10 M	\$1 K 9 w \$10 M	\$1 K 90 w \$10 M	\$1 K 900 w \$10 M	\$9 K 9 kw \$10 M	\$90 K 90 kw \$10 M

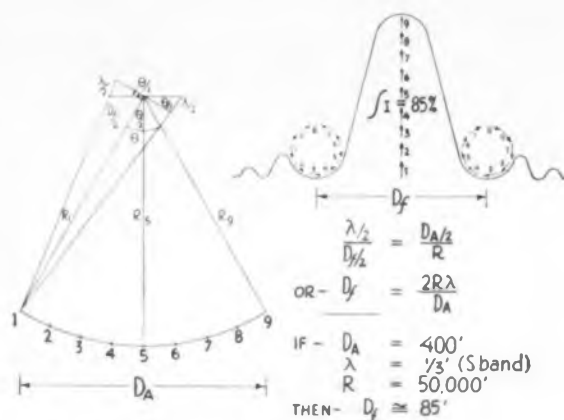

Fig. 6a: For efficiency, radio energy should be sharply focussed so all parts of wave front arrive at point of focus in phase as shown by drawings.

permanent long-term uses, there are places where wires are not practical as, for instance straight up into the upper atmosphere and out into space.

To efficiently transmit power by radio, it is necessary to confine the energy as narrowly as possible. This is best done by focussing the energy in distinction to normal radar practice where a plane wave is produced or where in effect the antenna is focussed at infinity. For focussing, a spherical wave front is produced so that all parts arrive at the point of focus in phase as shown in Fig. 6A. In this Fig. the spherical wave front is imagined as being cut into strips, each of which contributes to correspondingly numbered vectors at the focal spot. For points to either side of the central focus point, the various contributions arrive in systematically varying phase so that at the first null the contributions add up to 0 for complete cancellation, and so on in the conventional diffraction pattern.

Of interest in considering power transmission is the diameter of the focal spot, which determines the size of the antenna which must be used to capture the transmitted energy. This is given by the formula

$$D_f = \frac{2R\lambda}{D_a}$$

The other significant fact is that ideally 85% of the transmitted energy passes through the regions bounded by the first null. Approximately 75%

Fig. 7: The salient features of the microwave powered rotary-wing platform are illustrated

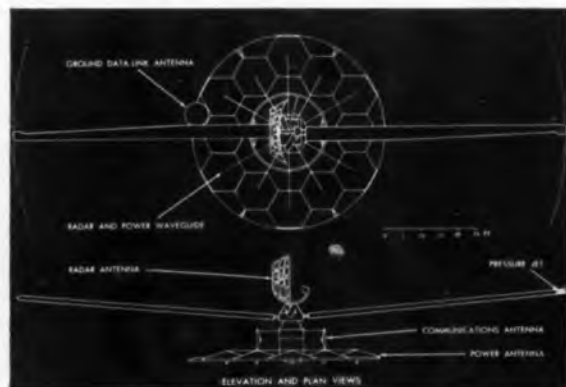

of the energy passing through the first nulls can be captured by an aperture which is $\frac{2}{3}$ the diameter of the focal spot defined by the first nulls.

Thus, for the case shown in the chart, energy could be transmitted from the ground to a 55 ft. diameter airborne antenna or absorber with an efficiency of 0.85×0.75 or approximately 64%. The transmitted wave could be formed from a horn feed and ellipsoidal reflector taking advantage of the property of an ellipse that it is generated by a point which moves so that the sum of its distances from the two foci is constant.

Other antennas can be used such as an elliptical cylinder fed by a phased linear array. The array itself could be made up of horns separately connected to amplifiers suitably phased and driven from a common source. By this means too great a power concentration at any point can be prevented.

Atmospheric breakdown is probably not a problem inasmuch as at 10 cm. the atmosphere at altitudes up to 200,000 ft. will support powers of the order of 1000 horsepower per square meter before breakdown occurs. The applications which we will consider will involve only 100 horsepower per square meter.

HELICOPTER PARAMETERS	
WEIGHT DATA	
Collector Antenna	3,000 lb
Rotor and Hub	3,500 lb
Power Plant (1 lb/hp)	2,000 lb
Structure	1,200 lb
	9,700 lb
WEIGHT EMPTY	9,700 lb
PAYLOAD	2,000 lb
SUPPLEMENTARY CHEMICAL FUEL	600 lb
TAKE-OFF GROSS WEIGHT	12,300 lb
ROTOR DATA	
Number of Blades	2
Diameter	160 ft
Average Chord	8 ft
Tip Speed	700 ft/sec
POWER DATA	
Rotor Power Req'd	1,550 hp
Auxiliary Power Req'd (10% RMP)	155 hp
Shaft Power Req'd @ 65,000 ft	2,000 hp

Fig. 8: The helicopter platform parameters are listed

Focussing Power

In applying focussed power to space vehicles, the prospects are not very encouraging. At 200 miles altitude with a 1000 ft. transmitting antenna the diameter of the focus spot would be 680 ft. There would probably be some atmospheric effects on the quality of the focus for an antenna as large as 1000 ft. in diameter. The capture antenna carried by the space vehicle would have to be impossibly large to capture a significant portion of the energy, but perhaps the most dismal prospect of all is that of pointing the 1000 ft. antenna accurately at the space vehicle. Such pointing would undoubtedly have to be done by electronic scanning methods since the antenna is too big to handle mechanically. Furthermore, a rather fancy phase control would be required to simultaneously change the direction to point of focus and maintain the spherical wave front for accurate focussing. The energy density, assumed to be uniform over the focal area, would be very low in view of being spread across

Microwaves in Space (Concluded)

680 x 680 sq. ft. or approximately 40,000 sq. meters, so that a 40,000 kw transmitter would be needed to produce an energy level at the space vehicle equivalent to what it can obtain from the sun for a greater proportion of its orbit.

Microwaves Power Helicopter

The fixed wing aircraft is the most economical of power. But it loses much of its utility because it must be in gross motion continuously and again requires accurate tracking. Consequently we have focussed our attention on the helicopter and have conducted a series of design studies with the assistance of various helicopter companies. These studies have shown that a helicopter powered by microwaves projected from the ground is not only feasible but practical. The salient features of this vehicle are shown in Fig. 7. It consists of a 50 ft. diameter receiving antenna which is made up of a number of smaller antennas each independently connected to a resistive load. This is done in order to make the full array less directive so that changes in attitude will not cause a loss of power. One or more of these individual antennas would be connected directly to a radar antenna if desired.

The resistive load is part of a heat exchanger which heats the working fluid of either an open or a closed cycle gas turbine engine. While the shaft of this engine could have been geared directly to the rotor this would have required a reaction rotor for the main body of the helicopter. It was decided instead to use the shaft power to pump air out through the two blades to pressure vents at the blade tips. In this way the only reaction of blade torque to main body comes through bearing friction and stray air currents. Stability studies have shown that the vehicle would maintain its position on the top of the beam to within a few feet in the gust conditions expected at 50 to 60,000 ft. altitude. Also, the trim tab con-

Fig. 10: Table shows the efficiencies of the individual processes involved to obtain an overall efficiency of 5.9% from primary power to shaft power

HELICOPTER POWER REQUIRED	
Primary Power to Microwave Power	.50
Transmission Beam	x .85
Atmospheric Transfer Efficiency	x .95
Intercept Percentage	x .75
Capture Antenna Efficiency	x .70
Heat Exchanger Efficiency	x .98
Engine Efficiency	x .30
Over-all Efficiency	<u>.059</u>
Over-all Power Req'd	= 2,000 / .059 ≈ 32,000 hp
Over-all RF Power Req'd	= 32,000 / 2 ≈ 16,000 hp
	= 12,000 kw

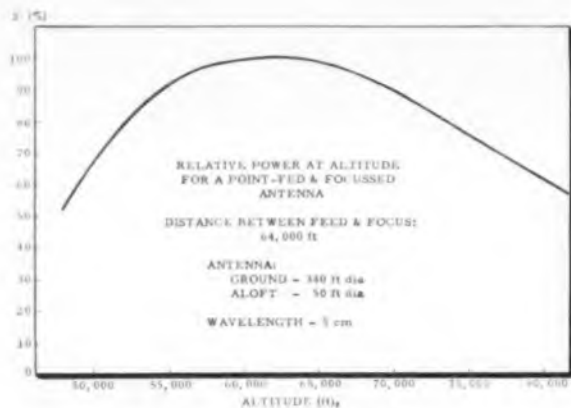

Fig. 9: Helicopter must be within 5000 ft in altitude in order to receive at least 80% of power

trol is sufficiently sensitive that altitude will be maintained within a few feet and attitude within 0.5° . Using the polarization of the microwave power as a reference the vehicle can be stabilized in heading to well within 1° so that no difficulty will be experienced in aligning the communication antennas and telemetering antennas for point to point work.

Fig. 8 shows the parameters of the helicopter. The two most significant things of note here are the 2000 pound payload which can be used for auxiliary communication, infrared or radar purposes, and the data on power which shows that it is possible to support such a vehicle at above 60,000 ft. with 2000 horsepower.

I also direct your attention to the supplementary chemical fuel load which would carry the vehicle aloft and position it on the beam. By this approach the problem of pointing the antenna is completely avoided.

We have already seen that the vehicle must be within 15 or 20 ft. of the center of the beam to intercept a fair proportion of the power. Fig. 9 shows that the vehicle must be within about 5000 ft. in altitude in order that it not lose more than 20% of the power. Actually the power figure contemplates still air. If there is a wind, lift is realized from it, and less power is required from the ground.

Fig. 10 shows the efficiencies of the individual processes involved which lead to an overall efficiency of 5.9% from primary power to shaft horsepower. Sixty of Mr. Brown's super-power tubes would provide the 12,000 kilowatts required. FM modulation of the power would make use of the scattered radiation by permitting the broadcast of intelligence over a wide area inasmuch as the horizon is over 300 miles away from 50,000 ft.

Twenty super power-supported platforms would provide air surveillance and communication over the principal inhabited areas of the world. Because the platforms are so stable in position, they would provide points of reference at the top of a highly accurate base line. This could be used by astronauts and aeronauts for navigation purposes. One possibility which has been suggested is that some of the microwave power could be diverted to an extremely powerful gas discharge light to provide a beacon for both air and space travel.



By CHARLES T. PALUDAN
*Deputy Chief, Measuring System Section
Missile Instrumentation Branch
Guidance and Control Laboratory
Development Operations Division
Army Ballistic Missile Agency
Huntsville, Alabama*

Thermistors—the key to . . .

Bio-Medical Measuring in Space

Before man orbits, his physiological behavior in space must be known. Since their reactions approach human, primates have been tested. One problem was measuring their breathing rate during ballistic flight. This article presents a successful solution—using thermistors.

DURING the summer of 1958 this branch was assigned the problem of measuring several bio-medical parameters on a primate during ballistic flight. A breathing rate measuring device was one of these.

Device Requirements

The devil requirements were:

- (1) A unit and circuitry small in mass and volume,
- (2) Operation on 28 vdc,
- (3) No ac or chopper noise due to the proximity of an EKG amplifier,
- (4) Stability unaffected by changes in ambient temperature,
- (5) Ability to withstand severe shock and vibration, including IRBM re-entry,
- (6) Circuit input supply and telemetering output voltages on a common ground, and
- (7) Availability in a short time.

In view of the requirements, a non-amplified system was sought. As the primate was rather small, a sensor of very low mass was necessary.

The problem was essentially that of a flow meter. A survey of previously experienced instrumentation showed that a dissipation principle might provide the required solution. Experimentation with a thermistor was suggested by the sensitivity needed to detect changes in such a small air flow.

The smallest commercially available thermistors were tried. Small (0.1 in. sq.) wafer thermistors* would have been satisfactory, but a glass-coated bead thermistor showed even greater sensitivity. Its diam-

Because the primate's exhaled air stream is quite small in diameter, the sensor of the respiratory gauge was mounted on a cross-bar attached to the subject's helmet.



* Available from Thermistor Corp. of America.



Fig. 1: Unmounted glass-coated bead thermistors used in the space respiratory gauge have a diameter of 0.014 inch.

Bio-Medical Measuring (Continued)

eter was about 0.014 inch.** Unmounted units of this type are shown in Fig. 1.

Circuitry

A simple bridge circuit would have worked very well with the unit selected. Unfortunately, the only available d-c power was to be tied to the common ground of the telemetering system output. A voltage-divider circuit was thus dictated.

A temperature compensation thermistor was unnecessary when the sensor was self-heated to such a level that it was far more sensitive to flow than to temperature. This level was reached at a sensor temperature above 100°C. Operation below this level tended to be temperature sensitive, the effect being a shift in the reference, or "no-breath," signal level.

Maximum sensitivity requirements prevented operation much in excess of 100°C because of the flattening of the thermistor's temperature-resistivity curve. In the final version, a temperature level of about 110°C to 120°C was used. In still air, the heat balance of the thermistor will stabilize the temperature at about 120°C. When the dissipation of heat from the thermistor is increased by convection in a moving stream of air, the temperature drops several degrees. Fig. 2 is the final circuit. The zener diode across the output protects the telemetering system from over-voltage in case of malfunction.

** Available from three sources: GB38L1, Fenwal Electronics, Inc.; 38C2, Victory Engineering Corp.; and, L118, Thermistor Corp. of America.

Results

Laboratory results are shown best in Fig. 3. The actual primate was not available at ABMA, so an electronic technician was used to provide the data shown. He was able to vary his breathing rate for brief periods so as to duplicate anticipated values. However, his breathing depth was not easily changed. Final experimentation at the School of Aviation Medicine, U. S. Naval Air Station, Pensacola, Fla., provided proof that the amplitude of the signal was adequate. The change in signal level was found to be sufficient up to about 180 breaths per minute.

Output of the system was a function of both rate and depth of breathing. No attempt was made to

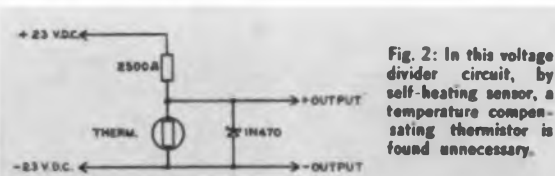
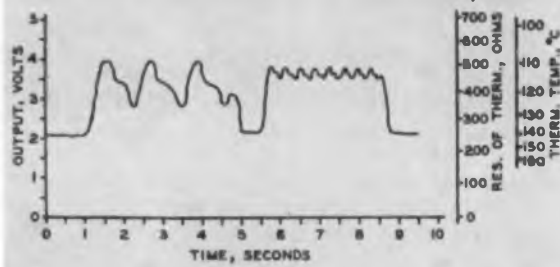

Fig. 3: Because the primate was not available at gauge construction site, a technician was used to obtain laboratory results.



measure depth in this particular case, but it is believed it could be done if the air flow were restricted by a mask or similar device. In that case the resultant output would have twice the frequency shown in Fig. 3 because both inhaled and exhaled air would strike the thermistor bead.

The thermistor was so placed as to measure the flow of exhaled air from the nostrils only. Inhaled air, being undirected in a stream external to the nostrils, had little or no effect. The frequency shown in Fig. 3 is, therefore, that of a complete exhale-inhale cycle. The exhaled air stream from the primate was found to be quite small in diameter; therefore, the thermistor was mounted on a cross-bar attached to a helmet worn by the subject.

A sneeze by the subject would drive the signal temporarily to one end of the scale in a characteristic manner. Chattering appeared as an absence of breathing so that a straight line, on-scale, resulted. These effects are readily recognizable.

During the first test flight with *Gordo* during December, 1958, in a JUPITER IRBM, the device worked perfectly. Variations in breathing rate were recorded. Several periods of chattering were noted and showed agreement with certain characteristic effects on the heart sound measurement and on the EKG zero level. A segment of the telemetered record is shown in Fig. 4.

Two more primates have been flown in a JUPITER missile. The second flight took place in May, 1959, carrying a squirrel monkey named *Baker* and an American-born rhesus monkey named *Able*. An extensive report on both flights has been published.³

The same type respiratory gauge was used for both *Able* and *Baker*. The thermistor was mounted directly to *Able's* body, rather than being supported externally as it was in the cases of *Gordo* and *Baker*.

The measurements on *Able* and *Baker* gave very good results. The telemetering records have the same appearance as those pictured for *Gordo*.

Acknowledgment

The author wishes to acknowledge the aid and co-

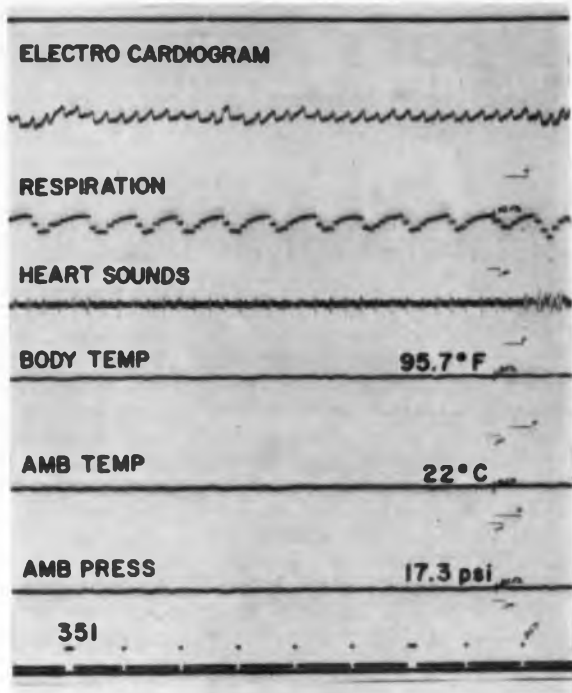

Fig. 4: Telemetering record from the first test flight in Dec. 1958.

operation rendered by the following: Maj. G. A. Champlin, M.C., U. S. Army; Mr. W. Carroll Hixson, School of Aviation Medicine, U. S. Naval Air Station, Pensacola, Fla.; and Messrs. Sanford W. Downs, J. T. Powell, and C. E. Crouch, ABMA.

References

1. Powell, J. T., "Bio-Medical Measuring Circuitry," Proceedings of the 1959 Telemetering Symposium at Denver, Colorado.
2. Dahlske, H. E., and Welkowitz, W., "Diagnosing with Strain Gages," *Electronic Industries*, Jan., 1959.
3. Graybiel, et al., "An Account of Experiments in Which Two Monkeys Were Recovered Unharmed After Ballistic Space Flight," *Aerospace Medicine*, 40, 12, December 1959.

"Teflon" 100

A NEW plastic, "Teflon" 100, is expected to find wide markets in the electronics and chemical processing industries.

Known as an FEP-fluorocarbon resin, the new material can be extruded or molded in thermoplastic processing equipment. It was de-



New FEP resin is expected to broaden applications as wire insulation for aircraft, missiles, and electronic component where resistance to ultra high frequencies is required.

veloped as a supplement to Du Pont's present line of "Teflon" TFE-fluorocarbon resins, which must be processed in a manner similar to powdered metals.

Like the TFE resins, "Teflon" 100 is virtually immune to chemical attack, has excellent electrical insulating, anti-stick, and frictional characteristics, and will not absorb moisture. The new plastic differs somewhat in heat resistance from the TFE resins which are rated for continuous service at up to 500°F and at higher temperatures for more limited periods of time. The usual continuous service ceiling for "Teflon" 100 FEP resin is (Continued on page 222)

What's New . . .

Printer-Plotter System

A REMARKABLY fast printer plotter system which gives large computers new eloquence, plotting out graphical or printed data at 300,000 points per minute from computer-processed magnetic tape, has been announced by Briggs Associates, Inc., Norristown, Pa. This is 5000 times faster than today's speediest commercially-available method for automatically plotting graphical data, the tape-fed X-Y plotter.

For missile scientists, it means an appreciable shortening of the time lag experienced in getting flight test information translated from computer language into easily-read output form.

Mass data normally requiring two-to-three full weeks to process can now be ready for evaluation within a few short hours, in accurate graph form and with all necessary printed annotations.

Of across-the-board significance in areas where large computers are used, the system permits computers to print out data almost as

rapidly as they can process it. Relatively slow print-out speed has been a major problem handicapping computer capabilities.

As a straight printer, without plotting, it is four times faster than the best conventional system now available. In a publishing or direct-mail application, for example, the system could print out 90,000 magazine or other address labels per hour—more than twice the capability of the fastest technique now available.

Additional applications are seen in such areas as computer account-and records-keeping work, in operations research, and even in the proving out of tapes used in numerical control of machine tools.

Offering excellent resolution, the equipment prints up to 100 plot points per inch. Overall accuracy of the system is 0.05% of scale width (10 inches). This is as high a degree of accuracy as is now obtainable in most plotting systems.

At its 300,000 points per minute

printing rate, the system plots up to 10 curves simultaneously on a 12-inch wide, continuous chart record, at the same time drawing its own grid lines and marking in title blocks, grid line identification, and other necessary bits of information. Maximum printing speed is 4000 lines per minute. Chart speed is 10 inches per second.

The Briggs equipment is a high-speed, electrolytic, sub-matrix



Engineer holds the patchboard unit which makes possible quick changes of instructions to the system. Equipment can print and plot 300,000 points/min. It is 4 times faster than best existing computer print-out system.

printer system. It consists, physically, of six cabinets and a console unit, requiring 100 square feet of floor space and costing, overall, in the neighborhood of \$300,000. Used for straight printing applications, the system would cost somewhat less.

Tilt-Lock Chassis Slide

A NEW, featherlight, tilt-lock chassis slide for applications on racks and cabinets is available from Chassis-Trak, Inc., 525 S. Webster Ave., Indianapolis 19, Indiana.

The new C-300 Detent Slide is the most compact tilt-lock chassis slide ever developed. Only 1.687 in. high and 0.352 in. wide, the detent slide can be installed in the smallest standard drilled rack panel increment, 1 $\frac{3}{4}$ in.

Model C-300 Detent Slides lock in three service positions—90° up, horizontal and 90° down. They support loads up to 50 lbs., and may be obtained in lengths of 12, 14, 16, 18, 20, 22 and 24 inches.

Hard, cold-rolled steel construction gives them high strength and



Computer-coded digital information on a 2400-ft. reel of magnetic tape can be translated into 500 pages of neatly stacked, graphed, printed, or printed-and-graphed data in just eight minutes.

Time Magnifier

A MOVIE camera that can stretch the events of one second into 28 hours is now in production. By combining optical, electronic and mechanical principles, the new ultra speed camera can take from 480 to 1,600,000 pictures per second on standard 35 mm film, in black and white or color.

The new camera was developed by Dr. Albert T. Ellis, associate professor of applied mechanics at the California Institute of Technology. He originally designed the basic instrument for the express purpose of photographing gas bubbles appearing in turbulent fluids.

Film lies with emulsion side inwards at the periphery of a circular shaped film box. The film remains stationary while a rotating mirror conveys the image from frame to frame.



wearing qualities. Slides are cadmium plated, then coated with Poxylube 75, a molybdenum disulfide dry film finish which provides permanent lubricant and protects against climatic conditions. Tests prove that Poxylube 75 withstands pressure loading of more than 50,000 psi at 25 fpm. Finish meets JAN 100-hour salt spray requirements and is approved for military use.

The detent slides can be used to mount utility chassis as well as component chassis. Thus, normally wasted rack space is put to practical use. The pull-out utility chassis serves as a combination writing or work surface plus storage drawer for connectors, blueprints, etc.

Actual set-up for photography of a cavitation cloud formed in degassed water by ultrasonic sound waves. Note the compactness of equipment.



Such bubbles are born and die within a few thousandths of a second, but during their short life span they produce cavitation, a highly destructive effect in hydrodynamics.

The improved commercial model, built by Benson-Lehner Corp., 1860 Franklin St., Santa Monica, represents the latest research instrument for magnification of time. It permits scientists and engineers to freeze motion while studying arc discharges, explosive reactions, fragmentation processes, high frequency fatigue and many other fast events.

Since no mechanical shutter can approach this speed, an electro-optical shutter is used which controls passage of light by means of

rapid electric pulses. The shutter assembly consists essentially of two polaroid filters and a cell filled with a special substance in an electrical field. When the field is off, no light passes through the assembly. When a high energy electric pulse is applied, the light is polarized in such a manner that it passes freely through the filters. One or two optical lenses focus the image onto a rotating mirror in the film box.

The film remains stationary while the mirror revolves at the rate of 100,000 rpm. The rotating mirror is a piece of nickel-plated aluminum shaped like a wedge and attached to the shaft of a high speed, air driven turbine. Placed at the center of the circular film box, the mirror directs the light rays to the film so that the image travels along the inside rim of the circular film box.

The speed of operation of the electro-optical shutter is determined by the speed at which the electric field is applied and removed. For the rates required in this camera, a very short pulse of 18,000 volts and 20 amps is used to control the field. The special pulser system designed for this camera permits effective exposure times of 0.05 to 1.0 microseconds.

Since very intense illumination is needed to provide good resolution at ultra fast exposure rates, the camera is equipped with its own lighting system, capable of producing 400,000,000 lumens with 3 milliseconds duration. This is about 60 times more illumination than provided by the most powerful flash bulb.

Chassis slide with detents permits service in three positions: up, down, and horizontal.



A REPRINT
of this article can be obtained by
writing on company letterhead to
The Editor
ELECTRONIC INDUSTRIES
Chestnut & 56th Sts., Phila. 39, Pa.

By **NORMAN C. PARRISH**
Research Specialist
Lockheed Missiles and Space Division
Sunnyvale, California

To accurately measure the stress components in a space vehicle, the instrumentation should be carefully selected and installed. Errors may arise from temperature effects, vibration and acceleration. There may be human errors in balancing the bridge circuit or mechanical errors due to surface conditions where the gage is attached. Calibration is important.

For Missile Measurements . . .

Selecting and Using

Fig. 1: Captive landing gear drop test using gages for detecting load magnitude and distribution of loads during 1/10 sec. loading.



A CAPTIVE vehicle will simulate the basic requirements for "experimental measurements" of a flight vehicle, but will differ in some instances because of environmental conditions. Therefore, the instrumentation engineer should select or create appropriate experimental measurement instrumentation. This instrumentation should be able to obtain and present the test data concisely and accurately for assimilation by data reduction equipment into its final form.

For "clean measurements," each instrument should have optimum characteristics for converting mechanical (input) change into a proportional electrical (output) change. The instrument selected here is the bonded wire strain gage.

Selecting a Gage

The strain gage for these "clean measurements" should be small and light, and be able to detect mechanical changes under both static and dynamic conditions. The strain gage must also be of simple construction and operation. A single strand of very fine wire meets these requirements. As the wire is deformed mechanically, it causes a proportional change in electrical output. This change can be interpreted as the mechanical strain on the base material being tested. So long as it is not affected by temperature, moisture, electrical transients or service conditions, the stability and accuracy of the measurement will be assured.

Bonded Wire Strain Gages

Using a Wheatstone Bridge

There are special Wheatstone bridge circuits designed for use with strain gages. (See Figs. 4 through 9.) The bridge balancing control of these circuits can be calibrated in micro-inches-per-inch, and will indicate the unit strain directly for pure tension and compression for "direction type" measurements. Indeterminate loading of a residual nature can be ascertained and converted into real numbers by cementing the gage in place, balancing the subsystem for zero output, releasing the residual stresses in the structure (by cutting or drilling), and reading the ΔR or ΔL direct.

Temperature Compensation

If Gages A and B are connected in the Wheatstone bridge as shown in Fig. 5, temperature compensation will result. Gage B is in compression when Gage A is in tension and is subjected to a strain proportional to the strain on A (in accordance with Poisson's ratio). The ratio of the strain (Poisson's ratio) varies between 0.25 and 0.35 for metals. Thus, the bridge output using this circuit might be 30% greater than if the temperature compensation (Gage B), were obtained by using a dummy gage. However, with this method, a calibrate run should be made to determine the exact ratio of the strain indicated by the gage arrangement.

The active and compensating gages should have very nearly the same resistance, the same gage factor,

and the same resistive sensitivity to temperature. This can be done by using strain gages from the same manufacturer's lot number. Since the resistance of both gages changes simultaneously with temperature, there is no unbalancing of the bridge circuit.

Dynamic Tests Using the Strain Gage

An increasing number of dynamic tests are becoming necessary, using the strain gage as the sensing device. The "umbilical cord," is used for captive systems where the ground station receives the signal directly. Tape recorders are used where recovery is probable and telemetry not desirable, or where storage of information and controlled playback is desired.

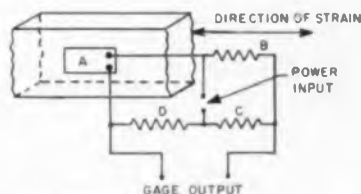

Fig. 4: Full bridge—single active leg (A) for simple tension compression using dummy gages or fixed resistors for B, C, and D.

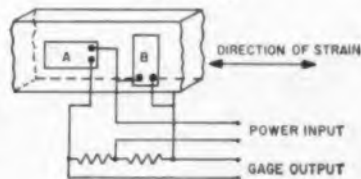

Fig. 5: Full bridge—two active legs and two temperature compensating gages or two fixed resistors for simple tension or compression using Poisson's ratio.

Strain Gage (Continued)

The telemetering system is also used in conjunction with tape systems when safe recovery of the test vehicle is only probable to assure complete and comprehensive data recording.

One of the basic measurements is the direction and degree of stress components in a complex structure. From properly located strain gages, adequately bonded to the surface of the structure, the principle axis as well as magnitude of the stresses can be determined.

Humidity and Temperature Effects

When a single element wire of one alloy has a change in electrical sensitivity, without a mechanical change, it can be attributed to either humidity or temperature effects. (Transients are not considered here.) To reduce these effects, the strain gage transducer has a secondary alloy added to the wire pattern. The different alloys are selected so the positive change in resistance due to temperature effects of one will balance the negative change in resistance of the other. This compensated gage, when waterproofed, will have a change in electrical resistivity that is more directly proportional to the mechanical changes in the material to which it is bonded. (See Fig. 10.)

The change in resistance of a strain gage placed in a "wheatstone bridge," will cause a relatively imperceptible resistance change to become a usable output signal. This signal can be telemetered or recorded directly by auxiliary equipment. However, a relatively uniform temperature must be maintained to further control temperature error in the circuit of the strain gage element within the "wheatstone bridge." Errors caused by moderate changes in temperature in the "wheatstone bridge" can further be reduced by including a strain gage of identical characteristic in another leg of the circuit.

The strain gage actually bonded to the test mem-

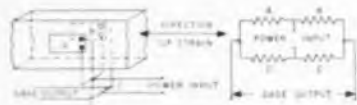

Fig. 6: Full bridge—two active legs (A & B) with temperature compensating resistors for bending only.

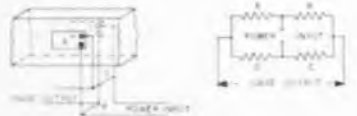

Fig. 7: Full bridge—two active legs (A & C) with two temperature compensating legs or fixed resistors for B & D—to measure tension with active leg to compensate for bending.



Fig. 8: Full bridge—four active legs maximum ΔR for pure tension specimen. This circuit compensates for bending.

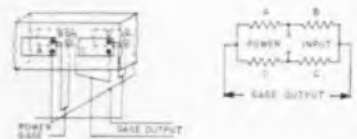

Fig. 9: Full bridge—four active legs for maximum ΔR in bending only. Not for simple tension or compression.

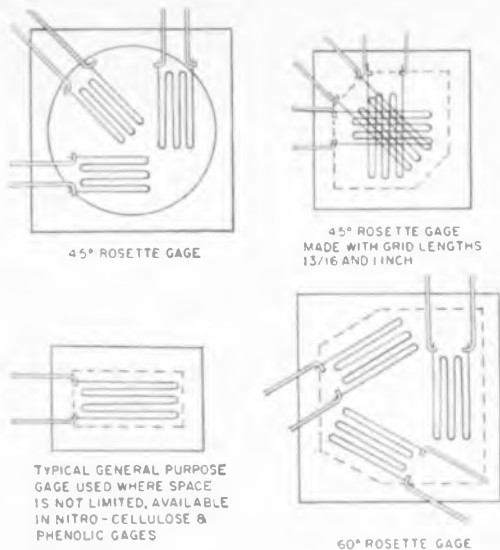

Fig. 10: Strain gage patterns.

ber for measuring strain is the "active arm." Quite often to increase the output signal change and to compensate for bending, or to isolate bending loads from twisting loads and tension loads, special circuitry with two or more gages is used. Temperature compensating gages may be used in lieu of fixed resistors for the inactive legs of the bridge. The use of fixed resistors is more apt to result in a resistance change error than when dummy gages are used.

The behavior of any measuring instrument is definitely affected by the nature of the material being measured. An interpretation of data obtained from the measuring system should be based on a careful understanding of the exact arrangement of the strain gages of the structural member under observation.

It is equally important to select the proper strain gage type for the test environment, and the strain gage used for replacement purposes. If a damaged gage is one of a multiple gage installation, it should be replaced with a gage from the manufacturer's same lot number and as near to being of an identical resistance as possible.

What the Strain Gage "Sees"

The apparent change in resistance of the strain gage sub-system is meant to indicate the actual mechanical changes in the base to which it is attached. Actually the strain gage system indicates the general summation of resistance changes seen by the strain gage sub-system and its components. Some effects "seen" by the sub-system are:

- The surface conditions to which the gage is attached—air bubbles, irregularities, or bumps under the gage.
- The temperature of the area to which the gage is attached, if not properly temperature compensated.
- The effects of the bonding material, electrical, thermal, and mechanical strain transfer. (An excessively thick bonding agent may have a pliability that does not transfer accurately the deformation of the base material or the temperature of the base

material, and time lag errors will result.) (Other problems arise when an A-C system is used.)

d. The distance of the gage from the surface attachment area (particularly in applications other than an absolutely flat surface).

e. The true alignment or transverse effects. (If the gage is allowed to be 3° from the intended axis, the result may in some instances, be in considerable error. For instances a 45° angle installation (to the principle axis) may be indicated and the installation installed at 43° . This will result in as much as a 20% error in the strain gage output.)

Additional effects "seen" by the strain gage circuit are:

a. Effects of lead resistance due to unequal lengths. This can be controlled by the three wire circuit system of Fig. 2.

b. Drift aspects due to resistance balancing. This can result from an improperly matched group of strain gages or fixed resistors used to obtain the proper null bridge balance.

c. Error of zero balancing or indicator linearity. This is more apt to occur in captive tests, but can be considered a human error.

d. Warm up or voltage drift effect when an inadequate warmup time is allowed.

e. General temperature error.

Mechanical errors due to surface conditions can be easily avoided, and should be eliminated. If air is entrapped under a gage during installation, it should be replaced.

Calibration Runs

A calibrate check run should be made before and after each test run. Then if all the disturbing influences have been taken into account and evaluated, an independent estimate of total error and accuracy can be made. Without a calibrate check one cannot assume less than a 20 micro-inch-per-inch error for each reading, even under optimum conditions.

The calibration of the instrument determines the functional relationship between the output and the values of the variables to be measured. Any other variables which might affect the instrument indication must be held constant.

The dissymmetry induced by the bridge circuit is a result of imperfect cancellations. A large per-

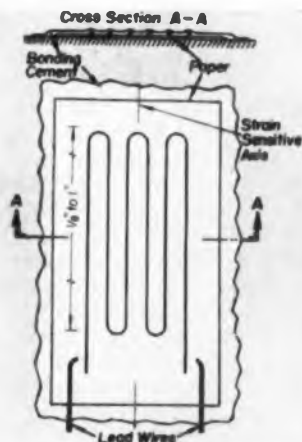

Fig. 11: Enlarged illustration of a bonded strain gage installation.

centage of attention should be directed to the errors induced by incomplete balancing and inadequate compensation. Such effect as hysteresis in the test structure cannot be cancelled by modification of the strain gage system as readily as improvements can be made in a strain gage installation.

For detailed installation, procedures outlined, are required. Information on rate of thermo rise, humidity effects, desired accuracy, and other significant environmental data should be available prior to the start of the test and when interpreting test results.



Fig. 12: Closeup of bonded strain gage.

Vibration, Acceleration and Waterproofing

Where there is acute vibration and acceleration, attention should be given to the installation of the inner connecting leads to prevent the transfer of loads into the gage which could result in a false output signal. (Figs. 2 and 3.) When high moisture content of the air is expected, moisture proofing for both internal and external strain gages should be used.

The thickness of waterproofing should be influenced by the cross-sectional area and load carrying capacity of the material being used.

Physical strength of the metal shielding material must be considered also.

Other considerations of gage installation are:

a. Possible damage to the gage installation during waterproofing. (Maintenance is appreciably reduced with waterproofing.)

b. Temperature effects may unbalance the bridge because of thermal insulation effects of waterproofing and resultant thermal time lag.

c. How dependable the transducer pickup will be and what percentage of cross talk will contaminate the desired signal, or other signals.

d. The overall cost of the system with respect to its accuracy and compatibility with the telemetry or recording instrumentation used.

e. Will the data from the instrumentation be compatible with the system capability and with existing or anticipated ground station capabilities.

f. When measuring a primary variable, it is necessary to know the errors of the system to the greatest possible accuracy.

Bibliography

- A. *Strain Gage Techniques*, W. Murry and E. K. Stein, Aug., 1957. UCLA
- B. *Strain Gage Primer*, C. Perry and H. Listner—McGraw-Hill
- C. "Problems Involved in Precision Measurements with Resistance Strain Gages," K. H. McFarland and J. Dimeff, Feb., 1956. North Atlantic Treaty Organ—Palais de Chaillot, Paris 16
- D. *Strain Gage Techniques*, Wm. M. Murry and E. K. Stein, MIT, Cambridge, Mass., 1956
- E. *Strain Gage Instruments and Accessories*, Baldwin-Lima-Hamilton Co., Jan., 1957

This is the third in a planned series of editorial features on Radio Frequency Interference arranged for by the editors of ELECTRONIC INDUSTRIES

A review of proposed space communications is given followed by an analysis of the interference aspects of each part of the system. The influence of man-made and celestial radiators on system performance is shown and a prediction is made of the improvement to be expected by appropriate design of each item.

RFI in Satellite Communications Systems

By O. M. SALATI

Assistant Prof.
Moore School of Electrical Eng'g.
University of Pennsylvania
200 S. 33rd St.
Philadelphia 4, Pa.

THE feasibility of artificial Earth Satellites has been amply demonstrated by the successful launching of more than 16 such vehicles during the past two years¹. All of these satellites carried radio equipment for reporting back various scientific observations. One of them established the first earth to active satellite voice relay. Long distance radio relay via the moon, as a passive reflector, has been reported by Sulzer² and others³.

Pierce^{4, 5} and later Handelsman and others^{6, 7, 8, 9, 10} have made theoretical studies of passive and active earth-satellite systems based on present state of the

art and extra-polations to 1975.

Studies of receiving equipment noise, Galactic noise, and propagation effects have been reported by Ewen¹¹, Strum¹², Leary¹³, Senior¹⁴, and Murphy¹⁵.

There is no indication in the literature that interference may be a problem to a satellite communications system. Findlay¹⁶ has reported on site measurements and procedures for selecting an interference free site for a radio astronomy observatory. Shapiro¹⁷ has mentioned a possible mechanism of interference but it has not been applied to a satellite system.

There are two classes of satellites, active and passive, and two classes of orbits, low (of the order of 500 to 3000 miles above the earth) and high (approximately 22,000 miles above the earth and stationary if it is an equatorial orbit).

The active satellite is made up of a suitable vehicle, an antenna, transmitter, receiver, and power supply. Once in orbit, many of the characteristics of the system are beyond change, thus one cannot take advantage of some improvements in the state of the art. If the active satellite becomes obsolete, it must be destroyed or its transmitter shut off to avoid having it become a source of interference. Because the satellite is active, it will be a source of interference unless suitable precautions are taken. For instance, it will radiate all harmonics and modulation splatter of its transmitter. Its receiver is vulnerable from spurious responses and intermodulation. This is true because its antenna may see more high powered transmitters than it would if it were located a few feet above the earth's surface. Since antennas of gain greater than one are used, a stabilizing mechanism will be required to avoid fluctuation and fading of signals.

The passive satellite is either a metallized balloon or a plane mirror. The balloon is essentially an isotropic radiator if its diameter is large compared with the wavelength of an incident plane wave and thus re-

Fig. 1: A low orbit satellite communication system is shown

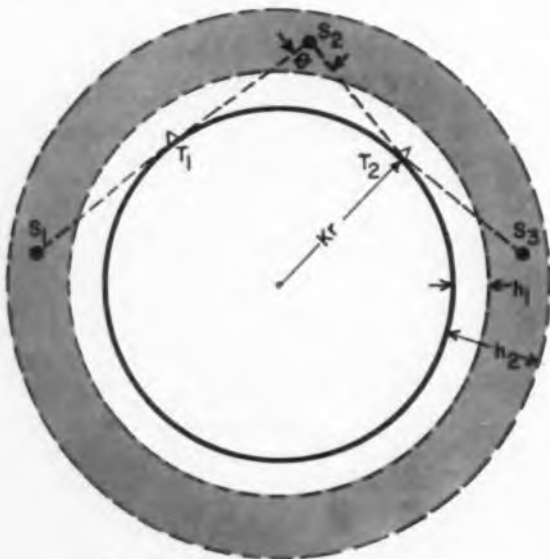

- r = Earth's radius = 4,000 miles
- $K = 4/3$
- h_1 = 500 miles = Minimum orbit altitude
- h_2 = 3,000 miles = Maximum orbit altitude
- T_1, T_2 = Location of transmitter or receiver
- θ = Angle of view of satellite

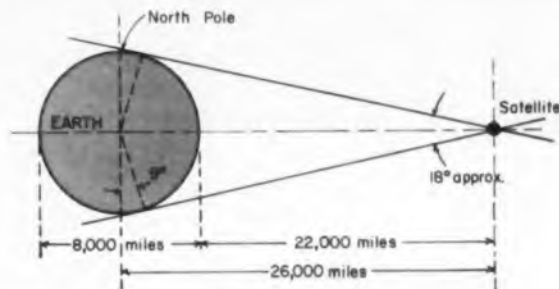

Fig. 2: The geometry of a 24 hour Equatorial satellite orbit

quires no orbital stabilization even when it is only slightly larger than a few wavelengths⁶. The passive satellite itself is not subject to interference nor is it a source of interference. It's only role in interference is that it relays all the signals which are incident on it and thus it provides a dense interference environment to the ground receiver.

Low Orbits

The period of revolution of a satellite in its orbit is given by:

$$T = \frac{2\pi R^{3/2}}{Gr} \quad (1)$$

Where: R = radius of orbit from earth's center
 r = radius of earth
 G = Gravitational constant at the earth's surface.

For low orbits, 500 to 3000 miles above the earth, the time of rotation is approximately 100 to 195 minutes. The orbits may be polar, equatorial, or whatever other orbit is desirable for the system. Because of the low orbit altitude, the satellites will be in continual motion with respect to an observer on the earth and the ground antennas must be able to track it. In addition, several satellites will be required for continuous communication between two points on the earth's surface since any particular one is visible for only a brief period (Fig. 1). The satellites may be spaced randomly in their orbits but a smaller total number will be required if they are in synchronous orbits. The low orbit provides some freedom from interference since the satellite does not see as many interfering sources as it would at higher altitudes (It sees an area bounded by a circle of diameter $T_1 T_2$ on the surface of the earth, Fig. 1).

High Orbits

If a satellite is in an equatorial orbit at an altitude of 22,000 miles above the earth, it will have a period of 24 hours and thus will hover over a fixed spot on the earth, Fig. 2. Actually, because of various uncertainties in orbits, the satellite's position will vary slightly and the ground antenna must have some tracking ability. Three satellites in the above orbit will provide continuous coverage between any pair of points on the earth's surface, Fig. 3, except within about 8° of the poles (the satellite subtends an 18° cone angle and thus sees almost a complete hemisphere).

Since the satellite, at this altitude sees essentially a hemisphere of the earth, it is much more prone to interference if it is active (see Active Satellites

above) or it provides a ground receiver with a high ambient interference level if it is passive (see Passive Satellites above).

The performance equations have been given by many persons^{4, 5, 6, 7}. These equations are repeated here for reference purposes. All of these equations can be simplified considerably for specific situations.

Passive Relay System

If a metalized sphere is used as the passive satellite, the signal to noise ratio at the receiver is given by:

$$\frac{S}{N} = \frac{P_t G_t A_r A_s}{4\pi^2 R_1^2 R_2^2 K T_n B} \quad (2)$$

$$\text{Where } G_t = \frac{4\pi A_t}{\lambda^2} \quad (3)$$

A_r, A_t = Receiver and transmitter antenna aperture areas in meters sq.

P_t = Transmitter power in watts

λ = Wavelength in meters

R_1, R_2 = Transmitter to satellite and satellite to receiver distances in meters

$$N = K T_n B \quad (4)$$

K = Boltzman's Const. = 1.38×10^{-23} Joules/°K

B = Bandwidth in cps

T_n = Effective noise temperature in °K of the receiver input circuitry.

Following the method of Ewen¹¹, T_n is given by:

$$T_n = T_G + (L_1 - 1) T_1 + (L_o - 1) T_o L_i + (L_w - 1) T_w L_i L_o + T_A + (L - 1) T_L L_1 L_o L_w + T_e L_1 L_o L_w L \quad (5)$$

Where: T_G = galactic background radiation field, Cosmic noise

T_1 = contribution of Ionosphere } Negligible above 250 MC

L_1 = loss due to Ionosphere }

T_o = contribution due to atmospheric oxygen

L_o = loss due to atmospheric oxygen

T_w = contribution from atmospheric water vapor } Negligible below 10,000 MC

L_w = loss due to atmospheric water vapor }

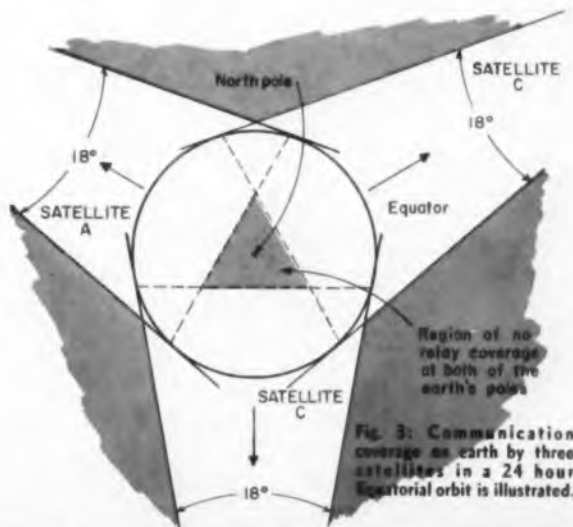

T_A = temperature distribution due to back lobes and side lobes of antenna viewing the earth's surface and other radiators

T_L = contribution from antenna efficiency and passive r-f hardware loss ahead of the first active circuit. Antenna efficiency is approximately 0.65

L = losses due to antenna efficiency and r-f hardware

T_e = effective noise temperature of all active circuits.

Typical value of T_e are:

Solid state maser	$T_e \leq 10^3$ Kelvin
Cooled Crystal mixer	$T_e \leq 150^\circ$ "
Rec. of 6 db noise fig. at 3 KMC	$T_e \approx 1160^\circ$ "
Rec. of 3 db noise fig. at 200 MC	$T_e \approx 580^\circ$ "

Because of all of the above mentioned losses, it may be difficult to realize a value of $T_e < 100^\circ K$ even for the best solid state maser.

Active Relay System

For the earth-to-satellite portion of the path, the signal to noise ratio at the satellite receiver is:

$$\frac{S_1}{N_1} = \frac{P_t G_t A_{r1}}{4\pi R_1^2 K T_{e1} B_1} \quad (6)$$

Where: A_{r1} = satellite receiver antenna aperture area in meters sq.

P_t = ground transmitter power in watts

G_t = ground transmitter antenna gain (numeric)

T_{e1} = effective noise temperature of satellite receiver input (same considerations as in above apply).

For the satellite to earth portion of the path, the ground receiver signal to noise ratio is:

$$\frac{S_2}{N_2} = \frac{P_{t0} G_r A_r}{4\pi R_2^2 K T_{e2} B_2} \quad (7)$$

Where: P_{t0} = satellite transmitter power in watts

A_r = ground receiver antenna aperture area in meters sq.

SUMMARY OF REPORTED SPACE COMMUNICATIONS SYSTEMS

GROUND STATIONS						SATELLITE					
Source	Transmitter P_t Power	Antenna Dia. Ft.	θ Degrees	S/N db	Receiver	Freq. KMC	Modulation Bandwidth or Pulse Length	Height above Earth, Miles	Antenna or Satellite Dia. Ft.	Transmitter Power P_{ts}	Rec.
Weber ¹⁰	7 megw	120	---	20	Parametric Amp.	5	20 MC	1,000	100	0	0
	100 w	60	---	20	NF = 5 db	1	20 MC	22,000	3.5		
Murphy ¹⁵	250 kw	50	0.1	40		10	30 μ sec (30 KC)	238,587	Moon 2160 miles	0	0
Senior ¹⁴	250 kw	60	0.1	10	NF = 10.4 db	10	5 μ sec (200 KC)	238,587	Moon 2160 miles	0	0
Wiesner ⁷	100 w	28 Trans 60 Rec.	---	24	100° K	0.4	4 MC	2,500	Isotropic Ant.	1 w	
	500 w	28 Trans 60 Rec.	---	24	100° K	0.4	100 KC	22,000	Isotropic Ant.	1 w	
	100 w	28	---	24	100° K	0.4 to 2	100 MC	2,500	Isotropic Ant.	100 w	
	500 to 1000 w	60	---	24	100° K	0.4 to 2	8 MC	22,000	Isotropic Ant.	100 w	
	10 kw	250	---	20	30° K	2	4 MC	2,500	100	0	0
	10 kw	250	---	20	30° K	2	1 KC	22,000	100	0	0
Pierce ⁴	100 w	250	---	20	NF = 6 db	3	5 MC	22,000	10	0.3 w	~ 40 db
	10 megw	250	---	20	NF = 6 db	3	5 MC	22,000	1000	0	0
	100 kw	250	---	20	NF = 6 db	3	5 MC	22,000	100	0	0
	50 kw	250	---	20	NF = 6 db	3	5 MC	22,000	100 Mirror	0	0
Handelsman ⁶	1200 kw	177	0.13	20	1000° K	3	4 KC	22,000	100	0	0
	80 kw	177	0.13	20	100° K	3	4 KC	22,000	100	0	0
	8 megw	177	0.4	20	1000° K	1	4 KC	22,000	100	0	0
	800 kw	177	0.4	20	100° K	1	4 KC	22,000	100	0	0
	120 megw	177	2	20	1000° K	0.2	4 KC	22,000	100	0	0
	20 megw	177	2	20	100° K	0.2	4 KC	22,000	100	0	0
	12 kw	316	0.07	20	1000° K	3	4 KC	22,000	316	0	0
	800 w	316	0.07	20	100° K	3	4 KC	22,000	316	0	0
	80 kw	316	0.2	20	1000° K	1	4 KC	22,000	316	0	0
	8 kw	316	0.2	20	100° K	1	4 KC	22,000	316	0	0
	1200 kw	316	1.0	20	1000° K	0.2	4 KC	22,000	316	0	0
	200 kw	316	1.0	20	100° K	0.2	4 KC	22,000	316	0	0
	12 w	1000	0.02	20	1000° K	3	4 KC	22,000	1000	0	0
	0.8 w	1000	0.02	20	100° K	3	4 KC	22,000	1000	0	0
	80 w	1000	0.07	20	1000° K	1	4 KC	22,000	1000	0	0
	8 w	1000	0.07	20	100° K	1	4 KC	22,000	1000	0	0
	1200 w	1000	0.3	20	1000° K	0.2	4 KC	22,000	1000	0	0
	200 w	1000	0.3	20	100° K	0.2	4 KC	22,000	1000	0	0

$$G_{ts} = \text{satellite transmitter antenna gain (numeric)}$$

$$= \frac{4\pi A_{ts}}{\lambda^2} \quad (8)$$

λ = wavelength in meters

T_g = ground receiver effective noise temperature.

Terrestrial Noise

There are two types of extra-terrestrial noise, discrete and diffuse background. Table 1 gives the power output of a few discrete noise sources⁶.

Table 1.
Some Discrete Galactic Noise Sources in Watts Sq. Ft. CPS

Source	200 MC	1000 MC	3000 MC
Cassiopeia A	10 ⁻²³	3x10 ⁻²⁴	10 ⁻²⁴
Cygnus A	10 ⁻²³	10 ⁻²⁴	7x10 ⁻²⁵
Taurus A	10 ⁻²⁴	10 ⁻²⁴	10 ⁻²⁴
Virgo A	10 ⁻²⁴	3x10 ⁻²⁵	10 ⁻²⁵

These sources contribute noise power or are part of the equivalent noise temperature T_g of the receiver when the receiving antenna or its side lobes is looking at them.

Diffuse galactic background noise has a maximum along the galactic plane and a minimum toward the galactic poles. This contribution to the equivalent noise temperature T_g is independent of the receiving antenna aperture since the background almost always fills the antenna beam when the beam is pointed at the source. Fig. 4 from Ref. 11 shows the maximum and minimum background as a function of frequency, and in addition includes contributions from the atmosphere (terms T_a and T_{ic} in Eq. 5). It will be noted that there is a "window" of low noise temperature from about 500 MC to 10,000 MC and it is assumed that most low noise relay systems will operate in this band.

The moon, and the planets Venus, Jupiter, Mars, and Saturn are the only other bodies having appreciable noise radiation. The planets have noise temperature of the order of 1°K or less and are thus of no interest as noise sources at this time in the above mentioned "window." The Sun has noise outputs of 10⁻²¹ to 10⁻²⁰ watts/sq.ft./CPS at 3000 MC and 10⁻²² to 10⁻¹⁹ watts/sq.ft./CPS at 200 MC. The moon has an equivalent noise temperature of about 150°K at 400 MC. Both the Sun and the Moon should be avoided by the main beam or the side lobes of the receiving antenna.

Antenna Characteristics & Interference

The antenna of a relay system serves as an impedance matching transformer between a transmitter or receiver and free space, as well as a means of directing the transmitted or received energy in a preferred direction. A typical antenna pattern would show a major lobe for the preferred direction of operation and undesired side and back lobes (Fig. 5). Because of the existence of the unwanted side lobes and back lobes there will be a contribution T_a to the equivalent temperature of the receiver circuitry (Eq. 5) and also, of course the radiation of energy in unwanted directions in the case of transmission. The latter will be a serious source of interference to other systems and in some cases to one's own system.

The equivalent temperature T_a of the antenna, be-

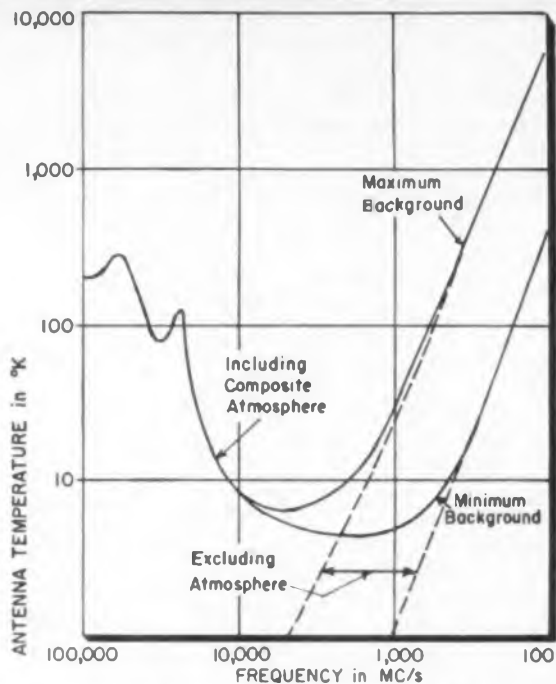

Fig. 4: The galactic background noise max. and min. is shown as a function of frequency and includes contributions from the atmosphere. Note the "window" of low noise temp.

cause of its side and back lobes viewing objects of various temperatures (the earth, buildings, other antennas, etc.), is obtained by integrating the entire solid angle of the sphere surrounding the antenna, in the antenna far field, and dividing by the integral of the antenna gain over a full sphere, that is ¹²:

$$T_a = \frac{\int_s T(\theta, \phi) G(\theta, \phi) ds}{\int_s G(\theta, \phi) ds} \quad (9)$$

Where: $\int_s G(\theta, \phi) ds = 4\pi$ (10)

ds = the solid angle given by $\sin \theta d\theta d\phi$

$G(\theta, \phi)$ = the antenna gain in the direction θ, ϕ .

$T(\theta, \phi)$ = the source temperature in the direction θ, ϕ .

The greatest contribution to this integral will come from the earth's temperature of 290°K when the antenna is looking skyward. The following example illustrates the problem:

Assume a 60 ft diameter parabolic antenna having side lobes down 30 db and back lobes down 40 db from maximum gain (Fig. 5). The effective noise temperature T_a , when the antenna is oriented so that its main beam points skyward or just grazes the surface of the earth and no discrete signals are present is given in Table 2.

Table 2.
Effective Noise Temperature of an Antenna

fMC	λ ft	Beamwidth Deg.	Antenna Sky In	Orientation Horizontal °K
100	10.0	9.3	2.15	5.0
1000	1.0	0.93	49.0	115.0
10,000	0.1	0.093	65.0	150.0

Antenna diameter = 60 ft.
Side lobes - 30 db, back lobes - 40 db

It will be noted that the effective temperature increases as the beam-width is narrowed for a constant ratio of main beam gain to side and back lobes, and that there is a large increase when the side lobes touch the earth's surface.

If the side and back lobes are decreased, Table 3 results for the antenna oriented skyward:

Table 3.
Effects of Side and Back Lobe Reduction
(60 ft diameter antenna)

f _{MC}	Side and Back Lobes	
	- 50 db	- 70 db
100	0.21°K	2.0°K
1000	28.7°K	0.02°K
10,000	140.0°K	19.0°K

It will be noted that a small reduction in side and back lobe level causes the effective antenna temperature to rise in one case. This is explainable since the side lobes at sky temperature are reduced more than the back lobes. One might thus be tempted to leave

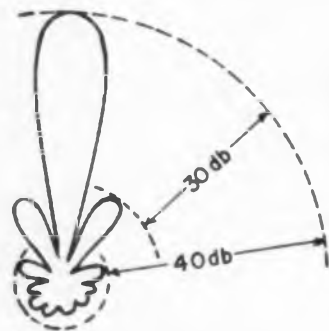

Fig. 5: Typical antenna radiation pattern is shown. The unwanted lobes can cause serious interference.

the side lobes alone and concentrate on back lobe reduction. Such a procedure is a fallacy, since discrete signals may enter the antenna via the side lobes and thus render the system ineffective. Further, side and back lobe level reduction causes the effective temperature to drop.

From the above example it can be seen that at certain frequencies, the use of masers or other low noise amplifiers may be of no value unless the antenna side and back lobes are reduced such that the effective antenna temperature is comparable or less than the amplifier noise temperature.

Antenna side and back lobes must also be reduced to avoid interference when transmitting or receiving. At certain frequencies, emissions from the antenna main lobe or side lobes may be scattered back to the receiver by way of the ionosphere and the earth¹² (Fig. 6a & 6b).

This particular mechanism may not be too important because it occurs at frequencies below those usually used in earth to satellite communications. On the other hand, since high power transmitters are available below 30 MC (100 kw average) the received signal may be high enough to cause overloading or nonlinear effects and therefore must be considered.

A similar interference mechanism is operable at higher frequencies due to tropospheric scatter systems (high transmitter power is again used—10kw or greater).

Before system power levels can be completely determined, allowance must be made for fading of signals as a result of multipath transmission, Faraday rotation of the plane of polarization of radio waves, small perturbations of the attitude of the satellite, reflections or attenuation by meteor trails, and Auroral effects^{13, 14, 15}.

Faraday rotation varies inversely with the frequency, and is essentially negligible at 10,000 MC but serious at 200 MC.

Absorption due to auroras varies inversely with the square of the frequency. An auroral sky is essentially opaque to radio waves below about 1000 MC and the effect has been noted over large areas of the earth's surface. Auroras may act as reflectors of unwanted signals and thus may constitute a source of interference.

Meteor trails and variations in the ionosphere may cause multipath effects and fading. Meteor trails may also provide a reflector for interfering signals.

Most of the above effects are usually lumped together and a fading allowance of 20 to 25 db provided. The interference effects on the other hand have not been studied in any detail.

Perturbations in satellite position or motion of the satellite with respect to the receiver can give rise to Doppler shift when two or more transmission paths are present⁸. The maximum Doppler frequency shift is given by:

$$f_d = \frac{fv}{c} \quad (11)$$

Where: f = carrier frequency

v = relative velocity between receiver and transmitter

c = velocity of light.

This effect will be most troublesome in low orbit satellite systems.

From the formulas, figures, and tables of the above text, one can compute the transmitter power requirements and antenna sizes if the receiver sensitivity is known, desired signal to noise ratios are selected, and estimates are made of path loss, fading, requirements and equivalent receiver input noise temperature.

Page 94 has a summary of system performance presented by various researchers. It can be seen that relatively large ground antennas and satellites have been proposed. The proposed ground transmitter outputs range from about 0.8 w to 120 megawatts. For passive satellites, the probable transmitter power will be in the range of 10 kw to 10 megawatts. For active satellites, the required ground transmitter power is usually below 1 kw.

Interference Considerations

The high power ground transmitters will probably be a source of interference to other services by way of antenna side and back lobe radiation, tropospheric scatter under some conditions of site location (probability is small, however) and radiation of harmonic power. Investigations have shown that high power transmitters in the frequency range of 200 MC to 10,000 MC may be expected to have harmonic outputs of the order of 20 to 40 db below maximum carrier power, and these outputs may be expected up to the 5th to 10th harmonic. The radiated harmonic power

is sufficiently high to cause serious interference. This problem is particularly peculiar to satellite communications because of high powers and large antennas that are proposed. It would seem that considerable effort should be expended in reducing harmonic output by filtering or other techniques.

The large antennas that are proposed can also be considered to be a source of interference if present day limits of 20 to 40 db suppression of side and back lobes continue to apply. It has been pointed out in *Antenna Characteristics and Interference* above that suppression of side and back lobes by a minimum of 50 db and preferably 70 db will be required if the equivalent antenna noise temperature T_a is to be comparable to or below the noise temperature of maser amplifiers. Such reductions in side and back lobes will reduce the probability of interference to the receiver since the interfering signal must now enter the system by way of the relatively narrow main lobe of the antenna. Such reductions will also materially reduce interference to other services from the ground transmitter for similar reasons.

Most receivers that are currently planned for satellite systems are of the superheterodyne type. They can be expected to have spurious responses. These responses are accurately predictable in frequency but not in amplitude. For conventional receiver circuits, interference signals of the order of milliwatts can be expected to be received by way of spurious responses. The new low noise receiver circuits are believed to overload rather easily and therefore they may be very vulnerable to interference. This subject must, of course, be studied in detail. It does appear, however, that considerable filtering in the receiver input circuitry may be required as the ambient interference level at the antenna rises because of increasing power and density of other equipments.

Satellite Considerations

Passive satellites of the spherical type return all signals that are incident on them. Such satellites in high orbits view more of the earth's surface than those in low orbits. Consequently they will provide the ground receiver with a higher ambient interference level. This phenomena can only be reduced by the use of directive passive satellites or by constructing them to be highly frequency sensitive. Both of these moves reduce the main advantages of such satellites, namely to provide all types of services to all customers.

Active satellites can expect interference from high power ground transmitter, particularly radars. This effect can be reduced somewhat by selective circuits in the satellite and by use of directive antennas. The satellite transmitter, particularly if it is of relatively high power—100 to 1000 w, may be a serious source of interference to other services. This phase of the problem must be studied further.

Most of the above mentioned interference effects are not peculiar to satellite systems. They are intensified, however, by the planned use of high power transmitters, large antennas, very sensitive and new receivers, and the presence of the satellite in an orbit at an altitude above the earth, much higher than conventional antennas.



Fig. 6a: Static interference and man-made signals, reflecting from the ionosphere, may enter the beam of receiving antenna.

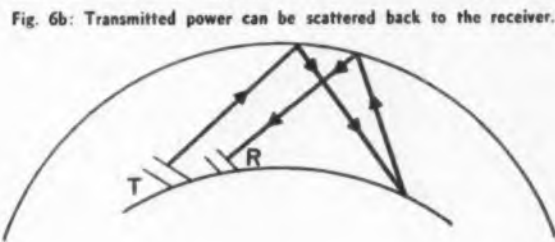

Fig. 6b: Transmitted power can be scattered back to the receiver.

So far the author has considered only a single satellite system. It is quite probable that many satellite systems will exist. This will impose additional considerations of system design and interference. For instance, unless all of the systems are planned with regard for each others existence, it is conceivable that more than one satellite may find itself in the beam of a transmitter or receiver antenna at the same time. If the satellites are in orbits of different altitudes, it is conceivable that one satellite may shadow another.

There are probably other considerations of similar nature which have not been considered here. Satellite systems must be considered on a world wide basis such as that followed on frequency allocations.

The author acknowledges the assistance of Mr. H. Kritikos of the Moore School Staff in the calculations of the effective antenna temperature.

References

1. "Satellites and Space Probes," *Electronics*, July 24, 1959, pp. 46-47.
2. "An U-H-F Moon Relay," Sulzer, P. G., *Proc. I.R.E.*, V. 40, No. 3, March 1952, p. 361.
3. "Lunar Radio Echoes," Trexler, J. H., *Proc. I.R.E.*, V. 46, No. 1, Jan. 1958, pp. 286-292.
4. "Orbital Radio Relays," J. R. Pierce, *Jet Propulsion*, V. 25, No. 4, April 1955, pp. 153-157.
5. "Transoceanic Communication by Means of Satellites," J. R. Pierce, R. Kompnyer, *Proc. I.R.E.*, Vol. 47, No. 3, March 1959, pp. 372-380.
6. "Performance Equations for a Stationary Passive Satellite Relay for Communication (22,000 mile altitude)," Handelsman, M., R.A.D.C.—TN-58-379, Astia AD-206898, Jan. 1959. (Not generally available.)
7. "Communications Using Earth Satellites," J. R. Wiesner, M.I.T., Summer course in Long Range Communications, 1959, to be published.
8. "Communicating in Space," L. P. Yeh, *Electronic Industries*, February 1959, V. 18, No. 2, pp. 54-58, 159, and March 1959, V. 18, No. 3, pp. 94-99.
9. "Interplanetary Communication and Navigation," P. A. Castruccio, *Westinghouse Engineer*, May 1958.
10. "Modern Communications Methods," Samuel Weber, *Electronics*, October 23, 1959, pp. 94-108.
11. "A Thermodynamic Analysis of Maser Systems," H. I. Ewen, *Microwave Journal*, V. 2, No. 3, March 1959.
12. "Considerations in High-Sensitivity Microwave Radiometry," Strum, P. D., *Proc. I.R.E.*, Vol. 46, No. 1, Jan. 1958, pp. 43-53.
13. "Communications of the Future," Frank Leary, *Electronics*, July 3, 1959, pp. 37-41.
14. "Radar Reflection Characteristics of the Moon," T. R. A. Senior, K. M. Siegel, Astia AD 206-373. (Not generally available.)
15. "Point-to-Point Communications Using the Moon as a Passive Reflector," R.A.D.C.—TN-58-310, Astia AD-148,980, Dec. 1958, pp. 4-8. (Not generally available.)
16. "Noise Levels at the National Radio Astronomy Observatory," Findlay, J. W., *Proc. I.R.E.*, Vol. 46, No. 1, January 1958, pp. 35-38.
17. "Interference from the Ionosphere," K. I. Shapiro, *Electronic Industries*, V. 18, No. 3, March 1959, pp. 76-78.
18. "ARPA Pushes Communications Satellite," *Aviation Week*, June 29, 1959, p. 18.



"BMEWS" Guards

(Above) Detection radar of the Air Force's BMEWS System reaches 165 ft. into the Arctic skies. Screens are 400 ft. long. (Below) High power klystron tubes for surveillance radar are tested in GE's lab in Syracuse, N. Y. Tube is made by Eitel-McCullough Co. A similar klystron tube is being developed by Varian Associates



BMEWS, the Ballistic Missile Early Warning System, is a long-range, ultra-high-speed radar warning system designed to give the North American Air Defense Command, the Strategic Air Command, and Civil Defense Agencies the brief but vital time needed to take defensive and retaliatory measures should an enemy attack the North American Continent.

Present plans call for three forward sites at Thule, Greenland; Clear, Alaska, and Fylingdale Moor,

Four high voltage transformers and full wave rectifiers produce 120,000 volt dc power supply for the BMEWS transmitters. Transmitters are being developed and produced by Continental Electronics Mfg. Co.





(Above) Automatic checkout and monitoring equipment for BMEWS uses punched cards and targets simulated on tape. (Below) Tracking radar is inside this 140 ft. dia. radome.



Against Sneak Attack

Yorkshire, England. The control center is at the North American Defense Command (NORAD) Colorado Springs, Colorado. A communications system (built by Western Electric Co.) provides instantaneous warning of an attack.

Radio Corporation of America's Missile and Surface Radar Div., Moorestown, N. J., is Prime System Manager for the project. Major subcontractors are General Electric Company, Goodyear Aircraft Corp., and Sylvania Electric Products, Inc.

Eitel-McCullough, San Bruno, Calif., and Varian Associates, Palo Alto, Calif., are supplying high power klystrons. Continental Electronics Mfg. Co., Dallas, Tex., is supplying transmitter power amplifiers, and D. S. Kennedy Co., Cohasset, Mass., is building the surveillance radar subsystem reflectors. General Electric's Heavy Military Electronics Dept. is designing, developing, and testing and placing in operation the surveillance radar subsystems.

GE, Syracuse, N. Y., is designing pulsed-Doppler detection radar, AN/FPS-50, Arrays of feed horns bounce beams off the face of the reflectors (the size of a football field). These beams form horizontal stationary fans, which spread across the polar regions to detect airborne objects. Radar range is 3,000 miles, or more than 10 times the range of the DEW line radars.

(Continued on page 100)

(Above) Huge detection radars at the halfway point in construction. Site is 600 miles above the Arctic Circle. (Below) RCA's dual-purpose tracking radar can detect and track hostile missiles at ranges exceeding 2,000 mi. It weighs 400,000 lbs.





(Above) All installations at the radar site are connected by "covered highways." (Right) Surveillance reflectors were produced by D. S. Kennedy Co., designed by GE. 1,500 ton reflectors are supported by these 42 in. dia. backstays and trusses.



"BMEWS" (Continued)



(Above) Electron Probe Duplexers being tested in GE's Syracuse lab. (Below) Transmitter Power Amplifiers being readied for testing in the same lab. Amplifiers are made by Continental Electronics Manufacturing Co. They provide power for the surveillance radar subsystem. Radio Corp. of America is the prime contractor.



RCA is providing Tracking Radars AN/FPS-49. This radar can both scan and track. It can scan over various sectors at different elevation angles. Upon detecting a target (over 2,000 miles away), the beam locks on and tracks the target.

Through a sub-system of electronic processing equipment, the radar information received is automatically interpreted and communicated instantaneously to NORAD headquarters at Colorado Springs. An interesting feature here is that the system will automatically compare the trajectory of suspected missiles with that of known satellites, meteor trails, and other atmospheric phenomena to assure accurate identification. Sensitivity is comparable to detecting in New York an object the size of a door over Los Angeles.

The tracking radar is enclosed in a radome with a diameter of 140 feet. Antenna and pedestal (built by Goodyear Aircraft Corp.) weigh almost 400,000 lbs. The antenna revolves on ball bearings the size of baseballs.

Computers at the forward sites are in pairs. One can take over the function of the other should scheduled or unscheduled shutdowns occur.

One of the most important contributions to the system's reliability is the automatic checkout and monitoring equipment. Vital points in the radar sub-system are monitored continuously to verify correct operation.

Any part of the system, or all of it, can be checked out automatically using punch cards and targets simulated on magnetic tape.

At the Zone-of-the-Interior (Colorado Springs) data from the forward sites are decoded, evaluated, modified by other intelligence, and displayed. A Display Information Processor appraises the threat level, and degree of confidence in incoming information. The final decision is then made by the Zone-of-Interior as to whether "this is an attack."

ELECTRONIC INDUSTRIES

A CHILTON PUBLICATION



The Challenge of Space

What we have, and
what we need.



an El
Staff
Report

April
1960



In the "change of thinking" that must come about before we can successfully cope with the problem of space travel research and development must find a new identity as a "commodity" on its own.

Reliability must be increased by a factor of about 30.

The increase will be made possible by radically new approaches to the reliability problem.

The

IN the electronic industry we have come to regard "growth" as a natural function of time. And to some extent, it is. But in our optimism we have lost sight of the fact that our growth up to this point, and particularly over the past ten years, has been accelerated tremendously by a number of significant government and industry policies. Not the least of these has been the heavy spending on defense electronics.

In the coming decade we must solve the many problems of space travel. Whether the same rate of progress is maintained during this period will depend on which of the existing policies are retained and on the others that are established to meet the changing conditions.

The solution of this over-all problem is of very vital interest to all electronic engineers, both those employed on defense electronic projects and those in commercial development work. As we shall see here, the line between the two is not nearly so clearly defined as one might think at first glance.

We are hearing a great deal these days about the need for a "change of thinking." Industry leaders are acutely aware of this need. They sense that a very

Under a \$200,000 contract from NASA Hughes designed a 30-lb. "atomic clock" (left) which will be housed in an orbiting space satellite. When its time is checked with another ammonia maser clock on Earth scientists will have their first check on Einstein's special law of relativity.

By **CREIGHTON M. MARCOTT**

Managing Editor,
"Electronic Industries"

First example of weapons system concept was this F-102A all-weather jet interceptor. Contract for the fire control system and guidance was let a year before the contract for the airframe went to Convair. Falcon missiles are the armament. Example of the airframe being designed around the fire control system.



CHALLENGE of SPACE!

What We Have and What We Need!

subtle, but significant change is occurring right now in the role that research and development is playing in the electronic picture.

Much of this change is due to the shifting of gears as we gather ourselves together for the assault on space. In a very real sense we have reached a plateau, however temporary, in the development of the industry.

In this article we are going to review some rather

simple questions, such as: How did the electronic industry get where it is today? What factors have been most influential in its growth? What unique contributions has defense spending made? What continuing effects can we expect defense spending to have? What effect is defense spending having on the growth possibilities of electronic firms?

For our look at the problem of defense electronics, and at the contributions and facilities that defense spending has made possible, we are going to look into a firm that is organized primarily for defense electronic work. We will be looking for the unique programs and abilities that will carry electronics into the space age—and we will be looking, too, at their problems.

We should realize, first of all, that almost 50% of the electronic industry's capability is taken up with Government and defense projects. Last year the figure was some \$4.5 billion.

This spending is apt to be regarded, by taxpayers, at least, only in the current light—that, during this year, some \$4.5 billion of their money will go into defense electronic spending. But this view is short-sighted. For years past, the government has supported the spending of billions of dollars on facilities and R&D. This spending has contributed immeasurably toward the over-all progress of the electronic industry, not just to that portion supplying military products.

If, as is expected, electronic industry becomes the

Semiconductor assembly line at Hughes, one of the world's largest.



No. 1 industry in the country in another 10 years, it will be hard to underestimate the role played by defense electronic spending.

New techniques, new components, new research projects, are not ends in themselves, nor are they limited to their immediate application to military products. The influences of research, personnel policies, education, have a very, very significant effect on the total electronics field, in areas far removed from what we would normally think of as defense electronic work.

The window through which we are going to look at the problems of defense electronics is the Hughes Aircraft Company of Culver City, California.

Briefly described, the Hughes Co. has a total payroll of 30,000 people scattered over 8 plants; seven plants in the Los Angeles area, and a plant in Tucson, Ariz. For the purposes of this article we will consider the company to be very young—only a little over 10 years old—which is approximately the length of time that they have been active in the electronic business.

The aircraft part of their name is a hangover from the early airframe building activities of Howard Hughes. There has been no airframe activity for years but the Aircraft Div. of Hughes Tool Co. is now working on a small 2-seat helicopter for military and commercial purposes.

Hughes serves as a most excellent example of the Defense electronic picture, however, because 90% of their business is done on defense projects. In terms of money, this comes to \$500 million a year—more than one-tenth of all defense electronic spending in the country.

They are geared to do defense work and they have developed some rather unique capabilities to handle it. In a sense their specializing in defense electronic work is both their strength and weakness, as we shall see as we take a look at the company's activities.

The second characteristic that makes Hughes such an admirable example is the fact that they had no previous long term history of manufacturing in the



Recorder in foreground (above) traces reaction of plane equipped with electronic controls as engineers "intercept" a simulated enemy bomber. The "seek-find-and-kill" control system (right) is shown with a typical interceptor in which it is installed.

electronic business. There were no bad habits to overcome; no established manufacturing methods which had to be re-evaluated; no established personnel policies to be changed; no tradition-bound executive staff to be re-educated. While many of their personnel came from long established companies, and perhaps brought prejudices of their own, there were no built-in company policies to be overcome. With this type of background it might be expected that growing pains and startling successes would be equally abundant—and this has been true.

Hughes got into the defense electronic business back in 1949. At that time a small group at the Hughes Co., whose primary activity had been building radio receivers for radio transmitter/receivers for aircraft, submitted a bid with a number of other electronics people on an automatic airborne intercept and fire control system. The system to be designed would fit in an interceptor aircraft, and would automatically handle firing of the aircraft's armament against incoming enemy bombers. The Hughes Co. got the con-



PLANTS

Sub-assemblies and components to be incorporated in electronic control systems manufactured at the Hughes main plant in Culver City are made in 20 of these buildings at the Los Angeles International Airport.



INTERCEPT SYSTEM

tract. The system that they designed subsequently was installed in all interceptor aircraft of the United States and Canada.

Just a word on the system. The interceptor aircraft, working with ground radar stations, would be directed toward the incoming bomber, and some time before reaching the bomber's position, the pilot would see on display in his cockpit indication of the bomber's location with suitable displays for him to follow in maneuvering his aircraft toward the target. The actual lining up of the aircraft and firing of the armament was handled automatically by the intercept system. In other words, the pilot needed only to come within the given range of the bomber and all other activity was taken care of by the automatic fire control system. This was the contract that put Hughes in the electronic business. At that point the only product being manufactured by the Hughes Co. was this airborne intercept system, subsequently developed into the MA-1, now in the F-196.

Coincidentally, with this airborne fire control system, Hughes developed the Falcon guided air-to-air missile, the GAR-1, which was the first operational air-to-air missile in the U. S. arsenal.

This system, as we said, was highly successful and was adopted for all U.S. interceptor aircraft. Hughes immediately jumped to front rank position as a defense electronic contractor. The problems that developed with this sudden emergence were quite serious and put a great burden on the Hughes management and on planning operations.

These problems are to some extent also true with the production of commercial products, but there the responsibility for the decision is at least much closer to home—in the front office—rather than in Washington.

The Weapons System Concept

Some ten years ago the military introduced the principal of military procurement called the "Weapons System Concept." In brief it called for what was a rather new approach at the time—placing the order for a complete piece of military equipment, mostly

aircraft, with one prime contractor. The "prime" could sub-contract—and would be expected to sub-contract—various portions of the work to smaller firms.

Since most of the equipments being ordered were airborne systems, the logical parties to handle the "prime" functions were airframe contractors.

This appeared to be rather a clean cut way for the military to handle its requirements. Instead of holding a number of firms responsible, now there would be only one. It seemed to simplify the procurement problems by many degrees.

There was another rather favorable aspect to the "weapons system concept." All the responsibility for the system design—and this was becoming exceedingly important—were in the hands of one party. It was logical to assume that a superior product should result.

Even at the earliest stages of the weapons system concept there was concern that the practice would create a handful of very large firms, growing fat on defense contracts, while the balance of the industry would have to scratch for the crumbs. As it turned out, the fears were rather exaggerated. There were still many, many products and functions that called for such specialized individual talents that small firms were indispensable.

At various stages it often seemed as though some confusion was arising as to just what the aim of the program was. The question was asked—is the



This plant in Fullerton, Calif., produces ground radar systems.



main item here the fire control system, and armament, or the airframe itself? Depending on the application, it might be either.

There was concern, too, over the possibility that the airframe manufacturers would set up electronic facilities of their own. If just one of them followed this tack, it was reasoned, the others would have to follow—for competitive reasons. And this, of course, has come to pass. Some of the largest electronic facilities are now under the wings of the large airframe contractors.

The electronic industry, in general, was in a rather difficult position during this time. Unable to bid as prime contractors they have had to be content to settle for sub-contracts from the prime contractors.

In later years, the military would take note of this situation and allow airframe manufacturers and electronics firms to bid as co-prime contractors.

In the bidding for one AST contract a few years back the military for the first time allowed electronics firms to bid "prime," on the theory that the airframe, in this instance, was of secondary importance.

Small business firms have been somewhat vulnerable under the weapons system concept, and the government has set up involved procedures to protect them. One of the requirements of any large contract is that the prime contractor must stipulate how much of the work will be done by sub-contractors.

The Small Business Administration has, as its principal function, the job of inspecting government contracts to see that the interests of small firms are not being infringed upon. Under the SBA's "set-aside" program certain items of government procurement are open only to bidding by small firms.

To a certain extent, the SBA can influence prime-contractors to sub-contract various portions to small

WEAPONS SYSTEM



Packed with electronic gear and guided missiles to hunt down targets in any weather, the Convair F-102A (left) is an example of the weapons system. Above, at Hughes' El Segundo plant technician balances memory drum of digital, first airborne digital computer to go into actual production as it rotates on jets of air. Below is seen a miniaturized "gating board," a component of this airborne computer that makes 6,250 decisions a minute.



business. But this practice must be limited, because the "prime" can always turn and argue that the quality of the end product is being jeopardized.

From the outset the "weapons system" concept has demanded of the prime contractor a high level of organization, and very diverse talents. This was true at the beginning, and has become increasingly so as the complexity of the equipment has grown.

With the increases in complexity have come added requirements for reliability, for quality control, for simplified manufacturing techniques and a wide range of research activities. These services can be supplied only by a large, well-organized firm.

There has been in the past, and there continues to be, grumbling from small firms that the large defense contractors are "keeping everything in the house that they can"—sub-contracting only those pieces that they cannot possibly make themselves. This grumbling no doubt has some basis in fact, but there are also very sound reasons why the "prime" or second-tier "prime" will choose to manufacture his own components, rather than farm the work out.

Reliability is one factor. It may well be that there is no manufacturer willing to manufacture to the specs demanded. Again, there is the question of source; if there is but one "sole supplier" there is a serious risk

that some day, given a strike or serious work stoppage, there may not be any parts available.

The tail-off in production, as production contracts are being phased out, is another factor. Previously, a large number of components were needed, so many that the large defense contractor could not consider manufacturing them himself. But now he has a large, workforce, and falling production. It may be that the outside work can be brought in to take up the slack.

While the outward results are the same, the philosophy is somewhat different.

The coin has another side, too: many of the larger concerns farm out work to small business that they can do better, and cheaper, themselves. But they want to avoid charges of being unfriendly to small business.

Evolution of the Weapons System Concept

In discussing the weapons system concept so far, the issue has appeared to be quite simple. One large firm is given over-all responsibility for the system design and management, and he, in turn, chooses certain sub-contractors to handle those parts of the job that he, the "prime," cannot handle.

This is, perhaps, the way the weapons system concept was first drafted, and first executed. But the form in which it appears today is something considerably different.

The change has been influenced by two significant trends: the size of the individual contracts and the diminishing number of contracts awarded. Playing a subsidiary role in these developments has been the transition from manned aircraft, to missiles, and now—to space vehicles.

For some years there was a feeling in the industry that a firm was either in a position to be a "prime," or not. To some extent this applied largely to airframe manufacturers but it was extended outside the airframe industry as well. It was largely a question of how "large" and diversified a company the company was, and how diversified. And it was a tribute, too, to their system management ability.

As the number of contracts narrowed, however, there developed a situation where the sub-contractor portions were as large, or larger, than the previous "prime" contracts. It could be very profitable, even



FALCON

Hughes' Falcon (right) was earliest missile in production. Produced at the Tucson, Ariz., plant it comes in two versions, the Infra-Red guided series shown at left and the radar-guided series at right.

In left photo it is shown in a test rig which subjects it to the type of vibration it must survive while being transported.



Hughes' Dr. R. R. Law demonstrates the Memo-Scope, an oscilloscope which retains images.

for the largest defense manufacturers to be tabbed for the sub-contract function.

In another variation of this defense bidding, companies having specialties in long diverse lines would join together and bid as a "team." In this case they would be co-primes. The number need not be limited to two partners, either. There might be three or more; for instance, for the air frame, the propulsion and the guidance and electronics. Of course, this arrangement calls for a very high degree of cooperation.

This interchangeability of roles leads to some strange arrangements. In the bidding on one contract, for example, a single defense contractor may bid simultaneously as a "prime" contractor and as a sub-contractor to another "prime." The relative sizes of the companies may play little or no part in the final decision.

The aim, of course, is to make up a combination that will be looked on favorably by the military agency. Occasionally, it boomerangs, for one of the partners, because the military may come back and stipulate to the other that one partner is unacceptable, that a certain outside firm must be brought in to fill one portion of the contract.

Mergers are also playing a part in defense elec-



tronics. For the small firm a merger supplies the much-needed capital, and for the medium-sized firm it provides the diversification necessary to guarantee a continuing piece of the defense work. If the firms chosen for merger are judiciously picked, so that their abilities provide diversification, and supplement other operations of the company, many of the advantages of a large corporation can be realized, with comparatively little investment.

All this twisting and turning is being accepted as necessary by industry, in light of the circumstances that exist today. But in accepting the fact that these circumstances exist, and that there is little that can be done about it, the electronic industry is forgetting the path it followed in its growth during the past two decades. The electronic industry's progress has been based fundamentally on technical "know-how." Many electronic companies have been built on the scientific knowledge of just one or two men. Now, the industry is moving into a new phase.

Systems Development Engineering

The government's move to this type of procurement has been dictated in part by the greatly increased importance of "system engineering." In effect, what the government did in adopting the "Weapons System Concept" was to pass on to industry the responsibilities for system design and management.

The next question is whether this is the only solution to the military's problem of designing weapon systems. Can industry know more about military equipment than the military themselves? In short,

Mobot Mark I, was designed by Hughes as the first mobile remote-controlled handling machine for use in radiation labs too dangerous for man. Sandia's R. W. Henderson and Hughes' Dr. A. E. Puckett are checking Mobot's ability to handle small equipment.

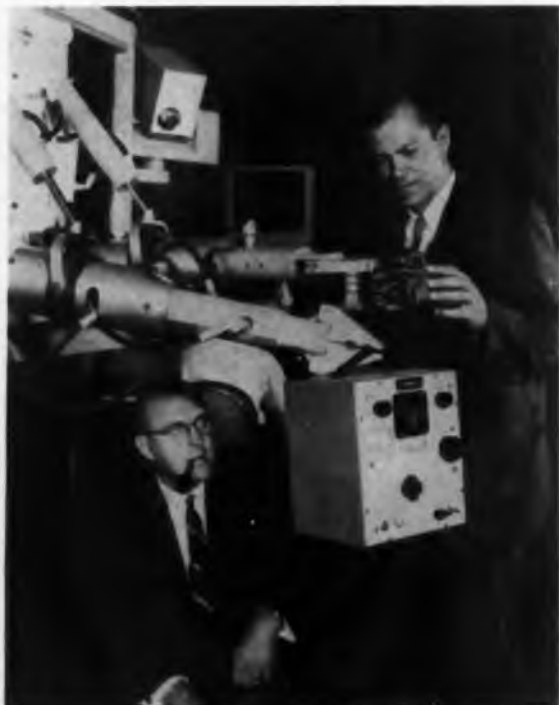

should not the system design engineering function be retained by the military, and contractors chosen directly, instead of through the present "prime" contractors?

Bue there is a question whether the government has the highly trained personnel necessary to handle the systems development function. There is general feeling that at one time the military agencies did have the people, but as the system design functions were handed over to industry, the abilities of the services were slowly dissipated through disuse.

The Air Force is making attempts right now, to take back some of the system design functions. It has been felt in many quarters, in light of the recent problems found in missile design and development, that the Air Force should take a stronger hand in administering the missile program.

Missiles vs. Manned Aircraft

Missiles differ from manned aircraft in one very significant aspect, there is no using up of equipment. When an interceptor aircraft or bomber had been flown so many hours it is retired, or completely rebuilt. Not so with missiles—at least not with operational missiles. They can be stored at their launching pads indefinitely, without deterioration. With dehumidifiers to control the rusting problem, they need little attention. So there is a self-limiting aspect to the missile business. Sooner or later there comes an end to the need for producing any more of a given kind.

That brings us up to the factor of obsolescence, and this is becoming a key consideration in government spending. New products and equipments are coming available at such a rapid rate that procurement men are increasingly reluctant to order more than a few of any given type. Here is another negative factor working against the progress of the industry. The production phases have been the most lucrative end of government work.

The transition to missiles did have one happy result for the electronic industry. It opened the door to prime contracts on a large scale.

Contracts for the large missiles—Atlas, Thor, Titan—continued to go to the airframe manufacturers but there was a considerable family of small missiles—air-to-air, for the most part—that could now be manufactured by electronics firms, directly. The guidance systems were far and away the most costly items in their construction.

Among these missiles were the Navy's Sparrow, manufactured by Raytheon, and the Sidewinder, manufactured by Philco. Hughes Aircraft has been responsible for the Falcon air-to-air missile, GAR-1, 2, 3, 4.

Early versions of the Falcon were radar guided. The GAR-4 now in production uses infra-red guidance, homing on the "hottest" element that it sees. In the case of enemy bombers it would sense the heat of its jet engines.

Falcon was the earliest missile to get into production. It is being manufactured at the Hughes plant in Tucson, Ariz. The peak work force in the plant totaled more than 7000 personnel.

Advance Planning

There are two possible approaches in military defense spending. The first calls for a technically strong military organization that carries out all advanced planning, and handles all the details of the system planning, including the system design. With all the requirements laid down the military then calls in private firms to handle the various phases of production.

In this picture all responsibility for advance planning is in the hands of the military. Each branch, specifically, would be responsible for visualizing the requirements of future weapons and equipment that will be needed.

The second approach, which has been followed in varying degrees over the past decade, is for the military to limit its activity to broad concepts, visualizing the types of weapons and leaving the system management to industry.

It is not too hard to see how this has come about. There is now behind us some ten years of very heavy spending on military programs. A good part of this spending has gone into facilities, into the training of engineering staffs, into basic research programs, into production machinery of all types. There has been set up a tremendous production potential, which requires a steady flow of work to be kept in operation. And these firms have also developed, over the years, some very fine system management staffs, capable of designing extremely complex equipment.

The existence of this production capacity and management ability is responsible for one of the most wasteful practices in the industry—the policy of throwing government contracts open to bidding by a large number of firms.

Upwards of a dozen of the largest electronic and

"SPACE FERRY"

"Space Ferry" is a joint project of Hughes and Lockheed. It could shuttle men and materials between earth and outer space for construction and maintenance of space stations.



aircraft firms in the country may be involved in the bidding on a single contract. Each of these companies may spend as much as \$300,000 on the research necessary to submit a proposal. And the research will take the talents of their very best engineers and scientists. To compete effectively calls for the most imaginative personnel available in the industry.

The waste inherent in this arrangement is obvious. Our best scientific talents are pitted against each other in a battle of paperwork, instead of being applied to the design of hardware. But the defense firms have no choice. Their existence depends on getting the military contracts, and getting the contracts in turn depends on researching the problem thoroughly—certainly as thoroughly as the competitors.

There is an axiom in the business that says, "Ignorance of the subject will cause you to bid low." On the surface there would seem to be an advantage to ignorance in bidding, but not in military contracts.

AUTOMATED FACTORY

Machine tool field is a natural for application of digital-automation techniques. Hughes collaborated with a leading machine tool manufacturer on this sophisticated system. Saleswise, it was something less than a success. Most likely reason—a commercially sound numerical control systems should be broadly applicable to many lines of machine tools. Hughes system was designed to fit one.

Various digital tapes that control numerically controlled machine tools are shown below with the machine parts that are their resultant.



The expected profit, after taxes, will be in the neighborhood of 2-3%. The knowledgeable bidders will have included this in their bid, so there is only a slight margin to work on. The very low bidder is unlikely to have profit left at all when the job is completed.

Competition in the defense electronics business has become much more competitive during the past few years, and the military has also become somewhat less benevolent. Up till four or five years ago contracts were sometimes let for no other reason than that the military felt a responsibility for the defense contractor's investment in facilities and personnel. But there is little, if any, of that type of thinking today.

However, these large, privately owned defense electronic facilities—and we have to remember that 50% of the electronic output is for the defense effort—represent a very strong influence in the government spending picture. With such large investments in equipment, factories and personnel these large firms cannot afford to sit idly by, waiting for the military to decide that a certain piece of equipment is needed. They must go ahead on their own, anticipating military needs, and carrying out the preliminary planning at their own cost—and at their own risk. In effect they must know as much about what the military needs, as the military do themselves.

They not only have to guess at the needs, but they must also have the problem of selling the ideas to the military once they have them in fairly concrete form. It is truly a complex business.

The common complaint on the part of defense contractors these days is that they no longer know who their customers are. This is particularly true of the missile industry where responsibilities are being shifted back and forth from week to week.

To compete for Government defense projects, a firm must be willing to spend a good deal of its own money on research. For instance, the usual form of the military defense project will work something like

this: The defense firm—such as Hughes—will foresee the need for a certain type of weapon for counter-measure gear or detection equipment, etc. Using their own funds they will investigate the problem to determine whether it is feasible, whether there is a possibility of interesting the military in providing funds for such a development. The money that goes into the initial study, which can be quite considerable, will be completely lost if the Government cannot be convinced that there is a future in this kind of equipment. If the Government is interested, the second stage of the project begins, probably partially supported by Government funds. If the second stage indicates that this piece of hardware can be successfully developed and serve a useful military purpose, stage three begins. This stage will be completely financed by the Government.

With some types of projects there is an additional production stage. It is in the production stages that a defense contractor can make his long-term profits. He can enhance his chances of being tabbed for the production phase by underwriting the original research himself.

Where outright R&D contracts are awarded by the Government, invariably the defense contractor will spend additional money of his own, over and above the amount awarded by the Government, again in the hope of being in a position to be considered for the production phases. There is, of course, no certainty on any of these counts. R&D contractors can be awarded and fulfilled, and the defense contractor who completes the contract may not be considered at all for the production.

Even prior to the R&D stage, the defense contractor who really aims for the sizable chunk of the defense spending will have an active heavily supported basic research program. At Hughes this facility, which moves next month into new laboratories at Malibu Beach involves 350 people. Among the activities being investigated by this group are masers, phosphor research, new vacuum tubes, thin film tech-



PARAMETRIC AMPLIFIER

This parametric amplifier plumbing (left) includes units which can double the range of ground and aircraft radar. Key unit in the parametric amplifier is this gold-bonded diode (right), itself no larger than a grain of rice.



niques, microwave tubes, and a variety of other techniques that might enter into the design of military and electronic equipment. This research facility has already turned out some very significant advances—one of the latest, the ruby maser announced this month—and several significant advances in semiconductor research. Again, the basic research program is a very necessary and continuing adjunct to the whole problem of keeping competitive in defense electronics.

It is not enough just to anticipate weapon demands. Defense contractors must actually get into the crystal-ball business, visualizing what tack the international situation will take, and what direction warfare is likely to go as a result.

For instance, Hughes, as a manufacturer of airborne systems, is vitally interested in the future of aircraft. One of the Hughes department heads, Dr. Rex C. Mack, manager of the Space Program Dev., within the Advanced Projects Development division, pointed out to a local meeting of the IRE in Pasadena, California, a few weeks back that there is now little possibility of a "conventional" world war. There are only two alternatives, a nuclear war, or series of small, local skirmishes. Dr. Mack foresees little possibility of the nuclear war because of the complete, and utter destruction which would certainly result. But he can imagine an international police force of satellites which could "monitor happenings throughout the world and destroy ballistic missiles no matter where they are launched."

This is the kind of thinking that has become a bread-and-butter necessity to defense contractors. There is an acute need for the contractor's Planning Group to sense the way things are going, so that they can be there with the equipment when it is needed. Their alertness to these problems is a very valuable asset to the country's defense capability.

At Hughes a 180-man staff is maintained in the company's Advanced Projects Lab., investigating projects which they believe may have military significance. The projects, almost all of which are company supported, range from a tactical airborne target radar to a system of hydrofoils. And all are being weighed against the question—what role can they play in the defense of the country!

A few weeks back a high-ranking military spokesman pointed out, in describing a brand new military weapons system, that it was so complex that for the first time the research and development costs on a weapon would equal the production costs.

The statement got only mild attention. It should have gotten much more—because it spells out the pattern for the future. Of all the items involved in the "change of thinking" that must come, none is more important than the attitude, on the part of both government and industry, toward research and development.

In the coming decade of concentration on the problems of space travel the pieces of hardware that are produced will become fewer and fewer but the amount of R&D necessary to bring them forth will increase by perhaps orders of magnitude.

To illustrate the financial side of this problem let us look at a few figures: In the typical defense con-

tractor's operation the profit on R&D is between 6% and 7%. The profit on production is typically in the neighborhood of 10%. At the end, after company-supported operations and other services, and taxes, are included, the typical profit on the over-all company activity will be between 2% and 3%.

In the situation that exists today we have a tail-off in production, so the most lucrative end of defense contracting is being curtailed. But the problem of the over-all profit margin remains, and the only source now is R&D. The answer is obvious—

CHECKOUT SYSTEM



Using special test equipment, engineers check out electronic control system installed in an all-weather interceptor at Culver City, Calif.

the government, and industry, has to be prepared to pay more of a premium for R&D efforts.

In effect, R&D must become a "commodity" on its own. This involves a very radical change of thought, because, historically, knowledge per se has not commanded a very high price. It is much easier to talk in terms of hardware.

Reliability

The key to our forthcoming jump into space travel is "reliability." And the most serious problem in reliability is that of the electronic equipment that will go aboard the space rocket.

We can approach the space age with reasonable confidence that the reliability problem will be solved because for years the electronic industry has been involved in a strenuous effort to give the military the reliability they felt necessary for military equipment. In the past five years alone the reliability of military equipment has been increased by a factor of about 10.

The research and development costs of these reliability programs have been borne by the military; otherwise they would not have been undertaken at all. The reason for this is quite obvious. It is too difficult to justify commercially—in dollars-and-cents—the prohibitive costs of a program aimed at 98% reliability.

EL SEGUNDO

Hughes' El Segundo plant (right), which manufactures the products of the Airborne Systems Group airborne armament and control systems.

Final test area (below) at Hughes' El Segundo plant. Here complete system is assembled for final check before delivery to military agency.



As an outgrowth of this new-found reliability, however, we see many new pieces of equipment coming into existence with extremely high reliability requirements of their own. Computers, for instance, due to the extremely high cost of down-time, are demanding orders of reliability that would have been considered completely unattainable only a half dozen years ago.

Ten years of studying the reliability problem also provides an invaluable yardstick for measuring the effectiveness of certain approaches. For instance, the most significant effort, up to now, has gone into component improvement. We have greatly improved transistors, semiconductor diodes, resistors and capacitors. The improvements have taken many forms. Manufacturing techniques have been improved, yields increased, production costs lowered. Encapsulating methods have taken a wide variety of forms, and many types of improved materials have been employed. Components have been—and are being—hermetically sealed, potted, specially mounted, all with an eye to meeting the demanding MIL specs.

In the most recent years the search has been for new materials, and the search, spectacularly successful, continues. The inter-metallics and ceramics are creating a new dimension in the electronic components field.

But many reliability engineers feel that the answer can no longer be looked for in new materials or new manufacturing techniques. With the background of the past decade of intensive study of the reliability problem, and seeing the massive reliability problem that faces us in the challenge of space travel, they feel that a new approach is called for. Not that new materials and methods will not continue to be important, but they can no longer be considered to hold the solution to the problem.

For the direction that reliability designs must take, the reliability experts are looking to the human brain itself. John von Neumann postulated the theory back in the early 1950's. He pointed out that the reliability of the individual brain cells was quite low—in fact, down right poor—but by means of redundancy—using thousands of cells perhaps where one could do the job—and a very sophisticated self-analysis mechanism that allowed the choice of the best operating cells, it was possible to achieve reliability factors of almost infinite magnitude.

This theory was treated at first as little more than a scientific curiosity. The components available for circuit design were then so large that redundancy—particularly on a scale suggested by von Neumann—was out of the question. It was difficult enough to design a piece of equipment to the dimensions that the military were demanding, much less throw in additional components for reliability's sake.

But the movement toward miniaturization was pushed. Smaller and smaller components were becoming available. And this was succeeded by micro-miniaturization. These researches and studies, too, were being financed by the military.

Some two years ago two separate micro-miniaturization programs were begun by the military. The Signal Corps launched a study of the "micromodule" concept, in which components are mounted on wafers—or grown on a wafer sub-strate—and then the wafers are cascaded to make the complete circuit. In the latest versions, the module wafers are only one-half of an inch square, and the completed circuit of a four-stage receiver, for example, might be approximately 1-in. long. This technique has the advantage of using presently available components, and it is extremely adaptable to automatic production.

The Air Force, on the other hand, is backing an investigation of "molecular electronics." This very sophisticated technique deals with the property of semiconductor materials which allows them, with the impregnation of certain impurities, to take on the characteristics of capacitors, resistors or inductors. In the highest sense a single piece of semiconductor material might contain, in various domains, all the components necessary for a complete operating circuit. At the present stage of thinking, this would be the ultimate in miniaturization.

The industry is developing many other techniques, as well; dealing with packaged circuits, printed cir-

cuits and depositing various materials on substrates. Essentially these are variations of one of the two techniques described above.

Out of the findings of these many programs—all, or mostly all, financed by the military—has come the feeling on the part of many reliability engineers that the time is close at hand when reliability will be able to take a complete new tack.

It may be possible to do just what von Neumann suggested; put in a given space many more components than are minimally necessary to do the job. And finally, to pick out the ones that are in optimum operating condition, from moment to moment.

Into the application of this theory will go a wealth of experience gained in designing automatic check-out equipment, feed-back techniques and control functions.

Equipment Reliability

On the subject of reliability it might be interesting to look at a program at Hughes designed to assess reliability in terms of number ratings, and



As part of experimental electron tube program technician welds together sections of special tube at Hughes' Culver City, California plant.

correlated with other aspects of equipment design.

The program is relatively new and is being conducted under Hughes' Ground Systems Group. It is headed by Dr. Arnold E. Small.

The over-all goal is to assess "Product Effectiveness." Into the problem go the aspects of reliability, maintainability, Reproducibility and Operability. These four end considerations determine pretty much the success of a product, both in a short-term and long-term sense.

What is desired is control over the "mixture" of these considerations through all stages of design and production. The overall picture includes development, procurement, fabrication, assembly, testing, delivery and field use. Of course, all these factors are weighed against cost.

The combination of reliability, maintainability, reproducibility and operability have been combined in a term, "assurance level." This is a measure, at Hughes, of the certainty with which the product can be released to the field.

The process can be demonstrated quite simply on a graph. The ordinate is labelled "assurance level."



Automatic assembly insures better reproducibility. This "machine-gun" staples semiconductors into circuits, eliminating hand work.

And the abscissa represents "time." "Time" more properly would be labelled "design, development, procurement, fabrication, assembly and delivery." We are literally following a piece of equipment from its conception through production to delivery.

It is possible to vary the mixture of the four basic elements at any point in order to come up with an optimum combination. Points plotted during the various stages would graph the level of "assurance" of the product at each stage.

Basic to the problem is a method of describing the four fundamental considerations in reasonably rigid quantities. Reliability, for instance, would be based on the mean-time-to-failure of the individual components, where known.

To stay abreast of the latest information on components' reliability Hughes participates, with more than a dozen other electronic firms, in an exhaustive reliability assessment program conducted at Battelle Memorial Institute.

Quality Control

It is difficult to imagine just where the whole field of Quality Control would be were it not for the original requirements laid down by military. Certainly many of the original MIL specs have been the goad that kept component manufacturers pushing for added reliability and better reproducibility of their products.

For inventory control, this IBM 705 computer is used. To maximize efficiency, the calendar was rewritten—discarding Saturdays, Sundays, and holidays. Throughout the El Segundo plants are reminders, "This is Day No. —." Thus, all departments work with the computer.



In some cases the military are still taking a very strong hand in controlling the quality of components. Where particularly critical parts are involved the military will underwrite the costs of "source inspection," going right into the components manufacturers plant and sampling the output.

When these "source inspected" components are delivered to the end equipment manufacturer he is bound, by law, to use them only in military gear. There are stiff penalties if any of the parts find their way into commercial equipment.

The reliability of individual components and parts has been a continuing headache for end equipment manufacturers, and various arrangements have been devised to cut down paper work and testing time at the assembly plant. The item of cost enters here. It might literally be possible to test every component that goes into a system but the cost of such a program would be so prohibitive that the final equipment would be priced out of all reason.

The feeling is that the logical party to control the reliability of parts is the component manufacturer, himself. It not only saves a good deal of time, paperwork and friction between the end equipment manufacturer and the component maker, but if there are adjustments to be made in the manufacturing process they can be made there at the plant.

There are also some abuses in the name of quality control. For instance, one small Eastern manufacturer contracted to provide magnetic amplifiers for one of the largest military and equipment manufacturers in the country. Part of the contract carried an "access clause"—engineers of the large manufacturer had to have free access to the area where the magnetic amplifiers were being assembled.

After some four years of operating under this arrangement the large manufacturer suddenly announced that they would no longer buy the units. They would now manufacture their own. The know-how, of course, came from the engineers who had been walking in and out of the plant for years.

Returning to the problem of guaranteeing the reliability of purchased parts; the end equipment man-

ufacturer is looking to reduce his own costs of testing. The simplest way is to put the burden on the component manufacturer, himself.

There are a number of arrangements to do this, and virtually all large military and equipment manufacturers have some form of agreement with their suppliers. We are going to look here at the arrangement that Hughes has with many of its suppliers. It is called Hughes Vendor Quality Certification Program—"V.Q.C." And its basis, in the words of the company, is that "No one can control the quality of a part as effectively as the company that makes it."

The program has five benefits to Hughes and to the supplier:

1. It cuts down duplication of effort in handling (retesting).
2. It reduces the possibility of rejections and returns.
3. It gives Hughes a better understanding of the supplier's problems.
4. It uncovers weakness in design or manufacturing techniques which can be corrected at the source—before parts are put in service.
5. It expedites delivery and payment.

There are two phases to the V.Q.C. Program. First is the certification of quality, and second, the certification of reliability under specified conditions.

In both cases Hughes specifies the tests that are to be made on the components before they are shipped to the Hughes plant.

When the supplier accepts a purchase order from Hughes that requires his cooperation under the V.Q.C. Program he finds the quality inspection requirements included in "Purchase Order Attachment Number Q8." It describes the specific tests and clearly stipulates Hughes' "Acceptable Quality Levels."

There are separate tests for each part.

A preprinted form is provided on which the supplier fills in the results of the tests. This form accompanies the shipment of parts and is signed by a company official. When they arrive at the Hughes plant they are sample checked again, and the find-



FLYING LAB.

Interior of T-29 flying laboratory (left) simulates flight of F-102 interceptor using Hughes' armament and control system. The T-29 has its million dollars worth of equipment (below) displayed prior to installation. Once aloft, test plane control is shifted from regular pilot to pilot in simulated F-102 cockpit; the "interceptor pilot" then flies the big airliner as though it were a jet. Special nose houses antenna.



ings at Hughes are checked against those found by the supplier.

This double check is made on a number of consecutive shipments. If the test findings at Hughes match those of the supplier the firm is considered qualified for the particular part shipped. Naturally, it is something of a feather in the cap of the supplier, when a top military equipment contractor certifies him as a reliable supplier.

The second phase of the certification plan deals with environmental testing of component parts. The environmental stresses on weapon systems are rugged so component parts must stand up under these stresses with a large margin of safety.

The initial qualification test proves out the design of the component part, but Hughes must also have assurance that the parts that come in month after month continue to meet the requirements.

This phase is covered by Purchase Order Attachment Q10, Reliability Test Requirements.

Q10 lists a set of environmental tests selected from the complete set that Hughes' engineering staff performed in qualifying the part. A complete detailed description of the test is given, both as to sequence and method. The supplier will be required, at scheduled intervals, to take as a sample, a number of parts from his production run and submit them to the tests listed. Sometimes the tests will be so involved that independent testing laboratories must be employed. The test results will go directly to Hughes for study.

When Hughes is satisfied that the requirements of Q10 have been met, payment is made to the supplier, covering the cost of the tests and the parts used.

Hughes anticipates that there will be a certain number of failures during the tests—in fact, they expect them. Details on the failure are invaluable and they are carefully gathered together at the Hughes plant. Sometimes Hughes will send for the failed parts so that their own engineering staff can inspect them.

Extrapolating here for a moment, it takes little imagination to see what dividends have been reaped by the whole electronic industry by this emphasis on highly reliable components.

In many plants where military source inspection is being carried out—and consequently, extremely rigid controls are in force—components for commercial equipment are coming off exactly the same line as those for military gear. But there is one pressing reason for the over-all high quality—the military demands it. Once the designing and testing work has been done it is not that much harder to build high quality units than it is to build mediocre products.

With all this emphasis on reliability, including source inspection, and rigid control over the suppliers through programs such as that of Hughes which we described above, there are many pieces of precision fire control gear and guidance equipment that have reliability factors of only 25 hrs. mean-time-to-failure. This is using the very best components available today.

If we are to make a round-trip-to-the-moon, the mean-time-to-failure will have to be increased to

somewhere in the neighborhood of 730 hrs., or about 30 times. Remembering that in the past five years we have managed to increase the reliability of military electronic gear by a factor of only 10, we can appreciate the magnitude of the problem, and why reliability engineers are looking for some new approach. This brings us again to the redundancy theory of von Neumann's we described earlier.

Manufacturing

During a period when the electronic industry, as a whole, has been mass-production conscious, defense electronic spending has demanded attention to high-quality, low-volume manufacturing methods. To meet the stringent MIL requirements defense contractors have had to devise complete new approaches in their manufacturing techniques.

Defense electronic equipment tends to fall somewhere between custom-built hardware and mass-produced units. The individual "black boxes" are apt to be so complicated technically that, seemingly, only highly skilled technicians should be employed in assembling them. But the large quantity of units needed makes this impossible; there are simply not enough highly skilled technicians available in the industry. And, too, such highly trained technicians make manufacturing very costly because the work force would have to be maintained even through periods when there was no work available. If they were let go it would be unlikely that they could be lured back.

So this is the problem for defense contractors. It is interesting to see how Hughes has organized its manufacturing operation to deal with it.

At Hughes' El Segundo plant, which manufactures the products of the Airborne Systems Division, the manufacturing goal is summed up as, "The visual controlled flow of materials through men and machines." If the philosophy is rather wordy, its execution is very clean.

In brief it describes a straight-line function. Materials, both raw materials and purchased components, are received at one end of the building. They are tested in adjacent departments and then "flow" to the assembling section. And here is the most unusual aspect of the Hughes operation.

The solution, at Hughes, was to break down the assembling job into such simple, uncomplicated movements that even unskilled personnel could be trained to handle the job within a reasonable training period. Actually, the training time now is estimated at about four hours.

The tool that has made this possible is what Hughes calls "Video-Sonics." As it implies, it is a form of audio-visual aid.

The assembly area is outwardly similar to other electronic plants in that there are rows and rows of assemblers; thirty or forty stations in each line.

In two significant aspects however, these installations are different. First of all, there is no bench. Instead, work is held in a special jig. And this jig, in turn, is held in a vise. The vise can be loosened at will and the work turned through 360° in any direction, if necessary.

Hughes found that benches only increased the possibilities of damage to the equipment when they were

being worked on. And they acted as a catch-all for small parts.

The other significant addition is the "Video-Sonics" unit located at each station. This unit describes step-by-step the sequence of operations in the assembly process.

The assembler listens to instructions through an earphone connected to the Video-Sonic unit. At the same time a picture of the chassis she is working on is flashed on the screen in front of her.

The instructions go something like this: On the screen she sees a picture of the chassis. A terminal is pointed out, and the instructions through the earphone tell her, "Solder the red wire to this terminal."

The voice portion then cuts off, and is replaced by music for a given period of time. Time-motion studies have determined how long it should take the assembler to solder the connection.

When the allotted time for the operation expires the audio cuts in again with new instructions while perhaps another terminal is indicated on the slides.

With this system there is little need for "flow" of chassis. One assembler, for example, might take up to 13 hrs. on a single unit. Most important, she can be wiring up a completely different type of chassis the following day, simply by changing the tape and slides in the Video-Sonic unit.

Is this method as fast as the mass-production methods of electronic manufacturing? No, but it minimizes much of the monotony of the manufacturing process, and it allows almost unbelievable flexibility.

With the Video-Sonic even semi-literate of backward areas—for instance, of Africa—might be able to assemble complicated electronic equipment. There would be only one requirement: to be able to communicate in the native language of the assembler.

There is an equally exciting prospect immediately at hand. Hughes is installing Video-Sonic units directly into completed mobile gear, to instruct technicians in checking out the complicated equipment. In one application, a semi-skilled technician checked out an exceedingly complex airborne detection system in half the time previously taken, and without making a single error.

In the over-all view it would seem almost certain that Video-Sonic units, or similar audio-visual equip-

ment, are bound to become an automatic requirement of future military gear. They greatly simplify the check-out procedure and add little to the cost of the equipment. In their simplest form they can consist simply of a roll of magnetic tape, and a slide projector.

Perhaps most important, these audio-visual units would reduce the training necessary for technical personnel, leaving more time for actual duty.

Inventory Control

In developing the EL Segundo manufacturing operation Hughes management saw a need for the closest control possible over the inventory of spare parts and raw materials.

The electronics industry differs from other industries to some extent in its inventory problem. While



At Hughes plant technician adjusts oven temperature in "growing" germanium crystals.

the amount of warehouse space set aside for storing materials may not be such a serious item there is a very serious financial consideration in the amount of money that can be tied up in parts and components awaiting assembly.

There is a general rule-of-thumb which accountants use to figure the cost of maintaining inventory. The cost is figured as 25 per cent of the total value of the inventory.

Based on this figure it is easy to see that in the case of a firm the size of Hughes, doing some half-billion dollars worth of business a year, the inventory represented a very serious problem, and an area in which really significant savings could be made.

The problem in cutting inventory is two-fold: to speed up delivery time from suppliers, and to hold just enough parts and components on hand to keep a steady flow of work through the plant.

As the inventory is cut, of course, the degree of control that must be exercised becomes more rigid. It would not do to have an assembler sitting idle while waiting for delivery of parts. What would be gained on one hand, would be lost on the other.

There is another angle to the inventory problem. Parts and components in stock represent money that is not working. Invested in other directions that same money could be earning interest.

So the problem Hughes faced at the El Segundo operation was to cut the time it took to turn over the inventory. At the time the study was begun, the

Reliability improvement by use of complete stand-by systems. Overall reliability approaches unity for a finite number of series elements, as the number of parallel elements is allowed to go to infinity.

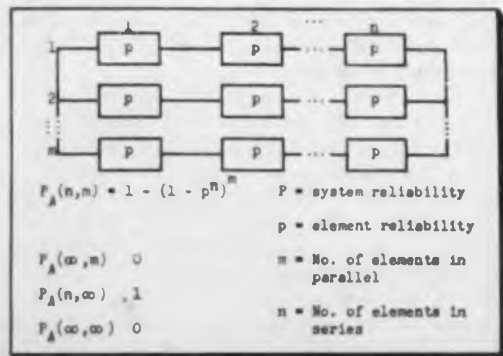

inventory was being turned over every six months. This is about average for the industry.

As Hughes studied the problem it became more and more obvious that the answer was a computer. Into the computer they could put information on the number of parts used, the delivery time for new parts, the cost of the parts. As parts were used up the computer would automatically tell when new parts should be ordered.

The computer that Hughes chose was an IBM 705, one of the largest computers on the market.

To adapt their operation to the numerical language of the computer Hughes "rewrote the calendar." The computer was interested only in working days. So thrown out now were the Saturdays, Sundays and holidays. The only days that counted were actual days worked.

This procedure is carried through the operation, from end to end. On the walls, in every department of the El Segundo plant, are cards, which are changed every day, reminding plant personnel that "This is Day No. —." This is the information that the computer needs to exercise its control over the purchasing and scheduling function.

This adaptation of the very latest techniques for handling the operations of company is one of the characteristics of Hughes. There seems always to be a very open-minded approach to management problems. Again this probably can be traced to the comparative youth of the company, and the fact that, as a defense contractor, they are first of all concerned with quality. The military have come to expect the very best equipment that can be built at the present level of the art. And the surest way of staying in the business of producing for the government is to turn out top quality products.

There is another aspect here that should be mentioned. Defense spending, more than any other phase of the electronic activity, has taught us that spending on equipment—test equipment, analyzers, laboratory computers—is the finest type of investment.

One representative of a British test equipment manufacturer, over here recently on a sales trip, marveled at the eagerness of U. S. electronic engineers to buy almost any piece of test equipment that seemed to fit their needs. This luxury started with defense contracts, but the spirit has now pervaded the industry. Engineers now simply refuse to work without what they consider the proper equipment, and this approach is paying dividends.

Environmental Testing

The most rigid requirements of all are set on electronic equipment that must operate in extremes of environment. This has created a whole new field of environmental testing, in which the goal is to duplicate on earth the conditions that Nature creates in space and the unusual conditions that exist with certain types of travel.

The Airborne Systems Gp. of Hughes is manufacturing integrated airborne fire control and guidance systems for interceptor fighters, so the environment is the aircraft itself. This is something of an advantage because the environmental conditions can be duplicated exactly—by installing the equipment in a typical airplane.



Semiconductors were by-product of military development program at Hughes. Here moving belt of partly-assembled semiconductors is guided into electric heating coil. Heat insures good connections.

To handle this test function Hughes has a Flight Test Div. totaling more than 500 personnel. There are 18 full-time pilots. Some of the personnel are located at Air Force bases, Holloman and Edwards—but the great bulk of activity is carried on right at the Culver City, Calif., plant.

On a typical day at Hughest Flight Test there will be as many as a dozen aircraft—F-102's, an F-106, B-57's, B-58, a couple of DC-3's or Convair T-29 "flying laboratories," in addition to Beech D-18's and helicopters. The air strip that runs alongside the Hughes plant is almost 10,000 ft long, probably the longest privately owned air strip in the country.

To back up this flight testing program Hughes also maintains a staff of top-flight airplane mechanics, and aerodynamicists. They must be thoroughly familiar with the very latest military aircraft.

This program is costly, but necessary, to the design of airborne systems. It allows Hughes to check out-equipment just as soon as it is completed, and drastically cuts the possibility of failure in the field. The equipment will have been tested repeatedly, very often in the aircraft in which it is to be installed, and under the exact conditions which will exist when it is in field use.

Military Diversification

Defense contractors, no less than commercial manufacturers, find that past research tends to lay the basis for new techniques. At Hughes, the design and production of airborne intercept systems brought them into heavy contact with radar. The fire control system for their intercept systems were largely radar controlled, and they relied on radar direction from the ground.

Army's Nike - Hercules missiles (left). Missile technology has accelerated the growth of research and development in the procurement picture.

Hawk (right) is a ground-to-air missile designed to search out and kill hostile aircraft or cruise-type missiles up to medium altitudes.



When the military emphasis moved to the need for detecting incoming enemy bombers, it was a natural step for Hughes to turn its attention to ground radar systems.

This was the beginning of Hughes' Ground System Group, which today is located in Fullerton, Calif., a suburb of Los Angeles.

It is referred to as the "fastest growing industry in the fastest growing county in the U. S." That is Orange County. The division today has 6,000 personnel. Three years ago they had a slim 800.

The Ground System Gp. is concerned with designing surveillance radar and complete intercept systems for ground tracking, recording and control of aircraft. They have recently delivered to the military two noteworthy advances in the radar-intercept techniques.

In the AN-MSQ-18 mobile "vest pocket" tactical air defense system which Hughes designed and built for the Army Signal Corps, the military acquired a highly mobile field air defense system that gives field commanders an instant picture of all air activity in their area.

Messages between elements of the system are sent in digital data, greatly reducing the possibilities of error, and reducing the size and complexity of system components.

The system is primarily designed for use with Hawk or Nike batteries, to provide the batteries with data on planes entering their zone of defense. At each battery there are coder-decoder units that convert the digital data to analog form for use by the operational missiles.

The mobile system also includes an Operations Central where information on all aircraft, both hostile and friendly, is displayed on radar indicators. The commander has the choice of either assigning targets to each of his anti-aircraft batteries, or merely monitoring the battle to make sure that his missile batteries are fulfilling their role.

The field air defense system bears the name "Mis-

sile Monitor."

The second Hughes development, and one of the most significant advances in the radar art, is Frequency Scan Radar, dubbed "Frescanar" by the company.

Where conventional radar, to plot 3-dimensional data, scans an area by mechanically turning back and fourth and up and down, Frescanar uses an antenna turning in only one plane, and a unique electronic scanning method that gives the same type of up and down sweeping motion as mechanical motion.

The principal of operation is rather simple. It is most easily understood if a diffraction grating is kept in mind.

The radiating unit is an elongated oblong, with apertures spaced at regular intervals. The basic frequency will now be fed into the system. Its wavelength is identical to the distance between the apertures, so that the wave front radiated will be parallel to the radiating unit, and will follow a direction determined by the angle of the antenna.

Now, using a staircase type of frequency shifting the incoming signal will be changed to a higher frequency. The aperture at the feed end will still be in phase but at all the other apertures the signal will be more and more out of phase, depending on how far they are from the feed point.

Finally, when the frequency has been displaced enough, the signal at the aperture furthest removed will be radiating no energy at all, while the aperture at the feed end is still a maximum. The radiated pattern then will be pulled toward the feed end.

By scanning a band of frequencies, then, it is possible to swing the beam from one side to the other.

The detection process takes advantage of this difference in frequencies. When the "return" appears at a certain frequency, then the direction is easily determined because only at a certain angle was a signal of that frequency transmitted. The changing frequency also is important from the angle of counter-counter measures.

There are two outstanding advantages to this type of radar. It makes it possible to provide a three-dimensional effect from a single antenna, transmitter and receiving channel. The same radar will now read simultaneously the range and bearing, and also the height, of distance objects.

In shipboard use Frescanar is particularly valuable because it eliminates the need for mechanically stabilizing the radar platform. Instead, the antenna is

stabilized electronically, with a changing signal corresponding to the ship's roll.

Engineer Recruitment

For all defense contractors the problem of recruiting and keeping engineers is critical—and Hughes is no exception. If anything Hughes' problem has been even more acute because they make no secret that defense electronics is their main business now and that it will continue to be in the foreseeable future.

The reluctance of engineers, at least in the early years, to join organizations that relied heavily on defense contracts was understandable. Today, after some 15 years of this type of activity, engineers' opinions have changed considerably. Government spending has been much more consistent than might have been expected a decade ago.

Nevertheless, personnel problems have ranked high, or have been a major concern, to Hughes virtually from its earliest days. The personnel problems, roughly, have been on two levels, and it is somewhat interesting to see how the company has organized itself to minimize the dislocations caused.

A few words, first, on the rather obvious effects that defense spending has had on engineer recruitment and salaries.

Because military equipment tends to be considerably more complex than commercial or consumer equipment the demand for engineering is much higher, and a greater number of engineers are needed for a given sales volume. The complexity, too, demands, in general, a more thoroughly trained and capable engineer.

Defense electronics spending has created an exaggerated demand for engineers because prime or upper-tier sub-contractors have had to go out and hire engineers quickly. This put the engineer in the role of a "seller" in a sellers' market. It has resulted in very sizable increases in the average wage of engineers over the past decade.

Hughes was one of the very earliest companies to go on a mass-hiring campaign for engineers. Back in the Mid-Fifties, they were caught somewhat by surprise by the very rapid growth of their business, and found themselves in very dire need of engineering talent.

Their problem was particularly serious because they were 3,000 miles from the large pools of engineering talent in the East. Their solution of this problem was typically forthright—they offered salaries so attractive that electronic engineers found it difficult to refuse. It has been reported—and company spokesmen do not deny—that for a time Hughes was so desperate for engineers that they were offering to double the salaries of East Coast engineers willing to move West. This was one of the very earliest "gold rushes" that defense electronics spending brought about. In later years the industry was to see a number of similar movements, if not on quite so spectacular a scale.

Within a few short years Hughes assembled one of the largest electronic engineering staffs in the country.

For all defense contractors the recruiting of en-

gineers is a critical problem. Though most companies have adjusted to the idea that pirating of engineers is a necessary evil there is still a good deal of bitterness. A number of firms, for instance, are now making it difficult for their engineers to get away to trade shows and engineering conventions. In their eyes these shows have become little more than hunting grounds for recruiters, and they are not going to make their job any easier.

To attract and hold engineers, Hughes has developed a rather fine combination of the attractions that industry in general feels are important to engineers and creative scientific thinking. Among the fringe benefits that Hughes extends to engineers and personnel in general, are a pension plan—which compares favorably with the better plans in industry—salaries that are if anything just slightly higher than the average for the industry, and of course the California climate.

The engineer gets a rather high degree of freedom and the company wherever possible provides engineers with separate offices—a practice not too common to the industry.

In one respect Hughes does extend considerable assistance to the engineer, and that is through its post-graduate program. The company already boasts a very high percentage of Ph.D. and Masters Degrees and the number of personnel who are studying for advanced degrees through the company's tuition-help program is unusually high.

With this combination, Hughes manages to attract and hold the engineers that they need for their projects. It is interesting to note, however, that except for the advanced degree program, Hughes does not extend any unusual benefits. The aim has been—or seems to have been—to combine as many of the attractive features as possible in one package.

One of the most recent innovations is a program to encourage engineers to contribute more papers and articles to technical journals. Bonuses of \$100 are paid for each article published in a recognized technical journal.

In this whole picture of engineer recruiting and

Frescanar antenna is housed here in clear plastic radome. While antenna spins horizontally, electronic scanning is moving pencil beam vertically as well, providing height, range and bearing data.



engineer morale, there seems to be much of the essence of Hughes Co.'s thinking. There is a well balanced program covering all aspects of the situation. There are no glaring omissions that would point to tradition-bound executive staff. The program seems to be well thought-out, and cleanly executed.

There is a quality of alertness, which has become characteristic of defense electronics, where the contractor's immediate problem is to know what the Government wants, who in the Government is its customer, and how to convince him as quickly as possible that the firm is capable of delivering the hardware. This emphasis on the new approach can possibly be tied to the fact that Hughes has a remarkably young staff. For instance, in the Advanced Projects Group, which is responsible for advanced thinking in the company, and which is heavily staffed with Ph.D.'s, the average age is slightly over 32 years.

Upper Management

Defense electronics puts a particular strain on upper management personnel. Because the planning aspect is so exaggerated, and system management calls for rather unusual skills, both technical and administrative, the type of personnel needed to head defense electronic contractors must be exceptionally brilliant and capable people.

At Hughes the management problem was further complicated because the firm, from the beginning, has lacked the strong leadership of the engineer-founder-leader-visionary expected in most electronic firms.

Howard Hughes no longer owns the company. In 1954 he turned over ownership to the Howard Hughes Medical Institute, a non-profit foundation which is one of his favorite philanthropies.

The strains of a very rapidly expanding company, with its monumental management problems, erupted, in 1953, in an incident which gave Hughes a reputation for erratic leadership. The four top management personnel in the firm walked out.

There was outspoken speculation at the time whether the company itself would survive. Actually the company not only survived, but deliveries were never interrupted, nor was there any deviation in the company's growth pattern.



Engineer holds typical computer flip - flop card used in the Dig-itape system which electronically controls machine tools.

A REPRINT
of this article can be obtained by writing on company letterhead to
The Editor
ELECTRONIC INDUSTRIES, Chestnut & 56th Sts., Phila. 39, Pa.

Three of the four executives went on to found successful operations of their own. Drs. Simon Ramo and Dean Wooldridge set up the firm that bears their name, and Charles E. (Tex) Thornton went on to great success with Litton Industries.

Interestingly enough, while Hughes is basically a young man's company, the soundest leadership has come from one of the distinguished veterans in the electronic industry, the present executive vice-president, Lawrence A. (Pat) Hyland, who came to Hughes in 1954 from Bendix Aviation Corp.

In 17 years at Bendix Dr. Hyland had been successively general manager of its radio division, vice-pres. in charge of research, and vice-pres. in charge of engineering. He was one of the pioneers in the development of radar while at Naval Research Laboratory.

In the five year's of Hyland's leadership the company has made tremendous strides in coordinating its many activities and in smoothing its growth.

Conclusions

Our successful conquest of the problems of space travel is linked inextricably with the techniques and engineering know-how that we have built up over the past few decades. To a large extent, we are talking here of what we have established to provide the military with advanced weapon systems, because the military has demanded the services of the best technical talent available in the country.

The problems of space, from an electronic standpoint, can be broken down into three categories; the first is technical, the other two matters of official policy.

The first problem is reliability. Not enough is being done about it, though we are doing much, much more than ever in the past. Many people in industry are aware that reliability needs more emphasis. The military, and quasi-military agencies influential in procurement must be made aware, too, of the need for accelerated spending in this department.

The second problem is a "change of thinking" regarding research and development. We must learn to consider R&D as a commodity. The people who control the government's purse strings must be re-educated to consider R&D as a commodity, as well.

Problem three, which we have not discussed here, is more coordinated control of the space-missile spending. At the moment NASA is charged with responsibility for our space programs. Its authority has been increased considerably over just the past few months, and it will soon be assuming a military-like status. But the military is still spending a good portion of the money allocated for space experiments. There is a good deal of duplication, and for the maximum effort this duplication will have to be eliminated. The problem is getting a good deal of attention in Washington and we can expect improvement in this direction within the next few years.

THE ALL-NEW SUBMINIATURE "D" PLUG DESIGNED FOR HIGH-PERFORMANCE APPLICATION

★ CINCH GOLDEN "D"

MONOBLOC CONNECTOR FEATURES:

- Monobloc insulators
- Low engagement/separation forces
- Probe-proof closed-entry socket contacts
- Golden Iridite finish—per Mil Q Q-P-416A, Type II Class 2
- Type GDI-30 per Mil-M-19833 or MDG per Mil-M-14E insulators
- Fully interchangeable with standard "D"

FOUR TYPES AVAILABLE: GOLDEN-D with closed-entry contacts in monobloc insulator.
 *GOLDEN-D with snap-in ungrounded coaxial contacts.
 *GOLDEN-D with grounded coaxial contacts.
 *GOLDEN-D with high voltage contacts.



9 CONTACTS

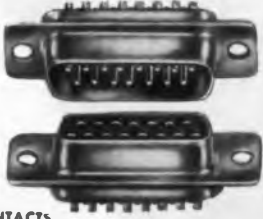

15 CONTACTS

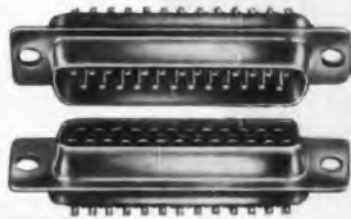

25 CONTACTS

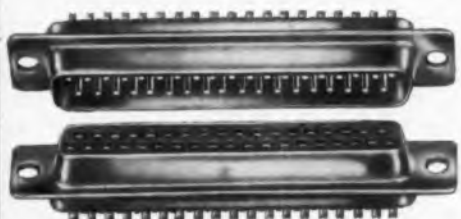

37 CONTACTS

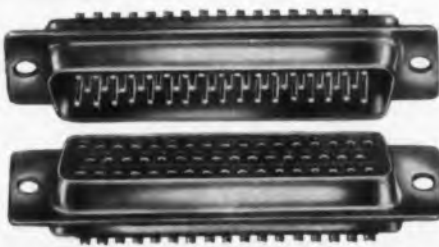

50 CONTACTS

The GOLDEN-D is in addition to the "D" line. It supplements the standard "D" which will continue in full production.

CONTACTS: Miniature socket contacts are closed-entry providing protection against damage by oversized test probes. Pins and sockets are gold plated for high reliability. Wire sizes No. 20 and smaller may be accommodated.

Coaxial contacts, except grounded coax, are designed to permit them to be snapped-in to the insulator after they have been secured to the cables. Contacts are also removable. Both straight and 90° coaxials are supplied. All feature captive center contacts. Coaxial cables within the range of .067" O.D. to .093" O.D. can be accommodated.

SHELLS: Tooled in all shell sizes common to the "D" line. Nomenclature, used to identify GOLDEN-D sizes, is identical to that for standard D's except that the letter M is added. Thus, standard D's are identified as DA, DB, DC, DD, and DE. GOLDEN-D's are the DAM, DBM, DCM, DDM, and DEM. "M" designates "monobloc." Floating mounting holes are available in all GOLDEN-D shells. These are designated by adding the letter "F" to the shell callout. For example, DAMF.

* Available at a later date.



Centrally located plants at Chicago, Illinois; Shelbyville, Indiana; City of Industry, California; St. Louis, Missouri

CINCH MANUFACTURING COMPANY

1026 South Maman Ave., Chicago 24, Illinois
 Division of United-Carr Fastener Corporation, Boston, Mass.

LAYOUTS

Tooling is complete to provide the GOLDEN-D standard layouts listed below. These layouts are interchangeable with similar patterns used in standard "D's". Thus any GOLDEN-D will mate with any standard "D" of the same shell size and layout.



STANDARD LAYOUTS

COAXIAL LAYOUTS

	layout	#20 contacts	ungrounded coax. contacts	cable accom.
DAM-15P or S	DAM-3C3P or S	0	3 Rt. Angle	.067"
DBM-25P or S	DAM-A7C2P or S	5	2 Straight	.067"
DCM-37P or S	DAM-A11C1P or S	10	1 Straight	.067"
DDM-50P or S	DBM-A17C2P or S	15	2 Straight	.067"
DEM-9P or S	DBM-21C1P or S	20	1 Straight	.067"
	DBM-13C3P or S	10	3 Straight	.067"
	DCM-27C2P or S	25	2 Straight	.067"
	DEM-5C1P or S	4	1 Straight	.067"



Circle 54 on Inquiry Card

Manufactured by agreement with Cannon Electric Company

Nothing is NEWER than like G-E Shadow Grid... anode... New products New engineering: direct-

MEANS LOWEST-NOISE PENTODE!

The new Shadow Grid tube is an advanced concept applied by General Electric. It makes possible high-gain pentode performance at a low noise level found up to now only in triodes. Electron flow is channeled *between* the wires of the screen grid. There is minimum contact of electrons with grid. Consequently, noise-producing screen current is held to a minimum. A plate-to-screen current ratio of 25 to 1 can be obtained with new General Electric Type 6FG5 for TV tuners.

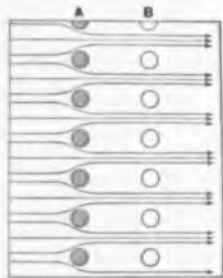

Electron flow from cathode past control grid is guided by electrostatic field in the vicinity of

Shielding grid (A) into streams passing between the wires of

Screen Grid (B), thus bypassing the screen grid and continuing to the plate.

ACTUATES RELAYS DIRECTLY!

General Electric's new 7427 cadmium-sulphide photoconductive tube is so sensitive to light variations, and can handle so much current (400 mw max dissipation), that the tube will operate a relay without amplification. Your costs are reduced. Spectrum of the 7427 matches the human eye. Check performance below:



Left: average characteristics, Type 7427

— AC (RMS) operation
- - - DC operation

Note this new tube's high sensitivity to light, with large current capacity. In series with a relay, the G-E 7427 helps form a simple, economical circuit which will handle scores of lighting, industrial, other control functions.

tubes . New concepts

New materials like 5-ply

like 7427  phototube.

heated cathode in 3DG4.

CUTS HEAT IN TV RECEIVERS!

Less heater power...less total power for set...less heat generated! The new General Electric 3DG4 power rectifier tube with direct-heated cathode brings you all three benefits. Special 3-ply cathode requires no filament, teams up with a new high-internal-reflectance plate material for maximum efficiency. Total power required is 42% less than the 5V3. Compare:

	NEW 3DG4	5V3
Heater power	12.5 w	19.0 w
Total watts in tube	29	50
Bulb temperature	171 C	206 C
Output current	350 ma	350 ma

NO "HOT SPOTS" ON ANODES!

General Electric has pioneered the use of 5-ply bonded material for tube anodes. Greatly superior in heat conduction and radiation, the new material prevents the formation of "hot spots" when tubes are running full-load. Gives sustained top-performance capability to a large and growing list of G-E receiving types.

Copper promotes the even distribution and faster dissipation of anode heat. Iron for strength. Aluminum for surface protection.

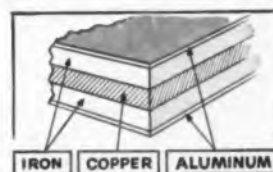

RECEIVING TUBE DEPARTMENT OFFICES:

New York, WI 7-4065, 6, 7, 8... Boston, DE 2-7122... Washington, EX 3-3600... Chicago, SP 7-1600
Dallas, RI 7-4296... Los Angeles, GR 9-7765, BR 2-8566... San Francisco, DI 2-7201.

Progress Is Our Most Important Product

GENERAL  ELECTRIC

Circle 55 on Inquiry Card

411-101

New Tech Data

for Engineers

Transistors

Availability catalog from Electronic Transistors Corp., 9226 Hudson Blvd., North Bergen, N. J. lists a complete line of germanium transistors. (412 types.) For switching, computing, entertainment, and industrial uses. The four-page, two-color catalog lists applications, type number, and description.

Circle 162 on Inquiry Card

Cleaning Technique

An 8-page booklet from Cobehn, Inc., Passaic Ave., Caldwell, N. J., describes their Spray-Clean Technique for chemically cleaning such components as transistors, diodes, vacuum tubes, jewel bearings, contact points, and other precision parts. The technique removes binders of oil, grease, wax, fingerprints, lapping compounds, rosin flux, etc. Illustrated are portable and bench type installations.

Circle 163 on Inquiry Card

Analyzers

Data sheet, 2-pages, available from Schlumberger Well Surveying Corp., Ridgefield Instrumentation Div., Ridgefield, Conn., describes line of Nuclear Magnetic Resonance (NMR) Analyzers for hydrogen and fluorine compounds. A section is devoted to fluorine determinations in semi-micro amounts as part of the solid propellants program of ARPA.

Circle 164 on Inquiry Card

Transformers

Four-page bulletin is offered by Stavid Engineering, Inc., U. S. Highway 22, Plainfield, N. J., describing the company's line of high power pulse transformers and inductor devices. Bulletin includes specifications on pulse transformers and charging reactors to 100 kv output with 10 a filament supply.

Circle 165 on Inquiry Card

High Vacuum Pumps

Data sheets from Ultek Corp., 920 Commercial St., Palo Alto, Calif., describe the company's line of electronic high-vacuum pumps. Applications include: vacuum tube processing, scientific measurements, thin film work and evaporation, particle accelerators, electron and molecular beam devices, and other general applications requiring clean high vacuum. Features of the pumps include: compact all-metal couplings with swivel flanges, no traps or baffles required, ultimate vacuum below 1×10^{-3} mm Hg, and low power consumption.

Circle 166 on Inquiry Card

Controls

Bulletin J-105, 16-pages, features: An expanded line of linear and rotary actuators—20 sizes delivering torques from a few in. oz. to 3500 in. lbs.; 6 basic types of remote positioners from low cost relay types to power transistor units with resolutions to one part in 250,000; machine tool point-to-point position and rate control; punch card formula and program control; and closed loop process control. Jordan Controls, Inc., 3235 W. Hampton Ave., Milwaukee 9, Wis.

Circle 167 on Inquiry Card

Cathode Ray Tubes

Six-page brochure features mechanical and electrical characteristics of 165 different industrial and military cathode ray tube types of the magnetic and electrostatic-deflection variety. Typical operating conditions, as well as such characteristics as overall length, type faceplate, basing, deflection angle and deflection factor are included. It can be used as a wall chart. Thomas Electronics, Inc., 118 Ninth St., Passaic, N. J.

Circle 168 on Inquiry Card

Thermocouple Adapter

Bulletin No. 2A, 2 pages, from Thermo Electric Co., Inc., Saddle Brook, N. J., describes their new spring-loaded bayonet-lock thermocouple adapter which converts any $\frac{1}{8}$ or $\frac{1}{16}$ in. dia. metal-sheathed thermocouple to a spring-loaded, bayonet-lock type with adjustable immersion lengths.

Circle 169 on Inquiry Card

DC Power Supplies

A 16-page catalog contains complete spec data for all DC Power Supplies in the company's standard line. Dressen-Barnes Corp., 240 N. Vinado Ave., Pasadena, Calif.

Circle 170 on Inquiry Card

Wave Analyzer Systems

Bulletin DB 9050a, 160 pages, describes and illustrates automatic wave analysis, "a versatile engineering tool" for Fourier and spectral power studies. Frequencies and amplitudes of vibration, flutter, noise, heart beats and other types of complex waves are automatically charted. Records can be of linear or squared amplitudes, or on a frequency vs time basis. Bulletin shows relation of magnetic tape recorder, playback loop transport, and wave analyzer. Charts and specs define accuracy and selectivity. Minneapolis-Honeywell, Industrial Systems Div., 10721 Hanna St., Beltsville, Md.

Circle 171 on Inquiry Card

Pulse Generator

Data sheet from E. H. Research Laboratories, Inc., 1922 Park Blvd., Oakland, Calif., describes their Model 120B Millimicrosecond Pulse Generator. The instrument has two outposts available which are independently variable in amplitude and pulse width. Repetition rate from internal source may be controlled from the front panel for continuous coverage 10 CPS to 10MC.

Circle 172 on Inquiry Card

Antenna System

The research publications office of General Bronze Corp.'s Electronic Div., Hook Creek Blvd., Valley Stream, N. Y., offers a paper on telemetry antenna systems. "A New Departure in Telemetry Antenna Systems" explains specific configurations, specs and applications of certain SVE antenna developments.

Circle 173 on Inquiry Card

Transistor Converter

Illustrated report, "Designing DC-DC Converters," presents detailed data on the design of tape wound core-transistor converters. An introductory section presents data on converter design factors, including transistor selection and characteristics of magnetic cores. The second half contains step-by-step info on two theoretical designs—a power converter and a DC to DC high voltage supply. Also included: circuit information and a chart with curves developed from a single tape wound core showing magnetizing current as a function of frequency. Magnetics, Inc., Butler, Pa.

Circle 174 on Inquiry Card

Fasteners

Brochure depicts assembly-cost savings case histories using speed nut brand fasteners. A total of 17 case histories in this illustrated brochure describe assembly savings in industries through the use of fasteners from a selection of more than 9000 variations. Tinnerman Products, Inc., P. O. Box 6688, Cleveland 1, Ohio.

Circle 175 on Inquiry Card

Potentiometer

Data sheet has specs on Model 157 Align-O-Pot. Model 157 is a lightweight, short stroke linear motion potentiometer. Bourns, Inc., P.O. Box 2112, Riverside, Calif.

Circle 176 on Inquiry Card



A Typical Example of Capacitor Characteristic

Sangamo Reference Data File 60-9 was aimed at clarifying the meaning of the word "characteristic" as it applies to the capacitor industry. It cited the ways in which the term was defined and gave examples of how characteristic is designated in Paper, Electrolytic and Mica capacitor nomenclature. This article will explain the term as it is used for a specific type of capacitor . . . the mica dielectric capacitor.

Under discussion will be a Sangamo fixed, mica dielectric, button style capacitor . . . the CB86PE102G. It has been stated previously that the characteristic letter "E" defines the capacitance stability of the unit during one "round trip" excursion from room temperature (+25°C) to minimum and maximum temperatures specified for the capacitor. Capacitance stability is evidenced by two capabilities of the product: (1) Temperature Coefficient. This is the dynamic change in capacitance as a function of temperature. (2) Capacitance Drift. This is a static change in the room temperature capacitance after the temperature excursion. It represents the ability of the capacitor to retrace its "temperature coefficient" curve. Let's further investigate these two capabilities of mica capacitors.

FIGURE 1
CAPACITANCE
IN MMFD

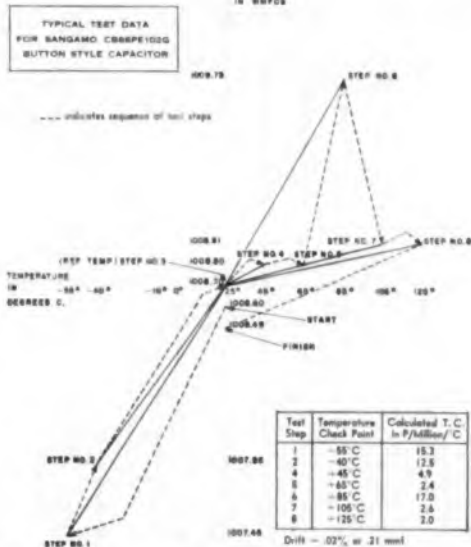

FIGURE 2
CHARACTERISTIC

Designator	Temperature Coefficient Parts/million/°C	Capacitance Drift
B	Not specified	Not specified
D	-100 to +100	0.3% or 0.3 mmf; whichever is greater
E	-20 to +100	±.1% + 0.1 mmf

Temperature Coefficient (T. C.) is defined as the parts per million change in capacitance for every degree change in temperature. In equation form, it is defined as:

$$T. C. = \frac{(C_2 - C_1) \times 10^6}{(T_2 - T_1) C_1}$$

Where: T. C. = Temperature Coefficient in parts per million per degree C.

C₁ = Capacitance at reference temperature (+25°C) in mmf

C₂ = Capacitance at test temperature in mmf

T₁ = Reference temperature (+25°C)

T₂ = Test temperature in degrees C.

Figure 2 shows a table setting forth values for three characteristic designators. If the T. C. and Drift of a mica capacitor fall within the limits of those values shown in Figure 2, then the capacitor can be said to have a B, D or E characteristic. However, the temperature range of the capacitor must be specified.

Now let's look at Figure 1 again. The primary objective of the test is to find the maximum value of T. C. throughout the specified temperature range of the capacitor. In this case the temperature range of the CB86PE102G is -55°C to +125°C. The ideal test would determine all instantaneous values of capacitance from -55°C to +125°C but, until recently, time has been the prohibiting factor in this test procedure. The capacitance is therefore measured at selected temperature test points throughout the specified range. Today, through the utilization of the latest equipment and procedures, Sangamo can obtain these "in-between" values in a fraction of the previous time. This approach means significantly better-tested components for customer equipment. For the purpose of this article, only the selected test points will be used for checking maximum T. C. throughout the temperature range.

Notice that in Figure 1 there are 10 capacitance readings . . . Start, Steps 1, 2, 3, 4, 5, 6, 7, 8 and Finish. The T. C. is calculated for each temperature check point other than 25°C using the above equation. These points are Steps 1, 2, 4, 5, 6, 7 and 8. The test results have been computed and are tabulated in Figure 1. If, after having computed the value of T. C. for all seven points, the maximum plus and minus values lie in-between the limits of any one designator, then the capacitor is said to meet that "characteristic".

Capacitance Drift is simply the element that defines capacitance stability of the unit during one "round trip" temperature excursion as shown in Figure 1. It is expressed as a percentage and is computed by dividing the greatest single difference between any two of the three values recorded at +25°C by the second value recorded at +25°C (Reference Temperature) multiplied by 100. It can also be expressed in mmf's. by subtracting the smallest capacitance value recorded from the largest of the three values recorded at +25°C. If this value is then compared with those values of Drift shown in Figure 2, the characteristic of the capacitor can then be determined.

Temperature Coefficient of capacitance is usually the parameter of greatest interest to design engineers. Drift is often of secondary importance. Sangamo feels that these two parameters should be stated separately in specifications and encourages its customers to state their requirements quantitatively and separately for T. C. and Drift. Further, a precision capacitance tolerance does not insure or indicate capacitance stability.

SC-40-2

SANGAMO ELECTRIC COMPANY, Springfield, Illinois
-designing toward the promise of tomorrow



Wayne Kerr RF Bridge Type B-601

BALANCED OR UNBALANCED MEASUREMENT of complex impedance



Wayne Kerr VHF Admittance Bridge Type B-801

Both bridges offer all these important features

- Balanced or unbalanced measurement
- Exceptional range
- Two or three terminal measurement
- High accuracy
- Transfer admittance measurement
- Series impedance measurement of semiconductors

RF BRIDGE TYPE B-601. Uses three terminal tapped-transformer ratio arm principle. Measures complex impedances, balanced or unbalanced, or balanced with center point grounded, and between any pair of terminals in a 3-terminal network. Extreme stability—very low impedance looking back into terminals and to ground at balance. Measures resistance, inductance, capacitance between 15 kc and 5 mc.

VHF ADMITTANCE BRIDGE TYPE B-801. Also uses 3-terminal, transformer ratio arm principle. Measures variety of components between 1 and 100 mc. Calibration independent of frequency, in terms of conductance and positive or negative capacitance. Separate external source and detector are available.

SPECIFICATIONS		
	B-601	B-801
Frequency Range	15kc-5mc	1-100mc
Capacitance	0.01-20,000 $\mu\mu\text{f}$	$\pm 230 \mu\mu\text{f}$ Susceptance Equivalent
Inductance	0.5 μH -50mH	
Resistance	10 Ω -10M Ω	10 Ω -10K Ω
Accuracy	$\pm 1\%$	$\pm 2\%$
PRICE	\$640.00	\$800.00

Special adaptors cover measurement of transistor and semiconductor parameters

OTHER INSTRUMENTS: Audio to VHF Bridges and Oscillators; Attenuators; Microwave Equipment; Vibration and Distance Meters; Waveform Analyzer; Voltmeters

Send for complete literature.



**WAYNE KERR
CORPORATION**

1633 Race St., Philadelphia 3, Pa.

Representatives in major U.S. cities and Canada

Circle 57 on Inquiry Card

New Tech Data

for Engineers

Thermal Design

Technical Report 7-8-9 describes and analyzes thermal problems affecting electron tubes in modern electronic equipment. Applications of thermion, a thermal analog tube, in quantitatively evaluating and experimentally alleviating these problems are presented. Research Council Inc., 1062 Main St., Waltham 54, Mass.

Circle 177 on Inquiry Card

High Speed Memories

A 4-page bulletin, DF 115.1, describes series of general purpose high speed memories. The Type RB, are made in a range of sizes from 128 to 1024 words and from 4 to 24 bits per word. They operate at rates up to 125 KC and provide both random access and sequential types of operation. Telemeter Magnetics, Inc., P. O. Box 329, Culver City, Calif.

Circle 178 on Inquiry Card

R-F Bridge

Illustrated bulletin, WK-B-601, describes the r-f Bridge, Type B-601. It describes features, principle of operation, spec, performance, and gives applications of the multi-ratio bridge, a highly accurate transformer ratio-arm bridge designed for resistance, capacitance and inductance measurements over a frequency range: 15 KC to 5 MC. Wayne Kerr Corp., 1633 Race St., Phila. 3, Pa.

Circle 179 on Inquiry Card

High-Pot Testing

A 12-page application bulletin, titled "Practical Hi-Pot Testing" is offered by Associated Research, Inc., 3777 W. Belmont Ave., Chicago 18, Ill. Separate sections cover ac and dc breakdown testing, with discussion on non-destructive tests of dielectric strength in wiring harnesses, motors, cables, solenoids, thermostats, and similar equipment.

Circle 180 on Inquiry Card

Fasteners

A 20-page catalog 592 shows complete line of Palnut spring tempered steel lock nuts, including regular hex, integral washer, acorn, wing and adjusting nut types. Gives details of design and locking principle, advantages, typical applications, dimensions, load ratings, materials and finishes. The Palnut Co., 83 L Glen Rd., Mountainside, N. J.

Circle 181 on Inquiry Card

Breadboard Components

Technical booklet, #4, on Mechanical Breadboard Components from PIC Design Corp., 477 Atlantic Ave., East Rockaway, L. I., N. Y., offers design hints and recommendations for instrument engineers and designers.

Circle 182 on Inquiry Card

Power Supply

George A. Philbrick Researches, Inc., 2885 Columbus Ave., Boston 16, Mass., has released a spec sheet on a compound regulated, dual power supply—Model R-100B. It contains characteristics, a general description, installation notes, operation data, and maintenance procedure.

Circle 183 on Inquiry Card

Vibration Test Systems

Bulletin #59-5, describes Series 70 Vibration Test Systems. System performance, components and accessories are covered. A description and dimensions of the 400 lb. force shaker is given as well as the control console. Unholtz-Dickie Corp., 2994 Whitney Ave., Hamden 18, Conn.

Circle 184 on Inquiry Card

Diffusion Furnaces

Bulletin No. 1081, 2-colors, 4-pages, from Lindberg Engineering Co., 2443 W. Hubbard St., Chicago 12, Ill., describes their gaseous and solid diffusion furnaces. The company offers a line of precision gaseous and solid diffusion furnaces for making quality transistor and semiconductor devices.

Circle 185 on Inquiry Card

Connectors

Buyers and engineers guide aids in selecting miniature K and D sub-miniature Cannon Connectors. The brochure includes detailed information on appropriate hardware and accessories. Schweber Electronics, 60 Herricks Rd., Mineola, L. I., N. Y.

Circle 186 on Inquiry Card

Nuclear Instruments

Specs for instruments for nuclear research and process control are featured in short form catalog, D-100, from Eldorado Electronics, 2821 Tenth St., Berkeley 10, Calif. Included are: Standard Instruments; Pulse Height Analyzers; Decimal Scalers; and Scalers.

Circle 187 on Inquiry Card

PUTTING MAGNETICS TO WORK



Open your eyes to new amplifier designs!

**See how to combine tape wound cores and transistors
for more versatile, lower-cost, smaller amplifiers**

Tie tape wound cores and transistors into a magnetic-transistor amplifier, and open your eyes to new design opportunities.

To start with, these are static control elements—no moving parts, nothing to wear or burn out. Next thing you find is that you reduce components' size—your amplifier is smaller and costs less. That's because between them the core and the transistor perform just about every circuit function . . . and then some.

For instance? The core has multiple isolated windings. Thus you can feed many inputs to control the amplifier. The core also has a square hysteresis loop, and thus acts as a low loss transformer. That means you save power. In addition, the core can store and remember signals—so time delay becomes simple.

There's no need for temperature stabilization, either. The transistor acts only as a low loss, fast, static switch—and in this function it has no peer.

How do you want to use this superb combination? As a switching amplifier—or a linear one? In an oscillator? A power converter (d-c to d-c or d-c to a-c)? You'll have ideas of your own—and if they involve tape wound cores, why not write us? Ours are Performance-Guaranteed. *Magnetics, Inc., Dept. EI-81, Butler, Pennsylvania.*

MAGNETICS inc.

New Tech Data

for Engineers

Drip-Proof Motors

Bulletin No. 196, describes design features of "Sterlicone Multi-Shielded" drip-proof motors. Motors can replace many totally-enclosed motors. Sterling Electric Motors, Inc., 5401 Telegraph Rd., Los Angeles 22, Calif.

Circle 188 on Inquiry Card

Noise Factor Improvement

Four-page bulletin, TF 165, describes a VHF-UHF Receiver Input System providing a pass-band of 200 MC without tuning, for governmental and commercial installations, to improve noise factor in receiver installations. A specification table permits selection of components for multi-receiver installation. The system offers a decreased noise factor (extending potential range and eliminates the need for more than one antenna. Resdel Engineering Corp., 330 So. Fair Oaks Ave., Pasadena, Calif.

Circle 189 on Inquiry Card

Transistor Base Tabs

Tech data sheet describes physical properties of partially coated metals used as base tabs in the manufacture of transistors, or as a solder-coated part acting as its own preform. Included is a description of metals and alloys that can be coated with the new process and the physical properties of the alloy-coated metals. Dimensional range of base materials and full or partial coatings are listed. Alpha Metals, Inc., 56 Water St., Jersey City 4, N. J.

Circle 190 on Inquiry Card

Delay Lines

Data sheet, M-1001, gives information on the theory of operation of fixed and variable magnetostrictive delay lines. Also listed are the range of design characteristics available for these delay lines such as fixed line characteristics, delay range, taps, variable delay lines, adjustments, impedance, temp. and associated circuitry. Control Electronics Co., 10 Separ Place, Huntington Sta., N. Y.

Circle 191 on Inquiry Card

Meter-Relays

Specialized expanded scale meter-relays are described in a 12-page catalog issued by Assembly Products, Inc., Chesterland, Ohio, and Voltron Products, So. Pasadena, Calif. Included are dimensions, prices, typical circuitry and ordering specs.

Circle 192 on Inquiry Card

Re-entry and Recovery

The General Electric Company, Missile and Space Vehicle Dept., 3198 Chestnut St., Philadelphia 4, Pa., has released two booklets describing re-entry and recovery projects in the Thor-Able and Atlas missile programs. The bulletins, PIB-20 and PIB-23, include close-up photos of the Thor-Able nose cone after a 5500-mile ICBM flight. The system used to recover the Atlas GE-RVX-2 is also described in detail.

Circle 193 on Inquiry Card

! MORE !

The literature mentioned here has been selected for contribution to or advancement of the electronic industries. These items are combed from several hundred bulletins, catalogs, and data sheet announcements received during the past month by ELECTRONIC INDUSTRIES. To keep interested readers informed of all new developments, a summary record is kept of ALL new products and tech data announcements received. For a copy of this month's list, please send your request on company letterhead to Readers' Service Dept., Electronic Industries, 56th & Chestnut Sts., Phila., Penna. or

Circle 161 on Inquiry Card

Capacitors

A 16-page, high-reliability capacitor catalog. Complete electrical specs, temp. characteristic graphs and construction details are presented for engineering reference. Capacitor types and case styles include high voltage midgrets, metallized paper, Mylar or Teflon, Kraft-Mylar and foil missile miniatures. Electron Products Technical Information Service, 2065 Huntington Dr., San Marino, Calif.

Circle 194 on Inquiry Card

Magnetic Data

Bulletin C-5, 24-pages, gives extensive design data, test data and magnetization curves for centricores (toroidal cores wound from thin magnetic tapes), stamped ring cores (made from laminations), and precision die-cut DU laminated cores. Also included is data on Super Squaremu "79" Centricores for magnetic amplifier applications. Test methods outlined follow recommended procedures standardized by industry committees and include circuit diagrams. Magnetic Metals Co., Hayes Ave. at 21st St., Camden 1, N. J.

Circle 195 on Inquiry Card

Checkout Equipments

A 4-page brochure describes 4 new Epsco automatic checkout equipments—an RMS-to-DC converter, a voltage-to-digital converter, a timer-counter and a digital printer. Militarized units meet MIL-E-4158B. They can be used to measure dc voltages, ac voltages, and the transient responses of servos which control time, frequency, ratio, thrust, roll, pitch and yaw. Equipment Div., Epsco, Inc., 275 Massachusetts Ave., Cambridge 39, Mass.

Circle 196 on Inquiry Card

PDM Telemetry

A 2-color illustrated brochure, No. 935, describes a ruggedized commutator, transistorized pulse-width modulator, and crystal-stabilized transmitter designed for airborne PDM telemetry systems. Includes detailed electrical, environmental, and physical characteristics and outline drawings. Tele-Dynamics Inc., 5000 Parkside Ave., Phila. 31, Pa.

Circle 197 on Inquiry Card

Rotary Switches

Catalog 399 from Oak Mfg. Co., 1260 N. Clybourn Ave., Chicago 10, Ill., describes a line of 125 low-power, rotary switches. The switches are offered as completely assembled units or as subassemblies—sections, shaft-index assemblies, miscellaneous hardware. Stock switches have one fixed and one adjustable stop, plus grooved shafts for "break-off" to length. Contacts are double-wiping type formed of silver-plated brass, shorting and nonshorting.

Circle 198 on Inquiry Card

Insulation Materials

Brochure from The Fiberite Corp., 512-528 W. Fourth St., Winona, Minn., contains detailed information on the company's compression molded high temperature insulation materials up to the 6000°F. range. The formulations carry MIL approval numbers and are used in the production of Polaris, Lar. and Bull-Pup.

Circle 199 on Inquiry Card

Microwave Components

Over 60 data sheets covering over 1000 coaxial and microwave components available from stock are being prepared by Omega Laboratories Inc., Rowley, Mass.

Circle 200 on Inquiry Card

WHY PAY \$1000 MORE?

For a Digital Voltmeter with $\pm .01\%$ Accuracy



FOR FULL FOUR-DIGIT ACCURACY IN VISUAL MEASURING JOBS—production checking, instrument calibrating, laboratory testing, receiving inspection — the NLS 481 Industrial Voltmeter is your best buy in digital instruments. Here's a precision instrument that matches — even surpasses — other dry-stepping switch meters in accuracy, speed, reliability . . . yet sells for \$1,000 to \$2,000 less! High-volume production techniques enable NLS to offer the 481 at just \$1,425.00, complete. Compare its performance with that of higher-cost competitive meters. Many major companies have . . . and they are now using the NLS 481 in quantities of 50 and more!

481 Specifications: Accuracy $\pm .01\%$. . . measures DC voltages from ± 0.001 to ± 999.9 . . . plug-in accessories permit measuring AC or low level DC voltages . . . balancing time: 1 second, average . . . input impedance: 10 megohms on all ranges . . . automatic indication of range and polarity . . . internal standard cell permits verification of calibration . . . one-package design (5¼" high, 15¼" deep for 19" rack) . . . available from stock for immediate delivery . . . \$1,425.00 complete.



Originator of the Digital Voltmeter

non-linear systems, inc. DEL MAR (SAN DIEGO), CALIFORNIA

NLS — The Digital Voltmeter That Works . . . And Works . . . And Works!

NOW  for L-Band

Small-size, light-weight

Tunable Magnetrons

power output, high

TWO POSSIBLE VTM APPLICATIONS

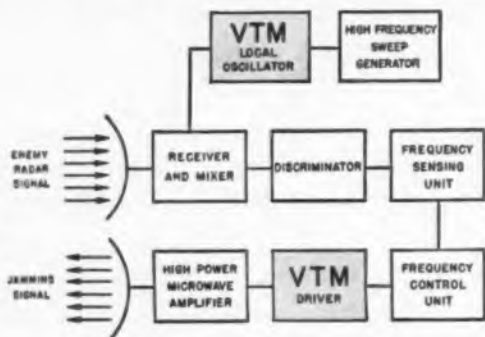

COUNTER-MEASURE SYSTEM

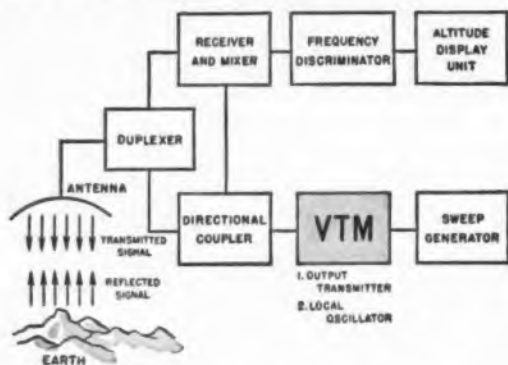

ALTIMETER APPLICATION

as well as S-Band.

General Electric Voltage-oscillate with uniform efficiency, linear tuning.

New L-Band VTM . . . 1000-2300 MCS

3 lbs. . . . Shown 1/4 Size



Features which make the new Z-5405 particularly valuable in equipments like sophisticated radar:

Linear Tuning. Permits designing simpler circuitry to use information generated.

High Efficiency. Eliminates need for forced air-cooling. Also reduces battery load, therefore lengthens battery life.

Uniform Power Spectrum. Assures driving traveling wave tubes at optimum conditions.

Smallest in Size, Lightest in Weight, Higher Power Output. Aids in design of compact, light-weight equipments.

Phone your nearest General Electric Power Tube Department office for samples and application assistance.

Schenectady, New York
FRanklin 4-2211

Chicago, Illinois
SPring 7-1600

Clifton, New Jersey
GRegory 3-6387

Dayton, Ohio
BAldwin 3-7151

Los Angeles, Calif.
BRadshaw 2-8566

Newtonville, Mass.
WOodward 9-9422

Washington, D. C.
EXecutive 3-3600

Progress Is Our Most Important Product

GENERAL  ELECTRIC

9545-8481-24



SHIELDED CABLES

designed for



**STEREO
HI-FI**



These low capacity cables are especially designed for use as leads between amplifiers, speakers and record changers of Stereo HI-FI units. Standard Two Conductor and Single Conductor cables are available and, where required, modifications of these cables can be developed to satisfy specific requirements.



LOW CAPACITY RECORD CHANGER TO AMPLIFIER EXTENSION CABLE

Two Stranded Conductors with clear polyethylene insulation extruded in parallel with a spiral wrapped tinned copper shield and a black extruded plastic jacket. Two styles available, with .030" wall insulation, 24 uuf per foot shield to conductor capacity and .017" wall insulation, 39 uuf per foot shield to conductor capacity.

LOW CAPACITY HI-FI AMPLIFIER INTERNAL SIGNAL CABLE

Two Solid Conductors in parallel with red and clear polyethylene insulation and spiral wrapped tinned copper shield with black extruded plastic jacket with 24 uuf per foot shield to conductor capacity.



For complete specifications for these and other Lenz Wires and Cables write today for the new Lenz Catalog.

STEREO RECORD CHANGER TO SPEAKER CO-AXIAL SINGLE CONDUCTOR LOW CAPACITY CABLE

Single Stranded Copper Conductors with polyethylene insulation, tinned copper full coverage shield and black or gray plastic insulation. Three styles available with shield to conductor capacities of 28, 31 and 33 uuf per foot respectively.



WIRES

and

CABLES

In Business Since 1904

LENZ ELECTRIC MANUFACTURING CO.
1751 No. Western Ave., Chicago 47, Ill.

Tech Data

for Engineers

Vibration Testing

Brochure published by MB Electronics, a div. of Textron Electronics, Inc., 781 Whalley Ave., New Haven, Conn., discusses the 5 critical points to be examined before investing in vibration test equipment. These 5 points cover performance, quality, service, scope of operations and acceptance of the product. In addition, the new booklet names each missile currently in production together with the prime contractor. The principles behind electromagnetic vibration exciters are described.

Circle 201 on Inquiry Card

Rotary Switch

Four-page catalog illustrates and describes new Type 212 longer life non-drift compact rotary switch. Molded glass alkyd housing exceeds MIL standards, has high mechanical strength, low toxicity and exceptional non-drift characteristics. Included are dimensional drawings and a page of standard stock assembly layouts for the instrument and radio series. Trolex Corp., 507 W. Elm St., McHenry, Ill.

Circle 202 on Inquiry Card

Connectors

A 6-page 2-color abbreviated catalog of the 4 basic series of Deutsch miniature connectors includes: DM series, solder-type; 2-DS Series, snap-in type; rack-and-panel, both rectangular and cylindrical; and hermetics. It includes cutaway drawings and detailed specs and a table showing the mating combinations of the interchangeable DM and DS Series. The Deutsch Co., Electronic Components Div., Municipal Airport, Banning, Calif.

Circle 203 on Inquiry Card

Coils

Data sheet from Preferred Coils, Inc., Box 14, Highland Station, Springfield 9, Mass., features their line of standard and miniature coils. The coils include relay coils, solenoid coils, precision chokes, MIL types, toroids, Hi-temperature coils and fine wire coils.

Circle 204 on Inquiry Card

Cable Fault Finder

Illustrated brochure describes the operation and application of the Model 722 Cable Fault Finder. Tech. specs are included. Smith-Florence, Inc., 4228 23rd Ave. W., Seattle 99, Wash.

Circle 205 on Inquiry Card

FRONT—Circle 62 on Inquiry Card →
BACK—Circle 63 on Inquiry Card →

New from Polarad

ANTENNA PATTERN MICROWAVE RECEIVER

ULTRA-BROADBAND COVERAGE

**2,000 to 75,000 mc
in a single unit**

- A** External Mixer. May be located at or near antenna, any distance up to 75 feet from receiver.
- B** Flexible cable connects mixer to receiver. Eliminates cumbersome rigid waveguide.
- C** Internal electronic 1000 cps sweep allows direct operation into any standard make AC antenna pattern recorder.
- D** CW, AM, FM and pulse reception.
- E** Sensitivity.
2 kmc to 10 kmc . . . -85 dbm.
10 kmc to 35 kmc . . . -80 dbm.
35 kmc to 75 kmc . . . -70 dbm.
- F** Linearity maintained over 40 db dynamic range.

The Model RW-T is another example of the versatility of the well known Polarad Model R Microwave Receivers. The RW-T is excellent to measure antenna gain, pattern, minor lobes, front-to-back ratio, SWR and bandwidth.



**POLARAD
ELECTRONICS
CORPORATION**

43-20 34th Street, Long Island City 1, N. Y.
Representatives in principal cities.

MAIL THIS CARD
for specifications. Ask your nearest Polarad representative (in the Yellow Pages) for a copy of "Notes on Microwave Measurements."

© P.E.C.



Model RW-T Microwave receiver being used to make antenna pattern measurements on Polarad range.

PD 1

POLARAD ELECTRONICS CORPORATION:

Please send me information and specifications on:



- Model RW-T Antenna Pattern Receiver
- Model KSS Microwave Power Source (see reverse side of page)

My application is _____

Name _____

Title _____ Dept. _____

Company _____

Address _____

City _____ Zone _____ State _____

New from Polarad

COMPACT MICROWAVE POWER SOURCE

1,050 to 11,000 mc 4 PLUG-IN UNITS



Model KSS Power Source being used to make antenna pattern measurements on Polarad Antenna Range. Can also be used for minor lobes, front to back ratio, SWR and gain measurements.

The new Polarad Model KSS features an advanced modulator design that provides CW, FM and internal square wave (10 to 10,000 pps). External pulse capabilities permit rise times to 0.15 μ sec. The unit has an adjustable attenuator and low incidental AM and FM at relatively high power.

- A Basic unit (HU-4) includes modulator and power supply into which is plugged any one of four R-F tuning units
- B that cover the frequency range 1,050 to 11,000 mc.
- Tuning units are equipped with UNI-DIAL control C that automatically tunes klystron cavity with reflector voltages.

Postage
Will be Paid
by
Addressee

No
Postage Stamp
Necessary
If Mailed in the
United States

BUSINESS REPLY CARD

First Class Permit No. 18, Long Island City 1, N. Y.

POLARAD ELECTRONICS CORP

43-20 34th St., Long Island City 1, N. Y.



MAIL THIS CARD

for specifications. Ask your nearest Polarad representative (in the Yellow Pages) for a copy of "Notes on Microwave Measurements."

FREE LIFETIME SERVICE
ON ALL POLARAD
INSTRUMENTS

**POLARAD
ELECTRONICS
CORPORATION**

43-20 34th Street, Long Island City 1, N. Y.

Representatives in principal cities.

© P.E.C.

ELECTRONIC INDUSTRIES

A CHILTON PUBLICATION

ELECTRONIC INDUSTRIES

ELECTRONIC INDUSTRIES

ELECTRONIC INDUSTRIES

ELECTRONIC INDUSTRIES

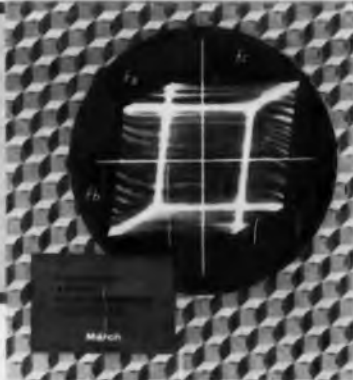

ELECTRONIC INDUSTRIES

ELECTRONIC INDUSTRIES

ELECTRONIC INDUSTRIES



ELECTRONIC INDUSTRIES

ELECTRONIC INDUSTRIES

ELECTRONIC INDUSTRIES

ELECTRONIC INDUSTRIES



EDITORIAL HISTORY and POLICIES

The development of the electronic industries is a 20th Century miracle. Its progress and expansion continue to create a unique and unparalleled growth pattern. An enormous range of materials are processed to produce the units employed in components and circuitry. These, in turn, activate an infinite variety of devices from the electronic baby sitter to interstellar ranging units.

To meet the challenge of keeping pace with this growth, to keep electronic engineers aware of all its concepts has been the editorial objective of **ELECTRONIC INDUSTRIES**—"Where the Engineer comes First!"—since 1942.

"EI's" Editorial policy has created an image in the minds of electronic engineers . . . an image resulting in **ELECTRONIC INDUSTRIES** being referred to as: the "applied engineering" information center for electronic engineers engaged in the design, research, development and operation of electronic components and equipment.

Undoubtedly one of the main reasons why **ELECTRONIC INDUSTRIES** has proved so valuable to the electronic engineer over the past 18 years is its staff. "EI" has one of the most effective—and stable—editorial staffs in its field.

*The following pages will give you some idea as to why **ELECTRONIC INDUSTRIES** has become the leading—and most useful—engineering publication in the electronic field.*

Every editor is an industry experienced engineer. (No journalism students, no news editors, no typewriter jockeys.) These men know the readers' interests at first hand—they write and talk his language.

BERNIE OSBAHR, Editor, has 20 years of experience; **CRAIG MARCOTT**, Managing Editor—16 years; **DICK STRANIX**, Associate Editor—10 years; **JACK HICKEY**, Associate Editor—11 years; **CHRIS CELENT**, Assistant Editor—12 years; **DR. ALBERT MURRAY**, Contributing Editor—41 years; and so on through the rest of the men who contribute to making "EI" the "applied engineering publication" of the electronic industry.

EDITORIAL CONTENT IS GEARED To the INDUSTRY'S DIVERSE NEEDS

The development of any single product in this diversified industry is sure to need the talents of many people. Design Engineers, Research Engineers, Development Engineers and Administrative Engineering executives are all influential, in varying degrees, in determining the future of an electronic product.

A positive editorial approach is necessary to fully serve such a complex group. **ELECTRONIC INDUSTRIES** has these principal thruways to reach them:

1. *Timely Applied Engineering Articles*
2. *Editorial Staff Studies*
3. *Monthly News Round-Up consisting of What's Ahead for the Electronic Industries, Late Marketing Statistics, Coming Events, News Briefs, International News and Washington News.*
4. *New Products and New Tech Data*
5. *Trends of Tomorrow*

All these editorial factors (History—Policy—Content) add up to the characteristics that make **ELECTRONIC INDUSTRIES** unique—and respected—in its field: Reliability—Quality—Stability.

From cover to cover **ELECTRONIC INDUSTRIES** serves the electronic engineer. This typical 2-page Table of Contents helps you select what interests you most.



ELECTRONIC INDUSTRIES EDITORIALLY LEADS the WAY!

All twelve monthly issues meet the challenge of giving electronic engineers the timely news, data, facts and engineering concepts they need.

Ever sensitive to industry needs, to requests from subscribers, the "EI" staff pioneered—or created exclusively—just in the past year—the following:

ELECTRONIC FREQUENCY SPECTRUM CHART

BACK-TO-BACK PLACEMENT OF ARTICLES PERFORATED PAGES

PROBLEM CLINIC

SYSTEM ENGINEERING SECTION

INTERNATIONAL NEWS

TRANSISTOR INTERCHANGEABILITY CHART

PROFILE OF "TODAY'S ELECTRONIC ENGINEER"

WIRE & CABLE REFERENCE CHART

PLASTIC REFERENCE CHART

TRANSISTOR SPECIFICATIONS

SURVEY OF MICROWAVE POWER TUBES

THERMOELECTRICITY—STATE OF THE ART

SYNCHRO REFERENCE CHART

SEMICONDUCTOR DIODE SPECIFICATIONS

THE THIMBLE TUBES

RECEIVING & SPECIAL PURPOSE TUBE LISTING

ELECTRONIC HARDWARE CHART

TUNNEL DIODES—MOST THOROUGH ANALYSIS

PROS & CONS OF FOREIGN COMPETITION

DEVELOPMENT OF NON-MILITARY PRODUCT LINES

SPECIAL PURPOSE CATHODE RAY TUBES

HUMAN FACTORS

RADIO FREQUENCY INTERFERENCE

THESE EDITORIAL EXTRAS REPRESENT ONLY A SAMPLING

In addition, there were dozens of feature articles—many written by the nation's outstanding engineers covering nearly 30 specialized industry segments.

Although the listing above is only a sample, it's certainly striking evidence of how "EI" is making its readers the best informed in the industry. And, they show the forces that give (and will continue to give) **ELECTRONIC INDUSTRIES** the great editorial impact and leadership which makes it the top engineering publication in its field.

INTERESTING FACTS DEPARTMENT

*If only one copy of **ELECTRONIC INDUSTRIES** were printed each month that single magazine would cost about \$96,000.*

To provide electronic engineers with one year of **ELECTRONIC INDUSTRIES** (12 Issues) required the following:

PAPER

5,593,815 sheets of paper in three sizes were required: 23" x 33½"; 33½" x 46"; 46½" x 67".

PAGES

The 5½ million sheets are equal to 183,010,600 individual printed pages.

MILES

If these 183 million pages were laid end-to-end, they would reach 326,392 miles into outer space.

INK

These pages required 16,386 lbs. of ink.

PRESS TIME

The printing of these pages required 8,359 hours of press time.

WRAPPER ADDRESSING

The placing of subscriber names and addresses on wrappers took 319 hours.

ADDRESS PLATES

The maintenance of all subscriber mailing stencils added up to 5,148 hours.

STENCILS

Over 1,808 hours were needed to emboss subscriber names, etc., in address plates.

CHANGES

During the year 38,721 subscriber address-plate changes were made.

PROOF READING

526 hours were required to make sure each subscriber's mailing plate was correct.

REPRINTS

More than 110,000 reprints of articles were ordered.

POSTAGE

It costs \$96,915 to send "EI" to its subscribers.

MILEAGE

The editors travelled over 36,000 miles in the fulfillment of their duties.

The adding-up of all these statistics proves one thing: When you start reading your copy of "EI" you have in your hands a professional magazine produced for you by one of America's most respected publishing corporations, "The Chilton Company."

ELECTRONIC INDUSTRIES

**The applied engineering magazine
for the electronic engineers who make
the design decision on today's—and tomorrow's
electronic components and equipment**

... the applied engineering information services provided you by "EI" cover the design and development of the electronic industry in these—and many other—technologies:

- Microwave
- Semiconductors
- Standards
- System Engineering
- Propagation
- Ultrasonics
- Infra-red
- Materials
- Solid State
- Guidance
- Data Processing
- Human Factors
- Radar Detection
- Radiation
- Nomographs
- Navigation
- Missiles
- Computers
- Controls
- Measuring & Test
- Interference
- Circuitry
- Etc., Etc., Etc.

Engineers, Scientists and Engineering Management men in original equipment manufacturing organizations, research facilities and the military commands read "EI" because they must keep abreast of technical developments in the electronic field. They are kept informed by ELECTRONIC INDUSTRIES: with:

TECHNICAL ARTICLES LIKE THESE



The Technical Information services found in twelve monthly issues of ELECTRONIC INDUSTRIES deal with:

- Progress reports on "state-of-the-art" in all major fields of related technology
- Design details and trends

- Applied engineering concepts
- Details of new products
- Reviews of product applications
- Technical evaluations
- Discussion of industry problems

Beside all this, ELECTRONIC INDUSTRIES provides subscribers with →

THESE EDITORIAL EXTRAS



And THESE TYPICAL REFERENCE ISSUES

ELECTRONIC INDUSTRIES

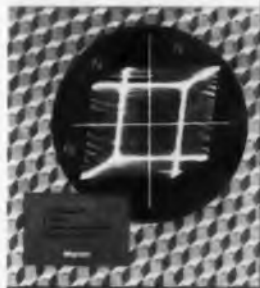

March IRE Convention Issue

The IRE National Convention and Show issue outlines the convention program, technical paper topics, symposia and their locations, booth numbers of exhibitors. New products to be unveiled are also shown. Plus all regular engineering feature articles.

ELECTRONIC INDUSTRIES

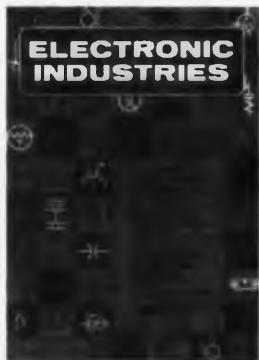

June Directory-Reference Issue

The "EI" directory published each June is the most complete, accurate, verified directory in the electronic engineering field. Listings include more than 4600 manufacturers — 2900 brand names—23,000 product listings —650 manufacturers reps . . . plus, hundreds of pages of permanent reference material for your files. This VERIFIED DIRECTORY is designed for your use all year-long.

ELECTRONIC INDUSTRIES



August WESCON Show Issue

Spotlights every phase of West Coast electronic research, development and manufacturing activities. Also featured is a comprehensive review of the WESCON show — program, papers, booth numbers, new products, etc. Plus, "EI's" exclusive Directory of West Coast Manufacturers, Representatives and Wholesalers.

ELECTRONIC INDUSTRIES



November Microwave Issue

"EI" brings you a rundown of all products designed for microwave use. Loaded with feature articles, technical data and new product information—this issue is one of the most eagerly sought for and used throughout the year. You receive for constant reference such features as: Directory of Microwave Manufacturers—Microwave Power Tube Specification Chart.

In fact, it's a matter of record that, ALL issues of ELECTRONIC INDUSTRIES are "reference issues."

ELECTRONIC INDUSTRIES

1960—what will this year mean to the electronic world? ELECTRONIC INDUSTRIES editors long expert at locating and analyzing trends will report—in depth—the challenges you will meet . . . the path your industry must take . . . the dynamic happenings in an industry that changes constantly.

That's why "Today's Electronic Engineers" read and respect the objective, complete facts they get in ELECTRONIC INDUSTRIES. One—just one—proof of "EI's" alertness to industry trends can be seen in the predications made in January 1959 when the editors made their forecast for that year.

January 1959 Predictions	Verification
Completely transistorized (except picture tube) battery operated portable TV sets will appear on the market.	<i>June 1st, New York Times: "Philco develops battery-powered, transistorized, portable TV set."</i>
More "plug-in" type auto radios where the set can double as a portable.	<i>Once the auto industry eliminates the theft problem, portable auto radios sales will increase.</i>
Increased hi-fi sales due to a gradual growing interest in stereo. Stereo disc sales will climb.	<i>September 6th, New York Times: "Manufacturers of stereo equipment and records anticipate even greater sales in the fall."</i>
A further increase in foreign imports. Engineering salaries in foreign countries and labor costs only about fifty percent of the U.S. Even with 12½% duty, foreign products can be placed on the American market at lower competitive prices.	<i>Business and Defense Services Administration, Dept. of Commerce reported: "During first 9 months of 1959 imports of electronic products was more than 2½ times the 1958 volume."</i>
Not much progress in Color TV or Pay TV. Black and White Sales should rise because of the increasing number of sets that are four-five years old and need replacement. Greatly increased markets for closed TV.	<i>March 24th, FCC announced no takers to date for test subscription TV. Department of Commerce (Year-end review) Black & White TV sets production up 29% over 1958. January 12th, New York Times: "Closed Circuit Reviewed. Uses seen widened. Future Bright."</i>
More money to be spent for military R & D, less for hardware.	<i>August 17th, U. S. News & World Report: "The total research budget is raised from 3 billions to 3.4 billions. Spending for aircraft and ships will decline. Only missile money up."</i>
The emergency of some new semi-conductor materials such as silicon carbide. The use of silicon in semiconductor devices may exceed use of germanium by year's end.	<i>Jan. 1960—U. S. Air Force announced the results of an 8 month survey proving the feasibility of new concepts and capabilities in solid state devices. "Growing" radio receivers, amplifiers, from pools of molten semiconductor material termed possible.</i>
Greatly increased pressure on engineering recruitment. Scientific personnel will be harder to get. Companies more selective but will offer much greater security advantages of selectees.	<i>Electronic Engineering "Help Wanted" advertisements in any newspaper provide the verification of this prediction.</i>
More emphasis on the development of devices that will convert heat into electricity, solar converters, electroluminescence, masers and other solid state devices.	<i>Battelle Memorial and Franklin Institutes reported in March 1959 a doubling of firms interested in sponsoring thermoelectricity research. April 1959, National Bureau of Standards reports its program of solid state research is now one of the most active fields in present-day science.</i>

ELECTRONIC INDUSTRIES

"Where the engineer comes first"

A Chilton Publication—56th & Chestnut Sts., Philadelphia 39, Pa.—SHerwood 8-2000

NOW AVAILABLE!

exclusive

ELECTRONIC INDUSTRIES Marketing Map

Marketing Map of the United States

showing

- *Distribution of electronic plants in the United States on a county basis*
- *Detailed breakdown of 8 major metropolitan areas*
- *Distribution of plant locations & electronic engineers in major states*
 - *4 color codes indicating number of plants by county*
 - *Suitable for framing and wall mount*
 - *52 x 33 inches in size*
 - *Orders filled and mailed same day*

QUANTITY IS LIMITED—ORDER YOURS TODAY

Prices:

Individual copies mailed in tubes	\$3.50 each
2 to 25 copies	3.50 each
26 to 100 copies	3.00 each
More than 100 copies	2.50 each

Please make checks payable to **ELECTRONIC INDUSTRIES** and mail to Market Research Department,
ELECTRONIC INDUSTRIES, 56th and Chestnut Streets, Philadelphia 39, Pennsylvania.

a major break-through in electronic marketing

POWERFUL NEW TOOLS YOU CAN USE—NOW—TO . . .

Pinpoint your prospects
Plot sales territories
Find new product markets
Perform market research

Define your market
Determine sales potential
Measure sales performance
Develop sources of supply



1. A new "EI Marketing Guide" book which supplies a state - by - state, county - by - county, product - by - product breakdown of electronic manufacturers product data. (Book in excess of 376 pages.)

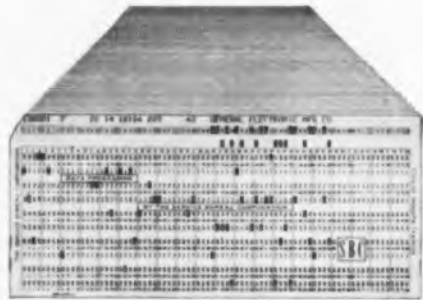

Company Name	Number of Electronic Engineers	State, County, City
Type of Plant	Major Products	Metropolitan Area and
Number of Employees	Minor Products	Space for Your Use

2. Up - to - the - minute product data from about 4,900 companies in the electronic industries available in 38,500 IBM punched cards.

These two new market research tools will enable you to spotlight the potential users of your products with a precision never before possible in the electronic industries and assist you in the marketing of your products.

Electronic products in this "EI Marketing Guide" and in the deck of IBM cards are classified under 101 major product numbers. They are further subdivided into an average of 31 sub product classifications under each major classification by the IBM punched cards (approximately 3,100 products).

Electronic manufacturers may acquire the "EI Marketing Guide" through a lease agreement with ELECTRONIC INDUSTRIES. A "deck" of the 38,500 IBM cards may be purchased for use on your own IBM facilities or on your local Service Bureau Corp. facilities. (80 Bureaus in U. S.)

For full explanation of the content and uses of the "EI Marketing Guide" book and "EI" census data in punched form, contact any of the ELECTRONIC INDUSTRIES' Regional Managers.

PLUS ANOTHER "EI" EXCLUSIVE

Profile of Today's Electronic Engineer—What is the age of the "average" engineer? What is his income? How much money would he like to make in the future? What would prompt him to change companies? What is the worth of his liquid assets? How many children? The answers to these and many other questions about the personal and career side of the engineer can be gotten from a deck of 2,000 IBM cards.

ELECTRONIC INDUSTRIES

Chilton Company Executive Offices:
56th & Chestnut Sts., Phila. 39, Pa.
SHerwood 8-2000

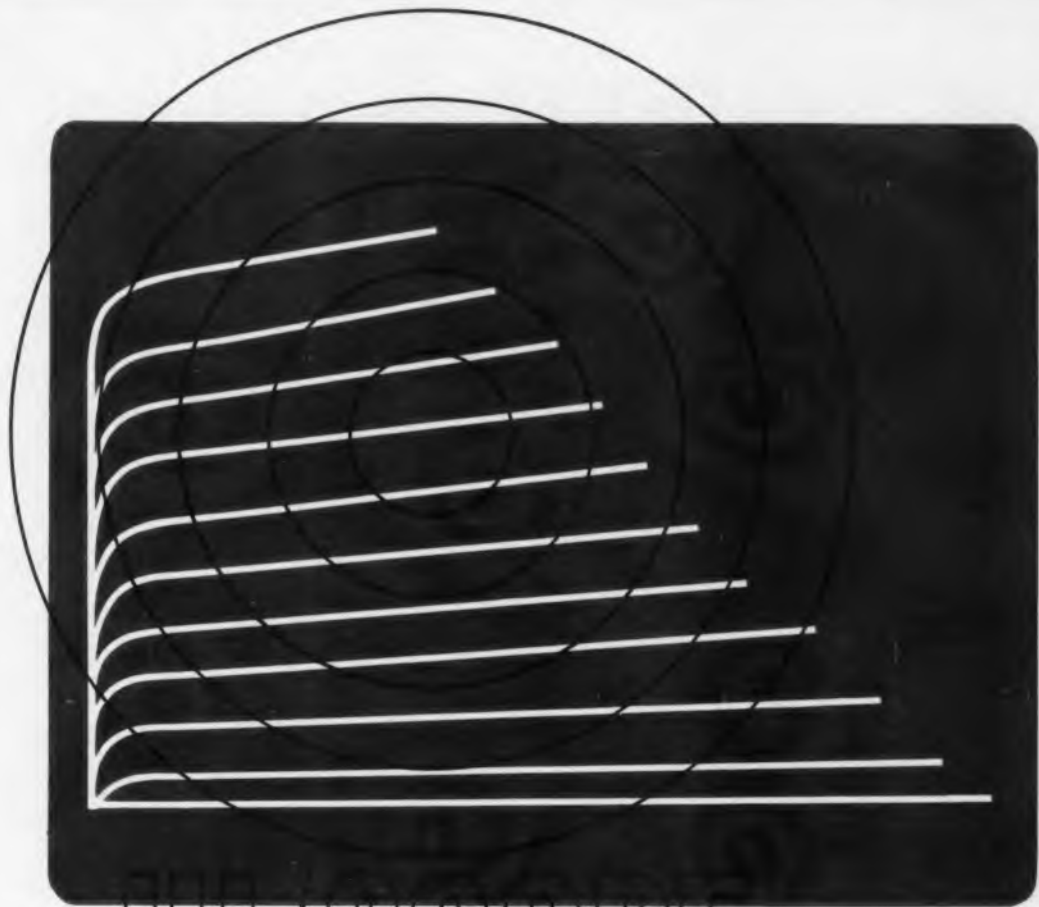

HI SCOPE

**General Transistor's
Program of Service
Especially Helpful in Designing
For Military Use**



General Transistor offers you a program of assistance that is truly unique in scope. This service, which we call HI/SCOPE, reflects the flexibility of our company. It can be personalized to anyone's requirements, and is especially helpful in designing for the military.

Here are some of the ways we are currently helping GT customers...ways in which we'd like to help you.

100% Lot Preconditioning

Let's assume you have equipment which must undergo severe environmental conditions...be subjected to high mechanical shock and vibration. To be certain that all the transistors you intend to use will withstand this type of exposure, we will set up a preconditioning program that will test out every single unit before we ship to you.



GENERAL TRANSISTOR CORP.

91-27 138th Place / Jamaica 35, New York

Special Electrical Parameter Testing

Certain transistor applications are so unusual that they cannot be completely described by standard parameters. If you are in such a position, we will design a test fixture to closely approximate actual circuit performance. This procedure will provide assurance that 100% of the transistors delivered to you will perform satisfactorily.



Special Selection on Standard Catalog Types

In many instances you may find that a standard catalog transistor is about 90% acceptable, but still needs improvement in a few parameters. In such a case, please ask us about the possibility of getting these improvements. We can tell you what increase in specifications is feasible, and produce the units to this spec. Thus, you get the desired parameters without having to redesign or wait for a custom-built semiconductor.

Special Reliability Testing Programs

Must your completed systems meet a high reliability requirement? If so, you may wish special procedures to be established with regard to your reliability programs. This is another GT service. When necessary, we will build such transistors on a specially designed production line, check them exhaustively to hold tight parameter tolerances, and subject large lots to specific and unique life tests. In many cases, we have established a program so that we ship those units which have high survival probability in your application. These things we have done, and will do again, at your request. Sound helpful?

Qualification Approvals

Let's consider the case where you want to design a certain transistor into a system for the government, yet a government specification does not exist for the transistor. You must be ready to substantiate your use of the non-standard part. Here's what GT can do to help your case. We will run a qualification approval procedure in the same format we would for a military type. Then we'll provide you with this necessary data. This will greatly accelerate your approval for use of this transistor type.

High and Low Temperature Testing

Standard transistor parameters are generally controlled at room temperature. Yet many systems must function at other ambients. If you have a problem specifying electrical parameters at room temperature in a manner that will be valid at high or low temperatures, we are ready to assist. General Transistor is prepared to run any measurements you dictate, at any specified ambient. We can do this on complete production lots if you feel it essential.

Special Coatings or Encapsulations

In your manufacturing process, do you expose transistors to any kinds of solvents or potting materials? If so, just let us know. By using special highly resistant coatings, we'll make sure that the transistor case and markings are not vulnerable to solvent attacks.

Cost Economies Through Parameter Modifications

Yield has a strong influence on transistor cost. To give you the best economies and at the same time give you the most desirable quality, we offer this working arrangement. At your request, General Transistor will suggest slight modifications of your specifications which will allow us to ship the major portion of a production run. We will make the necessary measurements and indicate what the various parameters should be and what proportions of the run will fall into pre-selected types. If you then design your system to use this production mix, you will benefit from some genuine economies.

Samples with Parameter Measurements

Assume you want to check out the margins in a design. You require upper and lower limit samples of a certain transistor type. We'll be happy to supply you with sufficient samples to cover the spread in one or two significant parameters. Thus, you can experimentally determine the performance of your circuit.

Circuit Design

If you are starting on a new program, you may want some information on what performance you can expect from state-of-the-art circuits. We will provide you with such typical circuits at your request, together with data on the performance of our transistor types within these circuits.

Special Production Runs

Assume that your transistor application is so unusual that units are not available from standard production. What can be done? We will analyze your requirements and decide whether it would be feasible to make a special production run of transistors to meet your needs.

These services are typical of GT HI/SCOPE.

*Write or call for specifics
relating to your own projects.*



GENERAL TRANSISTOR CORP.

91-27 138th Place / Jamaica 35, New York

Fits in an 8 3/4" slot



Measure 10cps to 110Mc with one compact meter

Comprehensive range for only \$1895. Never before has so broad a range been offered for so low a price—a combination made possible by closely integrating a simple heterodyne converter with a top-notch 10Mc counter. Frequencies up to 10Mc are measured by direct counting. To measure frequencies above 10Mc, the operator simply rotates reference frequency selector until panel meter shows strong deflection, then reads counter indication. Measurements take less than a minute to make. Accuracy far exceeds FCC requirements over communications range. Possible error is .00004% or less from 1Mc to 110Mc.

Frequency measuring range
10cps to 110Mc
Sensitivity
100mv rms into 1M ohms
up to 10Mc
100mv rms into 100 ohms
up to 110Mc
Accuracy
Oscillator accuracy \pm 1cps
Oscillator stability
3 parts in 10⁷ per week
Recording facility
Rear jack carries code signals
to actuate Beckman printer
Dimensions:
8 3/4" x 19" panel, 17" deep
Weight
Ready for rack: approx. 47 lbs.
In cabinet: approx. 60 lbs.
Price \$1895

Write for technical bulletin on Model 7175.



Beckman

*Berkeley Division
Richmond, California*

T24

← Circle 65 on Inquiry Card

Circle 333 on Inquiry Card

145

NEW

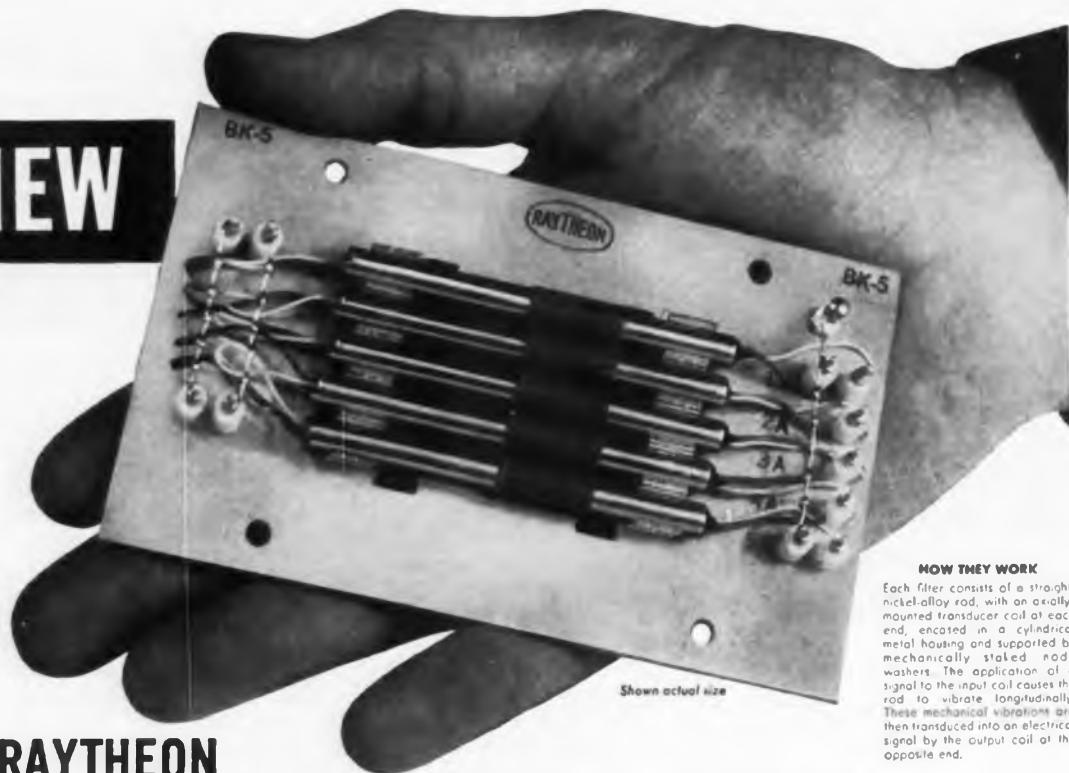

HOW THEY WORK

Each filter consists of a straight, nickel-alloy rod, with an axially-mounted transducer coil at each end, enclosed in a cylindrical metal housing and supported by mechanically stacked node washers. The application of a signal to the input coil causes the rod to vibrate longitudinally. These mechanical vibrations are then transduced into an electrical signal by the output coil at the opposite end.

RAYTHEON MAGNETOSTRICTION BANDPASS FILTER ARRAYS

cost less...weigh less...take less space

In addition to advantages in economy, size and weight, new Raytheon Magnetostriction Filters have better selectivity characteristics than equivalent electrical filter circuits and, once adjusted, remain permanently tuned. They are operable over a wide temperature range and will withstand considerable shock and vibration.

These features make them ideal for any applications involving single or multiple narrow-band filter channels. For example, they are used on *Shock and Vibration Test Equipment* (for frequency analysis or, using feed back, for smoothing out wave forms); *Spectrum Analyzers*; *Underwater Sound Analysis Equipment* (for identifying vibration frequencies); *Telemetry Equipment*, *Oscillators* and *Wireless Paging Systems* (to actuate selected receivers).

Sample orders for Raytheon Magnetostriction Filters are available with no minimum quantity restrictions. For data sheets write Dept. 2527.



INDUSTRIAL COMPONENTS DIVISION
57 Chapel Street Newton 58, Massachusetts

Features of Raytheon Magnetostriction Bandpass Filter Arrays

Unlimited combinations can be arrayed at accurately spaced frequency intervals — At 50 kc., center frequency can be adjusted within 0.3 cps.

More economical for arrays in 45 kc to 300 kc range — Priced from \$16 to \$39 per filter, depending on quantity and type.

Arrays are smaller and lighter — A bank of ten filters can be mounted on a 3" x 5" panel — total assembly weighs only ten ounces.

Higher Q and higher frequencies than toroidal coils — Q from 2000 to 15,000. Resonant frequencies from 45 to 300 kc.

Wide dynamic range — 40 to 55 db.

Stable over wide temperature extremes — Over range from -60°C to +80°C, maximum resonant frequency variation is only 8 ppm/°C.

Ideal impedances for transistor circuits — Single filter input impedances from 15 to 90 ohms, output impedances from 600 to 2000 ohms (depending on resonant frequency).

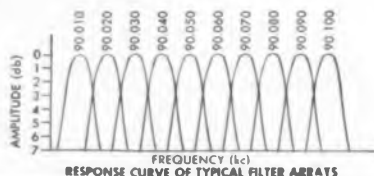

NOW BUILD A PRINTED CIRCUIT IN YOUR LAB IN 15 MINUTES

...you simply mask, etch, and
rinse new Corning FOTOCERAM®
grid boards for perfect circuits

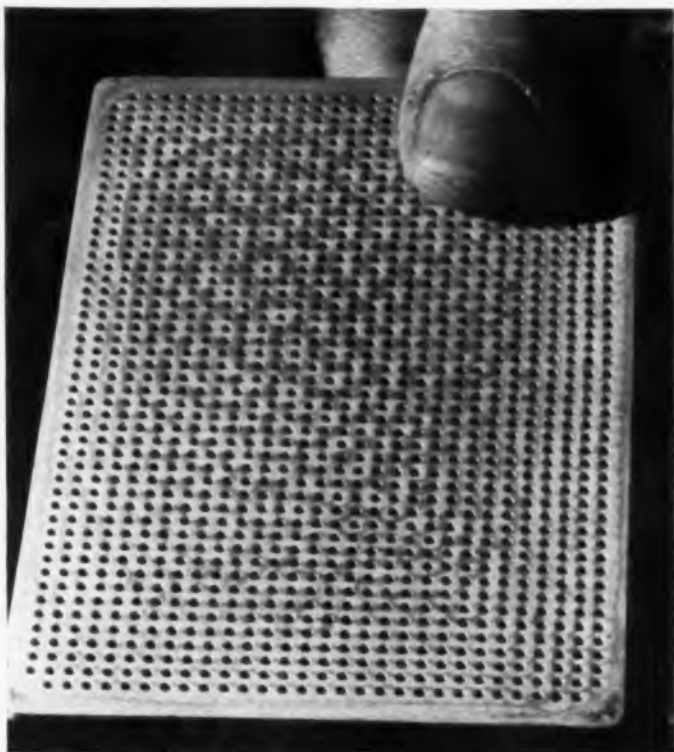

1. New Corning grid boards are already holed and coppered to give you maximum design flexibility.



2. Lay out the circuit run you want on one or both sides with tape or chemical resist.



3. Immerse in a copper etchant to remove excess copper.

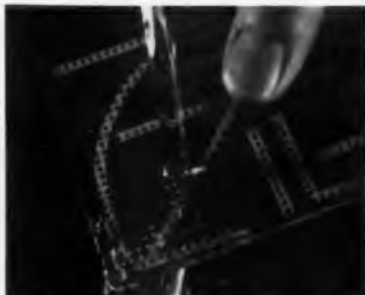

4. Rinse. That's all there is to making a board ready for use.

Take a new Corning FOTOCERAM copper-plated grid board. Apply a tape or chemical resist of your circuit pattern. Etch away the excess copper. Rinse the board, and strip the resist. You're ready to add components.

No adhesives are used. The board has 0.052 inch holes spaced 0.1 inch apart on centers. The holes, too, are already plated.

The base is FOTOCERAM, a glass-ceramic, a proved production material that's used widely in printed circuits which demand high strength, temperature resistance to 250°C., zero moisture absorption, nonflammability, and rigid dimensional stability.

Excellent through-hole plating. Hole plating is done with the same material used for circuit-run conductors. This provides exceptional thermal and electrical conductivity and negates the need for eyelets.

We have soldered, removed, and resoldered components to

these boards as many as fifty times without circuit-run failure.

No bending, bowing, delaminating. The FOTOCERAM base is a solid piece. There are no laminations which might bend, twist, or warp under high temperatures.

Three sizes. There are currently three boards, all $\frac{3}{16}$ " thick: 3" x 5", 6" x 8", 9" x 12". They can be trimmed to any shape with a simple glass cutter.

Small production runs. Some of our customers are using these boards for small production runs as well as R&D work.

Data sheets. Write to Corning Glass Works, 546 High Street, Bradford, Pa., for data sheets on the grid boards and FOTOCERAM printed circuit boards. For orders of 1000 or less, contact your distributor serviced by Eric Distributor Division.

*Trademark



CORNING ELECTRONIC COMPONENTS

CORNING GLASS WORKS, BRADFORD, PA.

It could
happen...

with

El-Menco
CAPACITORS!

NEW

Mylar-Paper Dipped

CAPACITORS

**TYPE
MPD**

INSURE FAILURE-PROOF PERFORMANCE!

Only 1 Failure in 7,168,000 Unit-Hours for 0.1 MFD Capacitors*

Setting a new standard of reliability!

*Life tests have proved that El-Menco Mylar-Paper Dipped Capacitors — tested at 100°C with rated voltage applied — have yielded a failure rate of only 1 per 716,800 unit-hours for 1 MFD. Since the number of unit-hours of these capacitors is inversely proportional to the capacitance, 0.1 MFD El-Menco Mylar-Paper Dipped Capacitors will yield **ONLY 1 FAILURE IN 7,168,000 UNIT-HOURS.**

SUPERIOR FEATURES!

• Five case sizes in working voltages and ranges:

200 WVDC —	.018 to .5 MFD
400 WVDC —	.0082 to .33 MFD
600 WVDC —	.0018 to .25 MFD
1000 WVDC —	.001 to .1 MMF
1600 WVDC —	.001 to .05 MFD

Write for Technical Brochure Giving Complete Information on the El-Menco Tubular Dur-Paper Line.

THESE CAPACITORS WILL EXCEED ALL THE ELECTRICAL REQUIREMENTS OF E.I.A. SPECIFICATION RS-164 AND MILITARY SPECIFICATIONS #MIL-C-91A AND MIL-C-28A.

FOR FAILURE-PROOF PERFORMANCE... COUNT ON EL-MENCO MYLAR-PAPER DIPPED CAPACITORS... FROM MISSILE GUIDANCE SYSTEMS TO DATA PROCESSING EQUIPMENT!

*Registered Trade Mark of DuPont Co.

SPECIFICATIONS

- TOLERANCES: $\pm 10\%$ and $\pm 20\%$. Closer tolerances available on request.
- INSULATION: Durez phenolic resin impregnated.
- LEADS: No. 20 B & S (.032") annealed copper-weld crimped leads for printed circuit application.
- DIELECTRIC STRENGTH: 2 or 2½ times rated voltage, depending upon working voltage.
- INSULATION RESISTANCE AT 25°C:
For .05MFD or less, 100,000 megohms minimum.
Greater than .05 MFD, 5000 megohm-microfarads.
- INSULATION RESISTANCE AT 100°C:
For .05MFD or less, 1400 megohms minimum.
Greater than .05MFD, 70 megohm-microfarads.
- POWER FACTOR AT 25°C:
1.0% maximum at 1 KC.



El-Menco
Capacitors

THE ELECTRO MOTIVE MFG. CO., INC.
WILLIMANTIC CONNECTICUT

Manufacturers of El-Menco Capacitors

- molded mica • dipped mica • mica trimmer • dipped paper
- tubular paper • ceramic • silvered mica films • ceramic discs

Arco Electronics, Inc., 64 White St., New York 13, N. Y.
Exclusive Supplier To Jobbers and Distributors in the U.S. and Canada

IMMEDIATE DELIVERY OF ELMENCO

capacitors

IN QUANTITIES UP TO 500 Per Item

CONTACT THESE AUTHORIZED ELMENCO INDUSTRIAL DISTRIBUTORS

The authorized distributors listed below carry a full stock of all Elmenco Capacitors and can give you immediate Delivery from stock.

ARIZONA: Radio Specialties & Appl. Corp., 917 N. 7th St. Phoenix; Standard Radio Parts Inc., 218 N. First Ave., Tucson

CALIFORNIA: Brill Elect., 610 E. 10th St., Oakland; Elect. Supply Corp., 2085 E. Foothill Blvd., Pasadena; Federated Purchaser Inc., 11275 W. Olympic Blvd., L. A. 64; Hollywood Radio Supply Inc., 5606 Hollywood Blvd., Hollywood 28; Pacific Wholesale Co., 1850 Mission St., San Francisco 3; Peninsula Elect., 656 S. 1st St., San Jose; Shanks & Wright Inc., 2045 Kettner Blvd., San Diego; Shelley Radio Co. Inc., 2008 Westwood Blvd., L. A. 25; R. V. Weatherford Co., 6921 San Fernando Rd., Glendale 1; Zack Electronics, 654 High St., Palo Alto.

COLORADO: Denver Electronics Supply Co., 1254 Arapahoe St., Denver 4

DISTRICT OF COLUMBIA: Capitol Radio Wholesalers Inc., 2120 14 St., N.W., Wash., D. C.

FLORIDA: Elect. Supply, 908 Morningside Dr., Melbourne; Elect. Supply, 61 N. E. 9th St., Miami

ILLINOIS: Newark Electronics Corp., 223 W. Madison St., Chicago 6

MARYLAND: Kann-Eliert Electronics Inc., Howard & Redwood Sts., Ball 1; Wholesale Radio Parts Co. Inc., 308 W. Redwood St., Baltimore 1.

MASSACHUSETTS: Cramer Electronics Inc., 811 Boylston St., Boston 16; Radio Shack Corp., 730 Commonwealth Ave., Boston 17.

NEW JERSEY: Federated Purchaser Inc., 1021 U. S. Rte. 22, Mountainside; Radio Elec. Service Co., Inc., 513 Cooper St., Camden 2.

NEW MEXICO: Midland Specialty Co., 1712 Lomas Bl. N.E., Albuquerque; Radio Specialties Co., Inc., 209 Penn Ave., Alamogordo.

NEW YORK: Arrow Elect. Inc., 525 Jericho Turnpike, Mineola, L.I.; Elect. Center Inc., 211 W. 19th St., N. Y. 11; Harvey Radio Co., Inc., 103 W. 43rd St., N. Y. 36; Lafayette Radio, 100 Sixth Ave., N. Y. 13; Terminal Elect. Inc., 236 W. 17 St., N. Y. 17.

PENNSYLVANIA: Almo Radio Co., 412 N. 6th St., Phila 23; George D. Barbey Co. Inc., 622 Columbia Ave., Lancaster; George D. Barbey Co. Inc., 2nd & Penn Sts., Reading; D. & M. Distributing Co., Inc., 2535 N. 7th St., Harrisburg; Phila. Elect. Inc., 1225 Vine St., Phila 7; Radio Elec. Service Co., Inc., 701 Arch St., Phila 6; A. Steinberg & Co., 2520 N. Broad St., Phila; Wholesale Radio Parts Co., Inc., 1650 Whitford Rd., York

TEXAS: All-State Dist. Co., 2411 Ross Ave., Dallas 1; Busacker Elect. Equip. Co. Inc., 1216 W. Clay, Houston 19; Engineering Supply Co., 6000 Denton Dr., Dallas 35; Midland Specialty Co., 500 W. Paisano Dr., El Paso; The Perry Shankle Co., 1801 S. Flores St., San Antonio

WASHINGTON: C & G Radio Supply Co., 2221 Third Ave., Seattle

CANADA: Electro Sonic Supply Co., Ltd., 543 Yonge Street, Toronto 5, Ont.

ARCO ELECTRONICS, INC.
NEW YORK • DALLAS • LOS ANGELES
Exclusive Supplier of ELMENCO Capacitors to Distributors and Jobbers in U.S.A. and Canada

Circle 68 on Inquiry Card

New Products

THUMBWHEEL SWITCH

Modular 10-position binary thumbwheel switch requires ½ in. panel space and has large, clear numbers. One number at a time is exposed thru the bezel window. Series TSB has



wafers replaceable in 10 sec. or fixed wafers if removable feature is not needed. Contacts are precious metal alloy. Switch is manually operated by ¼ in. thumbwheel in black or colors. Chicago Dynamic Industries, Inc., Precision Products Div., 1725 Diversy Blvd., Chicago 14, Ill.

Circle 206 on Inquiry Card

CABLE FAULT FINDER

Model 722, cable fault finder, measures elapsed time between a transmitted pulse and resulting reflections to locate shorts, opens, mismatches, or intermittents in coaxial or multiple-conductor cables from 10 to 200 ft. long. Faults appear as deflections along the horizontal trace on the face of a CR tube. An accuracy of 3% in ranging to a fault can be expected.



Better accuracy is obtained through experience. Models are available with ranges to 100 miles. Smith-Florence, Inc., 4228-23rd Ave. West, Seattle 99, Wash.

Circle 207 on Inquiry Card

HIGH PACKAGE DENSITY!

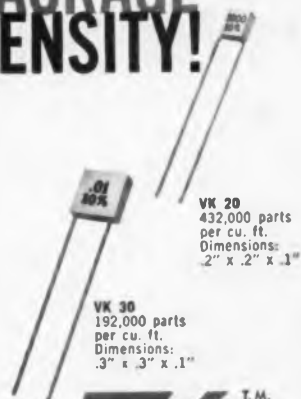

VK 20
432,000 parts per cu. ft.
Dimensions: 2" x .2" x .1"

VK 30
192,000 parts per cu. ft.
Dimensions: .3" x .3" x .1"

VK T.M.
micro-miniature
CERAMIC CAPACITORS

- Decimal dimensioned case
- Max. volumetric efficiency
- Contiguous flush-mount
- 47-10,000 mmf
- 200 vdc without derating
- -55°C to 150°C operation

"VK" capacitors are designed with square precision molded cases in only two sizes and a single standard 0.2" lead spacing for all values. Continuous life and environmental testing, plus 100% tests for Dissipation Factor, Insulation Resistance, and Capacitance guarantee that each "VK" capacitor in your circuit will perform as predicted.

ALSO UNCASSED FOR COMPLETE ASSEMBLY ENCAPSULATION

Same electrical characteristics as standard "VK" series. Each unit coated with a resilient protective compound. Dimensions: 47-100 mmf, .100" square; 120-270 mmf, .130" square; 330-1000 mmf, .150" square; 1200-3300 mmf, .250" square; 3900-10,000 mmf, .265" square.

Vitramon Incorporated
BOX 544 • BRIDGEPORT 1, CONN.

Circle 69 on Inquiry Card

NEW DELCO 50-AMP. TRANSISTORS

HIGHER CURRENT THAN EVER BEFORE FOR MILITARY AND COMMERCIAL USE

	2N1518	2N1519	2N1520	2N1521	2N1522	2N1523
Maximum Collector Current (Amps)	25	25	35	35	50	50
Maximum Collector to Base Volts, Emitter Open, Max I_{c0} 4ma	50	80	50	80	50	80
Minimum Open Base Volts (1-Amp. Sweep Method)	40	60	40	60	40	60
Maximum Saturation Volts at Maximum Collector Current	0.7	0.7	0.6	0.6	0.5	0.5
Gain at I_c at 15 Amps.	15-40	15-40	17-35	17-35	22-45	22-45
Minimum Gain at Maximum Collector Current	12	12	12	12	12	12
Thermal Resistance Junction to Mounting Base ($^{\circ}C/Watt$)	0.8	0.8	0.8	0.8	0.8	0.8

Characteristics at 25°C Maximum Junction Temperature 95°C

A new family of high current transistors featuring the 50-ampere 2N1522 and 2N1523. Two 25- and two 35-ampere types round out the line. All thoroughly tested and completely reliable. Available in production quantities. Call or write your nearest Delco Radio sales office for full product information and applications assistance.

DELCO
RADIO
RELIABILITY

Division of General Motors
Kokomo, Indiana

Newark, New Jersey
1180 Raymond Boulevard
Tel: Mitchell 2-6165

Chicago, Illinois
5750 West 51st Street
Tel: Portsmouth 7-3500

Santa Monica, California
726 Santa Monica Boulevard
Tel: Exbrook 3-1465

Detroit, Michigan
57 Harper Avenue
Tel: TRinty 3-6560



INHERENT STABILITY Assured in a DALOHM RSE Resistor

Even a powerhouse swing can't shock this RSE resistor out of the inherent stability that is standard in Dalohm resistors.

Stored on the shelf for months... or placed under continuous load... operating in severe environmental, shock, vibration and humidity

conditions... Dalohm precision resistors retain their stability because it has been "firmly in-fixed" by Dalohm design and methods of manufacture.

For all applications demanding resistors that meet or surpass MIL specifications, you can depend on Dalohm.

WIRE WOUND • PRECISION • HOUSED DALOHM TYPE RSE RESISTORS

A completely insulated resistor for toughest environmental conditions. Precision element is suspended in special shock absorbing material and inserted in metal tube.

Configurations: Type RSE for clip mounting; and in most ratings and resistances shown; Type RLS with radial leads; and Type RS with axial leads.

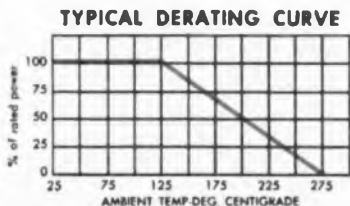

Write for Bulletins R-23, R-25 and R-30, with handy cross-reference file cards.

- Rated at 2, 3, 5, 7 and 10 watts
- Resistance range from .5 ohm to 175K ohms
- Tolerance $\pm 0.05\%$, $\pm 0.1\%$, $\pm 0.25\%$, $\pm 0.5\%$, $\pm 1\%$, $\pm 3\%$
- Temperature coefficient within 0.00002/degree C.
- Operating temperature range from -55° C. to 275° C.
- Smallest in size, ranging from $15/16'' \times .220''$ to $1-61/64'' \times .385''$
- Completely protected from moisture and salt spray
- Complete welded construction from terminal to terminal

SPECIAL PROBLEMS?

You can depend on DALOHM, too, for help in solving any special problem in the realm of development, engineering, design and production. Chances are you can find the answer in our standard line of precision resistors (wire wound, metal film and deposited carbon); trimmer potentiometers; resistor networks; collet-fitting knobs; and hysteresis motors. If not, just outline your specific situation.

from **DALOHM**
Better things in
smaller packages
DALE PRODUCTS, INC.
1304 28th Ave., Columbus, Nebr.



Here are the plain facts!

*... why it pays to specify and use dependable
BUSS FUSES*

IT'S A FACT! By specifying BUSS fuses, you obtain the finest electrical protection possible — and you help safeguard the reputation of your product for quality and reliability.

IT'S A FACT! BUSS fuses have provided dependable electrical protection under all service conditions for over 45 years—in the home, in industry and on the farm.

IT'S A FACT! To make sure BUSS fuses will give your equipment maximum protection, every one made is tested in a sensitive electronic device. Any fuse not correctly calibrated, properly constructed and right in all physical dimensions is automatically rejected.

IT'S A FACT! Whatever your fuse requirements, there's a dependable BUSS or FUSETRON fuse to satisfy them. Sizes from 1/500 ampere up and there's a companion line of fuse clips, blocks and fuseholders.

IT'S A FACT! The BUSS fuse engineering staff will work with you to help you find or develop the best-suited to your needs. This places the world's largest fuse research laboratory and its personnel at your command to save you engineering time.

For more information on BUSS and FUSETRON Small Dimension fuses and fuseholders, write today for Bulletin SFB.

BUSSMANN MFG. DIVISION, McGraw-Edison Co., University at Jefferson, St. Louis 7, Mo.

BUSS fuses are made to protect - not to blow, needlessly.

BUSS makes a complete line of fuses for home, farm, commercial, electronic, electrical, automotive and industrial use



FROM **Transitron**...INDUSTRY'S BROADEST LINE OF

MICRO-DIODES

MICRO-MINIATURIZATION POSSIBLE NOW!

YES — FASTEST DIFFUSED SILICON MICRO-DIODES AVAILABLE. They combine advanced diffusion techniques with extremely small size, to provide milli-micro-second switching speeds, excellent static, forward and inverse characteristics.

YES — ONLY SERIES OF HIGH QUALITY MICRO-REGULATORS. Series of 8 diffused-silicon micro-regulators provides stable voltage regulation and reference sources previously found only in considerably larger devices. Excellent dynamic resistance characteristics.

YES — BASIC FAMILY OF MULTI-PURPOSE MICRO-DIODES. Series of 3 high quality diffused-silicon micro-diodes provides voltage ratings up to 200 volts, current rating up to 50 milliamperes. May be considered for switching applications. Exceptional static, forward and inverse characteristics.

YES — EVEN A MICRO-STABISTOR.

This diffused-silicon stabistor is the micro-counterpart of Transitron's universally-known SG-22.

All of these new micro-diodes are **COMPLETELY COMPATIBLE** with present circuitry . . . provide the same excellent performance as larger Transitron diodes in 1/10th the space! Here is your chance to micro-miniaturize circuits **TODAY!**

VERY FAST SWITCHING MICRO DIODE			
TYPE	PIV	$E_f @ 5 \text{ MA}$	RECOVERY TIME
TMD-50	50V	0.75V	4 nsec
FAST SWITCHING MICRO DIODE			
TYPE	PIV	$E_f @ 20 \text{ MA}$	RECOVERY TIME
TMD-24	50V	0.85V	0.3 μ sec
TMD-25	100V	0.85V	0.3 μ sec
TMD-27	200V	0.85V	0.3 μ sec
SILICON MICRO REGULATOR			
TYPE	VOLTAGE @ 5 MA	POWER RATING @ 25°C	
TMD-01	5.1V	100 MW	
TMD-03	6.2V	100 MW	
TMD-07	9.1V	100 MW	
HIGH CONDUCTANCE MICRO-DIODE			
TYPE	PIV	$E_f @ 100 \text{ MA}$	POWER RATING @ 25°C
TMD-41	50V	1.0V	100 MW
TMD-42	100V	1.0V	100 MW
TMD-45	200V	1.0V	100 MW
SILICON MICRO STABISTOR			
TYPE	$E_f @ 1 \text{ MA}$	DYNAMIC RESISTANCE	
TMD-40	0.55V	60 OHMS	

For further information, write for Bulletin:

- PB-71A (High Conductance), PB-71B (Fast Switching),
- PB-71C (Very Fast Switching), PB-71D (Stabistor),
- PB-71E (Regulators); AN 1358A Application Notes.

Circle 73 on Inquiry Card

Transitron

electronic corporation • wakefield, massachusetts

"Leadership in Semiconductors"

SEE YOUR LOCAL AUTHORIZED TRANSITRON DISTRIBUTOR FOR QUANTITIES FROM 1 999.



Select here the
VOLTMETERS, AMMETERS,
Many are

AC



hp 403A Transistor ac Voltmeter—1 cps to 1 MC

Battery-operated, weighing less than 5 pounds and small enough to hold in your hand—this new transistor ac voltmeter measures $100 \mu\text{v}$ to 300 v (max. full scale sensitivity 1 mv) over frequencies 1 cps to 1 MC! Twelve voltage ranges; also reads direct in db from -72 to $+52$ db. 400 hour battery life equals 6 months of average use; battery voltage may be checked by front panel switch. Noise less than $30 \mu\text{v}$ on all but lowest range. Completely isolated from power line or ground interference. Average reading meter minimizes turnover and waveform errors. Accuracy $\pm 3\%$ to 500 KC, $\pm 5\%$ to 1 MC. Input impedance 2 megohms; generous 603 v overload capacity on higher ranges, 25 v maximum on lower ranges. \$250.00.

All of these widely useful -hp- instruments are available in rack-mounted -hp- voltmeter accessories—voltage dividers, coaxial connectors, voltage

DC



hp 405AR Digital Voltmeter
Automatic range, polarity

Here's true "touch-and-read" measuring simplicity. Automatic range, polarity selection; covers 0.001 v to 1,000 v. (Accuracy $\pm 0.2\%$ of reading ± 1 count). New, unique circuitry provides a stability of readings virtually eliminating fatiguing jitter in the last digit. Floating input, multi-electronic code output for use with digital recorders. Uses electronic computing circuits to insure low maintenance, trouble-free operation. Just 7" high! \$825.00.

Complete array of ac and dc measuring equipment

versatile, precision OHMMETERS you need. multi-purpose!



hp 400D
10 cps to 4 MC

Regarded by many as finest ac VTVM ever built. Covers all frequencies 10 cps to 4 MC, extremely sensitive, wide range, accurate within 2% to 1 MC. Measures 0.1 mv to 300 v (max. full scale sensitivity 1 mv), 12 ranges. Direct reading in v, db, 10 megohm input impedance with 15 μf shunt insures negligible loading to circuits under test. \$225.00.

hp 400L
Log VTVM—10 cps to 4 MC

Covering 10 cps to 4 MC, this new hp VTVM features a true logarithmic scale 5" long plus a 12 db linear scale. The log voltage scale plus long scale length provides a voltmeter of maximum readability, with accuracy a constant percentage of the reading. Accuracy is $\pm 2\%$ of reading or $\pm 1\%$ of full scale, whichever is more accurate, to 500 KC, $\pm 5\%$ full range. Range 0.3 mv to 300 v, 12 steps, (max. full scale sensitivity 1 mv). \$325.00.



hp 400H
1% accuracy VTVM

Here's extreme accuracy of 1% in a precision VTVM covering 10 cps to 4 MC. Big 5" meter has exact-reading mirror-scale, measures voltages 0.1 mv to 300 v (max. full scale sensitivity 1 mv), 10 megohm resistance with 15 μf shunt minimizes circuit loading. Amplifier with 56 db feedback insures lasting stability. \$325.00.



hp 410B
ac to 700 MC, also dc

Time-tested standard all-purpose voltmeter. Covers 20 cps to 700 MC, full scale readings 1 to 300 v. Input capacity 1.5 μf , input resistance 10 megohms. Also serves as dc VTVM with 122 megohms input impedance, or ohmmeter for measurements 0.2 ohms to 500 megohms. \$245.00.

*models! Also, inquire about
multipliers and shunt resistors.*

HEWLETT-PACKARD COMPANY

1004B Page Mill Road • Palo Alto, California, U.S.A.
Cable "HEWPACK" • Davenport 5-4451
Field representatives in all principal areas



**hp 412A Precision
Volt-Ohm-Ammeter**

At last a true, precision multi-purpose instrument. Measures dc voltage 100 μv to 1,000 v (max. full scale sensitivity 1 mv), 1% accuracy full scale. Measure currents 1 μa to 1 amp with $\pm 2\%$ accuracy full scale. 13 ranges. As ohmmeter measures 0.02 ohms to 5,000 megohms. Extremely low noise, drift. Recorder output provides 1 v full scale. \$350.00.



**hp 425A Microvolt-
Micromicroammeter**

New, high sensitivity, high stability instrument reading end scale voltages of 10 μv to 1 v in 11 ranges, or currents of 10 μa to 3 ma in 18 step, 1-3-10 sequence. Accuracy $\pm 3\%$ on all ranges. Drift less than 4 μv per day. Input impedance 1 megohm $\pm 3\%$ on all ranges. Also usable as 100 db amplifier with up to 1 v output from signals as small as 10 μv . \$500.00.



**hp 428A
Clip-On Milliammeter**

Employs radical new approach to current measurement which eliminates breaking leads, soldering connections or loading of circuit under test. Revolutionary "current sensing" probe clips around wire under test, measures the magnetic field around the lead. Easily measures dc current in presence of strong ac. Covers 0.3 ma to 1 amp in 6 steps; full scale sensitivity 3 ma. Accuracy $\pm 3\%$, probe inductance less than 0.5 μh . \$475.00.

—unique value, traditional -hp- dependability



NOW!

Bendix

25-AMP

POWER TRANSISTOR SERIES

Now in production by Bendix* are eight 25-ampere peak current power transistors capable of switching up to 1000 watts—and you can get immediate delivery on all eight types.

Newly improved in design, the transistors have a higher gain and flatter beta curve. The series is categorized in gain and voltage breakdown to provide optimum matching and to eliminate burn-out.

Current Gain hFE at Ic = 10 Adc	Maximum Voltage Rating			
	50 Vcb 30 Vce	60 Vcb 40 Vce	90 Vcb 70 Vce	100 Vcb 80 Vce
20—60	2N1031	2N1031A	2N1031B	2N1031C
50—100	2N1032	2N1032A	2N1032B	2N1032C

Ask for complete details on this newly improved Bendix transistor series . . . and on the entire Bendix line of power transistors and power rectifiers. Write SEMICONDUCTOR PRODUCTS, BENDIX AVIATION CORPORATION, LONG BRANCH, NEW JERSEY, or the nearest sales office.

West Coast Sales Office:
117 E. Providencia Avenue, Burbank, California
Midwest Sales Office:
2N565 York Road, Elmhurst, Illinois
New England Sales Office:
4 Lloyd Road, Tewksbury, Massachusetts
Export Sales Office: Bendix International Division,
205 E. 42nd Street, New York 17, New York
Canadian Affiliate: Computing Devices of Canada, Ltd.,
P. O. Box 508, Ottawa 4, Ontario, Canada

SEMICONDUCTOR PRODUCTS

Red Bank Division

LONG BRANCH, N. J.



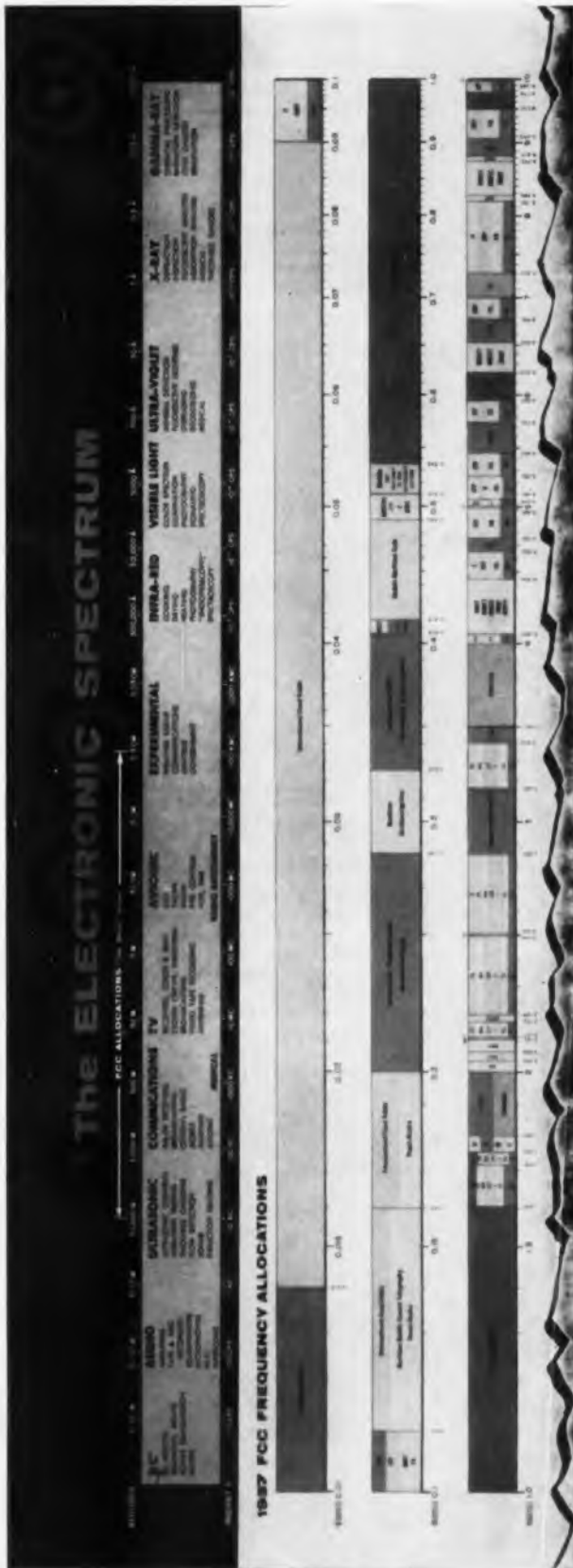

Immediate Delivery!

ELECTRONIC INDUSTRIES'
Exclusive

1960 ELECTRONIC SPECTRUM CHART

ORDER YOURS TODAY

- All latest revisions and up-dated specs
- 30 x 22 inches in size
- Printed to show service and frequency area in six colors with—
- Expensive lacquer proof ink that will not run. Allows you to varnish or shellac chart to prolong its life.
- Orders filled and mailed same day.
- Suitable for framing and wall mount or,
- Under glass desk-top reference.

Quantity is limited.

Over 2,000 copies already purchased!

Prices:

Individual copies mailed in tubes	\$1.00 each
1 to 25 copies	1.00 per copy
26 to 100 copies	0.75 per copy
More than 100 copies	0.50 per copy

Please make remittances payable to Electronic Industries and mail to Reader Service Department, Electronic Industries, Chestnut & 56th Streets, Philadelphia 39, Pennsylvania.

← Sample of 1957 Edition

USE.... *the right*
Tools
for the job



**LAMINATED TRANSFORMERS
 TO MEET CIRCUITRY REQUIREMENTS**

TYPES: POWER • FILAMENT • AUDIO • TRANSISTOR
 FILTER CHOKE • SATURABLE REACTOR

C-A-C transformers include special types meeting customer specifications as well as a group of standard types for 400 cycle power supplies. All are designed to meet the full requirements of MIL-T-27A specifications and are hermetically sealed in standard MIL-T-27A case sizes. C-A-C can supply Grade 1 through 6 with temperature characteristics of Class R, S, T or U. Encapsulated units using Epoxy Resins can be supplied for Grades 2 and 5. Class U components can be supplied molded in special high temperature resin. Write for additional technical information, specifications or application data.

Always Specify C-A-C Transformers

**COMMUNICATION
 ACCESSORIES
 COMPANY**

LEE'S SUMMIT,
 MISSOURI

Circle 76 on Inquiry Card

SPECIAL "HOT MELT" COMPOSITIONS for electronic component dipping, impregnating and potting.

- Controlled insulation resistance.
 - Softening point range from 155°F to 290°F.
 - Stability at -70°C.
 - Fungus resistant grades available.
 - Technical consultation available.



Send for **GENERAL SPECIFICATIONS CHART**
 Stock available for immediate delivery
 3440 HOWARD STREET • SKOKIE, ILLINOIS
 Telephones: ORchard 3-1050 • AMBassador 2-3339

BIWAX CORPORATION

Over 30 years of formulating experience

Circle 77 on Inquiry Card

New
Products

POTENTIOMETER

Precision SuperCon Linear Motion Potentiometer, Model 112. Parameters include: Linearity, 0.2%, length of stroke; resistance range, 250 ohms to 125 k ohms per in. of stroke; virtual



resolution, 1/35,000 per in. of stroke; wattage, one w per in. of stroke; temp. range, -55°C to +150°C. The life rating is up to 30,000,000 strokes depending on circuitry. Lengths of unit is 1 in. more than stroke desired. Computer Instruments Corp., 92 Madison Ave., Hempstead, L. I., N. Y.

Circle 208 on Inquiry Card

FREQUENCY CHECKER

PPM Package System is for measuring the frequencies of mobile-radio transmitters. It uses a Lampkin Micrometer Frequency Meter and a modified Measurements Corp. Model 111 Crystal Calibrator. When used with a WWV receiver, transmitter-frequency checks can be made to an accuracy of better than one part per million. The crystal calibrator is mod-



ified to include a 3½ in. dia. dial, which tunes the crystal and is calibrated in ppm with a range from +25 to -25 ppm. Lampkin Laboratories, Inc., Bradenton, Florida.

Circle 209 on Inquiry Card

New Products

TIME DELAY RELAY

STR Series relay provides: Instantaneous resetting, isolated load contacts, preset T/D 20-180 sec., voltage compensation, ambient temp. compensation, meets severe shock and vibra-

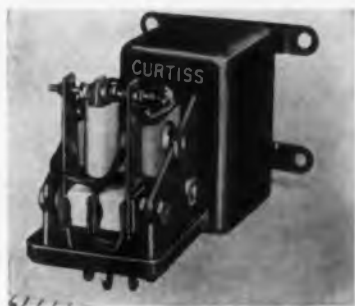

tion environments, and SPDT contacts. Voltage compensation is provided for operation on 22 to 32 vdc. Temp. compensation is over -65°C to $+125^{\circ}\text{C}$. Power drain less than 3 w after timing period: 10 w during timing. Contact rating 2 a at 28 vdc resistive load. Approx. dim. $1\frac{1}{2} \times 1\frac{3}{16} \times 1\frac{1}{2}$ in. Curtiss-Wright Corp., Electronics Div., Components Dept., 620 Passaic Ave., West Caldwell, N. J.

Circle 210 on Inquiry Card

! MORE !

The New Products mentioned here have been selected for contribution to or advancement of the electronic industries. These items are combed from several hundred new product releases received during the past month by ELECTRONIC INDUSTRIES. To keep interested readers informed of all new developments, a summary record is kept of ALL new products received. For a copy of this month's list, please send your request on company letterhead to Readers' Service Dept., Electronic Industries, 56th & Chestnut Sts., Phila., Penna. or Circle No. 161 on Inquiry Card.

crystal can size relays

by ADVANCE



—these construction features assure exceptional reliability:

Positive sealing. Advance's use of induction heating cuts rejects from faulty soldering to a negligible figure. Soldering is accomplished at high speed, hence damage to the relay due to heat transfer is eliminated.

RADIFLO testing for leakage is used to detect leaks as small as 10^{-6} cc/sec. All relays that pass this test will function after long shelf life.

RIQAP program approval. Under RIQAP, the Signal Corps constantly checks Advance's quality control and inspection, to insure military standards of reliability for all Advance customers, both military and industrial.

NOW CRYSTAL CAN RELAY MV 1035
meets the requirements of
MS24250-6 (USAF)



SPECIFICATIONS

- Coil resistance:** Available in 7 values, from 30 to 10,000 ohms.
- Shock:** 50 G's for 11 milliseconds.
- Vibration:** 10 to 34 cycles per second at maximum excursions of .4", 34 to 2000 cps 20 G's acceleration.
- Operating power:** Pull in power 250 milliwatts at 25°C .
- Contact rating:** 2 amps resistive at 32 VDC or 115 VAC.
- Life:** 100,000 operations minimum at rated current.
- Weight:** 0.45 ounce.
- Size:** $\frac{7}{8}$ " high x $\frac{5}{16}$ " wide x $\frac{23}{64}$ " deep.



ELGIN-ADVANCE RELAYS

A PRODUCT OF ELECTRONICS DIVISION
ELGIN NATIONAL WATCH COMPANY
2435 NO. NAOMI ST., BURBANK, CALIF.



This is the new **knight-kit ac vtvm**. It marks a major achievement in instrumentation... and a break-through in the professional instrument price barrier. Here is the only vtvm with **automatic range selection**... featuring a self-seeking mechanism which automatically selects the proper range when probes are touched to the circuit under examination. Simultaneously, a front panel light indicates the range in use. There are 11 ranges from 3 millivolts to 300 volts full scale; frequency response to 2.5 mc. Reads as low as 100 μ v. This precision instrument is an exclusive **knight-kit** development, designed for easy assembly. There is nothing like it on the market, in any form or at any price. Available only from Allied Radio... **\$99.50** only **\$9.00** down

Ask for detailed specification sheet covering the new **knight-kit AC VTVM**

ALLIED'S 1960 ELECTRONICS CATALOG
FREE



See the complete Knight-Kit line for professional and home use. Includes scores of instrument, hi-fi, Amateur and hobbyist kits—beat by design—the most for your money. For everything in Kits, for everything in Electronics, get the Allied 1960 Catalog. Send for FREE copy today.

ALLIED RADIO

ALLIED RADIO, Dept. 52-D
100 N. Waukena Ave., Chicago 90 Ill.
 Send details on Knight-Kit AC VTVM
 Send Free 1960 Allied Catalog No. 190A

Name _____
Address _____
City _____ Zone _____

Circle 79 on Inquiry Card

New Products

FLUX-FILLED WASHERS

Rosin flux-filled, solder washer eliminates need for separate fluxing. In contrast with the "point" contact achieved with solder rings, they provide intimate surface-to-surface con-



tact with the area being soldered. This insures uniform wetting and a more complete bond. Because of their solder-flux solder construction, these preforms provide instantaneous fluxing around the entire periphery of the washer. This overcomes the problem of localized flux action encountered when rings are used. Washers are alloyed in all standard combinations of tin, lead, cadmium, antimony, and silver. Alpha Metals, Inc., 56 Water St., Jersey City 4, N. J.

Circle 211 on Inquiry Card

FILTER

Linear phase shift (constant time delay), 36 DB per octave terminal slope, and cut-off frequency selectable in tenth-decade steps from 10 cps to 80,000 cps are features of Filter Model 1660. The instrument has 100K input impedance, 1 ohm output impedance, and the filter characteristics do not change with loading (in either high-pass or low-pass operation).

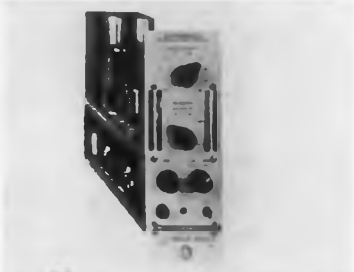

Each filter has an individual fully-isolated power supply, voltage steps from 0.1 to 1.0, and 0.1%. Dynamics Instrumentation Co., 1118 S. Mission St., So. Pasadena, Calif.

Circle 212 on Inquiry Card



actual size

For Immediate Delivery Of MOTOROLA TRANSISTORS Contact These DISTRIBUTORS

- | | |
|--|--|
| ALABAMA
Radio Specialties,
209 Penn Ave.
MEmphis 7-0370 | BOSTON
Lester Co.,
1420 Hatching
CApital 4-7063 |
| BIRMINGHAM
Aech Radio Supply Co.,
3101 Fourth Ave., So.
FARtles 2-0588 | JAMAICA, N. Y.
Lafayette Radio,
165-0 Liberty Ave.
ARtel 1-7000 |
| BOSTON
Cramer Electronics, Inc.,
811 Bayiston St.
COpley 7-4700 | LOS ANGELES
Wright Electronics,
820 West Olympic Boulevard
RICHmond 8-2444 |
| Lafayette Radio
110 Federal St.
HUbbard 2-7850 | MELBOURNE, FLA.
Electronic Supply,
909 Merrimack Dr.
PARKway 3-1441 |
| CANADA
General Radio Supply Co.,
800 Penn St.
WOODloom 4-8383 | NEW YORK
Lafayette Radio,
100 5th Ave.
WOOrth 8-5300 |
| SEASIDE RAPIDS
Danco Inc.,
618 First St., N.W.
EMpire 4-2493 | Wilgry Electronics,
136 Liberty St.
REctor 7-4400 |
| CHICAGO
Allied Radio Corp.,
100 N. Waukena Ave.
WYamarket 1-6800 | DAKOTA
Elmar Electronics,
140 11th St.
TEmplebar 4-3311 |
| Network Electric Co.,
223 W. Madison St.
Stato 2-2944 | PHOENIX
Radio Specialties,
917 E. 7th St.
ALPine 8-6121 |
| Semiconductor Specialists, Inc.
5706 Lloyd North Ave.
NAtional 7-8860 | SAN DIEGO
San Delco,
3821 Park Blvd.
CTpress 8-6181 |
| CLEVELAND
Main Line Cleveland, Inc.,
1260 E. 38th St.
EXpress 1-1900 | WASHINGTON, D. C.
Electronic Industrial Sales,
2345 Sherman Ave., N.W.
MUDson 3-5200 |
| DETROIT
Radio Specialties Co.,
496 Charlotte Ave.
TEmple 3-8800 | |



MOTOROLA

Semiconductor Products Division

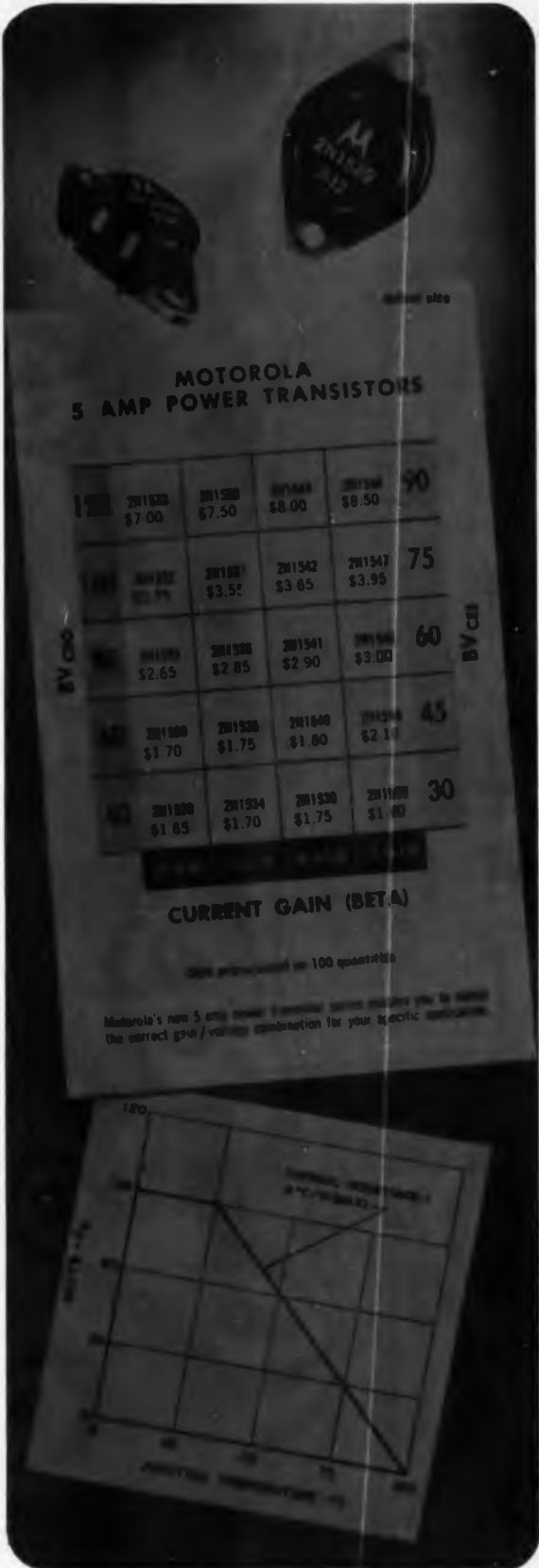

**FROM
MOTOROLA**

NEW 5 AMP POWER TRANSISTORS

*...offer Wider Selection of
Gain / Voltage Combinations*

This new Motorola 5 amp power transistor series offers significant advantages to designers of high-quality industrial and military equipment. Outstanding features include:

- All voltages are specified including BV_{CEO} , BV_{CES} , BV_{CES} and BV_{CBO} .
- Twenty gain/voltage combinations.
- Guaranteed maximum thermal resistance of $.8^{\circ}\text{C/W}$.
- Less driving power required because of higher gain.
- Maximum 2 to 1 beta range specified.
- 90 watts dissipation.
- 100°C maximum junction temperature.
- Hermetically sealed TO-3 package.

Units are designed for switching and amplifier applications from DC through the audio frequency range. High voltage and current ratings permit switching operation at power levels of up to 500 watts. High transconductance and low saturation make high beta units ideal for converter applications.

IMMEDIATELY AVAILABLE from your Motorola Semiconductor Distributor. For complete technical information, contact your Motorola Semiconductor district office:

BOSTON 385 Concord Ave., Belmont 78	Ivanhoe 4-8070
CHICAGO 81, 5234 West Diversy Avenue	Avenue 2-4300
DETROIT 27, 13131 Lyndon Avenue	Broadway 3-7171
LOS ANGELES 1741 Ivar Avenue, Hollywood 28	Hollywood 2-0821
MINNEAPOLIS 27, 7731 6th Avenue North	Liberty 5-2198
NEW YORK 1051 Bloomfield Ave., Clifton, N.J.	Gregory 2-5300
from New York	Wisconsin 7-2980
SAN FRANCISCO 1299 Bayshore Highway, Burlingame	Diamond 2-3226



MOTOROLA
Semiconductor Products Division

35 TO 250 AMPS



Tarzian high-current line combines thermal efficiency with mounting versatility and optional base polarity

The low junction current density of Sarkes Tarzian's high-current silicon power rectifiers results in longer, more reliable operating life. Compare these key Tarzian values with those of other comparably rated units, and you'll see why Tarzian rectifiers have won such wide acceptance among designers:

DC CURRENT	JUNCTION SIZE	THERMAL GRADIENT (Junction to base)	JUNCTION TEMP. RISE
35 amps	.375 Inch	9° Centigrade	60°C Maximum
100 amps	.75 Inch	5° Centigrade	60°C Maximum
150 amps	.875 Inch	7° Centigrade	60°C Maximum
200 amps	1.0 Inch	9° Centigrade	60°C Maximum
250 amps	1.125 Inch	11° Centigrade	60°C Maximum

*Available with stud mounting only

In addition to providing for maximum cooling and larger junction area, Tarzian's unique case styling produces a compact, easily mounted rectifier available in flush or stud mounting types. Tarzian high-current silicon power rectifiers are also available from stock in your choice of negative or positive base polarity.

For complete specifications and ordering information, contact your Sarkes Tarzian sales representative or write to Section 4574 E, Sarkes Tarzian, Inc., Semiconductor Division, Bloomington, Indiana.



SARKES TARZIAN, INC.

SEMICONDUCTOR DIVISION
BLOOMINGTON, INDIANA

In Canada: 700 Weston Rd., Toronto 9, Ontario
Export: Ad Auriema, Inc., New York City

Circle 81 on Inquiry Card

New Products

VOLTAGE REGULATOR

Model 1807-0300 transistorized voltage regulator is suited as a surge limiter to protect transistor amplifiers against the 80 v. transient peaks encountered in the 28 vdc aircraft

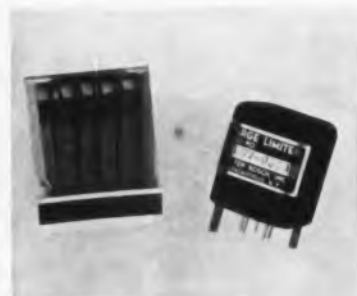

power supply as per MIL-E-7894. Electrical specs: load current, 500 ma dc max. with 80 v. transient input; operating range, 24 vdc to 31 vdc plus an 80v. exponential transient of 0.14 sec. time constant per MIL-E-7894; voltage drop, 1.6 vdc at 350ma.; max. output, 30 v. M. Ten Bosch, Inc., Application & Sales Dept., Pleasantville, N. Y.

Circle 213 on Inquiry Card

PARTS CLEANER

Parts Cleaner (Model RT-S-8-6) cleans sensitive switches, relays, choppers, semiconductors and other precision components and assemblies at the rate of 600 units an hr. A finely atomized spray of Cobehn solvent is combined with heated and filtered air and directed against all areas. Oil, grease, silicone lubricants, rosin flux, fingerprints, lapping compounds and other soluble and insoluble contamin-



ants are removed in seconds. Chemical cleanliness achieved without deposits of film or residue. A ventilation system exhausts vapors. Cobehn, Inc., Passaic Ave., Caldwell, N. J.

Circle 214 on Inquiry Card

Circle 82 on Inquiry Card →



FILTERS FOR ALL APPLICATIONS FROM STOCK

HERMETICALLY SEALED TO MIL-T-27A & MIL-F-18327 SPFCs.

MINIFILTERS

New Minifilters provide almost the same characteristics (with attenuation only slightly less) as the industry's standard interstage and line filters immediately below.

BPM band pass units are 10K input, output to grid; 2:1 gain. Attenuation is approximately 2 db \pm 3% from center frequency, then 35 db per octave.

HPM high pass units; loss of less than 6 db at cut-off frequency; attenuation of 30 db at 67 cut-off frequency, 40 db at 5 cut-off frequency. Input and output 10K.

LPM low pass units; loss of less than 6 db at cut-off frequency; attenuation of 30 db at 1.5 cut-off frequency, 40 db at 1.65 cut-off frequency. Input and output 10K.



STANDARD STOCK FREQUENCIES (number in figure is cycles)

BPM-400	BPM-10000	LPM-1000
BPM-750	HPM-500	LPM-2000
BPM-1000	HPM-1000	LPM-3000
BPM-1500	LPM-200	LPM-5000
BPM-2000	LPM-500	



Size For NEW Catalog



BPM case (MIL AF)
1 1/4 x 1 1/4"
Weight .1 oz.



HPM and LPM case (MIL AF)
1 x 1 x 1 1/4"
Weight .25 oz.

INTERSTAGE & LINE

These six basic types cover most popular filter applications and frequencies.

BMI band pass units are 10K input, output to grid; 2:1 gain. Attenuation is approximately 2 db at 3% from center frequency, then 40 db per octave.

HMI high pass units are 10K in and out. Attenuation is less than 6 db at cut-off frequency and 35 db at .67 cut-off frequency.

LMI low pass units are 10K in and out. Attenuation is less than 6 db at cut-off frequency and 35 db at 1.5 cut-off frequency.

HML high pass filters are same as HMI but 500/600 ohms in and out.

LML low pass filters are same as LMI but 500/600 ohms in and out.

BMI band pass units are same as BMI but 500/600 ohms input, output to grid, 9:1 gain.



STANDARD STOCK FREQUENCIES (number in figure is cycles)

BMI-60, 100, 120, 400, 500, 750, 1000, 1800, 2000, 3000, 4000, 5000, 8000, 10000
BTI-60, 100, 120
HMI-200, 400, 500, 800, 1000, 2000, 3000, 2800, 3000, 4000, 5000, 10000
HML-400, 1000
LMI-200, 300, 500, 1000
LML-1000, 1800, 2000, 2500, 4000, 8000, 10000, 12000



Base Height, BMI, LMI, BML . . . 1 3/8"
Height, HMI, HML, LML . . . 2 1/2"
Weight . . . 6 oz. and 8 oz.

TELEMETERING BAND PASS

UTC standard telemetering filters provide extreme miniaturization with maximum stability, a complete set of 18 filters taking 19 cubic inches. They are 100K in and out and have an insertion loss of less than 6 db, 4 pin header for small Winchester socket.

TMN units are within 3 db at \pm 7.5% of center frequency . . . down more than 18 db at \pm 25% . . . more than 40 db beyond 1.75 and .58 center frequency.

TMW are within 3 db at \pm 15% of center frequency . . . down more than 20 db at \pm 50% . . . more than 40 db beyond 2.5 and .4 center frequency.

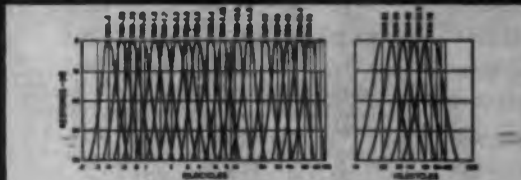

STANDARD STOCK FREQUENCIES (number in figure is KC)

TMN-.4	TMN-1.7	TMN-5.4	TMN-30	TMN-22
TMN-.56	TMN-2.3	TMN-7.35	TMN-40	TMN-30
TMN-.73	TMN-3.0	TMN-10.5	TMN-62.5	TMN-40
TMN-.96	TMN-3.9	TMN-14.5	TMN-70	TMN-52.5
TMN-1.3		TMN-22	TMN-70	



TMN-2.3 thru TMN-70
1 1/4 x 1/4 x 1 1/4"
Weight .1.7 oz.

TMN-4 thru TMN-1.7
1/4 x 1/4 x 1/4"
Weight .1.5 oz.

TELEGRAPH TONE CHANNEL

These band pass filters for multiplex transmitting and receiving provide maximum stability in miniature sizes. Both receiving and transmitting types are 600 ohms in and out, and employ 7 terminal header for sub-miniature 7 pin socket.

TBT transmitting filters are within 3 db at \pm 42.5 cycles from center frequency . . . down more than 16 db at \pm 170 cycles . . . down more than 7.5 db at adjacent channel crossover.

TBR receiving filters are within 3 db at \pm 42.5 cycles from center frequency . . . down more than 30 db at \pm 170 cycles . . . down more than 15 db at adjacent channel crossover.

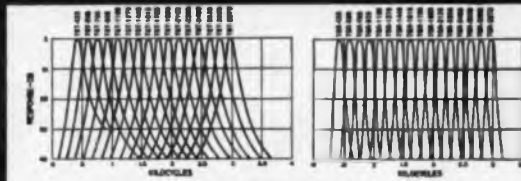

TRANSMITTING

TBT-425	TBT-1785
TBT-595	TBT-1955
TBT-785	TBT-2125
TBT-935	TBT-2295
TBT-1105	TBT-2465
TBT-1275	TBT-2635
TBT-1445	TBT-2805
TBT-1615	TBT-2975

STANDARD STOCK FREQUENCIES

(number in figure is cycles)

RECEIVING

TBR-425	TBR-1785
TBR-595	TBR-1955
TBR-785	TBR-2125
TBR-935	TBR-2295
TBR-1105	TBR-2465
TBR-1275	TBR-2635
TBR-1445	TBR-2805
TBR-1615	TBR-2975



TBT CASE
1 1/4 x 1 1/4 x 2 1/4"
Weight .8 oz. 1

TBR CASE
1 1/4 x 1 1/4 x 1 1/4"
Weight .15 oz.

And Special Units to Your Specifications

UNITED TRANSFORMER CORP.

150 Varick Street, New York 13, N. Y.

PACIFIC MFG. DIVISION: 4008 W. JEFFERSON BLVD., LOS ANGELES 14, CALIF.
EXPORT DIVISION: 13 EAST 40th STREET, NEW YORK 16, N. Y. CABLES: "ARLAB"

plastic

NYLON - TEFLON - POLYSTYRENE - POLYETHYLENE - PHENOLIC



Illumitronic has the most complete line of **PLASTIC ROD, TUBING and SHEET.**



Also **HARNESSING and CABLING materials:**
ZIPPERTUBING
SPIRAL WRAP
SPIRAL COVER
VINYL SLEEVING
LACING CORD
CABLE CLAMPS



illumitronic

sunnyvale,  california

engineering

Circle 83 on Inquiry Card

New Products

SILICON GLASS DIODES

Glass package $\frac{1}{4}$ w silicon zener diodes for computer and general applications. The series, Motorola types $\frac{1}{4}$ M6.8Z through $\frac{1}{4}$ M200Z, offers 43 separate voltages, from 6.8 through



200 v., in tolerances of 20, 10 and 5%. Also available in series or parallel matched sets with tolerances as close as 1%. Lower temperature coefficients and lower dynamic impedance with increased power capacity are featured in the series matched sets. Motorola, Inc., Semiconductor Products Div., Dept. NGD, 5005 E. McDowell Rd., Phoenix, Ariz.
 Circle 215 on Inquiry Card

SUBCARRIER OSCILLATORS

Transistorized voltage - controlled oscillators cover conventional signal, fractional-volt, and millivolt ranges. Type 1250 VCO's are for 0 to +3, 0 to +5; ± 1.5 , or ± 2.5 v. signals. Type 1251 (0.25 v. input) is compatible with $\frac{1}{4}$ -v. output pressure transducers. Type 1252, 20 mv for full deviation, are for bridge instrumentation. Oscillators operate from unregulated 28 v. source. Char-



acteristics: -55°C to 125°C , 100% RH, 30g RMS random vibration, 150g acceleration, and 200g shock. Tele-Dynamics Inc., 5000 Parkside Ave., Phila. 31, Pa.
 Circle 216 on Inquiry Card

for immediate delivery of

GENERAL INSTRUMENT semiconductors

at factory prices

call your authorized stocking distributor

CALIFORNIA

Electronic Supply Corp.
 Pasadena
 Newark Electronics Corp.
 Inglewood
 Pacific Wholesale Co.
 San Francisco
 San Dato
 San Diego
 Valley Electronic Supply Co.
 Burbank

CONNECTICUT

Sun Radio & Electronics Co., Inc.
 Stamford
 The Bond Radio Supply, Inc.
 Waterbury

FLORIDA

Electronic Supply
 Melbourne; branches in Miami,
 Orlando, St. Petersburg

ILLINOIS

Merquip Company
 Chicago
 Newark Electronics Corp.
 Chicago

INDIANA

Brown Electronics, Inc.
 Fort Wayne
 Graham Electronics Supply, Inc.
 Indianapolis

IOWA

Decco, Inc.
 Cedar Rapids

MARYLAND

Radio Electric Service Co.
 Baltimore

MASSACHUSETTS

The Greene-Shaw Co., Inc.
 Newton

NEW YORK

Delburn Electronics, Inc.
 New York City
 Hudson Radio & Television Corp.
 New York City
 Sun Radio & Electronics Co., Inc.
 New York City
 Standard Electronics, Inc.
 Buffalo, N. Y.

OHIO

Buckeye Electronics Distributors
 Columbus
 The Mytronic Co.
 Cincinnati
 Pioneer Electronic Supply Co.
 Cleveland

OKLAHOMA

Oil Capital Electronics
 Tulsa

PENNSYLVANIA

D & H Distributing Co.
 Harrisburg
 Harbach & Rademan, Inc.
 Philadelphia

TEXAS

Scooter's Radio & Supply Co.
 Fort Worth

WASHINGTON

Seattle Radio Supply Co.
 Seattle

WISCONSIN

Radio Parts Co., Inc.
 Milwaukee



Distributor Division
GENERAL INSTRUMENT CORPORATION
 240 Wythe Avenue
 Brooklyn 11, N. Y.

GENERAL INSTRUMENT

silicon
rectifiers

all the
available

JAN
TYPES

to meet MIL-E-1 specifications

JAN
Type
1N538



JAN
Type
1N540



JAN
Type
1N547



JAN
Type
1N253



JAN
Type
1N254



JAN
Type
1N255



JAN
Type
1N256

Maximum Values for GENERAL INSTRUMENT Military Type Silicon Rectifiers

Type No.	Peak Reverse Voltage (VDC)	DC Output Current (MA)		Maximum Reverse Current (MA)	Mounting	MIL-E-1 Technical Spec. Sheet No.
		Av. @ 135° C. Case Temp.	@ 25° C. Ambient			
1N253	100	1000	—	—	0.1*	Stud 1024A
1N251	200	400	—	—	0.1*	Stud 960B
1N255	400	400	—	—	0.15*	Stud 990B
1N256	600	200	—	—	0.25*	Stud 991B
1N538	200	—	750	250	0.350†	Axial Lead 1044A
1N540	400	—	750	250	0.350†	Axial Lead 1045A
1N547	600	—	750	250	0.350†	Axial Lead 1048A

*Averaged over 1 cycle for inductive or resistive load with rectifier operating at full rated current; case temperature 135° C.
†Averaged over 1 cycle for inductive or resistive load with rectifier operating at full rated current at 150° C. ambient.

Without qualification, these rectifiers are the finest available today, designed and manufactured to meet stringent government requirements and General Instrument's exceedingly high quality control standards.

General Instrument also makes a complete line of JAN type subminiature glass encapsulated germanium and silicon diodes . . . and all are offered in volume quantities for *on time delivery* at prices that reflect our years of production experience. Data sheets on any of these diodes or rectifiers are available upon request.



Semiconductor Division

GENERAL INSTRUMENT CORPORATION

65 Gouverneur Street, Newark 4, N. J.

Midwest office: 5249 West Diversey Ave., Chicago 39

Western office: 11982 Wilshire Blvd., Los Angeles 25

GENERAL INSTRUMENT CORPORATION INCLUDES F. W. SICKLES DIVISION, AUTOMATIC MANUFACTURING DIVISION, SEMI-CONDUCTOR DIVISION, RADIO RECEPTOR COMPANY, INC., THE HARRIS TRANSDUCER CORPORATION, MICAMOLD ELECTRONICS MANUFACTURING CORPORATION AND GENERAL INSTRUMENT — F. W. SICKLES OF CANADA LTD. (SUBSIDIARIES)

Gertsch Complex Ratio Bridge



—measures both in-phase and quadrature
voltage ratios — with high accuracy

This instrument cancels quadrature effects, giving a sharp, true null.

In eliminating quadrature voltage, this Gertsch bridge achieves an in-phase ratio accuracy as good as 0.001%. Quadrature voltage ratios are read as rectangular coordinates, tangent of phase-shift angle, or magnitude of phase-shift angle in degrees directly.

Write for complete data in Bulletin CRB.

- SELF-CONTAINED PHASE-SENSITIVE DETECTOR
- SIX-PLACE RESOLUTION
- TWO FREQUENCY RANGES
 - 30 TO 1000 CPS
 - 50 TO 3000 CPS

Gertsch

GERTSCH PRODUCTS, Inc.

3211 South La Cienega Boulevard, Los Angeles 16, California
UPTon 0-2761 — VERmont 9-2201

Circle 85 on Inquiry Card

Vector Electronics manufactures a complete line of structures for mounting circuitry easily, compactly and with good accessibility.

Vector experience and facilities guarantee delivery, performance and economical prices.

Vector

STRUCTURES
FOR
CIRCUITRY

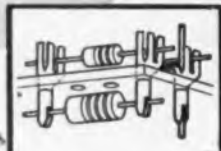

TERMINALS AND TERMINAL BOARDS



PLUG-IN UNITS



SOCKET TURRETS,
TERMINAL TURRETS,
TRANSISTOR TURRETS.



Write for catalog 10:

VECTOR ELECTRONIC COMPANY
1100 FLOWER STREET, GLENDALE 1, CALIFORNIA
TELEPHONE: CHAPMAN 5-1076



SOCKET TEST ADAPTOR,
CHANGE ADAPTORS,
EXTENDERS, ROTOPROBES
AND TUBE BASE PLUGS.

New Products

MODULAR POWER SUPPLY

Modular power supply, Model RS-450, provides 2 outputs of ± 300 -400 v.; or single output of 600-800 v. at currents up to 50 ma. Some specs: ac filament outputs, 6.3 VCT @ 2 a;



6.3 VCT @ 1.5 a; 6.3 VCT @ 1.5 a; current range, 0 to 50 ma, continuous duty; ripple and noise, 7 mv peak-to-peak max.; recovery time, less than 25 μ sec; input voltage, 105 to 125 vac. 60 to 400 cps; internal impedance, less than 1 ohm; load regulation, 0.03%; line regulation, 0.02%. Trans Electronics, Inc., 7349 Canoga Ave., Canoga Park, Calif.

Circle 217 on Inquiry Card

GANG SWITCH

Panel mounted push-button, "Compact," gang switch is supplied in any number of push-buttons from 2 switches up to 10, all locked and interlocked. No. 2 switches can be operated at the same time. Rebulbing is from front of panel. It can be supplied with lens sizes (square and round) and on any centers desired. Supplied in contact ratings up to 5 a at 28 vdc and reliable for over 100,



000 cycles of operation at rated load. Can be supplied in SPST up to 6 PDT or any combination. Pendar, Inc., Switch Div., 14744 Arminta St., Van Nuys, Calif.

Circle 218 on Inquiry Card

Save on
labor costs

Centralab's
heat-stable
plastic shaft
controls



SNAP into place

You can save on installation costs—up to \$10.00 per thousand units—because CENTRALAB Model 2 variable resistors SNAP into position.*

This exclusive "Snap-Tite" design is but one of the many features that make the Model 2 so practical. The thermo-setting plastic shaft is UL approved. You have a choice of six shaft lengths—and the shafts have service adjust screwdriver slots front and rear. The shaft and contact rotor are molded in one piece for rigid, vibration resistant construction.



SPECIFICATIONS

Resistance element: Composition
Resistance range: 250 ohms to 10 megohms
Taper: Available in seven standard tapers
Effective Rotation: 300°
Shaft Lengths: 3/8", 1/2", 5/8", 3/4", 7/8", 1"
Terminals: Standard, plug-in or wire-wrap
*Mounting: Interchangeable with panel piercing for bushing and twist tab mount

Further information and detailed engineering data available in CENTRALAB Engineering Bulletin EP-815. Write for your free copy.

Centralab
B5971 

ELECTRONICS DIVISION OF GLOBE-UNION INC.
938D E. KEEFE AVE. • MILWAUKEE 1, WIS.
In Canada: P. O. Box 400, Ajax, Ontario

VARIABLE RESISTORS • ELECTRONIC SWITCHES • PACKAGED ELECTRONIC CIRCUITS • CERAMIC CAPACITORS • ENGINEERED CERAMICS

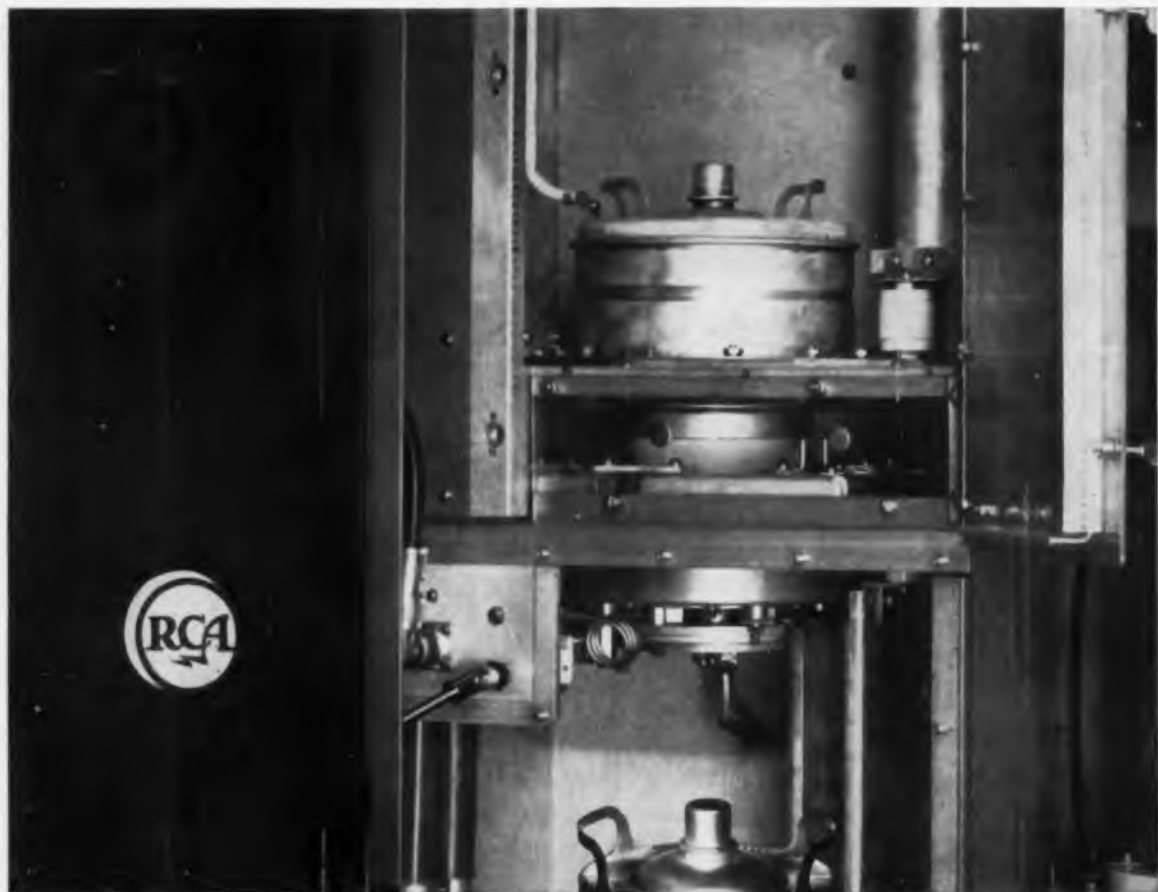

**NEW, UNIQUE RCA
5-KW FM TRANSMITTER
UTILIZES 4CX5000A
CERAMIC TETRODE**



RCA has recently developed a unique new 5-KW FM transmitter which utilizes the new technique of multiplexing. This provides simultaneous transmission of two or more program channels on the same RF carrier to meet increased demands of FM stations for additional program services.

The PA stage of the new BTF-5B transmitter is composed of a single Eimac 4CX5000A ceramic tetrode,

which produces the 5000-watt output. This tetrode offers high power gain and excellent stability to assure faithful transmission of the broadband multiplex signals.

That's why the 4CX5000A was the logical choice of discriminating RCA engineers. Its many exclusive ceramic design features help to make possible this conservatively rated, high power, air-cooled transmitter.

These ceramic extras are now available in more than forty Eimac tube types—used in many types of communication, pulse and industrial equipment.

EITEL-McCULLOUGH, INC.

San Carlos, California



Tele-Tech's ELECTRONIC OPERATIONS

The Systems Engineering Section of ELECTRONIC INDUSTRIES

APRIL 1960

SYSTEMS—WISE . . .

▶ A contract for the construction of 880 laminated steel yoke blocks for the 3-billion electron volt proton synchrotron being built at the James Forrestal Research Center of Princeton Univ. was awarded Eddystone Div., Baldwin-Lima-Hamilton Corp. The yoke blocks will form the cores of magnets that will hold protons in orbit as they are accelerated around a circular track.

▶ The U. S. Atomic Energy Commission has contracted with Motorola, Inc., Chicago, for a data gathering and logging system to provide continuous rapid surveillance of nuclear radiation levels and weather conditions in the area surrounding the Commission's National Reactor Testing Station, near Idaho Falls, Idaho. The system, uses radio transmitted bursts of audio tone.

▶ A 15-station microwave communications system, providing circuits for the operation of a 513-mile pipeline, has been installed by Collins Radio Co. for the Texas-New Mexico Pipe Line Company, Houston, Texas. The 16" pipeline, completed in 1958, extends from Aneth, Utah to Jal, N.M.

▶ Kellogg Switchboard and Supply Co., Chicago, will build a \$69,163 intercommunication system for the National Aeronautics and Space Administration's rocket launching site at Wallops Island, Chincoteague, Va. The transistorized system will handle up to 100 conversations simultaneously at a constant level to points 10 miles away.

▶ The most powerful transistorized electronic computers yet shipped were delivered recently by IBM Corp. to Sylvania Electric Products, Inc., for incorporation in the Air Force's Ballistic Missile Early Warning System. The two large, transistorized IBM 7090 computers, together with additional computing equipment, will become the basic instrumentation for the BMEWS data processing sub-system for which Sylvania is the subcontractor of Radio Corporation of America, prime BMEWS contractor.

▶ Contracts have been let by NASA for a network of 18 sites that will make up a world-wide tracking and ground instrumentation system for the Mercury Project. Prime contractor is Western Electric. Participating are Bell Telephone Labs., Whippany, N. J., Bendix Aviation Corp., Detroit, Mich., and Burns and Roe, N. Y.

▶ In 1959, American radio and TV networks contributed time and talent to 14 major national public service information campaigns, and gave support to 63 other national causes. It is estimated that the time and talent devoted to the 14 major campaigns alone would run to more than \$75,000,000.

▶ Texas Instruments Incorporated, Dallas, Tex., has been awarded a \$4.5 million contract by the newly formed Bureau of Naval Weapons for an advanced antisubmarine warfare (ASW) system. Delivery is scheduled to begin in 1961.

▶ Sperry Gyroscope Co., Great Neck, N. Y., is building a man-made "sea" to help solve problems in detection equipment (mainly SONAR) for antisubmarine warfare. The "sea" will be 400 ft long, 200 ft wide, and 25 ft deep.

Weather Radar Antenna

The 39 antennas forming a nationwide network of high-power storm-finding radars incorporate a piggy-back r-f head to supply r-f energy. Fitting directly behind the reflector, the unit eliminates the need to change waveguide run should new frequency be desired. Antenna systems are being built by I-T-E Circuit Breaker Co.



▶ A 120-mile microwave hop, longest in the U. S., has been put into service in Idaho, from Kimport Peak near Pocatello in the Rockies to Tabletop Mountain on Monida Pass. The Raytheon KTR one-watt, four-channel hop is one of seven which span the 440 airline miles between Pocatello and Billings, Mont., bringing network programs from Salt Lake City to KGHL-TV in Billings.

▶ A two-way radio communications system, including more than 165 MOTRAC radio units, has been ordered from Motorola by the Suffolk County (N. Y.) police dept. The \$220,000 contract includes 20 "Dispatcher" radios for motorcycles, 12 "Handie-Talkie" portable radio-phones, two 250-watt base stations, and 890-960 MC control and repeater stations.

▶ RCA has asked the FCC to adopt the method developed by that company for stereophonic radio broadcasting in the standard AM broadcast band. RCA states that its proposed broadcast system has provided "excellent stereophonic performance" in tests, and at the same time provides normal program transmission for reception by all existing non-stereo radio receivers, without any alteration."

A REPRINT
of this article can be obtained by
writing on company letterhead to
The Editor
ELECTRONIC INDUSTRIES
Chestnut & 56th Sts., Phila. 39, Pa.

Unfortunately the RFI detection equipment has not kept pace with the latest missile equipment. The missile equipment has been more sensitive than the detection equipment. A new system has been designed which should overcome this problem. This system boasts flexibility and sensitivity, and has provisions for recording and storing information.

New System Design for . . .

Detecting Interference to

FROM the initial date of operation at the Air Force Missile Test Center the need for a frequency control and analysis facility was recognized. Early in 1950 the Air Force Missile Test Center equipped a van, a B-29 aircraft, and a pre-fabricated building at Cape Canaveral so that interference could be analyzed. The stations had standard communications and electronic countermeasures, receiving, direction finding, analysis, and frequency measuring equipment. Equipment configurations corresponded to the missile test frequencies used in that era. Elec-

tronic equipments used were for the most part duplicates of or slight modifications to W. W. II radar, control, and communications systems.

While these equipments were then considered adequate, the second generation of missiles soon proved the need for new and more complex electronic support. As newer electronic equipments began to show up on the test range, with such missile programs as THOR, JUPITER, Redstone, and BOMARC, the inadequacy of the FCA capabilities became more and more evident.

New Facilities

Based on the realization of monitoring and analysis shortcomings, several approaches to modernization of the frequency control and analysis facilities were planned. The following steps in this direction were taken at AFMTC beginning in late 1955:

a. A new building for a field station on Cape Canaveral was programmed for and approved.

b. Three new C-131 aircraft were programmed for, approved and received. The best available frequency control and analysis

Fig. 1: Simplified block diagram shows the interference detection system. Flexibility is the keynote of system.

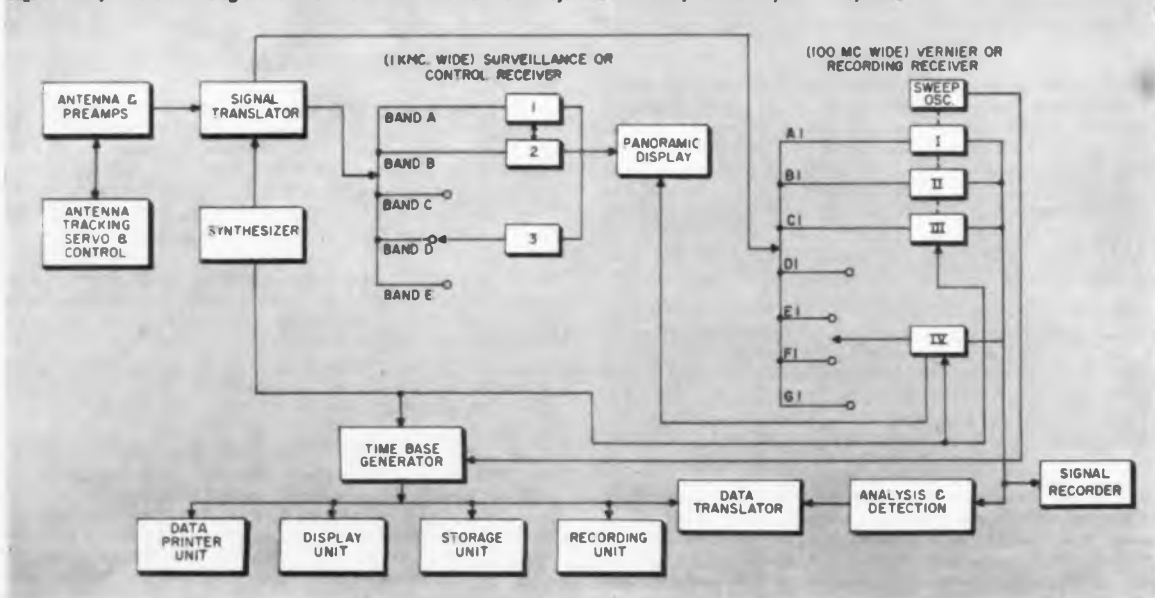
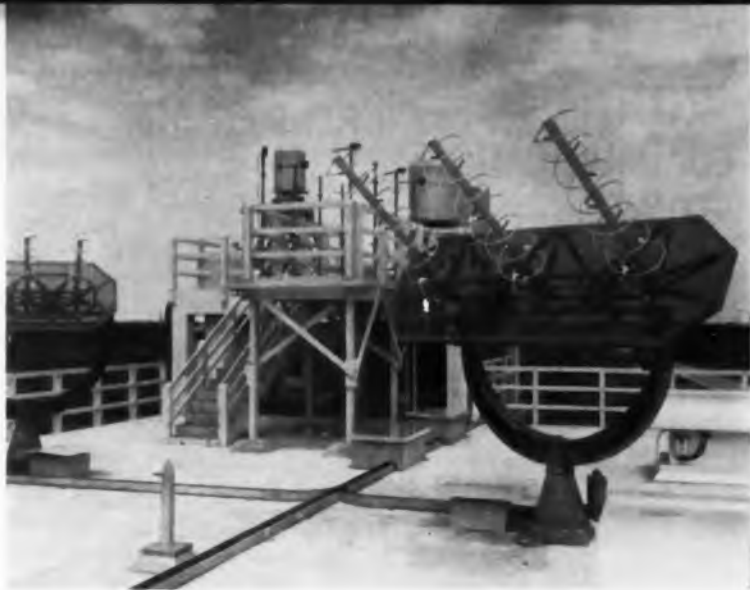

Fig. 2: Direction finding to an accuracy of 5° can be accomplished very rapidly.



By H. KILBERG

Frequency Control & Analysis
RCA Service Co.
AFMTC, Patrick A. F. Base, Fla.

Missiles

equipment was installed in these aircraft.

c. Obsolete vans were replaced with 4 new self-propelled vans especially designed for the utility and mobility required for the FCA program.

d. Two AN/SLR-2 countermeasures receiving systems were programmed in April 1957. These were approved and subsequently received.

Having completed these actions, the FCA program was considered adequate to handle the assigned responsibilities. However, with the advent of third generation missiles, satellites and space probes, we find that the present system is inadequate to effectively perform the FCA function.

Many cases indicate a lack of FCA capability commensurate with the new and highly sensitive instrumentation systems. Although the frequency control and analysis program has recognized these inadequacies, it needs only to be improved concurrently with the state of the missile or electronic art to be extremely effective.

With the advent of the installation of new equipment, many cases of interference have been solved. But the capability is lessening as newer instrumentation equipment is installed. Examples of both resolved and un-resolved interference highlight the point that interference is unpredictable and can be hazardous. A constantly alert network of interference analysis equipment and personnel are re-

quired to cope with these situations.

Radiation Hazards

The recognition of radiation hazards to fuel, personnel, and explosive ordnance material has placed a new and exacting requirement on the FCA program at AMR. The measurement of signal levels with respect to personnel and fuel hazards is rather straightforward. Simple equipment can be used. On the other hand, the techniques and equipments for determining the radiation hazards with the multitude of explosive ordnance items used in conjunction with the missile testing program require special considerations.

Practically every type of detonator, squib or pyrotechnic device has a different value of susceptibility to electromagnetic radiation. A complete evaluation of all such devices

must be made. Although relatively large values of electromagnetic power can be withstood without hazard to personnel and fuel, these values are usually quite small for safe radiation in the presence of ordnance items. This latter fact dictates very accurate, sensitive, and reliable equipment for measuring field intensity. As an example, one particular missile now at Canaveral uses 33 types of explosive ordnance items.

Basic System Concept

The function of the new RFI detection system at AMR has been established as follows:

1. To provide the capability to detect, analyze, locate, and record any electromagnetic signals which are causing or are capable of causing harmful interference.
2. To provide a detection, analysis and direction finding capability

Fig. 3: The frequency control and analysis room at Cape Canaveral is shown. Here all frequencies over Atlantic range are controlled.



ROHN COMMUNICATION TOWER No. 60

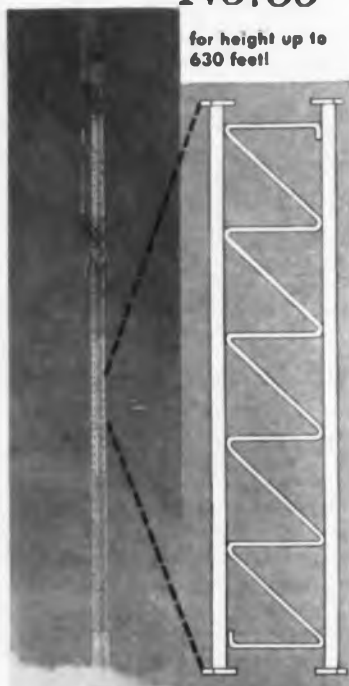

for height up to
630 feet!



Shown here is a ROHN No. 60 tower installed to a height of 200 feet with 3 five-foot side arms, mounting antenna for police radio communications.

★ This extremely heavy duty tower is designed for a wide variety of communications of all kinds.

★ This No. 60 ROHN tower is suitable for height up to 630 feet when properly guyed and installed.

★ Completely hot-dipped zinc galvanized after fabrication.

★ Designed for durability, yet economical — easily erected and shipped. ROHN towers have excellent workmanship, construction and design. Each section is 10 feet in length.

FREE

Details and complete engineering specifications gladly sent on request. Also ROHN representatives are coast-to-coast to assist you.

Write-Phone-Wire Today!

ROHN Manufacturing Co.

116 Limestone, Bellevue,
Peoria, Illinois
Phone 7-8416

"Pioneer Manufacturers of
Towers of All Kinds"

Circle 89 on Inquiry Card

RFI Detection (Continued)

for both cooperative and non-cooperative satellites and space probes in support of ARDC Project 1770.

3. To analyze the levels of electromagnetic radiation from high-powered transmitting equipments at AFMTC for determining degree of radiation hazard to personnel, ordnance and fuels.

4. To provide statistical data for analysis of frequency assignments and interference susceptibility on various assigned channels.

The system has been designed both mechanically and electronically modular. Thus various fundamental components can be arranged in a given configuration to meet a given requirement. The antenna systems will be composed of individual end fire elements in various array configurations. The simpler arrays will consist of two elements forming an interferometer with sum and difference outputs. Accurate direction finding can occur by use of the null pattern, and, simultaneously, signal from the sum pattern is analyzed and recorded. Other arrays that can be made from these individual elements are as follows:

1. Aircraft antennas designed to have small volume.
2. Large azimuth arrays allowing for complete 360° azimuth coverage at all times. These will be utilized primarily at major fixed facilities.
3. Long baseline interferometers utilized in support of Space Track to achieve latitude and longitude crossings.

Individual Element Capabilities

To best demonstrate the overall capability of the individual elements, the initial system will utilize a self-tracker consisting of an azimuth/elevation pedestal with sufficient elements to have a minimum gain of 20 db from 100 to 4000 MC. This tracker will be capable of self-tracking on any one of the bands, with vertical, horizontal, right-circular, or left-circular polarization. Further, it will have the capability of being expanded to an antenna with a gain of approximately 30 db.

This configuration will allow for

evaluation of (1) mutual coupling between the various elements, (2) accuracy and alignment problems of the array, (3) the ability to electronically switch beamwidth, and (4) various operational modes. For example, the tracker will have the capability of providing beamwidths of from 30° to 10° for signal acquisition and will be provided with a sector scan in both azimuth and elevation.

The scanning will be at both various azimuth and elevation rates as well as various angles of sector scan. This configuration will then be utilized to provide (1) a search capability, (2) a monitoring capability, or (3) a self-track capability. The entire antenna assembly can be dismantled, moved, and reinstalled in less than 4 days when suitable concrete foundation pads are available. This is considered necessary to meet various emergency or short notice requirements.

All signals are brought into the main area. There they are fed into a signal translator (refer to Fig. 1). The function of the signal translator and synthesizer is similar to that of a local oscillator/mixer combination in a standard receiver. However, these two units serve to take all incoming frequencies and break them down into bands consisting of 1000 and 100 MC steps. Center frequencies of the 1000 MC steps are identical, as are the 100 MC steps. Therefore, a single 1000 MC or 100 MC bandwidth i-f can be utilized over the entire range of from 100 MC to 10 KMC.

Control Receivers

The surveillance or control receivers (1000 MC wide) are capable of three modes of operation: (1) they can pan a 1000 MC segment of any of the bands, (2) they can be utilized in the signal-peek mode to analyze individual signals, (3) they can be utilized as manually tuned receivers where necessary. In practice, each control receiver will monitor 10 vernier (100 MC wide) receivers. The purpose of the vernier or recording receivers is twofold. First, they allow individual inspection of any 100 MC

portion of a band. Second, when used in a fixed oscillator mode, they are essentially fixed-tuned receivers to record or analyze individual signals. As these receivers are identical, they may utilize the same oscillator so that any portion of the band can be synchronously scanned; i.e., one common oscillator provides a sweep for any number of 100 MC segments. In essence, the entire band can be swept simultaneously with one sweeping local oscillator.

The basic motivation of both the control and vernier receivers is accommodating high signal densities with a minimum number of components. For example, 8 or 9 telemetry links could be covered with 8 or 9 i-f strips. The same i-f strips could be reutilized to cover either the command band or the radar band at a new time.

The control receivers are tied in with the vernier receivers by feeding each control receiver to a panoramic display. A marker is then generated on this display from the local oscillator signal of the individual vernier receiver. The operator can then manually tune any one of the vernier receivers to any signal displayed by the 1000 MC control receiver. In any specific operation, the operator would view any portion or all of a band of interest. He then has the capability to tune any one of the vernier receivers to any number of signals available within that band for either analysis or recording.

As indicated in the diagram, receivers 1 and 2 of the control receivers can be permanently attached to any two bands, in this case bands A and B. This will provide a continuous panoramic display of all signals. For example, the bands could be 2 to 3 kMC or 8 to 9 kMC. Receiver 3 is attached to a switch whereby it can be switched to band C, D, or E, etc. Where space and operators are a premium such as vehicles or aircraft, this configuration (a single receiver switching throughout the various bands) will be used. In larger installations, such as a building, the configuration as shown, where receivers 1 and 2 are being used for a specific operation and receiver 3 is alerted when instructions are received from any one of the major facilities, may

be used. Receivers 1 and 2 can also be switched if required.

Vernier Receivers

Receivers I, II, and III of the vernier receivers are in a sweep or pan display mode. This synchronous scan mode has several advantages. First, in keeping the number of sweep oscillators to a minimum there will be a minimum of interference within the system and hence a minimum of spurious radiation and indications. Further, all receivers are scanning 100 MC at the same rate. This facilitates the frequency measuring process and bandwidth control for highest detection probability. Receiver IV in this instance is utilized as a switched receiver to any one of several bands, and is indicated in the recording mode; i.e., it is fixed-tuned receiving its local oscillator injection from the synthesizer. Each one of the receivers is tunable over its own 100 MC range, either by sweeping using an externally injected accurately known signal, or it can be utilized in an AFC lock-on mode. Since all the receivers are

identical, switching presents no problem, nor does mode selection. This is also true of the control receivers.

It is to be noted that the segments A1, B1, C1, D1, etc., in the vernier receiver area actually represent 100 MC segments referenced back to the antenna and preamp. For example, C1 could represent 300 to 400 MC, D1 would be 400 to 500, E1 would be 500 to 600. Thus coarse frequency can be determined by noting into which position a receiver is set. Since the vernier receivers are also utilized to 10 kMC, highly accurate frequency measurement can be accomplished by using these receivers by themselves.

The center frequency of all the vernier receivers is identical, making it quite easy to inject at this point any specific type of receiver. For example, any special telemetry receiver, any special command receiver can be accommodated within the system. Techniques such as microlock, correlation can be added merely by converting the input frequency of the receiver added to that

(Continued on page 186)

IMMEDIATE DELIVERY OF ALL TYPES

BY THE LEADER FOR OVER 10 YEARS

GEN-PRO

NAVY TERMINAL BOARDS



Solid Block 17TB10



Feed-Thru Terminal Block 7TB12

Gen-Pro military terminal boards are manufactured and inspected in accordance with latest revision of MIL-T-16784, BuShips Dwg. 9000-S6505-B-73214 and BuOrd Dwg. S64101. Molding compound, per MIL-M-14E assures low dielectric loss, high insulation resistance, high impact strength.

NEW MINIATURE TYPES NOW AVAILABLE

Gen-Pro miniature type military terminal boards conform with Bureau of Ships Drawing RE10-D-764, as referenced in MIL Standard #242.

WRITE today for new catalog with illustrations & specifications

Miniature 26TB10

GENERAL PRODUCTS CORPORATION
Over 25 Years of Quality Molding
UNION SPRINGS, NEW YORK TWX No. 169

WASHINGTON

News Letter

LEE RENAMED TO FCC—Commissioner Robert E. Lee was renominated to the Commission for another seven-year term, beginning July 1 and running until June 30, 1967, by President Eisenhower four and a half months before the expiration of his term. Although it is an election year, and the FCC is now comprised of four Republicans and three Democrats, confirmation by the Senate is deemed certain probably in the latter part of May or early June. Senate Interstate Commerce Committee Chairman Warren Magnuson (D., Wash.) has indicated his group would not take up Commissioner Lee's nomination until the latter part of the Congressional session due to the pressure of other legislative affairs.

FCC APPROPRIATIONS—By the time the April issue of **ELECTRONIC INDUSTRIES** is published, the House of Representatives is expected to pass upon the appropriation of the FCC for the upcoming government fiscal year starting July 1. While the House Appropriations Committee had not, at our press deadline, allotted the funds for the Commission, it was deemed most probable that the increased appropriation of \$11,250,000 for the agency's regular activities compared with \$10,550,000 spent this year will be approved. But there was doubt that the House body would sanction the proposal for \$2,250,000 additional for a two-year research study of ultra high frequency transmission and reception, particularly aimed to settle the TV allocations problem. It was reported that House Committee members suggested this be cut back to \$250,000 and the FCC secure help for the project from the National Academy of Sciences.

MONEY FOR SMALL BUSINESS—Philip McCallum, Small Business Administrator, reported that \$472.5 million in proposed Government purchases were earmarked for small business award under the Agency's cooperative set-aside program during the six months ending December 1959. This will establish a record for the last half of any year in the Agency's history.

Mr. McCallum reported that of the \$472,522,680 in proposed Government purchases earmarked for exclusive bid by small firms, 10,989 prime contracts valued at \$393,244,229 resulted. The last half of 1959 shows a \$44 million increase in procurements set-aside for small firms over the like 1958 period.

TAX DEPRECIATION SYSTEM—Plant modernization would be encouraged and business men could meet foreign competition more effectively if our present tax depreciation system were overhauled.

The National Chamber of Commerce called for major revision of the system in presenting testimony before the House Ways and Means Committee. The Committee is considering Administration bills (H. R. 10491 and 10492) which would treat gains from the sale or exchange of depreciable tangible personal

IMPORTANT AREAS—That aviation and defense are two most significant areas for the electronics industry was emphasized by the annual spring meeting of the Electronic Industries Association in mid-March in Washington. Administrator E. R. Quesada of the Federal Aviation Agency and Major General Ralph T. Nelson, Chief Signal Officer of the Army, were the two major speakers at the session. As is well known, the Federal Aviation Administrator is fully cognizant of the need for a most comprehensive program of electronic aids and systems for jet flying safety and traffic control. General Nelson presented the requirements of the military services. A feature of the EIA meeting was a government-industry seminar evaluating defense market planning and methods to speed up production of new weapons systems.

COMPONENTS CONFERENCE—The first report of the Department of Defense on its component reliability program will feature the 1960 Electronic Components Conference to be held in Washington May 10-12. The conference's seven sessions will be devoted to an exchange of ideas and discussion of concepts and developments anticipated in the future. A principal speaker will be Maj. Gen. Earle F. Cook, Deputy Chief Signal Officer of the Army. The conference is sponsored jointly by the American Institute of Electrical Engineers, Electronic Industries Association, Institute of Radio Engineers and the Western Electronic Manufacturers Association.

*National Press Building
Washington 4*

ROLAND C. DAVIES

property as ordinary income instead of capital gains.

The Chamber opposed the bills, unless they are coupled with legislation or an improved Treasury program for a more realistic depreciation policy and practice with respect to depreciable lives and salvage adjustments. It was pointed out more is required in major tax depreciation revision than "a simple change in . . . capital gains treatment."

PRICE CONTROL—When prices are free to move up and down, you are better able to determine and adjust to relative scarcities, shifts in demand, changes in cost and the effects of new technology. Thus, prices perform an essential service. When price controls are clamped on, however, this service is weakened or lost.

This was pointed out by a Chamber of Commerce spokesman in urging a Senate Banking Subcommittee to disapprove the Clark bill (S. 2382). It would require the President to hold public hearings on proposed or actual price increases—which appear to him to threaten national economic stability—and to issue factual summaries of such hearings. He may also issue advisory statements.

FIRST CUSTOMER



"Do-it-yourself" data processing was inaugurated in New York City by IBM. Computer time may be rented by the hour. Personnel from Shell Oil Co. are shown using the equipment themselves.

AUTOMATION IN THE GOVERNMENT — The groundwork and first phase of a massive transition to automation is reported in a new Department of Defense publication just released through the Office of Technical Services, Business and Defense Services Administration, U.S. Department of Commerce.

Daily, some 1,200 to 3,500 requests for specific reports reach the Armed Services Technical Information Agency at Arlington Hall, Virginia. Agency operates to provide DOD agencies and their contractors, on request, with copies of research reports done by or for the military agencies. There are nearly a million documents in the ASTIA collection, which is growing at the rate of 30,000 titles per year.

PB 161306 "Automation of Asia," may be ordered from OTS, U.S. Department of Commerce, Washington 25, D. C. It contains 56 pages, price \$1.25.

LATEST ANTI-SUB PROBER called "Sniffer Gear" is now being pushed by the Navy. Submarines are detected from the ionic content of their exhaust fumes.

PRECISION PLATING

OF

**RHODIUM, GOLD OR SILVER
ON ALL METALS
GOVERNMENT SPECIFICATIONS
OR YOUR OWN MAINTAINED**

RICK ELECTROPLATING WORKS

EST. 1919

106 FULTON ST.

NEW YORK 38, N. Y.

Circle 335 on Inquiry Card

ELECTRONIC INDUSTRIES • April 1960

**35,000 SMASHING,
BATTERING IMPACTS—
and still working perfectly!**



**SHURE "TEN-FOUR"
COMMUNICATIONS MICROPHONE**

*proves its incredible durability
in this gruelling destruction test!*



New SHURE "TEN-FOUR" MICROPHONE, with exclusive Armo-Dur housing, and another microphone with standard die-cast metal housing were dragged for miles on a test drive over all kinds of pavements at speeds to 30 mph. In a matter of minutes, it was subjected to greater punishment than a lifetime of severest mishandling and here's the result:



Ten-Four with Armo-Dur Housing virtually unmarked—still performed perfectly!

Standard microphone with die-cast metal housing—cracked, broken, abraded—microphone inoperable.

For the microphone that stands up under severe operating conditions with no loss of high speech intelligibility, be sure to specify the Shure "Ten-Four" when you order your new communications equipment or replacements.

(Can be furnished with "Controlled Magnetic" or carbon cartridge.)

SHURE BROTHERS, INCORPORATED
222 Hartrey Avenue, Evanston, Illinois, Dept. 83-D

HIGHEST QUALITY MICROPHONES—FIXED-STATION AND MOBILE

Circle 91 on Inquiry Card

175

CUES

for Broadcasters

A Tube Change For Gates Remote Control

L. EDWIN RYBAK, Ch. Eng.

WGPA, Bethlehem, Pa.

Engineers are always seeking greater reliability. No piece of equipment is so perfect that it cannot stand some improvement; some increase of reliability.

Stations using the Gates RCM-12 or RCM-14 remote control equipment have probably discovered that

over long distances the telephone line characteristics can cause excessive losses (resulting in insufficient gain at the selective amplifiers; the receiving end. A change in telephone company cable pairs can increase losses, especially if the new cable pair is of smaller gauge wire.

If the gain, at the receiving end, is turned up sufficiently to provide proper control by tones, the noise level and interaction between selective amplifiers can cause erratic operation of the selective amplifiers; holding them on after the tone is removed. The interaction between amplifiers is the greater problem. Partition shields can be installed to minimize interaction. But, the overlap of tones is more difficult to eliminate. However, there is a simple, easy and effective way of overcoming the above enumerated difficulties. And it can be done without the addition of a line amplifier.

To overcome lack of gain in the receiving unit, substitute type 12AT7 tubes for the original type 12AY7. The higher gain of the 12AT7 will provide greater amplification giving the required gain at a lower setting of the receiving unit gain control. This will eliminate or at least minimize interaction between the selective amplifiers.

Service life of the 12AT7 is at least equal to that of the original 12AY7. No wiring changes are needed. Partition shields are unnecessary. No tone overlap occurs because the gain control setting is reduced. Since perfection in the reproduction of the amplified tone is not absolutely necessary, the slight difference in tube type characteristics is unimportant.

Over five years of operation has verified the original thinking and the change has the blessing of Gates Radio Co.

\$\$\$ for Your Ideas

Readers are invited to contribute their own suggestions which should be short and include photographs or rough sketches. Typewritten, double spaced text is requested. Our usual rate will be paid for material used.

BENDIX SR RACK AND PANEL CONNECTOR

with outstanding resistance to vibration

The Bendix type SR rack and panel electrical connector provides exceptional resistance to vibration. The low engagement force gives it a decided advantage over existing connectors of this type.

Adding to the efficiency of this rack and panel connector is the performance-proven Bendix "clip-type" closed entry socket. Insert patterns are available to mate with existing equipment in the field.

Available in general duty, pressurized or potted types, each with temperature range of -67°F to $+257^{\circ}\text{F}$.

Here, indeed, is another outstanding Bendix product that should be your first choice in rack and panel connectors.



FEATURES:

Resilient Insert • Solid Shell Construction • Low Engagement Forces • Closed Entry Sockets • Positive Contact Alignment Contacts—heavily gold plated Cadmium Plate—clear irridite finish • Easily Pressurized to latest MIL Specifications.

SCINTILLA DIVISION
SIDNEY, NEW YORK



Export Sales and Service: Bendix International Div., 205 E. 42nd St., New York 17, N. Y.

Canadian Affiliates: Aviation Electric Ltd., 200 Laurentien Blvd., Montreal 9, Quebec.

Factory Branch Offices: Burbank, Calif.; Orlando, Florida; Chicago, Illinois; Teaneck, New Jersey; Dallas, Texas; Seattle, Washington; Washington, D. C.

GET THE **FACTS!**

USE THIS FREE READER SERVICE CARD

Keep up to date—get the facts about the new products and equipment as they hit the market. ELECTRONIC INDUSTRIES' advertisers will be glad to send you complete literature giving specifications and data relating to those products advertised in this issue. To help you, the new product items, new literature and advertisements in this issue are numbered consecutively, from the front to the back of the book. The extra cards are for the use of your associates with whom you share your copy of ELECTRONIC INDUSTRIES.

Mail Card Below Today For Quick Information On New Products Described in This Issue. No Postage Needed.

FIRST CLASS
PERMIT NO. 36
PHILA., PA.

BUSINESS REPLY MAIL
NO POSTAGE STAMP NECESSARY IF MAILED IN UNITED STATES



POSTAGE WILL BE PAID BY
ELECTRONIC INDUSTRIES
c/o University of Pennsylvania
The Computer Center
P. O. Box 8221
Philadelphia 4, Pennsylvania

Circle the item number, fill in your name, title, company; detach and mail.

Postcard valid 8 weeks only. After that use own letterhead describing item wanted. **APRIL 1960**
Please send me further information on the items I have circled below.

1	2	3	4	5	6	7	8	9	10	11	12	13	14	15	16	17	18	19	20
21	22	23	24	25	26	27	28	29	30	31	32	33	34	35	36	37	38	39	40
41	42	43	44	45	46	47	48	49	50	51	52	53	54	55	56	57	58	59	60
61	62	63	64	65	66	67	68	69	70	71	72	73	74	75	76	77	78	79	80
81	82	83	84	85	86	87	88	89	90	91	92	93	94	95	96	97	98	99	100
101	102	103	104	105	106	107	108	109	110	111	112	113	114	115	116	117	118	119	120
121	122	123	124	125	126	127	128	129	130	131	132	133	134	135	136	137	138	139	140
141	142	143	144	145	146	147	148	149	150	151	152	153	154	155	156	157	158	159	160
161	162	163	164	165	166	167	168	169	170	171	172	173	174	175	176	177	178	179	180
181	182	183	184	185	186	187	188	189	190	191	192	193	194	195	196	197	198	199	200
201	202	203	204	205	206	207	208	209	210	211	212	213	214	215	216	217	218	219	220
221	222	223	224	225	226	227	228	229	230	231	232	233	234	235	236	237	238	239	240
241	242	243	244	245	246	247	248	249	250	251	252	253	254	255	256	257	258	259	260
261	262	263	264	265	266	267	268	269	270	271	272	273	274	275	276	277	278	279	280
281	282	283	284	285	286	287	288	289	290	291	292	293	294	295	296	297	298	299	300
301	302	303	304	305	306	307	308	309	310	311	312	313	314	315	316	317	318	319	320
321	322	323	324	325	326	327	328	329	330	331	332	333	334	335	336	337	338	339	340

YOUR NAME TITLE

FIRM

FIRM ADDRESS

CITY OR TOWN ZONE STATE

ALPHABETICAL LISTING OF

CIRCLE THE NUMBERS OPPOSITE THE NAMES OF THE

- A**
- 144 Acme Electric Corporation—Power supplies
 - 36 Acoustica Associates, Inc.—Ultrasonic equipment and cleaning materials
 - 13 Aerovox Corporation, HI-4 Division—Circuit plate assemblies
 - 140 Airborne Accessories Corporation—Modular control systems
 - 49 Allegheny Ludlum Steel Corporation—Electrical steels
 - 97 Allied Chemical, General Chemical Division—Electronic chemical distribution
 - 145 American Super-Temperature Wire, Inc.—Teflon insulated wire
 - 88 AMP Incorporated—Solderless taper pins
 - 98 Amphol-Horg Cable & Wire Div., Amphol-Horg Electronics Corp.—Coaxial cables
 - 99 Amphol-Horg Electronics Division—Amphol-Horg Electronics Corp.—Printed circuit components
 - 85 ARCO Electronics Inc.—ELMENDO capacitors for distribution
 - 98 Armos Steel Corporation—Thin electrical steels
 - 127 Audio Development Company—Telephone sets
- B**
- 95 Ballantine Laboratories, Inc.—Wide-band sensitive voltmeter
 - 100 Beckman Hershey Division, Beckman Instruments Inc.—Frequency meter
- C**
- 375 Bendix Aviation Corporation, Red Bank Div., Electron Tube Prods.—Backward-wave oscillator tubes
 - 75 Bendix Aviation Corporation, Red Bank Div., Semiconductor Prods.—Power transistors
 - 186 Bipfcher Corporation, The—Diode radiators
 - 77 Biwax Corporation—"Hot Melt" compositions for encapsulating
 - 103 Wiley Electric Co.—Standard
 - 141 Homac Laboratories, Inc.—Beacon magnets
 - 145 Bantion Electronics—Inductance bridge
 - 87 Borg Equipment Division Amphol-Horg Electronics Corp.—Sub-fractional horsepower motors
 - 41 Bourns Inc., Trimpot Division—Trimmer potentiometer
 - 109 Bruno-New York Industries Corp.—Pig tailoring machine
 - 81 Brush Instruments Division of Cleveite Corporation—Portable direct writing recorder
 - 52 Brush Instruments Division of Cleveite Corporation—Direct writing recording systems
 - 74 Bulova Electronics—Crystal controlled shift oscillator
 - 411 Bunnell & Co., Inc.—Toroidal variable coil
 - 72 Busemann Mfg. Div., McGraw Edison Co.—Fuses and fuseholders
- D**
- 131 Dade County Development Department—Plant location assistance
 - 71 Dale Products, Inc.—Precision resistors
 - 70 Delco Radio Division General Motors—60-Amp transistors
 - 40 Deutsch Company, The—DS miniature connectors
 - 122 Dialight Corporation—Pilot lights with built-in resistor
 - 16 Diamond Tool and Horseshoe Company—Electronic pliers
 - 160 DuPont, Electrochemicals Department—Conductive coatings
- E**
- 155 Eisler Engineering Co., Inc.—Welders and accessories
 - 98 Eitel-McCullough, Inc.—Ceramic tetrode
 - 28 Electra Manufacturing Company—Precision carbon film resistor
 - 332 EICO Electronic Instrument Co., Inc.—Kits and electronic catalog
 - 125 Elastic Stop Nut, AGA Div.—Time delay relays
 - 67 Electro Motive Mfg. Co., Inc., The—Mylar-paper dipped capacitors
 - 78 Elgin-Advance Relays Elgin National Watch Company—Crystal can size relays
 - 6 Engineered Electronics Company—Digital system breadboard
- F**
- 13 Fairechild Semiconductor Corp.—Silicon diodes
 - 17 Fansteel Metallurgical Corp.—Tantalum capacitors
 - 18 Fansteel Metallurgical Corp.—Silicon power rectifiers
 - 117 Fairmount Chemical Company, Inc.—Soldering flux
 - 188 Film Capacitors, Inc.—Power supplies
 - 329 Freed Transformer Co., Inc.—Toroidal inductors
 - 160 Fusite Corp., The—Hermetically sealed terminals
- G**
- 42 Garlock Electronic Products, The Garlock Packing Co.—Plastic insulators, sub-miniature tube and transistor sockets, connectors and shapes and parts
 - 60 General Electric Co., Power Tube Department—Voltage tunable magnets
 - 65 General Electric Co.—Receiving tube phototube
 - 8 General Electric Co., Semiconductor Products Dept.—Silicon rectifiers
 - 84 General Instrument Corporation, Semiconductor Division—Silicon rectifiers
 - 90 General Products Corporation—Terminal boards
 - 61 General Transistor Corp.—Testing assistance programming
 - 65 General Transistor Corp.—Testing assistance programming
 - 85 Gertach Products, Inc.—Complex ratio bridge
 - 830 Graphic Systems—Visual control board

Postcard valid 8 weeks only. After that use own letterhead describing item wanted. **APRIL 1960**

Please send me further information on the items I have circled below.

1	2	3	4	5	6	7	8	9	10	11	12	13	14	15	16	17	18	19	20
21	22	23	24	25	26	27	28	29	30	31	32	33	34	35	36	37	38	39	40
41	42	43	44	45	46	47	48	49	50	51	52	53	54	55	56	57	58	59	60
61	62	63	64	65	66	67	68	69	70	71	72	73	74	75	76	77	78	79	80
81	82	83	84	85	86	87	88	89	90	91	92	93	94	95	96	97	98	99	100
101	102	103	104	105	106	107	108	109	110	111	112	113	114	115	116	117	118	119	120
121	122	123	124	125	126	127	128	129	130	131	132	133	134	135	136	137	138	139	140
141	142	143	144	145	146	147	148	149	150	151	152	153	154	155	156	157	158	159	160
161	162	163	164	165	166	167	168	169	170	171	172	173	174	175	176	177	178	179	180
181	182	183	184	185	186	187	188	189	190	191	192	193	194	195	196	197	198	199	200
201	202	203	204	205	206	207	208	209	210	211	212	213	214	215	216	217	218	219	220
221	222	223	224	225	226	227	228	229	230	231	232	233	234	235	236	237	238	239	240
241	242	243	244	245	246	247	248	249	250	251	252	253	254	255	256	257	258	259	260
261	262	263	264	265	266	267	268	269	270	271	272	273	274	275	276	277	278	279	280
281	282	283	284	285	286	287	288	289	290	291	292	293	294	295	296	297	298	299	300
301	302	303	304	305	306	307	308	309	310	311	312	313	314	315	316	317	318	319	320
321	322	323	324	325	326	327	328	329	330	331	332	333	334	335	336	337	338	339	340

YOUR NAME TITLE

FIRM
 FIRM ADDRESS
 CITY OR TOWN ZONE STATE

FIRST CLASS
 PERMIT NO. 36
 PHILA., PA.

BUSINESS REPLY MAIL
 NO POSTAGE STAMP NECESSARY IF MAILED IN UNITED STATES

POSTAGE WILL BE PAID BY
ELECTRONIC INDUSTRIES

c/o University of Pennsylvania
 The Computer Center
 P. O. Box 8221
 Philadelphia 4, Pennsylvania



ADVERTISERS IN THIS ISSUE

ADVERTISERS FROM WHOM YOU DESIRE FURTHER INFORMATION

146 Greibach Instruments Corporation—Precision meters

H

- 34 Hewlett-Packard Company—Distortion analyzer
- 74 Hewlett-Packard Company—Voltmeters, ammeters and ohmmeters
- 114 Hoffman & Co., H. L.—Special tubes
- 82R Houston Instrument Corporation—X-Y recorder
- 2 Hughes, Semiconductor Division—Silicon switching diodes
- 4 Hughes, Vacuum Tube Products Division—Storage tubes
- 5 Hughes, Industrial Systems Division—Memory-type oscilloscope

PROFESSIONAL ENGINEERING OPPORTUNITIES

- 504 Bendix Aviation Corporation, Kansas City Division
- 546 Gates Radio Company
- 506 General Electric Co., Communication Products Dept.
- 507 General Electric Co., Missile & Space Vehicle Dept.
- 501 Lockheed/Missiles and Space Division
- 502 Magnavox Co., The
- 503 Motorola, Inc., Personnel Division

I

- 103 Ideal Precision Meter Co., Inc.—Panel meters
- 85 Illumitronic Engineering—Plastic rod, tubing, sheet, harnessing and cabling
- 81 Indiana Steel Corp.—Ceramic speaker magnets
- 136 Industrial Division, Chamber of Commerce, Hollywood, Florida—Industrial advantages
- 128 Industrial Electronic Engineers, Inc.—Digital display with one-plane presentation
- 152 Industrial Exhibitions Ltd.—Instruments—Electronic automation exhibition
- 834 Instruments for Industry, Inc.—Video amplifiers

J

- 80 Jennings Radio Manufacturing Corporation—Vacuum capacitors and relays
- 126 Johnson, E. F.—Nylon connectors
- 116 Jones Division, Howard H., Cinch Manufacturing Company—Plugs & sockets

K

- 146 Keithley Instruments—Micro-microammeter
- 162 Kester Solder Company—Resin-core solder
- 23 Keystone Carbon Company—Thermistors
- 101 Klein & Sons, Mathias—Pliers
- 327 Kulka Electric Corp.—Terminal blocks with selective terminal styles

L

- 102 Lavoie Laboratories, Inc.—Electronic counter
- 129 LeI, Inc.—Mixer-preamplifiers
- 61 Lens Electric Co.—Shielded cables stereo HI-FI

M

- 58 Magnetics, Inc.—Tape wound cores
- 53 Manson Laboratories, Inc.—Crystal frequency oscillator
- 141 Marconl Instruments—Capacity bridge
- 154 Markite Corporation—Conductive plastic potentiometers
- 121 M-Kinstry Metal Works, Inc.—Panel enclosures
- 187 Measurements, A McGraw-Edison Division—Mecycycle meter
- 14 Microtran Company, Inc.—Transformers
- 108 Microwave Associates, Inc.—Voltage variable capacitor
- 127 Miller Company, J. W.—Subminiature R.F. chokes
- 107 Minnesota Mining and Manufacturing Co.—Magnetic products, instrumentator tape

Employment—Use the handy card below to get more information on the engineering positions described in the "Professional Opportunities" Section which begins on page 225 of this issue.

Postcard valid 2 weeks only. After that use own letterhead describing item wanted.

APRIL 1960

PROFESSIONAL ENGINEERING OPPORTUNITIES

Please send me further information on the engineering position I have circled below.

501	506	511	516	521
502	507	512	517	522
503	508	513	518	523
504	509	514	519	524
505	510	515	520	525

YOUR NAME TITLE

HOME ADDRESS

CITY or TOWN ZONE STATE

NEW Subscription Order

APRIL 1960

Please enter a new complimentary subscription to ELECTRONIC INDUSTRIES

Company Name:

Name: Position

Company Address:

City: Zone State

Specific Products Manufactured

Postcard valid 2 weeks only. After that use own letterhead describing item wanted.

APRIL 1960

Please send me further information on the items I have circled below.

1	2	3	4	5	6	7	8	9	10	11	12	13	14	15	16	17	18	19	20
21	22	23	24	25	26	27	28	29	30	31	32	33	34	35	36	37	38	39	40
41	42	43	44	45	46	47	48	49	50	51	52	53	54	55	56	57	58	59	60
61	62	63	64	65	66	67	68	69	70	71	72	73	74	75	76	77	78	79	80
81	82	83	84	85	86	87	88	89	90	91	92	93	94	95	96	97	98	99	100
101	102	103	104	105	106	107	108	109	110	111	112	113	114	115	116	117	118	119	120
121	122	123	124	125	126	127	128	129	130	131	132	133	134	135	136	137	138	139	140
141	142	143	144	145	146	147	148	149	150	151	152	153	154	155	156	157	158	159	160
161	162	163	164	165	166	167	168	169	170	171	172	173	174	175	176	177	178	179	180
181	182	183	184	185	186	187	188	189	190	191	192	193	194	195	196	197	198	199	200
201	202	203	204	205	206	207	208	209	210	211	212	213	214	215	216	217	218	219	220
221	222	223	224	225	226	227	228	229	230	231	232	233	234	235	236	237	238	239	240
241	242	243	244	245	246	247	248	249	250	251	252	253	254	255	256	257	258	259	260
261	262	263	264	265	266	267	268	269	270	271	272	273	274	275	276	277	278	279	280
281	282	283	284	285	286	287	288	289	290	291	292	293	294	295	296	297	298	299	300
301	302	303	304	305	306	307	308	309	310	311	312	313	314	315	316	317	318	319	320
321	322	323	324	325	326	327	328	329	330	331	332	333	334	335	336	337	338	339	340

YOUR NAME TITLE

FIRM

FIRM ADDRESS

CITY or TOWN ZONE STATE

- 89 Minnesota Mining and Manufacturing Co. Minomac Division—Magnetic tape instrumentation recorder/reproducer
- 88 Monadnock Mills—Hard-anodized insulator wafers
- 80 Motorola, Inc. Semiconductor Products Division—5 AMP power transistors
- 106 Multhead Instruments, Inc.—Motor tachometers

N

- 124 National Ultrasonic Corp.—Ultrasonic cleaning equipment

- 12 New Departure Division, General Motors Corp.—Ball bearings
- 85 Non-Linear Systems, Inc.—Digital voltmeter

O

- 93 Ohmite Manufacturing Company—Variable transformers

P

- 149 Pennwood Numechron Co.—Digital clock
- 21 Philman Laboratories, Inc.—Tuning fork

- Philco, Lansdale Division—Switching silicon transistors
- 154 PIC Design Corp.—Master catalog of precision instrument parts
- 62 Polarad Electronics—Antenna pattern microwave receiver
- 63 Polarad Electronics—Microwave power source

R

- Radio Materials Company—Ceramic die capacitors
- 119 Raytheon, Industrial Components Division—Bandpass filter arrays
- 385 Riek Electroplating Works—Precision plating
- 89 Roha Manufacturing Co.—Communication tower
- 123 Rotron Manufacturing Company—Blowers

S

- 56 Sangamo Electric Company—Capacitors
- 81 Sarkis Tarzian, Inc., Semiconductor Division—Silicon power rectifiers
- 92 Scintilla Division, Bendix Aviation Corporation—Rack and panel connector
- 142 Sugal, Edward—Eyelet attaching machine
- 91 Shure Brothers, Incorporated—Communications microphone
- 331 Sisco Metachemical, Inc.—Electroplating equipment
- 94 Spectrol Electronics Corporation—Linear and non-linear precision potentiometers
- 109 Speer Resistor Division, Speer Carbon Company—Fixed composition resistors
- 5 Sprague Electric Company—Switching transistors
- 112 Sprague Electric Company—Interference, susceptibility, and integration problem assistance
- 106 Stackpole Carbon Company—Slide switches
- 125 Stromberg-Carlson, A Division of General Dynamics—Telephone relays

**FIRST CLASS
PERMIT NO. 36
PHILA., PA.**

BUSINESS REPLY MAIL
NO POSTAGE STAMP NECESSARY IF MAILED IN UNITED STATES

**POSTAGE WILL BE PAID BY
ELECTRONIC INDUSTRIES**

c/o University of Pennsylvania
The Computer Center
P. O. Box 8221
Philadelphia 4, Pennsylvania



**FIRST CLASS
PERMIT NO. 36
PHILA., PA.**

BUSINESS REPLY MAIL
NO POSTAGE STAMP NECESSARY IF MAILED IN UNITED STATES

**POSTAGE WILL BE PAID BY
ELECTRONIC INDUSTRIES**

CHESTNUT & 54th STS.
PHILADELPHIA 39, PA.

Chilton Company

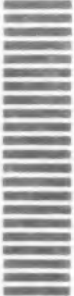

**FIRST CLASS
PERMIT NO. 36
PHILA., PA.**

BUSINESS REPLY MAIL
NO POSTAGE STAMP NECESSARY IF MAILED IN UNITED STATES

**POSTAGE WILL BE PAID BY
ELECTRONIC INDUSTRIES**

c/o University of Pennsylvania
The Computer Center
P. O. Box 8221
Philadelphia 4, Pennsylvania



- 83 Struthers-Dunn, Inc.—Relays—All types
- 10 Superior Tube Company—Cathode alloys of nickel, tungsten and zirconium
- 134 Sylvania Subsidiary of General Telephone & Electronics, Semiconductor Division—Germanium switching diode
- 100 Synthene Corporation—Laminated plastics
- 139 Syntron Rectifier Division, Subsidiary of Link-Belt Company—Silicon rectifiers

T

- 37 Tapes Group, Thompson Ramo Wooldridge, Inc.—Static inverter and voltage regulator
- 35 Taylor Fibre Co.—Laminated plastics
- 104 Texas Instruments Incorporated, Semiconductor Components Division—Tantalum capacitors
- 32 Tinnerman Products, Inc.—Tubular clip
- 115 Trak Electronics Co.—Wideband RF transformer
- 78 Transiltron Electronic Corporation—Silicon diodes
- 80 Transiltron Electronic Corporation—Silicon carbide rectifiers
- 47 Tung-Sol Electric Inc.—Miniature lamps

U

- 118 Ultrasonic Industries, Inc.—Ultrasonic cleaner
- 82 United Transformer Corp.—Filters for all applications

V

- 28 Valcor Engineering Corp.—Sil-noid valves
- 11 Vapor Heating Corporation, Vap-Air Aeronautical Products Division—Cooling effect detector
- 145 Varian Corporation—High-dielectric insulating tubing & sleeving
- 43 Varian Associates—Backward wave oscillators
- 80 Vector Electronic Company—Structures for mounting circuitry
- 44 Victoreen—Corona type voltage regulator tubes
- 69 Vitromon—Micro-miniature ceramic capacitors

W

- 103 Waveline, Inc.—Microwave instruments and components
- 87 Wayne Kerr Corporation—RF bridge, VHF admittance bridge



for the service
you need...
for the sizes you want...

SPEER RESISTORS

You're sure to find the sizes and types you want in Speer's complete line of 1/2-, 1- and 2-watt fixed composition resistors, which meet or exceed the requirements of specifications MIL R11 and RS 172. The fast, efficient service for which Speer has gained a wide reputation can also help you eliminate costly production delays. So next time, specify Speer! Speer now offers these new sizes:

Speer Type	MIL Style	Rating in watts	Body		Lead	
			Nominal Diameter	Nominal Length	Wire Size	Nominal Length
SR 1/2	RC 20	1/2	.138	.390	A. W. G. # 20	1 1/2
SR 1	RC 32	1	.225	.562	# 18	1 1/2
SR 2	RC 42	2	.312	.688	# 17	1 1/2

Other Electronics Divisions of Speer Carbon Company
Jeffers Electronics, Du Bois, Pa.
Onondaga Electronics, Syracuse, N. Y.



Speer Resistor Division
Speer Carbon Company, Bradford, Pennsylvania

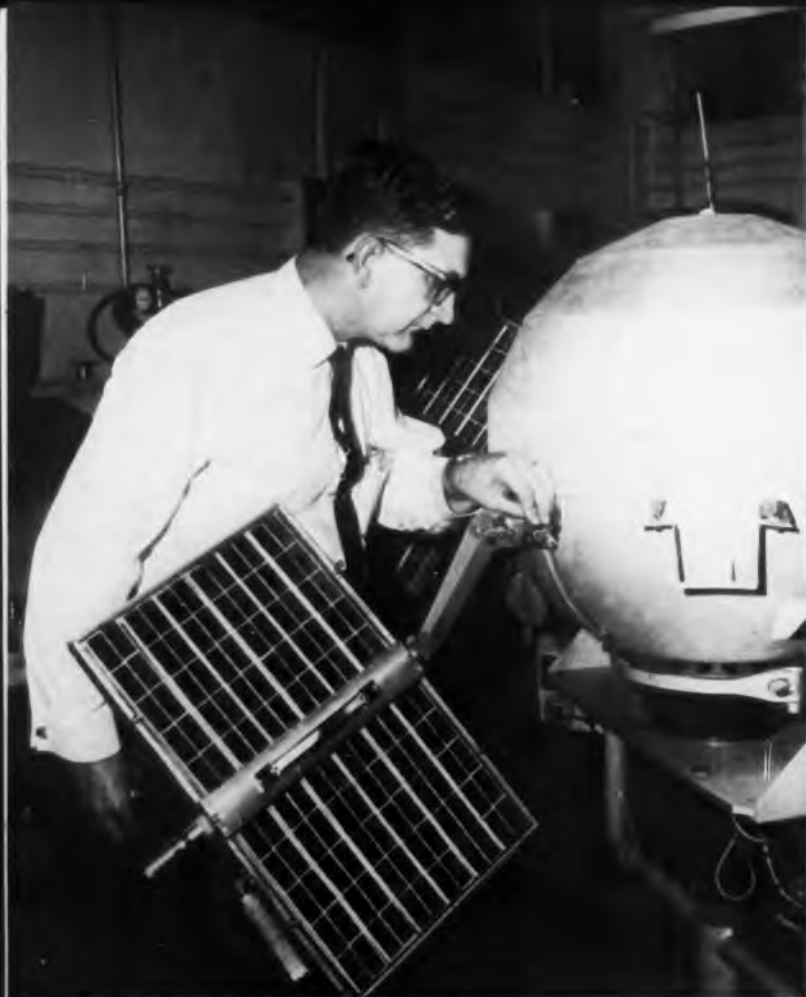

(Left) Technician checks one of the minute wires that feed power from the solar-cell paddles to batteries within space probe; (right, top) the "telebit" communications system is hooked up by its de-



veloper, J. E. Taber of STL; (right, bottom) nestled atop the third stage of its rocket booster and hooded by half of the fibreglass shroud, the brightly-painted shell of Pioneer V awaits final checkout.

Pioneer V...U. S. Solar Satellite #2

THURST into space on the morning of Friday, March 11th, 1960, from Cape Canaveral, Fla., *Pioneer V* is one of the most advanced space probe vehicles launched to date.

Spherical in shape, the satellite weighs approximately 91 lbs. Ringed inside its 26 in. diameter is the instrumentation, perfectly balanced for stability on a fibreglass platform. An antenna extends from the top of the payload to receive commands from earth and transmits collected data.

Pioneer V will collect information on meteorite impacts, the Earth-Venus orbit magnetic field,

(Continued on page 184)

Three units of a search-coil magnetometer are surprisingly small considering the importance of their function in the new space laboratory. The 1 lb. device collects magnetic field data.





Enlarged photograph of raw crystal



BULOVA CRYSTAL CONTROLLED ULTRA-STABLE SHIFT OSCILLATORS

Bulova shift oscillators are all that any electronics engineer could ask for in miniature crystal controlled packages!

Consider this new Bulova custom designed 18.5mc shift oscillator. Here's an assembly of two oscillators operating at 18.5mc. One is fixed, with a 1 pp 10⁷ stability. The other is a variable with equal stability, 1 pp 10⁷. The shift is accomplished by means of a variable air capacitor. How-

ever, the same shift, at the same frequency, can be affected with a "Varicap**".

This new ultra-stable shift oscillator is only one of many recent advances made by Bulova Electronics. For information on these specific units, or on how Bulova experience, in mastering component and system reliability, can help your program, write—

Department A-1361, Electronics Division, Bulova, 40-08 62nd Street, Woodside 77, New York

**TM: Pacific Semiconductor, Inc.



ACOUSTICA ULTRASONIC CLEANING REPLACES OLDER METHODS!



Texas Instruments, Martin Company, Bell Telephone Laboratories and many other firms are turning to Acoustica for better cleaning ultrasonically!

Now you can clean better and faster. In seconds—all dirt, dust, and soils are “cavitated” away ultrasonically. No scrubbing, no disassembling, maintenance costs are sharply reduced. Acoustica ultrasonic systems are application tested and *certified* for your particular needs. Send for details of complete Acoustica line of the most advanced ultrasonic equipment and cleaning chemicals. Acoustica Associates, Inc., Fairchild Court, Plainview, N. Y., 10400 Aviation Blvd., Los Angeles, Calif.



acoustica
ULTRASONIC CLEANING SYSTEMS

Pioneer V

and the temperature of the payload during flight.

The payload will reach the orbit of Venus approximately 130 days after launch. The planetoid will provide comprehensive data on the environs of the earth and Venusian space. Because experiments in such important areas as radiation, magnetic field and radio propagation are being conducted simultaneously, the interactions of these phenomena and their effects on one another can be studied for the first time.

Communications over an interplanetary distance of 50-million miles may be achieved for the first time in history.

By combining a “telebit” computer with a 150-watt transmitter, scientists at Space Technology Laboratories Inc., payload designers, hope to collect a variety of data in areas of previously unexplored space.

The miniature memory unit will store and calculate scientific information on the orbital path of Venus before sending it back to Earth via radio. The 150-watt transmitter is the most powerful radio ever flown in a Western deep-space probe.

With its transmitter turned off, “telebit” collects, stores, and tallies data collected by the deep-space planetary fact-finding instrumentation all at the same time. On command from the ground, “telebit” transmits information it collects through the large transmitter to Earth.

In spite of the complexity and greatly extended capability of this advanced, unprecedented telemetric system, the size of “telebit” and its interplanetary radio transmitter is surprisingly small. This was accomplished by miniaturization and modular construction, resulting in light-weight, and a high density packing factor.

Pioneer V's rich and colorful paint scheme, resembling the work of a geometric artist, was carefully calculated to counteract the temperature extremes of space and maintain an operable temperature inside the vehicle's instrumentation compartment.

FAST LOCAL B&A® SERVICE

meets your electronic chemical requirements
with same day or overnight delivery!



Yes, you can always count on prompt service when you order Baker & Adamson—American's leading line of chemicals for the electronics industry. Here's why:

Nationwide Service! General Chemical has 24 stock points for its "B&A" electronic grade chemicals. Strategically located in major industrial centers, they can provide quick, dependable delivery of electronic chemicals anywhere in the nation. In most cases, your order will be en route to you the same day we receive it.

Stocks built to meet your requirements! General Chemical offers America's most complete line of "Electronic Grade" chemicals . . . quality products especially made to meet every requirement for chemical purity and uniformity. Chances are your local B&A supply point already has most or all of the electronic chemicals you are now using. In addition, we will be glad to build local stocks to meet your special month-to-month requirements.

"One-stop shopping" saves you time! By filling all your electronic chemical needs at your local B&A supply point you save time—simplify ordering, record-keeping, inventory and bookkeeping. And you're sure of the highest in chemical quality and purity!

For further information, write or phone the nearest B&A supply point listed at right.

Albany, N. Y.	East St. Louis, Ill.
Atlanta, Ga.	Kennewick, Wash.
Baltimore, Md.	Houston, Texas
Baton Rouge, La.	Los Angeles, Calif.
Birmingham, Ala.	Milwaukee, Wisc.
Boston, Mass.	*Montreal, Quebec
Bridgeport, Conn.	Philadelphia, Pa.
Buffalo, N. Y.	Pittsburgh, Pa.
Charlotte, N. C.	Richmond, Va.
Chicago, Ill.	San Francisco, Calif.
Cleveland, Ohio	*Toronto, Ontario
Detroit, Mich.	*Vancouver, B. C.

*In Canada: Allied Chemical Canada, Ltd.

BAKER & ADAMSON®
"Electronic Grade"
Chemicals



GENERAL CHEMICAL DIVISION

40 Rector Street, New York 6, N. Y.

RFI Detection

(Continued from page 173)

of the vernier receiver input of i-f frequency. As the synthesizer will produce almost any desired frequency, in most instances only a coaxial mixer need be provided. The center frequency of the control receivers will probably lie above 1 or 2 kmc. Center frequency of the vernier receivers will probably be somewhere between 150 to 400 mc.

The control receivers are used in conjunction with the vernier receivers for receiver assignment. For example, if 10 signals are observed on the control receiver, the vernier receiver can be set to any one of these signals merely by moving a marker on the control receiver panoramic display. The data from each one of the vernier receivers is fed into an analysis and detection unit. This data is then fed to the data translator. At this point, all data is converted to binary coded decimal for suitable recording or display.

The data handling system may be divided into five functional sec-

tions: (1) the data translator which places incoming data in standard binary coded decimal form, (2) a recording unit which records the data on magnetic tape, (3) a display unit which presents the data to the operator in visual form, (4) a data printer which tabulates selected data either from magnetic tape playback or in real time, and (5) a data storage unit which remembers identified data for control purposes. The data converters with the associated panoramic receiver and oscilloscope display, offers several modes of operation. In the panoramic mode all 100 mc wide frequency bands are swept in one second repetitively.

The frequency of any signal in the band is recorded on magnetic tape, subject to acceptance and rejection information stored by the operator. The oscilloscope display presents exactly the same data as the usual panoramic display. Rejected frequencies may be blanked out of the display or accepted frequencies only may be displayed. Two types of acceptance and rejection are provided, single fre-

quency or frequency band. Band acceptance or rejection requires that the start and stop frequency information be fed into the data storage system from the console. This can be done either by programmed tape or by individual frequency selection.

Modes of Operation

In the manual mode of operation, the oscilloscope display is entirely independent of the recording unit and is employed for visual presentation. Whatever data are presented on the display unit may be recorded by manual command. In this mode the receiver is manually slewed to an r-f signal which the receiver then locks on. The various characteristics, frequency, bearing, signal strength, etc., of that signal are displayed by the display system. Acceptance and rejection criteria are observed.

The signal-seeking or automatic-search mode of operation is basically similar to the manual mode. The receiver automatically slews to a signal and locks on. The various parameters are then displayed and

SPECTROL PRECISION POTENTIOMETERS



Two valid reasons why **SPECTROL** delivers better non-linear pots *faster!*

REASON

1

COMPUTER DESIGNED



Spectrol uses an IBM 610 computer to turn out complex non-linear precision pots in record time, both single-turn and multi-turn. This in itself saves weeks of time, assures more accurate performance. Spectrol alone maintains a computer on the premises for this purpose.

How It Works. Design information in the form of X and Y coordinates or mathematical equations describing the particular parameters of a given non-linear function is entered in the computer. Previously programmed general equations automatically compute from these data points manufacturing directions in terms of winding equipment settings, cam angle and radii. An electric typewriter prints out winding machine set-up information on a form which is sent to production. Simultaneously, a punched tape is made to store data for repeat requirements.

recorded. The receiver then slews to the next signal and the cycle is repeated. As with the manual mode, both display and recording of data are under control of acceptance and rejection information stored in the storage unit.

Coarse frequency information is obtained by counting the pulses which are externally derived from time base. The 100 MC marker at the start of the sweep opens a gate. This allows the pulses to advance the counter from 000 to a full count of 999, at which point the gate is closed. Any video pulse is thus associated in frequency with the next lower integral megacycle. The first digits of frequency are obtained from contact closures on the receiver band switch. This is determined by the position that the vernier receiver is occupying.

Fine frequency information is obtained by use of the synthesizer. The primary function of the synthesizer is to provide the entire system with stable reference frequencies accurate to at least 10^9 .

As any accurate frequency can be generated, a zero beat can be obtained and the frequency from the synthesizer read out to the display unit and recorded if desired.

Initiation for the recording process may originate by operator's choice. The display unit affords a visual decimal presentation of all information such as frequency, bearing, signal strength, etc. The data printer transcribes to a printed page, data which has been recorded on the tape, or which is required for real time presentation. Thus, data may be displayed on a presentation board composed of readout devices similar to Nixies, it may be recorded on magnetic tape, or it may be printed out on a data printer unit.

The storage unit provides information with respect to signal lockout or reject or for purposes of sorting the magnetic tape data. This may be necessary when only certain information is desired. For example, if it becomes necessary to examine the signal density between frequencies of, for example, 200 to 250 MC, records taken over any in-

terval of time can be set back into the system for printout.

Summary

By 1959 a new spectrum surveillance system designed on functional concepts through exploratory engineering was needed. In June, a rudimentary system with automatic search capabilities was implemented for the frequency range from 40 to 1000 MC. The system provided frequency measurement, signal strength measurement, direction finding and a detection threshold of -120 dbm.

This facility was implemented to (1) evaluate system parameters for future FCA planning and programming, and (2) to provide immediate necessary support for WS-486L, Project 1770. Success with the new techniques has resulted in the immediate implementation of the Interference Detection System at AMR.

This article was originally presented at the Fifth Conference on Radio Interference Reduction and Electronic Compatibility conducted by Armour Research Foundation in October, 1959.

REASON

2

LIBRARY OF TAPES



Spectrol also maintains an extensive library of tapes with programs for the solution of general non-linear potentiometer design equations, saving hours of calculation time and providing error free results. Again, you receive a superior product sooner.

Let us know your design requirements. With Spectrol's time-saving techniques, you can expect a quote within a few days.

Contact your Spectrol representative for more details about Spectrol linear and non-linear precision potentiometers, or write direct. A 4-page specifications brochure is yours for the asking. Please address Dept. 44.

SPECTROL

ELECTRONICS
CORPORATION

1704 South Del Mar Avenue • San Gabriel, California



TARGET...
better than
99.99%
switching
transistor
survival

CBS NPN germanium switching transistors are being delivered to a military project specification with an objective of 99.99% survival in 1000 hours. This means that only one transistor in 10,000 can fail due to parameter changes . . . and catastrophic failure rate is even lower.

CHECK THESE SPECIAL RELIABILITY CONTROLS

100% PRODUCTION

- Every crystal identified throughout production
- Die thickness maintained within ± 0.00005 inch
- Contamination eliminated by "dry-box" assembly
- Microscopic inspection of all critical operations
- Aging at 100°C for 200 hours
- Temperature cycling from -65° to 85°C
- Detergent bomb testing at 100 psig
- Radflo testing to 10^{-12} standard cc/sec

RELIABILITY

- Voltage-biased, 55°C on 1000 hour life
- Storage, 85°C on 1000 hour life
- Intermittent operation, 150 mw for 1000 hour life
- Samplings 100 times larger than MIL-T-19500A
- Product identified with crystal for field survival analysis

ENVIRONMENTAL TESTING

- Shock, 500 G for 1 millisecond
- Vibration, 20 G for 20-2000 cps
- Soldering of leads, 260°C for 10 sec
- Fatigue of leads, 16 oz. pull, three 90° arcs

YOUR INQUIRIES INVITED

Inquiries regarding *your* special reliability requirements for NPN germanium switching transistors are invited. Please call direct . . . or your local sales office.



semiconductors

CBS ELECTRONICS, Semiconductor Operations • A Division of Columbia Broadcasting System, Inc.

Sales Offices: Lowell, Mass., 900 Chelmsford St., GLenview 4-0446 • Newark, N. J., 231 Johnson Ave., TAibert 4-2450 • Melrose Park, Ill., 1990 N. Mannheim Rd., FStebrook 9-2100 • Los Angeles, Calif., 2120 S. Garfield Ave., RAYmond 3-9081 • Atlanta, Ga., Cary Chapman & Co., 672 Whitehall St., JACKson 4-7388 • Minneapolis, Minn., The Heimann Co., 1711 Hawthorne Ave., FEderal 2-5457 • Toronto, Ont., Canadian General Electric Co., Ltd., LEannor 4-6311

Electronic Sources

Up-to-the-minute abstracts of articles appearing in
the leading foreign electronic engineering journals



ANTENNAS, PROPAGATION

Effect of Feeder Parameters on the Noise Factor and Sensitivity of a Receiving System. L. M. Masbbita. "Radiotekh," V. 15, No. 1 (1960). 10 pp. The use of feeders in modern ultrashort wave communication systems becomes inevitable. It is, therefore, necessary to know for the design and planning of such systems the effect of feeders on the systems' parameters. The effect of the feeder parameters on the noise factor and sensitivity of the system as a whole is found by means of determining the noise factor and transfer ratio of the feeder itself. The optimum matching of the receiver and the technique of determining the relative noise temperature of the antenna are also dealt with. (U.S.S.R.)

Receiving Medium-Wave Single-Conductor Traveling-Wave Antennas. C. P. Belousov and V. G. Yampol'skii. "Radiotekh," V. 15, No. 1 (1960). 10 pp. Single-conductor traveling-wave (Beveridge) antennas are well-known and widely used, but there does not exist any detailed information on its parameters in the medium wave range and the technique of its design has not been fully developed. This article analyzes the directional properties of the antenna, provides formulas for the radiation patterns, directive gain, and the antenna's physical parameters for given conditions. Full sample calculations for certain types of such antennas are given. (U.S.S.R.)

The Control Loops for Feeders. G. P. Nauheim and H. J. Prieur. "rt," Jan. 1960. 5 pp. A simplified technique of control system engineering is applied to the glassfeeder (fore-hearth). The control requirements are derived from the process data and an optimal control system is based on that. General types of instrumentation, suitable for this purpose, are discussed. (Germany.)

Rhombic Antennas with Optimum Performance. P. Miram and E. Palm. "Nach. Z." Feb. 1960. 10 pp. Rhombic antennas used so far have not yet reached the theoretical limit of optimum performance. This is partly attributable to their design. For this purpose, the radiation impedance and the attenuation factor have been investigated and improved formulae for the statements of theoretical calculations are proposed. (Germany.)



CIRCUITS

Relative Resistance to Noise of Two-Channel Correlation Receiver and a Receiver with a Square-Law Detector. V. B. Voyutskii. "Radiotekh," V. 15, No. 1 (1960). 4 pp. In comparing the two methods, the instability of the noise and the gain of the amplifiers should be taken into account. The article shows theoretically and by oscillograms obtained under working conditions the advantages of the correlation double channel receiver as compared with the single channel receiver with the square-law detector. When noise makes reception impossible in the single

channel receiver, signals are still readable in the correlation receiver. Certain systems of correlation reception provide immunity not only from internal noise of the receiver, but also from transmitter noise and under certain conditions from the noise picked up in the transmission media. (U.S.S.R.)

Emitter Follower in Pulse Operation. B. N. Faizulaev. "Radiotekh," V. 15, No. 1 (1960). 8 pp. The emitter follower is widely used in radio, electronic and computer techniques, performing roughly the same functions as a cathode follower, whose transient processes due to large signals have been fully analyzed, despite their great intricacy. This article attempts to perform the same function for a junction-transistor emitter-follower with a capacitive load operating on a large pulse signal. Both linear and nonlinear conditions of operation are examined, thus making the conclusions applicable to a wide sphere of the emitter follower application. Equivalent circuits of the emitter and its input and output impedances are provided, and its transmission characteristic analyzed. (U.S.S.R.)

The Problem of Designing Bridge Circuits by Means of the Dead-Short Method. A. Tolchan. "Avto. i Tel." Jan. 1960. 11 pp. Net structure as a general representation of a bridge circuit is proposed. Sufficient sign of possibility of designing a bridge circuit by means of the dead-short method is defined from the analysis of the complete net. (U.S.S.R.)

Resistance Voltage Dividers for Impulse Tests. K. Auleytner, R. Wlodarski. "Prace ITR," Vol. 5, No. 3. 39 pp. The present paper analyzes the problems of measuring the amplitude and shape of impulse voltages with accuracy sufficient for practical purposes. The measuring errors and the causes of their occurrence are discussed. (Poland.)

A Certain Problem in Solving Linear Circuits with Inductive Couplings Between Branches. T. Kaczorek. "Prace ITR," Vol. 5, No. 3. 11 pp. In the present paper, formulae are deduced enabling us to determine parameters of the circuits equivalent to a circuit composed of in parallel branches and one series branch. Each parallel branch contains an ideal source of voltage and impedance. Between all the branches there occur couplings of an inductive character. (Poland.)

Investigations on Nonhomogeneous Periodic Delay Lines. H. Wehrig. "Nach. Z." Feb. 1960. 11 pp. Various types of delay lines with a 3-dimensional grid structure have been investigated. The suitability of such delay lines for use as frequency controlling elements in a backward wave oscillator for the millimetric-wave region has been determined. (Germany.)

Parametric Amplifiers. H. Urbarz. "Nach. Z." Feb. 1960. 7 pp. The theory of parametric frequency-power relations and the state of the art of variable reactance amplifiers as far as August 1959 is summarized with the aid of the available literature. (Germany.)

Decimetric Wave Reactance Circuits Consisting of Electromagnetically Coupled Transmission Lines. O. Gold. "Nach. Z." Jan. 1960. 8 pp. General cascade circuit equations for reactance circuits using coupled transmission lines are derived from the transmission line equation for a coupled lossless three conductor system. When two ports of a four port network con-

REGULARLY REVIEWED

AUSTRALIA

AWA Tech. Res. AWA Technical Review
Proc. AIRE. Proceedings of the Institute of Radio Engineers

CANADA

Can. Elec. Eng. Canadian Electronics Engineering
El. & Comm. Electronics and Communications

ENGLAND

ATE J. ATE Journal
BBC Mono. BBC Engineering Monographs
Brit. C&E. British Communications & Electronics
E. & R. Eng. Electronic & Radio Engineer
El. Energy Electrical Energy
GEC J. General Electrical Co. Journal
J. BIRE. Journal of the British Institution of Radio Engineers
Proc. B.I.E.E. Proceedings of Institute of Electrical Engineers
Tech. Comm. Technical Communications

FRANCE

Ann. de Radio. Annales de Radioelectricite
Bull. Fr. El. Bulletin de la Societe Francaise des Electriciens
Cab. & Trank. Cables & Transmission
Comp. Rend. Comptes Rendus Hebdomadaires des Sciences
Onde. L'Onde Electrique
Rev. Tech. Revue Technique
Telonde. Telonde
Toute R. Toute la Radio
Vide. Le Vide

GERMANY

AEG Prog. AEG Progress
Arc. El. Uber. Archiv der Elektrischen Uebertragung
El. Rund. Elektronische Rundschau
Frequenz
Hochfreq. Hochfrequenztechnik und Elektroakustik
NTF. Nachrichtentechnische Fachberichte
Nach. Z. Nachrichtentechnische Zeitschrift
Rundfunk. Rundfunktechnische Mitteilungen
Vak. Tech. Vakuum-Technik

POLAND

Arch. Auto. i Tel. Archiwum Automatyki i Telemehaniki
Prace ITR. Prace Instytutu Tele- i Radiotechnicznego
Roz. Elek. Rozprawy Elektrotechniczne

USSR

Avto. i Tel. Avtomatika i Telemehanika
Radio. Radio
Radiotekh. Radiotekhnika
Rad. i Elek. Radiotekhnika i Elektronika
IZ. Acad. Bulletin of Academy of Sciences, USSR

Photocopies of all foreign articles are available at 75 cents per page, remitted with order. Unless otherwise indicated, articles appear in language native to country of origin.

A reprint of this section, "International Electronic Sources" is available without charge.

Requests for the above should be sent, on company letterhead, to:

Electronic Sources Editor
ELECTRONIC INDUSTRIES
Chestnut & 56th Sts.
Philadelphia 39, Pa.

Synthane makes and fabricates
laminated plastics



Why worry about fabricating laminated plastics? That's our job.

There is not much point to fabricating laminated plastics in your own shop. And there are good reasons why. One is the material itself.

Synthane laminates are available in sheets, rods, and tubes, and in over 33 standard grades. Choice of form and grade for your part is important. For example, a part which is basically tubular may have to be

cut from a sheet rather than a tube. Or the material itself may have to be modified in order to meet your requirements.

When you do your own machining, responsibility rests finally with you. The possibility of errors in dimensions, machining and tolerances, and of waste and delay suggest that you buy your laminated plastics from us

and let us do the fabricating for you. Call any of our representatives—in principal cities—for a quotation or get in touch directly with Synthane Corp., 11 River Road, Oaks, Pa.

SYNTHANE
CORPORATION **S** OAKS, PENNA.

Sheets • Rods • Tubes • Fabricated Parts
Molded-laminated • Molded-macerated

You furnish the print . . . we'll furnish the part

isting of two transmission lines are terminated by the ports of a two port reactance network while the other ports are loaded with reactances, this can be used to produce band-pass filters, bandstop filters, frequency branching networks, etc. (Germany.)

Transistor Stabilized Power Supplies, W. Larasa. "El. Tech." Feb. 1960, 5 pp. In this article circuits for keeping dc voltage constant which are based on the use of Zener diodes and transistors are dealt with. The author describes the series stabilizing circuit with transistors in detail and explains their design. (Germany.)

Normalizing of Integrating and Differentiating Circuits, K. H. Kerber. "El. Tech." Feb. 1960, 2 pp. Directions are given to normalize circuits integrating or differentiating cyclic events enabling numerical values to be simply obtained for deviations of phase delay and of the incremental function, that is, integration and differentiation errors. (Germany.)

Ladder Networks with Tchebycheff's Transmission Function, M. Trinchieri. "Alta Freq." Oct.-Dec. 1959, 38 pp. Ladder networks without poles are examined which perform Tchebycheff's transmission function between a generator and a load in 3 hypotheses: a generator with finite internal resistance, an ideal current generator, an ideal voltage generator. Starting from a conformal mapping of the plane of the complex frequencies p , the position is identified which must be occupied in the plane by the polynomial roots from which the synthesis of the desired network depends and consequently the relationship both between the different parameters which characterize the performance of the circuit, and the parameters and the value of the components of the circuit itself. (Italy.)

Equivalent Circuits of Generic Multi-Terminal Systems, G. Biordi and L. Piglione. "Alta Freq." Oct.-Dec. 1959, 13 pp. A non-reciprocal passive system with 4 terminals can be realized by an equivalent circuit (as far as the external behavior is concerned) which contains only 1 non-reciprocal 3-terminal element. If the system has $n+1$ terminals, it is possible to realize an equivalent circuit with $n/2$ 3-terminal elements if n is even, or $(n-1)/2$ if n is odd. A method to realize the equivalent circuit with the said minimum number of non-reciprocal 3-terminal elements is given. (Italy.)

Solid-State Maser Amplifier, S. A. Ahern. "El. Tech." Feb. 1960, 5 pp. The physics of maser operation, including the criteria used for selection of materials is introduced. A description is given of a practical cavity maser, and the system applications discussed. Possible future developments, in particular the traveling wave maser, are briefly discussed. (England.)



COMMUNICATIONS

Calculation of Noise in Radio Receivers, I. M. Aimbinder. "Radiotekh." V. 15, No. 1 (1960), 12 pp. On the basis of the reciprocity theorem and the fact that the noise level of linear systems is independent of output loading, design formulas were developed for calculating noise in radio receivers including their antennas and feeder devices. The calculation method used permits one to determine the total noise in linear passive networks both with lumped and distributed constants, and obtain simple formulas for calculating antenna noise including cosmic radiations noise and thermal noise due to the surrounding media, the ground and other sources. With certain reservations this method can also be used for calculating noise in active networks. Instead of the normal noise factor the author uses the "noise level factor" which is proportional to the level of the internal noise of the circuits under consideration. (U.S.S.R.)

Noise Stability of Frequency Telemetering System with Weak Pulse Noises, I. Chugin. "Avto. i Tel." Jan. 1960, 18 pp. The noise stability of the frequency telemetering system with pulse-noises of arbitrary duration is analyzed. The noise stability level and the optimum frequency deviation are determined. (U.S.S.R.)

Optimal Design of Frequency Synthesizers for Radiotelephones, S. Schmidt. "Prace ITR." Vol. 3, No. 3(9), 18 pp. Design problems are discussed of frequency synthesizers for duplex radiotelephony equipment with up to 100 channels. The development of such equipment and future requirements for f.s. in modern radiotelephones are considered. (Poland.)

Measuring Methods of Amplitude Modulation Suppression in FM Receivers, W. Paruszewski. "Prace ITR." Vol. 3, No. 3(9), 3 pp. The paper aims at determining the optimal measuring method of amplitude modulation suppression in FM receivers and at establishing adequate parameters of input signal. There are following basic methods: method of successive amplitude and frequency modulation, oscilloscope methods, filter methods, spectrum analysis method and nonlinear distortions measurement method. (Poland.)

Transmitter for 1-V.F. Dialling System, F. Keminaki. "Prace ITR." Vol. 3, No. 3(9), 27 pp. A 2280 c/s signal transmitter for 1-V.F. dialling system, elaborated by Telephony Automation Dept. of the Tele- and Radio Research Institute is described. (Poland.)

Numerals and Letters for Subscriber's Numbers in Local Automatic Telephone Networks, C. E. Galimberti. "Nach. Z." Feb. 1960, 7 pp. Two methods of the denotation of subscriber's lines have been adapted: A purely numerical and a combined letter and numeral designation. The paper described the result of an investigation carried out within the local network of Milan. (Germany.)

A Compander for Broadcast Programme Links, W. von Guttenberg and H. Hochrath. "Nach. Z." Jan. 1960, 6 pp. The application of companders is recommended for signal transmission paths or stores which are affected by interference. An investigation of various companders has shown that the best transmission quality is only achieved by means of a syllable compander operating at carrier frequency level when the transmission frequency band must not be much larger than the original frequency band. (Germany.)

The Calculation of Line Group for Carrying Excess Traffic by Means of Programme Controlled Computers, G. Bretschneider. "Nach. Z." Jan. 1960, 7 pp. A calculation of the capacity of the line group for carrying excess traffic is possible by means of a method which became known as the "scattering value method." This method has been modified so that the calculation can automatically be carried out by a programme controlled computer. (Germany.)



COMPUTERS

On Analog Computer Simulation of the Transfer Functions Without Using Differentiator Elements, B. Ya. Kogan. "Avto. i Tel." Jan. 1960, 10 pp. Different ways of simulation of the real rational transient functions without using differentiator blocks are compared. It is shown that the minimum number of required operation amplifier is $n + 1$ where n is the order of differential equation under consideration. (U.S.S.R.)

Parametrons and Their Use in Data Processing Systems, E. Schmitt. "El. Rund." Feb. 1960, 6 pp. Parametrons can increase the speed of operations in electronic computers. Basic circuits of the ferrite-core and diode

parametrons are shown and the effects of loss and detuning in the parametron circuit upon amplitude and build-up time are explained quoting a practical formula for the build-up time. (Germany.)

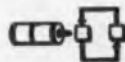

CONTROLS

Effect of Frequency and Amplitude Modulated Oscillations on Linear Systems, I. T. Turbovicb. "Radiotekh." V. 15, No. 1 (1960), 5 pp. The output voltage of the system is calculated as the product of the input voltage by the dynamic transfer constant of the system. This is a further development of the method originated by the author ("Radiotekh." 9, Nos. 2 and 12, No. 11) for quasi-harmonic signals. His method is considerably simpler than the spectral method of analysis and more accurate than the static method, since it is based on the Duhamel integral and its error can be estimated. The dynamic transfer constant, adopted by the author, differs from the static one by incorporating not only the instantaneous frequency value, but also the derivatives with respect to time of the frequency and the amplitude. (U.S.S.R.)

A Method of Calculating the Correlation Function at the Output of a Nonlinear System, I. M. Teplyakov. "Radiotekh." V. 15, No. 1 (1960), 8 pp. It is shown that in order to calculate the correlation function at the output of the system when normal noise is present at its input, it is sufficient to calculate the spectrum at the output of the system of two sinusoidal input signals. This method can also be used when a noise and a signal are impressed on the input of a nonlinear system, but in such a case the calculations become rather involved. (U.S.S.R.)

On Amplifiers of Error Signals in Electrical Control Systems, L. L. Dekabrun. "Avto. i Tel." Jan. 1960, 6 pp. There is explained a new principle of designing circuits for synchronous detection that makes it possible to considerably reduce the delay introduced to signal transmitting by amplifiers of slowly changing voltages. The circuits permit to widen the area of using such amplifiers in automatic control systems where galvanic feedback amplifiers cannot provide high accuracy. (U.S.S.R.)

On Variable Pulse System, V. I. Teverovskiy. "Avto. i Tel." Jan. 1960, 8 pp. The paper deals with the determination of the transfer function of a variable pulse system for a particular case when the system consists of a variable first-order unit connected serial to constant units. (U.S.S.R.)

Design of Second Order Optimum Control Systems Using Limited Gains of Control Circuit Elements, V. Eme I. Anov, A. I. Fedotova. "Avto. i Tel." Jan. 1960, 8 pp. The paper deals with getting optimum control processes in the second order automatic control systems when using limited gains of control circuit elements with the help of non-linear compensation devices of the key type. (U.S.S.R.)

On Stability of Servosystems with Random Disturbance, P. S. Landa. "Avto. i Tel." Jan. 1960, 6 pp. Conditions of excitation of the servosystem with non-linear element of backlash type are obtained. The probability of excitation of such a system is calculated as a function of time at the presence of noise. (U.S.S.R.)

On Connection of Transient Functions of Linear Systems with their Laplace Representation, N. S. Kochanov. "Avto. i Tel." Jan. 1960, 9 pp. There are considered methods of determining a discrete transient function of linear systems by the given representation and of finding its Laplace representation by the given values of the transient function. The methods do not require the calculation of algebraic equation roots. (U.S.S.R.)

THREE KLEIN PLIERS

to make electrical wiring easier

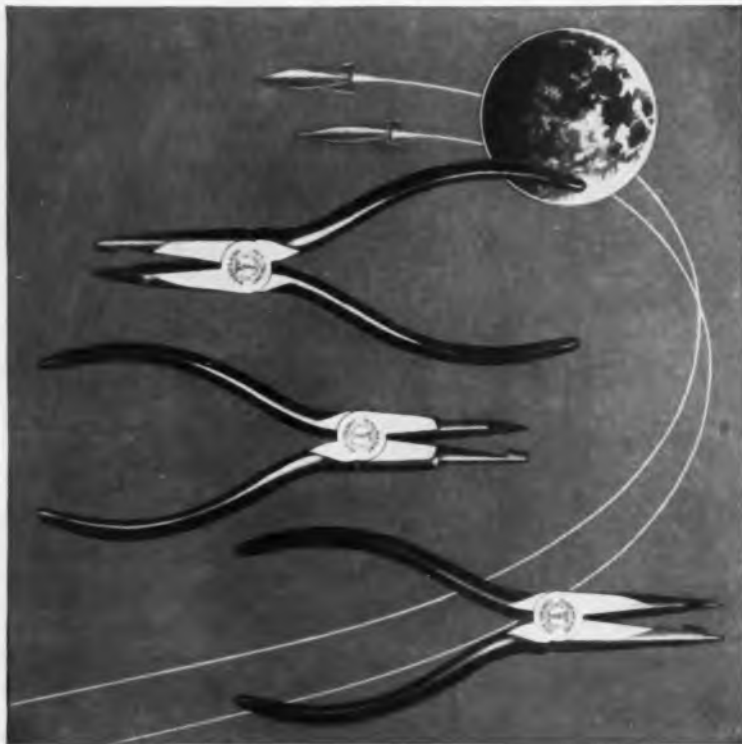

Here are three newly engineered Klein Pliers which will solve difficult problems in the wiring of electronic assemblies. Catalog 103-A describes these and scores of other pliers in the complete Klein line. If you wire electronic assemblies, write for a copy.

ALL-PURPOSE ELECTRONIC PLIER

Patent pending

Shear blade cuts flush and holds clipped end of wire

Requires no sharpening; will cut hard or soft wire. Smooth, continuous action prevents shock which may damage resistors. For bare wire up to 18 gauge.

No. 260-6—length 6 $\frac{3}{4}$ "

No. 260-6C—with coil spring that holds jaws open

NEEDLE-NOSE PLIER Patent pending

Similar to No. 260-6 but nose has been slimmed down to permit use in confined areas.

No. 261-6—length 6 $\frac{3}{4}$ "

No. 261-6C—with coil spring to hold jaws open

LONG-NOSE PLIER—KNIFE AT TIP

Pat. No. 2,848,724

Jaws behind blade hold clipped wire end firmly

A shear-cutting plier that will cut hard or soft wire. Blade is at the tip of the plier. Supplied with coil spring to keep jaws apart.

No. 208-6PC—length 6 $\frac{3}{4}$ "

Write for Catalog 103-A, which shows the complete line of Klein Pliers, including 20 pliers recently developed.



Mathias KLEIN & Sons

Established 1857

Chicago, Ill., U.S.A.

7200 McCORMICK ROAD • CHICAGO 45, ILLINOIS

Sources

Synthesis of Control System with Monotonously Decreasing Gain by Root-Locus Method. Yu. I. Rubinnovich. "Avto. i Tel." Jan. 1960. 8 pp. A periodically working control system with monotonously decreasing gain is considered. The synthesis problem is solved by introducing a quasi-majorant control system with constant gain instead of a given one. For this quasi-majorant system a proper compensation network is designed with the help of the root-locus method. (U.S.S.R.)

On Unbiased Estimating Desired Signal Non-Linearly Depending on Unknown Parameters. I. A. Hognulavsky. "Avto. i Tel." Jan. 1960. 6 pp. A method permitting the use sometimes of the linear theory to get the unbiased estimate of the desired signal in presence of noise is proposed; the signal depending non-linearly on unknown parameters. (U.S.S.R.)

On Reducing Non-Linear Control System Equations to Simplest Form. E. N. Rosenwasser. "Avto. i Tel." Jan. 1960. 5 pp. There are given formulae for a linear transformation reducing direct control system equations to the n^{th} order differential equation. The linear transformation makes it possible to simplify certain calculations of control systems, for example the determination of oscillations in the case of piecewise-linear characteristics. (U.S.S.R.)



GENERAL

Influence of Magnetization Irregularity on Core Static Characteristics. G. D. Kuzlov. "Avto. i Tel." Jan. 1960. 17 pp. Influence of magnetization irregularity on core static characteristics is considered. There is given the calculation of the core magnetization loops for symmetrical and biased magnetization and of the basic magnetization loop. (U.S.S.R.)

Examination of Technological Parameters Influencing Electrical Resistance of Thermosetting Pressed Forms. R. Feryszka. "Prace ITR." Vol. 3, No. 3(9). 18 pp. In the present literature thermal treatment is usually recommended in order to increase resistivity of thermosetting pressed forms to climatic conditions. A series of experiments are initiated in the Tele- and Radio Research Institute aiming at determining the influence of technological parameters of preparing and pressing processes on resistivity of pressed forms to humidity. (Poland.)

Atomic Alarm. F. Juster. "el and auto." Jan.-Feb. 1960. 8 pp. Automatic alarm and protection systems have been developed to limit as far as possible the effects of nuclear explosions. They are based on the various physical phenomena associated with atomic weapons. Three types of explosion detectors are described in this paper. (France.)

Medical Electronics—Review of the Field. A. V. J. Martin. "el and auto." Jan.-Feb. 1960. 3 pp. The introductory paper reviews some of the noteworthy or recent applications of electronics in the medical field. Three categories are listed: aids in application, aids in diagnosis, and aids in treatment. (France.)

Millimicrosecond Magnetization Reversal in Thin Magnetic Films. W. Dietrich and W. E. Proebster. "El. Tech." Feb. 1960. 3 pp. A special pulse equipment including a pulse sampling oscilloscope with an overall response time of 0.35 nsec for the observation of the millimicrosecond flux reversal in thin permalloy films is described. (Germany.)

Novel Geiger Muller Counter Circuit for Weak Beta-Ray Emission. M. Marxen. "El. Tech." Feb. 1960. 3 pp. Background variations and uncertainties form the most important cause of errors in measurements of weak beta-ray

WHEN SECONDS COUNT . . .

count on the *Lavoie* electronic counter

The optimum in reliability and versatility in measured frequency or time intervals.

The range of frequencies provided is from 10 cycles to 10 megacycles; range of time intervals is from 1 microsecond to 100 days. Unparalleled reliability is assured by a new concept in circuit design that utilizes magnetic beam switching tubes as decade dividers and scalars. The use of beam switching tubes eliminates the need for germanium diodes and reduces the number of components required.

In Research and Development, on Transmitter Sites, Missile Bases, Radar Sites, and on the production line . . . The Lavoie Counter provides versatility and reliability.



FEATURES:

- Digital Voltage Converter
- Wide Frequency Range
- Wide Time Interval Range
- In Line 8 Nixie® Readout
- High Reliability
- Automatic Decimal Point
- Designed to MIL Specifications
- Count-Down Time Base
- Controlled Reset
- Ease of Operation
- 0.1 Microsecond Resolution

Lavoie Laboratories, Inc.

MORGANVILLE, NEW JERSEY

precision measurement demands

WAVELINE MICROWAVE

instruments

ATTENUATORS
SLOTTED LINES
WAVEGUIDE COUPLERS
TERMINATIONS
FREQUENCY METERS
PHASE SHIFTERS
DETECTOR MOUNTS
PRECISION TUNERS



and components

MIXERS
FILTERS
ANTENNAS
ROTARY JOINTS
DIRECTIONAL COUPLERS
WAVEGUIDE TEES
DETECTOR MOUNTS
WAVEGUIDE SWITCHES



The ninety page Waveline catalog describing over 600 instruments, includes complete technical data, charts, illustrations and engineering reports.

WAVELINE

INC.
CALDWELL, NEW JERSEY

Phone Capital 6-9100
TWX Caldwell, N. J. 703

Sources

emission. The author describes an arrangement comprising a beta counter and a protective counter permitting to suppress the background value to less than 1 count per min. (Germany.)

The Continuous Automatic Measurement of Blood Pressure by Means of Control Equipment. H. J. Willmowsky. "rt." Dec. 1959. 7 pp. The author describes a system for automatically measuring the human blood pressure based upon the usual bloodless aphygomanometric method using the Riva-Rocci cuff technique (e.g. (1)). The principle of this method is as follows: the control criterion is the artery signal detectable in the elbow bend and the cuff pressure is controlled in such a way that it equals either the diastolic or the systolic blood pressure. (Germany.)

The Response of the Three-Phase Slipring Rotor, Part II. L. Hannakam. "rt." Dec. 1959. 7 pp. On the basis of the derived electromechanical system equations a general block diagram of the 3-phase slip ring rotor is given and simplified for certain special conditions, as small slip values and small deviations from a stationary zero position. The author describes how the system parameters which are required for this general representation are obtained by practical tests on a machine in operation. (Germany.)

Mean Value of a Rectifier Output by Computer. "El. Tech." Feb. 1960. 3 pp. (England.)



MEASURE & TESTING

Generator of Random Processes with Given Matrix of Spectral Densities. J. Matyash, Ya. Shikhanek. "Avto. i Tel. Jan. 1960. 7 pp. There is described the method of designing generator of stationary random processes with an arbitrary matrix of rational spectral densities. The generator has minimum number of flat non-correlated noise generators and of stable linear filters. Transfer functions of the filters can be determined quite easy by given spectral densities. The method is illustrated with an example for a case $n = 3$. (U.S.S.R.)

Frequency Synthesizers. B. Nowak. "Prace ITR." Vol. 5, No. 3. 36 pp. The frequency synthesizer is a source of stabilized operating frequencies. The operating frequency, as an output frequency of the synthesizer, is the result of a number of operations performed with one or a few standard frequencies. In the general case these operations will consist in the division, multiplication and changing of frequency. (Poland.)

Frequency Decade Generator. Eugeniusz Zachwatowicz. "Prace ITR." Vol. 2, No. 2(9). 4 pp. Principle of operation is given of a frequency decade generator synchronised with a standard frequency. Some technical data of the decade, covering the range 1 kc/s-10 Mc/s, built in the Tele- and Radio Research Institute, are described. (Poland.)

Anechoic Chamber Designed in the Tele- and Radio Research Institute. Jerzy Tralinski. "Prace ITR." Vol. 3, No. 2(9). 4 pp. The information is given on design problems of an anechoic chamber built in the Tele- and Radio Research Institute. The kind of sound-absorbing layer used in the chamber is described, i.e. type of material, dimensions of wedges, the way of mounting of wedges, structure of doors, etc. (Poland.)

Transient Storage Oscilloscope. A. E. Cawell and R. Reeves. "El. Tech." Feb. 1960. 10 pp. One main function of this oscilloscope is that it permits the immediate viewing and later examination at leisure of a waveform derived from a fast "once-occurring" opera-

tan-TI-cap †
**CAPACITOR
 STABILITY
 ASSURED
 BY 250-HOUR
 PERFORMANCE
 LOAD TEST**



**...expanded TI line of type SCM
 solid tantalum capacitors meets MIL specs**

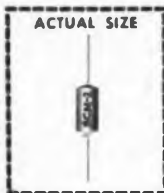

Another assurance to you of Texas Instruments capacitor reliability — 250-hour performance load test on a sample basis of *all* lots of the Type SCM series.

Your margin of design safety is greater with *tan-TI-cap* capacitors. Type SCM capacitors are 100% tested for capacity, dc leakage and dissipation factor, and are aged under load at elevated tempera-

ture. SCM units in all 203 standard ratings (6-35 volts, 1-330 μ fd.) meet and exceed the electrical and mechanical requirements of MIL-C-55057 (Sig. C) and/or MIL-C-21720A (NAVY) specifications for solid tantalum capacitors.

Contact your nearest authorized TI distributor or TI sales office today for your immediate and future delivery requirements.

† trademark of Texas Instruments Incorporated

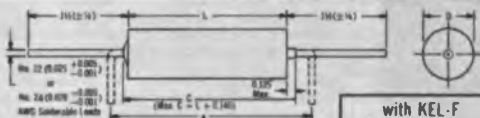

case size	D +0.010 -0.005	L ±0.031	*A ±0.031	wire size AWG	avg. wt. gms.	with KEL-F insulating sleeve		with Mylar insulating sleeve**		avg. wt. gms.	
						D +0.020 -0.010	L ±0.062	D ±0.010	L ±0.031		
F	0.125	0.250	0.482	24	0.4	0.162	0.337	0.5	0.135	0.322	0.4
B	0.175	0.438	0.688	24	1.1	0.210	0.525	1.3	0.185	0.510	1.2
G	0.279	0.650	0.988	22	2.7	0.315	0.735	3.1	0.289	0.722	2.8
H	0.341	0.750	0.988	22	3.3	0.377	0.835	3.9	0.351	0.822	3.4

* Dimension "A" determined by suspending a one-pound weight from one lead and rotating the case from the vertical position to the horizontal position, and then repeating the procedure for the other lead.
 ** Meets all requirements of MIL-C-55057 and MIL-C-21720A, including dimensions.



All lots of Type SCM *tan-TI-cap* capacitors are tested for performance stability at rated temperature and voltage prior to release for shipment. Performed on a lot sample basis, the test is run for 250 hours or until performance stability is established by successive time interval measurements of the principal parameters of each test capacitor.



Write to your nearest TI sales office on your company letterhead for Bulletin DL-C 1173 which gives detailed specifications on the complete SCM series.

TEXAS



INSTRUMENTS

INCORPORATED
 SEMICONDUCTOR-COMPONENTS DIVISION
 13500 N. CENTRAL EXPRESSWAY
 POST OFFICE BOX 312 · DALLAS, TEXAS

Circle 104 on Inquiry Card



SS-5
DP-DT spring return
0.5-amp. @ 125v ac-dc
U.L. Inspected.

SS-15
SP-ST pushbutton, momentary
contact 1-amp. @ 125v ac
U.L. Inspected.

SS-16
3-position special.
3-amps @ 125v ac.
U.L. Inspected.

GET ALMOST ANY NEEDED



SS-21
3-Position, 3-amps
@ 125v ac
U.L. Inspected.

SS-22
SP-DT, 1-amp.
@ 125v ac-dc
U.L. Inspected.

SS-23
DP-DT, 2-amps
@ 125v ac
U.L. Inspected.

SWITCHING ARRANGEMENT OR



SS-30
DP-DT miniature
0.5-amp. @ 125v ac-dc
U.L. Inspected.

SS-34
3P-DT, 3-amps
@ 125v ac
U.L. Inspected.

SS-36-1
SP-DT 6-amps
@ 125v ac
U.L. Inspected.

FEATURE WITH LOW COST



SS-36-1
SP-DT, 3-amps
@ 125v ac
U.L. Inspected.

SS-9
SP-DT spring return
3-amps @ 125v ac
U.L. Inspected.

SS-18
4-position special.
3-amps @ 125v ac
U.L. Inspected.

STACKPOLE SWITCHES!

Get This GUIDE TO MODERN SWITCHING ▶

Ask for 8-page Switch Bulletin RC-110

World's largest slide switch line—over 12 low cost standard types—dozens of economical adaptations—NEW colored knobs. Special conventional and miniaturized switches designed and produced for large quantity users. Electronic Components Division, STACKPOLE CARBON COMPANY, St. Marys, Pa.



Sources

tion. Some examples of such operations are the making and breaking of a switch or relay contacts, testing with high voltage impulses, strains or vibrations produced by a single impact and explosive shocks. (England.)



SEMICONDUCTORS

Thermal Processes in Junction Transistors. I. A. Popov. "Radiotekh," V. 15, No. 1 (1960), 6 pp. Both stationary and transient thermal processes are examined. This is necessary in order to be able to analyze pulse operation of transistors as well as for studying the behavior of various circuits in the first instants of their operation. Junction temperatures are found in terms of time, ambient temperature, and the power dissipated in the transistor. Equivalent circuits are given, and measurements of their parameters appended. (U.S.S.R.)

Simplified Equivalent Circuits for Linear Transistor Amplifiers. W. Bena. "El. Tech." Feb. 1960. 6 pp. Description of properties of various transistor equivalent circuits and of events taking place within transistors, followed by a presentation of simplified equivalent circuits for practical application. Examples demonstrate the computation of components of an equivalent circuit based on the knowledge of component values of another equivalent circuit. (Germany.)

Figure of Merit of the Junction Transistor and the Possibilities of Its Increase Due to the Introduction of a Built-in Field into the Base Region. "Prace ITR." Vol. 6, No. 2, 25 pp. The most suitable parameter for characterizing the amplifying properties of a transistor designed for high frequencies is the figure of merit. A detailed analysis of the value of this coefficient is carried out for diffusion transistors performed by means of the alloy technique, and the possibilities of increasing it by the introduction of constructional and technological changes are discussed. It is shown that the difficulties involved make it impossible to obtain high values of the coefficient. (Poland.)

Load Characteristics of Transistor Converter. T. Konopinaki. "Prace ITR." Vol. 8, No. 8(9). 9 pp. In previous papers, operation of 1-transistor converters and methods of their design, based on simplified formulas, were given. In the present paper waveforms occurring in 1-transistor converters are analyzed and formulae based on simplified assumptions, enabling the calculus of load characteristics, were derived. (Poland.)

Industrial Applications of Semiconductors. J. M. Lambert. "el and auto." Jan.-Feb. 1960. 6 pp. This is the first paper of a series devoted to the practical utilization of semiconductor devices. It deals with transistor circuits. First, the advantages and drawbacks of transistors are shortly reviewed. Then, several practical circuits are described. They are representative of the possibilities of transistors, and comprise a dc to ac converter, a dc to dc converter, a radio-activity detector, a neutron radiation detector, an rpm-meter, a stabilized power supply, a relay control circuit, and a bistable circuit. (France.)

Transistor Avalanche Voltage. L. van Biljon. "El. Tech." Feb. 1960. 6 pp. An expression giving the collector avalanche voltage in an alloyed junction transistor as a function of base resistance is developed from simple considerations of transistor currents. It is indicated how this expression may be used to predict the voltage where avalanche breakdown will set in for any value of base resistance, once the breakdown voltage at a particular value of base resistance is known. (England.)

**Choose from the
MUIRHEAD range of
MOTOR TACHOMETERS
FOR 60 & 400c/s**

SIZE
11



SIZE
15



SIZE
18



The quality and range of these small motor tachometer generators will meet your most exacting needs in data transmission systems, integrating loops, analogue devices and instrument servomechanisms.

Covering a wide range of control voltages, 60c/s or 400c/s, in sizes 11, 15 and 18 Muirhead Motor Tachometers are all available from stock.

MUIRHEAD TECHNIQUE

A technical journal edited and published quarterly by Muirhead & Co. Limited. Free on request. In addition to articles by our own engineers, giving news about the latest designs, developments and applications of Muirhead products, there are also many articles by engineers outside the company, describing specialized projects in which Muirhead equipment plays its part.

MUIRHEAD

Precision Electrical Instruments

MUIRHEAD INSTRUMENTS INC.,
441 Lexington Avenue, New York 17, N.Y., U.S.A.
Telephone: Murray Hill 2-8131

MUIRHEAD INSTRUMENTS LIMITED, Stratford, Ontario, Canada
Telephones: 3717 & 3718

MUIRHEAD & CO. LIMITED, Beckenham, Kent, England
Telephone: Beckenham 4988

446



easily
recognised



by
their
superior
performance
as

MUIRHEAD

Synchros



393

A GOOD RESOLUTION ON TAPE—

Tape high frequencies, whip the dropout problem with "SCOTCH" BRAND High Resolution Tapes



RIGHT HANDS UP, GENTLEMEN? Then repeat this phrase: "We resolve to get the tape that gets all the high frequencies—'SCOTCH' BRAND High Resolution Tape."

All levity aside, there's no need to settle for second-best. With "SCOTCH" BRAND Tapes 158 and 159 you get sharp resolution in high frequencies, good low frequency response—plus the consistent performance of a uniform tape.

Since "SCOTCH" BRAND high potency oxides are more efficient than ordinary oxides, a thinner coating can be applied to the polyester backing, and the sensitivity at short (1 mil) wave lengths is still about 3½ db greater than that of ordinary oxides. This thinner coating means a more flexible tape, permitting the intimate tape-to-head contact so necessary to sharp resolution in the higher frequencies. Thanks to "SCOTCH" BRAND silicone-lubricated binder system, backing and oxide are locked together as a system. Tape passes over heads friction-free, with even motion, minimizing phase and frequency shift distortion.

You can pack more pulses per inch, and get either standard or extra playing time with "SCOTCH" BRAND High Resolution Tapes. Your dropout count is lower because uniformity is higher. Only "SCOTCH" BRAND can draw on 3M's more than 50 years of experience in precision coating techniques. The result is a consistent tape with a uniform coating you can depend on for reliable performance.

"SCOTCH" BRAND High Resolution Tapes meet your need for top high-frequency response even in pulse code modulation (PCM) and pre-detection (video) applications; so switch now from tapes that may well be made obsolete by new instruments.

Whatever your application—data acquisition, reduction, or control programming—experienced "SCOTCH" BRAND technology has a dependable tape for the job. Sandwich Tapes 188 and 189 cut head-wear, eliminate oxide rub-off, last 10 times longer than ordinary tapes. New Heavy Duty Tapes 198 and 199 give long wear, minimize static charge build-up. High Output Tape 128 gives top output in low frequencies, even at temperature extremes. And "SCOTCH" BRAND Standard Tapes 108 and 109 remain the standard for instrumentation.

Your nearby 3M Representative serves as a convenient source in all major cities. For details consult him or write Magnetic Products Div., 3M Company, Dept. MBR-40, St. Paul 6, Minn.

© 1960 3M Co.
"SCOTCH" is a registered trademark of 3M Company, St. Paul 6, Minnesota.
Export: 99 Park Avenue, New York, N.Y. In Canada: London, Ontario.

SCOTCH BRAND MAGNETIC TAPE
FOR INSTRUMENTATION



MINNESOTA MINING AND MANUFACTURING COMPANY
... WHERE RESEARCH IS THE KEY TO TOMORROW



New Products

CONVERTER

Miniaturized digital-to-analog converter weighs 30 grams. For computer applications and pulse-repetition rate monitoring in laboratory instruments, it produces a dc output proportional



to input repetition rate. Model DAC-94, is a constant current generator which, when used with supply voltages of approx. 12 vdc, will deliver 0.01 μ a per pulse per sec. Other models available deliver up to 0.1 μ a. Output voltage can be programmed by adjusting load resistance. Linearity is $\pm 2\%$ for output voltages not exceeding 20 mv and for operating temp. between -20°F and 140°F . Transformer - Electronics Co., Industrial Park, Boulder, Colo.

Circle 219 on Inquiry Card

! MORE !

The New Products mentioned here have been selected for contribution to or advancement of the electronic industries. These items are combed from several hundred new product releases received during the past month by ELECTRONIC INDUSTRIES. To keep interested readers informed of all new developments, a summary record is kept of ALL new products received. For a copy of this month's list, please send your request on company letterhead to Readers' Service Dept., Electronic Industries, 56th & Chestnut Sts., Phila., Penna. or Circle No. 161 on Inquiry Card.

DELAY LINE

Type 7C Series, miniature delay line, for computers, radar and power circuits. Phase characteristics are automatically equalized to beyond 8 MC in many types, hermetically sealed



construction, operating temp. from -35 to $+125^\circ\text{C}$ with 500 v. peak working voltage, and temp. coefficient 0.005%/C°. Rise time is 7% of the time delay. Frequency response is over 10 MC bandwidth with attenuation less than 1.2 db/ μ sec delay at low frequencies. Models available with time delay ranging from 0.1 μ s up to 1.5 μ s, and impedance ranges from 150 ohms to 1,000 ohms. Ad-Yu Electronics Lab., Inc., 249-259 Terhune Ave., Passaic, N. J.

Circle 220 on Inquiry Card

ACCELEROMETER

A self-generating accelerometer, less than 0.1 in. in height, 0.5 in. in dia., and weighing $\frac{1}{4}$ gram. Housed in aluminum, the Model A-3109 accelerometer has an acceleration range of 0.5 to 500 g and has a useful frequency range of 3 to 4000 CPS and a sensitivity of 2 mv/g min. Operating range is -65° to $+250^\circ\text{F}$. Resonant frequency is 12 KC min. It is



equipped with a 4-ft. GLENNITE Blackline Low Noise Cable fitted with a GLENNITE C6P connector. Gulton Industries, Inc., 212 Durham Ave., Metuchen, N. J.

Circle 221 on Inquiry Card



REMEMBER!

For immediate information on "SCOTCH" BRAND Instrumentation Tapes, contact your nearest 3M branch office:

ATLANTA, GA. — 732 Ashby Street. N.W. Telephone: TRinity 6-4401

BEDFORD PARK, ILL. (Chicago Office)—6850 South Harlem Avenue, Argo Post Office. Telephone: GLOBE 8-2200 (Chicago—LUdlow 5-7800)

BUFFALO, N.Y.—330 Greene Street (P. O. Box 2012, Zone 5), Telephone: BAIlley 5214

CINCINNATI, OHIO—4835 Para Drive, Telephone: ELMhurst 1-2313

CLEVELAND, OHIO—12200 Brookpark Road, Telephone: CLearwater 2-4300

DALLAS, TEXAS—2121 Santa Anna Avenue (P. O. Box 28158), Telephone: DAVis 7-7311

DETROIT, MICH.—411 Piquette Avenue, Telephone: TRinity 5-7111

HIGH POINT, N. C. — 2401 Brevard Street (P. O. Box 151), Telephone: 3496

HONOLULU, HAWAII—1410 Kapiolani Boulevard, Telephone: 996-483

LOS ANGELES, CALIFORNIA—6023 South Garfield Avenue, Telephone: RAYmond 3-6641

NEWTON CENTER, MASS. (Boston)—1330 Centre Street, Telephone: DEcatur 2-9810

PHILADELPHIA, PENN. — 5698 Rising Sun Avenue, Telephone: PIlgrim 2-0200

RIDGEFIELD, NEW JERSEY (New York)—700 Grand Avenue, Telephone: WHItney 3-6700 (N.Y.—OXford 5-5520)

ST. LOUIS, MISSOURI—10725 Baur Boulevard, Telephone: WYdown 1-1320

ST. PAUL, MINNESOTA—367 Grove Street, Telephone: PRospect 6-8511

SEATTLE, WASHINGTON—3663 First Avenue South, Telephone: MUltal 2-5550

SOUTH SAN FRANCISCO, CALIFORNIA—320 Shaw Road, Telephone: PLaza 6-0800

MINNESOTA MINING AND MANUFACTURING COMPANY
...WHERE RESEARCH IS THE KEY TO TOMORROW



Circle 107 on Inquiry Card

NEW SILICON "PILL" VARACTOR

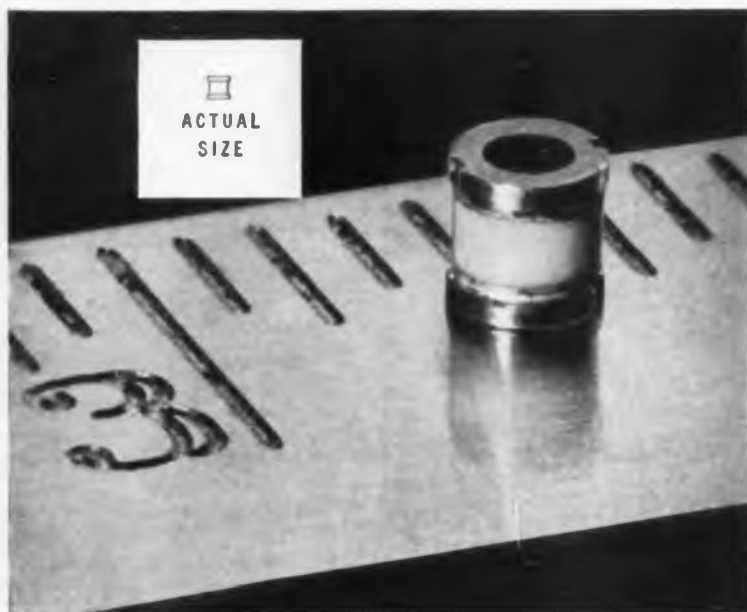

GREATLY REDUCES THE PACKAGE AS A FACTOR IN CIRCUIT DESIGN

specifically developed for:

- amplifiers at the higher microwave frequencies (1000 mc and above)
- travelling wave parametric amplifiers
- microwave computers as sub-harmonic generators
- amplifiers in which stray susceptance effects must be minimized
 - applications of varactors to stripline circuits
 - modulators for frequency synthesis

Experimental quantities are available with these nominal specifications	TYPE NUMBER	CAPACITANCE TOLERANCE (Zero Bias)	TYPICAL Q AT 6 VOLTS
	MA-4255X	0.1-0.5 μf	60-80
	MA-4256X	1.2-2.5 μf	50
	MA-4257X	2.5-4.0 μf	30

*Package shunt capacitance ~ 0.2 μf . Series lead inductance 10^{-9} henries.

Write or call:

MICROWAVE ASSOCIATES INC.

BURLINGTON, MASSACHUSETTS

Browning 2-3000 • TWX Burlington, Mass. 942.



New Products

IMAGE ORTHICON

Extended-life image orthicon tube for use in TV cameras uses a new target material and virtually eliminates image retention and its limiting effect on operating life. The 7611 image



orthicon is directly interchangeable with the 5820 and has identical performance characteristics except for the 7611's higher level of sensitivity over a longer operating life. For complete elimination of image retention, it should be operated near the upper limit of its operating temp. range of 104 to 130° F. Special feature: 1000 hr. warranty. Westinghouse Electric Corp., P. O. Box 284, Elmira, N. Y.

Circle 222 on Inquiry Card

POWDER CORE

For audio filter low frequency application, 160- μm moly-permalloy powder cores offer 28% higher inductance than with 125- μm cores. At least 10% fewer turns are required for given inductance. The higher inductance fewer turns ratio also permits use of heavier wire for windings,



reducing dc resistance and giving higher Q. The cores come in 8 standard sizes, ranging in outside dia. from 0.500 to 1.570 in., and inside dia. from 0.300 to 0.950. Magnetics Inc., Butler, Pa.

Circle 223 on Inquiry Card

VT2
VT2N



VT2E



VT2F

Popular, small Model VT2 (with overvoltage). Volts output: 0-120/132; amps output: 1.5 . . . Model VT2N (without overvoltage). Volts output: 0-120; amps output: 1.8. This model delivers more current than existing transformers of comparable size and price.

VT4
VT4N



VT4E



VT4F



Models VT4 and VT4N provide output capacity greater than other units of comparable size and price. Model VT4 (with overvoltage). Volts output: 0-120/140; amps output 3.5 . . . Model VT4N (without overvoltage). Volts output: 0-120; amps output: 4.75.



OHMITE®

VARIABLE TRANSFORMERS

Complete Line Now Available
from Stock



VT8
VT8N



VT8E



VT8F



VT8G

Models VT8 and VT8N offer the heavy capacity demanded for general laboratory and industrial applications. Model VT8 (with overvoltage). Volts output: 0-120/140; amps output: 7.5 . . . Model VT8N (without overvoltage). Volts output: 0-120; amps output 10.0. Units available for 240-volt input also.

Now you can get *fast delivery from stock* on 35 different models of Ohmite variable transformers. This newly expanded selection covers a high percentage of industrial needs. In it you will find single and three-phase units, two and three-in-tandem assemblies (not shown above), plus a variety of other cased and uncased models.

Ohmite "v.t." variable transformers combine fresh thinking in design with traditional Ohmite quality. For example,

positive current transfer is achieved with direct brush to slip-ring, pig-tailed connection. Adjustable shafts on sizes VT4 and VT8 extend either to the brush or the base side. These two models also are *interchangeable* with competitive makes of comparable ratings. The "N" types in all three models provide additional current without overvoltage. The next time you need variable transformers, select from the line with advanced design—Ohmite.

Write for NEW Stock Catalog 30.



OHMITE MANUFACTURING COMPANY

3662 Howard Street, Skokie, Illinois

RHEOSTATS RESISTORS RELAYS
TAP SWITCHES TANTALUM CAPACITORS DIODES
VARIABLE TRANSFORMERS R. F. CHOKES

Now - Modular Control Systems

New Airborne concept saves design time, helps you get faster delivery

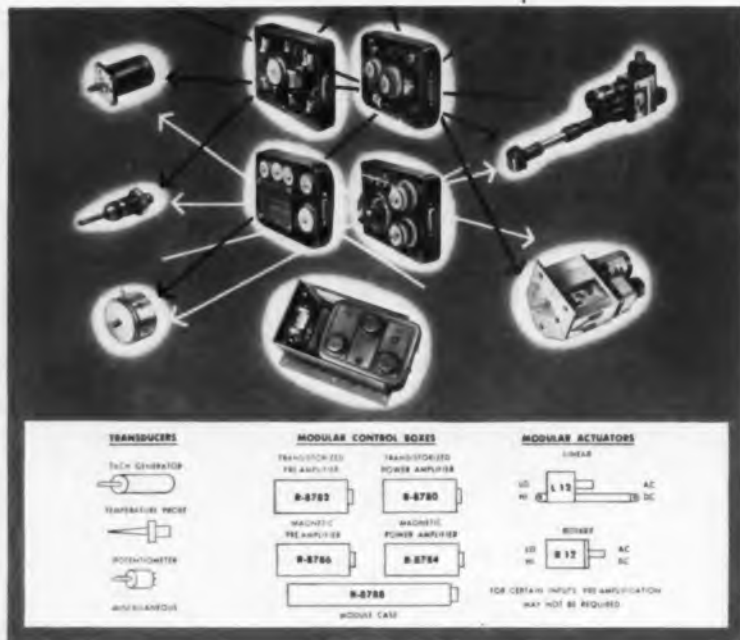

Heart of Airborne's new modular control systems is a contactorless control package consisting of a standardized case (3 x 3½ x 5 in.) into which packaged preamplifier and power amplifier subsystems are plugged. Amplifiers drive actuators having maximum operating loads up to 500 lb. (linear) or 100 in.-lb. (rotary). Modular design permits delivery of relatively complex systems in minimum time.

Over the past 6 years, Airborne has designed and produced a number of special electromechanical control systems for aircraft-missile use. While these have differed in their functions, many of them have nevertheless employed essentially similar components. Thus our policy has been to seek increasing standardization of parts through modular design—to the point where we can now offer complete systems engineered under this concept.

From transducer through actuator, these new Airborne systems are assembled entirely from standardized, interchangeable components. For many applications, you can de-

sign around these packaged systems as they stand—and thus reduce engineering time, lead time, and costs. In other instances, slight modifications of the modular units provide the basis for immediately available systems.

Get complete information on this latest Airborne development by requesting new Bulletin PS-5A. If you feel your requirements are unique and cannot be met with standardized units—however flexible—we still invite your inquiry. As mentioned, Airborne offers an extensive background in custom systems—for temperature control, servo control, and positioning.



Engineered Equipment for Aircraft and Industry
AIRBORNE ACCESSORIES CORPORATION
 HILLSIDE 5, NEW JERSEY • Offices in Los Angeles and Dallas

Circle 110 on Inquiry Card

New Products

TAPE READER

Punched tape reader, Model 909, with a companion spooler mechanism, Model 3299. A completely transistorized electronic readout system is included with output signals compatible



with most data processing systems. Reading speeds up to 200 characters per second are possible with the spooler, which accommodates paper or mylar tape up to 1 in. in width on 8 in. diameter reels. Without the spooler, it can read at rates up to 1000 characters per sec. and stop on a "STOP" character. Potter Instrument Co., Inc., Sunnyside Blvd., Plainview, L. I., N. Y.

Circle 224 on Inquiry Card

ENCODER

Addition to line of shaft position encoders, Model C-804, provides output of 3600 quanta per rev. in Datex code or 4096 quanta per rev. in Gray Code. It is capable of unlimited readout cycles and the sampling rate is limited only by the readout device. It



uses brush contacts of precious metal alloys. The etched disks are plated. It uses an 8½ in. disc. It is 9 in. in dia. and 3½ in. high, exclusive of the shaft. Datex Corp., 1307 So. Myrtle Ave., Monrovia, Calif.

Circle 225 on Inquiry Card

CINCINNATI SUB-ZERO CHAMBERS have the
FINEST REFRIGERATION SYSTEMS

Compact, so units occupy minimum floor space . . . fully automatic controls for testing under conditions of hi-lo temp, humidity, radiation, and altitude . . . through

Custom Engineered Design

- Hermetically sealed compressors
- Overload and under-voltage protection
- Pressure and electrical safety controls
- Refrigerants and refrigeration systems in accordance with nationally approved standards of design
- Air or water cooled systems
- Loss of refrigerants minimized by pressure equalization



For literature and estimates write

CINCINNATI SUB-ZERO PRODUCTS

General Offices & Plant
 3930-EI Reading Rd. • Cincinnati 29, Ohio
 Representatives in major industrial areas
 Member: Environmental Equipment Institute



Circle 120 on Inquiry Card



DUST-TITE

MOISTURE-PROOF

OIL TITE

McKINSTRY NEMA Type 12 PANEL ENCLOSURES

McKINSTRY Panel Enclosures built to NEMA Type 12 specifications give your electrical controls, terminals and instruments complete protection against oil, water coolants and extra protection in heavy dust-laden atmosphere. Before you buy, look into

the complete line of McKINSTRY NEMA Type 12 Enclosures for quality materials and workmanship at reasonable prices.

Write: Dept. 70-A for new Illustrated catalog and price list on complete line of McKINSTRY Enclosures and Fittings.



Circle 121 on Inquiry Card

ELECTRONIC INDUSTRIES • April 1960

DIALCO PILOT LIGHTS

with Built-in Resistor

(a patented DIALCO feature)

for the Neon Glow Lamp NE-51H (High Brightness)

RUGGED: The NE-51H Neon Glow Lamp is made to resist vibration and is proof against sudden failure. It may be operated at about 3 times the level of current applied to the standard neon lamp, and it will produce 8 times as much light—with long life! Requires low power—less than 1 watt on 250 V circuit. Recommended for AC service (may be used on DC circuits above 160 V).

BUILT-IN current-limiting resistor (U. S. Patent No. 2,421,321): For use on 105-125 volt and 210-250 volt circuits. In DIALCO Pilot Lights, the built-in resistor is completely insulated in moulded phenolic and sealed in metal.

COMPACT: Units are available for mounting in 9/16" and 11/16" clearance holes . . . in a wide choice of lens styles and colors, terminal types, metal finishes, etc.

Meet applicable MIL Spec and UL and CSA requirements.

Every assembly is available complete with lamp.

SAMPLES ON REQUEST—AT ONCE—NO CHARGE

Ask for Bulletin No. 100 and Catalogue L-161B.



Foremost Manufacturer of Pilot Lights
DIALIGHT CORPORATION

50 STEWART AVE., BROOKLYN 37, N. Y. • HYacinth 7-7600

Circle 122 on Inquiry Card



The B-58 Hustler, America's first supersonic bomber, is now in production for the U. S. Air Force at the Fort Worth, Texas, Plant of the Convair Division of General Dynamics Corporation. Carrying a crew of only three, the B-58 is designed to operate at altitudes above 50,000 feet and is powered by four General Electric J79 turbojet engines.

Sprague Awarded Contract For Engineering Assistance On B-58 Hustler

The abundance of electronic equipment fitted into the small, dense, supersonic B-58 Hustler calls for comprehensive interference control engineering. To obtain on-the-spot assistance for this extremely complex engineering problem, the Weapon System Manager for the Mach 2 bomber at Convair's Fort Worth Plant has awarded a special contract to the Interference Control Field Service Department of the Sprague Electric Company.

Under the terms of the contract Sprague will assist Convair with the integration of both electrical and electronic equipment of airborne and ground systems into an even more effective and reliable weapon system. Sprague staff engineers assigned

to the project are already at work at the Fort Worth Plant.

Sprague Interference Control Laboratories located in Dayton, Los Angeles, and North Adams, are supporting the Convair program as testing and sampling facilities. These laboratories are staffed by top interference and susceptibility control specialists, and are equipped with the most advanced instrumentation and model shop facilities.

For assistance with your Interference, Susceptibility, and Integration problems, write Interference Control Field Service Manager, Sprague Electric Co. at 12870 Panama Street, Los Angeles 66, California; 224 Leo Street, Dayton 4, Ohio; or 233 Marshall Street, North Adams, Massachusetts.

New

Products

FREQUENCY COUNTER

Electronic counter, Model 521G, automatically measures frequency and random events per unit of time or with the manual gate feature totalizes electrical events. Frequency range is



1 CPS to 1.2 MC. Accuracy is ± 1 count \pm the accuracy of power line frequency—usually $\pm 0.1\%$. ($\pm 0.01\%$ with optional crystal time base installed). Providing a 5-place registration, display time is adjustable to approx. 15 sec., or readings can be held until manually reset. Hewlett-Packard Co., 275 Page Mill Rd., Palo Alto, Calif.

Circle 226 on Inquiry Card

COAXIAL ATTENUATOR

Variable coaxial attenuator, Model AE-6, is first of a series of wideband coaxial variable attenuators which have flat attenuation vs. frequency characteristics and zero insertion loss. Characteristics are: Frequency range, 4-7 KMC; insertion loss, less than 0.5



db; attenuation variation vs. frequency, less than $\pm 5\%$ in db; power handling, 4 w avg.; VSWR, 1.5 max. Merrimac Research and Development, Inc., 517 Lyons Ave., Irvington 11, N. J.

Circle 227 on Inquiry Card



NOW—Two important contributions to printed circuit design—

The Microminiature Kernel
ATE-34 Adjustoroid[®] and a New Line
of Miniature Encapsulated Adjustoroids

Newest addition to the Burnell Adjustoroid line is the microminiature Kernel[®] ATE-34 and the miniature ATE-11, ATE-0 and ATE-4. One of the unique features of these new Adjustoroids is a flush slotted head providing for ease of adjustment and economy in height.

The new microminiature Kernel ATE-34 Adjustoroid and the miniature ATE-11, ATE-0 and ATE-4 are variable over a 10% range of their inductance. Fully encapsulated, they will withstand high acceleration, shock and vibration environments. All of the above meet MIL-T specifications, 27 Grade 4 Class R and MIL-E 15305 A. Write for Stock Sheet AT-34.

	Length/ Dia.	Hgt.	Wt.	Useful Freq. Range	Max. Q	Max. L in hys
ATE-0	1 1/16"	1"	1 1/2 oz.	1 kc to 20 kc	10 kc	5 hys
ATE-4	1 1/16"	1 1/16"	3.5 oz.	1 kc to 16 kc	6 kc	15 hys
ATE-6	1 1/16"	1"	1 1/2 oz.	10 kc to 100 kc	30 kc	.75 hys
ATE-10	1 1/16"	1 1/16"	.1 oz.	3 kc to 30 kc	20 kc	.75 hys
ATE-11	3/8"	1 1/16"	.75 oz.	2 kc to 25 kc	15 kc	5 hys
ATE-12	3/8"	1 1/16"	.75 oz.	15 kc to 150 kc	60 kc	1 hy
ATE-34	2 1/64"	2 1/32"	.1 oz.	3 kc to 30 kc	55 kc	1 hy

PAT. 2,792,029

If you haven't already done so—send for your free membership in the Space Shrinkers Club.

Burnell & Co., Inc.

PIONEERS IN microminiaturization OF
TOROIDS, FILTERS AND RELATED NETWORKS

Eastern Division
Dept. I-31
10 Pelham Parkway
Pelham, N. Y.
PEIham 8-5000
Teletype Pelham 3633



Pacific Division
Dept. I-31
720 Mission St.
South Pasadena, Cal.
Murray 2-2841
Teletype Pasocal 7578

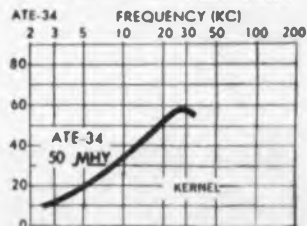
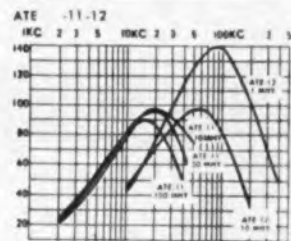
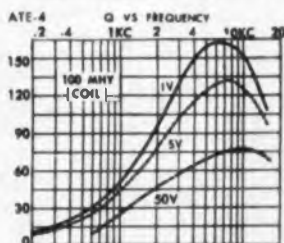
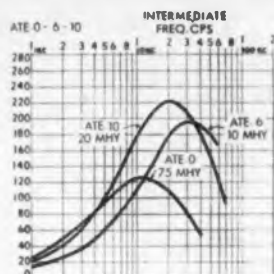

SPECIAL TUBES FOR SPECIAL USES:

EMI

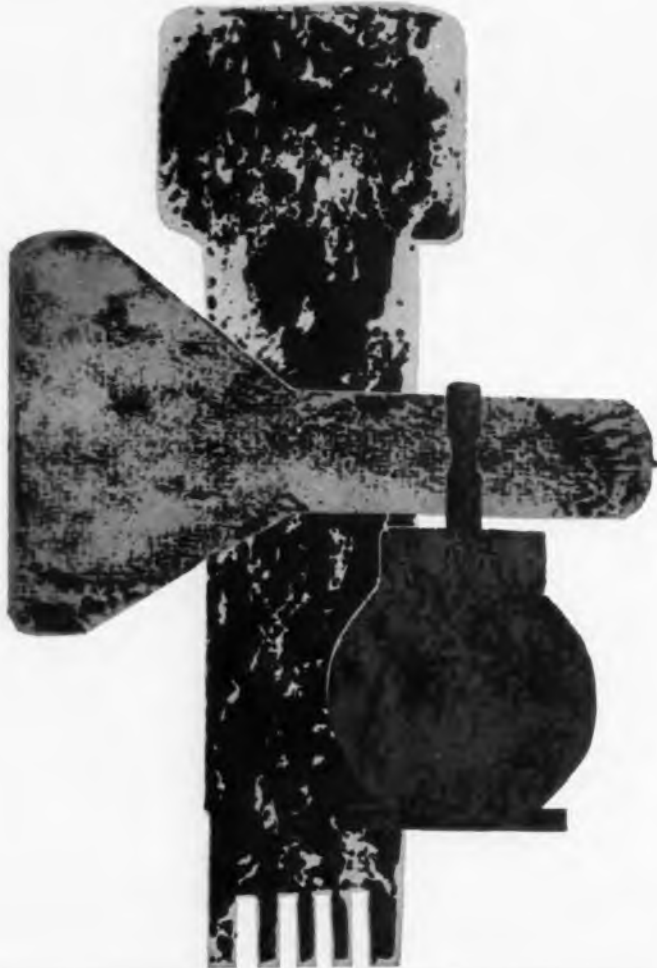

PHOTOMULTIPLIER TUBES / KLYSTRONS / MAGNETRONS
SPECIAL CATHODE RAY TUBES / TV CAMERA TUBES / STORAGE TUBES

E.M.I. Electronics Ltd. is one of the world's leading pioneers in the development of special high-performance tubes for military and commercial use. Through the Hoffman Electron Tube Corp., its United States Representative, a wide range of E.M.I. tubes are now available from inventory for such systems as missile and satellite tracking, ground mapping, weather radar, air traffic control, early warning, combat situation plotting by tactical television cameras, closed circuit television for industry, airborne radar, automatic landing, nuclear radiation scanning, and spectrophotometry. You can rely on E.M.I. for the highest standards of accuracy and reliability. Visit us at the IRE Show, Booth #1520. Write for full technical information to:

HOFFMAN ELECTRON TUBE CORP.
804 NEWBRIDGE AVENUE - WESTBURY - NEW YORK



New

Products

HIGH MU TRIODE

Improved version of the GL-6897 high mu, coplanar ceramic lighthouse triode. The new GL-6897 for long life CW operation, has a typical power output of 20 w at 1850 mc with



33% plate efficiency, plate current of 100 MA, plate voltage of 600 v., and r-f drive power of 2.5 w. It is shock tested to 400 g's and meets MIL-E-1/1037A. For microwave frequency communications service applications, it will operate at frequencies up to 2900 mc. Power Tube Department, General Electric Company, Schenectady 5, New York.

Circle 228 on Inquiry Card

CONTROLLER

Positioning and temperature controller operates standard dc electric valves or positioning actuators. It is a proportional pulse, modulating control, using silicon controlled rectifiers (SCR) as the output device. It occupies less than 28 in³ and weighs approx. 1.1 lbs. It requires 115 v., 400



cps input and tolerates a wide range of frequency and voltage. Controls operate over ambient temperature -65° to +250°F. Garrett Corp., AiResearch Mfg. Div., 9851 Sepulveda Boulevard, Los Angeles, Calif.

Circle 229 on Inquiry Card



**10 mc-
1,000 mc
Frequency
Response
with new
INCREDUCTOR®
Wideband RF
Transformer**

Other packaging available

FREQUENCY RESPONSE within $\pm 1/2$ db over 20 mc—500 mc frequency range and $\pm 1 1/2$ db from 10 mc—1,000 mc. **AVERAGE INSERTION LOSS** 1 db between 20 mc—500 mc and 2 db between 10 mc—1,000 mc.

SIZE $1 1/16" \times 2 1/4" \times 1 3/16"$, Hermetically sealed.

AVAILABLE IMPEDANCE RATIOS presently 200 ohms balanced to 50 ohms unbalanced. Other ratios to be announced.

TYPICAL APPLICATIONS Antenna matching, Input and Output matching of broad band push-pull for single ended amplifiers.

MILITARY SPECIFICATIONS On special order.

**MAGNETIC
COMPONENTS
DEPARTMENT**

**TRAK
ELECTRONICS CO.**

Division of
CGS Laboratories, Inc.

51 DANBURY ROAD, WILTON, CONNECTICUT
Circle 115 on Inquiry Card

We invite you to write for INCREDUCTOR® Wideband RF Transformer Technical Bulletin No. 460.



**For HEAVY DUTY WORK!
Severest Electrical Services**



P-506-CE—Plug with Cap



5-506-DB
Socket with deep Bracket

**JONES
PLUGS &
SOCKETS**

**500 SERIES
Proven Quality!**

**For 5,000 Volts, 25 Amperes
per Contact Alterable by
circuit Characteristics.**

Socket contacts of phosphor bronze, knife-switch type, cadmium plated. Plug contacts hard brass, cadmium plated. Made in 2, 4, 6, 8, 10 and 12 contacts. Plugs and sockets polarized. Long-leakage path from terminal, and terminal to ground. Caps and brackets, steel parkerized (rust proofed). Plug and socket blocks interchangeable in caps and brackets. Terminal connections most accessible. Cap insulated with canvas bakelite.

Write for Jones BULLETIN 22 for full details on line.



HOWARD B. JONES DIVISION
CINCH MANUFACTURING COMPANY
CHICAGO 24 ILLINOIS
DIVISION OF UNITED-CARR FASTENER CORP.

Circle 116 on Inquiry Card

NEW non-corrosive HYDRAZINE FLUX* ends residue problems on soldered joints, saves production time

HYDRAZINE FLUX leaves no rosin residue. New flux in water and water-alcohol solutions vaporizes completely at soldering temperature. Leaves no residue which would support growth of fungus. Will not corrode. Conforms to strict military requirements.

HYDRAZINE FLUX permits prefluxing. This means you can hold prefluxed parts before soldering—an efficiency measure

that can increase manhour output substantially.

Ideal for soft-soldering a wide range of copper and copper-based alloys in electronic applications.

Test Hydrazine Flux in your own plant. Write for a sample of Hydrazine Flux and technical literature . . . for name of your nearest distributor.

*U.S. Patent No. 2,612,459

Available only from Fairmount and its sales agents.

**Fairmount
CHEMICAL COMPANY, INC.**

Dept. E1, 136 Liberty St., N.Y. 6, N.Y. • Plant: Newark, N. J.
Circle 117 on Inquiry Card

ELECTRONIC INDUSTRIES • April 1960



My name is Paul M. Platzman,

I pioneered the ultrasonic industry. Two well known ultrasonic companies were founded by me. Now, my new organization, Ultrasonic Industries, Inc. is mass producing and selling ultrasonic equipment. No middleman's profit in this factory—direct-to-consumer deal. Tremendous savings are passed on to you. Ultrasonic cleaners are now within the range of everybody's budget. My products stand out because of their unbelievably low money-back-guaranteed prices, free five year service contract, and consistent trouble-free performance under the most grueling conditions. This is possible because my generators and transducers incorporate the latest advances in ultrasonic technology.

**DI SONTEGRATOR®
SYSTEM FORTY
ULTRASONIC CLEANER**

THE LOWEST PRICED ULTRASONIC CLEANER EVER SOLD! Buy one or 100 and save! Rugged, Efficient, Versatile, Fast . . . Cleans in Seconds • Simple One Knob Control • Compact • Saves Time and Money!

DISINTEGRATES injurious soils instantly! Semiconductors, relays, crystals, switches, precision potentiometers, optical parts, lenses, timers, meters, ceramics, gears, printed circuit boards, castings, bearings, filters, screens, valves, missile and avionic parts, and instruments.



**FABULOUS
INTRODUCTORY
OFFER \$99.95**

1/2 gal. cap.

including tank, connecting cable, and instruction manual (export model: 220V-50 cycles: \$7.50 add'l.). We will pay all shipping charges to any point within the U.S. (except Alaska and Hawaii) if you enclose check with order.

5 DAY TRIAL

Money refunded (less shipping charges) if not completely satisfied.

Unprecedented 5 year service contract The DiSONtegrator-System 40 is available from stock for immediate delivery in unlimited quantities.

FOR THE FIRST TIME A choice of 6 beautiful colors for office or laboratory decor: Ivory, Wheat yellow, Turquoise, Desert sand, Pale green, and soft grey. Specify color when ordering.

SEND CHECK WITH ORDER NOW TO: DEPT. 5-EI-4

ultrasonic industries



141 ALBERTSON AVENUE • ALBERTSON, L. I., N. Y. • PIONEER 1-4333

Circle 118 on Inquiry Card



CHILTON
ANNOUNCES
MAP
MARKETING ASSISTANCE PROGRAM

NOW AVAILABLE . . . MARKETING ASSISTANCE PROGRAM

Offering manufacturers counsel in marketing has long been a Chilton practice. But count on Chilton to move ahead with the times. Today Chilton's intensified activity in market research is a development that can help you get more out of your sales and advertising dollars. The stepped-up facilities—organized in depth and breadth—are identified as M-A-P, an efficient, penetrating Marketing Assistance Program.

If you are a manufacturer searching for new talents and tools in your marketing operations, Chilton can put a wealth of manpower and a multiplicity of facilities to work for you. All Chilton publications have marketing data representing years of selling experience and research in their respective fields. And Chilton's fully staffed Research Department is equipped to help you develop additional data to give even better direction to your marketing plans.

Chilton's standards of editorial excellence and quality-controlled circulation in 17 business publications are now linked with stronger and more complete marketing information for advertisers. Chilton representatives will be glad to give you more details.

Chilton

COMPANY
Control and Information
Publications in America

Address: 415, East 57th Street, New York 22, N.Y. • The Iron Age • Petroleum Age • The Engineer • Scientific American • Self and How to Succeed • The Commercial Car Journal • Sales Progress Review • Industrial Engineering • Small Business • Small Business & Service Company • White Paper Institute Week • Journal of Business Research • Electronic Age • Public Service & Government • Business Training and Development Journal

Cool Magnetrons and Power Tubes with Model D Blowers

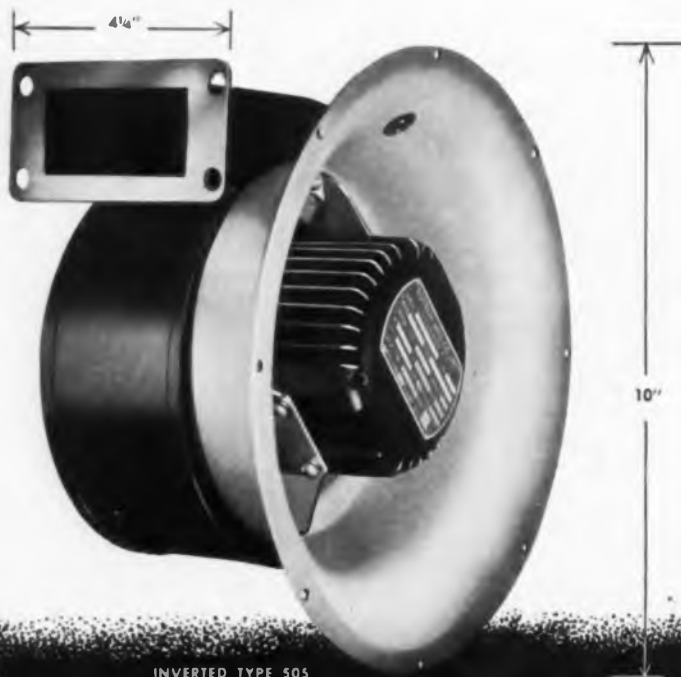

INVERTED TYPE 505

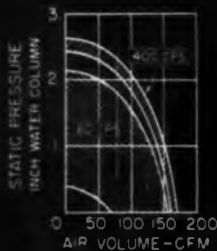

Shown is one of a family of high pressure blowers designed for turbulent cooling in Commercial and Military Electronic applications where space is at a premium and long trouble-free life is mandatory.

OPTIONAL AIR INLET & OUTLET ADAPTORS & MOUNTING SURFACES

SEE Catalog Sheets
40102-31
40102-32
30102-3



ROTRON

MANUFACTURING CO., INC.
WOODSTOCK • NEW YORK

New Products

MESA COMPUTER DIODES

High voltage silicon mesa diodes TI IN914 and TI IN916 switch from 10 ma forward current to 6 reverse in 4 musec max. This fast switching is coupled with a capacitance of 2 μ f



(max.). For up to 100 MC, both provide a min. rectification efficiency of 45% and a max. leakage of 25 μ ma at 20 v. They feature a high peak inverse voltage of 75 v. Both will dissipate 250 mw at 25°C and min. forward voltage is 1 v. at 10 ma. Both have an operating range of -65 to 150°C and a max. storage temp. of 200°C. They withstand 20,000 g's during acceleration and 1000 g's during shock. Texas Instruments Incorporated, P. O. Box 312, Dallas, Tex.

Circle 230 on Inquiry Card

SPEED REDUCERS

Miniature speed reducers are approx. 15/16 in. in diameter. They are made to MIL specifications, size 10 frame, in ratios from 9:1 to 3000:1. Precision A.B.E.C. -5 ball bearings throughout. Maximum rated output



torque is 35 in. oz. Backlash through the entire train is less than 30 min. measured at output shaft. Gears are cut to precision 2 or better. PIC Design Corporation, 477 Atlantic Avenue, East Rockaway, L. I., N. Y.

Circle 231 on Inquiry Card

FREE! ULTRASONIC CLEANING BULLETIN



Describes National Ultrasonic Corporation's:

- Applications Laboratory service. Your sample parts are cleaned ultrasonically and equipment and cost recommendations are made at no charge.
- STANDARDLINE medium power cleaners for all applications requiring average energy levels.
- HEAVYDUTYLINE high power cleaners for industrial applications requiring high energy density.
- NUClean solvents and detergents especially formulated for ultrasonic cleaning.



NATIONAL ULTRASONIC CORP.

111 Montgomery Ave., Irvington 11, N. J.
ESse 1-0550 • TWX NK 1030

Circle 124 on Inquiry Card

There's a *New* DIAL HEAD AGASTAT®



for every time/delay/relay application

Here's what you get with every Agastat time/delay/relay

- Easy adjustment
- Repeatable accuracy
- Instantaneous recycling
- Unaffected by voltage variations
- Low power consumption

GET THE WHOLE STORY—write today for Bulletin No. SR-10 and find out how Agastat can help you to solve your time delay problems. Write to Dept. A35-432.

AGA
DIVISION

ELASTIC STOP NUT CORPORATION OF AMERICA

1027 Newark Avenue, Elizabeth, N. J.
Gasaccumulator Co., (Canada) Ltd., 12 Gower Street, Toronto 16, Ontario

Circle 125 on Inquiry Card

ELECTRONIC INDUSTRIES • April 1960

NYLON TIP JACK
Available in all nylon body or as a metal-clad type to meet military specifications. Completely insulated—no auxiliary mounting hardware needed.

NYLON BANANA PLUG
A rugged, high voltage insulated plug for a wide variety of applications.

NYLON BANANA JACK
Molded nylon body provides voltage breakdown of 12,500 volts DC.

NYLON BINDING POST
Compact, completely insulated, pre-assembled 6-way binding post.

NYLON TIP PLUG
Designed for solderless connection—fits all standard tip jacks.

NYLON Voltage breakdowns up to 12,500 volts DC! CONNECTORS

These rugged Johnson connectors are molded of tough, low-loss shock-proof nylon—and will not chip or crack, even when subjected to extreme temperature changes or severe mechanical stress. Nylon provides high voltage insulation, with voltage breakdowns up to 12,500 volts DC. Metal clad tip jack meets MIL specifications (full specifications available on request). All connectors are designed for fast, easy mounting—and are available in 13 bright colors for coded applications.

OTHER CONNECTORS—Johnson also manufactures a complete line of standard connectors in addition to the nylon line described above. For complete information, write for our newest components catalog shown below.



NEW

DUAL BANANA PLUG
Extremely versatile—provides variety of application possibilities. Solderless design—tough shock resistant nylon body retains strength and low-loss characteristics over a wide range of temperature and high relative humidity conditions. Available in 13 permanent colors.

New Catalog

Write today for our newest electronic components catalog—complete specifications, engineering prints and current prices on:

- CAPACITORS • TUBE SOCKETS • CONNECTORS • PILOT LIGHTS
- INSULATORS • KNOBS, DIALS • INDUCTORS • HARDWARE



E. F. JOHNSON CO.

2016 Second Avenue S.W. • Waseca, Minnesota

Circle 126 on Inquiry Card

Telephone Coils

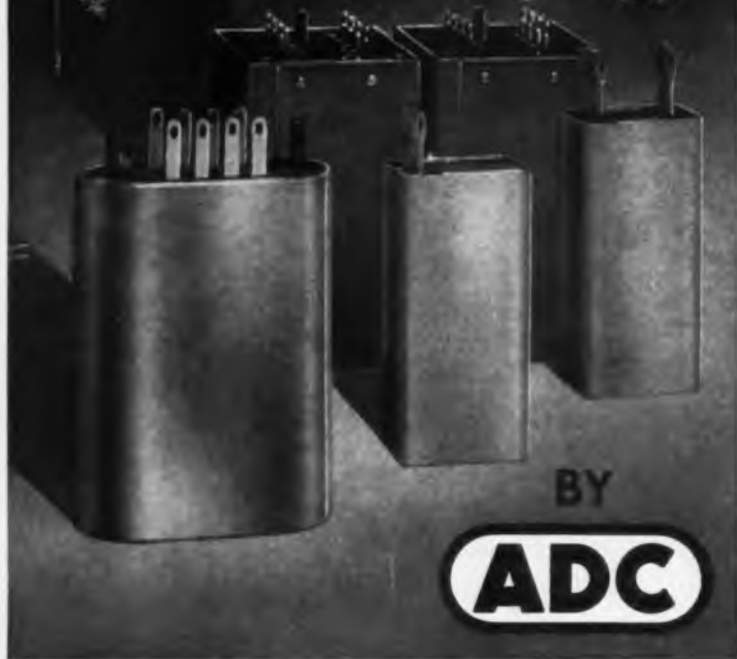

BY

ADC

In addition to their regular stock and custom transformers for the electronic industry, ADC has long been a dependable source of transformers and filters to the telephone and telegraph industry. When Western Electric announced they would no longer supply these components to manufacturers, ADC put their 24 years of experience to use designing and tooling a series of "coils" which are electrically and physically interchangeable with similar components made by The Western Electric Company. Many of these are in stock. If you use such components, we suggest that you write for more information. We believe you'll be pleased with both the price and delivery.

WRITE TODAY FOR TELEPHONE COIL LITERATURE



ADC
AUDIO DEVELOPMENT COMPANY
 2839 13th Avenue South • Minneapolis 7, Minnesota
 TRANSFORMERS • REACTORS • FILTERS • JACKS & PLUGS • JACK PANELS

New

Products

TUBE SOCKET

Tube socket for the GE GL6299 UHF planar triode for practical UHF lumped constant circuitry with assurance of bandpass stability as tubes are changed. The XV-100/6299 may



be used to 1000 MC or higher with no resonances over the band. It exceeds these environmental tests: Vibration, 10-55 CSP 1/64 in. excursion; altitude, 10,000 ft. (operative) and 40,000 (inoperative); drop test, 2 ft. (equipment units); bounce test, 5g for 3 hrs. (equipment units); humidity, per MIL STD 169. Other Mil specs, MIL STD 170, MIL E-16400 and MIL E-5400. Instruments for Industry, Inc., 101 New South Rd., Hicksville, L. I., N. Y.

Circle 232 on Inquiry Card

FREQUENCY MULTIPLIER

Frequency multiplier with band-switching for the 80-40-20-15 and 10 meter bands operates on a 6 to 10 v. r-f supply within 3350 to 4000 kc to produce desired fundamental on 80-40-20-15-10 meter bands. The Model 504C may be used as a driver for high powered class "C" or linear am-



plifiers and as a low power transmitter on either phone or CW when equipped with suitable power supplies, modulator and excitation. Barker & Williamson, Inc., Bristol, Pa.

Circle 233 on Inquiry Card

IN-LINE

DIGITAL DISPLAY

with ONE-PLANE PRESENTATION

Series 10,000



OUTSTANDING FEATURES

- Reliable, dependable, no moving parts
- All digits displayed on front surface viewing screen
- All digits uniform in size and intensity
- High-contrast viewing screen insures utmost visual sharpness
- Digit style of your choice to complement manufacturer's original equipment
- Colored digits of your choice for special environmental lighting
- Individual units may be assembled in groups for convenient panel mounting
- Dimensions: 1 1/16" wide, 2 3/4" high, 5 3/8" long

PRICE PER UNIT
\$1800

Quantity Prices on Request

WRITE TODAY FOR
COMPLETE DETAILED
SPECIFICATIONS

Representatives
in principal cities

INDUSTRIAL ELECTRONIC ENGINEERS, Inc.

Engineers and Manufacturers of
Fully Automatic Systems and Machines

5528 Vineland Avenue, North Hollywood, Calif.

Circle 128 on Inquiry Card



TAILOR THE TERMINAL TO THE BOARD



CAMBION Swaging Tools are designed to precisely seat and securely stake *all* CAMBION Terminals. For each type of terminal there's a CAMBION punch-and-anvil combination. Precision-machined from fine steel for long wear, standard sets are available for only \$5.00 each to match the following CAMBION Swaging Machines:

HAND SWAGERS for small volume staking. Can be used manually, in a kick press, or in a riveting machine. **PRESSURE SWAGERS** for normal production. These sturdy, hand-operated, cam-action rolling tools are easily adjustable for a wide range of board thickness. **HOPPER STAKERS** for high production. These semiautomatic stakers faultlessly feed and stake thousands of terminals without interruption at a rate of approximately 100 a minute. Write Cambridge Thermionic Corporation, 504 Concord Avenue, Cambridge 38, Mass. for full details on these and other products in the wide line of

CAMBION

The guaranteed electronic components
Circle 130 on Inquiry Card

MIXER-PREAMPLIFIERS

(For Maser and Parametric RF Amplifiers)

COMMAND MAXIMUM PERFORMANCE

From your
communications
and detection
equipment

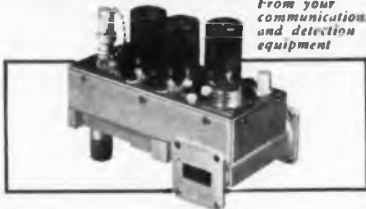

The LEL MMX-3 Mixer-Preamplifier covers the upper X-band from 10.5 to 12.4kmc. It provides stabilized IF-RF power gain of more than 25db over a 20mc band-pass centered at 60mc, with minimum noise figure making the MMX-3 ideally suited for Maser and Parametric post-amplification use as well as general microwave receiver applications.

Featuring:

Noise Figure9.0db nominal (Max. 9.5db)
Low Power Requirements170v @ 55ma

Send for comprehensive Microwave,
IF, RF Amplifier Catalog.

LEL

380 OAK STREET, COPIAGUE, N. Y.

Circle 129 on Inquiry Card

ELECTRONIC INDUSTRIES • April 1960

MIAMI... AN UNLIMITED SOURCE OF SKILLED TECHNICIANS!



There is no shortage of skilled and technical labor in Metropolitan Miami. Skills and semi-skills want to live here and...since workers are happier in their jobs, turnover is generally very low. The Dade County Development Department stands ready to help you with your plant location problems. Our assistance costs you nothing.

Send for complete Economic Study of Metropolitan Miami



A 30-section, economic survey has been prepared to assist you in determining how your operation can profit here. This study will be mailed to you—in strictest confidence—if you write on your letterhead to the address listed below.

WRITE: Richard P. Welsh, Director

DADE COUNTY DEVELOPMENT DEPARTMENT

345 Northeast Second Avenue • Miami • Florida

An agency of the Metropolitan Miami Government

Circle 131 on Inquiry Card

FAST...

FASTER...

FASTEST!

KESTER "44" RESIN-CORE SOLDER

No solder on the market works as fast, as sure as Kester "44" Resin-Core Solder... with its instant fluxing action. Flux-residue is non-corrosive, non-conductive... fungus resistant too. Available in all alloys, core sizes and diameters.

FOR HIGH SPEED
PRODUCTION
LINE SOLDERING

WRITE today for free 78-page Technical Manual
"SOLDER... Its Fundamentals and Usage."

KESTER SOLDER COMPANY

4210 Wrightwood Avenue, Chicago 39, Illinois
Newark 5, New Jersey • Anaheim, California • Brantford, Canada

OVER 61 YEARS' EXPERIENCE IN SOLDER AND FLUX MANUFACTURING

Circle 132 on Inquiry Card

The New Standard Of STABILITY At 5 mc...



BLILEY TYPE: BG61AH-5

ONE PART PER
BILLION

(with temperature control)

Bliley BG61AH-5 units have long been the unanimous choice for crystals at 5 mc. Now, this outstanding crystal has been ruggedized for applications that demand high stability under shock and vibration. The

ruggedized unit, Bliley type BG61AH-5, will withstand vibration from 10 to 200 cps at 10G and acceleration of 50G with frequency change less than

1 x 10⁻⁶. Request Bulletin 519.

BLILEY ELECTRIC COMPANY

UNION STATION BUILDING
ERIE, PENNSYLVANIA

Circle 133 on Inquiry Card

New

Products

DATA ACCUMULATOR

The Telecordex Model 180 is a multiple input recording and indicating data accumulator which records and stores sequential measurement pulses. Bi-directional input pulses at rates



up to 15,000 per sec. can be accepted from measurement devices that generate sequential pulses as a function of the parameter being measured. Each channel has a max. storage of $\pm 999,999$ counts. The output can be recorded by electric typewriter at 600 characters/min., by IBM Key-punch or Summary Punch at 50 cards per min., or by a tape perforator. SMA 582, Data Instrument, Div. Telecomputing Corp., 12838 Saticoy St., No. Hollywood, Calif.

Circle 234 on Inquiry Card

FREQUENCY STANDARDS

Frequency standards (transistor oscillators): The JKTO-PIP series of plug-in signal sources, offers frequency stabilities in the order of 1 part in 100 million per day. Available in 1.0, 1.8, 2.5, 3.0 and 5.0 MC. Two models are available: The JKTO-PIP (L) for ambient temp. to 75°C



and the JKTO-PIP (H) for temp. to 100+°C. JKTO-PIP series units have an output of 1 v. into 500 ohms, operating from 24 to 28 vdc. James Knights Co., Sandwich, Ill.

Circle 235 on Inquiry Card

Now available
in commercial
quantities!

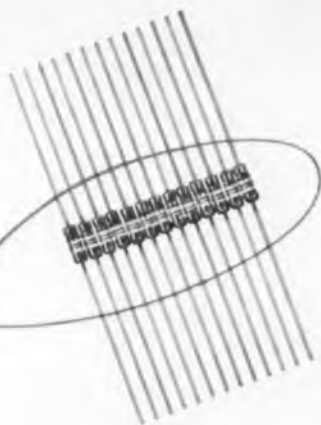

Sylvania D-1820 germanium High-Speed Switching Diode

4 mμSECS

**GUARANTEED
MAXIMUM
RECOVERY
TIME!**

SYLVANIA D-1820 is the forerunner of an outstanding family of diodes, designed, produced and controlled specifically for logic circuitry. The cost of this new SYLVANIA diode is low enough to make it especially attractive for use in quantity-produced electronic computers. SYLVANIA D-1820, and the circuits designed around this diode, feature:

high-speed operation — with recommended circuits, all units are guaranteed to provide a maximum recovery time of 4 millimicroseconds. However, recovery times of 2.5 millimicroseconds are typical.

long-life performance — proved in 1000-hours operating and 7000-hours storage life tests.

high reliability — basic point-contact structure has been field-proved for more than a decade. Withstands environmental conditions of shock and vibration.

exceptional uniformity of electrical characteristics—assures complete interchangeability within the type—result of modern automated-production techniques employed in the manufacture of SYLVANIA D-1820.

economy — SYLVANIA pioneered the field of germanium point-contact diode manufacture, has "know-how" of superior-quality, large-quantity economical production. SYLVANIA is able to pass these savings on to you.

simplicity—diode-logic circuitry is relatively uncomplicated, requires few components. It reduces computer construction costs. It adds to equipment reliability.

compactness—SYLVANIA D-1820 "package" is miniature all-glass.

availability—units can be supplied immediately through your local Sylvania Semiconductor Distributor or through your local Sylvania Field Office.

Complete sales information on quantity prices, delivery and sampling for your own evaluation is available from your local Sylvania Semiconductor Distributor or Field Office. For engineering data sheets on the new Sylvania D-1820 High-Speed Switching Diode or on any Sylvania Semiconductor Device, write Sylvania Semiconductor Division, Dept. 19-2, Woburn, Mass.

ELECTRICAL CHARACTERISTICS— SYLVANIA D-1820	
Absolute Maximum Ratings*	Typical Operating Conditions*
Fwd. Volt 1.3 V †	Fwd. Volt 0.9 V
Fwd. Curr.50 mA	Fwd. Curr.2.0 μA
Back Volt 20 V	Rev. Recovery 2.5 mμs
Pwr. Diss.80 mW	

†at 10 mA °of 20° C.

SYLVANIA

Subsidiary of **GENERAL TELEPHONE & ELECTRONICS**



STROMBERG-CARLSON

"BB" SERIES RELAYS



For your automation
...computing...control
circuit applications...

"TELEPHONE QUALITY"
at an ordinary price

To meet your needs for precision and durability in automation, computing and control circuitry, this relay provides telephone quality at an ordinary price.

The "BB" Series Relay accommodates up to 100 Form A spring combinations. It incorporates such important advantages as twin contacts, knife-edge pivot and special frame-armature construction. Like all Stromberg-Carlson relays, it is built to operate under extreme ranges of temperature and humidity. Prompt delivery is available on all orders.

For full information write to Telecommunication Industrial Sales, 126 Carlson Road, Rochester 3, New York.

STROMBERG-CARLSON
A DIVISION OF
GENERAL DYNAMICS

Circle 135 on Inquiry Card

New

Products

VIDEO & RF JACKS

The Type 925 Jack is similar to the Type 964 Jack; the difference being in the provision of a BNC connector mounted on the back of the Type 925 Jack. The heavy silver plated contact surfaces of this Jack are protected with a gold flash. Type



925 Jack is designed primarily for use in Types 921, 928, and 929 Jack Panels. Nems-Clarke Co., Div. of Vitro Corporation of America, 919 Jessup-Blair Drive, Silver Spring, Maryland.

Circle 236 on Inquiry Card

LEARN THE INDUSTRIAL ADVANTAGES OF HOLLYWOOD FLORIDA

- Ideal living and working conditions
- Abundant, contented, skilled and unskilled labor
- Modern industrial buildings available
- Excellently located industrial sites
- Rail, truck, air, water transportation
- Adjoining deep water Port Everglades
- Convenient to U.S. and Latin American markets
- Hub of Florida's fastest growing market

Write for Industrial Brochure
Inquiries held in strict confidence

INDUSTRIAL DIVISION, DEPT. EI
CHAMBER OF COMMERCE
HOLLYWOOD, FLORIDA

Circle 136 on Inquiry Card

Megacycle Meter

0.1 Mc to 940.0 Mc

Determines resonant frequency of tuned circuits, antennas, transmission lines, by-pass condensers, chokes, etc. Measures inductance and capacitance. Also used as a signal generator, wave meter, frequency meter, and in many other applications.

This compact, lightweight grid-dip meter is available in the frequency ranges indicated.



Model 58
Oscillator
2.2 Mc - 420 Mc



Model 58-LF
Oscillator
100 Kc - 4.5 Mc



Model 58-UNF
Oscillator
420 Mc - 940 Mc

Write for Bulletin

Laboratory Standards

MEASUREMENTS

A McGraw-Edison Division
BOONTON, NEW JERSEY

Circle 137 on Inquiry Card

New Products

PULSE TRANSMITTER

A 1 kw VHF pulse transmitter operates over 152 MC to 174 MC. Model 200A, delivers peak pulse power of 1000 w at a max. duty cycle of 50% into a nominal load impedance of 50 ohms. Input modulation is 1 to 4 v. peak into a 100 ohm termination. R-f output pulses constant through range of input pulse voltage. Overall r-f bandwidth is approx. 1.0 MC at the 6 db points. Operating ambient temp. range is 10° to 55°C. R-f output sig-

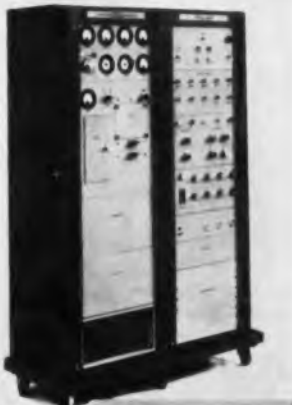

nal between modulation pulses is 30 db or more below the 1 kw output signal. It operates from a 208 v., 60 cycle, 3 phase, 4 wire input. Sierra Electronic Corp., 3885 Bohannon Dr., Menlo Park, Calif.

Circle 237 on Inquiry Card

PROBE

A subminiature probe designed for in-line use to provide quick make-and-break connections in conjunction with a matching jack or test point. Type PR-11 has a 0.040 inch diameter



heavily gold-flashed probe on each end of a straight Teflon body, and mates with most of the "Press-Fit" receptacles taking a 0.040 inch diameter probe. Sealectro Corporation, 139 Hoyt Street, Mamaroneck, New York.

Circle 238 on Inquiry Card

fci OIL FILLED HERMETICALLY-SEALED SELF-CONTAINED

Power Supplies

Electrical Characteristics

PART NO.	OUTPUT VOLTAGE	% RIPPLE AT RATED CURRENT	RATED CURRENT OUTPUT	MAX. CURRENT OUTPUT
PS-2S	2 KVDC	1%	5 MA	7.5 MA
PS-5S	5 KVDC	1%	5 MA	7.5 MA
PS-12T	12 KVDC	1.5%	1 MA	1.75 MA
PS-15T	15 KVDC	1.5%	1 MA	1.75 MA
PS-30T	30 KVDC	1.5%	1 MA	1.75 MA



- All models are designed with a full wave doubler circuit.
- Voltages on all models can be varied from zero to maximum.
- Safety-rated components assure long trouble-free life.
- Neutral case may be positive, negative, or left floating.

WRITE FOR FURTHER INFORMATION AND OUR COMPLETE CATALOG

ALSO MANUFACTURERS OF:



GREATER TUBULAR W.V. CAPACITORS

POLYESTER FILM W.V. CAPACITORS

Film Capacitors, Inc. 3400-06 PARK AVENUE, NEW YORK 56

Circle 138 on Inquiry Card

SYNTRON SILICON RECTIFIERS

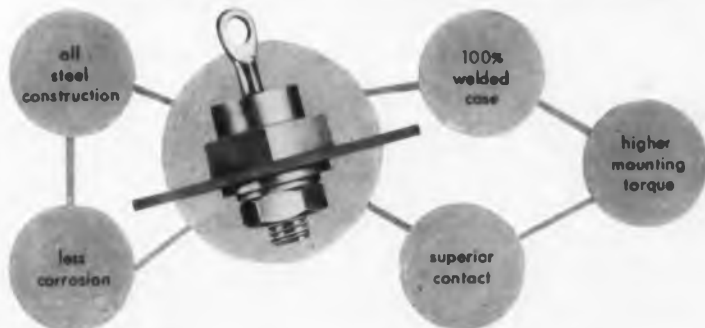

SYNTRON'S exclusive all steel construction provides higher mounting torque, superior contact and reduces corrosion. Maximum mounting torques 50-100 inch #.

Their 100% welded case, with no blind solder connections, assures positive contact, greater efficiency and long reliable life.

Write for complete technical data or contact your nearest SYNTRON Sales Engineer.

SYNTRON RECTIFIER DIVISION

SUBSIDIARY OF LINK BELT COMPANY

263 Lexington Ave.

Homer City, Penna.

Sales Engineers in: New York, Cleveland, Chicago, Los Angeles and Canada

worth looking at

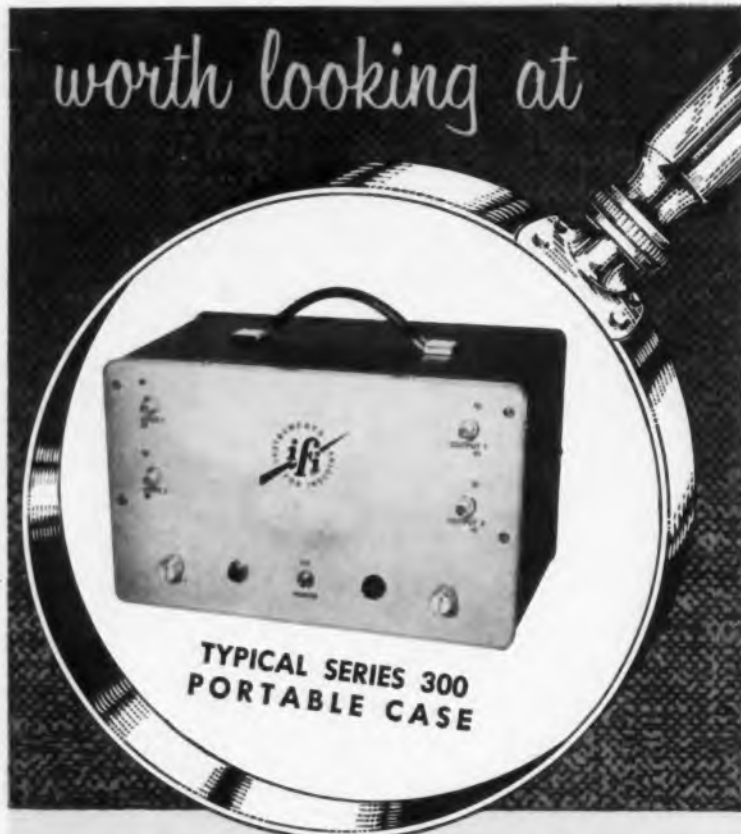

TYPICAL SERIES 300
PORTABLE CASE

SPECIFICATIONS

Bandpass	200 cps to 50 mc (M-600) 300 cps to 20 mc (M-630) 400 cps to 10 mc (M-600)
Gain	40 ± 1 1/2 db (M-600) 60 ± 2 db (M-630) 20 ± 1 1/2 db (M-600)
Input Impedance	90 ohm, VSWR less than 1.5
Output Impedance	90 ohm, VSWR less than 2.1
Max. undistorted output voltage - matched	2.0 VRMS
Max. undistorted output voltage - open circuit	6.0 VRMS max. load capacity 25 μ f for 3 db down at 50 mc (M-600) 65 μ f for 3 db down at 60 mc (M-630) 25 μ f for 3 db down at 20 mc (M-600)
Max. Pulse Output (Matched Load)	3.0 volts peak — positive or negative
Max. Pulse Output (Open Circuit)	7.0 volts peak — positive or negative
Pulse Rise Time	10 millimicroseconds
Max. Pulse Duration (10% drop)	60 microseconds (M-600) (M-630)
Pulse Delay Time	40 microseconds (M-600) 20 millimicrosec. (M-600) 30 millimicrosec. (M-630) 12 millimicrosec. (M-600) 500 millimicroseconds
Recovery Time (100 times overload)	Approximately 0 db
Noise Figure	20 db
Gain Control Range	Approximately 60 db
Linear Range at full gain	

GENERAL DESCRIPTION

Instruments for Industry, Inc. announces two new super video amplifiers: Models M-630 and M-600. These amplifiers can be used in much the same way as the M-600 amplifiers have been used by the electronic industry in recent years. That is, two M-630 or two M-600 amplifiers can be housed in a cabinet that includes a power supply and front panel connections. The present dual-amplifier combination using a pair of M-600 amplifiers, is designated Model M-300A. Now the same amplifier cabinet (see photograph) can be used for a pair of M-630 or M-600 amplifiers. The two amplifier sections can be operated separately, in cascade, in parallel, or in push-pull operation. Each section has a 50-ohm input and a 90-ohm output impedance for which there are separate input and output connectors on the front panel. For two-channel work, it is possible to use each amplifier as a complete amplifier with a gain of 20 db (if M-600 sections are used) or 60 db (if M-630 sections are used), two volts RMS output each.

Two 600's with Power Supply and cabinet or rack panel — Model 300A
Two 630's with Power Supply and cabinet or rack panel — Model 303
Two 600's with Power Supply and cabinet rack or panel — Model 300
600 Series \$225 ea.—300 Series \$595 ea.

INSTRUMENTS FOR INDUSTRY, Inc.
101 New South Road, Hicksville, L. I., N. Y.

ifi



Students engineers with two or more years of direct application in the fields of electronics or physics are invited to meet with Mr. John Blake in an informal interview or send complete resumes to: Dr. Personnel, IPI, 101 New South Road, Hicksville, New York.

New
Products

HIGH VOLUME FAN

Propeller fans, Model 1PB95W, deliver 550 CFM at a low decibel rating. Panel mounted units for electronic racks, for mobile or stationary generators, military vans, or field vehicles.



Powered by a continuous duty totally enclosed 115 v, 60 cps, single phase, shaded pole motor, which meets CC-M-636A. Ball bearings meet FF-B-171 and lubrication meets MIL-G-3278 with temp. range —68 to +93°C. McLean Engineering Laboratories, Princeton, N. J.

Circle 239 on Inquiry Card

PRESSURE TRANSDUCER

Flush-mounted pressure transducer with improved high-frequency performance, Type 4-327, in pressure ranges from 0-100 to 5000 psi gage and absolute, can measure high-fre-



quency transient phenomena. It is for use where accuracy must be maintained under rugged environmental conditions, such as in missile test stands, aircraft and missile engine test cells, high-pressure pneumatic systems and nuclear reactors. Consolidated Electrodynamics Corp., 360 Sierra Madre Villa, Pasadena, Calif.

Circle 240 on Inquiry Card

Feeds, stakes and fuses Eyelets in PRINTED CIRCUIT Boards
WITH 100%
RELIABILITY



EDWARD SEGAL
MODEL NR-ESSM
automatic eyelet
attaching machine

In every environmental test!

This revolutionary machine, supplied as a complete installation, is obsoleting manual eyelet attaching and soldering. Leading manufacturers, in many cases using batteries of them, find Segal's new Model NR-ESSM is a completely dependable automatic method of making continuous electrical circuits of the printed elements on opposite sides of a board — or a single side if desired. Stakes and fuses 30 eyelets or more a minute, top and bottom, with never a reject.

There are other models for cold staking flat and funnel type eyelets, and for feeding and staking tube pins and turret terminals with equal reliability. All are highly economical. Segal can improve your eyelet attaching production. Write section EI-4,



Manufacturers of eyeleting machinery,
special hoppers and feeding devices
132 LAFAYETTE STREET, NEW YORK 13, N. Y.

Circle 142 on Inquiry Card

Send for this *Free* SAMPLE FOLDER...



Contains 25 different test samples of
high-dielectric Insulating Tubing & Sleeving

Includes samples and descriptions of: Varglas
Silicone • Permafil-Impregnated Varglas Tubing
• Varglas Tubing and Sleeving • Varglas
Non-Fray Sleeving • Varflo Tubing and Sleeving
• Varflex Cotton Tubing and Sleeving •
Syntholvar Extruded Tubing.

Write today!

VARFLEX CORPORATION

506 W. Court St.

Circle 143 on Inquiry Card

ELECTRONIC INDUSTRIES • April 1960

Rome, N.Y.



Regulated, multiple voltage output +250 volts, +150 volts,
+70 volts, +70 volts, +250 volts, -35 volts, -50 volts, -60
volts, -70 volts, -250 volts D.C. 6.3 volts, 115 volts, A.C. Total
power capacity approx. 15 KW

EXPERIENCE and SKILL
are an inherent component
of every ACME ELECTRIC built
POWER SUPPLY

"Know your supplier" is pertinent advice as it applies to the design, engineering and construction of power supplies. Acme Electric not only knows the state of the art but is a recommended supply source. That's why you can expect specific advantages based on engineering experience, and backed-up by manufacturing facilities and trained manpower. If power supplies are an important part of your products, it will pay you to investigate the part Acme Electric can play in your procurement program.



Series regulated
Output 120, ±1% dc
● 0-6 amps.

ACME ELECTRIC CORPORATION

894 Water St.

Cuba, N. Y.

West Coast: 12822 Yukon Ave.

Hawthorne, Calif.

In Canada: Acme Electric Corp. Ltd., 50 Northline Rd., Toronto, Ont.

ORA 2420/1872

Acme Electric
TRANSFORMERS

Circle 144 on Inquiry Card

new, low-cost micro- microammeter



Model 414 offers high performance over 17 ranges for just \$280.00!

● The Keithley 414 Micro-microammeter is today's lowest-cost instrument for low current measurements in production tests, monitoring installations and experiments in the range of 10^{-9} to 10^{-11} ampere. The 414 can be used as the amplifier element in systems, such as reactor controls, thickness gauges, ionization gauge control in high-vacuum equipment. Contact meter models are available for go, no-go production tests, alarm and control systems.

SPECIFICATIONS

Ranges: 17 ranges in 1x and 3x steps, from 10 ma to 0.1 μA f.s.

Accuracy: Within $\pm 3\%$ of f.s. to 10 μA ; $\pm 4\%$ on lower ranges.

Input Voltage Drop: Below 5 mv all ranges with full-scale signals.

Response Time: Below 0.5 sec. all ranges, for any input capacitance to 5000 μf .

Zero Drift: Below 2% of f.s. per day.

Recorder Output: 5 volts with a 1 ma capability.

Price: Model 414 \$280.00

For full details, write:



**KEITHLEY
INSTRUMENTS**

12415 EUCLID AVENUE
CLEVELAND 6, OHIO

Circle 145 on Inquiry Card

New Products

SWITCH ATTENUATOR

Ferrite Switch Attenuator may be used in high power transmitter circuitry. Model No. W662-3A-2, may be used for range adjustment, static testing and slow modulation up to 250 kw.



Features include: Frequency range, 8.5 to 9.6 KMC; max. attenuation, 35 db min.; min. attenuation, 0.5 db max.; VSWR max., 1.3 Bilateral peak power, 250 kw; aver. power at 250 w; switching time, 20 msec.; switching rate, 2 CPS; driving power, 100 w max. Kearfott Co., Inc., Microwave Div., 14844 Oxnard St., Van Nuys, Calif.

Circle 241 on Inquiry Card

FREQUENCY CONVERTER

Magnetic-core frequency converter is designed to convert three-phase power to either single-phase or three-phase power at a frequency which is seven times supply frequency. Units available in 2.5, 5, 10 and 20 kw sizes for converting 60 CPS power to 420 CPS. Features: Exact multiplication



of input-line frequency; magnetic-core components; continuously adjustable or regulated output voltage; quiet operation. Cambridge Products Corp., 141 Main St., Cambridge 42, Mass.

Circle 242 on Inquiry Card



METERS THAT TAKE

125,000,000% OVERLOAD!

Because of the revolutionary bifilar frictionless (no pivot) movement, plus weightless light-beam pointer, GREIBACH PRECISION METERS withstand 100,000% overload surges. Then, for extraordinary overload risk applications, a special built-in Protective Circuit takes up to 125,000,000% overload surges without impairment.



FRICTIONLESS
BIFILAR
SUSPENSION
MOVEMENT

Only GREIBACH offers such overload immunity, along with: Sensitivity down to 0.2 microampere full scale. Accuracy better than $\frac{1}{4}$ of 1%. Energy dissipation as low as 4×10^{-10} watt. Permanent reliability. Mechanical ruggedness withstanding up to 500 G's shock.

GREIBACH PRECISION METERS are available in portable, bench and panel models with wide selection of ranges even up to 23 ranges in one meter: e.g., 2 / 5 / 1 / 2 / 5 / 10 / 20 / 50 / 100 / 200 / 500 μA / 1 / 2 / 5 / 10 / 20 / 50 / 100 / 200 / 500MA / 1 / 2 / 5-AMP.

Verify these extraordinary advantages by seeing actual demonstrations arranged upon request.



MODEL #700

NO PARALLAX FROM
ANY ANGLE

Full 6" flat scale. External light-beam power source.
5 $\frac{1}{2}$ " h x 8-5/16" w x 11 $\frac{1}{4}$ " d

Ask for Literature . . .

Technical details as well as complete specifications sent on request.



GREIBACH INSTRUMENTS CORPORATION

Circle 146 on Inquiry Card

New Products

TERMINAL BOARDS

Terminal boards with #1010 castellated terminals in 13 1/8-in. lengths and widths of 1/2, 1 1/2, 2, 2 1/2, and 3 in. Materials are laminated phenolic (MIL-P-15035B), laminated nylon phenolic (MIL-P-15047B), or laminated thermosetting glass cloth (MIL-



P-18177B). One-half in. wide board has single row of 25 #1010 terminals; others, double rows of 25 terminals. Terminals mounted on 3/8 in. centers. Cambridge Thermionic Corp., 445 Concord Ave., Cambridge 38, Mass. Circle 243 on Inquiry Card

PULSE GENERATOR

High speed pulse generator, Model B-5A. Pulse repetition rates are continuously variable from 1 cps to 10 MC in 7 ranges and features a rise and fall time of less than 8 mμsec. The Model B-5A has an electronic pulse delay that can be set to zero or is continuously variable from 0.030



μsec to 500 μsec in 5 ranges. Pulse width is continuously variable from 0.02 to 12.5 μsec in 4 ranges. Rutherford Electronics Co., Dept. M, 8944 Lindblade St., Culver City, Calif. Circle 244 on Inquiry Card

TEST IN THE LABORATORY ON THE PRODUCTION LINE WITH CVC HYGE

- HYGE 6000** Large laboratory model. Thrust capacity to 40,000 lbs.; acceleration, 2000G.
- HYGE 3000** Small laboratory model. Thrust capacity to 10,000 lbs.; acceleration, 500G.
- NEW PRODUCTION LINE HYGE 8500** Thrust to 15,000 lbs.; acceleration, 100G. Provides most widely specified shock pulses: MIL-E-5272A (11 ± 1 ms half-sine) and Ramo-Woolridge (6 ± 0.5 ms Sawtooth). 5 tests in 5 minutes at less than 5¢ per test.

You can produce and reliably repeat today's widest range of shock waveforms—half-sine, 1/4 cosine, sawtooth, square and combinations—with CVC HYGE.

You'll find a HYGE model to meet your requirements for laboratory or production line use. With HYGE, you'll have a compact source of stored energy at your fingertips for producing shock waveforms to meet most test specifications—and at a cost of only pennies per test. As new requirements develop, HYGE lets you adapt to them by adding a simple metering pin.



WRITE for HYGE Bulletins. Or, outline your requirements and ask for a specific recommendation.

Consolidated Vacuum Corporation
ROCHESTER 3, NEW YORK



Circle 147 on Inquiry Card

"SPOOLY" SAYS ..

Super-Temp FOR WIDEST VARIETY OF CABLES

Any high temperature cable the customer wants . . . using Teflon®, silicone rubber, nylon or PVC. You design it or we'll help you. Same fast delivery.

Coaxial Cables, Miniature & Jumbo Cables
Magnet Wire, Airframe Wire, Hook-up Wire
Teflon or Silicone Rubber Insulations

*DUPONT'S TFE RESIN

Save Time WITH Super-Temp

American Super-Temperature Wires, Inc.
32 West Canal Street, Winooski, Vermont • UNiversity 2-9636
General Sales Office: 195 Nassau St., Princeton, N. J. • WALnut 4-4450
A Subsidiary of Honey Industries, Inc., Wilmington, Del.



• Free! Send for 1960 Catalog. 88 pages of valuable data.

Wide-Range Self-Contained Precision Inductance Bridge



MODEL 63A

PRICE \$1500

- Inductance Range: .002 Microhenry to 1.1 Henry.
- Series Resistance Range: .002 Ohm to 110K Ohm.
- Built-in 1 to 100 KC Oscillator - Detector.
- No False or Sliding Nulls.

ALSO MANUFACTURERS OF THESE FINE INSTRUMENTS



DC Millivoltmeter



Capacitance Bridge



RF Distortion Meter



UHF Grid Dip Meter

Boonton **ELECTRONICS** Corp.

Morris Plains, New Jersey • Phone: JEfferson 9-4210

Teflon "100"

(Continued from page 85)

about 100°F lower. Both materials resist extreme cold—down to -450° F.

The new product is a major technical breakthrough resulting from 15 years of research studies. Du Pont spent \$19-million for research, development, and operating costs during the eight-year period prior to the start-up of a commercial plant for "Teflon" 100 at Parkersburg, W. Va.

Price of the new resin is \$11.60 a pound in truck-load quantities.

Specific uses for "Teflon" 100 FEP-fluorocarbon resin include jackets for coaxial and multi-conductor cable, aircraft wiring, molded electronic components, laboratory tubing, and chemical equipment linings.

These FEP resins applications will greatly expand the market areas served by "Teflon" fluorocarbon resins. The older TFE resins are widely used for electrical insulation, chemical-resistant hose, and lined pipe, bearings, seals, piston rings, packings and gaskets. Introduction of "Teflon" 100 FEP resin is expected to accelerate the development of uses which were not practical with TFE resins because of processing difficulties.

Du Pont's Film Department is marketing films made from "Teflon" 100. Coil-wound devices, capacitors, and printed wiring and circuitry are viewed as promising uses for the film.

Space Conference

The 1960 Conference on Electrical Engineering in Space Technology, April 11-13, Baker Hotel, Dallas, Texas, will feature the areas in which Electrical Engineering can support space science.

Authorities working in space R & D will discuss development and state-of-the-Art in four fields: Communications, Feedback Control & Guidance, Electrical Energy Conversion, and Instrumentation.

Dr. L. V. Berkner, President, Associated Universities, Inc., will speak on "Education and Space Technology" at the Monday Luncheon. Dr. J. R. Pierce, Dir. of Research, Bell Telephone Labs., Murray Hill, N. J., will speak at the dinner that evening. His topic will be "Adventure in Space Science (Fiction)."



A real heel might test a Fusite Terminal like this ... but he won't make it leak!

The adherence between glass and metal in a Fusite Hermetic Terminal is an easily demonstrated fact. There are several theories as to why our exclusive V-24M glass actually chemically bonds to the metal components. Cobalt and certain other metallic oxides in the glass oxidize the iron in the metal which is taken into solution. It is believed that through the solution of iron, a gradual decrease of the difference of thermal expansion between the glass and metal takes place at the glass-metal



interface. This inter-fusion of the two dissimilar materials gives Fusite Terminals their ability to withstand great mechanical and thermal shock and still pass Statiflux tests for glass cracks, hydrostatic pressure tests and helium mass spectrometer leak detection.

This fusion is reinforced by a strong compression of the metal ring around the glass made possible by a favorable thermal expansion balance of the glass, pins and housing.

The combination of fusion and compression provides a terminal so rugged that leaker rejection rate of components into which our terminal is fabricated is practically nil, even when roughly handled and subjected to extreme temperature changes.

Samples for your own testing are yours for the asking.

Write Dept. G-2.



THE **FUSITE** CORPORATION

6000 FERNVIEW AVE., CINCINNATI 13, OHIO

Woodford Mfg. Co., Versailles, Kentucky.

In Europe: FUSITE N. V. Koningsweg 16, Almelo, Holland

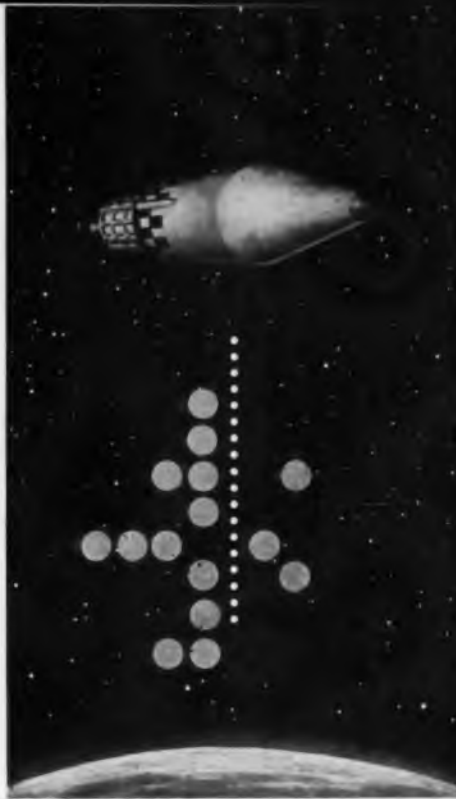

EXPANDING THE FRONTIERS OF SPACE TECHNOLOGY IN ELECTRONICS

Lockheed Missiles and Space Division has made significant contributions in electronics in such areas as: computer development; telemetry; radar and data links; transducers and instrumentation; antennas and electromagnetic propagation and radiation; ferrite and MASER research; data reduction and analysis; solid state electronics, including photovoltaic devices, electrochemistry, infrared optics; FM-FM data systems; PAM-PCM data links; and logical design.

Special emphasis is being attached to the research, design and development of improved military electronics systems for communications, including new methods of data transmission, reception and storage. Pioneering work is also being conducted in space vehicle borne computers, DC-AC inverters, non-gyro guidance systems. Studies in oceanography include underwater communication and navigation, and natural phenomena and military aspects of the deep sea.

Lockheed's programs reach far into the future and deal with unknown environments. It is a rewarding future and one that outstanding scientists and engineers are invited to share. If you are experienced in any of the above areas, or in related work, we invite your inquiry. Please write: Research and Development Staff, Dept. D-48, 962 W. El Camino Real, Sunnyvale, California. U.S. citizenship or existing Department of Defense clearance required.

Lockheed / **MISSILES AND SPACE DIVISION**

Systems Manager for the Navy POLARIS FBM; the Air Force AGENA Satellite in the DISCOVERER Program and the MIDAS and SAMOS Satellites; Air Force X-7; and Army KINGFISHER.

SUNNYVALE. PALO ALTO. VAN NUYS. SANTA CRUZ. SANTA MARIA. CALIFORNIA
CAPE CANAVERAL. FLORIDA • ALAMOGORDO. NEW MEXICO • HAWAII

PROFESSIONAL OPPORTUNITIES

Reporting late developments affecting the employment picture in the Electronic Industries

Design Engineers • Development Engineers • Administrative Engineers • Engineering Writers
Physicists • Mathematicians • Electronic Instructors • Field Engineers • Production Engineers

"Stimulate Originality To Speed Up R & D"

More young people should be encouraged to "leapfrog for the distant goals" say 51 of the nation's top scientists, researchers and educators. They met recently, under the auspices of the National Science Foundation, at Worcester Polytechnic Institute to discuss ways to speed up the country's research and development programs.

Research people, they concluded, too easily become preoccupied with goals of relatively small dimensions which promise little in significant discovery, and that progress will be influenced far more by those who can strike out with vigor and vitality for breakthroughs on the frontiers of science. They felt the young researcher is steered in the direction of conservatism by his education, research support, professional societies and his social and cultural environment. A conference resolutions committee recommended that colleges and universities:

1. Develop educational programs which require the student to exercise a high degree of originality and independence of thought. He should be challenged with creative experiences throughout his entire educational experience.
2. Bring talented youth into stimulative personal association with leading scientists and engineers.
3. Doctoral research should encourage more venturesome attitudes. A graduate student should not necessarily be penalized by failure to complete distant objectives.
4. Develop institutional policies which provide an encouraging environment for venturesome research. This starts with faculty members who themselves are creative.
5. Develop closer liaison between college, industrial and governmental research organizations.
6. Encourage undergraduate and

Teller to Direct Hertz Fund

The Hertz Engineering Scholarship Foundation (set up by Fannie and John Hertz of Yellow Cab and Hertz Rent-A-Car fame) to aid mechanical and electrical engineering students has initiated the California Bay Area Pilot Plan. It will provide early consideration for engineering scholarships to highly able math-science students in the lower grades of high school.

An interesting requirement of the scholarships is that awardees must express their intent to make their engineering skills available voluntarily to the Government if called upon during a national emergency, and further to take a course in American History, if adequate grounding in this subject was not obtained in secondary school.

Statistics show that of our nation's most talented high school graduates who do not go on to college, approximately 100,000 are deterred chiefly for financial reasons; perhaps another 100,000 for lack of motivation. Even in high school, 1 out of 5 students in the upper 25% of their class drops out of school before graduation. Of those who do graduate, more than one third do not go on to college.

graduate students who have novel, creative ideas to pursue the development of these ideas and help them to obtain financial support.

Recommendations to scientific and engineering societies:

1. Establish more effective practices which will increase the attendance and participation of talented young members at meetings of scientific and engineering societies.
 2. Encourage the presentation and publication of philosophical papers which look to the future of science and technology.
 3. Develop comprehensive pro-
- (Continued on page 233)

The program is under the direction of Dr. Edward Teller, Prof. of Physics at the University of California at Berkeley and Augusta A. Teller.

Further information on the Foundation may be obtained by writing to: Hertz Engineering Scholarship Foundation, 1314 Westwood Blvd., Los Angeles 24, California; or by writing to: Stevens Manning & Associates, 6351 Wilshire Blvd., Los Angeles 48, Calif.



John D. Hertz, Founder, Hertz Engineering Scholarship Foundation.

Scholarship Awards

The Radio Corporation of America has awarded sixty-one undergraduate scholarships to assist students preparing for careers in science, industry, the arts, and teaching. Twenty-seven of the awards were made in the fields of physics, chemistry, and engineering. The awards carry a grant of \$800.00.

FOR MORE INFORMATION . . .
on positions described in this
section fill out the convenient
inquiry card, page 179.

How will this picture look



in ten seconds?

With the high speeds of today's jet aircraft, keeping track of hundreds of planes is a difficult problem. The tactical situation is not only complex, but fast-changing.

Hughes Fullerton engineers have solved this problem with a unique and highly advanced digital computer. This computer simultaneously tracks large numbers of aircraft and provides three-dimensional coordinate and velocity information on them.

These Fullerton engineers have designed the computer to provide extrapolated position data to the observer several times per second. In addition, it will measure the position and report velocity characteristics changes every few seconds for each of a large number of targets.

The computer utilizes advanced semiconductor circuitry throughout. The outputs to the displays are made through high-speed digital to analog converters capable of providing an accuracy of one part in ten thousand — and within 10×10^{-6} seconds.



This giant transmitting antenna creates the beam for experimental antenna pattern measurements — part of the Hughes microwave research and development programs.

Housed in the tip of this Hughes survey meter is the smallest, fastest, most accurate radiation detector ever devised — just one example of Hughes' activities in the expanding field of nuclear electronics.



Utilizing the latest techniques in packaging and subminiaturization, Hughes Fullerton Engineers have designed this unit as a mobile system which will withstand rigorous field use.

Other Hughes activities provide similarly stimulating outlets for creative engineers. Constantly moving forward into new areas, Hughes projects include: hydrofoil systems, anti-submarine warfare systems, miniaturized communications systems, new solid state electronics devices, nuclear electronics systems and unique navigational systems — just to name a few.

The commercial activities of Hughes have many interesting projects for engineers in the research, development and manufacture of semiconductors, microwave components, storage tubes, radiation detectors, radiation handling equipment and microwave tubes.

Whatever your field of interest, you'll find Hughes' diversity of advanced projects gives you widest possible latitude for professional and personal growth.

Newly instituted programs at Hughes have created immediate openings for engineers experienced in the following areas:

Electroluminescence	Equipment Engineering
Infra-red	Microwave & Storage Tubes
Solid State Physics	Communications Systems
Digital Computers	Inertial Guidance
Reliability & Quality Assurance	Field Engineering
Systems Design & Analysis	Circuit Design & Evaluation

*Write in confidence to Mr. M. W. Welds
Hughes General Offices, Bldg. 6-C1, Culver City, Calif.*

Creating a new world with **ELECTRONICS**

HUGHES

HUGHES AIRCRAFT COMPANY
Culver City, El Segundo, Fullerton, Newport Beach,
Malibu, Oceanside and Los Angeles, California;
Tucson, Arizona.

Men

who refuse to get lost in the crowd. Engineers with a yen for challenge . . . who intend to see their ideas put into motion, These are the special breed of determined, creative, thinking individuals who staff the government and industrial division of the Magnavox Company. And Magnavox needs more people like them . . .



To

fill present openings at the three Magnavox military and industrial plants. In Fort Wayne, Indiana, where families enjoy the good life of a growing Mid-Western community. In Urbana, Illinois, home of the University of Illinois which has one of the largest communications, physics and radar research centers. Or in America's largest electronic community, Los Angeles, California.



FORT WAYNE, INDIANA



URBANA, ILLINOIS



LOS ANGELES, CALIFORNIA

Do

engineering to develop advanced anti-submarine warfare systems in conjunction with the Navy Department. Projects on tap for the future offer experiences just as challenging and rewarding—not only in ASW, but in Communications, Missiles, Airborne Radar and Data Processing Equipment as well.



Phone Dick Eary (collect, of course) at Eastbrook 9721 in Fort Wayne or write him for complete information.

Magnavox



COMMUNICATIONS



RADAR



DATA HANDLING



ASW



MISSILES

THE MAGNAVOX CO. • DEPT. 204 • Government and Industrial Division • FORT WAYNE, IND.

The development of ballistic and space vehicles present many challenges to the engineering team. The electronic engineer is and will continue to be an integral part of that team. He is needed in systems engineering, equipment and circuit engineering, and in component engineering. Each presents special problems and each has special opportunities for the growth of the electronic engineer.

Engineering for Space— Opportunity and Challenge

By **E. B. GILROY**

*Employee Relations Manager
Space Technology Laboratories, Inc.
P.O. Box 95001
Los Angeles, California*

ENGINEERING for missile systems and space vehicles provides rich opportunity and great challenge to the electronic engineer. The new industries, companies, and jobs directly related to the efforts of our nation in missile development and space exploration are manifold.

Since even the mundane problems in these new engineering tasks are complex in nature, and gigantic in size and scope; the future looks very bright for qualified engineers. There is constantly a search for men who can grasp, and resolve technical problems.

Adding new opportunities, and very special ones, is the commitment of our nation to space exploration. The transportation of equipment and humans from Earth to other points in the universe, requires the development of new equipment which surpasses the capacities, reliability, and versatility of present equipment.

The electronic engineer is and will continue to be an integral part of the technical team involved in the development and operation of space vehicles. For electronics is the way equipment and humans will sense, react, control, and communicate in space.

Along with these opportunities are many challenges. The development of a ballistic missile and a space vehicle places demands and responsibilities on the engineers associated with the projects. There can be many false starts; delays due to schedule slippage, or material shortages; and the normal frustrations of working on large-scale projects involving sizable numbers of personnel, equipment, and facilities.

One of the major challenges is the resolution of complex technical problems. Actually, the technical challenge is a "pioneering" challenge. Essentially it is extending our knowledge about materials, fuels, equipment, and personnel to new limits and new horizons.

Beyond the technical challenge are several other challenges equal to, or greater than it. For involved in space exploration are national survival and international prestige. Successes and failures take on greater meaning than "Back to the Drawing Board" connotes. The timing of projects, particularly completion dates, have political and international overtones. The race-for-space carries with it not only career opportunities but life-time challenges.

Opportunities

In general engineering areas, opportunities for electronic engineers can be categorized at three levels or three types. These are systems engineering, equipment and circuit engineering, and component engineering. It is very difficult to state at what level, or which type, offers the greatest opportunity. Each presents special opportunity.

Systems engineering offers to the experienced, mature and broad-gauged individual an opportunity to conceive, develop and evaluate tremendously complex systems for space vehicles. Not only are the problems of a technical nature complex, but due to the usual large number of personnel involved on development



REWARDING!

A feeling of accomplishment, comfortable salary, security, fine home, prestige in the community. Yes, these are the marks of a successful Motorola engineer in Chicagoland. But, what exactly makes a career at Motorola so rewarding—beyond the ordinary realm of material benefits?

Foremost is opportunity. For here a man is encouraged to use all of his creative talents to their fullest. He works on projects that spark vision, that inspire imagination. He works with men who recognize and respect his abilities . . . a calibre of men that he cannot help but admire.

Yes, a career at Motorola is deeply rewarding. You owe it to yourself to discover *exactly* how much. Simply clip the coupon below.

- Radar transmitters and receivers
- Radar circuit design
- Electronic countermeasure systems
- Military communications equipment design
- Pulse circuit design
- IF strip design
- Device using klystron, traveling wave tube and backward wave oscillator
- Display and storage devices
- 2-WAY RADIO COMMUNICATIONS
- VHF & UHF receiver
- Transmitter design and development
- Power supply
- Systems engineering
- Antenna design
- Selective signaling
- Transistor applications
- Crystal engineering
- Sales engineering
- Design of VHF & UHF FM communications in portable or subminiature development
- Microwave field engineers
- Transistor switching circuit design
- Logic circuit design
- T.V. circuit design engineering
- Home radio design
- New product design
- Auto radio design
- Mechanical engineering
- Semi-conductor device development
- Semi-conductor application work

**Also Splendid Opportunities in:
Phoenix, Arizona and Riverside, California**

Send Complete Resumé to:

MR. L. B. WRENN
Engineering Personnel Mgr.
Dept. A
4501 Augusta Blvd.
Chicago 51, Illinois



MOTOROLA Inc.



Space Engineering

(Continued)

projects, there is a great deal of personal inter-action.

The abilities to prepare written reports and present oral reports, to persuade and effect judicious technical compromise, and to furnish leadership for a vast technical team are characteristic of the Systems Engineer. For in addition to technical competency, systems engineering requires technical statesmanship.

For the "hardware" oriented engineer, the equipment, devices, and circuitry used in space vehicles will provide ample opportunity for creativity, ingenuity, and hard work. No system conceived in the minds of the most brilliant men will succeed in operations unless high-grade engineering translates the concepts into operating equipment.

The possibilities of micro-miniaturization and ruggedizing mean weight, load, size, and operating standards can be pushed to new extremes. This, of course, means the prospects for sophisticated equipment, which can perform amazing feats of communications, control and guidance, can be engineered for immediate application.

At the foundation for equipment and systems is the component. Perhaps, the component has been neglected. Certainly, the single item does not carry the "romance" of a total weapon system or space vehicle. Yet they will only operate reliably and as capably as the components comprising the total. The near-future offers great opportunity to engineers with a talent for developing high-performing and reliable components.

Indeed, never was the old saying "strong as the weakest link" more appropriate than in the space-age. The aim of authorities charged with the operation of a space-vehicle is to know that when launch occurs—a successful flight occurs. The breadth of a technical project may be great. The depth of the project must also be great. Residing at the foundation, is the component. It is the corner-stone for successful development work. There is great need for high-caliber de-

velopment engineers to enter and remain in this field.

Product areas for any of the systems, equipment, and component engineers are control and guidance; communications, tracking, and instrumentation; computation; and, data-processing and display. Each area is vital to successful flights. Each area offers great opportunity.

Mention should also be made of the opportunity for Project Engineers. Such engineers translate the progress made in research and development into prototype or operational working hardware. For an individual with the ability to distill the efforts of a technical team involved in developing new gear, and with the ability to direct production engineers in producing new gear, project engineering should be very attractive.

There must also be a touch of systems engineering in the Project Engineer. He must technically visualize how his project, whether computational or for communications, fits in the total system. Like the Systems Engineer, the Project Engineer must bring to his profession technical statesmanship.

Challenges

With the vast opportunities newly opened to the electronic engineer are vast challenges. The challenges may involve the need to develop highly reliable equipment, or they may be related to the problems of ruggedizing flight equipment. The challenges can even involve the planning of time and effort to maximize expenditures.

Whatever the challenge, there are many and they are great. The full resolution of the host of problems related to the development of missiles and space vehicles will take years. Indeed, it is possible that an attempt to resolve just the technical problems would require nothing less than gargantuan efforts. There are, however, some challenges which require immediate attention. One of these problems is to develop and produce reliable systems and equipment.

Unfortunately, the testing and use of missiles and space vehicles is neither private nor inexpensive. Great and highly interested audiences have an opportunity to see, hear about, and discuss the success



To the ELECTRONIC ENGINEER who neglected to MARRY THE BOSS' DAUGHTER:

Don't bother telling us how it happened . . . we almost know. It was Spring—or Fall, no matter—and there you were, alone with That Other Girl. You couldn't have been thinking of your professional future because you'd had to explain to her dad that you didn't drive a locomotive. But she was lovely, desirable and it seemed unthinkable not to share your breakfast Wheaties with her the rest of your days. So, of course, you married her instead of the boss' daughter and your father-in-law turned out to be a grand guy even though he now tells people proudly that you make TV sets or something.

Which pretty much leaves your career up to you, doesn't it?

We have some advice for you; we'll not guarantee that it's impartial, but check it for logic anyway: Look for a leading electronics corporation which is essentially an engineering firm, where not only your immediate supervisors but top management will be engineers. Being engineers, they're more likely to recognize ability and to reward achievement *fairly and impartially*. It figures, we think, that where there's an atmosphere of mutual confidence, respect and understanding you'll realize your maximum potential at least a little sooner and more surely.

You may be pretty sure that Bendix, Kansas City, meets the specifications outlined above or instead of mentioning them at all we'd probably follow the crowd by speaking only vaguely of "opportunity" and "challenge." You have criteria of your own . . . measure Bendix with them and let us help you if we may.



P.S. That girl you did marry will like Kansas City. So will you and the children. Practically everyone does.

Write Mr. T. N. Tillman, Professional Personnel, Bendix Box 303-OR, Kansas City, Missouri.

LONG TERM AEC PRIME CONTRACTOR



KANSAS CITY, MISSOURI

LEADERSHIP OPPORTUNITIES

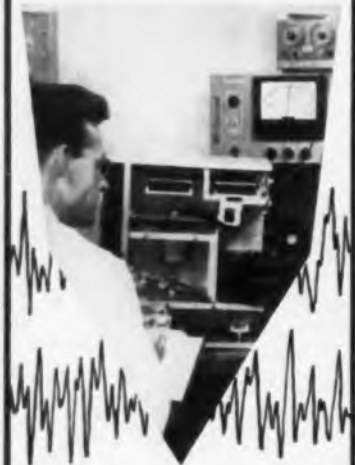

WITH GATES

Gates Radio is currently seeking engineers in various skill areas, including transistor circuitry, electro-mechanical, RF networks, audio systems, transmitters for AM, FM and TV broadcasting and communications transmitters—LF, MF, VHF and UHF.

Organized in 1922, Gates is one of the nation's pioneer manufacturers of electronic equipment, with operations in military and industrial electronics, broadcasting and communications. A few diversified projects would include the design and development of UDOP and DOVAP systems for measuring the velocity and position of guided missiles, homing beacon transmitters for the Navy, missile range intercommunication systems, and multiple geophysical amplifiers used in oil field explorations. Gates is also the nation's leading designer and manufacturer of AM and FM broadcast equipment.

Gates, in Quincy, Illinois, gives you the unharried and unhurried living of a small town with big city nearness . . . an ideal place to rear a family and live the good life. It may be just what you've been searching for. If so, write to Rog Veach, our personnel director for an interview. That's Box 290, Gates Radio Company, Quincy, Illinois.

GATES

Circle 505 on "Opportunities" Inquiry Card

Space Engineering

or lack thereof, of every major missile launch and flight. Every flight not only represents great scientific and engineering effort, but also major economic investment. The trials of a missile are the trials of a nation—scientifically and economically!

There is another challenge. It is international. In our era of rapid communications and fight for survival, the impression our nation makes upon the world to some degree depends on the success of the missile and space program. There are compelling reasons for developing and producing missile systems and equipment which will operate under any and all conditions. This is particularly true where international prestige is involved directly; and, national survival indirectly.

Concurrent with the challenge to develop and produce reliable missile systems, is the challenge for better performance. This means it is necessary to engineer components, equipment, devices, and sub-systems which can provide greater thrust, control, guidance and communications.

There is a tremendous need to emphasize the development of lightweight, rugged, reliable, and high performing missile products. The challenges of distances and targets requires an almost endless program to improve present state-of-the-art. The prospect of relaxing engineering and scientific vigilance in the missile industries appears bleak.

One suggested approach to improve performance and to assure reliability is to design and produce items with simplicity of function as a prime consideration. With simplicity of function comes ease of operation and maintenance. This hints of a shift in missile and space engineering.

Until recently, questions of whether a vehicle will work, or not work, were of primary consideration. While such questions are still of major interest, questions about how frequently will a vehicle work, and under how many different conditions, are being asked. In other words, the scientist and engineer of the future must not only prove that



ENGINEERS
SCIENTISTS

FUTURISM in contemporary R & D

Radical departures from traditional forms of scientific investigation are the keynote of Republic Aviation's forward-looking programs in space exploration and upper atmosphere flight. In an environment that regards with skepticism the seeming validity of conventional conclusions, engineers and scientists seek below-the-surface solutions of problems... bypassing the superficial.

Expanding the scope and depth of present programs is Republic's recently completed \$14 million Research and Development Center. Extensive facilities here are an invitation to professional men to realize the future by solving today's most perplexing problems.

SENIOR LEVEL OPENINGS EXIST IN THESE IMPORTANT AREAS:

Navigation & Guidance Systems / Radar Systems / Information Theory / Radio Astronomy / Solid State & Thermionic Devices / Microwave Circuitry & Components / Countermeasures / Digital Computer Development / Radome & Antenna Design / Receiver & Transmitter Design / Miniaturization-Transistorization / Radiation & Propagation (RF, IR, UV) / Telemetry-SSB Technique

Please forward resumes to:
Mr. George R. Hickman
Technical Employment Manager,
Department 15D



Please write direct to the above advertiser

Space Engineering

a project is feasible, but also that it is practical; and that a project successfully completed with conditions near perfect, can be successfully completed under any condition. Engineering, thus, has the challenge of translating theory into fact, and experiment into utility.

There is, finally, one other challenge. While superficially it appears almost elementary to understand, many engineers have not grasped the significance of using time and money wisely. Why is this? Is it because engineers have no appreciation for economics? Or is it because their training does not include the proper emphasis for this aspect of development work?

Why are time and money important to the missile engineer? The answers seem simple. There is a transcending requirement to develop, produce, and fly missiles and space vehicles within the shortest time cycle imaginable; and within the resources of the nation. Few societies, if any, can afford the luxury of writing blank checks in time and money, even for as vital a program as missiles and rockets. There is a limit to how long equipment can be designed, produced, tested, modified, and re-tested. Yet the "art" of forecasting and meeting schedules has not been a strength of the engineer. This challenge should be as intensively considered as those relating to the development of reliable and higher-performing equipment.

Speed up R&D

(Continued from page 225)

grams for digesting research knowledge.

4. Establish society meetings to develop more effective interchange of ideas between scientists and engineers in research areas of broad mutual interest.

5. Establish free forums at engineering society conventions where any member may make a short presentation of his creative work.

6. Actively promote and encourage financial support for research.

7. Foster among society members a recognition of the contribution which they can make by stimulating at an early age the creative development of youth.

A message to
Electronic Engineers
from R. P. Gifford,
Engineering Manager
of General Electric's
Communication Products
Department in
Lynchburg, Virginia—

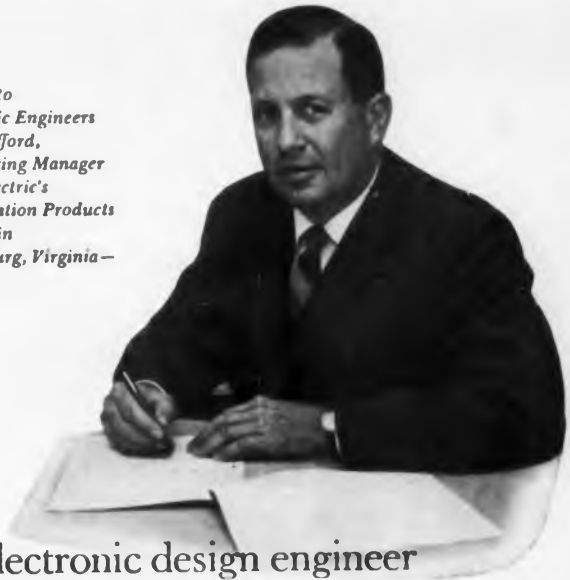

"An electronic design engineer earning \$10,000 should be a decision-maker *beyond* his project's immediate technical problems."

"I believe that any electronic design engineer earning \$10,000 or more welcomes the authority to make a variety of high-level business decisions—in such areas as features versus cost and reliability versus weight—working closely, of course, with his marketing counterparts in Product Planning and also with the Manufacturing Engineers.

"At Communication Products Department we give the experienced engineer the *necessary authority* to do just this. He generally enters the design project early in the development planning phase, so that he can take responsibility for estimating the project expense and schedule—thus contributing to the establishment of bogeys for product cost and delivery.

"Of course our communication systems must do the customer's job, but also they must be *marketable at a profit to the Department*; to make this come true is a vital part of the design engineer's challenge. This means exposure to many management problems and a rare opportunity to grow and move ahead rapidly.

"Our communication products are primarily commercial, including Mobile Radio, Microwave Radio Relay, Terminal Equipment, Telephone Carrier, Multiplex, and Personal Communication Systems. Military contracts also in the house include a 24-channel SSB tropospheric scatter system."

Right now, we have immediate openings for Advance, Development, and Systems Engineers who have significant backgrounds in these areas:

R.F. circuit design
Multiplex equipment
Microwave systems design
Solid state devices

Microwave plumbing, antennas
Piezoelectric devices
Mobile transmitter, receiver design

Electronic equipment mechanical design
Automatic test equipment D&D
Microminiaturization

For prompt consideration, forward your resume in confidence to Mr. W. J. Kelly, Dept. 24-MD

COMMUNICATION PRODUCTS DEPARTMENT

GENERAL  ELECTRIC

Mountain View Road, Lynchburg, Virginia

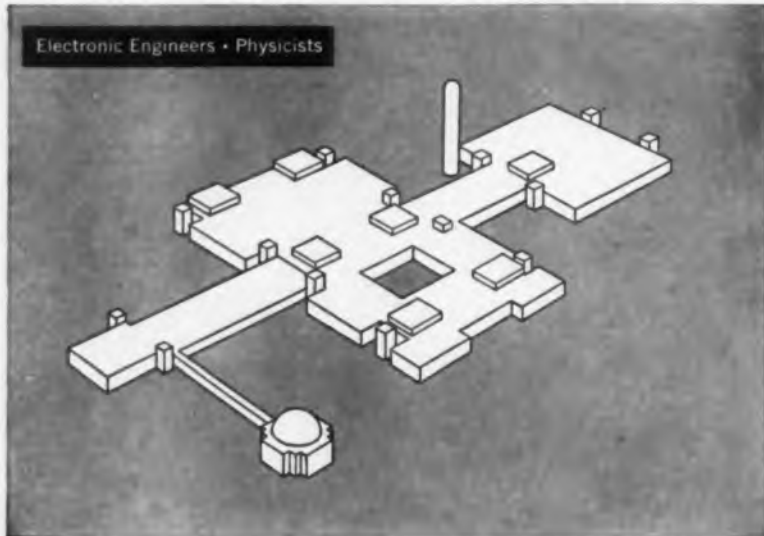

COMMUNICATIONS PHYSICIST
Plan applied research in such areas as telemetry and radar detection as affected by plasma sheaths. Interpret space communication needs and problems. MS or PhD in EE or applied physics.

SYSTEMS ENGINEER COMMUNICATIONS
EE or Physicist with 10 years' experience in systems design of airborne communications; to work on design of communication systems to meet requirements for future space vehicles.

ENGINEER-NAVIGATION AND GUIDANCE
To conduct analytical studies on inertial guidance and control for space vehicles. Should have background in closed-loop systems with 10 years of applicable experience and degree in EE or physics.

SYSTEMS ENGINEER NAVIGATION & CONTROL
EE with control systems background. Required are five years' experience in design of control and navigation systems, preferably in space vehicle systems.

ENGINEER ADVANCED ANTENNA & PROPAGATION STUDIES

To provide high level theoretical and experimental studies of antennas, propagation and target reflectors for all radio frequency bands, leading to new and improved concepts of equipment. BS, EE (advanced degree desirable). Six years' experience in above fields required.

ANALYSIS AND SYNTHESIS ENGINEER
Responsible for synthesis of new instrumentation and communication systems to meet missile and satellite requirements. Analytical knowledge in the field of instrumentation, communication and data processing with BS or MS EE essential.

INSTRUMENTATION SYSTEM TEST & EVALUATION ENGINEER
Coordinate tests on missile and satellite instrumentation systems. Requires experience in instrumentation and communication test and ground station equipment with BS, EE.

Other significant opportunities exist in the following areas:

- Systems Engineering • Aerodynamics • Space Mechanics • Arming & Fuzing Systems • Airframe Structural Design • Materials Studies • Flight Test Analysis • Vibration Engineering • Producibility Engineering • Human Factors • Plasma Physics • Gas Dynamics • Applied Mathematics • Ground Support Equipment • Reliability Engineering • Project Engineering

For further information regarding opportunities here, write Mr. Thomas H. Sebring, Div. 24D. You will receive an answer within 10 days.

MISSILE & SPACE VEHICLE DEPARTMENT



3198 Chestnut Street, Philadelphia 4, Pa.

Industry News

William Sichak, Director of the Transmission Laboratory at ITT Laboratories, Nutley, N. J., has been named a Fellow of the Institute of Radio Engineers (IRE).

Rear Adm. Mell A. Peterson (USN ret.), formerly Commander of the Naval Ordnance Laboratory, White Oak, at Silver Spring, Md., has been elected Executive Vice President and a Director of Bulova Research & Development Laboratories, Inc.

Appointment of Arthur O. Wolf as Manager of Spectron, A dept. of the Transducer Div., Consolidated Electrodynamics Corp., has been announced.

George Rowen has been elected Vice-President of Manufacturing, a newly created post at Sanders Associates, Inc., Nashua, N. H.



C. Rowen



J. Douglas

John J. Douglas is the new President of Lenkurt Electric Co., Inc., San Carlos, Calif., a subsidiary of General Telephone & Electronics Corp. He formerly was Vice-President and Treasurer of Automatic Electric Co., Chicago.

S. N. Lev has been appointed General Manager of the Moorestown Missile and Surface Radar Div., Radio Corp. of America.

P. R. Gehman is now Manager-Missile Applications Engineering in the Air Force Requirements Operation of General Electric's Missile and Space Vehicle Dept.

W. F. Minnick, Jr., has been named director of public relations of the Instrument Society of America. He will also continue to serve as promotion manager.

Roger Anderson has been named Manager of the Phonograph Cart-ridge Section of Shure Bros., Inc., Evanston, Ill.

George T. Griswold has been named Assistant Treasurer of Erie Resistor Corp., Erie, Pa.

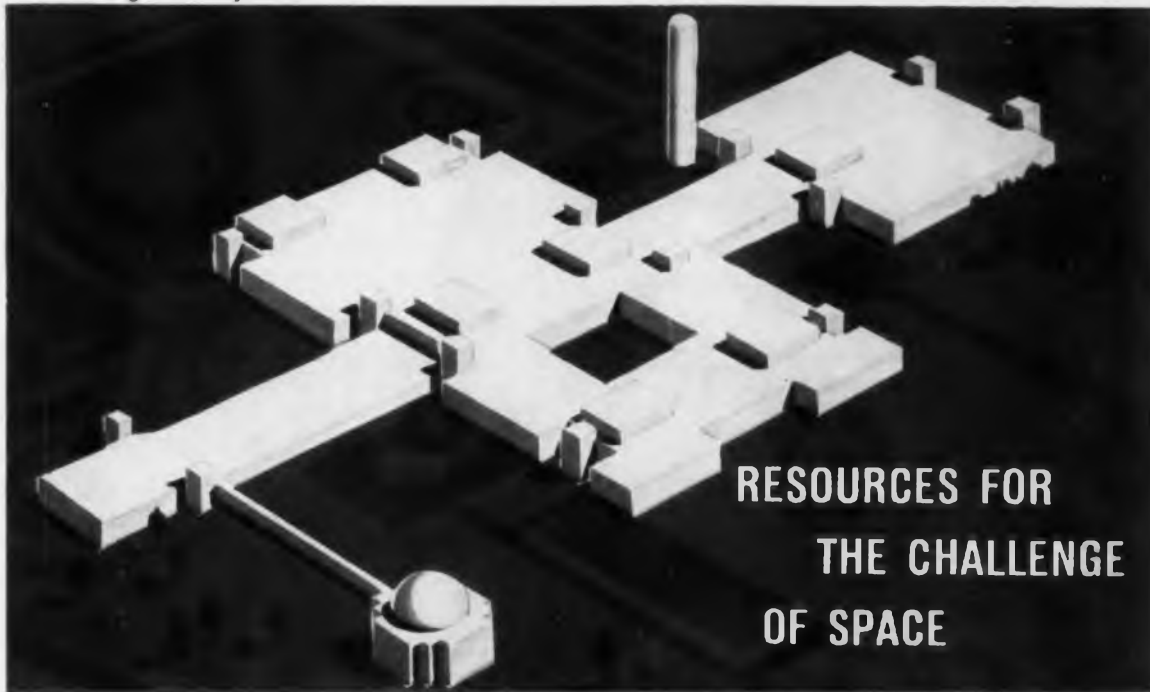

RESOURCES FOR THE CHALLENGE OF SPACE

...General Electric's New \$14,000,000 Space Research Center, to be built near Valley Forge Park 17 miles from Philadelphia

General Electric is carrying its tradition of pace-setting electronics research into the field of space vehicle applications, primarily through the agency of its Missile and Space Vehicle Department.

Qualified engineers interested in working in these areas are invited to review the opportunities described on this and the opposite page. Those who join us will work in a professional atmosphere with other highly trained and competent people who have taken part in such G-E achievements as the FIRST demonstration of effective space vehicle stabilization control and navigation, and the FIRST measurements in space of earth's magnetic field and infrared radiation.

Upon completion of the Department's Space Research Center in suburban Valley Forge, new and unique facilities will be available to our staff, to further long range programs in space electronics.

ENGINEER-TRANSISTOR CIRCUIT DESIGN

BS, EE or Physics with advanced degree desired. Five years' experience in circuit design, information theory and circuit philosophy.

ENGINEER-TELEMETRY DESIGN

Will design and evaluate airborne and ground telemetry, voice and video circuits and components. Thorough knowledge of both transmitter and receiver design, five years' experience; BS, EE required.

DIGITAL CIRCUIT DESIGN

To provide high level technical evaluation of digital techniques as applied to airborne digital and pulse circuitry, EE with five years' experience in this field.

ENGINEER-CONTROLS

Will be responsible for analytical studies in adapted controls, non linear systems and analogue and digital computation. Requires ten years of controls background with BS, EE or related degree.

ENGINEER-DYNAMICS

To conduct analytical studies in the dynamics of rigid bodies as applicable to navigation and control systems. Requires eight years of experience with MS degree in mechanics or physics.

ENGINEER-SYSTEMS ANALYSIS

Requires eight to ten years experience in analytical studies of complex systems, with some control experience. Background in analogue and digital equipment also desirable.

Check additional openings listed to the left, and write to Mr. Thomas H. Sebring, Div. 24D.

MISSILE & SPACE VEHICLE DEPARTMENT

GENERAL  ELECTRIC

3198 Chestnut Street, Philadelphia 4, Pa.

International



INSTRUMENTS ELECTRONICS AUTOMATION

OLYMPIA, LONDON 23-28 MAY 1960

More than 450 British and 100 foreign manufacturers of electronic equipment and scientific instruments will be showing their newest products at the 1960 I.E.A — the largest exhibition of its kind ever held in the world. If you are in this field, or planning automation in your office or plant, you should be there for nowhere else can be seen such a comprehensive display of the world's latest scientific achievements.

PLAN YOUR VISIT TO LONDON and the I.E.A NOW



For further details contact the
British Embassy or nearest
Consulate, or

INDUSTRIAL EXHIBITIONS LIMITED, 9 ARGYLL STREET, LONDON, W.1., ENGLAND

Industry News

The Crosley Div., Avco Corp., Cincinnati, Ohio, has appointed **Bert Fein** as Director of Manufacturing. He was formerly with the Federal Div., International Telephone & Telegraph Corp.

Matthew L. Devine has been elected President of Amphenol-Borg Electronics Corp.

Appointment of **Daniel E. Murphy** as Director of the Datalab Div., Consolidated Electroynamics Corp., a subsidiary of Bell & Howell Co., has been announced.



D. Murphy



J. Thompson

James H. Thompson will now serve as Assistant to the Vice-President of Stromberg-Carlson's Electronics Div., Rochester, N. Y.

Eugene B. Price has been named Manager of Materiel of Kinetics Corp., Solana Beach, Calif.

John J. Carpenter has been elected Vice-President of Bulova Watch Co., Inc., and General Manager of the firm's new Industrial and Defense Div., Jackson Heights, N. J.

A new position of Vice-President and General Manager (Defense Operations) has been created by the Crosley Div., Avco Corp. **James C. Elms**, formerly Vice-President of Ground Electronics and Communications, will serve in that capacity.

Price Electric Corp., Frederick, Md., has announced the appointment of **R. J. Harrant** as Vice-President.

Roy H. Lynn is now President of ITT Communication Systems, Inc., Paramus, N. J.

The appointment of **Joseph M. Hertzberg** as Vice-President-Marketing for Philco Corp.'s Government and Industrial Group has been announced.

Rudolph Maravich has been named Field Sales Manager of Rheem Semiconductor Corp., Mountain View, Calif.

a measure of
perfection...



IDEAL PRECISION

Panel Meters

a complete line for every application

IDEAL Panel Meters are assembled in controlled atmospheric and climate conditions and 100% inspected at every step of production to insure highest quality and dependability.

- D'Arsonval movements guarantee minimum accuracy of 2% (full scale).
- Rugged construction means trouble-free, long-lived service.
- Durable plastic meter cases provide greater clarity, easier readability.

For more information on the entire IDEAL line, write for Catalog No. 32.

IDEAL PRECISION METER CO., INC.
214 Franklin Street, Brooklyn 22, N. Y.

Sold to Electronic Parts Distributors
exclusively through

WALDOM ELECTRONICS, INC.
4625 West 53rd Street, Chicago 32, Ill.

Circle 153 on Inquiry Card

Industry News

Hermon H. Scott, President of H. H. Scott, Inc., Maynard, Mass., has been elected Chairman of the Board of Directors of the Institute of High Fidelity Manufacturers.



H. Scott



T. Hafer

Thomas W. Hafer has been named to the newly-created post of Manager-Corporate Manufacturing Engineering for Raytheon Co., Waltham, Mass.

Emmet Cameron and Howard Patterson have been appointed to two newly-created positions of Group Vice-Presidents and Ralph Kane to the new post of Vice-President of Foreign Operations at Varian Associates, Palo Alto, Calif.

MARKITE CONDUCTIVE PLASTIC POTENTIOMETERS



Type 3173

7/8" dia. rotary



Type 2064

Dual-element rectangular
rectilinear



Type 3033

1 1/8" dia. rotary

When the ultimate in quality and reliability is required . . . when there is no time for standby or interruptions . . . no room for component value variations . . . no tolerance of failure — then it's high time to specify MARKITE precision potentiometers. Here are only a few reasons why they provide performance beyond the expected:

- Linear stability for more than 50 million cycles
- Substantially infinite resolution
- Independent linearity to 0.05% in 1 1/8" dia. units and 0.01% in 5" dia. units
- Operation in ambient temperatures up to 200° C
- Shock and acceleration resistance in excess of 100g
- Rotational speeds up to 1,000 rpm
- Meet Military Specifications.

Write for Design Data and Catalog for Rotary and Rectilinear Potentiometers.

MARKITE

CORPORATION

155 Waverly Place • New York 14, N. Y.

Circle 154 on Inquiry Card



METAMORPHOSIS

See your R&D metamorphose into usable hardware. Our Inertial Guidance System contracts require that we add to our staff. If you have 3 to 5 years of experience, you probably qualify for a position of responsibility. Inquire today of Mr. C. T. Petrie, Manager, Research & Engineering Staff.



LITTON INDUSTRIES Electronic Equipments Division
Beverly Hills, California

Please write direct to the above advertiser

SPECIAL
WELDING TIPS,
HOLDERS
and
WELDING JIGS

MADE TO YOUR
SPECIFICATIONS



EISLER MAKES THE LARGEST ASSORTMENT OF SPECIAL, STANDARD WELDING TIPS, ACCESSORIES & WATER COOLED HOLDERS

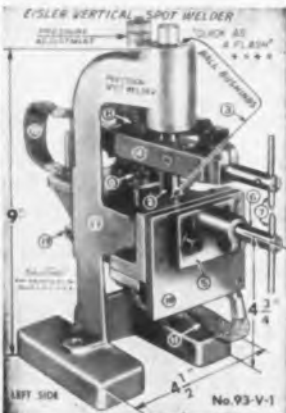

EISLER ENGINEERING CO., INC. 770 So. 13th St., NEWARK 3, N. J.

Circle 155 on Inquiry Card

for maximum reliability

**PREVENT
THERMAL
RUNAWAY**

Prevent excessive heat from causing "thermal runaway" in power diodes by maintaining collector junction temperatures at, or below, levels recommended by manufacturers, through the use of new Birtcher Diode Radiators. Cooling by conduction, convection and radiation, Birtcher Diode Radiators are inexpensive and easy to install in new or existing equipment. To fit all popular used power diodes.



with **NEW**
BIRTCHER
DIODE
RADIATORS



Birtcher cooling and retention devices are not sold through distributors. They are available only from the Birtcher Corporation and their Sales Representatives.

THE BIRTCHER CORPORATION
industrial division

4371 Valley Blvd. Los Angeles 32, California

Sales engineering representatives in principal cities.

FOR CATALOG
and
cost data write:



News of Mrs'
Representatives

REPRESENTATIVES WANTED

Jerold Electronics Corp., Jerrold Bldg., Philadelphia 32, Penna., is looking for representation for their line of industrial test equipment in: Texas, Oklahoma, Mississippi, Missouri, Arkansas, Kansas, Indiana, Illinois, and Michigan.

The Los Angeles Chapter of Electronic Representatives Assoc. has appointed Edward R. McCarthy Chairman of the Instrument Trade Div. for 1960. He is President and Founder of McCarthy Associates, Inc., electronic manufacturers reps, Pasadena, Calif.

Central Engineering Sales Co., Chicago, Ill., has been appointed midwest representative for Radiation Instrument Development Laboratory, Inc., Chicago.

SALES AWARD



Jacques Ebert (left) presents trophy "The Chemtronics Sales Award of the Year," to Art Cerf, Art Cerf & Co., Newark, N. J.

Allen C. Craft Jr., Atlanta, Ga., has been appointed rep for Associated Research, Inc., in Georgia, Alabama, and North and South Carolina.

The addition of the R. W. Farris Co., Kansas City, Mo., to its list of sales reps has been announced by Silicon Transistor Corp.

Magnetic, Inc., has appointed these reps: Schutter-Young Co., Beverly, Mass., for New England; Gislason Sales Co., Rochester, N. Y. for New York; Zak-Cowen & Assoc., Inc., St. Louis, Mo. for a 400 mile radius of St. Louis; and J. W. Marsh Co., Los Angeles, Calif., for California, Nevada, Arizona.

J. K. Rose & Co., Highland Park, Ill., has been appointed sales rep in Illinois and Wisconsin for Electronic Instrument Co., Inc.



MILLER SUBMINIATURE R.F. CHOKES

—smallest chokes available



These high reliability units are ideally suited for network and filter design . . . delay lines, and computer applications. Miller chokes have a 50 ma current rating, and an inductance range of 1 uh to 10 mh. Ratings are conservative, with a wide safety factor. Units can be encapsulated to meet military specifications. Low cost . . . immediate deliveries.

Send for MILLER Industrial catalog. You'll find over 1300 chokes, filters, transformers and coils listed, ready for immediate delivery. Request Miller Catalog No. 60

J. W. MILLER COMPANY
5917 South Main Street, Los Angeles 3, California



Circle 157 on Inquiry Card
ELECTRONIC INDUSTRIES • April 1960

News of Mrs' Representatives

Pyrometer Co. of America, Inc., has appointed Clarence B. Petty & Co., Needham Heights, Mass., rep in Maine, New Hampshire, Vermont, Rhode Island and the Eastern areas of Massachusetts and Connecticut.

The Ahearn and Soper Co., Ottawa, Canada, is now Canadian national rep for Rutherford Electronics Co.

Geo. Stevens Mfg. Co., Inc., has appointed A. L. Pritchard Co., St. Petersburg, as rep in Florida.

The Electronic Representatives Association has presented four special awards for "Excellence in Sales Management." Award Winners were: W. Noel Eldred, Vice-President, Marketing, for Hewlett-Packard Co., Palo Alto, Calif.; Earl U. Sala, Jr., General Sales Manager of the Bell Sound Div., Thompson-Ramo-Wooldridge, Inc., Columbus, Ohio; Norman A. Triplett, General Sales Manager of the Triplett Electrical Instrument Co., Bluffton, Ohio; and Lowell L. Wilkes, Jr., General Sales Manager for Cambridge Thermionic Corp., Cambridge, Mass. The awards were presented at ERA's "Silver Anniversary Banquet," Feb. 12.

FREE!
416 PAGE
**PIC
MASTER
CATALOG
#21**

Lists over 12,000

**PRECISION INSTRUMENT PARTS
and ASSOCIATED COMPONENTS**

Available From STOCK!

GEARS • SHAFTS • COLLARS • CLUTCHES •
BEARINGS • COUPLINGS • DIFFERENTIALS
• SPEED REDUCERS and many other Precision Engineered Parts & Components.

Send For Your
Copy Today.



PIC DESIGN CORP.

Subsidiary of **BEHRUS WATCH COMPANY, Inc.**

477 Atlantic Ave., East Rutherford, N. J.

Circle 158 on Inquiry Card

IN LESS THAN 4 SECONDS

FROM THIS

TO THIS

OR THIS

WITH THE REVOLUTIONARY
PRODUCTION AID TOOL!

"PIG-TAILOR"®



Fast operated
No accessories
2 minute set up

\$125.00

'PIG-TAILORING'

a revolutionary new mechanical process for higher production at lower costs. Fastest PREPARATION and ASSEMBLY of Resistors, Capacitors, Diodes and all other axial lead components for TERMINAL BOARDS, PRINTED CIRCUITS and MINIATURIZED ASSEMBLIES.

PIG-TAILORING eliminates: • Diagonal cutters • Long nose pliers • Operator judgment • 90% operator training time • Broken components • Broken leads • Short circuits from clippings • 65% chassis handling • Excessive lead wastage • Haphazard assembly methods.

PIG-TAILORING provides: • Uniform component position • Uniform marking exposure • Miniaturization spacing control • "S" leads for terminals • "U" leads for printed circuits • Individual cut and bend lengths • Better time/rate analysis • Closer cost control • Invaluable labor saving • Immediate cost recovery.

Pays for itself in 2 weeks

"SPIN-PIN"®

Close-up views of "SPIN-PIN" illustrate fast assembly of tailored-lead wire to terminal.

- No Training
- No Pliers
- No Clippings
- Uniform Crimps
- 22 Sizes

PAYS FOR ITSELF
THE FIRST DAY!

\$5.00 EACH



Write for illustrated book to Dept. EI-8



BRUNO-NEW YORK INDUSTRIES CORP.

DESIGNERS & MANUFACTURERS OF ELECTRONIC EQUIPMENT
460 WEST 34th STREET • NEW YORK 1, N. Y.

Circle 159 on Inquiry Card

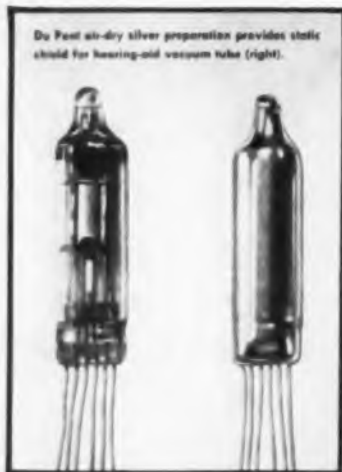

Du Pont air-dry silver preparation provides stable shield for hearing-aid vacuum tube (right).

COATING PROBLEMS?

Let Du Pont Specialized Conductive Coatings Help You Solve Them

Whatever your coating problem may be, Du Pont can provide you with a conductive coating to meet your needs. It may be a coating of silver, gold, platinum, palladium or a combination of these. You can use Du Pont conductive coatings for virtually all types of electronic circuits and components:

- Electrodes for barium titanate ceramic capacitors.
- Electrodes for mica capacitors.
- Electrodes for thermistor and piezo-electric bodies.
- Thermosetting compositions on metals, phenolics, epoxies and other non-ceramic bases.
- Firing on ceramic and glass (where coating is copperplated and tinned for hermetic sealing).
- Air-dry types for use on low-temperature, non-ceramic bases. (Static shielding.)

Write for bulletin on high-quality Du Pont conductive coatings of silver, gold, platinum and palladium. Mention application you have in mind. Du Pont will supply a formulation to fit your application, process or product features. Write: Du Pont, Electrochemicals Department, Ceramic Products Division, Wilmington 98, Delaware.



Better Things for Better Living... through Chemistry
Circle 160 on Inquiry Card

New Products

TUNNEL DIODES

Sample quantities of GE's second tunnel diode, EJ56A, a 1000 mc device, available. Features include a min. peak to valley current ratio of 5 to 1, a typical peak point current rating of 1 ma, which is held to $\pm 10\%$



and a typical negative conductance of 0.065 mho. Packaged in the TO-18 standard housing, pins 1 and 2 are positive electrodes connected internally to reduce lead inductance. Pin 3 is the negative electrode and connected to case. Rated for an operating junction temp. of -55°C to $+100^{\circ}\text{C}$. Typical peak point voltages are 55 mv and typical valley point voltages are 350 mv. General Electric Co., Semiconductor Products Dept., Liverpool, N. Y.

Circle 245 on Inquiry Card

HEADERS

All-epoxy header for use with either epoxy shells or conventional metal cases, replaces glass-to-metal seals in electronic applications. Since the header leads are embedded in cured, molded epoxy, there is no danger of cracked glass, no broken seals, no coefficient of expansion problem during the soldering operation. Header



leads are embedded to fit a standard seven-pin miniature socket. Variations are available for different applications. Epoxy Products, Inc., 137 Coit Street, Irvington, New Jersey.

Circle 246 on Inquiry Card



New Bendix BACKWARD-WAVE OSCILLATOR TUBES OPERATE IN FREQUENCIES FROM 40 KMC/S TO 85 KMC/S

The new line of Bendix® Backward-Wave Oscillator Tubes generates microwave energy at extremely high frequencies never before available.

These new tubes provide a wide range of usable frequencies for applications in: advanced types of multi-channel telephone and television systems, high definition short-range radar, highly directive communications, microwave spectroscopy and other fields where low power, voltage-tuned millimeter wave-length radio frequency energy is required.

For more detailed information on these tubes, write to: ELECTRON TUBE PRODUCTS, RED BANK DIVISION, BENDIX AVIATION CORPORATION, EATONTOWN, N. J.

MECHANICAL DATA

Output
Flange Special adapter to RG-9B/U (RG-97/U for TE-75)
Maximum Diameter 0.625"
Length 8"
Mounting Position Any
Weight 5 oz.
*Without magnet (tube only). Magnets arm available.

Available types

Type TE-75 with frequency range of 40 Kmc to 50 Kmc
Type TE-67 with frequency range of 49 Kmc to 59 Kmc
Type TE-66 with frequency range of 61 Kmc to 71 Kmc
Type TE-85 with frequency range of 70 Kmc to 85 Kmc



ELECTRON TUBE PRODUCTS



West Coast Sales & Service: 117 E. Providencia Ave., Burbank, Calif. • Export Sales & Service: Bendix International Division, 205 E. 42nd St., New York 17, N. Y. • Canadian Distributor: Computing Devices of Canada, Ltd., P. O. Box 508, Ottawa 4, Ontario.

Circle 326 on Inquiry Card

New

Products

CONVERTER

Airborne analog-to-digital converter, the M4, is completely transistorized for min. size and max. reliability. It performs a 12-bit conversion to an accuracy of ± 1 mv in 65 μ sec over

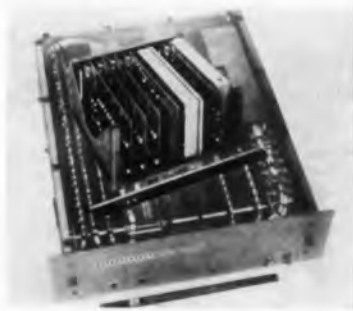

the temperature range of -55°C to $+70^{\circ}\text{C}$. Available for 3-decimal digit as well as 12-bit binary conversion, it is designed to meet the conditions required of MIL-E-5400B and MIL-E-005272. Packaging conforms to MIL-T-19600 (AER). Packard Bell Computer Corp., 1905 Armacost Ave., Los Angeles 25, Calif.

Circle 247 on Inquiry Card

DC POWER SUPPLY

Designed for lab. work, where a source of dc is needed for circuit testing, transistor testing and other requirements, portable dc power supply instrument plugs into a 60 cps, 95/130 v. circuit. The filtered dc output range is 0/45 v., and 0/2.5 a. The unit is continuously adjustable and stabilized



$\pm 1\%$ at any output setting regardless of any alternating current fluctuation. Also available in a standard rack model. Acme Electric Corp., Cuba, New York.

Circle 248 on Inquiry Card

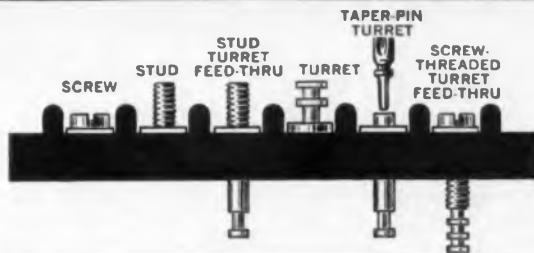

Pick your TERMINALS with KULKA TERMINAL BLOCKS!

What do you prefer for your connections—screw, stud, nut, turret, threaded-turret, taper-pin, feed-thru, or other terminal style? No longer must you compromise or improvise. Instead...

Select the terminal style or styles, together with type and size of terminal block. The Kulka Terminal Program will combine the two factors in a terminal block custom-fitted to your wiring and assembly needs. It's simple, expeditious, economical!

LITERATURE...Ask for the Kulka Terminal Style Catalog, listing many terminal designs and combinations. Let us quote on your requirements.



KULKA

KULKA ELECTRIC CORP.

633-643 So. Fulton Avenue
Mount Vernon, N.Y.

Circle 327 on Inquiry Card

X-Y RECORDER

Model HR-92

Unconditionally Guaranteed For One Year

LOW COST



Rugged, simple (8 1/2" x 11") plotter contains all essential features for 95% of all X-Y applications. Basic Model HR-92-1 is \$595.00 (USA) with 10mv/in. sensitivity, 1/2% accuracy.

Write for bulletin 792-4.



houston instrument
corporation

Box 22234 • Houston 27, Texas MO 7-7405

Circle 328 on Inquiry Card

Give your products
**MORE RELIABILITY and
 BETTER PERFORMANCE with**

**FREED
 QUALITY**

In stock for immediate delivery

TOROIDAL INDUCTORS

- MIL Grade 4 — Metal Case
- MIL Grade 5 — Molded
- Uncased Units
- Highest Q
- Highest self resonant freq.
- Low temperature coefficient
- No hum pickup—static construction
- Can be supplied with center taps



FREQUENCY RANGE: 500CP TO 15KC

Type	Max Q	Inductance Range
TI-11	290	1MH to 30MH
TI-12	255	1MH to 30MH
TI-1A	250	1MH to 30MH
TI-1	210	5MH to 20MH
TI-4	195	5MH to 5Hy
TI-5	130	5MH to 2Hy
TI-16	72	1MH to 2Hy

FREQUENCY RANGE: 10KC TO 50KC

TI-13	303	1MH to 500MH
TI-2	285	1MH to 500MH
TI-6	279	1MH to 400MH
TI-7	200	.500MH to 200MH
TI-17	110	.100MH to 100MH

FREQUENCY RANGE: 30KC TO 200KC

TI-18	115	1MH to 100MH
TI-8	140	1MH to 100MH
TI-10	185	1MH to 200MH
TI-9	175	1MH to 500MH
TI-19	100	1MH to 5MH
TI-3	260	1MH to 10MH
TI-3A	310	10MH to 100MH

**HIGH FREQUENCY
 TOROIDAL INDUCTORS**

FREQUENCY RANGE: 20KC TO 10MC

TI-21	205	.010MH to .150MH
TI-22	250	.010MH to .700MH
TI-23	210	.010MH to .500MH
TI-20	305	.050MH to 5MH

**Ruggedized,
 MIL STANDARD
 AUDIO TRANSFORMERS**

Case No.	Imped level—ohms	Appl.	MIL Std	MIL Type
BGA 1	Pr. 10,000 C T Sec. 40 000 Split A C T	Interstage	W4000	T74B11A1001
BGA 2	Pr. 600 Split Sec. A, B, 16	Matching	90001	T74B11A1002
BGA 3	Pr. 600 Split Sec. 135,000 C T	Input	90002	T74B11A1003
BGA 4	Pr. 600 Split Sec. 600 Split	Matching	90003	T74B11A1001
BGA 5	Pr. 7,000 Tap @ 4,000 Sec. 600 Split	Output	90004	T74B11A1001
BGA 4	Pr. 7,000 Tap @ 4,000 Sec. A, B, 16	Output	90005	T74B11A1002
BGA 7	Pr. 15,000 C T Sec. 600 Split	Output	90006	T74B11A1003
BGA 8	Pr. 24,000 C T Sec. 600 Split	Output	90007	T74B11A1004
BGA 9	Pr. 60,000 C T Sec. 600 Split	Output	90008	T74B11A1005

Partial listing only—send for complete catalog

FREED TRANSFORMER CO., INC.
 1723 Wehrfeld St., Brooklyn (Ridgewood) 27, N.Y.

New Products

PILOT LIGHT

Press-fit OMNI-GLOW Pilot Light is mountable from the front of panels. It uses four moulded-in nylon ribs to give a positive grip. Units push in through a 0.500/0.505 hole and snap into place on panels up to 0.065 thick. The unit can also be used on heavier



panels. The press fit unit cannot be removed by finger pressure, although it can be pried loose should replacement become necessary. Industrial Devices, Inc., 982 River Road, Edgewater, New Jersey.

Circle 249 on Inquiry Card

**How To Get Things Done
 Better And Faster**



BOARDMASTER VISUAL CONTROL

- ☆ Gives Graphic Picture — Saves Time, Saves Money, Prevents Errors
- ☆ Simple to operate — Type or Write on Cards, Snap in Grooves
- ☆ Ideal for Production, Traffic, Inventory, Scheduling, Sales, Etc.
- ☆ Made of Metal. Compact and Attractive. Over 500,000 in Use.

Full price **\$49.50** with cards

FREE

24-PAGE BOOKLET NO. Z-30

Without Obligation

Write for Your Copy Today

GRAPHIC SYSTEMS

Yonkersville, North Carolina

Circle 330 on Inquiry Card

SELECTIVE PLATING



**Production and Repair Plating
 without using immersion tanks**

Enables You to (1) Precision-plate selected areas economically — without disassembling components; (2) Deposit metals rapidly where conventional electro-plating is impossible or difficult. Mobile equipment takes the process to the job.

Write for Descriptive Brochure.

SIFCO METACHEMICAL, INC.

935 East 63 Street • Cleveland 3, Ohio
 A Subsidiary of The Steel Improvement & Forge Co.

AGENTS

MARLANE DEVELOPMENT CO., INC. PIDDINGTON & ASSOCIATES LTD. OHIO METACHEMICAL, INC. D & S AVIATION CO., LTD.
 153 East 26th Street 3219 East Foothill Blvd 2742 Second Street 471 Laurendes Blvd
 New York 10, N.Y. Pasadena, California Cuyahoga Falls, Ohio Port Yau, Montreal, Quebec

Circle 331 on Inquiry Card

← Circle 329 on Inquiry Card

ELECTRONIC INDUSTRIES • April 1960

ELECTRONIC INDUSTRIES Advertisers—April 1960

This index is published as a convenience. No liability is assumed for errors or omissions.

A	
Acme Electric Corporation	219
Acoustica Associates, Inc.	184
Aerovox Corp., Hi-Q Division	27
Airborne Accessories Corporation	202
Allegheny Ludlum Steel Corporation	65
Allied Chemical, General Chemical Div.	185
Allied Radio	160
American Super-Temperature Wires, Inc.	221
AMP Incorporated	41
Amphenol-Borg Electronics Corp.	
Amphenol Cable & Wire Div.	52
Amphenol Connector Division	36
Borg Equipment Division	42
Arco Electronics	149
Armco Steel Corporation	54
Audio Development Company	212

B	
Ballantine Laboratories, Inc.	62
Beckman/Berkeley Division	145
Bell Telephone Laboratories	38
Bendix Aviation Corporation	
Kansas City Division	231
Red Bank Division, Electron Tube	240
Red Bank Division, Semiconductor	156
Bircher Corporation, The	238
Biwax Corporation	158
Bliley Electric Company	214
Bomac Laboratories, Inc.	Inside back cover
Bonton Laboratories Corporation	
Bourns, Inc., Trimpot Division	57
Bruno New York, Ind. Corp.	239
Brush Instruments Division of Clevite Corp.	
Insert following page	66
Bulova Electronics	183
Burnell & Co., Inc.	205
Bussmann Mfg. Div., McGraw-Edison Co.	152

C	
Cambridge Thermionic Corporation	213
Cannon Electric Company	39
CBS Electronics	188
Centralab Electronics Division of Globe-Union, Inc.	167
Cinch Manufacturing Company	121
Cincinnati Sub-Zero Products	203
Cleveland Container Co., The	44
Clevite Transistor	Insert following p.
Communication Accessories Company	32
Computer Measurements Co.	61
Consolidated Vacuum Corporation	221
Control Switch Div., Controls Company of America	15
Corning Electronic Components, Corning Glass Works	147

D	
Dade County Development Department	213
Dale Products, Inc.	151
Dalco Radio Div. of General Motors	150
Deutsch Company, The	56
Diallight Corporation	203
Diamond Tool and Horseshoe Co.	29
Du Pont Electrochemicals Dept.	240

E	
EICO Electronic Instruments	244
Eisler Engineering Co., Inc.	238
Eitel-McCullough, Inc.	168
Elastic Stop Nut, Aga Div.	211
Electra Manufacturing Company	43
Electro Motive Mfg. Co., Inc., The	148
Elgin-Advance Relays, Elgin National Watch Company	159
Engineered Electronics	13

F	
Fansteel Metallurgical	30, 31
Fairchild Semiconductor Corporation	23
Fairmount Chemical Company, Inc.	207
Film Capacitors, Inc.	217
Freed Transformer	242
Fusite Corporation, The	223

G	
Garlock Electronic Products, The Garlock Packing Company	58
Gates Radio Company	232
General Electric	
Communication Products Department	233
Missile & Space Vehicle Department	234-235
Power Tube Department	130-131
Receiving Tube Department	122-123
Semiconductor Department	16, 17
General Instruments Corporation	164-165
General Products Corporation	173
General Transistor Corp., Insert following p.	142
Gerfsch Products, Inc.	164
Graphic Systems	242
Graibach Instruments Corporation	220

H	
Hewlett-Packard Company	49, 154-155
Hoffman & Co., H. L.	206
Houston Instrument Corporation	241
Hughes Aircraft Company	
Hughes Semiconductor Division	9
Hughes Vacuum Tube Products Division	10
Hughes Industrial Systems Division	11
Hughes General Offices	226-227

I	
Ideal Precision Meter Co., Inc.	237
Illumitronic Engineering	164
Indiana Steel Products Div. of Indiana General Corporation	46
Industrial Division, Chamber of Commerce	
Hollywood, Florida	216
Industrial Electronic Engineers, Inc.	213
Industrial Exhibitions, Ltd.	236
Instruments for Industry	218

J	
Jennings Radio Manufacturing Corporation	64
Johnson, E. F.	211
Jones Division, Howard B., Cinch Manufacturing Company	207

K	
Keithley Instruments	220
Kester Solder Company	214
Keystone Carbon Company, Thermistor Div.	37
Klein & Sons, Mathias	192
Kulka Electric Corp.	241

L	
Lavoie Laboratories, Inc.	193
Lel, Inc.	213
Lenz Electric Manufacturing Co.	132
Liton Industries, Electronic Equipment Division	237
Lockheed Missiles and Space Division	224

M	
Magnavox Co., The	228
Magnetics, Inc.	127
Manson Laboratories, Inc.	28
Marconi Instruments	244
Marlita Corporation	237
McKinstry Metal Works, Inc.	203
Measurements, A McGraw-Edison Division	50
Microtran Company, Inc.	76
Microwave Associates, Inc.	200
Miller Company, J. W.	239
Minnesota Mining & Manufacturing Company	
Scotch Brand Magnetic Tape	199
Mincrom Division	55
Mondrack Mills	64
Motorola, Inc.	
Personnel Division	230
Semiconductor Products Division	160, 161
Muirhead Instruments, Inc.	197

N	
National Ultrasonic Corp.	211
New Departure Division, General Motors Corporation	22
Non-Linear Systems, Inc.	129

O	
Ohmite Manufacturing Company	201

P	
Pennwood Numechron Co.	244
Philamon Laboratories, Inc.	35
Philco, Lansdale Division	18
PIC Design Corp.	239
Polarad Electronics	Insert following p. 132

R	
Radio Corporation of America, Semiconductor and Materials Division	Back cover
Radio Materials Company	Inside front cover
Raytheon Company	
Industrial Components Division	146
Republic Aviation	232
Rick Electroplating Works	175
Rohn Manufacturing Co.	172
Rotron	210

S	
Sangamo Electric Company	125
Sarkis Torlan, Inc. Semiconductor Division	162
Scintilla Division, Bendix Aviation Corp.	176
Segal, Edward	219
Shure Brothers, Incorporated	175
Sifco Metachemical, Inc.	242
Spectral Electronics Corporation	186, 187
Spear Resistor Division, Spear Carbon Company	181
Sprague Electric Company	6, 204
Stockpole Carbon Company	196
Stromberg-Carlson, A Division of General Dynamics	216
Struthers-Dunn, Inc.	48
Superior Tube Company	20
Sylvania, Subsidiary of General Telephone & Electronics, Semiconductor Div.	215
Synthane Corporation	190
Syntron Rectifier Division, Subsidiary of Link-Belt Company	217

T	
Tapco Group, Thompson Ramo Woolridge, Inc.	53
Taylor Fibre Co.	50, 51
Texas Instruments Incorporated	
Semiconductor-Components Division	195
Tinnerman Products, Inc.	47
Trak Electronics Co.	207
Transatron Electronic Corporation	45, 153
Tung-Sol Electric, Inc.	63

U	
Ultrasonic Industries, Inc.	207
United Transformer Corp.	163

V	
Valcor Engineering Corp.	40
Vapor Heating Corporation	
Vap-Air Aeronautical Products Division	21
Vari-flex Corporation	219
Varian Associates	59
Vector Electronic Company	166
Victoreen	60
Vitramon Incorporated	149

W	
Waveline, Inc.	194
Wayne Kerr Corporation	124

NEW...TYMETER DIGITAL CLOCK

12 and 24 HOUR READ OUT

- Front Panel Mount
- Desk or Bench Use
- Digits Resettable Individually

160-12H

Large $\frac{3}{8}$ " easy to read digits • Time is registered on 3 drums . . . minutes, 10 minutes and hour • Rotating visual 1 RPM calibrated seconds wheel • Digits resettable individually • Full vision in line read out digital display • Independent front panel time reset control's • Illumination provided by miniature lamp with independent control switch . . . jewel light panel indicator • Synchro-Synchronization seconds wheel control switch • Movement shock resistant to withstand shock of 2000 pounds per inch • Completely enclosed anodized metal dust-proof case . . . Height $4\frac{1}{2}$ " . . . Width 6" . . . Depth $3\frac{1}{4}$ " . . . front panel mount . . . desk or bench use • Available in 50 or 60 cycle . . . in all voltages AC • Precision instrument accuracy • UL approved motor and cord. Wt. $3\frac{1}{2}$ lbs.

Write for Catalog on Complete Line Showing Specifications

PENNWOOD NUMECHRON CO.
7249 FRANKSTOWN AVE.

PITTSBURGH 8, PENNA.
FRemont 1-4200

Circle 140 on Inquiry Card



HI ACCURACY 0.2%
LO CAPACITY .002 μ F

New Marconi Capacity Bridge enables difficult measurements such as temperature co-efficients, circuit strays and tube interelectrode capacities to be easily made. Capacitors already wired into circuits can be checked without removal by the three terminal "in situ" method.

Model 1342 uses the transformer ratio arm technique which permits measurement of small capacities at the end of long screened leads to be measured without loss of accuracy.

Brief Specification
Range: 0.002 to 1,111 μ F
Accuracy: $\pm 0.2\%$
Resistance range: 1 to 1000 M Ω
Frequency: 1 Kc
Decimal point inserted automatically



MARCONI
INSTRUMENTS



111 CEDAR LANE • ENGLEWOOD NEW JERSEY

Circle 141 on Inquiry Card

New

Products

POWER SUPPLIES

Five dual output transistorized power supplies, Model DME, in dual voltage ranges of 0-18, 0-36, 0-60, 0-100, and a fifth unit with output voltages of 0-36 and 0-100. Output



current of 0-1 a available in the 100 v. units, and 0-2.5 a in the lower voltages. Line regulation is 0.05% or 5 mv, whichever is greater. Ripple is less than 0.01% and recovery will not exceed 50 μ secs with overshoot less than 1.0% at full current and voltage. Mid-eastern Electronics, Inc., 32 Commerce St., Springfield, N. J.

Circle 250 on Inquiry Card

send for this

FREE

**EICO
Electronics
Catalog**



you save 50% on Top-Quality
Test Instruments
HI-FI • Ham Gear

KITS AND WIRED

for professional and home use

TEST INSTRUMENTS
battery eliminators
battery testers
bridges
decade boxes
electronic switch
flyback tester
oscilloscopes
probes
signal and sweep generators
tube testers
transistor tester
vacuum tube voltmeters
volt-ohm-milliammeters

HI-FI
stereo and monaural tuners
preamplifiers
power amplifiers
integrated amplifiers
speaker systems

HAM GEAR
cw transmitter
modulator-driver
grid dip meter

OVER 2 MILLION
EICO Instruments in use throughout the world.

LIFETIME service and calibration guarantee.
IN STOCK at your neighborhood EICO dealer.
Send now for FREE catalog EICN-4.

EICO

3100 N. BIRN L I C I N Y
praised by the experts
as BEST BUYS IN ELECTRONICS

Circle 332 on Inquiry Card

NEW RCA SILICON POWER TRANSISTORS

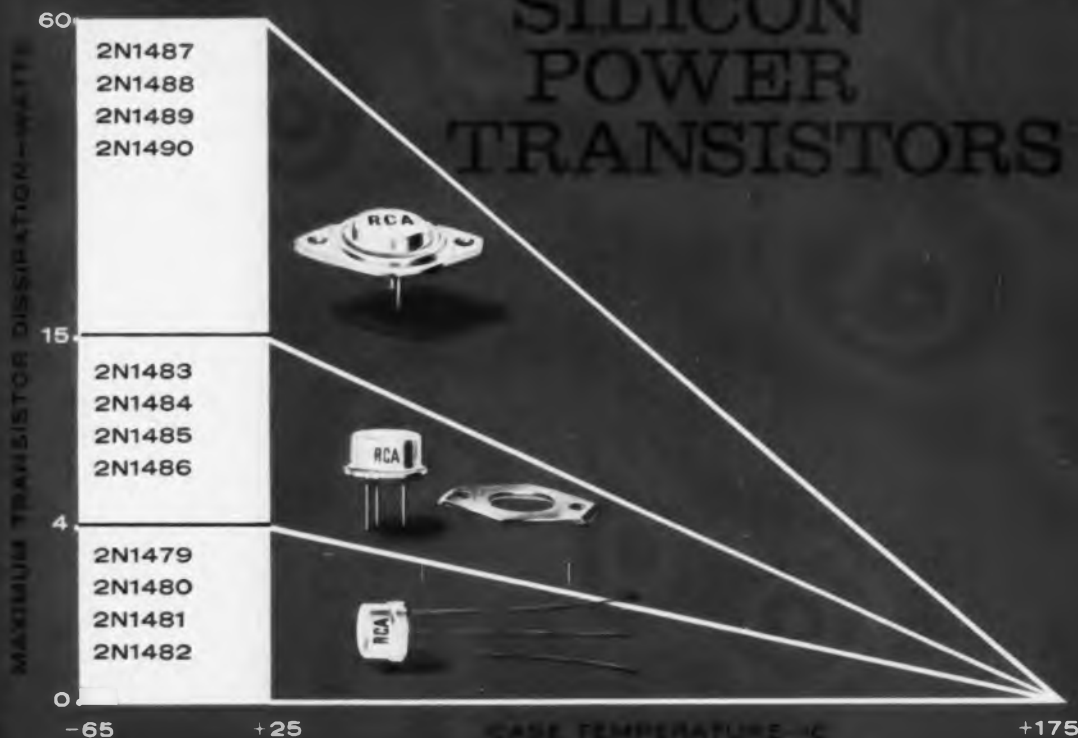

12 new N-P-N diffused-junction mesa types with low saturation resistance • high-temperature performance • high current beta • high power-handling capability

Out of RCA's broad experience in diffused silicon mesa techniques comes a comprehensive new line of medium, intermediate and high power silicon transistors, featuring low saturation resistance characteristics and high collector-current and voltage ratings.

These new RCA silicon types open the way to a wide variety of military and industrial applications—in power switching circuits such as dc-to-dc converters, inverters, choppers, solenoid drivers and relay controls; oscillator, regulator, and pulse-amplifier circuits, and as class A and class B push-pull amplifiers for servo and other audio-frequency applications.

RCA Silicon Power Transistors were developed in cooperation with U. S. Army Signal Corps, on an Industrial Preparedness Measure for military devices.

Contact your RCA Field Representative today for complete sales information. For additional technical data, write RCA Commercial Engineering, Section D-50-NN, Somerville, N. J.

ELECTRICAL CHARACTERISTICS						
Minimum and Maximum Values at Case Temperature = 25°C						
RCA Type	Min. V_{CE} (volts)	Min. V_{CE}^0 (volts)	Max. I_C (amp)	Max. I_{CBO} (μ a)	Max. Saturation Resistance (ohms)	h_{FE}
2N1479	40	40	1.5	10	$V_{CE} = 30V$ $I_C = 0.2amp$	$I_C = 0.2amp$ 15.75
2N1480	100	55	1.5	10	7	15.75
2N1481	60	40	1.5	10	7	25-100
2N1482	100	55	1.5	10	7	25-100
2N1483	60	40	3	15	$V_{CE} = 30V$ $I_C = 0.75amp$	$I_C = 0.75amp$ 15.75
2N1484	100	55	3	15	2.67	15.75
2N1485	40	40	3	15	1.00	25-100
2N1486	100	55	3	15	1.00	25-100
2N1487	40	40	6	25	$V_{CE} = 30V$ $I_C = 1.5amp$	$I_C = 1.5amp$ 10-50
2N1488	100	55	6	25	2.00	10-50
2N1489	60	40	6	25	0.67	25-75
2N1490	100	55	6	25	0.67	25-75

*sustaining volts



RADIO CORPORATION OF AMERICA

SEMICONDUCTOR AND MATERIALS DIVISION

SOMERVILLE, N. J.

ANOTHER WAY RCA SERVES YOU THROUGH ELECTRONICS

EAST: 744 Broad Street, Newark, N. J., HUmboldt 5-3900 - NORTHEAST: 64 "A" Street, Needham Heights 94, Mass., Hillcrest 4-7200 - EAST CENTRAL: 714 New Center Bldg., Detroit 2, Mich., TRinity 5-5600 - CENTRAL: Suite 1154, Merchandise Mart Plaza, Chicago, Ill., WHitehall 4-2900 - WEST: 6355 E. Washington Blvd., Los Angeles, Calif., RAymond 3-8361 - SOUTHWEST: 7905 Empire Freeway, Dallas 7, Texas, FLeetwood 7-8167 - GOVT: 224 N. Wilkinson St., Dayton, Ohio, BAIdwin 6-2366 - 1625 "K" Street, N.W., Washington, D.C., District 7-1260

AVAILABLE, TOO, THROUGH YOUR AUTHORIZED RCA DISTRIBUTOR

Communications



Instruments



Controls



Radar



Avionics



Missiles



Mobile Electronics

