

MAKING THE YEAR

Großdeutsch

TELE-TECH

& Electronic Industries

See page 75

Variable Resistors

A Prime
Electronic
Component

1925-30

1930-35

1935-40

1940-50

1950-55

SHARE THIS COPY
Please Route to



RMC Plant at Attica, Indiana

RMC DISCAPS

***the standard of performance
throughout the electronic industry***

RMC devotes its entire research, engineering and production facilities to the development and manufacture of ceramic capacitors. Production is controlled from basic powders to completed capacitor assuring absolute quality control. Every DISCAP is tested at twice its rated voltage before shipment. DISCAPS are available in temperature compensating, by-pass, stable capacity, high voltage and AC line types in addition to the exclusive new "Wedg-loc" types for printed wire circuits.



RMC Plant and General Office at Chicago, Illinois

3 RMC Plants to Serve You

RMC operates centrally located production plants at Chicago, Illinois and Attica, Indiana. The Research Division in Chicago houses development and engineering personnel continuously at work improving ceramic dielectrics. For standard or special types of ceramic capacitors specify RMC DISCAPS.



RMC Research Division at Chicago, Illinois

DISCAP
CERAMIC
CAPACITORS



RADIO MATERIALS CORPORATION

GENERAL OFFICE: 3325 N. California Ave., Chicago 18, Ill.

FACTORIES AT CHICAGO, ILL. AND ATTICA, IND.

Two RMC Plants Devoted Exclusively to Ceramic Capacitors

TELE-TECH

& Electronic Industries

FEBRUARY, 1955

FRONT COVER: VARIABLE RESISTORS—A PRIME ELECTRONIC COMPONENT. In addition to the sizes, construction, mounts, and materials of volume controls for the past 25 years, this illustration is also symbolical of the tremendous growth in annual output of the industry. In 1935 the variable resistor requirements for the radio and electronic industries were estimated at 9 million units a year. In 1940 there were 16 million. With the coming of television the figure jumped to 29 million in 1946. In 1950, a peak year, 89 million units were involved. Over 80 million units will be required in 1955. The design trend is ever towards miniaturization, and through the years the sizes of control units have been constantly reduced from 3 in. to the present 3/4 in. There is now a definite trend toward variable resistors with special printed circuit mounting terminals for printed circuits and automation. The year ahead may also see more use of the solderless "wire-wrap" techniques for attaching lead wires. The controls illustrated are through the courtesy of Chicago Telephone Supply Corp., Elkhart, Ind.

Totals: Engineering Futures, WCEMA Totals, Broadcasting Growth	3
As We Go To Press	17
Bargain Days for Uncle Sam	57
Another Look at Fee-TV	57
How Much Censorship?	57
TV Antenna Checkup	57
Radarscope: What's Ahead for the Electronic Industries	58
How To Plan for Color Television Broadcasting—Part One	
L. E. Anderson and W. O. Hadlock	60
Strength and Behavior of Guyed Towers—Part Two	D. A. Liamin 64
Cues for Broadcasters	67
Photoetched Microwave Transmission Lines—Part One	Norman R. Wild 68
"Vendor Rating" for Quality Control	H. C. Newton 71
Techniques for Measuring Capacitor Dielectric Absorption	Herbert E. Ruehleman 72
The Light Amplifier	75
Designing Potted Resistor Networks	Harry E. Myers 76
Television Stations Coming on the Air	78
Pulse Transformers Utilizing Ferrites	Michael J. Geroulo & Lawrence Hobson 80
New Subminiature Long Scale Indicating Instrument	A. D. Bedrosian 82
Ferrite Cored Antennas	Charles A. Grimmitt 84
Deflection Yoke Dies	Bernard B. Bycer 86
Potentiometer Characteristics	M. H. Hayes and J. L. West 97

DEPARTMENTS

Books	24	Letters	46	Personal	137
Bulletins	138	New Equipment	88	Tele Tips	34
Coming Events	20	News Briefs	94	Washington News Letter	92
Industry News	150	News of Manufacturers Reps	144		

TELE-TECH & ELECTRONIC INDUSTRIES*, Vol. 14, No. 2. Published monthly by Caldwell-Clements, Inc. M. Clements, President; M. H. Newton, Assistant to President; John J. Borghi, Vice President and Treasurer; M. B. Clements, Secretary. Acceptance under section 34.64 Postal Laws and Regulations authorized at Bristol, Conn., June 9, 1954. Additional acceptance at New York, N. Y. 75¢ a copy. Subscription Rates: United States and U. S. Possessions: 1 year, \$5.00; 2 years \$8.00; 3 years \$10.00. Canada: 1 year \$7.00; 2 years \$11.00; 3 years \$14.00. All other countries: 1 year \$10.00; 2 years \$16.00. Please give title, position and company connections when subscribing. Copyright by Caldwell Clements, Inc., 1955. Printed in U.S.A.

CALDWELL-CLEMENTS, Inc.

* Reg. U. S. Pat. Off.

Publication Office, Bristol, Conn.

Editorial/Business Offices 480 Lexington Ave., New York 17, N. Y., Tel. Plaza 9-7880

Another
Burnell
exclusive!

3 BIG REASONS

to check

BURNELL

first!

3 EXTRA REASONS TO CHECK BURNELL FIRST!

- * Proven Top Quality
- * Competitive Prices
- * Prompt Deliveries

Write Department G
for Catalog 102A



PACIFIC DIVISION: 720 Mission Street, South Pasadena, California

TELETYPE: YONKERS, N. Y. 3633

BURNELL & CO., INC.

Yonkers 2, New York

**FIRST IN TOROIDS
AND
RELATED NETWORKS**



ROTOROIDS® A continuously variable, stepless toroidal inductor which can provide a 4:1 range of maximum to minimum inductance in 180° rotation of a shaft. Write for new brochure which gives complete technical data.



TOROIDS Combining the advantages of toroidal type winding with the molybdenum permalloy dust core and other specially selected materials, these toroids provide higher Q than any other structure. They also provide greater stability of inductance vs. temperature and level in a smaller space. Their self-shielding properties permit compact assemblies of coils with a minimum of deleterious effects. Supplied to an inductance accuracy of 1%. Available in standard, miniature and sub-miniature sizes. Also in a wide variety of finishes, including *for the first time toroids molded in a new special material.*

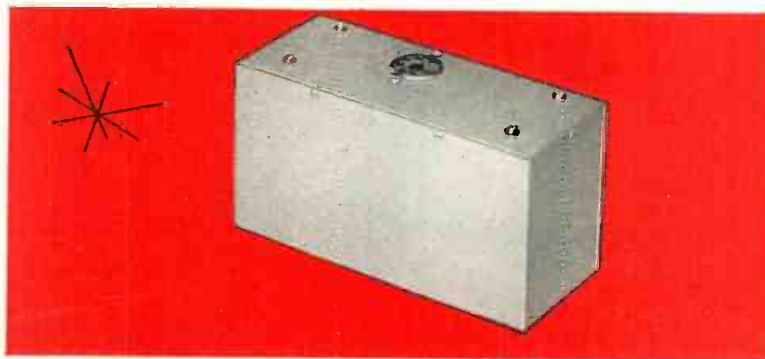

TELEMETERING FILTERS

Band pass filters available for every channel ranging from 400 to 70,000 cycles for band width between 15 - 40%. Low pass filters available for operation in either unbalanced or balanced line, and range in cut off frequency from 6 up to 10,500 cycles. Also, miniaturized filters that do not sacrifice attenuation characteristics, save up to 80% space.

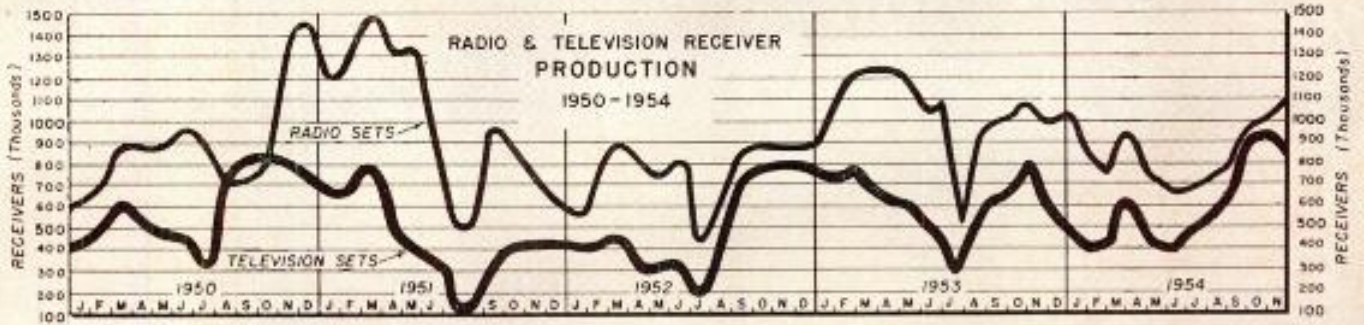

Broadcasting Growth

The 20th annual report of the FCC traces the number of authorized, licensed and operating broadcast stations since 1949. The chart below summarizes the 1949 to 1954 period:

Year	Grants	Deletions	Pending applications	Licensed	CP's on air	Total on air	CP's not on air	Total authorized
COMMERCIAL AM								
1949	200	85	382	1,963	43	2,006	173	2,179
1950	194	70	277	2,118	26	2,144	159	2,303
1951	116	35	276	2,248	33	2,281	104	2,385
1952	60	28	321	2,333	22	2,355	89	2,444
1953	187	23	250	2,439	19	2,458	126	2,584
1954	148	29	226	2,565	18	2,583	114	2,697
COMMERCIAL FM								
1949	57	212	65	377	360	737	128	865
1950	35	140	17	464	198	662	41	732
1951	15	91	10	534	115	649	10	732
1952	24	46	9	582	47	629	19	648
1953	29	79	8	551	29	580	21	601
1954	27	54	5	529	24	553	16	569
EDUCATIONAL FM								
1949	18	7	0	31	3	34	24	58
1950	25	4	3	61	1	62	20	82
1951	19	6	2	82	1	83	12	95
1952	12	4	1	91	1	92	12	104
1953	13	1	3	105	0	105	10	115
1954	9	2	1	117	0	117	6	123
COMMERCIAL TV								
1949	15	7	338	14	86	69	48	117
1950	0	8	351	47	57	104	5	109
1951	0	0	315	81	28	107	2	109
1952	0	1	216	96	12	108	0	108
1953	381	6	572	161	97	198	283	581
1954	174	81	260	104	298	402	171	573
EDUCATIONAL TV								
1952	0	0	1	0	0	0	0	0
1953	17	0	29	0	1	1	16	17
1954	13	0	17	0	0	0	24	30

WCEMA Totals

West Coast Electronic Manufacturer's Association (WCEMA) forwards some results of their recent engineering survey in the San Francisco area which are of considerable interest.

- Member companies questioned . . . 52
- Member companies replying . (54%) . . . 28
- Engineers and scientists employed . . . 1024
- More than 25 engineers on staffs . . . 11
- 10 to 25 engineers on staffs . . . 5
- Less than 10 engineers . . . 10
- Graduate electronic engineers . . . 330
- Graduate mechanical engineers . . . 91
- Graduate electrical engineers . . . 60
- Physicists . . . 55
- Chemists . . . 64
- Chemical engineers . . . 18
- Designers . . . 43
- Non-graduate electronic engineers . . . 106
- Non-graduate electrical engineers . . . 37
- Non-graduate mechanical engineers . . . 50
- Draftsmen . . . 76
- 40 hour work week . . . 27
- Companies offering 6 paid holidays per yr. 7
- Companies offering 7 paid holidays per yr. 12
- Companies offering 8 paid holidays per yr. 5
- Companies with pension plans . . . 6
- Companies paying 100% for pension plans 4
- Companies having employee insurance plans 23

Engineering Futures

From the 1955 Midwest College Placement Association's "College Recruiting Survey" the top table shows 1955 requirements for college men compared with previous years. Lower table gives 1955 gross monthly salaries for men without experience.

	1955 vs. 1954		1954 vs. 1953	
	No. of Companies Tech.	No. of Companies Non-Tech.	No. of Companies Tech.	No. of Companies Non-Tech.
More	32	17	32	15
The Same	102	101	69	68
Less	26	30	32	18
	160	148	133	101

Salary Range	1955 - Non-Veteran				
	No. of Companies				
	Technical		Non-Technical		
	B.S.	M.S.	Ph.D.	Bach.	Master
\$250 or under	1	-	-	5	1
251 - 275	1	-	-	3	-
276 - 300	7	-	-	24	4
301 - 325	13	2	-	44	11
326 - 350	43	12	3	41	22
351 - 375	67	19	1	22	18
376 - 400	26	34	2	4	20
401 - 425	-	39	3	-	8
426 - 450	1	9	7	-	-
451 - 475	-	1	-	-	-
476 - 500	-	7	-	-	-
501 - 525	-	11	-	-	-
526 - 550	-	21	-	-	-
551 - 575	-	12	-	-	-
576 - 600	-	4	-	-	-
601 - 625	-	1	-	-	-
	159	115	73	143	85

GOVERNMENT ELECTRONIC CONTRACT AWARDS

This list classifies and gives the value of electronic equipment selected from contracts awarded by government procurement agencies in December 1954.

Accelerometers	93,726	Field Coils	13,180	Public Address Sets	222,750
Actuators	42,205	Generators	319,528	Q Meters	26,640
Anodes, silver	220,625	Generators, conversion		Radar Sets, overhaul and repair	3,000,000
Batteries	67,633	nitrogen to oxygen	60,000	Radio Sets	581,758
Batteries, silver-zinc	891,131	Generators, diesel	229,580	Rawin Sets	369,888
Bridges, resistance	173,574	Generator Sets	421,348	Receivers, radio	1,407,796
Bus Bars, copper	27,515	Generators, starter	61,281	Receiving Sets, radio	69,473
Cable Assys	27,486	Generators, synchronizing	92,980	Receptacles, electrical	53,563
Cable, power	15,085	Handsets, telephone	47,875	Rectifiers	27,053
Coils, field	13,180	Headsets	171,640	Relay Assys	92,879
Compasses, magnetic	121,342	Heating Elements, thermocouple	29,222	Spare Parts, field coil	17,510
Computer Assys	43,390	Humidity Indicating Sets	28,298	Switchboards, degaussing	221,803
Computers	34,034	Hydrophones	65,102	Switchboards, telephone	94,336
Connector Plugs	29,210	Indicators	188,600	Switches, pressure	25,370
Connector Tubes	53,563	Inverters	142,194	Switches, rotary	37,122
Controllers, automatic, acoustic mine sweeping	135,168	Inverter Assys	194,792	Switching Units, cavity	34,131
Controllers, manual, acoustic mine sweeping	58,654	Keys	26,658	Sub Assys, telephone repeater	43,906
Cord Assys	32,686	Keys and Spares	46,567	Test Sets	69,960
Crystal Units	37,545	Kits, replacement	80,365	Transformers	94,090
Dials	26,392	Kits, modification	121,376	Transmitters, radio	63,226
Disconnects	34,938	Mass Spectrometer	42,650	Transmitting Sets, radio	2,155,220
Electrode Assys	79,362	Motor and Gear Assys	55,593	Tubes, electron	2,413,166
Equipment Modifications	2,120,520	Motors, electric	45,000	Welders	46,030
Facsimile Prints	175,430	Oscillographs	125,894	Welding Rod, brass	52,202
		Phase Monitors	49,872	Voltage Regulators, dc	113,272
		Projectors, 16mm sound motion	297,613	X-Ray Units	96,637

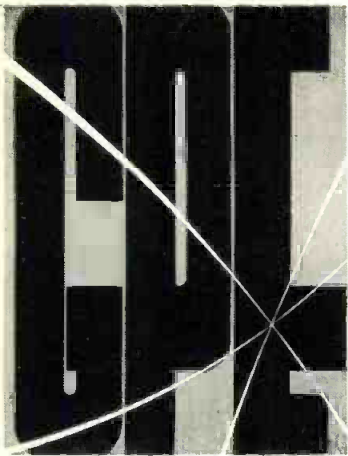

SERVES INDUSTRY

THROUGH *coordinated*

The producing companies of General Precision Equipment Corporation are engaged in the development, production and sale of advanced technological products. These products all have a broad common base: 1) they represent precision equipment in some form; 2) they derive from similar fields of technical competence; 3) they save labor, increase productivity, or achieve results which cannot be attained with even limited use of on-the-spot manpower.

A general view of the technical capacities of the GPE Producing Companies is given in the chart. But the chart cannot show the very close interrelation of these capacities nor the highly flexible application of facilities, techniques and capabilities which exists among these companies. This is achieved through GPE's basic operating policy—Coordinated Precision Technology.

GPE Coordinated Precision Technology operates in all areas—in research, development and manufacture. The record of the GPE Producing Companies in solving advanced technological problems and meeting the demand for high speed, precision, reliability, light weight and compactness at competitive prices is the result of this coordination, the constant application of the newest and most highly advanced techniques, and unremitting insistence on highest quality.

Perhaps the most conspicuous advantage of GPE Coordinated Precision Technology is that the concept and development of equipment and systems, and of solutions to the underlying technical problems, are not restricted by being confined to the specialized techniques of a particular field. In short, GPE Coordinated Precision Technology permits each company to seek the optimum solution for the customer by the application of all relevant techniques within the total capacities of the entire group. Address inquiries to:

GENERAL PRECISION EQUIPMENT CORPORATION
92 GOLD STREET, NEW YORK 38, NEW YORK

**CAPACITIES OF THE
GPE PRODUCING COMPANIES**

**PRECISION MECHANICS
and CERAMICS**

**ELECTRICAL EQUIPMENT
and COMPONENTS**

ELECTRONICS

**HYDRAULICS
and LIQUIDS HANDLING**

**PROFESSIONAL and INDUSTRIAL
TELEVISION EQUIPMENT**

INSTRUMENTATION

SERVOS and CONTROLS

**AUTOMATIC COMPUTERS
and COMPONENTS**

ULTRASONICS

RADAR and MICROWAVE

**MOTION PICTURE
and SOUND EQUIPMENT**

OPTICAL DEVICES

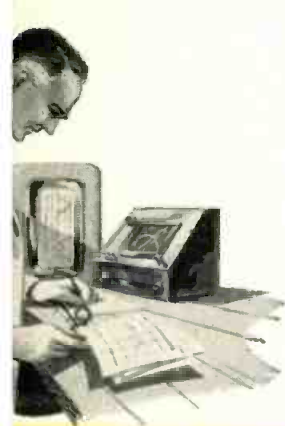

er **2200** scientists, engi-
ers, draftsmen, testers and
er technical personnel in
GPE Companies work in
fields covered by this chart.

THE PRODUCING COMPANIES



INTERNATIONAL PROJECTOR

J. E. McAULEY MFG. CO.

GENERAL PRECISION LABORATORY

THE HERTNER ELECTRIC

KEARFOTT COMPANY, INC.

www.americanradiohistory.com

The New SHURE "TWIN-LEVER"

CERAMIC PICKUP CARTRIDGE

for High Fidelity phonographs



PC Series for 33 $\frac{1}{3}$, 45, 78 r.p.m.

AN "AB" LISTENING TEST WILL PROVE THAT THIS CARTRIDGE SURPASSES ANY OTHER HIGH QUALITY COMMERCIAL CARTRIDGE FOR EQUIPMENT MANUFACTURERS!

Here is a "Balanced-Fidelity" cartridge designed for the equipment manufacturer to give you the maximum quality possible within your cost objectives.

A new frontier for the Ceramic principle has been crossed by the development of this cartridge. Designers of high fidelity phonographs and hi-fi radio or tv phono combinations, who have been "test piloting" this new "Twin-Lever" ceramic development, report an amazing superiority in tone quality that can be easily heard before the cartridge is even measured!

This "Twin-Lever" ceramic cartridge represents the ultimate in commercial high fidelity reproduction—without compensating preamplifiers! Smooth, wide range response from 30 to 13,500 c.p.s. Other features which help to make this new cartridge so outstanding in performance are: high compliance that virtually eliminates tracking distortion . . . extremely low effective mass provided by new specially-designed needles and new coupling . . . tailored needles on separate needle shafts, functioning independently for best 78 rpm response, too—as well as the superior micro-groove performance.

The new unique design eliminates "turnover" of either the cartridge or the needles. Both needles are in the same plane, and an ingenious, lever-operated shift mechanism gently moves each needle in and out of position.

RADICAL NEW DESIGN FOR NEEDLE REPLACEMENT!

Needle replacement is now so simple it can be done blindfolded!! This is a feature that will be of special interest to the ultimate users of your original equipment. Anybody can replace the needle, without tools, in a few seconds—while the cartridge remains in the pickup arm!

MODELS PC4 and PC5

Output Level at 1,000 c.p.s.	.40 volts (33 $\frac{1}{3}$, 45 rpm)
Output Level at 1,000 c.p.s.	.60 volts (78 rpm)
Frequency Response	30 to 13,500 c.p.s.
Compliance	1.30 x 10 ⁻⁶ cm/dyne
Tracking Force	5 gr. min.
Net Weight	7 grams
Dimensions	1 $\frac{1}{4}$ " overall length; $\frac{3}{8}$ " wide $\frac{1}{4}$ " high

ALSO . . .

New High Output Ceramic Cartridges NO LESS OUTSTANDING IN THEIR CONTRIBUTION TO LOW COST, FINE QUALITY REPRODUCTION ARE THE HIGH-OUTPUT CARTRIDGES, MODELS PC2 and PC3.

SHURE

The Mark of Quality

For further information on these remarkable new cartridges, write
SALES DIVISION—SHURE BROTHERS, INC., 225 W. HURON STREET, CHICAGO 10, ILL.

TELE-TECH

& Electronic Industries

M. CLEMENTS Publisher
DR. O. H. CALDWELL Editorial Consultant

BERNARD F. OSBAHR Editor
ALBERT J. FORMAN Associate Editor

DR. A. F. MURRAY Contributing Editor
JOHN H. BATTISON Contributing Editor

B. V. SPINETTA, Directory Editor

MARTHA USDIN, Assistant Editor

CARL THOMAS, Assistant Editor

R. C. DAVIES, Washington News Editor

CHARLES F. DREYER, Art Director

GAIL CARLSON, Editorial Secretary

STANLEY GERSTIN,

Contributing Editor

BUSINESS DEPARTMENT

M. H. NEWTON, Business Manager

HOWARD A. REED, General Sales Manager

PAUL J. CARNESE, Sales Promotion Manager

JOSEPH DRUCKER, District Manager

JAMES S. COLEMAN, Asst. Sales Manager

N. McALLISTER, Asst. Business Manager

CECILIA KAVANAUGH, Adv. Records

A. SHILLIN, Production Manager

480 Lexington Ave., New York 17, N.Y.

Telephone PLaza 9-7880

S. M. GASKINS, Western Manager

JOHN D. LUPTON, District Manager

201 N. Wells St., Chicago 6, Ill.

Telephone RAndolph 6-9225

CHRIS DUNKLE & ASSOCIATES

California Representatives

3257 W. 6th Street, Los Angeles 5, Calif.

Telephone DUnkirk 7-6149

1651 Market St., San Francisco 3, Calif.

Telephone UNderhill 3-5282

ELMER DALTON, Circulation Manager

JOHN J. BORGHI, Controller

Member



CIRCULATION NOW 27,000

An increase of 5,000, effective with the January 1955 issue, provides greater penetration of plants, stations and laboratories in the primary markets of the industry—Manufacturing, Broadcasting and Armed Forces procurement.

These are the markets with greatest buying power and greatest expansion, industrially and geographically.

The circulation of TELE-TECH is increasing in two ways:

1—Growth of TELE-TECH's Unit Coverage of top-ranking engineers—the magazine's basic readership, preselected for complimentary subscriptions.

2—Making paid subscriptions available to other engineers in research, design, production, operation and maintenance.

Although currently effective, the increased circulation cannot appear in audit statements until the first half of 1955 is audited.

THE ELECTRONIC INDUSTRIES DIRECTORY

Published annually as an integral section of TELE-TECH in June



ALSiMAG[®]
PRESSED
CERAMICS
ARE

Versatile!

V

me. Batteries of presses . . . rotaries, single stroke, U. S. and foreign. Enormous kiln capacity. 4 large, well-equipped plants.

E

xperience. Methods which have been perfected from 54 years of specialized experience.

R

esign service. Available without charge. Every effort made to find the best design . . . performance-wise and economy-wise.

S

election of materials. Widest in the industry. Careful matching with requirements. New bodies being developed constantly for unusual operating conditions.

A

pplications determine the material. You may choose from Lava, Silicon Carbide, Alumina (vitrified or porous), Cordierite, Steatite, Zircon, Zirconium Oxide, Magnesium Silicate, Aluminum Silicate, Forsterite, Titanium Dioxide. All available from this one source.

T

ooling. No problem with ALSiMag. Well equipped die shops. Expert machinists. Tooling at actual estimated cost.

I

icate Designs. ALSiMag's over-all delivery record is unsurpassed . . . complicated shapes, precision tolerances, intricate miniatures.

L

ow Cast. Superior quality. Achieved through the right equipment . . . right materials . . . all-important "know-how."

E

fficient production methods. Quality controlled manufacture. Well experienced, versatile personnel.

• ALSiMag may offer improvements for your application. Send in blueprint or sample today for price and delivery information.

53RD YEAR OF CERAMIC LEADERSHIP

AMERICAN LAVA CORPORATION

CHATTANOOGA 5, TENNESSEE

A SUBSIDIARY OF MINNESOTA MINING
AND MANUFACTURING COMPANY

Branch offices in these cities (see your local telephone directory): Cambridge, Mass. • Chicago, Ill. • Cleveland, Ohio • Dallas-Houston, Texas • Indianapolis, Ind. • Los Angeles, Calif. • Newark, N. J. • Philadelphia-Pittsburgh, Pa. • St. Louis, Mo. • South San Francisco, Calif. • Syracuse, N. Y. • Tulsa, Okla.

Standard Electronics DESIGNS AND DELIVERS *tomorrow's TV EQUIPMENT today!*



GREATER SAVINGS

... low initial, low operating and low tube replacement costs ... requires less floor space and minimum building alterations.

Actual figures prove that Standard Electronics transmitters' *low initial cost*, great operating economy, and reduced floor space requirements result in savings far greater than with any other transmitter. Rugged components and straightforward design make S-E transmitters an investment that yields the utmost in satisfaction over years of trouble-free operation.

Savings in operating costs alone amount to as much as \$145,000 (over 5 years-estimated) with a high power Standard Electronics transmitter. Power consumption is as much as 25% less than for competitive transmitters. Compact air cooling system is used throughout. No extra power costs for elaborate pumping and liquid cooling systems... no additional external blowers or external vaults.

Tube cost of S-E amplifier finals are only \$210 each, and all tubes are air cooled. Due to the additive type of final amplifier stage employed, higher-powered S-E transmitters are not dependent on a single, expensive amplifying tube with its concentrated heat load and cumbersome cooling apparatus.

Tubes are long life types, giving 5000 hours or more of operation even on channel 13, hence replacements are infrequent and maintenance costs minimum. Low emission visual tubes may be interchanged in aural section for even longer life. Similar types are extensively employed.

Easily installed transmitter units are entirely self-contained. Great flexibility is permissible in the arrangement of S-E cabinets to conform to existing walls and floor areas... takes fewer square feet of floor area to set up and fewer building alterations are necessary. S-E frames are smaller in all three dimensions than competitive types. They can be more easily moved through doorways, passageways, and elevators.



EFFICIENT DESIGN

... for ease of operation ...
safety ... accessibility ... control.

Simplicity of operation is assured by ganged tuning, so that adjustments are minimized. The RF input of S-E amplifiers is designed as two quarter-wave, tuned coaxial

lines operating in a grounded grid, cathode-input circuit, resulting in excellent isolation of the input and output circuits and exceptionally simple tuning. Complete metering equipment and trouble-light system provide a constant, visible check during operation.

Safety is a prime consideration in S-E design. Cabinets are equipped with interlocks where necessary and full provisions are made to insure electrical neutrality when not operating. Complete system of overload relays and circuits, recycling elements, time delays, and safety switches protects the transmitter from overloads and power transients.

All tubes are visible during operation through glass doors and are easily accessible from the front for ease of maintenance.

Control is provided by a full complement of meters and control circuit lights, for a continuous, visible check on every major circuit during operation. *Power monitoring* is an integral part of the output system, and it contains a switch so that reflected power may be read directly in watts. Elapsed time meters indicate total hours of operation of plates and filaments in final amplifier stages.



S-E TRANSMITTERS ARE FAR AHEAD

... in provision for future power growth,
in styling ... can be used NOW with color

Standard Electronics' *Add-A-Unit* feature permits starting with a 500 W. Driver and expanding to 5, or 10, or 20, or 25, or 40, or 50 KW. Or with S-E amplifiers you can *expand your present equipment* — any make... any power — to higher power, simply and economically, without obsoleting or replacing any of the existing equipment.

Proper operation with *color signals* is insured by elimination of back porch clamp. S-E transmitters meet and exceed all FCC requirements with regard to the signal delivered by the transmitter. Easily adjusted, overcoupled tuning circuits provide a broad-banded signal output closely conforming to specified levels over the entire authorized 6 mc channel.

Cabinetry by Dreyfuss is in the modern glass-and-steel tradition, emphasizing simple lines and practical usefulness. All tubes are visible through the full-length, plate glass doors. Line up cabinets form an impressive, glass-fronted array.

The design of
STANDARD ELECTRONICS
transmitters embodies every
feature of significance to the
TV broadcaster.

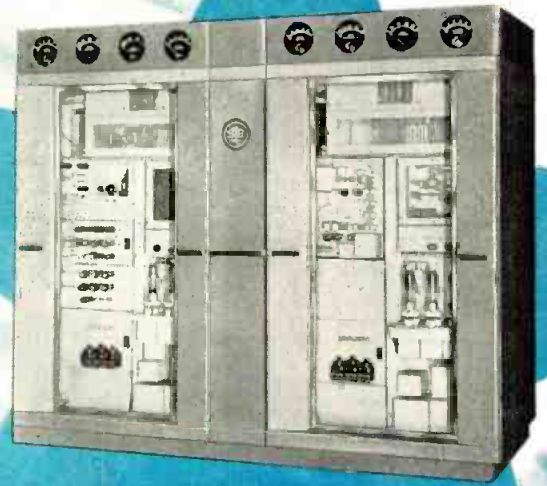

**500
WATTS**

e-x-p-a-n-d-a-b-l-e to
50 KILOWATTS

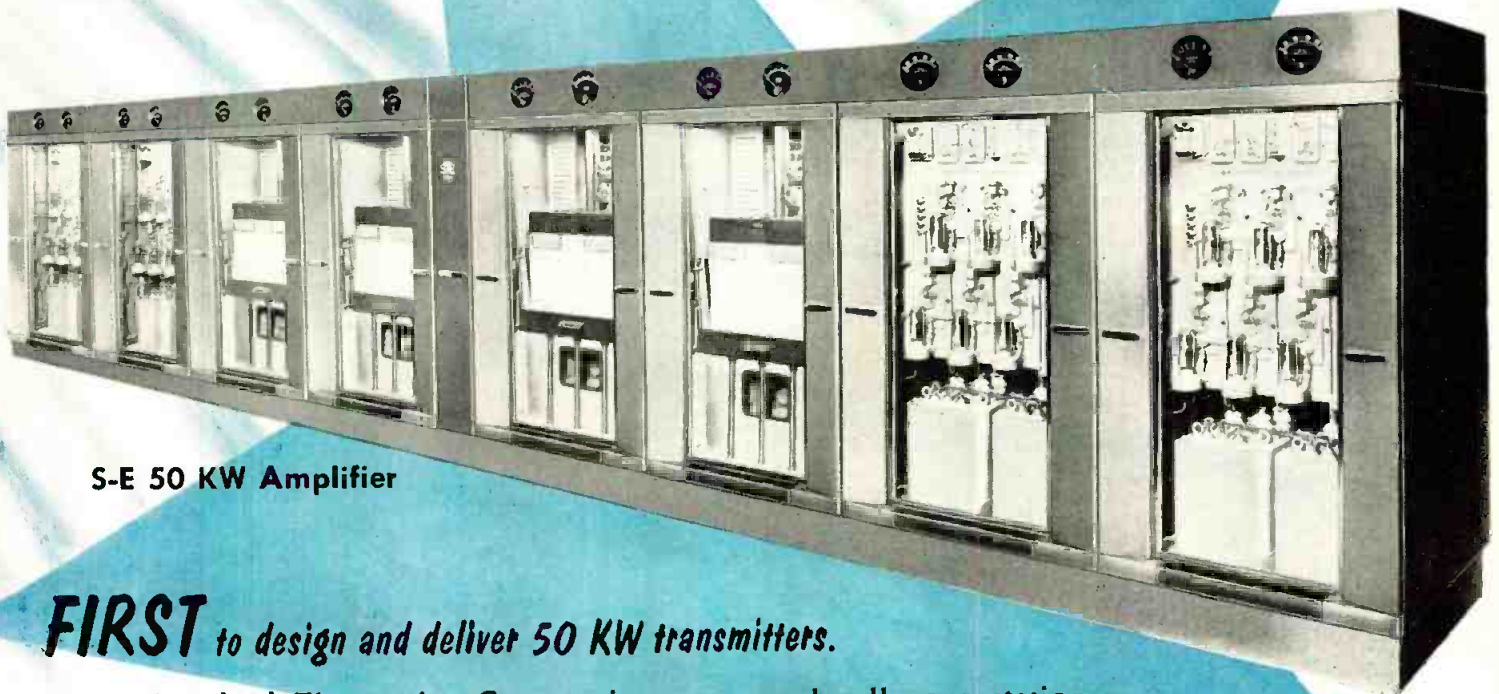

S-E 50 KW Amplifier

FIRST to design and deliver 50 KW transmitters.

Standard Electronics Corporation can supply all your station requirements including complete video equipment, film chains, film projectors, camera chains, studio accessories, master control and monitoring equipment, high gain antennas. Complete stations delivered on short schedule! Write, wire or phone to Standard Electronics for your transmitter needs.



standard electronics corporation

A SUBSIDIARY OF CLAUDE NEON, INC.
285-289 EMMETT STREET • NEWARK 5, N. J.
BIGELOW 3-5540

*devoted exclusively to the
engineering, manufacturing, and servicing of equipment
for the broadcast and television industry*

MOLDED PLASTIC TOROIDS

(M. P. Series) STOCKED UNITS FOR IMMEDIATE DELIVERY
TO MIL. SPECS - SHOCK, MOISTURE, TEMPERATURE . . .

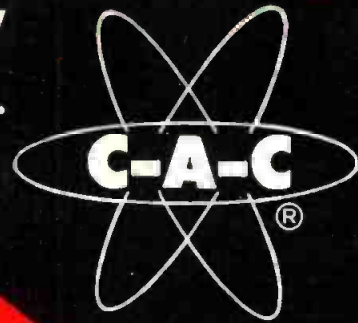

SIZE
.688 OD
.375 THICK
.738 H

TYPES
MP 050
MP 051
MP 053
MP 054

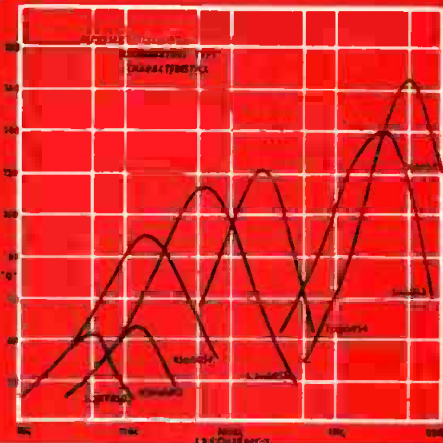

Other Subminiature molded plastic toroids—designs for all requirements—for chassis mount or printed circuits—See your CAC man or write us direct.



SIZE
1-1/16 OD
1/2 H
6-32 MTG.

TYPES
MP 206
MP 848

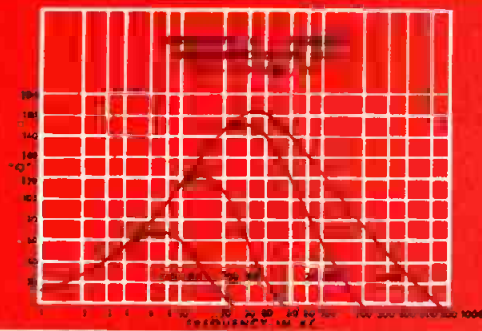
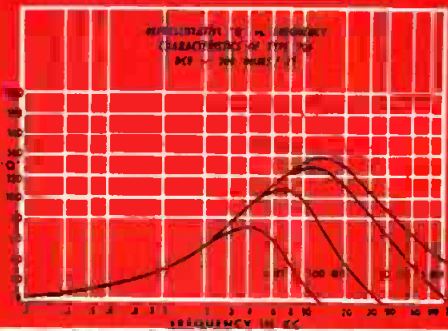

SIZE
1-5/16 OD
23/32 H
6-32 MTG.

TYPE
MP 930

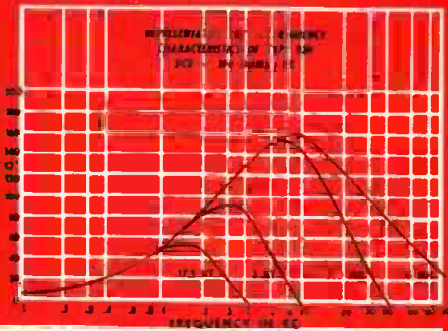

LIST OF STOCKED UNITS

All Other Values and Types on Special Order

Suffix Number	MP 206—	MP 930—	MP 254—
— 1	5.0 MH	5.0 MH	20 MH
— 2	6.0 MH	6.0 MH	24 MH
— 3	7.2 MH	7.2 MH	30 MH
— 4	8.6 MH	8.6 MH	36 MH
— 5	10 MH	10 MH	43 MH
— 6	12 MH	12 MH	50 MH
— 7	15 MH	15 MH	60 MH
— 8	17.5 MH	17.5 MH	72 MH
— 9	20 MH	20 MH	86 MH
— 10	24 MH	24 MH	100 MH
— 11	30 MH	30 MH	120 MH
— 12	36 MH	36 MH	150 MH
— 13	43 MH	43 MH	175 MH
— 14	50 MH	50 MH	200 MH
— 15	60 MH	60 MH	240 MH
— 16	72 MH	72 MH	300 MH
— 17	86 MH	86 MH	360 MH
— 18	100 MH	100 MH	430 MH
— 19	120 MH	120 MH	500 MH
— 20	150 MH	150 MH	600 MH
— 21	175 MH	175 MH	720 MH
— 22	200 MH	200 MH	860 MH
— 23	240 MH	240 MH	1.00 HY
— 24	300 MH	300 MH	1.20 HY
— 25	360 MH	360 MH	1.50 HY
— 26	430 MH	430 MH	1.75 HY
— 27	500 MH	500 MH	2.00 HY
— 28	600 MH	600 MH	2.40 HY
— 29	720 MH	720 MH	3.00 HY
— 30	860 MH	860 MH	3.60 HY
— 31	1.00 HY	1.00 HY	4.30 HY
— 32	1.20 HY	1.20 HY	5.00 HY
— 33	1.50 HY	1.50 HY	6.00 HY
— 34	1.75 HY	1.75 HY	7.20 HY
— 35	2.00 HY	2.00 HY	8.60 HY
— 36	2.40 HY	2.40 HY	10.0 HY
— 37	3.00 HY	3.00 HY	12.0 HY
— 38	3.60 HY	3.60 HY	15.0 HY
— 39	4.30 HY	4.30 HY	17.5 HY
— 40	5.00 HY	5.00 HY	20.0 HY
— 41	6.00 HY	6.00 HY	24.0 HY
— 42	7.20 HY	7.20 HY	30.0 HY
— 43	8.60 HY	8.60 HY	36.0 HY
— 44		10.0 HY	
— 45		12.0 HY	
— 46		15.0 HY	
— 47		17.5 HY	



SIZE
1-5/16 OD
23/32 H
6-32 MTG.

TYPE
MP 395

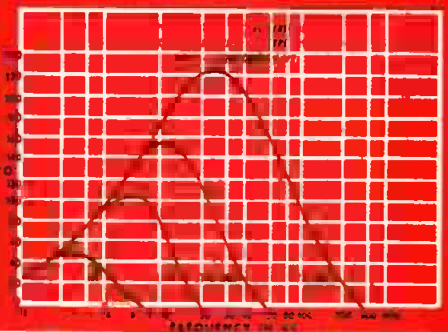

SIZE
2 OD
1 H
8-32 MTG.

TYPE
MP 254

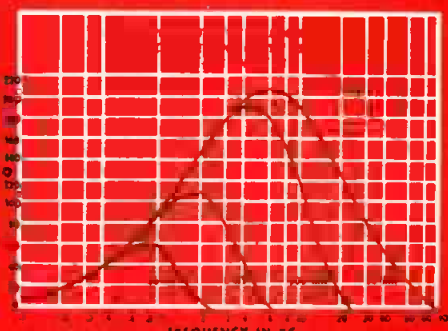

On printed circuits...

MALLORY

Capacitors
cut assembly time

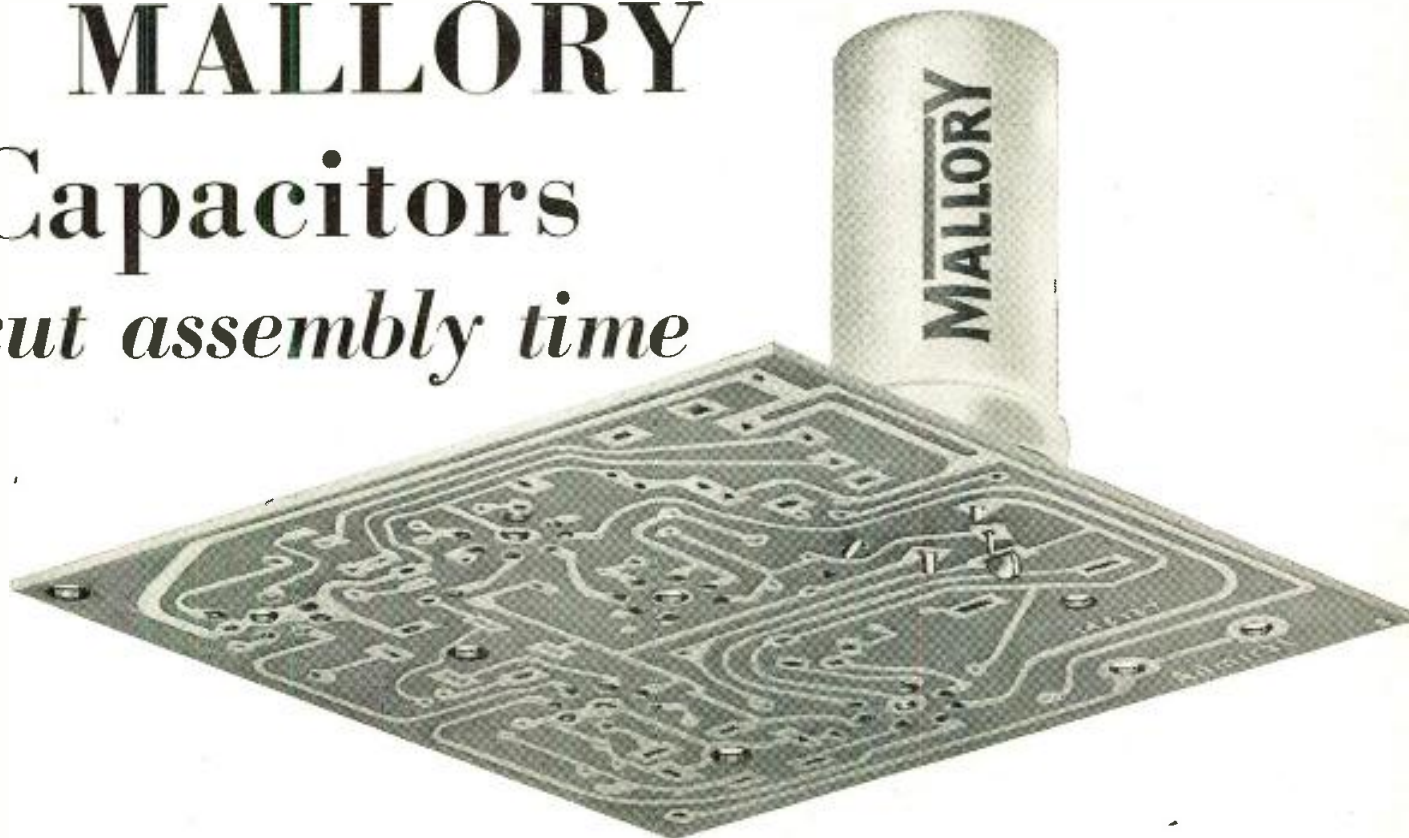

MALLORY

**Tubular Electrolytics
for Printed Circuits**

In addition to the FP electrolytic capacitors, Mallory manufactures a varied line of tubular capacitors applicable to printed circuit production. Write or call for technical information.

High-speed automatic production of electronic equipment using printed circuits can be materially improved when you use Mallory FP capacitors. A special line of these famous electrolytic capacitors has been developed by Mallory for the particular requirements of printed circuits.

Mounting prongs are self-positioning, so the capacitor fits quickly and surely into its correct position. The prongs are designed to provide clearance between the capacitor can and the chassis... permitting use of both sides of the panel for printed circuitry.

Smaller terminals save chassis space, and provide good connections with a minimum amount of solder. Aluminum risers stop short of the solder area... eliminate danger of contamination.

In addition to these special features, Mallory is continuing to develop further refinements applicable to printed circuit usage. Notable among these which will soon be available are new designs for hopper feeding of capacitors on automatic assembly machines.

Long the leader in the capacitor field, Mallory FP electrolytics can be relied on to give economy in production and high standards of dependability in service. For detailed literature or for a consultation with a Mallory capacitor specialist, write or call us today.

Expect more . . . Get more from **MALLORY**

Parts distributors in all major cities stock Mallory standard components for your convenience.

Serving Industry with These Products:

Electromechanical—Resistors • Switches • Television Tuners • Vibrators
Electrochemical—Capacitors • Rectifiers • Mercury Batteries
Metallurgical—Contacts • Special Metals and Ceramics • Welding Materials



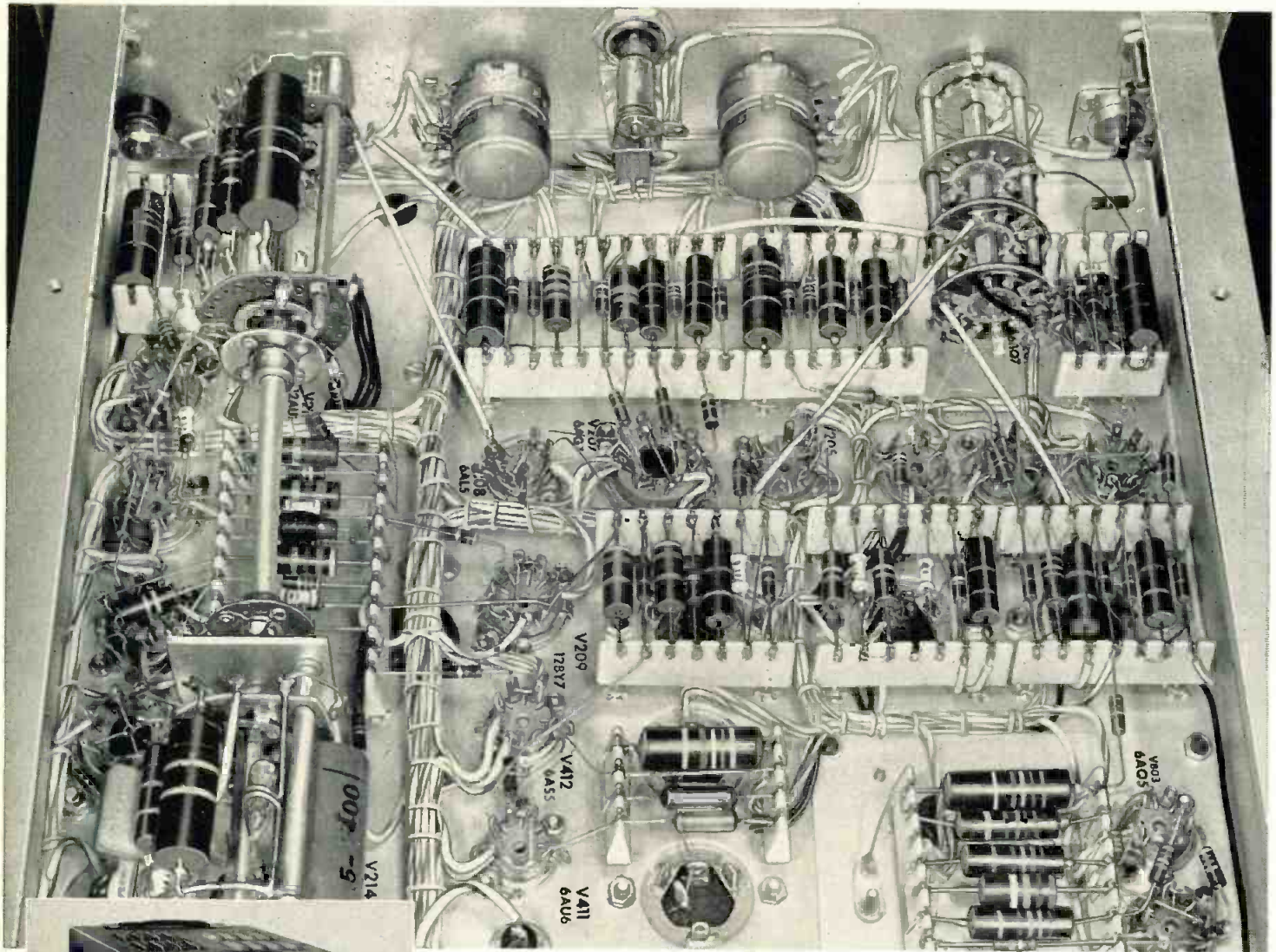

TEKTRONIX TYPE 524-D OSCILLOSCOPE

uses 243 Bradleyunits and 21 Bradleyometers

This portable, precision cathode-ray oscilloscope, made by Tektronix, Inc., of Portland, Oregon, is specifically designed for maintenance of television transmitter and studio equipment.

Its network of circuits employs hundreds of Allen-Bradley fixed and adjustable resistors . . . 264 units in all. Since these units are

rated at 70C . . . instead of 40C . . . stability of the oscilloscope circuit characteristics is assured.

Bradleyunits and Bradleyometers withstand extremes of temperature and humidity. So, if your electronic equipment must give quality performance, avoid trouble by specifying Allen-Bradley radio resistors.

Allen-Bradley Co., 1342 S. Second St., Milwaukee 4, Wis.



The Tektronix Type 524-D Oscilloscope features a built-in sync separator, variable delayed sweeps at the frame rate, d. c. to 10 mc frequency response, wide sweep range, 4 kv accelerating potential.



ALLEN-BRADLEY

FIXED & ADJUSTABLE RADIO RESISTORS

QUALITY

Sold exclusively to manufacturers of radio and electronic equipment

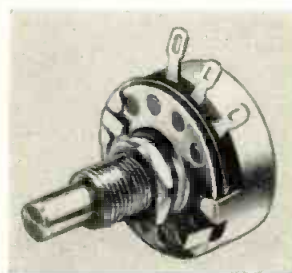

The Type J Bradleyometer has a solid molded resistor ring which can be made to satisfy any resistance-rotation requirement. All ferrous parts are made of corrosion-resistant metal. There are no riveted, welded, or soldered connections in the Bradleyometer.

NEW SINGLE LENS

GRAY TELOJECTOR

STAR PERFORMER....

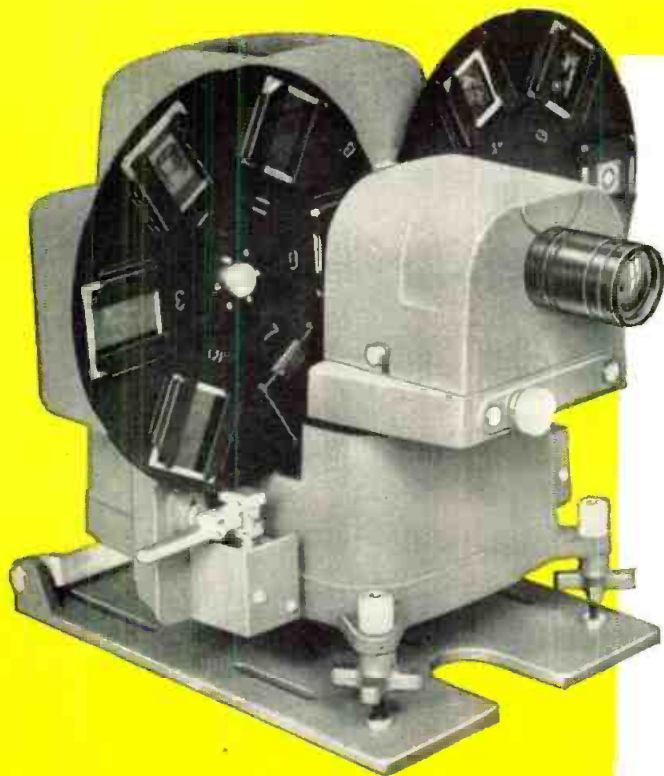

Complete Projection System

The New Gray 3B Telojector (2" x 2" Transparency Slide Projector) utilizes a single lens —permits superposing of two images on an optical axis . . . eliminates any need for external registration adjustment. The improved unit provides positive focusing of images on the camera tube with an uninterrupted sequence of slides for television commercials, news flashes and photographs or station and sponsors' identification.

for TV commercials

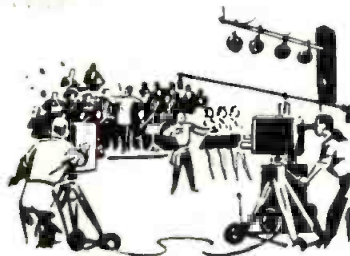

Precision Projection

BETTER Commercials at **LOWER COST**

Yes . . . **now** you can use better 2" x 2" transparencies in uninterrupted sequence at lower cost. Important too, Gray Telojector is low in initial cost . . . ideal for budget-minded program directors. Telojector is compact, light weight, trouble-free. Two turrets take up to 12 slides at one loading. Additional loaded turrets are substituted in a matter of a few seconds . . . providing unlimited continual sequence. Controlled locally at the unit or remotely at the master video console. Also, can be used with the Gray 35B Manual Control Box to produce superposition, laps, fades and slide changes at any desired rate.

GRAY RESEARCH

AND DEVELOPMENT CO., Inc., Hilliard St., Manchester, Conn.
Division of the GRAY MANUFACTURING COMPANY
Originators of the Gray Telephone Pay Station and the
Gray Audograph and PhonAudograph.

WRITE FOR:

Illustrated, detailed information on the **NEW, SINGLE LENS GRAY TELOJECTOR** and complete line of **Gray Television - Broadcasting Equipment.**



For Convenience and Safety

Standardize on BUSS FUSES

No matter what your fuse application may be — in television, radio, radar, avionics, instrument or controls — you can be sure there is a BUSS fuse to fit your exact needs.

Our complete line includes: standard type, dual-element (slow blowing), renewable and one-time types . . . in sizes from 1/500 ampere up, plus a companion line of fuse clips, blocks and holders.

You'll find that standardizing on BUSS fuses helps to simplify buying, stock handling and records.

And probably most important of all is your assurance that BUSS fuses will give dependable electrical protection under all service conditions. For every BUSS fuse normally used by the Electronic Industries is tested in a sensitive electronic device that makes sure the fuse is electrically and physically perfect.

Should you have a special problem in electrical protection . . .

. . . BUSS places at your service the world's largest fuse research laboratory and its staff of engineers. Whenever possible, the fuse selected is already available in local wholesalers' stocks, so that your device can be easily serviced.

More information is available on BUSS and Fusetron small dimension fuses and fuse holders. Just write for bulletin SFB. Be sure to get the latest information before your final design is crystallized.

BUSSMANN Mfg. Co.
(Div. McGraw Electric Co.)
University at Jefferson St. Louis 7 Mo.



TT255



Radio Receptor

announces the RR106

new type Germanium PNP Transistors

Selected pairs for efficient Push-Pull Audio Power Operation

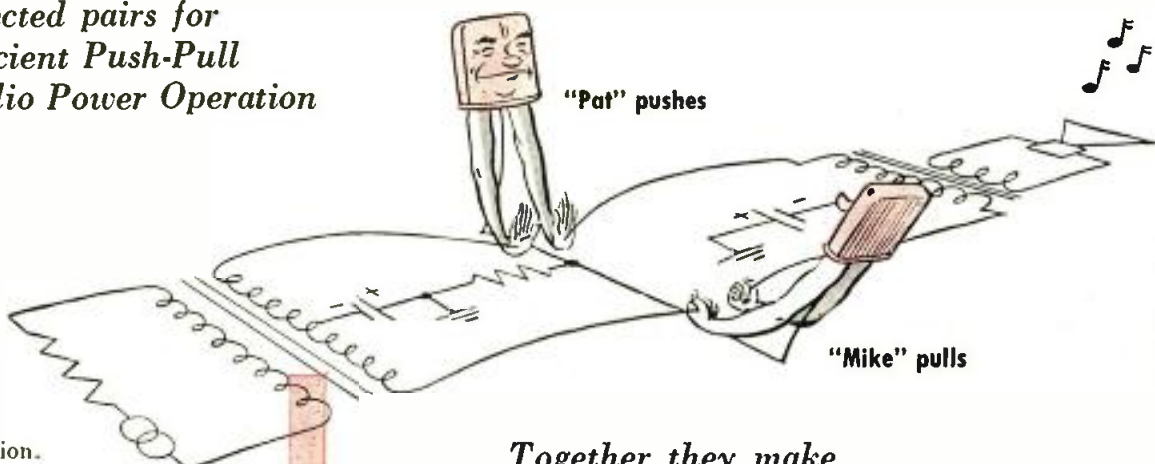

Featuring:

- ▶ Low distortion.
- ▶ Small, hermetically sealed construction.
- ▶ Low I_{co} .
- ▶ Matched for low distortion and equal current drain.
- ▶ Stable, reliable, long-life performance.

A few of many possible applications:

- ▶ Personal portable receivers
- ▶ Intercoms
- ▶ Servo amplifiers
- ▶ Magamp preamps
- ▶ Portable tape recorders

Together they make "beautiful music"

TYPICAL RR106 OPERATION

See figure 1

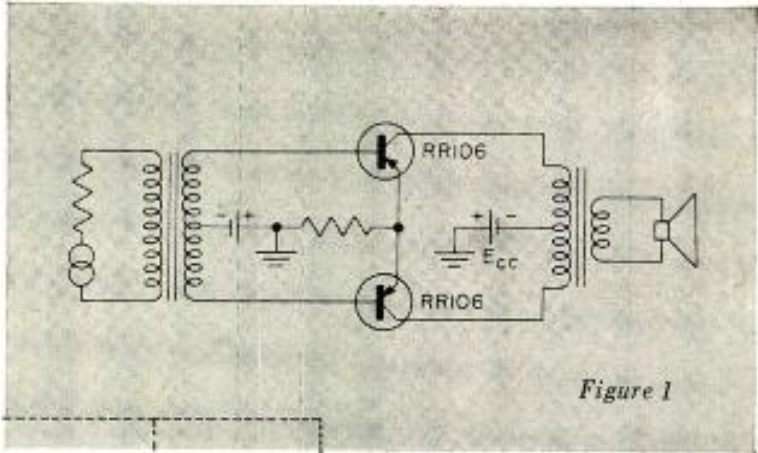

Figure 1

collector supply volts	zero signal collector current (total) (1)	max. signal collector current (total) (2)	circuit efficiency (3)	power gain	power output (4)
12	1 ma	25 ma	67%	18 Db	200 mw
9	1 ma	25 ma	67%	17 Db	150 mw
6	1 ma	25 ma	67%	15 Db	100 mw

For further information, without obligation, write Department T-4



1. This current level is established by the forward base bias and is essential to minimize distortion at low levels.
2. For rated power output. For normal commercial broadcast service the battery drain averages to approximately 10 ma. A class A amplifier, under similar conditions would drain approximately 37 ma!
3. This is total circuit efficiency and includes transformer losses as well as power dissipated in the emitter stabilization resistor.
4. This rating is established for a maximum harmonic distortion of 10% and for conservative operation at an ambient temperature of 45° C (113° F).

Semi-Conductor Division

RADIO RECEPTOR COMPANY, INC.

In Radio and Electronics Since 1922

Sales Dept.: 251 West 19th St., New York 11, N. Y.
 WAtkins 4-3633 Factories in Brooklyn, N. Y.



We also manufacture Selenium Rectifiers and Silicon and Germanium Diodes.

★ THIS IS IT! ★



NEW 3-WATT Blue Jacket[®]
miniaturized axial-lead wire wound resistor

This power-type wire wound axial-lead Blue Jacket is hardly larger than a match head *but it performs like a giant!* It's a rugged vitreous-enamel coated job—and like the entire Blue Jacket family, it is built to withstand severest humidity performance requirements.

Blue Jackets are ideal for dip-soldered sub-assemblies . . . for point-to-point wiring . . . for terminal board mounting and processed wiring boards. They're low in

cost, eliminate extra hardware, save time and labor in mounting!

Axial-lead Blue Jackets in 3, 5 and 10 watt ratings are available without delay in any quantity you require. ★ ★ ★

SPRAGUE TYPE NO.	WATTAGE RATING	DIMENSIONS L (Inches) D		MAXIMUM RESISTANCE
151E	3	1½	¼	10,000 Ω
27E	5	1½	⅜	30,000 Ω
28E	10	1½	⅜	50,000 Ω

Standard Resistance Tolerance: ±5%

SPRAGUE

WRITE FOR ENGINEERING BULLETIN NO. 111B

SPRAGUE ELECTRIC COMPANY • 233 MARSHALL ST. • NORTH ADAMS, MASS.

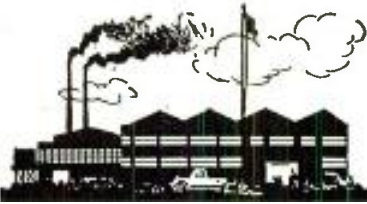

As We Go To Press...



Armstrong-RCA Suit Settled for \$1 Million

Settlement of claims for approximately \$1,000,000 against RCA and NBC by the estate of the late Major Edwin H. Armstrong, pioneer radio inventor, has been announced by David Sarnoff, Chairman of the Board of RCA. The Armstrong claims were instituted in 1948 in United States District Court. The amount paid in settlement was fixed by the former State Supreme Court Justice, Philip J. McCook, who acted as arbitrator.

In the original suit, filed in Wilmington, Del., Major Armstrong accused RCA and NBC of infringement on five of his basic patents on FM. He alleged that RCA sought to maintain a monopoly of the business of granting licenses under radio patents in the U.S. and "deliberately set out to oppose and impair the value" of his FM patents.

In his complaint Major Armstrong also charged that RCA had refused to take out a license under his patents and that it falsely represented that it had developed a set that did not infringe on his system.

Silicon Transistor Prices Slashed

Due to increasing production, Texas Instruments has reduced the prices of silicon transistors 25%, and the prices of silicon diodes by more than 30%. In quantities of 100 to 499, the transistors are available at prices ranging from \$10.50 to \$28, depending on type, and diodes at \$2.20 and \$3.45.

NBC Denies It Will Discontinue Color TV

There is no foundation of fact in any report that the National Broadcasting Co. will discontinue colorcasts on April 1, Mr. Sylvester L. Weaver, Jr., President of NBC, stated. "There are no changes in our previously announced plans for color television programming," said Mr. Weaver, "and we are going forward with these plans as per schedule. We look forward to continued advances and expansion in color programming during 1955."

Interstate Computer Hookup

General Electric has inaugurated a four-way hookup for the rapid processing of engineering and research problems on two giant computers. Linked in the communications system are GE plants in Evendale, Ohio, where the computing center of the Aircraft Gas Turbine Division is using a big IBM 701 on three shifts daily; the Medium Steam Turbine, Generator and Gear Department at Lynn, Mass., and the Large Steam Turbine-Generator Department at Schenectady, N. Y. Fourth point in the hookup is IBM's Technical Computing Bureau in New York City, where GE will rent a second 701 for a full eight-hour shift daily.

The link between the computing centers in this system is provided by IBM's recently announced Electronic Data Transceiver, a device which duplicates sets of punched cards at remote points by means of telephone, telegraph, or radio circuits. The Transceiver hookup augments a network of telegraphic equipment which GE has been using to deliver its problems and answers from turbine departments at Schenectady



Dale R. Cochran, General Manager of GE's Aircraft Gas Turbine Development Dept. at Cincinnati, gets signal from IBM's W. P. Westfall to start data transceiver, inaugurating hookup to New York. Dr. H. R. J. Grosch of GE observes

and Lynn to the computing facility in Evendale, near Cincinnati. The introduction of the transceiver into this type of operation will increase speed while at the same time increasing reliability in transmission.

MORE NEWS
on page 18



8-TRANSISTOR RADIO UNVEILED



An eight-transistor portable radio which operates for 500 hours using power solely from four standard flashlight cells will go on sale March 1 for \$79.95. The 5-lb. unit made by Raytheon Mfg. Co. measures 2-5/8 in. thick, 6-3/16 in. high, and 9-3/16 in. wide. By using special mercuric oxide batteries, which cost five times as much as ordinary type, 2500 hours of performance, the equivalent of five years of operation, can be obtained. Five CK760 transistors are used in converter, oscillator, i-f and detector stages. Other three units being weighed in photo are CK722's for audio stages. AVC, ceramic ferro-magnetic rod antenna and 3-1/2 in. speaker are other features incorporated in radio

As We Go To Press . . . (Continued)

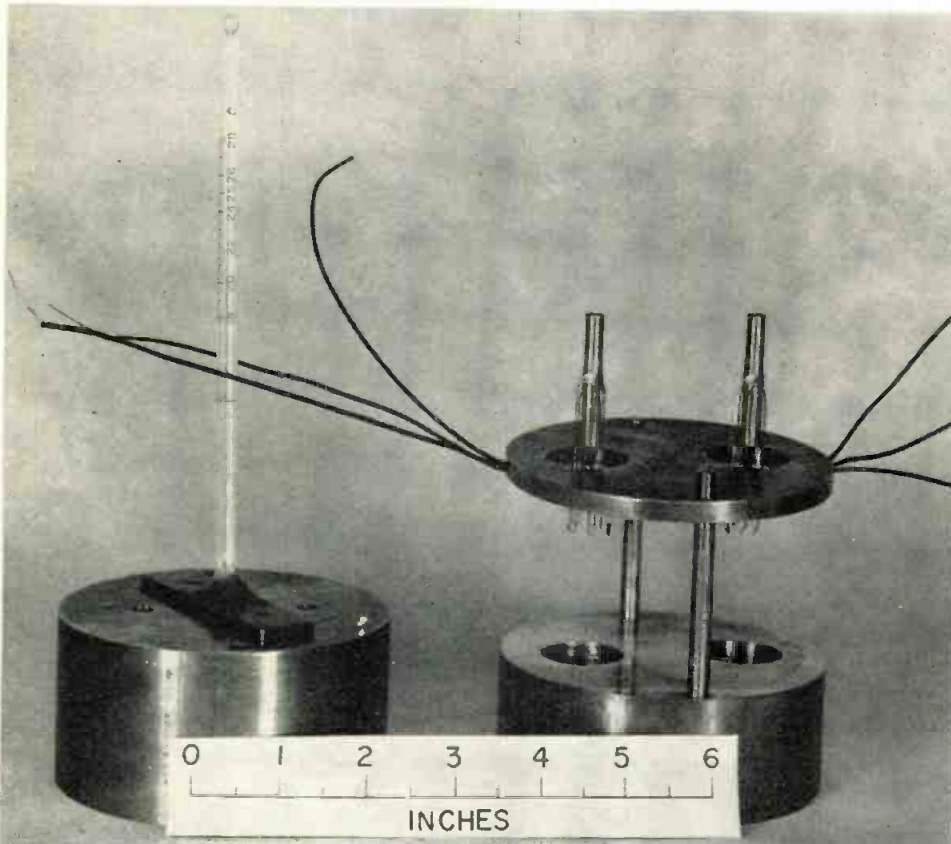

One of the NBS radiation balances showing the two gold source cups and their thermopiles on the right. The large copper block and thermometer on the left are placed on top when assembled

Sensitive Radiation Balance Developed

A radiation-balance microcalorimeter recently developed by Dr. W. B. Mann of the National Bureau of Standards precisely determines the emission rate of low-activity radioactive sources. The instrument does this by measuring the minute amounts of heat energy which accompany radioactive emission. It can be used to determine the intensity of a single source or to compare two sources of nearly equivalent energy emission.

For measurement of radioactive emission a cup form of the radio balance was designed at NBS. This instrument consists essentially of two cups, the temperatures of which are balanced against each other by means of two thermopiles arranged

around the equator of each cup and connected in opposition through a sensitive galvanometer. Thus, when there is no difference in temperature between the cups, there will be no deflection of the galvanometer.

A junction of two dissimilar metals, known as a Peltier junction, is soldered to the bottom of each cup. When an electric current is passed through a Peltier junction, heat is either absorbed or generated depending on the direction of the current.

To measure absolute values of radioactive emission, the radiation balance is first calibrated by determining the magnitude of the Peltier effect in the junctions soldered to the bottom of each cup.

almost 50 stations in a network hookup.

Under DuMont's contract with AT&T, the network paid for the cable facilities eight hours per day, seven days a week, but only 5% of the facilities which feed programs to stations were being used. Future plans envision contracting for cable facilities on an occasional basis when needed, and supplementing the reduction in live program service by distribution of film recordings.

DuMont Reduces Network Operations

A reduction in national coaxial cable facilities and personnel will be effected by the DuMont TV network. The cutback was prompted by the fact that networking, as distinct from station operation, has been an uneconomic activity. The network has also been overburdened by leased coaxial cable employed to connect

Stewart-Warner to End United States Output

Stewart-Warner Corp. has announced that its electric division would withdraw from the manufacture and sale of home radio and TV receivers and phonographs within the U.S. Activity will continue in Canada through its Canadian subsidiary, and in the export business. It was stated:

"This decision has been influenced greatly by the heavy load of electronics development and production work which we have undertaken for the United States Government, since such work requires the complete utilization of all of our physical facilities and technical personnel. We also have been influenced by our intention to emphasize the development of new electronic products for commercial and industrial applications.

"We have signed an agreement with the Hoffman Radio Corp. whereby Hoffman is assuming the warranty and service on these Stewart-Warner products."

NEW LIGHT AMPLIFIER REVEALED



Possible clue to "picture-on-the-wall" TV is a new method of direct light amplification discovered recently at the General Electric Research Laboratory, according to Dr. C. G. Suits (center), GE vice president and director of research. Shown here demonstrating an early model of the light amplifier are Dr. F. E. Williams (right), head of light generation studies at the Laboratory, and D. A. Cusano (left), young GE scientist credited with discovering the special light-amplifying phosphor film. Although the new scientific phenomenon may have great importance in the future of television, x-ray fluoroscopy, photography, "seeing-in-the-dark" devices, and other developments involving reproduction of picture images, Dr. Suits emphasizes no immediate applications should be anticipated and that the present importance "lies in the new scientific knowledge involved." GE's experimental light amplifiers have given off ten times as much light as that projected on them. See details on page 75

**MORE NEWS
on page 20**





*As TV turns more to film . . .
and with color coming . . .*

**YOUR FILM CHAIN
IS YOUR KEY TO
Quality**

**YOUR ADVANTAGE
IN GPL PRODUCTS**

GPL film equipment for television broadcasters is backed by more experience in motion picture equipment than any other supplier to the industry. GPL is part of the General Precision Equipment Corporation family, famous in motion picture equipment fields for Simplex commercial projectors and Ampro home projectors.

Through the GPE policy of coordinated precision technology, GPL's own capable staff is re-inforced with the technical know-how and facilities of its affiliates.

The results of this are known to the industry in the unique and widely accepted GPL 16 mm video recording camera, the GPL 16 mm and 35 mm monochrome telecine projectors, and now, superior color broadcast equipment.

As more program hours go to film, your station costs and profits will depend directly on your film equipment.

Right now — and the sooner the better — it will pay you to sit down with GPL engineers and discuss your film transmission problems. Here are the questions that confront you.

What are your maintenance costs? Operational efficiencies? Reliability? And, for your advertisers and audience — Quality?

And equally important — how does your present equipment fit into future plans? Color is coming. Will you be caught with your plans down?

GPL engineers will tell you about a new three-point long-range plan. It includes:

- Iconoscope conversion**
- New Vidicon chains**
- Build-up for color**

Start your survey today, of future needs. And call, write, or wire GPL for engineering consultation.



General Precision Laboratory

INCORPORATED

PLEASANTVILLE

NEW YORK

A SUBSIDIARY OF GENERAL PRECISION EQUIPMENT CORPORATION

Regional Offices: Chicago • Atlanta • Dallas • Pasadena

Justice Dept. Files Suit

A civil action charging Philco Corp. with violations of the Sherman and Clayton Acts has been filed by the Department of Justice. The complaint attacks Philco Corp.'s methods of distribution.

In commenting on the suit, Attorney General Herbert Brownell, Jr., said: "In the absence of monopoly or a combination in restraint of trade, a manufacturer may sell his products to whom he pleases, but once the products are sold they are the property of the purchaser. The complaint charges that a manufacturer may not lawfully restrict the customers to whom, or the territory within which, the purchaser from the manufacturer may resell the manufacturer's products."

When advised of the filing of the suit by the government, James H. Carmine, President of Philco Corp., said: "Through the years Philco has built up a loyal organization of more than 100 independent wholesale distributors whose function has been to provide the public with quality products on a volume basis at the lowest possible price. Our philosophy has been that each distributor should handle a designated territory and select active loyal dealers who will promote Philco products at the retail level, and provide the sales and service facilities which the public expects and to which we feel it is entitled.

"In a sweeping attack upon an established distribution system which has been widely used for years by manufacturers of brand name products to protect the public, the government is attempting to impose an entirely new concept of antitrust regulation and business control. The government's suit against Philco is a radical departure from previous legal precedents. It also presents a new and dangerous challenge to those manufacturers who are endeavoring to preserve the system of independent distributors.

"Philco does not think it violates the antitrust laws when it seeks to have its products handled by dealers who have been trained in Philco's standards of honest representation and full service to the customer. If its products are bandied about by untrained, unfranchised dealers, unknown to the manufacturer and unequipped to give service to the purchaser, not only the manufacturer, its distributors and its dealers selected by them will suffer, but most importantly the public will suffer."

Jan. 31-Feb. 4—AIEE Winter General Meeting, Hotels Statler and Clinton, New York, N. Y.

Jan. 31—Feb. 4—ASTM Annual Committee Week, Netherlands Plaza Hotel, Cincinnati, Ohio.

Feb. 8-10—10th Annual Reinforced Plastics Div. Conference, sponsored by Society of Plastics Industry, Hotel Statler, Los Angeles, Calif.

Feb. 10-12—7th Annual Southwestern IRE Conference and Electronics Show, sponsored by Dallas-Fort Worth section of IRE, Baker Hotel, Dallas, Tex.

Feb. 11-13—Audio Fair-Los Angeles, sponsored by Los Angeles Section of AES, Alexandria Hotel, Los Angeles, Calif.

Feb. 14-16—Conference on High-Speed Computers, Louisiana State University, Baton Rouge, La.

Feb. 17-18—Conference on Transistor Circuits, sponsored by IRE, professional Group on Circuit Theory, Science and Electronics Div. of AIEE, and Univ. of Pa., University of Pa., Philadelphia, Pa.

March 1-3—Joint Western Computer Conference and Exhibit, sponsored by IRE, AIEE, and Assn. for Computing Machinery, Statler Hotel, Los Angeles, Calif.

Mar. 9-11—Symposium on Electromagnetic Relays, Oklahoma A&M College, Stillwater, Okla.

Mar. 14-18—ASTE Western Industrial Exposition and Annual Meeting, Shrine Auditorium and Exposition Hall, Los Angeles, Calif.

March 21-24—1955 IRE National Convention, Kingsbridge Armory, New York, N.Y.

Apr. 5-7—RTCA Spring Assembly Meeting, sponsored jointly by RTCA and Los Angeles Section of IRE, Los Angeles, Calif.

April 6-10—World Plastics Fair and Trade Exposition, National Guard Armory, Los Angeles, Calif.

Apr. 14-23—International Trade Fair, Hannover, Germany.

Apr. 15-16—9th Annual Spring Technical Conference, sponsored by Cincinnati Section of IRE, Engineering Soc. of Cincinnati Bldg., Cincinnati, Ohio.

Apr. 18-21—24th National Packaging Exposition, sponsored by American Management Association, International Amphitheatre, Chicago, Ill.

Apr. 18-22—National Convention of Dept. of Audio-Visual Instruction

of Nat'l. Education Assn., Hotel Biltmore, Los Angeles, Calif.

May 10-21—Global Communications Conference, sponsored by Armed Forces Communications Assn., Hotel Commodore, New York, N. Y.

May 16-19—Electronic Parts Distributors Show, Conrad Hilton Hotel, Chicago, Ill.

May 16-20—National Materials Handling Exposition, International Amphitheatre, Chicago, Ill.

May 18-20—Nat'l Telemetering Conference and Exhibit, sponsored by IRE, AIEE, IAS, ISA, Hotel Morrison, Chicago, Ill.

May 26-27—Electronic Components Conference, Los Angeles, Calif.

May 31-June 3—3rd Basic Materials Exposition, Convention Hall, Philadelphia, Pa.

June 1-11—British Plastics Exhibition, Olympia, London, England.

June 20-23—2nd International Powder Metallurgy Congress, Reutte, Tyrol, Austria.

July 12-14—2nd Western Plant Maintenance Show, Pan Pacific Auditorium, Los Angeles, Calif.

Aug. 24-26—Western Electronic Show & Convention, San Francisco Civic Auditorium, San Francisco, Calif.

Aug. 26-Sept. 4—German Radio-Gramophone and Television Exhibition, Dusseldorf, Germany.

Sept. 6-17—Production Engineering Show and Machine Tool Show, Navy Pier and International Amphitheatre, Chicago, Ill.

Sept. 12-16—10th Annual Conference and Exhibit, sponsored by ISA, Shrine Exposition Hall and Auditorium, Los Angeles, Calif.

Sept. 30—Oct. 2—High Fidelity Show, Palmer House, Chicago, Ill.

Nov. 2-5—World Symposium on Applied Solar Energy, conducted under leadership of Stanford Research Institute, Phoenix, Arizona.

Nov. 14-17—2nd International Automation Exposition, Navy Pier, Chicago, Ill.

- ACM: Assoc. for Computing Machines.
- AES: Audio Engineering Society.
- AIEE: American Institute of Electrical Engineers.
- ASTM: American Society for Testing Materials.
- IRE: Institute of Radio Engineers.
- IAS: Institute of Aeronautical Sciences.
- ISA: Instrument Society of America.
- NACE: National Assoc. Corrosion Engineers.
- NARTB: National Assoc. of Radio and TV Broadcasters.
- RETMA: Radio-Electronics-TV Manufacturers Assoc.
- RTCA: Radio Technical Commission for Aeronautics.
- RTCM: Radio Technical Commission for Marine Services.
- URSI: International Scientific Radio Union.

More Simulators for Air Force

Three more simulator types will be engineered and built for the U.S. Air Force by the Electronics Div. of the Curtiss-Wright Corporation, according to an announcement by Roy T. Hurley, Chairman and President

of the company. Mr. Hurley said that the Air Force had already placed orders totaling \$6,391,206 for these new Simulators, which will reproduce faithfully the performance characteristics of the Douglas C-118A, the Lockheed C-121D, and the Convair C131.

INTEGRATED ELECTRONICS

...welded into one close knit organization of integrated responsibility. From the first step in research to the first production unit, the same engineering group is responsible for both design and development. This integrated operation eliminates diversion between early development and final responsibility for maximum production design. One group of specialists with one goal... the solution to your problem.

For the past ten years Hoffman Laboratories has been successfully solving advanced design and production problems in electronics and electro-mechanics. In almost every case it has been necessary to reach beyond the routine of development... to develop special test and analytic equipment... to formulate unique research procedures.

Hoffman Laboratories has never undertaken a development project that has not gone into production.

Write the Sales Department for your free copy of "Report From Hoffman Laboratories."



Interior view of Sound Chamber. Hoffman Laboratories has one of the West's largest and best equipped Environmental Test Laboratories.



A SUBSIDIARY OF HOFFMAN ELECTRONICS CORPORATION

- Navigational Gear
- Missile Guidance & Control Systems
- Radar
- Noise Reduction
- Countermeasures (ECM)
- Computers
- Communications
- Terminal Equipment
- Transistor Application

Challenging opportunities for outstanding engineers. Write Director of Engineering, Hoffman Laboratories, Inc. 3761 S. Hill Street, Los Angeles 7, California

POLARAD

COLOR

TV

AN INTEGRATED LINE OF EQUIPMENT FOR STUDIO AND LABORATORY

Fully integrated units that combine ease of operation with maximum stability. No additional accessories or power units required for operation.

Especially designed for:

- Testing receivers, transmitters, and terminal equipment.
- Laboratory test standards for development of color TV equipment.
- Checking components used for color TV.
- Alignment and adjustment of colorplexers or encoders.
- Testing convergence of tri-color kinescopes.

COLOR BAR GENERATOR — MODEL PT-203

A complete instrument with a color bar pulse forming unit, a complete colorplexer unit and regulated B+ and filament supplies. Provides NTSC color TV test signals, for receivers, transmitters, networks and components. Internal switching provides 19 different test patterns in the form of a composite NTSC video signal. Special self-balancing colorplexer provides exceptional stability over long periods of operation without readjustment, with "I" and "Q" outputs. (See colorplexer details.)

AUTO-SELF-BALANCED COLORPLEXER

MODEL PT-205

Incorporated in the Model PT-203 Color Bar Generator, available as a separate chassis for rack mounting. Designed for high stability and negligible drift, this unit replaces old encoder units of early design. This instrument multiplexes three simultaneous color video signals (R, G, B) and properly encodes them into color information and then combines them with sync pulses and color sync signals to form a standard NTSC color TV signal. Pulse or video signals to drive colorplexer may be obtained from special (R, G, B) pulse generators, color camera or color slide scanner. Subcarrier balance is stable and dynamically independent of signal level changes over long periods of operation. Driving signals are Subcarrier, Blanking, Sync and Vertical pulses. Full bandwidth "I" and "Q" modulation is used in the chrominance channel of the colorplexer. "I" and "Q" or "B-Y" and "R-Y" video test signals are available for receiver and monitor matrix alignment. Both positive and negative polarity signals are available at high and low impedance.

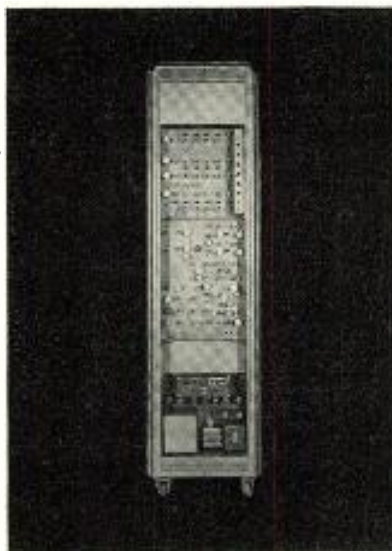

**COLOR BAR GENERATOR—
MODEL PT-203**

Output Signals: NTSC Composite
Video 2 Outputs 0—1.4 v. pk-pk
Output Signal Information:
Color Bars—6 Bars of Color (R, G,
B, C, Y, M) plus Blk/Wht
Gamma Bars—10 step grey scale
Black to White
Dots—White dots on a black field
External Video—Positive or
negative (Provision for mixing
ext. video with above).
System Bandwidth: Luminance
Channel 6 mc
Chrominance: "I" and "Q"
Channel per NTSC standard
Subcarrier balance stability: Drift
not greater than 6 mv (1.4
v. pk-pk signal), 8 hour operation.
Residual Subcarrier Unbalance:
1% Signal Level
Power Requirements: AC 105-125
volts 7 amps., 60 cps.

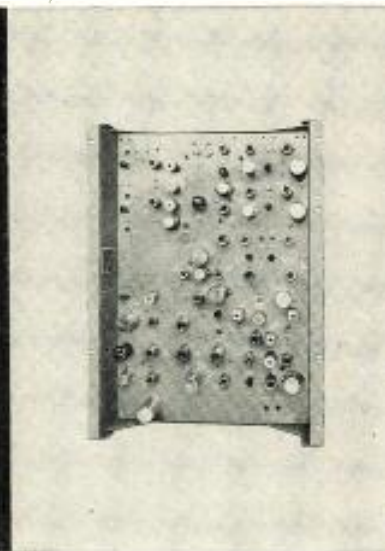

COLORPLEXER—MODEL PT-205

Output Signals: NTSC
Composite Video 2 Outputs
0—1.4 v. pk-pk
Available Test Signals: I, Q, Y,
R-Y, B-Y, (Neg. and Pos.) Video
Input Signals: Subcarrier
20-30 v. pk-pk, 3-579545 mc
Sync 3.0 v. pk-pk, negative
Vertical Drive 3.0 v. pk-pk
negative, R, G, B; 1 v. pk-pk
System Bandwidth: Luminance
Channel 6 mc
Chrominance: "I" and "Q"
Channel per NTSC standard
Subcarrier Balance Stability:
Drift not greater than 6
mv (1.4 v. signal), 8 hour
operation
Power Requirements:
AC 6.3 v. @ 12 amps.,
DC 280 v. @ 425 ma



ELECTRONICS CORPORATION

SYNCHRONIZING GENERATOR — MODEL PT-201

Compact unit provides RTMA standard driving, blanking and synchronizing pulses, as well as a composite video signal comprising vertical and horizontal dots for receiver tests (positive and negative). Used to drive color bar generators, or any other NTSC color TV generating equipment. Utmost stability assured through use of delay lines and by driving all pulses from leading edge of a crystal controlled oscillator. Unit may also be locked to synchronize with 60 cps line. External drive input jack permits operation with Color Subcarrier Generator. Complete with power supply.

COLOR SLIDE SCANNER — MODEL PT-210

A complete equipment integrated into only two racks which provides a high resolution NTSC composite color video signal obtained from standard 2 x 2 (35mm) transparencies. Designed for maximum stability and high signal to noise ratio. The optical head is complete with lenses employing V-type dichroic mirrors and Fresnel condensing lenses. The R, G, B signals obtained from three channel photo amplifiers are gamma corrected to give proper rendition to high lights and shading. Utilizes a highly stabilized colorplexer. (See complete description of Model PT-205 Colorplexer above.)

The scanning kinescope has fine resolution and is combined with the deflection and high voltage unit. The remaining chassis components contain a regulated low voltage power unit, a regulated filament power unit and a regulated photo multiplier power supply.

COLOR SUBCARRIER GENERATOR AND FREQUENCY DIVIDER UNIT

— MODEL PT-202. This rugged unit complete with regulated B+ and filament power provides standard NTSC subcarrier frequency with dual outputs and includes a frequency divider to provide a sync generator driving signal (31.5 KC) to convert standard B/W sync generators for color TV use. High stability achieved by temperature controlled crystal oscillator. All adjustments accessible at front of unit. Adapts any sync generator to NTSC color operation.

COLOR TV VIDEO MONITOR — MODEL M-200

Two portable units supplied with brackets for standard rack mounting. High definition color picture with exceptionally good color rendition is displayed on a 15 inch tri-color kinescope. Excellent for checking the quality of NTSC color video signals in the studio, on transmission lines or in the receiver factory. Special test jacks and switches are provided for analyzing R, G, B signals, matrixing and phase of color signals. Exceptionally good synchronizing capabilities over a wide range of signals. Special convergence circuits are employed to give maximum utilization of color kinescope. Model M200 has good color stability and is relatively insensitive to line voltage changes. Excellent dynamic circuit linearity assures good color stability over a wide range in signal level.

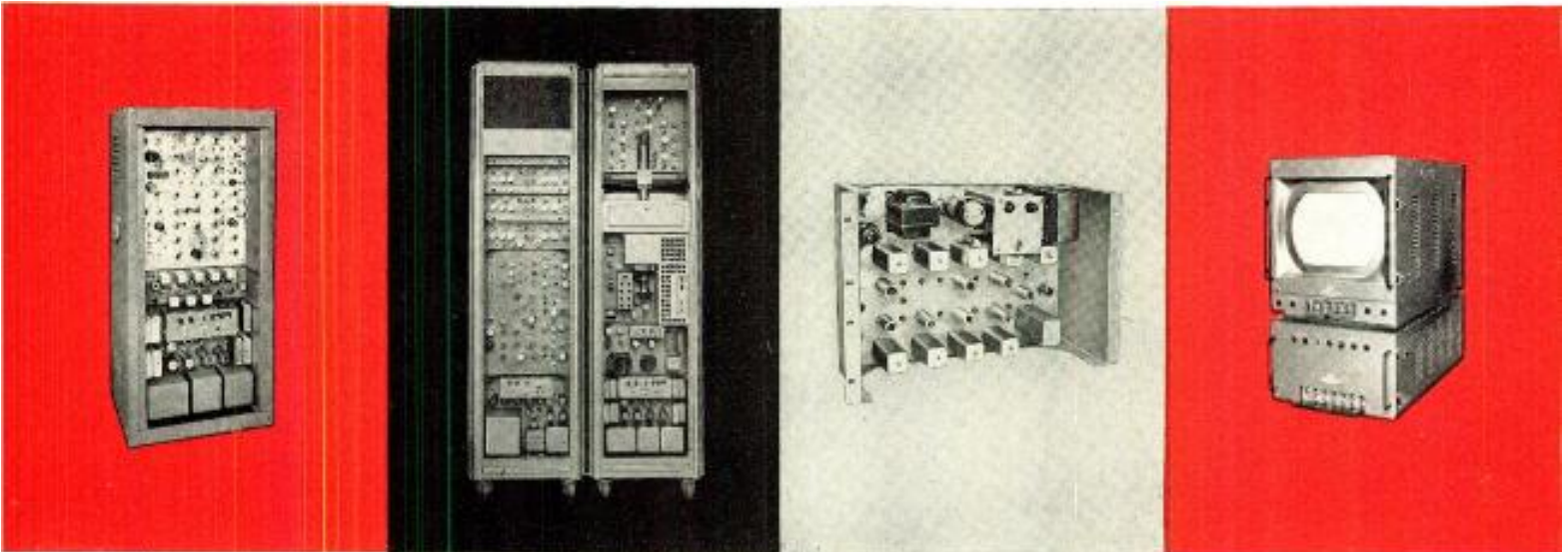

SYNCHRONIZING GENERATOR— MODEL PT-201

Output Signals: Sync. (Neg. and Pos.) 4 v. pk-pk across 75 ohms
Blanking (Neg. and Pos.) 4 v. pk-pk across 75 ohms
Horiz. Drive (Neg. and Pos.) 4 v. pk-pk across 75 ohms
Vert. Drive (Neg. and Pos.) 4 v. pk-pk across 75 ohms
Composite Video Output (Neg. and Pos.) 1.4 v. pk-pk across 75 ohms
Internal Dot Pattern or External Video—1.4 v. pk-pk across 75 ohms
Input Power: 105-125 v. 4.5 amps., 60 cps.

COLOR SLIDE SCANNER— MODEL PT-210

Output Signals: NTSC Composite Video 2 Outputs 0—1.4 v. pk-pk
Optical Head: Lens—F. 2.0 50 mm, Xenon lens in tractica mount
V-type dichroic mirrors
Color Slide 2 x 2 color Transparencies
Gamma Amplifier:
Three Channels (R, G, B)
Input Signal—1.4 v. pk-pk across 75 ohms
Output Signal—1.4 v. pk-pk across 75 ohms
Colorplexer: (See Model PT-205 above)
Deflection and High Voltage Unit:
Kinescope type 5AUP24;
Operating Voltage: 27 KV
Linearity: 2% across raster
Horizontal and Vertical
Photomultiplier Power Supply:
Electrically regulated. Filament Supply—AC line Regulated
Input Signals: Hor. Drive—3 v. pk-pk
Ver. Drive—3 v. pk-pk. Blanking Drive—3 v. pk-pk Sync. 3 v. pk-pk
Power Requirement: AC 105-125 v., 10 amp., 60 cps.

COLOR SUBCARRIER GENERATOR AND FREQUENCY DIVIDER UNIT—MODEL PT-202

Subcarrier Frequency Dual Output:
3.579545 mc/sec. \pm 0.0003%
with maximum rate of frequency change not exceeding 1/10 cps./sec.
Subcarrier Output Voltage: 25 to 40 volts
Frequency Divider Output:
31,468 cps.
Divider Output Voltage: 0 to 100 volts
Ambient Temperature: 40° F. to 110° F.
Power Requirements: AC 105-125, 2A, 60 cps.

COLOR VIDEO MONITOR—MODEL 200

Input Video Signal: 0.25 to 2.0 volts, pk-pk
Signal Polarity: Pos., Neg., Bal.
Input Impedance: 66 mmf across 2.2 megohms or 75 ohms
Resolution: 250-300 lines min. (Full utilization of NTSC Color Signal Bandwidth)
Linearity: (Hor. and Vert.) 2% across raster
Tricolor Kinescope: 15"
Focus: Electro Static
Net Weight: 175 lbs.
Power Requirements: 105-125 v., 4 amps., 50/60 cps.

AVAILABLE ON EQUIPMENT LEASE PLAN
FIELD MAINTENANCE SERVICE AVAILABLE
THROUGHOUT THE COUNTRY

43-20 34th STREET, LONG ISLAND CITY 1, N. Y.

REPRESENTATIVES • Albuquerque • Atlanta • Baltimore • Boston • Chicago • Cleveland • Fort Worth • Kansas City • Los Angeles • New York
Philadelphia • San Francisco • Seattle • St. Paul • Syracuse • Washington, D. C. • Canada, Arnprior—Export: Rocke International Corporation

AMPHENOL

builds for the ELECTRONICS INDUSTRY

The quality production of quality components for electronics is the object and the success of AMPHENOL. The variety of our expanding line of components reflects both the needs of electronics and the growing demand for AMPHENOL quality in every specification of important connectors and cable.



AN CONNECTORS

RF CONNECTORS

HERMETIC SEAL RECEPTACLES

MINIATURE AN-TYPE CONNECTORS

SUBMINAX RF CONNECTORS

BLUE RIBBON CONNECTORS

MINIATURE RACK & PANEL CONNECTORS

CABLE ASSEMBLIES & HARNESSSES

POTTED AN CONNECTOR ASSEMBLIES

RG COAXIAL CABLE

... components built to standard specifications or designed to the special requirements of the electronics industry ...

BOOKS

Analogue Methods in Computation and Simulation

By Walter W. Soroka. Published 1954 by McGraw-Hill Book Co., 330 W. 42 St., New York 36, N.Y. 390 pages. Price \$7.50.

Because analog representation and simulation offer engineers an affective tool for pre-design analysis and indirect experimentation with many products, considerable interest has been focused on the techniques for setting up computing elements analogous to physical systems. This book provides a comprehensive, though not exhaustive, examination of many practical techniques for making the required computations.

The first two chapters cover mechanical, electromechanical, electrical and electronic computing elements. The next two chapters describe linear and nonlinear algebraic equations. Chapters 5 and 6 are devoted to mechanical and electronic differential analyzers, while Chapter 7 covers the dynamical similarity between electrical circuits and mechanical systems. The last two chapters discuss equivalent circuits for various equations, and membrane and conducting-sheet analogies.

The author, Professor of Engineering Design at the Univ. of Calif., has done an excellent job in presenting this complex subject. The book is to be well recommended to those possessing a basic grounding in analog computation.

Acoustics

By Leo L. Beranek. Published 1954 by McGraw-Hill Book Co., 330 W. 42 St., New York 36, N.Y. 481 pages. Price \$9.00.

This new addition to the Electrical and Electronic Engineering Series thoroughly covers the theoretical and practical engineering considerations of audio design. The presentation of information is made in conventional textbook style. One of the most useful elements of the book, from the viewpoint of the engineer engaged in the development of acoustical devices, is the collection of empirical data which had previously been scattered among numerous books and periodicals.

The early chapters discuss wave equations, electro-mechano-acoustal circuits, sound radiation and acoustic components. The larger part of the book is devoted to the characteristics and design factors affecting microphones, loudspeakers, enclosures, and noise control. Although the chapter on acoustic measurements is adequate, a more extensive discussion of this critically important aspect would have been desirable. The final chapter deals with hearing, speech intelligibility and psycho-acoustic criteria. The large amount of clearly written technical information makes this volume a worthwhile addition to an engineer's library. AJF.

SEE

AMPHENOL

AT I. R. E.
IN NEW YORK

AMERICAN PHENOLIC CORPORATION *chicago 50, illinois*

In Canada: AMPHENOL CANADA LIMITED, Toronto



HEADQUARTERS
FOR YOUR
HERMETICALLY
SEALED
MINIATURE

TRANSISTOR and DIODE BASES and CLOSURES*

Electrical Industries is your dependable source of supply for all hermetically-sealed miniature components. Miniaturized transistor and diode bases with closures and sealed components for specialized requirements can be supplied quickly and economically. For samples and quotations on standard components or recommendations on "specials", call or write E-I, today!

ELECTRICAL INDUSTRIES

44 SUMMER AVENUE
NEWARK 4, NEW JERSEY

DIVISION OF AMPEREX
ELECTRONIC CORP.



Series No. 1 KOVAR BASES

WITH NICKEL
SILVER CASES

Three electrode hermetically sealed Kovar bases supplied with closures. Lead lengths and pin layouts as illustrated. Cases are available in three types. Closures are press-fit to bases.

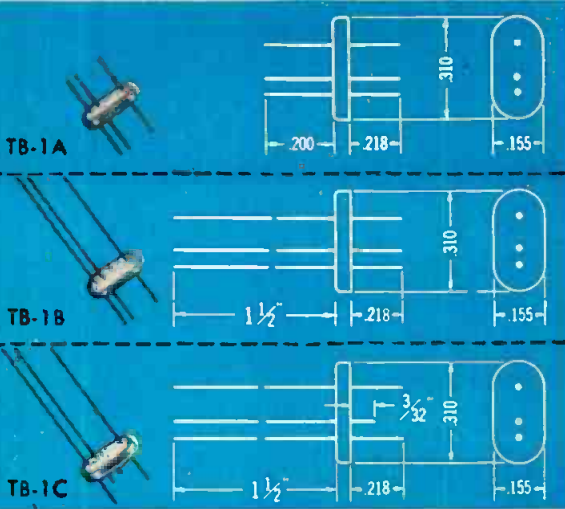

ALL CASES .300"
IN LENGTH



TC-1A
plain



TC-1B
with hole



TC-1C
with hole
and dimple

Series No. 3 COMPRESSION TYPE BASES & CLOSURES

WITH NICKEL
SILVER CASES

Compression type bases available in two, three and four lead types. Type TC-3 or TC-3A cases, illustrated, can be supplied. Cases are press-fit to bases.

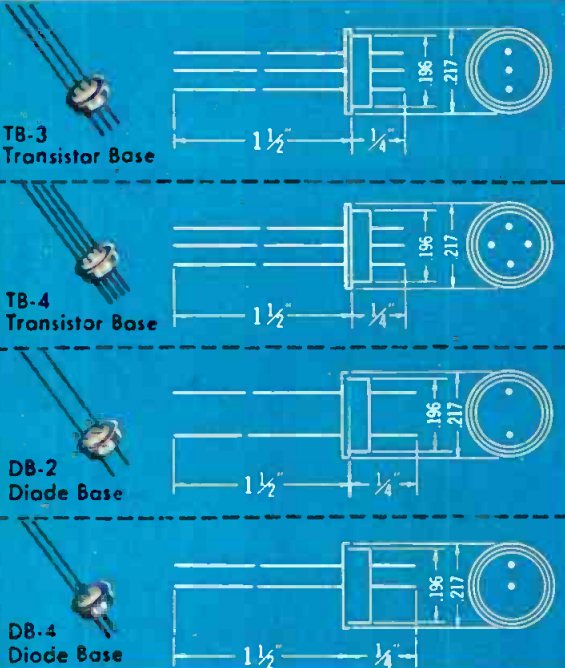

CASES AVAIL-
ABLE WITH OR
WITHOUT
DIMPLE

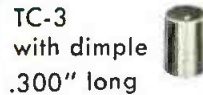

TC-3
with dimple
.300" long

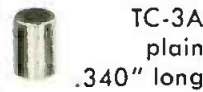

TC-3A
plain
.340" long

Where Special cases are required, E-I will quote on your requirements on receipt of your drawings or specifications.

Series No. 5 COMPRESSION BASES

WITH NICKEL
SILVER CASES

Available as illustrated. Cases are press-fit to bases.

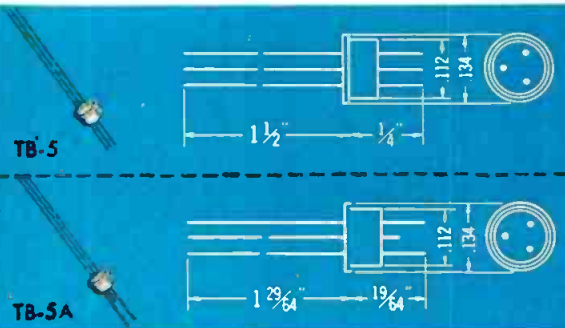

TC-5
with dimple



TC-5A
plain

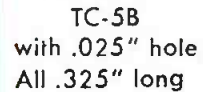

TC-5B
with .025" hole
All .325" long

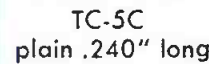

TC-5C
plain .240" long

Type TB-6 TRANSISTOR BASE

AVAILABLE WITH
TC-6 CLOSURE

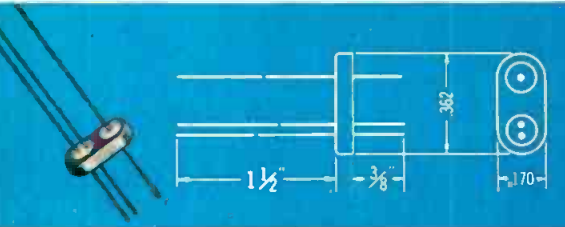

TC-6 CLOSURE
Plain case .300"
in length.

Type DC-5 GOLD PLATED

With welding projection. Available as DC7 without welding projection.

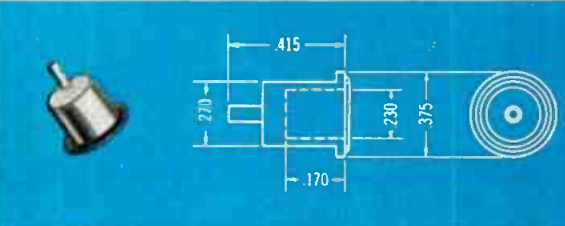

*PATENT PENDING ALL RIGHTS RESERVED



packs new power in with **FIVE**

Straight down the line these five ABC-owned stations bought new G-E 50 KW transmitters. And, to assure utmost coverage in each location, they installed special batwing antennas

designed by General Electric and ABC engineers. Soon, many extra millions of TV viewers will see the positive results of this network's equipment-expansion program.

For the latest advances in tubes, circuitry, and power, get the new G-E "50". It's ready for FCC-approved standard color signals. With a power-thrifty 5 KW driver, it streamlines operating costs beyond expectation.

Delivery of the new equipment from G.E. marks a highly-important step in ABC's consistent record of long-range power improvements begun early in 1953. The results to date? — Credit ABC with the following:

1. Better service to both audience and advertiser!
2. Widely-augmented coverage!

With a G-E "50" the same results are yours for the asking. Get the complete story about the newest in G.E.'s comprehensive transmitter product line. Write, wire or phone the local field sales representative now. *General Electric Company, Broadcast Equipment, Section X4825, Electronics Park, Syracuse, N. Y.* In Canada, write: *C.G.E. Electronics, 830 Lansdowne Avenue, Toronto.*



Frank L. Marx, Engineering Vice President, was in charge of ABC's program to achieve increased power for all flagship stations.

ALL flagship markets

G-E 50's

WABC-TV
New York

WXYZ-TV
Detroit

WBKB
Chicago

KGO-TV
San Francisco

KABC-TV
Los Angeles

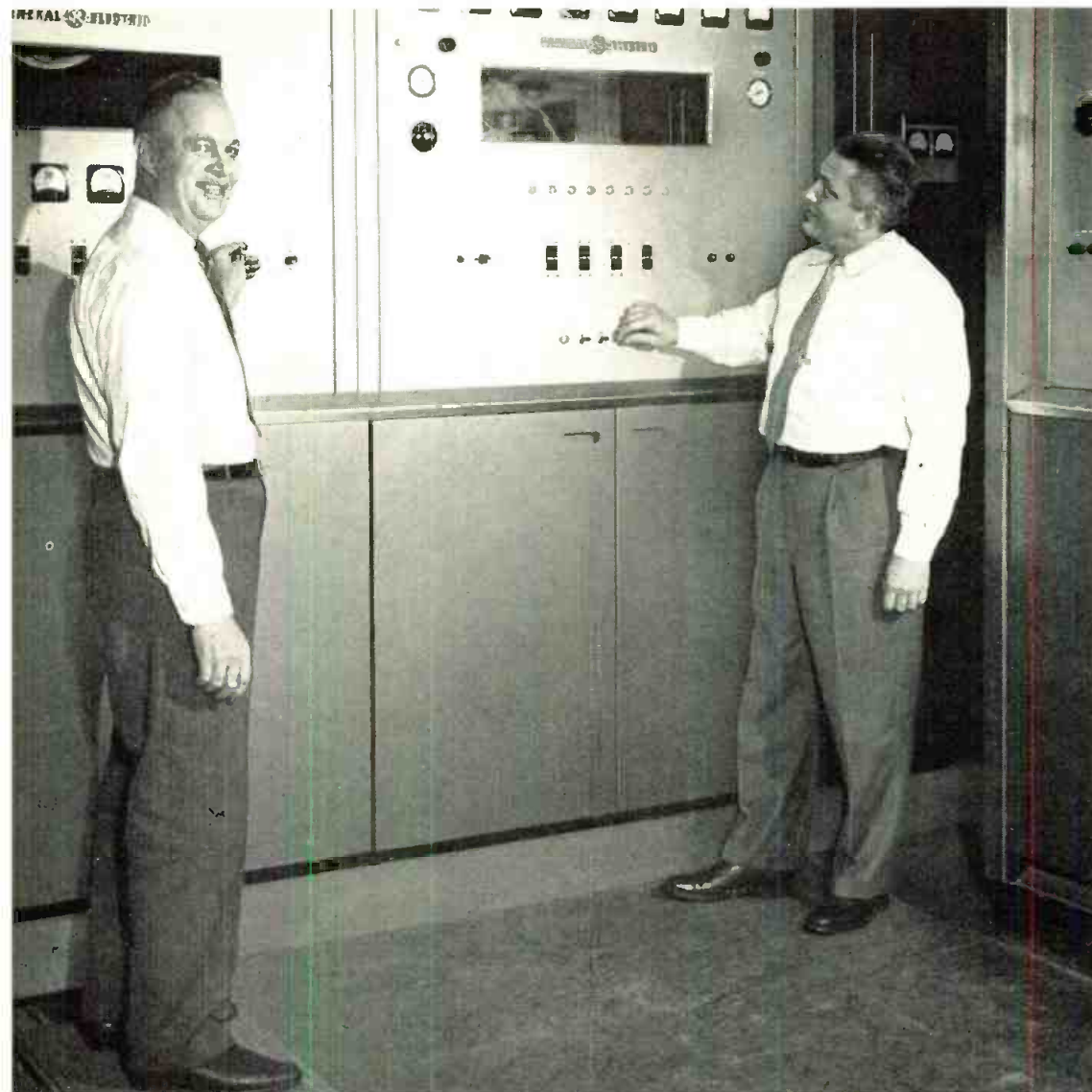

Joseph L. Sielski (Right), station engineer at WABC-TV, and Henry J. Treger (Left), assistant, inspect units in the new installation.

Progress Is Our Most Important Product

GENERAL  **ELECTRIC**

www.americanradiohistory.com



COMPLETE TELEVISION EQUIPMENT

for VHF and UHF...for
Black & White plus Color TV



TRANSMITTERS

powered from
100 watts to 100 KW



ANTENNAS

to fit every gain and
pattern requirement—
helical and batwing types



STUDIO EQUIPMENT

for complete audio
and video facilities



PORTABLE EQUIPMENT

to handle all remote services

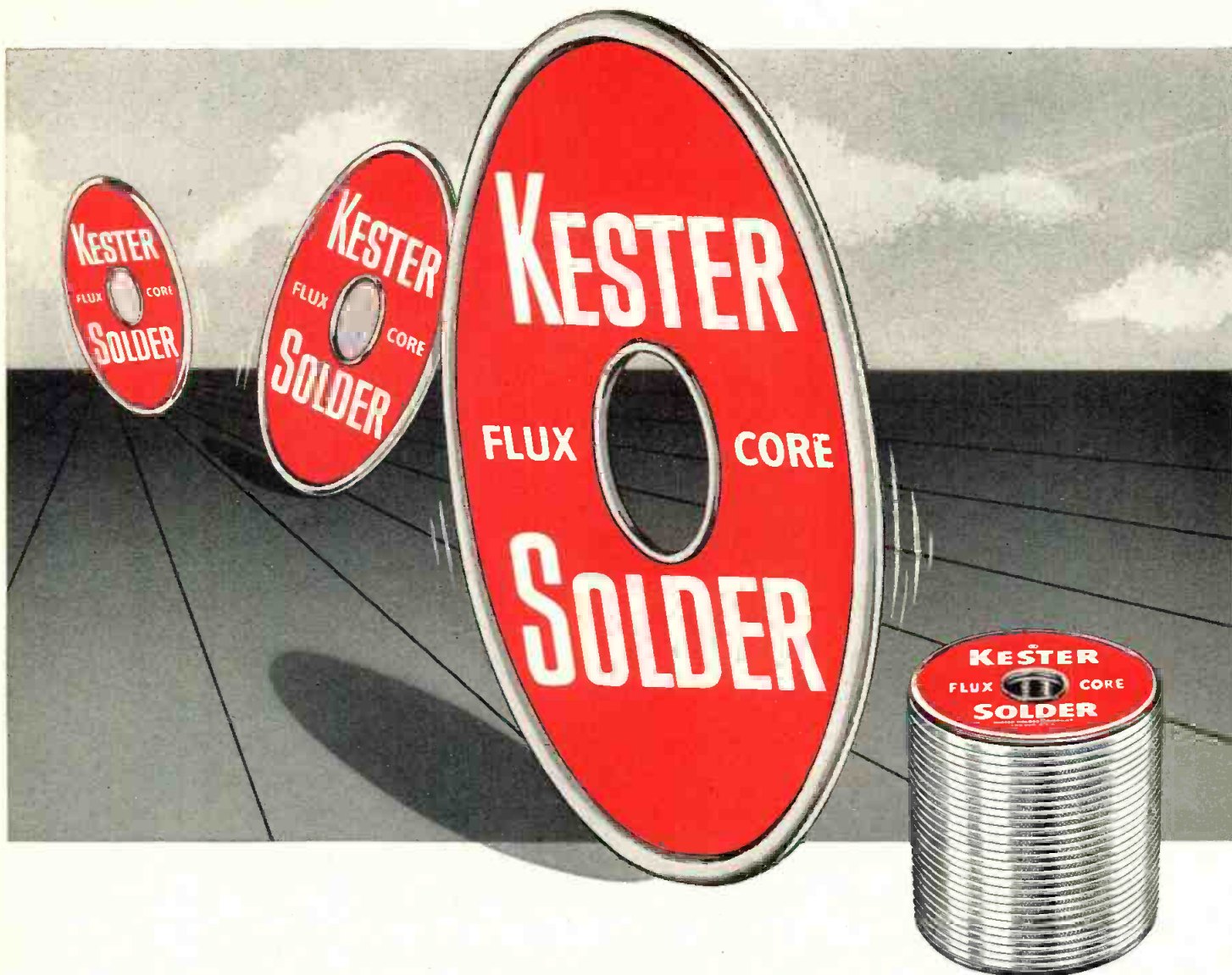

KEEPS 'EM ROLLING!



Only virgin metals are

KESTER "44" Resin, Plastic Rosin and "Resin-Five" Flux-Core Solders keep the production lines moving by providing the exactly right solder

used in Kester . . . further assurance of the constant solder alloy control combined with consistent flux formulae . . . all part of Kester Flux-Core Solder quality that'll "keep 'em rolling" for you!

. . .

BE SURE YOU GET KESTER'S new 78-page informative textbook "SOLDER . . . Its Fundamentals and Usage."

KESTER SOLDER

COMPANY 4210 Wrightwood Avenue, Chicago 39, Illinois; Newark 5, N. J.; Brantford, Canada



ALBERT PULLEY, *Chief Recording Engineer, RCA Victor Record Division*

Photo by Arnold Newman

“‘SCOTCH’ Brand High Output Tape meets all our demands for RCA Stereophonic recordings.”

ALBERT PULLEY, *Chief Recording Engineer, RCA Victor Record Division*, holds an enviable position in the field of audio engineering. His contributions to the development of high fidelity sound over a period of years have helped establish the United States as a leader in recorded sound. In addition, his brilliant and sensitive supervision of recordings by such masters as Toscanini, Stokowski and Koussevitsky have won him the warm praise of critics and technicians alike.

To meet the exacting standards demanded for RCA Victor “Red Seal” Stereophonic recordings requires the finest recording material available. That is why RCA uses new “SCOTCH” Brand No. 120A High Output Tape for their original recordings. With no increase in noise or harmonic distortion . . . 133% more output, new “SCOTCH” Brand No. 120A High Output Tape assures audio engineers clearer, greater dynamic range recordings. Have you tried it?



Reg. U.S. Pat. Off.
SCOTCH Magnetic Tapes
 BRAND

The term “SCOTCH” and the plaid design are registered trademarks for Magnetic Tape made in U.S.A. by MINNESOTA MINING AND MFG. CO., St. Paul 6, Minn. Export Sales Office: 99 Park Avenue, New York 17, N. Y. In Canada: Minnesota Mining and Manufacturing of Canada, Ltd., P.O. Box 757, London, Ontario.

www.americanradiohistory.com



1,000,000 WATTS

RCA IS **FIRST** WITH SUPER



This 25-KW Amplifier +

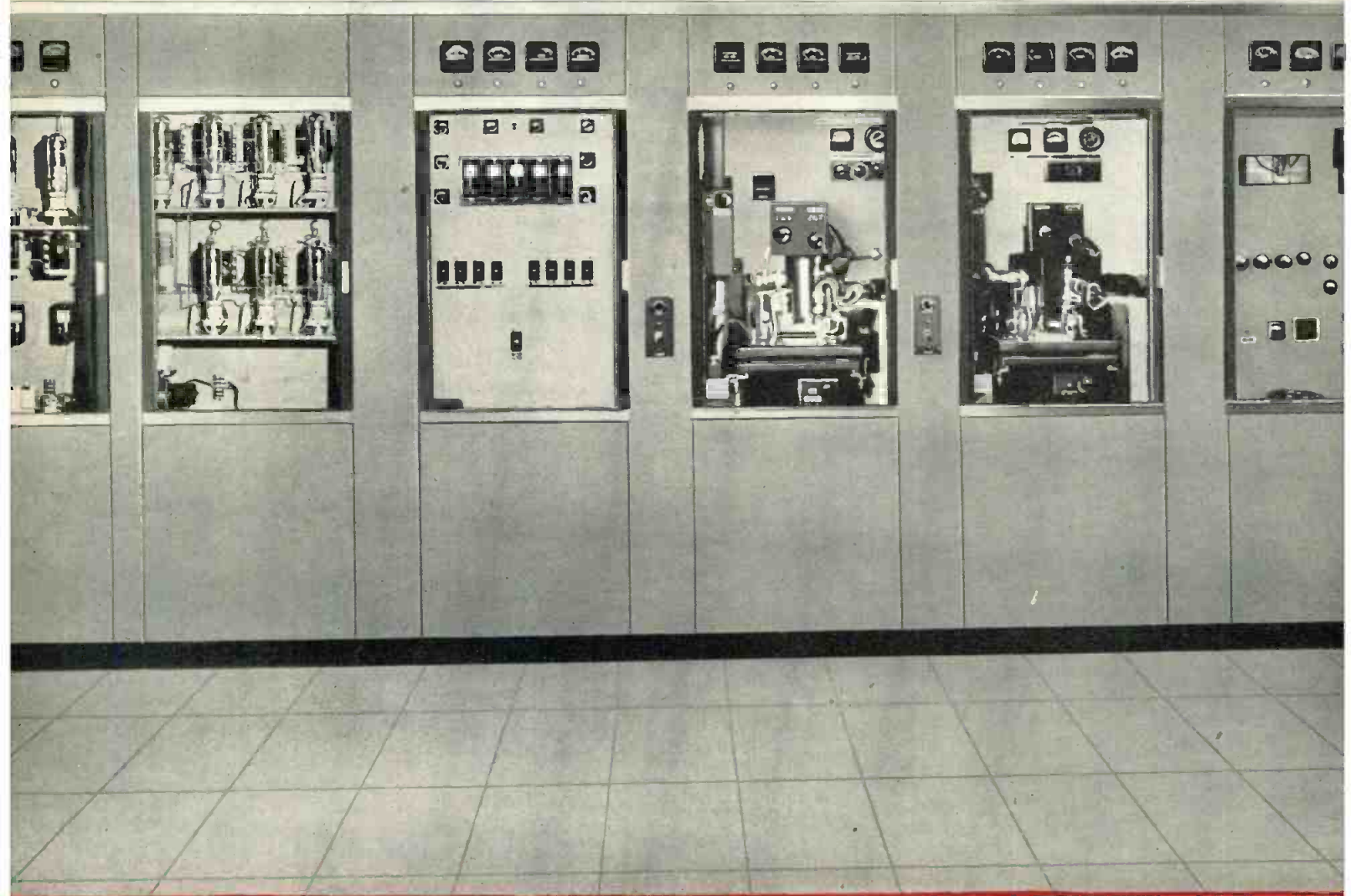

"ON-AIR" AT WBRE-TV

POWER UHF

This announcement marks another achievement in RCA high-power equipment leadership. For the first time, a commercial UHF television station is operating with an effective radiated power of one million watts! For the first time, a UHF station is getting coverage close AND far out! And best of all, super television power has proved just as easy to handle as lower powers.

How do you get started with RCA super power? You begin with your own RCA 1-KW transmitter. You add the new RCA 25-KW amplifier. You install the new RCA Super Power UHF Pylon (gain, 46)—and you're set to go with 1 million watts ERP. Power tubes in both RCA high-power amplifiers are conventional and interchangeable (no klystrons used). Amplifier plate voltages are low (6000 volts, max). Operating economy is remarkable (RCA's new super power, high gain antenna eliminates need for high power input. Power tubes have already set a record for "proved-in" life).

this Antenna =

One
million
Watts

New RCA Super Power UHF Pylon Antenna. Available Types: TFU-46AL, TFU-52-AM, TFU-60-AH. Signal Gain, 46, 52 and 60. The answer for economical 1-million watt operation.

Station-proved in daily commercial operation at WBRE-TV, the performance of RCA's 1-million watt UHF system is now an established record. Profit by RCA's engineering experience in high-power—and KNOW you've planned it right. Call your RCA Broadcast Sales Representative. In Canada, write RCA Victor Ltd., Montreal.

RCA Pioneered and Developed Compatible Color Television



RADIO CORPORATION of AMERICA
ENGINEERING PRODUCTS DIVISION

CAMDEN, N.J.

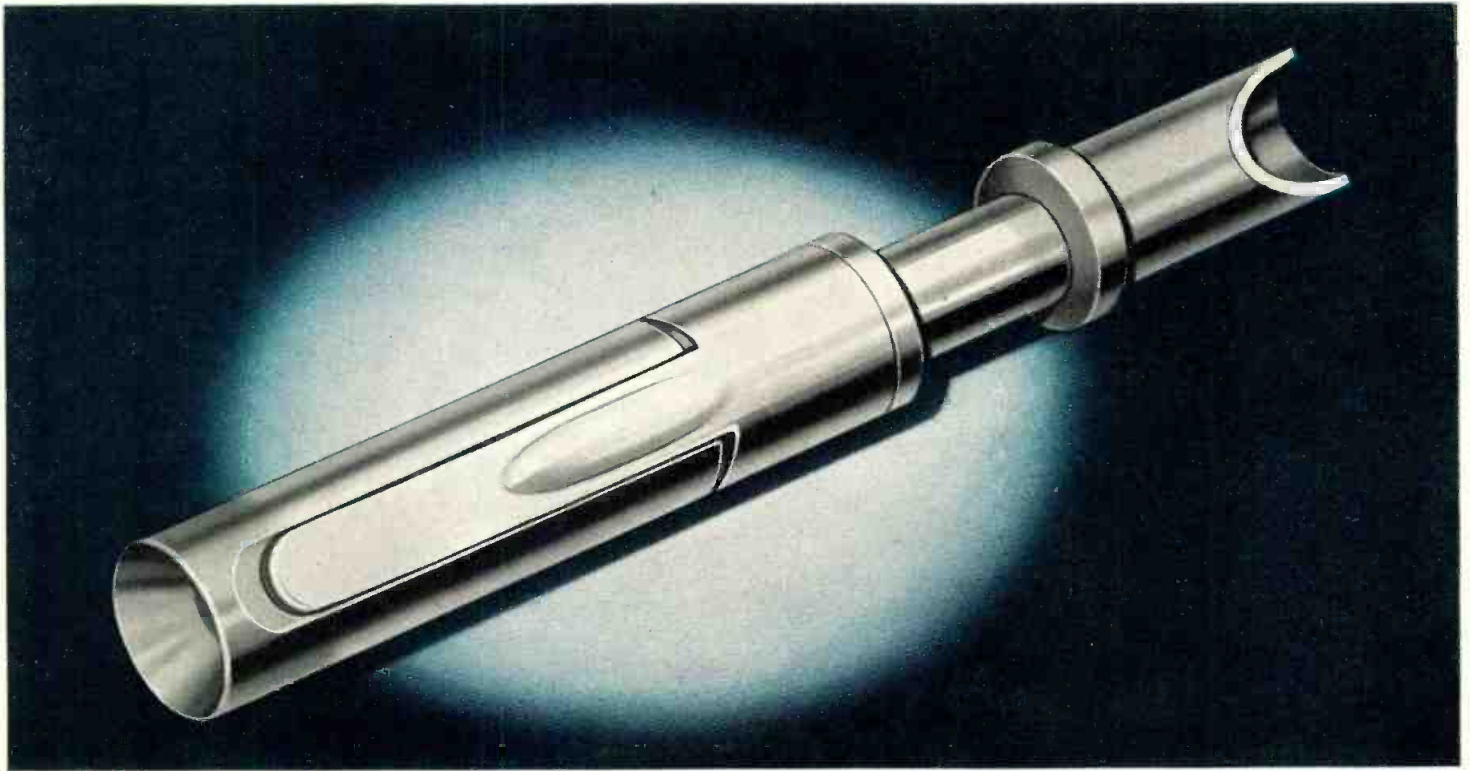

“CLIP-TYPE” closed entry socket contact
now standard in

BENDIX-SCINFLEX

ELECTRICAL CONNECTORS



*CANNOT be overstressed—
eliminates intermittent
circuit problems
resulting from socket
contact malfunction.*

The heart of any electrical connector is the socket contact. This is why the Bendix-Scinflex* socket contacts have always been machined from bar stock. Stampings, with their required thin sections, can be easily overstressed.

Even with the machined sockets, industry has been plagued with overstressed spring leaves due principally to the misuse of test probes and lax tolerances on pin contacts. Bendix engineers have now provided the only socket contact on the market today which completely eliminates all these problems.

The “Clip-Type” socket will not accept any oversize probe or pin, nor can one be forced into it. Also, no amount of wrenching or twisting of an acceptable pin or probe can possibly distort the spring clip. This new socket is now standard in all Scinflex connectors including those using solderless, high-temperature and thermocouple contacts.

Our sales department will be glad to furnish complete information on request.

*TRADE-MARK



SCINTILLA DIVISION of
SIDNEY, NEW YORK



Export Sales: Bendix International Division, 205 E. 42nd St., New York 17, N.Y.

FACTORY BRANCH OFFICES: 117 E. Providencia Ave., Burbank, Calif. • Stephenson Bldg., 6560 Cass Ave., Detroit 2, Michigan • 512 West Ave., Jenkintown, Pa. • Brouwer Bldg., 176 W. Wisconsin Avenue, Milwaukee, Wisconsin • 8401 Cedar Springs Rd., Dallas 19, Texas • American Bldg., 4 S. Main Street, Dayton 2, Ohio • 1701 “K” Street, N. W., Washington 6, D. C. • Boeing Field, Seattle 8, Washington.

MINIMUM CIRCUIT LOADING...

peak to peak
measurement
with input
impedance of
10 megohms shunted
by a capacitance
of only
15 micromicrofarads!

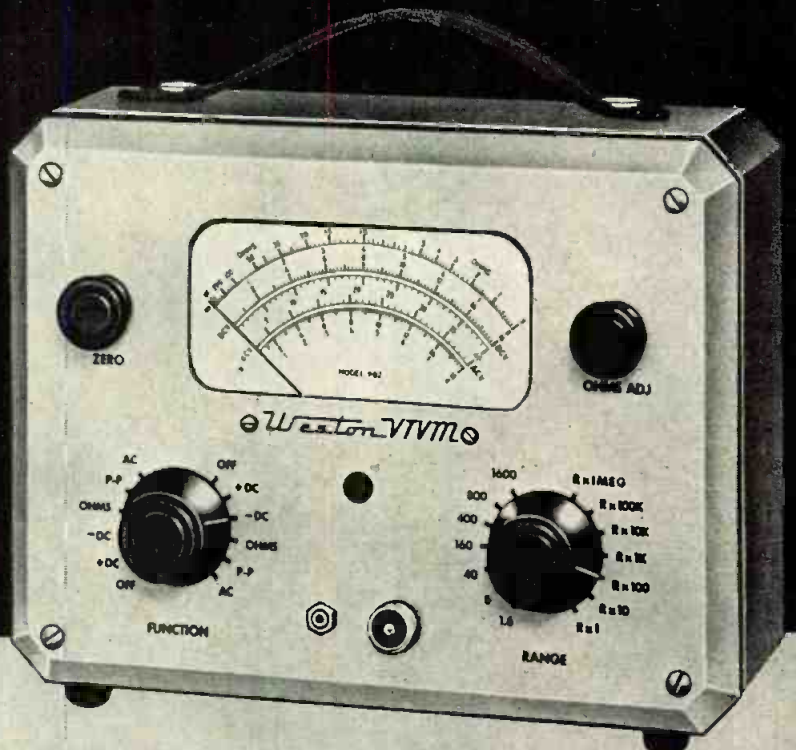

the 980 line

VACUUM TUBE VOLTMETER

Model 982

Other 980 Line Instruments

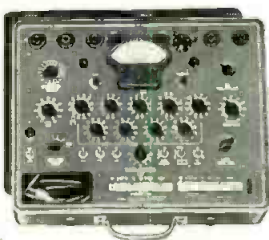

Model 981
Tubechecker



Model 980
Analyzer



Model 983
Oscilloscope



Model 985
Calibrator

Model 984
Sweep Generator



Here is the most convenient, most versatile and portable VTVM available. Battery operated, it is completely isolated from spurious response due to stray a-c fields and circulating ground currents. Accuracy is $\pm 3\%$ d-c, $\pm 5\%$ a-c RMS, sinusoidal wave form. Impedance 10 megohms d-c; 2.8 megs a-c RMS; 1 meg a-c at 130 mmf peak to peak; 10 megs at 15 mmf peak to peak with LC probe.

RANGES:

D-C and Peak to Peak Volts	1.6	8	40	160	400	800	1600
A-C Volts	1.6	8	40	160	400	800	1200
Low-C Peak to Peak Volts	16	80	400	1600			
Ohms	X1Meg	X100K	X10K	X1K	X100	X10	X1 (10 ohms center)

Frequency Response—to 300 KC on peak to peak; to 2 KC on AC rms; to 300 MC with RF probe, (available as accessory).

Battery Life—Battery A, Approx. 90 days, 8 hours, easily replaceable. Battery B, Approx. 1 year, 8 hours per day.

For complete details see your distributor, or write for literature . . . WESTON Electrical Instrument Corp., 614 Frelinghuysen Avenue, Newark 5, New Jersey.

WESTON

980 line

test equipment

TELE-TIPS

SALES LEADS can be sales woes, reports one company. Supposedly hot prospects were furnished by one magazine, based on numbers that readers circled on that publication's inquiry card, referring to an editorial item describing one of the company's products. After going to the expense of following up some 350 leads—without any sales resulting—the firm concluded that it's just too easy to circle a whole card full of numbers without being particularly interested in any one item. Looks like inquiry quality beats quantity in getting sales results.

"IF I KNEW you were coming I'd have played a tape," might be the new approach to the song of the near-same name. Magnecord has come up with a technique for making a cake by automation. Using a magnetic tape recorder-playback machine to measure combine and mix the ingredients in proper amounts and sequence, "MagneChef" does the job quickly and accurately.

GOLDEN WORRIES, the worries you have when you're a big corporation with a \$1 million debt, instead of a hole-in-the-wall company with no outstanding bills, are reflected in some of the stories told by Aerovox's articulate VP, Charlie Golenpaul. Like the true story about the fellow out West who complained bitterly about having to put up a \$500,000 warehouse to take care of inventory for the increased business he had. And the humorous gag about the successful oldtime shopkeeper who stopped his son (Harvard Business School, Class of '54) from taking inventory of his gigantic stock. "Listen, when I started in business 35 years ago all I had was a gross of pins, a gross of buttons, and two dozen spools of thread. Now look at the thousands of boxes full of goods. So far as I'm concerned, it's all profit."

SHAKESPEARE SAYS:

3-D: *Make thy two eyes, like stars, start from their spheres.* (Hamlet)
 STATIC ELECTRICITY: *And each particular hair to stand on end.* (Hamlet)
 BAD PROGRAMS: *The fault dear*
 (Continued on page 36)

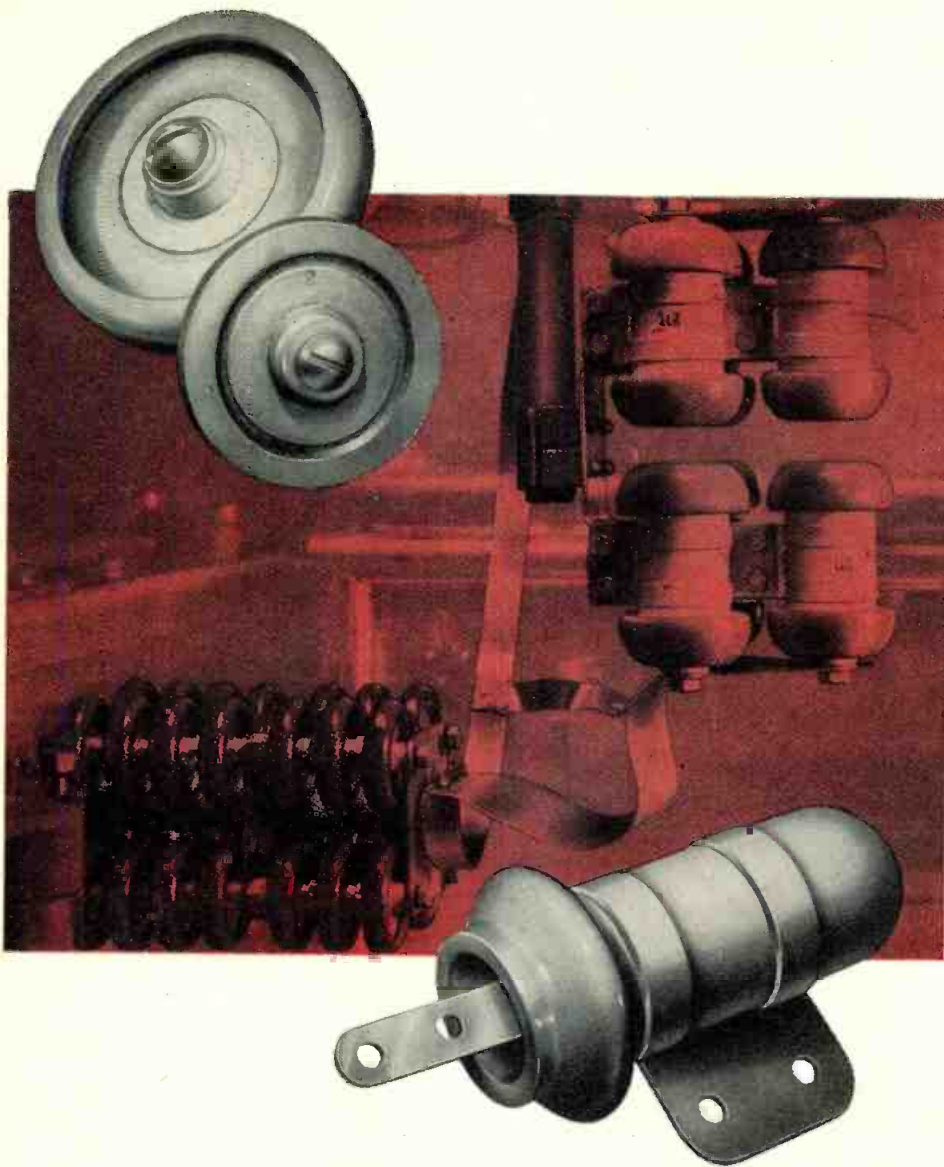

Aerovox H-P CERAMIC POWER and Transmitting Capacitors

Take advantage of that "New Look" in your electronic power assemblies! These ceramic-dielectric capacitors serve heavy-duty functions heretofore limited to mica types. H-P Ceramic Power Capacitors are particularly suited for broadcast, radio-communication, radar and similar assemblies; for industrial high-frequency equipment; for medical appliances, etc.

In both disc ("double-saucer") and cylindrical ("tubular") ceramic-dielectric bodies. Space- and weight-saving from 50% to 90% over corresponding micas. Competitively priced.

Also: Ease of mounting; ease of wiring in series or parallel; very low inductance connections; exceptional immunity to humidity, heat, cold, atmospheric pressure; wide range of designs, sizes, capacitances, voltages.

Get the FACTS!

Let our engineer-specialists collaborate in adapting these H-P capacitors to your equipment for that "New Look." Literature on request.

Hi-Q[®]
DIVISION

AEROVOX CORPORATION
 OLEAN, N. Y.

AEROVOX CORPORATION
 NEW BEDFORD, MASS.

ACME ELECTRONICS, INC.
 MONROVIA, CALIF.

CINEMA ENGINEERING CO.
 BURBANK, CALIF.

In Canada: AEROVOX CANADA LTD., Hamilton, Ont.
 JOSEPH ADDRESS: 740 Belleville Ave., New Bedford, Mass.

Another important SYLVANIA First
for your microwave equipment...

TR-ATR

100 KW 35,000 MC

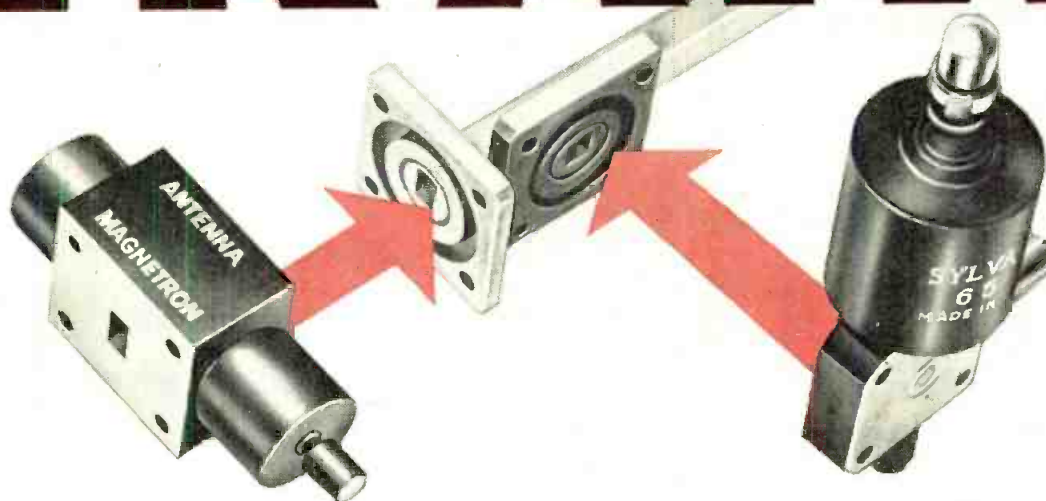

These high-power microwave components incorporate
“ceramic-windows” for peak performance at 100 KW
power levels—mounting is simplified



ATR Type 6546

featuring...

- ✓ new unitized construction
— dual ATR and mount in
one package — eliminate
“castle” mounts



TR Type 6545

featuring...

- ✓ metal reservoir—extends tube life
- ✓ doubly loaded Q of 50—
eliminates critical tuning at
any setting

ELECTRICAL SPECIFICATIONS

Center frequency..... 34,860 Mc.
Transmitter peak power (min)..... 20 kw.

LOW LEVEL CHARACTERISTICS

Equivalent conductance (max)..... 0.15
Tuning susceptance..... ±0.07

HIGH LEVEL CHARACTERISTICS

Arc loss (max)..... 0.9 db
Firing time (max)..... 10 secs.

ELECTRICAL SPECIFICATIONS

Tuning range..... 33,814—35,906 Mc.
Transmitter peak power..... 100 kw.
Leakage power (max)..... 30 mw.
Insertion loss (max)..... 2.5 db
Ignitor Interaction (max)..... 0.2 db
Recovery time (max)..... 4 usec.

For all your TR-ATR needs Sylvania offers a complete line. Write for complete data.
“Another reason why it pays to specify Sylvania”



SYLVANIA

Sylvania Electric Products Inc.
1740 Broadway, New York 19, N. Y.

In Canada: Sylvania Electric (Canada) Ltd.
University Tower Bldg., St. Catherine Street
Montreal, P. Q.

LIGHTING • RADIO • ELECTRONICS • TELEVISION • ATOMIC ENERGY

FULL VIEW FULL VALUE

WITH A
**HYCON
OSCILLOSCOPE
MODEL 617**



\$269.50

SHARP UNDISTORTED TRACE EDGE TO EDGE

The Model 617 Oscilloscope is a quality instrument, designed and constructed to laboratory standards.

The special flat face 3-inch CRT provides a sharp, undistorted trace for the full width of the scope.

Other features—such as high deflection sensitivity and 4.5 MC vertical bandpass—make the Model 617

ideal for general laboratory use, and for color TV testing and servicing. So before ordering new or replacement scopes, try the Hycon Model 617... for any application "where accuracy counts."

- 4.5 MC BANDPASS WITHIN ± 1 DB (VERTICAL AMPLIFIER)
 - HIGH DEFLECTION SENSITIVITY (.01 V/RMS PER INCH)
- INTERNAL CALIBRATING VOLTAGES
 - EDGE LIGHTED BEZEL
 - STURDY, LIGHTWEIGHT CONSTRUCTION



Hycon's line of matching, bench-stacking test instruments includes the Model 615 Digital VTVM and the Model 614 Standard VTVM. Distributed through Electronic Parts Jobbers.

Service facilities in your area.

Hycon Mfg Company

2961 EAST COLORADO STREET PASADENA 8, CALIFORNIA

"Where Accuracy Counts"

TELE-TIPS

(Continued from page 34)

Brutus, is not in our stars. (Julius Caesar)

APPLE POLISHING: *When I tell him he hates flatterers, he says he does, being then most flattered.* (Julius Caesar)

FILM EDIT: *This was the most unkindest cut of all.* (Julius Caesar)

MANAGEMENT CONSULTANT: *I have bought Golden opinions from all sorts of people.* (Macbeth)

STATION BREAK COMMERCIAL: *Out, damned spot! out, I say!* (Macbeth)

NATIONAL DEBT: *More is thy due than more than all can pay.* (Macbeth)

PRECISION GLASS screens of 300 mesh (90,000 holes per sq. in.) are being made by Corning Glass Works for cathode-ray tubes, replacing parts that are usually made of copper by an electroplating process.

GOOD REASON for educational TV is indicated in some statistics released by the National Citizens Committee for Educational Television. About 10 million people over 25 years old are functional illiterates, having completed less than five years of school. Nearly half of the adult population has never attended high school. Only 6% of American adults have completed a college education. One out of every six draftees is rejected by the armed services for lack of educational fitness.

HANDWRITING honors go to electrical and civil engineers, according to a poll of secretaries made by Norma Pencil Corp. The gal Friday brigade rated the engineers with 71% penmanship legibility, while the overall average was 59%. Advertising men, architects and aviators flunked badly, scoring as low as 25%.

HELP! Technical announcement received by the editors has us baffled, and we haven't been able to locate an encabulator specialist. Comments from engineers having experience with this device would be appreciated. It reads, in part:

"For a number of years, work has been proceeding in order to bring perfection to the crudely conceived
(Continued on page 44)

Smooth, Smoother, S-m-o-o-t-h-e-s-t

TV camera action ever known with

CAMERA EQUIPMENT

GRAVITY BALANCED ROCKER TYPE PAN AND TILT HEAD

You'll know what we're talking about the instant you try it! Our new **ROCKER** Head has almost gyroscopic action, smooth, effortless. No longer do you have to fight spring balance to make your tilts.

You establish absolute balance by positioning camera on **ROCKER** head platform and adjusting center of gravity with vernier control. Long and short lenses are compensated for with vernier adjustment. Prompting device may be added and balanced easily. Convenient brake handles and locking device for pan and tilt tension. Fits standard tripod and dollies. Lighter in weight—and more economical in price. See it—test it—it's a "must"!

Accessories that SURPASS accepted standards— for Studio, Mobile and Micro-Relay Equipment

New Model C **BALANCED** TV Head provides correct center of gravity in a **FLASH**— without groping.

No matter what focal length lens is used on the turret, the camera may be balanced by the positioning handle without loosening the camera tie-down screw. Something every camera man has always desired.

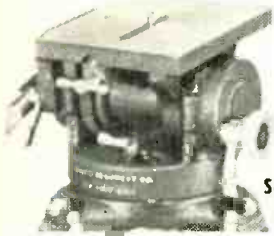

NEW PORTABLE 3-WHEEL COLLAPSIBLE DOLLY

Dolly folds to fit into carrying case—18"x12"x36". Weighs only 60 lbs. Has wheel in rear for steering, which may be locked for straight dollying.

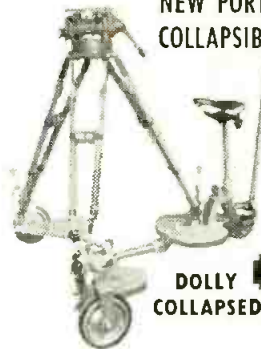

DOLLY COLLAPSED



MICRO RELAY

Micro wave relay beam reflector head, also metal tripod. Head is perfect for parabolas up to 6 ft. diameter, withstands torque spec's environmental treated. Tripod legs work in unison, one lock knob, spurs and rubber foot pads included.

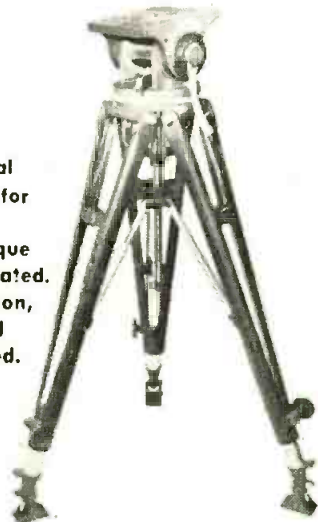

Famous **BALANCED** TV Head supporting a TV camera. Both are mounted on one of our all-metal tripods, which in turn is mounted on a **Ceco Spider Dolly**. Here is a "team" outstanding for versatility and maneuverability in studio or on location.



WRITE FOR COMPLETE ILLUSTRATED BROCHURE

FRANK C. ZUCKER

CAMERA EQUIPMENT ©

Dept. T-2-15 • 1600 Broadway • New York City

WHEN YOU SPECIFY . . . MAGNETIC SHIELDS SPECIFY . . .



MAGNETICS inc.

*Performance -
Guaranteed*

HERE'S WHY . . .

Shielding is a vital element in circuit design, and the Magnetics, Inc. "Performance-Guarantee" on your shields is your assurance that they have been designed and manufactured to meet *your* performance specifications. You then know, whether your shields have been made from Mumetal, A.E.M. 4750, or from any other commercially available magnetic or non-magnetic material selected to meet your needs, they will make money for you on the assembly line by eliminating waste.

You also know that these Performance-Guaranteed Magnetic Shields cost no more—indeed, despite the fact that you have a guarantee of performance, they are sold at prices standard in the industry. Let our Engineering Department design your shields and production engineer to your cost requirements . . . one more important Magnetics, Inc. service to our customers.

How Do You Like Your Shields? . . .

Painted, lacquered . . . or unfinished? Painted . . . to match any equipment shade you select? From *any* commercially available material to meet your performance and cost needs? That's exactly how they're furnished by Magnetics, Inc. . . . to meet *your* specifications.

WANT THE COMPLETE STORY?

Write us . . . on your company letterhead . . . we'll be delighted to answer your questions. No obligation, of course. . . .

MAGNETICS inc.

DEPT. TT-14, BUTLER, PENNSYLVANIA

MIGHTY PERFORMANCE

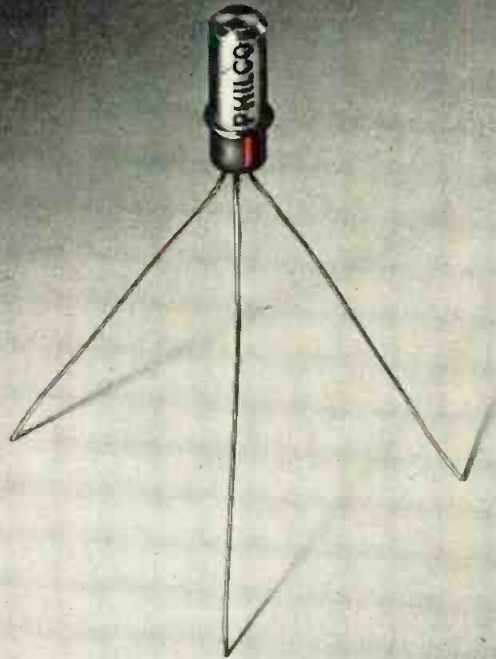

... IN A MINUTE PACKAGE !

with PHILCO Hermetically Sealed TRANSISTORS

Uniformity . . . low power consumption . . . small size . . . complete absence of microphonics . . . proven reliability . . . and resistance to shock and vibration. These are the all-important features of Philco alloy junction transistors which make them best for your application.

You will also welcome the simplified circuitry, ease of assembly and cost reductions now possible in transistorized products. And Philco production facilities

assure a dependable supply of high quality transistors —at a price which makes their use practical in new product design!

Employ Philco alloy junction transistors, and gain the benefits of their superior performance. Take the first step to improve your product and cut costs. Write today to Philco, Dept. T. Get complete technical specifications, price and delivery information on the Philco hermetically sealed transistor.

PHILCO CORPORATION

GOVERNMENT AND
INDUSTRIAL DIVISION

PHILADELPHIA 44,
PENNSYLVANIA

More IRC resistors are used by manufacturers



of military devices, instruments, computers,

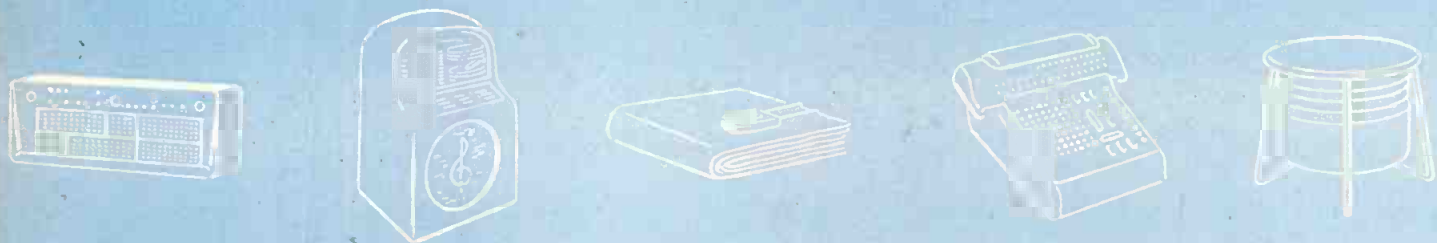

electronic and electrical equipment, appliances,



radio and television sets than any other brand.



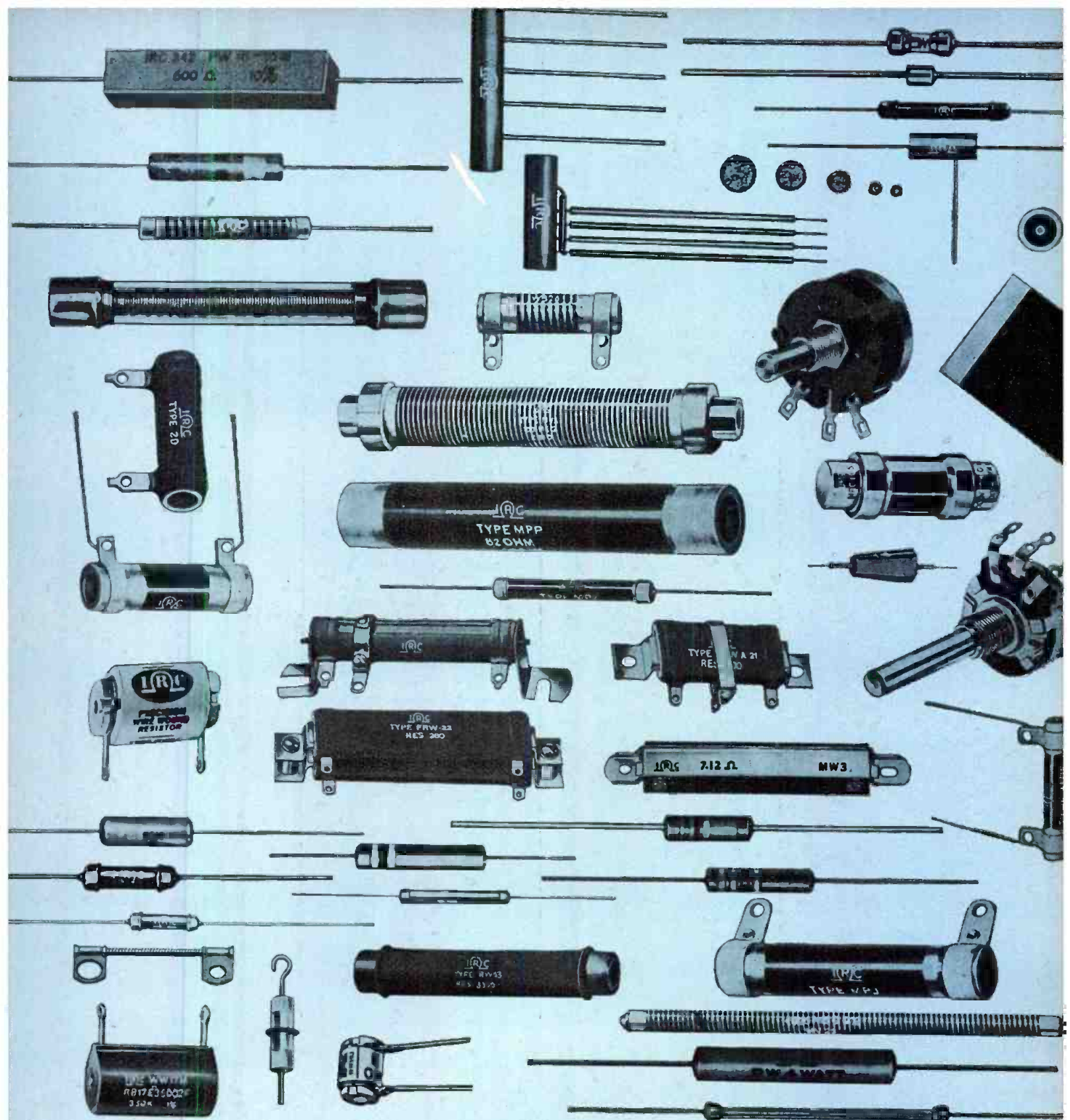

*IRC makes over 140 types of resistors
 we can afford to recommend without bias.*



International Resistance Company, 401 North Broad Street, Philadelphia 8, Pa.

Wholly Owned Subsidiaries: IRCAL INDUSTRIES, Los Angeles, California
 VAN DYKE INSTRUMENTS, Inc., St. Petersburg, Florida
 INTERNATIONAL RESISTANCE CO., Ltd., London, England

Canadian Branch: International Resistance Co., Ltd., 319 Carlaw Ave., Toronto

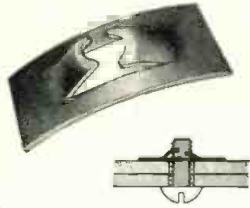

FLAT TYPE

One-piece self-locking spring steel fasteners. Replace threaded nuts, lock washers or spanner washers. Available in a wide variety of shapes and screw sizes.

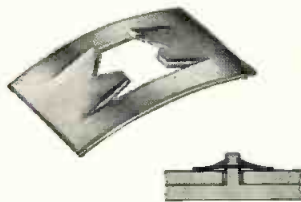

PUSH-ON

Zip over unthreaded die cast or plastic studs, rivets, nails, tubing, or wire to lock parts securely. Removable types available in many sizes.

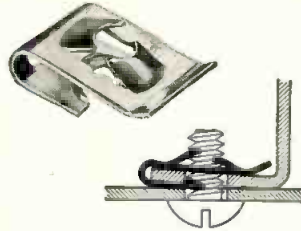

"J" TYPE

Snap over edge of panels and into center hole locations. Hold themselves in place for blind assembly. Full range of panel thicknesses and screw sizes available.

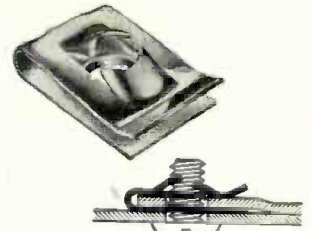

"U" TYPE

Perform same function as "J" type for reduced materials handling. Used where full bearing on lower leg of the SPEED NUT is required.

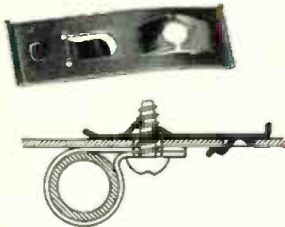

LATCH TYPE

Easily applied by hand, are self-retained in bolt-receiving position at center panel locations for blind attachments. Front mounting types are also available.

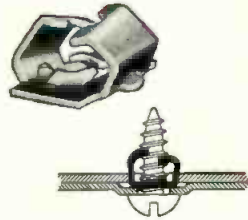

EXPANSION TYPE

For lightning-fast attachments in blind locations. Snap into mounting holes by hand. Screw spreads spring fingers, wedge-locks part in position. Secure, vibration-proof attachment.

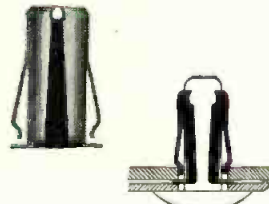

TUBULAR CLIPS

For use with unthreaded studs or rivets. Virtually "nails" panels together where there is access to one side only. Permanent lock or removable types.

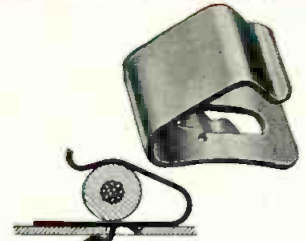

CABLE, WIRE, AND TUBE RETAINERS

Snap in place by hand, self-retained in position to receive wide range of cable, wire and tube sizes. Easily removed for service or re-location.

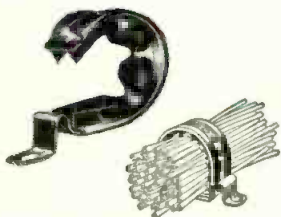

HARNESS CLAMPS

Open or close by hand — no tools needed. Attach to panel or pre-assemble to harness before installation. Cushioned to protect wires. Cannot open accidentally.

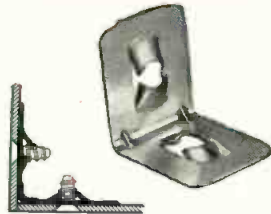

ANGLE BRACKETS

Combine bracket and fastener to reduce number of parts, speed up assembly and strengthen the structure. Variety of shapes and sizes.

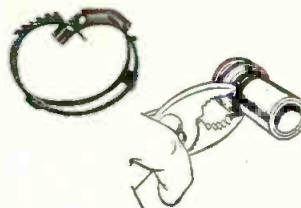

HOSE CLAMPS

Self-locking, ratchet-type design, one-piece low profile construction — no bolts, nuts or thumb screws. Fast and easy to apply and remove for medium- and low-pressure connections.

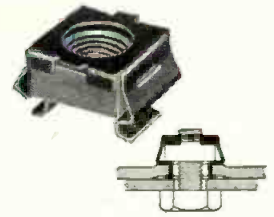

NUT RETAINERS

Retain square nuts in blind locations. No welding, clinching, staking — snap in by hand. Provided in a wide range of screw sizes. "U" and "J" type retainers available.



Engineer Savings into your products with SPEED NUTS® — The Fastest Thing in Fastenings!®

Assembly cost savings from 30% to 75% . . . increased product quality . . . reduced materials handling . . . far less field service problems. These are a few of the reasons why more and more manufacturers are specifying SPEED NUT brand fasteners. Write today for your copy of "Savings Stories" — a

book full of cost-saving fastening reports. **TINNERMAN PRODUCTS, INC.**, Box 6688, Cleveland 1, Ohio. *In Canada:* Dominion Fasteners Ltd., Hamilton, Ontario. *In Great Britain:* Simmonds Aerocessories, Ltd., Treforest, Wales. *In France:* Aerocessoires Simmonds, S. A., 7 rue Henri Barbusse, Levallois (Seine).

TINNERMAN

Speed Nuts®

MORE THAN 8000 SHAPES AND SIZES





SOME THINGS CAN'T BE RUSHED

IT TAKES TIME

TO DRIVE

SOME THINGS HOME...

... and it takes time to make a good recording disc

This is the era of short cuts in every industry. But PRESTO will not cut corners—or cut quality. There are six basic steps in making a PRESTO Recording Disc... and not a single step is ever hurried.

PRESTO's great investment of time... pays off in dividends for you. It assures you of the most brilliant performance in recording discs, and the greatest permanence as well.

**PRESTO GREEN · ORANGE · BROWN
AND WHITE LABEL DISCS ARE
USED THROUGHOUT THE
WORLD—WHEREVER
FINE RECORDING IS DONE**



PRESTO RECORDING CORPORATION
PARAMUS, NEW JERSEY

Export Division: 25 Warren Street, New York 7, N. Y.
Canadian Division: Instantaneous Recording Service, 42 Lombard St., Toronto

WORLD'S LARGEST MANUFACTURER OF PRECISION RECORDING EQUIPMENT AND DISCS

www.americanradiohistory.com

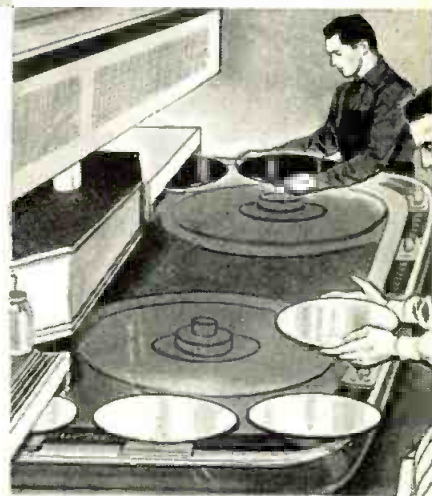

**TIME CONSUMING
STEP # 2**

**IN MAKING A PRESTO
RECORDING DISC**

Lacquer "makes" the surface of a recording disc. That's why PRESTO has a special lacquer formula and guards it as closely as atomic material. It is stored in constantly-agitated vats to insure even consistency. It is slowly flowed on to the polished aluminum blanks to precisely the thickness required. Then comes the long, leisurely, 1½ hour trip of the discs through the processing tunnel. PRESTO wouldn't shorten this trip by a second... because time is of the essence in making a fine recording disc.

Versatility Plus!

A New Voltage Regulated DC POWER SUPPLY

- for general laboratory and production line use
- power supply for many low voltage klystrons

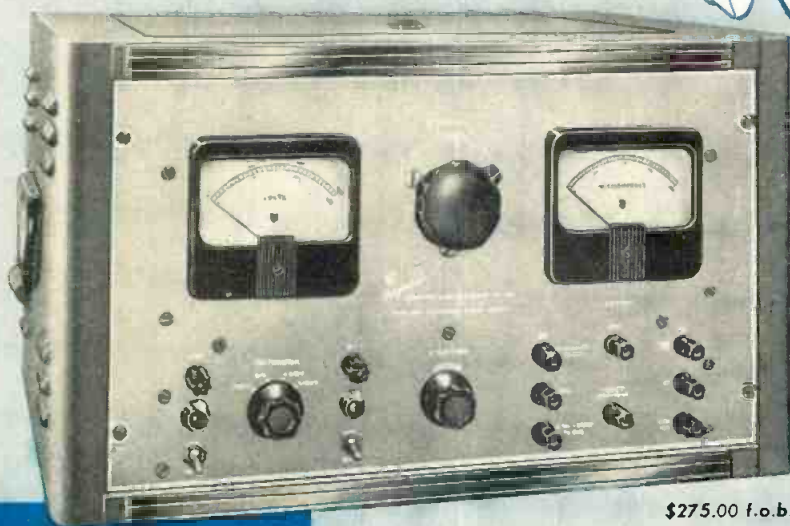

\$275.00 f.o.b. N. Y.

Features:

- Wider than usual output range:
"B" supply 0 to $\pm 600V$. at 200 ma.
"C" supply 0 to $-250V$. at 5 ma.
- Additional fixed supply $-250V$. at 50 ma.
- Unregulated 6.3V., 10A. C.T. filament supply
- Excellent voltage regulation (only $\pm .25V$.)
- Low ripple (less than 4 mv.)
- Input 115 or 230 Volts ac, 50/60 cps, single phase

The PRD Type 807 is a general purpose, constant voltage power supply, competitively priced to fit any instrument budget. It is conservatively rated for continuous service. Panel voltmeter monitors either supply voltage; milliammeter indicates "B" supply current. Write for bulletin.

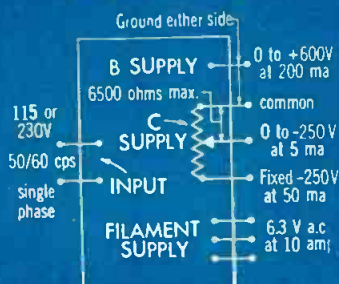

Flexible ground permits stacking of supplies to provide up to $-600V$. cathode voltage and an additional 0 to $-250V$. for the reflector of low voltage klystrons.

Polytechnic RESEARCH

& DEVELOPMENT CO. Inc

202 TILLARY ST.
B'KLYN 1, N.Y.
Telephone:
ULster 2-6800



Chicago Sales Office:
1 SO. NORTHWEST HWY., PARK RIDGE, ILLINOIS-TALcot 3-3174
Los Angeles Sales Office:
741 1/2 NO. SEWARD ST., HOLLYWOOD 38, CAL.-Hollywood 5-5287



(Continued from page 36)

idea of a machine that would not only supply inverse reactive current for use in unilateral phase detractors, but would also be capable of automatically synchronizing cardinal grammeters. Such a machine is the "Turbo-Encabulator." Basically, the only new principle involved is that instead of relying upon hydrostatic activation of the negative control mechanism the machine has a magnetic amplifier thrust action. The early attempt to construct a sufficiently robust spiral decommutator failed largely because of a lack of appreciation of the large quasi-elastic stresses in the gremlin studs. The latter were specifically designed to hold the roffit bars to the span-shaft. However, when it was discovered that wending could be prevented by a simple addition to the living sockets, almost perfect running was secured."

MOTORCYCLES are becoming one of the indirect victims of the electronic age. It seems that radar speed detectors used in conjunction with radio patrol cars are a more effective system for highway traffic control. In New York City alone, the new police procedure means that 186 of the 336 vehicles in the motorcycle corps will be retired. The ones to be retained will be used mainly for escorts and parking supervision.

NEW TWIST in labor relations comes from New Delhi, India. Government clerks, intent on calling attention to their wage demands, put in a couple hours' extra work, staying at their desks until 7 PM. Experts say there isn't much chance of this idea catching on in labor movements elsewhere.

LOW POWER TV, for small communities where operation would not otherwise be economically feasible, is contemplated by the FCC. In a Notice of Proposed Rule Making, it was indicated that regulations would be relaxed to permit satellite TV stations in cities with under 50,000 population. Minimum power requirements would be reduced to 100 watts for any antenna height, instead of 1 kw erp at antenna heights of 300 ft. above average terrain.

**Tops for
All Electrical Uses**



CLEVELITE*

LAMINATED PAPER BASE PHENOLIC TUBING

Outstanding for many years as the Top Performer, Clevelite is unmatched in its ability to meet unusual specifications.

Built-in Dimensional Stability, High Dielectric Strength, Low Moisture Absorption, Great Mechanical Strength, Excellent Machining Qualities and Low Power Factor make Clevelite Tubing outstanding.

Available in diameters, wall thicknesses and lengths as desired, for Collars, Bushings, Spacers, Cores and Coil Forms.



Our new Torkrite internally threaded and embossed tubing affords better control of adjustments in coil forms using threaded cores.

Write for your copy of the latest Clevelite brochure.

WHY PAY MORE? For Good Quality . . . call CLEVELAND!

*Reg. U. S. Pat. Off.

The **CLEVELAND CONTAINER Co.**
6201 BARBERTON AVE. CLEVELAND 2, OHIO

PLANTS AND SALES OFFICES at Chicago, Detroit, Memphis, Plymouth, Wis., Ogdensburg, N. Y., Jamesburg, N. J.

ABRASIVE DIVISION at Cleveland, Ohio

CANADIAN PLANT: The Cleveland Container, Canada, Ltd., Prescott, Ontario

REPRESENTATIVES

NEW YORK AREA R. T. MURRAY, 604 CENTRAL AVE., EAST ORANGE, N. J.
NEW ENGLAND R. S. PETTIGREW & CO., 62 LA SALLE RD., WEST HARTFORD, CONN.
CHICAGO AREA PLASTIC TUBING SALES, 5215 N. RAVENSWOOD AVE., CHICAGO
WEST COAST IRV. M. COCHRANE CO., 408 S. ALVARADO ST., LOS ANGELES



Take advantage of our
Fast Dependable Delivery.

ALTEC LANSING

"Lipstik"

MICROPHONE

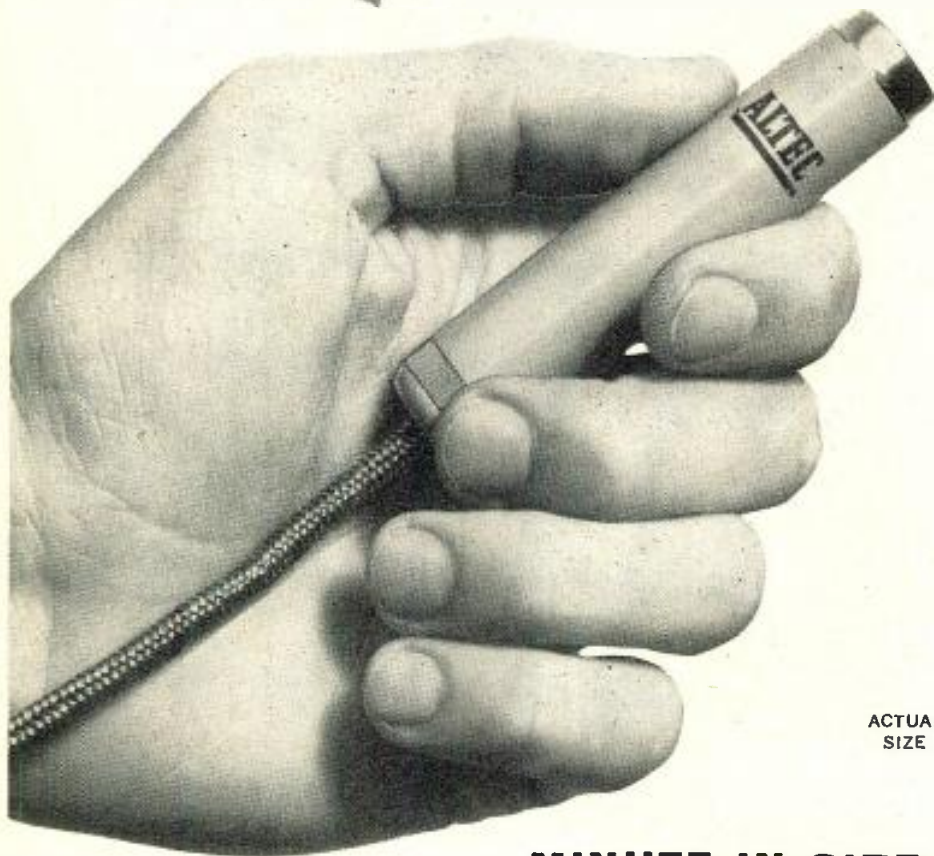

ACTUAL SIZE

**MINUTE IN SIZE
MAMMOTH IN PERFORMANCE
MAGNIFICENT IN QUALITY
UNIQUE IN VERSATILITY**

These are the qualities that set ALTEC'S new "LIPSTIK" apart from all other microphones.

The "LIPSTIK" is the answer to the universal demand for a microphone small in size ($\frac{5}{16}$ " in diameter and 3" long)—versatile in use (equally efficient for use on a stand, in the hand or clipped to the lapel)—superb in quality (see the incomparable frequency response which is unconditionally guaranteed).

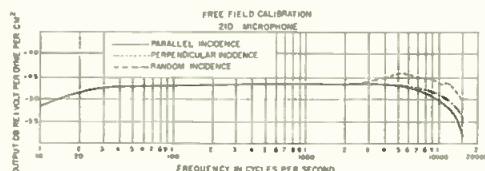

This microphone response curve is in agreement with measurements made by General Radio Company and other major acoustical laboratories.

Order as an M-20 system, which includes the 21D microphone — 165A base — P525A power supply, and all attachments.



A SOUND REPUTATION SECOND TO NONE

9356 Santa Monica Blvd., Beverly Hills, Calif.
161 Sixth Avenue, New York 13, N.Y.

Letters . . .

Developing "Super Engineers"

Editors, TELE-TECH:

Your December editorial on "It's Later Than You Think" was excellent as another step in meeting our critical technical manpower race with the Soviet Union. I am glad to see this problem receiving increasing recognition, though I think that our efforts are in danger of being misdirected. Most of the 10-point program which you recommended is sound, at least as far as it goes.

Where I think that you and others have stopped short of the heart of this problem is in not stressing the need for quality as well as quantity of the engineers we train. We try to compare our training programs with those of Russia on the basis of graduates per year in all scientific fields, probably because we can count heads better than we can measure what is in them.

Little is known as yet concerning the quality of the Russian engineers emerging from their accelerated training programs, but my guess is that the average quality is apt to decrease. There certainly is a real danger of our lowering the average quality of our own engineering graduates by any all-out effort to increase their numbers. I and many others feel that it may be more feasible and profitable to train a select group of "super engineers" than just to increase the total number of engineering graduates greatly.

My observation has been that many of our engineering schools find it necessary to gauge their teaching to the average or even to the lower quarter of their classes, particularly after the Freshman year, in order to avoid excessive mortality among the students. At private schools which operate primarily from tuition fees, this is a matter of economic necessity whereas in state schools, it is governed by vociferous protests from irate taxpayers whose sons get eliminated. At least one well-known school, however, seems to go to the opposite extreme of "pitching" to the top of the class and relaxing the requirements on the remainder sufficiently to avoid excessive mortalities. As a consequence, their top graduates are acknowledged as being excellent, but those who barely pass often are suffering from such acute mental indigestion as to be less useful than

(Continued on page 50)

A NEW TELEMETER STANDARD

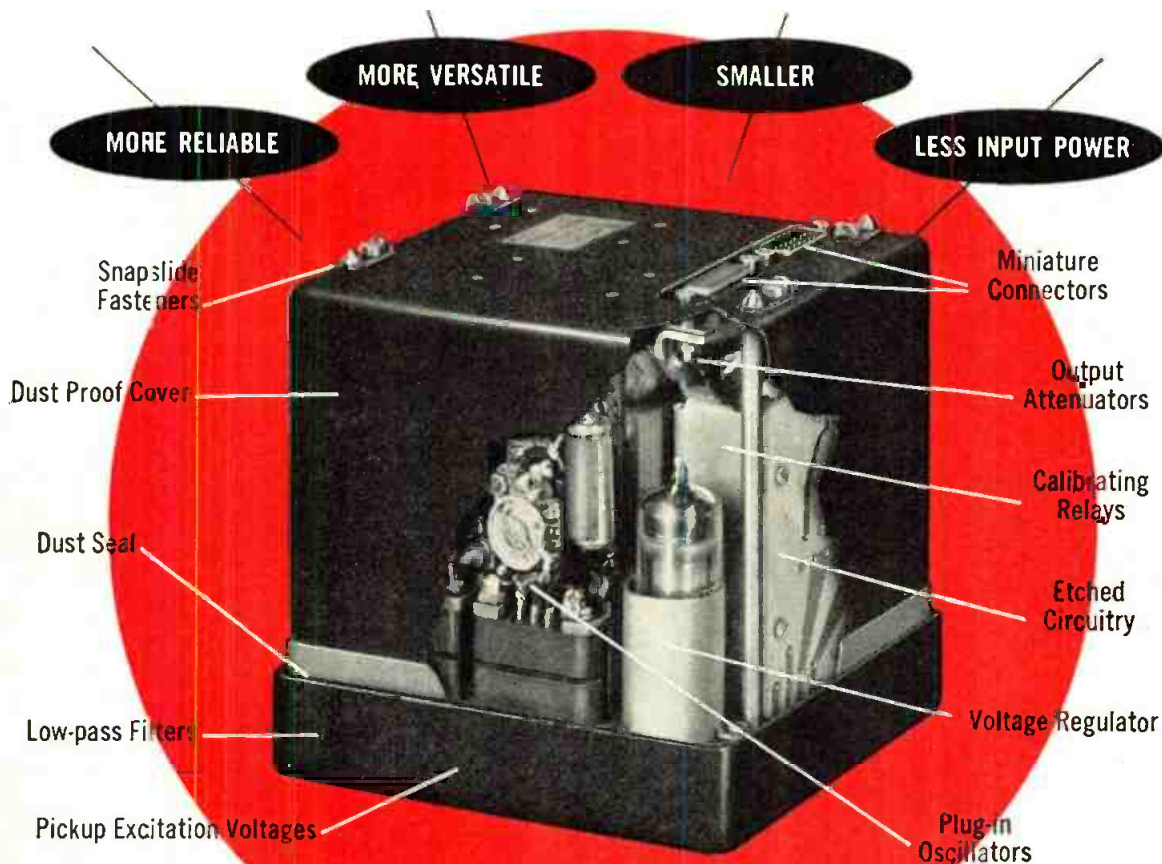

BENDIX-PACIFIC TATP-4 & 5 PACKAGES

These compact Bendix-Pacific Telemetry Packages offer users of telemetering systems a better means to instrument such quantities as pressure, force, temperature, voltage, acceleration and vibration.

The units are smaller and various combinations may be used to provide compact multi-channel systems of up to 18 subcarrier bands. Each unit operates on unregulated +150 VDC and 28 VDC since it contains its own voltage regulating circuits. Each unit may be provided with individual relays for switching oscillator inputs from signal to calibrate position. Model TATP-4 contains four and Model TATP-5 contains six separate and independent regulated +5 VDC excitation voltage

sources for use with resistance type pickups.

No vacuum tubes are required in mixing the outputs of the individual subcarrier oscillators to the composite audio signal for direct modulation of the RF transmitter, thus greatly improving the reliability of the system at a point where a tube failure would affect all subcarrier channels.

Standard Bendix Model TPP-6 Power Supplies are available to handle from one to three of these telemetry packages plus a 2 watt crystal controlled RF transmitter. Many types of interchangeable subcarrier oscillators are also available. RF amplifiers are available for increased power outputs up to 100 watts.

CHARACTERISTICS

	TATP-4	TATP-5
No. of bands	4	6
Subcarrier bands	1.7 kc. to 70 kc.	1.7 kc. to 70.0 kc.
Oscillator Types	TOE-30V, TOE-31V, TOR-8V, TOR-9V, TOL-9V	Same as TATP-4
Input Voltages	6, 12, or 24 VDC $\pm 10\%$ 150 VDC $\pm 10\%$	6, 12, or 24 VDC $\pm 10\%$ 150 VDC $\pm 10\%$
Weight (Less Oscillators)	Approx. 2 lbs.	Approx. 3 lbs.
Dimensions	5.0" x 5.0" x 4.5"	5.0" x 7.5" x 4.5"

Write for Complete Information

TYPICAL 10 BAND SYSTEM

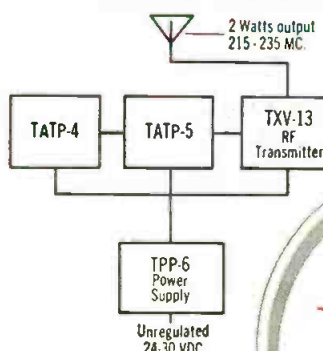

PACIFIC DIVISION • Bendix Aviation Corporation
11610 Sherman Way, North Hollywood, California

RADAR



SONAR



HYDRAULICS



TELEMETERING



ELECTRO-MECHANICAL

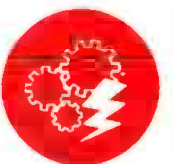

ULTRASONICS



Top pulse performance is an Eimac Tube Feature

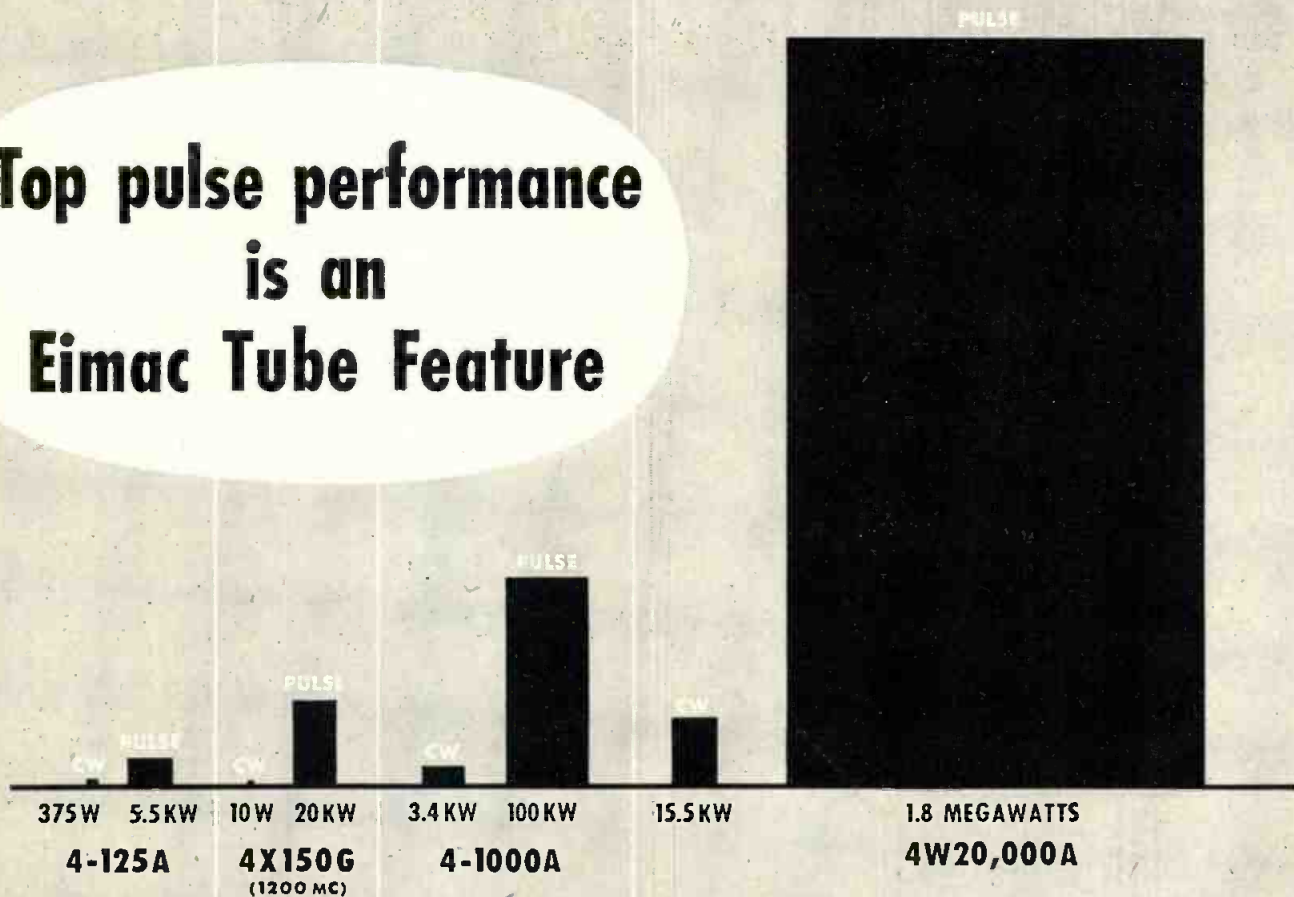

EXAMPLE OF HIGH POWER OUTPUT CAPABILITIES OF EIMAC TUBES
IN TYPICAL PLATE PULSED RF AMPLIFIER OPERATION

The chart on this page illustrates the amazing power capabilities of versatile Eimac broadcast and communications tubes in typical pulse amplifier application. Incomparable pulse performance is a feature of Eimac tubes stemming from reserve filament emission and ability to handle high electrode voltages and resulting currents. This, plus clean, simple design, free of troublesome internal insulators, and advanced production techniques, produces an unmatched quality enabling Eimac tubes to give long, reliable performance in pulse RF operation and pulse modulator service.

In addition to pulse rated CW tubes, Eimac has designed and produced many tube types specifically for pulse application. The 4PR60A radial-beam pulse tetrode, pictured here, is one of this famous family. An oxide coated cathode tube,



it delivers 300kw of power output in pulse modulator service with only one kilowatt of pulse driving power. From the 100T power triode, used in the first Navy sea radar tests, to the 4W20,000A, Eimac pulse-rated tubes have filled key sockets in sea, land and air pulse operation.

Contact our Technical Services Department for your free copy of Eimac application bulletin No. 3, "Pulse Service Notes."



EITEL-McCULLOUGH, INC.
SAN BRUNO, CALIFORNIA
THE WORLD'S LARGEST MANUFACTURER OF TRANSMITTING TUBES

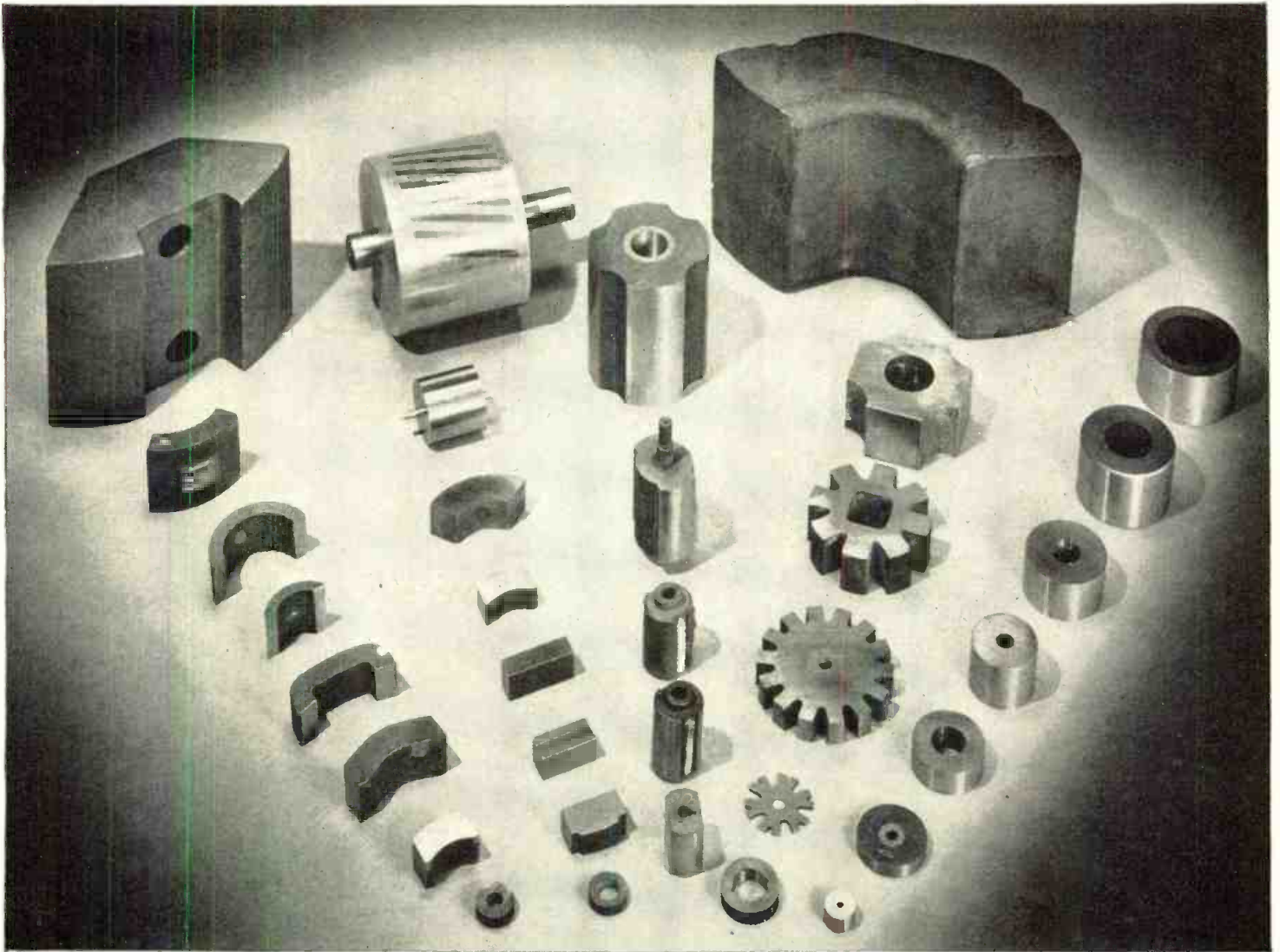

Magnets for rotors or stators ...any design or size you may require



"MAGNETIC MATERIALS CATALOG"

Write for your copy

Contains handy data on various types of Alnico Magnets, partial lists of stock items, and information on other permanent magnet materials. Also includes valuable technical data on Arnold tape-wound cores, powder cores, and types "C" and "E" split cores in various tape gauges and core sizes.

ADDRESS DEPT. T-52

The use of Alnico permanent magnets in rotor and stator assemblies of motors, generators, magnetoes and tachometers has revolutionized the designs of these devices. Whatever your need may be—from a tiny rotor for a timing device to a large slab for power generators—Arnold can take care of your requirements, either for experimental samples or production quantities.

- *Let us work with you.* You will have the advantage of working with a leading producer of rotor magnets, whose manufacturing and testing facilities—the most modern in the business—give you the best assurance of high quality standards and uniform performance.

W6D518-4

THE ARNOLD ENGINEERING COMPANY

SUBSIDIARY OF ALLEGHENY LUDLUM STEEL CORPORATION

General Office & Plant: Marengo, Illinois

DISTRICT SALES OFFICES . . . New York: 350 Fifth Ave.

Los Angeles: 3450 Wilshire Blvd.

Boston: 200 Berkeley St.



Letters . . .

(Continued from page 46)

corresponding graduates from the mass production state universities.

The logical (?) solution would seem to be to skim off the embryonic geniuses from all schools, preferably during high school or before, send them to special schools and accelerate and improve the quality of their training to whatever extent they can take. I recognize that this may seem to be a violation of our democratic traditions and that it also is fraught with economic and sociological complications. Potential rewards seem to justify the effort necessary to solve these problems. Looking over the members of our profession, one cannot help be impressed by the fact that a relatively few "geniuses" make most of the outstanding technical contributions which then are exploited by their less gifted colleagues. Advances in technology are what can beat Russia rather than just large-scale refinements and applications of our existing technology. Consequently, we may be harming ourselves worse in stunting the development of one man who might have been able to lick the problem of direct nuclear propulsion, or any of the host of other really important problems, than we would gain by doubling our rate of training average engineers.

It seems that relatively few schools are interested in or capable of upgrading their engineering and scientific training to the extent necessary. One obvious reason is the economic advantages of standardized curricula; they cannot justify setting up special "genius sections." Second, they take the viewpoint that they cannot cater to the needs of those few of their graduates who enter research and advanced development and need a high level of technological training. They try to adjust their curricula to the needs of the mythical average graduate, but this average graduate doesn't remain in technical engineering for more than five years or whatever time it takes him to drop hopelessly behind, because he can't read the technical literature intelligently enough to continue growing in his profession. Third, schools are placing greater reliance on graduate training in an effort to bring their men up to the necessary level of technical competence, and this, in turn, is having a degrading influence on quality of

(Continued on page 146)

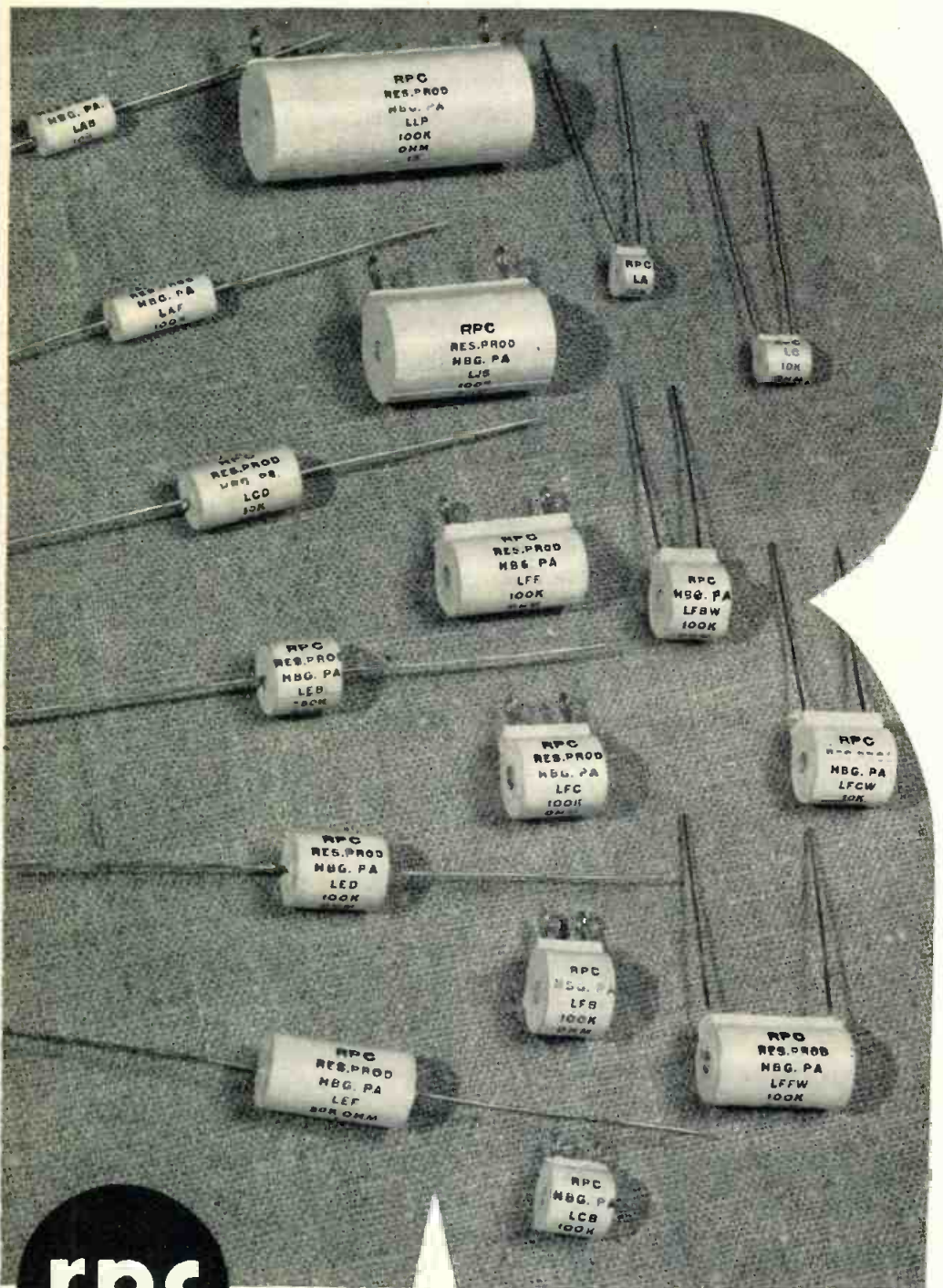

rpc

Encapsulated Precision Wire Wound Resistors Defy Shock, Vibration and Extreme Changes

Completely sealed in epoxy resin and wound on steatite bobbins, RPC has engineered Type L Resistors that are protected against extreme humidity, temperature and altitude conditions, mechanical damage, while maintaining dimensional stability.

Type L Resistors, in many tests, have withstood 30 humidity cycles of MIL-R-93A moisture resistance tests without deterioration. They fully meet the requirements of U.S. Govt. Specifications MIL-R-93A. Not affected by extremes in humidity, altitudes, and corrosive influences; protected against outside elements.

RPC can supply Type L on short notice with lug type terminals or wire leads; in a complete line of standard, midget and sub-miniature sizes. Wide range of performance! Write for catalog or additional details.

Sales representatives in all principal cities of the U.S.

RESISTANCE PRODUCTS CO.

714 RACE STREET • HARRISBURG, PENNA.

Makers of Resistors — High Megohm, High Voltage, High Frequency, Precision Wire Wound

here's why you get
EXTRA LENGTH
plus
**EXTRA
 STRENGTH**



with **LR audiotape** on **Mylar** polyester film

NOW YOU can get the *extra length* that many tape recording applications require, without any sacrifice in strength or durability. For the new Type LR Audiotape, made on 1-mil "Mylar," actually has greater impact, tensile and tear strength than even the conventional plastic-base tape of 50% greater thickness.

And because "Mylar" withstands extreme temperatures and is virtually immune to humidity, LR Audiotape stands up longer under the most severe conditions of use and storage.

This Longer Recording Audiotape is now available in 900, 1800 and 3600-ft. reels. Audio also offers a complete standard line of Audiotape on "Mylar," in 1, 1½ and 2-mil base thickness. Test it—compare it with any other tape on the market. In *performance* and *durability*, it speaks for itself!

HOME RECORDISTS — CHURCH RECORDISTS:

Enter Audio Devices' **BIG PRIZE CONTESTS** for the best articles on "How I Use My Tape Recorder."

WIN a V-M "tape-o-matic" recorder, plus \$100 cash, plus 20 7-inch reels of Audiotape. Ten other valuable awards, too!

Contest closes April 1, 1955. See your Audiotape dealer, or write to Audio Devices today for complete details. There's nothing to buy!

Table I TESTS AT 75°F, 50% RELATIVE HUMIDITY

	Yield Strength	Breaking Strength
1 mil Acetate	3.7 lb.	3.9 lb.
0.9 mil "Mylar"	4.2 lb.	7.6 lb.
1.45 mil Acetate	5.0 lb.	5.5 lb.

Table II TESTS AT 75°F, 90% RELATIVE HUMIDITY

	Yield Strength	Breaking Strength
1 mil Acetate	1.8 lb.	2.5 lb.
0.9 mil "Mylar"	4.1 lb.	7.6 lb.
1.45 mil Acetate	3.0 lb.	4.1 lb.

The above test data, taken under conditions of both winter and summer humidity, show the marked superiority of 1-mil "Mylar," not only over the thin cellulose acetate base, but over the standard 1.45-mil acetate as well.

*Dupont Trade Mark

AUDIO DEVICES, Inc.

444 Madison Avenue, New York 22, N. Y.
 Offices in Hollywood • Chicago
 Export Dept., 13 E. 40th St., N. Y. 16, N. Y., Cables "ARLAB"



PANORAM DOLLY gives camera complete mobility; smooth panning, dolly shots, running shots, special effects. Two man crew.



CINEMOBILE offers extreme maneuverability. Camera boom raises hydraulically. Ideal for smooth dollying, panning, etc. Two man crew.



HOUSTON-FEARLESS TC-1 CRANE raises camera to extremely high and low positions. Permits "fluid motion" shots. Foot-operated panning.

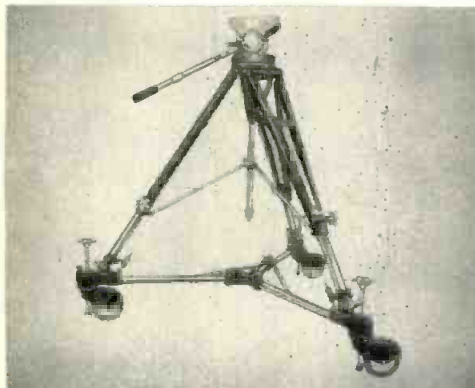

HOUSTON-FEARLESS All-Metal Tripod on Tripod Dolly gives mobility to cameras at low cost. Completely portable. Ideal for remotes.

CAMERA is counterbalanced in Model PD-3 TV Pedestal by Houston-Fearless, enabling cameraman to raise or lower with ease.



WHICH TYPE OF CAMERA MOUNT SHOULD YOU BUY?

Proper mounting of television and motion picture cameras is essential for efficient operation, smooth production and good showmanship. Choice of mobile equipment should be determined by the size of your studio, types of shows, size of camera crew, camera equipment used, budget and many other factors.

Each piece of Houston-Fearless equipment shown here has been designed

for a specific purpose. Each is the finest of its type, the standard of the industry.

A Houston-Fearless representative will be happy to analyze your requirements and recommend the equipment that will serve you best. Write or phone: The Houston-Fearless Corp., 11801 West Olympic Boulevard, Los Angeles 64, California. BRadshaw 2-4331. 620 Fifth Avenue, New York 20, N. Y. CIRCLE 7-2976.



MODEL BT-1 CRANE has power drive, hydraulic lift. Provides lens height from 2' to 10'. Fearless is operated by cameraman. Rolls smoothly, raises, lowers, turns on own radius. Developed for Motion Picture Research Council.



TV PEDESTAL MODEL PD-1 by Houston-Fearless is operated by cameraman. Rolls smoothly, raises, lowers, turns on own radius.

THE TAPE YOU'VE BEEN WAITING FOR!

SOUNDCRAFT
PLUS 50
 (50% EXTRA PLAYING TIME)
 magnetic recording tape

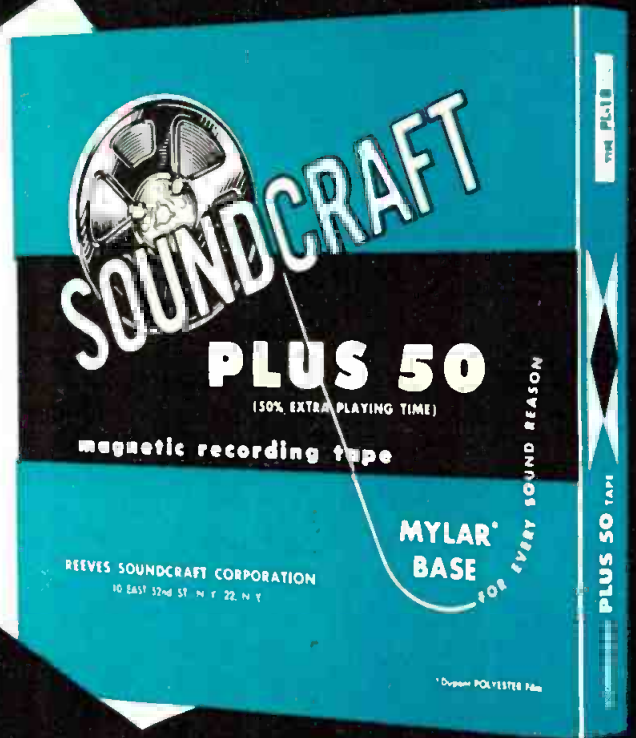

- 50% EXTRA PLAYING TIME
- EXTRA STRENGTH "MYLAR" BASE
- FULL DEPTH OXIDE COATING
- . . . YET COSTS NO MORE

PLUS 50

is the *perfected* "long-playing" magnetic tape, bringing you 50% extra playing time with no compromise in strength or recording quality.

One reel of "Plus-50" is equal in recording or playback time to 1½ reels of standard tape. More listening per reel . . . less time changing reels. Best of all, Soundcraft "Plus-50" *actually costs less per foot* than quality acetate-base tapes!

The secret of "Plus-50" lies in its extra thin "Mylar" base (1 mil as compared to 1.5 mils in acetate tapes). "Mylar," DuPont's Polyester Film, con-

tains no plasticizer. It will not cup or curl. Elongation and shrinkage from heat, cold and humidity are barely measurable. And it's far stronger than the thicker acetate . . . one third as strong as steel!

There has been no compromise in the development of "Plus-50"—a big advantage for you! The oxide coating is *constant, full-depth*—to maintain correct frequency response, output level, and bias characteristics. No machine adjustments are needed. "Plus-50" can be interspliced with other fine quality tapes without level change.

See your Soundcraft Dealer for "Plus-50" as well as these other famous Soundcraft Magnetic Recording Tapes:

Soundcraft Recording Tape (in the box with The Red Diamond) the all-purpose "Standard of the Industry."

Soundcraft Professional Tape (in the box with The Blue Diamond) for radio, TV and recording studios. Splice-free up to 2400 feet. Standard or professional hubs.

Soundcraft LIFETIME® Tape (in the box with The Yellow Diamond) for priceless recordings. DuPont "Mylar" base. For rigorous use . . . perfect program timing. Store it anywhere virtually forever.

Soundcraft Tapes are the world's finest—and yet they cost no more.

FOR EVERY SOUND REASON

REEVES **SOUNDCRAFT** CORP.
 10 East 52nd St., New York 22, N.Y.

Hughes

high temperature operation

Silicon

extremely high back resistance

Junction

exceptionally stable characteristics

Diodes

Now you can take advantage of silicon's operating temperature range and obtain, at the same time, a semiconductor device with phenomenally high back resistance. Actually, many of the types of the new Hughes Silicon Junction Diodes provide essentially an open circuit in the back direction. This means that many entirely new circuit applications are now made possible.

The entire line of these new Silicon Junction Diodes is packaged in the one-piece, fusion-sealed glass body, originated and developed at Hughes. This now-famous construction is impervious to moisture penetration—ensures electrical and mechanical stability. With their axial leads and subminiature size, Hughes diodes are easier to mount, easier to spot-weld or solder. So, when temperature or high back

resistance requirements call for silicon, be sure to specify *Hughes Silicon Junction Diodes*.

Electrical features: Good forward conductance . . . very sharp back voltage breakdown . . . extremely high back resistance.

Physical features: One-piece, fusion-sealed glass body. . . axial leads for easy mounting . . . subminiature size.

Actual size, diode glass body: 0.265 by 0.103 inches, maximum. Body is coated with opaque silicone enamel to shield crystal from light. Color-coded on cathode end. Ambient operating temperature range: -80° to +200° C.



		SEMICONDUCTOR SALES DEPARTMENT	
<i>Aircraft Company, Culver City, Calif.</i>			
		New York Philadelphia	Syracuse Chicago

the first NEW DESIGN of selenium rectifiers IN OVER 20 YEARS

KOOL-SEL[®]
Pat. pend.
by PYRAMID

No center mounting
Full air ventilation between plates
Light contact and constant assembly pressure
No center hot spots
Lightest weight per unit of output power
Lower initial forward resistance—better voltage regulation
Smaller overall size for each rating—cost no more

Better for all electrical and electronic equipment because of

- Improved convection cooling
- Simpler mounting
- Longer life and minimum aging
- Designed for more rugged service and rated for use in high ambient temperatures

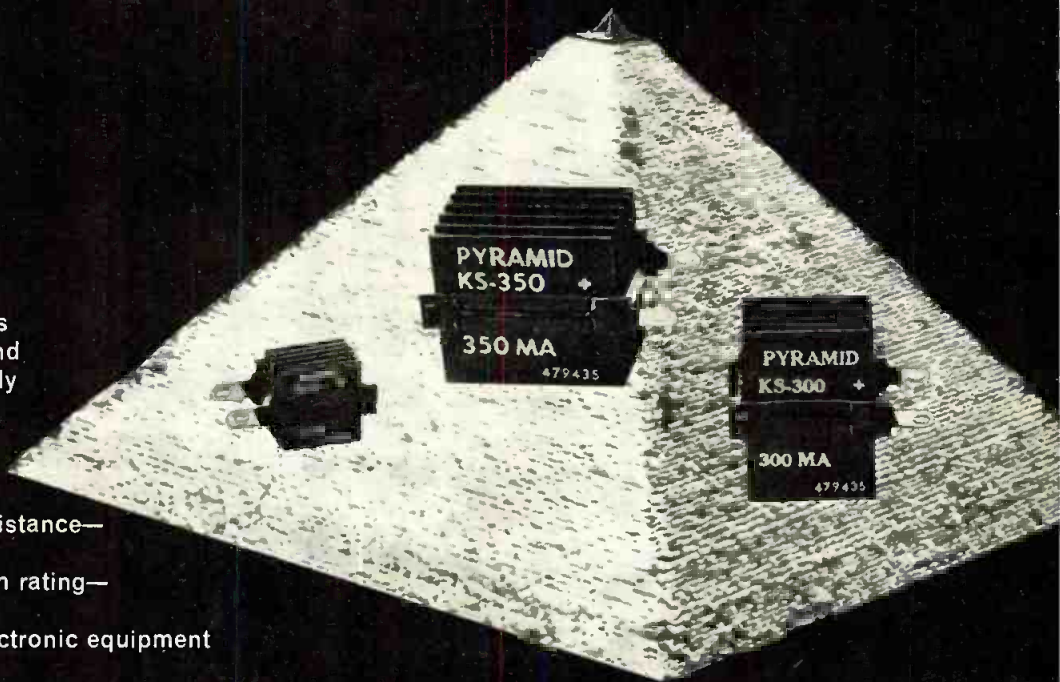

KOOL-SEL[®] **Important** is the rectifier most readily adaptable to printed circuit applications.

Because of the fixed edge mount yoke, assembly requires only one whistler die, one hole fixed, one hole variable to three dimensions. For complete information write

RECTIFIER DIVISION



PYRAMID ELECTRIC COMPANY North Bergen, N. J.

new design freedom with

Sprague Button Ceramic Capacitors



Self-Tapping Stud Style

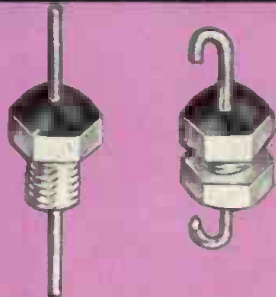

Flatted Screw Thread Mounting Style

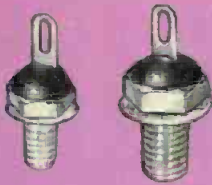

Screw Stud Mounting Style



Dual-Section Threaded Shell Style



Sprague button ceramic capacitors offer distinct advantages to designers of ultra-high-frequency TV receivers and electronic equipment. These tiny capacitors are available in many styles for coupling, bypass, and feed-thru applications. Their wafer-dielectric construction makes possible higher self-resonant frequencies than with capacitors using conventional dielectric tubes. Button stand-off types, for example, minimize ground inductance and hold it at a fixed value while providing a short, uniform bypass to ground. They also provide effective shielding of the capacitor element by the outer metal shell. Sprague button capacitors are sealed against moisture by a high temperature resin, and are conservatively rated at 500 volts d-c.

For complete engineering data, write for Bulletin 605A to Technical Literature Section, Sprague Electric Company, 233 Marshall Street, North Adams, Massachusetts.

Sprague, on request, will provide you with complete engineering service for optimum results in the use of ceramic capacitors—buttons, discs, plates, printed r-c networks, high-voltage molded, etc.

WORLD'S LARGEST CAPACITOR MANUFACTURER

SPRAGUE®



Ferrule Shank and Clip Style

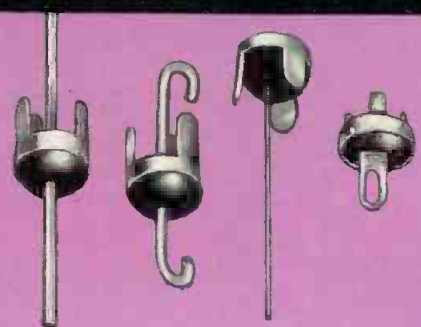

Tab Mounting Style

TELE-TECH

& Electronic Industries

O. H. CALDWELL, Editorial Consultant ★ M. CLEMENTS, Publisher ★ 480 Lexington Ave., New York 17, N. Y.

Bargain Days for Uncle Sam

Today the government is receiving the most colossal bargains ever offered in their purchase of military electronic equipment. From every quarter come rumors and reports that government contracts today are being let at prices that in some instances are even below the cost of the materials involved.

Why are manufacturers grabbing at available jobs even though they know they will lose money? First, the present trend to consolidate equipment items and to offer them as a package to one prime bidder has the effect of reducing the number of prime manufacturers. Prime manufacturers so reduced have to rely on subcontracting in order to stay in business. But, with the concurrent policy of production "slow-up" and delivery "stretch-out" the larger prime manufacturers, also desirous of retaining their large engineering staffs and keeping their production facilities rolling, keep most of the work in the house and subcontract for less and less. The new government fiscal year starts in July and the hope is that more military electronic contracts will be forthcoming in early Fall. But meanwhile the desperate struggle of the manufacturers to maintain trained staffs and to make productive use of plants and facilities goes on. We know that the government doesn't expect any manufacturer to produce without "fair profit," but apparently it does not have provision in its procurement procedures to "guarantee" at least the costs of materials and overhead to responsible bidders. The present policy should be carefully reviewed. With the low profits in commercial products, and with losses in military contracts, the government may unwittingly be forcing disastrous conditions on the industry. It is also in a sense creating on the one hand conditions which it seeks to destroy on the other. Reducing the number of prime contractors has the effect of supporting big business or monopoly. And this later has to be taken apart by anti-trust suits.

Another Look at Fee-TV

A few years ago (July 1952) we discussed the technical and operational considerations affecting subscription television service. At that time we noted the growing trend that "program costs are becoming so tremendous that even our largest advertisers have had to trim down their schedules by going on alternate weeks." In addition to this economic problem, many theater shows, first run movies and sports events have not been made available to the home audience. Also, there has been considerable criticism—at times unjustified—of the poor quality of programs.

Perhaps the practice of allowing the public to select and pay for the programs it wants will cure these ills. We can't be sure, and we do not see how anyone else can proclaim a positive yea or nay at this point. But we

are sure that it's desirable to set it up on a commercial basis to permit evaluation. You never know unless you try. Experimentation is the cortex behind all American industry.

Indications are that the FCC plans to give full consideration to fee-TV this year. The companies that have fought so long for its adoption, including International Telemeter, Skiatron, and Zenith's Phonevision, should be heard with a sympathetic ear.

TV Antenna Checkup

Way back in March 1954, in the editorial headed "Let's Solve Our Own Problems!," we called especial attention to the "over-enthusiastic" advertising claims of antenna manufacturers whose published performance curves were dreams rather than realities. A strong industry self-policing was urged to avoid government intervention. We hate to say "We told you so" but nevertheless, it's a fact. The Federal Trade Commission is now looking into this situation and there's a possibility of a citation as well as a trade-industry conference. Orchids for the engineers, however. RETMA has established a new antenna standards committee which is scheduled to have its first meeting next month. Tight engineering standards will go a long way toward keeping exaggerated sales claims in check.

How Much Censorship?

Good intentions often do not result in good accomplishments. The policy of the Commerce Department's Office of Strategic Information appears such an example. In the words of the agency's director, R. Karl Honaman, "Because the cold war poses certain problems in the exercise of freedom of the press, we desire to define the objectives of this new office as plainly as possible. At the outset we emphasize that we do not propose government censorship, real or implied. This Office is concerned only with the kinds of information and 'know how' a potential enemy could use to injure us, yet which cannot be properly handled by (security) classification." Such data would be submitted voluntarily by editors for OSI approval prior to publication.

There are a number of ramifications quite likely to go contrary to stated intentions. For one, a well established precedent of "voluntary cooperation" takes on a "mandatory" flavor in time. But most important is the questionable value of cutting off free access to non-classified technical information. Considering that American publications have a much wider circulation in the U.S. than anywhere else, the reduced dissemination of information would probably cause still greater harm to our own engineers and scientists. Responsible editors usually screen out material of direct military value in any event, since they are acutely aware of the significance of specific developments in their field.

RADARSCOPE

Revealing important developments and trends throughout the spectrum for radio, TV and electronic research, manufacturing and operation

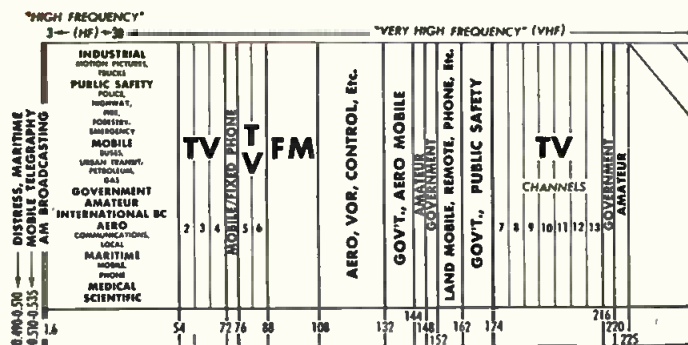

NEW GOVERNMENT agency, the Office of Strategic Information, is under fire for advocating a "voluntary" curb on the publication of non-secret technical data which might aid unfriendly nations. The Freedom of Information Committee of the American Society of Newspaper Editors charged that such intervention is a kind of censorship, and that a clear definition of strategic information has not been formulated by OSI.

RADIO INTERFERENCE with complex weapons systems continues to receive the great attention necessary, both with regard to spurious radiation as well as intentional jamming. At a recent meeting at Armour Research Foundation, Defense Department official John W. Klotz estimated that over \$200,000,000 is spent annually on the department's interference control program. As an example he cited an airborne transmitter which renders the plane's altimeter useless at certain frequencies, and also triggers beacon marker lights on the instrument panel.

GEODIMETER for measuring distances accurately by using an electronic-optical means is being evaluated by the Corps of Engineers' Research and Development Labs. The device was developed by Swedish geodesist Dr. Erik Bergstrand. (Technical details given on page 68, Sept. 1954 *Tele-Tech & Electronic Industries*.)

HIGH-PURITY SILICON



Dr. Hubbard Horn, physical chemist at the General Electric Research Lab., is demonstrating the "zone melting" process for production of high-purity silicon. This method of refining consists of successive recrystallizations of silicon as an ingot is slowly drawn through a gas-filled quartz tube. Induction coils can be seen, wrapped around the outside of the tube, causing the slowly moving ingot to melt in narrow zones. Impurities remain in the molten regions and are swept to the end of the bar.

TROPICALIZATION of military electronic gear with organic mercurial fungicides may be revived because of the recent discovery that certain vinyl-polysulfide resin blends form coatings that are highly impervious to mercury vapor.

ADVISORY COMMITTEE on Application of Machines to Patent Office Operations, under the chairmanship of Dr. Vannevar Bush, concludes that it would be unwise to attempt a transition to complete mechanization at this time. Instead, it recommends that work with industry and governmental agencies proceed in a limited area to develop new machines and techniques for full application at an appropriate time.

NARTB has made strong protests to Rep. Sam Rayburn, Speaker of the U.S. House of Representatives for the 84th Congress, concerning his statement that TV cameras will be banned from public Congressional hearings.

SILICON crystals produced by General Electric have reached a new level of perfection. Evidence of this is a quantity called "lifetime," referring to the length of time that an excess of electrons purposely injected to measure crystal quality takes to disappear. Usually this period is a few ten thousandths of a second or less. The lifetime of the new crystals is in excess of a thousandth of a second.

PRODUCT CONSUMPTION in the U.S. will double the present rate by the end of the next decade, and do it with an available work force only 11% greater than today's, according to John J. Rudolf, supervisor of automation for Minneapolis-Honeywell.

SOLAR ENERGY

UTILIZATION of the sun's radiation to create sugar and starch out of carbon dioxide and water outside of the living cells of green plants has been reported by Dr. Daniel Arnon of the Univ. of California. This pioneer achievement employs chloroplasts removed from the living plant to perform photosynthesis. Previous attempts had met with only partial success. The synthesis of the various compounds—the basic function of living cells—was determined with the aid of radioactive carbon dioxide and phosphorus. "The achievement of extracellular photosynthesis," in Dr. Arnon's words, "brings nearer the day when man, after mastering the secrets of the process of green cells, will reduce his age-long dependence on crop plants for food and energy by devising his own photosynthetic reactions driven directly

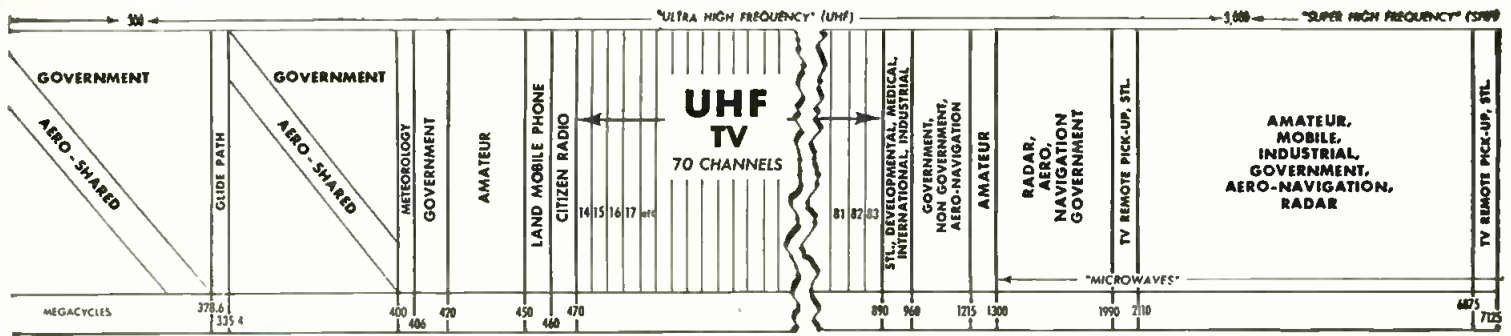

by the energy of the sun. When this proves attainable, it will usher in an era of unlimited abundance for the benefit of mankind."

TV FILM

PROS AND CONS of live versus canned TV programs are the subject of lively discussions among technical, production and advertising personnel. On the pro-film side are the facts that fluffs can be edited out, troubles caused by illness of the star performer are circumvented, and good quality re-runs are available. On the pro-live side are the facts that one-shot shows cost less to produce, a greater feeling of presence is possible, and medium quality kinescoped prints are available. One thing is sure, however. TV film output is growing rapidly. According to a *Barron's* report, there are some 500 companies at work in some phase of the field, covering everything from spot commercials to feature length movies. Approximately 75 of these are considered important producers. Annual industry sales are estimated to range from \$150 million to \$200 million. Looking ahead, many producers have filmed their original series in color, and are waiting for the market to catch up with them.

AVIATION

HOTTEST CONTROVERSY in the aircraft-electronic field is behind the scenes fight over a new hush-hush navigation system developed for the military. Certain quarters are trying to foster acceptance by commercial airlines on the basis that the new system has a number of advantages, including greater accuracy. Most of the commercial people are set against the idea, claiming it has a number of shortcomings, and would require extensive replacement of new and expensive equipment presently in use. From an outsider's viewpoint, much better mutual understanding between the military and commercial people would result if more data could be revealed and discussed. Security regulations prevent disclosure here of how the system works, but it should be interesting to keep the system's name in mind for future reference—it's TACAN.

ELECTRON TUBES

HIGH VACUUM technology has made a major forward stride, according to a report made by Dr. Daniel Alpert of Westinghouse at a joint meeting of the American Physical Society and the American Association for the Advancement of Science. A vacuum as great as one quadrillionth of an atmosphere, 100,000 times greater than the highest vacuum produced previously, can be created in a straightforward manner by ion pumping. In

this process the individual gas molecules are ionized, and then driven into a solid surface from which they do not escape. This development opens new horizons—and problems—in field emission, surface physics, surface chemistry and other items which can lead to improved electron tubes. Diffusion of gases through the walls of the vacuum container become a serious consideration at these pressures.

RADIO

TOTAL REVENUE of the radio broadcasting industry in 1953 was \$475.3 million, a gain of 1.1% over 1952, according to a recently released FCC report. When added to the previously reported figure of \$432.7 million for TV broadcasting, a record total of \$908 million is obtained for time and talent. Radio networks and their 22 owned stations reported total revenues of \$97.3 million in 1953, or 3.3% below 1952, and profits (before federal income taxes) amounted to \$10.4 million in 1953, or 7.1% below the previous year. A total of 2,457 stations reported revenues of \$378.0 million, which is 2.4% over 1952, and profit amounted to \$44.6 million, or 8.8% below the previous year. The profit for all radio networks and stations came to \$55 million in 1953, or 8.4% under 1952. When added to TV profits of \$68 million, total broadcast profits amount to \$123 million, or 6.4% above 1952. 1953 was the first year in which TV profits exceeded those of radio. According to unofficial statistics, 1954 revenues reflected a significant increase over 1953.

BATTLEFIELD RADAR

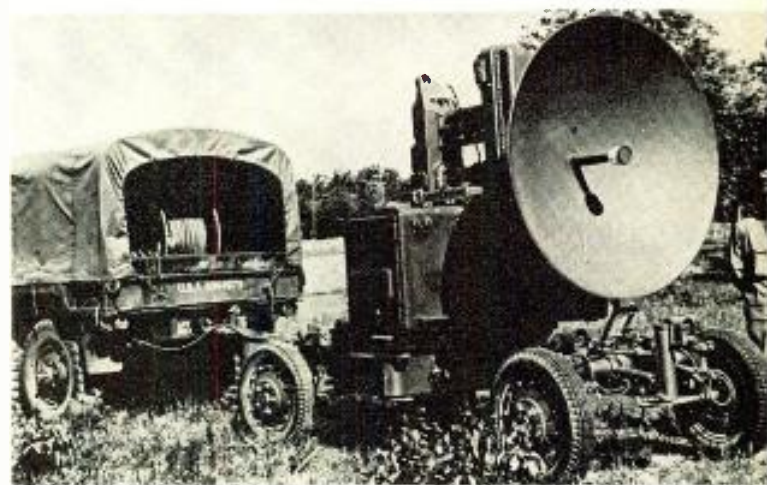

New radar mortar locator, developed jointly by the U.S. Army Signal Corps and Sperry Gyroscope Co., acts as a sentry, warns of enemy movements, and pinpoints enemy mortar locations. This mobile unit, designated the AN/MPQ-10, was sent to front lines in Korea in Dec. 1952. Remotely controlled unit automatically tracks enemy trajectories, and supplies corrective data and location coordinates for friendly Artillery Fire Direction Center.

How to Plan for Color

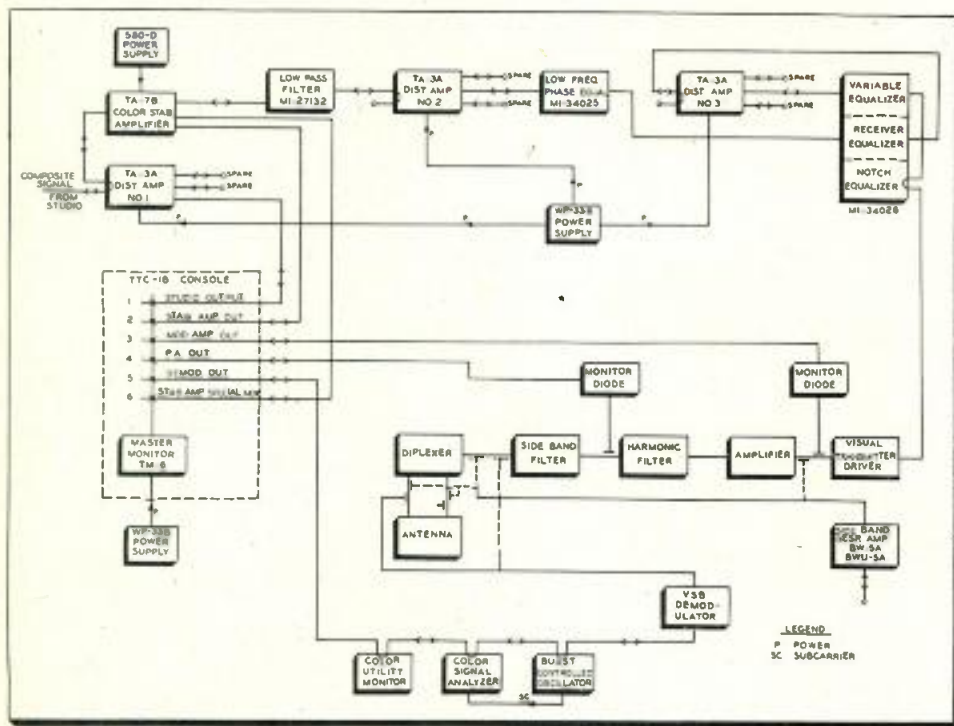

Fig. 1: Block diagram of equipment required for Plan #1 for telecasting network color programs

Practical three-step sequence provides for logical expansion of facilities from handling network programs, slides and films, to live studio originations

By L. E. ANDERSON & W. O. HADLOCK
Engineering Products Dept., Radio Corp. of America, Camden, N.J.

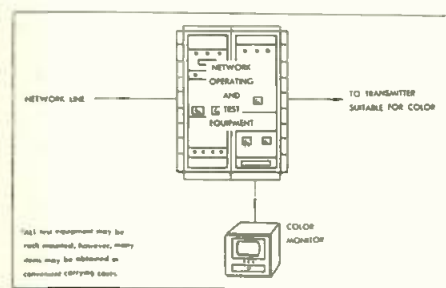

Fig. 2: Pictorial arrangement of equipment for telecasting color programs from network feed

COLOR TV affords great opportunity for profitable expansion by TV stations—since it has unlimited attraction for advertisers and sponsors of programs. TV station program and production departments have already had the chance to work with and test color TV on network shows and spots—live and on film. Color will add new life and impact in selling many products.

Equally intense is the interest in color TV exhibited by planners and broadcast engineers, who have

placed many requests for technical information and practical plans. Much information has already been published on the subject (see *Broadcast News* #77, Jan.-Feb., 1954). Further indication of the rapid progress in color TV is the existence of various RCA-equipped TV stations that are programming color on regular schedules. RCA has delivered color TV equipment (similar to that described in plan #1) to more than 100 TV stations. Presently, every present and prospective TV station will include color programming in their plans, whether immediate or long range.

PRACTICAL THREE-STEP PLAN

In answering the need for planning information, RCA TV system engineers studying the likely course of color TV development have worked up three practical station equipment plans. These plans correspond to the probable sequence of steps which many stations will fol-

low in building up to a full scale color operation. Originally, RCA engineers visualized four or more steps. However, technical equipment advances enabled further simplification.

Step #1

The installation of equipment required for telecasting network color programs.

Step #2

The addition of "3-V" color film equipment for telecasting color films and slides.

Step #3

The addition of equipment for telecasting color studio programs.

CONSIDERATIONS IN CHOOSING A PLAN

In order to reduce the number of variables and simplify the presentation of this material, only "combined" or "integrated" operation is considered. As such, color facilities are added to existing monochrome operations which already include transmitter, film, editing, studio, dis-

PLAN #1 EQUIPMENT

COLOR TEST EQUIPMENT

Qty.	Description
1	Type WR-61A Service Color Bar Generator (for adjusting monitors and receivers)
1	Type WA-7B Linearity Checker
1	Type WA-6B Color Signal Analyzer
1	Type WA-4A Burst Controlled Oscillator
1	WA-9A Calibration Pulse Generator
1	Type TO-524-D TV Oscilloscope
1	Type 500 Scopemobile for MI-26500
1	Video Jack Panel
10	Video Jack Plug
5	Video Jack Cords
1	*Type WA-3B Grating and Dot Generator
	*Grating and dot patterns are included as output signals of the TG-2A Sync Generator, however, a separate source of signal may be desired.

PLAN #1

COLOR NETWORK OPERATING EQUIPMENT

Qty.	Description
1	*Type TA-7B, Color Stabilizing Amplifier
1	580-D Power Supply
1	TM-10B, Color Monitor
1	Cabinet for TM-10B (or Rack Mounting Adaptor)
1	Set of Phase Correction Equalizers
1	**Color Correction Kit for Demodulator
3	TA-3A Distribution Amplifiers
1	WP-33-B Power Supply
2	Type BR 84 Cabinet Racks
1	Video Jack Panel
10	Video Jack Plug
5	Video Jack Cords
	To originate a color test signal for receiver adjustment, the following is required at the transmitter location:
1	Type WA-8A, Color Stripe Generator

*For studio use another stabilizing amplifier is required. A second TA-7B is desirable, however an existing TA-5D may be modified.

**Demodulator Conversion Kit is to convert either a BW-4A or a BWU-4A Demodulator assumed to be part of station's existing equipment.

Television Broadcasting

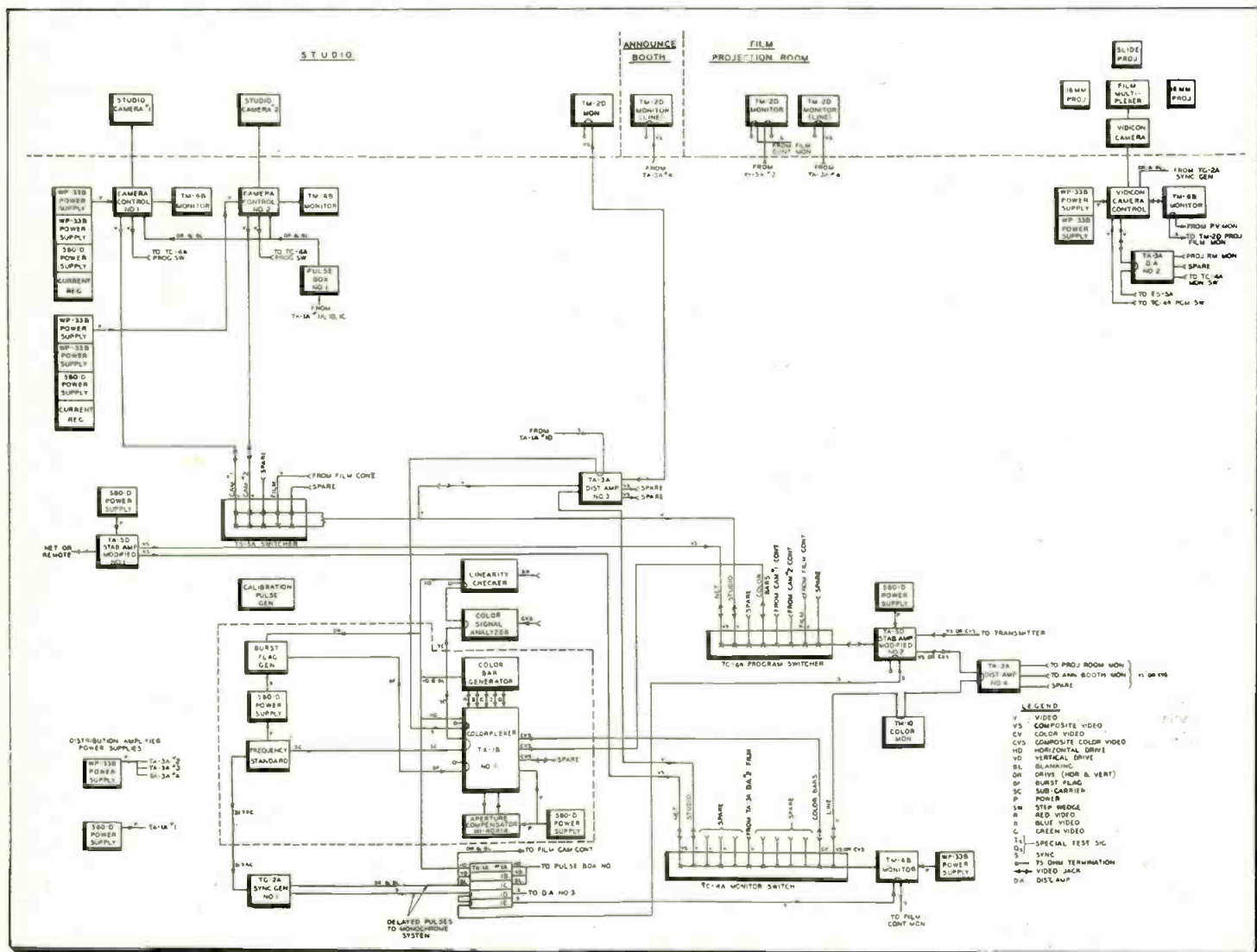

Fig. 3: System connection diagram of Plan #1 equipment shows power supplies, test equipment, controls, encoder, monitors, amplifiers and generators

tribution amplifiers, switching facilities and a certain amount of standard rack equipment.

It is worthy to note that the three equipment plans are also practical when used for "completely new" installations in which case the additional equipment mentioned above, plus equipment normally required for monochrome operation, would be needed.

The planner's choice of one of the three plans will depend, of course, on the amount of investment permitted, the type of programming contemplated, the network facilities available and the extent of future plans and remote programming.

Of course, the simplest and most inexpensive type of station to equip would be one that plans to use color network programs only. However, in such a station there would be no

means of presenting essential local advertising material or station call letters. A more practical station is one which can present local film programs interspersed with network (such as that provided by plan #2).

One step further, and a wise beginning (where the budget permits), is the addition of live camera facilities as well as film. This permits local live talent showings, personal interviews, and most important, the "on-the-spot" showing of sponsors' products.

Practically every successful station will eventually utilize at least one live color camera. Larger or multi-studio stations will wish to plan on several color cameras with elaborate associated control and switching facilities.

It is the purpose of this article to describe the three plans in detail,

discuss planning considerations in general, and to assist the TV planner in determining the class of operation which meets his requirements. These plans do not necessarily represent any existing station, but they illustrate how color equipment may be used simply and efficiently.

The plans represent the simplest way to include color in existing TV station programming, and the most economical way to expand this operation in the future. The planner should remember that each item of equipment provided has been carefully selected and engineered to fit together and operate as a system. The equipment represents only the basic "musts" for network and live color operation. Each of the plans is designed so that there is no unnecessary duplication of existing monochrome facilities, or between

Color Television (Continued)

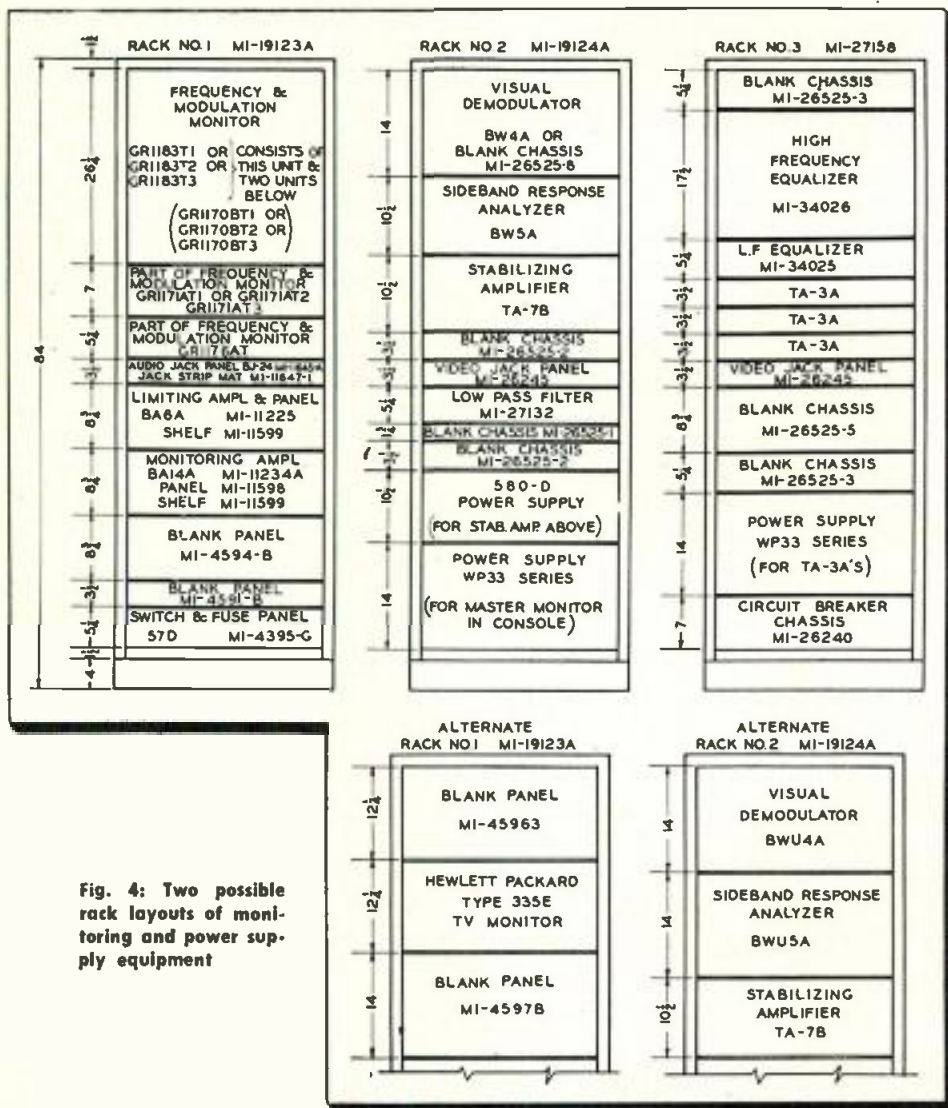

Fig. 4: Two possible rack layouts of monitoring and power supply equipment

plans 1, 2, and 3. Some stations may elect to make up their own arrangements of equipment to satisfy particular requirements existing at their station. While this is possible, the integration of color equipment with existing monochrome arrangements can become complex.

SUMMARY OF THREE PLANS

An important consideration in selecting one of the three plans is the provision of appropriate space. Only general mention of space is made here, since detailed rack space layouts are included in the material to follow.

Here are the several classes of operation which may be considered.

Plan #1—Telecasting only color programs received from the network. All local originations—including station breaks—continue to be in monochrome only. Only a few inexpensive items of additional equipment are required and the very small amount of extra space needed for these will be available in any station.

Plan #2—Telecasting network color programs plus locally originated slide and film programs in color. This requires that the station install the "3-V" color film camera, projector and slide facilities of plan #2. All locally originated live programs will continue to be in monochrome. However, the station can greatly increase its percentage of color programs by adding color shorts, cartoons and such color feature films as may become available.

Plan #3—Telecasting network color programs plus all types of local color programs including live color. Studio originated commercials and local programming immediately become available providing new sources of revenue and programming. This, of course, requires a color studio camera, as outlined in plan #3. Providing live studio programs are not too elaborate, it is quite possible to do it in existing space. This means that the color camera will be used in the present monochrome studio. The existing control room may be too small for

the added control equipment so that a new separate control room may be needed. This, of course, is preferable in any event so that color rehearsals can be held without disturbing monochrome operation. In many cases the new control room can be provided by "double-decking" or "under-slinging" the present control room. In other cases a "clients' booth" or observation gallery may be used.

CUSTOM PLANS—Telecasting network programs in color plus large-scale local programs in color (beyond the scope of plan #3). This, of course, is something that will come eventually for many stations and will require special assistance or custom planning. These stations may require the addition of considerable studio and control room space. Stations which will originate color programs for a network will have to take some such step.

TRANSMITTER COLOR MODIFICATIONS

The first step, of course (before proceeding to plans #1, #2, or #3) is to make sure that the transmitter will handle color satisfactorily. All of the RCA TV Transmitters in use today were designed with color requirements in mind. However, color requires closer tolerances than were originally contemplated and for this reason minor circuit modifications will be necessary in some models. Parts, and engineering supervision for the installation of these parts, are furnished at no charge for all post-war RCA TV transmitters.

Once the transmitter is adjusted for the stringent requirements of color, it will be in extra good adjustment for monochrome. All of the equipment arrangements described here assume that the same transmitter will be used for both color and monochrome. Where a microwave STL is used between studio and transmitter this may also be used for both systems although some modifications may be necessary to provide best operation for color (see later description).

PLAN #1 EQUIPMENT FOR NETWORK COLOR PROGRAMS

Many TV stations may elect to start in color programming by installing first the equipment needed for telecasting color programs received from the network. The equipment of plan #1 is a practical arrangement for the TV station affiliated with a network. The plan #1 equipment package includes (a) all equipment (video input, monitoring

and correcting networks) needed to transmit network color pictures and (b) color test equipment necessary to check the quality of these signals. All of this equipment is used later in plans #2 and #3.

The arrangement of plan #1 equipment for network color is shown pictorially in Fig. 2. The necessary equipment is shown in a subsequent list and the functional arrangement of equipment is illustrated in the diagrams of Figs. 1 and 3.

VIDEO INPUT EQUIPMENT

The video input or terminal equipment required for color network reproduction can be kept separate from that used for monochrome—or may be integrated to a certain extent. However, when the latter is done, some additional equipment must be added or modifications made to existing equipment in order that the color signal may be faithfully reproduced.

The video input equipment for plan #1 consists essentially of 2 color stabilizing amplifiers, three distribution amplifiers and necessary power supplies. The new RCA TA-7B, an advanced design color stabilizing amplifier, is furnished in plan #1 and is recommended for optimum transmission quality. However (at the studio location only), it is possible to substitute an existing RCA TA-5B, C or D stabilizing amplifier, if properly modified for color operation. TA-3A distribution amplifiers are recommended; however, an existing TA-1A may be used.

VIDEO INPUT OPERATION

Assuming that the color network program is brought into a studio location remote from the transmitter, it must first pass through a color stabilizing amplifier, TA-7B (or modified types TA-5B/C/D). The network signal is fed from the output of the stabilizing amplifier to the switching system, types TS-5A, TS-11A or TS-20 video relay switcher. From the output of the switching system, the color signal is then fed to the STL (which may or may not require modification) depending on the make and model numbers. Recent relay equipment designs will operate with color. At the transmitter site, the color network signal is received and fed to a distribution amplifier, preferably TA-3A (TA-1A may be used provided two sections are paralleled), and then to the high-frequency phase equalizer and another TA-3A distribution amplifier. The output of this distribution

amplifier then feeds a low-frequency phase equalizer. At this point, a TA-7B stabilizing amplifier is required (which cannot be a modified TA-5B/C/D) to provide the proper setup and white stretch adjustments for proper operation of the transmitter.

A block diagram of the equipment required for telecasting network color programs is shown in Fig. 1.

DISTRIBUTION AMPLIFIERS

RCA Distribution Amplifiers TA-1A, TA-3A and TA-4A are used throughout plans 1, 2 and 3. These units are particularly useful in both monochrome and color systems.

In the plans the TA-1A Video Distribution Amplifier is shown in a monochrome system to which color equipment has been added. This amplifier contains five independent channels and is suitable for color with adaptation. Stations who wish to use existing TA-1A's for color must parallel two sections of the TA-1A for each color channel needed. Paralleling these sections will provide necessary sending end termination.

This newly designed video distribution amplifier provides sending end termination which makes it particularly applicable in color systems. (Continued on page 130)

COLOR PLAN	EQUIPMENT INVOLVED	PROGRAM SOURCES PROVIDED OR USE INTENDED
Plan #1	Network color equipment Recommended test equipment	Permits transmission of color program received from network source Suggested for use by all stations in checking, controlling and maintaining a high quality picture
Plan #2	Color bar and local origination equipment Color vidicon (3-V) film and slide chain	This provides color bars for system checking and advance training of personnel. These are must items for local origination—film/slide or live. Permits the origination of color pictures from 16 mm and 35mm motion picture film and 2 x 2 slides
Plan #3	Color studio camera equipment	Permits origination of live studio pictures in color

Fig. 5. Chart of several testing arrangements. Plan #1 equipment is basis for Plans #2 and #3

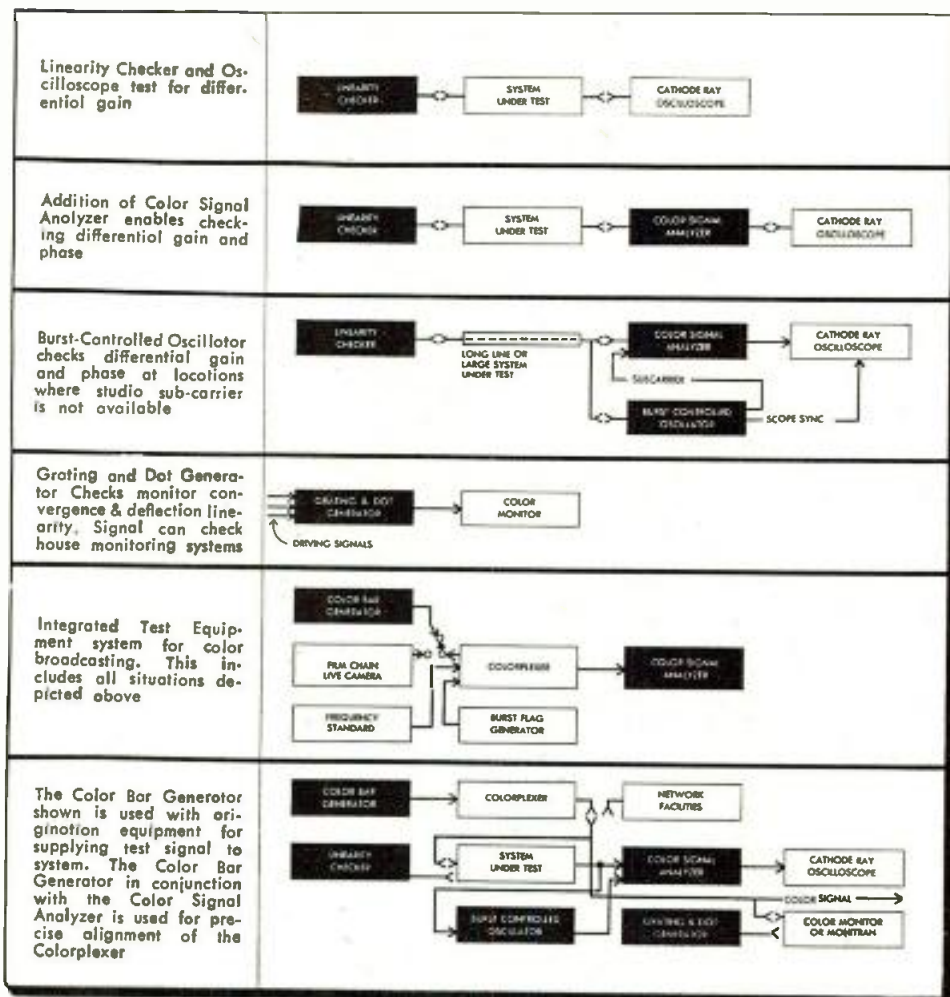

Strength and Behavior

The ability to maintain directivity, of prime largely upon guy wire size, tension, angle

Note that in other than normal guying cases, when the sag is very pronounced, angle A_1OA should be considered. Expressed mathematically, angle

$$A_1OA = \frac{\Delta}{R}$$

(radians), where R is the tower's height and Δ = the movement of the tower's top. The tower is assumed to sway collinearly. This ratio of $\frac{\Delta}{R}$

in tower guying seldom exceeds .0015 radians or 5.16 minutes. The sine of 45° is .70711 and that of $(45^\circ + 0^\circ - 5.16')$ is .70722. The discrepancy is then of the order of 1/100 of 1%.

Making the above assumption we have by geometry:

$$s_w = (AB_w \sin \gamma_w) \text{ \& } s_L = (AB_L \sin \gamma_L)$$

and:
 wherein

$$AB_w = \sqrt{(s_o + \Delta)^2 + (s_o \text{ ctg} \beta)^2} \text{ \& } AB_L = \sqrt{(s_o - \Delta)^2 + (s_o \text{ ctg} \beta)^2}$$

The wind pressure per ft. of cable

$$= w_w = \left(\frac{2}{3} \times \frac{\text{pd}}{12} \right) \text{ Cos} \beta = \left(\frac{\text{pd}}{18} \right) (\text{Cos} \beta)$$

where p is the wind pressure per sq. ft. on flat surface, and d is the outside diameter of the cable (in.).

Let us note that

$$w_r = \sqrt{w_w^2 + w_g^2}$$

At "no wind" the horizontal force P_0 is parallel to the base. The corre-

sponding force in A_1KB coordinates is P_{xw} , and in A_1MB coordinates, is P_{xL} . The true horizontal components of the latter two forces are respectively:

$$P_2 = P_2^1 \text{ Cos}(\beta_L - \varphi) = \frac{P_{xL}}{\text{Cos} \beta_L} \text{ Cos}(\beta_L - \varphi) = (P_{xL}) (\text{Cos} \varphi + \text{tg} \beta_L \text{ Sin} \varphi) \quad (10)$$

and

$$P_1 = P_1^1 \text{ Cos}(\beta_w + \varphi) = \frac{P_{xw}}{\text{Cos} \beta_w} \quad (11)$$

$$\text{Cos}(\beta_w + \varphi) = (P_{xw}) (\text{Cos} \varphi - \text{tg} \beta_w \text{ Sin} \varphi)$$

The transformed equation (3) will read then:

$$\text{tg} \beta_w = \left(\frac{w_r s_w}{2 P_{xw} \text{ Sin} \gamma_w} + \text{ctg} \gamma_w \right) = \left(\frac{w_r AB_w}{2 P_{xw}} + \text{ctg} \gamma_w \right) \quad (3-2)$$

and:

$$\text{tg} \beta_L = \left(\frac{w_r s_L}{2 P_{xL} \text{ Sin} \gamma_L} + \text{ctg} \gamma_L \right) = \left(\frac{w_r AB_L}{2 P_{xL}} + \text{ctg} \gamma_L \right) \quad (3-1)$$

Note that P_0 , P_1 and P_2 are the horizontal components of the true guy tensions P_0^1 , P_1^1 and P_2^1 respectively.

Fig. 4: Coordinate system analysis of displacement and force acting on guys AB

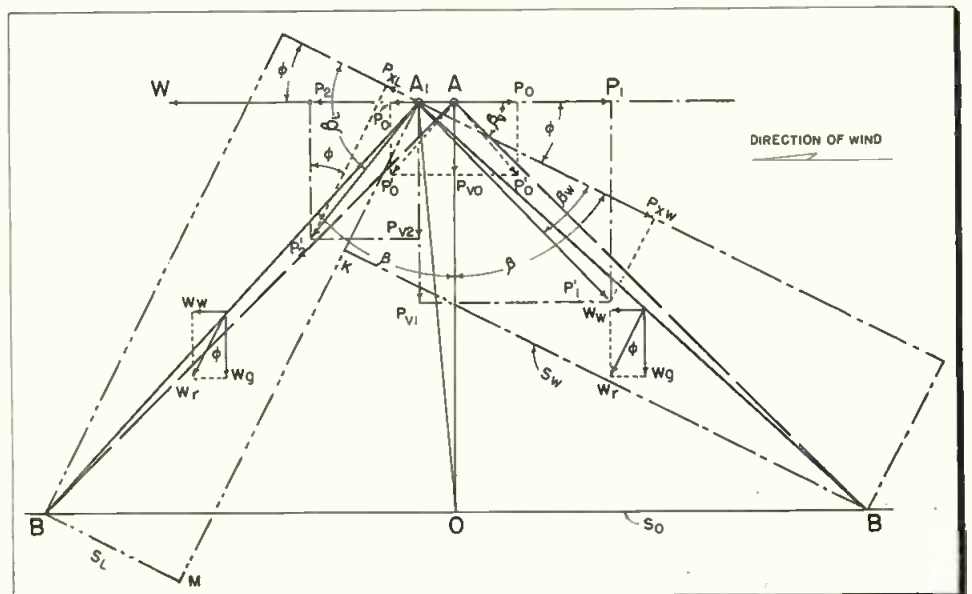

Part of triangular cross-section tower, showing flange steel wrap-around plate welded to pipe section, and angle iron bracing

By Dr. D. A. LIAMIN
 Chief Engineer
 Tower Structures Inc.
 Gregg St., Lodi, N.J.

(Part One of this article, published last month, covers basic structural requirements, microwave considerations, and equation nomenclature.)

Let us now refer to and consider Fig. 4: AB is the windward guy, and if there is no wind, the gravity force w_g alone acts perpendicularly to OB and thus, fulfills the conditions assumed in the derivation of above equations.

When wind is present and acts in the plane of paper, the resultant force is w_r . Let us draw through point A a line parallel to w_r , and another line through point B perpendicular to w_r , both of these lines intersecting at R.

We now have a new coordinate system A_1KB in which KB represents the abscissa and A_1K the ordinate. Since w_r is perpendicular to KB, we may use the above equations with following corrections:

Replacing $(OB = S_0)$ by $(KB = S_w)$ and (A_1O) by (A_1K) ; also angle β by γ_w .

The same procedure is followed in obtaining the new coordinate system for the leeward guy BMA_1 .

The magnitude of angle A_1OA usually amounts to a few minutes and may be neglected, so that angle OA_1B may be set = to angle $OAB = \beta$.

of Guyed Towers

Part Two
Of Two Parts

importance in microwave work, depends of inclination and the guying pattern

The total length of each guy measured at its respective tension is as follows:

$$l_0 = \frac{s_0}{\sin \beta} + \frac{w_g^2 \sin \beta s_0^3}{24 P_0} + \frac{l_0 P_0^1}{AE} \quad (12)$$

$$l_1 = AB_w + \frac{w_r^2 \sin \gamma_w s_w^3}{24 P_{xw}^2} + \frac{l_0 P_1^1}{AE} \quad (13)$$

$$l_2 = AB_L + \frac{w_r^2 \sin \gamma_L s_L^3}{24 P_{xL}^2} + \frac{l_0 P_2^1}{A \times E} \quad (14)$$

Note that:

l_0 = the initial length of both guys at no wind condition.

l_1 = the length of windward guy when wind is present, and

l_2 = the length of leeward guy when wind is present.

At no wind condition, both guys, being symmetrical and having the same tension, must be of the same length.

Due to wind pressure, the only change in length occurring in both guys is that of elastic stretch, which means that:

$$\left(l_0 - \frac{l_0 P_0^1}{AE} = \left(l_1 - \frac{l_0 P_1^1}{AE} \right) = \left(l_2 - \frac{l_0 P_2^1}{AE} \right) \quad (15)$$

and, consequently,

$$\left(\frac{s_0}{\sin \beta} + \frac{w_g^2 \sin \beta s_0^3}{24 P_0^2} \right) = \left(AB_w + \frac{w_r^2 s_w^3 \sin \gamma_w}{24 P_{xw}^2} \right) = \left(AB_L + \frac{w_r^2 s_L^3 \sin \gamma_L}{24 P_{xL}^2} \right) \quad (16)$$

Using the right part of Eq. 16, we have:

$$(AB_w - AB_L) = \left(\frac{w_r^2}{24} \right) \times \left[\frac{AB_L^3 \sin^4 \gamma_L}{(P_{xL})^2} - \frac{AB_w^3 \sin^4 \gamma_w}{(P_{xw})^2} \right] \quad (16-1)$$

By law of static equilibrium:

$$P_1 = P_2 + W \quad (17)$$

Combining Eqs. 10, 11, 3-1 and 3-2, we have:

$$(P_{xw}) (\cos \varphi - \text{ctg} \gamma_w \sin \varphi) = P_{xL} (\cos \varphi + \text{ctg} \gamma_L \sin \varphi)$$

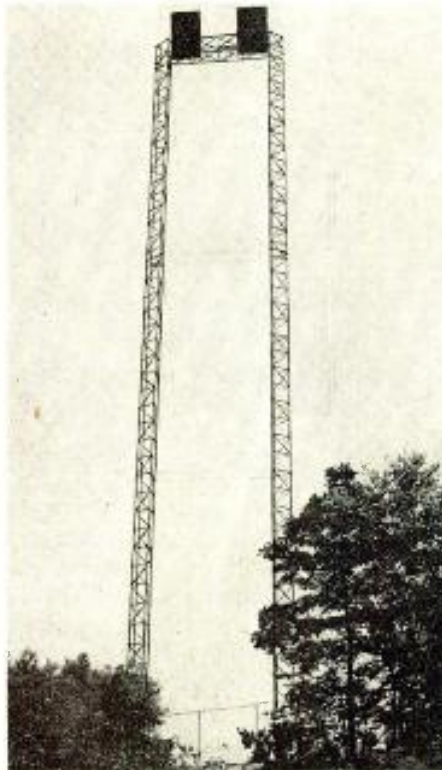

H-type tower supporting microwave reflectors

$$+ \left(w_r \frac{\sin \varphi}{2} \right) (AB_w + AB_L) + (W) \quad (18)$$

Eq. 18 and 16-1 express the relation between P_{xw} and P_{xL} , so that with known data for any particular case (including the numerical value of the maximum permissible deflection Δ), the values of P_{xw} and P_{xL} can be determined as illustrated in the forthcoming numerical example.

Example 1: Reference is made to Fig. 4

Data:

- $s_0 = 600$ ft. $w_g = .796$ lbs./ft.
- $\beta = 45^\circ$ $A = .228$ sq. ins.
- $W = 3,000$ lbs. $E = 21,000,000$
- $d = \frac{5}{8}$ in. (H.S. 19 wire strand)
- $p = 30$ lbs./sq. ft. (on flat surface)
- $\Delta = .7$ ft.

Solution:

$$AB_0 = \frac{600}{\sin \beta} = 848.524274$$

$$AB_L = \sqrt{599.3^2 + 600^2} = 848.03331$$

$$AB_w = \sqrt{600.7^2 + 600^2} = 849.02326$$

$$w_r = \frac{30 \times 5 \times .70711}{18 \times 8} = .73657292$$

$$w_r = \sqrt{.796^2 + .7365729^2} = 1.0845071$$

$$\varphi = \text{Arc Cos} \left(\frac{.796}{1.0845} \right) = 42.787^\circ$$

$$\sin \varphi = .6791775; \cos \varphi = .733974; \text{tg} \varphi = .925343;$$

$$\gamma_w = (\beta + \varphi) = 87.787^\circ; \sin \gamma_w = .9992522; \cos \gamma_w = .0386657; \text{ctg} \gamma_w = 038695;$$

$$\gamma_L = (\beta - \varphi) = 2.213^\circ; \sin \gamma_L = 0386657; \cos \gamma_L = .99925; \text{ctg} \gamma_L = 25.84338;$$

$$s_w = AB_w \times \sin \gamma_w = 848.38836;$$

$$s_L = AB_L \times \sin \gamma_L = 32.789802;$$

From Eq. 3-2:

$$\text{tg} (\beta_w) = \frac{460.385877}{P_{xw}} + .038695;$$

From Eq. (3-1):

$$\text{tg} (\beta_L) = \frac{459.849073}{P_{xL}} + 25.84338;$$

From Eq. 10 and 11: $P_1 = (P_2 + 3,000)$;

$$(P_{xw}) (\cos \varphi - \text{tg} \beta_w \sin \varphi) = (P_{xL}) \times (\cos \varphi + \text{tg} \beta_L \sin \varphi + (3,000))$$

Inserting numerical values:

$$P_{xw} = 25.8392 P_{xL} + 5,122.28165$$

From Eq. 16-1:

$$20.200651 = \left(\frac{1373.6535}{P_{xL}^2} - \frac{610,176,381}{P_{xw}^2} \right)$$

Combined and regrouped:

$$1.0 = \left(\frac{67.4811609}{P_{xL}^2} \right) - \frac{30,296,960.8}{(25.8392 P_{xL} + 5,122.28165)^2}$$

Using trial-and-error method, obtain:

$$P_{xL} = 5.682 \text{ and } P_{xw} = 5,269.1$$

$$\text{tg} \beta_w = .12607 \quad \beta_w = 7.186^\circ$$

$$\text{tg} \beta_L = 106.7742 \quad \beta_L = 89.463^\circ$$

From Eq. 10: $P_2 = 416.2214$;

From Eq. 11: $P_1 = 3,416.2214$;

Max. Tension In Windward Guy

$$P_1 = \frac{5,311.62}{\cos (\beta_w + \varphi)}$$

Max. Tension In Leeward Guy

$$P_2 = \frac{606.62}{\cos (\beta_L - \varphi)}$$

Required Tension

The required initial tension in the guys is then calculated as follows:

From Eq. 16:

$$\left(\frac{s_0}{\sin \beta} + \frac{w_g^2 \sin \beta s_0^3}{24 P_0^2} \right) = \left(AB_w + \frac{w_r^2 s_w^3 \sin \gamma_w}{24 P_{xw}^2} \right)$$

Instituting the above obtained values and solving for P_0 , obtain: $P_0 = 1,599.55$

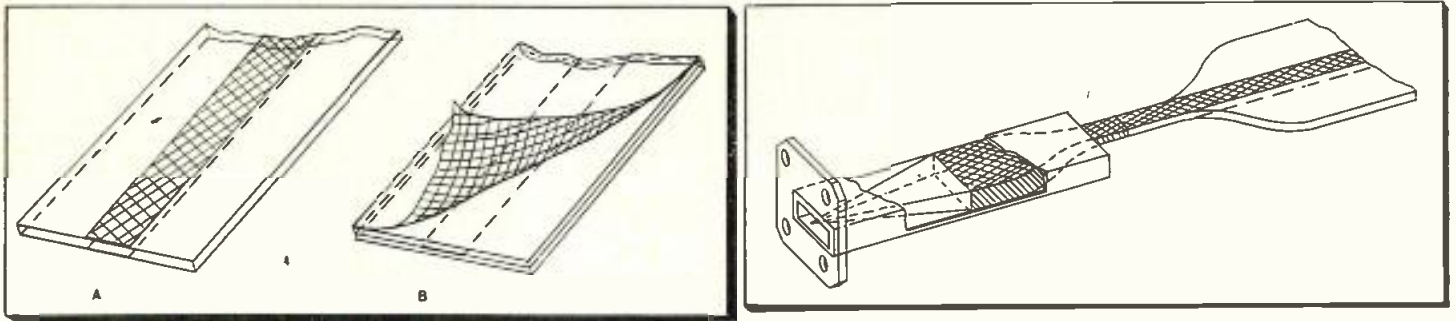

Fig. 1: (l) Comparison of (a) parallel plate and (b) tri-plate line construction. Fig. 2: (r) Waveguide-to-parallel plate transition

MICROWAVE transmission lines and components are usually heavy and bulky, and frequently represent a major cost item in the production of radar and communications equipment. It has long been felt that a strip type transmission line consisting of a sandwich of metal foil and dielectric filling could be constructed that would lend itself well to easy fabrication using simple and conventional photoetching techniques.

Two types of lines adaptable to photoetching techniques were considered: (1) the conventional parallel plate type Fig. 1a, and (2) the three-plate modified coaxial type Fig. 1b. Initial work was done on the former because it would be simpler to manufacture and more readily adaptable to the design of microwave circuits.

It was hoped to minimize radiation leakage in the parallel plate line in three ways: (1) by varying the characteristic impedance, (2) by selecting the optimum ratio of strip width to bottom plate width, and (3) by determining the most satisfactory boundary between air and dielectric.



By
NORMAN R. WILD
Sanders Associates
Nashua, N.H.

Since most of our measuring equipment was in waveguide, it was first necessary, in order to experiment with parallel plate transmission lines, to develop transitions

from conventional waveguides to parallel plate lines. Fig. 2 illustrates a transition from a 220 ohm waveguide to parallel plate transmission line, the impedance of which could be changed simply by altering the width of the metal foil bonded to the surface of the dielectric. While it was felt that radiation leakage would increase with frequency, initial work was begun at X-band because of possible applications to many airborne microwave systems.

Attenuation characteristics of the parallel plate line were determined by insertion loss measurements. Radiation characteristics were meas-

Fig. 5: (l) Attenuation-frequency characteristics of tri-plate line
Fig. 6: (r) Variation of coupling with lateral spacing at 4200 mc

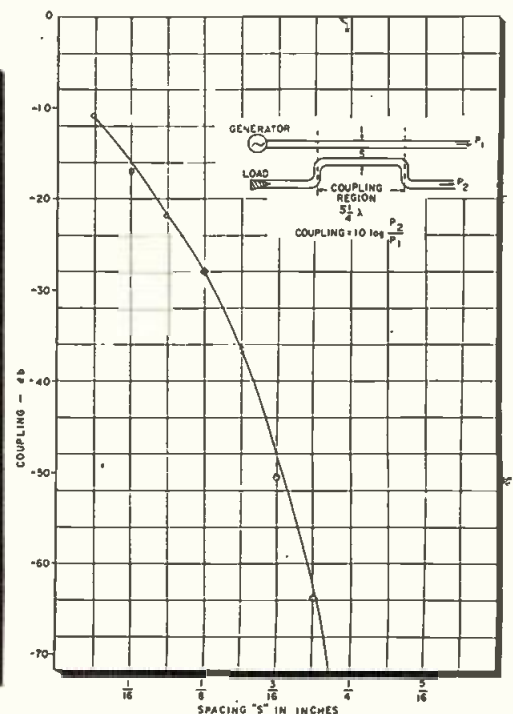
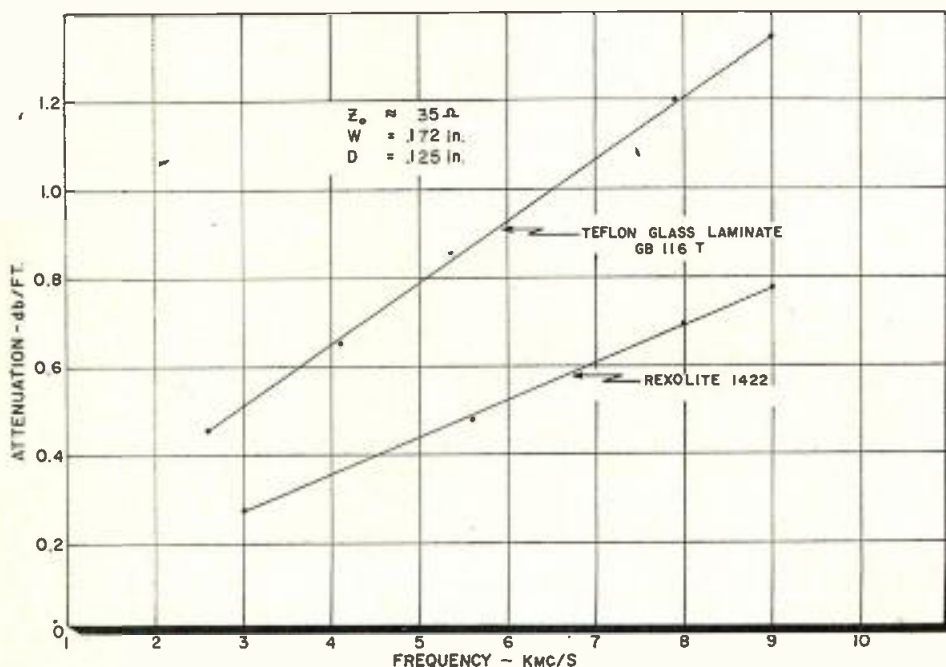

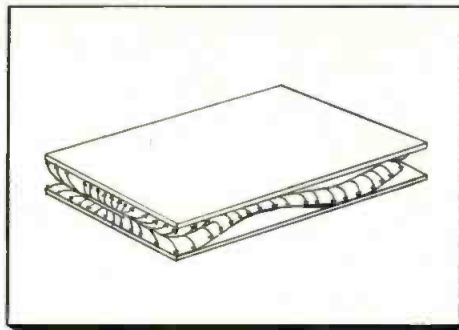
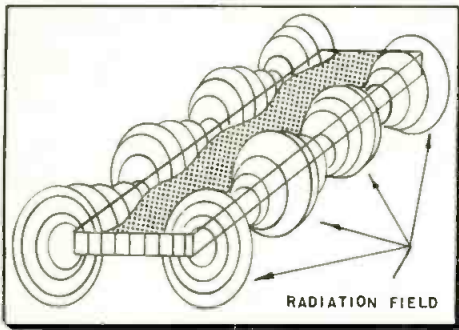

Fig. 3: (l) Field distribution in parallel plate line. Fig. 4: (r) Tri-plate line field

Transmission Lines

Part One
of Two Parts

ured by using a small pick-up horn to sample energy along the axis of the transmission line at a distance of 1½ in. from its center. Considerable cross-polarized leakage existed. While it could be argued that these were not radiating fields, but merely fringing fields that were not entirely confined within the physical limits of the line, experiments showed that these fields were decaying at a $1/D^2$ rate and not as a true exponential field decay.

Radiation Leakage

Experiments demonstrated that whenever network discontinuities were present, such as crystal holders, matching transformers, etc., the radiation leakage in parallel plate lines greatly increased. It was felt that this radiation leakage would be a serious disadvantage in certain types of radar systems because, for one thing, it would complicate physical structures by necessitating the use of special shielding. Further, it would complicate measurement techniques and procedures. Since radiation leakage was attributed to the fringing of the TEM fields, (Fig. 3), it was decided at this time to investigate the three-plate transmission line in which, theoretically at least, no electric fringing fields exist normal to the axis (Fig. 4).

Attenuation and leakage measurements were made at X-band using the waveguide to three-plate line transition shown in Fig. 12. The three-plate line used was fabricated by clamping a 3/16 in. wide copper foil center conductor between two 1/16 in. polystyrene sheets which were, in turn, clamped between two heavy brass plates that functioned as the two outer conductors. Leakage was found to be -70 db, and insertion loss was measured as 2

db/meter. The line used in this study had a nominal characteristic impedance of 35 ohms.

Mode Purity

Encouraging as these measurements were, however, another problem was encountered. This was severe leakage, of the order of -25 to -30 db, in the region of a dis-

continuity presented by a component such as a transition or a matching transformer. This leakage was attributed to simultaneous existence in the line of both parallel plate and coaxial transmission modes. The co-existence of these two modes made the tuning of various networks practically impossible, since a good impedance match for one mode would not be satisfactory for the other.

Parallel plate mode, it was reasoned, could be excited in the region of discontinuities by virtue of their unbalance effect on the line, thereby causing a potential difference between the outer plates and, hence, a radiating electric field normal to the axis of the line.

The parallel plate mode was eliminated by positioning the screws which hold the Tri-plate sandwich together (Fig. 13) close enough to the center strip so they function as shorting bars. This forced the two outer plates to remain at equal potential, and, as a result, the line always remained balanced.

For the sake of simplicity, it was decided to investigate the characteristics of Tri-plate transmission line in the region of "C" band. Since the wavelength at this frequency is

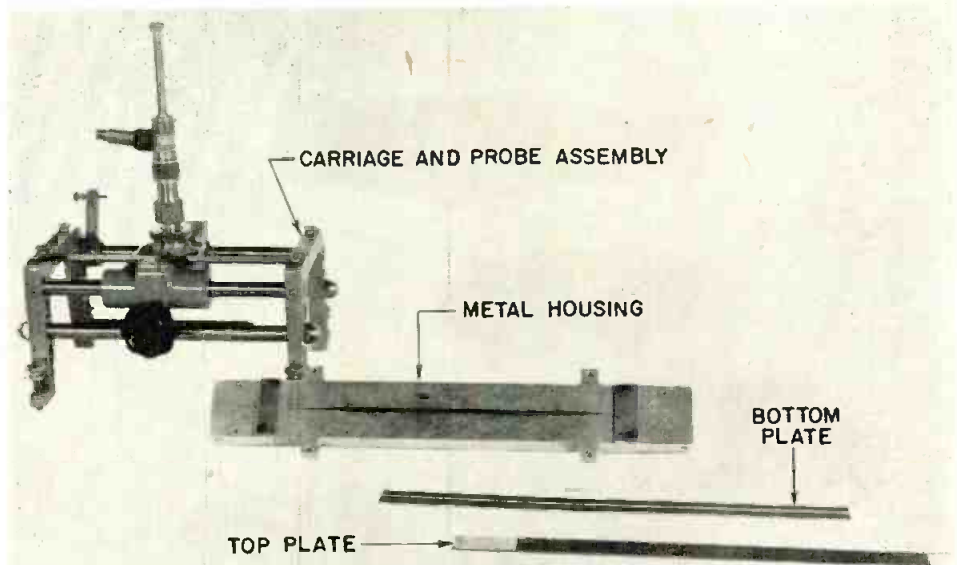

Fig. 7: Unassembled tri-plate slotted line showing strip components

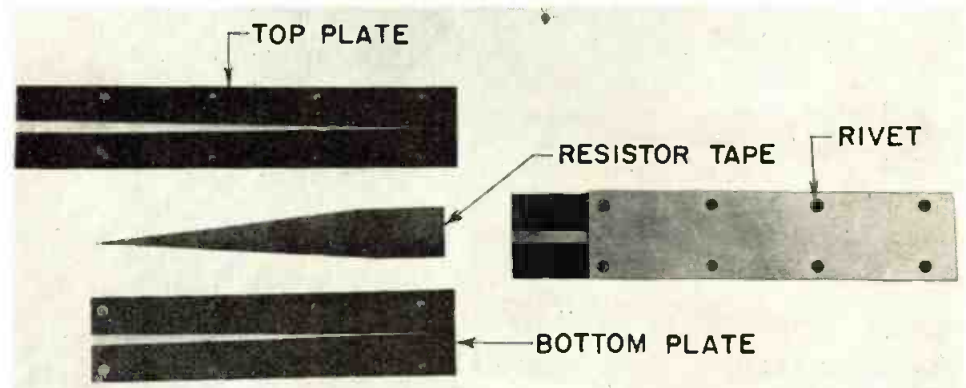

Fig. 8: Matched load in tri-plate line unassembled (l) and assembled (r)

Photoetched Lines (Continued)

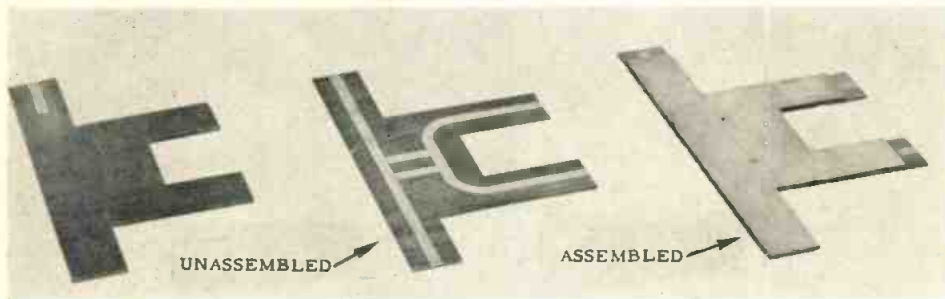

Fig. 9: Directional coupler on tri-plate transmission line

approximately $2\frac{1}{2}$ times longer than at "X" band, the physical separation between the two outer plates is a less significant fraction of a wavelength. Consequently a negligible voltage gradient exists along the shorting pins, thereby more efficiently forcing the two outer plates to remain at equipotential. Radiation leakage was thus reduced to -50 db or better in the region of even severe discontinuities when measured with the pick-up horn at a distance of 1 in. from the center of the line. Attenuation was measured as 0.37 db/ft. at 4200 mc.

Tri-plate lines tested up to this point consisted of copper foil mechanically bolted to polystyrene

slabs. A more convenient method of manufacture was found in photoetching. In this process the center conductor of the Tri-plate line was photoetched on one side of each of two identical pieces of copper-clad teflon-glass laminate. The two pieces were then fastened together with rivets, their unetched outside surfaces serving as the two outer conductors of the Tri-plate line. The rivets served the dual purpose of holding the sandwich together and functioning as electrical shorting pins between the two outer conducting surfaces. In the region of discontinuities it was found to be advantageous to use closer spacing between rivets. By etching the cen-

ter conductor on both dielectric plates instead of only one of them, the line is made insensitive to clamping pressure. In this type of construction, the outer layers may separate as much as $\frac{1}{8}$ in. without any observable change in VSWR and with less than a 15° phase shift.

Substantially the same transmission characteristics were obtained with the new photoetched lines as with the earlier lines, with one exception: attenuation losses were greater; not sufficiently so, however, to prohibit the use of this cheaper, more convenient method of transmission line fabrication in microwave circuitry. Graphs of attenuation versus frequency for Tri-plate lines, using both teflon-glass laminate and polystyrene as the dielectric, are shown in Fig. 5.

A final test in this investigation of the characteristics of photoetched microwave transmission lines was made to determine the cross coupling which existed between parallel strips of Tri-plate line. Results are shown in Fig. 6. Lateral attenuation between adjacent lines at 4200 mc exceeds 70 db per $\frac{1}{4}$ in. separation, demonstrating the rapid field decay experienced with this type of transmission line.

Part Two will appear in the March Issue

Fig. 10: (l) VSWR vs. length and width of series stub. Fig. 11: (r) VSWR vs. L/λ_L for open circuited shunt stub

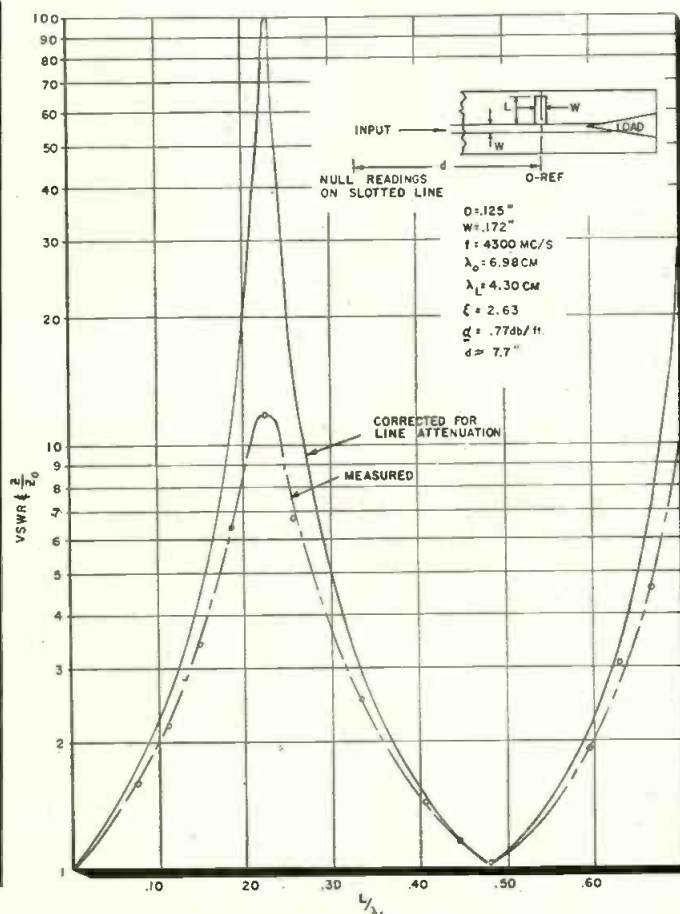
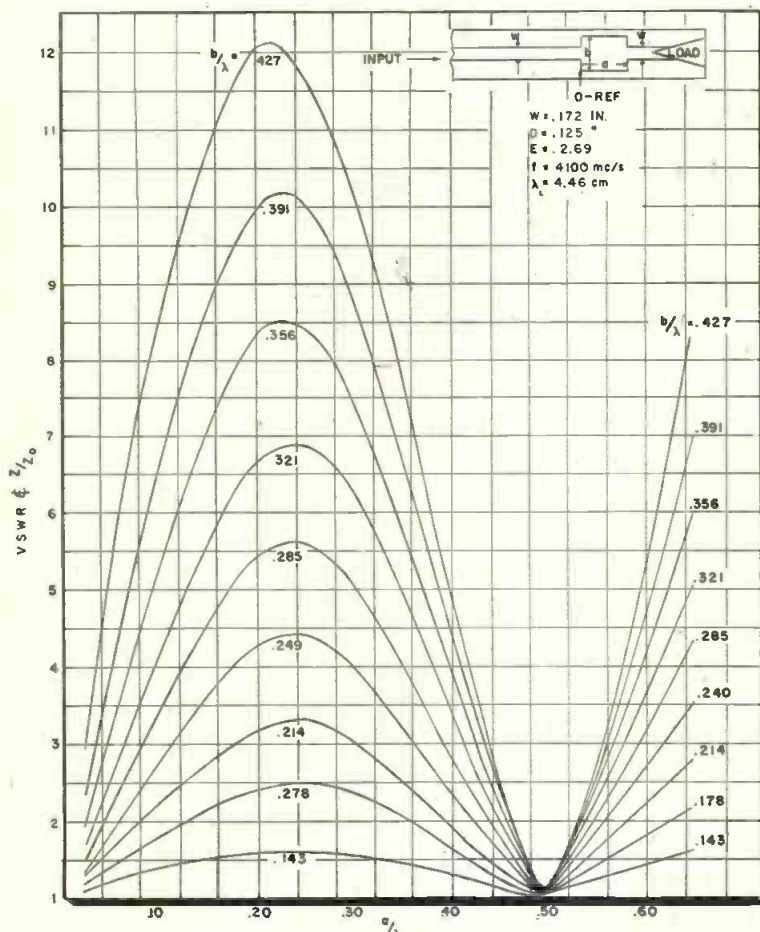

"Vendor Rating" for Quality Control

Statistical techniques provide an effective system for rating vendor quality

By H. C. NEWTON
Quality Control Manager
Bendix Radio Division
Bendix Aviation Corp., Towson, Md.

THE Bendix Radio Vendor Rating System began as an attempt to apply modern statistical techniques to one of the principal problems of Receiving Inspection: the evaluation of individual vendor product quality. It has now become one of the most productive programs in the history of Bendix Quality Control.

Obtaining high quality parts and materials is a never-ending task for any large manufacturing plant. The electronics manufacturer may purchase as many as 20 million units per month from more than 2500 suppliers. The difficulty of maintaining a detailed, easily available picture of these transactions, by ordinary clerical methods, is obvious. Yet it has always been necessary to do just that, in order to provide a proper background for the evaluation, selection, or rejection of outside suppliers.

Both Purchasing and Quality Control Departments agreed to conduct a study combining Purchasing's experience in the field with the knowledge of statistical techniques which had been acquired by Quality Control. The purpose was to devise a system of vendor quality rating that would provide a complete, comparative and universally applicable picture of vendor quality, while, at the same time, effecting a considerable reduction in the clerical burden necessary for the maintenance of the required records.

It was believed, by the Quality Control Engineers, that this could be done through the use of standard statistical techniques similar to those already in use in other phases of Quality Control. The engineers channeled their efforts into two main categories:

1. Compiling data
2. Providing a continuous history of individual vendor quality.

The work in the first category was simplified by the fact that inspectors from the Quality Control Department were already strategically placed and easily available for the collection of data. Further advantage

lay in the well-established use of the technique of statistical sampling, which permits a reduction in the amount of receiving inspection necessary, and hence, in the amount of

data which was finally collected.

But even with these considerable advantages, the data obtained was so extensive and so diverse that it
(Continued on page 140)

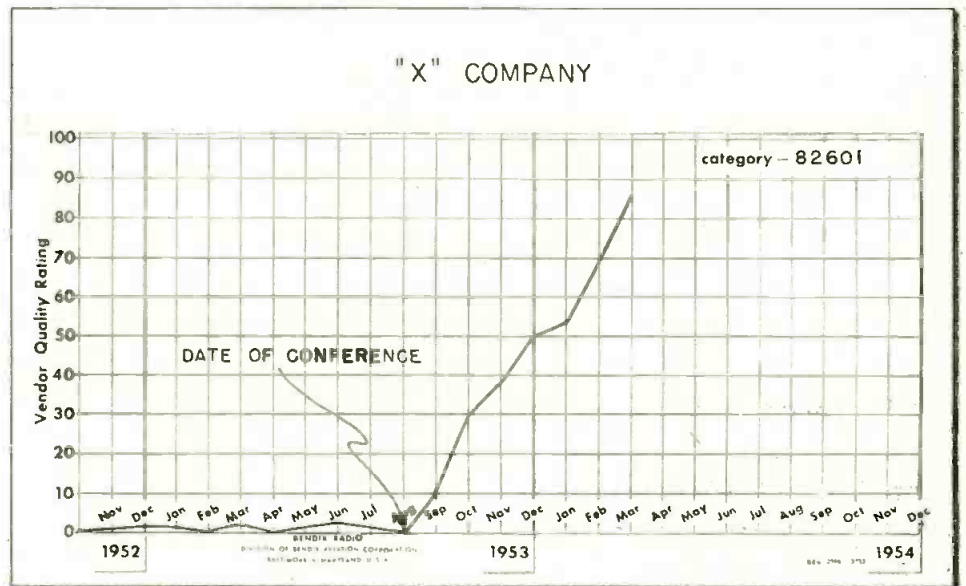

Fig. 1: Company card graphically shows increase in rating after joint conference

Key-punch operator prepares receiving inspection data for use in rating system



Techniques for Measuring

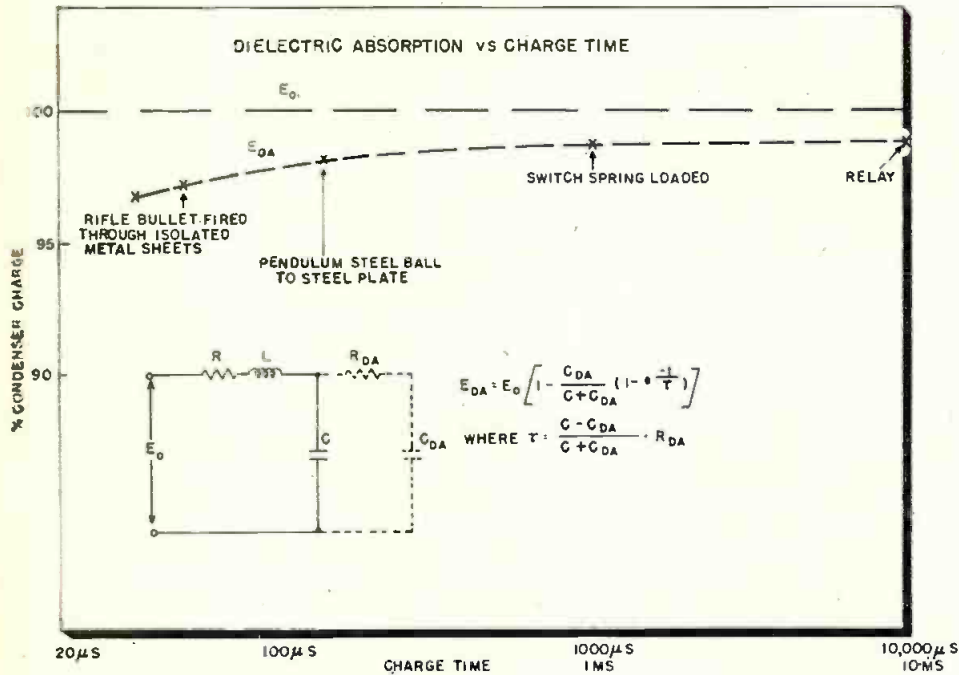

Fig. 1: Influence of dielectric absorption on typical paper condensers is seen in curves at top

Simple test equipment accurately predicts dielectric absorption as a function of dielectric material, applied voltage, charge-time, discharge-time and temperature

By HERBERT E. RUEHLEMANN,* Roller-Smith Corp.
1825 W. Market St., Bethlehem, Pa.

THE accepted definition of dielectric absorption defines it as a certain apparent loss in charge which is not available on the condenser plates, and which varies with dielectric material, applied voltage, charge or discharge-time and temperature.

We are interested in dielectric absorption primarily for its effect on the RC-timing circuits which are presently used in a variety of circuit applications. These circuits are unique in that the voltage at one, or several, condensers has to change with time in conformance with predicted nonlinear equations. Dielectric absorption causes a deviation from theoretical values and introduces errors from various factors and conditions which normally cannot be controlled. Knowledge of these factors and their effects is extremely helpful in predicting circuit behavior.

The influence of dielectric absorption as it affects accuracy in RC-timing circuits is briefly shown in Table I. This table lists a comparison of time measurements obtained with a specific RC-timing circuit using high quality paper condensers and

polystyrene condensers. The measurements with paper condensers having dielectric absorption show that mean timing values vary with charge-time and discharge-time and are influenced by previous circuit history. These mean time values may change by more than 1%, and their maximum deviation is high and erratic. However, this deviation can be minimized when certain conditions are kept constant, although these conditions are difficult to control in practical applications.

Polystyrene Condensers

With polystyrene condensers, which have negligible dielectric absorption, the charge or discharge time or previous history conditions have no effect on time values and timing accuracy. Although a polystyrene condenser will operate satisfactorily in high accuracy timing circuits, its application often is restricted because of space limitations or possible exposure to higher temperatures. Several newly developed dielectric materials have recently become available, and their characteristics with regard to dielectric absorption have been investigated.

The influence of dielectric absorption on timing accuracy may be understood from the test results plotted in Fig. 1. The loss of charge due to dielectric absorption can be diagrammatically shown as the amount of charge which flows in a capacity C_{DA} , which is connected in parallel to the condenser C through a high

Fig. 2: Condenser Dielectric Absorption Tester. Reference capacitor is 1 mfd. polystyrene type

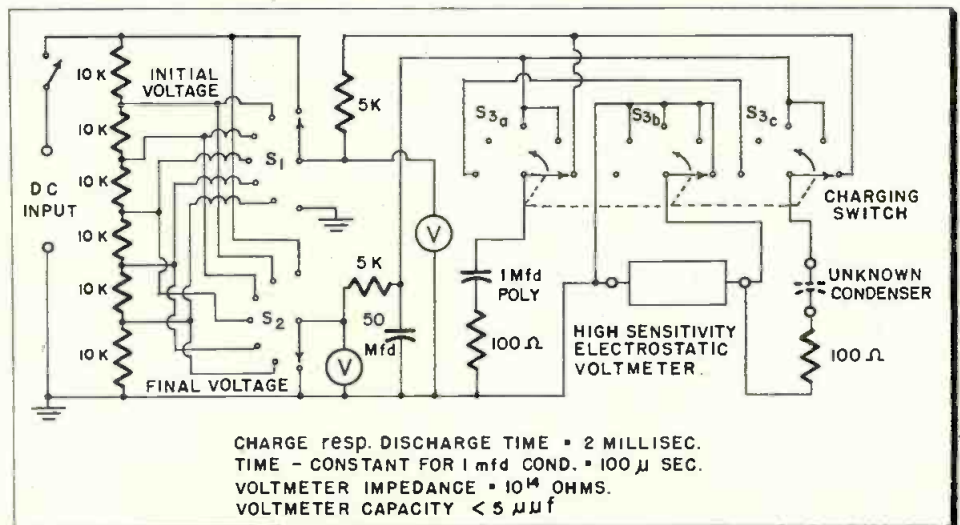

* This article was prepared while Mr. Ruehle-
mann was employed at the U.S. Naval Ord-
nance Lab., White Oak, Silver Spring, Md.

Capacitor Dielectric Absorption

series resistance R_{DA} . During the charge-time a certain amount of charge is supplied to the condenser C_{DA} by the power supply, and the voltage loss on the condenser plates is dependent on the charge time. This influence in a typical paper condenser is demonstrated by the curves of Fig. 1. Measurements have also been made whereby a condenser C is charged from a low impedance source (storage condenser) for more than ten time-constants. The theoretical voltage which should be expected in the condenser C is defined as E_0 , which equals 100%. The actual voltage measured after several minutes, when the charge has been lost from the plates as a result of the dielectric absorption, is defined and plotted as E_{DA} . Because a certain amount of charge soaks in



Fig. 3: Developmental model of tester

the dielectric during the charge-time, the voltage loss due to dielectric absorption increases with decreasing charge-time. (Fig. 1 indicates the various methods which were used to vary the charge-time.) These tests show that, in most cases, the voltage loss due to dielectric absorption is approximately the same

TABLE I

Type of Condenser	Dis-charge Time (min.)	Charge Time (min.)	Time Mean Value of 10 Readings (sec.)	Max. Dev. (msec.)	Max. Time Error (%)	Change of Mean Value (%)
High quality paper condenser	3	3	57.541	45	0.079	—
	1	1	57.414	60	0.104	-.22
	0.01	1	57.427	93	0.162	-.20
	0.01	3	57.669	209	0.363	+.22
	0.01	1	57.854	43	0.145	+.55
	0.01	6	58.075	94	0.160	+.93
Polystyrene condenser	0.01	1	30.427	21	0.069	
	0.01	6	30.430	22	0.073	
	0.01	12	30.428	20	0.066	

TABLE II

Kind of Dielectric	Voltage Loss* 0-600 V	Voltage Recovery* 600-0 V	Leakage Resistance Ohms**	Ratio:***
Polystyrene	0.26	0.07	1.6×10^{11}	0.27
Mylar/Polystyrene	1.69	1.09	10^{12}	0.645
Mylar	3.4	1.8	10^{12}	0.515
Vitamin Q	6.3	4.5	3×10^{11}	0.715
Prokar	8.8	6.2	$.85 \times 10^{11}$	0.705

* After 30 seconds

** At room temperature

*** Voltage Recovery
Voltage Loss

for charging-times ranging from 1 to 10 msec. and that its effect is large enough to be measured accurately. Charge- or discharge-times of this magnitude are commonly encountered in practical applications, so that under conditions where greater accuracy is required, dielectric absorption cannot be neglected.

Absorption Tester

The effects described were used in the design of a Condenser Dielectric Absorption Tester. This device allows a fast and simple determination of the dielectric absorption of condensers under certain fixed conditions. The general test procedure is to compare the unknown condenser with a very well designed 1 mfd. polystyrene condenser which has negligible dielectric absorption. The circuit is shown in Fig. 2. By means of a spring-loaded wafer switch, both the unknown and reference condenser can be simultaneously charged or discharged for approximately 2 msec. from or to a large

storage condenser (50 microfarad). The initial charge in the condenser can be set by means of a selector switch which taps the voltage source in six equal steps. In this manner the condensers under investigation can be checked either under charge or discharge conditions.

During the contact time of 2 msec, all three condensers reach an equilibrium voltage, since in testing a 1 mfd. condenser this charge-time exceeds the circuit time-constant by a factor of twenty. Using such a condenser and a 624 vdc power source, tests with increments of 100 v can be performed. For precision measurements the exact value of voltage increments must be calculated in cases in which the capacity of the unknown condenser deviates from 1 mfd. In the final position, the spring-loaded wafer switch automatically inserts a sensitive electrometer-type meter between the ground side of the reference condenser and the low side of the unknown condenser. Prior to this final position, the switch shorts the instrument and connects it to ground.

Fig. 4: Readings for 7 different capacitors

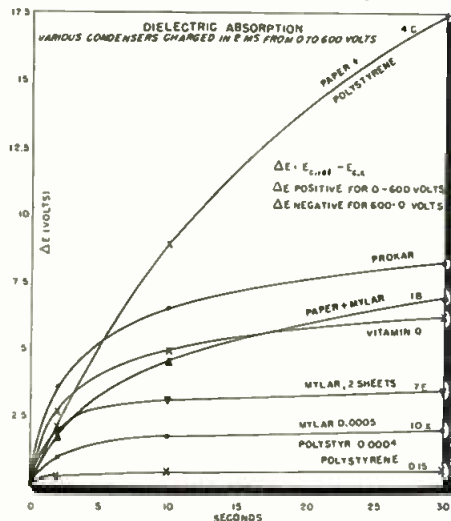

Dielectric Absorption (Continued)

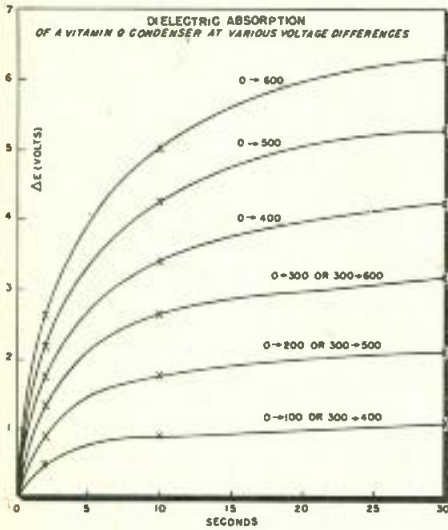

Fig. 5: Loss is proportional to voltage change

The instrument shows the voltage increase or decrease in the unknown condenser as a result of dielectric absorption versus time after switch operation.

In most of the tests, a Keithley Vacuum Tube Electrometer Model 200 was used. This meter has an input impedance higher than 10^{14} ohms, shunted by approximately 6 mmfd. When the leakage resistance of the unknown condenser is above 10^{12} ohms times microfarads, its influence on the instrument readings can be neglected; when its value is lower, its influence must be determined separately. However, condensers having a leakage resistance of less than 10^{12} ohms times microfarad should not be used in high quality RC-timing circuits. For these studies, the insulation of the tester and of the reference condenser was checked and determined to be above 10^{12} ohms.

It is necessary to use a large storage capacity to charge both condensers because the impedance of a properly designed storage condenser is low and does not change with the life of the equipment. In the case of the discharge of both condensers from different initial voltages to zero final voltage, a storage condenser would not be necessary. For easier operation and to get comparable results between charge and discharge tests, the storage condenser is used in both cases. The Dielectric Absorption Tester is shown in Fig. 3. On the left side of the panel are the two knobs for selecting the initial and final voltage, as indicated on the corresponding instruments. The upper knob on the right side serves to rewind the spring-loaded wafer switch, which, by pushing the but-

ton below, is released and passes the various contact positions in a total of approximately 4 msecs. On the lower part of the panel are three pairs of terminals and a master switch. The left pair is for the dc voltage input, the center pair for connecting the unknown condenser, and the right one for inserting the vacuum tube electrometer. Condenser and electrometer terminals above ground are mounted on polystyrene sheets.

The dielectric absorption of various types of condensers under various conditions were checked with this equipment. The device has been proven to be reliable in determining the quality of a condenser

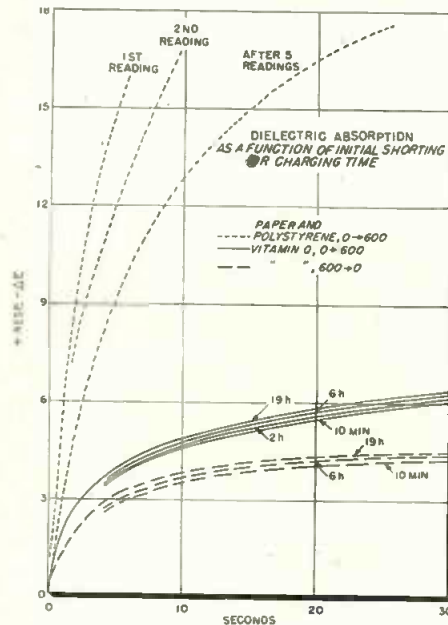

Fig. 6: Short tests with Vitamin Q condensers

with regard to its dielectric absorption. It has been helpful in determining the effects of various materials and also of various different production techniques.

Dielectric Materials

Fig. 4 shows various instrument readings vs. time for seven different condenser types. All condensers were charged from zero to 600 v after an initial shorting-time of more than ten minutes. The curves represent mean values of ten readings. In most of the cases the voltage loss, due to dielectric absorption, is close to its final value within 30 secs. It is believed that this time interval is sufficient to allow accurate determination of the quality of the condenser under test.

From this plot, it may be noted

that the two condensers with one sheet of paper added to polystyrene or mylar respectively will reach an equilibrium after an appreciably longer time than 30 secs. and that the initial voltage increase is slower.

The polystyrene condenser which was selected for these tests shows a small amount of dielectric absorption. This fact may be confusing in that its dielectric absorption should be zero when compared to the reference condenser of the tester. However, the apparent discrepancy is a result of the manufacturing technique used in the condenser tested. The condenser section of this sample was not baked at a high enough temperature or for a sufficient time so that minute air bubbles were trapped in the section, thereby causing the dielectric absorption observed.

Voltage Dependency

To demonstrate the change in voltage loss due to dielectric absorption as function of applied voltage, the data obtained with a Vitamin Q condenser are presented in Fig. 5. The values shown are mean values of several readings. In the first series of tests, after an initial shorting-time of more than ten minutes, the condenser was charged from 0 to 100 v and increased to 600 v by increments of 100 v. In this voltage range, the dielectric absorption was proportional to the change in applied voltage. This behavior was also confirmed in a second series of tests in which the condenser was precharged to 300 v for more than 10 mins. and in which the voltage then was raised to 400, 500, and 600 v respectively. Such tests show that the change of voltage alone determines the amount of dielectric absorption and not the potential, as shown in the case of 0 to 200 v equaling 300 to 500 v. In practically all of the condensers checked, this roughly linear relationship between voltage change and dielectric absorption was observed.

It is known that the voltage loss does not reach its final value in 30 secs. A longer time, which varies
(Continued on page 100)

Fig. 7: Variations with temperature

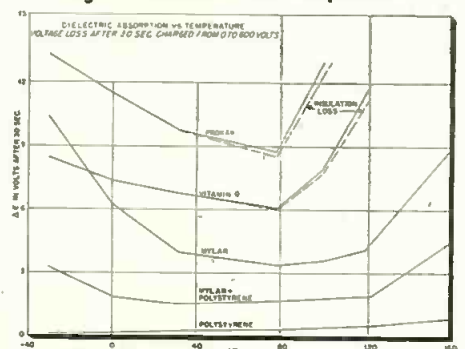

The Light Amplifier ✓

Long sought scientific goal achieved in new cell providing a light gain of 10. Positive step toward picture-on-the-wall TV

LAST month scientists from the General Electric Research Laboratory in Schenectady, N.Y. demonstrated their light amplifier, a long sought scientific goal. Dr. C. G. Suits, vice president and director of research, indicated that this development might be the clue that will ultimately permit the achievement of picture-on-the-wall television. Im-



Fig. 2: D. A. Cusano (l) developer of the light amplifying phosphor and Dr. F. E. Williams display light amplification cell

mediate applications were foreseen in x-ray fluoroscopy, photography, "seeing-in-the-dark" devices and other developments involving reproduction of picture images. Dr. F. E. Williams, head of light generation studies at the research laboratory credited D. A. Cusano with the development of the light-amplifying phosphor used in this cell.

Fig. 1 portrays diagrammatically the construction of the light amplification cell. In the demonstration ultraviolet radiation was used as the exciting source and the visible emission was greenish yellow in appearance. A gain of ten, i.e., ten or more visible photons per incident ultraviolet photon was obtained. Another noteworthy fact is that the cell appeared to be comparatively linear. Varying the incident radiation produced proportional variations in visible light output.

D. A. Cusano, in a paper entitled "Field Enhanced Solid-State Luminescence" given before the American Physical Society meeting last month, pointed out that large in-

Fig. 1: Diagram showing the construction and elements in GE's new light amplifier

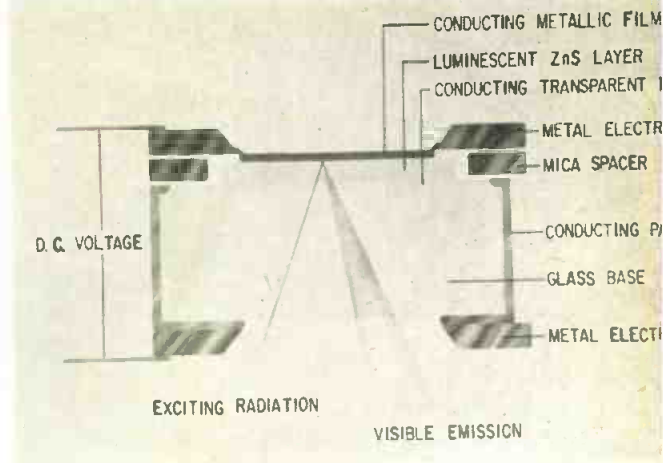

creases in the luminescent brightness of ultraviolet excited or x-ray excited zinc sulfide layers have been observed when these phosphors are subjected to electric fields. The application of 100 volts d-c across vapor deposited ZnS:Mn films approximately 10 microns thick (10^7 V/cm) has been observed to increase the brightness 50 times. The single phosphor layer therefore acts as an image intensifying screen.

With reference to Fig. 1, several other interesting points should be mentioned. The exciting and visible radiation need not be essentially reflective as illustrated. The cell can be built in a "series" configuration with the exciting radiation on one side and the visible emission emanating from the other. By changing the impurity in the zinc sulphide phosphor, visible emissions in different colors can be achieved. Other forms of exciting radiation, such as an electron stream, can be used. A basic point of cell operation seems to be that the

visible emission is always frequency displaced from the incident radiation. In view of this, it is evident that the cell offers developmental opportunities for a new type of color-TV display device.

It is possible to connect light amplification cells in series and thus obtain an overall arithmetic gain proportional to the gain of the individual cells. However one problem still encountered with the cell is its relatively long time constant (appr. 4 sec).

The cell demonstrated has a round screen approximately 4 in. in diameter. The applied d-c field voltage ranged between 100-150V. and field current ranged up to approximately 15 m. The scientists reported that apparently there is no limitation to the size of screen that can be built but existing equipment at the laboratories does not permit the construction of large size screens comparable to today's TV picture tube sizes.

Fig. 3: Visual portrayal of light amplification. Two photos were printed simultaneously from consecutive negatives using same lens, lens opening and exposure time. Printing process accounts for detail loss in circled photo of unamplified scene

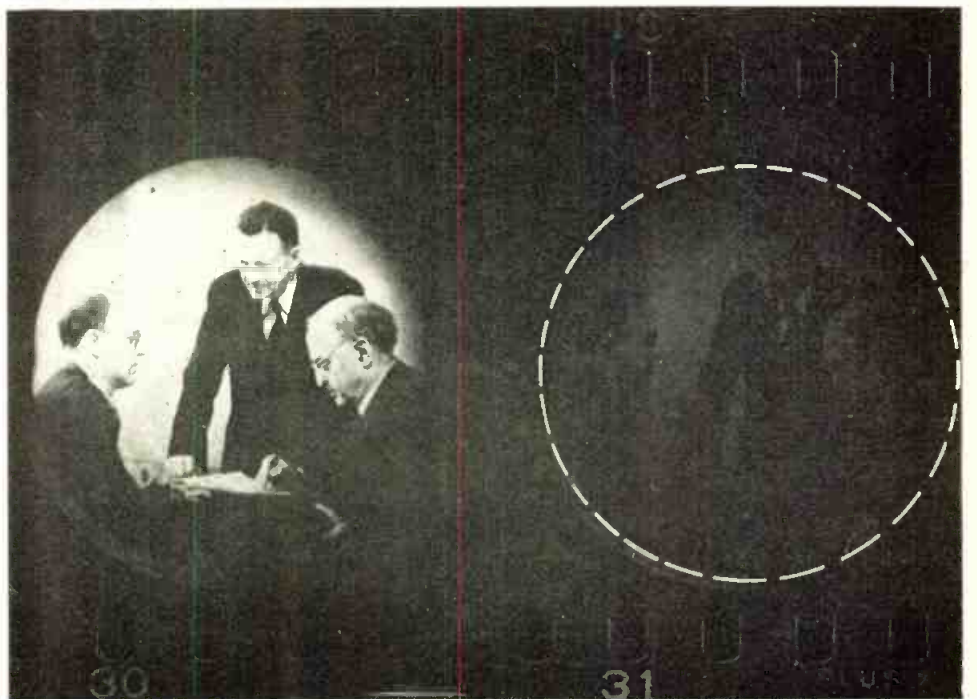

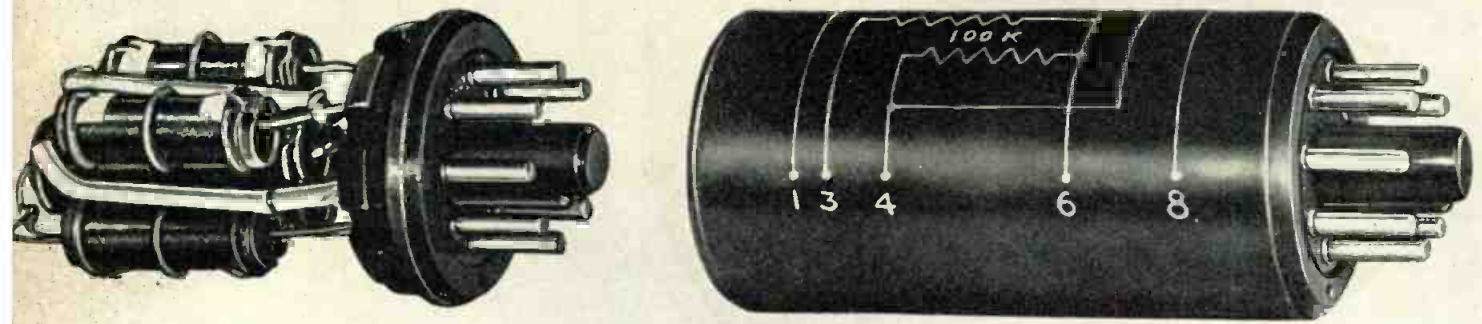

Fig. 1: Potted network incorporating 5 precision wire-wound resistors, before, and after, encapsulation. Schematic on casing is determined by user

Designing Potted Resistor Networks

A POTTED resistor network can be defined as the encapsulation of any given number of precision wire-wound resistors of specified values into one compact unit having the shape and size specified by the user. From a design standpoint, this arrangement lends itself particularly well to resistance circuitry applications requiring miniaturization, rapid assembly and ease of replacement.

The development of potted resistor networks was begun in 1953, but the ground work had actually been laid two years earlier, during I-T-E's research into single, encapsulated, precision wire-wound resistors. At that time, the Resistor Div., under a contract from a leading electronics manufacturer, undertook a thorough study of all existing resistors, with an eye toward improving their ability to withstand greater extremes of temperature and humidity.

Steatite-Resistor Types

Two basic types of construction were in use at that time for fabricating precision wire-wound resistors. The first utilized a steatite bobbin which was impregnated and covered with either a paper or acetate label after winding. The second featured a steatite bobbin, contained within, and solder sealed to a steatite shell. There were many kinds of impregnation used in the paper or acetate label type described here; however, none of these provided the reliability required by many applications. The solder sealed type, while qualitatively more acceptable than the other basic type, proved to be expensive and difficult to manufacture.

Work was begun on this type to reduce construction costs while retaining its superior reliability under

atmospheric conditions. Many methods were initiated and discarded, and many materials were scrutinized before discovering the potting compound of epoxy resin which is now used in the manufacture of precision wire-wound resistors. This new resin included all the electrical and mechanical properties needed to meet the critical requirements of the user.

Much time and energy was spent in learning and developing correct techniques before bobbins could be machined quickly and accurately from rods of cured epoxy resin. Manufacturers supplying us with steatite bobbins were later introduced to this new resin. This was done in order that they might supply the new bobbin in quantity as the demand increased.

Methods were thus derived where these bobbins could be encapsulated with the liquid epoxy resin after winding. This technique is not to be



By
H. E. MYERS
Ch. Engr.
Resistor Div.
I-T-E Circuit
Breaker Co.
Philadelphia, Pa.

confused with vacuum impregnation, which was standard procedure at that time. The encapsulation method produced a solid cylindrical resistor which was light in weight and extremely durable. And, in addition, this new resistor, unlike the solder sealed types, was truly a hermetically sealed unit.

With the encapsulation of single resistors by epoxy resins thus firmly established, the way was open for

Fig. 2: Network incorporating 10 resistors of various values and 3 trimmer potentiometers

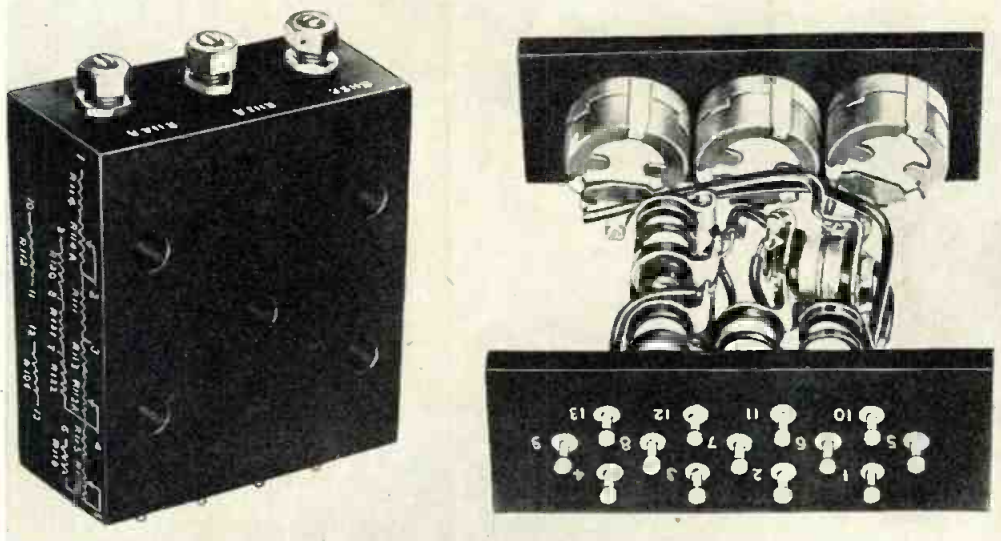

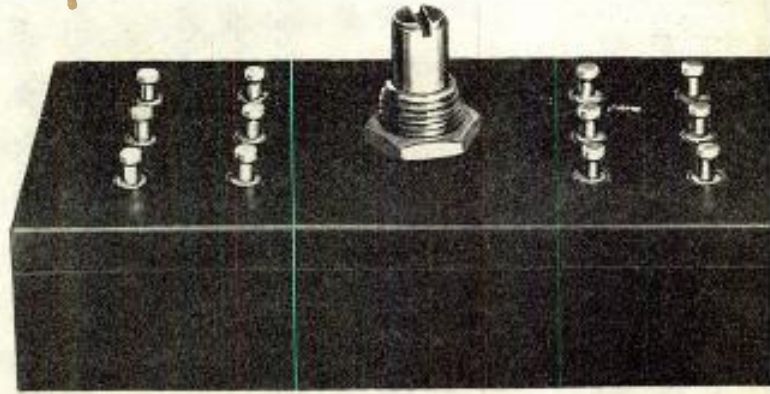
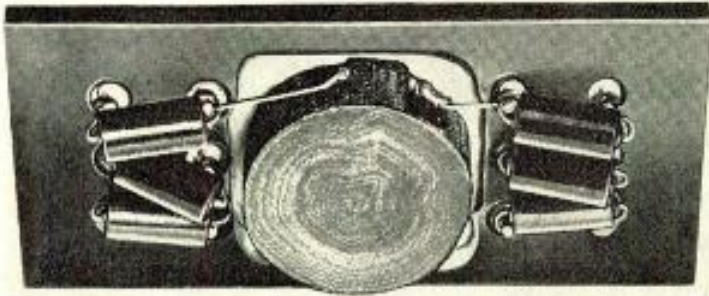

Fig. 3: The 6 precision resistors in this network were potted separately to meet user's stability requirement of .003%. Pot is used to balance a bridge circuit

The methods derived for encapsulating single precision resistors in epoxy resin have led to network mounting techniques which find unlimited design possibilities

the arrival of potted resistor networks.

Design Considerations

Space consideration on a specific application early in 1953 prompted an experiment of combining several resistors together into a single unit, with the use of epoxy resin. The unit was designed for plug-in application, into a standard octal base tube socket. (See Fig. 1)

A common method then practiced for encompassing many resistors within a given unit was to enclose them in a soldered sealed can. The resistors which were used in this method were usually of the steatite core type. This method had, and still has, its limitations; however, the development of epoxy type resins with low-heat cure and high-heat distortion made multiple-resistor encapsulation not only possible but highly

practical for the following reasons: (1) Resistor components are protected from rough handling and hermetically sealed against severe atmospheric conditions; (2) network bodies are solid, having no dead air space, thereby assuring their being unaffected by extreme temperature and pressure variations; (3) networks are lightweight as the specific gravity of the resin used is from .95 to 1.43; (4) non-conductiveness—the volume resistivity of epoxy resin in ohms/cm is 9.2×10^{12} at 130°C .; (5) network bodies are non-corrosive and all metal parts are either silver or nickel plated or tinned dipped; (6) shapes and sizes are governed only by the engineers requirements, and may be of intricate or simple design, spherical, square or rectangular shapes; (7) networks are compact—some units currently in service, incorporate from two 2-watt to thirty $\frac{1}{4}$ -watt resistors.

(8) Resistance tolerances to 0.1% are possible, though there are limitations imposed by the resistance values and physical sizes specified; (9) surpasses MIL-R-93A specifications; (10) fungus proof—an inherent characteristic of epoxy resin; (11) network ambient operating temperatures up to 150°C .; (12) equal temperature coefficient of expansion is assured as identical type epoxy resin is used for terminal boards, bobbins and final encapsulation; (13) various mounting methods, i.e., wire lead, plug-in, screw type, or any other style specified by the user; (14) chassis mounting provides for high heat dissipation, (wattage ratings), see Fig. 4; (15) use of these networks in end-products reduces final assembly time considerably.

Manufacturing Procedure

Any one of many methods may be used in manufacturing potted resistor networks. The following is a typical procedure applicable to most requirements: A specific number of subminiature precision wire-wound resistors are first wired to a terminal board which is molded of epoxy resin. Extreme precaution must be taken when wiring resistors to the terminal board, since no changes can be made once the encapsulation process has been completed. After wiring, each resistor in the network is checked by a Kelvin or Wheatstone bridge to assure accuracy of the nominal value specified by the customer. The complete network is then temperature cycled five times between the ranges of -55°C to $+85^\circ\text{C}$.

After cycling, the units are placed in molds (aluminum, brass, steel and plastic have been used with somewhat the same success) the metal molds having been coated with pan glaze for ease of release. The specific type of epoxy resin used for
(Continued on page 136)

Fig. 4: Heat dissipation differential when resistors are mounted normally, and when network-mounted

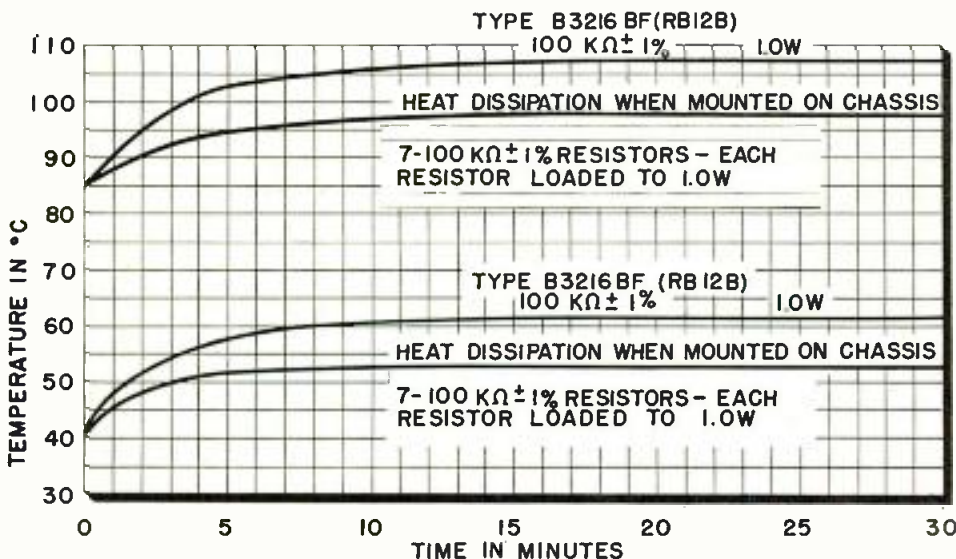

Television Stations Coming on the Air

Geographical listing of stations coming on the air in the United States presenting data on each one in following order: Call Letters (licensee is given where call letters have not yet been assigned by FCC); Channel No.; Address.

ALABAMA

BIRMINGHAM

WJLN-TV; 48; P.O. Box 5767
WEDB; 10 (NCE); 714 Protective Life Building

DOTHAN

WTVY; 9; Cotton Wood Road

MUNFORD

WEDM; 7 (NCE); 714 Protective Life Bldg., Birmingham

SELMA

WSLA; 8; P.O. Box 1447, Montgomery

ARIZONA

PHOENIX

KTVK; 3; 4701 N. 24th St.

ARKANSAS

EL DORADO

KR88; 10; c/o Station KVMA, Magnolia

FORT SMITH

KNAC-TV; 5; 15 Court St.

HOT SPRINGS

KTVR; 9; 912 Central Ave.

LITTLE ROCK

KETV; 23; c/o U.S. Corp. of Ill., 33 N. LaSalle St., Chicago, Ill.

KTHV; 11; 119 E. Capitol

CALIFORNIA

CORONA

KCOA; 52; Pico Blvd., Santa Monica

EL CENTRO

KPIC-TV; 16; 71495 San Geronimo Rd., Rancho Mirage

LOS ANGELES

KBIC-TV; 22; 6540 Sunset Blvd., Hollywood

MODESTO

KTRB-TV; 14; P.O. Box 593

SACRAMENTO

KBET-TV; 10; 926 J St.

KBIE-TV; 46; 6540 Sunset Blvd., Hollywood

SAN DIEGO

KUSH; 21; 1245 Broadway

SAN FRANCISCO

KBAY-TV; 20; 321 S. Beverly Dr., Beverly Hills

SAN JOSE

KQXI; 11; 702-10 Commercial Building

VISALIA

KAKI; 43; 400 E. Tulare St., Tulare

COLORADO

DENVER

KRMA-TV; 6 (NCE); 414 14th St.

CONNECTICUT

BRIDGEPORT

WCBE; 71 (NCE); Conn. State Board of Education, State Office Building, Hartford

HARTFORD

WCHF; 24 (NCE); Conn. State Board of Education, State Office Building

NEW HAVEN

WELI-TV; 59; 221 Orange St.

NEW LONDON

WNLC-TV; 26; 281 State St.

NORWICH

WCNE; 63 (NCE); Conn. State Board of Education, State Office Building, Hartford

STAMFORD

WSTF; 27; c/a P. M. Brown, Washington Loan & Trust Building, Washington, D. C.

DISTRICT OF COLUMBIA

WASHINGTON

Washington Metropolitan TV Corp.; 20; 1125 Vermont Ave.
WOOK-TV; 50; 8th & Eye Ss., N.W.

FLORIDA

CLEARWATER

WPGT; 32; P.O. Box 1146

DAYTONA BEACH

WMFJ-TV; 2; 444 N. Beach St.

JACKSONVILLE

WOBS-TV; 30; 1036 Mary St.

MIAMI

WMFL; 33; Miami-Biscayne Hotel
WMIE-TV; 27; Hotel Everglades
WTHS-TV; 2 (NCE); Lindsey Hopkins Vocational School, 1410 N.E. 2nd Ave.

TAMPA

WFLA-TV; 8; P.O. Box 1410
WTVT; 13; P.O. Box 1077

WEST PALM BEACH

WEAT-TV; 12; P.O. Box 70

GEORGIA

THOMASVILLE

WCTV; 6; c/o E. D. Rivers, Sr., Lakeland

IDAHO

POCATELLO

KWIK-TV; 6; P.O. Box 768

TWIN FALLS

KLIX-TV; 11; P.O. Box 432

ILLINOIS

CHAMPAIGN

WTLC; 12 (NCE); University of Illinois, 119 Gregory Hall, Urbana

CHICAGO

WHFC-TV; 26; 3350 S. Kedzie Ave.
WIND-TV; 20; 400 N. Michigan Ave.
WOPT; 44; 408 S. Oak Park Dr., Oak Park
WTTW; 11 (NCE); 38 S. Dearborn

EVANSTON

WTLE; 32; 2201 Oakton St.

INDIANA

FORT WAYNE

WANE-TV; 69; Fort Wayne Bank Building

NOTRE DAME

WNDU-TV; 46; c/o Michiana Telecasting Corp.

IOWA

SIoux CITY

KCTV; 36; c/o U.S. Corp. of Ill., 33 N. LaSalle St., Chicago, Ill.

KANSAS

MANHATTAN

KSAC-TV; 8 (NCE); Kansas State College

KENTUCKY

ASHLAND

WPTV; 59; 321 8th St., Huntington, West Virginia

LEXINGTON

WLAP-TV; 27; Radio Building
WLEX-TV; 18; 136 N. Limestone

LOUISVILLE

WQXL-TV; 41; 2549 S. 3rd St.

NEWPORT

WNOP-TV; 74; 606 Monmouth St.

LOUISIANA

BATON ROUGE

WBRZ; 2; P.O. Box 1926

LAFAYETTE

KLFY-TV; 10 (TS KVOL-TV); P.O. Box 992
KVOL-TV; 10 (TS KLFY-TV); P.O. Box 1070

NEW ORLEANS

WCKG; 26; Melrose Building, Houston, Texas
WCNO-TV; 32; 515 Baronne St.

MARYLAND

BALTIMORE

WITB-TV; 72; 7 E. Lexington Ave.
WTLF; 18; 912 N. Charles St.

CUMBERLAND

WTBO-TV; 17; 31 Frederick St.

MASSACHUSETTS

BOSTON

WGBH-TV; 2 (NCE); 84 Massachusetts Ave., Cambridge
WJDW; 44; 172 Delfern Dr., Beverly Hills, California

BROCKTON

WMFJ-TV; 2; 225 Washington St., Boston

WORCESTER

WAAB-TV; 20; 34 Mechanic St.

MICHIGAN

ANN ARBOR

WUOM-TV; 26 (NCE); 310 Maynard

BATTLE CREEK

WBCK-TV; 58; 402 Security National Bank Building

DETROIT

WBID-TV; 62; 8000 E. Jefferson St.
WTVS; 56 (NCE); 474 W. Warren Ave.

FLINT

WJRT; 12; 2200 Fisher Building, Detroit

GRAND RAPIDS

WMCN; 23; 123 Pearl St., N.W.

MARQUETTE

WAGE-TV; 6; 2525 W. Wisconsin Ave., Milwaukee, Wisconsin

MUSKEGON

WTVM; 35; 6 Fountain St., N.E. Grand Rapids

MINNESOTA

HIBBING

KHTV; 10; 3100 First National Bank Building, St. Paul

MINNEAPOLIS

KEYD-TV; 9; Foshay Tower

MISSISSIPPI

COLUMBUS

WCBI-TV; 4; c/o Station WCBI

TUPELO

Tupelo Citizens TV Co.; 9; 7 Oakdale St., Syracuse, N. Y.

MISSOURI

CLAYTON

KFUO-TV; 30; 801 De Mun Ave.

JEFFERSON CITY

KRCG; 13; 210 Monroe St.

KIRKSVILLE

KTVO; 3; 2513 N. Court, Ottumwa, Iowa

ST. LOUIS

WIL-TV; 42; Chase Hotel

NEBRASKA

SCOTTSSBLUFF

KSTF; 10; 2923 E. Lincolnway, Cheyenne, Wyoming

NEVADA

HENDERSON

KLRJ-TV; 2; 300 Fremont St.

NEW HAMPSHIRE

KEENE

WKNE-TV; 45; 17 Dunbar St.

NEW JERSEY

ATLANTIC CITY

WCOC; 52; c/o D. Mackay, 207 W. Swissvale Ave., Pittsburgh, Pennsylvania

CAMDEN

WKDN-TV; 17; 2881 Mount Ephraim Ave.

NEW BRUNSWICK

WTLV; 19 (NCE); TV Studio, Box 48, Rutgers University

NEW YORK

ALBANY

WPTV-TV; 23; Hotel Ten Eyck
WTVZ; 17 (NCE); Bureau of Audio & Visual Aids, Univ. of the State of N. Y., State Education Dept.

BINGHAMTON

WQTV; 46 (NCE); Bureau of Audio & Visual Aids, Univ. of the State of N. Y., State Education Dept., Albany

BUFFALO

WTVF; 23 (NCE); Bureau of Audio & Visual Aids, Univ. of the State of N. Y., State Education Dept., Albany

ITHACA

WHCU-TV; 20; Savings Bank Building
WIET; 14 (NCE); Bureau of Audio & Visual Aids, Univ. of the State of N. Y., State Education Dept., Albany

NEW YORK

WGTV; 25 (NCE); Bureau of Audio & Visual Aids, Univ. of the State of N. Y., State Education Dept., Albany
WNYC-TV; 31; 2500 Municipal Building

ROCHESTER

WCFB-TV; 15; 87 Seneca St., Geneva
 WRNY-TV; 27; 40 N. Main St., Glensville
 WROH; 21 (NCE); Bureau of Audio & Visual Aids,
 Univ. of the State of N. Y., State Education Dept.,
 Albany

SYRACUSE

WHTV; 43 (NCE); Bureau of Audio & Visual Aids,
 Univ. of the State of N. Y., State Education Dept.,
 Albany

NORTH CAROLINA**CHAPEL HILL**

WUNC-TV; 4 (NCE); Communications Center, Uni-
 versity of North Carolina

FAYETTEVILLE

WFLB-TV; 18; P.O. Box 512

GASTONIA

WTVX; 48; Air-Pix Corp., Lawell

WASHINGTON

North Carolina TV Inc.; 7; Bank of Washington
 Building

WILMINGTON

WTHI; 3; P.O. Box 604A, Carolina Beach

NORTH DAKOTA**GRAND FORKS**

KNOX-TV; 10; c/o Carroll E. Day

OHIO**CINCINNATI**

WQXN-TV; 54; Station WQXN-TV; Cincinnati 25

CLEVELAND

WERE-TV; 65; 1501 Euclid Ave.
 WHK-TV; 5000 Euclid Ave.

COLUMBUS

WOSU-TV; 34 (NCE); Station WOSU-TV; Columbus 10

ELYRIA

WEOL-TV; 31; Elyria Savings & Trust Building

LIMA

WIMA-TV; 35; 224 N. Main St.

MANSFIELD

WTVG; 36; Madison Theatre

MASSILLON

WMAC-TV; 23; 601 First National Bank

TOLEDO

WTOH-TV; 79; 3315-19 Cadillac Tower, Detroit,
 Michigan

OKLAHOMA**ARDMORE**

KVSO-TV; 12; 1614 Stanley St.

MIAMI

WMIV; 58; P.O. Box 420, Wichita Falls, Texas

OKLAHOMA CITY

KETA-TV; 13 (NCE); P.O. Box 2005, Norman

TULSA

KSPG; 17; P.O. Box 2680
 KOED-TV; 11 (NCE); P.O. Box 2005, Norman

OREGON**KLAMATH FALLS**

KFJI-TV; 2; P.O. Box 692

PORTLAND

KLOR; 12; 1019 S.W. 10th St.

SALEM

KSLM-TV; 3; Senator Hotel

PENNSYLVANIA**ALLENTOWN**

WQCY; 39; P.O. Box 689

ERIE

WLEU-TV; 66; 806 Park Ave., Meadville

HAZLETON

WAZL-TV; 63; 708 Hazleton National Bank Building

LANCASTER

WWLA; 21; 306 Southway, Baltimore, Maryland

PHILADELPHIA

WIBG-TV; 23; 1425 Walnut St.

PITTSBURGH

WTVQ; 47; 5 S. Jefferson, Dayton, Ohio

SHARON

WSHA; 39; 542 S. Oakland Ave.

WILLIAMSPORT

WRAK-TV; 36; 244 W. 4th St.

RHODE ISLAND**PROVIDENCE**

WPRO-TV; 12; 24 Masen St.

SOUTH CAROLINA**CAMDEN**

WACA-TV; 15; Station WACA-TV

SPARTANBURG

WSPA-TV; 7; 224 E. Main St.

SOUTH DAKOTA**RAPID CITY**

Black Hills Broadcasting Co.; 3; P.O. Box 1752

TENNESSEE**JACKSON**

WDXI-TV; 7; Williams Building

TEXAS**AMARILLO**

KLYN-TV; 7; P.O. Box 2387

BEAUMONT

KFDM-TV; 6; 1420 Calder

BIG SPRING

KBST-TV; 4; 702 Johnson St.

CORPUS CHRISTI

KTLG; 43; 2104 Jackson St., Dallas

DALLAS

KDTX; 23; Magnolia Building

KLIF-TV; 29; 2104 Jackson St.

EL PASO

KOKE; 13; 4530 Delta St.

FORT WORTH

KFJZ-TV; 11; 1201 W. Lancaster Ave.

HOUSTON

KTVP; 23; Magnolia Building, Dallas

KXYZ-TV; 29; Gulf Building

LUBBOCK

KFYO-TV; 5; 914 Avenue J

LUFKIN

KTRE-TV; 9; P.O. Box 701

SAN ANTONIO

KALA; 35; Kirby Building

KCOR-TV; 41; 310 S. Flores St.

SWEETWATER

KPAR-TV; 12; 7400 College Ave., Lubbock

WACO

KWTX-TV; 10; 108½ S. 6th St.

UTAH**PROVO**

KOVO-TV; 11; 108 W. Center

VIRGINIA**PETERSBURG**

WPRG; 8; 701 Union Trust Building

RICHMOND

WOTV; 29; 826½ W. 4th St., Winston-Salem, North
 Carolina

WASHINGTON**PASCO**

KEPR-TV; 19; P.O. Box 702, Yakima

SEATTLE

KCTL; 20; 200 W. Mercer St.

VANCOUVER

KVAN-TV; 21; 707½ Main St.

WEST VIRGINIA**BLUEFIELD**

WHIS-TV; 6; 623 Commerce St.

CLARKSBURG

WBLK-TV; 12; 211½ 5th St.

HUNTINGTON

WHTN-TV; 13; 4th Ave.

WHEELING

WLTV; 51; 321 8th St., Huntington

WISCONSIN**GREEN BAY**

WFRV-TV; 5; Northern Building

LA CROSSE

WTLB; 38; c/o George Becker, 270 Park Ave., N. Y.,
 N. Y.

ALASKA**FAIRBANKS**

KFIT; 2; P.O. Box 939; Anchorage

FACTORY TEST FOR NEW WEAT-TV TRANSMITTER

STANDARD Electronics Corp. of Newark, N.J., a Claude Neon subsidiary, has tested and shipped a 10 KW TV transmitter plus a complete complement of station equipment for Station WEAT-TV, Channel 12, West Palm Beach, Fla. Testing program was carried out with the transmitter and station equipment set up as a complete station layout at the factory. In addition to

the 10 KW high-band TV transmitter, station equipment includes complete video equipment, Vidicon film chain, film projectors, 2 Multicon studio chains, complete master control equipment covering every phase of operation of the new station (control consoles, amplifiers, power supplies, racks, monitors, etc.) and a high gain Alford antenna.

Pulse Transformers Utilizing

By MICHAEL J. GEROULO
and LAWRENCE HOBSON
Sprague Electric Co.
North Adams, Mass.

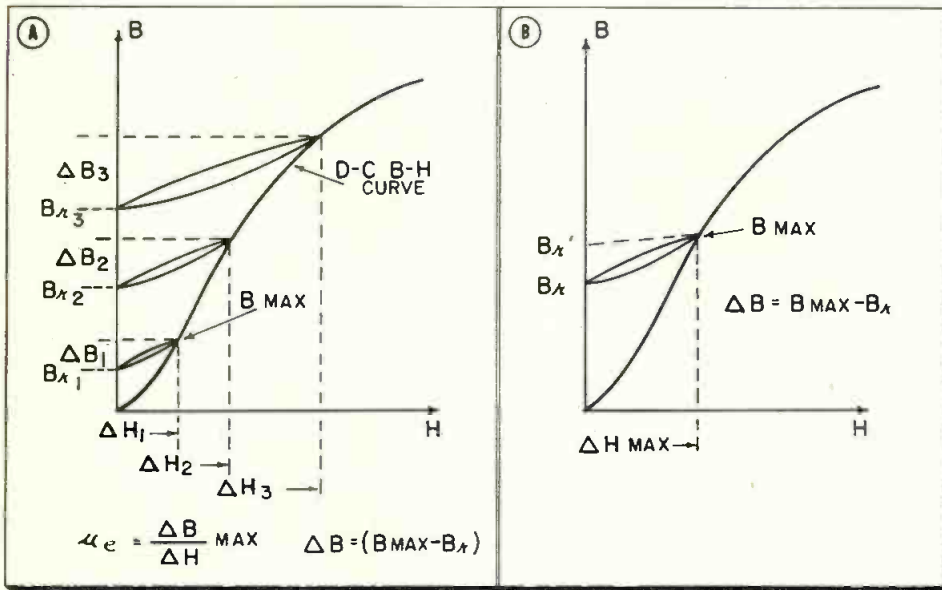

Fig. 1: Magnetization characteristics of a core material when pulse is applied

Analysis of core material characteristics facilitates design of low-power, miniature transformers used in digital computers and other high speed circuitry

PULSE magnetization¹ normally refers to any magnetization of a magnetic material where the applied magnetic field, H, is unidirectional, resulting in small displaced hysteresis loops. Fig. 1(A) shows that when a pulse magnetization, ΔH , is applied to a material, the change of B, the magnetic flux density, is to some B_{max} and back to a remanence B_r . Succeeding pulses of magnetic field ΔH , will form a B-H loop, for example, from B_{r1} to B_{max1} . In general, the change of B for a given change of H, or the value ΔB , is equal to $(B_{max} - B_r)$ and the pulse permeability is defined as $\mu_p = \Delta B / \Delta H$.

Density Change

When a high speed pulse is applied to a magnetic material, the change of magnetic flux density from B_{max} to B_r departs from the normal path and as shown in Fig. 1(B), arrives at $B_{r'}$ instead of B_r . The flux density then takes a finite time to decay from $B_{r'}$ to B_r . For maximum pulse permeability, defined as the slope of a straight line from B_r to B_{max} , it is necessary that the flux density be at B_r before the next pulse is applied. The time, t, for B to decay from $B_{r'}$ to B_r places a maximum limit on the

repetition frequency of the pulses applied. A relationship has been found between the time, t, and the magnetization, H. This will be discussed later.

The pulse characteristics of two types of materials were obtained by using a test circuit as shown by Fig. 2. A 2D21 hydrogen thyatron was used to generate half-sine-wave pulses. The value R_1 was selected so that the voltage drop V_1 was about 3% or less the total voltage across the sample; therefore, the integrator can be considered to be effectively across the sample itself. The voltages were measured using a 513D Tektronix oscilloscope. Two methods were used to select R_2 and C_2 . First, R_2 was set so that the ratio X_c/R met a minimum satisfying condition for the longest pulse widths, which meant that for the shorter pulse widths X_c/R was much smaller.

The other method used was setting the value $\omega CR = K$ where K was held the same for the different pulse widths. These two methods showed the same relationships existing between curves of different pulse widths, which was an increase in the slope of the ΔB vs ΔH curves as pulse width increased. The only difference was a slight shifting of the curves, when using the two meth-

ods, causing the pulse permeability of the linear portions of the curves to differ by about 8 to 10%. The values of ΔB and ΔH were calculated by the formulas shown in Fig. 2, using the second method mentioned, in which ωCR was held constant. This was found to give a more accurate comparison between curves of different pulse durations. The lag of B vs H was obtained by the measurement of the voltages V_1 and V_2 and observing the time that V_2 reached zero with relation to the time V_1 reached zero. A method similar to this was used by R. D. Robinson² in an investigation of ferrite cores for pulse durations from 0.1 μ sec. to 0.3 μ sec.

Experimental Results

The pulse characteristics of two types of ferrites were measured. The ferrites used were of nickel zinc and manganese zinc composition with initial permeability values of approximately 500 and 800.

Fig. 3 shows the ΔB vs ΔH curves for pulse widths, τ , of 0.3, 0.6, 1.0 and 2.0 μ secs. It is noted that the pulse permeability for all cases remains fairly constant up to applied fields of one oersted, then gradually de-

Fig. 2: Test circuit for obtaining pulse characteristics employs hydrogen thyatron

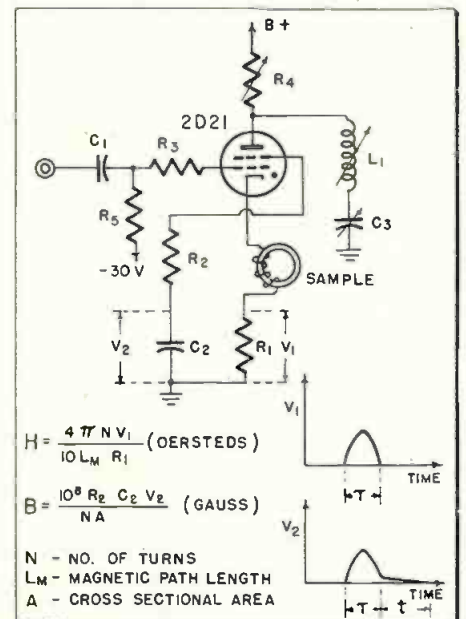

Ferrites

creases as larger fields are applied. A comparison of curves also shows that the higher permeability materials are superior at the lower magnetization values, but the opposite is true for magnetizations of approximately 1.5 oersteds and higher. It also was found that the slope of the ΔB vs ΔH curve increased as the pulse duration increased, thus giving a larger effective pulse permeability for the wider pulses. This was not an unusual feature, the normal B-H curves vary in the same manner as a function of sine wave frequencies. Table I illustrates some of these results obtained from the previous curves. The table shows the pulse permeabilities of four pulse durations at various values of ΔH and a comparison to the normal magnetization permeabilities. At the lower magnetizations the change in μ_p for an increase in pulse width from 0.3 to 1.0 $\mu\text{sec.}$ was approximately 12%, but the changes in μ_p for increases from 1.0 to 2.0 $\mu\text{secs.}$ were very slight and for all practical purposes were negligible. It is interesting to note that the pulse permeability μ_s for signals of very low frequency and small incremental magnetization was fundamentally the same as that found for 1.0 and 2.0 $\mu\text{secs.}$ It was therefore concluded that pulses of widths larger than 2.0 $\mu\text{secs.}$ would not effectively increase the slope of the ΔB vs ΔH curve at the lower magnetizations. A curve for a pulse of 4.0 $\mu\text{sec.}$ duration was plotted and this was verified. Compared to the curve for 2.0 $\mu\text{sec.}$ pulses there was no change of the slope up to values

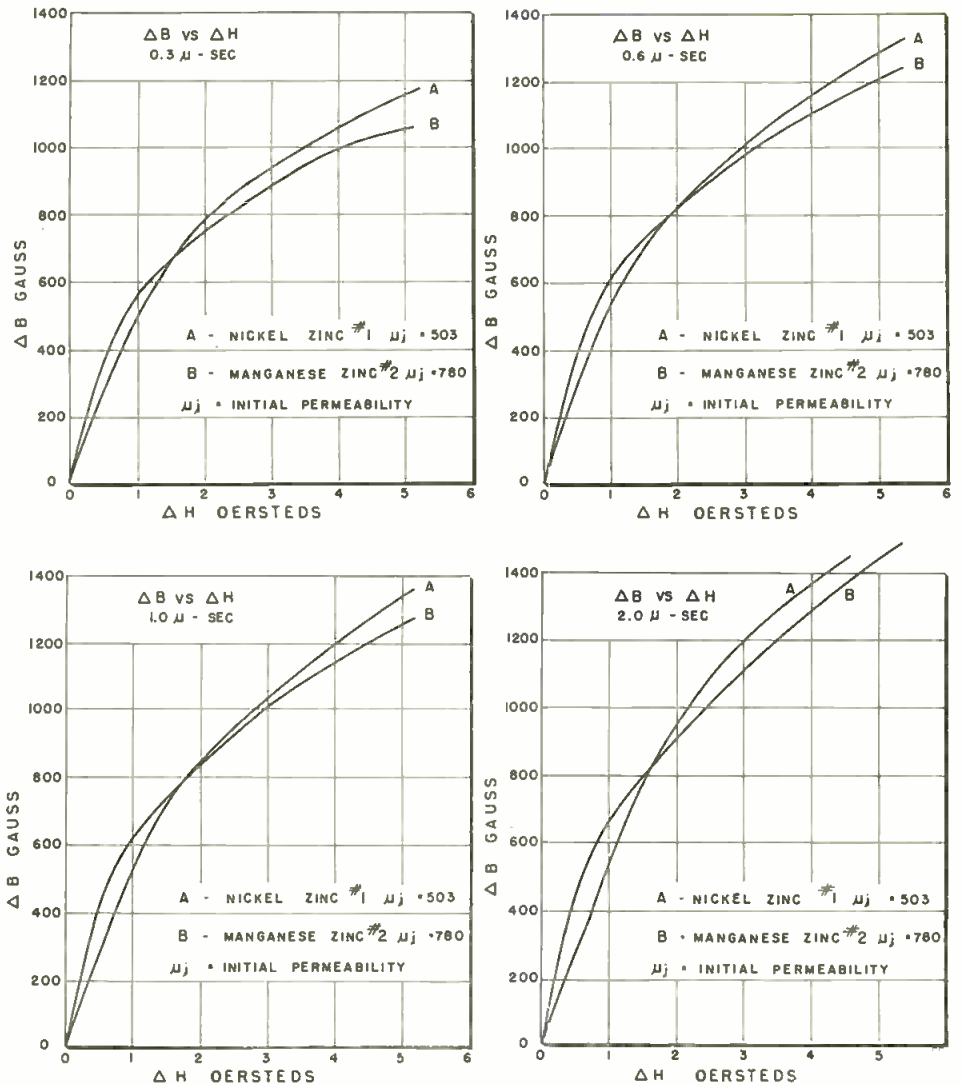

Fig. 3: ΔB vs. ΔH curves for pulse widths of 0.3, 0.6, 1.0 and 2.0 microseconds

of ΔH equal to 1.5 oersteds.

Another interesting property of these materials is the time, t , in which the flux density drops from B_r to B_r . When a pulse is applied to a magnetic material, the permeability is that value of slope from B_r to B_{max} . After the magnetization falls to zero on completion of the pulse the flux is B_r and following a finite

time drops to B_r . If a signal is applied before this transition takes place, there will be a decreasing of the slope representing μ_p . For maximum value of μ_p , the pulse repetition rate should have a period larger than the time t . Fig. 4 shows a plot of the ratio t/τ vs ΔH . The values of the ratios fell within the shaded areas or
(Continued on page 120)

Fig. 4: Plot of t/τ vs. ΔH

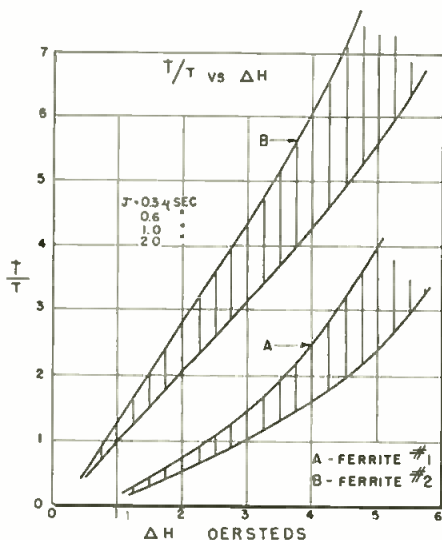

TABLE I

τ $\mu\text{-SEC.}$	FERRITE #1 $\mu_i = 503$						FERRITE #2 $\mu_i = 780$					
	$\Delta H = 0.5$ Oersteds		$\Delta H = 1.0$ Oersteds		$\Delta H = 2.0$ Oersteds		$\Delta H = 0.5$ Oersteds		$\Delta H = 1.0$ Oersteds		$\Delta H = 2.0$ Oersteds	
	μ_P	μ_N	μ_P	μ_N	μ_P	μ_N	μ_P	μ_N	μ_P	μ_N	μ_P	μ_N
0.3	480	1300	475	1500	385	1000	650	3800	545	2300	390	1375
0.6	550	1300	525	1500	415	1000	750	3800	600	2300	410	1375
1.0	550	1300	545	1500	425	1000	870	3800	620	2300	420	1375
2.0	550	1300	550	1500	480	1000	880	3800	660	2300	460	1375
μ_s	550 (NOMINAL) AT $\Delta H = 0.65$ OERSTEDS						900 (NOMINAL) AT $\Delta H = 0.55$ OERSTEDS					

UP—PULSE PERMEABILITY (0.3→2.0) $\mu\text{-SEC.}$
 μ_s —PULSE PERMEABILITY OF SLOWLY VARYING MAGNETIZATION (4000 CY/SEC.)
 μ_N —NORMAL MAGNETIZATION PERMEABILITY

New Sub-Miniature

Compact permanent magnet-moving coil type meter, developed for the military, has a 260° pointer deflection and 500 μ a sensitivity; is vibration- and moisture-proof

By A. D. BEDROSIAN,
Signal Corps Engrg. Labs, Fort Monmouth, N.J.

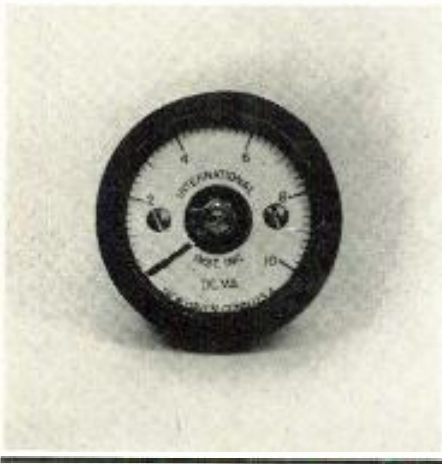

Scale length	2.20 in.
Angular pointer deflection	260°
Accuracy, end scale	$\pm 3\%$
Terminal resistance	380 ohms
Flange diameter	1.25 in.
Barrel diameter	1.00 in.
Barrel depth	1.25 in. $\pm \frac{1}{4}$ in. for terminals
Weight	2.5 oz.

Fig. 1: Developmental model of long-scale meter

A NEW electrical indicating meter of miniature dimensions having the basic scale readability found only in much larger conventional type instruments has been developed under joint Signal Corps-Air Force sponsorship. The design evolved is a panel mounting type unit having a $\frac{1}{4}$ -in. diameter flange and a 1-in. diameter barrel. It has a 260° scale—the actual length of the scale arc being approximately $2\frac{1}{4}$ in. The instrument is comparatively light in weight, requires lesser amounts of materials for manufacture, takes up appreciably less panel and back-of-panel space and yet has a scale length in excess of the conventional $2\frac{1}{2}$ -in. 90° scale instrument. The lowest range commercially feasible now is somewhat less than 500 μ a dc.

Development

The development specifications for the instrument, as contained in the contract awarded July 1950, to International Instruments Inc., New Haven, Conn. stipulated that the following technical characteristics were to be met:

a. The ranges desired were 0-100 μ a, 0-500 μ a and 0-1 ma, dc; 0-300, 0-1000 and 0-3500 vdc; 0-150 vac; 0-100 ma and 0-1 amp. r-f. The dc voltmeters were to be 1000 ohms/volt and external rectifiers and thermocouples were permissible for the ac and r-f ranges. In addition, these instruments were to be within an accuracy of $\pm 3\%$ if possible, and shielded against magnetic influence for use on either magnetic or non

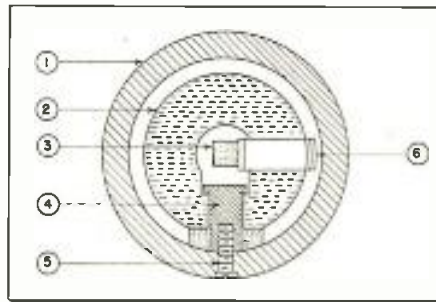

Fig. 2: Model using radially charged magnet: 1. soft iron pole face 2. magnet 3. plastic coil support 4. magnet clamp 5. magnet support screw 6. coil form

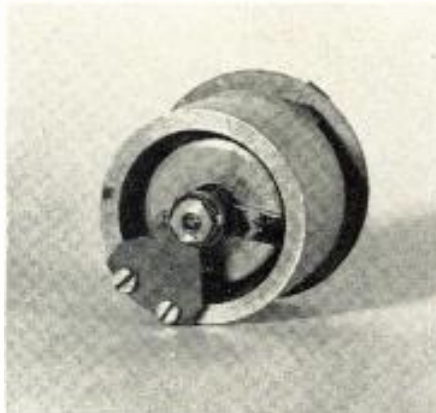

Fig. 3: Model above, which had 180° deflection

magnetic panels at least 0.09-in. thick.

b. Physical requirements included barrel diameter and depth behind panel not to exceed 1 in. The flange diameter was to be $\frac{1}{4}$ in. and scale length a minimum of $2\frac{1}{4}$ in., the pointer encompassing 250°, or greater, deflection. It was also specified that the instruments developed be capable of watertight mounting to the panel, and removable from the front of the panel without the necessity of reaching in back to fuss with securing means.

c. Consistent with the above limitations it was further required that the instruments be sealed against moisture, be rugged enough to withstand severe vibration and shock impacts and in addition meet the electrical performance requirements

such as response time, damping factor, momentary and sustained overload, voltage drop, power consumption, insulation resistance etc. normally expected of larger conventional instruments.

The task was broken down into three major parts. First, effort would be directed toward the development of a movement, secondly, a case, and lastly, the necessary accessories.

Movement

Nothing in the development specification ruled out the moving magnet, moving iron or some hitherto unfamiliar type of mechanism being produced, provided the electrical and other characteristics specified were met. However, the 250°, or greater, pointer deflection requirement seemed to indicate that the most promising approach might lie in the permanent magnet—moving coil design.

The first experimental unit utilized a radially charged magnet. The magnetic system is shown in Figs. 2 & 3. Much trouble was experienced in properly charging the magnet and a satisfactory pointer deflection greater than 180° could not be attained. In the second mechanism a disc magnet axially polarized was tried. This is shown in Fig. 4. Using this scheme it was found that total magnetic flux theoretically available (in a magnet of the mass) could not be used to optimum advantage. At this point clashing of the convolutions of the control springs and distortion due to extreme rotation was noted. Work was begun to redesign the springs and also to explore the possibilities of using a more satisfactory magnetic system.

After considerable investigation it was finally decided to use a bar magnet disposed at the bottom of the mechanism assembly. A core appropriately supported by a soft iron piece would be attached to one end of the magnet to serve as the inside pole. The other pole would likewise

Long Scale Indicating Instrument

be a soft iron piece almost completely surrounding the core and attached to the opposite end of the bar magnet. This construction is shown in detail in Fig. 6: No. 1 is the bar magnet at the base; No. 4 represents one pole of the magnetic system (the core and core supports), and No. 11 the other or outer pole. Fig. 5 shows this design partially assembled.

This model was capable of up to 270° pointer deflection. However there was noticeable contraction or crowding both at the lower and upper ends of the scale. Refinements were begun to reduce the crowding at the ends, to make the mechanism easier to assemble and more rugged, and to increase its sensitivity. The outer pole was reduced in mass and the solid lugs connected to the core and the outer pole at the base were removed. The top regulator was removed from the scale and added to a revised bridge which was now also attached to the outer pole. This improved mechanical design enhanced ruggedness and ease of assembly considerably. A slight increase in sensitivity was achieved due to improvement of the flux paths from the magnet to the air gap.

Housing

The mechanism itself was now considered an assembly feasible for large scale production and around which the case could be designed. The case, according to the specification, had to be itself sealed and in

turn capable of watertight mounting to the panel. A deep drawn metal cup with a threaded lip was designed. At the bottom of the cup two small holes were provided for the terminal studs. After the instrument mechanism was dropped inside the cup and secured from the bottom a bezel or ring with an adequately gasketed glass window would be screwed on the lip, thereby forming a good seal. These studs were sealed

with insulating gaskets and served a dual purpose, as terminals of the instrument and as means of securing the mechanism to the case.

Various ideas were considered for mounting the case so that it could be easily removed from the front of the panel, including the use of an adapter. This adapter was secured to the panel by a threaded ring assembly and sealed watertight to the panel by the use of an "o" shaped gasket. The meter housing would have two lugs welded on to the outside of the barrel and an "o" ring gasket on the underside of the front bezel. In use the meter would be inserted inside the adapter and given a slight twist to be tightly secured in place, similar to a bayonet base lamp. This idea was workable but somewhat cumbersome. It was discarded in favor of a clamp type flange which would slip over the meter bezel and be screwed on to the panel. This method could then serve both as an effective clamp as well as an external scale. Details of the case and flange clamp are shown in Fig. 7.

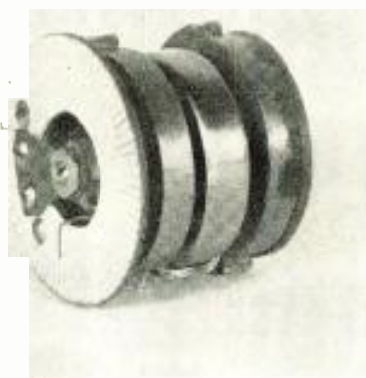

Fig. 4: Disc magnet had severe shortcomings

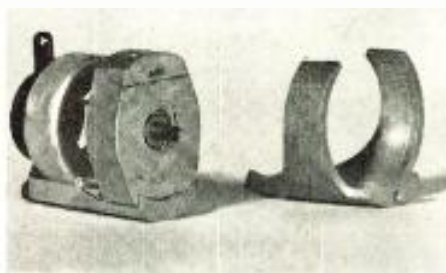

Fig. 5: Final version employs a bar magnet

Testing

A number of samples were now fabricated in the 0-1 ma range and extensive electrical and mechanical tests performed. Initially a number of failures caused by mechanical deformation of parts, loosening screws, hooked springs etc. were experienced as a result of the tumbling and shock tests. The deformation of

(Continued on page 128)

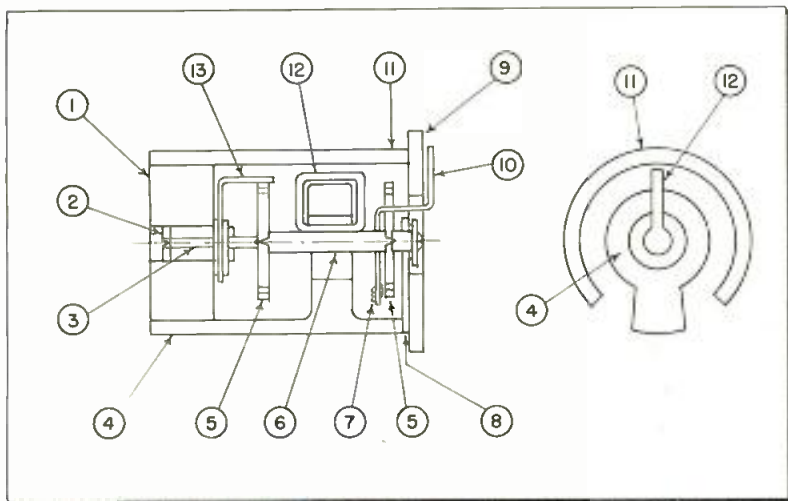

Fig. 6: Meter construction: 1. magnet with tapped insert 2. jewel screw 3. jewel screw 4. core & core support 5. hair spring 6. pivot staff 7. counter balance 8. jewel screw support 9. scale 10. pointer & cross arm 11. outer pole 12. coil form 13. bottom regulator

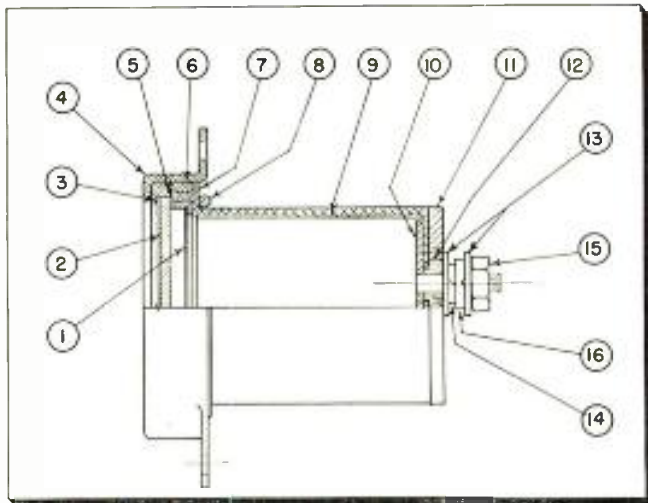

Fig. 7: Case and flange clamp assembly: 1. "L" retaining ring 2. crystal 3. gasket 4. flange clamp 5. sealing ring 6. bezel 7. case 8. "O" ring 9. insulating sleeve 10. filler plate 11. retaining plate 12. bushing 13. washer 14. lock washer 15. hex terminal nut 16. split nut

Improving Ferrite Cored

Operation and design aspects of these widely used units point up methods for improving the performance and production techniques

common ferrites in use today are nickel-zinc and manganese-zinc.

The magnetic properties, which vary from hard to soft, of the finished product are determined by the chemical formula, completeness of crystallization, density and crystal size. The latter three are affected by the forming or pressing operation and the firing cycle. Physically the material is very hard and brittle, similar to ceramics in properties.

Principles Of Operation

The theory of operation of a ferrite antenna is the same as that of any other type antenna. The object, of course, is to have the highest possible r-f voltage induced in the antenna winding. The voltage induced then is the number of turns times the derivative of the enclosed flux with respect to time. In a tuned circuit this voltage is multiplied by the Q of the tuned circuit.

The main factors then which determine the effectiveness of a loop antenna are 1) the number of turns, 2) the amount of flux linked by those turns and, 3) the tuned circuit Q. Anything which can increase any of these three factors without decreasing either of the other two will increase the pickup of the antenna.

The ferrite antenna operates mainly by increasing the flux linkages by means of the high permeability of the core. Since this material is low in losses it can be used to increase the Q of the circuit, but this is limited in practical usage as will be seen later.

In actual usage in the set the antenna designer is limited by these considerations: 1) Physical dimen-

sions—the antenna must of necessity fit into the cabinet design. 2) Inductance—the inductance is limited in that it must match the production tuning capacitor to cover the desired frequency band. For the broadcast band this inductance normally is somewhere between 150 and 300 microhenries. 3) Q—the Q of the circuit must, of course, be high enough to give a certain degree of selectivity but it cannot be too high because of the normal tracking tolerances in production tuning capacitors where an antenna with high Q might be more insensitive at a slight mistrack than an antenna with lower Q. This upper limit on Q varies from 150 to 200 depending on capacitor quality. 4) Cost—as in any other design for production the cost of the unit must be low enough to justify its use. 5) Stability—the unit must be stable enough to maintain set sensitivity limits over the range of humidity, temperature, etc., to which the unit will be exposed in use.

The main need in the design of the antenna then is to obtain a product of the proper inductance, within Q limits, and with the greatest number of flux linkages at the least cost.

The factors which control the flux



By
CHARLES A. GRIMMETT
Radio & TV Dept.
General Electric
Co.
Syracuse, N. Y.

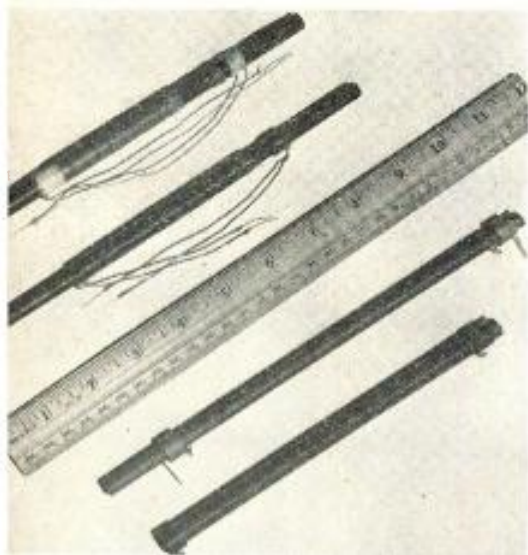

Fig. 1: (Top to bottom) Old style cotton covered wirewound antenna, old style plastic coated type, current home and portable radio type;

UNTIL the advent of the ferrite cored antenna, the usual built in antenna for broadcast receivers (540-1600 kc) consisted of a large flat coil of wire usually oval in shape and mounted on one of the flat surfaces of the radio cabinet. Since the coil was air cored the factors controlling sensitivity were number of turns, coil area, and Q. These three factors were in turn limited by the minimum capacity of the tuning capacitor, the cabinet size, and the proximity of the antenna to the metal parts of the receiver.

With the customers demanding smaller and more compact sets it became more and more difficult to find a place where a large area coil could be mounted far enough away from the chassis to give good sensitivity.

The idea of using a high permeability material for an antenna core to increase the effective area of the antenna is not new. As early as September, 1939, W. J. Polydoroff filed a patent (2,266,262) for an antenna with a core of powdered iron. And, in November 1940, Kihn, Harvey and O'Neill issued a report on "Loop Antennae with Ferromagnetic Cores."

These early experiments all involved the use of a ferromagnetic core of finely divided iron pressed in a binder. These antennae did improve the performance of a smaller antenna, but the mass of material necessary to obtain this improvement made the cost prohibitive. A higher permeability, lower loss material was needed and was found in the ferrites.

The ferrites are spinal crystals of the general formula M (Fe₂O₃) where M is any divalent metal or mixture of divalent metals. The most

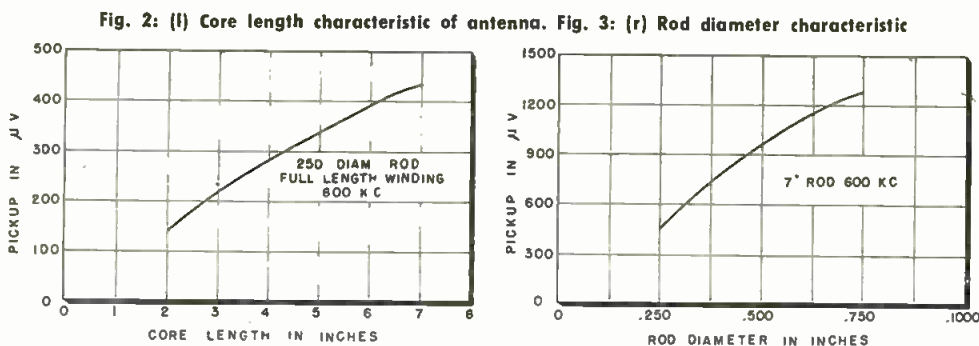

Antennas

linkages are effective permeability of the core material, area of the coils, and number of turns. Inasmuch as these factors are interdependent, optimum design calculation becomes a complex problem. Thus considerable experimental data is also needed to effect the optimum design.

Effective Permeability

The effective permeability (the ratio of the inductance of the coil with a core to the inductance without a core) of a core of high toroidal permeability is controlled very strongly by the length to diameter ratio of the coil. The following table shows this effect:

$$\mu_e = d^2 (\mu' - 1) + 1$$

where μ_e = effective permeability

$$D = \frac{D_1 + D_2}{2}$$

D_1 = Coil O. D.

D_2 = Coil I. D.

d = Core O. D.

L = Coil Length

μ' = From table

L/d (μ)	5	10	100	inf.
1	2.25	2.90	3.2	3.5
2	3.29	4.65	6.5	7.6
3	3.85	5.92	10.1	12.3
4	4.22	6.94	15.0	17.7
5	4.46	7.69	20.0	24.0
6	4.59	8.15	25.0	31.0
8	4.74	8.75	34.0	36.0
10	4.83	9.14	41.6	62.5

Since the toroidal permeability of this material is in the order of 200 it can be seen from this table that the length to diameter ratio rather than the toroidal permeability of the core controls the effective permeability. Thus to obtain maximum effective permeability per pound of material, and thus maximum performance per dollar spent, it is necessary to make the core as long and as small in di-

Fig. 4: Winding length characteristic

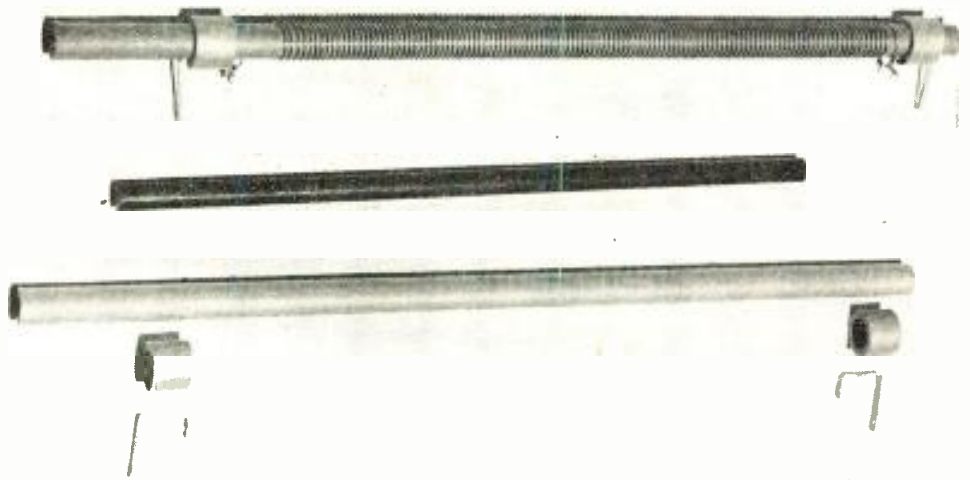
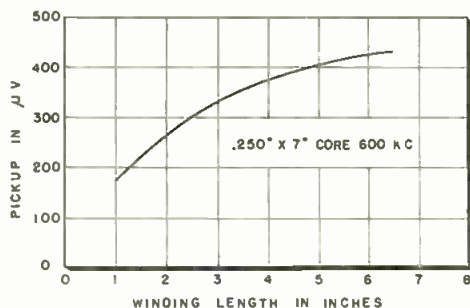

Fig. 5: Exploded view of ferrite rod antenna for radios currently in production.

ameter as is feasible from the manufacturing standpoint. See Figs. 2, 3.

Core Area

The pickup of the antenna is directly proportional to its cross sectional area if all other factors are held constant. However, in the section on effective permeability it was seen that the length to diameter ratio changes the effective permeability. Thus an increase in area does not bring about a proportionate increase in pickup unless the antenna length is increased correspondingly. An increase in diameter without change in length does bring some increase in pickup since the length to diameter ratio decreases by the square root of the area increase. This would indicate that the ideal design would be a core as long and as large as possible, but here again the economics of the situation enter into the picture.

In the above discussion the optimum performance was obtained without regard to the volume of material. In practical usage, however, the maximum performance per pound of material must be considered. Here, as in the section on effective permeability, the maximum performance per pound turns out to be the core which gives the highest length to diameter ratio.

Thus, the most effective core is the longest core which the physical design of the set can accommodate with the maximum diameter as dictated by economics and again the physical limitations of the set.

Windings

Since the optimum core design to give the maximum flux in the core has been determined it remains now to find the best winding to take advantage of this flux.

When the investigation of the use of ferrite antennae first started it was proposed that the most effective winding was a small concentrated winding at the center of the core since according to theory the flux density was highest at the core center. This theory at face value appeared to have much merit but experimental data failed to confirm it. It was found experimentally that a solenoid winding the full length of the core gave better pickup than a concentrated solenoid or universal winding at the center. See Fig. 4.

These results can be explained in that the flux density distribution in the core is fairly constant except at the ends and the spreading out of the winding increases the number of turns for a fixed inductance value which more than compensates for the loss in flux concentration. See Figs. 6 and 7.

It was also found that if the windings were coupled too closely to the core the Q suffered greatly. The Q increases rapidly as the separation of core and winding increases up to about one wire diameter, and then begins to decrease slowly.

The Q vs. wire size also has an optimum point which varies according to physical shape and core material and must be determined experimentally.

Once the optimum Q has been determined the Q below that value can, of course, be obtained by adjusting wire size, as shown in Fig. 8.

Core Material

The core material first released for this type of antenna was characterized by high Q (200-250) at 500 kc and lower Q (125-150) at 1500 kc in a full length distributed coil. The change in effective permeability

(Continued on page 110)

Deflection

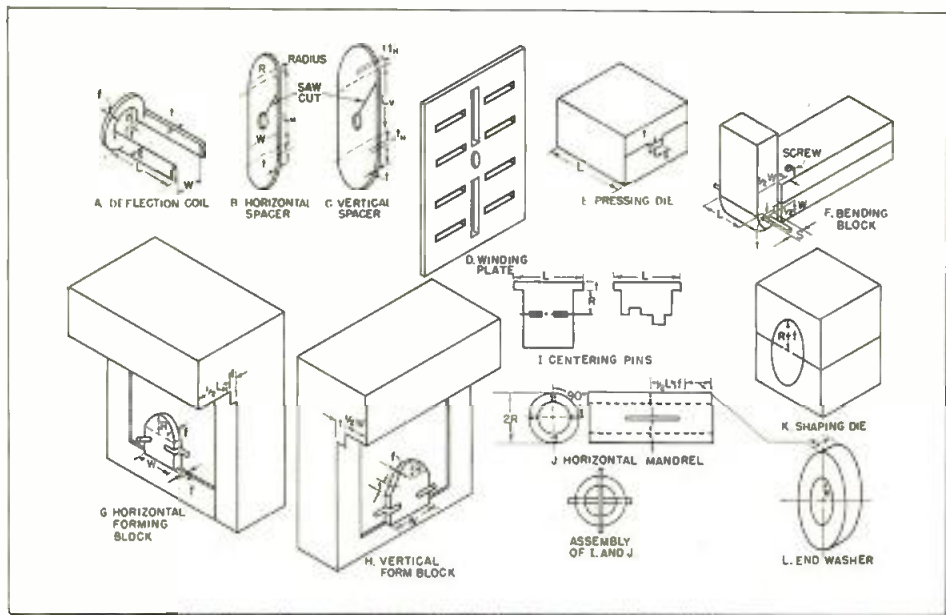

Fig. 1: Complete set of dies for constructing experimental deflection yokes.

Inexpensive lab-quality dies, which can be constructed of wood or hard plastic, have excellent design flexibility; speed the construction of experimental yokes

By **BERNARD B. BYCER**, Proj. Engr.
Raymond Rosen Engrg. Products Inc.
32nd & Walnut Streets
Philadelphia 4, Pa.

A METHOD has been found for constructing experimental deflection yokes which meets all lab standards of performance and cost. Basically, the method consists of winding a coil in a pancake fashion and then bending it into the desired shape. A set of single forming blocks, bending blocks, and assembly jigs are necessary. It is essential to keep them as simple as possible for laboratory work. The set of blocks to be described were used for the construction of miniature projection deflection yokes. However, these dies were scaled down from direct viewing yokes.

Before constructing a set of forming and bending blocks, preliminary data concerning the yoke is essential. The inductance is established by the circuit design. The number of turns for the scanning coil may be approximated by knowing the turns and the inductance of a similar coil. A proportion is set up where the inductance is proportional to the square of the turns, and the computations give a good approximation of the required turns for the new development coil. The scan output tubes (horizontal and vertical) with their transformers give the average dc current through the coils.

These figures are used to select the wire size. However, the wire size should be increased because the dc resistance of the calculated wire size does not permit a high degree of linearity for a good television picture. It is desirable to use the largest wire size possible. Knowing the number of turns and the wire size, including insulation, the wire tables indicate the volume required. This space factor is increased by a factor of 10% to allow for air space and the binding material necessary to hold the wires in place. Up to this point, the circuit design has determined the preliminary data for the scanning coil. The picture tube, with which the yoke will be used, determines the physical dimensions of the yoke.¹ This data furnishes the development engineer the length of the yoke and the I.D. With this data the development engineer can proceed to sketch the bending and forming blocks.

Fig. 2: Bending the circular part of the coil

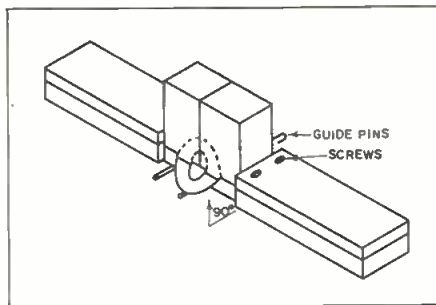

The winding plates are identical and will be described first. The winding plates (Fig. 1.D), consist of two pieces of brass, held apart by a spacer (Figs. 1.B and 1.C). The winding plates consist of two heavy pieces of brass with openings to permit the binding material to penetrate to the coils. The size and shape are not critical. The plates may be circular, rectangular, or square. The function of the spacer is to hold the two plates a given distance apart and to provide the core on which the coils are to be wound. The spacer is made a little larger than the desired thickness of the final coil. The length of the spacer for horizontal and vertical coils is determined in the following manner. The length is composed of the computed length for the horizontal and vertical coil plus the forming length. The width of the spacer can be scaled from a picture tube assembly drawing. This dimension is made slightly larger to prevent wire breakage. In the case of the vertical coils, the scanning length is shorter but the spacer is lengthened to overlap the horizontal coils by taking into account the additional thickness of the coil. This is shown on the spacer (Fig. 1C) and

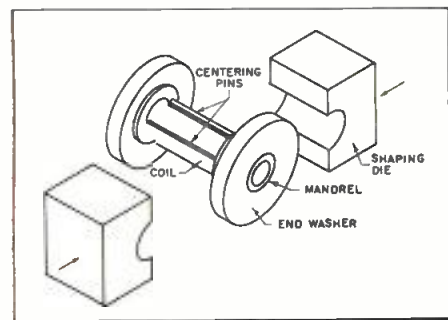

Fig. 3: Shaping dies fit over horizontal coil

on the forming blocks (Fig. 1H). A slot is out in the spacer to start the winding.

A set of bending blocks and matching forming blocks are necessary for each scan coil. The dimensions for the blocks are obtained in the following manner. The complete yoke is drawn in position over a full scale picture tube print. The window area, radius of the bent up wire, cross section of the wire for scanning (cosine, wedge, etc.) and the flare for the coil are scaled from the print by the use of dividers. In Fig. 1 the dimensions of the bending blocks

Yoke Die Construction

and forming blocks are shown. Identical letters are used to indicate the corresponding dimensions of the bending and forming blocks for creating a deflection yoke to fit the picture tube. These dimensions are the basis of achieving a deflection coil with the maximum sensitivity, using the longest possible coil, and placing the copper and the core closest to the electron beam. A Mandrel (Fig. 1J) is used for assembly. If the yoke is made to fit the flare of the tube, a dummy replica of the flare is made from the tube print.

Winding Procedure

The two winding plates are bolted together with the spacer between them. The center bolt, passing

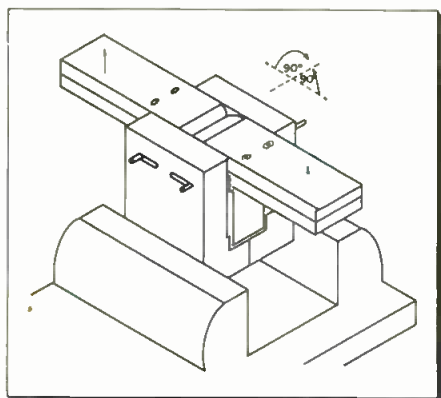

Fig. 4: Bending blocks are rotated 90°

through the two plates and spacer, is used to hold the unit in place on a small lathe or hand winding machine. A revolution counter is convenient and essential. Before starting to wind, the wire is placed in the slot of the spacer or it may be pulled out from the slot of the plate and wrapped around the bolt. Five turns are wound on and the revolution counter is set to zero. These turns are used for the beginning lead of the coil. While winding, the wire is held taut, by hand, and guided between the two plates. After the prescribed number of turns have been wound on, the wire is cut from the spool and the coil end lead is anchored to the bolt holding the plates together.

After removal from the winding machine the two plates, with the coil wound between them, are dipped into a pan of molten wax on a hot plate. This is done to provide a simple means of extracting the

coil from the spacer. The coil is wound very tight and close which only permits the wax to cover the wires without too much penetration. The plates are removed from the



Fig. 5: Miniature yoke with core removed

wax and permitted to cool. Later, the bolt is removed from the plates. The two plates, with the coil between them, are placed on a hot plate so that one plate is heated slightly. This heated side is separated from the spacer by wedging a screw driver between the plates and prying the plate off. The remaining plate is heated slightly and removed by placing a screwdriver in the slot of the plate and lifting the coil and spacer together. The start lead (in the spacer slot) is removed and pulled until five turns have been removed. The spacer is forced out from the window of the coil with care by hand. A jig was used by the writer to accomplish this in later models, but it is not necessary.

Scanning Coils

A pressing die (Fig. 1E) is used to spread the wires to the correct cross-section. The spacer was designed to pile the wire a little larger in height and smaller in width so as to fit in the channel of the pressing die. The die is placed between the jaws of a vise and squeezed together. The wire spreads out and fills in the channel. This operation was done originally in the bending blocks but was found simpler and requires less effort.

The coil is removed from the pressing die and placed and centered in the bending blocks which are then

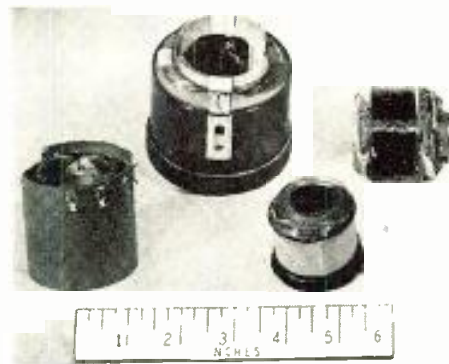

Fig. 6: Direct-viewing yoke and smaller types

bolted together. The circular part of the coil is then rotated 90° and pushed flat against the wall of the bending blocks (Fig. 2). Next, the forming blocks are placed against the bending blocks with the pins of the bending blocks engaging the guide holes in the forming blocks. The two bending blocks and two forming blocks are placed between the jaws of a vise. When the bending blocks are rotated 90° (Fig. 4) and swung around together, the inner wires of the bent up section become very taut and stretch across the curve on the forming block. In horizontal coils as the bent up wires become tight, the blocks slide toward the curved part preventing wire breakage and assuring a tight fit for final assembly. The bending blocks are unbolted, and the coil is removed.

The vertical coils are made in a similar manner. The vertical spacer (Fig. 1C) is made for a larger window to overlap the horizontal coils, while the guide holes of the forming blocks are horizontal instead of diagonal. The thickness of the horizontal coils are accounted for in the vertical forming block (Figs. 1C and 1H).

Assembly

The next step is to assemble the four coils, two horizontal and two vertical, very accurately. For convenience and durability, it is preferable but not essential to mount the four coils on a thin tubing consisting of bakelite or similar material. This is recommended to avoid tearing or scratching the inner wires during assembly on the picture tube and to prevent the adhesion of the coil to the tube neck because of heat.

The coils are assembled on a mandrel having an O.D. exactly the same as the bakelite tubing or the O.D. of the picture tube used (Fig. 1J). The length of the mandrel is determined from the total physical length of deflection coils (less the flared front)

(Continued on page 122)

New Components & Equipment

TRANSDUCER

Operation of the "Lyn-A-Syn" linear motion displacement transducer is based on the linear change in flux linkage between the primary coil and secondary coils with displacement of the high-

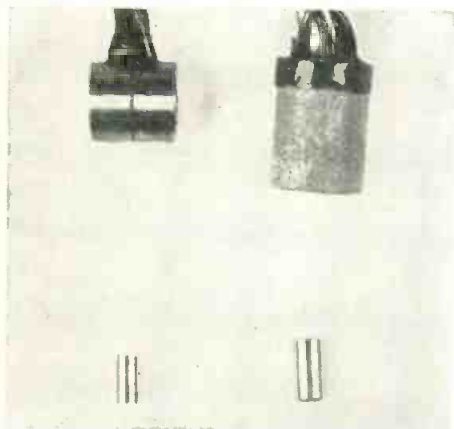

permeability metal core. Displacement of the core in either direction from the center null position causes a linear increase in output voltage. Units designed for power frequency or medium audio frequency operation at input voltages of 0.5 to 10 v. Size, 15/64 in. O. D. x 15/64 in. long for 0.003 in. linear displacement to 3/4 in. OD. x 9 1/2 in. long for 2.0 in. linear displacement. Minatron Corp., 9 Cliveden Pl., Belle Mead, N.J.—TELE-TECH & ELECTRONIC INDUSTRIES. (Ask for 2-21)

OUTLET BOX

The "Safecorde" outlet box contains 6 heavy duty standard receptacles, an on-off switch to control them directly, and a pilot light to indicate when voltage is on. Fused on both sides of the line to protect against shorts and excessive loads. Rated at 10 amps on 115 v ac or dc. Has a 5 x 5 x 2 1/2 in. grey hammertone finish steel housing. Unit is particularly useful in laboratories for



setups where several pieces of test apparatus, soldering irons, etc., are required. Prevents down time to other equipment and lighting circuits. The Kenru Co., Box 121 Parsippany, N. J.—TELE-TECH & ELECTRONIC INDUSTRIES. (Ask for 2-22)

TUBE TESTER

The VT T-1 tube tester is a mutual conductance and plate current unit capable of checking all tubes normally used in electronic work. Independent adjustments of plate, screen, filament,



signal, and bias voltages enable tests to be made under circuit application operating conditions. Completely self-contained. Requires no adapters or external meters. A new switch interlock system protects tubes against accidental damage. Size, 17 1/8 x 15 1/2 x 6 13/16. Weighs 40 lbs. Spare tubes, neon lamp, and fuses can be stored within unit. Special Contracts Div., CBS-Columbia, 170-53 St., Brooklyn, N. Y.—TELE-TECH & ELECTRONIC INDUSTRIES. (Ask for 2-23)

GASKETS

A series of rectangular "O" ring r-f and pressure gaskets for use with single or dual waveguide contact flanges provides more compact r-f and pressure-tight waveguide connections without loss of electrical performance. These rectangular gaskets have a circular cross section that, on compression, provide an airtight seal. To assure an adequate r-f seal, a silver plated copper strip is mounted on the inner periphery

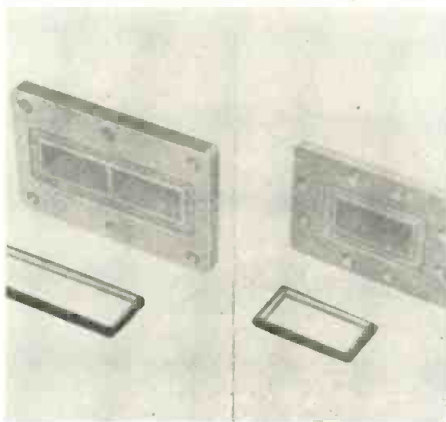

of the gasket. This provides a continuous electrical contact along both flange surfaces without disrupting the airseal. Airtron, Inc., Dept. B., 1105 W. Elizabeth Ave., Linden, N. J.—TELE-TECH & ELECTRONIC INDUSTRIES. (Ask for 2-24)

METALLIC COATING

A single metallic coating has been developed that has been applied to both glazed and bisque refractory ceramic bodies to which both hard and soft solders can be applied to form vacuum-

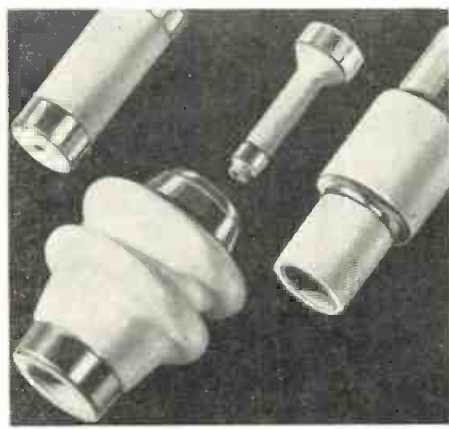

tight joints with metal parts or other non-metallic refractories. The new metallizing process eliminates the need for intermediate nickel or copper plating treatments. Enables direct application of hard solders that melt in the range from 1,000 F to 1,600 F. and soft solders that melt at 245 to 450 F to be applied directly to the metal coating. Frenchtown Porcelain Co., 93 Muirhead Ave., Trenton, N. J.—TELE-TECH & ELECTRONIC INDUSTRIES. (Ask for 2-25)

"FUSE-LAMP"

Made by H. Schurter AG., Lucerne Switzerland, the "Fuse-Lamp" consists of a solidly constructed fuseholder, a neon pilot light assembly with a built-in resistor, and a NE-51 neon glow lamp. The lamp lights if the fuse burns out so that the damaged fuse or circuit can be found. Suitable for any type of fused equipment—particularly that in which a number of fuses are used. Extends only 2 in. deep from mounting panel.

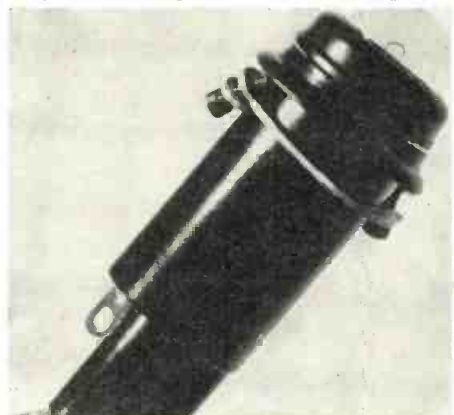

Net weight, 1 1/4 oz. Mounts in 2 7/8 in. hole. Current used only when lamp lights. Guaranteed for 10,000 actual working hours. Available through G. Keller, 5506 N. Bernard St., Chicago 25, Ill.—TELE-TECH & ELECTRONIC INDUSTRIES. (Ask for 2-12)

for the Electronic Industries

NOISE FILTER

A molded miniature radio noise filter, designed to fit a small motor and gear assembly, measures only $1\frac{3}{16}$ in. O.D. x $\frac{3}{4}$ in. long and serves as an integral part of the motor rather than an ex-

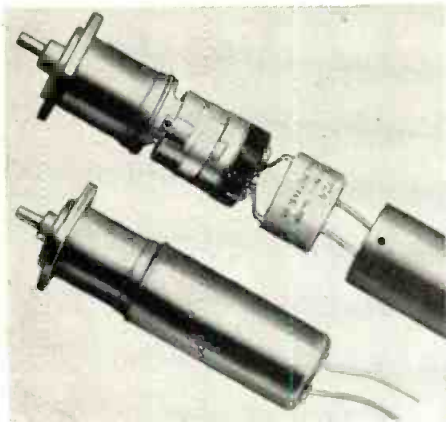

ternal accessory. The dual-section, continuous-duty unit features greater than 50 db attenuation from 150 kc to 1,000 mc. Operates satisfactorily in temperatures as high as 125°C. and exceeds Air Force specification MIL-1-6181-B. Meets metallized paper size with paper and foil reliability. A molded metal insert is drilled and tapped to simplify mounting. The Potter Co., Dept. TTN, 1950 Sheridan Rd. N. Chicago, Ill.—TELE-TECH & ELECTRONIC INDUSTRIES. (Ask for 2-15)

SELENIUM RECTIFIERS

A new design in selenium rectifiers features edge-mounted plates that provide full air circulation between the plates, light, constant pressure that eliminates center hot spots, smaller overall size per rating, and simpler mounting. Units operate and are rated for use in high ambient temperatures, and can be used in all types of electrical

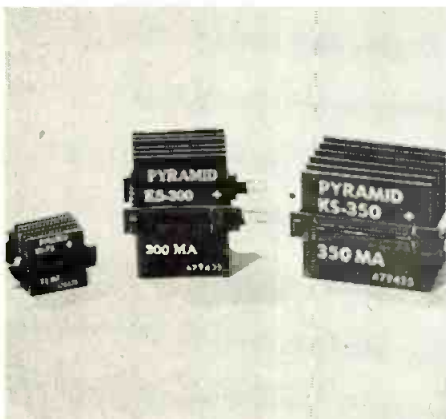

and electronic equipment, including radio and TV circuits. Furthermore, they can be used as replacements for all existing standard rectifiers. Pyramid Electric Co., 1445 Hudson Blvd., North Bergen, N. J.—TELE-TECH & ELECTRONIC INDUSTRIES. (Ask for 2-17)

TRANSFORMER

A three-phase 70 KVA plate transformer for TV transmitter use at 50 or 60 cps. delivers 7,000 v at 9.3 amps dc, or 6,000 v at 10.2 amps dc through a suitable filter. The new unit is an air-



cooled, open frame, dry type that keeps inrush current at less than 10 times the normal primary current for the first cycle at full load. Measures $37\frac{1}{8}$ in. high, $42\frac{3}{8}$ in. long, and $21\frac{3}{4}$ in. thick. Weight, approximately 1,700 lbs. Comes provided for convenient handling. Raytheon Manufacturing Co., Equipment Sales Div., Dept. 6120, Waltham, Mass.—TELE-TECH & ELECTRONIC INDUSTRIES. (Ask for 2-16)

BANDPASS FILTERS

Type HFF bandpass filters, covering the frequency range 200 to 2,000 mc, incorporate multiple tuned resonant circuits with an insertion loss of less than 1 db and will display typical Tschebycheff response. Specifications: center frequency, 200-2,000 mc. Bandwidth, 10-150 mc. Impedance 52 ohms—

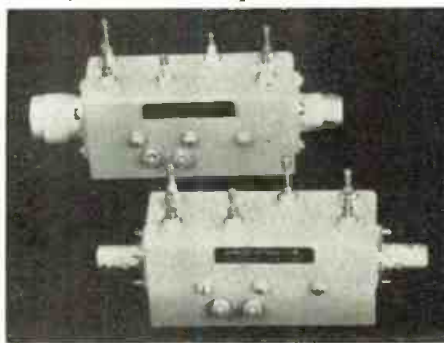

input and output. Connectors, BNC to 1,000 mc, Type N 1,000-2,000 mc. Peak-to-valley ratio, less than 1 db. Applied Research, Inc., 163-07 Depot Rd., Flushing, N. Y. TELE-TECH & ELECTRONIC INDUSTRIES. (Ask for 2-20)

MORE TECHNICAL INFORMATION

describing the new products presented here may be obtained by writing on company letterhead to New Products Editor, TELE-TECH & ELECTRONIC INDUSTRIES, 480 Lexington Ave., New York 17, N.Y., listing numbers given at end of each item of interest. Please mention title of position held.

VARIABLE TOROIDS

Two new types of miniature variable toroids, designated, VTI-C and VTI-D, with basic inductors corresponding to Burnell standard toroids, Types TC-0 and TC-6, have nominal inductances of

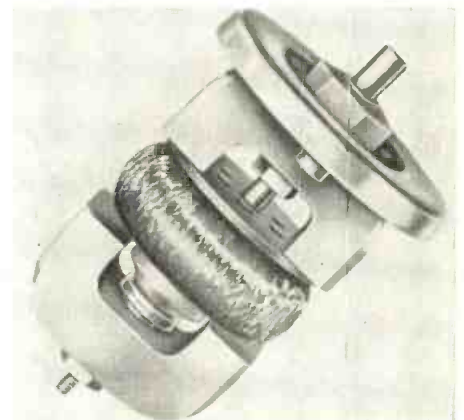

0.001 to 3.2 Hys and 0.00032 to 0.5 Hys, respectively. As normally furnished, the inductance range of any individual "Rotoroid," is from 50 to 150% of the nominal value. Inductance variation in the "Rotoroid" is obtained by the rotation of one pair of permanent magnets placed on opposite sides of the winding. No external dc power is required for biasing. Burnell & Co., Inc., Dept. A2, 45 Warburton Ave., Yonkers 2, N. Y.—TELE-TECH & ELECTRONIC INDUSTRIES. (Ask for 2-18)

DIODE CLIPS

Models 9000, X9000, and 9020, three types of clips capable of holding crystal diodes with 0.075 and 0.080 shaft diameters are available for standard terminal board thicknesses, or to specification. Model 9000 is for front panel mounting, X9000 is for front panel mounting with a blind hole for dip solder applications, and 9020 is for rear-of-panel connec-

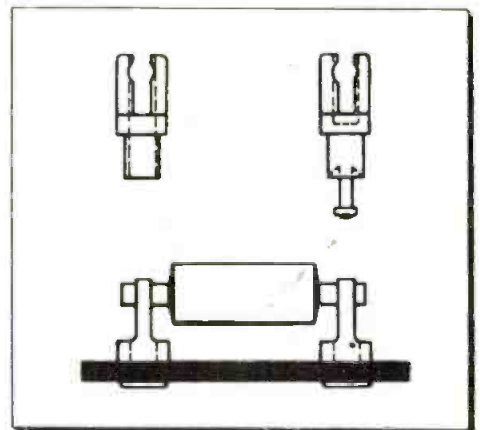

tions. Silver plate on half-hard brass assures good contact resistance. Available from stock separately, or mounted to customer specifications. Lerco Div., Lynn-Deatrick, Inc., 501 South Varney, Burbank, Calif. TELE-TECH & ELECTRONIC INDUSTRIES. (Ask for 2-19)

New Electronic Products

SERVOMETER

The R1040-6 servometer is composed of two instruments, a high-gain servo amplifier, and an aircraft type instrument panel indicator. The unit has 1/2% full scale accuracy from -55F to +160°F,



a voltage range of 105-125 v., and frequency variations from 300-450 cps. With a digital converter, the unit furnishes digitized information for local recording purposes. The R1040-6 is designed for resistive bridge-type sensing elements, such as pressure gages, accelerometers, and mechanical force-measuring devices. The sensing element output is amplified by a high-gain non-linear amplifier that drives a servo motor within the indicator. Radiation, Inc., Melbourne, Fla. TELE-TECH & ELECTRONIC INDUSTRIES. (Ask for 2-33)

PRECISION CHOPPER

The new precision chopper, C102, weighs less than 6 oz., and has a standard octal base and a hermetically sealed case. Average life of the unit under average operating conditions into a resistive load is 1,000 hrs. At 10 to 55 cps, it withstands 10 G vibration. With-



stands 30 G shock. Breakdown, 280 v. dc. Drive, 6.3 v. Frequency, 380 to 420 cps. Contacts, SPDT, 0.002 amps, 100 v. Diameter 1/8 in. Rumple, Inc., 2308 Beloit Ave., W. Los Angeles 64, Calif. TELE-TECH & ELECTRONIC INDUSTRIES. (Ask for 2-36)

MAGNETIC MEMORY

The "Tapedrum," based on an "inside-out" drum, can store more than 100 million bits of information and repetitively scan 200,000 bits 20 times/sec. A magnetic tape 14 in. wide is

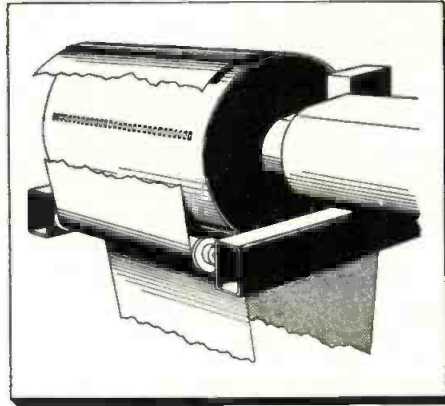

placed over a fast spinning bank of 128 recording heads. A tape area, accessible to the heads in any position of the tape, called a "page," can store 200,000 bits in the average access time of 1/40th second. If the capacity of one page is insufficient, the tape can be advanced to another page and the location for additional information. The device has the capacity of 200 conventional drum recorders. Clevite-Brush Development Co., Clevite Corp. Research Center, 540 East 105th St., Cleveland 8, O. TELE-TECH & ELECTRONIC INDUSTRIES. (Ask for 2-38)

CRYSTAL TEST SET

Type 390A-3 is a portable test set that can quickly detect any deterioration in crystal sensitivity without elaborate test setups. The unit measures relative noise figure of microwave mixer crystals and obtains approximate impedance checks when the selection of matched crystals is being made for use in balanced mixers. The theory that conversion loss can be predicted from the static voltage-current curve of the crystal permits the use of a simple dc technique to measure quantities mathematically related to crystal performance. The instrument indicates the nonlinearity of the forward portion of the E-I curve. Airborne Instruments Lab., Inc., 160 Old Country Rd., Mineola, N.Y. TELE-TECH & ELECTRONIC INDUSTRIES. (Ask for 2-34)

MORE TECHNICAL INFORMATION

describing the new products presented here may be obtained by writing on company letterhead to New Products Editor, TELE-TECH & ELECTRONIC INDUSTRIES, 480 Lexington Ave., New York 17, N.Y., listing numbers given at end of each item of interest. Please mention title of position held.

CONTROL SYSTEMS

An accurate digital supervisory control system, the "Electro-Span" can be used in conjunction with any electrical transmission medium. Voice communication can be time shared where voice channel

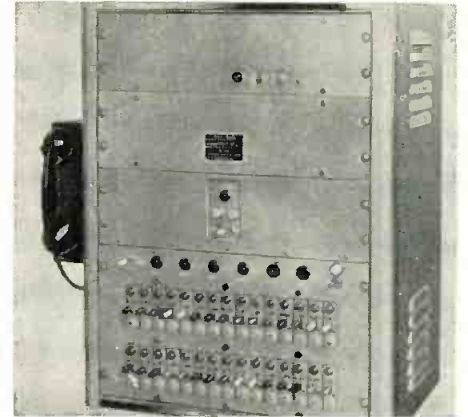

bandwidth exists. The "Electro-Span" tank gauging system provides remote measurement of liquid level. Provides tank selection, tank self-identification, and transmission of level information in 1/8 in. increments to 60 ft. The "Electro-Span" tone signal control system performs remote on-off control functions, alarm circuits, automatic pre-set fail-safe controls, etc. Pacific Div., Bendix Aviation Corp., 11600 Sherman Way, N. Hollywood, Calif.—TELE-TECH & ELECTRONIC INDUSTRIES. (Ask for 2-13)

AC ELECTRONIC VOLTMETER

The Model E-33 ac electronic voltmeter essentially consists of an attenuator, a multi-stage feedback amplifier, and a germanium diode full-wave bridge, and is designed to indicate voltages from 500 μv to 500 v. Frequency range extends 10 cps to 1.0 mc and is operated from a 105-130 v 60 cps power source. Power consumption is 15 w. Scale voltage is logarithmic over a range of 10 to 1. The whole voltage



range is covered by six decade ranges—0.005, 0.05, 0.5, 5, 50, and 500. Input impedance is 10 megohms shunted by 17 μf. Electronic Engineering & Service Co., Inc., 104 W. Jefferson St., Falls Church, Va. TELE-TECH & ELECTRONIC INDUSTRIES. (Ask for 2-37)



TEN OR TEN THOUSAND . . .
★ IDENTICAL
BECAUSE AUTOMATICALLY MADE
FOR AUTOMATION

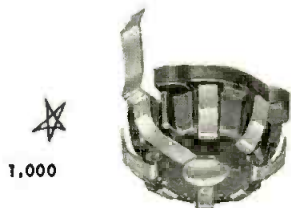

CINCH parts are made automatically, and therefore are made with precision metal and insulation components. These automatically assembled parts assure the uniformity and quality mandatory for use in **AUTOMATION** in the end users equipment.

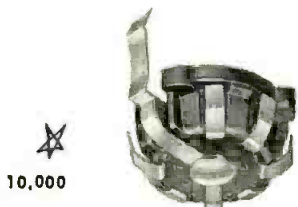

CINCH components available at leading electronic jobbers — everywhere.

Centrally located plants at Chicago, Shelbyville, Indiana and St. Louis.

CINCH will design new or re-design parts within the category of their manufacture to fit your particular plans. **CINCH** will also assist in the introduction in the assembly of **CINCH's** specially designed component in your radio and TV equipment.



Cinch
ELECTRONIC
COMPONENTS

CONSULT CINCH!
CINCH MANUFACTURING CORPORATION

1026 South Homan Ave., Chicago 24, Illinois
 Subsidiary of United-Carr Fastener Corporation, Cambridge, M



WASHINGTON

News Letter

Latest Radio and Communications News Developments Summarized by TELE-TECH's Washington Bureau

TV STATION OUTLOOK—The FCC deserves credit for its intensive work in eliminating the huge backlog of television station construction permit applications during the past two years so that it is now current with this task. It is forecast that during this year a total of more than 500 video transmitting stations in about 400 cities and towns should be in full public service. Out of this total only a virtual handful will be educational stations and both VHF and UHF commercial stations will be in operation.

IMPORTANT FACTOR—The expansion of television stations, together with the increased video coverage through satellite and community antenna stations, augurs well for continued high demand by the public for TV receivers. On the basis of this television expansion, black-and-white receivers, both for initial owners and in multiple TV home sets, will have another year of strong impetus in sales. Important for the future of television, too, is that the way will be paved in an orderly fashion for mass production of compatible color TV receivers through the present universal recognition by the public of the importance of this method of mass communication.

WORLD FREQUENCIES—Without a single day of hearings and through complete cooperation of the nation's aviation-marine-communications-radio services, the FCC Frequency Allocation and Treaty Division, headed by A. L. McIntosh, has completed the most complex international frequency reassignment in the Commission's history. The rearrangement of frequencies in these services was to carry out domestically the provisions of the Extraordinary Radio Allocation Agreement of Geneva in which 65 countries agreed on an orderly use of frequencies for the different radio services on a worldwide basis. In this cooperative effort nearly a thousand letters, telegrams and radiograms were exchanged between the FCC and radio administrations of foreign countries.

DEFENSE ROLE—The budget message of President Eisenhower, presented to Congress in mid-January, only gave broad outlines of the importance of electronics requirements for the national defense since electronic and radio needs of the armed services are virtually all "top secret." But with the new procurement programs of the military forces, together with the backlog of last year's undelivered equipment contracts, more than \$5 billion of the electronics-radio manufacturing industry's production as well as a substantial amount of its research and development work will be devoted to the national defense situation.

SENATE PROBES—Investigations by the Senate Interstate and Foreign Commerce and Judiciary Commit-

tees, respectively headed by Democratic Senators Magnuson (Wash.) and Kilgore (W. Va.), into ownership of AM radio and TV stations by newspapers, networks and radio set manufacturers are not expected to direct much attention into the manufacturing industry. Senator Magnuson was slated to center his body's attention on what changes were needed in the FCC's statute, the Communications Act, while Senator Kilgore's committee is to delve into the ownership of TV stations by networks and newspapers. The FCC's previously announced survey of the electronics-radio industry's patent licensing is to be the subject of further analysis by the Commission after the industry has presented its views on the FCC blueprint of the inquiry.

INDUSTRIAL COMMUNICATIONS—The Bell System at the request of the editor of this column furnished a statement of policies with regard to equipment leasing and maintenance agreements with private radio systems, licensed by the FCC, in which it was stated the leasing and maintenance policies are designed to strengthen rather than weaken frequency allocation patterns of the licensees. The FCC is now studying the Bell System's plans for serving private radio users to ascertain whether the licensees will have complete control over the operations of their equipment and systems.

FREQUENCY CONSERVATION—With the safety and special radio services operating around 700,000 transmitters and being the largest and most active group of radiocommunications facilities in use today, the FCC has instituted an intensive survey of means of alleviating the growing problem of scarcity of frequencies. The Commission stated its long-range program calls for geographic assignment, reduction of channel spacing and allocation of additional spectrum space. Use of microwave systems and of the 460-470 mc band are means, too, which the FCC is considering as helpful in the solution of the "spectrum drought."

LITTLE HOPE—In view of the federal government's budget situation and the administration's opposition to further tax reductions, the Radio-Electronics-Television Manufacturers Association's efforts in this Congress for a reappraisal of the damaging effects on the excise levies on radiobroadcast and television receivers are expected to be fruitless. RETMA President Glen McDaniel declared his organization will strongly petition Congress to cut in half these levies on the basis that the radio-TV industry was discriminated against by the 83rd Congress (1953-54), in its reduction of the excise tax on household appliances from 10% to 5%.

*National Press Building
Washington, D. C.*

*ROLAND C. DAVIES
Washington Editor*



THE INDUSTRY'S FIRST AIR FORCE TRANSISTOR

Now Available!

● G.E.'s NEW Junction Transistor, 2N43A, is the first to be written into Air Force specifications! MIL-T-25096 (USAF) was actually written around this G-E product developed for the Military. It meets the most rigorous requirements on electrical and mechanical characteristics, and reliability. Spread in beta (gain) is held to a 2:1 ratio—far narrower than for ordinary transistors.

Designed for mass production at low cost, this P-N-P transistor offers performance characteristics second to none! It is the completely dependable audio amplifier for *commercial* and *military* applications. Include it in your design plans now while production lots are rolling through the assembly line.

For complete specifications and details on applications write today. *General Electric Company, Section X4825, Germanium Products, Electronics Park, Syracuse, New York.*

DESIGN FEATURES:

- EXCEPTIONALLY HIGH BETA (GAIN)**... and spread is held to 33-66.
- STURDY CONSTRUCTION**... built to comply with rigorous vibration and shock requirements. Welded seam keeps transistor free from solder-flux contamination.
- SEALED JUNCTION**...contamination gases permanently eliminated!
- HIGH POWER OUTPUT**...case design makes possible a collector dissipation of 150 MW.
- HERMETIC SEAL**...unaffected by moisture.
- HIGH TEMPERATURE OPERATION**...rated for a maximum junction temperature of 100°C.
- LONG LIFE**...stable performance throughout the life of your equipment.
- SMALL SIZE**...extremely compact design provides added flexibility for all applications.



THE MILITARY DESIGN
USAF-2N43A per specification
MIL-T-25096

COMMERCIAL DESIGN - 2N43A

Absolute Maximum Ratings:

Collector Voltage (Referred to base)	-45 volts
Collector Current	-50 ma
Emitter Dissipation	25 mw
Collector Dissipation	150 mw
Storage Temperature	100°C
Collector Cutoff Current (-45 V)	-10 microamps

Electrical Characteristics, Common Base

($V_c = -5V$, $I_e = 1\text{ ma}$, $T = 25^\circ\text{C}$)

Input Impedance (h_{11})	30 ohms
Output Admittance (h_{22})	1.0 μmhos
Feedback Potential Ratio (h_{12})	4×10^{-4}
Current Transfer Ratio (h_{21})	0.9775

Progress Is Our Most Important Product

GENERAL  **ELECTRIC**

Electronic Industries News Briefs

Capsule summaries of important happenings in affairs of equipment and component manufacturers

AEROVOX CORP. of New Bedford, Mass. has acquired **HENRY L. CROWLEY & CO., INC.**, West Orange, N.J. manufacturers of powder-irons and steatite products.

AMPEX CORP. has moved its Chicago district office to 156 E. Ontario St. Midwest district sales manager for sound equipment is C. Arthur Foy.

ANAHEIM DIV. of ROBERTSHAW-FULTON CONTROLS CO. has become the **AERONAUTICAL DIV.** Located at Anaheim, Calif., this division produces intricate components for aircraft and guided missiles.

BUDD-STANLEY CO. INC., 48-01 22nd St., Long Island City, N.Y., have been appointed licensees to manufacture "Microstrip" printed circuits for microwave application. "Microstrip" is a patent of I. T. & T.

BURNDY ENGINEERING CO., INC. has announced relocation of their N.Y. sales office to 20 E. 1st St., Mt. Vernon, N. Y. to serve the territories of N.Y.C., L.I., northern N.J., and upstate N.Y. through the Glens Falls section.

CBC ELECTRONICS CO., INC. has moved its executive offices, research lab and production facilities to 2601 N. Howard St., Philadelphia, Pa.

CLAROSTAT MFG. CO., INC. has arranged to purchase **CAMPBELL-INDUSTRIES, INC.** of Chattanooga, Tenn. Campbell manufactures highly specialized resistance products of the carbon type.

CROSLY DIV. OF AVCO MFG. CO. has been awarded contract to produce 3 units of **VOLSCAN**, air traffic control system, to be installed at military air bases in the U.S.

ELECTRONIC RESEARCH ASSOC., INC. have moved their facilities to a new plant at 67-69 E. Center St. in Nutley, N.J. which provides 100% expansion in space and facilities.

EMC RECORDINGS CORP. of St. Paul 6, Minn., producer of pre-recorded magnetic tapes has opened its first European office at Wasserstrasse 13, Dueseldorf, Germany. Karl-Georg Busley, General European Representative, will direct and coordinate all EMC recording work in Europe.

EPSCO, INC. has moved their engineering offices and production facilities to 588 Commonwealth Ave., Boston 15, Mass.

FLEETWOOD CORP. composed of former key personnel of **WILLYS MOTORS ELECTRONICS DIV.** will manufacture and supply TV equipment for studios, remote and closed circuit use at their plant at 1037 Custer Drive, Toledo, Ohio. John W. McGee, former general manager of Willys Electronics Div. is Fleetwood president.

GENERAL CERAMICS CORP. has licensed **COMPAGNIE GENERALE de TELEGRAPHIE SANS FIL**, France, to produce "Ferramics," magnetic core materials used in the electronic industries.

GENERAL ELECTRIC CO. has announced a general reduction in list prices on all tone signalling equipment used with two-way radio communication equipment. Price cuts range from \$4 to \$500 on 17 different pieces of equipment.

GENERAL ELECTRIC CO. has established a Communication Equipment Center in Redwood City, Calif. to serve the western demand for G-E two-way radio equipment. Irvin H. Webster is manager of the center.

GENERAL ELECTRIC has revealed plans to center complete engineering and manufacturing of GE germanium rectifiers and diodes at its Clyde, N.Y. plant.

GENERAL INSTRUMENT CORP. is completing a five-point program of expanding its Canadian operations including construction of a plant at Waterloo, Ontario, increased production in Canada, establishment of product research lab., additional personnel and new equipment.

GENERAL TRANSISTOR CORP., a new company at 95-18 Sutphin Blvd., Jamaica 35, N.Y. will engineer and manufacture high quality transistors and related semi-conductor products.

GUDEMAN CO. of Chicago, Ill. has purchased **DILECTRON, INC.**, ceramic capacitor manufacturer of Monrovia, Calif. Dilectron's plant will be known as the **DILECTRON DIV. OF GUDEMAN** whose other plants are in Chelsea, Mich.; Los Angeles and Sunnyvale, Calif.

HELIPOT CORP. of South Pasadena, Calif. recently held open house in its new plant at No. 3, Six Points Rd., Toronto, Ont., Canada.

HETHERINGTON, INC., Sharon Hill, Pa. has entered into manufacture of coils, solenoids, transformers, small motors, ignitron coils, in addition to making precision aviation-type switches.

ILSCO CORP. formerly **ILSCO COPPER TUBE & PRODUCTS, INC.**, has been acquired by Oliver L. Bardes of Cincinnati, Ohio. Andrew H. Stubbers continues as president.

INSULINE CORP. has opened its new plant at 186 Granite Street, Manchester, N.H. Dedication ceremonies including presentation of a plaque to President Samuel J. Spector, were broadcast over radio and TV.

INTEGRATED MICA CORP. of Woodmere, New York has completed design of equipment to produce mica sheets in thicknesses varying from tissue paper to 1/8" at a price expected to make it a substitute for some of the better grades of paper used in the electrical industry. Made entirely from overlapping mica flakes held together by cohesion, the product will not burn at any temperature and is claimed to be virtually ageless.

KAY-LAB of San Diego, Calif. will soon launch construction of a 150x200 foot building within 8 miles of San Diego.

KETAY INSTRUMENT CORP. has purchased the majority stock interest in **VARI-OHM CORP.** of Amityville, N.Y. Ketay has also announced its plan to exchange stock and consolidate with **NORDEN LABORATORIES CORP.**

MATHIAS KLEIN & SONS is established in its new plant and offices at 7200 McCormick Rd., Chicago 45, Ill.

JAMES B. LANSING SOUND, INC., Los Angeles, Calif. has added a plant adjacent to its home office for the exclusive production of cabinets under a new production line method.

LYNN ELECTRONIC RESEARCH CO. and **LYNN-DEATRICK, INC.** have combined under the name of **LERCO DIV. OF LYNN-DEATRICK, INC.** Their new plant is located at 501 S. Varney, Burbank, Calif.

MAGNETIC RESEARCH CORP. has moved to a larger location at 200 Center St., El Segundo, Calif. The new plant increases by 4 times the former facility.

METHODE MFG. CORP., 2021 W. Church-ill St., Chicago 47, Ill., has prepared a printed circuit handbook on "Utilization of Prefabricated Wiring." The 32-page book contains detailed information on the techniques of printed wiring and prefabricated circuitry.

MICRO SWITCH DIV. OF MINNEAPOLIS-HONEYWELL REGULATOR CO. has opened a new research and product development center at 387 Corona St., Denver, Colo. The new center supplements research activities at the main location in Freeport, Ill.

MINNEAPOLIS-HONEYWELL REGULATOR CO. has purchased all of the outstanding capital stock of **DOELCAM CORP.** of Boston, Mass., manufacturer of precision instruments and control equipment.

MONSANTO CHEMICAL CO. has announced that scientists at their **MOUND LABORATORY**, operated for the **ATOMIC**

ENERGY COMMISSION, have developed an atomic battery making use of a thermopile which converts the heat from radioactive decay into electricity.

MOTOROLA, INC. has opened a new research lab for operations research and dynamic systems analysis related to guided missiles and various ordnance devices at Riverside, Calif. The new building provides 22,000 sq. feet of floor space.

MYCALEX CORP. OF AMERICA has opened 3 new sales offices. The Pacific Sales Div. is at 5657 Wilshire Blvd., Los Angeles, Calif.; the Chicago office is at 6677 N. Northwest Highway and the Minneapolis office is at 801 S.E. 8th St., Minneapolis 14, Minn.

NATIONAL VULCANIZED FIBRE, Wilmington, Del., has named a staff for its new research and development lab at Yorklyn, Del. Gerald H. Mains will direct the lab and Alfred J. Green will manage the new project.

NEW YORK AIR PROCUREMENT DISTRICT has relocated at 111 E. 16th St., New York. The District has contractual, production and inspection control over Air Force contractors from Long Island, N.Y. to Fairfield County, Conn.

NORTH HILLS ELECTRIC CO., INC. has moved its factory and offices to 203-18 35th Ave., Bayside 61, N.Y.

PANELLIT, INC. of Skokie, Ill. has affiliated with **TALLER & COOPER, INC.** The newly formed **TAL-COOPER DIV.** will handle marketing and application engineering of Taller & Cooper products.

POLARAD ELECTRONICS CORP. has acquired a new plant at 43-20 34th St., L.I.C., N.Y., in addition to the present facility at 100 Metropolitan Ave., Brooklyn, N.Y.

RAYTHEON MFG. CO. announces that construction is under way for an electronics lab for engineering and research in Wayland, Mass.

SCHAFFER CUSTOM ENGINEERING has relocated its facilities at 235 S. 3rd St., Burbank, Calif.

SERVOMECHANISMS, INC. has begun construction of a new building at 12500 S. Aviation Blvd., Los Angeles International Airport, to replace the 5 smaller buildings now being used at El Segundo, Calif.

SHURE BROTHERS, INC., plans to begin construction on a modern, one-story plant in Evanston, Ill. The new building is scheduled for completion in Spring, 1956.

SYLVANIA ELECTRIC PRODS. INC. Board of Directors has approved the plan to purchase TV picture tube manufacturing facilities of **NATIONAL UNION ELECTRIC CORP.** at Hatboro, Pa.

SYLVANIA ELECTRIC PRODS. INC. has completed a new building for production of TV picture tubes in Fullerton, Calif.

TAPE RECORDERS INC., 1501 W. Congress St., Chicago 7, Ill. has begun operation as manufacturer of three new magnetic tape recorders to be merchandised as the "Tri-Fy" line. President is Hugh Daly.

TEXAS INSTRUMENTS has purchased a 6-acre tract in Houston, Texas and plans are being considered for construction of a new plant for **HOUSTON TECHNICAL LABS**, a T-I subsidiary.

USECO, INC. of Glendale, Calif., formerly **U. S. ENGINEERING CO.** has been purchased by **LITTON INDUSTRIES, INC.** USECO has entered extensively into the fields of etched and printed circuitry.

VITRAMON, INC. has moved into a new plant in Long Hill, Conn. which will provide twice the floor space of their former plant.

WATERS MFG., INC., Waltham, Mass., has purchased the assets and facilities of **AEROHM CORP.** Potentiometers made by both companies will be sold under the trade-mark, "Aerohm."

only

RAYTHEON KTR-100 series

Color TV microwave relay

**PROVIDES ALL
THESE EXTRAS AT
NO EXTRA COST**



FLEXIBLE . . . operates at any desired frequency within the Broadcast, Common Carrier, or lower portion of the Government bands.

MAXIMUM VIDEO INTELLIGENCE . . . meets or exceeds FCC and RETMA color specifications.

LOWEST COST . . . in first cost, installation cost, operating cost and servicing cost.

CONVENIENT . . . only four compact, luggage-type packages with all parts easily accessible.

DEPENDABLE . . . with long-life tubes and simplified circuitry. Waterproof, weatherproof, shock resistant.

PERFORMANCE PROVED . . . by leading television stations across the nation (names on request).

SIMPLIFIED, RUGGEDIZED, MINIATURIZED . . . backed by the Raytheon reputation for *Excellence in Electronics*.

VERSATILE . . . for STL, remotes, network or common carrier interconnection; intercity or intracity links; industrial, educational or community television; radar relaying.

Engineered especially for television, Raytheon KTR-100 Microwave provides a simplified, integrated system for highest quality color or monochrome transmission. Adaptable by interchangeable RF plumbing for broadcast, common carrier or government bands . . . easily tuneable in the field to exact frequencies . . . packaged for simplified installation, control and servicing . . . with built-in multiplexed audio — in brief, one basic system for all applications all *at no extra cost*. Bulletin 3-110 gives complete information. Write for it. Address Dept. 6130-TL



Specialists in Microwave for Television

RAYTHEON MANUFACTURING COMPANY

Equipment Marketing Division

WALTHAM 54, MASSACHUSETTS

Convenient

ACCURATE POWER MEASUREMENTS . . .

FROM 500 to 11,000 MC



This versatile FXR Universal Power Meter, and rugged Matched Coaxial Thermistor Mount, make an unbeatable laboratory or production line team. Here is your assurance of faster, more reliable c-w or pulsed power measurements . . . over broad frequency ranges. These are instruments of proven dependability . . . designed, engineered and built with the specialized know-how for which FXR is recognized in Precision Microwave Test Equipment.

UNIVERSAL POWER METER

FXR MODEL NO. B830A

- Extend range 0.1 to 100 milliwatts full scale
- Accommodates any resistance within $\pm 10\%$ of 50, 100, 150, 200 or 250 ohms
- Positive or negative temperature coefficient
- Bias ranges from 3 to 40 milliamperes
- Bias can be pre-set on meter
- Extra protection against bolometer burn-out

MATCHED COAXIAL THERMISTOR MOUNT

FXR MODEL NO. N215A

- VSWR less than 1.5 from 500 to 11,000 mc
- DC circuit self-contained—200 ohms operation at 34 milliwatts
- Two rugged thermistors used as detecting elements
- Exceptionally high burn-out level
- Plug-in replaceable elements
- Designed for highest accuracy

See the COMPLETE LINE of
FXR PRECISION MICROWAVE
TEST EQUIPMENT

Write today for complete Catalog

FXR
PRECISION MICROWAVE
TEST EQUIPMENT

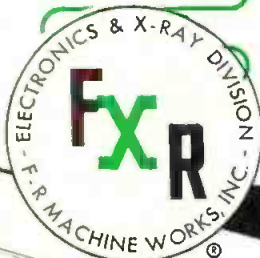

Electronics & X-Ray Division

F-R MACHINE WORKS, Inc.

26-12 BOROUGH PLACE, WOODSIDE 77, N. Y.

Potentiometer Characteristics

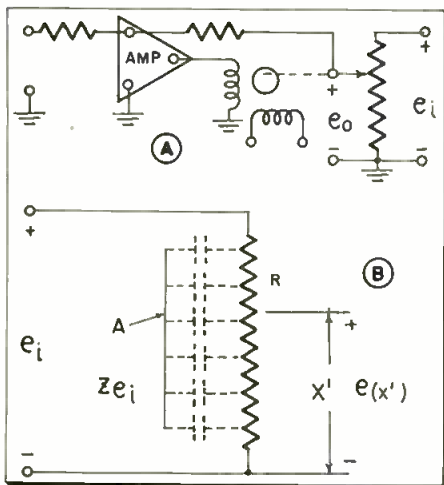

Fig. 1: (a) Potentiometer in typical carrier type analog computer. (b) Phase shift circuit

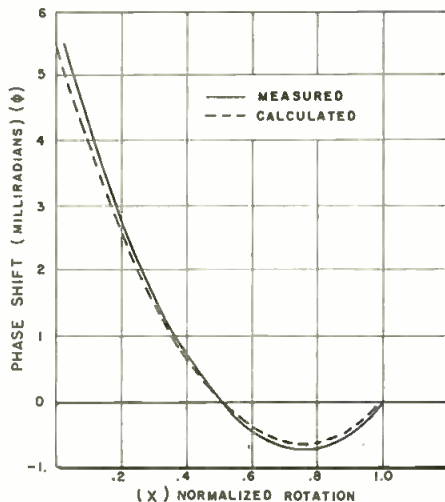

Fig. 2: Plot of phase shift and rotation of 15-turn, 25-k pot, measured and calculated

Examination of low frequency phase shift results in means for improving performance of analog computers

By M. H. HAYES and J. L. WEST

Link Aviation, Inc.
Binghamton, N. Y.

OF fundamental importance to persons concerned with analog computation is the problem of accuracy. The major factor limiting the over-all accuracy of the analog computer is individual component accuracy and performance (in contrast to digital computers in which accuracy is limited only by complexity). In most analog devices, and especially those employing a carrier system one such component is the potentiometer. The potentiometer is used frequently to convert a shaft position to a corresponding voltage.

In analog computers, carrier systems are commonly employed. Here it is most undesirable for a component to generate unwanted quadrature voltage; such voltages are a source of noise and tend to reduce accuracy even in those systems employing quadrature rejecting techniques. It is the purpose of this discussion to describe the phase shifts of potentiometers typically employed in analog computers at frequencies normally utilized. Theoretical expressions and experimental curves for the phase shift will be given. Means of correcting for, or avoiding this phase shift are described.

A typical application of a potentiometer in such a carrier type ana-

log computer is shown in Fig. 1a, in which a voltage e_i is applied between one end of the potentiometer and the ground or reference end; it is desired to obtain between the wiper arm of the potentiometer and ground a voltage e_o , which is directly proportional to the normalized rotation of the wiper arm x . Deviations from the relation

$$e_o = e_i x$$

are caused by the following (assuming the potentiometer to be perfectly linear):

(1) Resistive Loading. This error in theory may be reduced by shunting the potentiometer. Although this error contributes to inaccuracy, it usually does not contribute to malfunctioning of the system (as does a quadrature voltage).

(2) Capacitive Loading. This type of loading is analogous to resistive loading; however it can be removed only by removing the source of capacity.

(3) Phase Shift Within the Potentiometer. This phase shift is caused mainly by capacities between the resistance wire constituting the potentiometer and nearby conductors, such as a metallic case, or a conducting form (mandrel) on which the resistive element is wound. This phase shift is appreciable in 400 cycle analog systems, and can be detrimental even at 60 cycles. Inductance of the windings, as a rule, is not of

great importance at frequencies of interest in most analog computation except for very low resistance potentiometers. It is the phase shift caused by capacitive currents flowing to adjacent conductors that will be discussed here.

To obtain relationships for the phase shift, referring to Fig. 1b, consider that some conducting object, A, near the resistance wire element of the potentiometer is at a potential ze_i , where z is a number between zero and one (i.e. frequently the potential of A is not fixed by direct connection, but is allowed to float). Let it be assumed that a capacity C, uniformly distributed, exists between the resistive element and A; and the resistance of the potentiometer is R. Then the current in the potentiometer, $i(x')$, and the voltage $e(x')$ (x' is a point on the resistance wire as measured from the ground

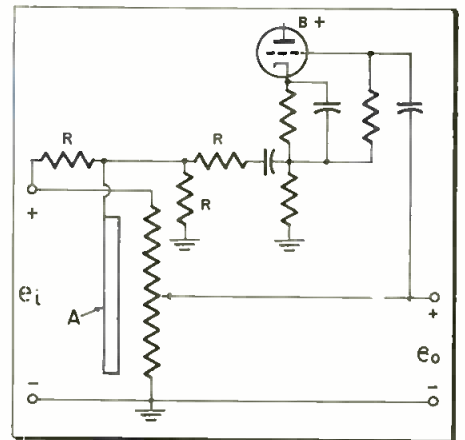

Fig. 3: Cathode follower determines wiper volts

or reference end) is given by:

$$\frac{di(x')}{dx'} = j\omega C'[e(x') - e_i z] \quad (1a)$$

where

C' is the capacity per unit length ω is 2π times the frequency in cps and,

$$\frac{de(x')}{dx'} = R' i(x'), \quad (1b)$$

R' is the resistance per unit length.

These equations will be recognized as the equations of a transmission line, and may be solved to obtain $e(x')$, subject to the conditions;

$$e(0) = 0, \\ e(1) = e_i.$$

(Continued on page 126)

Survey of

New Products of the Month

Capsule summaries of latest electronic developments provide handy reference for engineers in the market for new equipment and components

COAXIAL CONNECTORS. Newly-designed r-f quick-disconnect coaxial connectors are available in plugs, jacks, panel-jacks, receptacles, and right-angle plugs for 50 ohm impedance cables. Made by Tru-Connector Corp., 416 Union St., Lynn, Mass. (Ask for A-2-39)

DECADE COUNTERS. Four types, a 20 kc scaler, a 40 kc scaler, a 100 kc scaler, and an output stage scaler operating at 10 CPS that can feed a mechanical counter have been announced by Ransom Research, P.O. Box 382, San Pedro, Calif. (Ask for A-2-40)

PHOTOCONDUCTIVE CELL, CE 705, announced by the Continental Electric Co., Geneva, Ill., is a new lead sulphide miniature unit that is one of the components employed in the IBM's data processing machine, Type 702. (Ask for A-2-41)

SELF-LOCKING NUTS, announced by The Kaynar Company, Kaylock Div., 820 E. 16th St., Los Angeles, Calif., occupy but half the space of comparable anchor nuts and have a fifth their weight. (Ask for A-2-43)

MAGNETIC TAPE RECORDER. The "Warren 77-7" has self-contained power. Operates at 3.75 in./sec. Provides 1-hr. recording or playing time on 5 in. reel- $\frac{1}{4}$ in. tape. By J. C. Warren Corp., 21 Hanse Ave., Freeport, N. Y. (Ask for A-2-45)

I-F TRANSFORMER, announced by the F. W. Sickles Div. of General Instrument Corp., Chicopee, Mass., is $\frac{1}{3}$ smaller than conventional i-f transformers. The $\frac{1}{2}$ in. unit is used for pocket radios, communications applications, and with transistors. (Ask for A-2-47)

MAGNETIC AMPLIFIER. Six improved versions of the "Moto Mag" have been announced for use in remote control devices, computers, positioning servos, 2-phase motors, etc., by Keystone Products Co., 904 23rd St., Union City 2, N. J. (Ask for A-2-48)

PHONOGRAPH CARTRIDGE. The IP ceramic phonograph cartridge, made by Sonotone Corp., Elmsford, N. Y., for high compliance and frequency response, is available for fine groove records (33's and 45's) and standard groove 78's. (Ask for A-2-49)

TOROIDAL COILS, called "Rotoroids" by Burnell & Co., Inc., 45 Warburton Ave., Yonkers 2, N. Y., can be used at all audio frequencies above 300 CPS. Max. to min. inductance ratio at least 4 to 1. (Ask for A-2-50)

PILOT LIGHTS by Dialight Corp., 60 Stewart Ave., Brooklyn 37, N. Y., now include a subminiature series which mounts in a single 15/16 in. clearance hole without insulation mountings. Socket, lamp, and connections insulated from bushings. (Ask for A-2-51)

TERMINAL. An extruded, flag-type, compression-installed terminal, the "Hylug," was recently developed by Burndy Engineering Co., Inc., Norwalk, Conn., for side-entrance aircraft wiring installations. (Ask for A-2-52)

CHOPPER. A modification of the Model C-976 DPDT chopper, recently announced by James Vibrapowr Co., 4036 N. Rockwell St., Chicago 18, Ill., for 60 CPS, can be used for 20 to 420 CPS. Engineering report available. (Ask for A-2-53)

"HELIPOWER," a new 100 kw transmitter and 1-bay helical antenna was recently announced as a package for VHF TV channels 7 through 13 by General Electric Co., Electronics Park, Syracuse, N. Y. (Ask for A-2-54)

RESISTOR, made in accordance with MIL-R-93A specifications and called Type 1273 by The Daven Co., 191 Central Ave., Newark 4, N. J., is a sub-miniature, encapsulated unit $\frac{1}{4}$ in. diam. by 5/16 in. long. (Ask for A-2-55)

PULSE GENERATOR, WA-9A, announced by RCA, Engineering Products Div., Camden, N. J., facilitates measurement of studio color-signal voltage by broadcast stations. Also applicable in measuring monochrome voltages. (Ask for A-2-56)

MERCURY PLUNGER RELAYS, made by Ebert Electronics Corp., 212-26 Jamaica Ave., Queens Village 28, N. Y., are UL approved for listing at rates of 60 amps or 3 hp at 115 v. ac for heavy duty; 35 amps or 2 hp std. (Ask for A-2-57)

SEALS. "Advac" seals by Advanced Vacuum Product Inc., Div. General Ceramics Corp., 188-22 Liberty St., Stamford, Conn., are available as assembled brazed terminals, custom built seals, complete assys, and soft solder terminals. (Ask for A-2-42)

CAPACITORS. Film Capacitors, Inc., 3400 Park Ave., New York, N. Y., are employing a new plastic film to produce small, lightweight units that operate at temperatures to 125°C. with voltages from 2 to 60 kv. (Ask for A-2-44)

"TRI-LOOP" ANTENNA. The 16 element "Tri-Loop," made by Prodelin Inc., 427 Bergen Ave., Kearny, N. J., is said to be the first VHF antenna to provide super gains in a standardized model. Can deliver 316-kw ERP. (Ask for A-2-46)

TV PICTURE TUBE TESTER, Model 590, announced by Hickok Electrical Instrument Co., 10606 Dupont Ave., Cleveland 8, O., used with any standard Hickok dynamic mutual conductance tube tester, enables an overall "light" efficiency check of a TV picture tube. (Ask for A-2-14)

TUBELESS MAGNETIC AMPLIFIER, dc regulated power supply, EM-28-1B, by Engineered Magnetics, 11812 Teale St., Culver City, Calif., has adjustable voltage within 28 to 32 v. dc. Single phase input fluctuates between 105 and 125 v. and 380 to 420 CPS ac. (Ask for A-2-15)

APERTURE EQUALIZER, announced by Harrison Laboratories, 53 Industrial Rd., Berkeley Hts., N.J., provides a phaseless high boost for TV. Generally useful for "peaking-up" wide band circuits. Adaptable to flying spot scanners, film pickup, etc. (Ask for A-2-16)

MINIATURE CERAMIC CAPACITORS, produced by Film Capacitors, Inc., 3400 Park Ave., New York, N.Y. are housed in ceramic jackets with thermosetting plastic end-fill. Especially impregnated to minimized temperature coefficient. (Ask for A-2-17)

FLAT-FRAME SWITCHES, called "NF-switches, by Switchcraft, Inc., 1328 N. Halsted St., Chicago 22, Ill., are adaptable to any stack or "pile-up" of contact springs. Fine silver contacts. Rated 3 amps, 120 v ac, non-inductive load. (Ask for A-2-18)

TRANSMITTER RACKS for 19 and 30 in. rack panels are being produced by Premier Metal Products Co., Inc., 3160 Webster Ave., New York 67, N.Y. Made of No. 16 gauge sheet steel with No. 12 gauge steel bottoms. Welded throughout. Panel mounting angles 3/16 in. thick. (Ask for A-2-19)

SWITCH, ISEI, a completely sealed subminiature snap-action switch, 7/8 x 21/64 x 11/32 in. in size, by Micro Switch Div., Minneapolis-Honeywell Regulator Co., Freeport, Ill., gives trouble-free operation from -65°F to 180°F. (Ask for A-2-36)

HI-FI TAPE DECK, the "MOTEK", made by Fenton Co., 15 Moore St., New York 4, N.Y. has separate capstan, takeoff, and takeup motors. Eliminates levers, brake shoes, springs, clutches, etc. Response better than 50 to 10,000 CPS. (Ask for A-2-29)

SPEAKER PHONE, developed by Telecom, Inc., 1019 Admiral Blvd., Kansas City 6, Mo. enables two-way communication between a loudspeaker and all telephones in any Telecom automatic dial system. Eliminates push-to-talk levers and buttons. (Ask for A-2-30)

POWER SUPPLY, the "MagniVolt," high-performance ac to dc regulated selenium rectifier has dc output ratings of 4 to 30 VDC and 5 to 30 amps full loads. AC input, single phase, 60 cps. Made by Inet, Div., Leach Corp., 4441 Santa Fe Ave., Los Angeles 54, Calif. (Ask for A-2-20)

OIL-IMMERSED TRANSFORMER, a high voltage unit for alternating and high voltage test equipment and power supplies, introduced by Condenser Products Co., Div. of New Haven Clock and Watch Co., 140 Hamilton St., New Haven, Conn. is made in both 60 CPS and 400 CPS types to 5 KVA. (Ask for A-2-21)

AUDIO SHIFT NETWORK for single side-band receiving and transmitting applications, Model 350, Type 2Q4, by Barker & Williamson, Inc., 237 Fairfield Ave., Upper Darby, Pa., provides a constant 90° phase shift $\pm 1.5^\circ$ over a 300-3,000 CPS audio range. (Ask for A-2-22)

FUSION-ALLOY GERMANIUM TRANSISTORS, Types CK760, CK761, and CK762, announced by Raytheon Mfg. Co., 55 Chapel St., Newton 58, Mass. have alpha cutoff frequencies of 5, 10, and 20 megacycles, respectively. All are hermetically sealed. (Ask for A-2-23)

METER MULTIPLIERS, Types MFA and MFD resistors, made by Resistance Products Co., 914 S. 13th St., Harrisburg, Pa., generally used with 1 ma instruments, are hermetically sealed, precision wire-wound high voltage units that comply fully with JAN-R-29 specifications. (Ask for A-2-24)

WIRELESS MICROPHONE, the "Port-O-Vox," eliminates cables. Employs 5 subminiature tubes in a pocket fm transmitter. Input power, 200 mw on a frequency of 27.51 MC. Made by Port-O-Vox Corp., 521 West 43rd St., New York 36, N.Y. (Ask for A-2-25)

TURNTABLE. The three-speed Model CB-33, made by Gates Radio Co., Quincy, Ill., is controlled by one flip-type lever. Accommodates 45 RPM records. Eliminates spindle change for 33-1/3 and 78 recordings. Slip-page practically eliminated. (Ask for A-2-27)

COMMUNICATIONS MICROPHONE, Type B 110, made by Ronette, Amsterdam, and distributed by Ronette Acoustical Corp., 135 Front St., New York 5, N.Y., has an output level of 1 mV/uBar, working into a 5 megohms load. Output impedance 2200 mmfd. (Ask for A-2-28)

CAPACITORS. A new line of metallized paper capacitors, sold under the name, "Epicon," by Electron Products, Inc., 1220 E. Green St., Pasadena, Calif., are available in 200, 400, and 600 v ratings. Impregnated with a special formula Epoxy resin. (Ask for A-2-37)

COAX CONNECTOR SERIES, the DM, announced by Dage Electric Co., Beech Grove, Ind., are $\frac{1}{2}$ the size of a standard BNC. Weatherproof. Designed for use with miniature cables up to 3/16 in. diam. Feature a positive lock, quick disconnect coupling. (Ask for A-2-38)

SUBMINIATURE RELAY, Series 2005, announced by Guardian Electric Mfg. Co., 1621 W. Walnut St., Chicago 12, Ill., is 6 pole, double-throw, hermetically sealed, 5 amp unit said to meet specifications MIL-R-6106-A, Class A and MIL-R-5757-B, Class A. (Ask for A-2-11)

BENCH BRAKE, Model U322, made by W. Whitney Stueck, Inc., Old Saybrook, Conn., for the production of custom instrument boxes and radio chassis, singly or in short run production, has rated capacity of a $\frac{3}{8}$ in. flange on 22 gauge mild steel or heavier equivalent in softer materials. (Ask for A-2-35)

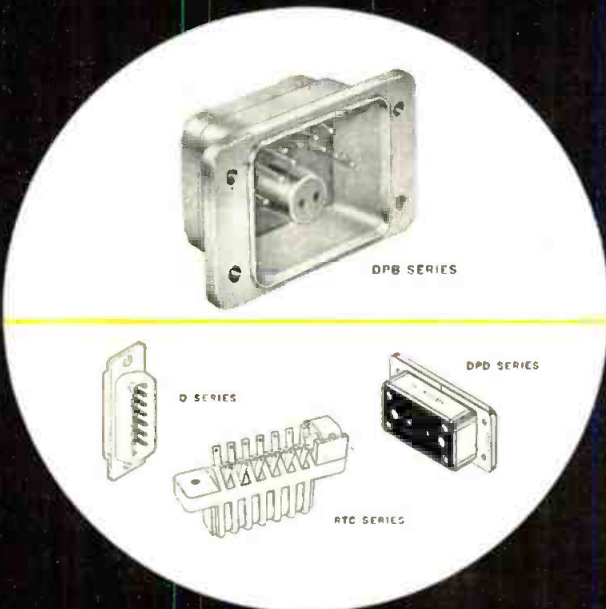

*for rapid disconnect
use cannon
"unit plug-in"
connectors*

speed up inspection...testing...maintenance! facilitate interchangeability!

You can connect, disconnect, interchange, replace, test, and inspect instruments, assemblies, and sub-assemblies easily and rapidly when you use Cannon "Unit Plug-In" multi-contact electric connectors.

You'll find some with shells . . . some without. Shell style units . . . in a wide variety of designs . . . are ruggedly constructed to take the many "in" and "out" operations of rack, panel, chassis, and sub-assembly applications. Varied, simple, but always rigid mounting facilities provided on each connector half. Standard, miniature, sub-miniature sizes.

Either connector half may be made into a plug by use of an end bell. Up to 156 contacts. And . . . an amazing number of combinations of contacts for control, audio, thermocouple, co-ax, twin-ax, as well as pneumatic connections. In single- or double-gang. Special moisture-proofed types. Standby units feature gold-plated contacts to withstand deterioration and corrosion.

Write for full information. Write TODAY!



first in connectors

CANNON PLUGS

Please refer to Dept. 201

CANNON ELECTRIC COMPANY, 3209 Humboldt Street, Los Angeles 31, California. Factories in Los Angeles; East Haven; Toronto, Canada; London, England. Contact representatives and distributors in all principal cities.

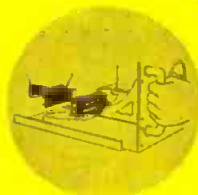

BOURNS

sub-miniature

TRIMPOTS

TRADE MARK



PROVIDE THE ULTIMATE IN CIRCUIT TRIMMING

Simple screwdriver adjustment...

The TRIMPOT is a 25 turn, fully adjustable wire-wound potentiometer, designed and manufactured exclusively by BOURNS Laboratories. Electrical settings in increments of $\frac{1}{4}$ to $\frac{1}{2}$ % are securely maintained during vibration of 20 G's up to 2,000 cps or sustained acceleration of 100 G's. BOURNS' unique self-locking design eliminates cumbersome locknuts. Power rating is $\frac{1}{4}$ watt at 100° F. Standard resistance values from 250 ohms to 25,000 ohms are available for immediate delivery. Information on higher and lower resistances on request.

BOURNS TRIMPOTS are accepted as standard components by aircraft and missile manufacturers and major industrial corporations.

9 TRIMPOTS
TAKE LESS
SPACE THAN
A 2¢ STAMP



Tiny cross-sectional size—only $\frac{1}{4}$ " x $\frac{5}{16}$ "—and rectangular shape save valuable panel space. Instruments are easy to mount individually or in stacked assemblies with two standard screws through the body eyelets.

BOURNS also manufactures precision potentiometers to measure Linear Motion; Gage, Absolute, and Differential Pressure and Acceleration.



BOURNS LABORATORIES

6135 MAGNOLIA AVENUE • RIVERSIDE, CALIFORNIA

Technical Bulletin On Request, Dept. 172

© B. L. PATENTS PENDING

Dielectric Absorption

(Continued from page 74)

appreciably with various types of condenser dielectrics, is necessary for absolute measurement. On the other hand, when a series of measurements is made in short intervals with the same condenser, a certain amount of dielectric charge may remain after each test in the condenser dielectric. Therefore, it is necessary to short the condenser after each test for several minutes before the next test is performed. In most cases, several minutes in the shorted position are sufficient to guarantee a fairly good accuracy of measurements.

A series of short tests with various shorting-times has been made with all the condenser types tested. For illustration, the results obtained with a Vitamin Q condenser are plotted in Fig. 6. The voltage loss due to dielectric absorption, with the condenser shorted for various times ranging from 10 mins. to 19 hrs. before testing, shows only small deviations, the loss appearing greater when the condenser is shorted for a longer time. The same results were obtained with all the other types of condensers tested except in the case of a tested condenser using a combination of paper and polystyrene. This condenser had a high voltage loss on the first reading whenever the condenser was shorted for a long time before the test. After approximately five subsequent readings with 10 mins. shorting-time in between, the voltage loss was appreciably smaller and fairly constant, as shown in Fig. 6. This fact indicates that 10 mins. shorting-time is not sufficient to discharge the dielectric when it has been previously exposed to the field for 30 secs.

No study has been made to determine the cause of such behavior. However, it is generally known that paper condensers, when not sufficiently dried and impregnated, act in a similar way. This paper-polystyrene condenser had not been impregnated so it may be that during the baking process moisture was entrapped within the condenser.

Recovery Voltage

All the condensers tested were checked at room temperature using the method to discharge from a higher initial voltage to a lower final voltage. The condensers were shorted before the tests for various shorting-times ranging from 10 mins. to 19 hrs. They were initially charged for 1.5 mins. at each test.

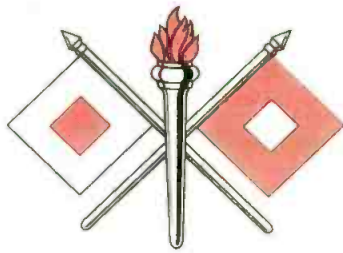

CBS-Hytron Qualifies for Signal Corps Honor Inspection Program



CBS-Hytron is the first and (as of January 15, 1955) the only receiving-tube manufacturer qualified for the Signal Corps honor inspection program . . . the Reduced Inspection Quality Assurance Plan — RIQAP.

The Signal Corps Supply Agency has informed CBS-Hytron: "The completeness of your manufacturing process and quality controls, the supporting inspection records, and the quality of your end product have enabled us to adopt a reduced inspection plan on your Electron Tubes."

The Signal Corps found that CBS-Hytron is producing a quality of product which is "either equal to or better than the Acceptable Quality Level established by the Government."

Equivalent quality of product is available to you, too.

Quality products through *ADVANCED-ENGINEERING*



CBS-HYTRON Main Office: Danvers, Massachusetts
A Division of Columbia Broadcasting System, Inc.

A member of the CBS family: CBS Radio • CBS Television • Columbia Records
CBS Laboratories • CBS-Columbia • CBS International • and CBS-Hytron

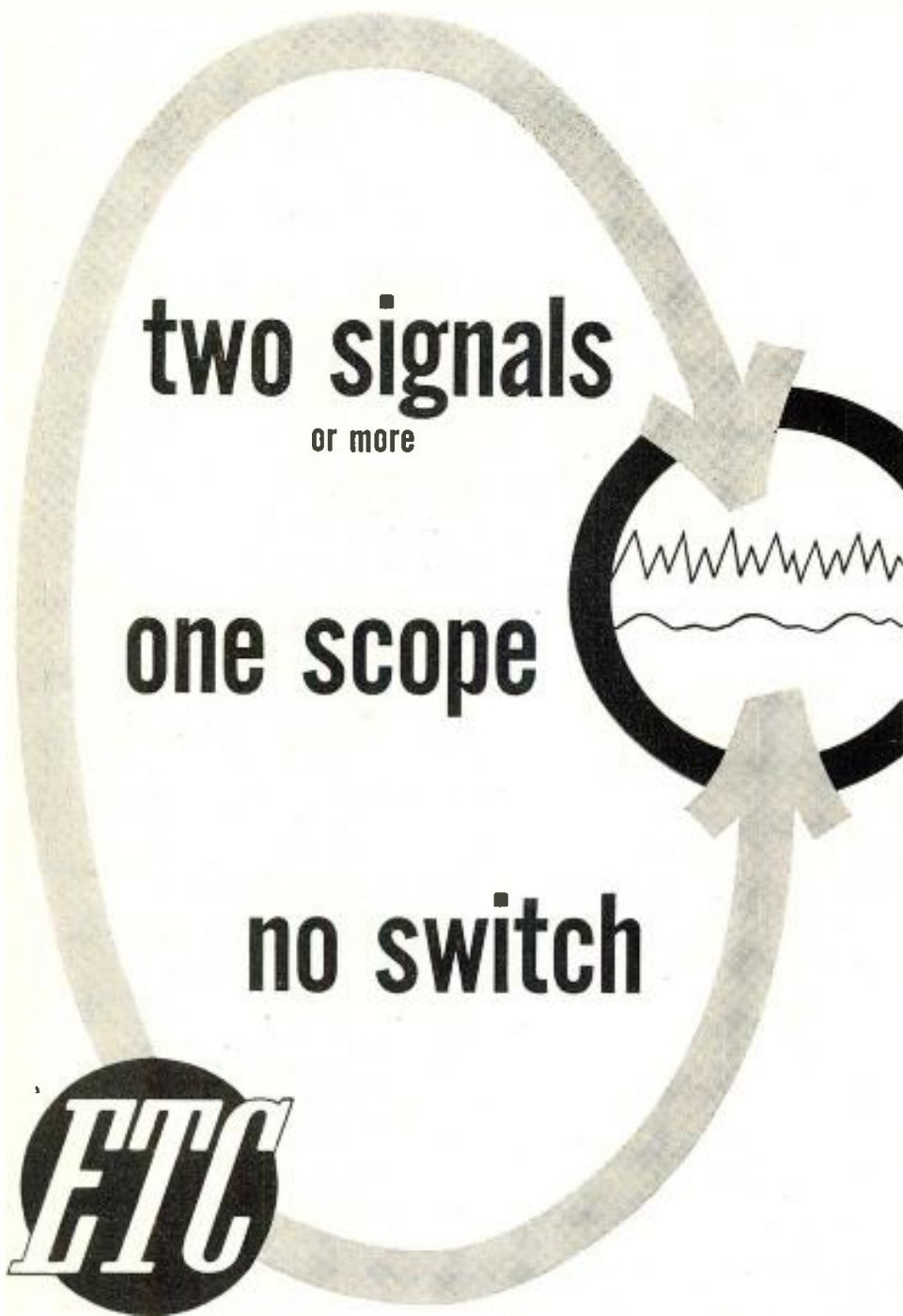

two signals
or more

one scope

no switch



ETC multi-channel oscilloscopes and multi-gun tubes display up to 8 independent phenomena *simultaneously* on the face of a *single* cathode ray tube . . . without switching.

Write for complete catalog.

electronic tube

C O R P O R A T I O N

1200 E. Mermaid Lane

Philadelphia 18, Penna.

Dielectric Absorption

(Continued from page 100)

Readings obtained with the same Vitamin Q condenser are presented in Fig. 6.

The readings indicate that there is only a small deviation due to varying the shorting-time in this range; however, the voltage recovery is appreciably lower than the voltage loss in the tests previously described. This lower voltage recovery was confirmed for all types of condensers measured. The ratio of recovery voltage to voltage loss on the other hand is different for various types of condensers and is shown in Table II.

This difference cannot be explained as influenced by the leakage resistance because all samples used in the tests except one had an insulation resistance of more than 10^{11} ohms times microfarad at room temperature. This difference may be explained by noting that, in the case of the charging measurements, the dielectric is subjected to a high field during the entire measurement time (30 secs), while the decrease in field strength because of voltage loss is small. During this period, the dielectric is being formed and is removing charge from the plates. In the case of the discharge measurements, only the small field from the recovery voltage is present during the time of the measurement so that the forces tending to produce dielectric recovery are small and in opposition to the charge accumulating on the condenser plates.

Temperature Effects

An attempt was made to measure the dielectric absorption of these various condensers when exposed to different temperatures. Fig. 7 shows the voltage losses after 30 secs. vs. temperature when the condensers are charged from 0 to 600 v. Readings at higher temperatures should be corrected in cases where the leakage resistance of the condenser has dropped below 10^{11} ohms times microfarad. Such a correction is shown by the dotted lines for the Vitamin Q and Prokar condenser. Similar correction may be necessary for the Mylar condenser and the Mylar-paper combination, but their leakage resistance vs. temperature was not determined.

All condensers, except the polystyrene, also show an increase in voltage loss at lower temperatures. This increase cannot be explained by a decreased leakage resistance, which, for these quality condensers,

TORTURE TESTED



ASTRON Mylar* Series "X"†
Capacitors

...to insure dependable operation from
~~-65°C~~ to ~~150°C~~ **150°C** **WITHOUT DERATING**

ASTRON adds a new dimension to the capabilities of Mylar* plastic capacitors... reliable operation from 65°C to 150°C... even up to 200°C with proper derating and adjustment.

These new Series "X"† miniature capacitors utilize Mylar and other new dielectrics, specially processed by exclusive techniques—the important result of creative ASTRON research—to gain the most reliable high temperature operation yet achieved. Fully proven, in service, Series "X" capacitors have been subjected to every conceivable torment that could possibly be encountered by a capacitor... they offer the efficient solution to applications where space, weight and performance are vital.

The new operating dimension of Series "X" capacitors adds up to 40% more to the high temperature operating limits of conventional Mylar units... plus good capacitance stability... increased mechanical strength... higher insulation resistance... low power factor... excellent retrace characteristics and long life.

ASTRON Mylar Series "X" surpass Spec. MIL-C-25A... available in a wide range of case styles with extended foil or inserted tab construction... units hermetically sealed with glass-to-metal closures for complete protection from severe environmental effects.

Need special or conventional extra high temperature capacitors to effectively meet unique operating requirements? Then you'll want complete engineering data on Astron's Series "X"... write today, outlining your specific problems.

*Reg. Du Pont Trademark

†Trademark

ASTRON

C O R P O R A T I O N

255 GRANT AVENUE

EAST NEWARK, N. J.



Be sure to see us at Booth #368 March IRE Show.

Compact case styles to meet every operating requirement



Series "X" Type XQF
Tubular



Series "X" Type XXJ
"Squeeze seam" Case



Series "X" Type XD
Bathtub Case

EXPORT DIVISION:
ROCKE INTERNATIONAL CORP.
13 EAST 40TH STREET
N. Y., N. Y.

IN CANADA:
CHARLES W. POINTON
8 ALCINA AVENUE
TORONTO 10, ONTARIO

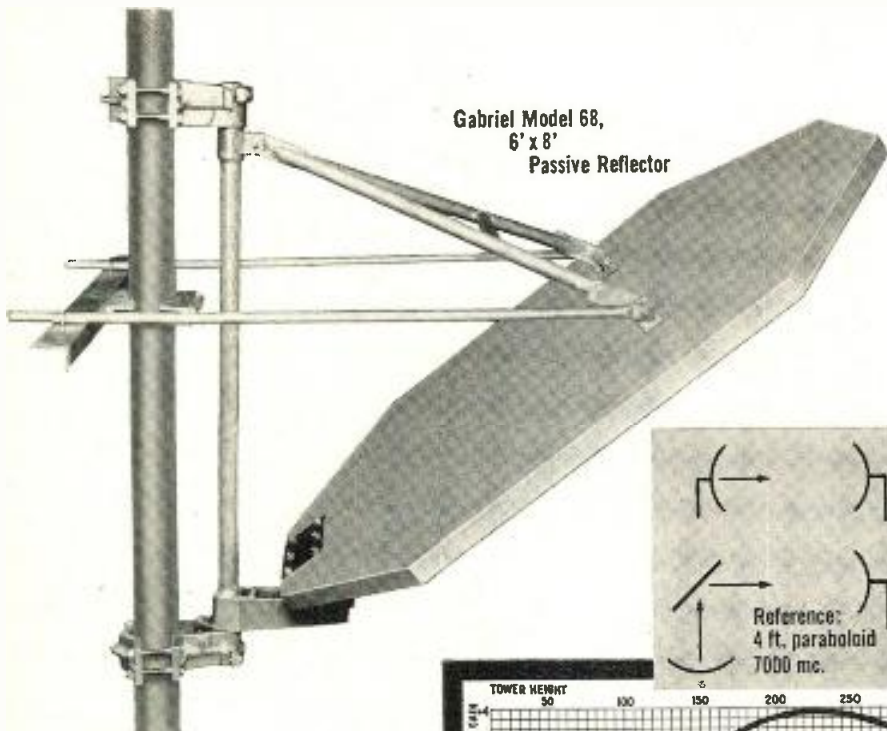

Gabriel Model 68,
6' x 8'
Passive Reflector

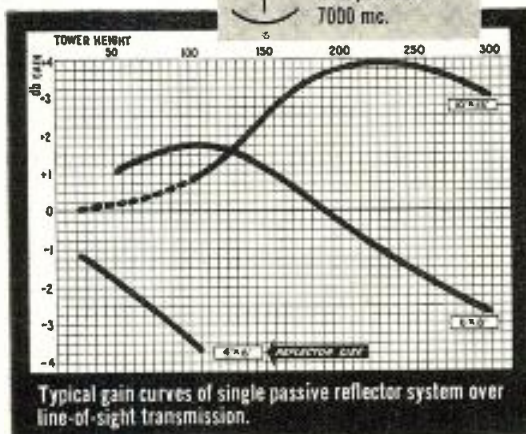
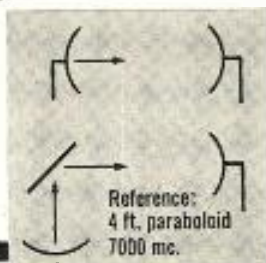

Typical gain curves of single passive reflector system over line-of-sight transmission.

gain
"PEAK"
 performance at lower cost
 with
GABRIEL passive reflectors

Fast . . . accurate . . . easy adjustment permits peaking Gabriel Passive Reflectors in microwave relay links to gain maximum point-to-point transmission at lower overall cost. Gabriel's new design offers increased system efficiency that can out-perform line-of-sight transmission.



Adjusting elevation dome
by one man on tower.

- Two lead-screw systems permit continuous, stepless adjustment in azimuth and elevation by one man on the tower with only a hand wrench.
- Mounting on the tower can be done usually by a two-man crew, with total man-hours cut as much as 50%.
- Increased gain over line-of-sight transmission is obtainable with optimum size reflector for various tower heights.

Ask for Gabriel recommendations for your system.

Write for Bulletin PR-11 for complete mechanical and electrical systems data.

Gabriel Electronics Division
 THE GABRIEL COMPANY, Endicott Street, Norwood, Mass.



Dielectric Absorption

(Continued from page 102)

should be negligible at the low temperature range. There may be a small influence from humidity at the terminals, although precautions were taken to prevent such occurrence. It is believed that a certain amount of this increase in dielectric absorption at lower temperatures is due to the fact that, at lower temperatures, the dielectric absorption process is slower so that a smaller percentage of the dielectric absorption is covered during the charge cycle and a larger percentage occurs afterwards.

Evaluation

The test results which were obtained with this dielectric absorption tester allow one to analyze the dielectric absorption under various test conditions.

First it can be stated that the dielectric absorption D can be expressed as a voltage loss which is directly proportional to the charge voltage (see Fig. 5).

$$D = cE_{ch} \quad (1)$$

The factor c depends on the material which is used as a dielectric and increases with temperature (see Figs. 4 and 7).

$$c = f(\text{Mat}), (T) \quad (2)$$

The voltage loss due to dielectric absorption D increases with time. This time consists of two parts, the charge-time and the time lag between disconnecting the condenser from the power source to the instant at which the measurement is taken. Therefore:

$$t = t_{ch} + t_m \quad (3)$$

It is obvious that during a long charge time the dielectric absorption will be supplied by the power source, thus no voltage loss can be detected afterwards.

When the condenser is fully charged its dielectric is exposed to a field which is determined by the voltage of the power source. When thereafter the condenser is disconnected from the source, the voltage at the condenser plates drops only for a small amount as a function of leakage and dielectric absorption. The field to which the dielectric is exposed after disconnection is practically the same as that at the end of the charge-time.

Therefore, to get reliable measurements the charge-time must be as short as possible, just sufficient to guarantee a fully charged condenser (see Fig. 1).

The increase in voltage loss vs.



Now Fairchild is able to miniaturize potentiometers and still give you the accuracy and reliability you need.

This advance is made possible by Fairchild's continuous and extensive research on new materials such as epoxy-resin and halogenated polyethylene insulating materials, and precious metal alloy resistance wire, and by thorough evaluation of these materials in our own environmental testing facilities. These advances are maintained by our rigid quality control program on materials, processes, and manufacturing.

MINIATURIZATION

without
sacrificing performance

Fairchild miniature precision potentiometers meet applicable portions of MIL-E-5272A for humidity, vibration, temperature cycling, fungus resistance and salt spray. These units, in $\frac{7}{8}$ " and $1\frac{1}{8}$ " diameters, meet the same requirements for accuracy and reliability as most standard precision units up to 2" in diameter.

No matter what factors govern your choice of precision potentiometers, you'll find the answer in Fairchild's complete line. Write Dept. 140-59E, Fairchild Camera and Instrument Corporation, Potentiometer Division, 225 Park Avenue, Hicksville, Long Island, New York.

FAIRCHILD
PRECISION POTENTIOMETERS

Where accuracy is

VITAL!

You Can Depend On ARC Test Equipment



With unfailing accuracy and speed, the ARC Type H-14 Signal Generator provides pre-flight or bench-maintenance checks of ARC Omni and Localizer Receivers. In less than one minute the H-14 can check one unit or an entire squadron simultaneously.

This dependable precision safeguard verifies up to 24 omni courses, to-from and flag-alarm operation, calibration accuracy,

omni course sensitivity and left-center-right on localizer. In addition, it transmits vocal instructions to pilots along with test signals.

ARC provides the companion H-16 Standard Course Checker for precision checking on the course accuracy and phase measurement of the H-14, or any other omni signal generator. Both instruments are sold only direct from factory. Detailed literature sent on request.

Dependable Airborne Equipment Since 1928

Aircraft Radio Corporation

BOONTON, NEW JERSEY



Type H-14 Signal Generator



Type H-16 Standard Course Checker



Omni Receivers
UHF Receivers
Transmitters
10-Crystal Adapters

Dielectric Absorption

(Continued from page 104)

time does not follow a simple exponential function. The increase is much faster at the beginning than towards the end. The test data show that it can be expressed by the following equation:

$$D = cE_{ch}(1 - \epsilon^{-\alpha(t_{ch} + t_m)^n}) \quad (4)$$

The tests showed also that the exponent (α) depends upon the dielectric and decreases with temperature. Its behavior is similar to that of a time constant, consisting of C and R, where both values are determined by the dielectric material (see Fig. 1). The C-value increases with temperature and the R-value decreases with temperature, resulting in a higher amount of dielectric absorption obtained in a shorter time.

What is true for the charge-time of the condenser is likewise true for its history (see Fig. 6). When a condenser is charged for a certain period, a charge due to dielectric absorption has soaked into the dielectric. This portion, D_H must be completely removed before a measurement is taken. If not completely removed, the voltage loss which can be detected at the measurement is lower for the amount which was left in the condenser dielectric. so that:

$$D = (cE_{ch} - D_H) 1 - \epsilon^{-\alpha(t_{ch} + t_m)^n}$$

This equation is very similar to those found by various authors in the past.¹ Pellat especially arrives at the same general law for the anomalous or "viscous" displacement.² He calculates in his theory the whole displacement under various conditions, whereas in this report only the "viscous displacement" or "dielectric absorption" is considered.

Prokar Condenser

An attempt has been made to determine the factors c , α , and n for several condenser samples which had been tested. For a Prokar condenser at room temperature these values are approximately:

$$c = 0.017, \alpha = 1/3.5, n = 0.5 \quad (6)$$

These values mean that a Prokar condenser at room temperature loses approximately 1.7% of its charge because of its dielectric absorption. In $(1 \times 3.5)^2$ seconds approximately 63% of the dielectric absorption can be detected and in $(10 \times 3.5)^2$ secs. 99.9% respectively.

It has become apparent that standard procedures concerning measurement and definition of dielectric ab-

**HERE IS THE CRITICAL
POINT OF DIFFERENCE
IN A-N CONNECTORS...**

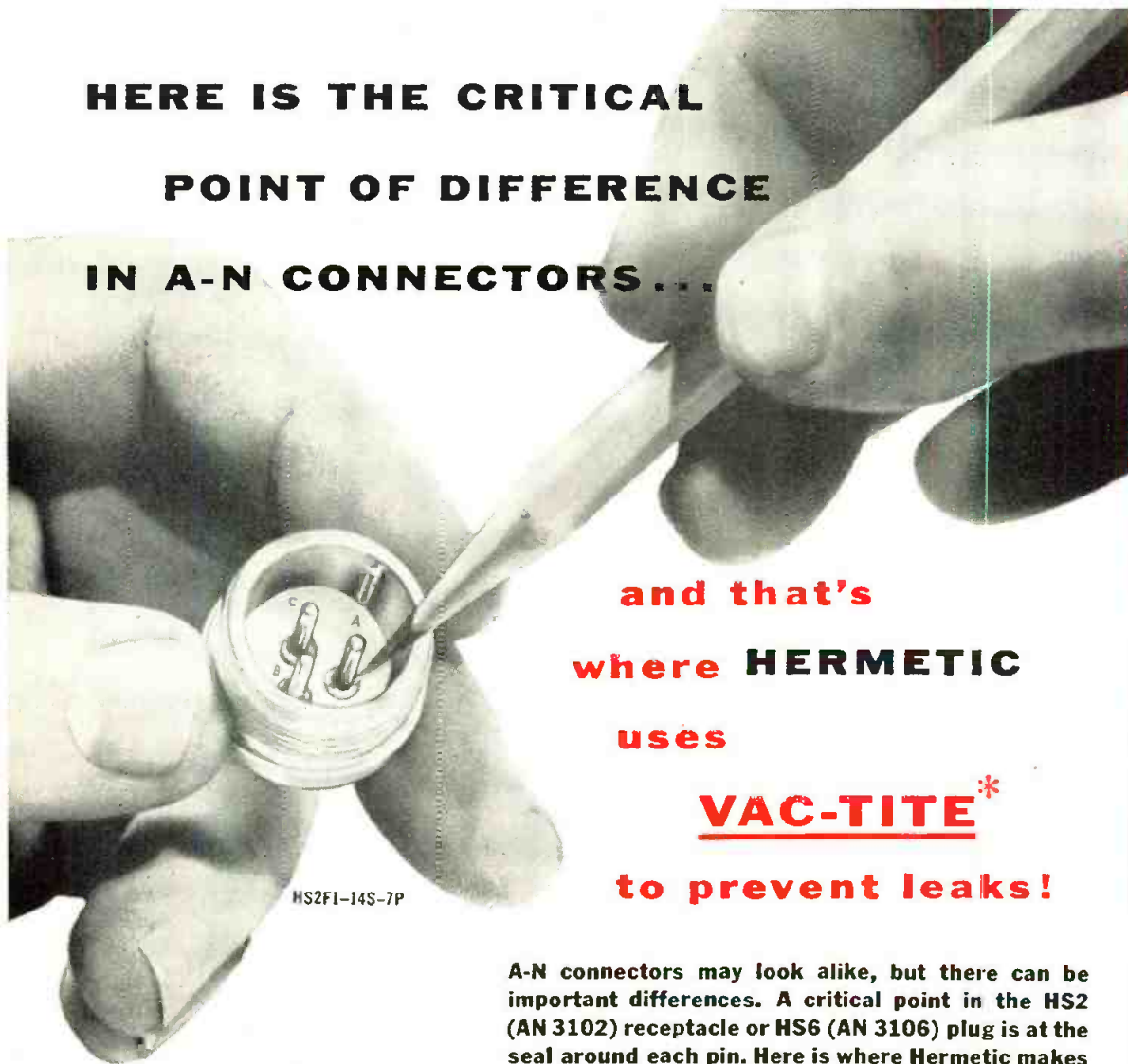

**and that's
where HERMETIC
uses**

VAC-TITE*
to prevent leaks!

A-N connectors may look alike, but there can be important differences. A critical point in the HS2 (AN 3102) receptacle or HS6 (AN 3106) plug is at the seal around each pin. Here is where Hermetic makes use of Vac-Tite* glass-to-metal construction... to insure the leak-proof performance you seek in this type connector:

Tough instrumentation problems often dictate use of HS 2 (AN 3102) receptacles and HS 6 (AN 3106) plugs. Superior performance is wanted and superior performance you'll get with Hermetic:

- Vacuum tight (Mass spectrometer proven)
- Arc-resistance of glass
- High-temperature operation
- Corrosion resistance
- 100% moisture and pressure resistant
- Shock and vibration proof
- Equivalent to MIL-C-5015

In addition to our standard line of HS 2 and HS 6 connectors, special units with particular plating requirements, varied flange style, and extra-high pressure resistance, etc., are being designed and manufactured to meet the most specialized needs.

Let us serve you... Write for drawings, engineering data and your copy of the "Encyclopedia Hermetica".

*Vac-Tite is HERMETIC'S new, vacuum-proof, compression-construction, glass to metal seal.



HERMETIC SEAL PRODUCTS CO.

33 South Sixth St., Newark 7, New Jersey

F I R S T & F O R E M O S T I N M I N I A T U R I Z A T I O N



HS6-20-7P



HS2-10SL-3P



HS2-28-21P (Mod.)



HS2-28-15P



HS2-14S-7P



AND10427-14S-6P (Mod.)



HS6-20-33P



HS6-22-19P

SAVE TIME IN CIRCUIT DESIGN



*The Rectifier You Need
... When You Need It!*

For the design and development engineer Bradley Selenium Rectifier Kits are a real time saver. The seven kits offer a broad choice of rectifiers, all complete units, all with standard commercial coding. Miniature rectifiers from 1.5 ma D.C. up to 3700 volts peak inverse. Power rectifiers from 100 ma D.C. to 10 amperes D.C. up to 740 volts. The smallest rectifiers have 3/16-inch diameter plates, the largest 5- x 6-inch plates. There's a type and size for every conceivable need.

Bradley Rectifier Kits are low in cost, too. The rectifiers are produced by Bradley's standard, high quality production methods — the proven high-vacuum process. With Bradley kits you always have the rectifier you want — no more waiting for samples, no more delayed projects. Write today or ask your jobber for complete details and prices.

BRADLEY LABORATORIES, INC.

170A Columbus Avenue, New Haven 11, Conn.



Dielectric Absorption

(Continued from page 106)

sorption do not exist. Only a few condenser manufacturers specify the dielectric absorption of their products, but even these manufacturers use different measurement standards so that exact comparison cannot be made from their data. When, however, the initial shorting-time and the charge-time, or vice versa, are kept within definite limits the dielectric absorption can be defined as a percentage loss in voltage. The equipment herein described and the tests performed may contribute to final regulations for the measurements and to a definition of the dielectric absorption of condensers.

References

1. L. Hartshorn, "A Critical Resume of Recent Work on Dielectrics," *J. Inst. Elec. Engrs. (London)*, vol. 64, p. 1152; Nov. 1926.
2. M. H. Pellat, "Polarisation réelle des diélectriques conséquences de cette polarisation," *Annales de chimie et de physique*, ser. 7, vol. 18, p. 150; 1899.

This paper was presented at the 1954 National Electronics Conference.

Color-TV Symposium

The 2nd Annual Color-TV Symposium by the Philadelphia Section of the Institute of Radio Engineers begins on March 1 in the new Physics Building at the University of Pennsylvania starting at 8 PM. Registration forms may be obtained from R. Bowley, WPTZ, 1619 Walnut Street, Phila. 3, Pa. Program is as follows:

- Mar. 1: **Fundamentals of Color-TV**
J. W. Wentworth—RCA Victor
- Mar. 8: **Color Signal Generating Equipment**
D. O'Brien—CBS
- Mar. 15: **Color Reproducing Tubes and Associated Components**
B. Loughlin—Hazeltine Corp.
- Mar. 22: **Color Decoding Circuits**
J. Avins—RCA Industry Service Lab.
- Mar. 29: **Measurement and Equalization of Amplifiers and Transmission Systems for Color Service**
H. Kelly—Bell Laboratories
- Apr. 5: **Colorimetry Problems in Color-TV and the Effect of Transmission Errors on Color Reproduction.**
H. Weiss—General Electric Co.

NAVY SERVICE AWARD



Assistant Sec Nav For Air James H. Smith, Jr., fastens navy distinguished civilian service award button on James E. Gall. Mr. Gall, a native of Trenton, N. J. is presently employed by the Army Signal Corps in Washington, D. C. The award was given for his improved electronic techniques while employed at the Naval Research Lab.

STACKPOLE

FIXED COMPOSITION RESISTORS



BLACK -0	BLACK -0	BLACK -	GOLD = ±5% TOL.
BROWN -1	BROWN -1	BROWN -0	SILVER = ±10% TOL.
RED -2	RED -2	RED -00	NO BAND = ±20% TOL.
ORANGE -3	ORANGE -3	ORANGE -000	
YELLOW -4	YELLOW -4	YELLOW -0000	
GREEN -5	GREEN -5	GREEN -00000	
BLUE -6	BLUE -6	BLUE -000000	
VIOLET -7	VIOLET -7	GOLD -MULT. BY .1	
GRAY -8	GRAY -8	SILVER -MULT. BY .01	
WHITE -9	WHITE -9		



These standard resistance ratings have been carefully selected to cover every circuit requirement while avoiding costly and unnecessary overlapping of values. All Stackpole 1/2-, 1-, and 2-watt resistors are reg-

ularly supplied in each of the ranges and tolerances indicated. Through this standardization you are assured of maximum quality and faster deliveries plus easier stocking of resistors for you.

Electronic Components Division

STACKPOLE CARBON COMPANY, St. Marys, Pennsylvania

These **269** RETMA Values Meet Every Modern Circuit Need!

±20%	±10%	±5%	±20%	±10%	±5%	±20%	±10%	±5%	±20%	±10%	±5%
10	10	10		390	390	15000	15000	15000		560000	560000
		11			430			16000			620000
	12	12	470	470	470		18000	18000	680000	680000	680000
		13			510			20000			750000
15	15	15		560	560	22000	22000	22000		820000	820000
		16			620			24000			910000
	18	18	680	680	680		27000	27000	1.0 Meg	1.0 Meg	1.0 Meg
		20			750			30000			1.1 Meg
22	22	22		820	820	33000	33000	33000		1.2 Meg	1.2 Meg
		24			910			36000			1.3 Meg
	27	27	1000	1000	1000		39000	39000	1.5 Meg	1.5 Meg	1.5 Meg
		30			1100			43000			1.6 Meg
33	33	33		1200	1200	47000	47000	47000		1.8 Meg	1.8 Meg
		36			1300			51000			2.0 Meg
	39	39	1500	1500	1500		56000	56000	2.2 Meg	2.2 Meg	2.2 Meg
		43			1600			62000			2.4 Meg
47	47	47		1800	1800	68000	68000	68000		2.7 Meg	2.7 Meg
		51			2000			75000			3.0 Meg
	56	56	2200	2200	2200		82000	82000	3.3 Meg	3.3 Meg	3.3 Meg
		62			2400			91000			3.6 Meg
68	68	68		2700	2700	100000	100000	100000		3.9 Meg	3.9 Meg
		75			3000			110000			4.3 Meg
	82	82	3300	3300	3300		120000	120000	4.7 Meg	4.7 Meg	4.7 Meg
		91			3600			130000			5.1 Meg
100	100	100		3900	3900	150000	150000	150000		5.6 Meg	5.6 Meg
		110			4300			160000			6.2 Meg
	120	120	4700	4700	4700		180000	180000	6.8 Meg	6.8 Meg	6.8 Meg
		130			5100			200000			7.5 Meg
150	150	150		5600	5600	220000	220000	220000		8.2 Meg	8.2 Meg
		160			6200			240000			9.1 Meg
	180	180	6800	6800	6800		270000	270000	10.0 Meg	10.0 Meg	10.0 Meg
		200			7500			300000			11.0 Meg
220	220	220		8200	8200	330000	330000	330000		12.0 Meg	12.0 Meg
		240			9100			360000			13.0 Meg
	270	270	10000	10000	10000		390000	390000	15.0 Meg	15.0 Meg	15.0 Meg
		300			11000			430000			16.0 Meg
330	330	330		12000	12000	470000	470000	470000		18.0 Meg	18.0 Meg
		360			13000			510000			20.0 Meg
									22.0 Meg	22.0 Meg	22.0 Meg

THE VALUE OF HERMETIC SEALING OF RELAYS

The performance of some relays is improved considerably by hermetic sealing. Particularly is this the case on relays which have delicate springs, fine gauge wiring and small physical size.

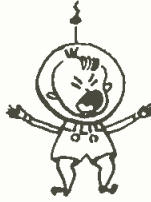

These types are naturally sensitive to the embarrassing consequences of unsympathetic environments and give much more rhythmic performances when protected by an encompassing metallic membrane from the wanton attacks of pliers, screw drivers, thumbs, or church keys.



On the other hand, relays employing switch contacts which have to make and break electrical circuits have an addiction, when hermetically sealed, to the production of various black deposits in the immediate vicinity of the switch. Some engineers claim these result from traces of volatile hydrocarbons trapped in the insulation.



They suggest that harmful effects of such deposits are avoided by using only materials like granite, soapstone or concrete. Unfortunately, these present certain difficulties in fabrication.



In general, two expedients seem most successful to date. One is to ignore the deposits. They usually only reduce the life expectancy, important only if the relay is placed in service. (Since most sealed relays spend their days on a shelf in a depot warehouse, this consideration may usually be dismissed.)

The other was proposed by an Air Force captain who may as well remain nameless, both because he was actually trying to use equipment and because his most effective solution runs somewhat counter to entrenched government prejudice. He increases the life expectancy of relays (yes — Sigma relays, worse luck) approximately five-fold, by drilling in each carefully pressure-tested enclosure --- one small hole.



SIGMA

SIGMA INSTRUMENTS, INC.
86 Pearl Street, So. Braintree, Boston 85, Mass.

Ferrite Antennas

(Continued from page 85)

from 25 to 65°C. was in the order of 6%. This material was used in portable sets but because of the high temperature drift it was considered to be unsatisfactory for home receiver use. Its Q was high enough that it was considered desirable to sacrifice some Q if a better temperature drift characteristic could be obtained. The vendors were requested to develop such a material.

These early cores were also characterized by wide tolerances ($\pm 20\%$ in Q and effective permeability), high warpage, and much physical variation ($\pm \frac{1}{4}$ in. in length, .025 in. in diameter). The vendors were asked to correct this.

Later a new material was developed which was felt to be satisfactory for home receiver use. This material has a Q of the order of 120 across the entire band, a temperature drift of effective permeability less than 2% from 25°C. to 60°C. effective permeability and Q toler-

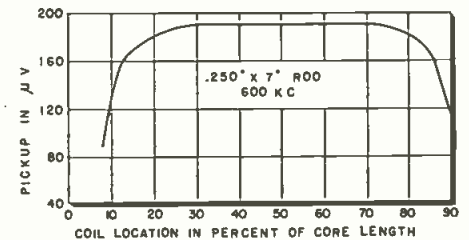

Fig. 6: Coil location characteristic

ances of $\pm 10\%$, low warpage and much better physical tolerances ($\pm \frac{1}{8}$ in. in length, .020 diameter.) The effective permeability of this material is very close to that of the original high drift material.

Both the original material and the new material are subject to vibration instabilities. A rod could be shifted as much as 20% in effective permeability just by tapping it on the table. For a long time, it was believed, this shift was caused by earth's magnetic field, but is now believed to be due to a molecular instability. The presence of a magnetic field merely accelerates the change.

Shift Correction

This shift was corrected in manufacture by vibrating the cores until they reached a stable point. A production type stabilizing method has now been developed which reduces the vibration shift to less than 1%. These stabilized cores retain their stable condition as long as they are not exposed to high magnetic fields. The vendors have been asked to de-

(Continued on page 116)

Introducing **FERRAMIC "Q"**

by **GENERAL CERAMICS**

A NEW HIGH Q, LOW LOSS, HIGH FREQUENCY CORE MATERIAL WITH STABLE CHARACTERISTICS

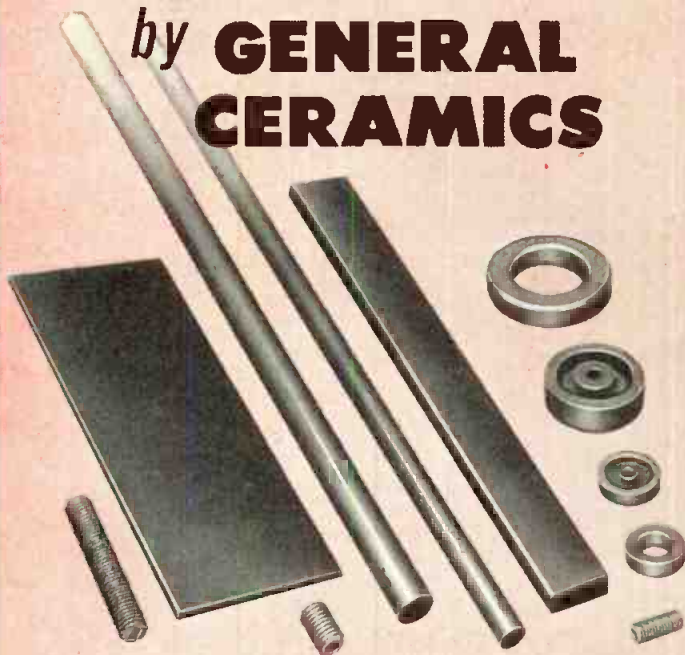

An ideal Core Material for Antenna Rods, Filter Inductances, Loading Coils, RF Coils and all other Applications Requiring High Performance up to 30 Megacycles.

Ferramic "Q" is an exclusive development of General Ceramics Corp. It was created to overcome the instabilities that characterized previous high performance ferrites. Exhaustive tests prove that Ferramic "Q" is completely stable in respect to age, shock, vibration, temperature. In addition this new material features higher Q and lower losses than former materials at all frequencies up to 30 Megacycles. Cost-wise, Ferramic "Q" offers extremely favorable comparison with competitive materials. For complete details, call, write or wire today.

OUTSTANDING ADVANTAGES OF FERRAMIC "Q" ARE SHOWN IN COMPARATIVE CHARACTERISTICS OF IDENTICAL COILS WITH CORES OF FERRAMICS J AND N, AND THE NEW FERRAMIC "Q" MATERIAL



CUP CORE F-261



RING CORE F-108



ANTENNA ROD F-214 - 8" LONG

	L	C	Q
Ferramic J	154	65	50
Ferramic N	120	210	65
Ferramic Q	73	350	175

Coil consists of 20 turns #28 AWG S.F. wire random wound. Cup cores mating surfaces ground (no air gap). Inductance measured in micro-henries, capacitance measured in micro-micro-farads on Boonton Model 260-A Q-Meter. Frequency 1000 Kcs.

	L	C	Q
Ferramic J	90	280	60
Ferramic N	60	425	100
Ferramic Q	35	725	400

Coil consists of 25 turns #20 AWG S.F. wire wound uniformly on toroid. Inductance measured in micro-henries, capacitance measured in micro-micro-farads on Boonton Model 260-A Q Meter. Frequency 1000 Kcs.

	L	C	Q
Ferramic J	340	75	120
Ferramic N	270	95	160
Ferramic Q	210	120	350

Coil consists of solenoid of 85 turns #26 AWG S.F. wire. Space wound along approx. 80% of rod length and centered on rod. Inductance measured in micro-henries, capacitance measured in micro-micro-farads on Boonton 260-A Q meter. Frequency 1000 Kcs.

TABLE OF MAGNETIC PROPERTIES OF OTHER FERRAMIC® BODIES

PROPERTIES	UNIT	C	E	G	H	I	Q
Initial Perm. at 1 mc/sec.	—	250	750	410	850	900	125
*Max. Perm.	—	1100	1710	3300	4300	3000	400
*Sat. Flux Density	Gauss	4200	3800	3200	3400	2000	3300
*Residual Mag.	Gauss	2700	1950	1050	1470	700	1800
*Coercive Force	Oersted	2.1	.65	.25	.18	.30	2.1
Temp. Coef. of initial Perm.	%/°C	.40	.25	1.3	.66	.30	.10 max.
Curie Point	+°C	330	160	160	150	70	350
Vol. Resistivity	ohm-cm.	Med.	Med.	High	Med.	Med.	High
Loss Factor:	$\frac{1}{\mu\omega}$						
At 1 mcs/sec.	—	.00007	.00008	.00008	.00030	.0003	.000020
At 5 mcs/sec.	—	.0008	.0020	.00075	.00155	.005	.000050

*Measurements made on D.C. Ballistic Galvanometer with Hmax = 25 oersteds. Above data is based on nominal values.

TYPICAL ANTENNA ROD MEASUREMENTS

FREQUENCY	Q	C=mmf.
0.6	334	344
0.8	350	189
1.0	350	120
1.2	338	83
1.4	318	60

TEMPERATURE COEFFICIENTS

Antenna Rod No. F-214 (.330 x 8"). Standard Test Coil - Space wound solenoid 85 turns #26 AWG. Formex copper, occupying approx. 80% of length of rod and centered on rod. (Resonates at 1 Mc. with 120 mmf.)

$$TC = \frac{\% \Delta \mu_0}{\mu_0} (25^\circ \text{ to } 75^\circ \text{C})$$

Temp. Coeff. of Rod +1.0 to +2.0
Temp. Coeff. of Coil only = 0



General CERAMICS CORPORATION
TELEPHONE: VALLEY 6-5100
General Offices and Plant: KEASBEY, NEW JERSEY.

MAKERS OF STEATITE, ALUMINA, ZIRCON, PORCELAIN, SOLDERSEAL TERMINALS, LIGHT DUTY REFRACTORIES, CHEMICAL STONWARE, IMPERVIOUS GRAPHITE, FERRAMIC MAGNETIC CORES

NEW lightweight model! **CANOGA Wobulator**

**SWEPT FREQUENCY SIGNAL
GENERATOR with OSCILLOSCOPE**



**Used in Radar, Communication
and Television Applications**

- Manufacturing
- Servicing
- Testing

Of receiving equip-
ment including
Video, RF, IF, and
distributed
amplifiers.

FREQUENCY RANGE... 2.0 to 1000 mcs.
Continuous single knob tuning with cali-
brated dial.

FREQUENCY SWEEP... Any bandwidth
of 100 mcs. or smaller.

AMPLITUDE VARIATION... Less than
0.01 db/mc.

OUTPUT VOLTAGE... 0.1 volts across 50
ohm resistive load.

ATTENUATOR... The output level is con-
tinuously adjustable by means of a wave
guide beyond cut-off attenuator cali-
brated in 1 db divisions.

DISPLAY... 5" CRT.

SENSITIVITY... Detector for built-in am-
plifier and CRT presentation has a sen-
sitivity approx. 60 db below 0.1 volt;
gain and bandwidth measurements can
be accomplished on circuits having a loss
as great as 60 db.

POWER SUPPLY... Self-contained, all
DC voltages regulated. Input 105-125
volts, 50-400 cps, approx. 100 watts.

SIZE... 12" x 13" x 17".

WEIGHT... Approx. 50 lbs.

PRICE... \$1500.00

Write today for complete detailed information

CANOGA CORPORATION

Radar Systems, Antennas,
Receivers, Test Equipment

**5955 SEPULVEDA BLVD.
VAN NUYS, CALIFORNIA**

New Technical Products for the Electronic

DECADE CAPACITOR-DIAL

The "Dekapacitor-Dekadial" provides
1,000 incremental steps of 0.001 μ f each.
Direct capacitance readings are made
on the stacked deck of dials. The outer
and middle dials have nine clearly



marked positions. Tenths and hun-
dredths of μ f are respectively selected
by these dials. Thousandths of μ f are
selected by the inner dial which has
ten scale divisions. An easy-to-mount
plastic dial indicator is supplied with
each unit. Solid silver electrical con-
tacts on "dry-filmed" ceramic switches.
Mounts in a 7/16 in. panel hole. Elec-
tro-Measurements, Inc., 4312 S. E. Stark
St., Portland 15, Oregon TELE-TECH &
ELECTRONIC INDUSTRIES. (Ask for
2-27)

BOBBIN CORES

Performance-guaranteed bobbin cores,
made of 4-79 Mo "Permalloy" or "Or-
thonol" and "48 Alloy" or "Magnesil"
have very rectangular hysteresis loops
under pulse conditions. Made of ultra-
thin tape, the units range in thickness
from 0.001 in. down to 0.000125 in., and
from 1.0 in. down to 1/16 in. in width.
They can be used in the form of a shift-
register, a coincident-current matrix, a



core-diode memory system; or as
switching cores, harmonic generators,
or pulse transformers, and are espe-
cially suited for use as memory cells in
electronic computers. Magnetics, Inc.,
Butler, Pa. TELE-TECH & ELEC-
TRONIC INDUSTRIES. (Ask for 2-28)

TV CAMERA

The "Tel-Eye," cigar-box-size TV
"station," weighs only 8 $\frac{1}{4}$ lbs. and is
only 10 in. long, 6 $\frac{3}{4}$ in. high, and 4 $\frac{3}{4}$ in.
wide. The unit is merely plugged into a
standard 117 v. ac wall socket and the

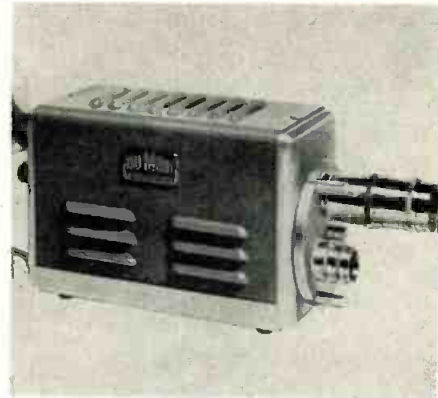

output then attached to the antenna
terminals of any standard TV receiver.
Brightness and contrast controls are
then set and the lens is focused. Oper-
ates under normal room lighting with-
out technically trained personnel. It
is used for a wide variety of business
and industrial applications. Allen B.
Du Mont Laboratories, Television
Transmitter Dept., 1500 Main Ave.,
Clifton, N.J. TELE-TECH & ELEC-
TRONIC INDUSTRIES. (Ask for 2-29)

I-F STRIP

The PC-4 printed circuit i-f strip is
an advanced-design, low-cost compo-
nent for use in monochrome TV sets
having a sound carrier i-f frequency
of 41.25 mc and a video carrier i-f fre-
quency of 45.75 mc. Specifications: I-f
bandwidth greater than 3.25 mc. Sensi-
tivity, for all TV applications with 70
mc input to mixer grid for 1 v. output
at second detector with zero bias. Plate

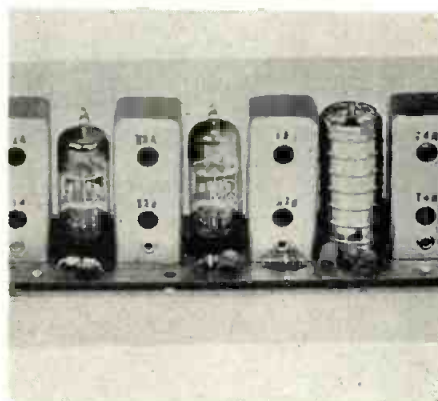

supply, 150 v. Filament supply, 6.3 v.
at 1.05 amps. Current drain, 28 ma at
3 v. AGC. Size, 6 $\frac{3}{4}$ x 1 $\frac{15}{16}$ in. Allen D.
Cardwell Electronics Productions Corp.,
97 Whiting St, Plainville, Conn. TELE-
TECH & ELECTRONIC INDUSTRIES
(Ask for 2-31)

Industries

MOUNTING POST

A new component called the "Totem-pole" has been developed to improve the "bug resistance" of model and production wiring in government and industrial gear. The unit provides support

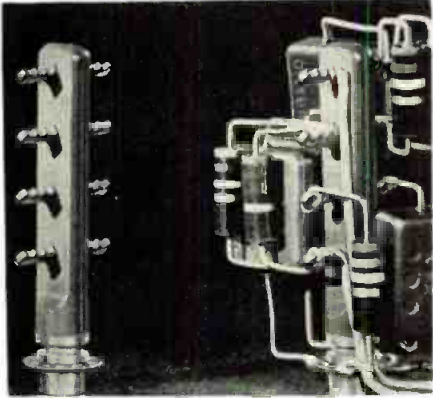

for small components such as: resistors, diodes, and transistors at their operating points. Critical leads to grid suppressor resistors, for example, can be reduced to pigtailed. A "Melamine" pole provides low-tracking, heat-resistant properties. Mounts with a single chassis drill hole. Can be re-used for model mock-up or component replacement. Sangamo Electric Co., 1301 N. 11 St., Springfield, Ill., TELE-TECH & ELECTRONIC INDUSTRIES. (Ask for 2-30)

MICROWAVE DETECTOR

The Model 433 microwave envelope detector permits direct viewing of high level r-f pulse envelopes. Push-pull outputs are provided by two microwave diodes which terminate the collinear arms of the magic tee. These output voltages can be applied directly to the vertical deflection plates of a CRT. With care, bandwidths of 100 mc/sec. can be attained, and the viewed pulse

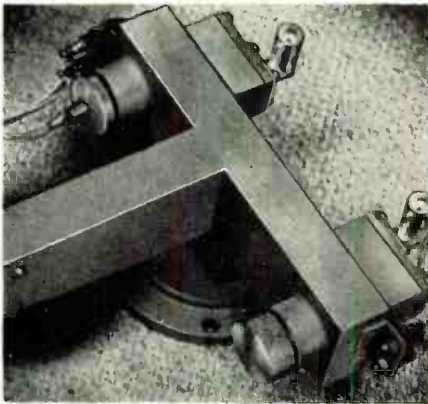

is virtually distortion free. Available with center frequencies of 9.25 KMC (RG-52/U) and 5.65 KMC (RG-50/U) Aircraft Armaments, Inc., 4003 Seven Mile Lane, Pikesville 8, Md. TELE-TECH & ELECTRONIC INDUSTRIES. (Ask for 2-32)

Photocircuits

C O R P O R A T I O N

"PRINTED" CIRCUIT
SWITCH PLATES
COMMUTATOR
& CODE DISCS



NEW "MELACON" PROCESS
gives you

MELAMINE SURFACE FLUSH CIRCUITRY

A NEW LAMINATING
PROCESS FOR FLUSH
"PRINTED" CIRCUITRY

These are some of
"MELACON'S" ADVANTAGES:

FLUSH SURFACE. Finest available surface finish!

HIGHEST ARC RESISTANCE.

NICKEL-RHODIUM Plating. For smooth, hard, long life contacts. (Silver-Rhodium, Silver and Gold plating available as needed).

COMPOSITE LAMINATE. The conductor is embedded flush in pure tempered Melamine on a Melamine-glass core based on a lower-cost composition backing. (Switch plates and commutator discs can be backed with either aluminum or steel for rigidity and strict flatness.)

LONG LIFE. With the proper combination of "Melacon", brush pressures and contact materials, satisfactory life experiences of 100 million revolutions have been reported.

We can supply either the fabricated plates and discs or complete electro-mechanical assemblies.

Photocircuits Corporation has pioneered printed-etched circuitry processes and now offers long enduring flush surfaced (bounceless) conductor configuration and Melamine to satisfy the most exacting specifications. The "Melacon" Process represents Photocircuits Corporation's newest achievement in coplanar electro-formed circuitry, resulting in low costs for the most complex or the simpler patterns.

Photocircuits

C O R P O R A T I O N

Dept. TT2, GLEN COVE, NEW YORK
Glen Cove 4-4000 • Flushing 3-5050

This
Engineering
Brochure
FREE
on request.

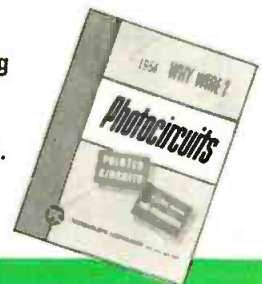

Pioneers in Cost-Cutting Printed Circuit Techniques

*Trade Mark

BOSTON: 25 Huntington Ave. • Commonwealth 6-7705
CHICAGO: 4258 W. Irving Park Rd. • Palisades 5-1170
DAYTON, O.: 25 South Main Bldg. • Fulton 6377
LOS ANGELES: 2407 Melrose Ave. • Webster 3-7276

PHILADELPHIA: 1531 Spruce St. • Kingsley 5-1205
ROCHESTER: 3 Juniper St. • Culver 7635
KANSAS CITY: 903 McGee St. • Victor 8090
CHARLOTTE, N. C.: 1323 The Plaza • Edison 4-9739
BIRMINGHAM, ALA.: 404 Dexter Ave. • Phone 2-1369



DATA

FOR



NEW—RCA-6BQ6-GTB/6CU6, 12BQ6-GTB/12CU6, and 25BQ6-GTB/25CU6 are directly interchangeable with similar types in the 6BQ6 family. In comparison with previous versions, these types retain the same desirable characteristics, but feature a modified mount design to provide higher perveance and to permit higher ratings.

RCA OSCILLOGRAPH TUBES—RCA-5ABP1, 5ABP7 and 5ABP11 flat-faced cathode-ray tubes feature electrostatic focus, electrostatic deflector, and post-deflection acceleration. These 5-inch oscillograph tubes differ only in spectra-energy emission and persistence characteristics of their respective phosphors. Outstanding features: very high deflection sensitivity, high spot intensity, and high grid-modulation sensitivity. The exceptionally high deflection sensitivity and low capacitance of the pair of deflecting electrodes provided for vertical-deflection, make this pair of electrodes especially suited for operation from wide-band amplifiers. The small size and high brilliance of the fluorescent spot gives finer detail in oscillographic traces . . . even with high-speed phenomena



NEW—RCA-5U4-GB is the "heavy duty" version of the 5U4-G. The improved design permits operation at higher peak and average currents, especially desirable when used in power supplies of TV receivers and radio equipment having high dc requirements. Additional important features of the RCA-5U4-GB include: double-wing plate design (for more plate area and increased heat conduction) . . . increased plate thickness (for more uniform heating) . . . double mica spacers (which provide better support, more resistance to shock, vibration) . . . flared base which engages button stem (eliminates need for cementing, reduces possible loose bases) . . . button stem (reduces electrolysis and leakage).

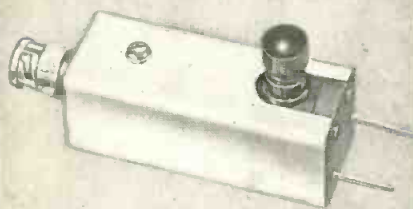

RCA WG-298A UHF DEMODULATOR—connects between the output of the WR-86A sweep generator and a 300-ohm termination for use in measuring the approximate standing-wave ratio of a 300-ohm-transmission line throughout the UHF range of 300-950 Mc. The WG-298A may also be used with other instruments such as the WR-40A, WR-41B or any UHF sweep generators using a 50-ohm BNC type output connector.



RCA WR-86A UHF SWEEP GENERATOR—recommended for continuous production line testing and general service applications on color and black-and-white TV. This instrument is also useful for checking converters, tuners, filters and other equipment operating in the 300 to 950 Mc range. The WR-86A provides wide sweep range continuously adjustable to 10% of indicated dial frequency up to 850 Mc; up to 85 Mc for frequencies from 850-950 Mc; flat output with a max. voltage amplitude variation of 0.1 db per megacycle over the swept range; high output voltage at least 0.6 v across 50 or 300 ohms, and wide range attenuation continuously adjustable over a range of 60 db.

For technical data, write RCA, Commercial Engineering, Section DD-4, Harrison, N. J.
ELECTRON TUBES—SEMICONDUCTOR DEVICES—BATTERIES—TEST EQUIPMENT—ELECTRONIC COMPONENTS

DESIGNERS

RCA-2D21—a sensitive, four-electrode thyatron, of the indirectly heated cathode type for use in relay applications. It has a high control ratio (essentially independent of ambient temperature over a wide range), extremely small pre-conduction or gas-leakage currents right up to the beginning of conduction, very low grid-anode capacitance and grid current. The 2D21 is not affected appreciably by line-voltage surges and, in a high-sensitivity circuit, can be operated directly from a vacuum phototube.



RCA-5879—is a sharp-cutoff pentode of the 9-pin miniature type intended for use as an audio amplifier in applications requiring reduced microphonics, leakage, noise, and hum. It is especially well-suited for input stages of medium-gain public address systems, home sound recorders, and general-purpose audio systems.

RCA MULTIPLIER PHOTOTUBES—**RCA-6342, 5819 and 6199** multiplier phototubes are "head-on" types for use in applications involving low-level, large area light sources. Coupled with suitable phosphors, these tubes are especially useful in scintillation counters for detecting and measuring nuclear particle radiation. Spectral response of these types covers the range from 3000 to 6200 angstroms with maximum response at about 4000 angstroms. Types 6199 and 5819 have luminous sensitivity values of 24 and 25 amperes per lumen respectively when operated with a supply voltage of 1000 volts. Type 6342 has a luminous sensitivity value of 7.5 amperes per lumen with a supply voltage of 1250 volts, or 35 amperes per lumen with 1500 volts.



RCA-4X150-A—a very small and compact forced-air-cooled beam power tube for use in power amplifier or oscillator service at frequencies up to 500 megacycles and also as a wideband amplifier in video applications. The 4X150-A has a maximum plate dissipation of 150 watts. Terminal arrangements of this power tube facilitate its use with tank circuits of the coaxial type. Additional features: unipotential cathode... integral radiator... coaxial-electrode structure. Max. length: 2.468", max. diameter: 1.645".

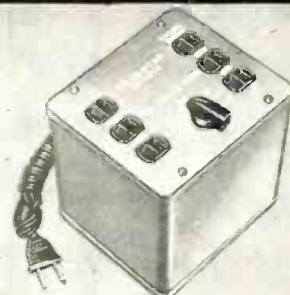

RCA WP-25A TV ISOTAP—designed for use as either an adjustable isolation transformer or as an adjustable autotransformer to facilitate testing and trouble-shooting of series string circuits in radio and TV receivers, and other electronic equipment. Seven-position selector switch permits adjustment of primary voltage in 5-volt steps for operation from any supply-line voltage from 105 to 130 v. Output voltages of approximately 105, 115, and 130 v are provided throughout the supply-line voltage range.



RADIO CORPORATION of AMERICA
TUBE DIVISION

HARRISON, N. J.

...is this the kind of PERFORMANCE YOU NEED FROM RESISTORS

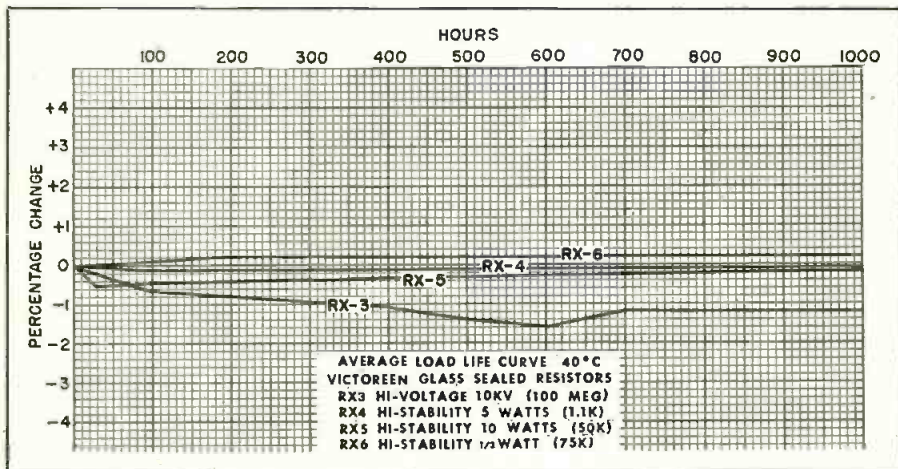

The performance of Victoreen glass sealed resistors as indicated by this 1000 hour life-test, surpasses all expectancies. If this performance is almost unbelievable, we invite you to duplicate this test in your own laboratory. We will furnish samples.

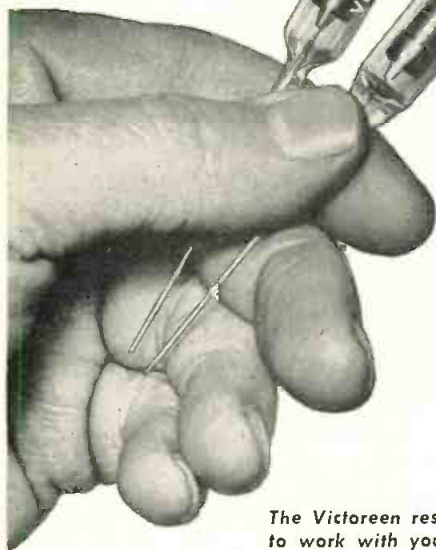

The new Victoreen developed carbon resistors, encapsulated in inert, gas-filled, glass tubes provide high wattage dissipation or high voltage capacity with unusually high stability and long life. The high performance standards of these new resistors make them especially desirable in avionic, sonic, radar, computer, television circuits and other applications where quality is important. Victoreen should be your first choice of resistors.

The Victoreen research staff are available to work with you on electronic problems.



The Victoreen Instrument Co.

COMPONENTS DIVISION: 3814 Perkins Ave., Cleveland 14, Ohio

Ferrite Antennas

(Continued from page 110)

velop a material which does not exhibit this tendency.

There is now available a newer material not fully evaluated which has much high Q and lower temperature drift and does not exhibit the vibration shift.

Production Considerations

Up to now this report has covered mainly the theoretical aspects of the ferrite cored antenna but a few of the production aspects should also be considered.

One of the design requirements was that the winding be at least one wire diameter away from the core. Another requirement in production usage is that the inductance of the assembly not vary more than 1/2% from a standard.

The original use of this type antenna was as a purchased unit in which the vendor supplied assemblies consisting of a close wound

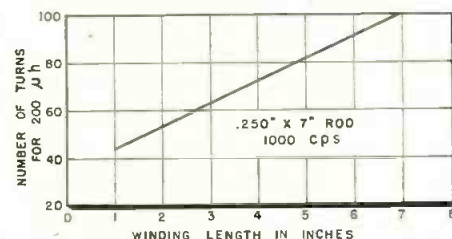

Fig. 7: Turns-winding length relationship

winding of #24 wire with heavy insulation such as polyethylene coating or a double cotton serving. The turns and spacing on these assemblies were hand adjusted to give the proper adjustment. This system was found to be undesirable because of the expensive wire and the excessive labor involved in the final adjustment.

To take care of these problems a design was evolved using a paper tube whose inside diameter is equal to the maximum core outside diameter, plus a small allowance for warpage, and whose length is greater than the core length. On this tube is wound a spaced winding equal in length to the core and terminating at each end with a sleeve and appropriate terminal. The tube is long enough that the core can be adjusted to the proper inductance without extending beyond the end of the tube. With this assembly the core can easily be moved for adjustment with little time spent on hand labor. The assembly also lends itself to automatic adjustment.

This method has one other ad-



Type 874-D20 Stub

Probe coupling variations caused by mechanical distortions in the line are practically eliminated by mounting the driving knob for the pick-up probe in a fixed position. The unique arrangement, shown above, results in uniform positive drive without slippage. The absence of teeth or grooves in the drive mechanism makes for smooth adjustment. Ball-bearing mounting for both drum and pulley, in addition to reducing wear, reduces the driving force required and adapts the line to motor drive. A new drive is being developed by G-R — to be announced soon.

Type 874-LV
Micrometer Vernier

the *Finest* "Line" ever offered at the price!

The new G-R Slotted Line is amazingly smooth performing . . . offers many significant new design features . . . is extremely valuable for VSWR, impedance and voltage measurements and for determinations of attenuation, power and mismatch at any frequency from 300 to 5000 Mc.

This instrument is superior in both electrical characteristics and mechanical features and is specifically designed for adaptability to automatic motor drive. It makes possible accurate measurements on antennas, lines, coaxial components and all types of equipment operating at vhf and uhf.

The many significant improvements offered in this new Slotted Line are a result of a continuing and intensive G-R research program aimed at providing the vhf-uhf engineer with the finest tools available . . . precision equipment which is inexpensive, rugged, light-weight, and equally useful in laboratory or field.

The new Type 874-LBA is in keeping with this G-R concept around which has been built a complete and integrated line of coaxial elements, oscillators for any frequency range, quality signal and pulse generators, a unique impedance and admittance measuring device, a highly sensitive high-frequency detector and many other instruments and accessories. Write for complete descriptive literature.

- Type 874-LBA Slotted Line \$220
- Type 874-D20 Adjustable Stub for tuning the crystal rectifier . . . \$11
- Type 874-LV Micrometer Vernier for measuring high VSWR ratios . . \$23

Wide Frequency Range — 300 to 5000 Mc; useful down to 150 Mc and well over 5000 Mc.

Built-In Crystal Detector — electric field within 50-ohm, air dielectric line is sampled by an electrostatic pick-up probe and then detected by a crystal rectifier; both are mounted in a sliding carriage.

Minimum Built-In VSWR — line and connectors introduce residual VSWR of less than 1.025 to 1000 Mc, less than 1.07 at 4000 Mc.

Constancy of Probe Coupling — within 1½% along entire 50-cm line — spring-loaded nylon plugs at probe carriage ends bear on outer conductor, practically eliminating "play" and consequent changes in probe coupling.

Precision-Tooled Probe Carriage — made of cast bronze, it slides on tightly fitting bronze bearings — felt washers at ends prevent dirt from entering carriage — oil holes provided for long-lasting lubrication of bearings.

Sturdy Line Construction — outer conductor is rigidly clamped on heavy brass castings and stiffened by two ½" stainless-steel rods — rugged center conductor is of steel tubing with heavy copper and silver plating, supported by two teflon insulators at ends; these insulators are electrically compensated to eliminate reflections.

G-R Universal Type 874 Connector at Ends — this low-loss connector has proven superb for instrument use — its VSWR is less than 1.04 to 4000 Mc; its universal construction permits any Type 874 Connector to plug into any other, materially reducing set-up time and the need for large stocks of male and female components; connections and disconnections are made instantly.

Dimensions — 26 x 4½ x 3½ inches.

Net Weight — only 8½ pounds.

GENERAL RADIO Company

1915-1955

40 Years of Pioneering

in Electronics

WE SELL DIRECT
Prices are net, FOB Cambridge
or West Concord, Mass.

90 West Street NEW YORK 6
8055 13th St., Silver Spring, Md. WASHINGTON, D. C.
920 S. Michigan Avenue CHICAGO 5

A
BRIGHT FUTURE

IN
ORIGINAL RESEARCH

FOR
ELECTRONIC ENGINEERS
PHYSICISTS *and*
MECHANICAL ENGINEERS
WITH
SYLVANIA

It is not surprising that many contributions and advances in the field of electronics have been made by Sylvania engineers. Our company has always placed heavy emphasis on original research, development and product design, offering engineers wide latitude for exploration and creative expression.

As a result, growth opportunities for engineers are virtually unlimited, as Sylvania aggressively advances in its growth tradition.

To aid our engineers in their progress, Sylvania also provides financial support for advanced education, as well as liberal insurance, pension and medical programs.

The following **PERMANENT POSITIONS** are now open at:
BOSTON & BUFFALO ENGINEERING LABORATORIES

Section Heads, Engineers-in-Charge, Senior Engineers, Engineering Specialists and Junior Engineers for Research, Design, Development and Product Design on complex subminiaturized airborne electronic equipment and computers, experienced in:

Pulse Techniques
Electro-Mechanisms
Microwave Techniques
Microwave Applications
Circuit Design
Equipment Specifications
F. M. Techniques
Miniaturization
Servo Mechanisms
Transistors
Heat Transfer
Shock & Vibration
Technical Writing

Analytical Problems
Antenna Design
Applied Physics
Systems Development
& Testing

Component Selection
Component Analysis
& Testing
Component Specifications
Digital Computer Circuits
& Systems
Mechanical Design

Please forward complete resume to:

MR. CHARLES KEPPLER

SYLVANIA 
ELECTRIC PRODUCTS INC.

175 Great Arrow Avenue, Buffalo, New York

Ferrite Antennas

(Continued from page 116)

vantage in that it adjusts the effective permeability of each assembly to the same values, and thus tends to minimize the sensitivity variation.

Another winding method which has been proposed but not yet evaluated would consist of winding a layer of paper on the core, then the winding with bare wire, then another layer of paper. This method would involve an automatic winder with three feeding heads so the coil could be wound in one operation. The bare wire would run through friction contacts so that the machine could be set to shut off automatically at the proper inductance.

The paper overcoat in this proposal and the wire insulation in the present design are solely to meet Underwriters' Laboratories requirements. They are not necessary from the performance standpoint.

Some other general considerations arise in the design and use of these antennae which must be considered.

One major consideration is that of

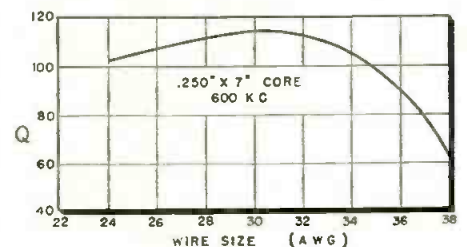

Fig. 8: Q-wire size relationship

hum modulation. This becomes a problem because of the fact that the permeability curve of the ferrite material is non-linear. Thus when a 60 cps flux exists the permeability of the core is changing at a 60 cps rate which, of course, modulates the signal being picked up. In checking hum pickup in a typical receiver it has been found that the flux excursion at 60 cps is 10,000 times that at 600 kc for the same voltage developed across the winding.

Other Considerations

Another consideration appears when the assembly is being tested for inductance in comparison to a standard unit. If the test signal level is very high compared to a normal broadcast station signal, and if the B-H curves of the core in the standard and the core in the test unit are significantly different the test inductance and the operating inductance may not correlate. Generally speaking this occurs only when the coil to be tested is used as part of an oscillator circuit. The normal Q

TUNG-SOL

6550



BEAM

POWER

AMPLIFIER

HIGH POWER CAPABILITIES (Up to 100 watts output in pairs) • LOW DISTORTION OUTPUT • EXTREMELY UNIFORM CHARACTERISTICS • LONG LIFE

first in its power range . . . designed specifically for audio service

The Tung-Sol 6550 is a brand new and direct approach to the high power design requirements of high fidelity audio amplifiers. For outputs up to 100 watts, two 6550's in push-pull will provide the same power now attained in most existing designs by the use of four or more tubes. In addition to greater audio output, use of the new 6550 results in simplified electrical balance, reduced maintenance and lower cost. The Tung-Sol 6550 is not directly interchangeable with the 6L6, 5881 or KT66 class of tubes. With proper circuitry, however, the 6550 will provide full power output with approximately the same grid voltage drive as the smaller tubes. The 6550 is produced under laboratory conditions with exhaustive quality control to assure premium performance and long life.

Rugged Construction—The advanced design features which have made the Tung-Sol 5881 so extremely reliable are embodied in the 6550.

- 1 Glass button stem construction is strong and compact and provides a rugged support for the tube structure.
- 2 Micanol wafer and metal shell base provides full lifetime electrical insulation and greater mechanical strength.
- 3 Cathode materials of exceptional stability give more uniform emission with greater life expectancy. Cathode is not poisoned by inactivity during standby periods.
- 4 Maximum control of grid emission achieved by gold plating and carbonizing.
- 5 Triple gettering promotes long, gas-free life. Getters are confined by a spray shield to prevent mica contamination.
- 6 Life tests are made under severe overload conditions to assure adequate safety factor.



The TUNG-SOL engineering which has produced the 6550 is constantly at work on a multitude of special electron tube developments for industry. Many exceptionally efficient general and special purpose tubes have resulted. Technical data sheets, or circuitry suggestions for the 6550 may be obtained by writing to Tung-Sol Commercial Engineering Department.

TUNG-SOL ELECTRIC INC., Newark 4, New Jersey — Sales Offices: Atlanta, Chicago, Columbus, Culver City (Los Angeles), Dallas, Denver, Detroit, Newark, Seattle
TUNG-SOL makes All-Glass Sealed Beam Lamps, Miniature Lamps, Signal Flashers, Picture Tubes, Radio, TV and Special Purpose Electron Tubes and Semiconductor Products.

MECHANICAL DATA

Coated Unipotential Cathode	Bulb—Short St-16
Outline Drawing	
Base	Large Wafer Octal 8-Pin Mical with Metal Sleeve B8-86
Maximum Diameter	2 1/16"
Maximum Overall Length	4 3/4"
Maximum Seated Height	4 7/16"
Pin Connections	Retma Basing 7S
Pin 1—Base Shell	Pin 5—Grid No. 1
Pin 2—Heater	Pin 7—Heater
Pin 3—Plate	Pin 8—Cathode and Grid No. 3
Pin 4—Grid No. 2	
Mounting Position	Any

ELECTRICAL DATA

(INTERPRETED ACCORDING TO RETMA DESIGN CENTER SYSTEM)

DIRECT INTERELECTRODE CAPACITANCES — No Shield

Grid #1 to Plate	0.85 μf
Input	14.0 μf
Output	12.0 μf

RATINGS

Heater Voltage (AC or DC)	6.3 \pm 10% VOLTS
Maximum DC Plate Voltage	600 VOLTS
Maximum Plate Voltage (Triode Connection)	450 VOLTS
Maximum Plate Dissipation (Triode Connection)	40 WATTS
Maximum DC Grid #2 Voltage	400 VOLTS
Maximum Grid #1 Voltage	—300 to 0 VOLTS
Maximum Plate Dissipation	35 WATTS
Maximum Grid #2 Dissipation	6.0 WATTS
Maximum DC Cathode Current	175 MA.
Maximum Heater-Cathode Voltage	
Heater Positive (Peak) (DC not to exceed 100V)	+200 VOLTS
Heater Negative (Peak or DC)	—300 VOLTS
Maximum Grid #1 Circuit Resistance (Fixed Bias)	50 KILOHMS
Maximum Grid #1 Circuit Resistance (Self Bias)	250 KILOHMS
Maximum Bulb Temperature	250 °C

HEATER CHARACTERISTICS

Heater Voltage	6.3 VOLTS
Heater Current	1.8 AMP.

TUNG-SOL[®]

ELECTRON TUBES

VLF

... Very Low Frequencies



• **RADIO INTERFERENCE**
• **and FIELD INTENSITY***
• **measuring equipment**

• Stoddart NM-10A • 14kc to 250kc

• Commercial Equivalent of AN/URM-6B

VERSATILITY.... The NM-10A is designed to meet the most exacting laboratory standards for the precise measurements, analysis and interpretation of VLF radiated and conducted radio-frequency signals and interference. Thoroughly portable, yet rugged, the NM-10A can be supplied with accessories to fulfill every conceivable laboratory and field requirement.

EXCELLENT SENSITIVITY.... The NM-10A sensitivity ranges from one microvolt-per-meter to 100 microvolts-per-meter, depending upon whether rod or shielded loop antennas or line probe are used.

ACCURACY.... Each equipment is "hand calibrated" in the Stoddart Test Laboratories by competent engineers. This data is presented in simplified chart form.

DRIPPROOF.... Sturdy dripproof construction allows long periods of operation in driving rain or snow without adverse effects.

FLEXIBLE POWER REQUIREMENTS.... The ac power supply permits operation from either 105 to 125 volts or 210 to 250 volts ac, at any frequency between 50 cps and 1600 cps.

Stoddart RI-FI* Meters cover the frequency range 14kc to 1000mc

HF NM-20B, 150kc to 25mc
Commercial Equivalent of AN/PRM-1A. Self-contained batteries. A.C. supply optional. Includes standard broadcast band, radio range, WWV, and communications frequencies. Has BFO.

VHF NM-30A, 20mc to 400mc
Commercial Equivalent of AN/URM-47. Frequency range includes FM and TV bands.

UHF NM-50A, 375mc to 1000mc
Commercial Equivalent of AN/URM-17. Frequency range includes Citizens band and UHF color TV band.

STODDART AIRCRAFT RADIO Co., Inc.
6644-G Santa Monica Blvd., Hollywood 38, California • Hollywood 4-9294

Ferrite Antennas

(Continued from page 118)

meter or Q-X checker voltages are not high enough to cause trouble.

The temperature drift characteristics have already been mentioned. Care should be taken to see that the assembly is not used in a circuit where extreme changes of ambient temperature may occur.

As previously mentioned, the stabilized assemblies should not be exposed to high level ac or dc flux. If this precaution is taken there should be no significant trouble from permeability shift due to vibration of properly stabilized rods.

The core material is very hard and brittle, similar to ceramics in physical properties, so care must be taken that the assemblies are not subjected to excessively rough handling which might cause breakage.

1. Jaderholm. *Proc. I.R.E.*, Dec. 1945. p. 904.

Pulse Transformers

(Continued from page 81)

sectors for each of the two classes of materials. Sector B represents the values of ratio vs ΔH for pulse durations of 0.3, 0.6, 1.0 and 2 μ secs, for the manganese zinc ferrite of initial permeability 780. Sector A is for the same pulse durations and represents values for nickel zinc ferrite of initial permeability 503. Notice that at the value of $\Delta H = 1$ oersted the time t is the same as, or lower than, the value of the pulse duration itself and that the lower permeability material has generally a faster recovery for all values of ΔH . From a plot of this type limits that must be placed on pulse repetition frequencies can be derived.

The data presented makes possible several conclusions at this time:

1. For magnetizations of approximately one oersted and smaller, the lag of B vs H makes it possible to employ duty cycles of 50% and greater. The duty cycle limits are indirectly determined by the value of ΔH .

2. Pulse permeability is a function of pulse width and ΔH for pulse durations of approximately one μ sec and smaller. For larger pulse durations, the pulse permeability appears for all practical purposes only a function of ΔH .

References

¹Glasoe and Lebacqz, M.I.T., "Pulse Generators," McGraw-Hill.
²R. D. Robinson, "Design of Low Power Pulse Transformers Using Ferrite Cores," Thesis, M.I.T., August 29, 1952.

COVERAGE

where you want it



Uni-directional antenna.

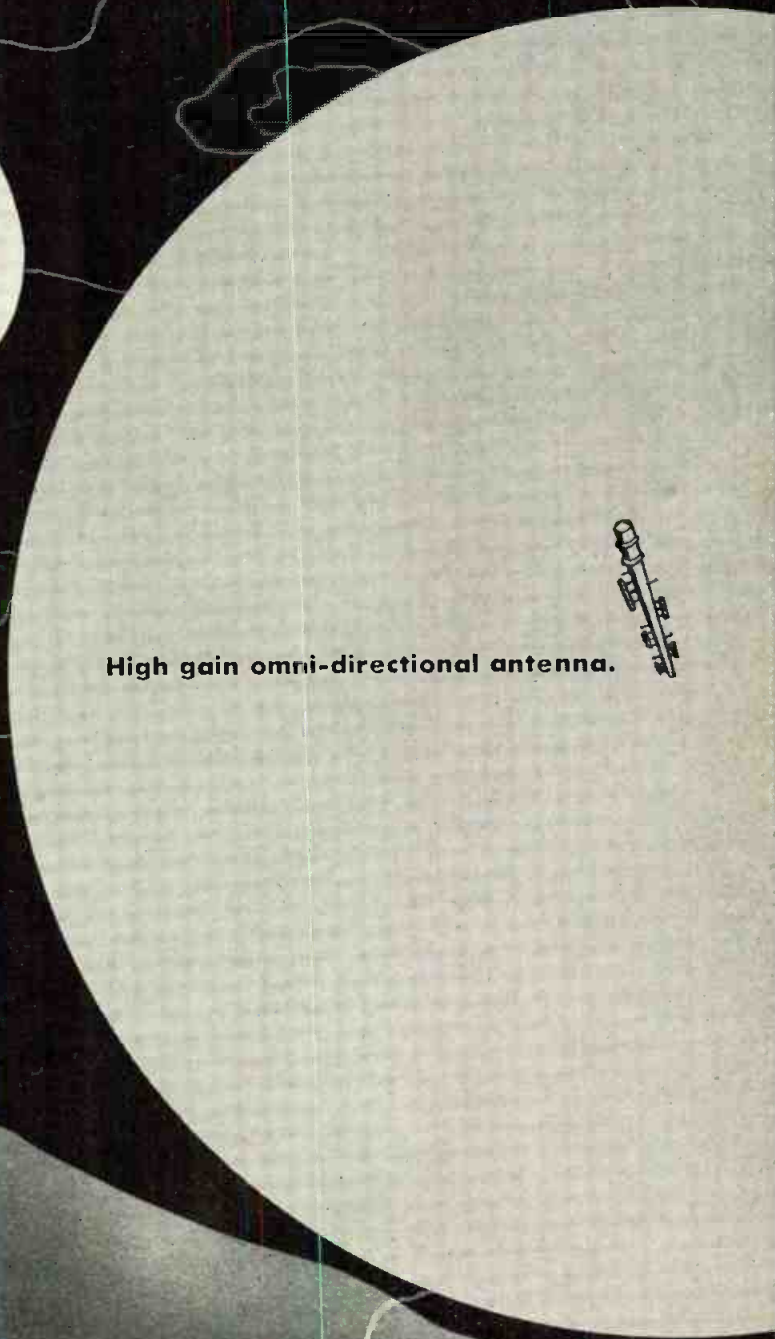

High gain omni-directional antenna.

Very low VSWR point-to-point
microwave antenna.

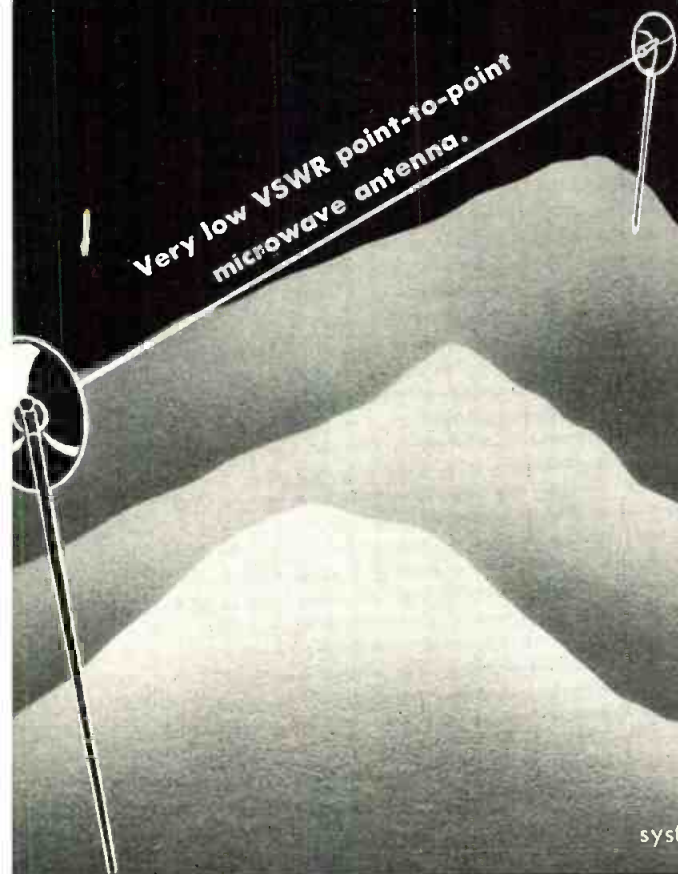

Useless coverage is expensive to you and can be offensive to your neighboring radio systems through signal interference. For coverage where you want it, look to Andrew for performance guaranteed systems, the lower cost solution of your transmission problems in VHF, UHF and Microwave communications. Our high technical standards are backed by a 30 year record of accepting systems responsibility.

Bring your coverage problem to Andrew—our engineers will analyze your system and make specific recommendations to achieve "coverage where you want it."

Andrew
CORPORATION

363 EAST 75TH STREET, CHICAGO



SINCE 1915 LEADERS IN AUTOMATIC CONTROL

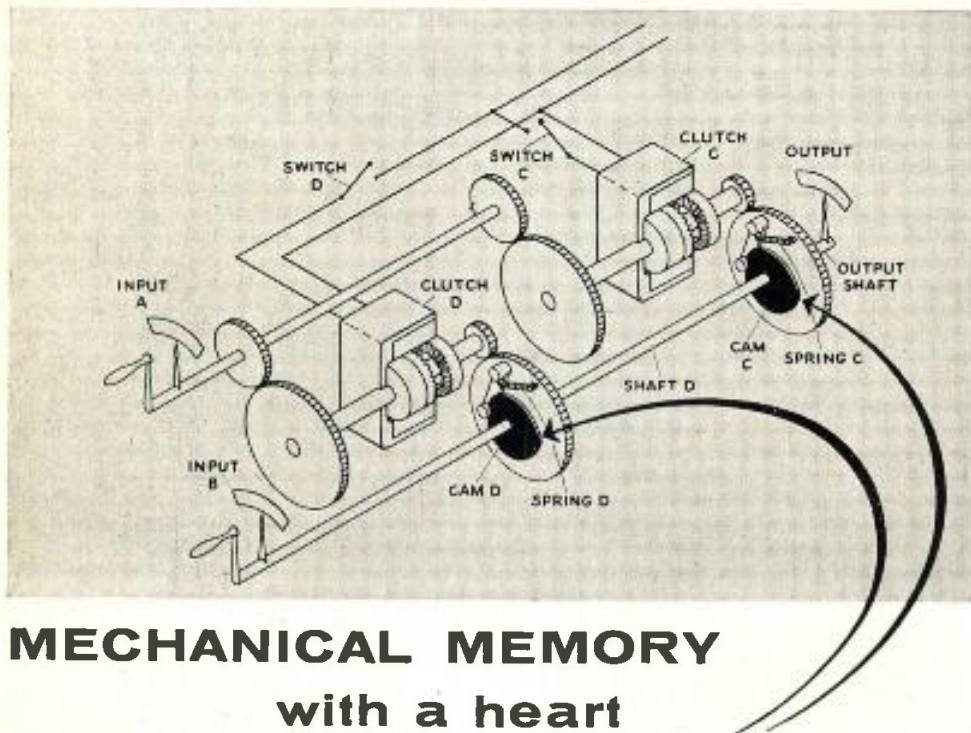

MECHANICAL MEMORY with a heart

Ford Instrument Company engineers draw on the entire scope of scientific knowledge to solve each problem. In a recent project, Ford found good use for components it developed a score of years ago to produce a mechanical memory system whose accuracy is independent of the time interval, and which meets a military requirement of absolute reliability.

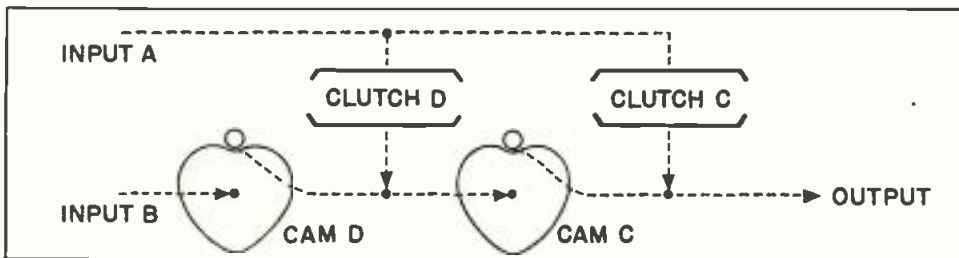

In an instrument in which the input quantities may vary with time, it is desired to produce an output equal to the change in one quantity A since the time t_1 , added to the value that a second quantity B had at time t_1 . At the same time it is desired to store another output equal to the change in quantity A since a second time t_2 , added to the value that the quantity B had at that time t_2 . It is further desired at any subsequent time to be able to read the first output or alternately the second output.

The storing of this information is accomplished by closing clutch C at instant 1 and clutch D at instant 2. The first output is then read directly at any subsequent time and the alternate output by opening clutch C. To recycle — clutch D is then opened.

Whatever problems must be solved in designing and manufacturing computers and controls, skills in electronics, magnetics, hydraulics and mechanical and electrical techniques are called upon by Ford engineers to develop the best instruments for the purpose.

If you have a problem in control engineering, Ford Instrument Company's forty years of experience in high precision design and production will help you find the answer.



FORD INSTRUMENT COMPANY
DIVISION OF THE SPERRY CORPORATION
31-10 Thomson Avenue, Long Island City 1, N.Y.

46

Yoke Dies

(Continued from page 87)

plus the thickness of two end washers (Fig 1L). The mandrel is covered with an overlapping layer of gummed krafted paper or reasonable facsimile. The paper must be wound with its gummed side outwards and the overlap should be about $\frac{1}{8}$ -in. The length of the wrapper should be equivalent to the length of the inner coil (horizontal). If a heavier wrapper is desired, two layers may be used. Slots are cut out for the 90° points by using a razor blade.

Larger Coils

The larger coils (horizontal) are placed on the mandrel over the paper core. The centering pins, Fig. 1I, are used to locate the 90° points. A shaping die (Fig. 1K) having an I.D. corresponding to the O.D. of the horizontal coil and the length of the scanning coil, is cut in half to form a semi-circle. The shaping die is placed over the horizontal coil on the mandrel and clamped in a vise (Fig. 3). They are tightened until the ends butt together. The shaping die with coil and mandrel intact is removed and then a C-clamp is used to hold the unit together. Two end washers are slid on the mandrel one at each end, and the unit is again placed in the vise so that the two washers are in contact with the vise. Meanwhile, the C-clamp holds the coil in the shaping die. The vise is tightened, pressing the end washers completely on mandrel. The coil fits the contour of the mandrel. The space between the washer and the shaping die has been calculated to give the prescribed thickness of the bent up section.

The front end washer (opposite the terminals of coil) is removed and another washer, cut exactly to the flare of the picture tube, is slid on the mandrel. This unit is placed in a vise with the washer in contact with the jaws of the vise and tightened. The unit is removed from the vise and another C-clamp is used to hold the end washers on the mandrel. In order to hold the coil in this shape, the C-clamp and the shaping die is removed so that the outer surface may be covered with a form setting lacquer. The C-clamp and the shaping die are replaced and the coil permitted to dry.

The vertical scanning coils are constructed in the identical manner and the process will not be repeated here. The vertical mandrel (not shown) is similar to the horizontal one and differs only in that allow-

ENGINEERS

of unusual abilities can find a future at FORD INSTRUMENT COMPANY. Write for information.

PRODUCT INFORMATION?

If that is what you need, use the cards below to get it quickly, through . . .



Listings continued from preceding page

- 560 Institute of Radio Engineers—Radio Engineering show
- 561 International Resistance Co.—Resistors
- 562 Jennings Radio Mfg. Corp.—Vacuum relays
- 563 Johnson Co., E. F.—Transmitting components
- 565 Jones Div., Howard B. Cinch Mfg. Corp.—Plugs & sockets
- 566 Kahle Engineering Co.—Production machinery
- 567 Kenyon Transformer Co.—Miniature, molded, T line transformers
- 568 Kester Solder Co.—Flux core solder
- 569 Librascope, Inc.—X-Y plotter & recorder
- 570 Magnetics, Inc.—Magnetic shields
- 571 Mallory & Co., Inc., P.R.—Capacitors for printed circuits
- 572 Measurements Corp.—UHF standard signal generator
- 573 Melpar, Inc.—Engineering personnel
- 574 Microtran Co.—Transformer catalog
- 575 Minnesota Mining & Mfg. Co.—Magnetic recording tape
- 576 New Hermes Engraving Machine Corp.—Engraving stock
- 577 N.R.K. Mfg. & Engineering Co.—Microwave assemblies, radar components
- 578 Peerless Div., Altec Lansing Corp.—Isolation transformers
- 579 Phalo Plastics Corp.—Wire & Cable
- 580 Philco Corp.—Hermetically sealed transistors
- 581 Photocircuits Corp.—Printed circuits
- 582 Polarad Electronics Corp.—Color TV lab & studio equipment
- 583 Polytechnic Research & Development Co., Inc.—DC power supply
- 584 Precision Paper Tube Co.—High dielectric bobbins
- 585 Presto Recording Corp.—Recording discs
- 586 Printed Circuits, Inc.—Printed circuits
- 587 Pyramid Electric Co.—Selenium rectifiers
- 588 Radio Corp. of America—TV transmitters, pylon antennas
- 589 Radio Corp. of America—TV picture tubes
- 590 Radio Corp. of America—Tubes & test equipment
- 591 Radio Material Corp.—Ceramic disc capacitors
- 592 Radio Receptor Co.—Germanium PNP transistors
- 593 Radio Shack Corp.—FM & AM tuners, amplifiers
- 594 Raytheon Mfg. Co.—Point contact & silicon diodes
- 595 Raytheon Mfg. Co.—Color-TV microwave relay
- 596 Reeves-Hoffman Corp.—Low frequency crystals
- 597 Reeves Soundcraft Corp.—Extra play magnetic tape
- 598 Resistance Products Co.—Precision wire wound resistors
- 599 Royal Metal Mfg. Co.—Industrial chair
- 600 Shallcross Mfg. Co.—Precision resistors
- 601 Shure Brothers, Inc.—Ceramic phono cartridges
- 602 Sigma Instruments, Inc.—Relays
- 603 Sorenson & Co., Inc.—Magnetic voltage regulators
- 604 Specific Products Co.—Changeable chassis
- 605 Sprague Electric Co.—Miniaturized wirewound resistors
- 606 Sprague Electric Co.—Ceramic capacitors
- 607 Stackpole Carbon Co.—Fixed composition resistors
- 608 Standard Electronics Corp.—TV transmitters, studio & film equipment
- 609 Stoddart Aircraft Radio Co.—Radio interference & field intensity meters
- 610 Sylvania Electric Products Inc.—Microwave equipment, TR-ATR
- 611 Sylvania Electric Products Inc.—Engineering personnel
- 612 Tinnerman Products, Inc.—Fasteners, nuts
- 613 Transradio Ltd.—Low capacitance & attenuation cable
- 614 Tung-Sol Electric Inc.—Beam power amplifier tubes
- 615 United Catalog Publishers, Inc.—Parts & equipment catalog
- 616 U. S. Components, Inc.—Connectors, printed card receptacles
- 617 U. S. Engineering Co.—Etched & printed circuits
- 618 Varflex Corp.—Insulating tubing & sleeving
- 619 Victoreen Instrument Co.—Glass sealed resistors
- 620 Welch Mfg. Co., W. M.—Vacuum pump catalog
- 621 Westinghouse Electric Corp.—Engineering personnel
- 622 Weston Electrical Instrument Corp.—Test equipment, VTVM, scope, calibrator

MAIL CARD TODAY



NOT GOOD AFTER
APRIL 1, 1955

TELE-TECH

& ELECTRONIC INDUSTRIES

480 Lexington Avenue, New York 17, N. Y.

FIRST CLASS
PERMIT No. 22273
(Sec. 34.9, P.L.&R.)
NEW YORK, N.Y.

FIRST CLASS
PERMIT No. 22273
(Sec. 34.9, P.L.&R.)
NEW YORK, N.Y.

BUSINESS REPLY CARD
NO POSTAGE STAMP NECESSARY IF MAILED IN UNITED STATES

POSTAGE WILL BE PAID BY

TELE-TECH
& ELECTRONIC INDUSTRIES

480 LEXINGTON AVENUE
NEW YORK 17, N. Y.

Caldwell-Clements, Inc.



BUSINESS REPLY CARD
NO POSTAGE STAMP NECESSARY IF MAILED IN UNITED STATES

POSTAGE WILL BE PAID BY

TELE-TECH
& ELECTRONIC INDUSTRIES

480 LEXINGTON AVENUE
NEW YORK 17, N. Y.

Caldwell-Clements, Inc.



Do you want more information about

PRODUCTS

advertised in

TELE-TECH

& ELECTRONIC INDUSTRIES

Use the convenient postage-free cards below to get information quickly about products listed here—all advertised in this issue

LEADING MANUFACTURERS

are using space in this issue to acquaint you with their products. Perhaps you want more information on some of them—on one or two, or possibly a score. You can cover all of your needs with the cards below. They are convenient and postfree.

- 501 Aerovox Corp.—Ceramic power & transmitting capacitors
- 502 Aircraft Radio Corp.—Test equipment
- 503 Alford Mfg. Co., Inc.—TV-transmitting antenna
- 504 Allen-Bradley Co.—Fixed & adjustable resistors
- 505 Altec Lansing Corp.—Small microphones
- 506 American Lava Corp.—Pressed ceramics
- 507 American Phenolic Corp.—Connectors, cable, harnesses
- 508 Andrew Corp.—Transmitting antennas
- 509 Arnold Engineering Co.—Magnets for rotors or stators
- 510 Astron Corp.—Capacitors
- 511 Audio Devices, Inc.—Extra length mylar magnetic tape
- 512 Bendix Aviation Corp., Pacific Div.—Telemetering systems
- 513 Bendix Aviation Corp., Scintilla Div.—Closed entry socket contact connectors
- 514 Bennett Manufacturing Co.—Metal enclosures, panels, chassis
- 515 Berndt-Bach, Inc.—Kinescope recording camera
- 516 Bomac Laboratories, Inc.—Microwave tubes, duplexers, silicon diodes
- 517 Bourns Laboratories—Trimmer potentiometers
- 518 Bradley Laboratories, Inc.—Selenium rectifier kits
- 519 Burnell & Co., Inc.—Variable toroids, telemetering filters
- 520 Busmann Manufacturing Co.—Fuses, fuse blocks & holders
- 521 California Institute of Technology, Jet Propulsion Lab.—Engineering personnel
- 522 Camera Equipment Co.—Pan & tilt heads, dollies
- 523 Cannon Electric Co.—Unit plug-in connectors
- 524 Canoga Corp.—Wobblers
- 525 CBS-Hytron—Receiving tubes
- 526 Cinch Mfg. Corp.—Parts for automation
- 527 Cinema Engineering Co.—Attenuators for control consoles
- 528 Cleveland Container Co.—Laminated paper base phenolic tubing
- 529 Collins Radio Co.—Broadcast equipment
- 530 Communication Accessories Co.—Molded plastic toroids
- 531 Corning Glass Works—Fixed glass capacitors
- 532 Cunningham, Son & Co., Inc., James—Crossbar switches
- 533 Dage Electric Co., Inc.—Special connectors
- 534 Eitel-McCullough, Inc.—Broadcast & communications tubes
- 535 Eitel-McCullough, Inc.—Air system sockets
- 536 Electrical Industries—Transistor & diode bases & closures
- 537 Electronic Tube Corp.—Multi-channel oscilloscopes
- 538 Fairchild Camera & Instrument Corp.—Miniature potentiometers
- 539 Federal Telecommunication Labs.—Engineering personnel
- 540 Ford Instrument Corp.—Automatic control systems
- 541 F-R Machine Works, Inc.—Power meters, coaxial thermistor mount
- 542 Freed Transformer Co., Inc.—Test instruments, transformers & filters
- 542A Gabriel Electronics Div., Gabriel Co.—Passive reflectors
- 543 General Ceramics Corp.—Coil core material
- 544 General Electric Co.—TV transmitters, studio equip., antennas
- 545 General Electric Co.—Uni-level amplifiers
- 546 General Electric Co.—Transistors
- 547 General Precision Equipment Corp.—Precision technology
- 548 General Precision Labs., Inc.—TV broadcast film equipment
- 549 General Radio Co.—Microwave slotted line
- 550 General Transformer Co.—Transformers
- 551 Gray Research & Development Co.—Transparency slide projector
- 552 Helipot Corp.—Delay line technical paper
- 553 Heppner Manufacturing Co.—Low cost speakers
- 554 Hermetic Seal Products Co.—Glass-metal seals
- 555 Hoffman Laboratories, Inc.—Military electronic research
- 556 Houston Fearless Corp.—Dollies, cranes, pedestals
- 557 Hughes Aircraft Co.—Silicon junction diodes
- 558 Hughes Research & Dev. Labs.—Engineering personnel
- 558A Hycon Mfg. Co.—Oscilloscopes VTVM's
- 559 Hycor Co., Inc.—Sound effects filter, program equalizer

Listings continued on next page

Use these postage-free cards to get further information



Write in boxes the code numbers of products for which you want information. See list above and on next page.

--	--	--	--	--	--

Your company

Company address

Your name

Your title

TELE-TECH—FEB. 1955

CALDWELL-CLEMENTS, INC., 480 Lexington Avenue, New York 17

Write in boxes the code numbers of products for which you want information. See list above and on next page.

--	--	--	--	--	--

Your company

Company address

Your name

Your title

TELE-TECH—FEB. 1955

CALDWELL-CLEMENTS, INC., 480 Lexington Avenue, New York 17

NOT GOOD AFTER APR. 1, 1955

POSTAGE CARD

ance must be made for the overlap of the bent up section of the horizontal coil.

Assembly

The four coils, in their final form, are ready for assembly. The horizontal mandrel, with the two coils clamped in place, is used to start the assembly process. The pressing die is removed, while the C-clamp holds the two end washers. Insulation necessary to prevent voltage breakdown is wrapped on the back of the bent up section which will be adjacent to the vertical coils. The greatest mechanical and electrical stress and strain exists on the wire where it is bent at a 90° angle. Arcing is most pronounced at the adjacent 90° bend of the horizontal and vertical coils.

Vertical Coils

The vertical coils are removed from the vertical mandrel. The centering pins are then pulled out of the horizontal mandrel to permit the vertical coils to be forced over the horizontal coils with greater ease. Strips of bakelite or other material are used to fill in the space of the centering pins and take up the slack that exists around the periphery of the coil. Proper insulation is necessary to prevent arcing between the bent up section of the vertical coil and the iron core. The scanning length of the coils are wrapped with an adhesive insulating tape. This holds the coils and bakelite strips firmly. If a molded-iron core of the proper dimensions is not available, high quality iron wire may be used until a final design is achieved. If iron wire is used, two bakelite collar washers sized to fit the coil O.D. with a saw cut are snapped-on the deflection yoke with each pushed against the bent up section of the vertical coil (Fig. 5). To provide an even base on which to wind the core, two half sections of bakelite tubing of the proper I.D., cut to a length which gives a force fit between the collar washers, are forced into place over the coils. The C-clamp is removed, but the end washers are not. The mandrel, with the deflection yoke, is mounted on the winding machine (or hand-winder, small lathe etc.). The iron core is wound as neatly as possible and anchored. The iron wire must not appear as a shorted turn about the yoke. This means a good oxide coating should be present and the last turn of wire must not be looped around and twisted together. The mandrel is removed from the winding machine.

The deflection yoke is then slid

NEW! NEW! NEW!

MAGNETIC VOLTAGE REGULATORS

These Magnetic Voltage Regulators, or Regulating Transformers, are the first units in a comprehensive line of equipment of this type being developed by Sorensen. They are primarily intended for incorporation into other equipment, where performance becomes more effective when the incoming line voltage is stabilized. However, they can be used as auxiliary line stabilizers.

The units now available have capacities of 15, 30, 60, and 120 VA. Soon to be added will be units of 250, 500, and 1000 VA capacities.

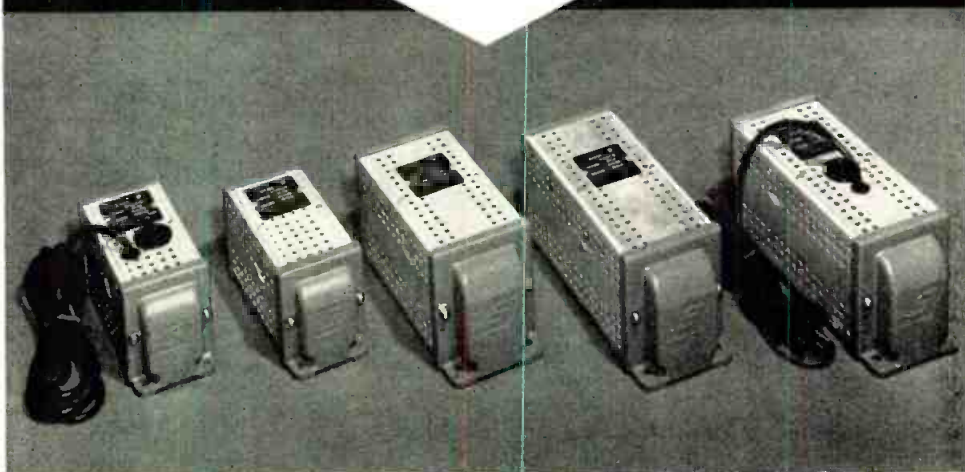

ELECTRICAL SPECIFICATIONS

Input voltage range	95-130 VAC, 1 ϕ , 60 cycles.
Output range	115 VAC, RMS, 1 ϕ .
Regulation accuracy	$\pm 0.5\%$ against line changes.
Load conditions	$\pm 0.5\%$ against line at any given load from 0 to full load.
Time constant	From 2 to 6 cycles for line changes.

MECHANICAL SPECIFICATIONS

Model MVR15	Length 6 $\frac{1}{2}$ "	Width 2 $\frac{3}{4}$ "	Height 3 $\frac{1}{2}$ "
Model MVR30	Length 6 $\frac{1}{2}$ "	Width 2 $\frac{3}{4}$ "	Height 3 $\frac{1}{2}$ "
Model MVR60	Length 8 $\frac{1}{4}$ "	Width 3 $\frac{1}{2}$ "	Height 4 $\frac{1}{4}$ "
Model MVR120	Length 9 $\frac{1}{4}$ "	Width 3 $\frac{1}{2}$ "	Height 4 $\frac{1}{4}$ "

Send for Catalog MVR1, which gives full information on the magnetic voltage regulator line.

Since Sorensen is now offering a new type of line voltage regulator, your inquiries regarding special requirements in magnetic voltage regulators will be welcomed. Write to the Sales Engineering Department, Sorensen & Co., Inc., 375 Fairfield Avenue, Stamford, Conn.

SORENSEN

SORENSEN & CO., INC., 375 FAIRFIELD AVENUE, STAMFORD, CONN.

Air-System Sockets



Eimac air-system sockets are custom designed to provide adequate cooling with the most economical blower requirements for several Eimac radial-beam power tetrodes.

4-400A/4000 air-system socket is employed with Eimac tube type 4-400A. Air enters through the bottom of the socket and is guided by a pyrex glass chimney, assuring efficient cooling of the various seals. If desired, this socket may also be used with Eimac 4-125A and 4-250A.

4-1000A/4000 air-system socket is designed for use with Eimac tube type 4-1000A. Air entering the bottom of the socket is guided by a pyrex glass chimney toward the plate seal, assuring correct cooling even during maximum rating operation of the tube.

4X150A/4000 air-system socket provides adequate air cooling and high frequency circuit arrangement for Eimac 4X150A and 4X150D. Air enters the socket through the bottom and is guided by a ceramic chimney.

4X150A/4010 socket is identical to the 4X150A/4000 except that this socket is complete with grounded cathode connecting tabs.

Eimac air-system sockets and chimneys are also available as separate units.

For further information contact our
Technical Services Department.

EITEL-McCULLOUGH, INC. SAN BRUNO CALIFORNIA
The world's largest manufacturer of transmitting tubes

Yoke Dies

(Continued from page 123)

off the mandrel onto the bakelite tubing. The reason for the bakelite tube mounting was discussed earlier under construction of the scanning coils. If no inner tubing is used, the wrapping paper is pulled out from within the yoke. A form set lacquer is painted over the inner wires of the yoke and the wrapper is placed back in its original position. The yoke is slid back on the mandrel and permitted to set until the lacquer hardens. In either case of inner tubing (bakelite or paper), the horizontal and vertical coils are connected in series respectively so they will aid each half in generating their respective scanning fields. The leads may be anchored to the inner tubing, housing, or on a washer located between the core and the vertical bent up section.

Conclusion

Unfortunately designing deflection yokes is laborious. Unless one is very lucky, it is necessary to make the dies of soft wood originally. They are shaped up and altered until the proper coil is achieved. When the dimensions were fixed, the writer had the bending and the forming blocks milled out of cloth base bakelite. All corners must be rounded off and all burrs removed to prevent wire breakage. With a durable set of dies, quite a number of deflection yokes have been made in the manner described. The construction has been found quite simple and versatile. When the yoke was completely checked and hi-voltage tested, good raster pattern and focusing were achieved. Before complete assembly, the coils were repeatedly checked for breakage and leakage. For good insulation, the wires had a double coating of formvar or formex.

Modifications

Many modifications of this method and dies have been tried. After winding the coil between the two brass plates, the coil can be freed by the use of thread, string, or tape instead of the use of wax. The cosine yokes are easily made. One brass winding plate is milled with a taper so that the winding coil has a wedged shape cross-section area. The horizontal mandrel has the centering pins located approximately 45° apart instead of 90°. The vertical mandrel is elliptical in shape to accommodate the cosine contour of the horizontal windings. It is found preferable to



fill in the horizontal window area with bakelite to give a smooth inner surface. The vertical window is filled in only when an iron core is used.

Where the wide angle deflection is desired, these dies simplify deflection yoke construction. The forming blocks in the bending operation have the guide holes cut in a manner so that one end of the bending blocks are closer together than the other, giving a tapered coil, wider at the front. A tapered spacer was used to wind the coil. The mandrels for the coils were turned out on a lathe to fit the contour of the tube flare.

The merits of these dies are numerous. Where miniaturization and compactness are desired these dies excel where other methods fail. Construction is uniform and the thickness of the coils are at a minimum. Coil length is the largest possible giving maximum sensitivity. The wires are straight and provide uniform distribution of the deflecting flux field.

1. B. B. Bycer, "Design Considerations for Scanning Yokes," *Tele-Tech Magazine*, Aug. 1950

Guyed Towers

(Continued from page 66)

continuous beam. Should this not be the case, i.e. when all CL's = (center lines) of guy tiers (points of support) are not lying on a straight line during the sway of the tower, the distribution and magnitude of forces and moments are entirely different.

It cannot be overemphasized that guyed towers cannot be calculated in the same manner as rigid structures such as bridges.

The series of empirical equations presented here are free from arbitrary assumptions. Their use, employing the methods indicated, can greatly simplify computation proceedings.

Joint Atomic Congress

Plans for a Nuclear Congress and Atomic Exposition to be held Dec. 12-17 in Cleveland have been announced by the Engineers Joint Council and 12 supporting organizations representing more than 250,000 American scientists, engineers and industrialists. The largest single project of the combined engineering and scientific societies of the nation will have the active support of private enterprise and of government, in the power and other atomic fields.

ELECTRICAL ENGINEERS

or

PHYSICS GRADUATES

with experience in

RADAR or ELECTRONICS

or those desiring to enter these areas...

The time was never more opportune than now for becoming associated with the field of advanced electronics. Because of military emphasis this is the most rapidly growing and promising sphere of endeavor for the young electrical engineer or physicist.

Since 1948 Hughes Research and Development Laboratories have been engaged in an expanding program for design, development and manufacture of highly complex radar fire control systems for fighter and interceptor aircraft. This requires Hughes technical advisors in the field to serve companies and military agencies employing the equipment.

As one of these field engineers you will become familiar with the entire systems in-

involved, including the most advanced electronic computers. With this advantage you will be ideally situated to broaden your experience and learning more quickly for future application to advanced electronics activity in either the military or the commercial field.

Positions are available in the continental United States for married and single men under 35 years of age. Overseas assignments are open to single men only.



Hughes Field Engineer H. Heaton Barker (right) discusses operation of fire control system with Royal Canadian Air Force technicians. Avro Canada CF-100 shown at right

Relocation of applicant must not cause disruption of an urgent military project.



Scientific
and
Engineering
Staff

HUGHES

RESEARCH
AND
DEVELOPMENT
LABORATORIES

Culver City,
Los Angeles
County,
California



New!

**"P" TYPE
ENCAPSULATED
RESISTORS**

**Stable... Small...
Light-weight...**

Shallcross "P" Type Encapsulated Resistors are ideal for installation where stability, dependability, and minimum size and weight are a must. These radically new resistors offer the performance advantages of hermetically-sealed steatite resistors at less cost.

Because of the unique Shallcross method of encapsulating windings, "P" type resistors have greater maximum resistances, longer leakage paths, and higher wattage ratings.

Shallcross "P" type resistors are available in six MIL-R-93A lug-type styles and five axial lead styles with wattage ratings ranging from .500 to 3.5 watts. All styles meet and exceed JAN-R-93A, Characteristic A.

Complete information on sizes, ratings, and test results of Shallcross "P" type precision wirewound resistors is available in Engineering Bulletin L-30. Write for your copy today.

SHALLCROSS MANUFACTURING CO.
518 Pusey Avenue, Collingdale, Pa.

Shallcross

See Us at the I.R.E. Show, Booths 599 and 561 Components Ave.

Potentiometers

(Continued from page 97)

However, the algebra is simplified considerably, if it is realized that the contributions to the current $i(x')$ by quadrature voltages constitute a second order effect, equations 1(a) and 1(b) can be written:

$$\frac{di(x')}{dx'} = j\omega C (x' - z) e_1 \quad (2a)$$

$$\frac{de(x')}{dx'} = R i(x'). \quad (2b)$$

Solving 2a and 2b subject to the previously mentioned conditions, the voltage $e(x')$ is:

$$e(x') = e_1 x' \left\{ 1 + \frac{j\omega RC}{6} (x' - 1)(x' + 1 - 3z) \right\} \quad (3)$$

and the current $i(x')$ is:

$$i(x') = e_1 \left\{ \frac{1}{R} + \frac{j\omega C}{2} [(x')^2 - 2zx' + (z - \frac{1}{3})] \right\} \quad (4)$$

Thus if the potentiometer resistance is known and if it is assumed no capacitive loading exists, the phase shift, that is the phase relationship of the voltage applied to the potentiometer may be determined as:

$$\Phi(x) = \frac{\omega RC}{6} (x - 1)(x + 1 - 3z) \quad (5)$$

As examples, consider the element near the resistance wire to be held at ground potential, such as in potentiometers with the case grounded. In this event, z is equal to zero and the phase shift in the potentiometer is given by:

$$\Phi(x) = \frac{\omega RC}{6} (x^2 - 1). \quad (6)$$

This phase shift causes a maximum quadrature voltage of $WRC/9\sqrt{3}$ to exist at $x = 1/\sqrt{3}$

In a typical potentiometer employed in a servomechanism, the value of C was about 400 μmf (conveniently measured on a capacitance bridge), in which case this voltage is $3 \times 10^{-3} e_1$ at 400 cycles, if R is 5,000 ohms.

On the other hand, if the element, A , near the resistance wire is left free to float as is common in some of the potentiometers available in the present market, it will assume a potential $e_1/2$. This may be deduced by reasons of symmetry. In this event the variation of phase shift with wiper arm displacement will be given by the equation:

$$\Phi(x) = \frac{\omega RC}{6} \left(x^2 - \frac{3}{2}x + \frac{1}{2} \right) \quad (7)$$

and causes a maximum quadrature voltage at

$$x = \frac{1}{2} \pm \frac{1}{2\sqrt{3}}$$

$$\frac{1}{12\sqrt{3}} \frac{2\pi fRC}{6} e_1$$

Typical values of C and R for this particular type of potentiometer are 8,000 μmf , and 25,000 ohms respectively giving a value for the quadrature component of $6.0 \times 10^4 e_1$ at 60 cycles. A plot of the variation of the wiper arm with displacement of the wiper arm is shown in Fig. 2.

If this element, A, causing the capacitive currents is floating with respect to ground potential, and is available externally, it is possible by driving this element at a given computed potential of

$$e_a = e_z = \frac{1}{3} (1+x) e_1 \quad (8)$$

to maintain the phase shift due to these capacitive currents equal to zero. This is derived from equation 5.

One system for implementing the last proposal is shown in Fig. 3 in which a cathode follower is used to determine the wiper arm voltage, and the output of the cathode follower is added passively to the excitation voltage e_1 to obtain the voltage

$$\frac{1}{3} (1+x) e_1$$

This would require a reasonably high performance cathode follower but such can be constructed with one or two tubes. This technique was employed in a system in which it was desired to have as little quadrature voltage as possible at the wiper arm of the potentiometer.

The preceding relations of voltage and current distribution along the potentiometer can be derived on the basis of classical electric line theory. If, after the answers have been obtained, a series approximation is made which is consistent with the conditions of the problem, answers identical to those obtained here would result.

In those systems in which it is desired to maintain the phase shift in potentiometers to a minimum, the previously mentioned technique can be employed. Alternatives to this scheme, of course, are to use potentiometers which do not have, close to the resistance wire element, any metallic object which can cause large capacitive currents to flow. There are several such types of potentiometers as this on the market, one of which employs a single wire element providing infinite resolution and good linearity as well.

Send for this **FREE SAMPLE FOLDER**

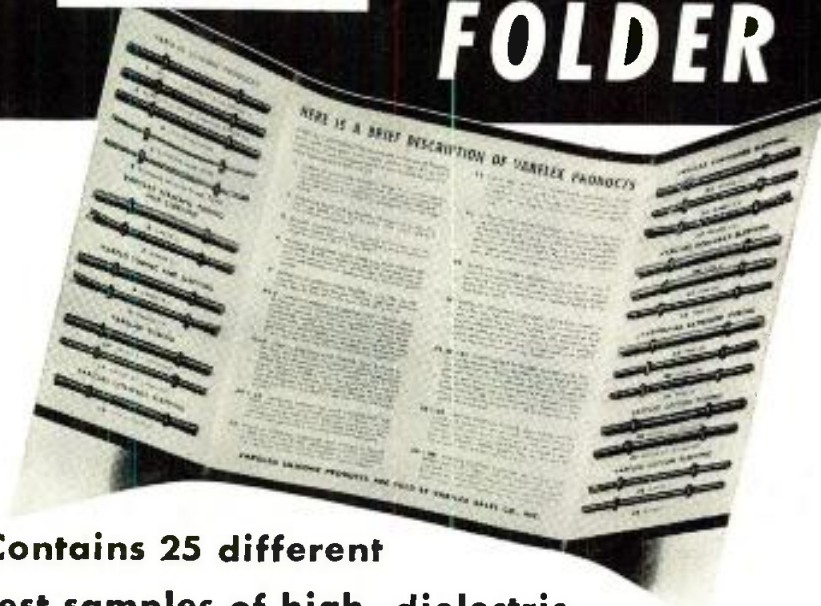

Contains 25 different test samples of high-dielectric **INSULATING TUBING and SLEEVING**

Includes samples and descriptions of . . .

VARGLAS SILICONE—Class H tubing, sleeving, lead wire, tying cord. Withstands temperature from -85°F to 500°F .

PERMAFIL-IMPREGNATED VARGLAS TUBING—Fiberglas impregnated with General Electric Permafil.

VARGLAS SLEEVING AND TUBING—synthetic-treated, varnished, lacquered, saturated and others.

VARGLAS NON-FRAY SLEEVING—three types available. Withstands temperatures up to 1200°F .

VARFLO TUBING AND SLEEVING—full range of colors, sizes and grades. Vinyl coated Fiberglas.

VARFLEX COTTON TUBING AND SLEEVING—varnish or lacquer impregnated—all NEMA grades.

SYNTHOLVAR EXTRUDED TUBING—listed by UL for use at 105°C . Various formulations to meet unusual requirements.



**MAIL COUPON TODAY
FOR SAMPLE FOLDER**

VARFLEX CORPORATION
508 W. Court St., Rome, N. Y.

Please send me free folder containing samples of your electrical tubing and sleeving.

I am particularly interested in insulation for

Name

Company

Street

City Zone State

LOWER YOUR SET COSTS

WITH THIS LOWER-PRICED DEPENDABLE SPEAKER

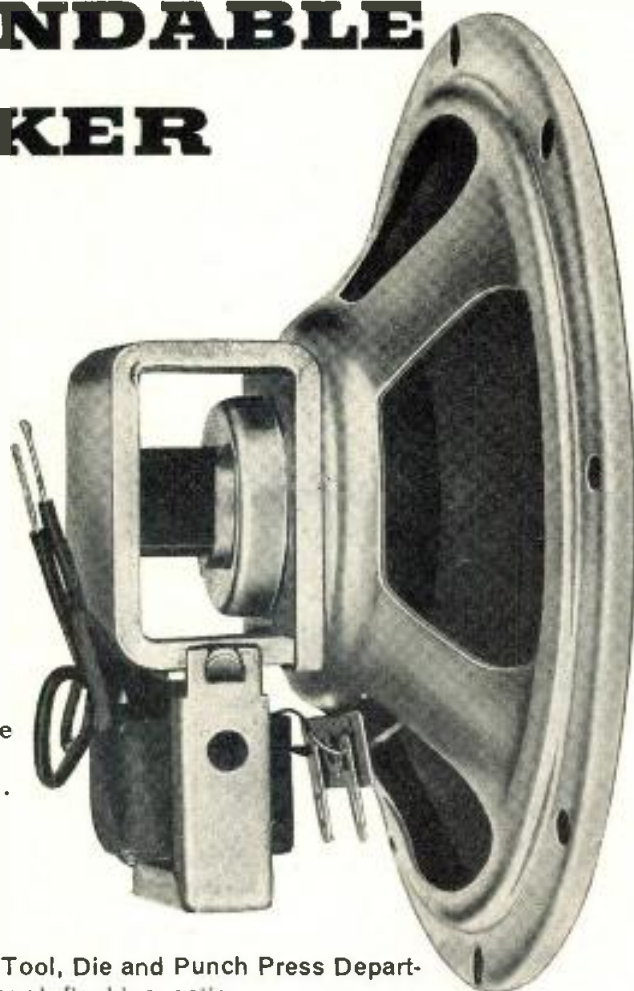

A line of 4" and 5" speakers designed for peak performance. Break off or cast magnet may be used.

Low priced only because of unusually efficient manufacturing techniques.

Produced under rigid quality control. Metal stampings completely manufactured in our own Tool, Die and Punch Press Departments. Exceptionally thorough final inspection.

Plugs, transformers and/or brackets to your specifications.

Lower your set costs with this dependable speaker. Write for further information TODAY.

OTHER HEPPNER PRODUCTS:
Ion Traps, Centering Devices, Fly-Back Transformers and Focomags.

HEPPNER

MANUFACTURING COMPANY
ROUND LAKE, ILLINOIS
(50 Miles Northwest of Chicago)
Phone: 6-2161
Specialists in Electro-Magnetic Devices

Representatives:

JAMES C. MUGGLEWORTH, 324 Haddon Avenue, Collingswood 7, New Jersey • RALPH HAFHEY, R.R. 1, U.S. 27, Coldwater Rd., Ft. Wayne 8, Indiana • IRV. M. COCHRANE CO., 408 So. Alvarado St., Los Angeles, Calif. • JOHN J. KOPPLE, 60 E. 42nd St., New York 17, N. Y.

Indicating Instrument

(Continued from page 83)

parts and loosening of screws were corrected by strengthening of the parts and the selection of screw and thread combinations which insured maximum engagement and tight fit. The spring problem was solved by the use of beryllium copper springs with convolutions so spaced that even under severe shock, hooking or snarling was avoided. In addition, considerable trouble was experienced with the pivots mushrooming and blunting. The dimensional limitations of the case precluded the use of a shock isolator to mount the mechanism so it was decided to utilize silicone backed "shock protected" jewels. A noticeable improvement resulted from this change.

In the electrical tests damping and power consumption left much to be

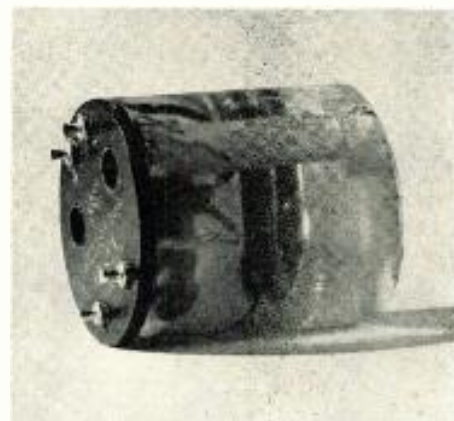

Fig. 8: Meter accessories are potted

desired and accuracy and response time were not quite up to expectations. Intensive effort was made to improve these characteristics. The scale linearity was improved by some additional tailoring of the outer pole piece and accuracy was improved by making the critical parts to closer tolerances and by careful assembly and adjustments. Substantial improvements could not be made in the other characteristics due to the inherent limitations of the long scale design and the relatively low air gap flux—750 gauss average.

Accessories

The best plan devised for housing the external accessories was one of a potted assembly. This assembly, illustrated in Fig. 8, is completely sealed and may be mounted on the equipment chassis remote from the meter itself or readily coupled to the back of the meter. Coupling is accomplished by the proper design of the two mounting holes in the as-

sembly and the necessary hardware for same to correspond to the terminal stud size, location and alignment.

Review

The limitations of the magnetic materials now commercially available made it impossible to attain the 0-100 μ a range desired; the best possible is around 350 μ a. In addition, due to the large power consumption a satisfactory thermocouple-instrument combination could not be worked out. However the final design models meet, in large measure, the aims and objectives of the project, consistent with the time and funding available. The meters developed in all other ranges are mechanically sound and take into account the extreme conditions of temperature, humidity, vibration and shock incident to use by the Armed Forces. In addition the design of the instrument is such that manufacture by mass production techniques is possible.

Long Island IRE Lectures

The spring lecture series for the Long Island Section of the Institute of Radio Engineers has Measurements for the Electronic Engineer as its principal theme and includes the following program:

- Feb. 3: Audio and Radio Frequencies
W. R. Thurston—General Radio Co.
- Feb. 10: Oscillography
W. G. Fockler—A. B. DuMont Labs. A.
A. Emmerling—General Electric
- Feb. 17: Microwaves
A. B. Giordano—Polytechnic Institute of
Bklyn
- Feb. 24: Transmitters & Receivers
N. G. Oman—RCA Victor
C. E. Page—Hazeltine
- Mar. 2: The Millimeter Range
A. G. Fox—Bell Telephone Labs.

These meetings begin at 7:30 PM at the Stratford Ave. School in Garden City, L.I. Price for series is \$4 for IRE or AIEE members, \$6.00 for non-members. Checks are payable to L.I. Section, IRE c/o J. H. Niedert, 9 Surrey Road, New Hyde Park, N.Y.

EXCEPTIONAL SERVICE AWARD



Dr. W. H. Huggins receives highest Air Force Decoration for Exceptional Civilian Service from Lt. Gen. T. S. Power, Commander of Air Research and Development Command. The citation reads in part, "... Successfully established new approaches in the fields of electronics, hearing and communication . . ." He is now Professor of Electrical Engineering at Johns Hopkins Univ.



the world's no. 1 producer of semi-conductors

presents **GOLD BONDED DIODES**
of **"GOLD STANDARD"**
PERFORMANCE

Look at the "specs"!
Look at the actual, unretouched oscillograms. These pre-tested Raytheon Gold Bonded Diodes have the characteristics and the uniformly dependable performance to make them your No. 1 choice. Many other Raytheon Gold Bonded point contact and silicon diodes are available. Write for data.

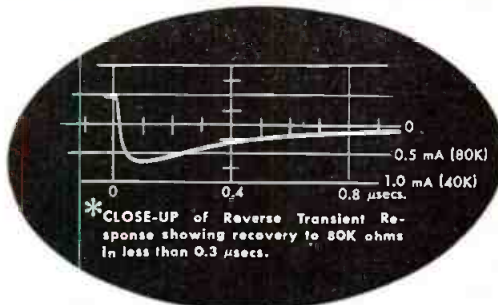
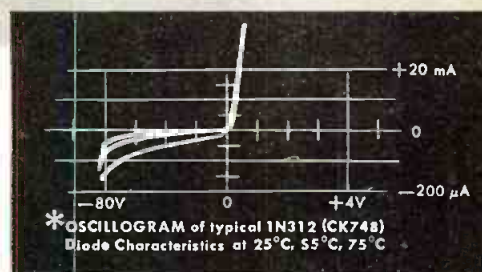

*These are unretouched photographs taken in the Raytheon Semiconductor Diode Laboratory.

Representative Gold Bonded Types	FORWARD 25°C ma. at +1 volt	REVERSE	
		25°C μa at volts	55°C μa at volts
1N308 (CK741) with 50% higher conduction than its nearest competitive type	300	500 at -8	1500 at -8
1N310 (CK745) for high voltage, high resistance	15	20 at -20 100 at -100	150 at -20 300 at -100
1N309 (CK747) with unbeatable transient characteristics	100	100 at -20	350 at -20
1N312 (CK748) 100% tested for forward and reverse transient response	30	50 at -50	200 at -50
1N313 (CK749) high voltage, extra high resistance ALL with 150 milliwatt dissipation rating ALL with -50°C to +90°C ambient temperature rating	20	10 at -20 50 at -100	50 at -20 200 at -100



Excellence in Electronics

RAYTHEON MANUFACTURING COMPANY

Semiconductor Division — Home Office: 55 Chapel St., Newton 58, Mass. Bigelow 4-7500

For application information write or call the Home Office at: 4935 West Fullerton Avenue, Chicago 39, Illinois, NAHonal 2-2770

589 Fifth Avenue, New York 17, New York, Plaza 9-3900 • 622 South La Brea Ave., Los Angeles 36, California, WEbster 8-2851

RAYTHEON MAKES ALL THESE:

RELIABLE SUBMINIATURE AND MINIATURE TUBES • SEMICONDUCTOR DIODES AND TRANSISTORS • NUCLEONIC TUBES • MICROWAVE TUBES • RECEIVING AND PICTURE TUBES



R5-E VACUUM RELAYS for pulse forming networks, antenna transfer switching, guided missiles applications

are small, high voltage relays with a 12 or 24 volt DC actuating solenoid located in the base of the unit. Designed for minimum space requirements, the relays are 3 inches long and 2 inches in diameter. All types have flanges for easy mounting and none of them depend on flexible leads to carry current.

Their vacuum dielectric has over 30 times the dielectric strength of air making possible a fast acting 10 KV relay of compact design. Current ratings of 10 amperes RMS are obtained by the use of tungsten contacts. Series-break contacts include normally open, normally closed, and single pole double throw types.

A transmit-receive relay is also available with SPDT contacts and another NO contact which grounds the receiver when the relay is in the transmit position. This type R5-F is enclosed in a copper housing with three coaxial fittings. The housing shields the switch and provides a good ground connection for the receiver. It will handle antenna power up to 5 KW at frequencies up to 30 mc. when operating into a flat 51.5 ohm line.

Send for catalog literature describing these and larger relays manufactured by Jennings for DC, 60 cycle, and RF applications up to 85 KV and several hundred amperes.

Visit Our Booth #436 at the I. R. E. Show.

JENNINGS RADIO MANUFACTURING CORP. • 970 McLAUGHLIN AVE. P.O. BOX 1278 • SAN JOSE 8, CALIF.

Color Television

(Continued from page 63)

tems. It is used throughout these plans and features variable gain from 0 to 2 and a sync addition circuit for mixing sync. The TA-3A is a single input amplifier with 3 outputs.

TA-4A PULSE DISTRIBUTION AMPLIFIER

The TA-4A is a new concept in distribution amplifiers. It is specially designed for handling pulse signals such as horizontal drive, vertical drive, blanking and sync. A pulse regenerating circuit is included for reshaping input pulses so that degradation of these pulses may be eliminated. The output pulses may be varied in amplitude for 0 to 5 volts. The TA-4A is a single input—3 output, amplifier which provides sending end termination.

PHASE CORRECTION EQUALIZERS

In order to comply with the FCC standards, two phase correction equalizers must be installed in the input line to the transmitter as shown in Fig. 1. These provide a calculated amount of phase pre-distortion to make up for phase distortion in the rest of the system. The low-frequency network compensates for the phase shift in the vestigial side-band filter. The high-frequency network compensates for the deficiency in high-frequency response of the receiver. This equipment is rack mounted external to the transmitter with other items such as the color stabilizing amplifier and distribution amplifier.

MONITORING EQUIPMENT

In order to be able to visually monitor the picture transmitted, a Type TM-10B color monitor is required. The color monitor must be fed from a high-quality demodulator. Most stations presently have either a BW-4A or BWU-4A demodulator. With minor modifications either of these may be used. A demodulator conversion kit is supplied as part of plan #1 equipment for making the necessary changes. Fig. 1 indicates the use of a standard monochrome monitor (in addition to the tri-color monitor). This unit is not listed in the "required equipment" because the monitor which is part of the standard transmitter control console can be used for this purpose.

WA-8A color stripe generator—During a normal operating day, there is seldom opportunity to broadcast the colorplexed color bar signal so that servicemen may have

the opportunity to check the installation and alignment of color receivers. This has been solved by the design of the RCA WA-8A color stripe generator which is included in plan #1.

This instrument is inserted in series with the video transmission line feeding the transmitter. It produces two color bursts, one at the beginning and one at the end of each horizontal scanning line. This produces a stripe of color information which is hardly perceptible on a monochrome monitor. In color transmission it has been found that in some cases multi-pan effects have a tendency to cancel the color burst. Therefore, if a color receiver is not checked against an actual color signal, it is not possible to tell whether the receiver is actually operating as it should. When the color stripe generator is broadcast along with regular monochrome transmission, the serviceman need merely adjust the horizontal frequency control until the color circuits of the receiver are activated by the burst at the beginning of each line. The burst at the end of each line then produces a yellow-green stripe at the right-hand edge of the color picture. Thus, it enables the serviceman to determine that the transmission path is passing the color burst and that the color circuits of the receiver are functioning. This instrument makes it possible to transmit color information without interfering with regular commercial monochrome transmissions.

EQUIPMENT CABINET RACKS

In plan #1 two 84-in. cabinet racks are furnished to accommodate the network, monitoring and test equipment, and take care of some future needs. One will be used at the studio location for mounting the stabilizing amplifier, power supply and patching facilities; the second at the transmitter location will house the stabilizing amplifier, distribution amplifier, and phase correction networks. The station will undoubtedly have other rack space available at the transmitter for the power supplies required. It is possible that some stations may require only one cabinet rack instead of the two specified.

At the outset at least, the TV station may desire to keep color re-broadcast facilities as a separate system. At the transmitter, therefore, a group of video jack equipment has been recommended to allow patching between the various phase correction networks, amplifiers, and monitors. If additional patching is required at the studio,

**March
21-24**

The
Radio-Electronic

SPECTACULAR

of 1955!

**See!
Hear!**

IRE

National Convention

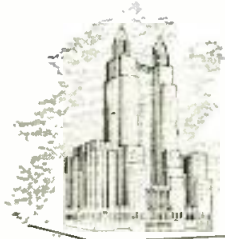

and

Radio Engineering Show



At both the Waldorf-Astoria (convention headquarters) and Kingsbridge Armory, you'll attend what actually amounts to 22 conventions fused into one. Hundreds of scientific and engineering papers will be presented during the many technical sessions, a large number of which are organized by I R E professional groups. You'll meet with the industry's leaders—enjoy the finest meeting and recreational facilities in New York.

At the Kingsbridge Armory and Kingsbridge Palace, you'll walk through a vast panorama of over 700 exhibits, displaying the latest and the newest in radio-electronics. You'll talk shop with the industry's top manufacturers—enjoy the conveniences provided for you in the world's finest exhibition halls, easily reached by subway and special bus service.

Admission by registration only. \$1.00 for I R E members, \$3.00 for non-members. Social events extra.

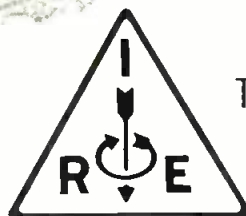

The Institute of Radio Engineers

1 East 79 Street, New York

ENGINEERS yours will be a SUCCESS STORY

with

Westinghouse

where you will share in important and exciting achievements at our

Electronic Tube Division

IN ELMIRA, NEW YORK

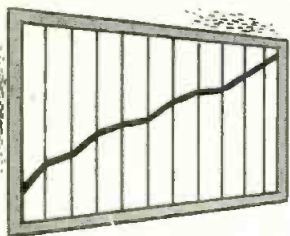

Development & Application Engineers: Receiving, microwave (including traveling waves), image orthicon or vidicon tubes; solid state devices.

Electrical Design Engineers: Designing, costing and guiding construction of processing and testing equipment, e.g. atmosphere furnaces, electrical welders, induction heaters, X-ray seasoning and test units, waveguide apparatus, transistor life test units.

Manufacturing Engineers: Pilot and manufacturing processes for image orthicon, solid states, micro-wave, receiving tubes, color TV, and magnetrons. Also PROCESS QUALITY CONTROL.

We Offer You An Enjoyable Life in N. Y. State's Resort Lakeland . . . and a Rewarding Career.

Company representative is interviewing in Chicago Feb. 11th . . . N.Y. City Feb. 18th . . . Los Angeles Feb. 25th . . . and Boston March 4th. Interviews can also be arranged in your area, or travel expenses paid if invited to Elmira for interview. Send resume to:

Supervisor of Employment & Training

WESTINGHOUSE Electronic Tube Div., P. O. Box 284, Elmira, N. Y.

Color Television

(Continued from page 131)

the quantities of these items should be increased accordingly. Fig. 4 illustrates two possible rack layouts of monitoring equipment (one for VHF and one for UHF).

TEST EQUIPMENT FOR COLOR TELEVISION

Every station manager and engineer immediately recognizes the necessity of proper test equipment to check and assure adherence to the rigid performance specifications of color TV. RCA has developed a complete line of color test equipment for this purpose, and has included only the "must" items as a part of plan #1. The package includes the necessary units to cover most every phase of testing to assure that the system will pass the composite network signal with a minimum of distortion. The charts of Fig. 5 show several possible testing arrangements. All of the equipment is



Fig. 6: Linearity checker has step-wave output

not only profitably used in plan #1, but is also necessary with the color origination equipment of plans #2 and #3.

TEST EQUIPMENT OPERATION

As in monochrome operations, the monitors must be in A-1 condition. Since the TM-10 color monitor is more complex than the monochrome instrument, naturally there is a more complex adjustment procedure. Two instruments are used in these adjustments, as follows: The WA-3B grating and dot generator is used to adjust the deflection linearity of any monitor by means of the grating pattern signal output. This signal produces a grid pattern on the monitor consisting of horizontal and vertical lines. Any difference in the spacing of the lines over the face of the monitor represents non-linear deflection.

The dot output of the WA-3B is used for checking the beam convergence adjustment of color monitors. The dots are really rectangles about 9 lines in each dimension, but adjustable in size to suit the individual

CO-AX

4 mmf/ft

★ **ULTRA LOW** capacitance & attenuation

WE ARE SPECIALLY ORGANIZED TO HANDLE DIRECT ORDERS OR ENQUIRIES FROM OVERSEAS SPOT DELIVERIES FOR U.S. BILLED IN DOLLARS—SETTLEMENT BY YOUR CHECK CABLE OR AIRMAIL TODAY

TYPE	μF/ft	IMPED.Ω	O.D.
C1	7.3	150	.36
C11	6.3	173	.36
C2	6.3	171	.44
C22	5.5	184	.44
C3	5.4	197	.64
C33	4.8	220	.64
C4	4.6	229	1.03
C44	4.1	252	1.03



NEW 'MX and SM' SUBMINIATURE CONNECTORS
Constant 50Ω-63Ω-70Ω impedances

TRANSRADIO LTD. 138A Cromwell Rd. London SW7 ENGLAND

CABLES: TRANSRAD, LONDON

using the instrument. If the convergence is not set properly, dots of three different colors appear displaced from one another by the divergence of the respective beams. If properly adjusted, only white dots appear on the monitor with a minimum of color fringing.

Next, the distribution amplifiers, stabilizing amplifiers, switching equipment and studio transmitter links require consideration. Each piece of equipment through which the signal must pass introduces distortion. Even though this distortion may be very small, it is still there and the accumulative effects of many units in series may well prohibit the proper transmission of color video. Four parameters must be contained well within reasonable limits. These parameters are amplitude vs. freq., frequency-phase, differential gain, and differential phase. Differential gain is defined as the change in gain measured against the increase in signal amplitude. Differential phase is defined as the change in phase measured against signal amplitude at the particular frequency in question.

PARAMETER MEASUREMENT

Three instruments are provided for the precise measurement of these parameters. They are the linearity checker, the color signal analyzer, and the burst controlled oscillator. Of course, the necessity for using an oscilloscope with these instruments is also paramount. The differential gain characteristics can be measured by using only the *linearity checker*, *RCA type WA-7B*, and the *television oscilloscope*, *RCA type TO-524-D*.

The linearity checker (Fig. 6) has output consisting of low-freq. step wave with an RF signal superimposed on it. This signal is fed into the system under test and the output is observed on a 524-D oscilloscope after being passed through a high-low filter. When the filter switch is in the high position the step wave is removed from the output signal and only the RF components remain. Any change in amplitude of the RF envelope from beginning to end of sweep indicates differential gain distortion and the per cent change in amplitude of the RF pattern indicates the differential gain distortion in the system. The linearity checker in conjunction with the *color signal analyzer*, *RCA type WA-6A*, is used to measure the subcarrier phase shift and the differential phase of the transmission system.

These measurements can also be made utilizing a colorplexed color

NOW! YOU SAVE UP TO \$50

WHEN YOU BUY A REALIST

HI-FI TUNER AT RADIO SHACK

1955 MODELS! HUNDREDS SOLD TO ENTHUSIASTIC USERS!



FM TUNER \$39.95

- ARMSTRONG FM WITH FOSTER-SEELEY DISCRIMINATOR!
- 5 MICROVOLT SENSITIVITY FOR 30 DB QUIETING!
- TUNED RF STAGE! DOUBLE-TUNED LIMITER! AC SUPPLY!
- AUTOMATIC FREQUENCY CONTROL (AFC)! 180kc BANDWIDTH!
- AUDIO OUTPUT 1V FOR 100% MODULATION! HUM 60 DB DOWN!
- FREQUENCY RESPONSE 20-20,000 CYCLES PLUS-MINUS 1/2 DB!
- DIRECT-FEED TAPE RECORDER JACK! AUX. PHONO INPUT!
- POWER AND TUNING CONTROLS — USE WITH ANY AMPLIFIER!
- ULTRA-COMPACT 4 1/4" H x 9 1/2" W x 6 3/8" D! COMPLETE!
- ORDER NO. 36-888M BY MAIL! ADD POSTAGE FOR 6 1/4 LBS.

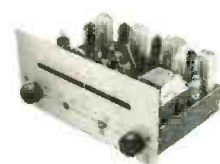

AM TUNER \$29.95

- EXACT MATCH OF REALIST FM TUNER! SAME COMPACT SIZE!
- TUNED RF STAGE! AC SUPERHET CIRCUIT! AC SUPPLY!
- 5 MICROVOLT SENSITIVITY! 8kc BANDWIDTH 6 DB DOWN!
- BUILT-IN FERRITE STICK ANTENNA! BUILT-IN TAPE JACK!
- PLUS-MINUS 3 DB 20-5000 CYCLES! HUM 60 DB DOWN!
- POWER AND TUNING CONTROLS — USE WITH ANY AMPLIFIER!
- ORDER NO. 36-887M BY MAIL! ADD POSTAGE FOR 6 1/4 LBS.

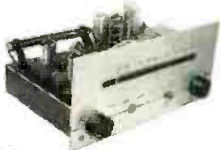

REALIST 10 WATT HI-FI AMPLIFIER!

- BUILT-IN RIAA-EQUALIZED PREAMP!
- 20-20,000 CPS ±1 DB AT 3 WATTS!
- SEPARATE BASS AND TREBLE CONTROLS!
- 5 TUBES! PUSH-PULL TWO 6V6GT!
- ORDER NO. 33-303M BY MAIL! 10 LBS.

\$29.95



RADIO SHACK CORPORATION

167 Washington Street, Boston 8, Massachusetts

and 230-234 Crown St., New Haven 10, Conn.

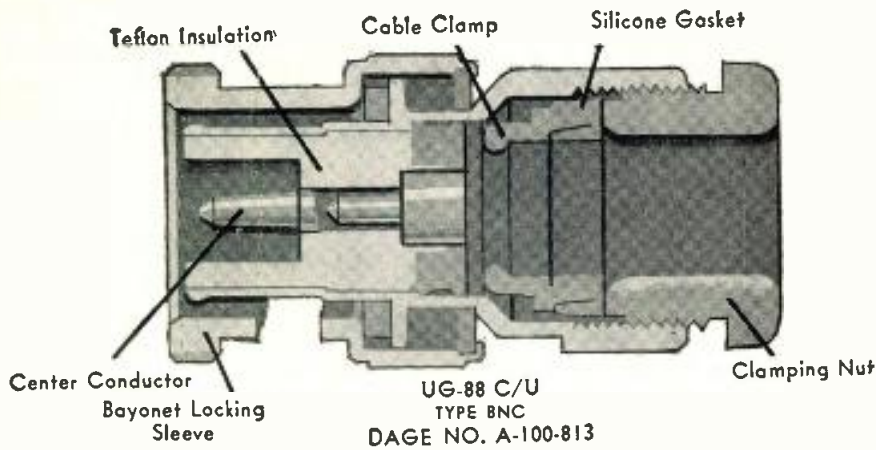

Design with Dage!

Dage engineers are interested in *your* design problems . . . even before you have them! Call on Dage at the very beginning of your next project—see for yourself how skillfully Dage can help you coordinate details and overcome design "bugs."

Your RF connector order placed with Dage receives the careful attention it de-

serves. Dage expertly designs, carefully makes all types of RF connectors including Type N, C, BNC, improved BNC's and SM's. Dage designers are *specialists* in producing your *special* connectors.

Remember, on *your* next project—"Design with Dage"; call Dage . . . even before you start!



UG-88 C/U
TYPE BNC
DAGE NO. A-100-813



Write Dage today for your copy of Catalog 201. Write, phone or wire your RF connector order to Dage today!

DAGE ELECTRIC COMPANY, INC., 67 NORTH SECOND STREET, BEECH GROVE, IND.

X-Y PLOTTER AND RECORDER



RECORDS
TWO INDEPENDENT
VARIABLES FROM
ANALOG OR DIGITAL
INPUTS

A compact, desk-size unit designed for general purpose graphic recording from analog or digital inputs with standard Librascope converters or special modifications engineered to customer requirements. Unique pen travel, fast and dependable. Full chart visibility allowing curve generation to be observed at all times. Write for detailed catalog information.

Mechanical and electrical
analog computers, digital
computers, input-output
devices and components.

Computers and Controls

LIBRASCOPE
A DIVISION OF GENERAL PRECISION EQUIPMENT CORPORATION
1607 FLOWER ST., GLENDALE, CALIF.

LIBRASCOPE, INCORPORATED

Color Television

(Continued from page 133)

bar signal from the color bar generator furnished in plan #2. If the color bar and origination equipment of plan #2 is installed in advance, the phase of each of the primaries and their complements plus the "I" and the "Q" signals can be measured directly using the color signal analyzer. It should be pointed out here that the WA-1D color bar generator (supplied in plan #2) is a very powerful tool in making color measurements. In conjunction with the signal analyzer it is used for precise alignment of the colorplexer modulator circuits. As a source of color signal for routine measurements throughout the system it is unsurpassed.

In many instances a source of subcarrier for use with the signal analyzer may not be available such as at a transmitter location remote from the studio facilities. To measure the four parameters involved in color transmission of a studio transmitter link, it would be necessary to have available a source of subcarrier. The WA-4A burst controlled oscillator fulfills this requirement. The color burst is picked off the incoming signal and used to precisely control a crystal oscillator the output of which is a continuous subcarrier signal.

CALIBRATION PULSE GENERATOR

The RCA type WA-9A Calibration Pulse Generator is designed for the precise calibration of studio signal voltages. The generator can be installed in a television system as one input to a switcher or it may be made available at a jack panel so that it can be patched to any part of the system as desired.

For permanent installation, it is convenient to have the WA-9A installed in master control and on one cable fed to all studios or other sources of signal so that operating personnel can have it available at any time. It can also be used to calibrate all master monitors and oscilloscopes by merely substituting it for the normal input signal. When it is used as a video input to a switcher, it can be rapidly switched in and out for precise matching of video signals from various sources.

Another important application is in setting up the processing amplifier in the 3V color film chain. Here the WA-9A makes possible an accurate match between all three color channels. Switches are provided on the processing amplifiers for rapidly

switching between the signal voltages and the calibration pulse signal.

The 524-D oscilloscope is an instrument designed especially for television applications. The wide band width coupled with the precisely controlled sweep circuits provide for observing almost every conceivable point of interest in a composite signal. The trigger circuits make it possible to examine very minutely the vertical synchronizing interval as well as each horizontal line. This is a very useful feature when determining the position of the burst with respect to the horizontal sync and blanking signals.

An instrument of great versatility (not included in plan #1, but existing in most TV stations) is the WA-21B video sweep generator. This instrument has a swept output from 100 kc to 10 mc and is used for determining the amplitude-frequency characteristics of video systems.

Another instrument (available as an accessory but not included in plan #1) is the WR-61A service generator. This is a serviceman's type instrument and can be used equally well for the adjustment of color monitors and receivers since it has an r-f output. It produces on the color monitor a series of vertical color bars, ten in number and evenly spaced over the reproduceable spectrum. It cannot be used for generating "on-the-air" signals since the output is non-standard.

Part Two Will Appear
In the March Issue

New Automation Firm

General Cybernetics Corp. has been formed as an affiliate of the Angle Computer Co., Inc., Glendale, Calif. to design and manufacture automatic control systems and components as well as computing units for the field of automation and the military.

SYLVANIA VISIT



Asst. Secy. of the Army Frank Higgins opened his recent tour of West Coast contract installations with an inspection of Sylvania's Electronic Defense Lab. at Mountain View, Calif. Shown checking over electronic components used at the lab are Lt. Gen. W. B. Palmer, H. Lehne, director of the lab, Secy. Higgins and Brig. Gen. W. P. Corderman

THE NEW WAY TO MARK EQUIPMENT....

with

GRAVO *flex*

the first chip-proof, flexible engraving stock

on the versatile

Engravo *graph*

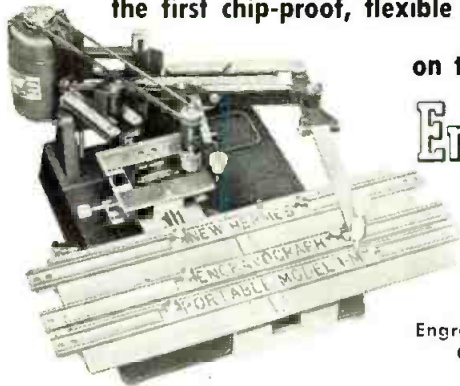

Send for booklets
Engravo-graph Booklet 1M-94
Gravoflex Booklet 94

So simple to engrave Gravoflex. Lettering stands out permanently on contrasting background. No paint needed. 10,000 Engravo-graphs used for engraving on metals and plastics. Only Engravo-graph has these patented features:

- Adjustable for 15 ratios.
- Self-centering holding vise.
- Automatic depth regulator.
- Adjustable copy holders.

NEW HERMES ENGRAVING MACHINE CORP.

13-19 UNIVERSITY PLACE, NEW YORK 3, N. Y.

shear it



bend it



form it



punch it

HIGHEST PRECISION in low frequency crystals

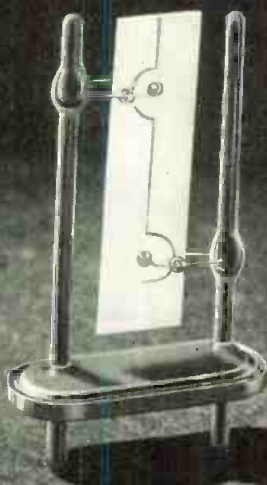

Precision plus, that's what you get with every Reeves-Hoffman low frequency crystal unit. For exact control of all low frequencies from 12 kc to 1000 kc—specify Reeves-Hoffman crystals.

Write today for further information and prices.

RH-1



REEVES - HOFFMAN CORPORATION

a subsidiary of Claude Neon, Inc.

CHERRY AND NORTH STREETS

CARLISLE, PENNSYLVANIA

ABOVE ALL... U. S. C. CONNECTORS

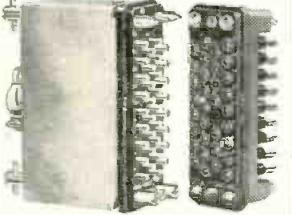
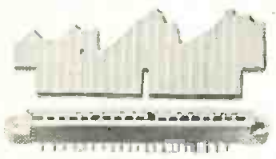
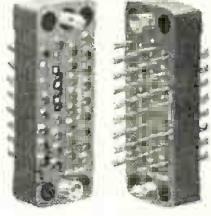

<p>HEAVY DUTY CONNECTORS</p> <p>980-34F2 980-34HRSL 980-34M2SL</p>  <p>For use on rack and panel type equipment in communication and power circuits. U. S. C. heavy duty multi-contact connectors offer</p> <ul style="list-style-type: none"> • Maximum number of heavy current contacts • Mechanical and electrical dependability of operation in a minimum of space. • available 7 to 34 contacts 	<p>PRINTED CARD RECEPTACLES</p>  <p>UPCR-18</p> <p>U. S. C. Printed Card Receptacles offer</p> <ul style="list-style-type: none"> • Channel Strength and Snap-in Contacts • Dependability of operation over range of printed card thickness • Available - Single and double Row, Wire Solder and Wire Wrap - From 6 to 44 contacts 	<p>MINIATURE CONNECTORS</p> <p>MI-34F MI-34M</p>  <p>For Multi-Contact Plug-in</p> <ul style="list-style-type: none"> • Maximum Strength • Dependable Electrical Performance • Minimum of Space • Available 5 to 75 contacts <p style="text-align: center;"><i>Over 1000 types available</i></p> <p style="text-align: center;"><i>Write us for information on your connector problems</i></p>
--	--	--



U. S. COMPONENTS, Inc.

Associated with U. S. Tool and Mfg. Co., Inc.
454-462 East 148th Street, New York 55, N. Y. CYPRESS 2-6525-6

See us at Booth #625 I.R.E. Show, Mar. 21-24, 1955.



Microwave Assemblies, Radar Components, and Precision Instruments . . . manufactured and designed to your specifications.



N. R. K. MFG. & ENGINEERING CO.

4601 WEST ADDISON STREET • CHICAGO 41, ILL. • SPing 7-2970
West Coast Representatives TUBERGEN ASSOCIATES 2232 W. 11th St., Los Angeles 6, Calif.

Resistor Networks

(Continued from page 77)

encapsulation depends upon the heat dissipation characteristics required of the network. Various curing processes can be employed; however, we have found that the most satisfactory curing process to date has been a partial cure at 25°C. for approximately one hr. For the final curing, the length of time and the degree of temperature are governed by the specific type of epoxy resin used. Normally, a maximum of six hrs. has proved sufficient for final curing.

After extraction from the molds, the networks are again put through the same electrical tests that were made prior to encapsulation. This is followed by the marking of terminals and stamping of identification as required by the user.

One of the more desirable characteristics of the networks is that they lend themselves perfectly to applications requiring rapid assembly and ease of replacement in end-products. They may be easily designed to plug-in, or wire-in, by virtue of convenient rows of terminals or leads. Networks can also be mounted securely through the use of only two screws in a given location on the chassis; heretofore impossible, where use of single wire-wound precision resistors were specified. The mounting of networks to the chassis of equipment provides far greater and more rapid heat dissipation, which in turn allows the internal component size to be smaller.

Fig. 4 indicates the heat dissipation differential when single resistors are mounted in normal position and when a network containing individual resistors is mounted to a metal chassis in 40°C. and 85°C. ambients.

Of interest and importance to design engineers where instances of miniaturization are paramount is the fact that the use of such networks affords complete design flexibility.

Reduced Prices on Silicon Semiconductors

Texas Instruments Inc. announces reduced prices on all five types of silicon transistors by 25% and on both types of silicon junction diodes by more than 30%. Texas Instruments has remained the exclusive commercial source for the new high temperature, high frequency silicon transistor since its announcement in May. TI silicon junction diodes were introduced in March.

PERSONAL

David A. Kemper has joined Stancil-Hoffman Corp. as director of engineering. He will handle designs of all magnetic recording and reproducing equipment for the firm.

Rush S. Drake has become field engineer for Eitel-McCullough Inc., electron power tube mfr., covering the territory of Washington, Oregon and part of Idaho and Montana.



R. J. Marshall



F. G. Mullins

Frank G. Mullins, Jr. has joined Fairchild Recording Equipment Co. as mgr. of engineering and Special Counsel and Robert J. Marshall was promoted from Chief Engineer to head of the New Product Development group at this company.

Dr. Ernest A. Lederer has been promoted to the newly created position of chief engineer for Westinghouse Electronic Tube Div. Carmen E. Remich replaces him as manager of engineering and Dewey D. Knowles becomes the new Manager of Product Administration.

Dr. Donald B. Sinclair has been appointed Vice President for Engineering of General Radio Co., Cambridge, Mass. Dr. Sinclair has served the company since 1936 in the capacities of Engineer, Assistant Chief Engineer, and Chief Engineer.



D. B. Sinclair



V. J. Nexon

Victor J. Nexon has been appointed President of Microwave Services, Inc., communications consulting engineer. Col. S. K. Wolf, former President, has been appointed Professor of Management at New York Univ. Graduate School of Business Administration and becomes a senior partner in the consulting firm of Management & Technical Services.

Unexpected peaks like this →



Look like this →



With the →



UNI-LEVEL AMPLIFIER

HERE you have the answer to any audio engineer's prayers. The G-E Uni-Level Amplifier automatically compensates for level changes encountered between different audio sources. Its expansion-compression characteristics smooth out and increase average levels for all types of program material. You'll get higher average output. You'll save time and effort while performance is greatly improved.

USE: In TV-FM-AM Broadcasting • In Public Address Systems • In Recording Studio Applications



MAIL THE COUPON (AT RIGHT) NOW FOR COMPLETE SPECIFICATIONS

General Electric Co., Broadcast Equipment, Sec. X4825, Electronics Park, Syracuse, N. Y. Please send me information and detailed specs on the new G-E Uni-Level Amplifier.

NAME

ADDRESS

CITY STATE

Progress Is Our Most Important Product
GENERAL ELECTRIC

TELE-TECH

CLOSING DATES

25th of second month preceding date of issue, for all ads requiring proofs, composition, foundry work, key changes, etc.

1st of preceding month for complete plates only—no setting.

20th of preceding month—Publication Date. Cancellations not accepted after 1st of preceding month.

Caldwell-Clements, Inc., 480 LEXINGTON AVENUE, NEW YORK

KINESCOPE RECORDING

with **Guaranteed Results!**
OR YOUR MONEY BACK

NOW, A DUAL-PURPOSE AURICON "SUPER 1200" CAMERA with TeleVision-Transcription "TV-T" Shutter...

...designed for Kinescope Recording...and also shoots regular Live Action 16 mm Sound-On-Film Talking Pictures with no Camera modification! The "Super 1200" Camera with "TV-T" Shutter (Pat. Appl'd. for 1949) can Kinescope Record a 30 minute continuous show using 1200 foot film magazines. Write today for information and prices.

USE AURICON "TV-T" KINESCOPES FOR:

- ★ DELAYED RE-BROADCASTING
- ★ SPONSOR PRESENTATIONS
- ★ COMPETITION CHECKS
- ★ PILOT KINESCOPES
- ★ SHOW-CASE FILMS
- ★ "HOT KINES"
- ★ AIR CHECKS

Auricon 16 mm Sound-On-Film Cameras are sold with a 30-day money-back guarantee. You must be satisfied!

Auricon 50 ft. Kinescope "TV-T" Demonstration Films are available on loan to TV Stations and Film Producers. Please request on your letterhead.



BERNDT-BACH, INC.
6926 Romaine St., Hollywood 38, Calif.
MANUFACTURERS OF SOUND-ON-FILM RECORDING EQUIPMENT SINCE 1931

BULLETINS

"Super-High" Voltage Transmission

"Alcoa Expanded ACSR for 'Super high' Voltage Transmission," available at the Alcoa Sales offices of Aluminum Co. of America, 732 Alcoa Building, Pittsburgh 19, Pa., describes basic research, engineering investigations, and the laboratory and field tests involved in the development of ACSR—aluminum conductor, steel reinforced. (Ask for B-2-32)

Cores-Laminations-Shields

A data sheet released by Magnetics, Inc., Dept. X-11, Butler, Pa., illustrates and describes the tape wound cores, laminations, and magnetic shields produced by the company. Bulletin P.C. 103 gives standard sizes, electrical specifications, and finishes of molybdenum "Permalloy" powder cores. Literature available on letterhead request. (Ask for B-2-33)

Germanium Diodes

Hughes Aircraft Company, Semiconductor Div., Florence Ave. at Teale St., Culver City, Calif., offers a brochure that illustrates, describes, and presents engineering data covering a new line of miniature gold junction diodes. (Ask for B-2-34)

Lugs, Connectors and Terminals

Catalog 50, issued by Ilco Copper Tube & Products, Inc., Mariemont, Cincinnati 27, O., is an exceptionally comprehensive and serviceable wire-clipped, loose-leaf publication that presents and graphically indexes the company's extensive line of UL and CSA approved automotive lugs, "E-Z," "Fast-Test," multiple, and rectangular solderless lugs, soldering lugs, crimp and sheet terminals, neutral bars and can neutrals, fuse clips, ground rod clamps, connectors, switch blades, etc. Has an approved "Wire Range Chart." Each product classification has dimensional illustrations accompanied with technical data. (Ask for B-2-11)

Servo

A 24-page illustrated booklet, released by Servo Corporation of America, 20-20 Jericho Turnpike, New Hyde Park, N.Y. pictorially presents the company staff and plant facilities, and some of the more than 50 major equipments, created by the concern. (Ask for B-2-19)

Selenium Rectifiers

Bulletin No. 1006, released by Union Switch & Signal, Division of Westinghouse Air Brake Co., Pittsburgh 18, Pa., describes the basic design and gives the basic application and ratings of "Selenium Slims" and other tubular selenium rectifiers made by the company. (Ask for B-2-20)

Synchronous Recorder

An illustrated folder, prepared by Arcurus Manufacturing Corp., 4301 Lincoln Blvd., Venice, Calif., describes the "Film-O-Tape" recorder that records 16mm single perforated magnetic sound, magna-striped, or 1/4 in. magnetic sound tape. (Ask for B-2-22)

Magnetic Pick-up

Electro Products Laboratories, 4501 N. Ravenswood Ave., Chicago 40, Ill., have released a technical data sheet covering the standard Model 3010-A and miniature Model 3015 magnetic pick-ups; also, the Model 3400A voltage amplifier for magnetic pick-ups. (Ask for B-2-23)

Electricity

Seventh in a series begun in 1948 by the Edison Electric Institute, 420 Lexington Ave., New York 17, N.Y., the 1945-1955 edition of "I Want to Know About The Electric Industry" is presented in the form of answers to 28 questions concerning the U.S. electricity production rank, how fast the country is moving in production, how many customers it has, and how much fuel is used in meeting their requirements. (Ask for B-2-21)

Kenyon TRANSFORMERS
Meet All Government and Commercial Requirements
Inquiries Invited

Kenyon TRANSFORMER CO., INC.
840 Barry St., New York 59

TV Microwave Relay

Raytheon Manufacturing Co., Dept. 6130, 100 River St., Waltham 54, Mass., has announced the release of Bulletin 3-110, an 8-page brochure describing the KTR-100A television microwave relay equipment (Ask for B-2-25)

Electrometers

A new 12-page catalog, released by Keithley Instruments, 3868 Carnegie Ave., Cleveland 15, O., includes introductory data on electrometer characteristics, circuit discussions, and equipment photographs. Seventeen connection diagrams show how instruments are used. (Ask for B-2-24)

Dubbing

The 1954-1955 12-page bulletin C issued by The Dubbings Co., 41-10 45th St., Long Island City 4, N.Y., describes the range of tape and disc recording services rendered by the company's audio laboratory for broadcast stations, sound studios, record companies, etc. (Ask for B-2-12)

Color TV

"Color Television Film Shooting Practices," (Tentative as of Sept., 1954.) prepared by CBS Television Engineering Department, contains tentative recommendations with regard to staging, lighting, cameras, film, and sound recording. (Ask for B-2-13)

Printed Circuitry

The advantages of printed circuitry for electrical and electronic systems are thoroughly covered in a 12-page bulletin, "Mechanize your Wiring . . ." With Copper-Clad Phenolite" issued by National Vulcanized Fibre Co., Wilmington 99, Del. (Ask for B-12-14)

Measuring and Testing Instruments

Federal Telephone and Radio Co., 100 Kingsland Road, Clifton, N. J., has issued a general catalog covering the company's line of capacitors, meters, oscillators, filters, thermometers, measuring sets, etc. Send requests to Rudolf Feldt, manager, Instrument Division. (Ask for B-2-15)

Selenium Rectifiers and Diodes

SR-1A, catalog data bulletin, issued by International Resistance Co., 401 N. Broad St., Philadelphia 8, Pa., presents 8 pages of comprehensive data on construction applications, types, ratings, curves, specifications, and dc characteristics relating to "Microstak" selenium rectifiers and diodes. (Ask for B-2-16)

Transformers

Central Transformer Co., 910 W. Jackson Blvd., Chicago 7, Ill., has issued a 4-page brochure that illustrates a variety of special transformers used in communications, nucleonics, ordnance, and electronic controls, and incorporates a page of formulae used in transformer and reactor computations. (Ask for B-2-18)

Electronic Filters

New literature prepared by Communication Accessories Co., Hickman Mills, Mo., describes the company line additions of electronic filters. The new units are illustrated and their electrical characteristics are given with response curves, sizes, and mounting dimensions. (Ask for B-2-26)

Resistors and Resistor Networks

Cinema Engineering Co., Div. of Aerovox Corp., 1100 Chestnut St., Burbank, Calif., has issued two new catalog sheets. One illustrates and gives technical data covering the CE "PW" resistors for automation and printed wiring; the other similarly covers the CE hermetically sealed resistor networks. (Ask for B-2-28)

OBTAIN THESE BULLETINS

described here by writing on company letterhead to Bulletins Editor, TELE-TECH & ELECTRONIC INDUSTRIES, 480 Lexington Ave., New York 17, N.Y., listing numbers given at end of each item of interest. Please mention title of position held.

UHF Standard Signal Generator

with Low Hum Level



SPECIFICATIONS:

Frequency Range: 300 to 1000 Mc.

Frequency accuracy $\pm 0.5\%$.

Output: 0.1 uv to 1.0 v across a 50-ohm load.

Modulation: 0 to 30% from an internal 1000-cycle oscillator. External modulation from 50 to 20,000 cys. Residual hum modulation less than 0.5%.

Power Supply: 105 to 125 volts, 60 cycles, 120 watts.

Leakage: Negligible.

MODEL 84-TV

FEATURES:

- DC operation of oscillator tube filament.
- Wide continuous frequency coverage.
- Frequency calibration accurate to $\pm 0.5\%$.
- Output dial calibrated in microvolts.
- Negligible stray field and leakage.
- Special design mutual inductance type attenuator.
- Low harmonic content.
- Low residual hum modulation.

USES:

The versatility of this instrument makes it adaptable to many applications within its frequency range; for driving slotted lines and other impedance measuring devices; for measuring the characteristics of UHF filters, traps, antennas, matching networks and other devices.

Laboratory Standards



MEASUREMENTS
CORPORATION
BOONTON · NEW JERSEY

plan your
production
with
KAHLE
machinery

built specifically for your operation

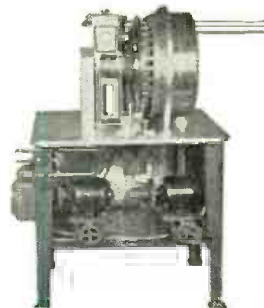

Industry leaders in electronics, glass, and allied fields have continuously keyed their operations to KAHLE Machines for over a quarter of a century. *Your* production rate, *your* specifications, *your* requirements—are "planned-in" KAHLE Machines.

Call KAHLE for
"machines
that think for you!"

Kahle
ENGINEERING
COMPANY

1314 SEVENTH STREET
NORTH BERGEN, N. J.

This New 48-Page Vacuum Pump Catalog FREE On Request

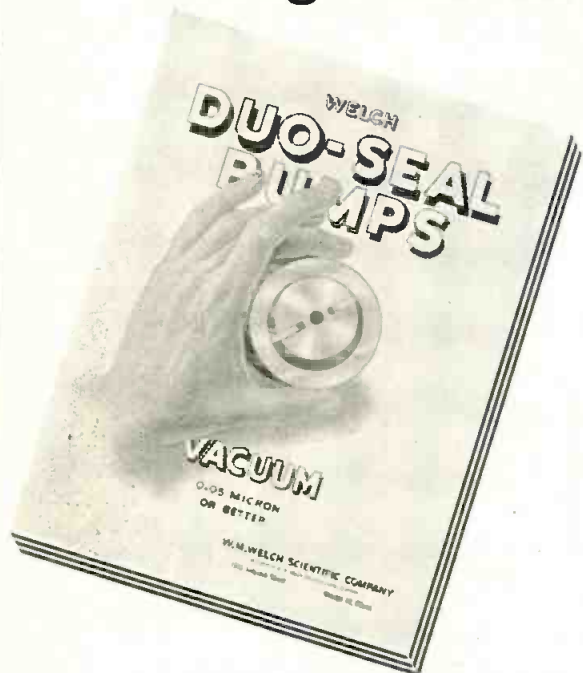

Contains a complete description, including performance of Welch Duo-Seal Pumps ranging from 21 liters to 35 liters per minute, as well as a greatly enlarged listing of Diffusion Pumps, Vacuum Gauges and Accessories.

If you do not have your copy **WRITE FOR IT NOW!**

W. M. WELCH SCIENTIFIC COMPANY
DIVISION OF W. M. WELCH MANUFACTURING COMPANY
ESTABLISHED 1880

1515 Sedgwick St., Dept. J, Chicago 10, Illinois, U.S.A.
Manufacturers of Scientific Instruments and Laboratory Apparatus

1440 pgs.

Fully catalogs Radio-TV-Electronic parts & equipment: Tubes, Transmitters, Test Equipment, Comm. Receivers, Transformers, Capacitors, Antennas, Resistors, Coils & Relays, Recording & PA Systems, Hardware, Tools, etc., etc. **OFFICIAL BUYING GUIDE OF THE INDUSTRY**

1440 page MASTER

for everything in Electronics

Make rapid selections from one industry-wide MASTER CATALOG complete with SPECIFICATIONS, ILLUSTRATIONS, DESCRIPTIONS, DIAGRAMS, PRICES on thousands of Radio-TV-Electronic parts and equipment.

NEW! 1955 BUYING GUIDE

List \$6.50

As low as **\$1.95** • Over 85,000 • Fully indexed items • 8½" x 11"
as • Over 8,500 illus. • Weighs 6 lbs.

From leading parts distributors or write to:
UNITED CATALOG PUBLISHERS, INC.
110 Lafayette Street, New York 13, N. Y.

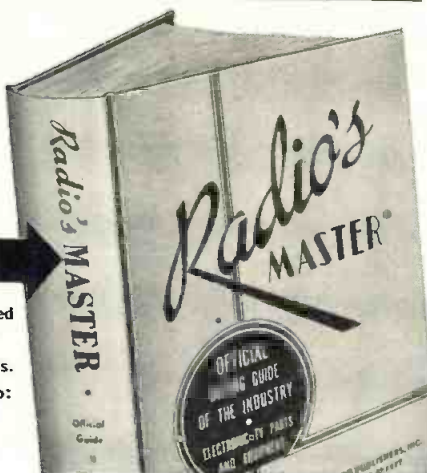

IMPORTANT NOTICE TO READERS

Changes of address require four weeks' notice. Notify your Postmaster and TELE-TECH Circulation Department at the earliest possible moment.

When ordering change, please **INCLUDE IMPRINTED WRAPPER** showing exactly how magazine is now addressed. This will enable us to put the change into effect with a minimum of delay.

"Vendor Rating"

(Continued from page 71)

could not be efficiently assimilated into the plan as envisaged.

The solution to this problem was found in the punched card machine section, which had already been used for Payroll, Accounting, and other departments. The Calculators, Sorters, Collators, and other machines in this section proved to be ideal for the compilation and recording of the extensive Vendor Rating Data.

Rating the Vendor

With this accomplished, the Quality Control Engineers concentrated their efforts on devising a method of rating the vendor. Here, the problem involved the complex mathematics peculiar to the science of Statistical Quality Control. By the use of a well-known "test of significance" formula, and with reference to the Government's AQL standards, a simple 0-100 rating range was established.

With the rating of 70 taken to be acceptable quality, it was then possible to rate each vendor according to the quality of his product, and to see, at a glance, whether or not he was measuring up to the quality standards established. With each vendor's rating plotted monthly on an individual graph, a continuous history of vendor quality was provided. Colored tabs affixed to the cards permit a quick check of the vendor's quality level. Gold indicates top quality, a green tab means acceptable quality, and yellow is for unacceptable quality. A vendor who is rated unacceptable for three successive months is given a red tab which indicates that corrective action must be taken. The graph cards are posted on a large rack in the Quality Control office.

The success of the Vendor Rating System cannot be measured solely on the basis of its usefulness in selecting suppliers, although it has made that problem a great deal less difficult. The long-run value of the system is in its contribution to the smoothness of the overall relationship between purchaser and vendors.

Vendor Conferences

When a vendor gets a red tab, a conference is arranged between the vendor and representatives of Purchasing and Quality Control. Usually, this meeting is held in the plant and the vendor is given a chance to see the Vendor Rating System at first hand. When it is not

possible to arrange a meeting in the plant, the Quality Control Department's Field Engineers are called on to confer with the vendors. With the precise information that the System provides, quality problem—in most cases—can be ironed out in these meetings. Oftentimes, the trouble is in misinterpretation of prints and specifications and a simple discussion is all that is necessary to prevent further rejections.

The most important effect of these meetings and the cooperative action that they produce is the improvement of product quality. In addition, they permit a valuable exchange of ideas on overall quality control operations . . . an exchange that is particularly beneficial in that it deals with the very practical aspects of the subject . . . it gets down to the "dollars and cents" level. And, with the two different viewpoints represented in open discussion, minor flaws in procedures and techniques are revealed, discussed, and usually corrected.

Fig. 1 illustrates the results of one of these conferences. "X Company," a manufacturer of electronic components, had a zero rating for many months. Frequent letters and telephone calls had produced no results. Yet, this same vendor had an industry-wide reputation for quality components. A conference revealed that most of the rejects were the result of print misinterpretation. The graph shows the effects of this conference.

Other Advantages

Many additional benefits have resulted from the installation of the system. First, it has helped to foster cooperation between Bendix Radio and its vendors. As stated in a booklet recently sent to all our vendors, when an accepted shipment is acknowledged, it means that "Bendix Radio and one of its vendors have gone into partnership . . . not in the accepted sense, to be sure, but a partnership, nevertheless, in which Bendix Radio and the vendor are cooperating to turn out a quality product."

Secondly the Vendor Rating System has already done much toward eliminating conditions leading to rejected material. The presence of vendors' representatives in the plant eager to discuss the new system, and their increasing realization that the system can help them improve their positions in today's highly competitive market are signs of a developing spirit of cooperation that can do a great deal of good.

The Vendor Rating System has

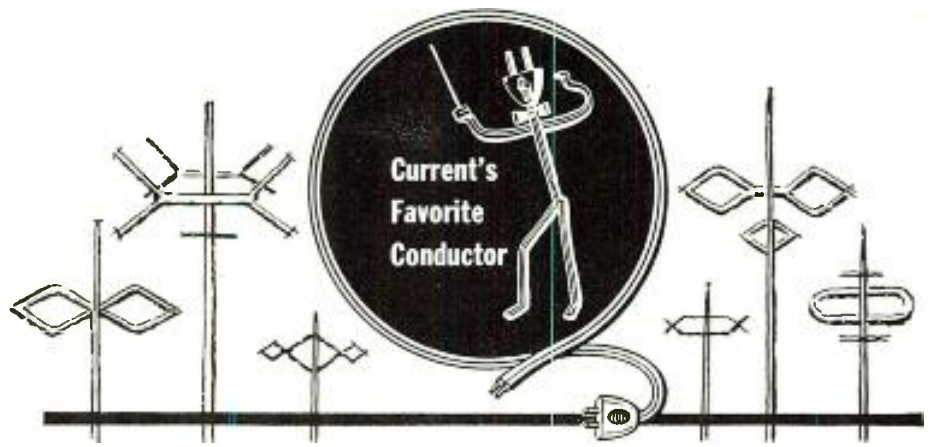

Stay Tuned To Quality In Radio - Television Wires & Cables **PHALO QUALITY**

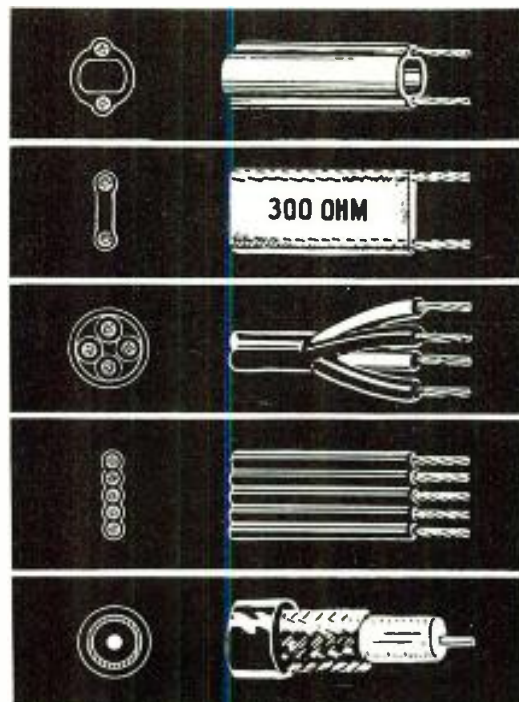

PHALO TUBULAR
300 OHM LINE

•
PHALO FLAT
300 OHM LINE

•
PHALO ROUND
ROTOR CABLE

•
PHALO 4/C FLAT
ROTOR CABLE

•
PHALO SOLID
COAXIAL CABLE

For A More Complete
Phalo Quality Story
— Get This Catalog



PHALO PLASTICS CORPORATION

21-25 FOSTER STREET, WORCESTER, MASS.

Southern Plant: Monticello, Miss.

Insulated Wires, Cables and Cord Set Assemblies

Cunningham
ESTABLISHED 1930



crossbar

A truly superior switch
for
**MASTER CONTROL AND
MONITOR SWITCHING OF
AUDIO & VIDEO CIRCUITS**
Also
**COMPUTERS • TELEMETERING
TELEPHONY • DELAY LINES
ETC.**

Advantages

Extreme flexibility
Fast quiet switching
Crosstalk down 60 Db at 10 MC
Any group of setups may be held
intact while setting up others
Provision for spot or remote control
Strapwiring eliminated
Excellent HF characteristics
Palladium contacts
Reduced cost
Compact design, small size
Low operating power—2.5 watts
Simple "package" installation

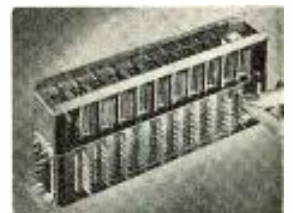

- Individual magnets at each cross-over.
- Maximum, six conductors per circuit.
- Life-tested to 100 million operations.

JAMES CUNNINGHAM, SON & CO., INC.
Dept. T-1, Rochester, New York Tel: BAKER 7240

High Dielectric Bobbins



For High "Q" Coils

PRECISION

MADE TO YOUR EXACT SPECIFICATIONS IN ANY SIZE, SHAPE, QUANTITY

Precision coil bobbins are fabricated from high dielectric materials and quality controlled to the most minute tolerances . . . Yet, because they are made on special high production equipment, they're available to you for prompt delivery at low unit cost.

Cores are spirally wound dielectric kraft, fish paper, acetate, phenol impregnated or combinations. Flanges are cut to any specification for all types of mountings.

Request illustrated bulletin. Send specifications for samples.

We also manufacture paper tubes in all sizes, shapes, ID's and OD's.

Sales Representatives in:

- | | |
|---|---|
| New England:
Framingham, Mass., Framingham 7091 | Philadelphia:
Philadelphia, Pa., Chestnut Hill 8-0282 |
| New York, New Jersey:
Jersey City, New Jersey,
Journal Square 4-3574 | Northern Ohio, Western Pennsylvania:
Cleveland, Ohio, Atlantic 1-1060 |
| Upstate New York:
Syracuse, N.Y., Syracuse 76-8056 | Indiana, Southern Ohio:
Logansport, Indiana, Logansport 2555 |
| Maryland:
Baltimore, Maryland, Plaza 2-3211 | Missouri, Southern Illinois, Iowa:
St. Louis, Missouri, Sterling 2318 |
| Canada: Montreal, Quebec, Canada, Walnut 2715 | California:
Pasadena, California, Sycamore 8-3919 |



PRECISION PAPER TUBE CO.

2057 W. CHARLESTON ST. CHICAGO 47, ILL.
Plant No. 2: 79 Chapel St., Hartford, Conn.
Also Mfrs. of Precision Coil Bobbins

For **HEAVY DUTY WORK!**
Severest Electrical Services

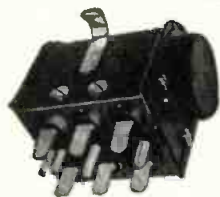

P-506-CE—Plug with Cap



S-506-DB
Socket with deep Bracket

**JONES
PLUGS &
SOCKETS**

**500 SERIES
Proven Quality!**

For 5,000 Volts, 25 Amperes
per Contact Alterable by circuit Characteristics.

Socket contacts of phosphor bronze, knife-switch type, cadmium plated. Plug contacts hard brass, cadmium plated. Made in 2, 4, 6, 8, 10, and 12 contacts. Plugs and sockets polarized. Long leakage path from terminal, and terminal to ground. Caps and brackets, steel parkerized (rust-proofed). Plug and socket blocks interchangeable in caps and brackets. Terminal connections most accessible. Cap insulated with canvas bakelite.

Write for Jones BULLETIN 20 for full details on line.



Jones

HOWARD B. JONES DIVISION
CINCH MANUFACTURING CORPORATION
CHICAGO 24, ILLINOIS
SUBSIDIARY OF UNITED-CARR FASTENER CORP.

Write today for your free
copy of this Technical Paper.

ask for data file

206

A Precise, Wide-band,
Continuously Variable
Delay Line

BY NORMAN GAW, JR.
AND DAVID SILVERMAN
Helipot Corporation
MELVIN B. KLINE
Instrument Division
Allen B. DuMont Laboratories, Inc.

Presented at THE 1954 WESCON

436



Helipot

first in precision potentiometers

Helipot Corporation / South Pasadena, California

a division of BECKMAN INSTRUMENTS, INC.



**printed
circuits**

Write for bulletin
"laboratory quality at
mass production cost"
covering basic printed
circuit design and pro-
duction information.

Specialists in advanced
Circuitry design and
production.

printed circuits, inc.
BLOOMFIELD, CONN.

“Vendor Rating”

(Continued from page 141)

also benefited the Research and Development and Design sections. One of the chief problems in these sections is the procurement of the high-quality components often needed in the construction of pre-production units and in other phases of their operations. The Vendor Rating System provides a ready reference list of high-rated vendors which is very useful in this special type of purchasing.

Still another benefit is the present plan for reduced sampling. In essence, reduced sampling is a prescribed procedure for reducing sample size in the inspection of incoming shipments. It is permitted—where military contracts are concerned—only after certain very precise requirements are met. In order to satisfy these requirements, complete records of vendor product quality must be available.

During the course of their work on vendor rating, the Quality Control Engineers noted that the formulae used in calculating quality ratings were very similar to those ordinarily used in setting up a reduced sampling plan. Moreover, the data to be compiled under the Vendor Rating System appeared to be adequate for reduced sampling. A study of the subject was initiated, which resulted in the present reduced sampling plans; these plans save hundreds of dollars every month.

Additional advantages evolving from expanded use of the punched card machines were tabulation of scrap reports, assembly reports and inspection data, delayed disposition system providing constant surveillance over movement of incoming material, simultaneous records for Accounting, Product Control and Receiving departments and reduction in file space, increased ease in handling and improvement in accuracy and efficiency.

Thus, the value of the Vendor Rating System consists not only in its success in providing useful information about the quality of products but it also initiated new plans and ideas for Quality Control.

IFI Moves

Instruments for Industries, Inc., electronic development and production firm, has moved to the building at 150 Glen Cove Rd., Mineola, recently vacated by the Cox & Stevens Aircraft Co. IFI was formerly located on Old Country Rd., Mineola.



Custom-made Metal Enclosures and Components
for Radio - Electronic Industries

A prime and dependable source in metal
fabrication since 1906.

Cabinets • Consoles • Enclosures
Panels • Chassis • Frames

Shock-mounted cabinet, telescoping chassis.

Stainless and non-ferrous cases and chassis.

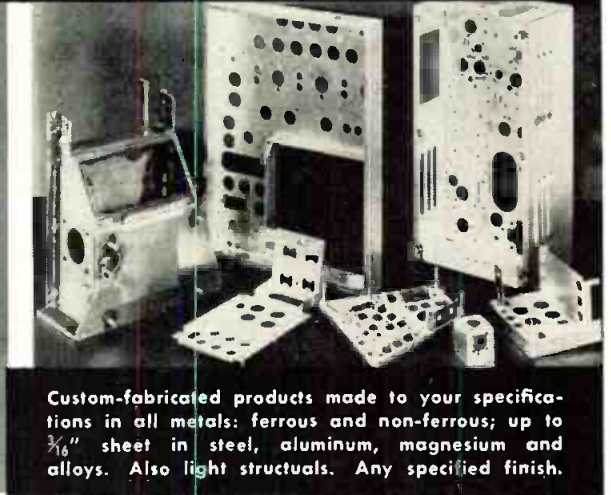
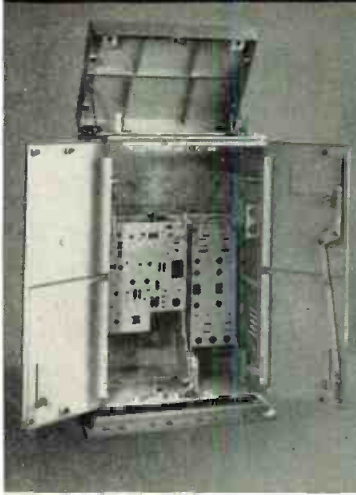

Custom-fabricated products made to your specifications in all metals: ferrous and non-ferrous; up to 3/16" sheet in steel, aluminum, magnesium and alloys. Also light structurals. Any specified finish.

BENNETT

MANUFACTURING COMPANY

38 RAILROAD STREET
ALDEN, NEW YORK

WRITE TODAY for our new
FACILITIES CATALOG —
a colorful 16-page brochure.

REPRESENTATIVES:
Some territories open.
Write for details.
Dept. T-2

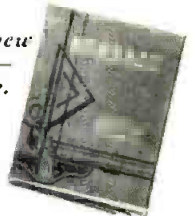

Stability and Opportunity for ELECTRONIC ENGINEERS who want more room to grow

Top opportunities for achievement and recognition are open at FTL... key unit of the world-wide, American-owned IT&T System. FTL's long-range development program offers stability and security. Finest facilities — plus broad and generous employee benefits.

INTERESTING ASSIGNMENTS IN:

Radio Communication Systems • Electron Tubes
Microwave Components • Electronic Countermeasures
Air Navigation Systems • Missile Guidance
Transistors and other Semiconductor Devices
Rectifiers • Computers • Antennas
Telephone and Wire Transmission Systems



SEND RESUME TO:
PERSONNEL MANAGER,
BOX TT-2

Federal Telecommunication Laboratories

A Division of INTERNATIONAL
TELEPHONE AND TELEGRAPH CORPORATION
500 Washington Avenue, Nutley, N. J.

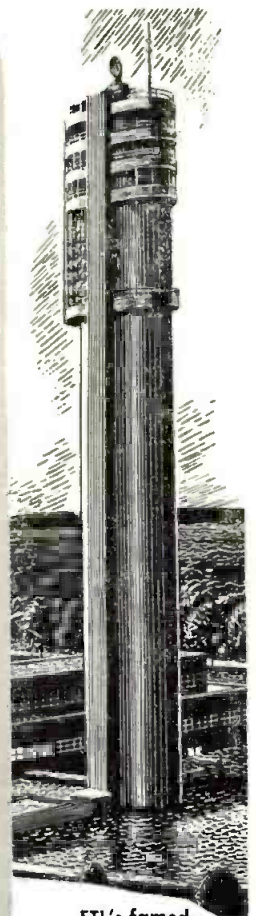

FTL's famed
Microwave Tower
— 28 minutes
From N. Y. C.

Developers
of the
Corporal
Guided
Missile.



JET PROPULSION LABORATORY

CALIFORNIA
INSTITUTE OF
TECHNOLOGY

*Active in all phases
of electronics and physics
related to guided missiles
and jet propulsion.*

The nation's foremost guided-missile research and development facility, established in 1940, offers exceptional opportunity for engineers and research scientists in the fields of guidance and control, information theory, computers, electro-mechanical devices, instrumentation, and related aspects of electronic research. The Laboratory offers an ideal blend of academic and industrial environments and maintains a high level of technical competence. Attractive salaries are offered.

*A brochure describing
opportunities and activities
at the Laboratory will be
sent upon request.*

JET PROPULSION LABORATORY

California Institute of Technology
4800 OAK GROVE DR.,
PASADENA 3, CALIFORNIA

News of MANUFACTURERS' REPS

Manufacturers Reps are wanted in the New York City and Philadelphia areas as well as for the states of Ohio and Indiana to sell a line of soldering irons imported from England. (Ask for R-2-1)

William G. Kelly has been named sales representative in Iowa and Nebraska for Pyramid Electric Co., N. Bergen, N. J.

J. E. Joyner, Jr. has been appointed rep for Orradio Industries, and, with Harry Cole and Went Moore, will cover the territory of Ala., Ga., S. Car., N. Car., Tenn.

Tri-Onic Sales, Inc. of Detroit, Mich., have been appointed Industrial Sales Rep for Erie Resistor Corp.

A. T. R. Armstrong, Ltd., 700 Weston Rd., Toronto 9, Ont., Can. have been appointed Canadian Sales rep. for the capacitor Div. of Good-All Electric Mfg. Co., 112 W. First St., Ogallala, Neb. H. E. Walton Co., 15310 E. Warren Ave., Detroit, Mich., have become Michigan sales reps for this division and Wm. J. Doyle Co. 7002 N. Western Ave., Chicago, Ill., will cover the state of Wisconsin for the firm.

Tubergen Assoc., with offices at 2232 W. 11th St., Los Angeles 6, Calif. have been appointed reps for Monson Mfg. Co. in the southern Calif.-Ariz. area. Exclusive representation in the Nev.-North and Central California area has been awarded to Harold Newman, 420 Market St., San Francisco 11, Calif., and Howell Sales Co., 1250 First Ave. S., Seattle 4, Wash. will cover Wash., Ore., Ida., W. Mont., British Columbia and Alaska for the firm. In the east, the firm has appointed Koppke Associates, 60 E. 42nd St., New York 17, N.Y. to represent it in N.Y., Long Island, northern N.J. and lower Conn. Lowry Dietrick, 1401 Swantek St., Pittsburgh, Pa. covers western Pa. and W. Va., Earl Schenck, P. O. Box 223, London, Ohio covers Ohio, Ind., Ky., and Tenn., and Tri-Onic Sales, 10116 Puritan St., Detroit, Mich. covers Michigan and Toledo, Ohio.

Engineering Services Co., located at 6635 Delmar Blvd., St. Louis, Mo. have become sales and engineering reps for Teletronics Lab., Inc., 54 Kinkel St., Westbury, N.Y. in the territories of Mo., Kans., Neb. and Ia.

Allen S. Nace, 7601 Parkview Rd., Brecksville, Ohio, will represent Centralab industrial and manufacturing accounts and Frank A. and James Daugherty of 1120 Croyden Rd., Cleveland, will serve distributor accounts in Ohio, excepting Dayton and Cincinnati, and in Erie, Crawford, and Mercer counties of Pa.

Robinson Aviation, Inc. of Teterboro, N. J. have appointed the following Mfrs., reps for the Airborne and Industrial Divisions: Associated Engineering Service, Inc., Washington 5, D. C. to cover Dist. of Col., Md. and Va.; Engineered Sales Co., Chicago 41, Ill. to cover Ia., Wis., Ind. and No. Ill.; and Engineering Sales Co., St. Louis 5, Mo. to cover Mo., Kans., Neb. and So. Ill.

L. M. Beier Co., with offices at 6518 W. North Ave., Chicago 35, Ill. will represent Leach Relay Co. Div. of Leach Corp. in the states of Ill., E. Ia., E. Wis., while B. S. Woodman, Inc., of 1570 Northside Drive, N.W., Atlanta, Ga. will cover the states of Ala., Fla. and N. C.

John G. Twist Co., 2800 N. Milwaukee Ave., Chicago, Ill. will represent Bradley Labs., Inc., mfr. of selenium and copper oxide rectifiers and self-generating photoelectric cells in the territory of Ill. and Wis.

East Asiatic firms newly appointed to represent Aircraft Radio Corp of Boonton, N.J., are C. Itoh & Co. of Tokyo and Thai Wealth Corp., Ltd. of Bangkok, Thailand.

International Rectifier Corp., El Segundo, Calif. has appointed Atlas Radio Corp., Ltd., 560 King St., W., Toronto 2b, Ont. Can., as exclusive sales reps throughout Canada.

Edward F. Aymond Co., 4312 Maple Ave., Dallas, Tex., are reps covering Texas (excluding El Paso), Okla., Ark. and La. for Dale Products Inc. of Columbus, Neb.

Miles C. Wagner, Jr. of 215 E. River Rd., Tucson, Ariz. has become representative for the complete line of electronic hardware made by Lerco Div. of Lynn-Deatrick, Inc., in Ariz., N.M., Colo., Utah, and the San Diego, Calif. area.

L.A. "REPS" OFFICERS



1955 Officers of Los Angeles Chapter of "The Reps" are (l. to r.) Mal Mobley Jr., Exec. Secy.-Treas.; W. Bert Knight of W. Bert Knight Co., President; Vern T. Rupp of V. T. Rupp Co., Vice-Pres.; and Walter S. Harmon of W. S. Harmon Co., Secy.-Treas.

NEW! 1955

**MICROTRAN
TRANSFORMER CATALOG!**

LISTS HUNDREDS OF MINIATURE
TRANSFORMERS AVAILABLE
AS STOCK ITEMS!

Miniaturizing? Don't gamble!
Use these field-tested and
proven MIL-T-27 type designs.

- No sampling expense — no wasted time!
- Eliminate redesign of production equipment!
- Used in guided missiles, airborne equipment, servos, transistor amplifiers, high temperature applications, and many, many other applications.

Immediate delivery at key industrial distributors!

Write — right away

— for the brand new 1955 Microtran Catalog! Gives detailed information about available stock items: Hermetically Sealed, Molded, Encapsulated, Cased.

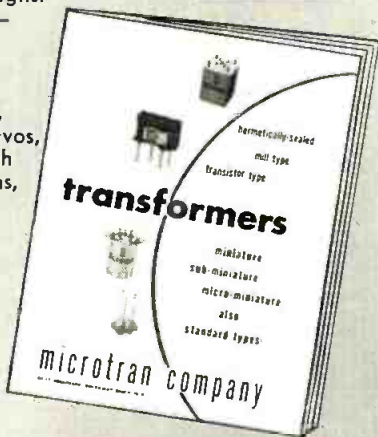

microtran co. 84-11 Blvd., Rockaway Beach, N.Y.

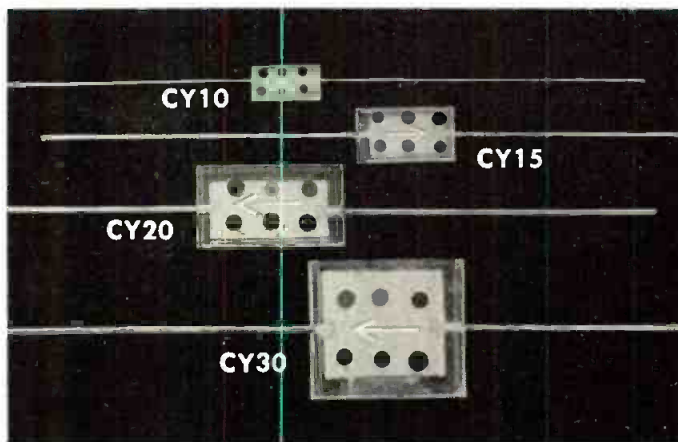

Corning Fixed Capacitors are alternate layers of conductor and dielectric sealed under heat and pressure in a glass case of same composition as the dielectric. Result is a monolithic structure. Shown actual size are four standard pigtail types.

**CORNING
FIXED GLASS CAPACITORS**

stable, rugged, miniaturized

Corning Fixed Capacitors assure excellent moisture resistance, high temperature operation, and extremely high reliability. Now in mass production, these capacitors are available at attractive prices.

Check these features of Corning Capacitors —

The Dielectric—A homogeneous, scientifically produced continuous ribbon of glass; no foreign inclusions, no cracks, no imperfections.

Construction—Only three simple elements: (1) The glass dielectric and case of identical composition; (2) active metal foil plates; (3) the pigtail wire leads—bright, clean and ready to solder. No potting materials, no impregnants, no mechanical slips, no plastic cases. Corning Fixed Capacitors are fused together into a solid, strong, monolithic block. To affect or change their excellent electrical characteristics, you would have to mechanically destroy the capacitor.

Electrical Characteristics—(A) Temperature coefficient is $+140 \pm 25 \text{ ppm}/^\circ\text{C}$. over the range of -55°C . to $+85^\circ\text{C}$. Variation of TC at any given temperature between individual units is less than 15 ppm. The TC remains the same after repeated cycling. The capacitance drift is less than 0.1% and usually less than the error of measurement. This means reliable, predictable circuit control. (B) Dissipation factor is not more than 0.1% at 1 kilocycle.

Operating Temperature—Standard temperature range of -55°C . to $+85^\circ\text{C}$. can be extended to 150°C . with derating. Units available to Military Specification MIL-C-11272A.

Miniaturization—The illustration above shows four standard pigtail types of Corning Fixed Capacitors actual full size. We can pack a lot of capacitance into a small space. The CY10, for example, measuring $\frac{3}{16} \times \frac{3}{16} \times \frac{3}{16}$ is available up to 240 uuf at 300VDCW. The CY30 is available up to .01 uf at 300VDCW.

Tolerances—The standard tolerance for capacitance is $\pm 10\%$. Units are also available in 5, 2 and 1% tolerance.

We would like to send you additional information, prices, and samples.

We invite discussion of variations you might need for custom applications, and we manufacture many special types of capacitors. Write, wire, or phone us.

Other Corning Capacitors

- Medium Power, Transmitting
- High Capacitance, Canned
- Subminiature Tab Lead
- Special Combinations



CORNING GLASS WORKS

New Products Division
CORNING, NEW YORK

Corning means research in Glass

**CHANGEABLE
CHASSIS**



Speed-Chassis

The Speed-Chassis is a flexible breadboard assembly with interchangeable socket arrangements which can be mounted on a relay rack. Dust cover and panel are available to make successful breadboard assemblies both permanent and neat.

Four insulated tie-point strips and one grounded tie-point strip are provided. Individual plates are available, with holes already punched, to fit all needs. In addition, three sizes of blank plates are cataloged.

IMMEDIATE DELIVERY



SPECIFIC PRODUCTS

14515 DICKENS STREET
SHERMAN OAKS 4, CALIF.

WHERE PERFORMANCE COUNTS

specify these 3 ϕ , 400 ~ isolation transformers

Hermetically sealed meet MIL-T-27 grade 1, class A requirements

Primaries 115V, 3 ϕ Δ
380-1000 cycles

T-806-H Sec. 26V, 3 ϕ Y
0.65 amp A.C. per ϕ

T-810-H Sec. 26V, 3 ϕ Y
1.3 amp A.C. per ϕ

	Dimensions	Weight
T-806-H	2½" x 4" x 1½"	1.95 lbs.
T-810-H	3½" x 4" x 1½"	2.4 lbs.



Write today for quotation on your special requirements.

PEERLESS
Electrical Products

A DIVISION OF



9356 Santa Monica Blvd., Beverly Hills, Calif.
161 Sixth Avenue, New York 13, New York

Letters

(Continued from page 50)

graduate training. As evidence of this, many schools have been forced to abolish the thesis requirement at the Master's level because of lack of research facilities and supervision.

We are reaching the point at which the Master's Degree will mean no more if as much as the Bachelor's Degree did 25 years ago and the next logical step will be to degrade the Doctorate and impose a new super post-doctoral program. In short, we could approach the absurdity of "letting education eat up life" and not releasing our best scholars until they have passed their most productive years. A fourth indictment of our engineering educational system is that advancement in the teaching profession is coming to depend too much upon publications and acquisition of advanced degrees and too little upon outstanding teaching ability. The trouble, of course, is that engineering education is one of the "screwiest" professions man has ever devised, in the sense that untrained teachers (often graduate students with no real interest in teaching) are made instructors and thrown up against the flood of students with no opportunities for supervision or correction of their classroom mistakes. Department chairmen cannot install dictaphones or television cameras in classrooms to supervise their staff and can't even visit a class without danger of upsetting the instructor's equilibrium. Consequently, they learn of their poor instructors only through belated student protests and learn of their good ones chiefly through contact with reminiscing alumni. Imagine what any factory would be like if the foremen were locked up in offices!

Obviously, I can't offer solutions to all these problems, but a few points seem worth thinking about. We may need two types or levels of engineering education: one for the average engineers and a more intensive and deeper training for the smaller number of those who are capable of it. This special training probably will require special schools where all such students will be in competition with those of their own intellectual bracket. Most states probably could not support and operate such schools so they may need to be subsidized at the national level.

One last observation: — though there is a need to train super-engineers, there is a terrifically greater need to train super-diplomats. One tenth of our expenditure on defense,

DIRECTIONAL TV-Transmitting ANTENNA AMCI Type 1030

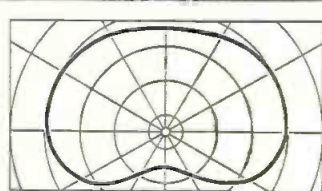
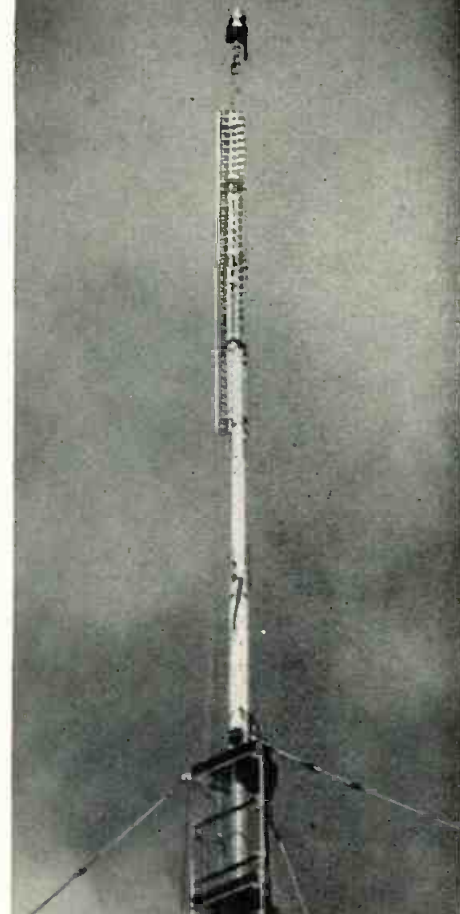

Similar to the Type 1040 Slotted-ring Antenna, but with pattern shaping members connected to alternate active rings, the Type 1030 provides a controlled pattern adjustable to service requirements. Pattern and antenna shown are of WEAT-TV, Channel 12, West Palm Beach, Florida.

Easy installation is an important advantage of the type 1030 Antenna. This lightweight, yet sturdy, antenna can be easily and conveniently mounted on supporting mast after mast has been erected.

Ask for Bulletin T-255

ANTENNA SYSTEMS—COMPONENTS
AIR NAVIGATION AIDS—INSTRUMENTS



ALFORD
Manufacturing Co., Inc.
299 ATLANTIC AVE., BOSTON, MASS.

ENGINEERS

DESIGNERS • DRAFTSMEN

Electronic Mechanical



THE MELPAR SYMBOL STANDS FOR Growth - Progress - Leadership

IN RESEARCH AND DEVELOPMENT
OF ELECTRONIC EQUIPMENT

Diversified and Challenging
Problems

A real appreciation and
recognition of
the individual's merit and ability

An opportunity for
qualified men to join a
company that is steadily growing

A location that offers
many advantages

Our
Technical Personnel
Representative will give
you complete details of the
opportunities available to men
qualified in the following fields:

- Network Theory
- Microwave Technique
- UHF, VHF or SHF Receivers
- Analog Computers
- Digital Computers
- Magnetic Tape Handling Equipment
- Radar and Countermeasures
- Packaging Electronic Equipment
- Pulse Circuitry
- Microwave Filters
- Flight Simulators
- Subminiaturization Techniques
- Electro-Mechanical Design

send complete resume to
Technical Personnel Representative,

melpar, inc.

A Subsidiary of the Westinghouse Air Brake Co
452 Swann Ave., Dept. TT-14
Alexandria, Virginia
or 11 Galen St., Watertown, Mass.

if used intelligently, could train a terrific team of true career diplomats who might keep us out of these periodic international messes. Isn't it silly to support three national institutions for training the world's finest officers, and not have a similar institution for training diplomats? Diplomacy should be our first line of defense and we should settle for nothing short of the best.

(Name withheld)

(The writer of this letter is a former Chairman of the Electrical Engineering Dept. of a leading university. He is presently in charge of a phase of military electronic development at a major company. Ed.)

Use of Immigrants

Editors, TELE-TECH:

Your article "Stop wasting Engineers" was followed by an equally important and pertinent editorial, "It's Later Than You Think." (Sept. & Dec. 1954 issues.)

I agree with your proposals 1 to 10 in principle, but I would think, that point 9 has greater importance than you seem to attach. After all, what's the use of talking about "career opportunities" if we cannot produce figures that will match many salesmen's?

A further means for relieving the shortage can be found to some extent by allowing a greater number of specialists to immigrate. Look at Canada. Its industrial expansion was assisted by the influx of American capital and European technicians, latter word being used in a broad sense.

I am in the electronics industry up here, and I have occasion to talk to representatives from American firms about typical engineering, assembly and test departments for radar etc., where immigrants constitute 20-50% of the work force, with gratifying results. They are always surprised and impressed by the large proportion of immigrants employed.

There is of course the question of security restrictions—but let's not fool ourselves! With millions engaged in this industry, it simply can't be airtight. Besides, our best security measure must be our constant progress—which is so much jeopardized.

Keep up your campaign, and let me congratulate you again!

Very truly yours,
Harold G. Lenz
Project Engineer

Broadcast Transmitter Engineering
Canadian General Electric
Toronto, Canada

(Continued on page 148)

The chair you try before you buy



ROYAL

America's most popular
INDUSTRIAL
CHAIR...

INCREASES EFFICIENCY
INCREASES WORK OUTPUT

60 DAY FREE TRIAL

Now—test Royal's famous No. 515 chair in your own plant without cost or obligation! See why the country's top firms choose it for superior durability and versatility. Write for free trial chair today!

metal furniture
since '97



ROYAL METAL MANUFACTURING CO.
175 N. Michigan Ave., Dept. 122, Chicago 1
Factories: Los Angeles • Michigan City, Ind.
Warren, Pa. • Walden, N. Y. • Golt, Ontario
Showrooms: Chicago • New York City
Los Angeles • San Francisco
Authorized dealers everywhere

MAIL COUPON TODAY!

Royal Metal Mfg. Co., 175 N. Michigan Ave.,
Dept. 122, Chicago 1, Ill.

- We want to test your No. 515 stool for 60 days without obligation. Send short _____ tall _____ model.
- Please send your new catalog of industrial seating.

Name _____

Firm Name _____

Address _____

City _____ Zone _____ State _____

TOP QUALITY

Broadcast/Communication
Transmitting Components

High Power Variable and Fixed Inductors

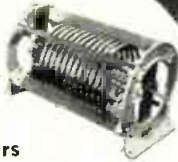

Pioneers in the inductor field for commercial equipment, Johnson's complete line begins with small wire wound units for low power stages and extends to big, high power copper tubing types. There's a Johnson inductor "your size" and all offer you the benefit of many years engineering achievement and highly advanced production techniques.



RF Contactors

Designed for high voltage RF switching—suitable for many other applications. Fast action—rugged and compact. Two sizes: 17 KV and 22 KV peak. Current: 25 amps. per contact, no holding current required. Mounts in any position.



Tower Lighting Filters

Low impedance to 60 cycle current—high impedance to RF. Antenna radiation resistance changed less than 1% to comply with FCC regulations. Also serves as a static drain device when used with grounded AC circuits. Three windings rated 10 amps. each at 60 cycles—impedance 0.3 ohms. Available for panel mounting or in weatherproof cabinet

Other Johnson Broadcast Accessories

- Phase Sampling Loops
- Isolation Inductors
- Static Drain Chokes
- Strain and feed-thru insulators

New Catalog!

Johnson manufactures a wide range of components and equipment for broadcast and commercial transmitter applications. A complete broadcast equipment catalog is available on request—write to:

BROADCAST SALES DIVISION



E. F. JOHNSON COMPANY

225 SECOND AVE. S.W. • WASECA, MINN.

Letters

(Continued from page 147)

Technicians Needed

Editors, TELE-TECH:

Your editorial "Stop Wasting Engineers!" in the September, 1954, issue of TELE-TECH & ELECTRONIC INDUSTRIES was very enlightening. We have read and reread it with increasing interest particularly in view of a number of other articles dealing with the same subject—notably the one by Benjamin Fine in the New York Times of November 7. Since we are also interested in technical training, the problem of qualified technical people is of profound interest, and we feel that the problem of training is of interest not only to government and the public, but also to private industry. We are interested in the technician as well as the engineer and scientist in that many engineers are forced to devote time to activities that technicians could adequately handle. In many cases an adequate technician backup would release engineering personnel so they could assume their proper activities, thereby increasing individual and over-all productivity.

Sincerely yours,
Gail W. Woodward

Technical Dept.
Philco Corp.
22 St. & Lehigh Ave.
Philadelphia 32, Pa.

New RCA Laboratory

An engineering laboratory for the development of specialized electronic fire-control systems for military aircraft will be established by RCA in the greater Boston area. Dr. Robert C. Seamans, Jr., nationally known authority on airborne electronics, has been appointed manager. Location is still to be determined, but it is expected to be equipped and in operation by early February. By the end of 1955, it will provide employment for approximately 100 scientists, engineers, and laboratory personnel.

Canadian Missile Award

Award of an initial contract for electronic timing equipment for the Canadian Dept. of Defense's new test facility near Edmonton, Alberta, has been announced by Burgess Dempster, president of Electronic Engineering Co. of California. The contract calls for the design and construction of electronic timing equipment similar to that developed by Electronic Engineering Co. for the U. S. Navy and the U. S. Air Force guided missile test facilities.

CHOOSE JOHNSON

FIXED OR VARIABLE INDUCTORS

for

- Commercial and Military Transmitters
- Electronic Heating Equipment
- Electronic Medical Devices

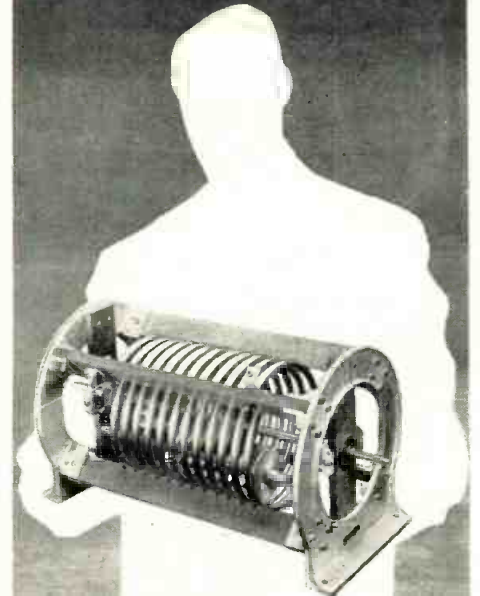

Wondering about an inductor for high power RF equipment? Frequently, the perfect choice is a standard inductor made by Johnson, pioneer manufacturer in the commercial inductor field.

With an unmatched choice of types and sizes, an inductor from Johnson's complete line may solve your selection problem—and economically too!

224 SERIES. Illustrated above—finest quality, heavy-duty variable inductor available for high power RF applications, the 224 copper tubing wound variable inductor is especially designed to handle heavy current in continuous duty. Conductors and contact wheel assembly are heavily silver plated with silver soldered terminations to withstand heating. Cast aluminum end frames allow maximum air circulation and maintain perfect winding alignment. Models with maximum inductance ratings from 14.5 to 75 μ h are available with 30 and 40 ampere current ratings. Special 224 inductors are available in designs for operation to 54 mc and above—corona shields, other special equipment may be supplied on order.



200 SERIES

A sample coil from the 200 series illustrates the general construction features which have made these coils virtual "standards" for industrial and broadcast use. Essentially airwound, with slotted, glass bonded mica supports, their open construction provides exceptional current carrying capacity for their size. Extremely compact due to edgewise copper windings—they're economical, easy to mount and offer a choice of inductances from 8 to 320 μ h. Nominal 10, 15, 20 amp. ratings.

There is a Johnson Inductor "your size"! Fixed or variable units, wire wound, edgewise wound and tubing wound are available for high or low power applications. Write today for your free copy of the new Johnson Inductor Catalog. Address inquiry to:

Broadcast Sales Department



E. F. JOHNSON COMPANY

224 SECOND AVE. S.W. • WASECA, MINN.

FIXED

and adjustable

CINEMA

attenuators

for

CONTROL CONSOLES

Mixing, branching
corrective loss
networks. Write
for catalogue on
your letterhead.



CINEMA ENGINEERING CO.

DIVISION AEROVOX CORPORATION

1100 CHESTNUT ST. • BURBANK, CALIF.

**ETCHED AND PRINTED
CIRCUITS**

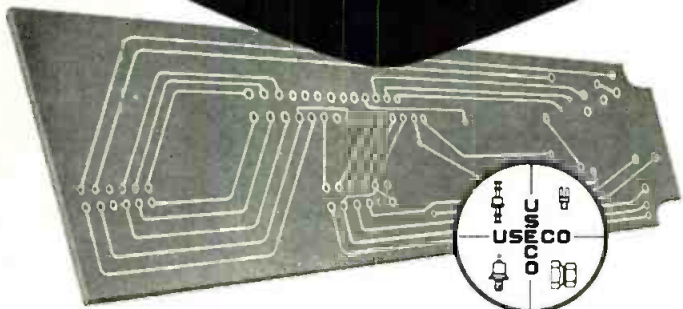

Long a recognized leader in standardized electronic hardware and terminal board fabrication, U. S. Engineering Co. now offers expanded facilities for the mass production of *quality* etched circuits to your prints. Prototype inquiries as well as production runs are invited. Cost estimates and quotations are given immediate attention. Send for new illustrated 8-page Brochure.

U.S. ENGINEERING CO.

A Division of Litton Industries, Inc.

521 COMMERCIAL ST., GLENDALE 3, CALIF.

TELE-TECH & ELECTRONIC INDUSTRIES • February 1955

TRANSFORMERS . . .

. . . specified for the usual

. . . demanded for the
unusual



"GTC" Transformers for television receiver applications . . . custom-designed high quality at minimum cost.

NEW Complete Catalog Now Available . . .
Your quick approach to easy specifying of custom requirements.

"GTC" Transformers for industrial and commercial applications . . . accurately engineered and fully recognized for finest quality.

Manufacturers specify "GTC" . . . for audio uses, communication, radar devices, test equipment, transmitters, and various other electronic-controlled devices.

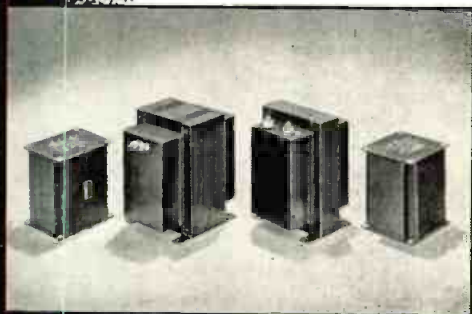

"GTC" Military Transformers . . . designed to meet rigid government specifications and to perform under the most severe and continuous operating conditions. MIL-T-27.

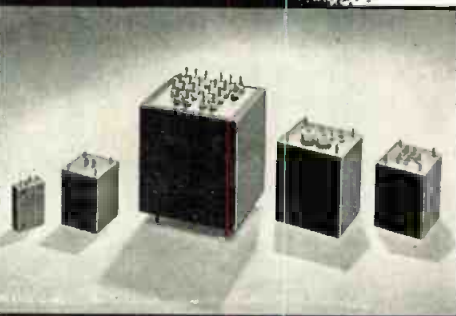

Skilled engineering techniques make GTC a source for transformers in highly specialized and extremely unusual applications. Utilization of these techniques results in greater dependability, quality and better construction.

Our completely self-contained plant's modern equipment guarantees transformer production in any quantity, to meet your requirements. We welcome your inquiry and will supply production samples where desired.



**GENERAL
TRANSFORMER COMPANY**

serving industry since 1928

18240 Harwood Avenue, Homewood, Illinois
(Suburb of Chicago)

For product information, use inquiry card on last page.

149

from
MIKE

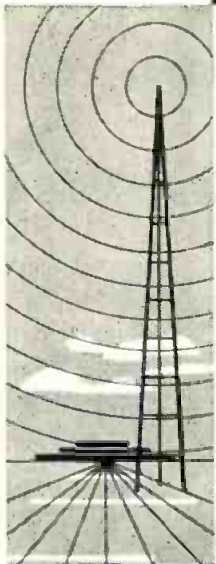

to

ANTENNA

Collins

**Your one best
source for
broadcast equipment**

855 35th St., N.E.,
Cedar Rapids, Iowa
261 Madison Avenue,
New York 16
1930 Hi-Line Drive,
Dallas 2
2700 W. Olive Ave.,
Burbank
Dogwood Rd., Fountain City,
Knoxville, Tenn.
Petroleum Bldg.,
Tallahassee, Florida
74 Sparks St.
Ottawa, Ontario



**INDUSTRY
NEWS**



Harold F. Bersche, 10-year veteran of RCA sales and merchandising activities, has been advanced to the post of Mgr., Marketing Services Dept., RCA Tube Div. **Durward M. Branigan**, formerly Promotion Mgr. for the Receiving Tube and Transistor Marketing Dept., has been promoted to Mgr. Distributor Sales.

Samuel Sinclair has been appointed to head the new National Vulcanized Fibre Co. sales office in the Industrial Office Bldg., Newark, N.J.

Robert Tate has been named Sales & Service Mgr. for the Eastern Div of Servomechanisms, Inc.

John Gilmore has become General Sales Mgr. for Kay Electric Co., Pine Brook, N.J. instrument manufacturer.



J. Gilmore

G. Yarbrough

Gramer Yarbrough has been elected Chairman of the Southern California Council of WCEMA for 1955. He is assistant mgr. of American Microphone Co. **Hugh P. Moore**, president of Acme Electronics, Inc. is vice chairman and **D. C. Duncan**, vice president of Helipot Corp., S. Pasadena is secretary-treasurer of the group.

Robert L. Rod has been promoted to the position of assistant to vice pres. **John A. Herbst** of Bogue Electric Mfg. Co., Paterson, N.J. He was previously assistant director of research and development at the firm.

John B. Cunningham, **Joel Dean**, **Oliver R. Grace**, **J. A. Slonim** and **Victor M. Leventritt** have been elected to the Board of Directors of Technograph Printed Electronics, Inc. **Hubert L. Shortt** was reelected president and **Mr. Leventritt** was elected secretary and treasurer.

Kenneth R. Rickey has been elected vice president of Lenkurt Electric Co., San Carlos, Calif. Rickey is controller of the company.

Col. Richard L. Hopkins has been appointed vice president of American Electro Metal Corp. and will direct its business administration and supervise special metals production.

(Continued on page 152)

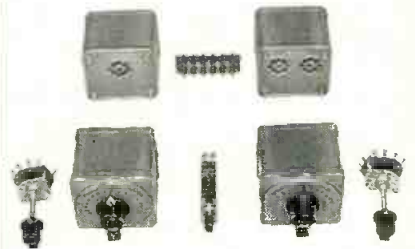

**simplify
custom
installation**

The 4200 Sound Effects Filter and 4201 Program Equalizer are now available in component form, as illustrated, for the custom builder.

In addition to the flexibility of installation, all the features and characteristics of the standard models are retained.

The high and low sections of either model may be obtained separately. Complete wiring instructions included.

Send for Bulletin TB-4



Model 4200 Sound Effects Filter
(Send for Bulletin S)



Model 4201, Program Equalizer
(Send for Bulletin E)

*Representatives in
Principal Cities*

HYCOR
Company, Inc.

11423 VANOWEN STREET
NORTH HOLLYWOOD 2, CALIF.

TELE-TECH ADVERTISERS — FEBRUARY, 1955

AEROVOX CORP.	34	GABRIEL ELECTRONICS DIV., GABRIEL CO. ..	104	POLYTECHNIC RESEARCH & DEVELOPMENT CO., INC.	44
Agency—Austin C. Lescarboura & Staff		Agency—Larcom Randall Adv.		Agency—George Homer Martin Assoc.	
AIRCRAFT RADIO CORP.	106	GENERAL CERAMICS CORP.	111	PRECISION PAPER TUBE CO.	142
Agency—Burke Dowling Adams, Inc.		Agency—George Homer Martin Assoc.		Agency—Symonds, MacKenzie & Co., Inc.	
ALFORD MFG. CO., INC.	146	GENERAL ELECTRIC CO.	26, 27, 93, 137	PRESTO RECORDING CORP.	43
Agency—Engineered Advertising		Agency—Maxon Inc.		Agency—Lewin, Williams & Saylor, Inc.	
ALLEN-BRADLEY CO.	12	GENERAL PRECISION EQUIPMENT CORP.	4, 5	PRINTED CIRCUITS, INC.	142
Agency—Fensholt Advertising Agency Inc.		Agency—Geer, DuBois & Co., Inc.		Agency—Charles Palm & Co.	
ALTEC LANSING CORP.	46	GENERAL PRECISION LABS., INC.	19	PYRAMID ELECTRIC CO.	55
Agency—Dan B. Miner Co., Inc.		Agency—Burke Dowling Adams, Inc.		Agency—Burton Browne Adv.	
AMERICAN LAVA CORP.	7	GENERAL RADIO CO.	117		
Agency—Power and Condon Adv.		Agency—K. E. Morang Co.		RADIO CORP. OF AMERICA	
AMERICAN PHENOLIC CORP.	24	GENERAL TRANSFORMER CO.	149	30, 31, 114, 115, Cover 4	
Agency—Burton Browne Adv.		Agency—Sander Radkin Adv. Agency, Ltd.		Agency—Al Paul Lefton Co., Inc.	
ANDREW CORP.	121	GRAY RESEARCH & DEVELOPMENT CO.	13	RADIO MATERIALS CORP.	Cover 2
Agency—Burton Browne Adv.		Agency—Taylor & Greenough Co.		Agency—Turner Adv. Agency	
ARNOLD ENGINEERING CO.	49	HELIPOT CORP.	142	RADIO RECEPTOR CO.	15
Agency—Walker & Downing, General Agency		Agency—Darwin H. Clark Co.		Agency—Walter J. Zimmerman Assoc.	
ASTRON CORP.	103	HEPPNER MANUFACTURING CO.	128	RADIO SHACK CORP.	133
Agency—Conti Advertising Agency, Inc.		Agency—Burton Browne Adv.		Agency—Engineered Adv.	
AUDIO DEVICES, INC.	51	HERMETIC SEAL PRODUCTS CO.	107	RAYTHEON MFG. CO.	95, 129
Agency—Rickord & Co., Inc.		Agency—Ari-Copy Adv. Agency		Agency—Walter B. Snow & Staff, Inc.	
		HOFFMAN LABORATORIES, INC.	21	REEVES-HOFFMAN CORP.	135
BENDIX AVIATION CORP., PACIFIC DIV.	47	Agency—Anderson-McConnell Adv. Agency		Agency—W. H. Long Co., Inc.	
Agency—Show Co.		HOUSTON FEARLESS CORP.	52	REEVES SOUNDCRAFT CORP.	53
BENDIX AVIATION CORP., SCINTILLA DIV. ..	32	Agency—Toggart & Young Adv.		Agency—J. M. Mathes, Inc.	
Agency—MacManus, John & Adams, Inc.		HUGHES AIRCRAFT CO.	54	RESISTANCE PRODUCTS CO.	50
BENNETT MANUFACTURING CO.	143	Agency—Foote, Cone & Belding		Agency—Olion-Sidman Adv. Agency, Inc.	
Agency—H. J. Weil, Inc.		HUGHES RESEARCH & DEV. LABS.	125, 152	ROYAL METAL MFG. CO.	147
BERNDT-BACH, INC.	138	Agency—Foote, Cone & Belding		Agency—Kuttner & Kuttner, Inc.	
Agency—Abbott Kimball Co. of Calif., Inc.		HYCON MANUFACTURING CO.	36		
BOMAC LABORATORIES, INC.	Cover 3	Agency—Hixson & Jorgensen, Inc.		SHALLCROSS MFG. CO.	126
Agency—Larcom Randall Adv.		HYCOR CO., INC.	150	Agency—Harry P. Bridge Co.	
BOURNS LABORATORIES	100	Agency—Allen, Dorsey & Hatfield, Inc.		SHURE BROS., INC.	38
Agency—McCarty Co.		INSTITUTE OF RADIO ENGINEERS	131	Agency—Walker B. Sheriff, Inc.	
BRADLEY LABORATORIES, INC.	108	Agency—Conti Advertising Agency, Inc.		SIGMA INSTRUMENTS, INC.	110
Agency—Charles Brunelle Co.		INTERNATIONAL RESISTANCE CO.	40, 41	Agency—Meissner & Culver, Inc.	
BURNELL & CO., INC.	2	Agency—Arndt-Preston-Chapin-Lomb & Keen Inc.		SORENSEN & CO., INC.	123
Agency—Hicks & Greist, Inc.				Agency—Moore & Co., Inc.	
BUSSMANN MANUFACTURING CO.	14	JENNINGS RADIO MANUFACTURING CORP. ..	130	SPECIFIC PRODUCTS CO.	145
		Agency—L. H. Waldron Adv. Agency		Agency—Allen, Dorsey & Hatfield, Inc.	
CALDWELL-CLEMENTS, INC.	140	JOHNSON CO., E. F.	148	SPRAGUE ELECTRIC CO.	56
CALIFORNIA INSTITUTE OF TECHNOLOGY, JET PROPULSION LAB.	144	Agency—Firestone Goodman Adv. Agency, Inc.		Agency—Harry P. Bridge Co.	
Agency—Perrett Co.		JONES DIV., HOWARD B., CINCH MFG. CORP. 142		SPRAGUE ELECTRIC CO.	16
CAMERA EQUIPMENT CO.	37	Agency—Symonds, MacKenzie & Co. Inc.		Agency—Stuart Sande Adv.	
Agency—J. M. Kesslinger & Assoc.		KAHLE ENGINEERING CO.	139	STACKPOLE CARBON CO.	109
CANNON ELECTRIC CO.	99	Agency—Conti Advertising Agency, Inc.		Agency—Horry P. Bridge Co.	
Agency—Willard G. Gregory & Co.		KENYON TRANSFORMER CO.	138	STANDARD ELECTRONICS CORP.	8, 9
CANOGA CORP.	112	Agency—Picard, Marvin & Redfield		Agency—Wehner Adv. Agency	
Agency—Elmer W. Ayer Adv.		KESTER SOLDER CO.	28	STODDART AIRCRAFT RADIO CO.	120
CBS-HYTRON	101	Agency—Paul J. Steffen Co.		Agency—Allen, Dorsey & Hatfield Inc.	
Agency—Bennett & Northrop, Inc.		LIBRASCOPE, INC.	134	SYLVANIA ELECTRIC PRODUCTS INC.	35
CINCH MFG. CORP.	91	Agency—Western Adv. Agency, Inc.		Agency—J. Walter Thompson Co.	
Agency—D. T. Campbell Inc.		MAGNETICS, INC.	38	SYLVANIA ELECTRIC PRODUCTS INC.	118
CINEMA ENGINEERING CO.	149	Agency—Londo Adv. Agency		Agency—Deutsch & Shea, Inc.	
Agency—R. L. Power		MALLORY & CO., INC., P. R.	11		
CLEVELAND CONTAINER CO.	45	Agency—Aitkin-Kynett Co.		TINNERMAN PRODUCTS, INC.	42
Agency—Nesbitt Service Co.		MEASUREMENTS CORP.	139	Agency—Meldrum & Fewsmith, Inc.	
COLLINS RADIO CO.	150	Agency—Frederick Smith Adv. Agency		TRANSRADIO LTD.	132
Agency—W. D. Lyon Co.		MELPAR, INC.	147	Agency—Reynell & Son Ltd.	
COMMUNICATION ACCESSORIES CO.	10	Agency—Equity Adv. Agency		TUNG-SOL ELECTRIC INC.	119
Agency—Carl Lawson Adv. Co.		MICROTRAN CO.	145	Agency—E.-M. Freystadt Assoc., Inc.	
CORNING GLASS WORKS	145	Agency—Hiram Ashe Adv., Inc.			
Agency—Charles L. Rumrill & Co., Inc.		MINNESOTA MINING & MFG. CO.	29	UNITED CATALOG PUBLISHERS, INC.	140
CUNNINGHAM, SON & CO., INC., JAMES ..	141	Agency—Batten, Barton, Durstine & Osborn Inc.		Agency—Daniel Dekoven Adv.	
		NEW HERMES ENGRAVING MACHINE CORP. ..	135	U. S. COMPONENTS, INC.	136
DAGE ELECTRIC CO., INC.	134	Agency—Lester Harrison, Inc.		Agency—Jarrett Advertising Agency, Inc.	
Agency—Jim Bradford Adv.		N.R.K. MFG. & ENGINEERING CO.	136	U. S. ENGINEERING CO.	149
		Agency—Kreicker & Meloon, Inc.		Agency—O. K. Fagan Adv. Agency	
EITEL-McCULLOUGH, INC.	48, 124	PEERLESS DIV., ALTEC LANSING CORP.	146	VARFLEX CORP.	127
Agency—Conner-Jackson-Walker-McClure Adv.		Agency—Dan B. Miner Co. Inc.		Agency—Barlow Advertising Agency, Inc.	
ELECTRICAL INDUSTRIES	25	PHALO PLASTICS CORP.	141	VICTOREEN INSTRUMENT CO.	116
Agency—George Homer Martin Assoc.		Agency—George T. Meicall Co.		Agency—Scheel Advertising Agency	
ELECTRONIC TUBE CORP.	102	PHILCO CORP.	39		
Agency—Harry P. Bridge Co.		Agency—Hutchins Adv. Co., Inc.		WELCH MFG. CO., W. M.	140
		PHOTOCIRCUITS CORP.	113	Agency—H. A. Hooker Adv. Agency, Inc.	
FAIRCHILD CAMERA & INSTRUMENT CORP. ..	105	Agency—Kotulu Co.		WESTINGHOUSE ELECTRIC CORP.	132
Agency—G. M. Basford Co.		POLARAD ELECTRONICS CORP.	22, 23	Agency—Equity Adv. Agency	
FEDERAL TELECOMMUNICATION LABS	143	Agency—James R. Flanagan Adv. Agency		WESTON ELECTRICAL INSTRUMENT CORP.	33
Agency—J. M. Mathes, Inc.				Agency—G. M. Basford Co.	
FORD INSTRUMENT CORP.	122				
Agency—G. M. Basford Co.					
F-R MACHINE WORKS, INC.	96				
Agency—C. M. Johnson & Assoc., Inc.					
FREED TRANSFORMER CO., INC.	152				
Agency—Franklin Adv. Agency					

While every precaution is taken to insure accuracy, we cannot guarantee against the possibility of an occasional change or omission in the preparation of this index.

FREED

*Sets A NEW
Standard for performance*

PRECISION TEST INSTRUMENTS



No. 1040 VACUUM TUBE VOLTMETER. Self contained — A.C. operated. High impedance — wide frequency. For use at audio and supersonic frequencies.

No. 1010A COMPARISON BRIDGE. Self contained — A.C. operated. Ideal for laboratory and production testing of resistors, condensers and inductors.



No. 1020B MEGOHM-METER. DIRECT READING. Self contained—A.C. operated. Electronically regulated supply, 1 megohm to 2 million megohms.

No. 1060 VACUUM TUBE VOLTMETER. A 50 megohm input impedance wide frequency range V.M. for use at audio and supersonic frequencies.



No. 1030 LOW FREQUENCY "Q" INDICATOR. DIRECT READING. Measures "Q" factor of coils, also inductances, distributed capacity, impedances and dielectric loss.

No. 1110A INCREMENTAL INDUCTANCE BRIDGE. For accurate testing of communication and television components under load conditions.

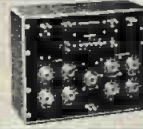

TRANSFORMERS & FILTERS



TOROIDAL INDUCTORS. 60 CPS to 1 MC. Also miniature inductors from 1000 CPS to 100 KC.

MILITARY PULSE TRANSFORMERS. Constructed to MIL - T - 27 specifications. Designed for optimum pulse performance.



MINIATURE AUDIO. Hermetically sealed — constructed in accordance with MIL - T - 27 specifications.

HERMETICALLY SEALED COMPONENTS. Constructed in accordance with MIL - T - 27 specifications.



PRECISION FILTERS. 10 CPS to 1 MC.

HIGH FIDELITY. 1/2 DB 20 CPS to 30 KC.



**COMPLETE CATALOG ON REQUEST
FREED TRANSFORMER CO., INC.**

1726 Weirfield St.
Brooklyn (Ridgewood) 27, N. Y.



(Continued from page 150)

Mr. Harry Nash has joined the germanium and silicon diode sales and applications staff at International Rectifier Corp., El Segundo, Calif.

Reagan C. Stunkel has been appointed Vice President of the newly-formed Hydro-Aire Electronics Division.

Charles Eisler, Jr. has become President of Eisler Engineering Co., Inc., Newark, N.J., and Dr. Charles Eisler, founder of the firm, is now Chairman of the Board.



C. Eisler



R. G. Maddox

Ralph G. Maddox, former Technical Service Mgr. of Prodelin, Inc., manufacturer of TV and Microwave antenna system facilities, has been appointed Vice Pres. in charge of Technical Sales and Service.

J. R. McGovern has become District Sales Engineer for Sola Electric Co. in Manitoba, New Brunswick, Nova Scotia, Ontario, Prince Edward Island and Quebec, Canada.

Robert E. Kessler has been appointed Mgr. of the Communication Products Div. of Allen B. DuMont Labs., Inc.

Russell E. Meyers has been appointed mgr. of manufacturing facilities and engineering at General Electric Co.'s Capacitor Dept. in Hudson Falls, N.Y.

Phillip F. LaFollette was elected President of Hazeltine Corp. W. M. McFarland, Vice Pres. of Hazeltine Electronics Corp. and Secy. of Hazeltine Corp. was elected Director of those companies and Executive Vice-Pres. of Hazeltine Electronics for Administration. O. M. Dunning, Vice Pres. of Hazeltine Electronics Corp. was elected a Director, and Webster H. Wilson, Assistant Vice-Pres. was appointed Head of the Government and Commercial Dept.

D. S. W. Kelly has been placed in charge of preparation of Allen-Bradley electronic data and publications under the direction of William W. Garstang, chief engineer of the Radio Div. in Milwaukee, Wis.

Digital Communication Engineers

*with
experience
in
the
fields
of*

Systems
Engineering
Miniaturization
Circuit
Development
Electromechanical
Development
Digital
Techniques

Long-Range Information Transmission

New advancements in the field of long-range information transmission are being made at Hughes with digital techniques.

Areas of Work

To further expand work in this area, Hughes Research and Development Laboratories are interested in people with experience in airborne communication systems, digital storage, low frequency measurements, modulation systems, miniaturized packaging, audio, IF and RF circuitry in the HF range, analog to digital—and other data conversion methods.

Scientific and Engineering Staff

Hughes

RESEARCH
AND DEVELOPMENT
LABORATORIES

CULVER
CITY,
LOS
ANGELES
COUNTY,
CALIFORNIA

Relocation of applicant must not cause disruption of an urgent military project.

6738 . . . First again in the field of tube miniaturization, Bomac developed a new type TR tube designated the 6378. Designed specifically for airborne radar equipment, the 6378 is a miniaturized version of the 1B24A (another Bomac first), 1B60 and the 1B24. Size was cut in half, and weight was reduced by one fifth with no sacrifice in performance or efficiency.

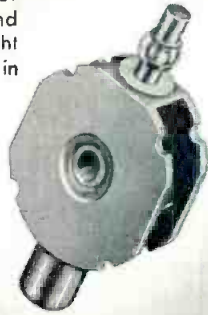

1N23D . . . Bomac was the first to manufacture the 1N23D silicon diode. System designers, for the first time, could obtain a diode with greatly increased sensitivity and superior electrical characteristics in relation to existing types.

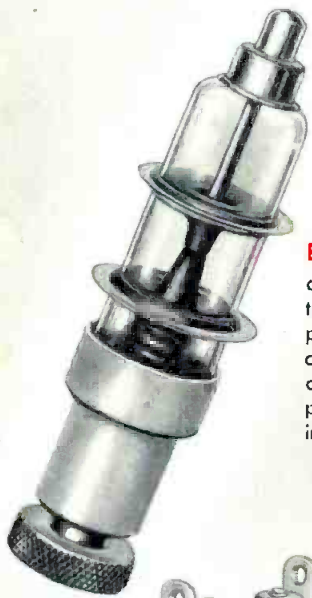

BL-25 . . . The BL-25 TR tube, designed and developed by Bomac, was the first cell-type tube system — engineered to withstand high power levels and maintain recovery time over a long period of life. The BL-25, although originally designed for a specific piece of equipment, has proven its versatility in various applications within the industry.



BL-58 . . . Bomac was the first to develop shutter tubes and integral TR-shutter combinations for continuous crystal protection. The BL-58 was the first integral TR-shutter combination developed by Bomac. With integral TR-shutter operation, bulky waveguide shutters could be eliminated at considerable savings in size and weight. This tube has now been superseded by improved models.

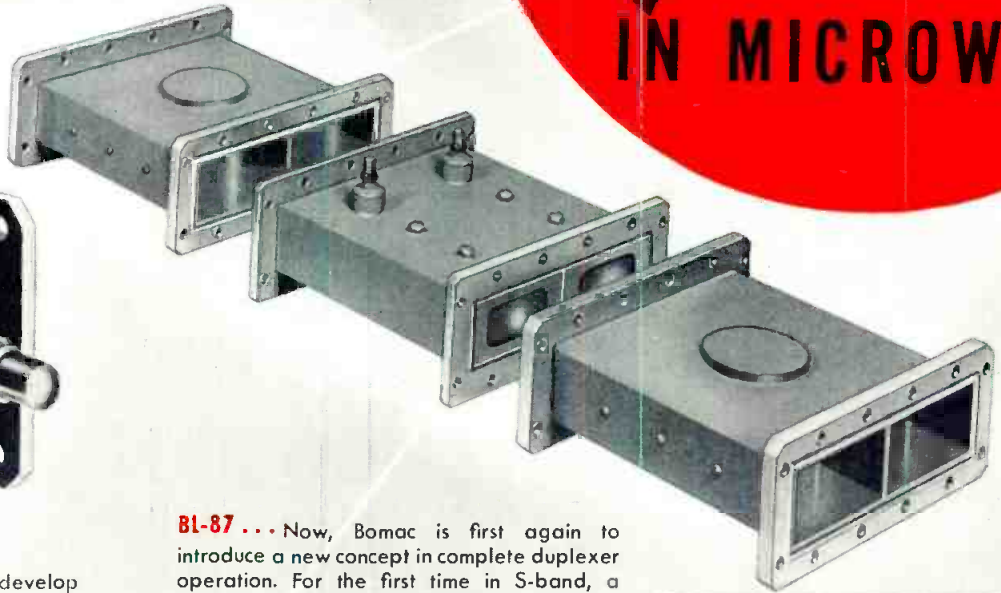

BL-87 . . . Now, Bomac is first again to introduce a new concept in complete duplexer operation. For the first time in S-band, a complete duplexer is offered to the industry. The BL-87 is a dual TR tube, complete with perfectly matched hybrids to assure maximum efficiency and long life. Systems designers can now be assured of reliable duplexer operation because Bomac's hybrids are designed specifically for their dual TR tubes. Bomac is first again in design and development of microwave tubes.

Bomac Firsts IN MICROWAVE

BL-509 . . . Bomac's BL-509 was the first complete duplexer offered in one compact unit. Combining a Bomac dual TR tube having integral shutters with two perfectly matched hybrid junctions in a single unit, the BL-509 provides duplexer operation and continuous crystal protection in one package. Light weight and compact, the BL-509 assures superior electrical performance and mechanical simplicity.

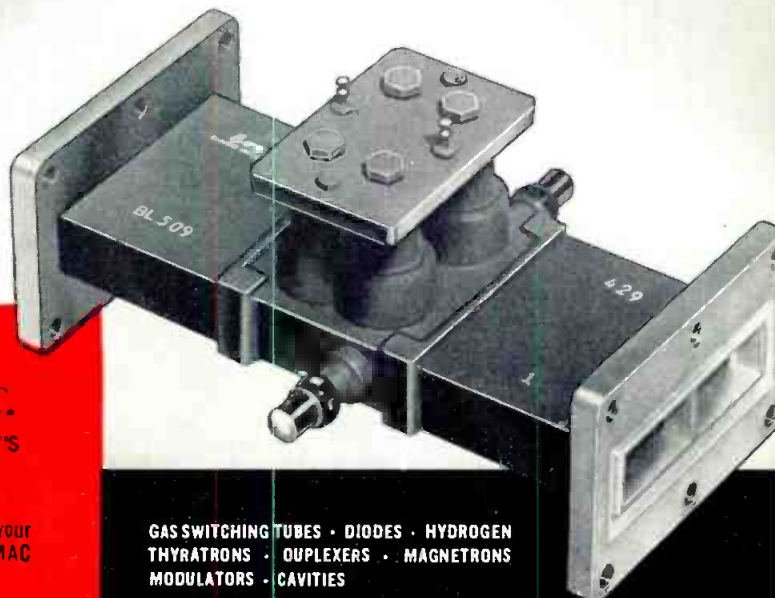

BOMAC DUAL TR DUPLEXERS			
Tube	Frequency (MC)	Tube	Frequency (MC)
G334	8490-9578	BL71	8500-9600
(BL-27)		BL78	8490-9578
BL29	9325-9425	BL87	2700-2900
BL35	15000-17000	BL507	8490-9578
BL47	9325-9425	BL600	8490-9578
BL60	5400-5900		

Bomac Laboratories, Inc.
BEVERLY, MASSACHUSETTS

We invite your
inquiries regarding

- ENGINEERING
- DEVELOPMENT
- PRODUCTION

Catalog on request Write on your
company letterhead Dept. T-2 BOMAC
Laboratories, Inc., Beverly, Mass.

GAS SWITCHING TUBES • DIODES • HYDROGEN
THYRATRONS • DUPLEXERS • MAGNETRONS
MODULATORS • CAVITIES

RCA 'BALANCED' LINE...

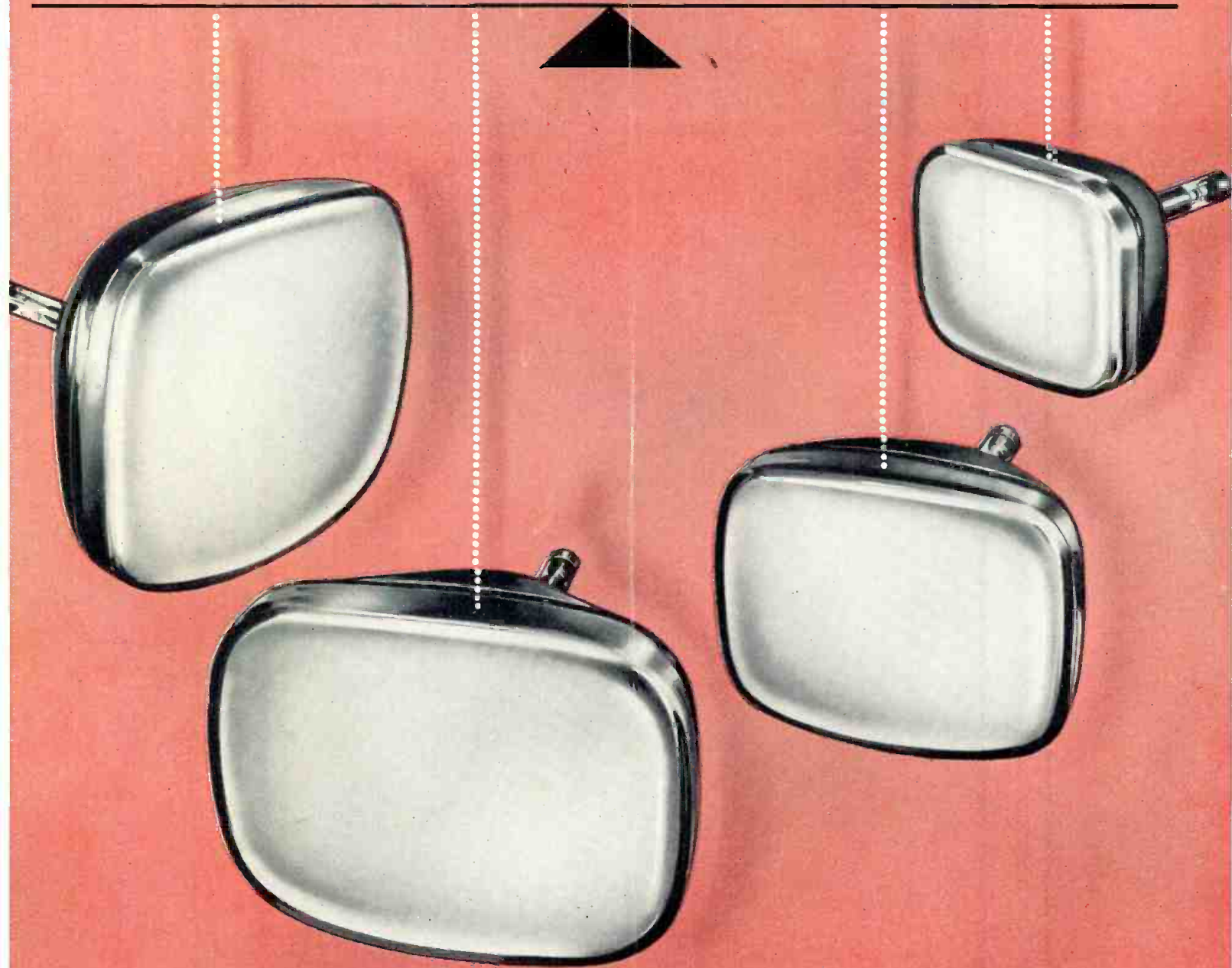

... for quality benefits

POPULAR RCA PICTURE TUBE TYPES

Type	Deflection		Type	Deflection	
	Angle	Focus		Angle	Focus
14HP4	70	E	21AVP4-A/ 21AUP4-A	72	E
17AVP4	90	E	*21AWP4	72	M
17HP4/17RP4	70	E	*21YP4	70	E
17LP4/17VP4	70	E	*21ZP4-B	70	M
*21ALP4-A	90	E	*21YP4-A	70	E
*21AMP4-A	90	M	21ZP4-A	70	M
Aluminized screen		E—Electrostatic			M—Magnetic

The RCA picture tube line is balanced for a variety of sizes and characteristics to suit your TV designs—but, best of all, RCA picture tubes give you top quality both initially and during life. That's why you receive added values from RCA picture tubes:

—*Low line rejects in your plant means lower costs to you.*

—*Long life in your sets means greater customer satisfaction.*

RCA picture tube quality stems from careful attention to details, rigid quality controls, and constant investigation of new materials, new processes, improved designs.

The continued quality leadership of RCA picture tubes gives you outstanding quality and performance at value-packed prices.

When you specify RCA picture tubes—you specify quality.



RADIO CORPORATION of AMERICA
ELECTRON TUBES
HARRISON, N. J.