

# ELECTRONIC INDUSTRIES

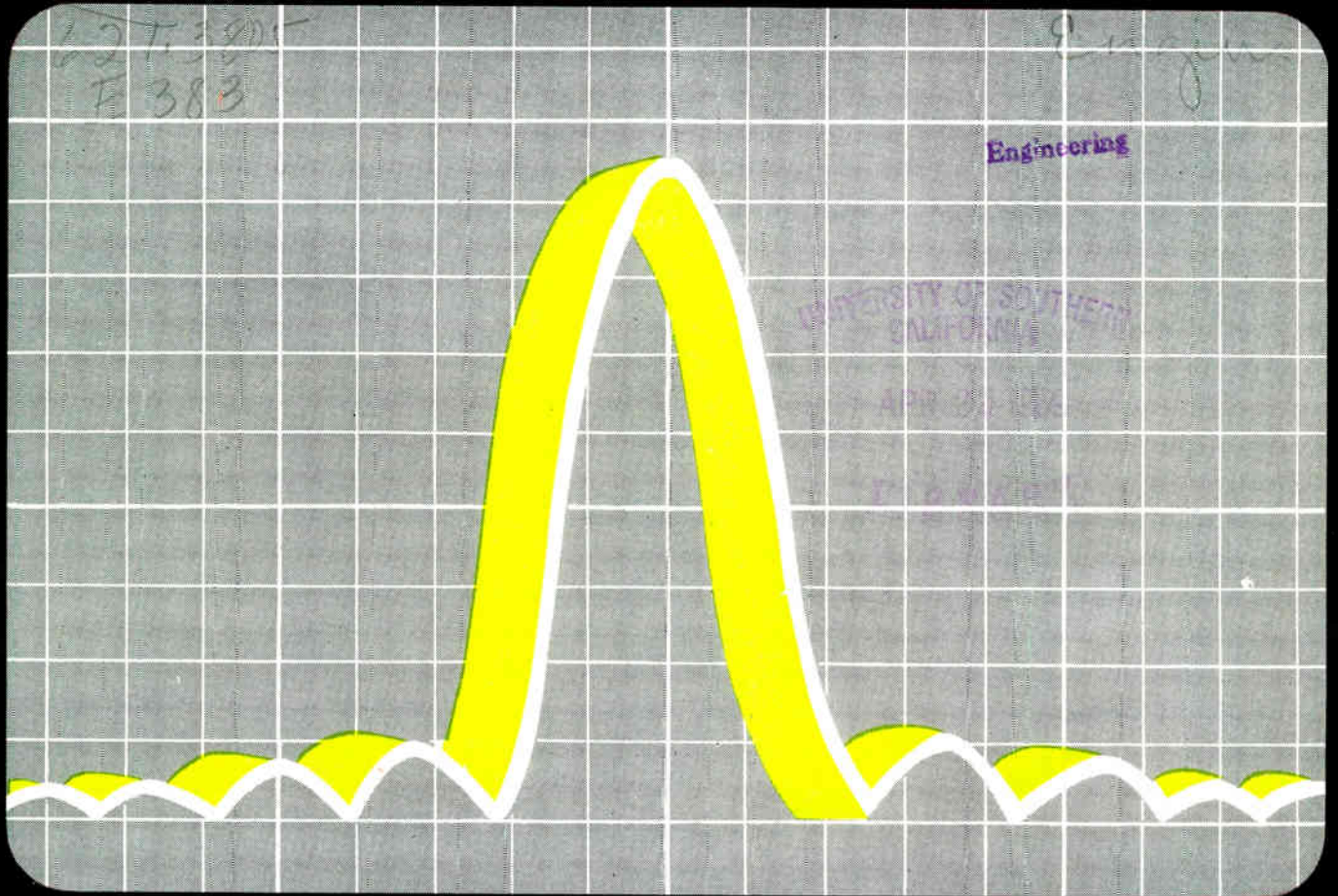

## DESIGNING SPECTRUM ANALYZERS

● Tubes or Transistors?  
Designing RF Anechoic Chambers

April • 1959

A Chilton Publication

# THE **PROVED** REPLACEMENT

for tubular ceramic and mica capacitors . . .

# RMC DISCAPS

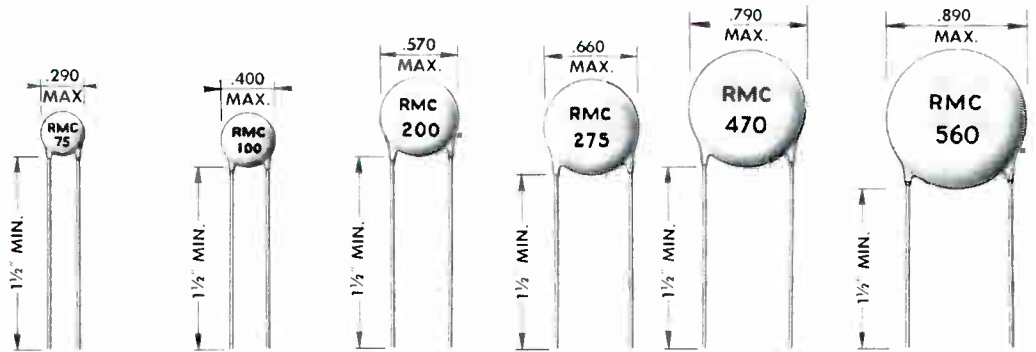

TC	1/4 Dia.	5/16 Dia.	1/2 Dia.	5/8 Dia.	3/4 Dia.	7/8 Dia.
P-100	1- 5 MMF	6- 10 MMF	11- 20 MMF	—	—	—
NPO	2-15	16- 33	34- 69	70- 85 MMF	86-115 MMF	116-150 MMF
N- 33	2-15	16- 33	34- 69	70- 85	86-115	116-150
N- 75	2-15	16- 33	34- 56	57- 68	69-125	126-150
N- 150	2-15	16- 33	34- 67	68- 75	76-140	141-200
N- 220	3-15	16- 33	34- 75	76-100	101-140	141-200
N- 330	3-15	16- 47	48- 75	76-100	101-150	151-200
N- 470	3-20	21- 51	52- 80	81-120	121-200	201-250
N- 750	5-30	31- 75	76-150	151-220	221-300	301-470
N-1500	10-56	57-120	121-220	220-300	300-470	471-560
N-2200	20-75	76-150	151-200	201-300	301-680	—

Temperature coefficients up to N-5200 available on special order.

## SPECIFICATIONS

**POWER FACTOR:** Over 10 MMF less than .1% at 1 megacycle. Under 10 MMF less than .2% at 1 megacycle

**WORKING VOLTAGE:** 1000 V.D.C.

**TEST VOLTAGE (FLASH):** 2000 V.D.C.

**CODING:** Capacity, tolerance and TC stamped on disc

**INSULATION:** Durez phenolic-vacuum waxed

**INITIAL LEAKAGE RESISTANCE:** Guaranteed higher than 7500 megohms

**AFTER HUMIDITY LEAKAGE RESISTANCE:**

Guaranteed higher than 1000 megohms

**LEADS:** No. 22 tinned copper (.026 dia.)

**TOLERANCES:**  $\pm 5\%$   $\pm 10\%$   $\pm 20\%$

These capacitors conform to the E.I.A. specification for Class 1 ceramic capacitors.

The capacity of these capacitors will not change under voltage.



Leading manufacturers of electrical and electronic products have proved by their continued use that Type C DISCAPS replace tubular ceramic and mica capacitors at lower cost.

Type C DISCAPS are available for varied applications in a wide range of capacities and temperature coefficients. These capacitors feature smaller size, lower self inductance, and greater dielectric strength. Rated at 1000 working volts, Type C DISCAPS assure trouble-free performance and cost no more than ordinary 600 volt capacitors. Specify Type C DISCAPS for your product, their many mechanical and electrical advantages combine with a lower initial price permitting substantial production cost reductions.

... also available with *Fin-Lock Leads* for printed wire boards

DISCAP  
CERAMIC  
CAPACITORS



**RADIO MATERIALS COMPANY**

A DIVISION OF P. R. MALLORY & CO., INC.

GENERAL OFFICE: 3325 N. California Ave., Chicago 18, Ill.  
Two RMC Plants Devoted Exclusively to Ceramic Capacitors

FACTORIES AT CHICAGO, ILL. AND ATTICA, IND.



# ELECTRONIC INDUSTRIES

ROBERT E. McKENNA, Publisher

BERNARD F. OSBAHR, Editor

**B**Y-BYE tubes, transistors have taken your place! . . . or have they?

"Nuvistor" is the name given to a new series of receiving type vacuum tubes embodying bold new design concepts and manufacturing techniques. Availability was announced by RCA last month and the technical characteristics of these tubes are reported in this issue on page 64.

The new tubes are "thimble" size and from this standpoint they are not unlike the GE design for the 7077 ceramic triodes announced about a year ago, and which functioned so well in a 960.5MC Class B power output stage in Pioneer IV. To us this "thimble-sized" tube trend is most important and most significant.

For several years now semiconductors (diodes and transistors) have been "star" performers of the show for many electronic design engineers. In the overall, this has been a good situation because it has spurred the growth of another great electronic industry. But experience has shown that these products do have application limitations. Unfortunately these limitations have not always been carefully considered in new equipment designs. It is possible to completely negate the many desirable advantages of semi-conductors by improper application.

Recently we had an opportunity to review a "white paper" on this subject entitled "Examples of Transistor Mis-

applications." The text lists thirteen different design situations, but without going into individual detail the paper indicates:

- (a) An apparent constant pressure from the military for complete transistorization of electronic equipment. Yet in many instances it can be shown that an all-tube design, or a hybrid design, might be more advantageous, economical, reliable, safer and provide superior performance.
- (b) From the consumer, industrial and commercial spheres, a preoccupation with the "glamour" of semiconductors. This results in unwise design engineering pressures (for the same reasons as in (a) above) in order to produce a "popular" package that will effect sales.

When radio came along the prediction was that the phonograph business was doomed. When TV arrived, radio had had it. But if we look at these industries today, we find all of them bigger and better than ever.

Our hats are off to the designers of these new tubes. Their new concepts have yielded some very promising products that equipment designers and specifiers would do well to study carefully. Tubes and semiconductors properly applied and working together can produce an electronic future of vastly greater proportions than now envisioned.

## Tubes . . . . Those Old Soldiers!

Designers of the Nuvistor have developed these curves to depict operational areas and limits of vacuum tubes and transistors

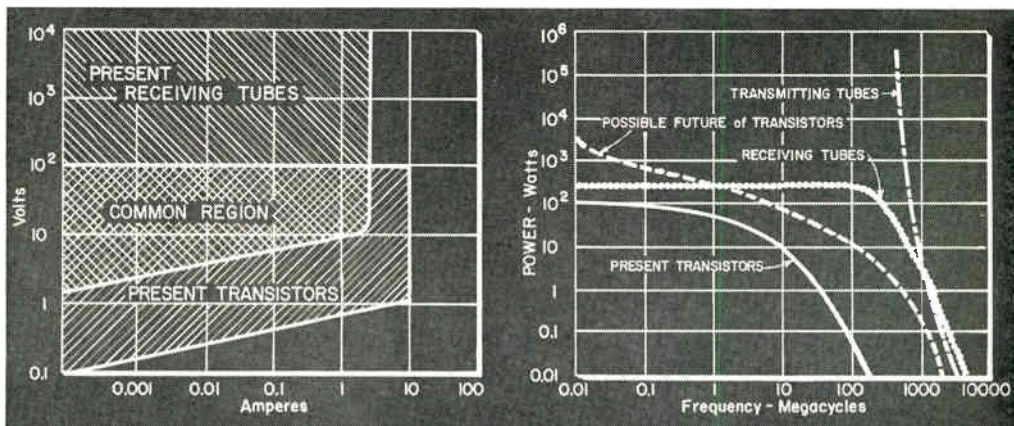

ROBERT E. McKENNA, Publisher  
BERNARD F. OSBAHR, Editor

CREIGHTON M. MARCOTT  
Managing Editor

RICHARD G. STRANIX  
JOHN E. HICKEY, Jr.  
Associate Editors

CHRISTOPHER CELENT  
Assistant Editor

DR. ALBERT F. MURRAY  
Contributing Editor

ROLAND C. DAVIES  
Washington News

MARIE T. McBRIDE  
Directory Editor

ELMER KETTERER  
Art Editor

CHARLES F. DREYER  
Cover Designer

#### EDITORIAL CORRESPONDENTS

Washington—1093 National Press Bldg.

GEORGE BAKER

RAY M. STROUPE

N. R. REGEIMBAL

San Francisco—1355 Market Street

EUGENE R. TARNOWSKY

#### BUSINESS DEPARTMENT

WALTER M. DeCEW

Promotion Manager

ELMER DALTON

Circulation Manager

GORDON HERNDON

Production Manager

#### REGIONAL SALES MANAGERS

Philadelphia Office—

56th & Chestnut Sts.

SH 8-2000

JOSEPH DRUCKER

New York Office—100 East 42nd St.

Phone OXford 7-3400

GERALD B. PELISIER

(Metropolitan N. Y.)

MENARD DOSWELL III

New England

Chicago Office—360 N. Michigan Ave.

RANDolph 6-2166

GEORGE H. FELT

Cleveland Office—930 Keith Bldg.

SUPERior 1-2860

SHELBY A. McMILLION

Los Angeles—198 S. Alvarado St.

DUNKirk 7-4337

B. WESLEY OLSON

San Francisco Office—1355 Market St.

UNDERhill 1-9737

DON MAY

Atlanta 3, Ga.—

911 William-Oliver Bldg.

JACKson 3-6791

JOHN W. SANGSTON

Dallas—Meadows Bldg., Expressway

at Milton

EMERson 8-4751

HAROLD E. MOTT

London, WI—4 Old Burlington St.

D. A. Goodall Ltd.

A. R. RACE

GERard 6517/8/9

JOS. C. HILDRETH, Board Chairman  
G. C. BUZBY, President

Vice Presidents: P. M. Fahrendorf,  
Leonard V. Rowlands, George T.  
Hook, Robert E. McKenna; Treasurer,  
William H. Vallar; Directors: Maurice  
E. Cox, Frank P. Tighe, Everit B. Ter-  
hune, Jr., Russell W. Case, Jr.,  
John C. Hildreth, Jr., Charles A. S.  
Heinle, John H. Kofron. Washington  
Member of the Editorial Board, Paul  
Wooton.

Comptroller, Stanley Appleby.

ELECTRONIC INDUSTRIES, April, 1959. Vol. 18, No. 4. A monthly publication of Chilton Company. Executive, Editorial & Advertising offices at Chestnut & 56th Sts., Phila. 39, Pa. Accepted as controlled circulation publication at Phila., Pa. 75¢ a copy; Directory issue (June), \$3.00 a copy. Subscription rates U. S. and U. S. Possessions: 1 yr. \$5.00; 2 yrs. \$8.00. Canada 1 year, \$7.00; 2 yrs. \$11.00. All other countries 1 yr. \$18.00; 2 yrs. \$30.00. Copyright 1959 by Chilton Company. Title Reg. U. S. Pat. Off. Reproduction or reprinting prohibited except by written authorization.

# ELECTRONIC INDUSTRIES

Vol. 18, No. 4

April, 1959

## MONTHLY NEWS ROUND-UP

Radarscope: What's Ahead for the Electronic Industries.....	4
As We Go To Press.....	7
TOTALS: Late Marketing Statistics.....	15
Snapshots . . . of the Electronic Industries.....	24
Coming Events .....	22
Electronic Industries' News Briefs.....	30
International News .....	13
Electronic Shorts .....	8
Washington News Letter .....	102
Next Month in Electronic Industries.....	57
At the IRE Show.....	16

Editorial: Tubes . . . Those Old Soldiers!.....	1
Tubes or Transistors?.....	58
R. E. Mae	
The Thimble Tubes.....	64
Designing a Spectrum Analyzer.....	66
R. Saul & E. Luloff	
Design and Build an Anechoic Chamber.....	72
R. F. Kalar	
Production Welding with Electrons.....	76
Designing RDF Antennas.....	77
R. C. Benoit, Jr. & F. Caughlin, Jr.	
What Cathode is Best for the Job?.....	84
J. J. Bawe	
Sonar Transducer "Squirts Sound".....	90
Breaking the Tungsten Barrier.....	92
Observations and Trends—From the Show.....	150
Professional Opportunities .....	185
Puerto Rico's Opportunities in Electronics.....	186
E. T. Ellenis	

International Electronic Sources .....	119
--	-----

## NEW PRODUCTS & TECH DATA

New Tech Data for Engineers.....	144
New Products .....	99

## DEPARTMENTS

Personals .....	50	Letters .....	46
Tele-Tips .....	32	Industry News .....	198
Books .....	37	News of Reps .....	201





# Highlights

## Of This Issue

### Tubes or Transistors?

page 58

The development of transistors has now reached a stage where we can say that certain inherent obstacles to further development exist. Frequency range, ambient temperature, high-voltage applications, nuclear radiation—these requirements will limit transistor use well into the foreseeable future. It is time to spell out just where transistors can be expected to do the job best and where tubes should be used.

### Designing a Spectrum Analyzer

page 66

What can a spectrum analyzer do? What should the user know before purchasing his instrument? It is important to both the manufacturer and his customer that these questions be explored fully. Here one of industry's most prominent manufacturers of spectrum analyzers presents design criteria to guide the engineer.

### An R-F Anechoic Chamber

page 72

When radio wave measurements are made at outdoor sites, the reflected energy causes measurements to be unreliable and weather conditions can be difficult on engineers making tests. These problems are overcome by having your own anechoic chamber. Complete details for its design and construction are given.

### Designing Radio Direction-Finding Antennas

page 77

The number of direction finding antenna techniques available to the design engineer range from the simple Adcock system to the more sophisticated Doppler and Wullenweber systems. Here the various techniques, basic design data, and relative merits and deficiencies of the different systems are described.

### What Cathode is Best?

page 84

Types of construction available to the design engineer fall into two groupings—tubes and discs. For various applications he will find that seamless, welded and drawn, lapped-seam or locked-seam fabrication may offer certain advantages. Choice of active or passive base material will affect the hum characteristics and life of the tube.

### Observations & Trends—From the IRE Show

page 150

The four-day period of the IRE Show and Convention provides an unparalleled opportunity to observe the significant trends in the electronic industry. With the cream of the industry's engineers in attendance, and papers being delivered on the subjects of most pressing concern, and project exhibits by more than 900 exhibitors we have in capsule form a small-scale projection of the industry as a whole. Here is how EI's editor's see the trends—

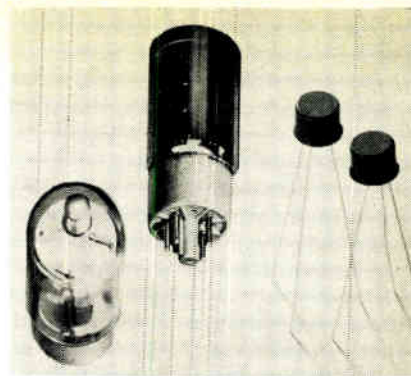

Tubes or Transistors?

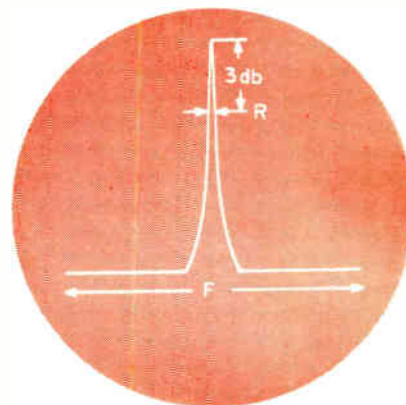

Designing a Spectrum Analyzer

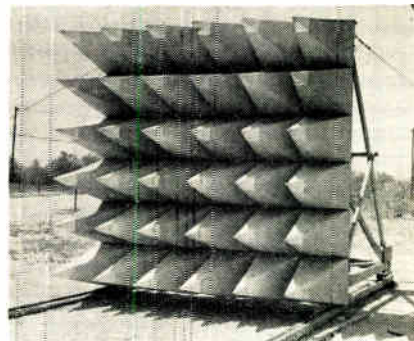

An R-F Anechoic Chamber

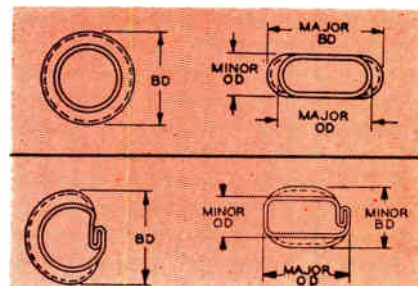

What Cathode is Best?

Designing Radio Direction-Finding Antennas

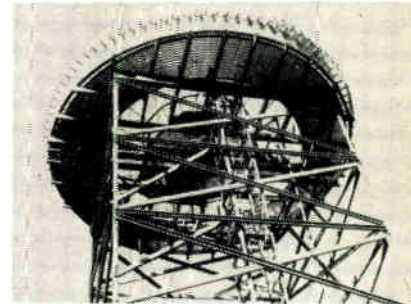

# RADARSCOPE

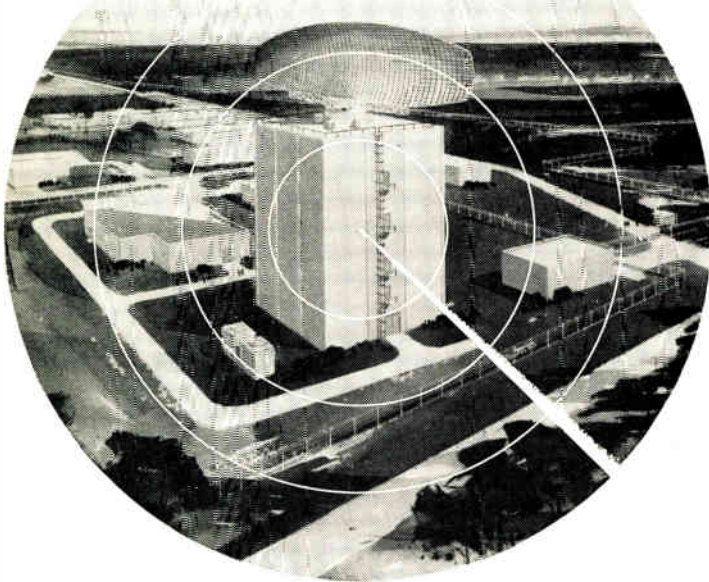

## FOR MISSILE DETECTION

This high-powered air-search radar is now being constructed at Thomasville Aircraft and Warning Station, Ala., by Sperry Gyroscope Co. Nine stories high and 60 ft. wide, it houses radar equipment, personnel, machine shop. It is part of SAGE system.

U. S. ELECTRONIC FIRMS are likely to find that the only way to meet the competition in overseas markets is to set up their own manufacturing operations abroad. With Europe's new Common Market and proposed Free Trade Area plans taking shape there is a good possibility that U. S. manufacturers will be squeezed out by the low labor costs, high tariffs and market proximity.

DEFENSE SPENDING may be taking a big piece of the nation's budget but non-defense spending has increased more over the past 4 years. According to Tax Foundation Inc. defense spending for Fiscal Year 1959 will be \$49.8 billions, up from \$48.6 billion in 1954. In the same period non-defense spending jumped from \$19.1 to \$31.0 billion.

THE AIRCRAFT AND MISSILE industry is finding that the use of tape-controlled milling techniques cuts out three of every four hours needed to set up a conventional milling machine.

THE SIGNAL CORPS LABS is so concerned over this tubes-vs.-transistors tug-of-war that they have completely divorced their Vacuum Tubes and Semiconductor divisions. In that way they have minimized the possibilities of decisions on military gear being affected by personal prejudices.

ELECTRONIC HIGHWAYS may be closer than we think. In all previous thinking it has been accepted that a cable of some sort would have to be buried in the highway surface. But the new plans announced in a paper presented at IRE call for a simple metallic stripe painted down the middle of the road. On new construction it would be imbedded in the surface; on old roads it would be painted on like the white dividing lines.

SILICON TRANSISTORS, formerly licensed for export by the Dept. of State, will now be licensed by the Bureau of Foreign Commerce. Export control is being transferred from the Dept. of State because the transistors are finding increased industrial use. They were formerly primarily used in military equipment.

A FIVE-MAN COMMISSION, to study and report on U. S. telecommunication resources, with special attention to the radio spectrum, has been recommended to Congress. Members would be appointed by the President. The proposed Commission on Telecommunication Management would study the role of the Federal government in the management of U. S. telecommunication resources; the administrative organization to handle the government's responsibilities; the procedures for allocating frequencies; and the division of frequencies between government and non-government users.

## TRACKING SPACE VEHICLES

Signals from the first successful space probe missile were tracked by this huge antenna at Goldstone Tracking Station, Camp Irwin, Calif. The 110-ft. high, 85 ft. wide antenna, is by Blaw-Knox.

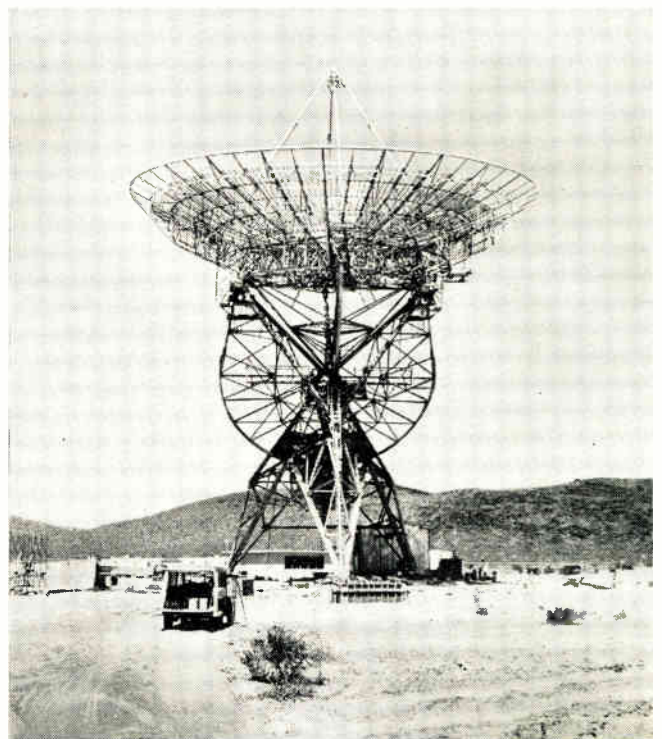



**AN INGENIOUS SOLUTION** to the financial problems of community educational TV and small commercial TV stations is being attempted by stations WMSB-Michigan State Univ. and commercial station WILX-TV. The two are collaborating at the nation's first combination educational-commercial TV operation on a shared-time basis. WMSB, with G. E. equipment, is providing 38½ hrs. of educational programming weekly over the Ch. 10 outlet, mostly between 9:30 a.m. and 2 p.m. WILX-TV has an even longer broadcasting schedule. The latter will be paying WMSB for use of its facilities. The arrangement solves two problems: capital for the educational TV station and public service programs for the commercial outlet.

**THE AIRCRAFT INDUSTRY** employs about 67% of its total force of 84,900 scientists and engineers in research and development projects. In addition, 62% of a total employment of 51,500 technicians is also working in R&D.

**DOUBLE-FACED TV PICTURE TUBES** are finally out of the talking state and into a commercial version. Sylvania last month sampled to various TV receiver manufacturers a 23-in. picture tube with the safety panel bonded to the face plate. The "bonded shield" tube is approximately the same height and width as conventional 21 in. 110° tubes. The sharp corners and relatively flat face are said to result in approximately 20 sq. in. of additional viewing area. The outer glass plate acts as a safety glass, and is expected to make possible radical changes in cabinet design. The new construction is also claimed to eliminate undesirable reflections from side light, increased light output and clearer overall pictures.

**SPEAKING WITH SIGNAL CORPS** spokesmen at the IRE Show we got an interesting picture of the direction that their research is taking, and the progress made over the past few years.

At Ft. Monmouth they have just constructed a room lined with ½-in. steel plates in which they will conduct high pressure experiments. They are talking now of pressures of 3,000,000 psi, and eventually of up to 10,000,000 psi. One of the major problems they are now encountering is controlling such environments. In fact, environmental control is the single greatest problem today in basic research. One of their high-pressure experiments aims at compressing ammonia to a solid state.

In the microwave field they are developing pulse cables to handle up to 80 megawatts. And they have their sights on cables that will handle 100 megw.

As an outgrowth of their experiments in "cold-cathode amplifiers" they envision inverted tube constructions, where, in a configuration of concentric rings, the plate will be the small center cylinder and the cathode will be the large outer cylinder. There will then be a very large emitting surface.

## TUBES OR TRANSISTORS?

**THE VALUE OF COMPETITION** was never better illustrated than in the present scrap between the long-entrenched tube people and the up-and-coming transistor groups. For years tube research moved along at its own leisurely pace. There were a few improvements, but they came slowly, and so gently that no one got shaken up. Even the announcement of transistors did not shake their complacency. And the wild claims that transistors would soon completely replace tubes only added to their confidence: this was too ridiculous to consider seriously. But 10 years and steady pressure from the eager transistor men whittled away the vacuum tube business. The tube industry faced the challenge: come up with significantly new developments or face steadily declining business. And what has resulted? The greatest flood of new developments in the industry's history. "Stacked" tubes, ceramic-to-metal, low-plate-voltage tubes, cold-cathode amplifiers, the new "Nuvistor" introduced last month. And small tubes, too; GE's 7077 is only slightly larger than a transistor.

Actually this story is not new. Radio broadcasting faced the same problem a few years back when television came on the scene. For a while it seemed as though radio was going right through the bottom. But when they took stock of themselves and analyzed what they could do best, and went ahead and did it, they came back stronger than ever.

That is the job that the tube industry faces now.

## HIGH-ALTITUDE TESTS

Altitudes up to 300,000 ft. are simulated in this 4-ft. diameter plastic globe at Boeing Aircraft Co., Seattle, Wash., to check corona discharge from airborne antennas under space conditions.

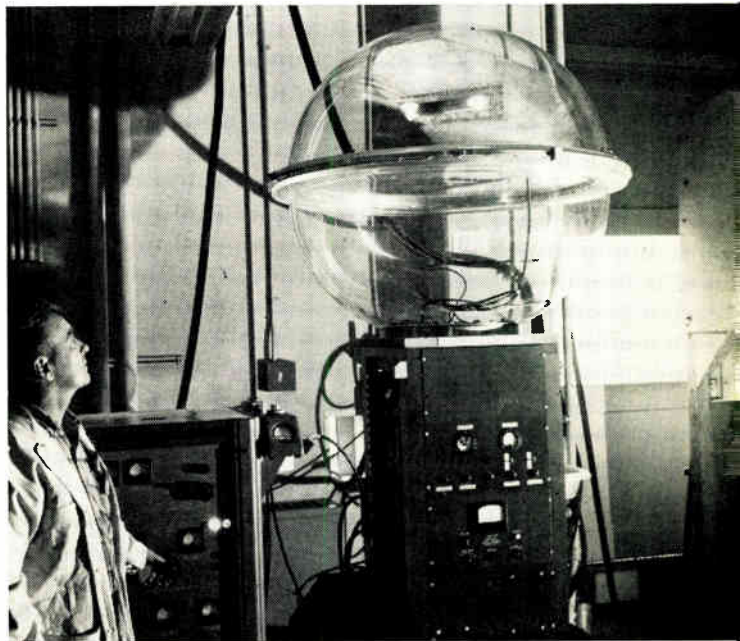

# NEW

## Formulation 40

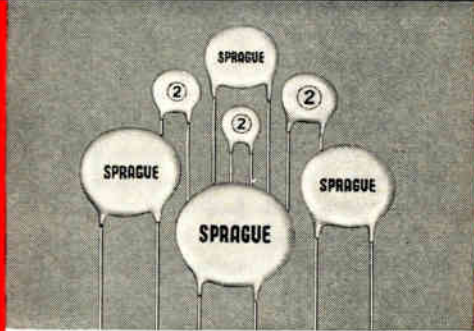

### flattens temperature-stability curve of *Cera-mite*<sup>®</sup> Disc Capacitors

Cera-Mite Ceramic Capacitors are now *smaller, more stable...* thanks to Sprague's new ceramic body Formulation 40. The increased dielectric constant of this newly developed ceramic body gives Cera-Mite Capacitors *three* times the capacitance per unit size than heretofore possible. Capacitance change with temperature over the operating temperature range is negligible.

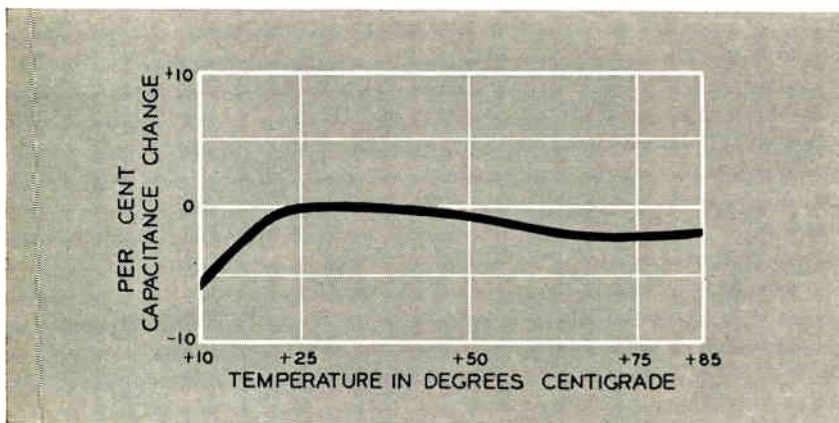

TYPICAL CURVE OF CAPACITANCE CHANGE WITH TEMPERATURE

Cera-Mite Capacitors are now available in Formulation 40 from .001 to .02  $\mu\text{F}$ , 250, 500 and 1000 volts d-c. Engineering Data Sheets 6106 and 6120 list complete ratings and specifications.

Address literature requests to Technical Literature Section, Sprague Electric Company, 233 Marshall St., North Adams, Massachusetts.

**SPRAGUE**<sup>®</sup>  
THE MARK OF RELIABILITY

**SPRAGUE COMPONENTS:**

CAPACITORS • RESISTORS • MAGNETIC COMPONENTS • TRANSISTORS • INTERFERENCE FILTERS • PULSE NETWORKS  
HIGH TEMPERATURE MAGNET WIRE • CERAMIC-BASE PRINTED NETWORKS • PACKAGED COMPONENT ASSEMBLIES  
HPB 45-194



# As We Go To Press...

## SPACE PLATFORM



Dr. Carl A. Frishe, president of Sperry Gyroscope and Nathan P. White, engineering chief examine stable platform which will guide nation's first "man in space."

## Sky Reflectors Relay Signals

International Telephone & Telegraph company has patented a new long distance communication system. The system makes use of man-made reflectors in the sky for short wave communications.

The reflectors may be "hung" from the sky by airplane, guided missile, cannon or balloons. Among the materials that may be dropped from aircraft or artillery shells are ionized gas, metallic chaff or nitric oxide. In the daytime nitric oxide is acted upon by the sun and forms a dense cloud or electrified particles which make a good reflector.

Using this system, a more reliable over-the-horizon communication system can be maintained. This system will overcome the problems caused by the shifting layers of the ionosphere which are now used.

## 30,000 Work in Space Exploration

A space exploration program, carried on by a 30,000 work force that includes an exceptionally high proportion of skilled scientific, technical and craft personnel is reported on in a study available from the U.S. Dept. of Labor, Bureau of Labor Statistics, 341 9th Ave., New York 1, N.Y.

## Space Satellite Communications Network

A world-wide communications network could be set up immediately by using existing space equipment, the House Committee on Science and Astronautics was told today.

In an open hearing held by the committee, Mr. R. P. Haviland, a satellite engineer with the General Electric Co., testified that a communications network was one of the first practical uses to be found in space exploration.

According to Mr. Haviland, sixteen small satellites, relaying signals from one to the other, would provide the necessary coverage for radio or TV transmission. He estimated that the cost for each station would run about \$2.5 million.

Maintenance costs would amount to an additional \$50 million a year, making the first year's expenses around \$100 million, he said.

These smaller satellites, according to Haviland, are "short-term" stations. Eventually, however, he sees the larger, or "long-term" station, as the best answer to the communication needs of our shrinking globe.

Although the amounts of money mentioned were large, Mr. Haviland felt that costs per message sent would be relatively low.

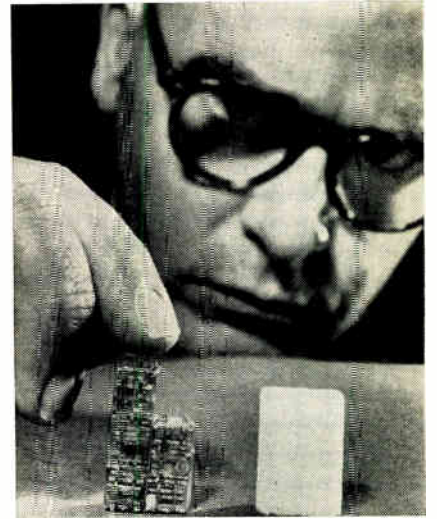

Military radio is scaled down to lump-sugar size by the "micro-module" technique.

## "Micro-Modules" Now At Hardware Stage

Engineering samples of 15 micro-modules were made available to industry last month by RCA, prime contractor for the Signal Corps' "micro-module" concept of miniaturization.

The hardware becomes available just 11 months from the time that the program was first announced.

The engineering samples cover a wide range of circuits, including binary divider, gate i-f amp., audio amp., mixer, sawtooth generator, clipper and pulse generator.

In making the announcement the Signal Corps re-emphasized their belief that this program was the logical step toward solid circuits, in which all circuit components will be cast in a block.

During the IRE Show Texas Instruments demonstrated one version of this type construction—a multi-vibrator.

The Signal Corps also reported that industry is showing great interest in the "micro-module" technique.

Inquiries have been received from 312 manufacturers, with 146 expressing an outright desire to participate in the program.

## RECORDING PYROMETER

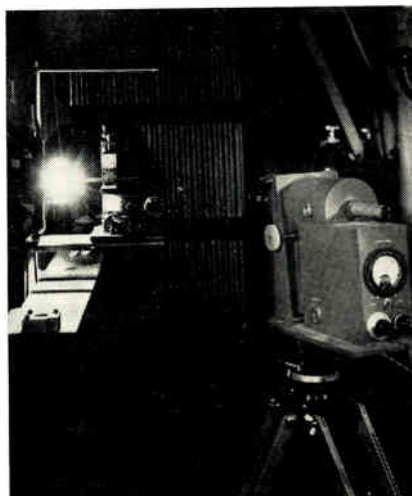

Auto-Optic Recording Pyrometer measures surface temperatures from 1400° to 3000°C. in material studies conducted by Avco R & D. Division.

For More News  
See Page 8

# ELECTRONIC SHORTS

▶ Sealed circuits in television sets have proven so reliable that on the average a technician would have to replace only one circuit board in two-and-one-half years of servicing sets equipped with the boards. This estimate was made today by Donald H. Kunsman, president of the RCA Service Company, in an address before the National Appliances and Radio-TV Dealers Association at its annual convention here. This estimate is based on an analysis of service calls over a six-month period throughout the country. One board has been replaced for every 5,000 service calls.

▶ The electronics industry's over-all volume will reach a minimum total of \$14.3-billion this year, compared with \$13-billion in 1958, and \$13.3-billion in 1957, the previous record year, according to Mr. Robt. E. Lewis, Sylvania president. He also predicted that the electronics industry, recognized over the past decade as "the world's fastest growing major industry," will exceed \$25-billion annually in sales and revenues by the end of the next decade.

▶ Leo A. Hoegh, Director, Office of Civil and Defense Mobilization, has announced the recommendations and conclusions reached by the Special Advisory Committee on Telecommunications. The report emphasized the immediate need for strengthening of the telecommunications organization. Further, that the Government's entire administrative organization for managing telecommunications be studied to ascertain whether improvements can be effected. It advocated review of the national table of radio frequency allocations to determine whether the current division of r-f space as between government and non-government users properly serves the national interest. The Committee recommended the establishment of a 3-man board, reporting to the President, for effecting these improvements. Instead of the 3-man board suggested, Mr. Hoegh is recommending that the Congress be asked to establish a commission of 5 members.

▶ A cost-plus-fixed-fee contract, estimated at \$381,446, for an experimental electronic system to provide a human pilot, or flight control system, with more suitable elevation position information during approach, landing, and rollout operations, was awarded Gilfillan Bros. by the Bureau of Research and Development, Federal Aviation Agency. The contract is a step toward ultimate development of an all-weather landing system for all present and anticipated classes of aircraft. The experimental Range and Elevation Guidance for Approach and Landing (REGAL) system will be installed at the National Aviation Facilities Experimental Center, Atlantic City, N. J., for test evaluation.

▶ A new transatlantic cable will be laid from Newfoundland to Scotland, running via Greenland and Iceland. The cable is primarily designed to improve communications for air traffic control and other aviation purposes across the North Atlantic; its use is expected to solve many of the point-to-point radio communications problems that have plagued transatlantic flight and have resulted in serious delays for passengers and additional costs to airlines.

▶ The U. S. Army Ordnance Corps has awarded a contract for \$500,000, which is expected to be increased to more than \$2,000,000, to GE's Missile and Space Vehicle Department. It covers research and development of a warhead arming and fuzing system for the Army's Little John surface-to-surface rocket.

▶ An estimated savings of \$2½-million yearly to the USAF is expected to result from a recent invention by two engineer-scientists of the Air Research and Development Command's Air Proving Ground Center (APGC), Eglin Air Force Base, Florida. The money-saving device, called a "proximity scorer," electronically tells a pilot just how close his missiles are coming to the target.

▶ Delivery of an automatic data-recording and monitoring system for use in the test program of the highly advanced Pratt & Whitney Aircraft J-58 jet engine has been made by the Systems Division, Consolidated Electrodynamics Corporation. The J-58 will deliver 50% more power than the most powerful present U. S. military or commercial jet engine.

▶ ARPA has designated the program to develop a 1,500,000-pound thrust super booster for heavy space payloads "Project Saturn."

## As We Go To Press . . .

### Electronics Delegation Going to USSR

Six American electronics specialists will be leaving shortly for a three-week visit to the U. S. S. R. where they will meet with their Soviet counterparts and visit electronics laboratories and plants. The visit culminates two years' negotiations with Soviet authorities in connection with the U.S.-U.S.S.R. Agreement on Exchanges and is reciprocity for the visit by a Soviet delegation of electronics specialists who came to this country last November.

In the Soviet Union the Americans will be the guest of the State Committee for Radio Electronics of the Council of Ministers. The EIA was host to the Soviet group last fall.

The Chairman of the International Division of the EIA, Mr. Ray C. Ellis, Vice President of Raytheon Manufacturing Co., heads the American group. Others on the delegation are Mr. Frank W. Mansfield, Chairman of the Marketing Data Policy Committee of the EIA and Director of Marketing Research of the General Radio & Electronics Co.; Mr. Julian K. Sprague, President of Sprague Electric Co.; Dr. Conrad H. Zierdt, Jr., of the General Electric Co.; Dr. Imre Molnar of the General Telephone Labs., and Mr. Charles P. Marsden, Jr., Chief of the Electron Devices Section of the National Bureau of Standards in Washington, D. C.

Mr. Louis A. Burgess will act as interpreter for the American delegation.

### MOBILE MISSILE



The Corporal missile, mobile launching equipment and crew are shown at a demonstration at Fort Bliss.





## Subminiaturization — *State of the Art*

*The trend to new techniques* in subminiaturization has brought up some weird approaches! While there may be some merit to the technique illustrated, there is a definite shortage of little people.

Although this trend to smaller and smaller systems and components presents certain production problems, reliability is never sacrificed at Hughes. To provide you with subminiaturized products that stand up under the most severe of environmental conditions, Hughes utilizes the most advanced equipment in the industry.

The following three pages give you three specific examples of reliable Hughes components. You'll find full details on Hughes Zener diodes, TONOTRON\*

storage tubes, and precision crystal filters.

In addition to these, other Hughes Products devices which provide you with this "built-in" reliability include: special-purpose oscilloscopes... precision crystal filters... rotary switches... thermal relays... MEMOTRON® and TYPOTRON® display storage tubes... diodes, transistors and rectifiers with uniform performance... and industrial systems which automate a complete and integrated line of machine tools.

\*Trademark of H.A.C.

*For additional information regarding any component or system please write: Hughes Products, Marketing Dept., International Airport Station, Los Angeles 45, California.*

Creating a new world with *ELECTRONICS*

**HUGHES PRODUCTS**

© 1959, HUGHES AIRCRAFT COMPANY

SEMICONDUCTOR DEVICES • STORAGE AND MICROWAVE TUBES • CRYSTAL FILTERS • OSCILLOSCOPES • RELAYS • SWITCHES • INDUSTRIAL CONTROL SYSTEMS

ELECTRONIC INDUSTRIES • April 1959

Circle 9 on Inquiry Card, page 105

9

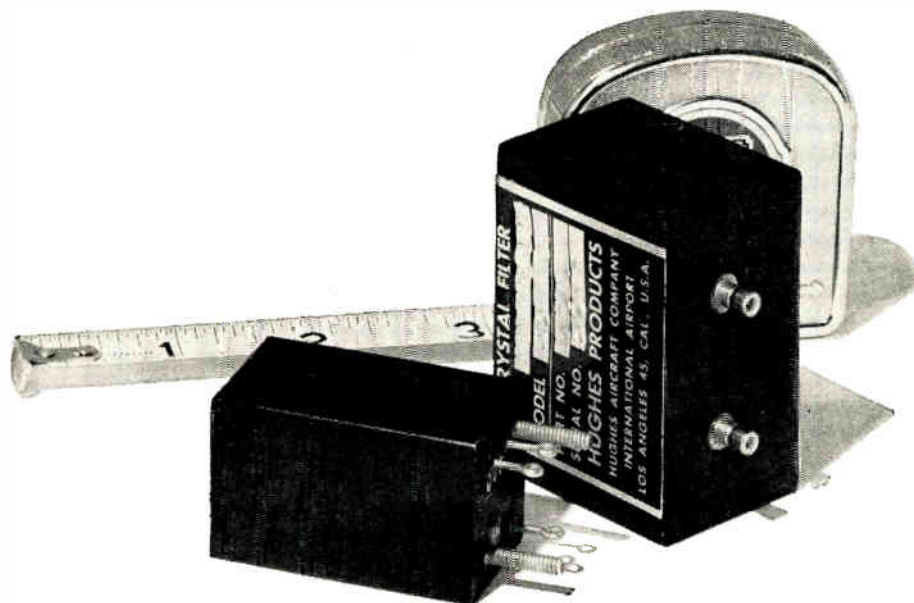

## PRECISION PERFORMANCE LEVELS set by Hughes Crystal Filters

Now you can obtain high performance crystal filters previously available only for special military developmental contracts and Hughes-built systems. Utilizing unique design and advanced manufacturing techniques, these Hughes crystal filters provide a degree of performance previously unobtainable.

These crystal filters have center frequencies of 30 kc to 30 mc. In addition, you can take advantage of seven distinct features:

1. High frequency filtering
2. High selectivity
3. Low passband ripple
4. Low insertion loss
5. Small size and weight
6. Excellent temperature stability
7. Excellent shock and vibration stability

A complete engineering service for network and filter design is available to you. To obtain specifications for crystal filter types currently available, or for information concerning engineering capabilities, please write: Hughes Products, Marketing Dept., International Airport Station, Los Angeles 45, California.

### TYPICAL BANDPASS FILTERS DELIVERED BY HUGHES PRODUCTS

	<u>No. 1</u>	<u>No. 2</u>	<u>No. 3</u>
Center Frequency	30 mc	10 mc	6 mc
6 db bandwidth	170 kc	40 kc	2 kc
60/6 db bandwidth ratio	1.35	2.3	1.4
Minimum Stop-band Attenuation	60 db	60 db	60 db
Maximum Passband Ripple	±1 db	±0.6 db	±0.75 db

*Creating a new world with ELECTRONICS*

**HUGHES PRODUCTS**

© 1959, HUGHES AIRCRAFT COMPANY

SEMICONDUCTOR DEVICES · STORAGE AND MICROWAVE TUBES · CRYSTAL FILTERS · OSCILLOSCOPES · RELAYS · SWITCHES · INDUSTRIAL CONTROL SYSTEMS



# At The IRE Show...

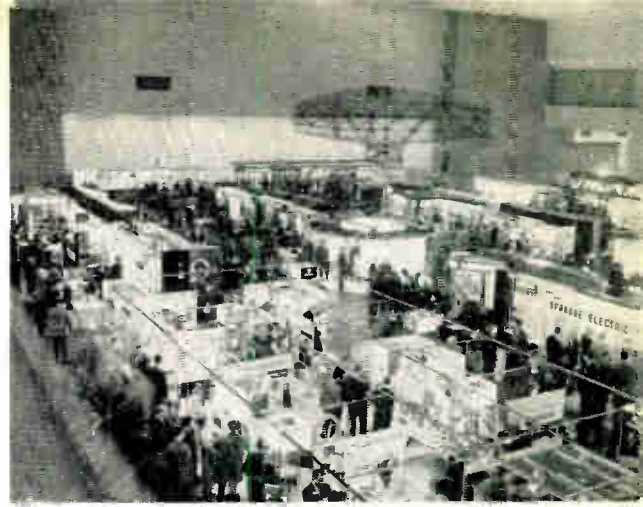

This year's show (above) set two records in numbers of visitors, and of exhibitors

Opening day crowd (below) topped 18,000, greatest turnout ever for the show and convention



Dr. Vladimir K. Zworykin briefed newsmen on Medical Electronics at morning session

For  
Observations & Trends  
from the  
1959 IRE Show  
See Page 150

Products were exhibited by more than 900 exhibitors



Beep from Vanguard I radio featured the opening ceremonies



**PHILCO Transistors operate**

**51,614,343**

**SERVICE HOURS\***



*in High-Speed Computer Circuits*

**with only 8 Failures!†**

Total Transistor Service Hours To Date	Total Transistors	Total Failures‡	Report
1,068,111	99	0	ELECTRONICS, Oct. 1, 1957, pg. 167
5,460,000	600	1	ELECTRONICS, Oct. 1, 1957, pg. 167
1,250,000	125	0	PHILCO REPORT, Feb. 10, 1959
16,000,000	10,192	2	WJCC REPORT, Feb. 1957
8,640,000	8,000	2	PHILCO REPORT, Feb. 12, 1959
19,196,232	18,601	3	PHILCO REPORT, Nov. 19, 1958

Carefully documented reports now reveal that Philco electro-chemical transistors have amassed more than fifty-million hours of operation in six computers under actual field conditions. Here is proof of the outstanding performance and reliability that electronics engineers and designers have come to expect from Transistor Center, U.S.A. Of course, these transistors are still operating in their original high speed computer switching circuits . . . extending service life data on these transistors beyond the limits of any previously published information.

When you think of transistors, think first of Philco. Make Philco your prime source for all transistor information.

*Write to Lansdale Tube Company, Division of Philco Corporation, Lansdale, Pa., Dept. EI-459*

†Failures due to all causes including human error.

\*Documented service hours in these six computers only. Total transistors hours in similar circuits are many times this amount.

**PHILCO CORPORATION**  
**LANSDALE TUBE COMPANY DIVISION**  
**LANSDALE, PENNSYLVANIA**





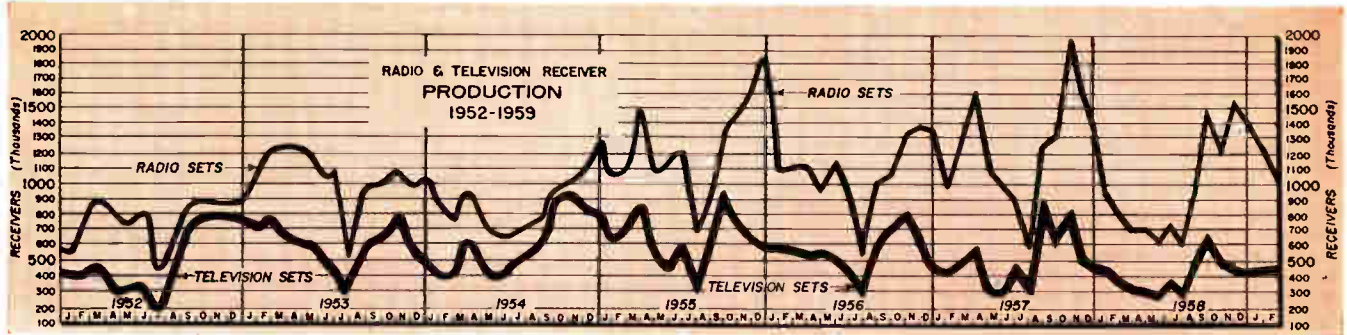

**GOVERNMENT ELECTRONIC CONTRACT AWARDS**

This list classifies and gives the value of electronic equipment selected from contracts awarded by government agencies in February 1959.

Adapter, headset	46,386
Amplifiers	161,654
Amplifiers, servo	66,443
Amplifiers, synchro signal	34,801
Antennas	31,901
Antenna kits, search	229,445
Batteries, dry	427,184
Batteries, primary, water activated	30,857
Batteries, storage, acid	111,312
Beacon, radio	93,540
Cable, armored	28,238
Cable assemblies	395,954
Cable, electronic	57,002
Cable, telephone	107,510
Capacitors	200,999
Cathodic protection	46,500
Computers	478,150
Connectors, cable	1,901,951
Connectors, panel	210,900
Controls, radio	154,712
Converter, SSB	83,819
Converter wave form	110,784
Crystal units	54,340
Dummy loads	66,025
Generator, scan pattern	44,909
Insulators	113,290
Kit, modification	37,878
Kit, repair, voltage regulator	48,825
Meter, frequency	685,804
Meter, watt	88,725
Microphones	270,270
Oscilloscope	100,611
Potentiometer	30,360
Positioning equipment, short range electronic	146,005
Radar sets, accessories	3,627,535
Receiver, radio	80,062
Receptacle, connector	29,920
Rectifiers	170,077
Recorder, magnetic variation	121,750
Recorder reproducers, accessories	344,479
Relay, armature	76,862
Relay assemblies	45,584
Research & Development	3,769,553
Servo motors	396,459
Signal generators	144,962
Solenoids	25,460
Spare parts, radar	880,047
Switchboard equipment	729,662
Switch, ferrite	40,521
Switch, pressure	29,467
Systems, telemetry	512,068
Synchros	336,356
Tape, magnetic	35,376
Test sets, telephone	49,245
Thermocouple assemblies	538,536
Transducers	125,000
Tube, electron	2,912,686
Tube, magnetron	755,210
Wire	80,481

**FACTORY SALES OF TRANSISTORS**

(000 omitted)

	1954	1955	1956	1957	1958
Original Equip.					
Units	1,293	3,505	11,770	24,964	39,927
Dollars	\$4,855	\$11,804	\$32,524	\$63,369	\$95,314
Distributors					
Units	12	111	723	1,304	2,472
Dollars	\$130	\$268	\$1,095	\$2,302	\$11,324
Direct Government					
Units	7	16	185	85	160
Dollars	\$89	\$93	\$3,329	\$679	\$787
Export					
Units	6	15	162	2,385	4,492
Dollars	\$48	\$88	\$404	\$3,389	\$5,305
Total					
Units	1,318	3,647	12,840	28,738	47,051
Dollars	\$5,122	\$12,253	\$37,352	\$69,739	\$112,730

**FACTORY SALES OF SEMICONDUCTOR DIODES**

(In Millions of Dollars)

Year	Germanium & Silicon	All Other	Total
1952	20	N.A.	N.A.
1953	25	N.A.	N.A.
1954	20	N.A.	N.A.
1955	30	N.A.	N.A.
1956	50	N.A.	N.A.
1957	73	30	103
1958	97	19	116

N A—Not Available

—EIA 1959 "Fact Book"

**FACTORY SALES TO THE INDUSTRIAL MARKET**

(In Millions of Dollars)

TYPE OF EQUIPMENT	1954	1955	1956	1957	1958
Computers and Processing	\$47.0	\$72.0	\$125.0	\$265.0	\$290.0
Testing and Measuring	110.0	145.0	170.0	210.0	220.0
Navigational Aids	60.0	65.0	70.0	95.0	100.0
Landmobile	90.0	95.0	120.0	150.0	155.0
Microwave					
Broadcasting					
Industrial Controls			115.0	150.0	160.0
Nuclear-Electronic Apparatus			22.0	27.0	35.0
Medical and Therapeutic	343.0	373.0	110.0	139.0	145.0
Commercial Sound			110.0	136.0	140.0
Communication			30.0	36.0	40.0
Miscellaneous			78.0	92.0	95.0
TOTAL	\$650.0	\$750.0	\$950.0	\$1,300.0	\$1,380.0

# Electronic Industries International



## Russia

### **Visiting Engineers**

Dr. Donald B. Sinclair, General Radio Co., Concord, Mass., discusses East-West business problems with a delegation of Russian Engineers here on a visit sponsored by the State Dept.

## UNITED KINGDOM

### **Remote Controlled Truck**

Newton Abbot, Devon—ERIC, Electronic Remote and Independent Control, system will soon be guiding two driverless tractor-trailers for British Railways. The tractors, Robotugs, are scheduled for service in April.

The system uses two sensing coils fixed to the front of the tractor trailer to pick up signals from a wire taped to the floor along the desired route. The truck is controlled from a remote control panel.

## SOUTH AMERICA

### **Telephone Equipment**

Brasil—Telephone exchanges and equipment for the new Capital, Brasilia, now being built in the center of the country, will be furnished by Ericsson do Brasil Comercio e Industria, S. A., a subsidiary of L. M. Ericsson Telephone Co. The contract—over \$2,000,000—calls for a 5000 line, automatic crossbar, central station and 8 smaller exchanges.

## SWEDEN

### **Sidewinder to Sweden**

Stockholm—The U. S. Navy-developed Sidewinder, air-to-air guided missile, will become standard armament in the Swedish Air Force's J-32B Lance, J-34 Hawker Hunter, and the J-35 Dragon. Purchase agreements for "a considerable number" of Sidewinders have been signed by Maj. Gen. Torsten B. Rapp, RSAF, Assistant Chief of Staff for Air Material, Royal Swedish Air Force, and Adm. Arleigh A. Burke, USN, Chief of Naval Operations.

### **Engineers visit U.S.**

Stockholm—Executives of Hammarby Bakelit Industri A.B. visited Tri-Point Plastics, Inc., Albertson, L. I., to observe the company's equipment and techniques for processing "Teflon" fluorocarbon plastic. The equipment inspected included extruders developed by the Long Island firm to produce an improved type of "Teflon" resin rod and tube stock used in production of high-precision electronic components.

## NETHERLANDS

### **New Instrument Plant**

Amersfoort—High Voltage Engineering Corp., Burlington, Mass. is plan-

ning to establish a manufacturing plant in Amersfoort. The company manufacturers Van de Graaff and electron linear accelerators for nuclear physics research, electron beam processing, supervoltage x-ray therapy, and industrial radiography.

## WEST GERMANY

### **New Rep for Narda**

Munich—Schneider, Henley & Co., G.M.B.H., Masimiliansplatz 12 a, has been appointed sales and service representative in West Germany for the Narda Microwave Corp., Mineola, New York.

### **German Scientist US-Bound**

Munich — Dr. Adolph Goetzgerger, semiconductor physicist, formerly with Siemens & Halske, Munich, is joining Shockley Transistor Corp., Palo Alto, Calif. as senior physicist.

### **IBM Builds New Center**

West Berlin—IBM Deutschland, German subsidiary of IBM World Trade Corp., will occupy a new 9-story building in West Berlin's new commercial center, the Ernst-Reuter-Platz. It will serve as headquarters for IBM Deutschland. The ground floor Data Processing Center will have an IBM 650 available for business and scientific organizations.

## PUERTO RICO

### **Track "Take" Computer**

San Juan—The Puerto Rican Government is using Univac computers to total up the "take" from legalized off-track betting on horse racing. The Government collects about 5% of the net profits made by the track operators on all off-track bets. In 1957 the track paid a little over \$2,000,000 into the treasury. It was the 6th largest source of the government's income.

## **Monthly Translation**

Melton Mowbray, Leicestershire—An English translation of one of Russia's leading technical journals, "Stanki i Instrument," is being published monthly in Britain by the Production Engineering Research Association under the title, "Machines and Tooling".

The publication covers R & D in production and improvements in equipment and methods in Russia based on operating experience. Some of the subjects dealt with in recent issues are: high frequency heating, the problems of automation, ultrasonics, and speed reducing mechanisms.

## **Error Detector**

Automatic error correcting device, Autoplex, permits use of data processing equipment at the receiving end of h-f, long range, communications systems. Fourteen of the devices, manufactured by Marconi's Wireless Telegraph Co., Ltd., Chelmsford, Essex, have been ordered by the British C. P. O.

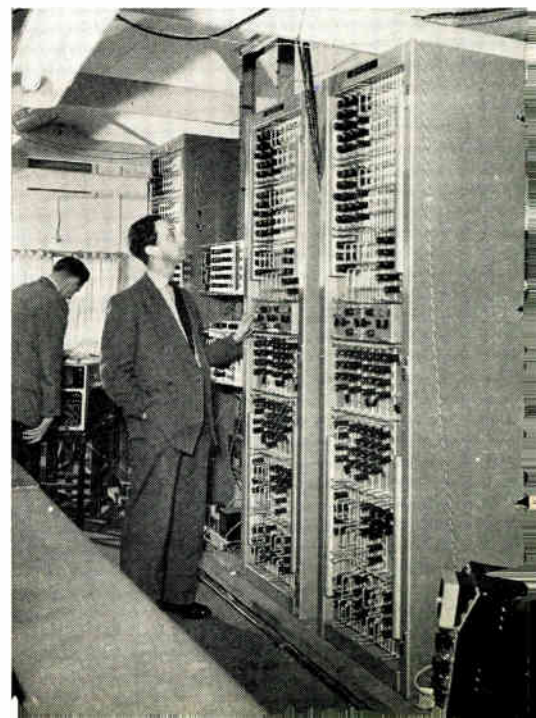





FROM THE TAPCO GROUP...  
**Electronic Subsystems  
and Components  
for Weapon Systems**

**AT TAPCO...**

**A unique combination of electronic,  
electrical and mechanical skills**

Your project may require microwave subsystems and components. Or a complete ground support check-out device. Or servo-controlled subsystems and components for a whole new vehicle concept. On each of these the TAPCO Group can design, develop, and manufacture your requirements on schedule.

The TAPCO Group is experienced in the design and manufacture of electronic controls, including closed-loop servo systems and components, positioning controls, and small power-system alternators. Experience with microwave components includes coaxial and wave guide switches, power dividers, stripline microwave

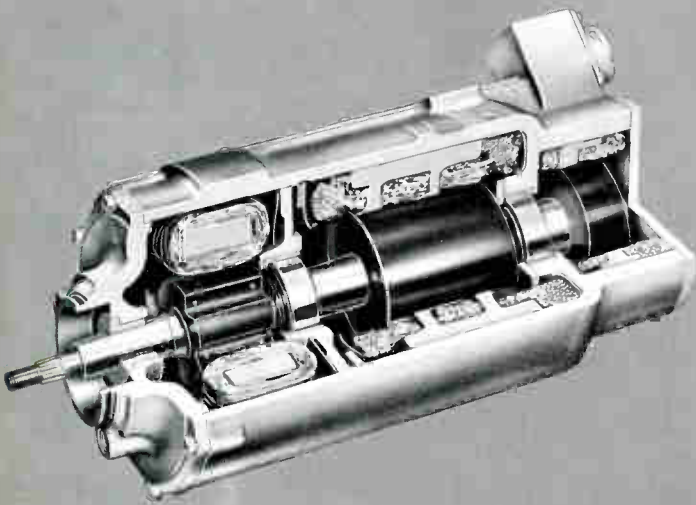
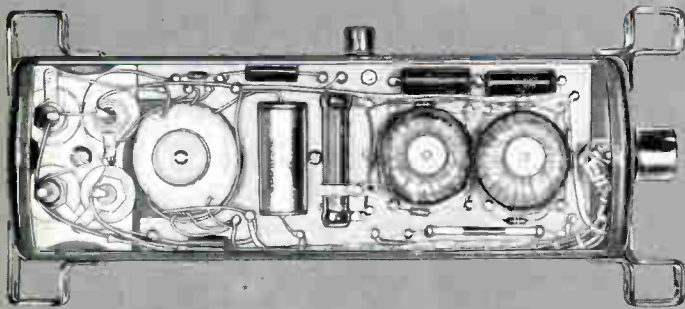

APU tuned circuit speed control and alternator TAPCO designed and produced for 2400/400-cycle surface-to-air missile power. Alternator uses new-type permanent magnets that are fully short-circuit stable. Also incorporates unique flux-switching generator for speed control.

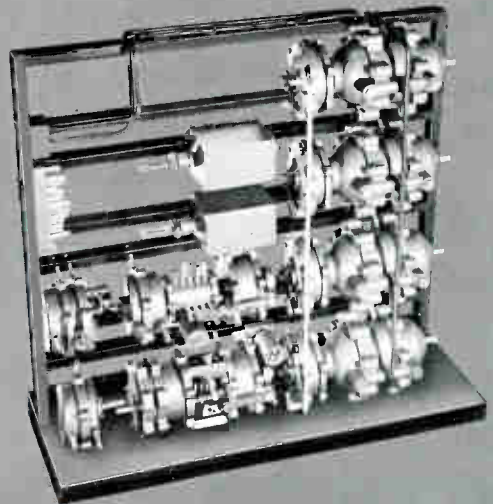

AICS, a high temperature (600°F) pneumatic computing control system, designed for air-induction inlet control or thrust reverser control for jet aircraft.



Precision position and speed servos in this TAPCO-developed ground support unit perform programmed check-out of missile guidance equipment. Readily adaptable to advanced antenna positioning and tracking systems.



filters, and microwave antennas.

Air-vehicle electronic systems developed by the TAPCO Group include highly sensitive electro-pneumatic controls capable of maintaining the speed of rotating electrical machines within plus-or-minus ¼ % in either parallel or isolated operation under widely varying loads, ambient temperatures, and vibration. TAPCO-developed APU speed controls provide an accuracy of one part in 100,000 (.001%) under missile environmental conditions.

At TAPCO you'll find an unusual combination of electronic, electrical and mechanical skills ready to serve you.

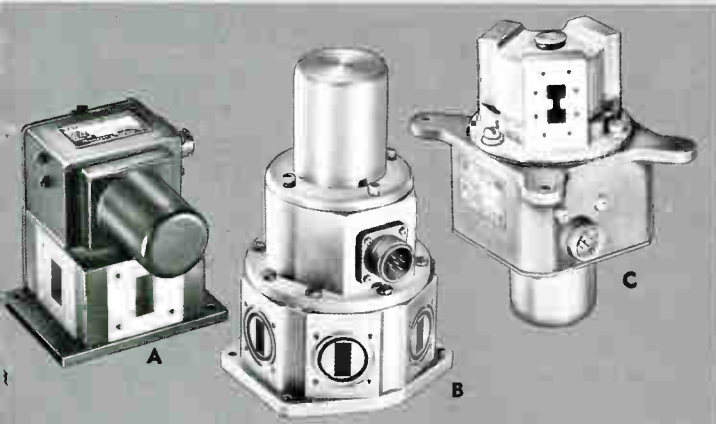

Thousands of TAPCO-developed wave guide switches are used in vital aircraft and missile systems. (a) Unique power-splitting feature of rectangular wave guide switch permits switching full wave-guide power. (b) New single-pole 4-throw design has inter-channel attenuation in excess of 100 db. (c) Double-ridged wave guide switch has noise-free interlocking actuator.

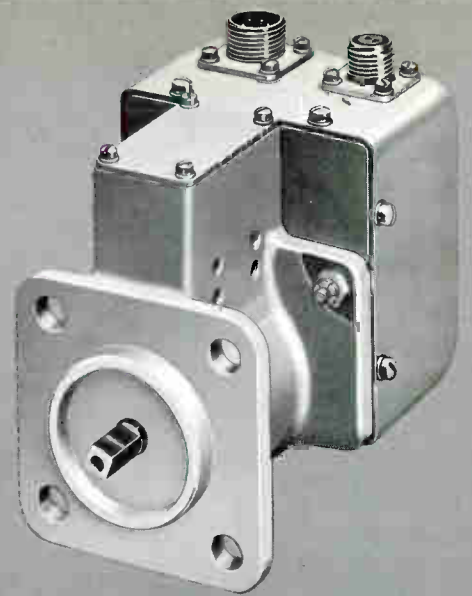

Magnetic speed sensing devices developed and produced by TAPCO Group for high-speed applications up to 100,000 rpm. Designs eliminate need for slip-rings, rotating permanent magnets, and complicated fly-ball mechanisms.

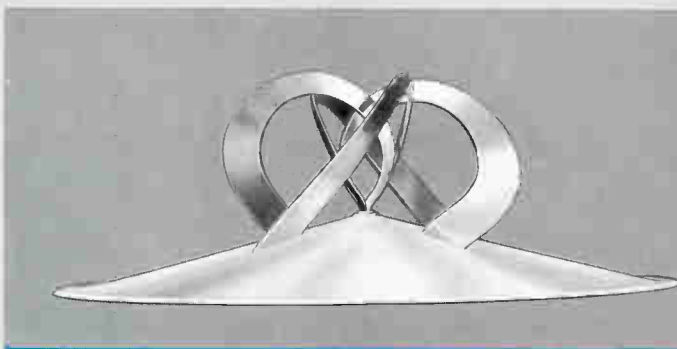

An advanced TRW microwave antenna design available in integrated microwave transmission subsystems from the TAPCO Group. Frequency range: 1 octave. VSWR: under 2:1. Polarization: dual horizontal and vertical.



**TAPCO GROUP**

*Thompson Ramo Wooldridge Inc.*

CLEVELAND 17, OHIO

DESIGNERS AND MANUFACTURERS OF SYSTEMS, SUBSYSTEMS AND COMPONENTS FOR THE AIRCRAFT, MISSILE, ORDNANCE, ELECTRONIC AND NUCLEAR INDUSTRIES

Primary Standards Laboratory at TAPCO, where all secondary test equipment is calibrated at statistically-determined intervals to assure the accuracy of electronic products.



## Electronics Research and Production Facilities at TAPCO

The combination of engineering and manufacturing competence represented in the \$160,000,000-per-year activities of the TAPCO Group provides an integrated capability of unusual effectiveness for the design and manufacture of electronic products. In addition, the electronic facilities and competence of the corporation's RAMO-WOOLDRIDGE Division are available to the TAPCO Group.

Our scientists and engineers can move rapidly on simultaneously-programmed projects. Analog and digital computers speed the design of electronic systems, then simulate their operation for test purposes. Components, electronic systems and subsystems designed in the TAPCO Group are produced within the Group.

Let us show you how we can design, develop, and manufacture electronic subsystems and components to meet your performance, reliability, and delivery requirements.

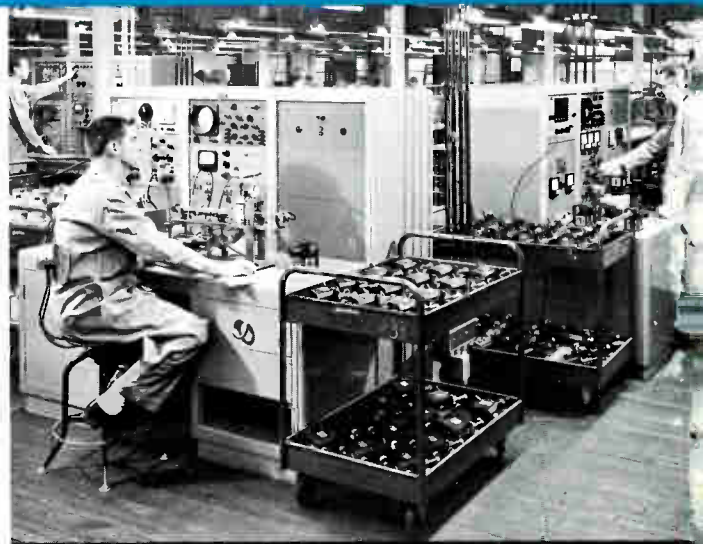

Production testing of microwave components at TAPCO.



# TAPCO GROUP

*Thompson Ramo Wooldridge Inc.*

CLEVELAND 17, OHIO

DESIGNERS AND MANUFACTURERS OF SYSTEMS, SUBSYSTEMS  
AND COMPONENTS FOR THE AIRCRAFT, MISSILE, ORDNANCE,  
ELECTRONIC AND NUCLEAR INDUSTRIES



Now

# A NEW 50 VOLT SUBMINIATURE PAPER CAPACITOR



meets requirements of MIL-C-25A K characteristic

## FOR TRANSISTORIZED APPLICATIONS

Astron's new 50 volt hermetically sealed subminiature paper capacitors have the reliability required by specification MIL-C-25A.

These units operate at temperatures from  $-65^{\circ}\text{C}$  to  $+125^{\circ}\text{C}$  without derating. The capacitance variation is less than  $\pm 3\%$  over the entire operating temperature range. High insulation resistance, low power factor, unusually low resonance loss are combined in this new light-weight subminiature unit.

In response to a definite engineering need, Astron's new type AQF is compactly designed and offers superior performance characteristics for low voltage transistorized applications.

Write today for complete technical information.

SPECIALISTS IN CAPACITOR MINIATURIZATION

**ASTRON**  
CORPORATION  
255 GRANT AVENUE, E. NEWARK, N. J.



### PARTIAL LIST OF RATINGS AVAILABLE

CAP. MF	DIA. x LENGTH
0.027	.235 x 3/4
0.068	.312 x 7/8
0.1	.312 x 7/8
0.27	.400 x 1-3/8
0.47	.500 x 1-1/4
1.0	.562 x 1-5/8
2.0	.750 x 2-1/8

### TYPICAL CAPACITANCE VS. TEMPERATURE

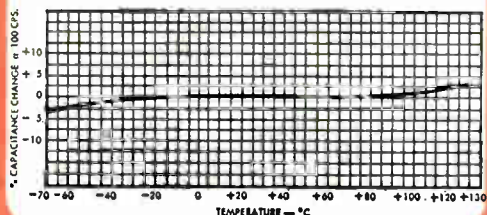

AVAILABLE FROM YOUR ASTRON  
AUTHORIZED STOCKING DISTRIBUTOR

EXPORT DIVISION  
ROCKE INTERNATIONAL CORP.  
13 EAST 40TH ST.  
NEW YORK, N. Y.

IN CANADA:  
CHARLES W. POINTON  
6 ALCINA AVE.  
TORONTO, ONTARIO

# Coming Events

**A listing of meetings, conferences, shows, etc., occurring during the period March-May that are of special interest to electronic engineers**

- Apr. 1-30: 9th Plenary (CCIR) International Radio Conf., CCIR; Biltmore Hotel, Los Angeles, Calif.
- Apr. 2-3: Conference on Silicon Carbide, Air Force Cambridge Research Center, Boston, Mass.
- Apr. 2-3: Conf. on Electrical Applications in the Textile Industry, AIEE; Heart of Atlanta Motel, Atlanta, Ga.
- Apr. 2-4: Meeting, AIP, Optical Society of America; Hotel New Yorker, New York, N. Y.
- Apr. 5-9: Annual Convention, Edison Electric Institute, New Orleans, La.
- Apr. 5-10: 5th Nuclear Congress, ISA, ASME, IRE; Municipal Auditorium, Cleveland, Ohio.
- Apr. 6-7: 2nd National Symp. on Chemical & Petroleum Instrumentation; ISA; St. Louis, Missouri.
- Apr. 6-7: 3rd Annual Astronautics Symp., AFOSR; Sheraton Park Hotel, Washington, D. C.
- Apr. 6-9: 16th Annual British Radio and Electronic Component Show, Radio & Electronic Component Mfg's Federation; Grosvenor House & Park Lane House, London, Eng.
- Apr. 6-10: 40th Annual Convention, American Welding Society, Hotel Sherman, Chicago, Ill.
- Apr. 7-10: Numerical Control of Machines in Production Processes, UCLA and Purdue Univ.; Campus, Purdue Univ.
- Apr. 8-9: Railroad Conference, ASME; Sheraton Hotel, Chicago, Ill.
- Apr. 8-10: Southern District Meeting, AIEE; Dinkler Plaza Hotel, Atlanta, Ga.
- Apr. 12-16: International Conf. on Fracture, AFOSR, ONR, NSF, NAS/NRC; Mass. Institute of Technology, Cambridge, Mass.
- Apr. 12-19: World Congress of Flight, Air Force Assoc.; McCarran Field, Las Vegas, Nev.
- Apr. 14-15: 4th Industrial Instrumentation & Control Conf., Armour Research Foundation, Chicago, Ill.
- Apr. 16-18: Southwestern IRE Conf. & Exhibit (SWIRECO), IRE; New Dallas Memorial Auditorium & Baker Hotel, Dallas, Texas.
- Apr. 16-30: Engineering, Marine, Welding, and Nuclear Energy Exhibition, London, Eng.
- Apr. 18-19: Spring Director's Meeting, National Alliance of TV & Electronic Service Assoc.; Hermitage Hotel, Nashville, Tenn.
- Apr. 18-22: Annual Meeting, American Society of Tool Engineers; Schroeder Hotel, Milwaukee, Wis.
- Apr. 20-21: Conference on Analog & Digital Recording & Controlling, IRE, AIEE, ASME, ISA; Bellevue-Stratford Hotel, Philadelphia, Pa.
- Apr. 20-24: Industrial Photographic and TV Exhibit, London, Eng.
- Apr. 21: Round Table With Distributors, Mfg's, and Reps. Assoc. of Electronic Parts and Equipment Mfgs., Chicago, Ill.
- Apr. 21-22: Spring Tech. Conf. on Electronic Data Processing, IRE-Cincinnati Section; Engineering Society Bldg., Cincinnati, Ohio.
- Apr. 22-24: Rubber & Plastics Conf., AIEE-East Central District; Sheraton-Mayflower Hotel, Akron, Ohio.
- Apr. 22-24: 3rd Annual Technical Meeting, Institute of Environmental Engineers; LaSalle Hotel, Chicago, Ill.
- Apr. 25-30: Annual Meeting, Scientific Apparatus Makers Assoc.; The Greenbrier, White Sulphur Springs, West Virginia.
- Apr. 26-28: Southwestern Regional Conference, National Assoc. of Music Merchants; Hilton Hotel, San Antonio, Texas.
- Apr. 27-30: Int'l Symposium on Physical Chemistry of Extractive Metallurgy, Metallurgical Soc. of AIME; Penn-Sheraton Hotel, Pittsburgh, Pa.
- Apr. 29-May 1: Northeastern District Meeting, AIEE; Hotel Syracuse, Syracuse, N. Y.
- Apr. 29-May 3: Management - SAM Conference, ASME; Statler-Hilton Hotel, New York, N. Y.
- Apr. 30-May 2: Meeting, American Physical Soc.; Willard & Raleigh Hotels, Wash., D. C.
- Apr. 30-May 3: National Convention, American Women in Radio & TV; Waldorf-Astoria Hotel, New York, N. Y.

#### Abbreviations:

- ACM: Association for Computing Machinery  
AFOSR: Air Force Office of Scientific Research  
AIEE: American Inst. of Electrical Engrs.  
AIME: American Institute of Mining & Metallurgical Engineers  
ASME: American Society for Mechanical Engineers  
ASTM: American Society for Testing Material  
CCIR: International Radio Consultative Committee  
EIA: Electronic Industries Assoc.  
IAS: Institute of Aeronautical Sciences  
IRE: Institute of Radio Engineers  
ISA: Instrument Society of America  
ONR: Office of Naval Research  
SAE: Society of Aeronautical Engineers  
SMPTE: Society of Motion Picture & TV Engineers  
SPI: Society of Plastics Industry

## As We Go To Press . . .

### Evapor-Ion— An Electronic Pump

Latest development in high-vacuum pumps is the so-called "Evapor-Ion" or electronic pump. This unique pump removes many times its own volume of air from a system—yet it operates with no outlet. Titanium wire is fed onto a post heated by electron bombardment from the filament. The titanium evaporates and, upon striking the cooled pump wall, condenses as a thin layer.

Gas molecules wander into the pump from the vacuum chamber, collide with the surface of the wall, and chemically combine with the titanium. Chemically active gases, which comprise over 99 per cent of the air, are held as compounds by the titanium. As each layer of titanium becomes chemically saturated, a fresh layer is deposited. The inert gas molecules are ionized by electrons emitted by the filament. The electrical field of the accelerator grid violently repulses these ions and drives them into the titanium layer, where they are buried by subsequent titanium evaporation. This constant removal of gas molecules by evaporation and ionization produces a pressure in the range of from  $10^{-4}$  to  $10^{-9}$  mm Hg, uncontaminated by the fluids used in conventional pumps. Nitrogen is pumped at speeds as high as 2000 liters per second.

#### SOME HIGHLIGHTS OF 1959

- May 6-8: Electronic Components Conference, WCEMA, IRE, EIA, AIEE; Benjamin Franklin Hotel, Phila., Pa.
- May 18-20: Electronic Parts Distributors Show, Assoc. of Electronic Parts & Equipment Mfg., Inc.; Conrad Hilton Hotel, Chicago, Ill.
- Aug. 18-21: WESCON, West Coast Electronic Mfgs. Assoc. & 7th Region IRE; San Francisco, Calif.
- Oct. 12-14: Nat'l Electronics Conf., IRE, AIEE, EIA, SMPTE; Hotel Sherman, Chicago, Ill.
- Nov. 9-11: Radio Fall Meeting, IRE, EIA; Syracuse, N. Y.
- Nov. 16-18: JEDEC General Council; Bellevue-Stratford Hotel, Phila., Penna.
- Nov. 30-Dec. 1: Eastern Joint Computer Conf., IRE (PGEC), AIEE, ACM; Hotel Statler, Boston, Mass.



**RELIABILITY  
IN THE PALM  
OF YOUR HAND...**

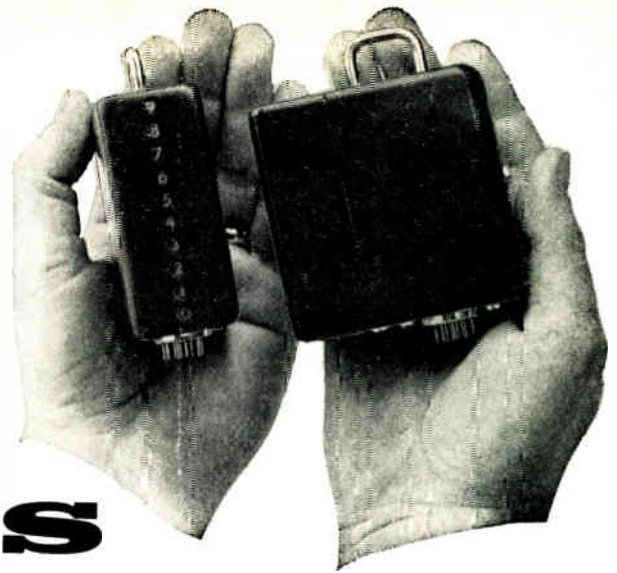

**NEW**

**EECO N-Series**

*Transistorized*

**DECADES**

*for extremely reliable pulse-counting and frequency-division applications  
in the frequency range of 0 to 250,000 pulses per second.*

**FEATURES**

The new EECO N-Series miniaturized and transistorized plug-in decimal counters feature simple power-supply requirements, low power consumption, small size, and extreme reliability. Saturation techniques, along with consistent derating of component tolerances result in a group of Transistorized Decades that will work dependably from 0 - 250 kcs even under adverse conditions of environment and power supply variations. All units are completely compatible with EECO T-Series Germanium plug-in circuits. In addition, an auxiliary 9-step staircase output is available. Most units are designed to plug into a special 13-pin miniature tube socket; other units plug into a standard 29-pin socket (Continental No. MM-29-22S). Mating socket is furnished with each decade.

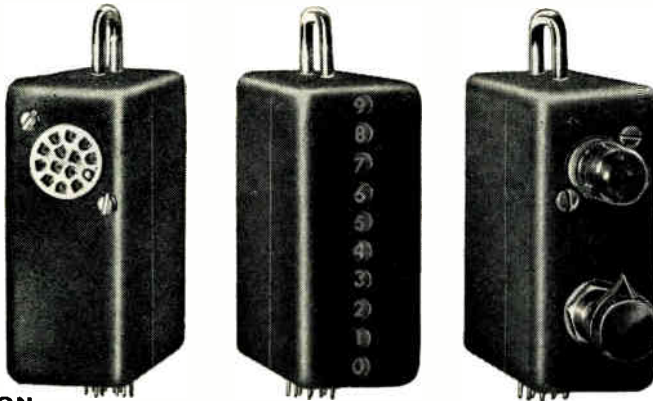

ONE-HALF  
ACTUAL SIZE

**WIDE SELECTION**

EECO N-Series plug-in Transistorized Decades are available in a wide range of models. The counting circuitry is standardized for the various models. Provisions for visual readout and/or preset controls are as follows:

MODEL	DESCRIPTION
N-101	No readout.
N-102	Incandescent readout.
N-104	Incandescent readout (remote). Typically a projection readout module.
N-105	Nixie readout. (Can be cabled to remote Nixie.)
N-106	Nixie readout with preset control switch. (Can be cabled to remote Nixie.)
N-107	Incandescent readout with inputs for external preset control.
N-108	Incandescent readout (remote) with inputs for external preset control.
N-111	No readout, but with 1-2-4-2 code

**TYPICAL SPECIFICATIONS**

The N-102 Transistorized Decade (with internal incandescent readout) employs four binary stages operating in a 1-2-4-2 code. Visual readout consists of the numerals 0 through 9 displayed vertically and illuminated by incandescent lamps. Total power consumption is approximately one watt. Outputs include (N/10), (N/10)', and a 9-step staircase, which may be adapted for a visual display by means of an emitter follower and DC voltmeter.

**ELECTRICAL SPECIFICATIONS**

**INPUT**

Minimum Trigger Input: (0-100 kcs): 7 volts positive pulse or step at 0.5  $\mu$ sec. rise time; (100 kcs to 250 kcs): 7 volts positive pulse or step at 0.2  $\mu$ sec. rise time.  
Maximum Operating Frequency: 250 kcs.  
Input Impedance: 470  $\mu$ mf. capacitance, max.  
DC Reset Input is provided (normally supplied by T-129 DC Reset Generator).

**OUTPUT (No Load)**

Amplitude: 8 volts, peak to peak.  
Output Levels: (N/10) and (N/10)': -11 volts DC and -3 volts DC, nom. Staircase: -11 volts DC to -3 volts DC in 9 steps.  
Rise Time: (N/10): 0.5  $\mu$ sec.; (N/10)': 0.5  $\mu$ sec.  
Type: (N/10), (N/10)', and 9-step staircase.  
Load: Typical, two N-Series decades or two T-Series flip-flops. (Load information available on request.)

**PHYSICAL SPECIFICATIONS**

Dimensions: 1-5/16" wide x 3" deep x 3-7/8" seated height (including handle). Dimensions are exclusive of external addenda found in external preset and Nixie models.  
Mounting: Plugs into standard 9-pin miniature socket. (Some other models require a special 13-pin miniature socket, which is furnished with each such unit.)  
Pin Connections: Arranged for in-line wiring of power and grounds.  
Operating Temperature Range: -54°C to +71°C.

NOTE: 0 to 5 megacycle models available soon.

*Additional information on N-Series Transistorized  
Decades and other EECO products available on request.*

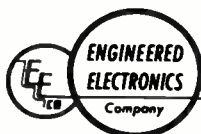

**ENGINEERED ELECTRONICS COMPANY**  
(a subsidiary of Electronic Engineering Company of California)  
506 East First Street • Santa Ana, California



**SPACE PROBER**

At the Boulder Labs of NBS this 60-ft. paraboloidal reflector probes space mysteries. Designed and built by GB Electronics it is constructed to withstand 120 mph winds.



**AUTO RADAR (above)**

Delco Radio has arrived at this "breadboard" stage in the development of a radar-type proximity warning device for automobiles.

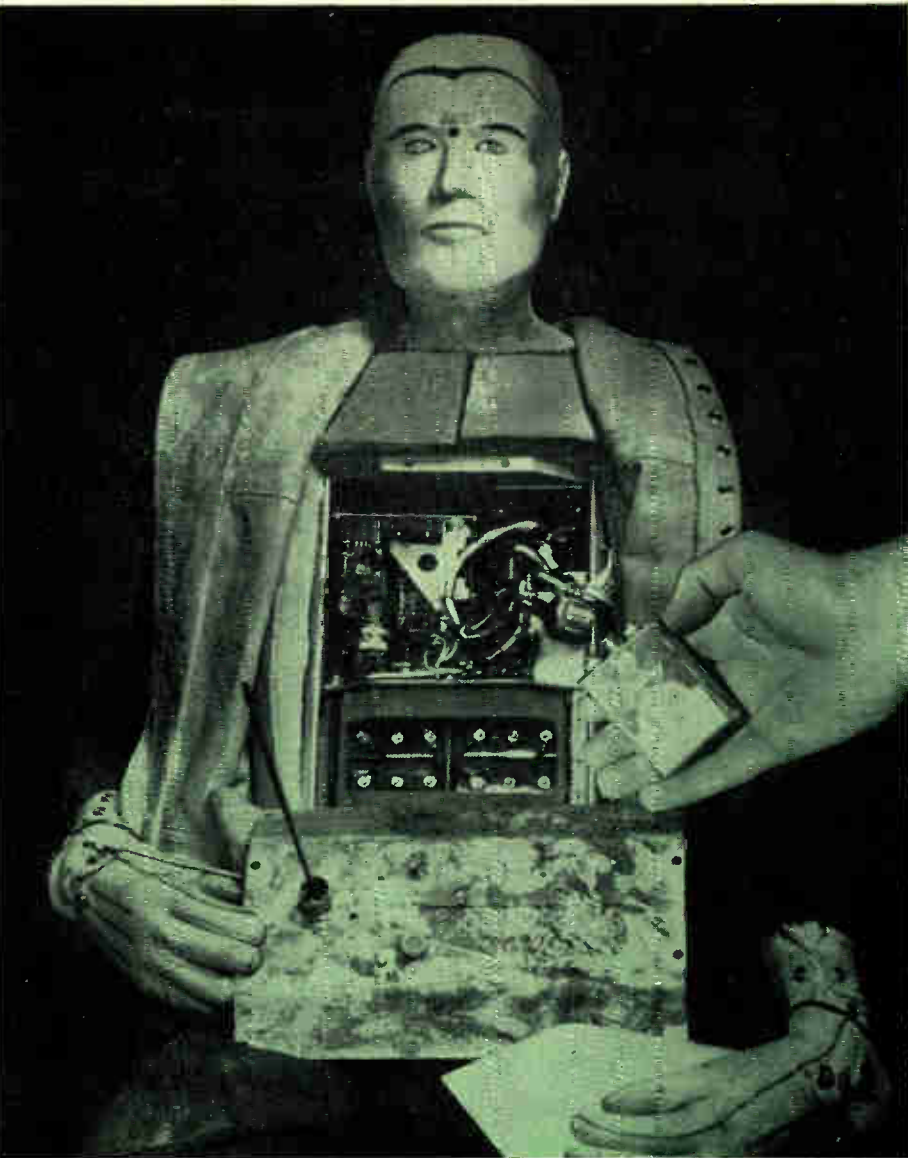

**"HURRICANE SAM"**

Six-foot tall, life-like dummy is used in AF tests to develop supersonic flight escapes. Fired into space at 1,500 mph "Sam" contains numerous strain gauges and accelerometers to transmit stresses and strains. 25 compact Yardney Silvercel batteries provide the power

# Snapshots . . . of the Electronic Industries

**AIR CONDITIONING COMPUTER (left)**

Special computer developed by Westinghouse analyzes over 50 factors affecting the cooling needs of a home, and in 24 seconds decides what size air conditioning unit is needed.





#### RADIO SEXTANT

Collins Radio's Ted Willis discusses features of the AN/SRN-4 radio sextant on board the USS Compass Island with skipper Capt. J. H. Brandt and Lt. J. W. Kuncas. The new Collins sextant will track both the sun and moon under all weather conditions.

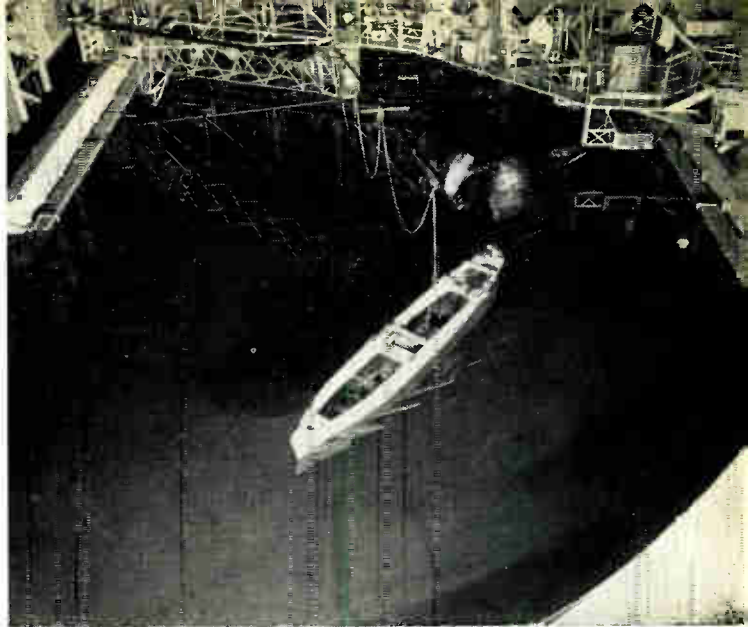

#### CHECK SHIP DESIGN

The Navy's David Taylor Model Basin, where engineers check out hull designs, has ordered a Computer Language Translator from Electronic Engineering Co. of California that will convert the language of one computer into a form suitable for input to another.

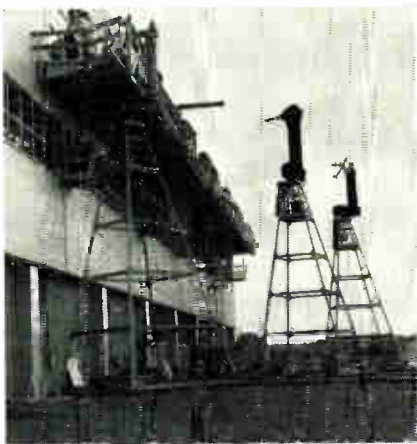

#### ANTENNA R&D

These are three of the seven radiation patterns measuring ranges on which Boeing checks out the efficiency of new antenna designs. Airplane models on towers can weigh up to 1,000 lbs.



#### LIGHTING PANELS

Electroluminescent lighting panels for commercial applications announced by Westinghouse are available as rectangular plates in sizes from 2x2 to 24x24 in. Colors are green, blue or yellow.

#### ROCKET TESTS

At Rocketdyne, Div. of North American Aviation Inc. mechanics align the thrust chamber of rocket engine. Special alloy ducts, supplied by Allegheny Ludlum Steel Corp. carry liquid oxygen to the thrust chamber.

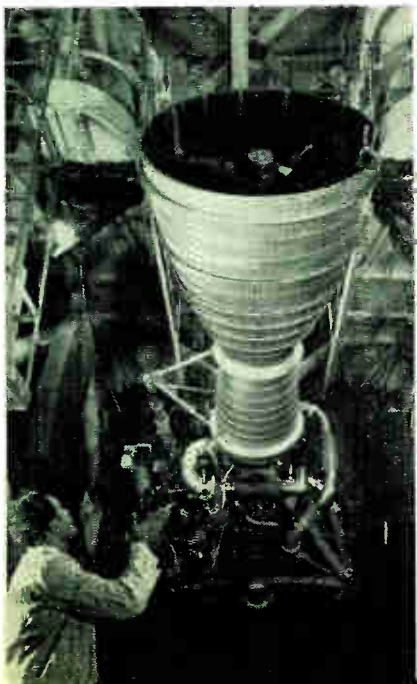

#### NEW DIELECTRIC MATERIAL

"Eccosphere" is the name that Emerson & Cuming have tagged on this new dielectric material developed for use in molding compounds, radomes, heat barriers, casting resins

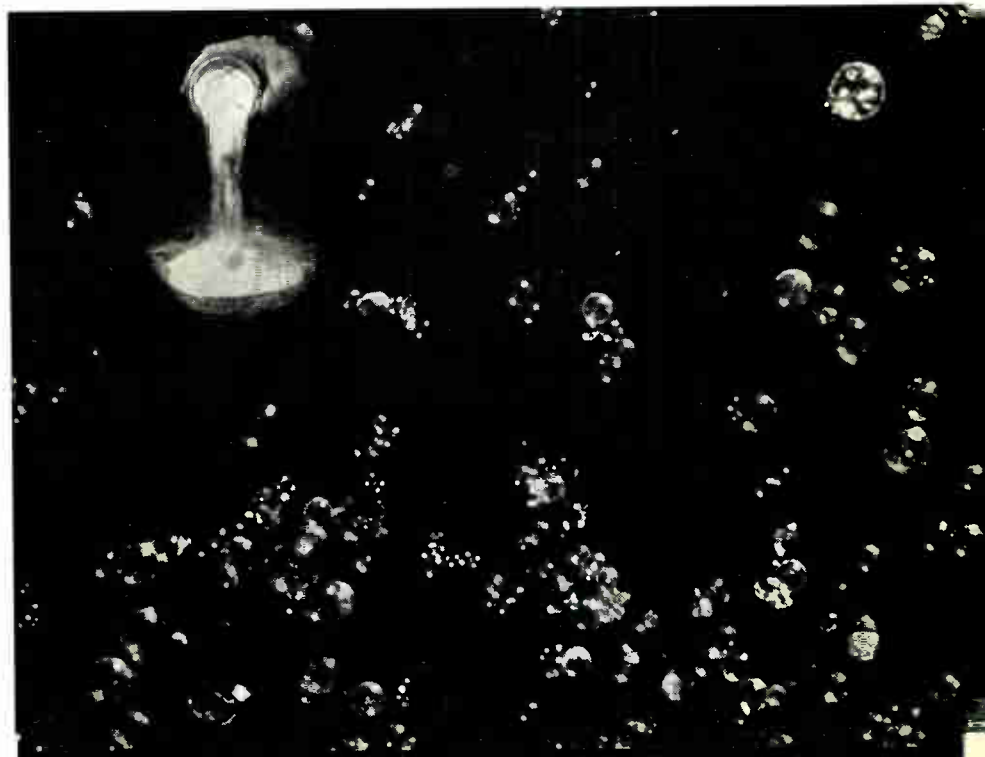

# Radio Receptor Germanium DIODES

**GOLD  
BONDED**

will fill every  
circuit requirement

... a full range of  
standard EIA types as well as  
special DR types

**HIGH TEMPERATURE TYPES**

1N198\* 1N277

**HIGH CONDUCTANCE TYPES**

1N270 1N281

**COMPUTER TYPES**

1N276\* 1N191 1N192

**GENERAL PURPOSE TYPES**

1N67A	1N97A	1N117A
1N68A	1N98A	1N118A
1N89	1N99A	1N126A*
1N90	1N100A	1N127A*
1N95	1N116A	1N128*
1N96		1N198

\*JAN types

They're designed for long life and extreme reliability — and manufactured under Radio Receptor's unique gold bonding process which assures dependable high forward conductance without sacrificing desirable low reverse leakage.

The listed diodes are only a fraction of the line. Radio Receptor DR types as developed by General Instrument Corporation have in most cases characteristics far in excess of any of the standard types. And all these germanium diodes are available in volume quantities for immediate delivery. Write us for full information.



Semiconductor Division

**GENERAL INSTRUMENT CORPORATION**

65 Gouverneur Street, Newark 4, N. J.



GENERAL INSTRUMENT CORPORATION INCLUDES F. W. SICKLES DIVISION, AUTOMATIC MANUFACTURING DIVISION, RADIO RECEPTOR COMPANY, INC. AND MICAMOLD ELECTRONICS MANUFACTURING CORPORATION (SUBSIDIARIES)

GENERAL INSTRUMENT DISTRIBUTORS: Baltimore: D & H Distributing Co. • Chicago: Merquip Co. • Cleveland: Pioneer Electronic Supply • Los Angeles: Valley Electronics Supply Co. • Burbank: Milwaukee: Radio Parts Co., Inc. • New York City: Hudson Radio & Television Corp. • Sun Radio & Electronic Co. • Philadelphia: Herbach & Rademan, Inc. • San Diego: Shanks & Wright Inc. • San Francisco: Pacific Wholesale Co. • Seattle: Seattle Radio Supply • Tulsa: Oil Capitol Electronics



*for all the  
programming features  
you want...*

Patchcord Systems by

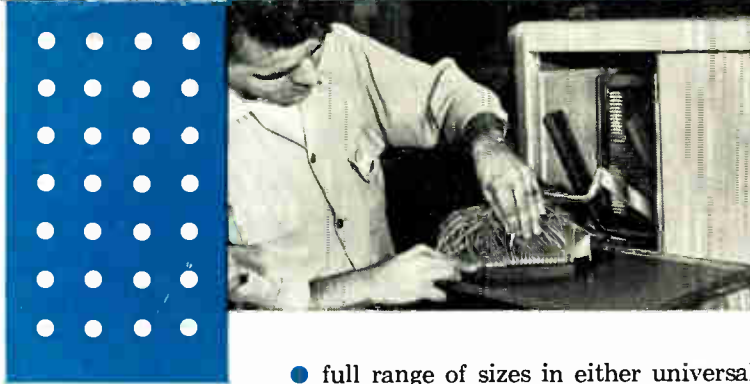
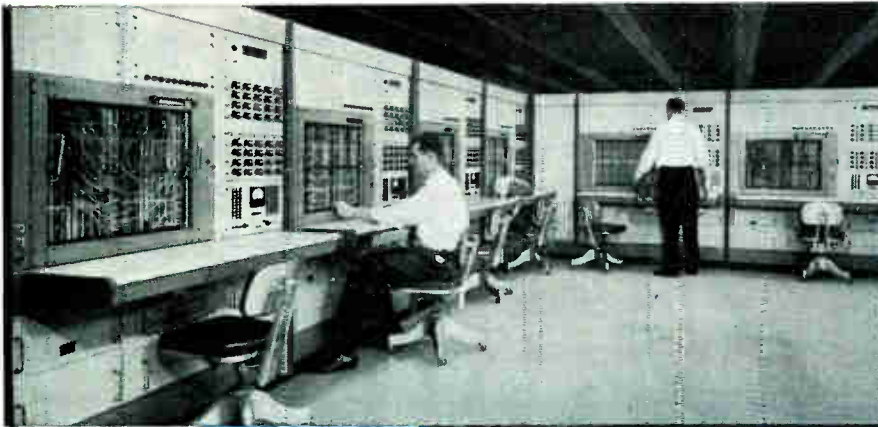
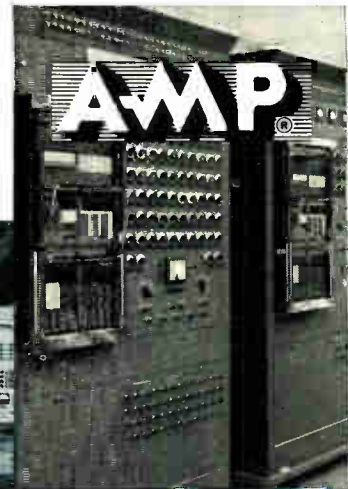

*In data processing and telemetering equipment, analog computers and other low signal level circuits, A-MP Patchcord Programming Systems and Panels offer the precise features you need, many of them exclusive. Here are a few:*

- full range of sizes in either universal or shielded types
- shielded systems feature patchcords constructed of coaxial cable and boards of unique cellular design which provide complete isolation for all signal circuits and positive grounding for all shields
- patented wiping action pre-cleans all contact surfaces whenever pre-programmed removable boards are placed in service
- frame mechanism assures positive contact when closed yet opens easily for quick board changes
- for complete data on patchcord system sizes, patchcords, and specifications on electrical characteristics (including voltage and current ratings—leakage resistance, capacitance and inductance) send for AMP's all new Programming Systems Catalog.

**AMP INCORPORATED**  
GENERAL OFFICES: HARRISBURG, PENNSYLVANIA

A-MP products and engineering assistance are available through subsidiary companies in: Canada • England • France • Holland • Japan

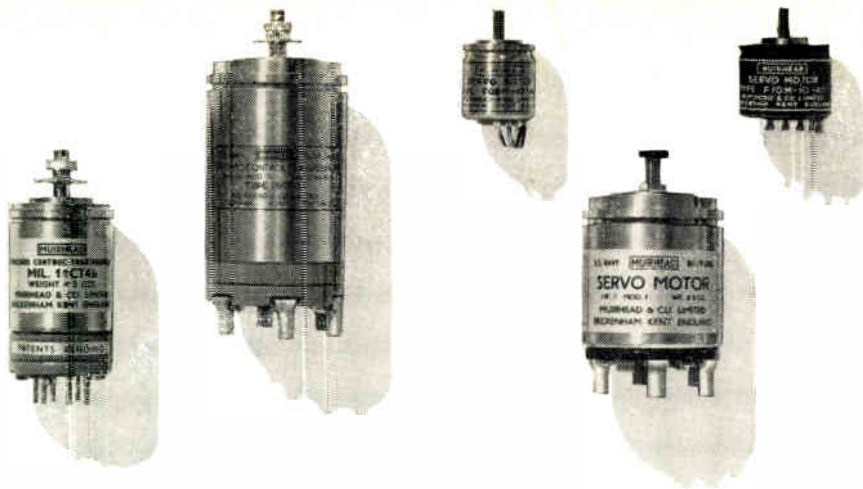

# Synchros galore!

All shapes and sizes of synchros and servos for every conceivable duty, built to established specifications and ready for immediate delivery.

MUIRHEAD Synchros are backed by more than 20 years' synchro manufacturing experience.

*Ask for the comprehensive Broadsheet.  
Specific data sheets  
and prices are available on request.*



# MUIRHEAD

## PRECISION ELECTRICAL INSTRUMENTS

MUIRHEAD INSTRUMENTS INC., 677 Fifth Avenue, New York 22, N.Y., U.S.A.

MUIRHEAD INSTRUMENTS LIMITED, Stratford, Ontario, Canada.

MUIRHEAD & COMPANY LIMITED, Beckenham, Kent, England.

**Mailed**

to  
any

part  
of

the  
world

on request

**MUIRHEAD**

# TECHNIQUE

A Journal of Instrument Engineering  
for  
Scientists, Engineers, Technicians,  
Research Workers

**MUIRHEAD & CO. LIMITED**  
**BECKENHAM · KENT**  
**ENGLAND**



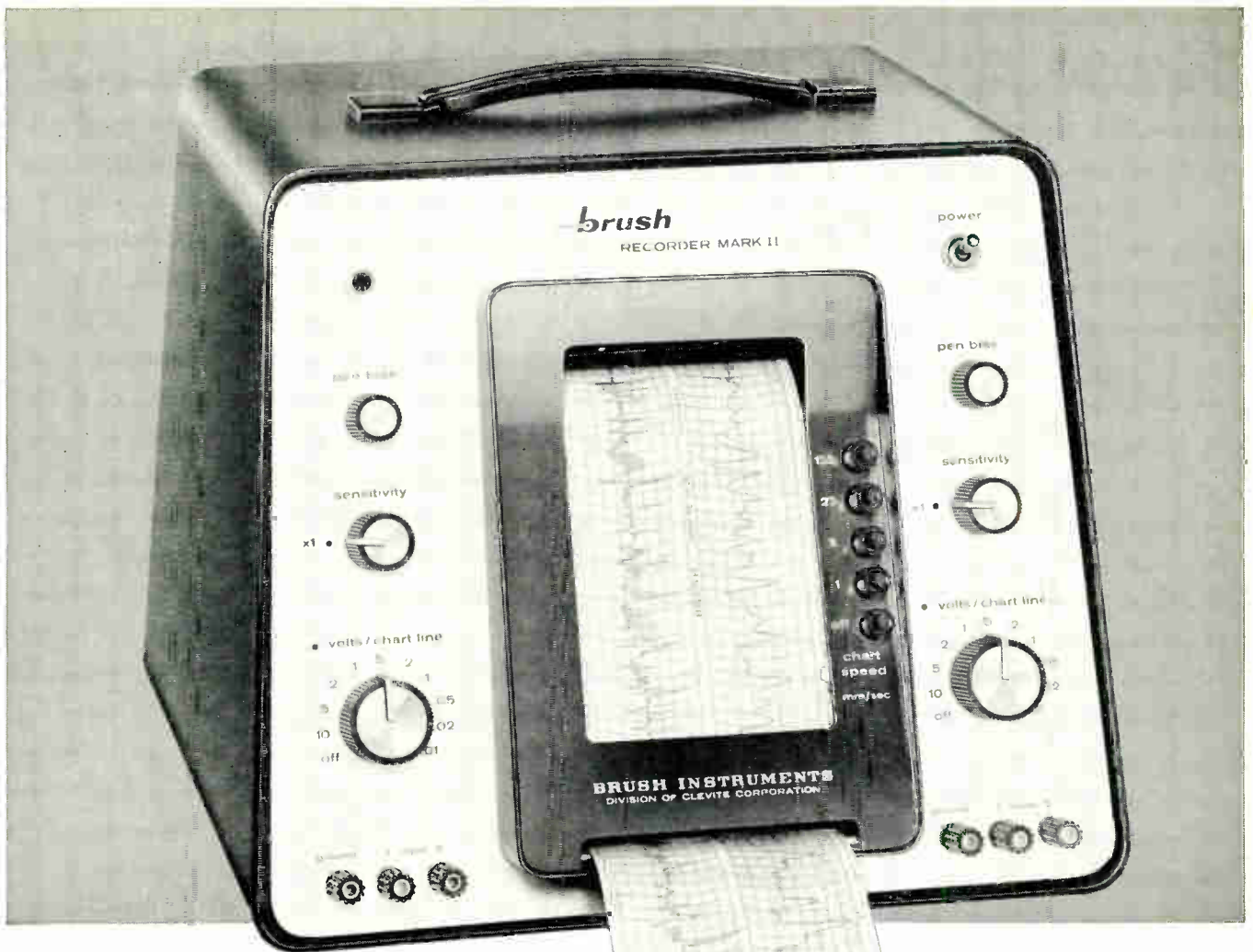

BRUSH  
RECORDER MARK II

*At last!*

# New Oscillograph Package

## AS "IDIOT-PROOF" AS YOU'VE HOPED FOR

- Built-in amplifiers
- Permanently calibrated
- Instant paper loading
- "White glove" writing system

**brush** INSTRUMENTS

DIVISION OF

3405 PERKINS AVENUE

**CLEVITE**  
CORPORATION

CLEVELAND 14, OHIO

IMMEDIATELY  
AVAILABLE  
FROM STOCK  
\$1350

Factory branches, service and warehousing at Arlington, Va., Boston, Cleveland, Los Angeles and Seattle; engineering representatives in all key locations.

# Electronic Industries' News Briefs

Capsule summaries of important happenings in affairs of equipment and component manufacturers

## EAST

**KAHLE ENGINEERING CO.** has recently acquired the Lamp & Tube Equipment Dept. of Alfred Hofmann & Co. This line complements Kahle's original line of machinery.

**E. I. du Pont de Nemours & Co.** have announced that their new "Teflon" 100-X FEP-fluorocarbon resin will be available late this year at a price of about \$12 a lb. The present development price is \$19 a lb.

**TELECHROME MFG. CORP.** has announced their merger with Encapsor Products Inc. Encapsor will now operate as a wholly owned subsidiary of Telechrome.

**SYLVANIA ELECTRIC PRODUCTS INC.** has announced the development of a new measuring instrument which assures rapid and accurate orientation of silicon and germanium crystals used in the manufacture of transistors, diodes, and other semiconductor devices. Instrument is said to be better than conventional and more complicated reflection, microscopic, and X-ray methods.

**SPERRY GYROSCOPE CO.,** Electronic Tube Div. has announced receipts of orders for 60,000 2K25 klystron tubes. The order for \$877,430 has been placed by the U. S. Air Force.

**RAYTHEON MFG. CO.** and **MACHLETT LABORATORIES, INC.** have approved an agreement providing for the merger of the two companies, subject to the approval of the stockholders of both companies.

**NATIONAL CO.** has announced the signing of a \$5.5 million prime contract with the Navy for a quantity of "no drift" radio receivers. This is the third multi-million dollar contract received by the electronics firm in recent months.

**KAY ELECTRIC CO.** announces that it has been appointed exclusive distributor in the United States and Canada for DRD Meters, the complete line of direct-reading digital frequency meters manufactured by Sivers Lab, Stockholm, Sweden.

**CIRCUIT INSTRUMENTS INC.,** wholly-owned subsidiary of International Resistance Co. is being merged with IRC. Its name will be changed to International Resistance Co., Circuit Instruments Div.

**GENERAL ELECTRIC CO.,** Communication Dept. has transferred headquarters to Lynchburg, Va. Two-way radio, microwave, power line carrier current equipment and military communication units will be engineered and manufactured in this new modern plant facility.

**GENERAL CERAMICS CORP.** has announced the formation of the Applied Logics Div., an autonomous unit, to design, manufacture and market improved buffer memory systems for special computer applications.

**BURNDY CORP.** has contracted to acquire H. H. Buggie, Inc., of Toledo, Ohio. Burndy, manufacturer of electrical connectors, thus broadens their line of connectors for the electronics market.

**RADIATION INC.** and **LEVINTHAL ELECTRONIC PRODUCTS, INC.** jointly announced that discussions are in progress of a proposal to merge the two firms. As proposed, Leventhal will become a wholly owned subsidiary of Radiation and will continue operation under present management.

**BENDIX AVIATION CORP.** has announced that it had entered into an agreement for the acquisition of the business and substantially all the property and assets of M. C. Jones Electronics Co., Inc., Bristol, Conn.

**TAYLOR FIBRE CO.,** Norristown, Pa., has broken ground for a new warehouse for the storage of vulcanized fibre under carefully regulated humidity conditions. The building is part of a capital improvements program which will see more than \$1 million spent on projects scheduled for completion in 1959.

**RADIO CONDENSER CO.** has acquired Production Research Corp. of Camden, N. J. It will become a wholly-owned subsidiary.

**G-L ELECTRONICS, INC.** now has available fully encapsulated, aluminum cased tape wound toroidal cores that are volt-proof and chip-proof and that are packaged, ready-to-wind units for use in magnetic amplifiers, saturable reactors and special transformers.

**EMERSON RADIO & PHONOGRAPH CORP.** has announced a pilot production contract amounting to more than \$2 million to its Government Electronics Div. by the U. S. Air Force, Air Materiel Command, Wright Field, Ohio for the fabrication of a radar altimeter.

## MID-WEST

**RADIO CORP. OF AMERICA** will establish new quarters for its Surface Communications Systems Laboratory, now located in Tucson, Ariz., at a site 20 miles southeast of that city.

**ASSEMBLY PRODUCTS, INC.,** Chesterland, Ohio, now have available a new line of 6-inch panel meters with a dc linearity within 1% of full scale. The Model 661 may be mounted in any kind of panel because its 1-piece steel back shields it from magnetic fields.

**INTERNATIONAL TELEPHONE & TELEGRAPH CORP.** has received a contract to study space vehicle terminal guidance methods by the Air Research & Development Command of the Air Force. The agreement has been reached with ITT Laboratories in Fort Wayne, Ind., and will be fulfilled by the Astrionics Laboratory there.

**CONSOLIDATED ELECTRODYNAMICS CORP.** has established a government liaison office in Dayton, Ohio. This office will supplement activities of the company's district office in Detroit.

**CLEVITE CORP.** has announced that it has completed negotiations and is working out final agreements for the acquisition of Walco Products, Inc., East Orange, N. J., and its associated phonograph needle manufacturing companies, Electrovox Co., Inc., and Precision Products, Inc.

**ULTRADYNE, INC.,** Albuquerque, New Mexico, has released the new voltage controlled Model DCS-4 pressure to voltage system, in which the Model S-30 pressure transducer is combined with stable transistorized electronic circuitry containing mostly passive elements.

**GENERAL ELECTRIC CO.'S** Computer Dept. has received approval to expand its Deer Valley plant even before the new plant is fully occupied in Phoenix, Ariz.

**MOTOROLA INC.** has established a Solid State Materials Laboratory as an organized part of the recently established Solid State Electronics Dept. at their Phoenix, Ariz. location.

**CURTISS-WRIGHT CORP.'s** Electronics Div., Albuquerque, New Mexico, have available a new low cost transistor curve tracer for engineering, training, production and servicing applications.

**MINNEAPOLIS-HONEYWELL REGULATOR CO.,** Heiland Div., is expanding its Denver facilities for the second time in two years to meet the growing production and engineering requirements. The new addition will be used for wiring and testing of the division's industrial recording instruments.

## WEST

**ELECTRONIC ENCLOSURES, INC.** has announced expansion of their manufacturing facilities and offices to larger more modern quarters. They now occupy 12,500 sq ft building at 3629 Holdrege in the Jefferson industrial tract.

**NORTHROP CORP.** is expanding into the new field of advanced systems for long-range radio communications through acquisition of Page Communications Engineers, Inc.

**BRANSON INSTRUMENTS, INC.,** has opened a factory branch at 12438 Ventura Blvd., Studio City, Calif.

**SERVOMECHANISMS, INC.** has received an order from the Chrysler Corp. for the production of liquid oxygen tanking computers. The computer, which accurately measures, controls, and indicates the level of liquid oxygen in the missiles tanks, is for use in the Jupiter.

**WESTERN GEAR CORP.,** Precision Products Div., has let a contract for construction of a new Reliability and Quality Assurance Building centrally located on the company's 26 acre Lynwood plant property.

**ELCO CORP.** has announced that its wholly owned Pacific Coast subsidiary, Elco Pacific, has taken new, larger quarters at West Los Angeles, Calif.

**CONSOLIDATED ELECTRODYNAMICS CORP.,** Systems Div., has just received contracts totaling \$3.1 million from Convair Astronautics for production of ground-support equipment for the Atlas missile program.

**TAMAR ELECTRONICS, INC.,** has acquired a 10,000-sq ft facility for expanded microwave-electronics research projects.

**BECKMAN INSTRUMENTS, INC.,** has received a \$225,000 contract from Boeing Airplane Co. for a new high-speed analog computer which will help increase the effectiveness of the Bomarc Weapon System.

**ALPAR MFG. CO., INC.,** has moved to 220 Demeter St., Palo Alto, Calif. from their former Redwood City location.

**LITTON INDUSTRIES** has bought the Times Facsimile Corp., a subsidiary of the New York Times Co.

**EITEL-McCULLOUGH, INC.** has announced a company-wide 1959 construction program of facilities in San Carlos and San Bruno, Calif. and in Salt Lake City, Utah.



# ANN OUN CING

CONVAIR INSTRUMENTS  
*designers and builders of:*  
*electromechanical instruments*  
*mechanical instruments*  
*ac & dc measuring instruments*  
*transducers*

# 2900A

DC VOLTMETER  
 $\pm 10$  MICROVOLTS TO  $\pm 1000$  VOLTS



Range:  $\pm 10$  microvolts to  $\pm 1000$  volts, in 9 decaded steps.

Zero Drift: Less than  $\pm 1$  microvolt (referred to the input) over 2-hour period.

Power Sensitivity:  $10^{-14}$  watts at full scale.

Amplifier Output: Approx.  $\pm 1$  volt at 0.1 milliamperes for full scale reading.

Combines direct reading voltmeter with chopper-stabilized DC amplifier... Accuracy within  $\pm 3\%$  (above noise level) of full

scale... Zero-center meter movement provides polarity indication without switching or lead reversal... Rugged, all transistor, etched-circuit construction... Illuminated mirror scale.

*A twist of a knob releases chassis from hand carrying case, for insertion in 3-unit modular rack.*

Prices:\*

Model 2900A DC Voltmeter	\$395.00
Model 2901A Hand Carrying Case	90.00
Model 2902A 3-Unit Rack	175.00

For complete information, write today for CI Bulletin No. 29-2.

\* (ALL PRICES FOB SAN DIEGO)

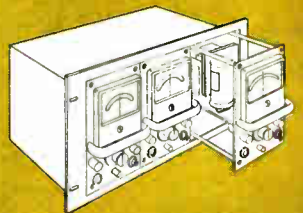

CONVAIR INSTRUMENTS/CONVAIR, A DIVISION OF GENERAL DYNAMICS CORPORATION

3595 FRONTIER STREET,  
 SAN DIEGO, CALIFORNIA



## Speaking of service... have you heard what PRICE is doing?

Wherever electronics buyers get together, you hear talk about the new service policies of Price Electric. Accustomed as they are to Price quality and design leadership, buyers find this deluxe service an added reason for specifying Price's Husky Relays. From the time of the first inquiry until the relays are delivered, Price's Sales-Service Department expedites every facet of the operation to assure complete customer satisfaction.

Husky Relays are everywhere . . . from the satellites to your car radio. Give us a try on your next relay requirement.



**SEE THE NEW 1959 LINE OF PRICE RELAYS**

Write or Call



**PRICE ELECTRIC CORPORATION**

Frederick, Maryland MOument 3-5141

## Tele-Tips

**SALES ENGINEERS** should appreciate this one.

The letter was obviously written by an illiterate salesman:

"Dear Boss: I seen this outfit which they ain't never bought a dime's worth of nothing from us and I sole them a couple hundred thousand dollars worth of guds. I am now going to Chawgo."

Two days later a second letter arrived at the home office:

"I cum hear and I sole them half a milyon," it said.

Both letters were posted on the bulletin board with a note appended by the company president:

"We been spendin too much time hear tryin to spel, instead of trying to sel. Let's watch those sails. I want everybody should reed these letters from Gooch who is on the rode doin a grate job for us, and you should go out and do like he done."

**ENGINEERING DESIGN** should be simple. This fact isn't stressed nearly enough. That's why we're so taken with this little summation that John Howell of B & H Instrument Co. tossed off at a recent convention: "*The ultimate in a well engineered product is a black box that meets all the design requirements and has nothing in it.*"

**ARMAMENT** carried by 1 supersonic fighter bomber equals the destructive power of an entire WW II bomber formation.

**AUDIO THEORY** is being challenged. For years it has been accepted that most of the power in musical sounds is concentrated within only a few octaves in the middle register. But John G. McKnight of Ampex questions this. He says that the peak energies at the upper and lower extremes of the audible range are substantially as great as those in the mid-range. Future equipment, then, should have not only a flat frequency response, but also a power range that is linear throughout the audio spectrum.

(Continued on page 36)



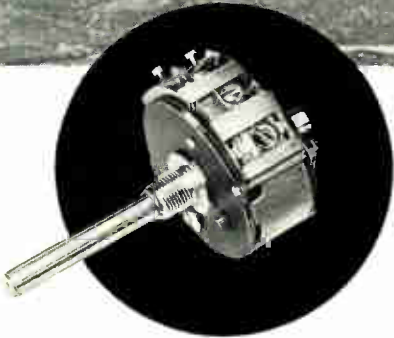

## Demonstrated Precision and Reliability

"Workhorse" of the world's airlines, the famed Douglas DC-7 employs Clarostat Series 42 Precision Potentiometers for flap-position indication. This is one more example of Clarostat precision, proved under day-in day-out working conditions.

## CLAROSTAT PRECISION POTENTIOMETERS Series 42

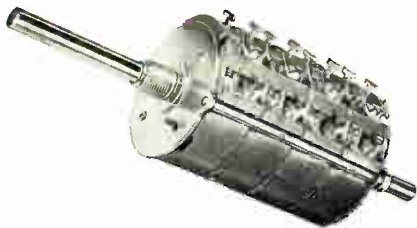

Series 42 potentiometers are wire-wound and offer resistance tolerance of  $\pm 5\%$ , linear or tapered. Closer tolerances on special request. They are available in a wide variety of electrical and mechanical characteristics to meet application and environmental conditions. Standard units are rated at 3 watts @ 40° C., while special high-temperature units are available for operation up to 230° C., with a rating of 0.25 watt. Units may be ganged by means of threaded rods and end plates. Switches for limited or continuous rotation models are available.

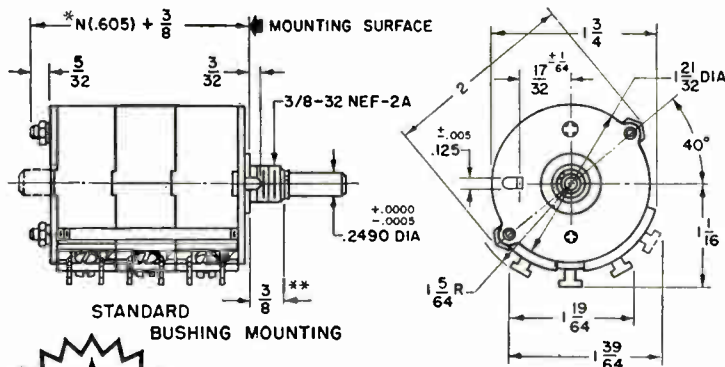

### SPECIFICATIONS

**Power Rating:** 3 watts @ 40° C.  
 .25 watt @ 230° C. (high-temperature type)  
**Typical Weight:** 0.196 lb.  
**Insulation Breakdown Tests:**  
 Between terminals and ground for 1 minute,  
 1000 v.a.c. @ 3.4 Hg.  
**Resistance Range:** Linear, 1 to 100,000  
 ohms Tapered, 350 ohms per degree of rotation.  
**Resistance Tolerance:**  $\pm 5\%$ .  
**Taps:** To requirements.  
**Rotation:** Mechanical and electrical,  
 291°,  $\pm 3\%$ . Effective, 280° to  $\pm 3\%$ .  
**Torque:** 1 to 6 oz./in.



WRITE FOR COMPLETE DETAILS...  
**CLAROSTAT MFG. CO., INC., DOVER, NEW HAMPSHIRE.**

*Clarostat Means Precision You Can Count On*

another **MOTOROLA** first . . .



# 25amp power transistors

## FOR HIGH CURRENT SWITCHING and AUDIO APPLICATIONS

- 25 amps D.C. collector current
- Collector to base voltage; up to 80 volts
- High current gain: 25 at 25 amps (typical)
- Exceptionally rugged dynamic breakdown characteristic
- Low saturation resistance: 0.012 ohms (typical)
- Standard TO-3 package with oversized pins . . . available with or without low impedance solder terminals
- Excellent Beta linearity
- Meets or exceeds mechanical and environmental requirements of MIL-T-19500A
- Conservative maximum ratings and special testing methods assure long life . . . extreme reliability
- Immediately available "off the shelf" from your Motorola distributor

MAXIMUM RATINGS			
JEDEC NUMBER	COLLECTOR TO BASE VOLTAGE volts	COLLECTOR TO EMITTER VOLTAGE volts	COLLECTOR D. C. CURRENT amps
2N1162	50	35	25
2N1164	80	60	25
Maximum Junction Temperature — continuous			90°C
Maximum Junction Temperature — intermittent			100°C
Collector Dissipation for Mounting Base Temperature of 30°C: 50 watts Operating Temperature Range: -65° to 90°C			

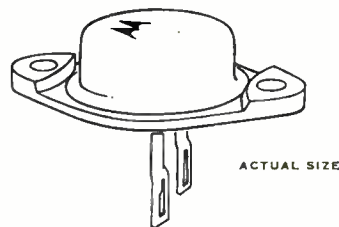

**Other Motorola Quality Products Include:**  
 Switching Transistors  
 Mesa Transistors  
 Zener Diodes  
 Silicon Rectifiers  
 Audio Transistors

**REGIONAL OFFICES:**  
 RIDGEFIELD, NEW JERSEY  
 540 Bergen Boulevard  
 WHitney 5-7500  
 CHICAGO 44, ILLINOIS  
 4900 West Flourney Street  
 ESTebrook 9-5200  
 HOLLYWOOD 28, CALIFORNIA  
 1741 Ivar Avenue  
 HOLlywood 2-0821



MOTOROLA INC., 5005 E. McDOWELL, PHOENIX, ARIZONA





## IF IT CALLS FOR RELIABILITY (AS ATLAS DOES) SPECIFY TRIMPOT® (AS CONVAIR DOES)

In applications such as the Atlas ICBM where uncompromising reliability, high performance and miniature size are vital, Convair-Astronautics specifies Bourns Trimpot potentiometers. Hundreds are used in the pre-flight checkout, launching and flight control of Atlas missiles. If the dependability of components is also important to your projects, investigate Trimpot... **the original leadscrew actuated potentiometer**... made only by Bourns. Write for our new summary brochure number 4.



### **BOURNS**

*Laboratories, Inc.*

P. O. Box 2112D, Riverside, Calif.

Plants: Riverside, California  
and Ames, Iowa

In Canada: Douglas Randall (Canada), Ltd.,  
licensee

Exclusive manufacturers of TRIMPOT®, TRIMIT®. Pioneers in potentiometer transducers for position, pressure and acceleration





... for Complete Reliability Under Severe Environmental Conditions

## Tele-Tips

(Continued from page 32)

**MICROWAVE TAPE** syndicates are being considered to extend the flexibility of video tape recording. The plan is to use the networks' early morning off-time hours to transmit taped programs to stations for video re-taping. The material will be held for future use.

**THE U. S.** now has more radio and TV sets than people. The latest count shows 150 million radios and 50 million TV receivers.

**AIRCRAFT FIRMS'** requirements read like the pickin's in a junk shop. On a typical day the purchasing agent might order: diapers, diamonds, pipe tobacco, wooden marbles and leg makeup. The diapers are handy for cleaning bombsight lenses; the diamonds are for grinding wheels; pipe tobacco is used in smoke generators to test ventilating systems; wooden marbles are utilized in metal bonding to equalize vacuum and to apply pressure to uneven tool surfaces; and the leg makeup is applied to employees' hands for photographic purposes.

**RADIO & TV** reception was suffering severe interference in another case reported to the FCC at Havre de Grace, Md. The loud buzz which disrupted reception was traced to a defective electric fence on a local farm.

**CLOSED-CIRCUIT TV** found an application tailor-made to its abilities at the recent International Stamp Exhibition in N. Y. Several TV receivers were located around the auction room to permit prospective buyers to get a close-up view of the stamps up for bids.

**"THE ARMY IS 'HEP'."** As of last June over 56% of all the officers of the active Army (excluding the Medical Corps and JAG) had a bachelor's degree or higher. Nearly 13% had a master's degree or doctorate. Among officers of the Regular Army the proportion was even higher; over 75% being college graduates and over 18% having higher degrees.

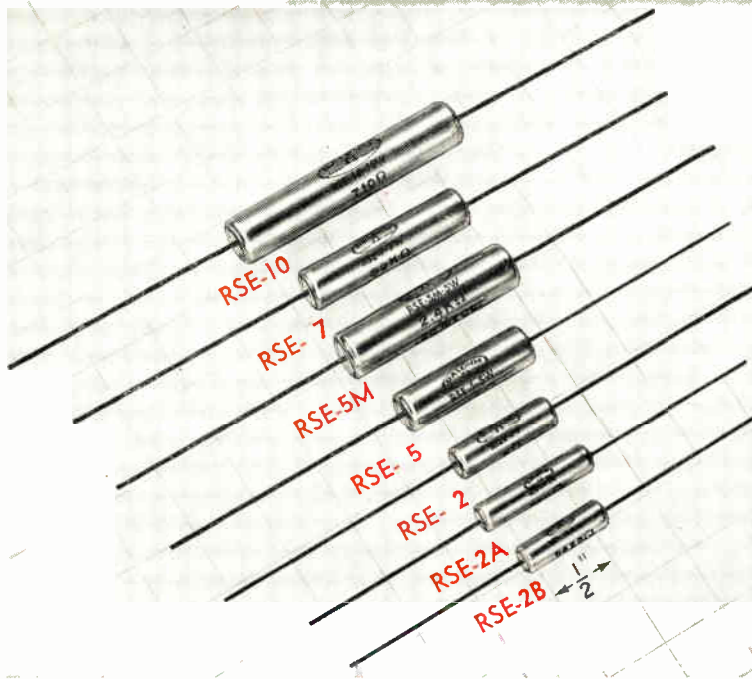

## TYPE RSE POWER RESISTORS

Wire Wound, Precision, Miniature, Ruggedized

RSE-2A DERATING CURVE

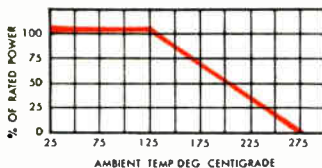

### JUST ASK US

The DALOHM line includes precision resistors (wire wound and deposited carbon); trimmer potentiometers; resistor networks; collet fitting knobs and hysteresis motors designed specifically for advanced electronic circuitry.

If none of the DALOHM standard line meets your needs, our engineering department is ready to help solve your problem in the realm of development, engineering, design and production.

Just outline your specific situation.

**DALE  
PRODUCTS  
INC.**

1304 28th AVE.  
COLUMBUS, NEBRASKA

A precision wire wound power resistor encapsulated in shock absorbing material; then encased and sealed in a metal tube to overcome demanding environmental conditions, yet maintains miniature size.

This ruggedized resistor will surpass the most severe mechanical shock and vibration requirements.

- Rated at 2, 3, 5, 7 and 10 watts
- Resistance range from .5 ohms to 175K ohms, depending on size and type
- Tolerances:  $\pm 0.05\%$ ,  $\pm 0.1\%$ ,  $\pm 0.25\%$ ,  $\pm 0.5\%$ ,  $\pm 1\%$  and  $\pm 3\%$ .

**TEMPERATURE COEFFICIENT:** Within  $\pm 0.00002/\text{Deg. C.}$

**COMPLETE PROTECTION:** 100% impervious to moisture and salt spray.

**WELDED CONSTRUCTION:** Complete welded construction from terminal to terminal.

**RUGGED HOUSING:** Sealed and inserted in metal tubing.

**SMALLEST IN SIZE:** .220 x 11/16" to .395" x 1-61/64".

**MILITARY SPECIFICATIONS:** Surpasses MIL-R-26C

Write for Bulletin R-25



# Books

## Conductance Design of Active Circuits

By Keats A. Pullen, Jr. Published 1959 by John F. Ryder Publisher, Inc., 116 W. 14th St., New York ..11. 344 pages. Price \$9.95.

Here is a new approach to the design of active circuits.

The non-linearity of electron tubes and transistors has for many years complicated design of active circuits associated with these designs. This book represents a proven method of overcoming these complications. The conductance approach utilizes a technique whereby a non-linear circuit may be linearized on a point-by-point basis. This definitive book explains and illustrates the theory and mathematics involved in this technique.

It presents the conductance technique as applied to the design of a wide variety of vacuum tube transistor amplifier, mixer, and oscillator circuitry in the broadest sense. To make the conductance technique completely understandable, numerical examples are given throughout.

## Electro-mechanical Energy Conversion

By David C. White and Herbert H. Woodson, Published 1959 by John Wiley & Sons, Inc., 440 Fourth Ave., New York 16. 646 pages. Price \$12.50.

The author starts from the fundamentals of analytical dynamics to establish a sound base for understanding the interactions in an electro-mechanical system. These fundamentals are then used to analyze typical energy converters. The essential concepts of electro-mechanical energy conversion are illustrated by the analysis of several simple transducers. In recognition of the importance of dynamic behavior and system design, this book discards masses of detail about steady state characteristics and device design in favor of a thorough treatment of dynamic characteristics of energy converters, feedback control system theory, and their interrelations.

## Noise in Electron Devices

Edited by Louis A. Smullin and Hermann A. Haus Published 1959 by John Wiley & Sons, Inc., 440 Fourth Ave., New York 16. 413 pages. Price \$12.00.

This book provides a comprehensive discussion, stressing the mathematical theory and basic physical phenomena, rather than detailed design techniques. The most modern points of view are presented regarding cathode noise phenomena, signal amplification and microwave tubes, solid state noise, and methods of designing low noise tubes. Since the emphasis is on fundamentals processes, the material presented can well serve as background for the understanding of such devices as masers and parametric amplifiers.

(Continued on page 40)



announces **NEW BREAK-THROUGH**  
**IN HYSTERESIS MOTOR DESIGN**



**HEAT RISE BARRIER IS LOWERED TO ONLY  
20° - 38° C., DEPENDING ON H.P. RATING**  
**Sub-Fractional • Low Noise • No Vibration • Synchronous**

The new DALOHM Hysteresis motor provides all the desirable characteristics of such motors, yet doesn't have the usual heat rise handicaps. Small and lightweight, its new pancake configuration is space saving.

- Low noise
- Maintains synchronous speed at rated load
- No vibration or magnetic strays
- Reaches full RPM in 1 revolution
- Exceptionally low cost
- Operates on any frequency up to 120 c.p.s., giving an infinite selection of speeds up to 3600 RPM

**RUNNING TORQUE:** 2.8 inch/oz. to 28 inch/oz.

**VOLTAGE:** 115 V., 60 c.p.s.

**SPEED:** 1800 RPM

Write for *Bulletin R-80*

Ideally suited for facsimile machines, Hi-Fi turntables, tape recorders, tele-metering and many other types of equipment where constant synchronous speed is essential.

### JUST ASK US

The DALOHM line includes precision resistors (wire wound and deposited carbon); trimmer potentiometers; resistor networks; collet fitting knobs and hysteresis motors designed specifically for advanced electronic circuitry.

If none of the DALOHM standard line meets your needs, our engineering department is ready to help solve your problem in the realm of development, engineering, design and production.

Just outline your specific situation.

**DALE  
PRODUCTS  
INC.**

1304 28th AVE.  
COLUMBUS, NEBRASKA

**Whatever you need in silver you can find at the  
HANDY & HARMAN SILVER SUPERMARKET**



*Silver  
Supermarket*

Special today—and every day—silver in every form and grade you can name. By the ounce, inch, foot, and every other measure known to man.

All are of the consistent quality that has made—and kept—Handy & Harman first in the manufacture and development of silver and silver alloys for industry.

At the right are some of the general forms of silver made by Handy & Harman (what you don't see, ask for):

- Fine Silver (wire, strip and foil)
- Silver Anodes and Grain for plating
- Silver Contact Alloys
- Silver Powders
- Silver Flake and Paint
- Silver Brazing Alloys
- Silver Electronic Solders
- Silver Sintered Metals
- Solder-Flushed Silver Alloys
- Silver Chloride and Oxide
- Coin Silver (wire and strip)
- Silver Bi-Metals
- Gold, Platinum and other precious metals also available in every form you need

**VISIT OUR BOOK  
DEPARTMENT**

We have five Technical Bulletins giving engineering data on the properties and forms of Handy & Harman Silver Alloys. We would like you to have any or all of those that particularly interest you. Your request, by number, will receive prompt attention.

- Fine Silver . . . . . Bulletin A-1
- Silver-Copper Alloys . . . Bulletin A-2
- Silver-Magnesium-Nickel . . . Bulletin A-3
- Silver Conductive Coatings . . . Bulletin A-4
- Silver Powder and Flake . . . Bulletin A-5

**Your NO. 1 Source of Supply and Authority on Precious Metal Alloys**



**HANDY & HARMAN**  
General Offices: 82 Fulton St., New York 38, N. Y.

OFFICES AND PLANTS  
ATLANTA, GA.  
BRIDGEPORT, CONN.  
PROVIDENCE, R. I.  
CHICAGO, ILL.  
CLEVELAND, OHIO  
DETROIT, MICH.  
LOS ANGELES, CALIF.  
OAKLAND, CALIF.  
TORONTO, CANADA  
MONTREAL, CANADA



# NO MORE EXTERNAL BOOSTER AMPLIFIERS...

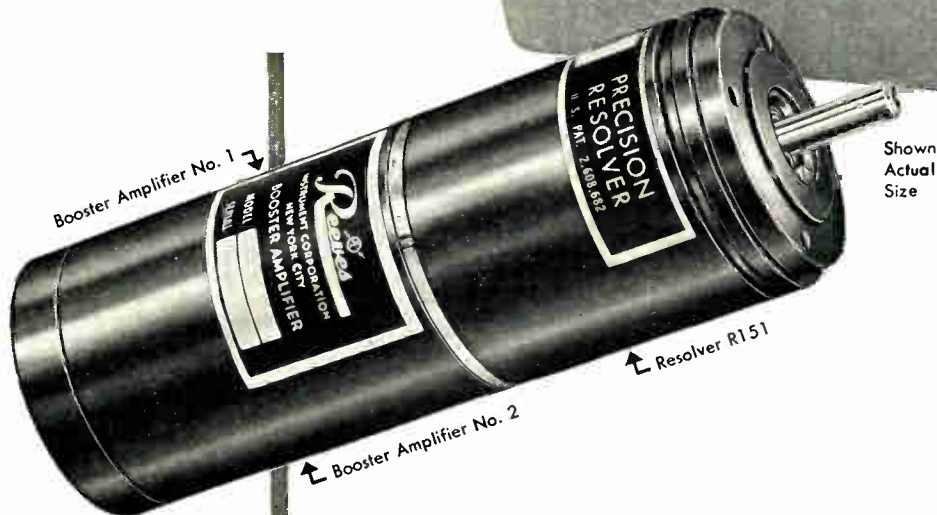
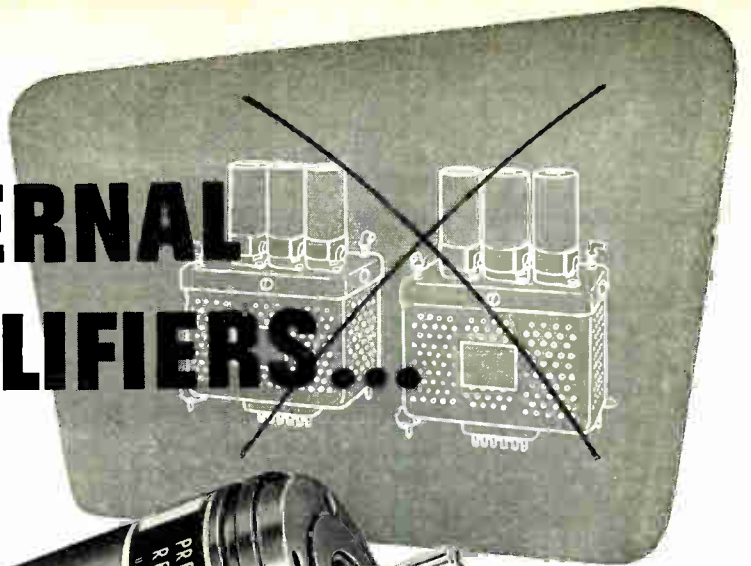

## specifications

Transformation ratio:  $1.000 \pm .001$   
 Phase shift:  $0^\circ \pm 3'$   
 Functional accuracy: 0.1%  
 Input impedance: over 8 megohms  
 Frequency: 400 c.p.s.  $\pm 5\%$   
 Max. amplitude: 14 V. r.m.s.  
 Temp. range:  $-55^\circ \text{C. to } 80^\circ \text{C.}$   
 Power requirements:  
 30 V. d.c. @ 6 ma. per amplifier

## REEVES CONTINUOUS RESOLVER CHECKER



Provides continuous  $360^\circ$  check on resolver functional accuracy, and yields permanent record of results.

**ENGINEERS:** Rewarding careers at Reeves in the fields of radar, guidance, and computer systems.

## with the new combination resolver-booster

by **Reeves**  
INSTRUMENT CORPORATION

**An outstanding advance in MINIATURIZATION without sacrifice of performance or precision.**

Shown FULL SIZE in the illustration above, this latest Reeves achievement in miniaturization for airborne applications takes up a fraction of the space occupied by a conventional resolver with external boosters. Yet performance, accuracy and dependability are in every way equivalent or better.

The new Reeves Combination Resolver-Booster consists of the time-proven R151 Precision Resolver with two PLUG-IN TRANSISTORIZED BOOSTER AMPLIFIERS built onto it as shown. The amplifiers provide standardization for transformation ratio and phase shift over a wide range of temperatures. Specifications given are maintained for production units without culling. Additional data on request.



1RV59

## REEVES INSTRUMENT CORPORATION

A Subsidiary of Dynamics Corporation of America, Roosevelt Field, Garden City, N. Y.

# Tape specs are getting tougher every year



\* *higher recording densities*  
(up to 2,000 bits per inch)

\* *more tracks*  
(16 channels per inch)

\* *greater accuracy*  
(1 error per 40 million)

...but not too tough for Audiotape

Keeping *ahead* of its customers is the only way a magnetic tape manufacturer can meet the rapidly rising standards being set for its product. And often the standards are as varied as they are exacting. Special slitting tolerances, coating thicknesses, base materials and magnetic oxides are rapidly becoming more usual than novel. Audio Devices' battery of Automatic Certifiers is one of the unique means used to make sure EP Audiotape always meets customer specifications.

Type EP Audiotape is the *extra precision* magnetic recording tape for applications in computing, automation, telemetering and seismography. The Automatic Certifier records and plays back every inch of the EP Audiotape under test. These tests can be so demanding that if the tape fails to reproduce a single test pulse out of the 40 million put on a single reel, the entire reel is rejected. There are no ifs, ands or buts.

This is one of many special quality-control operations to which EP Audiotape is subjected. From raw materials to hermetically sealed containers, every reel gets individual attention.

EP Audiotape quality is so well verified by instruments like the Automatic Certifier that every reel is guaranteed to be defect-free! For more information write for free Bulletin T112A. Write Dept. TT, Audio Devices, Inc., 444 Madison Avenue, New York 22, N. Y.

**TYPE EP audiotape** TRADE MARK

**AUDIO DEVICES, INC.**  
444 Madison Ave., N. Y. 22, N. Y.  
In Hollywood: 840 N. Fairfax Ave.  
In Chicago: 5428 Milwaukee Ave.  
Export Dept.: 13 East 40th St., N. Y., 16  
Rectifier Division: 620 E. Dyer Rd., Santa Ana, Calif.

## Books

### *The Pulse of Radar; The Autobiography of Sir Robert Watson-Watt*

Published 1959 by The Dial Press, Inc., 461 Fourth Ave., New York 16. 438 pages. Price \$6.00.

Of all the scientific inventions that affected the outcome of World War II, radar was undoubtedly one of the most decisive. This book is the story of the life of the carpenter's son from Scotland who first conceived of radar, developed it, convinced soldiers and politicians that they must use it, and as a result revolutionized the whole of modern war.

Once the young scientist had hit upon his early ideas and had tested them, there began a desperate race to ring England with a radar network before Hitler's planes could begin their attack. Then, because radar was ready in time, the RAF was able to win the battle of Britain. Here is the story of how it was done.

This work is a valuable and fascinating book which is not only an outstanding contribution to the history of our times, but also the human story of a great career.

### *Mobile Radio Telephones*

By H. N. Gant. Published 1959 by The MacMillan Co., 60 Fifth Ave., New York 11. 125 pages. Price \$4.50.

Now that the techniques of wireless have opened up the higher frequency bands, and succeeded in greatly reducing the size of the necessary equipment, mobile radio has become a natural and most helpful aid to business and administration. Previous books on this subject have been written for the technicians—design, installation, and maintenance engineers—but the author, realizing that mobile radio is now so much the executive's responsibility, has written this book especially for those people constantly dealing with and organizing transport.

He concerns himself with the uses of mobile radio telephones from a commercial point of view and discusses in full its applications, benefits, and limitations.

### *The Technical Writer*

By J. W. Godfrey and G. R. Parr. Published 1959 by John Wiley & Sons, Inc., 440 Fourth Ave. New York 16. 340 pages. Price \$8.50.

Good writing not only demands accuracy and clarity but also the ability to select illustrations, present data, and display the material in the most attractive way to the reader.

This book was undertaken to give the writer of technical literature that insight into the technique of presentation and production. Many books on

(Continued on page 44)





*Another Tinnerman Original...*

## Cost-cutting Tubular **SPEED CLIP**<sup>®</sup> takes positive "bite" to hold assemblies tight!

In seconds, you can front-mount trim, name plates, grilles, knobs, insulation, with Tubular **SPEED CLIPS**. And at interesting savings in assembly time and costs!

Snap these quality spring-steel fasteners into holes in metal, plastic or wood. Then press the mounting studs, nails or rivets into the clips to complete the attachments... anywhere along your assembly line.

As the **SPEED CLIP** is inserted, spring fingers compress, then expand behind the panel to lock tight. The rolled-in end permits easy entrance, but bites hard into the stud to prevent back-off or vibration-loosening.

Tubular **SPEED CLIPS** are available for a full range of stud sizes and panel thicknesses. Permanent lock or removable types.

Check your Sweet's Product Design File (Section 8/Ti) for data on Tubular **SPEED CLIPS** and

other **SPEED NUT** brand fasteners. Then call your Tinnerman representative for samples and additional information. If he isn't listed under "Fasteners" in your Yellow Pages, write to:

**TINNERMAN PRODUCTS, INC.**  
Dept. 12 • P.O. Box 6688 • Cleveland 1, Ohio

**TINNERMAN**  
*Speed Nuts*<sup>®</sup>



**FASTEST THING IN FASTENINGS**<sup>®</sup>

CANADA: Dominion Fasteners Ltd., Hamilton, Ontario. GREAT BRITAIN: Simmonds Aerocessories Ltd., Treforest, Wales. FRANCE: Simmonds S. A., 3 rue Salomon de Rothschild, Suresnes (Seine). GERMANY: Mecano-Bundy GmbH, Heidelberg.

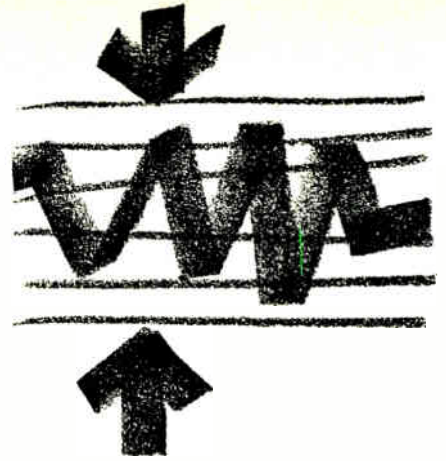
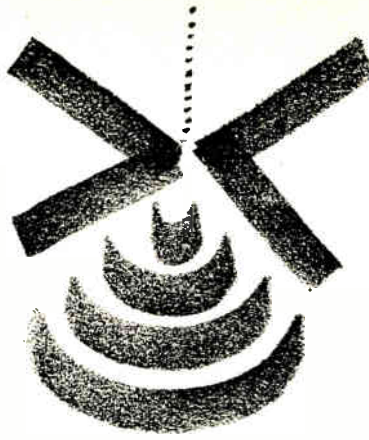
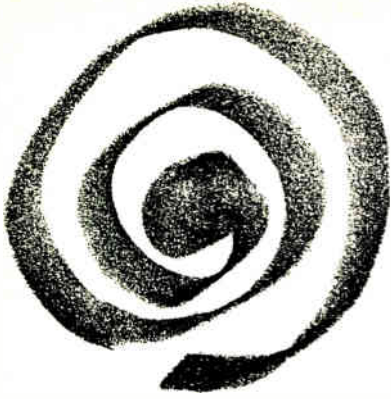

## SATELLITE-PROVED RELIABILITY...

in the 215 mc to 245 mc telemetering band

**THE MODEL REL-09 HF** is a ruggedized miniature R-F power amplifier. With a solid history of reliability in current missile systems, the unit proved its indifference to the adversities of space environment by functioning perfectly while in orbit as part of the Vanguard satellite. The 5-inch, 1-pound amplifier delivers an 11-watt output to a 52-ohm load with a 1.4-watt input drive. For full specs, write for Data File EI-724-1.

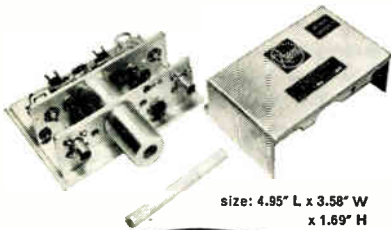

size: 4.95" L x 3.58" W  
x 1.69" H

## LOUD, CLEAR SIGNAL FROM 1760 MILES...

in the 215 mc to 260 mc telemetering band

**THE MODEL REL-10 R-F POWER AMPLIFIER**, with outputs from 10 to 100 watts, dramatically increases the range of missile and aircraft telemetering systems . . . teams up with presently available FM transmitters . . . withstands adverse space environments as demonstrated during the full range of the 1760-mile Thor shot; as part of the 75,000-mile Lunar Probe; and on the Atlas Project Score satellite. For full specs, write for Data File EI-725-1.

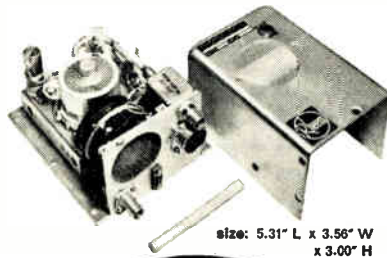

size: 5.31" L x 3.56" W  
x 3.00" H

## PROVED DAILY AT WHITE SANDS...

only  $\pm 6\mu\text{V}$  input drift in eight hours

**THE MODEL REL-120**, a completely transistorized, high-input-impedance, direct-coupled, instrumentation d-c amplifier, demonstrates these features in ground instrumentation in daily use at White Sands Proving Grounds: (1) long life resulting from use of passive elements; (2) low heat generation from average required input power of only 10 watts; (3) self-contained power supply compatible with 60 or 400 cycles. For full specs, write for Data File EI-726-1.

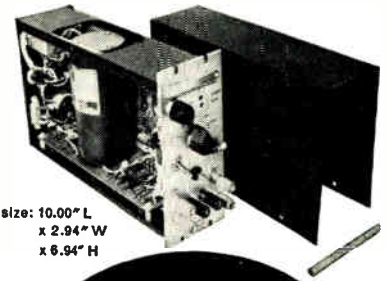

size: 10.00" L  
x 2.94" W  
x 6.94" H



**RHEEM MANUFACTURING COMPANY**  
DEFENSE AND TECHNICAL PRODUCTS DIVISION  
11711 WOODRUFF AVENUE, DOWNEY, CALIFORNIA



**RHEEM MANUFACTURING COMPANY**  
DEFENSE AND TECHNICAL PRODUCTS DIVISION  
11711 WOODRUFF AVENUE, DOWNEY, CALIFORNIA



**RHEEM MANUFACTURING COMPANY**  
DEFENSE AND TECHNICAL PRODUCTS DIVISION  
11711 WOODRUFF AVENUE, DOWNEY, CALIFORNIA



**THE  
ARCTIC EYE  
THAT NEVER  
SLEEPS**

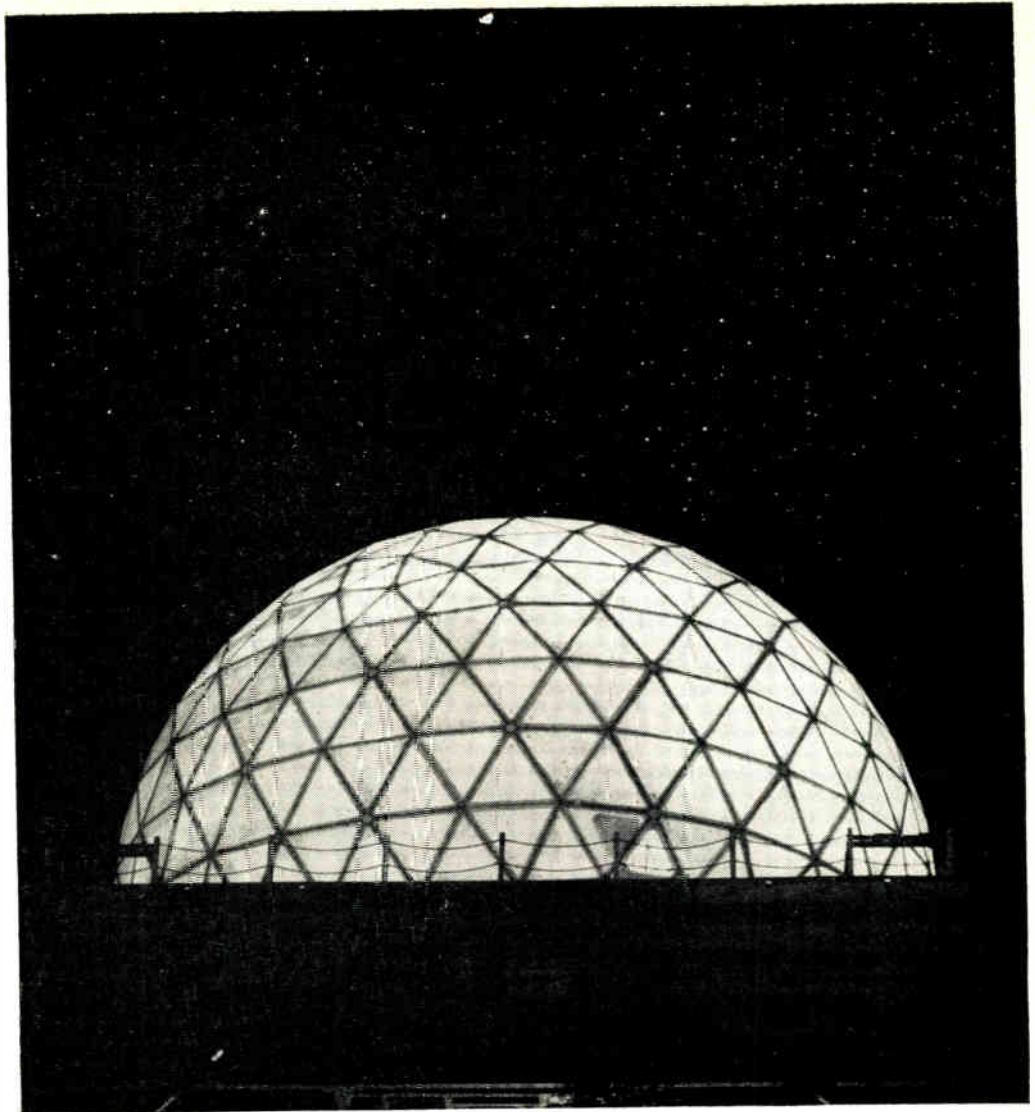

This plastic radome houses a radar antenna constantly scanning the skies to detect the presence of aircraft. A line of these radars provides early warning of any threatening approach to the North American continent.

The Distant Early Warning Line is now on perpetual guard duty. Spanning the Arctic from Baffin Island to Alaska, this great system was conceived at the Lincoln Laboratory of M.I.T. and produced under the leadership of Western Electric.

But first the DEW Line had to be engineered into a workable system. This was done at Bell Telephone Laboratories.

The obstacles were formidable. Conventional means of communication—telephone poles, cables and even line-of-sight microwave radio—weren't feasible. A complicated system had to be made to operate reliably in a climate so cold that outdoor maintenance is impracticable farther than a few hundred feet from heated habitation.

Whenever possible, Bell Laboratories engineers utilized well-proven art. But as it became necessary, they innovated. For example, they designed and directed the development of a new and superior radar which automatically scans the skies, pinpoints a plane and alerts the operator.

To reach around the horizon from one radar station to another, they applied on a massive scale a development which they pioneered—transmission by tropospheric scatter. Result: at a DEW Line Station you can dial directly a station more than a thousand miles away and converse as clearly as with your home telephone.

Bell Laboratories' contribution to the DEW Line demonstrates again how telephone science works for the defense of America.

**BELL TELEPHONE LABORATORIES**  
WORLD CENTER OF COMMUNICATIONS RESEARCH AND DEVELOPMENT



## Books

(Continued from page 40)

the art have been mainly concerned with the putting down of information in an orderly way and in logical sequence—some have been preoccupied with glamour and composition. This approach is fundamental and sometimes necessary, but in this book the authors have assumed that the would-be writer is grounded in the principles of composition and requires mainly to avoid common pitfalls and put polish on his work.

### *The Theory and Design of Magnetic Amplifiers*

By E. H. Frost-Smith. Published 1958 by John Wiley & Sons, Inc., 440 Fourth Ave., New York 16. 487 pages. Price \$12.50.

Magnetic amplifiers used in industry also play a valuable part in reducing the servicing requirements for industrial instruments, where it is often not permissible to use electronic devices due to the high maintenance and replacement costs usually associated with the latter.

The aim of this book is to give an account of the theory of magnetic amplifiers and to link up the theory with the design in a way which, it is hoped, will be of value, not only to the professional engineer, but also to the university student.

### Books Received

#### *Fundamentals of Nuclear Energy and Power Reactors*

By Henry Jacobowitz. Published 1959 by John F. Ryder Publisher, Inc., 116 W. 14th St., New York 11. 144 pages, paper bound. Price \$2.95.

#### *Video Amplifiers*

Edited by A. A. Shure, Ph.D. Published 1959 by John F. Ryder Publisher Inc., 116 W. 14th St., New York 11. 88 pages, paper bound. Price \$1.80.

#### *Fundamentals of Radio Telemetry*

By Marvin Tepper. Published 1959 by John F. Ryder Publisher, Inc., 116 W. 14th St., New York 11. 136 pages, paper bound. Price \$2.95.

#### *Designing and Building Hi-Fi Furniture*

By Jeff Markell. Published 1959 by Gernsback Library, Inc., 154 W. 14th St., New York 11. 224 pages, paper bound. Price \$2.90.

#### *CQ Anthology*

Edited by Wayne Green. Published 1958 by Cowan Publishing Corp., 300 W. 43rd St., New York 36. 168 pages, paper bound. Price \$2.00.

#### *Abridged Valve Data*

Published 1959 by English Electric Valve Co. Ltd., Chelmsford, England.

#### *Techniques of Accurate Measurement of Antenna Gain*

By H. V. Cottony. Published 1958 by U. S. Dept. of Commerce, National Bureau of Standards. 10 pages, paper bound. Copies may be obtained from Supt. of Documents, U. S. Government Printing Office, Washington 25, D. C. Price 15¢.

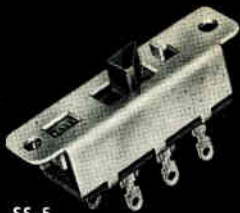

**SS-5**  
DP-DT spring return  
0.5-amp. @ 125v ac-dc.  
U.L. Inspected.

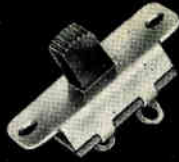

**SS-15**  
SP-ST pushbutton, momentary  
contact. 1-amp. @ 125v ac.  
U.L. Inspected.

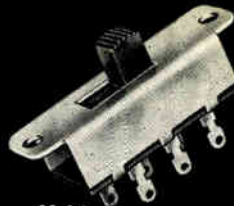

**SS-16**  
3-position special.  
0.5 amp. @ 125v ac-dc.

## THINK HOW YOU CAN



**SS-31**  
3-Position, 3-amps  
@ 125v ac.  
U.L. Inspected.



**SS-32**  
SP-DT, 1-amp.  
@ 125v ac-dc.  
U.L. Inspected.

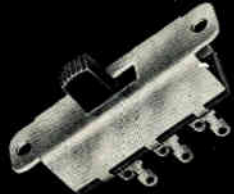

**SS-33**  
DP-DT, 3 amps  
@ 125v ac.  
U.L. Inspected.

## IMPROVE YOUR PRODUCT



**SS-50**  
DP-DT miniature.  
0.5-amp. @ 125v ac-dc.  
U.L. Inspected.



**SS-8**  
3P-DT, optional  
detent. 1 amp. @ 125v ac.



**SS-27**  
SP-DT spring return.  
3-amps @ 125v ac.  
U.L. Inspected.

## WITH THESE LOW COST



**SS-26-1**  
SP-DT, 3-amps  
@ 125v ac.  
U.L. Inspected.



**SS-9**  
SP-DT spring return.  
3-amps @ 125v ac.  
U.L. Inspected.

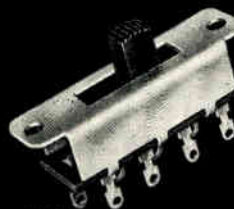

**SS-18**  
4-position special.  
0.5 amp. @ 125v ac  
for 10,000 cycles

# STACKPOLE SWITCHES!

## Get This GUIDE TO MODERN SWITCHING

Ask for 8-page Switch Bulletin RC-11D

World's largest slide switch line—over 12 low cost standard types—dozens of economical adaptations. NEW colored knobs. Special conventional and miniaturized switches designed and produced for large quantity users. *Electronic Components Division, STACKPOLE CARBON COMPANY, St. Marys, Pa.*





CK5842

CK5847

**High** performance

**High** gain

**LOW** noise

**WIDE** band



with these

**Reliable FRAME GRID\*  
MINIATURE TUBES**

**for military and industrial microwave relay I. F. service**



<b>CK5842</b> (417A) Triode*		<b>CK5847</b> (404A) Pentode
27000	$G_m$ ( $\mu$ mhos)	13000
27.0	$I_p$ (mA)	13.5
9.0	$C_{in}$ ( $\mu$ f)	7.2
1.8	$C_{out}$ ( $\mu$ f)	3.15
—	$C_{G-P}$ ( $\mu$ f)	0.05 max.
0.55 max.	$C_{P-K}$ ( $\mu$ f)	—



\*Grounded Grid Service

Tubes shown actual size

Raytheon Frame Grid construction assures: strength and rigidity  
high transconductance • low capacitance • low microphonics



**INDUSTRIAL TUBE DIVISION**  
**RAYTHEON MANUFACTURING CO.**

Reliable Miniature and Subminiature Tubes • Filamentary Tubes • VR Tubes • Rectifiers • Thyratrans • Cathode Ray Tubes  
New York, Plaza 9-3900 • Boston, Bigelow 4-7500 • Chicago, National 5-4000 • Los Angeles, NOrmandy 5-4221  
Baltimore, SOuthfield 1-1237 • Cleveland, Winton 1-7005 • Kansas City, Plaza 3-5330

# imc



## SERVO MOTOR-GENERATORS FOR INSTANT ERROR-SIGNAL RESPONSE



A significant result of Induction Motors' creative engineering program in recent years is the growing series of precision servo motor-generators . . . Sizes 8, 11, 18 (shown above) plus sizes 10, 15, and 20.

These units constructed to meet the latest applicable MIL specifications covering extreme environmental conditions incorporate the design objectives of light weight, high performance, and reliability at reasonable cost.

The high torque-to-inertia characteristic of these servo motor-generators offers high acceleration and immediate accurate response to error signals.

#### GENERATOR CHARACTERISTICS

Input: 18V 400 cps, 1.65 watts  
Voltage gradient per 1000 RPM:  
0.27V  
Temperature range:  $-55^{\circ}\text{C}$ . to  
 $+150^{\circ}\text{C}$ .  
Null Voltage (max): 0.015V rms  
Phase shift: within  $10^{\circ}$  of Reference

#### SIZE 8

O.D. = 0.750  
L = 2-1/32  
J = 0.75 gm  $\text{cm}^2$   
Wt. = 2.86 oz.

#### MOTOR CHARACTERISTICS

Input: 18V 400 cps 4.7 watts  
per phase  
Torque at Stall: 0.42 oz. in.  
No Load Speed: 6200 rpm  
Power Factor: 0.875  
Theoretical Acceleration at  
Stall: 39000  $\text{rad}/\text{sec}^2$

Design characteristics of IMC's Size 8 to Size 20 series of servo motors and servo motor-generators, as well as full technical data on IMC DC motors and dynamotors; axial, vaneaxial, and centrifugal blowers; hysteresis and torque motors; synchros and solenoids, can be obtained by writing on company letterhead to IMC's Sales Engineering Dept. All IMC components can be designed to your particular requirements with the same precision and accuracy.

## Induction Motors Corp.



570 MAIN STREET/WESTBURY, L.I., N.Y./EDGEWOOD 4-7070 • 6058 WALKER AVE./MAYWOOD/CALIF.

## Letters

to the Editor

### "Perforated Pages"

Editor, ELECTRONIC INDUSTRIES:

I take this opportunity to thank ELECTRONIC INDUSTRIES for their effort to continuously provide a more useful magazine.

The simple addition of perforating the pages of technical articles to facilitate removal for further distribution and filing is commendable.

Harold Gruen  
Engineering Department

Govt. & Industrial Div.  
Philco Corp.  
Philadelphia 44, Pa.

"I like the perforated pages—an excellent innovation."

F. M. Oberlander  
Radio Corp. of America

### "Spurious Response Tests"

Dear Mr. Silverstein:

Your article, "Testing for Spurious Responses" in ELECTRONIC INDUSTRIES, October, 1958, has touched on a very timely subject. I quite agree with your observations on the following points:

1. The so-called Crystal Impedance Meters (C.I.M.) are incapable of detecting the majority of spurious responses.

2. Present day overtone crystals show a rather high rate of failures.

No doubt, industry is hampered in manufacturing good crystals, as long as specifications are based on test data obtained by means of the usual C.I.M.

It was found that some spurious oscillations can be detected by approaching the point of resonance of the C.I.M. both from frequencies higher and lower than the resonance; however, even then only a fraction of unusable crystals were discovered.

It appears that chiefly the low-impedance circuits used in the C.I.M.'s are responsible for damping these responses and no doubt they could be modified. However, even then they would not approach the speed and accuracy of your sweep method.

As an interim measure we are using an oscilloscope in the mixer circuit of one specific receiver, whenever its crystal oscillator is tested for the first time. The spurious frequencies invariably show up as "beats" of approximately 50 Kc which is in good agreement with your graph showing  $\lambda f$  versus amplitude. On the latter, no quantitative observations were made here, but I venture to guess

(Continued on Page 48)



Actual size,  
3-inch ultrahigh-resolution tube

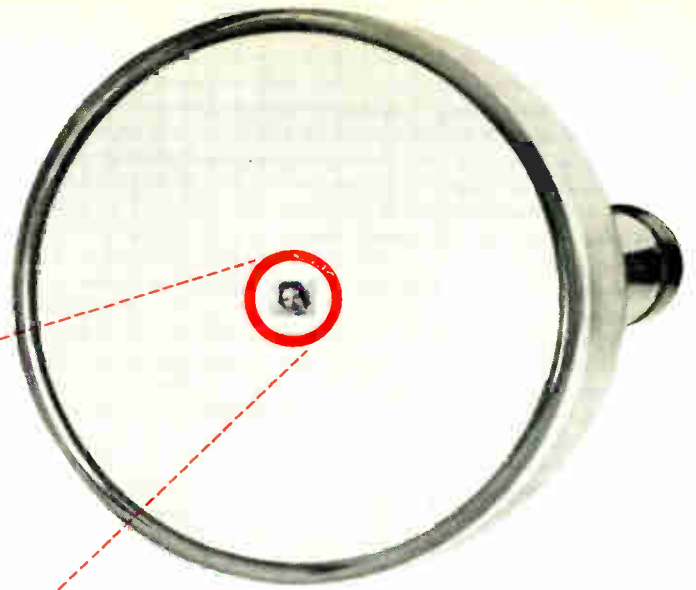

# Now... 262 Square Inches of information in $\frac{1}{20}$ Square Inch!

New CBS-Hytron ultrahigh-resolution tubes, for example, can compress into 0.047 square inch all the detail on a 21-inch picture tube screen. This is twice the resolution previously attainable . . . resolution far beyond the capabilities of the unaided human eye and modern printing. And the closest yet to the resolution of modern photographic film.

#### 12 CBS-HYTRON UHR TUBES IN PRODUCTION

These tubes offer a choice of four resolution levels . . . three screen sizes . . . and three screen phosphor characteristics. They are even more rugged and dependable than standard oscilloscope tubes. And they can be supplied with interchangeable yoke, focus coil and video driver stage to achieve maximum resolution. Check the table for summary data. Write for complete technical Bulletin E-330 and information regarding your particular application.

TYPE NUMBER	RESOLUTION (Lines per Inch)	SPECTRAL COLOR	PERSISTENCE TIME
3AVP5	1500	Blue	Very Short
3AVP11	1000	Blue	Short
3AVP16	500	Near UV	Very Short
3AWP5	2000	Blue	Very Short
5CQP5	1500	Blue	Very Short
5CQP11	1000	Blue	Short
5CQP16	500	Near UV	Very Short
5CRP5	2000	Blue	Very Short
7AVP5	1500	Blue	Very Short
7AVP11	1000	Blue	Short
7AVP16	500	Near UV	Very Short
7AWP5	2000	Blue	Very Short

**MANY APPLICATIONS NOW POSSIBLE** Many new and advanced applications become practical in strip radar • photo reconnaissance • visual indication • photo reproduction • information transfer • industrial and medical closed circuit TV • remote data pick-up • information conversion • etc.

*More reliable products through*

*Advanced-Engineering*



**tubes**

**CBS-HYTRON**, Danvers, Massachusetts  
A Division of Columbia Broadcasting System, Inc.

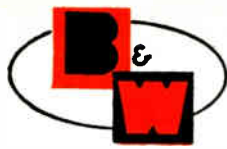

**INSTRUMENTS**

**FOR PRECISION CIRCUIT ANALYSIS**

Proved in every type of service, these quality instruments are used by experts for FCC "proof-of-performance" tests and supplied as original equipment with many broadcast station installations.

**MODEL 404  
LINEAR DETECTOR**

- RF detection and audio bridging circuits.
- 40 db pad adjusts in 10 db steps.
- 400 kc to 30 mc range with 20-30 volt RF carrier.
- Flat frequency response from 20 to 50,000 cycles.
- Approx. 1 db insertion loss.
- Impedance as bridging transformer approx. 6,000 ohms; with single-ended input, approx. 10,000 ohms.



**MODEL 200 AUDIO OSCILLATOR**

- Frequency Range: 30 to 30,000 cycles.
- Frequency Response: Better than  $\pm 1$  db. 30 to 15,000 cycles with 500 ohm load.
- Stability: Better than 1%.
- Calibration:  $\pm 3.0\%$  of scale reading.
- Voltage Output: 10 volts into 500 ohm load.
- Distortion: Less than .2% at 5 volts output.



**MODEL 400 DISTORTION METER**

- Frequency Range: Fundamentals from 30 to 15,000 cycles. Measures Harmonics to 45,000 cycles.
- Sensitivity: .3 volts minimum input required for noise and distortion measurements.
- Calibration: Distortion measurements  $\pm .5$  db. Voltage measurements:  $\pm 5\%$  of full scale at 1000 cycles.
- Residual Distortion: .05%—3—15,000 cycles.
- Residual Noise: .025% or less.



**MODEL 300 FREQUENCY METER**

- Frequency Range: 0 to 30,000 cycles in 6 ranges.
- Sensitivity: 0.25 volts minimum input.
- Wave Form: Operates on any wave form with peak ratios of less than 8 to 1.
- Calibration: When referenced against 60 cycle line frequency, all other frequencies will fall within 5%.



**MODEL 600 DIP METER**

- Covers 1.75 to 260 mc in 5 bands.
- Monitoring jack & B+ OFF switch.
- Shaped for use in hard-to-get-at places.
- Sturdy, color coded, plug-in coils.
- Adjustable, 500 microamp meter.



**Barker & Williamson, Inc.**

Beaver Dam Road, Bristol, Penna.

Specialists in Designing and building equipment to operating specifications

B&W also design and manufacture filters for: ANTENNAS • RADIO INTERFERENCE • RADIO RANGE • UHF and VHF as well as many special types designed to performance specifications. Available to commercial or military standards.

**Letters**

to the Editor

(Continued from page 46)

that they are of the same order of magnitude as given by you.

I would like to keep in touch with you on this subject. The following two questions appear to be of immediate importance:

What is being done to make industry test on a more realistic basis?

What are the spurious responses at other than room temperatures?

H. G. Lenz  
Project Engineer

Bendix Radio, Div. of  
Bendix Aviation Corp.  
Baltimore 4, Md.

**"Wire—In Electronics"**

Editor, ELECTRONIC INDUSTRIES:

This is to request a reprint of the article "Wire—In the Electronic Industry" which appeared in the December, 1958, issue of ELECTRONIC INDUSTRIES.

It was with great pleasure that I read this article since this information is coming more and more to the attention of the design engineer and usually has to be procured from volumes of spec material.

D. A. Wilson  
Design Engineer

Bendix-Pacific Division  
Bendix Aviation Corporation  
North Hollywood, Calif.

**R.C.A. to Build Missile Plant in Van Nuys, Calif.**

R.C.A. will establish a major missile and radar center at Van Nuys, California. The new facility, located on a 50-acre tract in the San Fernando Valley, 15 mi. NW of Los Angeles, is scheduled for partial occupancy by late summer. The location was chosen because of its proximity to other missile system manufacturers, airframe manufacturers, and military centers in the greater Los Angeles area. Initial projects for the new plant include missile check-out and launch, information handling, and radar systems.

**Wisconsin Plant Space**

A new directory listing 381 industrial buildings in Wisconsin available for sale or lease is being distributed by the Wisconsin Division of Industrial and Port Development, Governor's Office, Madison 2, Wisconsin.



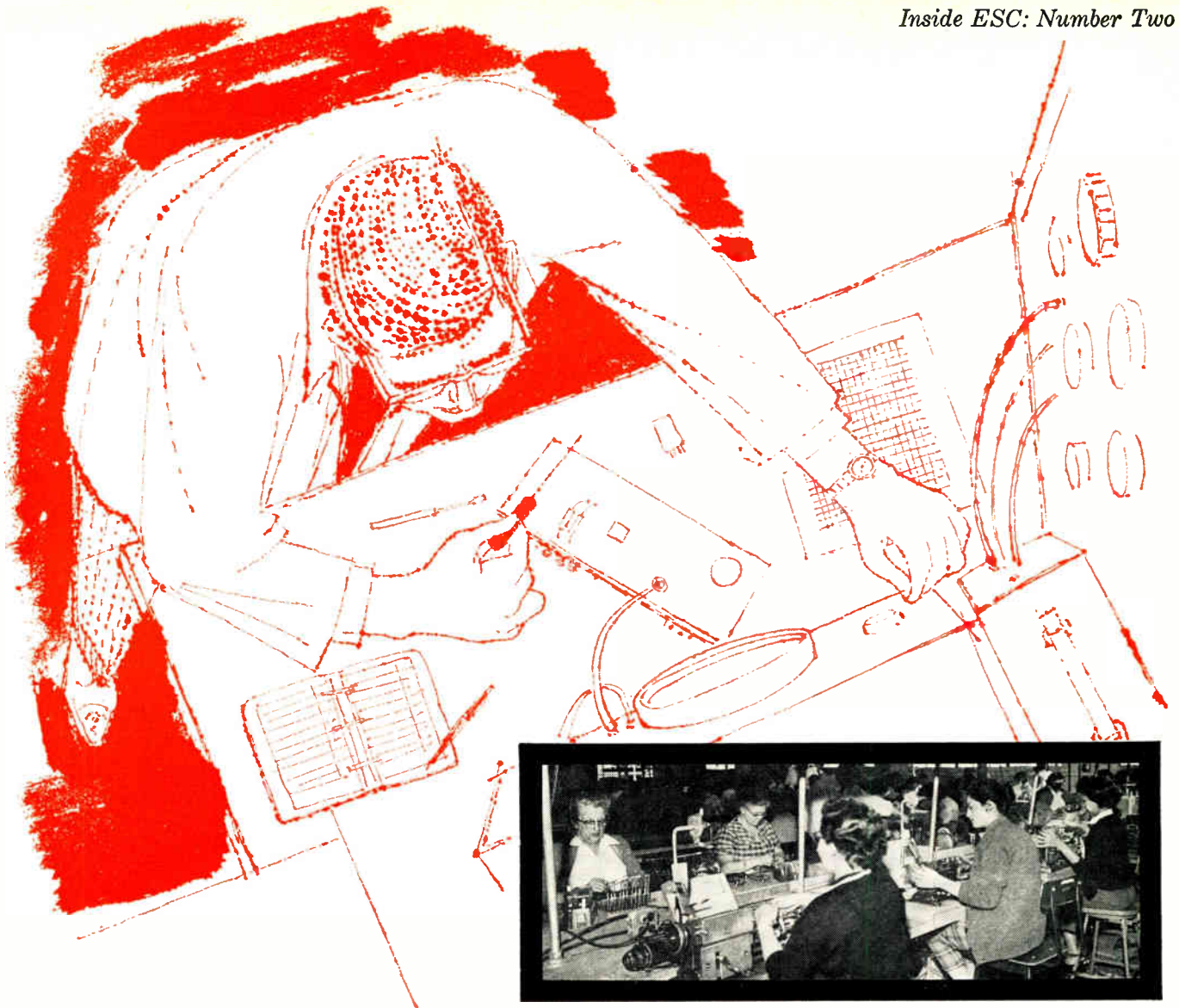

# ESC DELAY LINES are CUSTOM-BUILT, CUSTOM-CHECKED!

At ESC, America's leading producer of custom-built delay lines, the challenge of perfection is renewed with every prototype assignment. Each delay line must meet precise, individual specs...each is painstakingly built under close engineering supervision...each is rigorously custom-checked against specially devised test standards.

In addition, complete and definitive laboratory reports—which include submitted electrical requirements, photo-oscillo-

grams (which indicate input and output pulse shape and output rise-time), the test equipment used and an evaluation of the electrical characteristics are submitted with all prototypes.

This is the way ESC custom-builds and custom-checks every unit. Backed by exciting new developments at ESC's research laboratories, these facilities insure a steady flow of custom-built delay lines for the most stringent requirements of military and commercial applications.



# ESC

WRITE TODAY FOR COMPLETE TECHNICAL DATA.

*exceptional employment opportunities for engineers experienced in computer components...excellent profit-sharing plan.*

**CORPORATION** 534 Bergen Boulevard, Palisades Park, New Jersey

Distributed constant delay lines • Lumped-constant delay lines • Variable delay networks • Continuously variable delay lines • Pushbutton decade delay lines • Shift registers • Pulse transformers • Medium and low-power transformers • Filters of all types • Pulse-forming networks • Miniature plug-in encapsulated circuit assemblies

# THREE KLEIN PLIERS

## to make electrical wiring easier

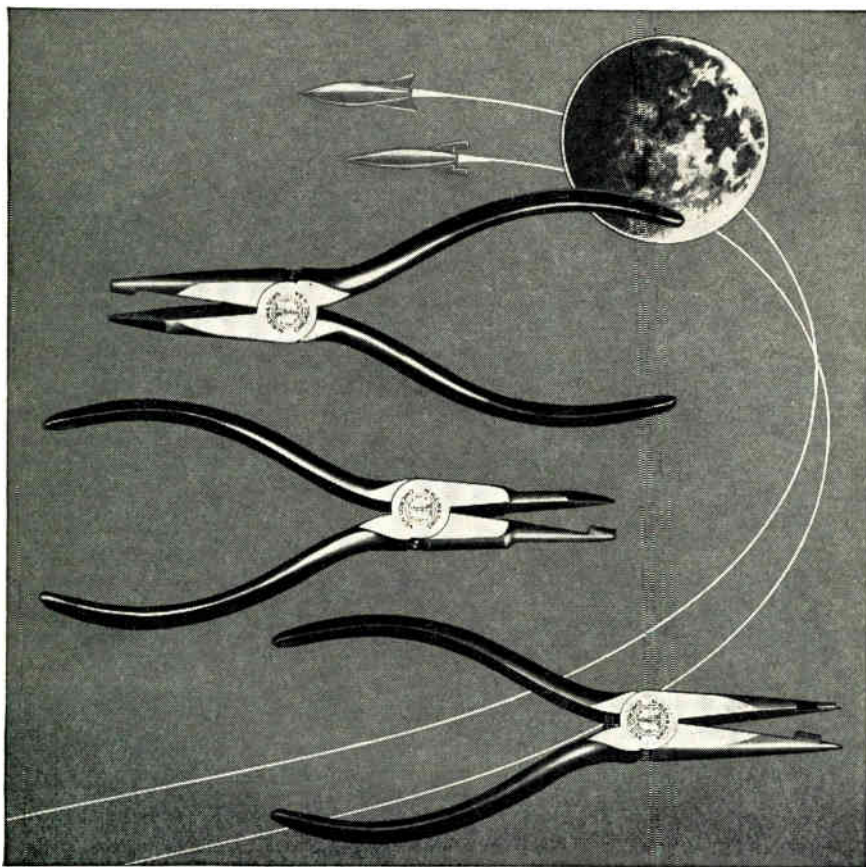

Here are three newly engineered Klein Pliers which will solve difficult problems in the wiring of electronic assemblies. Catalog 101-A describes these and scores of other pliers in the complete Klein line. If you wire electronic assemblies, write for a copy.

### ALL-PURPOSE ELECTRONIC PLIER

Patent pending

Shear blade cuts flush and holds clipped end of wire

Requires no sharpening; will cut hard or soft wire. Smooth, continuous action prevents shock which may damage resistors. For bare wire up to 18 gauge.

No. 260-6—length 6 $\frac{3}{8}$ "

No. 260-6C—with coil spring that holds jaws open

### NEEDLE-NOSE PLIER

Patent pending

Similar to No. 260-6 but nose has been slimmed down to permit use in confined areas.

No. 261-6—length 6 $\frac{3}{8}$ "

No. 261-6C—with coil spring to hold jaws open

### LONG-NOSE PLIER—KNIFE AT TIP

Pat. No. 2,848,724

Jaws behind blade hold clipped wire end firmly

A shear-cutting plier that will cut hard or soft wire. Blade is at the tip of the plier. Supplied with coil spring to keep jaws apart.

No. 208-6PC—length 6 $\frac{3}{8}$ "

Write for Catalog 101-A, which shows the complete line of Klein Pliers, including 20 pliers recently developed.



## Personals

William R. Fraser has been appointed to the newly-established position of Consulting Engineer—Product Design, for engineering and designing of complex broadcast transmitters in the General Electric Co.'s Technical Products Dept.

August F. Jones has been promoted to Chief Engineer of the Cuban Telephone Co., Havana, Cuba, an operating company of the International Telephone and Telegraph Corp.

Donald Kirk is now Senior Staff Engineer - Communications Engineering, at Philco Corp.'s Government and Industrial Div. He was formerly Director of Engineering for the Jerrold Electronics Corp.

Ernest E. Thornton has been appointed Sales Engineer for Ling Electronics, Inc., Calif. He was formerly Supervisor of Technical Training at Northrop Aircraft, Inc.



E. Thornton

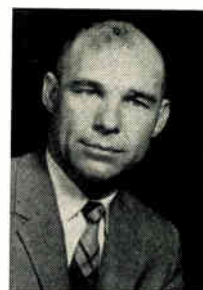

D. Orr

David V. Orr has been appointed Chief Engineer of B&H Instrument Co., Inc., Ft. Worth. He was formerly Assistant Project Engineer with Temco Aircraft Corp.

J. F. Hinchey is now Field Engineering Manager for Burroughs Corp.'s ElectroData Div.; J. F. Kalbach is now Associate Director of Engineering, and R. W. Anderson is Manager of Quality Assurance.

Walter J. Albersheim, formerly of Bell Telephone Labs., has joined the staff of Spencer - Kennedy Laboratories, Inc., Boston, as Chief Engineer.

George G. Crewson, Jr., is now Field Engineer at General Controls Co., Industrial Controls Div. He was formerly Advisor to Pakistan's Industrial Productivity Centre in the Ministry of Industries.

Kenneth A. Zimmerman is now Engineer in Charge of Research and Development at Hamner Electronics Co., N. J. He was formerly with Applied Science Corp. of Princeton.



**Mathias KLEIN & Sons**  
 Established 1857 Chicago, Ill., U.S.A.  
 7200 McCORMICK ROAD • CHICAGO 45, ILLINOIS



# MICROWAVE TEST EQUIPMENT WAVEGUIDE ASSEMBLIES



**PRECISION CALIBRATED ATTENUATORS**  
8 units cover 2.60 to 40.0 Kmc/Sec  
.5 to 40.0 db range at  $\pm 0.2$  db accuracy  
Rugged design - broadband operation -  
low VSWR



**CALIBRATED - SHIELDED ATTENUATORS**  
611 — 8.2 to 12.4 Kmc/Sec  
711 — 12.4 to 18.0 Kmc/Sec  
.3 to 35 db  
1.15 Max VSWR



**WAVEGUIDE ADJUSTABLE SHORTS**  
Non-contacting shorts — micrometer or knob adjustments — non backlash.  
Type 661 8.2 to 12.4 Kmc/Sec



**MICROWAVE NOISE SOURCES**  
Waveguide tube mounts and power sources provide direct reading noise measurements 2.6 to 40.0 Kmc/Sec.  
2200-8-DR  
18.0 to 26.5 Kmc/Sec

## Precision Test Instruments

2600 to 90,000 MCS.

A complete line of test instruments . . . precision built . . . rugged in design . . . easy to operate and maintain . . . for laboratory or field use . . . versatile. Dependability and low cost are achieved by the latest volume production techniques. A 90 page catalog available upon request describes over 600 instruments and presents photos, electrical and mechanical data, charts, curves and engineering information.



**ATTENUATORS  
SLOTTED LINES  
WAVEGUIDE COUPLERS  
TERMINATIONS  
FREQUENCY METERS  
PHASE SHIFTERS  
DETECTOR MOUNTS  
PRECISION TUNERS**



**SHIELDED LEVEL-SET VARIABLE ATTENUATOR**  
8.2 to 12.4 Kmc/Sec  
.2 to 20.0 db Locking



**DETECTOR MOUNTS**  
Broadband Crystal — Bolometer mounts fixed and tunable — non contacting shorts — R.F. chokes — twenty types cover all bands —  
Type 614  
8.2 to 12.4 Kmc/Sec

## STANDARD GAIN HORNS

8 units cover 2.60 to 40.0 Kmc/Sec — 15 db gain — 30° beam width — low VSWR rugged design — gold plated — calibrated

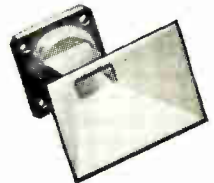

## SLOTTED SECTIONS

Designed to provide maximum accuracy and sensitivity. Nine units cover 2.60 to 40.0 Kmc/Sec.



Type 764

Cavity Machined to Tolerance of .0005 ins.  
Cavity Brazed to Tolerance of  $\pm .001$



## TYPICAL RIGID PRODUCTION SPECIFICATIONS

Angular  $\pm 0^\circ 15'$   
Squareness and Parallelism .002 in. per in.  
Machined Dimensions  $\pm .002$  in.  
Brazed Dimensions  $\pm .005$  in.  
Surface Finish  $\frac{32}{\sqrt{R}}$   
Pressure 15 PSI  
Material 6061-T6 Alum. Alloy

## CUSTOM MICROWAVE ASSEMBLIES

Brass . . . Aluminum  
Magnesium

Complete facilities for the design, development and production of assemblies to the customer's special requirements. Utilization of the most modern manufacturing techniques makes possible the low cost, high volume production of all Microwave assemblies including extremely complex units such as those pictured here.

Phone Capitol 6-9100  
TWX Caldwell, N. J. 703

**WAVELINE** INC.  
CALDWELL, NEW JERSEY

Sales Engineering  
Representatives in  
all Principle Cities.

# TRANSFORMERS for APPLICATIONS UP TO 350°C

Engineering "know how" and manufacturing facilities are available at Acme Electric to produce prototypes or production runs of transformers that must function with operating temperatures up to 350°C.

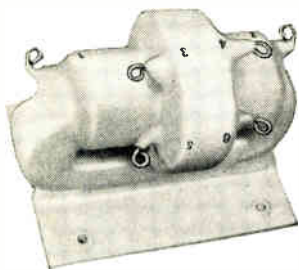

T-36127  
Weight: 14 ounces. VA: 47.8  
50°C rise, 125°C ambient  
12 KV test @ 30,000 feet

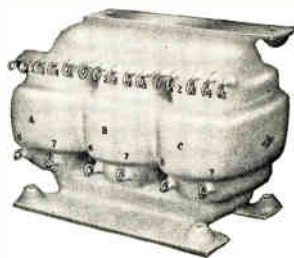

T-34671  
Weight: 4¼ lbs. VA: 705  
165°C rise, 125°C ambient  
12 KV test @ 30,000 feet

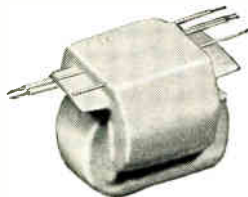

T-34894  
Weight: 260 grams VA: 26.4  
30°C rise, 125°C ambient  
6.2 KV test @ 30,000 feet

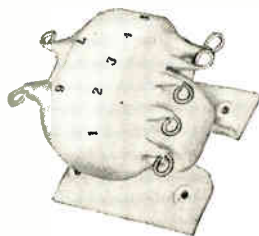

T-36196  
Weight: 235 grams. VA: 32  
31°C rise, 125°C ambient  
5.2 KV test @ 30,000 feet

## ACME ELECTRIC CORPORATION

894 WATER STREET CUBA, NEW YORK  
West Coast Plant: 12822 YUKON AVE., HAWTHORNE, CALIF. PO 3254

**Acme Electric**  
TRANSFORMERS



### COVERING THE SHOW

Telecopter, of KTLA-Los Angeles, transmits picture and sound while flying over the Chicago skyline during the recent National Association of Broadcasters Show. It was a feature of the GE exhibit.

### \$12 Million Worth of Equipment

More than \$12,000,000 worth of radio and television broadcasting equipment, including three completely equipped color television studios, was exhibited at the 37th Annual Convention of the National Association of Broadcasters in the Conrad Hilton Hotel.

It was the largest exhibition of broadcasting equipment ever held at an NAB convention, and probably the largest ever held anywhere.

The emphasis in many exhibits was on the use of transistors and other semi-conductor parts to reduce drastically the size and power requirements of radio and television broadcasting equipment.

Two firms featured television studio lighting equipment controlled by silicon resistors.

### NAB Membership at Record High

The National Association of Broadcasters announced that all three membership categories—AM radio, FM radio and television—have reached new record highs.

William Carlisle, NAB manager of station relations, gave the following current membership totals: AM Radio—1,515; FM Radio—424; Television—337.

### Trees Stop UHF Signal

Howard Head, consulting engineer to the Association of Maximum Service Telecasters, reported that Association's members on a study his organization had made of the effect of trees on the strength of a television signal.

Trees standing in the way of a broadcast television signal can reduce the effectiveness of the UHF signal by as much as a factor of 10.1 or more. Even the shadows cast by trees can lessen the signal, Mr. Head stated.

Tests leading to the conclusion were conducted at Salisbury, Md., by Mr. Head and his colleagues in a special MST project, with data subsequently submitted to the Television Allocations Study Organization for analysis and report to the Federal Communications Commission.



# Electron Tube News

—from SYLVANIA



*Announcing the Sylvania*

**SARONG CATHODE**

**A NEW ERA IMPROVEMENT IN THE HEART OF THE ELECTRON TUBE**

## Sylvania Sarong Cathodes pave the way to new performance standards for present and future tube types

Out of the advanced research laboratories of Sylvania's Electron Tube Division comes a revolutionary innovation in cathode coating, Sylvania Sarong. Sylvania scientists and engineers have succeeded in transforming conventional cathode coating into a thin uniform film that is precision-wrapped and securely bonded around each cathode sleeve.

Now in use in nearly one million Sylvania tubes, it is already contributing to a new efficiency in electron tube performance. It promises to open the way to new tube designs that will outperform many of today's advanced devices. First tubes to incorporate the Sarong Cathode are a number of Sylvania Tuner Types.

### **New Cathode Uniformity**

Sylvania Sarong insures that every cathode will be

coated uniformly and precisely because its thickness, texture, length and weight are pre-controlled before application. The thickness of Sylvania Sarong coating is held to tolerances five times closer than conventional sprayed coatings. This new superiority in coating uniformity has already contributed to a reduction in cathode-grid shorts and intermittent short circuits.

### **Reduced Noise**

The uniformity of Sylvania Sarong coating makes it possible to obtain an over-all uniformity in spacing between cathode and grid never before achieved in mass produced electron tubes.

Preliminary tests indicate that this results in an improved noise figure of up to 0.6 db for TV. It also contributes to more uniform and higher levels of

## Here are some of the ways Sarong



**1. Uniform coating thickness** of Sylvania Sarong Cathode means more uniform plate current, higher and more uniform levels of Gm and reduced noise

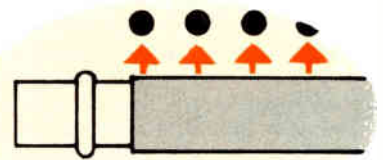

**2. Sharp even edge** and greater uniformity of Sarong coating virtually eliminates the possibility of end-leakage and contributes to better cut-off



# improvement in the heart of the electron tube

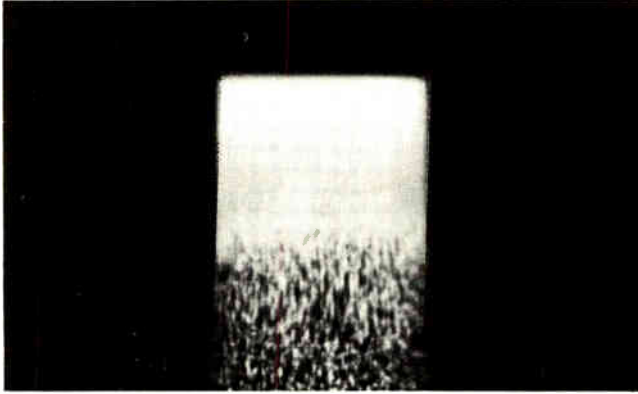

Photomicrograph comparison of a conventional cathode, left, and Sylvania's Sarong Cathode in operation shows its

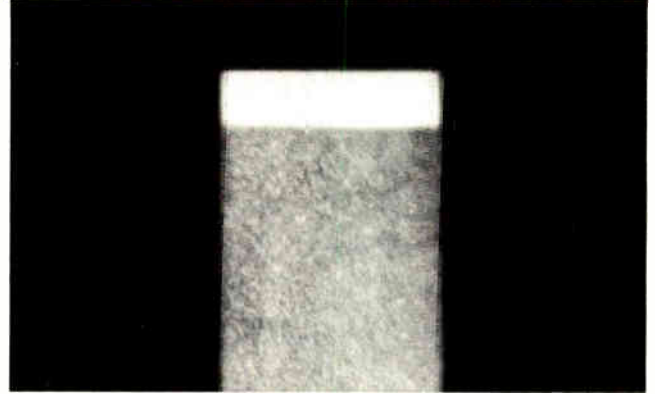

superior coating uniformity contributing to better emission and more uniform heat distribution

Gm and also to a more uniform plate current.

Because Sarong coating can be held to much closer tolerances, new tube designs incorporating more closely spaced elements become possible . . . opening the way to standards of tube performance never before achieved.

## More Uniform Emission

The even distribution and smooth texture of Sylvania Sarong assures a new uniformity in cathode emission. The possibility of hot spots is virtually eliminated. Preliminary tests have already shown that Sarong Cathodes have pulse emission characteristics some 10% greater than conventional cathodes. Interface impedance due to poor coating adherence has also been improved, promoting better electron flow.

## Better Cut-Off

Because Sylvania Sarong results in a more uniform surface and a more clearly defined coating, sharper cut-off characteristics and better control are achieved. The Sarong coating also eliminates the possibility of coating particles adhering inside the cathode sleeve.

## Improved Temperature Distribution

All of the physical properties of Sylvania Sarong coating contribute to a new uniformity in cathode temperature. This contributes to noise reduction and better over-all performance throughout life. It enables the tube to tolerate a wider range of operating conditions, such as varying heater voltages, without great changes in emission.

## Cathodes contribute to better tube performance



**3. Better diameter control** with Sarong coating makes a closer spaced tube structure possible with higher Gm, more gain



**4. More uniform heat distribution** is possible with Sylvania Sarong Cathodes. Hot spots are virtually eliminated and the life and over-all performance of the tube is improved

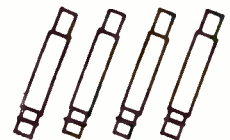

**5. Sylvania Sarong Cathode coating** makes possible a new uniformity of cathode emission from tube to tube

# Other New Sylvania Developments

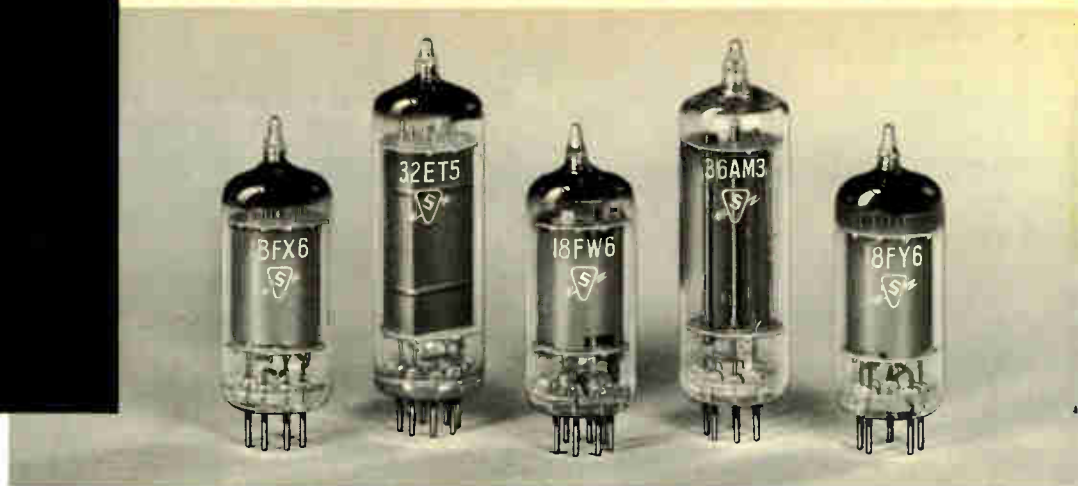

**Type 18FX6—**  
Dual control miniature semi-remote cut-off pentode

**Type 32ET5—**  
Miniature beam power pentode

**Type 18FW6—**  
Miniature semi-remote cut-off pentode

**Type 36AM3—**  
Miniature half-wave rectifier

**Type 18FY6—**  
Miniature high mu triode double diode



## New 100 ma All American Five

Radio set designers can now secure all of the performance advantages of the famous All American Five design with lower heater power and reduced heat dissipation. This opens the way to substantial economies in set components without a sacrifice of over-all set quality.

The Sylvania 100 ma All American Five includes the following types: 18FX6, 18FW6, 18FY6, 32ET5

and 36AM3. The function of each type corresponds directly in order to the standard All American Five types 12BA6, 12BE6, 12AV6, 50C5 and 35W4.

The new 100 ma All American Five tube complement is already being designed into the sets of one major radio manufacturer. Contact your Sylvania representative now for full information on the new types or write Sylvania directly.

## New Spiral Accelerator C-R-T

Now ready for production at Sylvania's Industrial and Military C-R-T Department is one of the new high-quality cathode-ray tubes—the Spiral Accelerator. Designed for high-quality scope applications the advanced tube sets a new standard for high linearity and superior resolution. This is achieved through the spiral design that gives a smoother voltage gradient from deflection plates to screen.

Sylvania stands ready to produce Spiral Accelerator types to fit your specific needs. Contact your Sylvania representative or write Sylvania directly. We will welcome the opportunity to discuss your special cathode-ray tube requirements with you.



New Sylvania Spiral Accelerator C-R-T



# SYLVANIA

SYLVANIA ELECTRIC PRODUCTS INC.  
1740 Broadway, New York 19, N. Y.  
In Canada: P. O. Box 1190, Station "O",  
Montreal 9.

LIGHTING • TELEVISION • RADIO • ELECTRONICS • PHOTOGRAPHY • CHEMISTRY-METALLURGY



# Next month

## TRANSISTOR AMPLIFIERS FOR TV RECEIVERS

The next move for transistors is into the TV receiver field. Using drift transistors, such as the 2N247, a 3-stage video amplifier has been designed which more than fulfills the video requirements of a large picture tube.

## THE DAYTON "AIRBORNE ELECTRONICS" CONFERENCE

Over the past few years we have seen more and more of the defense dollars going into electronic guidance and control systems, for missiles and aircraft. In step with this growth has been the increasing importance of the National Airborne Electronics Conference, meeting this year in Dayton on May 4, 5 and 6. Here is a review of what visitors can expect to see and hear.

## DYNAMIC RELIABILITY PLANNING

Determining the reliability of systems is the most significant problem of the electronic industry. Due to the variations in component characteristics and stability, it is dangerous to go by average values or ratings. Component application must consider the dynamic limits of parameters and stresses.

## THERMAL STRESSES ON KLYSTRON WINDOWS

The power output of klystrons is limited by heating of the output cavity windows, but the exact cause has not previously been determined. This new study separately evaluates the effects of secondary electron bombardment and dielectric losses at frequencies below 2,000 MC.

## Plus all our other regular departments

Our regular editorial departments are designed to provide readers with an up-to-the-minute summary of world wide important electronic events. Don't miss Radarscope, As We Go To Press, Electronic Shorts, Coming Events,

El Totals, Snapshots of the Electronic Industries, El International, News Briefs, Tele-Tips, Books, Rep News, International Electronic Sources, Personals, Industry News and New Products.

## COMING SOON:—

"1959 Microwave Power Tube Chart"—The move into the upper frequency bands has been made possible by the very considerable improvements and new designs in microwave tubes. Over 800 tubes are now available covering the microwave spectrum, including the long-established klystrons and

magnetrons, and the family of wave tubes, traveling wave and backward wave. This feature will include all the technical specifications, with introductory information to guide the engineer in evaluating each parameter.

## Watch for these coming issues

### \*JUNE

17th Annual Directory &  
All-Reference Handbook

### \*AUGUST

WESCON Convention

### \*NOVEMBER

Microwave Issue

By **ROBERT E. MOE**

*Manager-Engineering,  
Receiving Tube Dept.  
General Electric Co.,  
Owensboro, Ky.*



# TUBES or

**T**HE popular notion that transistors will undoubtedly replace vacuum tubes in the near future has received a lot of publicity, due in part to the natural enthusiasm and optimism of the many new firms designing and manufacturing semiconductor devices. There is, of course, no doubt that transistors will take over some of the application areas previously served by tubes, and that there will be some grey areas where either tubes or transistors will serve equally well, but the fact is that there are many, many fields where tubes are, and will continue to be, superior.

The advantages and disadvantages of each device, under the wide variety of operating conditions and circuit requirements, should govern the choice for a particular application, and the following discussion is intended to bring out those which are pertinent to such an analysis.

The purpose of this discussion is to present briefly a few extracts from the available data, and list references giving more complete information, to allow a realistic assessment of performance and reliability factors of interest to the designer of electronic equipment.

Broadly speaking, electronic equipment breaks down into two groups—entertainment, including radio and TV, on the one hand, and industrial and military on the other. The first may be disposed of at this time by the statement that cost will continue to be the governing factor dictating the use of tubes, except in the personal portable field, and the output stages of car radios.



R. E. Moe

In the industrial and military fields where cost is less of a factor, the relative performance and reliability factors must be examined more critically.

The following points have been chosen as prime factors that should guide the designer's choice, depending of course on his equipment specification requirements:

1. Power input (efficiency).
2. Ambient or hot spot temperature.
3. Upper frequency limit.
4. Noise figure.
5. High voltage requirement.
6. High power output requirement.
7. Spread of characteristics and tolerances.
8. Combination and multiple units.
9. Nuclear radiation.
10. Reliability.
11. Physical size and weight.

Let us see how tubes and transistors compare on each of these counts.

### *Power Requirements*

If available power input is limited, and high power output is not a prime requirement, transistors

*Ed: It has become commonplace in the trade to hear reports of over-transistorization — transistors being used where their inherent weaknesses put them at a disadvantage. This has been particularly true in military gear where the practice is doubly serious because the price is paid in terms of reliability. We do not pretend to know where the fault lies. It is enough to say that these mistakes are being made. We hope that this article will provide a fresh basis on which design engineers and those specifying electronic equipment can intelligently answer for themselves the question—tubes or transistors?*



*The development of transistors has now reached a stage where we can say that certain inherent obstacles to further development exist. Frequency range, ambient temperature, high-voltage applications, nuclear radiation—these requirements will limit transistor use well into the foreseeable future. It is time to spell out just where transistors can be expected to do the job best and where tubes should be used.*

# TRANSISTORS?

## *Ambient Temperature*

Owing to the inherent nature of semiconductors, their characteristics are far more sensitive to changes in temperature than are tubes, so that germanium and to a lesser extent silicon units show considerable variation in parameters with changes in temperature, and reach a limiting capability around 100°C and 200°C junction temperature, respectively. Tubes, on the other hand, can operate well above 200°C bulb temperature in the glass types, and over 400°C in ceramic, with practically no change in characteristics. Thus the use of transistors under varying ambient conditions requires a great deal of attention to temperature compensation elements and feed-back circuits, where in most cases these precautions are unnecessary when using tubes. (For the 2N176,  $I_{co}$  is specified at a maximum of 3.0 ma at 25°C and 30 volts, and a maximum of 15.0 ma at 90°C junction temperature and 30 volts.) In fact, the serious degradation in performance of transistors with increasing temperature may well make their use uneconomical because of the low gain per stage, or limited output available at the high end of the operating temperature range, well before the advertised temperature limit is reached.

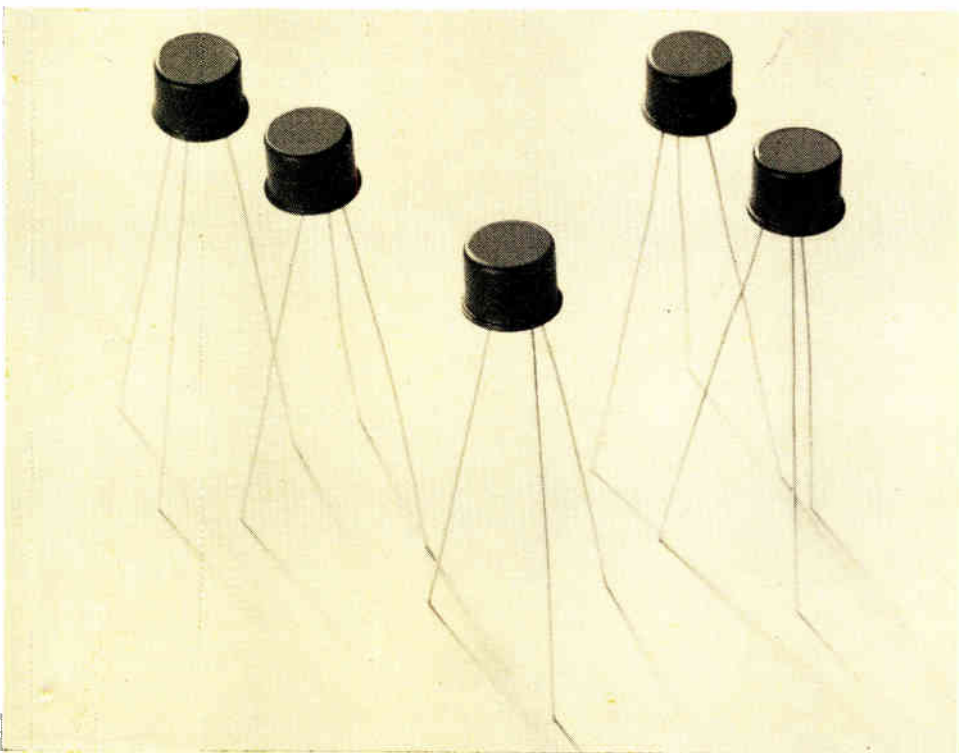

are the logical choice. For example, in hearing aids, personal portable radios, or even space satellites, which are supplied by battery power, the low drain and high efficiency of these devices are the prime factors. On the other hand, if the equipment is to be AC operated, these factors are of little consequence, and other considerations may well favor tubes over transistors. For example, fixed station receivers and transmitters, or multiple PA systems, should be simpler and more economical using tubes.

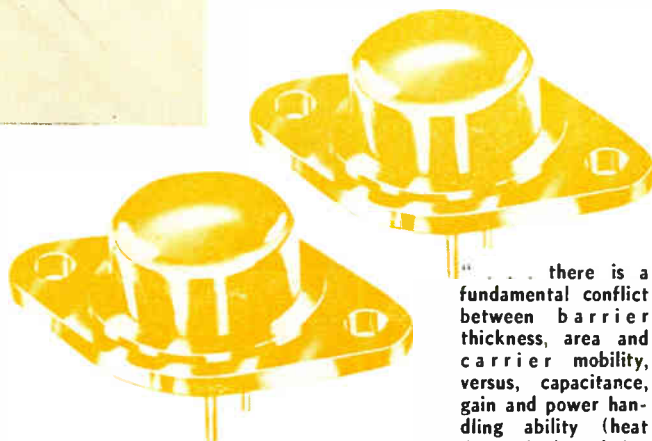

“... there is a fundamental conflict between barrier thickness, area and carrier mobility, versus, capacitance, gain and power handling ability (heat dissipation) with increasing frequency.”

# Tubes or Transistors

(Concluded)

There is also the need for precautionary measures when soldering transistor leads, to prevent overheating the junction and damaging it permanently.

To quote Captain W. I. Bull: "Presently the temperature requirements for components range from  $-65^{\circ}$  to  $+200^{\circ}\text{C}$ . Guided missile and Mach 2-plus manned aircraft may require components capable of providing reliable operation in ambients of  $250^{\circ}$  to over  $500^{\circ}\text{C}$ . The goal for the development of an entire line of high temperature,  $500^{\circ}\text{C}$  component parts, is 1965. In view of the temperature limitations of germanium and silicon transistors, new semiconductor materials will have to be investigated (and this means "developed, perfected, and reduced to practical manufacture."—ed.), and device devel-



"Because of the inherently better insulation afforded by vacuum devices it is expected that tubes will be more reliable for high-voltage applications for some time to come."

opment programs must be initiated on the most promising materials if the military's high-temperature part objective is to be met.

## Frequency

With presently available constructions and techniques, transistors become increasingly difficult and expensive to build for operation above 500 KC. Refinements, of course, are being introduced, but there is a fundamental conflict between barrier thickness, area, and carrier mobility, versus capacitance, gain and power handling ability (heat dissipation) with increasing frequency. Tubes, of course, have this to some extent owing to transit-time effects and interelectrode capacitance loading, but to a much smaller extent. Even the most optimistic predictions by transistor manufacturers provide little hope that they will take over present VHF and UHF tube applications (from 100 to 1,000 MC) in the foreseeable future, unless other considerations than cost and gain govern the choice. As an example, some

mobile communications equipment are now being transistorized. There are very few transistor types registered for this kind of operation, and none with approved military specs.

Also, several set manufacturers have produced experimental samples of transistorized portable TV receivers, but they will admit that it was necessary to exercise a great deal of selection to find the right kind of transistor to perform several of the more critical functions, and that would certainly not be practical at this time.

## Noise

Although relatively free of microphonics and variable leakage path noise contributions, transistors have an inherently higher random noise output than tubes, when considered on a noise power basis ( $K\Delta f$ ). Thus transistors may well be chosen for low level stages of audio pre-amplifiers to eliminate microphonics and hum, but be unsuitable for wide-band IF or RF amplifiers in radar or television, where a noise figure approaching the theoretical minimum is a prime requirement. The ceramic 7077 is quite a bit better than the best transistor for ultra-low frequency flicker noise.

## High Voltage

Because of the inherently better insulation afforded by vacuum devices, it is expected that tubes for high-voltage applications, both diodes and multi-element, will be simpler, more economical and more reliable than semiconductors for some time to come. Such things as high-voltage sweep tubes, rectifiers, and dampers for supplying 20 kv to television picture tubes or radar indicator scopes will be difficult to displace, unless some more efficient methods are found which can tolerate the lower breakdown voltage limitations of semiconductors.

Another aspect of this same weakness is the inability of transistors to withstand power supply transients as experienced in aircraft generator systems, which have been found to vary between  $-25$  and  $+80$  volts on a 28-volt DC system,<sup>3</sup> or diode breakdown when using a continuity meter to check out a circuit, inadvertently applying excess reverse voltage to the semiconducting element. In fact, the elaborate protective devices necessary in the former case make such applications of dubious value.

To quote a Collins Radio author,<sup>3</sup> "In summary, it can be said that transistors and other semiconductor devices can be successfully used in environments exhibiting the hazard of extreme positive and negative voltage transients *if* proper design techniques are used. It must be recognized that protection of equipment from transients, especially that using power transistors, represents some sacrifice in required space (size or parts density), efficiency (power dissipation and box temperature), equipment), equipment cost (cost of added components and cooling system), and to a lesser degree, weight. As the state of the art in the use of transistors is still relatively young, more desirable protection systems or higher voltage transistors may be developed in the future. Until then, we must either eliminate the transient from the primary power source or else accept the additional components of the protective



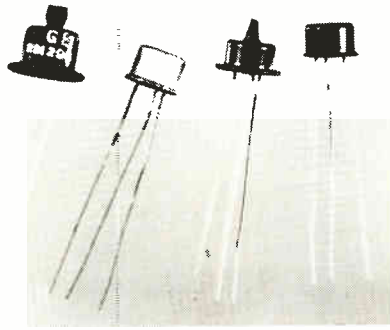

"The properties of semiconductors are more difficult to control in production . . . resulting in a much wider spread of product characteristics."

systems. The reduction of primary power transients would undoubtedly improve the reliability of other components in airborne equipments."

### High Power

Because of the elaborate measures necessary to cool the junction of a power transistor, and the relatively expensive components necessary to filter and regulate a low-voltage, high-current supply, vacuum tube power amplifiers will probably continue to have an economic advantage for some time to come. A modifying factor here, however, is introduced by the possibility of eliminating the output transformer in the case of low impedance loads such as the voice coil of a loud-speaker, allowing this saving to balance out the difference noted above. The choice then rests on a companion characteristic, linearity, which is easier to achieve with tubes than with transistors.

In addition to the fact that linear characteristics are easier to achieve with tubes, transistors have the added difficulty of variable input and output impedance from small to large signals, making driving and matching difficult, and adding to the distortion.

### Spread and Control of Characteristics

At the present time, the properties of semiconductors are more difficult to control in production than those of tubes, resulting in a much wider spread of product characteristics. In most cases, this spread is too wide for any one intended application, requiring the selection and labeling of several different portions of the overall product falling into various groupings for gain, breakdown voltage, etc. This has produced a tremendous multiplicity of type numbers (over 700, not counting experimental), with various combinations of these properties, and, depending on the yield in each area, widely varying costs. Some of this variation will undoubtedly be reduced by further manufacturing refinements, but some of it may be inherent in the nature of the device, because of the sensitivity of the semiconducting material to extremely minute amounts of contamination. As a result, where spread of characteristics, or close tolerances, or the ability to turn out a uniform product over an extended period is a prime consideration, tubes should continue to be superior.

For example, the custom is to release a quantity

of type numbers for transistors made with a given physical arrangement, and test them to identical limits and characteristics, except for one critical parameter. In other words, it is impossible to control this latter characteristic, so it must be accomplished by selection. For instance, the following groups of types are identical except for Alpha cutoff frequency!

2N444 — 0.5 mc	2N519 — 0.5 mc
2N445 — 2.0 mc	2N520 — 3.0 mc
2N446 — 5.0 mc	2N521 — 8.0 mc
2N447 — 9.0 mc	2N522 — 15.0 mc
	2N523 — 21.0 mc

This is obviously a serious obstacle to standardization.

For further evidence, the following news item is of interest:

### Transistor Preferred Circuits

National Bureau of Standards program to develop preferred transistor circuits, similar to preferred tube circuits developed earlier, has run into a snag because of extremely wide variability of characteristics in transistors. Whereas transconductance of a group of Mil-standard tubes normally varies only  $\pm 10\%$ , corresponding important characteristics of transistors, such as short-circuit current gain, may vary 200% or more."

Also, examination of the few MIL specifications available for transistors will reveal that they control only a very few characteristics, and these to

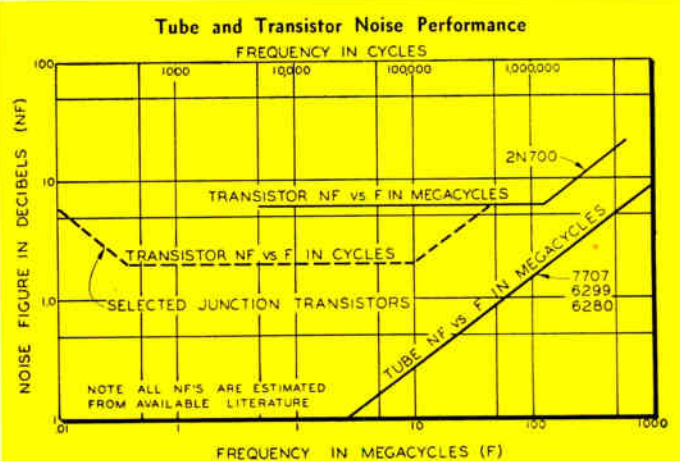

### Transistor Available Power Outputs—As a Function of Frequency

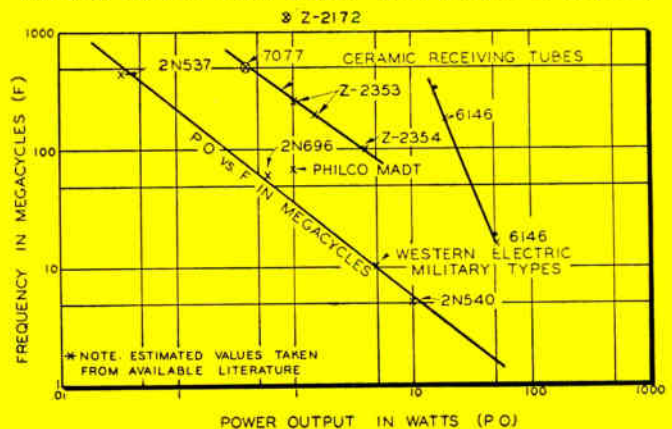

## Tubes or Transistors (Continued)

very much looser AQL values than the corresponding tube characteristics. By contrast, MIL specifications for tubes now represent an extremely good guarantee of reliability over a 1,000-hr. period.

The really basic consideration here is admirably outlined and explained by Marshall Pease, Associate Editor of *The Microwave Journal*, September-October 1958 issue, in an article entitled "On the Virtues of Separability—Tubes vs. Intrinsic Devices."<sup>5</sup> While the entire article is well worth reading, the main point is that in intrinsic devices, the various factors such as frequency, power density, coherence of electron flow, and some elements of circuitry are functions of sub-microscopic or ionic arrangements, and so inter-related as to be essentially uncontrollable. On the other hand, tube structures separate the beam forming, power producing, and frequency control functions far better, and give far more flexibility to the circuit designer.

### Multiple-Unit Devices

As a corollary to the above difference in product control and variability, it is easy to see that tubes will continue to have an economic advantage in multi-function units, such as twin triodes or triode-pentodes, where such combinations in transistors would not prove practical. For example, if the yield of a particular tube element, when tested to the allowable customer limits, were 90%, the yield of a two-unit tube with random variations in each element would be  $0.9 \times 0.9$ , or 81%. Contrast this with present transistor yields in any one spread of characteristic limits of around 25%, and a twin-unit yield would become  $0.25 \times 0.25$ , or about 6%!

### Nuclear Radiation

The available unclassified data show transistors to be definitely vulnerable to high energy gamma radiation, which does not affect tubes to any measurable degree. For thermal and fast neutrons, the various reports indicate that for equal dosage, glass tubes will last about 100 times as long, and ceramic tubes about 1,000 times as long as a transistor. To quote an ASTM report:<sup>6</sup>

"The results that have been obtained in the preliminary phase of this program can be summarized as follows:

"1. Thermal neutrons are not a major contributing factor to the deterioration of semiconductor devices:

"2. For the integrated doses used, gamma radiation causes surface damage which results in changes in leakage currents. Partial recovery may occur when the device is removed from the radiation field.

"3. Fast neutrons appear to cause bulk changes in materials.

#### PERFORATED PAGES!

In response to many reader requests the pages in the main editorial section have now been perforated. This will enable readers to easily remove material for their reference files. If the copy of *Electronic Industries* you receive already has pages removed that you want, please let us know. We'll be glad to provide the missing pages.

Table 1  
COMPONENT FAILURE RATES

	Failures/1,000 Hrs./Component
<b>Capacitors</b>	
Ceramic .....	.00048
Mica .....	.00042
Paper .....	.00094
Tantalytic .....	.0041
Chopper, Mechanical .....	.114
Coils, Small RF, IF Transformers, etc. ....	.0021
Connectors .....	.0047
<b>Crystals</b>	
Oscillator .....	.0151
Rectifier .....	.0037
<b>Diodes</b>	
Germanium .....	.002
Silicon .....	.002
Filter, Line .....	.012
Heater .....	.007
Meter .....	.032
Motor .....	.023
Potentiometers .....	.0021
Pulse Forming Network .....	.0346
Relays .....	.0296
<b>Resistors</b>	
Carbon Composition .....	.0008
Carbon Deposited .....	.0013
Wire Wound .....	.0014
Solenoid .....	.0133
<b>Switches</b>	
Stepping .....	.442
Toggle .....	.007
Thermistor .....	.010
<b>Transformer</b>	
High Voltage and Power .....	.0191
Low Voltage .....	.0032
Transistor .....	.010
Tubes, Receiving .....	.010
Variac .....	.006

"4. In reactor irradiations, silicon rectifying devices which deteriorate will probably fail in the forward direction with increases in forward resistance and break-point voltage. For the integrated doses used, germanium devices generally suffer major damage in the reverse direction only.

"5. For most applications, silicon diodes and rectifiers tested could probably be used to  $10^{13}$   $nv_e t$ , and the silicon and germanium transistors irradiated could probably withstand  $5 \times 10^{11}$   $nv_e t$  under the conditions of test. These limits are considerably below the limits that would be caused if radiation damage on the bulk materials above is considered. The basic processes of semiconductor devices are probably disturbed by the presence of the radiation field, causing the radiation resistance of the devices tested to be considerably lower than would be expected by considering the basic properties of the semiconductor materials."

An examination of another voluminous study, an Admiral Report, reveals this same ratio: "The 6L6WGB beam power, the 5639 subminiature video amplifier, the 5840 subminiature pentode, the 5670 miniature twin triode, and the 5876 subminiature UHF survived the irradiation, but had control grid currents in excess of the maximum specification. . . . The 6112 subminiature twin triode, and the 5751 miniature triode all survived the CP-5 experiment." From Admiral Report No. 8, Phase 1, July, 1957.) The interesting point, however, is that the transistor tolerance limit is about equal to the human tolerance limit, and that tubes are relatively unaffected at



this dosage. This means that while it may be possible to evacuate personnel and protect them from an atomic explosion, it would be highly impractical to bury or shelter all electronic equipment, and if the equipment was expected to survive in operating condition, it better use tubes.

It is interesting to note that the U. S. Army Signal Corps has become concerned about this and other tactical aspects of the use of transistors in the design of military gear, including missiles, and is publishing a comparison of its own, entitled "A Report of the Current Status and Future Trends in Electronic Tube and Transistor Electronics."

Additional material may be found in "Radiation Effects in Semiconductor Devices," and "Effects of Gamma Radiation on Transistor parameters."<sup>7</sup>

### Reliability

In terms of survival under equivalent operating conditions, there is practically no information comparing tubes and transistors directly, except for some studies by Bell Laboratories on some of their own early types. These indicate comparable figures for their best tubes and best transistors, under practically ideal operating conditions, or around 0.03% per 1,000 hours. Other less accurate figures in military gear have given about 0.1% per 1,000 hours for both.

As a practical matter, voluminous specifications, both manufacturers' and military, are available which guarantee a "floor" under allowable failure rates of tubes, and a very good probability that most lots will give better than 99% survival at 1,000 hours under maximum rated conditions, whereas such survival specifications and documented data are completely lacking for transistors. This is not to say that transistors do not have a very high *potential* reliability, possibly somewhat better than that of tubes, but that prediction, control, and statistical evidence of consistent survival under comparable environmental conditions are not yet available, and will probably take ten years to accumulate. This will render impossible any calculations of system reliability or the value of such provisions as multiple channel redundancy.

A typical list of failure rates of components in a number of military equipments is shown in Table I in the appendix, where both tubes and transistors have been used in various portions of the equipment, as well as germanium and silicon diodes. It will be noted that in this particular set of data, the tubes and transistors came out about even at 1.0% per thousand hours. It should be noted, however, that in general it takes three or four times as many transistors to perform the same functions as currently available military tube types, because of their lower gain-bandwidth factor and single-unit limitations, so that it would appear that the over-all equipment reliability using tubes is still about three to four times as good.

In fact, one example of comparable designs of a servo-amplifier required only eight tubes in the original prototype, but wound up with forty transistors in the redesigned version! Obviously, it will take a considerable improvement in the reliability

of transistors to make up for this initial handicap.

There is one further feature of transistors, which, although greatly improved in the last two years since the original papers in the aforementioned Transistor Reliability Symposium, is nevertheless a serious and disturbing factor, and that is shelf life. There is, of course, the effect of storage at high temperatures, which shows definite deterioration at 85°C for germanium,<sup>8</sup> and also the effect of small amounts of contaminants inside the sealed enclosure affecting the surface condition of the germanium crystal.<sup>9</sup> As sealing, exhaust, and gettering techniques approach that of vacuum tubes, this effect will undoubtedly be reduced, but the inherently greater sensitivity of the resistivity of the semiconducting surface to extremely minute amounts of contaminants is a problem which is not, fortunately, found in tubes.

### Physical Size

Transistors have an obvious advantage over tubes on both of these counts, except for ceramic tubes, but the unit itself is not the whole story. In the case of power transistors, the heat sink and radiator must be many times the size of the transistor, and may well be larger than a tube of the same output rating, since the junction temperature must be kept much lower than that of the tube envelope. Similarly, in large installations involving many thousand units, the air conditioning may have to be just as large for transistors, in spite of their lower power consumption, since the *allowable rise* cannot be as great. Heat flow and thermal calculations are fairly long and involved, so it is impossible to generalize, but this hidden factor must be borne in mind when considering tubes vs. transistors from this standpoint.

This paper was presented at the AIEE Winter Meeting, Feb. 1959.

### Bibliography

1. "Factors in the Reliability of Germanium Power Transistors," by A. B. Jacobsen, *Proc. of the Transistor Reliability Symposium*, Sept. 17, 1956, N. Y. University Press.
2. "Transistor Reliability and Military Requirements," by S. E. Petrillo and Howard Moss, *Proc. of the Transistor Reliability Symposium*, Sept. 17, 1956, N. Y. University Press.
3. "Transients and the Transistor in Airborne Applications," by M. W. Caquelin, Collins Radio Co. internal publication CER-878, Dec. 1, 1958.
4. *Aviation Week*, Aug. 4, 1958.
5. "On the Virtues of Separability—Tubes vs. Intrinsic Devices," by Marshall Pease, *Microwave Journal*, Sept.-Oct., 1958, Vol. 1, No. 2, published by Horizon House 160 Warren St., Boston 19, Mass.
6. "Effects of Radiation on Electronic Components: Semiconductor Devices," by M. A. Xavier, S. Nelson, A. Yefsky, A. Walters, and G. J. Rotariu, *Symposium on Radiation Effects on Materials—Vol. 2*, ASTM Special Technical Publication No. 220, June 20, 1957.
7. *Proc. of the Transistor Reliability Symposium*, Sept. 17, 1956, pp. 77 and 96.
8. *Proc. of the Transistor Reliability Symposium*, Sept. 17, 1956, p. 18.
9. *Proc. of the Transistor Reliability Symposium*, Sept. 17, 1956, p. 28.

### Additional Material Not Reference In Text

- "The Effect of Nuclear Radiation on Selected Semiconductor Devices," by G. L. Keister and H. V. Stewart, *Proc. of the I.R.E.*, July, 1957.
- "Evaluation of Z-2353 Tubes at 590°F Temperatures," Missile and Ordnance Systems Department, General Electric Co., Burlington, Vt.
- "Electron Tubes for Critical Environments," by Walter H. Kohl and Philip Rice, Mar. 1958, WADC Technical Report 57-434, ASTIA Document No. AD-151158.
- "Physical Mechanisms Leading to Deterioration of Transistor Life," by G. C. Messenger, p. 147, Vol. ED-5, *IRE Transactions on Electron Devices*, July, 1958.

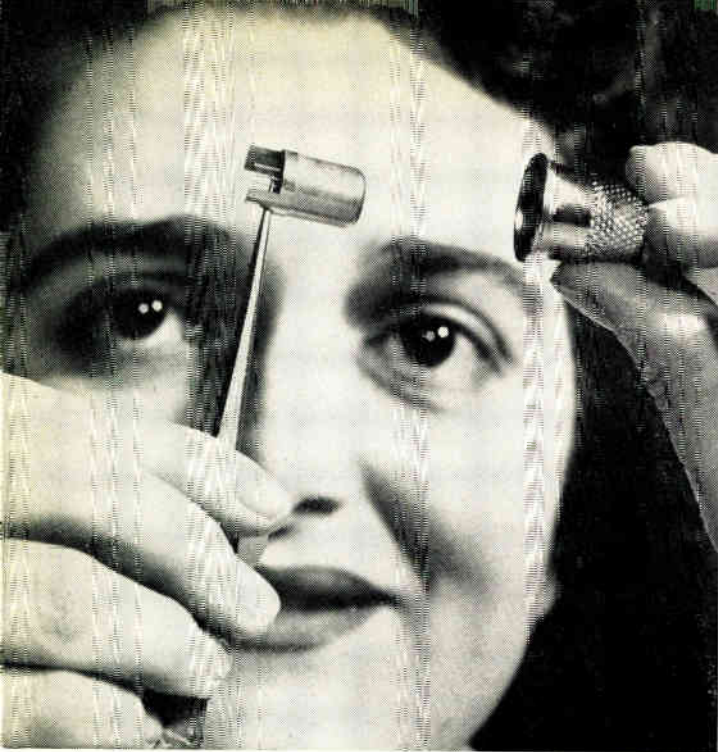

# The Thimble Tubes

Production of this rugged tube—the Nuvistor—is expected in 1960.

## RCA Nuvistor

**T**HE "Nuvistor" is a tube design based on a new concept developed by the RCA Electron Tube Division. This concept makes possible thimble-size, more reliable and efficient, higher-performance, and more rugged electron tubes particularly suited for highly mechanized production.

The new design is a breakthrough in the effort to reduce the size and power drain, and to increase the performance and reliability of electron tubes.

The name of the new tube design is based on the words "nueva" and "vista" meaning "new" and "prospect." Hence, new look or Nuvistor.

Currently included in the developmental program are a small-signal triode, a small-signal tetrode, and a beam power tube.

### *Applications*

It is expected that tubes of the Nuvistor design will be useful in TV sets, communications receivers, high-speed data-processing equipment, compact electronic equipment for jets, guided missiles, and military vehicles, as well as numerous other industrial and entertainment applications.

### *Construction Features*

Construction of the Nuvistor starts with a strong ceramic base-wafer which serves as a platform. An  
*(Continued on page 96)*

A microscope aids in inserting inner assembly into the metal case.



The model parts and assembly jig are approximately 10 times larger than actual size.

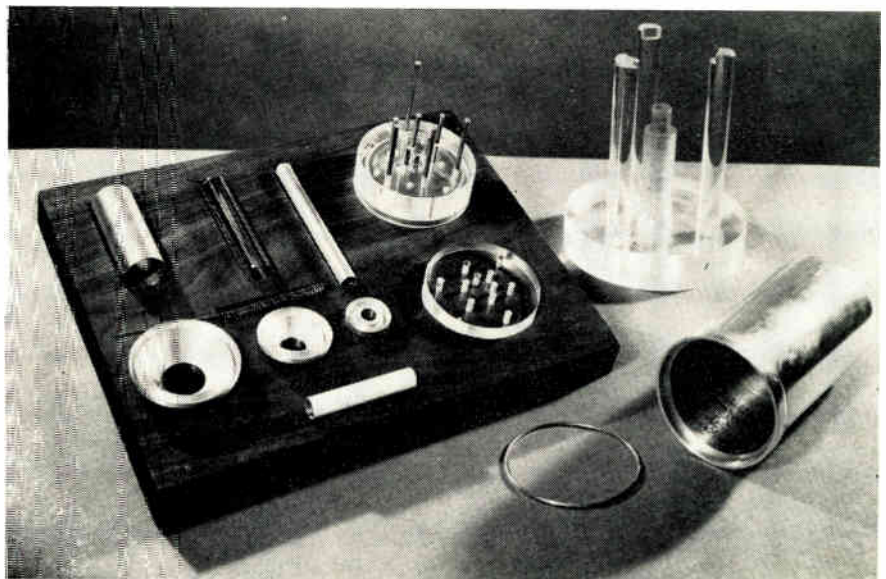



A TINY ceramic tube manufactured by General Electric and now, hurtling through space in the Pioneer IV sun satellite, has made possible the longest point-to-point radio communication in history—an important “first” in space exploration.

The tube, a receiving type 7077 a half inch long and a half inch in diameter is being used as a transmitting tube with an output of 200 mw at 960.05 MC. This higher frequency, as compared with the previously-used transistor transmitting frequencies of 108 MC, permits more accurate tracking.

The Pioneer IV radio signals apparently are continuing beyond the distance of those transmitted by the recent Soviet sun satellite, and thus have literally set a “universe record.”

*UHF Amplifier*

The continued extension of many services into the UHF region of the spectrum has increased the need for tubes that will produce usable gain as UHF amplifiers under a wide variety of environmental conditions. The many and varied requirements of present-day UHF service necessitate tube designs that differ radically from the conventional.

The 7077, a military tube intended primarily for UHF grounded-grid amplifier service, is a triode having features that make it particularly well suited for use where a high level of performance is required under severe environmental conditions.

The dual requirements of low noise and high power gain are probably the most important imposed on UHF amplifier tubes. The lowest possible noise figure is required so that the equipment will exhibit a signal-to-noise ratio sufficiently high to ensure that the performance is not limited by the noise inherent in the low-level stages, when detecting weak signals. High power gain is required to prevent the noise contributed by succeeding stages from being a determining factor in the over-all noise level of the equipment. High gain in the input stage also reduces the number of stages needed to attain the required over-all-gain.

Good UHF performance requires that a tube have

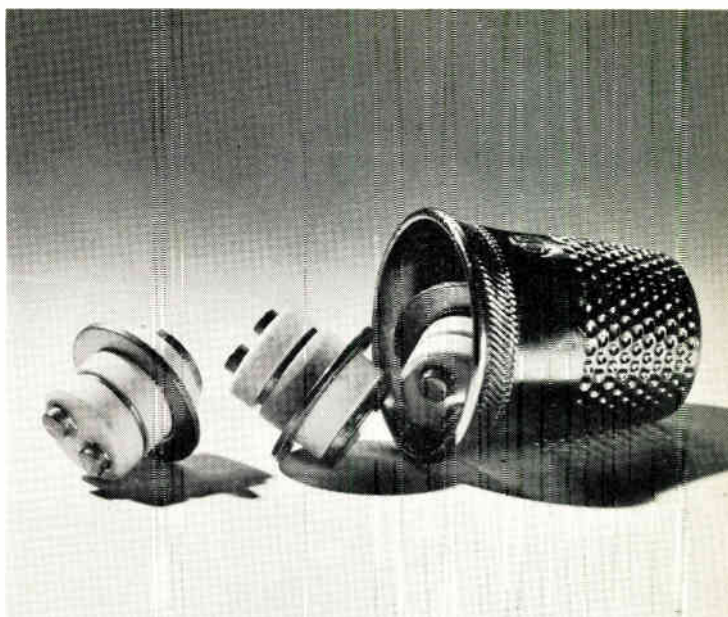

This type of ceramic tube was used in the Pioneer IV sun satellite.

extremely low interelectrode-capacitances and provisions for incorporation of the tube elements in a circuit with connecting leads of minimum inductance. These requirements dictate a small physical size for the tube. Dielectric losses are accentuated at ultra-high frequencies, and the materials chosen for tube construction must be those that hold these losses at acceptably small values.

While not unique to UHF operation, many present-day applications subject tubes to severe environmental conditions beyond the capabilities of conventional tubes. Long life with little degradation of electrical characteristics has also become increasingly important. Special materials and construction techniques are needed to cope with these problems.

*Construction*

The 7077 is designed and manufactured to meet all of the foregoing requirements. It is of small size and is rugged in construction; alternate rings of metal and ceramic are brazed together into a solid unit, (Continued on page 97)

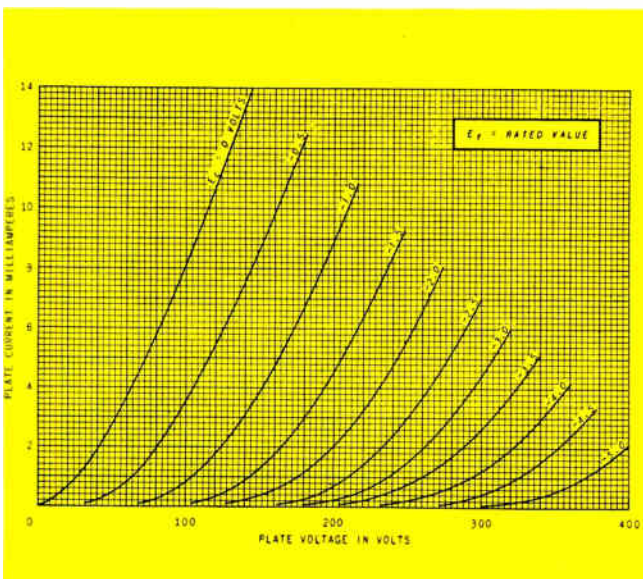

(Left) Plate characteristic curves of the ceramic GE 7077. (Below) Average characteristics for  $E_b = 250$  v. shown on p. 97

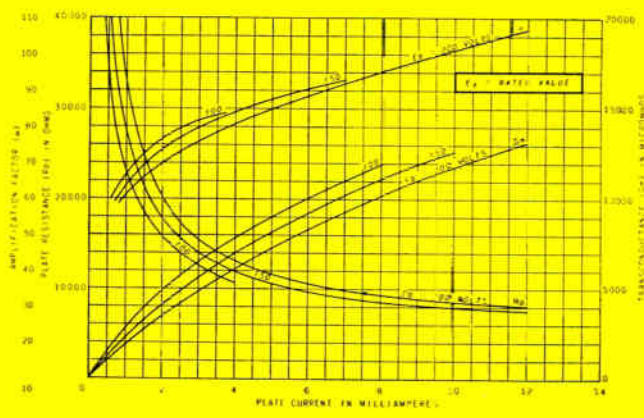

*Design knowledge is valuable not only to the instrument manufacturer but also to the user. Only with this information can a buyer be sure that he is purchasing equipment best suited for his purpose. Presented here are complete design criteria.*

# Designing a Spectrum Analyzer



By **ROBERT SAUL**,  
Chief Test Engineer  
and **ELAINE LULOFF**,  
Development Engineer  
Polarad Electronics Corp.  
43-20 34th St.  
Long Island City 1, N. Y.

A SPECTRUM analyzer visually presents the spectra of signals applied to its input terminals on a cathode ray tube (CRT). The power distribution of a signal as a function of frequency therefore appears on the screen of the analyzer. Fig. 1 is the basic block diagram of a spectrum analyzer.

A sawtooth waveform from the sweep generator causes the local oscillator to be swept between two frequency limits in a linear manner. This corresponds to frequency modulation.

The swept local oscillator output is heterodyned in the mixer with the signal being analyzed. The latter has already passed through several stages of frequency conversion and amplification. The mixer output will equal the frequency differences between the components of the converted r-f signal and the local oscillator output.

The narrow band amplifier amplifies only that part of the signal which falls in its pass band at any time. It may be compared to a window, past which the spectrum is being swept. Only a small part of the spectrum is allowed through at any time.

After passing through the i-f amplifier, the signal is detected and then amplified by the video amplifier to a level suitable for application to the vertical deflection plates of the CRT.

Part of the output of the sweep generator is applied to the horizontal plates and sweeps the signal

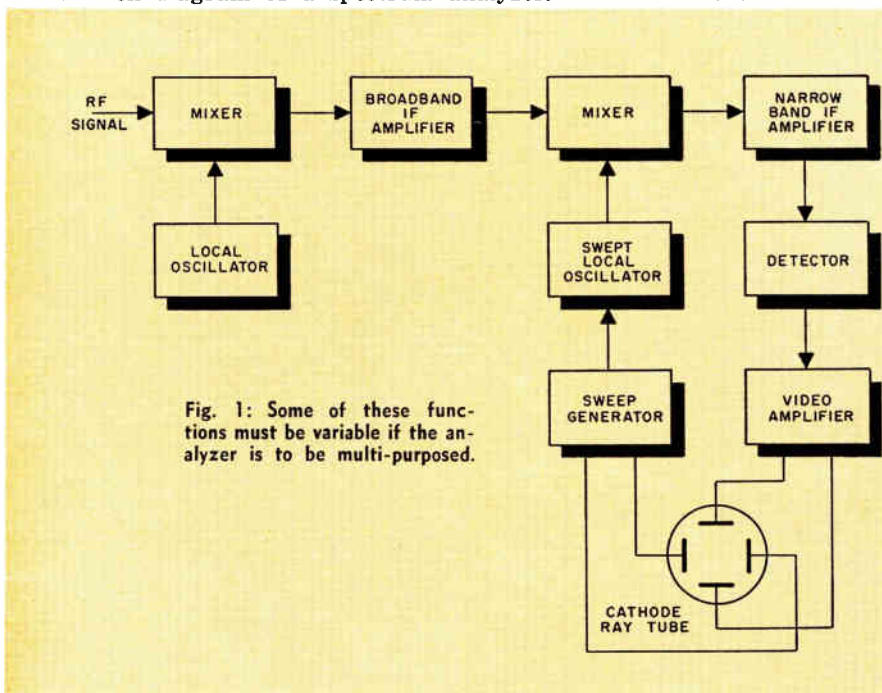

Fig. 1: Some of these functions must be variable if the analyzer is to be multi-purposed.



across the screen, causing the power spectrum to appear.

Design criteria for spectrum analyzers are governed by the applications for which the instruments are to be used. If a spectrum analyzer is to serve more than one purpose, it is often desirable to make certain characteristics variable.

### Local Oscillators

The first local oscillator should be tunable throughout the range of the r-f signals to be observed. The range of frequency sweep should cover the principal region of the spectrum. For a rectangular pulse, at least three or four zeros should be visible on either side of the center lobe.

### Broadband I-F Amplifier

#### Center Frequency

One of the most important considerations in the design of a spectrum analyzer is the center frequency of the broadband i-f amplifier,  $f_i$ . The spectrum analyzer can be regarded simply as a superheterodyne receiver. Since there is no selectivity in the tuning circuit, undesired image response must be kept off the screen by using a sufficiently high intermediate frequency. This can be seen by referring to Fig. 2.

The center frequencies of the two images are spaced apart by twice the intermediate frequency. Each side lobe covers a frequency range of  $1/\tau$  where  $\tau$  is the pulse length, and the center lobe covers a frequency of  $2/\tau$ . Therefore, the fourth side lobe of one image spectrum will overlap the third side lobe of the other, when  $2f_i$  is equal to  $8/\tau$  or when  $f_i$  equals  $4/\tau$ .

To maintain a separation of 6 side lobes between the two center lobes the intermediate frequency must be chosen so that

$$f_i = \frac{4}{\tau_{\min}} \quad (1)$$

where  $\tau_{\min}$  is the shortest pulse the analyzer will be required to handle. This separation of center lobes is sufficient to produce a distinct image.

A superheterodyne receiver is sensitive to more than two image frequencies. In using a spectrum analyzer, these higher order images may appear on the CRT screen. Although they are of much lower amplitude than the first-order images, they may be observed when a CW signal of large amplitude is present. Frequently they cause inadequate separation of image spectra and considerable confusion.

#### Bandwidth

The bandwidth necessary for the wide band i-f amplifier depends on the purpose for which the spectrum analyzer is to be used. Because of its narrow spectrum, a single CW signal does not require broadband i-f amplification. However, if it is desired to compare two CW signals, the amplifier response must be flat over a range wide enough to cover both signals. This need arises quite often when comparing an incoming signal with the output of a local oscillator.

The spectrum of a single-tone amplitude modulated signal can be shown to consist of the original carrier frequency plus a pair of side frequencies, one

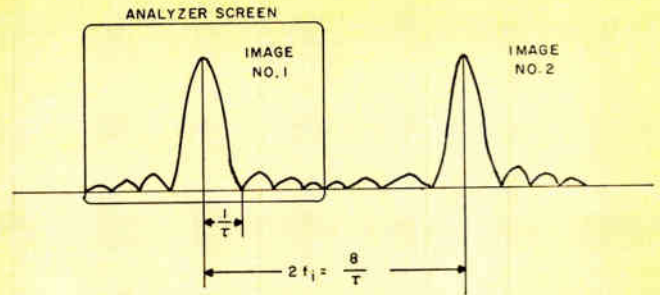

Fig. 2: Appearance of spectra when center frequency is  $4/5$ .

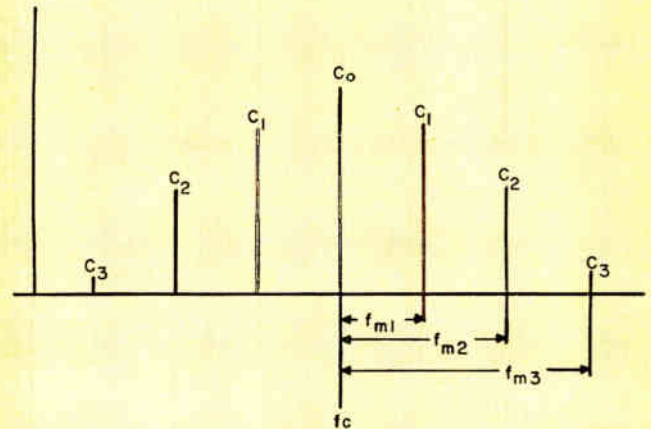

Fig. 3: A sine wave, amplitude modulated by 3 tone signals.

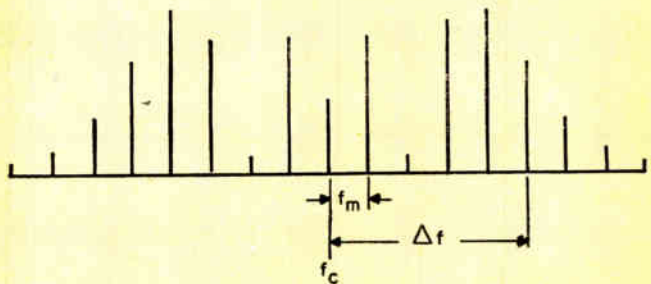

Fig. 4: Spectrum of a single tone frequency modulated signal.

above and one below the carrier. The frequency difference between the carrier and either side band is equal to the modulating frequency, which is the frequency of the envelope of the modulated signal.

If the modulating wave is complex, each frequency component in the modulating wave contributes a pair of side frequencies to the spectrum. These side frequencies are located equidistantly on each side of the carrier, and are spaced away from the carrier by the frequency of the modulating wave being considered.

The spectrum of a sine wave amplitude-modulated by 3 single tone signals is shown in Fig. 3. The wide band i-f amplifier must have a bandwidth wide enough to accommodate a signal with a frequency range twice as great as the frequency of the modulating component with the highest frequency, in this case the signal of frequency  $f_{m3}$ .

The width of the spectrum of a frequency modulated signal is infinite. However, only those components with amplitudes 1% or more of the amplitude of the unmodulated carrier contribute significantly to

# Spectrum Analyzer (Concluded)

the spectrum. This reduces the width of the spectrum to a workable value.

Fig. 4 shows the spectrum of a typical frequency modulated wave. The components of the spectrum are separated by an amount equal to the frequency of the modulating signal,  $f_m$ . The symbol  $\Delta f$  represents the maximum frequency change occurring in the modulated wave.

A modulation index,  $m_f$ , is defined as the ratio of the maximum frequency deviation to the modulating frequency. Therefore,

$$m_f = \frac{\Delta f}{f_m} \quad (2)$$

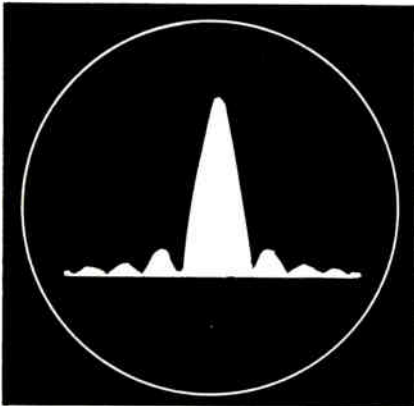

Fig. 5: A pulse-modulated wave with adequate resolution of envelope but not of PRF lines.

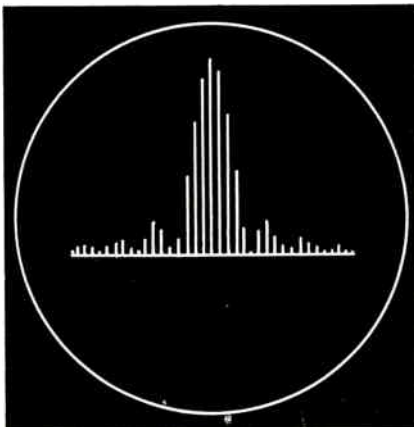

Fig. 6: A pulse-modulated wave with adequate resolution of envelope but poor definition due to excessively high sweep frequency.

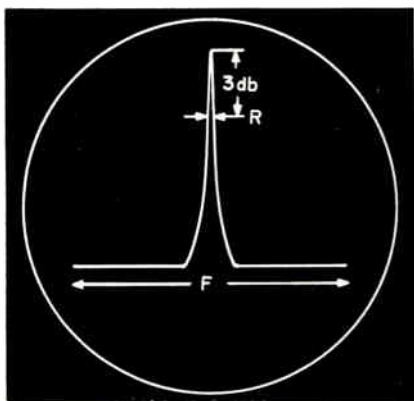

Fig. 7: Spectrum analyzer display of a continuous wave signal.

The larger the value of  $m_f$ , the wider the significant part of the spectrum of the frequency modulated wave. This spectrum width determines the bandwidth of the wide band amplifier when a spectrum analyzer is to be used for the analysis of a frequency modulated signal.

If the analyzer is to resolve pulses into their various frequency components, the pulse with the widest spectrum will determine the minimum permissible bandwidth of the wide band amplifier. This corresponds to the narrowest pulse to be examined. The frequency response must be level over a wide enough range to allow linear amplification over the significant portion of the spectrum.

## Swept Local Oscillator

The swept local oscillator should be tunable over the entire frequency range of signals to be analyzed. The range of frequency sweeps must cover the principal part of the spectrum. For a rectangular pulse, at least 2 or 3 lobes on either side of the main lobe should appear on the CRT screen.

The sweep width, in CPS, is referred to as the dispersion of the spectrum analyzer. As dispersion is increased, a greater part of the spectrum appears on the analyzer screen.

## Sweep Rate Choice

The pattern on the CRT screen is a series of vertical lines, referred to as PRF lines, the envelope of which corresponds to the spectrum of the applied

Fig. 8: Plot of the loss in sensitivity due to the sweep rate.

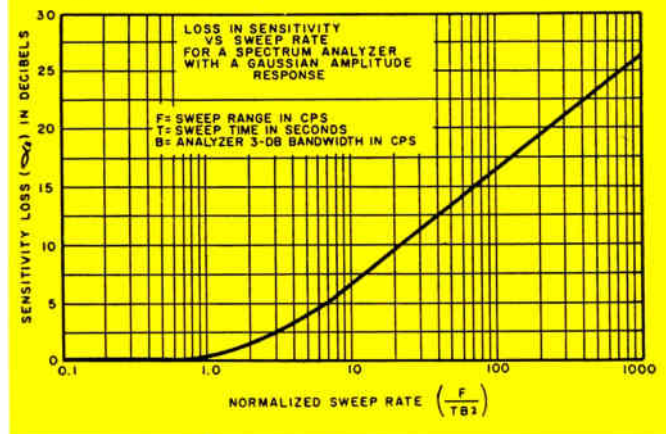

signal. Each line on the screen is produced by an r-f pulse. These lines should not be confused with the actual spectral lines of a non-continuous spectrum.

For adequate outlining of the spectrum on the screen, 50 lines should appear between the third minima on the screen. Figs. 5 and 6 show analyzer displays with varying detail.

If  $f_s$  represents the sweep frequency in cycles (or sweeps) per second, and  $f_r$  represents the repetition rate of the r-f pulse in pulses per second, the number of pulses per sweep cycle,  $N$ , is expressed by

$$N = f_r / f_s \quad (3)$$

Letting  $b$  represent the sweep length on the analyzer



screen, the separation between pulses,  $S_p$ , is then given by the relationship

$$S_p = b/N = bf_s/f_r \quad (4)$$

where  $S_p$  has the same units as  $b$ .

Eq. (4) shows that the lowest pulse repetition rate sets the upper limit for the sweep frequency to obtain an adequate number of lines in the spectrum display. The spectrum will appear emptier as the sweep frequency is increased.

The spectral display is independent of the form of the sweep voltage. A linear sawtooth is chosen because it provides equal spacing between lines in the display and also because the return trace, which is blanked from the screen, is of short duration.

### CW Signal Use

A CW signal produces a trace on the spectrum analyzer screen as shown in Fig. 7. If the sweep speed of the analyzer is very low, the trace is a plot of the band-pass characteristic of the narrow band i-f amplifier. This may be explained as follows: Only one line exists in the spectrum of a CW signal. Heterodyning this single line with the swept wave from the swept local oscillator again results in a one line spectrum. Now, however, this line is being swept in frequency with time. Delivering this signal to the narrow band amplifier is equivalent to applying a signal of constant amplitude to the amplifier and varying its frequency. Plotting the output would result in the frequency response curve of the amplifier.

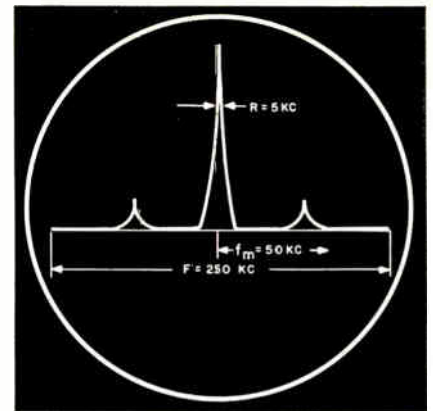

Fig. 10: Spectrum analyzer display of single tone amplitude modulated signal.

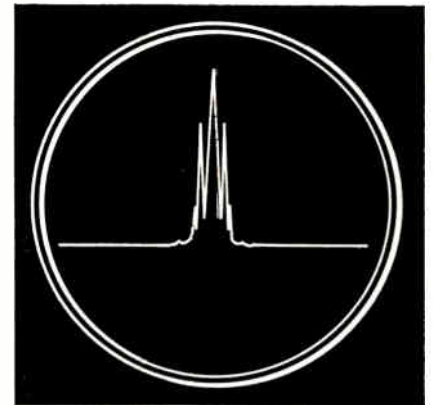
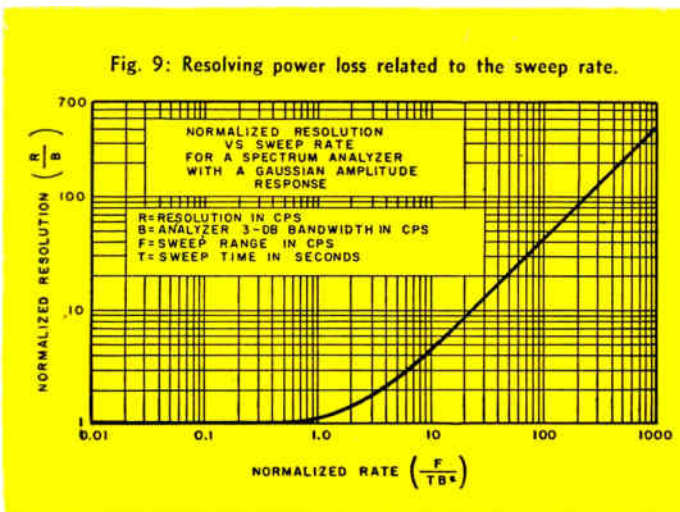

Fig. 11: Similar to the signal in Fig. 10 except for course resolution.



Since the plot on the screen of the CRT is nothing more than the amplitude vs. frequency output of the narrow band amplifier, it is the frequency response curve or band pass characteristic of the amplifier. If the sweep is rapid, the response of the tuned circuits may be too slow to allow the swept input to fully charge and discharge the amplifier circuit, and amplitude becomes a function of sweep rate. As the sweep rate is increased, the pip becomes reduced in amplitude and widened out.

We introduce the term resolving power,  $R$ , to represent the ability of the narrow band amplifier to produce a distinct and sharp response at a given sweep frequency.  $R$  is taken to be the displayed width

of the CW pip at the 3 db points. This is illustrated in Fig. 7. Thus, if the pip is 25 KC wide at the 3 db points, the resolution,  $R$ , is said to be 25 KC. Two pips of equal amplitude and separated in frequency by  $R$  as so defined would barely be distinguishable from each other on the screen.

Both the resolving power and the sensitivity of the analyzer are degraded when the sweep rate is increased, due to the limited response time of the tuned circuits.

The loss of sensitivity due to the sweep rate is given by

$$a_s = [1 + 0.195 (F/TB)^2]^{-1/4} \quad (5)$$

where,  $B$  = 3 db bandwidth of the narrow band i-f amplifier in cps,

$F$  = sweep width (dispersion) in cps, and

$T$  = sweep time interval in seconds. Thus,  $F/T$  is the sweep rate in cps per second.

The loss in resolving power due to the sweep rate is given by

$$R/B = [1 + 0.195 (F/TB)^2]^{1/2} = 1/(a_s)^2 \quad (6)$$

$R/B$  may be interpreted as the apparent bandwidth of the spectrum analyzer when sweeping, relative to the steady-state bandwidth.

Eqs. (5) and (6) are plotted in Figs. 8 and 9, respectively.

A spectrum analyzer having an i-f bandwidth of 5 KC and displaying 25 MC at a sweep frequency of 20 CPS would have a loss in sensitivity, due to scanning, of 9.5 db, while the resolution,  $R$ , would be 44 KC. To obtain a resolution substantially equal to the i-f bandwidth, the dispersion would have to

## Spectrum Analyzer (Continued)

be reduced to below approximately 300 kc in this example. The sensitivity would then be, for all practical purposes, equal to the zero-sweep-rate value.

### Bandwidth Choice

#### Amplitude Modulated Signal

The resolution of a spectrum analyzer, and therefore the bandwidth of the narrow band i-f amplifier, is effective regardless of the type of signal being analyzed. A typical spectrum analyzer display of a single amplitude modulated signal is shown in Fig. 10.

To separate adjacent signals of equal amplitude the frequency differences between these signals must be at least equal to the analyzer resolution. For unequal signals, the frequency difference must be greater due to the tendency of the large pips to mask the adjacent smaller ones. Thus, the lowest modulating frequency which can be discerned by observation of the pair of side bands adjacent to the carrier is somewhat higher than  $R$ .

The lines in the spectrum of an amplitude modulated wave are separated by an amount equal to the frequency of the modulating signal. Hence, a spectrum analyzer with an i-f bandwidth of, say 25 kc, would not be suitable for the detailed analysis of a voice modulated signal.

However, such a signal might still be identified as being amplitude modulated by the serrated appearance of the carrier pip on the analyzer screen, as illustrated in Fig. 11. If the resolution is extremely coarse compared to the width of the side bands, the signal will appear as a pip fixed in position and bobbing up and down in amplitude.

#### Frequency Modulated Signal

For frequency modulation, it is apparent that for proper display of the side-band structure the spectrum analyzer should have a resolution good enough to separate adjacent side-bands. Since these side-bands are generally of unequal amplitude the analyzer resolution should be smaller than the lowest modulating frequency.

The lines on the spectrum of a frequency modulated wave are separated by an amount equal to the frequency of the modulating signal. If the spectrum analyzer resolution is so coarse as to include all of the significant side frequencies of the modulated signal, the display appears as a single pip, constant in amplitude and shifting back and forth in frequency.

#### Pulse Modulated Signal

Recall that the center frequency of the wide band i-f amplifier is determined by the minimum pulse

#### PERFORATED PAGES!

In response to many reader requests the pages in the main editorial section have now been perforated. This will enable readers to easily remove material for their reference files. If the copy of Electronic Industries you receive already has pages removed that you want, please let us know. We'll be glad to provide the missing pages.

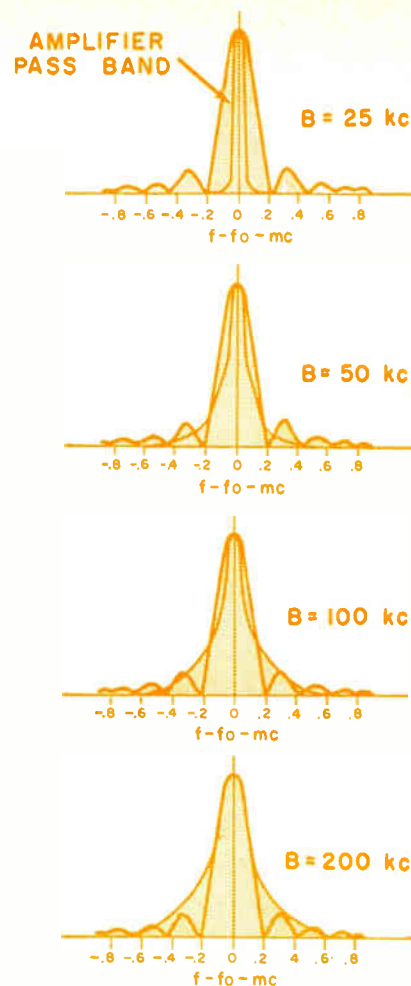

Fig. 12: Effect of varying the bandwidth of a narrow band amplifier.

length. The maximum pulse length determines the bandwidth of the narrow band i-f amplifier.

The width of the main lobe of the spectrum of a pulsed signal is equal to  $2/\tau$ , where  $\tau$  is the pulse width. Bandwidth varies inversely with pulse length. Therefore the greater the pulse length the smaller the width of the spectrum of the pulse, and the smaller the width of the main lobe. For adequate resolution, the bandwidth must be narrow compared to the width of the main lobe,  $2/\tau$ . It has been found that no difference exists between the display on the analyzer screen and the actual spectrum if the following relationship is satisfied:

$$B\tau \leq 0.1 \quad (7)$$

where  $B$  is the bandwidth of the narrow band i-f amplifier and  $\tau$  is the pulse length. Fig. 12 shows the effect of varying  $B\tau$ . It can be seen that the first effect as  $B\tau$  increases is that the minima are no longer zero.

Theoretically, an infinitely small bandwidth would be ideal. However, in actual circuits a smaller bandwidth is accompanied by instability of the local oscillators in the spectrum analyzer and of any CW signal which is to be analyzed.

When analyzing a pulsed signal, a loss of sensitivity occurs if the bandwidth is not wide enough to accommodate the pulse. The variation in sensitivity is

$$\alpha = 3\tau B/2 \quad (8)$$



and the variation in power sensitivity is

$$B = \alpha^2 = (9 \tau^2 B^2)/4 \quad (9)$$

Fig. 13 is a plot of the loss of sensitivity as a function of  $B\tau$ .

Another reason for maximizing bandwidth is given in the next section.

#### Incidental Frequency Modulation

In operating a spectrum analyzer, it is unavoidable that undesired frequency modulation will distort the signal. The FM may arise either in the swept local oscillator or in the tuning stages of the analyzer.

As the sweep frequency of the analyzer is increased, the amplitude and form of the output signal becomes dependent on the sweep rate. This is the result of the limited response time of the r-f and video amplifiers. The amplitude of a CW signal is observed to decrease as sweep speed is increased.

If there is incidental FM present it will cause the amplitude of the output signal to fluctuate violently, even though the signal level is much greater than the level of the noise. This effect is most noticeable when the analyzer is used for CW analysis, in which instance amplitude measurement is made exceedingly difficult.

The results of incidental FM may be minimized by either decreasing the sweep speed or increasing the narrow band i-f amplifier bandwidth. The second method is preferred because it reduces the requirements for frequency stability. The bandwidth is therefore kept as wide as possible.

Fig. 13: Sensitivity loss as a function of signal pulse width and bandwidth of analyzer.

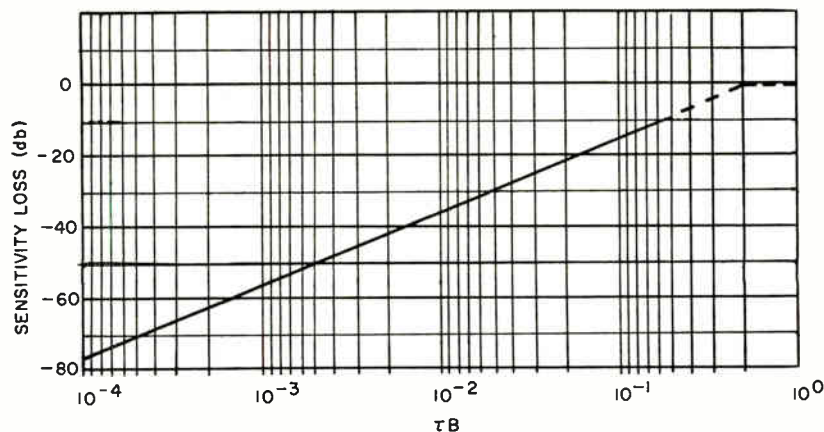

#### Video Amplifier Bandwidth

After passing through the i-f system, the signal is detected and fed to the video amplifier. The function of the video amplifier is to amplify the spike to a level suitable for application to the vertical deflection plates of the CRT. The bandwidth of the video amplifier should therefore be great enough so that the rise time of the spike will not be seriously degraded. Referring to Fig. 7, the time duration of the spike between the 3 db points may be taken as

$$W = RT/F \quad (10)$$

where:

$W$  = time deviation of the spike between the 3 db points,

$R$  = resolving power of the analyzer,

$F$  = sweep width (dispersion), and

$T$  = sweep time.

To simplify matters, let us assume that the rise time of the spike is equal to  $W/2$ . Making use of the fact that the rise time of a Gaussian amplifier is given by

$$\tau_r = 0.5/B = RT/2F \quad (11)$$

where  $B$  is the 3 db bandwidth, we obtain, for the minimum allowable bandwidth of the video amplifier,

$$B = 0.5/\tau_r = F/RT \quad (12)$$

Thus in a spectrum analyzer having a 25 KC resolution, with a maximum dispersion of 25 MC and a maximum frequency of 20 sweeps per second, the video amplifier bandwidth should be at least 20 KC.

It is the i-f bandwidth and not the bandwidth of the video amplifier which determines the resolution of the spectrum. All of the spectrum resolution has been accomplished by the time the signal reaches the detector.

The video amplifier should amplify the transient signal without excessive loss in amplitude because of its bandwidth. Except for this, the characteristics of the video amplifier are of relatively little importance, since the exact form of the transient is never observed.

## Sensitive, Compact Photoconductive Cells

**A**UTOMATIC measurement and control systems, made possible by advances in photoconductive cell technology are now being developed in a wide range of applications for both military and industrial use. From street lights to missiles, the tiny light sensitive cell is now promoting a greater flexibility of operation and wider range of automation than was

considered possible only a few years ago. One of the photoconductive cell manufacturers, which is exclusively concerned with the development of this type of cell is the Clairex Corporation of 19 West 26 Street, New York, N. Y.

Scores of applications employ-  
(Continued on page 182)

These new photoconductive cells are small, sensitive and low in cost.

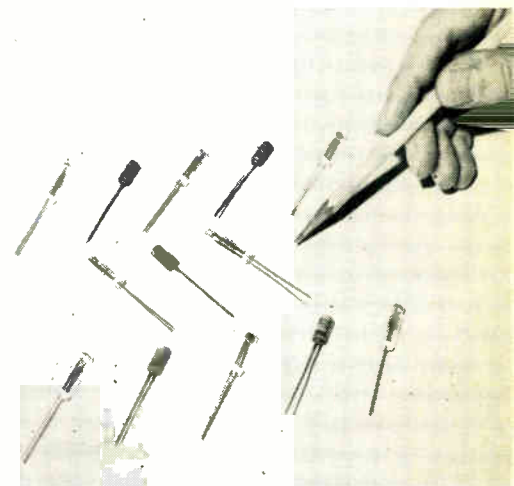

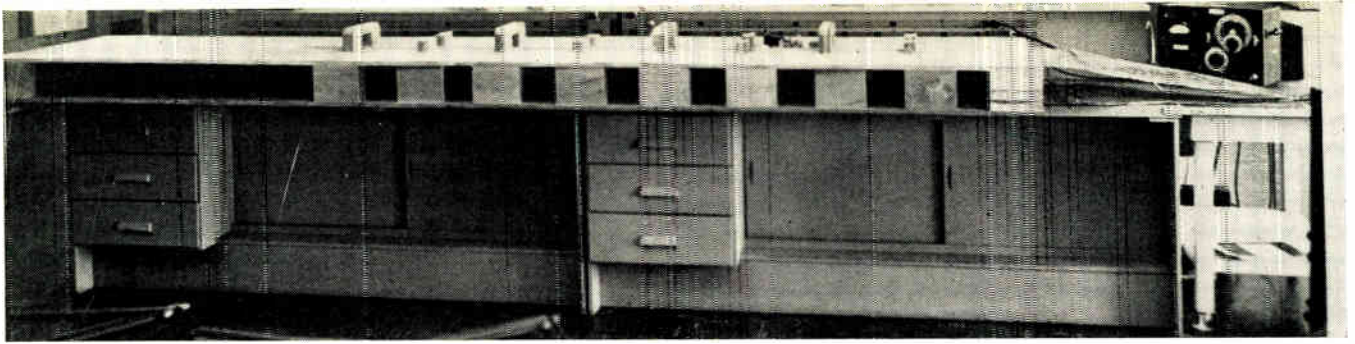

Fig. 1: Test set-up was used to evaluate low-frequency absorbing materials. It involved use of a specially constructed parallel-plate line

*For R-F Measurements . . .*

# Design and Build an Anechoic Chamber

*When radio wave measurements are made at outdoor sites, the reflected energy causes measurements to be unreliable and weather conditions can be difficult on the engineers making tests. These problems are overcome by having your own anechoic chamber. Complete details for its design and construction are given.*

**By R. F. KOLAR**

*Engineering Dept.  
Radio Corp. of America  
RCA Victor TV Div.  
Camden 8, New Jersey*

**T**HERE has been a need for r-f anechoic chambers ever since electromagnetic wave measurements have been made. The most obvious use for such rooms is for evaluating systems such as antennas. Other uses include keeping undesirable fields within reasonable limits to minimize interference problems.

When radio wave measurements are made at outdoor sites, the energy reflected from the earth and nearby objects causes measurements to be unreliable. The data may be too difficult to repeat and agreement between different sites may be poor. Other disadvantages of outdoor sites include work stoppages due to bad weather conditions and the necessity of subjecting the engineers to unpleasant working conditions. The recent development of low-frequency, broad-band absorbers has made it possible to make radiation tests indoors at frequencies as low as 50 MC.

### *Chamber Requirements*

Several satisfactory chambers have been constructed for use at frequencies above 400 MC.<sup>1</sup> The

material used in these rooms reflects less than 2% of the normally incident energy at the frequencies for which it was designed. These high-frequency anechoic chambers provide data at least as reliable as outdoor sites. The new materials, which will be described, have similar electrical characteristics at frequencies as low as 50 MC and should be equally useful for measurements at these lower frequencies.

A study of TV antennas and TV interference phenomena can be made in an anechoic chamber which cuts-off at 50 MC since the low-frequency end of the TV spectrum is at 54 MC. Interference at frequencies below 50 MC is usually conducted on the power line rather than radiated through space. Consequently, screened room techniques are used to measure the intensity of such conducted interference.

### *Absorber Types*

There are two basic types of absorbers. One makes use of the resonance properties of certain systems



having relatively small thickness.<sup>2</sup> They are useful where it is necessary to absorb energy only over a narrow band of frequencies. The other is the broadband type which cannot depend upon resonance effects. These absorbers consist of a dissipative material matched to the impedance of free space in order to dissipate energy over a wide frequency range. The lossy material is usually suspended in a plastic or in mats of curled animal hair. The medium must be thick enough to absorb enough of the energy passing through it so that any reflected from the back surface will not return to the room through the front surface. The required thickness is about  $0.3 \lambda$ . This figure will vary slightly depending on the material.

*Impedance Matching:* The material must provide a good impedance match to the space within the chamber to prevent energy from being reflected from the front surface of the absorber. The matching device must not be frequency-sensitive. When it is designed so it is effective at the lowest frequency to be used, it must continue to give a good match as the frequency is raised. It is well known that such a broadband match between a transmission line and load can be obtained with a tapered-line section.

The absorber can be tapered either geometrically or electrically. Electrical tapering is accomplished by varying the amount of loss with the depth, the heaviest loading being at the base of the absorber. It was found that the manufacturing problems associated with electrical tapering made such an absorber economically undesirable.

A more satisfactory method of obtaining a match between the dissipative medium and the space within the chamber is to use a gradual transition such as a wedge, cone, or pyramid. This technique has been used extensively for waveguide terminations and to absorb sound waves.<sup>2</sup>

A simple configuration should be used to keep manufacturing costs reasonable. The most economical tapered section is a wedge, since a rectangular block of absorbing material can be cut diagonally and the 2 halves placed back to back to form a wedge without waste. A wedge is a good matching section so long as the electric vector is oriented normal to its edge. However, if the radiating source is polarized parallel to the edge, the absorbing efficiency of the configuration will be reduced appreciably.<sup>3</sup> If the polarization of the source is random or unknown, it is necessary to use a cone or a pyramid, neither of which is sensitive to polarization.

*Optimum Design:* The optimum design for a hair-type absorber has a laminated base.<sup>4</sup> That is, the absorber behind the matching section consists of several layers of material having varying electrical resistivity. This provides discon-

tinuities between energy which is successively reflected until it is absorbed. The optimum design is very critical and difficult to control during manufacture. A constant-density absorber is more economical and reliable; though it must be somewhat thicker than the optimum design.

### Measurements

The effectiveness of microwave absorbers can be measured by using 2 horn antennas.<sup>1</sup> One is used for transmitting a beam toward the sample and the other for receiving the reflected energy. The energy reflected is compared with that reflected from a metal sheet in order to determine the percent power reflected. For normal incidence a single horn, which is well matched to a waveguide, can be used. The swr which is measured in the waveguide when an absorbing sample is placed before the horn, is a measure of the reflected energy.

*Slotted-Line Measurements:* For frequencies as low as 50 MC, slotted-line measurements cannot be made conveniently because of the prohibitive size of the apparatus. Two measuring methods have been used to evaluate low-frequency absorbing materials. The first involves the use of the specially constructed slotted parallel-plate line shown in Fig. 1. The second makes use of a movable wall illuminated by a distance source. Although it was felt that the slotted line measurements were accurate, the possibility of some errors existed. Only a small sample could be measured in the slotted line and it was possible that a large sample would perform quite differently. Furthermore, at frequencies above 200 MC, excessive radiation from the line made the measurements unreliable. Therefore, no high-frequency data could be obtained from the line. Consequently, the wall shown in Fig. 2 was built in order to verify the slotted-line measurements and to extend the upper-frequency limit of the data.

*Wall Tests:* In order to make reliable tests on a wall, it is desirable to build the wall about one wave-

Fig. 2: A wall section was constructed for testing purposes

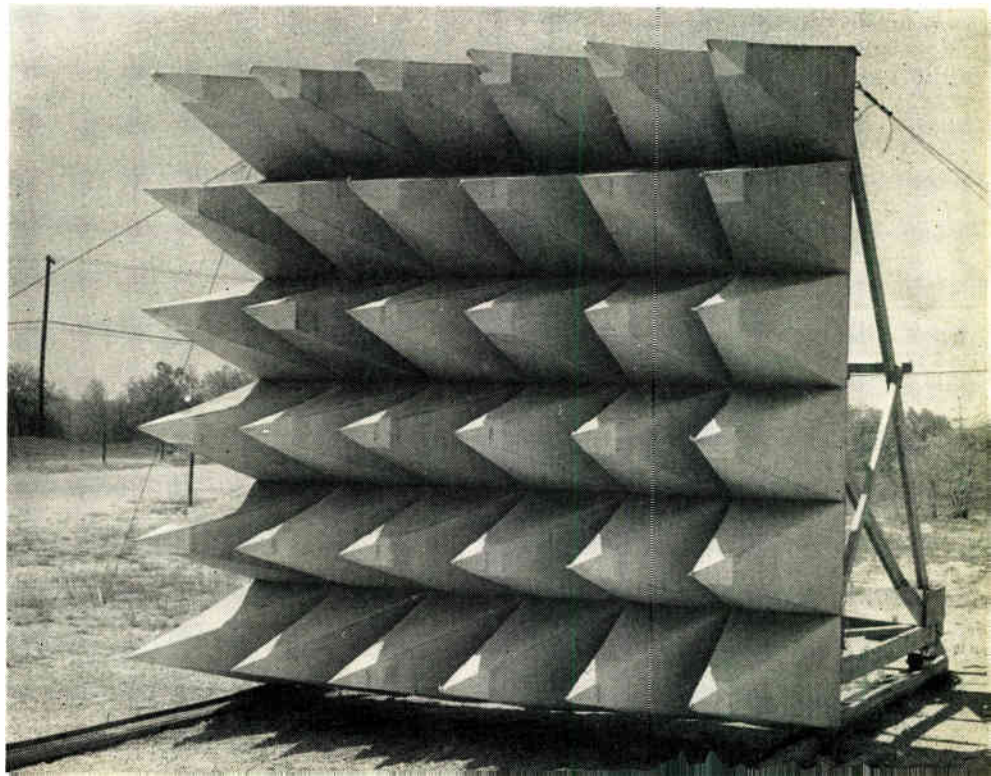

## Anechoic Chamber (Continued)

length square. Constructional and experimental problems made it necessary to build a smaller structure. The completed wall was 12 ft square so that accurate data could be obtained only at frequencies above 80 MC. Fig. 3 compares slotted-line and wall data for a specific absorber. The circles are slotted-line measurements on 3 samples of the same material which was used on the wall. The solid curve represents measurements of the material mounted on the wall. There is good agreement between the 2 types of measurements at those frequencies where both can be considered reliable, that is from 80 MC to 200 MC. There is no reason to expect the reflection coefficient to rise substantially at any higher frequency, provided the absorber does not present a surface discontinuity to the approaching wave front. The dashed curve shows the effect of removing 8 in. from the tips of the pyramids to make such a discontinuity. There is a slight rise in the reflection coefficient at the high frequencies.

In view of the agreement between the slotted-line and free-space measurements, it is safe to conclude

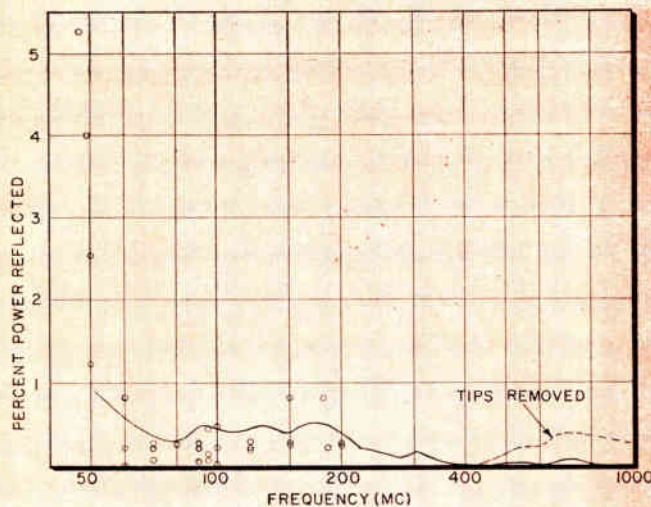
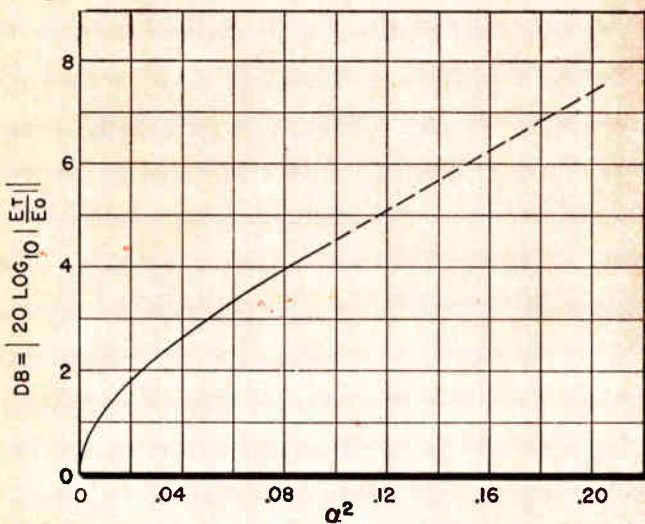

Fig. 3: Comparison of slotted line and wall measurements

Fig. 4: Error in measured field in a room 2.5 wavelength cube vs. reflection coefficient of the walls



that the low-frequency slotted-line data are adequate for the design of an absorber so long as the following conditions are met.

1. The sample should be oriented in the line in the same way it is to be mounted on the walls of the room.
2. The absorber efficiency should be independent of the polarization or else the room should be used only where the signal is polarized for maximum absorber efficiency. The absorber configuration determines whether it is sensitive to polarization.
3. Normal precautions for making accurate slotted-line measurements must be taken.
4. The absorber should not present a surface discontinuity which is an appreciable portion of a wavelength at any frequency to be used.

**Resistance Measurements:** Resistivity measurements can be used as a guide in the manufacture of absorbing materials. These measurements are made by measuring the dc resistance between two 1/16 in. diameter probes which penetrate the material to a depth of 1 3/4 in. The separation between the probes is 1 1/2 in. Since these measurements are unreliable, they can only be used as a rough guide to the absorbing qualities of the material. The dc resistance of typical hair-type absorbers is between 100 and 200 ohms.

### Room Size

At UHF and higher frequencies, a moderate size room may be many wavelengths on a side. At the lower frequencies a careful study of the minimum allowable room dimensions should be made to keep construction costs from becoming excessive.

In calculations involving radiating systems, the terms of the electromagnetic field equations, which decrease more rapidly than the first power of the distance, are usually neglected. The transmitting and receiving antennas must be separated more than  $1\lambda$  to keep the error introduced by neglecting those higher-order terms below 1%.<sup>5</sup>

From the above, it is obvious that the long dimension of the room must be at least  $1\lambda$ . In addition, imperfectly absorbing walls must be located at some distance from the antennas. The surface of the absorber should be at least  $\lambda/2$  from the center of a small antenna to prevent the wall from affecting its performance. If the separation between antennas is  $1\lambda$  and the clear area around each antenna location is  $\lambda/2$ , the inside dimensions of a chamber would be  $1 \times 1 \times 2\lambda$  for small antennas. This means that the inside dimensions of a 50 MC chamber should be about  $20 \times 20 \times 40$  feet.

Other limitations may be imposed on the chamber by the characteristics of the systems to be evaluated. For example, large-aperture antennas must be separated at least  $2D^2/\lambda$ , where  $D$  is the largest aperture dimension and  $\lambda$  is the wavelength.<sup>6</sup> This separation is necessary in order to keep the phase variation across the aperture below  $\lambda/16$  while gain measurements are being made. If the room is to be used exclusively for tests where only a single antenna is within the enclosure, as for antenna impedance measurements, the chamber could be appreciably smaller.



## Room Errors

Even with walls which reflect only 2% of the incident energy, the field within the room will exhibit variation from the free-space values. The magnitude of these variations will be greatest at frequencies where the reflection coefficient is greatest—that is, at the low-frequency end of the spectrum. The errors will also be a function of the room size. The variations will decrease as the size of the room is increased.

Fig. 4 is a curve showing the maximum deviation from free-space values to be found in a room  $2.5\lambda$  cube as a function of the reflection coefficient of the walls. The source was considered to be in the center of the room in computing values for this curve. The maximum error shown in this figure exists near a wall and will vary with the distance from the source. The curve is shown as a broken line above a value of the power reflection coefficient  $\alpha^2 = 0.10$  since beyond this point the approximations used in its derivation are no longer accurate. When the reflection coefficient is greater than 0.10, the maximum error to be found in the room will be at least as great as that shown by the broken line.

## Construction

In order to realize maximum energy absorption in an anechoic chamber, it is necessary to give particular attention to the room corners, the doors, and the floor.

**Wall Shape:** There has been considerable controversy regarding the proper wall shape for anechoic chambers. As early as 1936 attempts were made to eliminate standing waves in acoustic reverberation chambers by constructing rooms of non-rectangular shape. There is, however, no convincing evidence that any advantage is to be gained by not using parallel walls. Therefore, this discussion will consider only rooms with rectangular walls.

**Exterior Material:** When an EM wave impinges on the surface of the absorber, a portion is reflected back into the room, but most of it passes into the material. Dissipation takes place as the wave pene-

### PERFORATED PAGES!

In response to many reader requests, the pages in the main editorial section have now been perforated. This will enable readers to easily remove material for their reference files. If the copy of *Electronic Industries* you receive already has pages removed that you want, please let us know. We'll be glad to provide the missing pages.

trates the material. When it reaches the back surface of the absorber, a portion will be reflected back into the material and the rest will pass into the space outside if the room is not shielded. Most of the energy that is reflected from the back of the absorber will be dissipated before it can return to the chamber. The energy which goes into the space outside the chamber can interfere with outside experiments. Similarly, electromagnetic waves originating outside the room need only pass through the absorber once before entering the chamber. If the outside of the room is shielded, the interference problem is eliminated. Hence, it is advisable to shield the outside walls of the chamber.

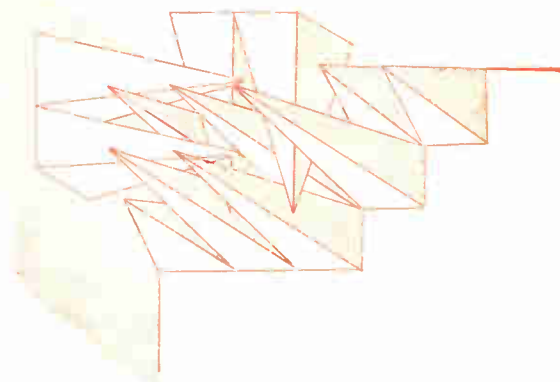

Fig. 5: Construction of a room corner

**Room Corners:** It is necessary to cover nearly all of the wall surfaces in an effective anechoic chamber. The corners of the room present a unique problem where long, tapered sections are used. If one wall is completely covered with absorbing pyramids, those near the corner will prevent placing absorbers on the adjoining walls near the corner. The result is that substantial portions of the walls will be uncovered.

If the pyramids on adjoining walls are offset by half the base dimension, the tips of the pyramids mounted on one wall can be sandwiched between those mounted on the adjacent wall. The use of short pyramids makes it possible to fill the space even nearer the corner, as shown in Fig. 5. The remaining space can be filled with pads of absorbing material.

**Filler Pads:** Hair-type absorbers are well adapted for use as filler pads. They are easy to install since they can be forced into small openings without being damaged. A pad having relatively little dissipative material in it would offer little surface reflection, but a large amount of energy would pass through it, be reflected from the conducting wall, and returned to the room.

A very high density pad, on the other hand, would absorb most of the energy which enters it, but the reflection at the air-material interface would be high. Therefore, an optimum pad for the available depth must be used.

**Optimum Pad Design:** It has been found that, for a given thickness, the most effective pad is one made up of layers of material of varying density. The top layer should be low density to reduce surface reflection. An effective configuration is one made of a 3-in. thick layer of high density material sandwiched between two, 3-in. layers of low-density material. The low-density material has an average resistance of about 11,000 ohms when measured as described above. The high-density material measure about 4000 ohms. This 9-in. thick base pad will return about 30% of the incident energy to the room. Although this figure sounds high, it is not serious because relatively little of the wall area will reflect this much energy. It is an appreciable improvement over having portions of the wall uncovered.

(Continued on following page)

### Floor

The floor, as well as the walls, should be covered with absorbers. This poses another problem since the absorbers cannot be walked upon. There are, however, many materials which can be used as flooring. One requirement for a satisfactory material is that it must be transparent to electromagnetic energy at those frequencies for which the room is being designed. Perhaps the best solution would be a rope net; however, a more substantial floor would be desirable. There are many plastic laminates available which have sufficient compressive strength to support flooring. Styrofoam could be used as flooring material as well as for the supports. The fiberglass laminate known as "polyglass" has been found to be virtually transparent at frequencies as high as 1000 MC. Wood can be used in moderation. A good floor would be one where the entire area is covered with polyglass and those areas subject to excessive loads have wooden walks which could be removed for precise measurements.

It has been pointed out that all surfaces of the room should be covered with anechoic material. This means that the doors must also be considered. Short pyramids like those used in the corners of the room can be used at the edge of the door so that it can be opened and closed without binding on the jamb. Reference 8 has a good description of anechoic chamber door construction.

Currently available absorbers make it possible to construct a room which will be anechoic at all frequencies above 50 MC. There are 2 basic broad-band absorbers available. These are the hair-type absorber and the plastic absorber. Each has its own advantages and disadvantages.

A study of the results of measurements on absorbers shows that data taken in a slotted line are sufficient to determine the optimum design for an r-f absorber, provided sufficient care is taken in obtaining the data.

An anechoic chamber should have rectangular walls and should have minimum inside dimensions of  $1 \times 1 \times 2$  wavelengths. In order to cover all the wall surface, it is necessary to use short absorbers and filler pads in the corners and on the doors.

### References

1. W. H. Emerson, A. G. Sands, and M. V. McDowell, "Broad-Band Absorbing Materials," *Tele-Tech and Electronic Industries*, vol. 14, pp. 74-75, 134-137; Nov. 1955.
2. Hans Severin, "Nonreflecting Absorbers for Microwave Radiation," *IRE Trans. on Antennas and Propagation*, vol. AP-4, #3; pp. 385-392; July 1956.
3. E. Meyer and H. Severin, "Absorption Devices for Electromagnetic CM Waves and Their Acoustic Analogs," *Zeitschr. f. Angew. Physik.*, vol. 8, pp. 104-114; March 1956.
4. R. F. Kolar, "Radio Frequency Absorbers for Frequencies Above 50 MC," *Proc. Nec.*, vol. 12, pp. 56-66; April 15, 1957.
5. R. F. Kolar, "Fields in Imperfect Electromagnetic Anechoic Chambers," *RCA Review*, vol. 17, pp. 393-409; Sept. 1956.
6. S. Silver, "Microwave Antenna Theory and Design," *Rad. Lab. Series*, vol. 12, McGraw-Hill Book Co., Inc., New York, p. 574; 1949.
7. Erwin Meyer, "Reverberation and Absorption of Sound," *Jour. Acoustical Soc. Am.*, vol. #8, p. 155; 1937.
8. L. J. Beranek and H. P. Sleeper, Jr., "The Design and Construction of Anechoic Sound Chambers," *Jour. Acoustical Soc. Am.*, vol. #18, pp. 140-150; July 1946.

## Production Welding with Electrons

A PRODUCTION welder utilizing the concentrated energy of a focused beam of high velocity electrons to weld metal has been intro-

Mounted on top of the cabinet is the vacuum chamber which contains the electron gun and collet for rotating the work. All controls are mounted in the console-cabinet.

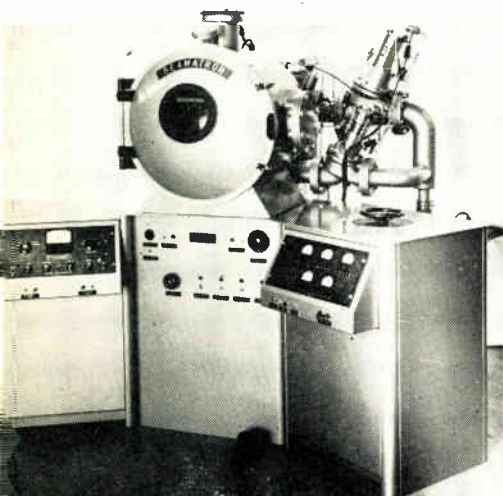

duced by High Vacuum Equipment Corp. The firm is located at 2 Churchill Rd., Hingham, Mass.

These new welders, termed BEAMATRON, will be used to weld those high temperature reactive metals and super-alloys which are so important in today's nuclear, electronic and missile hardware. They are capable of welding metals ranging from aluminum to zirconium. By this process, it is possible to weld tungsten, tantalum or molybdenum to each other or to other metals, with results unattainable by previously known methods.

The use of electrons in welding is possible only in a high vacuum, hence the union of electronic and vacuum techniques to produce a new welding process.

A bright future is predicted for BEAMATRON equipment in application involving metals which react unfavorably with minute amounts

of oxygen, nitrogen or hydrogen. It is a notable improvement over other welding processes such as the dry-box or shielded arc. Operation in high vacuum provides the most inert atmosphere—an atmosphere many times more pure than the best commercially available inert gases.

Because most impurities trapped in metal become volatile in high operating vacuum, the entire weld zone, not just the surface, is purified. The net result is a weld joint with physical properties and life expectancies which cannot be obtained by other means. At the same time the unit cost of such items as nuclear fuel jackets and electronic parts is reduced by the elimination of costly shielding atmospheres and the reduction of rejects.

The unit has been designed for  
(Continued on page 94)





R. C. Benoit, Jr.



F. Coughlin, Jr.

# Designing RDF Antennas

*There are a number of direction finding antenna techniques available to the design engineer ranging from the simple Adcock system to the more sophisticated Doppler and Wullenweber systems.*

By **RICHARD C. BENOIT, JR.**  
and **FRANCIS COUGHLIN, JR.**

Rome Air Development Center  
Griffis Air Force Base  
New York

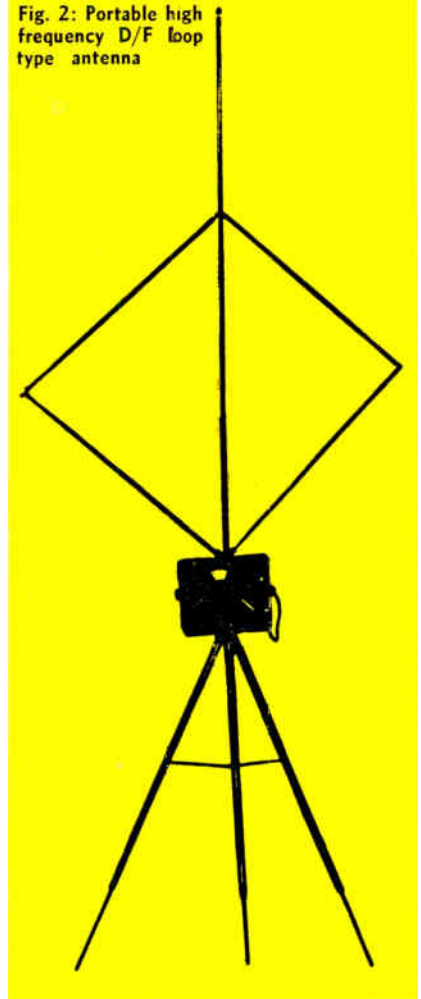
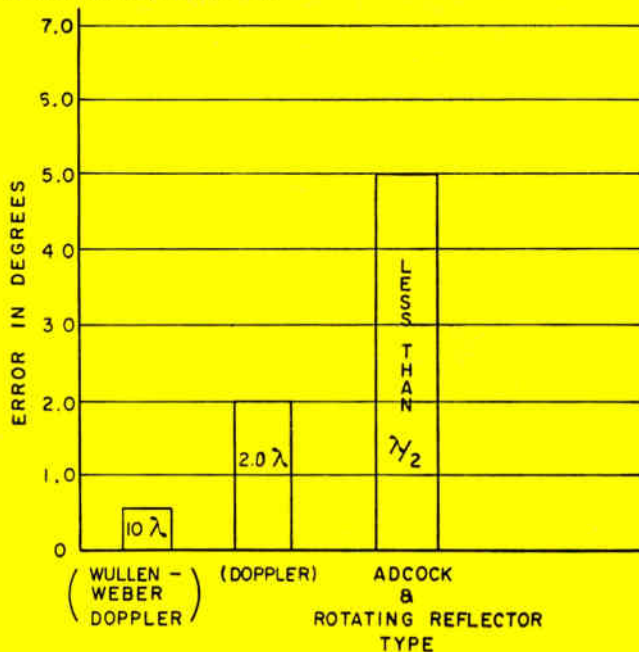

Fig. 2: Portable high frequency D/F loop type antenna

Fig. 1: Relative accuracy vs. aperture



IN radio direction finding above 100 MC the overall operational bearing accuracy is generally governed by instrumental inaccuracies, the operator's skill and the site environment. Instrumental error can be controlled by the selection of advanced techniques and precision engineering, operator errors can be minimized by proper selection and training of personnel; and environmental errors can be minimized by the use of antenna arrays that are not adversely affected by reflected or refracted energy which interferes with the direct signal.

Of all the error producing elements that can be controlled in a direction finding configuration, the siting problem is considered to be the greatest source of error. In this paper the authors will discuss antenna techniques applicable to radio DF in the frequency range of 100 to 400 MC and present practical and economical solutions to the site error problem by the

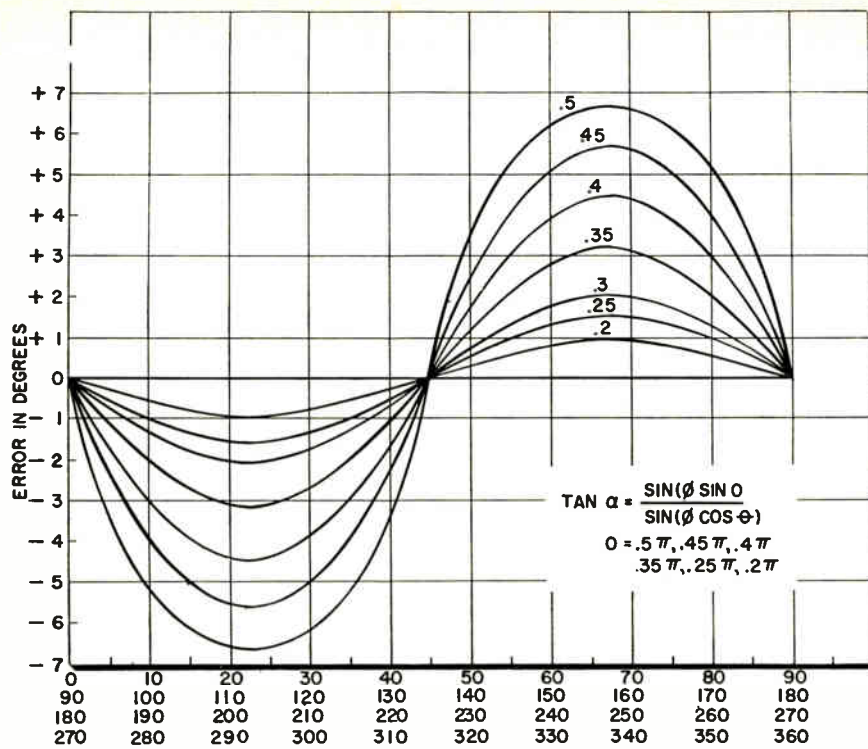

Fig. 3: Calculated octantal error vs. element spacing elevated H Adcock

## RDF Antennas (Continued)

use of medium and wide aperture antenna arrays.

The effective aperture of the antenna array determines the susceptibility of the system to environmental errors which are caused by reflective and refractive elements in the antenna array's environment. Previous work indicates that as the aperture is increased error resulting from wave front disturbance will decrease due to the resolving capability of the array.

### Aperture Considerations

Direction finder antenna systems for the purposes of this discussion will be divided into 3 basic categories. The narrow aperture array which is defined as a configuration whose aperture is less than  $0.5\lambda$ . Typical systems in this category are the loop, the Adcock in its various forms and the arrangement wherein a reflector is rotated about a fixed vertical dipole. Most direction finders in general use today employ narrow aperture arrays and are susceptible to site errors. In general, systems of this type are capable of resolving the bearing to an ac-

curacy of  $5^\circ$  at an average good site.

A medium aperture antenna system is defined as one whose aperture lies between  $0.5$  and  $5\lambda$ . Doppler type of direction finders are normally classed under this category.

Medium aperture arrays, when installed at sites that would normally be considered fair to poor for a narrow aperture system, exhibit performance characteristics in terms of accuracy on the order of  $2^\circ$  or better.

Wide aperture systems are defined as those whose aperture is in excess of  $5\lambda$ . Both the Doppler and Wullenweber may be applied in this type of system and, when installed at normally fair to extremely poor sites, provide accuracies on the order of  $0.5^\circ$  or better. In properly designed wide aperture systems, practically all of the error may be attributed to instrumentation.

### Narrow Aperture Systems

World War I direction finders operating in the medium frequency range, in general, employed ro-

tatable loop type antennas which are susceptible to polarization and site errors. However, loop equipments are comparatively simple and because of this fact they still find wide application aboard ships, for portable use, in those applications where simplicity is of paramount importance and operational limitations can be tolerated. Figure 2 shows a lightweight portable loop type h-f radio DF developed by the USAF for air rescue applications. In general, the largest dimension or aperture of a loop antenna usually does not exceed  $0.1\lambda$ . Therefore, they can be classed as narrow aperture antennas.

The necessity for physically rotating the loop to obtain azimuth information, presented many problems particularly at medium and lower frequencies. The radio goniometer application was conceived by Bellini and Tosi. It permitted the use of fixed crossed loop antennas to overcome this problem. Basically in the radio goniometer, 2 loops displaced  $90^\circ$  in azimuth are each connected to stator field windings which are also displaced by  $90^\circ$ . A rotor winding with an indicating pointer is placed in the stators magnetic field. The rotor is then connected to a detector and when rotated to a null, the angle corresponds to the direction of the signal received.

The basic Adcock antenna con-

Fig. 4: A four-element Adcock antenna

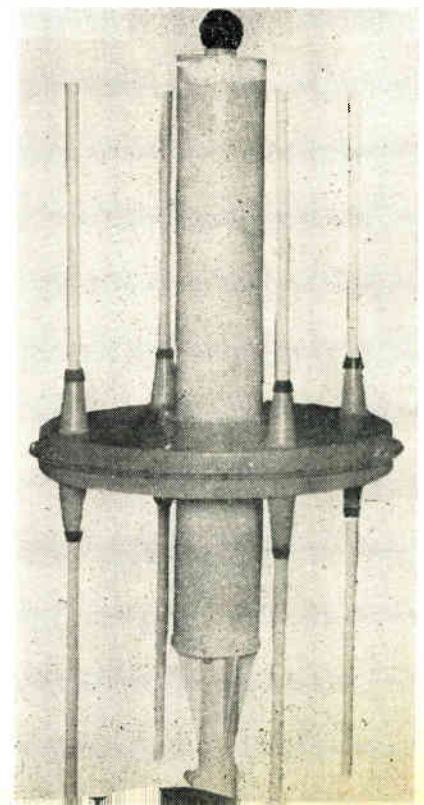



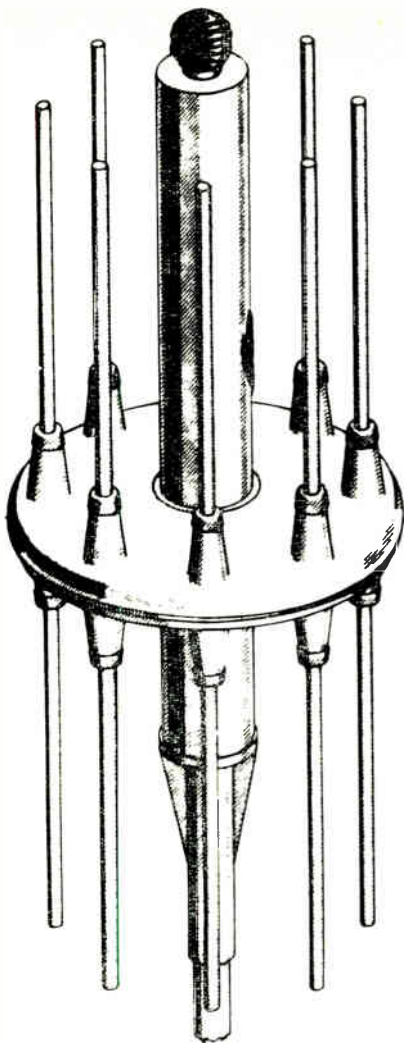

Fig. 5: 8-element Adcock D/F antenna

sists of 2 spaced vertical members which theoretically responds only to the vertically polarized component of the received wave front and, therefore, is not subject to polarization errors.

This type of antenna offers considerable advantage in terms of accuracy over loop antennas when receiving other than ground wave signals. In the design of Adcock antennas, considerable care must be exercised in terms of symmetry and component balance. Several variations of the basic Adcock technique have been evolved. In its simplest form, the Adcock consists of a rotating assembly composed of 2 vertical elements spaced horizontally not more than  $0.5\lambda$ . Fixed crossed Adcocks with goniometers are employed where a physically fixed array is desired. In the crossed Adcock configuration, the spacing generally does

not exceed  $0.25\lambda$  in order to minimize octantal error. Figure 3 shows the calculated octantal error for various element spacings. The most popular Adcock version in use today at VHF and UHF is the crossed elevated H type. It employs a capacitive or inductive goniometer as shown in Fig. 4. However, other versions are widely used. Figure 6 illustrates a rotating H type of Adcock for operation in the 225 to 400 MC band. Figure 5 shows the 8 element array, another version of the Adcock which results in lower octantal error.

In the design of the elevated H configuration, the elements must be raised sufficiently above the ground to minimize the effect of the ground on electrical symmetry.

Another narrow aperture antenna configuration is illustrated in Fig. 7 and has been successfully employed in a UHF direction finder for Air Force use as a navigational aid.

The antenna consists of a stationary, vertical dipole about which a multi element parasitic reflector is rotated at a speed of 1800 RPM. As the reflector rotates, it amplitude modulates the received signal at the rotation frequency. The resulting rotating horizontal field pattern obtained is unidirectional and essentially cardioid in shape. The reflector drive motor also rotates a 2 phase generator, whose frequency is equal to the frequency of modulation applied to the received signal. The bearing of the received signal is thus proportional to the phase difference between the modulation envelope of the r-f and the reference voltage.

This arrangement exhibits essentially the same characteristics as the Adcock in susceptibility to polarization errors. The optimum spacing for an antenna of this type is about  $0.25\lambda$  at the design frequency. Due to the absence of a goniometer and the direct connection of the antenna element to the detector, an advantage in sensitivity over the Adcock is realized. Frequency coverage on the order of 2:1 can be realized with this arrangement. The system accuracy is comparable to the Adcock.

(Continued on following page)

Fig. 6: Rotating Adcock, 225-400 MC

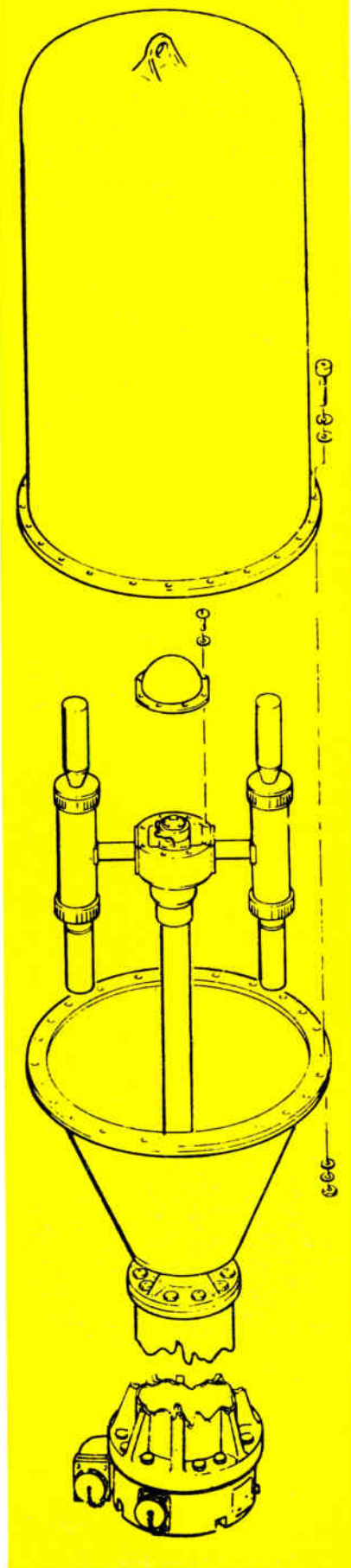

# RDF Antennas (Continued)

## Wide & Medium Apertures

In general medium and wide aperture direction finding antenna configurations provide the greatest operational advantages in terms of performance. Since World War II, great strides have been made in this area. The Wullenweber and Doppler principles have been successfully employed in this respect.

## Wullenweber Technique

During World War II, the Wullenweber technique was conceived and successfully reduced to practice in the high frequency region by German scientists. This technique is essentially a method in which the equivalent pattern of a mechanically rotating planar array of antennas is obtained by means of a number of fixed antenna elements. The elements are symmetrically disposed in a circle, and a circle of symmetrically disposed discrete reflectors or a continuous circular reflector placed within the antenna ring.

In order to convert this configuration to the equivalent of a rotating planar array, it is neces-

sary to select a sector of adjacent elements and, in effect, progressively rotate the sector around the array by some means of commutation. In addition, it is necessary to properly delay the signals from the various antenna elements selected so that the signals will arrive at a common mixing point in phase and thus be additive.

Figure 8 illustrates the principle involved. It shows a group of 7 adjacent antenna elements placed on an arc of a circle and a signal source at a sufficient distance so that the wave front arriving at the antennas can be considered planar.

As can be seen, the wave front

arrives first at the elements shown in Plane 1 and at time intervals later at the elements in Planes 2, 3 and 4. Therefore, to achieve the desired planar antenna pattern, it is necessary to delay the signal arriving at the elements in Planes 1, 2 and 3 by the amount of time required for the wave front to travel in free space from these planes to Plane 4, wherein the outermost elements of the sector are found.

In the design of a Wullenweber array, the accuracy of the system is dependent upon the aperture selected up to about  $30\lambda$ . Figure 9 indicates the approximate beam-width obtainable with a given aperture. From this graph, it is clearly indicated that apertures in excess of  $30\lambda$  contribute little to improved accuracy performance, and apertures less than  $5\lambda$  do not provide commensurate performance with the system complexity. In actual practice, a properly designed  $10\lambda$  system with a  $6^\circ$  beam-width at the half power points will provide accuracies on the order  $0.5^\circ$  providing the instrumentation is such as to permit accurate bisection of the main lobe presented on the indicator scope.

Theoretical studies and practical applications have indicated that the optimum element-to-element and element-to-reflector spacings are  $\lambda/4$  at the design frequency, however, practically it is possible to vary the spacings from  $\lambda/8$  to  $\lambda/2$  without appreciable performance degradation thereby providing frequency coverage on the order of 4:1.

Theoretical considerations indicate that up to 50% of the elements can be simultaneously

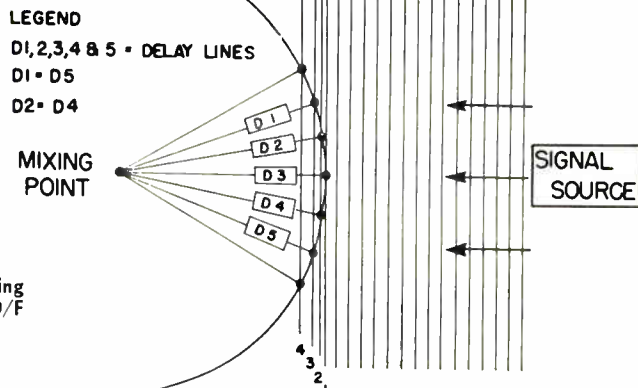

Fig. 7: A rotating reflector type D/F antenna

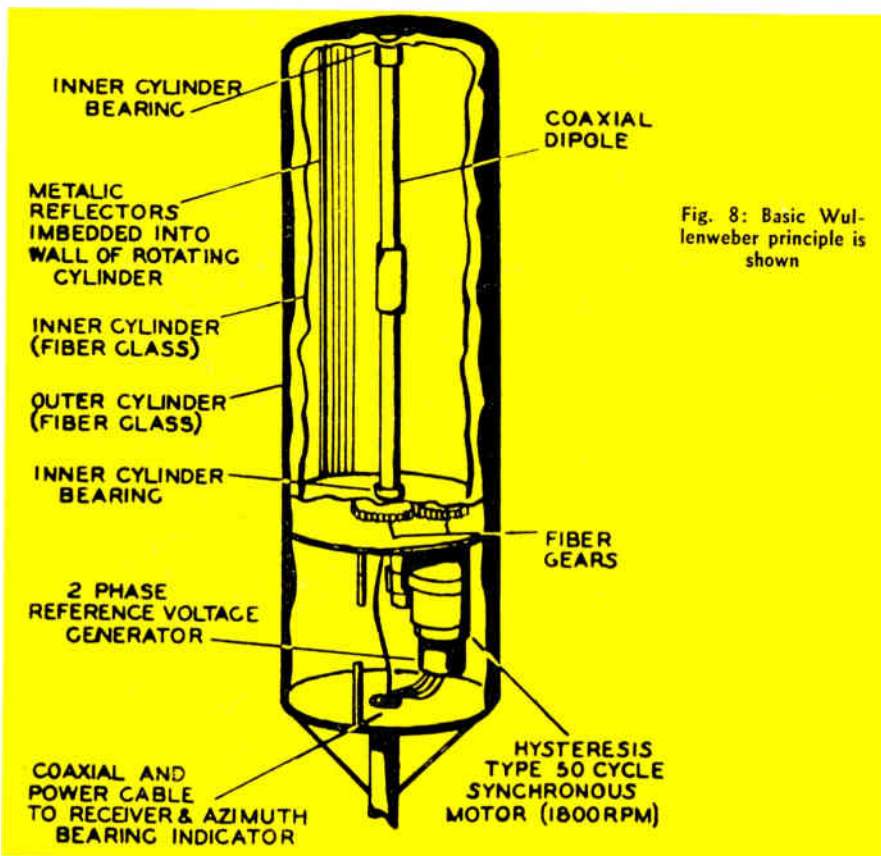

Fig. 8: Basic Wullenweber principle is shown



scanned, however, in practice it has been found that scanning approximately 35% of the total number of array elements will provide optimum performance. Any greater number than this will not provide appreciable performance improvement and will unduly complicate the commutator assembly.

The Wullenweber principle has been applied to an Air Force direction finder operating above 100 MC.

Theoretically a Wullenweber array will approximately exhibit the gain characteristics of a planar array and reflector having the same number of elements as simultaneously scanned in the Wullenweber. However, losses in the commutator must be considered in comparing the 2 configurations.

In comparison to previously discussed narrow aperture systems, the Wullenweber configuration exhibits negligible zero shift characteristics over the wide usable frequency band.

In the design of a system of this type, extreme care must be exercised in the design and construction of the antenna feed lines. They must be as uniform as possible. The commutator, which includes the phasing circuitry, must be precision engineered to insure low losses, proper phasing and maximum side lobe suppression. Previous Wullenweber equipments have made use of mechanical scanning techniques. However, electronic switching techniques making use of the latest solid state achievements should be employed in future developments to provide lower losses and higher scanning speeds.

A wide aperture DF system employing this technique has decided advantages over the narrow aperture systems, such as the Adcock, in terms of sensitivity, azimuth accuracy under other than ideal conditions, wideband performance and the ability to simultaneously resolve the bearings of several signals on the same frequency, providing they are separated in azimuth by more than the beam width of the antenna and its minor lobes. The term, "Multi-Signal Direction Finder" comes from the latter quality. Greater sensitivity is obtained as a result of the antenna gain and accuracy is im-

proved by the use of a wide aperture array. The disadvantages of such a system are its physical aspects, especially at the lower frequencies and the economic considerations.

An Air Force developed UHF Wullenweber DF is depicted in Fig. 10. This equipment covers the frequency range of 150 to 600 MC and provides 0.5° accuracy. It utilizes 100 vertical elements symmetrically disposed in a circle 10 meters in diameter. Thirty-six of 100 elements are simultaneously scanned at 600 RPM.

moving a receiving element in a circular path as shown in Fig. 11.

If a single signal is incident on such a moving antenna, the received signal will be frequency modulated. The peak frequency deviation of the signal in CPS, as determined by Doppler's principle, will be

$$\Delta f = \frac{RW}{C} f_c$$

where W is the angular velocity of the antenna in radians/sec, R is the radius in feet of the circular path of the antenna,  $f_c$  is the fre-

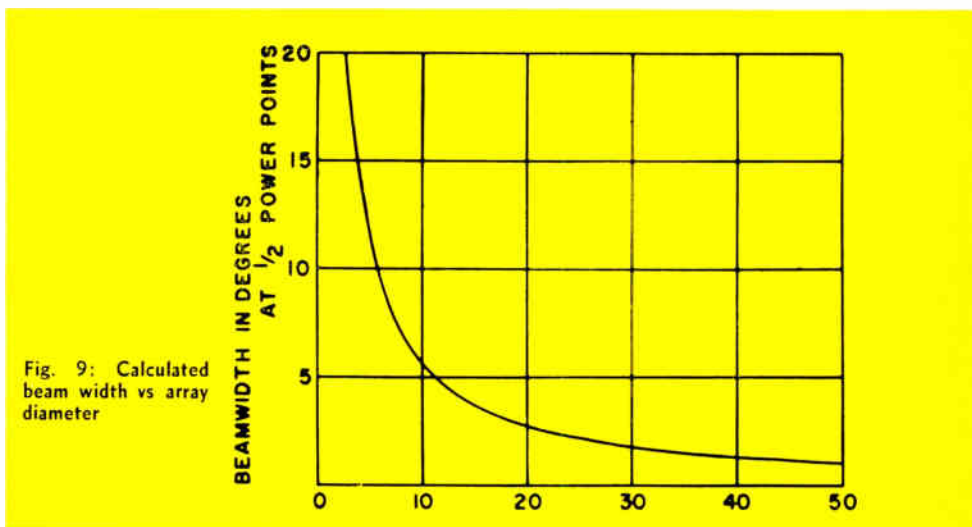

Fig. 9: Calculated beam width vs array diameter

#### Doppler Technique

The Doppler principle, when applied to radio direction finding, provides a system possessing high operational accuracy which is not critical in terms of siting. This technique is readily applicable to both wide and medium aperture configurations: however, it is most advantageously employed in medium aperture systems.

In order for a direction finder to be classified as a Doppler type, it must possess the equivalent of a moving antenna of some form or simulation of this antenna motion by the rapid sequential switching of fixed antenna elements. From Doppler's principle for wave motion as applied to radio waves, it can be shown that the frequency of a received signal differs from the frequency of the transmitted signal when the receiver has a component of velocity in the direction of wave travel. In an idealized Doppler DF, the motion of the receiver is obtained by

frequency of the incident signal in CPS, and C is the velocity of light in FPS.

In a complete revolution of the antenna, the instantaneous frequency varies from  $(\Delta f + f_c)$  to  $(\Delta f - f_c)$ .

#### Antenna Rotation

A single receiving element that is continuously and uniformly rotated, as described, in a horizontal plane will cause the received signal to be phase-modulated in a sinusoidal manner at the frequency of rotation of the element. In Fig. 11 at Position A, the antenna is moving perpendicular to the wave front away from the source, and the induced signal has the same instantaneous frequency as the wave in space. Although the frequency change at Position A is zero, the rate of change is a maximum and is negative. The frequency change at B is a maximum and is negative, but the rate of change of frequency is zero. At position C, the frequency change is zero, but the rate

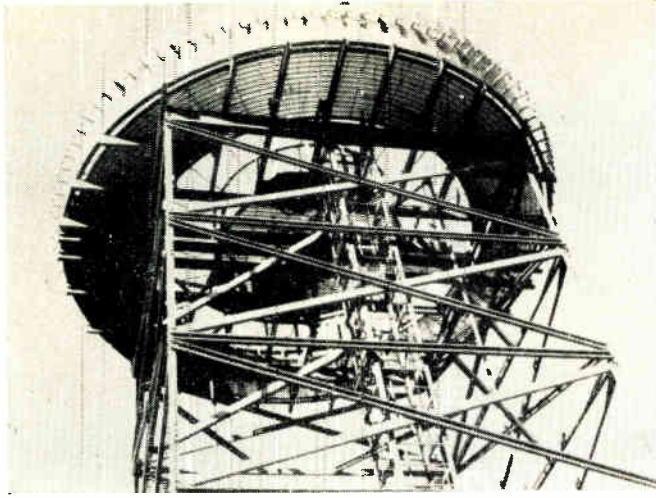

Fig. 10: Photo shows a UHF Wullenweber antenna

## RDF Antennas (Concluded)

of change is a maximum and is positive. At D, the antenna is travelling in the direction of arrival and toward the source. The induced signal has a maximum positive change of frequency and a zero rate of change.

By demodulating the phase modulated, received signal produced by the antenna rotation motion and comparing the phase of this sinusoidal voltage to a reference phase generated by the antenna motion, the relative phase angle can be measured. It is equal to the bearing angle of the received signal.

Physically rotating an antenna element in a system as described above is not practical from a mechanical viewpoint except at extremely high frequencies. To overcome this difficulty, the single rotating element is replaced by a series of elements equally spaced around the circumference of a circle of the desired aperture. These elements are in turn sequentially sampled at a rapid rate to simulate the rotating antenna.

In the case of the Wullenweber system, the aperture of the system is essentially determined by the number of elements simultaneously scanned. In a Doppler system the aperture is essentially equal to the diameter of the antenna array.

Theoretically, a Doppler direction finder may be designed with an aperture from  $0.5\lambda$  to the point of physical impracticability. In practice it has been found that ultimate performance is achieved

with apertures on the order of 1 to  $5\lambda$ . If an aperture in excess of this figure is desired, it is more advantageous to employ the Wullenweber technique because of increased gain and multi-signal capabilities.

After an aperture of approximately  $2\lambda$  is achieved in a Doppler system, very little performance improvement is gained, except at extremely poor sites where the DF antenna is located in the midst of and below other antennas and reflecting structures. Under poor sitting conditions, where the reflected signal from all directions approaches 20% of the direct signal, it has been found that a  $2\lambda$  Doppler DF will provide approximately a 10:1 improvement in accuracy over a  $\lambda/4$  Adcock system. Except at extremely poor sites, the indicator and associated circuitry

becomes the limiting factors in terms of overall system accuracy.

Based on the above conclusion, it is desirable to select as wide an aperture approaching  $2\lambda$  as is commensurate with tolerable physical considerations and other established parameters.

Since the spacing between elements must be well below  $0.5\lambda$  at the highest operating frequency and not less than  $\frac{1}{8}\lambda$  at the lowest operating frequency, the number of elements employed is dictated by the aperture of the array.

Experience has shown that optimum performance is achieved in terms of signal sensitivity and blending when the maximum phase step between adjacent elements is approximately  $135^\circ$ . However, values up to  $165^\circ$  may be employed with reduced performance capabilities.

In general, a well-designed system of this type will provide frequency coverage on the order of 2.5:1 and exhibit extremely low zero shift characteristics over this range.

### PERFORATED PAGES!

In response to many reader requests the pages in the main editorial section have now been perforated. This will enable readers to easily remove material for their reference files. If the copy of Electronic Industries you receive already has pages removed that you want, please let us know. We'll be glad to provide missing pages.

In order to effectively extract directional information from the antenna array, the elements must be sampled by a commutator arranged to provide blending from one antenna to the next. The output of a simple FM detector will then closely approximate a sine wave. It

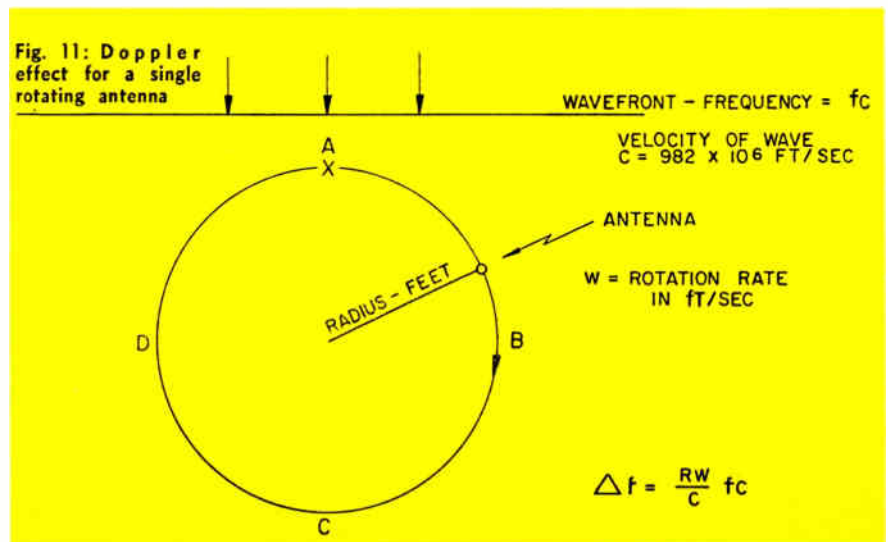



can be compared to a fixed phase reference voltage to obtain the azimuth of the received signal.

In selecting the antenna sampling rate, several factors must be considered. In order to achieve maximum DF sensitivity, the scan rate must be as great as possible considering the bandwidth limitations of the receiver i-f system. A scan rate either above or below the voice frequency range is desirable to minimize interference with audio communications. It should be held below the value which requires critical matching and balancing of components.

Scanning may be accomplished either by mechanical or electronic methods. Mechanical methods by their very nature are limited in terms of speed. Electronic methods employing solid state devices are ideally suited for this application.

Figure 12 shows a recently developed USAF radio DF based on the Doppler principle, which covers the frequency range of 225 to 400 MC. The antenna array has an aperture of  $2\lambda$  at 400 MC and consists of 12 antenna elements which are electronically scanned at a rate of 200 CPS. Extensive field tests indicate that this equipment is virtually unaffected by the site environment and possesses an operational accuracy of better than  $2^\circ$ .

### Conclusions

In the design of a radio DF the technique selected and the resulting equipment employed are dictated by the application; the required performance; the quality of the immediate environment; the tolerable physical dimensions of the antenna system; and the economic factors involved.

From an analysis of the available material, it is evident that the narrow aperture systems are by far the simplest and lowest in cost. However, except where excellent sites are available and accuracy is not of paramount importance, they are not recommended.

In terms of accuracy, gain and multi-signal capabilities, the highest degree of performance is achieved with a wide aperture Wullenweber system under the most adverse siting conditions. Systems of this nature are comparatively

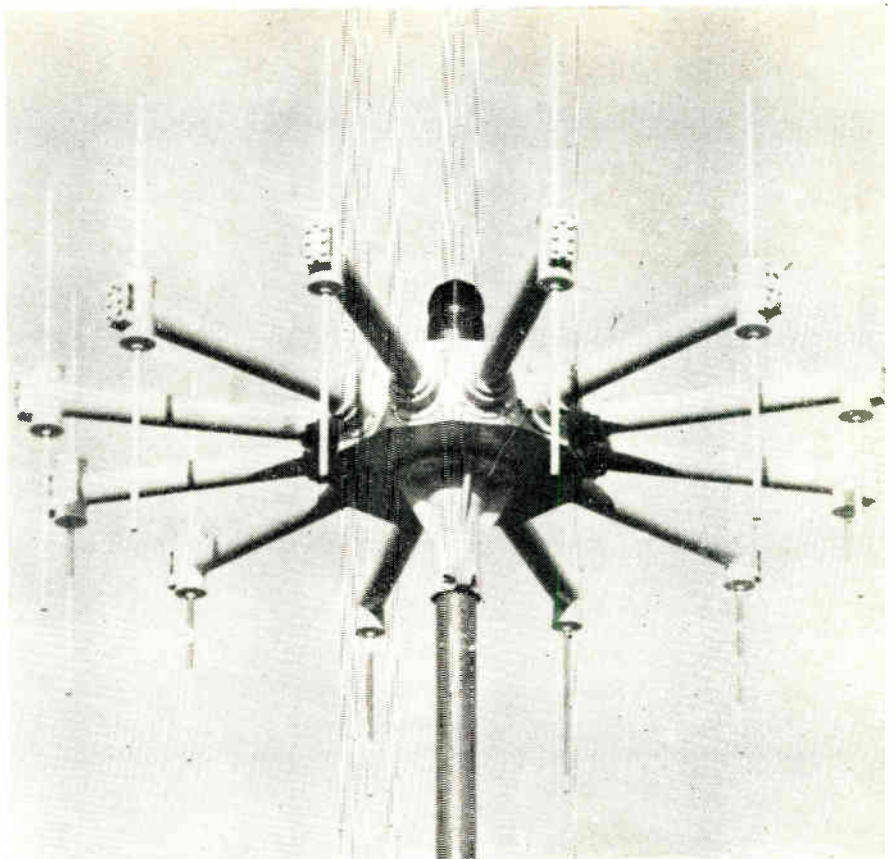

Fig. 12: Doppler antenna for 225-400MC

large, complex and from an economic standpoint must be fully justified by the performance requirements.

In the majority of applications, a medium aperture Doppler type DF offers the best possibilities. It is relatively small in size, provides a high degree of accuracy under adverse sitting conditions and is relatively low in cost. However, it does not exhibit the sensitivity and multi-signal capabilities of the Wullenweber.

The state of the art in wide and medium aperture DF antenna design has advanced to the point where basically, the accuracy of the DF is limited by the instrumentation and associated circuitry.

### Acknowledgment

The authors wish to express their sincere appreciation for the valuable assistance and cooperation given by Mr. Paul Hansel of the Servo Corp. of America and their colleagues at the Rome Air Development Center in the preparation of this paper.

### References

1. Fantoni, J. A. and Benoit, Jr., R. C.: "Applying the Doppler Effect to Direction Finder Design" (Part I), *Electronic Industries*, Pages 75-77 & 147, Jan. 1957, Part II, Pages 66-67 & 124, Feb. 1957.
2. Hansel, P. G.: "Doppler-Effect Omnidirection," *Proceedings of the IRE*, Volume 41, No. 12, Dec. 1953.
3. Earp, C. W. & Godfrey, R. M.: "Radio Direction Finding by the Cylindrical Differential Measurement of Phase," *Journal IEE*, Volume 94, Part III A, #15, Mar.-Apr. 1947.
4. Boulet, J. L. L.—Masters Thesis, University of Illinois, "Investigation of Doppler Effect in Determining Direction of Arrival of Radio Waves," September 1947.
5. Boulet, J. L. L., Anderson, J. M. & O. Meara, TR "Doppler-Type Direction Finding," Technical Report #8, ONR Contract N6-ori-71, Radio Direction Finding Research Laboratory Dept. of Electrical Engineering, University of Illinois.
6. Hansel, Paul G.—U. S. Patent #2,481,509 titled "Directional System," issued Sept. 13, 1949.
7. Hansel, Paul G.—U. S. Patent #2,490,050 titled "Navigation System" issued Dec. 6, 1949.
8. Hansel, Paul G.—U. S. Patent #2,449,553 titled "Doppler Radio Compass" issued Sept. 21, 1948.
9. Hansel, Paul G.—U. S. Patent #2,476,977 titled "Radio Direction Finder" issued July 26, 1949.
10. Benoit, Jr., R. C. & Furlow, M. W.: "Design For Wide Aperture Direction Finders," *Tele-Tech & Electronic Industries*, pages 60-62 & 102-108, Sept. 1955.
11. Benoit, Jr., R. C. & Fantoni, J. A., "USAF UHF Direction Finder," 1956 IRE National Convention Record, Part 8.
12. Benoit, Jr., R. C. & Coughlin, Jr., F., "New Trends in Directional Communications," 1958 IRE National Convention Record, Part 8.
13. Williams, H. Paul, "Antenna Theory and Design," Sir Isaac Pittman & Sons, London, England.
14. Kraus, John D., "Antennas," *McGraw Hill Book Company*, New York, N. Y.
15. Gray, Dwight E.—"American Institute of Physics Handbook," *McGraw Hill Book Company*, New York, N. Y., 1957.
16. Keen, R., "Wireless Direction Finding," 4th Edition, 1947. *Hiffe & Sons, Ltd.*, London, England.

By JOHN J. BOWE

Superior Tube Co.  
Narristown, Pa.

# What Cathode is Best for the Job?

*Types of construction available to the design engineer fall into two groupings—tubes and discs. For various applications seamless, welded and drawn, lapped-seam or locked-seam fabrication may offer certain advantages. Choice of active or passive base material will affect the hum characteristics and life of the tube.*

**T**ODAY the electron tube user has a wide assortment of materials and forms from which to select a cathode tailored to the requirements of the application. Standard cathode sleeves in 11 different materials and in four forms for re-

ceiving, power, industrial and other types of electron tubes and three different types of disc cathodes for cathode ray tube guns are available.

Indirectly heated cathodes are used in the majority of today's

receiving tubes. The metal sleeves, coated with alkaline earth oxides as a source of electrons, are furnished commercially in four forms: seamless, Weldrawn (welded and drawn), Lockseam and lappedseam. Three forms of another type of indirectly heated cathode—the disc cathode, with the cathode assembled in a round piece of ceramic—are supplied for cathode ray tube guns.

Seamless cathodes are manufactured from tubing which is cold drawn from a 2-inch OD heavy-wall tube. Welded and drawn cathodes (Weldrawn) are fabricated from tubing which is cold drawn from a tube made from strip metal. The strip is rolled into a tube form, passed under a welding head to form a fusion weld, then drawn to size in the same way as seamless. The seam is undetectable except by etching and microscopic examination. Lappedseam cathodes are made by simply lapping the edges of the metal strip and forming into the desired cathode configuration. Lockseam cathodes are made by mechanically locking the edges of the strip by a pressure fold.

Fig. 1: Melts for drawing into experimental tubes are produced in this electric furnace.

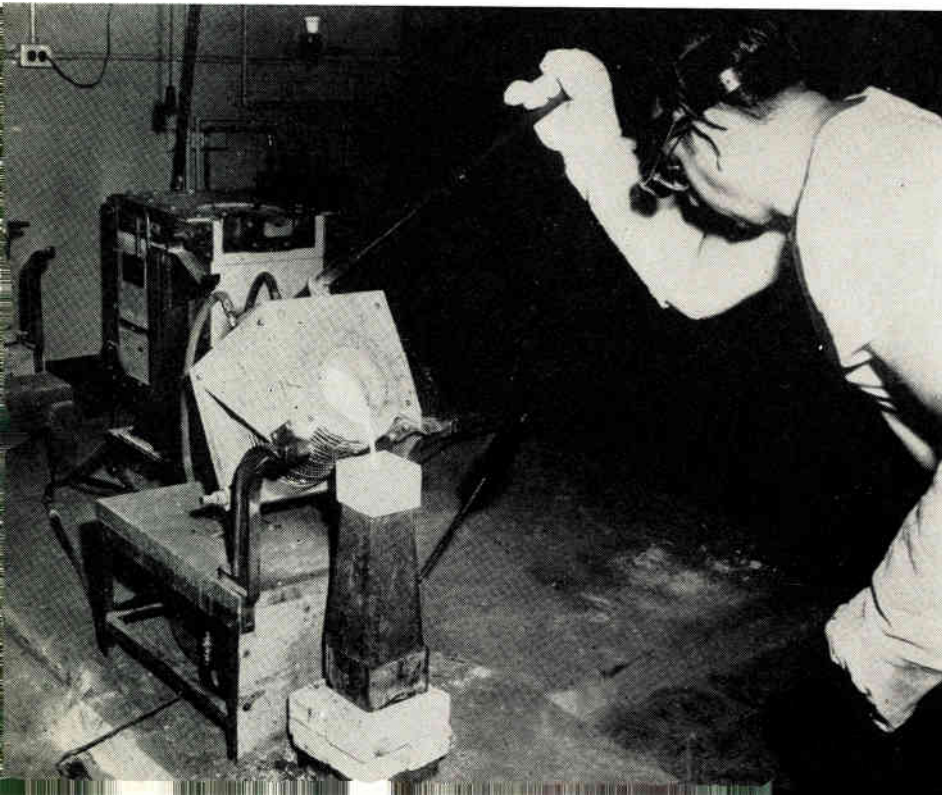



## Seamless and Weldrawn Cathodes

Seamless and Weldrawn cathodes have a more uniform cross section, weigh less and have less mass, and their weight can be more easily controlled. These can be important considerations in certain applications. Perhaps the greatest advantage of seamless and Weldrawn cathodes is the greater dimensional control possible than is the case with Lockseams and lapsesams. In the latter, the metal strip is formed in a machine with no other work done on it. Because both seamless and Weldrawn cathodes are made from tubing which is reduced in size by drawing, the tolerance spread can be held to much closer limits. The tolerance on the OD, for example, can be held to  $\pm 0.00025$ -in. on cathodes with 0.030-in. OD or smaller, compared to  $\pm 0.0005$  for Lockseam and lapsesam.

Moreover, the drawing process

## SEAMLESS CATHODE SHAPES

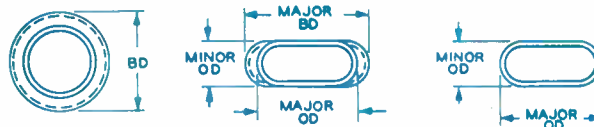
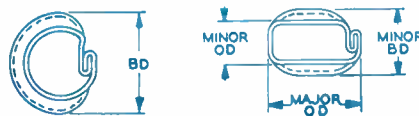
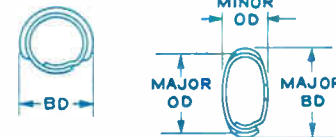

Fig. 2: Cathodes are made in 3 different forms; each has its own unique application.

## LOCKSEAM CATHODE SHAPES



## LAPSEAM CATHODE SHAPES



gives better control of wall thickness of the metal. This is extremely important in the manufacture of shaped cathodes (Fig. 2), which are formed by squeezing around a mandrel in a press. Since the size of the mandrel remains constant, any variation in wall thickness of the round tube will end up as a variation in the outside dimensions of the shaped tube.

Even closer control of wall thick-

ness in shaped cathodes is possible with a system of weight control. This consists of weighing tubing of exactly the same length. Variations in wall thickness show up as a variation in weight.

Rectangular cathodes are used in applications which require more power for a given frequency, such as radar, underwater telephone cables and TV. The rectangular shape makes possible a uniform

Table 1. Chemical analysis of cathode materials

### CHEMICAL ANALYSIS

Alloy	ASTM Grade	Form	Cu max. %	Fe %	Mn max. %	C max. %	Mg %	Si %	S max. %	Ti max. %	Other	Ni + Co min. %
Active CATHALLOY A-30		L, W Disc*	0.05	0.10 max.	0.05	0.03/0.10	0.01/0.06	0.02 max.	0.005	0.01	Al .03/.08	99.25
CATHALLOY A-31	7	L, W Disc	0.10	0.10 max.	0.05	0.03/0.10	0.01/0.06	0.02/0.06	0.005	0.02	W 3.75/4.25	94.50
CATHALLOY A-32		L, W Disc	0.05	0.10 max.	0.05	0.03/0.10	0.01/0.06	0.02 max.	0.005	0.01	Al 0.03/0.08 W 2.00/2.50	96.25
Passive CATHALLOY P-50	22	L, W Disc	0.04	0.05 max.	0.02	0.05	0.01 max.	0.02 max.	0.005	0.01		99.50
CATHALLOY P-51		L, W Disc	0.04	0.05 max.	0.02	0.05	0.01 max.	0.02 max.	0.005	0.01	W 3.75/4.25	95.25
Active D-H 799	2	L & Disc	0.04	0.05/0.10	0.05	0.08	0.01/0.10	0.12/0.20	0.005	0.01		99.25
INCO 225	3	L, S Disc	0.20	0.20 max.	0.20	0.08	Not Specified	0.15/0.25	0.008	Not Specified		99.00
D-H 599	4	L & Disc	0.04	0.05/0.10	0.10	0.08	0.01 max.	0.15/0.25	0.005	Not Specified		99.25
D-H 399	6	L	0.04	0.05 max.	0.02	0.08	0.01 max.	0.15/0.25	0.005	Not Specified		99.25
INCO 330	10	L, W Disc.	0.15	0.20 max.	0.30	0.08	Not Specified	0.10 max.	0.008	Not Specified		99.00
INCO 220	11	L, S Disc	0.20	0.20 max.	0.20	0.08	0.01/0.10	0.01/0.05	0.008	Not Specified		99.10

Forms: L—Lockseam and Lapseam, S—Seamless, W—Weldrawn (welded and drawn), D—Disc Cathodes.

# Cathodes (Continued)

close distance of cathode wall from the grid.

## Lockseam and Lapseam Cathodes

Lockseam and lapseam cathodes are formed from metal strip. The strip for Lockseam cathodes varies from 0.0021 to 0.005 in. thick. Lockseam cathodes can be furnished in all standard cathode materials; in round, oval, elliptical, rectangular and special shapes (Fig. 2), in sizes down to and including 0.040-in. OD. Smaller sizes are impractical because of the difficulty of locking the seam. They can be beaded at any location that is 0.040-in. or more from the end of the cathode and can be furnished with serrated lock, vertical rib or integral tab.

Lapseam cathodes have the ad-

vantage of providing a tighter fit in the hole of the mica. There is a small (0.0005-in. max.) opening between the overlapping surfaces, resulting in a slight spring action during processing. The tighter fit eliminates cathode vibration and thereby prevents micro-phonics. They are available in all standard cathode materials; in round, oval and elliptical shapes, and in all sizes from 0.040-in. outer diameter down to the smallest required. They can be beaded at any location that is 0.040-in. or more from the end of the cathode.

## Disc Cathodes

Consisting essentially of a beaded metal tube assembled to a ceramic disc and with a metal cap welded on the top, disc cathodes derive their name from the fact

that the oxide-coated emitting surface is the flat metal cap (disc) rather than the tubular sleeve.

One of the functions of the base metal in a cathode is to supply reducing agents for the activation of the oxide coating. Since only the cap in a disc cathode is coated with oxide, only it needs to have reducing elements in its composition. In

**A REPRINT**  
of this article can be obtained by  
writing on company letterhead to  
The Editor  
**ELECTRONIC INDUSTRIES**  
Chestnut & 56th Sts., Phila. 39, Pa.

disc cathodes, therefore, the caps can be made from an "active" cathode material—one that rapidly activates the oxide coating—while the metal sleeve can be of a "passive" material. This reduces sub-

**Table 2. Mechanical and Physical Properties of Cathode Materials**

### PHYSICAL PROPERTIES

CATHODE NICKEL

Alloy	Thermal Expansion Coefficient (x10 <sup>-6</sup> in./in./°F)	Electrical Resistivity (micro-ohms cm)		Temperature Coefficient of Resistivity (ohm/ohm/°F.)	Density lb./in. <sup>3</sup>	Special Features
		68 °F.	1000 °F.			
Active CATHALOY A-30	8.97	9.14	26.41	0.00276	0.322	Aluminum alloy for long life.
CATHALOY A-31	8.74	16.04	24.12	0.00169	0.337	Tungsten alloy for strength.
CATHALOY A-32	Tentative 8.42	Tentative 12.78	Tentative 26.00	Tentative 0.00199	0.330	Tungsten and aluminum alloy for shock resistance and low interface impedance.
Passive CATHALOY P-50	8.69	7.65	26.55	0.00368	0.322	Very pure, for extremely long life.
CATHALOY P-51	Tentative 8.74	Tentative 16.04	Tentative 24.12	Tentative 0.00169	0.337	High strength alloy for extremely long life.
Active D-H 799	7.83			0.0025	0.321	High silicon alloy.
INCO 225					0.321	High silicon alloy.
D-H 599	7.40			0.0025	0.321	High silicon, very low magnesium alloy.
D-H 399	7.40			0.0026	0.321	High silicon, very low magnesium and manganese alloy.
INCO 330					0.321	Low silicon alloy.
INCO 220					0.321	Low silicon. Low magnesium alloy.

Forms: L—Lockseam and Lapseam, S—Seamless, W—Weldrawn (welded and drawn), D—Disc Cathodes.



limation, which results from the use of certain reducing elements.

Disc cathodes are supplied in three forms—standard, miniature and sub-miniature. They differ in the size of the shank and cap. (Fig. 3.)

The standard disc cathode is the one in widest use in cathode ray tubes of television and radar sets, electronic test instruments, computer storage tubes, and other special beam type tubes. The ceramic diameter is 0.490-in. and the cathode shank diameter 0.121-in.

A special adaption of the standard form is the narrow neck disc cathode. It has the same size cathode shank as the standard cathode but the diameter of the ceramic has been reduced about 25% to 0.365-in. This permits production of cathode ray tubes with a narrower glass neck so that the deflection angle of the cathode ray tube can be considerably increased

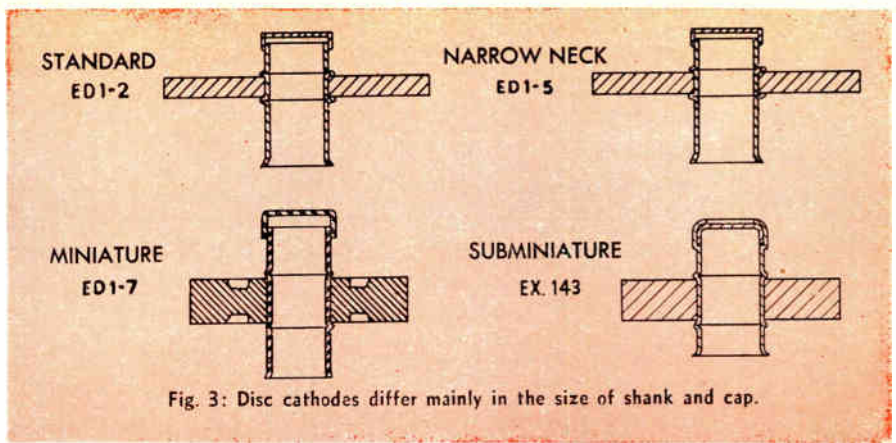

Fig. 3: Disc cathodes differ mainly in the size of shank and cap.

and the length of the tube thereby shortened.

The miniature disc cathode has not only the smaller .365-in. OD ceramic but also a smaller shank. Both shank diameter and shank length have been reduced about 25%. Shank diameter is .090-in. and length of shank including cap is .220 to .280-in.

An advantage of miniature disc

cathodes over standard and narrow neck types is the lower heater power required. Miniature disc cathodes can use heaters with ratings of 6.3 v-450 ma and 6.3 v-300 ma compared to 6.3 v-600 ma usually required.

For even greater savings in space and heater power, a sub-miniature disc cathode has been developed. It has a shank of 0.065-in.

#### MECHANICAL PROPERTIES

Alloy	Temper	Tensile Strength (x 1000 psi)	Yield Strength (x 1000 psi) 0.2% Offset	% Elongation in 2 in.	Rockwell Hardness
Active CATHALLOY A-30	1	75 max.	15/30	50/30	B 70 max.
	2	75/95	40/70	25/12	B 75/90
	3	95/120	75/110	10/4	B 90/105
CATHALLOY A-31	1	85 max.	15/40	50/30	B 80 max.
	2	85/105	50/80	25/12	B 80/95
	3	105/140	85/125	10/4	B 95/C 35
CATHALLOY A-32	1	85 max.	15/40	50/30	B 80 max.
	2	85/105	50/80	25/12	B 80/95
	3	105/140	85/125	10/4	B 95/C 35
Passive CATHALLOY P-50	1	75 max.	15/35	50/30	B 70 max.
	2	75/95	40/70	25/12	B 70/90
	3	95/120	75/110	10/4	B 90/105
CATHALLOY P-51	1	85 max.	15/40	50/30	B 80 max.
	2	85/105	50/80	25/12	B 80/95
	3	105/140	85/125	10/4	B 95/C 35
Active D-H 799	1	85 max.	15/40	50/30	B 80 max.
	2	85/105	50/80	25/12	B 80/95
	3	105/130	85/125	10/4	B 95/C 35
INCO 225	1	85 max.	15/40	50/30	B 80
	2	85/105	50/80	25/12	B 80/95
	3	105/130	85/125	10/4	B 95/C 35
D-H 599	1	85 max.	15/40	50/30	B 80 max.
	2	85/105	50/80	25/12	B 80/95
	3	105/130	85/125	10/4	B 95/C 35
D-H 399	1	85 max.	15/40	50/30	B 80 max.
	2	85/105	50/80	25/12	B 80/95
	3	105/130	85/125	10/4	B 95/C 35
INCO 330	1	75 max.	15/30	50/30	B 70 max.
	2	75/95	40/70	25/12	B 75/90
	3	95/120	75/110	10/4	B 90/105
INCO 220	1	75 max.	15/30	50/30	B 70 max.
	2	75/95	40/70	25/12	B 75/90
	3	95/120	75/110	10/4	B 90/105

Forms: L—Lockseam and Lapseam, S—Seamless, W—Weldrawn (welded and drawn), D—Disc Cathodes.

## Cathodes (Continued)



First step: Spraying the cathodes with a coat of barium-strontium-calcium-carbonate.



Second step: (above) Assembling the cathodes in vacuum tubes.

Tubes are tested for cathode life, rate of activation, emission level and sublimation characteristics.

## Testing Cathode Materials

Third step: Close the tube, evacuate the air, and activate the cathodes.

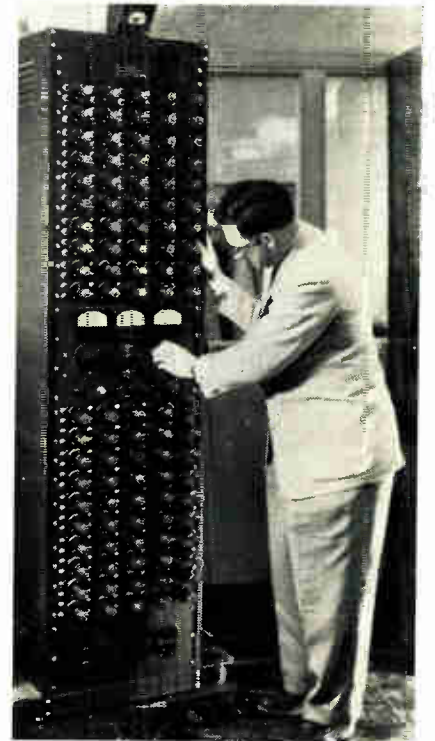

diameter compared to 0.090-in. for the miniature cathode. Length of shank, including the cap, is 0.220-in. It can be furnished with any size ceramic.

The commercial application of the subminiature disc cathode awaits the development of a suitable small-size heater by the tube industry. When this has been done, the new cathode will help greatly to extend miniaturization in the design of electron tubes.

Both miniature and subminiature disc cathodes can also be supplied with the standard 0.490-in. ceramic for easy insertion in stand-



ard cathode ray gun structures.

In all three forms of disc cathodes, the "E" dimensions—the distance from the ceramic to the top of the emission cap—is 0.098 in. to 0.101 in. and is held to a tolerance of  $\pm 0.0005$  inch.

Close control of the "E" dimension is important in order to assure uniform distance from the top of the coating to the aperture in the No. 1 cut-off grid, a cup which encloses the cathode. Uniform cut-off of electron flow from the cap through the aperture is possible only when the grid has uniform cut-off characteristics, and this in turn depends upon maintaining an exact distance from coating to aperture. Without exact control of electron cut-off, black areas in the television picture can become gray, and white areas muddled.

### Cathode Materials

In sleeves for indirectly heated cathodes, the base metal serves as a mechanical support for the emitting coating, transfers heat energy to the coating, and supplies reducing agents for activation of the coating.

The base metal is almost always pure nickel or nickel with small additions of other elements. Selection of a cathode base metal, is usually a matter of compromise among various performance characteristics desired. Active cathode alloys are recommended where the greatest speed of activation is desired. Passive alloys offer low rate of barium evolution, minimum sublimation and freedom from interface impedance.

The close relation between cathode performance characteristics and the type of base metals is seen in the following (Fig. 4):

1. Rate of Activation. This is controlled to a great extent by the quantity of uncompounded reducing agents present in the nickel alloy. Some of these agents are aluminum, magnesium, silicon, titanium and carbon. Where the greatest speed of activation is desired, the use of active cathode alloys is recommended.
2. Rate of Free Barium Evolution. This depends upon the type and quantity of reducing agents present in the cathode

alloy. A high rate of barium evolution is associated with active alloys. An active cathode alloy is required where high-speed tube production is paramount. A passive cathode alloy is recommended where freedom from undesired grid emission is essential.

3. Rate of Sublimation. Cathode alloys are formulated and controlled to produce the least amount of volatile metallic materials. Operating and processing temperatures and cathode design are extremely important in controlling the rate of sublimation. Magnesium is quite volatile and for this reason Mg content is carefully limited.

4. Interface Impedance. Cathode alloys not depending upon silicon for activating the coating are usually favored for VHF and pulsed applications. The impedance of the interface has been shown to be due to the resistance and capacitance effects of compounds formed by reactions of base metal reducing agents with coating materials. Silicon-nickel cathode alloys produce undesirable blocking layers in tubes operated at high frequency or under cut-off conditions. Similar effects have been observed when the bond between coating and base metal is not perfect, even though coating peel is not visible. This gives rise to reports of interface impedance even where the base metal does not contain silicon.

5. Heater-Cathode Leakage. This is of importance where unusually low hum levels are required. The passive type of cathode is beneficial for this characteristic.
6. Life. This is the most complex cathode problem of all, since it is dependent upon a great number of cathode alloy, coating and processing variables. Individual manufacturing techniques in the production of electron tubes determine the optimum choice of cathode material for this characteristic. High current density and extreme cathode temperature reduce the effective

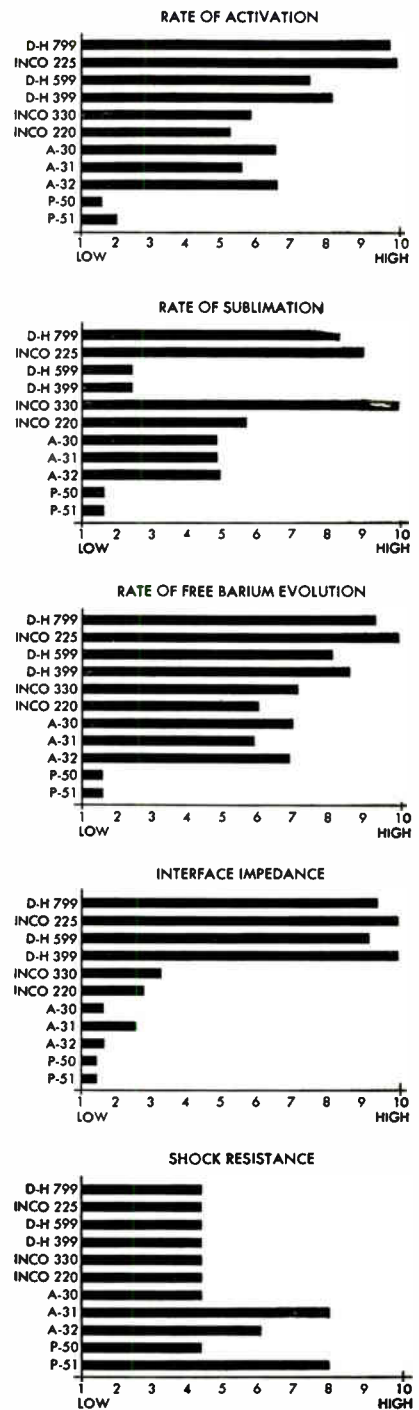

Fig. 4. Cathode characteristics have a close relationship to base materials.

tive life of the cathode. Passive alloys are generally recommended for applications requiring extremely long life.

The accompanying tables list the chemical analysis, mechanical and physical properties and performance characteristics of 11 cathode materials offered by Superior Tube Company. These comprise most of the materials used in cathode production today. The Cathaloy materials have been developed and trade-marked by Superior.

## Sonar Transducer "Squirts Sound"

**T**HE new, highly directional transducer "squirts" energy out the end, not unlike a garden hose squirting water. It is considered a break-through in sonar transducers. The device, known as SEFAR, was developed by Acoustica Associates, Inc., of Long Island, N. Y.

SEFAR consists of a driving transducer, a coupling section, and a waveguide. The combined length of the transducer and coupling section is about 1 wavelength. The waveguide can be from 10 to 30 wavelengths. Barium titanate, lead zirconate, magnetostrictive materials, or ferrites can be used as the transducer element. The coupling section and the waveguide can be fabricated of brass, steel, aluminum, or plastics. Waveguide is from one to one and one-half inches in outer diameter. The materials used are inexpensive and fabrication techniques are relatively simple. These factors com-

water. A study will show that the energy will actually be reinforced and emanate from the end of the waveguide.

Rather than have a conventional directive transducer which is about 10 to 20 or 30 wavelengths in diameter, this particular array achieves the same directivity by being 10 to 30 wave lengths long. The low cross sectional area creates very little water turbulence. In fact, the design is such that unless water hits it head-on there will be no response.

A working model operating at 10 kilocycles was built. It is roughly 13 feet long. This unit showed an overall efficiency, from electrical input to sound output in water, of 65%. The beam width was 20° wide. Now, this particular array will deliver about 10 to 30 watts per pound as compared to conventional transducers of equal directivity which have a watts per

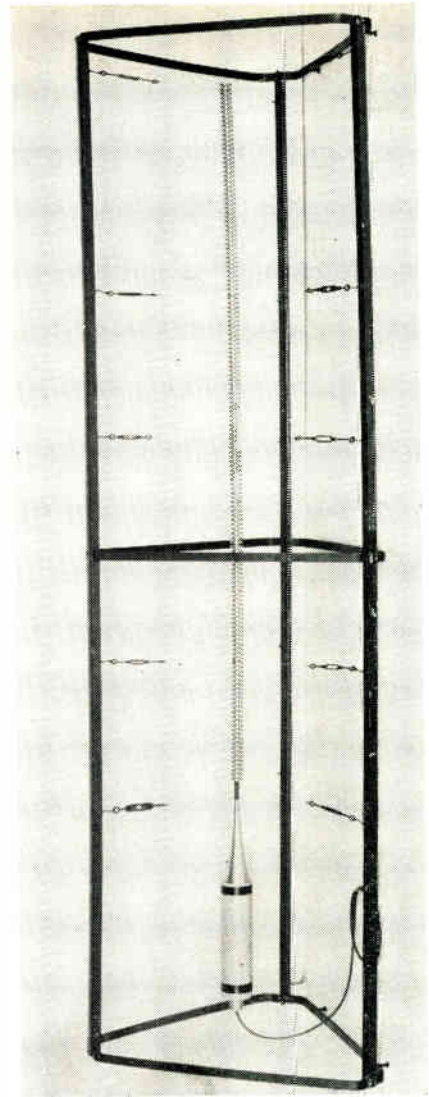

Unit is 13 ft long and 1 in. in diameter. Operating frequency is 10 KC

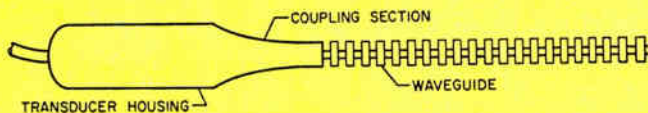

Outline drawing shows the general shape of the SEFAR unit.

bine to make the unit considerably less costly than existing sound sources.

### Operation

At one end of the unit there is a directional driving transducer. It sends energy down the coupling section and waveguide. The transfer section or waveguide slows the sound energy down. The energy is slowed by a factor of five as compared to a solid metal rod. The slowed energy's velocity then equals the velocity of sound through

pound ratio of roughly one. As mentioned earlier, it is not subject to noise created by towing or other movement.

### Some Applications

This device may be used for anti-submarine warfare; sonar; communications both in water and if modified, in air; for simulated weapon fire; and for remote control tactical warfare problems. A small version could be carried by a frogman using a small portable sonar set. Another version could be used

by shore stations for listening purposes at sea. Unit can be adapted to conventional sonar sets.

At present these units do not operate as rotating or swivel units. However, this is quite possible in the near future. For ship board submarine search use, three of them could be mounted 120° apart. By proper phasing, they could be made very directional and would have the same rotating beam as conventional sonar transducers, with much greater range.

### Background Information

The theory of the end-fire, directive sound source was first developed and tested at the Harvard Acoustics Research Laboratory in 1953 and 1954 by Dr. Miguel C. Junger, a consultant for Acoustica.

(Continued on page 94)



# UNIVERSAL



No. 24872

## TRANSISTOR SOCKET FOR CONVENTIONAL WIRING

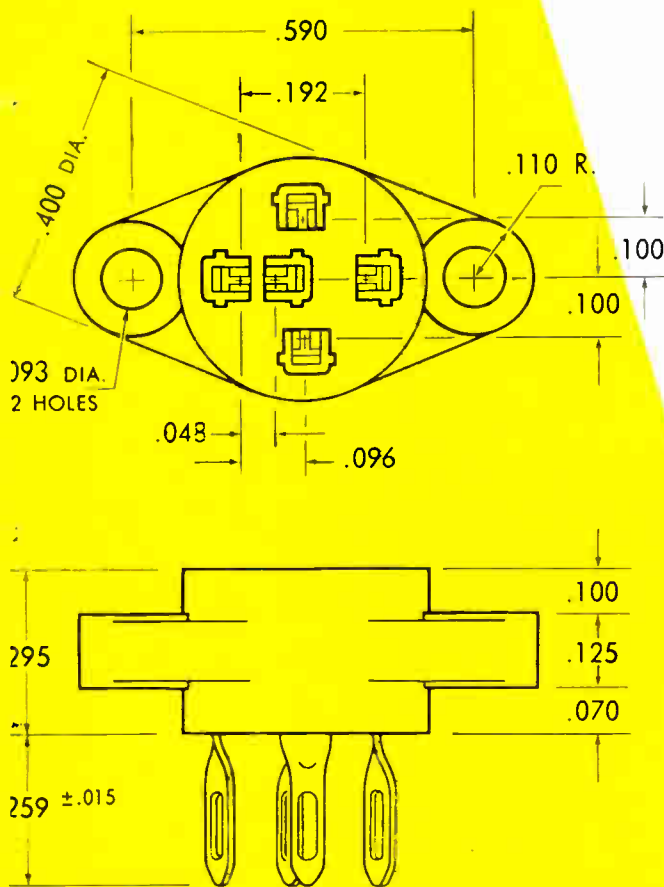

No. 24872



For use with transistors designed to the triangular base layout .2" x .1" (JETEC-30) contact centers, as well as the three contact in-line (.048 x .192 contact centers). This socket was originally designed for the all transistor TV set; however, its future applications are many; industrial communications, test equipment, bread board circuits, etc.

This design features an exceptional subminiature contact designed for the absolute minimum in intermittent failures, and an all molded monoblock construction with mounting holes provided as part of the casting. Assemblies are available in G. P. Black and low loss Mica-filled Phenolic.

The drawing shows five contacts but any number can be omitted to meet your particular contact layout.

Contacts are of Phosphor bronze,  
Cadmium plated .0001 (P24).



**Cinch**  
ELECTRONIC  
COMPONENTS

Centrally located plants at Chicago, Illinois; Shelbyville, Indiana; LaPuente, California; St. Louis, Missouri.

### CINCH MANUFACTURING COMPANY

1026 South Homan Ave., Chicago 24, Illinois

Division of United-Carr Fastener Corporation, Boston, Mass.

Circle 74 on Inquiry Card, page 105

# What's New . . .

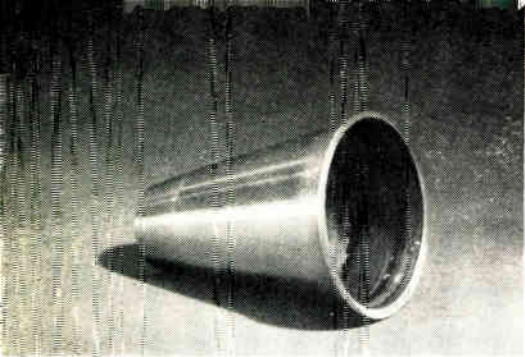

Shear spinning of rolled tungsten sheet.

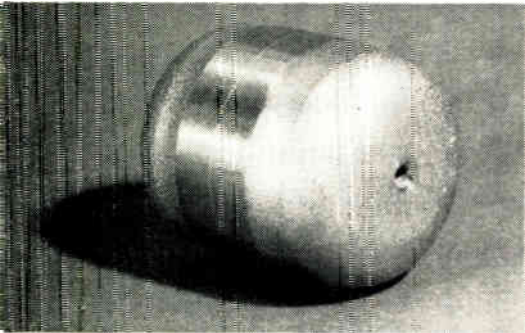

Two drawn cups brazed together with gold form container for radioactive material

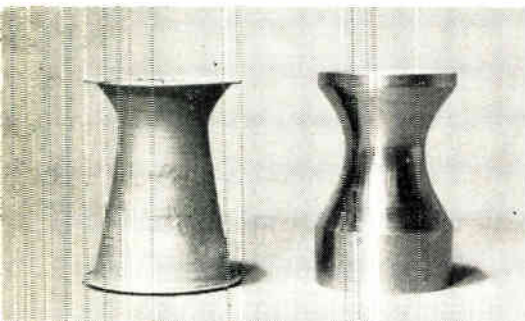

Rocket nozzle designs from spun rolled sheet.

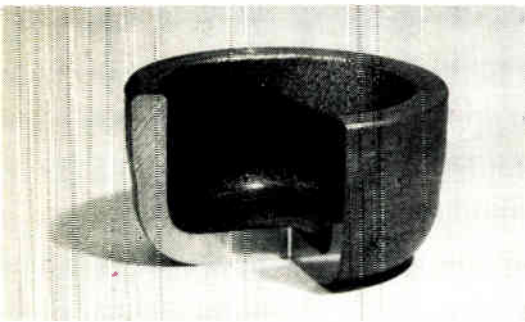

Deep drawn cup from 0.170 in. rolled plate.

(Below) Nozzle orifice is made from alloyed metal powder. It is compacted to shape, sintered, and machine finished.

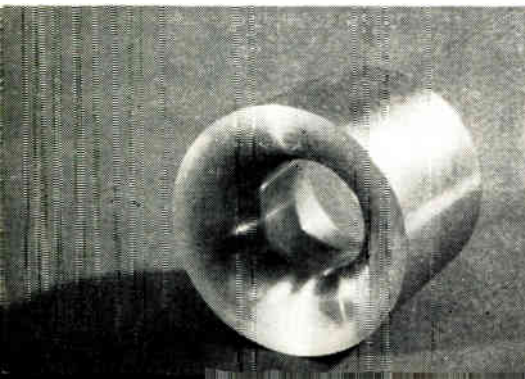

## Breaking the Tungsten Barrier

THE constant pressure to obtain greater reliability and longer life in electronic tubes and controls; to reduce component sizes; and to construct the research equipment for the exploration of new high temperature phenomena has made it necessary to develop processes for the fabrication of pure tungsten products. And now it appears that tungsten will assume an important role in rockets and space vehicles.

It is in this area of development that a significant break-through has been made at Fansteel Metallurgical Corp., North Chicago, Ill.

One of these developments is forging.

Forgings are made in a series of steps or sequences, taking advantage of tungsten's increased ductility as it is subjected to further working. The forging technique may be used for a simple rivet, the target in a new design of X-ray tube, the throat of a rocket nozzle, or any one of a variety of electronic tube components.

Large X-ray targets can be made by pressing tungsten powder into preformed shapes, which can then be sintered and forged to acceptable density. There are numerous products that can be fabricated by this method.

Another new development is seamless tungsten tubing produced by hot extrusion. The tubing illustrated was reduced by 70% of its original area, thereby showing the extent to which hot tungsten metal will flow under the proper conditions.

The process of deep drawing tungsten, to our knowledge has never been done prior to the last few months. In expanding the limits of fabrication to this extent, an endless stream of component parts for a variety of uses can be imagined. For instance, deep-drawn tungsten boats make it possible to fire electronic tube components to higher temperatures so that better tubes can be manufactured. It opens up the possibility of designing continuous metal evaporating equipment which in turn will reduce processing costs. Advanced design engineers may now consider the deep drawing of other tungsten sheet metal parts, such as vector control devices for missiles and rockets.

Deep drawing and machining can extend the use of pure tungsten for gyroscope rotors. With

*(Continued on page 171)*

Progressive steps in forging are shown in the background; this method is used to make large X-ray target (left foreground). Seamless tube (right) made by hot extrusion.





# COMBAT MOBILITY

*telecommunications move  
up-front with the advance*



***Kleinschmidt teletypewriters maintain constant contact,  
in print, between U. S. Army command and field positions***

On the go...bouncing over bunker or beachhead ...Kleinschmidt teletypewriters accurately, efficiently send and receive printed messages. Developed in cooperation with the U. S. Army Signal Corps, these units instantly provide both sender and receiver with identical data...*printed on*

*paper!* In recognition of its quality, Kleinschmidt equipment is manufactured for the U. S. Army under the Reduced Inspection Quality Assurance Plan. This kind of proved experience is now available for unlimited advances in electronic communications for business and industry.

# KLEINSCHMIDT



**DIVISION OF SMITH-CORONA MARCHANT INC., DEERFIELD, ILLINOIS**

Pioneer in teleprinted communications systems and equipment since 1911

## Sonar Transducer

(Continued from page 90)

It was on this basis that Acoustica was awarded Contract No. Nonr-2431(00) in November 1957. This authorized the company to conduct a research and development program that resulted in SEFAR.

Several models have been built for operation at 10 KC. The most satisfactory model was a brass configuration 13 feet long and 1 inch in diameter with a barium titanate transducer. This model was tested at NOL and U. S. Underwater Sound Laboratory. It exhibited a directivity index of 21 db, an efficiency of 65%, and power-handling capability of over two kilowatts. Directivity was identical when used as a transmitter or receiver. Directivity can range from 45° to less than 10° in beam-widths. Models have been designed for operation at frequencies ranging from below 500 CPS to 25 KC. A design has been made for an element which will operate at 400 CPS at an acoustic power level of 1 megawatt.

## Production Welding with Electrons

(Continued from page 76)

welding tubing or parts up to 3 1/8-in. diameter and in lengths up to 10 ft. A turntable can be installed for spot welding quantities of small parts.

The designers have placed a strong emphasis on simplicity, reliability and safety. Production personnel can be easily trained to operate the equipment. Previous ability to perform conventional welding operations is not a prerequisite.

All controls, instruments and the high voltage power supply are housed in an attractive console-style cabinet. The vacuum chamber, containing the electron gun and collet for rotating the work, is mounted on top of the cabinet. The high-capacity vacuum pumping system is located behind. Controls are simple and grouped within easy reach and direct sight of the operator.

- dewpoint to  $-180^{\circ}\text{F}$
- low-initial cost
- minimum maintenance
- completely automatic
- complete oil rejection

TRINITY

# Heat-Les

## COMPLETE PRESSURIZATION SYSTEMS

for  
CABLES,  
WAVE GUIDE,  
FEED SYSTEMS

- Complete systems available in building-block form, utilizing the exclusive, revolutionary Heat-Les dryer that eliminates all heat-reactivation of desiccant.
- 100% automatic, dependable operation for unattendable installations. Eliminates costly, bothersome cylinder-gas or cartridge-replacing operations.
- Provides extra-low dewpoints for high dielectric characteristics at high frequencies in transmission lines and feed systems.
- Field and factory service available for design, development and installation services . . .

WRITE for complete details on Trinity Pressurization Packages.

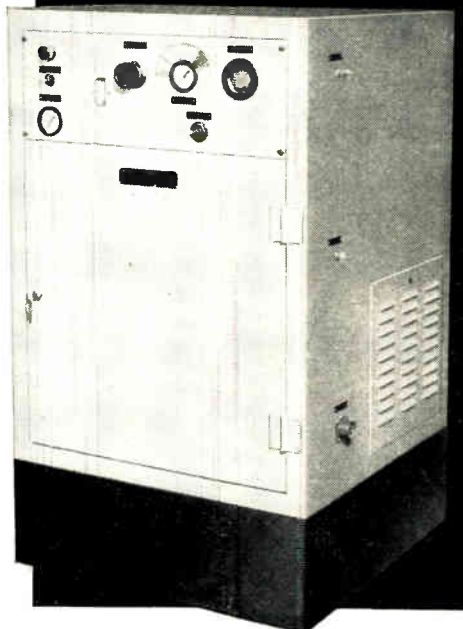

TRINITY

### DRY AIR SYSTEMS FOR ELECTRONIC APPLICATIONS

TRINITY EQUIPMENT CORPORATION, CORTLAND, NEW YORK



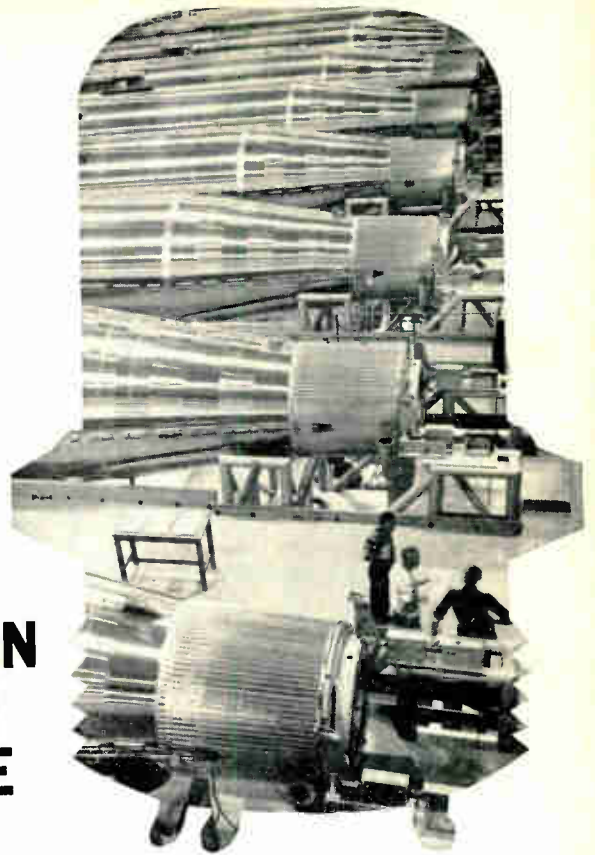

# THIS VOLTAGE REGULATION PROBLEM HAD TO BE SOLVED

## FOR AUTOMATIC INSPECTION MACHINES



*Hoffman Silicon ZENER Devices were the solution*



Circuit applications of zener devices in Voltage Regulator Test Set:  
 1. As shunt voltage regulator.  
 2. As a reference element, regulated power supply.  
 3. As a current limiter to prevent saturation.



Design engineers of American Bosch Arma<sup>®</sup>, in order to develop a completely automatic VOLTAGE REGULATOR TEST SET, required extremely stable and close tolerance circuit components. Hoffman Zener Devices were chosen to solve three major circuitry problems: (1) as shunt voltage regulation in a rectifier circuit, (2) as a reference element in a regulated power supply, and (3) as current limiters to prevent saturation in a transistor circuit.

ABAMCO engineers, using Zener circuitry, were able to create a production test instrument which eliminates operator judgment error and decreases labor to 25% of previous requirements.

Hoffman Semiconductor, who pioneered the development of Silicon Zener Devices, offers you the widest selection of voltage types and power dissipation ratings in the field.

Consult our Semiconductor Application Specialists in your immediate area or write to Department ZD.

*If you need a job in electronics done quicker and better, contact*

**Hoffman Electronics**  
 CORPORATION  
 SEMICONDUCTOR DIVISION  
 930 PITNER AVENUE EVANSTON, ILLINOIS



# Thimble Tubes

(Continued from page 64)

array of tube electrode assemblies is erected on this platform. Each assembly is held rigidly in place by a tripod-like structure. Nuvistor tubes are made of ceramic materials and strong metals such as steel, molybdenum, and tungsten.

The electrodes are strongly supported from one end in a cantilever fashion. This construction feature eliminates the need for mica support discs or spacers. All the electrodes are small, light cylinders. They are able to withstand a high degree of shock or vibration because of their shape and low mass.

All the joints in the complete tube are processed at white heat (temperature of approx. 2,000° F) in a brazing furnace and then in a vacuum-exhaust furnace. As a result, the parts are joined in their original strain-free positions. Since the tube elements are accurately secured in this manner, the possibility of shorts developing in the tube during operation is greatly reduced.

Assembler loads the grid and grid flange. The plate and plate flange are already on the jig.

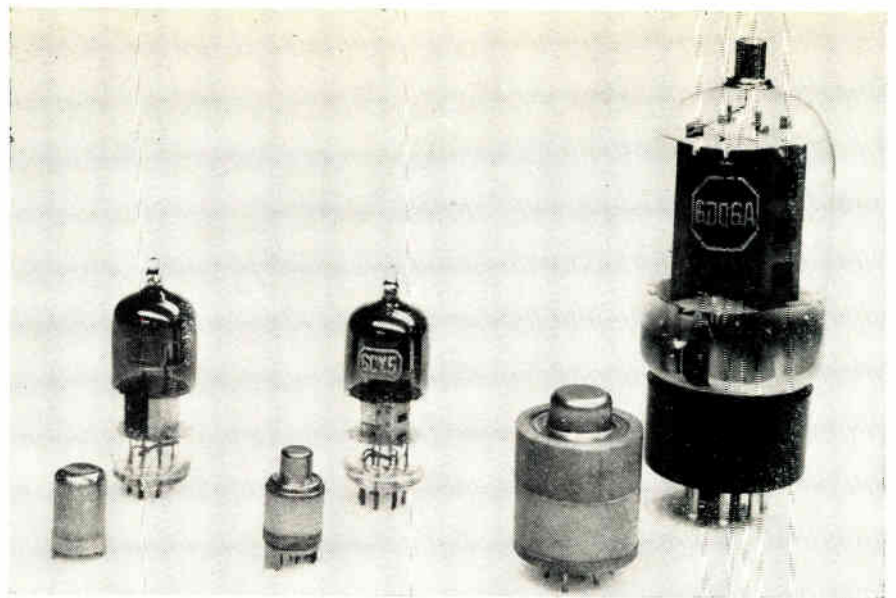
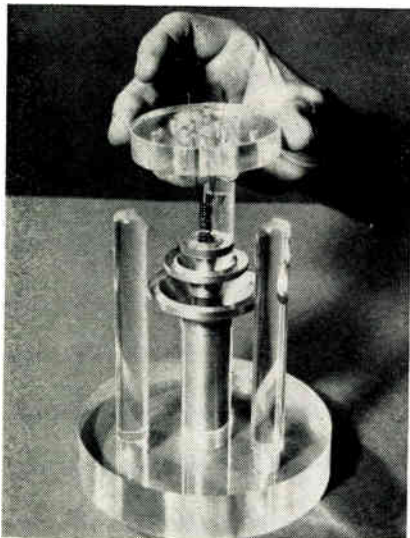

Three of the new type tubes are shown beside their present day counterparts.

## Construction Advantages

1. Cylindrical symmetry and cantilever support of the electrodes provide a combination of high cathode efficiency and permit the use of accurate jigs for parts assembly.
2. By the use of brazing instead of spot welding for the joining of materials, a potential source of failure is removed and residual strain in assembly is eliminated.
3. There are no miccas to fray under vibration or to interfere with high-temperature brazing and the exhaust processing of the tube.
4. High-temperature processing eliminates many of the gases and impurities that are difficult to remove during manufacture of tubes of conventional design in which glass and mica limit the processing temperatures.
5. Indexing lugs on the base of the Nuvistor permit safe and easy insertion into the tube socket and prevent damage to leads.
6. Because the tubes have been degassed at high temperatures, they can be expected to operate at temperatures in excess of those permitted with conventional types.

Here the cathode sleeve & flange have been loaded; now, heater & base wafer added.



Assembling coated cathode cup over cathode sleeve after assembled mount brazing.





# Thimble Tubes

(Continued from page 65)

with element terminals forming integral parts of the structure.

Although the 7077 was designed primarily for UHF service, its low-noise properties make it suitable for lower frequency operation in applications where tube noise is a critical factor. An especially important application is use of the 7077 as the intermediate-frequency amplifier input tube in microwave receivers.

Cross-sectional view of GE 7077 shows how close spacing and rigid element positioning are maintained.

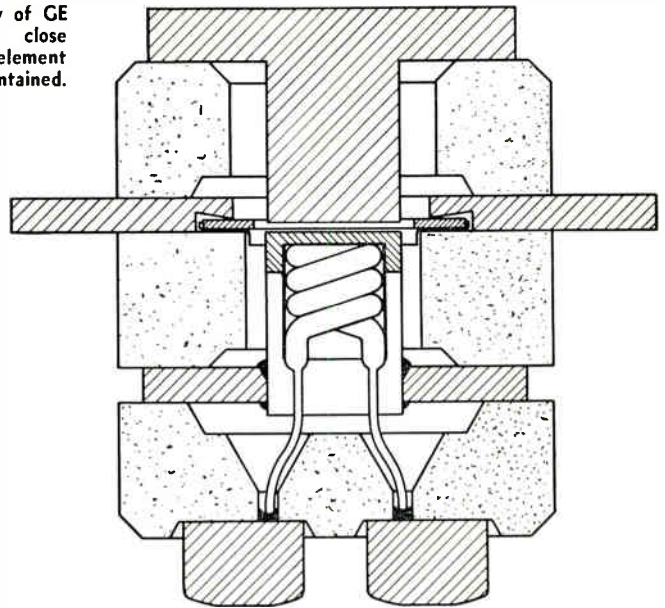

Ed.—General Electric revealed several other ceramic tubes under development at the IRE Show. For more information see p. 152.

## GE 7077 TECHNICAL DATA

### GENERAL

#### Electrical

Heater for Unipotential Cathode:

Voltage (AC or DC).....	6.3 v.
Current.....	0.24 a.

#### DIRECT INTERELECTRODE CAPACITANCES\*

Plate to Cathode and Heater.....	0.01 $\mu\mu\text{f}$
Cathode and Heater to Grid.....	1.7 $\mu\mu\text{f}$
Plate to Grid.....	1.0 $\mu\mu\text{f}$
Heater to Cathode.....	1.1 $\mu\mu\text{f}$

#### MECHANICAL

Mounting Position—Any

#### MAXIMUM RATINGS

Plate Voltage.....	250 v.
Positive Peak and DC Grid Voltage.....	0 v.
Negative Peak and DC Grid Voltage.....	50 v.
Plate Dissipation.....	1.0 w.
DC Cathode Current.....	10.0 ma.
Heater-Cathode Voltage:	
Heater Positive with respect to cathode.....	100 v.
Heater Negative with respect to cathode.....	100 v.
Envelope Temperature†.....	250 °C
Grid-Circuit Resistance.....	0.01 Megohms

\* Measured using a grounded adapter that provides shielding between external terminals of tube.

† For applications where long life is a primary consideration, envelope temperature should be maintained as close to room temperature as practical.

### AVERAGE CHARACTERISTICS

Plate Supply Voltage.....	250 v.
Resistor in plate circuit (by-passed).....	18000 $\Omega$
Cathode-Bias Resistor.....	82 $\Omega$
Amplification Factor.....	90
Plate Resistance, approximate.....	9000 $\Omega$
Transconductance.....	10000 Micromhos
Plate Current.....	6.5 ma.
Grid Voltage, approximate.....	-5 v.
$g_m = 50$ Micromhos.....	

### TYPICAL OPERATION

#### GROUNDING-GRID AMPLIFIER—450 MEGACYCLES

Plate Supply Voltage‡.....	250 v.
Resistor in plate circuit (by-passed)‡.....	18000 $\Omega$
Cathode-Bias Resistor.....	82 $\Omega$
Plate Current.....	6.5 ma.
Bandwidth, approximate.....	7.5 MC
Power Gain, approximate.....	14.5 db
Noise Figure (Measured with power-matched input, using argon lamp noise source), approx.....	5.5 db

‡ Lower supply voltage and a lower value of resistor may be used in the plate circuit with some sacrifice in uniformity of performance.

Exhaust and final seal take place when the tube envelope has been added to assembly.

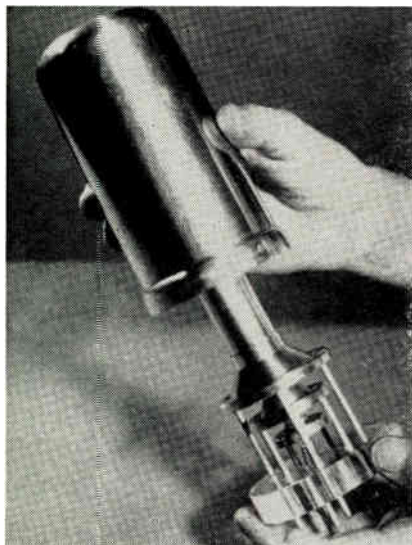

## RCA NUVISTOR (SMALL-SIGNAL TRIODE)

### ELECTRICAL:

Heater, for Unipotential Cathode:

Voltage (AC or DC).....	6.3	volts
Current.....	0.14	amp

### DIRECT INTERELECTRODE CAPACITANCES (APPROX.):

Grid to Plate.....	2.4	$\mu\mu\text{f}$
Grid to Cathode, Heater and Shell.....	5	$\mu\mu\text{f}$
Plate to Cathode, Heater, and Shell.....	2.2	$\mu\mu\text{f}$
Plate to Cathode.....	0.5	$\mu\mu\text{f}$
Heater to Cathode.....	1.8	$\mu\mu\text{f}$

### CHARACTERISTICS, CLASS A<sub>1</sub> AMPLIFIER:

Plate Voltage.....	40	75	volt
Grid Resistor.....	1	—	megohm
Cathode Resistor.....	—	150	ohms
Amplification Factor.....	32	32	
Transconductance.....	10700	10500	$\mu\text{mhos}$
Plate Current.....	7	9	ma
Grid Voltage (approx.) for plate current of 10 $\mu\text{a}$ .....	—	-6	volts

### MAXIMUM RATINGS:

Plate Voltage.....	100	v.
Grid Voltage.....	-50	v.
Peak Positive Grid Voltage.....	2	v.
Plate Dissipation.....	1	w.
Peak Heater-Cathode Voltage:		
Heater negative with respect to cathode.....	100	v.
Heater positive with respect to cathode.....	100	v.

THE FIRST COUNT-DOWN WAS . . .

# Inside AN R.F. SHIELDING ENCLOSURE

Proper functioning of critical missile electronic guidance systems demands exhaustive pretesting in the laboratory, on the production line and at the launching site. One very important pre-testing procedure is analyzing the performance of electronic components, sub-systems and systems in an area completely free of RF interference.

Shielding, Inc. is a supplier of RF Shielding enclosures for use in both the Thor and Atlas programs. As a designer and producer of RF shielding enclosures from the **largest ever built** to standard, modular rooms, Shielding has the experience and abilities to fill critical RF shielding requirements — with either a standard or custom-designed enclosure.

Missile and communication equipment manufacturers and government officials know from experience that Shielding enclosures offer the **highest RF shielding effectiveness** available for construction material used . . . incorporate **extra mechanical design features** and **installation versatility** not found in conventional enclosures.

Whatever your RF interference needs, Shielding will deliver an enclosure to your specifications. Write or wire, outlining your problems, to Shielding, Inc. You will receive a prompt appraisal.

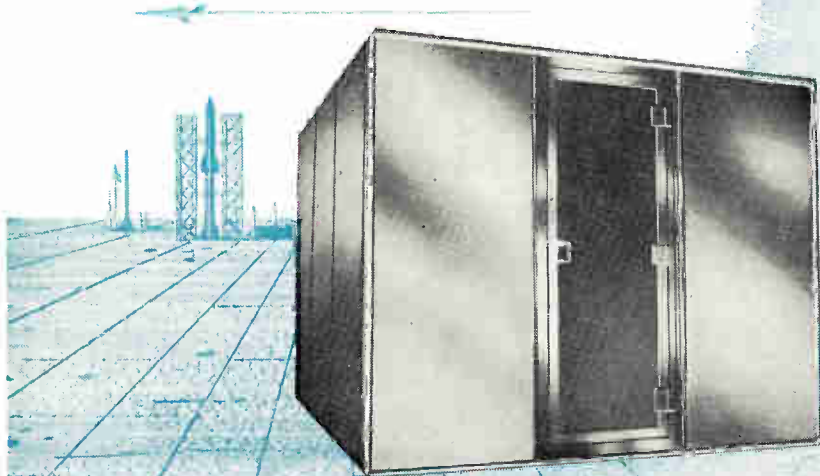

## SHIELDING, INC.

68 N. READE AVE.  
RIVERTON, N. J.

CHICAGO — R. EDWARD STEMM • DENVER — WILLIAMS & ASSOCIATES • FORT WORTH — MITCHELL SPEARS COMPANY • SEATTLE — G. M. GILLET COMPANY  
LOS ANGELES — CARL A. STONE ASSOCIATES, INC. • CANADA — STARK ELECTRONICS SALES LTD., AJAX, ONTARIO



**R-F POWER AMPLIFIER**

Model A-25 r-f power amplifier extends the effective range of standard telemetering transmitters in the 215-260 mc band. It features miniature construction, stabilized circuitry, and

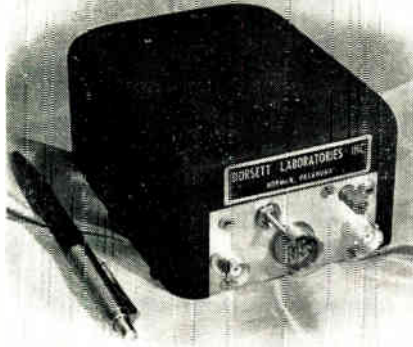

improved thermal characteristics. It has a 25 w. output with a 2 w. input drive; input and output nominal 50 ohms. No blower or forced air cooling is required. Supply requirements are 450 v. plate, 225 v. screen and either 6.3 or 12.6 ac/dc fil. It is designed for FM or PM systems, but is adaptable for AM with slightly reduced power output. Dorsett Laboratories, Inc., 401 E. Boyd, Box 862, Norman, Okla.

Circle 193 on Inquiry Card, page 105

**CONTROL KNOBS**

Line of standard plastic control knobs conform with MS-91528. There are 4 basic knob types. Each is available in 3 shaft sizes. Finishes are either gloss, matte, or two color specs. Color and finishes may be intermixed. Knobs are made of plastic, type 111, class H2, per specification L-P-349.

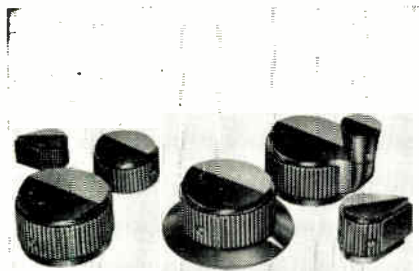

Set screws are cadmium plated, class 3, type 11, per specification QQ-P-416. Inserts are brass, composition 4, hard, per specification QQ-B-613. National Company, Inc., 61 Sherman St., Malden, Mass.

Circle 194 on Inquiry Card, page 105

**VARIABLE FIELD MAGNET**

Variable field permanent magnet features: Continuously variable magnetic field strength, for any chosen gap, readily interchanged pole faces, and variability of gap from 0 to 4 1/2

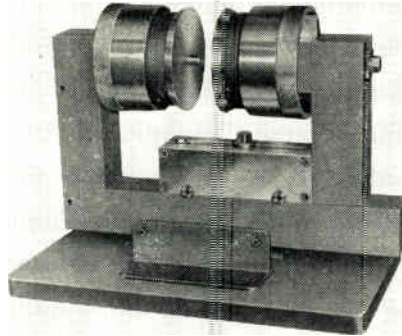

in. Field strengths continuously variable over a 20 to 1 ratio of maximum to minimum are obtained at any chosen gap by means of adjustable magnetic shunt rings. Negligible hysteresis and indefinitely long magnetic lifetime are secured by use of oriented ceramic magnetic material. Laboratory for Science, 5431 College Ave., P. O. Box 2925, Oakland 18, Calif.

Circle 195 on Inquiry Card, page 105

**TUMBLE-FINISHER**

Model RA Rollbrader, a 0.5 cu. ft. tumble-finisher features a barrel drive system using four neoprene rollers and dual drive shafts. Variable speed drive is adjustable from 20 to 46 rpm. Typical uses include short runs of small production parts, experimental processing, precision finishing of deli-

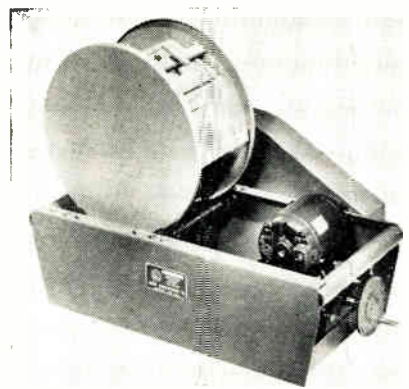

cate parts and similar small volume work. It is 25 1/4 x 31 x 17 1/2 in. Barrel is 8 3/4 in. wide with roller flanges 17 3/8 in. in dia. Rampe Manufacturing Company, 14915 Woodworth Avenue, Cleveland 10, Ohio.

Circle 196 on Inquiry Card, page 105

**WIRING DUCT**

All-white wiring duct matches the white interiors of control panels as required by J.I.C. (Joint Industry Conference). It provides high light reflectance and allows greater in-

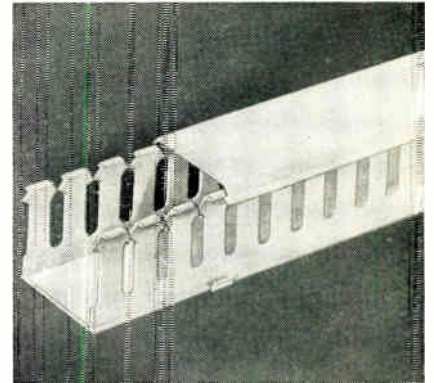

ternal visibility. It is made of Polyvinyl Chloride plastic and does not incorporate fiber fillers; therefore does not support fungus growth and will not irritate the hands of installers. It is available in any of 19 standard sizes ranging from 1/2 x 1/2 in. to 3 x 4 in. and is supplied in standard lengths of 5 ft, 6 ft, or 7 ft lengths. Panduit Corp., Dept. EIP, 14461 Waverly Ave., Midlothian, Ill.

Circle 197 on Inquiry Card, page 105

**VOLTAGE REGULATOR TUBE**

Ruggedized, subminiature, metal-ceramic, corona discharge, voltage regulator tubes cover the 400 to 4000 v range. Regulation is 1.0% over a 10<sup>-11</sup> to 10<sup>-7</sup> amp current range. Pre-breakdown current is less than 10<sup>-12</sup> amp at room temperature. Temperature range is -55° C to 200° C. Di-

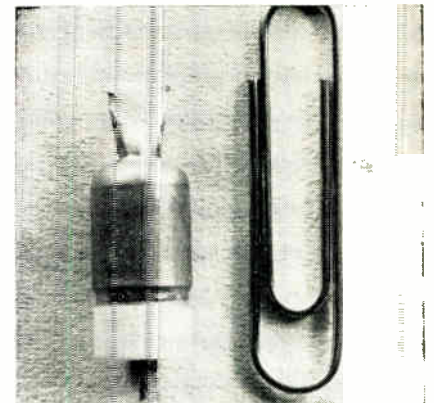

mensions are 0.65 in. long (excluding tubulation and anode pin) x 0.3 in. O.D. Overall length, including tubulation and anode pin, is less than 1 in. Radiation Research Corp., 1114 First Ave., New York 21, New York.

Circle 198 on Inquiry Card, page 105

**HEAT EXCHANGER**

LC-5 air-to-liquid heat exchanger is mounted within an electronic rack and uses room air of up to 125°F. at altitudes of up to 10,000 ft. as the cooling medium. The pump, motor,

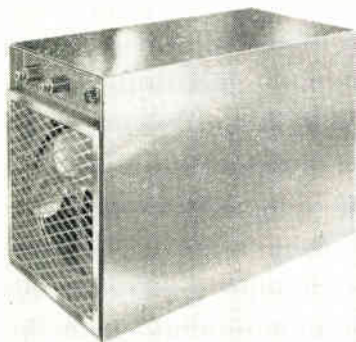

fan, relief valve, flow switch and storage tank are contained within the aluminum casing. All electrical controls are located remote from the unit. It dissipates 2000 w of heat from Monsanto Type OS-45 oil at a circulation rate of 3 gal/min. Meets MIL-E-4158, MIL-T-4807, and MIL-STD-170. Ellis and Watts Products, Inc., P. O. Box 33, Cincinnati 33, Ohio.

Circle 199 on Inquiry Card, page 105

**X-BAND MAGNETRONS**

Tubes, type 2J42B and a ruggedized version of type 6027H, designed for missile and other airborne applications, are fixed-frequency X-band devices. Minimum peak power outputs are 14 kw for the 2J42B, and 18 kw for type 6027H. They withstand 5g vibration at 10 to 500 cps with less than 3 MC frequency shift and less than ±0.5 MC frequency mod-

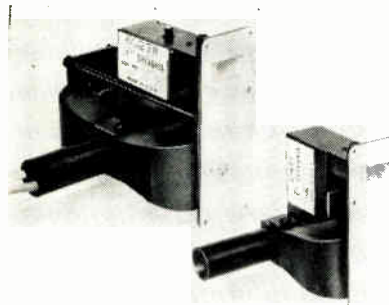

ulation. In addition, both types are capable of withstanding 50g shock for 4 msec, and may be operated at altitudes as high as 60,000 ft. Sylvania Electric Products Inc., 1740 Broadway, New York 19, N. Y.

Circle 200 on Inquiry Card, page 105

**ANGLE AND T-DRIVES**

Angle and T-drives, Series 12 for transmitting power at right angles in cramped space. These 1:1 ratio units may be integrally combined with any of Metron's miniature speed re-

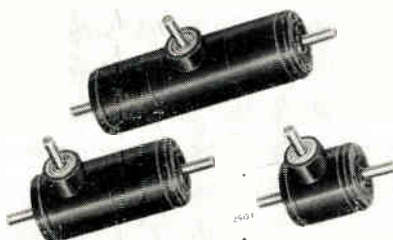

ducers, or between 2 or more of these speed reducers. Drives handle up to 24 oz.-in. of torque. Speeds to 10,000 RPM are reached without excessive wear. Maximum power transmitted is 0.025 HP. Forty-eight pitch, 20° PA miter gears, lubricated with MIL-G-3278 grease, are used. Case OD is 1.062 in. Metron Instrument Company, 432 Lincoln St., Denver 3, Colo.

Circle 201 on Inquiry Card, page 105

**MAGNETIC CORE TESTER**

A production and laboratory instrument, Model RK-100, is for testing tape wound cores, ferrite cores, and relays. Two units may be operated synchronously for core plane and coincident current testing. Features include: 2.0% meter for rough settings—precision resistors for current measurements—0.1 ma to 1.0 a current pulse—0.1 μsec. to 1 msec. current

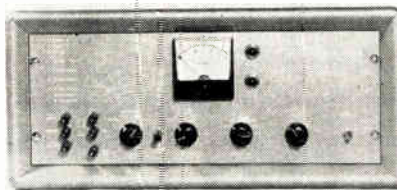

rise time—9 pulse logical patterns—handling of switching times to 35 msec.—requires only one winding on core being tested. Arkay Engineering, Inc., 225 Santa Monica Blvd., Santa Monica, Calif.

Circle 202 on Inquiry Card, page 105

**FERRITE ISOLATORS**

Covering the frequency range from 3.95 to 12.4 KMC in 3 broadband models, these ferrite isolators have an insertion loss of 1.0 db and a vswr of 1.2. Each covers an entire waveguide

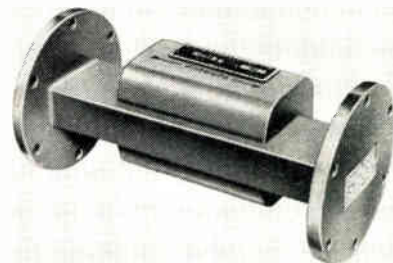

band. Rated at 5 w. they can handle up to 25 w. with a temporary electrical degradation. Model 1205 covers the 2 x 1 in. range; min. isolation is 16 db. Model 1204 covers the 1½ x ¾ in. range; min. isolation is 20 db. Model 1203 covers the 1 x ½ in. range; min. isolation is 30 db. Polytechnic Research & Development Co., Inc., 202 Tillary St., Brooklyn 1, N. Y.

Circle 203 on Inquiry Card, page 105

**AC VOLTAGE DIVIDER**

Model DT-72, Dekatran, linear ac voltage divider, is a laboratory standard for measuring voltage ratios with a linearity accuracy of better than 0.0001% (1 ppm). Toroidal transformers are combined to provide 7 decades of accurate voltage division. Accuracy is maintained over a wide range of audio frequencies, input voltages and ambient temperatures.



It uses an in-line dial configuration to increase ease of operation and reading. May be mounted in a standard relay rack. Electro Measurements, Inc., 7524 S. W. Macadam Ave., Portland, Oregon.

Circle 204 on Inquiry Card, page 105





## *BUSS Fuses provide Maximum Protection against damage due to electrical faults*

When an electrical fault occurs, BUSS fuses quickly clear the circuit. By preventing useless damage, BUSS fuses help to get your equipment back in operation sooner. Users of your equipment are safeguarded against the expense of unnecessary repair bills.

BUSS fuse dependability also prevents needless blows that 'knock' equipment out-of-service without cause. Users are protected against irritating and often costly shutdowns due to faulty fuses blowing when trouble does not exist.

### **Electronic Testing Assures Dependability in BUSS Fuses**

Every BUSS fuse is tested in a sensitive electronic device that automatically rejects any fuse not correctly calibrated, properly constructed and right in all physical dimensions.

By specifying BUSS fuses, you are providing the finest electrical protection possible, — and you are helping to safeguard the reputation of your product for quality and reliability. To meet your needs, the BUSS fuse line is most complete.

If you have an unusual or difficult protection problem . . . let the BUSS fuse engineers work with you and save you engineering time. If possible, they will suggest a fuse already available in local wholesalers' stocks, so that your device can easily be serviced.

For more information on BUSS and FUSETRON Small Dimension fuses and fuseholders, write for bulletin SFB.

Bussmann Mfg. Division McGraw-Edison Co., University at Jefferson, St. Louis 7, Mo.

*BUSS fuses are made to protect — not to blow, needlessly*



A COMPLETE LINE OF FUSES FOR HOME, FARM, COMMERCIAL, ELECTRONIC, AUTOMOTIVE AND INDUSTRIAL USE.

**CONGRESS TAKES HAND**—Because of the importance of launching a full-scale study of the r-f spectrum to determine the government's use of radio frequencies, House Interstate & Foreign Commerce Committee Chairman Oren Harris (D., Ark.) has planned a comprehensive survey of the spectrum by a staff of technical experts, drawn from all areas of radio frequency use. The study will be conducted by the newly formed Interstate Commerce communications and power subcommittee, also headed by Mr. Harris. Last year, vigorous objections by broadcasting-television interests killed in the House, a Senate-passed resolution which would have instituted a joint Congressional survey of the government's use of radio frequencies.

**SPECTRUM ANALYSIS**—Chairman Harris has asked the House for a \$150,000 fund for the spectrum study and for the establishment of the technical staff which he termed one "of the most important undertakings of this committee in a long time." He stated that "The study will include present and future uses by military and other governmental agencies, radio and television stations, and other private parties, of the radio spectrum, and legislation needed to establish proper governmental machinery and procedures to assure a fair distribution of available frequencies among all these users."

**STAFF AVAILABILITY**—The House committee's spectrum survey does have the problem as to the availability of well-grounded, experienced technical personnel of the caliber needed to make the comprehensive study of the government's use of radio frequencies. One possibility under consideration by Chairman Harris was that communications and frequency experts who have retired recently could compose a valuable element of the projected technical staff. Such experts could direct younger radio-electronics engineers who would be interested in such an assignment to start their career. The House committee might also obtain the services of some personnel on loan from government agencies or the military services.

**TELEVISION ALLOCATIONS**—With the ever-increasing requirements of the mobile radio services, the FCC may have to treat VHF television just as it has AM broadcasting spectrum space over the years. This is the consensus of authoritative TV-radio consulting engineers both in the government and in private practice. The view of these engi-

neering experts is that the FCC may be forced to make a "nation-wide competitive" VHF system with the present 12 channels through reduction of VHF mileages, varying of powers and heights, directional antennas, precision offset, and adjacent-channel interference which would virtually mean the establishment of an entirely new VHF system. While desirable from the standpoint of these engineers, the plan of Commissioner T. A. M. Craven for 25 continuous VHF channels, it is felt this plan cannot be effectuated because of the pressing spectrum requirements of the non-broadcast radio services.

**LEGISLATION ON CONTACTS**—Legislation which would bar anyone from written or personal communication with members and employees of the FCC regarding either adjudicatory or rulemaking proceedings, unless the communications are made part of the public record, has been introduced in the House by Interstate & Foreign Commerce Committee Chairman Harris. The legislation was the result of disclosures last year before the House Legislative Oversight Committee made to the FCC commissioners and top staff officials by applicants for television stations and their attorneys to influence FCC decisions. The legislation also provides that for the election of regulatory commission chairmen, including the FCC, by the commissioners for terms not to exceed three consecutive years instead of the present provision in the case of the FCC where the Chairman is appointed by the President.

**PLANS COMMISSION**—To carry out the recommendations submitted to President Eisenhower late last year by his Special Advisory Committee on Telecommunications, including a study of the role of the federal government in the management of the United States "telecommunications resource," the establishment of a five-member Commission on Telecommunications Management to serve for one year was proposed to Congress in letters from Office of Civil and Defense Mobilization Director Leo A. Hoegh, sent at the direction of the President to both the Senate and the House of Representatives. The recommended legislation, sent in the form of a "draft joint resolution," proposed the President should appoint the five members of the commission and the study and investigation by that body would be financed through the President's national defense emergency fund.

*National Press Building  
Washington 4*

*ROLAND C. DAVIES  
Washington Editor*



# Creative Microwave Technology

Published by MICROWAVE AND POWER TUBE DIVISION, RAYTHEON MANUFACTURING COMPANY, WALTHAM 54, MASS., Vol. 1, No. 2

## NEW ONE-WATT COMMUNICATION KLYSTRONS COVER GOVERNMENT AND COMMON CARRIER BANDS

Designed primarily for use in microwave relay links, the QK-661 and the QK-754, one-watt transmitter klystrons, operate at frequencies of 7,125 to 8,500 Mc and 5,925 to 6,425 Mc, respectively. The QK-661 is the first tube of its kind to cover the entire government band. The QK-754 is the first of a planned series of tubes to cover the entire communications band.

Both are mechanically tuned, integral-cavity, long-life, reflex-type tubes. The QK-754 uses a coaxial output; the QK-661, a waveguide output.

To insure efficient operation the tubes are available with integral cooling fins or with a heat-sink attachment suitable for connection to the chassis.

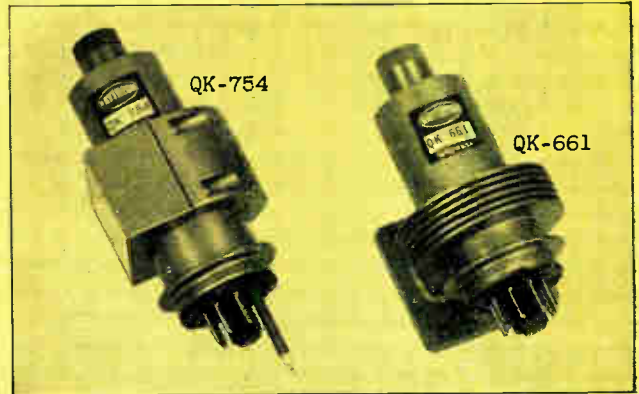

Typical operating characteristics

	QK-754	QK-661
Frequency Range	5925 to 6425 Mc	7125 to 8500 Mc
Power Output	1.5 watts	1.6 watts
Electronic Tuning (to half-power pts)	50 Mc	25 Mc
Modulation		
Sensitivity (10 V pk-to-pk mod volt)	1 Mc/V	600 Kc/V
Temp. Coefficient	$\pm 0.1$ Mc/ $^{\circ}$ C	$\pm 0.1$ Mc/ $^{\circ}$ C

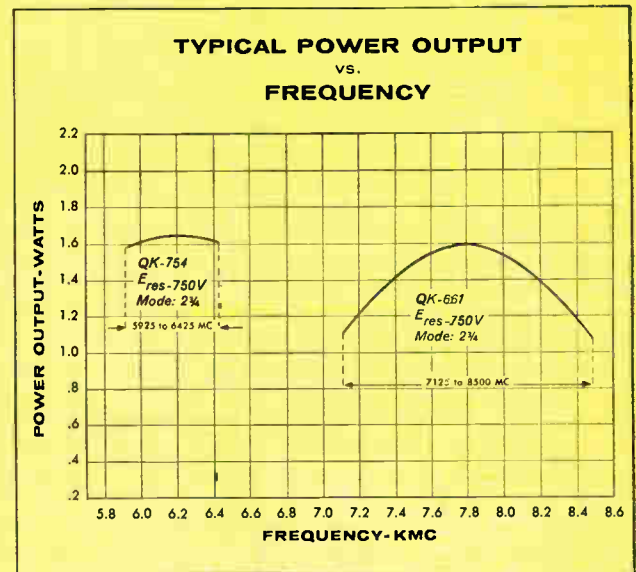
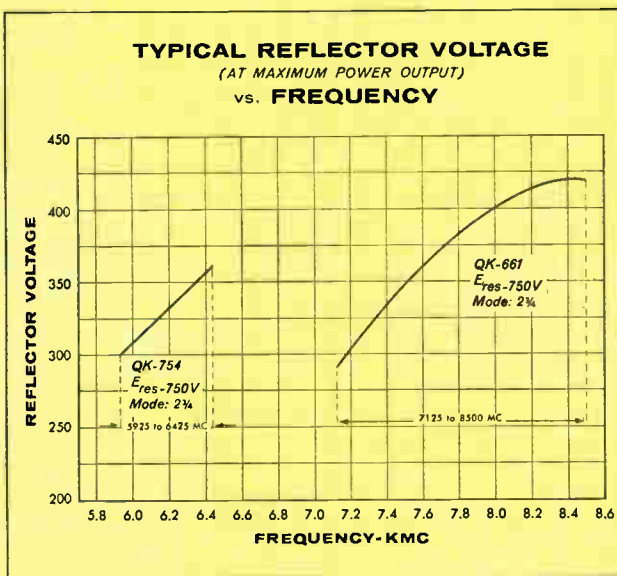

You can obtain detailed application information and special development services by contacting: Microwave and Power Tube Division, Raytheon Manufacturing Company, Waltham 54, Massachusetts

*Excellence in Electronics*



**A LEADER IN CREATIVE MICROWAVE TECHNOLOGY**

# HOW TO MEASURE VSWR

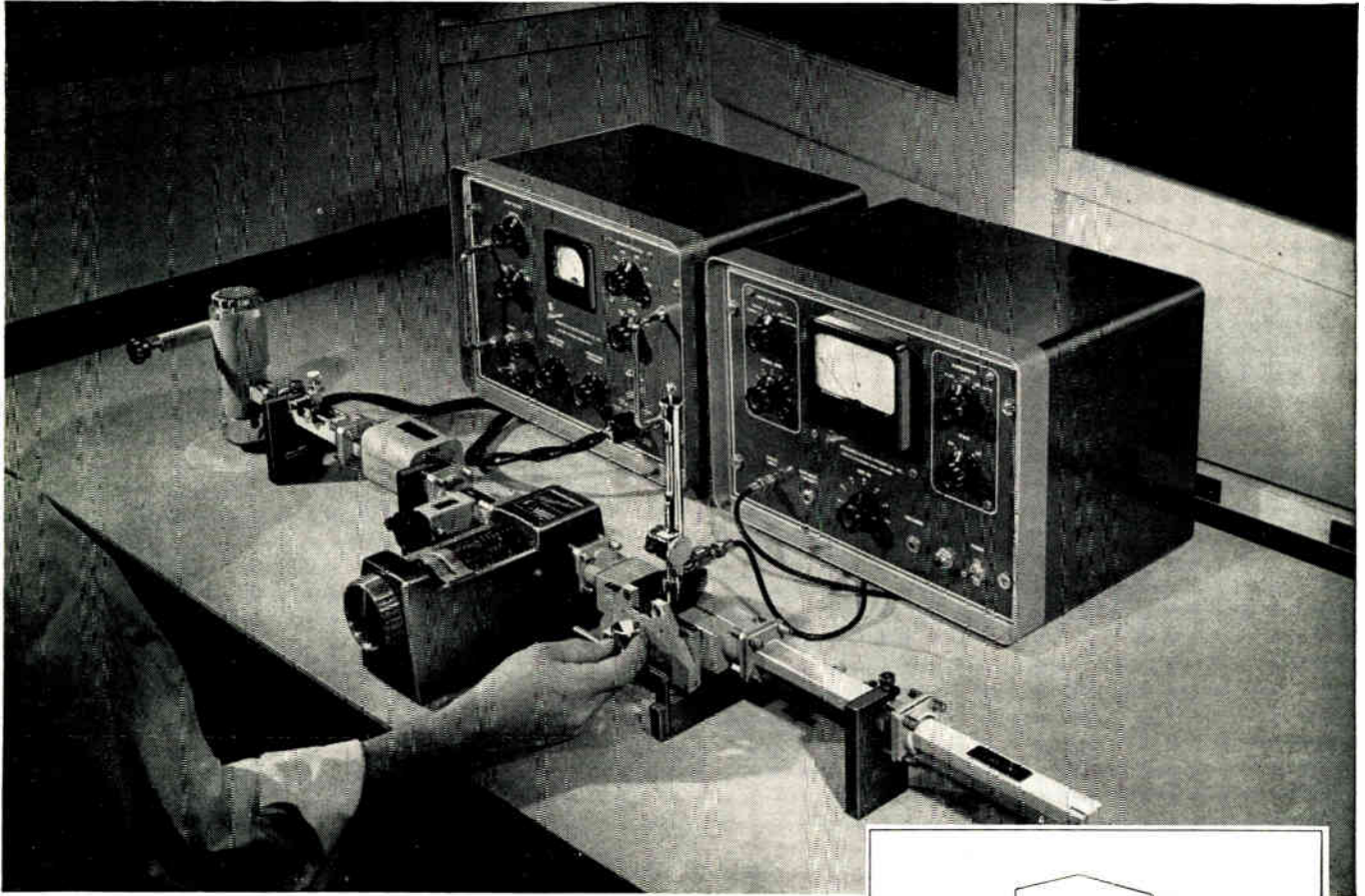

This microwave measurement bench is for the determination of Voltage Standing Wave Ratio using the slotted-line technique. Other systems utilizing directional couplers or magic tees for measurement of VSWR are known, but the use of the Slotted Section assures maximum accuracy.

Regardless of the technique used, accurate readings depend on the precision of the test instruments involved. When it comes to microwave test instruments PRD produces the widest range of the most precise equipment available anywhere in the world.

You will notice in the measurement bench shown that there are four test components separating the klystron tube mount from the Slotted Section. These are: A Slide Screw Tuner, ferrite Isolator, Level Set Attenuator, and a broadband direct reading Frequency Meter. THE USE OF THESE FOUR COMPONENTS IN THE TEST LINE IS MANDATORY FOR PRECISE VSWR MEASUREMENTS!

The reason for this is clear when you consider the interrelationship between VSWR, power, and frequency.

The Slide Screw Tuner is used to match the klystron output to that of the tandem test line, thereby maximizing its output and increasing its stability.

The use of the ferrite Isolator assures klystron frequency and power stability by shielding the source generator from changes in impedance further down the line. It accomplishes this with negligible attenuation of the incident power. The Level Set Attenuator is used to adjust the amount of power feeding the remainder of the test line.

The reaction Frequency Meter accurately monitors the output of the klystron by a resonant dip on the Standing Wave Amplifier.

A Slotted Section, tuned Broadband Probe, Standing Wave Amplifier, and matched Termination complete the precision waveguide, X-band, VSWR bench. A Klystron Power Supply to provide the signal source with power and modulation and a Fixed Waveguide Attenuator to simulate the unknown are also shown.

Special problems in VSWR and other related measurements? — Contact our Applications Engineering Department.

We at PRD have pioneered the development of precision microwave test instruments . . . PRD is the only pioneer company today producing microwave test instruments exclusively. In fact, we're just about the largest microwave company in the world . . . our cable address is MICROWAVE, New York, USA.

For technical details and specifications covering products shown write:

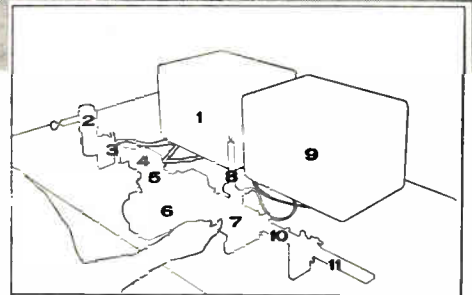

## TEST INSTRUMENTS USED IN THIS X-BAND VSWR BENCH

- 1—809 Klystron Power Supply, catalog page F-10
- 2—703 Shielded Tube Mount, catalog page F-8
- 3—303-A Slide Screw Tuner, catalog page B-14
- 4—1203 Isolator, catalog page A-21
- 5—159-A Level Set Attenuator, catalog page A-17
- 6—535 Frequency Meter, catalog page D-12
- 7—203-D Slotted Section, catalog page B-11
- 8—250-A Broadband Probe, catalog page B-12
- 9—277-A Standing Wave Amplifier, catalog page E-7
- 10—UNKNOWN—represented by a 140 Fixed Waveguide Attenuator, catalog page A-11
- 11—116-A Waveguide Termination, catalog page A-19

## MICROWAVE ENGINEERS-SCIENTISTS

Positions offering stimulating challenges with unlimited potential are now open at PRD. Please address all inquiries to Mr. A. E. Spruck, PRD, 202 Tillary Street, Brooklyn 1, New York.



## Polytechnic Research and Development Co., Inc.

202 Tillary Street, Brooklyn 1, New York. Telephone: ULster 2-6800

West Coast Office: 2639 So. La Cienega Blvd., Los Angeles 34, California. Telephone: TExas 0-1940



# **NEW** HIGH VOLTAGE NPN TRANSISTORS ALLOW TUBE REPLACEMENT AND CIRCUIT COMPATIBILITY



ACTUAL  
SIZE

GT's new high voltage germanium alloyed junction transistors now allow the same optimization as formerly could be realized only with vacuum tubes. These characteristics plus conventional "transistor" advantages offer new design opportunities in computers, magnetic memory cores, data processing equipment, gas filled indicator tubes and other applications where reduction of space, weight and high reliability are prime requisites.

The GT 1200 is particularly suited to drive gas filled display tubes, such as the Burroughs Nixie® and Pixie®, without changing existing circuitry other than altering voltages so as not to exceed the rating of the transistor.

		GT 1200
Collector to Base Voltage (Emitter Open)	$I_c = 25 \mu A$	90 Volts Min.
Emitter to Base Voltage (Collector Open)	$I_e = 25 \mu A$	20 Volts Min.
Collector to Emitter Voltage (Punch Through)	$I_e = 25 \mu A$	90 Volts Min.

Supplied in T0-9 case

GT 1201 — GT 1202, in addition to driving gas filled display tubes, are ideally suited for driving high inductance loads, driving transformer coupled loads and allow more nearly perfect impedance matching. These transistors are fast devices capable of handling high impedance loads and large signal swings.

	GT 1201	GT 1202
Collector to Base Voltage (Emitter Open)	$I_c = 25 \mu A$ 75 Volts Min.	45 Volts Min.
Emitter to Base Voltage (Collector Open)	$I_e = 25 \mu A$ 20 Volts Min.	20 Volts Min.
Collector to Emitter Voltage (Punch Through)	$I_e = 25 \mu A$ 75 Volts Min.	45 Volts Min.

Supplied in T0-9 case

Write today for Bulletin GT 1200



## GENERAL TRANSISTOR

C O R P O R A T I O N

91-27 138TH PLACE

JAMAICA 35,

NEW YORK

IN CANADA: DESSER E-E LTD., 441 ST. FRANCIS XAVIER, MONTREAL 1, QUEBEC. FOR IMMEDIATE DELIVERY FROM STOCK, CONTACT YOUR NEAREST AUTHORIZED TRANSISTOR DISTRIBUTOR OR GENERAL TRANSISTOR DISTRIBUTING CORP., 91-27 138TH PLACE, JAMAICA 35 NEW YORK. FOR EXPORT: GENERAL TRANSISTOR INTERNATIONAL CORP., 91-27 138TH PLACE, JAMAICA 35, NEW YORK.

©N

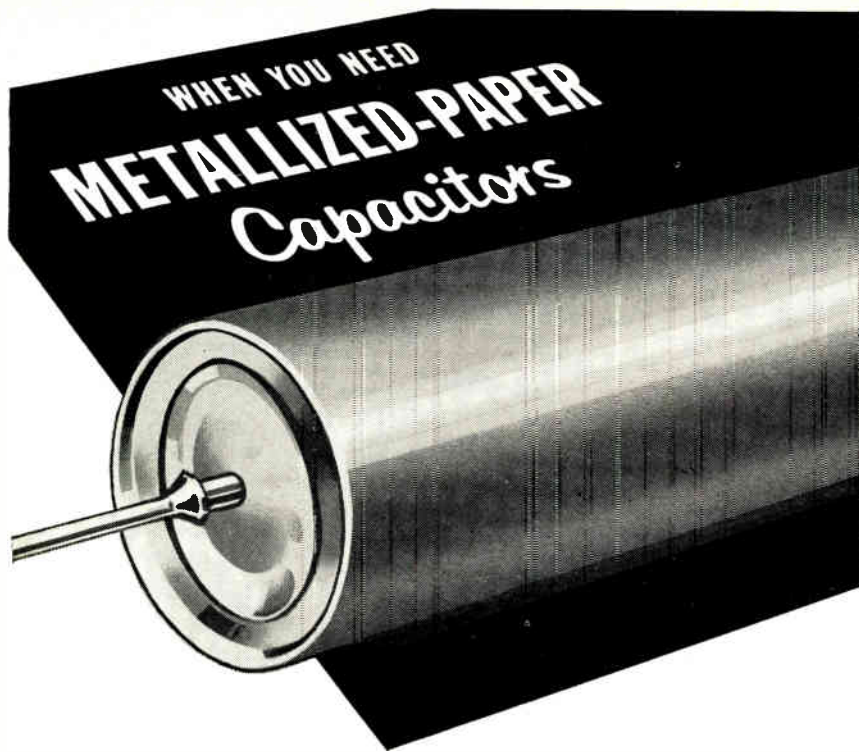

for MINIMUM SIZE

... the exceptionally reduced sizes and light-weight of Aerovox metallized-paper capacitors makes them ideal for those applications where space is at a premium.

for MAXIMUM PERFORMANCE

... the unique properties of Aerovox metallized-paper capacitors—ruggedness, reliability, and high safety factor assure you of longer equipment life.

for WIDEST OPERATING TEMPERATURES

... Aerovox metallized-paper capacitors are available in a wide variety of case styles for operation at temperatures ranging from  $-65^{\circ}\text{C}$  to  $-125^{\circ}\text{C}$ .

Complex electronic equipment such as guided missiles, computers, airborne receivers, transistorized radios and color TV have successfully applied Aerovox metallized-paper capacitors. You are invited to consult with our capacitor specialists for experienced assistance in selecting the right metallized-paper capacitor for your particular needs. Complete detailed information, quotations, delivery schedules, available on written request.

**AVAILABLE NOW...**

**50 VDC METALLIZED — PAPER  
MINIATURE CAPACITORS**

**AEROVOX CORPORATION**  
NEW BEDFORD, MASSACHUSETTS

In Canada: AEROVOX CANADA LTD., Hamilton, Ont.

**New Products**

### AIRBORNE RECEIVER

The rack type ATR-100 contains 4 type 1403 Airborne Receivers, one type SDU-203 Spectrum Display Unit and one Type CSD-170 Crystal Storage Drawer. The Type 1403 receivers

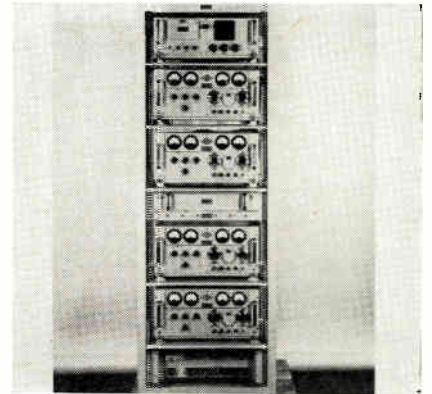

are double superheterodyne type with a noise figure of less than 8db. They incorporate phase-lock detection and offer a choice of 2 sec. i-f amplifiers of different bandwidths, one of 500kc at the 3db points with an attenuation of 60 db 500 KC each side of center frequency and the other of 100kc with better than 60db attenuation 250kc each side of center frequency. Nems-Clark Co., 919 Jesup-Blair Dr., Silver Springs, Md.

Circle 205 on Inquiry Card, page 105

### X-Y RECORDERS

Recorder consists of a basic plotter with separate input modules for general purpose, computer, low-level differential, time base, curve following, and other specialized functions. Improvements include faster slewing speeds, greater accuracies, 0.05% internal calibration, 10  $\mu\text{v}$  sensitivity,



internal Zener diode reference, improved vacuum hold down system, vernier control between ranges, remote operation of function modules. Electro Instruments, Inc., 3540 Aero Court, San Diego 11, California.

Circle 206 on Inquiry Card, page 105



<b>New</b>	
	<b>Products</b>

### POWER SUPPLY

High-voltage power supply units are used in precision spectroscopy and fast coincidence applications using 14-stage photomultiplier tubes. The HV25 series has an output volt-

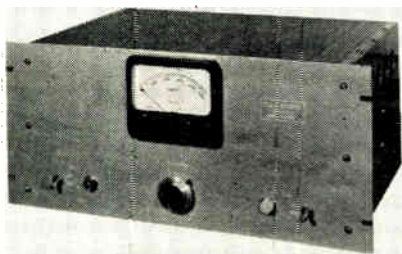

age range of 800-2500 v; the HV 15 series, a range of 400-1500 v. Both types can deliver an output current of 8 ma and both have a polarity-reversing switch. Plug-in units T-2 for temperature and/or C-1 for chopper stabilization, may be added to the HV 15 or HV 25 power supply units at any time, without making wiring changes. The Victoreen Instrument Co., 5806 Hough Ave., Cleveland 3, Ohio.

Circle 207 on Inquiry Card, page 105

### CABLE

Intercommunication cable has color-coded, paired copper conductors in Size No. 22 AWG. It is designed for intercom, annunciator, telephone, and call systems; also data processing equipment and industrial automation. It comes in pairs of 6, 11, 16, 26, and 51. Insulation is Flamenol (poly-

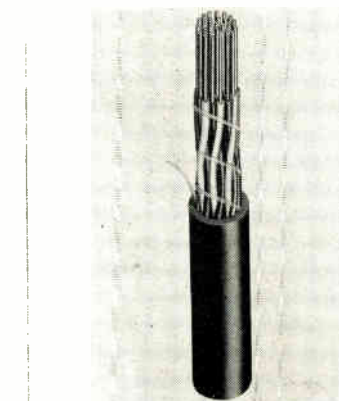

vinyl chloride). The over-all jacket is a tough Flamenol. Stripping is made easy by the use of a nylon rip cord under the jacket. General Electric Co., Wire & Cable Dept., Bridgeport 2, Conn.

Circle 208 on Inquiry Card, page 105

# for **SSB** transmissions: a new rapid test instrument

- incredibly simple to operate
- compact complete unit occupies only 19 1/4" of panel height
- exceptionally low-priced



## PANORAMIC'S SSB-3

### a sensitive spectrum analyzer

Panoramic's Model  
SB-12a Analyzer

Now, Panoramic has incorporated in one convenient package the equipment you need to set up . . . adjust . . . monitor . . . trouble-shoot SSB and AM transmissions.

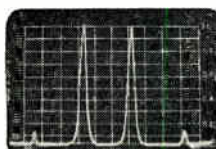

**Two Tone Test\***  
Fixed sweep width 2000 cps. Full scale log sideband tones 1.5 kc and 2.1 kc from carrier (not shown). Odd order I.M. distortion products down 37 db.

#### Hum Test\*

Indication of one sideband in above photo increased 20 db. Sweep width set to 150 cps reveals hum sidebands down 54 db and 60 db.

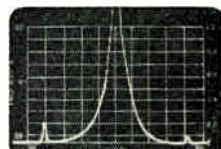

- pre-set sweep widths of 150, 500, 2000, 10,000 and 30,000 cps with automatic optimum resolution for fast, easy operation
- continuously variable sweep width up to 100 kc for additional flexibility
- 60 db dynamic range
- 60 cps hum sidebands measurable to -60 db
- high order sweep stability through AFC network
- precisely calibrated lin and log amplitude scales
- standard 5" CRT with camera mount bezel
- two auxiliary outputs for chart recorder or large screen CRT

### a stable tuning head

- 2 mc to 39 mc range with direct reading dial free of hum modulation

### a two-tone generator

- two separate audio oscillators with independent frequency and amplitude controls
- output 2 volts max. per tone into 600 ohm load, combined in linear mixer
- I.M. of two tones less than -60 db

### internal calibrating circuitry

- two RF signal sources simulate two-tone test and check internal distortion and hum of analyzer
- center frequency marker with external AM provisions for sweep width calibrations

★ See Panoramic Analyzer No. 3 describing testing techniques, etc., for single sidebands. A copy is yours for the asking.



Write, wire, phone RIGHT NOW for technical bulletin and prices on the new SSB-3. Panoramic instruments are PROVED PERFORMERS in laboratories, plants and military installations all over the world. Send for our new CATALOG DIGEST and ask to be put on our regular mailing list for the PANORAMIC ANALYZER featuring application data.

540 South Fulton Avenue, Mount Vernon, N. Y.

Phone: OWens 9-4600

Cables: Panoramic, Mount Vernon, N. Y. State

# ETC New Rack-Panel Oscilloscope that opens new testing horizons

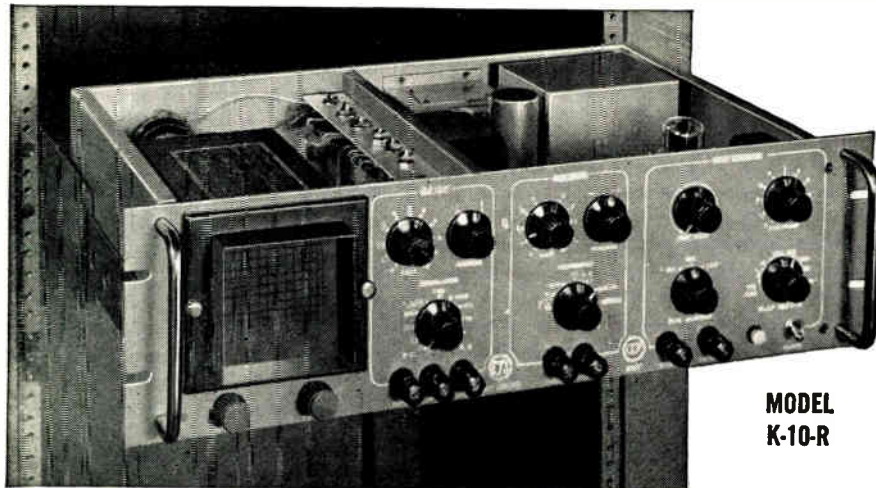

MODEL  
K-10-R

## 5" scope performance

WITH A NEW 3½"  
SQUARE TUBE

### HIGHLIGHT SPECIFICATIONS

- CRT type 41HAP1.
- 115 v. A.C., 60-400 cyc. ±10%.
- Sensitivity: .028 v./in. (vertical amplifier), 0.3 v./in. (horizontal) P/P.
- Frequency response flat to D.C.; vert. amplifier 3db @ 300 kc.; horiz. amplifier 10% @ 100 kc.
- Input impedance 2 megohms, 40 μf.
- Linear sweep time base 2 cps. to 30 kc., 0.5 sec. to 33 μsec.
- Amplitude 0.1 v. P/P. Square wave at power line frequency. Accuracy overall ±1%.
- 5.25" high x 19" wide x 11.375" deep.
- Printed circuits.

WRITE FOR  
COMPLETE  
SPECI-  
FICATIONS



... GIVES SO MUCH, IN SUCH LITTLE  
SPACE ... AT SO LOW A PRICE

Here, at last, is a full quality, truly professional 'scope priced within easy reach ... and designed to a size that can be used in practically any rack-mounting set-up, even where space is distinctly limited.

The "heart" of this miniaturized ETC Model K-10-R assembly is its unique ETC Type 41HAP1 square-faced 3½ C-R tube. This provides a raster size equivalent to that of a conventional 5" round tube.

Operational features of the K-10-R far exceed those of ordinary 'scopes of comparable size or price.

### Headquarters for MULTI-BEAM OSCILLOGRAPHY and dependable C-R Tubes

Standard and special ETC oscilloscopes range from single-channel styles such as the K-10-R (above) to types recording from 2 to 8 channels on a single tube face. ETC Cathode Ray Tubes range from single-gun to 10-gun types. Write for catalog.

## New Products

### DIGITAL DECODER

Electro-mechanical decoder, HS-59, can be set to respond to any one of 20 million combinations of coded digital pulses. The code can be changed without using tools in less than 1

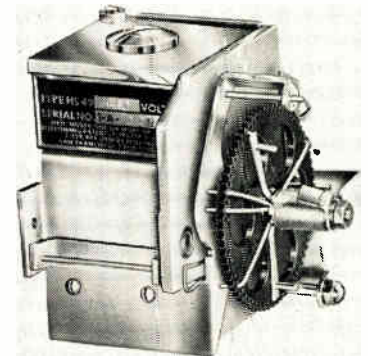

min. The decoder is a redesign of the Secode 49HS decoder which had a code capacity of some 300,000 different combinations. Both types are intended for use where remote signaling or control is required and where a telephone dial or similar pulse producing device is used for transmission of coded information. Secode Corp., 555 Minnesota St., San Francisco, Calif.

Circle 209 on Inquiry Card, page 105

### SILICONE RUBBER

Silicone rubber product, Cohrlastic FSR, is a form of silicone rubber, fibrous in nature, somewhat resembling sponge and foam in properties. Properties include: high permeability, good tear resistance, good tensile strength, density in the range of 20 lbs/cu. ft., good compression-deflec-

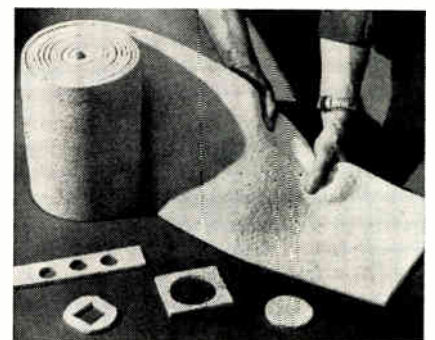

tion characteristics, and useable temperature range -65° F to 500° F. It is available in sheets ¼ in. thick, 9 in. wide and 6 ft. long. The Connecticut Hard Rubber Co., 407 East St., New Haven 9, Conn.

Circle 210 on Inquiry Card, page 105

# electronic tube corporation

1200 E. MERMAID LANE

PHILADELPHIA 18, PENNA.



# NOW AVAILABLE FROM FILTERS, THE LEADER

# NEW

**First AC Powrmite<sup>®</sup> Micro-Miniature Relay**



# NEW

**First Relays with built-in arc suppressed coil**



# NEW

**AC Sub-Miniature Relays**



# NEW

**.2 Grid Space Powrmite Micro-Miniature Relays with new "Sensi-Tork" motor**



**New! First AC Powrmite micro-miniature relay.** The new Powrmite crystal can micro-miniature relay is the smallest, lightest AC relay made today.

**New! First relays with built-in arc suppressed coil.** In the same micro-miniature size Filters' Powrmite is also made with a built-in arc suppressed coil to cut radio interference a minimum of ten to one. Available also in four and six-pole sub-miniature relays, Filters arc suppressed relays increase life and reliability of associated circuitry.

**New! AC sub-miniature relays.** Filters now manufactures the smallest, lightest four and six-pole sub-miniature hermetically sealed relays for AC operation.

**New! .2 grid space Powrmite micro-miniature relays.** All types of Filters Powrmite micro-miniature relays are now available in .2 grid space in all mounting styles; .2 grid space relays feature Filters new "Sensi-Tork" motor, a Filters development for greatest reliability and sensitivity.

Filters, the leader, and specialist in the development and manufacture of micro and sub-miniature rotary relays makes a complete line of general purpose, latching (both 2, 4 and 6 DPDT) and 5/8" sub-miniature hermetically sealed relays. The Powrmite, Filters' popular micro-miniature relay, has long been acclaimed by hundreds of users as the most reliable in the field. Write for catalog!

Leading manufacturer of hermetically sealed rotary micro and sub-miniature relays.

Main office and plant: Port Washington, N. Y.: POrt Washington 7-8220.  
West coast office: 13273 Ventura Blvd., Studio City, Calif.: STANley 3-2770

## **FILTERS, INC.**

Circle 123 on Inquiry Card, page 105

Quan-Tech's Transistor-Regulated Power Supplies



Model 103

# POWER SUPPLY SPECIFICATIONS

you can count on!

You'll find Quan-Tech's low voltage, precisely-regulated power supplies ideal for laboratory use and for specific applications. So lightweight and compact. Take only a minimum of bench space. Short-circuit current is held to a safe value, *automatically*.

Four models regulated from  $\pm 0.25\%$  or  $\pm 25$  millivolts for line and load combined. Feature low ripple, low internal impedance, small size ( $8\frac{1}{4}'' \times 5'' \times 6\frac{3}{4}''$  deep; weight,  $7\frac{1}{2}$  lbs.).

- MODEL 101 0-8 v. DC, 0-2 amps. . . Price \$195
- MODEL 102 0-14 v. DC, 0-1 amp. . . Price \$175
- MODEL 103 0-30 v. DC, 0- $\frac{1}{2}$  amp. . . Price \$175
- MODEL 105 0-50 v. DC, 0- $\frac{1}{4}$  amp. . . Price \$205
- Also
- MODEL 104 0-50 v. DC, 0-1 amp. . . Price \$375

All models, racks, special units — including closer regulation, current metering, etc. — furnished to your specifications.

Write or call us for complete information!



**QUAN-TECH LABORATORIES**

**Morristown, New Jersey**

Circle 49 on Inquiry Card, page 105

## HIGH-Q



# KELVIN TOROID INDUCTORS

rapid delivery on prototype and production quantities

High Q factors, excellent stability vs. temperature and current, and self-shielding effects are the main features of Kelvin toroid inductors wound on molybdenum permalloy dust cores.

The coils are supplied to the exact inductance required at *no extra charge*. Standard inductance tolerance is  $\pm 1\%$ .

Available in three forms:

UNCASED, with protective wax coating.

HERMETICALLY SEALED in steel cases to MIL-T-27A specifications.

ENCAPSULATED in hi-temp plastic to withstand extreme humidity and severe mechanical shock.



Send for bulletin KT-1

5907 Noble Ave., Van Nuys, Calif. • STanley 3-2666 • STate 2-6662

## New Products

### AMPLIFIER KLYSTRON

VA-802 is 1 kw, CW, air-cooled, 4-cavity klystron. It can be continuously tuned for 1700 to 2400 MC and is focused with a permanent magnet. It has been designed for application

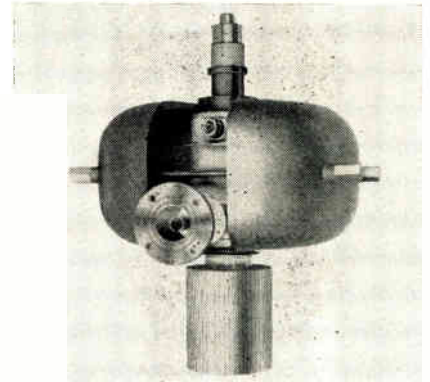

in forward scatter communication systems. Power Gain: 40 to 50 db; Power Output into flat line: (VSWR = 1.1 or less) 1000 w; r-f Drive Power—for maximum efficiency tuning: 0.1 w max.; Efficiency: typical: 40%; Operating Bandwidth Sync tuned: 4 MC, Stagger tuned: 6-8 MC; Beam Voltage: 6 kv; Beam Current: 500 ma. Varian Associates, 611 Hansen Way, Palo Alto, Calif.

Circle 211 on Inquiry Card, page 105

### RESISTOR

Hermetically sealed, deposited carbon resistor, DCH-5, is pure crystalline carbon, deposited on a ceramic rod. No binder or filler is used. It has a class A seal. Rated at 5 watts, it measures  $4\frac{1}{4} \times 9/16$  in. and the resistance range is from 100 ohms to 150 Megohms. It is rated at 100% power up to 70° C. and derates to 0

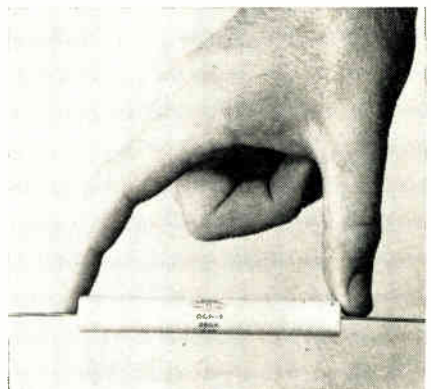

at 160° C. Standard tolerance is  $\pm 1.0\%$ . It can be either lead or clip mounted. It has two axial terminals treated to facilitate soldering. Dale Products, Inc., Box 136, Columbus, Nebraska.

Circle 212 on Inquiry Card, page 105



# I-T-E CAN SUPPLY ALL YOUR LARGE WAVEGUIDE TEST EQUIPMENT

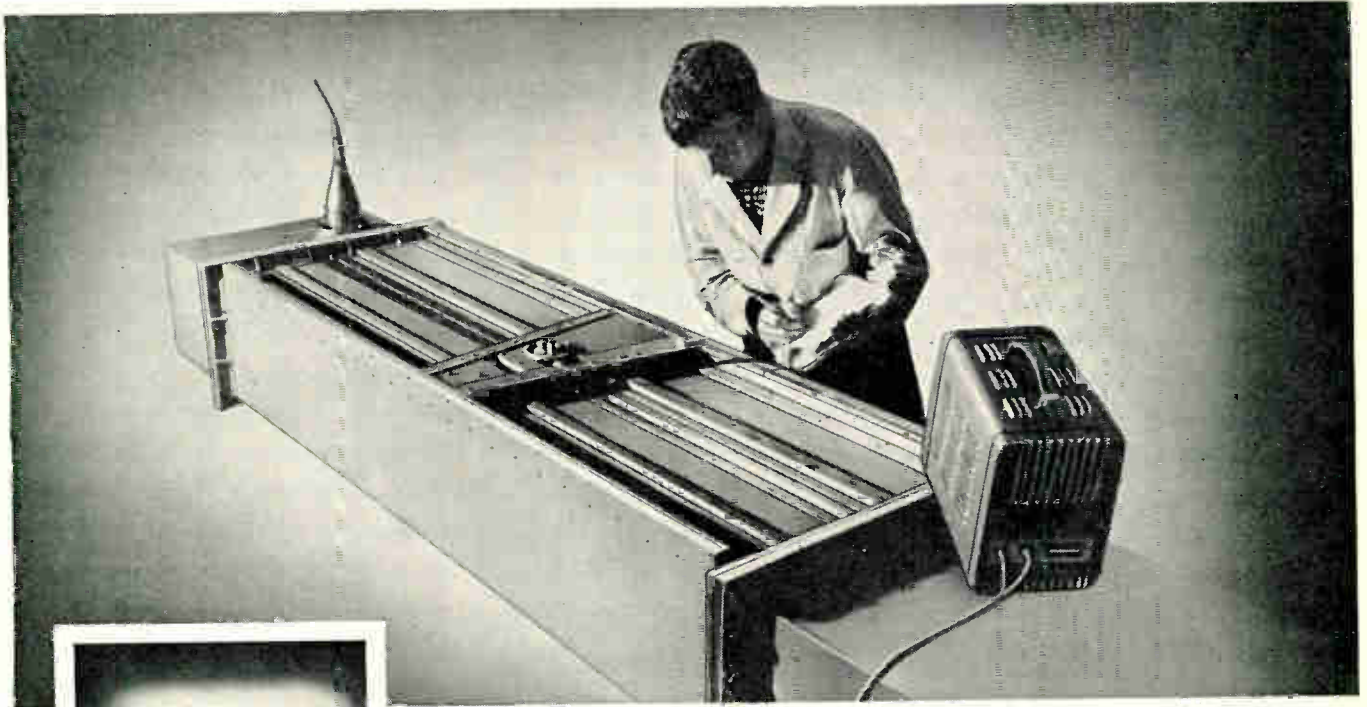

**Slotted lines** are supplied complete with probe and carriage. Residual SWR is less than 1.02:1 over the frequency band. Available in sizes WR770 through WR2300.

Here are a few examples of the waveguide test equipment and components currently available from I-T-E to meet the testing and operating requirements of multi-megawatt radar and scatter communications systems. This equipment reflects I-T-E's broad experience in all phases of large waveguide design and manufacture.

Take advantage of I-T-E's specialized knowledge of waveguide testing and the precision fabrication capabilities of a specially equipped waveguide shop. Facilities such as these assure you of the highest standards of quality, maximum economy, and excellent delivery—in single or production quantities.

If you have a requirement or problem relating to waveguide test equipment, write I-T-E Special Products Division, 601 E. Erie Ave., Philadelphia 34, Pa. And ask for your copy of free-space wave length vs. guide wave length conversion tables for large waveguide.

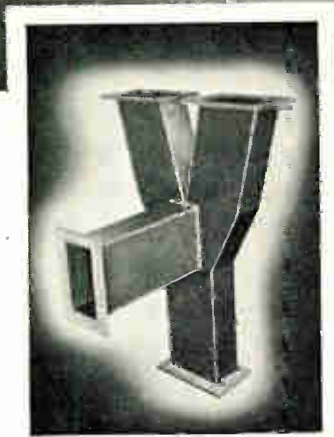

**Folded hybrid tee**

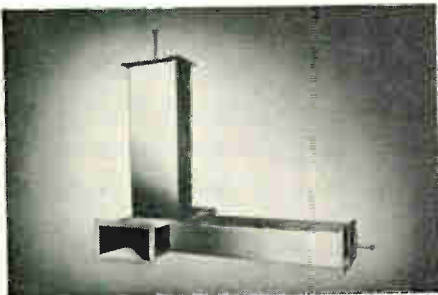

**E-H plane tuner**

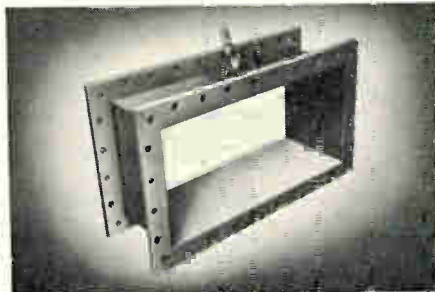

**Close-loop directional coupler**

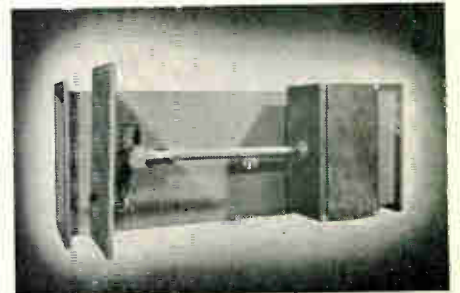

**Motorized short circuit section**



**I-T-E CIRCUIT BREAKER COMPANY**  
Special Products Division • 601 E. Erie Avenue • Philadelphia 34, Pa.

# another Potter First



**THE  
NEW POTTER "909"**

**Now...** a device that **READS** and **STOPS** faster, better

The compact '909' Perforated Tape Strip Reader now makes it possible to process information from perforated tape into digital data computer systems at high speed and low cost. Simple to operate by clerical personnel, the '909' is completely transistorized, and will give maximum performance with complete reliability.

The '909' is a compact unit, suitable for console or rack mounting. Here are some of the performance features, available for the first time in equipment of this type:

- Character reading speeds up to 1000 char/sec.
- Simple In-Line threading
- 3 Millisec starting time
- Stops on STOP Character, (0.2 millisec) and will read next character after start
- 100 x 10" operation pinch roll
- Photo Diode Head reads any tape (including oiled yellow teletype tape)
- Reads 5, 6, 7 or 8 level tape with sprocket channel
- Ambient temperature up to 125° F. with 10,000 hour life
- Built to meet requirements of MIL-E-4158A

### Specifications

**Tape Speed:**

10 to 100 ips

**Tape Width:**

Any Standard Width

**Power Requirements:**

115V, 60 Cycle, 1 Phase

**Control:**

Remote/Level Inputs

Contact your Potter representative or call or write direct for further information.



The mark of  
Engineering Quality

**POTTER INSTRUMENT COMPANY, INC.**

Sunnyside Boulevard, Plainview, N. Y.  
Overbrook 1-3200

Potter has career opportunities for qualified engineers who like a challenge, and the freedom to meet it.

<b>New</b>	
	<b>Products</b>

### POTENTIOMETER

All-metal precision multi-turn potentiometer, Model 590, withstands temperatures of 200° C. It is available in ranges from 25 to 120,000 ohms. Standard linearity tolerance is

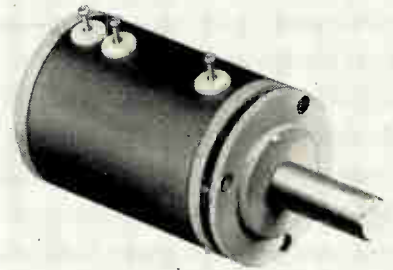

±0.3%. The 1 in. diameter unit operates over a temperature range of -65° C to +200° C. It will operate in a relative humidity of 95%. It functions above 20g vibration from 55 to 2000 cps, withstands a 30g shock and meets all specifications to an altitude of 30,000 ft. Spectrol Electronics Corp., 1704 S. Del Mar Ave., San Gabriel, Calif.

Circle 213 on Inquiry Card, page 105

### OSCILLATOR

Model RD-146, 1 MC High Stability Oscillator, features a calibrated trimmer control for making accurate frequency adjustments against crystal aging without comparison to another



standard. The dial (readability accuracy better than 2 parts in 10<sup>6</sup>), may be related to the known drift rate and may be varied and set over 6 cycles. It employs a quartz resonator under proportional oven control, furnishes a 1 MC output stabilized to better than 1 part in 10<sup>6</sup> per day. Modification in operating frequency from 0.8 to 1.2 MC may be furnished. Manson Laboratories, Inc., Dept. G, Box 1214, 375 Fairfield Ave., Stamford, Conn.

Circle 214 on Inquiry Card, page 105



It could  
happen...

with

**El-Menco**  
**CAPACITORS!**

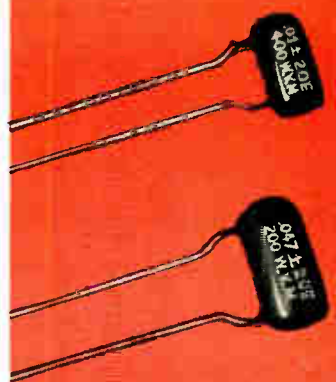
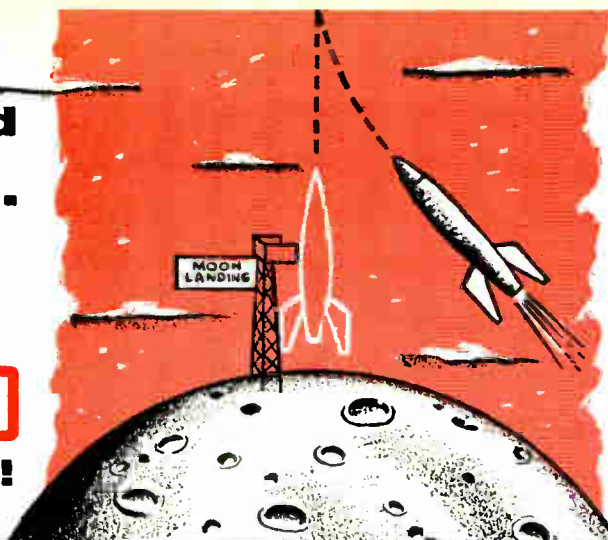

**NEW**

*Mylar-Paper Dipped*

**CAPACITORS**

**TYPE  
MPD**

**INSURE FAILURE-PROOF PERFORMANCE!**

**Only 1 Failure in 7,168,000 Unit-Hours for 0.1 MFD Capacitors\***

**Setting a new standard of reliability!**

\*Life tests have proved that El-Menco Mylar-Paper Dipped Capacitors — tested at 100°C with rated voltage applied — have yielded a failure rate of only 1 per 716,800 unit-hours for 1 MFD. Since the number of unit-hours of these capacitors is inversely proportional to the capacitance, 0.1 MFD El-Menco Mylar-Paper Dipped Capacitors will yield **ONLY 1 FAILURE IN 7,168,000 UNIT-HOURS.**

**SUPERIOR FEATURES!**

• Five case sizes in working voltages and ranges:

200 WVDC —	.018 to .5 MFD
400 WVDC —	.0082 to .33 MFD
600 WVDC —	.0018 to .25 MFD
1000 WVDC —	.001 to .1 MMF
1600 WVDC —	.001 to .05 MFD

Write for Technical Brochure Giving Complete Information on the El-Menco Tubular Dur-Paper Line.

THESE CAPACITORS WILL EXCEED ALL THE ELECTRICAL REQUIREMENTS OF E.I.A. SPECIFICATION RS-164 AND MILITARY SPECIFICATIONS #MIL-C-91A AND MIL-C-25A.

FOR FAILURE-PROOF PERFORMANCE... COUNT ON EL-MENCO MYLAR-PAPER DIPPED CAPACITORS... FROM MISSILE GUIDANCE SYSTEMS TO DATA PROCESSING EQUIPMENT!

\*Registered Trade Mark of DuPont Co.

**SPECIFICATIONS**

- **TOLERANCES:** ±10% and ±20%. Closer tolerances available on request.
- **INSULATION:** Durez phenolic resin impregnated.
- **LEADS:** No. 20 B & S (.032") annealed copper-weld crimped leads for printed circuit application.
- **DIELECTRIC STRENGTH:** 2 or 2½ times rated voltage, depending upon working voltage.
- **INSULATION RESISTANCE AT 25°C:** For .05MFD or less, 100,000 megohms minimum. Greater than .05 MFD, 5000 megohm-microfarads.
- **INSULATION RESISTANCE AT 100°C:** For .05MFD or less, 1400 megohms minimum. Greater than .05MFD, 70 megohm-microfarads.
- **POWER FACTOR AT 25°C:** 1.0% maximum at 1 KC.



**El-Menco**  
*Capacitors*

**THE ELECTRO MOTIVE MFG. CO., INC.**  
WILLIMANTIC CONNECTICUT

Manufacturers of El-Menco Capacitors

- molded mica • dipped mica • mica trimmer • dipped paper
- tubular paper • ceramic • silvered mica films • ceramic discs

Arco Electronics, Inc., 64 White St., New York 13, N. Y.  
Exclusive Supplier To Jobbers and Distributors in the U.S. and Canada



**Belden**

WIREMAKER FOR INDUSTRY SINCE 1902  
CHICAGO

WIRES · CABLES · CORDS

**WIRE**

### THE WIRE YOU NEED

- for EVERY ELECTRONIC application
- Correctly Rated—Quality Controlled

- for positive performance
- for the most complete line for all electronic applications
- for most advanced construction designs, insulations, and shieldings correctly service-rated
- for dependable uniformity under strictest quality control
- for complete information in an easy-to-read catalog
- for fast service

*You Can Depend on Belden . . . Ask Your Belden Jobber*

One Wire Source for  
Everything Electrical & Electronic

**Belden**  
WIREMAKER FOR INDUSTRY  
SINCE 1902  
CHICAGO



Magnet Wire • Lead Wire • Power Supply Cords,  
Cord Sets and Portable Cord • Aircraft Wires  
Electrical Household Cords • Electronic Wires  
Welding Cable • Automotive Wire and Cable

08A0218



*Up-to-the-minute abstracts of articles appearing in the leading foreign electronic engineering journals*



## ANTENNAS, PROPAGATION

**Lens Aerial Design, Simple Geometrical Method,** G. P. Foldes and L. Solymar. "E. & R. Eng." February 1959. 3 pps. A graphical method is described of designing a lens for an aerial that will realize a prescribed amplitude and phase distribution function in an aperture, when fed by a given primary source. (England.)

**Currents on Strip Aerials,** T. B. A. Senior. "E. & R. Eng." February 1959. 4 pps. An exact expression is obtained for the longitudinal distribution of current excited on a perfectly-conducting strip by a normally-incident plane wave, and computations are carried out for quarter and half-wave aerials. (England.)



## CIRCUITS

**The Automatic Compensator as d.c. Amplifier,** W. Luck. "El. Rund." February 1959. 3 pps. Static and dynamic features of electronically balanced d.c. compensators are deduced and hints for their optimal design given. Considerations of frequency response demonstrate the great influence of internal amplification on the transfer characteristic. The equations for the bandwidth make it clear, that the scope of application for the compensator as d.c. amplifier with particularly low drift can essentially be appreciably extended. Normalized diagrams show the transfer properties of the compensator amplifier. (Germany.)

**Considerations of the Stability of Oscillators,** G. Forster and W. Spyra. "El. Rund." February 1959. 5 pp. The stability of oscillator circuits depends on many factors some of which are examined in detail and calculated. Although these results may generally be used, research has been carried out especially with oscillators of TV tuners in a frequency range of about 200 mc/s. The main result obtained is that the Q factor of the resonant circuit should be as high as possible. Accordingly, the coupling between valve and resonant circuit of the oscillator, which may be variable, for instance, by the load capacitance of the grid without additional capacitance, should be as small as possible. Formulae are given for its optimal design. (Germany.)

**Network Function Approximation,** H. Debart. "Cab. & Trans." January 1959. 13 pp. The object of this paper is to propose a new method, combining the advantages of the previously known ones. Essentially, it is a unit-radiation circle approximation method, adaptable to the Lee Wiener or Darlington transformation. (France.)

**Diode Phase Detectors, Characteristics of Simple and Balanced Push-Pull Circuits,** S. Krishman. "E. & R. Eng." February 1959. 6 pp. A theory common to diode phase-meters and phase-sensitive detectors is worked out for two types generally known as the simple push-pull and the balanced push-pull detectors. The general case of unequal sinusoidal voltages being compared for phase is discussed and it is shown that equality of the two comparison voltages, assumed by previous workers to be the most suitable for phase-meter use, is inconvenient in certain cases. (England.)

**Network Synthesis, Balanced Asymmetrical RC Types,** J. T. Allanson. "E. & R. Eng." February 1959. 4 pp. A method is outlined for the synthesis of RC networks which are balanced with respect to earth but are asymmetrical, and it is shown that such networks may have a lower pad loss than the corresponding symmetrical lattice. (England.)

**The Pentode Gyrator,** Gerald E. Sharpe. "ATE J." October 1958. 4 pp. A gyrator may be constructed from four pentodes, no other network element being necessary. The method is based on a theory of ideal active elements recently proposed by the author. (England.)

**Some Aspects of Permeability Tuning,** W. D. Meewezen. "J. BIRE." January 1959. 14 pp. First permeability tuned circuits are analyzed and compared with capacitance tuned circuits. Second the paper deals with the construction of permeability tuners. Finally, a tuner is described which features an adjustable tuning law, as well as approaching the ideal linear frequency law more closely than do most of the commercially used tuning capacitors. (England.)

**Application of Magnetic Amplifiers to Engineering Problems,** A. D. Cawdery and H. T. Carden. "Brit. C. & E." March 1959. 5 pp. The purpose of this article is to consider the magnetic amplifier from the point of view of the project engineer. It is not an attempt to give rigorous design information but to consider the selection of a magnetic amplifier for a particular application. The various types of magnetic amplifier connection in present-day practice are discussed and a typical application of each is presented. (England.)

## REGULARLY REVIEWED

### AUSTRALIA

AWA Tech. Rev. AWA Technical Review  
Proc. AIRE. Proceedings of the Institute of Radio Engineers

### CANADA

Can. Elec. Eng. Canadian Electronics Engineering  
El. & Comm. Electronics and Communications

### ENGLAND

ATE J. ATE Journal  
BBC Mono. BBC Engineering Monographs  
Brit. C.&E. British Communications & Electronics  
E. & R. Eng. Electronic & Radio Engineer  
El. Energy. Electrical Energy  
GEC J. General Electric Co. Journal  
J. BIRE. Journal of the British Institution of Radio Engineers  
Proc. BIEE. Proceedings of Institute of Electrical Engineers  
Tech. Comm. Technical Communications

### FRANCE

Ann. de Radio. Annales de Radioelectricite  
Bull. Fr. El. Bulletin de la Societe Francaise des Electriciens  
Cab. & Trans. Cables & Transmission  
Comp. Rend. Comptes Rendus Hebdomadaires des Seances  
Onde. L'Onde Electrique  
Rev. Tech. Revue Technique  
Telonde. Telonde  
Toute R. Toute la Radio  
Vide. Le Vide

### GERMANY

AEG Prog. AEG Progress  
Arc. El. Uber. Archiv der Elektrischen Uebertragung  
El. Rund. Elektronische Rundschau  
Freq. Frequenz  
Hochfreq. Hochfrequenz-technik und Elektroakustik  
NTF. Nachrichtentechnische Fachberichte  
Nach. Z. Nachrichtentechnische Zeitschrift  
Rundfunk. Rundfunktechnische Mitteilungen  
Vak. Tech. Vakuum-Technik

### POLAND

Arch. Auto. i Tel. Archiwum Automatyki i Telemehaniki  
Prace ITR. Prace Instytutu Tele-I Radiotechnicznego  
Roz. Elek. Rozprawy Electrotechniczne

### USSR

Avto. i Tel. Avtomatika i Telemehanika  
Radio. Radio  
Radiotek. Radiotekhnika  
Rad. i Elek. Radiotekhnika i Elektronika  
Iz. Acad. Bulletin of Academy of Sciences, USSR.

• Photocopies of all foreign articles are available at 50 cents per page, remitted with order. Unless otherwise indicated, articles appear in language native to country of origin.

• A reprint of this section, "International Electronic Sources" is available without charge.

Requests for the above should be sent, on company letterhead, to:

Electronic Sources Editor  
ELECTRONIC INDUSTRIES  
Chestnut & 56th Sts.  
Philadelphia 39, Pa.



## COMMUNICATIONS

**Interference Caused by Intermodulation Occurring at High Frequency in a Superheterodyne Receiver**, W. Rotkiewica and J. Temler. "Prace ITR." Vol. 2, No. 3. (6). The paper contains a description of phenomena accompanying high frequency signal intermodulation in a superheterodyne receiver, as well as a mathematical analysis and the results of investigations of these phenomena. (Poland.)

**Temperature Dependence of Carrier-Current Circuit Attenuation**, M. C. Fouilleul. "Cab. & Trans." January 1959. 10 pp. The variation law of attenuation as a function of temperature and frequency is derived from the experimental measurements. The obtained data may be applied to cables in actual operation and constitute valuable information for the design of temperature effect correcting networks. (France.)

**"Quality Management" and Its Application to Operational Quality Supervision of Complex Transmission Systems**, A. M. Gervaise. "Cab. & Trans." January 1959. 13 pp. The author shows how the well-known quality diagrams used for supervising mass production of simple elements may also be applied to quality supervision of complex systems, the application of statistical methods to which finds its justification in the very large number of elements involved in their overall performance. (France.)

**A Long-Distance Waveguide Telecommunication System**, L. Lewin. "Brit. C. & E." February 1959. 4 pp. A long-distance waveguide communication system is described using pulse code modulation on a millimeter wave carrier in helical-wound wave guide. A bandwidth capable of handling, for example, several hundred TV channels should ultimately be attainable. (England.)

**Long-Distance Transmission by Waveguide, an Introductory Survey**, H. E. M. Barlow. "Brit. C. & E." February 1959. 4 pp. (England.)

**A Transistor Private Telephone Exchange**, N. W. Morgalla. "ATE J." October 1958. 17 pp. The potentialities of transistor switching are explored in a laboratory telephone exchange equipped for ten subscribers' lines and two links. All normal facilities are provided but ringing is replaced by a musical tone to accommodate transistors in the speech path. (England.)

**"One-at-a-Time" Operation in Telephone Exchanges**, L. J. Murray. "ATE J." October 1958. 6 pp. The concept of handling calls one at a time by means of common control equipment is traced from its origins in single-position manual exchange working to proposed new systems using fast-operating electronic control equipment. (England.)

**Downcoming Radio Waves, Measurement of Characteristics**, James R. Wait. "E. & R. Eng." March 1959. 2 pp. This article outlines a scheme for measuring the angle of arrival, azimuth, and polarization of a downcoming radio wave. (England.)

**A Modern Frequency Shift Telegraph Receiver**, E. J. Allen. "El. Eng." March 1959. 4 pp. The article describes a radio telegraph receiver which is claimed to represent an entirely new approach to high-grade h.f. radio teleprinter reception. (England.)

**An Electronic Coder and Decoder for Teleprinter Signals**, J. Das. "El. Eng." March 1959. 5 pp. The coding and decoding of messages as used in teleprinters have been simulated with electronic circuits. (England.)



## COMPONENTS

**The Efficiency of Modern Dry Rectifiers**, H. Dornheim. "El. Rund." February 1959. 2 pp. The general calculation of conventional circuit efficiency is given, in addition electrical data of selenium, silicon and germanium rectifiers is given and their efficiency compared. (Germany.)

**A Timing Relay with Velocity Dependent Delay**, A. Voget. "El. Rund." February 1959. 3 pp. The article shows how a (hyperbola) function of reciprocal proportionality i.e. velocity, may be replaced by an exponential, in which range this equivalent function still has permissible errors, and the design of a simple timing relay with velocity dependent delay. (Germany.)

**H. F. Exponential-Line Transformers**, S. G. Young. "E. & R. Eng." February 1959. 5 pp. The mathematical theory of an exponential line is summarized and a practical method for designing such lines is described. (England.)

**Electronic Components in Relation to Design**, R. Walsh. "ATE J." October 1958. 6 pp. Research has contributed a modern range of electronic components having new qualities. The complementary and contradictory characteristics of these qualities when in association, are discussed. (England.)

**Sealed Contact Reed Relays**, J. G. Bannochie and R. A. E. Furse. "ATE J." October 1958. 12 pp. This article introduces the topic of sealed contact reed relays and describes briefly the construction and properties of two types with which the authors have been concerned. (England.)

**Saturable-Transformer Switches**, Brian D. Simmons. "E. & R. Eng." March 1959. 9 pp. Details are given of the design and construction of a saturable transformer used in a selection system, in which a large number of magnetic-drum heads share common read and write amplifiers. (England.)

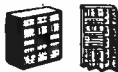

## COMPUTERS

**Digital Techniques for Small Computations**, Yngvar Lundh. "J. BIRE." January 1959. 8 pp. A special digital method of computation of simple algebraic functions of 1 to 4 variables is described and analyzed. The system is programmed by interconnection of units according to a block diagram formulation of the problem. The calculation speed is relatively low, but the logical design is very simple. (England.)

**A Fast Method of Reading Magnetic-Core Memories**, H. J. Heijn and N. C. de Troye. "Phil. Tech." 10 Feb. 1959. 15 pp. A memory system is described which contains 1024 words of 44 bits and employs cores of ferrocube 6D3, a material having a rectangular hysteresis loop. (Netherlands, in English.)

**Digital Computer Engineering**, R. Veelken. "Nach. Z." February 1959. 4 pp. The design of transistorized computing sections and programming sections in electronic computers is the object of this paper. The technical elements of the circuit technique are closely related with the construction of the equipment from logical elements. (Germany.)

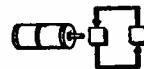

## CONTROLS

**On Electronic Control of Low-Power Motors**, H. Volz. "El. Rund." February 1959. 3 pp. The first part of the article discusses circuits of low-power motor regulation and controls by means of which all possible interference may be suppressed, and the now following second part calculates a numerical example. (Germany.)



## GENERAL

**The Problems of Reliability and Maintenance in Very Large Electronic Systems for Shipboard Use**, G. C. F. Whitaker. "Proc. AIRE." December 1958. 18 pp. At the detailed design level the author suggests a number of possible approaches for the achievement of high reliability. He cites existing examples for each approach and invites discussion by specialists. Considering such systems as a whole the statistical pattern of component failure is discussed and taking practical examples the probable period of fault free operation is derived. Typical figures are cited. The importance of rapid repair under battle conditions is stressed. (Australia.)

**Vacuum Crystal-Pulling Devices**, H. Bumm. "Vak. Tech." February 1959. 3 pp. The article describes the various methods for physical and chemical cleaning (e.g. zone-melting after Pfann in horizontal crucibles for Germanium, zone-melting after Keck without crucible, floating zone-melting, for silicon). In addition theoretical considerations on which these methods are based are presented. (Germany.)

**The Production of Thin Films by Evaporating Anorganic Substances In Vacuo**, Albert Ross. "Vak. Tech." February 1959. 11 pp. The article summarized what experiences have been made so far in carrying out evaporation processes in vacuo on a technical scale. (Germany.)

**Human Information Processing**, K. Kupfmüller. "Nach. Z." February 1959. 7 pp. Some general conclusions relating to human information processing can be drawn from observations of the human behaviour. In all processes investigated in detail so far, the speed of human information processing has been below approximately 50 bits/sec. (Germany.)



# IRE Salutes Government Research

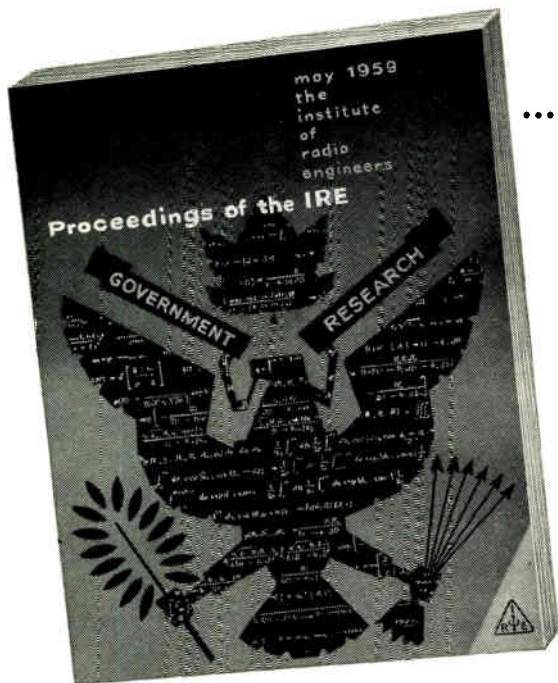

Again government projects make the news as space satellites relay world weather data and rockets orbit the sun. The *Institute of Radio Engineers* salutes government contributions to progress in radio-electronics in the *Special May Issue* of **PROCEEDINGS OF THE IRE**.

The big May **PROCEEDINGS OF THE IRE** gives deserved recognition to the government laboratories and bureaus engaged in electronics research and development, and brings to its readers information about the invaluable work being done by engineers and technicians in federal employ. Included are 40 technical papers dealing with the most important aspects of current projects.

## Radio-Electronics Behind the Headlines

This Special Issue reveals how the government is meeting the challenge of creating new and better electronic devices for peaceful and utilitarian purposes, as well as how it is meeting the pressing need for advanced national defense systems. Also discussed are future safeguards for the security of the free world.

Presentation of this special issue on *Government Research* is in keeping with the IRE's policy of bringing to the world of radio-electronics the latest news of subjects of special interest and significance. Such a practical policy enables the IRE to provide a valuable service to the industry by making technical material and pertinent information available not only to its 72,000 members, but to informed non-members as well.

Read this informative report on *Government Research* in the publication that records progress. If you are not a member of the IRE, be sure to reserve a copy of the May **PROCEEDINGS**, now.

### PARTIAL CONTENTS OF THIS GOVERNMENT RESEARCH ISSUE:

- "The Basis of Our Measuring System" by A. G. McNish, National Bureau of Standards
- "The ODFL Microelectronics Program" by T. A. Pruge, J. R. Nall & N. J. Doctor, Diamond Ordnance Fuze Labs.
- "VFL Propagation Measurements for the Radux-Omega Navigation System" by C. J. Casselman, D. P. Heritage & M. L. Tibbals, U. S. Naval Electronics Lab.
- "Submarine Communication Antenna Systems" by R. W. Turner, U. S. Naval Underwater Sound Lab.
- "Some Characteristics of Persistent VHF Radio Wave Field Strengths Far Beyond the Radio Horizon" by L. A. Ames, E. J. Martin & T. F. Rogers, Air Force Cambridge Research Center
- "Phenomena of Scintillation Noise in Radar Tracking Systems" by J. H. Dunn, D. D. Howard & A. M. King, U. S. Naval Research Lab.
- "On Models of the Atmospheric Radio Refractive Index" by B. R. Bean & G. D. Thayer, National Bureau of Standards
- "Image Intensifiers and Image Converters for Military and Scientific Use" by M. W. Klein, Engineering Res. & Dev. Labs.
- "A Light-Weight and Self-Contained Airborne Navigational System" by Staff, Defense Research Board, Canada
- "The CAA Doppler Omnirange" by S. R. Anderson & R. B. Flint, U. S. Dept. of Commerce
- "Pulsed Analog Computer for Simulation of Aircraft" by A. N. Herzog, U. S. Naval Training Device Center
- "Progress and Problems in Army Communications" by R. E. Lacy, U. S. Army Signal Res. & Dev. Labs.
- "The Engineering of Communication Systems for Low Radio Frequencies" by J. S. Belrose, W. A. Hatton, C. A. McKerrow & R. S. Thain, Defense Research Board, Canada
- "Numerical Approach to Electronic Reliability" by J. J. Naresky, Rome Air Development Center

### The Institute of Radio Engineers

1 East 79th Street, New York 21, N.Y.

- Enclosed is \$3.00
- Enclosed is company purchase order for the May 1959 issue on Government Research

Send this special issue of Government Research to:

NAME \_\_\_\_\_

COMPANY \_\_\_\_\_

ADDRESS \_\_\_\_\_

CITY & STATE \_\_\_\_\_

All IRE members will receive this May issue as usual. Extra copies to members, \$1.25 each (only one to a member)

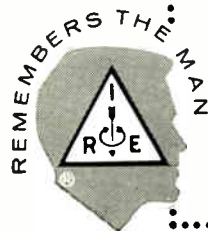

**The Present State of the Development of Solid State Molecular Amplifiers**, K. G. McKay. "Nach. Z." February 1959. 7 pp. The principles and properties of solid state masers with two and three energy levels are discussed. The present state of the development in this field is considered and conclusions are drawn with a view to future applications. (Germany.)

**Standard Plug-In Units Reduce Engineering Design Time**, J. R. Simpson. "El. & Comm." January 1959. 4 pp. The elimination of time consuming calculations is one of the principal features of these versatile building block units. (Canada.)

**A Tape Message Sorter**, John Rywak. "El. & Comm." January 1959. 4 pp. The versatility and efficiency of modern transistor circuitry is demonstrated by the equipment described in this article which, although specifically designed for reading, sorting and reproducing punched paper tape, embodies principles and practices which are capable of far wider use. (Canada.)

**Approximation of a Function by Smoothing of Residual Differences**, J. Legras. "Cab. & Trans." January 1959. 13 pp. The paper is a description of a new calculation technique which allows, given a function and its approximation by a polynomial, to closely follow the changes introduced in their residual difference by successive modifications to this polynomial. (France.)

**The Training of Electronic Maintenance Engineers**, H. C. A. Dale. "Brit. C. & E." February 1959. 4 pp. Part II: New Training Techniques. Up to the present time, the training of maintenance engineers has largely consisted of a theoretical training period followed by a period of working with an experienced man on the job. A new system of training is proposed which is based on more logical principles and which, it is claimed, will enable trainees to become more efficient and useful at an earlier stage of their training. (England.)

**Growing Export Trade in Electronics**, C. C. Gee. "Brit. C. & E." February 1959. 3 pp. Attention has been drawn to the low figures that are being quoted for the exports of British electronic and allied products. This article, which first appeared in The Financial Times Survey "Electronics and Automation" on 1st December, elaborates this theme, and stresses the growing importance of the computer, and data-processing sector of the British electronics industry. (England.)

**A Sensing System for Punched Cards or Continuous Punched Foil**, S. Morleigh. "El. Eng." March 1959. 2 pp. (England.)

**Magnetic Refrigeration**. "E. & R. Eng." March 1959. 5 pp. (England.)



## INDUSTRIAL ELECTRONICS

**The Application of Micro-Wave Energy in Industry**, W. Schmidt. "Nach. Z." February 1959. 6 pp. The production of high-power CW magnetrons permits the application of micro-wave energy to dielectric heating processes. The methods differ from the inductive and capacitive heating methods in the medium wave and short wave range where the magnetic and electric energy spaces are separated. (Germany.)

**Influence of the Peltier Effect in Resistance Welding**, T. C. Balder. "Phil. Tech." 10 February 1959. 5 pp. A theoretical estimate shows that the Peltier effect causes a difference of about 10% between the amount of heat available for the one weld and that available for the other. The Peltier effect is also probably responsible for the unequal deterioration shown by the electrodes in spot-welding machines. (Netherlands, in English.)

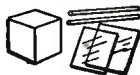

## MATERIALS

**Technological Problems of Dielectric Ceramics of Very High Dielectric Constant**, W. Pajewski. "Prace ITR." Vol. 2, No. 3 (6). The paper deals with the problem of the synthesis of raw materials used for the production of ceramics having very high dielectric constant. Special consideration has been given to the synthesis of barium titanate from technical titanium oxide and barium carbonate. (Poland.)

**Mica, a Material in High-Vacuum Technique**, Werner Espe. "Vak. Tech." February 1959. 5 pp. A comprehensive review of the application of mica in high-vacuum technique. (Germany.)

**Temperature and Frequency Variations of the Electric and Magnetic Properties of a Nickel-Zinc Ferrite**, J. Rozes. "Cab. & Trans." January 1959. 11 pp. (France.)



## MEASURE & TESTING

**Electronics in Radiation Measurements**, K. Franz. "Nach. Z." February 1959. 7 pp. Valve and transistor circuits, with which stabilities in the order of magnitude of  $10^{-4}$  can be achieved, are used for the supply of currents to radiation detectors and electromagnets in radiation measurement equipment. (Germany.)

**Radio Telemetry, Part I—Systems**, A. J. Shimmins. "Proc. AIRE." December 1958. 13 pp. This paper is concerned with systems of radio telemetry, i.e. of making measurements of electrical and physical quantities under conditions which do not permit us to approach the equipment and make the measurements at the site of origin, in the normal manner. (Australia.)

**Sampling of Signals without D. C. Components**, A. R. Billings. "E. & R. Eng." February 1959. 3 pp. It is shown that a signal contained in a finite frequency band can only be sampled unambiguously at sampling frequencies lying within certain permitted bands, where the last of these bands extends to infinity. (England.)

**Recommended Method of Expressing Electronic Measuring Instrument Characteristics**, 2. Cathode-Ray Oscilloscopes. "J. BIRE." January 1959. 8 pp. (England.)

**Some Uses of Statistical Methods in the Manufacture of Radio and Television Receivers**, A. I. Godfrey. "J. BIRE." January 1959. 14 pp. Statistical methods are described which help to reduce variation in the successive stages of receiver manufacture, assisting in the control of quality. (England.)

**Surface Impedance, Measurement at V.H.F.**, J. C. Anderson. "E. & R. Eng." February 1959. 5 pp. The high-frequency surface impedance of a conducting material may be measured by use of a coaxial transmission line. The method described does not require the use of a calibrated r.f. meter, and employs a specimen in the form of a disc. (England.)

**Measurement of Phase and Amplitude at Low Frequencies**, R. J. A. Paul and M. H. McFadden. "El. Eng." March 1959. 8 pp. A description is given of a low frequency oscillator and phase measuring equipment. (England.)

**Measurement of Magnetic Fields by Nuclear Resonance**, G. C. Lowe. "El. Eng." March 1959. 3 pp. A simple feedback circuit is described which employs the phenomenon of nuclear magnetic resonance to measure magnetic fields over a wide range with a minimum of readjustment of the circuit elements to an accuracy of at least 0.01 per cent. (England.)

**The Recording and Collocation of Waveform (Part I)**, R. J. D. Reeves. "El. Eng." March 1959. 8 pp. Instrumentation for applied circuit analysis is conspicuously incomplete by the absence of oscillogram recorders. In Part 1 of this article various aspects of strobography are discussed. (England.)



## RADAR, NAVIGATION

**Location and Control in Space**, E. Rehbock. "Nach. Z." February 1959. 8 pp. The paper is a summary of problems relating to location and control in space. In addition to passive and active DF methods as well as radar methods, also inertial navigation is treated. (Germany.)

**Radar Development for Air Defense**, by the staff of the Royal Radar Establishment, Ministry of Supply. "ATE J." October 1958. 4 pp. (England.)

**Quartz Delay Lines for Radar Systems**, A. F. J. Swift. "Brit. C. & E." February 1959. 4 pp. Delay lines, both the electrical and electromechanical type find many uses in present-day radar systems. This article concentrates on the principles and characteristics of electromechanical or ultrasonic lines which prove an advantage when delay times of 2 microseconds to 3 milliseconds are required, but the power available is at relatively low levels. (England.)

**The Performance of Doppler Navigation Systems**, T. G. Thorne and J. A. Billings. "Brit. C. & E." March 1959. 4 pp. A review is given of the performance of military Doppler equipment under various conditions, and reference is made to the important design features that control the accuracy and reliability of Doppler systems. It is considered that this information is of much value when assessing the suitability of Doppler equipment in civil aircraft. (England.)

**Some Problems in the Display of Information for Air Traffic Control**, D. D. Lipman. "Brit. C. & E." March 1959. 7 pp. This article discusses in a practical way some of the many problems encountered in arriving at an efficient and reliable system for the display of air traffic control information. (England.)



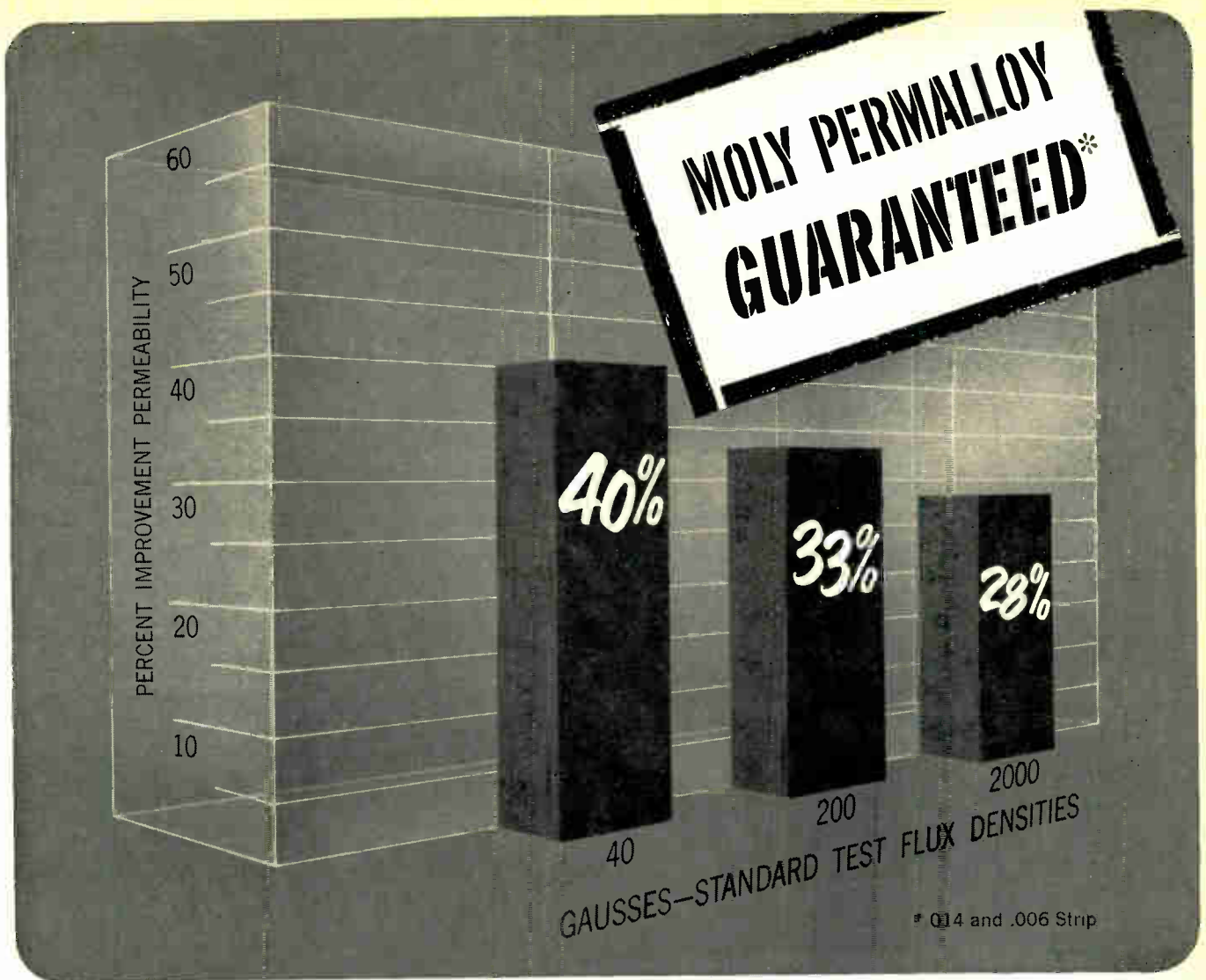

## GUARANTEED PERMEABILITY OF MOLY PERMALLOY... at values higher than old average specifications

Molybdenum Permalloy nickel-iron strip is now available from Allegheny Ludlum with *guaranteed* permeability values. And the new guarantees are much higher than the old typical values. This exceptionally high quality means absolute uniformity for the user—new consistency and predictability for magnetic core performance.

Improved permeability of A-L Moly Permalloy is the result of Allegheny's program of production research on nickel-bearing electrical alloys. A similar improvement has been made in AL-4750 strip steel. Research is continuing on silicon steels including A-L's famous Silectron (grain oriented silicon steel), plus other magnetic alloys.

WSW 7273

Another plus in dealing with Allegheny Ludlum is the operation of complete lamination fabrication and heat treatment facilities. A-L's years of experience in producing quality laminations result in practical know-how in solving problems common to core materials.

This working knowledge is available to all. Give us a call for prompt technical assistance on *any* problem involving electrical steels, laminations, or magnetic materials. Write for more information on A-L Moly Permalloy. *Allegheny Ludlum Steel Corporation, Oliver Building, Pittsburgh 22, Pa. Address Dept. EI-16.*

### ALLEGHENY LUDLUM

STEELMAKERS TO THE ELECTRICAL INDUSTRY

Export distribution, Electrical Materials: AIRCO INTERNATIONAL INC., NYC 17

Export distribution, Laminations: AD. AURIEMA, NYC 4





## SEMICONDUCTORS

**Design of D.C. Push-Pull Transistor Converters**, T. Konopinski and M. Politowski. "Prace ITR." Vol. 2, No. 3 (6). Methods of design encountered in the literature concern mainly converters using a single transistor. The present paper presents an equivalent circuit of a push-pull transistor converter, along with a method of finding explicit relations between particular parameters of this kind of circuit. (Poland.)

**A New Application of Germanium Diodes in TV Receivers**, W. Bruch. "El. Rund." February 1959. 7 pp. Germanium diodes and their advantages in comparison with other switches are discussed; the application of the diode is described; and the possibilities of continuous control by diodes are dealt with. In particular, control of the oscillator frequency in the TV tuner is discussed with various examples. (Germany.)

**The Four-Layer Transistor Diode, a Bistable Semiconductor two-Terminal Device**, W. A. Mayerhofer. "El. Rund." February 1959. 4 pp. An introductory explanation of the physical operation of a four-layer transistor diode is given by comparison with two (inter-connected) silicon-junction transistors and finally, several simple circuit examples are considered. (Germany.)

**Transistor Equivalent Circuit, Alloyed-Junction Types at High Frequencies**, D. A. Green. "E. & R. Eng." March 1959. 7 pp. The purpose of this article is to present a new equivalent circuit for a transistor, which is valid at all frequencies where the device gives useful gain. (England.)

**High-Power Transistor D.C. Converters, Designs for Silicon and Germanium Transistors**, T. R. Pye. "E. & R. Eng." March 1959. 10 pp. Transistor circuits for converting from d.c. to d.c. (or A.C.) are reviewed. The transformer-coupled push-pull circuit is examined in some detail, and examples are given of designs using both silicon and germanium power transistors. (England.)



## TELEVISION

**Some Aspects of Synchronization in Television Receivers**, J. Van der Goot. "P. AIRE." November 1958. 17 pp. (Australia.)

**Noise Immune Synchronizing Circuits for Television Time Base Circuits**, D. J. Howlett and L. Buduls. "P. AIRE." November 1958. 10 pp. (Australia.)

**Present Techniques in Television Film Recording**, G. Healy. "P. AIRE." November 1958. 13 pp. (Australia.)

**The Synchronization Separator—an Unexpected Observation**, J. Goldthorp. "P. AIRE." November 1958. 2 pp. (Australia.)

**The Television Outside Broadcast Vehicle**, R. Thyer. "PP. AIRE." November 1958. 7 pp. (Australia.)

**Improvements in Television Receiver Design**, F. C. N. Smith. "P. AIRE." November 1958. 12 pp. (Australia.)

**ABN Television Transmitter**, F. M. Shepherd. "P. AIRE." November 1958. 6 pp. Series of articles on television. (Australia.)

**Television IF Amplifiers with Linear Phase Response**, A. N. Thiele. "P. AIRE." November 1958. 17 pp. (Australia.)

**The ATN Television Centre**, M. H. Stevenson. "P. AIRE." November 1958. 8 pp. (Australia.)

**Phase Shift Consideration in Television Broadcasting and Reception**, M. W. Davies. "P. AIRE." November 1958. 10 pp. (Australia.)



## TRANSMISSION

**Computation of Transitions from Rectangular Waveguides to "Pi"- and "H"-Shaped Waveguides**, A. L. Gutman. "Radiotek." Jan. 1959. 9 pp. Graphs are plotted for computing the external parameters of the transition. The optimum longitudinal profile of the transition is determined. A system of engineering computation is proposed. (U.S.S.R.)

**Theory for Helical Transmission Lines with Finite Wire Thickness Derived from the Polarization Inside the Wave Guide**, G. Piefke. "Arc. El. Uber." July 1958. 8 pp. The propagation constant of all modes which can exist on a helical line can be determined by this theory. It is assumed that the wave length is far greater than the separation between centers of neighboring wires. (Germany.)

**Determination of the Non-Deviative Absorption of the Ionosphere by Continuous and Automatic Field Strength Measurements**, H. Schwentek. "Arc. El. Uber." July 1958. 8 pp. The conditions of a suitable transmission path are discussed. An analysis of the field-strength's frequency distribution measured by a statistical counter renders possible the separation of the various transmission paths from each other. Thus, absorption values for hourly intervals can be determined. (Germany.)

**Propagation in Band Wave Guides with Circular or Square Cross Sections**, M. G. Andreasen. "Arc. El. Uber." Sept. 1958. 5 pp. It is shown that fundamental modes polarized parallel to the plane of curvature are affected most heavily by the radius of curvature of the wave guide. (Germany.)

**Loci for Transformations of Transmission Lines**, G. Epprecht. "Arc. El. Uber." Jun. 1958. 5 pp. This paper discusses the graphical solution for determining the influence of a quadripole onto the following network. (Germany.)

**Transformation Theorem by Weissfloch, and Its Application to Determine the Dielectric Constant**, G. Gobiet. "Arc. El. Uber." Sept. 1958. 8 pp. When a dielectric disc is used as quadripole in a parallel line or wave guide, a simple analytical relation exists between the transformation parameter, and the dielectric constant. Weissfloch has devised a simple experimental method for the determination of K. The paper describes the experimental methods, and develops a related experimental measuring method. (Germany.)

**Modified Two-Hole Directional Coupler**, W. Geoffrey. "E. & R. Eng." 1 p. Jan. 1959. This article describes a modification to the two-hole, interference type, co-directional coupler in a rectangular waveguide system which enables it to be tuned to give perfect directivity at any wavelength within a wide frequency range. (England.)

**The Characteristic Impedance and Phase Velocity of High-Q Triplate Line**, K. Foster. "J. BIRE." Dec. 1958. 10 pp. The derivation of the impedance and phase velocity for high-Q triplate line is considered. (England.)

**Waveguide Switches and Branching Networks**, J. W. Sutherland. "El. Eng." 5 pp. Feb. 1959. Waveguide switches of the "barrel" type and those actuated by shutters, gas discharge tube switches, and ferrite switches are described and discussed. A comparison of the properties of each type is made. The properties of the branching tee in waveguide, and several of its applications are discussed in detail. A multiple branching network using hybrids is described. (England.)

**Measurement of the Properties of a Strip Line and Its Transition Junction**, F. Norman. "Proc. AIRE." December 1958. 7 pp. This paper covers some aspects of wave propagation along a parallel strip transmission line and through a coaxial line to strip line transition junction. The design criteria for the line are discussed and a description is given of a method of measuring the properties of strip lines, employing a conventional coaxial line standing wave indicator connected to the strip line through an unknown junction. (Australia.)

**The Electroforming of Waveguide Components**, P. Andrews. "El. Eng." March 1959. 3 pp. Certain waveguide components cannot easily be made by normal machining processes and in these cases electro-forming is often a useful method. In this article a simple acid-copper electroforming process is described which is suitable for laboratory or small scale production use. (England.)



## TUBES

**The Knowledge in Physics as a Basis for Modern Electronic Valve Engineering**, K. Poschl. "Nach. Z." February 1959. 5 pp. A number of problems out of physics and mathematics are connected with the technical progress in the field of electronic valves. (Germany.)

**Investigations of Two Tube-Oscillator Circuits with Feedback via a Pi-Network**, E. Frisch. "Arc. El. Uber." Sept. 1958. 6 pp. The paper investigates two tube-oscillator circuits with feed-back via a pi-network. Two types of such oscillator circuits are of practical interest. One of these relates to variable frequency which has the advantage of covering an extremely wide frequency range. The other type behaves like a differential bridge oscillator, and requires no transformer, and needs less gain for its operation. (Germany.)

**The Behavior of Oscillators with Different Loads**, W. Herzog. "Nach. Z." Jan. 1959. 8 pp. A pi-network oscillator with parallel and series circuit losses has been investigated for the purpose of clarifying the problem whether a reduction of the load impedance of oscillators with an appropriate increase in gain produces an increase in the Q-value when this is effected by removing the losses in the form of adding parallel impedance to the load. It has been found that the losses do not help to increase the Q-value. (Germany.)

\* \* \*



**Cannon Audio Connectors are standard on practically all top-ranking microphones**



**LESS NOISE!**

You'll find exactly the type and size you need in the extensive Cannon Audio Line... standard of the industry... constantly improved and modernized.

Nine basic Series... with hundreds of layouts and contact variations. In cord, rack/panel/chassis, audio and low level, portable, hermetically sealed, miniature and sub-miniature, and power supply types.

Microphone connectors with the famous Cannon "Latch-Lock" feature.

More than 200 Cannon-Diamond Co-Axial types, plus accessories.

All designed to give you what you want... Less Noise... Quiet, Continuous Operation... Quick Disconnect... Years of Service!

Write for Audio Bulletin PO-7. For information on co-axial connectors ask for Bulletin DC-2.

For an interesting discussion of the broad subject of "Reliability," write for Cannon Bulletin-R-1.



Full information in Bulletins PO-7 and DC-2



**CANNON ELECTRIC COMPANY, 3208 Humboldt Street, Los Angeles 31, California.** Factories in Los Angeles, Salem, Massachusetts, Toronto, Melbourne, London. Manufacturing licenses in Paris and Tokyo. Representatives and distributors in all principal cities.

◆ **RF Co-Axials**



one of the most complete lines available anywhere

**X, XK, XKW**



for low level circuits 10-15 amp. contacts

**P, O**



with famous "Latch-Lock." 2-3-4-5-6-8 contacts

Get quiet, continuous operation Use **CANNON PLUGS** for all modern audio equipment

**BRS**



special sealed connectors for extreme moisture conditions 3 or 6 contacts

**UA**



built to RETMA standard specifications. Gold plated contacts

**XLR**



audio cord type. Latest development. Modern and quiet in all respects

**CANNON PLUGS**

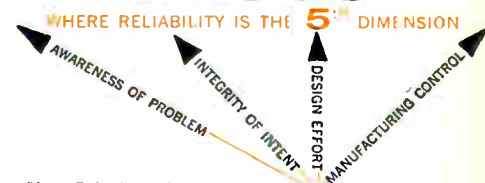

Please Refer to Dept. 201

Circle 57 on Inquiry Card, page 105

To simplify your design problems

# CHICAGO STANDARD

will send you



these useful

## TRANSFORMER CATALOGS

These two reference books are invaluable aids to design engineers. They list over 1,100 CHICAGO STANDARD stock transformers . . . hermetically sealed and open mounting units, for a wide range of military and industrial applications . . . with detailed electrical and physical specifications given on each one.

All of the transformers listed in these catalogs are available for immediate delivery through your CHICAGO STANDARD distributor. Write now for your free copies.

**CHICAGO STANDARD** TRANSFORMER CORPORATION

3516 ADDISON STREET • CHICAGO 18, ILLINOIS

Export Sales: Roburn Agencies, Inc., 431 Greenwich St., New York 13, N. Y.

## New Products

### DC AMMETER-VOLTMETER

Precision portable d-c ammeter-voltmeter has 49 possible ranges in one instrument. The instrument has a heavy duty rugged black plastic case, 8 $\frac{7}{8}$  x 7 $\frac{7}{8}$  x 4 in. which is sealed



against dust and moisture, and protects the self-shielded D-Arsonval (moving coil) movement. A hand calibrated mirrored scale, 6.1 in. long (155 mm), with finely balanced knife edge pointer, combine to eliminate parallax errors in reading. It features accuracy better than 0.5% on all divisions of the scale at an ambient temperature of 25° C., and a spring shock mounted—jewel movement. National Electronics, Sheridan, Wyoming.

Circle 215 on Inquiry Card, page 105

### PREAMPLIFIER

Model PRU-( )-L Preamplifier for any frequency between 400 and 1,000 MC. Uses G.E. 7077 ceramic triode in a grounded grid (single stage) circuit with high Q resonant cavity plate circuit. The three db bandwidth is approximately 10 MC. Noise figure is

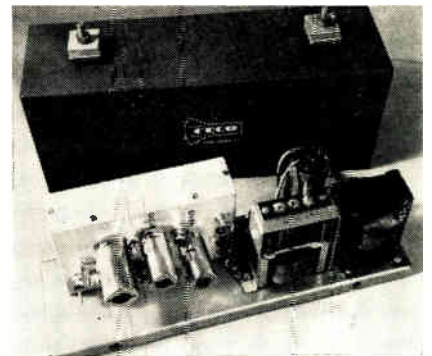

6 db  $\pm$  1 from 400 to 600 MC.; 7 db  $\pm$  1 from 700 to 1,000 MC. Gain, 10 db minimum. Self contained power supply, 117 v, 50-60 CPS, 10 watts. Community Engineering Corporation, Box 824, State College, Pennsylvania.

Circle 216 on Inquiry Card, page 105



**New**  
**Products**

**FREQUENCY COUNTERS**

Model 1300 Series counters have time bases with fixed selective times of 0.1, 0.5 and 1.0 sec.; 5 and 10 sec. extension; fixed special time basis and preset variable time bases, single and



multiple channel, and crystal and tuning fork standards. Count-down time base. Input: sine waves, 5 to 150,000 CPS; pulses, 0 to 150,000 CPS. Accuracy:  $\pm 1$  count. Display time: adjustable from 0.1 to 10 seconds. Sensitivity: 50 mv RMS (5 mv optional). Input impedance: 1 megohm. I-L-S Instrument Div., The Meriam Instrument Co., 4529 W. 160th St., Cleveland 35, Ohio.

Circle 246 on Inquiry Card, page 105

**HYBRID TEES**

Hybrid Tee sections for use with large waveguide can be used as test equipment or as a functional part of a system. Waveguide sizes range from WR770 through WR2300, covering a UHF frequency range of 320 to 1450 MC. They can be used to build power dividers, balanced mixers, sideband modulators, power discriminators and

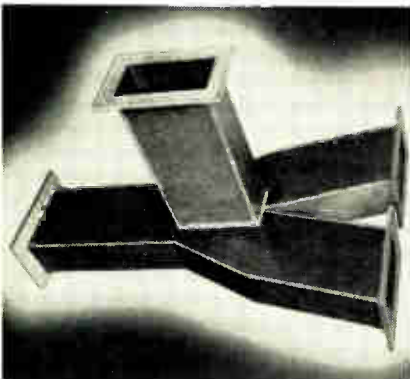

phase detectors. They are fabricated from 6061T6 aluminum alloys. Close sheet metal tolerances—to within 1/64 in. provide low voltage standing wave ratios. I-T-E Circuit Breaker Co., 1900 Hamilton St., Phila., Pa.

Circle 247 on Inquiry Card, page 105

**ONLY ACOUSTICA  
ULTRASONIC CLEANERS  
HAVE MULTIPOWER!**

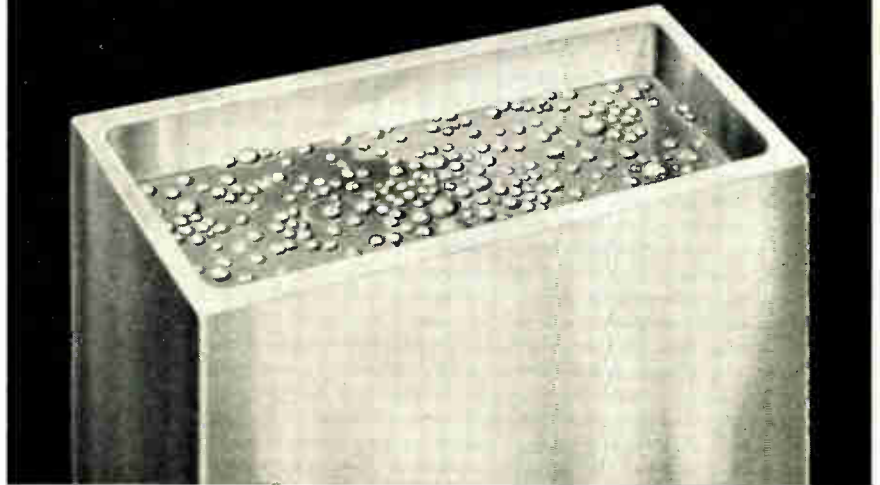

**MAJOR BREAKTHROUGH  
IN ULTRASONIC TECHNOLOGY!**



In determining which ultrasonic cleaner to buy, remember that all ultrasonic cleaners are not alike. There is variation in uniformity of cavitation. There is variation in the transducer — and the transducer is the heart of an ultrasonic cleaner. The Multipower transducer developed by

Acoustica research, multiplies the power and efficiency of ultrasonic action. Cleaning is faster, labor costs are lower.

Acoustica ultrasonic cleaners are engineered and produced to the finest standards, unequaled in quality and value. Off-the-shelf in capacities from 1 to 75 gal. or custom built to 5000 gal. Expert Acoustica engineers can help you with your cleaning problems.

Send for further information.

**acoustica**

Leader in research and development of ultrasonic systems

Acoustica Associates, Inc.  
Dept. EI, 26 Windsor Ave., Mineola, N. Y.

Send information describing advantages of Acoustica ultrasonic cleaners.

Name \_\_\_\_\_  
Company \_\_\_\_\_  
Address \_\_\_\_\_  
City \_\_\_\_\_ Zone \_\_\_\_\_ State \_\_\_\_\_

Circle 59 on Inquiry Card, page 105

for purification of metals . . .

# LINDBERG'S NEW FLOATING ZONE SCANNER

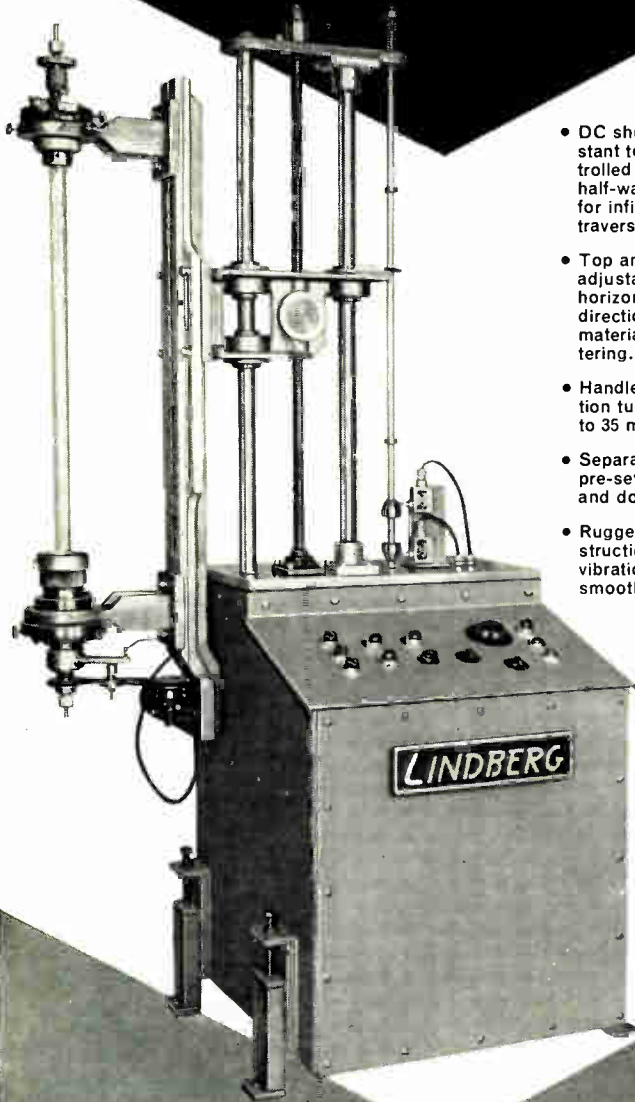

- DC shunt-wound, constant torque motor controlled by thyatron half-wave rectifier for infinitely variable traverse speeds.
- Top and bottom holders adjustable in both horizontal and vertical directions for easy material and seed centering.
- Handles quartz protection tubes up to 35 mm diameter
- Separate controls can be pre-set for up travel and down travel speeds.
- Rugged, accurate construction eliminates vibration and provides smooth traversing.

This new Lindberg vertical floating zone scanner has been expertly designed to provide more accurate and precise production of high purity semi-conductors and metals. Write for Bulletin 1600.

## LINDBERG HIGH FREQUENCY DIVISION

Lindberg Engineering Company • 2450 W. Hubbard St., Chicago 12, Ill.

New

Products

### SPECTRUM ANALYZERS

Model LA-18M, Spectrum Analyzer, features a 10 MC to 44,000 MC range. The basic unit has 3BNC connectors for the 10-1000 MC range; a type N connector on a detachable coaxial

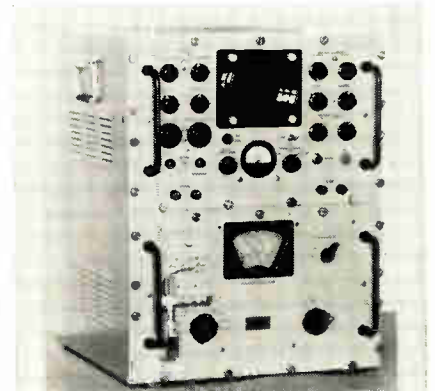

mixer for 1,000-16,000 MC, and, as accessory units, 4 panelmount, detachable wave guide mixers for the 8.2 KMC to 44 KMC frequency bands. Frequency calibration is accurate to  $\pm 0.1\%$  at operating frequency of local oscillator. It shows signal amplitude on the vertical axis vs. frequency on the horizontal axis, and permits selection of square law or linear detection. Lavoie Laboratories, Inc., Morganville, N. J.

Circle 217 on Inquiry Card, page 105

### SPRAY ETCHER

A high-speed laboratory model pump spray etcher for printed circuitry. PVC and titanium construction is used throughout. It has a variable spray nozzle pattern. Uses ferric chloride or chromic acid to etch sides simultaneously on boards up to 16 in. x 22 in. Small, compact, model has



transparent construction which permits view of work. 25 gal. capacity. Size 48 x 25 x 36 in. Power 115 vac 60 CPS @ 15 amps. Centre Circuits, Inc., P. O. Box 165, State College, Penna.

Circle 218 on Inquiry Card, page 105



# NEW FROM TI

## 1N2175 SILICON PHOTO-DEVICE SWITCHES FROM DARK TO LIGHT CURRENT IN 2 MICROSECONDS

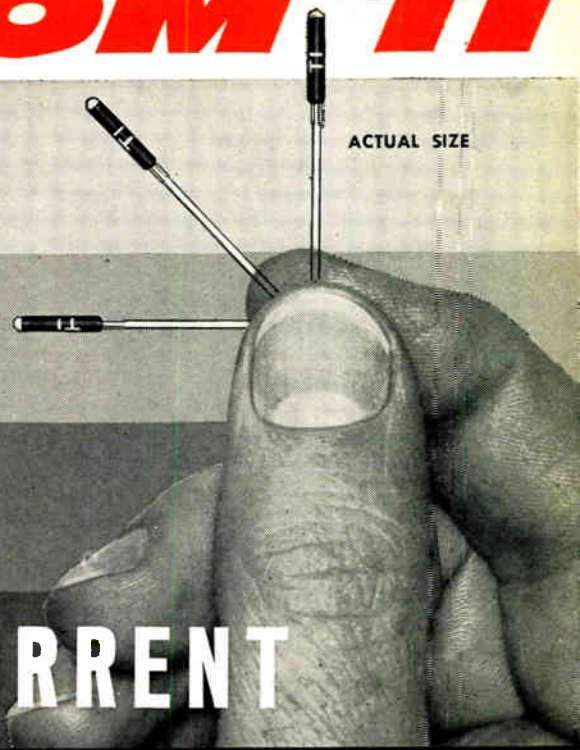

**TI 1N2175 subminiature unit is ideal for punch-card or tape data processing, and many other control systems**

Now you can get quadrupled sensitivity and unprecedented design flexibility with the new subminiature TI 1N2175 Photo-Device.

Easily activated, the 1N2175 switches from a low dark current of only  $0.5 \mu\text{a}$  to a high light current of  $1200 \mu\text{a}$  at 1200 ft-candles — *within 2  $\mu\text{secs}$* . Rated at 250 mw at  $25^\circ\text{C}$ , the 1N2175 operates over a range of 1-50 volts, and derates linearly to  $125^\circ\text{C}$ . Minimum operating temperature is  $-55^\circ\text{C}$ .

Specify the TI 1N2175 today and get immediate *off-the-shelf* delivery in 1-999 quantities from all authorized TI distributors and production quantities through TI sales offices.

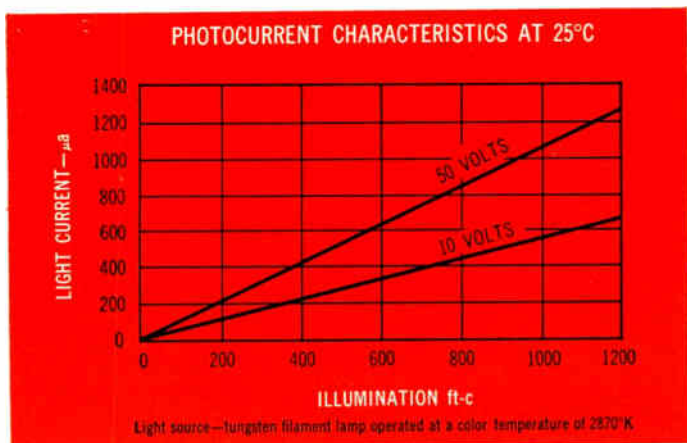

from THE WORLD'S LARGEST SEMICONDUCTOR PLANT



**TEXAS INSTRUMENTS**  
INCORPORATED  
SEMICONDUCTOR-COMPONENTS DIVISION  
POST OFFICE BOX 312 • 13500 N. CENTRAL EXPRESSWAY  
DALLAS, TEXAS

Interested in  
Learning Why

METROPOLITAN  
**MIAMI**

HAS BECOME THE  
INDUSTRIAL GIANT  
OF FLORIDA?



HAS 2,400  
MANUFACTURING  
CONCERNS  
NOW IN OPERATION?

FOR THE FOURTH  
CONSECUTIVE YEAR,  
HAS GAINED ONE-THIRD  
OF ALL NEW  
MANUFACTURING JOBS  
IN THE STATE?

**Management Executives—**

Send for new complete economic  
study of Metropolitan Miami

A 30 section, complete economic survey has just been prepared with complete data which will assist in determining how your particular operation can profit here. This important study will be mailed to you in strictest confidence — if you write, on your letterhead, to the address listed below. Sorry — we can't accept employment resumes. Seems like everyone wants to live in Miami.



Write:

John N. Gibson, Director  
Dade County

Development Department

Section 72  
Chamber of Commerce Building  
345 N.E. Second Avenue • Miami, Florida

An agency of the  
Metropolitan Miami government

Circle 61 on Inquiry Card, page 105

**New Products**

**ANALYZER**

Model BA-7 antenna pattern analyzer designed to utilize r-f crystals in a video detector system, requires a max. of 1  $\mu$ w r-f power for a max. range of measurement of 45 db r-f



in one step. A dc biasing circuit is included to permit the use of conventional barretters, requiring a dc bias between 0 and 10 ma. The biasing circuit is designed so that the burnout of barretters cannot occur due to transients in the bias circuit. Useful for measuring very high power ratios such as occur in making antenna pattern measurements, leakage measurements on r-f transmission equipment, and cross-talk of r-f switches. Weinschel Engineering Co., 10503 Metropolitan Ave., Kensington, Md.

Circle 219 on Inquiry Card, page 105

**SERVO MOTORS**

Size 10 and 11 geared servo motors. The integral gearhead units can be supplied in a wide range of ratios with reductions as required up to 8000:1. They are available with windings for 25, 55 or 115 vac 400 cps. Other voltages available. They are designed to operate in ambient tem-

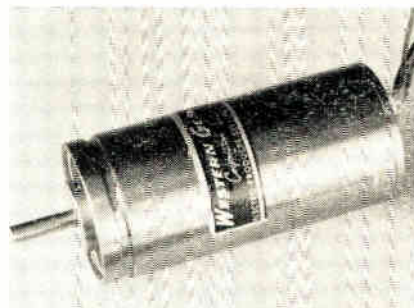

peratures from  $-65^{\circ}$  C to  $+125^{\circ}$  C. The geared servo motors measure 2 17/64 in. in length. Western Gear Corporation, Electro Products Division, 132 West Colorado Street, Pasadena, California.

Circle 220 on Inquiry Card, page 105

★★★★★ ★★★★★

IN EVERY FIELD, THERE IS ONE  
FOREMOST NAME... IN SONIC  
ENERGY, THAT NAME IS BENDIX

**FACTS YOU MAY NOT  
KNOW ABOUT SONIC  
ENERGY CLEANING—**

You probably know that Bendix Sonic Energy Cleaning is in truth a *production tool*—a practical method for (1) lowering cleaning costs while (2) improving product performance and (3) reducing the number of rejects. But perhaps you don't know the where-why-who needed to justify investment in equipment.

WHERE applicable (it isn't always), Bendix Sonic Energy Cleaning has set some new records for efficiency and economy (we'll show you case histories to back this up).

WHY Bendix® is today's top authority on this system can be answered in one word—*experience*. Bendix has lead since the early days, pioneering Sonic Energy Cleaning.

WHO can use it? Who cannot? That's easy to determine—Bendix maintains an Applications Laboratory where production experience is teamed with the latest facilities in finding the answer.

If you can use it to real advantage, Bendix has a complete line so that the best equipment for your particular needs can be selected quickly.

GET THE AUTHORITATIVE FACTS . . .  
SEND FOR THIS FREE REPORT



The principles and workings of Sonic Energy Cleaning are illustrated, described and analyzed in detail. A five-step plan is outlined to help you determine feasibility of Sonic Energy Cleaning for you. To get your

copy, write PIONEER-CENTRAL DIVISION, BENDIX AVIATION CORPORATION, 2720 HICKORY GROVE ROAD, DAVENPORT, IOWA.



**SONIC ENERGY CLEANING**

Circle 62 on Inquiry Card, page 105



**New**  
**Products**

**SUBCARRIER OSCILLATORS**

Voltage-controlled FM subcarrier oscillators for ground-station telephone, radio, or microwave data-transmitting use. Oscillators plug into a transmitting multiplexer with con-



ventional 9-pin octal connectors. Tubes are mounted externally to dissipate heat. Modulation and fine-frequency can be adjusted manually. RDB/IRIG subcarrier channels 1 through 7 are standard. Filament power can be either ac or dc. Input is  $\pm 2.5$  v into 500 K ohms, and output is 3 v at 5 K ohms from low pass output filter. Linearity is  $\pm 0.75\%$  of bandwidth, and harmonic distortion does not exceed 0.5%. The Geotechnical Corp., P. O. Box 28277, Dallas 28, Tex.

Circle 229 on Inquiry Card, page 105

**PHASE ANGLE VOLTMETER**

A multi-functional phase angle voltmeter designed for phase-sensitive null indication, and as a ratiometer for zeroing and testing precision syn-

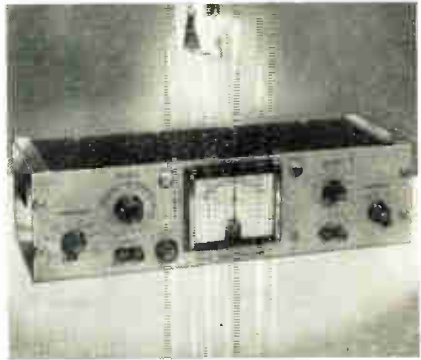

chros, servo-mechanisms and transducers. It is being used to align highly critical control equipment in the Atlas Missile. North Atlantic Industries, Inc., 603 Main Street, Westbury, L. I., New York.

Circle 230 on Inquiry Card, page 105



**SHIELDED CABLES**

*designed for*

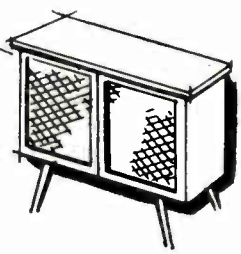
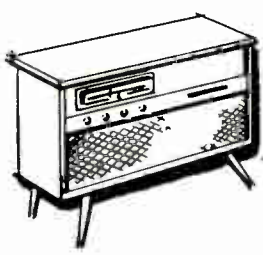

These low capacity cables are especially designed for use as leads between amplifiers, speakers and record changers of Stereo HI-FI units. Standard Two Conductor and Single Conductor cables are available and, where required, modifications of these cables can be developed to satisfy specific requirements.



**LOW CAPACITY RECORD CHANGER TO AMPLIFIER EXTENSION CABLE**

Two Stranded Conductors with clear polyethylene insulation extruded in parallel with a spiral wrapped tinned copper shield and a black extruded plastic jacket. Two styles available, with .030" wall insulation, 24 uuf per foot shield to conductor capacity and .017" wall insulation, 39 uuf per foot shield to conductor capacity.

**LOW CAPACITY HI-FI AMPLIFIER INTERNAL SIGNAL CABLE**

Two Solid Conductors in parallel with red and clear polyethylene insulation and spiral wrapped tinned copper shield with black extruded plastic jacket with 24 uuf per foot shield to conductor capacity.



**STEREO RECORD CHANGER TO SPEAKER CO-AXIAL SINGLE CONDUCTOR LOW CAPACITY CABLE**

Single Stranded Copper Conductors with polyethylene insulation, tinned copper full coverage shield and black or gray plastic insulation. Three styles available with shield to conductor capacities of 28, 31 and 33 uuf per foot respectively.

*For complete specifications for these and other Lenz Wires and Cables write today for the new Lenz Catalog.*

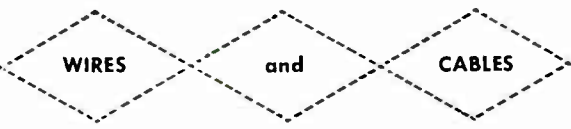

In Business Since 1904

**LENZ ELECTRIC MANUFACTURING CO.**  
1751 No. Western Ave., Chicago 47, Ill.

## MAGNETIC TAPE & DRUM HEADS

*quality control from prototype to production*



The Magnetic Head Division of General Transistor Western Corporation designs and produces premium quality magnetic heads to your specifications . . . at lowest cost. Special quality control checks insure an extremely narrow channel to channel and head to head uniformity; all metal construction plus precision lapped gaps and mounting surfaces account for their excellent reputation in the computer and missile field. Write or call now for complete design portfolio.



Subsidiary of  
General Transistor Corporation

**General Transistor Western Corporation**

6110 Venice Boulevard, Los Angeles, California • WEbster 3-5867

**New**

**Products**

### I-F FILTER

Selective i-f filter weighs less than 12 oz. Performance data: Center frequency 460 kc; -6 db 440 kc 480 kc; -90 db 415 kc 505 kc. Input/output impedance 17,500 ohms. Insertion loss

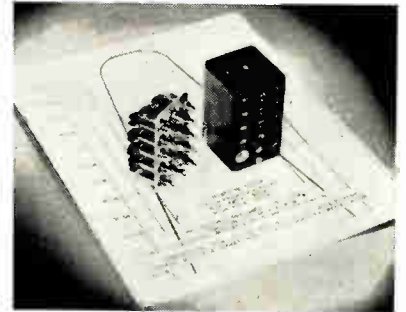

approximately 14 db (output impedance of 75 ohms, loss is 43 db). Temperature stability = CF shift 500 cycles  $-40^{\circ}$  C to  $+65^{\circ}$  C. Meets MIL-T-27A. Temperature stability equals 0.1% or better. 100 to 6 db bandwidth ratios of less than 2 are obtained. At 500 kc center frequency, there is less than 1 db/section insertion loss. Peak to valley ratio is less than  $\frac{1}{2}$  db. Unit is operable above 50,000 ft. Hermetic Seal Transformer Co., 550 N. 5th St., Garland, Tex.

Circle 221 on Inquiry Card, page 105

### VARIABLE RESISTOR

Variable resistor, Model 8 Radi-ohm, measures 0.286 inches in diameter and 0.110 inches in depth. The unit is rated at 1/10 watt and has a component density of 188/in<sup>3</sup>. Production quantities have resistance values



of 500 ohms to 10 megohms in a wide range of tapers. This micro-miniature control has a minimum rotational life of 25,000 cycles. Globe-Union, Inc., Centralab Div., 900 E. Keefe Avenue, Milwaukee 1, Wisconsin.

Circle 222 on Inquiry Card, page 105



## TRANSISTORIZED INTERCOM EXCEEDS MIL-E-5272B SPECS

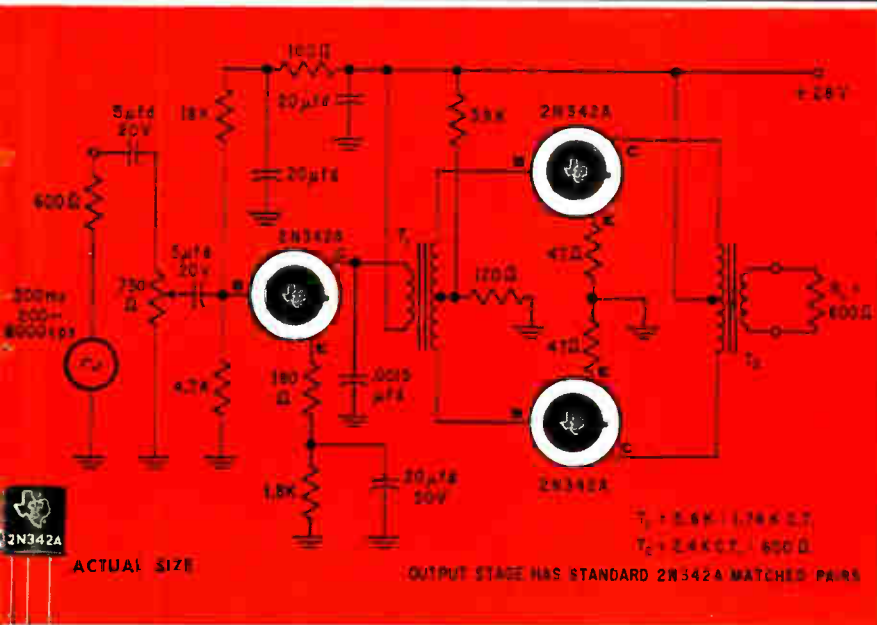

### CIRCUIT SPECIFICATIONS

150-mw output from  $-55^{\circ}\text{C}$  to  $100^{\circ}\text{C}$  at less than 10% harmonic distortion over frequency range

Frequency response @  $25^{\circ}\text{C}$  stable within  $\pm 2$  db of 1000 cps 100 mw reference level from 200 to 8000 cps

Frequency response @  $-55^{\circ}\text{C}$  and  $100^{\circ}\text{C}$  within  $\pm 3$  db of  $25^{\circ}\text{C}$  frequency response

Less than 3-db gain variation @  $-55^{\circ}\text{C}$  and  $100^{\circ}\text{C}$  compared to  $25^{\circ}\text{C}$  measurement

## LOUD AND CLEAR AT $100^{\circ}\text{C}$ !

... with TI **2N342A** silicon transistors from stock

You can satisfy the  $71^{\circ}\text{C}$  equipment requirements of MIL-E-5272B at  $100^{\circ}\text{C}$  with the intercom amplifier circuit shown above — using TI 2N342A silicon transistors with ... guaranteed 3-to-1 linear beta characteristics ... 85-v collector-to-emitter breakdown, giving a wide safety range with 28-v aircraft supplies ... plus dissipation capability of 1 watt at  $25^{\circ}\text{C}$  and 200 mw at  $125^{\circ}\text{C}$ .

The newest addition to the *use-proved* TI 2N339 series introduced in 1957, this medium-power unit carries the full-year TI guarantee and is immediately available *off-the-shelf* from all TI distributors in 1-249 quantities. For production quantities, contact your nearest TI sales office.

TYPICAL INTERCOM AMPLIFIER PERFORMANCE CHARACTERISTICS USING 2N342A TRANSISTORS

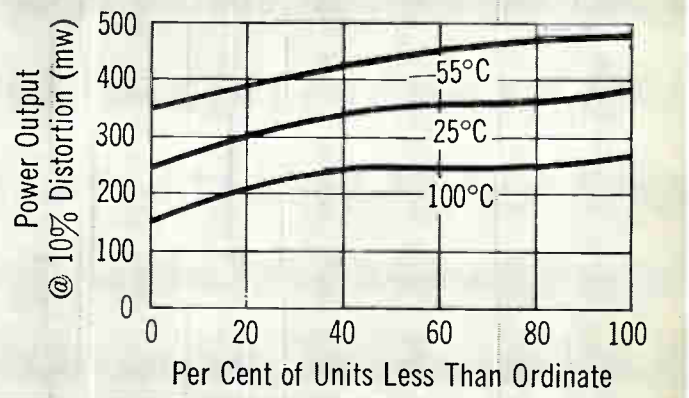
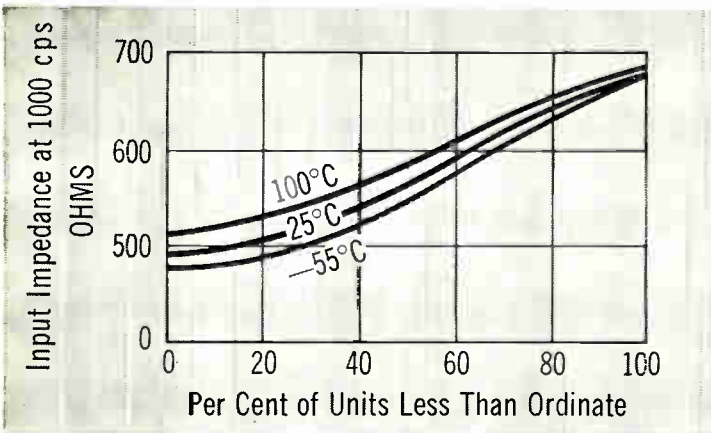

from THE WORLD'S LARGEST SEMICONDUCTOR PLANT



**TEXAS INSTRUMENTS**  
INCORPORATED

SEMICONDUCTOR-COMPONENTS DIVISION

POST OFFICE BOX 312 • 13500 N. CENTRAL EXPRESSWAY  
DALLAS, TEXAS

SPECIALLY BUILT TO WITHSTAND  
SEVERE OPERATING CONDITIONS



**Bendix**  
*Red Bank*

# HARD GLASS TUBES



6094  
BEAM POWER AMPLIFIER

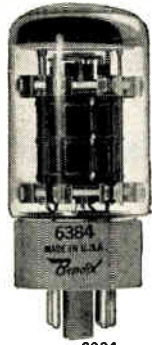

6384  
BEAM POWER AMPLIFIER



6754  
FULL-WAVE RECTIFIER

- Ideal for modern high-performance aircraft and missiles.
- Processing at higher vacuum and under the higher heat permitted by the hard glass reduces gas and contamination and provides greater operating stability at higher temperatures.
- Ceramic element separators prevent emission loss from high heat and vibration.
- Solid aluminum oxide heater-cathode insulator eliminates shorts, reduces leakage.

For complete line of tubes, write RED BANK DIVISION, BENDIX AVIATION CORPORATION, EATONTOWN, NEW JERSEY.

ELECTRICAL RATINGS*	6094 Beam Power Amplifier	6384 Beam Power Amplifier	6754 Full Wave Rectifier
Heater Voltage (AC or DC)**	6.3 volts	6.3 volts	6.3 volts
Heater Current	0.6 amp.	1.2 amp.	1.0 amp.
Plate Voltage (Maximum DC)	300 volts	750 volts	350 volts
Screen Voltage (Maximum DC)	275 volts	325 volts	—
Peak Plate Voltage (Max. Instantaneous)	550 volts	750 volts	—
Plate Dissipation (Absolute Max.)	14.0 watts	30 watts	—
Screen Dissipation (Absolute Max.)	2.0 watts	3.5 watts	—
Heater-Cathode Voltage (Max.)	±450 volts	±450 volts	±500 volts
Grid Resistance (Maximum)	0.1 Megohm	.1 Megohm	—
Grid Voltage (Maximum)	5.0 volts	0 volts	—
(Minimum)	-200 volts	-200 volts	—
Cathode Warm-up Time	45 sec.	45 sec.	45 sec.

\*For greatest life expectancy, avoid designs which apply all maximums simultaneously.

\*\*Voltage should not fluctuate more than ±5%.

MECHANICAL DATA	6094	6384	6754
Base	Miniature 9-Pin	Octal	Miniature 9-Pin
Bulb	T-6½	T-11	T-6½
Maximum Over-all Length	2½"	3½"	2¾"
Maximum Seated Height	2¾"	2½"	2½"
Maximum Diameter	¾"	1¼"	¾"
Mounting Position	Any	Any	Any
Maximum Altitude	80,000 ft.	80,000 ft.	80,000 ft.
Maximum Bulb Temperature	300°C	300°C	300°C
Maximum Impact Shock	500G	500G	500G
Maximum Vibrational Acceleration	50G	50G	50G

West Coast Sales and Service: 117 E. Providencia Ave., Burbank, Calif.  
Canadian Affiliate: Computing Devices of Canada, Ltd., P. O. Box 508, Ottawa 4, Ont.  
Export Sales & Service: Bendix International, 205 E. 42nd St., New York 17, N. Y.

**Red Bank** Division



Circle 66 on Inquiry Card, page 105

## New Products

### POTENTIOMETER

APW ½ in. water-tight potentiometer has a glass-to-metal solder sealed header, including terminal lugs installed with a glass-to-metal seal, and positioned for easy wiring. The

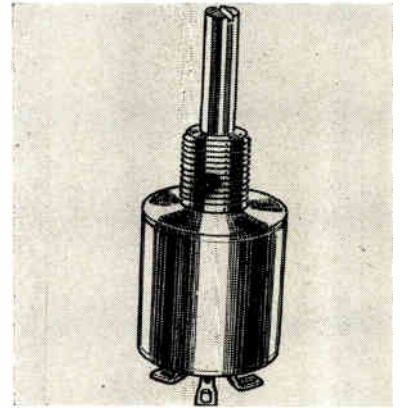

brass case is plated in conformance with military requirements. It is sealed against moisture and salt spray by means of an "O" ring shaft seal, as specified in MIL-E-5272A. The terminal board is solder sealed to the case. It derates to 0 w at 125°C. It is available with mechanical rotation stops, special winding angles, resistance values to 100K ohms and tighter linearity tolerances. Waters Manufacturing, Inc., Boston Post Rd., Wayland, Mass.

Circle 223 on Inquiry Card, page 105

### SILICON RECTIFIER

Rated at 1600 volts peak inverse and 500 ma. dc., the Type S-5207 Silicon Rectifier will replace up to 5 type 6x4 tubes in parallel. Pin connections are identical so the units are interchangeable. Rugged con-



struction and characteristic long life found in silicon rectifiers makes type S-5207 an ideal replacement or original equipment item. Sarkes Tarzian, Inc., Rectifier Div., 415 North College Avenue, Bloomington, Indiana.

Circle 224 on Inquiry Card, page 105





## NEW FUSION-SEALED glass capacitors defy environmental stresses

Corning's new CYF-10 capacitors are guaranteed to be four times better than MIL specs require on moisture resistance.

All the data we've gathered to date indicates that with the new CYF-10 you have a capacitor that is *practically indestructible* under severe environmental stresses.

For example, these CYF-10's will withstand MIL-STD 202A moisture conditions for over 1000 hours with no signs of deterioration.

To make the CYF-10 impervious to environmental stresses we've completely encapsulated the glass dielectric capacitor element in a glass casing. This encapsulation is completely fusion-sealed against moisture, salt, corrosion and weathering.

If you need both high reliability and miniaturization, the new CYF-10's—the only FUSION-SEALED capacitors available—are worthy of your investigation. For complete details, write to Corning Glass Works, Bradford, Pennsylvania.

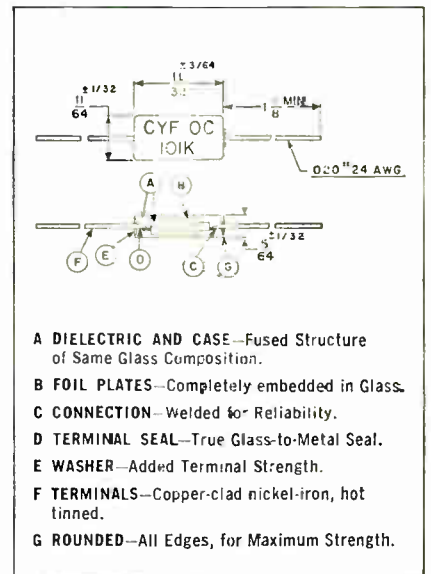

**CORNING GLASS WORKS**

Electronic Components Department

CORNING MEANS RESEARCH IN GLASS

# Phil A. Ment— Caught the mailman just in time with his ELECTRONIC INDUSTRIES subscription renewal.

Now Phil doesn't have to worry about missing "EI's" 17th Annual Directory & All-Reference Handbook, published in June. This immense book (over 400 pages) is his year-round reference for electronic equipment buying data—plus, his best source of information on electronic symbols, terms, statistics, codes, specification materials, etc.



**Have YOU mailed your renewal?**

## SPECIAL

WELDING TIPS, HOLDERS and WELDING JIGS

MADE TO YOUR SPECIFICATIONS

EISLER MAKES THE LARGEST ASSORTMENT OF SPECIAL, STANDARD WELDING TIPS, ACCESSORIES & WATER COOLED HOLDERS

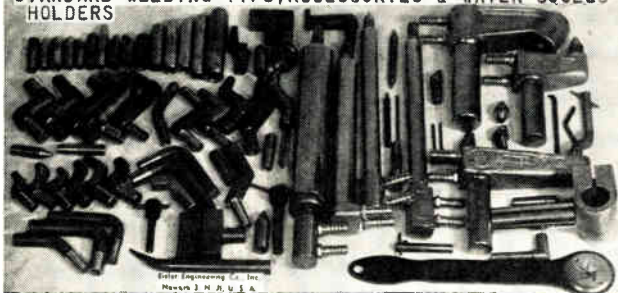

Eisler Engineering Co., Inc.  
Newark 3, N. J., U. S. A.

### EISLER VERTICAL SPOT WELDER

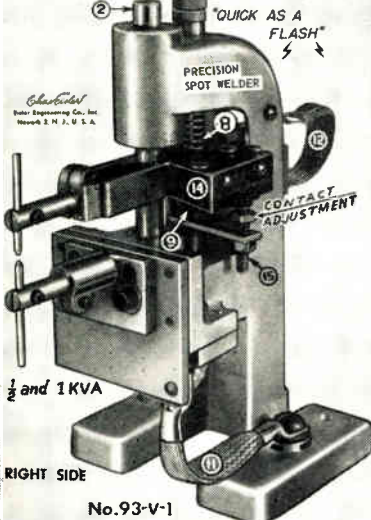

### EISLER VERTICAL SPOT WELDER

MADE IN SIZES 1/2-1-2-3-5 KVA

### LONG ARM SPOT WELDER WITH 1 KVA TRANSFORMER

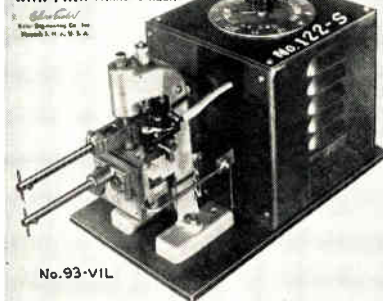

## EISLER ENGINEERING CO., INC.

770 So. 13th St. NEWARK 3, N. J.

**New**

**Products**

## CALIBRATOR

Model 55 Automatic Calibration Unit is a highly accurate signal source for checking the accuracy of voltage signals. It may be used manually or automatically with 12 mea-

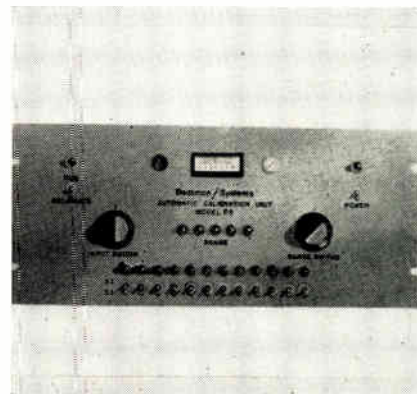

suring devices and their associated transducers. An automatic remote calibration run may be programmed into the unit by using 5 available remote control leads to command a 5 range calibration run into the measuring devices. It can be used to calibrate, set-up and check-out oscillographs, recording potentiometers, telemetry systems and data handling systems. Beckman Instruments Co., Systems Div., 325 N. Muller Ave., Anaheim, Calif.

Circle 225 on Inquiry Card, page 105

## SWITCHES

Switches for corrosive atmospheres use gold-laminated contacts and slip rings. In tests conducted on the Type 11-CM-32 (a single-pole, 32-position, shorting type switch), the unit was suspended in a sulphur atmosphere at 45° C for 245 hours. The initial

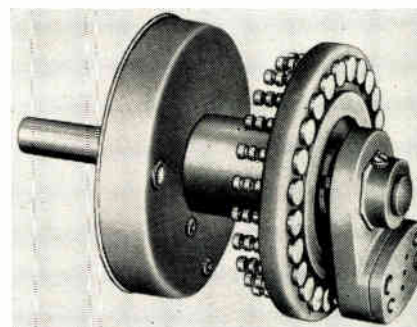

contact resistance reading before suspension in this atmosphere was 0.001 ohm to 0.002 ohm. After completion of the tests, the contact resistance was 0.0021 to 0.0025 ohm. The Daven Company, Route 10, Livingston, N. J.

Circle 226 on Inquiry Card, page 105



Stamp on top of bulb clearly shows date Bell Laboratories installed Tung-Sol/Chatham 5R4WGY rectifier tubes. September 9, 1958, five years, over 43,000 hours later, the tubes were removed.



## Tung-Sol/Chatham tubes operate 43,000 hours – more than five years

Bell Laboratories, Murray Hill, New Jersey — research and development center for new and better telephone components — recently removed two Tung-Sol/Chatham 5R4WGY rectifier tubes, forerunner of the improved 5R4WGB, after more than five years of unbroken, high-quality operation.

Records revealed that on March 20, 1953, Bell Laboratories installed the rectifier tubes in a frequency distribution amplifier operated at Murray Hill. Removal date: September 9, 1958, more than five years and 43,000 service hours later. Comparison with the normal 5R4WGY warranty of 500 hours underscores the extraordinary performance of these Tung-Sol/Chatham tubes.

More and more tube users in all areas of industry are gaining similar benefits of long-life reliability found throughout Tung-Sol/Chatham tubes. You can too! When you need replacements . . . the next time you order new electronic equipment, specify Tung-Sol/Chatham tubes! For further information, to fill a special socket, contact: Chatham Electronics, Division of Tung-Sol Electric Inc., Newark 4, New Jersey.

 **TUNG-SOL®**

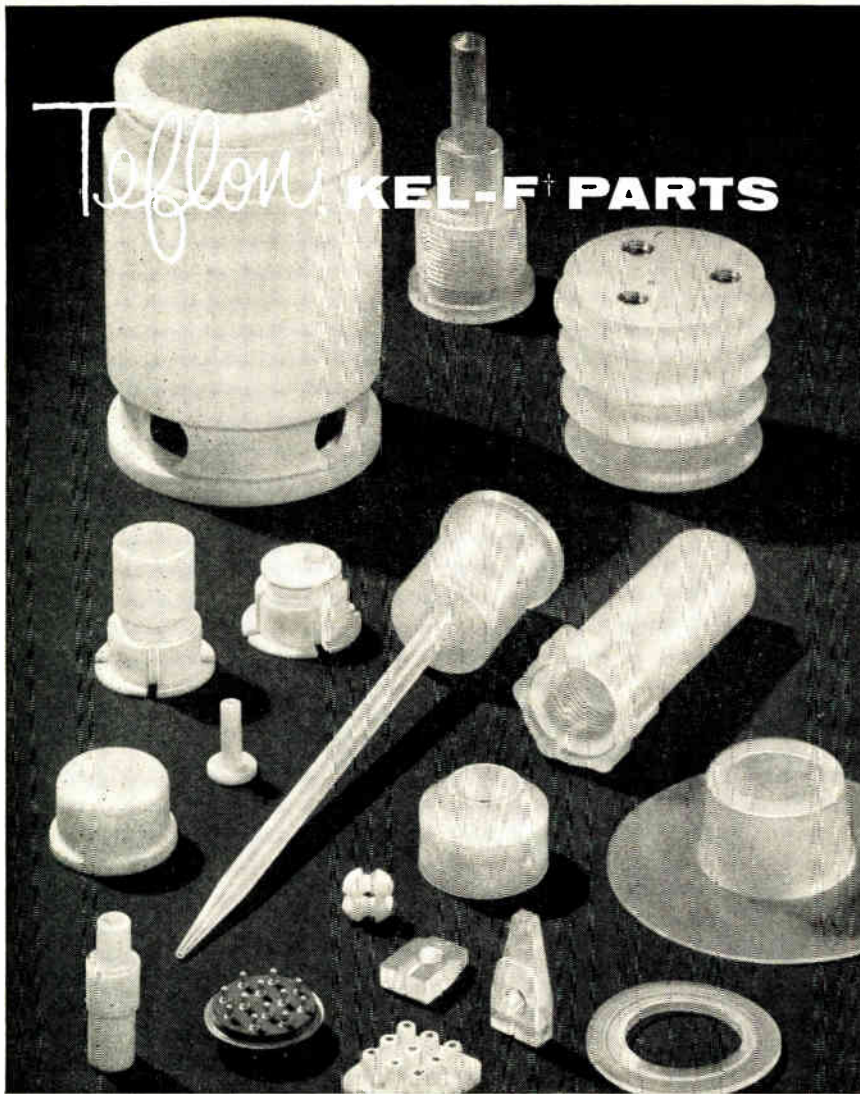

## THE DIFFERENCE IS IN THE MAKING

Good quality fluorocarbon parts require special processing techniques. This is why Garlock's United States Gasket Plastics Division is called upon so often to fabricate parts of fluorocarbon plastics. They have the personnel, the facilities, and unequalled experience in handling TEFLON and KEL-F. They specialize in precision molding and machining where close tolerances, intricate shapes, delicate wall sections, inserts, molding around metal, and threaded parts are involved.

If you have a difficult fluorocarbon problem, why not send it to your local Garlock office for quotation? Guarantee yourself the best in parts, methods, and price.

**U**nited  
**S**tates  
**G**asket

For Prompt Service, contact one of our 30 sales offices and warehouses throughout the U. S. and Canada, or write The Garlock Packing Company, Palmyra, New York.

\*DuPont Trademark  
†M.M.&M. Trademark

Plastics Division of  
**GARLOCK**



**New**  
**Products**

### TUBE SHIELD LINER

"Therma-flex," tube shield liner, accepts all dia. tubes and retains the tube in shock and vibration. Material is heat treated beryllium copper. The liner extends into the space occupied

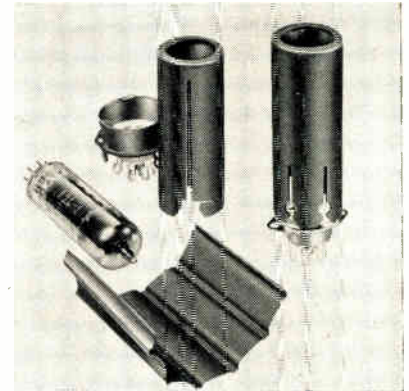

by the tube before insertion and forms a spring curve which flexes to the contours of the tube. This liner with the NW type shield will reduce the bare bulb temperature of tubes by more than 50% and when used with the TR type shield will reduce the bare bulb temperature approximately 35%. Meets MIL-S-9372 (USAF), MIL-S-19786 (NAVY) and SCL-6307/2 (SIGNAL CORPS). International Electronic Research Corp., 145 W. Magnolia Blvd., Burbank, Calif.

Circle 227 on Inquiry Card, page 105

### COAXIAL TERMINATIONS

RDL-30N is a member of a line of high power coaxial terminations which cover the dc-10 KMC range. It

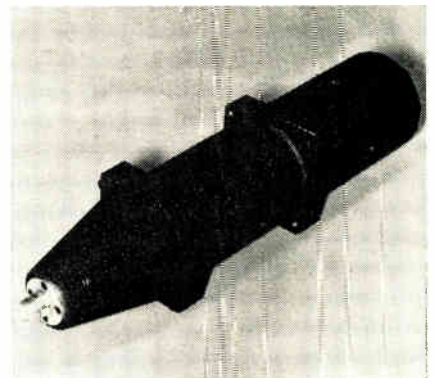

is rated at 200 watts without forced cooling. Voltage Standing Wave Ratio is below 1.2 to 4 KMC. Radar Design Corporation, P. O. Box 38, Pickard Drive, Syracuse, New York.

Circle 228 on Inquiry Card, page 105





to querulous Thomas McHector McVector  
**GLUE WAS THE IDEAL AND PERFECT CONNECTOR!**

Trouble with McH. McV. was he didn't think ahead! To the day when the horse would be replaced by the automobile, the plane and the missile; and each, in turn, with its own needs for a new type of connector! Until an entirely new connector system had to be devised.

You have come to know this as the Varicon Connector system, the industry's synonym for "reliability" and whose limitless applications are limited only by your own imagination. Elco also provides you with the most complete line of printed circuit components, tube-sockets and shields.

Why not write for the Catalogs and Technical Bulletins relating to those components in which you are interested. Today?

**IF IT'S NEW... IF IT'S NEWS... IT'S FROM**

**ELCO CORPORATION**

"M" St. below Erie Ave., Phila. 24, Pa., CU 9-5500

Elco-Pacific: 2200 Centinella Avenue, West Los Angeles 64, Cal., GR 8-0671

**ELCO'S SERIES 5002**



P. C. Varicon Connectors: sectional design, female part; for 1 to 44 contacts. Male member consists of contacts supplied on plastic strips. Bulletins 101A and Staking Bulletin TB001.

**ELCO'S SERIES 7001**



Subminiature P. C. Varicon Connectors: for maximum number of contacts in minimum space; plus all Varicon reliability, versatility factors. Bulletins 106A and TB001.

**ELCO'S SERIES 5301**



Board-to-board Printed Circuit Connectors. Contacts supplied in disposable plastic strips. Offers any number of contacts, spacing, location and board angulation. Bulletins 108A and TB001.

# POWER SUPPLIES



UTILITY



LABORATORY



GENERAL-PURPOSE



SPECIAL



TRANSISTORIZED



OEM

## APPLICATION-ENGINEERED BY REFLECTONE

You *could* shop among the more than 400 power-supply manufacturers to find just the right supply for each of your design, test or production problems as it arises. But why not check first with a manufacturer experienced in using and producing power supplies for all types of applications.

Take advantage of Reflectone's *comprehensive* experience and diversity of engineering approaches. Select from Reflectone's ever-expanding line of Application-Engineered designs.

With nearly two decades of experience in advanced systems design and development, Reflectone offers you the engineering know-how and manufacturing skills which guarantee you reliable performance in your application.

WRITE FOR ENGINEERING SPECIFICATIONS

# REFLECTONE

THE REFLECTONE CORP. • STAMFORD, CONNECTICUT

Circle 73 on Inquiry Card, page 105

## New Products

### CORROSION TEST CABINET

Transparent test cabinet meets A.S.T.M. and U.S. Government Specs. The transparent water jackets house 2 electric heaters, and extend to full width of cabinet. Test specs

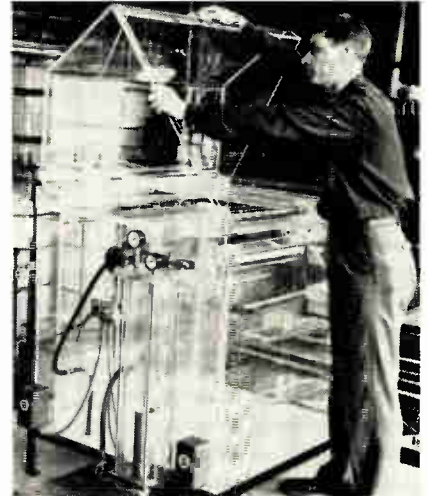

allow tolerance of  $-3^{\circ}$ ,  $+2^{\circ}$ F. The cabinet holds to  $\pm 1/2^{\circ}$ F. Danger of "hot bottom" is eliminated which would ordinarily cause vaporizing of contaminated condensate on the cabinet floor. Progress of tests can be observed, front and back, through water-jacket "picture windows" without opening lid, interrupting the process of handling specimens. The G. S. Equipment Co., 15583 Brookpark Rd., Cleveland 30, Ohio.

Circle 248 on Inquiry Card, page 105

### POWER SUPPLY

Solid-state computer power supply delivers 7 different dc voltages, all of which except one, are series regulated. One is shunt regulated. Output voltage is regulated to  $\pm 1.0\%$  for line and load variations. The com-

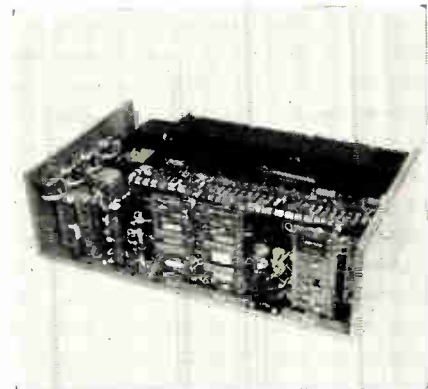

plete power supply occupies about one cubic foot of space (21 in. deep, 7 in. high and 12 in. wide). Bogue Electric Manufacturing Co., Iowa Ave., Paterson, New Jersey.

Circle 249 on Inquiry Card, page 105

Circle 34 on Inquiry Card, page 105



NEW ALLEN-BRADLEY

# Adjustable Fixed Resistor

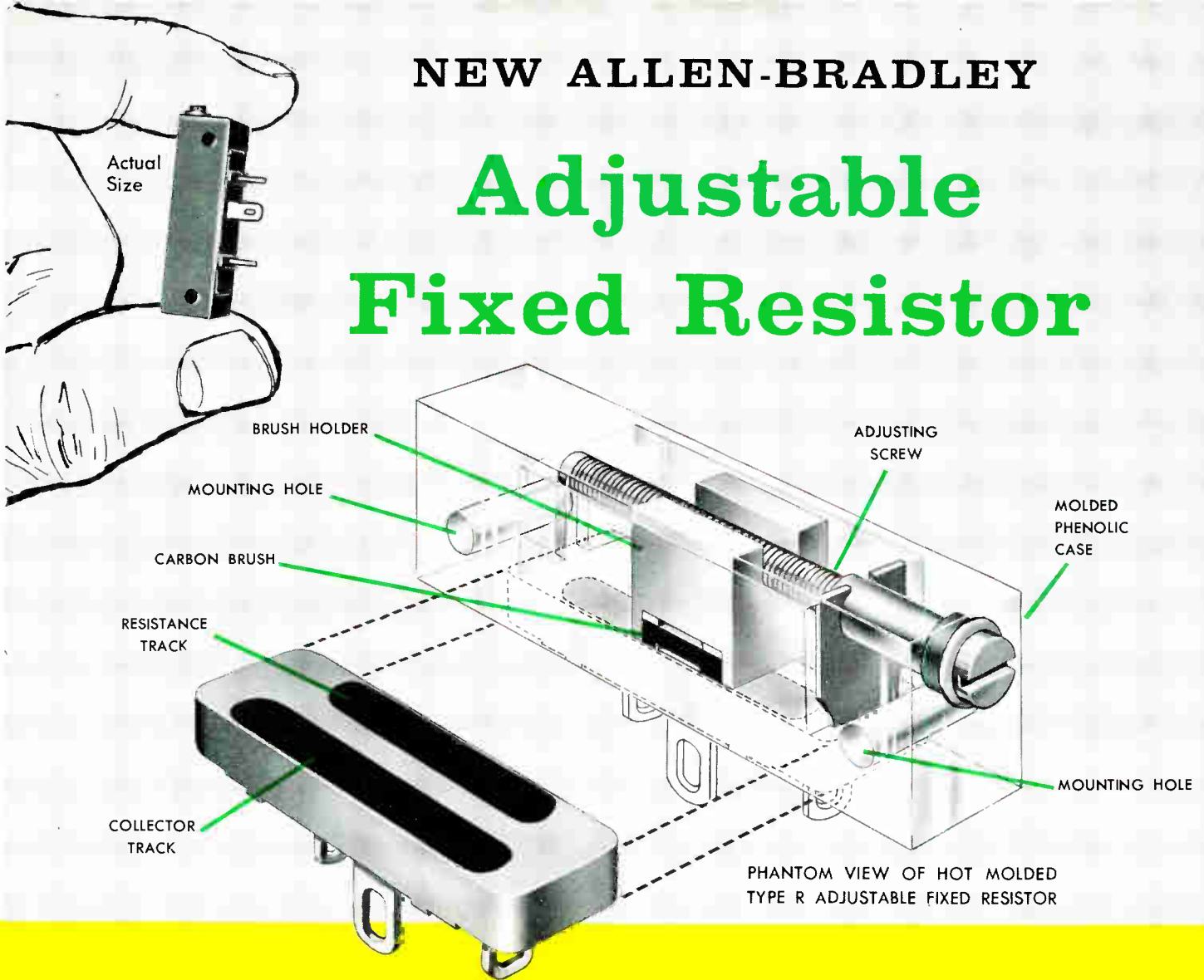

Exclusive hot molded dual track resistance element and carbon brush give unmatched reliability and long life

## SPECIFICATIONS

**Power Rating:** ¼ watt at 70°C ambient  
**Voltage Rating:** 350 volts maximum  
**Temperature Range:** 55°C to 120°C  
**Resistance Range:** total resistance values from 100 ohms to 2.5 megohms  $\pm 10\%$  or  $\pm 20\%$   
**Adjustment:** approximately 25 turns  
**Dimensions:** approximately 1¼" x 21/64" x ¼"  
**Terminals:** lug and pin type terminals on 0.1" grid system and are gold plated for ease of soldering.

Here's a new, compact, adjustable fixed resistor—the Type R—with Allen-Bradley's exclusive hot molded resistance element. It's the same type resistance element used in the popular Type J and Type G units . . . which have proved unequalled for reliability and long life. Operation is exceptionally smooth—no abrupt resistance changes occur with adjustment. The molded case of the Type R adjustable fixed resistor is watertight and dust-tight. The mounting for the moving element is self-locking to assure stable setting—and the entire unit can be "potted" after adjusting. The adjustment screw has a "free wheeling" clutch to prevent damage.

Send for complete information on this latest addition to the Allen-Bradley line of *quality* potentiometers.

Allen-Bradley Co., 222 W. Greenfield Ave., Milwaukee 4, Wis.  
In Canada: Allen-Bradley Canada Ltd., Galt, Ont.



# ALLEN-BRADLEY

QUALITY

## ELECTRONIC COMPONENTS

# ARE YOU INTERESTED IN Cutting Assembly Costs?

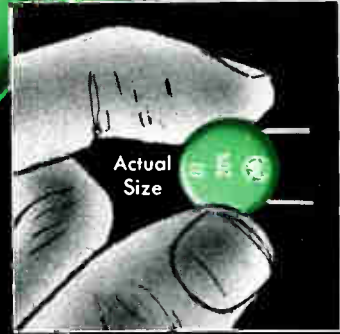

## A New Process... plus a New Concept in Ceramic Capacitor Standardization!

... provides superlative  
electrical properties

New "Auto-Coat process" makes high speed machine assembly possible—but it also makes manual assembly quicker—at lower cost!

Allen-Bradley's new "Auto-Coat process" provides a tough, smooth insulating coating of uniform thickness—it does not use wax or other sticky impregnants which are bound to clog automatic machines. The physical uniformity of these capacitors permits accurate mechanical or manual insertion on printed boards.

With "rundown" on leads eliminated, the capacitor is permitted to rest directly on printed boards—for solid, three-point mounting. Costly cleaning or crimping of wires to prevent soldering failures is a nightmare of the past; lead inductance is less.

### Allen-Bradley Type A Ceramic Capacitor

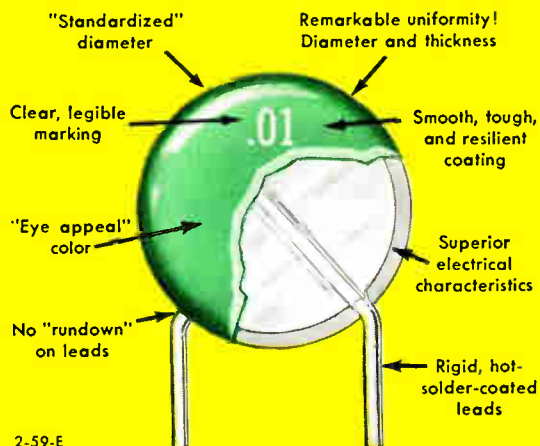

2-59-E

Standardization on only *one size* of capacitor—0.55" diam— for most values, permits scientific selection of ceramic materials with the *optimum* dielectric constant for *each* capacitance value. Through such advanced design technique, Allen-Bradley Type A ceramic capacitors provide greater dielectric strength and greater breakdown voltage . . . creepage paths are also increased. In addition, the coefficients of temperature, frequency, and voltage are lower . . . and the power factor is lower, too.

Allen-Bradley's standardizing on *one size* for all capacitance values has produced a *superior* capacitor that can be assembled by machines on printed boards at lower cost. Manual assembly costs are reduced, and capacitor inventory costs are also reduced.

Allen-Bradley Type A capacitors are available in general purpose, stable, and temperature compensating types in the most frequently used values. Send for new data sheets.

Allen-Bradley Co., 222 W. Greenfield Ave., Milwaukee 4, Wis.  
In Canada: Allen-Bradley Canada Ltd., Galt, Ont.

# ALLEN-BRADLEY

## ELECTRONIC COMPONENTS

QUALITY



THE "THIRD HAND" FOR SMALL ASSEMBLIES



**x-acto**®

**LOCK-GRIPLIER**  
Pat. No. 2,766,646

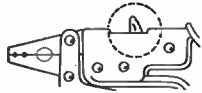

**LOCKING KEY FREES BOTH HANDS:** Pushing the locking key forward automatically locks the jaws. Jaws released instantly by pulling back on the locking key.

New multi-purpose tool to pick up and grasp small parts for soldering or other operations; as a vise to free both hands; to secure rivets; to cut small wire; to strip insulation; as a brad or staple setter.

**ONE HAND ACTION:** Quick one-hand adjustment for size and lock-up leaves the other hand entirely free.

No. 800 .....\$4.50

New Catalog of X-ACTO PRECISION HAND TOOLS for INDUSTRY. FREE on request.

At your ELEC-TRONIC PARTS JOBBER or order direct.



HANDICRAFT TOOLS, INC.  
a division of X-ACTO, INC.  
48-41J Van Dam St., L.I.C. 1, N. Y.

**Multi-Purpose Tool** serves as:

- (1) Plier
- (2) Vise
- (3) Wire Cutter
- (4) Stripper
- (5) Crimper
- (6) Tweezer
- (7) Wrench
- (8) Heat Sink

Circle 86 on Inquiry Card, page 105

**50% SAVINGS**  
with

**BEAD CHAIN®**  
Multi-Swage Parts

**CONTACT PINS**



**TERMINALS**



**JACKS**



**FRICTION CONTACTS**



also **PRINTED CIRCUIT MINIATURE PARTS**

Contact pins, terminals, jacks or any small tubular parts. Maximum 1/4" diameter x 1 1/4" length.

Send sketch for quotations.

**BEAD CHAIN DRIVES**

Low-speed positive drives or motion transfer ... at far less cost!



Send for Multi-Swage or Bead Chain Drive Catalogs!

**THE BEAD CHAIN MFG. CO.**

201 MOUNTAIN GROVE ST., BRIDGEPORT 5, CONN.

Circle 88 on Inquiry Card, page 105

**PURCHASING AGENTS  
CHECK LIST  
FOR INDUSTRIAL SEATING**



✓ **COMFORT FEATURES TO MINIMIZE FATIGUE, BOOST PRODUCTION**

Want to cut energy-robbing fatigue? Look for body contoured backrest, large comfortable seat, spring steel backrest support that maintains correct firmness and fit for life of chair.

✓ **ADJUSTMENT FEATURES FOR EFFICIENCY, VERSATILITY**

Fit the chair to the job, and worker output rises! 4-Way adjustable back enables individual to move backrest up, down, backward, forward so it correctly supports small of back. Telescoping legs, adjustable at 1" increments, keep the worker at right height for the bench and job.

✓ **CONSTRUCTION FEATURES FOR LONGER SERVICE, MINIMUM MAINTENANCE**

Better-built chairs, require less repair, fewer replacements — give top value over the years. Look for welded tubular-steel frames, pre-shaped masonite seats, non-chipping oven-baked enamel finish — these are signs of good dollar value construction. Steel leg glides prevent gouged floors, no exposed bolts to cause worker injury.

**YOU  
GET  
THEM ALL  
IN THE**

**Royal 515**  
... AMERICA'S TOP PRODUCTION CHAIR

SEND FOR FREE COMPLETE INDUSTRIAL SEATING CATALOG #7001

Shows dozens of specialized chairs and stools. Explains fatigue-free seating principles, helps choose the right chair for every job.

**ROYAL METAL MANUFACTURING CO.**

One Park Avenue, New York 16, Dept. 52-D

Circle 87 on Inquiry Card, page 105

### Receiving Tubes

Revised edition of booklet ETR-1541 describes the concept and manufacturing techniques of service-designed receiving tubes. Included are detailed descriptions of construction changes in the 1J3, 6AF4, and 6AF4-A and the line of broad tolerance tubes produced specifically for TV service. General Electric Co., Receiving Tube Dept., 316 E. 9th St., Owensboro, Ky.

Circle 161 on Inquiry Card, page 105

### Phenolic Tubing

Two-page, 2-color, brochure from Cleveland Container Co., 6201 Barberton Ave., Cleveland, Ohio, describes a spirally wound laminated paper-base phenolic tubing. Included are: general properties, fabrication methods, applications, and a property chart.

Circle 162 on Inquiry Card, page 105

### Potentiometer

Data sheet 1357, on the 1 $\frac{3}{4}$  in. "Helipot," Series 5500, single-turn, precision potentiometer, is available from Helipot Div., Beckman Instruments, Inc., 2500 Fullerton Rd., Fullerton, California. Included are: Dimensional drawings, power rating curve, and a photograph.

Circle 163 on Inquiry Card, page 105

### Test Instruments

Illustrated catalog of precision laboratories test instruments No. 558, includes low frequency "Q" indicators, comparison and limit bridges, incremental inductance comparison bridges, incremental inductance bridges, universal bridges, null detector and vacuum tube voltmeters, harmonic distortion meters, megohmmeters, decade inductors, and decade capacitors. Freed Transformer Co., Inc., 1726 Weirfield St., Brooklyn 27, L. I., N. Y.

Circle 164 on Inquiry Card, page 105

### Capacitors

Bulletin 4-32B describes two new ratings of subminiature, polarized, tantalum electrolytic capacitors from P. R. Mallory & Co., Inc., 3029 E. Washington St., Indianapolis 6, Indiana. The two new ratings are: 35 mfd at 12 vdc and 50 mfd at 4 vdc.

Circle 165 on Inquiry Card, page 105

### Generators

Data sheet from John Oster Manufacturing Co., Avionic Division, 1 Main St., Racine, Wis., lists and gives technical details on its complete line of generators. Included are ac and dc tachometer, rate, tachometer with squirrel cage rotor, damping and dc motor generators.

Circle 166 on Inquiry Card, page 105

### Sintered Nylon

A 4-page brochure on Nylasint nylon parts, nylon components formed by cold pressing and oil sintering nylon powders in a process somewhat similar to that used in forming powdered metal parts is available from Halex Corp., c/o The Polymer Corp., 2120 Fairmont Ave., Reading, Pa. The bulletin includes property and application data on standard oil-impregnated parts with inorganic fillers designed for new or improved uses for nylon as compared to injection molded nylon.

Circle 167 on Inquiry Card, page 105

### Recorder/Reproducer

A 2-color, 4-page, technical brochure describes the specifications, operational characteristics and design features of the MINCOM 7-track Video Band Magnetic Recorder/Reproducer. The bulletin includes color photographs of actual oscilloscope traces, calibrated in  $\mu\text{sec/cm}$ ; these waveshape photos point up the equipment's quality reproduction of transient phenomena occurring at frequencies from 400 cps to 1 MC. MINCOM Div. of Minnesota Mining & Mfg. Co., 2049 So. Barrington Ave., Los Angeles 25, Calif.

Circle 168 on Inquiry Card, page 105

### Diodes

Bulletin E from Electronet Div., Rue Products, 1628 Venice Blvd., Venice, Calif., describes germanium and silicon diodes now added to the firm's Encapsulet line of encapsulated components. The 5-page bulletin stresses construction. Featured are self-contained, silver-plated terminals and plated fastening studs which permit direct-to-chassis mounting and eliminate terminal boards. Applicable MIL specs are noted.

Circle 169 on Inquiry Card, page 105

### Ceramic Insulator

Bulletin 1590A, 4-pages, 2-colors, describes Ceramicite, a high temperature ceramic insulator. The bulletin contains application notes, physical properties, graphs, and design parameters for Ceramicite seals. Consolidated Electrodynamics, Transducer Div., 300 North Sierra Madre Villa, Pasadena, Calif.

Circle 170 on Inquiry Card, page 105

### Generators

A line of separate electric generators manufactured by D. W. Onan & Sons, Inc., Minneapolis 14, Minn., is described and illustrated in a 4-page folder, F-141. Three types of generators are described. Also, control specs: switchboards, rheostats, wall mount switchboards and manual transfers.

Circle 171 on Inquiry Card, page 105

### Radioactivity Measuring

A 76-page, 2-color catalog from Nuclear-Chicago Corp., 229 W. Erie St., Chicago 10, Ill., describes over 125 products for detecting, counting, and recording radioactivity—including systems for use in industrial and biomedical research, clinical medicine and nuclear education. Sections are devoted to nuclear training devices, scalars, ratemeters, gamma, and neutron survey meters, radioactive sources and chemicals, and nuclear accessories.

Circle 172 on Inquiry Card, page 105

### Electronic Type

A method of using a standard manual or electric or proportional-spacing typewriter for special impressions needed in electronics, is the subject of a booklet published by Remington Rand, Div. Sperry Rand Corp., 315 4th Ave., New York 10, N. Y. It is the first in a series designed to show how any of 18 different fields can make a profitable use of interchangeable typewriter type.

Circle 173 on Inquiry Card, page 105

### Magnetic Shielding

Data Sheet 142, an engineering report, illustrates, gives tabulated summary and fully describes a proposed technique for comparatively evaluating the effectiveness of shielding magnetic tape in Netic Co-Netic tape preservers, versus unshielded tapes. Magnetic Shield Div., Perfection Mica Company, 1322 No. Elston Ave., Chicago 22, Ill.

Circle 174 on Inquiry Card, page 105

### Silicon Rectifier

Illustrated data sheet gives descriptions, data and specifications on silicon power rectifiers. Electrical and mechanical characteristics and data on performance for diodes with capacities of 6, 20 and 40 a. per cell and with peak inverse ratings of from 50 to 500 v. are given. Syntron Company, 263 Lexington Avenue, Homer City, Penna.

Circle 175 on Inquiry Card, page 105

### Selenium Photocells

An 8-page bulletin, PC-649A, "Selenium Photovoltaic Cells" published by International Rectifier Corp., 1521 E. Grand Ave., El Segundo, Calif., describes a line of self-generating photocells. Over 25 standard selenium cell types are described, including cell structure and operation, performance characteristics, output current curves and typical applications in electrical and industrial engineering, chemistry, photography, photometry and medicine.

Circle 176 on Inquiry Card, page 105





a continuing series on technical topics of specific interest to engineers

## How important are the functions of various impregnants in paper capacitors?

Capacitors using impregnated kraft tissue paper dielectric are available with a variety of impregnating materials. These materials are generally waxes, oils, or thermo-setting plastics. The electrical "personality" and capabilities of the completed capacitor is, in part, determined by the characteristics of the impregnant. The components application engineer must be familiar with the available materials in order to judiciously prescribe the proper component for a given application.

**MINERAL OIL** is an excellent electrical insulating medium. It possesses low electrical loss factor, is quite stable in dielectric constant over operating temperatures ranging from  $-65^{\circ}\text{C}$  to  $+85^{\circ}\text{C}$  and from low audio to radio frequencies. It exhibits extremely high dielectric strength and comparatively good insulation resistance characteristics. It is used to provide the operating conditions described as "E" characteristic in Military Specification MIL-C-25A.

**ANOTHER SPECIAL IMPREGNATING OIL** is used which is similar to mineral oil in physical and electrical characteristics, but is stabilized and purified to further improve the electrical characteristics and extend the operating temperature range to  $125^{\circ}\text{C}$ . This is supplied for "K" characteristic paper capacitors of specification MIL-C-25A. At Sangamo, the designation for this special impregnating oil is "Etherm".

**CHLORINATED BIPHENYL** is a synthetic oil that is manufactured under carefully controlled conditions of purity. Paper capacitors using this impregnant are often chosen for applications where fire hazards are a consideration because it is virtually non-flammable. Chlorinated biphenyl possesses a higher dielectric constant and provides an effective mechanism for decreasing the comparative size and cost of large value capacitors. It is used almost exclusively for impregnating capacitors designed for power frequency applications including those used for power factor correction in alternating current circuitry. This material is used to provide the "D" and "F" characteristics of MIL-C-25A. At Sangamo, the designation for Chlorinated biphenyl is "Diaclor".

**A POLYESTER RESIN** impregnant is a non-melting solid which is used where physically rugged capacitor sections of good electrical characteristics over an operating temperature range from  $-55^{\circ}\text{C}$  to  $+85^{\circ}\text{C}$  are desired. Its dielectric constant falls between that of chlorinated biphenyl and mineral oils and its capacitance stability during operating life is excellent. At Sangamo, the designation for polyester resin is "Resinex".

**STABILIZED CHLORINATED NAPHTHALENE** is a wax which is often used in light weight capacitors of minimum size where some sacrifice in electrical characteristics, such as lower insulation resistance at all temperatures and somewhat higher power factors can be tolerated and where an operating temperature range from  $-40^{\circ}\text{C}$  to  $+85^{\circ}\text{C}$  is acceptable. Its high

dielectric constant results in light weight units of small size and provides the "H" characteristic operating requirements of MIL-C-25A. At Sangamo, the designation for stabilized chlorinated naphthalene is "Sangwax".

**SILICONE IMPREGNANTS** are chemically stable synthetic oils and are available over a wide viscosity range. They are used when extreme operating temperatures are specified and low dielectric losses are desirable. Silicone oils are liquid throughout their recommended operating temperature range.

### Specification Guide Of The Various Impregnants Used in Sangamo Paper Capacitors

IMPREGNANT	SANGAMO CAPACITOR TYPE DESIGNATION
Mineral Oil	Type 50, 60, 70, 42 and 43
Etherm	Type SB, SD, SMB, SMD, 50K, 60K and 70K
Diaclor	Type 71, 50, 60, 40, 41, 75 and 80 (Referred to as can, oil paper, types)
Resinex	Type 33 (molded tubular)
Sangwax	Type 50, SA and SC

NOTE: With the exception of the Type 33 all of these capacitors are housed in hermetically sealed metallic containers. The Type 33 is molded in a thermo-setting non-hygroscopic plastic case. The "S" series types are housed in tin coated brass tubular containers with compressed glass solder seal ends. These units are most applicable where "High Reliability" is a necessity.

Engineering Catalogs Numbers 2421 and 2422 give full information and are available upon request for your files.

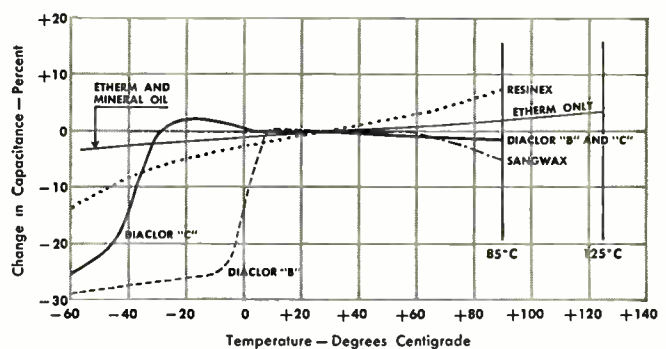

Composite curve of paper capacitors using five Sangamo impregnants for capacitance variations with temperature at 1000 cycles per second.

SC59-2

**SANGAMO ELECTRIC COMPANY, Springfield, Illinois**  
--designing towards the promise of tomorrow



## **How to keep your cut-off sharp!**

Audio filter designers use molybdenum permalloy powder cores when they want razor sharp attenuation that will hold

Audio filter designers, faced with a crowded frequency spectrum, specify molybdenum permalloy powder cores to rigidly define channel cut-offs . . . with sharp, permanent attenuation at channel cross-overs.

Moly-permalloy, with virtually no resistive component, makes a core with almost no core loss. The resultant high Q means sharp attenuation of blocked frequencies in both the high and low band pass ranges. This is permanent—moly-permalloy cores were developed specifically to provide a very long term inductance stability.

Compare molybdenum permalloy to powdered iron. See the smaller size and the superior stability despite unusual fluctuations in current or temperature. Even unstabilized permalloy powder cores are more stable with temperature swings

than cores made of any other material. And . . . stabilized cores are at least four times more inductance-stable than unstabilized cores.

What's more, there's no longer any guesswork! We have published limits within which the designer can depend on core performance. These limits—and full information on our Performance-Guaranteed permalloy powder cores—await your inquiry. *Magnetics, Inc., Dept. EI-61, Butler, Pa.*

**MAGNETICS inc.**



### Magnetic Amplifiers

A new standard line of low level linear magnetic amplifiers is described in Bulletin #S-921 issued by Magnetic Amplifiers, 632 Tinton Ave., New York 55, N. Y. Completely static, the solid state devices are used in connection with such signal sources as strain gauge transducers, thermocouples, resistance thermometer bridges, photo cells and meter shunts. They are designed for use in 60 or 400 CPS with either proportional dc or ac output. The bulletin furnishes performance specs; also detailed data on principles of operation and a characteristics curve chart.

Circle 177 on Inquiry Card, page 105

### Hi-Fi Stereo

Brochure, 16-pages, is an informative guide to high fidelity stereo and monophonic speaker systems and components. It contains information, tips and practical suggestions of interest to those contemplating building or improving a monophonic or stereophonic high fidelity speaker system. Also a complete illustrated description of every speaker and component in the range offered by University. Desk Bl 1, University Loudspeakers, 80 So. Kensico Ave., White Plains, N. Y.

Circle 178 on Inquiry Card, page 105

### Resistors

Bulletin 162 describes 3 assortments of precision resistors and tantalum capacitors. One assortment consists of tantalum wire capacitors in a variety of case sizes, capacitance and voltage values. Another consists of power type precision resistors and another of metal film precision resistors. Ohmite Manufacturing Company, 3670 Howard Street, Skokie, Ill.

Circle 179 on Inquiry Card, page 105

### Microwave Equipment

Two-page Bulletin, #100, from Polytechnic Research & Development Co., 202 Tillery St., Brooklyn, N. Y., describes the Pacemaker line of microwave test equipment. Featured is the Standing Wave Amplifier, Type 277A, frequency 1000 CPS  $\pm$  2%; bandwidth selection 15, 50 or 550-2500 CPS; sensitivity 0.1  $\mu$ v full-scale deflection @ 15 CPS bandwidth.

Circle 180 on Inquiry Card, page 105

### Silicon Power Rectifier

Fansteel Metallurgical Corp., Dept. EIP, North Chicago, Ill., has just announced the availability of information which describes their 20 amp. silicon power rectifiers. The Type 6A operates at voltages from 50 to 400 volts in multiples of 50 volts. They were designed for high temperature service.

Circle 181 on Inquiry Card, page 105

### Navigation Module

A 2-color brochure describing navigation module Model 2374 for operation of VOR/LOC and marker beacon is available from Lear, Inc., 3171 South Bundy Drive, Santa Monica, Calif. The brochure contains installation drawings and engineering and performance specs.

Circle 182 on Inquiry Card, page 105

### Transistors

Brochure G-150A covering specifications on their line of improved high frequency germanium alloyed junction transistors types 2N444A through 2N447A and 2N519A through 2N523A is available from General Transistor Corp., 91-27 138 Pl., Jamaica, N. Y. These improved "A" versions provide higher voltage ratings and generally tighter specifications than were previously found in types 2N333-2N447 and 2N519-2N523.

Circle 183 on Inquiry Card, page 105

### Cable

Aeronautical & Instrument Div., Robertshaw-Fulton Controls Co., Santa Ana Freeway at Euclid Ave., Anaheim, Calif., has issued a 4-page illustrated booklet, "This is Cable Systematics." It describes the division's capabilities and facilitates for custom electronic cabling for aircraft and missile industries, from design and development through fabrication and installation.

Circle 184 on Inquiry Card, page 105

### Transistor Course

Folder, PA-276, describes the revised and expanded edition of the CBS-Hytron Transistor Course, a home-study course, which includes the latest, up-to-the-minute information on transistor devices and applications. This new version of the course offers 10 lessons covering simplified basic transistor theory with practical experiments and servicing techniques for amplifiers, oscillators, rectifiers and deflection circuits. CBS-Hytron Advertising Service, Parker St., Newburyport, Mass.

Circle 185 on Inquiry Card, page 105

### Germanium Diodes

Technical information about Hughes Products' Semiconductors, International Airport Station, Los Angeles 45, Calif., complete line of Gold Bonded diodes is available. These diodes feature fast recovery, high forward conductance, low reverse leakage and high peak inverse voltage. They were designed for severe environmental conditions.

Circle 186 on Inquiry Card, page 105

### Resistor

Type PC5, a low operating temperature, 5-w. resistor designed for printed circuit use is described in data bulletin P-5, International Resistance Co., 401 N. Broad St., Phila., Pa. The type PC5 resistor is designed for aircraft and missile applications where printed circuitry is used solely as a means of improving uniformity and reliability of a product.

Circle 187 on Inquiry Card, page 105

### Control Panels

The advantages of centralizing motor starters in control panels are discussed in a 4-page illustrated technical bulletin, 58-C, offered by the Richardson Scale Co., Clifton, N. J. It cites the savings in initial costs, wiring, engineering time, and reduced maintenance costs that result from mounting the starter centers in control panels at the time the panel is constructed.

Circle 188 on Inquiry Card, page 195

### Microwave Tubes

Form T-291, a 4-page, condensed catalog of its tube lines: klystrons, magnetrons, display tubes, traveling wave tubes, backward wave oscillators, miniature noise sources, duplexers and TR tubes is available from Litton Industries, Electron Tube Div., 960 Industrial Rd., San Carlos, Calif.

Circle 189 on Inquiry Card, page 105

### Printed Circuit Drilling

Bulletin 858 from Zagar, Inc., 24000 Lakeland Blvd., Cleveland, Ohio, describes the company's printed circuit board drilling equipment. Featured are special insert assemblies for quick change advantages.

Circle 190 on Inquiry Card, page 105

### Inductive Voltage Divider

Gertsch Products, Inc., 3211 South La Cienega Blvd., Los Angeles 16, Calif., has issued information about their RatioTran. The RatioTran is an ac inductive voltage divider. It is unaffected by temperatures below 250°F and is capable of voltage division accuracies of 0.001%.

Circle 191 on Inquiry Card, page 105

### Microwave Tubes

Six-page, 2-color tube chart from Bomac Laboratories, Inc., Beverly, Mass., lists, in tabular form TR, ATR, Pre-TR, Dual & Triple TR and ATR tubes and attenuator tubes. Included are pressurizing windows, duplexers and components, magnetron tubes, spark gap tubes, surge protectors, shutter tubes, and reflex klystron tubes.

Circle 192 on Inquiry Card, page 105

### Closed Circuit TV

A 12-page, illustrated handbook offers guidance on planning closed circuit TV programs. It includes a complete breakdown of closed circuit costs, a checklist of when and how to use closed circuit for education or communication, and a description of a closed circuit network concept. Cost breakdown details all cost items in program origination, reception, and line and loop charges. Latest models of theatre type television projection equipment for mass audience closed circuit reception are pictured and described. Giantview Television Network, 440 4th Ave., N. Y.

Circle 231 on Inquiry Card, page 105

### Lacing Cord

Illustrated 4-page brochure on 76 synthetic lacing cords and tapes carried in inventory is available from Alpha Wire Corp., 200 Varick St., New York 14, N. Y. It offers a listing of complete specifications as to tensile strength, diameter, stock colors, thickness, standard put-up, etc. on all types of lacing cords and tapes in a variety of finishes and materials in accordance with general and military specifications.

Circle 232 on Inquiry Card, page 105

### Miniature Relay

Tech data, Bulletin 160-1, on Wheelock Signals Crystal Case Relay, Series 160, is available from Wheelock Signals, Inc. Long Branch, New Jersey. The relay was designed for service in airborne and portable equipment requiring subminiature components. It is hermetically sealed in a compact gas-filled case with a hot tin dip finish and provides a minimum of 100,000 operations in ambient temperatures ranging from  $-65^{\circ}\text{C}$  to  $125^{\circ}\text{C}$ .

Circle 233 on Inquiry Card, page 105

### Shielding

Engineering and product brochure, 1959 edition, features complete line of r-f shielded enclosures, anechoic chambers, dust-free rooms and environmental consulting activities. Comprehensive engineering data is supplemented by construction illustrations. Shielding Inc., Engineering Dept., Riverton, N. J.

Circle 234 on Inquiry Card, page 105

### Permanent Magnets

Catalog No. 20, describes permanent magnets for microwave load isolators. It describes the basic sizes and shapes of "C" type magnets available for this application. Indiana steel Products Company, Valparaiso, Indiana.

Circle 235 on Inquiry Card, page 105

### Automation

New Product Information Folder contains descriptions and specifications of "building-block" type automation machines for mechanizing and integrating production and assembly operations. These include floor feeders and orientors, rotary hoppers, self-compensating grinder controls, high speed automatic hardness testers and electronic inspection systems for multiple dimension gaging and selective segregation of parts. Radio Corporation of America, Industrial and Automation Division, 12605 Arnold Avenue, Detroit 39, Michigan.

Circle 236 on Inquiry Card, page 105

### Oscillator

Variable frequency oscillator, Model 1011, frequency range 100 CPS to 5 MC, is described in a new tech bulletin from Technitron Engineering Co., 1952 E. Allegheny Ave., Phila. 34, Pa. The 2-page bulletin gives complete electrical and physical specifications on the oscillator and suggestions for uses as a wide band frequency source for trigger generators, computer "clocks," computer "word" generators and other similar applications.

Circle 237 on Inquiry Card, page 105

### Mica Isolators

Data sheet K-5, 8-pages, contains 29 outline drawings of mica wafer shapes available without tooling costs, and describes how transistor reliability is increased when low cost plentiful mica wafers are used as isolators in heat sink applications. Magnetic Shield Division, Perfection Mica Company, 1322 No. Elson Ave., Chicago 22, Ill.

Circle 238 on Inquiry Card, page 105

### Hydraulics

Hydraulic pneumatic and vacuum catalogue contains flow charts, J.I.C. piping, and helpful information for engineering and maintenance departments. Contains complete data on the Lenz "O" ring seal tube fittings, flare fittings, pipe fittings, tube benders, and other hydraulic components. Lenz Company, Box 1044, Dayton 1, Ohio.

Circle 239 on Inquiry Card, page 105

### Nylon Shapes

Bulletin on Nylatron GS (molybdenum disulphide filled) nylon shapes is available from The Polymer Corp. of Pennsylvania, Reading, Penna. It gives the property advantages of the material in such applications as gears, rollers, bearings, washers, wear strips and pads, and other applications. Included are physical property data and specific stock shape size availabilities.

Circle 240 on Inquiry Card, page 105

### Ball Bearings

Conversion tables giving other manufacturers' numbers for equivalent miniature ball bearings are featured in a bulletin on RMB miniature ball bearings prepared by Landis & Gyr, Inc., 45 West 45th St., New York 36, N. Y. Information is given on tolerances, clearances, lubrication and packaging, ball separators, as well as a full description of the "Filmo seal" principle. Information is provided on calculation of load capacity.

Circle 241 on Inquiry Card, page 105

### Telemetry Systems

Reference bulletin, No. RTS-A-MRS, illustrates typical telemetry receiving systems and describes individual TDI building-block components: receivers, subcarrier discriminators, master controls, record-monitor-mixers, power supplies, and pre-wired mounts. Descriptions also cover the TDI decommutation set and tape error compensation system. It gives detailed examples of systems for receiving FM/FM, PAM/FM/FM, PDM/FM/FM signals. Marketing Dept., Tele-Dynamics Inc., 5000 Parkside Ave., Phila. 31, Pa.

Circle 242 on Inquiry Card, page 105

### Switches and Actuators

Bound reference catalog, ES-59, on basic switches and actuators contains a comprehensive definition of terminology used in the switch industry, as well as photos, specifications, dimensional drawings, and modification information on switch types and their actuators. Electrosnap Corporation, Switch Division, 4218 West Lake Street, Chicago 24, Illinois.

Circle 243 on Inquiry Card, page 105

### Engine Driven Equipment

Four illustrated pamphlets "Power Talks" cover electrical and technical characteristics of engine driven generating equipment. The pocket-sized bulletins discuss electric generating plants, air-cooled engines, separate generators, their operation, and their use. D. W. Onan & Sons, Inc., Minneapolis 14, Minn.

Circle 244 on Inquiry Card, page 105

### Insulation

An 8-page brochure describing and illustrating fiberglass building insulation is available from Owens-Corning Fiberglas Corp., Dept. 690, Toledo 1, Ohio. The publication contains pertinent information about the standard fiberglass building insulation, faced with kraft paper; foil-faced; foil-enclosed; pouring wool; blowing wool and perimeter insulation.

Circle 245 on Inquiry Card, page 105





## SHRUNK BY EXPERTS

Burnell & Co. may not be experts in the art of head shrinking. But when it comes to toroids, filters and related networks, Burnell has the know-how to solve an infinite variety of small space problems. The new **MICROID**® filters by Burnell & Co. are a notable achievement in the shrinking of filters which can be designed for low pass or band pass applications.

For example, as a low pass filter, Type *MLP* starts at 400 cps. Physical size is 11/16" x 1-11/16" x 1/2" max. For higher frequencies from 5 kc up to 100 kc, size is 3/4" x 1" x 1/2".

The band pass filter, Type *MIT* pictured here, ranges from 7,350 cycles

up to 100 kc. Physical size is 1/2" x 19/32" x 15/16", weight .3 ounces, band width 15% at 3 db and + 60% - 40% at 40 db. Wherever space and performance are critical requirements, miniaturized **MICROID**® low pass and band pass filters provide utmost reliability as well as more unit surface economy on printed circuit boards. Completely encapsulated, they are ideally suited to withstand high acceleration, shock and vibration environments.

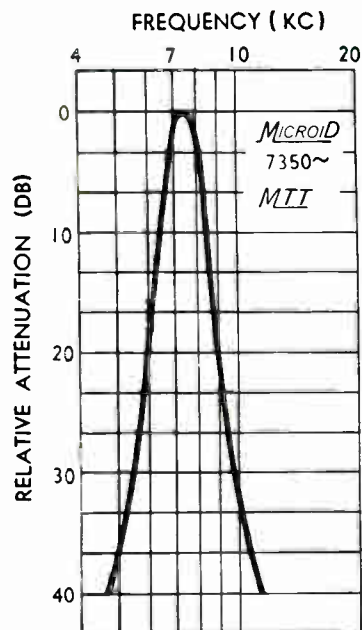

® REGISTERED TRADE MARK

*Burnell & Co., Inc.*

PIONEERS IN TOROIDS, FILTERS AND RELATED NETWORKS

EASTERN DIVISION  
DEPT. 7578  
10 PELHAM PARKWAY  
PELHAM, N. Y.  
PELHAM 8-5000  
TELETYPE PELHAM 3633



PACIFIC DIVISION  
DEPT. 7578  
720 MISSION ST.  
SOUTH PASADENA, CALIF.  
RYAN 1-2841  
TELETYPE PASACAL 7578



# Observations & Trends

## HUMAN ENGINEERING

High-speed aircraft are presenting knotty problems to designers of **display instrumentation**. The addition of high-pressure suits to the pilot's natural handicaps has increased the concern over the possibilities of vertigo brought on by the need for taking the pilot's attention away from the primary job of controlling the aircraft.

The complexities of operating a nuclear reactor forced a thorough study of just what functions would be handled by the human operator and which by automatic machines. NRL assigned the operator the controlling task but gave him the option of turning over to the machines the routine maintenance of reactor power level at a constant level. A system of automatic alarms was set up to warn the operator to take corrective actions whenever the operation of the reactor leads to unsafe conditions. Thus man's ability as a general purpose computer capable of dealing with low probability alternatives is utilized to keep the reactor from developing power levels and rates which

would actuate automatic shutdown.

Recent research in the **CRT-human observer** relationship, so far as the threshold of detection is concerned, has determined that the output brightness is a function of the input signal voltage taken to the  $5/2$  power. This effect suppresses contrasts in the low absolute brightness region and accentuates contrasts in the high absolute brightness level. By introducing non-linear amplification the transfer function can be varied to 0.8, the improvement of detection being on the order of 6 db, equivalent to increasing transmitter power by a factor of 4.

## MEDICAL ELECTRONICS

Although much work is being done by electronic research and manufacturing firms, especially in designing equipment to monitor and control the heart, there is still the one big stumbling stone—interdiscipline communication. This factor must be overcome before rapid advancement can be made in the fields of medical electronics. Further, the economic situa-

tion must be favorably improved for the manufacturer. One way of doing this is by the establishment of independent engineering and testing facilities. These will relieve the manufacturer of some of the present risks and delays.

Slowly, but definitely, advances are being made, through medical electronics, in therapy, diagnosis, teaching and research. Human space flight is helping to expedite the various research and development programs in this sphere.

## COMPUTERS

Computers will be available in the near future that are **500 times** as fast as the present units. Interference, resulting from the time lag encountered in long circuits, will be kept to a minimum by miniaturizing as far as possible.

As a new venture, a computer has been used in the synthesis of a digital computer building block. Since there is usually more than one solution to any network problem, the economics of hand calculations had to be considered. Use



Texas Instruments' solid-circuit multivibrator, with all circuit components cast in a solid block, was one of the highlights of the Show

*With the cream of the industry's engineers in attendance, and papers being delivered on the subjects of most pressing concern the 4-day period of the IRE Show provides an unequalled opportunity to observe trends of the industry. From what they saw and heard, here is what EI editors see happening in the near future . . .*

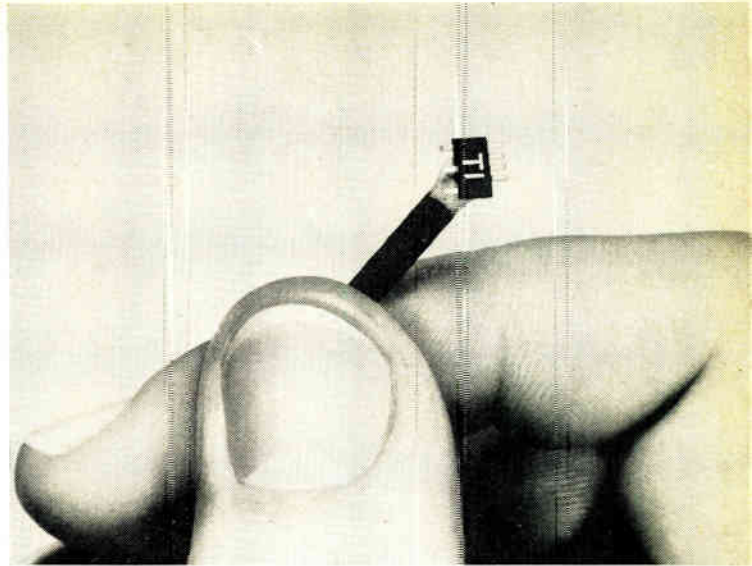

A new technique permits the design of a circularly disposed antenna array by means of which a large aperture is obtained in both planes. A shaped reflector in the vertical plane achieves the vertical aperture, while maintaining the circular array in the horizontal plane.

## From The IRE Show

of the computer will permit optimization of design.

**Mid-air collisions** will be eliminated by a computer that checks a pilot's flight plan with other craft operating in the area—both before and during flight.

In a few decades, our grade school students may be equivalent to today's Ph.D.'s. Machines which permit rapid back-and-forth interchange between student and teacher—feedback—will be the basis. Although these machines may not be electronic, present electronic techniques seem to fit in naturally with the requirements.

### PROPAGATION & ANTENNAS

Much work continues to be done in the field of classifying radar return from various terrain—specifically, the average radar cross section for all types of terrain at any frequency, incidence angle, and under all weather conditions is being determined.

Many systems are being used in these studies. Some groups are using miniature models; others

are pressing mathematical models into service. In any case, all seem to be in agreement that it is impractical, if not impossible, to measure all types of actual terrain.

Countermeasures, telemetering, and missile communications have increased the need for **circularly polarized antennas**. Crossed dipoles fed in quadrature, and cylindrical antennas mounted on ground planes were the only types available in the past. Now a conical helix offers a circularly polarized, unidirectional, broad band antenna structure.

### INFORMATION THEORY

The theory of statistical separability is going to get more attention as the need for a suitable device for the study of complex environments and constraints upon the connection system increases. Some work has been done and the mathematical theory of prediction has been borne out. When the simulation model has failed, it has justly been attributed to a bias effect or special cases not thoroughly covered by the mathematical theory.

### RELIABILITY

The old battle cry is still with us—"make it smaller, make it cheaper, and make it **more reliable**." As any reliability engineer  
*(Continued on page 154)*

Aerial view of New York's Coliseum, again the site of this year's IRE National Convention and Show



# STANPAT SOLVES THE GHOSTING PROBLEM

**NEW resin-base STANPAT  
ELIMINATES GHOSTING,  
offers better adhesion qualities  
on specific drafting papers!**

### THE PROBLEM

Some of our longtime customers first called our attention to the "ghosting" problem. Certain tracing papers contain an oil which could be leached out by the STANPAT adhesive (green back) causing a ghost.

### THE SOLUTION

A new STANPAT was developed (red back), utilizing a resin base which did not disturb the oils and eliminates the ghost. However, for many specific drafting papers where there is no ghosting problem, the original (green back) STANPAT is still preferred.

### WHICH ONE IS BEST FOR YOU?

Send samples of your drawing paper and we will help you specify. Remember, STANPAT is the remarkable tri-acetate pre-printed with your standard and repetitive blueprint items—designed to save you hundreds of hours of expensive drafting time.

### SO SIMPLE TO USE



**1. PEEL**  
the tri-acetate adhesive from its backing.

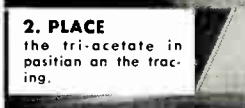

**2. PLACE**  
the tri-acetate in position on the tracing.



**3. PRESS**  
into position, will not wrinkle or come off.

### STANPAT CO.

WHITESTONE 57, N. Y., Dept. 101  
Phone: FLushing 9-1693-1611



- Enclosed are samples of the drafting paper(s) I use (identify manufacturer). Please specify whether Rubber Base or Resin Base STANPAT is most compatible with these samples.
- Send literature and samples of STANPAT.
- Please quote price on our enclosed sketches which we are considering to have pre-printed.

NAME \_\_\_\_\_  
FIRM \_\_\_\_\_  
ADDRESS \_\_\_\_\_  
CITY \_\_\_\_\_  
ZONE \_\_\_\_\_ STATE \_\_\_\_\_

Circle 89 on Inquiry Card, page 105

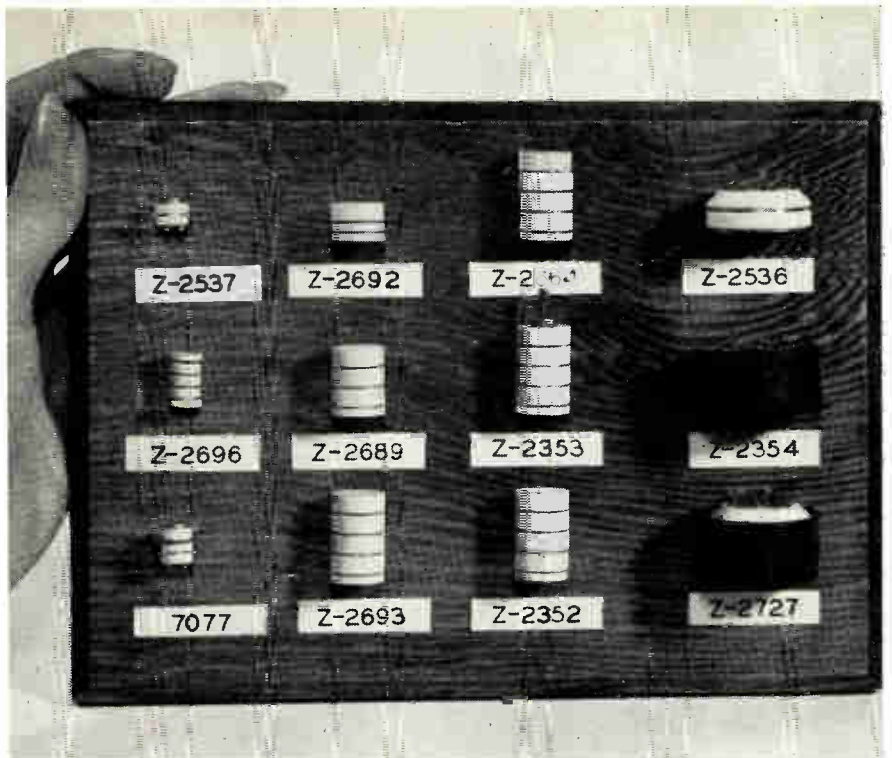

New ceramic receiving tubes, introduced by GE at the IRE Show, include: UHF diodes and triodes, cold cathode voltage reference diodes, and power output triodes and pentodes.

## New Ceramic Tubes

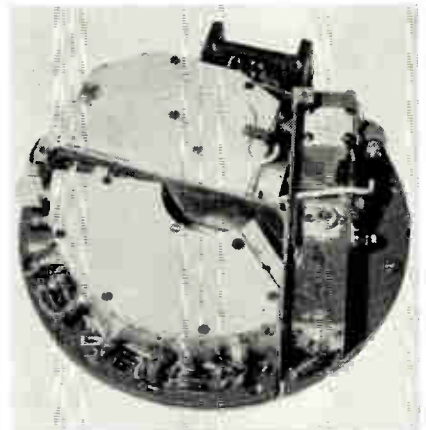

This transmitter, carried in Pioneer IV, used a 7077 as the final amplifier stage.

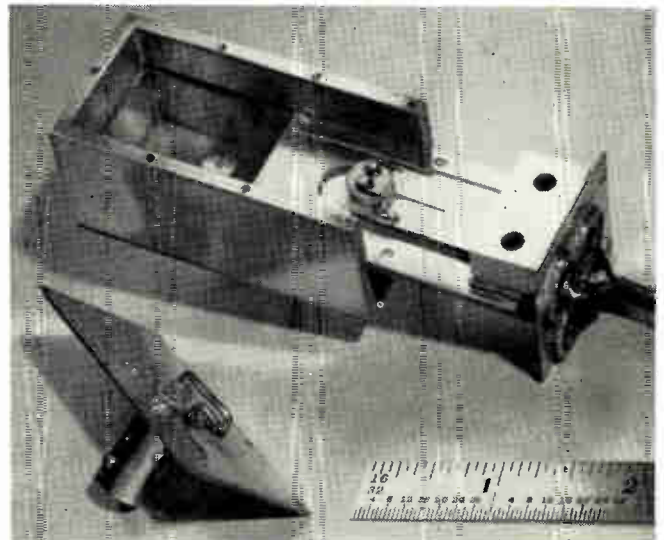

Simplicity and small size feature this 1200-MC r-f stage using the 7077. Employing strip lines as resonant elements, the stage provides 15 db gain with an 8-db noise figure. It occupies less than 3 cu. in.



# CUT COSTS OF TEST EQUIPMENT BY 20% WITH Technical Information Service

Case histories have shown that companies waste up to 20% of their annual expenditures for test equipment.

A prime cause is the failure to make the best buy obtainable because each company did not know the full range of available equipment. Collecting and maintaining complete, timely, and accurate product information is difficult—could cost as much as \$25,000 a year to service—and yet could be incomplete and inaccurate.

A prodigious number of crucial engineering and purchasing man-hours are squandered in test equipment procurement. Tracking down sources of supply takes days and, often, weeks. Key personnel are trapped by protracted correspondence and sales interviews while obtaining full specifications and prices. When modifications are involved, workloads increase geometrically. This costly routine must be repeated every time new purchases are made.

*Now, for the first time, you can plug these hidden profit leaks through the use of a completely new concept in instrument evaluation for procurement.*

Technical Information Service (TIS) provides you with complete, timely product information about *all* available electronic test equipment. In a matter of minutes you can possess detailed descriptions of equipment produced by every manufacturer in the business, from the largest to the smallest, without bias in favor of either. What's more, the descriptions include the *full specifications*, price, and the names and addresses of local sales representatives—all you need to initiate procurement.

Consider the benefits enjoyed by clients of Technical Information Service.

## SINGLE SOURCE OF SUPPLY INFORMATION

Clients have the only central source of supply information designed specifically for their electronic test equipment requirements. Completely categorized, up-to-the-minute information makes the user a technical expert capable of quickly evaluating complete spec-by-spec comparisons of competitive equipment. Since TIS maintains accurate files by constant check of all sources for additions and changes in specifications and prices, clients may make inquiry by phone or letter on any test instrument problem at any time.

With such information at their fingertips, clients can make their purchases with total awareness of what the market has to offer. Procurement is made with minimal demands on key personnel and their time. Many clients find that this accelerated purchasing procedure has earned an extra bonus in expediting tight-schedule projects for which the test equipment is needed.

## COMPLETE, ACCURATE INFORMATION

Clients receive detailed data on more than 4,500 separate instruments manufactured by some 400 different companies. Constant review of the entire instrument field by graduate engineers keeps data on specifications, prices, and models up to date at all times.

Suppliers are queried on incomplete or dubious information, if necessary, before their products are included in any TIS release.

Since all products are described without charge and without advertising claims, small and large manufacturers are on equal footing. Their instruments speak for themselves with bald facts, free of slanted claims or persuasive case histories. Clients make their own evaluations from complete, factual information.

## SUPPLIER RESEARCH SERVICE LOCATES "CUSTOM" INSTRUMENTS

Often, seemingly built-to-order requirements can be satisfied by minor modification to standard instruments. The complete listing of all large and small manufacturers of stock items provides a ready reference for such inquiry, either directly by the client or through the efforts of TIS.

In those cases where unique equipment is a necessity, TIS Supplier Research surveys the market for the client, collecting all the pertinent information he requires to initiate serious negotiations with suppliers.

## COMPLETE PRIVACY

Whether TIS is locating sources for unique requirements or providing information on standard equipment, clients maintain a cloaked identity during all stages of inquiry. The Client conducts negotiations with the suppliers in whom he is interested.

## FOUR-VOLUME DIRECTORY

Clients of the tax-deductible Technical Information Service receive a free, four-volume, handsomely bound encyclopedia of standard equipment and sources published twice a year and supplemented constantly. Three volumes are devoted to descriptions of equipment. The fourth volume is an extensive cross-index of manufacturers and their representatives. Completely free of advertising, the directories give clients a complete, factual picture of all standard electronic test instruments. Clients of Technical Information Service receive both the Directories and Supplier Research Service.

## PROVEN IN USE

For the past two years TIS has served such clients as General Electric, M.I.T., Lincoln Labs., General Motors, NASA, Litton Industries, Naval Ordnance Lab., Hewlett-Packard, Lockheed Aircraft, Western Electric, RCA, Marconi Instruments, Eglin AFB, American Bosch Arma, and hundreds of others. The merit of TIS is proven by the fact that many clients have contracted additional service for other departments and projects.

## FREE BROCHURE GIVES KEY TO SAVINGS

One subscriber saved more than three times the cost of TIS within a week! You will have the key to how it was done when you go through the TIS brochure which tells all . . . shows how TIS reduces even the hidden, seldom-counted costs of the old-fashioned way of instrument procurement. Send for your copy of this FREE brochure today. No obligation. Use the convenient coupon below.

VOL. I—Sources • VOL. II—Modifiers • VOL. III—Scalers  
VOL. IV—Index of Manufacturers and Representatives

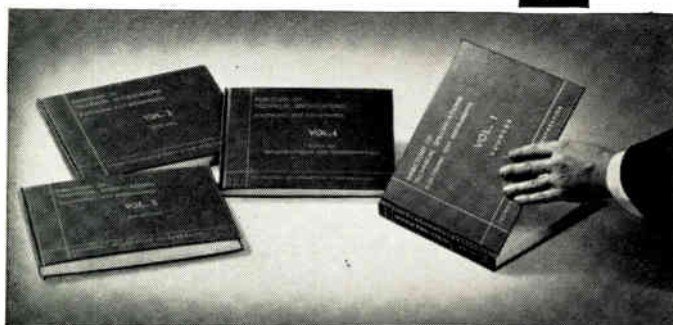

## Technical Information Corporation

41 Union Square, New York 3, New York, WATkins 4-2111

I am interested in knowing more about Technical Information Service. Please send me your free brochure immediately, at no obligation.

NAME \_\_\_\_\_ TITLE \_\_\_\_\_

DEPARTMENT \_\_\_\_\_ COMPANY \_\_\_\_\_

ADDRESS \_\_\_\_\_

## Observations & Trends from the IRE Show

(Continued from page 151)

can attest, these do not usually go hand-in-hand. Compatible or not, this is one of the big problems of today.

The reliability problem starts, and usually can end, with the **components engineer**. Many systems for reliability and quality control have been devised. One suggested method is for the component manufacturer to set up testing procedures that are satisfactory to all of his clients. This requires getting all of the customers to agree on a set of standards. Each usually has his own. With this method, testing costs can be held to a minimum and material delivered promptly.

A system for reliability, the **redundant system**, while not new is creating a lot of interest. The redundant system roughly is the application of two parts or units for the same job. There are several unique variations of this method to obtain reliability.

Studies have shown that redundancy can reduce system failure. This does, however, have the disadvantages of being heavier, larger, requires more maintenance and is more costly. This system is OK where system failure can mean loss of life or many dollars.

### MILITARY ELECTRONICS

Today military electronics is almost completely in the **missile area**. Military electronics runs from launch checkout, to telemetering, to guidance systems. One of the largest cost factors in missiles is electronic equipment.

Another area that has been under fire is our **radar systems**. With today's missile speeds and altitudes our early warning and search systems can not do the job required. Almost as fast as a new system is developed, it becomes obsolete. Much work is being done to get higher power radars, better antennas, and more sensitive receivers. However, there is a limit to what extent these can go.

What's needed is a radically new approach to the detection problem.

**Inertial navigation** for airborne vehicles, as well as for ships at sea, is rapidly becoming a primary navigational mode. This system is expected to replace the time-honored methods. It offers high accuracy with minimum size and weight.

### ULTRASONICS

The search for better materials for ultrasonic use is in high gear. Materials such as potassium-sodium niobate and lead titanate zirconate, as well as barium titanate have been the subjects of much research and development. Better materials are being sought for delay line applications as well as for sonar type transducers.

The **potassium-sodium niobate material** offers low dielectric constant and high coupling coefficient in certain regions. This should make this material desirable for solid acoustical delay line use, especially where thin sectioned transducers are required.

Two compositions of titanate

## Here's BIG HELP IN TERMINAL WIRING!

### The New JONES FANNING STRIP

Connections are made through Fanning Strip, on bench or anywhere apart from barrier strip, and quickly slipped into assembly.

Designed for use with Jones Barrier Terminal Strips Nos. 141 and 142, for 1 to 20 terminals.

Simplifies and facilitates soldering. Insures positive correct connections. Saves time. Ideal for harness or cable assembly. Strong construction: Brass terminals, cadmium plated. Heavy bokelite mounting.

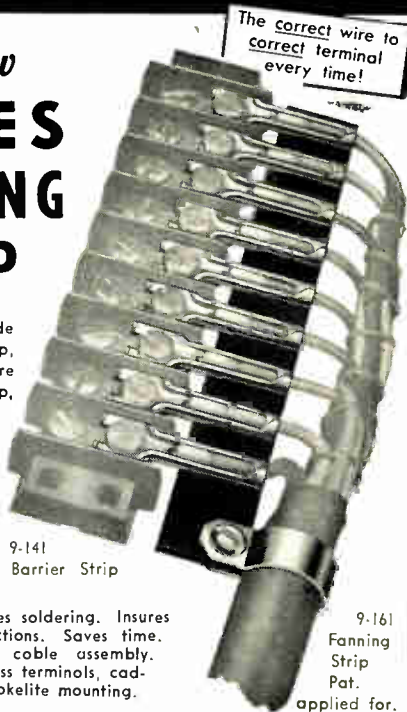

9-141  
Barrier Strip

9-161  
Fanning  
Strip  
Pat.  
applied for.

Send for complete data on this new basic improvement!



**HOWARD B. JONES DIVISION**  
CINCH MANUFACTURING COMPANY  
CHICAGO 24, ILLINOIS  
DIVISION OF UNITED-CARR FASTENER CORP

Circle 128 on Inquiry Card, page 105

## FOR LEAK-DETECTION DEVICES

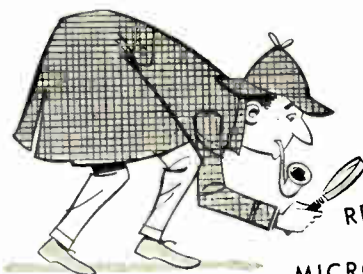

## NITROUS OXIDE

READILY  
DETECTS  
MICROSCOPIC  
LEAKS

Infrared determination of nitrous oxide provides a safe, sensitive and flexible method of leak detection. This method is not affected by usual atmosphere components such as moisture, carbon dioxide and hydrocarbons. In addition, nitrous oxide will not harm pieces being tested and is more economical than other gaseous agents.

**OHIO NITROUS OXIDE: ODORLESS AND INERT • NONTOXIC  
• NONCORROSIVE • NONFLAMMABLE • ECONOMICAL**

**FREE TECHNICAL AID** is available in the use of nitrous oxide for leak detection. For further information, please request the following bulletins:

- 1A Chemical, Physical and Pharmacological Properties of Nitrous Oxide with Results of Corrosion Tests
- 1B Gas Service Equipment for Nitrous Oxide Supply

**Ohio Chemical**  
OHIO CHEMICAL & SURGICAL EQUIPMENT CO.  
(A Division of Air Reduction Company, Incorporated)   
MADISON 10, WISCONSIN

Circle 129 on Inquiry Card, page 105



zirconate ceramics, one of which is well suited for radiating transducers and the other for hydrophone applications were described. The original discovery of piezoelectric coupling in this material was first made at the National Bureau of Standards. This material shows great promise in the sonar field.

One well known ultrasonic manufacturer introduced the first consumer-type product at the IRE Show—an ultrasonic dishwasher. This aroused quite a bit of interest. The ultrasonic dishwasher may some day replace the conventional types. It will do a more thorough job with less soap and water, and will eventually be smaller than those now in use.

### INSTRUMENTS

The demands on magnetic recording are increasing. Where it was common to hear, some years ago, of recording 40 or 50 channels, today test requirements are calling for up to 500 channels.

Since all channels are being read as analogs—usually from strain gauges—there is need for high speed analog-to-digital converters.

Research aimed at increasing the density of recording on a magnetic medium has established (a) that the recorded pulse width obtained from a given head is approximately five times the width of a pulse ideally reproduced by the same head and (b) the record current must be approximately twice the current required for medium saturation to make the pulse location error unmeasurable.

### RADIO RECEIVERS

Transistors are unlikely to find truly wide spread application to automobile radio receivers until the present high circuit costs can be overcome.

Drift transistors, offering high gain and low feedback capacitance, are offering a partial answer to the problem.

Better engineering design can also shake down the costs. Detection, gain control and audio driver circuits, and front end design are being re-evaluated for transistor applications.

### MICROWAVE

In the millimeter wavelength  
(Continued on page 156)

# PRECISE TEMPERATURE STABILIZATION

## WITH MANSON CRYSTAL OVENS

RD-134



### Mercury Thermal Switch CRYSTAL OVEN

Quickly-detachable cover, without screws, permits easy access to crystal without dismounting oven from equipment. Vacuum bottle encasing internal structure eliminates temperature gradients and reduces external heat transfer.



RD-134  
(disassembled)

The highest temperature regulation ever obtained in a thermostatically-controlled oven is yours with the Manson RD-134. For stabilization of crystals (or other devices), this low-cost, 6-ounce, transistorized unit embodies a thermometer-type mercury switch for constant-memory temperature setting and the elimination of contact noise. Cycling is held to within  $\pm 0.01^\circ\text{C}$  and the oven meets MIL-T-945A specifications for vibration and shock.

**SPECIFICATIONS:**  
**TEMPERATURE CONTROL:** Within  $\pm 0.01^\circ\text{C}$  at fixed ambient; within  $\pm 0.05^\circ\text{C}$  from  $-40^\circ\text{C}$  to  $+70^\circ\text{C}$  ambient.  
**OVEN TEMPERATURE:**  $75^\circ\text{C}$  at  $25^\circ\text{C}$  ambient.  
**STABILIZATION TIME:** approx. 15 min.  
**HEATER:** 1.5 watts; available for 6.3, 12 or 24 volts, AC or DC. (special voltages on request).  
**CRYSTAL HOLDER:** accommodates HC-6/U, plug-in mounting.  
**DIMENSIONS:** 1 11/16" dia. x 4 7/16" length.  
**WEIGHT:** 6 ounces.  
**VIBRATION and SHOCK:** Meets MIL-T-945A specifications.

RD-130



### Proportional CRYSTAL OVEN

Furnished at  $75^\circ\text{C}$  temperature setting; special settings from  $10^\circ\text{C}$  to  $100^\circ\text{C}$  above ambient available on request; accommodates HC-6/U holder (other mounts available); 3 1/2" high, 1 9/16" panel-mounted sub-assembly construction; meets MIL specifications.

AND NOW, to meet more critical short-term requirements, Manson offers the first commercial proportionally-controlled oven. Closest possible temperature control with no cycling; complete freedom from noise and surge modulation. Vernier adjustment of operating temperature possible. Usable over military environmental temperature range. Positive closed-loop control maintains oven temperature to within 1/1000 of ambient change.

MANSON



LABORATORIES, INC.

375 FAIRFIELD AVE.

STAMFORD, CONN.

PHONE: DAVIS 5-1391

Write for complete engineering specifications and application data.

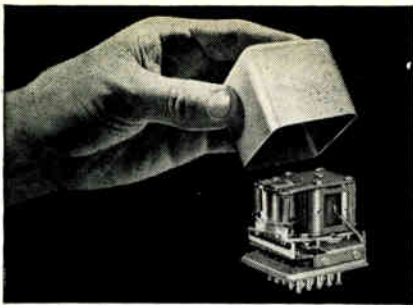

## HOW TO USE REGOHM

**the plug-in device that regulates input voltage down to  $\pm 0.05\%$**

Wherever system performance requires precision regulation of input voltage, REGOHM earns a place. And wherever circuitry includes vacuum tubes, REGOHM will substantially extend tube life. The REGOHM is a voltage regulator of great sensitivity and stability, providing stepless continuous control over a wide frequency range. Light in weight, low in cost, its applications are almost unlimited. Here are typical applications:

- General Electric Co.—for Halogen Leak Detectors
- Empire Devices Products Corp.—for Noise & Field Intensity Meters
- Consolidated Electrodynamics— for Diatron Mass Spectrometers
- Stoddard Aircraft Radio— for Power Supplies
- Hevi-Duty Electric Company— for Airport Lighting Brightness Control

How you may use REGOHM in your own applications will become clear to you from design data, performance specs and case histories, available to you on request.



**ELECTRIC REGULATOR CORPORATION**  
NORWALK CONNECTICUT  
Circle 97 on Inquiry Card, page 105

## Observations

(Continued from page 155)

bands—above 40 kmc—noise suppression is difficult because of the lack of matched crystals for the balanced mixer.

The problem is being re-examined to find the optimum intermediate frequency for use with a single ended mixer.

This question is also being asked: Can a single ended mixer operated at a higher IF have a sensitivity comparable to that of a balanced mixer?

Microwave has found a new application—in measuring the lifetime of semiconductor crystals. The technique utilizes the absorption of microwave power upon injection of minority carriers, as well as the measurement of the time constant of decay of power absorption upon the cessation of a pulse of injected current.

Research is aimed at reducing the gain of a TW tube to spurious signals within its pass-band, when the tube is driven well into the saturated region by some signal within the pass-band. It is found that suppression of these spurious signals is proportional to the input power and inversely proportional to the frequency of the saturating signal.

In the field of low noise parametric amplifiers and converters, noise figure measurements of under 1 db have been obtained for a regenerative converter designed for an input frequency of 900 MC.

Low-loss circulators have been developed in S-band and L-band. By connecting a low-loss, high isolation circulator to a one port maser or reactance amplifier, maximum gain-bandwidth is obtained and the degrading effect of the second stage noise is minimized.

Recent advance in the field of passive electronic intelligence systems have required the design of multi-element high gain directional antenna arrays. The resulting feed structures have allowed little variation in the power output distribution. Recently strip transmission line corporate feed structures have been developed with a variety of output distributions in a relatively small physical package. To maintain a low input

## New ROHN SELF SUPPORTING COMMUNICATION TOWER

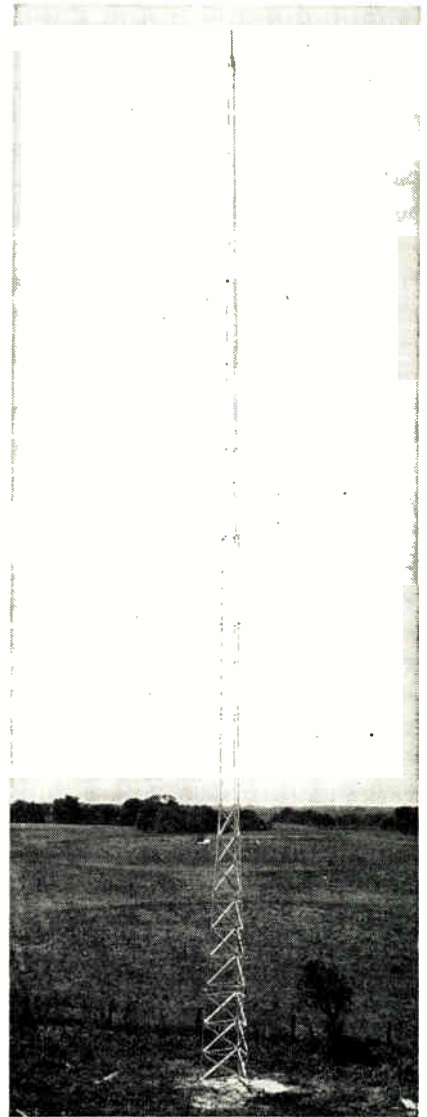

- ★ 120 ft. in height, fully self-supporting!
- ★ Rated a true HEAVY-DUTY steel tower, suitable for communication purposes, such as radio, telephone, broadcasting, etc.
- ★ Complete hot-dipped galvanizing after fabrication.
- ★ Low in cost—does your job with BIG savings—yet has excellent construction and unexcelled design! Easily shipped and quickly installed.

**FREE** details gladly sent on request.  
Representatives coast-to-coast.

**ROHN Manufacturing Co.**

116 Limestone, Bellevue,  
Peoria, Illinois

“Pioneer Manufacturers of  
Towers of All Kinds”

Circle 98 on Inquiry Card, page 105



VSWR, designs incorporating tapered sections and quarter-wave stepped transformers have been utilized.

### SPACE ELECTRONICS

"Ionization blackout" is a phenomena observed when space vehicles hit the high temperature gases created during re-entry. This causes severe ionization conditions around the aircraft, seriously attenuating RF telemetering signals transmitted during this portion of the flight.

One solution to the problem, now being attempted, is to have a continuous-loop magnetic tape recorder in the space vehicle store the vital data collected by the instrumentation system during ionization blackout, and re-transmit the data after the vehicle has passed through the ionization region.

Interest is being shown in using a radar signal to carry intelligence as well as its primary function. Bunching the radar pulses provides a limited form of intelligence to be transmitted and the return from the airborne beacon can also be varied to provide an identification signal.

The free-rotor gyroscope is competing strongly with the single-axis gyro as inertial reference. It does not need gimbaling or liquid flotation of the rotor assembly. Its rotor is supported and turns on a spherical, gas-lubricated bearing.

### Components Conference Program Finalized

The 1959 Electronic Components Conference program has been finalized. A good assortment of papers covering a wide area of interest in the field of electronics are being presented at the Ben Franklin Hotel in Philadelphia on May 6, 7, & 8. The titles of the timely sessions are High Speed Data Processing, Transmission Devices, Extreme Environments, Space Electronics, Electronic Materials, Microminiaturization and Semiconductors.

A large turnout is anticipated, so the registration committee urges all to please register early to avoid any delays or inconvenience. For registrations contact Mr. Irwin A. Egendorf, Registrations, 1959 Electronic Components Conference, International Resistance Co., 401 N. Broad St., Phila. 8, Pa.

after  
**60**  
years

no soldering application's  
too difficult!

# Kester Solder

Kester's latest development . . . "44" RESIN-CORE SOLDER has a perfected activated resin flux for faster assembly line soldering. Used by leading electronic manufacturers everywhere.

WRITE today for free 78-page Kester technical manual "SOLDER . . . Its Fundamentals and Usage."

## KESTER SOLDER COMPANY

4210 Wrightwood Avenue, Chicago 39, Illinois  
Newark 5, New Jersey • Brantford, Canada



**Over 60 Years' Experience In Solder And Flux Manufacturing**

Circle 99 on Inquiry Card, page 105

# TRU-OHM RESISTORS and RHEOSTATS

## Designed to MEET and EXCEED MIL Specifications

TRU-OHM is your prime source for quality resistors and power rheostats to meet your most intricate requirement . . . for civilian or military applications. A TRU-OHM representative is in your area to serve you.

Find out why TRU-OHM is America's No. 1 Source for Wirewound Resistors and America's Fastest Growing Source for Power Rheostats . . . Your inquiry will receive immediate attention.  
VISIT BOOTH #2405 AT THE I.R.E. SHOW

Our latest catalog is  
available upon request

## TRU-OHM PRODUCTS

Division of Model Engineering & Manufacturing, Inc.

General Offices:  
2800 N. MILWAUKEE AVE.  
CHICAGO 18, ILL.  
FACTORY:  
HUNTINGTON, INDIANA

From the manufacturer of the widely used and well known FM-3 Frequency Meter and the later FM-6 Frequency Meter comes the newest addition to a growing family of fine instruments. The newest, the FM-7 provides in a small package all of the essentials for the maintenance of mobile communications systems.

# NEW FREQ METER

**MEASURES AND GENERATES: 20 mc to 1000 mc**  
**ACCURACY: 0.0001% exceeding FCC requirements 5 times**  
**MODULATION: AM, 30% at 1000 cps; FM, 1 kc at 30 mc**  
**5 kc at 150 mc, or 15 kc at 450 mc max.**



**MODEL FM-7**

As optional equipment the FM-7 may be combined with the new DM-2 Deviation Meter as illustrated. The DM-2 is a new Dual-Range Deviation Meter with 15 kc and 7.5 kc full scales.

WRITE OR CONTACT YOUR GERTSCH REPRESENTATIVE FOR FULL DETAILS

**GERTSCH PRODUCTS, Inc.**

3211 South La Cienega Boulevard, Los Angeles 16, California  
 TEces 0-2761 - VErmont 9-2201



Circle 101 on Inquiry Card, page 105

## New Products

### PULSE TRANSFORMER

Model PCT 325, Pulse Current Transformer, allows precision monitoring of pulse amplitude and wave-shape. It features fast rise-time (20  $\mu$ sec.), ability to monitor currents

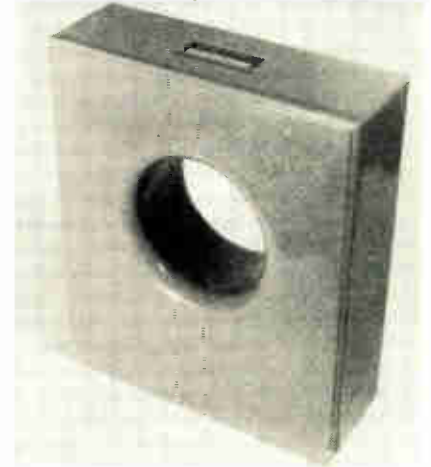

at very high voltages (300 kv pulse in oil, 30 kv ac, dc, or pulse in air) or where a large aperture is needed (3.5 in. dia.). Used with a calibrated oscilloscope for monitoring pulse currents from milliamperes to hundreds of amperes, beam currents in particle accelerators, and currents in electronic devices. Pearson Electronics, Inc., 707 Urban Lane, Palo Alto, Calif.

Circle 250 on Inquiry Card, page 105

### CABINETS

The EMCOR Cabinets offer a compact and centralized housing arrangement which is ideal for a test control center. The human engineering feature developed and incorporated in the modular design bring all equipment and instruments within easy reach and sight of the operator.



Rugged steel construction and advanced frame design afford increased load carrying capacity for greater versatility and flexibility for instrumentation. Elgin Metalformers Corp., 630 Congdon Ave., Elgin, Ill.

Circle 251 on Inquiry Card, page 105

### WHY NOT TRY TURRETS?

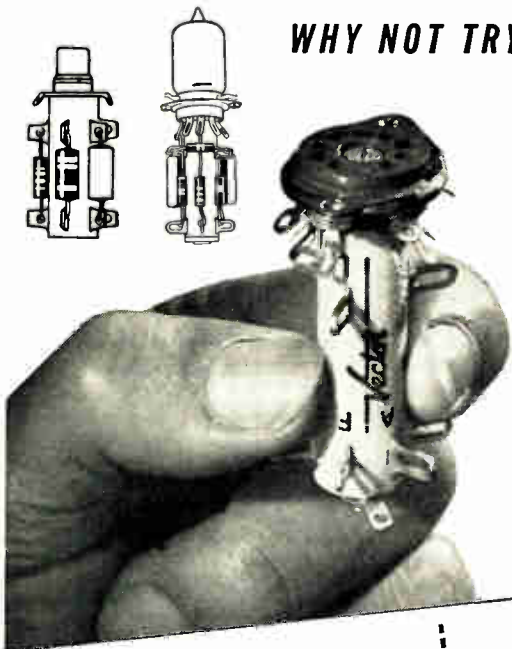

### TUBE SOCKET-and TRANSISTOR-TURRETS

... simplify transistor and other component wiring, cut down assembly time and make up into compact, sturdy structures ... Eliminate useless lead length and thus improve performance ... Save design time for engineers. Also available in military version.

**Vector**  
**STRUCTURES FOR CIRCUITRY**

Available in many sizes and types to fit every need:— Post, Deck, Wall and Tinker Turrets; with plugs and cases as required.  
 — Write for Catalog.

VECTOR ELECTRONIC COMPANY, 1100 Flower St., Glendale 1, Calif. • Tel. CH 5-1076





It's the  
**EXTRAS**  
that make a  
GOOD tube  
**GREAT!**

**Amperex**  
**5894**

HIGH-SENSITIVITY  
VHF/UHF TWIN TETRODE

with these **Amperex EXTRAS:**

- maximum ratings to 250 Mc
- reduced ratings to 500 Mc
- 40 watts anode dissipation
- powdered glass base and top for greater mechanical strength
- internal neutralization
- typical VHF/UHF life over 5 years

**TYPICAL RF OPERATION, CLASS C, PUSH-PULL**

	CCS	CCS	ICAS
DC Plate Voltage	750	600	750 volts
DC Grid No. 2 Voltage	250	250	250 volts
DC Grid No. 1 Voltage	-80	-80	-80 volts
DC Plate Current	2x80	2x100	2x90 ma
DC Grid No. 2 Current	17	16	14 ma
DC Grid No. 1 Current (approx.)	2x1.5	2x2.5	2x1.7 ma
Driving Power (approx.)	4	3	6 watts
Power Output (approx.)	85	90	96 watts
Frequency	250	200	250 Mc

Other **Amperex** replacement favorites:

- 6146 High-sensitivity beam power tube
- 6360 High-sensitivity VHF/UHF twin tetrode; 14 W anode dissipation
- 6939 Miniature UHF twin tetrode; 5 W anode dissipation
- 866AX Mercury vapor rectifier



ask your distributor  
about extra-quality  
**Amperex**  
replacement tubes

**Amperex ELECTRONIC CORP.**

230 Duffy Avenue, Hicksville, L. I., N. Y.

Circle 103 on Inquiry Card, page 105

**New Products**

**POTENTIOMETER**

Model 875 subminiature potentiometer features linearity to  $\pm 0.1\%$  of full scale. It offers a resolution as high as 0.06%. Resistance ranges from 200 ohms through 100,000 ohms per section are available. The unit is wire wound, has servo mount, and up to 4 sections can be ganged on a common shaft. A sine-cosine version is

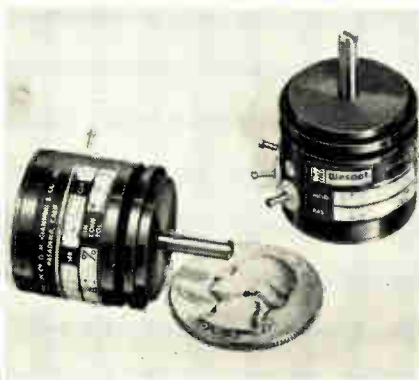

also available. It is designed for use in missiles, jet engine instrumentation, airborne computers, and other applications. G. M. Giannini & Co., Inc., 918 E. Green St., Pasadena 1, Calif.

Circle 252 on Inquiry Card, page 105

**FLAT-MOUNT JACK**

Miniature jack, Type SKT-103 PC, mounts flat against a printed-wiring board. It has a double-prong steel strap in front, and a connection lug at the rear. The jack mounts in 3 holes forming a triangle in a grid coordinate layout. It is dip-soldered from the underside of the board. It

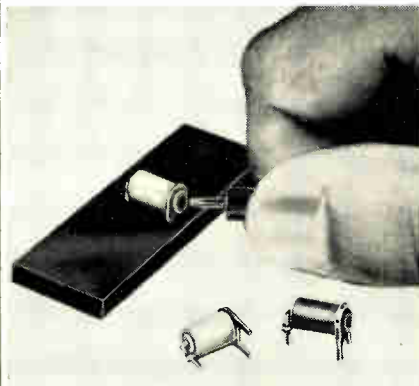

takes an 0.080 in. probe with no strain on the contacts because of the self-aligning Teflon hole. Contacts are of heat-treated Beryllium 25. Sealectro Corporation, 610 Fayette Ave., Mamaroneck, N. Y.

Circle 253 on Inquiry Card, page 105

**STATIC**  
or  
**DYNAMIC**  
pressure  
measurements  
to  
**600° F.**



**STATHAM P277**  
**Pressure Transducer**  
(shown full size)

Your best choice for a wide range of high temperature applications is the new Satham P277 Pressure Transducer.

All of its variations operate within specifications from  $-65^\circ$  to  $+600^\circ$  F., with the accuracy and dependability characteristic of Satham unbonded strain gage instruments.

For further information write for  
Data File EI-599-1.

**STATHAM INSTRUMENTS, INC.**  
12401 West Olympic Boulevard  
Los Angeles 64, California

*Satham*

Circle 104 on Inquiry Card, page 105



When you specify  
**CONNECTORS**...

specify  
*Automatic*

Highest standards of quality. Modern high speed automatic machinery, and up-to-date production procedures, based on over 15 years experience in the manufacture of precision parts for the Army, Navy, Air Force and Atomic Energy Commission.

More and more companies in the electronics and telecommunications industries are specifying "Automatic's Connectors."

Our engineers are always ready to discuss your special requirements.

Manufacturers of  
RF FITTINGS • RF CONNECTORS  
COAXIAL RELAYS • COAXIAL SWITCHES  
COAXIAL CABLE ASSEMBLIES • DIRECTIONAL COUPLERS • INSULATED CONNECTING RODS AND SHAFTS • POWER PLUGS • AUDIO PLUGS • BAYONET LOCK AND PUSH ON SUB-MIN CONNECTORS

WRITE, WIRE OR PHONE FOR FURTHER INFORMATION.

*Automatic*  
METAL PRODUCTS CORP.

321 Berry St., B'klyn 11, N. Y. EVergreen 8-0364  
Circle 106 on Inquiry Card, page 105

## APT System Speeds Machine Tool Control

A technique similar to the paper roll in a player piano has been adapted, greatly refined, and a "language" added, for the machining of complex aircraft and missile parts which offers savings in skilled manhours of 80 to 95%.

The new system, called APT (Automatically Programmed Tool), uses a high speed digital computer to calculate the numerical data necessary to program the motions a numerically controlled machine tool makes in cutting metal components for aircraft and missiles.

APT was developed by the Massachusetts Institute of Technology under an Air Force contract with the cooperation of member com-

panies of the Aircraft Industries Association.

In one method of machine tool operations, punched paper tape operates a machine that cuts out a metal part. The holes in the tape specify the cutting movements. This method was first demonstrated at M.I.T. nearly seven years ago.

This system saved time and money, but preparation of instructions for new production items required a programmer to spend long hours in calculating the moves of the tool and to express these in numerical form on the tape.

It is now possible, through the use of a large, general purpose digital computer, to develop thousands of separate machine control instructions with a minimum of human effort. The key is the written APT language, with a large computer working out the series of instructions which control the machine tool.

Tape might contain "ON KUL, ON SPN, GO RGT, TL LFT, CIRCLE/CTR AT, + 2, + 3, RADIUS, 5."

Translated, this sentence means: "Turn on the coolant, turn on the spindle, go right with the tool on the left side along the circle whose center is located at x equals 2, y equals 3, with a radius of 5." The "language" consists of some 100 other words, none containing more than six letters.

### HOW AN ION ROCKET ENGINE WILL OPERATE

A rocket engine to create ions and harness them for propulsion will work this way:

It will employ a chemical propellant whose molecules offer the highest possible weight. Among "ideal" propellants are uranium tetrachloride, thorium, mercury and the alkali metals, cesium and rubidium.

Vaporized, the propellant will be fed into an electrically charged chamber. There an electric arc or a metallic plate generating 100 times the heat of a large electric stove will knock loose an electron from each molecule of vaporized propellant. In losing an electron, each molecule will assume a positive charge, becoming an ion.

The newly created ions will be pulled out of the ionizing chamber by the attraction of an electrostatic field and then jolted by 12 kv to effective velocities of 300,000 to 400,000 mph.

The current of speeding ions— $10^6$  times greater in number and 350,000 times heavier than the stream of electrons in a TV picture tube—will be harnessed for propulsion by being directed through a cylindrical thrust chamber approximately 2 ft. long and 9 in. in diameter. Propulsive force will come from the vehicle's reaction to the escape of ions from the chamber.

The electrons left over from the ionization process also will be directed through a thrust chamber to add a tiny increment of additional thrust.

—Rocketdyne Div.,  
North American Aviation Inc.

## Hughes' Currie Wins 'Outstanding E.E.' Award

Dr. Malcolm R. Currie, co-head of the electron dynamics department of Hughes Aircraft Company, Culver City, Calif., has been named the "outstanding young electrical engineer of 1958" by Eta Kappa Nu, national honor society.

Currie, 31, won the award for his technical contributions in the field of low noise electron guns and backward wave oscillator development.

The society's announcement of the 23rd annual prize credits Currie with "a major technical breakthrough in connection with noise in microwave tubes which already has made possible more than twice the sensitivity heretofore attainable in microwave receivers such as those used in radar and high frequency relay systems."



# Stromberg-Carlson

"TELEPHONE QUALITY"

## Relays

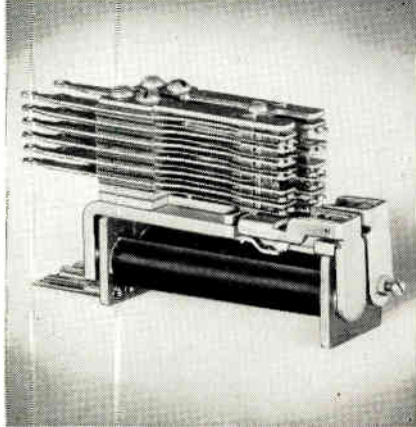

... available immediately for any part of your operation that depends on electromechanical switching.

Proven by many years of meeting the exacting requirements of the telephone industry, these twin-contact relays of unsurpassed reliability are available in many types. The following are representative:

**Type A:** general-purpose relay with up to 20 Form "A" spring combinations. This relay is excellent for switching operations.

**Type B:** a gang-type relay with up to 60 Form "A" spring combinations.

**Type BB** relay accommodates up to 100 Form "A" springs.

**Type C** (illustrated): two relays on the same frame. A "must" where space is at a premium.

**Type E:** has the characteristics of Type A relay, plus universal mounting arrangement. Interchangeable with many other makes.

Complete details and specifications on all Stromberg-Carlson relays are contained in our *new relay catalog*. Contents include: spring combinations, table of equivalents, contact data, variations and special features, plus complete mounting and cover information.

The catalog is available on request.

## STROMBERG-CARLSON

A DIVISION OF GENERAL DYNAMICS CORPORATION

Telecommunication Industrial Sales  
126 Carlson Rd. • Rochester 3, N. Y.



Circle 108 on Inquiry Card, page 105

## New Products

### R-F BRIDGE

A multi-ratio bridge for the measurement of resistance, capacitance, and inductance over a wide range of frequencies between 15 KC and 5 MC. The instrument, employing the tapped



transformer principle, measures complex impedances, balanced and unbalanced, or balanced with the center point grounded, and any pair of terminals in a 3-terminal network. It has the advantage of good stability because the impedance looking back into the terminals and the impedance to ground at balance are both low. Transistor Adaptors are available. Wayne Kerr Corp., 2920 N. 4th St., Philadelphia 33, Pa.

Circle 254 on Inquiry Card, page 105

### VISUAL-AUDIO TRAINER

Learnoaide, a visual-audio training unit, cuts assembly training programs as much as 50%. It synchronizes a color slide projector with a customized tape recorder providing assembly instruction presentations. Trainees determine their own learning pace through any step-by-step assembly process by controlling sequences with a stop-start-repeat feature. Changes in assembly procedures are accomplished by substituting a

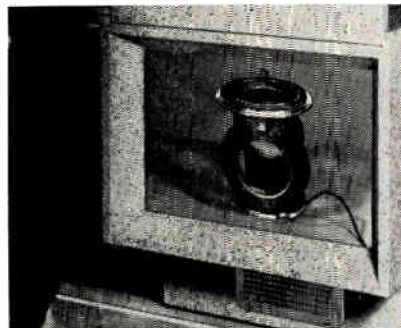

new slide and re-recording the corresponding part of the tape. A speaker for group instruction and headset jacks for individual instruction are provided. Lear Inc., P. O. Box 688, Grand Rapids, Mich.

Circle 255 on Inquiry Card, page 105

when every second counts...

... count on **THERMAL** time delay **RELAYS**

by **DIALCO**

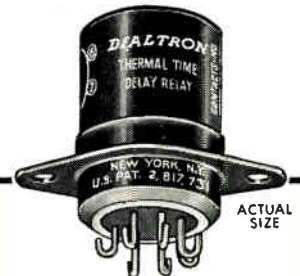

### Hermetically Sealed

Rugged—built to meet conditions of  
**high altitude**  
**high vibration**  
**high temperature**

DIALCO RELAYS exhibit no resonance from 5 to 1,000 CPS at 10 G's; are not damaged by 50 G's shock; are fully compensated for temperatures from -65° C to +125° C.

Available in delays from 1 to 300 seconds; heater voltages up to 150 V. interchangeable on DC or AC of any frequency with a power drain of 4 watts. SPST normally open or normally closed contacts are rated at 6 amps at 115 V. AC or 3 amps at 28 V. DC resistive.

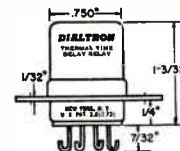

### SUB-MINIATURE

Lightweight (3/4 oz.)  
Standard 7-pin plug-in or solder terminals with mounting flange

Dialtron Corp., 203 Harrison Pl., Brooklyn 37, N. Y.

Send data on Thermal Time Delay Relays to:

Name \_\_\_\_\_  
Position \_\_\_\_\_  
Company \_\_\_\_\_  
Address \_\_\_\_\_

## DIALTRON

CORP.

203 Harrison Pl., Brooklyn 37, N. Y.  
HYacinth 7-7600

Circle 109 on Inquiry Card, page 105

# RELIABILITY... THE SOLUTION TO YOUR ELECTRONIC COMPONENT PROBLEMS

Designing reliability into electronic components and instrumentation is Borg Equipment Division's business. Borg's reliable engineering, research and production facilities are at your service for commercial or military projects. Bring your component reliability problems to Borg. You'll enjoy working with our cooperative, creative engineering staff. The result will be a sound, practical and reliable solution at a considerable saving of time and money. Here are just a few of the products manufactured by Borg . . .

FREQUENCY STANDARDS

AIRCRAFT INSTRUMENTS

POTENTIOMETERS

MULTI-TURN COUNTING DIALS

FRACTIONAL H. P. MOTORS

SPECIAL DESIGNS

WRITE FOR COMPLETE ENGINEERING DATA



*Built  
by Borg*

**BORG EQUIPMENT DIVISION**

Amphenol-Borg Electronics Corporation  
JANESVILLE, WISCONSIN

Circle 110 on Inquiry Card. page 105

## New Products

### ENCLOSURES

Enclosures feature 1½ in. wide, 14 gauge steel, box channel construction with reinforced, built in 12 gauge caster mounts, and lift eye receptacles for rugged protection and mo-

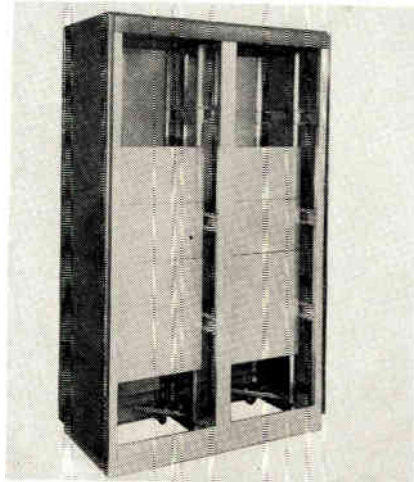

bility. Heavy duty ¼-20 hardware with lock washers are used. Finish and hardware salt spray resistance over 100 hours. Drip proof tops, special adaptations and design assistance available. Most regular Amco system accessories are interchangeable in the new line. Conforms to EIA mounting standards. Amco Engineering Co., 7333 West Ainslie St., Chicago 31, Ill.

Circle 256 on Inquiry Card, page 105

### TAPER PIN CONNECTORS

Type UPCC-FDTP connector has 2 rows of taper pin terminals linked mechanically and electronically for use with AMP 53 taper pins. Positive re-entrancy of the male pins is assured each time by the "Molding-Assist Closed Entry." The connectors are available in total contacts of 7,



11, 15, 19, 23 and 32 or custom configurations may be obtained to meet specific requirements. For critical environments and military applications. U. S. Components, Inc., 454 E. 148th St., New York 55, N. Y.

Circle 257 on Inquiry Card. page 105

## ARNOLD transistorized power supply

... a regulated  
lightweight  
inverter,  
built to  
aircraft  
and missile specs.



### FEATURES

- Constant output voltage as battery discharges.
- 1/5 weight, 1/2 size of comparable dynamotors.
- Withstands short circuit indefinitely.
- Withstands input voltage transients of 70 volts for 0.1 sec. and 60 volts, indefinitely.
- Output voltage drift only 1.5% from -55° to +71°C.

### SPECIFICATIONS

#### D. C. OUTPUT Model 591-A

Input Voltage: 24-30 VDC

Output Voltage: Any from 25-1200 VDC

Output Power: 60 watts regulated

Regulation: Line: ±0.5% for 6V variations

Load: ±1.0% for ½ L to FL

Ripple: 0.3% RMS

Size & Weight: 3" OD x 3 7/8" high; 22 oz.

#### A. C. OUTPUT Model 591-AC

Input Voltage: 24-30 VDC

Output Voltage: 115 VAC, 400 cps, 1 phase

Output Power: 50 V.A. square wave

Regulation: Frequency: ±0.5%

(line & load) Voltage: ±2.0%

Size & Weight: 3" OD x 3 7/8" high; 22 oz.

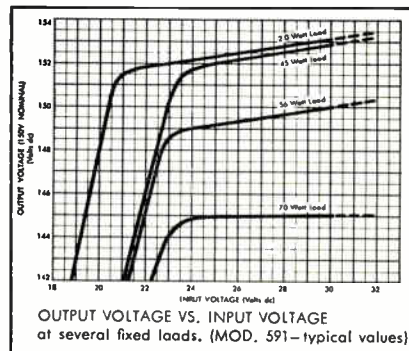

Write or 'phone for literature

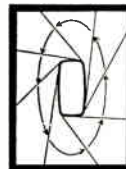

**ARNOLD  
MAGNETICS  
CORPORATION**

4613 W. Jefferson Blvd.  
Los Angeles 16, Calif.  
REpublic 1-6344

Circle 111 on Inquiry Card. page 105



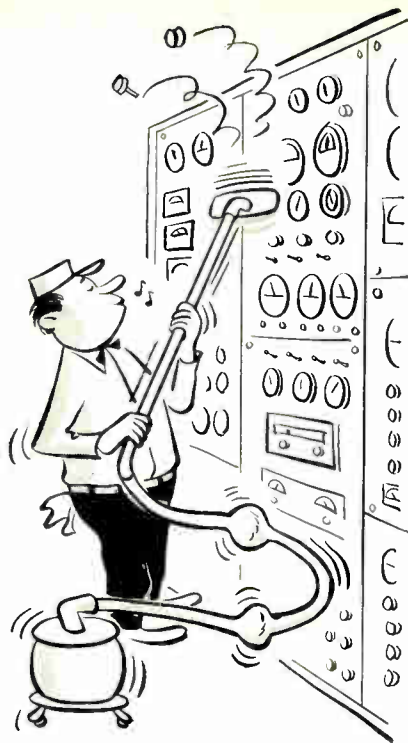

## Clean precision parts more safely

New Freon\* solvents by Du Pont minimize cleaning hazards

- **Low toxicity**—“Freon” solvents are odorless and much less toxic than ordinary solvents—vapors won't cause nausea or headaches.
- **Won't burn or explode**—Underwriters' Laboratories report “Freon” solvents non-explosive, non-combustible and non-flammable.
- **Non-corrosive**—“Freon” solvents remain neutral through repeated degreasing use without the need of inhibitors.
- **Negligible effects on plastics, elastomers, insulation and color codes**—“Freon” solvents remove oil and grease with minimum swelling of plastics or rubber and without crazing or softening paint, wire coatings or insulation.
- **Leaves no residue**—“Freon” solvents evaporate completely, leave no deposit.

New “Freon” solvents by Du Pont degrease sensitive mechanical and electronic assemblies without damage to delicate parts. Since no inhibitors are needed, no residue is left on the parts, and “Freon” solvents can be recovered and reused without re-inhibiting. Write for free “Freon” solvents booklet. E. I. du Pont de Nemours & Co. (Inc.), “Freon” Products Division 554, Wilmington 98, Delaware.

\*Freon is Du Pont's registered trademark for its fluorinated hydrocarbon solvents.



**FREE BOOKLET!**  
No obligation—write for booklet which tells how new “Freon” solvents by Du Pont minimize cleaning hazards.



Better Things for Better Living  
... through Chemistry

Circle 112 on Inquiry Card, page 105

## New Products

### E-I-R. METER

Battery powered, portable E-I-R meter has transistorized circuitry. The Model 110A measures 1 mv to 1000 v full scale in 13 ranges; input resistance is 101 megohms. 18 cur-



rent ranges provide measurement of full scale values from 1 millimicroamp to 300 ma; voltage drop for all ranges is 100 mv. Direct-reading resistance scales indicate resistances from 10 ohms to 100 megohms, center scale. Accuracy of indication is  $\pm 2.0\%$  of full scale for voltage and current measurements, and  $\pm 4.0\%$  midscale for resistance. Belleville-Hexem Corporation, 638 University Ave., Los Gatos, Calif.

Circle 258 on Inquiry Card, page 105

### SWEEP GENERATORS

Models H-3, H-D, L-D and S-D sweep generators feature new cabinet designs and improved circuitry. Also featured are high output and low leakage. Designed for production test or developmental checkout applications, they have crystal controlled single frequency, or harmonic plug-in

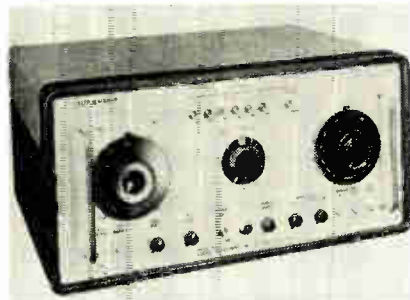

markers, with external marker provisions. Variable frequency plug-in markers are available. Dimensions are 20 x 10 x 15 in. Input is 115 vac. Telonic Industries, Inc., Beech Grove, Ind.

Circle 259 on Inquiry Card, page 105

## NOW FROM BORG... A NEW LIGHTWEIGHT MICRODIAL!



You asked for it . . . here it is! The all-new, lightweight Borg Microdial. An anodized aluminum control knob makes this dial light, bright and more attractive. Three rows of knurled bands make setting quick, easy. Wear and corrosion resistant . . . meets fifty-hour salt spray requirements. Presently available in 3-digit, 10-turn models with or without finger-tip brake which locks settings in place. The aluminum control knob is mounted directly on the shaft to be controlled—this prevents backlash. Inline digital presentation makes the easiest dial reading ever. See your Borg “Tech-Rep” or write direct for more information.

MICROPOTS • MICRODIALS • MOTORS



*Built by Borg*

**BORG EQUIPMENT DIVISION**

AMPHENOL-BORG ELECTRONICS CORPORATION  
JANESVILLE, WISCONSIN

Circle 113 on Inquiry Card, page 105

for maximum reliability

## PREVENT THERMAL RUNAWAY

Prevent excessive heat from causing "thermal runaway" in power diodes by maintaining collector junction temperatures at, or below, levels recommended by manufacturers, through the use of new Birtcher Diode Radiators. Cooling by conduction, convection and radiation, Birtcher Diode Radiators are inexpensive and easy to install in new or existing equipment. To fit all popularly used power diodes.



## with NEW BIRTCHER DIODE RADIATORS

**B**

Birtcher cooling and retention devices are not sold through distributors. They are available only from the Birtcher Corporation and their Sales Representatives.

### THE BIRTCHER CORPORATION Industrial Division

4371 Valley Blvd. Los Angeles 32, California

Sales engineering representatives in principal cities.

Circle 114 on Inquiry Card, page 105

FOR CATALOG  
and  
test data write:

## New Products

### SLIDE RULE

Pocket-sized calculator combines a Faber-Castell 13-scale log-log slide rule on one side and an adding machine on the other. Slide rule has 5 in. scale length, includes K, A, B,

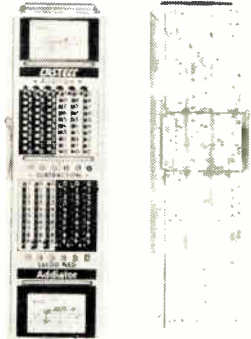

C1, C, D, P, LL<sub>1</sub>, LL<sub>2</sub>, LL<sub>3</sub>, e<sup>x</sup> resp. scales for computing proportions, squares and square roots, cubes and cube roots, multiplication, division, tables, trigonometric and log-arithmetic calculations, compound multiplication and division, etc. On the reverse side, it adds and subtracts to 999,999. Made of aluminum and brass. Includes automatic credit balance window. Harrison Home Products Corp., 565 Fifth Ave., New York 17, N. Y.

Circle 260 on Inquiry Card, page 105

### RECORDING UNIT

"Datascopes," a recording-projecting oscillograph puts into permanent immediate visual form physical variables such as: electrical, optical, acoustical, chemical or thermal. Records transient phenomena ranging from dc to 5000 cps and projects them on a 4 in. viewing screen. Data

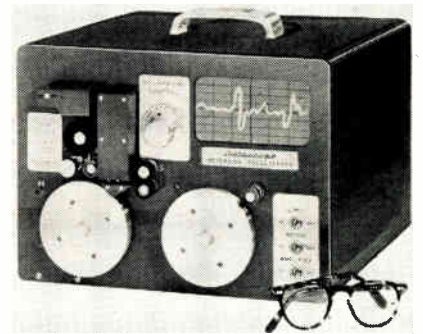

may be transported backward and forward for detailed visual inspection. Full-sized images may be preserved as direct photographs. Microsound, Inc., 4627 Leahy St., Culver City, Calif.

Circle 261 on Inquiry Card, page 105

## RUGGED and RELIABLE New! TRANSISTORIZED

The A. W. HAYDON COMPANY'S  
TRANSISTORIZED SUB-MINIATURE  
ELECTRONIC TIME DELAY RELAYS!

### SAVE SPACE AND WEIGHT!

	Miniature Series	Sub-Miniature Series
Cross Section	1 <sup>7</sup> / <sub>16</sub> " x 1 <sup>7</sup> / <sub>32</sub> "	3 <sup>1</sup> / <sub>32</sub> " x 1 <sup>1</sup> / <sub>16</sub> "
Length	2 <sup>1</sup> / <sub>4</sub> " long	2" long
Weight	6 ounces	3 ounces
WRITE FOR:	Bulletin AWH TD-503	Bulletin AWH TD-504

### TEST-PROVED PERFORMANCE!

High Temperature: 125°C (250°F)  
Vibration: 2000 CPS at 15 g.  
Contact arrangements up to 4 pole double throw.  
Unique transistorized R.C. time constant network.  
Time Delays from 50 MS to 120 seconds. Longer Delays available.  
Hermetically sealed housings.

MEET  
REQUIREMENTS  
OF MIL-E-5272A.



The A.W. HAYDON Company

219 NORTH ELM STREET, WATERBURY 20, CONNECTICUT

Design and Manufacture of Electro-Mechanical Timing Devices



MINIATURE  
ELECTRONIC  
TIME DELAY RELAYS  
31200 SERIES

SUB-MINIATURE  
ELECTRONIC  
TIME DELAY RELAYS  
31300 SERIES





# Over **49,000\*** Information Requests



Have ALREADY Come in to Sellers  
of Electronic Products  
Thru the  
**June, 1958 Directory & All-Reference Issue**  
of **ELECTRONIC INDUSTRIES!**

## AND NOW—9 MONTHS LATER—

This Unique Purchasing Guide  
is STILL Stimulating  
a Constant Flow of Inquiries!

Send space reservations,  
plates and copy to:

**ELECTRONIC  
INDUSTRIES**

A Chilton Publication  
Chestnut & 56th Streets  
Philadelphia 39, Pa.

NO CASUAL WHIM—NO IDLE CURIOSITY . . . takes these engineer-buyers week after week, month after month, into the pages of this popular directory of 2,600 electronic products.

The fact is, ELECTRONIC INDUSTRIES DIRECTORY—after 16 years of publication—is firmly entrenched as a standard working tool of the electronic industry.

Hundreds of enthusiastic letters from users of the 1958 E.I. Directory prove—again—how indispensable it has become as an industry purchasing guide—as an engineers reference handbook. Just tell your E.I. representative you'd like to see these testimonies.

For lively, all-year response to your 1959 product directory ad—this year schedule it to appear in the fifty five thousand (55,000) copies of ELECTRONIC INDUSTRIES JUNE DIRECTORY AND ALL-REFERENCE ISSUE.

\* This is a minimum figure only. It does not include thousands of phone calls, telegrams and letters direct to manufacturers from directory readers.

**ACT NOW! CLOSING DATE IS MAY 1st, 1959**

# A FULL LINE OF SERVOSYSTEM ANALYZERS

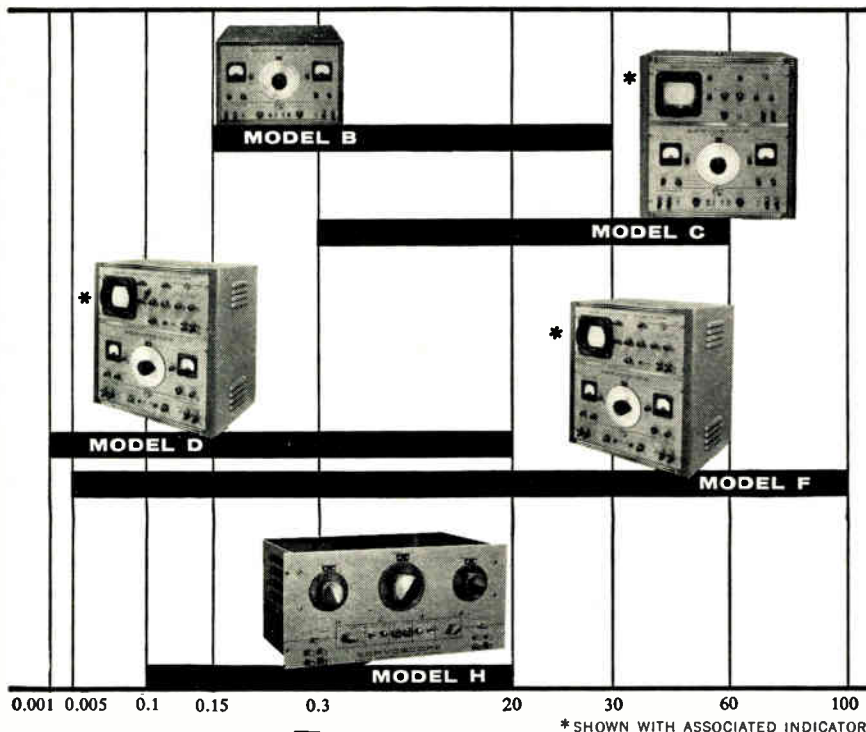

Choose from **5** dependably accurate models covering ranges from **.001 to 100 cps.**

SERVOSCOPE® makes preproduction problem-solving on servo systems, equipment, and components accurate—and flexible.

Wide range coverage. Fast direct-setting and read-out. High-accuracy measuring of phase, transient response, and gain. Plus—rapid plotting of Nyquist, Bode, or Nichols diagrams.

The result: safe, dependable control system evaluations—in advance—of ultimate operating behavior patterns.

**The SERVOSCOPE servo analyzer is a versatile precision instrument with a full range of applications . . .**

for the laboratory—in design and test stages of control systems  
on the production line—for system inspection, quality control  
and as a teacher—in the university and in industry. A proven training aid in theory and practice.

**SERVOSCOPE—most widely used method for control behavior analysis—because of features, according to the model selected, like these:**

- Covers the frequency range from .001 to 100 cps in the choice of five standard models.
- Evaluates AC carrier and DC servo-systems.
- Generates sine wave, modulated carrier wave, and square wave phaseable signals with respect to either electronic linear sweep or sinusoidally modulated reference signal.
- Frequency calibration accuracy of  $\pm 2\%$ ; phase measurement accuracy of  $\pm 1\%$ .
- Accepts any carrier frequency from 50 to 5,000 cps.
- Indicates by means of SERVOSCOPE Indicator or oscillograph recording.

Discover the **full** benefits of the SERVOSCOPE!

Write for complete specifications and application tips—today!



**SERVO  
CORPORATION  
of AMERICA**

20-20 Jericho Turnpike, New Hyde Park, L. I., N. Y.

Discover **FACTS** about new **SERVOBOARDS**, too!

Find out about the economy, flexibility, and space-saving techniques new Servo Corp. "Breadboards" offer design groups. Write for new brochure TDS-1100A.

## New Products

### DISPLAY UNIT

Lenticular optical multi-message display stores all the messages on a common viewing screen. Then, any

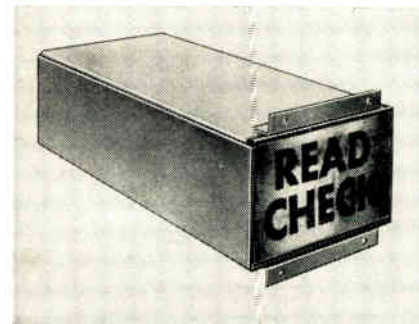

one of the messages can be selected and displayed by lighting a miniature incandescent bulb. There is no interference between messages, and switching from one to another is instantaneous. The devices can also visually present digits, letters, words, charts, or photographs. Type LD-22, displays 16 messages on a  $2\frac{1}{4} \times 2\frac{1}{4}$  in. viewing screen; Type LD-35, displays 20 messages on a  $3 \times 5$  in. viewing screen. Burroughs Corp., Electronic Tube Div., P. O. Box 1226, Plainfield, N. J.

Circle 274 on Inquiry Card, page 105

### PN DIODES

Diffused silicon pn junction diode designed as a variable capacitance with low loss at high frequencies. Meets MIL-E-1 outline 7-1 for cartridge-type crystal rectifiers and will fit most standard crystal holders. In the standard MA-460 series, the pin end is connected to P-type material on the top of a small "mesa" and the N-side of the silicon element is connected to the base. The reversed polarity unit denoted by the suffix R

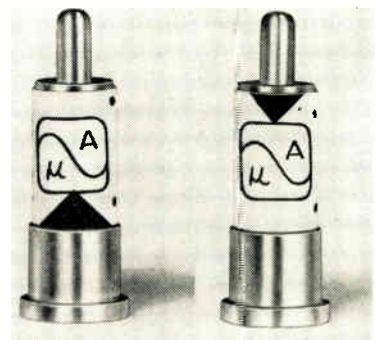

is also available. Minimum cutoff frequencies are graded in 10 KMC steps starting with the suffix A at 20 KMC. Units are available to 60 KMC. Microwave Associates, Inc., Burlington, Mass.

Circle 275 on Inquiry Card, page 105



# FANS AND BLOWERS

to cool the tough ones

When modern design requires cooling, it means fast, efficient cooling — with minimum weight addition.

Heinz Mueller fans and blowers have shown outstanding ability to meet military specifications for performance and extreme durability. Now, these same characteristics are also available for commercial applications . . . wherever precision is vital.

Call a Heinz Mueller engineer for design help on the "tough ones." We've already solved something close to the problem you're facing now.



## BLOWER

Delivers 75 C.F.M. at 6000 R.P.M. using 2 3/4" blower wheel. With filter for radio noise suppression. Military or commercial specifications. Motors 6 to 220 volt D.C. or 60 cycles A.C. 400 cycles on special request. Blowers from 2 to 200 C.F.M. with 1" to 4" wheels.



## TUNNEL FAN

Weighs only 14 oz., but delivers 150 C.F.M. at 3100 R.P.M. 4" fan. Can supply 2 C.F.M. to 250 C.F.M. with 2" to 10" blades.

FAN — Miniature precision design delivers 20 C.F.M. at 10,000 R.P.M. 2" dia. 10-blade fan. Motor 27.5 volt D.C. Weight 4 oz.



## METAL FAN BLADES

2" to 5" diam. Sizes

Aluminum or steel.

Fans can be furnished with plain hole, metal hub or rubber grommet.

Maximum air movement. Minimum horsepower requirement. Maximum air quietness.

## HEINZ MUELLER ENGINEERING COMPANY

1906 N. Cicero Ave., Chicago, Illinois

Circle 118 on Inquiry Card, page 105

## Wound to Meet Your Prototype and Production Needs

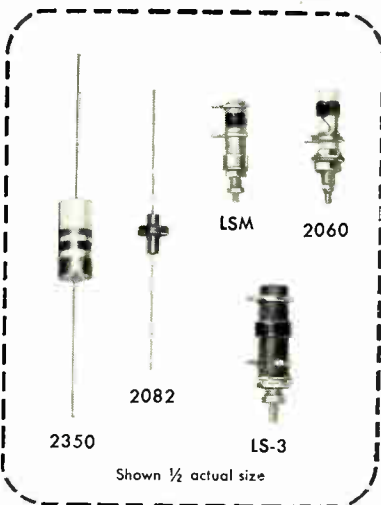

CAMBION® standard wound coils are available in types and sizes covering requirements in the broadest range of frequencies. Wound on ceramic or phenolic forms — vertical for conventional circuits and vertical and horizontal for printed circuits — many feature the Perma-Torq® tensioning device, which allows locking of tuning cores while still tunable. Special windings on shielded forms available to meet your needs.

Most prototype specifications can be filled from the broad CAMBION coil line. Unusual requirements can be handled by the widely-known CAMBION 0-8 Laboratory Coil-Development Department. And for your regular production, count on the same quality in any quantity. Another excellent aid for prototypes or lab experimenting is the CAMBION Coil Kit, containing 10 coil forms wound in overlapping inductance ranges from 2  $\mu$ h to 80  $\mu$ h. For complete details, write to Cambridge Thermionic Corporation, 504 Concord Avenue, Cambridge 38, Massachusetts.

Circle 119 on Inquiry Card, page 105



In this brochure—complete facts on DIALCO's

# DATALITES®

For the Computer-Automation Industries

DATALITES by DIALCO are ultra-miniature Indicator Lights specially designed to meet the critical requirements of the computer-automation fields. Made in 2 basic styles: *Lamp Holders with DIALCO's own replaceable Lamp Cartridges* (see above); or integrated DATALITES with *Built-in Neon Lamps* which are *not replaceable* (see below). Ultra-compact, single units mount in 3/8" clearance hole; the twin-lamp assembly mounts in 3/4" clearance hole.

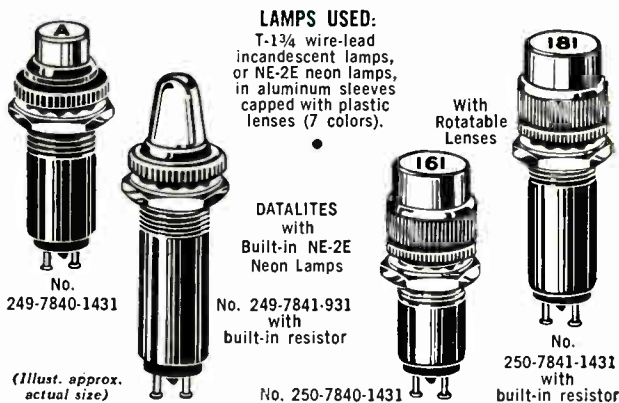

### LAMPS USED:

T-1 3/4 wire-lead incandescent lamps, or NE-2E neon lamps, in aluminum sleeves capped with plastic lenses (7 colors).

(*Illust. approx. actual size*)

DATALITES have fully insulated terminals and conform to all applicable military specifications. Integrated units are available *with or without built-in resistors*. The cylindrical lenses can be hot-stamped with digits, letters, etc. Complete details in *Brochure L-160*. Send for it now.

**SAMPLES ON REQUEST—AT ONCE—NO CHARGE**



Foremost Manufacturer of Pilot Lights  
**DIALIGHT CORPORATION**

50 STEWART AVE., BROOKLYN 37, N. Y. • HYacinth 7-7600

Circle 120 on Inquiry Card, page 105

# NAVY TERMINAL BOARDS



Made to Navy drawing 9000, 56505 B, 73214, Rev. H.

Designed by the Bureau of Ships and covered by applicable MIL specs, these boards or blocks are ideal for other heavy-duty assemblies and services. Available in several different lengths and number of terminals. Supplied in MAI-60 glass-filled Alkyd as per MIL-M-14 with latest revision. Threaded studs of manganese-bronze, molded in plastic. Slotted brass nuts. Other Navy types also available.

## WRITE FOR LITERATURE . . .

Latest Kulka Terminal Block Catalog sent on request. Let us have your terminal block problems and requirements. Our specialty!

**KULKA ELECTRIC CORP.**

633-643 So. Fulton Avenue  
Mount Vernon, N. Y.

**KULKA**

Circle 124 on Inquiry Card, page 105

## MEASUREMENTS' Standard SIGNAL GENERATOR

75Kc to 30Mc

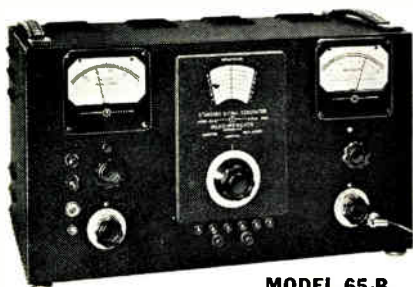

MODEL 65-B

Provides test signals for measurement of sensitivity, selectivity, overload, distortion, noise and stage gain characteristics. Meets most exacting requirements for laboratory use and production testing.

WRITE FOR BULLETIN

*Laboratory Standards*

**MEASUREMENTS**  
A McGraw-Edison Division  
BOONTON, NEW JERSEY

Circle 125 on Inquiry Card, page 105

*Just Published!*  
A definitive new work on principles, phenomena, materials...

## SEMICONDUCTORS

Edited by N. BRUCE HANNAY  
Bell Telephone Laboratories  
Murray Hill, New Jersey

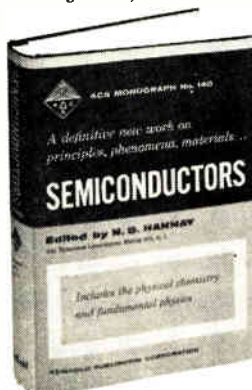

1959  
770 pages  
\$15.00

Here is an unrivaled, indispensable reference on the fundamental physics and physical chemistry of semiconductors, with detailed analyses of important semiconducting materials. The emphasis throughout is on basic principles and phenomena.

Order your on-approval copy today from—

**REINHOLO PUBLISHING CORPORATION**  
Dept. M-444, 430 Park Avenue,  
New York 22, N. Y.

Circle 126 on Inquiry Card, page 105

## New Products

### HALL GENERATORS

Ultrathin Indium Arsenide Hall generators, Type SBU 525, are 0.012 inches thick. These Axial field Hall generators are for making measurements in long narrow coils or travel-



ling wave tube assemblies with 0.250 inch and 0.150 inch diameter compensated tangent field probes. GRH Halltest Co., 157 South Morgan Blvd., Valparaiso, Indiana.

Circle 262 on Inquiry Card, page 105

### OHMMETER

Direct-reading, linear-scale ohmmeter measures the voltage drop produced across the unknown resistor by a constant current source. It is accurate to 0.25% of full scale on its 11 measuring ranges from 1 ohm to 1 megohm. It is 12 x 8 x 9 in. A combination of ac feedback and heavy,

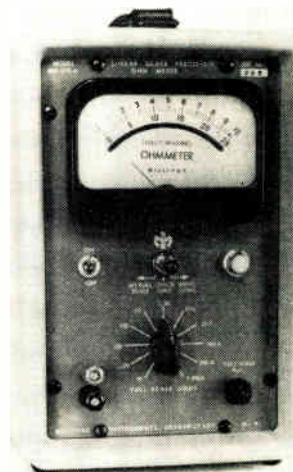

over-all dc feedback gives this amplifier effective stabilization. It uses a dc modulator rated at 10,000 hrs. guaranteed life. Millivac Instruments Div., Cohu Electronics, Inc., P. O. Box 997, Schenectady, N. Y.

Circle 263 on Inquiry Card, page 105



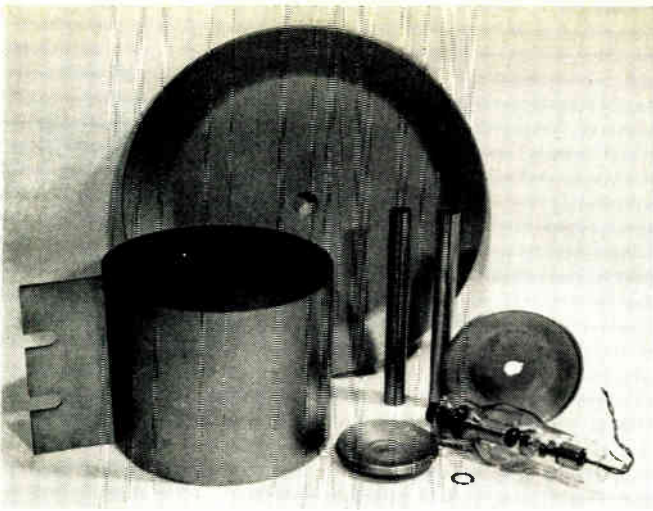

The approximate limits of fabricability as of six months ago. X-ray targets have little deformation; tubing formed from thin sheet; and, heating element formed on a large radius.

## Tungsten

(Continued from page 92)

about 20% increase in density over the tungsten alloys now being used, the drawn rotor may make it possible to decrease the size of gyro-controls and yet retain their operational integrity. Also, from the standpoint of reliability as a function of thermal expansion the wrought tungsten rotor will have no equal. Tungsten has the lowest coefficient of thermal expansion of any of the metals used in rotor construction.

A hollow unit composed of two drawn tungsten cups brazed together with gold, about the size of a potato, has an interesting possibility. The eye of the potato is actually a hole drilled in the bottom of one of the cups prior to assembly. The little potato was concocted to suggest its use as a radioisotope container.

Probably the most exciting part of the tungsten fabrication development program is the fabrication of rolled tungsten plate or sheet by spinning. The ability to fabricate tungsten by this method could very well have far-reaching implications in our race for space.

Chief interest and most important objective in continued development is in the field of rocket nozzles, and possibly other articles such as re-entry nose cones.

Crucibles, twice diameter in length, are spun from wrought sheet.

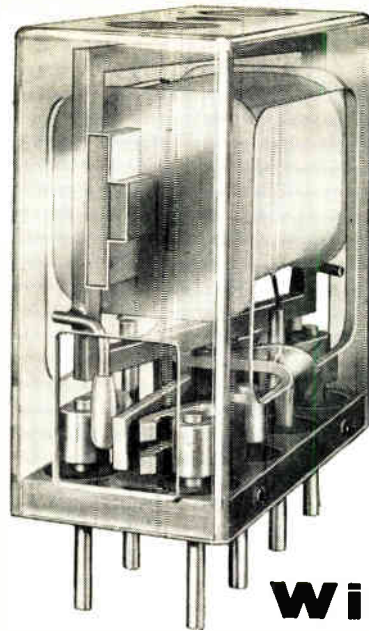
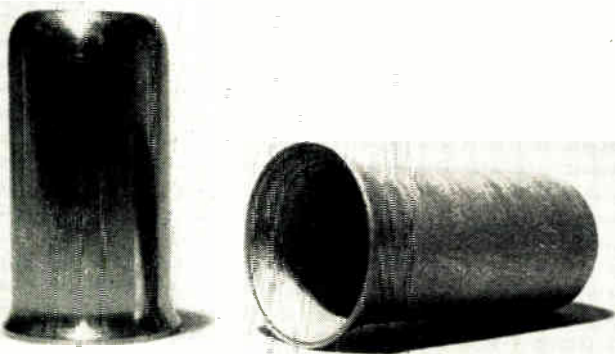

**3 times  
actual size**

Mock-up of CLARE Type F Relay enlarged to show operating mechanism. Note bifurcated contacts which enable this relay to handle a wide variety of contact loads.

## With this ONE RELAY

**You can handle contact loads from 3 amperes  
down to 1 microampere, 1 millivolt**

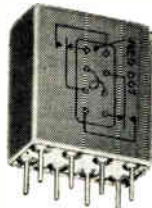
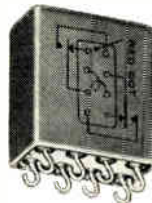

**ACTUAL SIZE**

All popular mounting arrangements are available. Terminal arrangements nicely suited to 1/10 inch grid spacing.

In one relay—the Type F—CLARE provides a precise component of unusual flexibility for long life operation under a wide variety of contact loads.

Tests have shown a performance of over 22,500,000 operations at 0.1 ampere, 115 volts a-c. Minimum contact life at 3 amperes is 100,000 operations. Contacts have carried 1 microampere, 1 millivolt for 700,000 operations with a failure resistance of 500 ohms, with no misses recorded.

This amazing low-level life is primarily a result of the use of gold plated contacts. These same contacts, however, will carry up to 3 amperes.

A special plug-in mounting arrangement that will stand extreme shock and vibration is now available.

The CLARE Type F Relay is hermetically sealed, operates perfectly in a wide range of temperatures, withstands heavy shock and vibration—is fast and more than moderately sensitive.

**Send for Engineering Bulletin  
No. 124**

Write or call C. P. Clare & Co., 3101 Pratt Blvd., Chicago 45, Illinois. In Canada: C. P. Clare Canada Ltd., 2700 Jane Street, Toronto 15. Cable Address: CLARELAY.

**CLARE RELAYS**  
FIRST in the industrial field

# How To Get Things Done Better And Faster

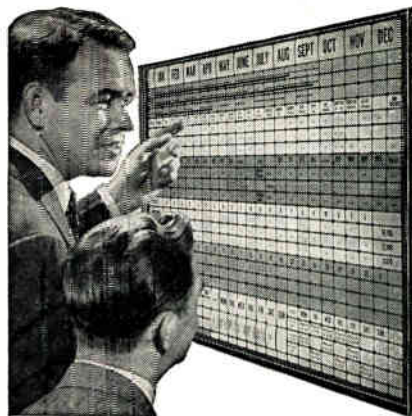

## BOARDMASTER VISUAL CONTROL

- ☆ Gives Graphic Picture — Saves Time, Saves Money, Prevents Errors
- ☆ Simple to operate — Type or Write on Cards, Snap in Grooves
- ☆ Ideal for Production, Traffic, Inventory, Scheduling, Sales, Etc.
- ☆ Made of Metal, Compact and Attractive. Over 350,000 in Use

Full price **\$4950** with cords

**FREE** 24-PAGE BOOKLET NO. Z-10  
Without Obligation

Write for Your Copy Today

## GRAPHIC SYSTEMS

55 West 42nd Street • New York 36, N.Y.  
Circle 94 on Inquiry Card, page 105

send for this

**FREE**

**EICO  
Electronics  
Catalog**



you save 50% on Top-Quality  
Test Instruments  
HI-FI • Ham Gear

## KITS AND WIRED

for professional and home use

- |  |   |
|--|---|
| <p><b>TEST INSTRUMENTS</b><br/>battery eliminators<br/>battery testers<br/>bridges<br/>decade boxes<br/>electronic switch<br/>flyback tester<br/>oscilloscopes<br/>probes<br/>signal and sweep generators<br/>tube testers<br/>transistor tester<br/>vacuum tube voltmeters<br/>volt-ohm-milliammeters</p> | <p><b>HI-FI</b><br/>stereo and monaural tuners<br/>preamplifiers<br/>power amplifiers<br/>integrated amplifiers<br/>speaker systems</p> |
|--|---|

**HAM GEAR**  
cw transmitter  
modulator-driver  
grid dip meter

**OVER 1 MILLION**  
EICO instruments in use throughout the world.

LIFETIME service and calibration guarantee.  
IN STOCK at your neighborhood EICO dealer.  
Send now for FREE catalog EIN-4

**EICO** 33-00 N. Blvd., L. I. C. 1, N. Y.  
... praised by the experts  
as **BEST BUYS IN ELECTRONICS**  
© 1959 ELECTRONIC INSTR. CO., INC.

Circle 95 on Inquiry Card, page 105

# New Products

## SEMICONDUCTOR SLICER

Automatic production machine for slicing semiconductor crystals has a relieving mechanism to avoid contact between the wheel and crystal during spindle retraction thereby improving

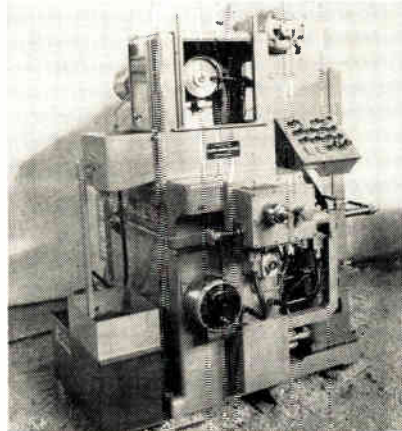

surface finish. Adjustable speed spindle drive allows for variations in diamond wheel size and quality and different semiconductor materials. Plunge cut feed is hydraulic, fully compensated. Flow control valve may be locked in position to prevent unauthorized adjustment. It will slice an ingot section up to 4 in. in length. Fitchburg Engineering Corp., Fitchburg, Mass.

Circle 264 on Inquiry Card, page 105

## DELAY-LINE

Magnetostrictive delay lines with insertion losses as low as 12 db, use a high-efficiency propagation medium which permits use of up to 3 fewer amplifier stages, since the output is usually high enough to drive a diode directly. Low-level signal troubles in the high ambient noise applications are eliminated. Featured is improved temperature stability. Temperature coefficients of delay of 5 ppm/C° for fixed delay and some variable models, and 25 ppm/C° for the other variable



models. Can be supplied with a delay stability of  $\pm 0.05\%$  over a temperature range from  $-60^{\circ}\text{C}$  to  $+90^{\circ}\text{C}$ . They permit high storage density in small volume. Deltime, Inc., 608 Fayette Ave., Mamaroneck, N. Y.

Circle 265 on Inquiry Card, page 105

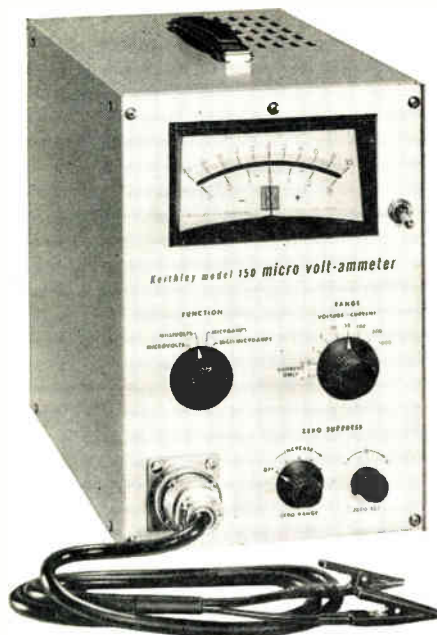

measure down to

**0.03  $\mu\text{V}$**

The Keithley 150 sets a new standard of sensitivity for dc voltmeters. Typical uses include output measurements from strain gages, thermopiles and ion chambers, as well as Hall effect studies, corrosion work and molecular weight analysis.

Functions and measurement spans of the 150 are: dc voltmeter, 1 microvolt to 1 volt full scale; ammeter,  $10^{-3}$  to  $10^{-10}$  ampere full scale; dc amplifier, gains of  $10$  to  $10^7$ ; and null detector, with 0.5 to 2 second response. Features include:

- zero stability as a voltmeter within 0.1 microvolt per day; as an ammeter, within  $2 \times 10^{-11}$  ampere per day.
- zero suppression up to 100 times full scale.
- optional floating or grounded input.
- short term noise within 0.03 microvolt peak to peak (0.006 microvolt RMS).
- rugged construction, relative insensitivity to vibration, 60-cycle fields, or thermal EMF's.

Write today for your copy of Keithley Engineering Notes, Vol. 7 No. 1 describing the Model 150.



**KEITHLEY  
INSTRUMENTS, INC.**

12415 Euclid Ave., Cleveland 6, Ohio

Circle 93 on Inquiry Card, page 105



C. E. Jones (left), Daystrom Systems, and K. W. Reece, Ebasco Services, examine blueprints of Power Station Computer.

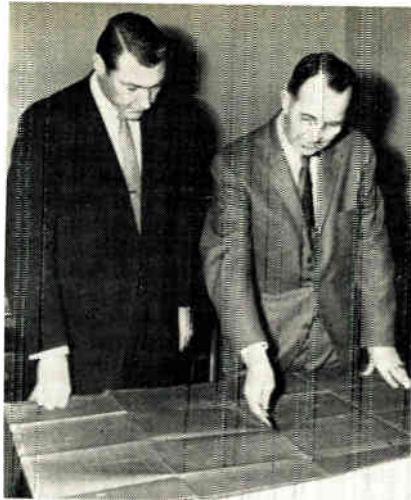

### Computer Operates Power Station

A solid state computer will fully control the start-up, operation, and shut-down of a new 225,000 kw power generating station to be built by Ebasco Services, Inc., for the Louisiana Power & Light Co. at Little Gypsy, La. (near New Orleans). The computer system was designed and built by Daystrom Systems, La Jolla, Calif., a division of Daystrom, Inc.

Over 800 different "steps" are involved in start-up or shut-down. Between each step the computer will scan over 700 different temperatures, pressures, flow rates, and valve and switch positions, and automatically change the positions of the valves and switches. The computer will continuously monitor all phases of the station's operation and will turn over the operation of the plant to human operators should some malfunction occur.

The station will have a normal complement of human operators for safety and maintenance.

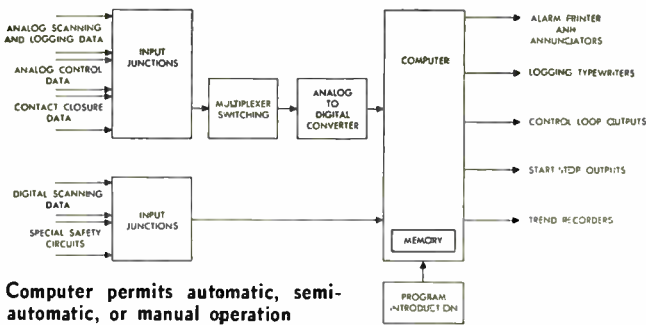

Computer permits automatic, semi-automatic, or manual operation

### HIGH THERMAL CONDUCTIVITY "HOT MELT" COMPOUNDS for power transformer potting

- Excellent heat dissipating properties.
- Increased power output through cooler unit operating temperatures.
- Minimum equipment necessary.
- No curing or baking after potting.
- Odorless with high cold flow.



Send for GENERAL SPECIFICATIONS CHART on INSULATING and SEALING COMPOUNDS  
3440 HOWARD STREET • SKOKIE, ILLINOIS

Telephones: ORchard 3-1050 • AMBassador 2-3339

**BIWAX**

**BIWAX CORPORATION**

Over 30 years of formulating experience

Circle 130 on Inquiry Card, page 105

# CLARE lowers prices on all Mercury-wetted contact relays

## Reductions range from 7½% to 10%



Type HG



Type HGP



Type HGS



Type HG2



Type HG4

When prices for just about everything are continuing to rise, and all thinking men are concerned over the danger of inflation, it is important news when a manufacturer makes a significant price reduction.

Increased production resulting from the wide acceptance of Clare Mercury-Wetted Contact Relays, together with improvements in skill and in manufacturing equipment and methods, make it possible for Clare to reduce prices in spite of rising labor and material costs.

A price reduction ranging from 7½% to 10% will be applied to all orders placed after March 31, 1959, for Clare Mercury-Wetted Contact Relays—Types HG, HGP and HGS. The reduction will also affect multi-element relays such as HG2, HG3, HG4, etc.

These lower prices for relays whose life is measured in *billions of maintenance-free operations* will be exciting news to all designers of continuous-duty, high-speed switching devices and systems.

Write or Wire: C. P. Clare & Co., 3101 Pratt Blvd., Chicago 45, Illinois. In Canada: C. P. Clare Canada Ltd., 2700 Jane Street, Toronto 15. Cable Address: CLARELAY.

## CLARE RELAYS

FIRST in the industrial field

Circle 131 on Inquiry Card, page 105

# NOW!

## New ultrasonic detergents and solvents from NARDA... the leader in mass-produced ultrasonic cleaning equipment

Narda research makes news again—with a new ultrasonic detergent and a new ultrasonic solvent, developed especially for ultrasonic cleaning. Although designed to work hand-in-hand with Narda SonBlaster cleaning equipment, Blast ONE and Blast TWO make even ordinary ultrasonic equipment do a better job.

Check the specifications below—decide whether you need the detergent or solvent (or both)—and order from your local distributor today. If he's out of stock, mail us your order directly and include his name. Address: Dept. EI-17.

### BLAST



A complex, scientifically designed detergent for use in ultrasonic water-washing equipment. Odorless and nonflammable, entirely safe for all delicate surfaces.

Contains no harsh ingredients. Promotes cavitation, reduces surface tension, rapidly out-gasses interfering air entrainments from solutions. Protects against redeposition of soil. Rinses off completely. High buffering capacity of synergistic value—pH 10.5. To use, dilute 1/2 ounce Blast ONE to one gallon hot or cold, soft or hard water.

One gallon	\$ 4.50
One case (six gallons)	25.50
Three cases (18 gallons)	70.20
Five-gallon drum	21.00

All prices F.O.B. Mineola

### BLAST



A cold degreasing solvent for use in ultrasonic cleaning and degreasing equipment. Dries fast in seconds. Zero residue and nonflammable. It does not contain carbon

tetrachloride. *Least toxic solvent available anywhere.* Entirely safe for all delicate surfaces. Contains no harsh ingredients. Promotes vigorous cavitation. Moisture-free. Displaces water from metal surfaces. Use undiluted in ultrasonic cleaning tank.

One gallon	\$ 3.20
One case (six gallons)	18.60
Three cases (18 gallons)	54.00
Five-gallon drum	15.25
55-gallon drum	121.00

All prices F.O.B. Mineola

Contact Narda for immediate delivery on a complete line of ultrasonic cleaning equipment—transducerized tanks and submersible transducers—from 30 watts to 2.5 KW. For custom-designed installation and unique electro-acoustic applications, including cleaning, soldering, welding, drilling and non-destructive testing, consult our subsidiary, Alcar Instruments, Inc., at the address below.



**the narda** ultrasonics corporation  
625 MAIN STREET, WESTBURY, L. I., N. Y.  
Subsidiary of The Narda Microwave Corporation

Circle 132 on Inquiry Card, page 105

- Advance Relays
- Automatic Electric
- Besson and Robinson
- Collins Electronics
- C. P. Clare
- Elgin Neomite
- E. M. S.
- Guardian Electric
- Kurman
- Leach Relays
- Monitor
- Phillips Control
- Potter & Brumfield
- R-B-M
- Div. Essex Wire
- Struthers Dunn
- Terado
- And Others



## Now... Buy



### 24 HOUR DELIVERY from RELAY SALES

Send for our Catalog C-9  
Phone West Chicago 1100  
TWX West Chicago, Ill. 3464-U  
Write P.O. Box 186-EV, West Chicago, Ill.

Circle 133 on Inquiry Card, page 105

## You may not need eyes to line things up any more

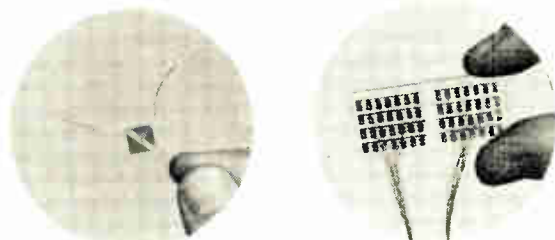

Wherever the human eye is used for precise alignment work, there's a good chance we can lay lead sulfide down on glass in the precise pattern that will let you do the job electrically. Making such Kodak Ektron Detectors in precise configurations and complex arrays, and duplicating them in quantity, is a specialty of ours.

Spectral response of these photoresistors extends over a broad range. They are particularly sensitive in the infrared. This lets you use cool-running light sources where heat might affect accuracy of measurement. Signal-to-noise ratio is low, units are rugged, unaffected by vibration.

You find out more by writing to Special Products Sales, and asking for the new pamphlet, "Kodak Ektron Detectors."

**EASTMAN KODAK COMPANY**  
Rochester 4, N. Y.



Circle 134 on Inquiry Card, page 105





# NEW DC-to-30 MC

## DUAL-BEAM Oscilloscope

*with Calibrated Sweep Delay*

TYPE 555

### SWEEP DELAY

Simultaneous display of pulse chain (upper beam) and third pulse on an expanded delayed sweep (lower beam). Portion of original display that appears on a faster delayed sweep is identified by trace brightening.

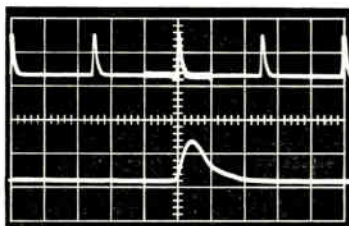

**T**wo electron beams, each with its own X and Y deflection plates, help make possible a highly versatile dual-beam oscilloscope.

Either of the two time-base generators in the Type 555 can deflect either beam for dual and single displays, and either can deflect both beams for a dual display on the same time base.

With one time-base generator functioning as a delay generator, the start of any sweep generated by the other can be held off for a selected time interval with a high degree of accuracy. Both the original display and the delayed display can be observed at the same time. The "triggered" feature can be used to obtain a jitter-free display of signals with inherent jitter.

Signal-handling versatility is provided by nine available types of plug-in preamplifiers, any combination of which can be used in the two fast-rise vertical channels. In addition to the many application areas opened with Tektronix plug-in preamplifiers, a three-channel or four-channel display is available through use of the time-sharing characteristics of Type C-A Dual-Trace Units in one or both channels.

Please call your Tektronix Field Engineer or Representative for complete specifications.

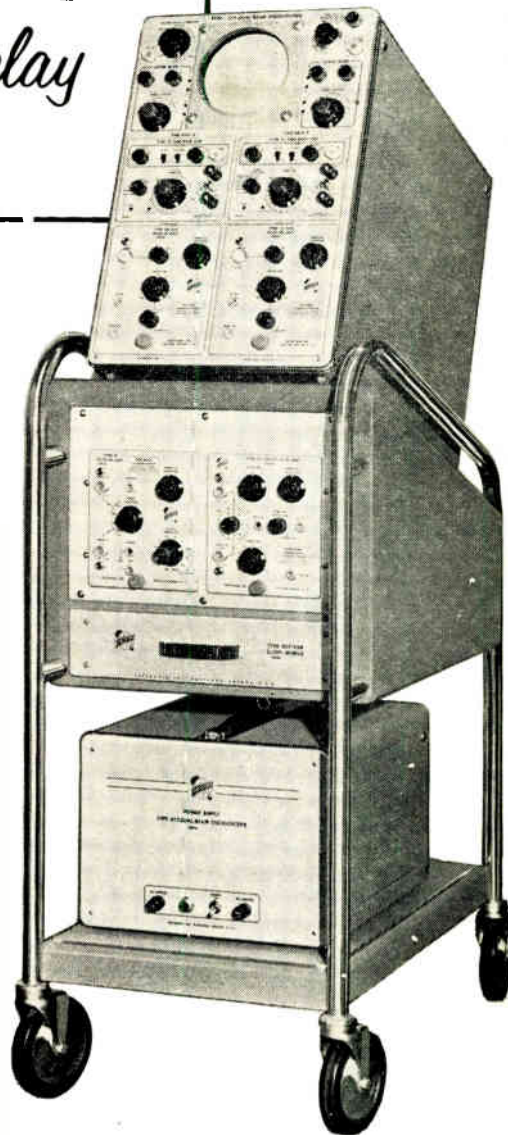

## Characteristics

### INDEPENDENT ELECTRON BEAMS

Separate vertical and horizontal deflection of both beams.

### FAST-RISE MAIN VERTICAL AMPLIFIERS

Passbands—dc-to-30 mc with Type K Units.

Risetimes—12 nsec with Type K Units.

All Tektronix Plug-In Preamplifiers can be used in both vertical channels for signal-handling versatility.

### WIDE-RANGE TIME-BASE GENERATORS

Either time-base generator can be used to deflect either or both beams.

Sweep ranges—0.1  $\mu$ sec/cm to 12 sec/cm. 5 x magnifiers increase calibrated sweep rates to 0.02  $\mu$ sec/cm.

### SWEEP DELAY—Two modes of operation.

Triggered—Delayed sweep started by signal under observation.

Conventional—Delayed sweep started by delayed trigger.

Delay range—0.5  $\mu$ sec to 50 sec in 24 calibrated steps, with continuous calibrated adjustment between steps.

### HIGH WRITING RATE

10-KV Accelerating potential provides bright traces at low repetition rates and in one-shot application.

### REGULATED POWER SUPPLY

PRICE, Type 555 without plug-in preamplifiers . . . \$2700

Includes Indicator Unit, Power Supply Unit, Scope-Mobile, 4-10 x atten. probes.

Price f.o.b. factory

## Tektronix, Inc.

P. O. Box 831 • Portland 7, Oregon

Phone CYpress 2-2611 • TWX-PD 311 • Cable: TEKTRONIX

TEKTRONIX FIELD OFFICES: Albertson, L.I., N.Y. • Albuquerque • Atlanta, Ga. • Branzville, N.Y. • Buffalo • Cleveland • Dallas • Dayton • Elmwood Park, Ill. • Endwell, N.Y. • Houston Lathrup Village, Mich. • East Los Angeles • West Los Angeles • Minneapolis • Mission, Kansas Newtonville, Mass. • Orlando, Fla. • Palo Alto, Calif. • Philadelphia • Phoenix • San Diego St. Petersburg, Fla. • Syracuse • Towson, Md. • Union, N.J. • Washington, D.C. • Willowdale, Ont.

TEKTRONIX ENGINEERING REPRESENTATIVES: Hawthorne Electronics, Portland, Oregon., Seattle, Wash.; Hytronic Measurements, Denver, Colo.; Salt Lake City, Utah.

Tektronix is represented in 20 overseas countries by qualified engineering organizations.

*Tektronix manufactures seventeen other laboratory oscilloscopes, ten of which are also available as rack-mounting instruments.*

# crystal can size relays

by **ADVANCE**

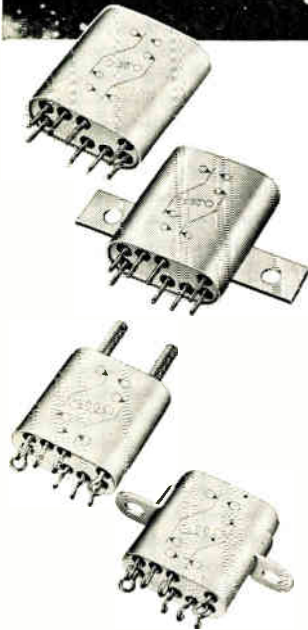

**ADVANCE MV SERIES**  
offered in 3 terminal  
arrangements...6 mount-  
ing arrangements, and 7  
resistance values (30 to  
10,000 ohms).  
— AVAILABLE AT  
**ADVANCE DISTRIBUTORS**

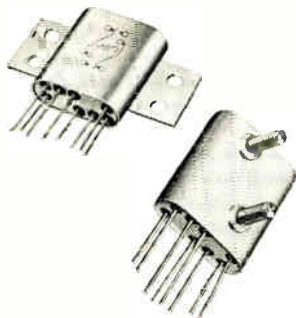

## ADVANCE RELAYS



A PRODUCT OF ELECTRONICS DIVISION  
**ELGIN NATIONAL WATCH COMPANY**  
2435 N. NAOMI ST., BURBANK, CALIFORNIA

*—these construction  
features assure  
exceptional reliability:*

**Positive sealing.** Advance's use of induction heating cuts rejects from faulty soldering to a negligible figure. Soldering is accomplished at high speed, hence damage to the relay due to heat transfer is eliminated.

**RADIFLO testing for leakage** is used to detect leaks as small as  $10^{-8}$  cc/sec. All relays that pass this test will function after long shelf life.

**RIQAP\* program approval.** Under RIQAP, the Signal Corps constantly checks Advance's quality control and inspection, to insure military standards of reliability for all Advance customers, both military and industrial.

\*Reduced Inspection Quality Assurance Plan of the U.S. Army Signal Corps.

### SPECIFICATIONS

**Coil resistance:** Available in 7 values, from 30 to 10,000 ohms.  
**Shock:** 50 G's for 11 milliseconds.  
**Vibration:** 10 to 34 cycles per second at maximum excursions of .4".  
34 to 2000 cps 20 G's acceleration.  
**Operating power:** Pull in power 250 milliwatts at 25° C.  
**Contact rating:** 2 amps resistive at 32 VDC or 115 VAC.  
**Life:** 100,000 operations minimum at rated current.  
**Weight:** 0.45 ounce.  
**Size:** 7/8" high x 5 1/64" wide x 23/64" deep.

*Our Applications Engineering Dept.  
will be pleased to work with you on your  
special application problems.*

## New Products

### FREQUENCY STANDARD

Model TQ 60C, frequency standards, perform well in uncontrolled environments such as found in the operation of military ground support equipment and industrial applications.



Specs: Frequency range, 50-100 cycles per second; accuracy,  $\pm 0.1\%$ ; operating life, 1000 hrs. minimum; output signal, square wave  $6.5 \pm 1$  to  $8 \pm 1$  peak volts. 100K load; temperature-operating,  $+15^\circ$  C to  $+40^\circ$  C; temperature-storage,  $-55^\circ$  C to  $+100^\circ$  C; operating altitude, at least 15,000 ft.; power input,  $28 \pm 2$  vdc., 1.5 w max. The Gyrex Corp., 3003 Pennsylvania Ave., Santa Monica, Calif.

Circle 266 on Inquiry Card, page 105

### UHF FERRITE ISOLATOR

Model IUH1, is designed to operate in the 500-700 MC region of the UHF band. Transitions from this reduced height guide to full height guide or to coaxial line can be supplied. These transitions will provide a match over the entire band. Minimum transmit/receive isolation is 9 db; maximum insertion loss is 1 db.

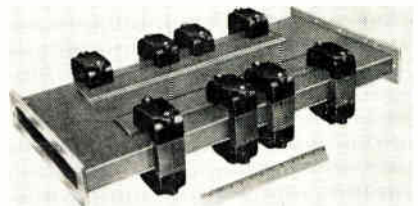

Average power handling capacity is 10 kilowatts without cooling; peak power is 10 megawatts. Raytheon Manufacturing Company, Special Microwave Device Group, River Bldg. #2, Waltham 54, Massachusetts.

Circle 267 on Inquiry Card, page 105



Now from **CLEVITE** . . .

# HIGH POWER TRANSISTORS



*Clevite offers new types with improved reliability and power handling capacity.*

**EIA REGISTERED TYPES WITH:**

- Improved seal for long life.
- Saturation voltage less than 1 Volt at increased maximum rated current of 15 amperes.
- Average thermal resistance 0.7°C per watt.
- Current gain controls: 60-150 at 5 amperes.
- 100% test for resistance to transient burn out.
- Either standard pins or solder lugs.

**TECHNICAL DATA**

Typical Electrical Characteristics at 25°C

	2N1147 2N1146	2N1147A 2N1146A	2N1147B 2N1146B	2N1147C 2N1146C
Collector to Emitter Voltage Shorted Base (I <sub>C</sub> = 1 amp)	30V (Min)	40V (Min)	60V (Min)	75V (Min)
Saturation Voltage (I <sub>C</sub> = 15 amps)	1.0V (Max)	1.0V (Max)	1.0V (Max)	1.0V (Max)
DC Current Gain (I <sub>C</sub> = 5 amps)	60-150	60-150	60-150	60-150
DC Current Gain (I <sub>C</sub> = 15 amps)	35	35	35	35
<b>Absolute Maximum Ratings</b>				
Collector Current	15 amps	15 amps	15 amps	15 amps
Collector to Base Voltage	40V	60V	30V	100V
Collector to Emitter Voltage	40V	60V	80V	100V
Power Dissipation at 70°C Case Temperature	25W	25W	25W	25W
Junction Temperature	95°C	95°C	95°C	95°C

**OTHER CLEVITE DIVISIONS:**

- Cleveland Graphite Bronze • Brush Instruments
- Clevite Electronic Components • Clevite Harris Products
- Clevite Ltd • Clevite Ordnance • Clevite Research Center
- Intermetall G.m.b.H. • Texas Division

**CLEVITE**  
**TRANSISTOR PRODUCTS**  
 241 Crescent St., Waltham 54, Mass. TWinbrook 4-9330



# 750 MILS TO 55°C-100 TO 600 PIV

**New**  
**Products**

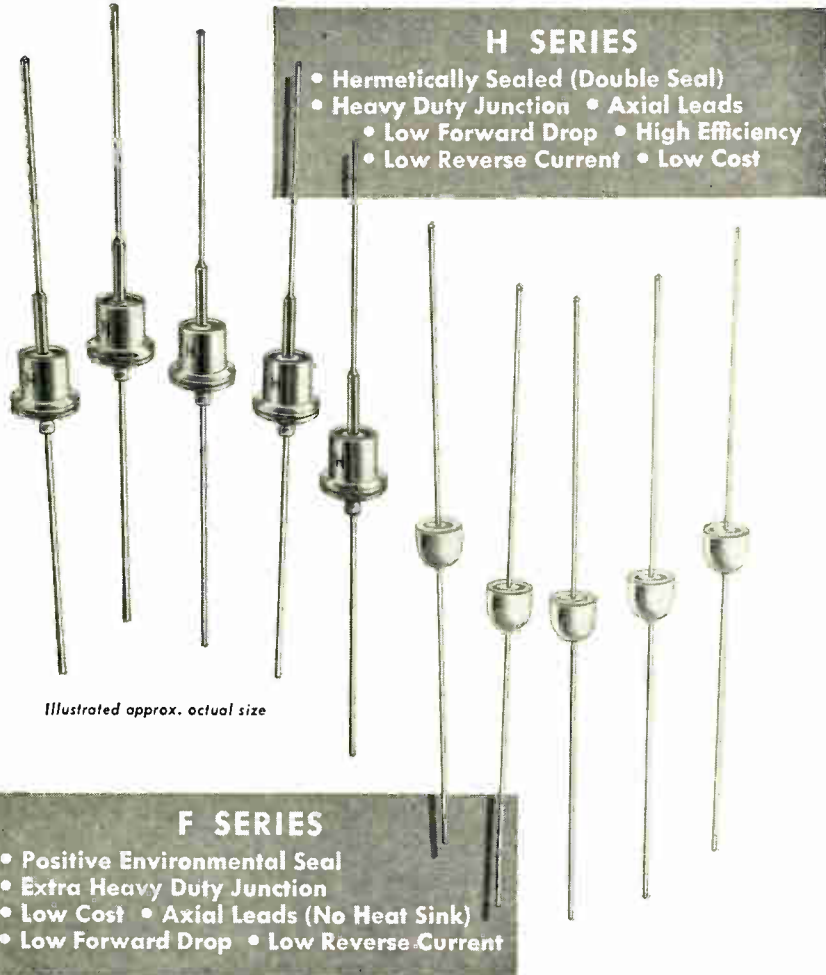

**H SERIES**

- Hermetically Sealed (Double Seal)
- Heavy Duty Junction
- Axial Leads
- Low Forward Drop
- High Efficiency
- Low Reverse Current
- Low Cost

**F SERIES**

- Positive Environmental Seal
- Extra Heavy Duty Junction
- Low Cost
- Axial Leads (No Heat Sink)
- Low Forward Drop
- Low Reverse Current

Illustrated approx. actual size

## THYRATRON TUBE

Thyratron, type VTP 7386, is adaptable to circuits employing C6J, C6JA, 5685 or 5C21 tubes. Peak anode current rating is 100 a, compared to 77 a for the older units. It



“triggers” when the control grid falls between -3.0 and -7.5 vdc, assuming maximum forward plate voltage of 1000 v. It will also pass current with less than +75 v on the plate if the grid is at least +3 v. Continuous anode current rating is 6.4 a (dc meter reading), or 12.8 a for 50% duty cycle not exceeding 15 sec. “on” intervals. Max. recommended frequency is 440 cps. Ambient temp. range is -55°C to +75°C. Vacuum Tube Products Co. Inc., 2020 Short St., Oceanside, Calif.

Circle 268 on Inquiry Card, page 105

## SWITCH

The E13-00A switch features 0.110 overtravel and 1½ h.p. rating. The case features environment-resistant interlocking design and standard mounting dimensions. Offers long life cycle and repeatability. Button is wear-resistant nylon. It accepts both

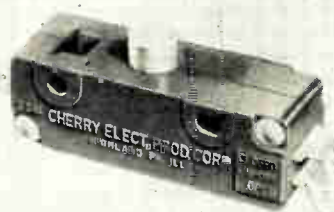

snap-in actuators and actuators secured by mounting screws. U. L. rated: 15 amp, 125/250 vac; ¼ h.p., 125 vac; 1½ h.p., 250 vac. Cherry Electrical Products Corporation, 1650 Deerfield Rd., Highland Park, Ill.

Circle 269 on Inquiry Card, page 105

# Tarzian

## F & H SERIES SILICON RECTIFIERS

### F SERIES—ELECTRICAL RATINGS—Capacitive Loads

S. T. Type	Max. Peak Inverse Volts	Max. RMS Volts	Current Ratings—Amperes											
			Max. D. C. Load			Max. RMS			Max. Recurrent Peak			Surge — 4MS Max.		
			55 C	100 C	150 C	55 C	100 C	150 C	55 C	100 C	150 C	55 C	100 C	150 C
F-2	200	70	.75	.5	.25	1.875	1.25	.625	7.5	5.	2.5	75	75	35
F-4	400	140	.75	.5	.25	1.875	1.25	.625	7.5	5.	2.5	75	75	35
F-6	600	210	.75	.5	.25	1.875	1.25	.625	7.5	5.	2.5	75	75	35

### H SERIES—ELECTRICAL RATINGS—Capacitive Loads

S. T. Type	Max. Peak Inverse Volts	Max. RMS Volts	Current Ratings—Amperes											
			Max. D. C. Load			Max. RMS			Max. Recurrent Peak			Surge — 4MS Max.		
			55 C	100 C	150 C	55 C	100 C	150 C	55 C	100 C	150 C	55 C	100 C	150 C
10H	100	35	.75	.5	.25	1.875	1.25	.625	7.5	5.	2.5	75	75	35
20H	200	70	.75	.5	.25	1.875	1.25	.625	7.5	5.	2.5	75	75	35
30H	300	105	.75	.5	.25	1.875	1.25	.625	7.5	5.	2.5	75	75	35
40H	400	140	.75	.5	.25	1.875	1.25	.625	7.5	5.	2.5	75	75	35
50H	500	175	.75	.5	.25	1.875	1.25	.625	7.5	5.	2.5	75	75	35
60H	600	210	.75	.5	.25	1.875	1.25	.625	7.5	5.	2.5	75	75	35

Write for design notes No. 30 and 31

VISIT US AT THE IRE SHOW—BOOTH #3053

**SARKES TARZIAN, INC., Rectifier Division**  
DEPT. EE-2, 415 NORTH COLLEGE AVE., BLOOMINGTON, INDIANA

In Canada: 700 Weston Rd., Toronto 9, Tel. Roger 2-7535 • Export: Ad Auriema, Inc., New York City





**FIRST  
IN  
CLASS**

## **NIKE HERCULES**

With deadly accuracy the U.S. Army's new Nike Hercules ground-to-air guided missile streaks out to meet an approaching enemy air force. Its nuclear warhead can wipe out an entire formation.

Western Electric selected Teflon\* insulated wire for use in building the alert guidance and control systems of this faster, higher climbing Nike.

As leading specialists in high temperature insulated wires and cables, the men and women at Hitemp are proud of this choice, and the role Teflon wiring plays in giving America a strong new perimeter of defense.

## **HITEMP WIRES, INC.**

1200 SHAMES DRIVE, WESTBURY, NEW YORK

\*Du Pont's trade name for Tetrafluoroethylene

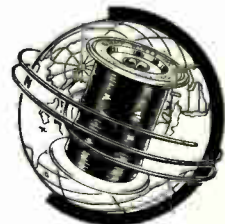

<b>New</b>	
	<b>Products</b>

**4-LAYER DIODE**

Type AD, 4-layer diode, is a self-actuated silicon switch similar in function to a relay or gas tube. It is turned on by a voltage pulse, turned off by dropping the current or revers-

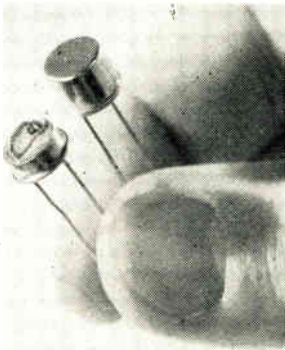

ing the voltage. To match circuit requirements, it is available with switching voltages of 30, 40, 50 and 200 v and holding currents of 5 to 45 ma. It can handle 300 ma steady dc or a 20 a pulse current. A string of four in series will switch 800 v, resulting in peak power of 16 kw, allowing use in magnetron pulsing, radar beacons and other modulator applications. Shockley Transistor Corp., Stanford Industrial Park, Palo Alto, Calif.

Circle 270 on Inquiry Card, page 105

**TERMINAL BLOCKS**

Series 409 terminal blocks eliminate splicing, increase insulation, stop electrical leakage and shorts, and generally simplify wiring work particularly in tight spots. Molded of high tensile strength bakelite for commercial uses, and available in other materials made in full compliance with electrical specs or MIL-M-

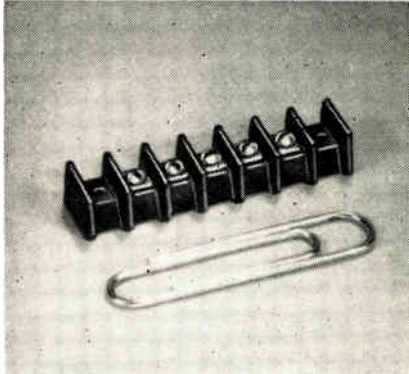

14. Made with 1 to 21 terminals, depending on size. Two mounting holes. Also available with turret lugs. KULKA Electric Corporation, 633-643 So. Fulton Avenue, Mt. Vernon, N. Y.

Circle 271 on Inquiry Card, page 105

High efficiency  
heat dissipation

$\Delta T$  between  
TRANSISTOR BASE  
and SUPPLY BASE  
**NEVER MORE  
THAN 2°C**

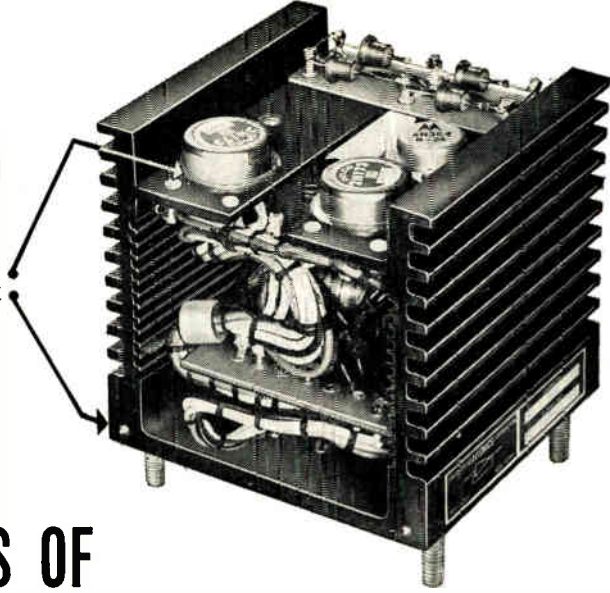

# 142 MODELS OF TRANSISTORIZED POWER

The high heat dissipation achieved by Avionics' Veridyne Power Supplies results from the unusual one-piece design of the finned aluminum extrusion case. This makes for a highly stable and reliable unit. All parts are accessible for quick easy servicing. Units feature positive short circuit protection, low ripple content, fixed and variable output.

- |   |
|---|
| <p><b>142 MODELS</b></p> <p><b>AC-DC PLUG-IN SUPPLIES</b></p> <ul style="list-style-type: none"> <li>• Input: 115 volts, 60 and 400 cps</li> <li>• Output: 6, 12, 24, 75, 150, 250, 300 volts DC</li> </ul> <p><b>DC-AC PLUG-IN INVERTERS</b></p> <ul style="list-style-type: none"> <li>• Input: 6, 12, 24 volts DC</li> <li>• Output: 115 volts, 60 and 400 cps</li> </ul> <p><b>DC-DC PLUG-IN CONVERTERS</b></p> <ul style="list-style-type: none"> <li>• Input: 6, 12, 24 volts DC</li> <li>• Output: 12, 24, 75, 150, 250, 300 volts DC</li> </ul> <p><b>LABORATORY POWER SUPPLIES</b></p> <ul style="list-style-type: none"> <li>• Input: 105 to 125 volts, 60 and 400 cps</li> <li>• Output: 0 to 32 volts; 1, 5, 10, 15 amps</li> </ul> <p><b>ALL GUARANTEED to meet specifications</b></p> |
|---|

Produced in one of Long Island's most modern electronics plants.

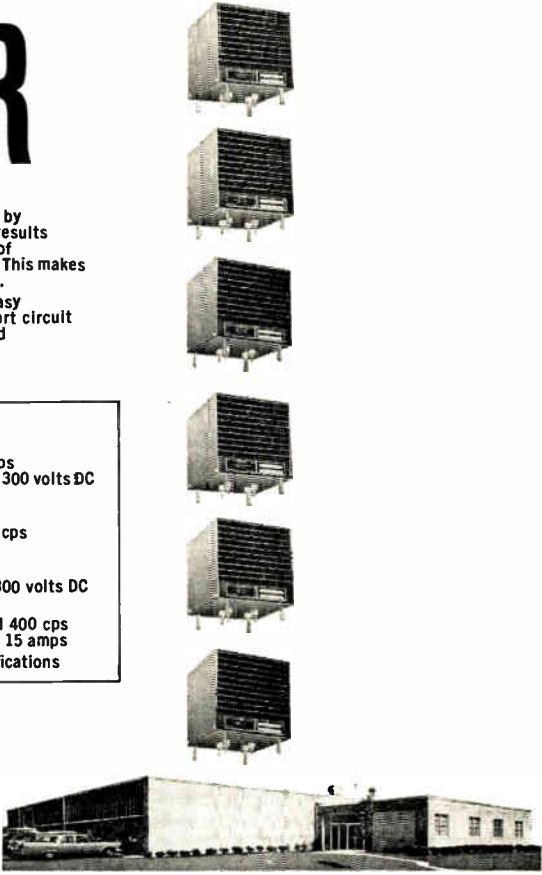

Industrial Products Division  
**CONSOLIDATED AVIONICS CORPORATION**  
800 Shames Drive • Westbury, New York  
Subsidiary of Consolidated Diesel Electric Corporation





# NEW MINIATURIZED UNITS FROM STOCK...

UTC has led the high Q coil and filter fields for over 25 years. Fresh examples of this leadership are represented in the UTC Minifilters and Miniductors described below. Though greatly miniaturized, the designs are conservative and will provide the exceptional reliability associated with all UTC products.

## UTC MINIFILTERS

Hermetically sealed to MIL-T-27A and MIL-F-18327 Specs.

UTC stock interstage filters have been an industry standard for over a decade. The new UTC miniature filters provide almost the same characteristics in an extremely miniaturized package. Attenuation of these minifilters is only slightly less than their larger counterparts, as is operating level. Special minifilters can be supplied for any frequency above the minimum shown for each group. Straight pin terminals are provided for printed or standard circuits.

BPM units (band pass) have 2:1 gain. Attenuation is approximately 2 db  $\pm$  3% from center frequency, and 35 db per octave as shown. Input 10,000 ohms, output to grid, tapped for 10,000 ohms output to provide flexibility in transistor circuits.

HPM units (high pass) have a loss of less than 6 db at cutoff frequency, and an attenuation of 30 db at .67 cutoff frequency. Input and output 10,000 ohms.

LPM units (low pass) have a loss of less than 6 db at cutoff frequency, and an attenuation of 30 db at 1.5 cutoff frequency. Input and output 10,000 ohms.



HPM and LPM case (MIL AG)  
1 x 1 x 1 3/8"  
Weight ..... 2 1/4 oz.



BPM case (MIL AF)  
3/4 x 3/4 x 1 1/8"  
Weight ..... 1 oz.

### STANDARD FILTERS STOCK FREQUENCIES

BPM—400	LPM—200
BPM—1000	LPM—500
BPM—2000	LPM—1000
BPM—10000	LPM—2000
HPM—500	LPM—3000
HPM—1000	LPM—5000

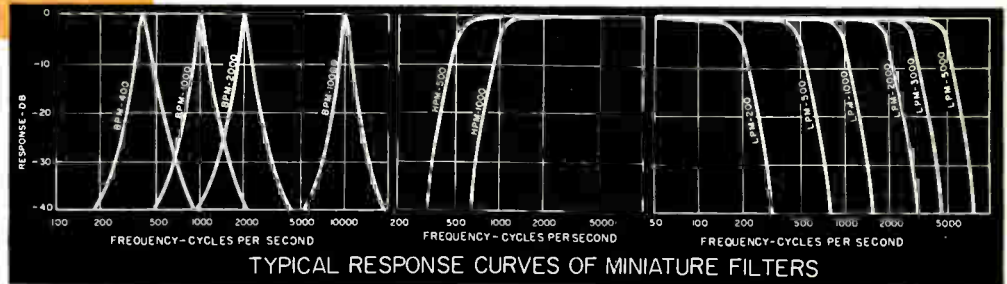

## UTC MINIDUCTORS

Hermetically sealed to MIL-T-27A Specs., MIL type TF5RX20YY

UTC Miniductors are ideal for transistor and printed circuit applications, providing high Q in miniature form. The ML-1 to 4 units are for medium low frequencies, adjusted to  $\pm$  3% at 1 V. 1 KC. The ML-5 thru 10 series are for lower frequencies, adjusted to  $\pm$  3% at 1 V. 400 cycles. The MM and MH units are for medium and high frequencies, adjusted to a tolerance of  $\pm$  2%. Temperature stability is excellent on all Miniductors,  $\pm$  1% from  $-55^{\circ}$  C. to  $+100^{\circ}$  C. The ML group are in a Hipermalloy shield case . . . The MM and MH coils are symmetrical toroids . . . for high coupling attenuation and low hum pickup. The DCMA MAX. shown is for approximately 5% drop in inductance.

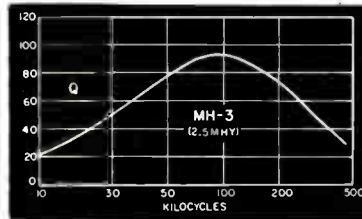
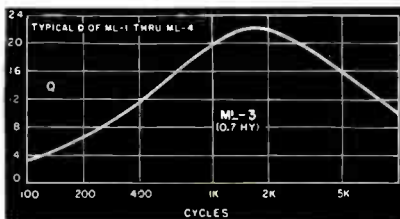
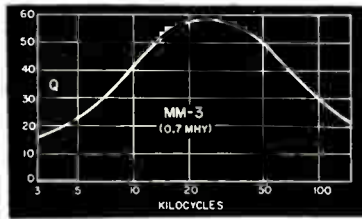
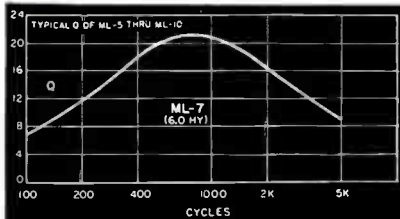

Type No.	Inductance (O BC)	DC MA Max.
ML-1	.25 Hy.	9
ML-2	.4 Hy.	7
ML-3	.7 Hy.	5
ML-4	1.4 Hy.	3
ML-5	2.5 Hy.	1
ML-6	4.0 Hy.	.7
ML-7	6.0 Hy.	.6
ML-8	10 Hy.	.5
ML-9	25 Hy.	.3
ML-10	60 Hy.	.2
MM-1	3. Mhy.	50
MM-2	5. Mhy.	40
MM-3	8.0 Mhy.	30
MM-4	12.5 Mhy.	25
MH-1	.6 Mhy.	75
MH-2	1.5 Mhy.	37
MH-3	2.5 Mhy.	28
MH-4	6 Mhy.	23



ACTUAL SIZE

And Special Units to  
Your Specifications

## UNITED TRANSFORMER CORPORATION

15D Varick Street, New York 13, N. Y.

PACIFIC MFG. DIVISION: 4008 W. JEFFERSON BLVD., LOS ANGELES 16, CALIF.

EXPORT DIVISION: 13 EAST 40th STREET, NEW YORK 16, N. Y.

CABLES: "ARLAB"

Circle 141 on Inquiry Card, page 105

**ALPHLEX®  
ZIPPER  
TUBING**

# NEWS

FROM ALPHA  WIRE

**NEW CONSTRUCTIONS OF  
ALPHLEX® ZIPPER TUBING  
PROVIDE GREATER  
VERSATILITY**



stock sizes: 1/2" to 4" I.D.  
IMMEDIATE DELIVERY  
WRITE FOR FREE CATALOG EI-4

Alphlex Zipper Tubing is the modern way to harness, cable and protect wire. Just zip to close—and just zip to re-open! If you wish, permanent seal. Saves you time, labor, money. Strong, flexible, durable. Versatility unlimited.

**ZIP-31:** polyvinyl sheet made from MIL-I-631C materials. All-purpose type, for general applications to 105°C.

**ZIP-44:** polyvinyl sheet made from MIL-I-7444A materials. Extremely flexible; for aircraft and low-temperature uses to -67°C.

**ZIP-50:** "sandwich" of aluminum foil laminated between 2 sheets of polyvinyl. For 100% RF shielding applications to 105°C.

**ZIP-90:** polyvinyl bonded to woven fiberglass sheet per MIL-I-3190A. For rough usage, abrasion resistance, and high-temperature uses to 130°C.

**ALPHLEX**  **TUBING**

Division Alpha Wire Corporation  
200 Varick Street  
New York 14, N. Y.

Circle 146 on Inquiry Card, page 105

## Photo-Cells

(Continued from page 71)

ing photoconductive cells in a dozen different fields are currently in use and many new ones are constantly being developed.

A photoconductor is basically a light sensitive semiconductor, the resistance of which varies with the light intensity—the greater the light, the less the resistance. Resistance is the most common parameter in electronic circuits. Thus if a resistance, which may be a critical element in a circuit, is replaced by a photoconductor, the circuit is translated into a critical function of light. This of course makes it possible to control any electronic device by light and, because of the nature of light, makes for a very large number of useful applications.

Cells are now available to work in the spectrum from X-rays to infrared, from a few hundred ohms to hundreds of megohms, from a few milliwatts to a fraction of a watt. They have sensi-

## Bright New Concept in Panel Lights!



The Alden Pan-Lite

**3 Times Greater Light Efficiency**  
because a new, tiny Alden bulb (only 1/4 the size of miniature bayonet bulbs) is sealed high up in its own translucent lens and mounted in front of the panel to provide maximum indication, that is . . .

**Visible From Any Angle — Any Distance**  
Lens glows like a red hot poker in a 180° arc.

**Non-Refracting — Unobtrusive When Unlit**  
Even brightest outside lights will not cause false indication

**Instantly Replaced From Front Of Panel**  
Merely drill a .348" hole and snap-in for mounting. Holds fast under shock or vibration. Bulb lens assembly replaces from front of panel.

**Eliminates Bulky Focusing or Refracting Devices**  
Since most conventional indicator light bulbs are located behind the panel they have to make use of bulky magnifying lenses or refracting devices.

**Variety Of Colors And Voltages**  
6V, 12V, 24V, 110-220V Neon  
Write for full information — today.

**ALDEN PRODUCTS COMPANY**

4123 Main Street • Brockton, Mass.

Circle 91 on Inquiry Card, page 105



**ANTENNAS**

Blade, slot, and folded-dipole air-borne antennas for commercial and military needs. Frequency ranges from 225 to 1050 mc.

Write for complete technical data...

**TACCO**

TECHNICAL APPLIANCE CORPORATION  
SHERBURNE, NEW YORK

Circle 92 on Inquiry Card, page 105

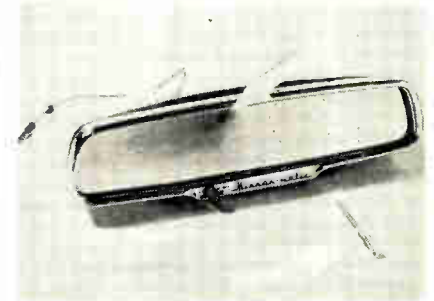

Automatic mirror in new cars depends on photoconductive cell for operation

tive areas from less than 1/1000 square inch to nearly a square inch. They are used with microvolts and hundreds of volts and with ranges of light level from approximately 1/1000 of a foot candle to 1000 foot candles—a range of a million.

This wide range of parameters makes it possible to employ these cells with conventional vacuum tube circuits, thyratrons, magnetic amplifiers, various relays, and transistors. The use with transistors is particularly intriguing in these days of miniaturization for aircraft, missiles, computers and other applications. The circuitry associated with these small devices can be very simple and inexpensive.





the right angle for  
printed circuit connections  
from

# Continental Connectors

New applications in printed circuitry are now possible with Continental Connector's new line of right angle pin and socket connectors. Computers, data processing units and ground support equipment for guided missiles, communications and commercial use have proven the high reliability of these precision miniature connectors.

Various contact arrangements and molding compounds increase the flexibility of use. Guide pins in the plug and guide bushings in the socket provide ease of insertion and prevent bending of contacts. Stainless steel mounting screws on the plug insure positive mounting and eliminate stress on dip soldered connections between pins and printed circuit board.

Other design variations include positive-locking polarizing screwlocks\* and dual terminations for solderless taper tab wiring.

\*PAT. NO. 2,746,022

For complete technical details on Continental Connector's line of right angle connectors, write today to Electronic Sales Division, DeJUR-AMSCO Corporation, 45-01 Northern Boulevard, Long Island City 1, N. Y. (Exclusive Sales Agent)

You're  
always  
sure  
with

# DeJUR

## Electronic Components

MANUFACTURED BY CONTINENTAL CONNECTOR CORPORATION,  
AMERICA'S FASTEST GROWING LINE OF PRECISION CONNECTORS

# DELCO POWER TRANSISTORS

**NEW TYPES**



**MILITARY  
COMMERCIAL**

TYPICAL CHARACTERISTICS AT 25°C

EIA	2N297A*	2N297A	2N665**	2N553
Collector Diode Voltage (Max.)	60	60	80	80 volts
HFE ( $I_c = 0.5A$ ) (Range)	40-100	40-100	40-80	40-80
HFE ( $I_c = 2A$ ) (Min.)	20	20	20	20
$I_{co}$ (2 volts, 25°C) (Max.)	200	200	50	50 $\mu a$
$I_{co}$ (30 volts, 71°C) (Max.)	6	6	2	2 ma
$F_{ae}$ (Min.)	5	5	20	20 kc
T (Max.)	95	95	95	95°C
Therm Res. (Max.)	2	2	2	2° C/W

\*Mil. T 19500/36 (Sig. C.)

\*\*Mil. T 19500/58 (Sig. C.)

NOTE: Military Types pass comprehensive electrical tests with a combined acceptance level of 1%.

Delco Radio announces new PNP germanium transistors in 2N553 series — the 2N297A and 2N665; designed to meet military specifications. These transistors are ideal as voltage and current regulators because of their extremely low leakage current characteristics. All are highly efficient in switching circuits and in servo amplifier applications, and all are in *volume* production! Write today for complete engineering data.

## DELCO RADIO

Division of General Motors • Kokomo, Indiana

BRANCH OFFICES

Newark, New Jersey  
1180 Raymond Boulevard  
Tel: Mitchell 2-6165

Santa Monica, California  
726 Santa Monica Boulevard  
Tel: Exbrook 3-1465



# PROFESSIONAL OPPORTUNITIES

Reporting late developments affecting the employment picture in the Electronic Industries

Design Engineers • Development Engineers • Administrative Engineers • Engineering Writers  
Physicists • Mathematicians • Electronic Instructors • Field Engineers • Production Engineers

## Electricity-Electronics Now Single Technology

"The separate development of the electrical and electronic industries is giving way to an accelerated blending process as a result of scientific progress and the demands of an expanding economy," says Dr. Elmer W. Engstrom, Senior Vice President of R.C.A.

"Recent developments in electronic research," he said, "have opened what appears to be a path of almost limitless technical advance" in such areas as power sources, lighting, home appliances, communications, and automation. Among some of the developments he mentioned were thermionic and thermoelectric generators which convert heat directly to electricity, the part electronics is playing in the research effort to achieve controlled thermonuclear fusion for primary power production, and new electroluminescent techniques applicable to lighting.

## NSF Fellowship Awards

The National Science Foundation has awarded 1100 graduate fellowships in the natural sciences and allied fields for the academic year 1959-1960. Successful Fellows were selected from 4506 applicants from all parts of the continental U.S. and its territories. 1979 persons were accorded honorable mention. 160 regular postdoctoral fellowships were awarded. Life sciences awards totaled 216; physical sciences, 866. The social sciences received 18 awards.

Recipients may attend any accredited nonprofit American or foreign institution of higher education. The graduate fellowships provide \$1,800 for the first year, \$2,000 for intermediate years, and \$2,200 for the terminal year of graduate study. Postdoctoral fellowships carry a stipend of \$4,500 per annum. Additional tuition, travel, and dependents allowances are provided.

## Age-Experience Win



W. MacDonald, Hazeltine Corp., presents awards to G. Hempfling (R) and E. Jungk (L) for distinguished services during 1958.

## Group to Help Electronic Firms on Gov't Contracts

The newly organized Electronics Small Business Council, headquarters at 1000 Vermont Ave., N.W., Wash., D.C., estimates its potential membership at 20,000. These smaller manufacturers employ nearly 5,000,000 workers.

The Council will watch procurement policies of military agencies. Emphasis is being placed on service to individual members by investigating complaints and assisting members in negotiations with government agencies. Two officials of the Council have been briefing Congressmen and their staffs on the Council's position on proposed legislation concerning the equitable distribution of government contracts to small and large concerns alike.

## Scholarship Program Cited

The Engineers Joint Council has honored the Westinghouse Educational Foundation and Carnegie Institute of Technology for conducting the George Westinghouse Scholarship Program.

In accepting on behalf of the Foundation, Dr. J. A. Hutcheson, Vice President in Charge of Engineering at Westinghouse, announced that the Foundation is  
(Continued on page 196)

## Engineers Give Views On Collective Bargaining

One out of five scientists and engineers in large business firms interviewed during a University of Michigan study (to be published in June 1959) favored some kind of collective action to improve their salary and social status. Ten percent of the total favored collective bargaining along union lines. About eight percent thought professional societies should collect and distribute salary and related information to their members and management.

Fifty percent of those interviewed were strongly opposed to any form of collective bargaining along union lines. Twenty-nine percent were mildly opposed.

Companies covered in the study included 4 chemical firms, 2 automotive and automotive parts companies, 2 electronics manufacturers, and 2 public utilities. All companies had substantial research and engineering departments of reasonably long standing.

## Science-Engineering Jobs Increase

Professional scientific and engineering jobs in industry expanded by 28% during the 1954-1957 period. Where these jobs are located and how fast they have been growing in various industries is outlined in a survey available from the U.S. Dept. of Labor, Bureau of Labor Statistics, 341 9th Ave., Room 1025, New York, N. Y.

The report shows that nearly 2,000,000 people were working as scientists, and engineers, in the U.S. in 1957.

FOR MORE INFORMATION . . .  
on positions described in this  
section fill out the convenient  
inquiry card, page 107.





San Juan Puerto Rico's beaches are like those found at other vacation-land islands. Recreation areas like this are among the "fringe" benefits.

**D**OTTED around Puerto Rico's lush semi-tropical foliage, new operations are proving that corporate life in the island is not only beautiful, it is as sweet as the abundant sugar cane. For a tax free profit of 34 cents on each sales dollar is not uncommon. In some cases, it's as high as 60 cents.

The experience of Carl E. Weller is a classic example of how enterprising Statesiders can make money in tax free Puerto Rico.

Most do-it-yourselfers know Weller's product, the famous soldering gun which is ready for action in five seconds. Weller invented the gun way back in 1940 when Puerto Rico was known as America's "back door."

The Second World War put a crimp in his plans to produce the gun and it wasn't until 1946 that Weller bought a burned out factory in Easton, Pennsylvania. He got in production just in time to hit the twin boom of the home workshop and television repair.

Business was so good Weller couldn't build-it-himself as fast as customers were doing-it-themselves. By 1949, the Easton plant was bursting at the seams. By this time Puerto Rico was beginning to make an impression on Stateside manufacturers for it had set into motion its "Operation Bootstrap" industrialization program.

At a radio parts show in Chicago, Weller met the Puerto Rican sales representative who told him

about the tax exemption and other incentives, the island's leaders were offering to U. S. manufacturers under the Bootstrap program.

Weller decided to see for himself, was sufficiently interested to set up in 1950, the Weller Mfg. Corp. of Puerto Rico to produce his soldering gun.

In the past five years he has built two more Puerto Rican factories. One to make a power sander and polisher. The second to produce sabre saws.

The fast growing U. S. affiliated electronics-electrical products industry by itself ships more than

A manufacturer and his family enjoying a picnic near Caguas





A modernistic plant  
built by General  
Electric Wiring De-  
vices, Inc.

*According to some personnel directors,  
many engineers give a lot of consideration  
to climate and location when job hunting.  
Here are some facts about a fast growing area  
which has a pleasant climate.*

**By E. T. ELLENIS**

*Technical Editor  
Economic Development Administration  
666 Fifth Ave.  
New York 19, N. Y.*

# Opportunities in Electronics

\$37 million worth of production to parent plants all over the States. In all, Puerto Rico since 1948 has attracted more than 500 U. S. manufacturers under Bootstrap. The range is from garment making to heavy industry.

Main spring of the Bootstrap program is a government agency known as the Economic Development Administration. EDA is based in San Juan but its promotional work is done in the States. U. S. headquarters are located in New York City (666 Fifth Avenue), Chicago, Los Angeles, and Miami. From these points, some 25 Industrial Representatives (IRs) fan out to talk to manufacturers about producing in Puerto Rico.

Simply put, here's what they say: Expand to Puerto Rico and you get complete freedom from federal taxes since Puerto Ricans, though U. S. citizens, have no vote in the U. S. Congress. No local taxes for ten years. This means you can enjoy a complete "tax holiday" for ten years.

EDA also helps you select, screen, and train your labor. A choice of government constructed plants are available. These are rented on a lease-option arrangement. You get plant counselling, marketing data and are aided in finding a place to live.

If you intend to close your present plant, fire your workers, and move lock, stock, and barrel, to the island Commonwealth, no dice. Puerto Rican law



specifically prohibits "run away" plants. Only genuine expansions or new product operations are eligible for Bootstrap incentives.

Electronically speaking, who's who in Puerto Rico and what are they making? You have the "blue chip" corporation like General Electric which has put in 3 plants in the past three years. There are equally well known giants like Weston Electrical Instrument, Sperry Rand, Proctor Electric, and W. R. Grace.

Then you have the smallish and medium sized companies, based all over the U. S. For example, there is the Endeveco Corp. in California, Howell Instruments in Texas, Tenna Manufacturing in Ohio, and Potter Instrument, Long Island. They're followed by a growing coterie of inventors and engineers who

*(Continued on page 190)*



Girls are assembling and inspecting light meter parts at Weston plant







## ELECTRONICS

# EXPANDING THE FRONTIERS OF SPACE TECHNOLOGY

**ELECTRONICS:** In the half century since the invention of the original audion tube by De Forest, the art of electronics has expanded to a fourteen billion dollar industry that is contributing in hundreds of ways to our knowledge of the universe and our understanding of life itself. At Lockheed, for example, over half the technical staff is engaged in electronics research and development.

**Significant contributions** to the advancement of the state of the art in electronics have been made by Lockheed engineers and scientists in such areas as: computer development; telemetry; radar and data link; transducers and instrumentation; microwave devices; antennas and electromagnetic propagation and radiation; ferrite and MASER research; solid state electronics, including devices, electrochemistry, infrared and optics; and data reduction and analysis.

Over one-fifth of the nation's missile-borne telemetering equipment was produced by Lockheed last year. Its PAM/FM miniaturized system provides increased efficiency at one-fourth the weight of FM/FM missile-borne systems.

Advanced development work in high-energy batteries and fuel cells has resulted in a method for converting chemical energy directly into electrical power that promises a fuel utilization of almost 100% and an energy conversion efficiency of 70% or better.

Areas of special capability in computer development include the design of large scale data handling systems; development of special purpose digital computing and analog-digital conversion devices; development of high-speed input-output equipment; and advanced research in computer technology, pattern recognition, self-organizing machines, and information retrieval.

Other major developments are: a digital flight data recorder able to record each of 24 channels every few seconds; digital telemetry conversion equipment to reduce telemetered test data to plotted form rapidly and inexpensively; advancements in the theory of sequential machines; and a high-speed digital plotter that can handle some four thousand points per second with the finished plot programmed into the data tape as a continuous curve.

Lockheed Missiles and Space Division is engaged in all fields of the art—from concept to operation. Its programs reach far into the future and deal with unknown environments. It is a rewarding future which scientists and engineers of outstanding talent and inquiring mind are invited to share. Write: Research and Development Staff, Dept. D-48, 962 W. El Camino Real, Sunnyvale, California.

*"The organization that contributed most in the past year to the advancement of the art of missiles and astronautics."*

NATIONAL MISSILE INDUSTRY CONFERENCE AWARD

## **Lockheed** / MISSILES AND SPACE DIVISION

SUNNYVALE, PALO ALTO, VAN NUYS, SANTA CRUZ, SANTA MARIA, CALIFORNIA  
CAPE CANAVERAL, FLORIDA • ALAMOGORDO, NEW MEXICO



would help. Fact of the matter is that the supply of Puerto Rican engineers and technicians just isn't big enough to meet growing industrial demand. And the gap is growing all the time.

For example, the University of Puerto Rico now graduates around 40 engineers a year. Yet new factories, opening at the rate of 100 a year, need many more. And this doesn't take in the non-manufacturing sector, growing equally fast.

In terms of numbers, Puerto Rico expects to have 2500 Bootstrap plants by 1975 compared with today's 500-plus. That should

Saber saw assembly line at Weller Electric's plant in Puerto Rico

## Puerto Rican Opportunities

*(Continued from page 187)*

want to go into business for themselves and have picked Puerto Rico as the place to make their new products.

What are they making? A partial list includes actuators, ammeters, capacitors, ceramic components, chokes, connectors, Christmas light sets, circuit breakers and meters, condensers, contact assemblies, coils, hair dryers, meters, roasters, shavers, toasters, instruments, wiring devices, printed circuits, radio components and tuning devices, radios, rectifier diodes, relay seals, resistors, galvanometers, magnistors, lead-in cables, transducers, television antenna and solenoid valves.

Following the footsteps of Carl Weller, several Stateside entrepreneurs and engineers are making the trek to go into business for themselves.

Quite a few smaller electronics companies are setting up Puerto Rican expansions with one part-engineer moving to the island Commonwealth to live there all year.

If you are an engineer or have a technical skill, you will find plenty of job opportunities. You don't have to know Spanish but it

### HIGHLIGHTS OF PUERTO RICAN LIVING

#### COST OF LIVING

Roughly comparable to Stateside for middle to upper middle class levels. As in the States, the bigger the city the higher the cost of living. Your dollar goes just about as far in San Juan as it would in New York, in Ponce as it would in Los Angeles, in Mayaguez as it would in Des Moines. You can get a maid for \$40 a month. Food is 5 to 10% higher but you'll save money on clothes. Business uniform is a \$7 pair of slacks and sport shirt. You pay no heat bills. Average costs for home-use electricity run from \$10 to \$15 per month; gas \$3.00, water \$2.50, telephone service \$4.50.

#### DWELLING TYPE AND COSTS

A three bed room apartment in a very good building costs about \$110 a month in San Juan. Apartments in outlying, but still choice, areas such as Rio Piedras and Bayamon are less expensive.

Renting a house in the San Juan area will cost anywhere from \$125 to \$250 a month, for a two or three-bedroom place with maids quarters. Most statesiders prefer to rent for the first few years before buying a house. Land is pretty expensive, around 80 cents a square foot but construction costs are much lower, and Levitt of the famous Levittowns is planning big developments of \$8000 homes so this may not be a problem.

#### CLIMATE

In a word, ideal. The island's mean temperature is 78 degrees year-round. The death rate of 7 per thousand is well below that of the U. S. Puerto Rico looks a lot like Southern California or Florida. Sun shines 360 days a year.

#### RECREATION FACILITIES

There is golf, big league baseball, swimming, skin diving, outdoor living and boating. You can belong to a beach club for \$50 to \$100 a year for the whole family. There are also social centers where dances, bridge games, and all sorts of events are held weekly. You have TV and radio too.

Music lovers may attend the annual Casals Festival, presentations by the local Symphony Orchestra, or the Opera Festivals which features stars from the States. Followers of the theater may either take part in the "Little Theater" or attend its offerings, and also see a Drama Festival which brings in Broadway stars in hit shows. Ballet schools are flourishing throughout the island. There are movie houses in key cities with latest Hollywood and foreign films.

#### SCHOOLS

Public schools conduct their classes in Spanish, with English taught as a second language. There are 19 accredited private schools for English-speaking children, ranging from kindergarten through high school. Most



be indication enough of the potential for engineering talents.

Add to this another factor. Puerto Rico's new industry is evolving rapidly from the old time light industry — handkerchiefs, artificial flowers—to solidly based medium and heavy industry which leans heavily on technical abilities and skills. So from artificial flowers you have high purity silicon used in transistor making. From handkerchiefs you have oil refining, petrochemical making, paper making and steel rolling. From novelties the move is to intricate components used in our guided missile program. You can inquire about technical job openings in Puerto Rico by writing to

The Department of Industrial Services, Economic Development Administration of Puerto Rico, P. O. Box 2672 San Juan, Puerto Rico.

Living and working in Puerto Rico can be beautiful. In fact so beautiful that very often Stateside managers and engineers feel guilty. You can't name too many other places around where you can hop in your car at lunch time drive ten minutes to an isolated white beach, swim and relax, and go back to work in a modern, air conditioned plant set among palm trees and tropical foliage. No after work traffic jams, no industrial dirt or smog.

You can join a beach club for \$60 to \$100 a year for the whole

family. Golf can be played all year. Beach and golf clubs also include dances and other social events. A maid can be had for \$40 a month. She'll cook, clean house and watch the baby when you're out. Electricity costs the same as in the States. You can send your kids either to private schools or public schools which teach Spanish and English.

No place on earth is a Utopia. There are problems involved in manufacturing and living in Puerto Rico but they're outweighed by the plus factors. For example, living here is not exactly dirt cheap. Real estate is high because the island is small, 100 by 35 miles. You'll pay more for food because quite a bit of it is shipped in from the States. But with new slaughter houses, flour mills, supermarkets, bakeries, and growing dairy farms, food prices figure to drop.

Because the island Commonwealth is far from Stateside markets, you might run into shipping

are sectarian, but will enroll students of other faiths. The San Juan area has two non-sectarian elementary schools; Ponce, three, and Mayaguez, one. Tuitions in private schools are lower than in the States. The University of Puerto Rico has an enrollment of 22,000.

#### LANGUAGE

Spanish is the mother-language of the people and is an advantage for the housewife dealing with domestic help. But English is spoken throughout educated, commercial and catering circles and is used in business correspondence with the United States. In the large cities, practically everybody speaks English—bus and taxi drivers, store clerks, barbers, businessmen, etc.

#### APPLIANCES

Anything you want and plenty of good repair service too. Cost a little more than in the U. S. because of shipping. Television sets, refrigerators, blenders, mixers, radios, vacuum cleaners, etc.

#### AUTOMOBILES

On large cars, Government has put a considerable excise tax to curb potential traffic problem. That's why you see plenty of small foreign cars—Jaguars, MGs, etc. Plenty of good roads, super highways.

#### TRANSPORTATION

The island is 35 miles wide, 100 miles long yet its highway system totals 2,850 miles of all-weather paved roads including four lane super highways. In the big cities, you have good bus service, much like in Los Angeles or New York. 10 cents a ride. For travel between towns, there is the "publico" a car-bus which will get you around the island. Car rental services are the same as in Miami, Chicago, etc. Drivers license costs \$6.00 and is good for four years.

#### PERSONAL TAXES

No federal income tax at all—ever. If you earn \$10,000 in Puerto Rico as an engineer, you save \$465.85, the difference between the Puerto Rican tax and Federal taxes.

To qualify for Puerto Rican personal taxes you must live there for six months.

There is no tax on dividend income earned by "Operation Bootstrap" plants. This means if you earn \$15,000, it is tax free. The same dividend income in the U. S. would be taxed \$3,447.

#### ENGINEERS INCOME

Frequently, engineers get an income bonus of 10 to 25% to move their families to Puerto Rico. Average income there is \$10,000 with many Stateside plant managers earning \$15,000. However, the trend is for many engineers to stake their first manufacturing fling in Puerto Rico where they can take advantage of full corporate and dividend tax freedom.



Peter Martinez, Western Industrial Rep., Economic Administration of P. R., Wilson Bradley Jr., General Manager and H. Dudley Wright, Pres. of Endeveco Corp. discuss opening of a new Endeveco manufacturing facility in P. R.

problems. But you can't beat Puerto Rico if you are a West Coast or Midwest manufacturer who wants to tap East Coast outlets. You can save a third on shipping by a Puerto Rican plant. With air transport shrinking the globe, you find West Coast electronics companies making sub components in Puerto Rico, shipping them to Los Angeles for final assembly into larger units—and at a good profit.

# THE UMBRELLA

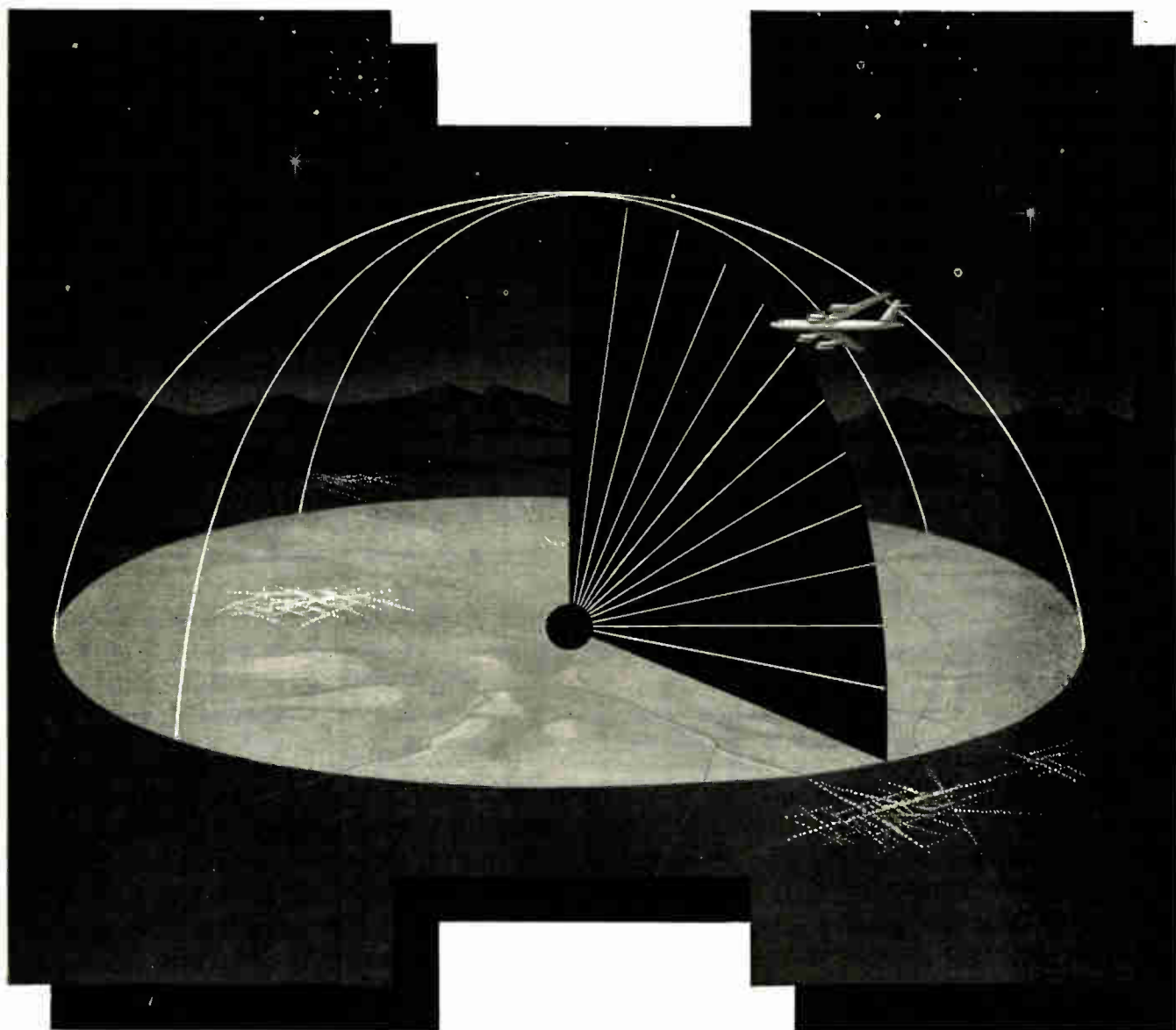



# THAT NEVER LEAKS

To achieve umbrella-like radar protection Hughes engineers at Fullerton, California, have developed systems which position radar beams in space by electronic rather than mechanical means. These unique three-dimensional radar systems are digitally programmed to instantaneously detect high-speed enemy aircraft, even at low altitude.

Other defense systems under development at Hughes in Fullerton are Data Processors which monitor the movement of hundreds of aircraft, store the information and assign defense weapons; radars with beams capable of detecting and tracking missiles; and new radar systems for installation on surface and subsurface naval vessels.

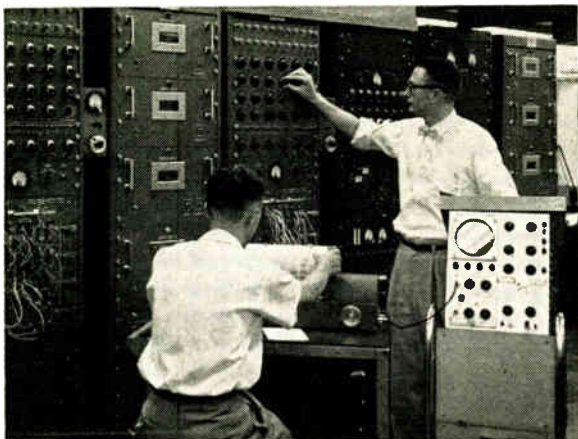

**Research & Development Engineers** use REAC computing equipment as an aid in such complex problems as systems simulation.

Other Hughes activities are delving into similarly advanced areas of electronics. Engineers at Hughes Research & Development Laboratories are probing into the effects of nuclear radiation on electronic equipment, studying advanced microwave theory and applications, and examining communication on a spatial scale. Applying this advanced type of creative engineering to commercial projects is the task of engineers at the Hughes Products activity.

The highly advanced and diversified nature of Hughes projects offers creative engineers and physicists the opportunity to build a rewarding career in a progressive and expanding environment.



**Reliability** of the advanced Hughes Electronic Armament systems can be insured only with the equally advanced test equipment designed by Hughes El Segundo engineers.

*Newly instituted programs at Hughes have created immediate openings for engineers experienced in the following areas:*

Semiconductors	Development Engineering
Field Engineering	Systems Analysis
Microwave Engineering	Industrial Systems
Industrial Dynamics	Circuit Design
Communications	Components Engineering
Digital Computers	Electron Tubes

*Write in confidence, to Mr. Tom Stewart,  
Hughes General Offices, Bldg. 6-C4, Culver City, California.*

© 1958, HUGHES AIRCRAFT COMPANY

*Creating a new world with ELECTRONICS*

## HUGHES

HUGHES AIRCRAFT COMPANY  
Culver City, El Segundo,  
Fullerton and Los Angeles, California  
Tucson, Arizona

# Translate Non-Classical Techniques Into Advanced Underseas Warfare Systems

**SAMPLE PROBLEM:** How do you achieve maximum information transfer in an undersea communications system capable of being used by two submerged missile-firing submarines—without a third submarine stationed in between being able to detect their presence?

Secure Undersea Communications—  
One of the Many Aspects of  
ASW Presenting Technical Problems  
of Major Dimensions

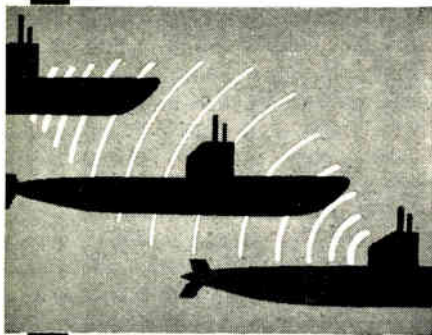

With anti-submarine warfare entering a critical new era, projects now in progress at the Heavy Military Electronics Department offer a broadening challenge to men who can conceive and apply original technology for:

- \* Long-Range Search Sonar Systems
- \* Mine Warfare Sonar Systems
- \* Doppler Sonar Systems
- \* Diverse Undersea Communications Systems

If you are interested in the growing complexity of sonar and ASW technology, you are invited to look into the many opportunities for advanced engineering in this field with HMED.

#### Positions at Several Levels

Write to:  
Mr. George B. Callender, Div. 24-MD  
Heavy Military Electronics Dept.

**GENERAL ELECTRIC**  
Court Street, Syracuse, New York

## Gen. Sarnoff Receives Award

Brig. Gen. David Sarnoff, Chairman of the Board, R.C.A., receives plaque from the Electronic Representatives Assoc. for his "contributions to the electronic industry". L. to R: R. A. Stang, A. Saftler, Gen Sarnoff, I. Brown, W. Shulan, and J. Hunter.



## Electronics—5th Largest U. S. Industry

The Electronic Industry entrenched its position as the 5th largest manufacturing group in the U.S. during 1958. A new sales record, including distribution, servicing, and broadcasting revenues, of \$13.3 billion was established. This data is included in the 1959 Fact Book published by the Electronic Industries Association, 1721 DeSales St., N.W., Washington, D.C.

The military purchased equipment valued at \$4.1 billion during 1958—up \$200 million from 1957. Equipment sold to industrial users gained \$80 million over 1957. Tubes and semiconductor sales declined from \$900 million to \$860 million.

## Astronomers Needed

"Space age demands will triple the need for astronomers in the U.S. in the next 10 years," says Prof. Leo Goldberg, head of the Univ. of Michigan Dept. of Astronomy. Many of the new astronomers will be attracted to the field from the neighboring fields of physics, mathematics and engineering.

Urgently needed now are astronomers for calculating trajectories for space vehicle, for advice on space vehicle instrumentation, and for studying conditions on other planets. The most pressing shortage exists in the field of celestial mechanics which deals with the orbits of planets and provides, among other things, the information needed to chart a rocket course to the Moon, Mars, and Venus.

## Learning Blocks Removed With New Code Course

"Reinforcement," a psychological principle of learning which gives approval, confirmation or praise immediately after the student responds, is featured in a new "Sound-N-Sight" code course published by John F. Rider Publisher, Inc., 116 West 14th St., New York.

The course, developed by Lewis Robins and Reed Harris, former Deputy Director of the U. S. Information Agency, is said to eliminate memory training. The "plateaux," which cause difficulty in rising from one code speed to the next, are eliminated by increasing speed one word per min.

Materials of the course include long-playing records, flash identification cards, and an instruction book. Three courses are available covering speeds from 0 to 20 words per minute.

## Small Business Research Program

The Small Business Administration, Lafayette Bldg., Washington, D.C., has announced regulations governing a program of grants to institutions for research into problems of small businesses.

Grants, not exceeding an aggregate amount of \$40,000 each, may be made to finance research studies concerning the managing, financing, and operation of small business concerns to develop information and techniques usable by public or private organizations to aid small businesses, and to develop information which improves knowledge of the economy through research in the small business sector.



## New Combat Radio Has 400 Channels

Development of the latest mobile multi-channel radio set designed for the U. S. Army to be used in forward area combat communications was announced by the Department of the Army.

The set was designed and developed for the Signal Corps by the Westinghouse Electric Corp. Electronic Div. near Baltimore, Maryland. The AN/GRC-53 is one-third smaller and only half the weight of field equipment currently performing a similar function.

It was officially demonstrated at the Pentagon heliport. As part of the demonstration two soldiers set up the equipment and had it operating on the air in 24 minutes.

The equipment is housed in a standard Army shelter mounted on a  $\frac{3}{4}$  ton truck. Equipment provides 400 channels in the band of 50 to 150 megacycles. It can provide simultaneous transmission facilities for 12 traffic channels over paths of up to 20 miles. Twenty-four persons can use the system simultaneously without interference.

## Stations to Broadcast "Discomfort Index"

This Summer, U.S. weather stations will calculate and announce the prevailing "discomfort index", the combination of heat and humidity which theoretically makes people uncomfortable. The index figures will enable managers of office buildings, hotels, etc. to judge when they should turn on their air conditioning equipment. It also enables utilities to judge the power load for air conditioning. Some industries and Government operations dismiss their employees whenever the discomfort index reaches a certain figure.

## \$1000 Award Established

The Copper & Brass Assoc. has announced an award competition to honor the year's most significant advancement in the use, application, or metallurgy of copper, brass, bronze, or other copper-base alloys. Winners of the competition will receive \$1000 and a bronze award to be presented on May 13 at the Association's Annual Meeting in Hot Springs, Va. Information about the award program can be obtained by writing to 420 Lexington Ave., New York 17, N.Y.

ENGINEERS...PHYSICISTS

# NEW opportunities at Motorola in Chicago

give yourself and your family  
all the big city advantages at a  
relaxed midwest pace, while you  
**ADVANCE YOUR CAREER**

Outstanding career opportunities are waiting at the many Motorola research and development laboratories in the Chicago area. This is your opportunity to advance your career with a swiftly expanding company, working in the most modern and well instrumented laboratories... with liberal employee benefits, including an attractive profit sharing plan and association with men of the highest technical competence.

You'll like living in one of the beautiful suburbs of the playground of the midwest, where there are endless social, cultural, and educational activities to choose from the year-round. Exciting life or quiet life—Chicago offers either.



### MILITARY POSITIONS OPEN

- Radar transmitters and receivers
- Radar circuit design
- Antenna design
- Electronic countermeasure systems
- Military communications equipment design
- Pulse circuit design
- IF strip design
- Device using klystron, traveling wave tube and backward wave oscillator
- Display and storage devices

### CIVILIAN POSITIONS OPEN

#### 2-WAY RADIO COMMUNICATIONS

- VHF & UHF Receiver • Transmitter design & development • Power supply
- Systems Engineering • Selective Signaling • Transistor Applications • Crystal Engineering • Sales Engineers

#### PORTABLE COMMUNICATIONS

- Design of VHF & UHF FM Communications in portable or subminiature development.

#### MICROWAVE FIELD ENGINEERS



Write to:

Mr. L. B. Wrenn Dept. C  
MOTOROLA, INC.  
4501 Augusta Blvd., Chicago 51, Ill.

ALSO . . . there are excellent opportunities in  
**PHOENIX, ARIZONA • RIVERSIDE, CALIFORNIA**



# MOTOROLA

ENGINEERS/EE/ME/AE

# FOCAL POINT FOR CAREERS IN SYSTEMS ENGINEERING

## General Electric's New Defense Systems Dept.

From many diverse disciplines in engineering and the sciences, capable men are coming together to form the nucleus of the new Defense Systems Department—an organization devoted exclusively to conceiving, integrating and managing prime defense programs, such as:

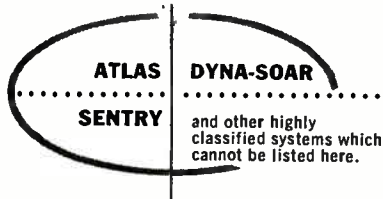

Whether you are a systems engineer now or not, the inauguration of this new department presents a rare opportunity for bringing your own career into sharp focus in systems engineering.

- Immediate assignments in
- SYSTEMS PROGRAM MANAGEMENT
- WEAPONS ANALYSIS
- WEAPONS SYSTEMS INTEGRATION
- ELECTRONICS • DYNAMICS
- COMPUTER LOGICAL DESIGN
- PRELIMINARY DESIGN
- APPLIED MATHEMATICS
- ADVANCED SYSTEMS DEVELOPMENT
- SYSTEMS EVALUATION
- THEORETICAL AERODYNAMICS

Please direct your inquiry in strictest confidence to Mr. E. A. Smith, Dept. 4D.

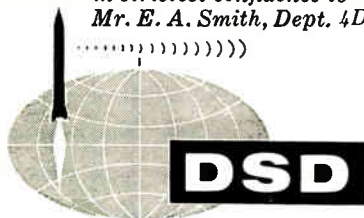

DEFENSE SYSTEMS DEPARTMENT

GENERAL  ELECTRIC

300 South Geddes Street  
Syracuse, New York



## ELECTRONIC WAVE DEMONSTRATION

Dr. Achille Capecelatro explains simply what makes up an electronic wave during a demonstration at the American Institute of Physics Show at the Hotel New Yorker.

### "General Transistor Corp."

The feature, "1959 Transistor Interchangeability Chart" in the March 1959 issue of ELECTRONIC INDUSTRIES included a list of the abbreviations used to identify companies listed in the chart.

The letters "GT" were not defined. They refer to the General Transistor Corp., 91-27 138th Pl., Jamaica 35, N. Y.

### IPC Recommends Program

"The Serviceman and Printed Circuits" was the theme of a special session of the Institute of Printed Circuits, Inc., held at the St. Moritz Hotel, New York, on March 25, 1959.

A panel consisting of representatives of printed circuit manufacturers, service managers, and members of the IPC discussed recommendations and ideas for IPC activities to educate service and repairmen in the techniques of working with printed circuit boards.

### PINPOINTING SATELLITES

The IBM 704 data processing system, used to compute satellite orbits, can predict within seconds a satellite's position over any point on earth which it will pass.



### Scholarship Program

(Continued from page 185)

planning to donate laboratory equipment to all the accredited college electrical engineering departments in the U. S.

The scholarship program, now in its 20th year, was established to encourage science education. Since 1938, the Foundation has spent almost \$800,000 in the program. 139 men have received degrees from Carnegie Tech; 80% of these went on to graduate level studies.



# advanced RADAR SYSTEMS ENGINEER

Starting Salary to  
**\$14,000**

A position for a man with broad experience in radar systems development and systems design engineering.

Write in confidence to:

Box 143  
Electronic Industries  
Chestnut & 56th Sts.  
Philadelphia 39, Pa.



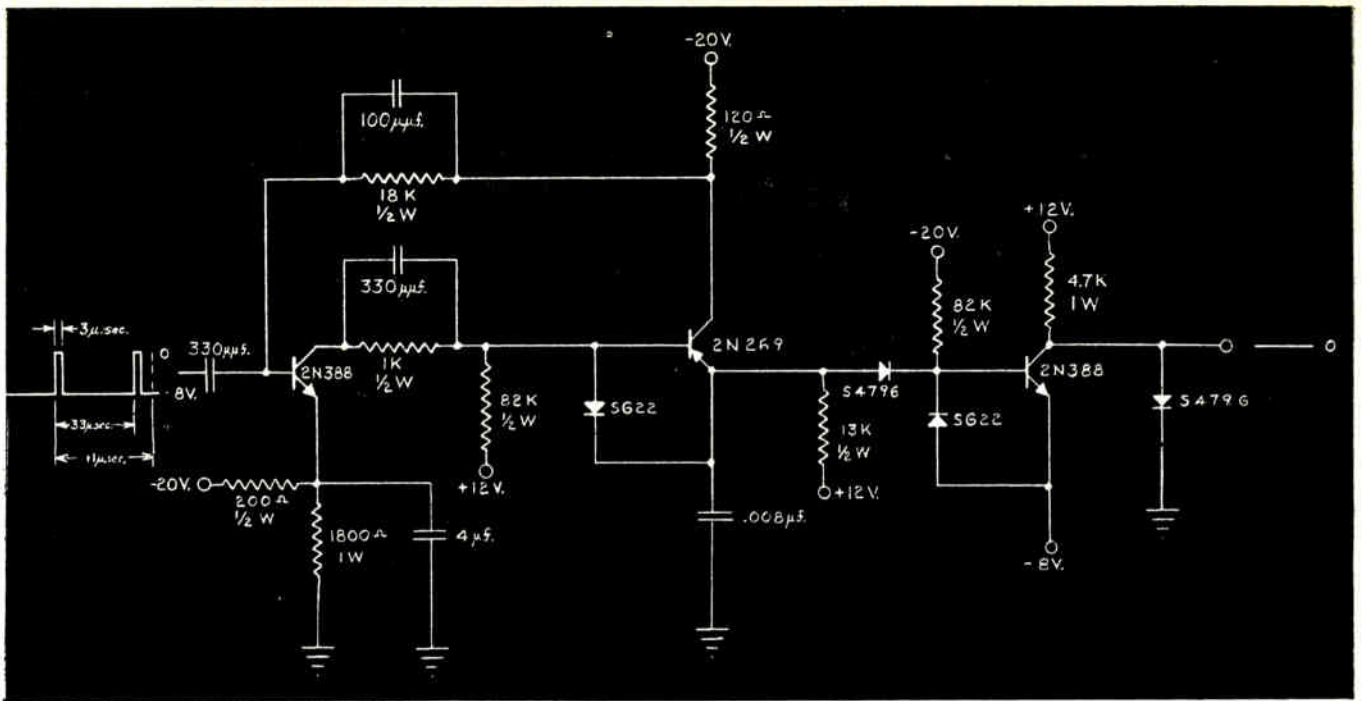

# FOR COMPUTER AND DATA-PROCESSING ENGINEERS...

**NCR** has select openings at the New National Engineering-Research Center in Dayton, Ohio

## HERE ARE THE TYPES OF ENGINEERS WE NEED:

### COMPUTER ENGINEERS:

\*\*\***Senior Systems Engineers**—Strong Theoretical and Design Knowledge in Electronic Engineering, including familiarity with electro-mechanical digital machines. Prefer experience with commercial application of digital-processing equipment, will consider scientific or defense application. Operational experience a distinct asset. Advanced degree desired.

**Your Work at NCR**—analyze and direct product improvement of digital computers.

\*\*\***Senior Circuit Designers**—experienced in the design, development and analysis of transistorized computer circuits, including application of magnetic cores to high-speed memories.

**Your Work at NCR**—opportunities involving decision making concerning reliability, cost and component selection are offered.

\*\*\***Senior Circuit and Logical Designers**—similar experience and duties as noted for Senior Circuit Designers plus evaluation and de-bugging arithmetic and control areas of computer systems.

### DATA-PROCESSING ENGINEERS:

\*\*\***Senior Electronic Design Engineers**—experienced in the development of logical design using standard computer elements.

**Your Work at NCR**—to evaluate and design transistorized circuits including voltage regulated power supplies and circuitry related to decimal to binary coding.

### WHERE YOU WILL WORK...

at NCR's NEW Engineering Research Center, Dayton, Ohio.

You'll be working under the most stimulating and advanced R and D facilities with broad creative freedom in the engineering field which is yours.

### HOW DO I APPLY?

Simply send your résumé to: Mr. K. D. Ross, Professional Personnel Section E, The National Cash Register Company, Dayton 9, Ohio.

THE NATIONAL CASH REGISTER COMPANY, DAYTON 9, OHIO

ONE OF THE WORLD'S MOST SUCCESSFUL CORPORATIONS

75 YEARS OF HELPING BUSINESS SAVE MONEY

• TRADEMARK REG. U.S. PAT. OFF.

*National*

VERSATILE DATA PROCESSING  
ADDING MACHINES • CASH REGISTERS  
ACCOUNTING MACHINES • NCR PAPER

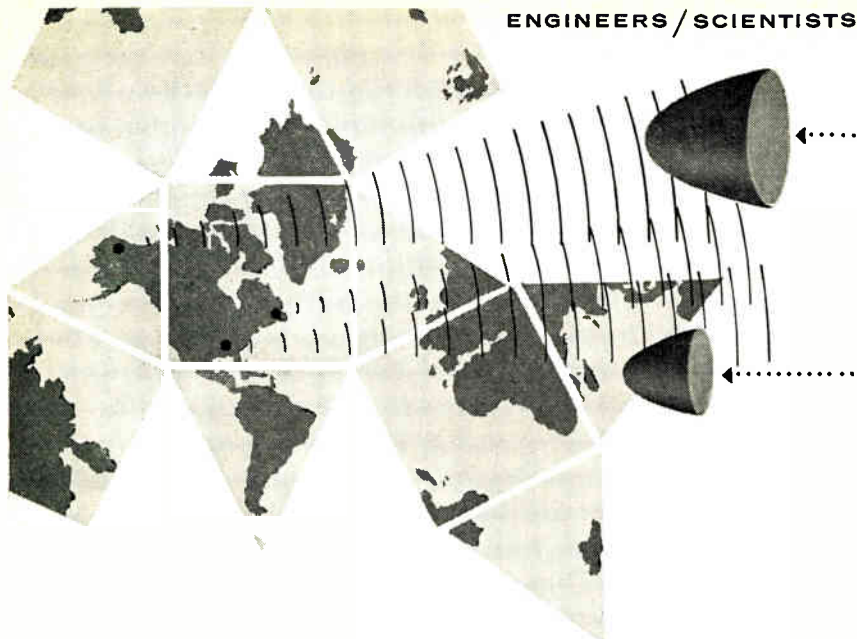

**GENERAL ELECTRIC'S OBJECTIVE:**  
 .....  
**CREATE NEW LONG-RANGE**  
**RADAR SYSTEMS TO REPLACE**  
**BRUTE FORCE DETECTION METHODS**

The Missile Detection Systems Section invites engineers with high creative and analytical abilities to join —

**SYSTEMS DEVELOPMENT GROUP**, which initiates and formulates basic systems concepts related to extremely long-range radar. Optimize the relationship between operational requirements and the most recent developments in the electronic art.

**SYSTEMS EQUIPMENT GROUP**, which converts generalizations established by Systems men into detailed components that comprise engineering specifications of the systems. Issue purchase specifications; conduct liaison.

At least 4 years' related experience required in one or more of these areas: Radar Systems Engineering; Electronic Countermeasures Systems Engineering; D&D of Antennas, R F Components, UHF & Microwave Receivers, Data Processing Equipment, or Video Display; Computer Applications

*Salaries fully competitive, commensurate with experience.*

*Write in confidence to: Mr. Joseph L. Wool, Div. 24-MD  
 Missile Detection Systems Section*

HEAVY MILITARY ELECTRONICS DEPT.

**GENERAL  ELECTRIC**

Court Street, Syracuse, New York

## Industry News

Thomas W. Melia has been appointed Assistant Manager of Sperry Gyroscope Company's Surface Armament Div. and John M. Geiger appointed Sales Manager.

Bernard J. O'Neill has been named to the newly created post of Vice President in Charge of Engineering at Magnetic Amplifiers, Inc., New York. He was formerly Chief Engineer at Magnetic Amplifiers, Inc.

Major General George I. Back (USA, Ret.) has been elected a Director of the International Resistance Co. Prior to his association with IRC, he was Chief Signal Officer of the United States Army.

Harvey Riggs, President of International Electronic Research Corp., Burbank, has been elected President of the Strategic Industries Assoc. He succeeds T. S. Coleman of Coleman Engineering Co.



H. Riggs



D. L. Dailey

D. L. Dailey has been appointed Marketing Research Manager for Texas Instruments Inc., Semiconductor-Components Div. He had been Manager of Marketing Research for the Dept. of Economics for Battelle Memorial Institute, Columbus, Ohio.

John P. Manley has been named Vice President and Marketing Manager of General Ceramics Corp., Keasbey, N. J.

Ray W. Macdonald, Vice President in Charge of the International Div., Burroughs Corp. has been elected a Director of the corporation.

The Unholtz-Dickie Corp. has been formed in Hamden, Conn. The firm will provide professional engineering services on vibration problems. John A. Dickie has been elected President. Karl Unholtz will serve the new company as Vice President and Chief Engineering Officer.

A. S. Garcia has been elected President of Secode Corp. He was formerly with Arthur Young & Co.



# Industry News

C. W. Martel is now Manager, Advertising & Sales Promotion, Semiconductor Div., Raytheon Manufacturing Company, Mass.

Joseph P. O'Reilly has been elected Vice President and General Manager of Ferroxcube Corp. of America. He had previously been General Manager.

Thomas D. Hinkelman has been appointed Manager of Products Planning and Market Research at Motorola Semiconductor Products Div., Phoenix. Raymond G. Hanson, Jr., is now Manager of Advertising and Sales Promotion.

George F. Hannaum, Director, Industry Planning Service, Aircraft Industries Assoc., has been named Assistant General Manager of the Association.

David R. Miller is now Director of Marketing for Colorado Research Corp., Broomfield, Colo.



D. Miller



J. Jackson

John T. Jackson has been elected a Vice President of International Telephone and Telegraph Corp.

Terry R. Burton has been named Manager of Advertising and Sales Promotion at BJ Electronics, Borg-Warner Corp. He was previously Advertising and Public Relations Director at Cubic Corp.

Charles L. Race has been named District Manager for a new military communications sales office being established by General Electric Co. in Syracuse, N. Y.

Frank H. Day, Radiological Physicist, has been appointed Head of the Nuclear Standards Dept. of The Victoreen Instrument Co., Cleveland.

F. C. Huyck & Sons has appointed Dr. O. G. Haywood as Corporate Group Vice President for Military Products and Industrial Instruments.

(Continued on page 200)

# FLIGHT DATA AND CONTROL ENGINEERS

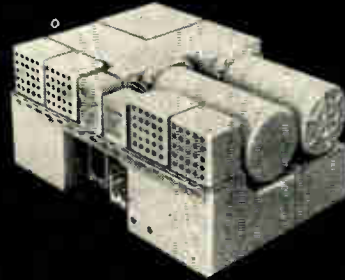

Centralized Air  
Data Computer

High level assignments in the design and development of system electronics are available for engineers in the following specialties:

- **ELECTRONIC AND FLIGHT DATA SYSTEMS AND CONTROLS** A wide choice of opportunities exists for creative research and development engineers having specialized experience with control devices such as transducers, flight data computers, Mach sensors, servo-mechanisms and circuit and analog computer designs utilizing transistors, magnetic amplifiers and vacuum tubes.
- **SERVO-MECHANISMS AND ELECTRO-MAGNETICS** Requires engineers with experience or academic training in the advanced design, development and application

of magnetic amplifiers, inductors and transformers.

- **FLIGHT INSTRUMENTS AND TRANSDUCERS DESIGN ANALYSIS:** Requires engineers capable of performance analysis throughout preliminary design with ability to prepare and coordinate related proposals.
- **DEVELOPMENT:** Requires engineers skilled with the analysis and synthesis of dynamic systems including design of miniature mechanisms in which low friction, freedom from vibration effects and compensation of thermo expansion are important.
- **PROPOSAL AND QUALTEST ENGINEER** For specification review, proposal and qualtest analysis and report writing assignments. Three years electronic, electrical or mechanical experience is required.

Forward resume to:  
Mr. G. D. Bradley



DIVISIONS

AIRESEARCH MANUFACTURING, LOS ANGELES • AIRESEARCH MANUFACTURING, PHOENIX

AIRESEARCH INDUSTRIAL • AERO ENGINEERING

AIR SUPPLY • AIR CRUISERS • AIRESEARCH AVIATION SERVICE

9851 SO. SEPULVEDA BLVD., LOS ANGELES 45, CALIFORNIA

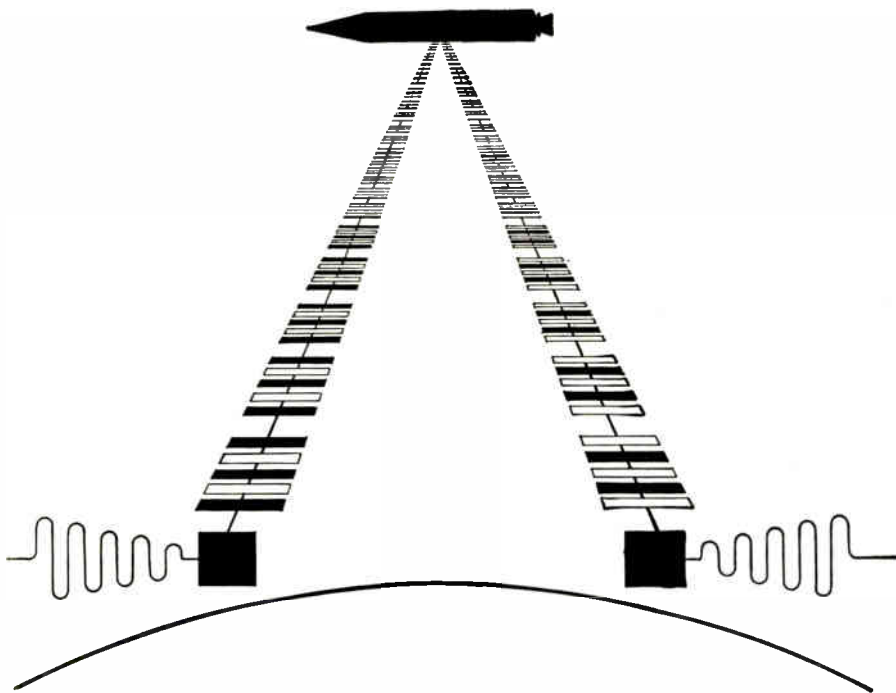

## Probing Electronic Frontiers With MELPAR

Our mission is simply stated: advancing the state of the art in electronics to satisfy the demands of the space age and the increasingly complex problems of defense.

To the experienced engineer with an inquiring mind we extend an opportunity to blaze new technological trails and to constantly explore the parameters of his personal ability.

Opportunities are available in the following areas of Melpar's diversified activities:

### Reconnaissance Systems Engineering Department

Airborne Equipment  
Ground Data Handling Equipment  
Ground Support Equipment  
Simulation & Training Systems

Communication & Navigation Systems  
Detection & Identification Systems  
Chemistry Laboratory  
Antenna & Radiation Systems  
Applied Physics Laboratory  
Analysis & Computation Laboratory

For details about these openings and facts on a dynamically growing organization, write to:  
Technical Personnel Representative



**MELPAR** Incorporated

A Subsidiary of Westinghouse Air Brake Company  
3012 Arlington Boulevard, Falls Church, Virginia  
10 miles from Washington, D. C.

## Industry News

(Continued from page 199)

Ralph J. Hippert is now Advertising Manager at Cannon Electric Co., Los Angeles. He was formerly with the U. S. Borax and Chemical Corp., Los Angeles.

Richard Smetana has been appointed Sales Manager of the Transidyne Div. of Spectrol Electronics Corp.

James W. Swaine is now Vice President of Allied Chemical's General Chemical Div. He had been the Division's Technical Director.

Edward Waldman has been named General Manager at Electro Industries Corp., Long Island City and George Brown, Sr. has been named Chief Engineer.



E. Waldman

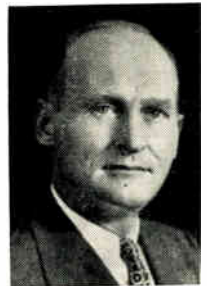

E. Pool

E. J. Pool is now President of the Cinch Manufacturing Co., Chicago. He had been Vice President and General Manager.

C. C. (Ced) Sjoberg is now Executive Vice President; Richard Bloniarz is Vice President of Engineering; Charles Stahl is Treasurer and Edward W. Watts is Sales Manager of Gertsch Products, Inc., Los Angeles.

Leon Robbin has been elected to the Board of Directors of P. R. Mallory & Co., Inc., Indianapolis.

Douglas C. Lynch has been elected Vice President and Managing Director, RCA International Div.; Humboldt W. Leverenz is now Director of Research, RCA Laboratories.

Arthur B. Williams, Sales Manager of Engineered Electronics Co., Santa Ana, Calif., has been elected a Vice President of the firm.

George S. Shaw, former Vice President and Director of Engineering at Radiation, Inc., has assumed the position of Staff Vice President. Dr. Charles R. Burrows is now Vice President and Director of Engineering.

John W. Lazur has joined Hughes Aircraft Co. as Manager of Military Planning. He was formerly Director of the Military Equipment Dept., Dumont Laboratories, Clifton, N. J.



## News of Reps

### REPS WANTED

Manufacturer of cabinets, transit cases, equipment covers, dielectric devices, etc., and the potting of electronic components is looking for manufacturers representatives. Write to: Dama Plastics Co., Swarthmore Industrial Center, Springfield, Penna.

Chicago Telephone Supply Corp., Indiana, has named Richard Purinton, Inc., as its rep. in Massachusetts, Connecticut, Vermont and New Hampshire.

The Lester Johnson Co., Cleveland, has been appointed Ohio sales rep for the Aeronautical and Instrument Div., Robertshaw-Fulton Controls Co.

Aeromotive Engineering Products, Ltd., Pointe Claire, Montreal, Quebec, has been appointed sales rep in Canada for Assembly Products, Inc., Chesterland, Ohio.

Pacific Electronic Controls Corp. has named the Wesrep Corp., Los Angeles, as rep in the western defense areas of the United States in addition to the states of California, Arizona, Nevada and New Mexico.

The Rucker Co., Oakland, Calif., is now rep for the American Bosch Div., American Bosch Arma Corp. in California, Oregon, Washington, Nevada, Arizona, Idaho, Alaska and Hawaii.

B-I-F Industries, Inc., Providence, R. I., has appointed Instrument Laboratory, Inc., Seattle, as sales rep in Washington, Oregon, Idaho (except for the extreme southeast corner) and Alaska.

General Instrument Corp., Newark, and Electronic Tube Corp., have jointly appointed A. H. Fogelman Assoc., Washington, D. C., as their rep for government relations.

Danco Corp., Fairview Village, Pa., is now rep in the Middle Atlantic States for Telemeter Magnetics, Inc., Los Angeles.

A new electronic field sales engineering company, Elliot March Associates, Massapequa Park, N. Y., has been organized to provide service for manufacturers of precision components to military and commercial OEM's in the New York City-Long Island area.

(Continued on page 202)

# EXPANDED RESEARCH

to advance new concepts of  
SPACE FLIGHT

⊕ Expanded Research programs to meet the most complex technological requirements of the Space Age are only one of the far-reaching objectives of the new multi-million-dollar Lockheed Research Center, near Los Angeles. Destined to become one of the nation's major research installations, its programs are broad in scope and designed to investigate new frontiers of space flight.

⊕ A primary consideration in planning the new Research Center was to provide environment for scientific freedom and ideal research conditions—using the most advanced equipment available. This modern, integrated research facility will touch almost every aspect of aviation and transportation—leading toward exploration into completely new or relatively undeveloped fields of science and industry.

⊕ On completion, most of Lockheed's California Division's research facilities will be located in this single area. The Center will provide complete research facilities in all fields related to both atmospheric and space flight—including propulsion, physiology, aerodynamics and space dynamics; advanced electronics in microwave propagation and infrared; acoustics; mechanical and chemical engineering and plasma/magneto-hydrodynamics; thermal electricity; optics; data communications; test and servo-mechanisms.

⊕ The first phase of the advanced research building program has already begun—with initial construction of a \$5,000,000 supersonic wind tunnel and high-altitude environmental test facilities.

⊕ Scientists and engineers of high caliber are invited to take advantage of outstanding career opportunities in this new Lockheed Research Center. Openings now exist for thoroughly qualified personnel in: Electronics; aero and thermo dynamics; propulsion; servo-mechanisms; materials and processes; structures and stress; operations research; research in optics, infrared, acoustics, magnetohydrodynamics, instrumentation, mechanics and hydraulics; mathematics and in all phases of design.

⊕ Write today to: Mr. E. W. Des Lauriers, Manager Professional Placement Staff, Dept. 1404, 1708 Empire Avenue, Burbank, California.

# LOCKHEED

## CALIFORNIA DIVISION

BURBANK, CALIFORNIA

# UNIVAC OFFERS

## CHALLENGING

# CAREER OPPORTUNITIES

Increase your professional status. Assure your future security. Build a satisfying life-time career. Investigate the wide range of interesting and challenging opportunities now available at all levels in the following areas:

Transistor Circuit Design	Component Reliability
Data Processing Systems	Communications and Data Entry
Weapons Systems	Specifications and Standards Engineering Writing

For immediate consideration, send inquiry and resume to:

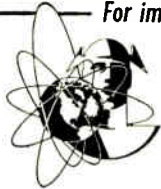

MR. R. K. PATTERSON • Dept. A-3

**Remington Rand Univac**

DIVISION OF SPERRY RAND CORPORATION

2750 WEST 7th STREET • SAINT PAUL 16, MINNESOTA

Circle 506 on "Opportunities" Inquiry Card, page 107

## TRANSMITTERS

## RCA MOORESTOWN

Invites Inquiries From Transmitter Engineers Who Wish To Contribute To Advanced Missile Detection Programs.

Project BMEWS (Ballistic Missile Early Warning System) and other advanced missile detection systems have created unlimited technical opportunities for engineers to participate in the development and design of transmitters ranging from very low power to super-power radar transmitters delivering peak power in the multi-megawatt range.

The scope of original design effort ranges from the design of low power pulse and RF circuits to the design of super power hard-tube pulsers and RF cavity type amplifiers.

Experience in the development and design of communications, TV, radio and radar transmitters or their components is required. A knowledge of high power tube design and the application of klystron and magnetron tubes would be beneficial.

Salary to \$16,000.

Please address all inquiries to:

Mr. W. J. Henry, Box V-25D  
RCA, Moorestown, New Jersey  
(Only 8 miles from Philadelphia)



**RADIO CORPORATION OF AMERICA**

Missile and Surface Radar Division

## News of Reps

(Continued from page 201)

EFCO N (Electronic Fabricators, Inc.), New York, N. Y., has appointed the following sales reps: R. G. Dailey Co. in Texas, Louisiana, Mississippi and Arkansas; Fowler Beach Corp. in upper New York State and W. H. Stork, Marion, Iowa, in Iowa and Nebraska.

Key Resistor Corp., Calif., has appointed Pacific Electro-Sales, Inc., Los Angeles, as rep in Southern California, Southern Nevada, and Arizona.

The Georator Corp. has appointed the following reps: E. A. Janse Assoc., Mass., New England area; Cozens & Cudahy, Inc., Illinois, Wisconsin, and Indiana; and Travco Assoc., Metropolitan New York area.

Littelfuse, Inc., Des Plaines, Ill., has appointed William J. Purdy Co., San Francisco, rep in the Northern California area.

Kee Enterprises, Inc., New York and Philadelphia, announced a change in corporate name to: Crane & Egert Corp.

Blair Sales Co., Inc., is now rep in the Metropolitan New York-New Jersey area for the Distributor Sales Div., Jerrold Electronics Corp.

International Electronic Engineering, Ltd., Santiago, Chile, has been appointed sales and service rep in Chile for the Narda Microwave Corp.

American Measurement & Control, Inc., Mass., has appointed the following reps: Randolph Engineering Corp. for Southern California, Arizona, and New Mexico; Egbert Engineering Assoc. for Northern California, Oregon, Washington, Idaho, and Nevada; and Podeyn & Schmidt for Metropolitan New York, Long Island, and Northern New Jersey.

The Frank W. Taylor Co., DeWitt, N. Y., has been appointed sales rep in the Upstate New York area for Columbus Electronics Corp.

McCarthy Associates is now rep for the Cohu Electronic, Inc., Millivac and Massa line in California, Arizona, and Nevada and the Gerard S. Leeds Co. is rep in the Washington, D. C., area.

Mid-Eastern Electronics, Inc., has appointed Zak-Cowen & Assoc., St. Louis, sales rep in Missouri, Kansas, Iowa, Nebraska and Southern Illinois.



## News of Reps

A new electronic sales rep firm, Jay Stone and Associates, Box 583, Sunnyvale, Calif., will handle accounts in the Northern California area.

Continental-Diamond Fibre Corp., Newark, Del., has appointed Summers Electric Co., Inc., Dallas, as reps in Texas.

Paul D. Aaron is now rep for Detroit Controls, Div. American Standard, Bridgeport, Conn., in Metropolitan New York and Northern New Jersey.

Landseas - Eastern Co., Ltd., Tel-Aviv, Israel, has been appointed sales and service rep in Israel for the Narda Microwave Corp., Mineola, N. Y.

Avion Div. of ACF Industries, Inc., has appointed Bauman and Bluzat, Chicago, as sales rep for Illinois, Wisconsin, Indiana, and Western Michigan.

National Co., Inc., Chicago, has appointed 3 sales reps. They are: William F. Hemminger, Miami, for Florida; Kenneth G. Reinhardt, Indianapolis, for Indiana and Kentucky; and Neal Bear Corp., West Richfield, O., for Western Pennsylvania, Ohio and West Virginia.

Vis-U-All Products Co., Grand Rapids, Mich., has appointed Edwin A. Schultz, Indianapolis, rep for Indiana and Kentucky; L. J. McTaggart, Buffalo, New York, rep for Upstate New York; and L. E. Barnhart, Jacksonville, for Alabama, Florida, Georgia, North Carolina and South Carolina.

Price Electric Corp., Frederick, Md., has appointed George T. Wright & Assoc., Inc., rep in Northern Ohio, Western Pennsylvania, and all of West Virginia.

The Jack Field Sales Co. has moved its offices to 109 Valley Rd., Montclair, N. J.

Traverlab, Inc., is now sales rep for Schmidt Instrument Co.'s products and services.

(Continued on page 204)

# FROM CONCEPT

ENGINEERS

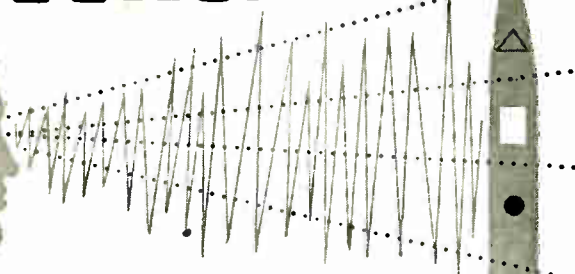
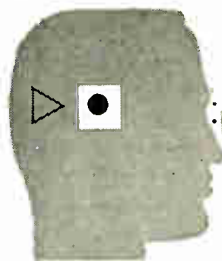

# TO HARDWARE

See your personal efforts  
integrated into the total flight system  
with a prime contractor...

## REPUBLIC AVIATION

It's an unnerving experience, in this era of systems engineering, for a man to work long and hard on a subsystem or component project and then see the product of his labor leave the plant in a packing case on its way to a prime contractor for systems installation. How different is the picture at Republic Aviation! Working for this prime systems contractor you will have the opportunity to see the total flight system take shape and the satisfaction of seeing your personal efforts become an important part of it. You'll broaden your experience and professional interests by working with capable men from varied disciplines on advanced electronics for every type of flight vehicle—from guided missiles to helicopters.

### Decide NOW to join this Prime Contractor

Gain accelerated advancement by becoming a ground floor participant in Republic's \$35 million R&D program aimed at bringing about substantial breakthroughs in aeronautics and space technology. A new order of career progress is waiting for engineers and scientists at Republic Aviation.

*Investigate these electronic opportunities with Republic*

**Inertial Guidance & Navigation / Digital Computer Development / Systems Engineering / Information Theory Telemetry-SSB Technique / Doppler Radar / Countermeasures Radome & Antenna Design / Microwave Circuitry & Components Receiver & Transmitter Design / Airborne Navigational Systems Jamming & Anti-Jamming / Miniaturization-Transistorization Ranging Systems / Propagation Studies Ground Support Equipment**

Among other advantages, Republic offers a comprehensive employee benefit program including company paid hospitalization, surgical, accident & life insurance, tuition (2/3), 2 fold pension plan, individual merit rated increases & many other benefits.

*Please send resume in complete confidence to:*

**MR. GEORGE R. HICKMAN**  
Engineering Employment Manager, Dept. 13 D



**REPUBLIC AVIATION**

Farmingdale, Long Island, New York



**GIVE YOUR PRODUCTS**

**MORE RELIABILITY AND BETTER PERFORMANCE WITH**

**FREED**

**QUALITY**

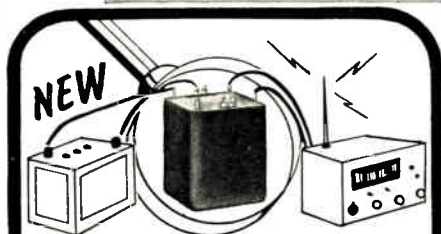

**HERMETICALLY SEALED DC TO DC and DC TO AC TRANSISTOR CONVERTERS**

- Meets MIL Specifications
- Maintenance Free, Long Life Operation
- Exceptionally High Efficiency
- Highly Compact Package
- No Moving Parts

By combining the best square loop magnetic materials with the latest in transistor development Freed transistor converters solve power supply problems of operating communications equipment from low voltage batteries. AVAILABLE FROM STOCK DC TO DC CONVERTERS

Freed No.	Input VDC	Output VDC	IDC	Size
MAC- 6.2.1	6.3	150	.049	2 1/4" W x 2 1/2" D x 3 1/2" H = DC2B
MAC- 6.3.1	6.3	195	.080	3 7/8" H x 3-9/16 x 3-1/16 = JB
MAC-12.2.1	12.6	300	.043	DC2B
MAC-12.2.2	12.6	180	.072	DC2B
MAC-12.4.1	12.6	390	.100	JB
MAC-12.4.2	12.6	245	.170	JB
MAC-12.4.3	12.6	350	.120	JB
MAC-12.4.4	12.6	225	.218	JB
MAC-26.2.1	26	250	.100	DC2B
MAC-26.2.2	26	600	.043	DC2B
MAC-26.2.3	26	360	.072	DC2B
MAC-26.4.1	26	600	.140	JB
MAC-26.4.2	26	450	.190	JB
MAC-26.4.3	26	450*	.190	JB

\*Top of 225 Volts Also available for AC Square wave output at slightly higher ratings. DC TO AC CONVERTERS

Freed No.	Input Voltage	Output VA	Output Voltage and Frequency	Output Regulation	Weight
MAC-10.30.1**	6 volt battery	350 wath max. Fixed Load	115 volts* 60 cycles		7 lbs
MAC-12.20.1**	12 volt battery	370 wath fixed load	115 volts* 60 cycles		7 lbs
MAC-12.30.2**	12 volt battery	350 wath max.	115 volts* 60 cycles	10%	14 lbs

**FREED QUALITY INSTRUMENTS FOR**

**PRECISION LABORATORY TESTING**

**NO. 1110-AB INCREMENTAL INDUCTANCE BRIDGE**

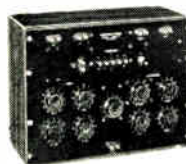

Inductance: 1 Millihenry to 1000 Henry  
Maximum Direct Current: 1 Ampere

**NO. 1620 VARIABLE TEST VOLTAGE MEGOHMMETER**



Variable DC test voltage: 50 to 1000 volts  
Resistance range: 1 megohm to 4,000,000 megohms

Send for NEW TRANSFORMER AND INSTRUMENT CATALOGS

**FREED TRANSFORMER CO., INC.**

1726 Weirfield Street, Brooklyn (Ridgewood) 27, N. Y. Circle 144 on Inquiry Card, page 105

**News of Reps**

(Continued from page 203)

E. V. Roberts and Assoc. is now rep in California and Arizona for the Vicon Corp.

Scheel International, Inc., Chicago, has been appointed export sales rep for Sonora Electronics, Inc., Chicago.

Avtronics, Inc., Los Angeles, is now rep for Guardian Electric Mfg. Co., Chicago, in the Southern California area.

Shockley Transistor Corp. has appointed the Shephard-Winters Co., Los Angeles, as sales rep in Southern California and Arizona.

S & M Associates, Fairlawn, N. J., have been appointed as rep by Lenz Electric Mfg. Co., Chicago, in Metropolitan New York and Long Island and the adjacent counties of Westchester, Putnam and Dutchess, N. Y., and Fairfield, Conn.; also in the Northern part of New Jersey, including Mercer, Middlesex and Monmouth counties.

Near, Inc., is now rep for the Fairchild Controls Corp. in the New England area.

James C. Branham, Santa Monica, is now rep in Northern California for Ferro Cast and the Electronics Div. of the J. B. Rea Co., Inc.

Servo Corp. of America, New York, has appointed 2 new sales reps. They are: TESTCO, Seattle, Wash., in Washington and Oregon; and Custom Engineering Co., Dayton, Ohio, in Michigan, Ohio and Kentucky.

Royal V. Mackey, Jr., is now rep in the Upstate New York territory for the Silicone Products Dept., General Electric Co.

J. Platt Hamerslag, Jr., is now sales and service rep in the San Francisco, Calif., area for Lewis-Shepard Products, Inc.

The W. L. Maxson Corp. has appointed Robert J. Stein as rep in Ohio, Michigan, Illinois, Wisconsin, Minnesota, Iowa, North and South Dakota, and Government installations, primarily Wright-Patterson and Gentile Air Force Bases.

Boonton Electronics Corp., New Jersey, has appointed NLR Assoc. (Norman L. Riemenschneider) sales rep in New Jersey, New York City, Long Island and Westchester area.

**New sub-miniature capacitor meets MIL-C-92 (Proposed)**

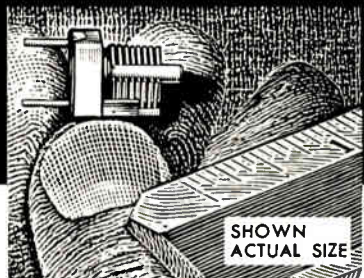

High torque-to-mass ratio—excellent mechanical stability!

Designed for high torque-to-mass ratio and excellent mechanical stability, the tiny "T" capacitor shown above has a "Q" greater than 3000 at 1 mc. and a very low temperature coefficient. Rotor and stator plates permanently soldered . . . rotor contact spring is beryllium copper . . . plates are .0003" silver-plated brass . . . ceramic is Grade L-4 or better steatite, DC-200 treated. Terminals provided for printed circuit board applications. Requires only two small machine screws for chassis or panel mounting. Available for use on government contracts in production quantities with approval of the U. S. Army Signal Corps only.

For specifications and further information on the "T" capacitor described above, write for Data Sheet 758.

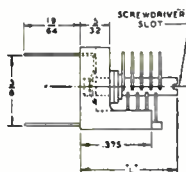

ACTUAL SIZE

**OTHER CAPACITORS**—In addition to the sub-miniature "T" capacitor described above, E. F. Johnson also manufactures a complete line of other air variable capacitors. Types include: ceramic soldered Type "L's", Type "M" miniatures, Type "K" to JAN-C-92, and many other types. For complete specifications on all Johnson electronic components, write for your copy of our newest components catalog, described below.



**New Catalog**

Write today for our newest components catalog, listing complete specifications and prices!

- Capacitors • Knobs and Dials
- Sockets • Inductors • Pilot Lights • Connectors • Insulators



**E. F. JOHNSON CO.**

2320 Second Ave. S.W. • Waseca, Minn. Circle 145 on Inquiry Card, page 105



# ELECTRONIC INDUSTRIES Advertisers — April 1959

ACME ELECTRIC CORPORATION Scheel Adv. Agency, Inc.	52	ELECTRO MOTIVE MFG. CO. Cory Snow, Inc.	117	PHILCO CORP., LANSDALE TUBE DIVISION Maxwell Associates, Inc.	14
ACOUSTICA ASSOCIATES, INC. Freedman & Ross, Inc.	127	ELECTRONIC TUBE CORPORATION The Harry P. Bridge Company	112	PIONEER CENTRAL DIV. BENDIX AVIATION CORP.	130
AEROVOX CORPORATION Lescarbourea Advertising, Inc.	110	ENGINEERED ELECTRONICS COMPANY Frank A. Thorne, Adv.	23	MacManus, John & Adams, Inc.	104
ALDEN PRODUCTS CO. W. Robert Robotham Adv.	182	ESC CORPORATION Keyes, Martin & Company	49	POLYTECHNIC RESEARCH & DEVELOP- MENT CO., INC.	104
ALLEGHENY LUDLUM STEEL CORP. W. S. Walker Advertising, Inc.	123	FILTERS, INC. Burton Browne Advertising	113	POTTER INSTRUMENT COMPANY, INC. McClellan Advertising, Inc.	116
ALLEN-BRADLEY COMPANY Insert following p.	140	FRED TRANSFORMER CO., INC. Franklin Adv. Agency	204	PRICE ELTRIC CORPORATION H. W. Buddemeier Company, Inc.	32
ALPHA WIRE CORP. Zam & Kirshner, Inc.	182	GARRETT CORPORATION, THE J. Walter Thompson Company	199	QUAN-TECH LABORATORIES Frederick Smith Adv. Agency	114
AMPEREX ELECTRONIC CORP. Sam Groden, Incorporated	159	GENERAL ELECTRIC CO. DEFENSE SYSTEMS DEPT.	196	RADIO CORPORATION OF AMERICA, ELECTRONIC TUBE DIVISION	169
AMP INCORPORATED M. Russell Berger, Inc.	27	GENERAL ELECTRIC CO. HEAVY MILITARY ELECTRONICS DEPT.	194, 198	Al Paul Lefton Company	202
ARNOLD MAGNETIC CORP. Balsam Advertising, Inc.	162	GENERAL INSTRUMENT CORPORATION, SEMICONDUCTOR DIV.	26	MISSILE AND SURFACE RADAR DIV. Al Paul Lefton Company	202
ASTRON CORPORATION Conti Advertising Agency, Inc.	21	Walter J. Zimmerman Associates, Inc.	109	RADIO MATERIALS COMPANY Turner Adv. Agency	45
AUDIO DEVICES, INC. Marsteller, Rickard, Gebhardt & Reed, Inc.	40	GENERAL TRANSISTOR CORPORATION Conti Advertising Agency, Inc.	132	RAYTHEON MANUFACTURING CO., INDUSTRIAL TUBE DIVISION	103
AUTOMATIC METAL MFG. CO. Daven Associates	160	GENERAL TRANSISTOR WESTERN CORPORATION	158	Walter B. Snow and Staff, Inc.	103
BARKER & WILLIAMSON, INC. Babcock, Rome, Carberry & Murray, Inc.	48	Neale & Associates	172	RAYTHEON MANUFACTURING CO., MICROWAVE & POWER TUBE DIV.	39
BEAD CHAIN MFG. CO. Kelly Nason, Inc.	143	GERTSCH PRODUCTS, INC. Ray Lamberg Adv.	38	Donahue & Coe, Inc.	140
BELDEN MFG. CO. The Fensholt Advertising Agency	118	GRAPHIC SYSTEMS Diener & Dorskind, Inc.	164	REEVES INSTRUMENT CORPORATION The Edward W. Robotham Co.	170
BELL TELEPHONE LABORATORIES, INC. N. W. Aver & Son, Inc.	43	HANDY & HARMAN Hazard Advertising Company, Inc.	179	REFLECTONE CORP., THE Moore & Company, Inc.	174
BENDIX AVIATION CORP., RED BANK DIV. MacManus, John & Adams, Inc.	134	HAYDON CO. A. W. Cory Snow, Inc.	95	REINHOLD PUBLISHING CORP. Maxwell Sackheim & Co., Inc.	202
BIRTCHE CORP. THE Guerin, Johnstone, Jeffries, Inc.	164	HITEMP WIRES, INC. Duncan-Brooks, Inc.	09*	RELAY SALES, INC. Mandabach and Simms, Inc.	203
BIWAX CORPORATION E. H. Brown Advertising Agency	173	HOFFMAN ELECTRONICS CORPORATION Sander Rodkin Adv. Agency, Ltd.	193	REMINGTON RAND UNIVAC Mullen and Associates, Inc.	42
BOMAC LABORATORIES, INC. Larcom Randall Advertising, Inc.	162, 163	HOUSTON FEARLESS CORP. Taggart & Young, Inc.	168	REPUBLIC AVIATION Deutsch & Shea, Inc.	156
BORG EQUIPMENT DIV., AMPHENOL- BORG CORP. E. R. Hollingsworth & Associates	35	HUGHES AIRCRAFT COMPANY Foote, Cone & Belding, Inc.	46	RHEEM MANUFACTURING COMPANY Getz and Sandbora, Inc.	143
BOURNS LABORATORIES, INC. Allen, Dorsey & Hatfield, Inc.	29	ILLINOIS CONDENSER COMPANY Sander Rodkin Adv. Agency, Ltd.	121	ROHN MANUFACTURING CO. Jackson, Haerr, Peterson & Hall, Inc.	145
BRUSH INSTRUMENT DIVISION OF CLEVITE CORP. Duffy, McClure & Wilder, Inc.	149	INDUCTION MOTORS CORP. Pike & Becker, Inc.	115	ROYAL METAL MANUFACTURING COMPANY William Hart Adler, Inc.	178
BURNELL & CO. Mohr & Eicoff, Inc.	101	INSTITUTE OF RADIO ENGINEERS, THE Raymond Schoonover, Adv.	112	SANGAMO ELECTRIC COMPANY Arthur R. Mogge, Inc.	145
BUSSMANN MFG. DIV. MCGRAW EDISON CO.	167	I-T-E CIRCUIT BREAKER COMPANY Gray & Rogers Adv.	154	SARKES TARZIAN, INC. Argyle Wampler, Adv.	166
CAMBRIDGE THERMIONIC CORP. James Thomas Chirurg Co.	125	JOHNSON CO., E. F. Firestone, Goodman, Inc.	157	SERVO CORPORATION OF AMERICA Smith, Winters Mabuchi, Inc.	98
CANNON ELECTRIC COMPANY Anderson-McConnell Adv. Agency, Inc.	47	JONES DIVISION, HOWARD B., CINCH MFG. CORP. Symonds, MacKenzie & Company, Inc.	50	SHIELDING, INC. Conti Advertising Agency, Inc.	012*
CBS-HYTRON, A DIVISION OF COLUMBIA BROADCASTING SYSTEM, INC. Bennett & Northrop, Inc.	126	KEITHLEY INSTRUMENTS, INC. R. J. McFarlin & Co.	114	SIERRA ELECTRONIC CORPORATION L. C. Cole Company, Inc.	6
CHICAGO STANDARD TRANSFORMER CORP. Stral Advertising Company	91	KELVIN ELECTRIC COMPANY M. Dorsey and Associates, Adv.	157	SPRAGUE ELECTRIC COMPANY The Harry P. Bridge Company	44
CINCH MANUFACTURING COMPANY Campbell & Associates	171, 173	KESTER SOLDER COMPANY Paul J. Steffen Co.	152	STACKPOLE CARBON CO. The Harry P. Bridge Company	152
CLARE & CO., C. P. Reincke, Meyer & Finn, Inc.	177	KLEIN & SONS, MATHIAS The Buchen Company	93	STANPAT CO. Richard & Gunther, Inc.	159
CLEVITE TRANSISTOR PRODUCTS Chambers Wiswell Shattuck Clifford & McMillan, Inc.	33	KLEINSCHMIDT, DIVISION OF SMITH- CORONA MARCHANT, INC. Alex. T. Franz, Inc.	170	STATHAM INSTRUMENTS, INC. Getz and Sandbora, Inc.	161
CLAROSTAT MFG. CO., INC. Lescarbourea Advertising, Inc.	180	KULKA ELECTRIC CORP. Lescarbourea Advertising, Inc.	131	STROMBERG-CARLSON, DIV. OF GENERAL DYNAMICS CORP. The Rumrill Co.	175
CONSOLIDATED AVIONICS CORP. Howard A. Harkavy, Inc.	183	LENZ ELECTRIC MANUFACTURING CO. Merchandising Advertisers, Inc.	128	SYLVANIA ELECTRON TUBE DIV. Insert following p. 52	182
CONVAIR INSTRUMENTS, CONVAIR DIV. OF GENERAL DYNAMICS CORP. Lennen & Newell, Inc.	135	LINDBERG ENGINEERING COMPANY Don Colvin & Company, Inc.	188, 189	TECHNICAL APPLIANCE CORP. (TACO) Lescarbourea Advertising, Inc.	133
CORNING GLASS WORKS The Rumrill Company, Inc.	130	LOCKHEED, MISSILES AND SPACE DIV. Hal Stebbins, Inc.	201	THOMPSON-RAMO-WOOLDRIDGE, INC., TAPCO GROUP Meldrum & FewsSmith, Inc.	153
DADE COUNTY DEVELOPMENT DEPT. Charles W. Hoyt Company	36, 37	LOCKHEED, THE CALIFORNIA DIVISION OF LOCKHEED AIRCRAFT CORP. Hal Stebbins, Inc.	146	TECHNICAL INFORMATION CORPORATION Smith, Winters Mabuchi, Inc.	175
DALE PRODUCTS, INC. Ayers, Swanson and Associates, Inc.	183	MAGNETICS, INC. Lando Advertising Agency	155	TEKTRONIX, INC. Hugh Dwight Advertising	010*
DEJUR-AMSCO CORP. Friend-Reiss Advertising, Inc.	184	MANSON LABORATORIES, INC. Moore & Company, Inc.	168	TELONIC INDUSTRIES, INC. Leland Oliver Company	129, 133
DELCO RADIO, DIV. OF GENERAL MOTORS CORP. Campbell-Ewald Company	167	MARCONI INSTRUMENTS Williams Advertising Service Corp.	170	TEXAS INSTRUMENTS INCORPORATED Don L. Baxter, Inc.	94
DIALIGHT CORPORATION H. J. Gold Co. Adv.	161	MEASUREMENTS DIV. MCGRAW-EDISON CO. Ray Ellis Advertising, Inc.	200	TINNERMAN PRODUCTS, INC. Meldrum & FewsSmith, Inc.	157
DIALTRON CORP. H. J. Gold Co. Adv.	163	MELPAR, INC. M. Belmont Ver Standig, Inc.	195	TRINITY EQUIPMENT CORP. Lescarbourea Advertising, Inc.	138
DU PONT DE NEMOURS, E. I., FREON PRODS. DIV. Batten, Barton, Durstine & Osborn, Inc.	174	MOTOROLA, INC. Kolb & Abraham, Inc.	34	TRU-OHM PRODUCTS, DIV. OF MODEL ENGINEERING LTD. & MFG., INC. Sander Rodkin Adv. Agency	137
EASTMAN KODAK COMPANY The Rumrill Company, Inc.	172	MOTOROLA, INC., SEMICONDUCTORS Advertising Associates	167	TUNG-SOL ELECTRIC, INC. E. M. Freystadt Associates, Inc.	158
ELECTRONIC INSTRUMENT CO., INC. (EICO)	136	MUELLER ENGINEERING CO., HEINZ Mandabach and Simms, Inc.	28	UNITED STATES GASKET CO., PLASTICS DIV. OF GARLOCK PACKING CO. Hutchins Adv. Co.	181
EISLER ENGINEERING CO. Walter J. Zimmerman Associates, Inc.	139	MUIRHEAD & CO., LIMITED NARDA ULTRASONICS CORP. John Mather Lupton Co., Inc.	197	UNITED TRANSFORMER CORP. Shappe-Wilkes, Inc.	158
ELCO CORPORATION Fein and Schwerin, Inc.	156	NATIONAL CASH REGISTER CO. McCann-Erickson, Inc.	154	VECTOR ELECTRONIC CO. M. Dorsey and Associates Adv.	51
ELECTRIC REGULATOR CORPORATION Smith, Winters, Mabuchi, Inc.	176	OHIO CHEMICAL & SURGICAL EQUIP- MENT CO. Arthur Towell, Inc.	011*	WAVELINE, INC. Harvey B. Nelson, Adv.	143
ELGIN NATIONAL WATCH CO. ADVANCE RELAYS Balsam Advertising, Inc.		ONAN & SONS, INC., D. W. Graves & Associates, Inc.	111	X-ACTO, INC. Bass and Company, Inc.	
		PANORAMIC RADIO PRODUCTS, INC. Harold Marshall Adv. Company, Inc.	08*		
		PENTA LABORATORIES, INC. Allen, Dorsey & Hatfield, Inc.			

\*In Operations Edition only  
While every precaution is taken to insure accuracy, we cannot guarantee against the possibility of an occasional change or omission in the preparation of this index.

*the strongest link  
in your 1959 selling program will be . . .*

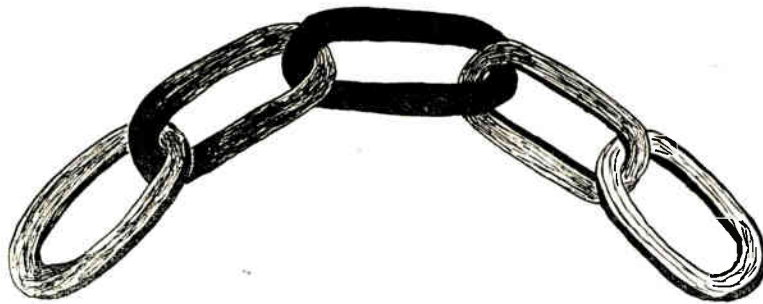

## **ELECTRONIC INDUSTRIES' JUNE DIRECTORY AND ALL-REFERENCE ISSUE**

**LOOK AT IT THIS WAY.** The comparisons a buyer makes when he goes to the catalog ads in his product directory are often decisive. They can make or break all your previous selling efforts.

In 1959 one directory will go into the hands of more potential buyers in the electronic manufacturing market than any other. That is **ELECTRONIC INDUSTRIES' JUNE DIRECTORY**.

It has by far the largest O.E.M. circulation. And it has more subscribers in the United States than any commercially published directory in its field.

During the 12 months starting June 1959, a catalog-type ad in the **ELECTRONIC INDUSTRIES'** directory could again and again be the pay-off point for interest you have stimulated by direct mail, sales calls, publicity, and regular advertising.

**So Plan Now FOR A SPREAD, AN  
INSERT, OR MULTIPLE PAGES IN  
ELECTRONIC INDUSTRIES' JUNE DIRECTORY  
AND ALL-REFERENCE ISSUE**

- The only electronic industry directory combined with a major compilation of engineers' reference data.
- The most complete product guide in its field, listing the manufacturers of over 2,600 different classes of electronic products.
- Easiest-to-use product break-downs, based on the Electronic Industries Classification. (EIC code.)
- More than 100 pages of year-round technical reference data.

**CLOSING DATE FOR INSERTION ORDERS AND PLATES—MAY 1st, 1959**

# **ELECTRONIC INDUSTRIES**

Chestnut & 56th Sts.  
Philadelphia 39, Pa.  
SHerwood 8-2000

A Chilton Publication





**TWO NEW RCA "FIRSTS"**

# 0.6-watt heater-power Vidicons

...for transistorized TV cameras



RCA-7263 for Severe Environmental Conditions

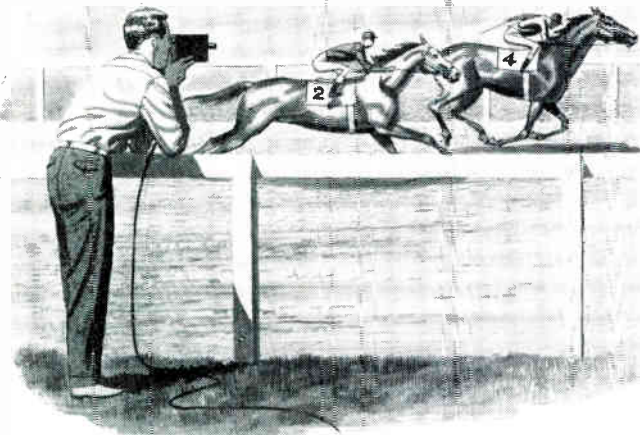

RCA-7262 for Moderate Environmental Conditions

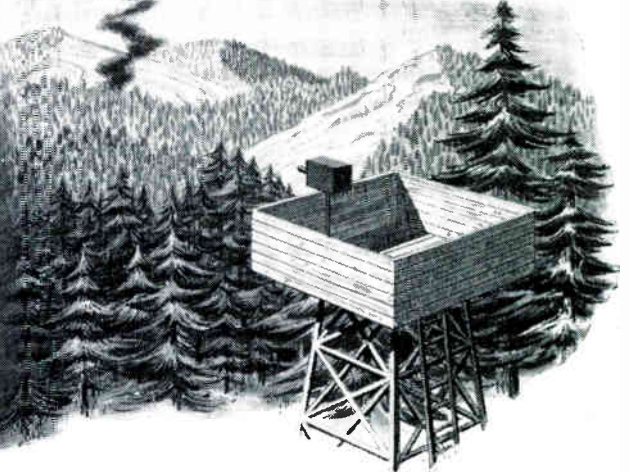

Lowest heater-power Vidicons in television today, these new short-length types are opening a new era in compact transistorized TV camera designs. Only 5 $\frac{1}{8}$  inches long, these remarkable camera tubes operate with only 0.6 watt of heater power—actually one-third less than any other commercial type Vidicon. Both types feature fast cathode warm-up time. And, thanks to a closely controlled photoconductive layer, both types provide pictures with uniform background—and consistent performance from tube to tube.

RCA-7263 is for use especially in new TV cameras designed for operation under severe environmental conditions involv-

ing shock, vibration, humidity, and altitude. This Vidicon type is tested in combination with associated components under environmental conditions according to the techniques of military specifications MIL-E-5272B and MIL-E-5400.

RCA-7262 is for use in new, compact camera designs for industrial and broadcast applications—where environmental requirements are moderate.

Want more details on these remarkable low-heater-power Vidicons? Just call your RCA Field Representative. Or, for comprehensive technical data on either or both types, write to RCA Commercial Engineering, Sec. D-50-Q, Harrison, N.J.



**RADIO CORPORATION OF AMERICA**

Electron Tube Division

Harrison, N. J.

Also Available at Authorized RCA Industrial Tube Distributors.

RCA Field Representatives are here to help you:

**INDUSTRIAL TUBE PRODUCTS SALES**

- Newark 2, N. J., 744 Broad Street, HUmboldt 5-3900
- Chicago 34, Ill., Suite 1154, Merchandise Mart Plaza Whitehall 4-2900
- Los Angeles 22, Calif., 6355 E. Washington Blvd. RAymond 3-8361
- Detroit 2, Mich., 714 New Center Bldg., TRinity 5-5600

**GOVERNMENT SALES**

- Newark 2, N. J., 744 Broad St., HUmboldt 5-3900
- Dayton 2, Ohio, 224 N. Wilkinson St., BAldwin 6-2366
- Washington 6, D.C., 1625 'K' St., N.W., DIstrict 7-1260