

# ELECTRONIC INDUSTRIES

& TELE-TECH

Solar Power—What's the Future?  
Comparing Printed Wiring

March • 1957

Hilton Publication

SHARE THIS COPY!  
Please Route to



# Greater STABILITY

## RMC DISCAPS

### Type C

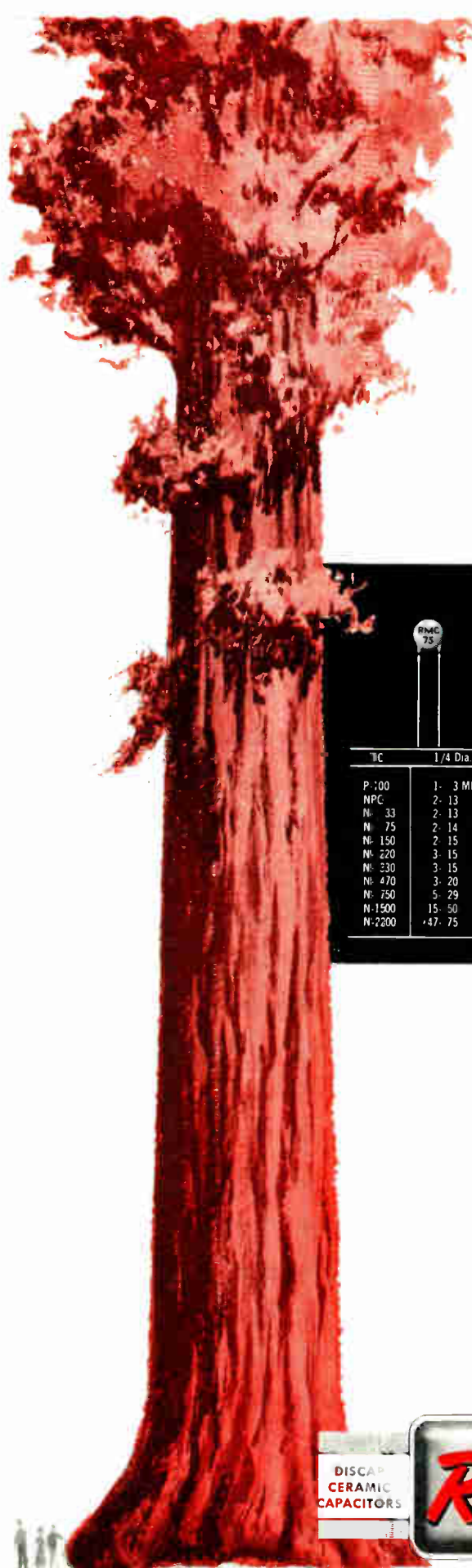

	RMC 75	RMC 100	RMC 200	RMC 275	RMC 470	RMC 560
TC	1/4 Dia.	5/16 Dia.	1/2 Dia.	5/8 Dia.	3/4 Dia.	7/8 Dia.
P:100	1- 3 MMF	4- 9 MMF	10- 20 MMF			
NPC	2- 13	14- 29	30- 69	70- 85 MMF	86-115 MMF	116-150 MMF
N: 33	2- 13	14- 29	30- 56	57- 62	63-100	101-150
N: 75	2- 14	15- 27	28- 56	57- 68	69-110	111-150
N: 150	2- 15	16- 30	31- 68	69- 75	76-140	141-150
N: 220	3- 15	16- 30	31- 75	76- 90	91-130	131-190
N: 330	3- 15	16- 30	31- 75	76-100	101-150	151-190
N: 470	3- 20	21- 40	41- 80	81-120	121-200	201-240
N: 750	5- 29	30- 68	69-150	151-180	181-300	301-350
N: 1500	15- 50	51-120	121-200	201-250	251-330	331-560
N: 2200	47- 75	76-150	151-200	201-275	276-470	471-560

Temperature coefficients up to N-5200 available on special order.

### SPECIFICATIONS

**POWER FACTOR:** Over 10 MMF less than .1% at 1 megacycle. Under 10 MMF less than .2% at 1 megacycle.

**WORKING VOLTAGE:** 1000 V.D.C.

**TEST VOLTAGE (FLASH):** 1750 V.D.C.

**CODING:** Capacity, tolerance and TC stamped on disc

**INSULATION:** Durez phenolic-vacuum waxed

**INITIAL LEAKAGE RESISTANCE:** Guaranteed higher than 7500 megohms

**AFTER HUMIDITY LEAKAGE RESISTANCE:** Guaranteed higher than 1000 megohms

**LEADS:** No. 22 tinned copper (.026 dia.)

**TOLERANCES:**  $\pm 5\%$   $\pm 10\%$   $\pm 20\%$

These capacitors conform to the RETMA specification for Class 1 ceramic condensers.

The capacity of these condensers will not change under voltage.

In temperature compensating capacitors, RMC Type C DISCAPS are the accepted standard in the electronic industry. Inherent stability provides for rated capacities that will not change under voltage. Type C DISCAPS are rated at 1000 working volts and cost no more than ordinary 600 volt capacitors.

If you use ceramic capacitors it will pay you to investigate RMC DISCAPS. Write for information on your letterhead.

VISIT BOOTH 518 I.R.E. SHOW

DISCAP  
CERAMIC  
CAPACITORS

**RMC**

**RADIO MATERIALS CORPORATION**  
GENERAL OFFICE: 3325 N. California Ave., Chicago 18, Ill.  
Two RMC Plants Devoted Exclusively to Ceramic Capacitors  
FACTORIES AT CHICAGO, ILL. AND ATTICA, IND.

# ELECTRONIC INDUSTRIES

## & TELE-TECH

Vol. 16, No. 3

March, 1957

FRONT COVER: Semiconductor research has given us photodiodes capable of converting a large portion of the solar energy striking them into useful electricity. The sun has suddenly become a "component" of an increasing number of electronic devices. Facts about solar energy, the "design characteristics" of our sun, can be found on page 58.

### MONTHLY NEWS ROUND-UP

Rodarscope: <i>What's Ahead for the Electronic Industries?</i> .....	2
As We Go To Press.....	5
TOTALS: <i>Late Marketing Statistics</i> .....	7
Electronic Industries' News Briefs.....	16
Washington News Letter.....	88
New Tech Data for Engineers.....	146

<b>Editorial: Science Consultants; Convention PR; Creative Engineering</b> .....	57
<b>Solar Power—What are the Facts?</b> .....	A. E. Laak 58
<b>Report on Silicon Solar Cells</b> .....	Dr. M. B. Prince 60
<b>Transistor Tests Predict H-F Performance</b> .....	R. L. Pritchard 62
<b>Seven Methods of Printed Wiring</b> .....	A. E. Stane 64
<b>Product—Exhibitor Guide to IRE</b> .....	67
<b>See These Products at IRE</b> .....	69
<b>R-F Shield Design</b> .....	C. S. Vasaka 72
<b>Accelerometers—Which Type for the Job?</b> A. Orlacchia & G. Hieber	75
<b>Tiny Bits of Wire Form Flip-Flop</b> .....	78
<b>Transistors Prove Themselves</b> .....	78
<b>New "Breadboard" Cuts Lab Time</b> .....	79
<b>Resistor Reactance in Pulse Circuits</b> .....	H. Fried 80
<b>Broadband Microwave Receiver Design</b> .....	B. Rasen & R. Saul 81
<b>International Electronic Sources</b> .....	91

### NEW ELECTRONIC EQUIPMENT

New Products . . . for the Design Engineer.....	83
New Products . . . for the Electronic Industries.....	86

### DEPARTMENTS

Tele-Tips .....	24	Books .....	44
Industry News .....	32	News of Reps.....	51
Personals .....	110		



### Report On Solar Power 58

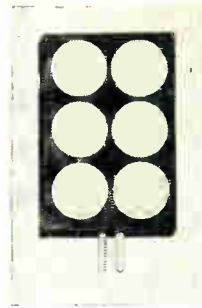

An answer to the questions: Just how much solar energy is available? What is the maximum efficiency to be expected from future solar batteries? What is the status of solar research?

### Printed Wiring Methods 64



Of all the printed wiring methods introduced during the past years seven general processes have survived. Here are the advantages and disadvantages of each.

### Tips On Shielding 72

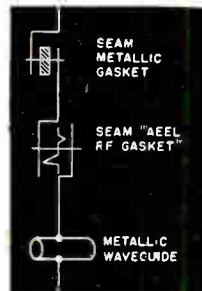

Report on a series of exhaustive tests by the Navy to find the minimum shielding requirements for airborne equipment and the most effective shielding materials.

### Which Accelerometer? 75



Choice of the right accelerometer depends upon frequency response, range, temperature environment and accuracy. Here is how major types compare.

ELECTRONIC INDUSTRIES & Tele-Tech, Mar., 1957, Vol. 16, No. 3. A monthly publication of Chilton Co. Executive, Editorial & Advertising offices at Chestnut & 56th Sts., Phila., Pa. Accepted as controlled circulation publication at Phila., Pa. 75¢ a copy. Subscription rates U. S. and U. S. Possessions: 1 yr. \$5.00; 2 yrs. \$8.00; 3 yrs. \$10.00. Canada 1 yr. \$7.00; 2 yrs. \$11.00; 3 yrs. \$14.00. All other countries 1 yr. \$10.00; 2 yrs. \$16.00. Copyright 1957 by Chilton Co. Title Reg. U. S. Pat. Off. Reproductions or reprinting prohibited except by written authorization.

# RADARSCOPE

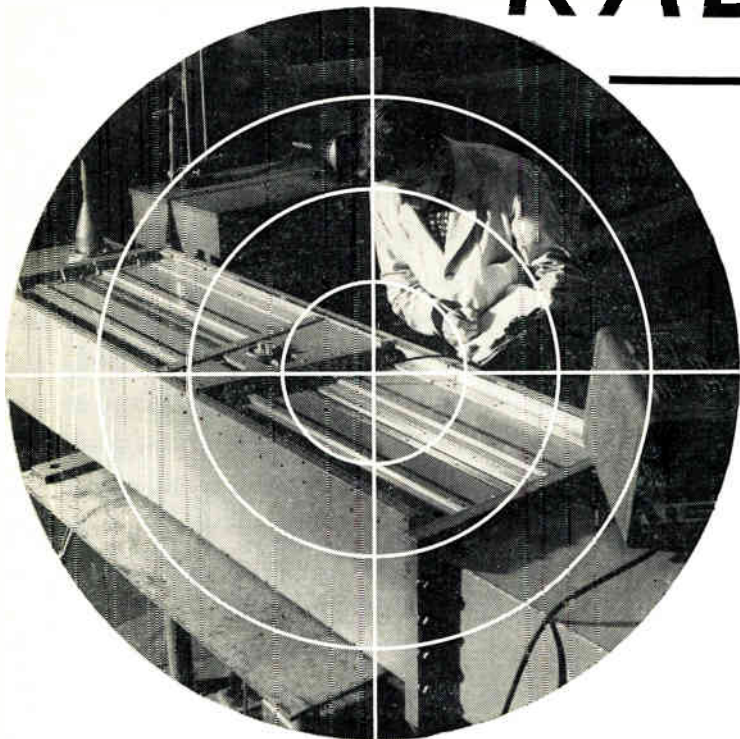

## FOR LOW-FREQUENCY RADAR

Slotted line for waveguide, size WR-2100, was developed by IRE Circuit Breaker's Engineering Products Section for the low frequency radar and scatter communications field. Inherent VSWR is less than 1.02 over the entire band. (On display at IRE, Booth 1313.)

**NEW MICROWAVE AMPLIFIER** which utilizes the spinning motion of the electron in a paramagnetic crystal under the influence of a magnetic field was described last month at a meeting of the American Physical Soc. in N. Y. The new amplifier has very low noise and wideband amplifying characteristics. The noise level possible is reported to be some 1000 times better than is now available with conventional circuitry. This increase in sensitivity could revolutionize radar technology and UHF and microwave transmission as we know them today.

**TRANSISTORIZED SHORTWAVE RADIO** will be introduced by Magnavox this year that will be priced at a fraction of the price of competitive shortwave radios using tubes.

**COLOR TV** last month took a sharp upturn on the basis of two optimistic announcements. J. Walter Thompson, N. Y. ad agency announced that they had installed complete closed-circuit color facilities to provide trial runs for color TV advertisements, first sign that the ad business had become serious about the possibilities of the new medium. At the same time RCA, in what many officials construed as a move to encourage other firms to enter the color field, announced a rise in prices of a number of their color models. Their lowest-priced, \$495 model, however, remained the same. While no industry

officials would admit that the rise in RCA's prices would bring in new competition a number of officials have in the past complained that the RCA prices were too low and unrealistic.

**TRANSISTOR LIFE EXPECTANCY** is still undetermined, but life tests are showing eye-opening results. At the Air Force Cambridge Research Center transistorized flip-flop circuits have now logged 13,000 hours of continuous operation without failure. Very little deterioration of the point-contact transistors has been noted. Similar results are reported for a 16-stage regenerative pulse amplifier circuit after more than 5,000 hours of operation.

**NUCLEAR SCIENTISTS** are quietly working toward an application of the hydrogen bomb principles that will settle for all time the power problems of mankind. The serious obstacle has been a container to house the 10,000,000°C. temperatures necessary for "controlled fusion"—the fusion of hydrogen atoms. Now scientists report the generation of magnetic lines of force of 1,600,000 gauss, more than 100 times more powerful than any previously created. With this tool, say the scientists, the reaction can be contained within a given space by the magnetic lines of force alone—effectively a "magnetic bottle."

**"THROW-AWAY TV?"** Portable TV sets are reaching the category of an "impulse purchase"; an item that the customer buys and carries home. In time, say industry officials, these portable receivers, and transistorized portable radios will be sold not only through appliance stores, but also in super-markets, specialty stores and other outlets.

## JET COMMUNICATIONS

Convair electronics engineers are proving out the 1,000-mi. communication system for the new Model 880 jet transport with this 17-ft. wingspan model. Model duplicates the 880's electrical properties, and houses a transmitter to generate test signals.

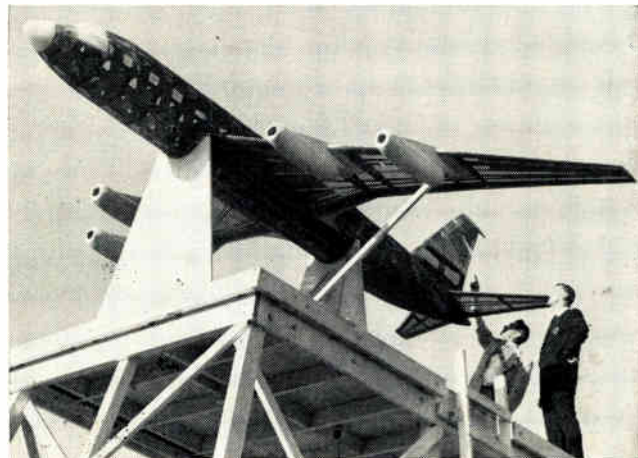

## Analyzing current developments and trends throughout the electronic

### industries that will shape tomorrow's research, manufacturing and operation

**THE GERMAN GOVERNMENT** is so concerned over pirating of German engineers that they have issued restrictions against foreign firms advertising for such personnel in the country's newspapers. German engineers may now quit their employment only at quarterly periods during the year and must give 6 weeks advance notice, according to Dr. H. H. Woerdemann, pres. of Magnetic Research Corp., Los Angeles.

**NEW BATTERIES.** General Electric last month announced a new tiny battery with a projected life of more than 20 years. It has 60 times the voltage of a common flashlight battery, is 1-in. long and less than 1/3 in. in diameter. It weighs less than 1/5 oz. and produces 90 v. The present price of the battery is \$12.50, but the company believes mass production could bring the price down to \$1.

Miniature nuclear-powered battery, approximately the size of the head of a tack and putting out about 20 microwatts, was announced by Elgin National Watch Co. and Walter Kidde Nuclear Labs. The battery utilizes the decay energy of a beta-emitting radioisotope as its source of energy. Applications of the battery are expected to be in hearing aids and miniature portable radios.

**NEW UNDERSTANDING** of the soldering problem was turned up by Western Union's investigation of rosin flux. WU found that at normal atmospheric temperatures the acid in rosin flux is locked in a wholly inert condition within the molecular structure of the rosin. Flux action is largely dependent on temperature. At a minimum temperature no acid is liberated and no fluxing action takes place. At an optimum temperature considerable acid is liberated and fluxing action is more than adequate. And, then, at a temperature only slightly higher than optimum, fluxing action ceases. In fact, at the higher temperatures the rosin with the acid all volatilized actually impedes soldering. The usable temperature range is 477° to 550°F.

**NEW "IONOVAC"** high-fidelity speaker now going into production at DuKane Corp., St. Charles, Ill. is the first practical American use of ionized air to replace diaphragms in loudspeakers. It is expected to have wide application also as a generator of ultra-sonic waves. Developed from a European design it uses a small quartz cell in which the air molecules are ionized by a high frequency, high voltage current. When a varying field is applied to the ionized cloud it contracts and expands in the same manner as the cone of a loudspeaker. Since there is little mass, the cloud dimensions can follow the audio-frequency signal with little difficulty.

## ENGINEERING EDUCATION

**INCREASINGLY EVIDENT** among the "Engineers Wanted" columns are offers to pay full or partial tuition for undergraduate or graduate courses on the university level. At the same time, a number of firms are setting up company-sponsored training courses for engineers that will keep them abreast of the latest developments. And there seems to be less and less quibbling about whether "company-time" is involved. It would appear that within the next ten years we will see develop a "cradle-to-the-grave" educational program for engineers, with the employer taking a large share of the responsibility.

**ENGINEERING SECRETARIAL COURSE** is being offered by the Business Training College, Wood St. and Blvd. of the Allies, Pittsburg 22, Pa. that will provide personnel to assist engineers who do not have time to concern themselves with details that can be handled by a secretary understanding the engineering language.

## TEST MISSILE

Four-story Lockheed test missile X-17 points skyward, ready for flight, at Patrick Air Force Base, Florida. A three stage rocket, the X-17 weighs more than six tons. The Air Force reports that the X-17 is saving millions in missile program.

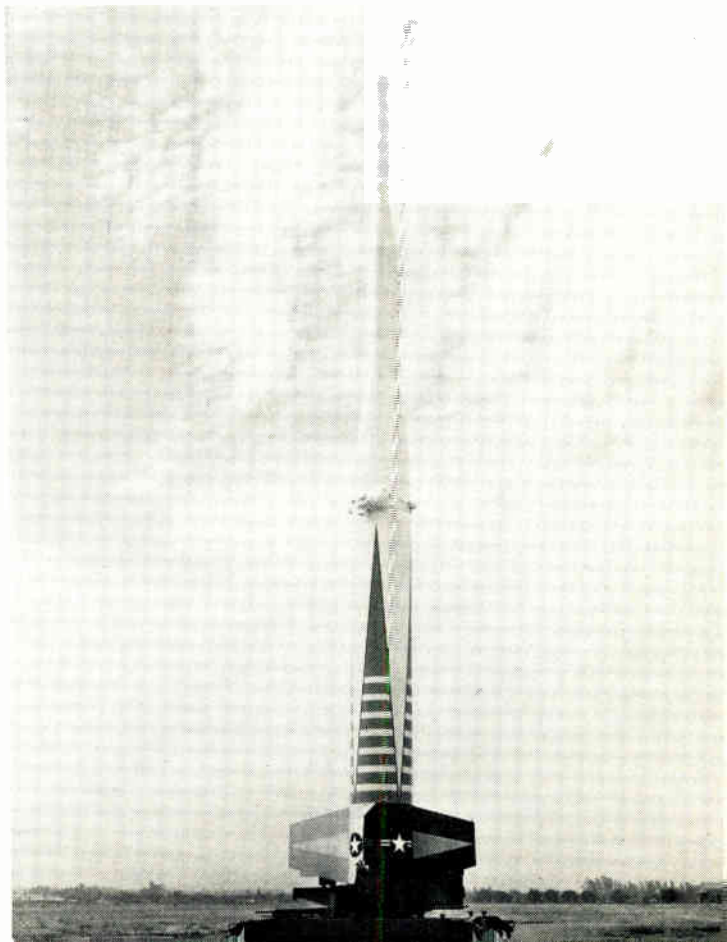



# THIS IS IT

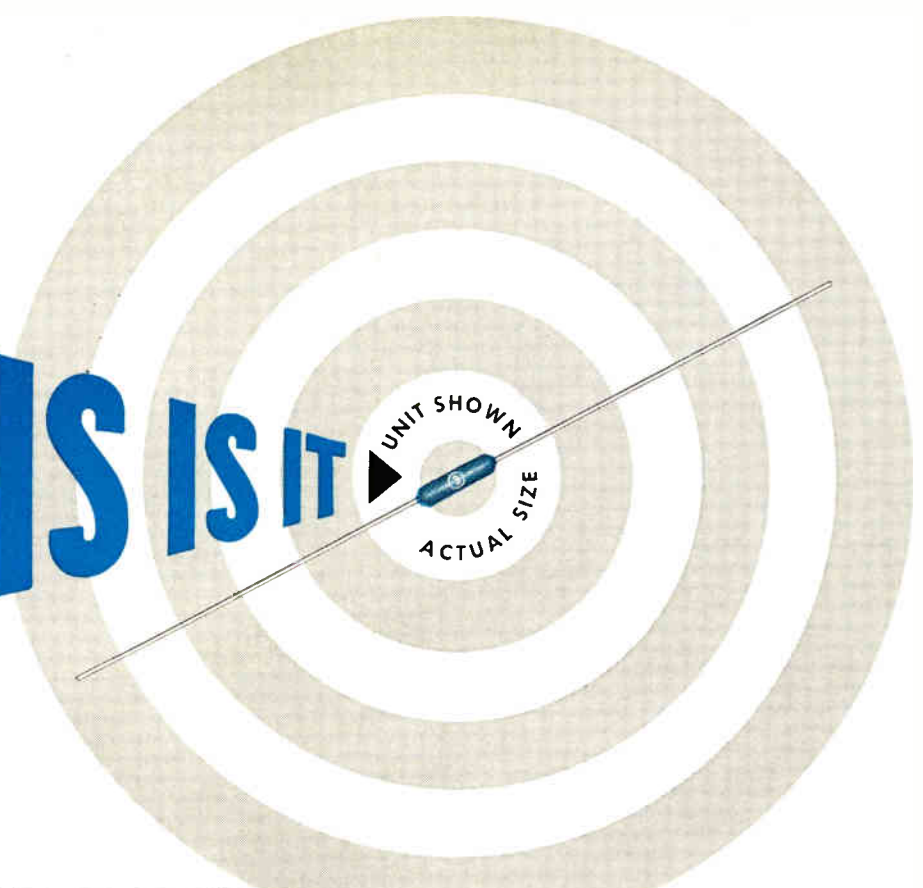

## NEW 3-WATT Blue Jacket<sup>®</sup> miniaturized axial-lead wire wound resistor

This power-type wire wound axial-lead Blue Jacket is hardly larger than a match head *but it performs like a giant!* It's a rugged vitreous-enamel coated job—and like the entire Blue Jacket family, it is built to withstand severest humidity performance requirements.

Blue Jackets are ideal for dip-soldered sub-assemblies . . . for point-to-point wiring . . . for terminal board mounting and processed wiring boards. They're low in

cost, eliminate extra hardware, save time and labor in mounting!

Axial-lead Blue Jackets in 3, 5 and 10 watt ratings are available without delay in any quantity you require. ★ ★ ★

SPRAGUE TYPE NO.	WATTAGE RATING	DIMENSIONS L (inches) D		MAXIMUM RESISTANCE
151E	3	1 $\frac{1}{2}$ "	1 $\frac{3}{4}$ "	10,000 $\Omega$
27E	5	1 $\frac{1}{2}$ "	3 $\frac{1}{4}$ "	30,000 $\Omega$
28E	10	1 $\frac{1}{2}$ "	3 $\frac{1}{4}$ "	50,000 $\Omega$

Standard Resistance Tolerance:  $\pm 5\%$

# SPRAGUE

WRITE FOR ENGINEERING BULLETIN NO. 111B



SPRAGUE ELECTRIC COMPANY • 233 MARSHALL ST. • NORTH ADAMS, MASS.

# As We Go To Press...

## Data Net Keeps Track Of Army Stockpiles

The army is keeping pace with the latest advances in automation and data handling. In order to keep close control over an inventory of over a million items—from tanks to transistors—the Army Signal Corps and the Long Lines Department of AT&T are today operating a new electronic data processing network, designed to speed up the flow of supplies and keep stockpiling to a minimum.

The system, named CONUS-DTSN, for Continental United States—Data Transceiver Switching Network, is the outgrowth of the “fast-communication” concept of Project MASS (Modern Army Supply System).

Telephone lines connect switching centers in Philadelphia, Atlanta, Chicago, Kansas City and Oakland. Interconnected to these centers are 33 military installations. Data transceivers of the International Business Machines Corporation are used to exchange information on punched cards between all network points. Cards punched at one end of a circuit can be duplicated rapidly at the other end using communications lines. An estimated million such transactions can be handled daily.

Initial users of the network are Quartermaster, Ordnance, Signal, and Overseas Supply Agency in New York and San Francisco.

## ATOMIC BATTERY



Tiny battery delivers usable current for 5 years. Developed by Elgin and Kidde Nuclear Labs it converts atomic energy to light and then to current.

## TV SWITCHER

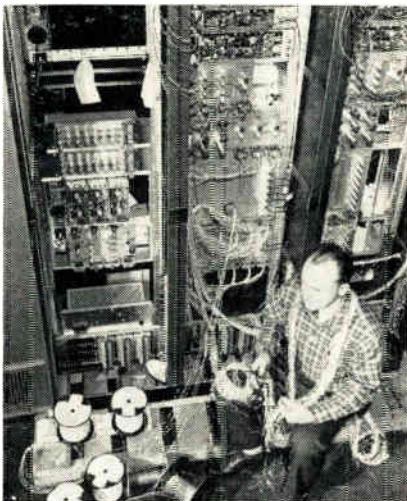

More than two miles of precision wiring are going into this new TV switching unit being built by General Electric for KVOO-TV, Tulsa

## New G. E. Radar Mortar Locator

The new General Electric AN/MPQ-4 radar mortar locator is intended to provide a sharp decrease in casualties in any future conflicts. Its purpose is to “pinpoint” an enemy mortar within seconds after initial firing of the weapon. In addition, the AN/MPQ-4 may be used to locate points of impact of the Army’s own mortar shells for purposes of directing fire. In either case, location may be made almost immediately after a shell passes through the equipment’s radar beams.

## New IRE Affiliate Plan

The Institute of Radio Engineers has adopted a plan which will permit qualified non-IRE members to become affiliated with certain of the IRE Professional Groups *without* first joining IRE.

In effect, the IRE is extending the specialized services of its twenty-four Professional Groups to every field of engineering and science to keep pace with the rapidly spreading influence of electronics in every walk of scientific and technological life.

## 25-Watt Sun Battery Opens New Horizons

Solar energy has left the micro-power stage—Hoffman Electronics Corp. has developed a 25 watt solar energy converter panel. Shown for the first time at a symposium on solar energy converters and applications in Washington, D. C., the unit contains high-efficiency silicon solar cells which can convert 10 per cent of the sun’s energy into usable electricity.

The new large-scale converter can be used to power unmanned radio transmitter or receiver systems, telephone relays, or weather stations. In each case, the solar energy converter, with storage batteries for dark-hour operation, would give continuous operation of unattended equipment.

With a variety of possible remote applications in mind, Hoffman has engineered the unit to use modular construction and hermetically sealed cells. Since there is no life-loss, the units will operate indefinitely. Aside from sun-powered broadcast receivers, Hoffman has developed a solar flashlight, a solar highway warning flasher, and an experimental model of a sun-powered miniature transmitter-receiver, designed for air-sea rescue service.

During the past year and a half, the cost of solar cells has been reduced by a factor of five, and efficiency has been raised. The gap is steadily closing between the cost of solar energy systems and the cost of conventional power sources.

News of this latest advance in the use of solar power raises the hope that unattended navigation aids and radio warning markers might be powered by solar cells. Such devices, placed on high mountain peaks, could warn off-course aircraft and prevent crashes.

MORE NEWS ON PAGE 11

# look to Stemco Thermostats first for precise, sensitive temperature control

If your product requires precise, sensitive temperature control . . .  
if it's scheduled for volume production—look to Stemco thermostats first.  
Since Stevens produces the broadest range of bimetal thermostats  
in the industry, chances are you can use a standard production-line  
unit to satisfy all your special requirements exactly. This saves design,  
development and tooling expense . . . cuts down on lead time . . .  
gives you a better, proven thermostat at lower cost — sooner.

- 1 TYPE S Adjustable Positive-acting, with electrically independent bimetal. Adjusting stem and terminals to customer specification. See Bulletin F-2006.
- 2 TYPE S Non-Adjustable. Electrically identical to adjustable Type S. Single-stud mounting. Operates to 650°F. Rating: 15 amps at 115 volts AC, 10 amps at 230 volts AC. See Bulletin F-2006.
- 3 TYPE SA Adjustable. Snap-acting with electrically independent bimetal. Also single-pole, double-throw. Adjusting stem and terminals to customer order. See Bulletin L-6397-A.
- 4 TYPE SA Non-Adjustable. Is electrically identical to adjustable Type SA. Non-inductive-load rating 15 amps at 115 volts AC, 10 amps at 230 volts AC. See Bulletin L-6397-A.
- 5 TYPE SM Manual Reset. Mechanically and electrically same as adjustable and non-adjustable Type SA except for manual reset feature. See Bulletin L-6397-A.
- 6 TYPE W. Adjustable (shown) or non-adjustable types. Snap action prevents arcing. Operation to 350°F. Rated at 12 amps at 115 volts AC, 8 amps at 230 volts AC. See Bulletin L-6395.
- 7 TYPE A Semi-Enclosed. Insulated, electrically independent bimetal disc gives fast response and quick, snap-action control. Operation from -40° to 400°F. Various mountings and terminals. See Bulletin L-9070.

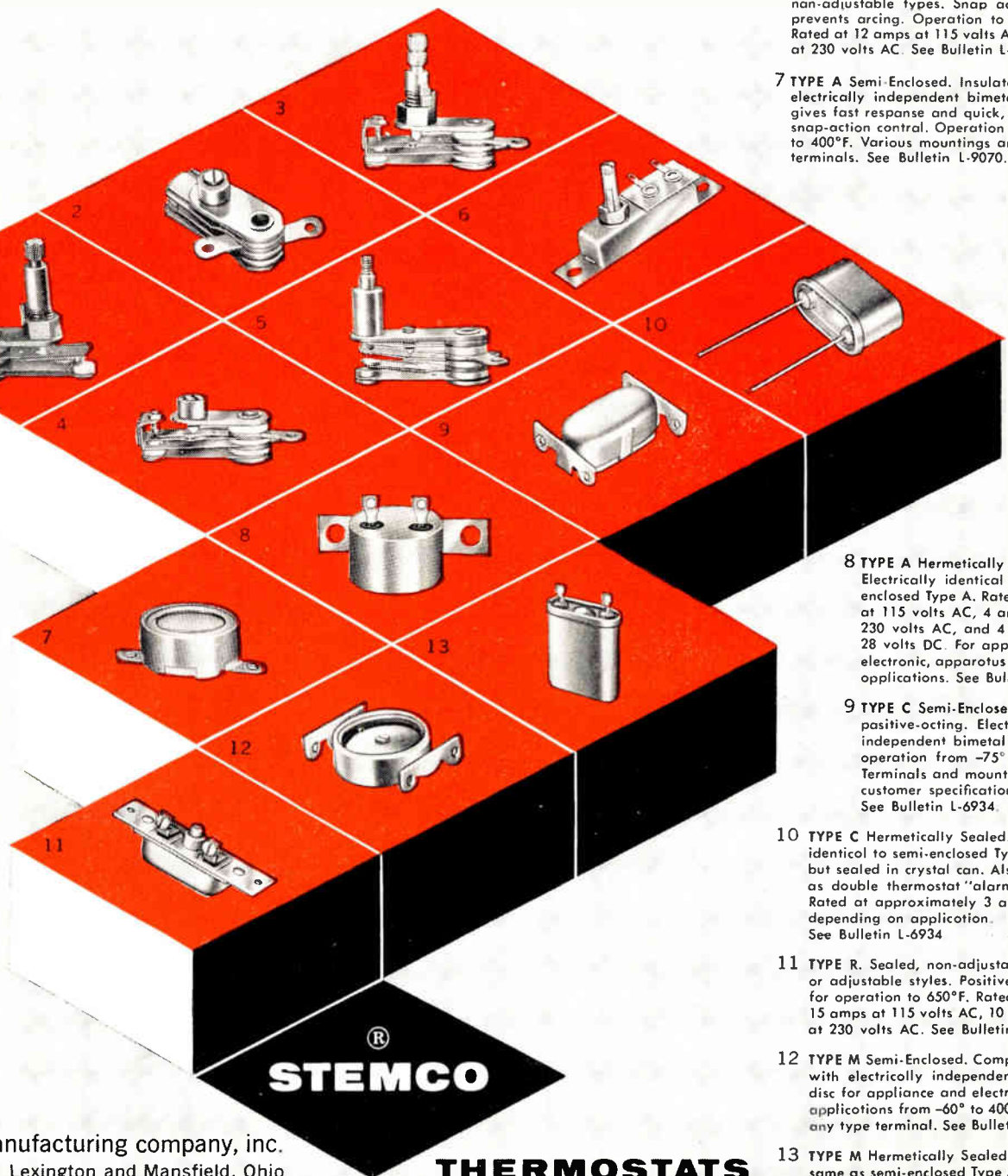

- 8 TYPE A Hermetically Sealed. Electrically identical to semi-enclosed Type A. Rated at 8 amps at 115 volts AC, 4 amps at 230 volts AC, and 4 amps at 28 volts DC. For appliance, electronic, apparatus applications. See Bulletin L-9070.
- 9 TYPE C Semi-Enclosed. Small, positive-acting. Electrically independent bimetal strip for operation from -75° to 300°F. Terminals and mountings to customer specifications. See Bulletin L-6934.

- 10 TYPE C Hermetically Sealed. Electrically identical to semi-enclosed Type C but sealed in crystal can. Also supplied as double thermostat "alarm" type. Rated at approximately 3 amps, depending on application. See Bulletin L-6934.
- 11 TYPE R. Sealed, non-adjustable (shown) or adjustable styles. Positive acting for operation to 650°F. Rated at 15 amps at 115 volts AC, 10 amps at 230 volts AC. See Bulletin F-2003.
- 12 TYPE M Semi-Enclosed. Compact unit with electrically independent bimetal disc for appliance and electronic applications from -60° to 400°F. Virtually any type terminal. See Bulletin F-2009.
- 13 TYPE M Hermetically Sealed. Electrically same as semi-enclosed Type M. Rating: 8 amps at 115 volts AC, 4 amps at 230 volts AC, 4 amps at 28 volts DC. See Bulletin F-2009.

STEVENS manufacturing company, inc.  
Lexington and Mansfield, Ohio

**STEMCO**  
**THERMOSTATS**



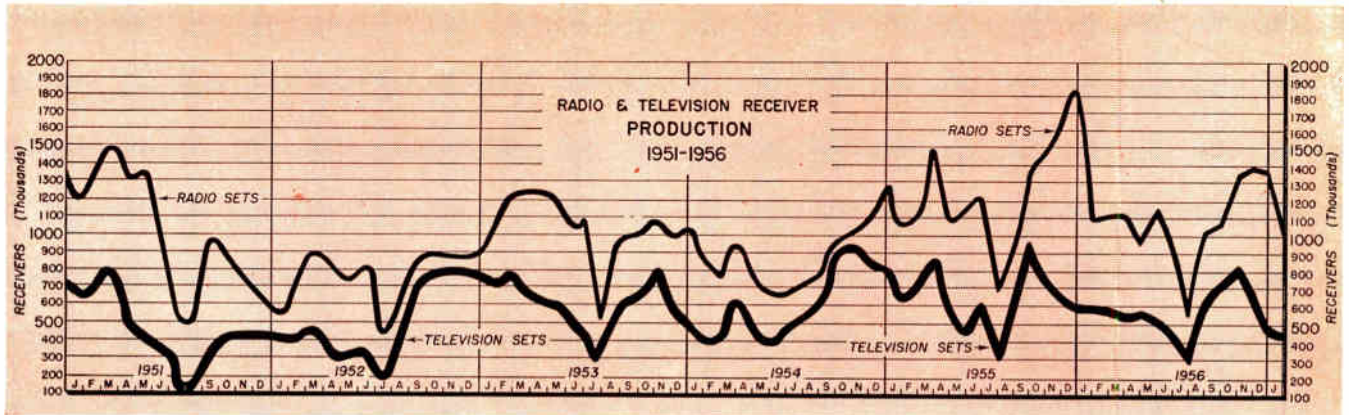

**JOBS CREATED**

Every 100 Industrial Jobs Create These Additional Jobs.

Bus Drivers	0.42	Plumbers	0.13
Dressmakers	0.44	Carpenters	2.6
Printers	0.22	Librarians	0.14
Architects	0.06	Nurses	1.0
Editors & Reporters	0.25	Postmen	0.50
Technical Engineers	0.14	Bakers	0.33
Dept. Store Clerks	2.5	Doctors	0.57
Bank Clerks	0.66	Musicians	0.44
Beauticians, Barbers	1.0	Food Clerks	1.3
Electricians	0.22	Shoe Repairmen	0.16
Florists	0.13	Bookkeepers	2.0
Shoe Clerks	0.20	Farmers	28.5
Lawyers & Judges	0.44	Painters	1.0
Stenos & Typists	2.2	Truck Drivers	4.0
Policemen	0.57	Cooks	0.66
Miners	2.2	Teachers	0.50
Plasterers	0.13	Dentists	0.20
Photographers	0.14	Tailors, Furriers	0.40
Waitresses	1.6	Firemen	0.30
Cleaners & Laundrymen	1.6	Gas Station Attendants	0.40
Highway Workers	0.10	Newsboys	0.09
Real Estate Agents	0.16	Pharmacists	0.25
Mechanics, Machinists	2.2	Telephone Operators	1.0
Entertainers	0.13	Hardware Clerks	0.44

**RADIO AND TV SET PRODUCTION—1956**

	Television	Auto Radio	Total Radio
Jan.	558,347	519,648	1,078,624
Feb.	576,282	437,611	1,093,506
March	680,003	478,272	1,360,113
April	549,632	299,253	992,982
May	467,913	282,611	1,060,165
June	553,025	296,256	1,073,775
July	336,931	198,565	566,697
Aug.	612,927	198,087	990,845
Sept.	894,211	349,790	1,319,189
Oct.	820,781	547,818	1,348,864
Nov.	679,993	609,139	1,381,831
Dec.	626,984	840,359	1,715,209
<b>TOTAL</b>	<b>7,387,029</b>	<b>5,057,409</b>	<b>13,981,800</b>

—RETMA

**MANUFACTURING**

Product	1939	1944	1952	1955
Resistors	19	46	20	110
Capacitors	38	48	60	90
Transformers	42	100	105	110
Tubes	23	40	19	25

—RETMA

**GOVERNMENT ELECTRONIC CONTRACT AWARDS**

This list classifies and gives the value of electronic equipment selected from contracts awarded by government procurement agencies in January, 1957.

Amplifiers	504,220	Kits, Radar Modification	294,156	Rectifiers, Metallic	25,215
Amplifiers, Audio	233,154	Kits, Modification	477,544	Relays	232,245
Analyzers	311,622	Meters	62,052	Resistors	126,369
Antennas	92,242	Microwave Equipment	187,871	Simulators, Target	92,541
Antenna Towers & Supports	1,515,560	Multimeters	160,560	Speakers	141,143
Batteries, Storage	289,050	Oscillographs	79,997	Switches	57,842
Cable Assemblies	668,052	Public Address Sets	49,703	Switching Assemblies	189,260
Computers & Accessories	15,299,725	Radar Course Generators	154,031	Synros	33,249
Connectors	77,400	Radar Equipment	3,937,152	Telemetering Equipment	130,587
Converter Equipment	172,524	Radiac Equipment	1,028,665	Teletype Equipment	2,465,425
Crystal Holders	47,375	Radio Beacon Sets	3,517,808	Television Equipment	43,713
Crystal Units	101,674	Radio Receivers	1,368,723	Test Sets	803,538
Fire Control Equip.	3,092,764	Radio Receiver-Transmitters	8,523,417	Test Sets, Radar	389,203
Handsets	64,701	Radio Transceivers	1,245,940	Transformers	99,780
Headsets	296,111	Radio Transmitters	584,322	Tubes, Electron	2,909,683
Isolators	31,558	Radiosonde Equipment	280,524	Wire & Cable	2,303,806
Kits, Computer Modification	348,130	Recorders	68,205	X-ray Equipment	36,568

Installed World-Wide for  
Greater Wiring Dependability

# CHESTER

*plasticord-plasticote®*

## WIRES & CABLES

PLASTICOTE INSULATION



PLASTICOTE JACKET

STRANDED COPPER CONDUCTOR

Plasticote Multiple Conductor Cable—multiple conductors (No. 16 AWG to No. 26 AWG) bare or tinned, solid or stranded annealed copper are available.

Plasticote Miniature Wire and Cable—single or multiple conductors bare or tinned, solid or stranded copper with thin wall Plasticote insulation.



Plasticote Hook-up Wire—made to conform to the requirements of Specification JAN-C-76 and MIL-W-76A in solid or stranded constructions.



Plasticote Coaxial Cable—(RG/U) to conform to JAN-C-17A and MIL-C-17B requirements are available. Special designs of coaxial cable transmission lines available.



Plasticote Intercom Cable—multiple conductors bare or tinned, solid or stranded annealed copper with tinned copper shield and Plasticote jacket.



See us at the  
I.R.E. Show,  
Booth 4602

**CHESTER  
CABLE CORP.**

60 HILL STREET, CHESTER, NEW YORK

A Subsidiary of Miami Copper Company



# ELECTRONIC INDUSTRIES & Tele-Tech

One of the Publications  
Owned and Published by  
CHILTON COMPANY

Address all mail to  
Chestnut & 56th Sts., Phila. 39, Pa.  
SHerwood 8-2000

BERNARD F. OSBAHR, Editor  
MAURICE CLEMENTS, Publisher  
ORESTES H. CALDWELL  
Editorial Consultant

CREIGHTON M. MARCOTT  
Managing Editor

ARNOLD LOOK  
RICHARD G. STRANIX  
JOHN E. HICKEY, JR.  
Assistant Editors

DR. A. F. MURRAY  
STANLEY GERSTIN  
Contributing Editors  
ROLAND C. DAVIES  
Washington News  
B. V. SPINETTA  
Directory Editor  
ELMER KETTERER  
Art Editor  
ELMER DALTON  
Circulation Manager  
BARBARA CROWERS  
Editorial Secretary

### BUSINESS STAFF

Philadelphia Office—

BLAIR McCLENACHAN  
Sales Manager  
GORDON HERNDON  
Production Manager  
WILLIAM D. McCARNEY  
Sales Promotion Manager

New York Office—100 East 42nd St.  
Phone OXford 7-3400

JOSEPH DRUCKER  
GERALD B. PELISSIER  
MENARD DOSWELL III  
Regional Managers

Chicago Office—360 N. Michigan Ave.  
RAndolph 6-2166

GEORGE FELT  
Regional Manager

Cleveland Office—930 Keith Bldg.  
SUperior 1-2860

SHELBY A. McMILLION  
Regional Manager

Los Angeles Office—

198 S. Alvarado St.  
DUnkirk 7-4337  
B. WESLEY OLSON  
Regional Manager

San Francisco Office—1355 Market St.  
Underhill 1-9737

DON MAY  
Regional Manager

Tulsa—Petroleum Building

420 S. Boulder St.  
LUther 4-1769

HAROLD J. MOTT  
JOHN W. SANGSTON  
Regional Managers

### OFFICERS and DIRECTORS

JOS. S. HILDRETH Board Chairman  
G. C. BUZBY, President

Vice Presidents: P. M. Fahrenfort,  
Harry V. Duffy, Treasurer, William H.  
Vallar; Secretary, John Blair Moffett;  
George T. Hook, Maurice E. Cox,  
Frank P. Tighe, Leonard V. Rowlands,  
Robert E. McKenna, Irving E. Hand,  
Everit B. Terhune, Jr., Russell W. Case,  
Jr., John C. Hildreth, Jr.

**GARLOCK and  
UNITED STATES GASKET**  
*integrate their sales forces*

United States Gasket Company—pioneers and leaders in the fabrication and application of **TEFLON\***, **KEL-F†**, Nylon and other Engineered Plastics—now will be known as *United States Gasket Company, Plastics Division of The Garlock Packing Company.*

The U.S.G. sales organization of plastics specialists has been integrated with the 125 Garlock salesmen at 30 sales offices and warehouses, strategically located in the principal industrial areas of the United States and Canada. The assistance of these men and large stocks of our products are now as near as your telephone.

**Other Advantages to You**

**EVEN GREATER KNOW-HOW . . .** To United States Gasket's unique knowledge of the Engineered Plastics for electrical, chemical, and mechanical services, throughout Industry, Garlock now adds its 70 years of experience and research in solving the sealing problems of Industry with packings, gaskets and closures for every conceivable need.

**INFINITELY GREATER LINE . . .** offers greater selection in suiting each problem—one reliable source for more of your requirements, simplified purchasing.

**GREATER RESOURCES FOR FURTHER RESEARCH AND DEVELOPMENT . . .** assures that U.S.G. will continue to lead the Engineered Plastics Industry. Continue to produce most of the advanced ideas and practices in the application of these plastics to commercial A.E.C. and military requirements.

With these greater facilities, we look forward to serving an even larger proportion of your requirements, helpfully, promptly, and economically.

UNITED STATES GASKET COMPANY, Camden 1, New Jersey



**U. S. DISTRICT OFFICES AND WAREHOUSES:** BALTIMORE 18, Md., 2828 Loch Raven Rd.; BIRMINGHAM 1, Ala., 519 South 19th St.; BUFFALO 2, N. Y., 38 Pearl St.; BOSTON 10, Mass., 80 Broad St.; CHICAGO 6, Ill., 600 West Jackson Blvd.; CINCINNATI 16, Ohio, 8329 Vine St.; CLEVELAND 13, Ohio, 1276 West Third St.; DENVER 2, Colo., 1863 Wazee St.; DETROIT 11, Mich., 2781 East Grand Blvd.; HOUSTON 3, Texas, 2105 McKinney Ave.; LOS ANGELES 21, Calif., 2303 East 8th St.; NEW ORLEANS 25, La., 3525 Lowerline St.; NEW YORK 6, N. Y., 114 Liberty St.; PALMYRA, N. Y., Maple Ave.; PHILADELPHIA 2, Pa., 20 South 15th St.; PITTSBURGH 22, Pa., 933 Penn Ave.; PORTLAND 9, Ore., 1036 N. W. 18th Ave.; SALT LAKE CITY 1, Utah, 322 Dooly Bldg.; SAN FRANCISCO 7, Calif., 750 18th St.; ST. LOUIS 8, Mo., 3635 Forest Park Blvd.; SEATTLE 4, Wash., 814 Lane St.; SPOKANE 4, Wash., West 610 Second Ave.; TULSA 20, Okla., 816 East 6th St.

**CANADIAN OFFICES AND WAREHOUSES:** EDMONTON, Alta., 8407 103rd St.; HAMILTON, Ont., 200 Queen St., North; VANCOUVER 5, B. C., 1925 West Georgia St.; MONTREAL 9, Que., 5215 De La Savare St.; TORONTO 2, Ont., 750 Bay St.; WINNIPEG 3, Man., 1436 Erin St.

\*duPont trademark †Kellogg trademark

**United  
States  
Gasket** *Plastics Division*

OF THE GARLOCK PACKING COMPANY

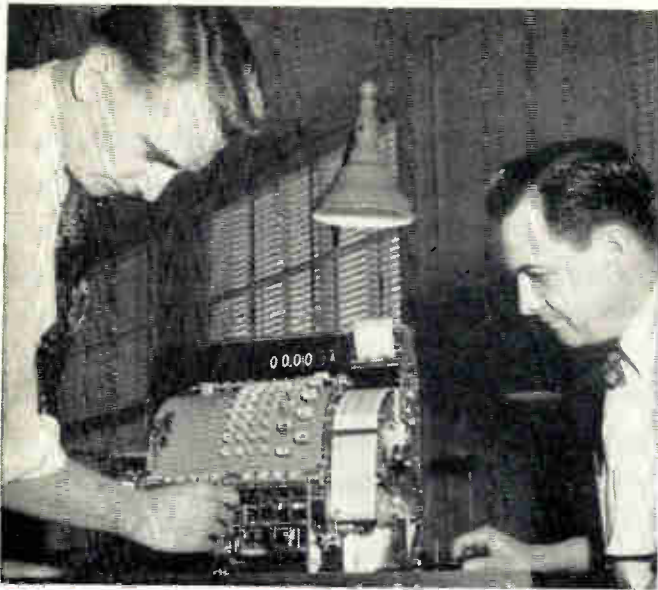

**MECHANICAL ENGINEERS** are using their skills in the design and development of new mechanisms required for business machines and for those mechanical products which are associated with electronic data processing equipment.

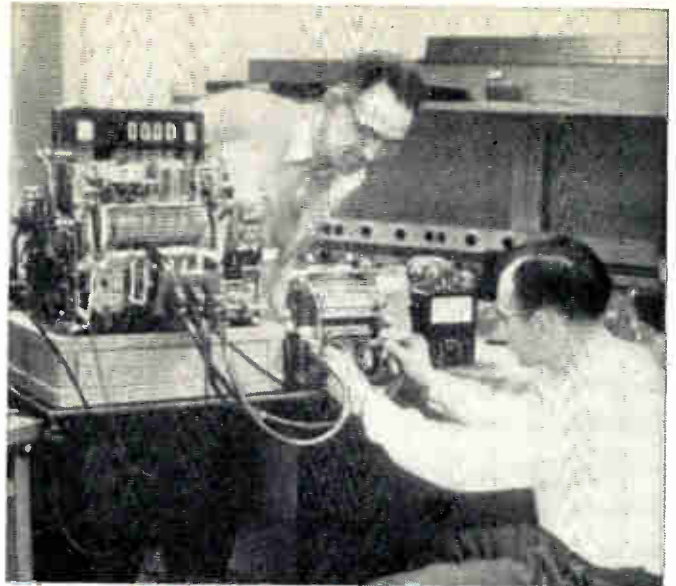

**ELECTRO-MECHANICAL ENGINEERS** are constantly faced with the problems of capturing information from the various input devices and converting this information into a usable form for subsequent use in data-handling equipment.

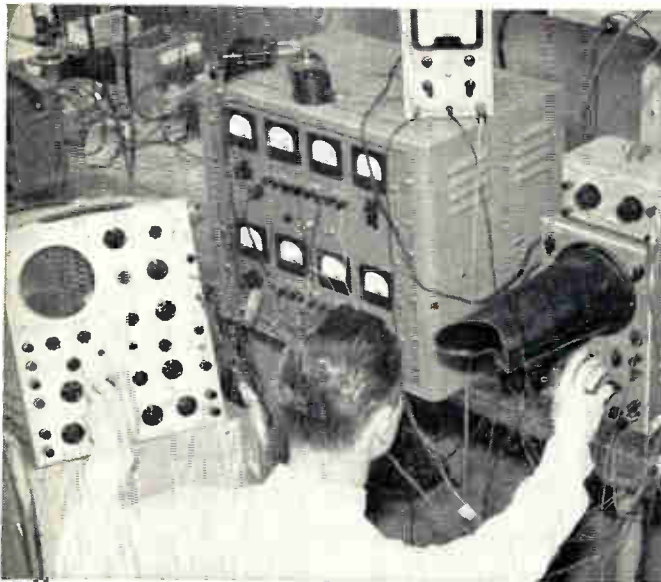

**ELECTRONIC ENGINEERS** enjoy an unparalleled freedom in the development of new types of circuitry and components which are necessary to maintain leadership in the competitive field of record-keeping automation.

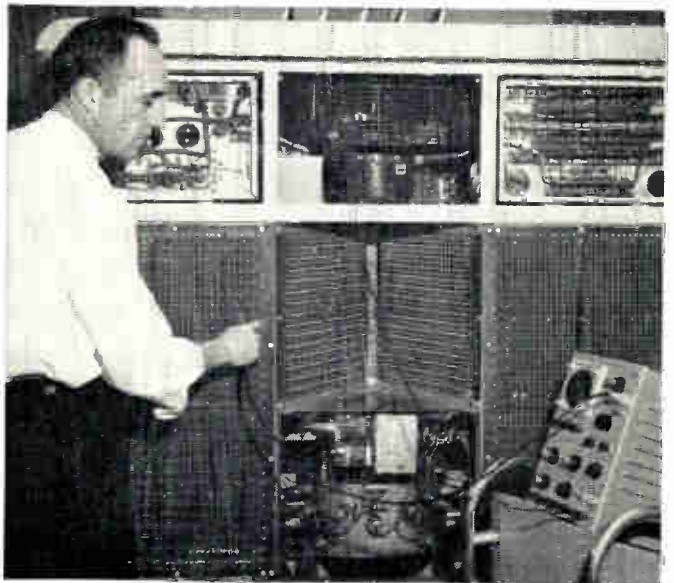

**COMPUTER ENGINEERS** backed by the company's computer research since 1938 are developing an economical, flexible digital computer to meet the requirements of all record-keeping applications.

# **ENGINEERING UNLIMITED**

**AT ONE OF THE WORLD'S MOST SUCCESSFUL CORPORATIONS**

If you are looking for a challenging opportunity with an established company which has tripled its sales in ten years—one that offers excellent starting salaries as well as permanent positions . . .

Act at once! Send resumé of your education and experience to Employment Department, Technical Procurement Sec. L, The National Cash Register Company, Dayton 9, Ohio.

# **NCR**

THE NATIONAL CASH REGISTER COMPANY

### Phosphors and Photoconductors

Four developmental electro-luminescent phosphors and a developmental photoconductive powder are being made available to industry in limited quantities by RCA's Tube Division.

These materials, separately or in various combinations, have great potentialities in a wide variety of applications. Applications include light amplifiers, transducers for direct conversion of non-visible radiation, and other opto-electronic devices such as data-storage units, delay lines, and switches.

The spectral characteristics of the four developmental electro-luminescent phosphors now obtainable from RCA, are peaked, respectively, in red, yellow, green, and blue regions.

### Test Missiles Save Millions

Two ingenious research missiles, especially designed to combine highest performance with low cost, are saving U. S. taxpayers millions of dollars as the nation's missile program moves forward.

Designated the X-7 and the X-17, Lockheed-built vehicles go through the paces of regular operational missiles. However, the X-7 ramjet vehicle is recovered from supersonic flight by parachute to fly again, and its big brother—the X-17—is only a fraction as expensive as the long-range ballistic missiles it simulates. The X-7 saves taxpayers about \$350,000 with each recovery and refight.

The X-17, itself a three-stage ballistic rocket which weighs more than six tons and stands as high as a four-story building, is nonetheless inexpensive as compared to full-scale operational missiles. The rocket is used to provide information on the problems which arise when the warhead of a ballistic missile re-enters the earth's atmosphere at high speed.

More News on Page 12

## ELECTRONIC SHORTS

▶ The first sun-powered radio-phonograph has an estimated value of \$5000. The 48-cell solar battery alone cost \$1000. Sunless days create no problem in providing power because the solar cells can be activated by two flood lights held about 3 ft. from this portable unit developed by Admiral Corp. The phonograph can be operated continuously for 2 hrs. and the radio for approximately 10 hrs. on 6 rechargeable flashlight-size standby cells. The standby cells can be recharged in the case by any light source by merely turning a switch.

▶ The engineer problem may be reduced by the use of low-cost digital computers. Mr. Maurice Horrell, General Manager of the Computer Div. of Bendix Aviation Corp., has pointed out that the general purpose computers are "lengthening the shadow" of the individual engineer and putting the U. S. in a better competitive position against the mass government training of engineers in Russia. The key to success in this field has been the development of computers that are within the price range of comparatively small industries as well as large ones. This would indicate computers in the \$50,000 class.

▶ The guided missile program of the USAF is now employing about 75,000 people. There are 16 prime contractors, 200 major subcontractors, and \$470 million of facilities devoted to testing ICBM and IRBM, according to Maj. Gen. Bernard A. Schriever, Commander of the Western Development Div. of ARDC. He cautioned that there is no such thing as an all-purpose guided missile and that we are still a long way from push-button type of warfare. It may be necessary, for actual test flights of extreme range, to extend the Patrick AFB, Fla., missile range over the Island of St. Helena, where Napoleon was exiled.

▶ Amplifying sound 400 times will afford relief for 60% to 65% of the hard-of-hearing public, about 3.5 million people in the U. S. Sonotone Corp. is now producing a small hearing aid worn entirely in the ear—without cords, batteries, or other external attachments. Employing transistors, and other subminiature components, it is powered by a mercury battery with a life expectancy of more than 50 hrs.

▶ Ceramic tube evaluation is prompting the USAF to bring early delivery pressure on Systems Development, Inc. for its Model 815 Life Test Set. The project is so "hot," original reason for the ceramic tubes, that all possible emphasis is being placed on automatic testing equipment. This is also due to the scarcity of civilian scientific personnel available for the project.

▶ Designated in the P-4 category, a new phosphor blend is a light-body color type particularly suited for use in the manufacture of aluminized TV picture tubes. The P-4 blend, state the developers, Du Pont Co., is the brightest, at a given energy level, which has been made available.

▶ The first Universal Digital Operational Flight Trainer (UDOFT) is being developed under contract for more than a million dollars by Sylvania Electric Products, Inc. The program is sponsored jointly by the USAF and USN. Cockpit controls and instruments are connected with floor-to-ceiling banks of computing and other electronic equipment which simulates flight. Eventually the UDOFT computer will be able to solve the equations for several cockpits simultaneously, allowing a group to receive simultaneous instruction, either in independent flights, in flight formations, or in simulated combat.

▶ Path testing for a radio relay system linking Rimouski and Seven Islands on the lower Quebec River has been completed. A forward scatter system is now being considered for extending communications to the area north and east of Seven Islands, according to the Quebec Telephone Co. engineers.

▶ The 44th electronics plant operating under Puerto Rico's tax-free industrialization program has launched full production at Fajardo. Modular Systems, Inc., is now making electronic modules which only 12 months ago made their U. S. commercial debut.

## FAP and MISHAP New Computer Diet

Mechanical dietitians at Lockheed Aircraft Corporation's Univac Scientific 1103A, just installed at the Missile Systems Division research laboratory, have devised a diet of "FAP" and "MISHAP" which they feed into the machine to make it "think" harder and so solve more complicated problems. The new diet invented by the missile mathematicians results in important programming shortcuts which will speed up this nation's missile development by as much as 50 per cent.

With MISHAP (missiles high speed assembly program) stored in its memory, the operator may feed the computer instructions using familiar alphabetic and decimal characters instead of the binary language usually necessary. In effect, MISHAP allows a computer operator to communicate with the machine in a common and easily understood alphabetic and arithmetic combination.

The Floating Arithmetic Package (FAP) when "memorized" by the computer allows the programmer to use certain computer "skills" not built into the machine; such as floating point arithmetic, standard transcendental sub-routines, or commonly used formulas, input and output on punched cards or magnetic tape, and diagnostic routines—having the computer indicate the flow of a problem within itself and having it indicate contents of selected portions of its internal storage or "memory."

## National Electronics Conference

The annual National Electronics Conference will be held Oct. 7-9, 1957, at the Hotel Sherman in Chicago. Nineteen fifty-seven president of the conference is Armour Research Foundation's Dr. Christopher E. Barthel, Jr. Bell and Howell's Howard H. Brauer is chairman of the board, and executive vice president is Joseph H. Enenbach, Illinois Bell Telephone.

# Coming Events

*A listing of meetings, conferences, shows, etc., occurring during the period March into April, that are of special interest to electronic engineers*

- Mar. 6-8: **Techniques of Supervisory Training (Pt. 1)**, sponsored by the American Management Association; at the Sheraton-Astor Hotel, New York.
- Mar. 11-13: **Establishment and Appraisal of the Management Development Program (Pt. 2)**, sponsored by the American Management Association; at the Sheraton-Astor Hotel, New York.
- Mar. 11-15: **The 1957 Nuclear Congress** includes: **2nd Nuclear Engineering & Science Congress**, sponsored by Engineers Joint Council; **5th Atomic Energy in Industry Conference**, sponsored by NICB; **International Atomic Exposition**, sponsored by AICE, AIMMPE, ASME and AIEE; **5th Hot Laboratories & Equipment Conference**, sponsored by the Hot Labs. Committee; all events in Convention Hall, Philadelphia.
- Mar. 18-21: **Annual National Conference** (concurrent with **Pacific Coast Plastics Exposition**), sponsored by The Society of the Plastics Industry; at the Biltmore Hotel, Los Angeles.
- Mar. 18-21: **IRE National Convention**, sponsored by all Professional Groups of IRE; at the Waldorf-Astoria and Coliseum, New York.
- Mar. 18-21: **Military Automation Exposition**; at the Trade Show Bldg., 500 8th Ave., New York.
- Mar. 21-23: **National Symposium on Telemetry, IRE Telemetry & Remote Control Grp.**; at Philadelphia.
- Mar. 25-27: **25th Annual Meeting**, sponsored by ASTE; at Shamrock-Hilton Hotel, Houston, Tex.
- Mar. 27-28: **Engineering Management Conf.**, sponsored by AIEE and ASME; at Penn-Sheridan Hotel, Pittsburgh, Pa.
- Mar. 27-29: **19th Annual American Power Conference**, sponsored by Illinois Institute of Tech. at Hotel Sherman, Chicago.
- Mar. 29-April 2: **Annual Show of Manufacturers of Radio-Electrical Components**; at "Porte des Expositions — Porte de Versailles," Paris.
- Apr. 7-11: **35th Annual Convention**, sponsored by NARTB; at the Conrad Hilton Hotel, Chicago.
- Apr. 8-10: **Techniques of Supervisory Training (Pt. 2)**, sponsored by the American Management Association; at the Sheraton-Astor Hotel, New York.
- Apr. 8-12: **Annual Welding Show**, sponsored by American Welding Society and AIEE; at Hotel Sheraton and Convention Hall, Philadelphia.
- Apr. 8-11: **National Electrical Industries Show**, sponsored by Eastern Electrical Wholesalers Assn., at 71st Reg. Armory, New York.
- Apr. 9-10: **Annual Industrial Electronic Educational Conf.**, sponsored by IRE Industrial Electronics Grp. and Armour Found.; at Ill. Inst. of Tech., Chicago.
- April 9-11: **14th Annual British Radio Component Show** (incl. TV, electronic and telecommunication equipment); **Radio & Electronic Component Mfrs. Federation**, 21 Tothill St., London S. W. 1; in London.
- Apr. 10: **Annual Meeting & Dinner**, sponsored by the Radio Pioneers; at Conrad Hilton Hotel, Chicago.
- April 11-13: **9th Southwestern Regional Conf. & Electronics Show**, sponsored by Houston Section, IRE; at Shamrock Hotel, Houston.
- April 11-13: **Nat'l. Simulation Council**, sponsored by IRE-PGEC, Houston Section, (as part of S. W. Reg. Conf.); at Shamrock Hotel, Houston.
- April 14-27: **U. S. World Trade Fair** (incl. electronic equipment and scientific instruments); at The Coliseum, New York.
- April 15-16: **Meeting of the Radio Technical Commission for Marine Service**; at the Shoreham Hotel, Washington, D. C.
- April 15-17: **National Symposium on Telemetry**, sponsored by IRE; at the New Sheraton Hotel, Philadelphia.
- April 23-25: **Symp. on Role of Solid State Devices in Electric Circuits**, sponsored by IRE and Dept. of Defense; at Engineering Society Bldg., New York.
- April 23-25: **5th Nat'l. Conf. on Electromagnetic Relays**; at Oklahoma Inst. of Technology, Oklahoma A. & M. College, Stillwater.
- April 24-25: **National Industrial Research Conf.**, sponsored by Armour Research Foundation; at Conrad Hilton Hotel, Chicago.
- April 24-26: **7th Region Tech. Conf. and Trade Show**, sponsored by Region 7, IRE; in San Diego.

### Abbreviations:

AICE: American Inst. of Chemical Engrs.  
 AIEE: American Inst. of Electrical Engrs.  
 AIMMPE: American Inst. of Mining, Metallurgical & Petroleum Engineers  
 ASME: American Soc. of Mechanical Engrs.  
 ASTE: American Society of Tool Engineers  
 IRE: Institute of Radio Engineers  
 NARTB: National Assn. of Radio & TV Broadcasters  
 RETMA: Radio-Electronic-Television Manufacturers Assoc.  
 SAMA: Scientific Apparatus Makers Assoc.  
 WCEMA: West Coast Electronic Manufacturers Assoc.

ANOTHER EXAMPLE OF HOFFMAN LEADERSHIP

## TRACKING THE SUN TO POWER A ROBOT WEATHERMAN



The world's first experimental sun-tracking solar energy converter has been developed by Hoffman to "follow" the sun across the sky for maximum utilization of the sun's power. In a robot weather station, a solar energy unit could supply power for the automatic and continuous transmission of vital data to a distant Weather Central for analysis; would never require attention, except for periodic inspection.

As a result of this new breakthrough in solar energy achieved by Hoffman with vastly improved 120C Rectangular Solar Cells, the sun's energy can be harnessed to power not only robot weather stations, but also transistorized radio receivers and transmitters, untended telephone relay stations and satellite signalling equipment.

The new 120C Rectangular Cell—a product of Hoffman Semiconductor research—has an improved conversion efficiency of 10%, produces 15 milliwatts of power per cell, yet costs less per watt of power generated than any previous solar cell! The long-range potential for Hoffman Solar Cell applications is virtually limitless.

If you would like additional information on scientific and industrial applications of solar energy, the Hoffman Semiconductor engineering staff will welcome your inquiry.

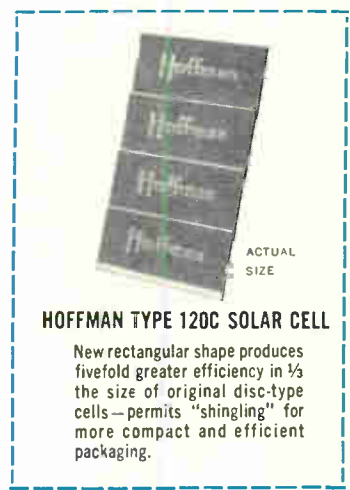

HOFFMAN TYPE 120C SOLAR CELL

New rectangular shape produces fivefold greater efficiency in 1/3 the size of original disc-type cells—permits "shingling" for more compact and efficient packaging.

# Hoffman SEMICONDUCTOR

A DIVISION OF HOFFMAN ELECTRONICS CORP.

930 Pitner Avenue, Evanston, Ill. • 3761 South Hill Street, Los Angeles, Calif.  
Formerly National Semiconductor Products • America's leading manufacturer  
of silicon junction solar cells, power rectifiers, diodes, zener reference diodes.

# *Announcing the Raytheon*

*— a new type of broadband,  
high power.....*



**QK520  
AMPLITRON  
TYPICAL OPERATION (PULSED)**

ANODE VOLTAGE .....	40 kv
ANODE CURRENT .....	35 amps
PEAK POWER OUTPUT .....	800 kw
AVERAGE POWER OUTPUT .....	1200 watts
EFFICIENCY .....	55%
OPERATING BAND ( $\pm 1$ db).....	1225-1350 Mc
PEAK POWER INPUT .....	80 kw
PHASE STABILITY WITH ANODE CURRENT .....	1°/amp

The Amplitron is a new type of tube developed by Raytheon, capable of power amplification at microwave frequencies. Amplification is obtained over a broad range of frequencies with no mechanical or electrical adjustments required. This device is a derivative of the magnetron and retains many of its advantages—such as high operating efficiency, construction simplicity, small size, light weight, low operating voltage. Where efficiency counts in high-power systems, the broadband Amplitron has applications of major significance.

The Amplitron uses crossed electric and magnetic fields, a reentrant beam produced by a magnetron-type cathode, and a non-reentrant broadband circuit matched at either end to external circuits.



# *AMPLITRON*\*

*cross-field microwave amplifier*

*.....high efficiency*

This amplifier has bandwidths of 10% with efficiencies of 50-70% over the entire band. Variations in anode current or voltage have little effect upon the total phase shift. This results in very low phase pushing and excellent reproduction of the input spectrum despite slow pulse rise time and ripple. Because the device has low insertion loss, duplexing may be accomplished at the input rather than the output of the final rf amplifier.

The Amplitron is another example of Raytheon's unequalled leadership in microwave tubes. A limited quantity of preliminary literature will be available shortly; to be sure of a copy, write now.

*See it at the I.R.E.—Raytheon Booths 2611-14*



*Excellence in Electronics*

**RAYTHEON MANUFACTURING COMPANY**  
Microwave and Power Tube Operations, Section PT-00  
Waltham 54, Massachusetts

\*Raytheon Trademark

# Electronic Industries' News Briefs

Capsule summaries of important happenings in affairs of equipment and component manufacturers

## EAST

**AIRCOM, INC.**, has opened new field engineering, sales & purchasing offices, devoted to the Microwave Div., at 1209 E. Grand Street, Elizabeth, N. J.

**KULITE TUNGSTEN CO.** has announced the acquisition of a building which they intend to modify and enlarge at 1040 Hoyt Ave., Ridgefield, N. J.

**SYLVANIA ELECTRIC PRODUCTS, INC.**, will start development and production operations under a \$1,400,000 defense contract for magnetrons at its Electronics Div., Williamsport, Pa.

**PERMACEL TAPE CORP.**, New Brunswick, N. J., has established a special Electrical Products Sales Div. The new division is under the direction of Norman Hickok.

**DAYSTROM NUCLEAR DIV., DAYSTROM, INC.**, announced that it has become the first company to file an application for a construction permit and license to build and operate the new AEC Research Reactor design known as the Argonaut.

**KAISER ALUMINUM & CHEMICAL CORP.** has announced purchase of the wire and cable business of the United States Rubber Co. The purchase, for an undisclosed amount in cash, includes U. S. Rubber's insulated wire and cable plant and inventories at Bristol, R. I.

**AIR REDUCTION SALES CO.** announced the company's acquisition of the assets and business of Jackson Products, Inc., of Detroit.

**BOSTON DIV., MINNEAPOLIS-HONEYWELL REGULATOR CO.**, newly formed, is composed of two sections . . . Semiconductor Products Section (formerly Transistor Div.) and Instruments Section (formerly Doelcam Div.).

**ELECTRONICS DEPT., HAMILTON STANDARD**, div. of United Aircraft Corp., is now in operation at their Broad-Brook plant following transfer of personnel, material and supporting operations.

**SPERRY ELECTRONIC TUBE DIV.**, Gainesville, Fla., plans to double production. The additional facility, to be completed by the summer of 1957, will produce multi-million watt klystrons for high-power missile guidance systems.

**FLIGHT RESEARCH, INC.**, Richmond, Va., manufacturers of photographic data recording instrumentation and business aircraft controls, has established a division for the manufacture of single crystal silicon.

**STEAM TURBINE DIV., WESTINGHOUSE ELECTRIC CORP.**, Lester, Pa., has a new "electronic assistant." It is an IBM 650 magnetic drum data processing machine. A typical problem for the machine is to determine the operating efficiency of a turbine while it is still in the planning stage.

**WESTERN ELECTRIC CO.** has constructed a new manufacturing plant in North Andover, Mass. The location will serve as headquarters for Haverhill-Lawrence and North Andover operations which are to be known collectively as the Merrimack Valley Works.

**OLDBURY DIV., HOOKER ELECTRO-CHEMICAL CO.**, Niagara Falls, N. Y., is now expanding its plant near Columbus, Miss., to produce additional sodium-chlorate. The enlarged plant will be completed early in 1958.

**HORIZONS, INC.**, Cleveland research organization, has announced receipt of a contract from the U. S. Naval Training Device Center, Office of Naval Research, for the development of a photo-sensitive thermoplastic resin.

**RADIO CORP. OF AMERICA** will furnish TV broadcast and closed-circuit systems for University of Georgia's new adult education center, which is now in final construction stages on the Athens campus.

**INSTITUTE OF BUSINESS ARTICLES**, 150-45 Village Rd., Jamaica 32, N. Y., announces the formation of a new department specializing in communications and radar fields. The Institute prepares details of manufacturing facilities and cost data for publication.

## MID-WEST

**P. R. MALLORY & CO., INC., DISTRIBUTOR DIV.**, now has new offices and facilities at 1302 East Washington Street, Indianapolis, Ind. J. Earle Templeton is Division Manager.

**GENERAL TELEPHONE LABORATORIES, INC.**, has been formed by General Telephone Corp., Chicago. The newly created organization has acquired the research and development personnel facilities of Automatic Electric Co., principal manufacturing unit of the General Telephone System.

**THE OHMITE MFG. CO.** of Skokie, Ill., inaugurated a new profit-sharing retirement plan this year. This move is another major step in an expanding employee relations program designed to further the already close and cordial relationship with more than 800 Ohmite employees.

**GENERAL PRECISION LABORATORY**, Pleasantville, N. Y., has delivered 33 newly developed large-screen projection television systems to the Upjohn Co., pharmaceutical manufacturers of Kalamazoo, Mich. This is a major step forward in the field of post-graduate education for practicing physicians throughout the U. S.

**SIMPSON ELECTRIC CO.** is completing a new plant at Mercer, Wis. The plant, completely self-contained, aids in decentralizing the company's manufacturing facilities.

**GENERAL ELECTRIC'S METALLURGICAL PRODUCTS DEPT'S** Edmore, Mich., plant becomes the Magnetic Materials Section of the department. General manager of the newly formed section is E. E. George.

**STANDARD CRYSTAL CO.**, Kansas City, Mo., manufacturer of frequency control units, has transferred the control to a local group headed by Eugene M. Strauss. New company officers are: Kenneth B. Thompson, President; Ernest O. Ruff, Vice-President; Alan K. Benjamin, Secretary; and, Eugene M. Strauss, Treasurer.

## WEST

**KINTEL** is the new trade name for Kay Lab. Retained in the new trade name is the "K" of Kay Lab, with "IN" a contraction of instruments, and "TEL" a contraction of television.

**LINK AVIATION, INC.**, Binghamton, N. Y., plans to open a research facility at 530 University Ave., Palo Alto, Calif. This operation will be under the general supervision of Earl D. Hilburn.

**TUR-BO JET PRODUCTS CO., INC.**, 424 S. San Gabriel Blvd., San Gabriel, Calif., specialists in engineering more power into tiny coils, has doubled production facilities. This enabled the company to expand from regional to a national service for manufacturers of relays, gyros, and solenoids.

**LOCKHEED MISSILE SYSTEMS** will carry out testing and research on new advanced missile systems and components at a 4,000-acre Santa Cruz mountain site.

**RESEARCH INSTRUMENT CO.**, Portland, Ore., has been organized by Franklin M. Brown. This company will produce precision electronic laboratory and production instruments.

**KAYNAR MFG. CO., INC.**, announced the construction of an 80,000 sq. ft. all-concrete building at 7801 Telegraph Road, Rivera, Calif. The combined land, building, and equipment represents an investment in excess of \$2,000,000.

**ALTEC LANSING CORP.**, Anaheim, Calif., has started an expanded program in the fields of high intensity sound. This will provide an accelerated program for the aircraft and electronic industry.

**SCIENTIFIC INSTRUMENTS DIV., BECKMAN INSTRUMENTS, INC.**, has announced the new 20,000 sq. ft. plant in Anaheim, Calif. Need for the new facility is based on continuing rapid expansion of the division.

**INSTRUMENT DEVELOPMENT & MFG. CORP.** has opened a new plant at 315 West Maple Street, Monrovia, Calif. The first 6,000 sq. ft. unit of the new plant has been engineered and equipped for speed, precision, and efficiency in producing complex assemblies and sub-assemblies for the electronics industry.

**CALIFORNIA TECHNICAL INDUSTRIES** is the new name for the former Color Television, Inc. The familiar "CTI" registered trademark remains unchanged. The name change was made to describe more closely the nature of the company's business.

**ELECTRONIC CONTROLS SYSTEMS, INC.**, an affiliate of the Stromberg-Carlson of the General Dynamics Corp., has leased a fourth building in the West Los Angeles area. The newly leased building is at 2205 Stoner Ave.

## FOREIGN

**RADIATION INSTRUMENT DEVELOPMENT LABORATORY**, Chicago, Ill., has entered into a manufacturing agreement with the Intertechnique Company of Versailles, France. This was done in order to promote the exchange of technical development and to provide better service to European customers.

**A. B. DU MONT LABS., INC.**, received an order for a complete Multiscanner system for the broadcasting of 16 mm films and slides from Television de Quebec (Canada), Limitee of Quebec, P.Q., Canada. The equipment will be utilized by station CKMI-TV, the English language affiliate of the existing French language station, CFCM-TV.

**F. J. STOKES CORP.**, Philadelphia, announced that one of the largest vacuum impregnating systems ever built will shortly be placed in service by the Government of Pakistan Railways at Karachi. The equipment will be used to impregnate with insulating varnish, the armatures and field coils of diesel-electric locomotive traction motors.

# Electron Tube News

## -from Sylvania

- contributing to equipment performance  
everywhere in electronics

**Sylvania adds its newest reliability factor  
to premium subminiature tubes**

- "White noise" vibration test is worthy measure of the superior construction of the button-header subminiature.

A full line of Sylvania "gold brand" subminiature tubes is now being "white noise" tested on a pro-

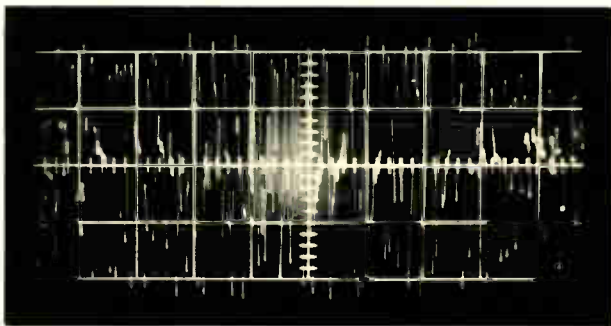

This unretouched oscillogram demonstrates the wide spectrum of frequencies inherent in the "white noise" vibration test, which is applied to the tube.

duction basis. Thus a new measure of reliability has been added to the tubes already acknowledged as the world's most reliable.

The "white noise" test presents a full range of frequencies over a broad spectrum at peak g-levels of 15 and provides a closer approximation of vibrational environment encountered in guided missile and other vehicular applications.

The ability of Sylvania subminiatures to submit to this more exacting test is dramatic proof of the superior construction of the button-header design. Stronger leads, vertical support in three rather than a single vertical plane, wider spacings - these and other features of the button-header have added considerable impetus to the accepted use of Sylvania "Gold Brand" subminiatures in guided missiles.



Here's a simple comparison of the advantage of Sylvania's "donut ridge" button-header over ordinary types. When the leads are bent sharply as shown, ordinary headers will flake, chip, or crack; but leads bend cleanly around the "donut ridge" in Sylvania "Gold Brand" subminiatures.

- in  
military  
equipment



For the first time by any manufacturer, subminiature tubes are being given the "white noise" vibration test in addition to the currently used static-vibration tests at 40 cps and 15 g. Types listed are now being tested for "white noise."

- Type 5636..... UHF pentode
- Type 5639..... Video pentode
- Type 5718..... UHF medium Mu triode
- Type 5719..... High Mu triode
- Type 5840..... UHF sharp cutoff pentode
- Type 5899.. UHF semi-remote cutoff pentode
- Type 5902..... Audio Beam Power Pentode
- Type 5977..... Medium Mu Triode
- Type 6021..... Medium Mu Double Triode
- Type 6111..... Medium Mu Double Triode
- Type 6112..... High Mu Double Triode
- Type 6205..... UHF sharp cutoff pentode
- Type 6206.. UHF semi-remote cutoff pentode
- Type 6788..... RF Pentode



### **New Subminiature RF Pentode is Tailor-made for Guided Missiles**

The new Sylvania Type 6788 features high gain in the audio region and has exceptionally low vibrational noise, making it ideally suited for guided-missile application.

It is the first subminiature tube released from Sylvania's guided-missile development program and is the only tube specifically designed for use as an amplifier where conditions of severe mechanical vibration are encountered.

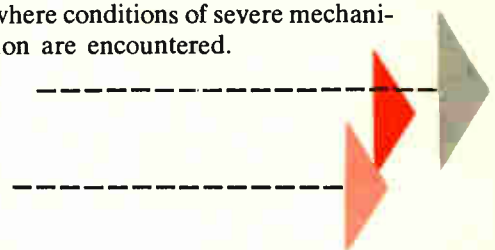



# everywhere in electronics

## New 110-Degree Picture Tube offers more picture per cubic inch of TV set

— other new tubes offered include 90° short-neck, non-ion trap types and a dramatic new development scheduled for early production.

New, shorter, lightweight, 110° deflection picture tubes will save as much as 20% in picture tube weight and will make it possible to design more compact, lighter TV consoles, as well as more portable TV sets.

Light weight and structural strength of the picture tube have been achieved in a new face-plate design. New trim set styling made possible by shorter lengths should provide new stimulus for the sale of black-and-white TV sets.

As a leading picture tube manufacturer, Sylvania is working closely with TV set makers to supply the industry's requirements for both 110° deflection types and 90° short-neck non-ion trap types. New developments will be made available early this year.

Compare a 21" bulb in 90° and the new 110° versions. New 110° offers considerable savings in depth per square inch of picture.

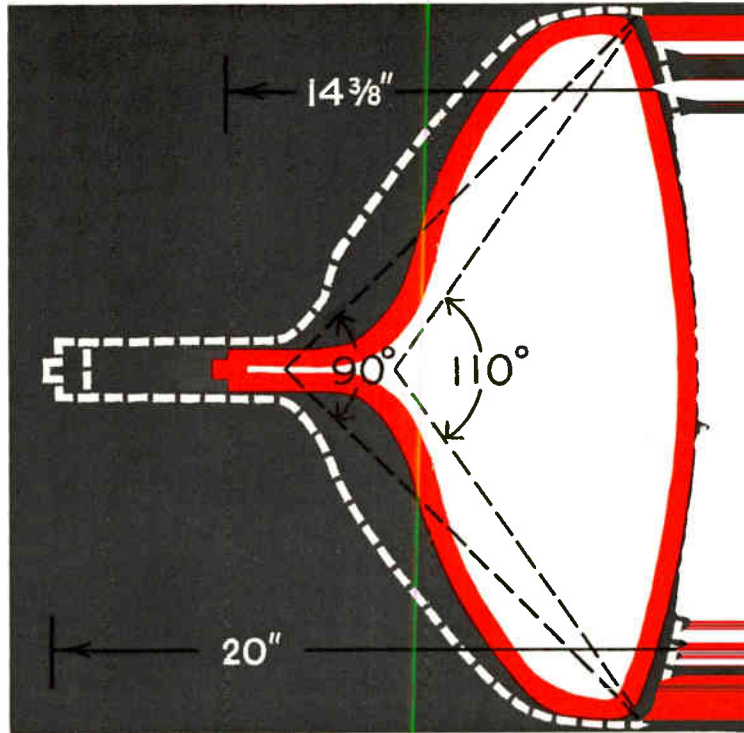

## Sylvania offers new types in a complete line of 12-volt tubes for hybrid auto radio



Type 12CY6 —  
New T5½ IF Pentode

Heater Voltage — 12.6 volts  
Heater Current — 200 ma.  
Transconductance — 3250 umhos  
Plate Resistance — 140K ohms  
Plate Current — 1.6 ma.  
Grid to Plate Capacitance — .18 uuf max.



Type 12CX6 —  
New T5½ RF-IF Pentode

Heater Voltage — 12.6 volts  
Heater Current — 150 ma.  
Transconductance — 3100 umhos  
Plate Resistance — 40K ohms  
Plate Current — 3.0 ma.  
Grid to Plate Capacitance — .05 uuf max.



Type 12J8 —  
New T6½ Transistor Driver

Heater Voltage — 12.6 volts  
Heater Current — 350 ma.  
Transconductance — 5400 umhos  
Plate Resistance — 4000 ohms  
Power Output — 20 mw.  
Total Harmonic Distortion — 5%

Sylvania's line of 12-volt tubes for hybrid auto radio features an RF pentode with high transconductance, an IF pentode with high gain and a transistor driver designed to match the input characteristics of single-ended or push-pull transistor output stages.

These developments reflect the specific design requirements which have been brought about by the hybrid radio design, particularly the need for high performance with fluctuations in voltage-supply conditions.

All auto-radio types are produced under Sylvania's well-known "noise-free" tube program which exerts tighter limits and more rigid controls on all factors influencing microphonism.

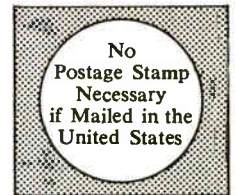
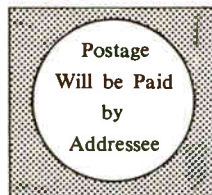

### BUSINESS REPLY CARD

(First Class Permit No. 46687, New York 19, N.Y.)

**SYLVANIA ELECTRIC PRODUCTS INC.**  
1740 Broadway  
New York 19, N.Y.



-contributing to product performance,  
everywhere in electronics

-in  
**computers**



The Type 6888 is a dual control computer pentode designed for long life and low failure rate. It is especially designed for pulse amplifier use, core driver and coincidence circuits.

It is built to the highest standards of reliability established for commercially available tubes and is dynamically tested for pulse characteristics under pulse test conditions.

The type 6888 is just one of a full line of Sylvania tubes especially designed for computer applications.

**Write for this complete brochure of Sylvania's  
 line of computer products**

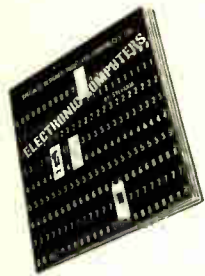

What every computer designer should know about Sylvania components is completely outlined in this 64-page book. Between these two covers is the complete story of Sylvania's stake in the computer field: its philosophy of reliability, its testing procedures, and its ability to develop the tube parameters required for computer applications.

-in test  
**equipment**



**Type 6D4 is specified for noise output**

The type 6D4 has been redesigned to meet the requirements of test-equipment manufacturers and is specified to produce, in its output, a wide range of random noise frequencies.

It's the first commercial tube ever to be so specified and typifies the co-operation between Sylvania and equipment manufacturers to produce tubes for special applications.

-Advanced  
**Engineering  
 Series**

**Series on Electron  
 Tube Life and  
 Reliability is  
 published by Sylvania**

As a service to the industry and in an attempt to explore the factors of design and application of reliable tubes, Sylvania is currently publishing a high-level technical discussion on tube reliability in chapter form.

This series is available to electronic engineering staffs through their chief engineer who may request it directly on company letterhead.



# SYLVANIA

LIGHTING • RADIO • TELEVISION • ELECTRONICS • ATOMIC ENERGY

SYLVANIA ELECTRIC PRODUCTS INC.  
 1740 Broadway, New York 19, N. Y.  
 In Canada: Sylvania Electric (Canada) Ltd.  
 Shell Tower Bldg., Montreal

Please send additional information on the items checked below.

- |  |   |
|--|---|
| <input type="checkbox"/> "white noise" test    | <input type="checkbox"/> premium subminiature tubes   |
| <input type="checkbox"/> type 6788             | <input type="checkbox"/> miniature deflection package |
| <input type="checkbox"/> 110° deflection tubes | <input type="checkbox"/> hybrid auto-radio tubes      |
| <input type="checkbox"/> type 6888             | <input type="checkbox"/> computer book                |
|  | <input type="checkbox"/> 6D4                          |

Name \_\_\_\_\_

Address \_\_\_\_\_

Company \_\_\_\_\_

**Use this handy  
 business reply card  
 to request  
 additional information  
 on these new Sylvania  
 tube developments**



# A DEPENDABLE SUPPLIER FOR 61 YEARS

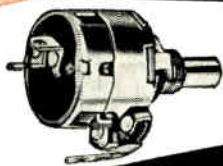
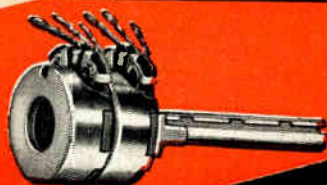
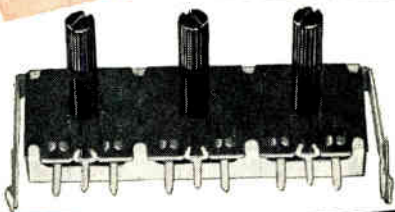

A CTS control can be tailored to your specific requirement. Consult CTS SPECIALISTS on your current variable resistor problems. Ask for 62 page catalog.

**WEST COAST SUBSIDIARY**  
Chicago Telephone of  
California, Inc.  
105 Pasadena Avenue  
South Pasadena, California  
L. A. Phone: CLinton 5-7186  
WX LA 1105

**CANADIAN SUBSIDIARY**  
C. Meredith & Co., Ltd.  
Brimleyville, Ontario  
Phone: 310

**EAST COAST OFFICE**  
130 N. Broadway  
Camden 2, New Jersey  
Phone: Woodlawn 6-1668  
TWX No. Camden NJ 380  
Phila. Phone: Market 7-3129

**SOUTHWESTERN U.S.A.**  
John A. Green Company  
137 Parkhouse  
Dallas 7, Texas  
Phone: Riverside 3266

**SOUTH AMERICA**  
Jose Luis Pontet  
Buenos Aires, Argentina  
Montevideo, Uruguay  
Rio de Janeiro, Brazil  
Sao Paulo, Brazil

**OTHER EXPORT**  
Sylvan Ginsbury  
8 West 40th Street  
New York 18, New York  
Phone: Pennsylvania 6-8239

**Specialized Technical Skills—**  
1500 job-trained, class-trained specialists . . . with a world-wide reputation for delivering variable resistors exactly as specified.

**Tremendous Production Facilities—**  
323,000 sq. ft. plant devoted to variable resistors.

**Your changing Requirements Anticipated—**continuous research develops new materials, designs and methods to meet your new requirements.

**Economical Uniform Assembly—**on a precision mass production basis.

**Dependable Delivery—**exceptionally good delivery cycle.

**Complete Line—**variable resistors for military, color and black and white TV, radio, and other commercial applications.

*Variable resistors shown 2/3 actual size*

## WEST COAST MANUFACTURERS:

Many types of variable resistors now in production at our South Pasadena plant. Your coil, transformer and compression molding business also invited. Prompt delivery. Modern versatile equipment. L. A. phone CLinton 5-7186.

FOUNDED



1896

**CHICAGO TELEPHONE SUPPLY**  
*Corporation*

ELKHART, INDIANA

**The Exclusive Specialists in Precision Mass Production of Variable Resistors**

BURTON BROWNE ADVERTISING

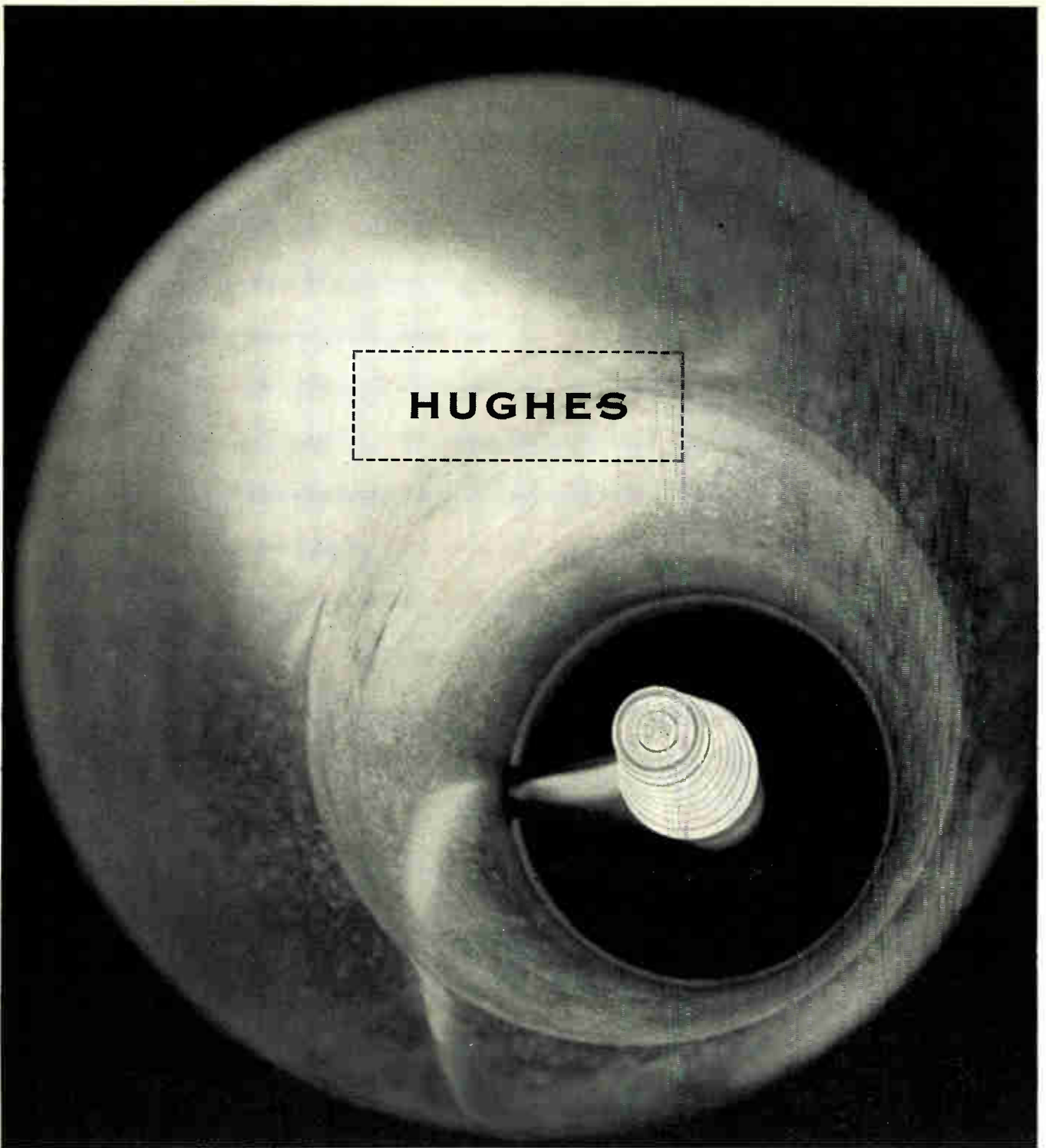

Test tube for studies of microwave propagation through ionized gases.

### *If you're interested in microwaves...*

You'll be interested in the work being done in the Hughes Research Laboratories.

One of the programs being pursued, for example, is a theoretical and experimental investigation of the propagation of microwave energy through ionized gases.

Calculation and measurements of faraday rotation, gyromagnetic resonance, and cut-off conditions at low and high micro-

wave power levels give insight into the formation of the discharges and point the way toward possible new active and passive microwave devices.

By turning new knowledge into new techniques, such programs serve as a bridge between basic research programs of the Hughes Research Laboratories and the development programs of the Company.

The Research Laboratories at Hughes are engaged in basic and applied research and development programs in a wide variety of fields, including antennas, radomes, microwave and storage tubes, masers, ferrite devices, microwave circuitry, instrumentation, and other fields.

*For further information during the I.R.E. Convention contact Mr. L. R. Norwood at EL dorado 5-4107, or write*

*Scientific Staff Relations, Research and Development Laboratories, Hughes Aircraft Co., Culver City, California*





#### SUBMINIATURE FILTERS

- for I.F. amplifiers, printed circuit use
- temperature compensated to .15% from  $-55^{\circ}\text{C}$  to  $+85^{\circ}\text{C}$
- for operations above 1 mc
- dimensions:  $13/16'' \times 2-1/2'' \times 2''$  high



#### ENCAPSULATED TOROIDS

- hermetically sealed
- high Q
- center-mounting permits stacking
- complete range of sizes and types
- dimensions:  $21/32'' \times 3/8''$



#### TOM THUMB TELEMETERING FILTERS

- miniaturized for guided missiles
- high temperature stability
- designed to withstand shock and vibration
- hermetically sealed —wt. 1.5 oz.
- dimensions:  $45/64'' \times 45/64'' \times 2''$  high



#### SUBMINIATURE ADJUSTOROIDS

- precise continuous adjustment of inductance over a 10% range
- no external control current needed
- hermetically sealed
- low cost—wt. .83 oz.
- dimensions:  $45/64'' \times 45/64'' \times 3/4''$  high



## you're all set to roll..

... with a toroid, filter or related network by Burnell.

For Burnell *specializes* in these components; in manufacturing them *and* in delivering them on schedule — at competitive prices.

Today Burnell makes toroids, and the filters of which they are the basic components, small enough to meet a multitude of new purposes . . . in aircraft and guided missiles . . . in receivers, carrier and telemetering systems.

Very likely we already have the answer to your network needs among our extensive files. If not, we can swiftly find that answer for you. Try us and see.

## Burnell & Co., Inc.



first in toroids, filters and related networks

DEPT. T-37, 45 WARBURTON AVENUE, YONKERS 2, N. Y. TELEPHONE: YONkers 5-6800  
PACIFIC DIVISION: . . 720 MISSION STREET, SOUTH PASADENA, CALIFORNIA. . TELETYPE: PASADENA 7578

You are warmly invited to visit our booth #2131, on the second floor of the IRE show.

# here are the specs. on Chemelec Connectors

- **TEFLON\* INSULATED**
- **COLOR-CODED**
- **COMPRESSION MOUNTED**
- **WITHSTANDING RIGID GOVERNMENT TESTS FOR SHOCK...VIBRATION**

\*du Pont's trademark for its tetrafluoroethylene resin.

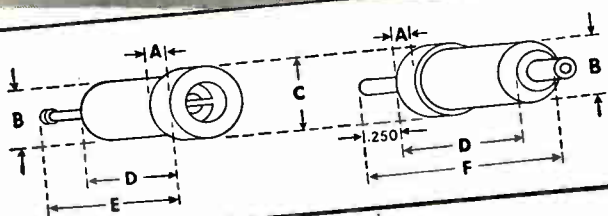

CHEMELEC CONNECTORS PART NO. CN-401	Male Dash Numbers	Mating Female Dash Numbers	Female (Only) Dash Numbers		Pin-Socket Dia. (Inches)
	M-40 M-50 M-64	F-40 F-50 F-64	F-80	F-80-L	
DIMENSIONS (inches)	"A"	.052	.046	.187	.040
	"B"	.199	.185	.185	.050
	"C"	.234	.234	.234	.064
	"D"	.349	.443	.443	.080
	"E"		.510	.640	
	"F"	.691			
TORQUE	Pin from body	4 in. oz.	8 in. oz.	7 in. oz.	7 in. oz.
	Body from 1/16" deck	8 in. oz.	14 in. oz.	14 in. oz.	14 in. oz.
	Body from 3/16" deck	11 in. oz.			
PULL	Pin from body	25 lbs.	25 lbs.	25 lbs.	25 lbs.
	Body from 1/16" deck	15 lbs.	12 lbs.	25 lbs.	25 lbs.
	Body from 3/16" deck	25 lbs.	25 lbs.	25 lbs.	25 lbs.
CAPACITANCE (at 1000 KC)	1/16" deck	.5 MMFD	.5 MMFD	1.5 MMFD	1.5 MMFD
	3/16" deck	.9 MMFD	.9 MMFD	1.5 MMFD	1.5 MMFD
FLASH OVER POINT (Short time—sea level)	4500 VRMS	4500 VRMS	3000 VRMS	5000 VRMS	
COLOR	white, red, green, blue, violet, yellow, orange, brown, grey, black.				
MOUNTING HOLE	.187*	.187*	.173*	.173*	
CONTACTS	Brass or Beryllium Copper				
FINISH	Hot tin dipped or silver plate and gold flash.				
ALSO MADE IN SUB-MINIATURE TYPE.					

\*With 1/64" x 45° chamfer.

SEE OUR EXHIBIT • BOOTH 4036 • I.R.E. SHOW  
FLUOROCARBON PRODUCTS INC., division of  
United States Gasket Co., Camden 1, New Jersey.

Sold through leading electronic parts distributors by Erie Resistor Corp.

*Fluorocarbon Products Inc.*

## Tele-Tips

**THESE ELECTRONIC TIMES:** Chicago hi-fi fan got three days in the county jail for trying to change the record at the wrong time. 'Seems the phono was under the dashboard of his car, and while he fumbled his car crashed into a parked taxi. He admitted, also, to having had five or six beers. Commented the court, "If someone wants to get high with hi-fi, he should get high at home."

**SOLAR SILLINESS.** An over-zealous ad agency turned out an artist's conception of an outboard motor powered by a square foot of solar cells. To which one of our friends was moved to quip, "How sili-con you get!"

**ELECTRONIC FRUIT INSPECTOR** is being used by the government to take the guesswork out of judging fruits and vegetables. Called the rephobiospect, it ferrets out hidden defects like rotten cores and off colors by use of colored beams of light.

**COMPLETE RECORD PLANT** that produces 2,500 12-in. LP's per 40 hr. week yet costs only \$7,500 is being offered by Microfusion Inc., of Ponce, Puerto Rico, a corporation formed by Lawrence Scully, of Scully Machine Co., makers of recording lathes, Emory Cook, of Cook Laboratories Inc. and John O'Sullivan. The process, called "Microfusion," makes records from vinyl plastic powder in one short direct step and is claimed to provide very decided economies over conventional methods, both in equipment and in operating costs. Reject rate is claimed to be under 5%.

**NEW ATOMIC FLASHLIGHT** that will provide light for many years without the aid of batteries or external power sources has been developed by New England Nuclear Corp. Illumination diminishes at a very slow rate; at the end of 12 years the light has lost only half its brightness.

(Continued on page 28)

# THIS IS HELIAX<sup>®</sup>...

*The truly FLEXIBLE*

*Air dielectric cable*

This latest ANDREW cable, introduced just 18 months ago, has received phenomenal industry acceptance. This is easy to understand, when you consider that HELIAX offers electrical performance equal to that of the finest copper cables, yet is far lower in price and much easier to install.

HELIAX has its own complete series of connectors, matching the superior electrical performance of the cable.

These fittings are pressurized and weatherproofed, and attach easily without special tools.

For a maximum of convenience in the field, HELIAX is normally supplied in complete assemblies, with end fittings factory attached. Available in  $\frac{7}{8}$ " and  $1\frac{5}{8}$ " sizes.

Continuous lengths to 3,000 feet.

*Write now for complete engineering data and  
a sample of this remarkable cable.*

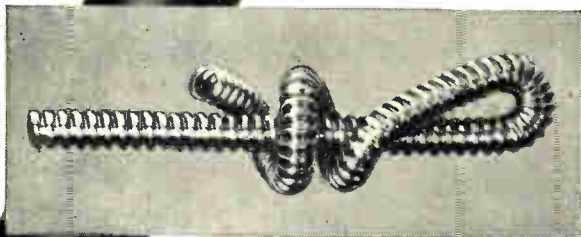

The secret of HELIAX lies in its corrugated outer conductor. As demonstrated at the left, this by itself can be bent on its own diameter without breaking, kinking or going out of round. These qualities give HELIAX its unusual flexibility, strength and ease of handling.

**Andrew**  
CORPORATION

363 EAST 75th STREET • CHICAGO 19



Offices: NEW YORK • BOSTON • LOS ANGELES • TORONTO  
ANTENNAS • ANTENNA SYSTEMS • TRANSMISSION LINES

# Industry's Highest Power Transistors

Combine stability with long life

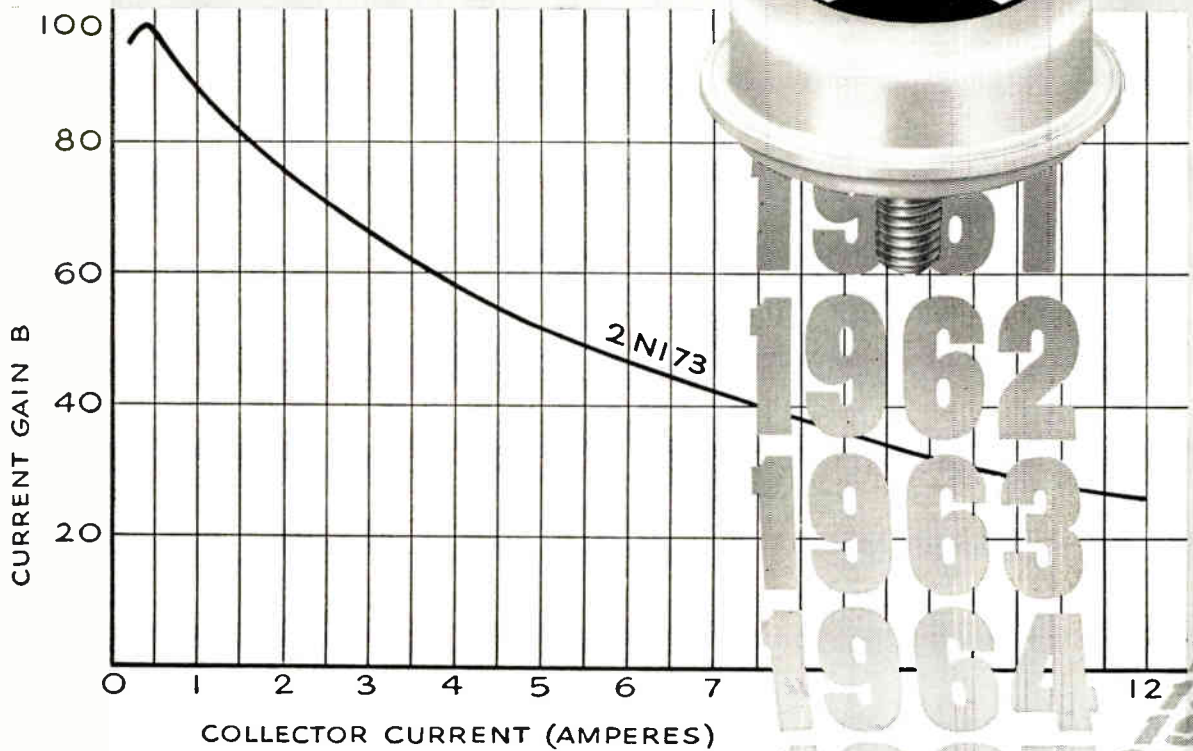

Delco Radio's 2N173 and 2N174 alloy junction germanium PNP transistors have unusual stability and reliability. These superior characteristics are retained by hermetic seal and proper internal atmosphere.

*In addition*, normalizing processes contribute to the high output power, high gain and low distortion characteristics that were designed into them. Delco Radio High Power transistors, ideal for your audio as well as general power applications, are produced by the thousands every day. Write for information and engineering data.

## TYPICAL CHARACTERISTICS

	2N173	2N174	2N277
Properties (25°C)	12 Volts	28 Volts	12 Volts
Maximum current	12	12	12 amps
Maximum collector voltage	60	80	40 volts
Saturation voltage (12 amp.)	0.7	0.7	0.7 volts
Power gain (Class A, 10 watts)	38	38	38 db
Alpha cutoff frequency	0.4	0.4	0.4 mc
Power dissipation	55	55	55 watts
Thermal gradient from junction to mounting base	1.2°	1.2°	1.2° C/watt
Distortion (Class A, 10 watts)	5%	5%	5%

# DELCO RADIO

DIVISION OF GENERAL MOTORS  
KOKOMO, INDIANA

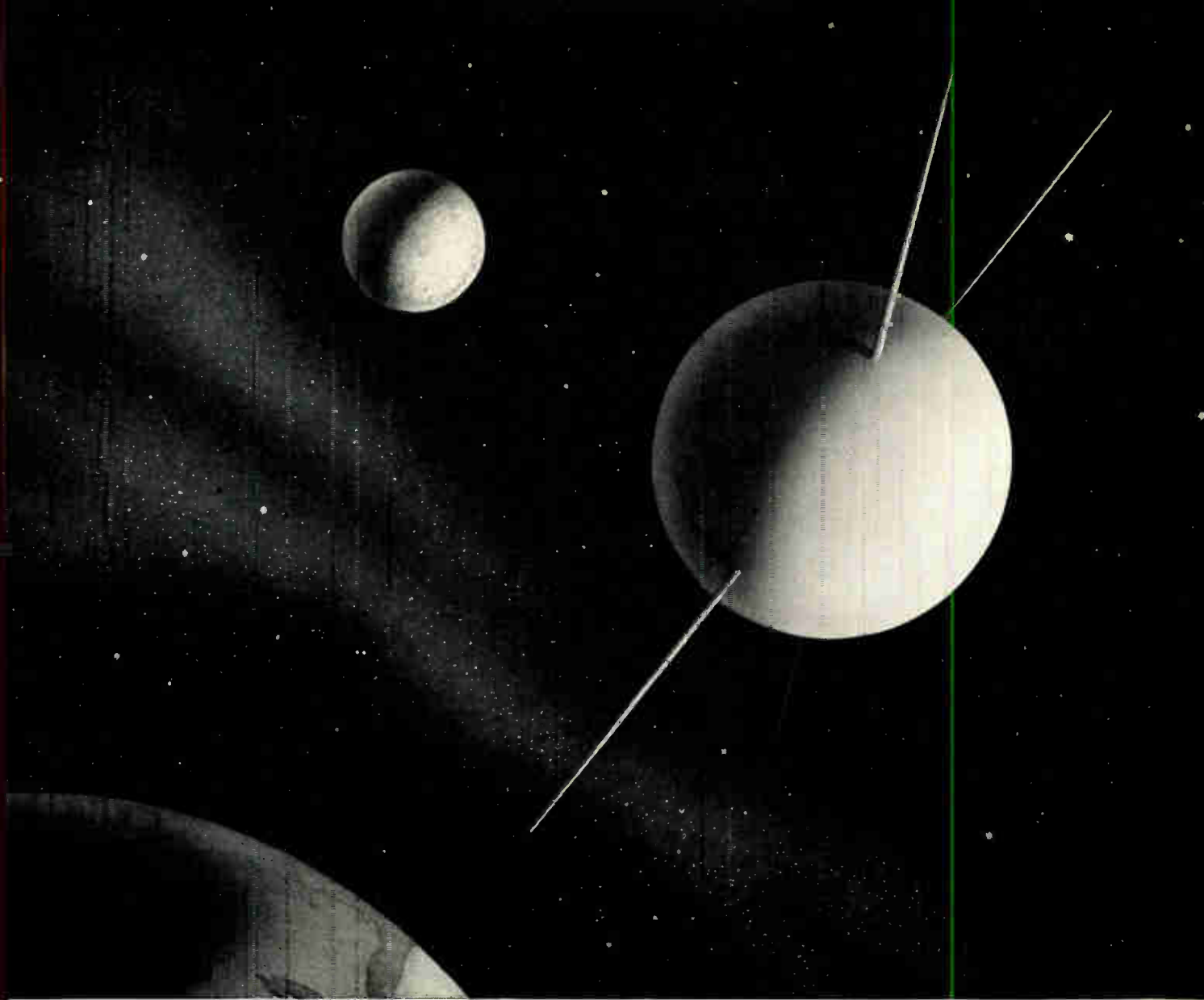

## recording the "man-made moon" on extra-precision audiotape

**E**ARLY in 1958 there will be a "new moon" in the sky — a 22-inch sphere circling the earth at a speed of 18,000 mph. Unlike our real moon, this one will be able to "talk" to Earth. And engineers from Army Ordnance Ballistic Research Laboratories at Aberdeen Proving Ground, Maryland will study these messages to learn new facts about our solar system.

This "moon-talk" — radio signals emanating from precision instruments inside the satellite — is so vital that it will be tape recorded for later analysis, interpretation and preservation.

The highest standards of reproduction must be met. There can be no distortion, voids, or other imperfections.

The tape chosen was extra-precision Type EP Audiotape.

The highest professional standards of quality and uniformity extend throughout the *entire Audiotape line*,

making it the best selection for *any* recording application.

Whether you are an engineer recording highly technical information or a neophyte placing his first reel on a tape recorder, Audiotape will speak for itself. It is now available in *five different types* to meet every recording need and every tape budget. \* trademark

*For complete information on the earth satellite recording project write us for a free copy of the December issue of Audio Record.*

### **AUDIO DEVICES, Inc.**

444 Madison Avenue, New York 22, N.Y.

Offices in Hollywood — Chicago

Export Dept., 13 E. 40th St., New York, N.Y.

Let **ERIE** DO IT

FOR YOU WITH



**PAC**

FROM OUR  
ASSEMBLY  
LINE TO  
YOURS



**Pre-  
Assembled  
Components...**

a new concept in  
**UNITIZED packaging**

PAC reduces costs! PAC (Pre-Assembled Components) simplifies complex automation assembly lines by eliminating many of the insertion heads required for individual components. PAC groups capacitors and resistors into a unitized modular package for quick installation in a printed circuit board.

PAC (Pre-Assembled Components) not only reduces the number of insertions and eliminates insertion equipment; it also means fewer items to purchase, smaller chassis area, fewer chassis holes, and reduced inspection. ERIE has complete facilities for designing PAC into your circuits, and for manufacturing these modules efficiently on high speed equipment.

Manufacturers are saving money and producing more compact and attractive radios, TVs and other electronic products through the use of custom built PACs. Write for Engineering Bulletin 450-1.

Experimental PAC Design Kits are offered for sale in three models, with standard 5-10-20% values and tolerances, enabling engineers to make up their own breadboard designs. The PAC Design Kit is your key to cost savings. Write for full description and prices.

**ERIE** ELECTRONICS DIVISION  
ERIE RESISTOR CORPORATION  
Main Offices and Factories: ERIE, PA.  
Manufacturing Subsidiaries  
HOLLY SPRINGS, MISSISSIPPI • LONDON, ENGLAND • TRENTON, ONTARIO

## Tele-Tips

(Continued from page 24)

**COMPUTERS** are writing some interesting success stories, but few that equal this one from England. Lyons Tea Co., operators of a large chain of restaurants and bakeries, decided back in 1950 that they needed a computer to handle their payroll and miscellaneous calculations. No computer manufacturers were available so the firm went ahead and built their own. It was so successful that other firms asked if Lyons would build one for them, too. Now Lyons has set up a separate subsidiary, already employing 70 persons, to build computers for other firms.

**AUSTRALIAN ENGINEERS** designing a tape recorder got the high frequency boost they were after by making the recording head resonant at the highest recorded frequency—8,000 cps.

**GERMAN TV SURVEY** of 18,000 TV set owners revealed that 26% did not own bathtubs. Nearly all explained, "We can get along without a tub—but not without TV."

**THE ELECTRONIC AGE** has caught up with our rodent friends. A new "Electronic Cat" using electric current, electrocutes up to five mice without resetting. The device consists of a plastic dome-shaped cage with a floor, both coated with a zinc film that conducts electricity. When the cord is plugged in, the interior of the cage is connected to one current pole, the surface to another. The mouse crawls into the cage through a hole on top. Standing on the floor, he soon touches the interior of the cage with tail or nose, completing the circuit and electrocuting himself.

**PORTABLE TV** has become the big weapon in breaking down sales resistance. One midwest manufacturer reports that 60% of the output of his assembly lines are the lightweight models.

# VERSATILITY



## TDI MINIATURE TELEMETRIC RECEIVING SYSTEMS

Miniature and mobile, here's a telemetric receiving system designed for a host of military and civilian applications . . . airborne, ground or marine!

For missile checkout, flight tracking experimental aircraft and missiles, the TDI systems are highly effective, even under the most severe field service conditions. They operate ideally with tape recording, oscillographic, photographic and similar types of recording equipment . . . and this rugged equipment can be installed in jeeps, autos and trailers.

Design-wise, these systems achieve substantial reductions in weight, size and power consumption—yet a high degree of accuracy, exceptional stability and simplicity of operation are maintained.

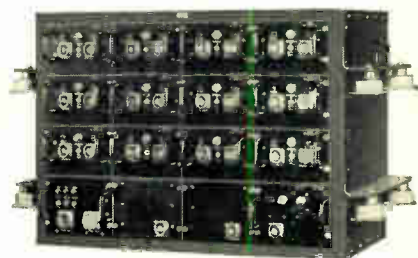

**TDI 12-Channel Receiver.** Modular construction permits wide flexibility of arrangement and actual form factor of receiving equipment. Packages or combinations in any number from one to eighteen units can be arranged in various mounting styles.

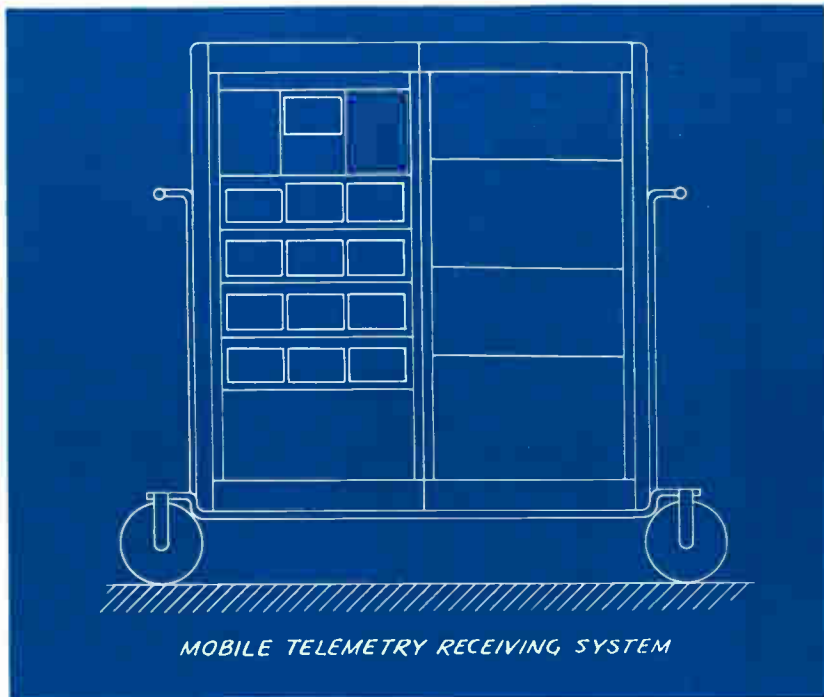

MOBILE TELEMETRY RECEIVING SYSTEM



**TDI Type 2701A 4-Channel Receiver.** Use as flexibly as 12-channel unit—split up in combinations to suit your particular receiving requirements. Ideal for flight line checkout.

◀ Telemetering on wheels! New portable test cart enables users to perform wide variety of telemetering functions in previously inaccessible locations, with greater efficiency and accuracy than ever before.

*Technical bulletins on miniature receiving systems and other TDI products available on request.*

TDI's newest office is now located at 305 Washington Avenue, S.E., Albuquerque, New Mexico

- TELEMETERING
- MISSILE GUIDANCE
- GROUND ELECTRONICS SYSTEMS
- AIRBORNE ELECTRONICS SYSTEMS

## TELE-DYNAMICS INC.

*A Raymond Rosen Corporation*

62ND AND WALNUT STREETS, PHILADELPHIA 4, PENNSYLVANIA

Western Regional Office: 18016 Ventura Blvd., Sherman Oaks, Los Angeles, California

Formerly, Raymond Rosen Engineering Products, Inc.

BEGIN YOUR  
RADIO  
ENGINEERING  
YEAR

## WITH MORE THAN 800 NEW IDEAS!

*No wonder engineers say the radio-electronics year begins in March! This year, the manufacturers and suppliers for this 12 billion dollar and still growing industry require all 4 floors of New York City's Coliseum to show you their new ideas.*

834 exhibitors representing more than 80% of the industry's productive capacity will display all that's new in equipment, component parts, instruments and production at *The Radio Engineering Show*. Attending the Show gives you an opportunity to talk with the men responsible for these newest advances in radio-electronics. The 55 technical sessions of *The IRE National Convention*, with over 200 new papers presented by 22 different professional groups, will also inform you of up-to-the-minute developments in your specialized field of electronics.

Begin the year right. See and hear all that's new in 1957 radio-electronics. Plan to attend or, better still, make your reservations today!

REGISTRATION: IRE Members \$1.00  
Non-members \$3.00

MARCH 18-21

The **IRE**  
National Convention  
Waldorf-Astoria Hotel  
and The Radio Engineering Show  
Coliseum  
New York City

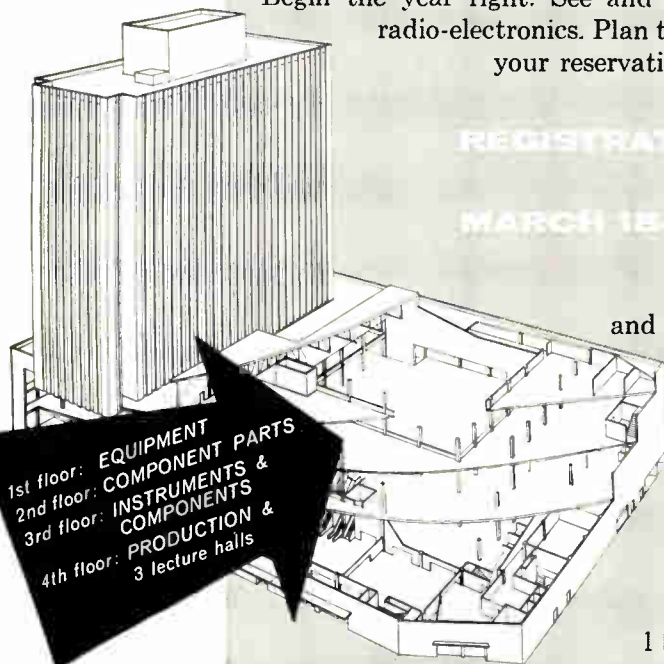

The  
Institute of  
Radio  
Engineers



1 East 79th Street, New York 21, N. Y.



Three unusual direct-display  
storage tubes by Hughes

## MEMOTRON

**FEATURES:** bright display . . . constant and uniform intensity of presentation . . . no perceptible transient decay . . . simplifies photography.  
**APPLICATIONS:** transient analysis . . . spectrum analysis . . . direct comparison of wave forms.  
**SPECIFICATIONS:** 100,000 inches/sec. writing speed . . . stores traces until intentionally erased . . . erasure triggered by push-button, or programmed voltage . . . electrostatic focusing and deflection.



## MEMO-SCOPE

Model 104, incorporating MEMOTRON, is a new memory oscilloscope with 5 optional preamplifiers to satisfy the most critical production, test and laboratory requirements.



## TONOTRON

**FEATURES:** half-tone presentation . . . excellent grey scale . . . controllable decay rate . . . compact design. **APPLICATIONS:** closed circuit TV . . . instrumentation . . . P.P.I. . . narrow band, slow scan TV.  
**SPECIFICATIONS:** 1,000 foot-lamberts brightness at 10 kv . . . electrostatic focusing . . . magnetic deflection . . . 60 lines per inch resolution . . . writing speed of 150,000 inches/sec.

## TYPOTRON

**FEATURES:** high brightness . . . permanent display until intentionally erased . . . rapid display of printed data . . . 63 character matrix. **APPLICATIONS:** digital computers . . . teletype reception . . . wherever printed data must be displayed rapidly for use by human operator. **SPECIFICATIONS:** writes up to 25,000 characters/sec. . . permanent storage until erased . . . almost instantaneous erasure . . . electrostatic focusing and deflection.

See demonstrations of these tubes and MEMO-SCOPE at the I.R.E. Show, booths 2801, 2803, 2805, Second Floor. For additional information write to:

HUGHES PRODUCTS • ELECTRON TUBES  
International Airport Station, Los Angeles 45, California

**HUGHES PRODUCTS**

© 1957. HUGHES AIRCRAFT COMPANY

## Industry

### News

Merle W. Kremer will now serve as General Manager of the Parts Div. of Sylvania Electric Products, Inc. His office will be at Division headquarters in Warren, Pa.

Maj. Gen. Francis H. Lanahan, USA (Ret.), has been elected President of Federal Electric Corp. of Lodi, N. J. During World War II, he was Chief Signal Officer for the Allied Forces in Europe. General Lanahan served as Commanding General of the Signal Corps Center at Fort Monmouth, N. J., from 1947 to 1951.



F. H. Lanahan



M. E. Markell

Max E. Markell has been appointed Manager, Equipment Sales, RCA Components Div. Before joining RCA Tube Division in 1945, he had been Senior Engineer, Vacuum Tube Branch, U. S. Signal Corps Laboratory.

Martin Kaplan has been advanced to Assistant Sales Manager, Electronic and X-Ray Div. of F-R Machine Works, Inc. Mr. Kaplan's technical background includes the design and development of many types of waveguide components and test equipment, and applied research on dummy loads as well as specification writing and analysis.

Garth J. Heisig has been named Director of Television Engineering for Motorola, Inc. Mr. Heisig was with MIT Radiation Laboratory for two years before joining Motorola in 1945.

Calvin K. Townsend was elected President of the West Coast Electronic Manufacturers Association. Mr. Townsend is Executive Vice-President of Jennings Radio Manufacturing Corp., San Jose.

Colonel Edwin L. White joined the staff of RETMA to direct a special informational program in frequency allocations study.

Franklyn E. Dailey, Jr., is now Manager of the Applied Science Section of the Research and Advance Development Dept. of Stromberg-Carlson.

Miles E. Goll and Burdette L. Bailey have been named managers of the Standard Products Div. and Meter Div., respectively of WacLine, Inc., Dayton, O.

(Continued on page 36)

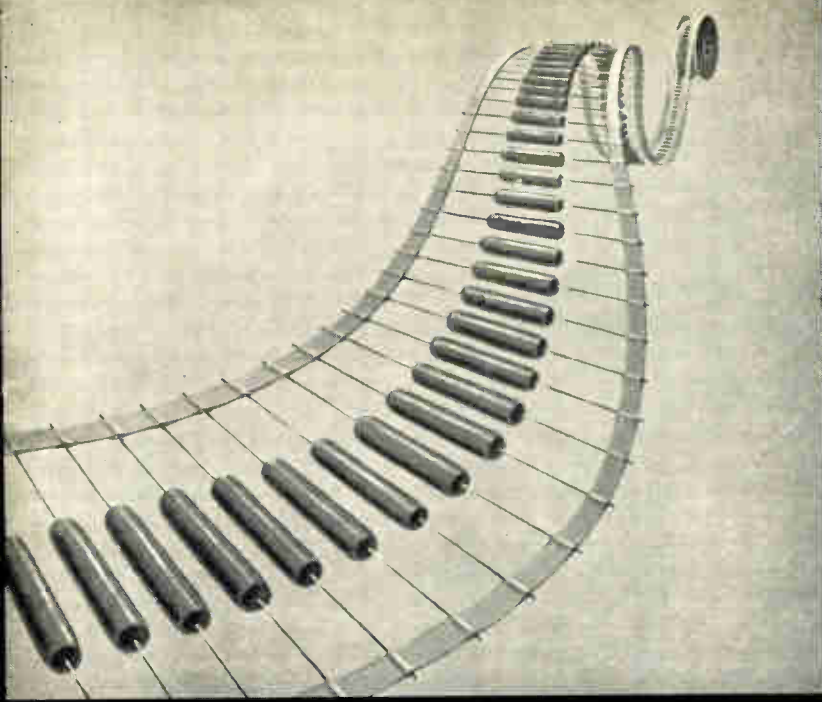

*If it's capacitors for automation...*

**C-D** *makes them...*

*makes them better*

*and packs them better, too!*

A perfect parade of many styles of automation capacitors (paper, mica, electrolytic and ceramic) packaged to match your automation equipment. C-D's automation packaging keeps leads straight, lead tolerances close, and your handling time to a minimum. While you have your eye on budget and time-and-motion studies, we keep *our* eye on your automation capacitor problems. C-D engineers will be happy to show you how you can save time *and* money by C-D's specialized pre-packaging. Let us help you with your automatic feeding problems. Write to Cornell-Dubilier Electric Corporation, South Plainfield, New Jersey.



CONSISTENT HI-DEPENDABILITY  
**CORNELL-DUBILIER CAPACITORS**

SOUTH PLAINFIELD, N. J.; NEW BEDFORD, WORCESTER & CAMBRIDGE, MASS., PROVIDENCE & HOPE VALLEY, R. I.; INDIANAPOLIS, IND.; SANFORD, FUGUAY SPRINGS & VARINA, N. C.; VENICE, CALIF.; & SUBSIDIARY, THE RADIART CORPORATION, CLEVELAND, OHIO; CORNELL-DUBILIER ELECTRIC INTERNATIONAL, N. Y.

meet  
**FRANK ROBERTS**  
 ...he's paid  
 to solve your problems

Frank is chief engineer, components division, at National Company. He heads the proficient engineering group whose job is to modify present catalog items, develop new components to meet your specifications, and to help solve your components problems. While our catalog lists over 300 different parts, over 60 per cent of orders received are for "other than catalog items;" therefore, National is geared to provide many types of special services.

The capabilities and facilities of National's components engineering division are as excellent as they are varied. Some of our facilities are illustrated.

Our capabilities include the design and development of:

1. Commercial and precision type variable capacitors.
2. Communications type filters and networks.
3. Chokes and special coils.
4. Knobs and precision vernier dial mechanisms.
5. The design and fabrication of special hardware for the electronic industry including coil forms, shaft locks, dial locks, insulated bushings and captive nuts.

In addition our components division offers:

1. Complete model shop facilities.
2. Efficient, low cost production facilities.
3. Reliability test programs. U.S.A. approved environmental test facilities.

If you have special components requirements or a design and development problem—we suggest you—write, wire or call NATIONAL (Malden, Mass. 2-7950) at once. Put National's 42 years of experience and expanded new facilities to work for you.

The sooner you have men like Frank Roberts working for you the sooner your components problems will be solved.

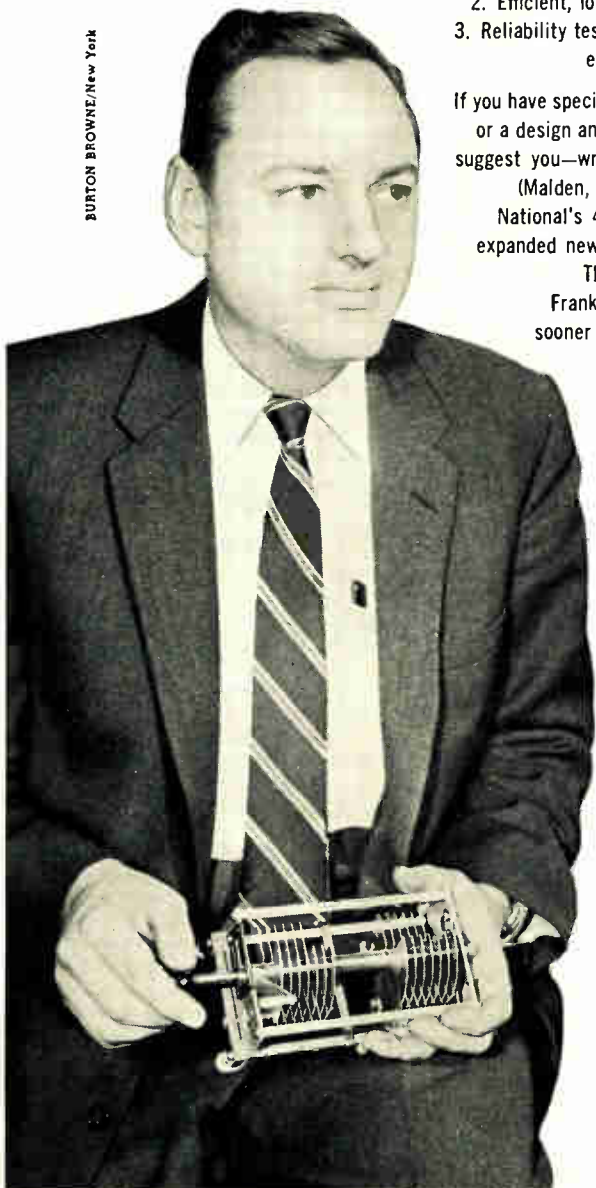

BURTON BROWNE/New York

MEET THE MEN FROM NATIONAL  
 AT THE I.R.E. SHOW—  
 Booths 1401-1407

Model shop facilities



Section of choke engineering labs.



Assembly line, components division



Mechanical engineering section, components division



Environmental test facilities. AR altitude chamber

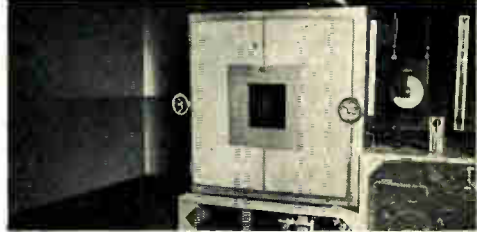

Engineers at work in components lab. No. 3



Eight out of every ten U.S. Navy ships use National Receivers



# Volts— Microfarads and Miniaturization

*.....for Transistor Circuitry*



The daily progress of transistor usage is calling for smaller, yet better components. Mallory is proud of their continuous contribution to miniaturization—smaller components without sacrifice of reliability.

In the power supply field, Mallory is a pioneer in the development and production of mercury cells. Their techniques have made possible mass production at highest quality levels. The constant voltage discharge characteristic is ideally suited for transistor operation.

Mallory subminiature Silverlytic<sup>™</sup> capacitors offer high capacity in a minimum space. Types TAP and TAW are available in a broad range of capacities at several voltage ratings. The newest, a tantalum capacitor designated as type TNT, is only .145 inch in diameter by  $\frac{3}{8}$  inch long. It is available in five basic sizes ranging from 80 mfd at 3 volts to 8 mfd at 50 volts.

Mallory will be glad to consult with you on specific problems of miniaturization and transistor application components, or supply full technical data on battery, capacitor and other Mallory products. Write us, or contact the Mallory representative—today.

Serving Industry with These Products:

**Electromechanical** — Resistors • Switches • Tuning Devices • Vibrators  
**Electrochemical** — Capacitors • Mercury and Zinc-Carbon Batteries  
**Metallurgical** — Contacts • Special Metals • Welding Materials

**Expect more . . . get more from**



Parts distributors in all major cities stock Mallory standard components for your convenience.

four good reasons for specifying

# ALSiMAG<sup>®</sup> alumina ceramics!

- 1 Highly specialized compositions.** Complete range of industry-approved ALSiMag Aluminas for exacting applications. New freedom in design from their outstanding performance at elevated temperatures and frequencies . . . superior electrical characteristics . . . higher compressive, tensile and flexural strengths . . . hardness (9 on Mohs' scale) . . . chemical inertness . . . greater resistance to impact, vibration, abrasion and repeated thermal shock. Custom formulations for special needs.
- 2 More production facilities.** Complete manufacturing facilities devoted exclusively to ALSiMag Aluminas, including special high temperature kilns. Rapid delivery in any quantity . . . simplest to most intricate designs. Precision tolerances.
- 3 More experience.** ALSiMag Aluminas are produced by skilled personnel, thoroughly familiar with the most modern methods . . . and highly specialized techniques perfected in over 55 years' experience in the manufacture of quality technical ceramics.
- 4 Dependable metal-ceramic combinations.** Standard or custom designs available in volume. Wide choice of metals combined with strong, rugged Alumina ceramics. Permanent bonding. Close dimensional tolerances. High or low temperature types . . . for hard or soft solder.

For complete information on ALSiMag Aluminas for your application, send blueprint or sketch with details of your operating procedure.



Ask for a free copy of Bulletin No. 362—ALSiMag Alumina Ceramics

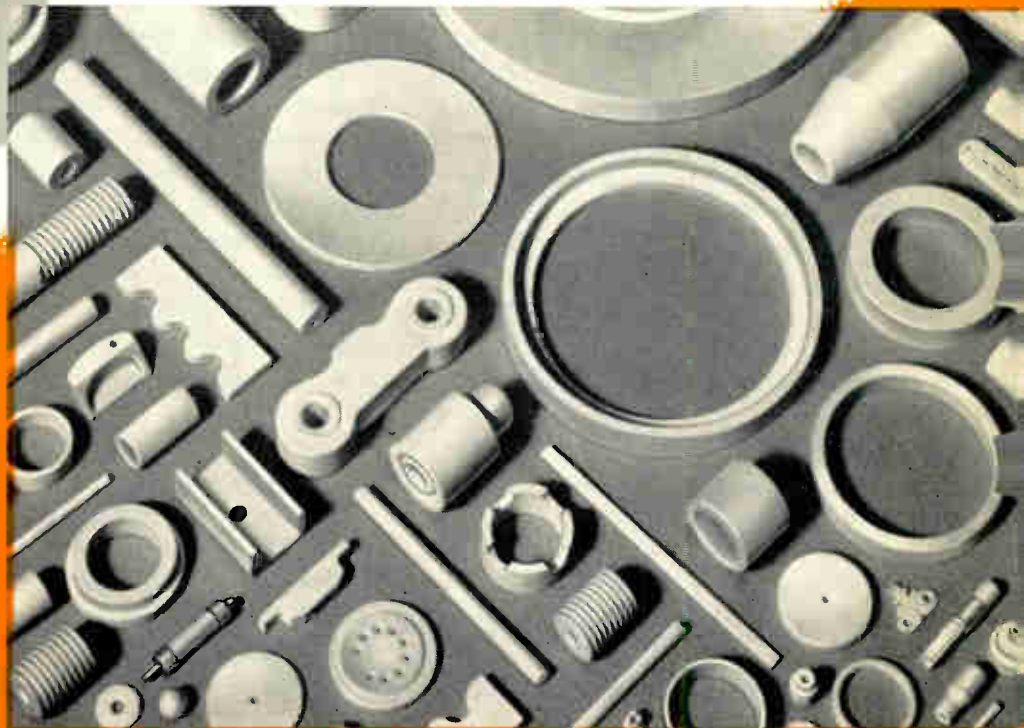

## AMERICAN LAVA

A SUBSIDIARY OF MINNESOTA MINING AND MANUFACTURING COMPANY



CORPORATION  
CHATTANOOGA 5, TENN.

55TH YEAR OF CERAMIC LEADERSHIP

For service, contact Minnesota Mining & Manufacturing Co. Offices in these cities (see your local telephone directory): Atlanta, Ga. • Boston, Newton Center, Mass. • Buffalo, N. Y. • Chicago, Ill. • Cincinnati, O. • Cleveland, O. • Dallas, Texas • Detroit, Mich. • High Point, N. C. • Los Angeles, Calif. • New York, Ridgefield, N. J. • Philadelphia, Pa. • Pittsburg, Pa. • St. Louis, Mo. • St. Paul, Minn. • San Francisco, Calif. • Seattle, Wash. Canada: Minnesota Mining & Manufacturing of Canada, Ltd., P. O. Box 757, London, Ont. All other export: Minnesota Mining & Manufacturing Co., International Div., 99 Park Ave., New York, N. Y.

# Industry News

(Continued from page 32)

Charles S. Rockwell has been named Vice-President and General Manager of the Ford Instrument Co. Div. of the Sperry-Rand Corp. For the past five years, he has been Vice-President and Works Manager of the Sperry-Farragut Div.

E. U. DaParma is now Vice-President of Operations over all product divisions of Sperry-Gyroscope Co. With the operations post, Mr. DaParma takes over direction of all engineering and production.

Thomas Dunsheath was promoted to the position of Technical Director of the Automatic Control Systems Section of Cook Research Laboratories. Mr. Dunsheath has been a Senior Engineer in the automatic control systems section since joining Cook in May of 1951.

Randolph M. Duncan has become Manager of General Electric's receiving tube plant, Owensboro, Kentucky. In his new position, he will be responsible for directing and administering all operations, facilities and personnel and the manufacture of electronic receiving tubes at Owensboro.



R. M. Duncan



N. H. Enenstein

Dr. Norman H. Enenstein is now Vice-President and Director of Engineering of Electro-Pulse, Inc., Culver City, Calif. Dr. Enenstein was formerly Project Head for a military Data Processing System at Hughes Aircraft Co.

Dr. I. I. Rabi, Nobel Prize-winning Professor of Physics at Columbia University, New York, and investment banker William Gregory, Jr., named to the Board of Hycon Mfg. Co., Pasadena.

John R. Johnson heads sales & manufacturing operations of Standard Coil Products Co., Inc., and Stanley A. Adams is mfg. coordinator of all Standard Coil plants.

Harold Torgerson promoted to Associate Dean, New York Univ. College of Engineering; Frank J. Bloom and Dr. Sidney Fishman appointed Technical Coordinators in the Research Div.

(Continued on page 38)



## NEW TEFLON SUBMinax<sup>®</sup> COAXIAL CABLES

Operate at 200° C! AMPHENOL—the first manufacturer to successfully extrude Teflon dielectric cable and leader in approved RG-/U Teflon cables—presents for the first time Subminax Teflon coaxial cables. Available in five types and in three impedances (50, 75 and 95 ohms), AMPHENOL Subminax cables meet the combined needs of miniaturized high temperature applications. Utilizing both extruded Teflon dielectrics and jackets, these new cables withstand a continuous operating temperature of 200° C, have higher power handling capabilities than corresponding polyethylene types and can be easily soldered under field conditions without “flowing”

RG-/U NO.	AMPHENOL NO.	IMPEDANCE OHMS	O. D. MAX.
187	421-106	75	.110"
188	421-105	50	.110"
195	421-171	95	.155"
196	421-109	50	.080"
—	421-637	75	.150"

Important to users is the fact that AMPHENOL Subminax Teflon Cables have been engineered to match an existing line of proved RF connectors, AMPHENOL's reliable Subminax connectors.

AMPHENOL ELECTRONICS CORPORATION  
Chicago 50, Illinois



# FIRST silicon transistors meeting NAVY SPECS

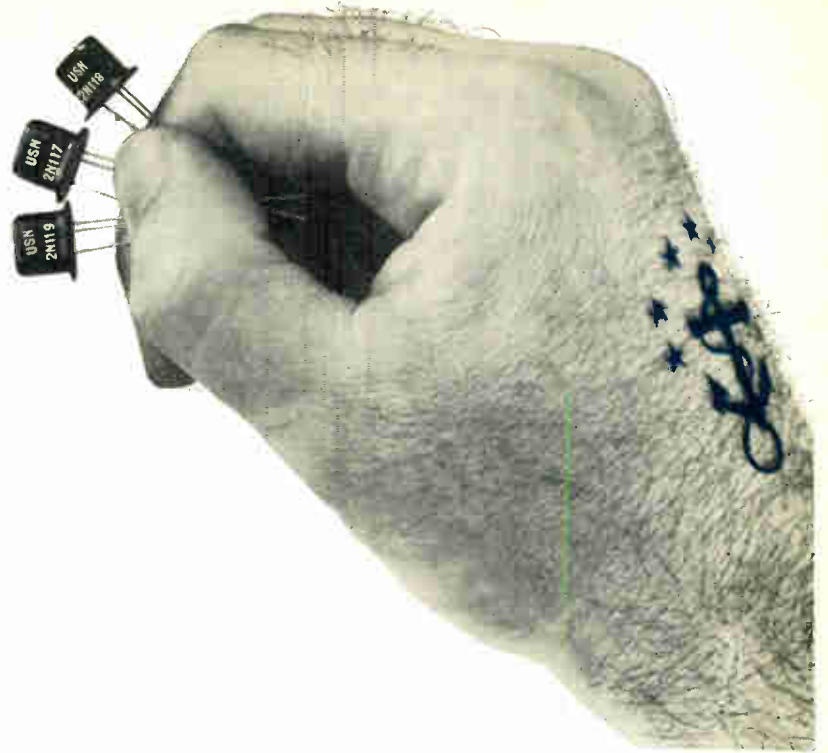

For *reliability* under *extreme* conditions... design with TI's military silicon transistors... built to give you high gain in small signal applications at temperatures up to 150°C. Made to the stringent requirements of MIL-T-19112A (SHIPS), MIL-T-19502 (SHIPS), and MIL-T-19504 (SHIPS) – these welded case, grown junction devices furnish the tremendous savings in weight, space, and power you expect from tran-

sistorization... *plus* close parameter control that permits you to design your circuits with confidence.

All 20 Texas Instruments silicon transistor types have proved themselves in military use. First and largest producer of silicon transistors, TI is the country's major supplier of high temperature transistors to industry for use in military and commercial equipment.

**degradation rate tests for TI's USN-2N117, USN-2N118, and USN-2N119**

test	condition	duration	end point at 25°C
lead fatigue	three 90-degree arcs	—	no broken leads $I_{CO} = 2 \mu A$ maximum at 5V $h_{OB} = 2 \mu$ mhos maximum $h_{FB} = -0.88$ minimum (USN-2N117) $h_{FB} = -0.94$ minimum (USN-2N118) $h_{FB} = -0.97$ minimum (USN-2N119) no mechanical defects interfering with operation
vibration	100 to 1000 cps at 10 G	3 cycles, each x, y, and z plane	
vibration fatigue	60 cps at 10 G	32 hours, each x, y, and z plane	
shock	40 G, 11 milliseconds	3 shocks, each x, y, and z plane	
temperature cycle	-55°C to +150°C	10 cycles	
moisture resistance	MIL-STD-202	240 hours	
life, intermittent operation	$P_C = 150$ mW, $V_C = 30$ V	1000 hours, accumulated operating time	
life, storage	150°C, ambient	1000 hours	
salt spray	MIL-STD-202	50 hours	

"Visit our booths (No. 2816 to 2820) at the 1957 I.R.E. Show, New York."

**LOOK TO TI FOR: SILICON HF, MEDIUM POWER, POWER, AND SMALL SIGNAL TRANSISTORS  
SILICON DIODES AND RECTIFIERS • GERMANIUM VHF, POWER, RADIO, AND GENERAL PURPOSE TRANSISTORS**

**pioneer producer of  
silicon transistors**



**TEXAS INSTRUMENTS  
INCORPORATED  
6000 LEMMON AVENUE DALLAS 9, TEXAS**

# American Beauty

## ELECTRIC SOLDERING IRONS

**MILLIONS OF  
MINUTE  
CONNECTIONS**

**ANY SIZE-  
ANY STYLE-  
ONE QUALITY  
the BEST!**

Today's complicated electronic and aircraft electrical circuits demand soldering equipment specially designed to make these countless tiny connections . . . accurately, dependably and quickly • American Beauty has a model and tip size to meet practically any specialized requirement. Highest quality tools that give top performance month after month in toughest production use • Send us your soldering problems . . . our years of specialized experience are at your service.

**AMERICAN ELECTRICAL HEATER COMPANY**



161-H

DETROIT 2, MICHIGAN

## Industry News

(Continued from page 36)

Sidney R. Curtis is now Senior Vice President of Stromberg-Carlson.

Ralph E. Bond is now Deputy General Manager for Administration of the Electronics Div., AMF.

George T. Bartek has assumed the duties of West Coast Regional Manager for Aircraft Products Sales for the Leland Electric Co.

John J. Kelley has been appointed to the position of General Manager of Philco Distributors, Inc.

John C. Dabney, formerly Director of Industrial Development for the State of Florida, has been appointed Director of Marketing of American Machine and Foundry Co. In his new position, Mr. Dabney will advise AMF business units and groups on all phases of marketing.



J. C. Dabney



J. Jipp

John Jipp of Ampex Corp., Redwood City, Calif., has been appointed Manager of the firm's Instrumentation Div., moving up from the post of Marketing Manager, which he has held since joining Ampex in November, 1953. In his new assignment, he will be in charge of instrumentation recorder research, development, and marketing.

David W. Martin named Manager, Govt. Products Div., The Magnavox Co., Fort Wayne, succeeding the late Barry Carlton.

Erwin Tomash elected President of Telemeter Magnetics, Inc., Los Angeles, succeeding Wm. K. Squires.

H. Thomas Larkins is Eastern Sales Mgr., Clifton Precision Products Co., Inc., in suburban Philadelphia at Clifton Heights.

John B. Hatch, Sr., appointed Director, Electronics Demonstration Clinic, at Alden Electronics Research Center, Westboro, Mass.

G. Robt. Mezger and W. F. Mayer named Vice Presidents of Measurements Corp., Boonton, N. J., subsidiary of Thomas A. Edison, Inc.

John M. Magida to new post of Director, Systems & Application Engrg., Davies Labs., Beltsville, Md.



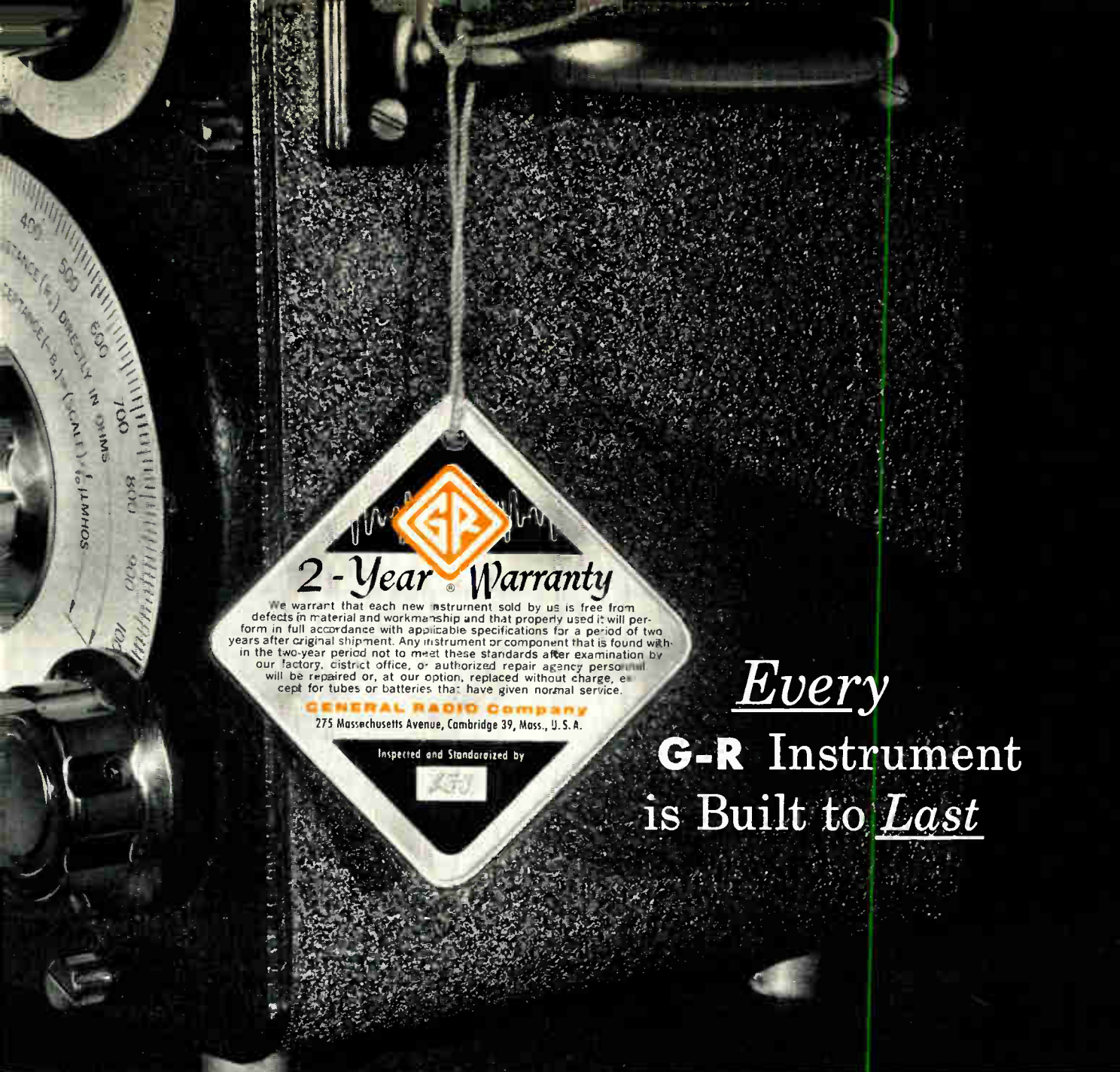

## 2-Year<sup>®</sup> Warranty

We warrant that each new instrument sold by us is free from defects in material and workmanship and that properly used it will perform in full accordance with applicable specifications for a period of two years after original shipment. Any instrument or component that is found within the two-year period not to meet these standards after examination by our factory, district office, or authorized repair agency personnel will be repaired or, at our option, replaced without charge, except for tubes or batteries that have given normal service.

**GENERAL RADIO Company**

275 Massachusetts Avenue, Cambridge 39, Mass., U. S. A.

Inspected and Standardized by



Every  
**G-R Instrument**  
is Built to Last

It is the essence of G-R's design and manufacturing philosophy that every General Radio instrument shall be built to operate as reliably years later as it did upon first purchase by the customer.

This policy has built the reputation for

quality and long life which has come to be synonymous with the G-R trademark and now makes possible a *two-year warranty* to purchasers of G-R products. This warranty applies to all newly purchased General Radio products shipped after March 1, 1957.



# General Radio Company

Since 1915, Manufacturers of Precision Electronic Equipment for Science and Industry

275 Massachusetts Avenue, Cambridge, Massachusetts  
NEW YORK PHILADELPHIA WASHINGTON, D. C. CHICAGO LOS ANGELES SAN FRANCISCO

Another  
product  
surprise  
from  
Helipot!

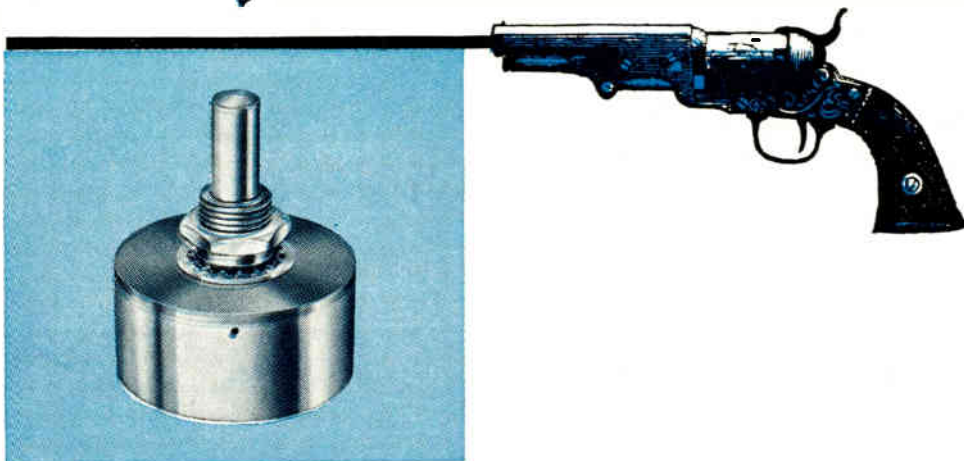

## Fanfare & Cigars



Tooting a symbolic clarion and passing out imaginary cigars, Helipot introduces one of its new-born offspring . . . the series 5300 precision potentiometer.

A single-turn unit, it's 1-1/4 inches in diameter . . . designed for bushing mounting. With its innards comfortably ensconced in an accurately drawn one-piece aluminum cup, the 5300 gives you ruggedness, compactness and long life. We proud papas direct your attention to such salient features as the range of total resistance . . . from 25 to 49,000 ohms . . . linearity as close as  $\pm 0.25\%$  . . . and considerable improvement in torque, noise and mechanical runout.

For vital statistics on this prodigy of a progeny, write for data file 324.

Helipot makes precision potentiometers . . . linear and non-linear . . . in the widest choice of sizes, mounting styles and resistances. Many models are stocked for immediate shipment. Our engineers will gladly adapt standard models to your requirements or design entirely new HELIPOT\* precision potentiometers for you.

Beckman®

**Helipot** Corporation: Newport Beach, California  
a division of Beckman Instruments, Inc.  
Engineering representatives in principal cities

955° REG. U. S. PAT. OFF.

Another product *surprise* from Helipot!



**SERIES 5700**

3" DIAMETER



3" DIAMETER

**SERIES 5700**

**SERIES**

2" DIAMETER



2" DIAMETER

**\*\*5600\*\***

**Critics Captivated!**

1 $\frac{7}{16}$ " DIAMETER



**SERIES 5400**



Discriminating engineers, the world's toughest critics, applaud the brilliant performance of Helipot's brand new trio - - series 5400, 5600 and 5700 single-turn precision potentiometers.

According to the program notes, these three virtuosi come in a choice of five mounting-and-bearing combinations. A one-piece, dimensionally-stable plastic housing eliminates a separate rear lid. There are tighter tolerances on linearity and mechanical run-out.

A new rotor design reduces mass . . . permits lower contact pressure . . . results in decreased coil wear, more reliable operation, greater life expectancy. Incidentally, torque is lower.

They're a quiet trio, too. Maximum noise, at 100 rpm, with 1 milliamp of slider current, is 100 millivolts.

Sweet music to any electronic designer's ear!

For complete information and specifications on these three new HELIPOT\* precision potentiometers, write for data file 324M.

Beckman®

**Helipot** Corporation: Newport Beach, California

a division of Beckman Instruments, Inc.

Engineering representatives in principal cities

708 \*REG. U. S. PAT. OFF.

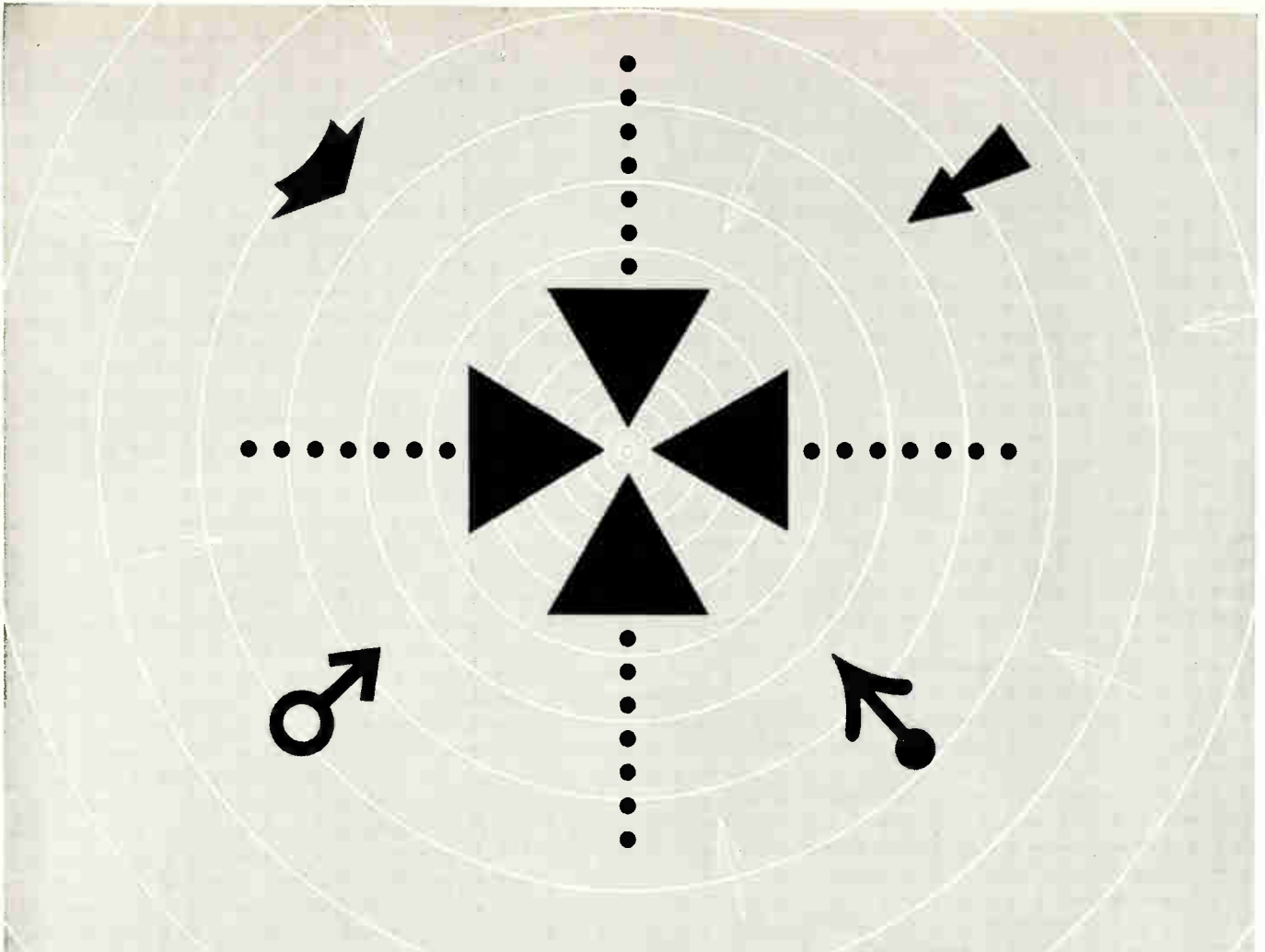

**±1%**

**TOLERANCE**



±1% tolerance capacitors are available from Efcon in production lots. Miniature capacitors of even greater precision will be made to your order, with either polystyrene or Mylar\* film dielectric.

Efcon precision miniature capacitors have the lowest dissipation factors of any film capacitors. Both polystyrene and Mylar\* film capacitors come in rigid, wax-impregnated cardboard tubes and in hermetically sealed metal cases. The hermetically sealed types feature glass-to-metal, solder-sealed terminals, and meet all applicable MIL specs.

All Efcon capacitors have extended foil construction with leads soldered directly to the foil, to minimize inductance and contact-resistance.

For analog and digital computers, communications filters, pulse-timing circuits and other equipment that demands temperature stability, precision and long-term reliability —specify Efcon capacitors!

**EFCON**

WHERE CLOSE TOLERANCE IS STANDARD TOLERANCE

**ELECTRONIC FABRICATORS, INCORPORATED** 682 BROADWAY, NEW YORK 12, N.Y.

WRITE DEPT. X FOR TECHNICAL DATA

\*DuPont trademark for polytetrafluoroethylene

# SOLID GLASS HEADERS



Val Cichowski  
V. P. Manufacturing



VS.

# MULTIPLE BEAD TERMINALS

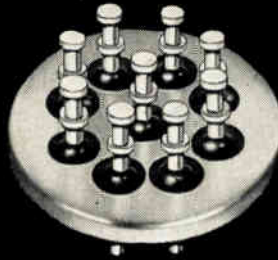

Andy Wyzenbeek  
V. P. Engineering

There are several reasons that Fusite customers have for going to a solid glass header. Compact size is one of them. While 1" diameter is about maximum for this type terminal, we can pack 21 electrodes into this space with the same voltage limits that would require either a much larger disc or fewer pins in a multiple bead terminal. Size for size this is a more rugged terminal than one using a light gage stamping. Where the terminal serves as a structural part of an electrical assembly, solid glass is better able to support stress. Before resting the case for solid glass, it is worthy of mention that it costs less per pin. Fusite offers a complete line of solid glass headers.

While our friend Cichowski presents a strong case for the solid glass header, a large percentage of Fusite Terminal business is still done in multiple bead terminals. There are good reasons. Wherever weight is a factor, you'll usually find a multiple bead terminal in a light gage stamping with its remarkably favorable weight to strength ratio.

This type construction is more versatile. When large sizes are needed, where very heavy pressures are involved or extreme conditions of any nature exist, they can best be coped with by using multiple beads in a heavy gage body.

While speaking of unusual conditions, it gives me an excuse to mention our special engineering section. Our line of standard terminals is very large but we are constantly at work developing special custom designs to solve specific problems. We solicit yours.



Jim Marsh  
V. P. Sales

If you found anything helpful in the words of wisdom from Val and Andy, I'm real happy for you. But frankly, I can't get too excited over which kind of terminal you buy. As long as it comes from Fusite, you can be sure it's the best of its type available. We develop our own glass formulas and do our own smelting right here at the plant. It gives us the best control over quality in the industry.

*Complete literature on all Fusite Terminals is yours for the asking. Write Fusite, Department U-2.*



THE **FUSITE** CORPORATION

6026 FERNVIEW AVE.,

CINCINNATI 13, OHIO

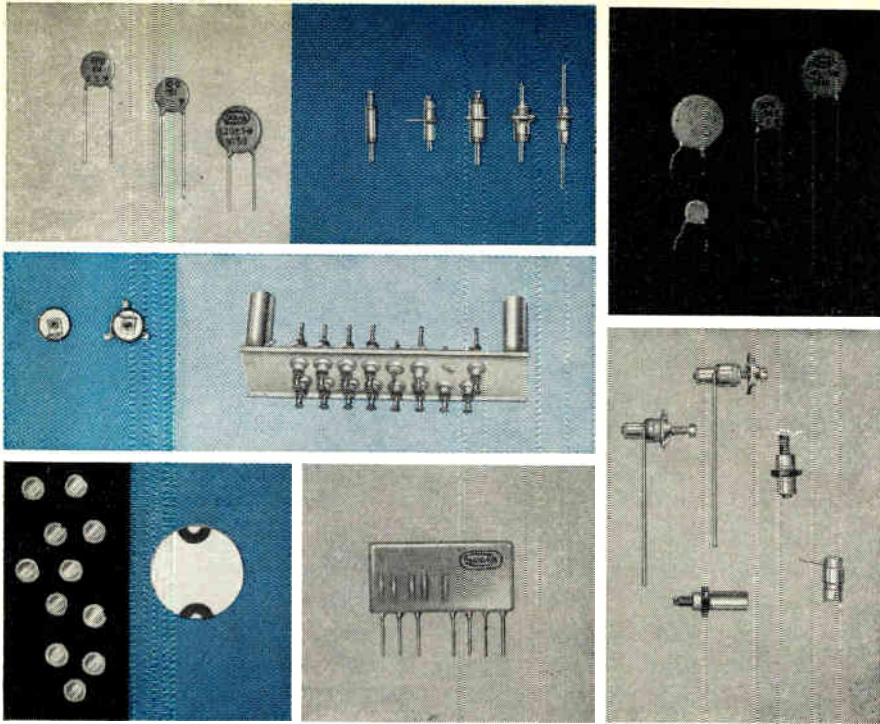

## for plus values in ceramic capacitors — S O L A R

We go all out to bring you more than just a satisfactory unit. Our items save assembly time, as well as offer exceptional space-saving features. Solar pre-thinking gives you a terrific start in the right direction.

**Note the variety** of Solar capacitors. Many stock items are available, covering a tremendous range of needs. Here is an excellent basis for integrating your networks.

**Quality? Reliability?** You can be sure that Solar—the company that is organized to deliver plus service—keeps its quality and reliability high.

**Streamlined production** at Solar requires no expediting, and keeps prices attractive. And we really service your account—anytime... anywhere. Service includes calls at your plant to help design equipment for assembling our capacitors at lowest cost.

*Write for the name of a nearby representative.*

"QUALITY ALWAYS"



**SOLAR MANUFACTURING CORP.**  
New York, N. Y.

SALES OFFICES: 46th & Seville, Los Angeles 58, Calif.  
4000 W. North Ave., Chicago 39, Ill.

CERAMIC CAPACITORS • PRINTED NETWORKS • PIEZO CERAMICS

## Books

### *Currents, Fields, and Particles*

By Francis Bitter. Published 1956 by John Wiley & Sons, Inc., 440 Fourth Ave., New York 16. 613 pages. Price \$8.50.

This text provides all students of science and engineering with a solid introduction to certain abstract concepts, including energy, momentum, electric and magnetic fields, conservation laws, impedance, and reactance. Throughout, the author has attempted to illustrate the importance of quantitative thinking, and his emphasis is on factual analysis.

Detailed treatment of optical and spectroscopic resolving power; elementary discussion of the wave-particle duality of energy and matter; resonance phenomena in circuits, gases, solids, and liquids; basic phenomena of atomic and nuclear physics; and, an elementary treatment of the Schrodinger wave equation, using Cartesian coordinates only, are a few of the special features marking this work.

### *A Primer To The Automatic Office*

By Dresser Engineering, Inc. Published 1956 by Automation Management, Inc., Westboro, Mass. 103 pages, paper bound. Price \$7.50.

The primer supplies its own definition to the word "automation" and traces the evolution of the word by quoting the definitions of authorities. Factory and office automation are illustrated by diagrams.

The book makes this point: thorough analysis of a present system is necessary before specific machines for automation are investigated. In fact, sometimes special machines or only the system's present machines are needed. Other times, manual or mechanical systems obtain the desired results at less cost.

### *Video Amplifiers*

By W. L. Kreizer. Translated from Russian into German by Dr. W. Rohde. Published 1956 by VEB Technik Berlin, Germany. 331 pages.

The text is a systematic and detailed introduction to the pulse and frequency characteristics of electronic circuits.

About one third of the book introduces these characteristics and deals with simple circuits described by first-order differential equations. A further section is devoted to the mathematics of second-order differential equations and the corresponding circuits, i.e., circuits containing a series or parallel combination of an inductance and a capacitance. The effects of various pulse, and in particular of saw-tooth pulses, shapes as well as sinusoidal input and their correlations are set forth.

Subsequently equalization circuits to compensate for high-frequency and for low-frequency distortion are considered and studied on the basis of

*(Continued on page 48)*



# REPORT ON STANDARDIZATION OF DUMMY LOADS



AS A SERVICE TO THE INDUSTRY  
REPRINTS OF ARMY ORDNANCE REPORT  
AVAILABLE UPON REQUEST  
BOGART MANUFACTURING CO., INC.  
315 SEIGEL ST., BROOKLYN, N. Y.

# NEW



**Model R**

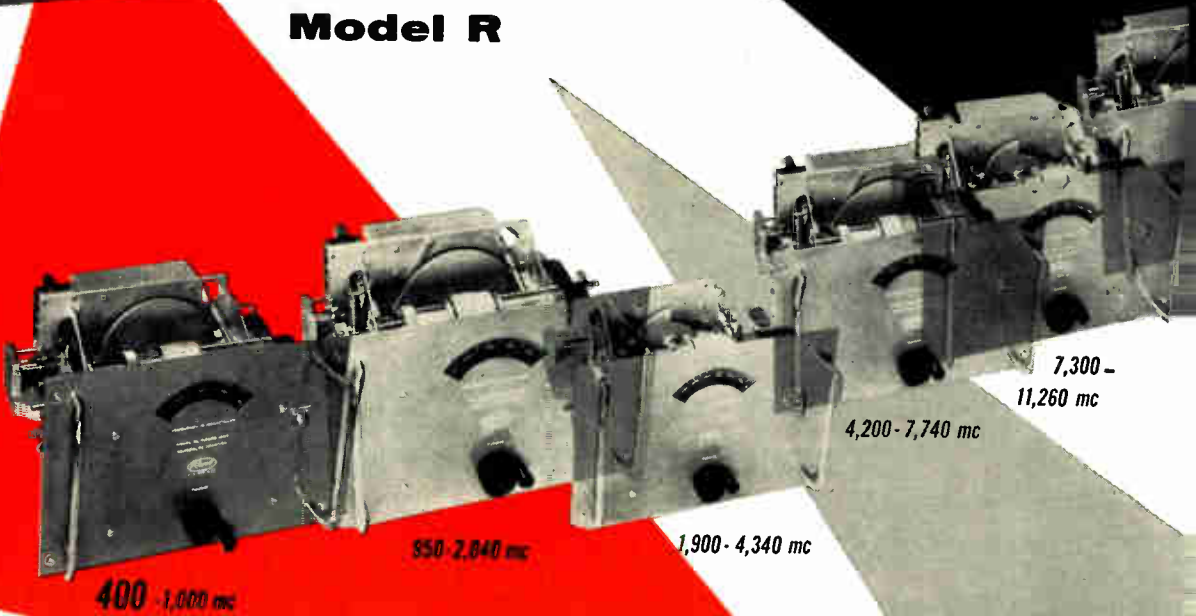

### *Note these special features:*

- AM, FM, CW, MCW, and PULSE reception.
- Uni-dial control.
- Direct reading.
- Broadband coverage.
- Output level reading directly in db.
- High sensitivity.
- Seven interchangeable plug-in r-f tuning units cover the entire frequency range.
- Low noise figure; excellent gain stability.
- Microwave preselection, tracked and double-tuned, used in the plug-in tuning units covering the range 400 to 11,260 mc.
- Audio, video, and trigger outputs.
- Special recorder output.
- High video output—low impedance.
- AGC and AFC circuits.

### *For these applications:*

- General communications.
- Field intensity meter.
- Frequency meter.
- Measurement of radiation and leakage of microwave devices.
- Measurement of bandwidth of microwave cavities.
- Measurement of relative power of fundamental and harmonic signal frequencies.
- Measurement of noise figure.
- Antenna field patterns.



# EXTENDED RANGE MICROWAVE RECEIVER!

## 400 to 22,000 mc



14,700-22,000 mc

9,500-15,600 mc

### SPECIFICATIONS:

#### Basic Receiver: Model R-B

#### Tuning Unit Frequency Ranges:

*Model RR-T .....	400- 1,000 mc
*Model RL-T .....	950- 2,040 mc
*Model RS-T .....	1,900- 4,340 mc
*Model RM-T .....	4,200- 7,740 mc
*Model RX-T .....	7,300-11,260 mc
*Model RKS-T .....	9,500-15,600 mc
*Model RKU-T .....	14,700-22,000 mc

#### Signal Capabilities:

AM, FM, CW, MCW, pulse

#### Sensitivity:

- (a) For Model RR-T: Minus 85 dbm
- (b) For Models RL-T, RS-T, RM-T, and RX-T: Minus 80 dbm
- (c) For Models RKS-T and RKU-T: Minus 65 dbm

Frequency Accuracy:  $\pm 1\%$

IF Bandwidth: 3 mc

Video Bandwidth: 2 mc

#### Image Rejection:

- (a) For Models RR-T thru RX-T: Greater than 60 db

Three new r-f tuning units double the frequency range of the well-known Polarad Microwave Receiver. Now more than ever the Model R becomes a basic multi-purpose instrument for microwave research and production in the field, in the laboratory, and in the factory.

This receiver is designed for quantitative analysis of microwave signals and is ideal for the reception and monitoring of all types of radio and radar communications within the broadband 400 to 22,000 mc. It permits comparative power and frequency measurements, by means of its panel-mounted meter, of virtually every type of signal encountered in microwave work.

It is compact and functional, featuring 7 integrally designed plug-in, interchangeable RF microwave tuning units to cover 400 to 22,000 mc; non-contacting chokes in pre-selector and microwave oscillator to assure long life and reliability; and large scale indicating meter for fine tuning control.

Call any Polarad representative or direct to the factory for detailed specifications.

- (b) For Models RKS-T and RKU-T: Spurious response rejection obtained through the use of a bandpass filter

#### Gain Stability with AFC: $\pm 2$ db

#### Automatic Frequency Control:

Pull-out range 10 mc off center

Recorder Output: 1 ma. full scale (1,500 ohms)

#### Trigger Output:

Positive 10-volt pulse across 100 ohms

#### Audio Output:

5 volts undistorted, across 500 ohms

#### FM Discriminator:

Deviation Sensitivity: .7 v./mc

#### Skirt Selectivity:

60 db - 6 db bandwidth ratio less than 5:1

IF Rejection: 60 db

#### Input AC Power:

115, 230 V ac, 60 cps, 440 watts

#### Input Impedance:

Models RR-T through RX-T: 50 ohms  
Models RKS-T & RKU-T: waveguide

VSWR: Less than 4:1 over the band

Range of Linearity: 60 db

Receiver Type: Superheterodyne

Maximum Acceptable Input

Signal Amplitude: 0.1 volt rms, without external attenuation

Video Response: 30 cps to 2 mc

Size: 17" w x 23" d x 19" h

Weight: 180 lbs. for basic unit with one tuning unit.

For private demonstration  
without obligation  
ask for the



to stop  
at your plant

**maintenance  
available by field  
service specialists**



\*U. S. PATENT NO. 2,774,243



**ELECTRONICS CORPORATION**

43-20 34th Street - Long Island City 1, New York

REPRESENTATIVES: Albany, Albuquerque, Atlanta, Baltimore, Boston, Chicago, Cleveland, Dayton, Denver, Englewood, Fort Worth, Kansas City, Los Angeles, New York, Philadelphia, Portland, Rochester, St. Louis, San Francisco, Schenectady, Stamford, Syracuse, Washington, D. C., Winston-Salem, Canada: Arnprior, Ontario.  
Resident Representatives in Principal Foreign Cities

# Your Demands Created

## HIGH VOLTAGE SILICON POWER RECTIFIERS



Sarkes Tarzian series type SM silicon rectifiers provide the practical, low cost solution to the high voltage silicon rectifier problem. Stable characteristics inherent in low voltage junctions are carried over to this series. If your application calls for high temperature and high voltage, send for complete information.

### ELECTRICAL RATINGS

S.T. Type	Max. Peak Inverse Volts	Max. RMS Volts	Current Ratings—Amperes								Jetc No.
			Max. D.C. Load		Max. RMS		Max. Recurrent Peak		Surge 4MS Max.		
			100°C	150°C	100°C	150°C	100°C	150°C	100°C	150°C	
80SM	800	560	.450	.225	1.12	.560	4.5	2.25	27.0	13.5	1N1108
120SM	1200	840	.425	.212	1.06	.530	4.25	2.12	25.5	12.7	1N1109
160SM	1600	1120	.40	.200	1.00	.500	4.00	2.00	24.0	12.0	1N1110
200SM	2000	1400	.375	.187	.940	.470	3.75	1.87	22.5	11.2	1N1111
240SM	2400	1680	.35	.175	.875	.437	3.50	1.75	21.0	10.5	1N1112
280SM	2800	1960	.325	.162	.812	.405	3.25	1.62	19.5	9.7	1N1113

### DIMENSIONS

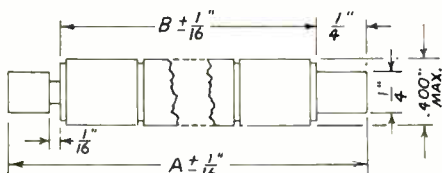

Figure 1

Figure 1		JETEC NO.
A	B	
1-15/32"	31/32"	1N1108
1-15/16"	1-7/16"	1N1109
2-13/32"	1-29/32"	1N1110
2-7/8"	2-3/8"	1N1111
3-11/32"	2-27/32"	1N1112
3-13/16"	3-5/16"	1N1113

## Books

(Continued from page 44)

the circuit theory presented in the preceding chapters. Distortion and its compensation as well as thermal and shot-effect noise in the input circuit, are also treated.

The last pages deal with the mathematics of a sequence of several stages. Frequency and pulse responses of special sequences are considered, amplification control with and without tubes is explained and non-linear distortions are studied.

The text may be called a thorough and integrated presentation of wide-band RC-amplifiers.

### The $j\omega$ —or Symbolic Method

By Harry Stockman, S.D. Published 1956 by SER Co., 543 Lexington St., Waltham, Mass. 312 pages, paper bound. Price \$3.50.

Some historical aspects of the  $j\omega$ —or symbolic method are given, and the operator  $j$  is introduced in an elementary fashion with reference to the complex plane. Conventional rules for calculation with complex quantities are reviewed. The spinning phasor and spinning sinor are introduced and the three significant steps in solving steady-state or ac problems are discussed.

Rules for calculation with time-dependent complex quantities are given. The  $j\omega$ —calculation method is then reviewed from the natural integrodifferential-equation-solution aspect, and differentiations and integrations carried out with direct reference to the already presented "engineering method." The concept of instantaneous power is presented with reference to the use of sinors, and formulas are given for sinor power.

### Books Received

#### Calculus Refresher for Technical Men

By A. A. Klaf. Published 1956 by Dover Publications, Inc., 920 Broadway, New York 10. 439 pages. Price \$1.95.

#### Electronic Metal Locators

By Harold S. Renne. Published 1956 by Howard W. Sams & Co., Inc., 2201 E. 46th St., Indianapolis 5, Indiana. 121 pages, paper bound. Price \$2.50.

#### Scatter Propagation Theory and Practice

By Ira Kamen & George Doundoulakis. Published 1956 by Howard W. Sams & Co., Inc., 2201 E. 46th St., Indianapolis 5, Indiana. 203 pages, paper bound. Price \$3.00.

#### ASTM Standards in Building Codes

Published 1956 by the American Society for Testing Materials, 1916 Race St., Phila. 3, Pa. 224 pages, heavy paper cover. Price \$2.75.

#### Basic Electronics

By P. B. Zbar & S. Schildkraut. Published 1956 by McGraw-Hill Book Co., Inc., 330 W. 42nd St., New York 36. 100 pages, paper bound. Price \$1.75.



## RECTIFIER DIVISION

415 N. College Ave., Dept. EE-1, Bloomington, Ind.

IN CANADA: 700 WESTON RD., TORONTO 9, TEL. ROGERS 2-7535  
EXPORT: AD AURIEMA, INC., NEW YORK CITY

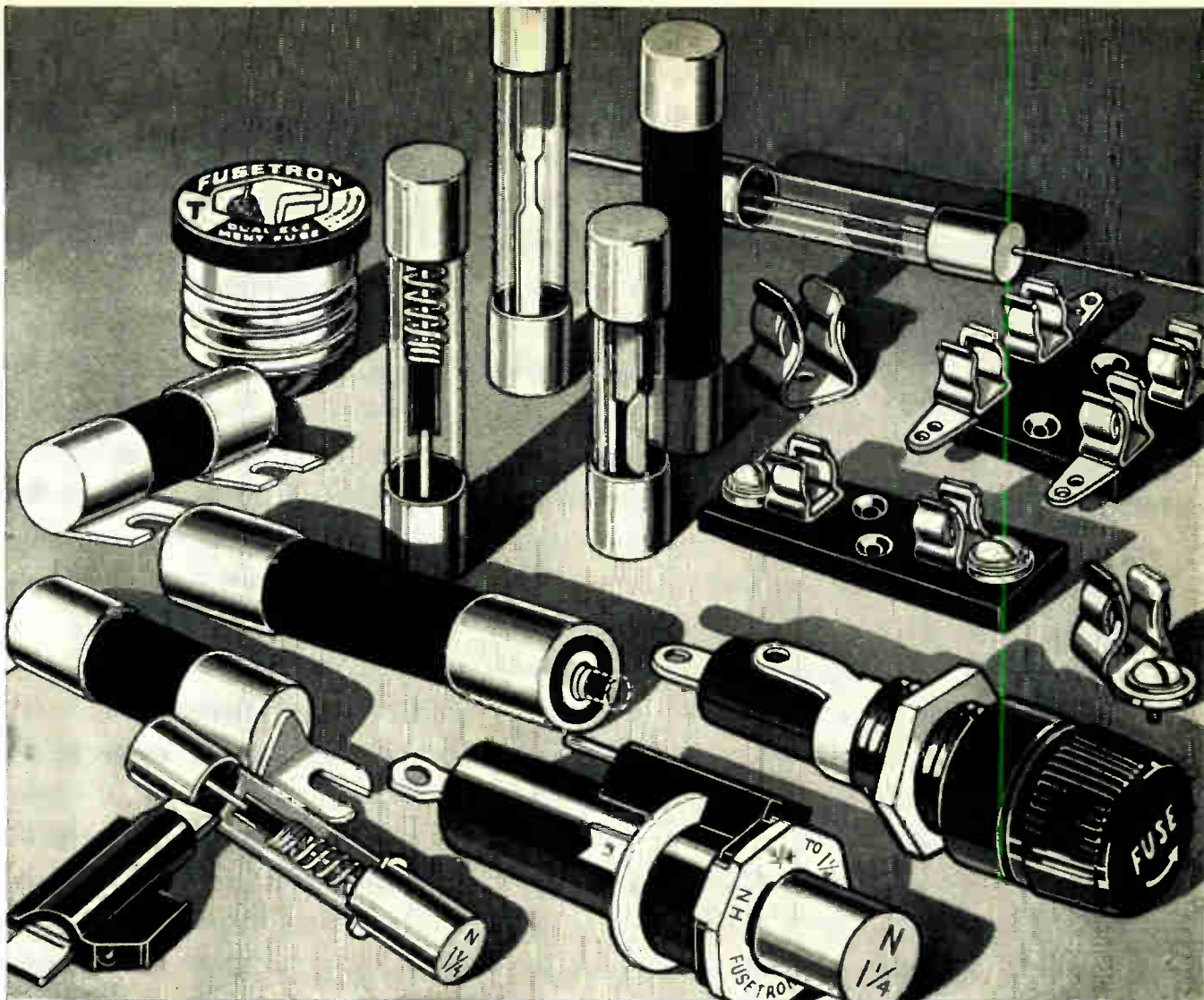

## You can rely on BUSS FUSES to operate as intended.

**Here's why**—With BUSS fuses, dependable electrical protection isn't left to chance. BUSS fuses are tested in a sensitive electronic device. Any fuse not correctly calibrated, properly constructed and right in all physical dimensions is automatically rejected.

The result,—BUSS fuses provide maximum protection against damage due to electrical faults. And just as important, they eliminate useless shut-downs caused by faulty fuses blowing needlessly.

With a complete line of fuses available, it is just good business to standardize on BUSS. The "trouble-free" operation of BUSS fuses helps to assure that your product will operate as intended . . . thus, BUSS fuses help to maintain the reputation of your product for quality and service.

*If you have an unusual or difficult protection problem, let the BUSS fuse engineers work with you and save you engineering time. If possible, they will suggest a fuse already available in local*

wholesalers' stocks, so that your device can be easily serviced.

For more information on BUSS and Fusetron small dimension fuses and fuseholders . . . Write for Bulletin TT, Bussmann Mfg. Co. (Div. of McGraw-Edison Co.), University at Jefferson, St. Louis 7, Mo.

*BUSS fuses are made to protect—not to blow, needlessly*



Makers of a complete line of fuses for home, farm, commercial, electronic, automotive and industrial use.

The books...

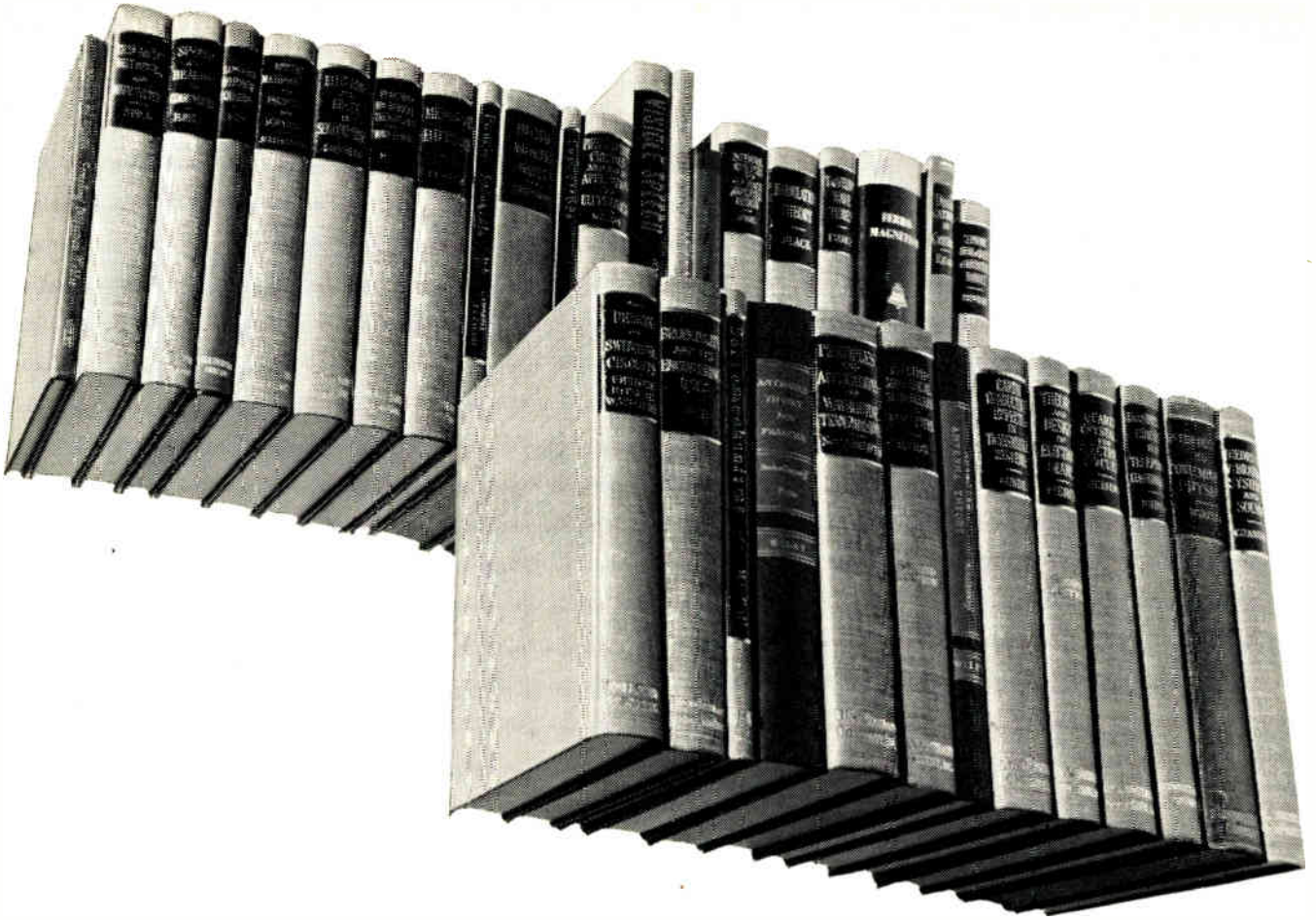

## How the scientific world shares in fruits of the telephone art

In their work to improve telephony the scientists and engineers of Bell Telephone Laboratories make important findings in many sciences. They thoroughly report these findings in professional journals and magazines. But sometimes, as knowledge accumulates in a vital field, a "treatment in depth" is prepared in book form.

Bell Laboratories authors have written 36 books to date and others are in preparation. Many have become classics in the Laboratories' primary field of communications. Many have become standard works of wide application because they provide a fundamental guide for technologies in other fields. For example, the design of automatic switching systems is of primary importance in computers; statistical quality control provides the indispensable basis for economical manufacture. Through their books these scientists and engineers and the Laboratories attempt to repay

benefits they receive from the published works of others.

The pictures on the opposite page show some Bell Laboratories authors of technical books. A complete listing of titles may be obtained by sending in this coupon.

Publication Department, Dept. 19

**BELL TELEPHONE LABORATORIES**

463 West Street, New York 14, N. Y.

Gentlemen:

Please send me a listing of titles, authors and publishers of books written by Bell Telephone Laboratories authors.

Name.....

Street.....

City..... State.....



**BELL TELEPHONE LABORATORIES**

*World center of communications research and development*

## ...the authors

Most of the books written by Laboratories authors are published by D. Van Nostrand Company. Other publishers include John Wiley & Sons and McGraw-Hill. Subjects include speech and hearing, mathematics, transmission and switching circuits, networks and wave filters, quality control, transducers, servomechanisms, quartz crystals, capacitors, visible speech, earth conduction, radar, electron beams, microwaves, waveguides, antennas, traveling-wave tubes, semiconductors, ferromagnetism.

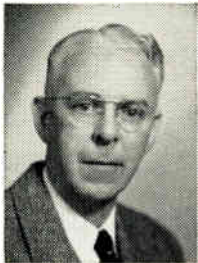

**Harold S. Black, B.S.**, in E.E., Worcester Polytechnic Inst., author of "Modulation Theory."



**John R. Pierce, Ph.D.**, California Inst. of Tech., author of "Traveling-Wave Tubes."



**Richard M. Bozorth, Ph.D.**, California Inst. of Tech., author of "Ferromagnetism."



**W. Thornton Read, M.S.**, Brown University, author of "Dislocations in Crystals."



**Hendrik W. Bode, Ph.D.**, Columbia University, author of "Network Analysis and Feedback Amplifier Design."



**Walter A. Shewhart, Ph.D.**, University of California, author of "Economic Control of Quality of Manufactured Product."

## News of Manufacturers'

## Reps

Jack Walter has joined the sales organization of Hyde Sales Co., 1341 Cherokee St., Denver.

Pinkney & Hine, 1925 Nicollet Ave., Minneapolis 3, Minn., will represent the Sorenson Company in North Dakota, South Dakota, Minnesota and Western Wisconsin.

R. G. Bowen, 446 Broadway, Denver, Colo. and the Burt C. Porter Co., 4310 Roosevelt Way, Seattle, Wash., were named reps for Filtors, Inc.

E. G. Oros Sales Co., 1194 Croyden Rd., Cleveland, Ohio, will represent the Astron Sales Corp., in the states of Ohio, West Virginia, and Western Pennsylvania.

Gassner & Clark Company, 6644 Northwestern Ave., Chicago, will handle sales to government and industry for Pyramid Electric Company in northern Illinois and southern Wisconsin. Henry D. Sarkis, 5608 Northwestern Ave., Chicago, will represent them to manufacturers of radio, television receivers, and phonographs in the same area.

Herbert L. Dienes Co., Phila., Pa. have just been appointed sales representatives for Waters Conely Co., Inc., manufacturers of Phonola phonographs. They will cover Eastern Penna., Delaware, Maryland, D. C., & Virginia. This sales firm has been active in the phonograph field for the past six years.

Samuel S. Egert Co., New York City, has been named to represent Nucleonics Products Co., Los Angeles 55, Calif.

Pivan Engineering Co. appointed to represent Sorenson & Co., Stamford, Conn. in Illinois, Indiana, Wisconsin and Eastern Iowa. They also handle Beta Electric Corp., a subsidiary of Sorenson.

McDowell Redlingshafer Sales Co. is now representing the Snyder Manufacturing Co., Philadelphia 40, Pa., in Nebraska, Kansas, Missouri, and Iowa.

Arnoux Corp., Los Angeles electronic instrument manufacturers, have announced the appointment of Fred F. Bartlett & Co., with offices in Phila., which will handle Washington, D. C., Maryland, Virginia, Delaware, and parts of New Jersey and Penna., and Bernard L. Michaelson Co., with offices in Dayton and Cleveland, will handle products in Ohio, Kentucky, and Indiana.

RMC Associates, 236 E. 75th St., New York, have made three additions to their staff. Herbert S. Kulik is with the field engineering group. Erwin F. Conrad joined the service and repair dept. and Herbert L. Rosenrauch enters the administration division. The firm also has an office in Bogota, N. J.

Ringer-Mezger Co., Inc., Glen Rock, N. J., has just been formed and will service Metropolitan New York, Long Island, Eastern Pennsylvania and New Jersey.

Weatherbie Associates, San Jose, Calif., has been organized as a rep firm and will cover Northern California and Nevada.



Jack Perlmuth, pres. of Perlmuth Electronic Assoc., accepts keys to sporty 1957 Fiat roadster from Dr. Gulton. His firm was top Gulton sales representative in the U. S.

A. Denish has been appointed a sales engineer with the M. A. Stolaroff Co., 4622 W. Slauson Ave., Los Angeles 43, Calif.

Morris F. Taylor Co., Silver Spring, Maryland, recently held their Annual Winter Sales Meeting in Silver Spring.

Mal Mobley, Jr., has joined the sales staff of E. V. Roberts & Associates, Los Angeles 16, Calif.

Bush & Wharfield, a newly formed rep firm, will operate out of Salt Lake City and Denver as reps for University Loudspeakers, Inc.

I. E. Robinson Co. is now representing the Sanborn Co. in Eastern Pennsylvania and Southern New Jersey. Their offices are located in Upper Darby and Camp Hill, Pa.

Jack E. Wilson, 4 Arrowhead Rd., Marblehead, Mass., will represent the Jensen Manufacturing Co. in the New England States.

Thomas H. Closs, Towson 4, Md., Dittman & Greer, Inc., Middletown, Conn., and Honolulu Electrical Products Co., Ltd., Honolulu, Hawaii, were named reps for the Hewson Co., Inc.

Frank A. Emmet Co., Los Angeles, has been appointed to represent the Glasseal Products Co. in Arizona, Southern Nevada and Southern California.

Ben Z. Rubin, 16222 Cheyenne Ave., Detroit 35, Mich., has been named representative for Allegheny Instrument Company.

Harold Holton has been appointed to the position of Electronic Sales Specialist for the Koehler-Pasmore Co., Detroit reps.

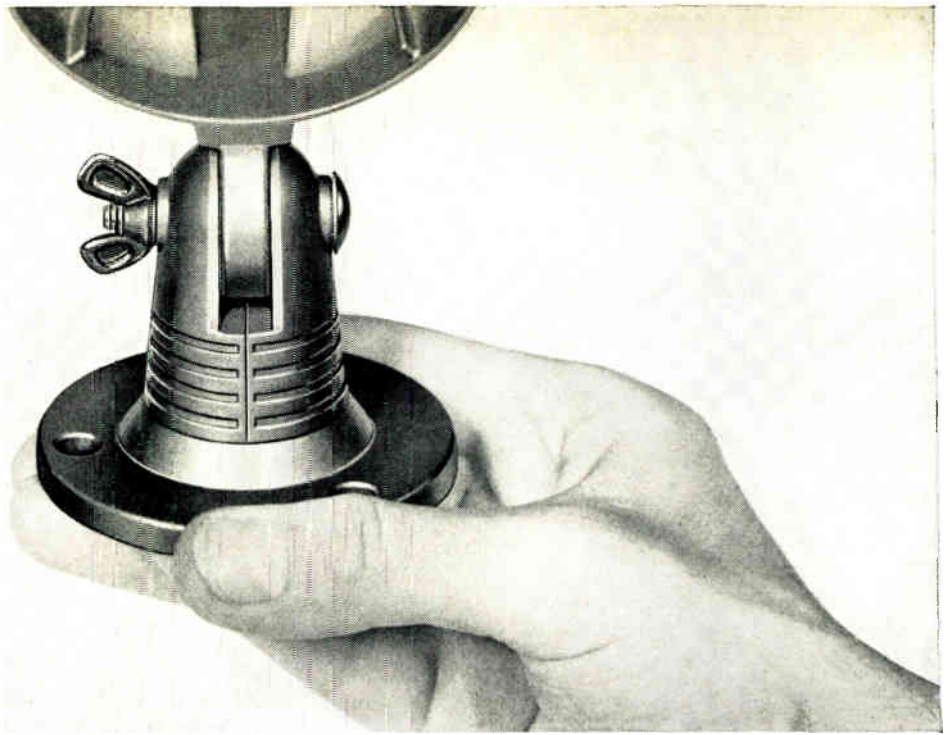

## WHAT HAS THIS SWIVEL MOUNT TO DO WITH...

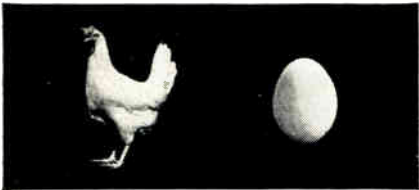

### Another great University first

As we've been saying... University "firsts" are worth having, worth working toward, worth waiting for. Not the first "Universal" joint to be incorporated into a bracket design, the new University omni-swivel bracket is the first that really works. It is also the only bracket that can fit directly on  $\frac{1}{2}$  inch pipe. Its *positive-lock* design, precision die-cast construction and versatility of application set new standards by which others will be judged.

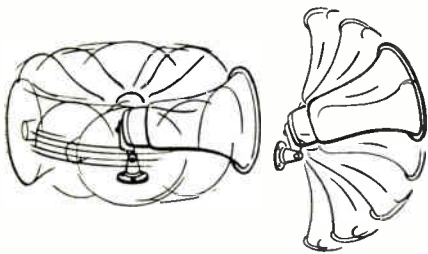

The University Positive-Lock omni-swivel base is standard equipment on the Models IB and MIL series paging and talk-back speakers, and Models CMIL and CIB series wide-angle paging speakers. Additional models will be so equipped in the near future.



### Progress that makes waste

As we've been saying... *being* the first is not as important to University as being first with a new design of *proven* quality... even if it means discarding achievements that no longer meet *our own* high standards. The serrated, die-cast swivel bracket being replaced by the new omni-swivel, is still superior to any other on the market today... yet we willingly discard it for the sake of true progress, the most important commodity University has to offer.

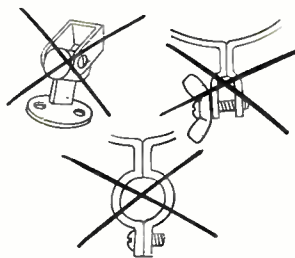

### Engineering that makes the difference

As we've been saying... the integrity and quality of good engineering is often where you can't see it, or touch it. Yet, these are what make the *difference* in brands... differences that spell success or failure of operation, really great value or a poor purchase. The drawing of the new University omni-swivel bracket unveils the ingenuity, meticulous detail and far-sighted design that are the ingredients of *every* University product.

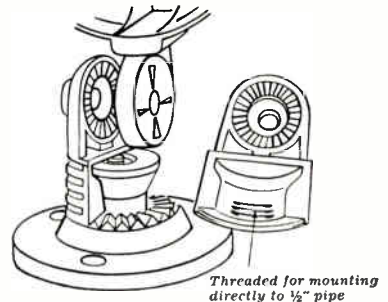

UNIVERSITY LOUDSPEAKERS, INC., 80 SOUTH KENSICO AVENUE, WHITE PLAINS, N. Y.

LISTEN

University sounds better



# TUBE DESIGN NEWS

GENERAL  ELECTRIC

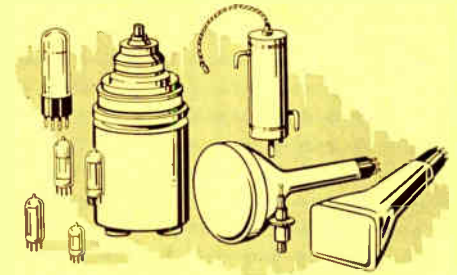

RECEIVING \* POWER \* CATHODE RAY

## Snow-White Cleanliness Extends to 5-Star Tube Parts Manufacture, Inspection, Handling

Broadened facilities for building G-E 5-Star high-reliability tubes under conditions of immaculate cleanliness, include dirt- and lint-free manufacture of the tube sub-assemblies.

All areas of General Electric's 5-Star Tube factory now are air-conditioned and pressurized to keep out dust. Workers, inspectors, and foremen who build and handle parts, wear the same lint-free Nylon and Dacron garments as employees who assemble and test 5-Star Tubes.

Grids are wound and cleaned with virtually no chance that a particle of dust or thread of lint will adhere, to cause tube "shorting". Heaters are formed, coated, (Continued on Page 2, Column 1)

## New G-E Voltage-Tunable Magnetrons in Development Permit Fast Tuning over Wide Range with Steady Output

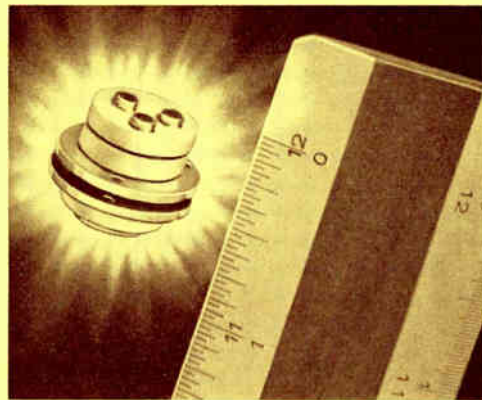

ABOVE, LEFT: the developmental Z-5112 voltage-tunable magnetron is only  $\frac{5}{8}$  in. high and  $\frac{3}{4}$  in. wide. ABOVE, RIGHT: preliminary tests prove essentially stable power output throughout 2000-mc tuning range.

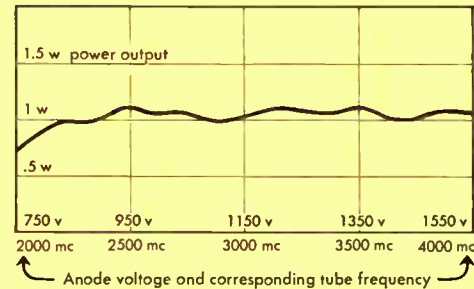

Latest developmental type in a series of voltage-tunable magnetrons pioneered by General Electric, the Z-5112 indicates the advantages which this group of tubes offers to designers of military equipment.

Recent tests of the Z-5112 prove its capability for rapid, efficient tuning over an extended frequency range, from 2000 mc to 4000 mc—with power output .5 w to 1 w throughout.

Counter-measures can benefit from this threefold tube advantage. Also, enemy jamming can be effectively circumvented by rapid tuning over a broad frequency spectrum with little or no reduction in signal power. With tube frequency a linear function of the anode voltage, the Z-5112 and other VTM types can be tuned merely by changing the potential of the anode. This makes for circuit simplicity.

Design benefits of General Electric voltage-tunable magnetrons now in development, are small size, light weight, and metal-ceramic construction. The latter adds strength, and gives high-temperature resistance. Tubes are designed to operate up to 60,000 feet altitude.

Besides being directly useful for counter-measure work, voltage-tunable magnetrons are suited to telemetering—for example, missile tracking; to FM altimeters; to air-navigation applications, broadband test equipment, and microwave communications generally.

Ask any G-E office listed on the next page for information on the development status of voltage-tunable magnetrons.

## G-E Snow-White Workers Check Progress on Their 5-Star Tube "Factory", to Operate at March I.R.E. Show

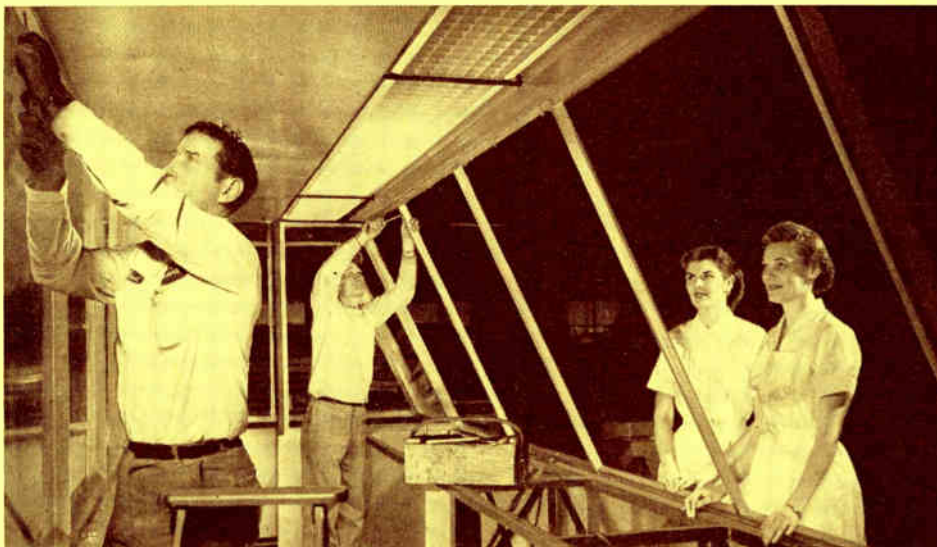

Featured at General Electric's exhibit at the New York I.R.E. Show, will be the actual assembly of 5-Star Tubes in an air-conditioned, pressurized working area, housed in a transparent plastic "factory". Trained operators from General Electric's 5-Star Owensboro, Ky., factory will assemble the tubes . . . Another G-E show highlight: first public demonstration of voltage-tunable magnetrons, described elsewhere on this page.

# 'Lightning-Rod' Filament Shield for G-E High-Voltage Rectifier Tubes Increases TV Dependability

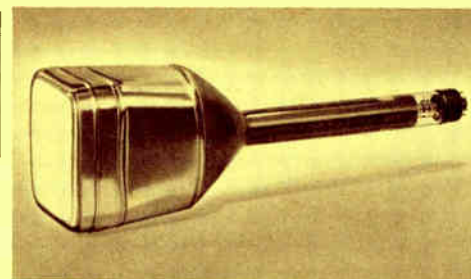

Special bulb design of Z-4399 optimizes resolution, accommodates several types of magnetic deflection yoke for presenting various kinds of information on face plate.

## New Z-4399 High-Resolution Tube Accents General Electric's Facilities For Special C-R Tube Development

Used primarily in equipment to pinpoint enemy mortar locations for quick counterfire, General Electric's Z-4399 C-R tube combines a group of features essential for its purpose—a 5½-in. square face plate that lends itself to a rectilinear coordinate display system; extremely high resolution; magnetic focus and deflection; a bright image brought about by aluminizing.

The tube's neck has been specially lengthened in order to (1) increase image resolution to a new standard of fineness and sharp definition, (2) accommodate several types of deflection yoke.

Designing C-R tubes such as the Z-4399 for specific military or industrial functions, is a job for which General Electric has extensive facilities in research, engineering skill, and equipment. Problems calling for the selection or origination of special C-R types are welcomed.



Among numerous steps taken to increase the reliability and long life of General Electric 1B3-GT and 1X2-A/B high-voltage rectifier tubes, mounting a "lightning-rod" shield beside the filament is important. Manufacturers of TV receivers thus are better protected against picture failures . . . . in sets in production, on test, and in owners' hands.

G.E.'s tungsten shield, or post wards off electrostatic pull on the tube filament . . . . thus minimizing pull-out and filament-to-anode shorts, and sharply reducing the incidence of broken filaments.

In addition, a highly adhesive filament coating further protects against arc-overs. Another special feature: the bulbs of G-E high-voltage rectifier tubes are ringed with conductive material to prevent vertical picture streaking that is caused by bulb charging.

To make sure that tube performance meets design targets, 1B3-GT's and 1X2-A/B's receive a 100% flyback test and a dynamic flyback life test—both at the top ratings for big-screen operation.

Realizing the importance to the TV industry of dependable, long-life rectifier tubes, General Electric is continuously improving its design, production, and test methods for these types.

ABOVE: a special tungsten post shields G-E tube filaments from electrostatic pull of high anode voltages. BELOW: checking 1B3-GT and 1X2-A/B rectifier types during G-E flyback life test that further safeguards tube performance.

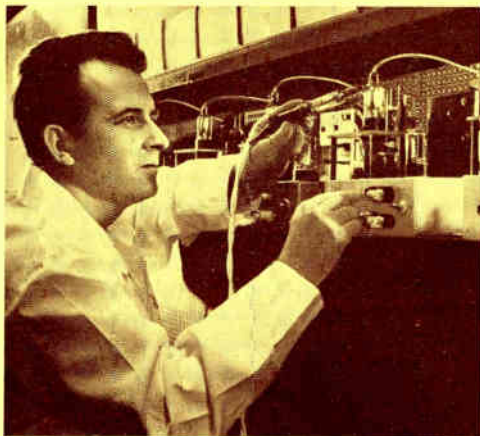

## Snow-White Cleanliness, 5-Star Parts

(Continued from Page 1)

and heat-treated . . . . other parts built and processed . . . . under the same strict conditions of near-surgical cleanliness.

There are 35 General Electric 5-Star Tubes, 11 of them subminiatures, meeting substantially every military and industrial need. Two new miniature types for computers are included in the line.

RIGHT: 5-Star Tube heaters, after forming and coating, are placed in individual glass cylinders for inspection. This helps guard heaters from contact with dust or lint until the tubes are assembled, exhausted, and sealed off.



## JUST PRINTED!



New, complete booklet on General Electric 5-Star Tubes — their design, manufacture, and testing. A "must" for designers who require maximum reliability in critical tube sockets. Ask for Booklet ETD-1425!

### EASTERN REGION

General Electric Company, Tube Sales  
200 Main Avenue, Clifton, N. J.  
Phones: (Clifton) GRegory 3-6387  
(N.Y.C.) Wisconsin 7-4065, 6, 7, 8

### CENTRAL REGION

General Electric Company, Tube Sales  
3800 North Milwaukee Avenue  
Chicago 41, Ill.  
Phone: SPring 7-1600

### WESTERN REGION

General Electric Company, Tube Sales  
11840 West Olympic Boulevard  
Los Angeles 64, Calif.  
Phones: GGranite 9-7765; BRadshaw 2-8566

*Progress Is Our Most Important Product*

**GENERAL ELECTRIC**

162-1C3

ELECTRONIC COMPONENTS DIVISION, GENERAL ELECTRIC COMPANY, SCHENECTADY, N. Y.



# International

## Selenium Photo-Cells and Sun Batteries

the most economical  
solar energy converter per  
milliwatt of output!

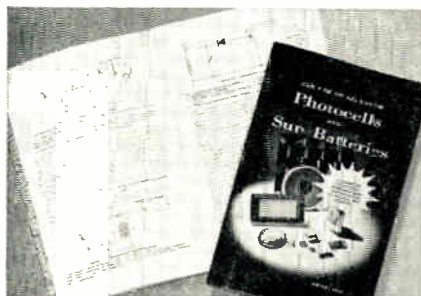

Write for the new  
72 Page booklet entitled

### "The Use of Selenium Photocells and Sun Batteries"

This handbook, of interest to scientists, engineers and experimenters, contains the basic theory and typical applications of photovoltaic cells. Copies are available for \$1.50 from our Product Information Dept.

For over 8 years, International Rectifier Corporation has been a recognized leader in the development and production of high quality selenium photoelectric cells for industrial applications. Drawing from 15 years experience in this field, International's research engineers have pioneered many of the recent advancements in the field devoted to the conversion of solar energy to electrical power. The resulting selenium sun batteries now available provide performance equal to any type of solar energy converter commercially available to industry today, *at a cost up to 50% below that of units utilizing other generating materials!*

International Rectifier Photo-Cells and Sun Batteries are available in a wide variety of sizes, mounted or unmounted. Hermetically sealed units can be supplied to operate

submerged in liquids or for outdoor applications where protection from corrosion is required. When applied and mounted properly, International's photovoltaic cells provide virtually unlimited life expectancy, evidence no irreversible fatigue or aging.

Whatever your application, from light measurement and control devices of all types to supplying power for transistorized equipment, you will find the most economical unit to specify is an International Photovoltaic cell.

For complete technical data on incident illumination intensity ranges, spectral response, ambient temperature range, etc., write on your letterhead to the Product Information Department for bulletins on all types of photocells available.



A WORLD OF DIFFERENCE

...THROUGH RESEARCH

## International Rectifier

C O R P O R A T I O N

EXECUTIVE OFFICES: EL SEGUNDO, CALIFORNIA · PHONE OREGON 8-6281

NEW YORK: 132 E. 70TH ST., TRAFALGAR 9-3330 · CHICAGO: 205 W. WACKER DR., FRANKLIN 2-3889

IN CANADA: ATLAS RADIOD CORP., LTD., 50 WINGOLO AVE. W., TORONTO, ONTARIO, RU 1-4174

THE WORLD'S LARGEST SUPPLIER OF INDUSTRIAL METALLIC RECTIFIERS

# Hyrel<sup>®</sup> Q the most reliable capacitors available anywhere!

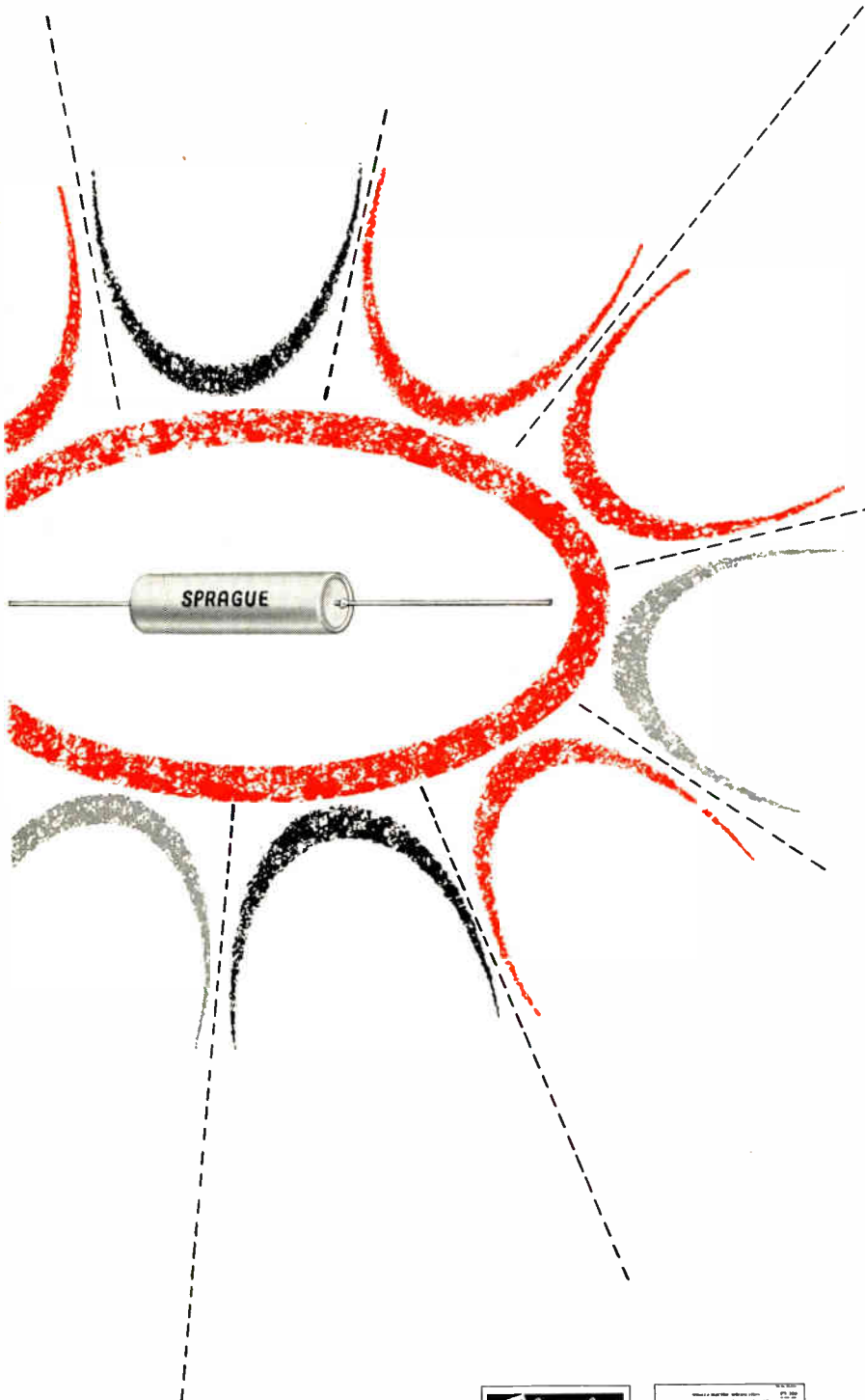

The name "Hyrel" heralds a complete new line of Sprague Capacitors conforming to the most rigorous set of capacitor specifications ever written. Techniques, materials, and processes combine to make it the most reliable paper capacitor possible within the present state of the art. After two years of exhaustive pilot runs, these high reliability units are in high volume production now.

In missiles, jets, warning networks, computers, controls . . . wherever reliability is important . . . Hyrel Q capacitors find scores of applications. A glance at Sprague Specification PV-100 tells you why. It's far above and beyond commercial or present MIL military levels . . . and it calls for outstanding performance under high *g* shock, vibration, humidity, immersion, as well as under accelerated life test. Complete facilities for making every test called for have been installed in a special plant area in which Hyrel Q capacitors are manufactured by specially selected personnel.

The first Hyrel Q capacitors—Type 195P—are subminiature metal-clad paper units hermetically sealed with *compression*-type glass-to-metal solder-seal terminals. Available in both conventional tubular and screw-neck mounting styles, all are Vitamin Q impregnated and designed for operation from  $-55^{\circ}\text{C}$  to  $+125^{\circ}\text{C}$ . Voltage ratings of 200, 300, 400, and 600 VDC are standard.

Complete technical information is provided in Engineering Bulletin 2900 and Specification PV-100. Both are available on letterhead request to the Technical Literature Section, Sprague Electric Company, 233 Marshall St., North Adams, Mass.



CAPACITORS • RESISTORS • MAGNETIC COMPONENTS • TRANSISTORS • INTERFERENCE FILTERS • HIGH TEMPERATURE MAGNET WIRE • PULSE NETWORKS • PRINTED CIRCUITS

SEE US AT THE I.R.E. SHOW - - BOOTHS 2416-18-20-22

# ELECTRONIC INDUSTRIES

## & TELE-TECH

M. CLEMENTS, Publisher • O. H. CALDWELL, Editorial Consultant • B. F. OSBAHR, Editor

### Science Consultants

The recent appointment of Dr. I. M. Levitt, director of Franklin Institute's Fels Planetarium, to the post of science consultant for the City of Philadelphia is a most significant development. In making this appointment, Mayor R. Dilworth has shown that Philadelphia's civic leaders are acutely aware of the constantly growing influences that science and engineering have on every citizen.

Basically Dr. Levitt acts as liaison with industry to aid the municipal authorities in solving scientific problems of health and welfare. We believe other cities in the U. S. might do well

to consider the appointment of non-political scientific consultants also.

The civilian uses of atomic energy are on the increase; applications of a great variety of electronic equipment are being extended to nearly every type of manufacturing or processing industry; growing populations and growing industries offer new complexities in air pollution; building codes need modernizing and simplifying; civic departments themselves need the very latest techniques and equipment that industry has to offer. Science consultants, therefore, can render an important community service.

### Convention PR

This was the title of an editorial we presented last year and with the 45th annual IRE Convention taking place March 18-21 in New York City, some of the suggestions concerning public relations at the exhibits might be worth repeating. It was suggested:

1. Does your booth clearly indicate what your company is selling? Lavish displays that fail to convey this factor clearly, obviously are costly and wasteful.

2. Have all people who will be in attendance at the booth been thoroughly primed? Do they know how to sell the company as well as the product? With the show larger than ever, nothing is

more frustrating to the visiting engineer than to find people manning impressive booths but totally unable to answer technical questions.

3. How about periodic policing? If you invest in a prime location in a top show it is very desirable to have a constant or periodic policing system in effect. Hats and coats tossed on display cases, an area littered with paper, cigar and cigarette butts, empty coffee containers etc. are real deterrents to capturing and holding an audience.

Other convention PR suggestions will no doubt occur to you and with the show only weeks away, the time for preparing your representatives is now.

### Creative Engineering

From time to time in the past we have written on the necessity of using available engineering manpower more efficiently. Trained engineers continue to be in acute short supply and there appears no reason to believe that supply will meet demand at any early date. It is surprising that manufacturers have taken so long to evaluate their engineering position and to develop internal programs which will permit an operation affording maximum individual creativeness. It is gratifying to note now, however, that such a trend is definitely under way.

In New England, for example, one

company has arranged management night courses for its electronic engineering staff. Many other organizations are now taking steps to make their engineers deskmen instead of benchmen. Bench positions are being filled with electronic technicians who have adequate training to build the circuits and make the required test measurements.

We believe this to be a healthy trend both for industry and the individual engineers concerned. We hope, too, that all electronic producers will soon be working in this direction.



# SOLAR POWER

Fig. 1: (Right) In the famous Americus experiment, Bell engineers powered rural phone lines from a battery of solar cells

*Here are design characteristics of the sun which will guide the engineer in developing solar powered equipment. Included is a report of recent developments in artificial solar energy—and a preview of power plants which may supersede atomic energy*

By **ARNOLD E. LOOK**

*Assistant Editor  
ELECTRONIC INDUSTRIES  
& Tele-Tech*

**O**UR sun is a bubbling, boiling fury of dissociated gas. This giant cauldron fuses 4 million tons of hydrogen into helium each second. The fusion releases energy in many forms, including low frequency variations in magnetic field, microwave, x-ray, light, and emitted particles.

Because of the distance between sun and earth, only about one ten-billionth of the sun's radiated energy falls on our outer atmosphere. Approximately 80 percent is filtered or reflected by the atmosphere. About  $85 \times 10^{12}$  kilowatts actually reaches the earth's surface. Despite this loss, solar energy falling on Lake Mead is six times the electrical energy produced by the generators at Boulder Dam. Maximum solar energy is about 100 watts per square foot—with the sun directly overhead on a cloudless day. Here in the United States, sunlight averages about 30 watts per square foot in summer, and 8 watts in winter. Averaged over



the whole year, each square foot receives 336 watt-hours of solar energy per day in Boston, 308 in New York, 596 in El Paso, 420 in Salt Lake, and 340 in Seattle.

Man's history is filled with attempts to improve on mere radiant energy from the sun. We have used fire, consuming the stored energy of previous years; windmills, powered by convection currents in the air; and hydraulic power, using the potential energy of sun-raised water. More recently, during the last hundred years, inventors have learned to use sunlight to make steam and distilled water. High temperature metallurgy is using giant reflectors to concentrate solar energy and approach 4000 degrees Centigrade.

We now have three main methods of using radiated solar energy. One is the storage of solar energy at low levels to provide heat for buildings. Houses are being heated this way as far north as Boston. The

# What Are The Facts !

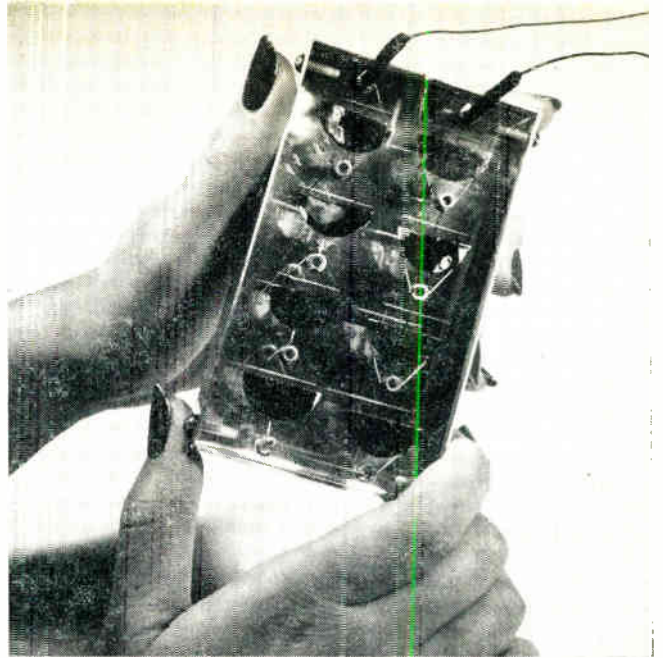

Fig. 2: Semiconductor research produced the silicon solar cell

process is similar to that used in the familiar greenhouse, where incident visible light is converted by plants and earth into infra red energy. The glass panels are opaque to the lower frequency energy and solar energy is trapped as heat within the greenhouse.

The second method of using solar energy is to concentrate it onto a small area, thus transforming the low temperature over a large area to a high temperature over a small area. A parabolic reflector 14 feet in diameter, focusing all incident solar energy onto one square inch, would provide an energy density transformation of better than 1:22,000. Under maximum conditions such a system could collect over 15 kilowatts of solar energy. A big advantage of such a system is that energy can be radiated to metallurgical specimens isolated from contaminating substances.

The third field of solar power involves conversion

of solar radiation to electrical energy. Both thermoelectric and photo-electric effects have been used. The simple, rugged construction of thermocouples, and the absence of critical materials have made them attractive for industrial temperature measurement. In recent years, workers in France and The Netherlands have produced thermocouple power supplies for transistorized radios. These supplies were designed for use with artificial heat sources, but can be powered by solar energy concentrated by mirrors or lenses. Conversion efficiency of thermocouples is low.

Selenium cells, with an efficiency running around 1 to 1½ percent, are extensively used for measurement and control with moderate illumination. These are the cells commonly used in light meters. They have been used as power supplies for transistor radios and other equipment, but they must be pro-

*(Continued on page 144)*

Fig. 3: The apparent sun temperature varies with frequency

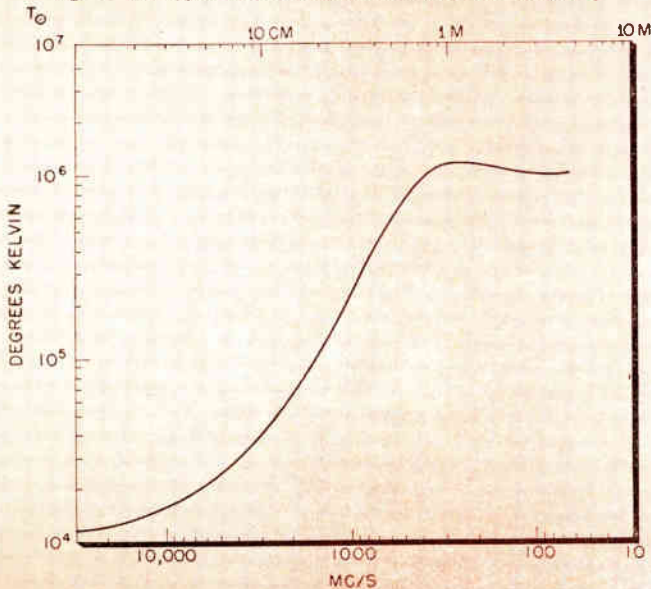
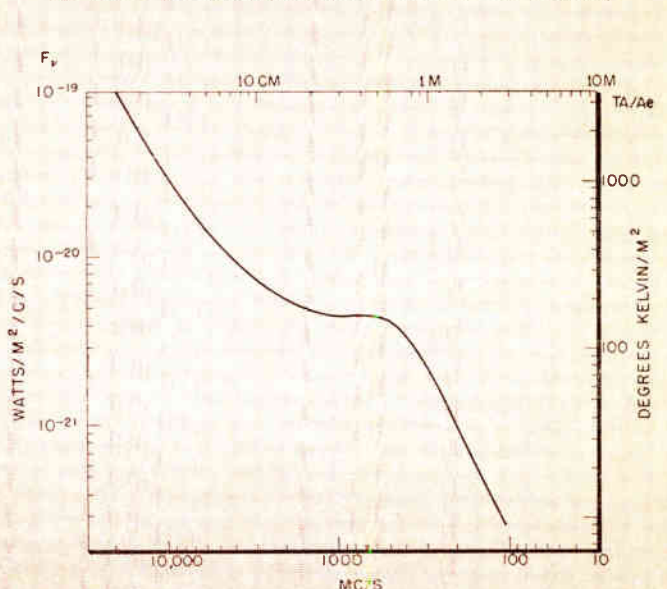

Fig. 4: Flux generated by the quiet sun varies with frequency



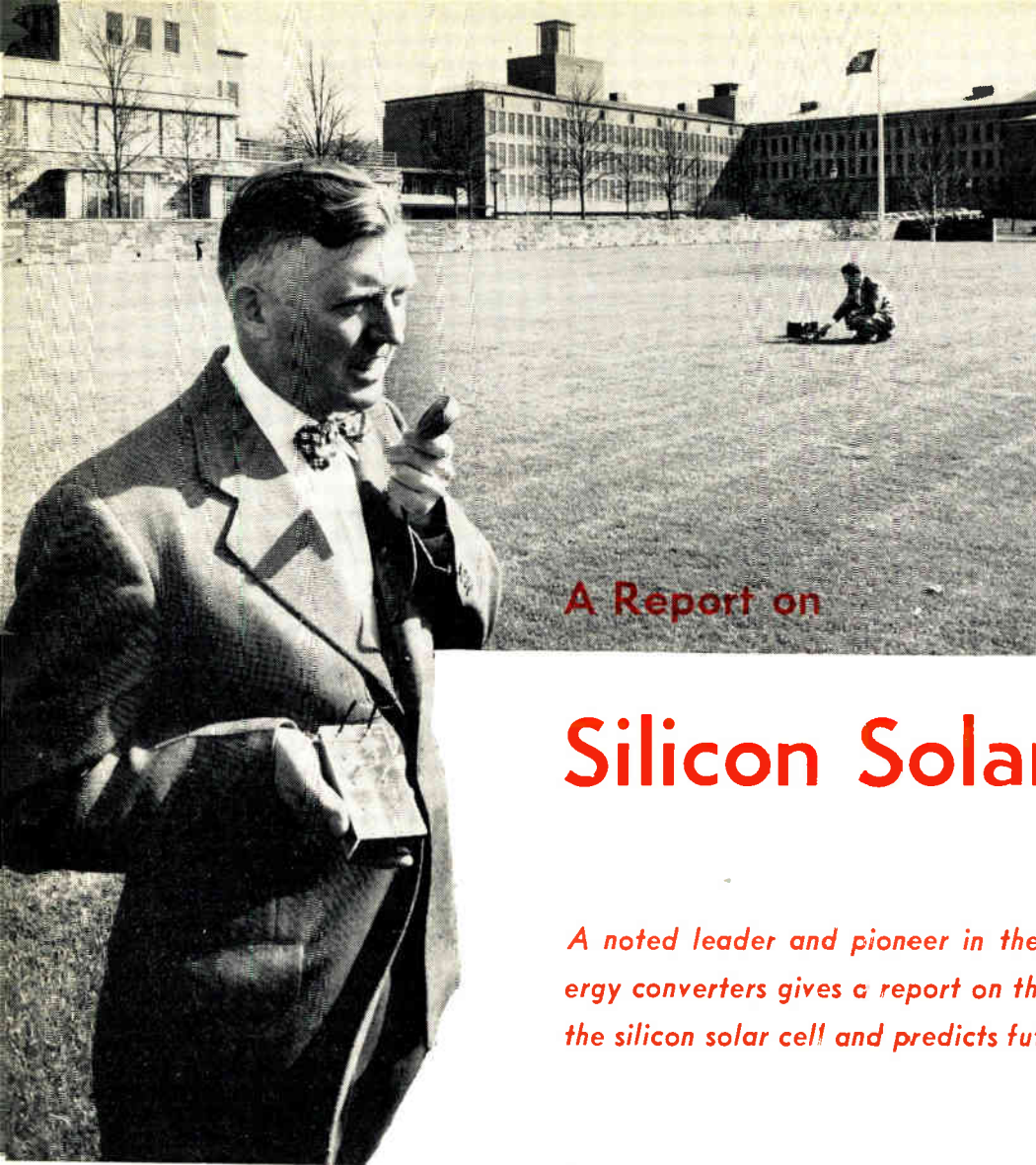

Fig. 1: Dr. Prince and D. E. Thomas demonstrate one of the first solar powered radio transmitters. This early solar battery had an efficiency of 6%, provided enough power for transmissions of several miles

By  
**Dr. MORTON B. PRINCE**  
*Director, Research and Development,  
 Hoffman Semiconductor Division,  
 Evanston, Illinois*

A Report on

# Silicon Solar Cells

*A noted leader and pioneer in the field of solar energy converters gives a report on the present status of the silicon solar cell and predicts future developments.*

During the past few years, great interest in the direct conversion of solar energy into some other form of energy has been developing. When one considers that approximately one kilowatt of sun power falls on every square meter of area when the sun shines, any device capable of converting even a small amount of this energy into electrical energy has great potentialities.

During the past century many experimenters have developed devices capable of converting up to 1% of the solar power into electrical power using thermopiles, photo-galvanic cells, and photovoltaic cells. About three years ago a huge jump in conversion efficiency to 6% was announced by Chapin, Fuller, and Pearson of the Bell Telephone Laboratories by using a silicon p-n junction device. The next year BTL announced a

further improvement in conversion efficiency up to 11%. Some of the better solar cells now being made have efficiencies up to 13%.

The active part of the solar cell is the same p-n junction now used in rectifiers, transistors, and other semiconductor devices. When light falls on the p-n junction, photons having sufficient energy to break valence bonds in the crystal create hole-electron pairs. If the photon is absorbed near the junction, the hole-electron pairs will diffuse into the junction region where the junction field will cause them to separate so the holes flow into the p-type material and the electrons flow into the n-type material. This builds up an external voltage on the device and causes current to flow through a load. The light acts as a current generator.

Fig. 2: The higher efficiency of small silicon solar cells leads to the use of many small cells instead of one large surface

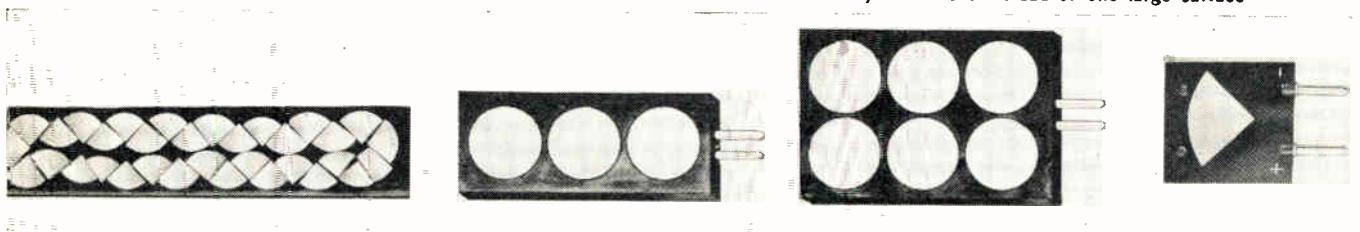

Table 1 lists some factors that reduce solar cell efficiency, along with the maximum numerical factor that can be expected. The product of these factors gives a top practical efficiency of about 15%. At present, the highest efficiency units are about one square centimeter in area, and are capable of delivering about 10 to 12 milliwatts of electrical power in bright sunlight.

It has been suggested that higher energy solar energy cells might be made by using semiconductors other than silicon, but investigations do not predict much over-all gain from the use of other materials.

There are two general uses for solar cells at present; primary power sources, and photoelectric detectors. Power applications frequently require some sort of storage or averaging accessory in order to provide continuous power, or high peak power over a short duty cycle. Such uses for solar cells include transistor radio receivers and transmitters, unattended telephone repeater stations, unattended weather stations, satellite equipment, intermittent signaling and lighting devices, toys, and novelties.

Photoelectric applications include the standard photoelectric "eye" applications with or without the use of intermediate relays, light meters, radiation detectors, temperature controls, and infra-red detectors. Silicon solar cells have proved suitable for both types of use. The greatest present drawback is the high cost of silicon solar cells—they are an expensive way to obtain large amounts of power. At the present time these solar energy converters should be considered only for low energy (less than 10 watts) applications, except where battery replacement is impossible.

The best commercial solar converters today have efficiencies up to 11%, cost about \$1 per square centimeter of active area, and are being made in sizes up to 7 square centimeters in area. The highest efficiency cells are the smallest ones. Future developments may bring devices able to convert about  $\frac{1}{3}$  more solar power than now. However, techniques are being developed that will permit these high efficiencies to be obtained for all solar cells, independent of size. There will be more important improvements in the size and cost of these cells.

Cells whose area is on the order of several square inches should be available in the not too distant future. These will be capable of supplying about one-half watt of power. As far as cost is concerned, many avenues of improvement are being explored, and there are hopes of cutting the price considerably. These improvements are to be found in raw material costs, in processing the raw material to make p-n junctions, and in manufacturing processes and packaging.

Thus with an increase in efficiency coupled with decreases in cost per unit area, one might expect to be able to buy enough cells to generate one watt of power for \$30, as compared to the present cost of \$100. If this expected cost of solar cells is amortized over a period as short as two years, it will be cheaper to use solar cells than dry batteries. Thus, the future for these solar energy converters looks extremely promising.

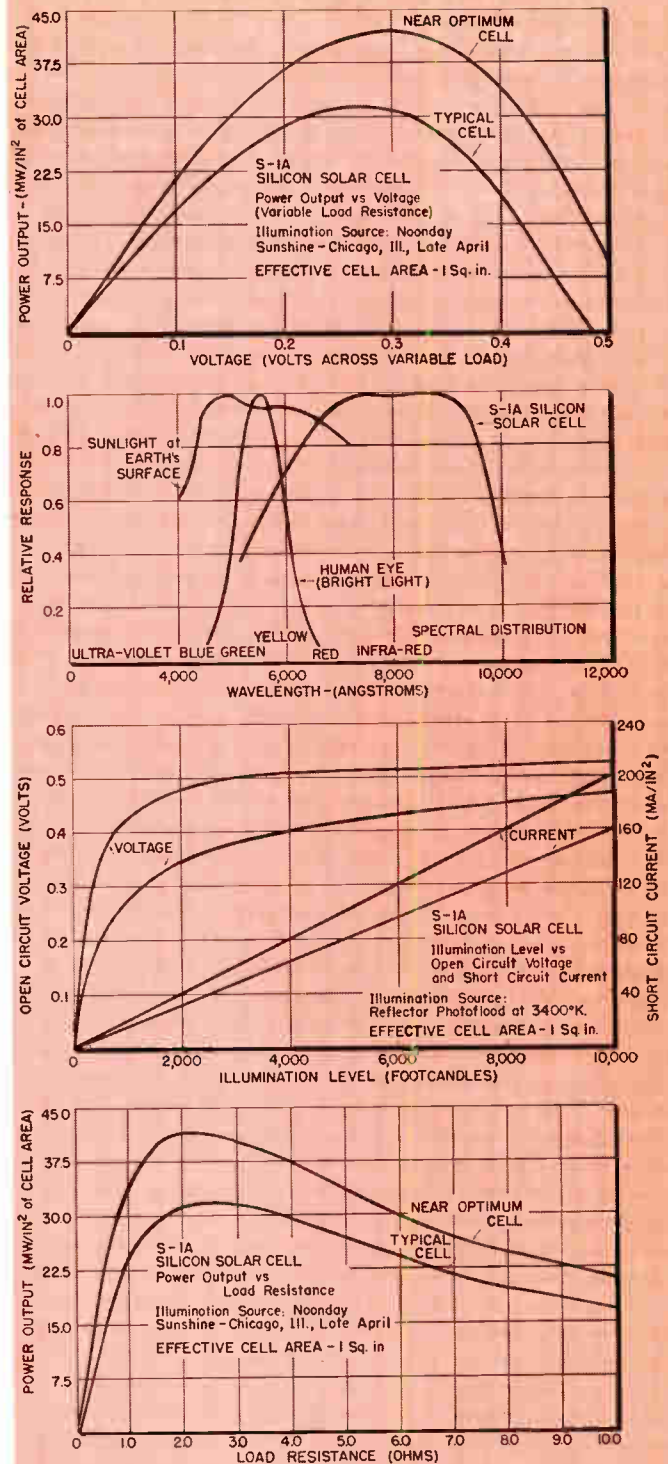

Fig. 3: The curves above present pertinent design information for power supplies designed around silicon solar batteries

TABLE 1

Factor	Numerical Value
Photons too weak	
Photons more than strong enough	.55
Output voltage less than energy required to create hole-electron pair	.55
Optical reflection	.8
Junction properties	.8
Internal resistance losses	.8
Product of Factors	.15

*Simple measurements give the three important high frequency parameters of junction transistors. Tests between 50 KC and 5 MC provide an estimate of transistor performance at higher frequencies*

# Transistor Tests Predict High Frequency Performance

**By R. L. PRITCHARD**

*General Electric Research Laboratory  
Schenectady, N. Y.*

Fig. 1: A practical circuit for estimating transistor inherent alpha-cutoff frequency

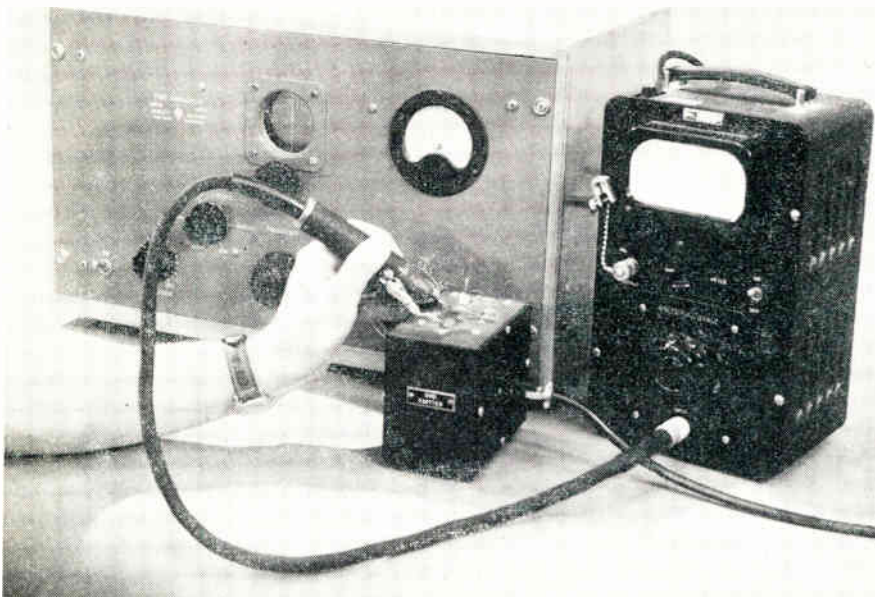

At low frequencies the performance of a junction transistor in transmission-type applications can be characterized by the usual four low-frequency small-signal parameters. At high frequencies, however, or for pulse applications, the performance is determined by three different parameters; the inherent<sup>1</sup> alpha-cutoff frequency  $f_{\alpha}$ , the a-c base spreading resistance  $r_b'$ , and the inherent<sup>1</sup> collector-base capacitance  $C_{cb}$ . In the case of the usual fused-junction, or alloy, transistor, the relation between the high-frequency power gain at a frequency  $f$  and these three parameters is given by the equation<sup>2-4</sup>

$$G_{av} = \frac{1}{25 f^2} \left( \frac{f_{\alpha}}{r_b' C_{cb}} \right). \quad (1)$$

On the other hand, for a high-frequency grown-junction transistor with a base contact approximating a line contact, a somewhat different



expression must be used if the ohmic base resistance is high relative to the Shockley et al emitter resistance  $r'_e = (25/I_e)$  ohms, with  $I_e$  in ma.<sup>2</sup>

$$G_{av} = \frac{1}{30 f^{3/2}} \frac{f_n^{1/2}}{C_c (r'_b r'_e)^{1/2}}$$

where:  $\left(\frac{r'_b}{r'_e}\right) \left(\frac{f}{f_n}\right) > 1$ . (2)

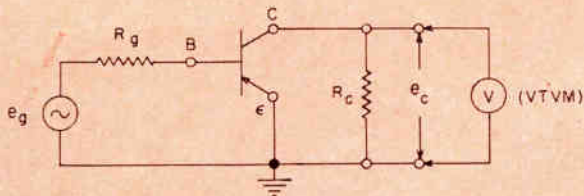

Fig. 2: Test circuit for common-emitter current amplification

Note, however, that in either case the gain is determined by these three fundamental high-frequency parameters. Furthermore, for pulse applications, rise and fall times are functions of these same parameters.<sup>5</sup> In this paper, methods of measuring each of these three high-frequency internal transistor parameters will be described briefly.

### Alpha-Cutoff Frequency

Alpha-cutoff frequency  $f_\alpha$  of a transistor can be measured directly by any one of a number of methods.<sup>6,7,8</sup> However, for transistors having high values of  $f_\alpha$ , e.g.  $f_\alpha > 30$  MC, fairly elaborate instrumentation may be necessary. An additional disadvantage also exists in the direct measurement of  $f_\alpha$  at high frequencies; the quantity of interest  $f_n$  in Eqs. (1) and (2) is the  $\alpha$ -cutoff frequency of the transistor without ohmic base resistance. If the product  $r'_b C_c$  is large relative to  $1/f_n$ , the measured  $\alpha$ -cutoff frequency  $f_\alpha$  may be significantly different from  $f_n$ . In fact in extreme cases it may be impossible to measure  $f_\alpha$ , inasmuch as  $|\alpha|$  may never decrease to 0.7!

In order to avoid this difficulty and in order to avoid very-high-frequency measurements, it is possible to estimate  $f_n$  by measuring the magnitude of the grounded-emitter current-amplification factor  $|h_{21}^e| \approx |\alpha/(1 - \alpha)|$  in the medium-

frequency range, e.g., 1-5 MC.<sup>9</sup> Because of the phase shift associated with  $\alpha$ ,  $|h_{21}^e|$  at high frequencies decreases with increasing frequency at approximately 6 db per octave.<sup>10</sup> At the inherent alpha-cutoff frequency  $f_n$ ,  $|h_{21}^e|$  has decreased to approximately 0.85. However, for the newer types of high frequency transistors (e.g. drift or diffused-

base) having appreciable built-in field effects (which give rise to excess phase shifts) the value of  $|h_{21}^e|$  at  $f_n$  may be considerably smaller and the magic number of 0.85 is not applicable. A more general approach to include such cases is to define the frequency  $f_T$  at which  $|h_{21}^e|$  has decreased to 1 and to use  $f_T$  in place of  $f_n$ . In other words, it turns out that the phase shift of the current-transfer constant is generally of more importance in practice than is the amplitude-frequency characteristic.

An additional advantage of measuring  $|h_{21}^e|$  rather than  $\alpha$  is that the dependence on base resistance  $r'_b$  is removed. On the other hand, considerable care must be taken to minimize emitter-base parasitic capacity in this measurement.

In theory at least, a single frequency measurement of  $|h_{21}^e|$  would be sufficient to determine  $f_n$ . For example, if  $|h_{21}^e| = 3$  at 5 MC, estimated  $f_n = 18$  MC or  $f_T = 15$  MC. However, in practice, since  $|h_{21}^e|$  may not vary exactly at 6 db per octave, it is desirable to measure  $|h_{21}^e|$  at, say, three frequencies and then to extrapolate  $|h_{21}^e|$  to 0.85 or to 1. in order to estimate the inherent alpha-cutoff frequency, or  $f_T$  respectively.

This method of measurement at 1-5 MC fails to yield an estimate of  $f_n$  if the latter is extremely high,

e.g. 500 MC (in which case 1-5 MC is essentially dc.) or if low-frequency alpha is very low. However, the method is satisfactory for a majority of the high-frequency transistors available at the present time.

### Ohmic Base Resistance

A number of methods have been suggested for measuring ohmic base

resistance  $r'_b$ . For example, Early has pointed out that  $r'_b$  may be deduced from measurements of low-frequency grounded-base voltage-feedback ratio  $h_{12}$  and open-circuit output-conductance  $h_{22}$  as functions of dc emitter current.<sup>11</sup> Also, it has been proposed to deduce  $r'_b$  from the values of low-frequency common-base short-circuit input impedance  $h_{11}$  and the current-amplification factor  $\alpha$  at low frequencies using the relation<sup>12</sup>

$$r'_b = \frac{h_{11} - r'_e}{1 - \alpha}, \quad (3)$$

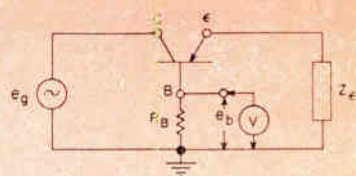

Fig. 4: Output admittance circuit

with  $r'_e = (25/I_e, \text{ma})$  as defined above. Both of these methods suffer from the disadvantage that  $r'_b$  may be a function of dc emitter current (especially in grown-junction transistors). In addition, the first method may yield erroneous values of  $r'_b$  owing to base-resistance-modulation effects due to space-charge-layer widening. Also, in the second method  $r'_b$  generally must be deduced from the difference between

(Continued on page 130)

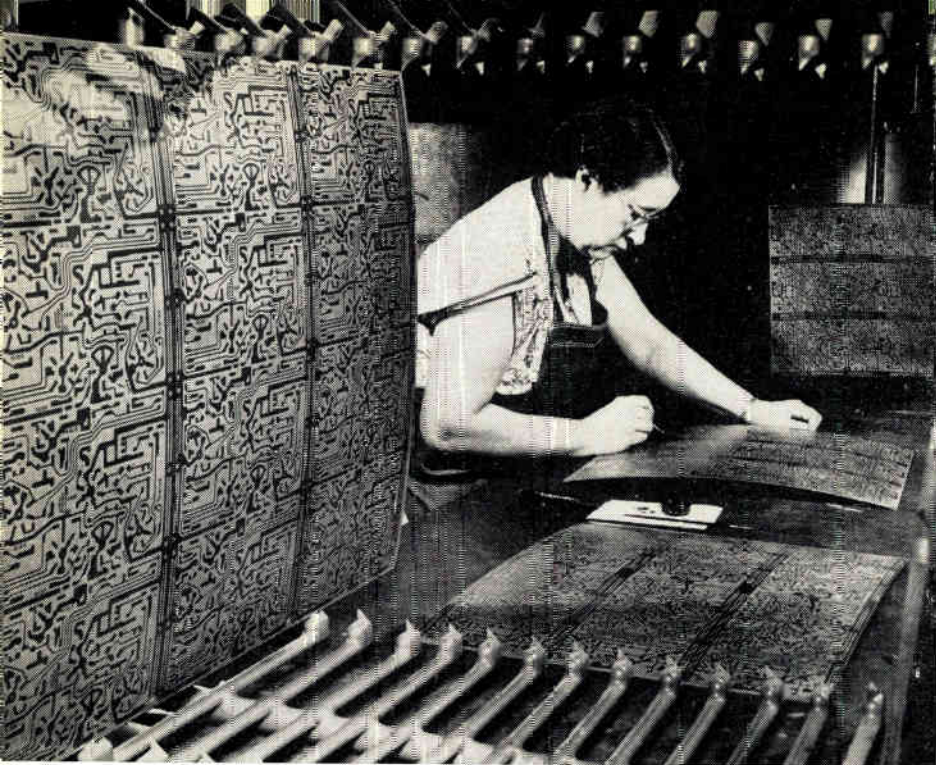

Fig. 1: At Admiral Corp. etched foil boards are produced 12 on a sheet

Fig. 2: First step is photographing a large drawing of the ckt.

THROUGH the years many processes for the manufacture of printed wiring units have been developed. Most of the processes have since been set aside in favor of what appears to be a category of seven general processes. Each of these 7 general processes has several issued patents which touch on various unique slants to the general process. In this article we will describe each of the 7 general processes and list the patent numbers which apply to each general process.

#### Acid Etching

First is the process known as "the acid etching of foil clad laminates." This process uses various insulating base materials clad with a conducting foil. The base materials are generally made up of thermosetting laminates comprised of a filler and binder, the qualities of which are dictated by the mechanical and electrical requirements of the end product. The conducting foil is clad to the base material

## Pro & Con On Seven Different Methods of Printed Wiring

*Presently available printing techniques vary widely in flexibility, the maximum definition possible, and adaptability to mass production. The advantages of the major processes are compared here, with a listing of the patents covering each*

By **ALVIN E. STONES**

Mandex Mfg. Co., Inc.  
2608 W. 16th St.  
Chicago 8, Ill.



during its laminating and curing cycle. At the same time the desired bonding characteristics are established through the use of an interleaved adhesive layer applied between the foil sheet and the base material sandwich.

Once the desired foil clad laminate is obtained, the surface of the foil is prepared for etching by imprinting upon it the image of the conductor pattern in a material that is resistant to the etching solution to be used. This protects the areas which will comprise the circuit pattern while the exposed areas are being etched away.

Many methods of imprinting the resist material are possible, such as Silk Screening; Photo Print; Off-Set Lithography; Flat Bed Press; Stenciling; and Painting. The silk screening method appears to be the most popular.

When the etching cycle is completed and the board removed from the etching bath, it is immediately washed and rinsed to remove all traces of the etchant. Otherwise, deleterious after-action may take place. The type of etchant used depends on the type of foil, the type of resist, and the type of finish plating specified.

When the resist material is removed the foil that remains is in the exact pattern of the wiring configuration originally imprinted.

This process appears advantageous because of its flexibility and extreme versatility, and also the fine definition of conductor patterns possible. Only simple and low cost equipment is required to set up an efficient operation, and any quantity of circuits can be accomplished with economic advantage. It is also a very simple transition to convert the crudest operation to an automatic set up.

Disadvantages of the process are that the chemical residue sometimes causes after-action and the areas of the insulating base material exposed by removal of the foil tend to absorb moisture. Also, through-hole connections in any great quantity are impractical.

Possible ramifications of this process would be flushed circuitry through resin build-up or by compression, formed circuit boards through the use of post forming base materials, complex circuiting

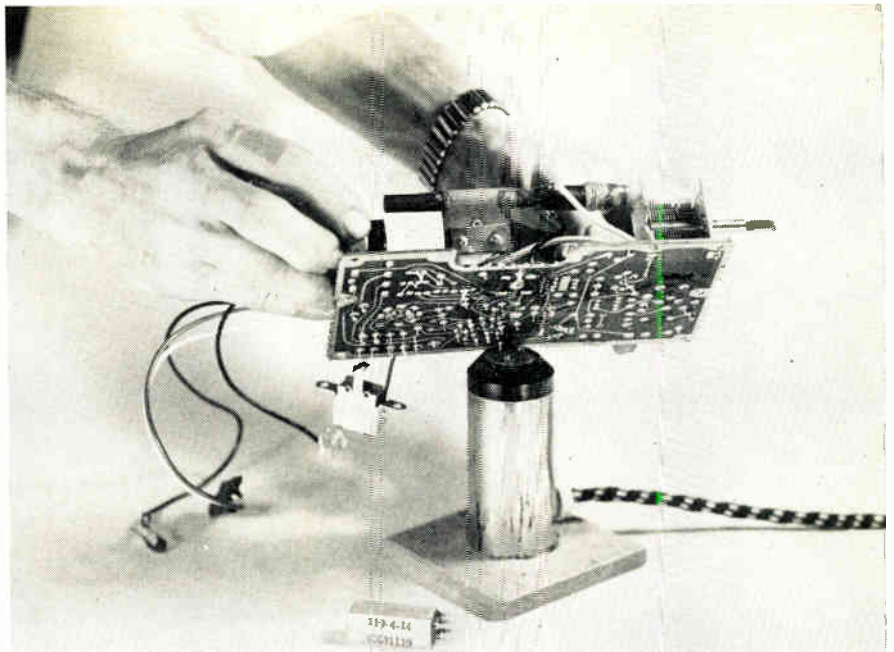

Fig. 3: Motorola's plated circuit chassis is here being selectively dip soldered

through multiple layer construction, and through-hole connection by means of selective after plating.

#### *Plated Circuit Method*

Next is the printed wiring process referred to as "The Plated Circuit Method." This process employs the principles of electroforming to the extent that all conductors are laid down in the desired pattern and thickness in an electroplating bath.

As with the acid etching process, this plated circuit method requires laminated insulating base materials of thermosetting character. With this plating process, however, there is no need for foil cladding the insulating base material, though the base material must be sand blasted or otherwise surface-prepared to

provide a tooth for the plating deposit.

In this plated circuit process the entire surface is sensitized for electroplating, either by dipping the board in a sensitizing material, by spraying the board with a sensitizing material, or by painting on a sensitizing material. Any of a number of sensitizing materials may be used, such as graphite, colloidal metallic silver, or one of the silver salts.

After drying, the board is prepared for plating by imprinting upon it the negative image of the conductor pattern in a stop-off that will resist the plating solution. The areas where a plated deposit is desired are exposed to the plating action while the insulating areas are protected by the resist material. After electroforming to the desired deposit thickness, the board is removed from the plating bath, and washed thoroughly to remove all traces of the plating solution.

When the resist material is removed the conductor pattern is exposed, with traces of the sensitizing deposit remaining over the insulating areas. This sensitizing deposit must be removed or converted to a non-conducting medium before the circuit board is used. This is easily accomplished by either mechanical or chemical action.

Fig. 4: Plated circuit, plated on both sides and having plated-through holes

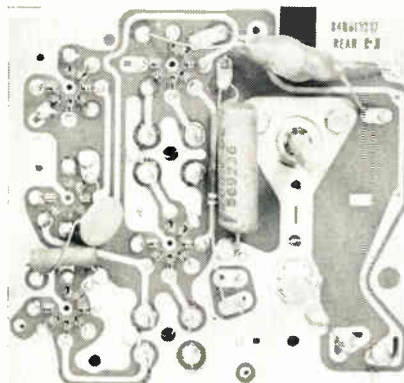

# Printed Wiring (cont.)

The plated circuit process is easily adapted to automatic procedures and extreme economics are possible at large quantity runs. Also in its favor; through-hole circuitry is accomplished as a function of normal procedure, and the conductor materials and deposit thicknesses are extremely versatile.

Disadvantages are the bonding characteristics and heat resistance of the plated conductors, the possibility of after-action by plating solution residue, and the high degree of moisture absorption caused by surface preparation of the insulating base material. Also, to realize the full economics, expensive complex machinery will be required which makes the process inflexible and rules out most possibilities for low quantity economics.

Among the future developments of this method could be flushed circuitry through resin build up, complex circuitry through multiple layer construction, and formed circuit boards, through the use of post formed or molded base materials.

Recently a new technique called the Transfer Method has been finding considerable use. This system is very similar to the plated circuit technique in that all conductors are laid down in the desired pattern and thickness through electroforming principles. How the conductor pattern is bonded to the insulating base material is the main digress-

*(Continued on page 153)*

Fig. 5: Laminating press for Inlaid Process

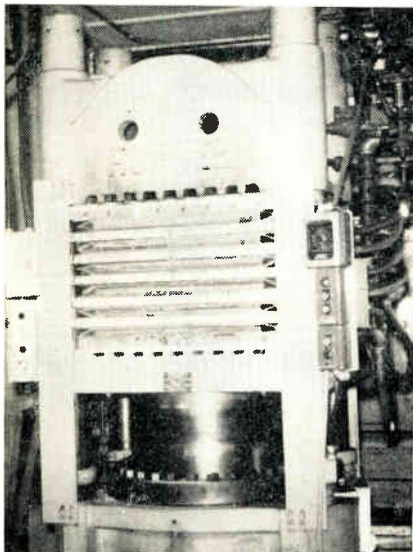

## PRINTED WIRING PATENTS

Patent Number Etched Foil	Potentee	Title of Patent	Date of Issue
378,423	J. Baynes	Method of Etching on One or Both Sides	Feb. 28, 1888
2,441,760	P. Eisler	Manufacture of Electric Circuit Components	May 25, 1948
2,587,568	P. Eisler	Manufacture of Electric Circuit Components	Feb. 26, 1952
2,602,731	T. D. Nierenberg	Method of Making Circuit Panels	July 8, 1952
2,607,825	P. Eisler	Electric Capacitor and Method of Making It	Aug. 19, 1952
2,631,092	P. A. Tatusko et al	Method of Etching Plates	March 10, 1953
2,683,839	J. T. Beck	Electric Circuit Component and Method of Preparing Same	July 13, 1954
2,693,023	F. E. Kerridge et al	Electrical Resistor and A Method of Making the Same	Nov. 2, 1954
2,695,351	J. T. Beck	Electric Circuit Components and Methods of Preparing the Same	Nov. 23, 1954
2,747,977	P. Eisler	Method of Making Printed Circuits	May 29, 1956
2,758,074	O. D. Black et al	Printed Circuits	Aug. 7, 1956
2,758,256	P. Eisler	Electric Circuit Components	Aug. 7, 1956
Re. 24,165	P. Eisler	Manufacture of Electric Circuit Components	June 12, 1956
<b>Plating</b>			
1,647,474	F. W. Seymour	Variable Pathway	Nov. 1, 1927
2,680,699	M. D. Rubin	Method of Manufacturing a Conductive Coated Sheet and Said Sheet	June 8, 1954
2,699,424	T. Nieter	Electroplating Process for Producing Printed Circuits	Jan. 11, 1955
2,699,425	T. Nieter	Electroplating Electrical Conductors on an Insulating Panel	Jan. 11, 1955
2,728,693	E. E. Cado	Method of Forming Electrical Conductor upon an Insulating Base	Dec. 27, 1955
2,758,074	O. D. Black et al	Printed Circuits	Aug. 7, 1956
<b>Die Stamped</b>			
636,203	H. Helberger	Electric Resistance	Oct. 31, 1899
2,508,030	S. J. Karns	Wiring Pattern for Electrical Apparatus	May 16, 1950
2,582,685	P. Eisler	Method of Producing Electrical Components	Jan. 15, 1952
<b>Transfer</b>			
2,447,541	R. N. Sabee et al	Method of Making Plastic Structure	Aug. 24, 1948
2,481,951	R. N. Sabee et al	Method of Making Tubular Plastic Article	Sept. 13, 1949
2,666,008	K. Enstein et al	Methods and Apparatus for Making Conductive Patterns of Predetermined Configuration	Jan. 12, 1954
2,692,190	N. Pritikin	Method of Making Inlaid Circuits	Oct. 19, 1954
2,706,697	P. Eisler	Manufacture of Electric Circuit Components	April 19, 1955
2,721,822	N. Pritikin	Method for Producing Printed Circuit	Oct. 25, 1955
2,747,977	P. Eisler	Method of Making Printed Circuits	May 29, 1956
<b>Metal Spray</b>			
2,066,511	H. G. Arlt	Wiring Device	Jan. 5, 1937
2,446,524	J. B. Brennan	Electrodes and Methods of Making Same	Aug. 10, 1948
2,474,988	J. A. Sargrove	Method of Manufacturing Electrical Network Circuits	July 5, 1949
2,599,710	A. M. Hathaway	Method of Making Electrical Wiring	June 10, 1952
2,616,994	H. P. Luhn	Rotary Switch	Nov. 4, 1952
2,760,036	R. C. Raymer	Metallic Film Potentiometer	Aug. 21, 1956
<b>Conductive Paint</b>			
2,353,061	D. J. Oldenboom	Circuit Connecting Device	July 4, 1944
2,566,666	A. S. Khouri et al	Printed Electronic Circuit	Sept. 4, 1951
2,611,040	C. Brunetti	Nonplanar Printed Circuits and Structural Unit	Sept. 16, 1952
2,641,672	N. C. Parrish	Electric Conductor	June 9, 1953
2,693,023	F. E. Kerridge et al	Electrical Resistor and a Method of Making the Same	Nov. 2, 1954
2,744,180	D. M. Sullivan	Electrical Contact or Circuit Component	May 1, 1956
2,752,663	J. S. White et al	Method of Uniting Terminals and Conductive Electrodes and Bonding Same to Ceramic Base	July 3, 1956
2,760,058	I. A. Gross	Radio Frequency Oscillator Mounting	Aug. 21, 1956
<b>Grid Pattern</b>			
2,478,274	R. B. Johnson	Circuit Connecting Device	Aug. 9, 1949
2,502,291	L. H. Taylor	Method for Establishing Electrical Connections in Electrical Apparatus	March 28, 1950
2,547,022	J. A. Leno	Electrical Connection and Circuits and their Manufacture	April 3, 1951
2,586,854	W. H. Myers	Printed Circuit Construction	Feb. 26, 1952
2,611,010	E. J. Sass et al	Printed Circuit Structure for High-Frequency Apparatus	Sept. 16, 1952
2,613,252	J. D. Heibel	Electric Circuit and Component	Oct. 7, 1952
2,688,582	R. J. Phair et al	Method of Forming Laminated Sheets	Sept. 7, 1954
2,694,249	R. Kopp	Manufacturing Method for Complex Electrical and Wireless Apparatus	Nov. 16, 1954
<b>Applications</b>			
2,506,604	R. P. Lokker et al	Method of Making Electronic Coils	May 9, 1950
2,524,939	I. L. Stephan et al	Integral Socket and Printed Circuit Panel	Oct. 10, 1950
2,569,550	H. M. Barton, Jr.	Tube Socket for Printed Circuits	Oct. 2, 1951
2,593,479	T. Nieter	Electrical Apparatus Using Metalized Circuits and Components Thereof	April 22, 1952
2,595,188	S. M. Del Camp	Tube Socket	April 29, 1952
2,634,310	P. Eisler	Electrical Connecting Strip	April 7, 1953
2,641,675	W. H. Hannahs	Printed Electrical Conductor	June 9, 1953
2,649,513	H. P. Luhn	Distributor and Method for Making the Same	Aug. 18, 1953
2,662,957	P. Eisler	Electrical Resistor or Semiconductor	Dec. 15, 1953
2,666,254	P. Eisler	Method of Manufacturing Electrical Windings	Jan. 19, 1954
2,670,530	G. M. Regnier	Method for Making Terminal Strips and the Like	March 2, 1954
2,693,584	M. J. Pifer	Electrical Component Assembly	Nov. 2, 1954
2,700,150	N. B. Wales, Jr.	Means for Manufacturing Magnetic Memory Arrays	Jan. 18, 1955
2,701,346	D. W. Powell	Connector for Circuit Cards	Feb. 1, 1955
2,703,854	P. Eisler	Electrical Coil	March 8, 1955
2,744,188	M. R. Olsen et al	Portable Hand Lantern	May 1, 1956
2,747,169	B. J. Johanson	Contact for Printed Circuits	Feb. 20, 1953
2,748,321	L. J. Kamm	Electrical Assemblies	May 29, 1956
2,752,537	J. W. Wolfe	Electrical Apparatus Wiring System	June 26, 1956
2,754,486	C. J. Hathorn	Printed Circuit Electrical Component	July 10, 1956
2,756,485	M. Abramson et al	Process of Assembling Electrical Circuits	July 31, 1956
2,757,319	R. Kopp	Wiring Assembly for Fixed and Removable Components	July 31, 1956
2,757,349	F. R. Erbal	Tube Socket	July 31, 1956
2,759,051	R. C. Lockwood et al	Sub-Miniature Electron Tube Unit	Aug. 14, 1956
2,759,098	W. W. White et al	Printed Circuit Bandswitching Television Tuner	Aug. 14, 1956
2,759,155	W. Hackenberg	Electrical Capacitor and Filter Unit	Aug. 14, 1956
2,760,127	N. L. Duncan et al	Capacitor Commutator	Aug. 21, 1956
2,760,176	S. M. Del Camp	Electrical Socket and Contact Therefor	Aug. 21, 1956
2,762,987	D. Mackey	Tunable Signal Amplifier Structure and Coupling Elements Therefor	Sept. 11, 1956
2,772,501	R. J. Malcolm	A Method of Manufacturing Electrical Circuit Components	Dec. 4, 1956

# Product-Exhibitor Guide To The IRE Show

*Previewing the important happenings at this year's Institute of Radio Engineers show at the Coliseum, New York City, March 18-21. Includes a handy check list that tells "where-to-find-it" and a listing of all technical sessions*

An attendance of at least 50,000 radio engineers and scientists is expected for the annual Institute of Radio Engineers National Convention and Radio Engineering Show, which will be held at the Waldorf-Astoria Hotel and the New York Coliseum, March 18-21, 1957.

A comprehensive program of 55 technical sessions is being set up by the Technical Program Committee with the assistance of all the IRE Professional Groups. Thirty-three sessions will be held at the Waldorf and 22 at the Coliseum.

All 4 floors of the huge Coliseum will be set aside for the use of 840 exhibitors at the Show. For registrants' convenience, computers and communications exhibits will be grouped together on the first floor; component parts exhibits on the second; instruments, microwave and components exhibits on the third; and production tools, materials and services exhibits on the fourth floor.

Heading the list of social events during the Convention will be a cocktail party the evening of the 18th and the annual banquet on the evening of the 20th, both to be held

in the Grand Ballroom of the Waldorf. Winners of annual IRE awards will be honored during the banquet.

Annual reports by Haraden Pratt, IRE Secretary, and W. R. G. Baker, IRE Treasurer, will be presented at another of the Convention's important events, the Annual Meeting on the opening morning of the Convention. Donald G. Fink, Director of Research of Philco and Editor of the IRE, will be the guest speaker and will discuss "Electronics and the IRE—1957."

An interesting ladies program has also been planned which includes a guided tour of an art gallery, a choice of two popular Broadway plays, a trip to West Point, a visit to *Living for Young Homemakers* magazine, a sight-seeing tour of New York City, and a luncheon-fashion show.

All registrations for the Convention and Show will take place on arrival either at the Waldorf or the Coliseum. Registration fees are \$1.00 for each IRE member, and \$3.00 for each nonmember. Payment of the fee entitles registrants to attend all sessions and exhibits.

Accelerometers—1812-2933-3031  
Adhesives—3901  
Alloys—4202-4207  
Amplifiers—1429-1725-2108-2830-3056-3117-3502-3051-3601  
Amplifiers, TWT—2509-3929  
Analyzers—2616-3119-3515-3905-4201  
Antennas—1314-1324-1409-1428-1623-1712-2344-2917-4318  
Electronic assemblies—4514  
Automation Systems—1624  
Batteries—1821-2127-2301-2711-2822  
Blowers—2334  
Cabinets—3833-4315  
Camera, oscilloscope—3610  
Capacitors—B-2-1213-1511-2123-2216-2217-2226-2232-2227-2239-2301-2309-2314-2333-2404-2409-2416-2601-2710-2725-2807-2832-2840-2933-2937-3706-3802-3933  
Ceramic Fabrication—1629-2930-4006-4216  
Choppers—2100-2505-2716-2841  
Coils—1112-1520-1530-2207-2219-2523-2405-2707-3924  
Coil Forms—4239-4317-4511  
Coil Winders—4107-4109-4130-4218-4301-4310-4502-4608  
Communication Equip.—1101-1212-1307-1401-1415-1423-1518-1609-1815-2122-3201  
Computers—1207-1301-1512-1513-1618-1702-1720-2401-2801-3011-3013-3616  
Computer Components—1201-1202-1811-2738  
Connectors—1201-2219-2222-2241-2427-2517-2633-2706-2733-2836-3313-3838-3911-3921-4049  
Cores—1720-1721  
Counters—1523-1620-3412  
Crystals, quartz—1517-2921-2311-2631-2736-3005-3041-3614  
Data recorders—1117-1320-1322-1801-1824-1912  
Delay lines—1511-2128-2131-2523-2736-2843-3412-3705  
Electro-mechanical assemblies—1519-2401  
Facsimile equip.—3230  
Fastening devices—3812-3903-4007-4207-4226-4231-4409  
Ferrite core materials—2424-3701  
Filters—1502-1626  
Flexible Shafts—4312-4522  
Frequency standards—3111-3926  
Frequency meters—2734-3008-3416  
Fuses—2739-2923  
Hardware—1118-1632-2219-3814-4012-4048-4051-4110-4504  
Insulators—4036-4313  
Kits—1107-2907-4042  
Lacing tape—4025-4105  
Lighting—2730  
Magnets—2201-2432-2829-2926  
Magnetic amplifiers—1433-2831-2929-3416-3602-3710-3944  
Magnetic materials—4001-4005  
Marking machines—4124-4230-4606  
Metals—2428-2722-3941-4015-4123-4211-4402-4523  
Metal contacts—2106-2838  
Metal stampings—4039-4106-4203-4318-4320-4406-4426-4429-4501-4603  
Meters—2126-2329-2523-2743-2814-3044-3104-3116-3308-3309-3605-3916  
Meters, VTVM—3053-3115-3121-3402-3204-3402-3947

Mica Products—1631-2221  
 Microwave—1332-1416-1621-2322-2510-2530-2611-3059-3114-3210-3218-3219-3226-3227-3232-3240-3318-3510-3602-3606-3607-3608-3702-3815-3819-3909  
 Modular Circuits—2601-2811  
 Motors — 1219-2229-2240-2315-2322-2431-2844-3227-3915-3920  
 Nameplates—4052-4407-4413  
 Navigation Equipment—1427-2322-3312  
 Oscilloscopes — 1902-2509-3009-3028-3103-3112-3201-3207-3242-3610  
 Ovens—1521-2006  
 Packaging—2515  
 Plastics — 4011-4016-4237-4304-4309-4404-4406  
 Plastics, laminated — 2113-2903-2904-4040-4215-4223-4408-4506  
 Plugs & Sockets—2535-2715-3838-3901-4235  
 Potentiometers — 1726-1807-2318-2339-2401-2501-2602-2713-2822-2841-2907-2919-3716  
 Power supplies—1429-2110-2118-2436-2636-2834-3022-3106-3107-3314-3417-3711-3940-3950  
 Printed circuits—1628-2234-2302-3057-3809-4050-4509  
 Printed circuit production equip—1425  
 Production equip. — 1234-1419-1516-2741-3410-3411-4125-4228-4306-4412-4417  
 Pulse control equip.—1720-1909  
 Pulse generators—3028-3228-3611  
 R-F equipment—2238-3315  
 Racks—1910  
 Radar—2322-2611-3059

Radio Teletype—3415  
 Rate Gyros—2335  
 Recorders—1211-1612-1916-3001-3005-3064-3065-3211-3947  
 Recording tape—1729  
 Rectifiers — 1915-2115-2116-2832-2936-2934-3806  
 Regulators—1327-2306-2415-2627-2817-3302  
 Relays — 1216-1905-1906-2004-2114-2120-2125-2214-2240-2305-2342-2402-2407-2426-2436-2502-2525-2628-2709-2714-2812-3008-3045-3110-3516-3802-3811-3821-3904  
 Resistors — 2130-2338-2404-2209-2405-2634-2637-2717-2718-2742-2802-2821-2840-3116-3208-3706-3831-3938-3945-3946  
 Seals — 2321-2526-3801-3824-3936-4022-4403  
 Semiconductors—1311-1402-1520-1602-1802-2507-2611-2705-2712-2808-2816-3806-3828-3912  
 Servomechanisms — 1811-1812-1903-2105-2129-2313-2322-2401  
 Shielded enclosures—1114-1325-1727-1825-2201-4212-4410  
 Shields—3704-4414  
 Solarcells—3830  
 Solder—2922-4221-4319-4521  
 Soldering Equipment—1329  
 Sonar equipment—1213-1711  
 Switches — 1226-1812-2109-2202-2225-2228-2337-2635-2708-2716-2839-2901-3034-3823-3835-3919  
 Tape—3901-4227-4610  
 Telemetering equipment—1709  
 Terminals — 2427-2827-3714-4013-4022-4213-4416-4424

Test equipment—1410-1421-1424-1431-1723-1728-1815-1921-2108-2128-2316-2319-2329-2608-2907-3015-3047-3056-3063-3101-3121-3122-3205-3215-3219-3222-3229-3236-3302-3308-3401-3402-3406-3407-3409-3501-3506-3516-3615-3709-3715-3826-3834  
 Thermistors—2230  
 Timers—2211-2430-2431-2701-2702  
 Toroids—2131-2632-2831  
 Towers—1223-1311  
 Transformers — 1203-1570-1812-1816-2116-2121-2212-2235-2243-2244-2312-2413-2611-2721-2817-3705-3805-1524  
 Tubes—1205-1602-1731-2231-2233-2410-2507-2611-2740-2813-3931-3939  
 Tubes, industrial—2218-2522  
 Tubes, microwave—2410-2530-2611-3237  
 Tubes, transmitting—2218-2410-2522-2740  
 Tubing—2317  
 Tubing, metal—4234  
 TV equipment — 1210-1410-1501-1709-2611-2633-3401  
 Ultrasonic equipment—1913  
 Ultrasonics—4605  
 Vacuum equipment — 3223-4202-4208-4214-4419-4505  
 Vibrators—2834  
 Vibration Equipment—1515-2506-2534-2806-2902-2925  
 Waveguide—1313 - 2527 - 3235 - 3241 - 3415-3810-3945  
 Wire and Cable—1630-2726-4104-4219-4229-4321-4323-4424-4570-4602  
 Wire markers—4205-4210

### TECHNICAL SESSIONS PROGRAM

	WALDORF-ASTORIA HOTEL					NEW YORK COLISEUM		
	Starlight Roof	Astor Gallery	Jade Room	Sert Room	Grand Ballroom	Horse Hall	Marconi Hall	Faraday Hall
Monday, March 18 2:30 - 5:00 p.m.	Session 1 NONLINEAR CONTROL SYSTEMS	Session 2 VEHICULAR COMMUNICATIONS	Session 3 PROPAGATION	Session 4 ULTRASONICS ENGINEERING I - AN EDUCATIONAL SESSION	Session 5 AERONAUTICAL ELECTRONICS	Session 6 MULTI-PLEX COMMUNICATIONS SYSTEMS	Session 7 INFORMATION THEORY - CODING AND DETECTION	Session 8 SOLID STATE DEVICES
Tuesday, March 19 10:00 a.m. - 12:30 p.m.	Session 9 AUTOMATIC CONTROL - GENERAL	Session 10 NAVIGATION	Session 11 NEW BROADCAST DEVELOPMENTS	Session 12 ULTRASONICS ENGINEERING II - TECHNICAL SESSION	Session 13 * ENGINEERING MANAGEMENT VIEWPOINTS	Session 14 ANTENNAS I - GENERAL	Session 15 INFORMATION THEORY - REVIEW AND RECENT ADVANCES	Session 16 MICROWAVE TUBES
Tuesday, March 19 2:30 - 5:00 p.m.	Session 17 GENERAL COMMUNICATIONS SYSTEMS	Session 18 MEDICAL ELECTRONICS	Session 19 NEW OPERATIONAL TECHNIQUES CONCERNING VIDEO TEST SIGNALS (A PANEL DISCUSSION)	Session 20 HIGH FIDELITY AND HOME MEASUREMENTS		Session 21 ANTENNAS II - BROADBAND ANTENNAS	Session 22 INFORMATION THEORY - APPLICATIONS	Session 23 (Joint) TELEVISION SYSTEMS DEVICES
Tuesday, March 19 8:00 - 10:30 p.m.	Session 24 (Joint) APPLICATION OF THE ELECTRONICS ART TO THE CIVIL - MILITARY NATIONAL COMMON SYSTEM OF AIR TRAFFIC CONTROL							Session 25 (Joint) MICROMINIATURIZATION - THE ULTIMATE TECHNIQUE
Wednesday, March 20 10:00 a.m. - 12:30 p.m.	Session 26 ELECTRONIC COMPUTERS I - DIGITAL COMPUTERS	Session 27 MAGNETIC RECORDING	Session 28 NUCLEAR INSTRUMENTATION	Session 29 CIRCUIT THEORY I - SYMPOSIUM ON MODERN METHODS IN NETWORK THEORY	Session 30 * ENGINEERING MANAGEMENT TECHNIQUES	Session 31 TRANSISTOR APPLICATIONS	Session 32 (Joint) MICROWAVE ANTENNAS	Session 33 ELECTRON TUBES - GENERAL
Wednesday, March 20 2:30 - 5:00 p.m.	Session 34 SYMPOSIUM: LONG RANGE TELEMETRY AND REMOTE CONTROL	Session 35 SPEECH ANALYSIS AND AUDIO AMPLIFIERS	Session 36 TRANSISTORIZING NUCLEAR INSTRUMENTATION	Session 37 (Joint) SYMPOSIUM: APPLICATIONS OF COMPUTERS IN BIOLOGY AND MEDICINE		Session 38 COLOR TELEVISION RECEIVERS	Session 39 MICROWAVES I - COMPONENTS	Session 40 PRODUCTION TECHNIQUES
Thursday, March 21 10:00 a.m. - 12:30 p.m.	Session 41 ELECTRONIC COMPUTERS II - SYMPOSIUM ON COMPUTERS IN SIMULATION, DATA REDUCTION, AND CONTROL	Session 42 CIRCUIT THEORY II - TRANSISTOR AND AMPLIFIER CIRCUIT DESIGN	Session 43 COMPONENT PARTS I	Session 44 INDUSTRIAL ELECTRONICS	Session 45 * RELIABILITY PROGRAMS	Session 46 SYMPOSIUM: DIGITAL TECHNIQUES FOR PROBLEMS IN TELEMETRY AND REMOTE CONTROL	Session 47 MILLIMICROSECOND INSTRUMENTATION - SPECIAL TOPICS	Session 48 MICROWAVES II - SWITCHES
Thursday, March 21 2:30 - 5:00 p.m.	Session 49 ELECTRONIC COMPUTERS III - MAINLY ANALOG	Session 50 CIRCUIT THEORY III - NETWORK DESIGN TECHNIQUES	Session 51 COMPONENT PARTS II	Session 52 ANALYSIS AND TECHNIQUES FOR IMPROVED RELIABILITY		Session 53 SYMPOSIUM: LOW LEVEL MULTIPLEXING FOR TELEMETRY AND REMOTE CONTROL	Session 54 INSTRUMENTATION II	Session 55 MICROWAVES III - GENERAL

\* Sessions terminate at 12:00 Noon



# See these Products at IRE

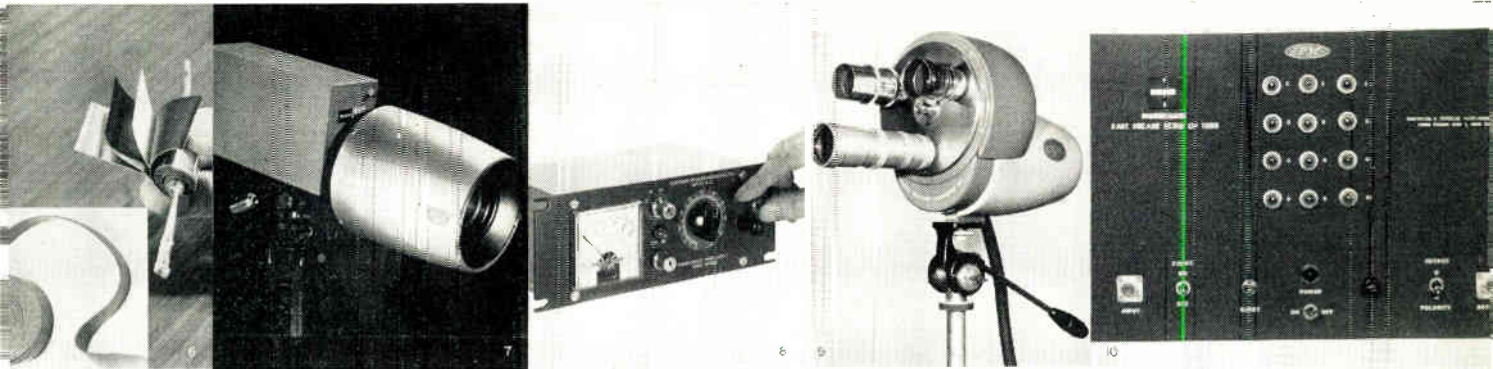

## 1—Falstrom Co.

Magnesium fabrication is playing an important role in air transportable equipment. Booth 4501.

## 2—Sanborn Co.

A self-contained 8-channel amplifier-recorder combination to record analog outputs. Booth 3601.

## 3—Universal Atomics Corp.

A new advanced medical precision ratemeter enables more reliable and faster analysis. Booth 3940.

## 4—Lambda Electronics Corp.

The new 1.5 a. Model C-1500 power supply features exclusive COM-PAK design. Booth 2436.

## 5—Packard-Bell Co.

Transistorized control amplifier is the "Mighty Midget" of aircraft fire power. Booth 3705.

## 6—Polymer Corp. of Pa.

Flexible Ferrotron tape and metallic strip provide new miniaturized basic components. Booth 4309.

## 7—Perkin-Elmer Corp.

The AUTO-ZOOM Lens, a variable focal length lens of superior quality for vidicon TV cameras. Booth 1228.

## 8—Electronic Research Assoc.

ERA Model 50TM/10 Power Supply is designed to provide low voltage regulated dc power. Booth 2705.

## 9—General Precision Lab.

A new 3-lens turret for industrial television cameras accommodates standard 16 mm lenses. Booth 1501.

## 10—Electrical & Physical Instr.

The Model 414 Fast Decade Scale of 1,000 was designed for high-speed nuclear counting. Booth 3117.

## 11—Narda Corp.

A series of broad band coaxial directional couplers provide flat coupling with low VSWR. Booth 3606.

## 12—Transitron Electronic Corp.

Three new series of voltage regulators satisfy a full range of power requirements. Booth 1915.

## 13—AMP Incorporated

"Snap-In" and "AMP Edge" printed circuit terminals will be exhibited and demonstrated. Booth 2427.

## 14—Marconi Instruments

A portable test set for mobile radio is the latest in the line of FM measuring instruments. Booth 3615.

## 15—F. J. Stokes Corp.

A high-production unit for aluminizing TV tube color plates or black-and-white picture tubes. Booth 4412.

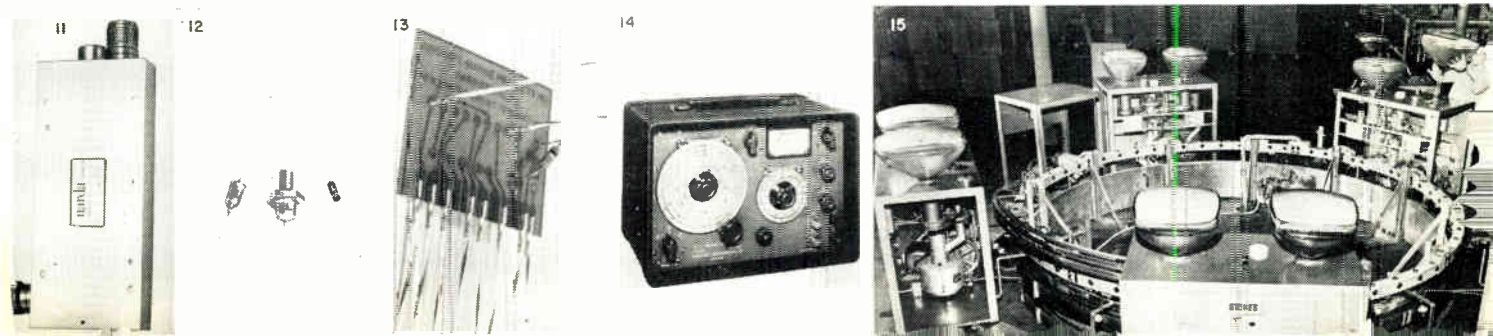

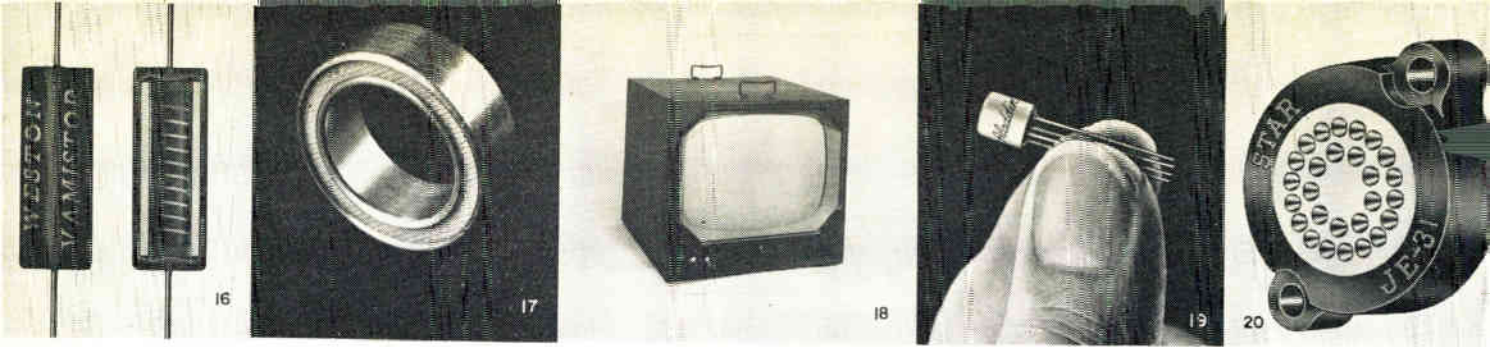

**16—Weston Electrical Instrument Corp.**

The Vamistor is a new precision metal film resistor featuring outstanding characteristics: high stability rating, low temperature coefficient, and meets all military specs. Booth 2907.

**17—Magnetics, Inc.**

A complete line of standard sizes of tape wound cores proposed by an AIEE-Sub-Committee. All these cores are available in both aluminum and phenolic core boxes. Booth 2533.

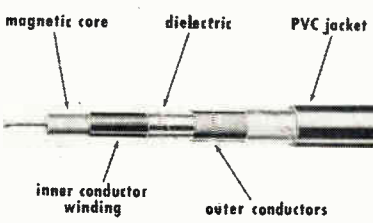

# See these Products at IRE

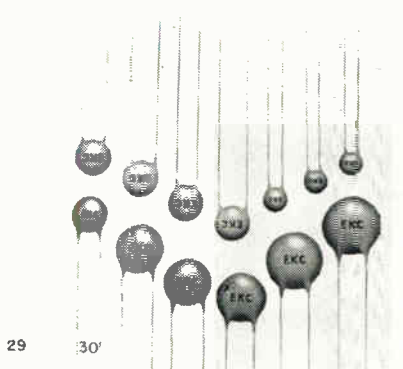
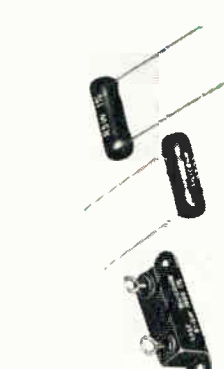
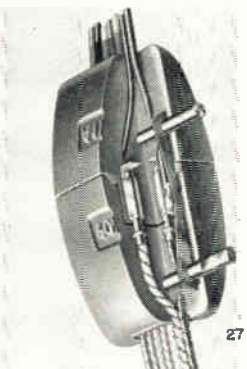
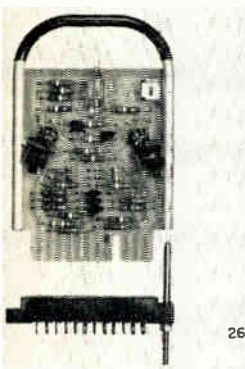

**18—Blonder-Tongue Laboratories, Inc.**

These video monitors, designated Model DVM, utilize 11 tubes plus an aluminized picture tube. Available in 14, 17, and 21 in. screen sizes and include a rugged cabinet. Booth 1210.

**19—Aladdin Electronics**

Micro-miniature pulse transformers and ferrite cored inductors having the same physical dimensions, 1/4 in. diameter by 1/4 in. length. Inductor values from 10  $\mu$ h to 1 h. Booth 1816.

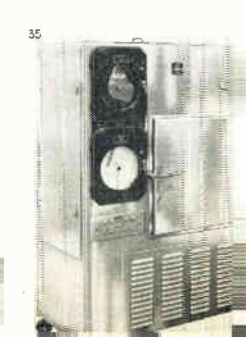
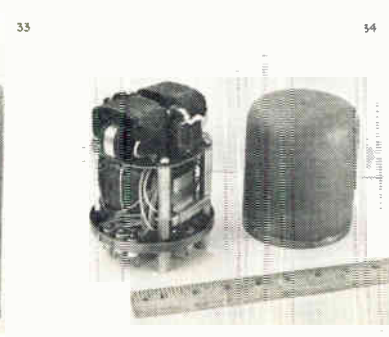
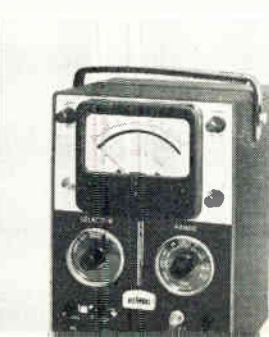
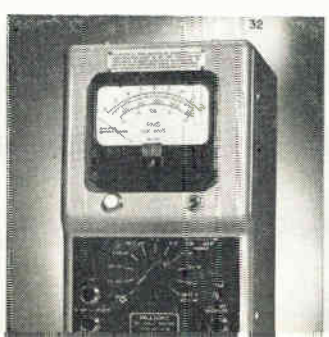
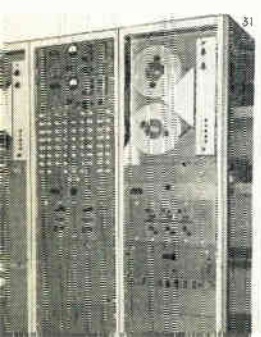



## 20—Star Expansion Products Co.

The JE-31 is one of a line of tube pin straighteners designed for use in the rapidly expanding computer field. Exhibit will also include socket wiring plugs. Booth 4505.

## 21—Microtran Co.

A new line of Epoxy molded plug-in, printed circuit, miniature transformers with a wide electrical rating range has been designed to meet MIL-T-27A, Grades 2 & 5. Booth 2312.

## 22—Sealectro Corp.

The new SKT-10 miniature test point jack is being demonstrated. Teflon "Press-Fit" terminals, breakaway connectors, and test point plugs will also be exhibited. Booth 3714.

## 23—Amphenol Electronics Corp.

Product display will feature many of the unique connectors for missiles, computers and communications designed during the past year, as well as standard components. Booth 2321.

## 24—Induction Motors Corp.

Model BD 1509D is a new dynamotor for application in guided missiles and telemetering installations. Brush life of 100 hrs. at 50,000 ft., between  $-40^{\circ}\text{C}$  &  $+71^{\circ}\text{C}$ . Booth 2229.

## 25—Spectrol Electronics Div.

Model "500" Series are quality 10-turn potentiometers  $\frac{7}{8}$  in. diam. Design superiority guarantees low-noise performance and consistently reliable operation. Booth 1726.

## 26—Computer Control Co., Inc.

The 3C PAC Series M product line features small, compact, fully compatible, fully transistorized, extremely reliable, digital computer packages. Booth 1322.

## 27—Alden Products Co.

Unique design and special production processes called the "IMI" (Integral Molded Insulation) makes it possible to mold contacts and leads with one hot shot of insulation. Booth 1614.

## 28—Sage Electronics Corp.

Type "R" silicone coated miniature resistors with radial leads are for 3, 5, 7 and 10 w. powers. Type "BT" are metal-clad sub-miniature resistor in 10 & 15 w. powers. Booth 3945.

## 29—Shallcross Mfg. Co.

The "2" Series Switches with up to a total of 15 wafers was made possible by improvements in manufacturing which previously limited the maximum to 6 wafers. Booth 2634.

## 30—Electra Mfg. Co.

A new line of ceramic disc capacitors has five different types: temperature compensating, AC line filter, general purpose, general by-pass and extended T. C. Booth 2338.

## 31—Davies Laboratory, Inc.

Model 600 Missile Recorder system, consisting of a remotely-controlled two-track airborne magnetic tape recorder, will record and play back typical IRIG FM/FM. Booth 3118.

## 32—Millivac Instrument Corp.

The new MV-02B AC VTVM has a frequency range of 2 cps-250 KC and a full scale voltage range of 3 mv.-1 kv. Fully electronically regulated plate current supply. Booth 3204.

## 33—A. B. Du Mont Laboratories, Inc.

The Type 405 combines 100 mv. full scale sensitivity with dual and differential input features. Other "400" series equipment will be exhibited. Booth 3201.

## 34—Raytheon Mfg. Co.

Miniaturized high-voltage transformers featuring evaporative cooling techniques include pulse, plate, and audio transformers. Units meet military specifications. Booth 2611.

## 35—American Instrument Co., Inc.

The Climate-Lab with Program Controller is an integral unit comprising a 9.6 cu. ft. test chamber, air conditioning equipment, and program controller. Booth 1905.

## 36—Underwood Corp.

A new delay line, Type 4D92, possesses a total delay of  $300 \pm 1\%$   $\mu\text{sec}$ . with taps available at every 1  $\mu\text{sec}$ . It features a maximum attenuation of only 4 db. Booth 1513.

## 37—General Ceramics Corp.

Magnetic memory planes are now built in any frame size up to and including 10 in. x 10 in. Improved design features planes with greater frame strength and rigidity. Booth 1629.

## 38—Precise Development Corp.

The Power-Lab operates your whole bench and shop. One instrument takes the place of more than 11 pieces of equipment. It supplies high, low, ac, or dc power. Booth 3122.

## 39—Eitel-McCullough, Inc.

This high power UHF klystron, 3KM50, 000PA, is being introduced. Featured will be a display on ceramic developments in the klystron, negative grid, and rectifier tube lines. Booth 2410.

## 40—Navigation Computer Corp.

The Reversible Indicating Binary Counter has completely automatic internal switching. Pulses may be fed into the forward and reverse inputs. Booth 1909.

## 41—Industrial Test Equipment Co.

Null Detector Model 60B is battery operated to provide isolation from power lines. It is well shielded against external fields and is suited for Schering bridges. Booth 3229.

## 42—Technicraft Laboratories, Inc.

Double ridged flexible and rigid waveguide assemblies and components, covering 2 to 5 KMC, complement the D-19 Series Guide which covers 4.75 to 11 KMC. Booth 3810.

## 43—United Shoe Machine Corp.

New models of Dynasert equipment for inserting a wide variety of components in printed wiring circuits can be fitted with interchangeable tooling. Booth 1419.

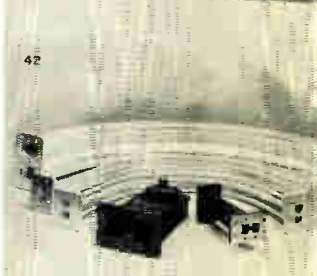
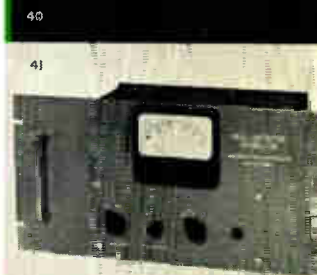
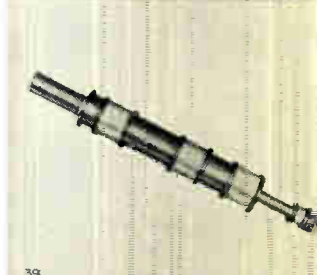
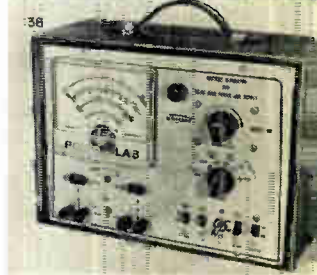
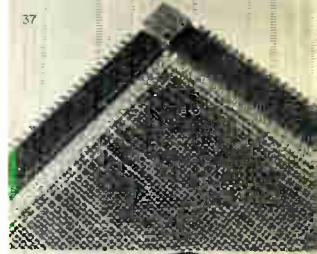

*Rule-of-thumb shield design commonly ignores reflection losses, resulting in over-designed equipment enclosures. The method presented here takes into account electric, magnetic, and plane wave reflection losses, and corrects for electrically thin sheets and shield discontinuities. Data for common shield designs have been calculated and are presented in extensive referencé tablès*

Shortcuts to

# R-F Shield Design



By **C. S. VASAKA**  
U. S. Naval Air Development Center  
Johnsville, Pa.

**E**LECTRONIC equipment may operate at frequencies as low as 60 cps and as high as 10,000 MC, and may generate undesired signals or be susceptible to signals generated by other equipment located nearby. It is to prevent such interference that equipment must be shielded.

One of the most difficult shielding problems occurs in aircraft, where many transmitters, receivers, and other sensitive equipment must be operated closely together, and where weight must be trimmed as closely as possible. This problem will be accentuated as the growing electronic demands of future aircraft require the integration of many electronic functions within one compact enclosure.

In addition to the shielded equipment enclosures, there are usually other barriers present to reduce the level of such undesired signals—the metallic aircraft structure, or a ship's hull and bulkhead. These additional barriers help reduce

the level of undesired signals at the outside antennas. In aircraft, however, structural shielding effects can range from 20 to 100 db; this amount of shielding is not enough to protect receiving antennas from undesired signals generated within the aircraft. Signal generating equipment must be adequately shielded in order to protect other equipment. Transmitter equipment cases must provide a shielding effectiveness of at least 100 db in order to reduce leakage of harmonics sufficiently.

Since it is difficult to shield against transmitter spurious radiation as well as receiver local oscillator radiation, adjacent equipment must be well shielded even if it does not generate high levels of undesired signals. It is generally found most practical to provide about equal shielding for each of two adjacent electronic equipments.

The shielding of integrated packages must usually attenuate a wide range of frequencies, and it is often found neces-

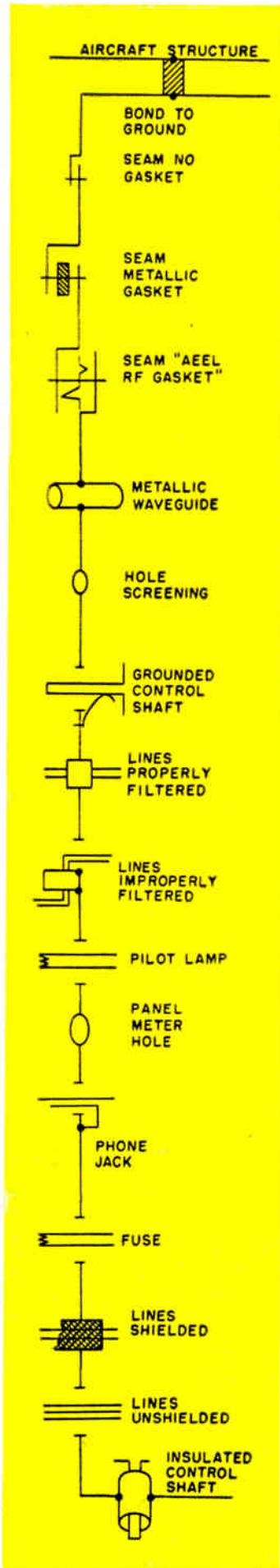

sary to provide additional shielding for some portions of the package.

The theory of shielding for transverse electromagnetic waves can be analyzed by use of transmission line equations.<sup>2, 3, 4</sup> The source of signal is considered to be a point source encased in a spherical shield, or two parallel current filaments encased in a cylindrical shield. These equations are rearranged and presented here in a condensed form so as to be applicable, with a good approximation, in the design of shielded enclosures.

### Terms

**S** = Shielding effectiveness or insertion loss representing the reduction (expressed in db) of the level of an electromagnetic wave at a point in space after a metallic barrier is inserted between that point and the source. Measurements are made in real powers, apparent powers, voltages, or currents.

**R** = Total reflection loss in db from both surfaces, neglecting the effect of multiple reflections inside the barrier.

**A** = Penetration or absorption loss in db inside the barrier.

**B** = A positive or negative factor which need not be taken into account when A is more than 10 db. It is caused by the reflecting waves inside the barrier and is calculated in db. When a metallic barrier has an A of less than 10 db, it is designated as "electrically thin"

$$S = R + A + B$$

$Z_s$  = Intrinsic impedance of metal. Vector form.

$Z_w$  = Impedance of incident wave in space. Vector form.

$\mu$  = Relative magnetic permeability referred to free space.  
= 1 for copper

= 200 to 1000 for ferrous metals at low frequencies.

= 1 for ferrous metals at microwaves.

$\mu_0$  = Permeability of free space =  $1.26 \times 10^{-6}$  henrys/meter

$$\text{Approximately } \frac{120\pi}{V}$$

**TABLE 1**

Penetration Or Absorption Loss For A Solid Metal Shield

Frequency	Copper		Iron		DB Loss Per Mil Thickness	
	G	$\mu$	G	$\mu$	Copper	Iron
60 cps	1	1	0.17	1000	0.026	0.334
1000 cps	1	1	0.17	1000	0.106	1.37
10 KC	1	1	0.17	1000	0.334	4.35
150 KC	1	1	0.17	1000	1.29	16.9
1 MC	1	1	0.17	700	3.34	36.3
15 MC	1	1	0.17	400	12.9	106.0
100 MC	1	1	0.17	100	33.4	137.0
1500 MC	1	1	0.17	10	129.0	168.0
10000 MC	1	1	0.17	1	334.0	137.0

NOTE: Other values of  $\mu$  for iron are taken to be as follows:  
3 Mc—600      10 Mc—500      1000 Mc—50

$\epsilon$  = Permittivity of free space =  $8.85 \times 10^{-12}$  farads/meter

$$\text{Approximately } \frac{1}{120\pi V}$$

**V** = Velocity of light in free space =  $3 \times 10^8$  meters/second

$$= f \times \lambda$$

**G** = Relative conductivity in reference to copper

= 1 for copper

= 0.17 for iron

**f** = Frequency in cps

$\lambda$  = Wavelengths in meters

$$\beta = \frac{2\pi}{\lambda}$$

$$\omega = 2\pi f$$

**r** = Distance from source to barrier in meters

$r_1$  = Distance from source to barrier in inches

**t** = Thickness of barrier in mils

**E** = Electric field component or electric intensity in volts/meter

**H** = Magnetic field component or magnetic intensity in amperes/meter

Fig. 2 (right): A poorly grounded receiver will have increased radiation and higher noise signals across its input

Fig. 1: Shielding effects per mil thickness of copper and iron

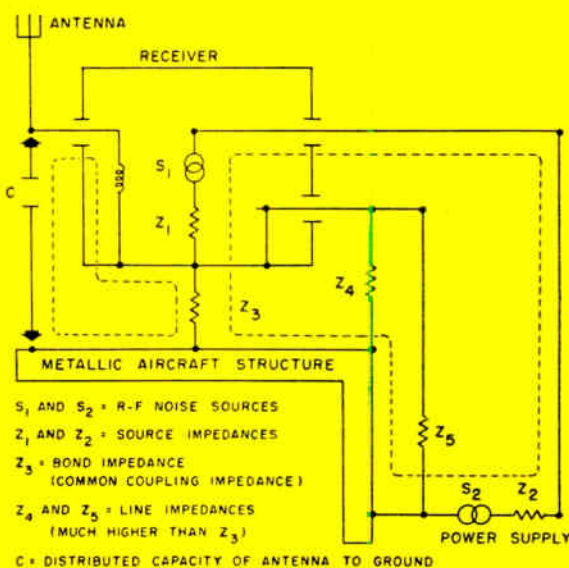
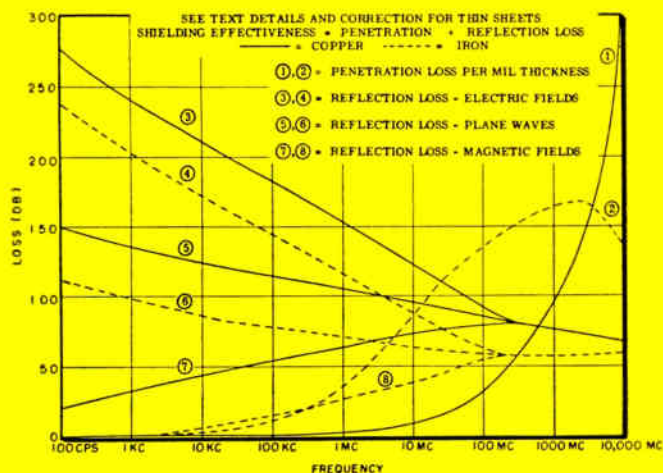

# R-F Shield Design (Continued)

T = Thickness of barrier in meters

$\alpha$  = Attenuation constant of metal in nepers/meter

$$\sqrt{\frac{\mu_0}{\epsilon}} = \text{Impedance of plane waves in free space}$$

= 377.6 ohms

= Approximately  $120\pi$

To find R

$$k = 20 \log_{10} \left| \frac{(Z_s + Z_w)^2}{4 Z_s Z_w} \right| \text{ in db} \quad (1)$$

$$Z_s = (1 + j) \sqrt{\frac{\mu f}{2G}} \times 3.69 \times 10^{-7} \text{ ohms} \quad (2)$$

$$|Z_s| = \sqrt{\frac{\mu f}{G}} \times 3.69 \times 10^{-7} \text{ ohms} \quad (3)$$

(Continued on page 114)

**TABLE 2**

Total Reflection Loss For Both Surfaces Of A Solid Metal Shield

Wave impedance much greater than 377 ohms (Electric Fields). Signal source 12 in. from shield.

Frequency	Copper		Iron		DB Loss*	
	G	$\mu$	G	$\mu$	Copper	Iron
60 cps	1	1	0.17	1000	278.7	241.0
1000 cps	1	1	0.17	1000	242.0	204.4
10 KC	1	1	0.17	1000	212.0	174.0
150 KC	1	1	0.17	1000	176.8	139.0
1 MC	1	1	0.17	700	152.0	116.0
15 MC	1	1	0.17	400	116.9	83.1
100 MC	1	1	0.17	100	92.0	64.4
1500 MC	1	1	0.17	10	**	**
10000 MC	1	1	0.17	1	**	**

\* If the penetration loss is less than 10 db, the total reflection loss must be corrected by use of the B factor given in text.

\*\* At these frequencies, the fields approach plane waves with an impedance of 377 ohms. See table 3 for plane waves.

NOTE: For distances much greater or smaller than 12 in., recalculate the reflection loss by using the formulas given in text.

**TABLE 3**

Total Reflection Loss For Both Surfaces Of A Solid Metal Shield

Wave impedance of 377 ohms (Plane Waves). Distance from signal source greater than  $2\lambda$ .

Frequency	Copper		Iron		DB Loss*	
	G	$\mu$	G	$\mu$	Copper	Iron
60 cps	1	1	0.17	1000	150.0	112.7
1000 cps	1	1	0.17	1000	138.0	100.5
10 KC	1	1	0.17	1000	128.0	90.5
150 KC	1	1	0.17	1000	117.0	78.8
1 MC	1	1	0.17	700	108.2	72.1
15 MC	1	1	0.17	400	96.4	62.7
100 MC	1	1	0.17	100	88.2	60.5
1500 MC	1	1	0.17	10	76.4	58.8
10000 MC	1	1	0.17	1	68.2	60.5

\* If the penetration loss is less than 10 db, the total reflection loss must be corrected by use of the B factor given in text.

NOTE: Plane waves in sufficient strength below 1 MC rarely exist in the vicinity of a shielded enclosure.

**TABLE 4**

Total Reflection Loss For Both Surfaces Of A Solid Metal Shield

Wave impedance much smaller than 377 ohms (Magnetic Fields). Signal source 12 in. from shield.

Frequency	Copper		Iron		DB Loss*	
	G	$\mu$	G	$\mu$	Copper	Iron
60 cps	1	1	0.17	1000	22.4	-0.9
1000 cps	1	1	0.17	1000	34.2	0.9
10 KC	1	1	0.17	1000	44.2	8.0
150 KC	1	1	0.17	1000	56.0	18.7
1 MC	1	1	0.17	700	64.2	28.1
15 MC	1	1	0.17	400	76.0	42.2
100 MC	1	1	0.17	100	84.2	56.5
1500 MC	1	1	0.17	10	**	**
10000 MC	1	1	0.17	1	**	**

\* If the penetration loss is less than 10 db, the total reflection loss must be corrected by use of the B factor given in text.

\*\* At these frequencies, the fields approach 377 ohms in impedance and become plane waves. See table 3 for plane waves.

NOTE: 1. At 60 cps for iron, the reflection loss is negative and becomes zero at 620 cps. Calculations further indicate that it again becomes zero at 31.5 cps and then positive for lower frequencies.

2. For distances much greater or smaller than 12 in., recalculate the reflection loss using the formulas given in text.

**TABLE 5**

B-Factor Correction For A Solid Metal Shield (DB)

Shield Thickness (mils)	60 cps	100 cps	1 KC	10 KC	100 KC	1 MC
	Copper, $\mu = 1, G = 1$ , Magnetic Fields					
1	-22.22	-24.31	-28.23	-19.61	-10.34	-2.61
5	-21.30	-22.07	-15.83	-6.98	-0.55	+0.14
10	-19.23	-18.59	-10.37	-2.62	+0.57	0
20	-15.35	-13.77	-5.41	+0.13	-0.10	
30	-12.55	-10.76	-2.94	+0.58	0	
50	-8.88	-7.07	-0.58	0		
100	-4.24	-2.74	+0.50			
200	-0.76	+0.05	0			
300	+0.32	+0.53				
Copper, $\mu = 1, G = 1$ , Electric Fields and Plane Waves						
1	-41.52	-39.31	-29.38	-19.61	-10.33	-2.61
5	-27.64	-25.46	-15.82	-6.96	-0.55	+0.14
10	-21.75	-19.61	-10.33	-2.61	+0.57	0
20	-15.99	-13.92	-5.37	+0.14	-0.10	
30	-12.73	-10.73	-2.90	+0.58	0	
50	-8.81	-6.96	-0.55	+0.14		
100	-4.08	-2.61	+0.51	0		
200	-0.62	+0.14	0			
300	+0.41	+0.58				
Iron, $\mu = 1000, G = 0.17$ , Magnetic Fields						
1	+0.95	+1.23	-1.60	-1.83		
5	+0.93	+0.89	-0.59	0		
10	+0.78	+0.48	+0.06			
20	+0.35	+0.08	0			
30	+0.06	-0.06				
50	0	0				
Iron, $\mu = 1000, G = 0.17$ , Electric Fields and Plane Waves						
1	-19.53	-17.41	-8.35	-1.31		
5	-6.90	-5.17	+0.20	0		
10	-2.56	-1.31	+0.36			
20	+0.16	+0.54	0			
30	+0.58	+0.42				
50	+0.13	0				

NOTE: This B Factor Correction has to be applied to the Reflection Loss shown in tables 2, 3, and 4 when the total Penetration Loss obtained from table 1 is less than 10 db.

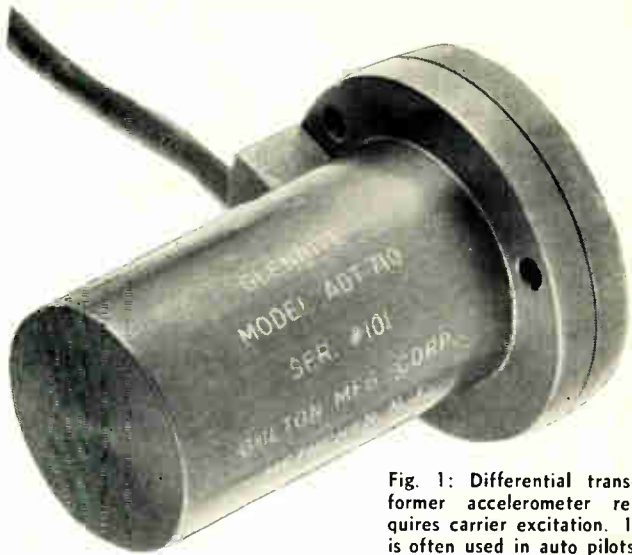

Fig. 1: Differential transformer accelerometer requires carrier excitation. It is often used in auto pilots.

*Differences among the various types of accelerometers fall into four basic categories: acceleration range, frequency response, accuracy, and temperature environment. Here is how the major types compare in each of these respects.*

# Accelerometers —Which Type For The Job?

By **ANTHONY ORLACCHIO**  
Chief, Electro-Mechanical Instrument Dept.

and **GEORGE HIEBER**  
Chief, Electro-Mechanical Design Group  
Gulton Industries, Inc.  
212 Durham Ave., Metuchen, N. J.

**ACCELEROMETERS** offer a convenient method of determining load factors, stress levels and transmissibility coefficients due to shock and vibration. Accurate knowledge of these quantities is necessary as the power-to-weight ratio on equipment continues to increase.

Accelerometers are not subject to bottoming, as are vibrometers. Their use is also increasing in the control field, in particular, inertial navigation. This instrument furnishes a convenient source of relative space coordinates.

### Accelerometer

An accelerometer is a seismic device; i.e., it consists of a mass and spring subjected to an external force. A simple seismic system is a second order



A. Orlacchio



G. Hieber

single degree of the freedom system (Fig. 4). The response of this system, when the base of the spring is subjected to a constant displacement sine wave input of varying frequency, is shown in Fig. 5. We are not concerned with the total movement of the mass compared to the input movement, but rather the difference between the two, (i.e., the spring deflection) compared to the input movement.

### Curve Significance

When the system is excited at its natural frequency  $\omega_n$ , the mass builds up amplitude to infinity, theoretically. In practice, large excursions of the mass at  $\omega_n$  are avoided by deliberately preventing the mass from building up energy. This is done with a damping device which dissipates the energy, changing it into heat as fast as the energy tends to build up. A seismic response, shown by the dotted line (Fig. 5) results. For constant displacement excitation, velocity varies directly with frequency, shown by the light dashed line. A damped seismic system can be used to measure velocity over a limited range, since the response curve is proportional to velocity in this region.

When the system is excited above its natural fre-



Fig. 2: Variable reluctance accelerometers readily form part of the variable inductance oscillator circuit when used in radio telemetry.

## Accelerometer (continued)

quency, the mass practically stands still in space and, therefore, the spring deflection is equal to the input deflection. For this reason, a seismic system can be used to measure displacement in this frequency range.

When the system is excited below its natural frequency, the mass tends to follow the movement of the input (although there may be a phase shift between plots of spring deflection vs. time and input vs. time). For constant displacement excitation, acceleration varies as the square of frequency; as shown by the heavy dashed line (Fig. 5) and it can be seen that a seismic system can be used to measure acceleration in the region below  $\omega_n$ . The physical action in this range is that the spring deflection is proportional to acceleration, because the force needed to accelerate the mass to make it follow the input is derived from the spring. Since  $F = ma$ , a measurement of spring deflection is proportional to acceleration.

It is obvious that means must be devised to measure spring deflection in such a way as to make it easily readable or to make it available for recording. We are concerned in this article with phenomena which occur so rapidly or remotely, that they must be recorded for proper interpretation. Our interest is on those devices which can change the physical measurement of spring deflection into an electrical signal.

### Transducers

Table 2 lists several commonly used accelerometer transducers and compares their relative characteristics. The ranges shown indicate the order of magnitude of the displacements which these devices can efficiently handle. The choice of transducer is dictated by the range of spring deflection to be measured.

Deflection of a spring mass system per unit acceleration is an indication of its sensitivity as well

as its natural frequency. The stiffer the spring, the less the deflection, the lower the sensitivity, and the higher the natural frequency. Transducers capable of sensing the smallest deflection would be used in accelerometers with the highest natural frequency. This is true in practice, as piezoelectric accelerometers have the highest frequency response and potentiometer accelerometers generally have the lowest.

### Accelerometer Characteristics

Table 1 lists the different types of accelerometers, along with their general characteristics.

The piezoelectric type (Fig. 3) has been widely used because investigations into shock and vibration phenomena require instruments with very high frequency response. Other advantages are its small size and availability in extremely high g ranges.

Fig. 3: Small size, high frequency response, and extremely high acceleration range are advantages of piezoelectric accelerometers.

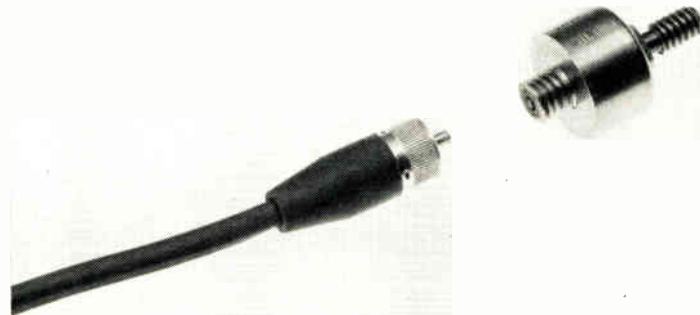

A draw back is that it is not capable of measuring a steady state acceleration, e. g., the centrifugal acceleration on a centrifuge. The reason for this is that the piezoelectric crystal is a charge generating device. This charge is generated as the crystal is deformed. As soon as the charge is generated, however, it tends to leak off through the external measuring circuit and through its own leakage resistance.

This type of accelerometer, therefore, is limited in its low frequency response to a value determined by the combination of charge generating capacity and the total load resistance. It is necessary to use electronic impedance matching networks to get the frequency response down to 5 cps. The calibration must of necessity be dynamic, and a dynamic calibration fundamentally is less accurate than static calibration.

The strain gage is widely accepted today because of several desirable characteristics. It is possible

to use this instrument with either ac or dc power, which makes it adaptable for a wide variety of measurement systems. In addition, the frequency response is good enough for many research programs. A most attractive feature is that it can be used with a minimum of external circuitry—battery, balance network, and galvanometer. The drawback to this type is the fact that it has very low output.

The differential transformer (Fig. 1) has been drawing interest as a control device, such as in auto pilots. Although this unit requires a carrier excitation, 400 cps voltage is often available, so this is no problem. As control systems are designed for a maximum of stability, the use of a carrier system is actually desirable. The sensitivity is high enough that little, if any, amplification is necessary. The balanced electrical construction tends to reduce drift and sensitivity shift due to temperature changes.

Potentiometer accelerometers have been widely used because of the minimum external circuitry needed and their high output. Their use is limited to slow moving accelerations. The major drawback is friction which limits resolution and accuracy.

The variable reluctance accelerometer (Fig. 2) is used principally where radio telemetry is employed. The main reason is that it lends itself readily for use with variable inductance oscillators, the accelerometer itself being part of the oscillator circuit.

The variable capacitance accelerometer has not been utilized to any great extent. It is inherently a high impedance device and has all the attendant difficulties, such as loading effects and noise problems. Due to its low temperature sensitivity it may eventually enjoy more widespread use.

Electronic accelerometers are used primarily for laboratory test work. Their very high sensitivity makes them useful where amplification equipment is not desirable or feasible. Their use on mobile equipment awaits the availability of more rugged transducing tubes.

The vibrating wire output is a frequency modulated signal, making it sensitive to power supply fluctuations. It is possible to utilize pulse counting techniques to measure the output and digitize for use with computers. This type of accelerometer has not been very popular because of the requirements for special circuitry.

### Calibration

The application of a known acceleration to an accelerometer can be simple and it can be difficult. The simplest technique is the  $\pm 1g$  calibration utilizing the earth's gravitational field. This force is  
(Continued on page 159)

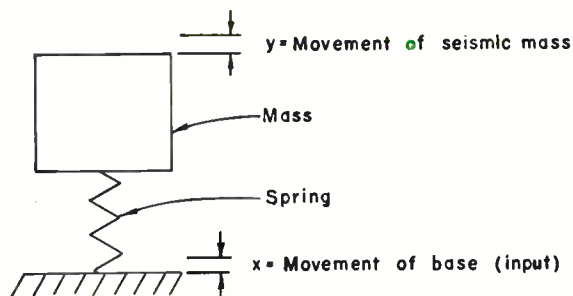

$$\text{Spring deflection} = y - x$$

$$\text{Relative response of system} = \frac{y - x}{x}$$

Fig. 4 (above): A mass and spring form the simple seismic system.

Fig. 5 (below): Seismic system response to a constant displacement by a sine wave of varying frequency applied to the spring base.

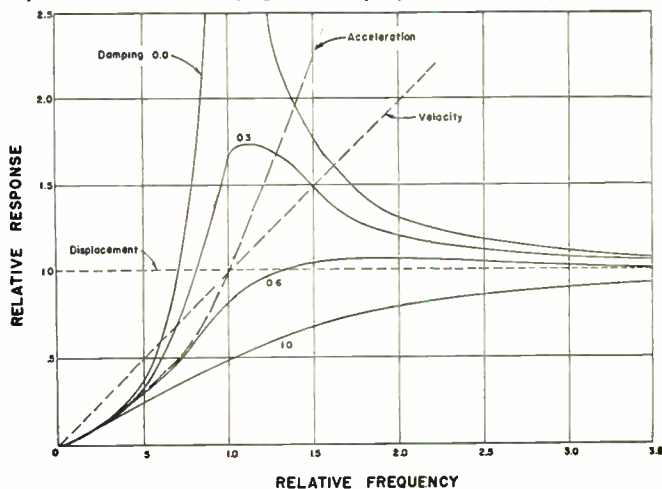

TABLE 1

Type of Accelerometer	Acceleration* Range in G's	Frequency* Range	Accessories Required	Accuracy (Incl. Linearity Hyst., Repeat.)	Temperature Range °F
Piezoelectric	.001 - 20,000	3 - 20,000	Cathode Follower required for measurements below 200 cps	5% of reading	-65 to +500
Strain Gage	.01 - 1000	DC - 1500	Carrier excitation (AC or DC) Balance Circuit	1%	-65 to +250
Vibrating Wire		DC - 20,000	Special amplifier and oscillator	2%	Temp. controlled at 130°
Variable Reluctance	.1 - 75	DC - 300	Carrier excitation	3%	-65 to +165
Electronic	.01 - 75	DC - 300	Stable Power supply and zeroing control	2%	-65 to +250
Differential Transformer	.01 - 1000	DC - 500	Carrier excitation, Balance circuit, Demodulator	1%	-65 to +165
Potentiometer	.2 - 75	DC - 60	Excitation (AC or DC)	2%	-65 to +165

\*These ranges are not for one instrument, but for several in each category.

# What's New . . .

## Tiny Bits of Wire Form Flip-Flop

The cryotron is man's first practical use of superconductivity—the ability of some metals to conduct current with no resistance at low temperatures below  $-420^{\circ}\text{F}$ . In its simplest form, the cryotron consists of a straight piece of wire with another wire—as fine as a human hair—wound around it as a control winding.



Fig. 1: Tube, transistor, and cryotron—two twisted wires form new computer element

Development of the cryotron was begun three years ago by Dudley A. Buck, a graduate student and instructor in the Electrical Engineering Department at M.I.T., in cooperation with the Lincoln Laboratory. It is the first useful application of a phenomenon discovered nearly 50 years ago but still not yet understood.

The first data-processing equipment in which the simple, tiny cryotron will replace complex tubes and expensive transistors is now being built at Arthur D. Little, Inc., in cooperation with the Massachusetts Institute of Technology. This first cryotron electronic catalog will use 215,000 cryotrons. A conventional computer to do the same job might require more than 50,000 vacuum tubes.

Present experimental circuits indicate that a large-scale digital computer can be made to occupy one cubic foot, not including re-

frigeration and terminal equipment. In contrast, today's digital computers fill whole rooms.

Below the critical temperature the straight wire conducts current with no resistance, but current in the control winding produces a magnetic field which destroys superconductivity in the straight wire and causes its resistance to return. Thus, current in the control winding can cut off current in the straight wire. Interconnect these single switches in great families and you have switching circuits of exactly the kind needed for many computers.

Cryotrons operate only at the extremely low temperature of liquid helium, whose boiling point is 4.2 degrees Fahrenheit above absolute zero. One part of any cryotron computer will be a special refrigerator, known as a cryostat, to liquify helium and generate these extremely low temperatures.

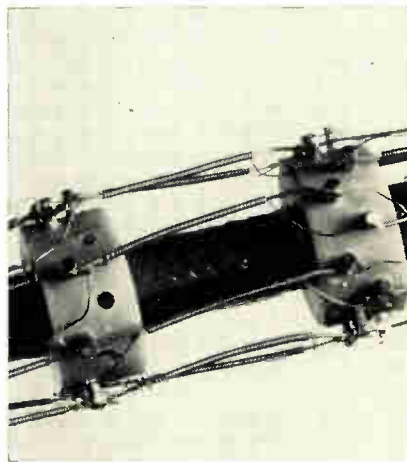

Fig. 2: This is a flip-flop circuit using the MIT-developed cryotron binary element

The small size of a cryotron is only one of its advantages. A much more important characteristic is basic simplicity. Cryotrons—single wires with tiny coils wrapped around them—can be made by automatic machines at great speed. And they can be made and pre-

assembled in long chains, so that circuits formerly requiring many hours for assembly may become routine manufacturing operations.

Another cryotron advantage is its small use of electric power; because resistance is negligible in superconductive circuits, the electric currents flow with little power loss.

One of its disadvantages at present is its slow speed. Even though a cryotron can switch from one condition to another as rapidly as a transistor or vacuum tube, the cryotron circuits switch electric currents among their countless paths relatively slowly.

Cryotrons today use wires of tantalum and niobium—two rare metals which are stronger than copper and which become superconductive at liquid helium temperatures. New metals and alloys may make possible faster operation.

## Transistors Prove Themselves

Many manufacturers of electronic equipment have been cautious about including transistors in their equipment until field tests and laboratory studies have established the reliability and operating characteristics of transistors. This philosophy has been followed generally by the normally conservative communications industry. Life and reliability tests have now showed that properly designed transistor circuits can give remarkably long service with a minimum of maintenance, and transistors are appearing in communications devices wherever their advantages balance the costs of employing them. For example, transistors are used in power line carrier equipment where their low power consumption and high reliability characteristics are key factors.



# New "Breadboard" Cuts Lab Time

Something new has been added to the art of "breadboarding." Science Electronics, Inc. has introduced their new Erec-Tronic system. With this system, each part is mounted on an individual base and the leads are permanently soldered to connector pins. Connections between components are then made by attaching patented Jiffy-Clips to the terminal pins. You don't have to solder. There is no strain on the leads of condensers and resistors — they last longer.

Another idea used in the Erec-Tronic system is the use of a perforated pegboard. Pegs under the individual mounting bases fit into the holes in the pegboard. Components are held in position, but they can be lifted off and replaced or shifted very easily. It is possible to stack breadboarded sub-

This photograph shows important details of the new Erec-Tronic breadboard system. Components are permanently mounted on individual bases; patented connectors make wiring and circuit changes simple, and give low contact resistance

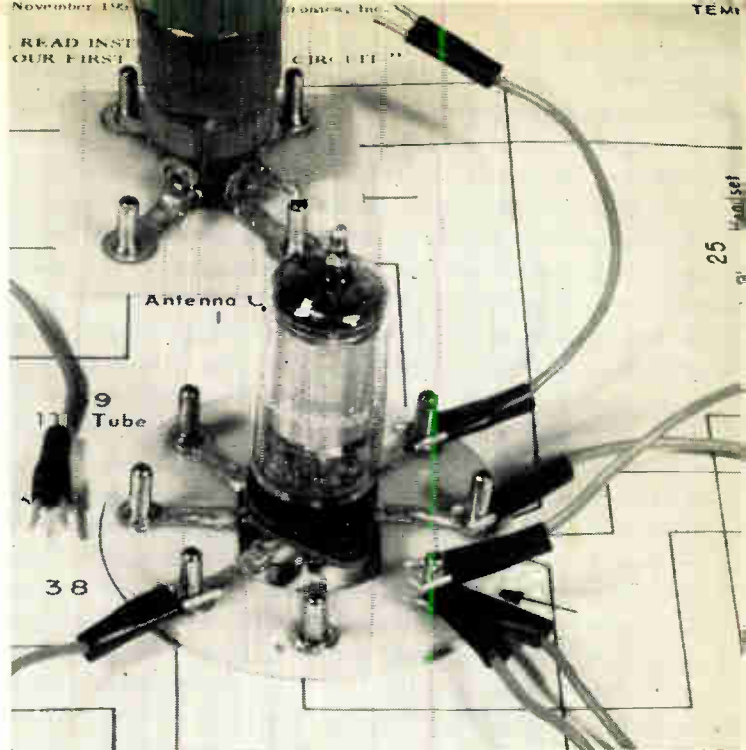

semblies or make other physical arrangements for convenience. A big advantage over systems commonly used in labs is that a whole board can be set aside, clearing the workbench for other projects without having to disassemble and reassemble a complex circuit.

The smaller educational kits have large schematics printed on templates. These templates enable a student to assemble a working circuit directly over the large schematic drawing, thus associating each component with its schematic representation.



Transistorized speaker unit boosts mobile radio output to overcome vehicle noise

In radio paging, a low frequency all transistorized receiver carried in the pocket forms part of a communications system which replaces P.A., bell, light and buzzer paging systems with both selective calling of individuals plus voice message facilities built into the miniature receiver.

The "Handie-Talkie" portable radiophones, produced by Motorola, now are transistorized in the audio and low frequency receiver stages providing lightweight (as little as

7-1/2 lbs.) two-way radio units which can be carried wherever man himself can go.

In this same type of unit, some models are powered by rechargeable nickel-cadmium wet cells. Formerly a vibrator power supply was used to supply the higher operating voltages. Now a transistor oscillator circuit serves this purpose, for efficient power conversion and long life with minimum maintenance. Transistors are also being used to advantage in more unusual, yet highly practical ways.

In vehicular two-way radio, a dynamic microphone has long been desired because of its excellent quality of voice reproduction. However, high ambient noise levels, low microphone output, and electromagnetic noise pick-up stymied design engineers until transistor amplifiers solved the problem. Retaining the same familiar palm size and form factor, and deriving power from the conventional carbon microphone "talking current" supply, the dynamic microphone with a built-in preamplifier is now

serving many two-way radio users.

Another recent innovation is the transistorized speaker introduced by Motorola. A conventional mobile two-way radio speaker with voice frequency bandpass characteristics is modified by building a transistorized audio power amplifier into the speaker housing. Taking the conventional one to two watts audio output of the conventional receiver, the speaker boosts the output to as much as 15 watts. The increased audio output helps overcome wind, engine, road and siren noise within the vehicle.

Power for the transistor amplifier is drawn from the vehicle battery. The speaker operates from either 6 volts or 12 volts with highest power output, of course, at the higher voltage.

Looking forward, we are just beginning to see some of the many ways in which transistors can serve the communications industry. We can expect that transistors will be designed into communications equipment as rapidly as the practical and economic value is proved.

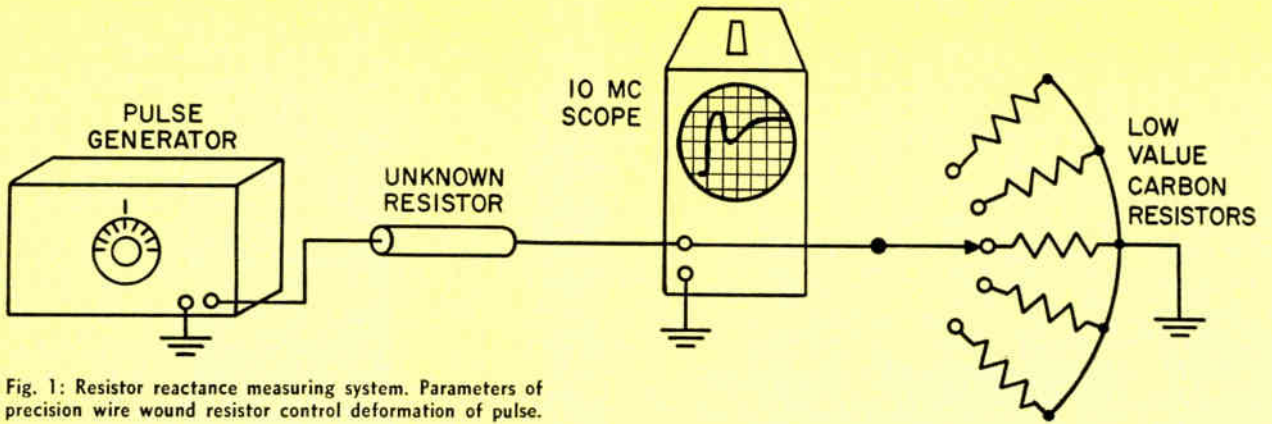

Fig. 1: Resistor reactance measuring system. Parameters of precision wire wound resistor control deformation of pulse.

## In Pulse Circuits

# Remember Resistor Reactance

There has been an increasing need for resistors of very high precision that could function properly in high speed pulse circuits. The major obstacle in the development of such resistors has been the lack of proper equipment to adequately measure their reactive components and actual rise time. A precision wire wound resistor is generally considered to be a resistive element in series with an inductance and, in turn, both are shunted by a capacitance (Fig. 2).



There are many types of bridge circuits that can be used to measure

*When a resistor is predominantly capacitive or inductive, the pulse symmetry will be sharply affected. This method tells the circuit designer precisely what the characteristics of his resistor are.*

By **HARVEY FRIED**

Chief Electrical Engr., Eastern Precision Resistor Corp.  
675 Barbey St., Brooklyn 7, N. Y.

either the effective capacitance or inductance of a resistor, but they all have one common failing. They cannot distinguish and yield information pertaining to the individual reactive components but can only supply the effective reactance.

In order to determine both the inductance and capacitance, careful measurements must be recorded at a series of frequencies. From

this information, an involved mathematical analysis can be made to determine the parameters of the resistor.

### Measurement Simplified

A much simpler system has been developed to facilitate the observation and measurement of the individual reactive elements of a resistor (Fig. 1). A 2  $\mu$ sec. pulse gen-  
*(Continued on page 122)*

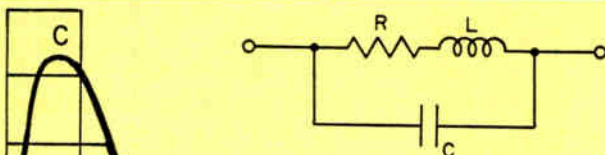

Fig. 2 (above): General conception of a wire wound resistor's parameters.

Fig. 3 (left): Decaying current indicates the predominant capacitance of a high value resistor.

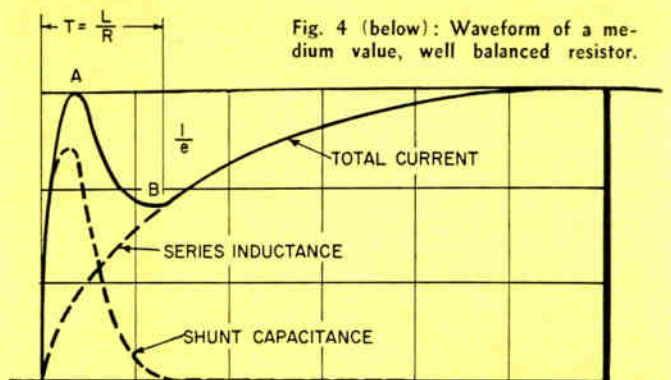

Fig. 4 (below): Waveform of a medium value, well balanced resistor.

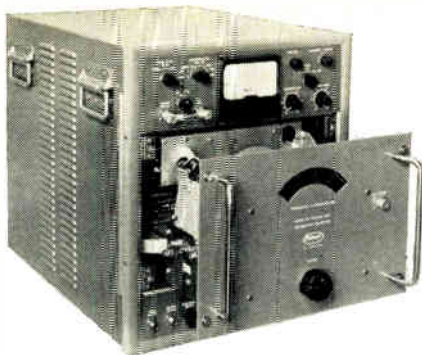

Fig. 1: Tuning heads are interchangeable.

Increased activity in the microwave region in recent years has created the need for microwave test and measuring equipment formerly available only at lower frequencies. One of the most demanding requirements was for a receiver that was not only versatile but also reliable and easy to operate.

A study of microwave labs throughout the country indicated that microwave receivers may be classed in one of the following categories: AM-FM reception; field intensity measurement; pulse, pulse time or pulse position demodulation; and as a sensitive microwave power meter. The objective would therefore be to design a single self-contained receiver to perform these functions while covering a frequency range from 950 MC to 11,260 MC. The problem resolves itself into one of designing four distinct receivers in a single unit and another of designing a simple, reliable broadband microwave tuning head. A block diagram and picture of the

*The problem resolves itself into one of designing 4 distinct receivers in one and designing a simple, reliable, broadband tuning head.*

Design for a

# Broadband Microwave Receiver

By **BERNARD ROSEN** *Eng'g Group Leader,*  
and **ROBERT SAUL** *Chief Test Engineer,*  
*Polarad Electronics Corp., 43-20 34th St.,*  
*Long Island City 1, N. Y.*

Polarad Model R Receiver is shown in Figs. 1 and 2.

## Frequency Range

The practical number of bands required to cover the microwave frequency spectrum is 4, each covering approximately a 2:1 frequency range. The frequency coverage of each head is limited by local oscillator, preselector and mixer design. External cavity klystron tubes are now available to cover each frequency range. The

5837 is used from 950 to 2040 MC, the 5836 from 1890 to 4320 MC, and the RK5721 from 4190 to 7720 and 7260 to 11,260 MC. Careful design enables octave broadbanding of these components without much sacrifice of their optimum design, narrow band performance.

Non-contacting, multiple choke sections, together with mode suppressors, enable design of external klystron cavity oscillators to cover a 2:1 frequency range. Use of a linear frequency dial simplifies fre-

Fig. 2: Typical microwave receiver block diagram. Four tuning heads permit covering the microwave frequency spectrum.

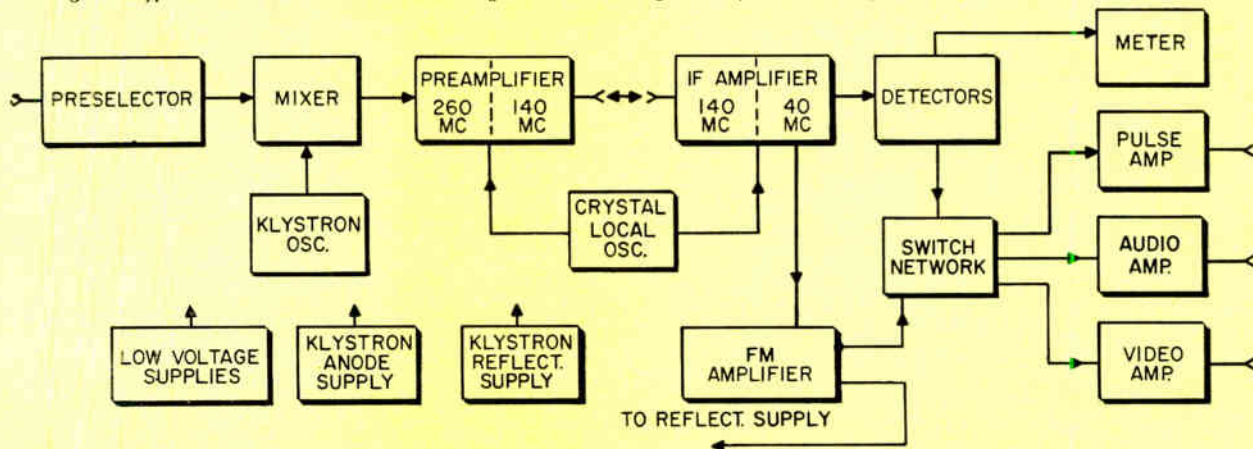

# Microwave Receiver (continued)

quency measurement and enables linear reflector voltage tracking. A simple mechanical arrangement to achieve such a dial is obtained by an adjustable hyperbola cam driving the oscillator choke section. The cam adjustments allow for frequency dial error of less than 1% with klystron tube variations. A single front panel tuning knob can then be made to drive the frequency dial, the oscillator tuning mechanism, the reflector tracking potentiometer and the multi cavities of the preselector. Fig. 3 illustrates a typical tuning head.

## Preselector

The design of the preselector is governed by the desired bandwidth, the allowable image rejection and insertion loss. Thorough design considerations show that 60 db image rejection can be achieved with a two-cavity preselector and a 260 MC first i-f. Though a higher noise figure cannot be avoided by selecting this high first i-f, the disadvantage is offset by enabling the design of a two-cavity preselector. A third cavity would allow the use of a lower first i-f but would increase the insertion loss and add to the complexity of the associated mechanical tracking mechanism. The insertion losses in both the 950 to 2040 MC and the 1890 to 4320 MC preselectors vary between 2 and 4 db, while those in the 4190 to 7720 MC and 7260 to 11,260 MC preselectors vary between 4 and 7

Fig. 3: One of the four tuning heads. Note the compactness.

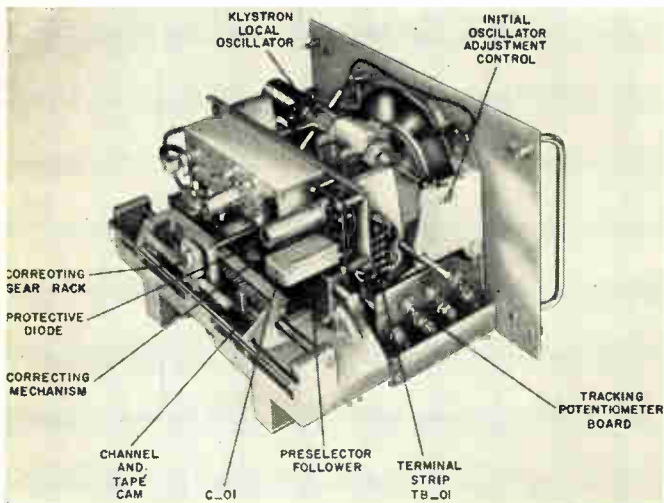
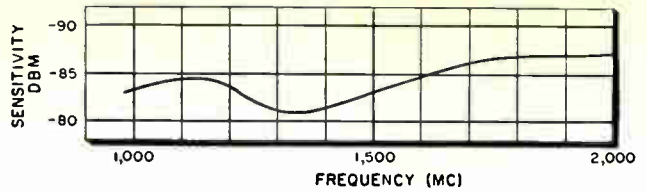

Fig. 4: Sensitivity for tuning head. Higher frequency units will vary 4 to 7 db.



db. Fig. 4 shows typical sensitivity (for twice noise power) for a tuning head.

Maximum allowable preselector bandwidth is dictated by required image rejection, while the minimum bandwidth is limited by the allowable mechanical tracking error between oscillator and preselector drive mechanism. For example, at 1000 MC the choke displacement in the cavity of 0.001 in. corresponds to a frequency change of 0.4 MC. Therefore, for a 3 MC i-f bandwidth and an 8 MC preselector bandwidth, 5 MC is the allowable tracking error which corresponds to  $\pm 0.006$  in. the mechanical tracking. This is a reasonable figure to insure optimum sensitivity with normal manufacturing processes and various field conditions of vibration and temperature. A design varying from an 8 MC bandwidth at 1000 MC to a 35 MC bandwidth at 11,000 MC enables obtaining a 60 db image rejection with a reliable mechanical drive system.

## Noise Figure

The Noise Figure of a broadband microwave receiver is largely dependent on the crystal and crystal mixer design. Both the signal input and the coaxial mixer output can be most efficiently coupled by means of an inductive

loop. Since the inductive loop represents a low reactive component which is approximately a short circuit at the local oscillator frequency, the local oscillator injection must then be a quarter wavelength (at center of frequency band) from the loop. The crystal mixer design must insure a low r-f impedance from crystal anode to ground. Where a cartridge type crystal such as the 1N23C is used in the 950 to 2040, 1890 to 4320 MC and 4190 to 7720 MC frequency bands, the low impedance is derived from the capacity that exists between the crystal and ground. In the high frequency band of 7260 to 11,260 MC, an r-f choke section is designed around the coaxial crystal to present a low r-f impedance without degradation of the i-f signal. Sensitivities in excess of -80 dbm for a 3 MC bandwidth can thus be obtained throughout the frequency range.

To prevent noise generated due to receiver tuning, it is essential to design tuning plungers in the oscillator and preselector with non-contacting elements. The use of teflon bearings with non-contacting choke sections further avoids the questionable reliability of spring finger devices and the associated maintenance problems.

The choice of the i-f bandwidth  
(Continued on page 167)

Fig. 5: Suggested test set-ups for receiver measurements.

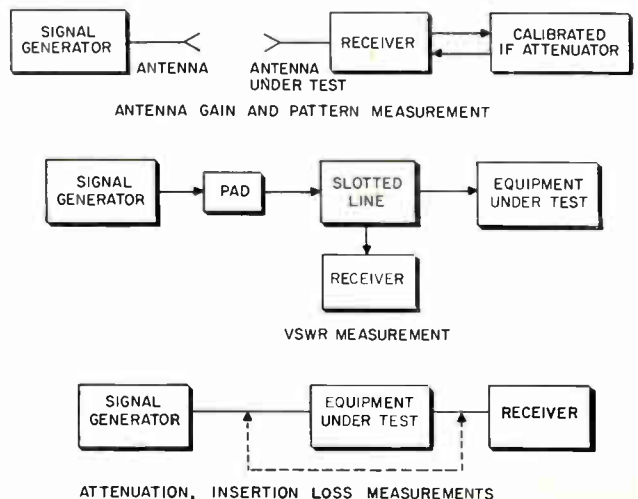

**SOLENOIDS**

An extensive line of solenoids designed to supply the magnetic focusing field for traveling-wave tubes is now available. As a result of exceptionally uniform winding, these units

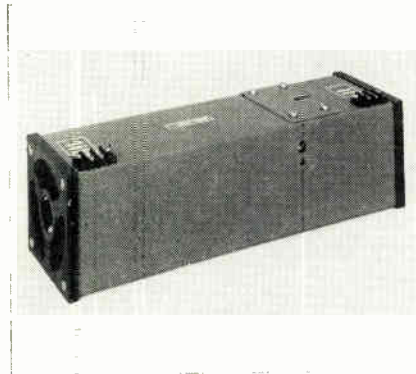

have a very small component of transverse magnetic field, thus providing optimum focusing for beam type tubes. The wide selection of solenoids include models which supply from 100 to 1000 gauss, with winding lengths of 8½ to 16 in. Solenoids with fields greater than 600 gauss are provided with a built-in blower to cool unit and tube. Menlo Park Engineering, 721 Hamilton Ave., Menlo Park, Calif.

Circle 83 on Inquiry Card, page 103

**SERVO AMPLIFIER**

The Model 1800-0700 is a miniaturized, hermetically sealed, plug-in transistor servo amplifier. It is primarily intended to receive signals from a synchro control transformer and to operate a size 15, 60 cps, 6.1 w. servo motor or equivalent. The amplifier is designed to meet the environmental requirements of Specification MIL-E-5400. Size: 1 3/16 x 1 11/16 x

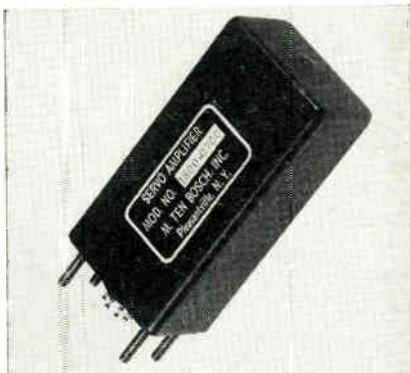

3 13/16 in. high. Input Impedance: 10,000 ohms (Nominal). Voltage Gain (Typical): 550 at 2 w. output. Phase Shift: Adjusted internally to provide essentially 90° shift. M. Ten Bosch, Inc., Pleasantville, N. Y.

Circle 84 on Inquiry Card, page 103

**CERAMIC MAGNET**

Indox V, a new oriented ceramic permanent magnet material that produces an extremely high peak energy product, and makes possible substantial savings in both magnetic material

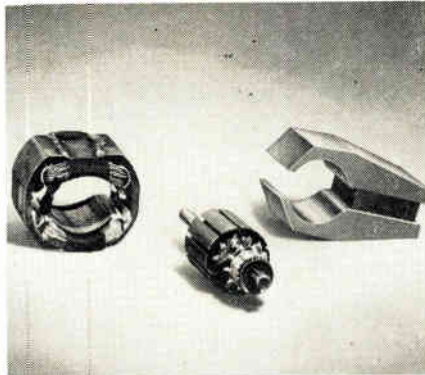

and space, has just been announced. Made of a newly developed ferrite magnetic material, which is oriented in the direction of pressing, Indox V produces a peak energy product of 3.5 x 10<sup>6</sup>, as compared to 1.0 x 10<sup>6</sup> for Indox I, which is non-oriented. Another advantage of Indox V over conventional materials is that it contains no critical materials. Indiana Steel Products Co., Valparaiso, Ind.

Circle 85 on Inquiry Card, page 103

**ROTARY SWITCH**

A new limit switch with innumerable applications is being manufactured. Hermetically sealed, the #9135 switch has a 360° rotary action with 180° pretravel, 180° over-travel. Available in 2 models for different applications, it comes with potted leads or pin connectors. The limit switch can be mounted flat with 4 fasteners or mounted vertically be-

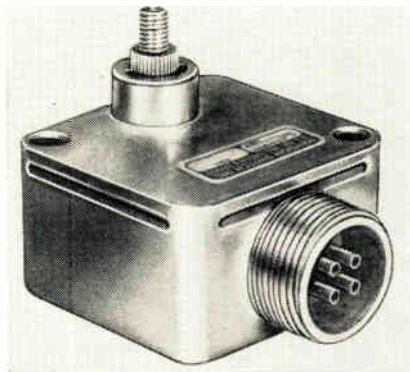

hind a retainer with washer and lock nut. Extremely compact, it measures 2 x 1¾ x 1 in. Case is heavy nickel silver and qualified to withstand great shock. Haydon Switch, Inc., Waterbury 20, Conn.

Circle 86 on Inquiry Card, page 103

**WAVEGUIDE**

Component parts are now made from oxygen-free high conductivity copper. Components such as straight sections, circular bends and adapters are at present available in the new

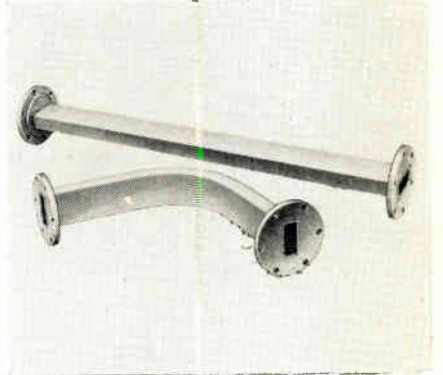

material in the WR-137 waveguide size. Used in combination with standard flexible waveguide components and windows, they readily lend themselves to installation for microwave relay systems operating in the 6000 MC region. Oxygen-free high conductivity copper has an attenuation between 2.0 and 2.4 db/100 ft. Airtron, Inc., Dept. B, 1103 West Elizabeth Ave., Linden, N. J.

Circle 87 on Inquiry Card, page 103

**TEST FACILITY**

The first independent commercial "White Noise" testing facility on the West Coast is now available. It is able to subject a test specimen to sound level intensities of 150 db over a cross sectional area of 64 sq. in. This sound level is obtainable on a random frequency basis covering 50 cps to 10 kc with the required sound pressure level energy present in each

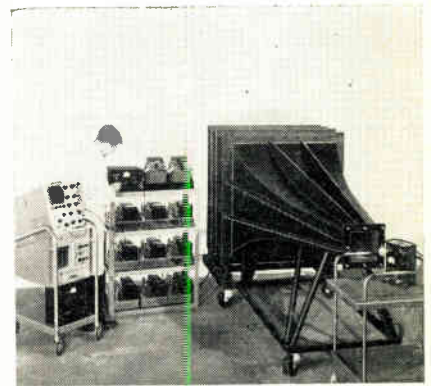

octave over the entire range. Using discrete frequency testing techniques, the equipment now available can provide sound levels from 150 to 155 db. Rototest Labs, Inc., 2803 Los Flores Blvd., Lynwood, Calif.

Circle 88 on Inquiry Card, page 103

**DC AMPLIFIER**

By performing very slight modifications to KINTEL's Model 111A Broadband DC Amplifier, the 0 (Zero) gain position becomes an open loop position. The user may then em-

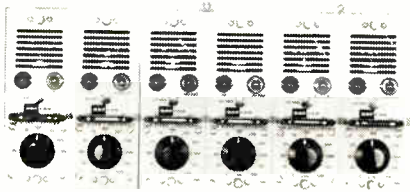

ploy his own feedback networks to provide up to 100% resistive or capacitive feedback around the amplifier. By choosing the proper input and feedback components, it is possible to select the desired gain, cause the amplifier to act as an integrator, generate complex linear transfer functions, etc. Kintel (Kay Lab), 5725 Kearny Villa Road, San Diego 12, California.

Circle 89 on Inquiry Card, page 103

**SERVO**

A new size 10 servo which is less prone to single phasing and designed specifically for use with a transistorized amplifier is now available. Outstanding feature is that Type 10-5052-23 will not single phase 1) with fixed phased energized, and 2) with a tuning capacitor 250% in excess of value required to tune control phase to unity power factor connected across



control phase. Precision electrical characteristics include 115 V. fixed phase 36 V. control phase with 3 w. phase stalled, 6500 RPM at no load and .26 in. oz. at stall min. John Oster Mfg Co., Avionic Div., Racine, Wisc.

Circle 90 on Inquiry Card, page 103

**CONNECTOR**

A new type rack and panel electrical connector, incorporating a solid shell and resilient insert to facilitate pressurization and to give maximum protection against the harmful effects

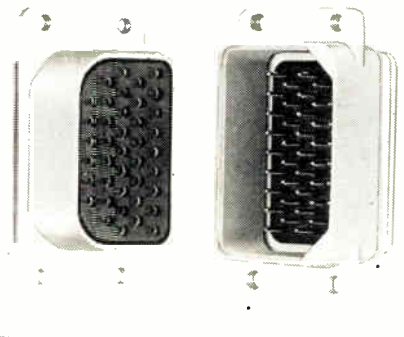

of vibration, has been developed. Connector will be known as the SR type. Features are: solid shells, resilient inserts, low contact engagement forces, easily pressurized to latest MIL specification, closed entry sockets, heavily gold plated contacts, cadmium plated clear irridite finish, operates in temperature range of -67° to +250° F. Scintilla Div. Bendix Aviation Corp., Sidney, N. Y.

Circle 91 on Inquiry Card, page 103

**FREQUENCY GENERATOR**

An unusually versatile wide-band Sweep Frequency Generator, designed for laboratory or production test usage where high stability and extreme constancy of output are essential, has been introduced. The Model 900, supplies a sweep signal at any frequency from 0.2 MC to approximately 1,000 MC, with sweep widths as high as 300 MC or as low as 0.1 MC.



The Sweep's r-f output, which is monitored carefully by matched crystal diodes feeding a 2-stage AGC amplifier, is flat within ±0.5 db over the entire VHF range. Jerrold Electronics Corp., 23rd & Chestnut St., Phila. 3.

Circle 92 on Inquiry Card, page 103

**CHOKES**

A complete set of high "Q" ferrite core choke coils offering 14 inductances from 150µh to 1 mh in MIL-SPEC inductance values is now offered. These compact chokes are in-

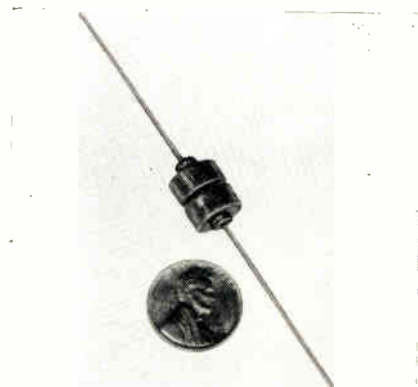

tended for use in networks and filters at frequencies from 50—1500 KC and may also be used as resonant elements in i-f and r-f circuits. Typical "Q" values are 142 at 240 KC and 182 at 460 KC for a 1 mh choke. Coil form length is 5/8 in. with 1 1/2 in. pigtail leads. Overall diameters range from 9/16 in. for the 10 mh choke to 7/32 in. for 150 µh unit. National Co., 61 Sherman St., Malden 48, Mass.

Circle 93 on Inquiry Card, page 103

**TUBE SOCKET**

No. 6000 Socket features extremely low capacitance between cathode and grid contacts and between grid and anode contacts for UHF amplifier service of the 6BY4 tube. Other outstanding characteristics of the socket include small size, operation up to 44° F, contacts of silver plated heat treated Beryllium copper, easy mounting of socket on chassis, and contact

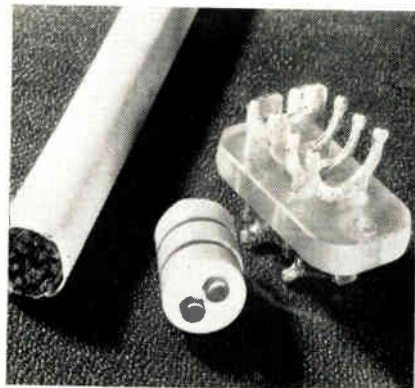

lugs notched for easy connection to associated circuitry. The tube may be inserted in the correct position only, and is readily removable from the socket. Jettron Products, Route 10, Hanover, N. J.

Circle 94 on Inquiry Card, page 103

## MISSILE BEACON

An improved radar beacon used for tracking rockets and guided missiles is being produced. A similar radar beacon (AN/DPN-19) is also being manufactured for the Armed



Forces, and, as the work horse for this type of application, has enjoyed tremendous success in connection with testing all types of missiles and drone equipment. The beacon consists of a receiver-transmitter, power supply including battery, antenna, and special interconnecting cables. Extremely compact, the unit is approximately 6 in. long. American Mach. & Fdry Co., 1085 Commonwealth, Boston, Mass.

Circle 95 on Inquiry Card, page 103

## RADOME TESTER

Of importance to the manufacturer of plastic radomes as well as firms installing and testing radar equipment is the Radome Boresight-Error Measuring System, Model 150. Automatically recording beam deflection as a continuous function of radome position, the process requires far less time and does not miss discontinuities often overlooked by manual, point-by-

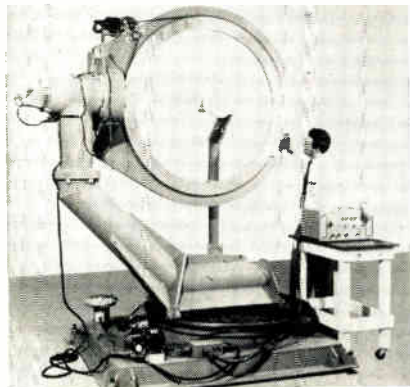

point measurements. Usually supplied as a complete system, combinations and modifications of the basic components are available separately. California Technical Industries, 1519 Old County Rd., Belmont, Calif.

Circle 96 on Inquiry Card, page 103

## RELAY LINE

The SPST HDC-1, accident-proof armored mercury plunger relay, is for all loads up to 60 a. at 115 vac. This rugged encapsulated-tube relay was specifically designed to withstand



shocks, blows and physical impact. For corrosive atmospheres, relay coils are also available in all standard operating voltages, fully encapsulated in approved polyester resin compound. These relays should be of great interest to those who demand the finest, and the highest degree of protection for every component. Ebert Electronics Corp., 212-26X Jamaica Ave., Queens Village 28, N. Y.

Circle 97 on Inquiry Card, page 103

## FREQUENCY DETECTOR

For telemetering, instrumentation, and automatic control, Type F-992 Magmeter detector provides an output current that is linearly proportional to frequency within the band from 375 to 425 cps. Similar detectors can be provided covering a 10% bandwidth at any center frequency from 30 cps to 5 KC. The output is suitable for operating a d'Arsonval indicating

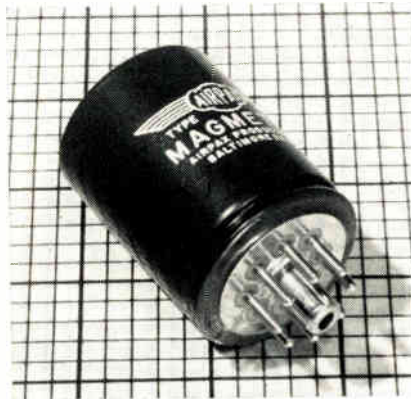

instrument, a servo type recorder, or a control circuit. Output is zero at low-frequency end of band providing fail safe indication in absence of input. Airpax Products Co., Middle River, Baltimore 20, Md.

Circle 98 on Inquiry Card, page 103

## GEARHEADS

Models G-11, G-15, and G-18 Precision Gearheads are designed to withstand the severe mechanical and thermal environments encountered in military and industrial applications. A



special flush-collar mounting insures permanently accurate mesh of motor pinion and first gear. Gearheads have AGMA Precision Class II or Class III gear form, 100% inspected on Schoppe and Faeser gear testers. Exacting quality control of parts makes long-lived components. They are available from stock in ratios from 10:1 to more than 4000:1. Feedback Controls, Inc., 899 Main St., Waltham, Mass.

Circle 99 on Inquiry Card, page 103

## AMPLIFIER

A new stable, non-overload pulse amplifier together with a precision single channel analyzer, all on one standard sized chassis has been developed. The amplifier, which employs delay-line clipping and long-tailed pair stages with feedback, has good stability, short rise-time, and excellent overload characteristics. Overloads as large as a factor of 100 are

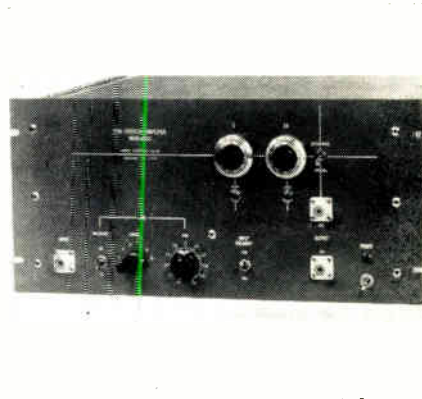

handled easily. The pulse height selector provides short time resolution, high base line and window stability, and low rate dependence. Hamner Electronics Co., Inc., P. O. Box 531, Princeton, N. J.

Circle 100 on Inquiry Card, page 103

**LEVEL INDICATOR**

The IN-1 consists of a variable gain amplifier broadly tuned to 1000 cps driving a rectifier type ac indicating instrument which responds to the average level. The time constant of

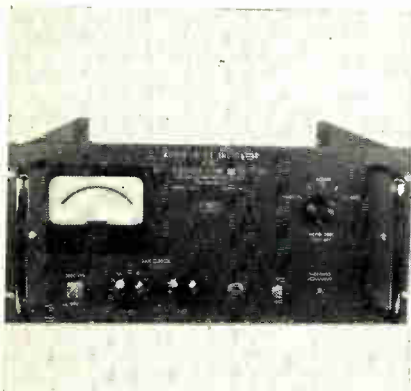

the indicating meter is adjustable to increase the accuracy of observation of small signals in the presence of noise. This unit makes an ideal companion instrument to the Bolometer Preamplifier, BA-1A, and the A-F Substitution Attenuator, CF-1, allowing the maximum use to be made of these instruments. Weinschel Engineering, 10503 Metropolitan Ave., Kensington, Md.

Circle 101 on Inquiry Card, page 103

**POLYRANGER**

A ruggedized, waterproof Polyranger meets Navy mil specifications as follows: Shock: A 3-ft. drop onto a concrete floor simulating approximately 200 g's; Accuracy: 0.5 of 1% full scale on all ranges; Ranges: 0-1.5/5/30/150 ma. 0-0.3/3/1/30/150/-300/500 v. (20,000 ohms/volt, 50  $\mu$ a.); Scale: 100 and 150 divisions; Waterproofing: Entire instrument

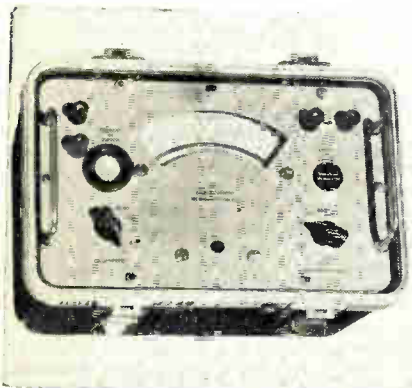

completely watertight; Vibration: Standard 60 cycle test; Temperature compensation: Completely compensated between ambient temperatures of 20° and 30°C. Sensitive Research Instrument Corp., New Rochelle, N. Y.

Circle 102 on Inquiry Card, page 103

**TV CAMERA**

A pocket-size live television camera has been developed for military airborne, mobile, and field closed-circuit TV applications. The ultra-miniature TV camera, was made possible by a



new design approach which combines transistors, specially developed transistor circuitry, and a new 1/2 in. vidicon camera tube. The pocket-size TV camera (JTV-1) weighs less than a pound and measures only 1 7/8 by 2 3/4 by 4 1/2 in. Used with an f/1.9 lens, it requires only 10 ft. candles of scene illumination for clear, contrasty pictures. RCA Defense Electronic Prod., Camden, N. J.

Circle 103 on Inquiry Card, page 103

**OHMMETERS**

Fast, automatic, and precise measurement of a wide range of resistance values, with very small currents passed through the test resistance, is provided in 2 new digital ohmmeters. Models 758 and 759 have been engineered specifically for laboratory and industrial applications. To assure maximum, trouble-free life, each model features an oil-sealed stepping



switch system. Resistance values are displayed in a horizontal line of inch-high luminous numerals with the decimal point and resistance symbol shifting automatically. Non-Linear Systems Inc., Del Mar, Calif.

Circle 104 on Inquiry Card, page 103

**SLOTTED LINE KIT**

The DIC-6207 Slotted Lines and Universal Carriage are designed to provide a maximum of flexibility and accuracy for standing wave measurements in the 1.7 to 5.85 KMC region.

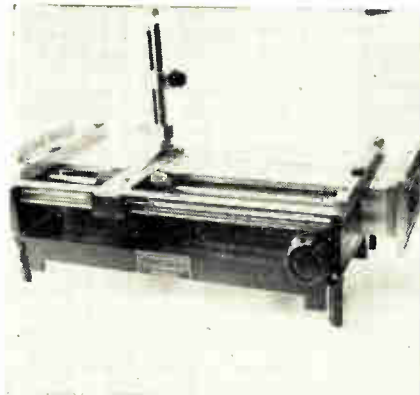

The basic design consists of a rugged universal carriage which will accept interchangeable precision slotted sections in 5 different waveguide sizes (RG-104/U, 112/U, 48/U, 49/U and WR-229). Other features include a stationary spinner knob for vernier control of probe position and a push button release control. Diamond Antenna & Microwave Corp., 7 North Ave., Wakefield, Mass.

Circle 105 on Inquiry Card, page 103

**CUTOFF SAW**

A simplified cutoff saw combining high precision with operating economy. The new saw is simple to operate, is quickly set-up, and uses low power. Outstanding among its features is unusually short set-up time. With conventional equipment, set-up often requires from 1 to 1 1/2 hr. Because of its compactness and portability, the saw offers high flexibility in

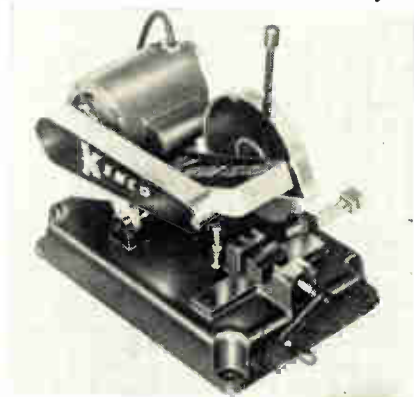

shops of all sizes. It will cut up to 3/4 in. bar stock in steel for production runs. It will also cut up to 1 1/2 in. in non-ferrous bar stock for production runs. Kenco Mfg. Co., 5211 Telegraph Rd., Los Angeles 22.

Circle 106 on Inquiry Card, page 103



**TACAN TESTER**

A portable TACAN test set, which permits rapid ground testing of airborne TACAN receiver-transmitter equipment while the equipment remains undisturbed in the plane, has



been announced. The test set may be used with either military airborne TACAN (AN/ARN-21) or the new commercial version. The set, designated as Type FTR 3156, provides rapid testing of frequency, sensitivity, power output, range, bearing, and identity tone. Type FTR 3156 weighs 17 lbs. and is 9 in. x 7 in. x 11½ in. deep. Federal Telephone & Radio Co., 100 Kingsland Rd., Clifton, N. J.

Circle 107 on Inquiry Card, page 103

**PARTS BIN**

A new do-it-yourself small parts bin, completely adaptable to any installation, will increase efficiency for all types of assembly production. This unique labor-saving device is called a SPEEDBIN. It is made of 12 standard heavy-gauge steel parts which can be arranged in a limitless number of designs. It is human-engineered to the physical capacities of

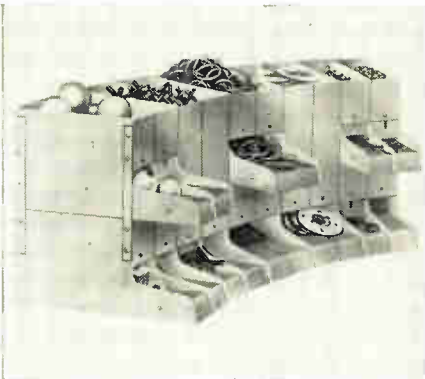

assembly workers. A typical installation of 6 bins forms an arc with a 19-in. radius in front of the operator, conforming to natural arm movement. Speed Assembly Equipment Co., Box 344, Fords, N. J.

Circle 108 on Inquiry Card, page 103

**CASTING RESIN**

Stycast 1090 is an epoxide casting resin of extremely low weight. It weighs less than half that of commonly used materials. Being completely unicellular, moisture absorp-

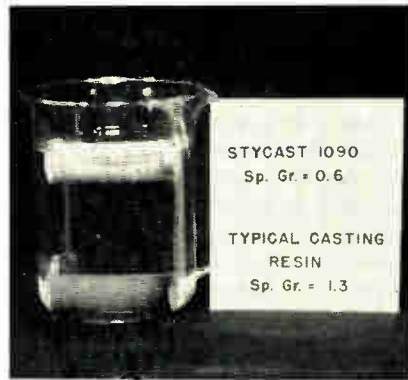

tion is negligible. Because of the low density, dielectric constant and dissipation factor are low. Adhesion to a variety of materials is excellent. Stycast 1090 is used to embed electronic assemblies, for low weight plastic tools and as a sealant. Room temperature cure is possible. Operating temperature is from -70°F. to +400°F. Emerson & Cuming, 890 Washington St., Canton, Mass.

Circle 109 on Inquiry Card, page 103

**ARMATURE WINDER**

A new high speed front loading 3-pole armature winder designed for long production runs and capable of winding as wide as a 5/16 in. random wound coil through a 1/32 in. slot has been developed. Model 233-A winds all sizes of skewed or straight 3-pole armatures for dc automatic clocks and many other applications. Much tighter armatures may be wound due

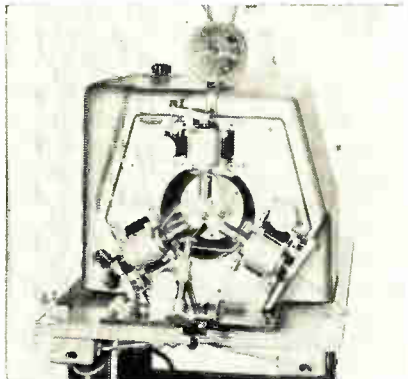

to high speed and level winding feature. Greater copper density per slot is attained by winding all 3 poles simultaneously in uniform layers. Geo. Stevens Mfg. Co., Inc., Pulaski Road at Peterson, Chicago 30.

Circle 110 on Inquiry Card, page 103

**RECORDER**

Two functions can be monitored simultaneously in their true wave forms with a new rectilinear writing galvanometric strip chart recorder. The DUAL recti/riter uses a single

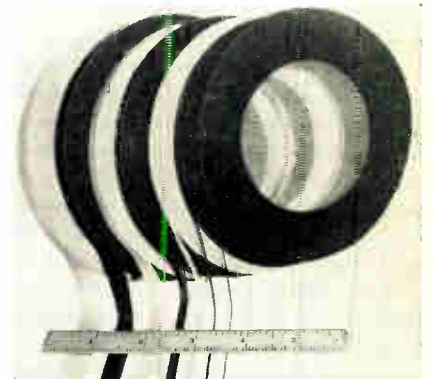

chart drive and records the 2 variables on a 2 channel rectilinear chart with a common time base. It has high deflection sensitivity and is adaptable to a variety of circuits. As the instrument has galvanometer meter movements, it is economical and highly reliable, with no warm-up time or drift problems. The unit is enclosed in a portable case. Texas Instruments Inc., Box 6027, Houston 6, Texas.

Circle 111 on Inquiry Card, page 103

**TAPES**

A new slitting technique producing standard 60 yd. rolls of any pressure-sensitive tape in precision widths as narrow as 1/32 in. has been developed. This new process leaves perfectly smooth clean edges and assures uniform width throughout the roll. For printed circuit master drawings they have all widths of narrow black photographic tape. Decimal sizes are



produced on short notice. Masking operations could be simplified by providing the exact width tape to cover the area to be masked, thus avoiding overlapping. By-Buk Co., 4314 West Pico Blvd., Los Angeles 19.

Circle 112 on Inquiry Card, page 103

**TV PROBE CONTINUANCE**—Television continued as the "piece de resistance" of the investigations of the Senate Interstate Commerce Committee under the \$225,000 budget approved for the committee's probes for the current session of Congress. The first major step in the current probe is a personal report by the FCC Commissioners before the committee, scheduled to start March 5, on its allocations progress.

**SUPPORTS UHF EXPANSION**—The Senate Committee made no bones about its support of deintermixture in the expansion of television when it asked the Senate to approve the \$225,000 probe budget. Its interrogation of the Commissioners was sharply critical of slow FCC efforts to solve the UHF situation. This criticism was epitomized in the language of the Committee's program in the TV field that "the failure to achieve fuller utilization of the UHF channels has greatly impeded the expansion of the nation's television system" and "the committee must continue its efforts in this field to assure the public of a sound, competitive nationwide television system."

**MICROWAVE PROCEEDING** — During February the FCC engineering and legal staffs concentrated their major efforts on the tremendous task of analyzing the approximately 200 replies received from the telephone and telegraph services, radio-electronic manufacturers, user organizations such as the petroleum, public utilities, trucking businesses, broadcasting networks and individual radio and television stations and other present or potential microwave users on the upcoming proceeding to determine who will be permitted to use frequencies above 890 megacycles, and to what extent. The analysis was slated to ascertain the position taken in the notices of appearance and to determine how much duplication occurred in their requests for participation in the microwave service.

**AVIATION OUTLAYS**—So that the Civil Aeronautics Administration and the US Air Force will be fully prepared for aviation's jet age, the President's budget contains substantial increases in funds for ground and airborne communications-electronics equipment. The CAA plans to spend \$149.5 million for air navigation facilities in the 1958 fiscal year against \$75 million appropriated for the current fiscal period. The programmed CAA facilities include 137 omniranges (VOR), 30 instrument landing systems, 21 long-range radar systems and 23 airport surveillance radar installations. The Air Force procurement figures included \$436,900,000 for ground equipment and \$28,600,000 for airborne facilities.

**PRE-HEARING CONFERENCES**—Just as important as the analysis of the filings were the staging during the latter part of February and the early part of March of pre-hearing conferences with those filing appearances by the FCC staff. These meetings are aimed to pare down the number of parties that will actually testify in the microwave hearings now slated to commence April 1. The Commission plans to get its time schedule of public hearings down to 30 days of testimony and cross-examination—the latter to be carried on by the Commissioners.

**FCC BUDGET**—With its workload for the 1958 fiscal year starting next July 1 anticipated to be heavier than in the past two fiscal periods, the FCC received in President Eisenhower's budget approval for total funds of \$8,950,000. This is an increase of \$1.1 million over the 1957 budget but not as much as the \$2 million increase asked by the Commission in its funds request to the Budget Bureau. Broadcasting and television activities of the FCC were estimated for 1958 to be \$1,760,742 compared with \$1,654,860 in the 1957 fiscal year. Safety and special radio services embracing mobile radio and microwave went up to \$1,038,528 in the 1958 appropriation estimate contrasted with the 1957 funds of \$873,001.

**ATOMIC-AGE NAVY**—Rear Admiral H. C. Bruton, Director of Naval Communications, has blueprinted the communications requirements for the atomic-age Navy. They comprise multichannel single sideband radio voice and teletype for the Fleet and large naval aircraft, forward scatter operation for all armed services across the North Atlantic and between the US and Alaska, and completion by 1960 of the world's most powerful and effective VLF radiocommunications station in Washington County, Maine, with 2,000 kilowatts. This Maine station is one of four Navy high-powered VLF stations.

**SOLVE INTERFERENCE PROBLEMS** — Cooperative Interference Committees, autonomous groups of radio users formed to resolve interference problems in radio services other than television and amateur operations were formed last year under proposals by the FCC Field Engineering and Monitoring Bureau. They have made notable progress in this field, the FCC recently reported. The organization of these citizens' committees has now grown to ten areas, covering all regions in the nation; and in Hawaii and Puerto Rico and the CIC activities are ironing out many hundreds of interference situations without governmental action and in speedy fashion. The IRE has rendered "effective support," the FCC stated.

*National Press Building  
Washington 4*

*ROLAND C. DAVIES  
Washington Editor*

# NEW DEVELOPMENTS



## IN SOCKETS



No. 22920

No. 22920—7 contact miniature molded vertically mounted socket with JAN type shield base. Mica insulation. Silver plated phosphor bronze contacts drop through .062" dia. clearance holes arranged on a .1" X and Y axis.

EXP-9553 — 8 contact button base subminiature molded, vertically mounted socket. Mica insulation. Silver plated beryllium copper contacts drop through .070" dia. clearance holes arranged on a .1" X and Y axis.

EXP-9553A—Same as above except insulation to withstand temperatures above 200° Centigrade.

No. 22024—7 contact flat press subminiature molded, vertically mounted socket for conventional wiring. Assembled with a special shield base to accept a subminiature shield with the "J" lock. Flat sided retaining nuts and screws are provided for mounting. Mica insulation. Silver plated beryllium copper contacts.

No. 22023—Same as above except insulation to withstand temperatures above 200° Centigrade.

No. 22022 — 8 contact button base subminiature molded vertically mounted socket for conventional wiring. Assembled with special shield base to accept a subminiature shield with the "J" lock. Mica insulation. Silver plated beryllium copper contacts.

No. 22021—Same as above except insulation to withstand temperatures above 200° Centigrade.

EXP-9542—7 contact miniature molded right angle mounted socket with JAN shield base. Mica insulation. Silver plated beryllium copper contacts drop through .062" dia. clearance holes arranged on a .1" X and Y axis.

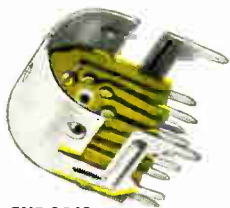

EXP-9542

EXP-9561 — 7 contact flat press subminiature molded right angle socket. Mica insulation. Silver plated beryllium copper contacts drop through .046" dia. clearance holes arranged on a .1" X and Y axis.

EXP-9561A—Same as above except insulation to withstand temperatures above 200° Centigrade.

EXP-9562—8 contact button base subminiature molded, right angle mounted socket. Mica insulation. Silver plated beryllium copper contacts drop through .046" dia. clearance holes arranged on .1" X and Y axis.

EXP-9562A — Same as above except insulation to withstand temperatures above 200° Centigrade.

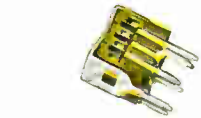

EXP-9561



EXP-9562



EXP-9553



No. 22024



No. 22022

## PRINTED CIRCUIT BY CINCH

These latest developments in printed circuit sockets offer the highest quality in material and workmanship to meet the most rigid government specifications. They insure positive contact and hold tubes securely in place. Maintenance and replacement easily made. They provide maximum insulation resistance and minimum high frequency loss. Adapted to printed circuit boards up to and including 1/8" thick.

Sockets shown enlarged.

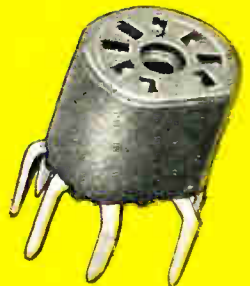

EXP-9553



No. 22024

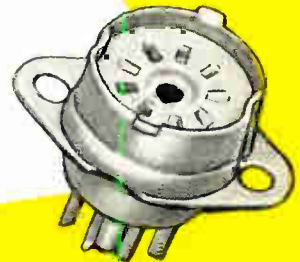

No. 22022



These sockets will take care of the three types of receiving tubes in use today: Miniature, Flat Press and Button.

The contacts are so spaced that they can be mounted in an incremental drill pattern as stated. This fact together with the exact precision and uniformity of Cinch sockets make them ideal for automatic assembly.



**Cinch**  
ELECTRONIC  
COMPONENTS

Centrally located plants at Chicago, Illinois; Shelbyville, Indiana; LaPuente California; St. Louis, Missouri.

VISIT CINCH  
BOOTH No. 2535,  
AT THE IRE SHOW

### CINCH MANUFACTURING CORPORATION

1026 South Homan Ave., Chicago 24, Illinois

For Your Connector Requirements —  
You Can Depend On Cinch

Subsidiary of United-Carr Fastener Corporation, Cambridge, Mass

*If forward voltage drop is a problem  
in your diode circuitry...see the*



**GOLD  
BONDED**

# RADIO RECEPTOR

## *Germanium Diode DR 385*

*Available now in  
production quantities  
for immediate delivery*

with controlled forward voltage drop  
between 0.34 and 0.37V at the  
10MA level

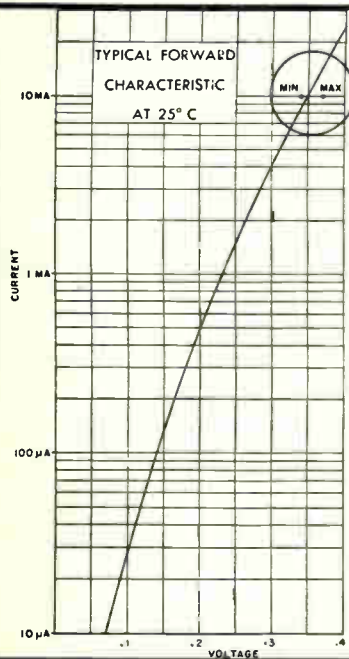

Design engineers working with transistorized circuits, computers and other applications will find that RRco. Type DR 385 has extremely low forward voltage drop as well as other desirable features... The specifications speak for themselves!

### Characteristics at 25° C

Forward voltage drop @ 10MA	
Minimum .....	0.34V
Maximum .....	0.37V
Maximum reverse current at -10V .....	10UA
Peak inverse voltage .....	60V

### Maximum Ratings at 25° C

Maximum inverse operating voltage .....	50V
Continuous DC forward current .....	100MA
Surge current for 1 second .....	500MA
Average power dissipation .....	80MW
Derating above 25° C .....	10MW/10° C

*DR 385 exhibits fast transient response and similar diodes  
can be offered fully tested to your recovery conditions.*

Further information on DR 385, or any other RRco. diode type will be sent you at once upon request to section T-3



*In Radio and  
Electronics Since 1922*

*Semiconductor Division*  
**RADIO RECEPTOR COMPANY, INC.**

240 Wythe Avenue, Brooklyn 11, N. Y. • Evergreen 8-6000

Radio Receptor Products for Industry and Government: Selenium Rectifiers • Germanium Diodes  
Thermatron Dielectric Heating Generators & Presses • Communications, Radar & Navigation Equipment

See us at the IRE Show, Booths 1307 & 1309

ELECTRONIC INDUSTRIES' exclusive monthly digest of the world's top electronic engineering articles



## ANTENNAS, PROPAGATION

**Spatial Harmonics in Electron Beams**, by Rudolf Mueller. "Arc. El. Uber." Dec. 1956. 6 pp.

In the coupled mode description of the traveling wave tube, the waves propagating in the conductor and in the beam are independently computed and subsequently their interaction is considered.

The present article is concerned with electron beams with periodic spatial structure, such as meander or cycloidal path, or with periodic variations of the dc conditions, such as velocity jumps.

A detailed account of the interaction between the space charge waves in an electron beam and the electromagnetic wave progressing in an intercepting meander structure is given. Two methods for this study are introduced: a) the beam path, i.e., a straight line is used as the basic coordinate system; b) the wave propagation path, i.e., the meander curve is used as the basic coordinate system. In both instances spatial harmonics result, either in the electromagnetic wave or in the space charge wave; the harmonics have the same frequency but different phase velocities.

Conditions of a space charge wave subjected to velocity jumps are considered. It is assumed that the space charge amplitude is not affected by the velocity jump but only the phase velocity of the space charge wave. The conductor equivalent would be a helix with a sudden variation in pitch.

The interaction of two electron beams progressing in opposite directions and separated by a screen is investigated; one beam is modulated. Conditions prevailing in a rippled beam tube are indicated, and space charge waves with periodically variable wave length are mentioned.

**Contribution to the Propagation of VHF Waves Over the Ocean**, by B. Abild. "Tech. Haus.," No. 5/6, 1956. 6 pp. This is a report of field-strength observations comparing a sea and a land path in North Germany. Three meter waves were used. Larger fluctuations on the sea path are reported and correlated with the different climatic conditions.

**The Radiating Properties of End-Fire Aerials**, by J. Brown and J. O. Spector. "Proc. B.I.E.E." Jan. 1957. 8 pp. An end-fire aerial, such as a yagi or a dielectric-rod aerial, can be regarded as a structure which supports the dipole type of surface wave. An analysis of such aerials is elaborated, and theoretical and experimental patterns for several end-fire aerials are compared.

**Distant Reception in the 3-Meter Radio Band**, by L. Klinker. "Hochfreq." Nov. 1956. 8 pp. Extensive measurements over several years of wave propagation at 3 meter waves over distances from 100 to 500 kilometers are reported to confirm the CCIR curves for Central Europe. Dependence on the time of the day, season, and weather and ionospheric conditions are investigated.

**Selection of Towers and Antennas for Microwave System Use. "Demodulator"** Dec. 1956. 5 pp. The article discusses some of the technical and economic factors that enter into the selection of towers and antennas.

**Cosmic Noise Background with High-Gain Antennas**, by N. G. Roman. "Report of NRL Progress." December 1956. 8 pp. The various types of cosmic radio noise sources are described and the positions of the strongest are quoted. The intensities of these sources are given in a form designed to permit the operator of a high-gain antenna to calculate easily the amount of disturbance he can expect from each source.

**Effect of Correlation between the Received Field Intensities in Diversity Systems**, by K. H. Schmelvosky. "Hochfreq." Nov. 1956. 3 pp. Assuming a Raileigh distribution for the incoming field at both antennas—i.e., a distribution obtained by a system of two-dimensional vectors in which the components obey the probability distribution,—the probability for the simultaneous fading at both antennas below a specified value is computed as a function of the correlation factor.

**R-F Absorbers for 50 Mc Up**, by R. F. Kolar. "El. Des." Jan. 15, 1957. 2 pp.

**Fading of Long-Distance Radio Signals and a Comparison of Space- and Polarization-Diversity Reception in the 6-18 Mc/s Range**, by G. L. Grisdale, J. G. Morris, and D. S. Palmer. "Proc. B.I.E.E." Jan. 1957. 13 pp.



## AUDIO

**Disturbances of an Acoustic Field Due to a Rigid Cylinder**, by O. Brosze. "El. Rund." Jan. 1957. 4 pp. The sound field in the neighborhood of an infinite rigid cylinder is computed, and several numerical samples involving the derived formula are given. An apparatus for the measurement of sound intensities is described, and it is used to compare the measured values with computed results; good agreement is reported.

**Apparatus for the Measurement of Reverberation Time**, by G. Odin. "Hochfreq." Nov. 1956. 6 pp. A beat-frequency generator feeds a loudspeaker which excites the hall to be measured. The voltage of a microphone positioned in the hall is filtered and continuously recorded on an instrument with logarithmic response. The time interval within which the sound level decreases between adjustable limits is automatically indicated.

**On the Subjective Appraisal of the Reproduction of Music by Loudspeaker Combinations**, by G. Kaufmann. "Tech. Haus." No. 5/6, 1956. 10 pp. The result of a series of tests with a large number of persons judging the reproduction quality of different loudspeakers. The reproduction most closely resembling the original radiation behavior was given preference on a statistical evaluation.

## REGULARLY REVIEWED

- AEG Prog. AEG Progress
- Aero. Eng. Rev. Aeronautical Engineering Review
- Ann. de Radio. Annales de Radioelectricite
- Arch. El. Uber. Archiv der elektrischen Ubertragung
- ASTM Bul. ASTM Bulletin
- Auto. Con. Automatic Control
- Auto. El. The Automatic Electric Technical Journal
- Avto. i Tel. Avtomatika i Telemekhanika
- AWA Tech. Rev. AWA Technical Review
- BBC Mono. BBC Engineering Monographs
- BC News. Broadcast News
- Bell Rec. Bell Laboratories Record
- Bell J. Bell System Technical Journal
- Bul. Fr. El. Bulletin de la Societe Francaise des Electriciens
- Cab. & Trans. Cables & Transmission
- Comp. Rend. Comptes Rendus Hebdomadaires des Seances
- Comp. Computers and Automation
- Con. Eng. Control Engineering
- Elek. Elektrichstvo
- El. Electronics
- El. & Comm. Electronics and Communications
- El. Des. Electronic Design
- El. Energy. Electrical Engineering
- El. Eng. Electronic Engineering
- El. Eq. Electronic Equipment
- EL. Ind. ELECTRONIC INDUSTRIES & Tele-Tech
- El. Mfg. Electrical Manufacturing
- El. Rund. Elektronische Rundschau
- Eric. Rev. Ericsson Review
- Fern. Z. Fernmeldetechnische Zeitschrift
- Freq. Frequenz
- GE Rev. General Electric Review
- Hochfreq. Hochfrequenz-technik und Elektroakustik
- IBM J. IBM Journal
- Insul. Insulation
- Iz. Akad. Izvestia Akademii Nauk SSSR
- J. B.I.R.E. Journal of the British Institution of Radio Engineers
- J. I.T.E. Journal of The Institution of Telecommunication Engineers
- J. IT&T. Electrical Communication
- J. U.I.T. Journal of the International Telecommunication Union
- Nach. Z. Nachrichtentechnische Zeitschrift
- NBS Bull. NBS Technical News Bulletin
- NBS J. Journal of Research of the NBS.
- Onde. L'Onle Electrique
- Phil. Tech. Phillip Technical Review
- Proc. AIRE. Proceedings of the Institution of Radio Engineers
- Proc. B.I.E.E. Proceedings of the Institution of Electrical Engineers
- Proc. IRE. Proceedings of the Institute of Radio Engineers
- Radiotek. Radiotekhnika
- Radio Rev. La Radio Revue
- RCA. RCA Review
- Rev. Sci. Review of Scientific Instruments
- Rev. Tech. Revue Technique
- Syl. Tech. The Sylvania Technologist
- Tech. Haus. Technische Hausmittellungen
- Tech. Rev. Western Union Technical Review
- Telonde. Telonde
- Toute R. Toute la Radio
- Vak. Tech. Vakuum-Technik
- Vide. Le Vide
- Vestnik. Vestnik Syazy
- Wirel. Eng. Wireless Engineer
- Wire. Wld. Wireless World

For more information, contact the respective publishers directly. Names and addresses of publishers may be obtained upon request by writing to "Electronic Sources" Editors, ELECTRONIC INDUSTRIES & Tele-Tech, Chestnut & 56th Sts., Philadelphia 39

# International ELECTRONIC SOURCES



## CIRCUITS

**High Fidelity at Moderate Price**, by Ph. Ramain. "Toute R." Jan. 1957. 4 pp. Detailed circuit diagrams, including component values, for a high-fidelity set are discussed. The response curves are considered on the basis of the theory developed by Fletcher and Munson.

**Making the Microphone a More Versatile Acoustic Tool**, by R. M. Carrell and A. H. Lind. "BC News." Dec. 1956. 6 pp.

**Electro-Acoustic Measurements of Model Rooms**, by W. Kraak. "Hochfreq." Nov. 1956. 8 pp. The theoretical basis and the practical implications of simulating actual halls on a reduced scale by electro-acoustic models are investigated. Propagation in the medium, effect of walls, resonator properties, absorbers, simulation of the audience, reflection on wall sections, and the effect of air absorption are studied.

**Bigradient Uniaxial Microphone**, by H. F. Olson, J. Preston, and J. C. Bleazey. "RCA." Dec. 1956. 12 pp. A second-order unidirectional microphone is described which consists of two uniaxial microphones connected in series opposition—the bigradient uniaxial microphone. The high discrimination of the microphone to sounds from the sides and rear make it useful for long distance sound pickup.

**Investigations of Pulses in Measurements of Room Acoustics**, by H. Niese. "Hochfreq." Nov. 1956. 11 pp. The requirements to be met by an acoustic pulse source adapted to produce reproducible and comparable results in the measurements of room acoustics are investigated. In particular the time function, the spectrum, and the directional characteristics of an advantageous sound source are considered with a view to judging the clarity of speech.

**A High Gain Transistor Preamplifier**. "Technical Communications." Nov. 1956. 3 pp. The circuit uses a single OC70 operating grounded emitter, on 250 volts with a voltage gain of 830.

**Is Magnetic Reproduction Worthwhile?** by A. S. Pratt and R. A. Mitchell. International Projectionist. Jan. 1957. 3 pp. A controversy regarding the relative merits of film sound reproduction methods, illustrating practical problems in the introduction of new techniques in an old art.

**The Development of a Miniature Battery-Operated Tape Recorder**, by W. R. Nicholas and A. D. Hildyard. "Proc. AIRE." Nov. 1956. 6 pp. The authors take us, step by step, through the experimental development of a mechanical drive, miniature tape recorder with battery-operated audio and bias circuits. Low-loss equalization at 8 kc was achieved by resonating the recording head to this frequency. By suitable control of the sharpness of the resonance curve, equalization control was achieved.

**High Fidelity Loudspeakers: The Performance of Moving Coil and Electrostatic Transducers**, by H. J. Leak. "J. BIRE." 14 pp. Objective tests of home-style loudspeakers are discussed.

**The Curves of Equal Sound Intensity for Continuous Sounds and for Separate Pressure Pulses**, by R. Feldtkeller. "Freq." Nov. 1956. 3 pp. The diagram plotting equal sound-intensity curves in a decibel-frequency coordinate system is applicable only to continuous sounds; pulses of a duration of less than 200 msec appear to have a lower sound intensity than would follow from this diagram due to the slowness of the ear. Probability-curve pulse sequences are studied to establish a suitable diagram for these short pulses.

**Circuits for Tape Recorders**. "Technical Communications." Nov. 1956. 18 pp. Circuit descriptions, performance figures, and test procedures are presented for two Mullard amplifiers.

**Designing a Pocketsize 5-Transistor Mixer-Amp**, by H. L. Aaronson & S. R. Blom. "El. Ind. Op. Sect." March 1957. 3 pp. Miniaturization is achieved in this dual-channel unit by using printed circuits, transistors, and tiny mercury batteries which give service for over 100 hours.

**Steep Cutoff Quartz Filters with Wide Bandwidth in Filters**, by W. Poschenrieder. "Nach. Z." Dec. 1956. 5 pp. An introductory discussion leads to the development of a filter having a quartz crystal in the parallel branch of a network. The effect of the crystal on reactive and resistive impedance components is studied in detail and equivalent circuits are introduced.

**The Characteristics of Parallel-TC Networks**, by D. H. Smith. "El. Eng." Feb. 1957. 7 pp. Typical curves of magnitude and phase of the transmission ratio are given for both balanced and unbalanced networks. An analytical treatment of the balanced network leads to an understanding of the factors affecting the selectivity.

**Investigations of Helices**, by K. Huebener. "Nach. Z." Dec. 1956. 4 pp. An experimental set-up to measure the effects of inhomogeneities, such as bends and variations in pitch, is described. The equivalent four-terminal networks are determined and the reflection coefficients are calculated.

**Electronic Blanking Eases Static**, by M. G. Bauer. Military Electronics, Jan. 1957. 3 pp. The blanking system is built around a coincidence gate which is designed to insert attenuation to the signal, and cancel out any transients introduced by the blanker itself.

**Frequency-Modulation Distortion in Linear Networks, With Special Application to Minimum-Phase Type Networks**, by R. F. Brown. "Proc. BIEE." Jan. 1957. 11 pp.

**Approach to Printed Circuitry—Part 2**, by D. Fox. "Screen Process Magazine." Dec. 1956. 3 pp. A discussion of methods of producing printed circuits, primarily concerned with techniques for producing small quantities of printed circuit boards.

**Regulating Medium and Low Voltages**, by D. M. Sanger and H. V. Houghton. "Auto. Con." Jan. 1957. 4 pp. Authors discuss gaseous voltage regulators, voltage reference tubes, series-tube regulators, shunt tube regulators, Zener diodes.

**Preferred Circuits—I**. "El. Mfg." Feb. 1957. 9 pp. Two dc power supply regulators and a blocking oscillator frequency divider developed by the National Bureau of Standards and recommended as "preferred circuits" by the Bureau of Aeronautics are discussed.

**Distributed-Parameter Variable Delay Lines Using Skewed Turns for Delay Equalization**, by F. D. Lewis and R. M. Frazier. "Proc. IRE." Feb. 1957. 9 pp. An analysis is given of this method of equalization, and the performance of experimental variable delay lines is discussed.

**Coronal Type Voltage Regulators**, by D. Ward. "Auto. Con." Jan. 1957. 1 p.

**Dip Soldering Printed Circuits**, by E. S. Miller and A. A. Johns, Jr. "El. Mfg." Feb. 1957. 6 pp. The system described consists of a group of axial-lead components mounted and dip soldered between parallel photo-etched boards. Such modular subassemblies are then mounted on a photo-etched distribution deck.

**The Serrodyne Frequency Translator**, by R. C. Cumming. "Proc. IRE." Feb. 1957. The serrodyne frequency translator uses linear sawtooth modulation of a transit-time device in order to shift the frequency of a signal being amplified by the device. Very little power is produced in undesired intermodulation frequency components.

**Plug-Ins Simplify System Design**, by R. A. Bailey. "Auto. Con." Jan. 1957. 4 pp. Using plug-in circuits, or modules, the systems engineer can design without recourse to circuit schematics. This technique of designing and building systems and equipment directly from functional diagrams is presented as a natural development in system design.

**Transistorized 25 Volt Regulated Power Supply**, by J. Giuffrida and W. O. Hamlin. "El. Des." Jan. 15, 1957. 2 pp. The power supply described in this article uses power transistors for regulation. Two junction transistors are cascaded to provide 1 per cent regulation from no load to 100 ma at 12.6 volts output. Unit can be used as a power supply for tests of 12 volt automobile radio tubes.

**Regulating DC Power**, by F. Benjamin. "Auto. Con." Jan. 1957. 3 pp.

**Printed Circuits by Electrostatic Methods**, by B. Darrel and S. Szpak. "El. Mfg." Feb. 1957. 3 pp.

**Direct-Coupled-Resonator Filters**, by S. B. Cohn. "Proc. IRE." Feb. 1957. A new analysis is presented of direct-coupled-resonator filters that results in excellent response at much greater bandwidths than has previously been possible.

**On Generalized Filter Theory**, by E. Henze. "Arc. El. Uber." Dec. 1956. 10 pp. Mathematical considerations are applied to filters. Linear ideal filters are considered as projections of the signal functions in the function space. An analytical filter theory is derived and some simple samples and applications are presented.

**Application of the Effective-Mass Theory to Several Specific Oscillatory Types**, by Th. O'Callaghan. "Freq." Nov. 1956. 8 pp. The effective mass is the equivalent mass of a resonant system and, hence, a function of frequency. Systems involving a sequence of masses and springs (coils and capacitors) with two alternating sections, similar systems with added springs connecting each mass to a stationary point, and simple closed-ring systems (for instance a benzene molecule) are calculated.

**Survey on the Computations of Filters with Losses**, by C. Kurth. "Freq." Dec. 1956. 6 pp. The "operational parameter theory" based on a power equivalence equation is set forth in this first installment. The power terms are expressed in filter data which are readily available.

**Analytical Approaches to Local Oscillator Stabilization**, by W. Y. Pan and D. J. Carlson. "RCA." Dec. 1956. 19 pp. The behavior of local oscillator tubes and circuit elements under complex conditions of heat flow is treated analytically. Theory and application are discussed and illustrated.

**The Mechanical Circuit**, by K. Schoenbacher. "Freq." Dec. 1956. 7 pp. This final installment of the article deals with the conversion of mechanical into electrical systems and with electrical systems based on the loop equations. No mathematics is used.

**Novel Method for the Realization of Response Curves for Two-Terminal Networks by Either Canonical Circuits or Circuits Without Coupled Impedance**, by R. Unbehauen. "Nach. Z." Dec. 1956. 6 pp. Brune's method for the design of canonical circuits is generalized, resulting in a reduction in the degrees of the two-terminal network function. Another method involving no transformers is also set forth.

**A Practical Method for the Formulation of the Hurwitz Polynomial in Filter Synthesis**, by F. Bauhuber. "Nach. Z." Dec. 1956. 6 pp. The various available methods are compiled and compared as to their usefulness in the case of several filter types, assuming the use of business machines or electronic computers. New methods of separating a given polynomial into a product of a Hurwitz polynomial and an anti-Hurwitz polynomial are introduced.

**An Approximate Representation of Attenuation Curves by Straight Lines**, by M. Gosewinkel. "Freq." Nov. 1956. 9 pp. A comparatively simple method for the representation of attenuation curves, involving straight lines, is set forth. It is particularly recommended for the evaluation of electromechanical equivalents in acoustics because of its ready applicability.

**The Mechanical Circuit**, by K. Schoenbacher. "Freq." Nov. 1956. 9 pp. The equivalence of electrical and mechanical oscillatory systems is considered. Simple rules for the equivalent circuitry of mechanical systems are presented.



## COMMUNICATIONS

**Carrier Current is the Answer**, by P. Whitney. "El. Ind. Op. Sect." March 1957. 2 pp. Where normal radio reception is precluded because of high noise levels, this easily constructed equipment can deliver up to 100 mv to receivers in the building, giving good reception.

**Broadband Microwave Receiver Design**, by B. Rosen and R. Saul. "El. Ind." March 1957. 3 pp. The authors discuss the design of a broadband receiver. The problem resolves into one of designing four distinct receivers in one, and designing a broadband tuning head.

**The Case for AM, FM, and Single-Sideband**, by R. W. Thorpe. "El. Ind. Op. Sect." March 1957. 3 pp. The author discusses the problems of reception in the presence of all kinds of noise and interference, and outlines the advantages and disadvantages of the different methods of radio communication now available to the communications system designer.

**Composition of Remote Control Signals by Means of the Combinational Use of Pulse Modes**, by M. A. Gavrilov. "Avto. i Tel." Dec. 1956. 22 pp. The article examines certain problems of the theory of composing signals by means of the combinational use of pulse modes. Concepts concerning a pulse and a pulse mode are refined. Expressions are derived for the relationship between the number of signals and the number of pulses and pulse modes required for their formation. Methods are examined for composing systems in which signals do not overlap.

**Portable Transmitter-Receiver at 145 MC**, by F. Ledoux. "Toute R." Jan. 1957. 4 pp. A detailed circuit diagram including component values for the transmitter-receiver is presented, and design considerations as well as performance are discussed.

**Radio Relay Maintenance**, by G. B. Woodman. "Wire and Radio Communications." January 1957. 4 pp. A discussion of maintenance problems found by Western Union in its radio relay system.

**Experimental Receiver with Thermoelectric Power Supply**, by J. Marsac. "Toute R." Jan. 1957. 5 pp. A thermoelectric power supply is described which supplies all power necessary for a 4-tube, low-consumption, conventional receiver. The set-up has been developed for a hot and humid climate. A unit of 120 thermocouples, heated by a butane flame, and cooled by the ambient temperature, constitutes the thermoelectric generator. Structural details of this unit are given.

**Transatlantic Telephone Cable System—Planning and Over-All Performance**, by E. T. Mottram, R. J. Halsey, J. W. Embling, and R. G. Griffith. "Bell J." Jan. 1957. 22 pp. The January issue of the Bell System Technical Journal is devoted to all phases of the new transatlantic telephone cable. Other papers in the same journal include: **System Design for the North Atlantic Link**; **Repeater Design for the North Atlantic Link**; **Repeater Production for the North Atlantic Link**; **Power Feed Equipment for the North Atlantic Link**; **Electron Tubes for the Transatlantic Cable System**; **Cable Design and Manufacture for the Transatlantic Submarine Cable System**; **System Design for the Newfoundland-Nova Scotia Link**; **Repeater Design for the Newfoundland-Nova Scotia Link**; **Power-Feed System for the Newfoundland-Nova Scotia Link**; and **Route Selection and Cable Laying for the Transatlantic Cable System**.

**On a Measure for the Excess in Letters in Natural Speech**, by G. Michel. "Freq." Dec. 1956. 2 pp. A simplification of a word, i.e., the exclusion of letters not required to distinguish the specific word from other words, is introduced. The advantages of such simplification for communication engineering, such as telegraphs and teleprinters, are pointed out. A measure for such simplification is defined.

**Telemetry Method for Low-Frequency Phenomena**, by W. Nicolai. "El. Rund." Jan. 1957. 5 pp. A 5 kc single-channel portable telemetry device for electrocardiograms and electroencephalographs having two alternative carrier frequencies of 400 and 5000 cps is presented. No visible distortion was observed over a 40 kilometer transmission path. A two-channel system, incorporating two sufficiently spaced carriers, is also described. Performance and operational details are given.

**A Stable F. M. Receiver with Preset Tuning**, by G. S. Robinson. "El. Eng." Feb. 1957. 3 pp. The receiver uses a crystal-controlled local oscillator. Circuitry, construction, and performance are described.

**Entropy in Science and Technology, Part IV—Entropy and Information**, by J. D. Fast and F. L. H. M. Stumpers. "Phil. Tech." Dec. 15, 1956. 12 pp. Important to theories of the transmission and the use of information, the concept of 'entropy' has come into use by communication engineers, linguists, psychologists and neurologists. The authors clarify and define entropy in this context.

**Reception of Pulse Messages of Arbitrary Form by Means of a Super-Regenerative Receiver**, by L. R. Ivach. "Radiotek." Nov. 1956. 9 pp. The author examines the reception of pulse messages of arbitrary form by a super-regenerative receiver with a separate heterodyne. It is shown that the criterion for comparing the effectiveness of pulses of varying shape and duration can be considered to be the area of the pulses.



## COMPONENTS

**A Report on Silicon Solar Cells**, by Dr. M. B. Prince. "El. Ind." March 1957. 2 pp. Dr. Prince reviews the present status of silicon photodiodes and describes the probable future development of the "Solar Cell."

**Shortcuts to R-F Shield Design**, by C. S. Vasaka. "El. Ind." March 1957. 5 pp. The author presents a method for calculating shields for electronic equipment.

**Seven Different Methods of Printed Wiring**, by A. E. Stones. "El. Ind." March 1957. 3 pp. This is a survey and evaluation of the common methods used to produce printed circuit boards.

**Resistor Reactance in Pulse Circuits**, by H. Friedl. "El. Ind." March 1957. 2 pp. Resistors may be predominantly capacitive or inductive, having sharp effects on pulse symmetry in high speed pulse circuits. The author tells the circuit designer how to find precisely what the characteristics of his resistor are.

**Electronic Time-Delay Relay with Ionization Chamber as Time-Determining Element**, by H. Jucker. "El. Rund." Jan. 1957. 2 pp. The resistance in a capacitor-resistor series combination is replaced with an ionization chamber. The grid of a control tube, the plate current of which actuates the relay, is connected between the capacitor and the ionization chamber, which combination thus establishes the grid bias. A photograph of the apparatus, circuit schematic, and performance curves are included.

**On the Engineering Aspects of Piezoelectric Crystals: I. Determination of Piezoelectricity and its Applications**, by H. O. Koch. "Freq." Dec. 1956. 10 pp. This first instalment of a survey article is concerned with general fundamentals as well as with the experiences of the author in the preparation of quartz crystals and the culture of Seignette salt crystals. Apparatus for the measurement of static, low-frequency and high-frequency data in connection with piezo- and ferro-electricity is described.

**The Unreliable Universal Component**, by M. A. Acheson. "El. Eq." Jan. 1957. 4 pp. The author makes a plea for more specialized specifications for electronic components to minimize costly selection procedures and variations in characteristics.

**Permanent Magnets (Part I)**, by Alun Edwards. "El. Energy." Jan. 1957. 6 pp. The substitution of permanent magnets for electromagnets is becoming more common; motors to five or ten horsepower have been so constructed. Size reductions and improvements in magnetic characteristics are resulting in important design changes in meters and other devices.

**Production Design of Compensated Attenuators**, by R. L. Kuehn. "El. Des." Jan. 15, 1957. 3 pp. Boundary conditions are derived for production of compensated attenuators requiring a minimum of individual adjustment.

**Performance Characteristics of Tantalum Capacitors**, by J. W. Maxwell. "El. Des." Jan. 15, 1957. 4 pp. Performance data on performance and reliability are presented.

**The Characteristics of Thermistors and Their Application in Science and Industry in Australia**, by J. W. Howes. "Proc. AIRE." Nov. 1956. 4 pp.

**Dial Testing Equipment**, by F. West. "Bell Rec." Jan. 1957. 4 pp. Laboratory equipment for testing dial pulse code generators is described.

**Dust on Relay Contacts**, by H. J. Keefer. "Bell Rec." Jan. 1957. 4 pp. The investigations and techniques resulting in relays nearly free from open contact failures are described.

**The Erosion of Electrical Contacts by the Normal Arc**, by W. B. Ittner and H. B. Ulish. "Proc. BIEE." Jan. 1957. 6 pp.

**Exploiting the Mercury Jet Switch**, by W. R. Davis. "Con. Eng." Feb. 1957. 4 pp. Design, applications, and present weaknesses of mercury jet switches are discussed.

**Glass Resistor for Use in Vacuum Systems**, by L. G. Sloan. "Rev. Sci." Dec. 1956. 3 pp. A conductive glass resistor for use in sealed high vacuum systems is described. Size is 0.195 in. long and 1/8 in. diameter, and resistances from 0.25 to 15 megohms are possible. Dissipation in vacuo is 25 milliwatts. Units can be thoroughly outgassed so as to introduce no appreciable gas during operation.

# International ELECTRONIC SOURCES

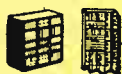

## COMPUTERS

**The Theory of Nonlinear Decision Elements Which Make Use of a Sectionally-Linear Approximation**, by B. Ia. Kogan. "Avto. i Tel." Dec. 1956. 11 pp. The basic relationships are derived for a decision amplifier with nonlinear admittances which are approximated stepwise. On the basis of the resulting relationship between the slope of the original nonlinear function and the slopes of the current characteristics of the diode circuits which are connected at the input of the amplifier and parallel to it, several methods of synthesizing function generators from diode elements are examined. These methods insure the lowering of the error in the function generator and permit the class of reproducible function to be broadened. A method is given for determining the current characteristics of diode circuits on the basis of the slope characteristics.

**Reliability of Redundant Systems**, by W. C. Sedlacek. "Con. Eng." Feb. 1957. 1 p. The author discusses a means of evaluating the reliability of series and parallel arrays.

**An Accumulator Unit for a Dekatron Calculator**, by R. Townsend and K. Camm. "El. Eng." Feb. 1957. 7 pp. The article describes a Dekatron unit in which decimal numbers may be added or subtracted, the sum being returned to the main storage unit multiplied or divided by ten or unity.

**Solution of Algebraic Equations on an Analog Computer**, by C. R. Cahn. "Rev. Sci." Oct. 1956. 3 pp.

**System Simulation with Analogue Computers**, by J. Embree. "Auto. Con." Jan. 1957. 3 pp. A general review of the subject, with suggestions concerning further development of analog computer techniques and applications for simulation.

**VHF Pulse Techniques and Logical Circuitry**, by D. E. Rosenheim and A. G. Anderson. "Proc. IRE." Feb. 1957. 8 pp. Newly developed techniques and components are combined in the design of an arithmetic unit to perform binary addition, multiplication, and storage at a pulse repetition rate of 50 mc.

**An Improved Linearity Control for Line Time-base Circuits**. "Technical Communications." Nov. 1956. 5 pp. The article describes a type of linearity control which is free from the main drawbacks of the present method of correction.

**The Measurement and Specification of Non-linear Amplitude Response Characteristics in Television**, by S. Doba, Jr. "Proc. IRE." Feb. 1957. 5 pp.

**Simulators—Some Applications in Industry**, by P. L. Hodges. "G.E.C. Journal." Oct. 1956. 8 pp. Examples are given of the application of analog computers to guided missile development and the basic principles involved in the conversion of mathematical equations into electrical equivalents are described.

**Sampled-Data Systems**, by D. J. Gimpel. "Con. Eng." Feb. 1957. 8 pp. A survey of the subject including definitions and illustrations of words, devices, and system properties.

**Dekatron Drive Circuit and Application**, by M. Graham, W. A. Higinbotham, and S. Rankowitz. "Rev. Sci." Dec. 1956. 3 pp. A reliable, one-tube drive circuit for decade glow transfer counter tubes is described. Application of the circuit is illustrated in a ten-channel glow tube register with automatic electric typewriter readout.

**The Junction Transistor as a Computing Element (Part 2)**, by E. Wolfendale, L. P. Morgan, and W. L. Stephenson. "El. Eng." Feb. 1957. 5 pp. The asymmetrical bistable circuit, blocking oscillators, and logical gates are discussed.

**Zero-Error Electronic Differentiation**, by H. Wittke. "El. Rund." Jan. 1957. 1 p. The conventional RC differentiation circuit is followed by a direct-coupled two-stage amplifier supplying a feedback which exactly compensates for the distortion introduced in the original circuit. The necessary relations between the tube and component values are derived and one numerical example for a specific embodiment of the circuit is included.

**How the Four-Tape Sorter Simplifies Storage**, by R. G. Canning. "Con. Eng." Feb. 1957. 3 pp. A merging-sort method is described which minimizes access time in magnetic-tape storage systems.

**Industrial Data-Reduction and Analogue-Digital Conversion Equipment**, by P. Partis. "J. BIRE." 28 pp. A survey of the field.

**Relaxation Oscillator Using a Gated Beam Tube**, by C. E. Tschiegg. "Rev. Sci." Dec. 1956. 1 p. The 6BN6 is used in a fast, low cost pulse generator. Circuit is simplified blocking oscillator or multivibrator requiring no transformer or additional tube for regenerative feedback. Pulse widths from about 0.5 to 400 microseconds can be obtained at repetition frequencies exceeding 1 Mc.

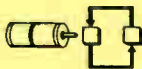

## CONTROLS

**Investigation of the Bore Hole as an Automatic Control Object When the Turbine Drilling Method is Used**, by Ia. B. Kadyrov. "Avto. i Tel." Dec. 1956. 12 pp. The author presents the results of theoretical and experimental investigations of the bore hole as a control object in turbine drilling. A comparative analysis is made of the regions of stability of a control system with a BAR-1 feed mechanism when the object is respectively examined as a member with distributed parameters, as an inertial member with lag, and as an inertial member. It is shown that when losses which depend upon the speed are neglected, the bore hole can be described as a control object with distributed parameters. Describing the control object as an inertial member with lag or as an inertial member can lead to incorrect results, especially at large depths.

**Signal Pickoffs for Control Systems—I**, by D. A. Davies. "El. Mfg." Feb. 1957. 8 pp. This article discusses various electrical pickoffs suitable for furnishing input and feedback signals for control. Covered in this article are resistance, electrolytic, capacitive, and piezoelectric devices.

**Ship Stabilization: Automatic Controls, Computed and in Practice**, by J. Bell. "Proc. BIEE." Jan. 1957. 7 pp. Predictions of the performance of a stabilizer by step-by-step and analog methods are a feature of this article: the functioning of the analog computer and examples of results are discussed.

**An Operational Magnetic Amplifier (Part I)**, by W. L. Marks. "El. Energy." Jan. 1957. 5 pp. Design steps for magnetic control amplifiers are discussed.

**Investigation of Steady-State Processes in Pulse Servo-Systems**, by Ia. Z. Tsvypkin. "Avto. i Tel." Dec. 1956. 13 pp. The article derives the expression for the steady-state error of pulse servo-systems. Various methods are presented for computing the error coefficients. The steady-state response of the simplest pulse servo-system is investigated.

**Applying Thyratrons to Control, Part II—Servo Applications and Stabilization**, by J. H. Burnett. "Con. Eng." Feb. 1957. 5 pp.

**Thyratron Circuit for Reliable Temperature Control**, by N. A. Frigerio. "Rev. Sci." Dec. 1956. 3 pp. Low cost xenon thyratrons are used in a reliable thyristor relay using very low control power. Practical designs are presented, with schematics.

**The New Radio-Controlled Ship**, by P. Bignon. "Toute R." Jan. 1957. 5 pp. The ship described won the 1st prize at the International Contest of Reduced-Model, Radio-Controlled Ships. The ship and the controlling transmitter-receiver combination are described.

**Grid Control of Thyratrons with Particular Reference to Servo-Mechanism Applications**, by K. R. McLachlan. "J. BIRE." 5 pp. The new approach described here enables a linear control of firing point to be achieved over the whole range from 0-180 degrees. A practical circuit is given, with experimental results.



## INDUSTRIAL ELECTRONICS

**An Electromagnetic Flow-Meter**, by D. I. Ageikin and A. A. Desova. "Avto. i Tel." Dec. 1956. A description is given of two variants of electromagnetic flow-meters. The paper examines methods for eliminating the transformer e.m.f.; a circuit for a secondary compensating device which eliminates the effect of line voltage fluctuations is also examined. Experimental results are cited.

**Cable Locator**, by G. Berg. "Tech. Haus." No. 5/6, 1956. 3 pp. An apparatus intended to identify a special cable in a large number of adjacent cables. The magnetic field surrounding a cable through which current is sent is detected by a sensitive ferrite search coil, amplified and applied to an earphone set.

**Adjustable Speed Drives: Key to Dynamic Materials Handling**, by J. E. Oram. "Con. Eng." Feb. 1957. 7 pp. Estimates run as high as 50% of total cost for handling of manufactured products. Adjustable speed drives are suggested as a key to successful coordination of the materials handling system with the manufacturing process.

**Hot Wire Liquid-Level Indicator**, by A. Maimoni. "Rev. Sci." Dec. 1956. 4 pp.

**Controlled Fusion Research—An Application of the Physics of High Temperature Plasmas**, by R. F. Post. "Proc. IRE." Feb. 1957. 27 pp. This reprint of an article originally published in the "Reviews of Modern Physics" presents a general summary of present knowledge of controlled fusion in high temperature plasmas.



## MATERIALS

**Solar Power, What are the Facts?** by A. E. Look. "El. Ind." March 1957. 2 pp. The author reviews our present understanding of the sun, and outlines the forms and amounts of solar energy available at the surface of the earth. Average daily insolation per square foot in the United States is between 300 and 500 watt-hours.

**Heat Control in Electronic Equipment (Part 2)**, by E. N. Shaw. "El. Eng." Feb. 1957. 8 pp. Distribution and flow of heat in rack-mounted, enclosed electronic units is explored.

**Estimating Leakage Factors for Permanent Magnets from Geometry of Magnetic Circuit**, by R. K. Tenzer. "El. Mfg." Feb. 1957. 4 pp.



**Soldering Fluxes and Flux Principles**, by A. Z. Mample. "Tech. Rev." Jan. 1957. 8 pp. An important study has been made of rosin flux for soldering; lifting the whole process from an art to a science. Essentially, it has been discovered that acid locked in the rosin molecule can be released for satisfactory soldering between 260 and 550 degrees F, and that complaints of inadequate flux action by rosin fluxes result from improper soldering temperatures.

**Heat Conduction Through Insulating Supports in Very Low Temperature Equipment**, by R. P. Mikesell and R. B. Scott. "NBS J." Dec. 1956. 8 pp. Insulating supports for storage vessels for cryogenic liquids were investigated. The principle of multiple thermal contacts is offered as providing simple rugged supports in small space. The best assembly tested consisted of a stack of stainless-steel plates, 0.0008 inches thick, giving thermal conduction under a load of 1,000 psi only 2% that of a solid conductor of the same dimensions. A small amount of dust between the plates greatly enhanced the insulating value of such a stacked support.

**Figuring Air Gaps for Maximum Pull of Opposing Electromagnets**, by K. W. Henderson. "El. Mfg." Feb. 1957. 3 pp.

**Field Homogeneity and Pole Distribution**, by J. D. Bjorken and F. Bitter. "Rev. Sci." Dec. 1956. Describes the design of a magnet for producing a uniform field. Calculations are based on cylindrical cores surrounded by rims.



## MEASURING & TESTING

**Accelerometers—Which Type For The Job?** by A. Orlacchio and G. Hieber. "El. Ind." March 1957. 3 pp. Differences among the various types of accelerometers fall into four basic categories: acceleration range, frequency response, accuracy, and temperature environment. Here is a survey of the major types.

**Regenerative Metering Detectors**, by L. L. Dekabrun. "Avto. i Tel." Dec. 1956. 9 pp. The article conducts a qualitative analysis of high-frequency regenerative detectors which can be used for measuring electrical conductivity and displacement. Specific circuits are given, and recommendations are made regarding the selection of the basic parameters.

**A New Method for Measuring the Parameters of Magnetized Ferrites at Microwave Frequencies**, by V. N. Vasil'ev. "Radiotek." Nov. 1956. The article describes a new method for measuring the complex permittivity and the complex components of the magnetic permeability tensor of magnetized ferrites. The method permits measurements to be made in wavelength range of from 0.8 to 20cm. The paper examines the theory of the method and cites the results of measurements made upon certain ferrites at wavelengths of the order of 3cm.

**Response of Peak Voltmeters to Random Noise**, by A. P. G. Peterson. "Experimenter." Dec. 1956. 6 pp. Calculated and experimental data are presented which make it possible to relate meter indications to the true rms amplitude of random noise. The use of a peak-reading voltmeter without a series resistor yields information about instantaneous peak voltages that cannot be obtained with other types of meters.

**Microwave Power Measurements Employing Electron Beam Techniques**, by H. A. Thomas. "Proc. IRE." Feb. 1957. 7 pp. The technique consists of accelerating an electron beam transversely through an evacuated section of waveguide carrying power in the TE<sub>10</sub> mode. Suitability as a primary standard is being investigated.

**A Report on Vibration Tests**, by G. Weinmann and A. Holz. "Nach. Z." Dec. 1956. 5 pp. The experiences gained in low-frequency and carrier frequency fault testing of communications equipment are set forth. Test methods, apparatus, and results are included. Simple and rapid testing are considered the main advantages of these methods.

**Microinhomogeneities in Magnetic Fields**, by H. H. Brown, Jr., and F. Bitter. "Rev. Sci." Dec. 1956. 4 pp. Inhomogeneity of a magnetic field can be measured by observing the voltage output of a coil moved through the magnetic field.

**A Mobile Test and Measuring Unit for Audience Research**, by H. Rhea. "BC News." Dec. 1956. 4 pp. Equipment and use of a mobile test vehicle are described.

**A Multiple-Channel Oscilloscope for Electrophysiology**, by P. E. K. Donaldson. "El. Eng." Feb. 1957. 6 pp. The techniques of electrophysiology are becoming more exact, and require simultaneous recording of a number of signals. The author examines available techniques and evaluates them in terms of cost per channel, complexity, and performance. An instrument providing a good compromise is described.

**An Oscillograph for the Simultaneous Recording of Mechanical and Electrical Phenomena in Electro-Mechanical Parts**, by F. Schmidt. "Nach. Z." Dec. 1956. 5 pp. Apparatus to record the mechanical as well as the electrical behavior of parts, and in particular of parts used in telephone dialing equipment, i.e., selectors and relays, is described. Coordination of various phenomena is thus readily established. Details of the apparatus and its performance are given.

**Project Rockoon**, by H. Friedman and J. E. Kupperian, Jr. Military Electronics. Jan. 1957. 4 pp. To investigate solar radiation effects on the D-region, data-searching rockets are sent up to 80,000 feet by balloon, then launched on command from a control ship. Command and telemetering systems are outlined.

**Magnetostrictive Electricity in Stain Gauges**, by I. Vigness. "Rev. Sci." Dec. 1956. Ferro-magnetic wires, conditioned by alignment of the circumferential component of the magnetic field in a preferred direction, generate electrical potentials when subjected to changes in elastic strain.

**The Measurement of the Coupled Impedance in Cable Shields at High Frequencies**, by H. Jungfer. "Nach. Z." Dec. 1956. 8 pp. A special arrangement of the cable to be measured is selected and details are described. Results for the frequency range between 10 MC and 1000 MC are reported; the error is about  $\pm 5\%$ . At high frequencies, the coupled impedance is found to increase approximately linearly with the frequency.

**Ballistocardiographic Instrumentation**, by H. W. Lewis, D. H. Smith, and M. R. Lewis. "Rev. Sci." Oct. 1956. 3 pp. After a definition and description of the mechanics and hydraulics of ballistocardiography, the authors describe an analog method involving an L-C-R circuit to form an electric analog of the body coupled to a fixed table.

**Step Function Pulse Technique for Ultrasonic Measurement**. "El. Eng." Feb. 1957. 1 p. A major limitation of the conventional ultrasonic inspection and thickness measuring systems employing a damped train of waves is that the pulse duration is long compared with the time in which it is required to receive echoes back from close ranges. In the step function pulse technique briefly described in this article, a square wave is used, the duration of which is sufficiently long for echoes generated by the leading edge to arrive back before the trailing edge of the wave affects the receiver.

**Waveguide Method for Measuring the Dielectric Properties of Materials at High Temperatures**, by V. I. Akserov and M. Ia. Borodin. "Radiotek." Nov. 1956. 9 pp. The authors examine the application of the short- and open-circuit methods in a waveguide for the purpose of determining the dielectric properties of materials at a wavelength of 3.2 cm in the temperature range of from 20 to 200 deg C.

**Use of Resistance Strain Gauges to Determine Friction Coefficients; A Compensation Curve for Use with the Strain Gauge Apparatus Type 1516: Shunt Balancing of Bridge Circuits**, by W. E. Green. "Technical Review." Dec. 1956.

**A Valve-Voltmeter for Synchro Testing**, by D. L. Davies. "El. Eng." Feb. 1957. 6 pp. A test instrument is described for accurate detection of synchro null positions and determination of the residual signal at these points.



## RADAR, NAVIGATION

**Radar Terrain Return at Near-Vertical Incidence**, by R. K. Moore and C. S. Williams, Jr. "Proc. IRE." Feb. 1957. 11 pp.

**Back-Scattering Characteristics of the Sea in the Region from 10 to 50 KMC**, by J. C. Wiltse, S. P. Schlesinger, and C. M. Johnson. "Proc. IRE." Feb. 1957. 9 pp. Results of tests at sea are compared with characteristics predicted from simple scattering mechanisms.



## SEMICONDUCTORS

**Transistor Tests Predict High Frequency Performance**, by R. L. Pritchard. "El. Ind." March 1957. 3 pp. Simple measurements can be used to derive the three important high frequency parameters of junction transistors. Performance at higher frequencies can be estimated from test results between 50 kc and 5 mc.

**The Study of the Transient Response of a Triggering Circuit Based Upon a Point-Contact Transistor, and the Formation of Pulses from a Sinusoidal Voltage**, by V. A. Kuz'min. "Radiotek." Nov. 1956. 7 pp. The article investigates transient processes in a triggering circuit based upon a point-contact transistor. A method is given for computing the duration of the leading edge of the output pulses when a voltage of arbitrary waveshape is applied to the input. A computation is made of the portion of the trailing edge of the output pulse, which corresponds to the transition through the active region when a negative voltage drop is applied at the input. The circuit is studied as a means for shaping pulses from a sinusoidal voltage.

**A High-Frequency Transistor RC Oscillator**, by L. N. Kaptsov. "Radiotek." Nov. 1956. 6 pp. This article analyzes the operation of a sine-wave RC oscillator based upon a point-contact transistor; the analysis is made for the range of frequencies which are comparable to the critical frequency for current gain. It is experimentally established that it is possible to achieve frequency modulation of the generated waves, and the oscillator is tested for continuous and intermittent operation.

**The Depth of Diffused Layers**, by W. L. Bond. "Bell. Rec." Jan. 1957. 5 pp. Relating to the recent technological advances in diffusion of conductivity layers into semiconductor crystals, the technique described here uses interference fringe patterns to measure the depth of some of the thinnest of diffused layers within about one millionth of an inch.

# International ELECTRONIC SOURCES

**Voltage Gain of Point-Contact Transistors Which are Used in Resonant Amplifiers**, by E. F. Vorob'eva. "Radiotek" Nov. 1956. 12 pp. The article describes a simple method for computing the voltage amplification of a resonant amplifier which uses point-contact transistors. An analysis is made of the effect of the frequency dependence of the transistor parameters and of the internal feedback upon the resonant voltage gain of a point-contact transistor in a circuit with a common base. On the basis of this analysis, graphs are plotted which express the dependence of the gain upon frequency in the range extending from low frequencies up to 1.5 mc for varying degrees of output mismatch. Experimental results are cited to verify the relationships presented.

**Power Supplies for the P1 Rural Carrier System**, by D. H. Smith. "Bell Rec." Jan. 1957. 3 pp. Semiconductor diodes and transistors are used in rectifier, voltage regulation, and control circuits in this power supply. Small storage cells are floated across the output to provide power during ac failure and to provide filtering.

**The Apparent Contact Potential of a Pseudo-Abrupt P-N Junction**, by H. Kroemer. "RCA." Dec. 1956. 7 pp. The capacitance-voltage relationship is studied for junctions which have constant impurity densities on both sides of the junction, but where the transition from the density value on the "n" side to that on the "p" side is not an abrupt one. It is found that the inverse square of capacitance of such a pseudo-abrupt junction varies linearly with voltage, as in the case of a truly abrupt junction. Differences exist in the contact potential, however, which can be utilized to obtain information about the internal structure of the junction.

**Measurement of Short Carrier Lifetimes**, by G. K. Wertheim and W. M. Augustyniak. "Rev. Sci." Dec. 1956. 3 pp. Semiconductor carrier lifetimes are investigated by using short pulses of high energy excitation electrons from a Van de Graaff accelerator. Modification of a standard accelerator for these measurements is discussed in some detail and some typical results are presented.

**How the Navy Set Up a Transistor Reliability Study**, by R. E. Martin. "El. Eq." Jan. 1957. 3 pp.

**Simplified Light Reflection Technique for Orientation of Germanium and Silicon Crystals**, by R. D. Hancock and S. Edelman. "Rev. Sci." Dec. 1956. 1 p. System uses zirconium-concentrated arc lamp to illuminate etched hemispherical end of crystal ingot. Characteristic patterns are reflected by different shaped pits of different crystal planes.



## TELEVISION

**Switching Control at Television Operating Centers**, by C. A. Collins and L. H. Hofmann. "Bell Rec." Jan. 1957. 5 pp. A non-technical description of the function of Bell System switching facilities used for switching video, and perhaps in the future simultaneous switching of audio, for network programs.

**Reduction of Co-Channel Television Interference by Precise Frequency Control of Television Picture Carriers**, by W. L. Behrend. "RCA." Dec. 1956. New, more precise methods of frequency control make possible the minimization of co-channel interference.

**A Flying-Spot Scanner for Televising 35 mm Film**, by F. H. J. van der Poel. "Phil. Tech." Dec. 15, 1956. 9 pp. System is designed for use with Continental 25 frame per second Gerber standard, uses uninterrupted film travel.

**A Video Automatic-Gain-Control Amplifier**, by J. O. Schroeder. "RCA." Dec. 1956. 13 pp. The system described is used to hold constant the peak-to-peak level of a television video signal. Design and performance data are included.

**Frequency-Dependent Graduation Equalization of TV Signals**, by H. Schoenfelder. "Arc. El. Uber." Dec. 1956. 25 pp. It is suggested to equalize the graduation for low frequencies only to reduce the resulting increase in the noise level in dark picture sections, since linearity of graduation for small picture areas is not important. Detailed circuit diagrams including component values of an experimental set-up are presented and the experimental results obtained are reported.

**Miniaturized Television Cameras Using the Miniature Vidicon**, by L. E. Flory, G. W. Gray, J. M. Morgan, and W. S. Pike. "RCA." Dec. 1956. 34 pp. Closed circuit and remote pickup TV cameras have been constructed using experimental 1/2 inch Vidicons and experimental transistors. Technical description includes schematics.

**NTSC Color TV System: 1. Colorimetric Principles**, by N. Mayer. "El. Rund." Jan. 1957. 6 pp. The colorimetric system underlying the FCC standards for television is explained for the benefit of German readers.

**A Method of Predicting the Coverage of a Television Station**, by J. Epstein and D. W. Peterson. "RCA." Dec. 1956. 12 pp.

**New Color TV Tube with Twin-Electron Beam**, by R. Tonnendorf. "El. Rund." Jan. 1957. 2 pp. This, a description of the Apple tube developed in this country.

**Test Signal for Measuring "On-The-Air" Color-Television System Performance**, by R. C. Kennedy. "RCA." Dec. 1956. 5 pp. A discussion of the test signal inserted by National Broadcasting Company during three lines of the vertical blanking interval of their color television transmissions.



## TRANSMISSION LINES

**A Non-Resonant Waveguide Window**, by A. E. Barrington and J. T. Hyman. "Proc. BIEE." Jan. 1957. 4 pp. Instead of relying on the anti-resonant properties of the iris, reflectionless transmission is obtained by the correct choice of waveguide dimensions to ensure perfect matching at the operating frequency between air-filled (or evacuated) and dielectric-filled sections.

**Transient Analysis of Coaxial Cables Considering Skin Effect**, by R. L. Wigington and N. S. Nahman. "Proc. IRE." Feb. 1957. 9 pp.



## TUBES

**The Life and Reliability of Valves**, by K. Rodenhuis, H. Santing, and H. J. M. van Tol. "Phil. Tech." Dec. 15, 1956. 12 pp. A thorough review of tube life and reliability, with discussion of remedies applied in design, manufacture, test, and application.

**A Miniature Vidicon of High Sensitivity**, by A. D. Cope. "RCA." Dec. 1956. New photoconductive material is used in a new sensitive miniature Vidicon pickup tube only 1/2 inch in diameter and 3 inches long. Spectral response is approximately 400 to 800 millimicrons.

**The Generation of Electromagnetic Waves by Means of a Traveling-Wave Tube With a Double-Helix Coaxial Line**, by V. S. Mikhalevsky, A. G. Dolganov, and V. D. Ivanova. "Radiotek." Nov. 1956. 11 pp. The authors discuss the results of an experimental investigation of the generation of electromagnetic waves by a traveling-wave tube with a retardation system (a double-helix coaxial line) as a function of the geometry, direction of winding, the manner in which the helices were connected and the operating regime of the tube. It is established that the experimental results correspond to the approximate theory which approximates the retardation system by means of helically-conducting cylinders; the paper shows that it is possible to use this theory for the approximate computation of certain parameters of a retardation system of finite length for small values of helix pitch.

**Waves in Electron Beams**, by R. Mueller. "Arc. El. Uber." Dec. 1956. 6 pp. An investigation of the space charge waves in an electron beam with periodic spatial structure (meander, cycloid) or periodic variation of dc conditions (velocity jumps) leads to spatial harmonics, in analogy to such waves in conductors. The theory is applied to several tubes, such as traveling wave tubes without delay lines, magnetrons, and two-beam backward waves.

**Viewing Storage Tube for Large Displays**, by H. O. Hook, M. Knoll, and R. P. Stone. "RCA." Dec. 1956. 12 pp. A 10-inch direct-view storage tube and a projection-type storage tube are described which are applicable to radar displays and for certain television and telemetering applications.

**Thyratron Recovery Time**. "Technical Communications." Nov. 1956. 9 pp. A distinction is made between deionisation time and recovery time—a series of graphs is presented to show variation of recovery time with grid voltage for various types of thyratron, with grid series resistor as a parameter.

**Operation of a Cold Cathode Gas Triode in a High Impedance Self-Biasing Circuit**, by M. Silver. "Proc. IRE." Feb. 1957. 4 pp. The author investigates the tendency of such tubes to fire without any triggering signal when operating in the dark and in the Townsend region.

**Receiving Tube Specifications**, by R. O'Fallon. "El. Des." Jan. 15, 1957. 2 pp. A general discussion of specifications, including discussion of test requirements and existing inadequate specifications.

**Systems with Centrifugal-Electrostatic Focusing of the Electron Beam**, by Z. S. Chernov. "Radiotek." Nov. 1956. 7 pp. A new electrostatic system is examined, which forms and focuses an electron beam in such a way that the electrons move with a helical motion. Electronic devices based upon this system (spiratrons) are described, such as the traveling-wave tube and the dual-beam amplifier, which do not require the magnetic focusing of the electron beam. Experimental data is given on the focusing action and high-frequency properties of such systems.

**Electron Guns with High Perveance**, by R. Hechtel. "Arc. El. Uber." Dec. 1956. 6 pp. The perveance of an electron gun is defined as the ratio of the electron current and the 2/3 power of the electron potential after acceleration; its importance is pointed out. Designs of high perveance electron guns are outlined and theoretical considerations are included.

**Vibration Tube Testing**, by L. B. Martin. "El. Des." Feb. 1, 1957. 4 pp. The problem of microphonic noise in subminiature receiving tubes is reviewed. The article discusses the methods used in one specialized program of microphonics study. Fast, accurate vibration test methods were developed and used in the program. Test methods and equipment are described.

## PATENTS

Complete copies of the selected patents described below may be obtained for \$25 each from the Commissioner of Patents, Washington 25, D. C.

**Mechanically Stabilized Oscillator, #2,759,102.** Inv. L. L. Burns. Assigned RCA. Issued August 14, 1956. The oscillator comprises two electron tubes, the plate of the second tube being capacitively coupled to the grid of the first tube. A magnetostrictive resonator provides stabilization. Two coils are disposed at points on the resonator which are separated by an uneven multiple of a half wavelength, each coil being connected into the cathode lead of one of the tubes, respectively.

**Electron Tube Thermoelectric Generator, #2,759,112.** Inv. W. Caldwell. Issued August 14, 1956. The electron tube is designed to convert heat directly into electricity. The electron-emissive coating on the cathode is closely spaced and insulated from a surrounding plate structure, the intermediate space being a vacuum. Electricity can be derived between the cathode and plate in response to the heating of the cathode.

**Television Receiver, #2,759,121.** Inv. N. W. Parker. Assigned Motorola, Inc. Issued August 14, 1956. The two windings of the output transformer in a color television receiver of the multi-beam type develop a pair of oppositely phased peaked sawtooth waves. A circuit for controlling the convergence of the cathode-ray beam comprises various resistance-capacitance networks to first produce two unpeaked sawtooth waves from the peaked ones and a parabolic signal and circuitry to suitably combine the three signals to result in a signal for the control of the convergence of the beam.

**Electronically Tunable Magnetron, #2,759,123.** Inv. H. K. Jenny. Assigned RCA. Issued August 14, 1956. The anode structure of the magnetron, which surrounds the cathode, is designed to form a plurality of radially extending cavities all in communication with each other in the region of the cathode. A resonator is formed by a further cavity, the ends of this latter cavity communicating with two of the anode cavities. The electron stream traverses this latter cavity.

**Antenna Arrays, #2,759,183.** Inv. O. MacDonald. Assigned RCA. Issued August 14, 1956. The antenna array comprises a sheet reflector one-half wavelength wide and several wavelengths long. A specially designed sinusoidal conductor element is arranged spaced from parallel to, and along the length of the reflector. Two feed terminals are arranged at adjacent points of the sheet reflector and the sinusoidal conductor.

**Compatible Image-Reproducing System, #2,759,993.** Inv. B. D. Loughlin. Assigned Hazeltine Research, Inc. Issued August 21, 1956. A band of monochrome signals having frequencies below the color-switching frequency intensity-modulates the beam when monochrome images are received. Further a band of monochrome signals having frequencies in the vicinity of the color-switching frequency deflect the beam lengthwise of the color-reproducing strips to minimize spurious color patterns in monochrome pictures.

**Tri-Color Television Picture Tube, #2,759,994.** Inv. T. Miller. Assigned Westinghouse Electric Corp. Issued August 21, 1956. Three electron guns and a screen having strips of fluorescent material arranged in groups of three strips corresponding to the three primary colors are provided. The beam from one gun carries an identifying pattern which generates a representative signal upon incidence on a strip of one of the primary colors. This identifying signal causes the beam to be modulated by the signal channel of the associated primary color.

**Radio Antenna, #2,755,469.** Inv. H. Etheridge. Iss. July 17, 1956. An inductive radio receiving antenna consists of two fine wires insulated from each other and wound together in the same direction in the shape of a coil. The two ends of the primary winding wire are open, one end of the secondary winding being connected to a radio receiver.

**Subscription Television System, #2,755,332.** Inv. W. S. Druz. Assigned Zenith Radio Corp. Iss. July 17, 1956. The timing of the clamping signal occurring during the retrace interval is varied within the retrace interval in accordance with a coding schedule. The clamping signal, video signal and synchronizing signal are added to form a composite signal for radiation to subscriber receivers.

**Identification Coder and Decoder, #2,754,496.** Inv. R. C. Embry and J. S. Duff. Iss. July 10, 1956. A plurality of AC current sources of varying frequency are supplied to a plurality of magnetic recording-reproducing heads when associated selective means are in one position. When the selective means are in another position, they connect the heads to a sensing circuit comprising amplifiers, frequency-selective filter units, and an indicating device, to cause operation of the indicating device by the subsequently sensed signals.

**Stabilized Discriminator, #2,755,378.** Inv. H. Stover. Assigned Collins Radio Co. Iss. July 17, 1956. A series resonant circuit having a capacitor connected serially to a tank circuit supplies the grid of a tube having equal resistors in plate and cathode leads, providing two outputs to two inversely connected diodes. The input sides of the diodes are shunted by a resistor, the center point of which supplies the output and is capacitively coupled to the tank circuit.

**Demodulator, #2,755,380.** Inv. N. P. Laverty and W. E. Peterson. Assigned Northrop Aircraft Inc. Iss. July 17, 1956. A varying-frequency square-wave voltage is converted into a peaked waveform by differentiation, which peaked waveform triggers a sawtooth wave having an amplitude proportional to the instantaneous square-wave frequency. A detector derives from the sawtooth wave a DC current varying in magnitude in accordance with the amplitude variations of the saw-tooth waves, adjustable DC clamping means establishing a reference level for the DC current.

**Video Frequency Amplifier, #2,758,159.** Inv. R. B. Dome. Assigned General Electric Co. Issued August 7, 1956. The video-amplifier stage is adapted to respond to video signals with positive synchronizing signals. The coupling capacitor of the stage has a capacitance sufficient to pass the lowest frequency. A grid leak resistor is provided having a resistance of the same order of magnitude as the cathode-grid resistance when grid current is being drawn.

**Limiters for Pulse Amplifier, #2,758,205.** Inv. S. Lubkin. Assigned Underwood Corp. Issued August 7, 1956. A feedback path connects an amplifier output with a gating circuit including at least one normally non-conducting diode, the cathode of which is at a predetermined positive potential. If the differential voltage fed back to the diode exceeds the predetermined potential, the diode conducts and reduces the input pulse amplitude.

**Traveling Wave Tubes, #2,758,242.** Inv. A. L. Samuel. Assigned Sperry Rand Corp. Issued August 7, 1956. The helical conductor in a traveling-wave tube surrounds the electron beam coaxially and is directly exposed to the beam. To minimize interception of electrons by the helical conductor, a helical shield member is disposed concentrically with the conductor. At least some convolutions of the helical shield member have a radial extent greater than the thickness of the helical conductor so that they extend between and inwardly beyond the turns of the helical conductor shielding it from the electron gun.

**Ferroelectric Recording and Reproduction of Speech, #2,775,650.** Inv. W. P. Mason and R. N. Thurston. Assigned Bell Telephone Laboratories, Inc. Issued Dec. 25, 1956. A record comprises a layer of ferroelectric crystalline material not more than a few microns thick superposed on a substratum of either platinum or palladium. A remanent polarization pattern is provided along a preselected path on the layer, which pattern corresponds to preselected continuous wave signals.

**Dual Channel Amplifying Circuit, #2,775,657.** Inv. J. J. Zaalberg van Zelst. Assigned Hartford National Bank and Trust Co. Issued Dec. 25, 1956. A main and a spare amplifier, each having a negative feedback circuit, are connected in parallel. If specified conditions are imposed on the negative feedback coefficients, both amplifiers will be operative in normal operation, the main amplifier contributing a larger portion of the output. In the event of failure of the main amplifier, the spare amplifier will maintain the previous output level.

**Electron Discharge Device, #2,776,388.** Inv. R. Adler. Assigned Zenith Radio Corp. Issued Jan. 1, 1957. A narrow slot in an accelerating electrode is arranged parallel to an elongated cathode to produce an electron sheet. A plurality of spaced conductive elements cover the slot and are electrically connected to the accelerating electrode. A pair of deflection-control electrodes are spaced to constitute a projection lens together with the screened slot aperture for focusing the electron beam on a two-electrode output system.

**Combined T.-R. and Low Power Switching Gas Discharge Device, #2,776,409.** Inv. L. Goldstein. Assigned International Telephone and Telegraph Corp. Issued Jan. 1, 1957. A resonant chamber inserted in a waveguide system contains a first ionizable medium and a first electrode system to control its ionization. A second ionizable medium is separately contained in a space partly formed by a capillary tube axially disposed in an opening in the first electrode system and extending through the resonant chamber. A second electrode system controls the ionization of the second ionizable medium.

**Means for and Method of Compensating Signal Distortion, #2,776,410.** Inv. G. Guanella. Assigned Radio Patents Co. Issued Jan. 1, 1957. The distorted signal is applied to a distortion-free circuit and to a circuit introducing a distortion similar to the original distortion. The transit times of the two signals through these two circuits are equalized and their relative magnitude and phase are so controlled that the combined output signal contains substantially no distortion.

**Photosensitive Layer Cell, #2,776,357.** Inv. N. F. Porath. Assigned General Electric Co. Issued Jan. 1, 1957. A support member shaped like a hollow shell and of a material substantially transparent to the rays to be measured is coated on its inner surface with a layer of photosensitive material. Suitable electrodes are provided in electrical contact with the layer.

**Frequency Conversion Circuit, #2,776,373.** Inv. W. D. Mischler. Assigned Bell Telephone Labs. Issued Jan. 1, 1957. The sum and difference modulation products are formed by a harmonic generator of the saturable reactor type. These products are applied to separate filters to select waves of different single frequencies harmonically or non-harmonically related to the original waves.

**Pulse System, #2,776,375.** Inv. F. P. Keiper. Assigned Philco Corp. Issued Jan. 1, 1957. One winding of a transformer is inserted in the collector circuit and another in the emitter circuit of a transistor. A voltage pulse across the first winding will increase the emitter current to its saturation level, at least during a portion of the pulse. A current limiting resistor is provided in the emitter circuit.

# International ELECTRONIC SOURCES

**Logarithmic Amplifier #2,774,825.** Inv. S. Sherr. Assigned General Precision Laboratory, Inc. Issued Dec. 18, 1956. A rectifier terminates a cascade amplifier. Several of the latter amplifier stages comprise a rectifier circuit, including a resistor, between their control grid and cathode, which operate as a diode for signals exceeding a predetermined level. Hence these signal portions initiate grid-current flow and are rectified. A time-delay network interconnects these rectifiers with the terminating rectifier to add their signals in phase.

**Stabilized Transistor Amplifier, #2,774,826.** Inv. Jean-Marie Moulon. Issued Dec. 18, 1956. The positive terminal of the single dc supply is connected to the movable arms of one potentiometer inserted between the windings of an input transformer and the input winding of a coupling transformer of the two-stage transistor amplifier. The negative terminal of the dc supply is connected to the output transformer. A second potentiometer connects the output winding of the coupling transformer with the primary winding of the output transformer. The movable arm of this potentiometer leads to the collector of the first transistor.

**Variable Resistance Instrument, #2,774,853.** Inv. E. C. Anthony. Assigned Bendix Aviation Corp. Issued Dec. 18, 1956. The support of a variable resistance has a continuous screw thread and a resistance element extending along the apex of the thread and being insulated therefrom. The follower includes a screw thread meshing with the supporting thread and carrying a contact element which makes a sliding contact with the outer face of the resistance element.

**Film-to-Video Translation Apparatus, #2,774,815.** Inv. F. N. Gillette. Assigned General Precision Lab. Inc. Issued Dec. 18, 1956. Successive pictures of a film are projected onto a video camera pick-up tube for conversion into a TV signal. The intermittent advance of the film and a light-interrupting set-up are synchronously operated by a motor, the speed of which is synchronized with the picture scanning repetition rate by means of a phase comparison control circuit.

**Direct-Coupled Amplifier, #2,777,018.** Inv. A. W. Russell. Assigned Allen B. Du Mont Laboratories, Inc. Issued Jan. 8, 1957. A pair of push-pull connected tubes draw their plate current from an unregulated power supply. Both cathodes are connected to the plate of a pentode constituting a common cathode resistor. The fluctuations of the power supply are applied to the control of the pentode which accordingly varies the push-pull amplifier gain.

**Resistor Elements Adapted for Use in Connection with Printed Circuits, #2,777,039.** Inv. E. P. Thias. Assigned to Standard Coil Products Co., Inc. Issued Jan. 8, 1957. A solid electrical resistor is shaped to be mounted in a recess of the dielectric base of a printed circuit. Spaced coatings of highly conductive solder adherent material establish the electrical connection to the printed circuit leads leading to the recess. The spacing between the coatings determines the resistance of the unit.

**Large Area Photocell, #2,777,040.** Inv. B. Kazan. Assigned Radio Corporation of America. Issued Jan. 8, 1957. Light-responsive material is filled into at least one perforation of an insulating layer. Two conductive sheets are bonded to the insulating layer, one on each side of the layer, the perforation registering with a window in each sheet. These sheets constitute two electrodes, the incident light determining the conductivity there between.

**Asymmetric Wave Guide Structure, #2,777,906.** Inv. W. Shockley. Assigned Bell Telephone Laboratories. Issued Jan. 15, 1957. A septum made of Hall-effect material is mounted in the passageway of a hollow wave guide, one septum edge contacting the wave-guide wall.

**Electron Beam Tubes, #2,758,244.** Inv. W. J. Dodds. Assigned RCA. Issued August 7, 1956. To inductively and capacitively couple the input end of a helix in a traveling-wave tube to an input line, a coupling ring surrounding the helix and spaced therefrom is provided inside the dielectric envelope of the tube. A conductor extending laterally from the helix input end and back over the helix in a direction away from the electron gun connects the coupling ring to the helix.

**Coaxial Phase Shifter, #2,758,285.** Inv. D. J. Le Vine. Assigned International Tel. & Tel. Corp. Issued August 7, 1956. A coaxial non-resonant structure for varying the phase of an electromagnetic signal consists of a closed-loop dielectric member. A conductor is wound with varying pitch around the member, and a hollow conductor displacably surrounds a given length of the member in dielectrically spaced coaxial relation therewith. Relative motion of the hollow conductor and the dielectric member carrying the conductor wound thereon will result in a phase shift of a signal propagated through the structure.

**Amplifier Semi-Conductor Volume Compression System, #2,759,052.** Inv. A. A. Macdonald and R. C. Balezore. Assigned Motorola, Inc. Issued August 14, 1956. The signal wave, which is to be phase-modulated onto a carrier, is first differentiated and then applied to a transistor stage. The transistor stage operating potential is so related to its output impedance that it amplifies and simultaneously symmetrically limits the amplitude of the differentiated signal wave. In a further network the output of the transistor is integrated to restore the original signal wave with the high-frequency high-amplitude components thereof being compressed.

**Wave Guide Antenna, #2,778,016.** Inv. L. J. Chu. Assigned The Gabriel Co. Issued Jan. 15, 1957. A pair of slots are arranged in opposite sides of a rectangular wave guide and near a closed end thereof. At this closed end is provided a conducting surface which extends beyond the sides of the wave guide and at right angles thereto.

**Magnetically Loaded Composite Conductors, #2,777,896.** Inv. H. S. Black. Assigned Bell Telephone Laboratories, Inc. Issued Jan. 15, 1957. Stripes of conducting magnetic portions alternate with magnetic insulating material to make up the inside surface of a wave guide. At least one dimension of the magnetic portions transverse to the direction of wave propagation is small compared to the skin depth, whereby penetration of the electric field into the wave guide wall is assured.

**Portable Self-Contained Electronic Stethoscope, #2,777,903.** Inv. O. E. Turner. Issued Jan. 15, 1957. A diaphragm to contact the patient's body closes the wider opening of a cone and a microphone is disposed at its apex. The microphone output is supplied to a volume and tone controlled amplifier which feeds a loud-speaker.

**Crystal Controlled Oscillator, #2,777,061.** Inv. A. H. Hargrove. Assigned Bendix Aviation Corp. Issued Jan. 8, 1957. A first parallel resonant circuit, resonant below the operating frequency range, is connected between the cathode of the oscillator tube and ground. A second parallel resonant circuit, resonant above the operating frequency range, is inserted between the cathode and the grid of the oscillator tube. The frequency-controlling crystal in parallel with a resistor is connected between the second resonant circuit and ground.

**Triple-Channel Time Sharing Switch, R. F. Higby.** Assigned Westinghouse Electric Corp. Issued Jan. 8, 1957. A multivibrator comprises three ring-connected electron tubes. The grid of each tube is connected to the plate of one other tube by a resistor and a capacitor and to the plate of the second other tube by a diode. Each cathode is individually grounded over a resistor.

**Receivers for Pulsed Frequency Modulation Carrier Systems, #2,774,817.** Inv. Ch. W. Earp. Assigned International Standard Electric Corp. Issued Dec. 18, 1956. Sampled signal amplitudes are converted into wave trains, the frequencies of which represent the amplitude. Upon reception, each wave train is transformed into two sets of two differently phased wave trains, and the two trains of each set are combined to produce an additional train having a phase indicative of the phase difference. The resulting two trains are used to reproduce the original signal.

**Card Translator, #2,774,821.** Inv. C. B. Brown, L. N. Hampton, and F. A. Thiel. Assigned Bell Telephone Labs. Issued Dec. 18, 1956. A punch card in a punch card assembly may be selectively displaced relative to the other cards, whereby certain photocells will be selected to respond in accordance with the coded information. Other photocells responsive to the signal area on the selected card will enable the selected photocells to respond.

**Circuit for Frequency Transformation of High-Frequency Oscillations, #2,775,690.** Inv. J. L. H. Jonker and G. Diemer. Assigned Hartford National Bank and Trust Co. Issued Dec. 25, 1956. An electron beam is intensity modulated by a signal grid. The tube further comprises two anodes and two deflection plates, each anode being connected to one of the deflection plates with a circuit resonant to a local frequency between the two common terminals. A second circuit, resonant to the beat-frequency, is arranged about the mid-point of the first resonant circuit; this circuit supplies a beat-frequency output.

**Triggered Gating System, #2,775,691.** Inv. J. L. Rennick. Assigned Zenith Radio Corp. Issued Dec. 25, 1956. The first grid and collector electrode sections of two pentagrid tubes are connected substantially as a multivibrator and triggered at the field repetition rate. The color signal, of the type subjected to periodic phase changes in translating color information, is applied to the second signal grids of both pentagrid tubes. A balanced output circuit and associated circuitry are provided to derive output signals of opposing phase from the two tubes.

**Microwave Antenna System, #2,775,761.** Inv. W. C. Jakes. Assigned Bell Telephone Laboratories. Issued Dec. 25, 1956. A plane reflector is positioned to receive the waves from a highly directive microwave radio antenna. Certain relative dimensions are imposed upon the distance between antenna and reflector, their dimensions, the wavelength, the projected area of the reflector, and the antenna aperture to secure either increased gain or extremely broad ranges of tolerable operating parameters.

**Single-Sideband Carrier-Wave Telephone System, #2,775,647.** Inv. J. Ensink. Assigned Hartford National Bank and Trust Co. Issued Dec. 25, 1956. In a multi-channel system, a multiplicity of groups with frequency spacings equal to twice the transmitted sideband and a plurality of signalling carriers associated with each channel and outside the transmitted sideband are transmitted. In the receiver, the signalling frequencies belonging to the channels of one group are jointly separated from the group before separation.

**Constant Output Amplifier, #2,777,904.** Inv. S. C. Milbourne. Assigned Bendix Aviation Corp. Issued Jan. 15, 1957. A negative-temperature coefficient thermistor varies the signal input amplitude as a function of the input signal. A negative feedback circuit including a similar thermistor and connected to the amplifier output supplies a 180° phase-shifted signal of the same frequency. The amplitude of both these signals is equally varied by indirectly heating the thermistors by the input signal. Algebraic addition of these signals results in a constant amplitude output, the amplitude being equal to the difference between the two signals.

for critical uses...  
or for assuring  
maximum operating  
uniformity for  
any product  
in any  
price class,  
there is no  
substitute for...



The sample matches the specifications  
... and each subsequent production unit  
is exactly like the sample ... *electrically  
and mechanically.*



**STACKPOLE**

*Ceramag*®

F E R R O M A G N E T I C C O R E S

Electronic Components Division, STACKPOLE CARBON COMPANY, St. Marys, Pa.

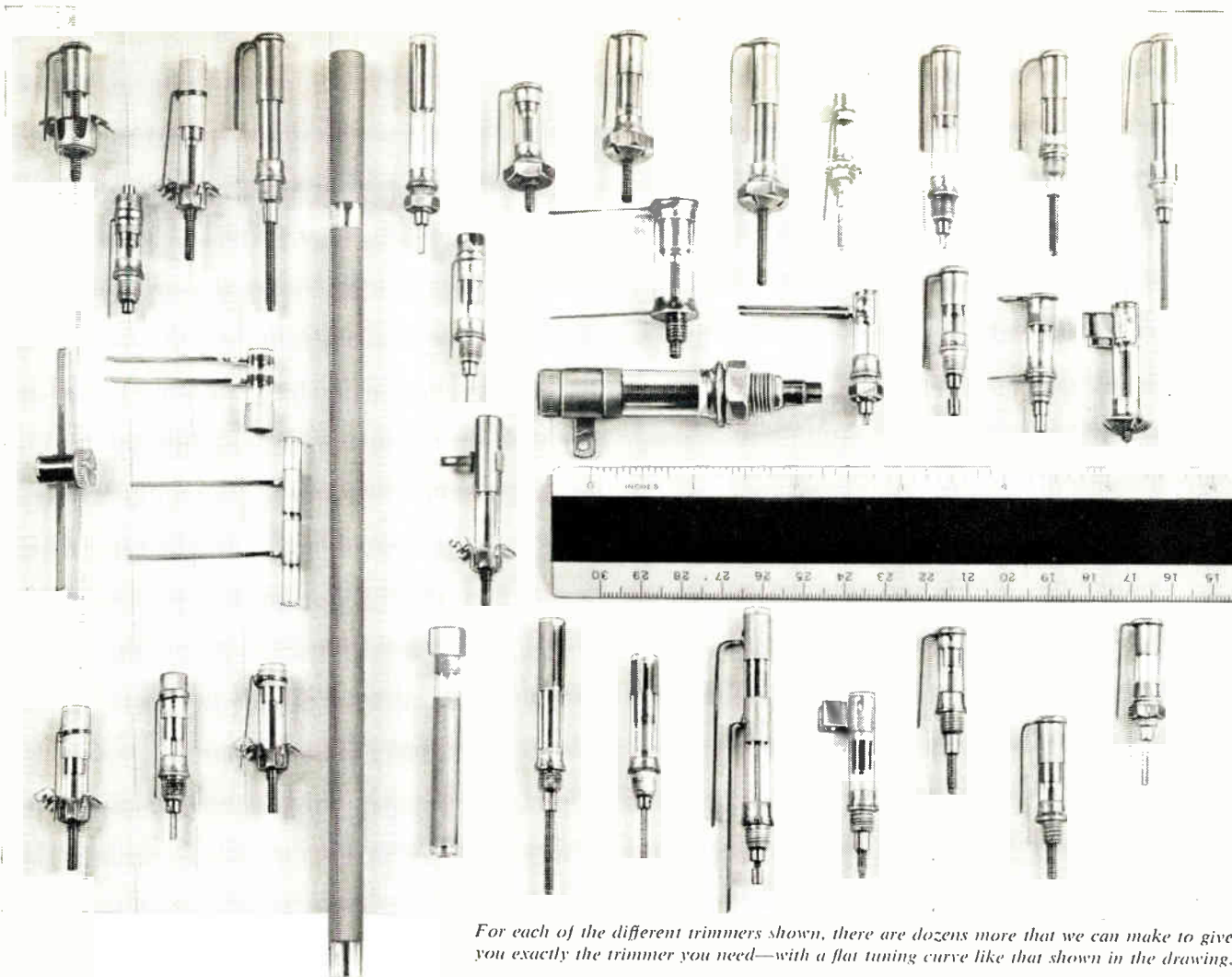

For each of the different trimmers shown, there are dozens more that we can make to give you exactly the trimmer you need—with a flat tuning curve like that shown in the drawing.

## Let us put our exceptional stability in a trimmer capacitor designed for your need

Just turn your requirements over to us and we'll design the type you need around the many important features that Corning Trimmer Capacitors alone combine.

Or, if you have your design pretty much worked out and want a manufacturer, let us show you how we go about giving you what you want along with extra measures of miniaturization and stability.

Starting by permanently bonding metal to tubes of rugged glass, we give you trimmers that have negligible capacity change even when ambient temperatures vary greatly. Temperature coefficients are  $+50 \pm 50 \text{ ppm}/^\circ\text{C}$ . or  $+200 \pm 50 \text{ ppm}/^\circ\text{C}$ ., depending on the core material used.

If you're working in critical applications, such as high frequency amplifiers and oscillator circuits, the Corning direct-traverse motion will simplify tuning. Because the tuning slug moves in and out

without turning, you get no reverse loops. A mushroom end spring eliminates microphonics and capacity shift under vibration.

Or, if you're interested more in the general high frequency range, you can get Corning trimmers with rotary tuning slugs. This economical design comes in a wide variety of mounting styles, push-on mounts, and split bushings, with saddle clips, wire leads, pan terminals or solder spots.

You can get both the direct-traverse type and the rotary style in ratings from .3 to 12.0 mmfd. to your design. You can also get a capacity range of from 2 to 30 mmfd. in a slightly larger version of our

TUNING CURVE FOR CORNING 1 TO 8 MMFD DIRECT TRAVERSE TYPE TRIMMER CAPACITOR  
Check made at 500 MCS on Boonton 150 A C Meter

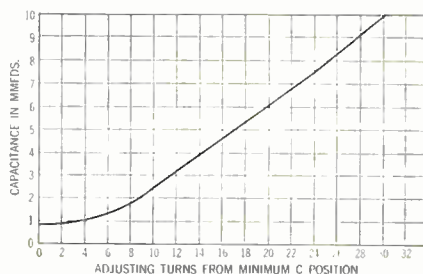

direct-traverse motion.

Whatever you need, write, wire, or phone Corning for facts on how we can help you. If you'd like more information, circle the publisher's inquiry number for catalog sheets.

**Other electronic products by Corning Components Department:** Fixed Glass Capacitors\*, Transmitting Capacitors, Canned High-Capacitance Capacitors, Subminiature Tab-Lead Capacitors, Special Combination Capacitors, Direct-Travel and Midget-Rotary Capacitors\*. Metallized Glass Inductances, Resistors.

\*Distributed by Erie Resistor Corporation



**CORNING GLASS WORKS,** 95-3 Crystal Street, **CORNING, N. Y.**

*Corning means research in Glass*



**solve  
your  
motor  
problems!**

**SAVE MONEY, TOO!**



**adapt from *WESTERN GEAR'S* many basic designs**

\* Motors are shown at same reduction as this photo of standard paper clip.

You can save production dollars by modification of prototype motors, fans and blowers, converters, alternators and generators. At the same time, you get the benefit of proven design and performance. Western Gear's extensive line of motors ranges from 1/500th to 4 HP, 50 to 1,000 cycles in frequency, any desired voltage, designed and built to meet military specifications. Our engineers will gladly help you on any rotary electrical equipment problem, show you how our production facilities can help cut product costs. Write for new catalog No. 254-A. Address General Offices, Western Gear, P.O. Box 182, Lynwood, California.

*"The difference is reliability" \* Since 1888*

5618

PLANTS AT LYNWOOD, PASADENA, BELMONT,  
SAN FRANCISCO (CALIF.) SEATTLE AND HOUSTON  
—REPRESENTATIVES IN PRINCIPAL CITIES



## MICROWAVE PROGRESS

### Frequency Measurement Devices

A couple of years back, it seemed to us that there were almost as many frequency measuring devices as frequencies. Anticipating that, sooner or later, some sort of definitive material would be needed, our engineer, Bob Lebowitz, consolidated the scattered, available information into his excellent report, "Frequency Measurement Devices"

This report provides a valuable summary of the various equipment types for measuring frequencies in the 300 to 40,000 mc/s range, and a succinct reference source for their respective design considerations and applications. It covers coaxial and cylindrical cavity wavemeters; crystal oscillator frequency standards; and use of stable reference spectral lines.

Most of the commercial requirements for precision are met by open circuited coaxial and right cylindrical waveguide cavities. Since the  $\lambda/4$  and  $3/4\lambda$  coaxial cavities can be made smaller than right cylindrical waveguide cavities, they are generally preferred for lower microwave frequency measurements. To overcome the critical design problem of contacting the movable plunger without introducing contact resistance in coaxial frequency meters, it has been found more satisfactory to use a non-contacting choke system rather than shorting fingers.

Broadband cavity frequency meters have accuracies that vary between .01 and 1%. For accuracies greater than .001%, low frequency quartz crystal standards are utilized. For microwave applications, multiplying and heterodyning means are required to compare the l.f. frequency oscillator signal with the signal of unknown frequency.

Although we've tried to cover most of the aspects of Bob Lebowitz' report in the preceding paragraphs, space has forced us to omit many of the important details. But, the full report on frequency measurement devices is available to you for the asking. Just request on your company letterhead, "PRD Report Vol. 2 No. 2A"



**Polytechnic Research and Development Co., Inc.**

202 Tillary Street • Brooklyn 1, N. Y. • Tel: UL 2-6800

Cable Address: MICROWAVE, NEW YORK



### PRD Precision Heterodyne Frequency Meter

provides direct reading of any frequency from 100 to over 10,000 mc/s to an accuracy of <.03%!

This is the one unit that has all the features required for both laboratory measurements and production and field testing of transmitters and receivers. Completely self-contained and portable, the 504 Precision Heterodyne Frequency Meter gives you quick, simple operation with both CRT and aural presentation, and a new, exclusive direct interpolating dial. Consisting of a spiral scale fitted with an adjustable index, the dial permits direct interpolation to 0.1 mc/s at all settings. *No calibration charts needed* when you use the 504 Heterodyne Frequency Meter.

#### SPECIFICATIONS

Frequency Range: measures 100 to over 10,000 mc/s; generates 500 to 900 mc/s and harmonics

Calibrator Accuracy: 0.002% at 5 mc/s crystal check points

Interpolation: < 0.03% between 5 mc/s crystal check points

Resettability: < 0.02%

Input Sensitivity: at 500 mc/s and above—30 dbm; at 100 mc/s—5 dbm

Heterodyne Oscillator: 500-900 mc/s

Crystal Calibrator: Built-in 5 and 50 mc/s quartz crystal standards. The 5 mc/s crystal is temperature-controlled.

Power Requirement: 115/230V, 50-60 cps, single phase, 125 watts

Price: \$695 f.o.b. Brooklyn, N. Y.

*For all the important details on PRD Heterodyne Frequency Meter, please request on your company letterhead, "PRD Technical Data Sheet 504A"*



CASE history  
number 6



## PISTON CAPACITORS AT WORK

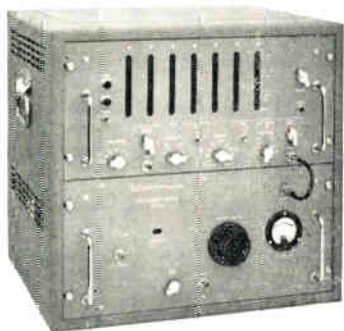
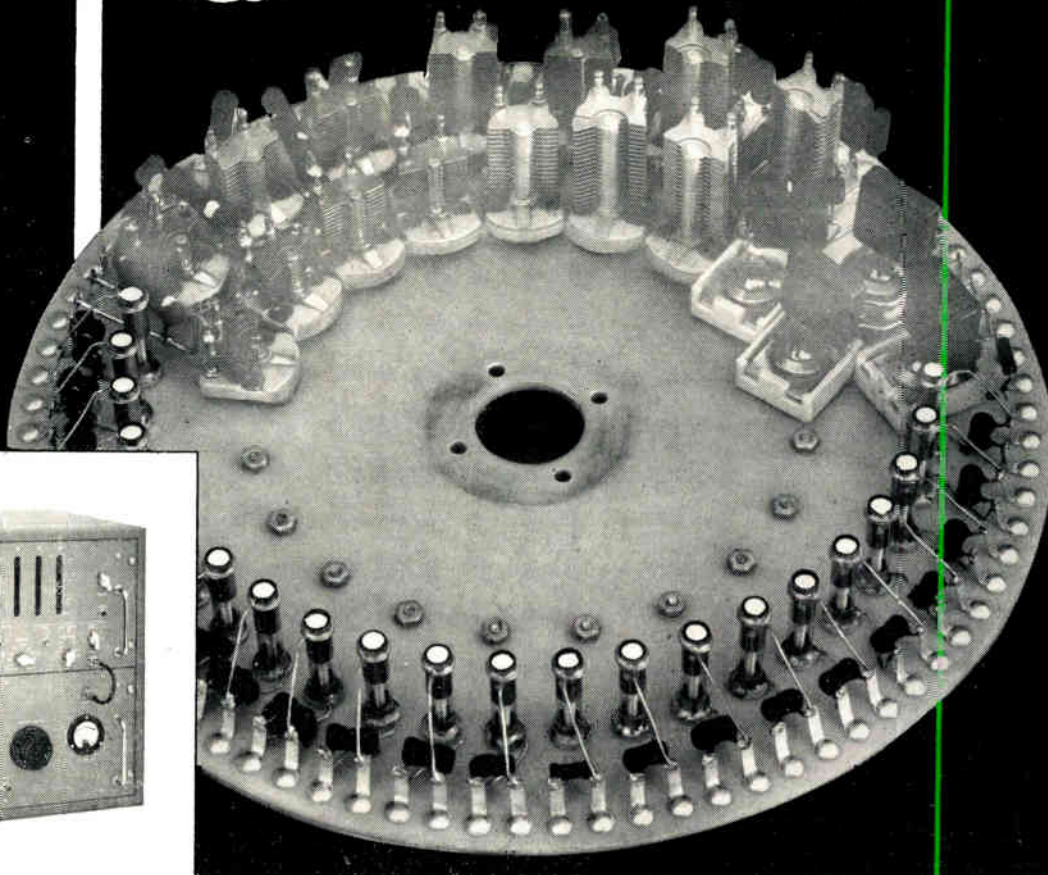

*trimmers achieve maximum measurement, accuracy  
and stability in BERKELEY frequency meters*

**PROBLEM:** To combine functions of precision wide-range frequency meter and universal counter and timer in one compact instrument—to measure frequency from 0 to 42 megacycles with an accuracy of  $\pm 1$  cps or greater and elapsed time from 1 microsecond to 10 million seconds with a maximum accuracy of  $\pm 1$  microsecond.

**SOLUTION:** Berkeley engineers specified 22 model VC11RGA JFD Trimmer Piston Capacitors in the 0-42 mc. harmonic frequency turret to assure precise repeatable selection of reference frequencies. The reasons JFD Variable Trimmer Capacitors were selected? . . . Because an ultra-stable compact, trimmer capacitor was needed to afford rapid and accurate tuning capacity in the reference oscillator circuit.

**RESULT:** Performance so outstanding that Berkeley, division of Beckman Instruments, Inc., has continued to specify JFD Piston Capacitors in their model 5571 Frequency Meters for 3½ years.

**MORAL:** If you are seeking *stability, shock-resistance, ultra-linear tuning and wide operating temperature range* in a trimmer capacitor, you'll find the best answer at JFD.

actual size

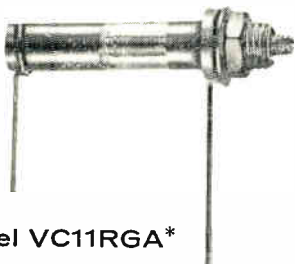

del VC11RGA\*

-10 mmf-glass dielectric-invar rotor)

**Why don't you take advantage of JFD Piston Capacitors in solving your circuit tuning problems?**

*\*One of the miniature and subminiature JFD Piston Capacitors now serving in printed and conventional electronic circuits. Write for literature.*



ELECTRONICS CORPORATION, 1462-62 STREET, BROOKLYN 19, N. Y.

*Go Forward with JFD Engineering!*



New stacked ceramic receiving tubes that can withstand heavy shock and vibration

**2CL40A** A new, small ceramic high vacuum rectifier or clipper diode that can be air or liquid cooled



**3CX100A5** A premium quality ceramic and metal 100 watt triode



**4CX300A** General purpose tetrode with 300 watts plate dissipation up to 500 MC

**EIMAC FIRST  
with ceramic tubes  
that can take it...**

In recent years equipment manufacturers and users have been introduced by Eimac to a series of ceramic tube firsts unequalled in the industry: klystrons, negative grid tubes, rectifiers and receiving tubes.

Clean, and rugged . . . these tubes can stand up to shocks and temperatures no glass tube can. Design and production advantages are a boon to equipment manufacturers and users alike.

As first in the field, Eimac has developed ceramic tube manufacturing techniques that have evolved into well established processes.

See this line of "tubes that can take it" at the Eimac exhibit, Booth 2410-12, National I.R.E. Show and Convention, March 18-21.



**4CX5000A** High power radial-beam tetrode especially suitable for single sideband operation



**4K50,000LQ** Four cavity klystro that delivers 10,000 watts of power at frequencies of 700 to 1000 M



**EITEL-McCULLOUGH, INC**  
SAN BRUNO · CALIFORNIA  
The World's Largest Manufacturer of Transmitting Tube



**THERE'S NO SUBSTITUTE FOR EXPERIENCE..**

**YESTERDAY - TODAY - TOMORROW**

**JUST ONE QUALITY...THE FINEST!**

# **KESTER SOLDER**

**INDUSTRY-TESTED AND PROVED FOR OVER 50 YEARS...**

You hear a lot about the remarkable showing of "Johnny-come-lately" solders from that second source of supply, based only upon test samples or short production runs. But there's no real substitute for regular on-the-job applications to prove the actual merits of a product like solder. That's why Kester Solder is the preferred choice of wise solder buyers and users everywhere; they know it has over half a century of genuine experience and unqualified production approval behind every spool. Write today for complete details.

**YOUR COPY FREE!** Kester's 78-page manual  
"SOLDER . . . ITS FUNDAMENTALS AND USAGE." Send today.

**KESTER SOLDER COMPANY**

4210 Wrightwood Avenue, Chicago 39, Illinois  
Newark 5, New Jersey, Brantford, Canada

# Electronics Engineers

## GROW FASTER IN AN ORGANIZATION THAT TRIPLED IN SIZE LAST YEAR

A variety of opportunities are now open at our Stamford, Connecticut Electronics Laboratory. This is AMF's central organization for electronics development in our General Engineering Laboratories — the organization that tripled its size last year. Let this kind of growth help speed your own career, in such programs as:

- Industrial electronics for application to machines such as: automatic pin spotter, cigarette and cigar-making machines, bakery machines.
- Radio-frequency development for point-to-point communications systems, radar, and special measuring instruments.
- Antenna development including design of narrow beam microwave antennas, antenna phasing devices, and antenna pattern tests and propagation measurements on AMF's antenna range.

*Openings for:*

### ELECTRONICS ENGINEERS

With interest in radio frequency circuits for development and application of communications and special devices.

### ELECTRONICS ENGINEERS (*Advanced*)

Experience in radio frequency circuits for development and application of communications and special devices. Will be responsible for organizing a group carrying out project objectives.

### ANTENNA ENGINEERS

Experience in test and measurement techniques on antennas and associated equipment. Will be trained for advanced work under direct supervision of experienced antenna engineers.

### ANTENNA ENGINEERS (*Advanced*)

To expand our present antenna group for the analysis and design of antennas, rotary joints, baluns, and feed systems. Capable of working with mechanical engineers and designers.

### ELECTRONIC PACKAGING ENGINEERS

With 5-10 years electronic experience in packaging of component units of electronic and electrical systems. Will work closely with circuit and system engineers from breadboard and schematic diagrams to organize the design of the finished product.

### OTHER OPPORTUNITIES ARE AVAILABLE FOR ENGINEERS AT ALL EXPERIENCE LEVELS, IN BOTH COMMERCIAL AND MILITARY FIELDS.

Full responsibility and authority are given to engineers to carry out all aspects of their tasks, including design, material specifications, prototype fabrication, test and reports. AMF supports a tuition reimbursement plan, post-graduate extension courses in Greenwich, and a liberal policy of attendance at symposiums and technical meetings. And you'll enjoy top salaries and regular merit reviews.

*Please send complete resume to MR. JOSEPH F. WEIGANDT*



GENERAL ENGINEERING LABORATORIES

**American Machine & Foundry Company**

Fawcett Building • Fawcett Place • Greenwich, Connecticut

## Personals

Wayne A. Brown is now Vice-President in charge of manufacturing, Pacific Division of Burnell & Co., Inc. He has been active in the electronics field for the past ten years.

Joseph A. Idank, an engineer for 28 years, has joined Dictograph Products, Inc., Jamaica 35, N. Y., as Chief Design Engineer.

Joseph P. Roveto has been named Manager of Semi-conductor Diode Sales for Raytheon Manufacturing Company's Receiving and Cathode Ray Tube Operations.

Lorian W. Willey has been appointed Vice-President of Air Associates, Incorporated, Teterboro, New Jersey. He will be responsible for material, purchasing, traffic and production control for the firm.



L. W. Willey



C. F. Woll

Charles F. Woll has been appointed to the newly created post of Manager, Value Engineering, Missile and Surface Radar Dept., Defense Electronics Products, Radio Corporation of America. He has been an engineering executive in the field for 21 years.

Dr. John K. Hilliard now has the post of Director of Advanced Engineering for the Altec Lansing Corporation at their Beverly Hills, Calif., plant.

R. T. Leitner was elevated to the post of Vice-President and Director of Engineering for the Technical Appliance Corporation, Sherburn, N. Y.

Melvin H. Murphy has been named Chief Electronic Engineer for Packard-Bell Electronics Corp.

Victor Savchuk, Jr., has been named Head of the Sonar Group in the Research and Advance Development Dept. of Stromberg-Carlson, Div. of General Dynamics Corporation.

Karl H. Horn has been appointed Chief Television Engineer for Motorola, Inc., Chicago 51, Ill.

Robert A. Cole has joined Tally Register Corp. as Chief Engineer.

Dr. Douglas H. Ewing, Vice-President, RCA Labs., has been named Vice-President, Research and Engineering, of the Radio Corporation of America. Dr. Ewing joined RCA in 1945 as Manager of the Teleran Engineering section of the RCA Victor Div.

*If you have this problem, investigate*

# GRIP-EZE®

—an example of Phelps Dodge's  
realistic approach  
to Magnet Wire research

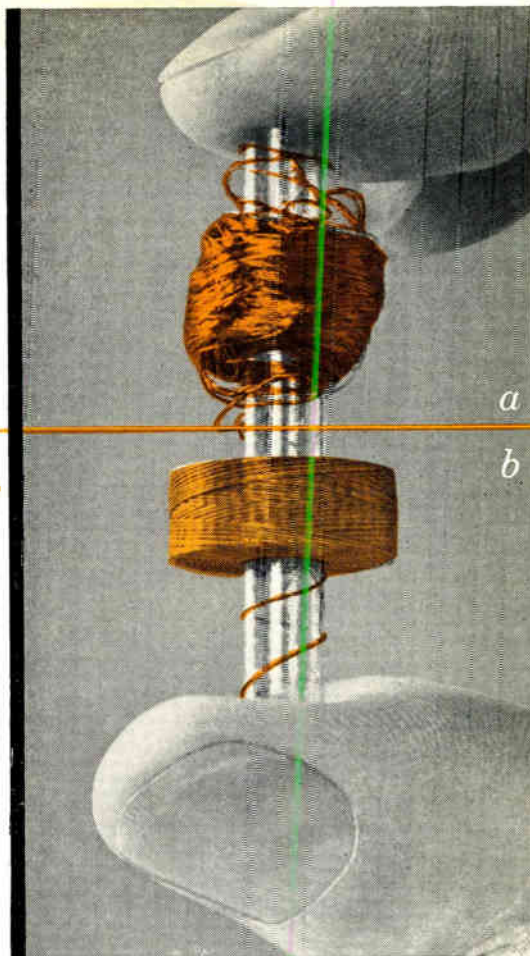

**THE PROBLEM:** To develop a solderable film-coated wire without fabric for winding universal lattice-wound coils without adhesive application.

**THE SOLUTION:** Phelps Dodge Grip-eze—a solderable film wire with controlled surface friction for lattice-wound coils that provides mechanical gripping between turns and keeps wire in place.

**EXAMPLE:** Coils wound with (a) conventional film wire; (b) Grip-eze. Note clean pattern of Grip-eze as compared to fall-down of conventional film wire.

*Any time magnet wire is your problem, consult Phelps Dodge  
for the quickest, easiest answer!*

VISIT OUR BOOTH, NO. 4516-4518, AT THE I.R.E. SHOW, MARCH 18-21

FIRST FOR  
LASTING QUALITY  
—FROM MINE  
TO MARKET!



**PHELPS DODGE COPPER PRODUCTS  
CORPORATION**

**INCA MANUFACTURING DIVISION**  
FORT WAYNE, INDIANA

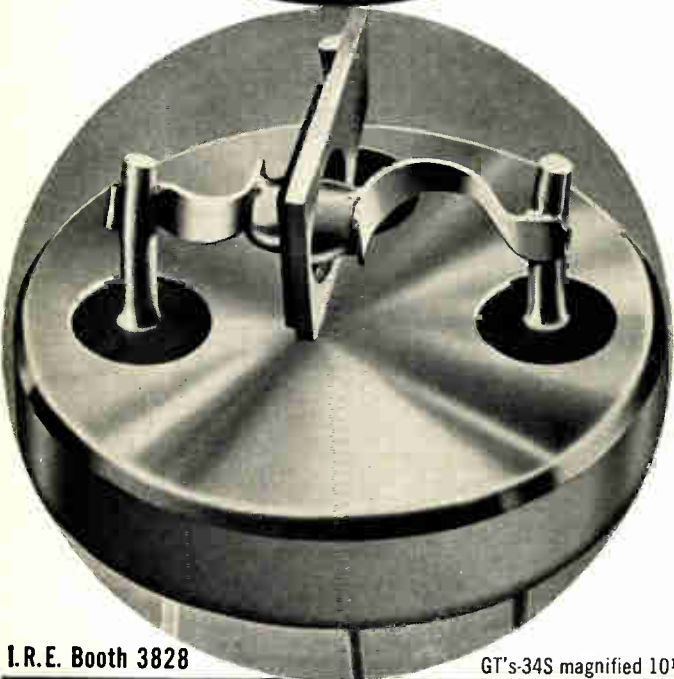
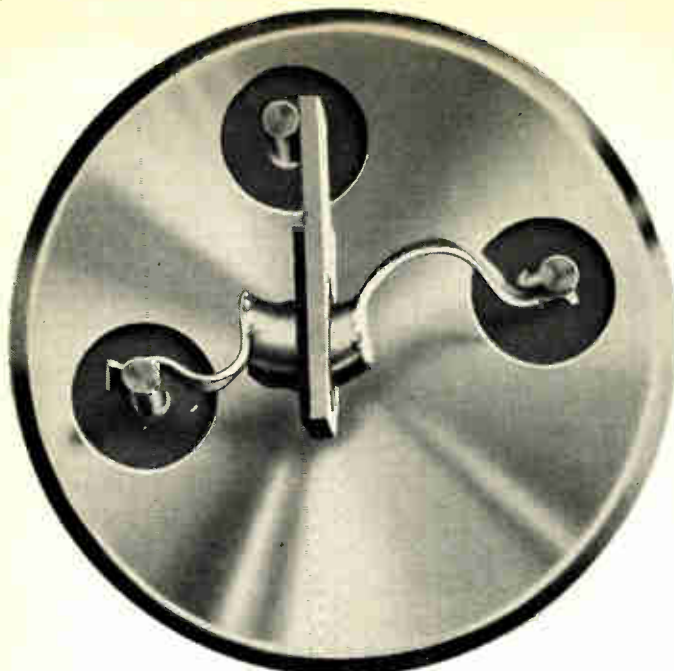

I.R.E. Booth 3828

GT's-34S magnified 10½ times.



# WHEN CAN ONE TRANSISTOR REPLACE 2?

In computer or in other applications where current must be amplified in either direction, you can now specify General Transistor's new GT-34S bi-directional transistor.

As developed by GT, this symmetrical transistor can also be used as a bi-directional switch when placed in series with the load. For greater reliability, to save production time, and for compactness you should examine GT's-34S . . . another reason for General's leadership in the manufacture and development of transistors for computers.

Write for Bulletin GT-34S for complete specifications.

Maximum collector to base voltage	40 volts
Maximum emitter to base voltage	40 volts
Peak current	½ amp.

DC current gain is  $> 10$  when  $I_b = 20 \text{ ma}$ ,  $V_{ce} \leq .3 \text{ V}$ .

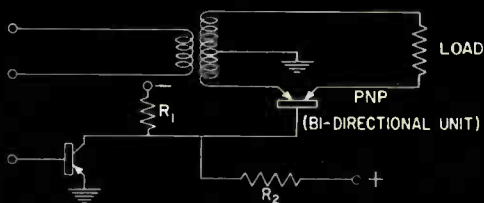

GENERAL TRANSISTOR CORP. 91-27 138th Place, Jamaica 35, N. Y.



OLympia 7-9700

# having your ups and downs?



if they involve EQUIPMENT KNOBS

# DALOHM has the answer!

Precision-made Dalohm knobs, incorporating an exclusive collet-fitting design, permit positive locking on the shaft without any of the damaging effects found in other knob securing methods—even when used on soft metal.

You can depend on



## TYPE K INDUSTRIAL KNOBS

for hard use at high/low temperatures

- Precision cast of thermo-setting plastic in easy grip shapes
- Knobs fit concentrically on shaft and can be positioned easily and accurately
- Pleasing appearance to match modern styling of apparatus
- Five sizes— $\frac{1}{8}$ ", 1-1/16", 1/4", 2/4", 3/4"
- Collets interchangeable for shafts  $\frac{1}{8}$ " to  $\frac{1}{4}$ "
- Highest quality at lowest price
- Standard escutcheons, pointers and indicators available

Write for Bulletin K-29

## TYPE MS MILITARY STYLE KNOBS

in accordance with MIL-K-25049

The incorporation of collet-fitting design into military style knobs offers the ultimate in airborne and other military knob applications.

- Maximum locking pressure on shaft eliminates any slippage from vibration or torque
- Precision made of tough, durable thermoplastic material which is fungus proof
- All metal parts are corrosion resistant
- Designed for flattened shafts
- Complete selection of skirts available as required by
- MIL Specs. Marking of skirts can be to your specific requirements

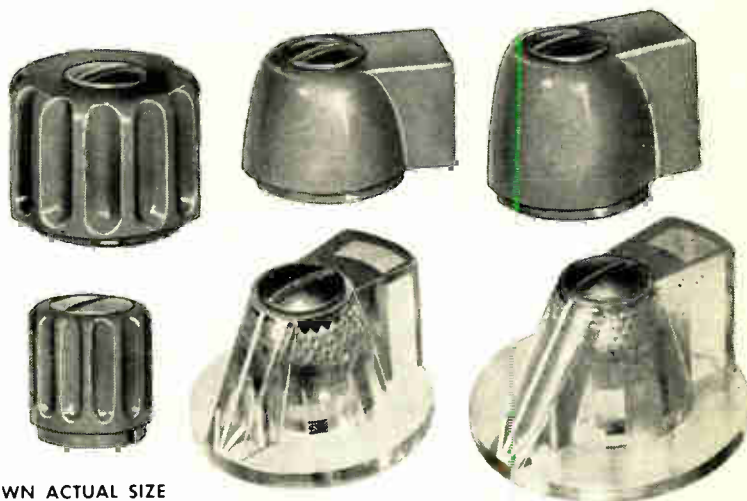

Write for Bulletin K-35

TYPE MS KNOBS SHOWN ACTUAL SIZE

## See It At The I. R. E. SHOW

You can see the complete line of DALOHM precision resistors, potentiometers and collet-fitting knobs, including the products depicted above, at the I. R. E. Show in New York, March 18-21.

You are cordially invited to stop at the Dale Products, Inc. booth, Number 2742-2744. We'll be looking for you.

**DALE  
PRODUCTS  
INC.**

1304 28th Ave.  
Columbus, Nebraska, U.S.A.

• **In Canada:**  
Charles W. Pointon, Ltd.,  
6 Alcina Ave.,  
Toronto, Ont.

• **Export Dept:**  
Pan-Mar Corp.  
1270 Broadway,  
New York 1, N.Y.

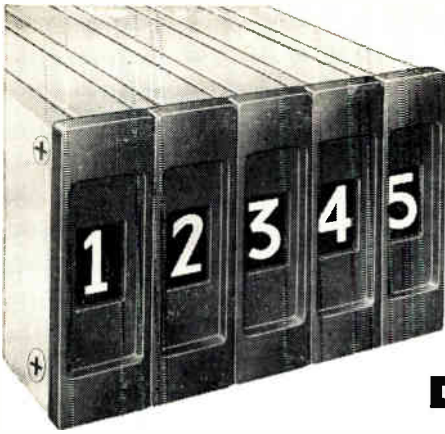

# New

## UNION

### Digital Indicator

**combines data readout  
and storage facilities**

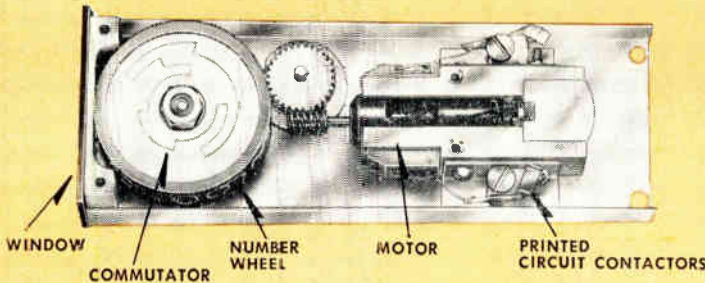
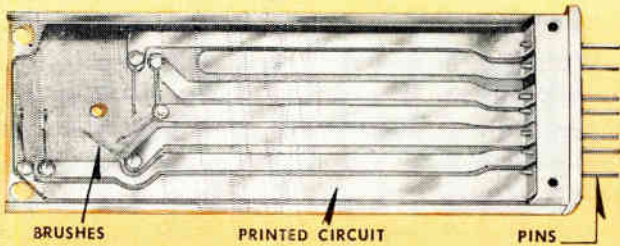

Physical characteristics: Over-all length...  $5\frac{1}{8}$ " , width...  $1\frac{19}{32}$ " , height...  $1\frac{41}{64}$ " , weight... .7 oz., operating time at 24 volts... .08 sec., life expectancy... 1,000,000 operations. Character size...  $\frac{3}{8}$ " x  $\frac{1}{4}$ " .

The new UNION Digital Indicator will satisfy most requirements for data display, either local or remote. It is a companion product to our Alpha-Numerical Data Display Indicator, but occupies only one-half the volume and requires under three watts power.

The ability of the indicator to operate as a storage facility, a readout device, and its inherent non-dissipating storage give it characteristics not to be found in any other indicator of this type.

The indicator is motor-driven and operates on a direct wire basis in response to binary code. The coded

decimal notation was chosen for prototype to demonstrate more familiar uses, but other notations can be used.

A typical application in a pipeline remote control system works like this: Telemetered digital data on temperature and pressure is received at a central station and entered into an intermediate storage. From there it is routed to the appropriate digital indicators for visual display and electrical storage for time programmed input to a telelog printer. Each indicator can store four binary bits and eliminates the use of relays for this purpose. Write for our new Bulletin 1011.

See our exhibit at the I.R.E. Show, Mar. 18-21, Booths 2122-2124.

GENERAL APPARATUS SALES

# UNION SWITCH & SIGNAL

DIVISION OF WESTINGHOUSE AIR BRAKE COMPANY

PITTSBURGH 18, PENNSYLVANIA

## Who Makes It?

Editor: ELECTRONIC INDUSTRIES, We are looking for a zero speed tachometer pickup for use in the continuous process industries. The device must be capable of producing a number of electrical pulses proportional to the input speed over the range from zero to 3000 rpm. Extreme reliability is important because of the high cost of down time in a continuous industrial process. There are no unusual environmental hazards other than dust, dirt and the possibility that explosion-proofing may be required in some applications.

Robert P. Einsel, Industrial Nucleonics, 1205 Chesapeake Ave., Columbus 12, Ohio.

## R-F Shield Design

(Continued from page 74)

R may be zero, positive, or negative, depending on the magnitude of the above ratio being equal, greater, or smaller than unity.

The corrected total reflection =  $R + B$  (algebraic sum) and it can be zero, positive or negative.

B can be zero positive or negative.

$S = R + A + B$  is positive and always greater than zero.

**To find  $Z_w$  for high-impedance fields (electric fields)**

Considering a very short non-resonant dipole, length  $\ll \lambda$

$$Z_w = \frac{E}{H} = \frac{1}{V\epsilon} \times \frac{1 + j\beta r - \beta^2 r^2}{j\beta r - \beta^2 r^2} \quad (4)$$

when  $r \gg \lambda$ ,

$$\text{then } Z_w = \frac{1}{V\epsilon} = 376.7 \text{ ohms} \quad (5)$$

when  $r \ll \lambda$ ,

$$\text{then } Z_w = -j \frac{1}{\omega\epsilon r} \text{ ohms} \quad (6)$$

$$= -j \frac{0.71 \times 10^{12}}{fr_1} \text{ ohms} \quad (7)$$

**To find  $Z_w$  for low-impedance fields (magnetic fields)**

Considering a very small loop, diameter  $\ll \lambda$

$$Z_w = -\frac{E}{H} = V\mu_0 \times \frac{j\beta r - \beta^2 r^2}{1 + j\beta r - \beta^2 r^2} \quad (8)$$

when  $r \gg \lambda$ ,

$$\text{then } Z_w = V\mu_0 = 376.7 \text{ ohms} \quad (9)$$

when  $r \ll \lambda$ ,

$$\text{then } Z_w = +j \omega\mu_0 r \text{ ohms} \quad (10)$$

$$= +j 0.2 \times 10^{-6} fr_1 \text{ ohms} \quad (11)$$

**To find R for plane waves**

By substituting in above formulas and reducing

(Continued on page 120)



**Now...an accomplishment so far reaching it will change the sights of all rectifier users**

**RADIO RECEPTOR'S improved new VACUUM process**

**\* PETTI-SEL**  
*\* High Current Density*  
**Industrial type SELENIUM RECTIFIERS**

*Developed by the famous Siemens Organization of West Germany and now manufactured by Radio Receptor Co. in the U. S. A.*

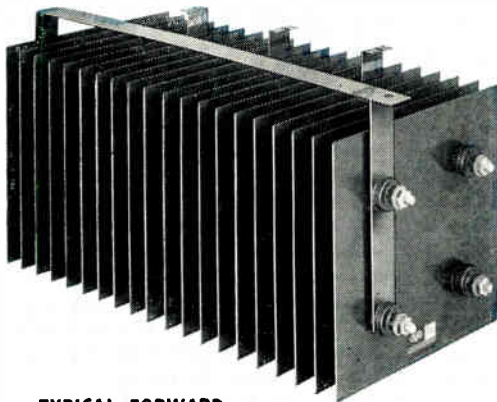

**Estimated life 100,000 hours**

**Much smaller cell sizes than conventional units of the same ratings**

**Lower forward voltage drop**

**Suitable for high temperature applications**

**TYPICAL FORWARD CHARACTERISTICS**

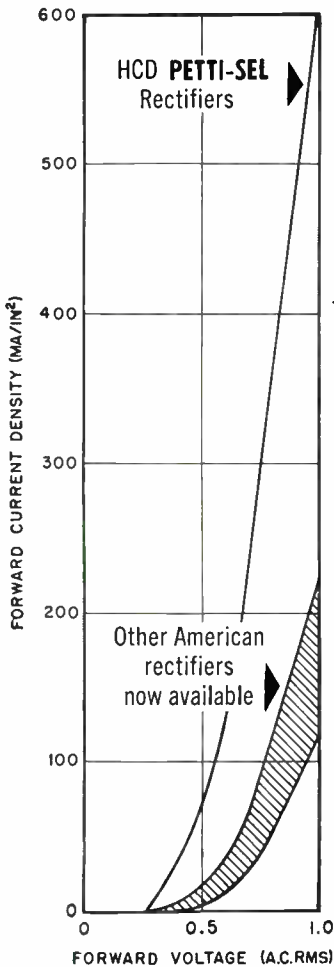

Far smaller in size than other rectifiers of the same current ratings, the new Radio Receptor HCD Petti-Sel units are manufactured under laboratory controlled conditions with fully automatic machinery, assuring new standards of product uniformity.

Field experience extending over several years with these rectifiers indicates an estimated life of 100,000 hours. This is largely attributable to the special process requiring no artificial barrier layer. Low forward voltage drop and low aging rate make the new Petti-Sel Rectifiers applicable to magnetic amplifiers and other control applications.

**TYPICAL AGING CHARACTERISTIC**

Cell size 4" x 4", single phase bridge (4-5-1-B) operated at 130 volts AC input, 8 amperes DC output current, resistive load, 35° C ambient temperature.

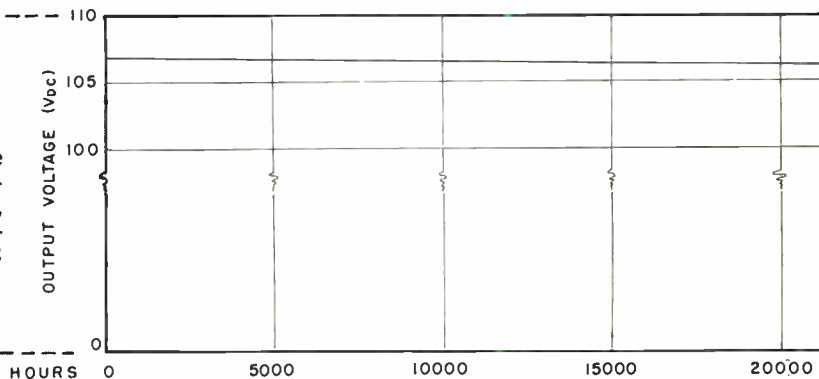

Watch for further announcements of unique developments on these history-making rectifiers. If you would like our new bulletin as soon as it is available, write today to Section T-3-R.

*Semiconductor Division*  
**RADIO RECEPTOR COMPANY, INC.**

*Radio and Electronic Products Since 1922*

240 Wythe Avenue, Brooklyn 11, N. Y. • Evergreen 8-6000

Radio Receptor Products for Industry and Government: Selenium Rectifiers • Germanium Diodes  
 Thermanon Dielectric Heating Generators & Presses • Communications, Radar & Navigation Equipment

# NOW...

## a completely new subminiature paper tubular capacitor

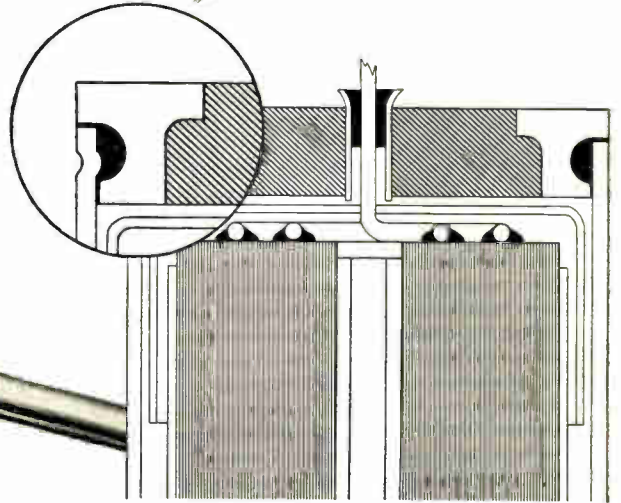
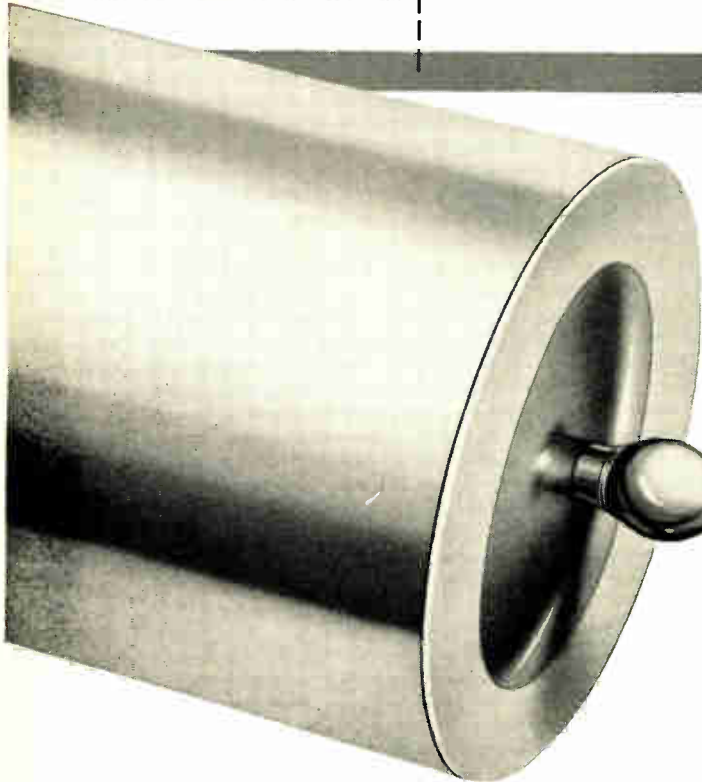
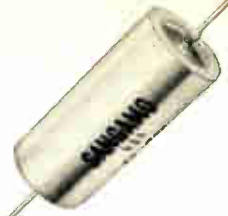

Because the terminal is mechanically retained in the case, independent of the captive solder seal, the new design permits perfect positioning with uniform accuracy.

## Hermetically sealed with Sangamo's new "Innerseal" terminal...for higher reliability...for longer service life

Here is today's latest development in miniaturized military type capacitors—a newly designed terminal for Sangamo subminiatures. This Sangamo engineering development offers many advantages over conventional seals.

The "Innerseal" structure seats and locates itself exactly on the case. Terminals cannot be cocked at angle, extend out of case, or be pushed too deeply into case and cause cupped

ends or section damage. It permits optimum performance and reliability through greater flexibility of internal design.

The solder is confined and automatically sealed. Solder or flux cannot run down inside case to cause life failures due to contamination. There are no cracked terminals due to solder time variation.

Write for full information—ask for Engineering Bulletin SC 57-3, or

**SEE THIS NEW CAPACITOR AT THE I. R. E. SHOW  
VISIT SANGAMO BOOTH 1213**

SC57-3

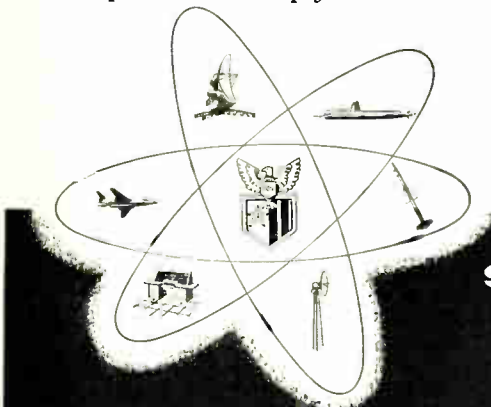

**SANGAMO ELECTRIC COMPANY**  
*Electronic Components Division*  
SPRINGFIELD, ILLINOIS

# ALL VIDEO TRANSMISSION TEST

## STANDARDS in a suitcase



The Original Full Foot and the Portable Unit Produce the same Precise Test Signals.



**TELECHROME**  
INCORPORATED

### Model 1003-B

Video Transmission Test Signal Generator

- ★ Completely self contained ★ Portable
- ★ Multi-frequency burst ★ Stairstep ★ Modulated stairstep
- ★ White window ★ Composite sync ★ Regulated power supply.

New, Telechrome Video Transmission Test Equipment is available as a completely portable 12 1/2" handle-in-hand mounting unit.

Everyday these Test Signals generated by Telechrome equipment, are transmitted Coast-to-Coast by ABC, CBS, ABC, The Bell System, Canadian Bell and leading independent TV stations throughout the U.S. and Canada. Hundreds of network affiliated TV stations and telephone TV centers thus check incoming video signals.

The compact, responsive, portable Model 1003-B is all that is required to generate signals for local and remote performance checking of your entire video, cable, or microwave facilities.

#### DELIVERY 30 DAYS

Literature on the above and more than 100 additional instruments for monochrome and color TV by TELECHROME are available on request.

The Nation's Leading Supplier of Color TV Equipment

28 Remick Drive Amityville, N. Y.  
Lincoln 3-3600

See Our Interesting Exhibit  
Booth 1701 IRE Show

**TELECHROME**  
INCORPORATED

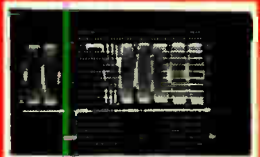

**MULTI-FREQUENCY BURST AMPLITUDE vs FREQUENCY.**  
Check wide band coaxial cables, microwave links, individual units and complete TV systems for frequency response characteristics without point to point checking or sweep generator.

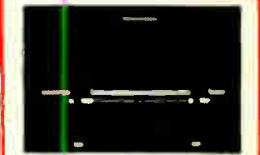

**WHITE WINDOW LOW & HIGH FREQUENCY CHARACTERISTICS.** Determine ringing, smears, steps, low frequency tilt, phase shift, mismatched terminations, etc. in TV signals or systems.



**STAIRSTEP SIGNAL** modulated by crystal controlled 3.579 mc for differential amplitude and differential phase measurement. Checks amplitude linearity, differential amplitude linearity and differential phase of any unit or system. Model 1003-C includes variable duty cycle stairstep (10-90% average picture level).

Model 608-A HI-LO CROSS FILTER for Signal analysis.



**MODULATED STAIRSTEP** signal thru high pass filter. Checks differential amplitude.

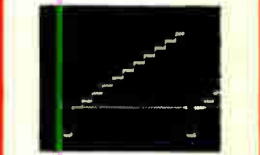

**MODULATED STAIRSTEP** signal thru low pass filter. Checks linearity.



TS2-A OSCILLOSCOPE CAMERA—Potentiometer type for instantaneous 1 to 3 inch photo-recording from any 5" oscilloscope.



TS2-A VIDEO TRANSMISSION TEST SIGNAL RECEIVER for precise differential phase and gain measurements. Compare for use with 1003-B.

*Best  
Value  
in all-  
purpose  
scopes*

WESTON Oscilloscopes, and other Weston test equipment, are available through local distributors. For complete information, write Weston Electrical Instrument Corp., Newark 12, N. J.—A subsidiary of Daystrom, Incorporated.

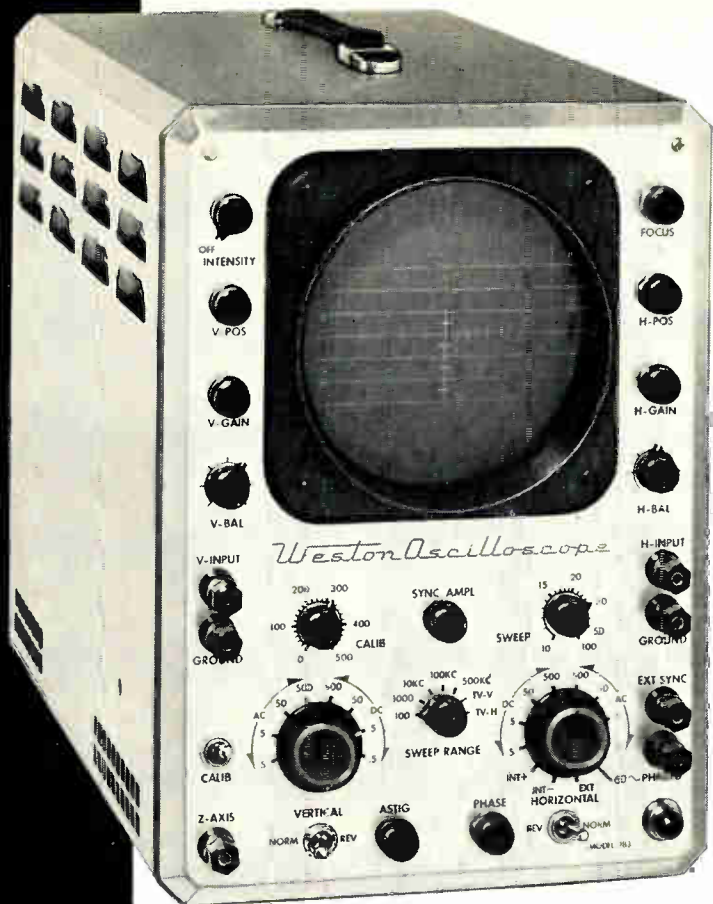

## WESTON OSCILLOSCOPE

- identical vertical and horizontal amplifiers, D-C and A-C coupled.
- 4.5 mc band width (for color)
- 15 mv sensitivity
- normal or flat faced tubes (high intensity)
- Z-axis modulation
- 3X horizontal sweep expansion
- identical phase shift to 1 mc—can be adjusted up to 6 mc
- etched circuit construction
- ease of calibration
- polarity reversal switch
- only \$395.50 (with flat faced tube \$430.50)

**WESTON**  
*Instruments*



SPOT WRITING RATE:

**FASTER**  
THAN  
THE  
**SPEED**  
OF  
**LIGHT**

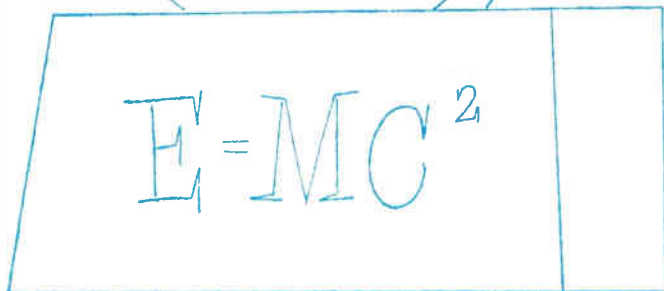

Developed to meet the precise needs of nuclear research and investigation, the Du Mont Type K1409 cathode-ray tube develops a spot writing rate exceeding the speed of light.

This is another example of the "can do" spirit and ability of the Du Mont Tube Research Laboratory.

For cathode-ray tubes, or multiplier phototubes of unusual abilities, call on Du Mont's "can do" . . .

**DU MONT**<sup>®</sup>

INDUSTRIAL TUBE SALES,  
**ALLEN B. DU MONT LABORATORIES, INC.**  
2 MAIN AVE., PASSAIC, N. J.

**99.07%**

**ENGINEERS  
AND  
DESIGNERS**

**STAY WITH**

**AC**

**THE ELECTRONICS DIVISION  
GENERAL MOTORS**

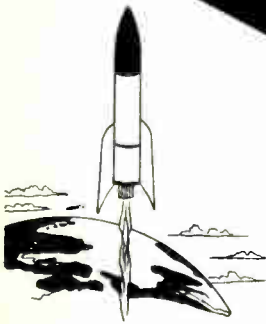

**Pioneering Opportunities in the Following Fields!**

- Missile Guidance
- Avionics
- Automotive-Aviation Electronic Products
- Computers
- Jet Engine Fuel Controls

AC turn-over figures are amazing. Less than 1%! Speaks highly for the advancement opportunities, working conditions and wages we pay our Engineers and Designers. It's been that way for years at AC. That's why we are so proud of and why you should investigate your Better Future at AC by writing

G. M.'s long-standing policy of decentralization creates unlimited opportunities for qualified Electrical, Mechanical Engineers and Designers. Masters Degree Program available at University of Wisconsin, Milwaukee to all eligible AC Engineers. Arrange a personal confidential interview in your locality by writing

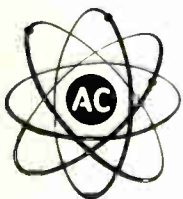

For Employment Application  
Mr. Cecil E. Sundeen, Supervisor of Technical Employment

**AC the ELECTRONICS DIVISION  
GENERAL MOTORS CORPORATION**

Flint 2, Michigan

Milwaukee 2, Wisconsin

(Continued from page 114)

$$R = 108.2 + 10 \log_{10} \frac{G \times 10^6}{\mu f} \quad (12)$$

**To find R for magnetic fields**  
By substituting in above formulas and reducing

$$R = 20 \log_{10} \left[ \frac{0.462}{r_1} \sqrt{\frac{\mu}{Gf}} + 0.136r_1 \sqrt{\frac{Gf}{\mu}} + 0.354 \right] \quad (13)$$

**To find R for electric fields**  
Similarly,

$$R = 353.6 + 10 \log_{10} \frac{G}{f^2 \mu r_1^2} \quad (14)$$

**To find A**

$$A = 3.338 \times 10^{-3} \times t \sqrt{fG\mu} \quad (15)$$

**To find B**

$$B = 20 \log_{10} \left| 1 - \left( \frac{Z_s - Z_w}{Z_s + Z_w} \right)^2 \times e^{-2(\alpha + j\beta)T} \right| \quad (16)$$

$$= 20 \log_{10}$$

$$\left| 1 - \left( \frac{Z_s - Z_w}{Z_s + Z_w} \right)^2 \times \frac{1}{\frac{\Lambda}{10^{10}}} \times \right.$$

$$\left. \left( \cos 7.68 \times 10^{-4} t \sqrt{f\mu G} - j \sin 7.68 \times 10^{-4} t \sqrt{f\mu G} \right) \right| \quad (17)$$

**If A is more than 10 db, then B becomes negligible.**

**Calculated Data**

Established formulas for shielding effectiveness were used to obtain the calculated data from 60 cps to 10,000 MC given in Tables 1 through 7 and graphically presented in Fig. 1. The ordinates for curves (1), (2), and (8) below 10 KC in Fig. 1 were too small to be properly represented graphically and they should be obtained from the tables.

For other distances, corrections must be made by using the established formulas given above. If the distance is much less than 12 in., the reflection loss to magnetic fields will be smaller and the reflection loss to electric fields greater. Fields inside the shielded enclosure may be as close as 1 in. away, while fields outside the shielded enclosure are usually at a distance of 12 in.

In practically all cases, the total shielding effectiveness is greater than the absorption, or penetration, loss alone. Despite this, many de-

(Continued on page 161)

SHIELDING'S *Universal* ENCLOSURE  
PROVIDES MAXIMUM SHIELDING EFFECTIVENESS  
. . . FOR COMPLYING WITH ALL APPLICABLE  
MILITARY SPECIFICATIONS.

# R. F. *interference* SUPPRESSED

Shielding has the practical solution to all your electro-magnetic suppression problems — the Shielding Universal Enclosure. Multi-Cell® design features either single or double shielding in cell or isolated type enclosure . . . interchangeable standard panels of solid and/or mesh material . . . a wide variety of enclosure sizes both standard and custom-built. A complete test report, performed by independent consulting engineers in accordance with military specifications, has just been completed — evaluating designs and different types of material used. For your copy of this report and the new Shielding folder giving all design details, write today to:



## SHIELDING, INC.

11 RESERVE STREET RIVERSIDE, NEW JERSEY

SALES OFFICES

CHICAGO — R. EDWARD STEMM

DENVER — WILLIAMS & ASSOCIATES

LOS ANGELES — CARL A. STONE ASSOCIATES, INC.

PORT WORTH — MITCHELL SPEARS COMPANY

CANADA — HJB ELECTRONICS SALES LTD., MISSISSAUGA, ONTARIO

# IMC...DYNAMOTORS

## for MISSILES and TELEMETERING

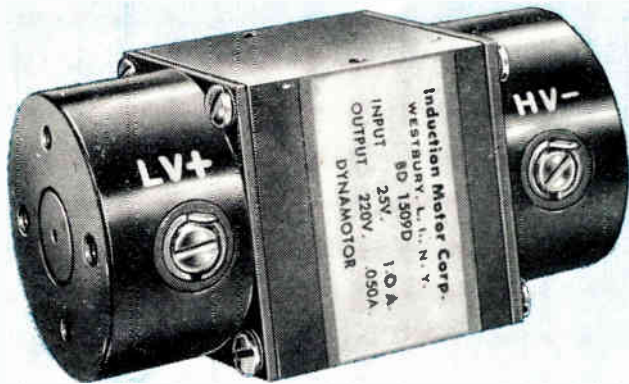

Induction Motors Corp. has developed another new dynamotor series to meet increasingly critical missile and telemetering requirements. The 1500 Frame DC series is designed for applications where light weight, compactness, high reliability and exceptional resistance to vibration and shock are essential.

The BD 1509D shown meets military specifications with regard to resistance to corrosion, salt spray, sand and dust, and other environmental influences.

### SPECIFICATIONS • BD1509D

**SIZE:** 1½" x 1½" x 3".

**POWER OUTPUT:** 10 w continuous; up to 25 w, depending on duty cycle and cooling.

**WEIGHT:** 1 lb.

**LIFE:** 100 hrs. brush life at 50,000 ft.

**AMBIENT TEMPERATURE RANGE:** -40°C to + 71°C standard.

**VIBRATION:** 3 g's from 5-600 cps along 3 mutually-perpendicular axes.

**CENTRIFUGE:** 30 g's in any direction.

**MECHANICAL SHOCK:** 40 g's in any direction.

Other units in the new 1500 Frame DC series are available in varying voltage outputs to meet a wide range of humidity, temperature, vibration or altitude requirements. Motor design and application consulting service available on request.



Visit our exhibit — Booth 2229 at the Radio Engineering Show  
**Induction Motors Corp.**  
 570 Main St., Westbury, L. I., N. Y. Phone EDgewood 4-7070

Circle 134 on Inquiry Card, page 103

## Resistor Reactance

(Continued from page 80)

erator with a repetition rate of 2 KC is used to drive the resistor under test.

A carbon resistor of relatively small value is placed in series with the test resistor. The voltage appearing across this carbon resistor is fed to a wide band oscilloscope. The value of the carbon resistor selected is kept very low so that the current in the series circuit and the resultant deformation of the pulse are controlled by the parameters of the precision resistor only.

Typical waveforms that are obtained from resistors of various values with differing reactances are shown in Figs. 3 to 8. Fig. 4 shows a resistor of medium value (25K) which has both inductance and capacitance and is well balanced. The current flowing in the circuit is controlled by 3 elements—the input waveform which has a rise time of approximately 0.03 μsec., the initial surge current due to the shunt capacitance, and the delayed rising current caused by the resistance and inductance in series. This re-

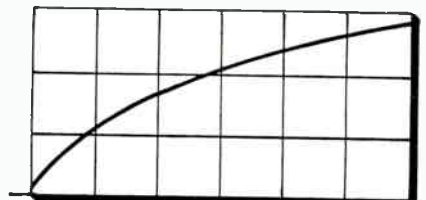
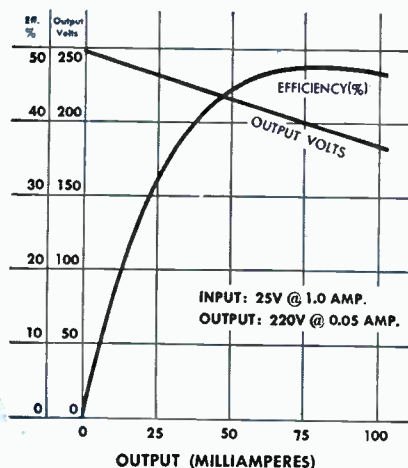

Fig. 5: A completely inductive low value resistor takes an increasing current shape.

sistor is still predominantly inductive in nature with a rise time constant (to reach 63.2% of rated current) of 0.1 μsec. From this information the actual inductance can easily be computed. The capacitance is more difficult to calculate but it can be measured as a function of the surge current in conjunction with a precision variable capacitor.

### Considerations

There are two cases to be considered. The first, Fig. 4, is a basically inductive resistor. This condition is fulfilled if after the initial surges the current is still rising to its final steady state value. If after the initial surge, the current is decaying to its final value, Fig. 3,

(Continued on page 128)



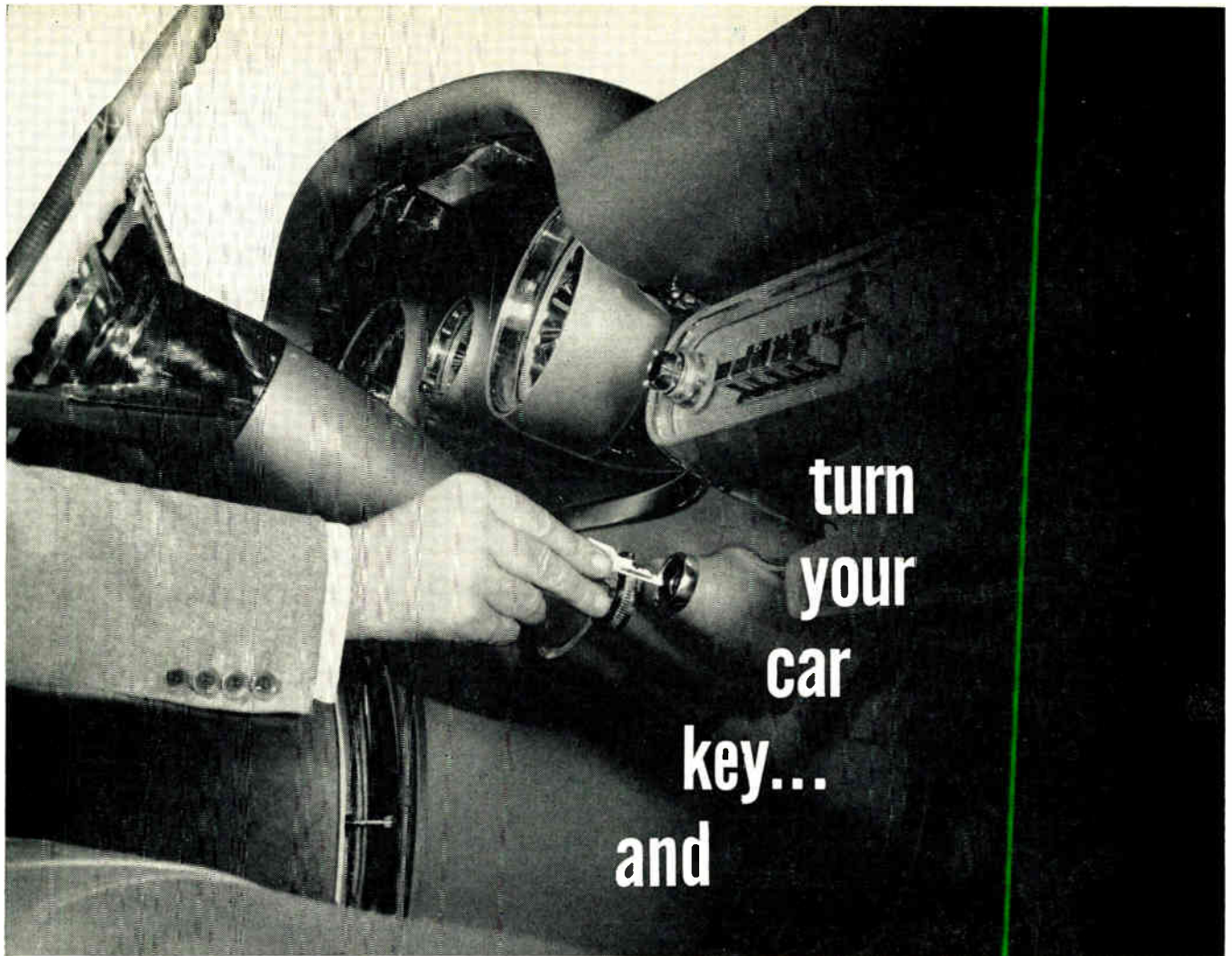

turn  
your  
car  
key...  
and

## Synthane laminated plastics report for work

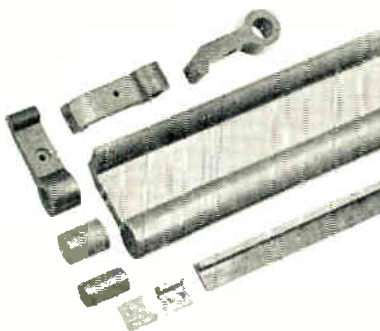

Breaker Arms for tractors and outboard motors are cut from lengths of molded laminated. Breaker arm bushings and rubber angles are important ignition components.

A turn of the ignition key and the thousands of parts which make up your car go to work as a team. Under the dash or under the hood are dozens of parts made of Synthane laminated plastics. They may seem insignificant but they're as necessary as an owner's license.

Take away Synthane laminated plastics and you have a car that won't start, a generator that won't run, lights that won't light, or a silent radio or motionless fan—which may give you some idea of the importance of a product like Synthane in the automotive industry.

Synthane laminates are excellent electrical insulators—they resist moisture—smile at oil—are easy to machine and mechanically strong. Synthane laminated plastics are available in sheets, rods and tubes or as parts completely fabricated to your designs and specifications.

For more information about the many properties of Synthane laminated plastics and how you can benefit by using Synthane materials and fabricating services, write for our latest product catalog. Synthane Corporation, 11 River Road, Oaks, Pa.



EASILY MACHINED



DIELECTRIC STRENGTH



OIL RESISTANCE



DIMENSIONAL STABILITY

**SYNTHANE** ... industry's unseen essential.

SYNTHANE CORPORATION, 11 RIVER ROAD, OAKS, PA.

**NEW LATCHING SUB-MINIATURE RELAYS**

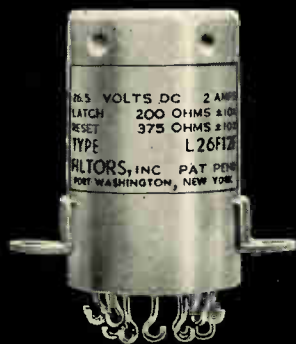

**SMALLEST —  
LIGHTEST**

BURTON BROWNE/New York

**EXCLUSIVE**  
WITH FILTORS, INC.

*By Filtors,  
smallest and lightest  
hermetically sealed latching  
sub-miniature relays,  
magnetically held—  
no power drain—  
and electrically reset.  
2PDT, 4PDT and 6PDT*

*High shock and vibration  
resistance.*

*All made to  
MIL-R-25018 (USAF)  
and MIL-R-5757C.*

*Dry circuit relays available*

*Write for catalog*

*Leading manufacturers of  
hermetically sealed  
sub-miniature relays.*

**FILTORS, INC.**

*Port Washington,  
Long Island, New York.  
Port Washington 7-3850*

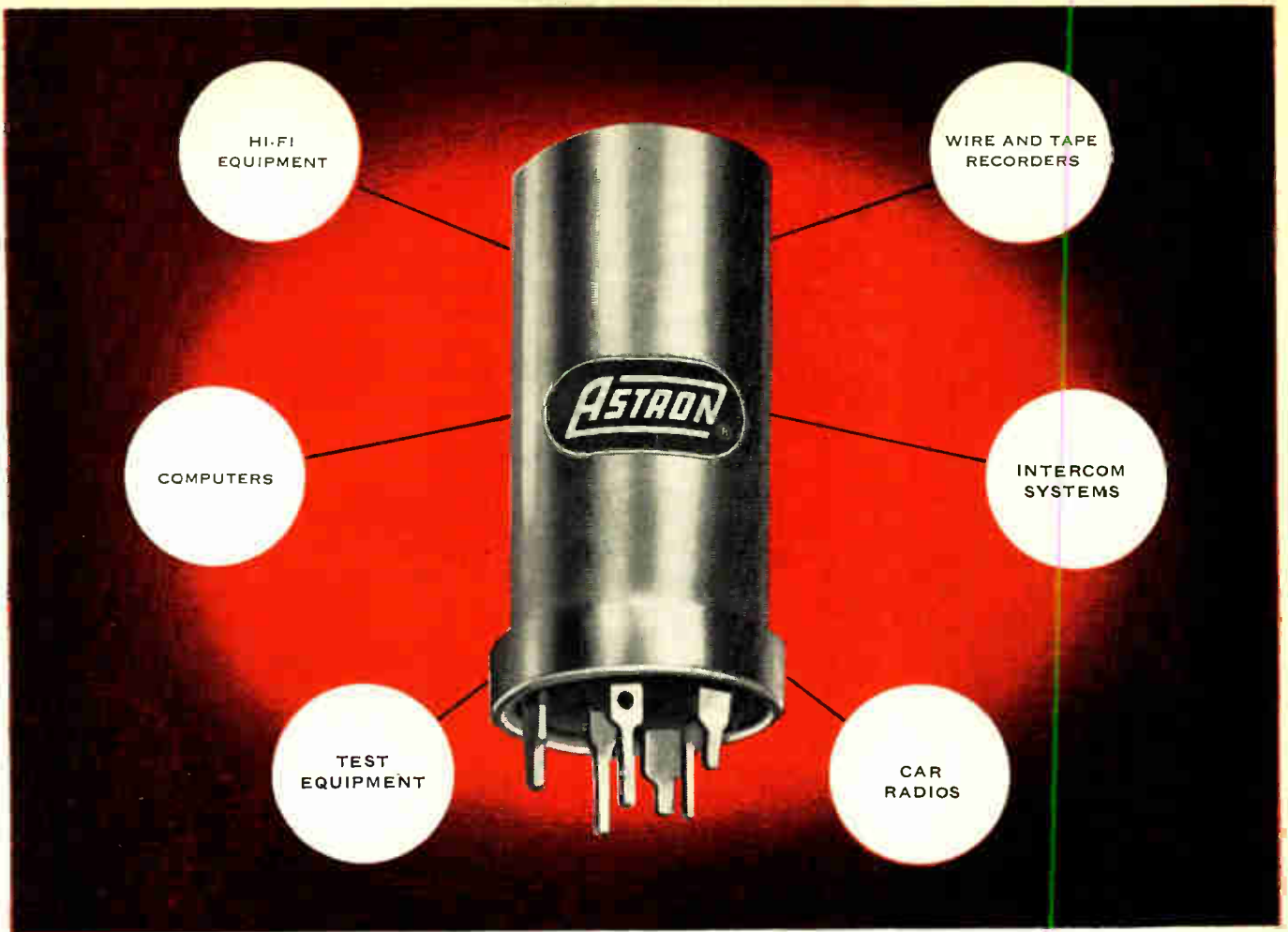

ASTRON 'SAFETY MARGIN' \*

## ELECTROLYTIC CAPACITORS

# for transistorized and printed circuits

### IMPORTANT DESIGN ADVANTAGES OF

#### ASTRON EZ AND EX ELECTROLYTICS

- \* MINIATURIZED SIZE—LIGHT IN WEIGHT
- \* DESIGNED FOR MINIMUM LOSSES —  
LOW DRAIN
- \* LONG "SHELF" AND OPERATING LIFE
- \* HERMETICALLY SEALED
- \* RUGGEDLY CONSTRUCTED

Today's low-voltage transistorized and printed circuits demand capacitors with absolute minimum leakage and impedance. To meet these exacting needs, Astron Engineers developed new miniaturized EZ and EX Electrolytics for ambient operation up to 85° C.

99.99% pure aluminum foil is specially anodized by an exclusive process . . . power drain is cut to a minimum. They are constructed to withstand extreme temperature changes and give reliable operation after periods of "long idleness."

Each electrolyte formula is scientifically compounded of special chemicals, selected for their high purity. Assembly steps are kept meticulously clean . . . the result: Safety Margin Construction, famous for its ability to withstand ripple currents, vibration, shock and wide temperature fluctuations. These hermetically sealed units are available in a broad selection of capacitance and voltage ratings.

Send today for further technical information . . . please describe your application; it helps us offer proper assistance to you . . . when special conditions require, we will design a prototype to meet your specifications.

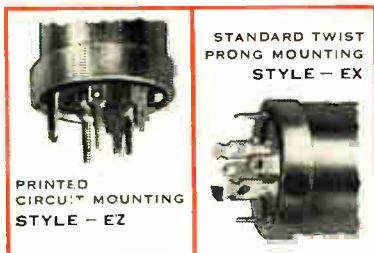

PRINTED  
CIRCUIT MOUNTING  
STYLE - EZ

STANDARD TWIST  
PRONG MOUNTING  
STYLE - EX

\*Trade-Mark

WEST COAST WAREHOUSE: 9041 WEST PICO BLVD., LOS ANGELES—EXPORT DIVISION: ROCKE INTERNATIONAL CORP., 12 EAST 40TH ST., N. Y., N. Y.—IN CANADA: CHARLES W. POIRTON, 6 ALCENA AVE., TORONTO, ONTARIO

Be sure to see us at Booth 2927, IRE Show

ELECTRONIC INDUSTRIES & Tele-Tech • March 1957

Circle 137 on Inquiry Card, page 103

125

**ASTRON**  
CORPORATION  
255 GRANT AVENUE EAST NEWARK, N. J.



ELECTRONICS CORPORATION  
A wholly owned subsidiary  
of ASTRON CORPORATION  
PECKVILLE, PENNSYLVANIA

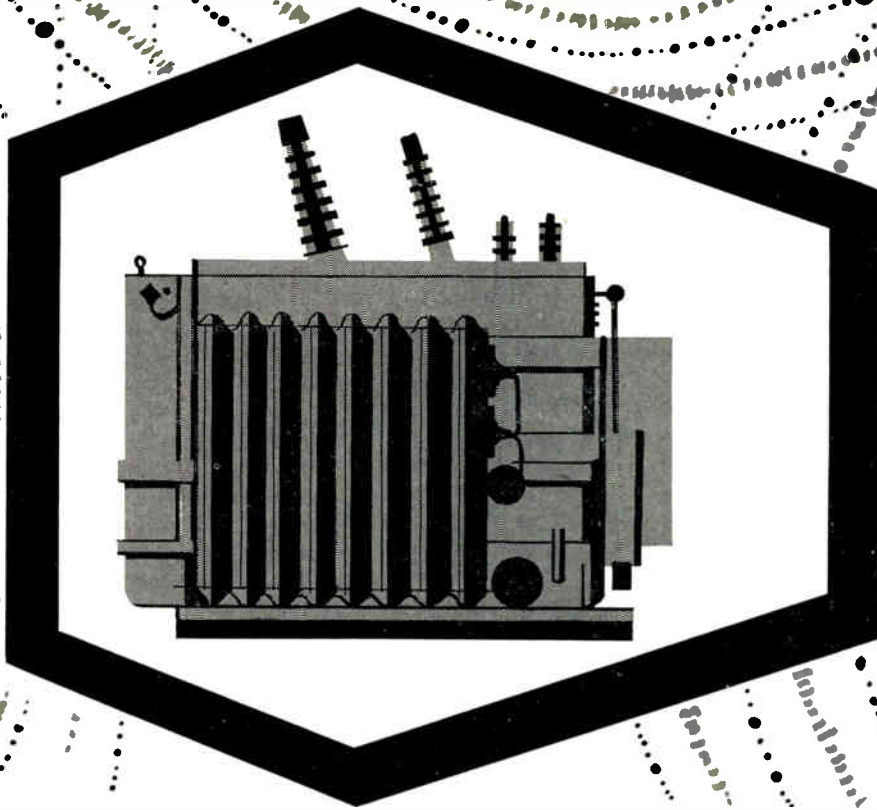

## how Westinghouse stretches transformer life through R-F studies in ACE enclosure

R-F interference which often occurs in power transformers comes under strict regulation by both the FCC and military authorities. Standardized tests have been set up to check this interference against allowable limits. But at Westinghouse Electric Company's new Transformer Test Center at Sharon, Pa., engineers go on to use these measurements of radio frequency to actually improve the life of transformers.

When r-f generation occurs in a transformer, it releases ionized gasses which have a deleterious effect on the transformer windings. Reducing, or eliminating the cause of gas ionization, indicated by the generation of r-f interference, greatly increases transformer life.

To make the accurate radio frequency measurements required, both the transformers and the delicate test instruments must be isolated from all sorts of outside radiations. A large Ace shielded enclosure—measuring 28 feet long, 32

feet wide, and 25 feet high—fulfills this requirement by providing a guaranteed attenuation of over 100 db for all frequencies from 14 kc to 1000 mc.

This Ace enclosure is constructed of prefabricated galvanized steel panels and frames (RFI-Design)\* which assures permanent warp-free protection. A unique feature of the enclosure is its 16- by 20-foot electrically operated vertical lift door. Air-operated contact fingers around the periphery completely seal the door against r-f leakage.

This example of Ace enclosures for r-f shielding is just one of the many "rooms" Ace has designed and supplied to meet the requirements of industry, military, and medical work. If you have a shielding problem in your plant, an Ace Engineer would be glad to discuss it with you and outline an effective, yet economical solution. Or write for a free catalog on Ace standard enclosures.

\*Lindsay Structure



**First and Finest in Shielded Enclosures**

ACE ENGINEERING & MACHINE CO., INC. 3644 N. Lawrence St. • Phila. 40, Pa.

SEE US AT THE I.R.E. SHOW — BOOTH 1727

*Rugged E-I Compression Seals* are the industry's standard for superior performance in commercial and military service. Practically indestructible, they provide the maximum immunity to shock, vibration and temperature changes.

Available in miniature or sub-miniature types, these super-dependable hermetic seals are supplied in economical standard types to meet practically any sealing requirement.

**Keyed to  
your electronic  
future...**

# E-I GLASS-TO-METAL SEALS\*

For complete information on the E-I line or recommendations on particular requirements, call or write:

## ELECTRICAL INDUSTRIES

44 SUMMER AVENUE, NEWARK 4, N. J.



*\*Patents Pending—all rights reserved*



**Single Lead Terminals**—Available in standard or custom designs.



**Plug-in Connectors**—for vibrator, chopper, lock-in and noval sockets.



**Transistor Closures**—Standard sealed bases, cans and diode closures available.



**Multiple Headers**—for every hermetic sealing requirement.

*See us at the I.R.E. Show!  
Booths 2526-2528*

# To the engineer capable of original thinking...

Highly accurate AiResearch electronic amplifier used in precision analogue computer networks. Built to withstand 50 G's vibration, has over 20 megohm input impedance and less than 1 ohm output impedance.

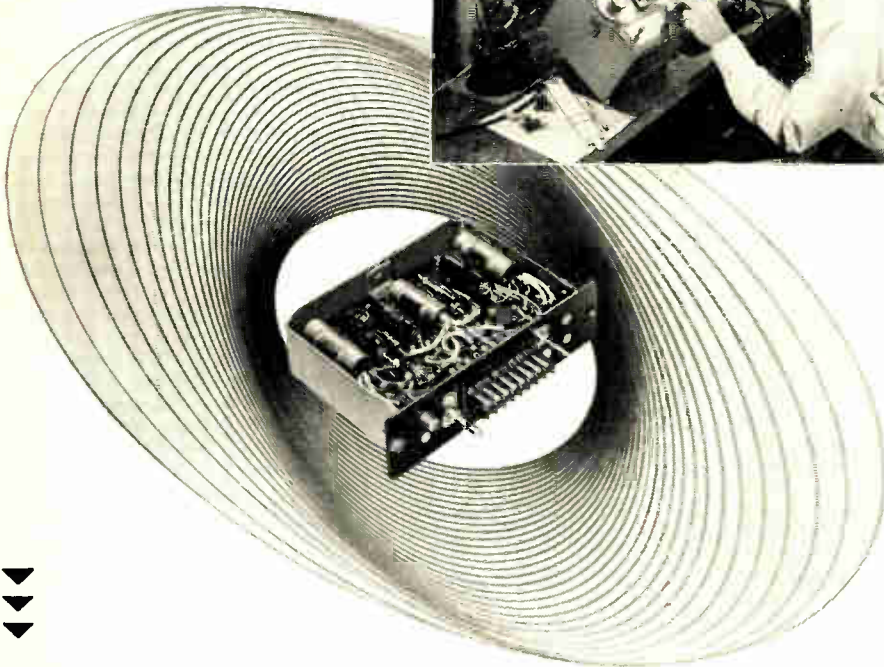

(Continued from page 122)  
the resistor can be considered basically capacitive.

For an inductive resistor, the capacitance is proportional to the height from the top of the surge current curve (A) to the bottom of that section of the curve (B). For a capacitive resistor the capacitance is proportional to the height

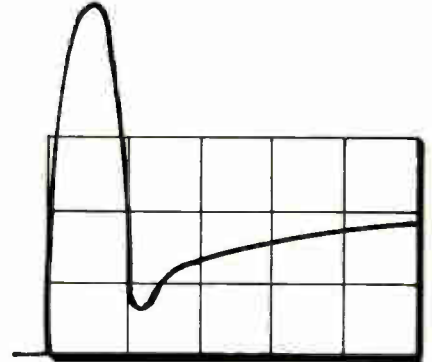

Fig. 6: Resistor has same value as that in Fig. 4; increased inductance and capacitance have consequently increased the rise time.

from the top of the surge current curve (C) (Fig. 3) to the steady state line (D).

Fig. 6 shows a resistor of the same value with increased inductance and capacitance and a consequently increased rise time. In Figs. 3 and 5 two extremes are shown, highly capacitive high value and completely inductive low value.

Fig. 7 shows a high value resistor that has a controlled low capacitance with a low rise time. Fig. 8 shows a resistor with a fixed

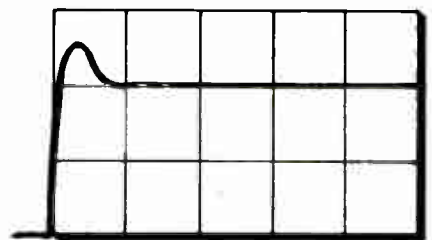

Fig. 7: A controlled low capacitance high value resistor is reflected by low rise time.

inductance that has its shunt capacitance increased by stages.

### Flexibility

As can be seen from these various curves, there is a great deal of flexibility in controlling all the reactive elements of a precision wire wound resistor. For a given value of resistance, it is possible to vary and adjust both the inductance and capacitance over an extremely wide range. This is becoming increas-

(Continued on page 130)

The Garrett Corporation has built an outstanding reputation for pioneering because of engineers whose minds are not shackled to the past... or even the present. We concentrate on the future.

If you're the sort of engineer to whom an obstacle is only a challenge, you'll be interested in working with us. You'll have the finest research and laboratory facilities at your disposal... have your choice of location among the Los Angeles, Phoenix and New York areas.

All modern U.S. and many

foreign aircraft are Garrett equipped. We have pioneered such fields as refrigeration systems, pneumatic valves and controls, temperature controls, cabin air compressors, turbine motors, gas turbine engines, cabin pressure controls, heat transfer equipment, electro-mechanical equipment, electronic computers and controls.

We are seeking engineers in all categories to help us advance our knowledge in these and other fields. Send resume of education and experience today to: Mr. G. D. Bradley



9851 S. SEPULVEDA BLVD., LOS ANGELES 45, CALIFORNIA

DIVISIONS:

AIRESEARCH MANUFACTURING, LOS ANGELES • AIRESEARCH MANUFACTURING, PHOENIX

AIRESEARCH INDUSTRIAL • REX • AERO ENGINEERING

AIRSUPPLY • AIR CRUISERS • AIRESEARCH AVIATION SERVICE

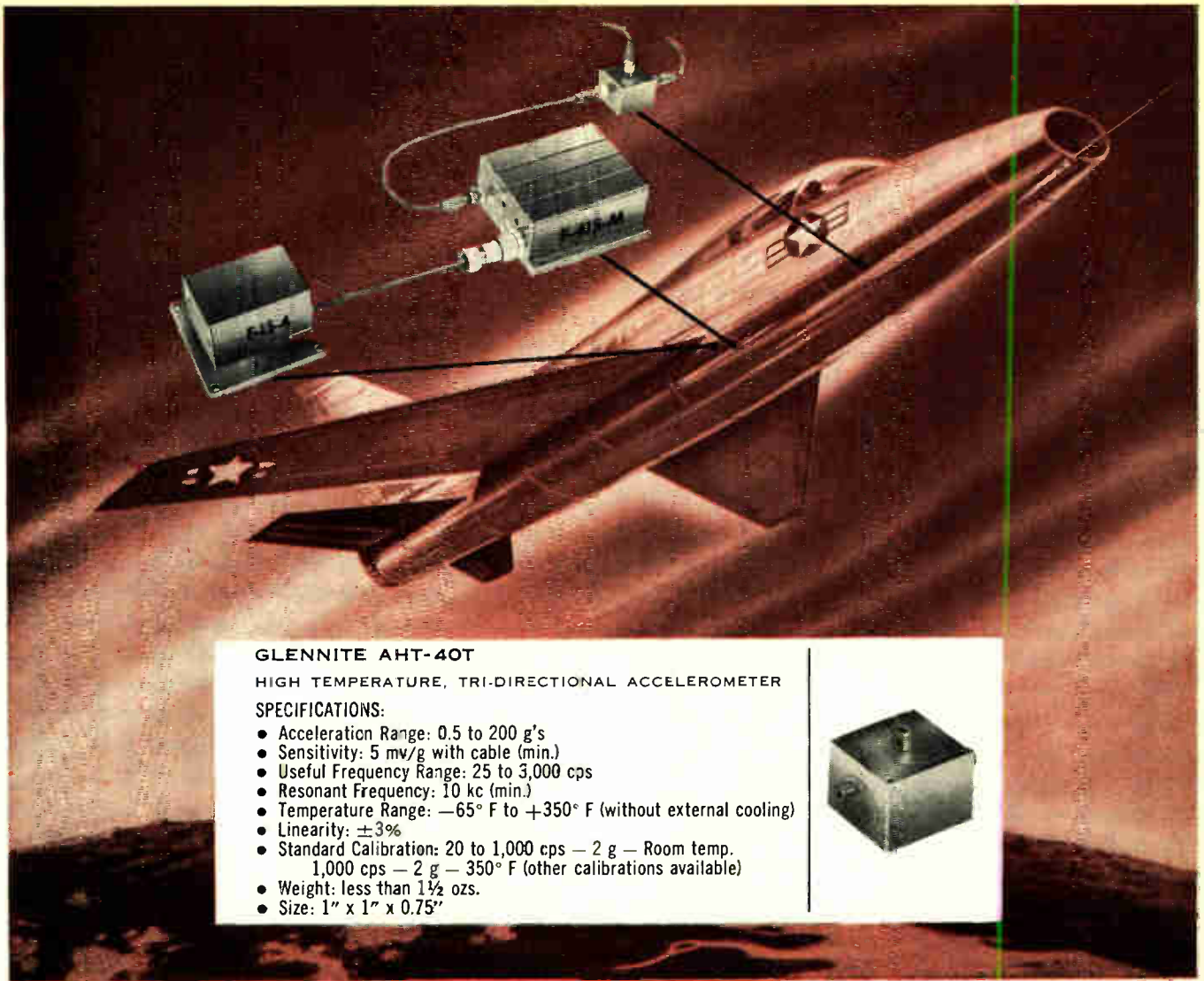

**GLENNITE AHT-40T**

HIGH TEMPERATURE, TRI-DIRECTIONAL ACCELEROMETER

**SPECIFICATIONS:**

- Acceleration Range: 0.5 to 200 g's
- Sensitivity: 5 mv/g with cable (min.)
- Useful Frequency Range: 25 to 3,000 cps
- Resonant Frequency: 10 kc (min.)
- Temperature Range: -65° F to +350° F (without external cooling)
- Linearity: ±3%
- Standard Calibration: 20 to 1,000 cps - 2 g - Room temp.  
1,000 cps - 2 g - 350° F (other calibrations available)
- Weight: less than 1½ ozs.
- Size: 1" x 1" x 0.75"



THE DESIGN ENGINEER'S CHOICE . . .

**GLENNITE® TRI-DIRECTIONAL ACCELEROMETERS**

And it's a choice more and more engineers are making every day. Because when they specify GLENNITE they're selecting from a most complete line of dependable units . . . wide-range piezoelectric, variable reluctance, potentiometer, differential transformer styles . . . with uni-directional or tri-directional designs . . . in regular, intermediate or high temperature ranges . . . precision components and instruments that custom-fit your most exacting requirements.

Prominent among these valuable designs are GLENNITE miniaturized tri-directional accelerometers, specially created to save all-important space and weight. These versatile units simultaneously measure three mutually perpendicular accelerations. The system illustrated above consists of a GLENNITE AHT-40T High Temperature, Tri-Directional Accelerometer with matching

F-415M Airborne Amplifier and F-15-4 Filter . . . all connected with GLENNITE High Temperature, Low-Noise Cables and Sub-miniature Connectors.

GLENNITE AHT-40T Accelerometers are bender-type, case isolated instruments that operate reliably up to +350° F without external cooling, and under severe environmental conditions. Their rugged design adapts them to impact measurements where violent changes in speed and atmosphere are encountered or for measurements of structural member vibration.

As an aid to better designing we have prepared further technical information about many GLENNITE environmental test instruments and associated systems. It is given in Catalog 257; send for your copy.

FROM RAW MATERIALS TO COMPLETE SYSTEMS . . .

**Gulston Industries, Inc.**

METUCHEN, NEW JERSEY



GULSTON INDUSTRIES, INC.

Be sure to see us at Booth 3031-2

©NTI

**J. W. JONES, M. D.**  
615 West River Drive  
MIDDLETOWN NEW JERSEY  
Office hours by appointment only  
Telephone MI 6-0395

*Prescription for Precision...*

**ARC Test Equipment**

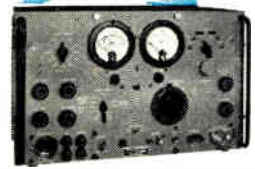

**Type H-14A**  
Signal Generator

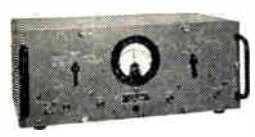

**Type H-16**  
Standard Course Checker

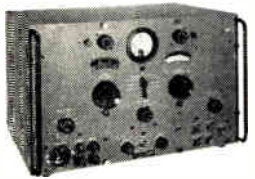

**Type H-12**  
UHF Signal Generator

Radio technicians and pilots trust ARC test equipment to keep airborne instruments in tune for precision navigation and communication.

**The Type H-14A Signal Generator** has two uses: (1) It provides a sure and simple means to check omnirange and localizer receivers in aircraft on the field, by sending out a continuous test identifying signal on hangar antenna. Tuned to this signal, individual pilots or whole squadrons can test their own equipment. The instrument permits voice transmission simultaneously with radio signal. (2) It is widely used for making quantitative measurements on the bench during receiver equipment maintenance.

**The H-16 Standard Course Checker** measures the accuracy of the indicated omni course in ARC's H-14A or other omni signal generator to better than 1/2 degree. It has a built-in method of checking its own precision.

**Type H-12 Signal Generator** (900-2100 mc) is equal to military TS-419/U, and provides a reliable source of CW or pulsed rf. Internal circuits provide control of width, rate and delay of internally-generated pulses. Complete specifications on request.

Dependable Airborne Electronic Equipment Since 1928

# Aircraft Radio Corporation

BOONTON, NEW JERSEY

- Omni/ILS Receivers • Course Directors • UHF and VHF Receivers and Transmitters • LF Receivers and Loop Direction Finders • 10-Channel Isolation Amplifiers • 8-Watt Audio Amplifiers • Interphone Amplifiers • Omnirange Signal Generators and Standard Course Checkers • 900-2100 Mc Signal Generators



(Continued from page 128)

ingly important today in such applications as high speed comparison circuits or in computers, where it is essential that the current in a circuit reach a predetermined value in an extremely short time.

Since these resistors generally have tolerances as low as  $\pm 0.02\%$ , low rise times are necessary to insure operation of the equipment to its fullest extent and at highest efficiency. These resistors are being

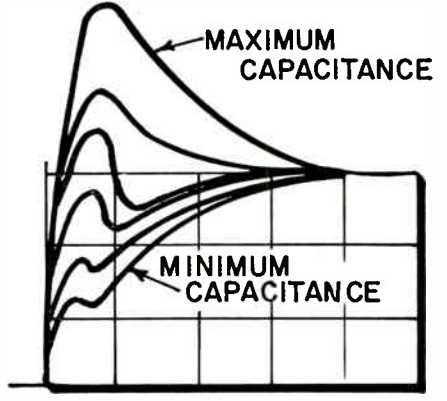

Fig. 8: A fixed inductance with a variable shunt capacitance yields these waveforms.

produced today in large production quantities with values ranging from 25  $\Omega$  up to over 2 megs, all with a rise time of less than 0.1  $\mu$ sec.

In addition to the low tolerance and rise time specifications, these are highly stabilized resistors capable of operation over long periods of time under varied environmental and ambient conditions.

An important aspect of this testing system is that modification of the circuit being fed by the pulse generator is easily accomplished. Thus, a configuration can be selected that closely approximates the actual circuit that is to be used and the rise time can be checked across any section or the whole of a series-parallel combination.

This, coupled with the fact that adjustments can be made in the characteristics of the wire wound resistors, allows a great deal of freedom in the construction of specialized resistor networks.

## Transistor Tests

(Continued from page 63)

two numbers of comparable magnitude. Furthermore, in this second method, an error also may be

(Continued on page 132)





# NEW HERMETIC POWER COMPONENTS

**HIGHEST RELIABILITY  
FOR MILITARY AND  
INDUSTRIAL USE**

Listed below are just a few of the 50 new stock items in the United hermetic power series. These MIL-T-27A power components add to the 200 other hermetic stock items of filter, audio, and magnetic amplifier types. Through the use of proven new materials and design concepts, an unparalleled degree of life and reliability has been attained, considerably exceeding MIL-T-27A requirements. Test proved ratings are provided, not only for military applications but for industrial, broadcast, and test equipment service (55°C. ambient).

For complete listing of these new items, write for Catalogue #56.

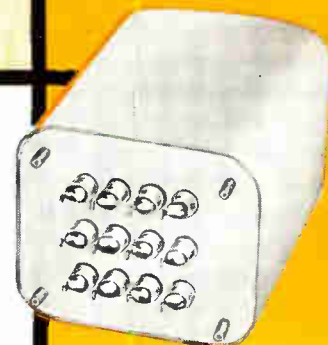

## MIL-T-27A RATINGS IN REGULAR TYPE

## INDUSTRIAL RATINGS IN BOLD TYPE

### TYPICAL POWER TRANSFORMERS, PRI: 115V., 50-60 cycles.

Type No.	HV Sec. C.T.	Approx* DC volts	DC MA	Fil. Wdg.	Approx* DC volts	MA DC	Fil. Wdg.	MIL Case																																						
11	500	L 180 C 265	65 55	6.3VCT-3A 5V-2A	L 170 C 240	75 65	6.3VCT-3A 5V-2A	HA																																						
	550	L 200 C 300	60 50		L 190 C 280	70 60			34	700	L 255 C 400	170 110	6.3V-5A 6.3V-1A 5V-3A	L 240 C 360	210 150	6.3V-6A 6.3V-1.5A 5V-4A	KA	750	L 275 C 420	160 105	L 260 C 380	200 140	37	730	L 245 C 390	320 210	6.3V-6A 6.3V-2A 5V-4A	L 210 C 350	420 310	6.3V-6A 6.3V-2A 5V-4A	NB	800	L 275 C 440	300 200	L 245 C 400	400 300	93	1000	L 370	280	6.3V-8A 6.3V-4A 5V-6A	L 340	340	6.3V-10A 6.3V-5A 5V-6A	OA	1200
34	700	L 255 C 400	170 110	6.3V-5A 6.3V-1A 5V-3A	L 240 C 360	210 150	6.3V-6A 6.3V-1.5A 5V-4A	KA																																						
	750	L 275 C 420	160 105		L 260 C 380	200 140			37	730	L 245 C 390	320 210	6.3V-6A 6.3V-2A 5V-4A	L 210 C 350	420 310	6.3V-6A 6.3V-2A 5V-4A	NB	800	L 275 C 440	300 200	L 245 C 400	400 300	93	1000	L 370	280	6.3V-8A 6.3V-4A 5V-6A	L 340	340	6.3V-10A 6.3V-5A 5V-6A	OA	1200	L 465	250	L 455	300										
37	730	L 245 C 390	320 210	6.3V-6A 6.3V-2A 5V-4A	L 210 C 350	420 310	6.3V-6A 6.3V-2A 5V-4A	NB																																						
	800	L 275 C 440	300 200		L 245 C 400	400 300			93	1000	L 370	280	6.3V-8A 6.3V-4A 5V-6A	L 340	340	6.3V-10A 6.3V-5A 5V-6A	OA	1200	L 465	250	L 455	300																								
93	1000	L 370	280	6.3V-8A 6.3V-4A 5V-6A	L 340	340	6.3V-10A 6.3V-5A 5V-6A	OA																																						
	1200	L 465	250		L 455	300																																								

\*After appropriate H series choke. L ratings are choke input filter, C ratings are condenser input.

United "H" series power transformers are available in types suited to every electronic application. Proven ratings are listed for both high voltage outputs... condenser and choke input filter circuits... military and industrial applications.



United "H" series filter reactors are extremely flexible in design and ratings. Listings show actual inductance at different values of DC. Bold listings are industrial applications maximums.



### A FEW TYPICAL LISTINGS OF FILTER REACTORS.

Type No.	Ind. Hys. @ DC	MA DC	Ind. Hys. @ DC	MA DC	Ind. Hys. @ DC	MA DC	Ind. Hys. @ DC	MA DC	Res. Ohms	Max. DCV* Ch. Input	Test V. RMS	MIL Case
H-71	20	40	18.5	50	15.5	60	10	70	35	500	2500	FB
H-73	11	100	9.5	125	7.5	150	5.5	175	15	700	2500	HB
H-75	11	200	10	230	8.5	250	6.5	300	9	700	2500	KB
H-77	10	300	9	350	8	390	6.5	435	6	2000	5500	MB
H-79	7	800	6.5	900	6	1000	5.5	1250	2	3000	9000	9x7x8

\*Based on maximum ripple voltage across choke in choke input filter circuit, in terms of DC output voltage.

### TYPICAL FILAMENT TRANSFORMERS, PRI: 105/115/210/220V., 50-60 cycles.

Type No.	Sec. Volts	Amps. (MIL)	Amps. (Ind)	Test Volts RMS	MIL Case
H-121	2.5	10	12	10000	JB
H-124	5	3	3	2000	FB
H-127	5	20	30	21000	NA
H-131	6.3CT	2	2.5	2500	FB
H-132	6.3CT	6	7	2500	JA
	6.3CT	6	7		
H-136	14, 12, 11CT	10	14	2500	LA

United "H" series filament transformers have multi-tapped primaries, good regulation, and are rated for industrial as well as military service.



United "H" series plate transformers incorporate dual high voltage ratings on tapped primaries to provide versatile units for a wide range of military and industrial electronic applications. Large units have terminals for site mounting for typical transformer use.



### TYPICAL PLATE TRANSFORMERS, PRI: 105/115/210/220V., 50-60 cycles.

No. Type	Sec. V. C.T.	Approx.* DC volts	MA DC	Choke No.	MA DC	Choke No.	Case
H-110	1050	380	275	H-75	385	H-77	MB
	1200	465	250	H-75	350	H-77	
H-113	2500	1050	280	H-77	340	H-77	5 1/4 x 6 x 7
	3000	1275	250	H-76	300	H-76	
H-115	3500	1500	265	H-77	350	H-77	8 3/4 x 6 1/2 x 8
	4400	1900	225	H-77	300	H-77	
H-117	5000	2125	900	H-79	1100	H-79	13 1/2 x 11 x 14 1/2
	6000	2550	800	H-79	1000	H-79	

\*After filter choke. All ratings are for choke input filter.

## UNITED TRANSFORMER CO.

150 Varick Street, New York 13, N. Y. • EXPORT DIVISION: 13 E. 40th St., New York 16, N. Y. CABLES: "ARLAB"

PACIFIC MFG. DIVISION: 4008 W. Jefferson Blvd., Los Angeles, Cal.

ENGINEERS • PHYSICISTS

Big things  
are happening

at the  
**MOTOROLA  
MILITARY ELECTRONIC  
LABORATORY  
IN CHICAGO**

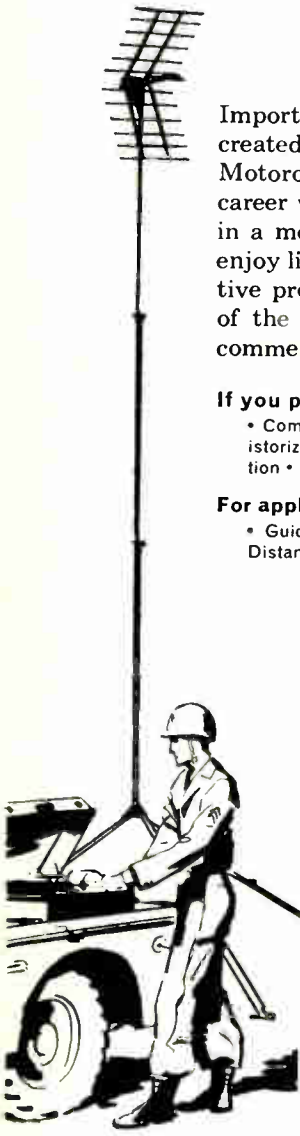

Important assignments from the armed forces have created *new* and outstanding opportunities at Motorola. This is your challenge to advance your career with a swiftly expanding company, working in a modern, well instrumented laboratory. You'll enjoy liberal employee benefits, including an attractive profit sharing plan, and association with men of the highest technical competence. Salaries are commensurate with ability.

**If you possess the following techniques:**

• Computers • Indicators and displays • Miniaturization • Transistorization • Pulse Techniques and Special Waveform Generation • Linear and Nonlinear Servo-Mechanisms

**For application to systems in the following areas:**

• Guidance • Data Handling • Data Transmission • Precision Distance Measuring • Weapon Control • Navigation • Ground Radar

CHICAGO, ILL.  
MILITARY LABORATORY

write to:

Mr. L. B. Wrenn Dept. C  
4501 Augusta Blvd., Chicago 51, Ill.

PHOENIX, ARIZONA  
RESEARCH LABORATORY

write to:

Mr. R. Coulter, Dept. C  
3102 N. 56th St., Phoenix, Ariz.

PHOENIX, ARIZONA  
SEMI-CONDUCTOR DIVISION

write to:

Mr. V. Sorenson, Dept. C  
5005 E. McDowell Road, Phoenix, Ariz.

RIVERSIDE, CALIF.  
RESEARCH LABORATORY

write to:

Mr. C. Koziol, Dept. C  
Box 2072, Riverside, Calif.



**MOTOROLA**

(Continued from page 130)

introduced if there is appreciable ohmic series resistance in the emitter region (which contributes to  $h_{11}$  and thereby yields too high a value for  $r_b'$ ).

The method that has been employed by the writer consists of measuring the magnitude of the grounded-base open-circuit voltage-feedback ratio  $h_{12}$  as a function of frequency in the low- to medium-frequency range, 50-1000 KC. In this case<sup>13</sup>

$$h_{12} = (h_{12})_0 + j\omega r_b' C_c, \quad (4)$$

where  $(h_{12})_0$  is the low-frequency value of  $h_{12}$  and is the sum of the Early voltage-feedback factor  $\mu_{ec}$  plus the product of  $r_b'$  and collector-base conductance of the inherent transistor. Note that in this measurement, the product  $r_b' C_c$  is measured directly. In general it is not necessary to separate  $r_b'$  from  $C_c$ , since it is the product  $r_b' C_c$  that actually is significant at high frequencies, cf. Eq. (1). If separation is desired, it should be noted that the capacity  $C_c$  appearing in Eq. (4) does not include stray capacities that may be included in a direct measurement of collector-base capacitance, which will be denoted here as  $C_{22}$ .

Eq. (4) is essentially valid at all frequencies for a fused-junction transistor (provided  $(\omega r_b' C_c)^2 \ll 1$ ). However, for a grown-junction transistor at high frequencies  $r_b'$  should be replaced by a complex frequency dependent base impedance  $z_b'$ . Note, however, that the frequency variation of this base impedance is taken into account in calculating the gain (Eqs. (1) and (2)) so that the quantity  $r_b'$  which appears in Eq. (4) is the low-frequency value of this base impedance  $z_b'$ . Hence, for either type of transistor, the measurement of  $h_{12}$  as a function of frequency in the low- to medium-frequency range will yield the parameter that is important in characterizing high-frequency gain.

The frequency range to be employed depends upon the transistor. It is especially convenient to choose a frequency such that  $(\omega r_b' C_c)^2 \gg (h_{12})_0^2$ , in which case measured

(Continued on page 134)

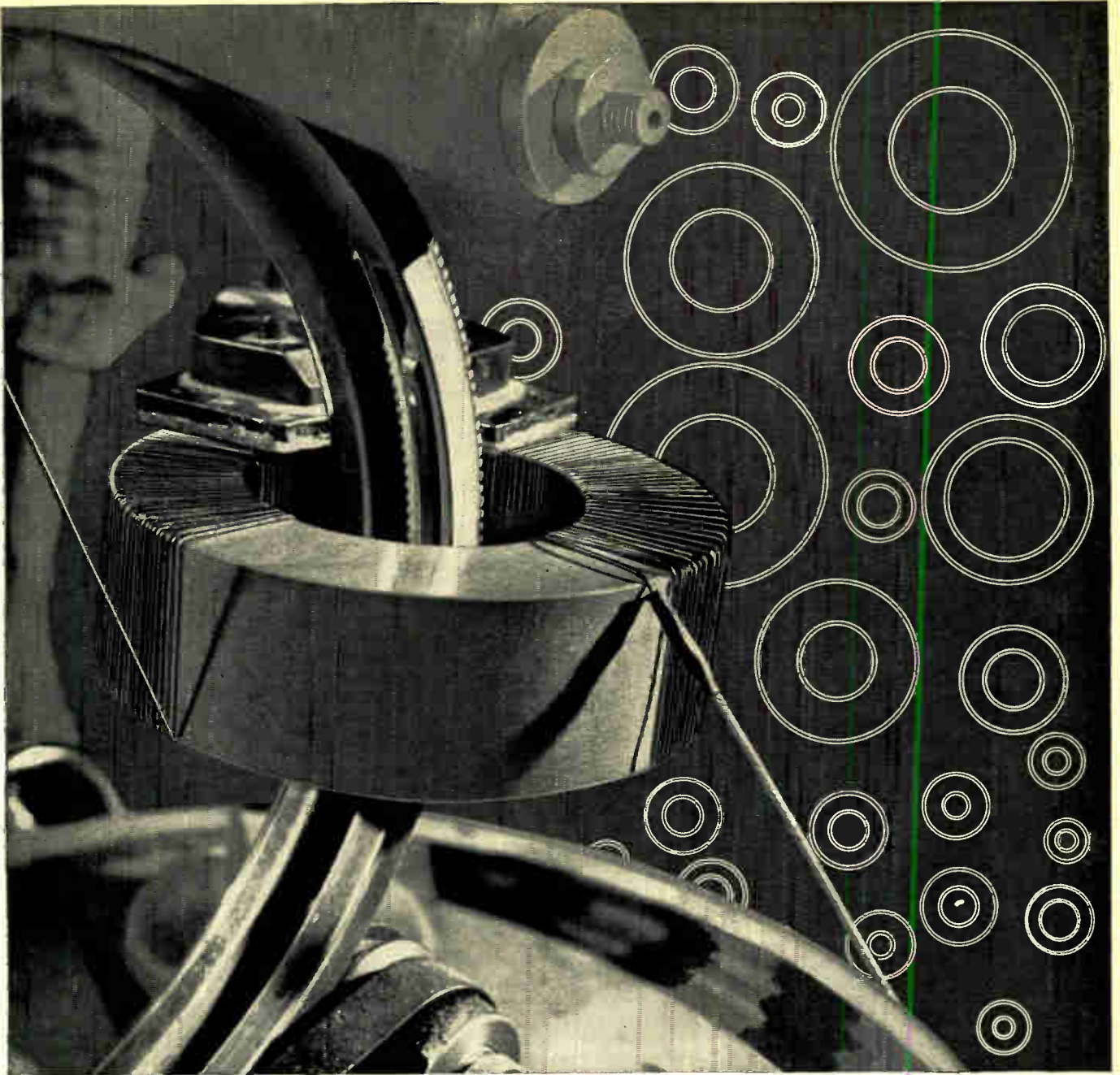

## **How will tape wound core users be affected by new size standards?**

If toroidal core winding is a familiar sight in your plant, you'll welcome news that standard sizes for tape wound cores have been proposed by the A.I.E.E.\* You are going to benefit from a high in consistency of core performance, brought about by our being able to concentrate on your most important sizes.

Magnetics, Inc. is now stocking all of the proposed standard core sizes in both aluminum and phenolic core boxes for immediate delivery. Consistency of core performance is increased because each size is made in large lots taken from the same alloy batch and dry hydrogen anneal. They all bear our exclusive Performance-Guarantee.

You can find all specifications for these AIEE-standardized tape wound cores in Catalog TWC-102, a new publication

which, incidentally, is the most comprehensive tape wound core text published anywhere by anybody. Your copy of this Catalog-Design Manual may be obtained by writing on your letterhead to *Magnetics, Inc., Dept. TT-34, Butler, Pa.*

**MAGNETICS inc.**

*\*Paper 57-206, Proposed Size Standards for Toroidal Magnetic Tape Wound Cores. Report of the Magnetic Amplifiers Material Sub-Committee, at the 1957 Winter General Meeting, A.I.E.E.*

# NEW!

## EECO COMPUTER-SERIES PLUG-INS

...a refinement of the building-block concept to a degree hitherto unknown, with each circuit a complete off-the-shelf packaged function.

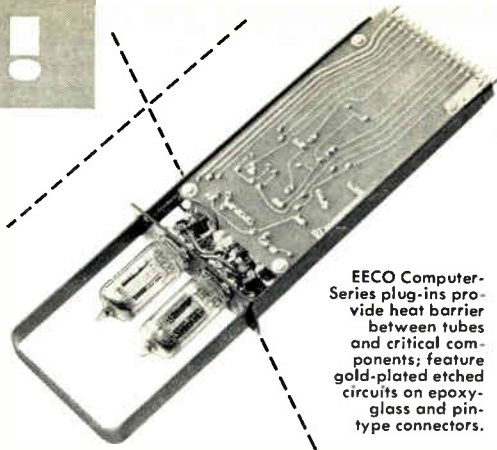

EECO Computer-Series plug-ins provide heat barrier between tubes and critical components; feature gold-plated etched circuits on epoxy-glass and pin-type connectors.

Originally developed for EECO custom systems and proven in critical use, this compatible series of digital and logic circuits is now available to the industry. Meet your project delivery schedules by reducing system-development time to a bare minimum and virtually eliminating drafting and layout time.

**PERFORMANCE** EECO Computer-Series plug-ins are performance engineered for application where ultra-conservative design at the component level is essential because of system complexity. System prototypes can generally be built directly, without need for the "breadboard" stage.

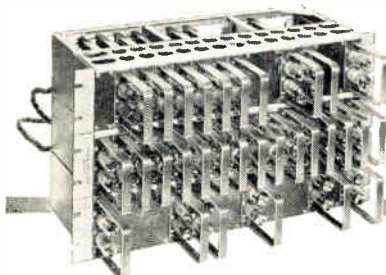

Three Mounting Frame Assemblies were stacked to house this Output Shift Register. Each Mounting Frame accommodates 15 plug-ins, is 3 1/2" x 19" for installation in 19" rack.

Rear view of Output Shift Register shows simplicity of point-to-point wiring.

Quick-Look section of EECO-built Project Datum installation at Edwards Air Force Base shows typical modular assembly of Computer-Series plug-ins

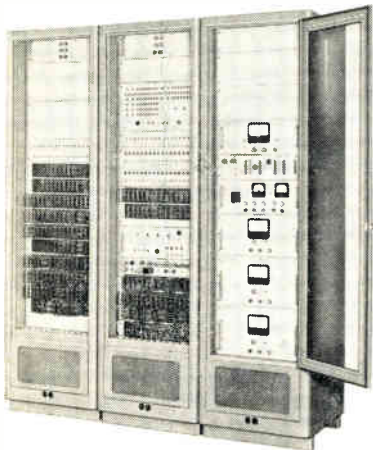
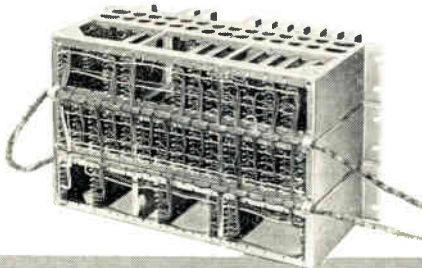

**\* QUICK FACTS:** Tube dissipation de-rated 75%; cathode current de-rated 50%. 1% components used where 5% required and 5% where 10% required. Reliable operation with  $\pm 20\%$  change in filament voltage, 30% change in tube transconductance. Isolating diodes on multiple inputs eliminates crosstalk. Low output impedance—in general, cathode follower. (One flip-flop will trigger another at the end of a 50-foot length of twisted pair!) Signal levels clamped. Computer-type tubes. Circuit trouble-shooting already done; layout basically completed. Packaging, heat-barrier, and ventilation problems solved. In-circuit test fixture available.

**CIRCUITS** You can concentrate on the design of systems, knowing you have available a full line of reliable, tested, and proven circuits, including:

- |                         |                               |
|-------------------------|-------------------------------|
| Flip-Flops              | Quadruple Cathode Followers   |
| Shift Register Elements | One-Digit Adder Matrixes      |
| DC "NOT" Circuits       | One-Digit Subtractor Matrixes |
| Delay Units             | One Shots                     |
| Pulse Mixer Amplifiers  | Neon Drivers                  |

plus 28 Diode Logic Units incorporating "And" and "Or" circuits. In addition, EECO stands ready to design diode logic circuits and produce plug-in units to yield any equation you may require. In short, custom-built logic to order—quickly!

**ELECTRONIC ENGINEERS AND PHYSICISTS**—EECO offers immediate opportunities for qualified engineers in the transistor, amplifier, data-handling, pulse, timing, and systems-design fields. Send a resume of your qualifications to R. F. Lander, Dept. CS.

\*Detailed information on new Computer-Series plug-ins, as well as on Standard-Series plug-ins, Systems Development Racks, Power Supplies, D-C Amplifiers, and other EECO products is available in Catalog No. 856-A. Write for your copy—today.

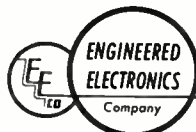

## ENGINEERED ELECTRONICS COMPANY

a subsidiary of Electronic Engineering Company of California

506 EAST FIRST STREET SANTA ANA, CALIFORNIA

(Continued from page 132)

$h_{12}$  yields  $r_b' C_e$  directly. However, it also is necessary, especially for a grown-junction transistor, to establish that  $|h_{12}|$  is directly proportional to frequency, so that Eq. (4) is valid. If  $(h_{12})_0$  is low ( $10^{-4}$ ), and if  $r_b' C_e$  is not too small (1000 ohm- $\mu$ f), frequencies of the order of 100 KC may be satisfactory. In some transistors it may be necessary to actually plot  $|h_{12}|$  as a function of frequency in order to determine  $r_b' C_e$ . Alternatively, it may be convenient to measure the frequency  $\omega_0/2\pi$  at which  $|h_{12}|$  has increased by  $\sqrt{2}$  times its low-frequency value  $(h_{12})_0$ ; Eq. (4) indicates that  $r_b' C_e = (h_{12})_0/\omega_0$ .

### Collector-Base Capacity

Measurement of collector-base capacity generally presents no problems and may be determined in a number of ways, e.g., by employing a capacitance bridge or a Q-meter.<sup>14</sup> If extreme accuracy is not desired, a voltmeter-ammeter method may be used, e.g., by measuring the voltage across a resistor connected in series with the base lead of the transistor and ground when a generator is applied between collector and ground and by employing a frequency for which the effect of low-frequency collector-base conductance is negligible. In this case, open-circuit collector-base admittance  $h_{22}$  is measured, which, at medium frequencies is approximately  $j\omega C_{22}$ . At higher frequencies, measured collector-base capacitance generally will decrease with frequency. However, the value of capacitance that is required for calculating gain according to Eqs. (1) or (2) is the low-frequency value.

### Measuring Circuits

Basic measuring circuits that have been used by the writer to measure the high-frequency parameters  $f_a$ ,  $r_b' C_e$ , and  $C_e$  described above are shown in Figs. 2, 3, and 4, respectively. For simplicity dc biasing arrangements are not included in the figures. (For example, dc bias can be supplied in series with both input and output circuits with no difficulty.) In each case, a generator capable of supplying a constant voltage at variable fre-

(Continued on page 140)



You get instant response—full soldering heat, 250 watts—in just 5 seconds from Weller Soldering Gun, Model 8250A. Triggermatic control for quick-as-a-flash "on-off" operation—no need to unplug between jobs. No waiting or tedious assembly. Always ready for a wide range of research, testing, design and development work in laboratories, model shops and industrial plants.

**KIT GIVES EXTRA VALUE**—Kit (8250AK) contains streamlined Soldering Gun with balanced pistol grip, dual spotlights; ample supply of famous Kester Solder, general purpose type; sturdy metal carrying case; tip for cutting plastic materials; smoothing tip for heat-sealing, joining thermo-plastics, etc.; 2 valuable instruction booklets.

**FULLY GUARANTEED FOR 1 YEAR**—Order from your Electronic Parts Distributor or write for catalog bulletin.

**Weller** ELECTRIC CORPORATION  
601 Stone's Crossing Rd., Easton, Pa.

Circle 147 on Inquiry Card, page 103



sick of being a **DATA DETECTIVE?**

solve **TRANSISTOR** selection problems this **NEW** easy way

**NEW TRANSISTOR LIST SUBSCRIPTION** available starting in April—\$12 per year

At last... a complete commercial transistor reference listing (>350) — includes maximum ratings and typical parameters such as  $r_e$ ,  $r_b$ ,  $r_c$ ,  $h_{fe}$ ,  $f_{\alpha}$ ,  $b$ , NF, etc. — cross indices.

Find the right transistor types in minutes... save valuable engineering time. Always up-to-the-minute... list revised semi-annually with intervening supplements.

Individual transistor lists sold separately—\$7.50

**DATA** Ask about our **ALL NEW Electronic Component Data Service**  
**Derivation And Tabulation Assoc., inc.**  
67-A Lawrence Ave., West Orange, N. J.

Circle 148 on Inquiry Card, page 103

ANOTHER **Bendix** ACHIEVEMENT

## A resilient insert rack and panel connector

Here is the new and improved Bendix Type SR rack and panel electrical connector with outstanding resistance to vibration. The low engagement force of this connector gives it a decided advantage over existing connectors of this type.

Pressurization is easily accomplished. The resilient inserts press firmly against the shell wall holding the contacts in exact position. Insert patterns are available to mate with existing equipment in the field.

Adding to the efficiency of this rack and panel connector is the performance-proven Bendix "clip-type" closed entry socket.

Here, indeed, is another outstanding Bendix product that should be your first choice in rack and panel connectors.



### OUTSTANDING FEATURES

Resilient Insert • Solid Shell Construction • Low Engagement Forces • Closed Entry Sockets • Positive Contact Alignment Contacts — heavily gold plated • Cadmium Plate—clear irridite finish • Temperature range —67° to +250°F. • Easily Pressurized to Latest MIL Specifications.



SCINTILLA DIVISION of  
SIDNEY, NEW YORK



Export Sales and Service: Bendix International Division, 205 East 42nd St., New York 17, N. Y.

FACTORY BRANCH OFFICES:

117 E. Providencia Ave., Burbank, Calif. • Paterson Building, 18038 Mack Ave., Detroit 24, Mich. • 5906 North Port Washington Rd., Milwaukee 17, Wisc. • Hulman Building, 120 W. Second St., Dayton 2, Ohio • 2608 Inwood Road, Dallas 19, Texas • Boeing Field, Seattle 8, Washington • 1701 "K" Street, N.W., Washington 6, D. C.

# IBM GROWTH promoted these men

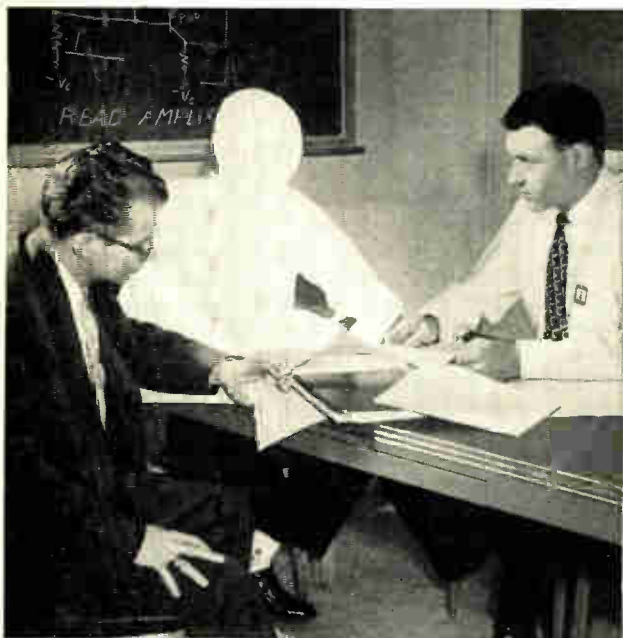

**PRODUCT DEVELOPMENT ENGINEER:** Before his recent promotion, this man was a member of a small engineering "team" (two M.E.'s, an E.E. and a model maker) in IBM's Poughkeepsie plant. His specific project entailed the creation of the "ultimate package in printed circuitry." His group "brainstormed" the project in continual sessions, putting the results in model form. Then the group would try to "tear the idea to shreds" in order to create something even better.

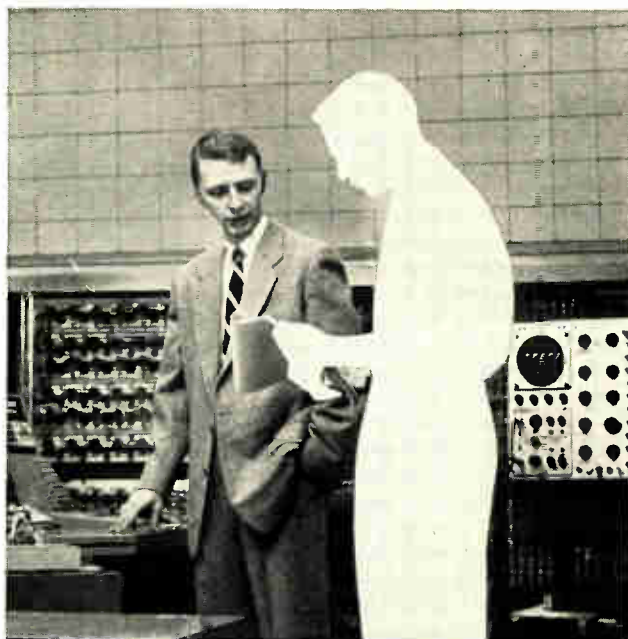

**PRODUCT CONTROL ENGINEER:** Promoted recently, this man formerly worked at IBM's Poughkeepsie manufacturing facilities. His job was to design information systems to insure a smooth flow of work through the plant. "It takes *creative* engineering ability to design these systems," he'll tell you, "and *administrative* ability to 'sell' a system to higher management and make it stick. If you possess this rare combination of abilities, this is the job for you!"

## Could you handle their responsibilities?

Jobs like these continually open up at IBM—due to rapid expansion. If you are an engineer or scientist—or have equivalent experience—you may be qualified for such a position. Innumerable opportunities exist in:

- Computer systems planning
- Numerical analysis and programming
- Electronic circuit design and packaging
- Electrostatic phenomena
- Real time systems engineering
- Photo and magnetic device memory
- Semi-conductor research, development, and manufacturing
- Manufacturing process control
- Computer systems testing
- Test equipment design

Economic experts rank the electronic computer with automation and nucleonics in growth potential. More than 10,000 electronic computers will be in operation by 1966. IBM sales have doubled, on the average, every five years since 1930. IBM engineering laboratory personnel quintupled in the past five years. IBM spent \$19,000,000 on research and new product development in 1956. Salaries are excellent; company-paid benefits set standards for industry today. Personnel turnover at IBM is less than one-sixth the national average.

FOR THE FACTS about an engineering career with IBM, just write, outlining background and interests, to:

R. A. Whitehorne  
Mgr. of Engineering Recruitment, Dept. 4603  
International Business Machines Corporation  
590 Madison Avenue, New York 22, N. Y.

### Where would you like to work for IBM?

IBM plants and laboratories are located in:

Endicott, Kingston, New York City, Owego, Poughkeepsie, N. Y.; San Jose, Calif.; Washington, D. C.; Greencastle, Ind.; Lexington, Ky.; Rochester, Minn.; Sherman, Texas. Branch offices in 189 cities throughout the U.S.A.



**IBM**

INTERNATIONAL  
BUSINESS MACHINES  
CORPORATION

Be sure to visit the  
IBM booth at the  
I. R. E. Show,  
March 18 through 21.

DATA PROCESSING • ELECTRIC TYPEWRITERS • TIME EQUIPMENT • MILITARY PRODUCTS

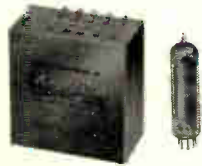

MEET THE  
**MIGHTY MIDGET**  
OF AIRCRAFT FIRE POWER

This new TRANSISTORIZED CONTROL AMPLIFIER weighs only 11 ounces...but it is a vital control element in the voltage regulation of an entire aircraft fire control system. Developed as part of an integrated power supply, the "MIGHTY MIDGET" operates from  $-65^{\circ}$  to  $+125^{\circ}$  C...reduces ripple to less than 50mv peak-to-peak...is adaptable to voltages of  $\pm 50$  to  $\pm 1000$ ...controls voltage regulation to  $\pm 1\%$ . Here is another example of Packard Bell's skill in developing lighter, more efficient airborne equipment... another result of more than 30 years of electronic leadership.  
*See it at the New York IRE SHOW... booths 3705-3707.*

**PACKARD BELL ELECTRONICS**  
TECHNICAL PRODUCTS DIVISION  
Los Angeles 64, California



# Planning better communications?

Microwave may be the answer  
... and Blaw-Knox has the towers

Improved service, reduced maintenance, and economy records of pioneer microwave installations are responsible for many companies planning new communications paths through the sky. Quite possibly, microwave can best answer your growth problems, and Blaw-Knox can best answer your tower questions.

Blaw-Knox Microwave Tower designs are based on more than 40 years of experience in building towers. For example:

- The first Blaw-Knox Towers, four 300' self-supporting towers erected over 40 years ago in Alaska, still stand in good service.
- The world's first atom bomb was supported by a Blaw-Knox Tower, ushering in the Atomic Age at Alamogordo, New Mexico, in 1945.
- First electronic contact was made with outer space by a radar signal to the moon, beamed from a Blaw-Knox Tower.

From such varied experience as this, Blaw-Knox engineers are well qualified to design and engineer the type of tower system that will best meet your present and future requirements. Blaw-Knox Microwave Towers meet or surpass government standards and recommendations of the Radio-Electronics-Television Manufacturers Association for safety, wind loading and quality of construction.

Get the full story of Blaw-Knox Tower design, engineering and fabrication services. Write today for your free copy of new Bulletin 2538.

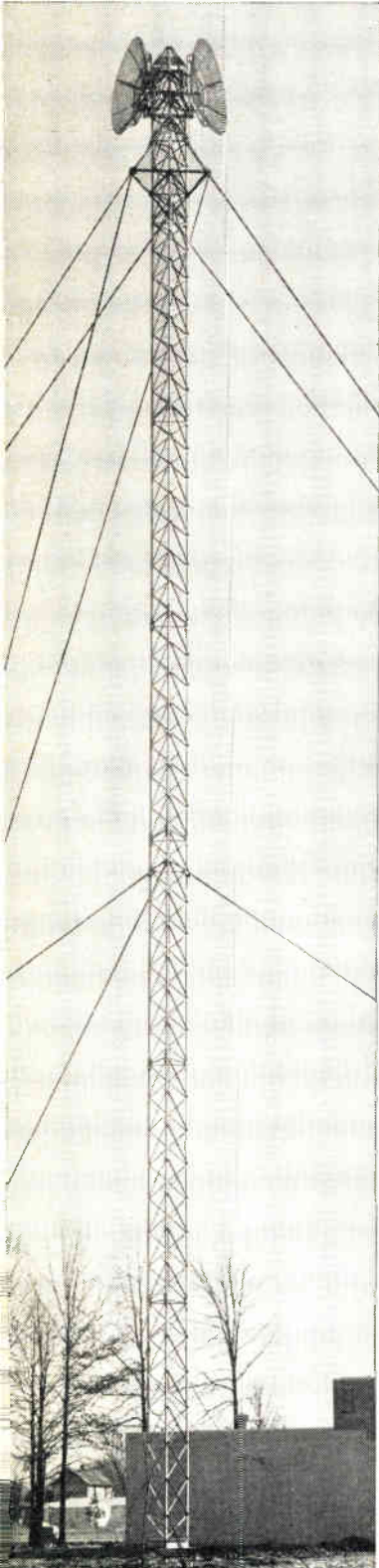

Special Blaw-Knox guyed tower for microwave communications

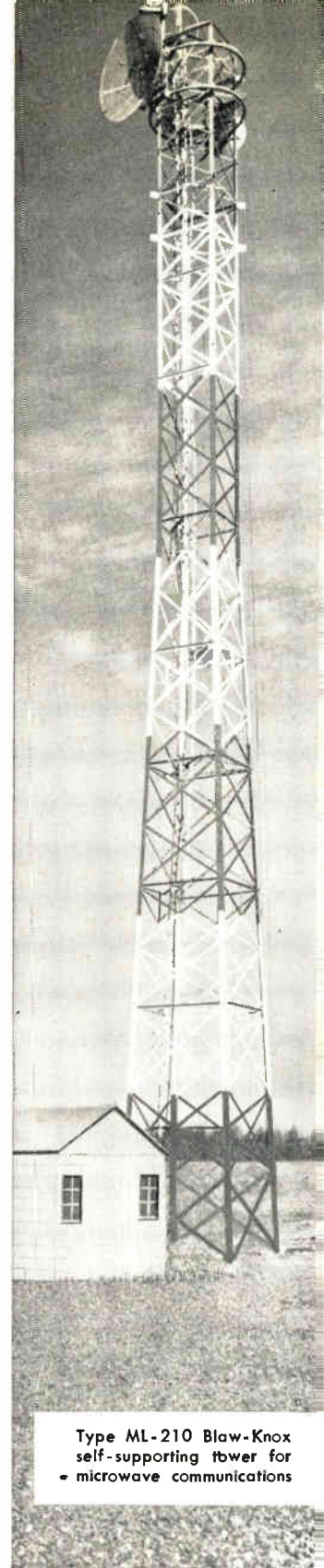

Type ML-210 Blaw-Knox self-supporting tower for microwave communications



**BLAW-KNOX COMPANY**

*Equipment Division*

*Pittsburgh 38, Pennsylvania*

**MICROWAVE TOWERS**

Guyed and self-supporting Microwave Towers, custom-built for each installation... and Transmission Towers... Antenna Towers—guyed and self-supporting for AM-FM-TV, Radar... parabolic antennas and other special structures



## Component Specification: ARNOLD

- ✓ SILECTRON CORES  
Types C, E and O
- ✓ TOROIDAL CORES  
Nylon and Aluminum cased
- ✓ BOBBIN CORES

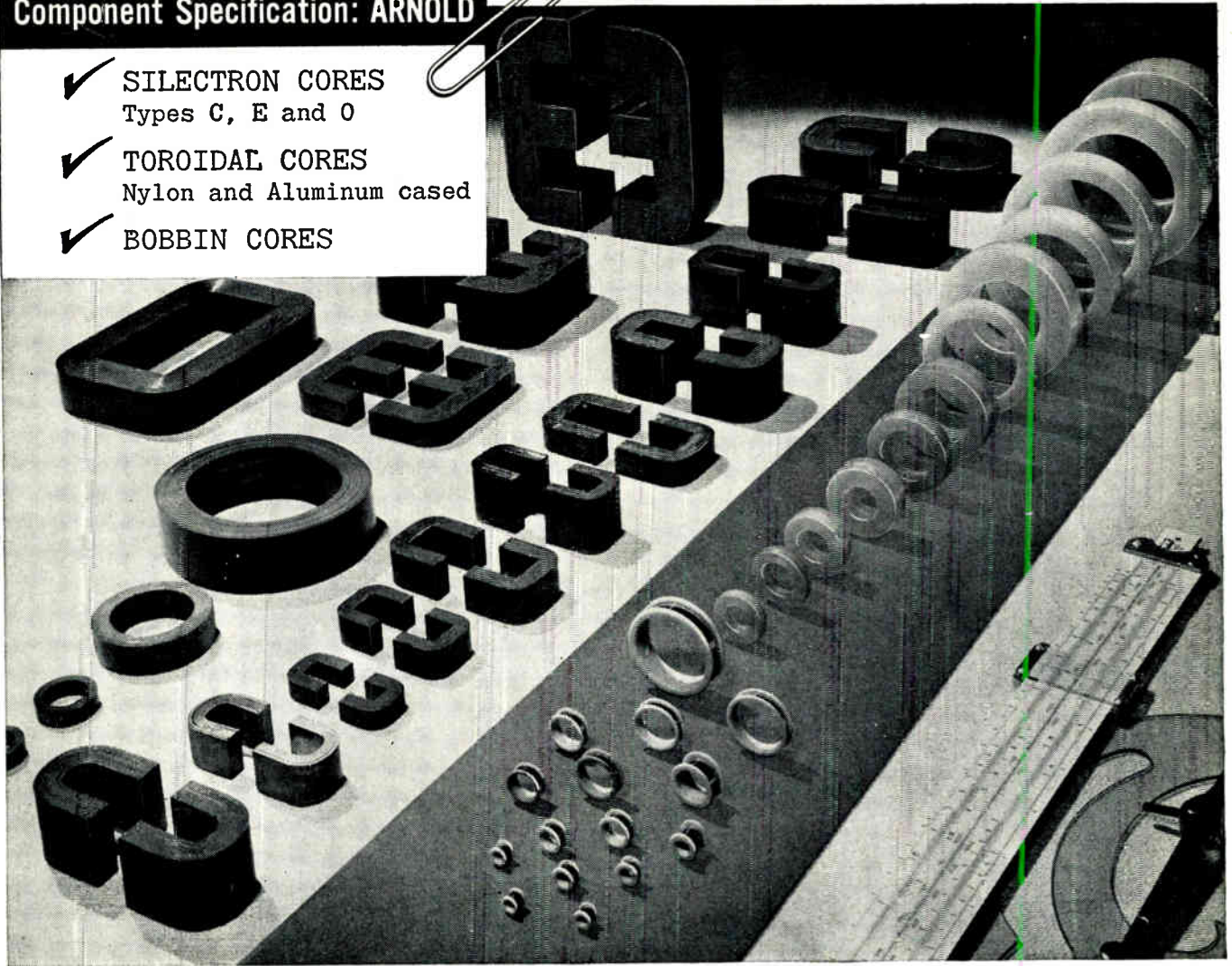

## The ARNOLD LINE-UP includes ANY TAPE CORES you need

### APPLICATIONS

We'll welcome your inquiries on your Tape Wound Core requirements for Pulse and Power Transformers, 3-Phase Transformers, Magnetic Amplifiers, Current Transformers, Wide-Band Transformers, Non-Linear Retard Coils, Reactors, Coincident Current Matrix Systems, Static Magnetic Memory Elements, Harmonic Generators, etc.

### ENGINEERING DATA

For data on the various types of Arnold Tape Cores, write for these Bulletins:

SC-107—Silectron Cores, Types C, E and O

TC-101A—Toroidal Cores, nylon and aluminum cased

TC-108—Bobbin Cores

ADDRESS DEPT. T-73

How to be *sure* of tape core performance and uniformity? Just specify and use *Arnold* Cores in your transformer, magnetic amplifier, reactor and computer assemblies, etc.

#### *Here's why!*

To begin with, Arnold is a fully integrated company, controlling every manufacturing step from the raw material to the finished core. Then, modern testing equipment permits 100% inspection of cores before shipment. Finally, you're matching your requirements against the most experienced and complete line of tape cores in the industry. Arnold produces Types C, E and O Silectron cores,

nylon and aluminum cased toroidal cores, and bobbin cores to meet whatever your designs may require in tape thickness, material, core size or weight. Wide selections of cores are carried in stock as standard items for quick delivery: both for engineering prototypes to reduce the need for special designs, and for production-quantity shipments to meet your immediate requirements.

*Let us help you solve your tape core problems.* Check Arnold, too, for your needs in Mo-Permalloy or iron powder cores, and for cast or sintered permanent magnets made from Alnico or other materials.

WSW6447

## THE ARNOLD ENGINEERING COMPANY



Main Office & Plant: Marengo, Illinois

Repath Pacific Division Plant: 641 East 61st Street, Los Angeles, Calif.

District Sales Offices:

New York: 350 Fifth Ave. Los Angeles: 3450 Wilshire Blvd. Boston: 200 Berkeley St.



# RADAR TEST SET\*

Completely checks both transmitter and receiver operations in the field or on the production line

\* Available for Ku, C, or X-Band Frequencies

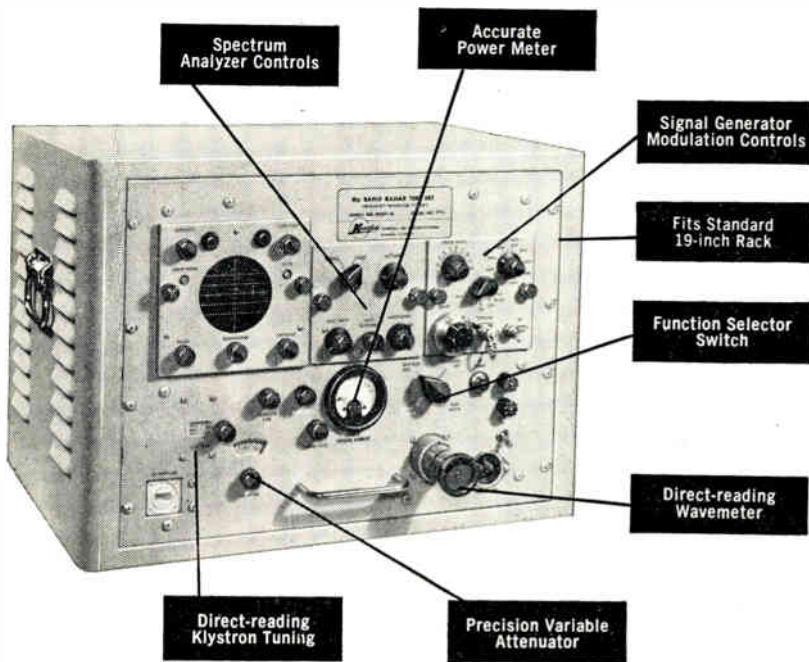

## KEARFOTT UNIVERSAL RADAR TEST SETS

A complete radar testing facility — includes Spectrum Analyzer, accurate Power Monitor, direct-reading Frequency Meter, versatile Signal Generators complete with variable pulse, saw tooth and square wave modulation. New improved design reduces testing time with increased accuracy. Operates on 60, 400 or 1200 cycles power.

Write for complete information on these versatile R.F. Test Sets. Available for Ku, C or X-Band Frequencies.

See Kearfott for PRECISION NAVIGATION INSTRUMENTS and Servo Systems Components.



**COMPANY, INC.**

LITTLE FALLS, NEW JERSEY

**WESTERN DIVISION**

253 VINEDO AVE., PASADENA, CALIF.

SALES OFFICES

**EASTERN OFFICE**  
1378 Main Ave.  
Clifton, N. J.

**MIDWEST OFFICE**  
188 W. Randolph St.  
Chicago, Ill.

**SOUTH CENTRAL OFFICE**  
6115 Denton Drive  
Dallas, Texas

Custom Microwave Components to your blueprints or ours. Send today for information on Kearfott Microwave Equipment.

(Continued from page 134)  
quency, plus a vacuum-tube voltmeter (VTVM) having a low input capacity and wide-band frequency response and capable of measuring voltages of the order of 1 mv, are necessary. The circuits of Fig. 3 and 4 actually may be combined into one piece of equipment by providing a means of shifting the VTVM from  $\epsilon$  to  $b$  and of shorting out the resistance  $R_B$  when making the  $h_{12}$  measurement.

In the circuit of Fig. 2, which is used to estimate inherent alpha-cutoff frequency, the resistance  $R_g$  must be large relative to the input impedance of the transistor (which may be as high as  $10^8$  ohms), but also must be a constant resistance over the frequency range employed. These two requirements are conflicting, and a low-capacity 10,000-ohm resistor is a reasonable compromise for 1-5 MC; for lower frequencies  $R_g$  can be increased, e.g., to 100,000 ohms. On the other hand, the value of  $R_c$  must be low relative to the output impedance of the transistor and shunting impedance of the VTVM but must be sufficiently high to provide a reasonable voltage for measurement. A value of 100 ohms is satisfactory. Parasitic capacity between  $b$  and  $\epsilon$  must be kept to a minimum so that the current through  $R_g$  will not be appreciably greater than the current entering the transistor. The value of the magnitude of the grounded-emitter current-amplification factor  $|h_{21}^e|$ , from which inherent alpha-cutoff frequency may be estimated in accordance with the discussion above, is given by the ratio

$$|h_{21}^e| = |e_c/e_g|(R_g/R_c). \quad (5)$$

If  $|e_g|$  is independent of frequency, the variation of  $|e_c|$  with frequency provides a direct measure of  $|h_{21}^e|$ , which in turn may be extrapolated to 0.85 to estimate the value of  $f_{\alpha}$ .

In the circuit of Fig. 3 which is used to measure the product  $r_b' C_c$  the voltage feedback ratio  $h_{12}$  is simply

$$h_{12} = e_c/e_g$$

Referring to Eq. (4), if  $|e_c|$  increases linearly with frequency for constant  $|e_g|$ , then

$$r_b' C_c = \frac{|h_{12}|}{\omega} = \frac{|e_c|}{\omega |e_g|} \quad (6)$$

(Continued on page 142)

# Motor - Gear - Trains

3:1 to 150,000:1 Ratio Range • Up to 18 Foot Pounds Torque

- Motors available: DC, 60 or 400 cycle, PM, split series, series, shunt, single phase and 2-phase. All are reversible.
- Available with either governor or brake.
- 1000 hour life minimum.
- Designed to meet MIL-E-5272A.
- Precision gearing throughout.
- Can be furnished up to 125°C.
- Designed for continuous duty or intermittent duty applications.



**Oster**<sup>®</sup>

MOTOR GEAR TRAIN											Size	Overall Length Inches-Max.	Motor Type	Mounting	Oster Type
Gear Ratio	No-Load Speed	Nominal Voltage D.C.	Voltage Range D.C.	No-Load Current	Normal Speed	Normal Load O.K. IN.	Normal Current	Operating Temp. Range							
5.68:1	1800	28	24-32	0.4	1800	5.0	1.0	-55° To +85°C	13	3.777	P.M. GOVERNOR	FACE	13R-9102-08		
17.9:1	600	28	24-32	0.4	600	12.0	1.0	-55° To +85°C	13	3.930	P.M. GOVERNOR	FACE	13R-9102-06		
32.3:1	300	28	24-32	0.4	300	12.0	1.0	-55° To +85°C	13	3.935	P.M. GOVERNOR	FACE	13R-9102-02		
67:1	150	28	24-32	0.4	150	12.0	0.6	-55° To +85°C	13	4.092	P.M. GOVERNOR	FACE	13R-9102-05		
85:1	150	27.5	-	.25	130	50.0	0.7	-55° To +85°C	13	4.095	P.M.	FACE	13R-9101-11		
109:1	100	28	24-32	0.4	100	32	0.6	-55° To +85°C	13	4.094	P.M. GOVERNOR	SYNCHRO	13R-9102-12		
109:1	180	27.5	-	0.4	175	30	0.5	-55° To +100°C	13	2.843	P.M.	FLANGE	13R-9104-01		
125:1	75-90	28	-	.25	70-85	20	0.3	-55° To +71°C	13	3.920	P.M.	FACE	13R-9101-13		
157:1	60	28	24-32	0.4	60	12.0	0.6	-55° To +85°C	13	4.095	P.M. GOVERNOR	FACE	13R-9102-03		
285:1	48	35	-	.25	40	160	0.6	-55° To +71°C	13	4.038	P.M.	FACE	13R-9103-01		
333:1	30	28	24-32	0.4	30	12.0	0.6	-55° To +85°C	13	4.317	P.M. GOVERNOR	FACE	13R-9102-04		
410:1	15	27	25-29	0.3	15	8.0	0.3	-55° To +85°C	13	4.400	P.M. GOVERNOR	FACE	13R-9102-11		
1043.8:1	5-10	27	24-30	0.15	7	30	0.2	-55° To +71°C	13	4.450	P.M. BRAKE	FACE	13R-9105-01		
1044:1	5-10	27	24-30	0.15	7	30	0.2	-55° To +71°C	13	3.910	P.M.	FACE	13R-9101-12		
2214:1	3-4	6	-	1.2	3.4	30	1.2	-55° To +71°C	13	4.454	P.M.	FACE	13R-9101-04		
3241:1	5.5	35	-	.35	5.5	18	0.4	-55° To +71°C	13	4.454	P.M.	FACE	13R-9101-03		
5933:1	1.3	30	-	.13	1.3	30	0.15	-55° To +71°C	13	4.816	P.M.	FACE	13R-9101-10		
21,707:1	2-3	120	-	.25	2-3	12	0.25	-55° To +71°C	13	3.475	P.M.	FLANGE	13R-9101-16		
322:1	80	110	-	0.2	30	240	0.3	-55° To +71°C	15	3.815	SPLIT SERIES	FLANGE	15R-9201-01		
407:1	22	27	-	0.2	20	8	0.2	-20° To +50°C	15	3.989	SPLIT SERIES	SYNCHRO	15R-9201-03		
433:1	30	26	-	0.6	25	260	1.2	-50° To +80°C	15	3.110	SHUNT	FACE	15R-9201-02		
955:1	33	27	-	0.6	12-18	420	1.0	-55° To +50°C	15	4.419	SPLIT SERIES	FLANGE	15R-9201-08		
26:1	240	27.5	24-29	0.65	240	40	1.3	-18° To +71°C	17	5.315	SHUNT GOVERNOR	SYNCHRO	17R-9251-01		
4.26:1	1800	28	-	0.6	1800	12	1.85	-30° To +55°C	24	4.640	SHUNT GOVERNOR	FACE	24R-9451-01		

Speed tolerance on governed motors is  $\pm 2\%$  over voltage and an ambient temperature range. Closer speed tolerance units can be designed to fit the particular application.

Many other variations available. There is an Oster motor-gear-train to fit your exact specification. Consult Oster specialists today, sending your detailed requirements.

Other products include servos, synchros, AC drive motors, DC motors, servo mechanism assemblies, synchro indicators, servo torque units, reference and tachometer generators, actuators, motor driven blower and fan assemblies and fast response solvers.

**John Oster** MANUFACTURING COMPANY  
 Your Rotating Equipment Specialist  
 AVIONIC DIVISION  
 Racine, Wisconsin

Engineers For Advanced Projects:  
 Interesting, varied work on designing transistor circuits and servo mechanisms.  
 Contact Mr. Zelazo, Director of Research, in confidence.

# DeJUR high precision panel instruments

**SERIES 100** Actual Size



1" Sealed Sub-Miniature — Meets smallest weight and space requirements. 9 meters can be mounted in only 3 3/4" square! Accuracy  $\pm 3\%$  of full scale.

**MODEL 131** 3/4 Actual Size



1 1/2" Ruggedized Miniature — Special ruggedized features to withstand heavy duty operation. Sealed windows and terminals.

**SERIES 647** 1/2 Actual Size

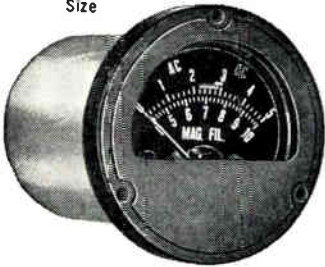

2 1/2" Multiple-Scale—Unique space saver. Provides up to 5 scales in all sensitivities. Sealed housing.

**MODEL 150** 3/4 Actual Size

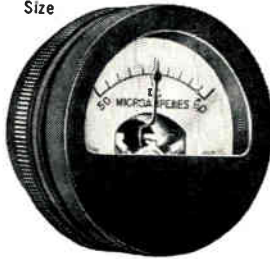

1 1/2" Sealed Miniature—Easy one hole mounting. Sealed windows and terminals. Square model available on order.

Precision instruments by DeJUR provide a combination of compact design, accuracy and high quality. All DC models use external pivot D'Arsonval movements, and are housed in metal cases.

Our engineering department will be glad to help you with special scales, ranges or specifications. For the complete technical data sheets write to Electronic Sales Division, DeJUR-Amsco Corporation, 45-01 Northern Blvd., Long Island City 1, N. Y.

**MODEL R-230** 1/2 Actual Size

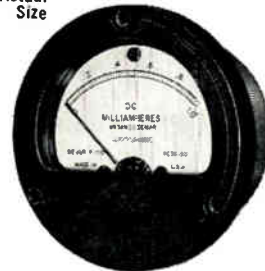

2 1/2" Ruggedized or Sealed—Withstands shock, vibration and temperature extremes. Sealed windows and terminals. Also available in 3 1/2" size.

**SERIES HD-654** 3/4 Actual Size



3 1/2" Elapsed Time Indicator—Easy to read 5 digit counters can be provided to register tenths of minutes or hours.

you're  
always  
sure with  
**DeJUR**

Booth 3911-13, I.R.E. Show

(Continued from page 140)

The impedance  $Z_e$  is necessary only to provide a dc path to the emitter but must be of sufficiently large magnitude to provide an open circuit for ac. So far as the determination of  $h_{12}$  itself is concerned,  $Z_e$  need not be especially high; a few thousand ohms would be sufficient. However, for the measurement of open-circuit collector-base admittance  $h_{22}$  (Fig. 4) the requirements are more severe and dictate that  $Z_e$  essentially be as large as possible. At the higher frequencies, where the shunting impedance of the VTVM is the limiting factor,  $Z_e$  may be chosen as a low-capacity resistor. However, at lower frequencies a somewhat better open circuit may be obtained by employing a parallel-tuned LC circuit. For example, in one piece of equipment used by the writer for the frequency range 20-200 KC, a tuned circuit provides  $|Z_e| > 20,000$  ohms over this frequency range, with a dc resistance of a few hundred ohms. Furthermore, the output of this low-frequency circuit is supplied to a wide-band pre-amplifier ahead of the millivoltmeter in order to permit measurement of relatively small voltages  $e_c$  without overdriving the transistor. For the higher frequency range a different circuit has been used in which  $Z_e$  is simply a 10,000-ohm low-capacity resistor, and the measurement of  $e_c$  is made with a low-capacitance probe-type high frequency VTVM. In these equipments, parasitic emitter-collector capacity must be kept to a minimum to avoid errors in the measurement of  $r'_b C_c$ , especially if the latter is small.

For the measurement of collector-base capacitance  $C_c$ , the VTVM is connected across  $R_B$ , as shown in Fig. 4, and the parameter  $h_{22}$  is measured as

$$h_{22} = e_b / R_B e_g, \text{ if } |e_b| < |e_g|.$$

A value of  $R_B = 10^3$  ohms is a convenient compromise between available signal amplitude and errors due to shunting by the VTVM. If  $|e_b|$  increases linearly with frequency for constant

$$|e_g|, h_{22} = j\omega C_{22}, \text{ and}$$

$$C_{22} = |e_b| / \omega R_B |e_g|. \quad (7)$$

This capacitance also includes the

(Continued on page 144)

# Westinghouse **IGNITRON TUBES** still the industry standard.

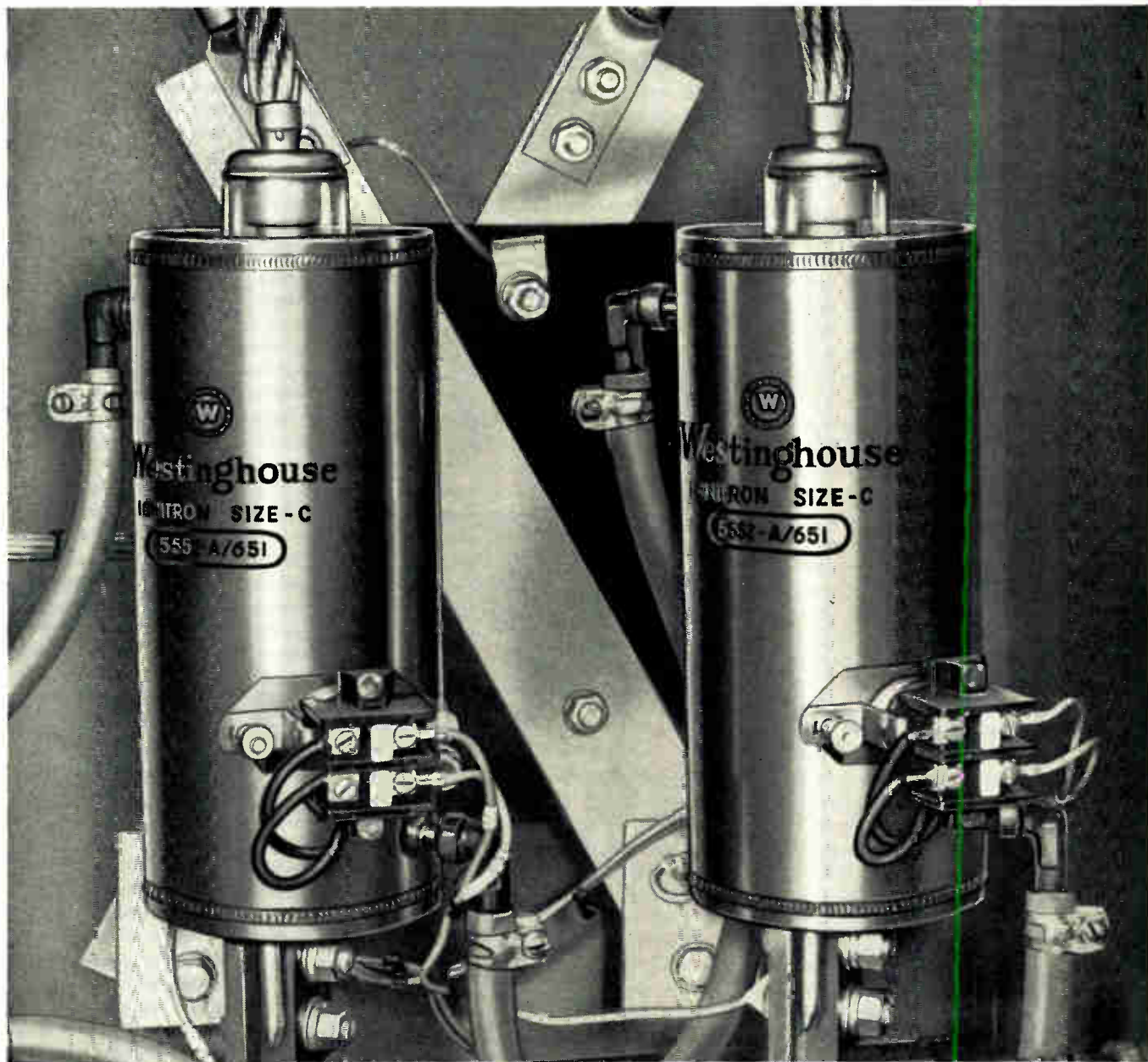

Westinghouse invented the Ignitron tube and has maintained a record of improvements that are today the accepted industry standards:

- kovar seals to permit use of steel envelopes • improved ignitors to assure accurate ignition.
- thermostatic control for overload protection and water savings.

For highest quality Industrial and Special Purpose tubes—always specify Westinghouse.

**YOU CAN BE SURE...IF IT'S Westinghouse**

7ET-4103-B

snarled  
up in  
coil  
winding  
problems?

...you need  
the new

## UNIVERSAL TOROYD WINDING MACHINE

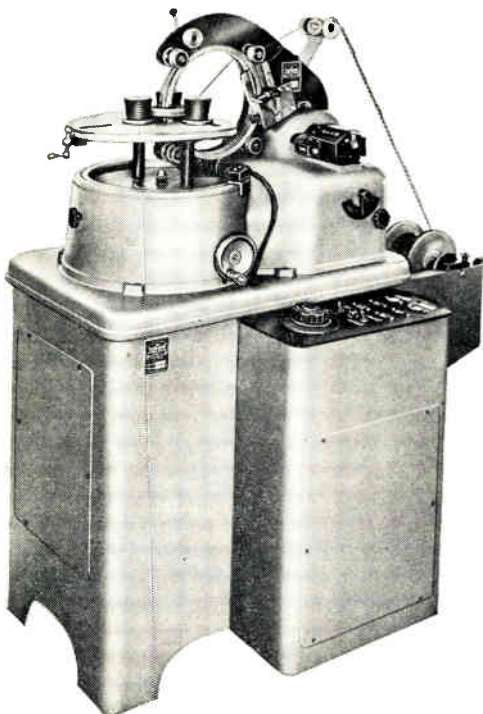

Ten times faster than hand winding . . . saves precious time and money. Highest accuracy, tight, even winding, simple operation, no wire breakage.

Six Models from small to super-size coils in wire sizes from #40 to #3. Complete electrical instrumentation.

Custom adaptations to special requirements.

Write Today for your Catalog of Universal Wire and Tape Winders.



Universal Manufacturing Co., Inc.  
410 Hillside Avenue, Hillside, N. J.

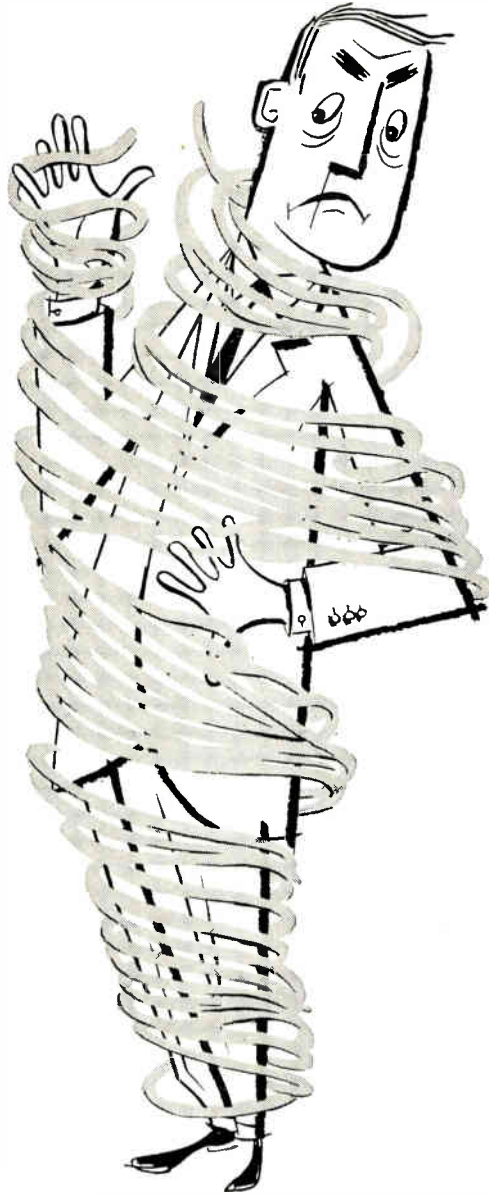

(Continued from page 142)

parasitic capacity between C and B in the circuit and transistor which must be subtracted from  $C_{22}$  to yield  $C_e$ .

The simplicity of the type of equipment used to measure these high-frequency parameters is illustrated by the photograph of Fig. 1, which shows a practical version of the  $|h_{21}|$  measurement in operation.

The writer is grateful to J. Lawrence for building and testing a number of practical versions of these measuring circuits. The concept of the frequency  $f_T$  introduced above is the result of informal discussions with colleagues: J. B. Angell, R. B. Adler, J. M. Early, and W. M. Webster on IRE/AIEE Task Group 28.4.7 on Transistor Internal Parameters.

### References

- <sup>1</sup> As distinguished from the measured, or terminal, characteristics; see discussions in text.
- <sup>2</sup> R. L. Pritchard, "Frequency Response of Grounded-Base and Grounded-Emitter Transistors," presented at AIEE Winter Meeting, New York, 22 January 1954. See also, "High-Frequency Power Gain of Junction Transistors," *Proc. I.R.E.* 43, p. 1078; Sept. 1955.
- <sup>3</sup> J. M. Early, "P-N-I-P and N-P-I-N Junction Transistor Triodes," *Bell Sys. Tech. J.* 33, p. 519; May 1954.
- <sup>4</sup> L. J. Giacoletto, "The Study and Design of Alloyed-Junction Transistors," *IRE Conv. Rec.* 2, pt. 3, p. 102; 1954.
- <sup>5</sup> For example, J. L. Moll, "Large-Signal Transient Response of Junction Transistors," *Proc. IRE* 42, 1780; Dec. 1954.
- <sup>6</sup> O. Kummer, "A Transistor Frequency Scanner," *IRE Conv. Rec.* 2, part 10, 81-87; 1954.
- <sup>7</sup> IRE Standard 56 IRE 28.S2, "Methods of Testing Transistors," *Proc. IRE* 44, 1552; Nov. 1956.
- <sup>8</sup> W. N. Coffey, "Measuring R-F Parameters of Junction Transistors," *Electronics* 29, 152-155; Feb. 1956.
- <sup>9</sup> This procedure was described by F. R. Stansel, "An Improved Method of Measuring the Current Amplification Factor of Junction Type Transistors," *Trans. IRE PGI-3*, 41-49; April 1954.
- <sup>10</sup> R. L. Pritchard, "Frequency Variations of Current-Amplification Factor for Junction Transistors," *Proc. IRE* 40, 1476-1480; Nov. 1952.
- <sup>11</sup> J. M. Early, "Effects of Space-Charge Layer Widening in Junction Transistors," *Proc. IRE* 40, 1404; Nov. 1952.
- <sup>12</sup> Lincoln Laboratory, Quarterly Progress Report Solid State Research, 1 Aug. 1954, pp. 6-7; MIT, Cambridge, Mass.
- <sup>13</sup> For example, R. L. Pritchard, "Frequency Variations of Junction Transistor Parameters," *Proc. IRE* 42, p. 792; May 1954.
- <sup>14</sup> For example, Figs. 43.8, 43.9 of reference 7.

## Solar Power

(Continued from page 59)

tected from damage by intense direct sunlight or very high temperatures.

The most promising development in direct conversion of solar energy to electric power has come from semiconductor research.

(Continued on page 148)

MEMO

To: The Television Industry  
From: Audio Division, Ampex Corporation

Ampex VR-1000, the world's first commercial magnetic tape recorder for video, was introduced in April, 1956, and was immediately given an overwhelming vote of confidence by the television industry. For the first time, up to 64 minutes of television sight and sound entertainment could be instantaneously recorded on a 12-1/2 inch reel of two inch magnetic tape and played back immediately with such clarity that most persons could not tell the Videotape recording from the live show.

Since November 30, this revolutionary development has been used by the networks on regularly scheduled shows each weekday night. Engineering-prototype Ampex Videotape Recorders, being delivered to the three major networks for regular service, immediately improve picture quality for the viewer and make large cost savings for their owners. Audiences in large areas of the country are already seeing this bright new live look on delayed telecasts.

The growing schedule of regular program use has afforded Ampex the opportunity to demonstrate in nationwide performances the advantages of Ampex Videotape. This severe test has re-emphasized Ampex's reputation for consistent quality and reliability and shows the flexibility of programming to which veteran broadcast users of the Ampex Audio Recorder have become accustomed.

Television programming of tomorrow is now being seen on West Coast television screens. The inclusion of an Ampex Videotape Recorder in your equipment plans will assure participation in television programming of the future for your station.

*Phillip L. Gundy*  
Phillip L. Gundy  
Vice President

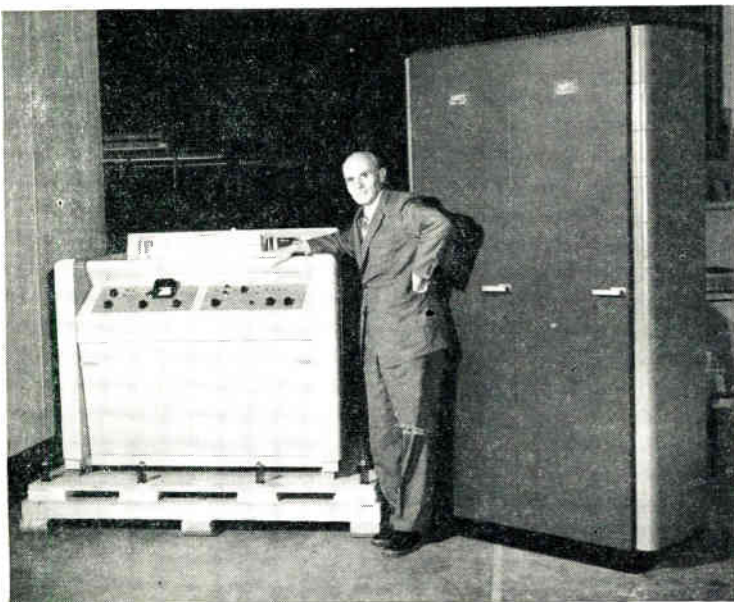

Alexander M. Poniatoff,  
Founder and Chairman of the Board of Ampex,  
with one of the pre-production  
Ampex Videotape Recorders (VR-1000)  
just before shipment.

# New Tech Data

## for Engineers

### Switches & Relays

Catalog of switches and relays manufactured by Jaidinger Manufacturing Co. of Chicago shows approximately 40 different switches and relays, ranging in size from standard to miniature, and describes the operation and characteristics of each. Complete specifications are included with photographs.

Circle 177 on Inquiry Card, page 103

### Spring Design

Fundamentals of spring design in sufficient detail to guide designers and engineers through the initial stages of spring design, the brochure contains the basic stress and deflection formulas, typical applications, and limitations of various types of springs. Associated Spring Corp., Bristol, Conn.

Circle 178 on Inquiry Card, page 103

### Equalizer-Amplifier

Model EA-4 video cable equalizer-amplifier is described in a bulletin issued by Ron Electric Co., Namuet, N. Y. Complete specifications are included along with an illustration. Unit is useful for TV, radar, pulse systems and multiplex circuits.

Circle 179 on Inquiry Card, page 103

### Capacitors

Catalog No. 616 contains 20 pages of information on miniature ceramic and feed-thru capacitors. Booklet is well illustrated and complete with specifications, both electrical and physical. Catalog, from Cornell-Dubilier Electric Co., South Plainfield, N. J., may be readily inserted in any note book.

Circle 180 on Inquiry Card, page 103

### Vibration Pickup

A 6-page bulletin describing both vibration pickups and meters has been issued by MB Manufacturing Co., Div. of Textron Inc., New Haven 11, Conn. Technical information and illustrations on pickups and meters includes design and method of operation, specifications and typical frequency-response curves.

Circle 181 on Inquiry Card, page 103

### High Voltage Relays

Complete technical data covering high voltage, high vacuum relays has been issued by Resitron Labs., Inc., 2908 Nebraska Ave., Santa Monica, Calif.

Circle 182 on Inquiry Card, page 103

### Laboratory Standards

Three new bulletins have been issued by Measurements Corp., Boonton, N. J. The 4-page bulletins cover the model 95 standard FM signal generator, model 275 intermediate converter and model 505 standard test set for transistors. Booklets are in 2 colors, complete with specifications, photograph and a block diagram.

Circle 183 on Inquiry Card, page 103

### Adhesives & Cements

A new 8-page brochure which describes a complete line of epoxide adhesives, cements and sealants is now available from Emerson & Cuming, Inc., 869 Washington St., Canton, Mass. These epoxides come in several forms; one form is flexible, another is capable of use at 600° F., while a third may be used in place of solder.

Circle 184 on Inquiry Card, page 103

### Sensitive Switches

A 24-page booklet describes a full line of sensitive switches for airborne equipment. The 2-color booklet contains photographs, illustrations and complete specifications for all switches. Switches in all shapes, methods of actuating, voltages and contact arrangements are described. Micro Switch, Div. of Minneapolis-Honeywell, Freeport, Ill.

Circle 185 on Inquiry Card, page 103

### Coils

An 8-page booklet, S-20, is available from the Stonite Coil Corp., Yardville, N. J. This colorful, illustrated brochure shows all phases of coil manufacturing.

Circle 186 on Inquiry Card, page 103

### Specialized Equipment

A new 2-color 36-page catalog describes the special and general purpose electronic testing equipment manufactured by Manson Labs., Inc., 207 Greenwich Ave., Stamford, Conn. Complete descriptions, photos, specifications and performance data are given for 50 types of equipment such as tube testers, power supplies, pulse and trigger generators, harmonic generators and many others.

Circle 187 on Inquiry Card, page 103

### Extension Cord

Pamphlet describes new over-the-floor extension cords, contains specifications and price list. Ideas, Inc., 615 S. 2nd, Laramie, Wyo.

Circle 188 on Inquiry Card, page 103

### Components

Catalog B5 contains 68 pages covering all types of connectors, plugs, sockets, plastic forms and transmission line. Complete with photographs, illustrations and specifications. Amphenol Electronics Corp., Chicago 50.

Circle 189 on Inquiry Card, page 103

### Terminals

Catalog LT-1 contains comprehensive data on construction, applications, specifications, dimensions and installation suggestions for hermetic seal terminals. Detailed charts and diagrams are included in this brochure from International Resistance Co., Philadelphia 8, Pa.

Circle 190 on Inquiry Card, page 103

### Accelerometers

Humphrey, Inc., 2806 Canon St., San Diego 6, Calif., has issued a 2-page pamphlet (A-100) describing their line of accelerometers. Complete specifications and photographs are included.

Circle 191 on Inquiry Card, page 103

### Ultrasonic Brazing

A 4-page brochure from Aeroprojects, Inc., 310 E. Rosedale Ave., West Chester, Pa., describes fully their ultrasonic equipment. This equipment permits joining of unstripped enameled aluminum wire without the use of flux.

Circle 192 on Inquiry Card, page 103

### Converters

A 4-page brochure, available from Power Sources, Inc., 6 Schouler Court, Arlington 74, Mass., describes newly developed DC-DC converters using all semiconductor devices.

Circle 193 on Inquiry Card, page 103

### Digital Comparator

A 4-page bulletin describing digital comparator that does not utilize tubes or relays is being offered by Norden-Ketay Corp., Commerce Rd., Stamford, Conn. The booklet is in 2 colors with illustrations.

Circle 194 on Inquiry Card, page 103

### Specialized Lighting

Mole-Richardson Co., 937 N. Sycamore Ave., Hollywood 38, Calif., has issued a 36-page booklet on specialized lighting equipment for all studio uses. Booklet is complete with specifications, pictures and prices.

Circle 195 on Inquiry Card, page 103



**FAST...PRECISE...AUTOMATIC  
RESISTANCE MEASUREMENTS  
FOR LABORATORY OR INDUSTRY**

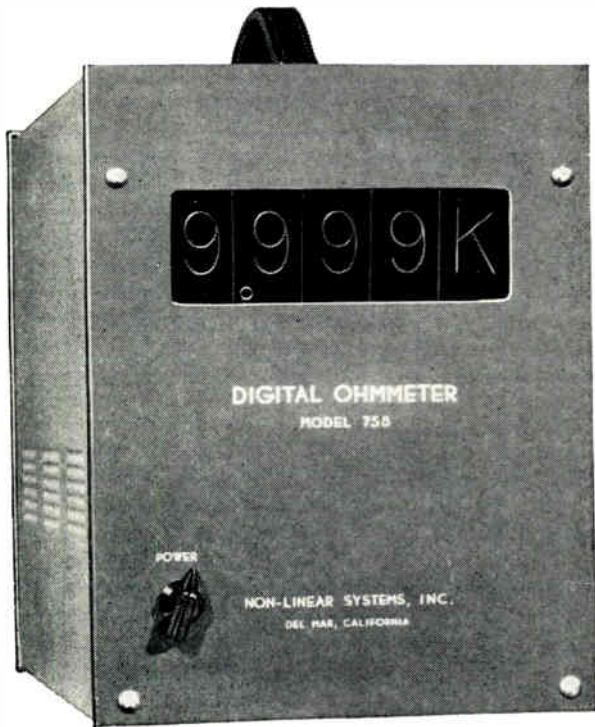

*Models 758 and 759 available in either rack mount or portable. Portable model is pictured above.*



FAST, AUTOMATIC MEASUREMENT of a wide range of resistance values, with an exceptionally high degree of accuracy, now is available in Non-Linear Systems Digital Ohmmeters. Resistance values are displayed in a horizontal line on one-inch-high luminous numerals clearly legible at distances to 30 feet. The readout decimal point location and range selection are automatic. And these instruments feature the exclusive NLS oil-sealed stepping switches, specifically re-designed for NLS digital equipment. This feature has been time-tested in the widely accepted NLS Model 451 Digital Voltmeter; it guarantees maximum maintenance-free life of stepping switches even in the presence of dust and humidity. Accuracy, ruggedness, high-speed automatic operation, reliability and economy adapt NLS Digital Ohmmeters to a wide variety of applications in laboratory, production, inspection and field testing... even with unskilled personnel. Ask your nearest NLS representative about these instruments... or mail the coupon below for full details.

**CHARACTERISTICS**

**Model 758 (4-Digit Display)**  
**RANGES:** .0001K to .9999K      100.0K to 999.9K  
 1.000K to 9.999K      1000K to 9999K  
 10.00K to 99.99K

**ACCURACY:**  $\pm 0.1\%$  of value read or 1 digit, whichever quantity is greater.

**Model 759 (5-Digit Display)**  
**RANGES:**      **ACCURACY:\***  
 0.0001K to 9.9999K       $\pm (0.01\% + 1 \text{ digit})$   
 10.000K to 99.999K       $\pm (0.01\% + 1 \text{ digit})$   
 100.00K to 999.99K       $\pm (0.03\% + 1 \text{ digit})$   
 1000.0K to 9999.9K       $\pm (0.05\% + 1 \text{ digit})$  to 5 meg.  
     $\pm (0.1\% + 1 \text{ digit})$  to 10 meg.

\*Percentages are expressed as % of value measured

**BOTH MODELS**  
**RANGE SELECTION & DECIMAL LOCATION:** Automatic  
**SIZES:** Rack Mount - 5 1/4" H, 19" W, 15 1/4" D.  
 Bench Top (Portable) - 11" H, 8 1/4" W, 15 1/4" D.  
**WEIGHT:** 33 lbs

**PRIMARY POWER:** 115  $\pm$  10v, 60 cycles, 75 watts.

**ACCESSORIES:** Data printing provision with automatic print control and Clary Printer or Electric Typewriter.

Connection and automatic control for card or paper tape punching equipment.

Multi-channel input scanners.

SEE US AT THE  
I.R.E. SHOW — BOOTH  
NUMBER 3041,  
3RD FLOOR



non-linear systems, inc.  
Del Mar, Calif. • Phone: SKYline 5-1134

ORIGINATORS OF THE  
DIGITAL VOLTMETER

Digital Ohmmeters • AC-DC Converters • Data Reduction Systems • Digital Readouts • Peak Reader Systems • Binary Decimal Converters • Digital Recording Systems

**NON-LINEAR SYSTEMS, INC.**  
 Dept. D-157, Del Mar Airport, Del Mar, Calif.  
 Send new Technical Bulletin 1256 with full information on NLS Digital Ohmmeters — Models 758 and 759.

NAME \_\_\_\_\_  
 COMPANY \_\_\_\_\_  
 ADDRESS \_\_\_\_\_  
 CITY \_\_\_\_\_ STATE \_\_\_\_\_

## ENGINEERS, *Electronic & Mechanical* PHYSICISTS:

# Melpar's Dynamic Growth Creates UNCOMMON OPPORTUNITIES

Melpar has doubled in size every 24 months during the past 11 years. This continuous growth, combined with our policy of individual recognition and organization into small project teams, creates opportunities uncommon to the industry.

As a Melpar staff member you will benefit from our policy of *individual recognition*, which means that your rate of advancement is determined solely by your skill and ability.

Our technical staff is organized into *small project teams*, each of which is assigned a specific problem and responsibility to carry through from conception to completion of prototype. Following a problem through research, design, development, and testing will give you the diversified background necessary to occupy high managerial positions.

In addition, the project team system gives more freedom to your creative talents and enables us to quickly recognize your achievements. These factors should be of particular interest to the engineer or physicist stymied by the complexity of a larger company.

Our ultra-modern laboratory is located on a 44-acre wooded tract in Fairfax County, Virginia. Here you can enjoy a relaxed suburban life with a full quota of golf, sailing, riding and other sports. The Nation's Capital with its renowned cultural and educational advantages is 10 miles away. Attractive housing is available traffic-free minutes from the laboratory.

- \* Complete company benefit program including financial assistance for study.
- \* Liberal travel and moving allowances.
- \* Qualified applicants will be invited to inspect the Laboratory at Company expense.

### OPENINGS EXIST IN THESE FIELDS:

Flight Simulators, Radar and Countermeasures, Network Theory, Systems Evaluation, Microwave Techniques, Analog & Digital Computers, Magnetic Tape Handling, UHF, VHF, or SHF Receivers, Packaging Electronic Equipment, Pulse Circuitry, Microwave Filters, Servo-mechanisms, Subminiaturization, Electro-Mechanical Design, Small Mechanisms, Quality Control & Test Engineering, Field Engineering, Antenna Design.



For Detailed Information, write:  
Technical Personnel Representative

**MELPAR** Incorporated

A Subsidiary of Westinghouse Air Brake Company  
3018 Arlington Boulevard, Falls Church, Va.  
10 miles from Washington, D. C.

(Continued from page 144)

Present silicon photo-diodes give about 10 percent efficiency, with a theoretical maximum around 22 percent. These cells, although still quite expensive, are possible power sources for unattended weather stations, satellite instrumentation, and other remote equipment. The future for these devices seems bright, but a little thought shows there is little likelihood they will drive large power consuming devices such as electric outboard motors. Even with an unheard-of 100 percent efficiency, and with maximum solar radiation, a ten horsepower outboard would require a cumbersome 75 square-foot solar battery.

Aside from the familiar sunlight, there are many other effects of solar energy. One is "airglow," a feeble light emitted by the upper atmosphere over the whole earth. It is usually too weak to be visible to the eye. This light gets its energy from solar ultra-violet light which ionizes atmospheric gases at great heights. Chemical reactions among the ionized products then release the stored energy as light.

Another phenomenon, which may have practical significance to satellite and manned space flight, is bombardment of the earth by ions and electrons from the sun. It is these particles which create the beautiful auroral light displays. The earth's magnetic field normally deflects these particles so they precipitate over limited regions of the earth, in the far North and South.

Solar energy is not steady, however. Solar eruptions occur which cause violent radiation in the meter wave band and sometimes into the centimeter band. During the eruptions, great jets of ions and charged particles spurt into space. If the solar disturbance faces the earth, dramatic effects follow the eruption. Eight minutes after the eruption, a burst of ultra-violet light reaches the earth, causing an intense ionization of the upper atmosphere, a short-wave radio fade-out, and a sudden brief disturbance of the earth's magnetic field. About 24 hours later, the jet of charged particles engulfs the earth. It

(Continued on page 150)

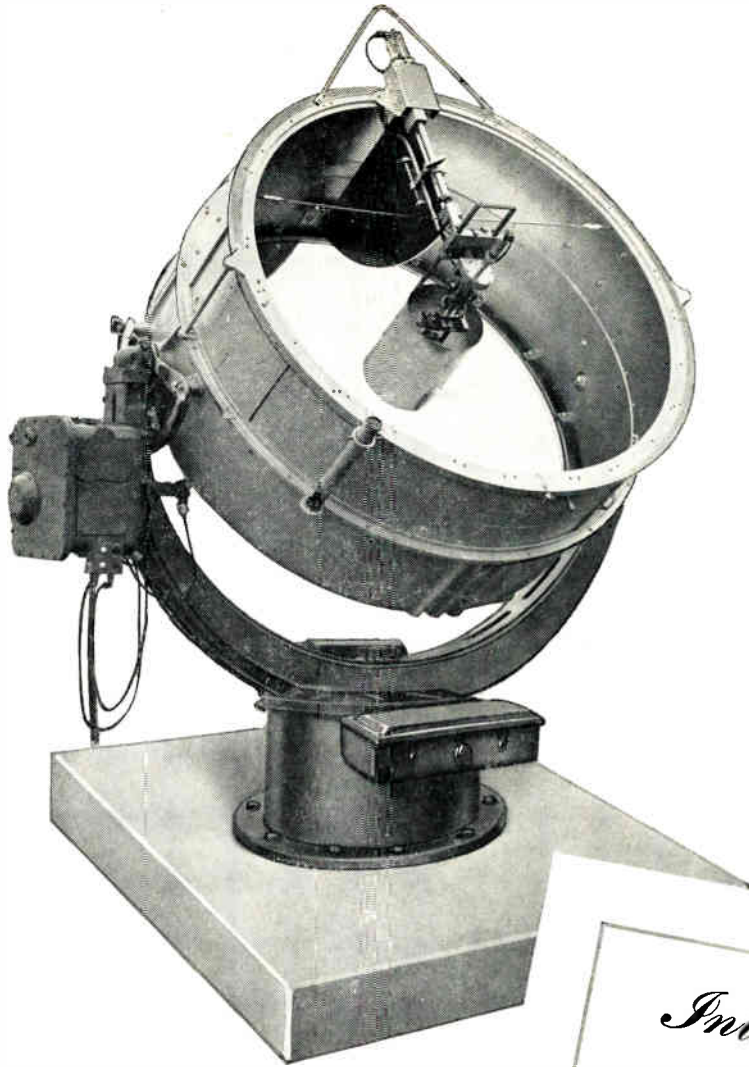

*Introducing*  
THE NEW ADL  
SOLAR FURNACE

## 3500°C of "pure" heat...

### **FOR HIGH-TEMPERATURE RESEARCH**

This is the new ADL solar furnace — a compact, flexible tool engineered for immediate application in high-temperature research.

With its highly polished, stellite-coated 60" paraboloid mirror, the furnace focuses the sun's rays into a spot of "pure" heat 6 millimeters across — a spot where temperatures reach 3500°C — half the surface temperature of the sun itself.

This is "pure" heat . . . since the test sample needs no crucible, there is no problem of contamination from a container, or from furnace walls. The high-temperature area can be sharply defined, and the desired temperature accurately controlled.

Heat can be turned on and off quickly, or maintained for hours at a time. Temperature and heat flux measurements are convenient and easy to make by means of instruments inserted through the viewing port at the back of the reflector. An experiment may be repeated within seconds by moving an unreacted part of the sample into focus. Adjustable-speed motors rotate the reflector on the horizontal and vertical axes.

The furnace can be modified to meet individual customer requirements. Arthur D. Little, Inc. invites your inquiries. Write:

## **Arthur D. Little, Inc.**

30 Memorial Drive, Cambridge 42, Mass.

# THE **NEW** ARTOS AUTOMATIC wire-stripping and TERMINAL-ATTACHING MACHINE

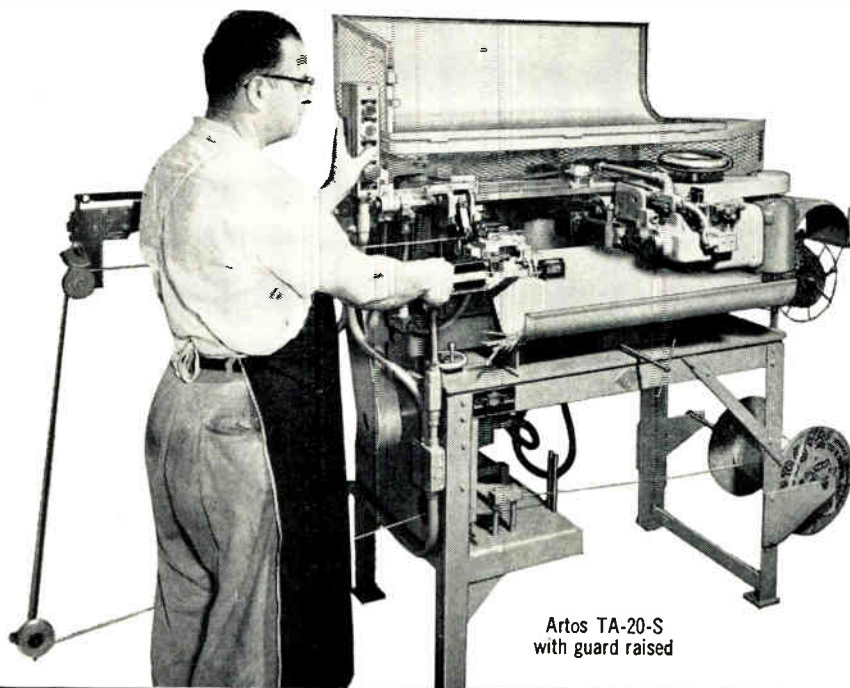

Artos TA-20-S  
with guard raised



This new Artos TA-20-S brings still greater speed and production economy to large-quantity users of wire leads with terminals attached. It *automatically* performs the following services *all in one operation*:

1. Measures and cuts wire to predetermined lengths.
2. Strips one or both ends of wire.
3. Attaches practically any prefabricated terminal in strip form, to one end of wire.
4. Marks finished wire leads with code numbers and letters. (Optional attachment not standard part of machine.)

**ALL OPERATIONS ARE AUTOMATIC.** Machine can be operated by unskilled labor. It is easily set up and adjusted for different lengths of wire and stripping. Die units for different type terminals simply and quickly changed. Production speeds up to 3,000 finished pieces per hour.

**ARTOS MACHINES ARE USED** by electric appliance, automotive, aircraft, electronics and other industries that want automation in the production of wire leads in quantity. Agents throughout the world.

Engineering consultation and recommendations given without obligation.

WRITE FOR  
BULLETIN

No. 655 on the  
Artos TA-20-S



## ARTOS ENGINEERING CO.

2753 South 28th Street

Milwaukee 46, Wisconsin

(Continued from page 148)

causes violent disruptions of the earth's magnetic field, produces tremendous earth currents which disturb cable communications, and causes extensive auroral displays which often reach far into the temperate zones.

Sunspots also tend to bring increased radiation from the sun. The increase is roughly proportional to the sunspot area. It is often circularly polarized. Although it is probably present at all frequencies, it causes noise in radio telescopes primarily in the centimeter region.

The study of solar energy may lead to a new source of power. We have already learned to produce the basic fusion reaction, in the hydrogen bomb. Our goal now is to produce the fusion reaction in a controlled form. The great significance of such a power source is that the proposed fuel, deuterium, is found in very large quantities in the sea. Even by present methods, deuterium fuel can be recovered from the sea at a small fraction of the cost of coal. A second, no less important advantage of fusion power is that it need not produce the deadly radioactive byproducts of the atomic reactor. Although the work is veiled in secrecy, recent announcements have revealed important advances in designing a fusion power plant.

Fusion occurs in the sun at about 30 million degrees Centigrade. At this temperature, all elements exist as a plasma of dissociated ions and electrons. Since no material can remain solid at this temperature, physicists have been trying to build some sort of "magnetic bottle" which would contain the reaction in magnetic fields. Within recent weeks, British scientists at the Harwell atomic energy laboratories have announced progress in achieving such a bottle. Further work here in the United States has resulted in very high energy magnetic fields, vastly greater than any previously attained. These advances raise the hope that we may eventually build "bottled sun" power plants. The Atomic Age may well be a mere prelude to the Fusion Age.



## LARGE WAVEGUIDE



Slotted line for waveguide size WR 2100. Covers range of 350-530 mc. Probes tunable over entire band. Inherent VSWR less than 1.02—slope less than 1.01. Features bolted and doweled aluminum construction.

# LARGE WAVEGUIDE & COMPONENTS WR 770 to WR 2300 (1450 down to 320 mc)

To complement the waveguide presently being supplied for major military and commercial applications in radar and scatter communications systems, we now offer a complete line of components and test equipment.

**Terminations.** Aluminum construction. Engineered to absorb virtually all incident power. Load is adjustable with locking device to secure it in any position.

**Attenuators.** Vane type designed to provide 20 db of attenuation with a minimum of mismatch. Calibration curves available.

**Directional couplers.** Bolted and doweled aluminum construction. Power split to customer requirements.

**Special components.** Including waveguide switches, duplexers, diplexers, series and shunt tees, rotary joints, and special shapes.

All items are in production now and are available on short term delivery. For more information, write I-T-E Circuit Breaker Company, Dept. 25, Special Products Division, 601 East Erie Ave., Philadelphia 34, Pa.



VISIT THE I.R.E. SHOW, March 18-21  
See this equipment displayed at Booth 1313-1315

**I-T-E CIRCUIT BREAKER COMPANY**  
Special Products Division

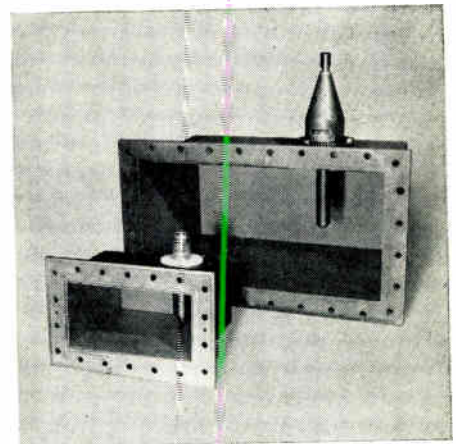

**Waveguide to coaxial transitions.** High-strength, lightweight aluminum construction. Supplied as standard with  $3\frac{1}{8}$  in. coaxial connector (for WR 770 size,  $1\frac{5}{8}$  in.). Adapters to other sizes available. All transitions designed for high power handling capacity.

■ Research and development at Lockheed Missile Systems Division laboratories in Palo Alto is of a most advanced nature. Particular areas of interest include microwaves, telemetering, radar, guidance, reliability, data processing, electronic systems, instrumentation, servomechanisms. Inquiries are invited from those qualified by ability and experience for exploratory efforts of utmost importance.

*Here members of the Electronics Division discuss systems radar problems related to measurement of missile trajectories. Left to right: K. T. Larkin, radar and command guidance; Dr. S. B. Batdorf, head of the Electronics Division; Dr. H. N. Leifer (standing), solid state; Dr. R. J. Burke, telemetering; S. Janken, product engineering.*

*Lockheed*

**MISSILE SYSTEMS DIVISION**

*research and engineering staff*

**LOCKHEED AIRCRAFT CORPORATION**

**PALO ALTO • SUNNYVALE • VAN NUYS**

**CALIFORNIA**



# I·R·E

## NATIONAL CONVENTION AND RADIO SHOW

Significant developments at Lockheed Missile Systems Division have created new openings for:

- Controls Systems Engineers** — to analyze and synthesize complex automatic control systems.
- Inertial Guidance Engineers** — to perform systems analysis and design of inertial guidance systems.
- Infrared Specialists** — to perform preliminary systems design and parametric optimization of advanced infrared detection systems.
- Data Processing Systems Specialists** — to perform advanced system development and design in new techniques of automatic data processing.
- Weapons Systems Specialists** — to perform basic analysis and systems evaluation of advanced weapons systems.
- Electronic Product Engineers** — to translate laboratory electronic systems into prototype models meeting the rigid requirements of modern weapons systems.
- Radar Systems Engineers** — to develop advanced radar systems associated with guided missiles.
- Theoretical Physicists** — to analyze propagation of electromagnetic waves through the ionosphere and through dielectric materials and study radiation problems pertaining to advanced antennas in the microwave and millimeter domain, including scattering problems related to the reflection of electromagnetic waves from simple and complex boundaries.
- Experimental Physicists** — to investigate microwave circuit components including ferrites and various millimeter wave techniques such as MAZUR.
- Antenna Specialists** — to design and develop airborne antennas and radomes for high speed missiles for telemetering, radar, and guidance systems application.
- Video Specialists** — to develop advanced systems for the transmission of visual data by electronic means.
- Circuit Design Specialists** — to design telemetering and guidance systems utilizing advanced circuit components.

Positions are open at the Palo Alto Research Center and Sunnyvale and Van Nuys Engineering Centers. M. H. Hodge, M. W. Peterson and senior members of the technical staff will be available for consultation at the convention hotel. Phone PLaza 14860 or 14861.



MISSILE SYSTEMS DIVISION

## Printed Wiring

(Continued from page 66)

sion from the plated circuit process and makes this transfer method unique.

In this process a metal plate, imprinted with a plating resist in the negative image of the circuit pattern, is used as the plating bath cathode. Upon this cathode is electroformed the desired thickness of conductors in the pattern determined by the open areas of the plating resist. When the plating cycle is completed the electroformed conductor pattern is lifted intact from the face of the permanent cathode by a pressure sensitive adhesive coated paper. This function of lifting the plated conductor pattern from the permanent cathode is made possible by using passivated nickel or stainless steel polished to a No. 8 finish as the plating surface. In either case a minimum purchase of the plating deposit to the open areas of the permanent cathode is obtained.

The proper selection of the plating resist material will result in the possibility of repeated usage of each permanent cathode. At present, 500 plating and transferring cycles is accepted as normal life for each imprinting of a cathode.

The adhesive coated paper with the conductor pattern adhering to it is then placed, with conductor face up, on the insulating base material laminating sandwich and passed on to the laminating press for the laminating and curing cycle. The adhesive coated paper sheet becomes the surface sheet of insulating base material, and therefore becomes the major determinant of the electrical characteristics of the printed wiring board. For the most favorable electrical characteristics it may be necessary to utilize a resin impregnated paper sheet that is fully cured. This would eliminate contamination and moisture entrapment.

Completion of the laminating and curing cycle and discharge of the laminating press exposes the printed wiring board with the conductor pattern neatly embedded into the insulating base material and perfectly flush with the insulating surface sheet.

## Temporary Cathode System

One variation of the transfer method is a technique called the temporary cathode system. The temporary cathode system uses a metal plate cathode with nickel or polished stainless steel plating surfaces, and imprinted with a plating resist in the negative image of the conductor pattern much as in the method described above. However, after electroforming the desired thickness of conductor the cathode is removed from the plating bath and stripped of its plating resist in a suitable solvent. The cathode with the electroformed conductor pattern intact on its surface is then placed conductor-face down on the insulating base material laminating sandwich and committed to the laminating press for the laminating and curing cycle. The temporary cathode is now the top platen for the laminating operation. Upon completion of the laminating and curing cycle and discharge of the laminating press the top platen is removed from the laminating sandwich exposing the printed wiring board with the conductor pattern neatly embedded into the insulating base material and perfectly flush with the insulating surface.

## Expendable Cathode System

A second variation of the transfer method is a technique called the expendable cathode system. This method uses a metal foil cathode of about .005 in. thickness in place of the metal plate cathode mentioned earlier. However, this metal foil is imprinted, and plated much as in the first variation discussed. After completion of the plating cycle, the metal foil cathode is removed from the plating bath and stripped of its plating resist in a suitable solvent. Then the expendable cathode with the electroformed conductor pattern intact on its surface is placed face down on the insulating base material laminating sandwich and committed to the laminating press. In this case, however, the foil cathode does not have enough body to serve as the top platen for the laminating operation and must be backed up by a standard press platen.

After laminating and curing and discharge of the laminating press, the insulating base material sand-

(Continued on page 154)

## COMMUNICATIONS SYSTEMS ENGINEERS

### I.R.E. CONVENTION March 18th-21st

Senior Members of the  
Hoffman Technical Staff  
will be at the Convention  
Hotel - Please telephone  
EL 5-3456 for appointment.

The expanding scope of advanced communications projects has created several unique positions in fields related to VHF, UHF, microwave transmission and reception, forward scatter and single sideband applications at Hoffman. Electronics engineers with appropriate backgrounds will find these new assignments professionally stimulating and financially rewarding. Please write or call Vice President of Engineering, Richmond 9-4831.

### Hoffman LABORATORIES, INC.

A SUBSIDIARY OF HOFFMAN ELECTRONICS CORP.  
3761 South Hill St., Los Angeles 7, Calif.

Circle 202 on Inquiry Card, page 103

## EISLER VERTICAL SPOT WELDER

MADE IN SIZES 1/2-1-2-3-5 KVA  
WITH OR WITHOUT TRANSFORMER OR TIMER.  
SENT TO ANY RADIO TUBE MANUFACTURER IN U.S.A.  
ON A 30 DAY FREE TRIAL BASIS.

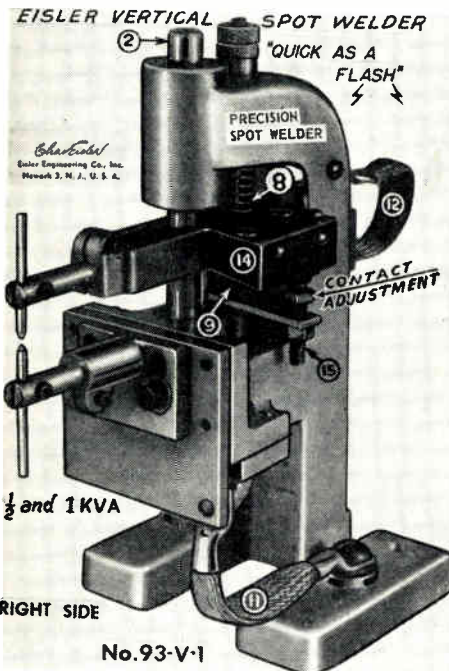

## EXHAUST MACHINES

EISLER MAKES MANY TYPES  
OF AUTOMATIC EXHAUST  
MACHINES FOR MANY PUR-  
POSES, 24, 36 AND 48  
HEADS. THIS IS NOT A NEW  
DEVELOPMENT WITH EISLER.  
THIS MACHINE HAS BEEN  
MADE BY US FOR OVER 35  
YEARS.

### Die Formed Process

Many printed wiring applications are employing a process which might be called "The Die Formed Process." This process requires that a die be made by etching, machining, or electroforming a metal plate in the pattern of the conductor configuration and mounting this plate on a heated bolster capable of maintaining the formed surface of the plate at an elevated temperature. A sheet of insulating base material is then placed beneath the heated die plate and dusted with a lightly covering layer of finely divided silver powder. The press is then closed and held closed under pressure in contact for about 15 secs while the temperature of the contact is held at an elevated level. On opening the press and dispersing the excess silver powder, the conductor pattern of

(Continued from page 153)

wich is exposed with the expendable foil cathode adhered face down to one surface. By properly selecting dissimilar foil and plating metals, the expendable cathode is removed through the principles of selective etching which exposes the conductor pattern neatly embedded into the insulating base material and perfectly flush with the insulating surface.

The transfer techniques are easily adapted to automatic processes, and have a very favorable unit cost position. In the case of all except the expendable cathode variation, there is complete freedom from any contact or association with acids or moisture. Also desirable is the extremely fine definition of conductor pattern possible, and the perfectly flush circuitry.

Drawbacks to the transfer techniques are the heavy equipment investment required, and the economic disadvantage resulting in low quantity runs. Also, with the exception of the expendable cathode variation, the transfer technique is extremely inflexible, and involves considerable preparation time for each job. Possible ramifications of this process are complex circuitry through sandwich build up, front to back through connections, and raised, flush, or debossed conductors. Also formed circuit boards are a reality through the use of post forming base materials.

SEND FOR  
CATALOG



Dr. Chas. Eisler, M.E. Founder  
CHAS. EISLER, JR., PRES.  
**EISLER ENGINEERING CO., INC.**

770 So. 13th St., NEWARK 3, N. J.

Circle 203 on Inquiry Card, page 103



sintered and embedded silver is exposed. Good adhesion to the insulating base material is obtained through mechanical purchase resulting from the high temperature and pressure embedding action occurring during the sintering of the silver. Good conductivity, of course, is assured having once sintered the silver.

A variation of this die formed process where foil clad laminates are used is also finding extensive use. In this variation, the die is used in place of the contiguous platen during the laminating and cladding operation of the insulating base material, and being so placed assumes the role of a debossing die.

A second variation of this die formed process uses a metal cutting die which punches the desired conductor pattern from the foil and subsequently embeds the conductor pattern into the insulating base material.

A final variation of this die stamp process requires that the insulating base material be molded with grooves and holes to the pattern of the desired circuit with the grooves having sharp vertical walls and a convex bottom. Over this molded slug is then placed the desired conducting metal foil which has been coated on one (1) side with a dry back adhesive—adhesive side down.

Next, a medium hard rubber block is placed upon the metal foil and this entire sandwich is placed beneath the ram of a punch press. The punch press is then actuated causing the punch press ram to impact the rubber block. This causes the rubber block to compress on the molded slug and by virtue of the slug design, as described above, the conducting pattern including holes is cut from the foil and forced into the grooves.

When the sandwich is removed from the punch press the rubber block is lifted and the foil scrap removed or salvaged revealing the molded slug with the desired pattern of conducting metal securely wedged into the vertical walled grooves. The chemical and mechanical bond obtained is sufficient to use while inserting components and final cure of the dry back adhesive is accomplished during the solder operation.

(Continued on page 156)

**QUALITY  
knight-kits  
FOR LAB, SERVICE &  
INDUSTRIAL USE**

fine electronic equipment  
in easy-to-build form

**knight-kit  
5" WIDE BAND  
OSCILLOSCOPE KIT**

- 2 Printed Circuit Boards
- 5 Mc Width for Color TV
- Hor. Sweep to 600 Kc
- 25 mv-inch Sensitivity
- DC Positioning Controls
- Z-Axis Input

Only **\$6900**

**knight-kit  
VOLTAGE CALIBRATOR KIT**

Permits use of any scope as a precision peak-to-peak AC voltmeter. Puts a true square-wave voltage on scope screen. Range switch and calibrated potentiometer selects any voltage between .01 and 100 volts in 4 ranges. Fifth position feeds external signal to scope for comparison. Has voltage regulator tube—output voltage stays constant with line variation from 80-135 volts. Accuracy,  $\pm 6\%$  on all ranges. Shunt capacitance only 15 mmf. Includes control for providing precision initial setting. Direct coupling of output provides ground reference for DC scopes. Complete kit includes all parts, case, full instructions. Shpg. wt., 5 lbs.

Model 83 Y 136. Voltage Calibrator Kit. Net **\$12.75**

Outstanding value in a quality scope, ideal for Color TV work and high-frequency lab applications. Wide-sweep range from 15 to 600,000 cps. Locks in at frequencies as high as 9 mc. Only 1 db down at 3.58 color burst frequency. Vertical response:  $\pm 3$  db, 5 cycles to 5 mc. Vertical sensitivity, 25 rms mv/inch. 20 mmf input capacity. Special features: cathode-follower vertical and horizontal inputs; 2nd anode of 1400 volts for high intensity trace; p-p vertical and horizontal amplifiers; faithful square wave response; positive and negative locking for excellent synch on complex waveforms; frequency-compensated input attenuator; Z-axis input, 1-volt peak-to-peak calibrating voltage; internal astigmatism control; blanking circuit to eliminate retrace lines, etc. Complete with all tubes (including CRT), parts, punched chassis, case, full assembly instructions. Shpg. wt., 40 lbs.

Model 83 YZ 144. Wide-Band Oscilloscope Kit. Net **\$69.00**

**FREE 356-PAGE CATALOG**

ALLIED'S 1957 Catalog lists dozens of other low-cost quality Knight-Kit test instruments, as well as the world's largest stocks of electron tubes, transistors, parts, audio equipment—everything in Electronics for industry. Write for FREE copy today.

All Prices Net F.O.B. Chicago

**ORDER FROM  
ALLIED RADIO**

Dept. 18-C-7, 100 N. Western Ave.  
Chicago 80, Illinois

Our 36th year

Circle 204 on Inquiry Card, page 103

★  
ULTRA LOW

capacitance  
& attenuation

TYPE	$\mu\text{mF/ft}$	IMPED. $\Omega$	O.D.
C1	7.3	150	.36
C11	6.3	173	.36
C2	6.3	171	.44
C22	5.5	184	.44
C3	5.4	197	.64
C33	4.8	220	.64
C4	4.6	229	1.03
C44	4.1	252	1.03

WE ARE SPECIALLY ORGANIZED  
TO HANDLE DIRECT ORDERS OR  
ENQUIRIES FROM OVERSEAS  
**SPOT DELIVERIES FOR U.S.**  
BILLED IN DOLLARS—  
SETTLEMENT BY YOUR CHECK  
CABLE OR AIRMAIL TODAY

**NEW** 'MX and SM' SUBMINIATURE CONNECTORS  
Constant 50 $\Omega$ —63 $\Omega$ —70 $\Omega$  impedances

**TRANSRADIO LTD. 138A Cromwell Rd. London SW7 ENGLAND**    CABLES: TRANSHAD, LONDON

ELECTRONIC INDUSTRIES & Tele-Tech

March 1957

Circle 205 on Inquiry Card, page 103

155

# 7 Sound Reasons for using KULKA TERMINAL BLOCKS on your Electronic Equipment



SEE OUR EXHIBIT IRE SHOW, 2D. FL. BOOTH 2901

Circle 206 on Inquiry Card, page 103

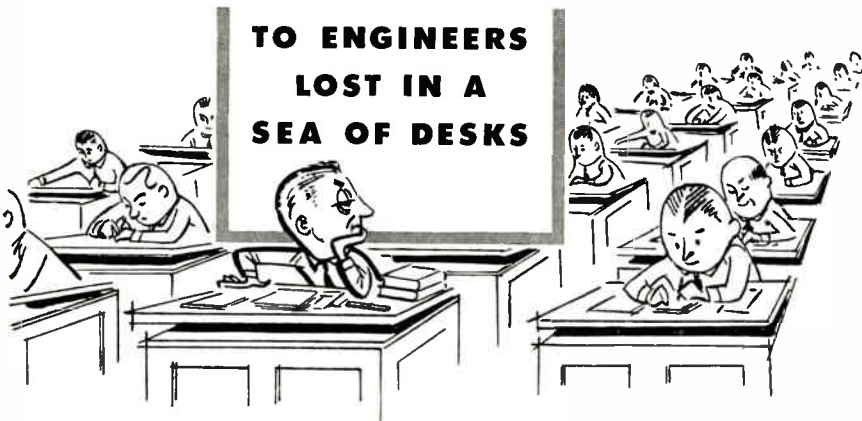

Are you one of them—the engineers, lined up ten deep and fifteen abreast, who are left to sink or swim in a sea of desks?

Fortunately we've never had that problem here at Electronic Engineering Company of California. You see, our management is composed entirely of professional engineers—men who experienced the sinking feeling of being stranded in a sea of desks before EECO was ever conceived. That's why, when they organized EECO, they resolved it would never happen here. And it hasn't.

So, if you're tired of squeezing your way between desks and stopping up your ears to hear yourself think, look no farther! You'll find the best possible working conditions, facilities, and atmosphere for creative engineering here at our new, prizewinning home in smog-free Santa Ana.

We have immediate opportunities for qualified engineers in the transistor, amplifier, data handling, pulse, timing, and systems design fields.

Send a resume of your qualifications to  
R. F. Lander, Dept. FR.



Electronic Engineering Company of California

1601 EAST CHESTNUT STREET · · · SANTA ANA · CALIFORNIA

Circle 207 on Inquiry Card, page 103

(Continued from page 155)

In the die formed process there is complete absence of any moisture or chemicals during the manufacture and low capital investment is required to begin production. Also the ease of blending into automation and the extreme economies possible with large quantity production are certainly desirable features.

The die formed process unfortunately lacks flexibility and the cost of small runs is high. Fine definition and close spacing is impractical and through-hole connections in any quantity would be economically impractical.

Possible ramifications of this process are raised, flush, or debossed conductors as determined by the travel of the forming die, formed circuit boards through the use of post forming insulating base materials, and through hole connections by means of selective after plating.

### Grid Pattern Method

For printed wiring with extreme performance demands there is a technique called the Grid Pattern method. As the name suggests, this takes the physical form of tasselated wire or expanded metal which will be electrically continuous between all points. To devise a circuit from this grid of continuous wire, discontinuities must be established by cutting the grid segments at points which will isolate the desired patterns. Support for the isolated patterns is accomplished by soldering the terminal tie points to the grid before the cutting operation. After completion of the cutting operation the interrupted grid becomes the wiring pattern as determined by the terminal tie points and described by the grid remains.

This Grid Pattern method has the advantages of ruggedness and high current carrying possibilities, with complete absence of moisture and chemicals during manufacture. The simplicity of construction make this method extremely applicable to small quantity runs and requires little or no investment in capital equipment.

This method lacks flexibility and versatility, and has a high unit cost. It would appear also to be entirely unsuited to automation. Possible ramifications of this method are

complex circuitry through multiple layer structure and formed circuits through bending of the grid pattern before securing at tie points.

### Sprayed Metal Process

One process which found considerable application during World War II is the "Sprayed Metal Process." This process uses various methods of depositing whole metal onto an insulating base material by mechanical means among which are spraying molten metal onto a pre-molded panel, then machining or grinding to bring out the conductor pattern; spraying molten metal through a stencil; die casting or pouring molten metal into preformed grooves in an insulating surface; metal evaporation through a stencil; evaporating a metal film completely over the insulating surface, and abrading off the metal with an abrasive through a circuit defining stencil; cathode sputtering through a stencil; also cathode sputtering a metal film completely over the insulating surface and abrading off the metal with an abrasive through a circuit defining stencil. Advantages are the complete absence of moisture and chemicals during manufacture and the heavy current carrying capacities made possible through the build up of metal. Disadvantages are the high unit cost, lack of flexibility and versatility, and the improbable application to automation.

Possible ramifications of this method are complex circuitry through multiple layer structure and formed circuits through deposition upon formed bodies.

### Conductive Paint

One process which underwent considerable development by the Government during WW II and is presently being used extensively in commercial application is the "Conductive Paint" method. In this process the conductor patterns are formed from paints having a finite unit of conductivity which generally require final firing to obtain the desired results. The method by which these conductor patterns are laid down are many, some of which are painting with a brush, stenciling, ruling pen, printing press, and rubber, metal or plastic stamp. One  
(Continued on page 158)

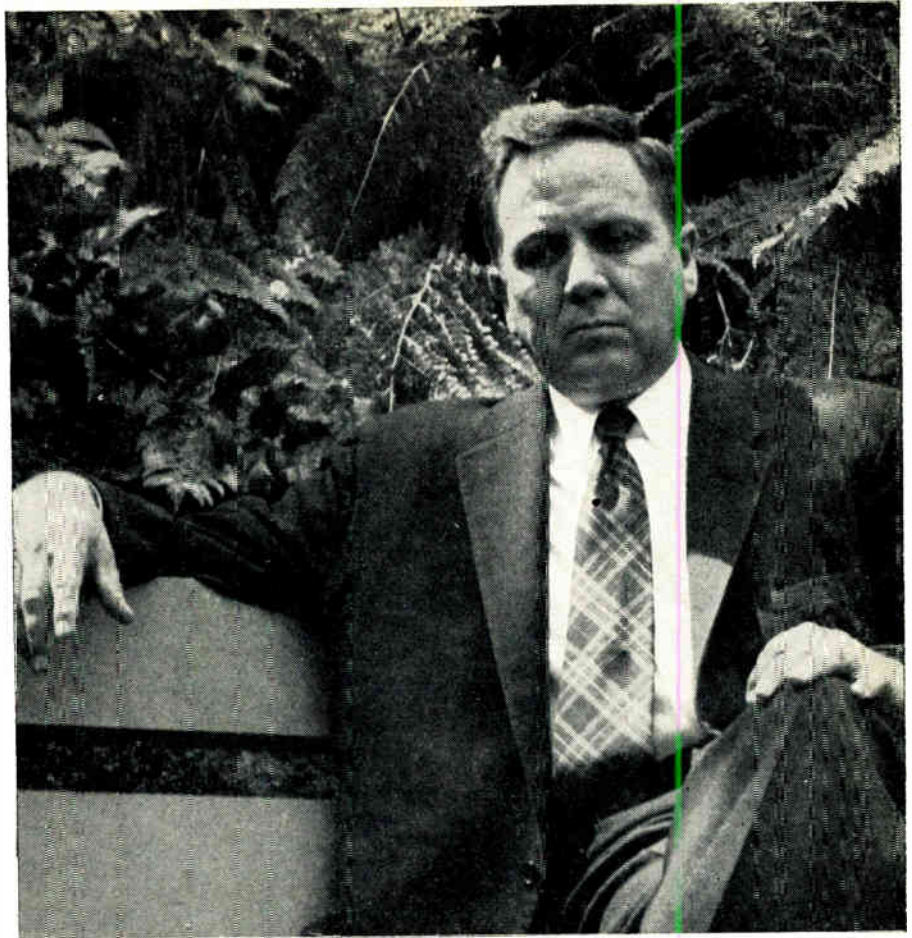

## "I can wait . . . . . . for the right EE"

Because I need, and will pay handsomely for men with a degree in Electrical Engineering and four to five years of practical experience in electronic equipment design engineering. And most likely you will earn more as a member of this manufacturers' representative organization, than you earn now — simply because you'll be worth more to us. We're a leader in our field and are located in Southern California where it's fun to play as well as work. FOR APPOINTMENT call before 8:00 A.M., Commodore Hotel, Murray Hill 6-6000.



Circle 208 on Inquiry Card, page 103

# MAGNETS

HIGH  
ENERGY  
PRECISION  
ALNICO  
PERMANENT  
MAGNETS

WE CARRY  
IN STOCK  
ALL SIZES,  
ALL SHAPES,  
ALL ALNICO  
GRADES . . .

When you  
need them  
— as you  
need them.  
Experimental  
or production  
quantities.

**PERMAG**  
services include:  
· ENGINEERING  
· PRECISION  
CUTTING  
· PRECISION  
GRINDING  
· MAGNETIZING

24 HOUR DELIVERY

Send for Catalog

**PERMAG CORP.**  
210 TAAFFE PLACE, BROOKLYN 5, N. Y.  
Phone: MAin 2-0114

# STROMBERG-CARLSON "BB" Series Relays

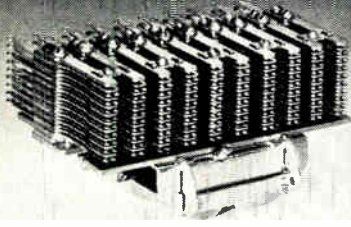

For your automation  
...computing...control  
circuit applications...  
"Telephone Quality"  
at an ordinary price

To meet your needs for precision and durability in automation, computing and control circuitry, this relay provides *telephone quality* at an ordinary price.

The "BB" Series Relay accommodates up to 100 Form A spring combinations. It incorporates such important advantages as twin contacts, knife-edge pivot and special frame-armature construction. Like all Stromberg-Carlson relays, it is built to operate under extreme ranges of temperature and humidity. *Prompt delivery is available on all orders.*

This catalogue will give you complete technical details and specifications. We will gladly send you a free copy on request. Please ask for Catalogue T-5000R.



## STROMBERG-CARLSON

A DIVISION OF GENERAL DYNAMICS CORPORATION  
TELECOMMUNICATION INDUSTRIAL SALES  
126 CARLSON ROAD, ROCHESTER 4, N. Y.  
Circle 218 on Inquiry Card, page 103

(Continued from page 157)

unique method for laying down a conductor pattern involves marking a metallic trace of titanium by a titanium stylus which can be further employed as a plating base. Electrostatic means of applying a conducting powder to an insulating surface in the proper circuit pattern then flash firing the powder into a sintered conductor have also been used. Features which make this Conductive Paint method appear advantageous are the complete absence of moisture and chemicals during the manufacture and the simplicity and versatility of construction which make this process entirely applicable to small quantity runs.

The Conductive Paint method has the disadvantages of high unit cost and the need for insulating base materials suitable for firing operations.

Possible ramifications of this method are complex circuitry through multiple layer structure and formed circuitry through deposition on formed bodies.

## Accelerometer

(Continued from page 77)

quite accurately known for any given geographical location.

The only important inaccuracy in this type of calibration is present in the electrical measuring equipment. This inaccuracy is a combination of instrument error and reading error.

Calibrating at higher dc accelerations is done with a centrifuge. To utilize this technique it is necessary to measure both the radius of the centrifuge arm and the velocity of rotation. Inaccuracies can be present in the electric measuring equipment and in the radius and rpm measurement.

The calibration techniques mentioned impose steady state (dc) acceleration upon the instrument to be tested. This does not completely describe the instrument's performance. It is necessary to determine the response to inputs of rapidly changing phenomena. Furthermore, an instrument such as the piezoelectric accelerometer must be calibrated by dynamic techniques.

The most useful dynamic tech-

# MEASUREMENTS' MEGACYCLE METER

Gives You Extended  
Coverage from  
100 Kc to 940,000 Kc

PRECISION GRID-DIP METERS



MODEL  
59  
Power Supply  
\$75.00

### MODEL 59-LF OSCILLATOR UNIT

Frequency Range:  
100 Kc to 4.5 Mc.  
Price - Oscillator Unit  
(Head) only \$98.50  
with Power Supply  
\$168.00



### MODEL 59 OSCILLATOR UNIT

Frequency Range:  
2.2 Mc to 420 Mc.  
Price - Oscillator Unit  
(Head) only \$98.50  
with Power Supply  
\$168.00



### MODEL 59-UHF OSCILLATOR UNIT

Frequency Range:  
420 Mc to 940 Mc.  
Price - Oscillator Unit  
(Head) only \$128.50  
with Power Supply  
\$198.00

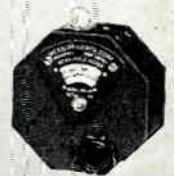

Measurements' Megacycle Meter is now available in a choice of three oscillator heads providing frequency range coverage from 100 Kc to 940,000 Kc. Thus, the utility of this versatile instrument has been extended, making it, more than ever, indispensable to anyone engaged in electronic work; engineer, serviceman, amateur or experimenter.

Laboratory Standards 

MEASUREMENTS CORPORATION  
BOONTON • NEW JERSEY

Circle 211 on Inquiry Card, page 103

nique is to subject the accelerometer to a sinusoidal input of varying frequency. This better describes the transfer function of the accelerometer than does a transient input.

The  $\pm 1g$  method can be used if the device is placed on a plate which rotates in a vertical plane. If the center of gravity of the seismic mass is located on the center line of rotation, the instrument will not be subjected to centrifugal force. It will be subjected to the force of gravity varying at a sinusoidal rate equal to the speed of plate rotation.

Another technique is to place the instrument on a mechanical or electromagnetic vibrator. This sinusoidal calibration is more difficult to tie down accurately; input amplitude being a dynamic measurement, subject to more error than a static measurement.

Occasionally, accelerometers are calibrated with shock machines. This does not normally supplant frequency response calibration but rather is performed as an additional check on accelerometers.

These shock calibrations, done either by drop pendulum or ballistic pendulum, are still more difficult to perform accurately than the frequency response calibration. The difficulty is measuring the velocity change upon impact. This entails measuring velocity of the pendulum before and after contact as well as measuring duration of contact.

#### Future Trends

From the requests that instrument manufacturers have been receiving, there are 4 primary requirements which are constantly becoming more severe. These are:

- Acceleration Range
- Frequency Response
- Accuracy
- Temperature Environment

Fortunately, these requirements do not all apply to the same instrument. No single application would simultaneously utilize the ultimate performance in all 4 categories. Extremely difficult specifications could be alleviated by consultation between instrument and system designers early in the design phase of a system.

(Continued on page 160)

**When  
the product  
specification is—**

*“leak-proof”*

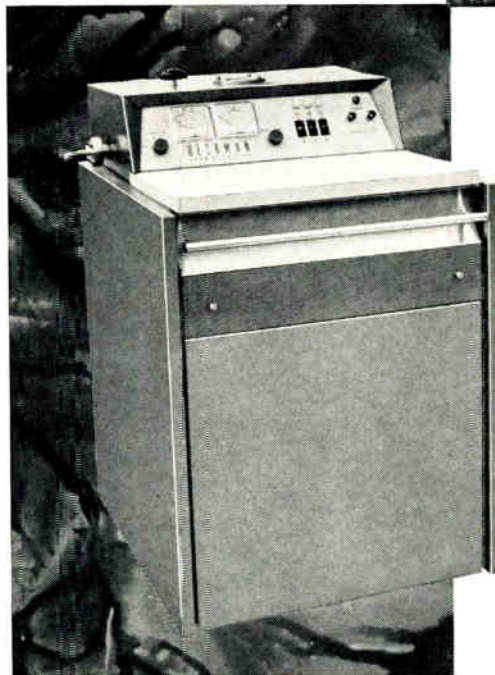

*specify the Beckman  
Leak Detector for  
quality control*

A radio-frequency mass spectrometer for fast and reliable detection of minute leaks. Widely used in many industries to test the sealing of components, sub-assemblies, assemblies and complete vacuum and pressure systems. Particularly effective in assuring conformance to military specifications, eliminating production rejections, establishing porosity of materials, guaranteeing shelf-life of sealed products.

- Uses safe, inert helium gas for swift, sure detection — without the self-poisoning of halogen detectors.
- Pin-points the smallest leaks — can detect one ppm of helium.
- Completely reliable—precision performance in a rugged industrial package.
- Table-top working area simplifies handling of small parts.
- Low maintenance cost — engineered for economical operation.
- Rolls anywhere in the plant for production, quality control or special testing.
- Low-cost, easy to operate.

*Write today for your guide to superior leak detection — Catalog P-2-56*



**Beckman**® / *Process Instruments*  
Beckman Instruments, Inc.  
Fullerton, California

Circle 212 on Inquiry Card, page 103

**Make your  
Ferrites with** →

These reactive synthetic MAPICOS, some especially developed for ferrite manufacture, are over 99% pure  $Fe_2O_3$ . Choice of suitable characteristics is made easy—many variations in particle-size and shape are available. Careful control contributes to uniformity of packing and shrinkage. Our iron oxide production experience and our ferrite research can help you accomplish best results. Manufactured in modern plants by modern methods. Experienced Columbian

**HIGH PURITY  
MAPICO®  
RED FERRIC OXIDES  
for TOP performance**

technicians are ready to cooperate in any problem involving the use of iron oxides for ferrite manufacture. Use your letterhead for working sample.

**COLUMBIAN CARBON COMPANY • MAPICO COLOR UNIT • 380 MADISON AVENUE  
NEW YORK 17, N. Y.**

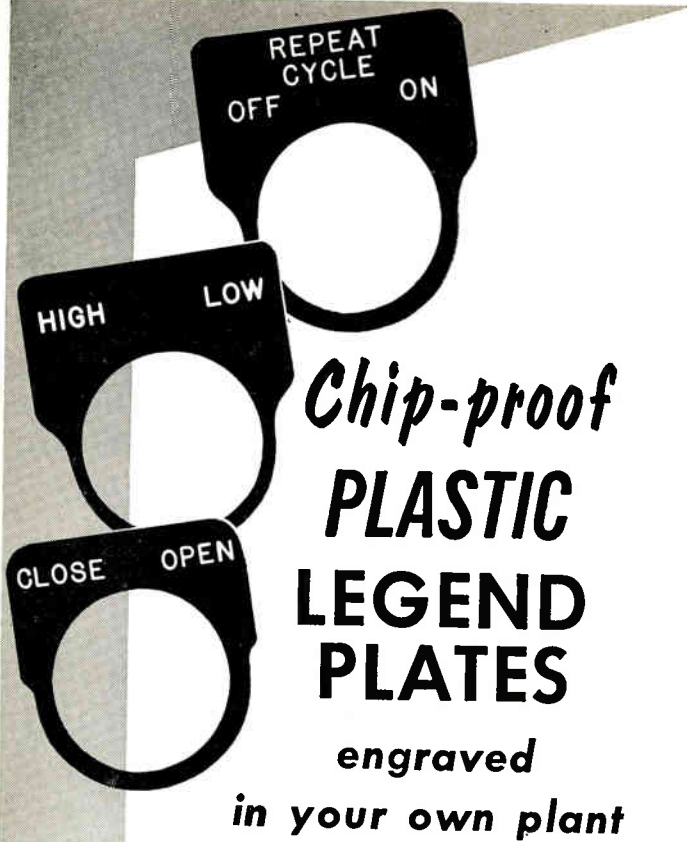

# Chip-proof PLASTIC LEGEND PLATES

engraved  
in your own plant

Tough **GRAVOFLEX** blanks are laminated in sharp contrast colors. No need to keep large inventory — all sizes, varied colors available on short notice. Low-cost **GRAVOFLEX** legend plates stand *up* better, stand *out* better!

Use the portable **ENGRAVOGRAPH** to mark legend plates to your specifications, on the spot, when you need them—with unskilled labor, because it's tracer-guided. Big savings on short runs and "one-shot" jobs. Eliminates costly delays. Over 16,000 in use.

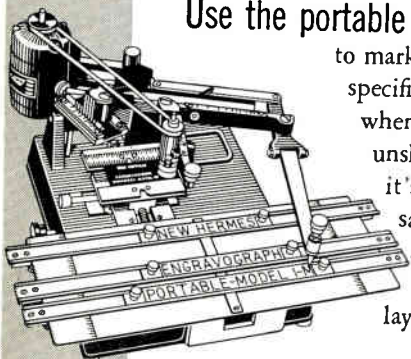

See demonstration at  
**BOOTH #1234**  
**I. R. E. SHOW**

Send for Booklet **KL-1** and sample plate.

**new hermes** ENGRAVING MACHINE CORP.  
13-19 UNIVERSITY PLACE, NEW YORK 3, N. Y.

## Accelerometer (Continued from page 159)

**TABLE 2**

Transduction Device	Range in inches	Primary Advantages	Disadvantages
Piezoelectric	.00005	Self-generating. High sensitivity. Linear.	Requires cathode follower to achieve full frequency range. Cannot measure static displacement. Must be calibrated dynamically. High impedance output.
Strain Gage	.0005	Low output impedance. Can be used with either AC or DC excitation.	Low output. Good linearity is maintained only up to 1% resistance change. Requires balance circuit.
Vibrating Wire	.0005	Output is directly in frequency, therefore, changes in power supply voltages do not affect calibration.	Non-linear. Requires special circuitry.
Variable Inductance (also called variable reluctance)	.005	Low output impedance	Non-linear — special precautions must be taken to achieve acceptable linearity. Generates harmonics in output. Requires balance circuit and demodulator.
Variable Capacitance	.005	Most simply constructed transducer. Inherent low sensitivity to temperature change.	High impedance. Requires balance circuit and demodulator.
Electronic	.005	High output	Relatively fragile. Requires very stable power supply to keep emission and plate voltage constant.
Differential Transformer	.050	Linear, input can be isolated from output. Inherent impedance matching ability.	Efficiency is low because of large airgap. Requires balance circuit and demodulator.
Potentiometer	.500	Requires the least external equipment for operation (can be used with only a battery and a voltmeter). Can be powered with AC or DC. High output.	Imparts friction to system. Resolution limited by the number of turns of resistance wire.



# TELEFUNKEN

## INDISPUTABLY...

the world's best professional microphones

PLEASE ASK ABOUT OUR DYNAMIC MICROPHONES FROM \$40.00 TO \$90.00

**\$390.00**

Ask about the new **CM-51** (only 4 1/2" high) Write for complete details

**AMERICAN ELITE, INC.**

Dept. TT  
7 Park Ave.  
New York 16, N. Y.



Circle 215 on Inquiry Card, page 103

## R-F Shield Design

(Continued from page 120)

signers ignore reflection losses, thus designing a shielded enclosure much thicker than necessary. At frequencies of about 10 KC, the available reflection loss should be included in the calculations in order to prevent over-designing the enclosure. In aircraft applications, this can result in important weight savings.

At frequencies as low as 60 cps, both penetration loss and reflection loss become negligible for magnetic fields, indicating that for lower frequencies, approximating dc, very thick metallic barriers would be necessary to shield against magnetic fields.

The tables indicate that in order to obtain a shielding effectiveness of 100 db at 60 cps for magnetic fields, it will be necessary to provide a metallic barrier made of iron with a permeability of 1000 and a thickness of about 300 mils.

### Shield Discontinuities

Unfortunately, a shielded equipment case cannot be constructed with one continuous metallic sheet; some discontinuities are necessary to accommodate input and output lines, power lines, antennas, front-panel seams, control shafts, ventilating holes, etc. The design and construction of these discontinuities become very critical when it is found necessary to incorporate them without appreciably reducing the shielding effectiveness of the overall shielded enclosure.

**Seams—No Gasket.** Clean metal-to-metal mating surfaces, together with good pressure contact obtained by use of set screws or rivets, are necessary to prevent leakage. Corrosion or anodizing cannot be tolerated.

**Seams—Metallic Gasket.** Considerable improvement can be obtained by using the various available types of metallic gasket. Clean metal-to-metal mating surfaces and a good pressure contact are still required. Corrosion and anodizing cannot be tolerated.

**AEEL R-F Gasket.** This new type gasket can be used in practically all applications. Essentially,

(Continued on page 162)



# Welwyn

## High Stability Resistors

DEPOSITED CARBON

MINIATURE POTENTIOMETERS

GLASS SEALED HIGH VALUE WELMEGS

VITREOUS ENAMEL COATED WIRE WOUND

ENCAPSULATED DEPOSITED CARBON RESISTORS

Welwyn precision products are manufactured in Canada and England. They are designed and constructed for the most exacting electronic requirements. These standards are uniformly maintained through rigid quality controls.

Please address communications to Dept. NC-8.

**Welwyn International, Inc.**

3355 Edgecliff Terrace, Cleveland 11, Ohio

Circle 216 on Inquiry Card, page 103

## ELECTRON TUBE PARTS

Thanks to our many years of unique production experience and the unusual facilities in manufacturing of METAL PARTS FOR TRANSMITTING RADAR and GEIGER COUNTER TUBES, you can count on perfect finish for all your precision tube parts to your exact specifications.

All Magnetron Waveguide and Anode cavities are hobbled (not machined) resulting in perfect uniformity.

Let us quote from your blueprints.

**Anton Machine Works**  
1226 Flushing Avenue, Brooklyn 37, New York

Standard & Magnetic Parallels • Standard & Adjustable V-Blocks • Diamond Holders • Milled Blanks

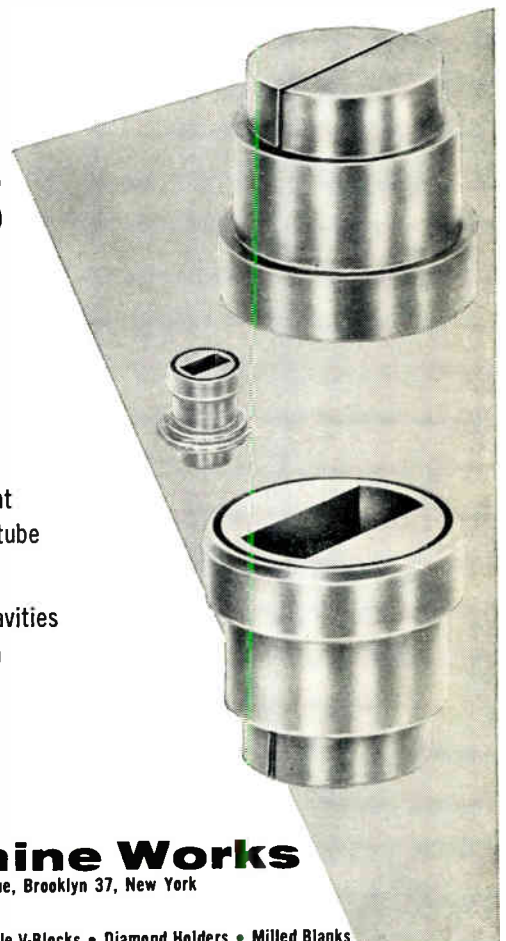

let Williams  
help you apply

**FERRIC  
OXIDES**

to the manufacture  
of your

**FERRITES**

You'll be well repaid by getting the facts on a special group of Pure Ferric Oxides, developed by Williams especially for use in the manufacture of ferrites.

Williams Ferric Oxides analyze better than 99%  $Fe_2O_3$ . They contain a minimum of impurities. They are available in a broad range of particle sizes and shapes. Among them, we're certain you'll find one that's "just right" for your requirements. The proper application of Ferric Oxides to the manufacture of Ferrites is our specialty.

Tell us your requirements . . . we'll gladly send samples for test. Chances are good that our Ferric Oxide "Know How" can save you considerable time and money. Address Dept. 30, C. K. Williams & Co., Easton, Pa.

**WILLIAMS**

**COLORS & PIGMENTS**

**C. K. WILLIAMS & CO.**

Easton, Pa. • East St. Louis, Ill.  
Emeryville, Cal.

**P.S.** We also produce IRN Magnetic Iron powders for the Electronic Core Industry, the Magnetic Tape Recording Industry and others. Write for complete technical information.

(Continued from page 161)

it is a 10-mil strip of beryllium copper, perforated to give jagged points on both surfaces. It can be imbedded in rubber and requires very little pressure to give a good metal-to-metal contact of the lowest possible r-f impedance bond. It does not require clean metal-to-metal mating surfaces and will tolerate a large degree of corrosion or anodizing on the mating surfaces.<sup>6, 7</sup>

**Holes and Screening.** Any holes in the equipment used for ventilation or for any other purpose will materially decrease the shielding effectiveness of the case. The larger the diameter of the hole and the higher the frequency considered, the greater will be the leakage. Holes must be kept as small as possible and not larger than those in a 22-mesh 15-mil copper screening, if more than a nominal 50 db shielding effectiveness is required.

**Waveguides.** Larger size holes are permissible if a waveguide is used as an attenuator below cut-off. For 100 db attenuation, the length of the waveguide must be 3 times the diameter of the hole. The permissible diameter can be obtained by dividing the wavelength (in meters) for the highest frequency used by 3.4.

**Control Shaft—Grounded.** Metallic control shafts protruding through the equipment case are grounded to the case by use of a gasket or serrated metallic fingers.

**Control Shaft—Not Grounded.** A control shaft made of insulating material can be allowed to protrude through the case by insertion inside a waveguide attenuator.

**Fuse Receptacle.** The fuse receptacle necessitates a large hole and should be provided with a metallic cap as shown in detail in reference.<sup>8</sup>

**Phone Jack.** The phone jack should be provided with a metallic cap.

**Meter Jack.** The meter jack should be provided with a metallic cap.

**Panel Meter.** The panel meter requires a large hole in the case and should be modified to provide a continuous shield. All meter leads should be filtered.

**Pilot Lamp.** The pilot lamp should be properly filtered or cov-

## Transistor Circuit Development

An unusual opportunity for an electronics engineer experienced in the application of transistors to digital circuits and to audio, IF, and RF amplifiers; RF oscillators; and power supplies. For use in Scatter, SSB and Digital Military Communications Systems.

Please address inquiries to:  
Mr. Frank C. Nagel

**The Ramo-Wooldridge  
Corporation**

5730 ARBOR VITAE STREET  
LOS ANGELES 45, CALIFORNIA

Circle 219 on Inquiry Card, page 103

## SUCCESSFUL DESIGN ENGINEER SAVES TIME, DOES BETTER JOB

Direct-from-the-  
factory product  
information is the  
key . . .

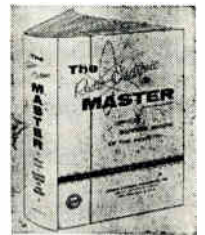

he finds it faster  
in The MASTER!

Production, design, development engineers and PA's rely on The MASTER. It's the quickest, easiest way to get current, direct-from-the-factory data on all products needed in production and research applications. The MASTER describes, illustrates, lists specifications and prices of over 125,000 electronic items—all systematically arranged for speedy reference.

1546 pages  
World's Largest  
Electronic Parts  
Catalog

Get the NEW

**1957 Radio-Electronic MASTER**

(21st edition)

of your electronic parts distributor today.

**ONLY \$2.95**

Write for list of distributors

**The Radio-Electronic MASTER**  
60 Madison Ave., Hempstead, N. Y.

Circle 220 on Inquiry Card, page 103

**ELECTRONIC INDUSTRIES & Tele-Tech • March 1957**

Circle 210 on Inquiry Card, page 103



ered with screening material or perforated metal.

#### Filtered Lines

All unshielded lines should be properly filtered with pi-section filters or feed-through capacitors. The degree of attenuation required of the filter depends on the level of undesired signals present on the lines themselves.

#### Unfiltered Lines

**Open Wiring.** Open wiring may be a point of excessive leakage when not filtered. Such lines can be tolerated if they do not carry high levels of undesired signals or do not provide an easy entry into the equipment.

**Shielded Conduits.** It may be found necessary to provide shielded conduit, or shielded transmission lines with an outer wall having a shielding effectiveness as effective as that of the shielded enclosure itself.

**Shielded Braid Conductors.** The braid shielding of all conductors should be carried well within the AN connector wall and grounded to it.

**Unshielded Antenna Lead-Ins.** Unshielded antenna lead-ins are entirely undesirable and are not permitted under the design requirements of Specification No. MIL-I-6181B. Unfortunately, they are still in use for receivers and transmitters up to 30 MC; however, steps are being taken to design systems with shielded lead-ins.

**Shielded Antenna Lead-Ins.** Shielded antenna lead-ins are used above 30 MC and are satisfactory, provided the shielding effectiveness of the transmission line is as effective as that of the shielded case itself.

#### Bonding To Ground

Because the best designed shielded enclosure, even without any discontinuities, is not a perfect shield, it is necessary to bond it to a common reference ground such as the aircraft structure through a mounting rack. A good bond will reduce the radiation leaking out of the shielded enclosure. This bond must not have an r-f impedance higher than 80 milliohms from 15 KC to 20 MC.<sup>9</sup> A poorly designed bond  
(Continued on page 164)

# YOKE

SPECIALISTS

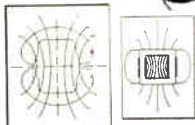

Series aiding field and parallel (bucking) field designs.

**COMPLETE LINE for every Military and Special purpose.**

- Yokes for 7/8", 1-1/8", 1-1/2", 2-1/8" neck diameter CR tubes.
- Rotating and fixed coil designs.
- Core material to suit your requirements.

Special test instruments can establish your yoke deflection parameters to an accuracy of  $\pm 0.1\%$ .

Consult Dr. Henry Marcy or Bernard Cahill on your new applications today.

Phone: Terrace 4-6103

170 Industrial Road • Addison, Ill.

Circle 221 on Inquiry Card, page 103

*syntronic*

**INSTRUMENTS, INC.**

## BIRD Model 43 *ThruLine* DIRECTIONAL WATTMETER

*Reads Directly... WATTS FORWARD*  
*WATTS REFLECTED... In 50 Ohm Coaxial Lines*

Measures POWER into the antenna in the actual operating circuit. Continuous monitoring if desired.

Measures reflected power, direct reading. In antenna matching work, results show directly in lower reflected power. Ideal for mobile equipment.

Tests 50 ohm r-f lines, antenna connectors, filters—quickly. **ACCURATE** because of high directivity and small frequency error.

**DIRECT READING**—no calibration charts, no full scale meter adjustments needed. Meter scale reads directly for all ranges and is expanded for better down-scale reading.

**CONVENIENT**—does not require reversal of r-f connections. No auxiliary power required.

Negligible power loss and insertion VSWR.

Full scale power range and frequency range are determined by the selection of plug-in elements from the following list.

**Frequency Range**—25-1000 megacycles in five ranges vis. 25-60 (A), 50-125 (B), 100-250 (C), 200-500 (D), 400-1000 (E).

**Power Range**—10, 25, 50, 100, 250, and 500 watts full scale. Available in most frequency ranges.

**Accuracy**—5% of full scale.

See us at IRE Show Booths 3215 & 3217



Model 43 with front element in operating position. Dimensions: 7" x 4" x 3" Weight, 4 pounds. SO239 jacks for PL259 plugs available.



**BIRD ELECTRONIC CORP.**  
1800 EAST 38TH ST., CLEVELAND 14, OHIO  
**TERMALINE Coaxial Line Instruments**

**VAN GROOS COMPANY**  
Sherman Oaks, Cal.

# BEST ANSWER for Tower Jobs—ROHN

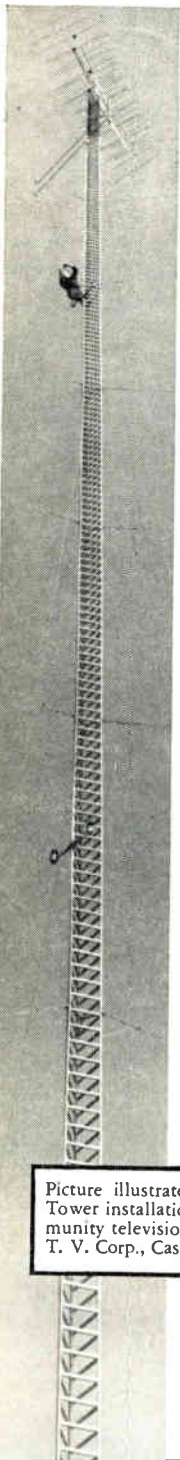

**AMERICA'S FINEST COMMUNICATIONS TOWER OF ITS KIND ... WITH EXCLUSIVE BUILT-IN ECONOMY**

- **REDUCE COSTS** by getting the right tower for the right job. When a job calls for a medium weight tower from 200-300 ft. guyed, or self-supporting from 50-66 ft., a Rohn tower can do the job at far less cost. Check your particular tower needs against the "job-rating" a Rohn tower has and you'll save money.

- **HOT DIPPED GALVANIZED** finishes are available. The erection is quick and easy as all towers are in 10 ft. sections. Rohn towers are designed for economy in erection as no specially trained help is required.

- **PROVEN DESIGN** that has been tested with thousands of installations. Workmanship is unexcelled. Mass production machinery is used for precision fabrication yet a big reduction in labor cost.

Picture illustrates 300 ft. Rohn No. 40 Tower installation as being used for community television by Caspian Community T. V. Corp., Caspian, Michigan.

Write, wire or phone for data and prices and nearest source of supply. ROHN representatives are coast-to-coast to serve you.

**ROHN Manufacturing Co.**

116 Limestone, Bellevue Peoria, Illinois

"Pioneer Manufacturers of TV and Communication Towers of All Kinds."

Circle 223 on Inquiry Card, page 103

(Continued from page 163)

will, in addition to increasing radiation from the case, permit undesired signals in the vicinity of the equipment to appear at the input of the receiver as shown in Fig. 2, and cause undesired response or malfunctioning.

### Inside The Shield

In many applications, it is possible to reduce the requirements in shielding effectiveness of the overall equipment case by first effecting suppression correctives within the equipment itself. Several techniques are: sample unit shields, filters right at the very source of undesired signals, partial metallic barriers, isolation of circuits by decoupling, partial shielding by use of proximity to ground, use of short leads, and use of common ground returns through the case itself.<sup>5</sup>

### Shielding Example

A 100-watt 50-ohm transmitter output is fed into an antenna by a shielded coaxial transmission line. Determine the type and thickness of the shielding required for the transmission line cable.

The inside diameter of the transmission line is taken to be 1/2 in. The proposed allowable levels for magnetic fields are 3000 uv/m/KC at 150 KC and 30 uv/m/KC at 10 MC when measured with the AN/PRM-1 8 in. loop at a distance of 12 in. The bandwidth of the AN/PRM-1 is 2 KC at 150 KC and 6 KC at 10 MC.

### Solution

**Allowable Levels at 12 in. from Shield**

At 150 KC,  $3000 \times 2 = 6000 \mu\text{v/m}$ ;

$$\frac{6000}{377} = 15.9 \mu\text{a/m}$$

At 10 MC,  $30 \times 6 = 180 \mu\text{v/m}$ ;

$$\frac{180}{377} = 0.477 \mu\text{a/m}$$

**Allowable Levels at Outside of Shield**

$$\text{At 150 KC, } 15.9 \times \frac{0.25 + 12}{0.25} = 780 \mu\text{a/m}$$

$$\text{At 10 MC, } 0.477 \times \frac{0.25 + 12}{0.25} = 23.6 \mu\text{a/m}$$

**Current in Transmission Line Conductor**

$$\frac{\sqrt{50 \times 100}}{50} = 1.41 \text{ a.}$$

**Levels Inside of Shield, 1/4 in. from Center Conductor**

$$\frac{1.41 \times 10^6 \times 39.4}{2 \times 3.14 \times 0.25} = 37 \times 10^6 \mu\text{a/m}$$

**Shielding Effectiveness Required at 150 KC**

$$20 \log_{10} \frac{37 \times 10^6}{780} = 93.5 \text{ db}$$

Note: The "Attenuation Loss" (the ratio of the two signals existing on the inner and outer sides of the shield) would be  $93.5 + 6 = 99.5 \text{ db.}^4$

**Shielding Effectiveness Required at 10 MC**

$$20 \log_{10} \frac{37 \times 10^6}{23.6} = 124 \text{ db}$$

**Thickness Required for a Solid Copper Shield (From Tables 1 and 4)**

At 150 KC—approximately 29 mils

37.5 db penetration loss

56.0 db reflection loss

93.5 db total loss

(Continued on page 166)

**Auricon Hollywood**

16mm SOUND-ON-FILM EQUIPMENT FOR TELEVISION NEWSREELS, TV FILM INSERTS AND KINESCOPE RECORDINGS... SOLD WITH A 30-DAY MONEY-BACK GUARANTEE. YOU MUST BE SATISFIED!

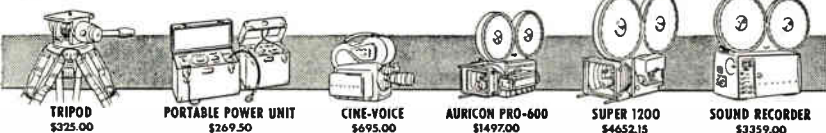

TRIPOD \$325.00

PORTABLE POWER UNIT \$269.50

CINE-VOICE \$695.00

AURICON PRO-600 \$1497.00

SUPER 1200 \$4652.15

SOUND RECORDER \$3359.00

WRITE FOR FREE ILLUSTRATED INFORMATION

**BERNDT-BACH, Inc.**  
6926 Romaine St., Hollywood 38, Calif.

MANUFACTURERS OF SOUND-ON-FILM RECORDING EQUIPMENT SINCE 1931

Circle 224 on Inquiry Card, page 103

For **HIGHEST ELECTRICAL & MECHANICAL Efficiency!**

*New*

# JONES 2400 SERIES PLUGS & SOCKETS

Improved Socket Contacts. Four individual flexing surfaces. Positive contact over practically their entire length.

Both Plug and Socket Contacts mounted in recessed pockets greatly increasing leakage distance, INCREASING VOLTAGE RATING.

Plug and Socket Contacts cadmium plated. Add to appearance of your equipment. Interchangeable with Jones 400 Series.

Ask for Catalog 21, Complete line Jones Plugs, Sockets, Terminal Strips.



P-2406-CCT Plug—with Cable clamp in top.  
S-2406-SB Socket with shallow bracket for flush mounting.



**Jones** HOWARD B. JONES DIVISION  
CINCH MANUFACTURING CORPORATION  
CHICAGO 24, ILLINOIS  
SUBSIDIARY OF UNITED-CARR FASTENER CORP.

Circle 225 on Inquiry Card, page 103

## MORE PRODUCTION ENGINEERS

are turning to *Sta-Warm*

for **SPECIALIZED ENGINEERING**

to help solve

their compound melting problems

Here are 5 steps to follow for improving your compound melting installation:

1. Ask for Engineering Analysis by Sta-Warm
2. Receive Recommendation Report from Sta-Warm
3. Order specialized compound melting equipment from Sta-Warm, if required
4. Enjoy simplified "package" installation
5. Profit continuously from satisfactory performance at pre-determined costs.

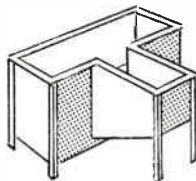

No obligation. Start with step 1 today, by writing to

**STA-WARM ELECTRIC CO.**

222 N. Chestnut St. • Ravenna, Ohio



"If You Can Wrap a String Around It, Sta-Warm Can Heat It for You."



**ENGINEERED EQUIPMENT** for melting and dispensing heated compounds

Circle 226 on Inquiry Card, page 103

ELECTRONIC INDUSTRIES & Tele-Tech • March 1957

True Hermetic Sealing assures Maximum Stability in

# AMPERITE RELAYS and REGULATORS

Simplest • Most Compact • Most Economical



STANDARD

PROBLEM? Send for Bulletin No. TR-81

## Thermostatic DELAY RELAYS

2 to 180 Seconds



MINIATURE

- Actuated by a heater, they operate on A.C., D.C., or Pulsating Current.
- Hermetically sealed. Not affected by altitude, moisture, or other climate changes.
- Circuits SPST only — normally open or normally closed.

Amperite Thermostatic Delay Relays are compensated for ambient temperature changes from  $-55^{\circ}$  to  $+70^{\circ}$ C. Heaters consume approximately 2 W. and may be operated continuously. The units are most compact, rugged, explosion-proof, long-lived, and — very inexpensive! TYPES: Standard Radio Octal, and 9-Pin Miniature.

Also — Amperite Differential Relays: Used for automatic overload, under voltage or under-current protection.

## BALLAST REGULATORS

Amperite Regulators are designed to keep the current in a circuit automatically regulated at a definite value (for example, 0.5 amp.) For currents of 60 ma. to 5 amps. Operate on A.C. D.C., Pulsating Current.

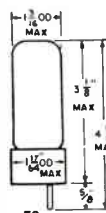
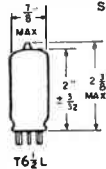

Hermetically sealed, they are not affected by changes in altitude, ambient temperature ( $-55^{\circ}$  to  $+90^{\circ}$  C.), or humidity. Rugged, light, compact, most inexpensive.

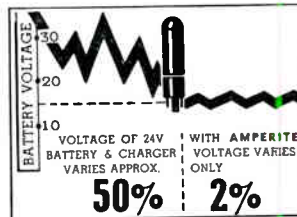

Write for 4-page Bulletin No. AB-51

**AMPERITE CO., Inc.**

561 Broadway, New York 12, N. Y.

Telephone: CAnal 6-1446

In Canada: Atlas Radio Corp., Ltd.

50 Wingold Ave., Toronto 10



Individual inspection and double-checking assures top quality of Amperite products

Circle 227 on Inquiry Card, page 103

# R-F Shield Design (Continued)

**TABLE 6**

Examples For Calculating Insertion Loss Of Solid Metal Shield Barriers

10 KC—10 Mils						
	Magnetic		Electric		Plane Wave	
	Copper	Iron	Copper	Iron	Copper	Iron
Reflection Penetration B Factor	44.20	8.0	212.0	174.0	128.0	90.5
	3.34	43.5	3.34	43.5	3.34	43.5
	-2.62	0	-2.61	0	-2.61	0
Total Loss (db)	44.92	51.5	212.73	217.5	128.73	134.0

60 CPS—Magnetic						
	1 Mil		10 Mils		300 Mils	
	Copper	Iron	Copper	Iron	Copper	Iron
Reflection Penetration B Factor	22.4	-0.9	22.4	-0.9	22.4	-0.9
	0.026	0.334	0.26	3.34	7.80	100.0
	-22.2	+0.95	-19.2	+0.78	+0.32	0
Total Loss (db)	0.23	0.38	3.46	3.22	30.52	99.1

	10 KC—30 Mils—Magnetic		1 KC—10 Mils—Magnetic	
	Copper	Iron	Copper	Iron
Reflection Penetration B Factor	44.20	8.0	34.2	0.9
	10.02	130.5	1.06	13.70
	+0.58	0	-10.37	+0.06
Total Loss (db)	54.80	138.5	24.89	14.66

**Table 6 (cont.)**

10 Mils—Copper

	150 KC			1 MC		
	Electric	Plane Waves	Magnetic	Electric	Plane Waves	Magnetic
Reflection Penetration B Factor	176.8	117.0	56.0	152.0	108.2	64.2
	12.9	12.9	12.9	33.4	33.4	33.4
	+0.5	+0.5	+0.5	0	0	0
Total Loss (db)	190.2	130.4	69.4	185.4	141.6	97.6

**TABLE 7**

Characteristics of Various Metals

Metal	Relative Conductivity	Relative Permeability at 150 kc	Penetration Loss (db/Mil) at 150 kc
Silver	1.05	1	1.32
Copper—Annealed	1.00	1	1.29
Copper—Hard Drawn	0.97	1	1.26
Gold	0.70	1	1.08
Aluminum	0.61	1	1.01
Magnesium	0.38	1	0.79
Zinc	0.29	1	0.70
Brass	0.26	1	0.66
Cadmium	0.23	1	0.62
Nickel	0.20	1	0.58
Phosphor-Bronze	0.18	1	0.55
Iron	0.17	1000	16.9
Tin	0.15	1	0.50
Steel, SAE 1045	0.10	1000	12.9
Beryllium	0.10	1	0.41
Lead	0.08	1	0.36
Hypernick	0.06	80000	88.5
Monel	0.04	1	0.26
Mu-Metal	0.03	80000	63.2
Permalloy	0.03	80000	63.2
Steel, Stainless	0.02	1000	5.7

**Eliminate  
Rhodium  
Plate  
Rejects!**

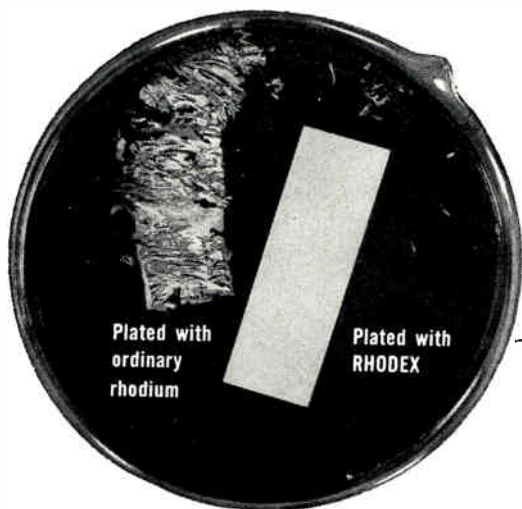

**only  
RHODEX**

**produces compressively stressed deposits**

assuring crack-free, peel-free service. Here's proof! The photograph demonstrates the high tensile stress of conventional rhodium electroplate and the CS of RHODEX. Dissolving the basic metal caused the conventional rhodium electroplate to disintegrate into small crystalline flakes. The Sel-Rex RHODEX electroplate remained unimpaired, and in a continuous film. RHODEX does not peel or crack regardless of thickness! Write for details.

Precious Metals Division

**SEL-REX CORPORATION**  
155 Manchester Place, Newark, N. J. Dept. El-3



Circle 228 on Inquiry Card, page 103

**SCATTER**

**SSB**

**DIGITAL**

**Communications  
Systems**

Unusual opportunities for senior electronics engineers experienced in the development and design of advanced equipment for Scatter, SSB, and Digital Communications Systems. Specialized areas of particular interest are frequency synthesizers, modulators, automatic tuning devices, broad-band amplifiers, and transistor circuits. HF, VHF, UHF and SHF military applications.

Please address inquiries to:  
Mr. Frank C. Nagel

**The Ramo-Wooldridge  
Corporation**

5730 ARBOR VITAE STREET  
LOS ANGELES 45, CALIFORNIA

Circle 229 on Inquiry Card, page 103

## Johnson

FIXED or VARIABLE  
INDUCTORS

FOR ...

- Commercial and Military Transmitters
- Electronic Heating Equipment
- Electronic Medical Devices

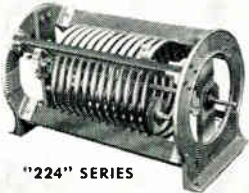

"224" SERIES



"202" SERIES

Wondering about an inductor for high power RF equipment? Your best choice is a standard inductor made by Johnson, pioneer manufacturer in the commercial inductor field. Johnson builds a complete line of heavy duty RF components, unmatched for choice of types and sizes. Inductors are available in both fixed and variable units, wire-wound, edgewise-wound and tubing-wound for high or low power applications.

For detailed information on Johnson's complete RF component line, write today for your free copy of catalog 535!



E. F. Johnson Company

2311 Second Ave. S.W. • Waseca, Minn.  
Circle 230 on Inquiry Card, page 103

At 10 mc—approximately 5.4 mils

54 db penetration loss

70 db reflection loss

124 db total loss

### References

1. Navy Dept., Bureau of Aeronautics, Washington 25, D. C. Spec. No. MIL-1-6181B, "Interference Limits, Tests, and Design Requirements; Aircraft Electrical and Electronic Equipment."
2. S. A. Schelkunoff, "Electromagnetic Waves," D. Van Nostrand Co., Inc., 1943.
3. J. C. Slater, "Microwave Transmission," McGraw-Hill Book Co., Inc., 1942.
4. U. S. Navy Air Development Center, Johnsville, Pa., Report No. NADC-EL-54129, "Theory, Design, and Engineering Evaluation of Radio-Frequency Shielded Rooms."
5. Wright Air Development Center, Dayton, Ohio, "Design Techniques for Interference-Free Operation of Airborne Electronic Equipment," 1952, USAF Contract No. AF33(038)-23341. (PB 111051.)
6. U. S. Naval Air Development Center, Johnsville, Pa., Report No. NADC-EL-52139, "Final Report, Evaluation of Seams and Gaskets Used in Shielding Enclosures, and Development of Correctives for Improvement."
7. V. Pulsifer, "Bonding Materials, Metallic Mating Surfaces: Low RF Impedance," of January 1954, Armour Research Foundation of the Illinois Institute of Technology Report, Contract No. AF33(038)23583.
8. U. S. Naval Air Development Center, Johnsville, Pa., Report No. NADC-EL-71-49, "Final Report, Radio Interference Tests and Modifications for Type AN-N6A Gun Camera and Type B-3B Camera Intervalometer."
9. Ibid. Report No. NADC-EL-172-50, "Investigation of ANA Specification AN-B-10a, 'Bonding; Electrical (For Aircraft), and Proposed Revision Thereto No. AN-B-10b.'"

## Microwave Receiver

(Continued from page 82)

represents a compromise between a value to reproduce narrow pulses and large deviation FM signals and requirements of CW sensitivity, preselector bandwidth and mechanical backlash. Final i-f bandwidth of 3 MC allows reproduction of a 0.2  $\mu$ sec. rise time without degradation and covers sufficient swing for most FM applications while preserving a minimum r-f pulse and CW sensitivity of -80 dbm. The proper choice of i-f frequencies and conversions insure ease of alignment stability and freedom from spurious responses. Following the preamplifier are several stages of 140 MC and 40 MC.

Improved noise figure can be obtained using a 260 MC grounded grid pencil triode preamplifier following the crystal mixer. Sufficient gain is required in the first i-f amplifier stage for the noise figure of the i-f amplifier to be determined solely by this first stage. It is found advantageous to match the preamp (140 MC) output impedance to 50  $\Omega$ , and to bring this output to a front panel connector. With this arrangement, an i-f attenuator can be used as a substitution device to calibrate accurately r-f attenuators or relative r-f

(Continued on page 168)

## Johnson

INDUSTRIAL &  
BROADCAST  
RF COMPONENTS

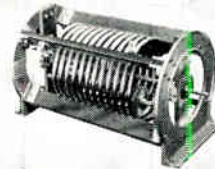

High Power  
Fixed and  
Variable  
Inductors

Pioneers in the commercial inductor field, Johnson's complete inductor line contains small wire-wound units for low power stages as well as large, high power copper tubing models. This wide line offers you an unmatched choice of types and sizes: fixed or variable units, wire-wound, edgewise-wound or tubing-wound for high or low power applications.

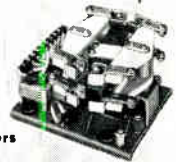

RF Contactors

Designed for high voltage RF switching—suitable for many other applications. Fast action—rugged and compact. Two sizes: 17 KV and 22 KV peak. Current: 25 amps per contact, no holding current required. Mounts in any position.



Tower  
Lighting  
Filters

Low impedance to 60 cycle current—high impedance to RF. Antenna radiation resistance changed less than 1% to comply with FCC regulations. Also serves as a static drain device when used with grounded AC circuits. Three windings rated 10 amps each at 60 cycles—impedance 0.3 ohms. Available for panel mounting or in weather-proof cabinet.

For detailed information on Johnson's complete RF component line, write today for your free copy of catalog 535!



E. F. Johnson Company

2310 Second Ave. S.W. • Waseca, Minn.  
Circle 231 on Inquiry Card, page 103

# PRESET COUNTER By FREED



Model 2020

The Freed Model 2020 Preset Counter is designed for low cost reliable counting applications, where accuracy and maintenance-free operation is required.

Cold cathode counting and trigger tubes, with simplified circuits, are used throughout which assure years of trouble-free counting service and low-power consumption.

Model 2020 is a 4-digit single preset counter capable of controlling any operation that is repeated up to 9,999 times. Any number from 1 to 9,999 may be preset on the 4-digit selector switches. When the preset total has been reached, the counter will provide an output pulse and close contacts on a relay. These outputs may be used simultaneously or separately to stop machines, actuate control signals, or trigger additional equipment.

## SPECIFICATIONS

**Maximum Count:** Four digits — 9,999  
**Maximum Counting Rate:** 300,000 counts per minute  
**Input Sensitivity and Waveform:** Not critical  
**Outputs:** Relay contact 10 Amperes  
 Pulse output 50 volts

**Size:** 8 x 6 x 12 inches  
**Weight:** 11 pounds  
**Power:** 25 watts  
 105-125 volts, 50-60 cycles  
**Price:** \$425.00

FREED ALSO MANUFACTURES TOTALIZING, PRESET, AND BATCHING COUNTERS

# ULTRASONIC TRANSFORMERS by FREED

All ultrasonic components are designed specifically for ultrasonic frequencies using the latest developments in magnetic and insulating materials.

## DRIVER and INPUT TRANSFORMERS

Frequency response:  $\pm 1$ Db 10 Kc. to 60 Kc.

Cat. No.	Application	Primary Imp.-Ohms	Voltage Ratio	Max. Power Watts	Max. Prim. DC per Side MA.
ULI-20	Transducer to PP811A	1, 2, 4		5	
ULD-30	PP6CM6 to PP811A		4.4:1	5	50
ULD-50	PP5881 to PP8000		1.7:1	25	90

## OUTPUT TRANSFORMERS

Frequency response:  $\pm 1$ Db 20 Kc. to 60 Kc.

Cat. No.	Application	Imp. in Ohms		Max. Power Watts	Max. Prim. DC per Side MA.
		Pri.	Sec.		
ULO-10	PP6083 to Transducer	7,600	1, 4	100	120
ULO-11		7,600	2, 8	100	120
ULO-12		7,600	4, 16	100	120
ULO-13		7,600	7.5, 30	100	120
ULO-30	PP811A to Transducer	12,400	1, 4	300	170
ULO-31		12,400	2, 8	300	170
ULO-32		12,400	4, 16	300	170
ULO-33		12,400	7.5, 30	300	170
ULO-34		12,400	25	300	170
ULO-35		12,400	125, 500	300	170
ULO-36	PP8000 to Transducer	12,400	250, 1000	300	170
ULO-37		12,400	75, 300	300	170
ULO-52		10,800	4, 16	500	230
ULO-53		10,800	7.5, 30	500	230
ULO-54	PP8000 to Transducer	10,800	25, 100	500	230
ULO-55		10,800	125, 500	500	230
ULO-56		10,800	250, 1000	500	230
ULO-101		5,400	25, 100	1000	430
ULO-104	PP Par. 8000 to Transducer	5,400	75, 300	1000	430
ULO-110		5,400	18.8, 75, 300	1000	430

All Components Listed Are Hermetically Sealed. To save development time a special series of kits are available. These include all reactive components and complete circuit diagrams of the amplifier.

Send for NEW 48 page transformer catalog. Also ask for complete laboratory test instrument catalog.

## FREED TRANSFORMER CO., INC.

1726 Weirfield St., Brooklyn (Ridgewood) 27, N.Y.  
 Circle 232 on Inquiry Card, page 103

(Continued from page 167)

signal levels anywhere in the frequency range of 950 to 11,260 MC. Dynamic ranges greater than 70 db can be measured before the noise level or non-linear action of preceding stages affect the measurement accuracy.

The use of a power amplifier as the last i-f stage provides a greater i-f overload capacity, since the last i-f stage is normally the first to overload. It is necessary to have 2 diode detectors. A low impedance detector is used for amplitude video detection, while the second, with variable time constants, is used for the AGC and meter monitoring circuit. The AGC discharge time constant is made much longer for pulse reception than for CW-AM detection. Provision can also be made on the same switch for a position to short the AGC line for linear voltage detection.

## Frequency Stability

For long-time frequency stability of the receiver, it is essential that all local oscillators except the first be crystal controlled. With the i-f frequencies previously chosen, it is possible to use harmonics (4th and 6th) from a single crystal oscillator at 30 MC to control the local oscillator frequency. Amplifiers can then be used to bring the amplitude to proper level for mixer injection. Stability can be maintained in the first local oscillator by the use of AFC. The simplest scheme to obtain AFC with a broadband microwave tuning head is to have an i-f discriminator control the klystron local oscillator reflector voltage.

The AFC i-f circuitry consists of a limiter and a narrow band 40 MC discriminator with a long video time constant dc coupled to the klystron reflector supply. Any drift in the local oscillator with respect to the input signal will produce a change in reflector voltage so as to change the klystron frequency to correct for the drift. The reflector characteristics of the 5836, 5837 and 5721 klystron tubes allow for a pull-in and pull-out frequency of at least  $\pm 6$  MC. The 40 MC limiters used for the AFC can also be used to drive a signal discriminator. The signal discriminator would

(Continued on page 170)

# NEW

magnetically  
-controlled

# COUNTER -DIVIDER



Using a "ladle-bucket" principle, magnetic cores in the unique Magnivider circuit set a new high of reliability and ruggedness wherever counting, scaling or frequency division is required.

Self-contained Magnivider plug-ins are ideal for your new equipment designs. Compared to conventional four-tube counters, one-tube Magnividors offer

- one-third the size
- 50% less power drain
- twice the reliability
- compatible scales of 9-10-11
- counting rates from 0 to 50 Kc.
- both low and high impedance outputs
- direct cascading without buffers

## Magnividors have a wide range of applications

- Random counting
- Preset counting
- Cycle counting
- Frequency division
- Timing chains
- Synchronizing circuits
- Accumulators

IRE Show—Booth 3944



Write for our Technical Bulletin 145 to obtain complete information and specifications.

## MAGNETICS RESEARCH COMPANY

Dept. 101

255 GROVE STREET  
WHITE PLAINS, N. Y.

Circle 233 on Inquiry Card, page 103

# ELECTRONIC INDUSTRIES & Tele-Tech Advertisers—Mar. 1957

AC ELECTRONICS DIVISION—GENERAL MOTORS CORP. .... 120	FILTORS, INC. .... 124	POLARAD ELECTRONICS CORP. .... 46, 47
Agency—E. H. Brown Advertising	Agency—Burton Browne Adv.	Agency—Howard A. Harkavy, Inc.
ACE ENGINEERING & MACHINE COMPANY .... 126	FLUOCARBON PRODUCTS, INC., DIV. U. S. GASKET CO. .... 24	POLYTECHNIC RESEARCH & DEV. .... 102
Agency—The Harry P. Bridge Company	Agency—The Michener Company	Agency—D. C. Smith, Inc.
AIRCRAFT RADIO CORP. .... 130	FORD INSTRUMENT COMPANY, DIVISION OF SPERRY RAND CORP. .... 170	RADIO CORPORATION OF AMERICA 08*, 09*, 014*, Cover 4
Agency—Burke Dowling Adams, Inc.	Agency—G. M. Basford Company	Agency—Al Paul Lefton Company
ALFORD MANUFACTURING CO., INC. .... 018*	FREED TRANSFORMER COMPANY .... 168	RADIO MATERIALS CORP. .... Cover 2
Agency—Engineered Advertising	Agency—Franklin Advertising Service	Agency—Turner Advertising Agency
ALLIED RADIO CORP. .... 155	FUSITE CORPORATION .... 43	RADIO RECEPTOR COMPANY, INC. .... 90, 115
Agency—George Brodsky Advertising, Inc.	Agency—Perry-Brown, Inc.	Agency—Walter J. Zimmerman Assoc.
AMERICAN ELECTRIC HEATER COMPANY. 38	G-V CONTROLS .... Cover 3	RAMO-WOOLDRIDGE CORP. .... 162, 166
Agency—F. B. Hubert Adv. Counselors	Agency—Art-Copy Advertising Agency	Agency—McCarty Company
AMERICAN LAVA CORP. .... 35	GARRET CORPORATION, THE .... 128	RAYTHEON MFG. COMPANY .... 14, 15, 015*
Agency—Power & Condon	Agency—J. Walter Thompson	Agency—Donahue & Co., Inc.
AMERICAN MACHINE & FOUNDRY COMPANY .... 110	GENERAL ELECTRIC COMPANY .... 53, 54	ROHN MANUFACTURING COMPANY .... 164
Agency—Deutsch & Shea, Inc.	Agency—Maxon Inc.	Agency—Jackson, Haerr, Peterson & Hall, Inc.
AMPERITE COMPANY .... 165	GENERAL RADIO .... 39	SANGAMO ELECTRIC COMPANY, ELECTRIC COMPUTER DIVISION .... 116
Agency—H. J. Gold Company	Agency—K. E. Morang Company	Agency—Arthur R. Mogge, Inc.
AMPEX CORPORATION .... 145	GENERAL TRANSISTOR CORPORATION .... 112	SARKES TARZIAN, INC. .... 48
Agency—Boland Associates	Agency—A. D. Adams Advertising	Agency—Argyle Wampler Advtg.
AMPHENOL ELECTRONICS .... 36	GULTON INDUSTRIES, INC. .... 129	SEL-REX CORP., PRECIOUS METALS DIV. .... 166
Agency—Burton Browne Adv.	Agency—Conti Advertising	Agency—Bass and Co., Inc.
ANDREW CORP. .... 25	HELIPOT CORPORATION .... 40, 41	SHIELDING, INC. .... 121
Agency—Frank C. Nahser, Inc.	Agency—Charles Bowes Advertising, Inc.	Agency—Conti Advertising
ANTON MACHINE WORKS .... 161	HOFFMAN ELECTRONICS CORP. .... 13, 154	SOLAR MANUFACTURING .... 44
Agency—Richard & Gunther	Agency—Dan B. Miner	Agency—Allen, Dorsey & Hatfield, Inc.
ARNOLD ENGINEERING COMPANY .... 139	HUGHES AIRCRAFT COMPANY .... 22, 31	SPRAGUE ELECTRIC COMPANY .... 56
Agency—W. S. Walker Advertising	Agency—Foote, Cone & Belding	Agency—Harry P. Bridge Co.
ARTOS ENGINEERING CO. .... 150	INDUCTION MOTORS .... 122	SPRAGUE ELECTRIC COMPANY .... 4
Agency—The Cramer-Krasselt Co.	Agency—Malesworth Associates	Agency—Stuart Sande Advertising
ASTRON CORP. .... 125	INSTITUTE OF RADIO ENGINEERS .... 30	STA-WARM ELECTRIC COMPANY .... 165
Agency—Conti Advertising Agency, Inc.	Agency—Raymond Schoonover Advtg.	Agency—E. T. Geddes
AUDIO DEVICES, INC. .... 27	INTERNATIONAL BUSINESS MACHINES .... 136	STACKPOLE CARBON COMPANY .... 99
Agency—Marsteller, Rickard, Gebhardt & Reed, Inc.	Agency—Benton & Bowles, Inc.	Agency—Harry P. Bridge Co.
BECKMAN INSTRUMENTS INC. .... 159	INTERNATIONAL RECTIFIER CORP. .... 55	STAINLESS, INC. .... 013*
Agency—Charles Bowes Advtg., Inc.	Agency—Western Advertising Agency, Inc.	STEVENS MANUFACTURING COMPANY .... 6
BELL TELEPHONE LABS., INC. .... 50, 51	I-T-E CIRCUIT BREAKER COMPANY .... 151	Agency—Paim & Patterson, Inc.
Agency—N. W. Ayer & Son, Inc.	Agency—Gray & Rogers	STROMBERG CARLSON COMPANY .... 158
BENDIX AVIATION CORP., SCINTILLA DIV. 135	JFD MANUFACTURING COMPANY .... 107	Agency—Charles L. Rumrill & Company, Inc.
Agency—MacManus, John & Adams, Inc.	Agency—Delphi Advertising	SYLVANIA ELECTRIC PRODUCTS, INC. 17, 18, 19, 20
BERNDT-BACH, INC. .... 164	JOHNSON COMPANY, E. F. .... 167	Agency—J. Walter Thompson Co.
Agency—Van der Boom Hunt McNaughton, Inc.	Agency—Firestone-Goodman Advertising Agency	SYNTHANE CORPORATION .... 123
BIRD ELECTRONIC CORP. .... 163	JONES, HOWARD B., DIVISION OF CINCH. 165	Agency—Arndt, Preston, Chapin, Lamb & Keen, Inc.
Agency—Scheel Advertising Agency	Agency—Symonds, MacKenzie & Co.	SYNTRONIC INSTRUMENTS, INC. .... 163
BLAW-KNOX COMPANY .... 138	KEARFOTT COMPANY, INC. .... 140	Agency—Burton Browne Advertising
Agency—Ketchum, MacLeod & Grove, Inc.	Agency—Western Advertising Agency, Inc.	TELECRONE INC. .... 117
BOGART MFG. COMPANY .... 45	KESTER SOLDER COMPANY .... 109	Agency—Powerad Company
BURNELL & COMPANY .... 23	Agency—Paul J. Steffen Company	TELE-DYNAMICS, INC. .... 29
Agency—Mohr Associates, Inc.	KITTLESON COMPANY .... 157	Agency—Al Paul Lefton Company, Inc.
BUSSMANN MFG. COMPANY .... 49	Agency—The Dreyfus Company	TELEFUNKEN .... 160
CAMERA EQUIPMENT COMPANY .... 016*	KULKA ELECTRIC MFG. COMPANY, INC. .... 156	Agency—Robert W. Orr & Assoc.
Agency—J. M. Kesslinger & Assoc.	Agency—L. D. Blehart Company	TELERAD MFG. CO. .... 170
CHESTER CABLE COMPANY .... 8	LITTLE, ARTHUR D., INC. .... 149	TEXAS INSTRUMENTS, INC. .... 37
Agency—George Homer Martin Assoc.	Agency—Larcum Randall Advtg. Inc.	Agency—Don L. Baxter, Inc.
CHICAGO TELEPHONE SUPPLY CORP. .... 21	LOCKHEED AIRCRAFT CORP. .... 152, 153	TRANSRADIO LIMITED .... 155
Agency—Burton Browne Advertising	Agency—Hal Stebbins, Inc.	Agency—Reynell & Son Ltd.
CINCH MANUFACTURING CO. .... 89	MAGNETICS, INC. .... 133	TRUSCON STEEL DIVISION, REPUBLIC STEEL CORP. .... 017*
Agency—D. T. Campbell, Inc.	Agency—Lando Advertising Agency	Agency—Meldrum & Fawcsmith, Inc.
COLUMBIAN CARBON CO., MAPICO COLOR UNIT .... 159	MAGNETICS RESEARCH COMPANY .... 168	UNION SWITCH & SIGNAL DIV. WESTINGHOUSE AIR BRAKE CO. .... 114
Agency—Samuel Croot Company, Inc.	Agency—Egan Advertising	Agency—Batten, Barton, Durstine & Osborn, Inc.
CONRAC, INCORPORATED .... 019*	MALLORY & COMPANY, INC., P. R. .... 34	UNITED CATALOG PUBLISHERS, INC. .... 162
Agency—Leech Advertising Co.	Agency—Aitkin-Kynett Company	Agency—Jack Gilbert & Associates
CORNELL-DUBILIER .... 32	MEASUREMENTS CORP. .... 158	UNITED TRANSFORMER COMPANY .... 131
Agency—Friend-Reiss Advertising	Agency—Frederick Smith Adv.	Agency—Shappe, Wilkes, Inc.
CORNING GLASS WORKS .... 100	MELPAR INC. .... 148	UNITED STATES GASKET COMPANY .... 9, 24
Agency—Chas. L. Rumrill & Co., Inc.	Agency—M. Belmont Ver Standig, Inc.	Agency—The Michener Company
DALE PRODUCTS, INC. .... 113	MOTOROLA, INC. .... 132	UNIVERSAL MANUFACTURING COMPANY, INC. .... 144
Agency—Ayres Swanson & Associates, Inc.	Agency—Kolb & Abraham	Agency—Richard & Gunther
DeJUR-AMSCO CORP. .... 142	NATIONAL CASH REGISTER COMPANY .. 10	UNIVERSITY LOUDSPEAKERS, INC. .... 52
Agency—Friend-Reiss Adv.	Agency—McCann-Erickson, Inc.	Agency—Promotion Affiliates
DELCO RADIO DIVISION .... 26	NATIONAL COMPANY, INC. .... 33	WELLER ELECTRIC CORP. .... 135
Agency—Campbell-Ewald Company	Agency—Burton Browne Advertising	Agency—Arndt, Preston, Chapin, Lamb & Keen, Inc.
DERIVATION AND TABULATION ASSOC., INC. .... 135	NEW HERMES ENGRAVERS, INC. .... 160	WELWYN INTERNATIONAL INC. .... 161
Agency—Raymond Nicholas Adv.	Agency—Mann-Ellis Advertising	Agency—Jack Gilbert Associates
DONNER SCIENTIFIC COMPANY .... 020*	NON-LINEAR SYSTEMS, INC. .... 147	WESTERN GEAR CORP. .... 101
Agency—Wank, Lougee McDonald & Lee	Agency—Phillips-Ramsey Company	Agency—Ruthrauff & Ryan, Inc.
DUMONT LABS, INC., ALLEN B. .... 119	ONAN & SONS, INC. D. W. .... 020*	WESTINGHOUSE ELECTRIC CORP. .... 143
Agency—Austin C. Lescarboura & Staff	Agency—Graves & Associates	Agency—McCann-Erickson, Inc.
EISLER ENGINEERING COMPANY, INC. .... 154	OSTER MFG. COMPANY, JOHN .... 141	WESTON ELECTRICAL INSTRUMENT CORP., A SUBSIDIARY OF DAYSTROM, INCORPORATED .... 118
Agency—Walter J. Zimmerman Assoc.	Agency—Burton Browne Adv.	Agency—G. M. Basford Company
EITEL-McCULLOUGH INC. .... 108	PACKARD-BELL COMPANY .... 137	Agency—Emery Advertising Corp.
Agency—Evans, McClure & Assoc.	Agency—Elwood J. Robinson & Company	WILLIAMS & COMPANY, C. K. .... 162
ELECTRICAL INDUSTRIES .... 127	PERMAG CORP. .... 157	Agency—Emery Advertising Corp.
Agency—George Homer Martin Assoc.	Agency—Joseph P. Schneider, Inc.	
ELECTRONIC ENGINEERING COMPANY OF CALIFORNIA .... 134, 156	PHELPS DODGE COPPER PRODUCTS .... 111, 05*	
Agency—Darwin H. Clark Company	Agency—Compton Advertising, Inc.	
ELECTRONIC FABRICATORS, INC. .... 42		
Agency—Mohr Associates		
ERIE RESISTOR CORP. .... 28		
Agency—W. S. Hill Company		

\*In Operations Section only.

# ENGINEERS — CAN YOU QUALIFY?

## ELECTRICAL and ELECTRONIC ENGINEERS

with at least 2 years experience in:  
Microwaves and Radar

Antennas  
Beacons  
Receivers  
Transmitters  
Pulse Circuits

Gyro Development

Digital Computers and Data Processing

Servo-mechanisms and Feedback Systems

Fire Control Systems

Analog Computers

Military Specifications

Electronic Circuitry

## NUCLEAR ENGINEERS and PHYSICISTS

with experience in the  
Control  
Metallurgy  
Physics  
Instrumentation  
of NUCLEAR REACTORS

## MECHANICAL ENGINEERS

with at least 2 years experience in:

Gyro Development

Fire Control Systems

Military Specifications

Product Design and Packaging of

Electro-mechanical Devices

For details write Philip F.  
McCaffrey at:



**FORD  
INSTRUMENT  
CO.** DIVISION OF  
SPERRY RAND CORP.

31-10 Thomson Ave.,  
Long Island City 1, N. Y.  
DIVISION OF SPERRY RAND CORP.

(Continued from page 168)

conform to the 3 MC i-f bandwidth and would have a linear swing with a sensitivity of 0.7 v. per megacycle.

Many pulse receiver applications require a constant level output pulse which preserves the width, repetition rate, and relative time position of the received r-f pulse. A pulse amplifier driven from the amplitude detector or the FM discriminator may be designed to satisfy these requirements and deliver a constant 10 v. pulse into a 100  $\Omega$  load impedance. For a signal-to-noise ratio greater than 15 db, the pulse amplifier output will be free of noise.

The sensitivity to modulated signals can be improved by using narrow band video amplifiers after the detector. One such technique would be to use a narrow band amplifier centered at the repetition rate of the received signal. Ten to 20 db improvement can be obtained using commercial standing wave amplifiers. A second method would be to design an audio amplifier with a bandwidth sufficient to accept most modulation frequencies. The signal-to-noise improvement would then be a function of the audio amplifier bandwidth. The audio amplifier also can be used for aural monitoring of AM or FM received signals.

Field intensity measurements require a calibrated meter or recorded output. A difference amplifier may be used to drive a meter and recorder. With the difference amplifier input monitoring the AGC line, the meter and recorder scale will be approximately linear in db and cover more than a 60 db range if sufficient i-f amplifiers are AGC controlled. With the amplifier input connected to the video detector and the AGC line grounded, the meter scale is linear but will cover a range of only 25 db.

Gain stability of less than 1db/24 hours requires not only that all power supplies be regulated, but also the filaments of critical amplifiers. Since incidental AM and FM in the klystron are a function of power supply stability and ripple, it is essential that both the reflector and anode supplies have good regulation and low ripple.



## SPECIAL PRODUCTS



### RELIABLE

"S" & "L" BAND

GUIDED MISSILE BEACONS

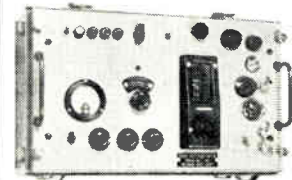

TEST SET  
TSG-147D

## TELE-FLEX

FLEXIBLE WAVEGUIDE



## TELE-GUIDE

RIGID WAVEGUIDE &  
COAXIAL COMPONENTS

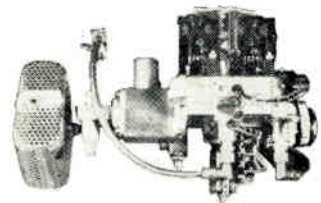

**Telerad**  
MFG. CORP.

GENERAL OFFICES

1440 BROADWAY • NEW YORK, N. Y.

BRYANT 9-0893

Circle 235 on Inquiry Card, page 103

Circle 234 on Inquiry Card, page 103



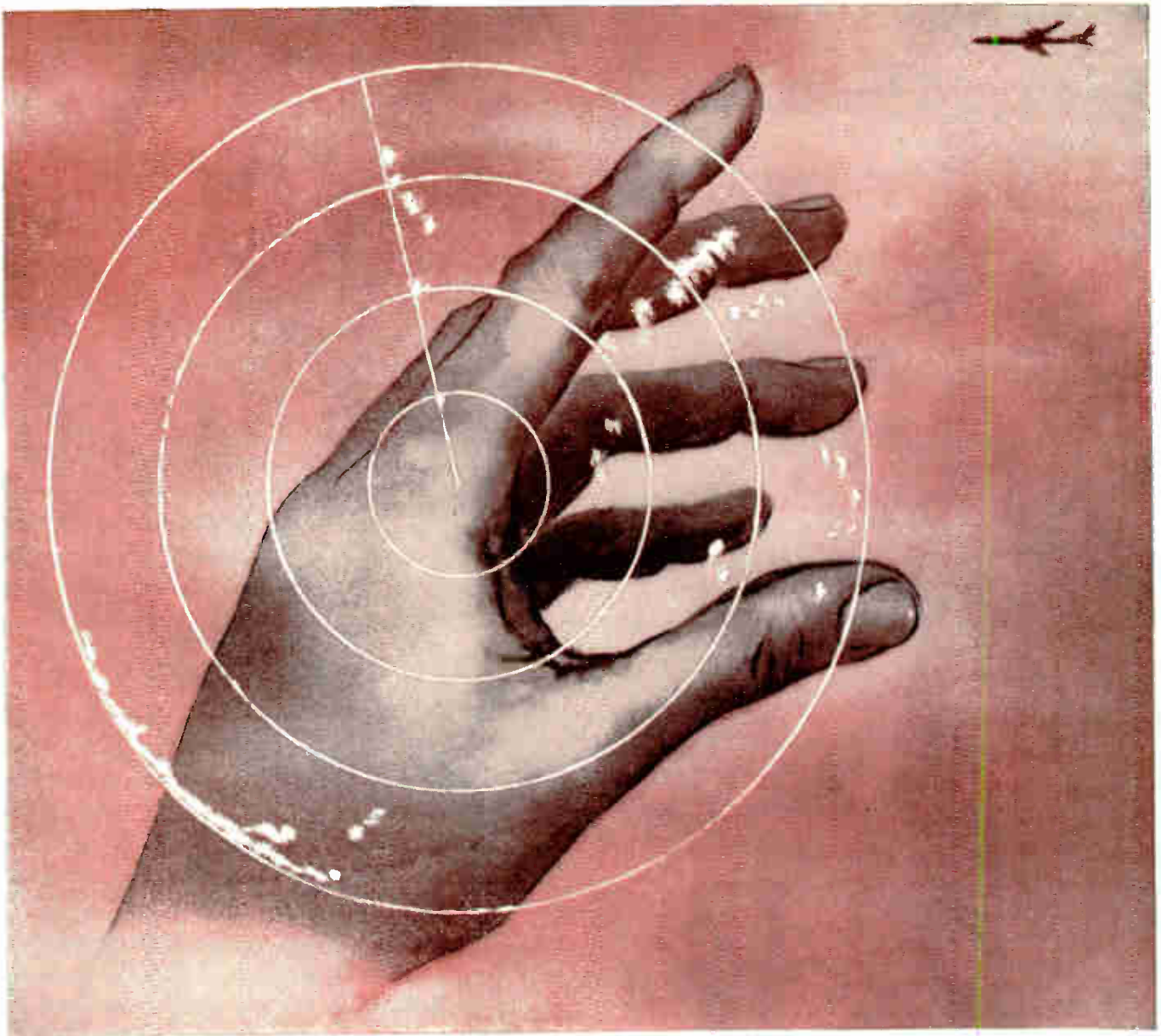

## Radar probes...

with no margin for component failure

G-V Thermal Relays and Thermostats provide the reliability which designers of radar must have to assure the dependable performance of their equipment. Throughout the entire field of electronic and aircraft equipment, the products of G-V Controls Inc. are known for sound design and reliable performance.

**G-V Hot Wire Time Delay Relays**  
*1/10 to 5 seconds with fast recovery*

**G-V Thermal Time Delay Relays**  
*Adjustable delays of 2 to 300 seconds*

**G-V Voltage & Current Sensing Relays**  
*For circuit protection*

**G-V Electrical Thermostats**  
*Hermetically sealed, still adjustable*

From coast to coast and in Canada, G-V's representatives are well-qualified to serve you.

Complete catalog data is available.

**G-V CONTROLS INC.**

50 Hollywood Plaza, East Orange, New Jersey



*Another  
RCA first in  
110° design*



## **RCA-17BZP4**

- Weight—only 10 pounds
- Length—only 12 $\frac{9}{16}$  inches
- No Ion-Trap Magnet Needed

Scale: 1 square = 1 inch

Pioneer in the development of 110°-deflection picture tubes for compact black-and-white TV receivers, RCA presents the 17BZP4—the 17-inch-type, rectangular, glass tube designed specifically to meet popular demand for large-screen TV in smaller, lighter-weight cabinets. Here is a very short picture tube with a large viewing area of 155 square inches—3 inches shorter than types having the same size faceplate and 90° deflection. Super-aluminizing produces bright, high-contrast pictures that have made RCA picture tubes famous. The new RCA electron gun of the “straight-type” design **DOES AWAY ENTIRELY WITH THE NEED FOR AN ION-TRAP MAGNET!**

Available in quantity to meet your production schedule, RCA-17BZP4 is another important addition to RCA's expanding family of 110°-deflection types—including the RCA-21CEP4, the first commercially available 110° tube, a 14-inch developmental type now available for sampling to equipment manufacturers, and a 24-inch type in development.

For sales information and delivery schedule on RCA 110°-deflection types, call your RCA Field Representative. For technical data, write RCA Commercial Engineering, Section C50Q, Harrison, N. J.

**NOTE:** *RCA can supply you with the horizontal and vertical deflection tubes and components needed for 110°-deflection-angle systems.*

### **RCA FIELD OFFICES**

**East:** Humboldt 5-3900  
744 Broad Street  
Newark 2, N. J.

**Midwest:** Whitehall 4-2900  
Suite 1181,  
Merchandise Mart Plaza  
Chicago 54, Illinois

**West:** Raymond 3-8361  
6355 East Washington Blvd  
Los Angeles 22, Calif.



**RADIO CORPORATION OF AMERICA**  
Tube Division

Harrison, New Jersey