

ELECTRONIC INDUSTRIES

CALDWELL-CLEMENTS, INC.



JUNE 1946



MASS PRODUCTION

World Radio History



Moisture-Proof ...and That's Not All!

1. New end cap is made of plastic.
2. Two brackets accommodate all four case sizes of Mallory AC Motor Starting Capacitors.
3. Bracket is installed by screws placed at any two points within center slot.

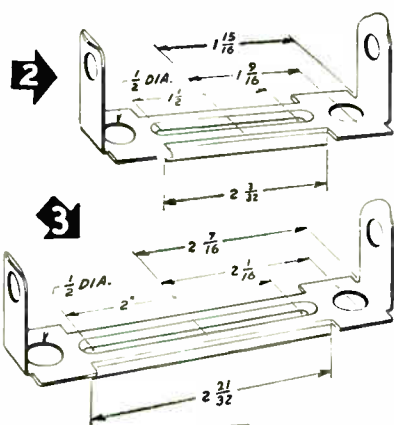

Want more details? Write for engineering data and specification folder #746-C.

FEW Mallory products in recent times have met with more whole-hearted enthusiasm than the Type "P" AC Motor Starting Capacitor.

To begin with, the capacitor is enclosed in a plastic case—a positive preventive of moisture absorption, the bane of the old-style cardboard insulated unit.

Next, it's equipped with splash-proof end cap and with an ingenious new type of mounting bracket. Together, these two features eliminate many extra parts and greatly simplify installation.

Finally, this Mallory Type "P" Capacitor is available in four case sizes . . . is interchangeable with former aluminum units . . . will fit any mounting hardware used for previous capacitors of comparable size.

P. R. MALLORY & CO. Inc.
MALLORY CAPACITORS
(ELECTROLYTIC, FILM and PAPER)

P. R. MALLORY & CO., Inc., INDIANAPOLIS 6, INDIANA

ELECTRONIC INDUSTRIES

Including INDUSTRIAL ELECTRONICS

★ IN THIS ISSUE JUNE, 1946 ★

FRONT COVER—MASS PRODUCTION	See page	4	
EDITORIAL		47	
SEPARATE CAVITY TUNABLE MAGNETRONS—G. D. O'Neill		48	
MASS PRODUCTION—H. Gregory Shea		51	
MEASURING AUDIO INTERMODULATION—Norman C. Pickering		56	
\$1000 AWARD WINNERS		59	
PHASE SENSITIVE BRIDGE DETECTOR—Paul H. Hunter		60	
FM RAILROAD RADIO SATELLITE SYSTEM—William S. Halstead		62	
ELECTRONIC USES IN INDUSTRY—W. C. White		66	
NUERNBERG TRIALS RECORDING SYSTEM—Philip C. Erhorn		70	
FACSIMILE METHODS FOR BROADCAST WORK		74	
TUBES ON THE JOB		76	
COUPLING METHODS FOR DIELECTRIC HEATING—Richard C. Kleinberger		78	
SURVEY OF WIDE READING		80	
NEW PATENTS ISSUED		82	
News of Industry	81	New Books Reviewed.....	130
Washington News	84	Personnel	132
Television Today	86	New Bulletins	137
What's New 88, 90, 92, 94, 96, 98			

ORESTES H. CALDWELL, Editor

M. CLEMENTS, Publisher

EDITORIAL STAFF—Stanley P. McMinn, managing editor; Ralph R. Batcher, consulting editor; William Moulic, electronic theory and design; H. Gregory Shea, industrial engineering applications; Josepha Zentner, Ph.D., patents and foreign reviews; Paul H. Hunter, instrumentation; E. T. Bennett, editorial records; Fred C. Hoffman, editorial production; Charles Dreyer, art director; Carl Buhner, circuit diagrams; Roland C. Davies, 1290 National Press Building, Washington, D. C., Washington editor.

READER SERVICE—J. Cosin, H. Mirtel; data research, H. Kulik.

CIRCULATION—B. V. Spinetta, circulation director; subscriptions; list compilation: B. Gollub, M. Groening, B. Ruchaisky.

BUSINESS—M. H. Newton, business manager; John Samborn, sales manager; Richard Fitzpatrick, western manager; R. F. Willett, New England manager; Lee Robinson, district manager; C. J. Stillman; Ben Morris, promotion manager; N. McAllister, production manager; J. E. Cochran, make-up; W. W. Swigert, credit manager; W. Kenneth Reynolds, E. Callahan.

BRANCH OFFICES—Chicago 6, R. Y. Fitzpatrick, 201 N. Wells St. RAN 9225; Cleveland 14, Citizens Bldg., 850 Euclid Ave., Main 8270; Los Angeles 14, Robert W. Walker, Walker & Minton, 403 W. 8th St., VAndike 9348; San Francisco 4, Eli C. Minton, Walker & Minton, 68 Post St., Sutter 5568.

CALDWELL-CLEMENTS, INC. — TEL. PLAZA 3-1340 — 480 LEXINGTON AVENUE, NEW YORK 17, N. Y.

Electronic Industries[®], June, 1946. Vol. V, No. 6. Regular price per copy 35 cents. Published monthly by Caldwell-Clements, Inc., 480 Lexington Avenue, New York 17, N. Y. M. Clements, President; Orestes H. Caldwell, Treasurer. Subscription: United States and possessions, Mexico, Central and South American countries, \$3.00 for one year; \$5.00 for two years; \$6.50 for three years. Canada, \$3.50 per year; \$5.50 for two years; \$7.15 for three years. All other countries \$5.00 a year. Entered as Second Class Matter, September 20, 1943, at the Post Office at New York, N. Y., under the act of March 3, 1879. Copyright by Caldwell-Clements, Inc., 1946. Printed in U. S. A. *Reg. U. S. Pat Off.

HYDROGEN THYRATRONS



for very high
pulse repetition
frequencies

ELECTRICAL RATINGS AND OPERATING CONDITIONS (TENTATIVE)

CHARACTERISTIC	4C35	5C22
Heater voltage	6.3 v $\pm 5\%$ -10%	6.3 v $\pm 7.5\%$
Heater current at 6.3 volts	5.5 to 6.7 amps	9.6 to 11.6 amps
Cathode heating time	180 sec. min.	300 sec. min.
Peak anode voltage	8.0 KV max.	16.0 KV max.
Peak anode current	90 amps max.	325 amps max.
Peak inverse anode voltage (Note 1)	6.0 KV max.	16.0 KV max. 5% of e_{py} min.
Average anode current	100 ma d-c max.	200 ma max.
Pulse duration (measured at $\frac{1}{2}$ amplitude)	6.0 μ sec. max.	6.0 μ sec. max.
Pulse repetition frequency	4000 p.p.s. max.	Note 2
Duty cycle (Note 3)	0.0008 max.	0.001 max.
Grid drive (Note 4)		
a) peak grid voltage	150 v min.	150 v min.
b) time of rise	1.0 μ sec. max.	1.0 μ sec. max.
c) grid pulse duration at 50 v min. amplitude	4.0 μ sec. min. 1500 ohms max.	4.0 μ sec. min. 500 ohms max.
d) impedance of grid drive circuit	200 v max.	200 v max.
Peak inverse grid voltage	-50° to +90° C	-50° to +90° C
Ambient temperature		

NOTE 1: In pulsed operation, peak inverse anode voltage during the first 25 microseconds after the pulse should not exceed 2.5 KV for the 4C35; 5 KV for the 5C22.

NOTE 2: Maximum pulse repetition frequency for the 5C22 (prf in pulse per second) depends on peak forward anode voltage (e_{py} in volts) and peak anode current (i_b in amps) according to formula

$$e_{py} \times i_b \times prf = 2.8 \times 10^9$$

NOTE 3: Duty cycle is defined as the product of pulse duration in seconds and pulse repetition frequency in pulses per second.

NOTE 4: Measurements at tube socket with thyatron grid disconnected.

FEATURES

The 4C35 and 5C22 Hydrogen Thyratrons developed by Sylvania Electric are specifically designed for pulsing service at high repetition frequencies, high peak current, and high voltages.

Because of the high mobility of hydrogen, the gaseous ions are converted to neutral molecules within a very short time after tube is shut off. This feature of the 4C35 and 5C22 permits operation at exceptionally high repetition frequencies.

Tubes may be operated over a wide range of ambient temperatures without significant change in their electrical characteristics.

CIRCUIT FOR PRODUCING RECTANGULAR PULSES

The 4C35 and 5C22 were specifically developed for use in the circuit below, designed to produce periodic rectangular pulses. Pulses are formed at levels of about twice the power supply voltage, thus giving savings in size and cost of supply.

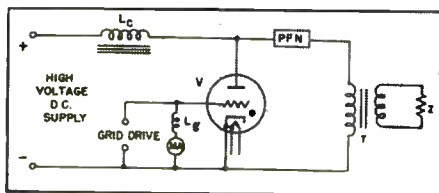

L_g Grid Choke
 L_c Charging Choke
PFN Pulse-Forming Network
T Matching or Pulse Transformer
Z Load
V 4C35 or 5C22

OTHER APPLICATIONS

Other suggested applications of the 4C35 and 5C22 include:

1. Switching in welding circuits, particularly of the capacitor discharge type.
2. Shock excitation of tuned circuit.
3. Excitation of piezoelectric crystals.
4. Use in induction heating circuits to replace spark-gap heaters, resulting in trouble-free and quieter performance.
5. Pulser for pulse time modulation circuits in which signals are produced by modulating the pulse repetition rate.
6. Servomechanisms and control circuits where relatively high a-e supply frequencies are used.

Sylvania invites inquiries on application of these tubes.

SYLVANIA ELECTRIC

Electronics Division . . . 500 Fifth Avenue, New York 18, N. Y.

MAKERS OF ELECTRONIC DEVICES; RADIO TUBES; CATHODE RAY TUBES; FLUORESCENT LAMPS, FIXTURES, WIRING DEVICES; ELECTRIC LIGHT BULBS

**TRY THORDARSON
MEISSNER
RADIART**
FOR SUPERIOR QUALITY
ELECTRONIC PRODUCTS *PLUS*
FASTER, BETTER — MORE COMPLETE SERVICE

Customers everywhere are applauding the decision of Maguire Industries, Inc. to sell these three groups of outstanding electronic products from a single sales source. They like the convenience, the new high in speedy, reliable service. Try it and you will like it too. For full information, write to the address below . . . today!

THORDARSON
TRANSFORMERS
TRU-FIDELITY AMPLIFIERS

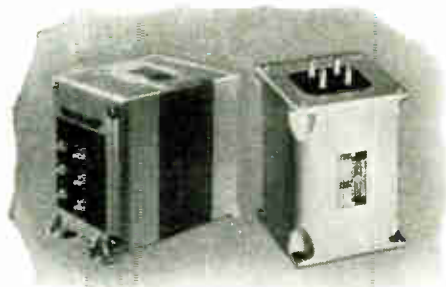

THORDARSON TRANSFORMERS

Precision-built transformers for all requirements . . . replacement, communication, sound amplifier, industrial, experimental and amateur. Tru-Fidelity Amplifiers with all modern features and improvements.

MEISSNER
COMPONENTS
SERVICE INSTRUMENTS

High quality components including antenna, R. F. and oscillator coils; standard, plastic and Ferrocart transformers; windings, coils, chokes and accessories. Service Instruments including the famous Meissner Analyst and Meissner Signal Calibrator.



MEISSNER ANALYST

RADIART
VIBRATORS
VIBRATOR POWER PACKS
RUST-PROOF AERIALS



RADIART VIBRATORS

Exact duplicate Vibrators designed for long life, minimum R. F. interference, low noise level and proper starting. Vibrator Power Packs . . . efficient, economical and dependable plate power. Rust-Proof Aerials newly designed to fit all cars; cowl, hood and under hood types.

**ELECTRONIC DISTRIBUTOR AND INDUSTRIAL SALES DEPARTMENT OF
MAGUIRE INDUSTRIES, INCORPORATED**
936 NORTH MICHIGAN AVENUE, CHICAGO 11, ILLINOIS
CABLE ADDRESS 'MAGINDUS

Now Better Than Ever!

Radiotone HOLLYWOOD



new...
improved
portable

Illustrated—RA-116 combination portable recorder phonograph and public address system

● **HERE'S GOOD NEWS!** Radiotone is back in commercial production with new, improved models, made by Ellinwood Industries, famous for Design Simplicity—Dependability. Now 10 years recording experience with thousands of units in service is combined with precision know-how and the latest production equipment. Check these features—note the improvements—then send for name of local representative and complete illustrated catalog describing the RA-116 and other models, including the R-116, 16" dual speed recorder without amplifier, the D116, 16" dubbing table and the TP-116, 16" transcription player and TP-112, 12" transcription player.

FEATURES:

DUAL SPEED—78 or 33½ rpm. instantly selected by an improved lever shift.

LEAD SCREW—Positive feed overhead lead screw. Direction of cut can be changed instantly and run-in grooves may be made when desired.

VARIABLE LINES—Number of lines per inch on the disc may be varied from 90 to 130.

DRIVE SYSTEM—Radiotone has perfected a positive silent drive insuring perfect motion, correct pitch, and stability. Speed accuracy is maintained within .3% at 78 rpm. and .4% at 33½ rpm.

DUO-CHROMATIC EQUALIZERS—Two controls allow continuously variable response over both high and low registers.

MULTIPLE INPUT CHANNELS—Two high impedance input channels are provided. (Low impedance also available.) Two jacks for microphone. The other two for phonograph pick-up or a zero level line.

MIXERS—Two independent volume controls are provided and may be operated simultaneously.

DEALERS—A few good territories open to qualified dealers having better-class clientele and reputation for superior service. Write and tell us about yourself.

VOLUME INDICATOR—A volume indicator meter is provided for accurate monitoring of recording level.

RADIO—an optional extra.

OUTPUTS—All output impedances are 8 ohms.

AMPLIFICATION STAGES—The amplifier has four stages as follows: one 7F7 dual pre-amplifier tube, one 7F7 tube for duo-chromatic equalizer stage and two 7F7 tubes in push-pull stage driving two 7C5 tubes in push-pull class "A". Power output is 14 Watts. Harmonic distortion less than 1%; inverse feed back is employed.

POWER REQUIREMENTS—110-120 Volts. 50 or 60 cycles AC. 150 Watts. May be used on DC by addition of converter.

SPEAKER—Heavy duty 12-inch high fidelity speaker of the permanent magnet dynamic type.

FINISH—Handsome leatherette case with chromium hardware. Exterior metal parts finished in baked crackle lacquer with chrome trim.

THE COVER

The young lady is doing a simple but very important job in the testing of radio sets mass produced by Emerson Radio and Phono. Corp. Her job involves meter testing the various wires, coils, and solder joints in the chassis so that she may reject any set which does not conform to inspection standards, and so that subsequent operations can be done without interruptions caused by rejected sets. When she locates trouble in a set at this stage of assembly, it is not only much easier for repairs to be made but also the possibility of damage as a result of unnecessary handling in later operations is reduced. Much of her job also has to do with testing for errors in assembly which may not be so obvious to workers following her operation. For example, this operator electrically checks a switch which automatically disconnects internal batteries when the cover of the radio is closed. Although very few of these switches are defective, she carefully checks the operation of each one to insure that when the cover is closed the batteries are not being discharged.

Industrial Servicing

Who is going to service industrial electronic installations? As plans begin to develop for production and sales, is sufficient thought being given to the proper maintenance of this apparatus after it is in the user's plant? Naturally the more complicated and expensive equipment will require servicing by experts trained by the manufacturers. Many small packaged units will require no more service than home radios, the replacing of a tube or a new condenser. But there will be much equipment that will fall between these extremes, too specialized for the regular electrician and not big enough to require a factory-trained expert.

The Vocational Training Schools may provide an answer to this problem. Many of these institutions have handled a lot of industrial training during the war. They have a staff of teachers who are experienced in a practical approach. In many cases special courses can be set up to cover any subject in which there is public interest. Short intensive training programs could easily be developed for proposed equipment service men from ten to twenty user companies.

ELECTRONICS DIVISION
Ellinwood
INDUSTRIES

150 WEST SLAUSON AVENUE · LOS ANGELES 3, CALIFORNIA · DEPT. R-100

Please send illustrated Catalog on portable Radiotone Recorder

Name _____
Company _____ Title _____
City _____ Zone _____ State _____

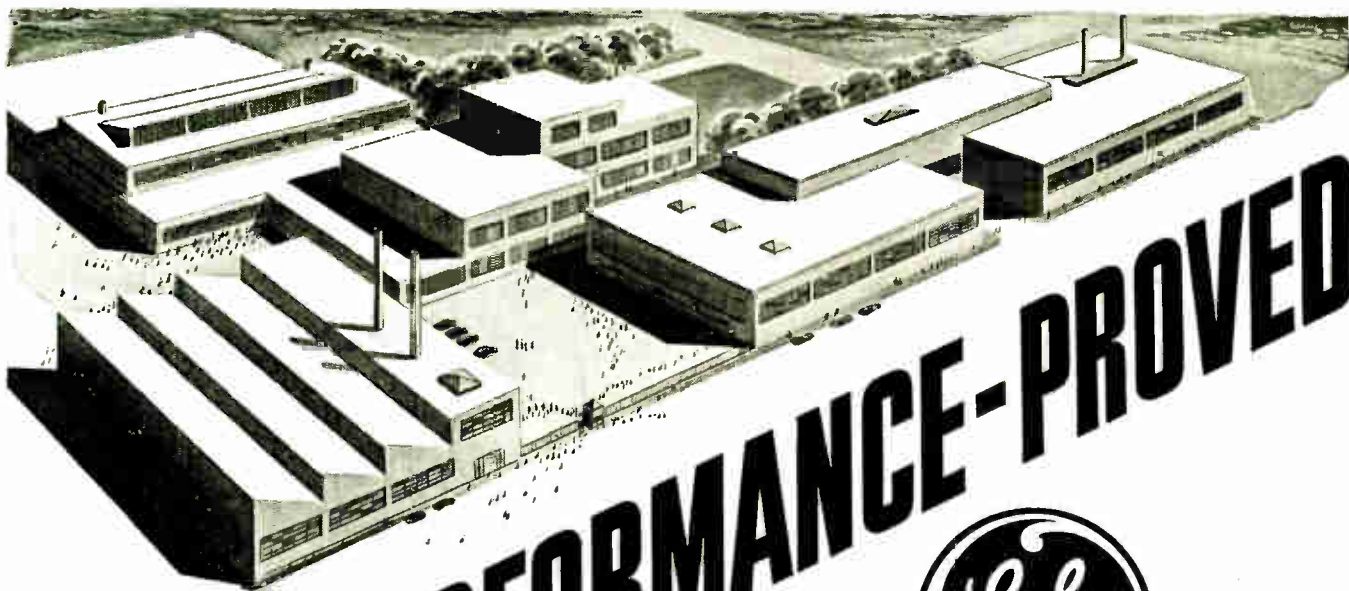

PERFORMANCE-PROVED



G-E electronic tubes for industry — like this h-f heating pair — have a background of successful factory service



Your SAFEST tube investment!

BY choosing your local G-E distributor or dealer as your source for electronic tubes, you avoid important elements of risk.

- You assure yourself that tubes you buy and install *will do the job*—because G-E tubes *have done the job before*, successfully, in hundreds, perhaps thousands of similar applications! G-E tubes are designed and built with that finest of all proving-grounds—industry itself—available to scan performance, check dollars-and-cents results, and finally say "O.K." in the form of substantial repeat orders. *General Electric leads in industrial electronic-tube volume.*
- You are guaranteed performance-to-specifications from each G-E tube—

because of G-E's ironclad warranty that covers operation *after* you have placed the tube in its socket and switched on the current!

- You are sure of having the tubes you need when you need them—from a competent, well-stocked local source—with delivery usually a matter of hours! Thus equipment shutdowns are avoided, conserving time and profits.

- Phone your G-E distributor or dealer today! Let him tell you about the G-E tube service—*finest and fastest*—which he can make available to you. *Electronics Department, General Electric Company, Schenectady 5, N. Y.*

TYPE GL-889-A, at top, is a high-vacuum oscillator triode with these max anode ratings: voltage 8,500 v, current 2 amp, input 16 kw, dissipation 5 kw . . . TYPE GL-575-A, bottom, is a half-wave mercury-vapor rectifier diode with these anode ratings: peak inverse voltage 15,000 v, peak current 6 amp, avg current 1.5 amp. . . In electronic heating, Type GL-889-A produces the high-frequency current; Type GL-575-A changes a-c power to d-c used by the oscillator tube.



Distributors and dealers everywhere, backed up by additional G-E tube stocks in centrally located key cities.

GENERAL ELECTRIC

162-E11-0050

FIRST AND GREATEST NAME IN ELECTRONICS

skilled springmakers . .
AND practical,
experienced engineers,
SPECIALISTS
in spring design
and manufacture

At Accurate



It takes people to make springs. Ours are specialized, highly trained, long-experienced people—well qualified to give you the finest in spring craftsmanship.

Q Our engineers too, are an important reason why you'll like Accurate Spring Service. They're old hands at spring-making . . . they've developed manufacturing systems and procedures that enable us to handle your jobs with the greatest speed and efficiency. These Accurate engineers are at your service on spring design problems. You will benefit from their practical assistance in designing exactly the right spring for your application.

Q Why not try Accurate on your next job.

Send for your copy of the new Accurate Spring Handbook. It's full of data and formulae which you will find useful. No obligation of course.

ACCURATE SPRING MFG. CO.
3808 W. Lake Street Chicago 24, Illinois

Accurate

Springs

SPRINGS • WIREFORMS • STAMPINGS

COPPER is the "Metal of Invention"

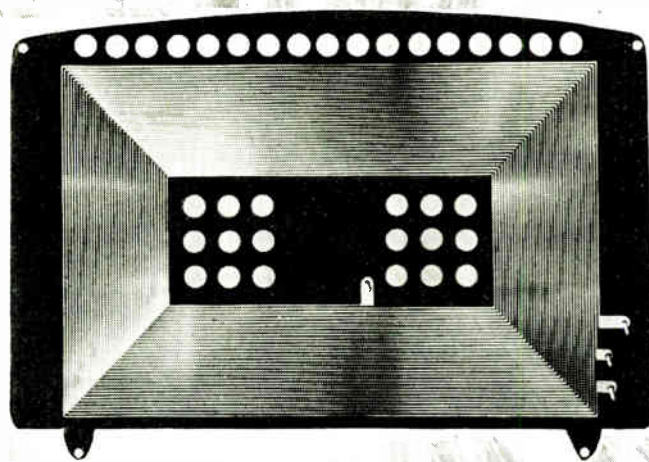

...SEE REVERE!

The Franklin Airloop Corp., 175 Varick St., New York 14, N. Y., makes this unique antenna to set manufacturers' specifications.

It is Revere copper that makes possible the unusual Franklin Airloop antenna. This is die-stamped out of .005" sheet, a single operation on automatic machines forming the loop and locking it into the backboard. The result is superior ruggedness, less distributed capacity, higher "Q," and lower cost.

Thus copper once again proves that its unique qualities make it "The Metal of Invention." Easy workability, high electrical and heat conductivity, corrosion resistance, availability in a variety of tempers and in sheet, strip, plate, bar and rod—copper by Revere serves the radio industry in many different ways.

Revere also offers copper alloys, aluminum and magnesium, and electric welded steel tube. Selection of the proper metal or alloy may at times be a matter for careful study; Revere is always glad to cooperate with engineers, designers and production men in working out the most economical and efficient applications.

REVERE PRODUCTS INCLUDE

Copper and Copper Alloys in sheet and plate, rolls and strip, rod and bar, tube and pipe, extruded shapes, forgings.

Aluminum Alloys in tubing, extruded shapes, forgings.

Magnesium Alloys in sheet and plate, rod and bar, tubing, extruded shapes, forgings.

Electric Welded Steel Tube in straight lengths or semi-fabricated to your designs.

REVERE

COPPER AND BRASS INCORPORATED

Founded by Paul Revere in 1801

230 Park Avenue, New York 17, New York
Mills: Baltimore, Md.; Chicago, Ill.; Detroit, Mich.;
New Bedford, Mass.; Rome, N. Y.

Sales Offices in Principal Cities, Distributors Everywhere.

Listen to *Exploring the Unknown* on the Mutual Network every Sunday evening, 9 to 9:30 p.m., EDST.

The Compact Instrument of Broad Utility

WESTON (MODEL 785) INDUSTRIAL CIRCUIT TESTER

(20,000 Ohms per volt-DC)
(1,000 Ohms per volt-AC)



Provides 27 carefully selected AC and DC voltage, current and resistance ranges on long legible scales. A versatile instrument for servicing, plant maintenance or laboratory needs . . . rugged and moderately priced. Details from your local WESTON representative, or direct from . . .

- for measurements in:
Electronic . . . Communication . . .
Sensitive Relay . . . Aircraft . . .
Lighting . . . Motor . . . and Industrial Control Circuits.
- Convenient Accessories:
Weston Socket Selectors, Model 666.
Weston Televerter for 5,000 or 10,000 Volts DC, Model 766

Weston *Instruments*

Weston Electrical Instrument Corp., 666 Frelinghuysen Ave., Newark 5, New Jersey.

Albany-Atlanta-Boston-Buffalo-Chicago-Cincinnati-Cleveland-Dallas-Denver-Detroit-Jacksonville-Knoxville-Los Angeles-Meriden-Minneapolis-Newark-New Orleans-New York-Philadelphia-Phoenix-Pittsburgh-Rochester-San Francisco-Seattle-St. Louis-Syracuse-In Canada, Northern Electric Co., Ltd., Powerlite Devices, Ltd.



It's What's Behind CLARE RELAYS That Keeps Them in Front

● Clare Relay engineers have "thrown away the book." They are not restrained in their relay designs by hidebound ideas, outmoded methods.

From this modern equipped research laboratory, pictured above, come the forward looking Clare "Custom-Built" Relays that free design engineers from old-time relay limitations.

Products of a progressive company, entirely devoted to making relays to meet the most exacting applications, Clare "Custom-Built" Relays encourage engineers in every branch of industry to count on the flexibility of Clare Relays and the skill of Clare engineers to provide unusual, new, and improved features to meet every requirement.

Do you want smaller, more compact construction to fit into streamlined equipment? Is your need for more efficient operation . . . ability to withstand unusual vibration . . . new and different electrical characteristics? Look to Clare for all these things . . . and more.

Clare Sales Engineers are located in all principal cities to help with your relay problems. The Clare Engineering Data Book will be mailed at your request. Address: C. P. Clare & Co., 4719 W. Sunnyside Avenue, Chicago 30, Illinois. Cable address: CLARELAY.

CLARE RELAYS

"Custom-Built" Multiple Contact Relays for Electrical and Industrial Use

World Radio History

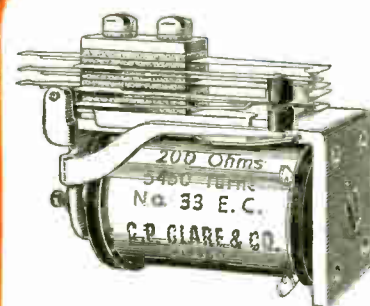

This Clare Type "G" d.c. Relay is a relay for the spot where inches and ounces count. Measures 2½" long.

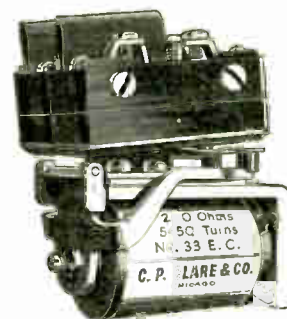

Clare Type "GMS" Relay uses standard Type "G" frame for operation of one or two snap-action switches.

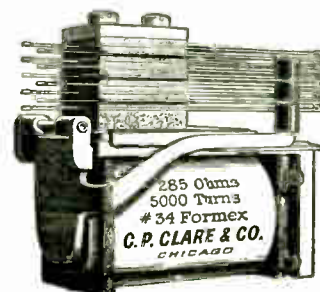

The Clare Type "GAC" Relay gives an equally compact relay for a.c. operation. Design permits very quiet operation.

**SENSITIVITY
CONTACT PRESSURE
DEPENDABILITY
COMPACTNESS
VERSATILITY
LONG LIFE**

this ONE relay has ALL 6 features

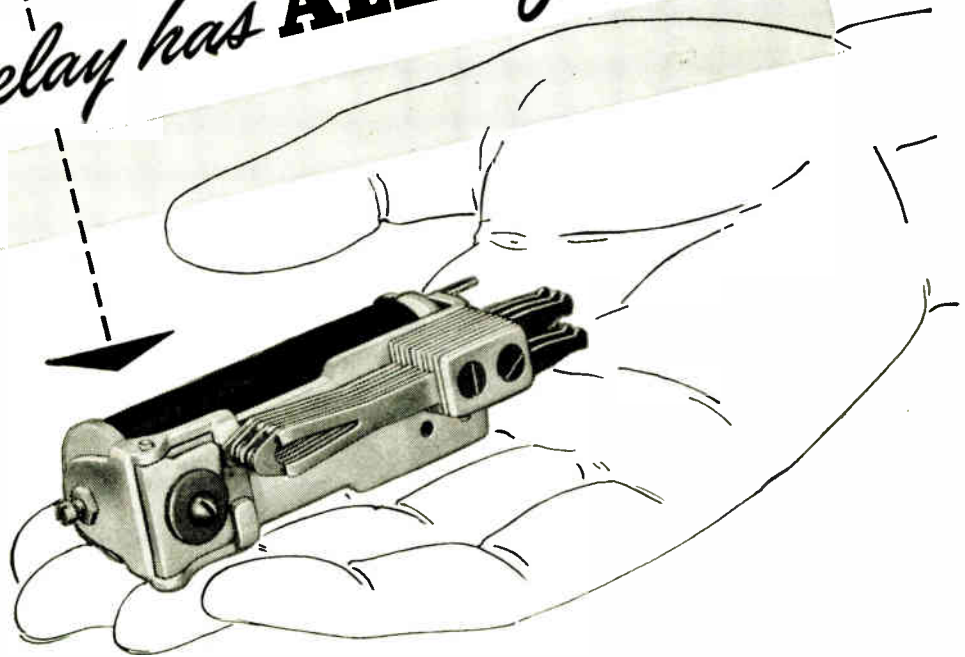

AUTOMATIC ELECTRIC'S CLASS "B" RELAY

Not just 2, 3, or 4—but all 6 features in this one great relay! That's why Automatic's Class "B" relay is the choice of so many experts throughout America. That's why you can buy it with positive assurance that this relay will meet the most exacting requirements.

Due to difficulties over which we have no control, we, like so many other manufacturers, cannot guarantee delivery in terms of our usual schedules. We believe, however, that you will decide to wait for this better relay.

Independent twin contacts for dependable contact closure... efficient magnetic circuit for sensitivity and high contact pressure... unique armature bearing for long wear under severe conditions... compact

design for important savings in space and weight. Made for coil voltages to 300 volts DC and 230 volts AC, with capacities up to 28 springs; also with magnetic-shielding cover, when desired.

The Class "B" relay, and many others, are shown in Catalog 4071. Write today for your copy.

Relays by

AUTOMATIC  ELECTRIC

AUTOMATIC ELECTRIC SALES CORPORATION
1033 WEST VAN BUREN STREET • CHICAGO 7, ILLINOIS
In Canada: AUTOMATIC ELECTRIC (CANADA) LIMITED, TORONTO

PARTS AND ASSEMBLIES FOR EVERY ELECTRICAL CONTROL NEED



MICA CERAMIC SOCKETS and INSULATORS

NOW AVAILABLE FOR THE FIRST TIME FOR CIVILIAN USE



ETS-4 Standard
4 Prong Socket



EMTS-4HVH 4 Prong
High Voltage or High
Frequency Socket



EAT-75 5-7
Prong Acorn Socket



ETS-5 Standard
5 Prong Socket



ETS-6 Standard
6 Prong Socket

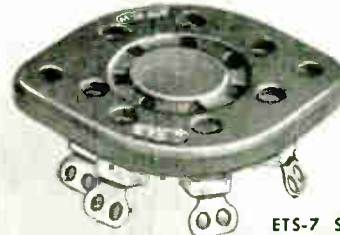

ETS-7 Standard
7 Prong Socket

BEST FOR HIGH FREQUENCY AND HIGH VOLTAGE APPLICATIONS



EII-250H 2 1/2"
Feed Through
Insulator

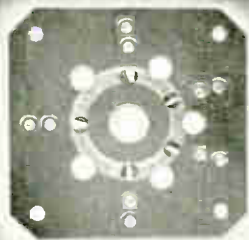

EMS-4-125A Five Prong
H. F. Socket with Air Hales



ENB-750 Through
Panel Bushing with
Plug Terminal



Sheet and Rod Stock
Available in many sizes



EBI-175H 1 3/4"
Feed Through Insulator



EBI-187H 1 7/8"
Compact Feed
Through Insulator



ESO-150 Stand-off
Insulator 1 1/2"



High-Voltage Twin
Bushing for Transformers

ORDER FROM YOUR DEALER OR WRITE TO

MADE EXCLUSIVELY BY

70 CLIFTON BLVD., CLIFTON, N. J.
CHICAGO 47; 1917 N. Springfield Ave., Tel. Albany 4310
EXPORT OFFICE: 89 Broad Street, New York 4, New York

ELECTRONIC MECHANICS
INC.

SEALED

**to stop air, oil, water
and current leaks
in h-f circuits**

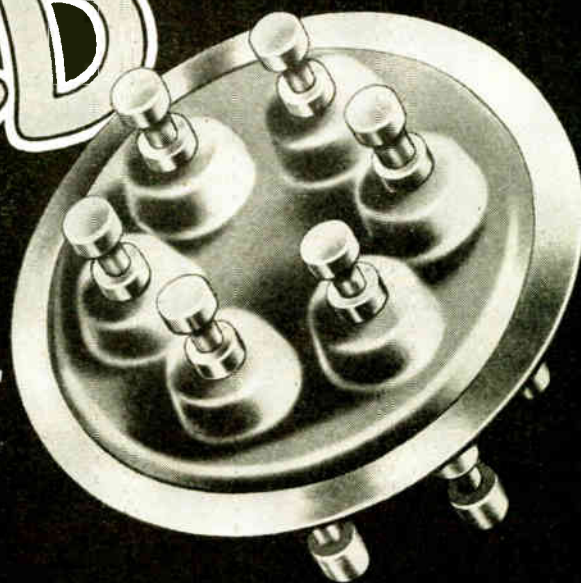

In high-frequency, high-voltage circuits, current arcs right through ordinary insulation or seeps away in high losses.

Specially-developed dielectrics are needed. One of these is Mycalex, a glass-bonded mica product made by the Mycalex Corporation of America, Clifton, N. J., and widely used for more than twenty-five years.

But even with Mycalex there still remains a difficulty when building units in which the insulation must be combined with metal conducting elements—as, for example, lead-ins or terminals.

For such units you need a current-carrying metal that will match the thermal expansion characteristics of Mycalex. Otherwise, unequal expansion and contraction rates will separate the metal inserts from the insulating material, letting oil, air and

moisture into the electrical system.

The metal also must offer adequate electrical conductivity... must suffer no corrosion that would reduce surface conductivity... must be workable into the small sizes and intricate shapes needed.

To get all these properties, Mycalex engineers always recommend Monel—one of the versatile INCO Nickel Alloys—to ensure the dependable hermetic seals they need.

MORE AND MORE ENGINEERS ARE "DISCOVERING" THE INCO NICKEL ALLOYS

Investigate the INCO Nickel Alloys whenever you have a tricky metal problem. Strong, tough, and corrosion-resisting as a group, each also offers the individual properties so frequently needed in electric and electronic applications.

★ ★ ★

Write for your copy of "INCO NICKEL ALLOYS for ELECTRONIC USES"—a summary of properties and recommended applications.

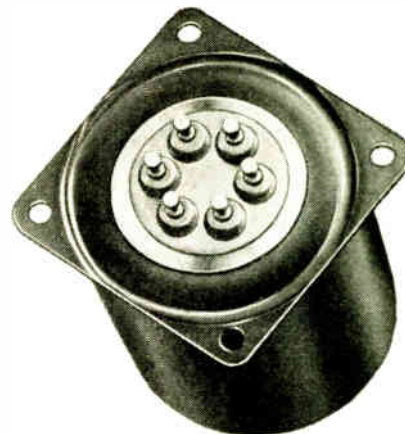

"EXTREMELY SATISFACTORY"

Six Monel terminals are molded into this Mycalex assembly for a transformer. After testing it for leakage, United Transformer Corporation reported it to be "extremely satisfactory for hermetic sealing purpose."

Because the coefficients of thermal expansion of Monel and Mycalex are so compatible, and because the surface conductivity of Monel cannot be reduced by corrosion, Mycalex engineers recommend Monel above all other metals for use with Mycalex.

THE INTERNATIONAL NICKEL COMPANY, INC., 67 Wall St., New York 5, N. Y.

NICKEL  ALLOYS

MONEL* • "K" MONEL* • "S" MONEL* • "R" MONEL* • "KR" MONEL* • INCONEL* • NICKEL • "L" NICKEL* • "Z" NICKEL*
*Reg. U. S. Pat. Off.

✓ CHECK THESE FEATURES...

—features that emphasize the versatility of The **DUMONT TYPE 247 OSCILLOGRAPH**

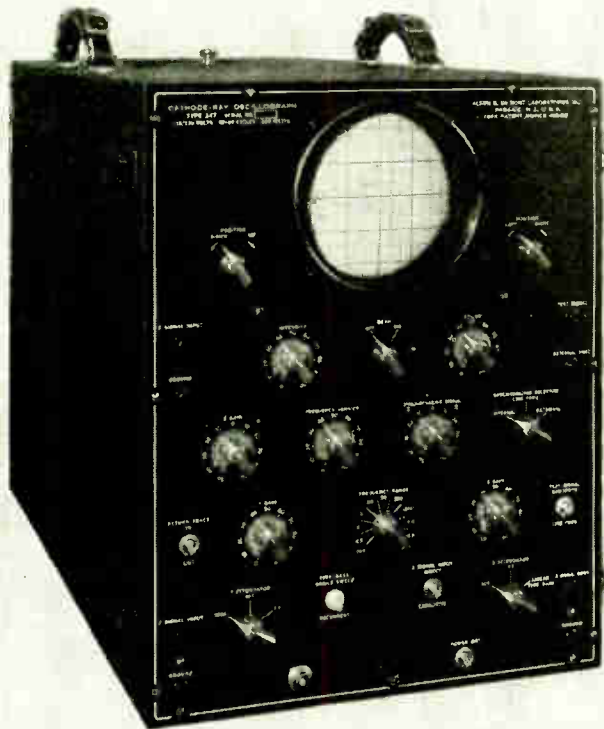

all these features *plus...*

exceptionally fine quality . . . well planned mechanical design . . . and completely dependable electrical performance . . . all of which make the DuMont Type 247 Cathode-Ray Oscillograph the logical choice for all applications that require a measuring instrument of fine accuracy.

★ WRITE FOR DESCRIPTIVE LITERATURE

© ALLEN B. DUMONT LABORATORIES, INC.

1 ✓ AUTOMATIC BEAM CONTROL FOR PHOTOGRAPHIC PURPOSES

Permits high-contrast photographic recordings by holding the spot brightness at zero until the transient under study is initiated — then the spot is automatically raised to full brilliance.

2 ✓ EXTENDED TIME BASE RANGE 0.5 to 50,000 C. P. S.

A compensated circuit assures a linear sweep at all operating frequencies. The single sweep operates over a range corresponding to 0.5 to 10,000 c.p.s. The sweep is initiated by the controlling signal.

3 ✓ VERTICAL AMPLIFIER RESPONSE UNIFORM—2 to 200,000 C. P. S.

The response curve does not exhibit a positive slope above 1,000 c.p.s., thus assuring a linear phase-frequency relationship for the amplifier.

4 ✓ HORIZONTAL AMPLIFIER MAY BE USED AS A D-C AMPLIFIER

This amplifier is direct-coupled throughout, with the exception of an input capacitor which can be shorted out by operating a front-panel switch.

5 ✓ 3,000-VOLT ACCELERATING POTENTIAL PROVIDES BRIGHTER CRT PATTERN

Sufficient brilliance for all but the highest writing rates without using special equipment.

DUMONT

Precision Electronics & Television

ALLEN B. DUMONT LABORATORIES, INC.. PASSAIC, NEW JERSEY • CABLE ADDRESS: ALBEEDU, PASSAIC, N. J., U. S. A.



Specify
***VITAMIN Q**
for

HIGHER VOLTAGES

(Real space savers)

HIGHER TEMPERATURES

(De-rating factor much smaller)

**HIGHER INSULATION
RESISTANCE**

(More than 20,000 meg. mfds. at room temperature)

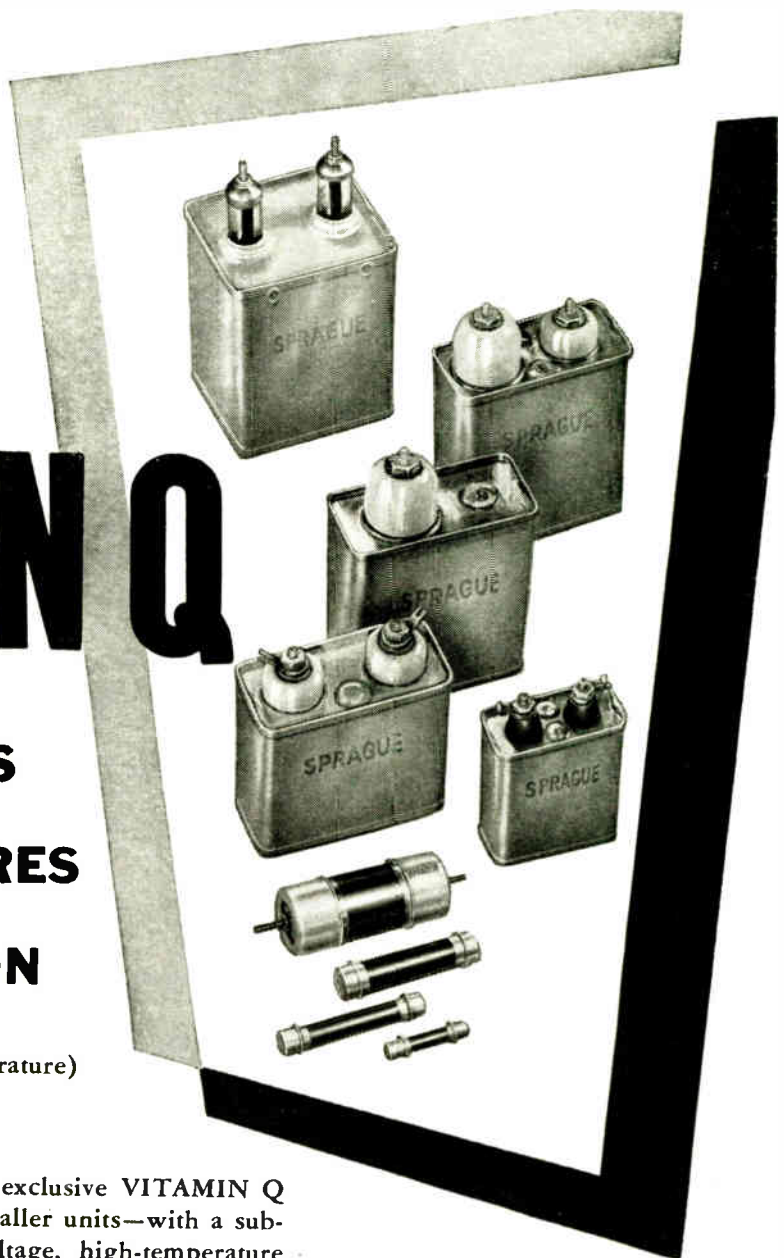

SPRAGUE CAPACITORS using the exclusive VITAMIN Q impregnant make possible the use of much smaller units—with a substantial safety margin—on numerous high-voltage, high-temperature applications ranging from transmitting to television. Where high temperature is not a factor, their unique characteristics assure materially higher capacity-voltage ratings for a given size.

Type 25P VITAMIN Q Capacitors operate satisfactorily at high voltages at ambient temperatures as high as 115° C. Insulation resistance at room temperature is *more than 20,000 megohm microfarads*. Throughout the temperature range of +115° C. to -40° C. they retain all virtues of conventional mineral oil-impregnated capacitors.

Sprague Electric Company, North Adams, Mass.

CAN TYPES 25P

Two standard types, one for 105° C. and one for 95° C. continuous operation. Other ratings available.

HERMETICALLY SEALED IN GLASS TUBES

Famous Sprague glass-to-metal end seals. Extended construction gives maximum flashover distance between terminals.



SPRAGUE

WRITE FOR CATALOG 20A . . .

including all Sprague Paper Dielectric Capacitor types.

CAPACITORS • *KOOLOHM RESISTORS • *CEROC INSULATION

**Trademarks Registered U. S. Pat. Off.*

STUPAKOFF ceramic products

"precision made" means
fewer headaches
for you

Ceramic parts that are dimensionally accurate and mechanically strong are "headache eliminators" for your production men. Stupakoff takes special precautions throughout all steps of design and manufacture to see that every item is as nearly perfect as modern precision mass-manufacturing methods can make it. As a result, your production of assemblies is speeded, and you have less waste of labor and materials.

The dependable high quality of Stupakoff ceramics assures complete satisfaction.

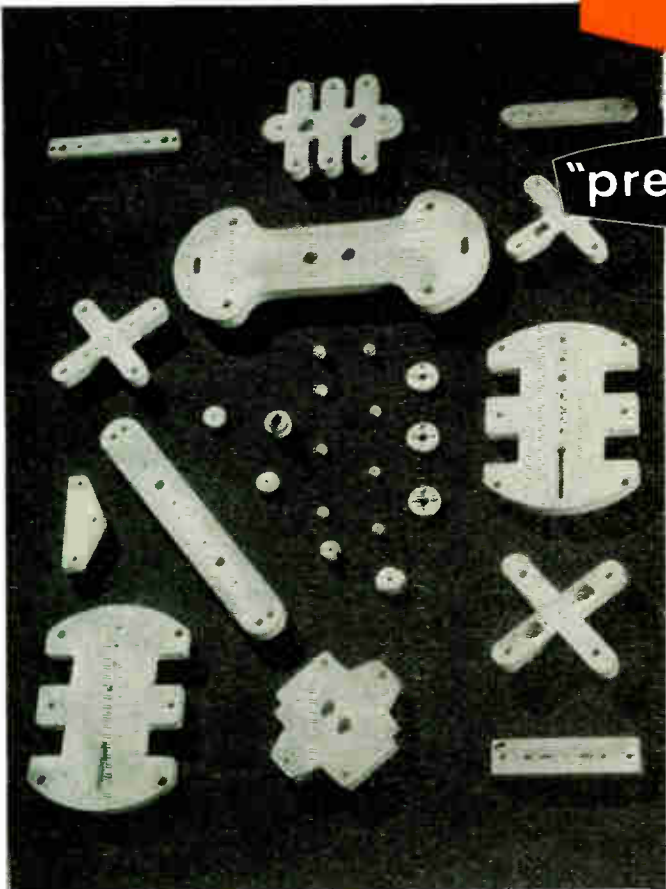

Precision grinding of fired ceramic parts assures uniformity.



Electrolimit gauging checks dimensions to the fifth decimal.

STUPAKOFF

CERAMIC AND MANUFACTURING COMPANY · LATROBE, PA.

Export Department, 13 E. 40th St., New York, N. Y. Cable Address: ARLAB, all codes.

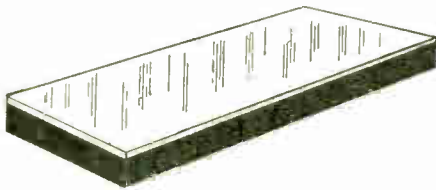
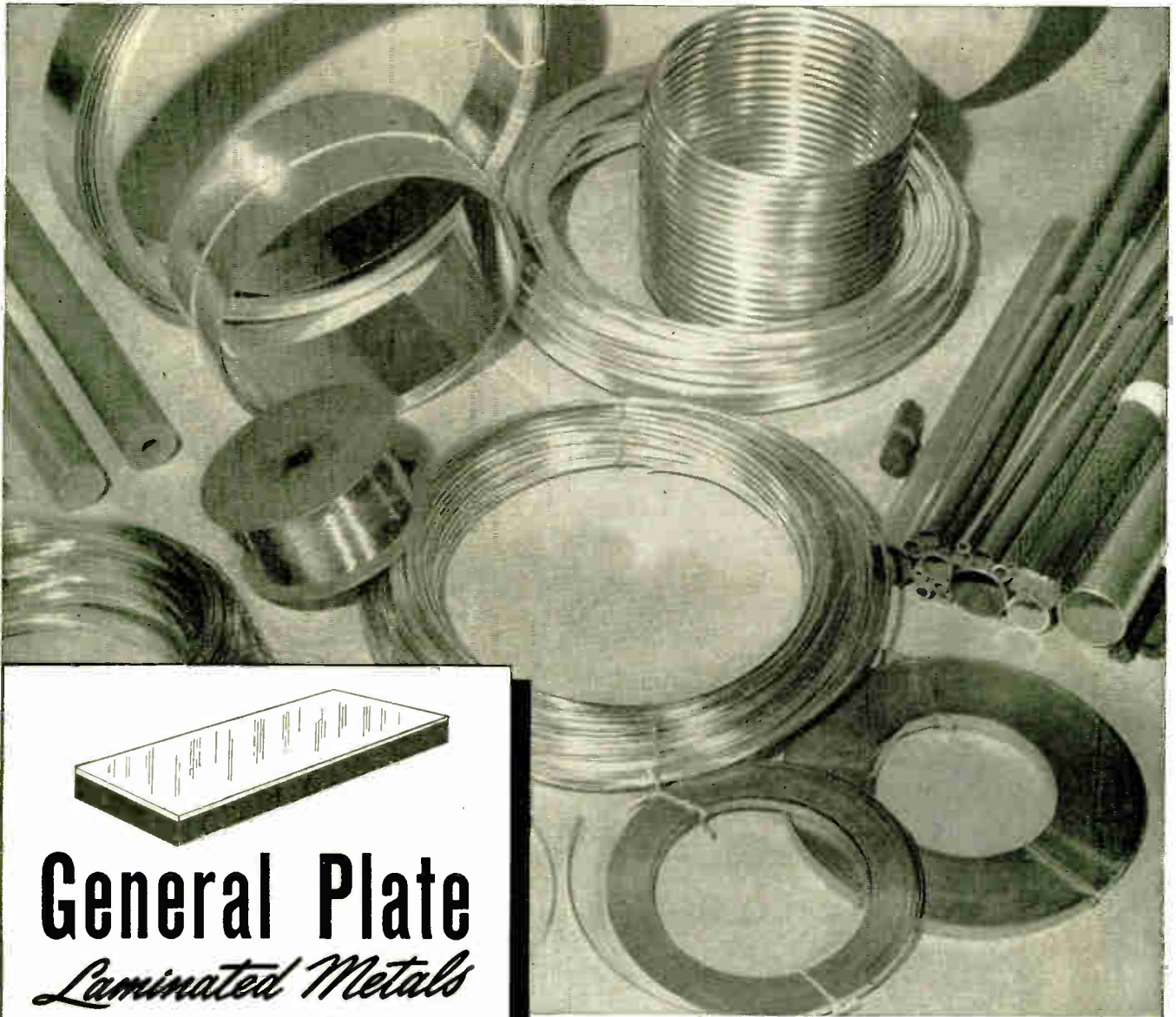

General Plate *Laminated Metals*

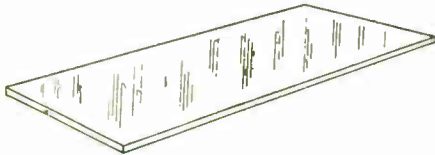

A Thin Layer of Precious Metal



Plus Inexpensive Base Metal

Gives You Precious Metal Performance . . . ECONOMICALLY

Solid metal performance at a cost slightly more than base metal . . . that's what you get with General Plate Laminated metals.

In addition to economy, these versatile laminated metals give you such advantages as ease of fabrication, workability, high corrosion resistance, better electrical performance and long life. They are available in flat stock, tube or wire . . . inlaid, covered one or both sides. Some fabricated assemblies such as electrical contacts are also available.

Investigate General Plate Laminated Metals, today. Use them in such applications as electrical equipment, chemical apparatus, electronic devices, appliances, mobile equipment and instruments.

General Plate engineers are available for consultation on your metal problems. Write for their services.

GENERAL PLATE DIVISION

of Metals & Controls Corp., Attleboro, Mass.

50 Church St., New York, N. Y.; 205 W. Wacker Drive, Chicago, Ill.; 2635 Page Drive,
Altadena, California; Grant Bldg., Pittsburgh, Pa.

It's Collins!

It's new!

It's ready!

... the Collins 30K—a NEW transmitter for amateur radio—thoroughly engineered for the continuous exacting requirements of “ham” operation. Check this partial list of features against your desires:

5 band operation • 500 watts input on CW • 375 watts input on Phone • Push-to-talk • Clean, sharp keying • Speech clipper • Bandswitching • Fully metered • Break-in operation • Vfo controlled

The high efficiency of the 30K assures a strong signal. In addition, the speech clipper circuit assists in maintaining a high modulation level, with no danger of overmodulation. Speech clipping also improves intelligibility. Brass pounders will proudly note the clean keying at any speed.

The exciter unit, built into a receiver type cabinet, may be placed on the operating desk. A highly accurate and stable variable frequency oscillator, the product of years of research and manufacturing experience, is calibrated directly in frequency. The frequency can be varied considerably without retuning the final.

The attractive appearance of this up-to-the-minute transmitter will improve any “shack.” Its smooth, easy operation will please you.

Write today for complete details. Collins Radio Company, Cedar Rapids, Iowa; 11 West 42nd Street, New York 18, N. Y.



The Collins 30K



FOR RESULTS IN AMATEUR RADIO, GET...

STACKPOLE

MOLDED IRON CORES

STANDARD AND HIGH-FREQUENCY TYPES

A pioneer in Iron Core production, Stackpole can supply practically any desired type from 100 cycles to upward of 175 megacycles and in an infinite variety of shapes, sizes and characteristics. Also available are High-Resistivity Cores showing a resistance of practical infinity; Insulated Cores wherein the screws are kept out of the coil field and "Q" consequently increased; Iron Cores for choke coils; and Side-Molded Iron Cores featuring uniform permeability with respect to linearity. Write for details and samples of any type.

for higher "Q" STACKPOLE SCREW-TYPE MOLDED CORES

These Stackpole developments are proving highly popular for circuits where small assemblies are the order of the day, and where "Q" must be kept at an absolute minimum. The cores themselves are threaded, thus eliminating the conventional brass core screw. Tubes can be threaded to fit cores if desired. More economical, however, is the use of a wire C-spring clip placed (obtainable from usual sources of supply) in a slot in an unthreaded tube. Stackpole Screw-Type Cores are ideal for the design of I-F and dual I-F Transformers for AM and FM.

IRON SLEEVE TYPES

... for better coils in less space

By use of Stackpole Sleeve Cores, much smaller cans of any material may be used to provide "Q" that is equal to, or better than, that of conventional cores and cans. Thus they facilitate an exceptionally high order of tuning unit efficiency in greatly reduced size. Cans are not always necessary — and, where they are, inexpensive aluminum containers may often be used.

LOOK FOR THE
STACKPOLE MINUTE MAN . . .
your assurance of
the highest in
molded materials
quality.

STACKPOLE CARBON CO., Electronic Components Division, ST. MARYS, PA.

PROVED...

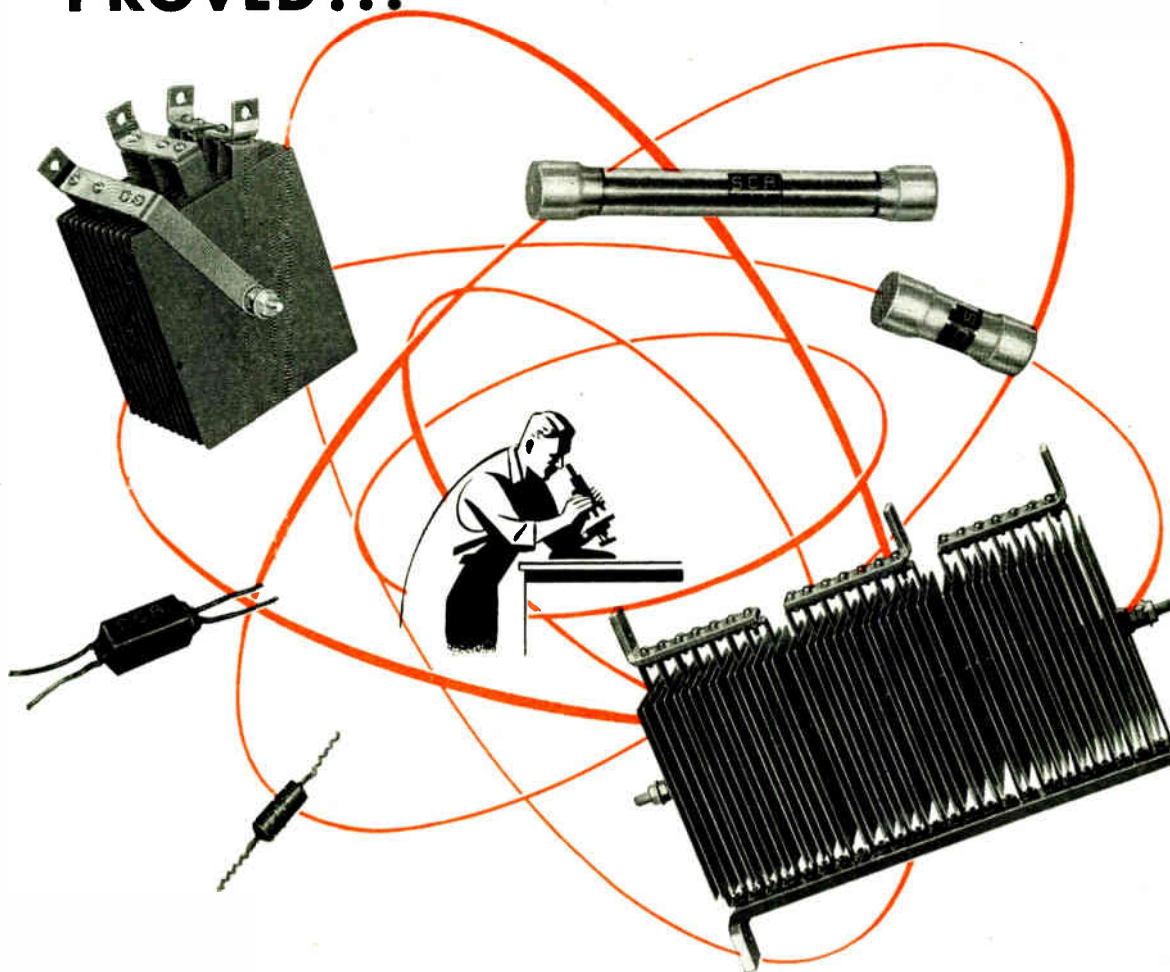

...and IMPROVED

SELENIUM RECTIFIERS

FROM 10 MICRO AMPERES TO 10,000 AMPERES

Manufacturers of a broad line of SELENIUM Power and Instrument Rectifiers, Photo-Electric Cells and allied scientific products.

Solve your rectification problems with SELENIUM. SELENIUM rectifiers are rapidly becoming standard in industry. Check these outstanding features:

- ✓ Permanent characteristics.
- ✓ Adaptability to all types of circuits and loads.
- ✓ Unlimited life—no moving parts.
- ✓ Immunity to atmospheric changes.
- ✓ High efficiency per unit weight.
- ✓ Hermetically sealed assemblies available.
- ✓ From 1 volt to 50,000 volts RMS.
- ✓ From 10 micro-amperes to 10,000 amperes.
- ✓ Economical—No maintenance cost.



SELENIUM CORPORATION OF AMERICA

Affiliate of **VICKERS**, Incorporated
1719 WEST PICO BOULEVARD • LOS ANGELES 15, CALIFORNIA
Export Division: Frazer & Hansen, 301 Clay Street, San Francisco 11, Calif.
In Canada: Canadian Line Materials, Ltd., Toronto 13, Canada

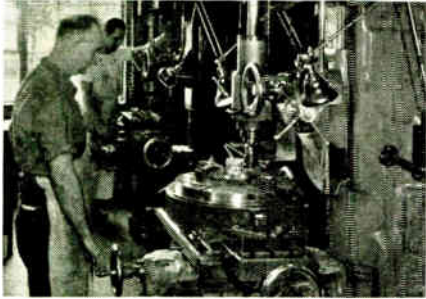

Light from two Dazors converges at the critical point of work on a precision jig boring machine (Omar Tool & Machine Co.).

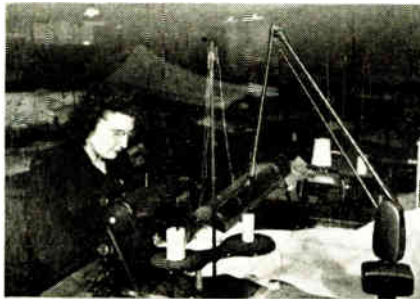

With Dazor light of the desired quantity and quality directed (without waste) where needed, this operator makes her Singer sing.



The Dazor and a Remington Rand Bookkeeping Machine here team up for the speed and accuracy demanded in modern accounting.

Lighting.. Individually Fitted..
DAZOR ALONE Floats!

Pan American Airways technician overhauling a Flux Gate Compass.



MOVES FREELY INTO ANY POSITION and STAYS PUT—WITHOUT LOCKING

YOU think of a *floating* object as something which moves, glides or drifts in any direction with effortless ease... a mental picture which fits perfectly the freedom of movement you find in a Dazor *Floating Lamp*.

With the Dazor you can concentrate glareless, shadowless light of high intensity on any horizontal or vertical work area. With the tips of your fingers you *float* it where needed—fit it to your seeing needs. When positioned, the lamp is firmly and auto-

matically held in suspension by a patented enclosed spring force. It *stays put* without locking, tightening or "friction" holding. Dazor alone *floats!*

In your plant and office are vital tasks which demand fast, accurate, comfortable seeing: Drafting, design engineering, precise machining, fine assembly, inspection, tests, repairs, accounting and bookkeeping... where specialized Dazor lighting will help increase and improve work output—save you money.

Phone Your Dazor Distributor

... for any additional information desired. A better idea, ask him to demonstrate the advantages of Dazor lighting under actual working conditions. For your distributor's name, if unknown to you, write to the Dazor Manufacturing Corp., 4483 Duncan Ave., St. Louis 10, Mo.

IN CANADA address inquiries to Amalgamated Electric Corporation Limited, Toronto 6, Ont.

CHOICE OF 4 BASES

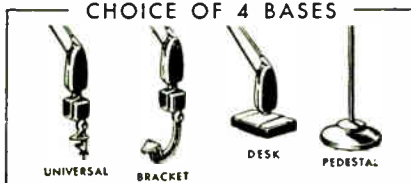

DAZOR *Floating* LAMPS

FLUORESCENT and INCANDESCENT



You can get FIBERGLAS advantages in laminated plastics parts

Fiberglas-base laminates afford many advantages and a unique combination of characteristics. Made with many different kinds of resins, laminates with *Fiberglas Cloth* or *Fiberglas Mat* as a base are used to solve a wide range of electrical and mechanical problems.

The finished materials—available in sheet form, in rods or tubes, or molded or shaped into special forms—are used in motors and generators as slot sticks, armature or stator end laminations, as brush holders, spacer blocks, in dry-type transformers, etc. The low-electrical-loss properties of several types of Fiberglas-base laminates have led to their

wide use for radio and electronic applications.

If the products you are designing or manufacturing require a material with high dielectric strength, dimensional stability, moisture and temperature resistance and/or adequate mechanical strength for high-frequency, low-electrical-loss parts—investigate Fiberglas-base laminates.

Most manufacturers of laminates make one or more types of Fiberglas-base products. If your supplier can't furnish the type you need, write—Owens-Corning Fiberglas Corp., Dept. 867, Toledo 1, Ohio. Branch Offices in Principal Cities

In Canada: Fiberglas Canada Ltd., Oshawa, Ontario



FOR VHF CIRCUITS YOU WANT THIS RESISTOR . . .

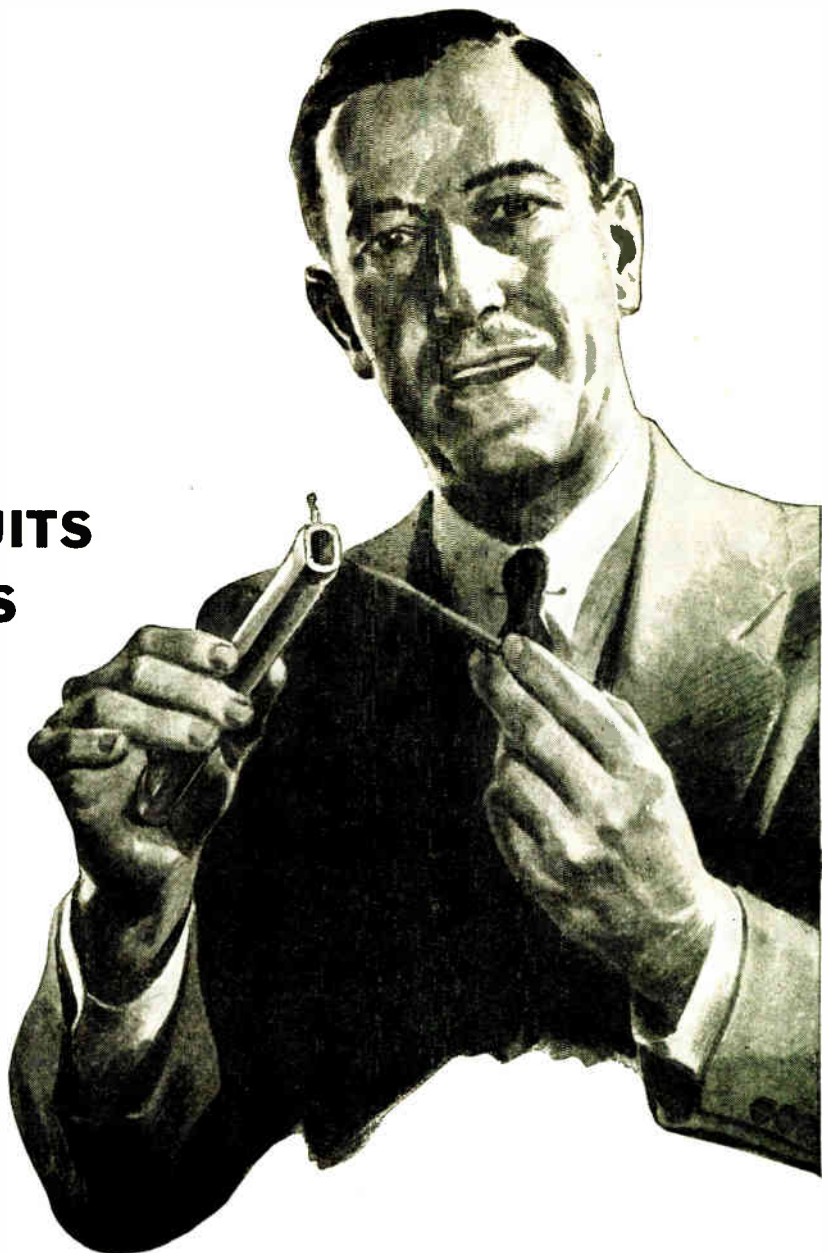
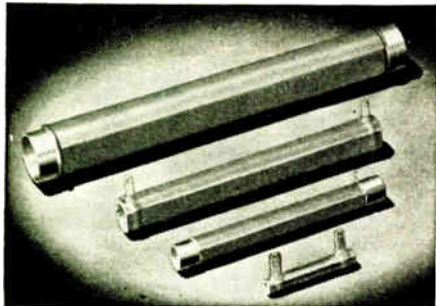

Ward Leonard Non-Inductive Bulletin 21 Resistors were designed especially to meet the exacting requirement of high-frequency applications. The unique design of the Ward Leonard Refractory accurately fixes the points at which the Ayrton Perry Windings cross. This reduces inductance and distributed capacitance to an absolute minimum. Bulletin 21 Resistors are Vitrohm Resistors

with the desirable characteristics of all Ward Leonard Vitrohm Resistors.

* * * *

Available in a wide range of sizes and resistance values, with ferrule or tab terminals. For further information see Bulletin 21.

Write for Bulletin 21 today

WARD LEONARD

RELAYS • RESISTORS • RHEOSTATS

Electric control  devices since 1892

WARD LEONARD ELECTRIC COMPANY
61 SOUTH STREET, MOUNT VERNON, N.Y. • OFFICES IN PRINCIPAL CITIES



INDIA

SUPERB SPECIMENS



AFRICA



NORRISTOWN, PENNA.

"CAT-HEAD"

Made by Taylor Fibre for SQUARE D COMPANY

Used in mechanism for switch equipment. Material is Phenol Fibre core, with Taylor Vulcanized Fibre surface sheets on both sides. This combines the strength and dimensional stability of Phenol Fibre with the high electrical and arc-resisting properties of Taylor Vulcanized Fibre.

Light in weight, high in dielectric strength and moisture-resistance . . . this "cat-head" is a good example of Taylor's specialized service to the electrical industry. In addition to its combination of desired electrical properties, Taylor Fibre is *fast* in production . . . and *accurate* in dimensions on any production process. The "cat-head," for instance, is rough-sawed from pressed sheets, then precision-shaved in production runs to Square D Company's specifications.

Whatever your problem, our engineers will gladly tell you, without obligation, exactly what Taylor Laminated Plastics can contribute to its solution. Write us today, sending sketch or blueprint . . . or outlining the characteristics you have in mind.

TAYLOR FIBRE COMPANY

LAMINATED PLASTICS: PHENOL FIBRE · VULCANIZED FIBRE—Sheets, Rods, Tubes, and Fabricated Parts
NORRISTOWN, PENNA. Offices in Principal Cities Pacific Coast Plant: LA VERNE, CAL.

PERMANENT MAGNETS MAY DO IT BETTER



FLUXMETER CLOSED
CIRCUIT TEST



Testing magnet in
an assembly similar
to the finished unit.

ACCURATE TESTING OF PERMANENT MAGNETS

Because the permanent magnet is one of the most vital parts of the instrument or apparatus in which it is used, testing methods of the mechanical and magnetic properties must be comparable to the actual working condition of the magnet.

Our testing department is equipped with every facility to insure accurate mechanical inspection. Every magnet is tested to magnetic specifications, so that they will function properly in their final assembly . . . reducing customers' inspections.

Fluxmeters, ballistic galvanometers, test fixtures and all associated precision apparatus used in testing and inspecting are constantly checked to maintain absolute uniformity.

Over 24,000 applications of permanent magnets have been developed by *Indiana Steel Products Company*, specialists in permanent magnets for over 35 years. You are invited to consult with our engineers. For data on magnet applications, write for new "Permanent Magnet Manual."

Producers of "PACKAGED ENERGY"

★ ★ ★ **THE INDIANA STEEL PRODUCTS COMPANY** ★ ★ ★

6 NORTH MICHIGAN AVENUE, CHICAGO 2, ILLINOIS



SPECIALISTS IN PERMANENT MAGNETS SINCE 1910

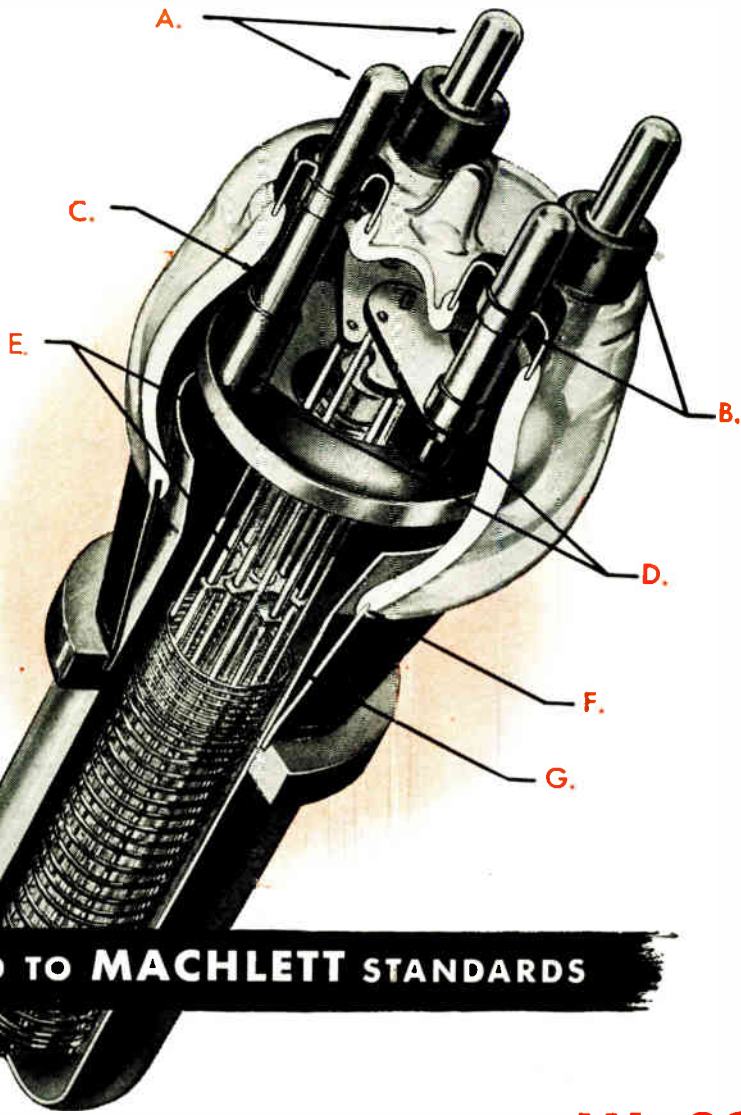

Sectional view of the ML-889-A, showing features typical of Machlett external anode tube construction.

- A. Gold-plated contact surfaces
- B. Rugged Kovar grid and filament seals
- C. One-piece high-conductivity copper grid and filament support leads
- D. Rigidly-supported grid and filament assemblies
- E. Surgically-clean internal parts
- F. Rugged Kovar plate seal
- G. One-piece anode and shield

REDESIGNED TO MACHLETT STANDARDS

For better performance and longer life! ML-892

HERE is another outstanding example of Machlett's ability to apply to the design and manufacture of high-power triodes its unique skills acquired in the manufacture of X-ray tubes. Remember, those skills were developed through almost 50 years of X-ray tube production—and an X-ray tube presents manufacturing problems of the greatest severity in the electron-tube art. Machlett's ability to solve those problems has resulted in making it the largest producer of X-ray tubes in the world. Note these features of the ML-892:

1. Heavy Kovar sections for grid and plate seals, instead of feather-edge copper. Result—greatly increased mechanical strength.
2. Grid assembly supported by heavy Kovar cup, for strength and stable inter-element spacing.
3. Filament assembly greatly strengthened to increase life and preserve correct spacing.
4. All internal parts processed by special

Machlett techniques which prevent contamination by foreign particles, assuring permanent outgassing.

5. Tube pumped by unique Machlett continuous, straight-line, high-voltage process, assuring same high standards maintained in Machlett high-voltage X-ray tubes.

• • •
For complete details of this greatly improved tube, write Machlett Laboratories, Inc., Springdale, Connecticut.

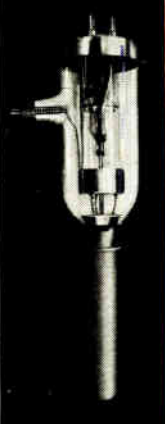

GENERAL CHARACTERISTICS		
	ML-892	ML-892-R
Filament Voltage	22	22 volts
Filament Current	60	60 amps.
Amplification Factor	50	50
Maximum frequency for full power	1.6	1.6 mc.
Capacity grid to plate	27	30 uuf
Capacity grid to filament	18	18 uuf
Capacity plate to filament	2	2 uuf
Cooling	Water	Air
	3 to 8 G.P.M.	400-700 C.F.M.



APPLIES TO RADIO AND INDUSTRIAL USES
ITS **49** YEARS OF ELECTRON TUBE EXPERIENCE

STRUTHERS-DUNN

Midget Relays

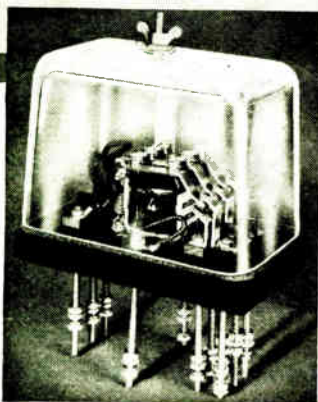
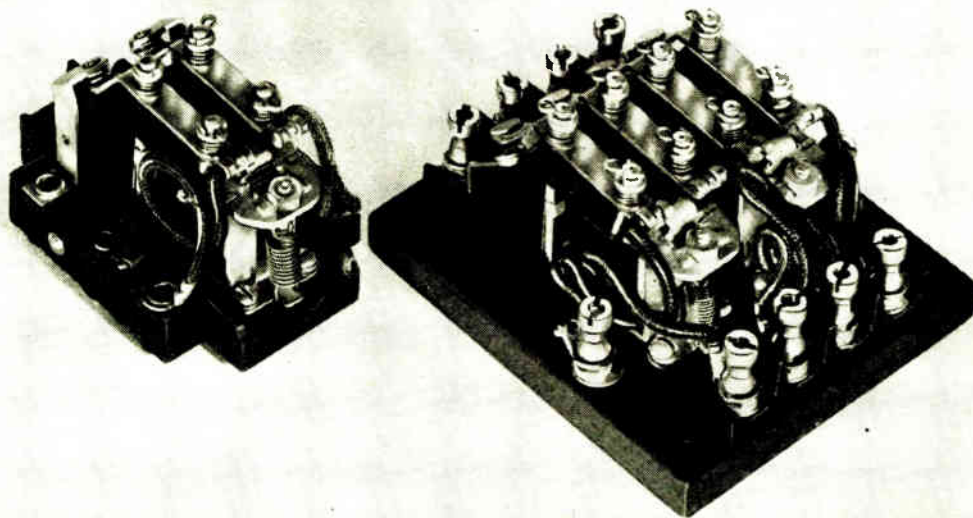

Glass enclosed type for switchboard mounting

SMALLEST SIZES CONSISTENT WITH DEPENDABLE OPERATION

● Designed for long, trouble-free performance wherever space, weight or moderate cost are important considerations. Available for a.c. or d.c. use as specified. *Exceptionally quiet on a.c. applications.* Conservative contact ratings (based on heater load values) are:

- 6 amps. at 115 volts a.c.
- 3 amps. at 230 volts a.c.
- 0.5 amp. at 115 volts d.c.

● Underwriters' approved. Individually tested. Ideally suited for built-in applications, control of small motors, heaters, audible and visual signals, lamp control and various other uses. Special adaptations available for radio-frequency, low-voltage loads, audio-frequency loads and other exacting uses.

Write for Struthers-Dunn Midget Relay Bulletin

5,327 RELAY TYPES

STRUTHERS-DUNN, Inc., 1321 Arch St., Phila. 7, Pa.



ATLANTA • BALTIMORE • BOSTON • BUFFALO • CHICAGO • CINCINNATI • CLEVELAND • DALLAS
DENVER • DETROIT • HARTFORD • INDIANAPOLIS • LOS ANGELES • MINNEAPOLIS • MONTREAL
NEW YORK • PITTSBURGH • ST. LOUIS • SAN FRANCISCO • SEATTLE • SYRACUSE • TORONTO

That hour-after-hour steady grind calls for
PERFORMANCE INSURANCE as provided by
AEROVOX Rating-plus CAPACITORS

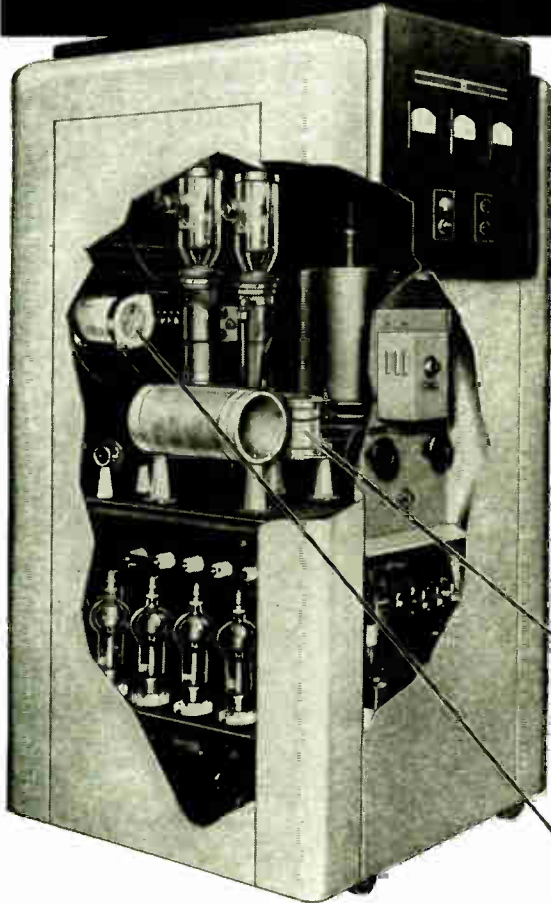

• This induction heating unit bears the name of a world-famous manufacturer. A great reputation is at stake. Such equipment must stand up—hour after hour, day in and day out, for months and years to come.

None but outstandingly dependable components can be risked in such equipment. And the selection of Aerovox Series 1940 stack-mounting capacitors is based on two good reasons:

First, Aerovox are rating-plus capacitors. A comparative study of specifications is invited. Second, Aerovox provides Continuous Service Rating Data for all its current-handling capacitors. The equipment designer knows precisely what such capacitors can and cannot do. These two points alone can write a performance insurance policy.

Continuous Service Rating Data
TYPES 1940-1950-1960-1970-1980
 Maximum Current in Amperes at an Ambient Temperature of 60° C.
 Barometric Pressure 25 to 32 inches Mercury and Relative Humidity 10 to 50%. Maximum Ambient Temperature 70° C.

TYPE 1940						
Cap. Mfd.	Test Volts ER.	Catalog Number	7000 kc.	1000 kc.	300 kc.	100 kc.
.000075	35,000					
.0001	35,000	1940-236	7.5	4.5		
.00015	35,000	1940-203	10.	6.	1.8	.6
.0002	35,000	1940-204	13.	8.	2.2	.8
.00025	35,000	1940-205	16.	12.	3.	1.2
.0003	35,000	1940-206	17.	13.	4.	1.5
.00035	35,000				5.	2.0
.0004	35,000				6.	2.4
.0005	35,000				7.	2.5
.0006	35,000				8.	3.3
.0007	35,000				10.	4.
.0008	35,000				10.	4.5
.001	35,000				12.	5.
.00125	35,000				12.	6.
.0015	35,000				14.	8.
.002	30,000				15.	8.
.0025	25,000				18.	10.
	25,000				21.	11.5
	20,000				22.	12.
					25.	13.
					30.	

• Interested in performance insurance protection for your assemblies? Then insist on rating-plus specifications and continuous service rating data—or simply specify AEROVOX. Literature on request.



FOR RADIO-ELECTRONIC AND INDUSTRIAL APPLICATIONS

AEROVOX CORPORATION, NEW BEDFORD, MASS., U.S.A.
 SALES OFFICES IN ALL PRINCIPAL CITIES • Export: 13 E. 40th St., NEW YORK 16, N. Y.
 Cable: 'ARLAB' • In Canada: AEROVOX CANADA LTD., HAMILTON, ONT.

SUPER PRO

Series 400



Less QRM---Phone or CW

When the bands are active it only takes one minute to find that you need Hammarlund's patented variable crystal filter to have a successful QSO—either phone or CW.

Look to the future! When the number of Hams doubles or trebles you will need the crystal filter that weeds-out the QRM . . . If you can't hear 'em, you can't work 'em!

Price (SP-400-X)
\$342.00
Including Speaker



HAMMARLUND

THE HAMMARLUND MFG. CO., INC., 460 W. 34TH ST., NEW YORK 1, N. Y.
MANUFACTURERS OF PRECISION COMMUNICATIONS EQUIPMENT

● "The impossible takes a little longer"...this is one way of saying that the draftsman lets no out-worn conceptions restrict his creative ideas. Yet without his specialized technique for expressing ideas on paper, the designs he creates could scarcely be turned into substance. As the draftsman relies on his own hands and eyes, he calls likewise on his drafting instruments to serve him functionally. So integral a part of his technique do they become, they are virtually his partners in creating.

For 78 years Keuffel & Esser Co. drafting equipment and materials have been partners, in this sense, in creating the greatness of America, in making possible our fleets of ships, our skyscrapers, our overwhelming weight of armor on the battlefield...So universally is K & E equipment used, it is self-evident that every engineering project of any magnitude has been completed with the help of K & E. Could you wish any surer guidance than this in the selection of your own "drafting partners"?

Because of their balance, smooth action and responsiveness to your hand, you will find that using MINUSA* Drawing Instruments is almost as natural as breathing. Their legs are round and tapered, without the harsh feel of sharp corners. Joints are firm, snugly fitted, and satin-smooth in operation. Yet these instruments are strong and durable, for their precision will outlast years of continuous use. For complete data on MINUSA* Drawing Instruments, write on your letterhead to Keuffel & Esser Co., Hoboken, N. J.

*REG. U. S. PAT. OFF.

partners in creating



Drafting, Reproduction,
Surveying Equipment
and Materials.
Slide Rules,
Measuring Tapes.



... the world's
mightiest fleet



... speediest
tanks



... tallest
skyscrapers

KEUFFEL & ESSER CO.
EST. 1867
NEW YORK • HOBOKEN, N. J.
CHICAGO • ST. LOUIS • DETROIT • SAN FRANCISCO
LOS ANGELES • MONTREAL

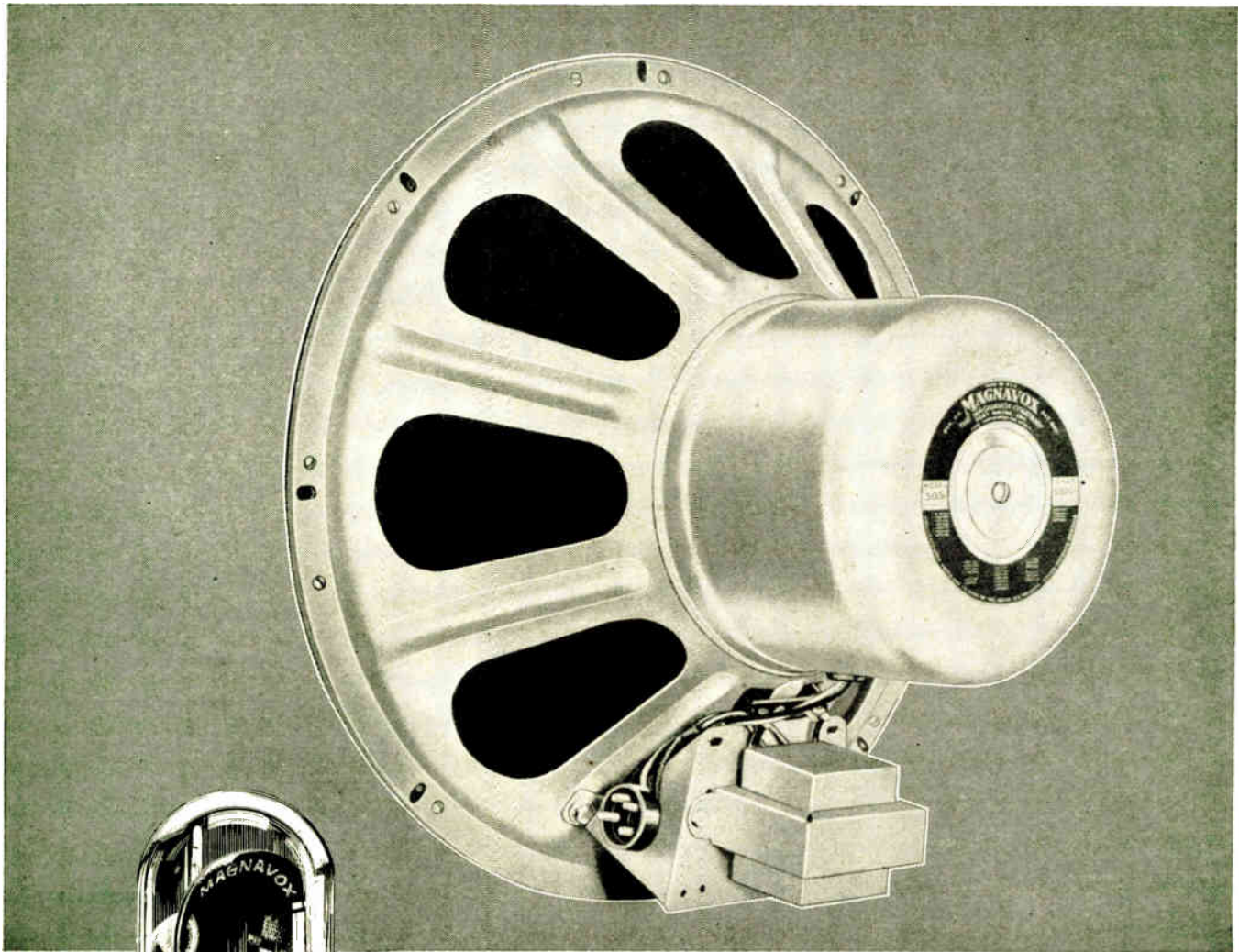

The Electrodynamic Speaker
—the first voice of all modern
sound reproduction.

Magnavox ...

loud-speaker headquarters since 1915

THE electrodynamic speaker, invented by Magnavox engineers in 1915, revolutionized the world of sound and made possible the development of all modern public address systems, radios and movies. Now, after three decades of continuous research and development, Magnavox is not only the oldest, but also the largest manufacturer of quality speakers.

Magnavox designers and engineers have achieved a breadth of experience and knowledge that enables them to meet your

specifications exactly. Magnavox supplies quantity requirements of the manufacturing trade — over 150 models are offered.

Our staff of trained engineers and designers stands ready to apply its developments to any of your speaker and component problems. Feel free to call on them at any time. And when you need speakers—specify Magnavox! There is no substitute for experience. The Magnavox Company, Components Division, Fort Wayne 4, Indiana.

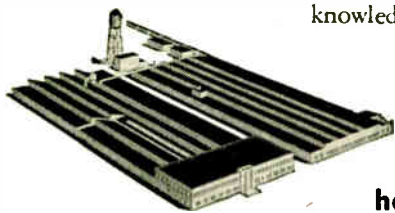

Magnavox

has served the radio industry for over 30 years

SPEAKERS • CAPACITORS • SOLENOIDS • ELECTRONIC EQUIPMENT



Using Resistance to Chemicals and Wear

THIS IS A *Plating Barrel*. And you might look a long while before finding a more appropriate application of plastics.

Several kinds of plating barrels are made of Synthane *laminated* plastics. Which is understandable because Synthane opposes the inroads of a variety of corrosive plating solutions, resists punishment from tumbling pieces.



Synthane has many more good properties and an army of practical uses . . . electrically, chemically, mechanically. If you've a place for this versatile material, let us pitch in and help you . . . with the right design, the right plastics for the job . . . the right men and equipment for economical fabrication. Write for our complete catalog of Synthane Plastics today.

SYNTHANE CORPORATION • 12 RIVER ROAD • OAKS • PENNSYLVANIA

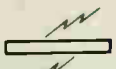
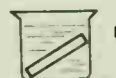
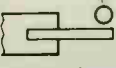
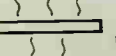
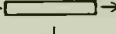

SYNTHANE TECHNICAL PLASTICS • DESIGN • MATERIALS • FABRICATION • SHEETS • RODS • TUBES • FABRICATED PARTS • MOLDED-MACERATED • MOLDED-LAMINATED

World Radio History

-  HIGH DIELECTRIC STRENGTH
-  LOW MOISTURE ABSORPTION
CORROSION RESISTANCE
-  IMPACT STRENGTH
-  STABLE OVER A WIDE TEMPERATURE RANGE
-  TENSILE STRENGTH
-  FLEXURAL STRENGTH

MANY MORE PROPERTIES—COMBINED

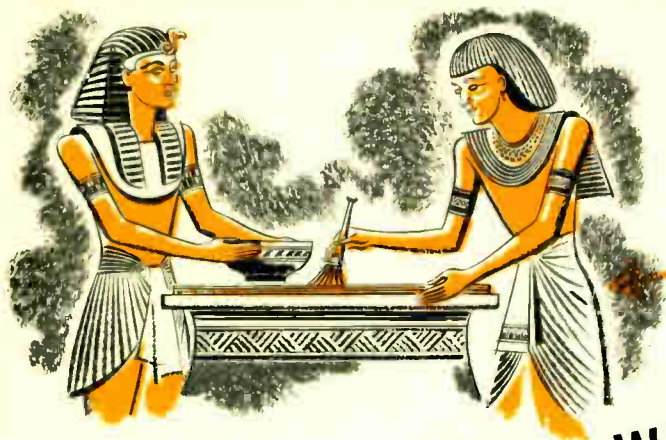

THE *Egyptians* STARTED IT

THE *Romans* HAD A WORD* FOR IT

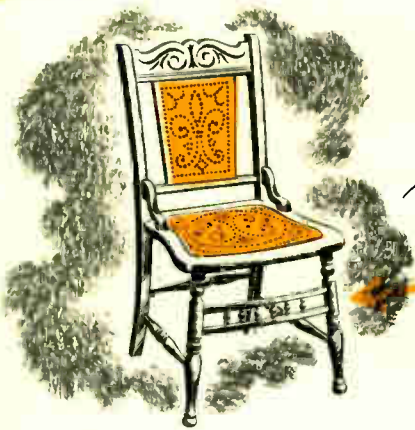

GRANDPA SAT ON IT

You HAVE A USE FOR THIS MODERN VERSION

Our type of plastics—laminated phenolics—is exactly what its name implies—made by applying heat and pressure to layers or **laminae* of paper, fabric or other materials impregnated with heat-reactive resins.

The Egyptians were probably the first to discover the principles of laminating, using thin overlayers of wood chiefly for beauty. Later, however, thin sheets of wood were bonded for economy and strength as well.

Now, in laminated phenolics such as Synthane, you

have in a single non-metallic material an excellent dielectric, resistance to corrosion from many chemicals, oils, waters, and atmospheres, mechanical strength, light weight (1/2 the weight of aluminum), ease of machining, and many more useful properties.

If you have not yet fully investigated the "laminates", or through military service have been out of touch with their uses, write in for a copy of the complete Synthane catalog today.



GET THIS GUIDE TO SYNTHANE

SYNTHANE

PLAN YOUR PRESENT AND FUTURE WITH SYNTHANE
TECHNICAL PLASTICS • SHEETS • RODS • TUBES • FABRICATED
PARTS • MOLDED-LAMINATED • MOLDED-MACERATED

World Radio History

SYNTHANE CORPORATION, 12 RIVER ROAD, OAKS, PA.

Gentlemen:

Please send me without obligation the complete catalog of Synthane technical plastics.

NAME _____

COMPANY _____

ADDRESS _____

CITY _____

ZONE _____

STATE _____



PERFECTION

In every field, one product stands out for its surpassing perfection. In the capacitor field El-Menco enjoys that distinction. Tested and proved under the severest wartime conditions, El-Menco Capacitors are right for the important role they are expected to play in the products of today and tomorrow. Write, sending in your specifications.

Foreign Radio and Electronic Manufacturers communicate direct with our Export Department at Willimantic, Connecticut, for information.

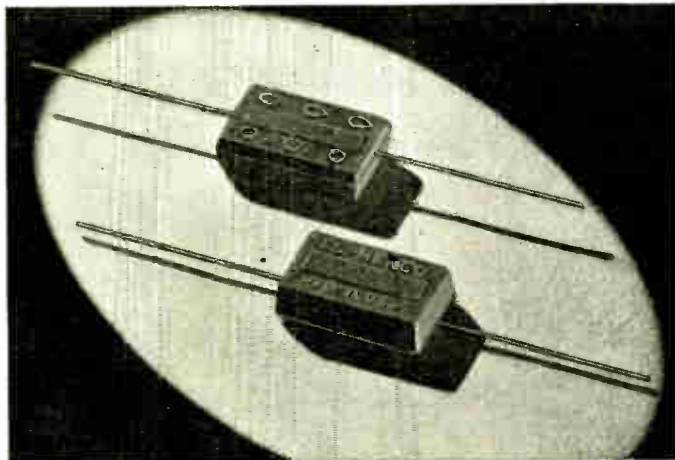

THE ELECTRO MOTIVE MFG. CO. • WILLIMANTIC, CONNECTICUT

MOLDED MICA **El-Menco** MICA TRIMMER
CAPACITORS

NOW! FM

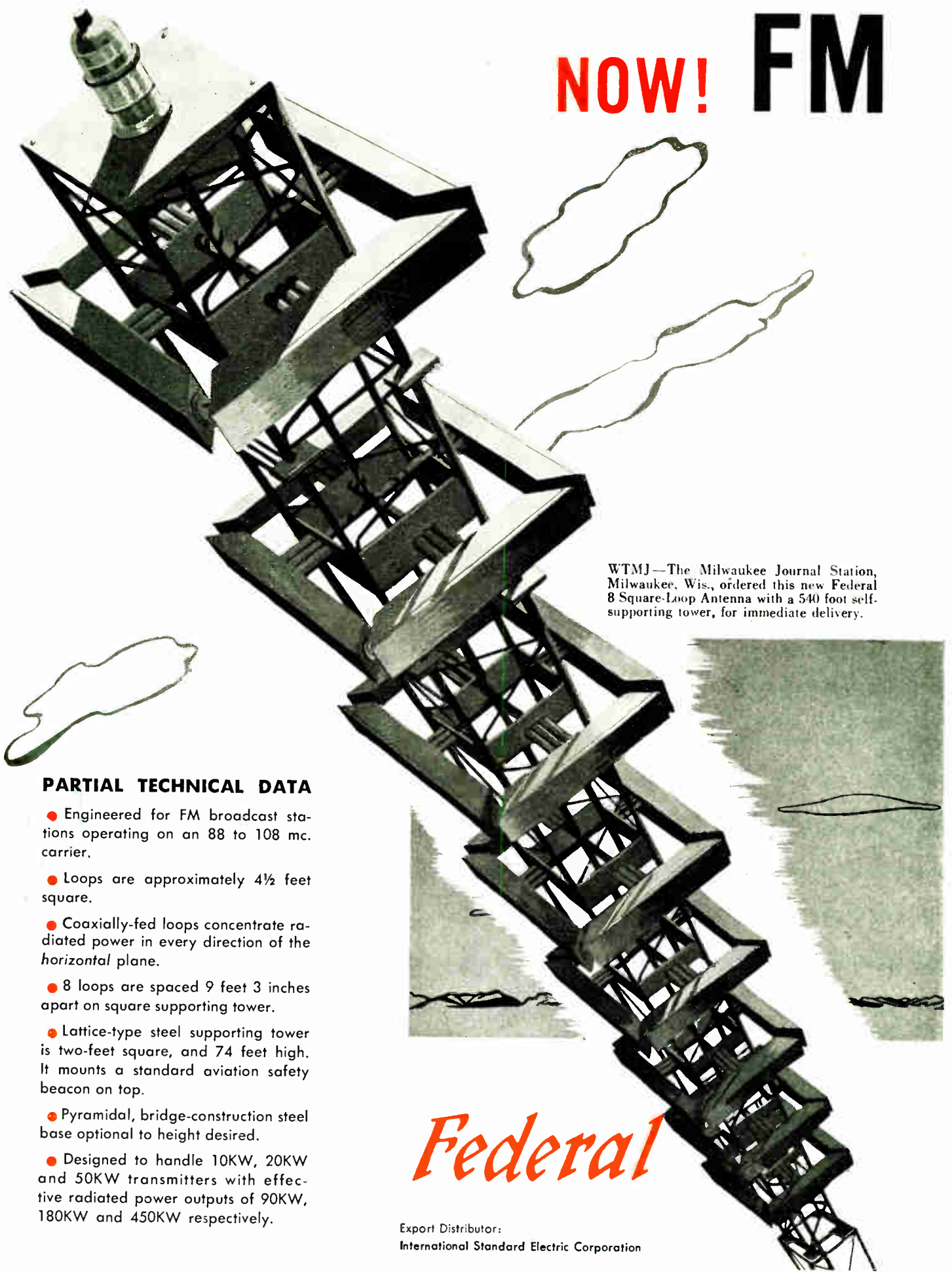

WTMJ—The Milwaukee Journal Station, Milwaukee, Wis., ordered this new Federal 8 Square-Loop Antenna with a 540 foot self-supporting tower, for immediate delivery.

PARTIAL TECHNICAL DATA

- Engineered for FM broadcast stations operating on an 88 to 108 mc. carrier.
- Loops are approximately 4½ feet square.
- Coaxially-fed loops concentrate radiated power in every direction of the horizontal plane.
- 8 loops are spaced 9 feet 3 inches apart on square supporting tower.
- Lattice-type steel supporting tower is two-feet square, and 74 feet high. It mounts a standard aviation safety beacon on top.
- Pyramidal, bridge-construction steel base optional to height desired.
- Designed to handle 10KW, 20KW and 50KW transmitters with effective radiated power outputs of 90KW, 180KW and 450KW respectively.

Federal

Export Distributor:
International Standard Electric Corporation

ANTENNA WITH NOMINAL POWER GAIN OF 9!

FEDERAL'S 8 SQUARE-LOOP ANTENNA PROVIDES 90KW EFFECTIVE POWER OUTPUT WITH A 10KW TRANSMITTER... 180KW WITH A 20KW TRANSMITTER... 450KW WITH A 50KW TRANSMITTER!

HERE IS STILL ANOTHER EXAMPLE of Federal's leadership in the entire field of FM... an 8-loop antenna with the highest power gain ever available in the FM broadcast service.

It radiates horizontally polarized waves so highly directive that very little energy is lost to useless ground or sky wave. Thus, with a power gain of 9, you can now get an effective power output of *90KW with a 10KW transmitter; 180KW with a 20KW transmitter and 450KW with a 50KW transmitter!* This not only means a great saving on the cost of original equipment, but important economies of operation as well.

Be prepared for future FCC action increasing the effective radiated power!

One antenna is built for use over the entire FM range...

88 to 108 megacycles. Only one predetermined stub adjustment per loop changes it for any frequency in this band. Also, antenna array may be fed in two sections with separate coaxial lines to allow for emergency auxiliary operation.

Structurally, the tower is designed not to disturb the circular pattern of the antenna's radiation... is supported on a rugged, pyramidal base. The entire unit withstands high wind velocities and heavy icing loads.

Coming at a time when the FCC has given the green light to FM station construction, this remarkable new antenna is another contribution to the advancement of FM transmission... part of the "completely packaged service" which Federal now makes available. A Federal engineer will be glad to give you full details.

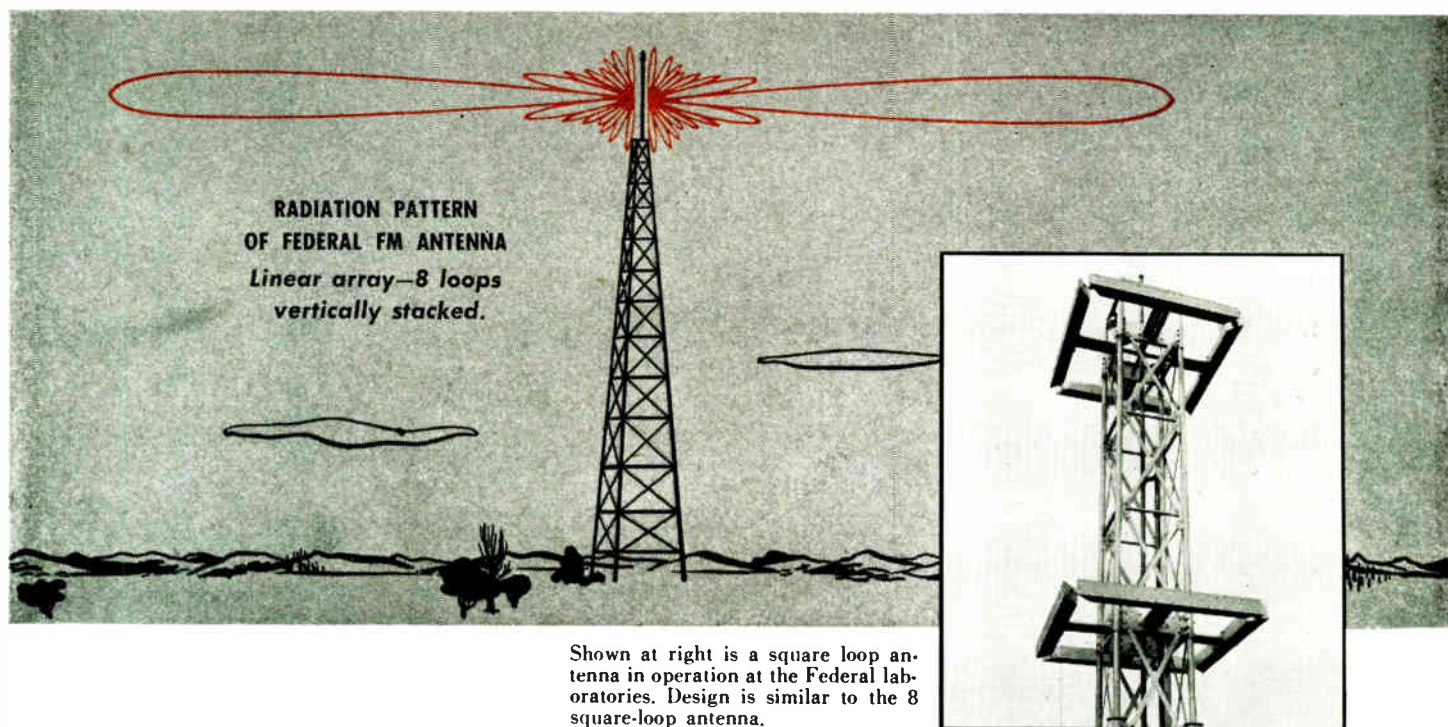

Telephone and Radio Corporation

Newark 1, New Jersey



HOW G-E LAMINATED PLASTICS CAN HELP IMPROVE YOUR PRODUCTS

GRADES OF G-E TEXTOLITE ARE AVAILABLE FOR YOUR MOST EXACTING NEEDS



• Regardless what your product may be—whether it's of a purely electrical, mechanical, thermal, or chemical nature—or even a combination of all these elements . . . the chances are good that after you have investigated the many grades of G-E Textolite you will find one that exactly fills your requirements . . . one grade that will do your job better than the others.

That's why G-E Textolite grade 1848 was selected for the end and back plates of this water-cooled booster coil for an induction heater. This grade is strong mechanically and has the necessary electrical and heat properties; consequently, it makes possible a rugged support for the coil—successfully withstands the heat of the application, and properly insulates the radio frequencies. And the ease with which grade 1848 can be sawed to shape, adds to the reasons why it was chosen for the job.

With over 50 grades of G-E Textolite to select from, each having an individual combination of properties, why not investigate the possibility of incorporating the benefits of this versatile non-metallic material in your products. Write to Section T-3, General Electric Company, Plastics Divisions, Chemical Department, One Plastics Avenue, Pittsfield, Mass.

G-E TEXTOLITE IS SUPPLIED IN THE FOLLOWING FORMS

Sheets, Tubes and Rods	Fabricated Parts	Molded Laminated Parts
Post-formed Laminates	Nameplates	Translucent Laminates
	Low-pressure Molded Parts	

A high-frequency booster coil mounted in an induction heater which heat treats metal. The end and back plates of this coil are fabricated from G-E Textolite 1848. This grade is used for general mechanical uses—has excellent resistance to wear—is fairly good electrically, and punches and machines excellently. Is used for panels, bus bar supports, motor slot wedges, etc.

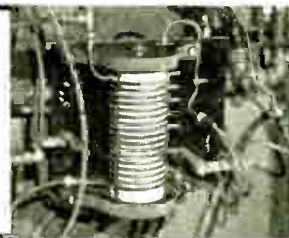

EVERYTHING IN

Plastics

GENERAL ELECTRIC

CD16E-5

GENERAL ELECTRIC PLASTICS FACTORIES ARE LOCATED IN
 Ft. Wayne, Ind. Meriden, Conn. Scranton, Pa.
 Taunton, Mass. Lynn, Mass. Pittsfield, Mass.

strength that is pre-destined

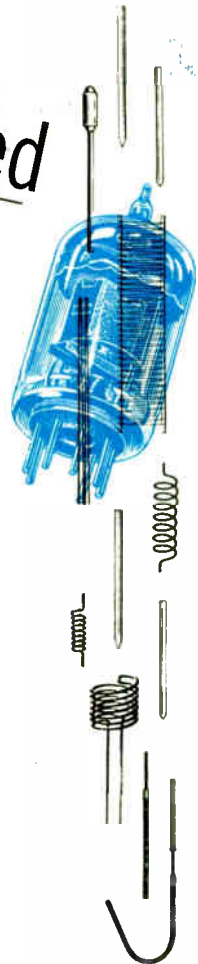

Callite Tungsten Heaters in these Tung-Sol Miniatures will weather vibration and shock

The tiny Tung-Sol Tube type 6AK5, not much bigger than an acorn, has an enviable record in military equipment for its ability to stand abuse and remain efficient under adverse conditions.

Features, that contribute to the remarkable ruggedness of this miniature tube, are its unique plate construction, the method of anchoring the mount, and its Callite tungsten heater. These heaters are processed by Callite for Tung-Sol with the right

proportions of tungsten to give the required life and stability, plus the strength to withstand vibration and shock.

Through years of research in tungsten, molybdenum and special alloys, Callite has developed metallurgical components with the special qualities that facilitate tube-making and result in fine products. It will pay you to investigate our complete range of metallurgical specialities. Call on us for cooperation on designs and appli-

cations. Callite Tungsten Corporation, 544 Thirty-ninth Street, Union City, New Jersey. Branch Offices: Chicago, Cleveland.

Callite
Tube components



HARD GLASS LEADS, WELDS, TUNGSTEN AND MOLYBDENUM WIRE, ROD AND SHEET, FORMED PARTS AND OTHER COMPONENTS FOR ELECTRON TUBES AND INCANDESCENT LAMPS.

Depend on **OHMITE** Experience FOR THE RIGHT RHEOSTAT CONTROL

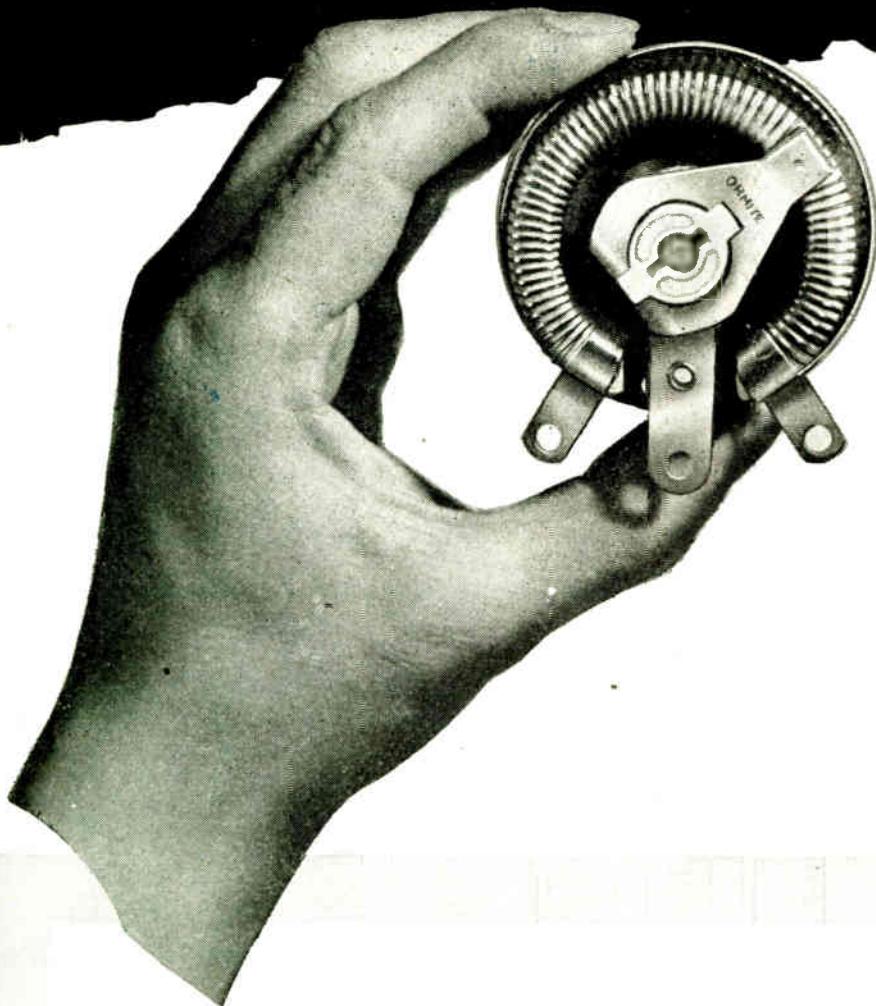

Time-proved Design! Widest Range of Sizes!

You get these advantages: (1) Ohmite experience with countless rheostat applications. (2) Service-proved Ohmite features that assure permanently smooth, close control. (3) Extensive range of sizes and types for easy, economical selection of the best unit for every application.

There are ten wattage sizes ranging from 25 to 1000 watts—from 1 1/16" diameter to 12" diameter—in uniform or tapered winding—in single or tandem units—in regular or special designs. Stock models from 25 to 500 watts, in many resistance values.

Consult Ohmite engineers on your rheostat control problem.

OHMITE MANUFACTURING COMPANY
4984 FLOURNOY STREET, CHICAGO 44, U. S. A.

Be Right with **OHMITE**

RHEOSTATS • RESISTORS • TAP SWITCHES • CHOKES • ATTENUATORS

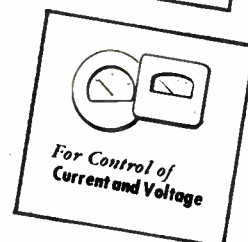
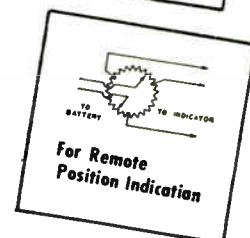
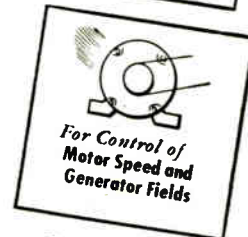
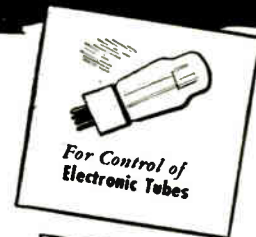

Send for Catalog
and Engineering
Manual No. 40

Write on company
letterhead for this
helpful guide in the
selection and applica-
tion of rheo-
stats, resistors, tap
switches, chokes
and attenuators.

The New **HARVEL** 912-C

Internal Curing **INSULATING VARNISH**

Cuts
CURING TIME
 UP TO **50%**

Compare These Schedules
 with **YOURS**

912 C Curing Schedules
 (Standard convection ovens)

2-4 hours . 285 deg. F.

3-5 hours . 260 deg. F.

4-6 hours . 250 deg. F.

(all curing times lower with
 infra-red equipment)

Here's a new insulating varnish, recently developed by IRVINGTON, which cuts curing time substantially! It is used with *existing equipment*.

Compare your present schedules with the baking times given above. Then estimate the savings in costs as well as the increased output. And remember, you can effect these savings without investing in equipment.

Moreover, 912 C provides *greater storage stability and shelf life*, yet has all the outstanding electrical and physical advantages of other HARVEL internal curing varnishes. For complete information, and samples, write to Dept. 50. Irvington Varnish and Insulator Company, Irvington 11, New Jersey.

Irvington Products

Include

Cotton, Fiberglas, or Rayon
 Tubings and Sleeveings —
 Varnished, Lacquered, or
 Vinylite Processed
 Non-Fraying Fiberglas Sleeveing
 Transformer Lead Tubings
 Wire Identification Markers
 — Varnished or Plastic
 Extruded Plastic Tubings
 Fibron Plastic Tapes
 Varnished Fabrics and Papers
 Slot Insulation
 Harvel and Irvington
 Insulating Varnishes
 Cardolite Resins

IRVINGTON

VARNISH & INSULATOR CO., Irvington 11, New Jersey



Why

THIS

TEAM IS

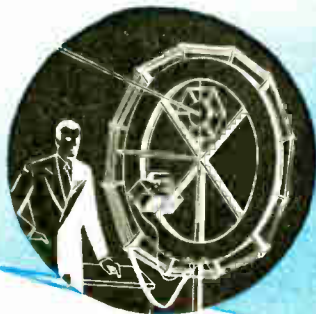

1920 Loop antenna for 400-500 meter ship-to-shore radio telephone receivers. Its design enabled earliest measurements of field strength.

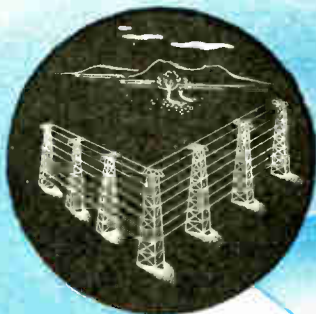

1929 Curtain antenna developed for beaming short-wave radio telephone messages to Europe and South America . . . improved commercial service.



1930 Half-wave vertical radiator, now in general use, was developed into practical form. It greatly improved signal output of broadcast stations.



1934 One of the first directional antenna arrays for broadcasting. Designed for WOR to concentrate signals in service area, eliminate radiation over ocean.

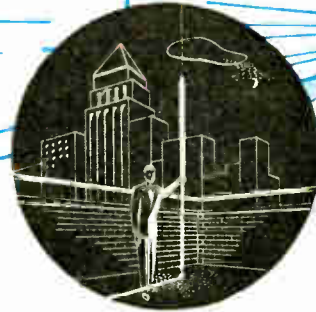

1938 Coaxial antenna for ultra high frequency communications, designed by Bell Laboratories, gave increased signal strength. Widely used in police radio systems.

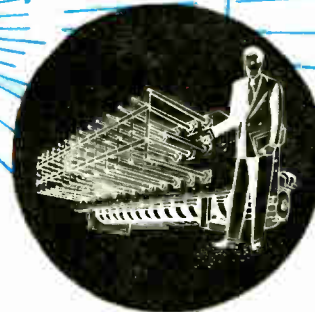

1941 Polyrod radar antenna was an important war contribution . . . helped sink many Jap ships. Its exceptionally narrow beam and rapid scanning gave high accuracy to big Navy guns.

1946 New 54A CLOVER-LEAF FM broadcast antenna has high efficiency and a circular azimuth pattern; is simple to install and maintain. May be used for any power level up to and including 50 KW.

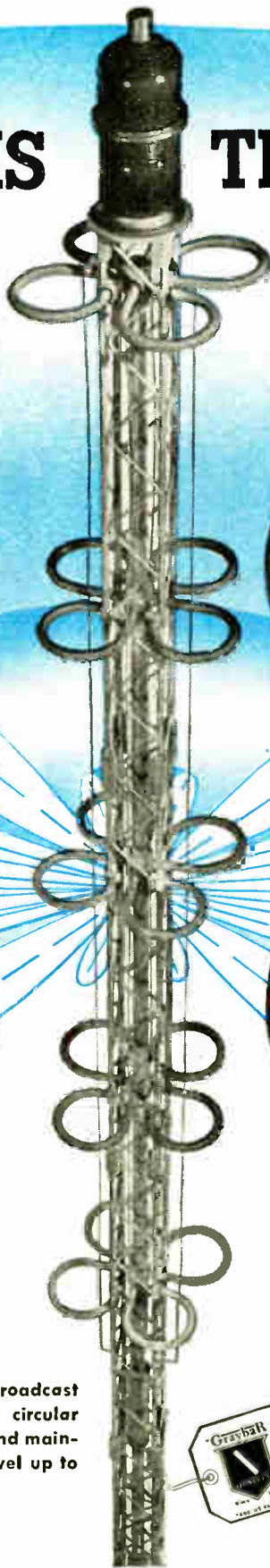

Up

ON ANTENNAS

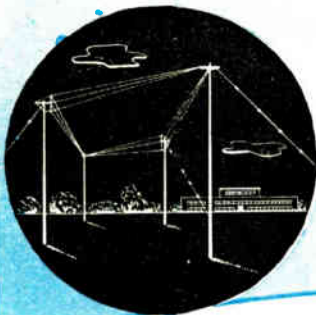

1930 Rhombic (diamond-shaped) antenna for 14-60 meters. It covers wide frequency range without adjustment. Still standard for this band.

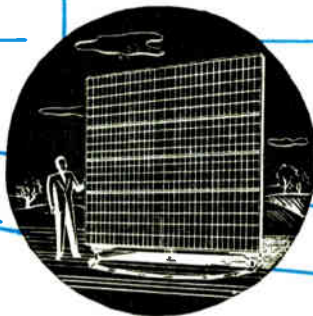

1944 Metal lenses, another Bell Laboratories development, focus microwaves like light. One type has a beam width of only 0.1° —or less than that of a big searchlight.

As pioneers and leaders in radio, Bell Telephone Laboratories and Western Electric have been vitally concerned with the development of improved antennas for more than 30 years.

From the long-wave days of radio's youth, right through to today with its microwaves, this team has been responsible for much of the progress in antenna design.

Progress based on Research

Following their long-established method of attack, Bell Laboratories scientists are continually *observing, investigating and measuring* the action of radio waves in space. Their research has covered wave lengths ranging from hundreds of meters to a fraction of a centimeter. In over a quarter-century of intensive study, they have learned how radio waves behave, day and night, under all sorts of weather conditions.

Out of this fundamental research have come such outstanding developments as the rhombic antenna, *musa* antenna, vertical half-wave radiator, curtain antenna, directional array, the polyrod and other improved radar antennas, the metal lens for microwaves and the new CLOVER-LEAF antenna for FM broadcasting.

What this means to YOU

Whether you are interested in AM or FM—equipment for broadcasting, point-to-point, aviation, mobile or marine use—here's the thing to remember. Every item of radio apparatus designed by Bell Laboratories and made by Western Electric is backed by just such thorough scientific research as has been given to antennas. It's designed right and made right to give you years of high quality, efficient, trouble-free service.



BELL TELEPHONE LABORATORIES

World's largest organization devoted exclusively to research and development in all phases of electrical communications.

Western Electric

Manufacturing unit of the Bell System and the nation's largest producer of communications equipment.



THE COUNTERSIGN OF DEPENDABILITY IN ANY ELECTRONIC EQUIPMENT

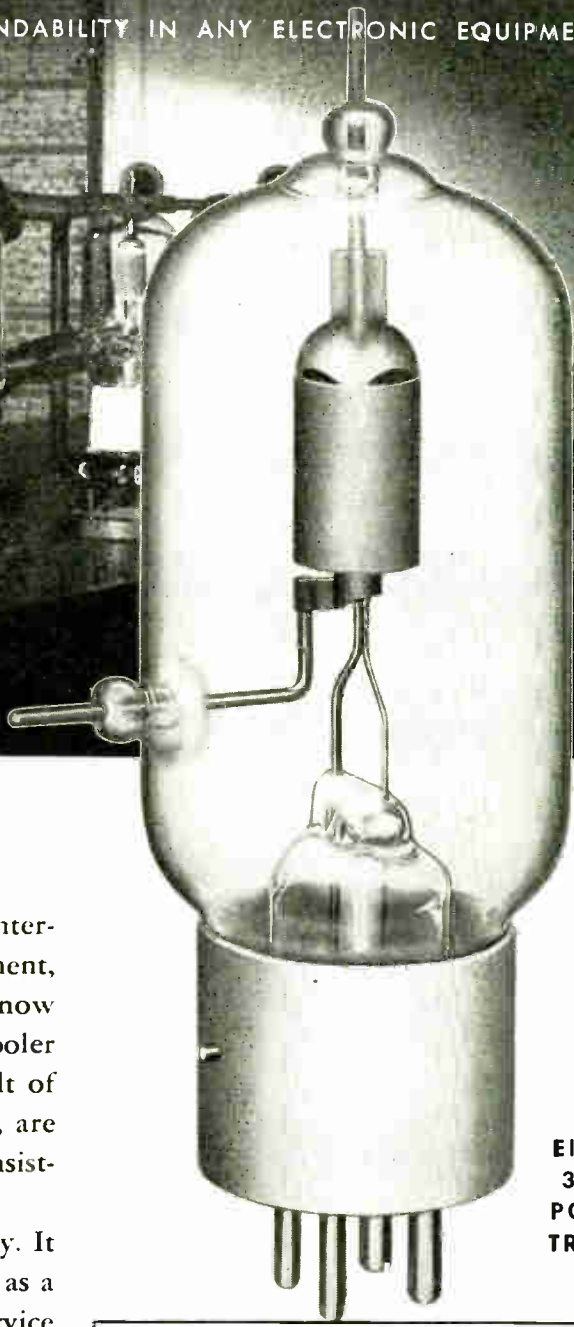
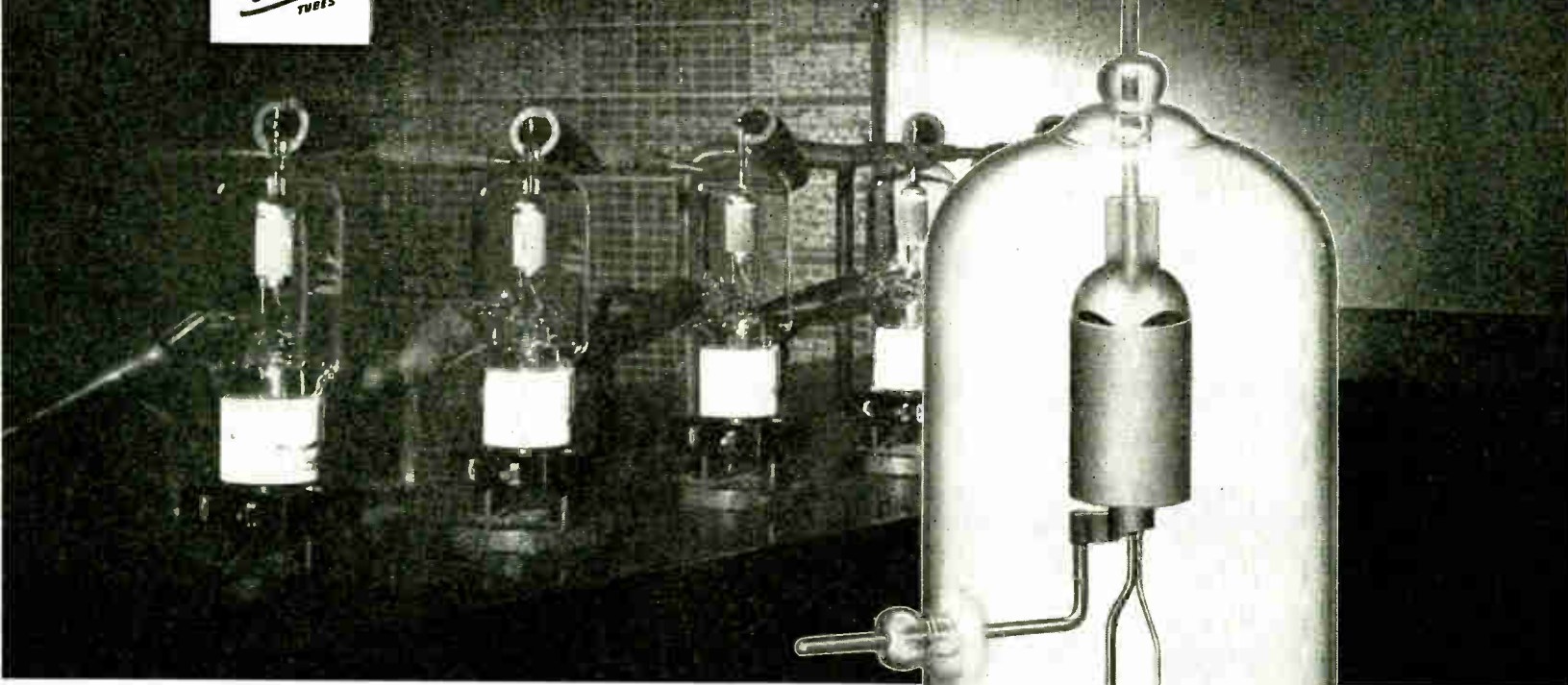

EIMAC 35TG POWER TRIODE

A BETTER 35TG

The famous Eimac 35TG VHF tube, with its low inter-electrode capacitances, its logical terminal arrangement, its lack of internal hardware, *is further improved*. It now has a non-emitting grid, an improved filament, and a cooler operating plate. These improved elements, the result of wartime developments in manufacturing technique, are being incorporated in many Eimac tubes and are consistently resulting in vastly increased life.

The 35TG is a power triode of wide applicability. It will function as a Class-C oscillator or amplifier, or as a Class-B audio or supersonic amplifier, and in such service will give excellent performance, due to its stability and low driving-power requirements.

Longer operating life is but one of the many advantages afforded by Eimac tubes. It will pay you to keep informed... see your nearest Eimac representative today, or write direct.

ELECTRICAL CHARACTERISTICS

Filament: Thoriated tungsten	
Voltage	5.0 volts
Current	4.0 amperes
Amplification Factor (Average)	39
Direct Interelectrode Capacitances (Average)	
Grid-Plate	1.8 uuf
Grid-Filament	2.5 uuf
Plate-Filament	0.4 uuf
Transconductance ($i_b = 100$ ma., $E_b = 2000$ V., $E_c = -30$ V.)	2850 umhos
Frequency for Maximum Ratings	100 mc

Follow the leaders to



EITEL-McCULLOUGH, INC.
1229-H San Mateo Ave., San Bruno, Calif.
Plant located at: San Bruno, California

Export Agents: Frazar and Hansen, 301 Clay Street, San Francisco 11, California, U. S. A.

CALL IN AN EIMAC REPRESENTATIVE FOR INFORMATION

- ROYAL J. HIGGINS (W9A10), 6005 Michigan Ave., Room 818, Chicago 5, Illinois. Phone: Harrison 5948.
- ADOLPH SCHWARTZ (W2CN), 220 Broadway, Room 2210, New York 7, N. Y. Phone: Cortland 7-0011.
- VERNER O. JENSEN, CO., 2616 Second Ave., Seattle 1, Washington. Phone: Elliott 6871.
- HERB BECKER (W6QD), 1406 S. Grand Ave., Los Angeles 15, California. Phone: Richmand 6191.
- M. B. PATTERSON (W5CI), 1124 Irwin-Keasler Bldg., Dallas 1, Texas. Phone: Central 5764.
- TIM COAKLEY (W1KKP), 11 Beacon Street, Boston 8, Massachusetts. Phone: Capitol 0050.

LITTLE COMPONENT*



HUGE SUCCESS

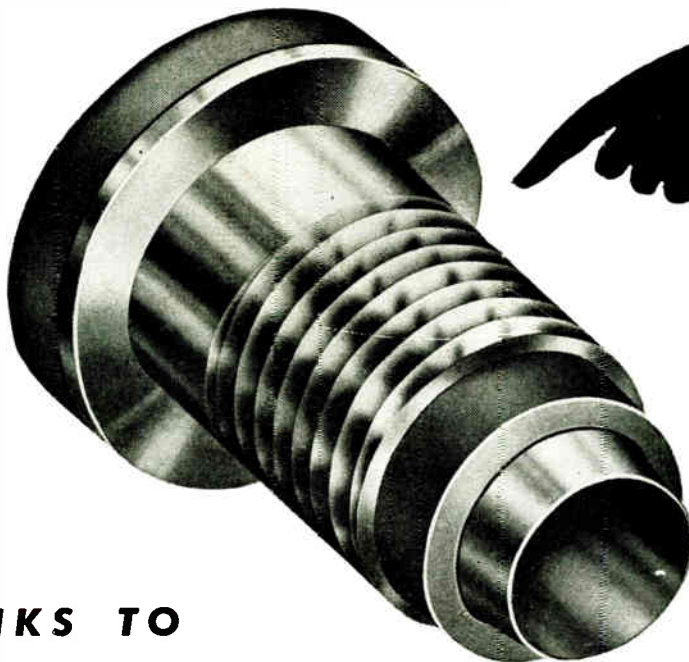

**... THANKS TO
MYCALEX**

THE "PERFECT" LOW LOSS INSULATION

The problem was to mold insulating material of exceptionally low loss factor and high dielectric strength into a closely integrated bond with a metal insert of high conductivity. The difficulty was acute, for both materials had to have virtually the same coefficient of expansion in order to insure an efficient electrical and mechanical seal. High resistance to arcing in the insulator was also imperative. It had to be moisture-proof and heat-resistant.

MYCALEX 410 (Molded Mycalex) proved to be the only solution after many other insulators had been tested and rejected . . . because MYCALEX has the ideal combination of electrical and mechanical

properties for today's high frequency applications.

Have you a problem involving the sealing of highest type insulation with metal? Are your specifications particularly exacting? More than 25 years of leadership in solving the toughest high frequency insulating problems make MYCALEX a "natural" to solve yours. Our engineers will be pleased to cooperate.

*PANEL JACK



MYCALEX CORPORATION OF AMERICA

"Owners of 'MYCALEX' Patents"

Plant and General Offices, CLIFTON, N. J.

Executive Offices, 30 ROCKEFELLER PLAZA, NEW YORK 20, N. Y.

You're the fellow in the gold fish bowl ...



IF YOU'RE THE MAN who specifies components, you're in the public eye. Even the tiniest part you buy has "big things" to say in the quality of your product. You can't boast about cutting costs . . . if it means cutting quality. And still you've got to get the "most" for the "least."

That's why, when it comes to capacitors, you do better at Cornell-Dubilier. Others can offer capacitors that

look like C-D's. But no one else can offer the wealth of experience, the engineering flexibility, the tremendous production facilities that C-D can. These are things that can't be imitated or copied. These are things that don't show up on cost sheets at all, but add up big in product dependability. They are available to any manufacturer who brings his capacitor problems to Cornell-Dubilier.



*Your inquiries are invited.
Cornell-Dubilier Electric
Corporation, South Plain-
field, New Jersey. Other
plants in New Bedford,
Providence, Worcester
and Brookline.*



CORNELL-DUBILIER

world's largest manufacturer of

CAPACITORS

MICA • DYKANOL • PAPER • ELECTROLYTICS

ELECTRONIC INDUSTRIES

Including INDUSTRIAL ELECTRONICS

O. H. CALDWELL, EDITOR ★ M. CLEMENTS, PUBLISHER ★ 480 LEXINGTON AVE., NEW YORK (17), N. Y.

Good Engineering = Better + Cheaper

Mass production, the keynote of an article in this issue, means giving the public better goods at a lower price. In times of prosperity like the present there is a demand for something "more expensive". But usually the public wants the high-value quantity product and will keep buying it as long as the price keeps coming down. Efforts in this direction, therefore, are very useful to the American economy. Engineers are the high priests of these cost-reduction efforts and get their results by careful attention to all details—by finding ways to do it better and cheaper.

New Features Needed

If the price can't be brought down, however, something fresh, new and useful must be brought out. Again it's up to the engineer. Cathode-eye tuning was in this class. So was the completely new order of dimensions introduced by the midget set or the single-control tuning system. On the contrary, new color in the plastic or a little gadget of doubtful utility is not enough to make an owner toss out his old set.

Too many manufacturers are banking on pent-up demand to absorb their 1946 sets even though these look and sound much like 1938 models. Let's see some really new engineering in home-receiver design. There's a pot of gold in it.

Product Studies

Recently, two unrelated incidents emphasized the importance of practical study of "product uses" even before the first design blueprint starts to shape up: (1) An expensive 17-tube electronic remote-control selector proved more economical for juke-box use than a simple step-by-step relay system. Saving 15 seconds during each record change, its greater income-producing possibilities more than offset its increased initial cost.

(2) A new garage-door actuator was in pilot-run pro-

duction. Extended test operations had shown perfect response up to 150 feet. The control unit at the garage was economical to build and sturdy in operation. The car transmitter was an exhaust-operated whistle, using a frequency just above the audio range. Two weeks before final word was to be given for quantity production, an installation was made in the suburbs. Close by was a neighbor who had several hound dogs. For awhile no one could figure out why the dogs suddenly started baying at queer hours all through the night. The system has since been redesigned.

Progressive Communications

The communication industries are being expanded and modernized to an extent hitherto undreamed of. Electronic devices are being introduced on a new scale into telephony and telegraphy, bringing new services and values into wire communication. Space radio is taking over more jobs. The international services are planning new trans-ocean projects which will put Uncle Sam definitely in the lead among the countries of the world. Communications remains one of the brightest spots in the bright electronic picture.

Facsimile on the March

Facsimile, radio's Cinderella, may shortly surprise the industry and attain an outstanding position in both home and business applications. The new improved facsimile outfits are turning out sharper, cleaner copy at greatly increased speeds. Continued devotion of seasoned engineers like Finch and Hogan is bearing fruit that may make facsimile one of the very valuable uses of the FM channels. Already plans are afoot among representative broadcasters to put out hundreds of "home printing presses" for nationwide experiment with public participation. Besides which, facsimile also has a host of commercial, government and police uses where it is uniquely appropriate.

WINNERS OF THE \$1000 EDITORIAL AWARDS

Prizes totalling \$1000 in cash, which were offered for the best engineering articles contributed to our April-December, 1945, issues, as outlined on page 95, March, 1945, have been awarded by the judges as follows: First prize (\$600) to Wesley M. Roberts; second prize (\$300) to Hans Beller and G. O. Altman; third prize (\$100) to W. S. Bachman. The judges were Capt. A. B. Chamberlain, F. H. Shepard, Jr., and Prof. J. B. Sherman. Full details of awards in this issue, page 59.

SEPARATE CAVITY

By G. D. O'NEILL

Research Engineer
Sylvania Electric Products, Inc., Flushing, N. Y.

By using an anode shaped like two interleaved crowns and an external cathode, wide frequency range is obtained

● Of the many new and useful microwave tubes developed during the war and upon which secrecy restrictions have since been lifted, several will find important industrial uses during years to come. Of these, an outstanding example is the interdigitated magnetron, which is a new form of magnetron tube adapted for use at relatively low electric and magnetic fields and tunable over a range of frequencies considerably greater than formerly believed possible.

This class of magnetron is the invention of Dr. Donald L. Benedict and the particular form shown in the photographs was developed by him and Francis C. Breeden in the Research Laboratory of Sylvania Electric Products, Inc.

Of particular interest is the fact that there are several gaps in the tube across which power is generated in much the same manner as in multi-cavity magnetrons, while at the same time there is only one resonant cavity. The manner in which such a tube operates will be explained for a typical modification which was developed for use in pulse-time communications equipment operating on a wavelength of 6 cm.

Tube details

In this application a tunable cavity intended for operation at a wavelength of about 6 cm. is used. The pulsed anode voltage applied is ordinarily of the order of 1,500 volts for a duty cycle of 10%, the duration of the pulses being 4 microseconds. The magnet, usually of the permanent variety, has a field strength of about 1,000 gauss. Under these conditions the peak instantaneous power output of the type of tube described is about 80 watts, the anode circuit efficiency being about 10%. The photograph (Fig. 1) shows one modification of the tube, the physical dimensions



Fig. 1. Evacuated portion of magnetron

being indicated generally by relation to the size of the hand holding the tube. Fig. 2 shows a typical

test cavity mounted in the permanent magnet.

The basic principle of the magnetron has been known for more than thirty years, although it is only recently that really powerful tubes have been produced. Recent progress has been made possible by exploitation of the resonant cavity, multiple gaps, and the low-field type of operation in which the field strength of the magnet is so low that the period of rotation of an electron is greater than the period of oscillation of the cavity. The manner in which these principles have been applied in the multi-cavity magnetron is discussed in the article, "Theory of Magnetron Tubes and Their Uses."*

One of the difficulties with most magnetrons is that they are not arranged to operate over a controllable range in frequency beyond that which is obtained by adjusting the fields and coupling device. The permissible adjustment in this case

*Theory of Magnetron Tubes and Their Uses' by H. Gregory Shea, p. 66, ELECTRONIC INDUSTRIES, Jan., 1946.

Fig. 2. Complete assembly with external cavity, magnet and output line

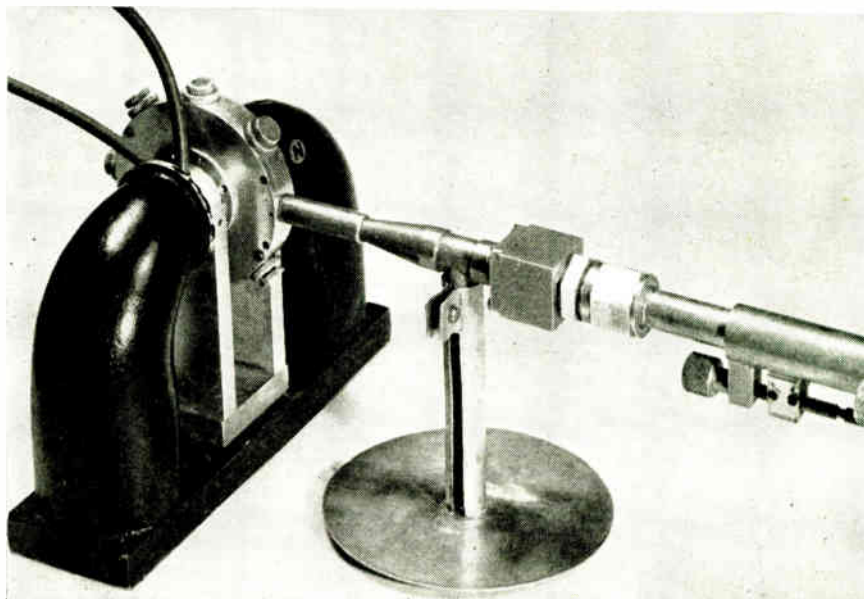

TUNABLE MAGNETRON

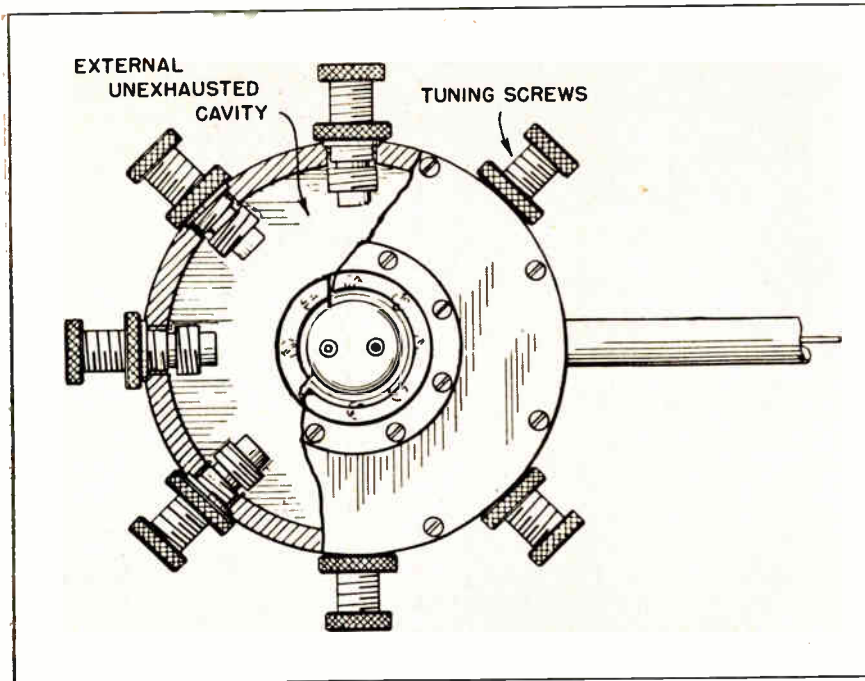

Fig. 3. Simplified plan view of cavity resonator with tuning screws

is rather narrow and is made only at considerable sacrifice of power generated as the frequency deviates from that at which optimum performance is obtained.

In the Benedict tube this difficulty is removed by adapting the tube to operate in a single external cavity resonator, the frequency of which is adjustable over a comparatively wide range. By giving proper consideration to design features of both tube and cavity, the frequency, once adjusted, is comparatively independent of fluctuations in the strengths of the electric and magnetic fields or of the load into which the tube is working.

In Fig. 1 it will be noted that the modification there shown is of the disc-seal type, in which the two discs are separated by a cylinder of glass and sealed on the ends by glass cups, one of which is provided with lead-in wires for heater and cathode. This tube is operated in an external cavity. The cathode is placed in the center of the tube, around which is placed the multipole anode. This anode is of two parts, which, for illustrative purpose, may be thought of as the continuation of the discs shaped as cylinders and cut to form a number of fingers, some of which are seen in Figs. 1 & 4. These fingers are intermeshed but not touching, the

arrangement being described as "interdigital." The threaded flange on one side of the discs is used to permit easy but positive insertion of the tube into the resonant cavity.

In operation the cathode of the tube is placed with its axis parallel to and in the center of the field of the magnet. Ordinarily, the cavity is held at ground potential while the cathode is made negative with respect to ground. A quanti-

tative treatment of the theory of the operation of the tube is beyond the scope of this article, but a brief general description of its operation will be given.

In common with other magnetrons, a heated cathode is provided to emit electrons which are drawn toward the anode. The motion of the electrons will be substantially at right angles to the direction of the magnetic field, the result being a force at right angles to both field and direction of motion, causing the electrons to travel in curved paths. By adjusting the potential of the anode with respect to cathode, the paths of the electrons may be made to sweep past the gaps between the anode fingers at grazing incidence.

Energy transfer

If there is a high-frequency voltage between adjacent fingers of the anode when electrons pass the gap, a transfer of energy occurs between electrons and cavity. Those which pass the gap at an instant when they are moving in the direction of increasing positive potential will have their kinetic energies increased by extracting energy from the cavity. These electrons return to the cathode and deliver the energy received from the cavity to the cathode in the form of heat. On the other hand, there will be an equal number of electrons passing the gap when the field is in the opposite direction. These are

Fig. 4. Section of assembly including transmission line and magnet

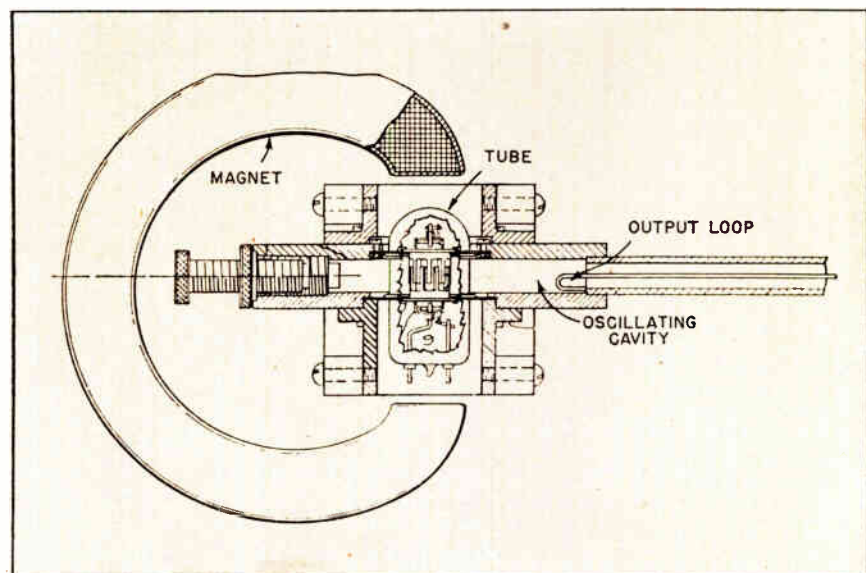

slowed down, the resulting decrease in kinetic energy being equaled by an increase in cavity energy.

Now the electrons which have delivered energy to the resonator during their first passage across the gap no longer have sufficient energy to return through the retarding field to the cathode, but instead will move in cycloidal paths through the space between anode and cathode, meanwhile alternately becoming bunched and unbunched. In subsequent passages past the gaps between adjacent fingers of the anode, the phase relation between voltage across the gap and electron motion is such that there is a further conversion of the kinetic energy of the electrons into electric power which flows into the cavity. Since an electron can extract power from the cavity only once before it returns to the cathode, while other electrons can deliver power to the circuit in each of several passages past the interdigital gaps, there is a net gain in power.

Fig. 3 shows, in simplified form,

a plan view of a cavity resonator adapted to use with the interdigitated magnetron. It will be noted that there are several tuning screws which are used to adjust the effective radius of the cavity, and the conventional loop on the end of a concentric transmission line is used for coupling out the power. Fig. 4 shows a section of the assembly including the transmission line and the tuning screw diametrically opposite, also electrodes and glass walls of the tube.

Referring to Fig. 4, one would normally consider that the resonant wavelength of the cavity would be about four times the distance between the anode of the tube and the effective radius of the cavity after giving due consideration to the loading which results from the interdigital capacitance of the anode fingers. For a wavelength of 6 cm. this would place the loop and the ends of the tuning screws at about the same location as the glass wall of the tube which would, of course, be an unsatisfactory condition, both me-

chanically and electrically. The solution of this difficulty is rather straightforward, however, no sacrifice in structural features being required.

It is elementary that a transmission line open at one end and shorted at the other has maximum shunt resistance across the open end for a signal of given wavelength when the electrical length of the line is a quarter wavelength. However, if the line is made three quarter wavelengths long, the shunt resistance is about the same as for the quarter-wave line. (For a lossless line the shunt resistances are infinite in either case.)

Three-quarter wave cavity

Applying this principle to the cavity, its diameter is increased so that it is effectively equivalent to a three-quarters wavelength line. This results in an added voltage loop within the cavity and permits placing the glass wall of the tube about midway between the voltage loops inside and outside the tube, thus reducing dielectric losses to a minimum. As a further advantage, the loop used for coupling the power to the transmission line may then be made of optimum shape and size, and placed in the most favorable position.

In the article by Shea it was pointed out that alternate cavity barriers in multi-cavity magnetrons are connected together or "strapped" in order to control moding. Presumably, if a tube could be strapped perfectly, it could oscillate in only the π -mode, wherein the voltage across any gap is always π radians out of phase with the voltage across the gaps next to it.

The interdigitated tube has no strapping in the usual sense. On the other hand, alternate fingers are connected to opposite discs, and to this extent the tube is strapped. The strapping thus obtained is not so tight that modes of oscillation other than the π -mode are forbidden. This appears to be a fortunate circumstance in some respects, for it has been found that the π -mode is not always the most useful one.

In the multi-cavity magnetron we regard the tube as being able to oscillate in a number of modes in which there is some definite wavelength corresponding to each mode. Under certain conditions oscillation may occur at more than

(Continued on page 122)

Fig. 5. Details of the internal construction of the interdigitated magnetron showing heater and anode

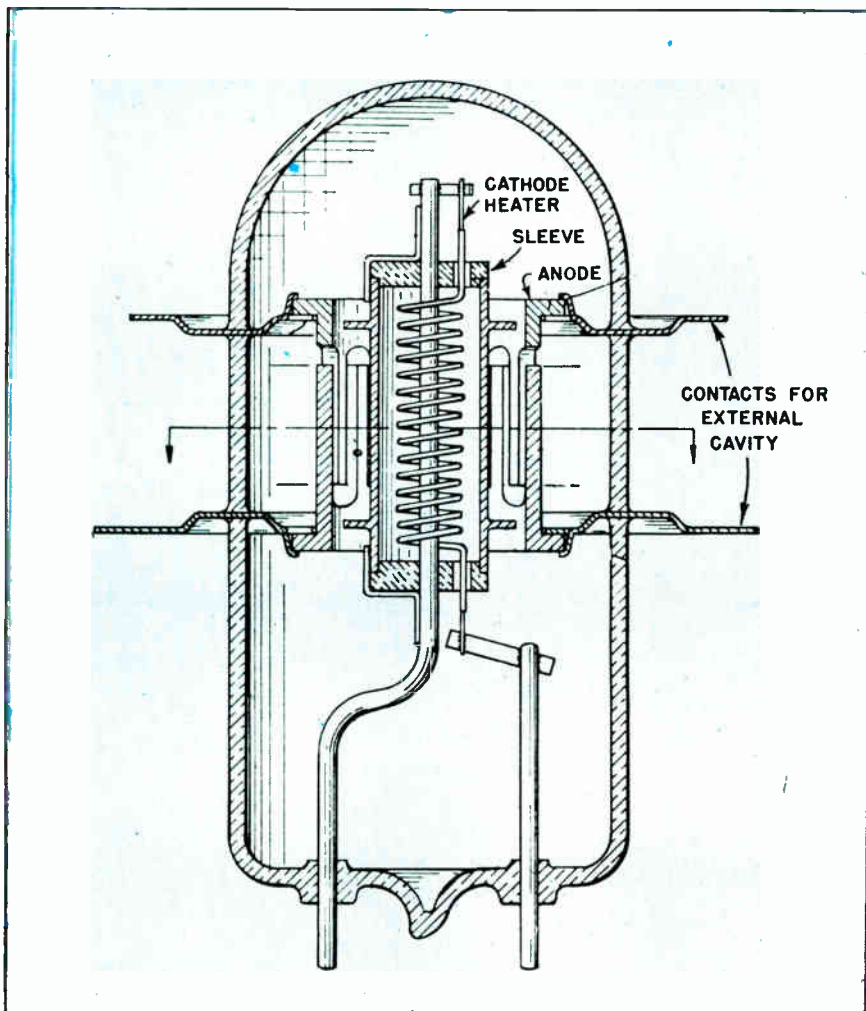

MASS PRODUCTION

By H. GREGORY SHEA

Associate Editor, ELECTRONIC INDUSTRIES

How standard high speed methods, with a few new twists, are used to get low cost sets to the public

• The first impression gained by a visitor to the receiver manufacturing plant of the Emerson Radio & Phonograph Co. is that the employes are working hard and earning their pay. This is in such con-

trast to the impression made upon strangers by some manufacturing operations—particularly during the war—that to the experienced factory executive the distinction is apparent within one minute. Were

anything needed to clinch the evidence of efficiency, the sight of completed sets coming off the production line at the rate of one every eighteen seconds and a glance at the tally sheet showing a count of

6



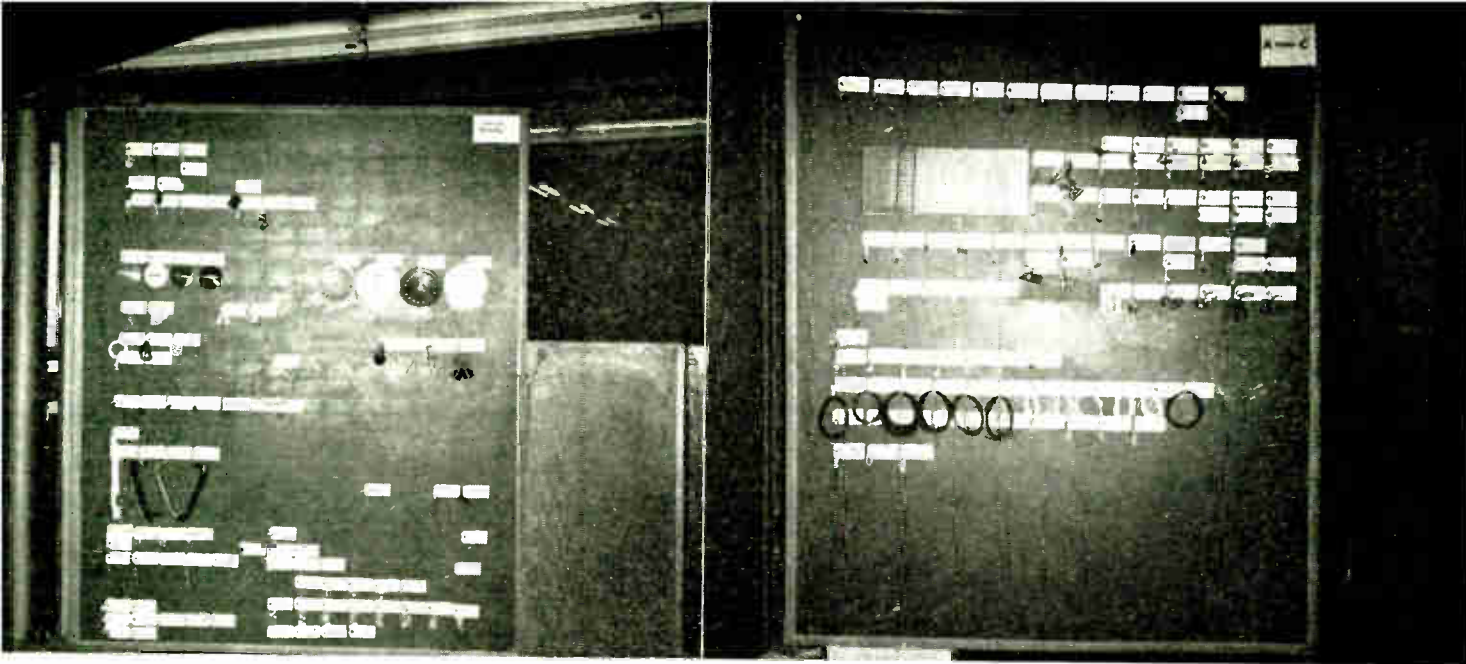

2, 3 just 200 for each of the three morning hours that have already elapsed would provide the required proof. How is it done? Does a magic formula exist here? Apparently not. The answer lies in the same combinations which are found in every

of a good production system. Supervision is all important. And of the three functions of an executive—to organize, deputize and supervise, the last is most often neglected. As can be seen from Fig. 1, the organization of the company is

In addition, it is not so departmentalized that it becomes necessary to have a vice-president in charge of introducing vice-presidents to each other, or as conceived by certain executives, a coordination department to make other departments do their job properly.

Certain points in the organization are of interest. First, as merchandising executive in chief, Benjamin Abrams keeps control of the traffic department so that he personally can direct the flow of shipments at all times to the neediest point in his distribution setup. But it is not the purpose of this article to discuss merchandising policies or methods.

Second, all activities which have anything to do with the producing of sets are concentrated under one head, that of the vice-president in charge of manufacturing and engineering. This is unusual.

It is quite common practice to have an independent engineering department co-equal in authority with a production department. In many places also an inspection and testing organization is operated separately, although in a number of cases this activity is directed by the engineering department.

However, separate departments cost money. The executive in charge must often be surrounded by the trappings of dignity and have a full quota of secretaries, assistants and other overhead persons. Furthermore, each department head must be approached by other department heads as an independent authority and the solution of matters of importance affecting both departments must be arrived at to a certain extent by negotiation and agreement—which is not always an easy matter. Furthermore, and this is an exceedingly important drawback, the subordinate personnel in

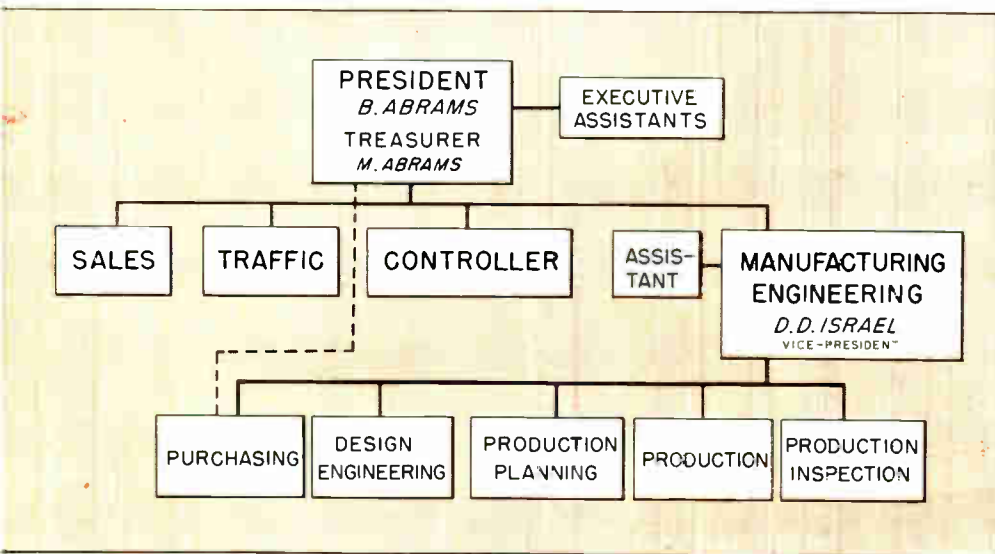

1 large and successful manufacturing operation. First, among the responsible causes is proper organization and supervision. Second, is the use

simple and straightforward. It contains no unnecessary layers or as the army expression goes—echelons of command.

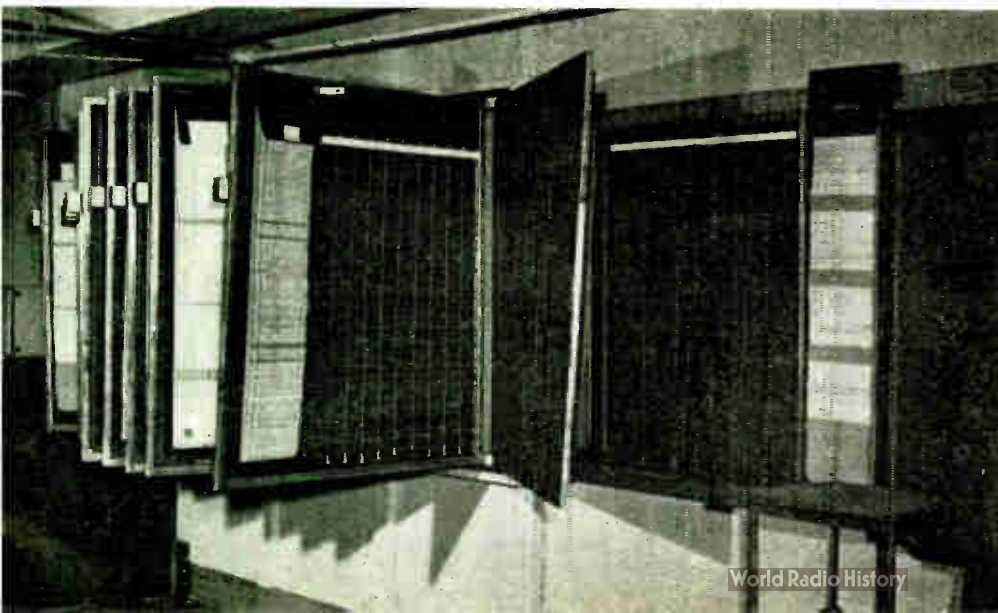



7 each department far more than its head tend to stand on their rights and avoid responsibility for untoward happenings by trying to make another department's employes appear at fault. Reduction in the number of departments tends to

minimize such buck-passing activities.

In the case of Emerson the foreman in charge of the production unit runs all inspection and testing except the final or "customer" inspection. The latter is an inspec-

tion done without meters on a purely listening basis just as a customer would listen before he buys. The only difference is that the inspector has certain check points and knows what to look for due to his experience.

Purchasing is also a function of the production and engineering department, but in certain instances, notably in the matter of cabinets, it is found advisable to obtain the benefit of the president's knowledge of the market. A feature of importance in connection with ordering is the maintenance of a number of swinging boards as shown in Fig. 2. These boards have affixed to them parts which are in stock and have become obsolete. It is the duty of design engineers to keep themselves familiar with their contents and to utilize such parts in new designs wherever possible.

Similar swinging boards are used to hold samples of products of outside manufacturers which might be used in production, again for the convenience of design engineers. (Fig. 3).

The production planning group is concerned with the making of schedules and the fitting of supplies into those schedules. It should be stated right here that if there is one thing that is rigid about the system used it is the schedules of production. They must be met and no excuses for failure to do so are acceptable. In order to keep a close check on this during the war, re-

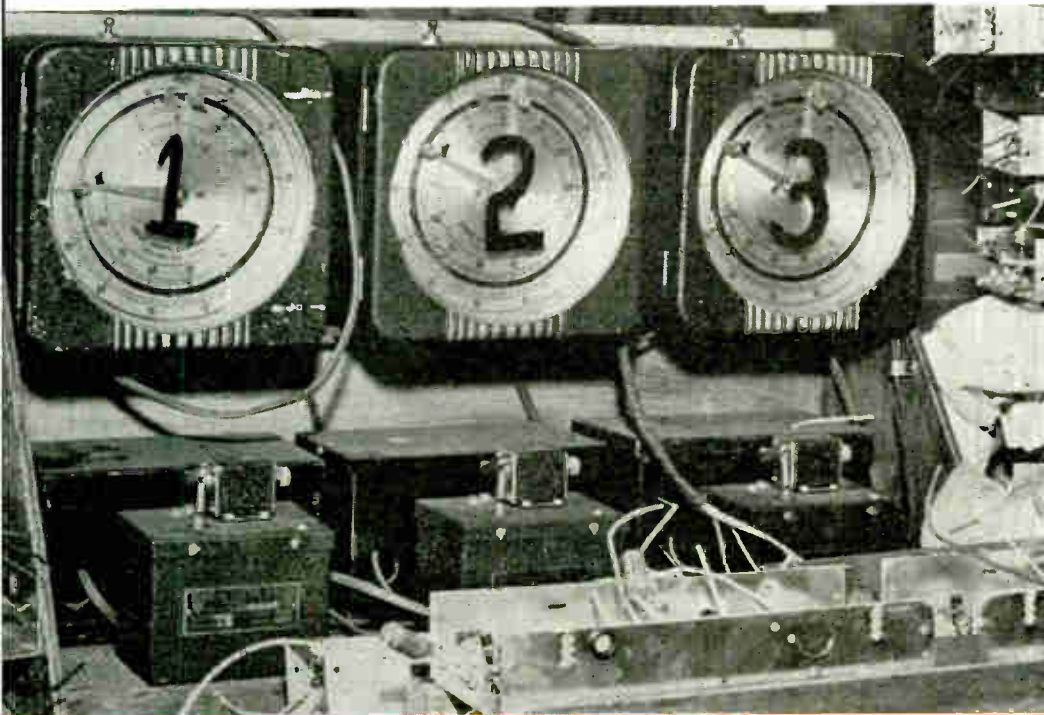

MODEL QUANTITY		MODEL QUANTITY		Per	Date

Part No.	Description	Per Set	Needed	Remarks

ISSUED BY		DATE

MODEL	CHASSIS INTO LINE	CHASSIS OFF LINE	PER SET	AMOUNT NEEDED	RECEIVALS

PRODUCTION SCHEDULE - CHASSIS ONLY							
PROD. UNIT	MODEL	WK OF	WK OF	WK OF	WK OF	WK OF	WK OF
1							
2							
3							
4							

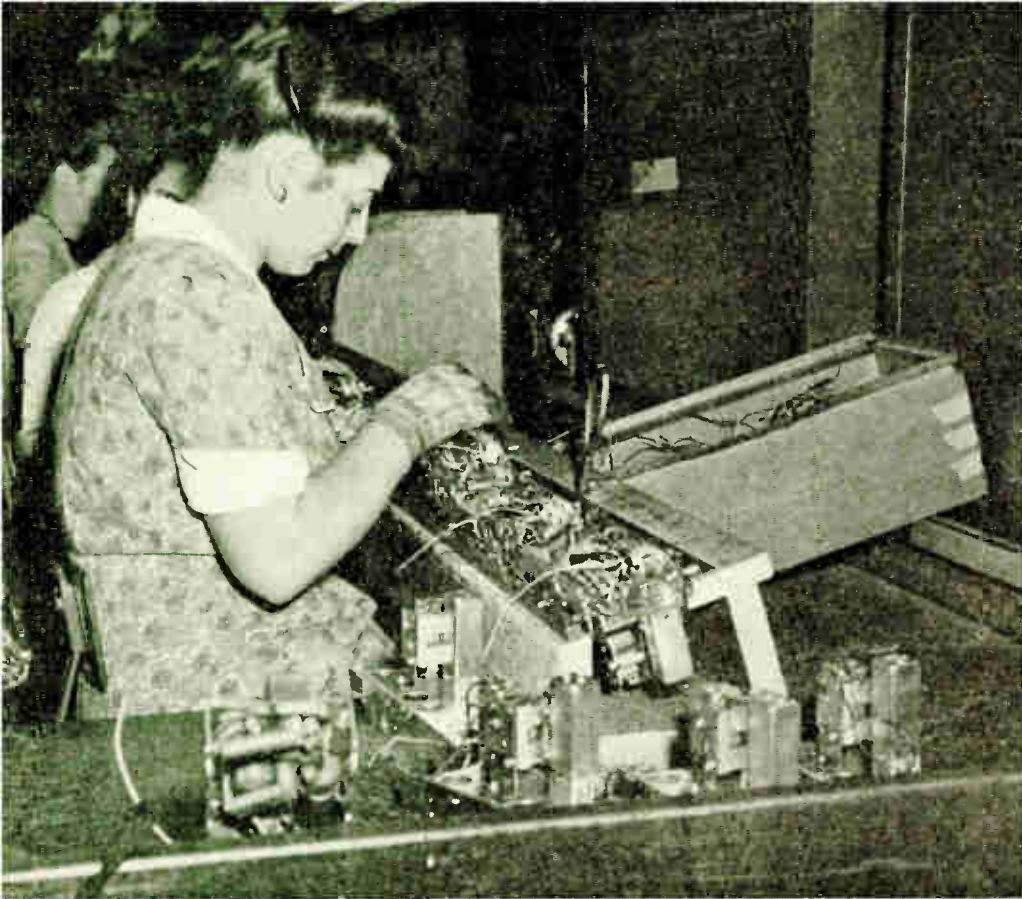

9

ports of the production results from the various lines were made at one hour intervals, but at present this has been extended to two hours, a figure which seems sufficient for control. Some of the forms used for a scheduling and reporting production as well as the productrol

boards are illustrated. (Figs. 4, 5).

Production planning keeps close control of the flow of material so that it knows at all times how much material of each kind is in stock, on the floor and is being shipped in the form of completed chassis. As any production man



11

knows this is important because of the tendency of material to disappear under benches and in other out of the way places.

The method of running the production lines is an important factor in obtaining results. A straight line assembly technic is used, Figs. 6, 7,

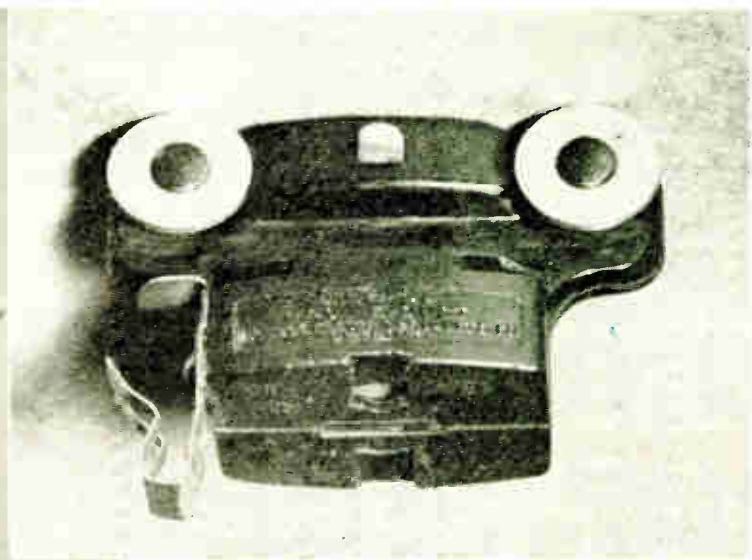

10a

feeding products in a "Z" path from one end of the room to the other. Chassis are designed rugged enough to stand fairly stiff handling during assembly. The feed-in of chassis at the beginning of the line is timed by means of a contact making clock. (Fig. 8). If the schedule is 200 per hour, the clock rings a



12 bell each 1/200 of an hour and a girl who handles the first operation must put a new chassis on the line before each ring of the bell. Incidentally, in order that there may be no failure at this crucial point, the first operation is slightly over-timed—made a little extra easy.

Each operation in the line is time studied to take 18 sec. and working at a normal pace no difficulty is experienced by the skilled operators in meeting the schedule. Although a conveyor belt has been considered, none has been installed as yet. Instead, the chassis are slid along wooden ways when each operation is completed. (Fig. 9).

It is an interesting fact observed here as well as in other shops that the girl operatives do not like to change either their operations or their work bench positions. As a result, absenteeism creates a serious problem in a production line of this type and the establishment of a filler group of girls who can be placed anywhere to take over empty line positions becomes quite important. However, even when an incentive premium of 10c an hour is offered, Emerson has found it difficult to obtain help for such roving assignments.

As the chassis moves along the line it finally acquires the semblance of a complete radio set and arrives at the alignment and inspection positions.

Here the ac line cord is plugged into a trolley type of plug, Fig. 10a, a supply of which is at hand. The

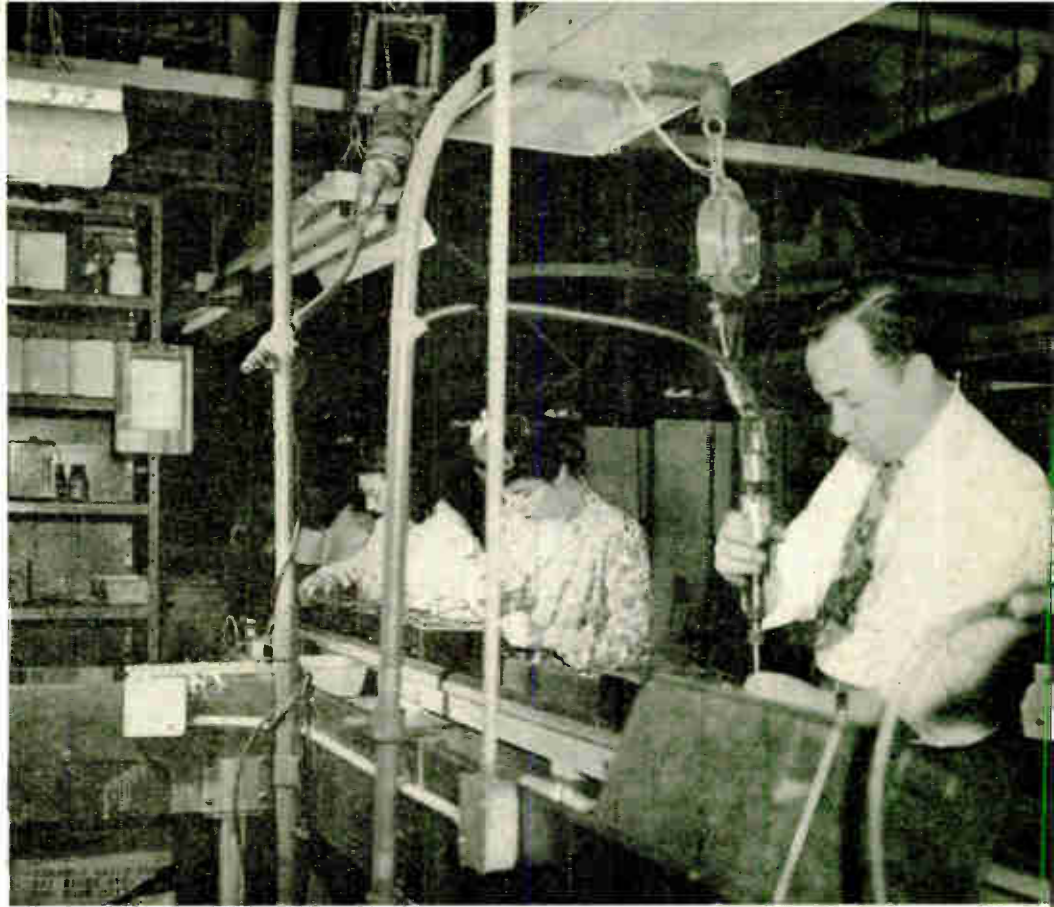

plug is then slid into a track against the live sides of which spring loaded contactors in the plug are made to press. As elsewhere in the line the operation of lining up the intermediate frequency channels can take only 18 sec., so each channel is reserved for one operative in a small booth built astraddle

the production line. Both the set under test and the live ac trolley pass through holes in the side of the booth, pushing aside small curtains used for test privacy.

Sets found defective in some manner are passed further along the line to a trouble shooting booth

(Continued on page 123)

13



MEASURING AUDIO

By **NORMAN C. PICKERING**

Pickering & Co., Inc., Oceanside, N. Y.

Methods and equipment for analyzing audio distortion by the interaction of two test signals

• It is well known that the response of a nonlinear network to a sinusoidal signal does not necessarily indicate the performance with complex waves. This is especially true of amplifiers with reactive loads, such as loudspeakers, recording cutters, and similar devices. Furthermore, two amplifiers may indicate the same amount of harmonic distortion, but sound different with the reproduction of music.

The usual method of measuring harmonic distortion in a system is to apply a pure sine wave to the input, filter the fundamental frequency from the output, and then measure the remaining voltage, which consists of hum, noise, and harmonics. Since the network has impressed on it only a single sine wave in the lower or middle frequency range (usually 400 cycles) this does not indicate the performance of the system under conditions where more than one frequency is being passed.



Fig. 1—Panel arrangement of the Model 502 Intermodulation Distortion meter

If two frequencies are being transmitted simultaneously by a network in which the current flow is not rigorously proportional to the impressed voltage, the output will

Intermodulation effects have more to do with molding the prevalent general opinion that "people do not like to hear 'high fidelity' reception" than any other item. This article analyzes some of the relations which may be found in audio amplifiers and describes equipment whereby intermodulation may be measured.

A linear amplifier will handle any number of frequencies simultaneously without one affecting the characteristics of the others. However, if any amount of nonlinearity is present these tones no longer remain independent. Beat notes are produced giving an effect known as intermodulation. Since the original tones in music and speech do not necessarily have a harmonic relation, these extra notes produce discordant effects.

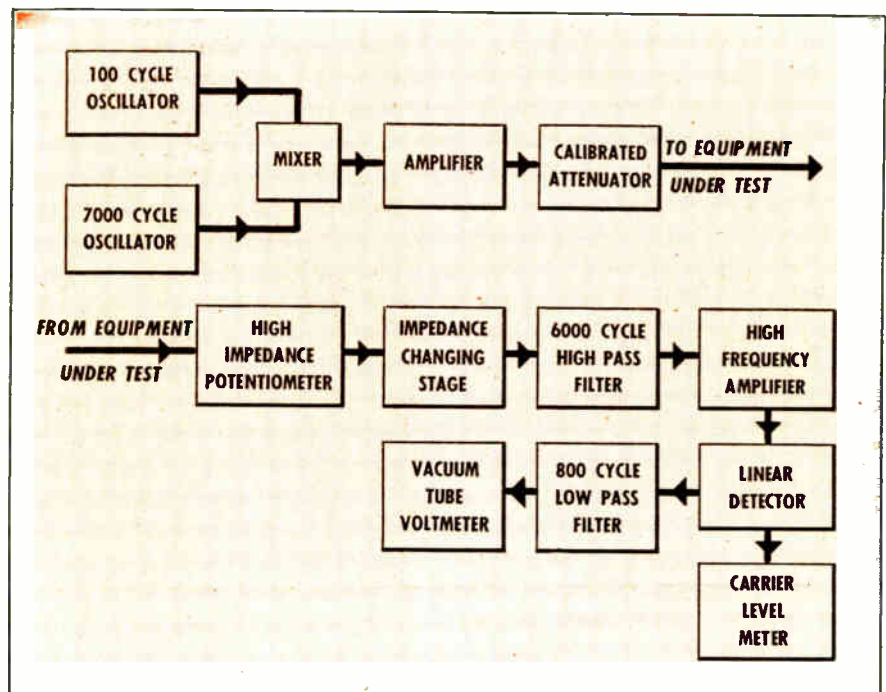

Fig. 2—Input and output channels of the distortion analyzer

contain, beside the two input frequencies f_1 and f_2 , integral multiples of f_1 and f_2 (harmonics) and the frequencies $f_2 + f_1$ and $f_2 - f_1$.

Inasmuch as most musical tones consist of a fundamental frequency and many strong harmonics, the slight change in tone-color caused by a small amount of added harmonics would not be noticed. It is

the addition of the non-harmonic frequencies, $f_2 + f_1$ and $f_2 - f_1$ which causes trouble. This kind of distortion is immediately apparent when two high pure tones, such as a flute and a coloratura soprano, are being transmitted together. The low tone heard along with the two high ones is entirely a result of this distortion.

The existence of these sum and

INTERMODULATION

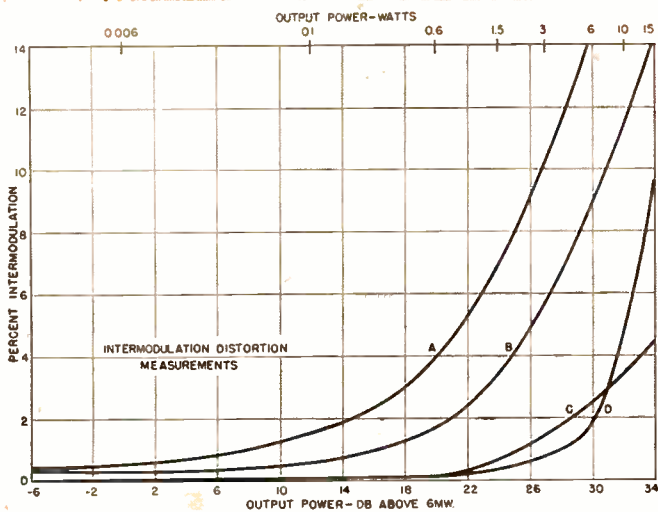

Fig. 3—Intermodulation in various amplifiers

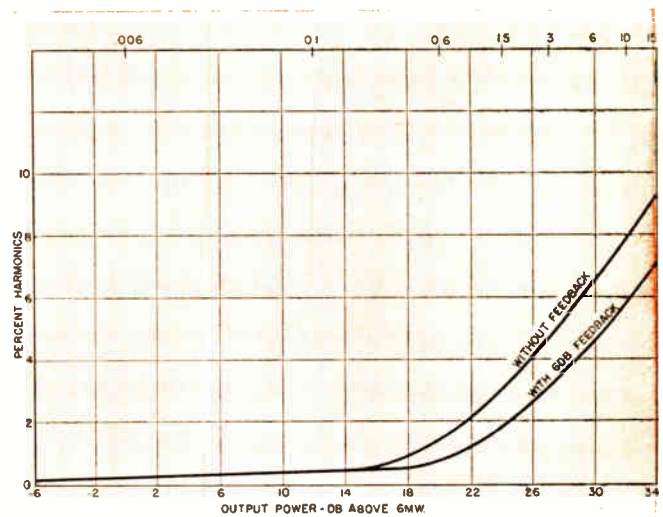

Fig. 4—Harmonic distortion in push-pull 6V6 amplifier

difference tones suggests a method of measurement of this distortion. Two frequencies, say 1000 cycles and 1100 cycles, could be applied to the system under test in equal amplitudes. A filter tuned to 100 cycles could be used to separate the difference frequency, the amplitude of which could then be measured. This method has the following disadvantages:

1. A slight percentage change in one of the test frequencies would change the frequency of the difference tone by a considerable amount. With a sharply selective band-pass filter this would necessitate a tuning control.
2. In order to measure small percentages of distortion, the filter would have to operate at a very low level. Hum pickup would be a serious problem under these conditions.
3. Inasmuch as the two test tones have to be fairly close together, the system still is being tested only in a narrow frequency band.

A further examination of the output spectrum of the nonlinear system shows that the principal components are f_1 , f_2 , $f_2 + f_1$, and $f_2 - f_1$. If f_1 were removed, the output would consist of a "carrier" frequency, f_2 , with sideband frequencies of $f_2 + f_1$ and $f_2 - f_1$. The energy contained in the sidebands is directly related to percentage modulation.

This then, suggests a better

method of measurement. The output from the equipment under test is filtered to remove the lower of the two test frequencies. The remaining frequency or "carrier" is modulated as a result of any non-linearity in the equipment under test. This modulated "carrier" is amplified and detected by a linear diode. The carrier is then removed by a low-pass filter. The remaining voltage is measured by a vacuum tube voltmeter, which is calibrated directly in percentage of intermodulation.

Fig. 2 is a block diagram of the instrument to be described. The instrument is constructed in three sections, arranged to mount in a standard relay rack, or in a separate case. The first section is the signal generator section. This unit consists of two phase shift oscillators of identical construction using stabilized resistors and mica capacitors as the frequency-determining elements. The oscillator power supply is voltage-regulated to prevent line disturbances from affecting either output voltage or frequency. The oscillator outputs are mixed, amplified, and applied to a precision attenuator.

The two frequencies used are 100 cycles and 7000 cycles per sec. These particular frequencies were chosen because they are representative of the limits of most audio apparatus. The 100 cycle and 7000 cycle tones are applied to the attenuator at zero level (1.73 v across 500 ohms). The attenuator has a range of 110 db in 1 db steps.

The second section is the measurements section. This consists of an input potentiometer for adjusting carrier level, an impedance transforming amplifier stage, a 6000-cycle high-pass filter, a high frequency amplifier, a linear diode detector, a 800-cycle low-pass filter, and a vacuum tube voltmeter which measures the ac component of the detector output. The two panel meters read carrier level (diode dc) and intermodulation percentage.

The third section is the regulated power supply for these two units. It is kept separate to facilitate convenient mounting of the other units, and to eliminate possible trouble from hum.

In operation, the instrument is rapid and convenient to use. The signal from the generator is applied to the input of the equipment to be tested. Inasmuch as the input impedance of the measurement section is one megohm, the instrument may be used across a comparatively high impedance circuit. The input leads are connected to the point at which it is desired to know the distortion. Voltages between 1v. and 400v. may be measured. The carrier level meter is set to a given line on the scale by means of a potentiometer. This adjustment sets the dc component of the rectified modulated signal to a uniform level for all tests. The ac voltage component is then applied to a vacuum tube voltmeter. VTVM indication is calibrated directly in percent intermodulation.

Measurements made with this in-

strument agree very well with listening tests. The difference between triode and beam power amplifiers is very clearly indicated. Fig. 3 is a plot of some intermodulation distortion measurements made on three different amplifiers. Curve A is a push-pull 6V6 amplifier with no feedback. Curve B is the same amplifier with 6 db of feedback. Curve C is a push-pull 6L6 amplifier with 20 db of feedback. Curve D is a push-pull 2A3 amplifier with no feedback. The 2A3 amplifier has less than 5% harmonic distortion at 15 w output. The 6L6 amplifier has less than 4% harmonic distortion at 25 w. The 2A3 amplifier shows lower intermodulation at medium power levels. Harmonic distortion characteristics of the 6V6 amplifier, with and without inverse feedback, are shown in Fig. 4. A comparison between these two figures clearly indicates the greater sensitivity of the intermodulation method of measuring distortion.

Results vs. theory

It is of great interest to derive the algebraic relationship between intermodulation distortion and harmonic distortion. Fig. 5 is a graphical representation of a nonlinear system with a single sine wave input. The symbols of the diagram are referred to in the equations below. Fig. 6 is a graphical representation of the same nonlinear system with two sine wave input signals. The symbols on this diagram also refer to the equations to follow. In both of these diagrams the condition of nonlinearity has been made very severe in order to give a clear physical concept of what happens to the signal under these conditions.

A relatively simple condition will first be set up in order to demonstrate the method, which will then be applied to a more practical type of nonlinearity.

The curve relating y (the dependent variable) to x (the independent variable) can be generally stated:

$$y = f(x)$$

Assuming a general expression for a second order curve (one which will produce second harmonic distortion):

$$y = ax^2 + bx + y_0 \quad (1)$$

In the condition shown in Fig. 5:

$$x = x_0 + E \sin \omega t \quad (2)$$

Substituting equation 2 in equation 1,

$$y = a(x_0 + E \sin \omega t)^2 + b(x_0 + E \sin \omega t) + y_0 \quad (3a)$$

and then solving algebraically, the equation of the output voltage is found to be:

$$y = (2ax_0 + b)E \sin \omega t - \frac{aE^2}{2} \cos 2\omega t + ax_0^2 + bx_0 + \frac{aE^2}{2} + y_0 \quad (3b)$$

The constant terms indicate the direct current output voltage, and

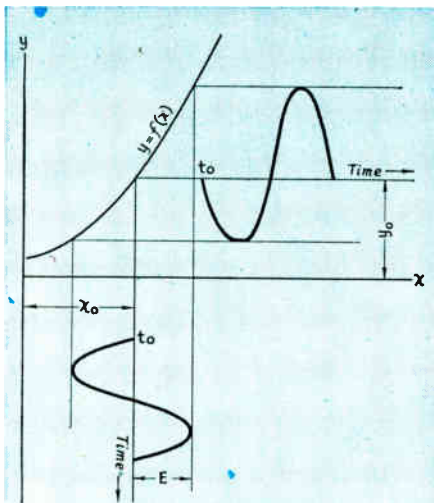

Fig. 5—Non-linear response to one frequency

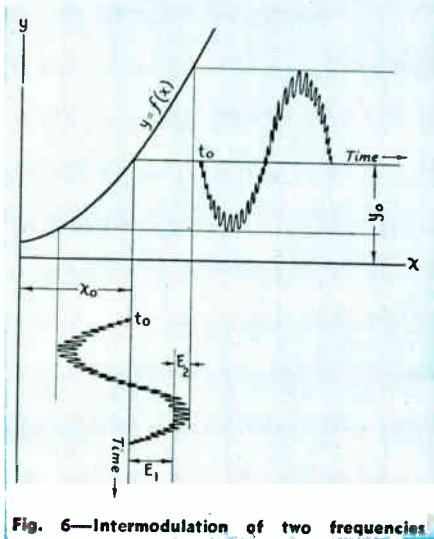

Fig. 6—Intermodulation of two frequencies

can be disregarded in a discussion of the signal voltages. The second harmonic distortion is the second harmonic voltage divided by the fundamental:

$$\frac{aE^2}{2(2ax_0 + b)E} = \frac{aE}{4ax_0 + 2b} \quad (4)$$

In a curve of this type the second harmonic distortion is proportional to the amplitude of the input voltage, and decreases with increasing dc operating voltage.

Using the same function to relate y to x , let us apply an input voltage consisting of two sine waves:

$$x = x_0 + E_1 \sin \omega_1 t + E_2 \sin \omega_2 t \quad (5)$$

Substituting equation 5 in equation 1:

$$y = a(x_0 + E_1 \sin \omega_1 t + E_2 \sin \omega_2 t)^2 + b(x_0 + E_1 \sin \omega_1 t + E_2 \sin \omega_2 t) + y_0 \quad (6a)$$

Solving algebraically for the simplest expression for y :

$$y = (2ax_0 + b)E_1 \sin \omega_1 t + (2ax_0 + b)E_2 \sin \omega_2 t - \frac{aE_1^2}{2} \cos 2\omega_1 t - \frac{aE_2^2}{2} \cos 2\omega_2 t + \frac{aE_1 E_2}{2} \cos (\omega_1 t - \omega_2 t) - \frac{aE_1 E_2}{2} \cos (\omega_1 t + \omega_2 t) + ax_0^2 + bx_0 + y_0 + \frac{aE_1^2}{2} + \frac{aE_2^2}{2} \quad (6b)$$

As in equation 3 the constant terms indicate the D. C. voltage. Eliminating these terms and passing the current through a high pass filter, cutting off below the frequency:

$$f = (\omega_1 t - \omega_2 t)$$

and, assuming k to be larger than 3, we obtain an expression for an output voltage:

$$y = (2ax_0 + b)E_2 \sin k\omega_1 t - \frac{aE_2^2}{2} \cos 2k\omega_1 t + \frac{aE_1 E_2}{2} \cos (k\omega_1 t - \omega_2 t) - \frac{aE_1 E_2}{2} \cos (k\omega_1 t + \omega_2 t) \quad (7)$$

This wave is seen to consist of a carrier of amplitude:

$$(2ax_0 + b)E_2$$

Second harmonic distortion of the carrier:

$$\frac{aE_2^2}{2}$$

Upper and lower sideband frequencies of amplitude:

$$\frac{aE_1 E_2}{2}$$

The expression for an amplitude modulated wave may be arranged in the form:

$$E = A_c (1 + m \cos \omega_m t) \cos \omega_c t \quad (8)$$

Where: A_c = amplitude of carrier
 $\omega_c t$ = frequency of carrier
 $\omega_m t$ = frequency of modulation
 M = degree of modulation

Substituting the equivalent terms in equation 8:

$$E = E_2 (2ax_0 + b) (1 + m \cos \omega_2 t) \cos \omega_1 t \quad (9a)$$

(Continued on page 124)

\$1000 AWARD WINNERS

Panel of distinguished judges chooses editorial articles of outstanding merit covering diverse electronic applications

• After more than a month of careful study, a panel of three judges has selected the winners of the \$1,000 Editorial Award offered by Electronic Industries, and the publishers, Caldwell-Clements, Inc., have been happy to send checks to the authors.

First Award of \$600 has been given by unanimous decision of the judges to Wesley M. Roberds of the Engineering Department of the Radio Corp. of America, Camden, N. J., for his article appearing in the May, 1945, issue of Electronic Industries entitled: "Design of Electronic Heating Generators".

Second Award, amounting to \$300, has been presented to a team of authors, Dr. Hans Beller and C. O. Altmann, both of whom are connected with the Carbonyl Iron Plant of the General Aniline & Film Corp., Linden, N. J. Dr. Beller is general manager of the plant. The title of their joint article is: "Radio Frequency Cores of High Permeability". It appears in the November, 1945, issue of Electronic Industries.

Third Award, of \$100, was given by the judges to W. S. Bachman who is an engineer with the General Electric Co., Receiver Division, Bridgeport, Conn. His article is entitled "Phonograph Dynamics" and appeared in the July, 1945, issue of Electronic Industries.

The distinguished panel of judges who were chosen to evaluate all



WESLEY M. ROBERDS
First Award \$600

editorial articles appearing in Electronic Industries between May and December, 1945, inclusive, and who had sole jurisdiction in making the Awards, were chosen as representing wide general knowledge of the whole field of electronic applications as well as considerable experience in specific fields.

The judges were: A. B. Chamberlain who is Chief Engineer of the Columbia Broadcasting System where he served for 11 years before the war and where he has lately returned after serving as a Captain in the U. S. Navy during the late unpleasantness.

Jesse B. Sherman, another of the

judges making up the panel of three, is Assistant Professor in the Department of Electrical Engineering of Cooper Union School of Engineering, New York.

Remaining member of the panel is F. H. Shepard, Jr., who is a Consulting Engineer specializing in electronic applications with offices in Summit, N. J.

Examination of the titles and contents of the articles which won the Awards for their authors indicates that the subjects cover a wide diversity of applications.

"Design of Electronic Heating Generators" by Roberds, is a scholarly presentation of the engineering problems involved in the choice of industrial oscillators for inductive and dielectric heating applications, the practical design of such equipment to make it of maximum value to users through the use of components correct for the purpose.

Beller and Altman, covering "Radio Frequency Cores of High Permeability", is on the technics of using the new soft iron powders of fine grain size with high efficiency insulators to make possible production of cores with permeabilities of 40 to 70 with comparatively low eddy current loss coefficients.

W. S. Bachman, on "Phonograph Dynamics", discussed the manner in which groove space restricts amplitude of reproduction, and how the cutter, stylus shape and mechanical Q limit fidelity.

G. O. ALTMANN
Joint Second Award \$300



Dr. HANS BELLER
Joint Second Award \$300



W. S. BACHMAN
Third Award \$100



PHASE SENSITIVE

By PAUL H. HUNTER

Instrumentation Editor—ELECTRONIC INDUSTRIES

Methods of ac vacuum tube operation without special rectifiers, including some applications to bridge type instruments and controls

• Because vacuum tube circuits for communications purposes generally have direct current supplies for anode and screen grid operation, many electronic engineers are unaware that complete ac operation of vacuum tubes is coming into widespread use. In particular, an ac operated bridge unbalance detector, illustrated schematically in Fig. 1, found very broad application during the war for such diverse purposes as uhf power measurement, industrial process recording and control, aircraft automatic pilots, FM transmitter frequency control systems, FM discriminators, etc. Developed independently by workers in several unrelated fields, this method combines the functions of phase and amplitude detection, full-wave rectification, amplification and bridge

operation in a vacuum tube circuit supplied by a single source of alternating current.

In the generalized circuit of Fig. 1, the amount and direction of current flow in a dc galvanometer is governed by the control variable, R_x , which may be any type of conversion element, such as a thermocouple, bolometer, pressure pickup, photocell, reactor, etc. In actual use for measurement or control, bridge balance usually is restored by either the manual or automatic resetting of an opposite element, shown as R_v in the figure, and the indication or control is then effected by the amount of restoration required.

A convenient arrangement for investigating the characteristics of unbalance detectors is given in Fig. 2. The resemblance of the unbalance detector to a full-wave, grid controlled rectifier system becomes obvious, the only difference being in the use of separate loads, R_1 and R_2 , to isolate the two trains of half-wave voltage pulses. Assuming a balanced condition, the voltage pulses across both R_1 and R_2 will have equal amplitudes, but will alternate at 180° intervals. Since E_1 and E_2 are of the same polarity with respect to the transformer center tap (point P), the average output voltage, E_0 , will be zero. Thus far the operating prin-

ciple is similar to that of an FM discriminator. Now if the voltage tap on R_v is moved from its electrical center (corresponding to balance), an ac potential will be applied to both grids. The effect of this grid signal on the tube conductances will, of course, depend on the signal polarity with respect to point P during the conducting half-cycles of these tubes. If the slider of R_v were adjusted above center, for instance, both anode and grid of V_1 would be positive at the same instant, while 180° later the anode of V_2 would become positive and the common grid negative. Under this unbalanced condition, the output pulses would be of unequal amplitude and E_0 would contain a dc component of positive polarity with respect to the cathode of V_2 . Conversely, an adjustment of R_v that places the grid voltage of V_2 in phase with its plate voltage will result in a negative polarity at the cathode of V_1 .

The versatility of this principle is demonstrated by the various application shown in accompanying figures. An ingenious application to high frequency measurement is shown in Fig. 3—a barretter bridge developed by E. Conrad of the Measurements Corp. for accurate measurement of high frequency signal generator output. In this instrument the element of con-

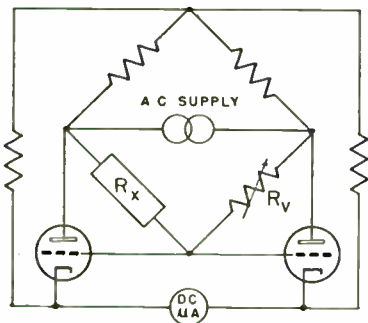

Fig. 1—Generalized bridge detector circuit

Fig. 2—Circuit for investigating grid controlled detectors

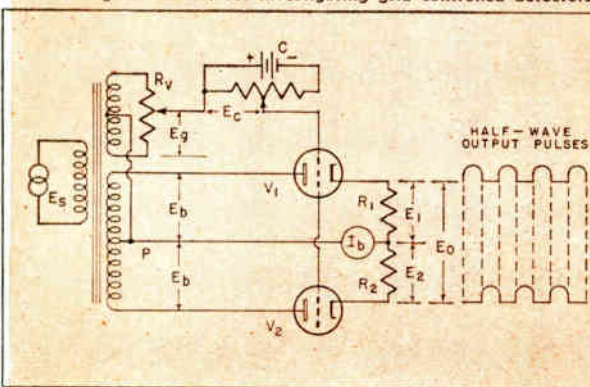
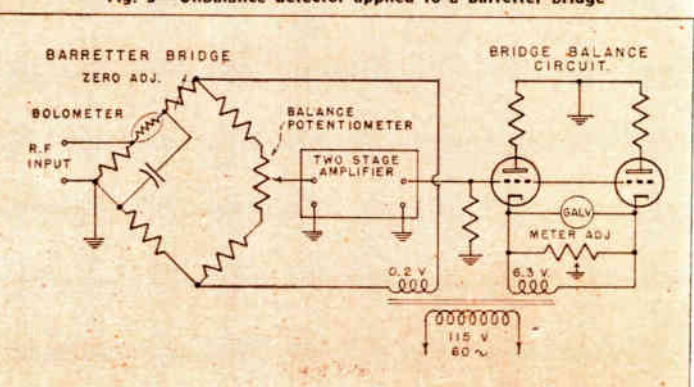

Fig. 3—Unbalance detector applied to a barretter bridge



BRIDGE DETECTOR

tol is a special bolometer element consisting of a fine platinum filament in an evacuated glass envelope. When heated by high frequency currents, the bolometer resistance increases. Ambient temperature response of the system

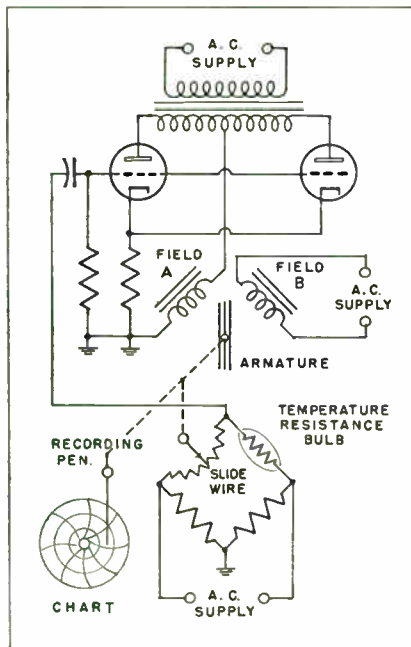

Fig. 4—Rebalance circuit for graphic recording

is prevented by enclosing the bolometer in a temperature controlled oven, or in some instruments, by inserting a "dummy" bolometer in an opposite arm of the bridge. Bridge balance is restored by manual adjustment of the rebalancing potentiometer. Careful design of the input network permits calibration of the rebalance dial in terms of microvolts across a standard impedance, using a standard battery cell and potentiometer having five place accuracy. This calibration is then maintained over the range from dc to 400 megacycles. The cathode-driven bridge balance circuit of this instrument overloads rapidly with increasing unbalance, providing automatic protection for the sensitive galvanometer.

The circuit of Fig. 4 shows an application to high speed industrial process recording. Various modifications of this arrangement have been developed by the Brown Instrument Co.¹, the Foxboro Co., the Bailey Meter Co.² and others, for recording variables such as temperature, pressure, liquid level,

flow, etc. The recording usually takes the form of a graph, on either polar or rectangular coordinate charts, showing the amount of bridge balance restoration in terms of the process variable as a function of time. In Fig. 4, the three ac supplies may be derived from separate taps on the secondary of a common power transformer. Since supply voltage variations have a proportional effect on all three branches of the circuit, the system has a tendency to be stable and self-regulatory. The restoration motor is of either rotary or solenoid type, while the slide wire shown in Fig. 4 may be replaced by a variable capacitor or other variable element, provided a fixed element of the same type is included in an opposite arm of the bridge. For control purposes, a regulating device may be substituted for the graphic recorder and rebalancing system. Balance would then be restored when the control variable returns to its predetermined operating point under influence of the process variation being controlled. However, since considerable time lag is usually present in control systems, especially when temperature correction is involved, the instantaneous response of this circuit will be of less importance to a control system than to a metering device. The lower torque requirements and longer service life of a variable air capacitor may be utilized by operating the system from a 1000 cycle oscillator. This higher frequency reduces the variable capacitor to practical dimensions, while the lower torque permits use of standard voltage amplifier tubes to control a relatively low power motor.

Electronic autopilot

Fig. 5 shows another version of the unbalance detector developed by the Aeronautical Division of the Minneapolis-Honeywell Regulator Co.³ for automatic flight control of aircraft. Three of these circuits were used in heavy bombers such as the B-29 Superfortress to control ailerons, rudder and elevators in response to signal voltages from the automatic pilot gyroscopes.

While dc operated amplifiers are usually inserted between the bridge

detector and rebalancing device, there appears to be no good reason why the anodes of all tubes in such a one-frequency system could not be supplied from a common ac source. The problem is merely one of amplifying small voltage variations at the common supply frequency. Elimination of separate rectifier and filter components would be quite an advantage from the standpoints of cost, weight and maintenance, especially in heavy duty equipment so often required for industrial process control.

In reviewing the peculiar advantages of the grid controlled rectifier principle of unbalance detection, it should be noted that the following characteristics have an important bearing on most instrument and control applications:

(1) Ability to detect minute changes in any one of the bridge elements and to sense the direction of such changes about any point to which the system is balanced.

(2) Positive coupling between cause and effect, due to the instantaneous response of the electronic system.

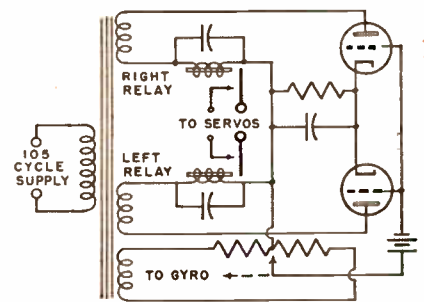

Fig. 5—Aileron control circuit for aircraft

(3) Almost unlimited design flexibility, permitting any type of "anti-hunt" characteristic or overload protection to be incorporated in the electronic coupling.

(4) Accurate and stable response, despite random variations in supply voltages.

(5) Simple maintenance, due to inherent circuit simplicity.

References:

1. Harrison, Wills, Side, "A Self Balancing Potentiometer," *Electronic Industries*, May 1943, p. 68.
2. Dickey, Hornfeck, "Electronic-Type Instruments for Industrial Processes," *Trans. of the A.S.M.E.*, July 1945, p. 393.
3. Gille, Sparrow, "Electronic Autopilot Circuits," *Electronics*, October 1944, p. 110.

FM RAILROAD RADIO

By **WILLIAM S. HALSTEAD**

Consulting Engineer, Farnsworth Tele and Radio Corp., Ft. Wayne, Ind.

Remote transmitters operating in 152-162 mc band controlled by induction signalling equipment for complete coverage

● A new FM satellite system, for extending the range of two-way VHF radio-telephone equipment in railroad terminal or main line operations, demonstrated its value in rail communications service during a three-day series of point-to-train, train-to-train, and intra-train tests conducted during March 19-21, 1946 by the Detroit, Toledo and Ironton Railroad, the Ford Motor Co., and Farnsworth Television and Radio Corp.

The new system, which may find a number of applications in the railroad communications field and in other VHF radio services, has one or more VHF satellite stations of frequency-modulation type operable in the 152-162 mc band in association with a central station which controls the satellite equipment via low-frequency (150-250 kc) FM induction radio signals impressed on already-existing wayside wires extending along railroad right-of-way between the stations. The same assigned carrier frequency is used by the different VHF stations.

In this manner, relatively great signal strength may be maintained at all parts of a large service area, such as a terminal district, or a



Remote control unit located in Detroit, Toledo and Ironton's Flat Rock yards being operated by E. A. Nicholas, president of Farnsworth (seated) and M. L. Bricker, vice-president of Ford

longitudinal-extending radio service zone along railroad main-line tracks. Each satellite station may be controlled locally, for zone communications in its particular service area, or by means of the induction radio circuits from the central station. This flexible arrangement

permits both the maintenance of high signal intensity throughout large service areas, when required, and local yard communications in different portions of the terminal area.

Thus, if the yardmaster at the central station in Yard 1 wishes to

Compact remote control unit installed in cab of Diesel locomotive

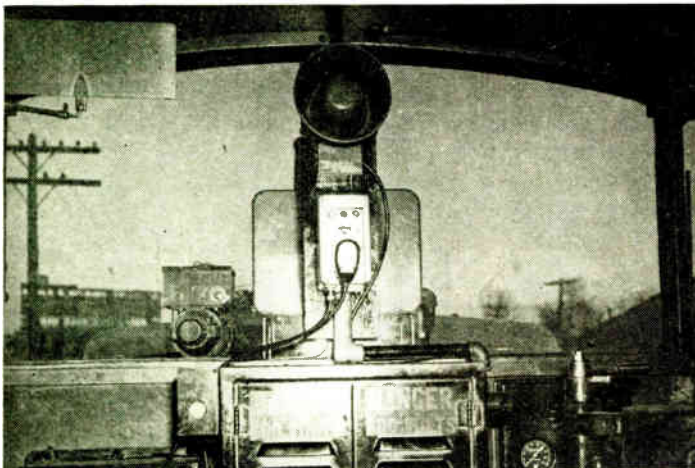

Outer housing for the mobile transmitter shown (left) from inside

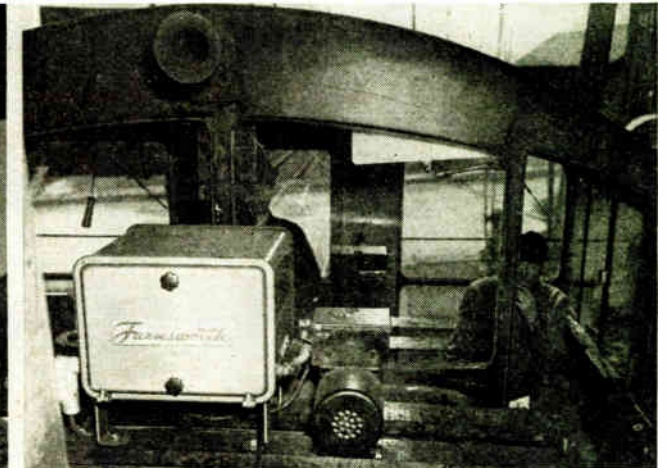

SATELLITE SYSTEM

communicate with the engineman of a switch engine in a remote portion of a large terminal area, such as Yard 2, which may be located beyond the normal communications range of the equipment in Yard 1, he may, by operation of a "LOCAL-REMOTE" selector switch, remotely control the low-power zone transmitter at satellite station 2, via induction radio signals impressed on the wayside wires extending between the two stations. A strong radio signal is thereby received on the "Called" locomotive in Yard 2, even though it may be within or between the large steel-frame buildings commonly found in industrial yard areas.

Strong signals from the locomotive transmitter are likewise picked up by a local receiver at the satellite station in Yard 2, and relayed via the induction radio link back to the yardmaster at the central station in Yard 1. In similar manner, a locomotive in other yard areas may be called, or all mobile units, including radio-equipped motor vehicles, in the entire terminal area may be reached without the use of excessively high power at any of the fixed stations or on the mobile units.

If local yard communication, as in Yard 1, is desired, the yardmaster at Yard 1 actuates the "LOCAL-REMOTE" selector switch and uses only the low-power VHF equipment at the central station. In the same way, the yardmaster in Yard 2 may establish communications with mobile units in his local service zone. Since FM is used, all the yard stations may be operated on the same assigned frequency without the serious heterodyne whistles which would be present if AM were used in the same terminal district.

In main-line operation, the satellite stations may be located at intervals along the railroad right of way over any desired distance. As the same VHF carrier frequency is used by the different satellite stations, a mobile unit may proceed from zone to zone without need to change frequency, as would be required in AM systems for effecting the same purpose.

The use of induction radio links between the satellite stations is an outgrowth of a system developed during the war period,¹ for remote control of a plurality of low-power medium-frequency zone transmit-

¹ "Induction Radio" by W. S. Halstead, Electronic Industries, pp. 86-89; 200-206, December, 1943.

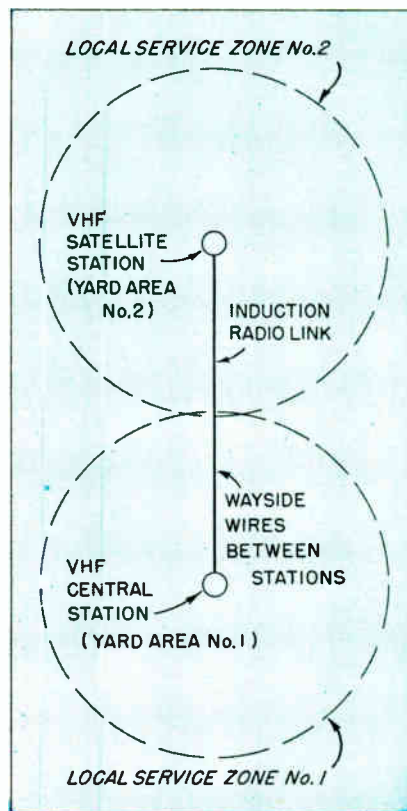

Schematic of VHF satellite system using induction radio link between fixed stations in different yards. Same carrier frequency is used by the two stations

Block diagram of the VHF satellite system with induction link between fixed stations as tested by Ford and Detroit, Toledo and Ironton railroad

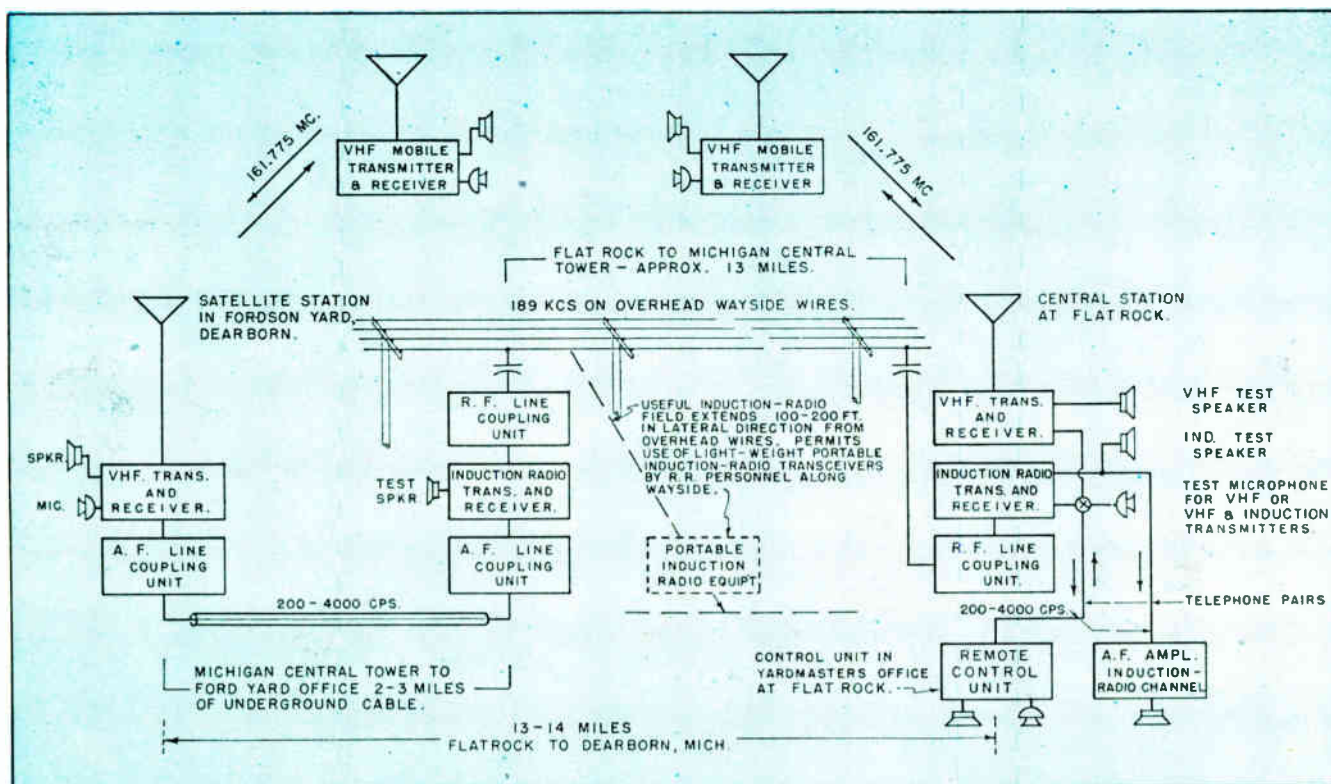

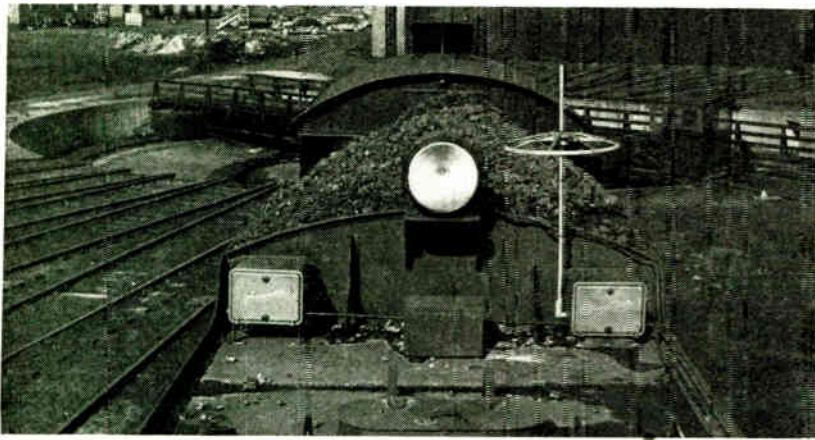

Installation of transmitter, receiver and power supply and cartwheel type ground-plane antenna on tender of the steam locomotive. Units shock mounted

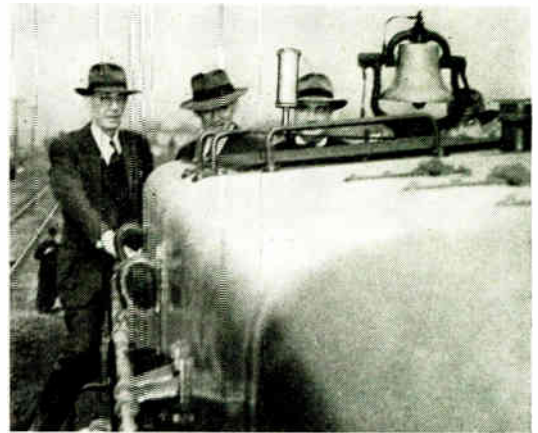

New low type antenna on Diesel engine sticks up no higher than locomotive bell

ters in different sections of a large service area by means of relatively low-frequency radio-carrier signal impressed on wire lines serving the respective zones.

The advantages of the new technic in tying together the VHF stations used in train communication include, in addition to those discussed in the above paragraphs, (1) the ability of an induction radio link to maintain two-way communications in event of line failure (all overhead lines could be prostrated, and severed at several places, without failure of the system, which utilizes all wires as a radio-wave conducting path); (2) the flexibility of tie-in connections with an induction radio circuit, in that additional transmitters and receivers may be coupled to the wayside wires at any point, and the same or different carrier frequencies used without interfering with the normal wire or carrier services; (3) the ability of an induction radio link to permit use of small

camera-size "radio paging" receivers, or light-weight "walkie-talkie" units, at points in the immediate vicinity of overhead wayside wires on which the radio carrier signals are impressed; (4) the improved audio-frequency response characteristics of induction-radio equipment, which may be substantially uniform between 200 and 4000 cycles, if desired; (5) the relative lack of line noise and cross-talk, particularly with FM carrier equipment, operative in the rf spectrum between 150 and 250 kilocycles; (6) the concentration of inter-station signal-conducting paths along the railroad's right of way, where the induction radio field surrounding the wayside wires may be utilized for many purposes by railroad personnel, rather than in a broad path through space.

In the tests of the new technic by DT&I, a low-power (10-watt) VHF frequency-modulated transmitter and an associated receiver, of unitized design, and operating

on a frequency of 161.775 mc, were installed on the wall of a small building, at the base of a water-tower, approximately 165-feet high, in the Flat Rock Yard of the DT&I railroad. This equipment was used as the central station of the system and functioned under experimental call letters W10XHG.

A new type of antenna, developed by Farnsworth, was mounted at the top of the water-tower, at a height of about 175 ft., above ground. The induction radio transmitter and receiver, also of unitized frequency-modulation type, operating on a frequency of 189 kc, were installed adjacent to the VHF apparatus. The induction equipment was coupled to the wayside wire circuits by series capacitors, with an attenuator in the output circuit of the transmitter to reduce the amount of rf power impressed on the line to about 1/2 watt.

The VHF and induction radio equipment was selectively controlled by means of telephone line

Installation of remote control unit, microphone and loud speaker in locomotive cab. Photograph was made from engineer's side of the cab

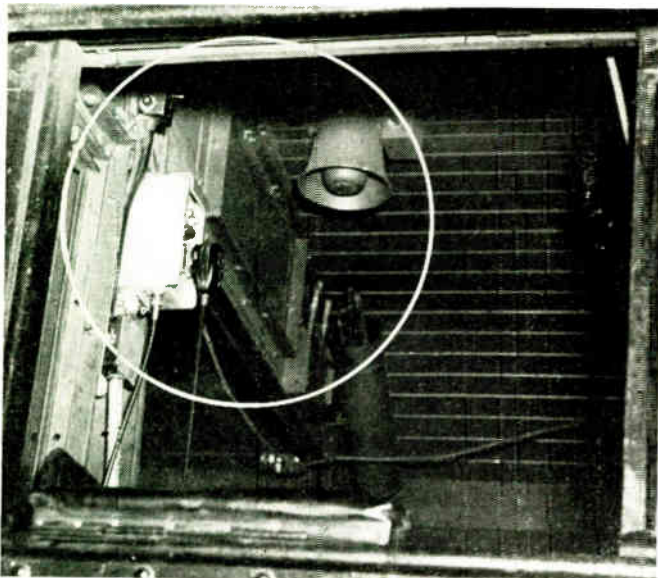

J. C. Ferguson, Farnsworth chief engineer (left) and William G. Clinton, DT&I communications engineer inside the radio equipped special coach

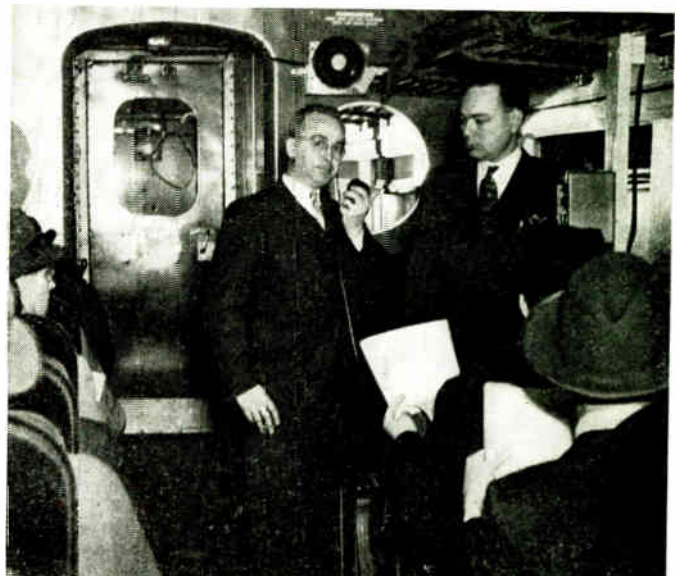

connections with the Flat Rock Yardmaster's office, about 1,000 ft. distant, where a remote control unit was located. The control unit included a loudspeaker, handset, amplifier and other controls. This was used to remotely control both the VHF and induction radio equipments, with a "LOCAL-REMOTE" selector switch being utilized to permit energization of the VHF equipment only, or both the VHF and induction radio units.

An audio amplifier and loudspeaker, shown at the right of the remote control unit, were connected with the induction receiver at all times. By means of the two separated loudspeakers, operating personnel at the control desk could readily distinguish between voice signals received via the VHF and induction radio circuits. A microphone and loudspeaker also were used at the location of the transmitters and receivers to facilitate test operations at that point.

A second induction unit, similar to that used at Flat Rock, was installed in a signal tower of the Michigan Central railroad, adjacent to a crossing of the DT&I and Michigan Central tracks. This location was selected since the overhead wires, which ran as a pole line along the DT&I tracks from Flat Rock to Dearborn, converged into a buried cable and extended underground from this point to the yardmaster's office at the Ford Motor Co. plant. The underground circuit was 2-3 miles in length and had a high capacity to ground, thus causing excessive attenuation of the rf carrier energy at the frequency used in the tests.

The induction radio receiver and transmitter at the Michigan Central tower were coupled to the overhead wire circuits by series capacitors, as at Flat Rock. A telephone pair, in the underground wire circuit, was used to permit remote control of the induction radio transmitter from the Ford Yard office, either by the yardmaster at that point or by automatic relay control during reception of VHF carrier wave energy by the space-radio receiver at the Ford Yard satellite station.

Signals received from Flat Rock
(Continued on page 126)

Map of complete satellite system: Master control communicates direct with locomotive No. 1 and through induction link and satellite space transmitter to locomotive No. 2; auxiliary control point communicates through satellite to locomotive No. 2; induction link provides signal to master control for monitoring satellite; locomotives communicate direct between each other

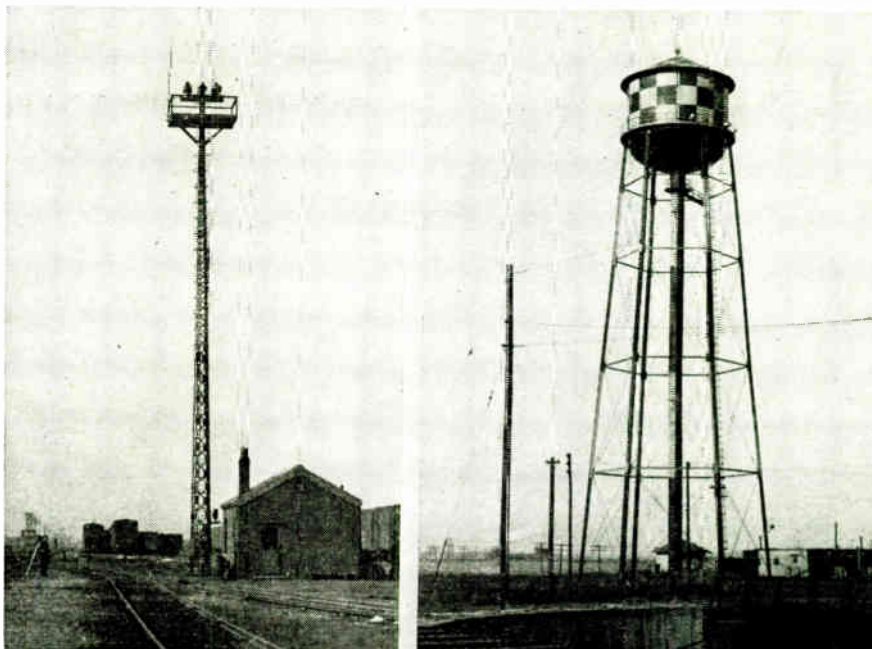

Satellite antenna atop a light tower

Main station antenna atop water tower

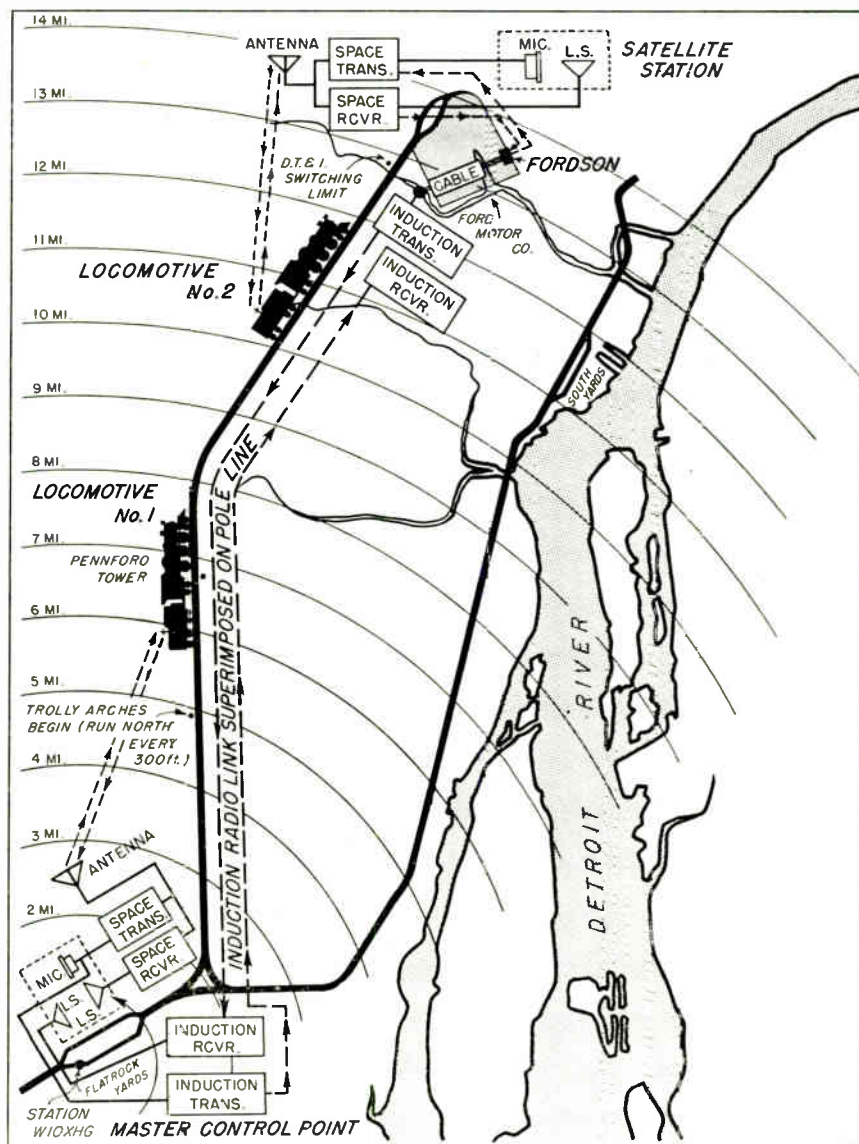

ELECTRONIC USES IN INDUSTRY

by **W. C. WHITE**

Electronic Engineer, General Electric Company, Schenectady, N. Y.

• This a fourth of a series of selected references published annually in "Electronic Industries" for those interested in the industrial applications of electronics. Each year has shown a change or trend in emphasis. For the past year, the application of electronics to measurement and process control has shown a marked increase. The interest and importance of this field will probably continue for some time.

The list of references is by no means complete as many hundreds of articles on the subject were published during the year. The selection is based primarily upon electronic applications in industry and, therefore, particular attention is paid to articles in trade journals where the application was treated from the viewpoint of the particular nature of a business.

The removal of classification on radio and radar wartime developments has had its effect on the literature, particularly in the radio communication field. Here the trends have almost been revolutionized. This effect is hardly apparent as yet in the industrial applications of electronics for reasons of war secrecy. However, it may be expected that some radar devices and technics will find application in the industrial field to an increasing extent from now on and this trend will be apparent in future articles.

Another result of wartime developments in radar has been the introduction of many new words or word meanings and phrases that have been secret until recently but are now available for general use. One phase of this is the idea of assigning words and phrases to designate devices and projects and this will probably continue. In general, these new terms are not from old word roots but rather are made up either from the initials of a descriptive phrase or old word or words being given a new meaning. In the latter case, the normal meaning of the word may or may not give a clue to the device or method. The word LORAN is a good example of the use of initials to form a new word. The words ROPE and TUBA are examples of

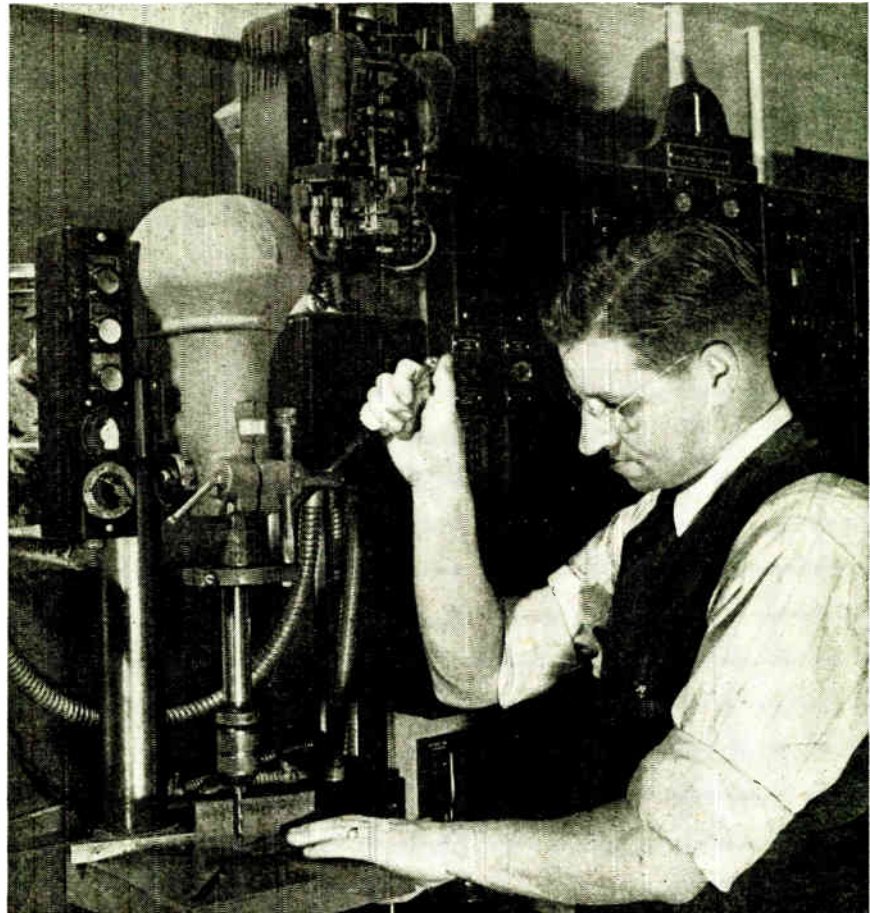

Typical application of Thymotrol electronic drive to small drill press provides operating speeds of from 25 to 1750 rpm and reverse, thus multiplying drilling usefulness, permitting tapping

words where there is some hint of the nature or appearance of the device, whereas CARPET and WINDOW give no clue. It is probable that this idea of applying a word or terse phrase to a new development or project will carry over as a postwar custom as it has appeal and a certain degree of usefulness.

In addition to these new words, there are many new terms and expressions that have come into being as a result of radar developments and some of these will find continued application in electrical engineering. The September, 1945, issue of "Electronic Industries" (see page 92) contains the best glossary of radar expressions that has appeared so far in this country.

The total number of articles on industrial electronics published in 1945 did not show a great increase over 1944, but there was apparently a trend toward more such articles in trade journals.

A few references are included that are not strictly electronic devices but involve items or methods closely associated or widely employed with electron tubes and their application.

Much the same arrangement and classifications are used as appeared in last year's summary. Also, as was the case last year, a few articles are listed that appeared too late in 1944 for inclusion with that year, or had previously escaped attention of the author.

Aircraft Applications

1. Aircraft Electronic Applications, A. P. Upton. "Proceedings of National Electronics Conference," 1944; v. 1, p. 110.
2. Electronic Turboregulator, W. H. Gille and H. T. Sparrow. "Aero. Engng. Rev.," Oct., 1944; v. 3, p. 37.
3. Electronics Sets Standard for Automatic Control, W. H. Gille and R. J. Kutzler. "Mach. Design," Nov., 1944; v. 16, p. 117.
4. Alternating Versus Direct Current for Aircraft-Radio Power Supply, D. E. Fritz and C. K. Hooper. "Sup. AIEE Transac.," Dec., 1944; v. 63, p. 1227 (disk 1466).
5. Latest Type AAF Blind Landing Equipment, M. E. Montgomery. "Electronic Industries," Jan., 1945; v. 4, p. 100.
6. Electronic Control for the Autopilot. "Aero. Digest," Feb. 1, 1945; v. 48, p. 102.
7. Development of Aircraft Instrument Landing Systems, H. H. Buttner and A. G. Kandoian. "Electrical Communication," v. 22, No. 3, 1945, p. 179.
8. Electronic Recorder Aids Flight Research, Thomas A. Dickinson. "Aero. Digest," Apr. 15, 1945; v. 49, p. 76.
9. Landing Airplanes by Instrument, H. H. Buttner. "The International Review" (of the I.T.&T.), June, 1945; p. 10.
10. Electronic Timer for Aircraft De-icer, D. W. Blöser and G. R. Holt. "Electronics," Dec., 1945; v. 18, p. 152.

Amplifiers

11. Principles of Klystron Amplifiers, R. O. Haxby. "Proceedings of National Electronics Conference, 1944; v. 1, p. 229.
12. Strain Gage Amplifier Design, W. Mehafey. "Proceedings of National Electronics Conference," 1944; v. 1, p. 351.
13. Low Frequency Amplification, K. R. Sturley. "Electronic Engng.," Nov., 1944, p. 236; Dec., 1944, p. 290; Jan., 1945, p. 335; Feb., 1945, p. 378; Mar., 1945, p. 429; Apr., 1945, p. 470; May, 1945, p. 510.
14. A Note on Amplifiers for Electrocardiography, G. D. Dawson. "Electronic Engng.," Dec., 1944; v. 17, p. 293.
15. Measuring Klystron Amplifier Features, Coleman Dodd. "Electronic Industries," Feb., 1945; v. 4, p. 76.
16. A Photoelectric Galvanometer Amplifier, Gabrielle Assel. "Electronics," Feb., 1945; v. 18, p. 126.
17. Zero Phase Shift Amplifier, L. R. Malling. "Electronics," Mar., 1945; v. 18, p. 136.
18. Design of L-C Phase-Shift Networks, Robert W. Woods. "Electronics," Apr., 1945; v. 18, p. 144.
19. Negative Feedback in Hearing-Aid Amplifiers, F. E. Planer and E. A. Morland. "Electronic Engineering," Apr., 1945; p. 450.
20. Strain-Gage Amplifier, N. G. Branson. "General Electric Review," Apr., 1945; v. 48, p. 55.
21. Design of Power Amplifiers for Operating Ink Recorders, Donald Robinson. "Electronic Engng.," May, 1945; v. 17, p. 493.
22. Vacuum Tube Amplifier for Measuring Very Small Alternating Voltages, L. C. Roess. "Rev. Of Sci. Instr.," July, 1945; v. 16, p. 172.
23. Survey of D-C Amplifiers, Maurice Artzt. "Electronics," Aug., 1945; v. 18, p. 112.
24. A D-C Amplifier of High-Current, Low-Impedance Output. "Electronics," Aug., 1945; v. 18, p. 212.

Carrier-Current Applications

25. Electronic Mine-Shaft Signal System at Magma Copper Co., Superior, Ariz. U. S. Mines Bur. Inf. Circ. 7318 (P35C7318).
26. Inductive Train Communication, L. O. Grondahl. "Ry. Sig.," Nov., 1944; v. 37, p. 625.
27. Power-Line Carrier Current Communications, P. R. Crooker. "Radio-Electronic Engng.," Nov., 1944; v. 3, p. 13.
28. Train Communication on the K.C.S. "Ry. Age," Nov. 11, 1944; v. 117, p. 724.
29. Applying Power Line Carrier Principles, F. S. Beale. "Electronic Industries," Jan., 1945; v. 4, p. 84.
30. Wired Radio Control for Street Lights, Jess L. Haley. "Elec. Lt. & Pr.," Jan., 1945; v. 23, p. 58.
31. Power Line Carrier Current Terminal Equipment, P. R. Crooker. "Radio-Electronic Engng.," Feb., 1945; v. 4, p. 10.
32. Carrier Current Versus Space Radio for Railroads. "Electronics," Feb., 1945; v. 18, p. 152.
33. Carrier Lighting Control, Robert E. Miller. "Elec. Cont.," May, 1945; v. 44, p. 62.
34. Power Line Carrier Channels, M. J. Brown. "Radio-Electronic Engng.," July, 1945; v. 5, p. 16.

35. Year of Train Telephone Tests, W. W. Pulham. "Ry. Mech. Engr.," July, 1945; v. 119, p. 310.
36. Rural Telephone Service Over Power Wires, R. Karl Honaman. "Elec. Wld.," Aug. 4, 1945; v. 124, p. 94.
37. Street Light Control, Jesse L. Haley. "Electronic Industries," Aug., 1945; v. 4, p. 98.
38. Automatic Load Control in the Southwest, E. E. George. Oct., 1945. "AIEE" (P2214).
39. Carrier-Current Relaying, A. J. McConnell, T. A. Cramer, H. T. Seeley. "AIEE Transac.," Dec., 1945; v. 64, p. 825.

Control Applications

General and Miscellaneous

40. Typical Industrial Electronic Applications, R. M. Serota. "Proceedings of National Electronics Conference," 1944; v. 1, p. 254.
41. Industrial Applications of Electronics, A. G. Turnbull. "Electrical News and Engng.," v. 53, March, 1944, p. 45; Apr., 1944, p. 51; May, 1944, p. 51.
42. Keep the Electrons Flowing, W. D. Cockrell. "Mill and Factory," Apr., 1944; v. 37, p. 96.
43. Electronics in Review, W. D. Cockrell. "The Iron Age," July 20, 1944; v. 154, p. 58.
44. D-C Saturable Reactors for Control Purposes, Harry Holubow. "Electronic Industries," Mar., 1945; v. 4, p. 76.
45. Practical Electronic Industrial Controls, Paul G. Weiller. "Electronics," Apr., 1945; v. 18, p. 95.
46. Electronic Applications in Industry, "Electronics," May, 1945; v. 18, p. 92.
47. Electronic Timing of Manufacturing Operations, D. Fidelman. "Radio-Electronic Engng.," May, 1945; v. 4, p. 9.
48. Measurement and Control With Vibrating Wire Instrument, "Electronics," June, 1945; v. 18, p. 160.
49. Cold Cathode Counter Control, L. Atkinson. "Electronic Engng.," June, 1945; v. 17, p. 553.
50. Type the Photoelectric Control to the Product Application, O. W. Livingston. "Elec. Mfg.," July, 1945; v. 36, p. 110.
51. Synchro Controls for Meters and Servos, Raymond Goertz. "Electronic Industries," Sept., 1945; v. 4, p. 78.
52. Electronic Timers, Samuel A. Porter. "Radio News," Oct., 1945; v. 34, p. 53.
53. Electronic Servo System, E. J. Thompson. "Radio-Electronic Engng.," Oct., 1945; v. 5, p. 12.
54. Servo-Mechanisms, D. C. Bomberger. "Bell Labs. Record," Nov., 1945; v. 23, p. 409.

Furnaces, Heating, Flames

55. Temperature Controls, Wartime Improved, James H. Burnett. "Elec. Mfg.," Jan., 1945; v. 35, p. 101.
56. Electronic Flame Cutter. "Steel," May 28, 1945; v. 116, p. 102.
57. Automatic Control of Glazing Furnace. "Electronics," June, 1945; v. 18, p. 188.
58. Phototube-Controlled Flame Cutter, David S. Walker. "Electronics," July, 1945; v. 18, p. 100.
59. Electronic Temperature Control, D. Fidelman. "Radio-Electronic Engng.," July, 1945; v. 5, p. 8.
60. Installing, Maintaining, and Servicing Electronic Temperature Control Systems, E. D. Schneider. "Elec. Contracting," Aug., 1945; v. 44, p. 149.
61. Vacuum-Tube Anticipator Controls Furnace Temperatures. "Electronics," Aug., 1945; v. 18, p. 188.
62. Electronic Control of Furnace Temperatures. "Elec. Engng.," Aug., 1945; v. 64, p. 289.
63. Electronic Regulator for Arc Furnaces. "Electronics," Nov., 1945; v. 18, p. 314.
64. Combustion Protective Controls, D. A. Campbell. "Instruments," Dec., 1945; v. 18, p. 868.

Motors

65. Electronic Motor Control, B. J. Dalton. "Proceedings of National Electronics Conference," 1944; v. 1, p. 291.

66. To Specify Electronic Equipment Know Its Characteristics, O. W. Livingston. "Elec. Mfg.," May, 1945; v. 35, p. 104.

Resistance Welding

67. Electronic Controls for Resistance Welding, Holbrook L. Horton. "Mach.," Oct., 1944; v. 51, p. 153.
68. Electronic Control of Resistance Welding Machines, W. T. Fanjoy. "Elec. News & Engng.," Dec. 1, 1944; v. 53, p. 49.
69. Energy Storage Welding, Harry J. Bichsel. "Mill & Factory," Jan., 1945; v. 36, p. 94.
70. Control Circuits for Resistance Welding, John D. Goodell. "Radio-Electronic Engng.," Jan., 1945; v. 4, p. 16.
71. Self-Forging Welder, C. H. Strange. "Electronic Industries," July, 1945; v. 4, p. 109.
72. Electronic Control Makes Bench Welder a Precise Production Tool, L. J. Gottschalk, Jr. "Mach.," Sept., 1945; v. 52, p. 168.

In Specific Operations

73. Electronics—Its Steel Plant Uses, J. H. Hopper. "Steel," July 10, 1944; v. 115, p. 106.
74. An Electrical Vibrator, H. J. Flint. "Mechanical Engng.," Nov., 1944; p. 715.
75. Electronic Mechanism Development for Process Plant and Laboratory, T. A. Cohen. "Proceedings of National Electronics Conference," 1944; v. 1, p. 77.
76. Electronic Magnetizer, H. J. Hague. "Electronic Industries," Dec., 1944; v. 3, p. 96.
77. Electronic Controls, Vin Zeluff. "Sci. American," Dec., 1944; p. 259.
78. PE Tube X-Ray Timer, H. D. Moreland. "Electronic Industries," Jan., 1945; v. 4, p. 96.
79. Automatic Liquid Level Controls, Theodore A. Cohen. "Electronics," Apr., 1945; v. 18, p. 120.
80. Application of Electrical Equipment for Ship-Propeller Milling Machine, H. Earl Morton and Orin G. Rutenmiller. "Elec. Engng.," Apr., 1945; v. 64, p. 205.
81. Electronics Insures Accurate Loop Control, L. U. C. Kelling. "Mach. Design," Apr., 1945; v. 17, p. 143.
82. Electronic Control of Automatic Riveter, Thomas A. Dickinson. "Electronic Industries," July, 1945; v. 4, p. 112.
83. Thyatron Rectifier Controls Steams Turbine Governor, J. H. Schroeder. "Elec. Wld.," July 21, 1945; v. 124, p. 68.
84. Electronic Control for Magnetic Clutches, Ralph L. Jaeschke. "Electronics," Aug., 1945; v. 18, p. 102.
85. Automatic Control of Vehicular Traffic. "Electronics," Sept., 1945; v. 18, p. 150.
86. Radio Door Actuator, R. G. Rowe. "Electronic Industries," Sept., 1945; v. 4, p. 96.
87. Phototube Weft Straightening. "Electronics," Nov., 1945; v. 18, p. 316.

Electron Tubes

88. The Lighthouse Tube; A Pioneer Ultra-High-Frequency Development, E. D. McArthur and E. F. Peterson. "Proceedings of National Electronics Conference," 1944; v. 1, p. 38.
89. The "Kodatron" Speedlamp, G. A. Jones. "Electronic Engng.," June, 1944; p. 16.
90. Recent Electron-Tube Developments, S. B. Ingram. "Elec. Engng.," Jan., 1945; v. 64, p. 22.
91. Electron Tube Principles, A. W. Kramer. "Instruments," Jan., 1945, p. 12; Feb., 1945, p. 82.
92. A Note on Grid Control Characteristics of Gas-Filled Relays, D. W. Gillings. "Electronic Engng.," Feb., 1945; v. 17, p. 372.
93. Disk-Seal Tubes, E. D. McArthur. "Electronics," Feb., 1945; v. 18, p. 98.
94. Development of Electronic Tubes, I. E. Mouroumteff. "IRE Proc.," Apr., 1945; v. 33, p. 223.
95. The "Teleion"; A Versatile Gas Discharge Relay Valve, J. Reiss. "Wireless Wld.," Aug., 1945; v. 51, p. 226.
96. Fundamentals of Electron Tubes, Ralph B. Immel. "Power Pl. Engng.," Aug., 1945; v. 49, p. 96.
97. Electronics and Development of Electronic Tubes, I. E. Mouroumteff. "Franklin Inst. Jour.," Sept., 1945; v. 240, p. 171.
98. Factors Determining Industrial Tube Life, John F. Dreyer, Jr. "Electronic Industries," Dec., 1945; v. 4, p. 94.

Electron Tube Applications

General and Miscellaneous

99. Laboratory Research Develops New Electronic Products, Parts I and II, G. E. Bourne. "Elec. News & Engng.," Oct. 1 and Nov. 1, 1944; v. 53, p. 55 and p. 66.
100. Survey of Power Applications of Electronics, A. C. Monteith and C. F. Wagner. "Elec. Lt. & Pr.," Nov., 1944; v. 22, p. 48.

SUBJECT INDEX

To assist in locating references to specific subjects, a complete Subject Index has been included with this compilation and may be found on page 106—Editor

101. Electronics in Industry. W. C. White. "IRE Proc.," Feb., 1945; v. 33, p. 75.
102. The Electronization of Industry. C. B. Jolliffe. "Elec. Mfg.," Feb., 1945; v. 35, p. 121.
103. Electronics in Railroad. John Markus. "Sci. American," Mar., 1945, p. 156.
104. ABC of Photographic Sound Recording. Edward W. Kellogg. "Soc. Motion Pict. Engrs. Jour.," Mar., 1945; v. 44, p. 151.
105. Some Navy Electronic Problems. J. B. Dow. "Elec. Engng.," Mar., 1945; v. 64, p. 87.
106. Electrical Engineering in the Postwar World. D. D. Knowles. "Elec. Engng.," Mar., 1945; v. 64, p. 106.
107. Electronic Ignition Systems. G. V. Eltgroth. "Electronics," Apr., 1945; v. 18, p. 106.
108. Is Industrial Electronic Technique Different? W. C. Cockrell. "IRE Proc.," Apr., 1945; v. 33, p. 217.
109. Electronic Principles Basis for Steel Wire Recorder. "Elec. News & Engng.," May 1, 1945; v. 54, p. 49.
110. Electronic Aids to Photography. Rufus P. Turner. "Radio News," May, 1945; v. 33, p. 32.
111. Electronic Sales Engineering. S. S. Egert. "Electronics," June, 1945; v. 18, p. 111.
112. Electrolysis Prevention on Underground Pipe. "Electronics," June, 1945; v. 18, p. 192.
113. Electronic Composition of Music. John D. Goodell. "Radio-Electronic Engng.," July, 1945; v. 5, p. 12.
114. Electronic Sound Effects; Equipment for the Production of Sounds by Purely Electronic Means. P. D. Saw. "Electronic Engng.," July, 1945; v. 17, p. 581.
115. Electronic Musical Instrument With a Photoelectric Cell as Playing Manual. W. Saraga. "Electronic Engng.," July, 1945; v. 17, p. 601.
116. Pulsed-Energy Fish Screens. "Electronic Industries," Sept., 1945; v. 4, p. 107.
117. Electronics in Electric Power Industry. C. F. Wagner. "Elec. Engng.," Sept., 1945; v. 64, p. 323.
118. Navy Proximity Fuse. "Electronic Industries," Nov., 1945; p. 104.
119. Frequency-Modulated Magnetic-Tape Transient Recorder. Harry B. Shaper. "IRE Proc.," Nov., 1945; v. 33, p. 753.

Fault, Flaw, Object Detectors, Alarms

120. The Aniseikon. W. Sommer. "Electronic Engng.," Oct., 1944; v. 17, p. 189.
121. Locating Land Mines. Paul P. Horni. "Electronic Industries," Jan., 1945; v. 4, p. 82.
122. PE Tube Smoke Sensing. Gilbert R. Sonbergh. "Electronic Industries," Mar., 1945; v. 4, p. 98.
123. The Lookator. J. T. Schott. "Bell Labs. Record," Oct., 1945; v. 23, p. 379.
124. Hydrogen Gauge—An Ultra-Sensitive Device for Location of Air Leaks in Vacuum-Device Envelopes. Herbert Nelson. "Rev. Sci. Instr.," Oct., 1945; v. 16, p. 273.
125. Geophysical Prospecting Equipment. D. Sheffet. "Electronics," Dec., 1945; v. 18, p. 116.

High-Frequency Heating

General and Miscellaneous

126. High-Frequency Induction Heating of Conductors and Non-Conductors. R. M. Baker and C. J. Madsen. "Proceedings of National Electronics Conference," 1944; v. 1, p. 360.
127. New Methods and Techniques in High-Frequency Heating. Eugene Mittelman. "Proceedings of National Electronics Conference," 1944; v. 1, p. 392.
128. Use of Radio Frequencies to Obtain High-Power Concentrations for Industrial-Heating Applications. Wesley M. Roberds. "IRE Proc.," Jan., 1945; v. 33, p. 9.
129. Load Rematching in Electronic Heating. Eugene Mittelman. "Electronics," Feb., 1945; v. 18, p. 110.
130. Vacuum Tube Converter—Key to Radio-Frequency Heating. J. M. Cage. "Allis-Chalmers Elec. Rev.," Mar., 1945; v. 10, p. 14.
131. Chicago Conference on Induction and Dielectric Heating. "Electronics," Mar., 1945; v. 18, p. 148.
132. Study Electronic Heat. "Electronic Industries," Mar., 1945; v. 4, p. 110.
133. Electronic Heating of Metals and Non-Metallic Materials. Holbrook L. Horton. "Mach.," Mar., 1945; v. 51, p. 147.
134. High-Frequency Heating and the Power Sales Engineer. L. M. Duryee. "Elec. Wld.," Mar. 3, 1945; v. 123, p. 72.
135. Unusual Methods of Applying Electronic Heat. E. D. Tillson. "Electronics," Apr., 1945; v. 18, pp. 150, 152, 154.

136. Frequency Limitations in H. F. Heating. J. B. Knox. "Elec. News & Engng.," May 1, 1945; v. 54, p. 52.
137. Induction and Dielectric Heating Equipment. "Electronics," Aug., 1945; v. 18, pp. 110-111.
138. A Bibliography of High-Frequency Heating. "Electronic Engng.," Aug., 1945; v. 17, p. 629.
139. Role of Automatic Rematching in High-Frequency Heating. Eugene Mittelman. "Elec. Wld.," Aug. 4, 1945; v. 124, p. 98.
140. Radio Interference and Electronic Heaters. J. P. Jordan. "Radio-Electronic Engng.," Sept., 1945; v. 5, p. 14.
141. Automatic Tuning of R-F Heating Generator. "Electronics," Nov., 1945; v. 18, p. 332.

Dielectric

142. Shielding of Dielectric Heating Installations. G. W. Klingaman and G. H. Williams. "Electronics," May, 1945; v. 18, p. 106.
143. Electronic Welding of Glass. E. M. Guyer. "Electronics," June, 1945; v. 18, p. 92.
144. Defrosting Frozen Food for Bakeries. "Electronics," June, 1945; v. 18, p. 154.
145. A Survey of Dielectric Heating. M. J. Maiers. "Elec. Engng.," June, 1945; v. 64, p. 210.
146. H.F. Heating Thaws Deep Frozen Foods. "Elec. Mfg.," June, 1945; p. 144.
147. Dielectric Defrosting of Frozen Produce. "Electronic Industries," July, 1945; v. 4, p. 111.
148. Longitudinal or Transverse Heating. D. I. Lawson. "Electronic Engng.," Aug., 1945; v. 17, p. 646.
149. Calculations for Dielectric Heating by High-Frequency Current (Design Charts). A. J. Maddock. "Electronic Engng.," Aug., 1945; v. 17, p. 635.
150. High-Frequency Dielectric Heating. A. E. L. Jervis. "Electronic Engng.," Aug., 1945; v. 17, p. 624.
151. Role of Frequency in Industrial Dielectric Heating. G. W. Scott, Jr. "AIEE Transac.," Aug., 1945; v. 6, p. 558.
152. Dielectric Heating in Industry. L. M. Duryee. "Elec. Wld.," Sept. 1, 1945; v. 124, p. 84.
153. Hardening of Plastics by High-Frequency Power. H. Stager and F. Held. (From The Brown Boveri Review, Sept., 1944, p. 298.) "The Engineers' Digest," Oct., 1945; v. 2, p. 519.
154. Dielectric Heating Fundamentals. Douglas Venable. "Electronics," Nov., 1945; v. 18, p. 120.
155. Furniture Fabrication. "Electronic Industries," Dec., 1945; v. 4, p. 108.
156. H.F. Heating in Heatronic Moulding. A. E. L. Jervis. "Electronic Engng.," Dec., 1945; p. 819.

Induction

157. Medium Frequency Power in Industry. H. Fehlmann and V. Widmer. "Brown Boveri Rev.," May, 1944; v. 31, p. 159.
158. The Surface Treatment of Metals and in Particular the Surface Hardening of

- Steel by High-Frequency Currents. "Brown Boveri Rev.," Sept., 1944; v. 31, p. 306.
159. Induction Heating in Radio Electron Tube Manufacture. E. E. Spitzer. "Transac. of the Electrochemical Soc.," v. 86, 1944.
160. High Frequency Induction Heating New Tool for the Metal Working Industry. A. O. Wood. "Steel Processing," Dec., 1944; v. 30, p. 795.
161. Some Peculiarities of Heating Steel by Induction. George I. Babat. "Jour. App. Physics," Dec., 1944; v. 15, p. 835.
162. Surface Hardening and Brazing With the Induction Heater. Gilbert C. Close. "Steel Processing," Jan., 1945; v. 31, p. 43.
163. Induction Hardening. Otto Weitman. "Electronics," Mar., 1945; v. 18, p. 101.
164. Induction Heat Works Metal Magic! S. H. Mortensen. "Allis-Chalmers Elec. Rev.," Mar., 1945; v. 10, p. 4.
165. Mercury Arc Converter Masters Metals in Deep Heating. H. F. Storm. "Allis-Chalmers Rec. Rev.," Mar., 1945; v. 10, p. 7.
166. Induction Heating of Moving Magnetic Strip. R. M. Baker. "Elec. Engng.," April, 1945; v. 64, p. 184.
167. Discussion on "Design of Electronic Heaters for Induction Heating." George H. Brown and J. P. Jordan. "IRE Proc.," Apr., 1945; v. 33, p. 267.
168. Application of High Frequency Induction Heating to Internal Metal Surfaces. H. E. Somes. "Elec. News & Engng.," Apr. 15, 1945; v. 54, p. 50.
169. Vacuum Casting of Electronic Parts. Kenneth Rose. "Metals & Alloys," May, 1945; v. 21, p. 1324.
170. Resin Coatings Baked by Induction Heating. A. P. Mazzucchelli and R. E. Nicolson. "Iron Age," May 3, 1945; v. 155, p. 46.
171. Mercury Arc Heating Frequency Converter. S. R. Durand. "Electronic Industries," June, 1945; v. 4, p. 74.
172. Tocco Hardening. H. B. Osborn, Jr. "Soc. Auto. Engrs. Jour.," July, 1945; v. 53, p. 377.
173. Induction Heating in Aluminum Fabrication. Gilbert C. Close. "Lt. Metal Age," July, 1945; v. 3, p. 8.
174. High-Frequency Induction Heating. Wesley M. Roberds. "Mech. Engng.," July, 1945; v. 67, p. 448.
175. Brazing With Electric Induction Heat. A. M. Setapen. "Steel," July 2, 1945; v. 117, p. 92.
176. Radio Heating and Mass Production Soldering. C. E. Tibbs. "Electronic Engng.," Aug., 1945; v. 17, p. 631.
177. Induction Brazing and Soldering. H. U. Hjermsstad. "Iron Age," Aug. 9, 1945; v. 156, p. 56.
178. Cube-Surface Coil for Producing a Uniform Magnetic Field. Sidney M. Rubens. "Rev. Si. Instr.," Sept., 1945; v. 16, p. 243.
179. Vacuum-Tube Radio-Frequency-Generator Characteristics and Application to Induction-Heating Problems. T. P. Kinn. "IRE Proc.," Oct., 1945; v. 33, p. 640.

Electronically generated heat, produced by a 5 kw oscillator, is here used in one of the G-E plants for soldering crystal shells. Illustration shows the fixture loaded, ready for work

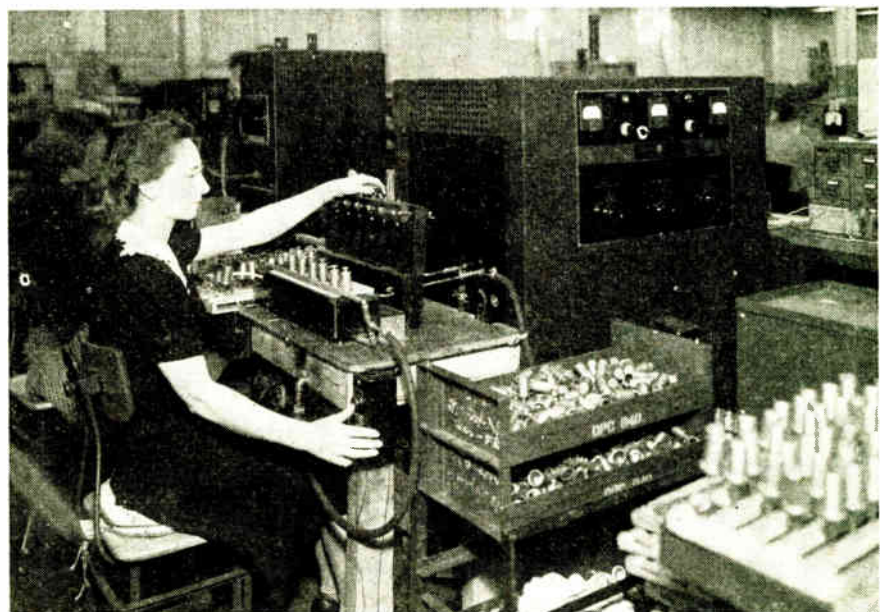

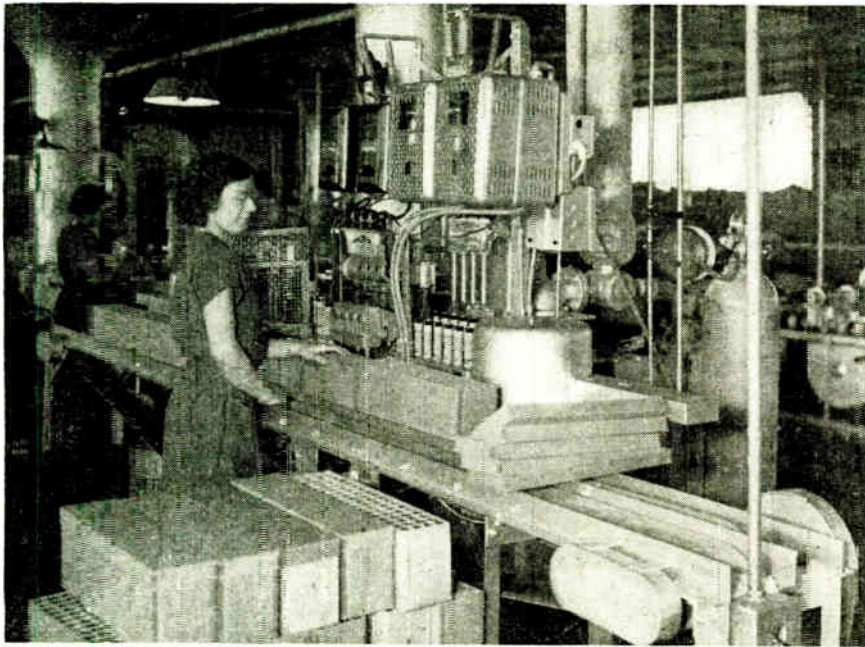

G-E photoelectric relays as used in the plant of the Bristol-Meyers Co., Hillside, N. J., control the position of toothpaste tubes in the expander during a cycle of the loading operation

180. Crucible Failure in the Induction Melting Process. Andrew Gemant and Joseph Sticner. "Jour. Applied Physics," Nov., 1945; v. 16, p. 661.
181. Capacitors for Induction-Heating Circuits. F. M. Clark and M. E. Scoville. "AIEE Transac.," Nov., 1945; v. 64, p. 791.

Measurements, Instruments, Recording, Testing

General and Miscellaneous

182. An Electrical Circuit for Harmonic Analysis and Other Calculations. T. B. Rymer and C. C. Butler. "Phil. Mag.," Sept., 1944; v. 35, p. 606.
183. A New Photo-Electric Method for Fourier Synthesis and Analysis. R. Furth and R. W. Pringle. "Phil. Mag.," Oct., 1944; v. 35, p. 643.
184. Electronics in Instrumentation. H. D. Middel. "General Electric Review," Nov., 1944; v. 47, p. 9.
185. Some Recent Applications of Electronics to Industrial Process Instrumentation. H. D. Middel. "Instruments," Mar., 1945; p. 144.
186. Electronic Mechanisms for Measurement and Control of Plant and Laboratory. Theodore A. Cohen. "Instruments," Apr., 1945; v. 18, p. 228.
187. Telemetering Equipment for the Transmission of Any Desired Measurements Over Long Distances. F. Jaggi. "Brown Boveri Rev.," Apr., 1945; v. 32, p. 147.
188. Electronic Circuits Perfrom Mathematical Processes. M. N. Beitman. "Radio News," May, 1945; v. 33, p. 72.
189. Electronic-Type Instruments for Industrial Processes. P. S. Dickey and A. J. Hornfecht. "A.S.M.E. Transac.," July, 1945; v. 67, p. 393.
190. Radar Techniques in Instrumentation. Everard M. Williams. "Instruments," Nov., 1945; v. 18, p. 780.

Chemical Field Applications

191. Direct Reading Instrument for Spectrochemical Analysis. M. F. Hasler and H. W. Dietert. "Jour. Optical Soc. of America," Dec., 1944; p. 751.
192. Electronics and the Chemical Industry. J. A. Hutcheson. "Chem. & Engng. News," Dec. 25, 1944; v. 22, p. 2170.
193. Electronic Tools in Chemical Research. R. H. Osborn and L. W. Beck. "Electronic Industries," Feb., 1945; v. 4, p. 82.
194. Geiger Counter Spectrometer for Industrial Research. H. Friedman. "Electronics," Apr., 1945; v. 18, p. 132.

Counting

195. Electronic Counting. Popular description of a device developed by John T. Potter of Potter Instrument Co. "Scientific American," Sept., 1944; p. 106.
196. Geiger Counters. J. D. Craggs. "Met-Vick. Gaz.," Oct., 1944; v. 20, p. 342.
197. Electronic Counter and Tachometer. E.

- G. Downie. "General Electric Review," Nov., 1944; v. 47, p. 50.
198. Electronic Counting. Max Weber. "Communications," Aug., 1945; v. 25, p. 42.

Electrical and Magnetic Quantities

199. Surge Type Insulation Tester Reflects Electronic Progress. N. Rohats. "Elec. Mfg.," Apr., 1944; v. 33, p. 97.
200. Cathode-Ray Tube Testing. J. R. Beers. "Communications," Oct., 1944; v. 24, p. 56.
201. Harmonic Synthesizer for Demonstrating and Studying Complex Wave Forms. J. M. Somerville. "Jour. Sci. Instruments," Oct., 1944; p. 174.
202. Production Tester for Mica. "Electronics," Nov., 1944; v. 17, p. 176.
203. Measuring Dielectric Properties. C. N. Works, T. W. Dakin and F. W. Boggs. "Sup. AIEE Transac. Section," Dec., 1944; vol. 63 (paper 1092, disk 1452).
204. New Type of Electron-Optical Voltmeter. L. Jacob. "I.E.E. Jour.," Part II, Dec., 1944; v. 91, p. 512.
205. Cathode-Ray Tube Traces. Hilary Moss. "Electronic Engng.," Dec., 1944; p. 285; Jan., 1945; p. 329; Oct., 1945, p. 723.
206. Frequency Meter for Use with Geiger-Muller Counter. Leon F. Curtiss and Burrell W. Brown. "Nat. Bur. Strds. Jour. Res.," Jan., 1945; v. 34, p. 53 (RP No. 1627).
207. Magnetic Permeability of Iron Wires at Radiofrequencies. Alva W. Smith, F. P. Dickey and S. W. Foor. "Jour. Applied Physics," Jan., 1945; v. 16, p. 57.
208. V.H.F. Measurements. D. Fidelman. "Radio-Electronic Engng.," Jan., 1945; v. 4, p. 7.
209. Tubeless Probe for VTVM. Howard L. Daniels. "Electronics," Feb., 1945; v. 18, p. 125.
210. The "Miniscope." M. Michaelis. "Electronic Engng.," Feb., 1945; v. 17, p. 360.
211. Cathode-Ray Null Detector for Wien Bridge. Charles Markey. "Electronics," Mar., 1945; v. 18, p. 125.
212. Radio-Frequency Bridges. H. L. Kirke. "I.E.E. Jour.," Pt. III, Mar., 1945; v. 92, p. 2.
213. Testing Magneto Coils. N. Rohats. "General Electric Review," Mar., 1945; v. 48, p. 49.
214. Electronic Mechanisms for Measurement and Control in Plant and Laboratory. T. A. Cohen. "Instruments," Apr., 1945; p. 229.
215. Dielectric-Constant Meter. Frank C. Alexander, Jr. "Electronics," Apr., 1945; v. 18, p. 116.
216. A Portable Instrument for Measuring Insulation Resistance at High Voltage. T. W. Atkinson and Robert B. Taylor. "Elec. Engng.," Apr., 1945; v. 64, p. 164.
217. Peak Kilovoltmeter for Ignition Testing. W. O. Henschke. "Instruments," May, 1945; v. 18, p. 308.
218. Vacuum-Tube and Crystal Rectifiers as Vacuumometers and Voltmeters at Ultra-High Frequencies. Arnold Peterson. "Gen-

- eral Radio Experimenter," May, 1945; v. 19, p. 1.
219. Cathode-Ray Tubes and Their Application. P. S. Christaldi. "IRE Proc.," June, 1945; v. 33, p. 373.
220. Taming the Vacuum-Tube Voltmeter. McMurdo Silver. "QST," July, 1945; v. 29, p. 17.
221. Two-voltage High-Potential Tester for Wire. H. T. McLean. "General Electric Review," Aug., 1945; v. 48, p. 37.
222. Special Cathode-Ray Techniques. B. M. H. Michel. "Radio-Electronic Engng.," Aug., 1945, v. 5, p. 5; Sept., 1945, v. 5, p. 8.
223. Transient Peak Voltmeter. C. Ryerson and M. Aronson. "Electronics," Sept., 1945; v. 18, p. 110.
224. Amplifier-Type Vibrating-Reed Frequency Meter. Rufus P. Turner. "Radio News," Sept., 1945; v. 34, p. 46.
225. A Modified Inverted Triode-Valve Voltmeter. H. G. Foster. "Electronic Engng.," Oct., 1945; v. 17, p. 731.
226. Industrial Test Equipment Design. Ted Powell. "Electronics," Oct., 1945; v. 18, p. 135.
227. Bridge Null Indicator. E. W. Herold. "Electronics," Oct., 1945; v. 18, p. 128.
228. New Method of Insulation Testing. E. F. Harter and G. L. Moses. "Instruments," Oct., 1945; v. 18, p. 682.
229. Electronic Wattmeter. L. P. Malling. "Electronics," Nov., 1945; v. 18, p. 133.
230. Resistance Measurement at High Impulse Voltages. Scott L. Shive. "Electronics," Nov., 1945; v. 18, p. 158.
231. Industrial Testing With High Voltage. "Electronic Industries," Nov., 1945; v. 4, p. 106.
232. Judging Mica Quality Electrically. K. G. Coutlee. "AIEE Transac.," Nov., 1945; v. 64, p. 735.

Liquids, Gases

233. Electronic Recording Flowmeter. E. C. Crittenden, Jr., and R. E. Shipley. "Rev. Sci. Instruments," Dec., 1944; v. 15, p. 343.
234. High-Vacuum Gauges. M. Pirani and R. Neuman. "Electronic Engng.," Dec., 1944, p. 277; Jan., 1945, p. 322; Feb., 1945, p. 367; Mar., 1945, p. 422.
235. Remote Water-Stage Indicators. Maurice E. Kennedy. "Electronics," Feb., 1945; v. 18, p. 130.
236. An A-C Operated Leak Detector and Ionization Gauge. R. B. Nelson. "Rev. Sci. Instruments," Mar., 1945, p. 55.
237. Alternating Field Induction Flow Meter of High Sensitivity. Alexander Kolin. "Rev. Sci. Instruments," May, 1945; v. 16, p. 109.
238. Electronic Moisture Indicator. Earl Seidlinger. "Radio News," May, 1945; v. 33, p. 35.
239. Turbidity Measurement of Oil in Water. "Electronics," June, 1945; v. 18, p. 180.
240. Pressuregraph. "Rev. Sci. Instruments," Sept., 1945; p. 256.
241. Circuit of Electronic Capacitance-Type Fuel Gauge. "Electronics," Nov., 1945; v. 18, p. 324.

Metals and Materials

242. Practical Strain-Gage Applications. R. O. Fehr. "Electronics," Jan., 1945; v. 18, p. 112.
243. Measuring the Elasticity of Synthetic Yarns. S. Silverman and J. W. Ballou. "Electronics," Feb., 1945; v. 18, p. 103.
244. Electric Gaging Methods. H. C. Roberts. "Instruments," Feb., 1945; v. 18, p. 82.
245. The Sonigage: A Supersonic Contact Instrument for Thickness Measurement. Wesley S. Erwin. "Soc. Auto. Engrs. Jour.," Mar., 1945; v. 53, p. 25.
246. Rapid Photoelectric Optical Distortion Tester for Plastic Windows. J. McG. Sowerby and W. H. Walton. "Jour. Sci. Instr.," Apr., 1945; v. 22, p. 71.
247. Tensile Testing of Textiles With Electronic Control. "Electronics," June, 1945; v. 18, p. 151.
248. Measurement of Stresses in Rotating Shafts. W. F. Curtis. "Electronics," July, 1945; v. 18, p. 114.
249. Elongation Recorder for Materials Testing. Jens Sivertsen. "Electronics," July, 1945; v. 18, pp. 154, 156, 158.
250. Strain-Gage Phono Pickup. "Electronic Industries," Aug., 1945; v. 4, p. 89.
251. Metal Sorter. "Instruments," Sept., 1945; v. 18, p. 662.
252. Gaging by the Blind. "Electronic Industries," Sept., 1945; v. 4, p. 104.
253. Electronics in Non-Destructive Testing of Materials. Robert Endall. "Radio-Electronic Engng.," Oct., 1945; v. 5, p. 5.
254. New Method of Sorting Metals. Antony Doschek. "Instruments," Oct., 1945; v. 18, p. 676.
255. Strain Analyzing and Recording Instruments. Claude M. Hathaway. "Electronic Industries," Oct., 1945; v. 4, p. 74.
256. Electronic Balancer for Rotating Parts. "Electronics," Nov., 1945; v. 18, p. 364.

(Continued on page 100)

NUERNBERG TRIALS

By PHILIP C. ERHORN

Engineering features of intercom-recording installation now being used during trials of the German war criminals

● With a scant two months to go before the opening of the trials, and only a mental picture of what might actually be necessary, the equipment was gathered together, chiefly from Signal Depots, and the OWI in New York, and shipped by air to Nuernberg. The technicians followed immediately, and a convenient office and prospective recording studio were selected in the then rather empty Palace of Justice where the trials were to be held.

The courtroom itself was in the process of being rebuilt to accommodate the members of the press and radio, visitors, and the extensive physical layout necessary to such a large trial. Convenient locations were selected for placing the control and amplifying equipment in the courtroom and after considerable deliberation and consultation with officials in charge, a comprehensive plan was drawn up which allowed plenty of room for expansion whenever the need arose.

Because the courtroom itself was still being reconstructed until very shortly before the trials opened, it was necessary to test most of the equipment in the office designated as the Shop and Recording Room.



View of the courtroom presently in use for the Nuernberg trials of the German war criminals

By combining the circuit testing of the "Translator" with innumerable tests under mock courtroom conditions, involving the training of the language interpreters, it was possible to iron out many troubles

thus insuring smooth operation.

As originally intended by IBM the "Translator" was a complete six-channel sound distributing system from microphones to earphones, for about 250 listeners. In

The author (rear) riding gain on one of the recording amplifiers



One of the units used in recording evidence presented to the Court

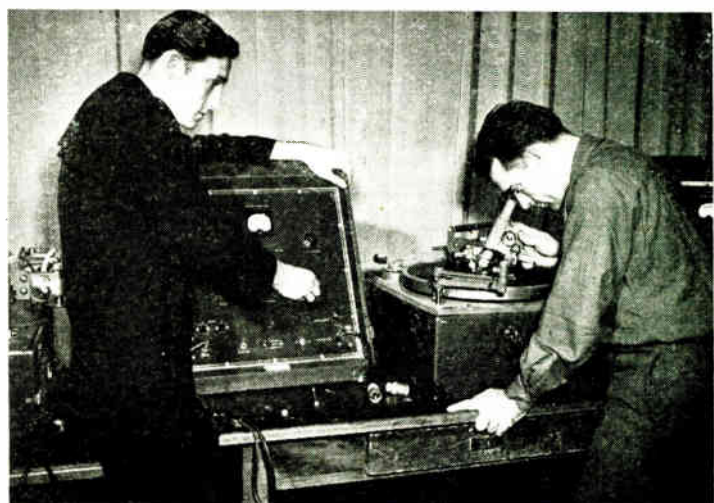

RECORDING SYSTEM

The International Military Trials now being held in Nuernberg, Germany, presented an unusual problem from the technical viewpoint. First, a translating system had to be worked out so that the trials could be carried on in four languages simultaneously, and then facilities for recording the four languages were requested. The importance of the occasion was demonstrated by flying a small group of communications and recording specialists directly to Nuernberg to supervise the

installation and operation. The Press Relations Department of USFET Headquarters in Frankfurt cooperated wholeheartedly by supplying a group of their experienced technicians, and the whole was coordinated under the administration of the Office of the United States Chief of Counsel for the Prosecution of Axis Criminality. The International Business Machine Company loaned their versatile "Translator" system, several of which have been used for international conferences.

channel mixer was utilized as well and its output fed into a low-gain input on the 76B.

Four microphones were allotted to the eight judges of the Tribunal, and these feed directly to the OP-7. Key switches were installed in each of these four microphone lines so that whenever one judge wishes to confer privately with his neighboring colleague, he can cut the microphone out and a terminating resistor of equal impedance value is automatically substituted.

A microphone is provided at the prosecution desk, one in the witness box, and another at the side of the presentation screen at the front of the courtroom. This latter is also used as a roving microphone whenever one of the defendants speaks from the "dock". A talkback microphone at the mixer console is used for cuing recording facilities at the opening and closing of each session of the court, and at intermissions. The console is lo-

order to simplify matters as much as possible, it was decided to use common microphone and mixer facilities for both translating and recording. Perhaps the best way to explain the numerous features is by reference to the block diagram. This has been broken down into sections showing the units in their

respective locations by rooms. It will be seen that there are eight microphones connected to two mixers. The main mixer is an RCA 76B consolette, which also provides line amplifier and monitor amplifier facilities. However, there are only four microphone channels available, so an RCA OP-7 four

Block diagram of the recording and interpreting system showing provision for verbatim testimony, for all translators, for recorders and for broadcasting

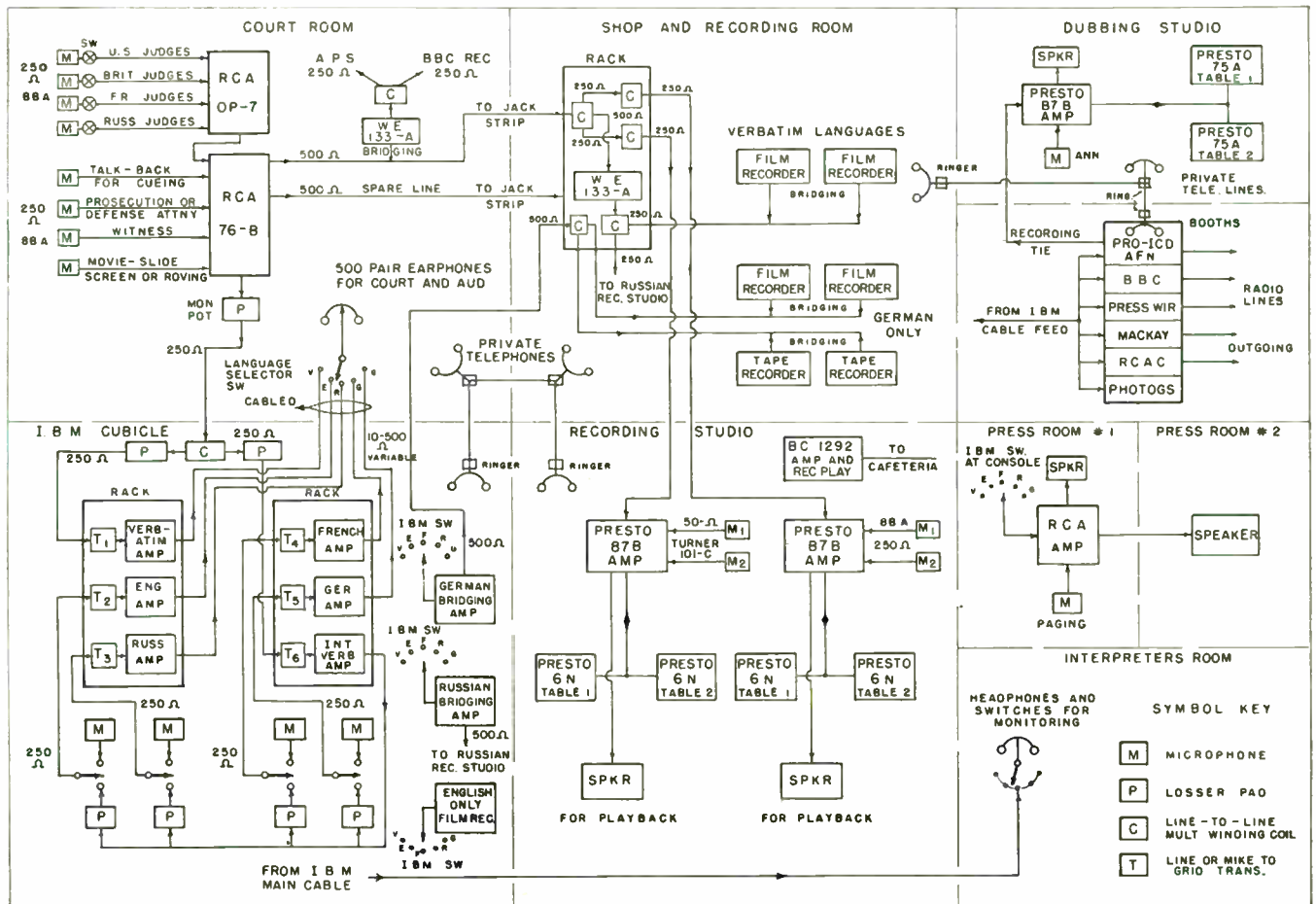

cated at the rear of the courtroom overlooking the entire floor, and opposite the newsreel booth.

Two lines were run from the output of the console line amplifier to the Shop and Recording Room in another wing of the building, one being the main recording line and the other a spare. These lines consist of the German version of our Signal Corps "Spiral-four" cable, in keeping with a policy of using German wire for the thousands of miles of dial telephone and power cable used in the building. The shielding is sufficient to keep out all traces of interference from a battery of heavy-duty Diesel generators in the yard below. (The courtroom is on the third floor.)

A Western Electric 133-A bridging amplifier installed at the console feeds the newsreel booth used jointly by Army Pictorial Service and British Paramount, and the BBC radio booth overlooking the courtroom. Policy does not allow the simultaneous broadcasting of the court proceedings, but BBC has its own recording facilities and broadcast recordings at a later time.

Translator equipment

Because it is necessary to monitor with earphones, the monitor amplifier was put to good use in feeding the translator equipment. This equipment occupies three racks and is in a cubicle adjoining the language interpreters' desks, where the operator can see both the interpreters and most of the courtroom.

Following the line feed from the monitor amplifier, several unusual features will be noted. A coil splits this feed to two of the rack amplifiers, first going through a 60 db pad and then a line to grid transformer. The rack amplifiers are Stromberg-Carlson Type 20, originally designed for two high-impedance microphone channels and a high-impedance phono channel with a wide range of output impedances. An impedance-matching tap switch and VI were added by IBM for output adjustment. In the interests of hum reduction, the phono channel wiring was cut out and 60 db pads were necessary to cut the level down to a more appropriate value for the high-gain inputs. The line-grid transformers afford a proper impedance match.

The output of the first five amplifiers feeds through a complex network of cables which distribute

sound to every person in the courtroom via a selector box and earphones. In this case position (or channel) No. 1 is the verbatim position. Whatever language is used on the floor of the court may be heard by switching the earphones across this channel. Position No. 2 is for the English translation; No. 3 for the Russian translation; No. 4 for the French translation, and No. 5 for the German translation. In order to hear any one of the four languages it is only necessary to switch the earphones across the proper channel.

All the interpreters constantly listen to the output of the No. 1 or verbatim channel. There are four groups of three interpreters. In the English group, for example, one translates Russian to English, another translates French to English and the third German to English. In the German group, one translates English to German, another French to German and the third Russian to German, and so on.

Each group has a hand microphone and a small switching box before it and is separated from the adjacent group by a partition of plate glass. The interpreters' microphones run directly through a toggle key on the switching box to their respective channel amplifiers. When this key is thrown in the opposite direction, a unique feature is brought into use.

By way of example, when Russian is being spoken on the floor of the court, the three Russian interpreters are temporarily idle. This would mean that Russian-speaking listeners in the Press or audience would of necessity turn their se-

lector dials to the No. 1 or verbatim channel to hear Russian. This was deemed inadvisable for two reasons. First, it was confusing to the non-technical, and second, it would mean constant switching in question-and-answer periods with attendant violent changes in the output load impedance of the various amplifiers. The small amount of inverse feedback used in the amplifiers could not compensate for these changing loads and it would then be necessary for the IBM equipment operator to switch each variable output manually.

Simplifying controls

This looked like a nasty chore, so it was decided to put the "idle" interpreting group to work. As was stated previously, the IBM feed from the console is split and fed to No. 1 and No. 6 amplifiers. The output of No. 6 is termed the Interpreters' Verbatim Channel and feeds only to each of the four interpreters' switch boxes through a 60 db pad mounted in the box.

Now, when Russian is spoken on the court floor the "idle" Russian interpreters throw their key-switches to the position opposite the microphone position, and the verbatim output of the No. 6 amplifier into the input of the No. 3 amplifier and thence to the regular Russian earphone channel. This applies to any language interpreting group when they hear their language spoken on the floor.

If all this seems very confusing, close scrutiny of the block diagram should help to make it clear. Arrows help in circuit tracing. But if

Everyone wore headphones at the trials; note Goering at left and next to him Hess, then Von Ribbentrop, Keitel and Rosenberg. In rear row are Doenitz, Raeder, Von Schirach, Sauckel and Jodl



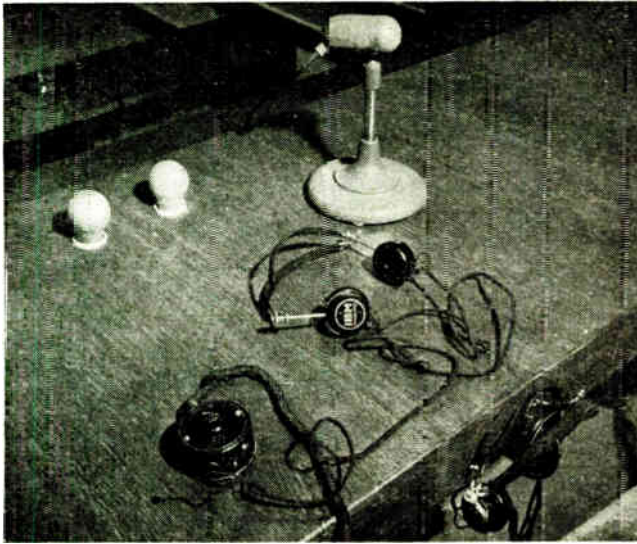

Translator equipment as used at the trials by each interpreter

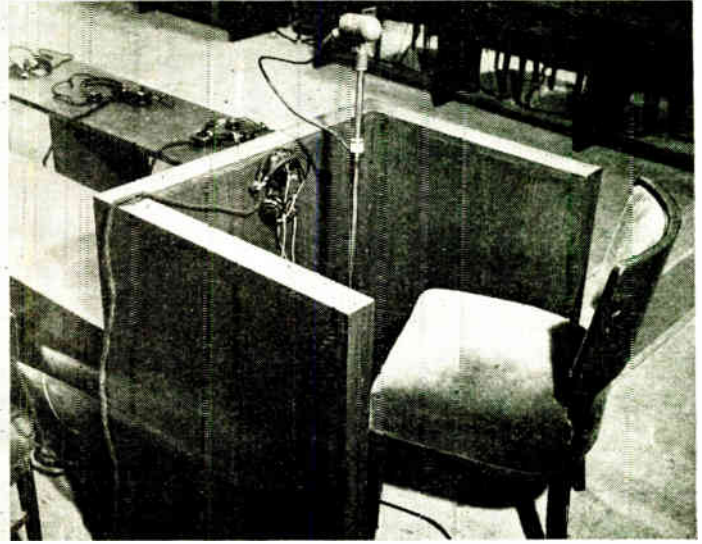

The witness stand showing headset, microphone and language selector

consideration is given to what happens when a French lawyer questions a German witness and a Russian judge interrupts while one is listening to the English channel, it will be seen that all twelve interpreters must be on their toes constantly. They must be alert to pass the microphone to their colleague or make use of the switching box as well. All the listener has to do is to stay "tuned" to his particular language channel, no matter what else happens. The operators and interpreters do all the rest.

Should the proceedings go too rapidly for the interpreters, they signal a monitor with colored cards. He in turn presses a button which lights either of two colored bulbs on the bench directly in front of the presiding judge. Yellow for "slower" and red for "stop". These lights are visible over the entire courtroom.

Switching method

The earphone switching boxes are mounted on the arms of the seats in the press and audience sections and on the vertical edges of the tables on the court floor. The earphones are hung on these boxes when not in use, and in conjunction with a well designed cable system, a neat installation resulted despite the fact that there are over 500 pairs of earphones to be accommodated. All earphones are a specially made high-impedance magnetic type. Beam-power 6L6G tetrodes in the output stages of the amplifiers carry the load with power to spare. Noise is kept to a minimum by shielding all low-level feeds, and using relatively high output microphones. The four in-

terpreters' microphones are RCA 88-A dynamics. Cardioid type microphones were used at first, but noise was troublesome from the wide angle pickup and low output level.

Tracing the main recording feed from the 76B console, note that it terminates on a jackstrip on a rack in the Shop and Recording Room. The lines may be patched to a variety of matching coils hanging on other jacks. The input and output of a Western Electric 133-A bridging amplifier also appear on the jackstrip.

The feed is split three ways through a coil, and two feeds then are run to a nearby office which is used for a recording studio. Each feed drives a Presto 87-B recording amplifier and two Presto 6-N dual-speed portable transcription turntables. Here two high-fidelity sets of discs of every word said on the floor of the court are cut. One set is for the War Department and is used as an accurate reference and for dubbing cuts for the use of war correspondents. The second set is for the Senate Library (historical research).

The recording studio is completely draped and carpeted. The double windows also can be draped to shut out all traces of extraneous noise. Whenever the court is not in session, the studio is available either for private recording or reference playback work. Normally, all four tables are occupied with recording the verbatim channel from the courtroom. Turner 101-C 50-ohm cardioid microphones may be used with one of the amplifiers and the RCA 88-A type are used with the 250-ohm input of the other amplifier.

Monitor speakers afford a constant check on what is happening as the proceedings are recorded, and a typist is concurrently occupied with a running card index of speaker, subject, and time for later reference and ease in locating on any disc. Several thousand double-sided 16-in. transcriptions have already been made, practically all of the discs being supplied by Audio Devices, Inc. Another item of interest in the recording studio is a Signal Corps BC-1292 amplifier and record player. This compact unit is used to pipe suitable music to the large cafeterias where everyone eats at lunchtime. A varied file of "V-Discs" is on hand for this purpose.

Film recorders

Several small embossed-film recorders made by the Frederick Hart Company are used as a convenience for the court stenographers in checking their Stenotype or shorthand transcripts. These machines allow over one hundred tracks to be recorded on a short reel of 35mm film base, and the playback head may be lowered on any track, quickly located by a numbering device.

Two recorders are necessary for continuous coverage, and are bridged off the output of the Western Electric amplifier which isolates the feed from the high-fidelity disc recording lines. At the conclusion of the trials, the verbatim film records are for the permanent use of the Navy Department.

By locating several of the earphone switching boxes in the IBM equipment cubicle in the court-

(Continued on page 111)

FACSIMILE METHODS

Possible use of FM channels by broadcasters, increased fidelity, higher speed and simplification, make new public service imminent



Pioneer expert John V. L. Hogan (standing) and engineer John W. Smith (Radio Inventions, Inc.) with complete Faximile BC equipment

• Once again, after numerous experimental periods during its rather extended growing period, facsimile is receiving attention as a means of supplying printed news service to the home over broadcasting channels. Incorporating numerous technics that were advanced by wartime developments, the system, as now planned, combines technical simplicity of equipment, high operating speed and reproduction fidelity to a degree that seems to this writer adequate for the needs of such a service. Several approaches are now under way.

The most vigorous work was started shortly after V-J Day when a group of broadcasters became interested in this service, due to efforts of WOR, and formed a committee called Broadcasters Faximile Analysis, to look into methods and facilities required to inaugurate such a service on existing broadcasting channels. This group engaged the aid of J. V. L. Hogan of Radio Inventions Inc., developers of the "Faximile"* system.

A preliminary study showed that

*The Hogan system utilizes the coined word "Faximile" to represent its principles, and the word "Faxprint" for the transcribed copy. Finch, on the other hand, uses the terms "Telefax" and "Faxogram," respectively.

this service could be inaugurated quite readily at nominal expense to the station by modulating its FM transmitter in the usual manner with pulses derived from scanning printed or illustrated material. In addition, committees were formed comprised of representatives of several companies that were active during prewar periods in the development of facsimile equipment, for the purpose of the establishment of methods and the study of the effectiveness of the system standards as recommended by previous studies. Joint cooperation of the broadcasters, manufacturers, and FCC representatives has therefore become effective in setting up tentative standards of value.

Summary of Faximile System Constants

PAGE SIZE:	TRANSMITTING	RECEIVING
Total	8 1/2" x 12"	9 5/16" x 12 6/7"
Useful	8.2" x 11.5"	8.2" x 11.5"
DEFINITION:		
Vertical	140	100 (equivalent)
Horizontal	105	105
COPY SPEED		MAXIMUM MODULATING FREQUENCY:
3 3/7 linear inches per minute		3,900 cycles (available)
28.1 square inches per minute		3,000 cycles (required)
4 pages (12 6/7" in length, per 15-minute broadcast period.)		
FRAMING AND SYNCHRONIZING SIGNAL:		TRANSMITTED BAND:
Line Use Ratio	7/8	6,100 to 13,900 cycles (available)
Facsimile Signal	315°	7,000 to 13,000 cycles (required)
Blank	15°	
Synchronizing Pulse	15°	
Blank	15°	
PAGE SEPARATION AND FRAMING PERIOD:		TYPE OF TRANSMISSION:
1/2 linear inch of page		Negative (maximum signal on black).
8 3/4 seconds (approximately)		Double side-band amplitude modulation of sub-carrier for either frequency or amplitude modulation of radio carrier.
SUB-CARRIER FREQUENCY:		Tone scale compensated for receivers having linear response in optical density with variations in input signal (logarithmic compression).
10,000 (plus or minus 5%) cycles		

INDEX OF COOPERATION

The index of cooperation is defined by the Institute of Radio Engineers as "the product of the total length of scanning lines by the number of scanning lines per inch." For the BFA system its value is 984. This index figure is useful when recorders producing smaller or larger copy than the original are required, since all recorders having the same index of cooperation and drum speed will produce copy without distortion of horizontal-to-vertical proportions and thus retain the required aspect ratio in the reproduction.

FOR BROADCAST WORK

Most of the present plans involve the use of rotating drums at both the transmitters and receivers operating in synchronism. In other words, the "lawn mower" type of receiver scanner seems to have replaced the oscillating arm scanners which were tried in previous broadcast service periods.

The master copy is affixed to a transmitting drum, which is rotated at a speed of 360 rpm and with an advance of the carriage that gives a definition of 105 lines per inch of copy height. At this speed, four pages of copy, each somewhat larger than 9 x 12 in., would be transmitted during a 15-minute broadcasting period.

As this copy is rotated it is scanned by a phototube and light source mounted on a carriage. The tube delivers a random series of pulses which are dependent on the light and shadows as they appear on the master copy. At the normal speed used, the horizontal definition is somewhat more accurate than the vertical definition. The AM pulses derived by amplifying the phototube current are used to amplitude modulate a subcarrier frequency of 10 kc. The modulated output of this system, which then covers a range of 10 ± 3 kc, therefore contains frequencies in the band between approximately 7 and 13 kc. In practice this range is extended to include all frequencies from 7,100 cycles to 13,900 cycles.

Use home FM sets

This amplitude modulated frequency range is thereupon applied to the normal modulation input of the FM transmitter and is handled in the same way as regular voice signals in the 6,000 to 13,000 cycle range are handled. In this way the signals can be received in the home, using regular FM receivers.

After frequency demodulation by the regular method in these receivers the pulses are applied to the actuating circuits of a scanning system which produces black and white marks on the paper strip of the receiver corresponding to the picture transmitted. At present relatively high speeds are obtained with the lawn mower type of scanning, some 28 sq. in. of copy being covered per minute in contrast with the prewar rate, which in cases was as low as 3 to 4 sq. in. per minute.

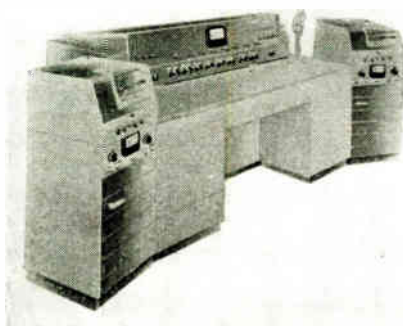

Finch version of complete equipment needed for facsimile broadcast by existing station with alternate scanners and control console

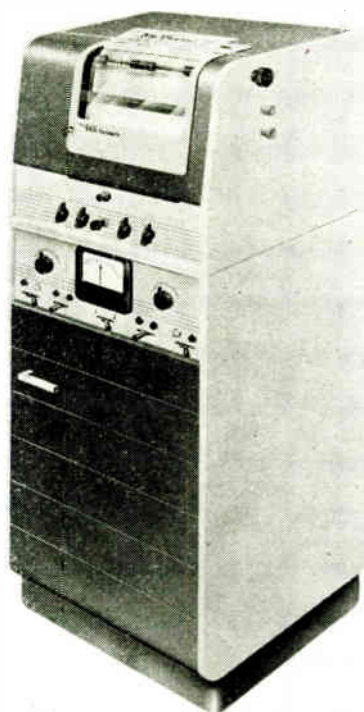

Above, transmitting scanner designed by Finch Telecommunications, Inc. Below, home receiving unit



As an example, this speed corresponds to approximately 540 words per minute, using the size and style of the type with which this article is set. This is, of course, much faster than a person is able to read. The two facsimile systems that are receiving most attention at this time are those of Hogan and of Finch. Both systems now are based on the use of a rotating scanning drum at the receiver.

Finch on the other hand is advocating even higher speeds of transmission, 44 to 46 square inches per minute, but there is a loss of fidelity at this speed which makes the reproduction of copy containing letters of this size less attractive. Before extensive broadcast service is under way however these factors will be standardized.

In the method finally developed, the marking spot is caused to travel across flat recording paper, fed continuously from a roll, between two recording electrodes which transmit electrical currents through the paper wherever a mark is to be made. Each recorded line is instantly visible.

The area of the marking spot is determined by the intersection of a "helix" (spiral) wire wound around a cylinder on one side of the paper and a strip of metal (the printer blade) mounted across the paper on the other side. By revolving the drum at the same speed as the scanning drum, this angle of intersection is caused to travel across the paper from left to right once for each revolution of the drum.

(Continued on page 117)

TUBES ON THE JOB

Tribo-electric Metal Sorting

One of the newest and most effective methods for industrial identification and sorting of pure metals, steels and non-ferrous alloys is tribo-electrification. A single test can be made in 2 to 5 seconds and the results are definite regardless of individual operators' technic in handling the testing head. The testing operation is also non-destructive to the metal under inquiry.

Tribo-electrification is a physical result producing very minute electrical currents when two pieces of metal are rubbed together, between which there is a chemical or metallurgical dissimilarity. When both pieces are identical no current is produced.

A new portable unit called the "Metalsorter" and made by Control Equipment Co., 547 Brushton Ave., Pittsburgh 21, Pa., uses this tribo-electric principle with a simplified circuit that makes production testing easy and fast. The resultant readings are shown on a calibrated dial scale on the cabinet panel, and will indicate immediately any deviation from a pre-set standard.

The simplified schematic shows the circuit details. The timing circuit is a 2050 type tube with the firing controlled by the voltage charge on the grid capacitor. A microbias circuit, with an adjustment knob on the tool head, is provided to balance out thermal effects in the micro-voltmeter indicating circuit. The microbias rectifier uses only 6.3 volts on its plates.

Dial readings show differences in metals tested

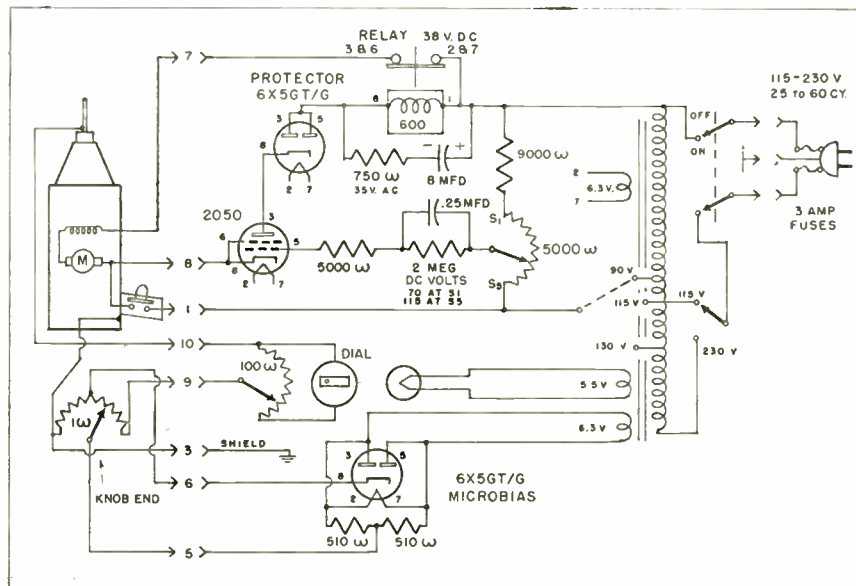

Metalsorter circuit; tribo-electric effect is measured on microvoltmeter dial after indicator is centered by adjustment of 6X5 microbias circuit. Timing of test period is made by 2050 tube

Making Cooking Utensils

A new electronic heating production unit is helping to solve one of the long standing problems of cooking utensil design. It is of course well known that stamping or deep drawing is one of the simplest and most economical methods for the manufacture of cooking pots and pans; but such formed vessels have several serious drawbacks. Because of the comparative thinness of the bottom plate they have poor and uneven heat distribution and the thermal capacity of the bottom is not sufficient to provide efficient energy transfer from the heat source to the contents of the vessel.

By the use of induction heating a heavy copper clad stainless steel disc can now be quickly silver-brazed to the bottom of a stainless steel vessel, giving the fabrication economies of stamping but with the efficient heat transfer of a correctly designed "cast" utensil. This brazing operation is done on Thermonic induction heating equipment which with its two position loading and heating provides smooth continuous output of work for one operator. Basically, the unit consists of a fixed upper head containing a large stainless steel plate which is heated by induction to a temperature of 1500° F. A movable lower head carries the fabricated assembly. This lower head is raised into the operating position by com-

pressed air. The equipment was designed and built by Induction Heating Co., 387 Lafayette St., N. Y. C.

The entire brazing operation takes about one minute. The cooking utensil, properly cleaned and



Induction heater for brazing bottom on cooking utensils. 2 place jig provides steady work flow

fluxed, is placed bottom side up on the lower assembly fixture together with a disc of shim-stock silver brazing alloy and the heavy reinforcing steel bottom disc. The assembly is then raised by compressed air and electronic heat applied while the joint is under pressure. The finished union is smooth and clean with a complete fillet around the edge of the disc. This built-up bottom shows excellent cooking heat flow characteristics.

Room-noise AVC

Featuring "room-noise" control of music volume for comfortable listening pleasure at all times, the first new Aireon juke box is now in operation in New York City. As conversation, dish clatter or other inherent room noise increases, the music level is proportionately raised. When the average room noise decreases, music volume drops. These changing noise levels are picked up by special microphones, peaked at 1200 cycles, and their outputs fed into the main amplifier as a grid voltage control. To prevent the music level influencing the AVC control, part of the main amplifier output is fed back into the control unit and bucks the total room pickup voltage. A short time delay is incorporated in the AVC.

The main amplifier has a 6L6 push-pull output stage conservatively rated at 13 watts with 3% distortion. The reproducer is a 15 in. Oxford speaker mounted in a tonal arch on top of the juke box. Supplementary 12 in. wall speakers are installed wherever necessary for proper sound coverage.

An extremely fast record selection cycle is another feature of this unit. Twenty-four ten-inch records are held vertically in a sliding rack. The turntable tilts from a vertical receiving position to a horizontal playing plane, bringing the record up to the pickup. Long record life is assured by the 1 oz. playing pressure of crystal pickup

housed in a magnesium tone arm. The stop mechanism is a trigger operated cam switch with almost no horizontal drag on the record grooves. Twenty-four solenoids provide stops for the control of the record selector motor and also act

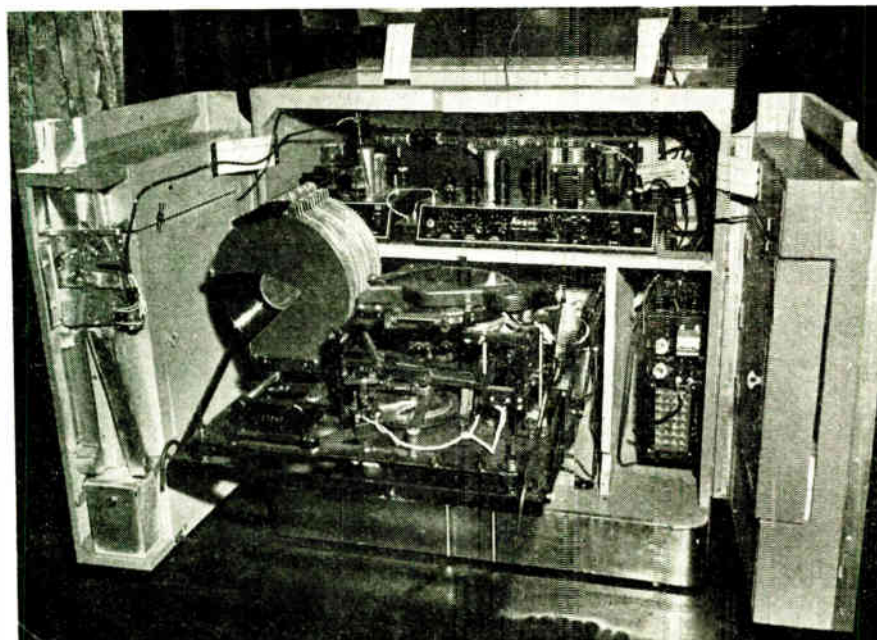

UNITED NATIONS SOUND SYSTEM

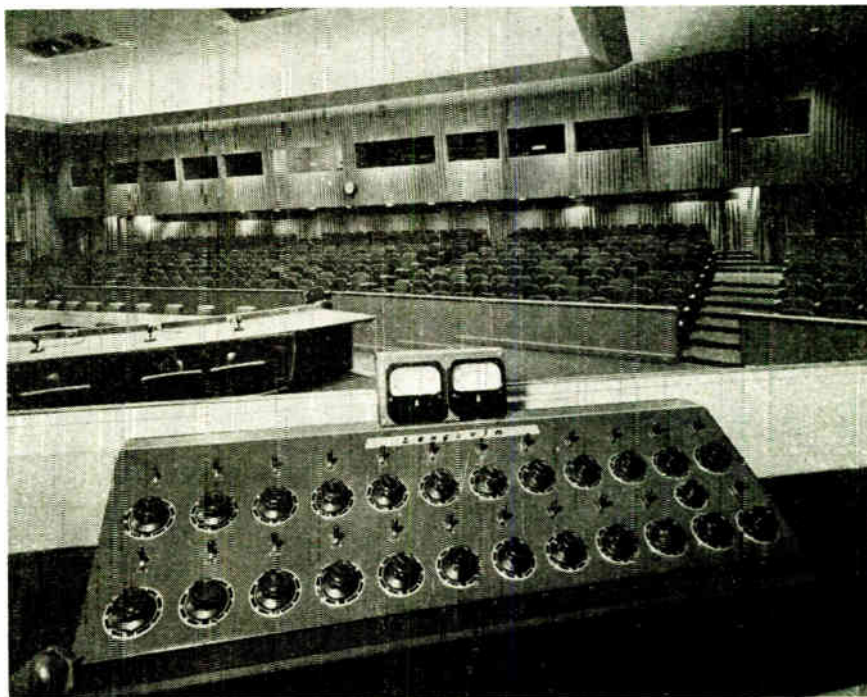

Complete control of the complex audio sound system installed in the United Nations Security Council Chamber at Hunter College, New York City, is centered in a 44 x 16 inch master panel. Floor pick-up is covered by 20 microphones and it can be fed collectively or individually into the 39 public address loud speakers, the interpreters' headphones or to special broadcasting, television and newsreel booths. Six separate channels carry the sound to a basement room where permanent recordings are made. The sound system, which conforms to standard FM requirements was built by Langevin Co., New York City.

as an accumulator of record selections.

The remote control transmitter stations of the record selector system use a single impulse control, and Aireon engineers say this system is about twice as fast as step-by-step relay selectors. Twelve different frequencies spaced between 149 and 289 kc and a phasing circuit provide twenty-four record selections. Each remote station contains a single vacuum tube which acts as a combination Colpitts oscillator, amplifier and rectifier. As a selector button is pushed, one tuned frequency unit is inserted in the tube circuits and the tube starts oscillating at that particular frequency. This output is then fed through the phasing circuit into one of two control circuit banks in the receiver-selector unit in the juke box. The receiver-selector contains 17 tubes, 12 of which are double triodes handling 24 keying circuits. A type 884 voltage regulator tube maintains constant voltage on the grids of the keying triodes. The plate voltages on these keying triodes are not rectified. A coaxial cable carries the impulses from the remote transmitter stations to the receiver-selector in the juke box.

World Radio History

COUPLING METHOD for

By **RICHARD C. KLEINBERGER**

Electronics Division, C. N. Burman Co., Paterson, N. J.

Design of transmission lines for matching impedances to obtain maximum power transfer to a remote load

• The matching of impedances by means of short-circuited and/or open-circuited transmission line sections is by no means a new art; however, the following analysis represents a slightly different approach to the problem than has heretofore been portrayed. In many applications of high-frequency dielectric heating the work is remotely located from the high frequency generator so that a transmission line of some sort to couple the two together is mandatory. The load is usually a complex impedance and some means also is necessary to match this impedance to the resistive impedance of the line to effect a satisfactory transfer of power.

This impedance matching may be accomplished by a conventional "Pi" or "T" network, or the line may be terminated in a loop coupled to a resonant circuit of which the work load is a component. The latter method is not as satisfactory as the former, as it is difficult to present to the transmission line an impedance containing no reactive component. A third method discussed here, needs only two adjustable matching stubs (Fig. 1). Theoretically the arrangement will effectively handle a load impedance of any magnitude; in practice it will accommodate a very wide range of load impedances. Advantages of this system are low losses, cheapness of construction, and flexibility of adjustment.

Matching stub design

The first step in the procedure is to design the matching stub A so that the load will present a pure resistance to the transmission line. The characteristic impedance, R_k of this stub may or may not be the same as the characteristic impedance, R_o , of the transmission line. It is not essential that it should be. It may be made any

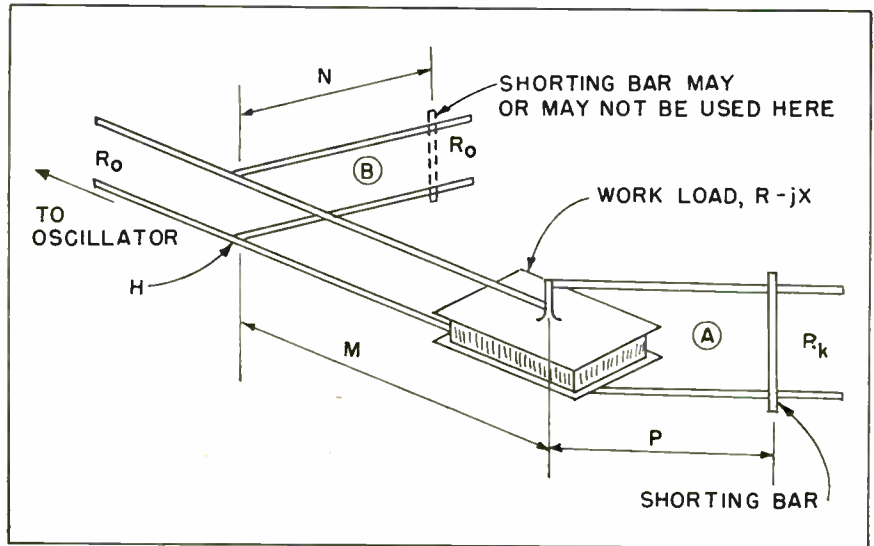

Utilization of line sections for matching load, is simplified by following prescribed routine in locating stub positions and dimensions

value that is convenient. This usually will be determined by mechanical considerations.

The designation of the load circuit as $(R - jX)$ represents an equivalent series resistance-capacitance circuit. For this analysis it will be necessary to determine the constants R' and X' of the equivalent parallel circuit. At the power factors normally encountered in dielectric heating the following approximate formulas may be used:

$$R' = \frac{R}{(PF)^2} \quad (1)$$

$$X' = X \quad (2)$$

where PF is the power factor.

At a power factor of .05 the error in these formulas is .25% and at a power factor of .10 the error is 1%. The short-circuited matching stub A should be so designed to have an inductive reactance equal in magnitude to the capacitive reactance, X' , of the load. The electrical length of the stub is deter-

mined from the following relation:

$$\theta^\circ = \arctan \frac{X'}{R_k} \quad (3)$$

where θ is the electrical length of the stub in degrees. The length P, in feet of the stub is found from the following:

$$P = \frac{2.73\theta^\circ}{F} \quad (4)$$

where F is the frequency in megacycles per second.

The impedance Z_s presented by the load in combination with matching stub A is now:

$$Z_s = \frac{1}{\frac{1}{R'} + j\frac{1}{X'} - j\frac{1}{R_k}} = R'$$

To determine the impedance of the load, a choice of methods is available. If a radio-frequency bridge is available, the reactance and equivalent series resistance of the load may be measured directly at the desired frequency. This probably is the most satisfactory

DIELECTRIC HEATING

method, but unfortunately a radio-frequency bridge is not always available.

The dielectric constant and the power factor of the material to be heated may be determined by means of a Q-meter. The geometry of the load and the frequency being known, sufficient data are now available to calculate the impedance of the load with reasonable accuracy.

An excellent method for determining the dielectric constant and power factor of a dielectric material by means of a Q-meter known as the "Susceptance Variation Method" has been described in detail by Hagopian.¹ This method will be accurate to within 2% for power-factors as high as .20. Its use is recommended where a Q-meter only is available.

It is now necessary to determine the distance M along the transmission line between the work and a point H, where the tuning stub B is located. In order that it be possible to effect an impedance match, it is necessary that the admittance of the line, looking toward the load be of such value that its conductance component will be equal

1
to $\frac{1}{R_0}$. The admittance of the line looking toward the load is given by:

$$Y = \frac{R_0 + jR_0 \tan \phi}{R_0 (R_0 + jR_0 \tan \phi)} \quad (5)$$

where ϕ is the electrical length in degrees represented by the distance M in feet; the relation being:

$$M = \frac{2.73\phi}{F} \quad (6)$$

Rationalizing the denominator of equation (5) and collecting terms gives:

$$Y = \frac{R_0 (1 + \tan^2 \phi)}{R_0^2 + R_0^2 \tan^2 \phi} + j \frac{(R_0^2 - R_0^2) \tan \phi}{R_0 (R_0^2 + R_0^2 \tan^2 \phi)} \quad (7)$$

Equation (7) is of the general form for the expression for admittance;

1. Richard H. Hagopian, Westinghouse Electric Corporation, Industrial Electronics Division, Baltimore, Md.

SUMMARY OF PROCEDURE

To match a dielectric-heating load to a transmission line the following procedure should be followed:

- 1.—Determine the impedance of the load, $R - jX$, by any of the three methods indicated.
- 2.—Determine the equivalent parallel circuit from equations (1) and (2).
- 3.—Design matching stub "A" by means of equations (3) and (4).
- 4.—Locate point "H" by calculating distance "M" by means of equations (6) and (9).
- 5.—Calculate the value of X_B from equation (10).
- 6.—Design matching stub "B" by means of equations (11) or (12) and equation (13).
- 7.—Final adjustment of the matching stubs and shorting bars will be determined by actual test under load.

$Y = G + jB$, in which G represents the conductance component and B the susceptance component. As stated previously the criterion for impedance match is that the conductance shall equal the reciprocal of the surge impedance of the line. From this then:

$$\frac{1}{R_0} = \frac{R_0 (1 + \tan^2 \phi)}{R_0^2 + R_0^2 \tan^2 \phi} \quad (8)$$

solving this for ϕ results in:

$$\phi = \arctan \pm \sqrt{\frac{R_0}{R_0}} \quad (9)$$

The distance M, is then determined from Equation (6). Whether the positive or the negative value of $\tan \phi$ is used is optional, but in general it would appear to be preferable to use the positive value as this will result in a smaller value for ϕ and consequently a shorter length for M.

The matching stub B should be so designed as to have a reactance value equal in magnitude and opposite in sign to the reciprocal of the susceptance term of Equation

(7). Denoting the value of this reactance by X_B we have:

$$X_B = \frac{-jR_0 (R_0^2 + R_0^2 \tan^2 \phi)}{(R_0^2 - R_0^2) \tan \phi} \quad (10)$$

The reactance X_B may be either inductive or capacitive, depending whether the result determined by formula (10) is positive or negative.

As it is desirable to have the length N of stub B as short as possible, for an inductive reactance a short-circuited stub would be used and for a capacitive reactance an open-circuited stub would be used. The final step in the problem is to determine the length of the stub B. Denoting the electrical length of the stub by ψ the relationships are as follows:

For a short-circuited stub:

$$\psi = \arctan \frac{X_B}{R_0} \quad (11)$$

For an open-circuited stub:

$$\psi = \arctan \frac{R_0}{X_R}$$

The length of the stub in feet is:

$$N = \frac{2.73\psi}{F}$$

Due to mechanical or other practical reasons there may be many applications where it is not feasible to use this method of coupling. Where it can be used it will be found to be highly efficient, easy to adjust and cheap to construct. As it is desirable to adjust the length M, a parallel transmission rather than a concentric line is preferred. With a parallel line mechanical means may be devised for adjusting the position of stub B along the transmission line.

In case this stub is to be an open circuit, its length may be adjusted by a telescopic arrangement of the conductors. Adjustment of short-circuited stubs is accomplished by varying the position of the shorting bar. As an additional precaution, the entire assembly should be inside a screened housing in order to prevent radiation from the lines and work-unit.

SURVEY of WIDE READING

Electronic news in the world's press. Review of engineering, scientific and industrial journals, here and abroad

Synthetic Quartz

N. Wooster and W. A. Wooster (Nature, London, March 9, 1946)

Fused silica is mainly converted into quartz when heated in a solution of sodium metasilicate at a suitable temperature. Some of the crystals obtained in this way are perfect but very small. However, when a natural quartz crystal was suspended by silver wire in the neighborhood of the fused silica and a suitable mineralizer added to the solution, the silica rod dissolved almost completely and an appreciable growth of the seed crystal was obtained in a period of hours.

As a rule the natural rhombohedral faces developed more smoothly than the prism faces. Closer inspection often revealed the positive rhombohedron faces to be like shingled roofs. The lattice spacings of the synthetic quartz are not distinguishable from those of the natural crystals on an X-ray powder photograph in a camera of 19 cm. diameter.

Low-Resistance Ammeter

A. Kolin (Review of Scientific Instruments, December, 1945)

A low-resistance ammeter is described which operates on the same principle as the electromagnetic flowmeter covered by A. Kolin in the May issue of the "Review of Scientific Instruments" and summarized on page 111 of the September 1945 issue of ELECTRONIC INDUSTRIES.

The ammeter is based on the generation of a pressure in a liquid conductor, for instance mercury, through which a current is passed at right angles to a magnetic field in which the liquid conductor is placed. When an electric current traverses the mercury positioned in the magnetic field, the lateral electromagnetic force exerted upon the mercury in the chamber will elevate or depress the communicating mercury level in the capillary to a height at which the manometric pressure will balance out the electromagnetically generated pressure.

A sensitivity of about 6 mm per ampere has been obtained for a particular arrangement with a flux

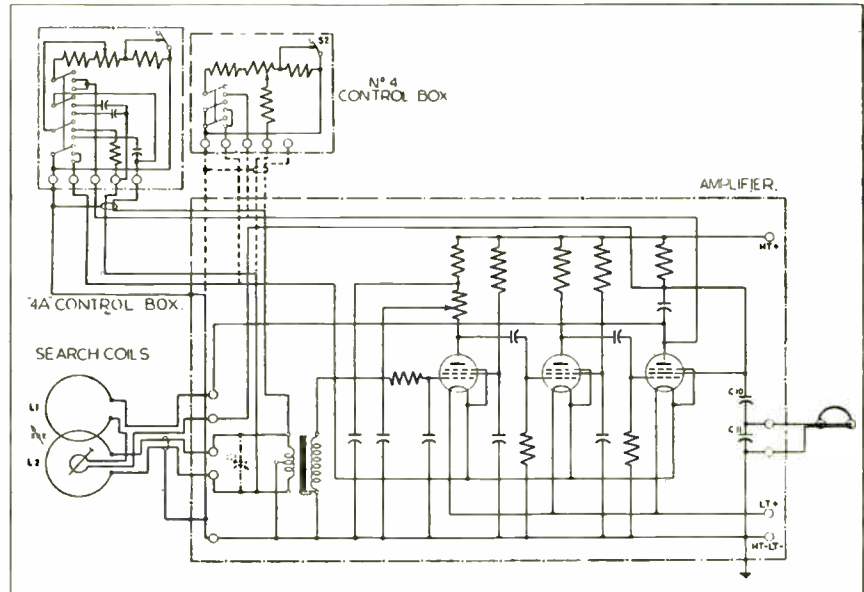

Mine detector capable of distinguishing materials having different loss angles

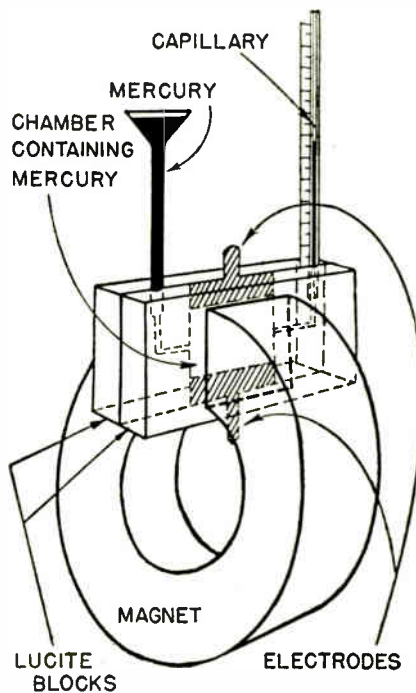

Mercury ammeter—sensitivity: 6 mm per ampere

density of approximately 2300 gauss and a width of the mercury chamber of 0.6 mm, the sensitivity may, however, be increased considerably. The internal resistance of this ammeter is in the order of 10^{-3} ohms. The instrument can readily be adapted for alternating current by

replacing the permanent magnet by an ac magnet. The use of the device as a relay is suggested.

Land Mine Detector

S. S. West (Electronic Engineering, London, March, 1946)

A new mine detector was designed to discriminate between objects introducing impedances with different phase angles, as for example between a mine and a ferrous loaded material under which it may be concealed. This discriminating action is assured by making the detector coil circuit phase sensitive. In other words it may be adjusted to respond more readily to coupling media introducing a specified phase shift than to any other material.

Two flat section coils L_1 and L_2 are arranged in parallel and partly overlapping position, the degree of overlap required being chosen to provide zero mutual coupling between the two coils. Consider the coils to be overlapped completely, i.e., the annular windings are coincident. Then the magnetic field from one coil will link with the other coil in a certain direction. If the two coils are placed side by side in the same plane, the magnetic field from the first coil links in the opposite direction. It follows that at some intermediate position the

(Continued on page 120)

NEWS OF INDUSTRY



This is what 300-ft microwave tower being erected by Federal Telecommunications Laboratories in Nutley, N. J., will look like

Electronic Conference Set for Fall

Plans for the resumption of the National Electronics Conference, Inc., are rapidly taking form. The Conference is to be held at the Edgewater Beach Hotel in Chicago, October 3, 4 and 5, and as usual is sponsored by the Illinois Institute of Technology, Northwestern Technological Institute, Chicago Section of the American Institute of Electrical Engineers, Chicago Section of the Institute of Radio Engineers with the cooperation of Chicago Technical Societies Council University of Illinois. Secretary of the Conference is E. H. Schulz of the Illinois Institute of Technology, Chicago 16, Ill.

Telechron Drops Warren

Warren Telechron Co., manufacturer of electric clocks and timing devices, has dropped Warren from its name, henceforth will be known simply as Telechron, Inc. Headquarters are in Ashland, Mass.

Lewyt to Make Own Home Sets

Lewyt Corp., 60 Broadway, Brooklyn, N. Y., is to manufacture and market a line of home radio receivers and phonographs under its own name. The line will include standard 5-, 6- and 8-tube superheterodynes in table models, portables and consoles as well as FM and television sets. Lewyt, a contract manufacturing firm for the past 58 years, will continue production of private brand sets and phonographs.

Cinaudagraph Moves

Cinaudagraph Speakers, Inc., has moved from Chicago to Slater, Mo. The shift has been made to provide additional manufacturing facilities. Supervision of all activities will be continued from Kansas City headquarters of Aieron Mfg. Corp., which recently acquired Cinaudagraph.

Shallcross Makes Variaten

Shallcross Mfg. Co., Collingdale, Pa., has acquired manufacturing rights and licenses to produce Variaten attenuators and other resistance devices developed by Cinema Engineering Co., Burbank, Cal. Cinema will represent Shallcross in the southwestern states.

RMA Chicago Meet

Radio Manufacturers Assn. has scheduled its convention and membership meetings for June 10-13 at the Stevens Hotel, Chicago. The gathering will include an industry banquet.

AIEE Schedules Summer Convention

The Summer Convention of the American Institute of Electrical Engineers is to be held in Detroit during the period June 24 to 28. Hotel Statler will be headquarters. An extensive technical program is being put together for every morning and two afternoons during the week.

GE Transmitter Now in Syracuse

Transmitter manufacturing, engineering and general management personnel which began moving to Syracuse from the General Electric headquarters in Schenectady early in the year has been practically completed. Included in the move are J. D. McLean, manager of sales; E. Lawrence, Jr., marine electronic equipment sales manager; W. R. David, broadcast equipment sales manager; H. M. Wales, aviation electronic equipment sales manager; and R. D. Jordan, advertising and sales promotion manager. P. G. Caldwell, television equipment sales manager, and T. Johnson, Jr., carrier communications sales manager, will maintain their headquarters at the Schenectady plant for the present.

Westinghouse Acquires Armstrong License

Westinghouse Electric Corp. has acquired a license for the use of all frequency modulation patents held by Maj. Edwin H. Armstrong. Effective immediately Armstrong patent developments will be incorporated in the full Westinghouse FM line including home receivers, railroad and special service transmitters and studio equipment.

Conventions and Meetings Ahead

Institute of Radio Engineers, New York Section, 330 West 42nd Street, New York, June 5, 1946.

American Society of Mechanical Engineers (Ernest Hartford, 29 W. 39th St., New York, N. Y.); Semi-Annual Meeting, June 17 to 20, Detroit, Mich.

American Physical Society. (Karl K. Darrow, Secretary, Columbia University, New York); June 20 to 22, 1946, Chicago, Ill.; July 12, 13, 1946, Berkeley, Calif.

American Society for Testing Materials (260 So. Broad St., Philadelphia, Pa.); Fortyninth Annual Meeting, June 24 to 28, Buffalo, simultaneously, Seventh exhibit of testing apparatus and related equipment.

Society for Experimental Stress Analysis (W. M. Murray, President, Central Square Station, Cambridge 39, Mass., Post Office Box 168); Spring Meeting, June 24 to 26, Hotel Statler, Buffalo, N. Y.

American Institute of Electrical Engineers

(H. H. Henline, 29 W. 39th St., New York); Summer Convention, June 24 to 28, Hotel Statler, Detroit. Pacific Coast Convention, Aug. 26 to 30, Seattle.

Instrument Society of America (Chairman of the Exhibit Committee, Paul Exline, P. O. Box 2038, Pittsburgh 30, Pa.); 1946 Exhibit and Conference, Sept. 16 to 20, Pittsburgh, Pa.

National Electronics Conference, October 3, 4 and 5, 1946, Edgewater Beach Hotel, Chicago.

Television Broadcasters Association, Inc., (500 Fifth Avenue, New York 18, N. Y. Room 1038, Will Baltin, Secretary); Conference, October 10 and 11, Waldorf-Astoria Hotel, New York City.

American Welding Society (Miss M. M. Kelly, 29 W. 39th St., New York, N. Y. PE 6-9220); Annual meeting, October 24, 1946, New York City and November 17 to 22, Atlantic City, N. J.

New Electronic Plant

Electronic Corp. of America has centered all manufacturing and sales operations in its new plant at 170-53rd St., Brooklyn. At the same time Samuel J. Novick has been elected chairman of the board and Garrard Mountjoy president of the corporation. Mountjoy has been vice-president in charge of engineering, and was formerly in charge of engineering for Lear, Inc., and Sparks-Withington & Co.

NEW PATENTS ISSUED

Multi-Phase HF Oscillator

According to the invention the output current of each tube in a three phase oscillator is jointly controlled by the output voltages of the two other tubes in such a way that the output voltage of the first tube is of equal magnitude but rotated in phase by 120° with respect to each of the two output voltages of the two other stages.

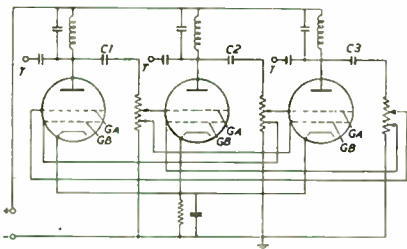

The parallel LC circuits in the plate supplies are anti-resonant to the generated frequency and so constitute a pure resistance of large magnitude. The two grids of each tube are connected to the output circuits of the two other tubes respectively. The product of the amplification factor times grid voltage for the two grids G_A and G_B must be equal for all tubes.

Under these conditions and if the grid voltages in each tube differ by $2\pi/3$, their resultant which effectively controls the current through the tube will differ in phase from either grid voltage by $\pi/3$, as illustrated in the accompanying vector diagram. As a result of the phase reversal through the tube, the plate voltage E_P will differ in phase from each of the grid voltages and there-

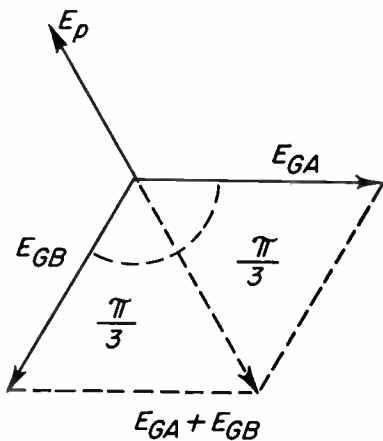

fore from each of the other plate voltages by $2\pi/3$.

Large blocking capacitors C are

used; they introduce practically no phase-shift and the slight phase error may be taken up in the tuning of the anti-resonant circuits. The three-phase output is taken off terminals T. Two identical triodes connected in parallel may replace one two-grid tube. The principle of the invention may be extended to the design of an oscillator generating any odd number of phases.

E. M. S. McWhirther and R. H. Dunn, Standard Telephones and Cables Ltd., (F) March 24, 1943, (I) January 22, 1946, No. 2,393,331.

Recording System

The phenomenon to be measured is caused to vary the frequency of the radio frequency oscillator, the frequency-modulated output of which is heterodyned to give a frequency-modulated audio wave. This

frequency-modulated audio frequency wave is applied to two balanced modulators, a 90° phase-shift being introduced between the preceding amplifier and one of the balanced modulators. A locally generated audio frequency, identical with the modulated frequency if the recorder is in balanced condition, is also applied to the pair of balanced modulators.

Any deviation of the frequency corresponding to the phenomenon to be recorded from the locally generated frequency will cause current to flow through the rotor windings of the two-phase motor and operate the motor to adjust the frequency of the local audio frequency generator by means of capacitor 17. Simultaneously, the motor controls the pen 20 recording the value of the phenomenon to be measured.

(Continued on page 121)

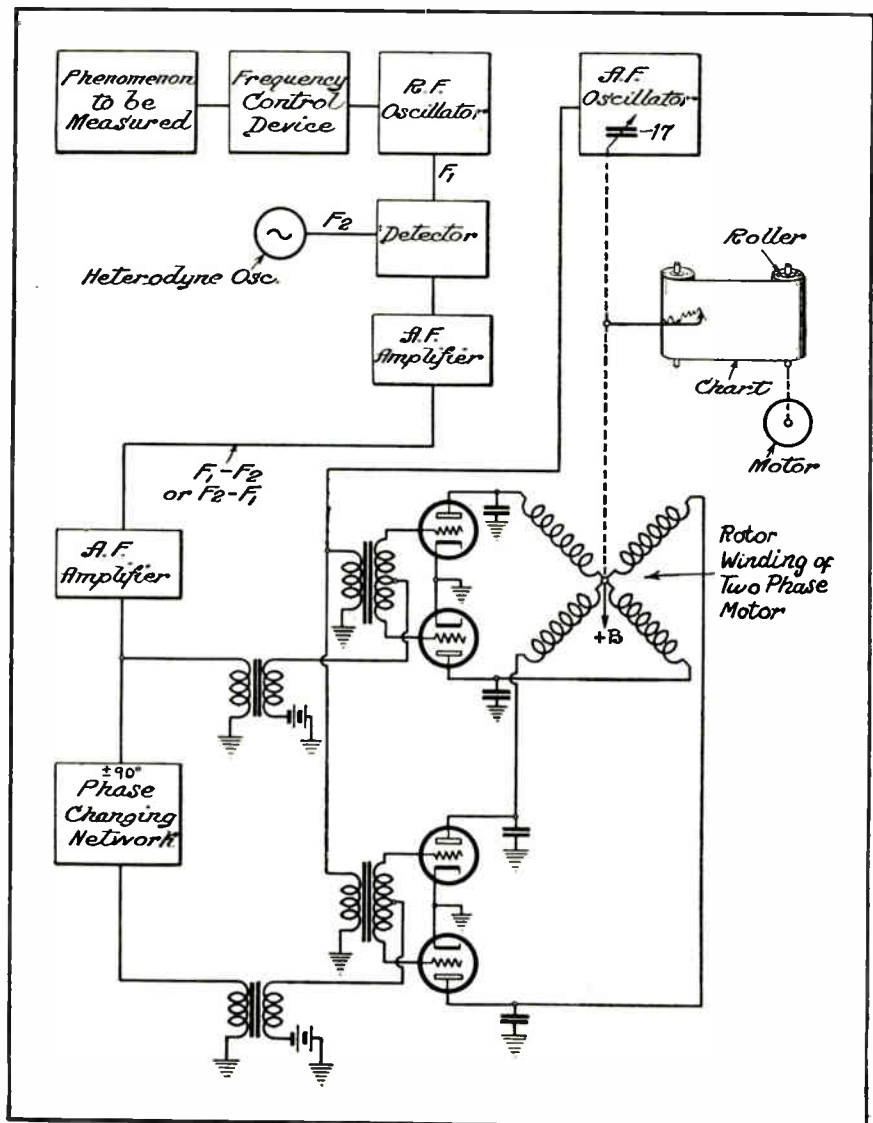

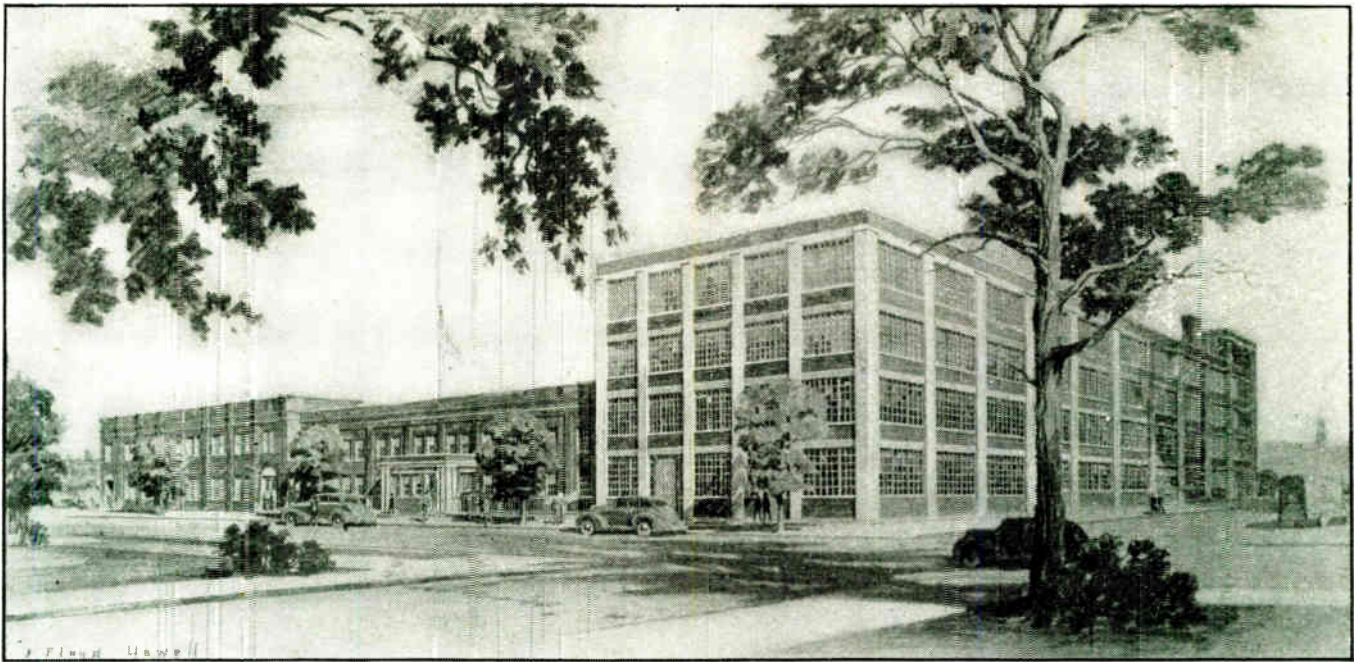

ISOLANTITE *is proud to announce*

the return of a pre-war management and a complete REORGANIZATION of our staff on a permanent peacetime basis — designed to serve you efficiently by offering you all the courtesies of our complete facilities devoted to the engineering and production of

STEATITE INSULATORS *and* COILFORMS *of all types*

CO-AXIAL TRANSMISSION LINE *and* FITTINGS

WAVEGUIDES *and* FITTINGS

ANTENNAS *and* SPECIAL ASSEMBLIES

OILBURNER ELECTRODE ASSEMBLIES *and* INSULATORS

REFRACTORIES *and* INDUSTRIAL CERAMICS

CERAMIC ARTWARE *of ALL DESCRIPTIONS*

ISOLANTITE, INC.

“FOUNDERS OF THE INDUSTRY”



BELLEVILLE, N. J.

343 CORTLANDT ST., ZONE 9

WASHINGTON

Latest Electronic News Developments Summarized
by Electronic Industries' Washington Bureau



PRICE RELIEF STARTS PRODUCTION MACHINE—

Pricing difficulties of receiving sets, as well as tubes and other important components have been largely remedied by OPA. This will alleviate production obstacles that have slowed up output of long-awaited home receivers with manufacturers losing substantially on sets, especially those in higher-priced categories. Straight 8% price increase across-the-board, in addition to boosts previously granted manufacturers, was allowed by OPA. While not as high as the boost desired by radio manufacturers—20% above 1941 prewar prices—which would swing industry back to full production, the new 8% hike will start up radio-electronic production machines, it is felt. Wholesale and retail dealers were directed to absorb part of latest increase. Receiving tubes with 27.5% boost in price above March, 1942, required by OPA to have 20% absorption by wholesalers of boost and 80% absorption by retailers.

CRITICS DON'T HAVE TO PAY BILLS—Accusations against radio the manufacturing industry because 1946 estimates do not project large production of FM receiving sets have come from critics who do not "pay the bills." FCC Commissioner Durr charged radio manufacturers are thinking "in terms of the old rather than the new" . . . Schenectady, N. Y., FM broadcaster and several leading FM engineers all claim FM is being hindered from its "revolution" of broadcasting. **But what none of these critics seem to realize or state is that the radio manufacturing industry is geared and ready to launch full-scale FM production when more FM broadcasting stations are on the air and the public definitely expresses its desire for FM receivers. It is to the best interest of the public, too, as at that time the best designs of FM sets will be available.**

CONSTRUCTION LIMITATION NOT HAMPERING NEW STATIONS—The \$1,000 exemption level on broadcasting, FM and television stations still is being continued by the Civilian Production Administration in its quest to conserve construction materials for veterans' housing, but in actuality the limitation is not hampering the establishment of new stations. Even though the National Association of Broadcasters, Radio Manufacturers and other broadcast and manufacturing interests had appeals to lift broadcasting-FM-television into the \$15,000 public utility status, "essential" construction of broadcast stations will in all probability receive approval by CPA local offices. The limitation does not include the equipment, antennas, radio towers, etc., so station owners are turning to already constructed quarters for studios and transmitter locations. Broad-

casting was only industry asking for blanket exemption from CPA limitations and CPA top officials felt if one industry was granted such a right it would establish a precedent and open wide the gates for other industries.

NEARLY HALF-BILLION DOLLARS OF SIGNAL CORPS SURPLUS—

As a result of surveys during the past year, the Signal Corps has declared surplus equipment with a total original cost of \$484,247,642 and made it available to the War Assets Administration for sale. Latter is using fully its manufacturer-agent disposal system. Approximately 250,000 different types and items of apparatus and parts comprise Signal Corps surplus in the ten Signal Corps depots. Other surplus disposal programs also surveyed by Signal Corps included undelivered items in contractors' plants and equipment in overseas theatres, latter being sold as much as possible in foreign countries. OPA has just established a pricing policy for government surplus items, mainly directed to aid in disposal of radio receiving and transmitting equipment in broadcasting, mobile and communications fields.

PRECEDENT IN TELEVISION STATION GRANTS—

In giving the Evening Star, leading Washington newspaper, one of the prized television channels out of four successful applicants, the FCC was thought to have established a precedent of authorizing local qualified and outstanding television applicants for stations in the various metropolitan centers where television is to be launched. FCC granted channels to NBC, Bamberger, DuMont and Evening Star, but refused application of a Washington advertising agency and also rejected Philco. Latter manufacturing company, however, is continuing high-definition television experimentation in Washington in connection with its Washington-Philadelphia radio relay system for television.

MOBILE RADIO DRAWS 6,000—Already up to the end of April, the FCC had received some 6,000 applications for mobile highway radiotelephony with equipment valued at over \$6,000,000 proposed. And this is only the beginning of experimental operations. In order to achieve stability in this mobile field, bus, trucking and taxicab industries have asked for five-year licenses. Radar, too, is becoming an important subject, hardly yet scratched in peacetime applications for service. FCC is planning inquiry into radar uses, patents, etc., during early summer.

National Press Building
Washington, D. C.

ROLAND C. DAVIES
Washington Editor

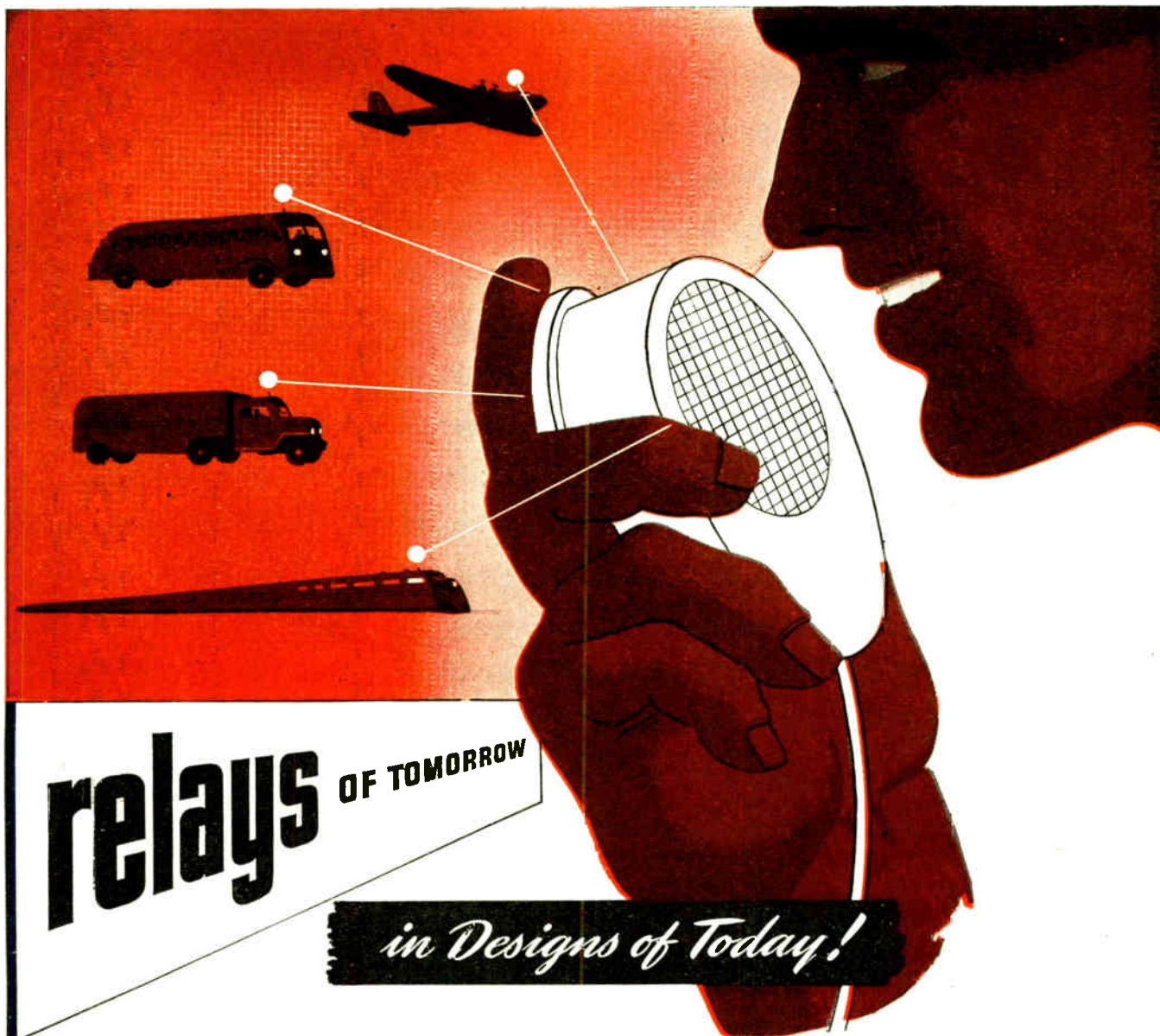

relays OF TOMORROW

in Designs of Today!

FOR COMMUNICATIONS IN TRAINS • TRUCKS • BUSES • PLANES...

Relays BY GUARDIAN — years ahead of today —

offer designers of two-way radios definite advancements which contribute to better long-life operation. This is especially evident with Guardian Relays and Switches used in two-way radios for trains, trucks, buses, planes.

For instance, Guardian's series 165-A Relay (A1 Si Mag insulated), for antenna changeover and break-in is small, compact, vibration-resistant. Laboratory tests with 2 normally open contacts prove series 165-A withstands vibration of 16.2 g.+ in both energized and de-energized positions. This is achieved by rugged overall construction and precise counterbalancing of the armature assembly. For H.F. and U.H.F. the series 165-A has a contact capacity to handle all required frequencies. Operates at temperatures ranging -65° to +160°F. and at altitudes from sea level to 50,000 ft. Truly, series 165-A merits a trial now! For V.H.F. antenna switching or keying try the war-tested Vacuum Switch Relay by Guardian.

Let us furnish cost-free information about the complete Guardian line of Radio Relays, also all Telephone Type Relays including the small Midget; and a special Switch used on push-to-talk circuits.

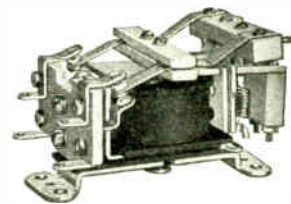

Series 165-A Relay

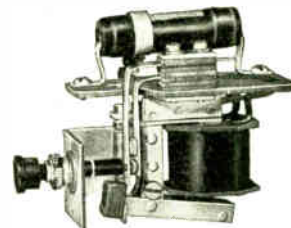

Series X-100 Relay

GUARDIAN  **ELECTRIC**

1622-G W. WALNUT STREET

CHICAGO 12, ILLINOIS

A COMPLETE LINE OF RELAYS SERVING AMERICAN INDUSTRY

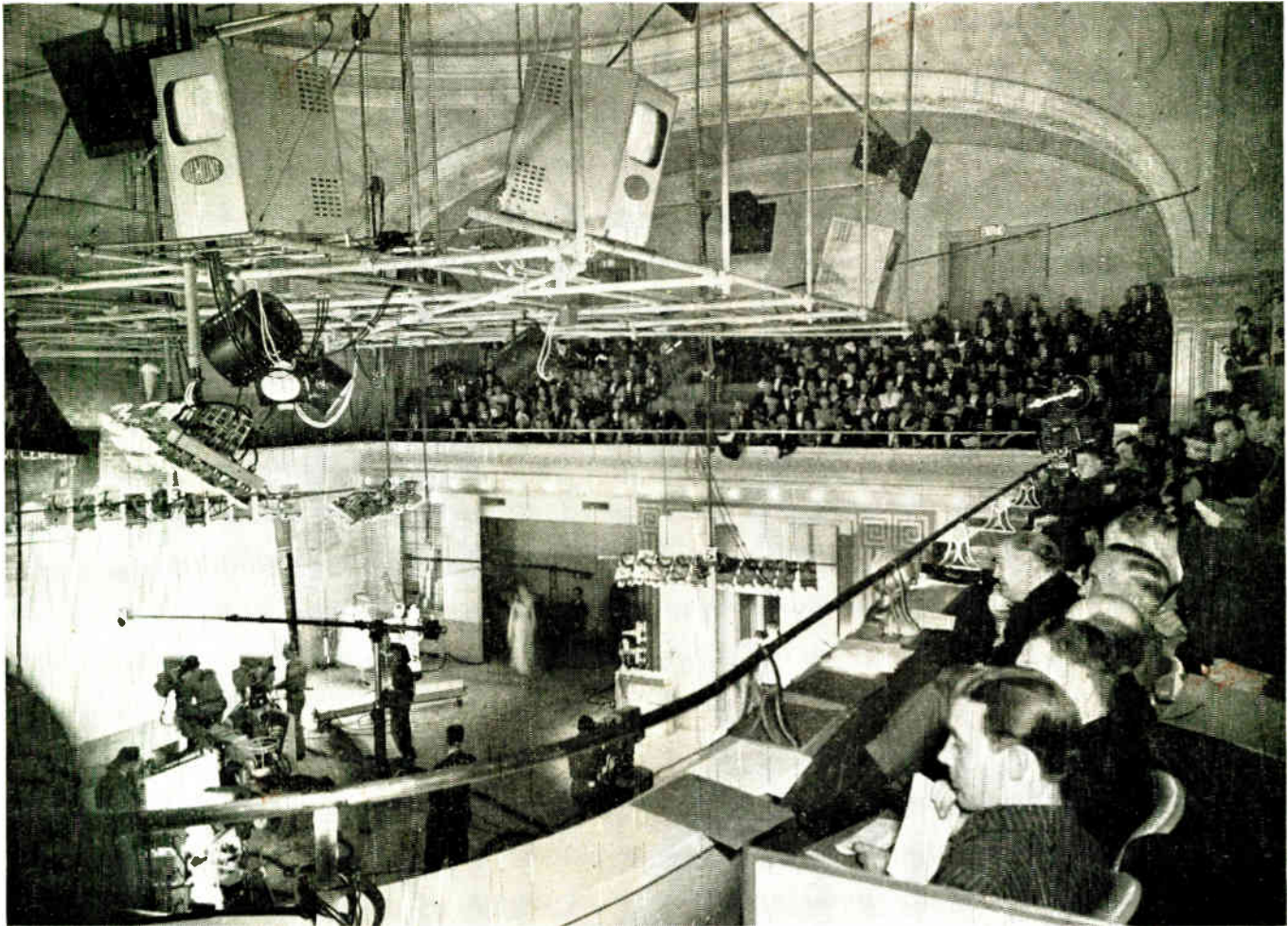

DU MONT'S WANAMAKER TELEVISION STUDIOS

DuMont's (New York) Wanamaker television setup includes three complete studios of which this is the largest (50 x 60 ft.) and has a spectator balcony seating 400. Light grid, carrying banks of reflector lamps, also carry large screen (20 in.) direct viewing sets. Equipment includes four cameras, two microphone booms. Smaller studios are 700 and 1200 sq. ft., have three and two cameras, respectively. Each studio has its own complete control room equipped with twin turntables for sound effects. In addition there is a master control room, and a motion picture projection room containing two each 16- and 35-mm projectors. Transmitter, with a fourth studio, are at 515 Madison Avenue, 2½ miles from Wanamaker's at 9th Street, programs being fed back and forth by specially matched cable telephone line. Transmitter is rated at 4 kw, will soon be replaced by one rated at 25 kw. Effective height of the antenna is 650 ft.

★ TELEVISION TODAY ★

New Developments in the Video Field

Color Television By Coaxial Cable

The last major objection on the practicability of color television as a network service has been eliminated, Frank Stanton, president of the Columbia Broadcasting System, indicated following a successful 450-mile transmission of ultra-high frequency television over the coaxial cable facilities from New York to Washington and back.

The test consisted of colored motion pictures and slides sent to Washington and back over the

*Title registered U. S. Patent Office.

coaxial loop set up by A.T.&T. Slides were used to test comparative transmissions of ultra high frequency television, developed by CBS, with low frequency black-and-white television.

The demonstration showed that, even though the definition of color pictures was decreased to some degree by the present characteristics of the cable, the added information conveyed by color compensated for the loss.

The test was made April 19 prior to removal from service of the New York-Washington cable by A.T.&T. for technical revision. The color

pictures originated on the tenth floor of CBS headquarters at 485 Madison avenue, New York, and sent by coaxial cable to the CBS television studios at Grand Central Station, thence by coaxial cable to the A.T.&T. Long Lines Building at 32 Avenue of the Americas. thence over the loop to Washington via Philadelphia and Baltimore. Retracing the path back to New York, over the other leg of the coaxial loop, the color pictures were sent by cable to the CBS ultra-high frequency transmitter, W2XCS, atop the Chrysler Tower where it was

(Continued on page 129)



"If we'd made this radiograph sooner...

...we'd have saved
\$30,000"

A manufacturer of valves, whose foundry technic seemed "okay," decided pilot radiographs weren't needed. But when machining was done and the valves assembled, enough were found defective to cause a loss of many thousands of dollars.

Radiography, put to work at the right time and place, pays off. Men who have figured *cost-wise* what it can do for them . . . to improve design, speed production, and lower costs . . . make full use of x-ray.

Radiographs show your engineers where to correct faulty design . . . how to reduce weight safely . . . how to cut costs at many stages of manufacture . . . how to build in extra dependability.

Order-jammed foundries get a welcome production

spurt when radiography shows how to get into sound casting production fast. High-value, high-volume machine shops operate at rock-bottom cost when radiographic inspection keeps internally unsound castings off the production line.

Welding gains acceptance . . . new markets . . . higher volume . . . because radiographs prove weldments sound.

And these are only a few high spots in radiography's list of industrial functions. You can find more—if you look for them—right in your own plant. Why not get together with your radiographer or the local x-ray dealer and see if you are missing any chances to make radiography pay extra dividends? Or write to

**Eastman Kodak Company, X-ray Division
Rochester 4, New York**

Radiography

—another important function of photography

WHAT'S NEW

Devices, products and materials the manufacturers offer



Microphone

A six-position cardioid type microphone, which is a combination of dynamic moving coil unit and ribbon type velocity element is being manufactured at Western Electric Co., 195 Broadway, New York. The quality is unchanged and the sensitivity remains practically the same over a wide pickup angle up to at least 120°.—Electronic Industries



FM Mobile Radio

A two-way communications system operating on the new fm band of 152 to 162 mc. for police, fire, public utility, taxicabs and other mobile services has been developed by Link Radio Corp., 125 W. 17th St., New York. The type 1906 mobile transmitter has a power output of 15 watts and is crystal-controlled, the crystal holder being temperature-stabilized. The type 1905 mobile receiver also is crystal controlled and has temperature-compensated components. Sensitivity better than 1 microvolt and low battery drain are characteristics of the receiver. Size of transmitter unit is exactly the same as receiver shown above.—Electronic Industries

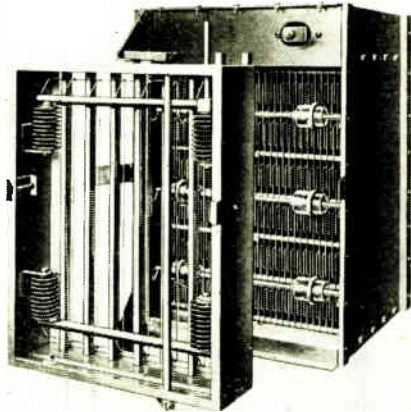

Air-Filter

The latest addition to the line of electronic air filters developed by the American Air Filter Co., Inc. Louisville 8, Ky., is the Electro-Cell unit, which has a capacity of 1,000 cfm per unit. As many sections as are needed can be combined for any particular installation.—Electronic Industries

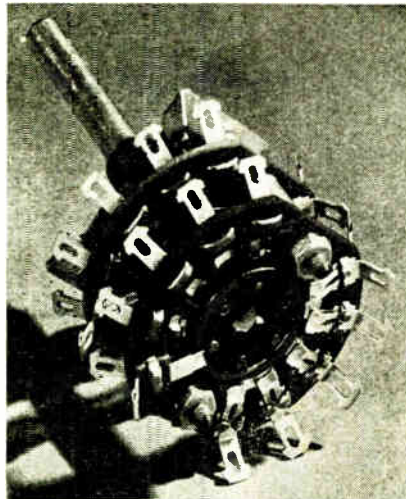

Switches

A new series of rotary multiple circuit switches has been developed by P. R. Malory & Co., Inc., Indianapolis 6, Ind. With phenolic or ceramic insulation and double wiping action on the terminal contacts, these units are suitable for frequency band and tone controls in radio receivers and low current, high frequency circuit selection in low power electrical and electronic devices.—Electronic Industries

Protective Coating

A protective coating highly resistant to acids, alkalis, chlorides, oils, brine, oxygen, gasoline and alcohol solutions has been developed by Lithgow Corp., 333 W. 40th Place, Chicago 9, Ill. Called Cotoid, it is based on synthetic resin, a thermoplastic which inhibits corrosion. The coating withstands a maximum temperature in air of 226°F and submerged temperatures up to 150°F; it does not crack under temperatures low as -20°F.—Electronic Industries

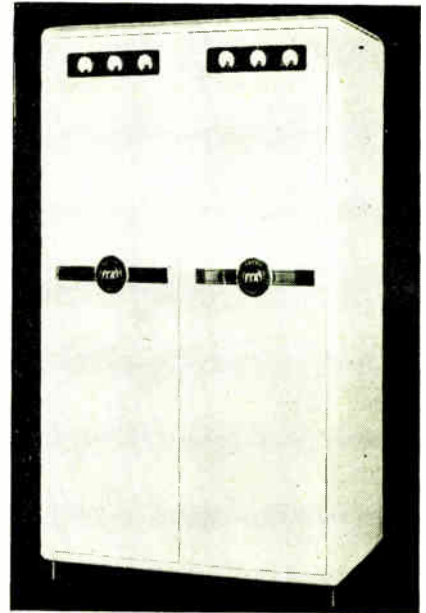

Ground Station Transmitter

A general purpose aviation ground station radio transmitter designed for low, high and very high frequency voice and cw transmission has been developed by Federal Telephone and Radio Corp., Newark, N. J. Type 184 permits various combinations of rf units, power supplies and modulators for local or remote control in the 200-450 kc., 2-20 mc. and 108-140 mc. bands. Outputs from 150 to 500 watts are possible depending on the frequency band. The transmitter operates on the 220 v., 50-60 cycle single phase line and is capable of being keyed up to 500 words per minute.—Electronic Industries

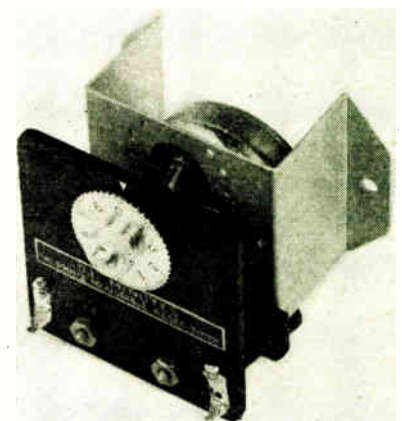

Reset Timer

Haydon Mfg. Co. of Forestville, Conn. is manufacturing a reset timer meeting most time delay relay timer requirements. The timer is available with either 1/10, 1, or 4 rpm motors giving a range of delay from 1 second to ten minutes. The motor has a magnetically controlled clutch, which automatically engages a gear train when energized and disengages when de-energized.—Electronic Industries

BUILD BETTER PERFORMANCE INTO ELECTRONIC TUBES WITH

Driver-Harris RADIO ALLOYS

For continued success no industry depends more on quality, precision and constancy of metals used, than radio. Small parts perform important functions and if not made of proper alloys that conform to rigid specifications the entire product is affected. Particularly is this true in the manufacture and development of Cathode-Ray Tubes.

Since the inception of radio Driver-Harris metallurgists have pioneered in developing and manufacturing special purpose alloys for this field. Today the leading manufacturers of Cathode-Ray Tubes use D-H alloys to help develop longer life and clearer images.

Driver-Harris makes alloys for every electronic tube requirement—for filaments, grids, plates, grid side rods, glass seals, cathode sleeves, socket prongs, filament support springs and mica straps. In addition there are over 80 other electrical heat and corrosion-resistant D-H alloys available for various electronic applications.

If the alloy you need hasn't already been developed tell us about it. Our engineers with 46 years experience are at your service.

Famous D-H Radio Alloys:

NICHROME* • GRIDNIC • MICKEL "A", "D", "E", "Z" • FILNIC*
74 ALLOY • 42 ALLOY • 52 ALLOY • NILVAR*

Driver-Harris COMPANY

Exclusive Manufacturers of Nichrome

HARRISON, N. J.

BRANCHES: Chicago • Cleveland • Detroit • Los Angeles
San Francisco • Seattle

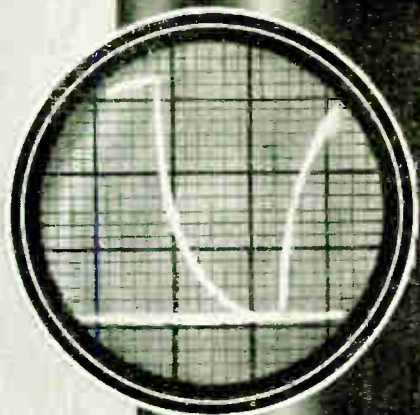

OSCILLOGRAPH



TELEVISION



RADAR

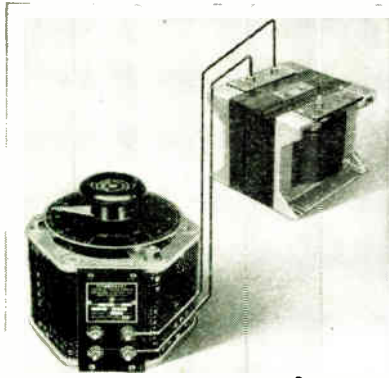

Variable Voltage Transformer

Combining a variable voltage transformer and a fixed ratio transformer in a single unit, Superior Electric Co., Bristol, Conn., has developed a transformer that handles high current loads with small physical size and low current rating. Standard models of these transformers will compensate for voltage variations of plus or minus 20%. They are made for 115, 230 and 440 volts.—Electronic Industries

Graphite Anodes

Featuring a new isolated getter trap, United Electronics Co., 42 Spring St., Newark 2, N. J., has designed two 300-watt transmitter type tubes with graphite anodes and clear glass bulbs. Heat radiation and thermal conductivity is much higher than that of tantalum metal plated tubes. The normal operating temperature for these graphite anodes is 500-600° C as compared to 900-1,000° C for tantalum plates. Average emission and gas content qualities are equal to or better than tantalum plate tubes.—Electronic Industries

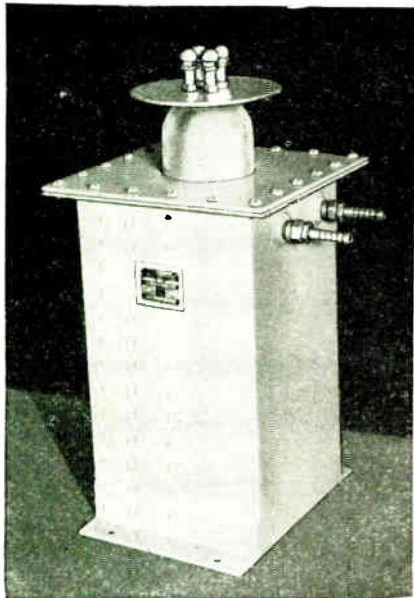

Mica Capacitors

KVA ratings are boosted by a factor of five by using the series 1780 water-cooled mica capacitors being manufactured by Aerovox Corp., New Bedford, Mass. The mica stacks of these units are in an oil bath. The capacitors are available in ratings up to 25,000 volts ac test and in capacitance values up to .01 mf.—Electronic Industries



Electrocardiograph

A direct-writing electrocardiograph, which records continuously for 30 minutes and has only two operating controls has been developed by Electro-Physical Laboratories, Inc., 25 W. 18th St., New York. The "Cardiatron" incorporates a 9-tube amplifier and especially developed interference reduction circuits. It operates on 110-120 volts, 60 cycle ac and consumes 100 watts.—Electronic Industries

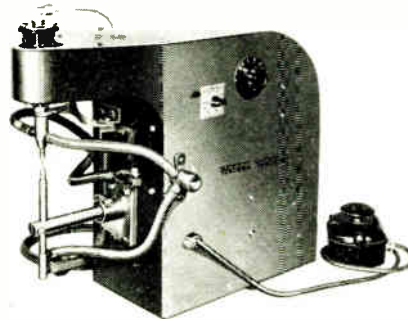

Spot Welder

For spot welding of light metals up to 18 gage C.R.S. the "Weldex" spot welder has been developed by Weldex Inc., 7347 McDonald Ave., Detroit 10, Mich. This bench type spot welder is air-operated, foot controlled and electronically timed. It has an adjustable pressure switch and consumes 3 KVA at 220 volts, 60 cycle, single phase.—Electronic Industries

Coil Checker

A vacuum tube coil checker with which 1000 to 5000 coils per day may be tested for shorted turns and open circuits is in production at Kartron, Inc. and being distributed by Starr and Thornbury, 4101 Rhodes Ave., North Hollywood, Cal. The checker is sensitive enough to detect a single shorted turn of No. 44 wire in a winding of ten thousand turns.—Electronic Industries

Glossmeter

The Henry A. Gardner Laboratory Inc., 4723 Elm St., Bethesda, Md., has developed an improved 60° glossmeter available in transformer or battery types. The instrument measures specular gloss of industrial finishes such as refrigerator enamels, automobile and railroad finishes, varnishes and lacquers of all kinds. Samples may be tested for change in gloss of surface resulting from weathering, wear, abrasion and other treatments.—Electronic Industries

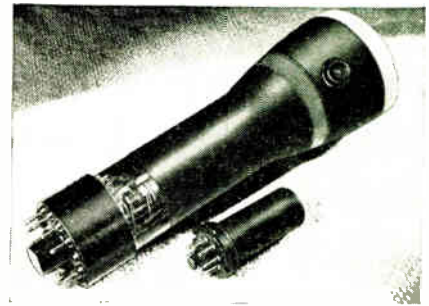

Cathode Ray Tube

A new 3 in. cathode ray tube, the 3JP, has been brought out by Allen B. DuMont Laboratories, Inc., Passaic, N. J. The 3JP uses electrostatic focusing and deflection and has greater brilliance and deflection sensitivity than the wartime types. The tube is directly interchangeable with the 3FP, if deflection voltages are suitably controlled.—Electronic Industries



Flexible Tubing

Flexible, non-collapsible tubing for ventilation, handling of air, gases or light solids is being manufactured at Spiratube Div., Warner Brothers, Bridgeport, Conn. The tubing is retractable to 1/3 its extended length, has a bursting strength of 170 psi, is fire-resistant and covered with thermoplastic.—Electronic Industries

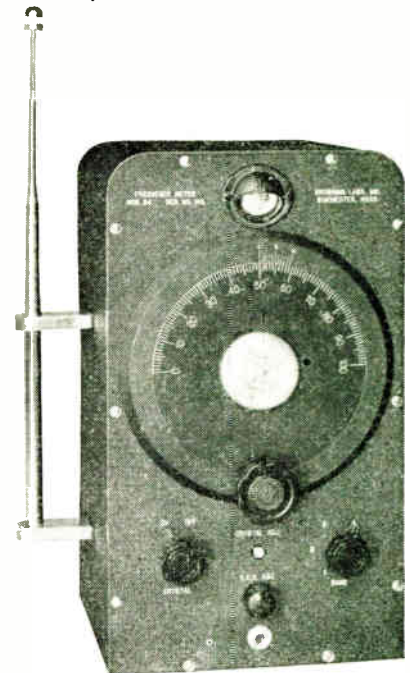

Frequency Meter

A frequency meter to check the range from 1.5 to 100 mc. of either AM or FM transmitters to an accuracy of .0025% has been developed by Browning Laboratories, Winchester, Mass. It uses a 100 kc. crystal as secondary standard. A machine cut dial with vernier turns the ECO.—Electronic Industries

PACKAGED R. F. RADAR ASSEMBLY ELIMINATES DESIGN HEADACHES

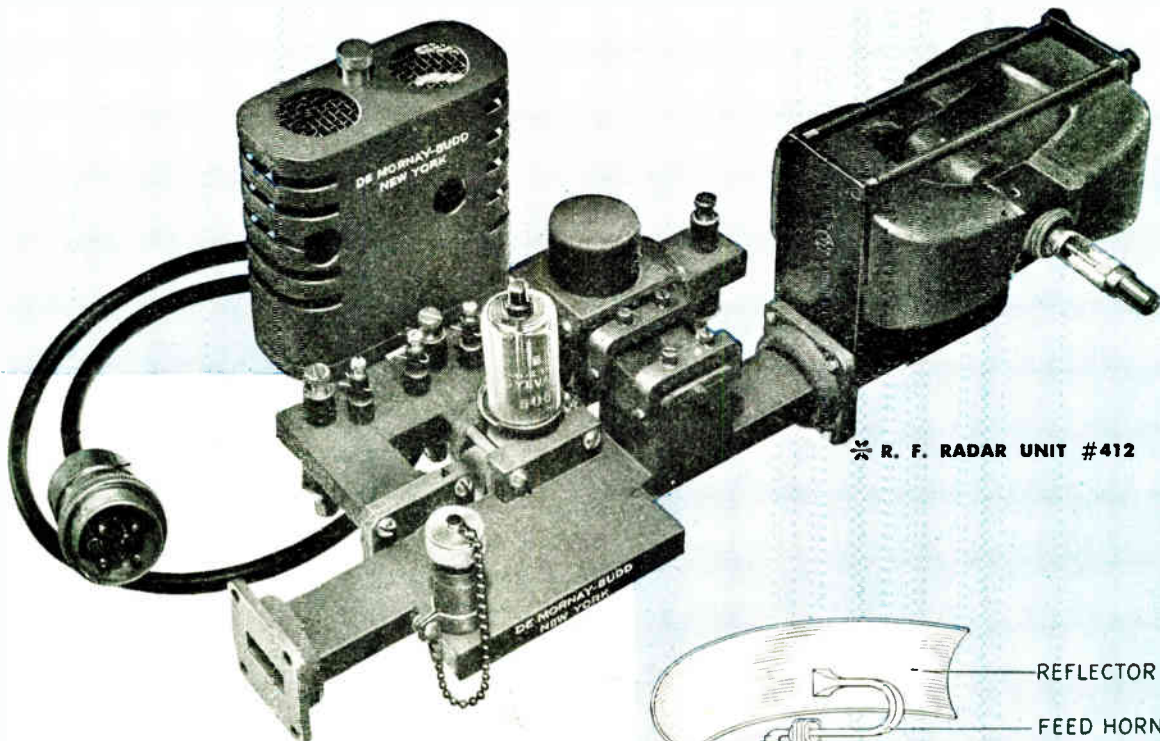

* R. F. RADAR UNIT #412

The DeMornay-Budd packaged R. F. Unit provides a complete R. F. assembly for microwave radar. It is now possible to obtain as standard items all the microwave R. F. components necessary in the fabrication of a complete radar—DeMornay-Budd Standard Transmission Line Components plus packaged R. F. Unit.

The R. F. Radar Unit is delivered complete and ready to operate. It is wired and contains all the necessary tubes and crystals. The unit uses a packaged magnetron capable of delivering 20 kw., peak power, at 9375 mc. Two type 2K25 local oscillator tubes are provided, one for receiver and A.F.C. and the other for beacon operation. A type 1B35 A-T-R tube, a type 1B24 T-R tube and the necessary type 1N21 crystals are included in the assembly. A 20 db. directional coupler permits accurate measurements to be made at any time with a maximum of convenience and safety.

Since the use of radar beacons is contemplated in the near future, the unit has been designed with a beacon cavity and crystal mount. The unit can be supplied without the beacon cavity and crystal mount and beacon local oscillator, and a termination supplied in their place so that it becomes a simple matter to convert to beacon operation when necessary.

We offer complete laboratory research facilities and have available such production test equipment as: Standing Wave Detectors, Calibrated Attenuators, Slug Tuners, Power Supplies, Square Wave Modulators, in addition to transmission line components shown in diagram above. Write for information or catalog.

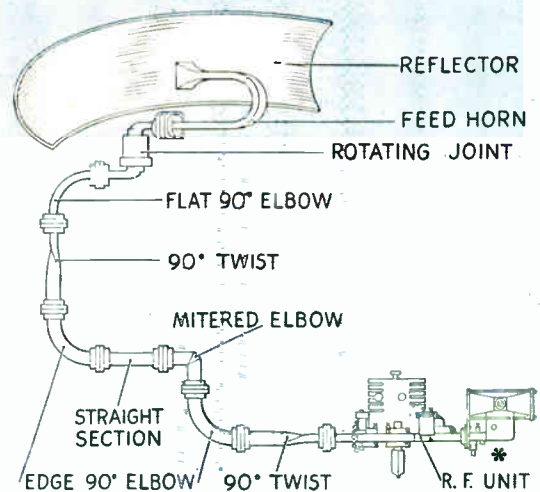

R. F. Radar unit #412 (indicated by asterisk) used in conjunction with standard DeMornay-Budd transmission line components.

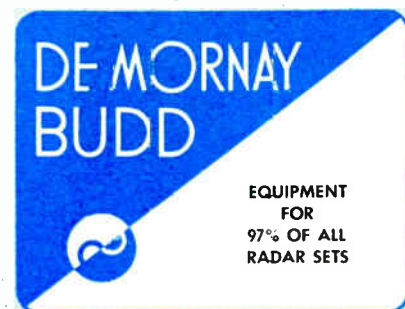

DE MORNAY-BUDD, INC.
475 GRAND CONCOURSE, NEW YORK, N. Y.

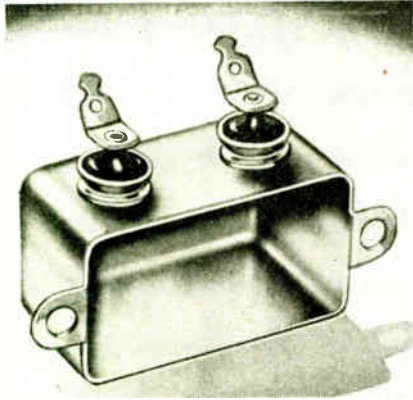

Hermetic Terminals

A new type of glass-to-metal hermetic terminal has been developed by Cincinnati Electric Products Co., Cincinnati, Ohio. No. 110—RHTL Fusite terminal is a single terminal equipped with a hollow tube and copper connecting lug. A conductive lead can be brought directly through the tube to the lug. The terminal was especially designed for the capacitor field.—Electronic Industries



Immersion Pyrometer

An immersion pyrometer, which may be used with several types of interchangeable thermocouples and has a 4 in. direct-reading scale calibrated from 0-1,500°F, 0-2,500°F or equivalent centigrade has been brought out by Pyrometer Instrument Co., 103 Lafayette St., New York. The instrument has an automatic cold end compensator and is constructed with a permanent magnet, low resistance type galvanometer.—Electronic Industries



Frequency Meter

A frequency meter for uhf and microwaves especially suitable as receiver frequency monitor has been developed by Lavoie Laboratories, Morganville, N. J. Models having an accuracy of 0.1% and a frequency coverage of 2 to 1 are available in the ranges from 100 to 2000 mc. Each instrument is individually calibrated.—Electronic Industries

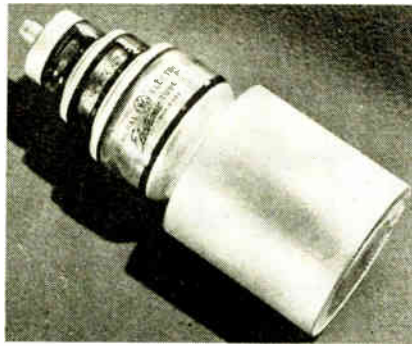

HF Transmitter Tube

A new screen-grid transmitting tube engineered for use in the FM bands by General Electric Co., Thompson Rd., Syracuse, N. Y., uses ring-seal contacts. Filament, grid and screen terminals are designed to permit plug-in installations. This new GL-7D21 has minimum internal inductance, complete internal shielding of the four electrodes and provision is made for a rf ground plane for possible external shielding. Plate ratings are such that a pair will handle the output for a 3 kw transmitter.—Electronic Industries



Penetration Tester

An instrument, which determines accurately the penetration properties and sizing of paper using the inks commonly used in printing has been developed by Testing Machines, Inc., New York. From a known sample of paper the penetrability of an unknown ink may also be determined.—Electronic Industries

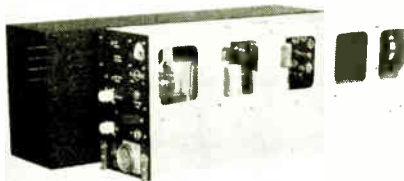

Aircraft Transmitter

The 17K-1, a lightweight aircraft transmitter for use in the 122-132 mc band has been brought out by Collins Radio Co., Cedar Rapids, Iowa. Providing 5 watts output for voice modulation, the transmitter has five crystal-controlled frequencies and may be remotely controlled. It uses 12 v. or 26.5 v. dc as power source.—Electronic Industries

Thermocouple-Ionization Gage

An ionization gage control for use with any standard ionization gage has been brought out by National Research Corp., Boston 15, Mass. The control is complete with power supply and in conjunction with type 507 ionization gage it will cover a range of 1mm. to 2×10^{-7} mm. of mercury. Outgassing provision, interlocking relay and zero adjust controls for amplifier balancing are also included.—Electronic Industries

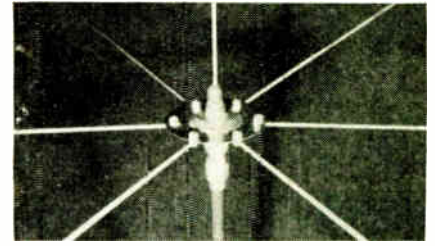

HF Antenna

A ground plane antenna designed to work in the 220-225 mc and 144-148 mc amateur bands has been brought out by the Workshop Associates, 66 Needham St., Newton Highlands 61, Mass. Conversion from 220 mc to 144 mc is accomplished by screwing on an extra tip to each radial arm.—Electronic Industries



Program Equalizer

A rack-mounted program equalizer for use in the broadcasting or recording fields is being made by Cinema Engineering Co., 1510 W. Verdugo Ave., Burbank, Cal. Both high and low ends of the sound spectrum can be regulated over a range of 16 db attenuation and 12 db equalization. Graduations are in 2 db steps. Attenuation is peaked at 100 cycles at the low end; with a key selector permitting high end peak equalization to be switched to 3, 5 or 10 kc. A cutout key allows pre-setting. The unit has a constant "K" circuit.—Electronic Industries

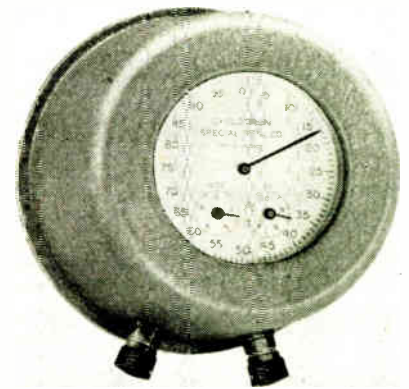

Impulse Register

To be used in connection with Geiger Muller counter sets, an impulse register registering up to 60 impulses per second has been brought out by Cyclotron Specialties Co., Moraga, Cal. It has 7,500 ohms dc resistance and will operate on as low as 100 milliwatts.—Electronic Industries

Wire Wound Resistors

Requirements for accuracy and stability are met by a series of precision resistors, available in five sizes, developed by Resistance Products Co., Div. of Electronic Mfg. Co., Harrisburg, Pa. Wound non-inductively on steatite forms, the resistance wire is a nickel-chrome or copper-nickel alloy. Double impregnation provides protection against humidity and corrosion.—Electronic Industries

NEW DESIGN POSSIBILITIES

... WITH THIS NEW LINE OF
SMALLER, LIGHTER, ENERGY-
STORAGE CAPACITORS

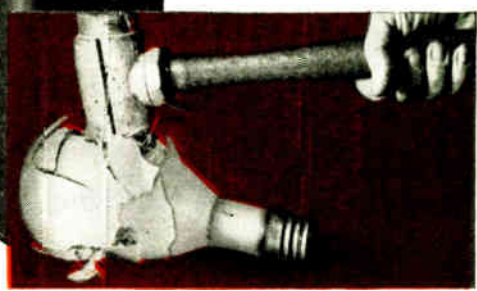
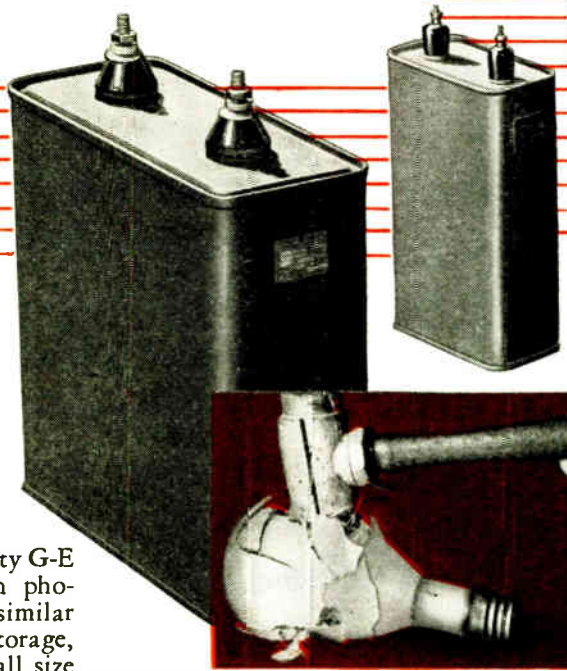
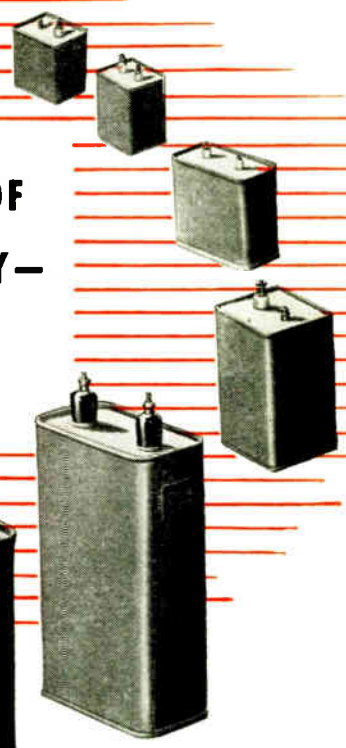

This flash photo was made possible by G-E capacitors.

For

High-speed flash photography,
Light-metal welding,
Electronic-timing
devices, etc.

A complete new line of light-duty G-E Pyranol* capacitors is now available for flash photography apparatus, light-metal welding, and similar applications requiring economical energy storage, fast discharge and service reliability. Their small size and light weight will help designers reduce the size of such equipment.

The high dielectric constant of Pyranol and its high dielectric strength provide outstanding electrical characteristics. Ambient temperature operating limits, at rated voltage, range from 0 to 50 C and the capacitance tolerances, measured at 25 C, are ± 10 per cent. The performance of these compact units has been thoroughly proved by several years of laboratory tests and actual operating experience in the field.

G-E light-duty energy storage capacitors are made in a wide range of ratings to fit practically every requirement of high-speed flash photography as well as

home and industrial welders of light metals. Careful construction, quality materials, and skillful design contribute to long life and efficient operation.

The accompanying table lists preferred ratings which can be promptly shipped. For further information on these ratings or on designs for special operating conditions, advise us of your problem through *Apparatus Dept., General Electric Company, Schenectady 5, N. Y.*

*Pyranol is G.E.'s trade name for askarel, a noninflammable liquid dielectric.



PREFERRED RATINGS *								
Max. D.C. Volts	Muf	Watt/Sec	Cat. No.	Base	Case Height in In.	Height Over Terminals in In.	No. of Terminals	Net Wt. Lb.
2000	25	50	25F903	A	4 19/32	5 7/64	2	5.2
2000	40	80	25F910	A	7	8 1/4	1	7.8
2500	25.5	80	25F911	A	7	8 1/4	1	7.8
3000	60	270	14F312	B	13 1/8	15 1/8	2	26
3350	17.8	100	25F912	A	7	8 1/4	1	7.8
4000	25/50	200/400	14F309	B	13 1/8	15 1/8	3	26
4000	100	800	14F311	C	12 7/8	15 1/8	2	56
4500	10	100	28F872	A	5 1/2	6 3/4	1	6
5000	25/50	313/625	14F305	D	13 1/8	15 1/8	3	46
6600	55	1200	14F313	C	12 7/8	16 5/16	2	56
7000	25	613	14F314	B	13 1/8	16 5/16	2	26

BASE DIMENSIONS (IN.) A 3 3/4 by 4 9/16 B 4 by 8 C 5 1/8 by 13 1/2 D 4 1/8 by 13 1/2

GENERAL ELECTRIC

407-101-5700

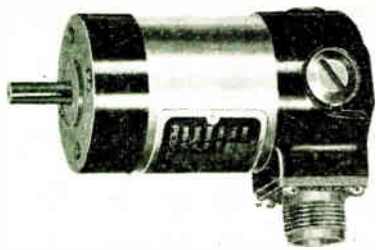

Aircraft Motor

Pesco Products Co., Div. of Borg-Warner Corp., Cleveland 6, Ohio, has developed a small aircraft motor rated at .03 h.p. with a speed of 7000 r.p.m. The motor is only 3 3/8 in. long and weighs 19 oz. It is designed for continuous operation and is explosion resistant. The model is one of a series of six coordinated frame sizes.—Electronic Industries

Sealed Rectifiers

A hermetically sealed selenium rectifier designed to withstand extremes in temperature and humidity is being manufactured by Westinghouse Electric Corp., East Pittsburgh, Pa. The rectifier consists of a tin plated hermetically sealed container in which the selenium cell is suspended in oil. The efficiency of the rectifier under extreme conditions is said to equal that obtained under normal conditions.—Electronic Industries

Process Timer

Photovolt Corp., 95 Madison Ave., New York, has brought out an adjustable timing relay with automatic resetting for timing period from 1/20 second up. The unit can be used for ac or dc on any frequency. Several timers may be used for sequence timing and recycling operation. The instrument is stabilized against line voltage variations.—Electronic Industries

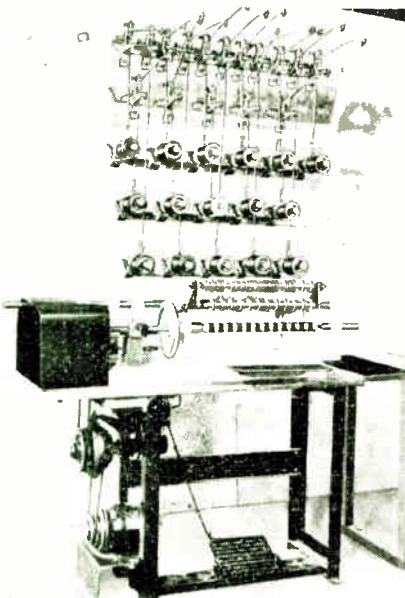

Coil Winder

A coil winding machine with a capacity of 2000 coils per day, in wire size ranges from 20 to 44 is being made by the Connecticut Specialties Co., Box 501, Stamford, Conn. The coil capacity ranges from the smallest to 6 in. The multiple coil winder uses a 1/2 hp motor at 800 to 2500 rpm.—Electronic Industries

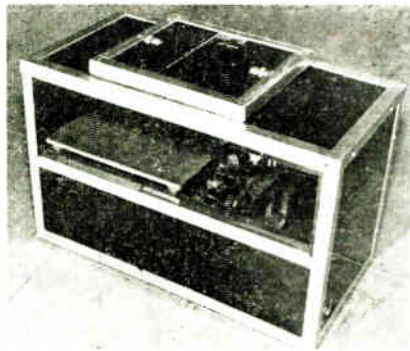

X-Ray Scanner

An x-ray scanner has been developed for use with Searchray 150 x-ray units by North American Philips Co., Inc., 100 E. 42nd St., New York 17. The scanner unit consists of a motor-driven table on which the specimen and film move beneath an adjustable slit, through which the x-rays pass. The unit overcomes distortion and displacement present in conventional methods of x-ray image recordings. It is designed for product quality control.—Electronic Industries

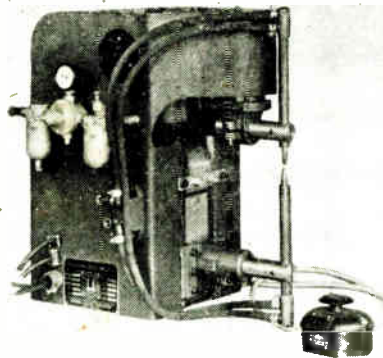

Spot Welder

A 7 1/2 KVA air operated plug-in bench type spot welder, which includes solenoid valve control of the air cylinder and pressure switch has been developed by Davis & Murphy, Davis Bldg., 5252 B'way, Chicago 40, Ill. The welder is equipped with air filter, pressure gage and automatic lubricator and can be furnished with electronic timer. The welding cycle is initiated by foot switch.—Electronic Industries

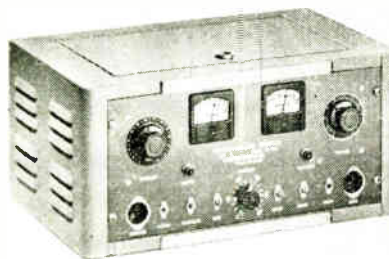

Geiger-Muller Counter

Cyclotron Specialties Co., Moraga, Cal., has developed a Geiger-Muller counter for use in radioactivity determination. The instrument is provided with a direct reading interpolation meter indicating single counts, a Lifschutz type sealing circuit, an external first stage, rear connections for oscillograph and switches for power, regulation test, reset, start and stop of counting. The high voltage output can be lowered to 150 v. to check threshold voltage.—Electronic Industries

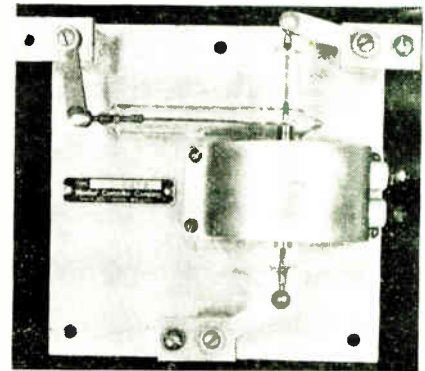

Vacuum Relay

A single-pole double-throw plate voltage vacuum relay type RC 9972 has been brought out by the Monitor Controller Co., Baltimore 2, Md. The contacts of the relay operate in vacuum with no external moving parts. It is designed for a max. dc voltage of 5,000 v., max. dc current 2 amps., coil voltage 120 v. dc, and coil current 35 ma.—Electronic Industries

Plastic Tank

Plugs, gages, carbide tipped tools, etc., may be protectively coated by dipping into the portable plastic coating melting tank designed by Aeroil Products Co., West New York, N. J. The "Midget-6" has a one-piece inner vat of cast aluminum and is provided with thermostatic controls to maintain heat. Power consumption is 1000 watts.—Electronic Industries

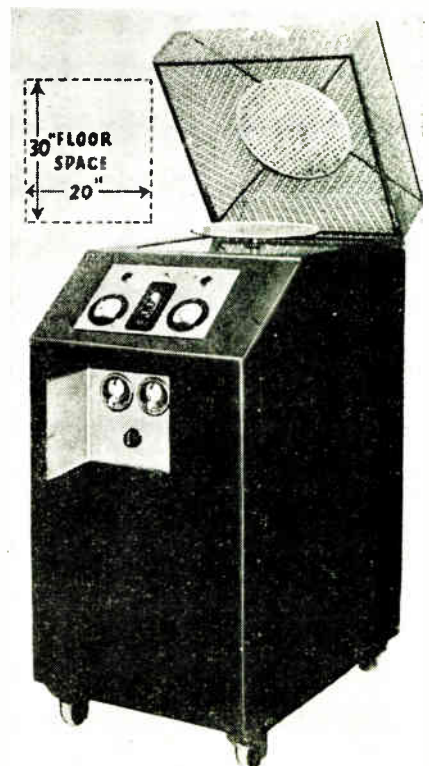

HF Heating Unit

A Thermal high frequency heating unit has been developed by W. T. La Rose & Associates, Troy, N. Y. The unit consumes 220 w. at 440 volts, ac three phase and uses Eimac tubes. Six pounds of material can be heated up to molding temperature in one minute. Dual safety interlock switches and automatic electric time control are provided.—Electronic Industries

More

Quality Components for the Electronic Industries

AMERICAN PHENOLIC CORPORATION

is now completing a sizable addition to its Chicago plant. This means a substantial increase of the already great facilities for production of quality parts for communications and electronics... components that have built the high reputation enjoyed the world over by products bearing the Amphenol name.

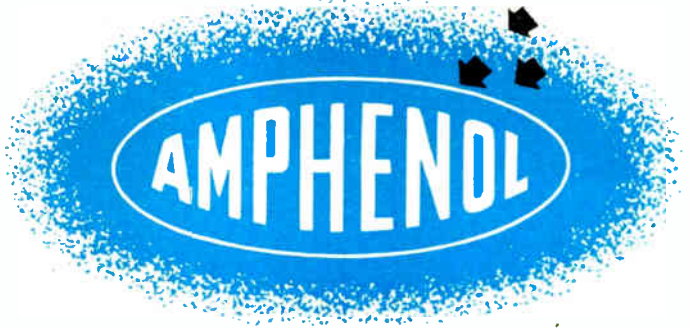

By this timely expansion of facilities American Phenolic Corporation is meeting its responsibility of leadership and specialization in mass production of quality components to better serve the rapidly expanding electronics industry.

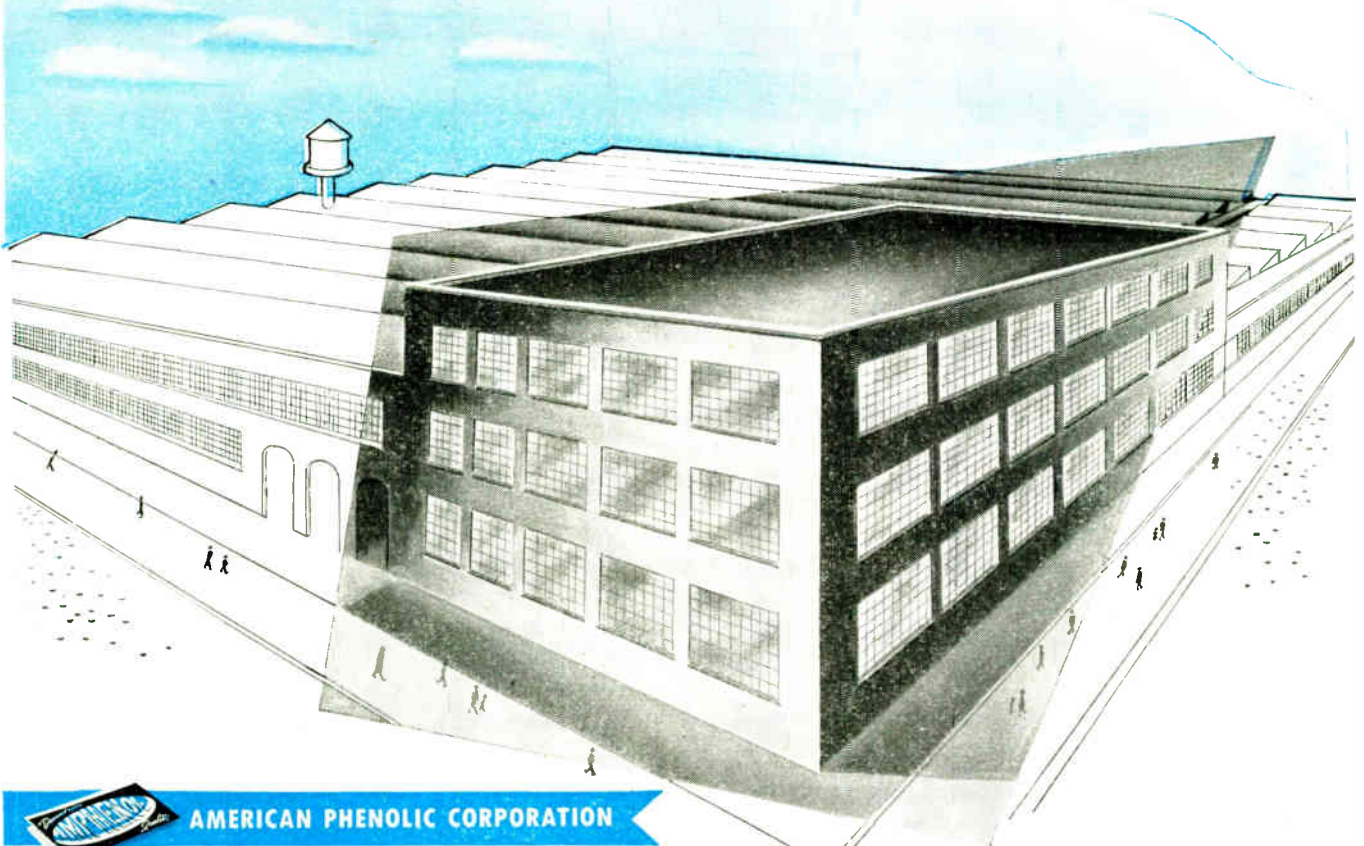

AMERICAN PHENOLIC CORPORATION

CHICAGO 50, ILLINOIS • IN CANADA • AMPHENOL LIMITED • TORONTO

COAXIAL CABLES AND CONNECTORS • INDUSTRIAL CONNECTORS, FITTINGS AND CONDUIT • ANTENNAS • RADIO COMPONENTS • PLASTICS FOR ELECTRONICS

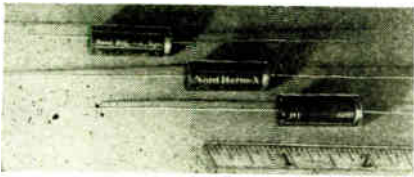

Tubular Capacitors

Capacitors made in sizes smaller than conventional units by the use of special thermoplastic material are being manufactured at Nord Mfg. Co., Bridgeport, Conn. Capacities from .001 mfd to 0.1 mfd up to 1000 volts dc working voltage are available. The units are hermetically sealed.—Electronic Industries



Transmitter Series

First of a series of modernized transmitters designed for amateur and other uses has been put into production by Transmitter Equipment Mfg. Co. Inc., 345 Hudson St., New York City. The series will include units of 75, 150, 250, 500 and 750 w. All will use as an exciter the basic 75 w unit (75 GA), which is a complete transmitter in itself arranged with pre-tuned oscillator and buffer stages for panel switching to 3.5, 7, 14, 21 and 28 mc. The oscillator may be either a built-in very stable variable frequency unit or either of two crystals. Complete unit has 18 tubes with an 814 for the final and four 6L6's for class AB2 modulation. There are three separate power supplies, one of them, for the exciter, being regulated. All adjustments are made from front panel which carries individual meters for the modulator, PA grid and PA plate. The 75 GA functions as a driver stage for higher powered final amplifiers in the line.—Electronic Industries



Geiger Counter

A Geiger counter tube with high sensitivity to Beta rays has been brought out by Cyclotron Specialties Co., Moraga, Cal. The overall efficiency of the tube is over 40%; its window made of mica is 0.006 in. thick. The counter is 3 1/2 in. in diameter and 5 in. long.—Electronic Industries

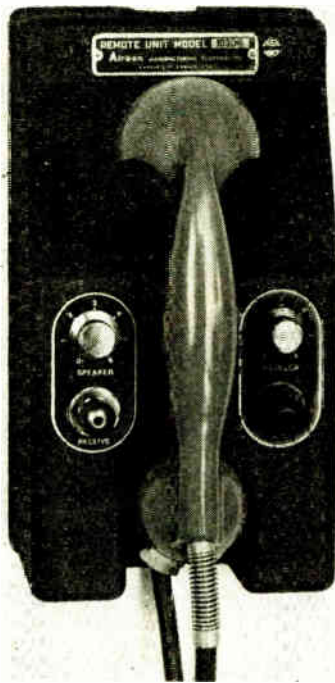

Remote Control Unit

A remote unit for railroad use has been developed by the Railroad Div., Aireon Mfg. Corp., Kansas City, Kans. The unit, which mounts in the cab or caboose, is designed to provide remote control over mobile VHF and induction equipment and to cut down background noise.—Electronic Industries

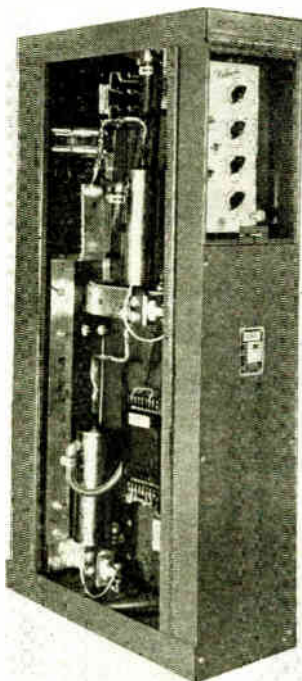

Non-Synch. Timer

The model 120-75 type S.E. non-synchronous timer-contactor for resistance welders, which uses only two relays has been brought out by Weltronic Co., 19500 West Eight Mile Rd., Detroit 19, Mich. The unit has a narrow construction and can be mounted in minimum space on either side of the welder. The timer panel may be replaced by loosening of two screws.—Electronic Industries



Resistance Comparator

For inspection, matching and grading of incoming shipments or on the production line the automatic resistance comparator, developed by Clippard Instrument Laboratory, Inc., Cincinnati, reads percent variation from the standard of -25% to +30% of resistances within a range from 100 ohms to 100 megohms. The instrument is line voltage compensated from 105 to 125 volts ac.—Electronic Industries

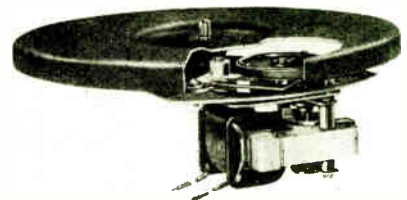

Phonograph Motor

An induction type rim drive constant speed motor for phonographs has been brought out by General Industries Co., Elyria, Ohio. The motor has a novel idler arrangement, needs no lubrication and is provided with a 9 in. turntable. Available in all ac voltages, 50 to 60 cycles.—Electronic Industries



Solenoid Valve

A three-way two-position valve, which may be used with water, alcohol, hydraulic fluids, air and other media is being manufactured by Allied Control Valve Co., South Norwalk, Conn. The unit weighs only one lb. and consumes 10 watts max. It operates under pressures up to 150 p.s.i. on ac or dc intermittent or continuous duty.—Electronic Industries

Centralab



The Mark of QUALITY

THE initials "CRL" in the diamond represent the research-laboratory and technical manufacturing facilities of Centralab a name outstanding for quality, precision and new developments in the field of radio and electronics.

Always Specify Centralab.



Centralab

Division of GLOBE-UNION INC., Milwaukee

PRODUCERS OF



Ceramic Trimmers
Bulletin 695



Ceramic High Voltage Capacitors
Bulletin 814



Variable Resistors
Bulletin 697



Tubular Ceramic
Capacitors
Bulletins 630 and 586



Selector Switches
Bulletin 722

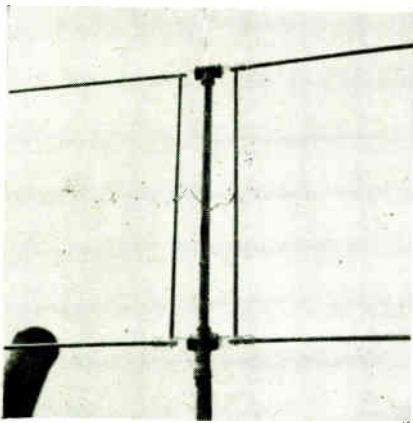

HF Antenna

A boltless antenna suitable for fm and television, which cuts the installation time in half has been brought out by Oak Ridge Antenna Co., Inc., 717 Second Ave., New York. The component parts may be interchanged to form single and double dipoles with or without reflectors and other arrays. The antenna is constructed of aluminum, lucite and steel throughout.—Electronic Industries



Multi-Pole Relay

A midget multi-pole relay with shunt coil for electronic applications has been brought out by the R-B-M Div., Essex Wire Corp., Logansport, Ind. Ranging in standard voltages from 1½ to 220 v. ac, the relay is available with contacts from one to four poles, normally open, closed or double break. The contacts are rated at 3 amps. 24 v., or 1 amp. 110 v. ac.—Electronic Industries



Power Tubes

A series of power triodes designed for use in electronic heating, rf power amplification, oscillators, etc., has been brought out by Electronic Products Co., 111 E. Third St., Mt. Vernon, N. Y. The tubes have smaller over-all size than conventional designs while retaining full power output and have a plate dissipation of 6.6 to 10 kw. depending on the type of service.—Electronic Industries

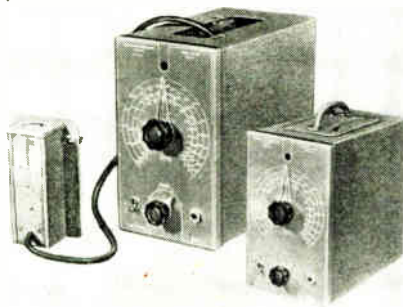

Portable Stroboscope

Vibratory, reciprocating or rotary motion can be "stopped" or slowed down for study with a compact stroboscope recently developed by Communications Measurements Laboratory, 120 Greenwich St., New York 6, N. Y. Speeds from 600 to 48,000 rpm are covered in four ranges. A self-blocking oscillator is used as a timing base. The light source is attached to the end of a four-foot cable which is convenient for motion study in small hard-to-get-at places.—Electronic Industries

Relay

Price Electric Corp., Frederick, Md., has developed a sensitive, single pole, double throw relay requiring very low operating current, which is adapted for use in temperature controls, timers, alarms, etc. The contacts are rated up to 1 amp at 115 volts ac non-inductive load.—Electronic Industries

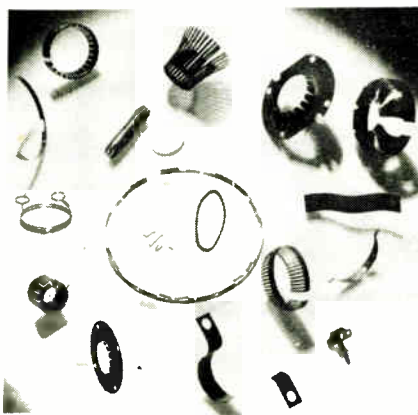

Beryllium Copper

Beryllium copper which has come into widespread use in the electrical industries by reason of its unique characteristics which permit hardening and other heat treating processes making possible the fabrication of many parts that cannot be made of other products, is being used very largely for parts going into the make-up of radar equipment. Instrument Specialties Co., Inc., Little Falls, N. J., has pioneered in the development of such products and is in a position to manufacture parts requiring extremely close tolerances and exact specifications.—Electronic Industries

Linear Potentiometers

A line of wire-wound linear potentiometers is an addition to a group of non-linear potentiometers recently brought out by Fairechild Camera and Instrument Corp., Jamaica, N. Y. The linear series, consisting of three models gives performance accuracies of .05% in the 5 in. diameter size, and .15% in the smallest, 2 in. size. The life of these models is greater than 1,000,000 cycles of operation while retaining initial accuracies.—Electronic Industries

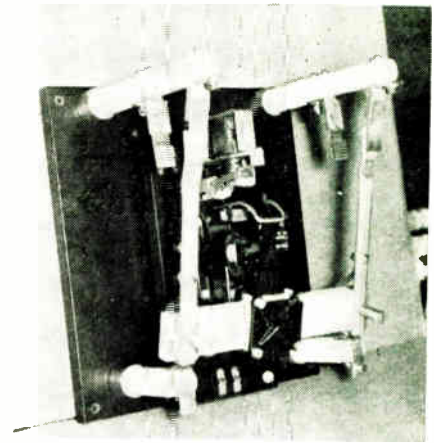

RF Transfer Switch

Monitor Controller Co., Baltimore 2, Md., has developed a rf transfer switch for connecting one of two load positions to a high frequency source of energy. The switch is double pole double throw magnetically operated and mechanically held. Max. frequency is 1mc., max. current 75 amps, and max. voltage is 15,000 v.—Electronic Industries

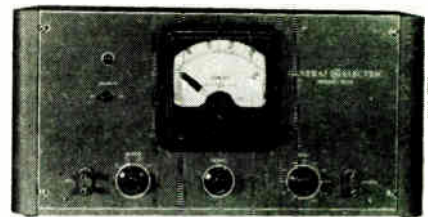

Audio Frequency Meter

For use in am and fm transmitter monitoring, the type YE-5 af. meter has been developed by the Specialty Div., General Electric Co., Thompson Road Plant, Syracuse, N. Y. Direct indication of frequency of an audio voltage over a range extending from very low pulses up to 50,000 cps. is given in 11 ranges. The unit is stabilized for line voltage variations from 105 to 125 volts.—Electronic Industries

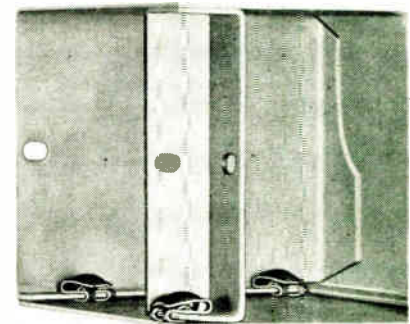

Assembly Nut

A new speed nut for sheet metal assembly work with a self contained cap to cover the protruding end of the screw is now being made by Tinnerman Products, Inc., 2111 Fulton Rd., Cleveland 13, Ohio. This feature prevents the sharp edges of the screw from chaffing or cutting wires or parts mounted within the assembly. The fact that this nut can be slipped over a mounting hole and is self-holding allows these nuts to be used for blind assembly.—Electronic Industries

THE MAN TO KNOW...

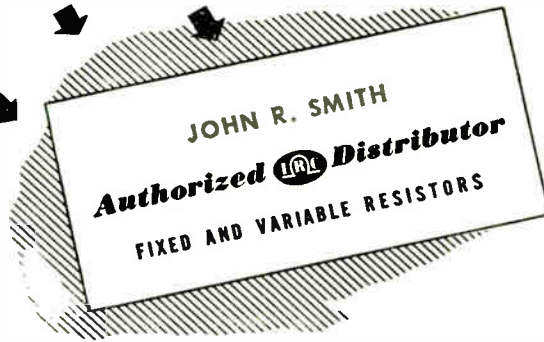

... when you need resistors in a hurry !!!

IRC distributors always have been valuable supplementary sources of supply to manufacturers of electronic and industrial equipment. During the war, they established an unusual record of service to manufacturers. IRC's more than 300 Authorized Distributors have proved themselves to be of the highest caliber, with exceptional organizations and facilities.

Under the newly-announced IRC Industrial Service Plan, these men are better prepared than ever before to give industrial users of resistance units

prompt, intelligent and complete service on all IRC standard products, listed in IRC Catalog #50. They are rapidly gearing to maintain adequate stocks of the most widely-used IRC resistors and their sales forces are conversant with electronic requirements.

When you need resistors in moderate quantities for experimental work, pre-production models, pilot runs, small production runs, and for service and maintenance—it will pay you to call upon your local IRC distributor. We shall be glad to furnish his name upon request.

Write to Dept. 2-F for IRC Catalog #50 and names of local IRC Distributors.

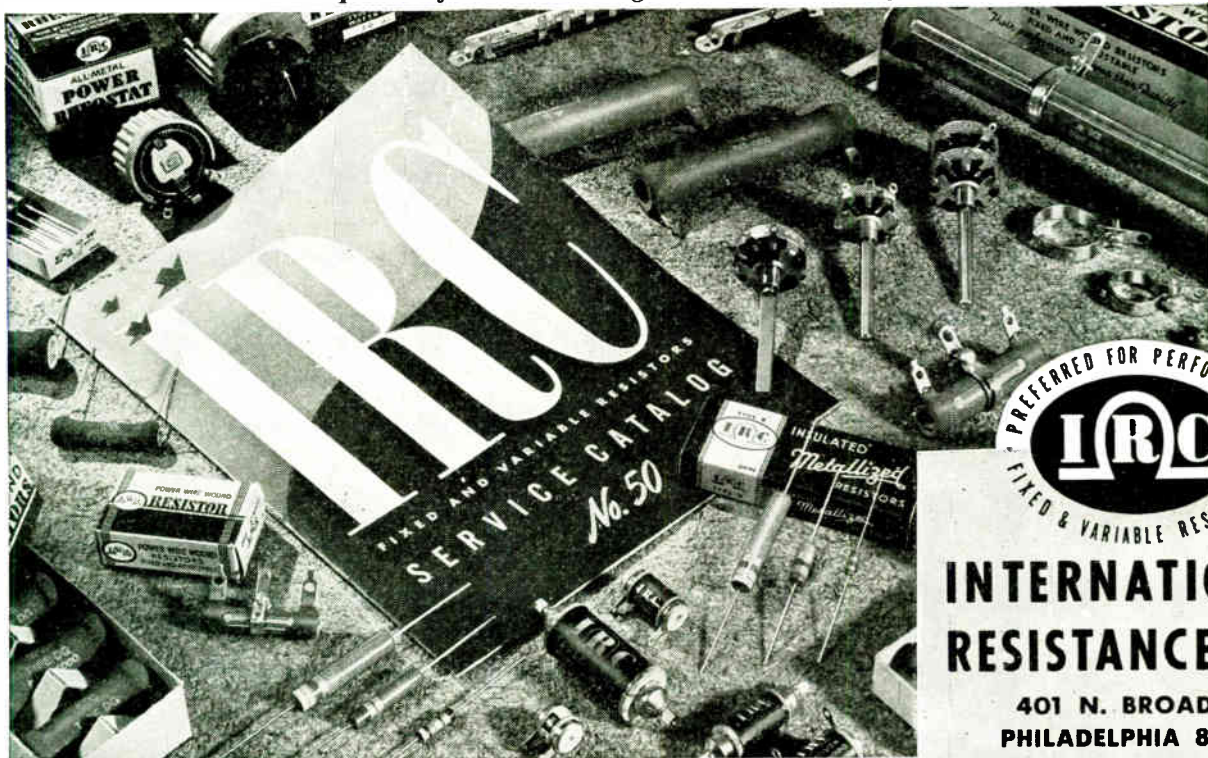

**INTERNATIONAL
RESISTANCE CO.**

401 N. BROAD ST.
PHILADELPHIA 8, PA.

Canadian Licensee:
International Resistance Co., Ltd., Toronto

FOR BETTER-THAN-STANDARD QUALITY... Standardize on IRC

LOW ABSOLUTE PRESSURES

Rapidly...Continuously

KINNEY

HIGH VACUUM PUMPS

Many of the war's top secrets now out of wraps suggest the amazing possibilities of low absolute pressures in processing: Kinney Vacuum Pumps served the war program with distinction and are now being used for dependable service in countless peacetime applications. Almost without exception in the United States and in a rapidly growing number of plants abroad, Kinney High Vacuum Pumps are standard equipment for exhausting lamps and tubes. They also provide the low absolute pressures for sintering alloy metals, coating lenses, refining rare metals and producing blood plasma, penicillin and other drugs. In fact, they are used effectively wherever a dry vacuum pump can be applied, including cyclotron evacuation and atom smashing. Kinney Single Stage Vacuum Pumps produce low absolute pressures to 10 microns; Compound Vacuum Pumps to 0.5 micron.

Send for Bulletin V-45

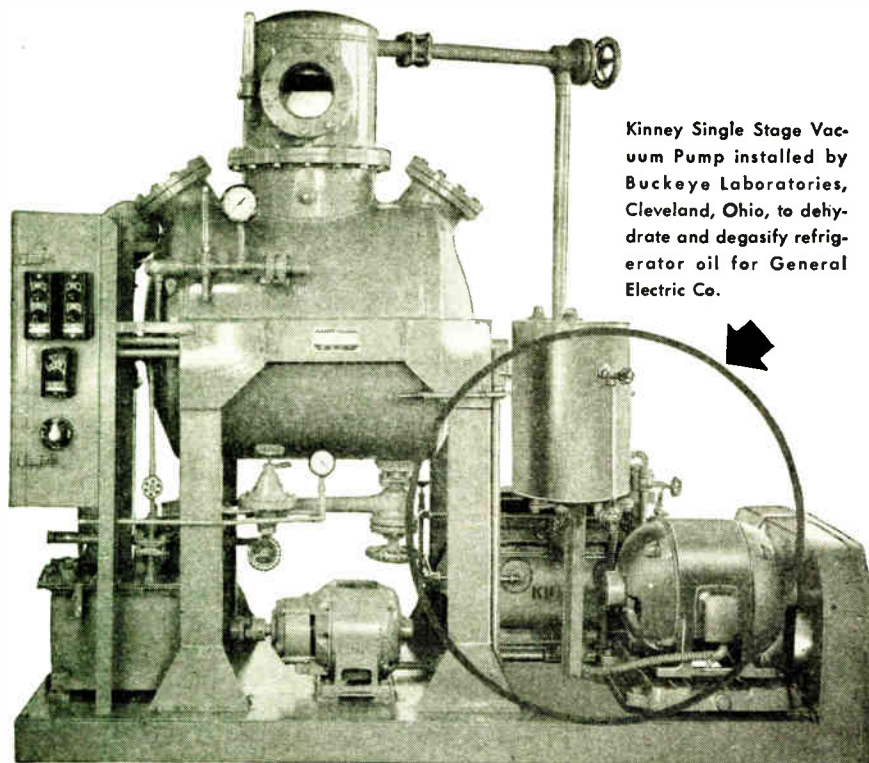

Kinney Single Stage Vacuum Pump installed by Buckeye Laboratories, Cleveland, Ohio, to dehydrate and degasify refrigerator oil for General Electric Co.

KINNEY MANUFACTURING CO.

3595 WASHINGTON STREET, BOSTON 30, MASSACHUSETTS

NEW YORK • CHICAGO • PHILADELPHIA • LOS ANGELES • SAN FRANCISCO

FOREIGN REPRESENTATIVES

General Engineering Co. (Radcliffe) Ltd., Station Works, Bury Road, Radcliffe, Lancashire, England
Horrocks, Roxburgh Pty. Ltd., Melbourne, C. I. Australia

W. S. Thomas & Taylor Pty. Ltd., Johannesburg, Union of South Africa

WE ALSO MANUFACTURE LIQUID PUMPS, CLUTCHES AND BITUMINOUS DISTRIBUTORS

ELECTRONIC USES

(Continued from page 69)

257. Photoelectric Method Speeds Analysis of Metal Particles for Powder-Molding. "Instruments," Dec., 1945; v. 18, p. 894.
258. Interference-Free Weatherometer. W. B. R. Agnew. "Electronics," Dec., 1945; v. 18, p. 160.

Meteorology

259. Cloud Heights and Densities. P. H. Houser. "General Electric Review," Apr., 1945; v. 48, p. 7.
260. Daytime Cloud Height Recording. J. Peterson and J. P. Foulds. "Instruments," Oct., 1945; v. 18, p. 695.

Other Specific Quantities

261. Automatic Map Tracer for Land Navigation. D. J. Faustman. "Electronics," Nov., 1944; v. 17, p. 94.
262. Measuring Arc Duration. J. S. Quill. "General Electric Review," Nov., 1944; v. 47, p. 22.
263. Electronic Oscillograph—Time Microscope. Otto Ackerman and Edward Beck. "Westinghouse Engr.," Nov., 1944; v. 4, p. 169.
264. Electronic Engine-Pressure Indicator. J. W. Head. "Electronics," Jan., 1945; v. 18, p. 132.
265. An Electronic Potentiometer Pyrometer. J. J. Fraser. "Electronic Engr.," Jan., 1945; v. 17, p. 340.
266. Electric Gaging Methods. H. C. Roberts. "Instruments," 1945. A serial January to October issues.
267. Smoke Density Indicator and Recorder for Industrial Plants. "Electronics," Feb., 1945; v. 18, p. 148.
268. New Form of Photoelectric Ultraviolet Spectrophotometer. David L. Drabkin. "Optical Soc. of America Jour.," Feb., 1945; v. 35, p. 163.
269. An Oscillographic Method for the Photometry of Photographic Flash Lamps. T. H. Projector and L. E. Barrow. "Rev. of Sci. Instr.," Mar., 1945; p. 51.
270. Electronic Tachometer. "Electronic Industries," Mar., 1945; v. 4, p. 80.
271. Gasket Pressure Meter. George H. Pfeiffer. "Electronic Industries," Mar., 1945; v. 4, p. 102.
272. Direct-Reading Color Densitometer. Monroe H. Sweet. "Electronics," Mar., 1945; v. 18, p. 102.
273. Supersonic Echo Depth Finders. Erwin Griebel. "Radio-Electronic Engr.," July, 1945; v. 5, p. 5.
274. Precision Testing of Electric Tachometers. M. A. Princi. "Elec. Mfg.," July, 1945; v. 36, p. 504.
275. Modern Measurement of Projectile Speeds. T. H. Johnson. "Electronic Industries," July, 1945; v. 4, p. 82.
276. Measuring Thickness. "Electronic Industries," Aug., 1945; p. 45.
277. Electronics Aids in Waterway Development. Eugene H. Woodman. "Electronics," Sept., 1945; v. 18, p. 120.
278. Ultraviolet Intensity Meter for Field Use. Howard L. Andrews. "Rev. Sci. Instr.," Sept., 1945; v. 16, p. 253.
279. Cyclic Flicker of Fluorescent Lamps. W. R. Weise. "Elec. Wld.," Oct. 27, 1945; v. 124, p. 80.

Special Electronic Instruments

280. Mass Spectrometer; A New Electronic Aid to Analysis. E. D. Hart. "Electronic Engr.," Oct., 1944; v. 17, p. 185.
281. Electronics of the Mass Spectrometer. J. A. Hipple, D. J. Grove and W. M. Hickam. "Elec. Engrng.," Apr., 1945; v. 64, p. 141.
282. The Betatron. Theodore Wang. "Electronics," June, 1945; v. 18, p. 128.
283. The Cyclotron—Granddaddy of the Atomic Bomb. "Elec. Mfg.," Sept., 1945; v. 36, p. 132.
284. 100-Million Volt Induction Electron Accelerator. W. F. Westendorp and E. E. Charlton. "Jour. Applied Physics," Oct., 1945; v. 16, p. 581.
285. The Cyclotron and Betatron. J. D. Cockroft. "Jour. Sci. Instr.," Nov., 1944; v. 21, p. 189.
286. 100-Million Volt Electron Accelerator. "Electronic Industries," Dec., 1945; v. 4, p. 90.

Medical, Psychological

287. The Electrocardiograph in Physiology and Medicine. L. N. Katz. "Proceedings of National Electronics Conference," 1944; v. 1, p. 465.
288. Applications of High-Frequency Phe-

RADIO SET DESIGNERS!

Federal's New MINIATURE Selenium Rectifier

Replaces 117Z6, 117Z3, OY4 and most other rectifier-type tubes in AC—DC—Battery Portable Radio Receivers



Assures . . .

- **REDUCED COSTS**
- **SPACE SAVINGS**
- **INSTANT STARTING**
- **LESS HEATING**

Reduced costs, because this rectifier unit not only costs less than the parts it replaces, but permits valuable savings in assembly time and expense. *Only two* soldered connections for complete installation—minimum mounting hardware required.

Space savings, because this single compact unit, only $1\frac{1}{4} \times 1\frac{1}{4} \times 11/16$ " , can be used in place of a rectifier tube, tube socket, and associated components. Leaves more room in chassis and permits reduction in receiver size.

Instant starting, because power supply operates instantaneously with selenium rectifier. Eliminates the usual warm-up time required with a vacuum-tube rectifier.

Less heating, because heat-producing filament of rectifier tube is eliminated. Gives substantially longer battery life.

This compact 5-plate unit embodies all the refinements of design and sturdy mechanical construction which have made Federal selenium rectifiers the standard of quality throughout the industry. Of all metal construction throughout, with no fragile parts—it will last many times longer than the average tube.

Now in full-scale production . . . orders can be filled almost immediately. Write for details.

Ratings: Federal 5-plate Rectifier-type 403D-2625
 Peak inverse voltage 380 volts
 Current carrying capacity 100ma DC

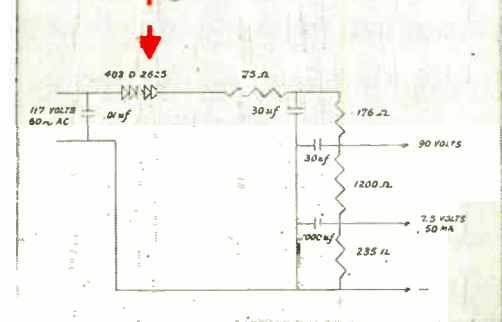
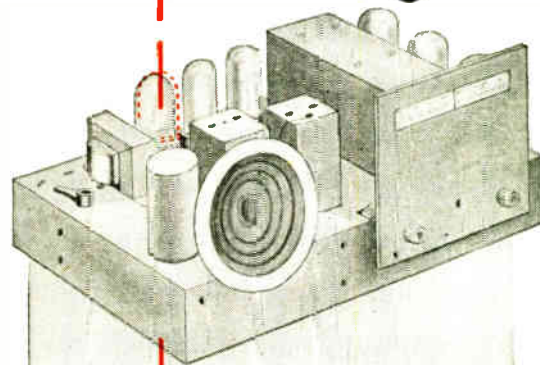

Circuit diagram of power supply for AC—DC—Battery portable radio receiver, using a 5-plate Federal rectifier unit in place of the conventional tube circuit.

Federal Telephone and Radio Corporation

Export Distributor:
 International Standard Electric Corporation.

Newark 1, New Jersey



COTO

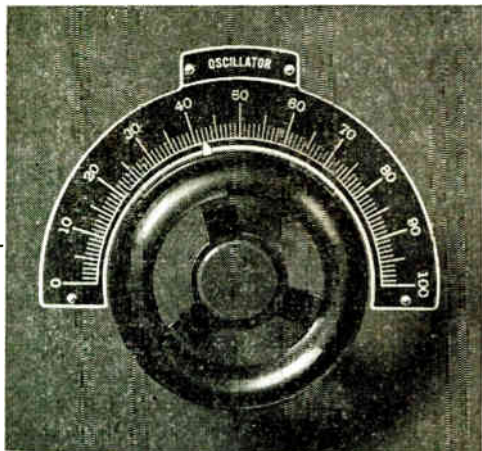

CONTROL WHEELS *for* PROMPT DELIVERY

Coto Bakelite Control Wheels may again be had in the familiar 2 1/4" and 3 1/4" diameters. They are supplied with aluminum scale complete, or wheel only as desired. Separate name plates in a wide choice of titles are also available for attachment on scale or for use over meters.

We solicit inquiries on quantity orders.

COTO-COIL CO., INC.

**COIL SPECIALISTS
SINCE 1917**

65 PAVILION AVE.

PROVIDENCE 5, R. I.

- nomena in Medicine. H. J. Holmquest. "Proceedings of National Electronics Conference," 1944; v. 1, p. 470.
289. The Electroencephalograph and Its Applications. Ralph Gerard. "Proceedings of National Electronics Conference," 1944; v. 1, p. 460.
290. Electronic Equipment in the Medical Profession. H. A. Carter. "Proceedings of National Electronics Conference," 1944; v. 1, p. 457.
291. Medical Uses of the Cyclotron. F. G. Spear. "Jour. Sci. Instr.," Feb., 1945; v. 22, p. 21.
292. Wavelength Allocation for Diathermy. H. A. Carter. "Archives of Physical Medicine," Feb., 1945; v. 26, p. 86.
293. The Cossor-Robertson Electrocardiograph. K. Richards. "Electronic Engineering," Feb., 1945; v. 17, p. 384.
294. Diathermy Problems. "Electronic Industries," Mar., 1945; v. 4, p. 107.
295. Electronic Detection of Deception. J. F. Kubis. "Electronics," Apr., 1945; v. 13, p. 192.
296. Electro-Medical Diagnosis and Therapy. John D. Goodell. "Radio-Electronic Engng.," May, 1945; v. 4, p. 16.
297. Electronic Stimulators for Medical and Physiological Purposes. W. Grey Walter and A. E. Ritchie. "Electronic Engng.," July, 1945; v. 17, p. 585.
298. Improved Electronic Stimulator. Rollin K. McCombs and Frank C. Walz. "Rev. of Sci. Instr.," Sept., 1945; v. 16, p. 249.
299. Development of Cardiac Diagnostic Instruments. Maurice B. Rappaport. "Radio News," Sept., 1945; v. 34, p. 25.

Miscellaneous

300. Fluorescent Lamps and Radio Reception. E. S. Mills and J. H. Campbell. "The Magazine of Light," June 20, 1940; v. 9, p. 30.
301. Design Factors in the Application of Relays to Electronic Circuits. R. H. Herrick. "Proceedings of National Electronics Conference," 1944; v. 1, p. 94.
302. Special Transformers for Electronic Ways. "Elec. Mfg.," Nov., 1944; v. 34, p. 117.
303. Relays in Industrial Tube Circuits. Ulrich R. Furst. "Electronics," Dec., 1944, p. 134; Jan., 1945, p. 136; Feb., 1945, p. 133.
304. Thermistors in Electronic Circuits. Ralph R. Batcher. "Electronic Industries," Jan., 1945; v. 4, p. 76.
305. Radiant Energy From Fluorescent Lamps. Matthew Luckiesh and A. H. Taylor. "Illum. Engng.," Feb., 1945; v. 40, pp. 77-88.
306. Intelligent Relay Specification Determines Product Performance. C. R. Underhill. "Elec. Mfg.," Feb., 1945; v. 35, p. 90.
307. Shielding HF Interference. Albert F. Murray. "Electronic Industries," Aug., 1945; v. 4, p. 108.
308. Graphical Symbols for Electronic Diagrams. "Electronics," Aug., 1945; v. 13, p. 136.
309. Thermistor Technics. J. C. Johnson. "Electronic Industries," Aug., 1945; v. 4, p. 74.
310. Silicon Crystals for UHF Detection Circuits. E. C. Cornelius. "Electronic Industries," Nov., 1945; v. 4, p. 74.
311. Glossary of Disk-Recording Terms. Howard A. Chinn. "IRE Proc.," Nov., 1945; v. 33, p. 760.
312. Wave Guides. S. J. Mallory. "Radio News," Dec., 1945; v. 34, p. 36.

Oscillators

313. Micro-Wave Oscillation Generators Using Velocity Modulated Beams. E. V. Condon. "Proceedings of National Electronics Conference," 1944; v. 1, p. 500.
314. Magnetron Oscillator for Instruction and Research in Microwave Techniques. J. T. Tykociner and L. R. Bloom. "Univ. of Illinois Bulletin," Jan. 18, 1944; v. 41 (priced at 40 cents).
315. Standard Frequency Source. H. L. Clark and H. Johnson. "General Electric Review," May, 1944; v. 47, p. 42.
316. Willans Oscillator Circuit. E. A. Hanney. "Wireless Wld.," Oct., 1944; p. 300.
317. Kinematics of Reflection Oscillators. A. E. Harrison. "Jour. App. Physics," Oct., 1944; v. 15, p. 709.
318. Klystron Oscillators. A. E. Harrison. "Electronics," Nov., 1944; v. 17, p. 100.
319. Theory of the Multivibrator. Harold W. Webb and Gordon E. Becker. "Jour. App. Physics," Dec., 1944; v. 15, p. 825.
320. Klystron Equipment. Jesse B. Sherman. "Electronic Industries," Jan., 1945; v. 4, p. 88.
321. Intermittent Behavior in Oscillators. W. A. Edson. "Bell System Tech. Jour.," Jan., 1945; v. 24, p. 1.
322. Reflex Oscillators. J. R. Pierce. "IRE Proc.," Feb., 1945; v. 33, p. 112.

- 323. Gas-Filled Tubes as Pulse Generators. F. J. G. van den Bosch. "Electronic Engng.," Apr., 1945; p. 474.
- 324. Linear Sweep Generators. Abraham Tatz. "Radio News," May, 1945; v. 33, p. 52.
- 325. Oscillators. R. G. Middleton. "Radio-Electronic Engng.," June, 1945; v. 33, p. 8.
- 326. Wide-Range Tuned Circuits and Oscillators for High Frequencies. Eduard Karpus. "IRE Proc.," July, 1945; v. 33, p. 426.
- 327. Reflex Oscillators. J. R. Pierce. "Bell Lab. Rec.," Aug., 1945; v. 23, p. 287.
- 328. Audio Oscillators and Their Applications. J. C. Hoadley. "Radio News," Sept., 1945; v. 34, p. 29.
- 329. Transitron Oscillator for High Stability. W. Muller. "Electronic Industries," Dec., 1945; v. 4, p. 110.

Precipitation

- 330. Electrostatic Spraying and Detearing. Harry Forsberg. "Iron Age," Oct. 19, 1944; v. 154, p. 50.
- 331. Electrostatic Air Cleaning. "Steel," Oct. 23, 1944; v. 115, p. 86.
- 332. The Mechanical-Electrical Dust Collector. "Pwr. Plant Engng.," Dec., 1944; p. 190.
- 333. Painting Without Tears. "Elect. Cont.," Apr., 1945; v. 44, p. 72.
- 334. Electrostatic Precipitation. L. R. Koller. "General Electric Review," Aug., 1945; v. 48, p. 13.
- 335. Collecting Oil Mists Electrostatically. A. H. Allen. "Steel," Aug. 6, 1945; v. 117, p. 120.
- 336. Electrostatic Paint Spraying and Detearing. "Electronics," Nov., 1945; v. 18, p. 336.

Radar

- 337. Radar to Study Bird Migration. (A letter to the Editor.) M. Brooks. "Science," Mar. 30, 1945; p. 329.
- 338. Elementary Principles of Radar. David W. Jefferies. "Aero. Digest," Sept. 1, 1945; v. 50, p. 101.
- 339. Glossary of Common Radar Expressions. Compiled by Editors of "Electronic Industries," Sept., 1945; p. 92.
- 340. Radio Detection and Ranging. "Modern Plastics," Sept., 1945; v. 23, p. 132A.
- 341. Radar Warfare. "Electronics," Oct., 1945; v. 18, p. 92.
- 342. First Instances of Peacetime Applications of Radar. "Elec. Mfg.," Nov., 1945; v. 36, p. 112.
- 343. Radar in the U.S. Army. Roger B. Colton. "IRE Proc.," Nov., 1945; v. 33, p. 740.
- 344. Principles of Loran in Position Location. R. W. Kenyon. "Electronic Industries," Dec., 1945; v. 4, p. 106.

Radio In Industry

- 345. Rock Island R.R. Radio. "Electronic Industries," Feb., 1945; v. 4, p. 110.
- 346. Talkies. "Electronic Industries," Mar., 1945; v. 4, p. 101.
- 347. Rock Island Railroad Radio Tests. Ernest Dahl. "Electronics," May, 1945; v. 18, p. 96.
- 348. Radio Cuts Three Hours Off Freight Train Time. "Radio News," July, 1945; v. 34, p. 76.
- 349. Two-Way Radio for Highway Freighters. Harry F. Chaddick. "Radio News," July, 1945; v. 34, p. 45.
- 350. Two-Way FM Solves Difficult Communication Problem. "Elect. Wld.," Sept. 1, 1945; v. 124, p. 82.
- 351. North Western Tests Train Radio. "Ry. Age," Sept. 8, 1945; v. 119, p. 406.
- 352. Train Communication Tests on I.C. "Rv. Age," Nov. 10, 1945; v. 119, p. 742.

Rectifiers (Power), Converters, Frequency Changers

- 353. A Survey of Power Applications of Electronics. A. C. Monteith and C. F. Wagner. "Proceedings of National Electronics Conference," 1944; v. 1, p. 261.
- 354. Power Rectifiers and Inverters. G. F. Jones and J. A. Cox. "Proceedings of National Electronics Conference," 1944; v. 1, p. 281.
- 355. Electronic Power Converter. W. N. Gittings and A. W. Bateman. "AIEE Transac.," Aug., 1944; v. 63, p. 585.
- 356. History and Development of the Electronic Power Converter. E. F. W. Alexander and E. L. Phillipi. "AIEE Transac.," Sept., 1944; v. 63, p. 654.
- 357. Pentode Ignitrons for Electronic Power



CODE BEACON FOR RADIO TOWERS

A 300 MM code beacon designed and built by ANDREW for lighting radio towers as aviation hazards. Required by the CAA on radio towers of 150 feet or greater in height. Two 500-watt prefocus lamps provide an intense light which passes through red pyrex glass filters and is radiated in a circular, horizontal beam by cylindrical fresnel lenses. Metal parts are made of light-weight cast aluminum, with hardware of corrosion-resistant bronze.



LIGHTING FILTER. The ANDREW Model 1803 lighting filter serves to connect the 60-cycle lighting voltage across the base insulator of a series excited tower without detuning the tower. Three windings provide for operation of code beacon and obstruction lights. Mica insulated by-pass condensers of ample current rating included. Also offered in weatherproof steel housing.

Pioneer Specialists in the Manufacture of a Complete Line of Antenna Equipment

ANDREW CO.
363 EAST 75th STREET
CHICAGO 19, ILLINOIS

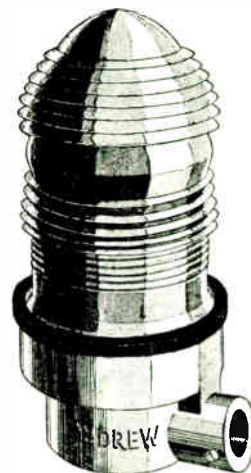
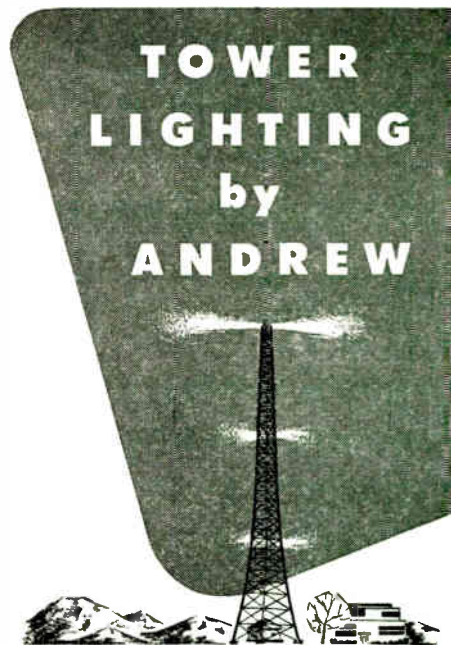

OBSTRUCTION LIGHT. Type 661 is a 100-watt unit fitted with a red fresnel lens to concentrate the light in a nearly horizontal direction. Used in pairs at $\frac{1}{3}$ and $\frac{2}{3}$ levels on radio towers for aircraft warning.

BURNOUT INDICATORS. Highly damped meter with special wattmeter scale indicates when code beacons or obstruction lights need re-lamping.

FLASHERS. Designed to flash 300 MM code beacons at rate of 40 cycles per minute, as prescribed by government regulations. Flashers have 25-ampere contacts and condensers for radio interference elimination. Use K-10347 for one or two beacons; use K-10348 to maintain constant 2000-watt load with three beacons.

TIME SWITCHES. Switch tower lights on at sunset and off at sunrise. Special astronomic dial follows seasonal variations in sunset and sunrise time. Photo-electric models also available.

LAMPS. A complete stock of lamps for code beacons and obstruction lights is carried for the convenience of users. Available in a wide variety of filament voltages.



**THE TIMING
MUST BE RIGHT**

In mechanical devices — as in music — the timing must be *right*. To insure perfect timing, specify Haydon Repeat and Interval Timers, Time Delay Relays, Contactors, Interrupters, Elapsed Time Indicators or other Haydon apparatus that suits your particular timing problems.

Haydon Timing Devices proved their absolute reliability in the thousands of important measuring and motivating functions they performed during the war.

Send for complete catalog.



HAYDONEERED TIMING
Haydon
MANUFACTURING COMPANY
INCORPORATED
Forestville, Connecticut

- Converters. H. C. Steiner, J. L. Zehner and H. E. Zuvers. "AIEE Transac.," Oct., 1944; v. 63, p. 693.
358. The Electronic Converter for Exchange of Power. F. W. Cramer, L. W. Morton and A. G. Darling. "Sup. AIEE Transac.," Dec., 1944; v. 63, p. 1059 (disk 1418).
359. Design of an Electronic Frequency Changer. C. H. Willis, R. W. Kuenning, E. F. Christensen and B. D. Bedford. "Sup. AIEE Transac.," Dec., 1944; v. 63, p. 1070 (disk 1418).
360. Analysis of Rectifier Circuits. E. F. Christensen, C. H. Willis and C. C. Herskind. "Sup. AIEE Transac.," Dec., 1944; v. 63, p. 1048.
361. Development of Excitron-Type Rectifier. H. Winograd. "Sup. AIEE Transac.," Dec., 1944; v. 63, p. 969 (disk 1455).
362. History and Development of the Electronic Power Converter. "Power Pl. Engng.," Dec., 1944; v. 48, p. 84.
363. Electronic Frequency Changer. F. W. Cramer, L. W. Morton and A. G. Darling. "Iron & St. Engr.," Jan., 1945; v. 22, p. 52.
364. Design of Sealed Ignitron Rectifiers for Three-Wire Service. M. M. Morack. "AIEE Transac.," Mar., 1945; v. 64, p. 103.
365. Rectifier Fault Currents. C. C. Herskind and H. L. Kellogg. "AIEE Transac.," Mar., 1945; v. 64, p. 145.
366. Transient Response of Controlled Rectifier Circuits. P. T. Chin and G. E. Walter. "Elec. Engng.," Apr., 1945; v. 64, p. 208.
367. Gaseous Rectifier Circuits. P. T. Chin. "Electronics," Apr., 1945, v. 18, p. 138; May, 1945, v. 18, p. 132.
368. Voltage and Current Relations for Controlled Rectification With Inductive and Generative Loads. K. P. Puchlowski. "Elec. Engng.," May, 1945; v. 64, p. 255.
369. Arc-Backs in Rectifier Circuits. R. D. Evans and A. J. Maslin. "AIEE Transac.," June, 1945; v. 64, p. 303.
370. Anode-Circuit-Breaker Criteria. E. W. Roehne and W. A. Atwood. "AIEE Transac.," June, 1945; v. 64, p. 337.
371. Analyses of the Voltage-Tripping and Quadrupling Rectifier Circuits. D. L. Waidelich and H. A. K. Taskin. "IRE Proc.," July, 1945; v. 33, p. 449.
372. Rectifier Installation at Alan Wood Steel Company. A. D. Howry. "Iron & St. Engr.," July, 1945; v. 22, p. 62.
373. Three-Phase Power From Single-Phase Source. Robert W. Woods. "Electronics," Aug., 1945; v. 18, p. 284.
374. 0-300 Volt Regulated Power Supply. Gerald W. Davis. "Radio News," Sept., 1945; v. 34, p. 38.
375. Cascade H.T. Generator. R. G. Mitschell. "Wireless Engr.," Oct., 1945; v. 22, p. 474.

Regulators, Exciters, Stabilizers

376. Electronically-Regulated Power Supplies. M. S. Kay. "Radio News," Nov., 1944; v. 32, p. 38.
377. Amplifier Theory Applied to Regulators. J. M. Cage. "Electronics," Jan., 1945; v. 18, p. 140.
378. Electronic Alternating-Current Power Regulator. L. B. Cherry and R. F. Wild. "IRE Proc.," Apr., 1945; v. 33, p. 262.
379. Basic Theory and Design of Electronically Regulated Power Supplies. Anthony Abate. "IRE Proc.," July, 1945; v. 33, p. 478.
380. Voltage Stabilizers. J. A. Uttal. "Electronic Industries," Aug., 1945; v. 4, p. 90.
381. Electronic Voltage Regulator Circuits. J. F. Sodaro. "Radio-Electronic Engng.," Aug., 1945; v. 5, p. 9.
382. Electronic Voltage Stabilization for High Current Rectifiers. L. W. Reinken. "Elec. Mfg.," Nov. 1945; v. 36, p. 106.
383. Stabilized D-C High-Voltage Supply. A. M. Gurewitsch and P. C. Noble. "General Electric Review," Dec., 1945; v. 48, p. 46.

X-Rays In Industry

384. Mobile Industrial X-Ray Unit. E. E. Charlton and W. F. Westendorp. "Electronics," Dec., 1944; v. 17, p. 128.
385. X-Ray Inspection With Phosphors and Photoelectric Tubes. H. M. Smith. "General Electric Review," Mar., 1945; v. 48, p. 13.
386. High-Speed X-Rays. Charles M. Slack and others. "Steel," Sept., 1945; v. 117, p. 120.
387. The Growth of Industrial Radiology. L. Mullins. "Electronic Engng.," Nov., 1945; v. 17, p. 760.
388. Industrial X-Ray Developments. C. D.

Superior

CATHODES

SEAMLESS

and

LOCKSEAM

(PATENTED)

SUPERIOR TUBE CO.

NORRISTOWN, PENNSYLVANIA

"THE BIGGER NAME IN SMALL TUBING"

(MAXIMUM O.D. $\frac{3}{8}$ ")



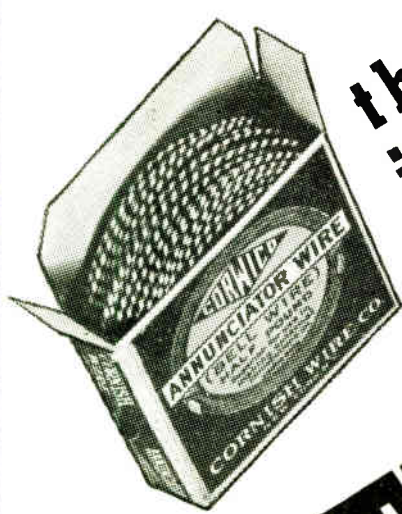

there
is
NO
SUBSTITUTE

for good, honest WIRE, unwinding itself
cross-country, through mighty public buildings and
humble cottages, in and out of America's radio sets and
legion other communications units. You are getting some
CORWICO Wire now . . . and more is on the way . . .

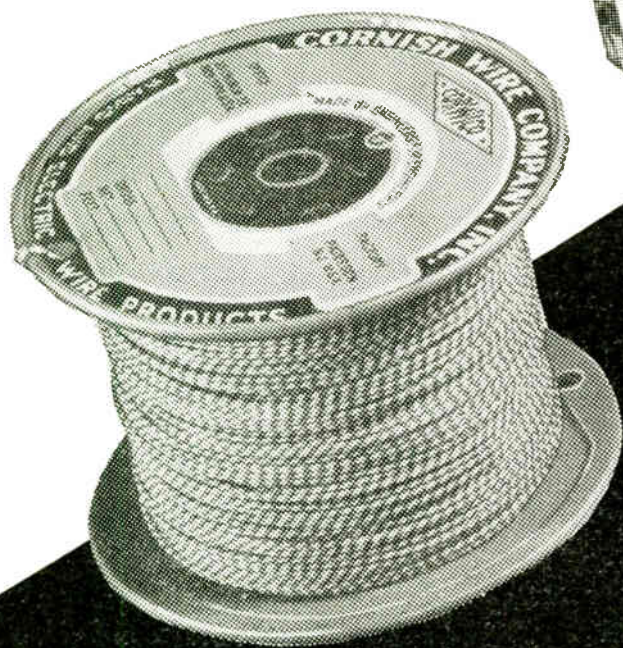
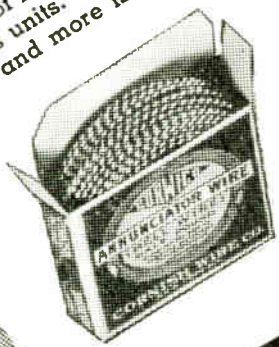

cornish
WIRE COMPANY, INC.

15 Park Row, New York 7, N. Y.

"Made by Engineers for Engineers"

Moriarty. "Elec. Engng.," Dec., 1945; v. 64, p. 433.
389. Industrial Applications Seen for X-Ray Gaging Devices. Robert C. Woods and Frederic Fua. "Elec. Mfg.," Dec., 1945; v. 36, p. 138.

INDEX

A

Actuator, Door	86
Air Cleaning.....	331, 332, 334, 335
Aircraft Ignition.....	107
Aircraft Power Supply	74
Air Leak Detector	124
Alarm, Smoke	122
Aluminum Fabrication	173
Aniseikon	120
Anticipator Furnace Control	61
Application to Aircraft	1, 2, 10
Arc Backs, Rectifier	365, 369, 370
Arc Duration Timer	262
Arc Furnace Control	63
Audio Oscillator	328
Automotive Ignition	107
Autopilot	6
Auto Two-Way Radio	349

B

Baking Resin	170
Balancer, Rotating Part	256
Bench Welder Control	72
Betatron	282, 284, 285, 286
Bibliograph, HF Heating	138
Bird Migration Study	337
Blind, Gaging by the	252
Blind Landing	5, 7, 11
Brazing, HF	162, 175, 177
Bridge, HF Measuring	211, 212, 227
Bullet Speed Measurement	275

C

Calculating Aids	182, 183, 188, 201
Capacitance Meter	215
Capacitors for HF Heating	181
Capacitor Storage Welding	69
Carbon Disulfide Detector	77
Cascade Generator	375
Case Hardening	158, 162, 163, 172
Casting, HF	169
Cathode-Ray Tube Traces	200, 205, 219
Chemical Industry Aids	192, 193, 194
Chemograph	193
Circuit Analyzers	226
Cloud Height Measurement	259, 260
Clutch Control, Magnetic	84
Coating With Resin	170
Coil Design, HF Heating	178
Color Grading	193, 272
Combustion Protective Control	64
Communication, Train	26
Concentrating, HF Heating	128
Control, HF Heater	129, 139, 141
Converter, 1 to 3-Phase	373
Cost, HF Heating	137
Counter Control	49
Crucible Failure, HF	180
Crystal Rectifiers,	218, 310
Curing Plastics	152, 153, 156
Cutting Torch Control	56, 58
Cyclotron	283, 285, 291

D

DC Amplifiers	23, 24
DC Saturable Reactor Control	44
Deception Detector	295
Deep Heating, Metals	165, 168
Defrosting Frozen Foods	144, 146, 147
De-icer, Aircraft	10
Densitometer, Color	272
Depth Finder	273
Detearing (Paint)	330, 333, 336
Developments, Electronic Devices.....	99, 101
Developments, Electron Tubes.....	88, 90, 93, 94, 97
Developments, HF Heating.....	127, 131, 135
Diagnostic Aids.....	287, 289, 290, 296, 299
Diathermy Wavelengths	292, 294
Dielectric Measurements.....	199, 202, 203, 215, 216, 221, 228, 231, 232
Disk Recording Terms	311
Disk-Seal Tube	88, 93
Distillation Control	77, 193
Door Actuator	86
Drift in Amplifiers	23
Dust Collecting	331, 332, 334

E

Economics of Applications	101
Electrocardiograph	287, 293, 299
Electrocardiograph Amplifier	14
Electroencephalograph	289
Electrolysis Prevention	112
Electron Accelerator	282, 284, 285, 286

Electron-Optical Voltmeter	204
Electrostatic Air Cleaning.....	331, 332, 334
Electrostatic Painting	330, 333, 336
Elongation Recorder	249
Emergency FM Radio	350
Energy Storage Welder	69
Engine Indicator	240, 264
Exciters	117
Excitron	361
Expressions, Radar	339

F

Fatigue Strength Analysis	248
Fault Detector, Line	123, 228
Fence Lighting Control	33
Film Color Densitometer	272
Fish Screens	116
Flame Cutter Control	56, 58
Flash Lamp Photometry	269
Flaw Detector	120
Flight Control	3
Flight Recorder	8
Flow Meter	233, 237
Fluorescent Lamp Interference	300
Fluorescent Lamp Radiations	305
FM Tape Recorder	119
Food Defrosting	144, 146, 147
Forging Welder	71
Frequency Changer (Power).....	359, 362, 363
Frequency Meter	224
Frequency Stable Oscillator	329
Frequency Standard	315
Frozen Food Defrosting.....	144, 146, 147
Fuel Gage	241
Fundamentals, Electron Tube	91, 96
Furniture Fabrication	155

G

Gages, High-Vacuum	234, 236
Gaging Device, X-Ray	389
Gaging Methods	244, 266
Galvanometer Amplifier	16
Gas Analysis	185
Gas-Filled Tubes	49, 92, 95
Gasket Pressure	271
Geiger Counters	196, 206
Geiger Counter Spectrometer.....	194
Geophysical Prospecting	125
Glass Welding	143
Glazing Furnace Control	57
Glide Path Indicator	9
Glossary of Symbols	308
Glossary, Radar Terms	339
Governor, Steam Turbine	83
Grain Size Determination	257
Graphical Symbols	308
Guides, Wave	312

H

Hardening Plastics	153
Hardening Surface	158, 162, 163, 172
Harmonic Analysis	182, 183
Hearing Aid Amplifier	19
Heating, Radio Interference	140
Heat Transfer	174
HF Heater Shielding	140, 142
High-Speed X-Rays	386
High-Voltage Generator	375
High-Voltage Line Carrier	27
Highway Radio	349
H-ion Measurement	185
Hoist Signalling	25
Hydrogen Gage	124

I

Ignition Systems	107
Ignition Testing	217, 230
Ignitron Exciter	117
Ignitrons, Power Conversion.....	357, 362, 364
Indicator, Engine	240, 264
Industrial Electrons.....	40, 41, 42, 43, 45, 46, 102, 106, 108, 98, 101
Industrial Tube Life	98, 101
Infra-Red Measurements	193
Injector Moulding Timing	47
Ink Recorder Amplifier	21
Insulation Testing.....	199, 202, 203, 215, 216, 221, 228, 231, 232
Interference From Fluorescent Lamps.....	300
Interference, Radio	140, 307
Intermittent Oscillators	321
Internal Surface Heating	168

K

Klystron Amplifier	11, 15
Klystron Oscillator	313, 317, 318, 320, 322, 327
Kodatron Speedlamp	89

L

Laboratory Measurements.....	186, 192, 193, 194, 214
------------------------------	-------------------------

Conant Instrument Rectifiers

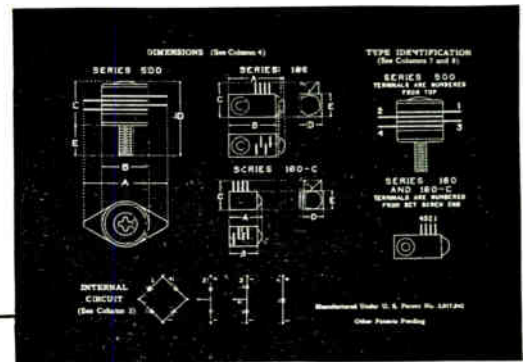

SPECIFICATIONS (STANDARD TYPES)

Col. 1	2	3	4	5	6	7	8	9					10								
Type	Series	Internal Circuit	Dimensions (Inches)					Mounting Screw Size	Weight (Grams)	No. of Terminals	Color				PEAK ELECTRICAL RATINGS		*List Price				
			A	B	C	D	E			1	2	3	4	Volts	Milliamps	Intermittent Volts	Continuous Volts	Intermittent Milliamps	Continuous Milliamps		
M	500	1	.890	.500	.485	.800	.328	6-32	13.012	4	red	no	blk	no	30	100	20	60	10	30	\$3.50
HS	500	2	.890	.500	.445	.800	.360	6-32	9.158	3	red	no	blk	—	15	100	10	60	5	30	2.70
T	500	3	.890	.500	.445	.800	.360	6-32	9.158	3	no	red	no	—	30	100	20	60	10	30	2.70
H	500	4	.890	.500	.400	.800	.392	6-32	7.730	2	red	no	—	—	15	100	10	60	5	30	1.50
B	160	1	.595	.485	.375	.250	.250	2-56	3.400	4	red	no	blk	no	30	15	20	10	10	5	3.50
BHS	160	2	.625	.550	.375	.250	.250	2-56	2.880	3	red	no	blk	—	15	15	10	10	5	5	2.70
BT	160	3	.625	.550	.375	.250	.250	2-56	2.880	3	no	red	—	—	30	15	20	10	10	5	2.70
BH	160	4	.625	.550	.375	.250	.250	2-56	2.700	2	red	no	—	—	15	15	10	10	5	5	1.50
B-C	160-C	1	.345	.297	.310	.220	.200	none	1.743	4	red	no	blk	no	30	15	20	10	10	5	3.50
BHS-C	160-C	2	.345	.297	.310	.220	.200	none	1.385	3	red	no	blk	—	15	15	10	10	5	5	2.70
BT-C	160-C	3	.345	.297	.310	.220	.200	none	1.385	3	no	red	—	—	30	15	20	10	10	5	2.70
BH-C	160-C	4	.345	.297	.310	.220	.200	none	1.293	2	red	no	—	—	15	15	10	10	5	5	1.50

Over ninety per cent of all rectifier requirements are served by 12 types—4 basic assemblies in 3 series. These 3 series are the three primary units of Conant rectifiers. Special types, however, can be developed as needed, and you'll find Conant ready to cooperate.

SERIES 500 UNITS are for general applications requiring greater output current for meters, relays or other apparatus requiring more than 1 milliamperes. Recommended for all such applications at commercial and the lower audio frequencies. Will also operate up to 50,000 c.p.s. in special applications wherein accuracy of readings is not essential.

SERIES 160 and 160-C are for applications requiring good frequency response over the entire commercial and audio range and especially when the meter, relay or other apparatus requires less than 1 milliamperes for operation. In some special applications these units may be operated at frequencies up to 15,000,000 c.p.s. with special circuit treatment.

SPECIAL TYPES are available in both series 500 and 160-C. When requesting a quotation on a special type include a sketch of the rectifier required or a circuit diagram showing source and frequency of the input voltage, resistance and kind of load, required load current and the ambient temperatures.

SERIES 500 Disc diameter .500 inch. Area each disc .15 square inch. Furnished with 3" braided, tinned copper leads. Finished in clear lacquer. Nickel plated end plates.

SERIES 160 Disc diameter .160 inch. Area each disc .02 square inch. Furnished with 3" stranded, tinned double silk covered copper leads. Nickel plated case. Assembly sealed with specially developed moisture proof compound.

SERIES 160-C Disc diameter .160 inch. Disc area, lead wire and length and moisture proof seal are identical with Series 160. Dimensions of the nickel plated case have been reduced to the most compact size. These units may be mounted in a standard midget fuse clip.

Conant Instrument Rectifiers are available from leading radio jobbers everywhere—consult your local jobber.





Instrument Rectifiers

ELECTRICAL LABORATORIES

6500 O STREET, LINCOLN 5, NEBRASKA, U. S. A.

20 Vesey St., New York 7, New York 518 City Bank Bldg., Kansas City 8, Mo. 1526 Ivy St., Denver, Colo.
 85 E. Gay St., Columbus, Ohio 1212 Camp St., Dallas 2, Texas 4214 Country Club Dr., Long Beach 7, Cal.
 600 S. Michigan Ave., Chicago 5, Ill. 378 Boulevard N. E., Atlanta, Ga. Export Div., 75 West St., New York 6, N. Y.
 1215 Harmon Pl., Minneapolis 3, Minn. 4018 Greer Ave., St. Louis, Mo. 50 Yarmouth Rd., Toronto, Canada

The Difference Between "We Think So" and "We KNOW So"

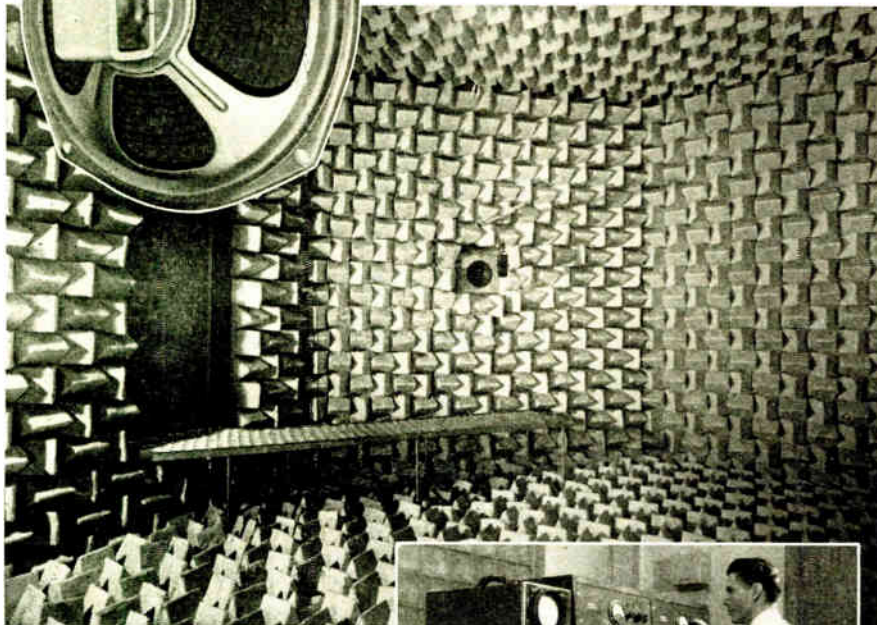
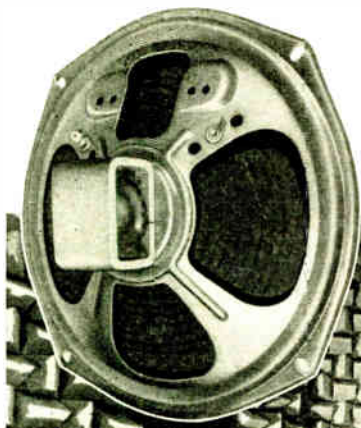

*Permoflux
Speakers*

**...are Engineered for Application in
this Stalactite Acoustical Chamber**

In this completely soundproof room, asymmetrical walls and carefully designed mass-interval baffles effectively reduce troublesome resonant harmonics and reflected sound to an insignificant value. Response curves are plotted which represent true performances so that Permoflux engineers can say "We Know So." Its use at Permoflux is characteristic of the many factors which make it possible to substantiate the fact that Permoflux Speakers provide the finest possible sound reproduction.

TRADE MARK
PERMOFLUX
PERMOFLUX CORPORATION
4900 WEST GRAND AVE., CHICAGO 39, ILL.



PIONEER MANUFACTURERS OF PERMANENT MAGNET DYNAMIC TRANSDUCERS

Lamp Flicker Measurements	279
Landing Aircraft	5, 7, 11
Land Mine Detector	121
Leak Detector	124, 236
Lie Detector	295
Life, Tube	98, 101
Light Flicker Measurements	279
Lighthouse Tube	88, 93
Lighting Control	33
Linear Sweep Generator	324
Line Fault Measurement	123
Liquid Flow Control	77
Liquid Level Control	79
Load Control, Automatic	38
Load Control, Turbine	83
Localizer, HF Heating	128
Localizer, Plane Landing	9
Lookator	123
Loop Control	81
Loran	344
Low-Frequency Amplification	13
Low-Frequency Oscillator	316
Low-Impedance Amplifier	24

M

Magic Eye Application	215
Magnetic Clutch Control	84
Magnetic Storage Welding	69
Magnetizer	76
Magneto Coil Testing	213
Magnetron Oscillator	314
Manufacturing Operation Timing	47
Map Tracer	261
Marker Beacon	9
Mass Spectrometer	193, 280, 281
Material Testing	243, 247, 249
	251, 253, 254
Mathematical Aids	182, 183, 188, 201
Mechanism, Servo	51, 53, 54
Metal Cutting Control	56, 58
Metal Sorter	251, 253, 254
Meter Movement Relaying	214
Mica Testing	202, 232
Microscope, Time	263
Microwave Oscillators	313, 314, 318,
	320, 322, 327
Migration of Birds	337
Mine Detector	121
Mine Shaft Signalling	25
Miniscope	210
Mist Precipitator	335
Mobile X-Ray Unit	384
Moisture Indicator	238
Motor Control	65, 66
Moulding Timing	47
Moving Object Detector	120
Multivibrator Theory	319
Music, Electronic	113, 115

N

Navy Electronics	105
Negative Resistance Oscillator	325
Neutron	323
Network, Phase Shift	18
Non-Conductors, HF Heating	126, 133
Null Indicator	227

O

Odograph	261
Oil Mist Collecting	335
Opener, Door	86
Optical Window Testing	246

P

Painting, Electrostatic	330, 333, 336
Particle Size Determination	257
Pathometer	295
Penetron	276
Pentode Ignitron	357, 362
Permeability Measurements	207
Phase Shift Amplifier	17
Phase Shift Detector	211
Phase Shift Network	18
Phosphor Inspection	385
Photoelectric Control	50, 87, 120, 122
Photoelectric Musical Device	115
Photographic Aids	110
Photographic Sound Recording	104
Photometry of Flashes	269
Phototube Timer	78
Physiological Aids	289, 290, 295, 297
Pick-Up, Strain Gage	250
Pipe Electrolysis Prevention	112
Plastic Heating	152, 153, 156
Plastics, Hardening	153
Polarity Correcter	112
Postwar Electronics	101, 106
Powder Metallurgy Aids	257
Power Applications	100, 117, 353, 354, 362
Power Inverters	353, 354, 356, 358, 362
Power Line Carrier	27, 29, 30, 31, 33, 34, 36
Power Supply, Aircraft	4
Power Supply, Regulated	374, 376, 379, 383
Precipitation	117

UNITED

Announces

THE GREATEST DEVELOPMENT

IN GRAPHITE ANODE TUBES!

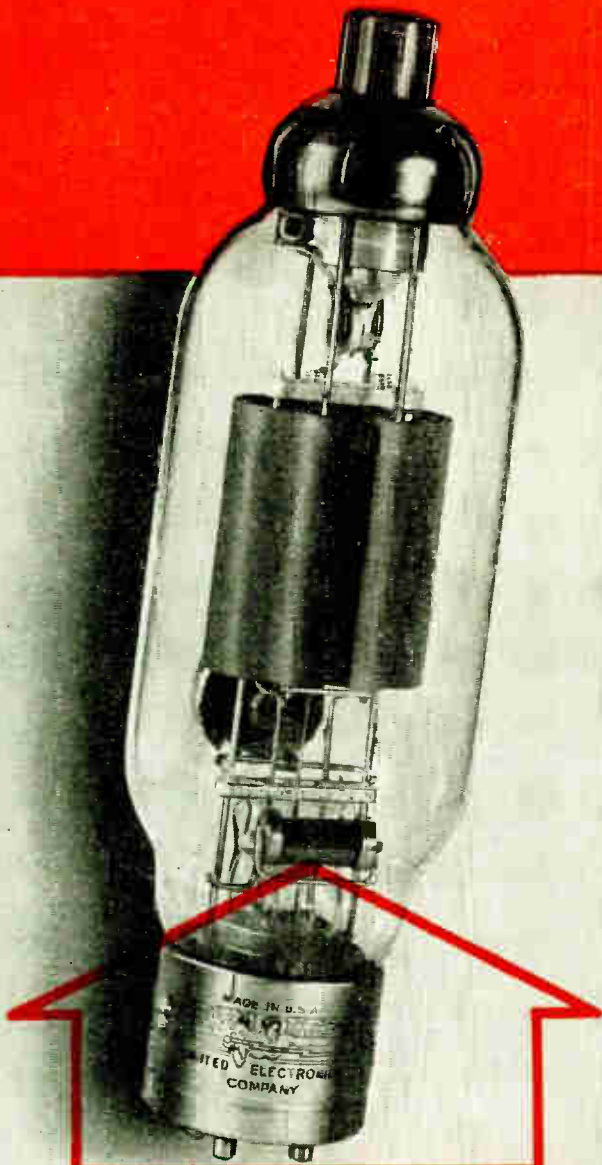

LOOK FOR THIS
"GETTER TRAP"
on all UNITED TUBES

Forecasting Higher Input and Efficiency Ratings

It is the consensus of opinion among electronic engineers, as a result of war experience, that graphite is superior to metal for internal anode tubes because of *unsurpassed thermal and non-warping properties.*

Heretofore, the enormous heat dissipating capacity of graphite anodes has been impeded by the use of free getters which deposited heavily on the bulb and tube elements.

The development of the *Isolated Getter Trap* by United has finally eliminated this long standing barrier to the full utilization of the superior features of graphite.

Gas content of these new United graphite anode tubes *average lower than that of any metal anode tubes of comparable size, and no gas can be liberated even on severe overloads.*

Available now with this new construction are types; HV-18, KU-23, 849, 838, 204A, 949A, 949H, V-70-D, 812H, and all of the diathermy types.

UNITED ELECTRONICS CO.

NEWARK, 2  NEW JERSEY

Transmitting Tubes EXCLUSIVELY Since 1934

Because of the bakelite-insulated metal-clad resistance element, these **CLAROSTAT SERIES MMR RESISTORS** in actual operation are . . .

Definitely COOLER

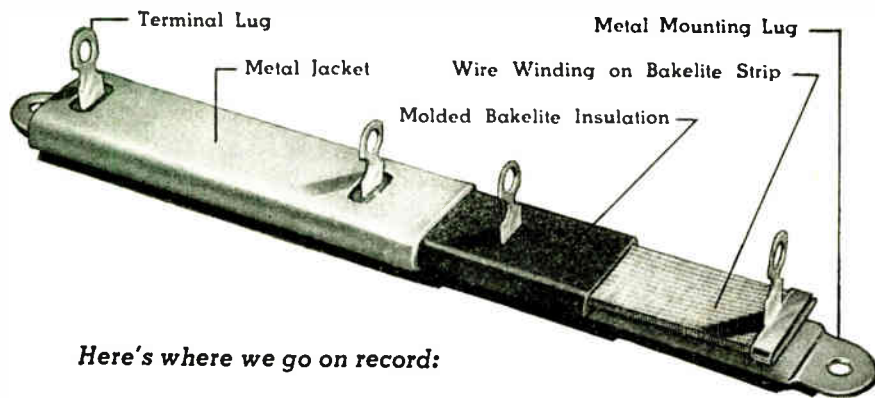
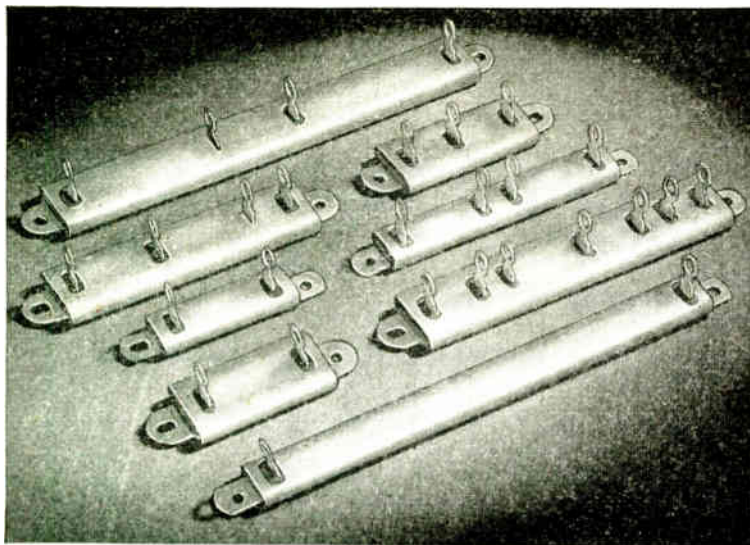

Here's where we go on record:

★Clarostat Series MMR bakelite-insulated metal-clad resistors are definitely **COOLER** than any other similar types, **SIZE FOR SIZE**; or putting it another way, these resistors will **DISSIPATE MORE POWER** for the same temperature rise, **SIZE FOR SIZE**.

That's our statement. We invite your own tests. Sample on request if you write on your business letterhead. Also detailed literature.



Controls and Resistors

CLAROSTAT MFG. CO., Inc. · 285-7 N. 6th St., Brooklyn, N. Y.

Precipitation, Fundamental Theory	334
Precipitron	331
Precise Welder Control	72
Pressuregraph	240
Pressure Indicator.....185, 193, 264, 271	
Pressure Regulator	193
Process Control	75
Process Measurements	189
Projected Speed Measurement	275
Propeller Milling	80
Prospecting, Geophysical	125
Protective Control, Combustion	64
Proximity Fuse	118
Pulsatron	323
Pulse Counting	198
Pulse Generator	323
Pulse Technique	123, 223, 323
Pyrometer	265
Pyrotron	185

R

Radar, Peacetime Use	342
Radar Technique Use	190
Radiations, Fluorescent Lamp	305
Radomes	340
Rail Flaw Detector	103
Railroad Carrier Versus Radio.....32, 35, 103	
Railway Communication.....26, 28, 32, 35, 103,	
345, 347, 348, 351, 352	
Railway Radio.....345, 347, 348, 351, 352	
Reactor Control	44
Recorder Amplifier	21
Recorder, Flight Data	8
Recorder, Wire	109, 119
Recording Terminology	311
Rectifier Circuits	360, 364, 366,
367, 369, 374	
Rectifier Faults	365, 369, 370
Reflex Oscillators.....317, 318, 320, 322, 327	
Regulated Power Supply.....374, 376, 379, 383	
Regulator, Arc Furnace	63
Regulator, Voltage	377, 378, 380,
381, 382, 383	
Relaying, Carrier	39
Relays for Electronic Circuits.....301, 303, 306	
Resin Coating	170
Resistance Welding Control.....67, 68, 69,	
70, 71, 72	
Riveter Control	82
Rotating Part Balancer	256
Rural Telephone Carrier	36

S

Sales Engineering	111, 134
Saturable Reactor Control	44
Screens, Fish	116
Self-Forging Welder	71
Servo Control	51, 53, 54
Shielding HF Heaters	140, 142, 307
Ship Propeller Milling	80
Silicon Crystals	310
Small Voltage Amplifiers	22
Smoke Detector	122, 267
Soldering, HF	176, 177
Sonigage	245
Sorter, Metal	251, 253, 254
Sound, Effects	114
Sound, Production	114
Sound, Recording	104
Sound, Reproduction	104
Spectrochemical Analysis	191
Spectrophotometer	185, 268
Speedlamp, Kodatron	89
Spot Welding	67, 69, 70, 72
Spraying, Electrostatic	330, 333, 336
Stabilizer, Voltage	380, 382, 383
Stable Oscillator	329
Standard Frequency Source	315
Steam Turbine Governor	83
Steel Hardening	158, 162, 163, 172
Steel Plant Applications	73, 81
Stimulators	297, 298
Straightener, Weft	87
Strain Gage	242, 248, 250, 255
Strain Gage Amplifier	12, 20
Street Light Control	30, 37
Strip Control	81
Strip Heating	166
Supercharger Regulator	2
Supersonics Application	245, 273
Surface Hardening	158, 162, 163, 172
Survey, Industrial Electronics	46
Sweep Generator	324
Symbols, Graphical	308
Synchro Control	51

T

Tachometer	197, 270, 274
Talk Amplifier	185
Talkies	346
Tape Recorder	119
Teleion	95
Telemetry	38, 187
Telephone Plant Tubes	90
Temperature Control	55, 57, 59, 60,
61, 62, 185	
Terms, Radar	339
Textile Testing	243, 247
Thawing Frozen Foods	144, 146, 147

Thermistors	304, 309
Thickness Measurements	245, 276
Three-Wire Rectifier	364
Thymotrol	65, 66
Time Microscope	263
Timer, Aircraft De-icer	10, 103
Timers	47, 52, 78, 262
Timing Manufacturing Operations.....	47
Tocco Hardening	172
Torch Control	56, 58
Traffic Control	85
Train Communication	26, 28, 32, 35
Transformers for Electronic Devices.....	302
Transient Peak Voltmeter	223
Transient Recorder	119
Transitron Oscillator	329
Truck Radio	349
Tube Life	98
Tuning, HF Heaters	129, 139, 141
Turbidity Measurements	239
Turbine Governor	83
Turboregulator	2

U

Ultraviolet Measurements.....	193, 268, 278
Unstable Oscillators	321
Utilities Use of Radio	352

V

Vacuum Casting	169
Vacuum Tube Voltmeter.....	209, 217, 218, 220, 223
Vehicular Traffic Control	85
Velocity-Modulated Oscillators	313
Vibrating-Reed Meter	224
Vibrating Wire Device	48
Vibration Analysis	248
Vibrator Drive	74
Voltage Multiplying Circuits	371
VT Fuse	118

W

Walkie-Talkies	346
Warfare, Radar	341
Water Level Indicator	235
Waterway Measurements	277
Watt Meter	229
Wave Guides	312
Wave Height Measurements	277
Weathering Tests	258
Weft Straightener	87
Wide Frequency Oscillator	326
Wire Recorder	109, 119
Wire Tester	221
Wood Fabrication	155

X

X-Ray Sample Analysis	194
X-Ray Timer	78

Y

Yarn Elasticity	243
-----------------------	-----

Z

Zero Phase Shift Amplifier.....	17
---------------------------------	----

NUERNBERG TRIALS

(Continued from page 73)

room, a feed is made available to record the output of any language interpreting channel. A film recorder is located in the cubicle and is used to record the output of the English channel only. No undue load is placed on the English language amplifier, since the high-impedance input of the recorder acts as a bridging load.

Several German communications type amplifiers with bridging input were obtained and two of them are utilized for this purpose. One amplifier is driven from the Russian language channel No. 3 and provides a cue circuit to the Russian recording studio located a consid-

Specialties

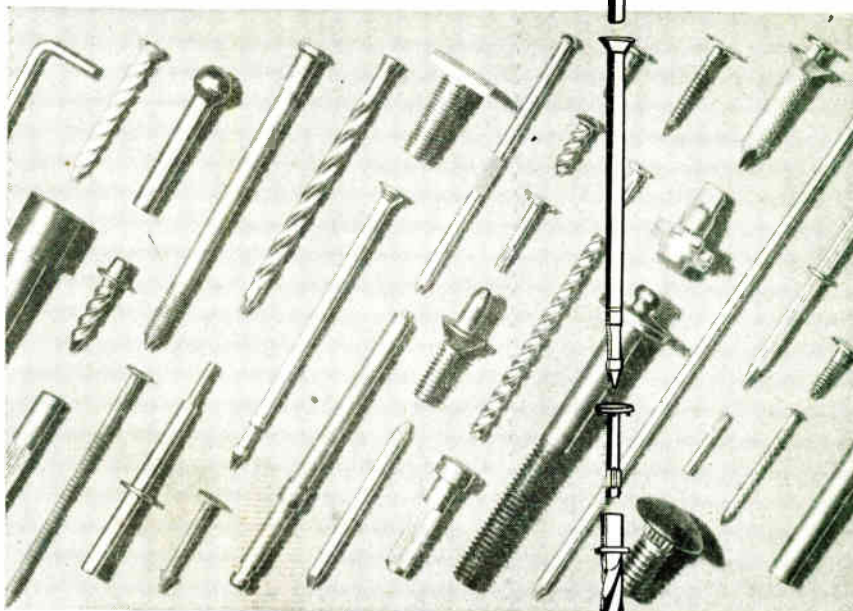

Cold-forged at a saving

If you need a special rivet, nail or threaded part—and soon—we can make it for you. Cold-forging offers you not only surprisingly quick delivery, but a substantial saving as well.

Steel, Stainless Steel, Monel, Brass, Copper, Bronze, Aluminum and Aluminum Alloys are everyday materials to us. A varied stock of sizes and metals is available to serve you.

Both economy of manufacture and strength of product are obtainable by using cold-headed parts. Send us a sketch or sample of your part. No obligation. Ask for free catalog.

JOHN HASSALL, INC.

412 OAKLAND ST., BROOKLYN 22, N. Y.



Special nails, rivets, screws
and threaded parts

**Competent
Transformer
Engineering**

... is a major element in Chicago Transformer's service to the Electronic Industry. If special transformer applications are involved in your new product plans, C. T.'s engineering staff offers the all-around experience and know-how that will best fit these items of your component requirements.

CHICAGO TRANSFORMER
DIVISION OF ESSEX WIRE CORPORATION
3501 ADDISON STREET · CHICAGO, 18

erable distance from the courtroom. Another bridging amplifier feeds a line which is terminated on the jackstrip in the Shop and Recording Room. Here the feed is split into two lines, one of which supplies a pair of film recorders for the



Signal Corps technicians use Hart tape recorders for verbatim reports at Nuernberg trials

use of the German court stenographers. The other line drives a pair of German magnetic tape recorders. The tapes are used by the Information Control Division of USFET and are broadcast by German stations daily. Thus, the German people may hear exactly what is going on in the court sessions.

These tape recorders are capable of great fidelity and make use of a colloidal-coated plastic tape about 9mm. in width. The recording speed is variable over a large range, the higher speeds naturally affording the best fidelity. The rewind speed is exceptionally high, and a half-hour tape may be completely rewound in a couple of minutes. Driving motor speeds are electronically controlled for constancy. Several models were used and heard, and all are unusually well designed, both electrically and mechanically. The range of the large models is comparable to high-fidelity disc recording and its recordings are quite noiseless. A pair of these recorders also is in use in the Russian recording studio. The verbatim recording line feeds them via the Western Electric 133-A amplifier in the shop rack.

Five observation booths for radio broadcast facilities and one for photographers overlook the courtroom on two sides. An earphone feed from all language channels was run to each booth. Tie lines link each booth with its respective transmitter located on the outskirts

1...10...100...1,000

...10,000...100,000...

1,000,000...10,000,000

Little
or
BIG

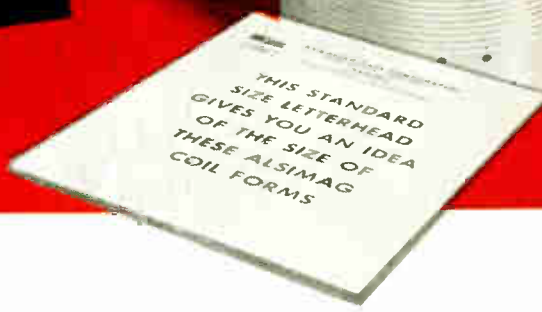
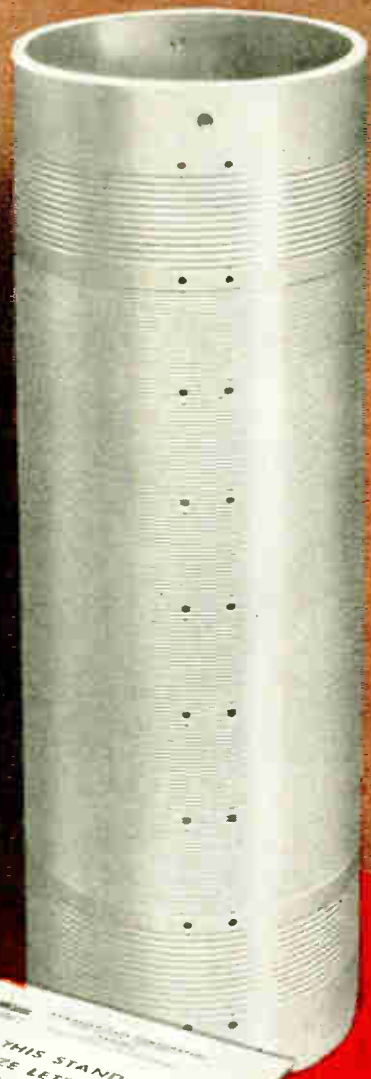

One or one million pieces, big or little, your best bet on technical ceramics is American Lava Corporation. For small quantities the experimental department is geared for prompt service. For large quantities you command special techniques, equipment and experience found



only at American Lava Corporation.

Your request will bring property charts which give physical characteristics of the more frequently used ALSiMag compositions. If your requirement demands special or unusual characteristics, the developmental laboratory may find exactly those characteristics in its research records, or develop them quickly for you.



These large, thin walled, coil forms (machined to close tolerances) are an example of American Lava Corporation craftsmanship in technical ceramics.

AMERICAN LAVA CORPORATION
CHATTANOOGA 5, TENNESSEE
43RD YEAR OF CERAMIC LEADERSHIP

ENGINEERING SERVICE OFFICES:
ST. LOUIS, Mo., 1123 Washington Ave., Tel: Garfield 4959 • NEWARK, N. J., 1013 Wiss Bldg., Tel: Mitchell 2-8159
CAMBRIDGE, Mass., 38-B Brattle St., Tel: Kirkland 4498 • CHICAGO, 9 S. Clinton St., Tel: Central 1721
SAN FRANCISCO, 163 Second St., Tel: Douglas 2464 • LOS ANGELES, 324 N. San Pedro St., Tel: Mutual 9076



Original Award July 27, 1942
Second Award February 13, 1943
Third Award September 25, 1943
Fourth Award May 27, 1944
Fifth Award December 2, 1944

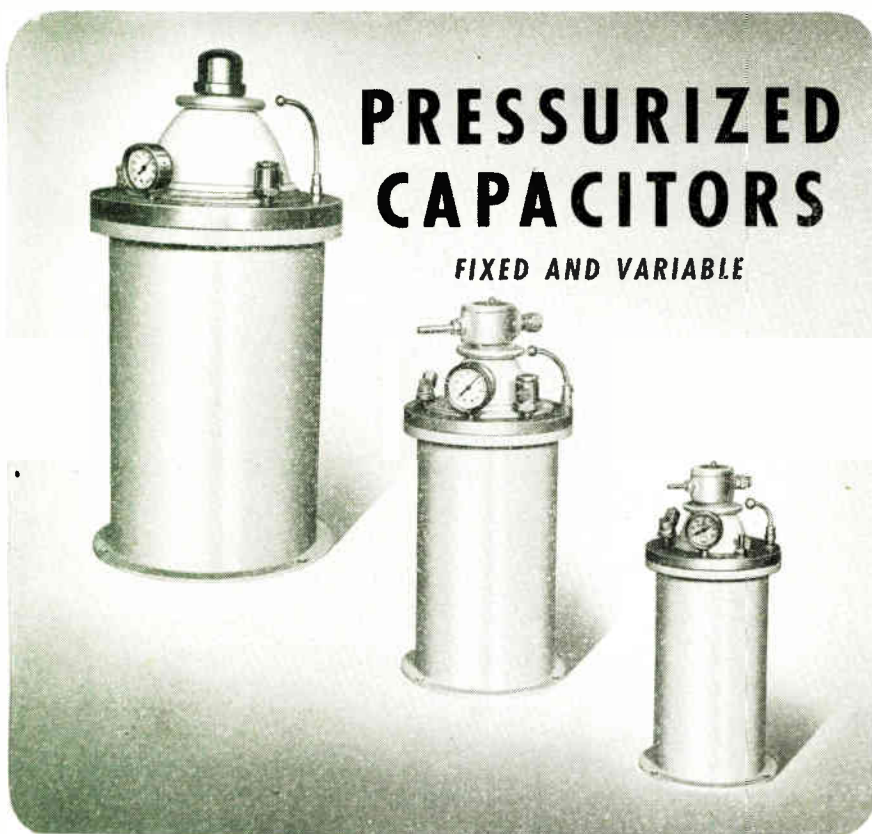

JOHNSON PRESSURIZED CAPACITORS FEATURE — LOW POWER FACTOR, HIGH KVA RATINGS, SMALL SPACE REQUIREMENTS, WIDE RANGE OF SIZES.

JOHNSON designed and built Pressurized Capacitors are available in fixed, variable and fixed-variable combination models with RMS voltage ratings up to 30,000 volts unmodulated and maximum capacitance range of 125 to 10,000 mmf.

These JOHNSON capacitors are ideal for handling circulating currents of high power transmitters and are widely used in tank circuits and antenna networks, as coupling capacitors for shunt excited vertical radiators and in high frequency equipment.

Built to assure positive pressure sealing, JOHNSON Pressurized Capacitors in actual use, have given trouble-free service for many years. They are electrically and mechanically engineered to assure highest operating efficiency and to withstand normal pressure with a large factor of safety.

JOHNSON Pressurized Capacitors offer you maximum capacity with minimum size and cost.

The famous JOHNSON line includes, Variable Capacitors, Tube Sockets, Variable and Fixed Inductors, Insulators and Radio-Electronic Hardware. Directional Antenna Phasing and Coupling Equipment, F. M. Iso-Coupler, Tower Lighting Chokes and Filters, F. M. and A. M. Coaxial Lines and Accessories, Open-Wire Transmission Line Supports, R. F. Contactors and Switches.

Write Dept. O for Data Sheet 2P Describing JOHNSON Pressurized Capacitors.



E. F. JOHNSON CO. • WASECA • MINNESOTA

of the city. One booth is used for direct shortwave broadcasts over the Armed Forces Network, and this booth is linked to a dubbing studio by both recording and field phone lines. Here dubbings of the proceedings' records may be mixed in with the radio commentator for simulating on-the-spot reporting. Presto equipment is similar to that in the main recording studio and is used chiefly for the convenience of the correspondents.

The two Press Rooms have constant monitoring facilities through the use of an RCA-PA amplifier bridged off a switching box located at the console in the courtroom. Any language may be put on the speakers. A microphone input provides for pageing whenever necessary.

Monitoring equipment

The interpreting staff is fairly large, since twelve interpreters must be on duty in the courtroom for each session. A complete relief staff is always stationed in a room adjoining the courtroom and ear-phone monitoring for their use is supplied by a cable feed from the IBM equipment. In order to coordinate the functions of each operating unit with a minimum of time delay in an emergency, a private phone line connects the various rooms. Standard Army field phones are used on a party-line circuit. Because a bell would be distracting in the courtroom, a flasher light is used in the signalling system.

As the first few weeks of the trials progressed, the justices of the Tribunal found difficulty in the language differences involved in their private conferences. This was further complicated by the inclusion of German defense attorneys at some of the conference sessions. It was therefore decided to install a translating system in the judges chambers, which would be very similar to that used in the courtroom. There was an immediate necessity for additional equipment, and this was soon flown in from the United States.

Six microphones were placed about the conference table and two parallel sets were of necessity, fed into the two inputs of the amplifier designated as the verbatim channel. RCA 88-A microphones are utilized in the parallel arrangement and matched with multiple line-grid transformers. Since the amplifiers are essentially high-impedance input, and the line length could be short compared with the

IN RECORD CHANGERS WEBSTER

really has
PERSONALITY!



MODEL 56



CHANGER MECHANISM

Sturdy Two-Tier Bonded Construction. Five Pillar sub-plate support. Heavy gauge copper plated steel parts. Graphite-Bronze Main Cam Bearing. Only Five Major parts move in change cycle. Stainless Steel Spindle — Cushioned to protect records.



PICK-UP ARM

Molded Plastic for low inertia. Low fundamental frequency eliminates resonant peaks. Ingenious mounting to give minimum vertical and lateral needle pressure. Pickup arm accommodates most standard cartridges having 1/2" mounting centers.



TURN TABLE

Full size heavy gauge steel for dynamic stability. 1 1/2" Graphite-Bronze Bearing. Roller Thrust Bearing. Rim concentric to .015". Long pile Static Flock.



AUTOMATIC SHUT-OFF

The Switch Trigger mechanism is designed to trip at less than .1 oz. pressure on OFF button. When arm is automatically indexed to OFF position after the last record is played, the weight of the arm trips the switch.



RIM DRIVE

Improved design gives maximum torque with minimum tire distortion.

Heavy Live Rubber Idler Wheel—
Centerless ground for accuracy—
Graphite-Bronze Bearing.



MOTOR

The Webster heavy duty motor is 62% more powerful than that used in most Record Changers. It is a 4-Pole, Shaded pole motor, with sufficient torque to start at any point in the change cycle. The Webster motor is specifically designed for Automatic Record Changer operation. Dynamic Balance and cushioned rubber mounting satisfactorily eliminate wow and rumble.

PRODUCTION MINDED DESIGN

This record changer is easy to handle on your production line. It may be placed on a bench without injury—it is easier to install. Two mounting methods are offered.

And in the field —

Low maintenance costs — fewer service repairs — better customer acceptance from Dealers and Owners alike.



**NOW IN FULL
PRODUCTION**

WEBSTER



CHICAGO

5610 BLOOMINGDALE AVENUE • CHICAGO 39, ILLINOIS

32 YEARS OF CONTINUOUS SUCCESSFUL MANUFACTURE

High
PERFORMANCE RELAY
AT A
Low PRICE

THE NEW SIGMA SERIES 41 RELAY

is streamlined for high volume applications and yet offers the standard of quality inherent in all Sigma Relays.

Construction Features:

- Beryllium copper armature and contact springs.
- Spring reed-type, armature hinge with low reluctance gap.
- High permeability, low-residual iron parts



41 R(dc), RZ(ac) 41 FZ(ac), F(dc)
Size: Unenclosed types: 1" x 1 7/32" x 2 3/16" *

* (Long dimension includes full length of mounting bracket).

Plug-in types: 1 1/2" x 1 1/2" x 1 7/8" high.

Minimum Input Requirements:

20 milliwatts for D.C. types.
0.1 volt-amperes for A.C. types.

Contacts: S.P.D.T.

Ratings up to 15 amperes with low voltage D.C. or up to 1 K.W. incandescent lamp load at 115 volts A.C., with sufficient input power.

For critical performance requirements at minimum cost, specify the Sigma Series 41 Relay.

SIGMA
Sigma Instruments, Inc.
Sensitive RELAYS
74 Ceylon St., Boston 21, Mass.

long runs in the courtroom, Shure and Turner crystal type microphones were originally supplied for use with the wire and film recorders.

The interpreters switching boxes had to be eliminated due to the wide difference in the input and output impedance of the amplifiers as used in this arrangement. However, no unusual difficulties were encountered and the entire system worked to the satisfaction of all concerned. The operators are sworn to secrecy, since it is necessary for them to monitor all that is said in the conference chambers.

Maintenance problems are varied. At first a great deal of difficulty arose from breaks occurring in cables unavoidably laid in heavily trafficked areas. Earphone connections are often broken at the switching boxes, and dirty switches from constant usage present noise problems. Shorted cable connections occasionally cause one cable feed to cross over into another. All equipment must be thoroughly checked before and after each court session to minimize breakdowns.

The entire proceedings are dependent upon the translating system for operation and must come to a complete halt when a breakdown occurs. Taking into consideration that a rather heterogeneous group of equipment is in use far from convenient sources of replacement, surprisingly little trouble develops.

The original small staff of technicians has been augmented by Signal Corps men who do both operating and maintenance work. All facilities are limited on a comparative basis and many short cuts have been born of necessity. In a permanent installation, with proper equipment, many of the pitfalls found in the past could be avoided. The Nuernberg trials installation could well serve as a model for the permanent facilities of the UN with its similar language problems.

Select-O-Phone to Kellogg

Kellogg Switchboard and Supply Co., Chicago, has purchased the assets and business of the Select-O-Phone Co., Providence, R.I. Select-O-Phone manufactures dial type intercommunicating systems, using both standard type telephones and loud speaker equipment. Future production of Select-O-Phone will be transferred from Providence to Chicago.

Noma Buys Oxford

Noma Electric Corp., 55 W. 13th St., New York City, has purchased the manufacturing facilities and inventories of Oxford Tartak Radio Corp., Chicago, manufacturer of speakers. Oxford Radio Corp. has been formed as a wholly-owned subsidiary of Noma. Head of the new company is John A. Proctor, other officers being Vice-President and General Manager Robert Adams, Treasurer Joseph P. Wharton, Jr., Secretary David E. Davis. Plans are to considerably expand Oxford Tartak production facilities.

Airborne to Airlines

What was formerly Columbia University's Airborne Instruments Laboratory, Inc., in Mineola, N. Y., and latterly has been operated by American Airlines, has gone commercial. A new company sponsored by a group of airlines has been formed under the corporate style Aeronautical Radio, Inc., and will undertake commercial assignments in addition to carrying on research and development work for the sponsoring companies. Hector R. Skifter, associate director of Airborne Instruments Laboratory during the war is president of the new company which employs a personnel of 171 of whom 65 are scientists and engineers. Associated with him is Chester D. May formerly of American Airlines, who is treasurer.

Burman Electronic Div.

C. N. Burman Co., 781 River Street, Paterson, N. J., has inaugurated an electronics division under the direction of Richard C. Kleinberger. The division will manufacture induction and dielectric heating equipment for general industrial purposes. The intention is to do custom designing to accommodate special applications. At present under construction are model generators of 1 kw. and 2 1/2 kw. output capacity, while a 50-kw. unit is still in the drafting board stage. Larger units, particularly in the induction field, are contemplated later. Kleinberger was formerly in the high-frequency-heating department of North American Philips, and later, with J. Allen Tuck, and did special consulting work for Westinghouse in this field.

DESIGNED AND ENGINEERED AT NO. 1 PLASTICS AVENUE

PROBLEM

TO MOLD COUPLING
DISC FOR RADIO
TUNING SHAFT.
MUST SERVE
DOUBLE PURPOSE:

- ① HIGH-FREQUENCY
INSULATION
- ② MECHANICAL
JOINT

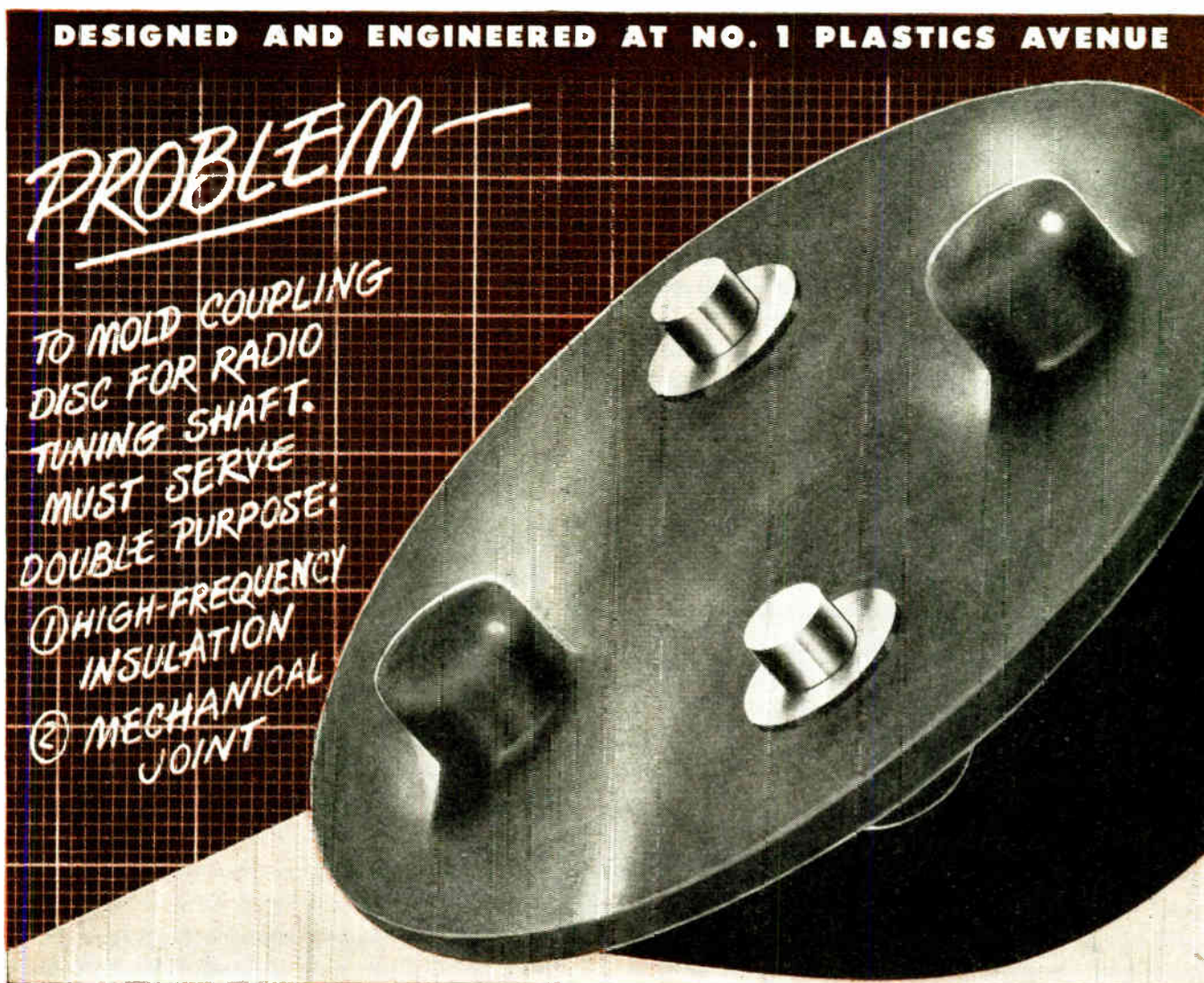

Another critical component molded in G-E mycalex

● A radio component had to perform double duty. It had to have the mechanical strength to couple a tuning shaft. It had to act as a high-frequency insulating disc for dial and panel.

This problem was brought to No. 1 Plastics Avenue. And was solved by new techniques in molding G-E mycalex—compound of glass and powdered mica with a unique combination of properties.

G-E mycalex provides the required high-frequency insulation and mechanical strength. This material affords firm anchorage for two metal coupling inserts on each side. There is no electrical leakage. And the

coupling disc withstands high operating temperatures.

Find out more about applications for G-E mycalex. A great many are now possible, thanks to the development of new materials and new molding processes.

SEND FOR YOUR OWN COPY. A new bulletin on G-E mycalex is just off the press. A helpful design handbook, it contains complete and up-to-date information for solving your high-frequency insulation problems with G-E mycalex—a hard gray-colored, stonelike material with a unique combination of properties. New grades of G-E mycalex and new G-E mycalex molding techniques which make wider and more economical applications now possible. Fill in the coupon and mail it today.

GENERAL  ELECTRIC

CD46-M10



PLASTICS DIVISIONS (T-10), GENERAL ELECTRIC COMPANY
1 Plastics Avenue, Pittsfield, Mass.

Please send me the new G-E Mycalex bulletin.

Name _____

Firm _____

Address _____

City _____ State _____

FREE! MAIL COUPON FOR

"Pocket Library of Engineering Data"

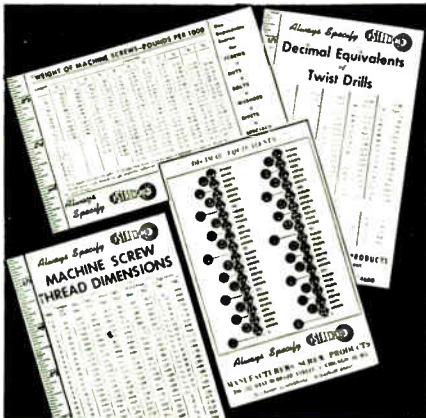

... AND A BAGFUL OF



if you use screws, nuts, bolts, washers, rivets, let us send you FREE the new "Pocket Library of Engineering Data," a fingertip reference to machine screw weights, decimal equivalents, machine screw thread dimensions, and decimal equivalents of twist drills. Also, you will be interested in receiving FREE a bagful of STRONGHOLD samples. This typical cross-section tells a better story than words. STRONGHOLD offers one dependable source of supply for every type of fastener, produced by modern equipment in our own factory.

NET PRICE CATALOG

An up-to-date fastener encyclopedia, reference guide, specification chart, and NET price list of precision-made STRONGHOLD products. Every purchasing agent and every engineer who specifies fasteners should have a copy. Mail coupon now.



**MANUFACTURERS
SCREW PRODUCTS**
272 W. Hubbard Street,
Chicago 10, Ill.
It's Faster to Phone
WHitehall 4680
Standardize on
STRONGHOLD

PASTE THIS COUPON ON YOUR LETTERHEAD AND MAIL

MANUFACTURERS SCREW PRODUCTS
272 W. Hubbard St., Chicago 10, Ill.

Please send me the items checked below.

"Pocket Library of Engineering Data".
 Bagful of STRONGHOLD screw products.
 NET Price Catalog.
 Prices on attached request.

Name.....
 Position.....
 Company.....
 Address.....
 City, Zone, State.....

**Tele Conference
Plans Exhibit**

Plans move forward apace for the Second Annual Television Conference of the Television Broadcasters Assn., Inc. (which has headquarters at 500-5th Ave., New York City) scheduled for the Waldorf-Astoria, October 10 and 11. The Conference which will be organized under the general theme "Television In Action" is to include an extensive exhibit of television receivers, transmitters and various studio equipment.

WCAU Goes Color

Philadelphia's television station WCAU will go completely color. It has withdrawn its application for a low frequency black and white license, will apply for a construction permit covering an uhf television station for color and improved black and white. Under an arrangement with Columbia programs will be transmitted over the New York-Philadelphia coaxial cable from CBS studios.

**Vitroseal Moves to
Covington Plant**

The Vitroseal Corp., maker of hermetic seals, has moved manufacturing operations to a new location at 28 East Electric street, Covington, Ky. Former location was Wyoming, O.

**Summer Conference on
Electron Ballistics**

Research personnel in industry and college teachers have been invited to attend a graduate conference devoted to the behavior of mass spectrometers, electron microscopes, and other electronic devices whose operation depends on the action of electron or ion beams. The lecturers for the conference will be Dr. Ladislav Marton, of the Division of Electron Optics of Stanford University, formerly with the Radio Corporation of America, and Dr. John A. Hipple, of the Westinghouse Research Laboratories, in charge of the development of the Westinghouse mass spectrometers.

The conference will be conducted by the Electrical Engineering and Physics Departments of Texas Agricultural & Mechanical College for three weeks. Dr. Marton will lecture from Monday, June 24, through Saturday, July 6. Dr. Hipple will commence his lectures Monday, July 1, and will conclude them Saturday, July 13.

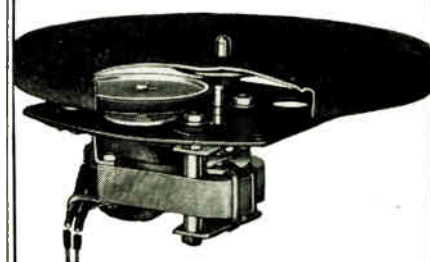
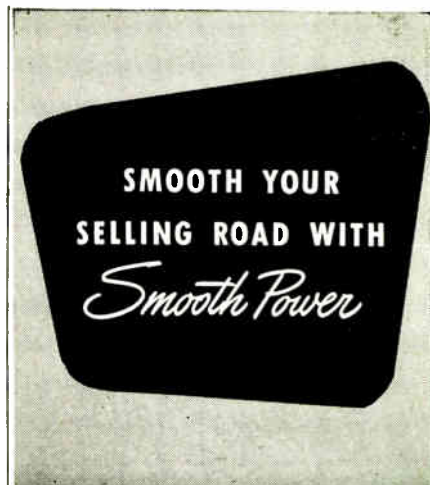

When you equip your new phonographs and record-changers with Smooth Power motors, you're adding a definite asset to your line. That's because every motor in the wide GI line has built into it that quick pick-up, quietness and smooth-as-velvet performance that users demand.

Then too, their modern design and accurate manufacture gives them long, trouble-free life... to add reliability to your products.

You can smooth your selling road if you standardize on Smooth Power motors.



DEPT. ML • ELYRIA • OHIO

FACSIMILE METHODS

(Continued from page 75)

This type of recorder can be used, however, with both the electro-sensitive coated paper and the electrolytic recording paper. In a third method with carbon backed paper recorder, the entire printer blade is controlled by the current so that it exerts more or less pressure on the carbon backing facing another strip of paper fed under it from twin rolls, leaving a mark of the desired shade at the instantaneous area of intersection.

When electrolytic recording paper is used, the printer blade is stationary — the facsimile signal current flows through the paper at the instantaneous point of intersection, causing electrolytic action between the moistened, impregnated paper and the printer blade, which produces a mark of corresponding shade at this point.

No processing is required before the copy becomes legible and, in addition, the home owner may either watch copy as it is being recorded, or may leave the recorder unattended during an entire day without missing his favorite facsimile program.

All of the equipment is designed for ease of operation and maintenance. The Hogan recorders can be loaded with a 400-ft. roll of Fax-paper simply by opening a frame, inserting the roll, laying the end of the paper in place and closing the frame. No threading of the paper between electrodes or rollers is required, so that the loading operation is easy enough for home use.

The 400-ft. roll of paper will last for about 24 hours of program reception, enough for about one average month's use at the contemplated transmission schedule of 16 pages per night (one hour). The paper used in both Hogan and Finch systems is moist when recording is done. The rolls are shipped with the desired degree of moisture content, in airtight containers.

In the Hogan equipment the recorder is equipped with a heater, so that his Faxprints are presented to the user in crisp and dry condition, which makes them pleasant to handle and easy to tear off. In addition, the machines are equipped to maintain the correct degree of humidity.

In the present system it is possible to provide for multiplexing where the facsimile picture is

THE *Individual* TOUCH

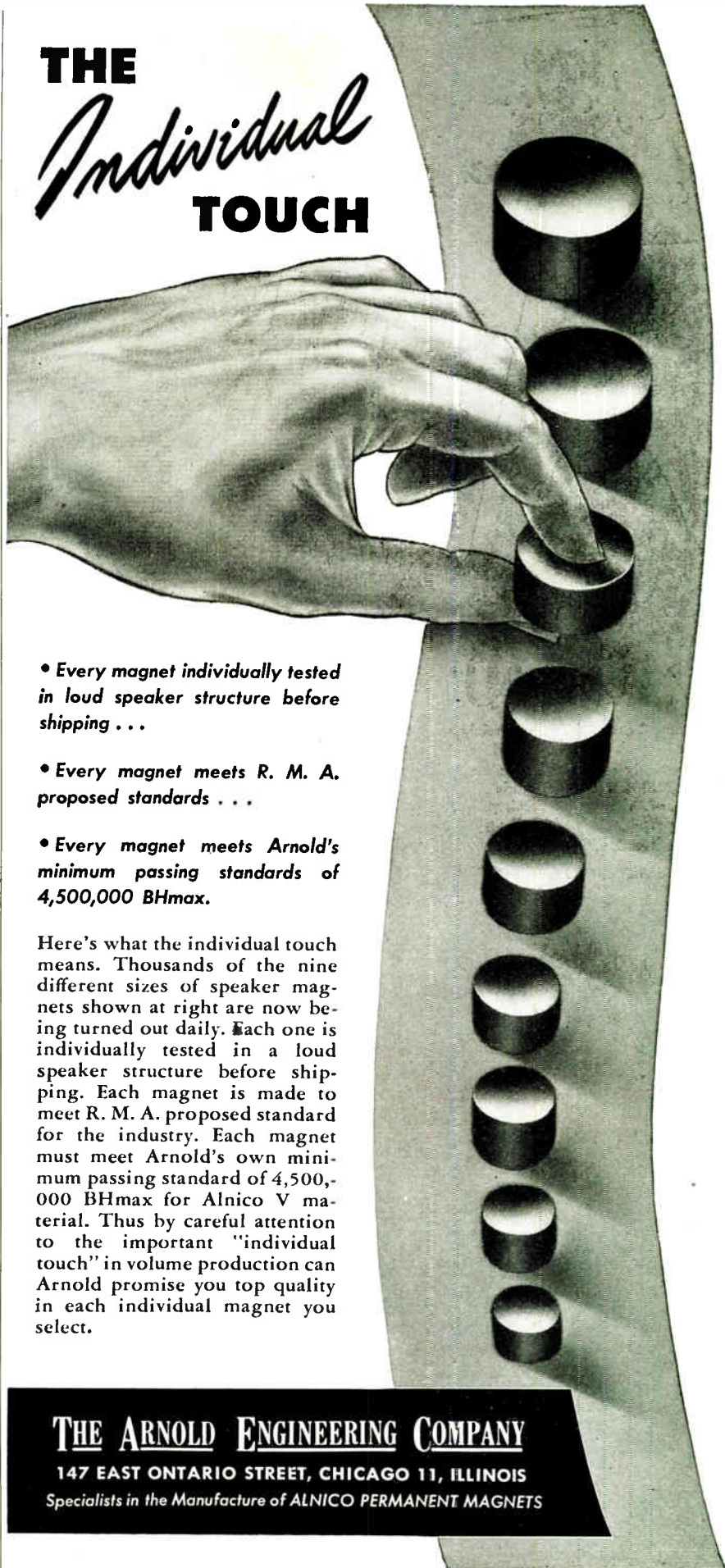

• Every magnet individually tested in loud speaker structure before shipping . . .

• Every magnet meets R. M. A. proposed standards . . .

• Every magnet meets Arnold's minimum passing standards of 4,500,000 BHmax.

Here's what the individual touch means. Thousands of the nine different sizes of speaker magnets shown at right are now being turned out daily. Each one is individually tested in a loud speaker structure before shipping. Each magnet is made to meet R. M. A. proposed standard for the industry. Each magnet must meet Arnold's own minimum passing standard of 4,500,000 BHmax for Alnico V material. Thus by careful attention to the important "individual touch" in volume production can Arnold promise you top quality in each individual magnet you select.

THE ARNOLD ENGINEERING COMPANY

147 EAST ONTARIO STREET, CHICAGO 11, ILLINOIS

Specialists in the Manufacture of ALNICO PERMANENT MAGNETS

Of course —
we're specifying

Seletron

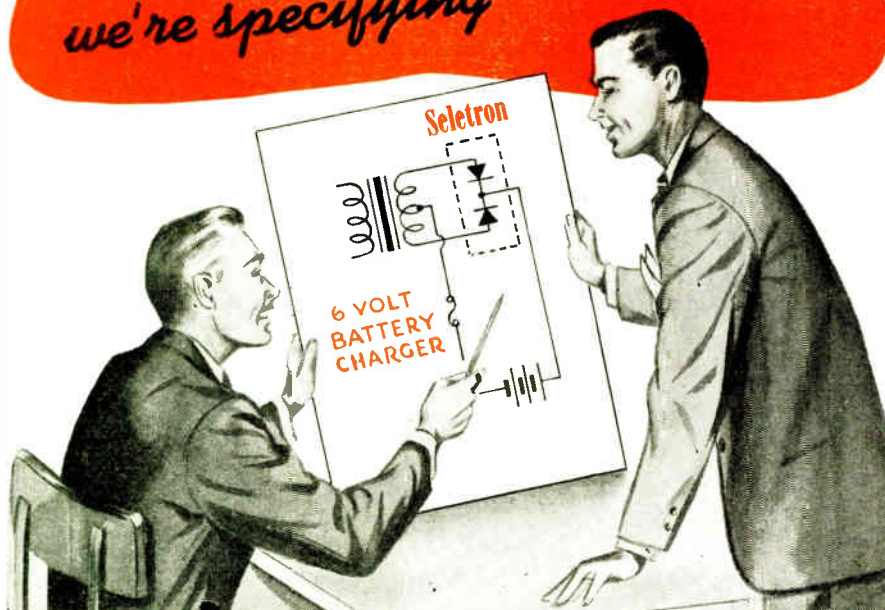

SELENIUM RECTIFIERS

For AC-to-DC conversion where minimum maintenance costs and maximum efficiency are required, circuit designers write SELETRON into their specifications . . . right at the start!

These precisely engineered selenium rectifiers are available in a wide range of sizes and output needs. SELETRON can be made LARGE (thousands of amperes), or small (milliamperes) . . . tailored-to-fit the special circuit you are now designing.

Let a SELETRON engineer consider your problem. His service and counsel are, of course, free without obligation.

MADE ON ALUMINUM

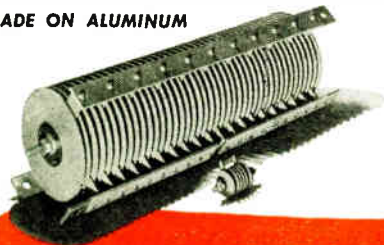

HERE'S WHY "IT'S SELETRON!"

1. Minimum weight and size for a given output
2. Maximum heat-dissipation value.
3. No fragile or wearing parts . . . trouble-free service life.
4. Uniformly high efficiency over a wide range of loads.



RADIO RECEPTOR CO., Inc.

Since 1922 in Radio and Electronics

253 WEST 19th STREET

NEW YORK 11, N. Y.

PERMANENT MAGNETS

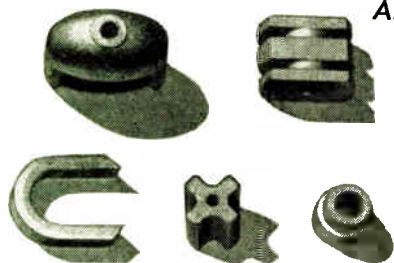

Alloys: COBALT • CHROME • ALNICO

The making of permanent magnets is an alloy, too . . . of experience, engineering, facilities. We'll be glad to tell you more. Write for bulletin.

THOMAS & SKINNER STEEL PRODUCTS CO.
1127 E. 23rd St., Indianapolis 5, Ind.

Thomas & Skinner

transmitted at the same time that voice modulation is going on, but the complications are greater and, at least at the start, facsimile transmission will probably take place only during the early morning hours when sound broadcasting is not being transmitted.

The Hogan transmitting equipment, which will be manufactured in the near future by the GE Co., now is mounted in a console that will fit well into the scheme of things within the control rooms of modern broadcasting stations. There will be two scanners, so that while a page is being scanned on one drum the other can be reloaded and adjusted to transmit the next page.

Separate scanner-amplifiers and line-amplifiers are provided for each, and a control panel makes it possible to instantly switch back and forth between them. One monitor recorder is kept in continuous operation, connected so as to print page after page of everything that is sent out on the air.

A second monitor recorder is arranged so that it can be connected to either scanner, and used to sample the transmission of a page which is being set up, thus enabling the operator to get an immediate and direct check on his adjustments. There is also included a page-separating signal generator, which will automatically transmit a design and a short slogan (or advertisement) between successive pages. This generator likewise transmits the special signals necessary for automatic framing and automatic synchronization of the home recorders.

Nominal broadcasting cost

The matter of cost to the broadcasting station is nominal, and the plan seems to offer considerable economic justification, inasmuch as it extends the number of hours that a station may be on the air with (what we may presume) will contain some revenue producing program material. It is quite possible to dispense with the scanners at the transmitter and use disc-recorded material, which simulates in every way the modulation pulses produced by direct scanning. Transcribed pictures and facsimile material will not, of course, have the direct spot news value unless specially handled transcription service is made available through a group of stations in some area. This is for the future to decide.

The cost to the user will be of the

Why leaders
in every field
use **PALNUTS**—



ALWAYS HOLD TIGHT

**EASY AND FAST
TO ASSEMBLE**

LOW IN COST

**WITHSTAND
HIGH TEMPERATURE**

**DO NOT DAMAGE
NUT OR NUT SEAT**



Used alone
as self-locking nut
on lighter assemblies.



Used as
locknut on heavier
assemblies.

● Send details of your application for recommendation and free samples. Ask for literature describing Palnut double-locking principle, advantages, types, etc.

THE PALNUT COMPANY

83 Cordier St.,
Irvington 11,
N. J.

**DOUBLE-
LOCKING**



PALNUTS

same order as a record changer. In other words, a console receiver can be equipped with a facsimile recorder or a record changer at about the same cost. The upkeep would consist of buying rolls of special impregnated paper. The cost of this paper will be of the order of $\frac{1}{8}$ to $\frac{1}{2}$ cent per page at the start, making a 16-page nightly newspaper cost approximately 5 cents for the paper used. It is presumed that some form of 24-hour time-clock would be incorporated in each receiver so that it could be scheduled to turn the machine on and off at the desired intervals so that early morning reception would be automatic.

The Broadcast Facsimile Analysis group representing those broadcasters who are most enthusiastic in support of the service consist of WOR, New York; WCAE, Pittsburgh (Hearst Radio); WOL, Washington (Cowles Broadcasting Co.); WINX, Washington (Washington Post); WWL, New Orleans; WGN, Chicago (Chicago Tribune); WNBH, New Bedford (Standard Times); WDRC, Hartford; WHK, Cleveland (Cleveland Plain Dealer); KMBC, Kansas City; Toronto Globe and Mail (FM Applicant); WQXR, New York (New York Times); WABC, New York; Boston Globe; KXOK, St. Louis (St. Louis Star-Times); WABF, New York; KYW, Philadelphia; WOKO, Albany; WFIL, Philadelphia (Philadelphia Inquirer); and Facimile, Inc. (subsidiary of Radio Inventions, Inc.).

During the meeting of the American Newspaper Publishers Convention it was disclosed that broadcasters who are to receive Finch facsimile apparatus include the following stations: WMGM, New York-FM affiliate of station WHN; KMGM, Los Angeles, California, both MGM interests stations; KJBS, San Francisco, Cal.; San Bernardino Broadcasting station at San Bernardino, Cal.; the Western Reserve Broadcasting Co., Cleveland, Ohio and the newspaper owned station WJJD in Chicago, Ill. (The Chicago Daily Sun).

JFD Adds Plant

JFD Mfg. Co., has added another plant to the five already operating in Brooklyn, New York, for the production of various electronic parts. The new factory will occupy a site at 16th avenue between 61st and 62nd street, and eventually will be the largest of the company's plants.

New!
Complete!
**RADIO
CATALOG**
Free!



**RADIO SETS
AMPLIFIERS
RADIO PARTS
ELECTRONIC EQUIPMENT**

Your copy of the complete, new Concord Catalog is ready! It offers you the greatest selection of guaranteed quality RADIO SETS, PHONORADIOS, RADIO PARTS, TEST INSTRUMENTS, BOOKS, TOOLS, AMPLIFIERS AND ACCESSORIES, AMATEUR KITS AND SUPPLIES . . . page after page of post-war engineered equipment and parts you have long been waiting for. All standard, top-quality lines. Thousands of items. Money-saving prices. See the thrilling MULTIAMP Add-A-Unit Amplifiers, brand new in the field, with sensational new flexibility, fidelity and power—EXCLUSIVE with CONCORD. Your copy is ready . . . and it's FREE. Rush this coupon today.

CONCORD

RADIO CORPORATION
LAFAYETTE RADIO CORPORATION

CHICAGO 7 ★ **ATLANTA 3**
901 W. JACKSON BLVD 265 PEACHTREE ST.

Concord Radio Corporation, Dept. J-66
901 W. Jackson Blvd., Chicago 7, Ill.

Yes, rush FREE COPY of the comprehensive new Concord Radio Catalog.

Name.....
Address.....
City..... State.....

Right where it belongs

PUTTING THE HORSE BEFORE THE CART

for finer instrumentation

Victoreen sub-miniature vacuum tubes, series VX with 10 milliamperes filament operation, grid current of 10^{-14} amperes and grid resistance of 10^{16} ohms or greater, offer tubes especially designed for exacting circuit requirements—rather than the expediency of using circuits designed around existing tube characteristics.

AVAILABLE AS PENTODES, TETRODES,
TRIODES AND DIODES

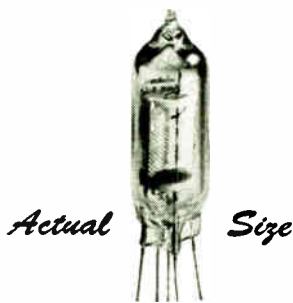

Actual Size

... and filling another
long recognized need



Victoreen Hi-meg vacuum sealed resistors supply the demand for a stable precision resistor in a range of 100 to 10,000,000 megohms.

Write for technical data on
VX tubes and resistors.

THE VICTOREEN INSTRUMENT CO.
3800 PERKINS AVENUE
CLEVELAND 14, OHIO

WIDE READING

(Continued from page 80)

effective mutual coupling between the two coils is zero; this is the position chosen for the detector. Metal parts in the vicinity of the coils will cause a change in the mutual inductance from zero to a positive or negative value.

These coils L_1 and L_2 are inserted in the feedback loop of a three stage amplifier which has negligible phase shift throughout the normal working frequency range. Consequently, for sufficient resistive coupling between the two coils L_1 and L_2 the circuit will operate as an oscillator at the resonant frequency which is approximately 1000 cycles per second. If, however, a ferrous object is located in the vicinity of the coils, the phase angle of the feedback path will differ by 90 deg. from the purely resistive case and the oscillations will occur at a frequency which provides the requisite 90 deg. phase shift. The amplitude will be less than in the resonant case. It will be obvious that all intermediate conditions of coupling will similarly provide oscillatory conditions.

Control boxes Nos. 4 and 4a provide manually adjustable separate feedback circuits introducing any desired amount of phase shift in parallel with the two-coil feedback. An initial degree of regenerative feedback will then be provided at a definite phase angle and the sensitivity of detection for any object whose phase angle is similar to that of this initial coupling will be higher than for other objects assuring the desired discrimination between materials of different phase angle.

Film Noise Spotter

J. P. Corcoran (Journal of the Society of Motion Picture Engineers, February, 1946)

A machine is described which permits location of noise on a sound film so that imperfections on the film may be readily painted out before rerecording. The past practice has been to inspect each foot of the sound tracks under a magnifying glass. The new method detects the imperfections in the film by running it through a small sound reproducer placed between the reels on a film cutting table. In order for the disturbing noises to be distinguishable in earphones, the normal signal is suppressed. Rate of film travel is about 100 fpm.



Quiet • POWERFUL
SM Fractional
H. P. Motor

The Home Power Servant
also handles many other
jobs efficiently, dependably



For quiet operation, dependable performance, long life, maximum power per ounce of weight and per inch of space, use SM Fractional H.P. Motors. Models from 1/10th to 1/200th H.P. Speeds of 3,000 to 20,000 R.P.M. Voltage from 6 to 220 AC-DC Large volume production to your exact specifications.

Small Motors, Inc.

DEPT. 50
53 WEST JACKSON BLVD.
CHICAGO 4

PATENTS

(Continued from page 82)

The system may record phenomena occurring at a considerable distance, it being only necessary to transmit the frequency of the detector output, loss of amplitude due to attenuation being of no consequence for correct recording. It is claimed that this arrangement provides an extremely sensitive recording device which functions immediately upon a slight change in the phenomenon to be measured.

H. O. Peterson, RCA, (F) February 11, 1942, (I) September 25, 1945, No. 2,385,641.

Form Signal League

The Signal League, civilian association of wartime communications officers and manufacturers was organized in Chicago with the election of officers and seven members of its board of governors. The League was established to encourage post-war application of wartime research, development and training in communications.

Major General James A. Code, Jr. (ret.), wartime assistant chief signal officer of the army and now vice-president of Automatic Electric Co., was elected chairman of the board of governors; William J. Halligan (Hallcrafters), was chosen president of the League; S. I. Neiman, wartime director of public relations for the Signal Corps here, was elected executive secretary and the following were elected to the Board of Governors: Edward W. Shepherd (Philco); Jerome J. Kahn (Standard Transformer); Leslie F. Muter (Radar-Radio Industries of Chicago); Frank J. O'Brien (Galvin); Oliver Read (Radio News); U. A. Sanabria (American Television Laboratories), and Horace M. Carleton (E. B. Mathewson). The League has established headquarters in the One No. LaSalle bldg., as an Illinois not-for-profit corporation.

Airdesign Shortens Title

Airdesign, Inc., is the new corporate style of Airdesign & Fabrication, Inc., Upper Darby, Pa. The company manufactures transformers. John A. Murphy, resident partner of Reynolds & Co., has been elected chairman of the board and David Warner of the same company also has become a member of the board.

Crystalab

TRADE MARK REG. U. S. PAT. OFF.

SPECIALISTS IN
SPECIAL CRYSTALS

COMPLETE COVERAGE



WHATEVER YOUR PROBLEM

SPACE, TOLERANCE, HOLDER TYPE, FREQUENCY,

CALL IN CRYSTALAB FOR THE ANSWERS

WRITE TO
DEPT. EI

CRYSTAL RESEARCH

LABORATORIES INC.

29 ALLYN ST., HARTFORD, 3, CONN., PHONE 7-3215

BOOKS *designed for the* ENGINEER

UNDERSTANDING MICROWAVES

by VICTOR J. YOUNG

For those who have not previously considered radio waves shorter than 10 centimeters. Provides foundation for understanding various microwave developments of past five years. To simplify explanations, mathematics are placed in footnotes wherever possible.

CHAPTER HEADS

The Ultra High Frequency Concept • Stationary Charge and its Field • Magnetostatics • Alternating Current and Lumped Constants • Transmission Lines • Poynting's Vector and Maxwell's Equations • Wave-

guides • Resonant Cavities • Antennas • Microwave Oscillators • Radar and Communication • Section Two is devoted to descriptions of Microwave Terms, Ideas and Theorems Index.

SPEED AND SIMPLICITY

A-C CALCULATION CHARTS

Student engineers will find that this book is invaluable. It simplifies and speeds any work involving AC calculations. The book contains 146 charts. Covers all AC calculations from 10 cycles to 1000 megacycles.

160 PAGES—PRICE \$7.50

OUT IN MAY—OVER 400 PAGES—PRICE \$6.00

ORDER TODAY

JOHN F. RIDER PUBLISHER, INC.

404 FOURTH AVENUE, NEW YORK 16, N.Y.

Export Division: Rocke-International Electric Corp., 13 E. 40th Street, New York 16, N.Y.

STANDARD CRYSTALS

For commercial airline, civilian aircraft, marine, police, railway, automotive, and other communication equipment.

Complete line for the amateur bands.

Custom units for laboratory, experimental, and specialized applications.

Let us engineer your frequency control problems.

Write for free catalog and other information.

STANDARD PIEZO COMPANY

Established 1936

Quartz Crystals and Frequency Control Equipment

Office and Development Laboratory

SCRANTON, PA.

CARLISLE, PA., P. O. BOX 164

CARLISLE, PA.



NEW and Ready for you!

Allied's 1946 CATALOG

*of Radio and
Electronic Supplies*



LARGEST AND MOST COMPLETE STOCKS... Under One Roof

You'll find this new Buying Guide extremely helpful and valuable today! Places over 10,000 items at your finger tips—for research, maintenance and production. Includes parts, tubes, tools, books, test instruments, public address and communications equipment. Concentrates all leading

makes here in one large central stock to give you faster, more efficient, more complete service—saves you time, work and money. Whatever you need... it pays to check with Allied. Write, wire or 'phone Haymarket 6800.

Everything in Radio and Electronics

ALLIED RADIO CORP.

833 W. Jackson Blvd., Dept. 32-F-6, Chicago 7, Illinois

FREE
Send for it
NOW

MAGNETRON

(Continued from page 50)

one mode, with the result that two or more wavelengths are observed. In the interdigitated tube this phenomenon has also been observed. In addition it appears possible to have two modes at the same frequency.

For example, consider the following case. The tube is set up in the cavity so that it may be rotated slowly on its axis while the cavity, loop, etc., remain stationary. A plot of power output against angle through which the tube has been rotated shows two maxima and two minima. The power observed is found to vary approximately in proportion to $(1 + A \cos 2\phi)^2$, where ϕ is the angle through which the tube has been rotated and A is a constant.

Now if, in this relation, A is zero—that is, if there is no variation in power in any radial direction—we assume that only a single mode is present. On the other hand, if A is not zero, we have a set of conditions which may be explained by assuming the presence of two coupled modes, one being the π -mode and the other a mode which is in phase with the π -mode at two diametrically opposite points and 180° out of phase at points midway between.

In a magnetron we take the mode number n to be $\phi N/2\pi$ where ϕ is the phase difference in radians between adjacent gaps and N is the number of gaps. Thus for an interdigitated magnetron with 16 fingers or gaps, the π -mode is mode 8. That is, the phase angle between two adjacent gaps is π radians or 180° . If the operation of this other mode is in phase with the π -mode across one gap and 180° out of phase at a gap one-fourth of the distance around the periphery of the anode, it could be either mode 2, (where $\phi = \pi/4$) or mode 6, (where $\phi = 3\pi/4$). If it is mode 2 the electric and magnetic fields would have to be very considerably greater than the critical values for the π -mode, while for mode 6 the difference is not great. As a matter of fact, this type of operation has been obtained with fields just greater than the critical fields for mode 6.

Shea gave curves for wavelength against mode number for 12-cavity magnetrons, both strapped and unstrapped. For the unstrapped case the wavelength decreases with mode number, while in the tightly strapped tube the wavelength in

the higher modes increases with strapping. It may be assumed that if the strapping is not too tight there may be two modes which will pull together at a common wavelength, one of which is mode 6 and the other mode 8 or the π -mode.

No-power points

There is no intention of implying that the presence of two points around the cavity where little or no power is obtained is explained only by assuming two modes in which the amplitudes and frequencies are equal. For instance, suppose that in two diametrically opposite places there are two fingers of the anode touching, or nearly touching, each other. We still have the possibility of oscillation, the voltage across adjacent gaps being unequal in magnitude—zero at the points of short circuit or close proximity, and maximum at the two points midway between. The two shorts would be current loops, while the fingers on one side of a disc probably would instantaneously be of opposite polarity from the fingers on the opposite side of the same disc. Again, there might be some asymmetry in the tube, intentional or otherwise, which would result in there being slight differences in the values of shunt impedance looking into the cavity at the various gaps, and which would show up as variations in power if the loop were carried around the periphery of the cavity. Oscillations of these kinds have been measured in tubes having asymmetries purposely introduced during assembly. In tubes having good symmetry, oscillations of these types have been observed in addition to the simple π -mode.

We return now to the case where it is found that the available power varies with the position of the loop in the cavity. If the anode structure, fields and cavity were perfectly symmetrical, it would be probable that, as the tube is rotated, the field configuration within the cavity would also rotate in such a way that the loop would cut the fewest flux lines and the tube would do the smallest amount of work possible.

As one alternative, it could be held that any except the π -mode should be suppressed, since, in this case, the power delivered would be independent of the position of the tube. On the other hand, when the tube is operating in the double mode at a single frequency the power obtainable is greater than in the π -mode and, possibly, greatest

when the power in the two modes is equal. Fortunately, the amount of asymmetry required to stabilize the position of the fields within the cavity is very small. An experimental tube made with the cathode mounted off axis 0.0035 in. was found to have more than enough asymmetry for this purpose.

At the present time a tube substantially identical to the one just described is in limited production.

MASS PRODUCTION

(Continued from page 55)

where the difficulty is diagnosed and repaired. (Fig. 12).

Following these tests the sets are ready for casing in their cabinets. At this point the work table is equipped with rubber covered rollers and the sets after insertion into the back of the cabinets travel on their faces on these rollers. (Fig. 13). When the chassis hold down screws have been driven, or the spring nuts tapped into place and the knobs placed on the control shafts the sets move into the "customer" inspection booth where they are turned on, jarred in several positions, tuned and listened to and passed for packing if correct.

It would be false to give the reader the impression that everything works perfectly at all times. As in other factories, stacks of semi-finished sets can be found, held up for a missing part and, therefore, necessitating double handling and storage with its train of difficulties due to dirt and accidental damage creeping in. (Fig. 14).*

It can be said, however, that in any factory the efficiency is related to the amount of idle time which a product must undergo as well as to the amount of production time spent upon it. On both these counts the manufacturing operations here described can be ranked first class.

RCA Buys Lancaster

Manufacturer of cathode ray picture tubes for receivers and also camera pickup tubes is to be concentrated by RCA Victor Division of Radio Corp. of America in Lancaster, Pa. The immense plant there built by the Government during the war has been purchased from the U. S. Navy Dept. by RCA. In addition to cathode ray tubes large vacuum tubes for broadcasting and other forms of communications and for power and control use in industry will be made.

NEW MODELS
Available Now!
of **ATR**
QUALITY PRODUCTS



BATTERY ELIMINATORS

FOR CONVERTING A.C. TO D.C.
New Models... designed for testing D.C. electrical apparatus on regular A.C. lines. Equipped with full-wave dry disc type rectifier, assuring noiseless, interference-free operation and extreme long life and reliability.

- Eliminates Storage Batteries and Battery Chargers.
- Operates the Equipment at Maximum Efficiency at All Times.
- Fully Automatic and Fool-Proof.

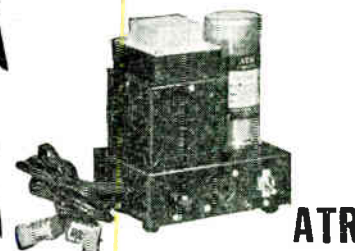

LOW POWER INVERTERS

FOR INVERTING D.C. TO A.C.
Another New ATR Model... designed for operating small A.C. motors, electric razors, and a host of other small A.C. devices from D.C. voltages sources.



STANDARD AND HEAVY DUTY INVERTERS

FOR INVERTING D.C. TO A.C.
Specially designed for operating A.C. radios, television sets, amplifiers, address systems, and radio test equipment from D.C. voltages in vehicles, ships, trains, planes, and in D.C. districts.

WRITE FOR NEW CATALOG—
JUST OFF THE PRESS!

AMERICAN TELEVISION & RADIO CO.
Quality Products Since 1931
ST. PAUL 1, MINN. U. S. A.

LOOK!

BEAM POWER TUBES

829-B push-pull R. F. beam power amplifiers. Exceptionally efficient, with full input at frequencies up to 200 Mc. Max. ratings are: 750 plate volts, 40 watts plate dissipation. While they last... Stock Number WPS116

\$4.95

R. W. T. BARGAINS of the MONTH

LOOK!

ACORN TUBES

Government Released. Sensational offer. Normally \$2.85-\$5!

Stock No. WPS 422: Type 954.
 Stock No. WPS 423: Type 955.
 Stock No. WPS 424: Type 956.
 Stock No. WPS 425: Type 957.

Socket for above.
 W8464, price 49c

69¢

FREE! Latest Bargain Flyer includes test instruments, record changers, communication receivers, ham transmitting tubes and many other electronic items you need today. Big new catalog coming! Get your name on our list!

Radio Wire Television Inc.

NEW YORK 13 BOSTON 10 NEWARK 2

Originators and Marketers of the Famous **Lafayette Radio**

Cut out coupon, paste on penny post card, mail today.

R. W. T. Dept. NF6

100 AVENUE OF THE AMERICAS, NEW YORK 13

Gentlemen: Send me FREE copy of your Latest Bargain Flyer and put my name on list for your Big New Catalog

NAME _____

ADDRESS _____

CITY _____ ZONE _____ STATE _____

INTERMODULATION

(Continued from page 58)

This is equivalent to equation 7. Setting the two equations equal to each other and solving for m:

$$m = \frac{aE_1}{2ax_0 + b} \quad (9b)$$

This expression has exactly the same form as the expression for harmonic distortion, eg. (4), and a magnitude exactly twice as great. This shows that for this type of non-linearity the intermodulation method of measurement is twice as sensitive as the usual harmonic method.

The same procedure can be followed for higher order distortion. Assuming a curve relating y to x:

$$y = ax^3 + bx^2 + cx + y_0 \quad (10)$$

Substituting equation 2 in equation 10 and solving for harmonics we find the amplitude of the second harmonic to be:

$$\frac{3ax_0^2 E^2 + bE^2}{2} \quad (11)$$

The amplitude of the third harmonic is:

$$\frac{aE^3}{4} \quad (12)$$

Taking the sum of both harmonics and dividing by the fundamental:

$$\frac{a(6x_0E + E^2) + 2bE}{a(3E^2 + 12x_0^2) + 8bx_0 + 4c} \quad (13)$$

Substituting equation 5 in equation 10 we find that the output, after removing D. C. terms and low frequency components, consists of the following:

A carrier frequency with an amplitude:

$$E_2 \left[\frac{12ax_0^2 + 2aE_1^2 + 3aE_2^2 + 8bx_0 + 9c}{4} \right]$$

Upper and lower sidebands with an amplitude:

$$E_1 E_2 \left[\frac{5ax_0 + b}{2} \right]$$

Second harmonic of carrier:

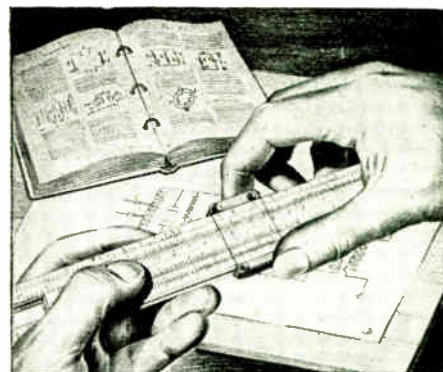

Can You "Measure Up"

to a good-paying radio-electronics job with a secure peacetime future?

"Post-War" is NOW! Don't be caught unprepared! Add CREI home study training to your present experience and step ahead of competition to a better job!

What's ahead for you in the field of Radio-Electronics? One thing is certain, Radio-Electronics is surging forth as one of America's foremost industries, offering promising careers for radiomen with modern technical training.

NOW is the time to take the time to prepare yourself for the important career jobs in radio-electronics engineering. You will find the knowledge gained from your CREI course useful almost from the beginning. Student C. Whitehead writes: "Your course has been of great value to me in that the knowledge I have gained has enabled me to meet technical situations satisfactorily and has given me the confidence to accept greater responsibility."

Your ability to solve tough problems on paper and then follow up with the necessary mechanical operation, is a true indication that you have the confidence born of knowledge . . . confidence in your ability to get and hold an important job with a secure, promising future. Investigate now the CREI home-study course best suited to your needs, and prepare for security and happiness in the New World of Electronics! Write for all the facts today.

• WRITE FOR NEW, FREE 36-PAGE BOOKLET

If you have had professional or amateur radio experience and want to make more money—let us help you qualify for a better radio job. TELL US ABOUT YOURSELF so we can plan intelligently a course best suited to your needs.—PLEASE STATE BRIEFLY YOUR BACKGROUND OF EXPERIENCE, EDUCATION AND PRESENT POSITION.



CAPITOL RADIO ENGINEERING INSTITUTE

E. H. RIETZKE, President

Dept. EI-6, 16th and Park Road, N. W. WASHINGTON 10, D. C.

Member: National Home Study Council · National Council of Technical Schools

Branch Offices:

New York City (7), N. Y. 170 Broadway
 San Francisco (2), Calif. 760 Market St.
 Chicago (2), Ill. 30 N. LaSalle St.
 San Diego (1), Calif. 316 C Street

$$\frac{3ax_0E_2^2 + bE_2^2}{2}$$

Third harmonic of carrier:

$$\frac{aE_2^3}{4}$$

There are other harmonics and sum and difference terms of very low amplitude which do not affect the present discussion.

Following the previous procedure, substituting in equation 8, and solving for m.

$$m = \frac{4E_1(5ax_0 + b)}{a(12x_0^2 + 2E_1^2 + 3E_2^2) + 8bx_0 + 8c} \quad (14)$$

Rearranging equation 13:

$$\text{Harmonics} = \frac{E[a(6x_0 + E) + 2b]}{a(3E^2 + 12x_0) + 8bx_0 + 4c} \quad (15)$$

Making E equal to E_1 and making E_2 equal to one-fourth E_1 and $E = 1$ (the condition used in this instrument)

$$m = \frac{20ax_0 + 4b}{a(12x_0^2 + 35/16) + 8bx_0 + 8c} \quad (16)$$

$$\text{Harmonics} = \frac{a(6x_0 + 1) + 2b}{a(12x_0 + 3) + 8bx_0 + 4c} \quad (17)$$

This shows that when the higher order terms are large the per cent intermodulation rises at a higher rate than does the arithmetic sum of the harmonics. This result is verified by the experimental data.

Distortion of a complex wave by any system can be measured accurately by this meter. It will indicate two or more times as much distortion as the usual harmonic method of measurement. The results of these tests agree very closely with listening tests of audible distortion, which is not always true of harmonic analysis. Application of the instrument should be largely found in broadcast and recording technics.

REFERENCES:

1. "Distortion Tests by the Intermodulation Method"—John K. Hilliard, Proceedings of the I.R.E., December, 1941, page 614.
2. "Principles of Electron Tubes"—H. J. Reich, pages 82, 115.
3. "Applied Electronics"—E.E. Staff of M.I.T., page 632.
4. "Electrical Engineers' Handbook"—Pender and McIlwain, Section 10, pages 55-59.
5. "Radio Engineering Handbook," Second Edition—Henney, pages 343 to 348.

For Delicate Soldering Tasks

VULCAN

Pygmy

ELECTRIC SOLDERING TOOL





Finds its way where there is little clearance or cramped space. Particularly useful for meters, electrical instruments, small radios and similar articles.

Standard 1/4 inch
Also available in 3/16 inches

VULCAN ELECTRIC COMPANY
DANVERS 13, MASS.

Makers of a wide variety of Heating Elements for assembly into manufacturer's own products and of Heating Specialties that use electricity.

COILS

ATLAS COIL WINDERS, INC.

392 STATE ST. STAMFORD CONN

WINDING Loops, I.F., R.F., Oscillator Layer & Random Wound coils. Experimental, etc.

EQUIPMENT We manufacture special winding equipment to order.

CONSULTANTS Analysis of, and advice on your own coil production problems.



WANTED

TELEVISION ENGINEER

Experienced television receiver senior engineer

RADIO ENGINEER

Experienced home set senior engineer

●

Both positions offer excellent opportunity and pay. Permanent.

Please apply in writing.

UNITED STATES TELEVISION MFG. CORP.

3 West 61st Street
New York 23, N. Y.

RAILROAD RADIO

(Continued from page 65)

via the induction-radio link were picked up from the wire lines at the Michigan Central tower, applied to the underground telephone pair, together with a relay-control voltage, and were impressed on the VHF satellite transmitter at the Ford plant, where they were radiated into space for reception by mobile units in the satellite service area. A carrier-operated relay in the induction-radio receiver was used to impress the relay-control voltage on the telephone pair; this was utilized at the Ford satellite station automatically to turn on the VHF transmitter during periods when induction radio signals were received from Flat Rock.

Similarly, a carrier-operated relay in the VHF receiver was used to apply control voltage to the telephone pair and thus cause energization of the unattended induction-radio transmitter at the Michigan Central tower.

The VHF satellite equipment at the Ford Yard had the same type of transmitter and receiver as was used at Flat Rock. A local microphone, with press-to-talk switch, and a loudspeaker were provided in order that the yardmaster at the Ford plant could establish two-way communications with mobile units in his local service area, in addition to the use of the equipment in satellite service via the remote control circuit from Flat Rock. A vertical antenna, similar to the one at the Flat Rock station, was mounted on the top of steel flood-light tower at a height of about 75 ft. above ground.

Two mobile units were utilized in the tests. One, a steam locomotive, was equipped with a 10-watt VHF transmitter and associated receiver, similar in design to those used at the fixed stations, which were mounted in an air-tight metal case on the rear deck of the tender. The air-tight housing construction was used in order to protect the radio equipment from the corrosive effects of sulphur fumes and other gases which are prevalent in the smoke from coal-burning steam locomotives.

An antenna, of experimental "cartwheel" ground-plane type, was supported on the side of the equipment housing as shown in the photograph. The total height of the antenna above the deck of the tender was 51 in. The base of the an-



Cameras Binoculars Telescopes *Lined with Cellusuede Flock*

When used as an interior lining, black Cellusuede flock does an efficient job of "blackening out" the insides of cameras, binoculars, and telescopes, because the flock does not reflect light rays . . . it absorbs them. A trial application will convince you that Cellusuede is inexpensive and easy to apply. Available for immediate shipment.

Cellusuede

FLOCK

Prices, Samples and Book-
Write for Color Card,
Methods of Application,
let explaining Uses and



LUGS THAT CAN LICK

Any Terminal Post And Wiring Problem

With these three heavily silver plated brass C.T.C. Terminal Lugs in your stock room, your terminal post and wiring problems are over. They provide strong, well-anchored terminal posts in a single, simple swaging operation. Once they are swaged to the board, their generous soldering spaces and quick heating feature makes wiring swift, neat and positive.

Left: C.T.C. TURRET TERMINAL LUGS are available with single or double soldering spaces. Made to fit $\frac{1}{32}$ ", $\frac{1}{16}$ ", $\frac{3}{32}$ ", $\frac{1}{8}$ ", $\frac{3}{16}$ " and $\frac{1}{4}$ " terminal board thicknesses. Midget TURRET TERMINAL LUGS for

delicate instrument assembly also available.

Center: C.T.C. SPLIT TERMINAL LUGS have a .050" hole through them permitting wiring from top or bottom side of board. Ideal for transformers or other potted units. Stocked to fit $\frac{3}{32}$ " terminal boards.

Right: C.T.C. DOUBLE END TERMINAL LUGS provide two terminal posts in one operation. May be wired from top and bottom. Electrical connection is perfect because both posts are part of same lug. Stocked to fit $\frac{3}{32}$ " terminal board thicknesses. Midget DOUBLE END TERMINAL LUGS also available.

For information on the complete line of C.T.C. TERMINAL LUGS and other C.T.C. components, write for C.T.C. CATALOG No. 100.



CAMBRIDGE THERMIONIC CORPORATION
441 Concord Avenue • Cambridge 38, Mass.

tenna was provided with means to permit the antenna to be swung down through an angle of approximately 90°, if this were required during coaling operations. A remote control unit, with microphone and loudspeaker, were installed in the locomotive cab at a location convenient to the engineman.

The remote control unit included (a) a loudspeaker volume control, (b) power-control switch, (c) a receiver "test" switch for opening the squelch circuit as a rough check on receiver sensitivity, (d) an "intercom" switch for permitting audio-

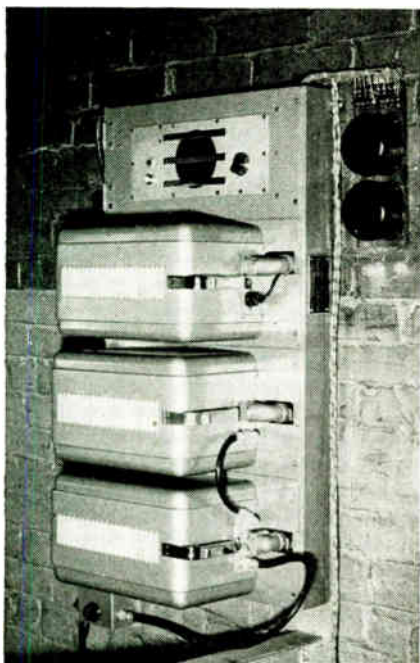

Induction radio satellite equipment (unattended) installed in tower along the DT&I route to Ford plant

frequency intercommunications between the cab and railroad personnel at the front or rear of the locomotive when supplementary remote control units are installed at those points, (e) a channel-selector switch for transferring the radio equipment from one rf channel to another, and (f) pilot lights. The loudspeaker was of weatherproof re-entrant type, capable of projecting a highly-intelligible voice signal into the cab with sufficient volume to override the pronounced ambient-noise levels found in steam-locomotive operation.

A second remote-control unit, identical with that used in the locomotive cab, was installed in a Pullman coach, which was coupled to the locomotive to carry the visiting railroad executives and communications engineers from different sections of the country who participated in the tests. A microphone and loudspeaker of the same types

used in the engine were used in the coach. By means of the "intercom" switch, two-way audio-frequency voice communications could be established between the coach and the engine cab, in addition to two-way radiotelephone communications with fixed stations or between trains.

A second locomotive, of Diesel-electric type, was also equipped with two-way VHF radio equipment. In this installation the transmitter and receiver, of the same types used on the steam locomotive, were temporarily mounted in an airtight metal case on the top of the engine hood. A dynamotor, operated by the 64-volt primary-power source of the Diesel engine, was installed next to the equipment casing and was utilized to provide filament and plate voltages. A new type of antenna, developed by Farnsworth for railroad use on engines and other mobile units where overhead clearance is limited, was installed on the top of the engine hood in proximity to the bell of the locomotive. This antenna, which was of extremely rugged construction, projected less than 11 in. above the motor hood, and actually had less height than the bell of the locomotive, as is shown by the photograph. No insulators were required at the point of support on the engine hood.

Antenna characteristics

Despite this unusually low structure, the antenna had propagation characteristics better than those of a conventional ground-plane antenna of greater height, and enabled solid two-way communications to be established with the Flat Rock yard office over air-line distances in excess of 13 miles. A remote control unit, microphone and loudspeaker, were mounted inside the cab.

With this equipment, solid two-way communications, with no flutter or other discernible signal-intensity variation, could be maintained between the central control point at Flat Rock and mobile units in any yard within the test area, involving air line distances of 13-14 miles. The tests included positioning of the engines between tall steel-frame buildings at the Ford plant, with large structures above and on both sides of the engines, intervening between the fixed stations and the mobile units. No discernible change was noted in the two-way communications at these test points, with direct two-way

American Beauty



ELECTRIC SOLDERING IRONS

are sturdily built for the hard usage of industrial service. Have plug type tips and are constructed on the unit system with each vital part, such as heating element, easily removable and replaceable. In 5 sizes, from 50 watts to 550 watts.

TEMPERATURE REGULATING STAND

This is a thermostatically controlled device for the regulation of the temperature of an electric soldering iron. When placed on and connected to this stand, iron may be maintained at working temperature or through adjustment on bottom of stand at low or warm temperatures.

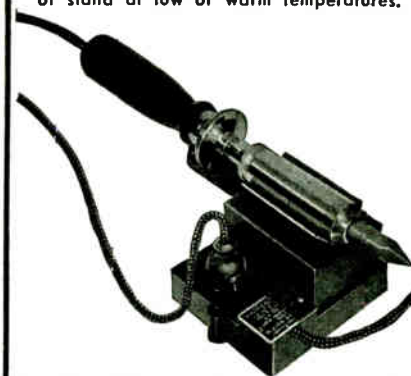

For descriptive literature write

111-1

**AMERICAN ELECTRICAL
HEATER COMPANY**
DETROIT 2, MICH., U. S. A.

contact being made between the locomotive and the Flat Rock station, more than 13 miles distant.

When "radio shadow" effects and "flutter" were noted at a few points in the Ford industrial area during test transmissions direct from Flat Rock, the satellite station at the Fordson yard was brought into service from Flat Rock, with the result that the shadow-effect and "flutter" were eliminated by the high-level signals from the local zone transmitter. During tests from the interior of the steel-roofed Locomotive Maintenance Building at the Ford plant, the radio-equipped

steam engine within this building maintained direct two-way voice communications with the second radio-equipped Diesel locomotive, located between two steel-frame buildings, and beneath a steel overhead-crane structure, at the yard of the Murray Body Works in the Detroit - Ecourse industrial area, about 7 miles from the Ford location.

During preliminary tests of the DT&I installation, the radio-equipped steam locomotive maintained solid two-way contact with the Flat Rock station over a distance of approximately 29 miles,

air-line, in open country along the main line tracks leading in a southwest direction from Flat Rock. It runs from Flat Rock to Dearborn, on the main line of the DT&I, in a northeast direction from Flat Rock, two-way communications were maintained throughout the trip between the Pullman coach and the Flat Rock yardmaster's office for a distance of 34 miles. No point was observed at which reliable communication could not immediately be established.

No heterodyne squeals or whistles were heard as the train moved from the primary service zone of the Flat Rock transmitter into the primary service zone of the Ford satellite transmitter at Dearborn. For a distance of several thousand feet at a location intermediate between Flat Rock and Dearborn, where equal signal intensity was obtained from each of the two fixed stations, the observers in the coach noted during one test that the voices of the different speakers at the Flat Rock and Ford yard offices, respectively, were alternately heard as the VHF signals from the two stations, under local control in this instance, varied in strength with respect to each other.

The successful common-frequency operation of a plurality of fixed stations along railroad right of way in this manner would be practicable only with FM equipment, since, with AM, heterodyne "squeals" would be caused by the interaction of the carriers. It thus appears that satellite systems of this general type will provide many useful functions in railroad operations when it may be desirable to bridge long distances between fixed stations and trains in remote zones along the right of way.

Ingenious New Technical Methods

To Help You with Your Reconversion Problems

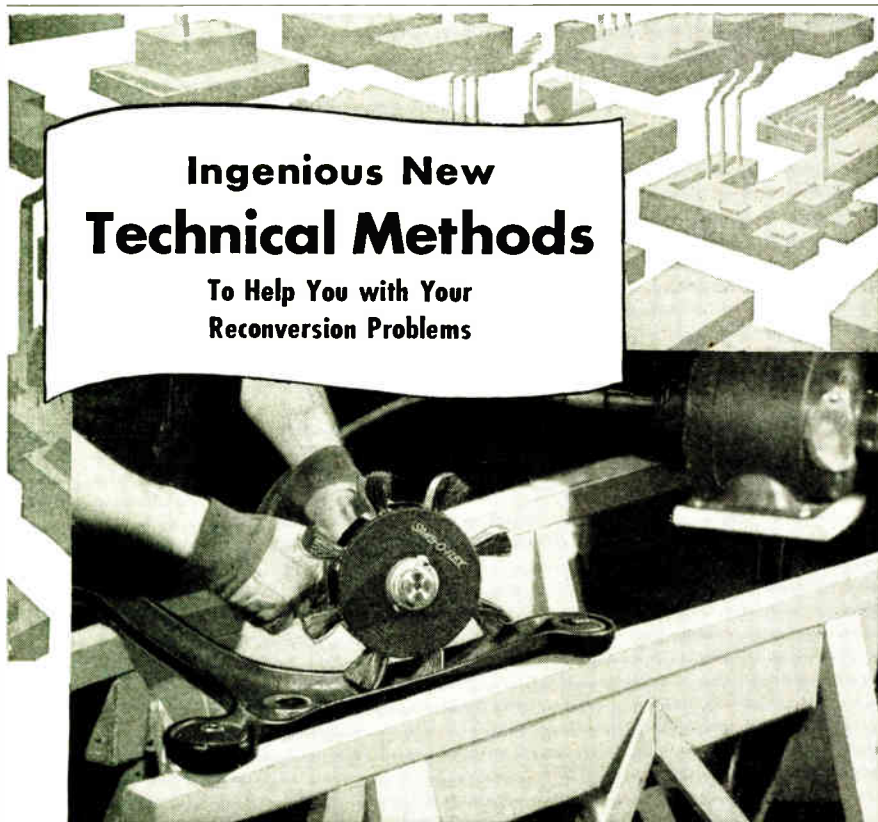

New Brush-Backed, Strip-Fed Abrasive Wheel Deburrs, Sands Any Surface!

For sanding in and around the most irregular contours—for deburring parts too large to be tumbled—for removing rust, paint and imperfections from wood, plastics, rubber, earthenware and metals—the new Sand-O-Flex brush-backed abrasive wheel is MOST PRACTICAL.

The central magazine houses a strip abrasive cartridge, to be fed out as needed in front of the eight brushes which "cushion" the abrasive, and force it evenly over the most difficult surfaces. The Sand-O-Flex comes in 3 sizes, and is adaptable to any stationary or portable motor shaft, with speeds up to 1750 RPM. Abrasives are available in grits for every need.

To help speed production in dry, dusty work atmosphere, many mills and factories urge workers to chew gum to help relieve dry throat. The reason: Because dust causes throat irritation and dryness—but chewing Wrigley's Spearmint gum helps keep workers' mouths moist and fresh. The result: Reduced work interruptions and "time outs" to the drinking fountain. Even when workers' hands are busy, they can refresh as they work "on the job." And the chewing action helps keep workers alert and wide-awake.

You can get complete information from the Sand-O-Flex Corporation, 4373 Melrose Ave., Los Angeles 27, California

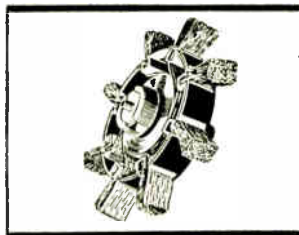

Abrasive Cartridge Shown Open



AA-73

TELEVISION TODAY

(Continued from page 86)

transmitted over the air and received on a color receiver in the CBS Building. The test included every step involved in network television service.

For comparative purposes, black-and-white pictures utilizing the low frequency black-and-white standards were picked up at the CBS television studios in Grand Central Terminal, carried to Washington and back over the same cable route as the color pictures and broadcast over Columbia's low frequency black-and-white transmitter, WCBW, also in the Chrysler Tower.

PUBLICATION CLOSING DATES

New printing schedules forced upon us by the continuing critical shortage of skilled help, compel us to publish our magazines **ON TIME**, on the following schedule. May we have your continued cooperation, please?

1st of preceding month for all ads requiring proofs, composition, foundry work, key changes, etc.

5th of preceding month for complete plates only—no setting.

25th preceding—Publication Date.

**ELECTRONIC
INDUSTRIES**

480 Lexington Ave., New York 17

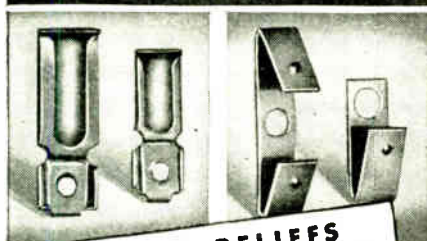
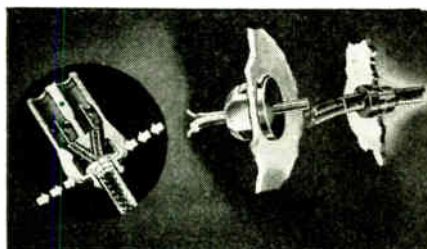

**STRAIN RELIEFS
HEATER PLUG CONTACTS
CUBE TAP CONTACTS**

Complete line for all applications.
Many sizes ready for shipment.
When writing for literature and samples, please state wire size.

HEYCO

**HEYMAN MANUFACTURING
COMPANY**

520 Michigan Ave. Kenilworth, N. J.

New Type Radio Service Information

"Photofact" Folder is the name of a new radio service aid which will be distributed nationally starting June 15 by the Howard W. Sams Radio Encyclopedia Service, 2924 E. Washington Street, Indianapolis, Ind. The purpose of the folders is to give more complete servicing information than has heretofore been available. Folders for each receiver are 4 to 12 page letter-size booklets, distributed in groups of 30 to 50, at \$1.50 per complete group. Each folder will be in the hands of the subscriber within 90 days after any set is placed on the market.

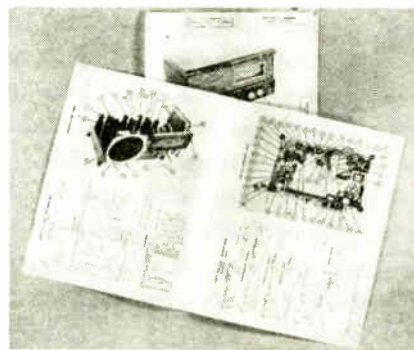

Arrangement of service data for typical receiver in Sams Photofact folder

Folders for each set will contain 2 to 12 photographs of the chassis taken from various angles so that every component is clearly recognizable and identified in an accompanying parts list. The list of parts will give specifications for each component, the manufacturer's part number, and numbers by which a correct replacement can be ordered from other manufacturers. Alignment stage procedure actual voltage and resistance measurements and gain data as well as a schematic diagram will be included.

In addition, subscribers become members of the Howard W. Sams Institute, constituting a board of some 30 experts who are available for consultation on servicing problems, shop operation, accounting and general business administration.

Essex Expands

Consolidating under one roof departments which were formerly housed separately, Essex Electronics has occupied new manufacturing quarters in Berkeley Heights, N. J. The company makes coils, chokes and transformers, has a second plant in Hackettstown, N. J.



W-J

**EMERGENCY SERVICE
IS MADE-TO-ORDER FOR
INDUSTRIAL RESEARCH
AND DEVELOPMENT
ENGINEERS**

RADIO and ELECTRONIC SUPPLIES were highly critical wartime needs . . . and W-J Emergency Service was specially developed to fill that need. Now, with procurement still a major problem, W-J Emergency Service continues to rescue many important Electronic projects from costly inefficiency and delay! It's a Radio or Electronic item currently made by any of the leading manufacturers, chances are we have it in stock or can get it for you quickly.

SEND FOR THIS NEW BUYER'S GUIDE!

An attractive 6" x 9" 100 page book in which over 10,000 items are listed. See the many interesting NEW devices . . . radio parts and equipment that offer industry and radio dealers new production and profit opportunities. Ask for a free copy on company stationery, please!



**WALKER-
JIMIESON, INC.**

311 SOUTH WESTERN AVE., CHICAGO 12, ILL.
Phone CANal 2525

NEW BOOKS

Relay Engineering

By Charles A. Packard. Published by Struthers-Dunn, Inc., Philadelphia, Pa., 1945. First edition, containing 640 pages with over 300 illustrations and many reference charts and tables. Price \$3.

Electrical relays form a most important part of some of the most common communications systems; the telephone, telegraph, teletype-writers, etc., and engineers in these fields are well acquainted with the details of their application in solving unusual selection and control problems. In quite another field, that of electrical power control, relays are used extensively to handle large amounts of power or to act as supervisory controls for emergency and safety provisions of circuits. It is the latter field of application that is primarily covered by the author in this pocket-sized flexible covered handbook on industrial relays. However, the material included is applicable to many other uses. Workers in both industrial and communications

equipment operation and design will find much useful information compiled in this manual.

The book covers the selection of relays, applications and circuits, auxiliary equipment, standards and much material relating to the specific problems of designing the coil and contact structures to meet specific needs. It is especially valuable to those who are concerned with unusual problems involving time delays and where special magnetic and mechanical facilities are used to bring about unusual characteristics.

Although the matter of correlating relay designs with electronic circuit designs is covered in only a minor way, the information carried by the other sections of the book is sufficient to enable electronic engineers to utilize relays to advantage. However, the book deals with the specific types of relays made available by one manufacturer's line and a certain portion is devoted to descriptions of specific items in that line. Still the author's treatment is broad enough to permit intelligent selection of any type of relay from other sources.

High Vacuum Technique

By J. Yarwood. Second Edition, Revised; Published 1945; John Wiley & Sons, New York; Chapman & Hall, Ltd., London. 140 pages, illustrated. Price \$2.75.

This book introduces in a simple manner the various industrial methods of obtaining high vacuum for industrial purposes. The first chapter describes the production of high vacuum, with a description of the various types of pumps in use.

A chapter is included on methods of degassing and the use of getters. This is followed by a review of the most important of the applications of high vacuum processes to industry and a reference list of the characteristics of various materials that are encountered in the process. It provides an excellent reference manual.

SNC to Vette

Hereafter it is to be SNC Mfg. Co., Chicago. The company, which manufactures transformers and has a factory in Glenview, Ill., has been taken over by John L. Vette, Jr., who will general manage it. William R. Daseke remains as chief of the engineering division.

"TIP" FOR BETTER SOLDERING

Select the **NEW G-E CALROD SOLDERING IRONS** with the "non-freezing," easy-to-replace, calorized-copper tips. They simplify maintenance in your shop. General Electric Company, Schenectady 5, New York.

A NEW AND IMPROVED LINE of G-E Calrod SOLDERING IRONS FOR INDUSTRIAL USE

THEY GIVE YOU THESE IMPORTANT ADVANTAGES:

- HIGH-SPEED SOLDERING
- UNIFORM PERFORMANCE
- LONG LIFE AND LOW MAINTENANCE
- CONVENIENT AND LOW-COST REPAIR

WRITE FOR BULLETIN GEA-4519.

GENERAL ELECTRIC

Precision CENTERED EYE Bending

With DI-ACRO BENDERS

DI-ACRO Precision Bending is accurate to .001" for duplicated parts. DI-ACRO Benders bend angle, channel, rod, tubing, wire, moulding, strip stock, etc. Machines are easily adjustable for simple, compound and reverse bends of varying radii.

DI-ACRO Bender No. 1
Forming radius 2" approx. Capacity $\frac{1}{2}$ " round cold rolled steel bar or equivalent. Also Benders No. 2 and 3 with larger capacities.

"DIE-LESS" DUPLICATING

Send for **CATALOG**
"DIE-LESS" DUPLICATING showing many kinds of "Die-less" duplicating produced with DI-ACRO Benders, Brakes and Shears.

← Pronounced "DIE-ACK-RO"

DI-ACRO PRECISION MACHINES "DIE-LESS" DUPLICATING

O'NEIL-IRWIN MFG. CO.
348 EIGHTH AVE. SOUTH • MINNEAPOLIS 15, MINN.



*Whatever
you want!*
If you . . .

- need capacitors . . . and need them NOW
- use large stocks of capacitors
- have been searching for certain types

These carloads of capacitors are a War Assets Administrator stock too big to catalog. This stock includes products of all leading capacitor manufacturers and represents just about every type and size of capacitor made. It is almost a dead certainty that the size and type you use — in the quantity you need — is in this enormous stock.

Quality is equal or superior to commercial standards. All units have been government inspected to meet Army and Navy specifications.

Prices are low enough to gain a considerable saving. Steer around production hitches and delays . . . these stocks are available to you now. Orders are filled as soon as they are received. (In response to a recent telephone order for 286,000 units, shipment was made within 24 hours. Six of these types had been on order from the manufacturers and our stock provided precisely those same units.)

If you have a job "hung up" because you must wait for delivery . . .

Telephone Canton 0820 Teletype Canton 280

TOBE DEUTSCHMANN CORPORATION

*Acting as Agents of the War Assets Administrator
under contract No. S1A-2-34*

CANTON, MASSACHUSETTS



GRACOIL

"One Good Turn - or a Million"

A NAME TO LOOK FOR
on **ELECTRICAL COILS**
and **TRANSFORMERS**

*Famous for years as
"COILS by DOYLE"*



LAYER-WOUND COIL



**LOW VOLTAGE
TRANSFORMER**



**GENERATOR
FIELD COIL**



RELAY COIL

★ "GRACOIL" is a new name that you can depend upon, because back of this name stand years of time-tested experience in electrical engineering. The same able craftsmen who established Doyle Coils as leaders in the field now carry on at the same location under the new corporate name—The GRAMER Company.

Be sure that the coil you buy bears the trademark name—"GRACOIL", for only then can you know that you have the best in electro-magnetic windings. Every "GRACOIL" is wound to the specified number of uniform turns from precision-gauged wire. Every "GRACOIL" is fully insulated, thoroughly impregnated, and properly laminated when supplied as a complete transformer. The most rigid inspections and tests make sure that each "GRACOIL" is worthy of the name it bears.

If your design calls for a special electro-magnetic application, let competent "GRACOIL" engineers make specific recommendations for you. Write today!



GRACOIL

"One Good Turn - or a Million"

THE GRAMER COMPANY
Electrical Coils and Transformers
2732 N. PULASKI RD., CHICAGO 39, ILL. U. S. A.

Designed for
Application

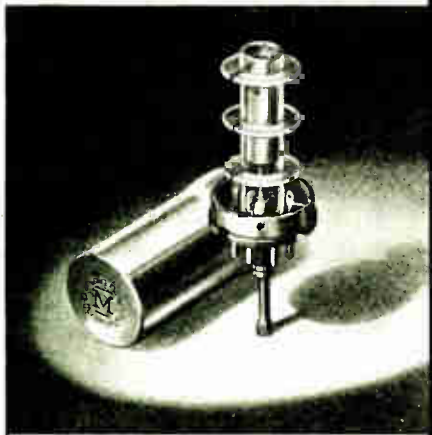

**The No. 74001
Tunable Coil Form**

Another new Millen "Designed for Application" product is the No. 74001 permeability tuned, shielded plug-in coil form. Standard octal base of low loss micro-filled Bakelite, polystyrene 1/2" diameter coil form, heavy aluminum shield, iron tuning slug of high frequency type, suitable for use up to 35 mc. Adjusting screw protrudes through center hole of standard octal socket. Special extension terminals facilitate connection to base pins.

**JAMES MILLEN
MFG. CO., INC.**

MAIN OFFICE AND FACTORY
**MALDEN
MASSACHUSETTS**



PERSONNEL

Sidney K. Wolf has been appointed manager of the new consumer products division of the Federal Telephone and Radio Corp., domestic manufacturing affiliate of the International Telephone and Telegraph Corporation. Wolf, who recently completed two years, service as a Colonel in the Army Air Forces, served during the war as technical advisor to General George C. Kenney, head of the Far East Air Forces, and to General W. D. Butler, Commanding General of the Eleventh Air Forces in the Aleutians. Prior to joining he served on the War Production Board as Deputy Director of the Radio and Radar Division, a post to which he was called a week after Pearl Harbor. Previously he was president of his own concern, Acoustic Consultants, Inc., and also was a member of the faculty of the Sheffield Scientific School, Yale University.



Sidney K. Wolf

Charles R. Burrows has been appointed director of the School of Electrical Engineering, Cornell University, Ithaca, N. Y. In 1924 he became a member of the radio research department of Western Electric Co. and contributed to the development of long-wave transatlantic radio-telephone transmitters and since has had long experience in ultra short wave propagation work.



Charles R. Burrows



James I. Benjamin

James I. Benjamin has been made manager of the Radio & Electronic Division of the Lewyt Corp., Brooklyn. He was formerly general manager for Pilot Radio Corp.

IMMEDIATE DELIVERY!



WRL Multitester
• Sturdy Steel Case
• 30-60 Degree Angle
• Stand it up or Lay
it Down
CAT. NO. 16-491

\$18.75

TEST LEADS
CAT. NO. 17-459 **\$.60**

Ranges: DC Volts—0/5/50/250/500 V. AC Volts—0/10/100/500/1000V. DC Mills—0/10/100 Mills. Ohmmeter—Low Range 0-500 Ohms. High Range—0-100,000—1 Meg. 3" Meter with sturdy D'Aronson movement. Size 5 1/2 x 8 x 3 1/4.

Phono Amplifier Kits

Complete with tubes, speaker, stamped chassis, resistors and condensers. Many other kits also available. Cat. No. 7-271. **\$9.15**
\$9.50 ea. Lots of 3, ea. . . .



**WRL LOW PRICED
TRANSMITTER KITS**

15, 35, 70, and 150
Watt types

On our toes at all times to give you the best in radio and electronic devices of all kinds. Immediate delivery to all parts of the world from the heart of America.

**WE INVITE INQUIRIES FROM
AGENTS, IMPORTERS, BROKERS**

FREE! 52 Page Catalog packed with savings in radio, electronic, and general merchandise. Send for your copy today.



Handy Tube Base Calculator 25c
Giant Radio Reference Map 15c
Address Dept. EI-6, Council Bluffs, Iowa



Formerly Wholesale Radio Laboratories

**GLASS
INSTRUMENT
BEARINGS**

GLASS "V" BEARINGS
made and set to your
specification



We specialize in the manufacture and mounting of all types of sapphire jewel bearings.

We welcome your inquiries

RICHARD H. BIRD & CO.

Incorporated

*Manufacturers of Jewel Bearings
for thirty years*

**1 SPRUCE STREET
WALTHAM, MASS.**

Dr. Alexander Ellett has been appointed director of research of the Zenith Radio Corp., Chicago. Since 1940, he has been head of Division 4 of the National Defense Research Committee and has had much to do with the development of the Navy's proximity fuzed shells.



Dr. Alexander Ellett

E. R. Ewald

E. R. Ewald has been made superintendent of the Electronics Division of the Rauland Corp., Chicago. Formerly, he was connected with RCA Victor Division at Lancaster where he was chief engineer of the cathode ray tube production engineering division.

Sylvan A. Wolin, a Solar executive for many years, is now sales and advertising manager of Pyramid Electric Co., 415 Tonnele Ave., Jersey City, N. J. The firm makes electrolytic capacitors and noise suppressors.

Dr. L. Grant Hector has been appointed director of research and engineering of Sonotone Corp., Elmsford, N. Y. Formerly director of engineering for National Union Radio Corp., he has lately been engineer in charge of a group in the Office of Scientific Research and Development which had to do with the development of sub-miniature tubes used in proximity fuzes.

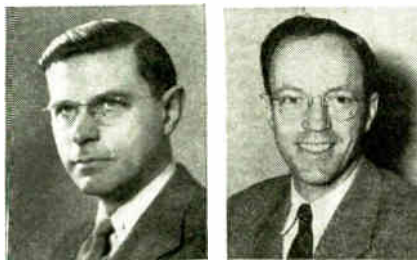

Dr. L. Grant Hector

Winfield Wagener

Winfield Wagener has been added to the sales engineering staff by Eitel-McCullough, Inc., San Bruno, Cal. He was formerly chief engineer for Heintz & Kaufman in charge of tube development and design, latterly headed the tube division of the Litton Engineering Laboratories.

The **FINEST MICROPHONES**
for P.A. and RECORDING!

AMPERITE VELOCITY MICROPHONE WITH PATENTED ACOUSTIC COMPENSATOR

New P. G. DYNAMIC WITH NEW SUPERIOR ELIPSOID PICK UP PATTERN!

AMPERITE KONTAK MIKES IDEAL FOR AMPLIFYING STRINGED INSTRUMENTS USED WITH ANY AMPLIFIER AND WITH RADIO SETS.

ASK YOUR JOBBER . . . WRITE FOR FOLDER

AMPERITE

561 BROADWAY NEW YORK

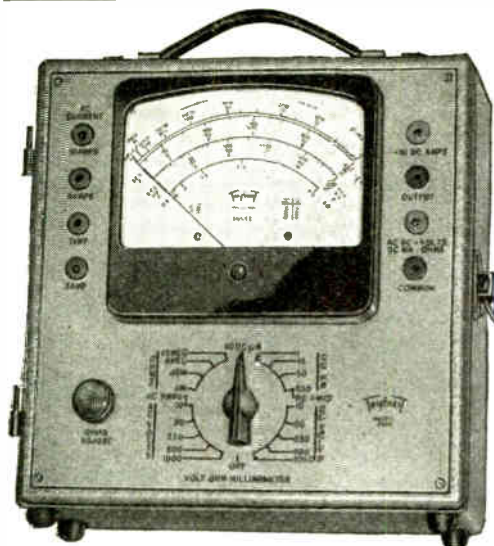

MODEL 2405
**Volt • Ohm
Milliammeter**

25,000 OHMS PER VOLT D.C.



SPECIFICATIONS

NEW "SQUARE LINE" metal case, attractive tan "hammered" baked-on enamel, brown trim.

■ **PLUG-IN RECTIFIER**—replacement in case of overloading is as simple as changing radio tube.

■ **READABILITY**—the most readable of all Volt-Ohm-Milliammeter scales—5.6 inches long at top arc.

Model 2400 is similar but has D. C. volts Ranges at 5000 ohms per volt.

Write for complete description

Triplet

ELECTRICAL INSTRUMENT CO.
BLUFFTON OHIO

**NEW ENGINEERING
NEW DESIGN • NEW RANGES**

50 RANGES

Voltage: 5 D.C. 0-10-50-250-500-1000 at 25000 ohms per volt.
5 A.C. 0-10-50-250-500-1000 at 1000 ohms per volt.

Current: 4 A.C. 0-.5-1-5-10 amp.
6 D.C. 0-50 microamperes—
0-1-10-50-250 milliamperes—
0-10 amperes.

4 Resistance 0-4000-40,000 ohms—4-40 megohms

6 Decibel -10 to +15, +29, +43, +49, +55

Output Condenser in series with A.C. volt ranges

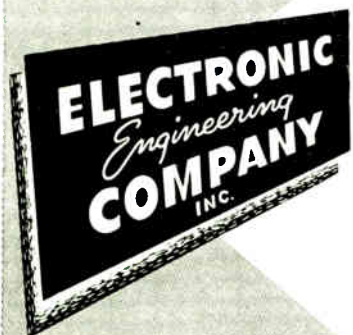

• The meeting of extraordinary applications—the designing and developing of new and specialized transformers—these are the day-by-day jobs Electronic Engineering is known for doing well.

Transformers

will meet your most exacting requirements, ordinary or unique—and the finest engineering talent and most complete electronic laboratories available are ready today to consult with and help you.

"SPECIALIZED
Transformer
ENGINEERS"

ELECTRONIC ENGINEERING COMPANY • 3223-9 WEST ARMITAGE AVE. • CHICAGO 47, ILLINOIS

John F. Rider, publisher of service manuals, has joined RCA Victor Division of Radio Corp. of America as a consultant on test equipment. His work will be in the test and measurement equipment section of RCA.

Robert L. Barr has joined the Ralph T. Brengle Sales Co. of Chicago. He will have charge of design application and engineering development. Was formerly sales manager for Clough-Brengle Co., and president of the Barr Mfg. Co.

Burton E. Shaw has been elected vice president of Photoswitch, Inc., Cambridge, Mass. He will have charge of engineering and production, was formerly vice president in charge of engineering in the Watts Regulator Co., research chief for Penn Electric Switch Co., and chief engineer of Gilbert & Barker Mfg. Co.



Burton E. Shaw



M. B. Lamont

M. B. Lamont has been made products manager in charge of electrical detail in radio, FM and television for the Television Bendix Radio Division, Bendix Aviation Corp., Baltimore. He was formerly connected with Philco Corp.

John L. Reinartz has been released from the Navy with the rank of Captain after having served 7 years as communications and electronics officer and has rejoined Radio Corp. of America. He will be connected with the commercial engineering and power tube sections in charge of the amateur radio program at the Lancaster, Pa., plant.

G. F. Metcalf has been appointed manager of the Electronics Laboratory of the General Electric Co., Syracuse, where he will have charge of electronic researches and development. L. M. Leeds has been added to the Transmitter Division of General Electric as a consulting engineer.

Paul D. Zottu, latterly chief engineer in the Thermex Division of the Girdler Corp., Louisville, Ky., has opened his own office as a consulting engineer and physicist at 314 Washington St., Newton, Mass.

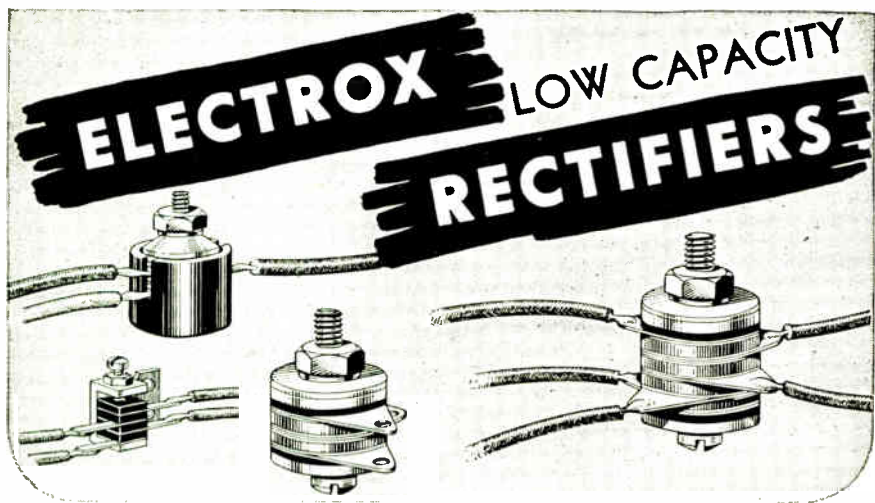

For dependable, trouble-free service in test sets, instruments, and similar electronic applications, use ElectroX Rectifiers, made by one of the oldest manufacturers of dry disk rectifiers. Finest quality, full and half wave low capacity copper oxide rectifier units; each unit inspected, tested, guaranteed right. Ask your parts supplier for ElectroX Rectifiers. If he cannot yet supply you, send us his name and ask for descriptive Bulletin 446.

ELECTROX DIVISION  **SCHAUER MACHINE CO.**
2077 Reading Rd. - Cincinnati 2, Ohio

TERMINALS

for
ELECTRIC WIRES

SMALL METAL STAMPINGS

in accordance with your blueprints

PRECISION PARTS

from Modern Equipment

PATTON-MacGUYER CO.

17 VIRGINIA AVENUE

PROVIDENCE 5. R. I.

For Immediate Delivery

TRANSFORMERS—105-125 V Pri., 5 V-190 Amp.
Sec.: hi-voltage insulation 15 KV.

A.C. VOLTMETERS—Weston #476—0-8 V.

TUBES—transmitting type VT 127A/100 TS.

Hi-voltage stand off INSULATORS on heavy
brass bases 12" x 1-3/16" also 4" x 1-3/16".

MAX DOLEN

5301 SNYDER AVENUE BROOKLYN 3, N.Y.

MANUFACTURERS — JOBBERS

.. AT LESS THAN WHOLESALE PRICES!

PRECISION RESISTOR — Over 1,000,000 in stock!
SELECTOR SWITCHES — Mallory 1331-1341-1351-1361 . .
and other types
MOLDED PAPER CONDENSERS — .006-.01-.02-.05-.1 mid.
GENERAL ELECTRIC 3" METERS—Square 0-1 DC MA

OTHER HARD-TO-GET ITEMS

A. MOGULL CO.

161 WASHINGTON ST.

New York 6, N. Y.

RICHARD S. WELLONS

Consulting Engineer

ELECTRONIC CONTROL

Industrial Applications

Product Development

Consultation

Reports

73 TREMONT ST.

BOSTON, MASS.

LOOKING FOR TIME AND LABOR-SAVING IDEAS?



Get this new
Free Ever Ready
Label Catalog!

Page after page
of practical ideas
for the smoother,
safer, simpler
functioning of all
departments from
office-to-factory.

Have a copy on
the desk of all
your key men!

Write today for
a FREE COPY.

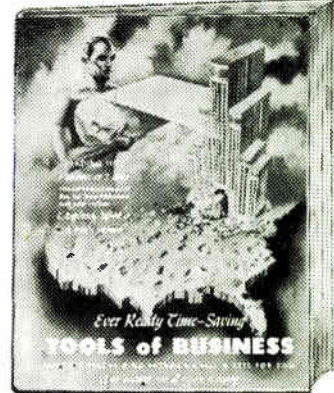

EVER READY *Label* CORP.

151 EAST 25th STREET

NEW YORK 10, N. Y.

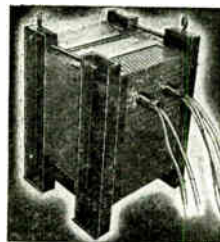

EISLER

IS WELL EQUIPPED
TO MAKE YOUR

TRANSFORMERS

EISLER OFFERS

- COMPETENT ENGINEERING
- PROPER SUPERVISION
- QUALITY MATERIAL
- RIGID TEST & INSPECTION
- GOOD DELIVERY
- SATISFIED CUSTOMERS

Capacities 1/4 to 300 KVA. Lighting—Distribu-
tion—Furnace—Auto—Phase Changer—Air or
Oil Cooled—Power—Special Transformers.

Write for Catalog

CHAS. EISLER
EISLER ENGINEERING CO.

778 So. 13th St.

Newark 3, N. J.

(near Avon)



NOW Available ARMY-NAVY RADIO SURPLUS

RADAR COMPONENTS

BC-221 Frequency meter, complete.....	82.50
947-A Magnetron Transmitter From SRC-547	86.00
MC-363-A Range converter 10 ampl. from SCR-547	85.00
BC-957-A Receiver Indicator From SCR-547	155.00
Ra-58-A Power unit from SCR-547.....	116.00
BC-412 Scope from SCR-268, with tubes...	59.50
BC-409 Pulse Ampl. from SCR-268 with tubes	59.50
BC-406 Receiver, from SCR-268 Freq. range 201-210 mc. 20 mc. 1F. Freq. 2mc bandwidth. 15 tubes.	29.95
with tubes	35.00
BC-436 Range units from SCR-268.....	35.00
BC-435-A Hi-Power Modulator with 8-304 TL's 2-250 TL tubes	99.00

COMMUNICATIONS SETS

RAK-7 R.C.A. SHIPBOARD RECEIVER	
9 tubes 15 kc-600 Kc. 115 v/60 cps oper. each	77.50
BC-603 85% COMPLETE, with MANUAL...	5.00
COLLINS ART-13, New xmtr used on B-29, xtal calib. CW-225 Watts; Phone-180 Watts Freq 1.8 mc-18. mc	325.00
ARC-5 Receivers complete.....	79.00
ARC-5 Transmitters compl. less dyn.....	109.00
BC-78-B Boonton Signal Gen. 15 mc to 55 mc; 190 mc to 230 mc. Used.....	55.00

Large Stock of Microwave Fittings in Stock. Send for Listing.

SPECIAL

CARDWELL transmitting variable air condenser TS-300-vs 300 mmf. for 5000 v. List 40.00 **Our Price \$14.95**

CONDENSERS

.25 mfd. 400 vdc. can Spr.....	.45
.25 mfd. 600 vdc. can Sol.....	.60
1. mfd. 500 vdc. (pyr. GE 23F303)	1.00
.85 mfd. 600 vdc. rd. can Aero. 55850	
1 1/2" x 1 3/4"	.30
.5—5 mfd. 400 vdc. th. rect. can.....	.60
4. mfd. 600 vdc. C-D.....	1.50
8. mfd. 600 vdc. C-D.....	2.88
2. mfd. 220 vac. C-D.....	1.25
500 mfd. 200 vdc. rd. 2 x 4 1/2 bakel. case...	1.95

PRECISION CONDENSERS

.25 mfd. 200 vdc. WE oil ±1%.....	.50
.535 mfd. 200 vdc. WE oil ±1%.....	.50
1. mfd. 200 vdc. WE oil ±1%.....	1.00
2.16 mfd. 400 vdc. WE oil ±1%.....	1.00
.4 mfd. 1500 vdc. WE oil ±1%.....	.70
.05 mfd. 1000 vdc. inv. mtg. GE pyr.....	.70
1 1/4 x 1 1/4 x 3/4	
.25 mfd. 1000 vdc. inv. mtg. GE pyr.....	.80
1 1/4 x 1 1/2 x 3/4	
.4 mfd. 1500 vdc. WE oil.....	.50
1—1 mfd. 7000 vdc. GE pyr.....	7.50
.25 mfd. 20,000 vdc. C-D.....	15.00

TRANSFORMERS

H. V. Plate XFMR'S	
115 v./860 vct. 510 M.A. oil.....	7.50
115 v./2750 v. 750 M.A. oil USN spec.....	45.00
115 v./750 vct. 110 MA/6.3 v.-5A/5 v.-3A.	6.95
Kenyon Fil. 115 v./5 v.-115 A.....	8.95
Modulation Transformer; 807 to pair of 807's	2.65
Modulation Transformer; 811's to 813.....	5.00
Driver; 6v6 to pair 811's.....	3.00
Single and double button mike-to-grid transformers	1.49

Large Inventory of 400 cps Transformers. Send for Listing.

I.F. Crystal Filter Unit for BC-312, BC-342	
Price	9.95

TUBES

304-TL, perfect.....	13.95
250-TL, perfect.....	10.00
5BP1 Syl.....	9.95
5FP7.....	14.95

SEND FOR CATALOG

All merchandise guaranteed. Mail orders promptly filled. All prices F.O.B. New York City. Send Money Order or Check. Shipping charges sent C.O.D.

**COMMUNICATIONS
EQUIPMENT CO.**
131B Liberty St., New York 7, N. Y.
Telephone WH 4-7658

He will specialize in high frequency heating applications and in equipment and component design.

Lawrence Bailey has joined the engineering staff of Spectrum Engineers, Inc., Philadelphia. He was formerly on the engineering staff of Station WBEN, Buffalo.

Franklin L. Snyder has been appointed engineering manager of the Sharon Transformer Division, Westinghouse Electric Corp., Pittsburgh. He has been connected with Westinghouse since 1923.

G. W. Fyler has been made assistant chief engineer of Galvin Mfg. Corp., 4545 W. Augusta Blvd., Chicago. He was formerly connected with General Electric Co. of Bridgeport, Conn.

William H. Cooper has been appointed chief engineer of the home receiver dept. of the Federal Telephone & Radio Corp., Newark, N. J. Formerly, he was connected with RCA where for eight years he was in charge of receiver design for export. Prior to that he was chief engineer for Pilot Radio Corp.

E. S. Seeley has been appointed a member of the Electro-Acoustics Committee of I.R.E. He is development and research engineer in the Commercial Engineering Group of Altec Service Corp., 250 W. 57th St., New York.

Joseph M. Perrone has been appointed director of research of the Watson-Standard Co., Pittsburgh. For the past three years he has been doing research and development work on protective coatings at Mellon Institute of Industrial Research.

Furst Starts Up

Furst Electronics has been organized in Chicago with headquarters at 800 W. North Ave., by Ulrich R. Furst. He was formerly chief electronic engineer for Russell Electric Co. The new company will manufacture electronic equipment for measurements and control applications.

ASTM Moves

American Society for Testing Materials occupied its new permanent headquarters at 1916 Race St., Philadelphia, May 1st. For many years headquarters had been at 260 S. Broad St., Philadelphia.

Plasticraft

MACHINED PARTS

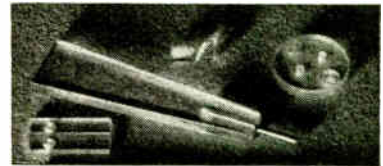

**LUCITE • VINYLITE • PLEXIGLASS
POLYSTYRENE • ACETATE**

Complete facilities for machining, marking, finishing—plastic sheet, rod or tube—any size, shape or quantity.

Send us your prints for quotations.

PLASTICRAFT PRODUCTS COMPANY

BAKELITE & PLASTICS
PARTS & SPECIALTIES

MANUFACTURED • FABRICATED
PRINTED • HOT STAMPED • ENGRAVED

20 Hudson St., New York 13, N. Y.
Worth 2-1837

JONES BARRIER TERMINAL STRIPS



2-142



2-142-3/4W



2-142-Y

Bakelite Barriers placed between terminals increase the leakage path and prevent direct shorts from frayed wires at terminals. Terminals and screws are of nickel plated brass. Insulation is of BM 120 molded Bakelite.

Illustrated are three types: Screw Terminals, Screw and solder Terminals and Screw Terminal above panel with solder Terminal below. For every need.

Six series cover every requirement: No. 140 — 5-40

screws, No. 141—6-32 screws, No. 142—8-32 screws, No. 150—10-32 screws, 151—12-32 screws and No. 152—1/4-28 screws.

These sturdy Terminal Strips will not only improve your electrical connections but will add considerably to the appearance of your equipment. A truly modern Terminal.

Write today for catalog No. 14 listing our complete line of Barrier Strips in addition to other Electrical Connecting Devices.

HOWARD B. JONES DIVISION
CINCH MFG. CORP.
2460 W. GEORGE ST. CHICAGO 18

NEW BULLETINS

Automobile Antennas

Side cowl, fender and cowl, underhood and concealed automobile radio antennas are described in a folder issued by the National Electronic Mfg. Co., 22-78 Steinway St., Astoria 5, L. I., N. Y. Sketches, dimensions and specifications of the antennas, which are designed to fit most available cars, are given. Also included are wirewound and carbon suppressors, interference elimination capacitors and connectors and adapters.

Wires and Cables

A series of booklets giving information, specifications, standard sizes, dimensions and other characteristics of various types of wires and cables has been issued by General Cable Corp., 420 Lexington avenue, New York. Included are these titles: "Bare and Tinned Wires and Cables", "Magnet Wire", "Flexible Cords and Fixture Wires", "Radio Wires", "Portable Power Cables", "Paper Insulated Power Cables", "Rubber Insulated Wires and Cables", "Telephone Wires and Cables", "Weatherproof Wires and Cables", "Varnished Cambric Insulated Wires and Cables", and "All-Asbestos and Asbestos-Varnished Cambric Insulated Wires and Cables". These booklets are bound as filing folders and additional or revised pages may be inserted, when issued.

Low Resistance Ohmmeters

Useful for shop and laboratory use are the "Megger" instruments for measuring low resistance described in a 4-page folder distributed by James G. Biddle Co., 1211-13 Arch St., Philadelphia 7, Pa. Included are the "Bridge-Meg" resistance tester — a combination Wheatstone bridge and insulation tester, the "Ducter" low resistance ohmmeter, which operates down to .000001 ohm and the Midget "Megger" circuit testing ohmmeter.

Aircraft Relays

The Aerotrol "400" series small size relays originally designed for military aircraft are now available to the industry and are described in a catalog issued by Cook Electric Co., Chicago 14, Ill. The 24-page booklet contains photographs, descriptions

Skill in METAL

SPECIALIZED

CABINETS

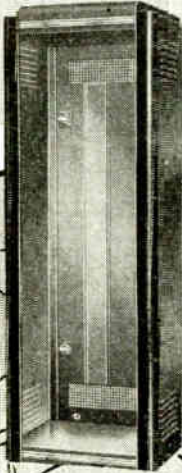

PANELS • CHASSIS • RACKS
with Beautiful Chrome Trim

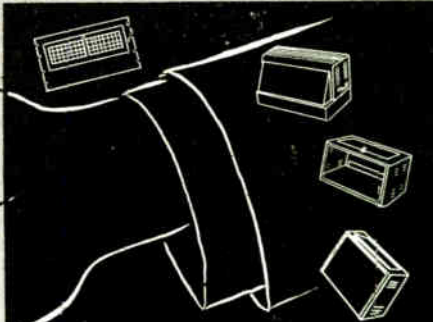

PAR-METAL PRODUCTS CORPORATION
32-62 — 49th STREET
LONG ISLAND CITY 3, NEW YORK
 Export Dept. — Roche International Corp.
 13 East 40 Street, New York 16

The time-tested Par-Metal line presents superior features of styling, design, and construction. True to policy, Par-Metal continues to specialize in Electronic Housings exclusively... and is therefore able to offer leadership in value. Compare! Write for Catalogue.

Laboratory Standards

FM

MODEL 78

SIGNAL GENERATOR

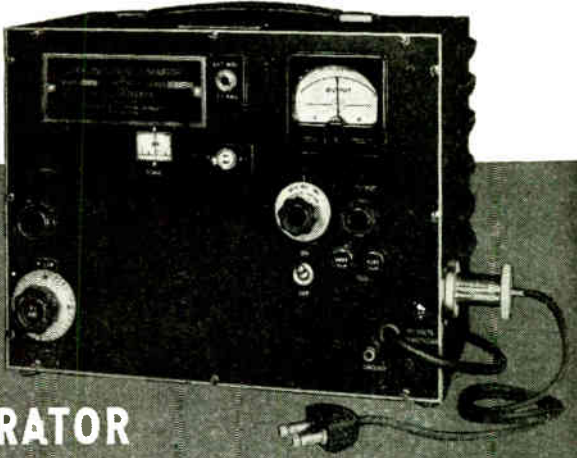

SPECIFICATIONS:

CARRIER FREQUENCY RANGE: 86 to 108 megacycles—individually calibrated dial.

OUTPUT SYSTEM: 1 to 100,000 microvolts with negligible carrier leakage.

OUTPUT IMPEDANCE: Constant at 17 ohms.

MODULATION: 400 cycle internal audio oscillator. Deviation directly calibrated in two ranges: 0 to 30 kc. and 0 to 300 kc.

Can be modulated from external audio source.

Audio fidelity is flat within two db from d.c. to 15,000 cycles.

Distortion is less than 1% at 75 kc. deviation.

PRICE: \$300.00 F.O.B. Boonton, New Jersey

PROMPT DELIVERY

MEASUREMENTS CORPORATION

BOONTON  NEW JERSEY

EASTERN PUMPS

COVER A WIDE RANGE OF PERFORMANCE

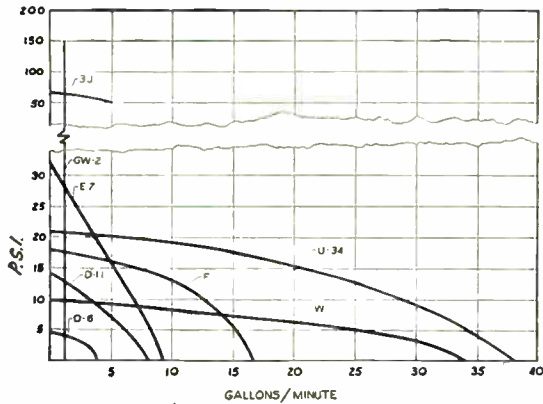

The performance chart shown above typifies the wide range of performance available through the selection of Eastern Midget Pumps. These pumps can provide the right equipment for your needs where small size and light weight combined with high performance and economy of operation are factors. They may be equipped with the easily adjustable stuffing boxes or rotary seals and will not leak at several times the maximum working pressures. Weights are from 2¾ to 100 lbs., capacity from ½ to 70 G.P.M. and pressures range up to 250 P.S.I. Standard models of many pumps are available in Monel Metal, Stainless Steel, Hastelloy "C", Cast Iron, Bronze and other metals and alloys. Models are motor driven, including Underwriters' approved explosion-proof motors, air driven or belt driven. Write for NEW CATALOG describing entire line of pumps.



EASTERN ENGINEERING CO.
94 Fox Street, New Haven 6, Conn.



MANUFACTURERS OF RADIO, ELECTRICAL
AND ELECTRONIC COMPONENTS

VOKAR Corporation

7300 HURON RIVER DRIVE · DEXTER, MICHIGAN

and specifications of the standard aerotrols, latching aerotrols, specially cased "stratopaxed" aerotrols and rotary relays for special applications. Illustrations of the plant facilities are also included.

Fuses and Lubricating Devices

Trico Fuse Mfg. Co., Milwaukee, Wis., is distributing a folder containing its published bulletins. Renewable fuses, which have a time lag are described as are cartridge fuses, colortop fuses, fuse pullers and clamps for fuse clips. The second part of the catalog contains specifications and descriptions of "Optomatic" constant level oilers, gravity feed oilers, wick feed oilers, thermal and bottle oilers. A bulletin on leak-proof air-guns is also included.

Tube Manual

Characteristics of over 450 receiving type vacuum tubes are presented in a loose-leaf manual of technical data published by the Tung-Sol Lamp Works, Newark, N. J. Complete diagrams, ratings and operating conditions are supplemented by a wealth of curves for the determination of plate and screen characteristics, power output, distortion, etc. A review of vacuum tube terminology and symbols, RMA standard ratings and Army-Navy preferred types is included. The improved loose-leaf binder is ideally suited to this type of reference manual.

Coaxial Cables

Coaxial cables and cable accessories are described and illustrated in a bulletin issued by the Andrew Co., 363 E. 75 St., Chicago 19, Ill. Detailed data of the electrical and mechanical properties of the cables are included. The folder also contains descriptions of dry air pumps, antenna coupling transformers, and coaxial plugs and jacks.

Electrical Instruments

Marion Electrical Instrument Co., Manchester, N. H., makers of glass-to-metal hermetically sealed instruments has issued a new catalog describing sealed and standard units. The sealed instruments are available in 2½ and 3½ in. sizes for all dc ranges. Round or square colored flanges in 12 different color shades also are provided for the instruments. The main part of the catalog is devoted to the standard

WANTED

TUNGSTEN SCRAP • TANTALUM SCRAP
 MOLY SCRAP • PLATINUM SCRAP
 NICKEL SCRAP

Send Sample or Description

MARTIN COLEMAN

596 BROADWAY, NEWARK 4, NEW JERSEY

Kahle

ENGINEERING COMPANY
ELECTRON TUBE MACHINERY
 All types, standard and special design.

Specialists in equipment and
 methods for the manufacture of:

RADIO TUBES	NEON TUBES
CATHODE RAY TUBES	PHOTO CELLS
FLUORESCENT LAMPS	X-RAY TUBES
INCANDESCENT LAMPS	GLASS PRODUCTS

On Production or Laboratory basis

1307-1315 SEVENTH ST., NORTH BERGEN, N. J., U. S. A.

R. A. DINZL

ELECTRONIC CONSULTANT

Ultra High Frequency Transmitters and Receivers,
 Pulse Modulation—High-Fidelity Sound Recording Prob-
 lems, Broadcast Studio Circuits and Equipment Selection

648 NOTTINGHAM PLACE

WESTFIELD, N. J.

TELEPHONE 2-4539

18 YEARS IN RADIO

**RADIO and
 ELECTRONIC**
Sale Specialists

BURSTEIN-APPLEBEE
 1912-1913

**BIG
 CATALOG
 FREE**

Latest developments in radio and elec-
 tronic parts and devices, newest "Ham"
 gear, "Gadgets" to delight the experi-
 menter, bargains in war surplus
 goods, all in new catalog for you.

BURSTEIN-APPLEBEE CO.,
 1012 McGee, Kansas City 6, Mo.

Send me FREE new B-A Catalog. EL. IND

I AM _____
 STATE CONNECTION IN INDUSTRY

NAME _____

ADDRESS _____

TOWN _____ STATE _____



LECTROHM RESISTORS

completely satisfy—

ALWAYS

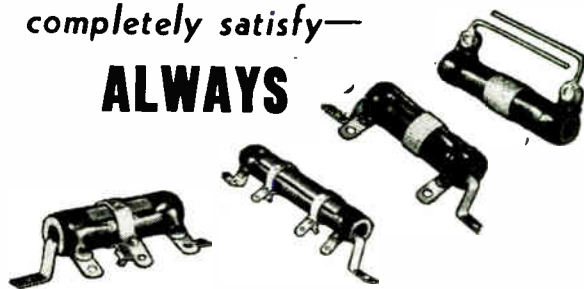

because —

- (1) Resistance wire is silver soldered to solder lugs in all Lectrohm Resistors, by special process, assuring perfect electrical bond under all conditions.
- (2) Lectrohm Resistors are designed and made by specialty resistor engineers—99% of Lectrohm's production is resistors.
- (3) Every Lectrohm Resistor is an integral unit with all parts completely embedded in vitreous enamel.
- (4) You will find all types and ratings in the Lectrohm Line, also power line and R.F. Plate Chokes and accessories.
- (5) Delivery is prompt.



Ask for the new Lectrohm Catalog and data book containing pertinent information on these Resistors and much valuable reference information.

LECTROHM
 INCORPORATED

5139 West 25th Street, Cicero 50, Illinois
 Division of
 National Lock Washer Co., Newark, N. J.

BAACH-INTERNATIONAL

EIGHT HEAD HOT-CUT FLARE MACHINE

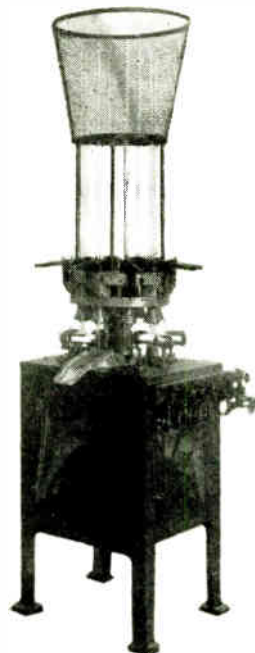

Automatic throughout.

Can be synchronized with auto-
 matic Stem machine.

Accommodates eight full
 lengths of glass tubing.

Cuts off and flares in one op-
 eration.

Production, 1000 flares per hour.

Made in two sizes: *Miniature machine*, for miniature flares and fluorescent starters, and *Standard machine* for standard size lamps, fluorescent and radio tubes.

Range of *Standard Machine*:

Glass tubing	35 to 42 gauge
Length of flares	5 mm to 80 mm
Forms flares up to	47 mm diameter
Net weight	1500 pounds
Boxed	1700 pounds

INTERNATIONAL MACHINE WORKS

Manufacturers of High Vacuum Pumps, Automatic Machinery for
 Incandescent Lamps, Electronic Tubes since 1916.

2027-46TH STREET, NORTH BERGEN, N. J., U.S.A.

Tel. UNion 3-7412. Cable Address "Intermach" North Bergen, N. J.



**WIRE & RIBBON
for
VACUUM TUBE
FILAMENTS & GRIDS**

● Many sizes and alloys for a range of applications such as miniature tubes, hearing aid tubes, low-current-drain battery tubes, receiving tubes ...

● Melted and worked to assure maximum uniformity and strength. WIRES drawn to .0004" diameter; RIBBON rolled to .0001" thickness ...

● Wollaston Process Wire drawn as small as .000010"; made to your specifications for diameter and resistance.

● SPECIAL ALLOYS made to meet individual requirements. Write for list of stock alloys.

SIGMUND COHN & CO.

44 GOLD ST. NEW YORK

SINCE  1901

instruments, which may be interchanged with the sealed types. Also described are some special instruments, such as a direct-reading fluxmeter and a multi-range meter tester.

Internally Water Cooled Tele Tube

An entirely new type of water- and forced-air-cooled television transmitting tube has been developed by RCA. Styled model 8D21, it is a twin tetrode of unique design intended for use as a class C, grid-modulated, rf power amplifier. In such service, it has a maximum



Two views of RCA's new internally water-cooled twin tetrode, complete above, and below, showing header with filament and No. 1 and No. 2 grids in position

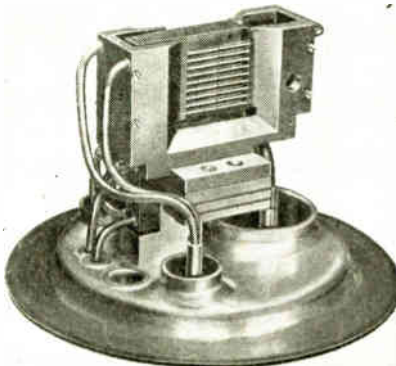

**INSTRUMENT
HOUSINGS
PANELS • CHASSIS**

*Manufactured to
your Requirements*

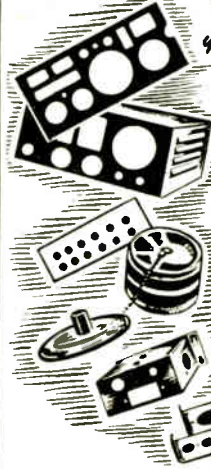

For RADIO,
ELECTRONIC,
& ELECTRICAL
PRODUCTS

• STAMPINGS,
ALL METALS

• Also Stamped
Automotive
Products

A complete manufacturing service: Fabricating, Stamping, Screw Machine Work, Assembling. Precision work, experienced fabrication, dependable service. Send Specifications for Estimates.

**STAMFORD METAL
SPECIALTY COMPANY**

Metal Work of Every Description

430 BROADWAY, NEW YORK 13

CAPACITORS -

OIL, PAPER and
ELECTROLYTIC

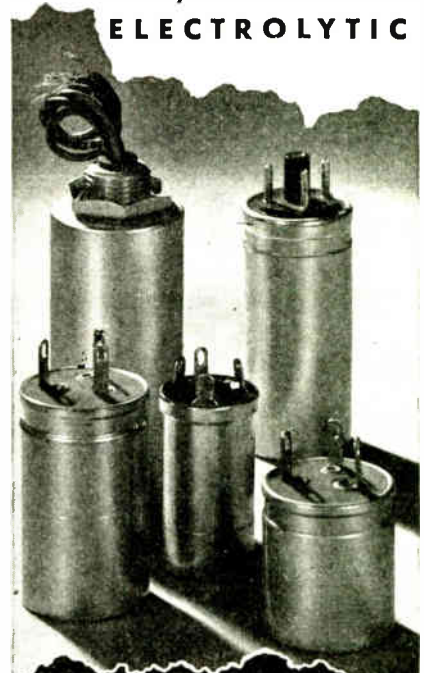

**Illinois
CONDENSER COMPANY**

1616 N. THROOP ST., CHICAGO 22, ILL.

ELECTRONIC INDUSTRIES

Advertisers, June 1946

	Page		Page
Accurate Spring Mfg. Co.	6	International Resistance Co.	99
Aerovox Corporation	29	Irvington Varnish & Insulator Co.	41
Allied Radio Corp.	122	Isolantite, Inc.	83
American Electrical Heater Co.	127	Johnson Co., E. F.	114
American Lava Corp.	113	Jones, Howard B., Div. Cinch Mfg. Corp.	136
American Phenolic Corp.	95	Kahle Engineering Co.	139
American Television & Radio	123	Keuffel & Esser Co.	31
Amperite	133	Kinney Mfg. Co.	100
Andrew Co.	103	Lapp Insulator Co., Inc.	20
Arnold Engineering Co.	117	Lectrohm, Inc.	139
Atlas Coil Winders, Inc.	125	Machlett Laboratories, Inc.	27
Automatic Electric Sales Corp.	10	Magnavox Company	32
Bell Telephone Labs	42, 43	Maguire Industries, Inc.	3
Bird & Co., Richard H.	132	Mallory & Co., Inc., P. R.	Cover 2
Burstein-Applebee Co.	139	Manufacturers Screw Products	116
Callite Tungsten Corp.	39	Maritime Switchboard	142
Cambridge Thermionic Corp.	126	Measurements Corporation	137
Capitol Radio Engineering Institute	124	Millen Mfg. Co., Inc., James	132
Cellusuede Products, Inc.	126	Mogull Co., A.	135
Centralab	97	Mycalex Corp. of America	45
Chicago Transformer Div. of Essex Wire Corp.	112	Ohmite Mfg. Co.	40
Clare & Co., C. P.	9	O'Neil-Irwin Mfg. Co.	130
Clarostat Mfg. Co., Inc.	110	Owens-Corning Fiberglas Corp.	23
Cohn & Co., Sigmund	140	Palnut Co.	119
Coleman, Martin	139	Par-Metal Products Corp.	137
Collins Radio Co.	17	Patton-MacGuyer Co.	135
Communications Equipment Co.	136	Permotlux Corp.	108
Conant Electrical Laboratories	107	Plasticraft Products Co.	136
Concord Radio Co.	119	Radio Corp. of America	Cover 4
Cornell-Dubilier Electric Corp.	46	Radio Receptor Co., Inc.	118
Cornish Wire Co., Inc.	106	Radio Wire Television Inc.	124
Coto-Coil Co., Inc.	102	Revere Copper & Brass Inc.	7
Crystal Research Laboratories, Inc.	121	Rider Publisher, Inc., John F.	121
Daven Co.	Cover 3	Schauer Machine Co.	134
Dazor Mfg. Corp.	22	Selenium Corp. of America	19
De Mornay-Budd, Inc.	91	Sigma Instruments, Inc.	114-8
Deutschmann Corp., Tobe	131	Small Motors, Inc.	120
Dinzl, R. A.	139	Sprague Electric Co.	14
Dolen, Max	135	Stackpole Carbon Co.	18
Driver-Harris Co.	89	Stamford Metal Specialty Co.	140
DuMont Laboratories, Inc., Allen B.	13	Standard Piezo Co.	122
Eastman Kodak Co.	87	Struthers-Dunn, Inc.	28
Eastern Engineering Co.	138	Stupakoff Ceramic and Mfg. Co.	15
Eisler Engineering Co.	135	Superior Tube Co.	105
Eitel-McCullough, Inc.	44	Sylvania Electric Products, Inc.	2
Electro Motive Mfg. Co.	35	Synthane Corp.	33, 34
Electronic Engineering Co., Inc.	134	Tab	141
Electronic Mechanics, Inc.	11	Taylor Fibre Co.	25
Ellinwood Industries	4	Thomas & Skinner Steel Products Co.	118
Erie Resistor Corp.	21	Triplet Electrical Instrument Co.	133
Ever Ready Label Corp.	135	United Electronics Co.	109
Federal Telephone and Radio Corp.	36, 37, 101	U. S. Television Mfg. Corp.	125
General Electric Co.	5, 38, 93, 115, 130	Victoreen Instrument Co.	120
General Industries Co.	116	Vokar Corporation	138
General Plate Div. of Metals & Controls Corp.	16	Vulcan Electric Co.	125
Gramer Co.	131	Ward Leonard Electric Co.	24
Guardian Electric Mfg. Co.	85	Walker-Jimieson, Inc.	129
Hammarlund Mfg. Co., Inc.	30	Webster-Chicago	114-A
Hassall, Inc., John	111	Wellons, Richard S.	135
Haydon Mfg. Co., Inc.	104	Western Electric Co.	42, 43
Heyman Mfg. Co.	129	Weston Electrical Instrument Corp.	8
Illinois Condenser Co.	140	World Radio Laboratories Inc.	132
Indiana Steel Products Co.	26	Wrigley Co., Wm.	128
International Machine Works	139		
International Nickel Company, Inc.	12		

"TAB"

That's A Buy

Complete New W.E. Oscilloscope

5 inch made by Western Electric for U.S. Army type BC412 Cost gov't over \$2000. Contains power supplies 115 V 60 CY; amplifiers and controls for Vertical and Horizontal position. Focus Intensity, Sensitivity, Spread, Sweep (fixed freq.) with new tubes 5PB4, 879, 5T4, Six 6L6, Two 6SJ7, 6AC7, 6116. Easily adapted to laboratory Radio service work or television. Completely housed heavy steel case. Exceptional "TAB" price \$65 ship wt. cased 200 lbs. Tested guaranteed new

WE Crystal 1N21 new sealed in lead 2 for.....	\$1.25
WE Crystal 1N22 new sealed in lead 2 for.....	1.50
WE Crystal 1N23 new sealed in lead 2 for.....	1.80
GE push button Start-Stop switch 2 for.....	1.50
CATHODE Ray Tube, new Gvt. Ins. 3 BP1.....	6.85
CATHODE Ray Tube, new 5A1P-1P1-BP4 ea.	9.85
RECTIFIER GE 872A new G'Ins. (L.P. \$7.50)	4.50
EIMAC or H.K. VT-127A with connectors.....	4.95
RCA 6AC7-1852 new Gvt. Ins. (L.P. \$1.75).....	.65
G.E. Neon 1/4 W.NE 16 (L.P. 42¢) 4 for.....	1.25
RCA 866A new Gvt. Ins. 2 for.....	2.90
807 new Gov. Ins. with Millen cap.....	1.95
RCA 6J4 new Gov. Ins. (L.P. \$8.35) 2.49 2 for	4.75
TUNGOSOL miniature 3A4 G'Ins. (\$1.55) 2 for	1.10
EIMAC 304TL used L.N. tested guaranteed.....	13.95
JOHNSON Socket No. 213 for 304TL.....	.90
SPAGHETTI asstment 10 lengths 3' each size.50
CONDENSER uprt. mg oil 4MFD600V.....	.85
COND. G.E. Pyranol 1MFD-1000V at .60 10 for	5.00
COND. G.E. Pyranol 3MFD-330VAC-1000VDC	.95
COND. CD&AVX oil 1MFD-600VW at .32 5 for	1.50
COND. Aerovox oil 1MFD-400VW at .30 5 for...	1.35
COND. G.E. 25MFD-1000VW at .34 10 for....	3.00
COND. AVX oil 1MFD-800VW at .27 10 for....	2.45
COND. SPRAGUE G'Ins. 5MFD 35WV 25 for	1.00
CONDENSER can drv uprt.mtg 500MFD 60WV	.95
CONDENSER WE oil 16MFD 400V 2 for.....	2.35
CND. SPRAGUE Gvt. Ins. 15MFD 35WV 10 for	.95
COND. SPRAGUE G'Ins. 5MFD 35WV 20 for	1.00

DAVEN ATTENUATOR NEW

Circuit "POT" Impedance 50000 in 2 DB. steps. Max. 60 Steps Type CP-630-S complete dial & knob Gvt. cost \$14.85 "TAB" \$7.95 2 for \$12.



AUTOSYNS BENDIX

Brand new Gov. sealed and inspected packed in overseas cans, synchro-transmitters AC. 115v. 60 cy. operation. Continuous heavy duty. Precision accuracy made for gun-fire control. Cost Gov. \$90 each. 5 lbs. each. "TAB" special 2 for \$18.

CONDENSER KIT 24 midget 0:1 Cornell Dub. 8 ea. size 1.2x2.3 x. 05MFD-300VW Gvt. Ins.	2.40
COND. G.E. pyranol 4MFD-600VDC wkg 2 for	1.90
COND. G.E. pyranol 2MFD-2000VDC wkg 2 for	4.25
COND. Wtghse 2MFD-5500VDC wkg (LP\$75) 12.50	12.50
SOCKET Heavy duty 50 watt steatite Ins. 2 for	1.70
Impedance Ouncer Jefferson 100 Hy. 3100±	.69
Crystal Det. JANIN 21 Sylvania Sil. C. 3 for	1.00
Micro wave ant. with coaxial enter. & mtg brkt.	.95
F.M. Television Rotatable UHF coupler.....	3.95
Micro-Switch leaf type 10A. 125V SPNO 3 for	1.00
G.E. DW 44 R.F. Thermtr 0-1A. 2 1/2" B' Case	3.95
Condenser tube dual 40 MFD 150VW 30 for.....	7.95
DAVEN SWITCH 13 circuits 25 amp. ets., 2 for	.98
HEINEMAN mag. circuit bkr. 20A or 3A or 5A	.97
CND. G.E. pyranol 3MFD-1000VDC WKG 2 for	2.50
COND. Aerovox oil 1MFD-1000VDC wkg.....	36.00
CO-Axial 52&72 ohm RG8&11u cable 100 ft.....	10.00
CHOKE G.E. 4HY. 1/2 A. 30 ohm wt. 10 lbs.....	2.95
RELAY Sen-Sigma 5AH 200 ohm 3.5 mA SPDT	2.25
RELAY Sen W.E. 3500 ohms SPDT S.A.cts.....	.97
RELAY 105 Ward L. 115V60CY 20 A.cts.....	1.90
DC Voltmtr DW 41 G.E. 2000V-1000 ohm 2 1/2"	8.95
DC Voltmtr 301 Weston 4000V-1000 ohm.....	11.95
DC Voltmtr 801 Weston 10000V-1000 ohm.....	12.95
AC Voltmtr NA 33 Wtghse 150V 2 1/2" B'C.....	2.95
G.E. DC DN1 miniature 1 ma G'Ins. 1 1/2" B'C.	3.25
DC Milliamtr One ma. 3" B'case R.S.....	4.95
Socket Amphenol octal S8TN mica B'ins 25 for	1.50
Socket Safety Amphenol 77A-4T two for.....	.75
LACING cord mildew resistant No. 6 treated lb.	1.90
Extractor Fuse Posts ths 3AG&4AD 4 for....	.98
CRYSTAL mtd alrcraft 1000KC std .02% accy.	7.95
Oscilloscope Conversion Kit 1C 412 contains all parts for sweep circuits and changes including diagrams	15.75
Additional engraved dialplates	3.75
Complete Kit all parts and dialplates.....	18.50
\$1 Min. orders FOB N.Y.C. Add Postage all orders and 25% deposit. WHITEHALL 3-3557. Send for catalog 300. Don't wait, rush orders as quantities are limited. Buy thru "TAB" and save.	

"TAB", Dept. D-6
Six Church Street, New York 6, N. Y.

NEW
VACUUM TUBES

THESE TUBES ARE ALL NEW, IN ORIGINAL BOXES, MFGD. BY R.C.A., HYTRON, RAYTHEON, SYLVANIA. We will sell only the minimum of \$100.00 worth or the entire quantity of any one item that may add up to less than the above sum.

4000—#954	\$.35
265—#955	\$.35
265—#956	\$.35
1500—#6SN7	\$.45
630—#VR 150/30	\$.55
400—#6AG7	\$.80
315—#3B24 same as 2x2	\$1.25
315—#5U4G	\$.30
315—#3BP1, cathode ray	\$4.50

NEW METERS

These meters are ALL NEW, absolutely standard in all respects. Round Flush Bakelite. We will sell only in lots of 50 or more of any one item.

1000—Weston 2½, Model 517, AC voltmeter 0-150	\$2.50
1000—Weston 2½, Model 506, DC voltmeter 0-20 volts, 1000 ohms per volt	\$3.00
1000—G.E. 2½, Model DW44, 0-8, amper Radio Frequency, BLACK SCALE	\$1.75
450—Weston 2½, Model 507, ext. couple, 750 MA Radio Frequency. Meter has a BLACK SCALE, caption is—Antenna Current Indicator. Controlled scale characteristics	\$1.75
250—G.E. 3½, Model AO22, AC voltmeter, 0-150	\$4.00
100—G.E. 3½, Model AO22, AC voltmeter, 0-300	\$6.00
150—G.E. 3½, Model AO22, AC ammeter, 0-5 Amper coil, 0-50 Amper scale	\$3.50
100—G.E. 3½, Model AO22, AC ammeter, 0-50 Amper, self contained	ea. \$3.75
400—G.E. 3½, Model AO22, AC ammeter, 0-80 Amper, self contained	ea. \$3.75

OIL FILLED CONDENSERS

ALL NEW CONDENSERS, G.E., PYRANOL AND SPRAGUE VITAMIN Q. Minimum quantity to be shipped on any one item will be 50 pieces.

750	50 MFD at	25 V DC	\$1.00
1200	10 MFD at	1,000 V DC	\$1.75
3000	10 MFD at	600 V DC	\$1.50
130	4 MFD at	600 V DC	\$1.00
1000	1 MFD at	4,000 V DC	\$2.75
3400	1 MFD at	3,000 V DC	\$2.25
1300	1 MFD at	2,000 V DC	\$1.50
200	.25 MFD at	3,000 V DC	\$2.00
1200	.05 MFD at	16,000 V DC	\$3.00
432	2x.15 MFD at	8,00 V DC	\$1.75
404	3x.6 MFD at	90 V DC	\$.40

MARITIME SWITCHBOARD
336 CANAL STREET
NEW YORK 13, N. Y.
WOrth 4-8217

plate-voltage of 6000 volts, a maximum total plate input of 10,000 watts, and a maximum total plate dissipation of 6000 watts. It may be operated with maximum rated input up to 300 megacycles.

The 8D21 is unique in that high-power capability at very-high frequency has been obtained by the use of a compact, high-current-density structure in which all electrodes, grids, screens, plates and part of the filaments are internally water cooled close to the active electrode areas.

The structure features a thoria-coated, multi-strand filament; low interelectrode capacitance; excellent internal shielding between input and output circuits; internal neutralization of the small feedback capacitance to eliminate need for external neutralization; internal by-passing of screen to filament to maintain the rf potential of the screen at ground potential and relatively short internal leads with consequent low inductances. The overall length of the 8D21 is only about 12 in. and its maximum diameter is 5¾ in. Because of electron optical principles incorporated in its design, the 8D21 has high power sensitivity and thus its driving-power requirements are low.

Columbia's Building

Its own new building at 5734 Elston Ave., Chicago, has been occupied by Columbia Wire & Supply Co. of Chicago. Several new products including antenna kits for standard broadcast and FM soon will appear.

Frazier and Peter Management Consultants

Howard S. Frazier, long time chief engineer for National Association of Broadcasters, and Paul F. Peter have formed the firm of Frazier and Peter, radio management consultants with temporary offices at 1730 Eye Street, Northwest, Washington 6, D. C. The firm will assist broadcasters and prospective broadcasters in all phases of management except legal and engineering. Peter was formerly director of research for the National Association of Broadcasters, has been affiliated with the Joint Committee on Radio Research, the Radio Corporation of America, the National Broadcasting Co. and is a pioneer in radio research and statistical analysis of broadcast operation, public attitudes and listening habits.

Vlf-Uhf Wattmeter

For power measurements in the frequency spectrum between 10 and 1,500 mc, the Bird Electronic Corp., 1800 E. 38th St., Cleveland 14, Ohio, has engineered a new compact type of wattmeter and wide-band termination suited especially for use with equipment having 50-ohm coaxial output terminals. The power range of this instrument is 1 to 500 watts. The unit consists essentially of a blower cooled wide-band constant-impedance design 50-ohm load with series-type thermocouples inserted at the transmitter output connector, and a dc millivoltmeter.

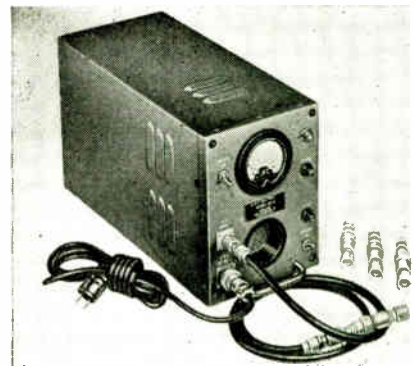

Wide-band impedance constancy is obtained by using a length of attenuating 50-ohm coax, terminated in a resistor of special design. The resistor determines the impedance at the lower frequencies while the line characteristics dominate at the higher frequencies; transition is smooth. Distribution of power loss changes in the same way. A forced-air blower system is incorporated to cool both the line and resistor.

The measuring elements are thermocouple ammeters inserted in the center conductor close to the transmitter connector. At the present moment, four types of thermocouples are available in four different power ranges. Meter readings with this unit are linearly related to power at fixed frequency. The thermocouples, through skin effect, increase in sensitivity with frequency. Curves are supplied with the instrument and show a single multiplying factor, which when applied to the meter scale reading, gives the power value at the working frequency. This working frequency should be known within 2%. The control of input impedance and the individual adjustment of the thermocouples permit the use of standardized calibration curves.



SWITCHES

ENGINEERED BY DAVEN

feature LOW and UNIFORM contact resistance

They are being specified, more and more, wherever precise and dependable operation is required, as in the better power and frequency selection equipments. Daven-engineered switches assure positive control.

FLEXIBILITY: number of poles and contacts per deck, and number of decks may be had in almost unlimited combinations.

TROUBLE-FREE OPERATION: heavy duty, laminated switch arms are self-wiping; switch arms and contacts are of special silver alloy for most applications; other metals are available for special needs.

PANELS: bakelite or ceramic, according to requirements, in almost any size and shape.

WIRING: break-before-make or make-before-break; choice of methods of connection—soldering lugs back of each live contact or soldering lugs mounted on a terminal board.

Consult Daven Engineers With Your Switch Requirements

THE **DAVEN** COMPANY
191 CENTRAL AVENUE
NEWARK 4, NEW JERSEY

RCA 8D21 TWIN POWER TETRODE

An important
contribution to
Television
Broadcasting

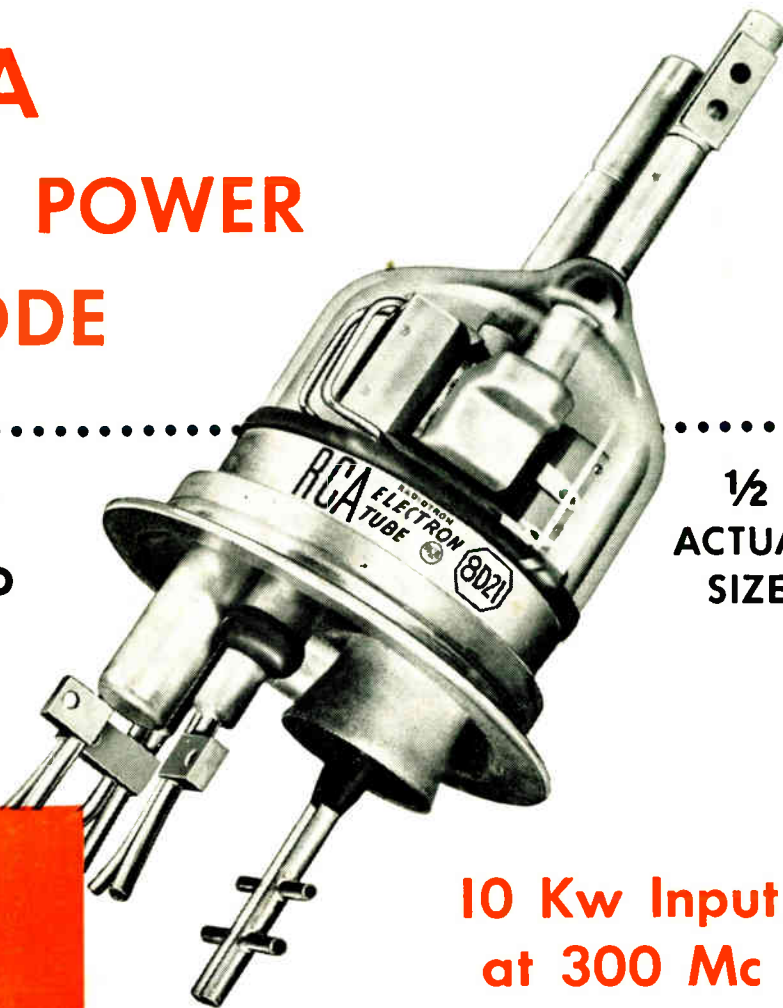

1/2
ACTUAL
SIZE

10 Kw Input
at 300 Mc



Unusual construction is indicated by this view of the header with filament, grid #1 and grid #2 in position. Precision cast and machined electrodes are connected to water ducts for internal cooling.

THE RCA-8D21 Push-Pull Power Tetrode for television and FM broadcasting service is a radical departure from previous transmitting tube designs in that high-power capability at very high frequencies is achieved through the use of an exceedingly compact, high-current-density structure in which *all electrodes are water-cooled* close to the active electrode areas . . . resulting in a concentration of power in a tube only 12 inches in over-all height and 5 3/4 inches in diameter!

The structure features a thoriated, multi-strand filament; low inter-electrode capacitances; excellent internal shielding between input and output circuits; internal neutralization of the small feedback capaci-

tance to eliminate need for external neutralization; internal by-passing of screen to filament to maintain the r-f potential of the screen at ground potential; and relatively short internal leads with consequent low inductances.

Because of electron optical principles incorporated in its design, the 8D21 has high power sensitivity and thus its driving-power requirements are low.

When used as a Class C, grid-modulated, push-pull, r-f amplifier in television service, the 8D21 has a maximum plate-voltage rating of 6000 volts, a maximum total plate input of 10,000 watts, and a total plate dissipation of 6000 watts. It may be operated with

maximum rated input as high as 300 Mc.

A technical bulletin on the RCA-8D21 is available on request. RCA Tube Application Engineers will be glad to work with you in adapting this or any other RCA tube type to your equipment designs. Address RCA, Commercial Engineering Department, Section D-7E, Harrison, N. J.



PRINCETON
LABORATORIES

THE FOUNTAINHEAD OF
MODERN TUBE DEVELOPMENT IS RCA.



TUBE DEPARTMENT

RADIO CORPORATION of AMERICA

HARRISON, N. J.